

DOCUMENT RESUME.

ED 219 652

CE 033 509

AUTHOR Farajollahi, Karim; And Others
TITLE Graphic Arts: Book Three. The Press and Related Processes.
INSTITUTION Mid-America Vocational Curriculum Consortium, Stillwater, Okla.
PUB DATE 82
NOTE 294p.; For related documents see CE 033 507-508.
AVAILABLE FROM Mid-America Vocational Curriculum Consortium, 1515 West Sixth Avenue, Stillwater, OK 74074.

EDRS PRICE MF01 Plus Postage. PC Not Available from EDRS.
DESCRIPTORS Competency Based Education; Criterion Referenced Tests; *Equipment Maintenance; *Graphic Arts; Instructional Materials; Learning Activities; Paper (Material); Postsecondary Education; *Printing; *Production Techniques; *Reprography; Supplies; *Technical Education
IDENTIFIERS *Printing Presses

ABSTRACT

The third of a three-volume set of instructional materials for a graphic arts course, this manual consists of nine instructional units dealing with presses and related processes. Covered in the units are basic press fundamentals, offset press systems, offset press operating procedures, offset inks and dampening chemistry, preventive maintenance and trouble shooting, other printing processes, cost awareness, binding and finishing, and calculating paper cutting. Each unit contains some or all of the following: performance objectives, suggested activities for teachers, information sheets, assignment sheets, job sheets, visual aids, tests, and test answers. Instructional materials in the publication are written in terms of student performance using measurable objectives. (MN)

 * Reproductions supplied by EDRS are the best that can be made *
 * from the original document. *

GRAPHIC ARTS: BOOK THREE
THE PRESS AND RELATED PROCESSES

ED219652

by

Karim Farajollahi

Gary Ogle

William Reed

Kenneth Woodcock

Developed by the

Mid-America Vocational Curriculum Consortium, Inc.

Board of Directors

- Merle Rudebusch, Nebraska, Chairman
- David Poston, Louisiana, Vice Chairman
- Amon Herd, Missouri, Parliamentarian
- James Dasher, Arkansas
- Bill Barnes, Colorado
- Ed Hankins, Kansas
- Pat Lindley, Texas
- Dan Elwood, South Dakota
- Bob Patton, Oklahoma
- Alan Morgan, New Mexico
- Larry Barnhardt, North Dakota
- Ann Benson, Executive Director

U.S. DEPARTMENT OF EDUCATION
NATIONAL INSTITUTE OF EDUCATION
EDUCATIONAL RESOURCES INFORMATION
CENTER (ERIC)

This document has been reproduced as
received from the person or organization
originating it.
Minor changes have been made to improve
reproduction quality.

- Points of view or opinions stated in this docu-
ment do not necessarily represent official NIE
position or policy.

"PERMISSION TO REPRODUCE THIS
MATERIAL IN MICROFICHE ONLY
HAS BEEN GRANTED BY

S. DEAN

TO THE EDUCATIONAL RESOURCES
INFORMATION CENTER (ERIC)."

COPYRIGHT - 1982

Mid-America Vocational Curriculum Consortium, Inc.

Printed by

Oklahoma State Department of Vocational and Technical Education

Stillwater, Oklahoma 74074



TABLE OF CONTENTS

Section A--Press

Unit I	Basic Press Fundamentals	G III - 1-A
Unit II	Offset Press Systems	G III - 19-A
Unit III	Offset Press Operating Procedures	G III - 63-A
Unit IV	Offset Inks and Dampening Chemistry	G III - 113-A
Unit V	Preventive Maintenance and Trouble Shooting	G III - 141-A

Section B--Related Processes

Unit I	Other Printing Processes	G III - 1-B
Unit II	Cost Awareness	G III - 21-B
Unit III	Binding and Finishing	G III - 43-B
Unit IV	Calculating Paper Cutting	G III - 63-B

FOREWARD

The Mid-America Vocational Curriculum Consortium (MAVCC) was organized for the purpose of developing instructional materials for its eleven member states. All member states participate in establishing annual development priorities, and the need for curriculum in graphic arts truly reflects regional needs.

Graphic Arts: Book Three, The Press and Related Processes, is the concluding publication of a series of three texts dedicated to a basic graphic arts curriculum. Although it can be taught as a single text, it is hoped that it will be used in conjunction with books one and two to provide continuity in student training. It is also hoped that the effort will provide industry with truly well trained technicians for the world of graphic arts and the varied skills it demands.

The success of this publication is due, in large part, to the capabilities of the personnel who worked with its development. The technical writers have numerous years of industry as well as teaching experience. Assisting them in their efforts were representatives of each of the member states who brought with them technical expertise and the experience related to the classroom and to the trade. To assure that the materials would parallel the industry environment and be accepted as a transportable basic teaching tool, organizations and industry representatives were involved in the developmental phases of the manual. Appreciation is extended to them for their valuable contributions to the manual.

Instructional materials in this publication are written in terms of student performance using measurable objectives. This is an innovative approach to teaching that accents and augments the teaching/learning process. Criterion referenced evaluation instruments are provided for uniform measurement of student progress. In addition to evaluating recall information, teachers are encouraged to evaluate the other areas including process and product as indicated at the end of each instructional unit.

It is the sincere belief of the MAVCC personnel and all those members who served on the committees that this publication will allow the students to become better prepared and more effective members of the work force.

Merle Rudebusch, Chairman
Board of Directors
Mid-America Vocational
Curriculum Consortium

PREFACE

The development of a basic curriculum in graphic arts and offset printing has been a rewarding effort because of the talented people who planned and wrote the materials. From that team of teachers, industry representatives, and trade and industrial staff members has come a series of three texts which should offer graphic arts students an excellent opportunity for learning the skills required in the world of graphic arts and offset printing.

The title of this concluding text of the series, *Graphic Arts: Book Three, The Press and Related Processes*, clearly indicates the objectives of the training. These are the areas where students will confront basic press fundamentals, develop skills in estimating job costs, binding and finishing, and roll up their sleeves and clean a press. Naturally, the text is designed to complement *Graphic Arts: Book One, Orientation, Composition, and Paste-Up*, and *Graphic Arts: Book Two, Process Camera, Stripping, and Platemaking*.

As complex as some printing activities are, the MAVCC format presents the procedures in logically ordered objectives that facilitate a comfortable learning rate. The format also frees the instructor to concentrate on reinforcing classroom instruction with films, field trips, and other activities that serve to maintain student interest at a high level and motivate students to learn and do.

Despite careful planning and editing, we know that the text may perhaps contain a typographical error or two. Letting us know when you find such items will be a great help in improving the product before reprint time. But most of all, your input about the major elements in the book will be valuable help for changing or adding objectives when the materials are revised and updated.

We do respond to your suggestions, and we hope the quality of the materials in *Graphic Arts: Book Three* will serve a positive role in the classroom and provide industry with the skilled people required to keep the art in graphic arts.

Ann Benson
Executive Director
Mid-America Vocational
Curriculum Consortium

ACKNOWLEDGMENTS

Appreciation is extended to those individuals who contributed their time and talents to the development of *Graphic Arts: Book Three, The Press and Related Processes*.

The contents of this publication were planned and reviewed by:

Mid-America Vocational Curriculum Consortium Committee

Bill Braun	Springer, New Mexico
James Brown, Jr.	Greeley, Colorado
Sandra Devall	Dickinson, Texas
Willard Gore	Mooringsport, Louisiana
David Hinkley	Grand Forks, North Dakota
Karim Farajollahi	Stillwater, Oklahoma
John Koonce	Emporia, Kansas
Warren Lyon	Lincoln, Nebraska
Eugene Shaver	Aberdeen, South Dakota
William D. Reed	Tulsa, Oklahoma
Tom Presley	Little Rock, Arkansas
Phyllis Miller	Columbia, Missouri

Thanks are extended to Don Ruby of Northeastern State University in Tahlequah, Oklahoma, for representing teacher education on this committee and to Ray Merritt for representing state supervisory personnel.

Special thanks are extended to Noel Wilcoxson, foreman of the Print Shop located at the Oklahoma State Department of Vocational-Technical Education, for his representation of industry on the committee and to the numerous other companies who provided references and technical materials.

Gratitude is expressed to Joan Dolan for editing and to the Graphics Division of the Oklahoma State Department of Vocational and Technical Education for typing and art work.

Special appreciation goes to Bill Braun for designing the cover of this publication.

The printing staff of the Oklahoma State Department of Vocational and Technical Education is deserving of much credit for printing this publication.

USE OF THIS PUBLICATION

Instructional Units

The *Graphic Arts: Book Three--The Press and Related Processes*, includes nine units. Each instructional unit includes some or all of the basic components of a unit of instruction: performance objectives, suggested activities for teachers, information sheets, assignment sheets, job sheets, visual aids, tests, and answers to the test. Units are planned for more than one lesson or class period of instruction.

Careful study of each instructional unit by the teacher will help to determine:

- A. The amount of material that can be covered in each class period
- B. The skills which must be demonstrated
 1. Supplies needed
 2. Equipment needed
 3. Amount of practice needed
 4. Amount of class time needed for demonstrations
- C. Supplementary materials such as pamphlets or filmstrips that must be ordered
- D. Resource people who must be contacted

Objectives

Each unit of instruction is based on performance objectives. These objectives state the goals of the course, thus providing a sense of direction and accomplishment for the student.

Performance objectives are stated in two forms: unit objectives, stating the subject matter to be covered in a unit of instruction; and specific objectives, stating the student performance necessary to reach the unit objective.

Since the objectives of the unit provide direction for the teaching-learning process, it is important for the teacher and students to have a common understanding of the intent of the objectives. A limited number of performance terms have been used in the objectives for this curriculum to assist in promoting the effectiveness of the communication among all individuals using the materials.

Following is a list of performance terms and their synonyms which may have been used in this material:

<u>Name</u>	<u>Identify</u>	<u>Describe</u>
Label	Select	Define
List in writing	Mark	Discuss in writing
List orally	Point out	Discuss orally
Letter	Pick out	Interpret
Record	Choose	Tell how
Repeat	Locate	Tell what
Give		Explain

Order

Arrange
Sequence
List in order
Classify
Divide
Isolate
Sort

Distinguish

Discriminate

Construct

Draw
Make
Build
Design
Formulate
Reproduce
Transcribe
Reduce
Increase
Figure

Demonstrate

Show your work
Show procedure
Perform an experiment
Perform the steps
Operate
Remove
Replace
Turn off/on
(Dis) assemble
(Dis) connect

Additional Terms Used

Evaluate
Complete
Analyze
Calculate
Estimate
Plan
Observe
Compare
Determine
Perform

Prepare
Make
Read
Tell
Teach
Converse
Lead
State
Write

Reading of the objectives by the student should be followed by a class discussion to answer any questions concerning performance requirements for each instructional unit.

Teachers should feel free to add objectives which will fit the material to the needs of the students and community. When teachers add objectives, they should remember to supply the needed information, assignment and/or job sheets, and criterion tests.

Suggested Activities for the Instructor:

Each unit of instruction has a suggested activities sheet outlining steps to follow in accomplishing specific objectives. Duties of instructors will vary according to the particular unit; however, for best use of the material they should include the following: provide students with objective sheet, information sheet, assignment sheets, and job sheets; preview filmstrips, make transparencies, and arrange for resource materials and people; discuss unit and specific objectives and information sheet; give test. Teachers are encouraged to use any additional instructional activities and teaching methods to aid students in accomplishing the objectives.

Information Sheets

Information sheets provide content essential for meeting the cognitive (knowledge) objectives in the unit. The teacher will find that the information sheets serve as an excellent guide for presenting the background knowledge necessary to develop the skill specified in the unit objective.

Students should read the information sheets before the information is discussed in class. Students may take additional notes on the information sheets.

Transparency Masters

Transparency masters provide information in a special way. The students may see as well as hear the material being presented, thus reinforcing the learning process. Transparencies may present new information or they may reinforce information presented in the information sheets. They are particularly effective when identification is necessary.

Transparencies should be made and placed in the notebook where they will be immediately available for use. Transparencies direct the class's attention to the topic of discussion. They should be left on the screen only when topics shown are under discussion.

Job Sheets

Job sheets are an important segment of each unit. The instructor should be able to and in most situations should demonstrate the skills outlined in the job sheets. Procedures outlined in the job sheets give direction to the skill being taught and allow both student and teacher to check student progress toward the accomplishment of the skill. Job sheets provide a ready outline for students to follow if they have missed a demonstration. Job sheets also furnish potential employers with a picture of the skills being taught and the performances which might reasonably be expected from a person who has had this training.

Assignment Sheets

Assignment sheets give direction to study and furnish practice for paper and pencil activities to develop the knowledges which are necessary prerequisites to skill development. These may be given to the student for completion in class or used for homework assignments. Answer sheets are provided which may be used by the student and/or teacher for checking student progress.

Test and Evaluation

Paper-pencil and performance tests have been constructed to measure student achievement of each objective listed in the unit of instruction. Individual test items may be pulled out and used as a short test to determine student achievement of a particular objective. This kind of testing may be used as a daily quiz and will help the teacher spot difficulties being encountered by students in their efforts to accomplish the unit objective. Test items for objectives added by the teacher should be constructed and added to the test.

Test Answers

Test answers are provided for each unit. These may be used by the teacher and/or student for checking student achievement of the objectives.

GRAPHIC ARTS: BOOK THREE
THE PRESS AND RELATED PROCESSES

JOB TRAINING: What the
Worker Should Be Able to Do
(Psychomotor)

RELATED INFORMATION: What
the Worker Should Know
(Cognitive)

SECTION A--UNIT I: BASIC PRESS FUNDAMENTALS

1. Terms and definitions
2. Basic theory of offset printing
3. Other names by which offset printing is known
4. Basic systems of a sheet fed offset press
5. Basic functions of offset press systems
6. Label parts of a cylinder system in a sheet fed offset press

UNIT II: OFFSET PRESS SYSTEMS

1. Terms and definitions
2. Components of an offset press inking system
3. Components of an offset press dampening system
4. Components of an offset press cylinder system
5. Components of an offset press feeder system
6. Components of an offset press register system
7. Components of an offset press delivery system
8. Offset press cylinder arrangements
9. Types of feeder systems and their functions
10. Types of delivery systems and their functions
11. Types of register systems used on sheet fed offset presses

JOB TRAINING: What the Worker Should Be Able to Do - (Psychomotor)

RELATED INFORMATION: What the Worker Should Know (Cognitive)

12. Label offset press components

UNIT III: OFFSET PRESS OPERATING PROCEDURES

1. Terms and definitions
 2. Safety precautions
 3. Reasons for efficient press operation
 4. Control functions of an offset press operator
 5. Control functions and their locations in a press system
 6. The sequence of how paper passes through a typical offset press
-
7. Set up the sheet control system
 8. Set up the image control system
 9. Operate an offset press from setup of systems through printed sheet delivery
 10. Wash up an offset press

UNIT IV: OFFSET INKS AND DAMPENING CHEMISTRY

1. Terms and definitions
2. Main ingredients of offset ink
3. Conditions of ink manufacture that benefit user
4. Types of ink
5. Conditions influencing printing performance of offset inks
6. Properties which affect the printing quality of offset inks

**JOB TRAINING: What the
Worker Should Be Able to Do
(Psychomotor)**

15. Conduct an ink cabinet inventory
16. Conduct an inventory of offset press dampening chemistry
17. Test solutions for pH

**RELATED INFORMATION: What
the Worker Should Know
(Cognitive)**

7. Rules concerning the care and storage of inks
8. The purpose of offset dampening solutions
9. Dampening solution ingredients and their purposes
10. Two methods of measuring pH
11. Acceptable range of pH for a fountain solution
12. Effects of alcohol in a fountain solution
13. Procedure for measuring alcohol in a fountain solution
14. Importance of ink and water balance

UNIT V: PREVENTIVE MAINTENANCE AND TROUBLESHOOTING

1. Terms and definitions
2. Advantages of a routine, thorough maintenance program
3. Areas of work in a preventive maintenance schedule
4. Preventive maintenance schedules and their periodic importance
5. Preventive maintenance procedures for daily cleanup

**JOB TRAINING: What the
Worker Should Be Able to Do
(Psychomotor)**

**RELATED INFORMATION: What
the Worker Should Know
(Cognitive)**

6. Preventive maintenance procedures for weekly cleanup
7. Preventive maintenance procedures for monthly cleanup
8. Procedures for daily, weekly, and monthly lubrication
9. Daily and weekly adjustment procedures
10. Monthly adjustment requirements
11. Steps in making an ink form roller check
12. Ink stripe configurations
13. Requirements for a preventive maintenance schedule in chart form
14. Sequence of troubleshooting technique
15. Categories of press troubles
16. Types of emulsification
17. Technique of avoiding emulsification
18. Conditions creating ink drying problems
19. Common ink troubles on the press and their causes
20. Guidelines for evaluating good print quality
21. Print quality problems and their causes
22. Troubleshooting guides for ink and dampening problems
23. Troubleshooting guides for paper stock problems

JOB TRAINING: What the Worker Should Be Able to Do (Psychomotor)

26. Determine lubrication requirements for specific presses
27. Set up a preventive maintenance schedule in chart form
28. Adjust dampener rollers to plate cylinder
29. Adjust ink form rollers to plate cylinder
30. Adjust plate cylinder to blanket cylinder
31. Adjust blanket cylinder to impression cylinder
32. Change a molleton cover
33. Degrease plate and impression cylinders
34. Deglaze ink rollers and blanket
35. Change blanket

RELATED INFORMATION: What the Worker Should Know (Cognitive)

24. Troubleshooting guides for process (image transfer) problems
25. Troubleshooting guides for mechanical problems

SECTION B--UNIT I: OTHER PRINTING PROCESSES

1. Terms and definitions
2. Type of copiers and duplicators and their characteristics
3. Characteristics of thermography, flexography, microfilming, and stamping

JOB TRAINING: What the Worker Should Be Able to Do (Psychomotor)

RELATED INFORMATION: What the Worker Should Know (Cognitive)

4. Difference between hand-cut film stencils and photographic stencils
5. Characteristics of gravure and engraving
6. Types of letterpresses and their characteristics

UNIT II: COST AWARENESS

1. Terms and definitions
2. Major components which determine printing job costs
3. Items to be considered in giving an estimate on a printing job
4. Cost awareness factors in a commercial shop and a school shop
5. Estimate costs of school shop printing jobs
6. Estimate costs of commercial shop printing jobs

UNIT III: BINDING AND FINISHING

1. Terms and definitions
2. Binding techniques
3. Major folding styles
4. Processes associated with finishing activities
5. Pad 20-pound stock
6. Pad carbonless paper
7. Drill paper stock for 3-ring binders

JOB TRAINING: What the
Worker Should Be Able to Do
(Psychomotor)

RELATED INFORMATION: What
the Worker Should Know
(Cognitive)

UNIT IV: CALCULATING PAPER CUTTING

1. Terms and definitions
2. Kinds of pulp used in paper-making
3. Four tests for determining grain direction
4. Base size and base weight
5. Base sizes of paper
6. Major families of fine paper
7. Commercial envelope number sizes and their dimensions
8. Formula for cutting paper stock
9. Formula for determining number of sheets to be cut for a printing job
10. Formula for making a combination cut
11. Use formula for cutting paper stock
12. Use formula to determine number of sheets to be used for a printing job
13. Make a combination cut using stock cutting formulas
14. Draw a cutting diagram

TOOLS AND EQUIPMENT

Adjustment manuals for various presses
Adjustment wrench
Allen wrench
Blanket wash
Box end wrench
Cleanup mats or wash up attachment
Cotton pads
Deglazer
Degreaser
Estimate sheet
Fountain solution
Ink
Ink knife
Installation sleeve
Jogger
Material cost sheet
New rolleton cover
New or spare blanket
Offset plate
One hundred sheets of scrap 20-lb. stock
One-inch wide strips of paper
or two .005 3M dampening gauges
Operator's manuals for various presses
Padding brush
Padding compound
Padding press
Paper drill
Paper stock, 8 1/2 X 11
pH testing strips or pH meter
Plate cleaner
Plate etch
Punched or marked guide for 3-ring binder
Roller conditioner-cleaner
Screwdriver
Shop towels
Solutions in containers for pH testing
Standard press tools for various presses
Talcum or blanket powder
Twenty five two-part sets of carbonless paper
Two pieces of chipboard
Water miscible cleaner

REFERENCES

- Anton, Karl V., Jr. *Handbook of Technical Articles*. Mineola, NY: Van Son Holland Ink Corp. of America, 1966.
- ATF Chief 15-17 Operator's Manual*. Whittensville, MA: American Type Founders, 1973.
- Bentley, R. G.; Olson, J. C.; Strandberg, C. E.; and Wiper, R. E. *Graphic Communication Series: Transparency Originals*. Chicago: A. B. Dick Company, 1970.
- Brockhuizen, Richard J. *Graphic Communications*. Bloomington, IL 61701: McKnight Publishing Company, 1973.
- Cogoli, John E. *Photo Offset Fundamentals*. Bloomington, IL 61701: McKnight Publishing Company, 1980.
- Davidson Dualith Operator's Manual*. Nashville 37202: Davidson Division, American Type Founders Company, Inc.
- Dennis, Ervin A. and Jenkins, John D. *Comprehensive Graphic Arts*. Indianapolis 46268: Howard W. Sams and Co., Inc., 1977.
- Easy Does It*. St. Paul, MN 55101: 3M Company, Industrial Graphics Department, Printing Products Division.
- Franklin Offset Catalog*. Salt Lake City: Porte Publishing Co., 1979.
- Hawkinson, Bruce, *Graphic Arts-A Curriculum Manual*. Santa Fe, NM 87503: Vo-Tech Division of NM State Department of Education, 1975.
- How to Be a Smooth Operator*. St. Paul, MN 55101: 3M Company, Printing Products Division, 1964.
- Lankford, William. *The Offset Press Dampening System*. Pittsburg 15213: Graphic Arts Technical Foundation, 1970.
- Models 350 and 360 Offset Duplicators Operating Instructions*. Chicago: A.B. Dick Company, 1973.
- Pressman's Guide*. St. Paul, MN 55101: 3M Company, 1971.
- Prust, Z. A., *Photo-Offset Lithography*. South Holland, IL: Goodheart-Wilcox, Co. Inc., 1977.
- Schabel, Adolph J. *Practical Problems in Mathematics-Printing Trades*. Albany, NY: Delmar Publishing, 1956.
- Shapiro, Charles. *The Lithographer's Manual*. Pittsburg, PA 15213: Graphic Arts Technical Foundation, Inc., 1968.
- Silver, Gerald A. *Printing Estimating*. Chicago: American Technical Society, 1970.
- Spence, Wm. D. and Vequist, David G. *Graphic Reproduction*. Peoria, IL 61615: Chas. A. Bennett Co., Inc., 1980.
- Teachers Guide for Training Offset Duplicator Operators*. Cleveland 44117: Addressograph-Multigraph Corp., Educational Division, 1966.



**BASIC PRESS FUNDAMENTALS
UNIT I**

UNIT OBJECTIVE

After completion of this unit, the student should be able to state the basic theory of offset printing, list five other names by which offset printing is known, and identify the basic systems of a typical sheet fed offset press. This knowledge will be evidenced by correctly performing the procedures outlined in the assignment sheet and by scoring 85 percent on the unit test.

SPECIFIC OBJECTIVES

After completion of this unit, the student should be able to:

1. Match terms related to basic press fundamentals with the correct definitions.
2. State the basic theory of offset printing.
3. List five other names by which offset printing is known.
4. Identify the basic systems of a typical sheet fed offset press.
5. Match the basic systems of a typical sheet fed offset press with their functions.
6. Identify the basic systems and the cylinders in a typical sheet fed offset press.

BASIC PRESS FUNDAMENTALS UNIT I

SUGGESTED ACTIVITIES

- I. Provide student with objective sheet.
- II. Provide student with information and assignment sheets.
- III. Make transparency.
- IV. Discuss unit and specific objectives.
- V. Discuss information and assignment sheets.
- VI. Demonstrate offset press systems by printing a job.
- VII. Invite manufacturers and other industry representatives to make demonstrations and/or describe products, equipment, and processes.
- VIII. Give test.

INSTRUCTIONAL MATERIALS

- I. Included in this unit:
 - A. Objective sheet
 - B. Information sheet
 - C. Transparency Master 1--Basic Systems of a Sheet Fed Offset Press
 - D. Assignment Sheet #1--Identify the Basic Systems and the Cylinders in a Typical Sheet Fed Offset Press
 - E. Answers to Assignment Sheet #1
 - F. Test
 - G. Answers to test
- II. Reference--Cogoli, John E. *Photo Offset Fundamentals*. Bloomington, IL 61701: McKnight Publishing Co., 1980.

BASIC PRESS FUNDAMENTALS UNIT I

INFORMATION SHEET

- I. Terms and definitions
 - A. Offset--The procedure of transferring a right-reading image to an intermediate carrier where it becomes wrong-reading, then transferring (offsetting) that image to a receiver where it again becomes right-reading
 - B. Offset printing--The process of printing from a flat surface with the image and nonimage areas kept separated by chemistry
 - C. Offset press--A piece of printing equipment which holds a roll or stack of paper, controls that paper through the process of imprinting an image on its surface, and delivers the paper to a stack or roll for further processing
 - D. Offset plate--A thin sheet of plastic or metal paper which directly or photographically receives an image that becomes ink receptive while the nonimage area of the plate remains water receptive
 - E. Feed--The operation of an offset press in starting paper into the press for printing
 - F. Register--To print the image in the exact same position on each sheet of paper
 - G. Deliver--The operation of an offset press in controlling the paper after the image is printed
 - H. Plate cylinder--The part of an offset press which holds the offset plate
 - I. Blanket cylinder--The part of an offset press which contains a rubber blanket to receive the image from the plate
 - J. Impression cylinder--The part of an offset press which applies pressure for image transfer to the paper
 - K. Ink--A substance which is applied to the image areas of an offset plate for transfer to the blanket and then to the paper
 - L. Fountain solution--A chemical mixture applied to the nonimage areas of an offset plate to repel ink

- II. Basic theory of offset printing--The chemical principle that grease and water do not readily mix

INFORMATION SHEET

III. Other names by which offset printing is known

- A. Lithography
- B. Offset lithography
- C. Photo lithography
- D. Photo offset lithography
- E. Photo offset

IV. Basic systems of a typical sheet fed offset press (Transparency 1)

- A. Feeder system
- B. Register system
- C. Delivery system
- D. Cylinder system
- E. Inking system
- F. Dampening system

V. The functions of the basic systems of a typical sheet fed offset press

- A. Feeder system--Controls the feeding of paper stock, either from a roll or as a single sheet from a stack
- B. Register system--Controls the positioning of the paper being fed through the press so that the image will print in the exact same position on each sheet
- C. Delivery system--Controls the paper after the image is printed by stacking or rewinding as a roll to facilitate further processing
- D. Cylinder system--Contains three cylinders or their equivalent that control the transfer of the image from the offset plate to the paper being fed through the press
- E. Inking system--Holds a reservoir of ink and controls its distribution to the image areas of the offset plate
- F. Dampening system--Holds a reservoir of dampening (fountain) solution and controls its distribution to the nonimage areas of the offset plate

Basic Systems of a Sheet Fed Offset Press

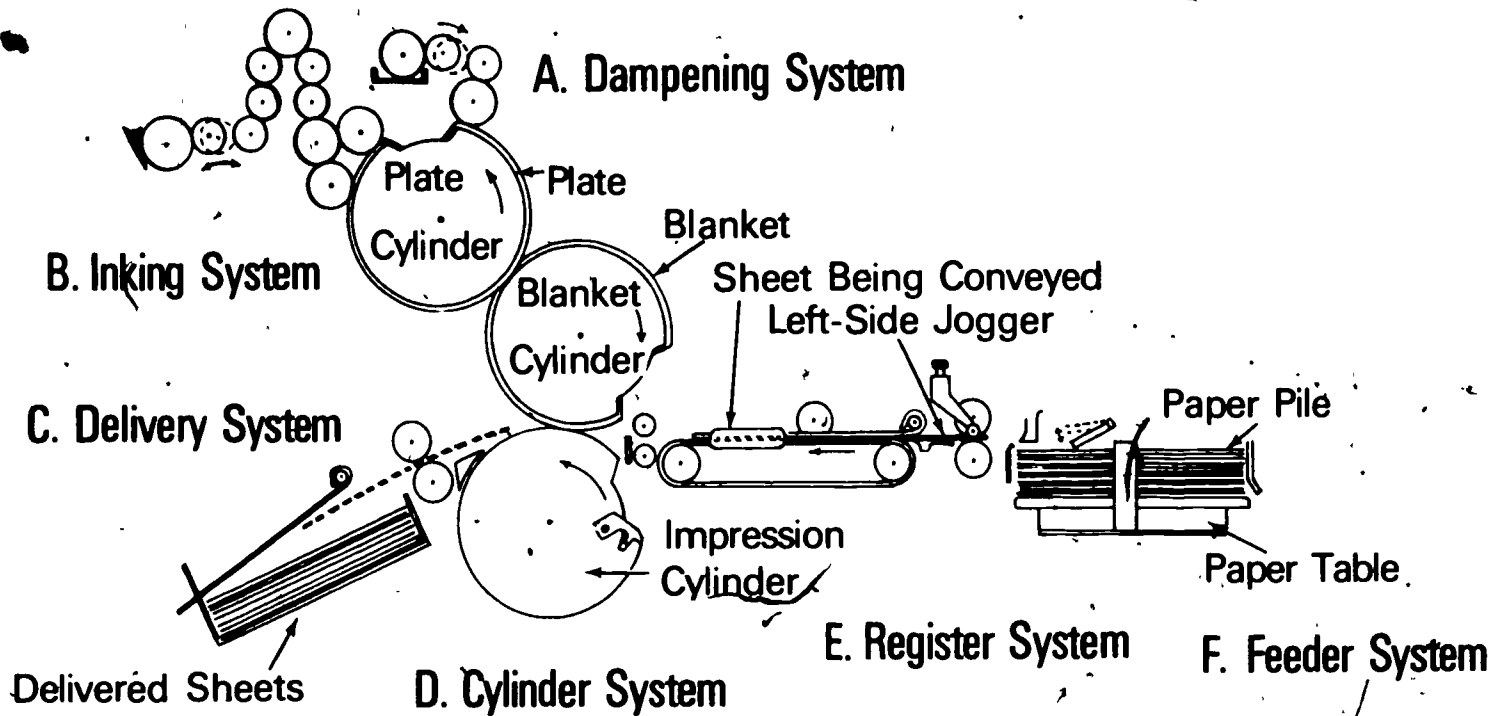

BASIC PRESS FUNDAMENTALS
UNIT I

ASSIGNMENT SHEET #1--IDENTIFY THE BASIC SYSTEMS AND THE
CYLINDERS IN A TYPICAL SHEET FED OFFSET PRESS

Directions: Insert the correct names of the systems and cylinders in a typical sheet fed offset press as they are depicted in the following illustration:

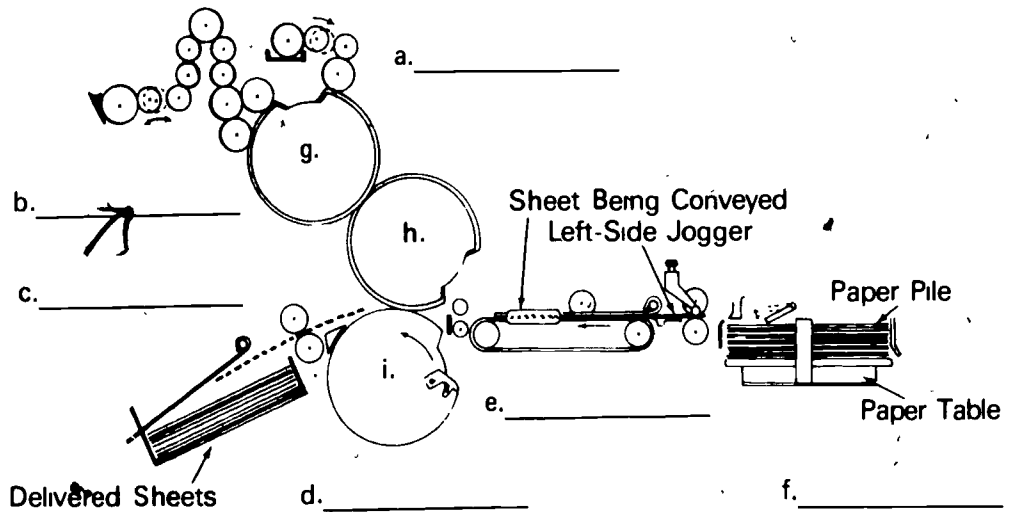

g. _____ h. _____ i. _____

BASIC PRESS FUNDAMENTALS
UNIT I

ANSWERS TO ASSIGNMENT SHEET #1

- a. Dampening system
- b. Inking system
- c. Delivery system
- d. Cylinder system
- e. Register system
- f. Feeder system
- g. Plate cylinder
- h. Blanket cylinder
- i. Impression cylinder

BASIC PRESS FUNDAMENTALS UNIT I

NAME _____

TEST

1. Match the terms on the right with the correct definitions.

- | | |
|---|--------------------------------|
| <p>_____ a. The procedure of transferring a right-reading image to an intermediate carrier where it becomes wrong-reading, then transferring that image to a receiver where it again becomes right-reading</p> | <p>1. Deliver</p> |
| <p>_____ b. The process of printing from a flat surface with the image and nonimage areas kept separated by chemistry</p> | <p>2. Feed</p> |
| <p>_____ c. A piece of printing equipment which holds a roll or stack of paper, controls that paper through the process of imprinting an image on its surface, and delivers the paper to a stack or roll for further processing</p> | <p>3. Offset printing</p> |
| <p>_____ d. A thin sheet of plastic or metal paper which directly or photographically receives an image that becomes ink receptive while the non-image area of the plate remains water receptive</p> | <p>4. Fountain solution</p> |
| <p>_____ e. The operation of an offset press in starting paper into the press for printing</p> | <p>5. Plate cylinder</p> |
| <p>_____ f. To print the image in the exact same position on each sheet of paper</p> | <p>6. Ink</p> |
| <p>_____ g. The operation of an offset press in controlling the paper after the image is printed</p> | <p>7. Blanket cylinder</p> |
| <p>_____ h. The part of an offset press which holds the offset plate</p> | <p>8. Offset press</p> |
| <p>_____ i. The part of an offset press which contains a rubber blanket to receive the image from the plate</p> | <p>9. Register</p> |
| <p>_____ j. The part of an offset press which applies pressure for image transfer to the paper</p> | <p>10. Impression cylinder</p> |
| | <p>11. Offset</p> |
| | <p>12. Offset plate</p> |

_____ k. A substance which is applied to the image areas of an offset plate for transfer to the blanket and then to the paper

_____ l. A chemical mixture applied to the non-image areas of an offset plate to repel ink

2. State the basic theory of offset printing.

3. List five other names by which offset printing is known.

- a. _____
- b. _____
- c. _____
- d. _____
- e. _____

4. Identify the basic systems of a typical sheet fed offset press.

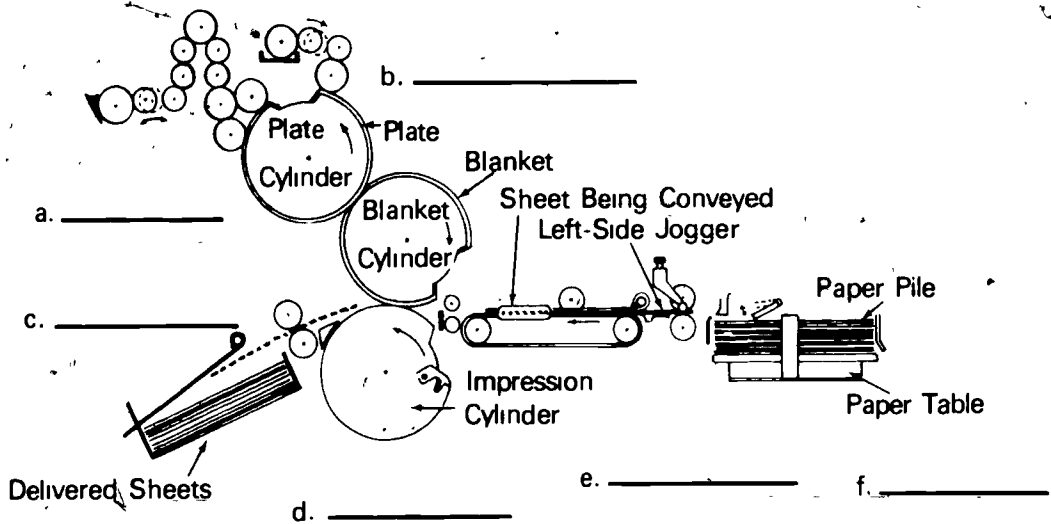

5. Match the basic systems of a typical sheet fed offset press with their functions.

- | | |
|---|---------------------|
| _____ a. Controls the feeding of paper stock, either from a roll or as a single sheet from a stack | 1. Inking system |
| _____ b. Controls the positioning of the paper being fed through the press so that the image will print in the exact same position on each sheet | 2. Feeder system |
| _____ c. Controls the paper after the image is printed by stacking or rewinding as a roll to facilitate further processing | 3. Delivery system |
| _____ d. Contains three cylinders or their equivalent that control the transfer of the image from the offset plate to the paper being fed through the press | 4. Dampening system |
| _____ e. Holds a reservoir of ink and controls its distribution to the image areas of the offset plate | 5. Cylinder system |
| _____ f. Holds a reservoir of dampening solution and controls its distribution to the nonimage areas of the offset plate | 6. Register system |

6. Identify the basic systems and the cylinders in a typical sheet fed offset press.

(NOTE: If this activity has not been accomplished prior to the test, ask your instructor when it should be completed.)

BASIC PRESS FUNDAMENTALS
UNIT I

ANSWERS TO TEST

1. a. 11 g. 1
 b. 3 h. 5
 c. 8 i. 7
 d. 12 j. 10
 e. 2 k. 6
 f. 9 l. 4
2. The chemical principle that grease and water do not readily mix
3. a. Lithography
 b. Offset lithography
 c. Photo lithography
 d. Photo offset lithography
 e. Photo offset
4. a. Inking system
 b. Dampening system
 c. Delivery system
 d. Cylinder system
 e. Register system
 f. Feeder system
5. a. 2
 b. 6
 c. 3
 d. 5
 e. 1
 f. 4
6. Evaluated to the satisfaction of the instructor

**OFFSET PRESS SYSTEMS
UNIT II****UNIT OBJECTIVE**

After completion of this unit, the student should be able to identify various components of offset press systems, and match types of systems used on offset presses with their descriptions. This knowledge will be evidenced by correctly performing the procedures outlined in the assignment sheet and by scoring 85 percent on the unit test.

SPECIFIC OBJECTIVES

After completion of this unit, the student should be able to:

1. Match terms related to offset press systems with the correct definitions.
2. Identify the components of the inking system of a typical offset press.
3. Identify the components of the dampening system of a typical offset press.
4. Identify the components of the cylinder system of a typical offset press.
5. Identify the components of the feeder system of a typical offset press.
6. Identify the components of the register system of a typical offset press.
7. Identify the components of the delivery system of a typical offset press.
8. Distinguish between the two types of dampening systems.
9. Identify offset press cylinder arrangements.
10. Match the types of feeder systems used on offset presses with their operations.
11. Match types of delivery systems with their descriptions.
12. Name the two types of register systems used on sheet fed offset presses.
13. Label offset press components.

**OFFSET PRESS SYSTEMS
UNIT II****SUGGESTED ACTIVITIES**

- I. Provide student with objective sheet.
- II. Provide student with information and assignment sheets.
- III. Make transparencies.
- IV. Discuss unit and specific objectives.
- V. Discuss information and assignment sheets.
- VI. Go to school shop area and show the systems on different presses or ask students to visit a print shop and make a report on the make of presses and describe the systems observed.
- VII. Give test.

INSTRUCTIONAL MATERIALS

- I. Included in this unit:
 - A. Objective sheet
 - B. Information sheet
 - C. Transparency masters
 1. TM 1--The Inking System
 2. TM 2--The Dampening System
 3. TM 3--The Cylinder System
 4. TM 4--The Feeder System
 5. TM 5--The Register System
 6. TM 6--The Delivery System
 7. TM 7--Types of Dampening Systems
 8. TM 8--Offset Press Cylinder Arrangements
 - D. Assignment Sheet #1--Label Offset Press Components
 - E. Answers to assignment sheet

F. Test

G. Answers to test

II. References:

- A. Bentley, R. G.; Olson, J. C.; Strandberg, C. E.; and Wiper, R. E. *Graphic Communication Series: Transparency Originals*. Chicago: A. B. Dick Company, 1970.
- B. Cogoli, John E. *Photo Offset Fundamentals*. Bloomington, IL 61701: McKnight Publishing Co., 1980.
- C. Dennis, Ervin A. and Jenkins, John D. *Comprehensive Graphic Arts*. Indianapolis, IN 46268: Howard W. Sams and Co., Inc., 1977.
- D. Spence, Wm. P. and Vequist, David G. *Graphic Reproduction*. Peoria, IL 61615: Chas A. Bennett Co., Inc., 1980.

OFFSET PRESS SYSTEMS
UNIT II

INFORMATION SHEET

I. Terms and definitions

(NOTE: The terms listed below may need to be localized according to usage in various regions of the U.S.)

- A. Form--The image on the offset plate to be printed on paper
- B. Form roller--The ink and/or dampening rollers which make contact with the offset plate that is attached to the plate cylinder
- C. Water system--A name synonymous with the dampening system
- D. Fountain--A tray reservoir which holds a supply of ink or water (fountain solution)
- E. Fountain roller--The roller which rotates in the ink and water fountains respectively to distribute ink and water to each of the systems
- F. Ductor roller--The roller which carries ink or water from the respective fountain roller to each system
- G. Vibrator roller--A hard surface gear driven or free turning roller which moves back and forth on its axis while rotating in contact with other rollers in the respective ink or water system to evenly distribute the ink or water

(NOTE: The vibrator roller is also called the oscillating or waver roller.)

- H. Distributor roller--Gear driven or free turning roller which rotates on its axis in contact with other rollers to aid in even distribution of water and ink in the respective systems and milling of ink in the ink system
- I. Idler roller--A free turning roller which contacts other ink rollers to aid in ink distribution
- J. Head clamp--That part of a plate cylinder which grips with pressure or holds with pins the leading edge of the offset plate as it is attached to the cylinder

(NOTE: The head clamp is also referred to as the plate clamp or gripper.)

- K. Tail clamp--That part of a plate cylinder which holds the trailing edge of the offset plate to secure its position on the cylinder

(NOTE: The tail clamp is also called the trailing edge clamp.)

INFORMATION SHEET

- L. Blanket--A thin sheet of rubber laminated to a backing sheet (usually canvas) that fits on the surface of the blanket cylinder
- M. Blanket clamps--The parts of the blanket cylinder which hold the blanket secure in position around the cylinder
- N. Sheet grippers--Several metal fingers attached to a shaft on the impression cylinder which grip the leading edge of the sheet of paper as it passes through the cylinder system

(NOTE: The leading edge of the press sheet of paper is commonly called the gripper edge.)

- O. Feed table--A component of the feeder system which holds a stack or pile of paper in position for feeding into the press
- P. Paper guides--Position the sheets that are stacked on the feed table by holding the paper on the sides and at the leading and trailing edges in exact position for entering the press
- Q. Pile height regulator--Controls the height to which the pile of paper will be maintained automatically for continuous feeding into the press
- R. Sheet separator--Small, thin, narrow, flexible metal finger(s) which is positioned against the leading edge of the paper pile and has the tip end bent to fit over the top of the leading edge about 1/4"; it aids in the feeding of one sheet at a time by separating a second or more sheets, causing them to remain on top of the pile
- S. Sucker tube--A hollow tube(s) through which a vacuum pump draws air causing a sheet of paper to be drawn to contact with the tube which then moves the sheet into the press
- T. Vacuum--Suction created through the sucker tube(s) by a vacuum pump intake
- U. Air blast--Air from the outlet of the vacuum pump that is blown through one or more tubes into the edges of the top few sheets on the paper stack on the feed table to control sheet separation for pickup of a single sheet by the sucker tube(s)
- V. Pull out roller--A free turning roller(s) which rotates in contact with a gear driven roller to pull the sheet of paper from the sucker tube(s) and deliver it to the register system
- W. Double sheet detector--A device which feels the thickness of the paper before it is fed into the register system and provides a means of stopping or deflecting the paper if two or more sheets are picked up by the sucker tube(s)
- X. Register board--A flat surface on which the sheet of paper is positioned between the feeder and cylinder systems

INFORMATION SHEET

- Y. Conveyor tapes--A set of tapes flat on the register board surface, which rotate around the board to move the paper through the register system
- Z. Paper control wheels or balls--Various size and composition wheels or balls which roll on top of the conveyor tapes to guide and/or hold the sheet in position on the register board
- AA. Sheet hold down strip--A thin, narrow, flexible strip(s) of metal the length of the register board which lays on top of a sheet of paper with a conveyor tape underneath to prevent sheet buckle
- BB. Side guides--A movable fixed position guide and a movable jogger guide to position and hold the sheet for pickup by the impression cylinder grippers
- CC. Paper stops--A set of guides to stop the forward motion of the sheet of paper so that it may be positioned by the side guides

(NOTE: The paper stops are also called the drop guides.)
- DD. Feed roller--A free turning roller which moves in and out of contact with a gear driven roller during each revolution of the press to move the sheet of paper from its register board position into the cylinder grippers
- EE. Sheet feeler--A small metal finger in position at the paper stop guides that feels for a sheet of paper and latches or unlatches the cylinder system in the print position
- FF. Delivery tray--A tray with positioning guides which receives the sheet from the cylinder system

(NOTE: The quantity capacity of the tray is approximately 500 sheets of 20 pound bond.)
- GG. Chain delivery--A delivery system which transfers the sheet from the cylinder system to a receiving table by means of gripper bars mounted on two parallel, revolving chains
- HH. Delivery gripper bar--A set of gripper fingers mounted on two parallel chains which rotate to pick up the sheet from the cylinder grippers and deliver it to a receiving tray or stacking unit
- II. Stripping fingers--Metal fingers which are positioned close to the surface of the impression cylinder which prevent the sheet of paper from following the cylinder rotation after the sheet is released to the delivery system
- JJ. Ejector roller--Rollers which aid in removing the sheet of paper from the impression cylinder and delivering it to the receiving unit
- KK. Ejector rings--Rings which slide from side to side on a lower gear driven ejector roller to aid in delivering paper to the receiving unit

INFORMATION SHEET

- LL. Delivery guides--Guides attached to the receiving unit which jog and hold the paper as each sheet is delivered to make a straightened stack
 - MM. Receding stacker--A receiving table attached to the offset press which automatically lowers as sheets of paper are delivered to it
- II. Components of the inking system of a typical offset press (Transparency 1)
- A. Ink fountain roller
 - B. Ink fountain
 - C. Ink ductor roller
 - D. Ink distributor roller
 - E. Ink idler rollers
 - F. Ink vibrator
 - G. Ink vibrator roller
 - H. Ink form roller
- III. Components of the dampening system of a typical offset press (Transparency 2)
- A. Water fountain
 - B. Water fountain roller
 - C. Water ductor roller
 - D. Water vibrator roller
 - E. Water form roller
- IV. Components of the cylinder system of a typical offset press (Transparency 3)
- A. Plate cylinder
 - B. Tail clamp
 - C. Head clamp
 - D. Plate
 - E. Blanket clamp
 - F. Blanket cylinder
 - G. Blanket
 - H. Impression cylinder
 - I. Sheet gripper

INFORMATION SHEET

- V. Components of the feeder system of a typical offset press (Transparency 4)
- A. Front paper guide
 - B. Double-sheet detector
 - C. Sheet separators
 - D. Vacuum sucker tube
 - E. Air blast nozzle
 - F. Paper side guide
 - G. Back paper guide
 - H. Pull out rollers
 - I. Pile height regulator
- VI. Components of the register system of a typical offset press (Transparency 5)
- A. Feed roller
 - B. Paper stop
 - C. Conveyor tape
 - D. Jogger side guide
 - E. Control wheel
 - F. Sheet hold down strip
 - G. Fixed side guide
 - H. Paper sheet
 - I. Paper stops
 - J. Jogger side guide
- VII. Components of the delivery system of a typical offset press (Transparency 6)
- A. Ejector rollers
 - B. Receiving tray
 - C. Stripping finger
 - D. Delivery gripper bars
 - E. Delivery cylinder

INFORMATION SHEET

F. Delivery gripper chains

G. Receding stacker

VIII. Types of dampening systems (Transparency 7)

(NOTE: Different press manufacturers use detailed variations to accomplish dampening with these types of systems and call them by trade names such as Dahlgren, Harris-Cottrell, Micro-Flow, Didde-Glaser, Miehle Matie, A. B. Dick, Aquamatic, and others.)

A. Conventional

1. Separate ink and water systems
2. Separate ink and water form rollers contacting the plate
3. Covered rollers
 - a. Molleton
 - b. Parchment
 - c. Paper or cloth sleeve
4. Noncovered rollers (barebacks)

B. Integrated

1. Separate ink and water fountains
2. Common form roller(s) contacting the plate
3. Noncovered rollers

IX. Offset press cylinder arrangements (Transparency 8)

- A. Two cylinder
- B. Three cylinder
- C. Four cylinder
- D. Perfector (blanket to blanket)
- E. Two color common impression cylinder
- F. Two color common blanket cylinder

(NOTE: The cylinder systems of offset presses have different arrangements with 2, 3, 4 or more cylinders used; the equivalent of the plate, blanket and impression cylinder is present in all arrangements.)

INFORMATION SHEET

X. Types and operation of feeder systems

- A. Sheet feed--Each sheet is picked up at the gripper edge after the trailing edge of the previous sheet moves past the sucker tubes

(NOTE: Small table top presses use a friction roller feed system.)

B. Stream feed

1. Each sheet is picked up at the trailing edge and pushed underneath the previous sheet
2. Pick up of the next sheet can be made immediately as the trailing edge moves toward the register system
3. Several overlapping sheets will be in position on the register board at one time

- C. Roll or web feed--The paper is mounted as a roll on the feeder system and can be delivered from the press as single sheets or rewound as a roll

XI. Types of delivery systems and their descriptions

- A. Tray--Paper is delivered to a receiving tray which must be emptied frequently

(NOTE: The tray delivery is also called chute delivery.)

- B. Chute with receding stacker--Paper is delivered and positioned on a table which automatically lowers

(NOTE: Many sheets may be held on this table.)

- C. Chain--Paper is delivered by gripper bars revolving on chains to a table which automatically lowers, allowing many sheets to be stacked

(NOTE: Some small presses with chain delivery systems do not have a receding stacker.)

- D. Roll or web--Paper fed from a roll is rewound after printing

XII. Types of register systems used on sheet fed offset presses

- A. Register board

(NOTE: The sheet is positioned by push or pull guides and on some models is delivered to the cylinder system by register swing grippers.)

- B. Feeder/buckle

(NOTE: The register is controlled laterally by positioning the sheet on the feed table; vertically, the image register is controlled by adjusting the buckle caused by overfeeding of the sheet into the open cylinder grippers and holding that buckle until the grippers close.)

The Inking System

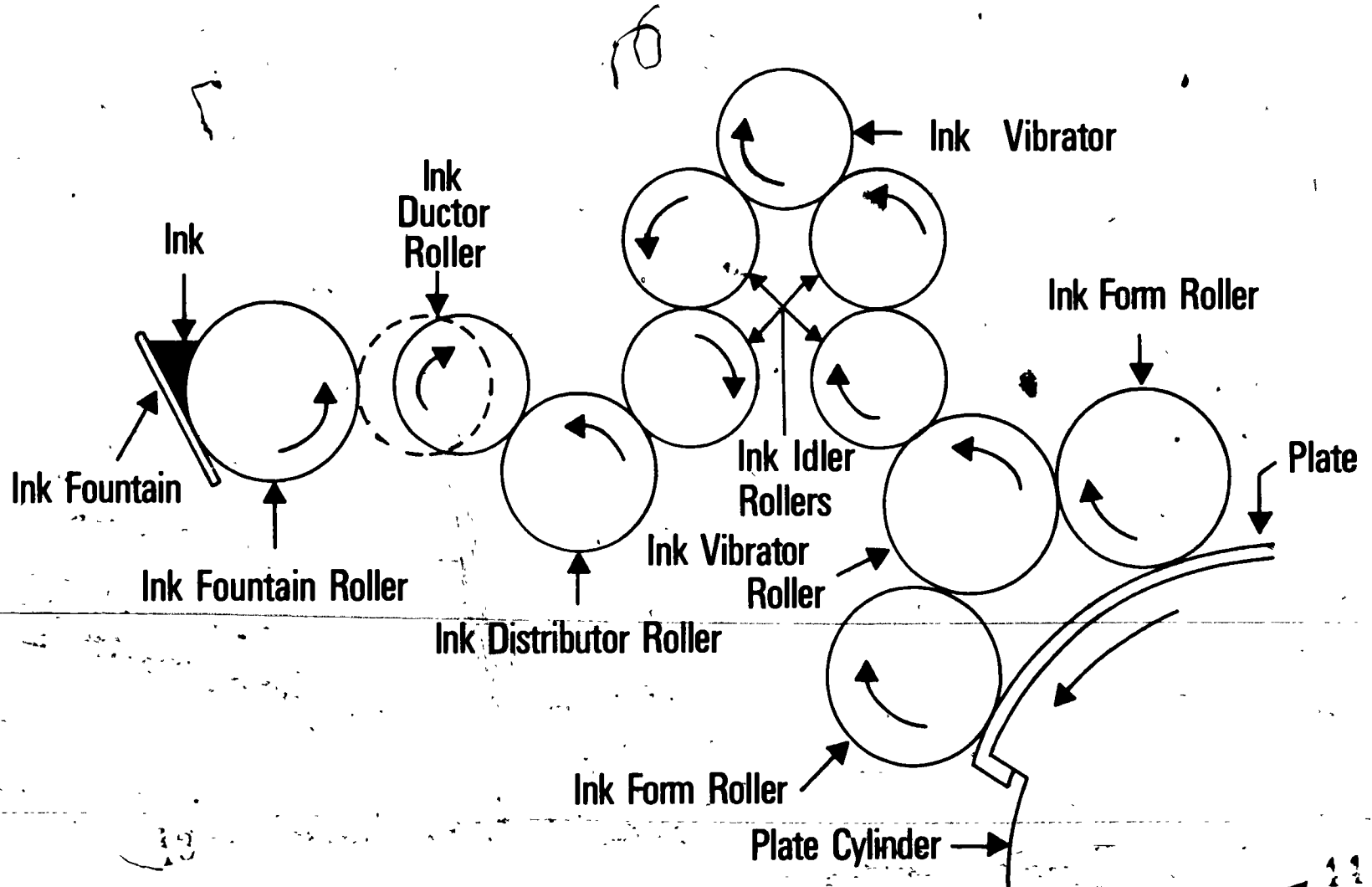

The Dampening System

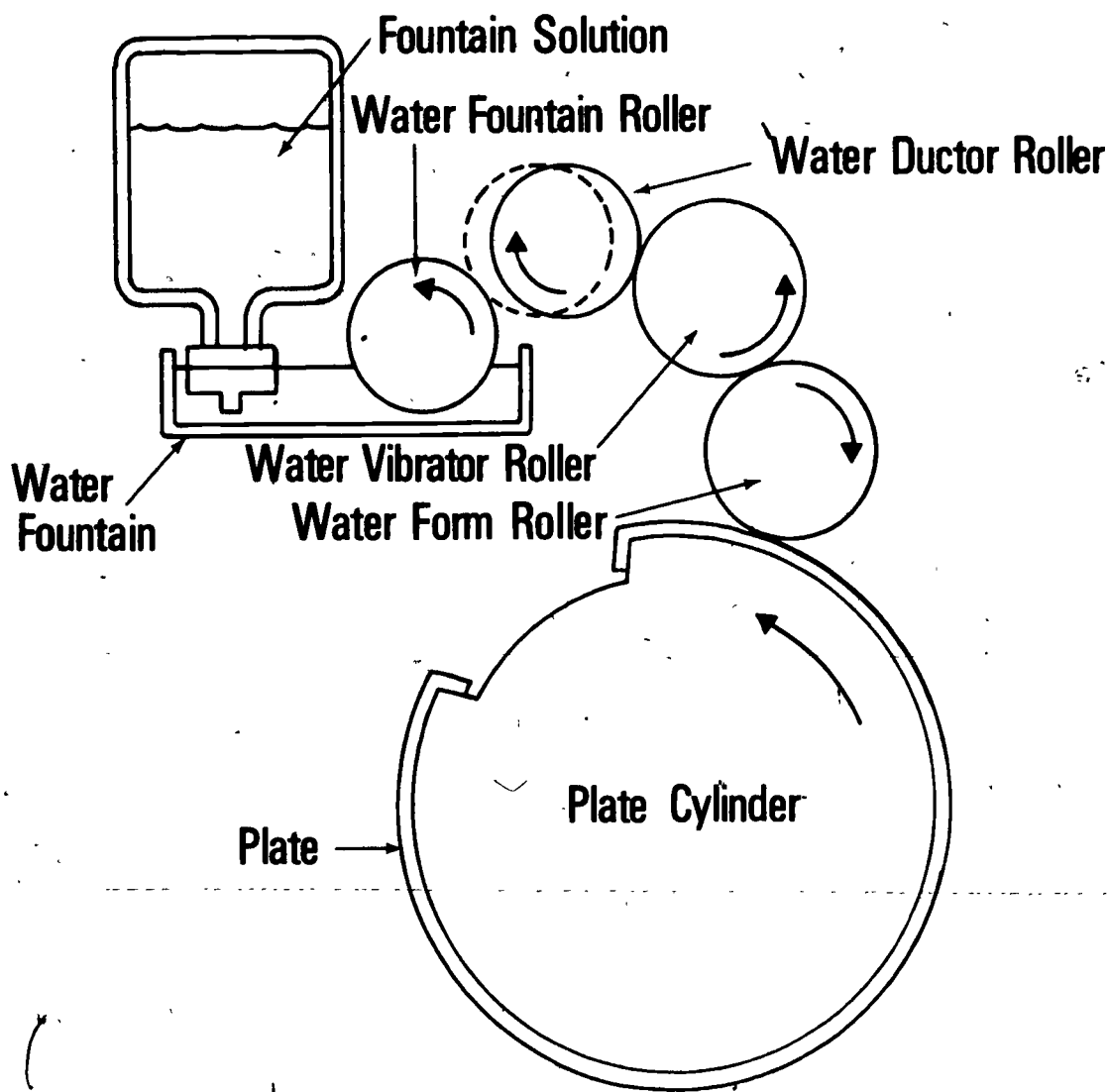

The Cylinder System

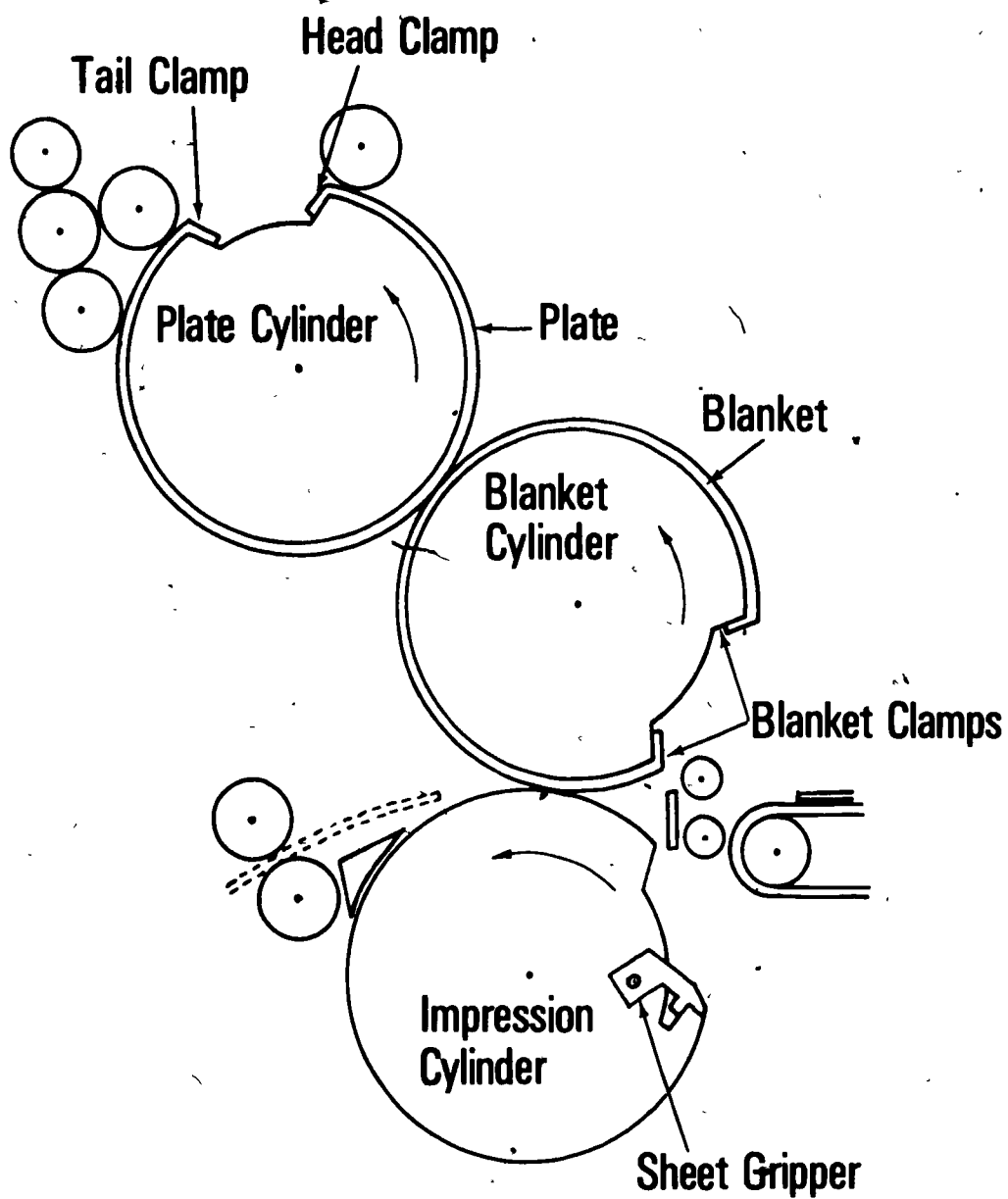

The Feeder System

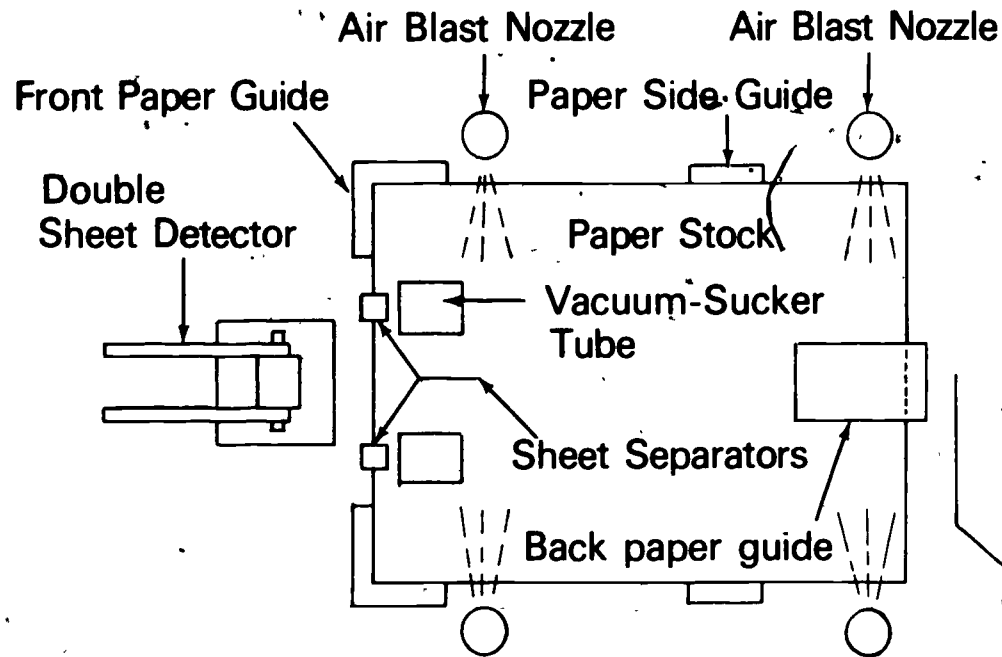

Top View of Feeding System

17

Side View of Feeder

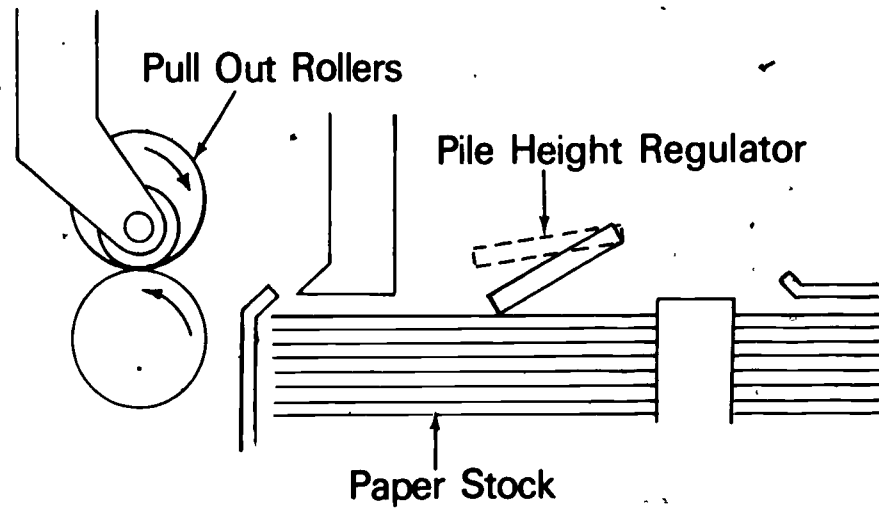

18

The Register System

Side View

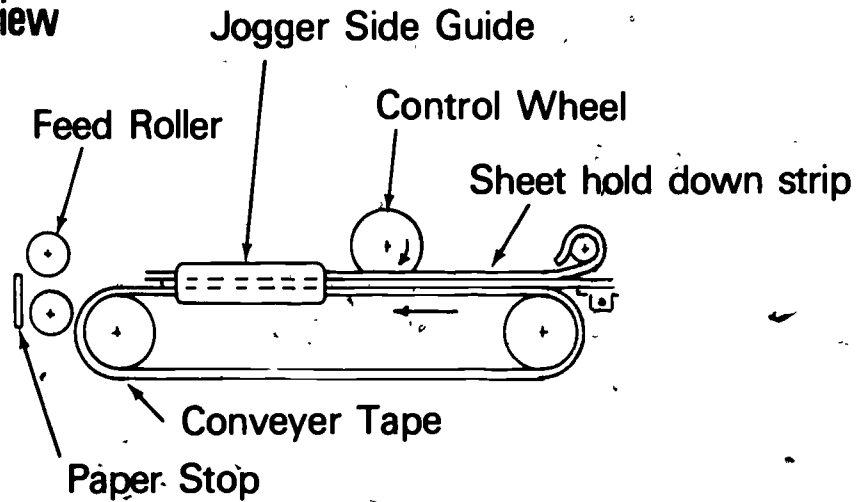

Top View

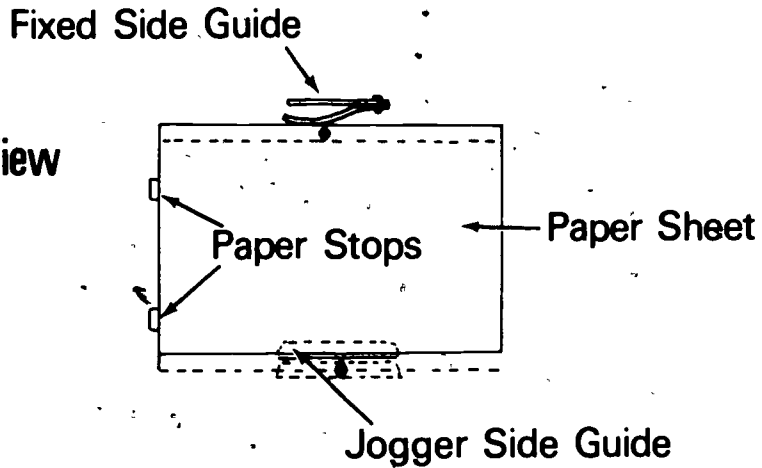

The Delivery System

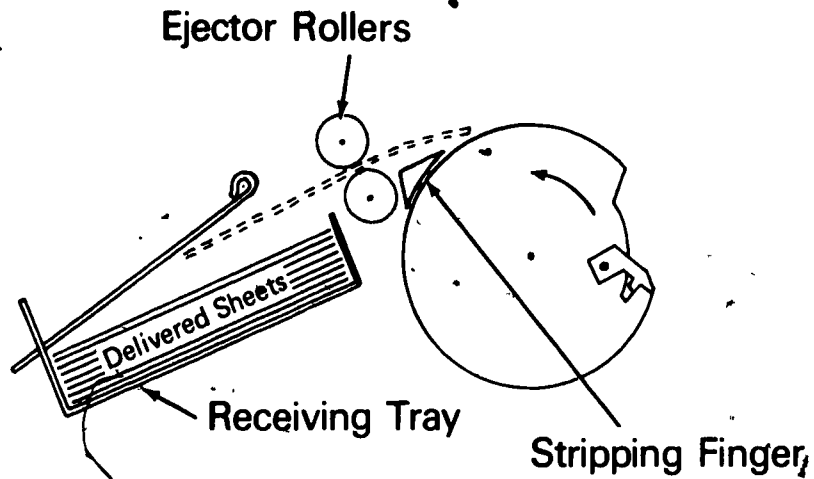

Tray Delivery

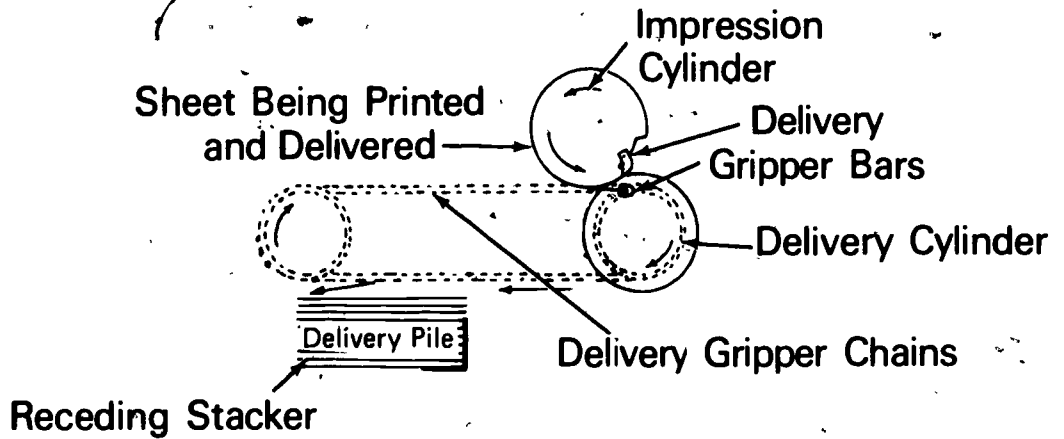

Chain Delivery With Receding Stacker

Types of Dampening Systems

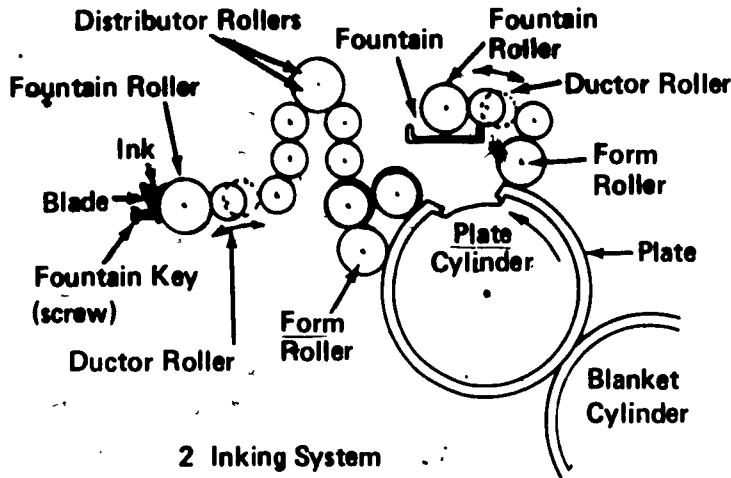

2 Inking System

Conventional Inking and Dampening System

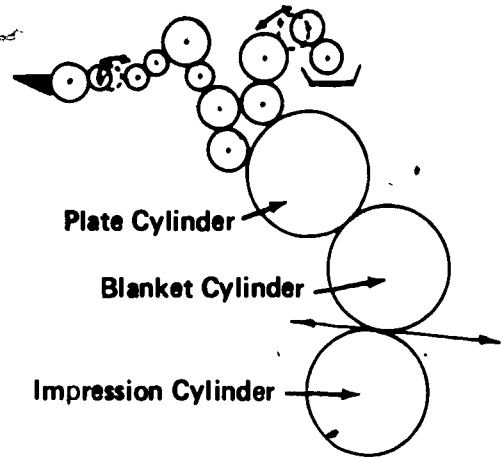

Integrated System
A.B. Dick

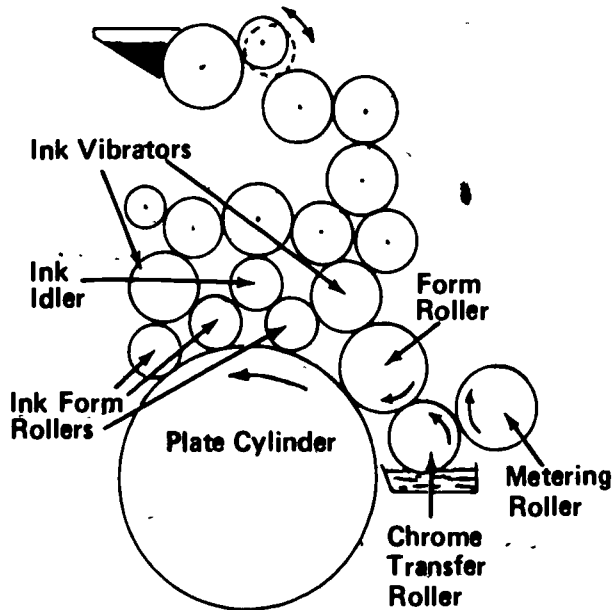

Integrated System
Dahlgren
Chrome Transfer Roller acts
as Pan Roller

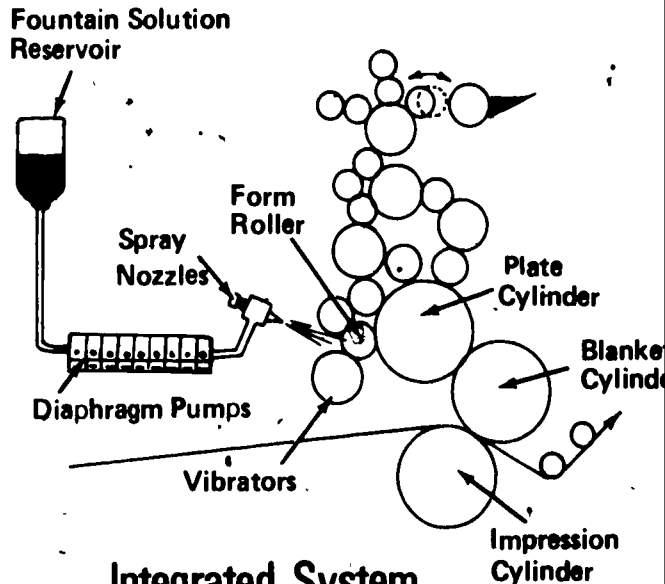

Integrated System
Didde-Glaser

Offset Press Cylinder Arrangements

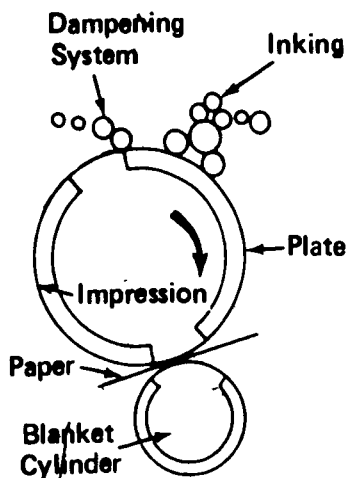

Two Cylinder

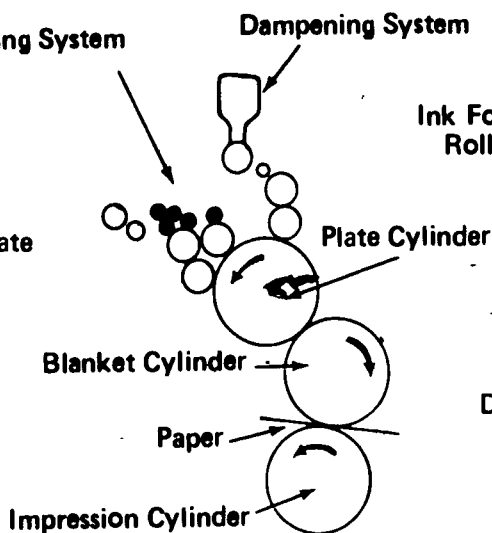

Three Cylinder

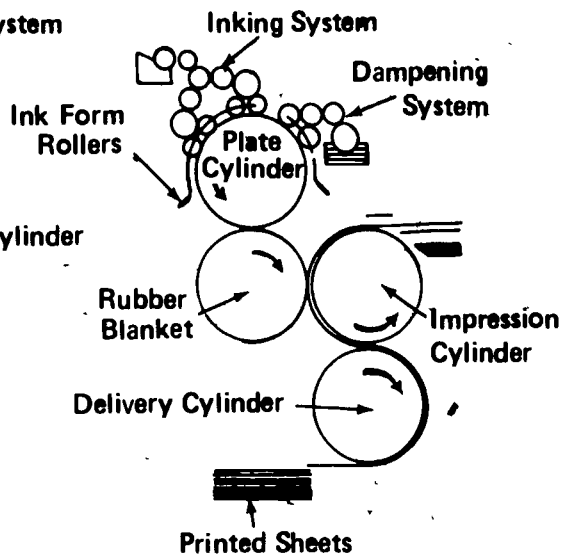

Four Cylinder

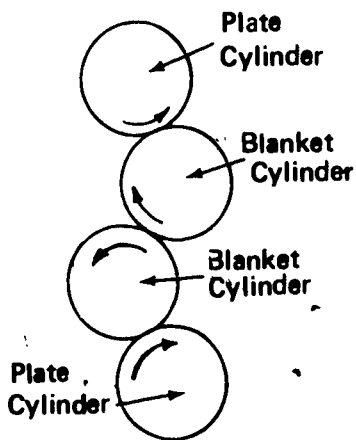

Perfector
(Blanket to Blanket)

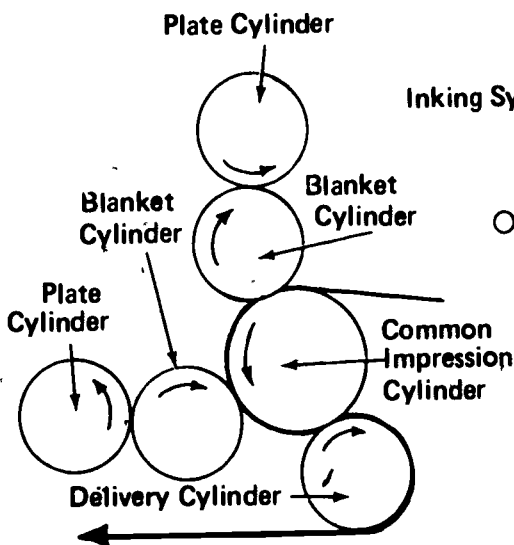

Two Color
Common Impression
Cylinder

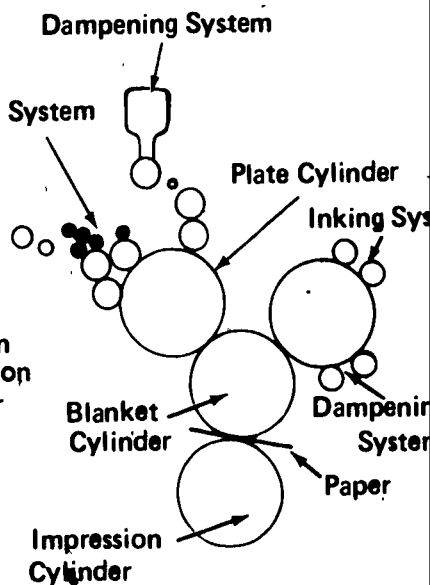

Two Color
Common Blanket
Cylinder

OFFSET PRESS SYSTEMS UNIT II

ASSIGNMENT SHEET #1--LABEL OFFSET PRESS COMPONENTS

1. Identify the components in the schematic cross section of the sheet-fed, single-color offset press shown below.

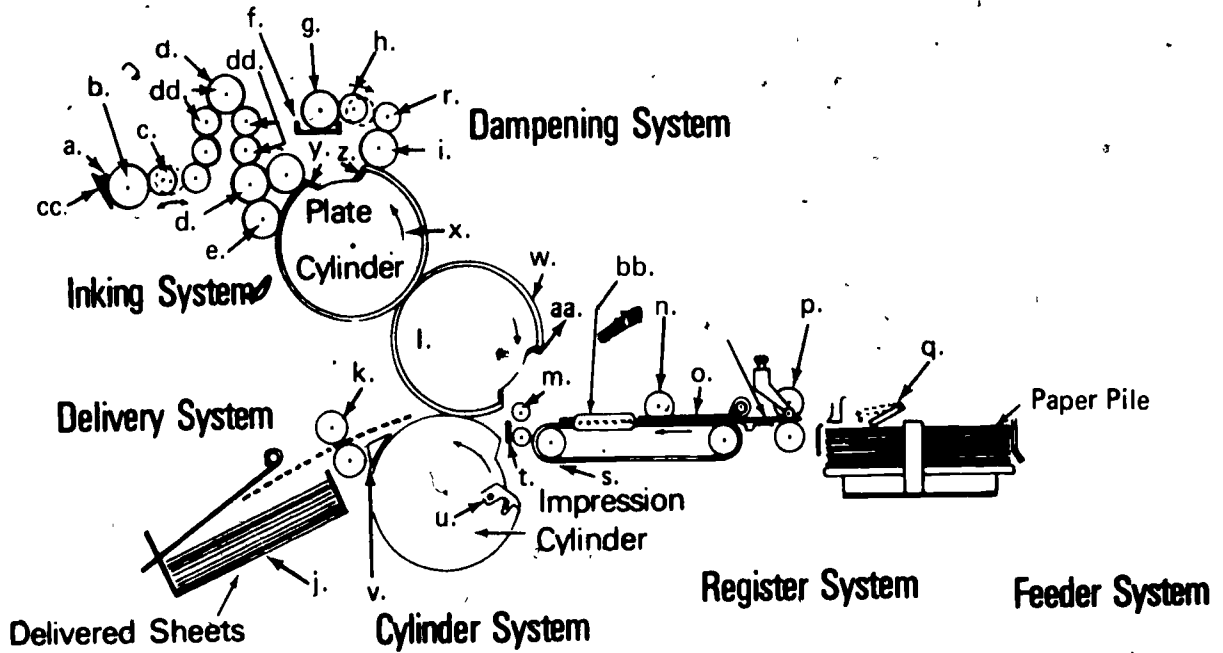

ASSIGNMENT SHEET #1

- a. _____
- b. _____
- c. _____
- d. _____
- e. _____
- f. _____
- g. _____
- h. _____
- i. _____
- j. _____
- k. _____
- l. _____
- m. _____
- n. _____
- o. _____

- p. _____
- q. _____
- r. _____
- s. _____
- t. _____
- u. _____
- v. _____
- w. _____
- x. _____
- y. _____
- z. _____
- aa. _____
- bb. _____
- cc. _____
- dd. _____

OFFSET PRESS SYSTEMS
UNIT II

ANSWERS TO ASSIGNMENT SHEET #1

- | | |
|--------------------------|--------------------------|
| a. Ink | p. Pull out rollers |
| b. Ink fountain roller | q. Pile height regulator |
| c. Ink ductor roller | r. Water vibrator |
| d. Ink vibrator | s. Conveyor tape |
| e. Ink form rollers | t. Paper stop |
| f. Water fountain | u. Sheet gripper |
| g. Water fountain roller | v. Stripping finger |
| h. Water ductor roller | w. Blanket |
| i. Water form roller | x. Plate |
| j. Receiving tray | y. Tail clamp |
| k. Ejector rollers | z. Head clamp |
| l. Blanket cylinder | aa. Blanket clamp |
| m. Feed roller | bb. Jogger guide |
| n. Control wheel | cc. Ink fountain |
| o. Sheet hold down strip | dd. Ink idler rollers |

OFFSET PRESS SYSTEMS
UNIT II

NAME _____

TEST

1. Match the terms on the right with the correct definitions.

- | | |
|--|--|
| <p>_____ a. The image on the offset plate to be printed on paper</p> | <p>1. Ductor roller</p> |
| <p>_____ b. The ink and/or dampening rollers which make contact with the offset plate that is attached to the plate cylinder</p> | <p>2. Fountain</p> |
| <p>_____ c. A name synonymous with the dampening system</p> | <p>3. Form roller</p> |
| <p>_____ d. A tray reservoir which holds a supply of ink or water</p> | <p>4. Sheet grippers</p> |
| <p>_____ e. The roller which rotates in the ink and water fountains respectively to distribute ink and water to each of the systems</p> | <p>5. Feed table</p> |
| <p>_____ f. The roller which carries ink or water from the respective fountain roller to each system</p> | <p>6. Paper guides</p> |
| <p>_____ g. A hard surfaced gear driven or free turning roller which moves back and forth on its axis while rotating in contact with other rollers in the respective ink or water system to evenly distribute the ink or water</p> | <p>7. Form</p> |
| <p>_____ h. Gear driven or free turning roller which rotates on its axis in contact with other rollers to aid in even distribution of water and ink in the respective systems and milling of ink in the ink system</p> | <p>8. Conveyor tapes</p> |
| <p>_____ i. A free turning roller which contacts other ink rollers to aid in ink distribution</p> | <p>9. Water system</p> |
| <p>_____ j. That part of a plate cylinder which grips with pressure or holds with pins the leading edge of the offset plate as it is attached to the cylinder</p> | <p>10. Fountain roller</p> |
| | <p>11. Head clamp</p> |
| | <p>12. Paper control wheels or balls</p> |
| | <p>13. Tail clamp</p> |
| | <p>14. Idler roller</p> |
| | <p>15. Distributor roller</p> |
| | <p>16. Vibrator roller</p> |
| | <p>17. Blanket clamps</p> |
| | <p>18. Pile height regulator</p> |

- _____ k. That part of a plate cylinder which holds the trailing edge of the offset plate to secure its position on the cylinder
- _____ l. The parts of the blanket cylinder which hold the blanket secure in position around the cylinder
- _____ m. Several metal fingers attached to a shaft on the impression cylinder which grip the leading edge of the sheet of paper as it passes through the cylinder system
- _____ n. A component of the feeder system which holds a stack or pile of paper in position for feeding into the press
- _____ o. Position the sheets that are stacked on the feed table by holding the paper on the sides and at the leading and trailing edges in exact position for entering the press
- _____ p. Controls the height to which the pile of paper will be maintained automatically for continuous feeding into the press
- _____ q. Small, thin, narrow, flexible metal finger(s) which is positioned against the leading edge of the paper pile and have the tip end bent to fit over the top of the leading edge about 1/4"; it aids in the feeding of one sheet at a time by separating a second or more sheets, causing them to remain on top of the pile
- _____ r. A hollow tube(s) through which a vacuum pump draws air causing a sheet of paper to be drawn to contact with the tube which then moves the sheet into the press
- _____ s. Suction created through the sucker tube(s) by a vacuum pump intake
- _____ t. Air from the outlet of the vacuum pump that is blown through one or more tubes into the edges of the top few sheets on the paper stack on the feed table to control sheet separation for pickup of a single sheet by the sucker tube(s)
19. Receding stacker
20. Sheet separator
21. Sucker tube
22. Delivery guides
23. Sheet hold down strip
24. Ejector rings
25. Side guides
26. Ejector roller
27. Delivery gripper bar
28. Stripping fingers
29. Register board
30. Air blast
31. Paper stops
32. Vacuum
33. Feed roller
34. Double sheet detector
35. Sheet feeler
36. Pull out roller
37. Chain delivery
38. Blanket
39. Delivery tray

- _____ u. A free turning roller(s) which rotates in contact with a gear driven roller to pull the sheet ~~of paper~~ from the sucker tube(s) and deliver it to ~~the~~ register system
- _____ v. A device which feels the thickness of the paper before it is fed into the register system and provides a means of stopping or deflecting the paper if two or more sheets are picked up by the sucker tube(s)
- _____ w. A flat surface on which the sheet of paper is positioned between the feeder and cylinder systems
- _____ x. A set of tapes, flat on the register board surface, which rotate around the board to move the paper through the register system
- _____ y. Various size and composition wheels or balls which roll on top of the conveyor tapes to guide and/or hold the sheet in position on the register board
- _____ z. A thin, narrow, flexible strip(s) of metal the length of the register board which lays on top of a sheet of paper with a conveyor tape underneath to prevent sheet buckle
- _____ aa. A movable fixed position guide and a movable jogger guide to position and hold the sheet for pickup by the impression cylinder grippers
- _____ bb. A set of guides to stop the forward motion of the sheet of paper so that it may be positioned by the side guides
- _____ cc. A free turning roller which moves in and out of contact with a gear driven roller during each revolution of the press to move the sheet of paper from its register board position into the cylinder grippers
- _____ dd. A small metal finger in position at the paper stop guides that feels for a sheet of paper and latches or unlatches the cylinder system in the print position

- _____ ee. A set of gripper fingers mounted on two parallel chains which rotate to pick up the sheet from the cylinder grippers and deliver it to a receiving tray or stacking unit
- _____ ff. Metal fingers which are positioned close to the surface of the impression cylinder which prevent the sheet of paper from following the cylinder rotation after the sheet is released to the delivery system
- _____ gg. Rollers which aid in removing the sheet of paper from the impression cylinder and delivering it to the receiving unit
- _____ hh. Rings which slide from side to side on a lower gear driven ejector roller to aid in delivering paper to the receiving unit
- _____ ii. Guides attached to the receiving unit which jog and hold the paper as each sheet is delivered to make a straightened stack
- _____ jj. A receiving table attached to the offset press which automatically lowers as sheets of paper are delivered to it
- _____ kk. A tray with positioning guides which receives the sheet from the cylinder system
- _____ ll. A thin sheet of rubber laminated to a backing sheet that fits on the surface of the blanket cylinder
- _____ mm. A delivery system which transfers the sheet from the cylinder system to a receiving table by means of gripper bars mounted on two parallel, revolving chains

2. Identify the components of the inking system of a typical offset press.

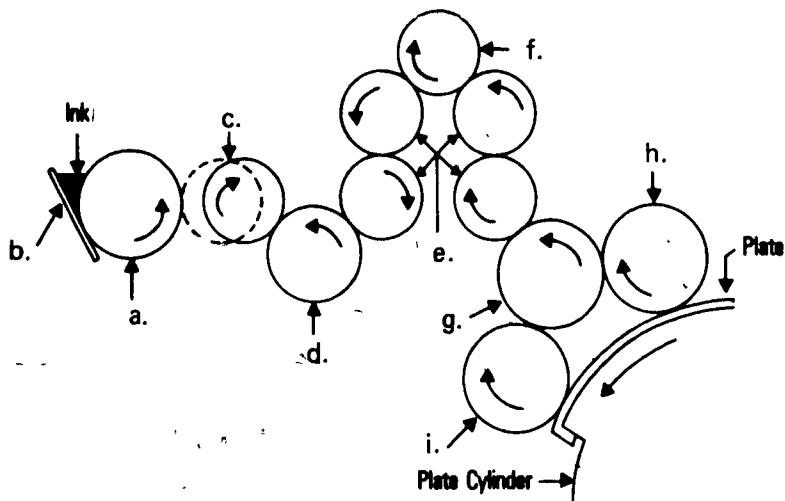

- a. _____
- b. _____
- c. _____
- d. _____
- e. _____

- f. _____
- g. _____
- h. _____
- i. _____

3. Identify the components of the dampening system of a typical offset press.

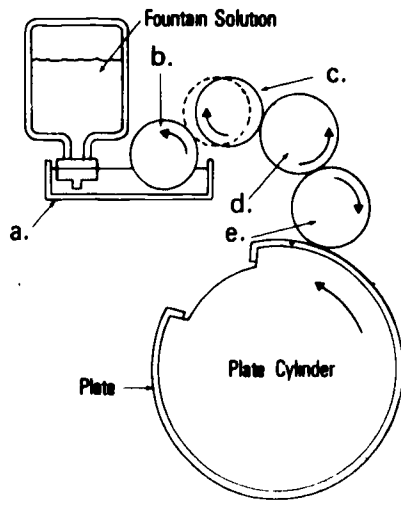

- a. _____
- b. _____
- c. _____

- d. _____
- e. _____

G11

4. Identify the components of the cylinder system of a typical offset press.

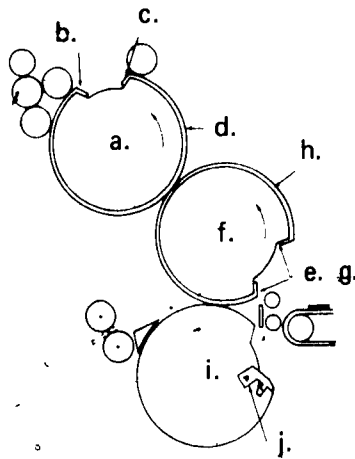

- a. _____
- b. _____
- c. _____
- d. _____
- e. _____

- f. _____
- g. _____
- h. _____
- i. _____
- j. _____

5. Identify the components of the feeder system of a typical offset press.

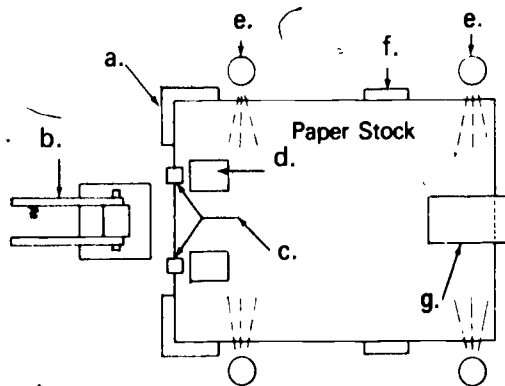

Top View of Feeding System

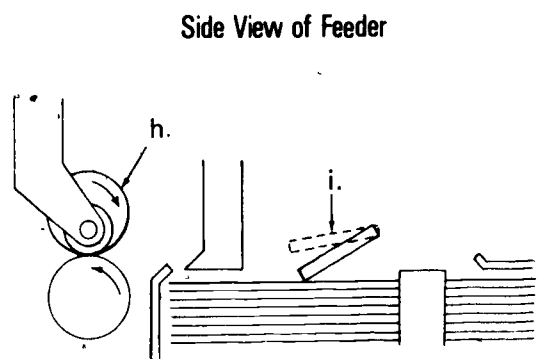

Side View of Feeder

- a. _____
- b. _____
- c. _____
- d. _____
- e. _____

- f. _____
- g. _____
- h. _____
- i. _____

6. Identify the components of the register system of a typical offset press.

Side View

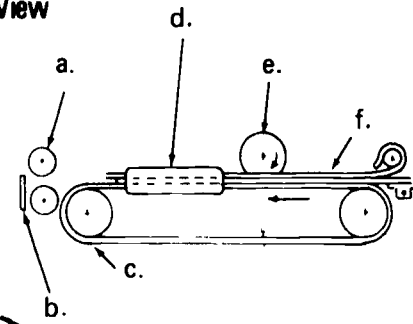

Top View

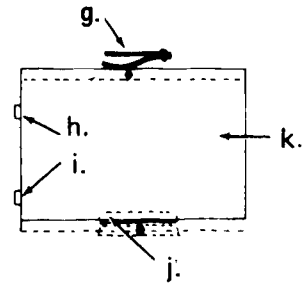

- a. _____
- b. _____
- c. _____
- d. _____
- e. _____
- f. _____

- g. _____
- h. _____
- i. _____
- j. _____
- k. _____
- l. _____

7. Identify the components of the delivery system of a typical offset press.

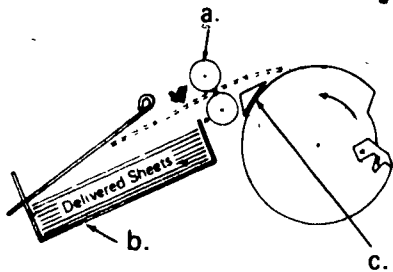

Tray Delivery

- a. _____
- b. _____
- c. _____
- d. _____

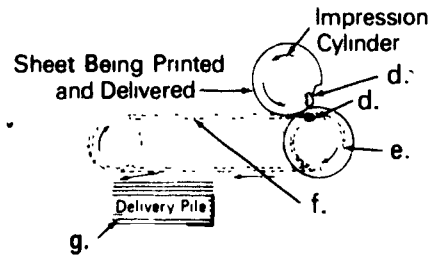

Chain Delivery With Receding Stacker

- e. _____
- f. _____
- g. _____

8. Distinguish between the two types of dampening systems by placing a "C" before descriptions of conventional systems and an "I" before descriptions of integrated systems.

(NOTE: Both systems may apply to one description.)

- _____ a. Noncovered rollers
- _____ b. Common ink and water rollers contact plate
- _____ c. Molleton covered rollers
- _____ d. Paper or cloth sleeve covered rollers
- _____ e. Separate ink and water form rollers contacting the plate
- _____ f. Separate ink and water fountains
- _____ g. Parchment covered rollers

9. Identify the various offset press cylinder arrangements.

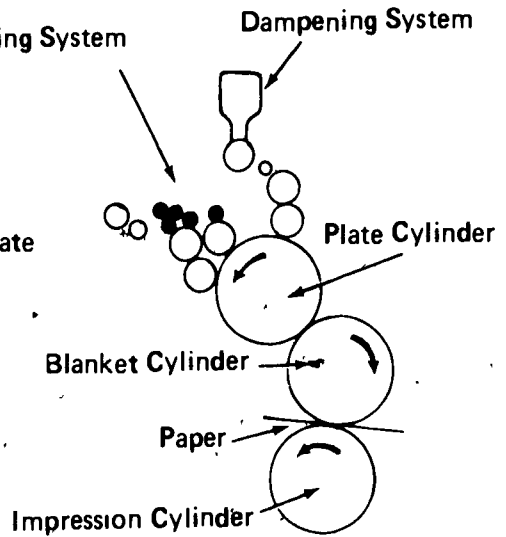
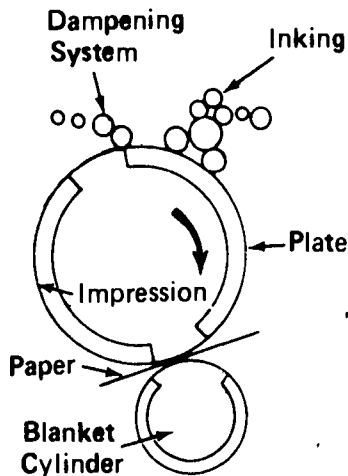

a. _____

b. _____

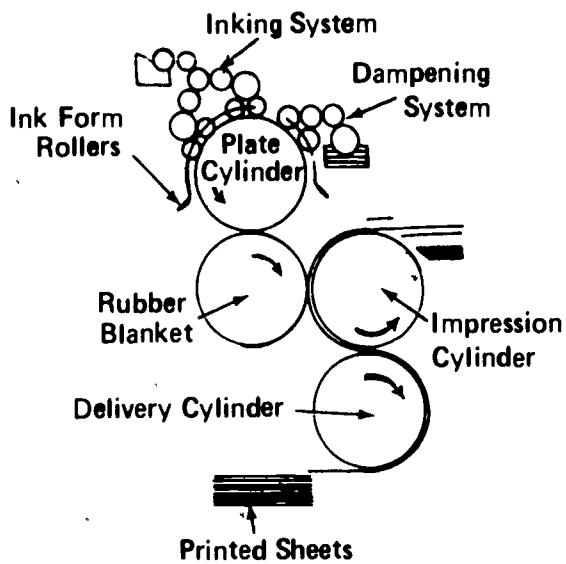

c. _____

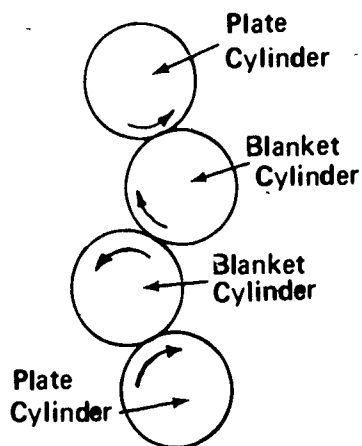

d. _____

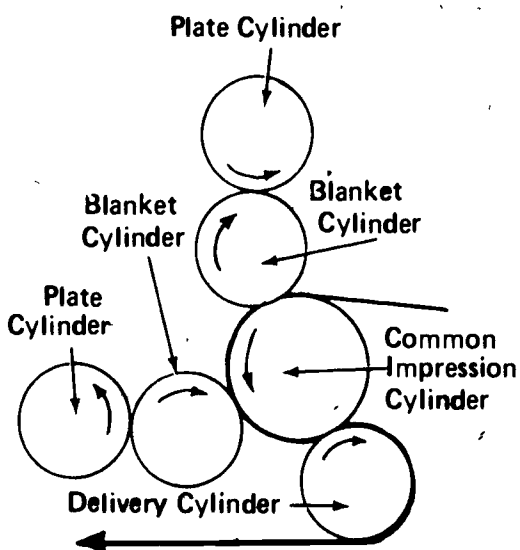

e. _____

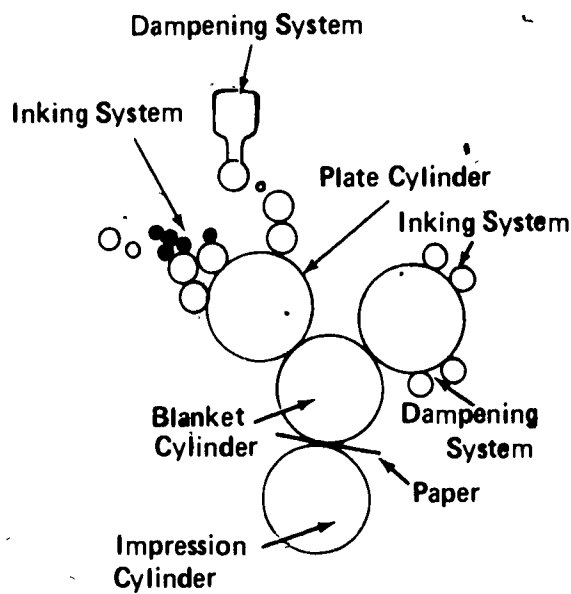

f. _____

10. Match the types of feeder systems on the right with their operations.

(NOTE: Answers may be used more than once.)

- | | |
|--|---|
| <p>_____ a. Each sheet is picked up at the trailing edge and pushed underneath the previous sheet</p> <p>_____ b. Pick up of the next sheet can be made immediately as the trailing edge moves toward the register system</p> <p>_____ c. Each sheet is picked up at the gripper edge after the trailing edge of the previous sheet moves past the sucker tubes</p> <p>_____ d. Several overlapping sheets will be on the register board at one time</p> <p>_____ e. The paper is mounted as a roll on the feeder system and can be delivered from the press as single sheets or rewound as a roll</p> | <p>1. Roll or web feed</p> <p>2. Stream feed</p> <p>3. Sheet feed</p> |
|--|---|

11. Match the types of delivery systems on the right with their descriptions.

- | | |
|--|--|
| <p>_____ a. Paper is delivered to a receiving tray which must be emptied frequently</p> <p>_____ b. Paper is delivered and positioned on a table which automatically lowers</p> <p>_____ c. Paper is delivered by gripper bars revolving on chains to a table which automatically lowers, allowing many sheets to be stacked</p> <p>_____ d. Paper fed from a roll is rewound after printing</p> | <p>1. Chain</p> <p>2. Tray</p> <p>3. Chute with receding stacker</p> <p>4. Roll or web</p> |
|--|--|

12. Name the two types of register systems used on sheet fed offset presses.

- a. _____
- b. _____

13. Label offset press components.

(NOTE: If this activity has not been accomplished prior to the test, ask your instructor when it should be completed.)

OFFSET PRESS SYSTEMS
UNIT II

ANSWERS TO TEST

- | | | | | | | | | |
|----|----|------------------------|----|-------------------------|-----|----|-----|----|
| 1. | a. | 7 | k. | 13 | u. | 36 | ee. | 27 |
| | b. | 3 | l. | 17 | v. | 34 | ff. | 28 |
| | c. | 9 | m. | 4 | w. | 29 | gg. | 26 |
| | d. | 2 | n. | 5 | x. | 8 | hh. | 24 |
| | e. | 10 | o. | 6 | y. | 12 | ii. | 22 |
| | f. | 1 | p. | 18 | z. | 23 | jj. | 19 |
| | g. | 16 | q. | 20 | aa. | 25 | kk. | 39 |
| | h. | 15 | r. | 21 | bb. | 31 | ll. | 38 |
| | i. | 14 | s. | 32 | cc. | 33 | mm. | 37 |
| | j. | 11 | t. | 30 | dd. | 35 | | |
| 2. | a. | Ink fountain roller | f. | Ink vibrator | | | | |
| | b. | Ink fountain | g. | Ink vibrator roller | | | | |
| | c. | Ink ductor roller | h. | Ink form roller | | | | |
| | d. | Ink distributor roller | i. | Ink form roller | | | | |
| | e. | Ink idler rollers | | | | | | |
| 3. | a. | Water fountain | d. | Water vibrator roller | | | | |
| | b. | Water fountain roller | e. | Water form roller | | | | |
| | c. | Water ductor roller | | | | | | |
| 4. | a. | Plate cylinder | f. | Blanket cylinder | | | | |
| | b. | Tail clamp | g. | Blanket clamp | | | | |
| | c. | Head clamp | h. | Blanket | | | | |
| | d. | Plate | i. | Impression cylinder | | | | |
| | e. | Blanket clamp | j. | Sheet gripper | | | | |
| 5. | a. | Front paper guide | f. | Paper side guide | | | | |
| | b. | Double-sheet detector | g. | Back paper guide | | | | |
| | c. | Sheet separators | h. | Pull out rollers | | | | |
| | d. | Vacuum sucker tube | i. | Pile height regulator | | | | |
| | e. | Air blast nozzle | | | | | | |
| 6. | a. | Feed roller | g. | Fixed side guide | | | | |
| | b. | Paper stop | h. | Paper stop | | | | |
| | c. | Conveyor tape | i. | Paper stop | | | | |
| | d. | Jogger side guide | j. | Jogger side guide | | | | |
| | e. | Control wheel | k. | Paper sheet | | | | |
| | f. | Sheet hold down strip | | | | | | |
| 7. | a. | Ejector rollers | e. | Delivery cylinder | | | | |
| | b. | Receiving tray | f. | Delivery gripper chains | | | | |
| | c. | Stripping finger | g. | Receding stacker | | | | |
| | d. | Delivery gripper bars | | | | | | |

OFFSET PRESS OPERATING PROCEDURES UNIT III

UNIT OBJECTIVE

After completion of this unit the student should be able to set up sheet control and image control systems. The student should also be able operate and wash up an offset press. This knowledge will be evidenced by correctly performing the procedures outlined in the assignment and job sheets and by scoring 85 percent on the unit test.

SPECIFIC OBJECTIVES

After completion of this unit the student should be able to:

1. Match terms related to offset press operating procedures with the correct definitions.
2. Select true statements concerning essential safety precautions.
3. List two reasons why efficient press operation is important.
4. Select offset press operator control functions.
5. Match control features with the press system in which they are located.
6. Indicate the sequence of how paper passes through a typical offset press.
7. Compare control features of offset presses.
8. Demonstrate the ability to:
 - a. Set up the sheet control systems.
 - b. Set up the image control systems.
 - c. Operate an offset press from setup of systems through printed sheet delivery.
 - d. Wash up an offset press.

✓

OFFSET PRESS OPERATING PROCEDURES UNIT III

SUGGESTED ACTIVITIES

- I. Provide student with objective sheet.
- II. Provide student with information, assignment, and job sheets.
- III. Make transparency.
- IV. Discuss unit and specific objectives.
- V. Discuss information and assignment sheets.
- VI. Demonstrate and discuss the procedures outlined in the job sheets.
- VII. After completing Job Sheet #1 the student could be given various kinds of stock (including envelopes) and various sizes to run for gaining some proficiency in controlling paper through the press.
- VIII. After Job Sheet #2 the student may be assigned Job Sheet #4 with all students rotating these two job sheets to insure that each student experiences image control systems preparation and wash up during a short time span.
- IX. After completion of Job Sheet #3 variations in the use of operator skills may be given by considering job order assignments in the following areas:
 - A. Types of plates
 1. Paper
 2. Electrostatic
 3. Photo-direct
 4. Metal
 - B. Types of paperstock
 1. Onionskin or manifold
 2. Bond
 3. Book (Coated and uncoated, text)
 4. Index
 5. Cover
 6. Card
 7. Envelopes

- 8. Carbonless
- 9. Gum label
- 10. Adhesive backed label
- C. Sizes of stock (from minimum to maximum)
- D. Colors of Ink (1, 2, 3, 4)
- E. Ink coverage
 - 1. Uniform
 - 2. Light
 - 3. Heavy
 - 4. Varying
 - 5. Halftones and/or solids
- F. Image position
 - 1. Loose register
 - 2. Tight register
 - 3. Duotone
 - 4. Overprint colors
 - 5. 3-color
 - 6. 4-color
 - 7. Print front and back
 - 8. Work and turn
 - 9. Work and tumble
- X. Instructor should discuss and demonstrate the press accessories and attachments available in the shop such as powder spray, ink, agitator, automatic blanket washer, second color unit, perforating and numbering unit, and envelope feeding unit.

INSTRUCTIONAL MATERIALS

- I. Included in this unit:
 - A. Objective sheet
 - B. Information sheet

- C. Transparency Master 1--Sequence of How Paper Passes Through a Typical Offset Press
 - D. Assignment Sheet #1--Compare Control Features of Offset Presses
 - E. Job sheets
 - 1. Job Sheet #1--Set Up the Sheet Control Systems
 - 2. Job Sheet #2--Set Up the Image Control Systems
 - 3. Job Sheet #3--Operate an Offset Press From Set Up of Systems Through Printed Sheet Delivery
 - 4. Job Sheet #4--Wash Up an Offset Press
 - F. Test
 - G. Answers to test
- II. References:
- A. *ATF Chief 15-17 Operator's Manual*. Whittensville, MA: American Type Founders, 1973.
 - B. *Models 350 and 360 Offset Duplicators Operating Instructions*. Chicago: A.B. Dick Company, 1973.
 - C. *Teachers Guide for Training Offset Duplicator Operators*. Cleveland 44117: Addressograph-Multigraph Corp., Educational Division, 1966.
 - D. *Davidson Dualith Operator's Manual*. Nashville 37202: Davidson Division, American Type Founders Company, Inc.
 - E. *How to Be a Smooth Operator*. St. Paul, MN 55101: 3M Company, Printing Products Division, 1964.
 - F. *Easy Does It*. St. Paul, MN 55101: 3M Company, Industrial Graphics Department, Printing Products Division.

OFFSET PRESS OPERATING PROCEDURES UNIT III

INFORMATION SHEET

(NOTE: This unit is developed on the premise that all types of offset presses possess the same basic systems which serve the same basic functions, have the same basic controls and produce the same basic end product; therefore, the basic operation procedures are similar for all types of offset presses.)

I. Terms and definitions

- A. Feed table extensions--Movable metal plates which attach at right angles to the feed table surface to extend its height and allow open space to accommodate the side and back paper guides when the feed table is at top position
- B. Hand wheel--A wheel on the operator's side of a press which allows the operator to turn the press through its cycle by hand
- C. Paper bail--A thin, narrow, long metal strip attached to the delivery system which aids in controlling the delivery of a sheet to the receiving tray
- D. Night latch--A position of slight separation of the rollers in the ink and dampening systems used when the press is not operated for a period of time to prevent flat stripes from forming on roller surfaces
- E. Setoff--A condition caused by wet ink from the image on the surface of one sheet rubbing off onto the surface of the next sheet in contact with the image
- F. Blanket wash--A petroleum base solvent prepared for washing rubber offset blankets and rollers; used for general press clean up
- G. Etch--A solution to condition the surface of an offset plate in the nonimage area to be more water receptive

II. Essential safety precautions

- A. *Hair* should be kept up
- B. *Loose clothing* should be avoided or bound up
- C. *Jewelry* such as bracelets, watches, rings, necklaces, etc. should be removed before operating a press
- D. *Dust cover* and *safety guards* should remain in place for operation
- E. *Press should be stopped to:*
 - 1. *Use tools* for adjustments

(NOTE: Always remove tools from press.)

INFORMATION SHEET

2. *Make hand adjustments* on moving parts
 3. *Wipe or clean* with a rag
 4. *Lubricate* any part
 5. *Clear paper jams*
 6. *Leave press area*
- F. *One designated operator* should have hands on the press at any one time
- G. *Specific permission* or assignment should be received before press is operated
- H. *Rags should be folded* rather than wadded in hand for cleaning
- I. *Dirty rags* should be placed in a metal container
- J. *Operator's manual* should be read before press is operated
- K. *Press work area* should be kept free of trash and clutter
- L. *Inspect and turn* press with the hand wheel at least one revolution before starting drive motor
- M. *Electrical connections* should be in full contact and free of frayed or broken insulation
- N. *Ventilation* of fumes should be good in the press area
- O. *Flammable liquids* should be stored in designated, protected area
- III. Two reasons why efficient press operation is important
- A. No income is received unless printed sheets are delivered from the press
 - B. Reduced profit potential results from inefficient use of time, equipment, and materials
- IV. Offset press operator control functions
- A. Control paper
 1. Feed
 2. Register
 3. Delivery
 - B. Control ink to plate image

INFORMATION SHEET

- C. Control water to plate nonimage area
 - D. Control image transfer quality
 - 1. Plate to blanket
 - 2. Blanket to paper
 - E. Control press wash-up
 - F. Maintain safe and orderly work area
 - G. Complete job order records for press operation
- V. Typical operator control features located on an offset press
- A. Feeder system
 - 1. Feed table raise/lower crank
 - 2. Paper feed guides
 - 3. Stack height regulator
 - 4. Vacuum control
 - 5. Airblast (blower) control
 - 6. Sheet separators
 - 7. Pull-out roller pressure
 - 8. Double sheet detector
 - B. Register system
 - 1. Sheet control wheels
 - 2. Sheet hold down strips
 - 3. Side register guides (including jogger)
 - 4. Paper stops
 - 5. Feed roller pressure
 - 6. Feed roller timing

INFORMATION SHEET

C. Delivery system

1. Ejector unit for tray and receding stacker
 - a) Rollers
 - b) Rings
2. Paper turning wheels for chain delivery
3. Stacker raise/lower crank
4. Stacker lowering speed control
5. Paper delivery guides (including jogger)

D. Cylinder system

1. Handwheel
2. Plate position
3. Plate to blanket pressure
4. Blanket to impression cylinder pressure
5. Vertical image position

E. Dampening system

1. Fountain solution (mixing)
2. Water feed control lever
3. Water form roller on/off knob
4. Water ductor roller on/off control

(NOTE: Some small presses feature a single lever control which allows the operator to contact water rollers to plate, contact ink rollers to plate, transfer image to the blanket cylinder and start feeder system with the movement of one lever.)

F. Inking system

1. Ink fountain adjusting screws
2. Ink feed lever
3. Ink form roller on/off knob
4. Ink ductor roller on/off control

INFORMATION SHEET

VI. Sequence of how paper passes through a typical offset press (Transparency 1)

- A. Paper placed on feed table
 - B. Feed table raises automatically
 - C. Sheet separators and air blowers separate sheets
 - D. Sucker tube lifts paper, moving it to pullout rollers
 - E. Pullout rollers move sheet to register board
 - F. Double sheet detector prevents more than one sheet from going to register system
 - G. Several moving tapes carry paper along register board
 - H. Balls and metal strips hold paper down on tapes
 - I. Stop fingers halt sheet for register to side position and for timing of feed into cylinder grippers; they move up and down
 - J. Feed rollers move sheet into cylinder grippers
 - K. Cylinder grippers grip sheet and guide it between impression and blanket cylinders
 - L. Image transfers to paper from blanket by pressure from the impression cylinder
 - M. After holding the sheet for less than one revolution the cylinder grippers open
 - N. Strippers separate the paper from the impression cylinder
- (NOTE: On chain delivery systems the paper is transferred from cylinder grippers to chain grippers at this point.)
- O. Ejector wheels guide the paper into receiving tray or stacker
 - P. Receiving tray or table (jogger) holds sheets

Sequence of How Paper Passes Through a Typical Offset Press

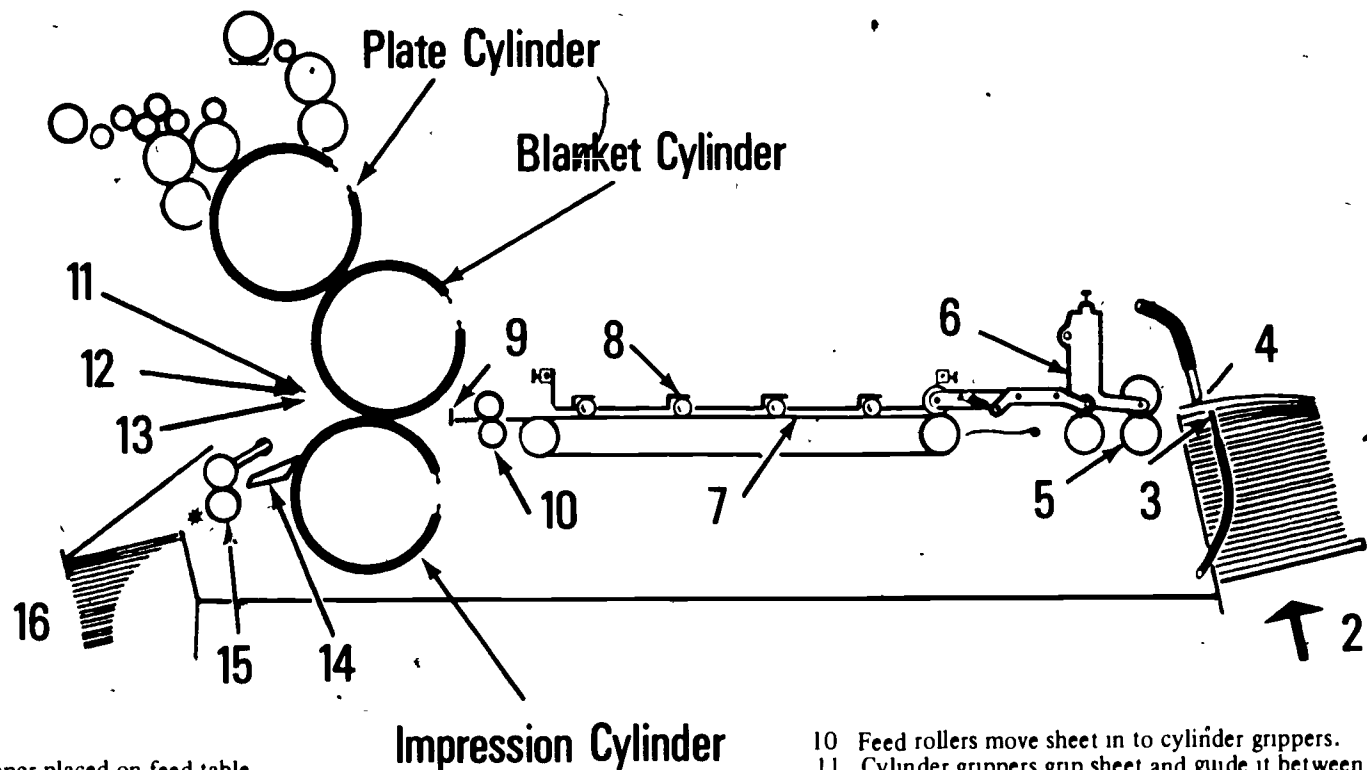

1. Paper placed on feed table.
2. Feed table raises automatically.
3. Sheet separators and air blowers separate sheets.
4. Sucker tube lifts paper, moving it to pull out rollers.
5. Pull out rollers move sheet to register board.
6. Double sheet detector prevents more than one sheet from going to register system.
7. Several moving tapes carry paper along register board.
8. Balls and metal straps hold paper down on tapes.
9. Stop fingers halt sheet for register to side position and for timing of feed into cylinder grippers; stop fingers move up and down.

10. Feed rollers move sheet in to cylinder grippers.
11. Cylinder grippers grip sheet and guide it between impression and blanket cylinders.
12. Image transfers to paper from blanket by pressure from the impression cylinder.
13. After holding the sheet for less than one revolution the cylinder grippers open.
14. Strippers separate the paper from the impression cylinder. (NOTE: on chain delivery systems the paper is transferred from cylinder grippers to chain grippers at this point)
15. Ejector wheels guide the paper into receiving tray or stacker.
16. Receiving tray or table (jogger) holds sheets.

OFFSET PRESS OPERATING PROCEDURES
UNIT III

ASSIGNMENT SHEET #1--COMPARE CONTROL FEATURES OF
OFFSET PRESSES

Directions: Compare the control features of several small presses. Go to school shop area, visit printing firms or departments, or use pictures of the four popular small presses in use by industry included with this assignment.

1. Make a list of similar control features found on all presses.

(NOTE: Manufacturers sometimes apply different names for similar features.)

2. Make a second list of control features unique to each press.
3. Turn the lists in to the instructor.

ASSIGNMENT SHEET #1

4 Popular Duplicators

ATF CHIEF
Model 15

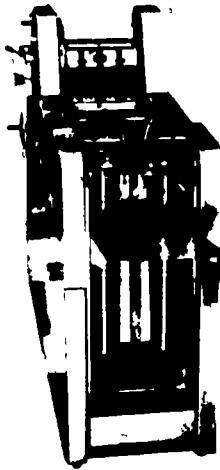

Minimum Sheet Size	3 x 5
Maximum Sheet Size	11 x 15
Paper Weights	11 lb. Manifold to 2 ply card
Maximum Printing Area	9 $\frac{3}{4}$ x 13 $\frac{1}{4}$
Gripper Margin	$\frac{3}{16}$ to $\frac{1}{16}$
Plate Size	10 x 15
Plate Thickness	.006
Blanket Size	10 x 15 $\frac{1}{4}$
Blanket Thickness	.065
Speed Range	4500 to 9000 IPH
Feeder Capacity	21 $\frac{1}{2}$
Delivery Capacity	2 $\frac{1}{2}$
Drive Motor	$\frac{1}{2}$ HP
Pump Motor	$\frac{1}{2}$ HP
Length	61
Width	28
Height	50
Weight	740 lbs
Inking Unit	10 Rollers
Dampening Unit	4 Rollers

ADDRESSOGRAPH
MULTIGRAPH
Model 1250

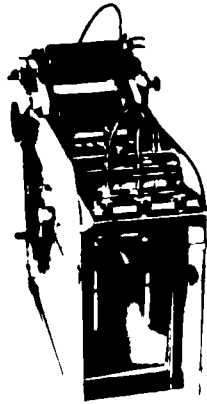

Minimum Sheet Size	3 x 5
Maximum Sheet Size	11 x 14
Paper Weights	13 lb to 110 lb
Maximum Printing Area	9 $\frac{1}{2}$ x 13
Gripper Margin	$\frac{1}{16}$
Plate Size	10 x 15 $\frac{3}{8}$
Plate Thickness	.006
Blanket Size	10 $\frac{1}{2}$ x 15
Blanket Thickness	.065
Speed Range	5 000 to 10 000 IPH
Feeder Capacity	20
Delivery Capacity	2
Drive Motor	$\frac{1}{2}$ HP
Pump Motor	$\frac{1}{2}$ HP
Length	60
Width	27 $\frac{1}{2}$
Height	48
Weight	640 lbs
Inking Unit	10 Rollers
Dampening Unit	4 Rollers

DAVIDSON
Dualith 500

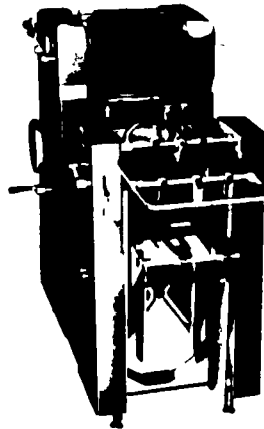

Minimum Sheet Size	3 x 5
Maximum Sheet Size	11 x 15
Paper Weights	8 lb. Manifold to 6 ply card
Maximum Printing Area	9 $\frac{3}{4}$ x 13 or 14
Gripper Margin	$\frac{3}{16}$
Plate Size	10 x 16
Plate Thickness	.004 to .006
Blanket Size	10 x 16
Blanket Thickness	.064
Speed Range	5 000 to 10 000 IPH
Feeder Capacity	24
Delivery Capacity	3 $\frac{1}{2}$
Drive Motor	$\frac{1}{2}$ HP
Pump Motor	$\frac{1}{2}$ HP
Length	64
Width	34
Height	57
Weight	710 lbs
Inking Unit	9 Rollers
Dampening Unit	4 Rollers

A B DICK
Model 360

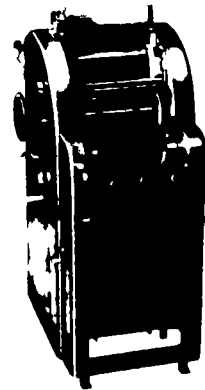

Minimum Sheet Size	3" x 5"
Maximum Sheet Size	11 $\frac{1}{4}$ x 17"
Paper Weights	12 lb. bond to 110 lb. index stock
Maximum Printing Area	10 $\frac{1}{2}$ x 16 $\frac{1}{2}$
Gripper Margin	$\frac{1}{4}$
Plate Size	10 $\frac{1}{4}$ x 18 $\frac{3}{4}$
Plate Thickness	.006
Blanket Size	10 $\frac{3}{4}$ x 18"
Blanket Thickness	.065"
Speed Range	4 500 to 9 000 IPH
Feeder Capacity	20"
Delivery Capacity	2
Drive Motor	$\frac{1}{2}$ HP
Pump Motor	$\frac{1}{2}$ HP
Length	45"
Width	28"
Height	52"
Weight	611 lbs
Inking & Water	12 Rollers

The above specifications are for basic comparison purposes only. For additional standard and optional variations please consult the individual manufacturers.

(Courtesy Industrial Graphics Department, Printing Products Division, 3M Company)

ASSIGNMENT SHEET #1

A. B. Dick Model 360

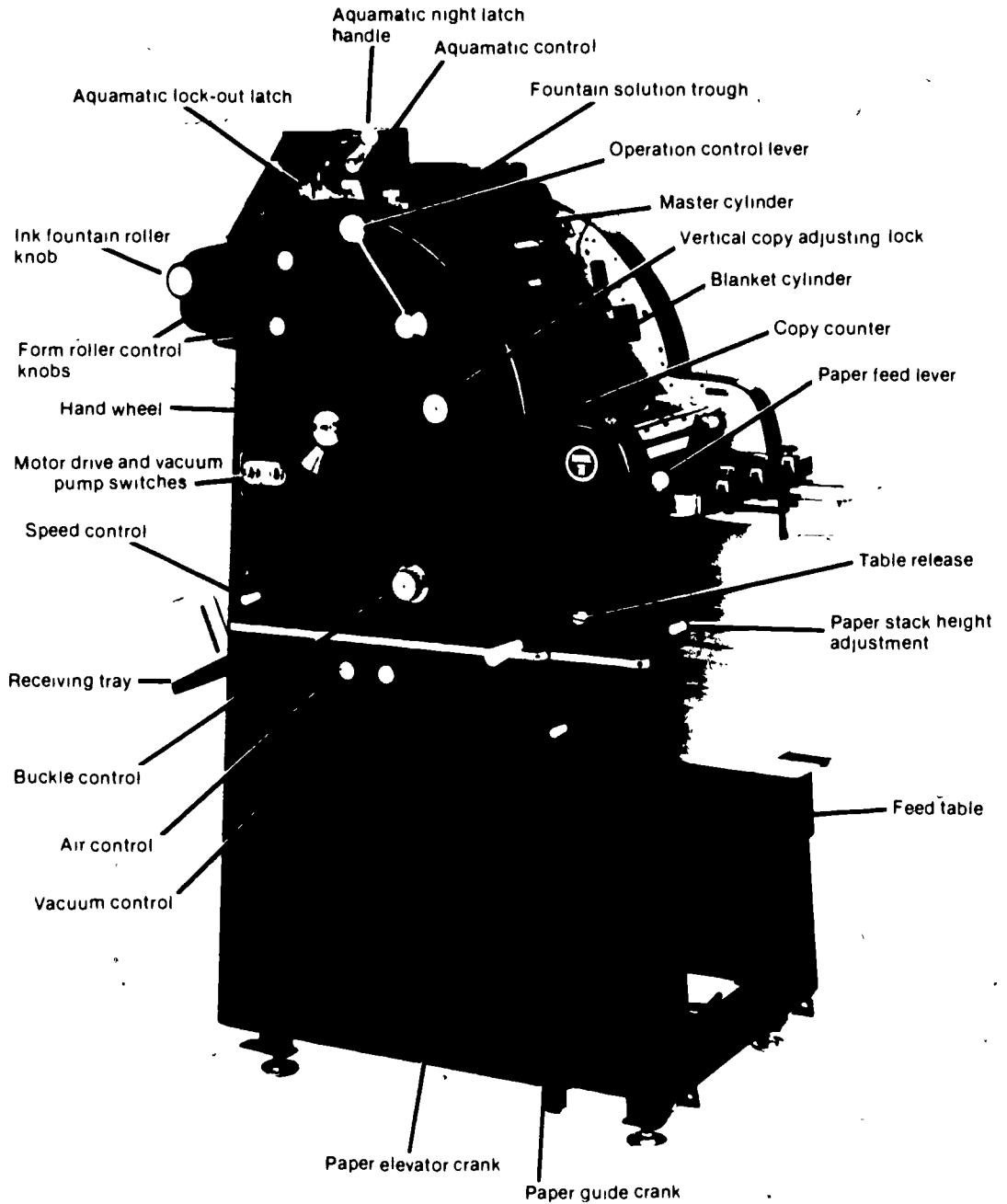

(Courtesy A. B. Dick Company)

ASSIGNMENT SHEET #1

Addressograph Multigraph Model 1250

Machine Features

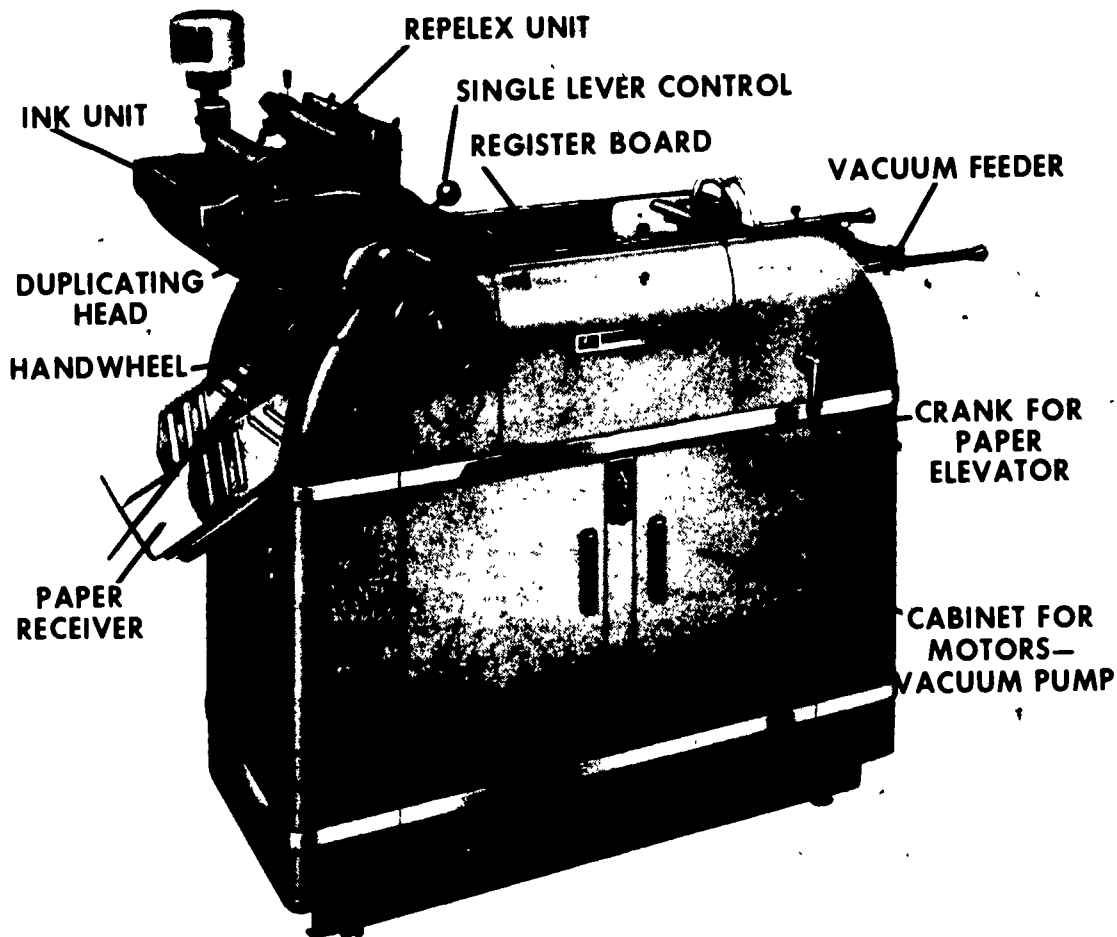

(Courtesy AM International, Inc.)



ASSIGNMENT SHEET #1

Addressograph Multigraph Model 1250

Machine Controls

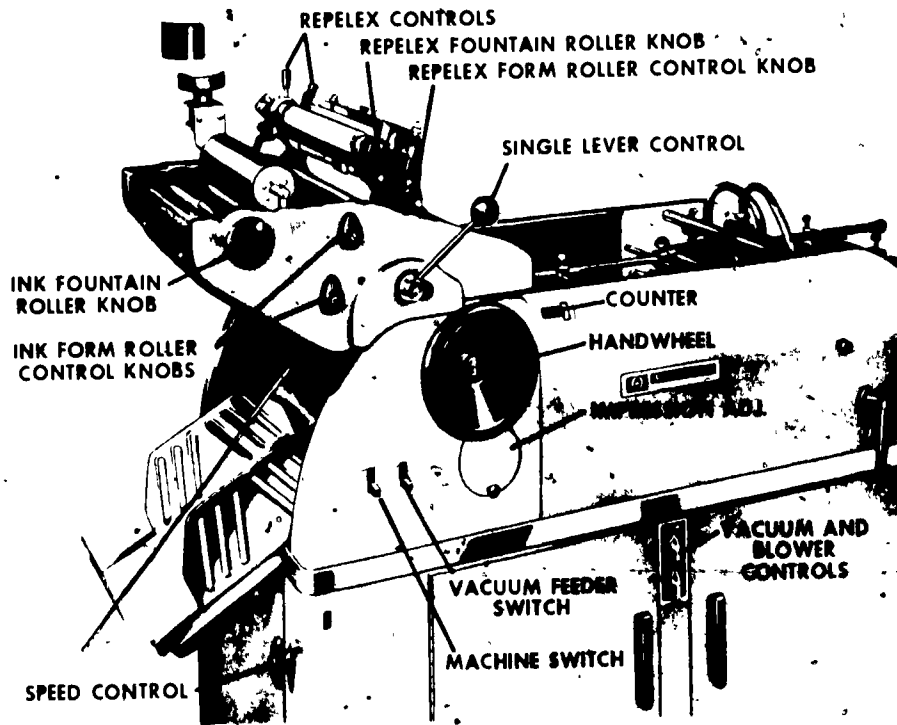

(Courtesy AM International, Inc.)



ASSIGNMENT SHEET #1

Davidson Dualith 500

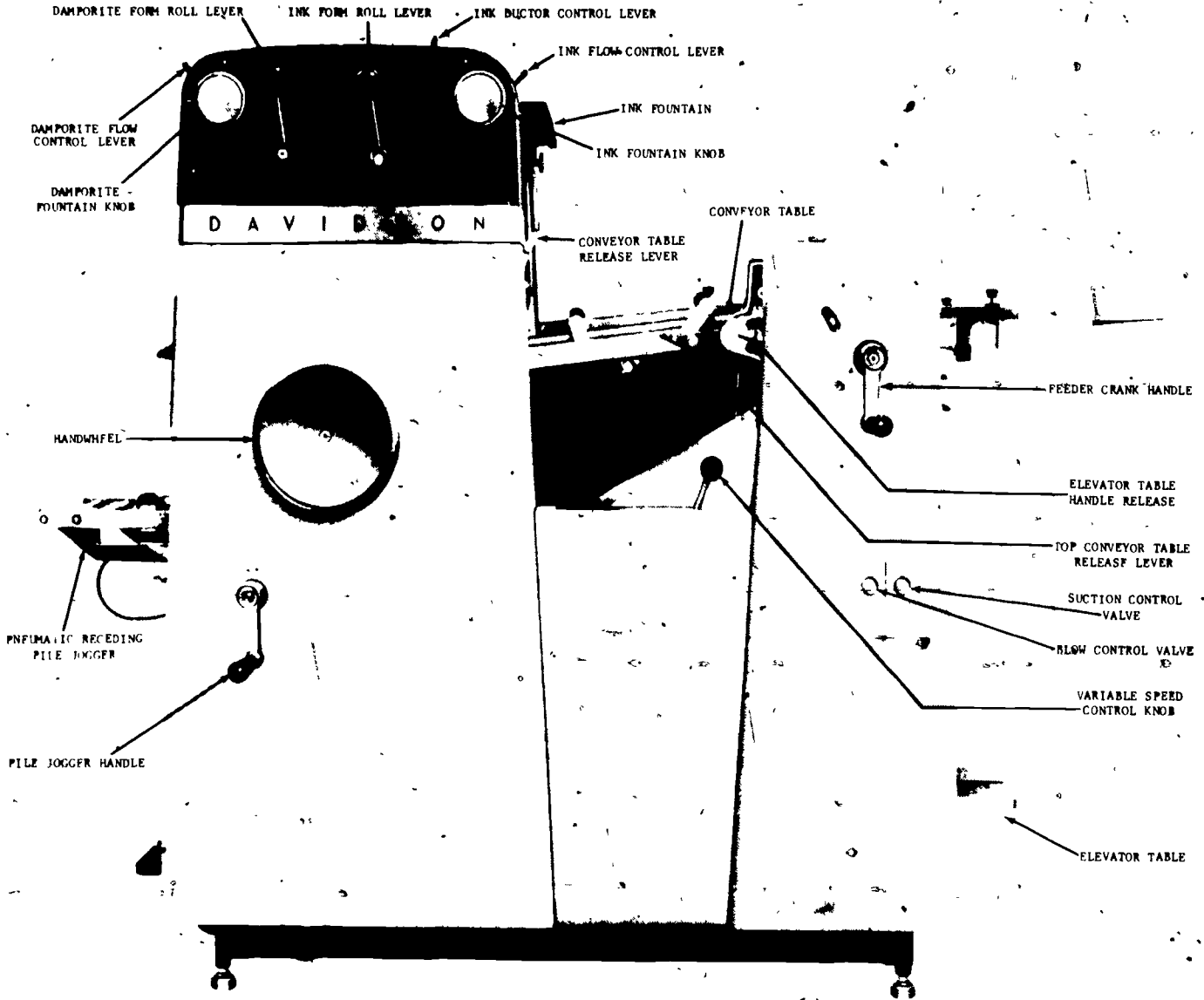

SIDE OF MACHINE

(Courtesy Davidson Division, American Type Founders, Co., Inc.)

ASSIGNMENT SHEET #1

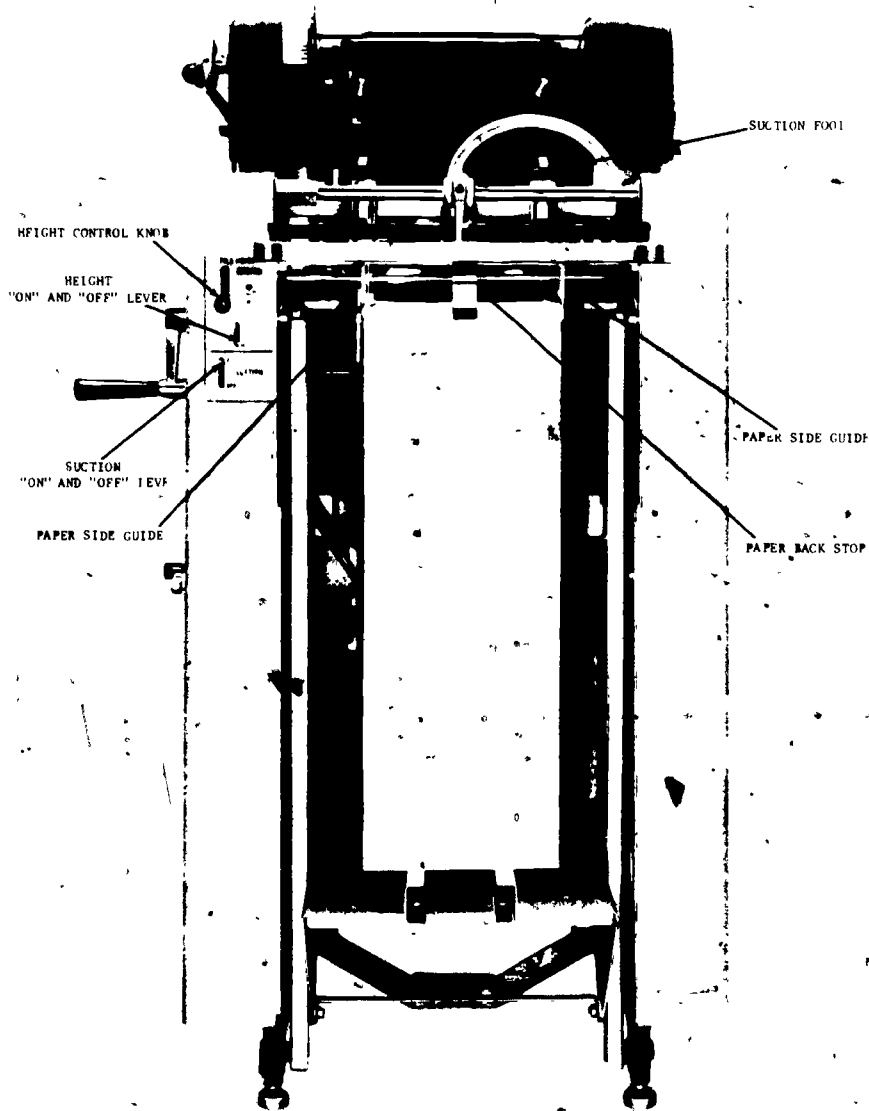
Davidson Dualith 500

FRONT OF MACHINE

(Courtesy Davidson Division, American Type Founders Co., Inc.)

ASSIGNMENT SHEET #1

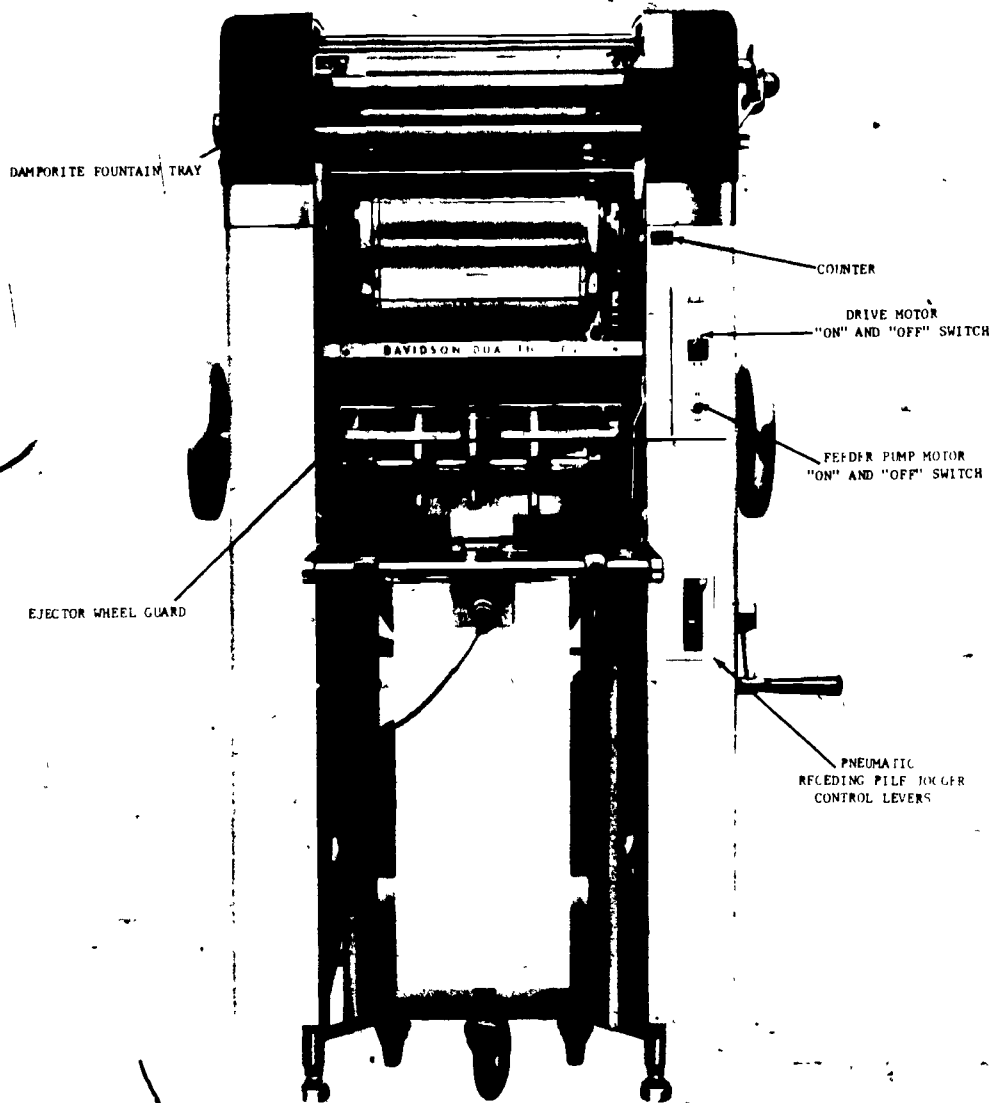
Davidson Dualith 500**BACK OF MACHINE**

(Courtesy Davidson Division, American Type Founders Co., Inc.)

ASSIGNMENT SHEET #1

Operating Controls on Chief 15 and Chief 17 (Delivery End)

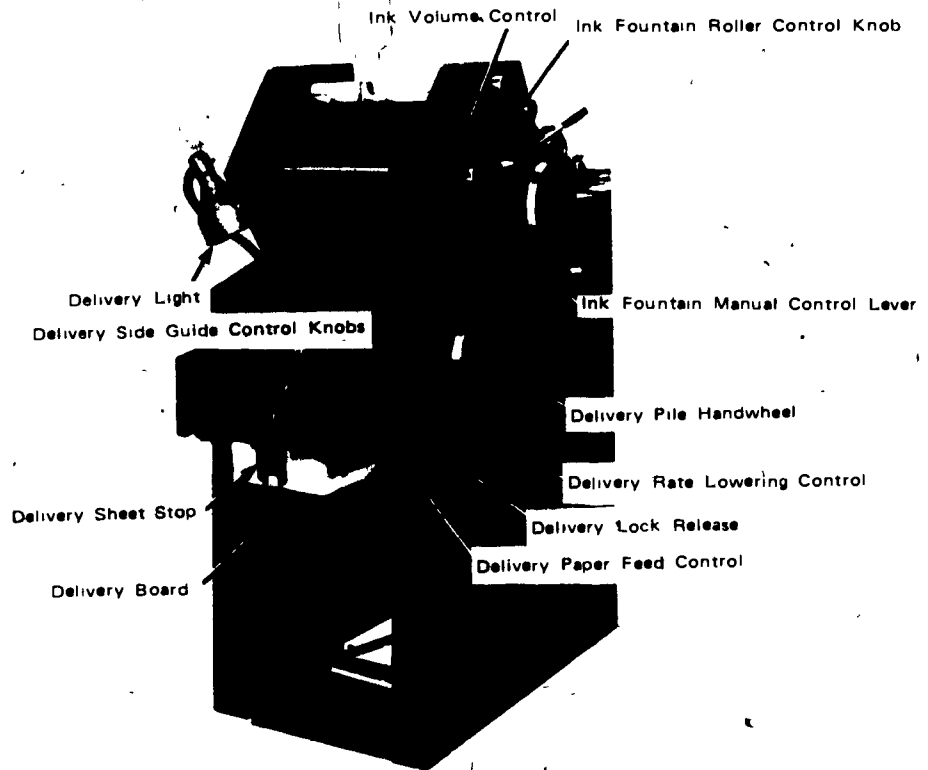

(Courtesy American Type Founders Co., Inc.)

Operating Controls on Chief 15 (Left Side)

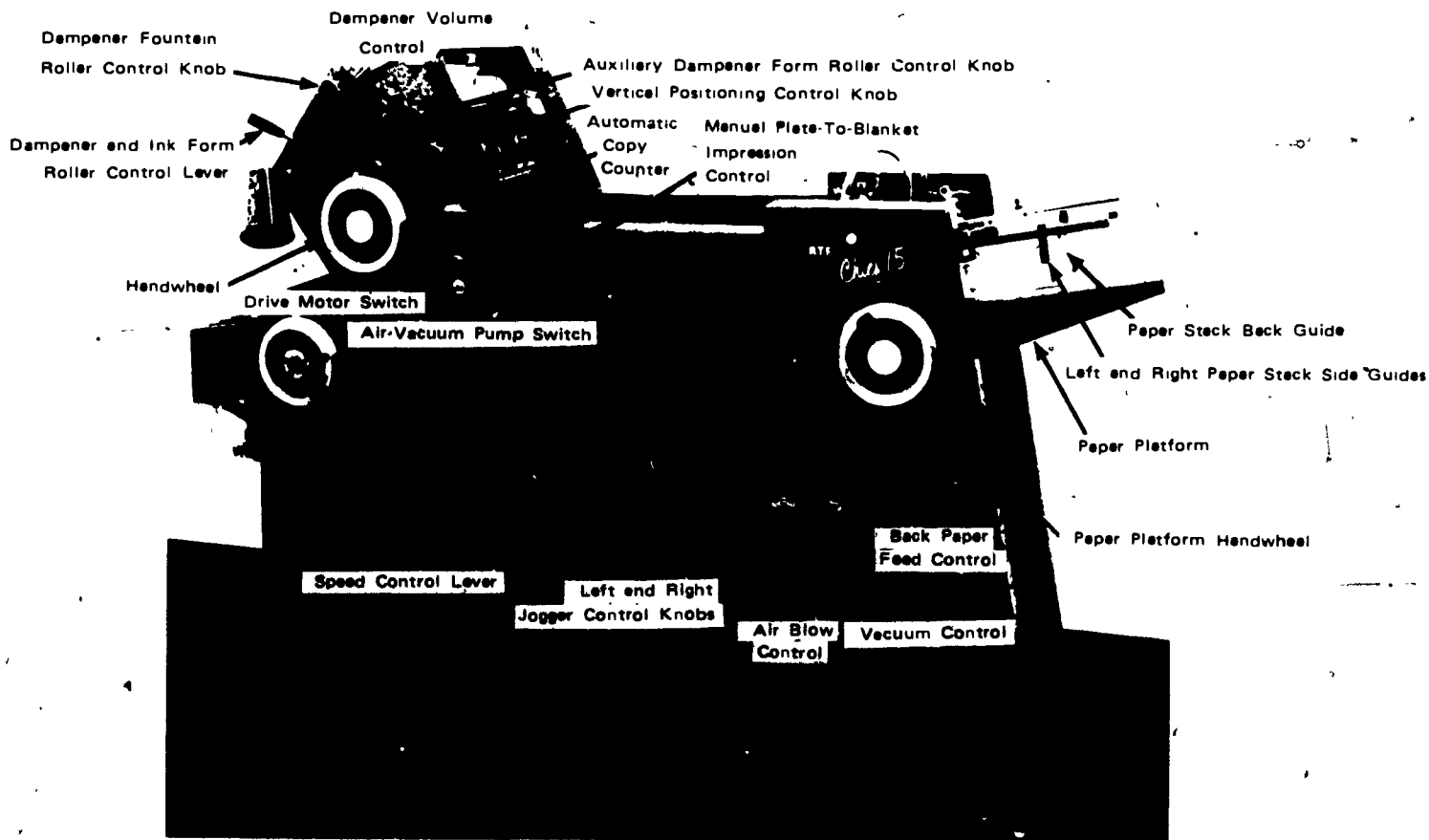

ASSIGNMENT SHEET #1

(Courtesy American Type Founders Co., Inc.)

OFFSET PRESS OPERATING PROCEDURES UNIT III

JOB SHEET #1--SET UP THE SHEET CONTROL SYSTEMS

- I. Tools and materials
 - A. Standard tools for specific press being set up
 - B. Paper stock, 8 1/2 x 11
 - C. Operator's manual for specific press being used

- II. Procedure

(CAUTION: Do not make adjustments on press while it is running.)

- A. Check with instructor before beginning this job sheet
- B. Set up feeder system
 1. Position front guides for width of paper to be fed so sheet is centered sideways on the feed board
 2. Set feed table extensions to support paper pile

(NOTE: Folding the sheet in half twice will divide it into fourths. Place the feed table extensions, the sheet separators, and the sucker tubes approximately at the 1/4 and 3/4 points. See Figure 1.)

FIGURE 1

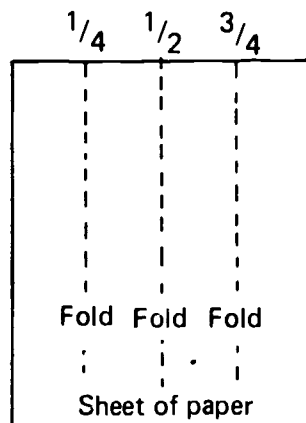

3. Place the support board for the paper pile on top of the feed table extensions

(CAUTION: The support board should not protrude so as to hit the paper guides as the feed table reaches its top position.)

JOB SHEET #1

4. Move the sheet separators to the 1/4 and 3/4 points (as determined by folding the sheet twice) of the gripper edge of the stock being run

(NOTE: Some small presses have fixed position sheet separators.)

5. Place stock to be run on the feed table support board
6. Raise feed table so top of pile is near the top feed position

7. Position the feeder side guides to touch the paper pile

(NOTE: Make sure the sheets are square against the front guides.)

8. Place back paper guide to hold sheets in position against front guides

(NOTE: The back guide must not bind the sheets.)

9. Move sucker tube(s) to a position in line with the sheet separators

(NOTE: Some small presses have fixed position sucker tube sockets so the sucker tubes may be moved to alternate positions.)

10. Slide pull out rollers to position near sucker tubes

11. Set stack height for weight for stock being fed

- a) Turn press on
- b) Allow stack to feed to pre-set height
- c) Turn press off
- d) Turn handwheel until sucker tubes are in the down position
- e) Observe the distance from the bottom of the sucker tube to the top of the stack
 - 1) 1/8" space is recommended for light weight stocks (16 pound or 20 pound Bond or lighter)
 - 2) 1/16" space is recommended for heavier weight paper
 - 3) Touch is recommended for heavier card and cover stock
- f) Adjust stack height regulator to change distance between sucker tube and stack if needed
- g) Lower paper pile slightly by using hand crank if stack height regulator setting is changed
- h) Repeat steps a through f until desired setting is obtained

JOB SHEET #1

12. Adjust the air blast to separate the top six or eight sheets when the sucker tubes are in the up and forward position and the stack is at top position

13. Adjust the vacuum to pick up only one sheet

(NOTE: A final setting of vacuum cannot be completed until the press is setup for register and delivery and sheets are fed continuously.)

14. Adjust double sheet detector

(NOTE: Small presses which feed directly into the cylinder grippers from the feed table do not normally have a double sheet detector.)

a) Fold a narrow strip of the stock to be fed so that one end protrudes about an inch

b) Slide that folded strip under the detector and adjust for the passing of one sheet and the stopping or deflecting of two or more sheets

15. Check pullout roller pressure

a) Insert a sheet of stock to be run between the pullout rollers

b) Pull the sheet from between the rollers by hand

(NOTE: A steady resistance should be noted as the paper slides from between the rollers.)

C. Set up the register system

(NOTE: Some small presses do not have a register board; registration is controlled by the sheet position on the feed table and the amount of sheet buckle as the paper is fed directly into the cylinder grippers.)

1. Turn handwheel until the jogger guide moves to its inward position

2. Move jogger guide to the desired final sheet position

3. Place a sheet of paper from stock to be run on the register board against the jogger side guide and front paper stops

4. Position the movable, fixed position side guide to hold sheet in place

5. Move conveyor tapes to carry the sheet flat and for best travel of the paper

JOB SHEET #1

6. Place paper hold down strips over conveyor tapes close to outer edges of sheets and side guides

7. Set paper control wheels or balls to aid in movement, positioning and retaining of the sheet for movement into the cylinder grippers

(NOTE: Running one or more wheels just off the trailing edge of the sheet at the paper stop position will prevent any bounce and will help hold each sheet in exact position.)

8. Adjust feed roller pressure if thickness of stock varies from previously run sheet

(NOTE: Check with instructor, then see operator's manual for specific press being set up.)

D. Set up the delivery system

1. Tray delivery

a) Position the receiving tray guides so sheet will be jogged as it is received and held in a straight stack

b) Position ejector rollers to run close to the side edges of the sheet if possible

(NOTE: If ejector rollers must pass through an image area for proper sheet delivery they must be coated [dampened] continuously to prevent streaking; check with instructor.)

c) Move ejector rings to control any troublesome curl in the delivered sheets

(NOTE: To prevent paper jams sheets must be removed frequently after press run begins; most receiving trays will hold a ream 500 sheets of light weight paper, i.e., up to 20 pound bond.)

d) Move the paper bail to aid in receiving and stacking the delivered sheets

2. Chute delivery with receding stacker

a) Position receiving table guides so sheet will be jogged as it is received and held in a straight stack

b) Set the ejector rollers to run as close to the side edges of the sheet as possible

(NOTE: If ejector rollers must pass through an image area for proper sheet delivery they must be coated or dampened continuously to prevent streaking; check with instructor.)

JOB SHEET #1

- c) Move ejector rings to control any troublesome curl in the delivered sheets
- d) Raise delivery table to highest point
- e) Allow 100-150 sheets to be delivered before engaging the stacker lowering mechanism

(NOTE: Large quantities of stock may be stacked before stock must be removed from the delivery table; to prevent ink from the image on the front of the stacked sheets from setting off on the backs of the sheets, stock should be removed in whatever quantities are necessary.)

3. Chain delivery

- a) Position paper turning guides or wheels for width of stock

(NOTE: Sometimes the turning guides will streak a heavily inked image area, so they should be positioned accordingly.)

- b) Raise the delivery table to the highest point
- c) Move paper guides and joggers to straighten and hold the delivered sheets
- d) Allow 100-150 sheets to be delivered before engaging the delivery table lowering device

(NOTE: Since large quantities of stock may be stacked before stock must be removed from delivery table notice should be given to prevent ink from the image on the front of the stacked sheets from setting off on the backs of the sheets; stock should be removed in whatever quantities are necessary.)

OFFSET PRESS OPERATING PROCEDURES
UNIT III

JOB SHEET #2--SET UP THE IMAGE CONTROL SYSTEMS

- I. Tools and materials
 - A. Standard tools for specific press being set up
 - B. Ink as specified by instructor
 - C. Fountain solution as specified by instructor
 - D. Offset plate
 - E. Shop towel (rags)
 - F. Operator's manual for specific press being set up
- II. Procedure
 - A. Check with instructor before beginning this job sheet
 - B. Set up inking system
 1. Replace rollers which have been removed from press
 2. Turn off all night latches
 3. Turn off ink form rollers
 4. Add limited quantity of ink to ink fountain
(NOTE: The type of ink used will be determined by the type of equipment, the type of water system, the type of stock, and other requirements; see job order or talk to the instructor.)
 5. Contact ink ductor roller to ink fountain roller
 6. Rotate ink fountain roller while adjusting the ink fountain screws until an even flow of ink is obtained between the ink fountain and ductor rollers
 7. Place single lever control in appropriate position
(NOTE: The single lever control is usually in the "off" or "neutral" position during the inking procedure.)
 8. Turn on press
 9. Turn on ink feed
 10. Run ink to system until an even velvety appearance shows on all ink rollers

JOB SHEET #2

11. Turn off ink feed

(NOTE: After initial inking, the quantity of ink fed to the system will depend on that required to cover the image area of the plate.)

12. Turn off press

C. Set up dampening system

1. Replace rollers which have been removed from press

2. Mix fountain solution

(NOTE: Basic dampening chemistry is covered in unit number IV. See instructor for specific usage.)

3. Add fountain solution to water fountain

(NOTE: On small presses with integrated ink and water systems only the water feed setting needs to be made after water is put in the fountain.)

4. Contact water ductor roller to water fountain roller

5. Rotate water fountain roller until ductor roller is soaked with fountain solution

6. Turn on press

7. Turn on water feed

8. Run press until water form roller cover is damp

(NOTE: Water form roller cover should not be wet enough to squeeze visible moisture from its surface.)

9. Refer to instruction manual or instructor for initial dampening procedure for "bare back" water rollers

D. Set up the cylinder system

1. Clean plate cylinder surface if needed

(NOTE: On presses where the plate does not cover the full cylinder surface the surface should be kept water receptive by cleaning and applying plate etch.)

2. Move plate cylinder head clamp to a square, centered position

3. Clean impression cylinder surface if needed

(NOTE: The impression cylinder surface should be kept as ink repellent as possible.)

JOB SHEET #2

4. Clean blanket surface with blanket wash
5. Wipe blanket surface dry
6. Attach plate to plate cylinder
 - a) Place gripper edge of plate in head clamp or on its pins
 - b) Rotate press by hand as plate is pulled around cylinder to attach tail clamp

(NOTE: Plate should fit parallel to edge of plate cylinder and be held taut around cylinder surface.)

 - c) Plate must be clean
 - d) Plate must have been coated with preservative
7. Clean impression cylinder surface if needed

OFFSET PRESS OPERATING PROCEDURES UNIT III

JOB SHEET #3--OPERATE AN OFFSET PRESS FROM SET-UP OF SYSTEMS THROUGH PRINTED SHEET DELIVERY

(NOTE: The application of this job sheet may be made to include the following variations to afford student experience with: 1. different types of plates: paper, electrostatic, photo direct, and metal; 2. varying types of stock: onionskin, bond, coated book, uncoated book, text, index, cover, card, carbonless, gum label, adhesive backed label, envelopes, and others; 3. different sizes of stock from minimum to maximum for a specific press; 4. printing one, two, three, or four colors of ink; 5. variety of ink coverage requirements: uniform, light, heavy, varying, halftones or solids; 6. different image position requirements: loose register, tight register, print front and back, work and turn, work and tumble; and others the instructor may include.)

I. Tools and materials

- A. Standard tools for specific press being set up
- B. Paper stock (size specified by instructor)
- C. Ink (specified by instructor)
- D. Fountain solution (specified by instructor)
- E. Offset plate
- F. Shop towels (rags)
- G. Cotton pads
- H. Blanket wash
- I. Plate etch

II. Procedure

- A. Check with instructor before beginning this job sheet
- B. Set up sheet control systems (see Job Sheet #1)
- C. Set up image control systems (see Job Sheet #2)
- D. Load stock to be run on feed table
- E. Position image on sheet being run to job specifications and set cylinder pressures

(NOTE: This procedure is called "make ready.")

1. Premoisten plate
2. Turn on press

JOB SHEET #3

3. Turn on water form roller
4. Turn on ink form rollers
5. Make image impression from plate to blanket

(NOTE: Contact for three or four revolutions is usually enough.)

6. Turn on air and vacuum
7. Turn on feed lever

(NOTE: Some small presses start feeding paper when vacuum is turned on.)

8. Allow two sheets to feed
9. Turn off feed lever

(NOTE: Some small presses stop feeding only when vacuum is turned off.)

10. Turn off air and vacuum
11. Turn off ink form rollers
12. Turn off water form rollers

(NOTE: On small presses with integrated ink and water systems there is no separate water form roller.)

13. Turn off press
14. Check position of image
 - a) For squareness
 - b) Vertically (relative to gripper edge of sheet)
 - c) Horizontally (relative to side guide edge of sheet)
15. Change image position as required
 - a) Squareness

1) Release plate tail clamp then angle plate around cylinder by adjusting angle of head clamp then reinsert tail clamp

2) For presses with adjustable drop guides, the sheet angle position may be changed by moving these guides

JOB SHEET #3

- b) Vertical--Adjust plate or blanket cylinder setting using vertical image position control knob
 - c) Horizontal--Move paper on feed table and/or register board side to side
16. Clean and dry blanket
 17. Repeat steps 1 through 16 until image is in position as specified by job order
 18. Evaluate image quality for proper impression settings

(NOTE: Observe image on blanket first. Image should be sharp with good ink coverage.)

- a) Plate to blanket
- b) Blanket to paper

(NOTE: If the thickness of the plate being used is different from the previous plate then plate to blanket pressure setting must be changed. If a lighter or heavier stock is being fed than the previous sheet then the pressure setting from blanket to impression cylinder will need to be changed.)

19. Change cylinder pressures as required
 - a) Plate to blanket (See operator's manual)
 - b) Blanket to impression cylinder (See operator's manual)

G. Complete press run

1. Set sheet counter to 0
2. Repeat steps E1 through E7 to begin run
3. Turn on ink feed
4. Reset ink fountain for ink flow to meet image requirements as press run progresses and maintain ink supply in fountain
5. Remove paper from receiving tray or stacker as required

(NOTE: Because of the condition of set off or delivery difficulties, some stocks must be removed more frequently in smaller quantities.)

6. Maintain fountain solution level in fountain and monitor distribution to plate

JOB SHEET #3

7. Remove a printed sheet from the delivery system periodically for inspection

(NOTE: Do not stop press.)

8. Make necessary adjustments to maintain image position and quality and to control paper feed and delivery throughout the press run
9. Follow steps E9 through E13 at the end of the press run
10. Remove last of printed sheets from delivery system
11. Remove plate
12. Clean plate (front and back)
13. Prepare plate for storage by applying gum to image side(s)
14. Clean plate cylinder and coat with plate etch
15. Clean and dry blanket
16. Clean impression cylinder

OFFSET PRESS OPERATING PROCEDURES
UNIT III

JOB SHEET #4--WASH UP AN OFFSET PRESS

- I. Tools and materials
 - A. Standard tools for specific press being washed up
 - B. Blanket wash
 - C. Cleanup mats or wash up attachment
 - D. Shop towels (rags)
 - E. Ink knife
 - F. Cotton pads
 - G. Plate cleaner
 - H. Plate etch

- II. Procedure

(NOTE: Ink and water rollers in integrated systems will clean up together with cleanup mat or washup attachment, bare back water rollers must be cleaned separately from ink rollers.)

- A. Check with instructor before beginning this job sheet

(NOTE: If press has been left in night latch position, night latches must be turned off.)

- B. Clean water system first
 1. Remove fountain bottle
 2. Drain water from fountain
 3. Remove covered water form-roller
- C. Remove ink from ink fountain
 1. Use ink knife being careful not to scratch ink fountain roller
 2. Use two two inch (approximate) strips the width of the ink fountain blade cut from used cleanup mats or other card stock
 - a) Slide one cardboard strip against the fountain blade under the ink until it touches the fountain roller

JOB SHEET #4

- b) Slide the second cardboard strip against the fountain roller surface ~~through~~ the ink until it touches the first cardboard strip
- c) Lightly squeeze the two cardboard strips together, and lift the ink out of the fountain

(NOTE: Lift the ink out slowly while folding the ends of the card strips toward each other to prevent dripping ink on press or floor.)

- 3. Discard ink by carefully folding inside several sheets of old stock

D. Clean ink fountain unit

1. By removing from press

- a) Remove fountain from press
- b) Clean ink fountain with blanket wash
- c) Clean ink fountain roller and ink ductor roller
 - 1) Rotate the press by turning handwheel to contact ink fountain and ductor rollers
 - 2) Turn rollers together and clean with blanket wash
 - 3) Remove ductor roller
 - 4) Clean ends of both rollers

2. By leaving on press

- a) Place cotton pads soaked with blanket wash on fountain blade against fountain roller
- b) Turn on ink feed to highest setting
- c) Finish press wash up procedure through step P
- d) Remove ink fountain
- e) Clean ink fountain
- f) Clean ends of ink fountain roller and ductor roller
- g) Proceed with press wash up procedures (Steps Q-Y)

JOB SHEET #4

- E. Attach clean up mat
1. Insert one end of mat in the head clamp like an offset plate
 2. Attach tail clamp
 3. Do not tighten tail clamp screws
- (NOTE: If a wash up attachment is used for cleaning the rollers the procedure will depend on the type of attachment; check with the operator's manual or the instructor.)
- F. Turn on press
- G. Slow the press to slowest speed
- H. Check on/off position of ink form rollers
1. With single lever control form rollers should be in the "on" position and lever in "neutral" or "off" position
 2. Without single lever control form rollers should be in the "off" position
- I. Apply small quantity of blanket wash to the top ink rollers
- J. Place ink form rollers against cleanup mat
1. With single lever, move lever to ink position
 2. Without single lever, move form roller knobs to "on" position
- K. Add blanket wash in small quantity as ink and blanket wash are absorbed by cleanup mat
- L. Repeat step K until cleanup mat is near saturation
- M. Move ink form rollers from against cleanup mat
1. With single lever, move lever to "off" or "neutral" position
 2. Without single lever, move form roller knobs to "off" position
- (NOTE: Form rollers should not be turned off until blanket wash is absorbed from rollers sufficient to prevent dripping when press is stopped.)
- N. Turn off press
- O. Remove cleanup mat
- (NOTE: Cleanup mats may be used once on each side but must be allowed to dry in between.)

JOB SHEET #4

- P. Repeat steps E through O until ink rollers appear clean
- Q. Clean ends of all rollers
- R. Wipe all rollers with blanket wash, then dry
(NOTE: Sometimes rollers need to be removed from press for proper wiping.)
- S. Clean plate cylinder with water base cleaner, then apply film of plate etch
- T. Clean blanket with blanket wash, then dry
- U. Clean impression cylinder with waterbase cleaner, then apply film of plate etch
- V. Replace all rollers which have been removed from press
- W. Replace ink fountain
- X. Set press in night latch position.
1. Place all controls in "off" position
2. Separate roller surfaces
- Y. Clean ink from side frames, side covers, control levers and knobs, and floor around and under press

105

OFFSET PRESS OPERATING PROCEDURES UNIT III

NAME _____

TEST

1. Match the terms on the right with the correct definitions.

- | | |
|--|--------------------------|
| <p>_____ a. Movable metal plates which attach at right angles to the feed table surface to extend its height and allow open space to accommodate the side and back paper guides when the feed table is at top position</p> | 1. Paper bail |
| <p>_____ b. A wheel on the operator's side of a press which allows the operator to turn the press through its cycle by hand</p> | 2. Night watch |
| <p>_____ c. A thin, narrow, long metal strip attached to the delivery system which aids in controlling the delivery of a sheet to the receiving tray</p> | 3. Feed table extensions |
| <p>_____ d. A position of slight separation of the rollers in the ink and dampening systems used when the press is not operated for a period of time to prevent flat stripes from forming on roller surfaces</p> | 4. Hand wheel |
| <p>_____ e. A condition caused by wet ink from the image on the surface of one sheet rubbing off onto the surface of the next sheet in contact with the image</p> | 5. Blanket wash |
| <p>_____ f. A petroleum base solvent prepared for washing rubber offset blankets and rollers; used for general press clean up</p> | 6. Setoff |
| <p>_____ g. A solution to condition the surface of an offset plate in the nonimage area to be more water receptive</p> | 7. Etch |

2. Select true statements concerning essential safety precautions by placing an "X" in the appropriate blanks.

- _____ a. *Hair* should be kept up
- _____ b. *Loose clothing* should be avoided or bound up
- _____ c. *Jewelry* such as bracelets, watches, rings, necklaces, etc. should be removed before operating a press

- d. *Dust cover and safety guards* should remain in place for operation
- e. *Press should be stopped to:*
 - 1) *Use tools* for adjustments
 - 2) *Make hand adjustments* on moving parts
 - 3) *Wipe or clean* with a rag
 - 4) *Lubricate* any part
 - 5) *Clear paper jams*
 - 6) *Leave press area*
- f. *One designated operator* should have hands on the press at any one time
- g. *Specific permission* or assignment should be received before press is operated
- h. *Rags should be wadded* rather than folded in hand for cleaning
- i. *Dirty rags* should be placed in a cardboard trash box
- j. *Operator's manual* should be read while press is running
- k. *Press work area* should be kept free of trash and clutter
- l. *Inspect and turn* press with the hand wheel at least one revolution before starting drive motor
- m. *Electrical connections* should be in full contact and free of frayed or broken insulation
- n. *Ventilation* of fumes should be good in the press area
- o. *Flammable liquids* should be stored wherever there is room for them

3. List two reasons why efficient press operation is important.

- a. _____

- b. _____

4. Select offset press operator control functions by placing an "X" in the appropriate blanks.

- a. Control ink to plate image
- b. Control water to plate image area
- c. Complete job order records for press operation

- _____ d. Control press wash-up
- _____ e. Maintain safe and orderly work area

5. Match the control features with the press system in which they are located by placing the number of the system on the right in front of the appropriate features.

(NOTE: Answers will be used more than once.)

- | | |
|---|--------------|
| _____ a. Feed roller timing | 1. Feeder |
| _____ b. Paper delivery guides | 2. Register |
| _____ c. Double sheet detector | 3. Delivery |
| _____ d. Vertical image position | 4. Cylinder |
| _____ e. Ink form roller on/off knob | 5. Inking |
| _____ f. Water form roller on/off knob | 6. Dampening |
| _____ g. Feed table raise lower crank | |
| _____ h. Sheet control wheels | |
| _____ i. Ejector unit for tray and receding stacker | |
| _____ j. Handwheel | |
| _____ k. Fountain solution | |
| _____ l. Ink fountain adjusting screws | |
| _____ m. Water feed control lever | |
| _____ n. Paper turning wheels for chain delivery | |
| _____ o. Paper feed guides | |
| _____ p. Sheet hold down strips | |
| _____ q. Stack height regulator | |
| _____ r. Plate position | |
| _____ s. Pull-out roller pressure | |
| _____ t. Side register guides | |
| _____ u. Stacker raise/lower crank | |
| _____ v. Vacuum control | |
| _____ w. Ink feed lever | |
| _____ x. Blanket to impression cylinder pressure | |

- _____ y. Paper stops
- _____ z. Sheet separators
- _____ aa. Stacker lowering speed control
- _____ bb. Feed roller pressure
- _____ cc. Plate to blanket pressure
- _____ dd. Air blast (blower) control

6. Indicate the sequence of how paper passes through a typical offset press by placing the numbers found in the drawing below in the space in front of the appropriate statement.

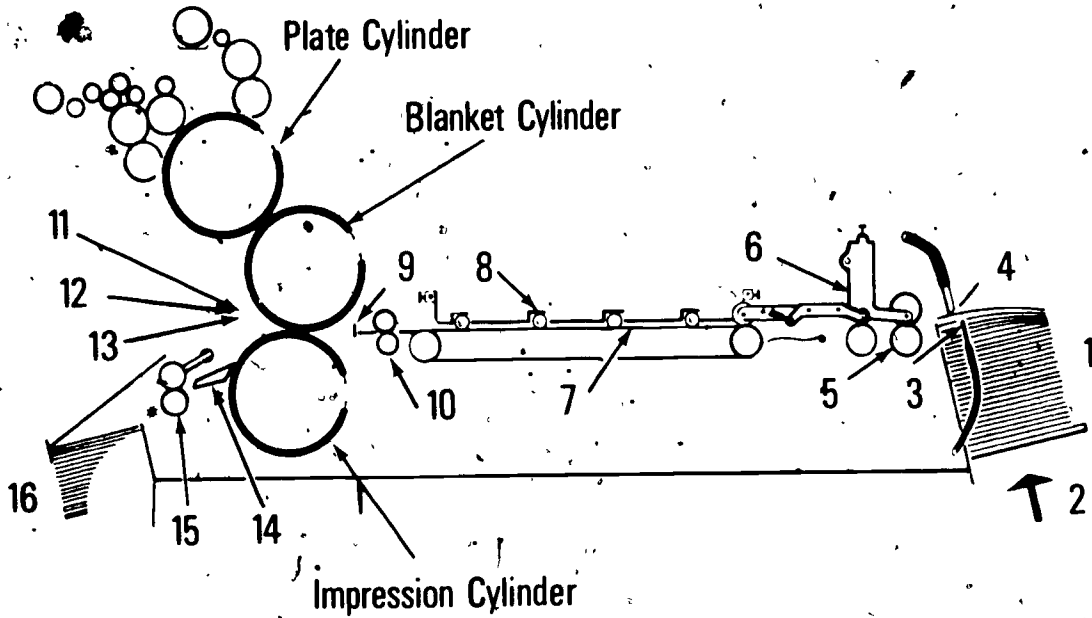

- _____ a. Pull out rollers move sheet to register board
- _____ b. Cylinder grippers grip sheet and guide it between impression and blanket cylinder
- _____ c. Receiving tray or table holds sheets
- _____ d. Paper placed on feed table
- _____ e. Several moving tapes carry paper along register board
- _____ f. Strippers separate the paper from impression cylinder

- _____ g. Stop fingers halt sheet for register to side position and for timing of feed into cylinder grippers; they move up and down
- _____ h. Sucker tube lifts paper, moving it to pull-out rollers
- _____ i. After holding the sheet for less than one revolution the cylinder grippers open
- _____ j. Feed table raises automatically
- _____ k. Image transfers to paper from blanket-by pressure from the impression cylinder
- _____ l. Ejector wheels guide the paper into receiving tray or stacker
- _____ m. Sheet separators and air blowers separate sheets
- _____ n. Balls and metal strips hold paper down on tapes
- _____ o. Feed rollers move sheet into cylinder grippers
- _____ p. Double sheet detector prevents more than one sheet from going to register system

7. Compare control features of offset presses.

8. Demonstrate the ability to:

- a. Set up the sheet control systems.
- b. Set up the image control systems.
- c. Operate an offset press from set up of systems through printed sheet delivery.
- d. Wash up an offset press.

(NOTE: If these activities have not been accomplished prior to the test, ask your instructor when they should be completed.)

OFFSET PRESS OPERATING PROCEDURES UNIT III

ANSWERS TO TEST

1. a. 3 e. 6
 b. 4 f. 5
 c. 1 g. 7
 d. 2

2. a, b, c, d, e, f, g, k, l, m, n

3. a. No income is received unless printed sheets are delivered from the press
 b. Reduced profit potential results from inefficient use of time, equipment, and materials

4. a, c, d, e

5. a. 2 i. 3 q. 1 y. 2
 b. 3 j. 4 r. 4 z. 1
 c. 1 k. 6 s. 1 aa. 3
 d. 4 l. 5 t. 2 bb. 2
 e. 5 m. 6 u. 3 cc. 4
 f. 6 n. 3 v. 1 dd. 1
 g. 1 o. 1 w. 5
 h. 2 p. 2 x. 4

6. a. 5 e. 7 j. 13 m. 3
 b. 11 f. 14 j. 2 n. 8
 c. 16 g. 9 k. 12 o. 10
 d. 1 h. 4 l. 15 p. 6

7. Evaluated to the satisfaction of the instructor

8. Performance skills evaluated to the satisfaction of the instructor

OFFSET INKS AND DAMPENING CHEMISTRY UNIT IV

UNIT OBJECTIVE

After completion of this unit, the student should be able to select true statements concerning the main ingredients of inks and describe the procedure for measuring alcohol in a fountain solution. The student should also be able to conduct an ink cabinet inventory, an inventory of offset press dampening chemistry, and test solutions for pH. This knowledge will be evidenced by correctly performing the procedures outlined in the assignment and job sheets and by scoring 85 percent on the unit test.

SPECIFIC OBJECTIVES

After completion of this unit, the student should be able to:

1. Match terms related to offset inks and dampening chemistry with the correct definitions.
2. Select true statements concerning the main ingredients of offset ink.
3. Name three conditions of ink manufacture that benefit the user.
4. Choose the type of ink that fits the descriptive phrase.
5. List three conditions influencing the printing performance of offset inks.
6. Name three ink properties which affect the printing quality of offset inks.
7. Select rules concerning the care and storage of inks.
8. State the purpose of offset dampening solutions.
9. Match dampening solution ingredients with their purposes.
10. Name the two methods of measuring pH.
11. Give the generally acceptable range of pH for a fountain solution.
12. Select effects of alcohol in a fountain solution.
13. Describe the procedure for measuring alcohol in a fountain solution.
14. Discuss the importance of ink and water balance.
15. Conduct an ink cabinet inventory.
16. Conduct an inventory of offset press dampening chemistry.
17. Demonstrate the ability to test solutions for pH.

OFFSET INKS AND DAMPENING CHEMISTRY UNIT IV

.SUGGESTED ACTIVITIES

- I. Provide student with objective sheet.
- II. Provide student with information, assignment, and job sheets.
- III. Make transparency.
- IV. Discuss unit and specific objectives.
- V. Discuss information and assignment sheets.
- VI. Demonstrate and discuss the procedures outlined in the job sheet.
- VII. The student should be familiar with the supply of inks and additives after making the inventory.
 - A. A job sheet could be made for the experimental use of each additive as production jobs are run.
 - B. Conditions of ink-water imbalance could be created by the instructor during production job runs (too much ink, too little ink, too much water, too little water). The press would be set up and running correctly before the problems are created.
 - C. If fountain concentrates recommended by small press manufacturers are used in the school shop, the pH of these could be tested in a variety of ratio mixtures.
- VIII. Invite a speaker from industry (preferably a press operator or supervisor) to talk to the class about ink-water balance and overcoming problems faced by a press operator.
- IX. Give test.

INSTRUCTIONAL MATERIALS

- I. Included in this unit:
 - A. Objective sheet
 - B. Information sheet
 - C. Transparency Master 1--Methods of Ink Drying
 - D. Assignment sheets
 1. Assignment Sheet #1--Conduct an Ink Cabinet Inventory
 2. Assignment Sheet #2--Conduct an Inventory of Offset Press Dampening Chemistry

- E. Job Sheet #1-Test Solutions for pH
- F. Test
- G. Answers to test

II. References:

- A. Cogoli, John E. *Photo Offset Fundamentals*. Bloomington, IL 61701: McKnight Publishing Co., 1980.
- B. Dennis, Ervin A. and Jenkins, John D. *Comprehensive Graphic Arts*. Indianapolis 46268: Howard W. Sams and Co., Inc., 1977.
- C. *Pressman's Guide*. St. Paul, MN 55101: 3M Co., 1971.
- D. Spence, Wm. D. and Vequist, David G. *Graphic Réproduction*. Peoria, IL 61615: Chas. A. Bennett Co., Inc., 1980.
- E. *Easy Does It*. St. Paul, MN 55101: 3M Company, Industrial Graphics Department, Printing Products Division.
- F. Anton, Karl V., Jr. *Handbook of Technical Articles*. Mineola, NY: Van Nostrand Reinhold Corp. of America, 1966.
- G. Lankford, William. *The Offset Press Dampening System*. Pittsburg 15213: Graphic Arts Technical Foundation, 1970.

114.

OFFSET INKS AND DAMPENING CHEMISTRY
UNIT IV

INFORMATION SHEET

- I. Terms and definitions
 - A. Viscosity--The resistance of ink to flow
 - B. Tack--The stickiness of the ink
 - C. Length--The ability of ink to flow and form long or short filaments
 - D. Opacity--The hiding or covering quality of ink
 - E. Transparency--The characteristic of low hiding or covering power which allows previously printed colors or the background paper to show through
 - F. Permanence (fastness)--A property of nonfading even though exposed to sunlight for long periods
 - G. Fugitive--A tendency to lose color or fade when exposed to sunlight for long periods
 - H. Resistant--An ink which is manufactured to withstand the action of such factors as gases, chemicals, heat, and moisture
 - I. Lakes--Ink body colors which are not particularly strong
 - J. Toners--Strong colors and highly concentrated
 - K. Metallic inks--Inks which contain finely ground metallic powder, with aluminum and bronze used to provide silver and gold colors
 - L. Water colors--Colors which produce flat effects
(NOTE: They contain no varnish.)
 - M. Resin--Natural organic substance from plants which is not soluble in water

INFORMATION SHEET

- N. pH--A symbol for the strength of acid or alkali in any solution, represented on a scale from 0-14 with 7 as neutral, 0 as acid, and 14 as alkaline (Figure 1)

FIGURE 1

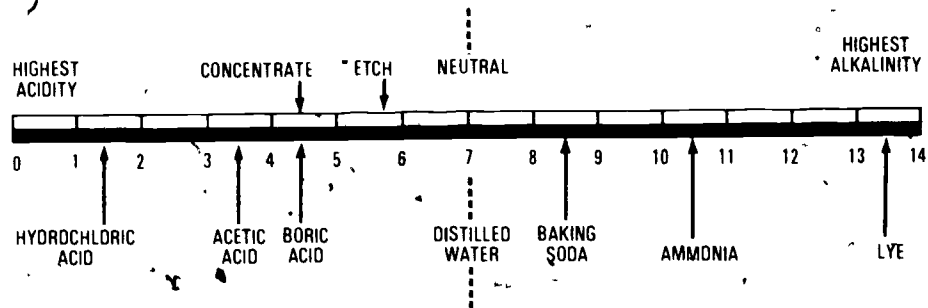

(Courtesy A. B. Dick)

- O. Relative humidity--The amount of water vapor in the air compared to the greatest amount possible at the same temperature
- P. Extender--A colorless substance mixed with ink to increase its covering power
- Q. Drier--Any substance added to speed the drying of ink
- R. Varnish--A thin, protective coating which is printed like ink on the stock; also used as an additive to vary ink properties
- II. Main ingredients of offset inks
- A. Vehicle--Forms the body bulk of the ink
1. Carries the pigment and binds the ink to the material being printed on
 2. Types of vehicles
 - a) Varnish (linseed oil)
 - b) Synthetic oils (dehydrated castor oil, epoxy oil, alkyd oil)
 - c) Resins
 - d) Solvents
 3. Factors determining vehicle selection
 - a) Purpose of ink
 - b) Printing process being used

INFORMATION SHEET

- c) Kind of paper
- d) Method of ink drying
- 4. Methods of ink drying (Transparency 1)
 - a) Absorption
 - b) Oxidation and polymerization
 - c) Resin-solvent (evaporation)
 - d) Moisture-set (precipitation)
 - e) Resin-oil (absorption and oxidization)
 - f) Coldset (cooling)

B. Pigment--The coloring in materials

1. Black pigments are primarily carbon produced by burning gas or oil
2. White pigments
 - a) Opaque whites (used as colorants)
 - b) Transparent whites (used as extenders)
3. Colored pigments are mostly synthetic produced by processing chemicals to make dyes

(NOTE: Colors which tend to fade in sunlight are called "fugitive." Colors prepared to resist fading are said to have "permanence." Colors which withstand the actions of gases, chemicals, heat and moisture are called "resistant.")

C. Modifiers--Driers, waxes, lubricants, gums, starches, extenders, varnishes, and/or wetting agents which affect the drying

(NOTE: Small amounts of one or more modifiers may be added by a press operator in order for the ink to work and dry properly under existing production conditions. Compounds for this purpose should be recommended by the manufacturer of the specific ink.)

1. Greases aid in ink setting and ink lubrication
2. Thin oils and solvents reduce tack
3. Wetting agent helps the vehicle to cover the pigment particles
4. Antioxidants slow down surface drying

INFORMATION SHEET

5. Deodorants eliminate odors of oil and dryers
6. Perfumes impart a fragrance to the ink

III. Conditions of ink manufacture that benefit user

(NOTE: Inks are manufactured for all printing processes. Each requires specific characteristics. Offset inks are made especially for use on offset presses. These inks must withstand the constant contact with the press dampening solution without emulsifying. Letter press inks should never be used on an offset press.)

A. Ink is mixed by batches and carefully weighed

(NOTE: The equipment is cleaned after each batch and the process begins all over again. Records are kept. Any problem with ink at the press can be solved more quickly by the manufacturer if the batch number is given. Many times in troubleshooting a press problem may be distinguished from an ink problem by use of ink from a different batch.)

B. Tested under actual printing conditions

C. Packages vary for convenient use and storage

(NOTE: Ink may be stored in tubes, cans, drums, tank trucks, and tank cars.)

IV. Types of ink and their descriptions

- A. Heat-set inks--Used on high speed presses with heating devices
- B. Quick-set inks--Dry by penetration and oxidization
- C. Gloss inks--Minimum penetration into surface of paper
- D. News inks--Dry by absorption on high speed presses
- E. Metallic inks--Metal powders suspended in a vehicle
- F. Magnetic inks--Have pigments that can be magnetized
- G. Process inks--Have special colors (magenta, cyan, yellow), transparency, and drying characteristics
- H. Rubber base inks--Dry quickly on most stock, but dry slowly on ink rollers

V. Conditions influencing the printing performance of offset inks

- A. Type of press being used
- B. Speed of press
- C. Stock surface being printed on

113

INFORMATION SHEET

VI. Ink properties which affect the printing quality of offset ink

A. Color (pigment)

(NOTE: Mass-tone refers to ink color, undertone is the background color, tinting strength is the color intensity, and opacity or transparency is the ability to cover.)

B. Body (consistency, viscosity)

C. Ability to dry (absorption, evaporation, oxidation)

VII. Rules for ink care and storage

A. Do not reuse ink after removal from ink fountain

B. Keep ink surface level when removing from can

C. Keep covers on all containers

D. Store inks in enclosed metal cabinet away from excessive temperature and light

E. Keep outside surfaces of cans and tubes free of ink spills

F. Observe shelf life recommendations of manufacturer

(NOTE: *Mixing of colors of inks* requires special tools and attention if colors are to be specific and repeatable. There is a PMS ink mixing system which is used almost universally that serves this purpose. To mix ink at the press with any predictable results and without a mixing system requires some knowledge of the results of mixing primary colors to achieve another color or get a lighter or darker shade or tint. For best results only inks manufactured for mixing should be used. Generally stronger colors (toners) should be added to weaker colors (lakes). Mixing should be done on a hard smooth surface using an ink knife or spatula to blend colors. If instructor desires to include mixing of colors of inks in the curriculum, it is recommended that a PMS mixing kit be acquired from one of the ink manufacturers and that manufacturer's instructions be followed.)

VIII. The purpose of offset dampening solutions--To keep the nonimage area of a well-processed offset plate clean

IX. Dampening solution ingredients and their purposes

A. Water--The main ingredient which provides the moisture to keep the nonimage areas clean

(NOTE: The desensitized film which holds water on the nonimage areas usually breaks down or wears off gradually. Water alone will not rebuild the desensitized film so chemicals are added to the water.)

INFORMATION SHEET

- B. Gum--The main desensitizing agent in the fountain solution; absorbed to the nonimage areas where it replaces the water holding desensitized film worn off the plate during the run

(NOTE: The gum is usually gum arabic or cellulose gum.)

- C. Acid--Improves the adherence of the gum to the nonimage area of the plate

(NOTE: Generally a pH between 4.0 and 5.0 is satisfactory. Increasing the acid does not keep the nonprinting area clean, but tends to break down color of ink, causes ink to emulsify, causes ink roller stripping, retards ink drying, and reduces the life of plate image.)

(CAUTION: When handling undiluted acids, ALWAYS ADD UNDILUTED ACIDS TO WATER, NEVER WATER TO ACID!)

- D. Chemical salts (ammonium dichromate)--Keeps the acid in the fountain solution from reacting chemically with the metal of the plate and prevents stripping of the metal ink rollers

- E. Buffers (nitrate salts)--Stabilizes the pH of a fountain solution

(NOTE: It is important that the solution contain the minimum of gum and acid needed to keep the plate running clean.)

X. Two methods of measuring pH (acidity)

- A. pH paper test strips (Figure 2)

(NOTE: These are impregnated with chemical organic compounds which change color when immersed in a solution. The color change is compared to a pH color chart which gives the pH value.)

FIGURE 2

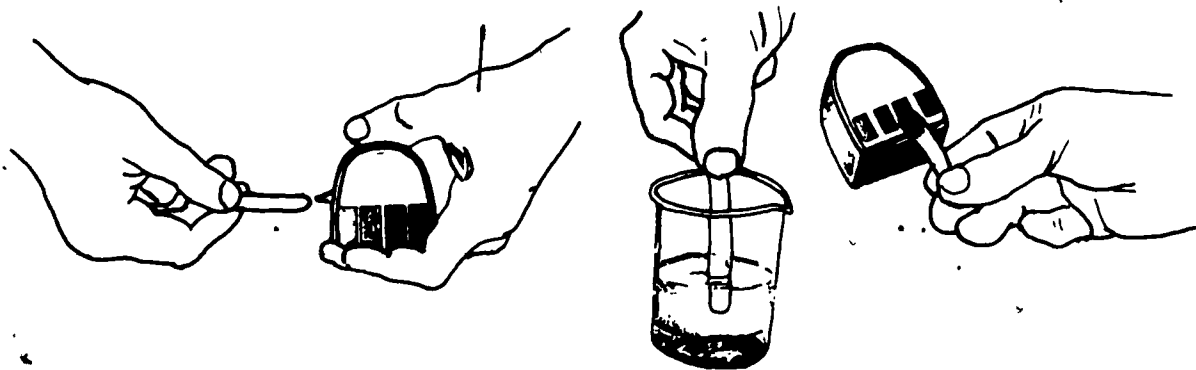

INFORMATION SHEET

- B. Electric pH meter--Gives a pH reading identified by a pointer on a scale (Figure 3)

FIGURE 3

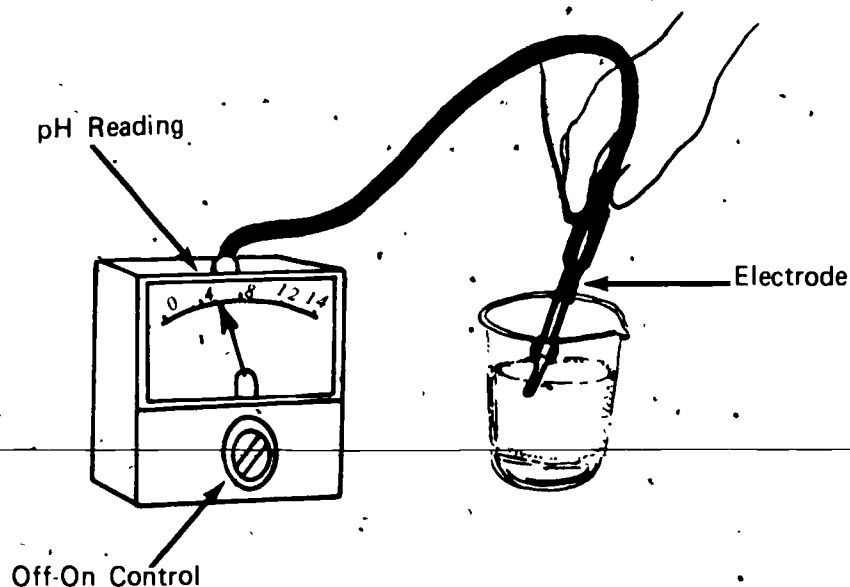

- XI. The generally acceptable pH range--Depends on the ink and paper being used; generally, a solution with a pH between 4.0 and 5.0 is satisfactory.

(NOTE: The pH of the fountain solution should be checked periodically throughout a press run.)

- XII. The effects of alcohol in a fountain solution

- A. Thinner film of solution on plate
- B. Less solution on plate
 - 1. Less dimensional change in sheet
 - 2. Ink drying usually faster

- C. Reduces droplet formation in ink

(NOTE: "Snowflaky" problems are minimized.)

- D. Better definition between printing and nonprinting areas

INFORMATION SHEET

E. "Balanced" running condition achieved more rapidly

(NOTE: Some systems require the use of alcohol. Isopropyl alcohol, also known as 2-propanol (isopropanol), is the type most widely used, and is available in three grades, 99%, 95%, and 91%. Most alcohol dampening systems require a minimum of 20% to 25% alcohol content. The use of alcohol in conventional systems is also beneficial. When mixing fountain solution, alcohol must be added LAST in order not to precipitate or separate gum out of the solution and not interfere in determining pH of the solution. 15% to 25% of solution in conventional dampening systems may be alcohol.)

XIII. Procedure for measuring alcohol in fountain solution--Determined by reading the specific gravity of the solution with a hydrometer and using a conversion chart to find the percentage of alcohol (Figure 4)

(NOTE: From 15% to 25% may be used, depending upon quality and type of paper (see figure 4). Using too much alcohol in the dampening solution causes problems. Gum is insoluble in alcohol, and when the concentration of alcohol exceeds 50% to 60% the gum is precipitated out of the solution. Alcohol changes the pH of the fountain solution and pH cannot be used as a control for the solution.)

FIGURE 4

Chart for
converting specific gravity to isopropyl alcohol content



Percent Alcohol in Solution	Solution Temperature				
	50°F 10.0°C	60°F 15.6°C	68°F 20.0°C	75°F 23.9°C	80°F 26.7°C
Solution With No Alcohol	.9997	.9991	.9982	.9973	.9966
15%	.9808	.9808	.9802	.9795	.9783
20%	.9745	.9737	.9757	.9741	.9737
25%	.9723	.9710	.9703	.9688	.9671
35%	.9608	.9570	.9552	.9532	.9518
45%		.9383			

For use with a specific gravity hydrometer (calibrated for 60°F)

(Courtesy Graphic Arts Technical Foundation, Inc.)

INFORMATION SHEET

XIV. The importance of ink-water balance

- A. The basic rule for proper adjustment of ink-water balance is to run minimum amount of ink which will give full color to the job and just enough water to keep plate clean
- B. One of the most important skills of the offset press operator
- C. Should be controlled to meet the needs of the plate
- D. Key to quality printing on the offset press
- E. Proper control demands accurate analysis of problems as they occur

(NOTE: Some symptoms at first appear the same even though they come from different causes.)

F. Excessive water problems

1. Water collects at trailing edge of plate or blanket
2. Wash marks in solid extending back from leading edge of a plate
3. "Snowflaky" printing
4. Emulsification of ink and water on roller plate or blanket

G. Insufficient water problems

1. Shadow dots in halftones close up (plugging)
2. Deposit of ink in nonimage area of the plate (catch-up or scumming)

(NOTE: For best results with any chemistry in the press room, name brand products should be matched and manufacturer's recommendations followed. Stock fountain concentrates usually work well when mixed as specified, but no assumptions should be made for trouble free operations.)

Methods of Ink Drying



Absorption

Nondrying Oils penetrate the paper and dry as they are absorbed

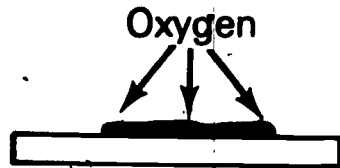

Oxidation

The vehicle absorbs oxygen from the air and becomes solid

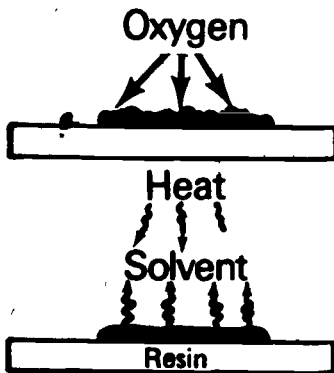

Polymerization

Oxygen sets up a reaction that turns small molecules into a gel, then into large molecules that harden

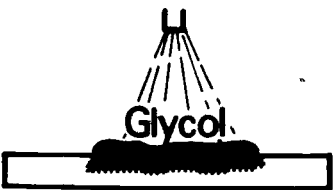

Resin-Solvent

The combination resin-solvent vehicle releases the solvent causing the resin to dry; process can be speeded by heating the printed vehicle

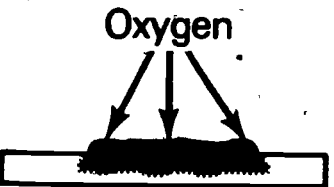

Moisture-Set

A glycol-resin vehicle is sprayed with water or steam; glycol mixes with water and is absorbed by the paper and the resin precipitates as a solid film

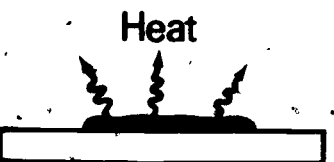

Resin-Oil

A combination of absorption and oxidation to achieve a quick-setting vehicle

Coldset

A wax and resin vehicle is heated, then becomes solid as heat is radiated away from the vehicle as it cools.

OFFSET INKS AND DAMPENING CHEMISTRY
UNIT IV

ASSIGNMENT SHEET #1--CONDUCT AN INK CABINET INVENTORY

Directions: Make an inventory list of all inks and additives in the ink storage area.

1. Divide the list by name brands
2. Divide the name brand lists by color
3. List ink additives separately
4. To the right of each additive listed, describe its use (see instructor if necessary)
5. Turn in results to your instructor

OFFSET INKS AND DAMPENING CHEMISTRY
UNIT IV

ASSIGNMENT SHEET #2--CONDUCT AN INVENTORY OF OFFSET
PRESS DAMPENING CHEMISTRY

Directions: Make an inventory list of all chemicals used to prepare fountain solution for all presses in the shop.

1. To the right of each chemical name, write the purpose of the chemical
2. List the different mixing ratios used for each chemical if applicable (see instructor if necessary)
Example: 1:30, 1:15, 1:7
3. Turn in results to your instructor

OFFSET INKS AND DAMPENING CHEMISTRY
UNIT IV

JOB SHEET #1--TEST SOLUTIONS FOR pH

- I. Tools and materials
 - A. Solutions in containers provided by instructor
 - B. pH testing strips or pH meter
 - C. Paper to record results
 - D. Pencil or pen
- II. Procedure
 - A. Insert test strip or meter probe into first container of solution (see Figures 2 and 3, Information Sheet.)
 - B. Read the results on test paper or meter
 - C. Record the pH value determined in step B
 - D. Repeat steps A, B, C with each solution
 - E. Indicate beside each pH value whether the solution is acid or alkaline (see Figure 1, Information Sheet.)
 - F. Indicate beside each acid or alkaline designation whether the solution is weak or extreme (see Figure 1, Information Sheet.)
 - G. Turn in results to the instructor

OFFSET INKS AND DAMPENING CHEMISTRY
UNIT IV

NAME _____

TEST

1. Match the terms on the right with the correct definitions.

- | | |
|---|----------------------|
| _____ a. The resistance of ink to flow | 1. Fugitive |
| _____ b. The stickiness of the ink | 2. Lakes |
| _____ c. The ability of ink to flow and form long or short filaments | 3. Metallic inks |
| _____ d. The hiding or covering quality of ink | 4. Resin |
| _____ e. The characteristic of low hiding or covering power which allows previously printed colors or the background paper to show through | 5. pH |
| _____ f. A property of nonfading even though exposed to sunlight for long periods | 6. Tack |
| _____ g. A tendency to lose color or fade when exposed to sunlight for long periods | 7. Transparency |
| _____ h. An ink which is manufactured to withstand the action of such factors as gases, chemicals, heat, and moisture | 8. Relative humidity |
| _____ i. Ink body colors which are not particularly strong | 9. Resistant |
| _____ j. Strong colors and highly concentrated | 10. Opacity |
| _____ k. Inks which contain finely ground metallic powders, with aluminum and bronze used to provide silver and gold colors | 11. Viscosity |
| _____ l. Colors which produce flat effects | 12. Toners |
| _____ m. Natural organic substance from plants which is not soluble in water | 13. Length |
| _____ n. A symbol for the strength of acid or alkali in any solution, represented on a scale from 0-14 with 7 as neutral, 0 as acid, and 14 as alkaline | 14. Water colors |
| _____ o. The amount of water vapor in the air compared to the greatest amount possible at the same temperature | 15. Permanence |
| | 16. Drier |
| | 17. Varnish |
| | 18. Extender |

- _____ p. A colorless substance mixed with ink to increase its covering power
- _____ q. Any substance added to speed the drying of ink
- _____ r. A thin, protective coating which is printed like ink on the stock; also used as an additive to vary ink properties
2. Select true statements concerning the three main ingredients of offset inks.
- _____ a. Synthetic oils are types of vehicles which form the body bulk of the ink
- _____ b. White pigments are primarily carbon produced by burning gas or oil
- _____ c. Colored pigments are mostly synthetic produced by processing chemicals to make dyes
- _____ d. Thin oils and solvents reduce tack
- _____ e. Some types of modifiers are driers, waxes, and gums
3. Name three conditions of ink manufacture that benefit the user.
- a. _____
- b. _____
- c. _____
4. Choose the type of ink that fits the descriptive phrase by placing the number on the right in the appropriate blank.
- | | |
|---|---------------------|
| _____ a. Used on high speed presses with heating devices | 1. Quick-set inks |
| _____ b. Dry by penetration and oxidation | 2. News inks |
| _____ c. Minimum penetration into surface of paper | 3. Metallic inks |
| _____ d. Dry by absorption on high speed presses | 4. Magnetic inks |
| _____ e. Metal powders suspended in a vehicle | 5. Heat-set inks |
| _____ f. Have pigments that can be magnetized | 6. Gloss inks |
| _____ g. Have special color, transparency, and drying characteristics | 7. Rubber base inks |
| _____ h. Dry quickly on most stock, but dry slowly on ink rollers | 8. Process inks |

5. List three conditions influencing the printing performance of offset inks.

- a. _____
 b. _____
 c. _____

6. Name three ink properties which affect the printing quality of offset inks.

- a. _____
 b. _____
 c. _____

7. Select rules concerning the care and storage of inks by placing an "X" in the appropriate blanks.

- _____ a. Keep covers on all containers
 _____ b. Reuse ink after it has been removed from the ink fountain
 _____ c. Store inks in open metal cabinet in very cool room
 _____ d. Keep ink surface level when removing ink from can

8. State the purpose of offset dampening solutions. _____

9. Match the dampening solution ingredients on the right with their purposes.

- | | |
|--|-------------------|
| _____ a. The main ingredient which provides the moisture to keep the nonimage areas clean | 1. Chemical salts |
| _____ b. The main desensitizing agent in the fountain solution; absorbed to the nonimage areas where it replaces the water holding desensitized film worn off the plate during the run | 2. Acid |
| _____ c. Improves the adherence of the gum to the nonimage area of the plate | 3. Water |
| _____ d. Keeps the acid in the fountain solution from reacting chemically with the metal of the plate and prevents stripping of the metal ink rollers | 4. Buffers |
| _____ e. Stabilizes the pH of a fountain solution | 5. Gum |

10. Name the two methods of measuring pH.

- a. _____
 b. _____

11. Give the generally acceptable pH range for a fountain solution.

12. Select effects of alcohol in a fountain solution by placing an "X" in the appropriate blanks.

- a. Increases droplet formation in ink
- b. Less dimensional change in sheet
- c. Ink drying usually faster
- d. "Balanced" running condition achieved more slowly
- e. More solution on plate

13. Describe the procedure for measuring alcohol in a fountain solution.

14. Discuss the importance of ink-water balance by listing three points related to the topic.

- a.

- b.

- c.

15. Conduct an ink cabinet inventory.

16. Conduct an inventory of offset press dampening chemistry.

17. Demonstrate the ability to test solutions for pH.

(NOTE: If these activities have not been accomplished prior to the test, ask your instructor when they should be completed.)

OFFSET INKS AND DAMPENING CHEMISTRY
UNIT IV

ANSWERS TO TEST

1. a. 11 g. 1 m. 4
 b. 6 h. 9 n. 5
 c. 13 i. 2 o. 8
 d. 10 j. 12 p. 18
 e. 7 k. 3 q. 16
 f. 15 l. 14 r. 17
2. a, c, d, e
3. a. Ink is mixed by batches and carefully weighed
 b. Tested under actual printing conditions
 c. Packages vary for convenient use and storage
4. a. 5 d. 2 g. 8
 b. 1 e. 3 h. 7
 c. 6 f. 4
5. a. Type of press being used
 b. Speed of press
 c. Stock surface being printed on
6. a. Color
 b. Body
 c. Ability to dry
7. a, d
8. The purpose of offset dampening solutions--To keep the nonimage area of a well-processed offset plate clean
9. a. 3
 b. 5
 c. 2
 d. 1
 e. 4
10. a. pH paper test strips
 b. Electric pH meter
11. Depends on the ink and paper, being used; generally, a solution with a pH between 4.0 and 5.0 is satisfactory
12. b, c
13. Description should include: The procedure for measuring is determined by reading the specific gravity of the solution with a hydrometer and using a conversion chart to find the percentage of alcohol

14. Any three of the following:
 - a. The basic rule for proper adjustment of ink-water balance is to run minimum amount of ink which will give full color to the job and just enough water to keep plate clean
 - b. One of the most important skills of the offset press operator
 - c. Should be controlled to meet the needs of the plate
 - d. Key to quality printing on the offset press
 - e. Proper control demands accurate analysis of problems as they occur
 - f. Excessive water problems
 - g. Insufficient water problems
15. Evaluated to the satisfaction of the instructor
16. Evaluated to the satisfaction of the instructor
17. Performance skills evaluated to the satisfaction of the instructor

PREVENTIVE MAINTENANCE AND TROUBLESHOOTING
UNIT V

UNIT OBJECTIVE

After completion of this unit, the student should be able to list the major areas of work in a preventive maintenance schedule and discuss the procedures for daily, weekly, and monthly maintenance. The student should also be able to relate lubrication and adjustment requirements to periodic schedules, complete troubleshooting charts, set up a preventive maintenance schedule in chart form, and clean and adjust equipment. This knowledge will be evidenced by correctly performing the procedures outlined in the assignment and job sheets and by scoring 85 percent on the unit test.

SPECIFIC OBJECTIVES

After completion of this unit, the student should be able to:

1. Match terms related to preventive maintenance and troubleshooting with the correct definitions.
2. List seven advantages of a routine, thorough preventive maintenance program.
3. Name the three areas of work in a preventive maintenance program.
4. Match preventive maintenance schedules with their periodic importance.
5. Select true statements concerning preventive maintenance procedures for daily cleanup after a day's run.
6. Complete a list of preventive maintenance procedures for weekly cleanup.
7. Complete a list of preventive maintenance procedures for monthly cleanup.
8. Select procedures for daily, weekly, and monthly lubrication.
9. Complete a list of daily and weekly adjustment procedures.
10. List three monthly adjustment requirements.
11. Arrange in order the steps in making an ink form roller check.
12. Identify ink stripe configurations.
13. Select true statements concerning requirements for a preventive maintenance schedule in chart form.
14. Arrange in order the sequence of troubleshooting technique.
15. Complete a list of categories of press troubles.

16. Distinguish between types of emulsification.
17. Describe the technique for avoiding emulsification.
18. Complete a list of conditions creating ink drying problems.
19. Match common ink troubles on the press with their causes.
20. List four guidelines for evaluating good print quality.
21. Match print quality problems with their causes.
22. Find the best solution to a problem concerning troubleshooting guides for ink and dampening problems.
23. Find the best solution to a problem concerning troubleshooting guides for paper stock problems.
24. Find the best solution to a problem concerning troubleshooting guides for process (image transfer) problems.
25. Find the best solution to a problem concerning troubleshooting guides for mechanical problems.
26. Determine lubrication requirements for a specific press.
27. Set up a preventive maintenance schedule in chart form.
28. Demonstrate the ability to:
 - a. Adjust dampener rollers to plate cylinder.
 - b. Adjust ink form rollers to plate cylinder.
 - c. Adjust plate cylinder to blanket cylinder.
 - d. Adjust blanket cylinder to impression cylinder.
 - e. Change a molleton cover.
 - f. Degrease plate and impression cylinders.
 - g. Deglaze ink rollers and blanket.
 - h. Change blanket.

PREVENTIVE MAINTENANCE AND TROUBLESHOOTING UNIT V

SUGGESTED ACTIVITIES

- I. Provide student with objective sheet.
- II. Provide student with information, assignment, and job sheets.
- III. Make transparency.

(NOTE: TM 1 is the only master designed to be made into a transparency; TM's 2 through 17 would be difficult to reproduce as transparencies, but they should be used to provide students with visual reinforcement for the objectives to which they are related.)
- IV. Discuss unit and specific objectives.
- V. Discuss information sheet.
- VI. Demonstrate and discuss the procedures outlined in the job sheets.
- VII. Invite a printing shop supervisor to talk to the class about the importance of preventive maintenance and some of the tricks of the trade in the art of troubleshooting.
- VIII. Discuss with the class the importance of proper ventilation when working with cleaners, deglazers, conditioners, and other solvents in the shop area; stress the flammable nature of these materials, the importance of keeping them away from heat and open flame, and the necessity for cleaning up with soap and water after using such solvents.
- IX. Prepare a realistic example of how much money a shop could lose if the equipment were down for a day, three days, a week, and impress upon the class that it is most frequently the lack of good preventive maintenance that causes down time.
- X. Read the assignment and job sheets carefully and have available the appropriate manufacturer's manuals for the students to properly complete these activities.
- XI. Have individual students give examples of how they have been personally affected by the lack of preventive maintenance on their automobiles or other possessions that require preventive maintenance.
- XII. Give test.

INSTRUCTIONAL MATERIALS

- I. Included in this unit:
 - A. Objective sheet
 - B. Information sheet

C. Transparency masters

1. TM 1--Suggested Preventive Maintenance Chart
2. TM 2--Guidelines for Evaluating Good Print Quality
3. TM 3--Scumming
4. TM 4--Gray, Washed Out
5. TM 5--Gray, Washed Out Dirty Background
6. TM 6--Copy Too Dark
7. TM 7--Uneven Printing
8. TM 8--Double Image or Blurred Copy
9. TM 9--Weak Spots or Spotty Copy
10. TM 10--Image Breakdown During Run
11. TM 11--Streaking
12. TM 12--Improper Register
13. TM 13--No Image at All
14. TM 14--Paper Curling in Receiver
15. TM 15--Paper Nicking on Edge
16. TM 16--Paper Missing Grippers
17. TM 17--Paper Wrinkling

D. Assignment sheets

1. Assignment Sheet #1--Determine Lubrication Requirements for a Specific Press
2. Assignment Sheet #2--Set Up a Preventive Maintenance Schedule in Chart Form

E. Job sheets

1. Job Sheet #1--Adjust Dampener Rollers to Plate Cylinder
2. Job Sheet #2--Adjust Ink Form Rollers to Plate Cylinder
3. Job Sheet #3--Adjust Plate Cylinder to Blanket Cylinder
4. Job Sheet #4--Adjust Blanket Cylinder to Impression Cylinder

5. Job Sheet #5--Change a Molliton Cover
6. Job Sheet #6--Degrease Plate and Impression Cylinders
7. Job Sheet #7--Deglaze Ink Rollers and Blanket
8. Job Sheet #8--Change Blanket

- F. Test
- G. Answers to test

II. References:

- A. Cagoli, John E. *Photo-Offset Fundamentals*. Bloomington, IL 61701: McKnight Publishing Co., 1980.
- B. *Easy Does It--An Introduction to the Art of Offset Duplicating*. St. Paul, MN 55101: Industrial Graphics Department, Printing Products Division, 3M Company, 1979.
- C. Spence, Wm. D. and Vequist, David G. *Graphic Reproduction*. Peoria, IL 61615: Chas. A. Bennett Co., Inc., 1980.
- D. *Pressman's Guide*. St. Paul, MN 55101: 3M Company, 1971.
- E. Anton, Kan V., Jr. *Handbook of Technical Articles*. Mineola, NY: Van Son Holland Ink Corporation of America, 1966.

PREVENTIVE MAINTENANCE AND TROUBLESHOOTING
UNIT V

INFORMATION SHEET

I. Terms and definitions

- A. Preventive maintenance--The performance of routine inspection, cleaning, adjusting, lubrication, and minor repairs which aid in preventing major equipment failure and process troubles
- B. Pumice powder--Powdered volcanic rock used for cleaning and scouring surfaces which must be free of oil residue
- C. Deglazer--A cleaner used to dissolve dried ink, solvent, and gum deposits on the surfaces of press rollers and blanket
- D. Degreaser--A cleaner used to remove oil and grease residue from the plate and impression-cylinder surfaces
- E. Water miscible cleaner--A cleaner which mixes with water to remove water soluble particles from press rollers, blanket, and cylinders
- F. Ink glaze--A thin layer of hardened ink, fountain solution, and blanket wash which forms on press rollers and blanket
- G. Paper glaze--A thin layer of tiny particles of clay, sizing, lint, and other paper components which forms on the press rollers and blanket
- H. Blanket powder--A powder used on the surface of a rubber offset blanket to protect it during storage and to aid in maintaining the blanket's resilience
- I. Sensitized roller--A rubber ink roller which will not hold ink on its surface because of fountain solution, etch, and other chemicals dried in the pores
- J. Troubleshooting--The process of analyzing problems and determining probable causes and applying possible solutions until a problem is solved
- K. Emulsification--A mixing of ink and fountain solution affecting the separation of image and nonimage areas of the offset plate
- L. Set-off--Ink is transferred from the front surface of one sheet to the back surface of the sheet above in the delivery pile
- M. Chalking--Ink on the paper turns dry and powdery
- N. Trapping--Ink dries so that succeeding colors will not adhere properly
- O. Tinting--Emulsified ink suspended in the fountain solution on the plate surface appears as a uniform tint on the printed sheet
- P. Scumming--Plate picks up ink in the clear areas and transfers to the clear area of the sheet
- Q. Piling--Ink builds up or piles on rollers, plate, and/or blanket

INFORMATION SHEET

- R. Picking--Ink tears away part of the paper coating as the sheet is printed; this appears as black spots in the blank areas of the printed sheet and white spots in the solid areas
- S. Misting--Ink flies into atmosphere as fine mist especially at high temperature and speed
- T. Toning--Ink adheres to nonimage area of plate because of lack of dampening and transfer to printed sheet

II. Advantages of a routine, thorough preventive maintenance program

(NOTE: One of the most important functions of a press operator is to keep the press running as trouble free as possible; equipment dealers who troubleshoot and repair presses emphasize that many common problems could be prevented merely by following a routine, thorough cleaning procedure.)

- A. Prevents time loss due to press breakdown
- B. Lengthens life of rollers and blanket
- C. Aids in delivering a clean product
- D. Prevents excessive wear on moving parts
- E. Insures longer periods of trouble-free press operation
- F. Increases production
- G. Insures good image transfer
- H. Provides opportunity to locate and correct potential problems on a scheduled basis rather than during a production breakdown
- I. Helps operator to be aware of potential problems
- J. Helps operator to become more familiar with press mechanical functions
- K. Helps operator to identify and correct troubles
- L. Presents an impressive, organized work station for view by the employer, customers, or visitors

III. The three areas of work in a preventive maintenance program

- A. *Cleaning* equipment and work area
- B. *Lubricating* equipment
- C. *Adjusting* operator controllable settings on equipment

IV. Preventive maintenance schedules and their periodic importance

- A. Daily--This is the regular daily cleaning that takes place after a day's run and is the most important of the preventive maintenance schedules

INFORMATION SHEET

B. Weekly--This usually takes place at the end of the work week and is designed for blanket rotation or protection of other press elements while the press is not in use (includes biweekly maintenance, too)

C. Monthly--This supplements daily and weekly cleaning and includes a complete cleaning of the total press from the top to the floor

V. Preventive maintenance procedures for daily cleanup after a day's run

(CAUTION: When press is under operation for automatic cleaning, all safety precautions should be observed; when manual cleaning takes place, the power plug should be removed from its receptacle and only one operator should be at the press.)

A. Ink system

1. Use the blanket wash normally used for cleaning the blanket during press run to clean ink rollers
2. Follow cleanup procedure outlined in Unit III

B. Dampening system

(NOTE: At best, molleton covers or sleeves will pick up some ink from the plate, but do not allow this ink to dry on roller surface.)

1. Wipe ink particles from roller cover using a cotton pad dampened with fountain solution, or
2. Remove covered rollers from press and loosen ink with blanket wash, then flush blanket wash from cover with running water
3. Remove excess moisture from cover by rolling the roller with open palms on top of paper towels on a flat surface
4. Clean metal dampening rollers with plate cleaner or a water miscible cleaner, or pumice powder and water to remove all ink, oil, or residue which repels water
5. A coating of gum arabic solution may be applied to metal rollers after cleaning
6. Change dampening roller cover if enough ink has been trapped on the surface to form an ink glaze that appears shiny

(NOTE: On presses with integrated ink and water systems, there are no molleton covered rollers; if water fountain roller runs coated with ink, then dampening rollers will be cleaned running in contact with ink rollers; if water fountain roller runs free of ink coating, then water fountain and ductor rollers must be cleaned separately from ink rollers.)

INFORMATION SHEET

C. Cylinders

1. Plate cylinder--Use plate cleaner or nonabrasive water miscible cleaner, then coat with plate etch
2. Blanket cylinder--Thoroughly clean blanket with blanket wash and water, then clean cylinder ends and dry blanket
3. Impression cylinder--Wipe ink from surface with plate etch, or remove ink with blanket wash or deglazer, then clean with plate cleaner, degreaser, or water miscible cleaner, then coat with etch

D. Press

1. Use a shop towel dampened with blanket wash
2. Wipe ink, paper lint, dust, and oil from side covers, side frames, support bars, cam shafts, and gear shafts

E. Work station

1. Clean work table surface
2. Clean chemical shelf; wipe containers
3. Place dirty shop towels in safety can
4. Place all waste paper in trash can
5. Arrange work station in orderly manner

VI. Preventive maintenance procedures for weekly cleanup

- A. Deglaze ink rollers and offset blanket
- B. Change blanket if rotation plan is followed
- C. Desensitize noncovered dampening rollers
- D. Degrease plate and impression cylinder surfaces

(NOTE: If blankets are not rotated, a good practice is to remove the blanket after cleaning, coat it with blanket powder, and leave it off the press over the weekend.)

- E. Clean ink ductor, cam truck or follower
- F. Clean plate clamps
- G. Clean delivery stripping rollers and rings or chain delivery clamps and paper turning wheels
- H. Wipe oil and dirt off floor area under press

INFORMATION SHEET

VII. Preventive maintenance procedures for monthly cleanup

- A. Unplug the power supply
- B. Remove all safety and dust covers.
- C. Begin at the top of the press and work to the bottom of the press to remove all paper lint and dust from the total press

(CAUTION: Use an air compressor when one is available, but be sure to wear eye protection when a compressor is used.)
- D. Clean oil, ink, paper particles, and dirt from vacuum and drive motors, side frames, cams, gears, levers, shafts, cylinder ends, and all hard-to-reach areas of the press
- E. Flush press vacuum pump with a mixture of solvent and oil.
- F. Clean vacuum and air blast filters, hoses, and air passages
- G. Clean upper and lower paper pull-out rollers or forwarding rollers
- H. Clean upper and lower paper feed rollers

VIII. Lubricating procedures

(NOTE: Parts should be lubricated AFTER cleaning procedures are completed.)

- A. Unplug the power supply; never lubricate a press while it is running
- B. Use lubricants recommended by the manufacturer; do not use motor oil for machine lubrication

(NOTE: Filling a reservoir may require a quantity of lubricant, but in all other cases use lubricant sparingly because too much lubricant may cause more problems than too little lubricant.)

- C. Daily lubrication--All friction points of exposed fast turning parts; the best time is just before beginning the day's run
- D. Weekly lubrication--All friction points of all exposed moving parts
- E. Monthly lubrication

1. Should follow monthly cleanup before covers are replaced
2. Lubricate all friction points as designated by manufacturer's lubrication chart

(NOTE: The manufacturer may not list all of the areas needing lubrication so the operator should observe and lubricate all points of friction.)

3. Fill vacuum pump oil bottle to designated level

INFORMATION SHEET

IX. Daily and weekly adjustment procedures

(CAUTION: Do not make adjustments without specific permission from your instructor, then refer to operator's manual, maintenance manual, or your instructor for settings.)

- A. Student should not make adjustments until approved as an operator by the instructor
- B. Adjustments should be made as necessary to make-ready for each job order and should be made at will as needed

(NOTE: Routine operator adjustments may require the operator to square image on sheet, move image side to side, raise or lower image vertically, increase or decrease ink flow, increase or decrease water flow, feeder set-up, delivery set-up, register board set-up, air blast, vacuum, and impression cylinder pressure.)

- C. Weekly adjustments should be those necessary to troubleshoot and solve problems

X. Monthly adjustment requirements

- A. Make an ink form roller check
- B. Adjust dampener rollers to plate cylinder

(NOTE: Procedures for adjustments on various presses are outlined in Job Sheet #1.)

- C. Adjust ink form rollers to plate cylinder

(NOTE: Procedures for adjustments on various presses are outlined in Job Sheet #2.)

- D. Adjust plate cylinder to blanket cylinder

(NOTE: Procedures for adjustments on various presses are outlined in Job Sheet #3.)

- E. Adjust blanket cylinder to impression cylinder

(NOTE: Procedures for adjustments on various presses are outlined in Job Sheet #4.)

XI. Steps in making an ink form roller check

(NOTE: To assure proper ink laydown and prevent plate wear, a check should be made of the ink form roller pressure on the plate cylinder; this procedure is applicable to most situations.)

- A. Ink up the press
- B. Gently drop the ink form rollers to the plate cylinder, then lift them
- C. Turn the handwheel to bring the plate around for inspection

INFORMATION SHEET

- D. Uniform stripes of ink 1/8" to 3/16" wide indicate proper adjustment
- E. Irregular ink stripes indicate either uneven settings or worn rollers, and adjustments should be made to correct the problem

XII. Ink stripe configurations and their significance

- A. Ideal setting--Uniform ink stripe 1/8" to 3/16" wide indicates proper adjustment (Figure 1)

FIGURE 1



- B. Roller worn at ends--Caused by form roller being set too tightly to oscillator roller; correct by resetting rollers or replacing them if desired setting cannot be obtained (Figure 2)

FIGURE 2



- C. Low area in center--Indicates improper grinding or improper manufacture and should be replaced (Figure 3)

FIGURE 3



- D. Roller swollen at ends--Results from continuously setting roller too tightly and should be replaced (Figure 4)

FIGURE 4



- E. Setting uneven--Too heavy on one end and too light on the other end; adjust rollers (Figure 5)

FIGURE 5



(Figures 1 through 5 courtesy 3M Company)

INFORMATION SHEET

XIII. Requirements for a preventive maintenance schedule in chart form (Transparency 1)

A. A preventive maintenance chart should include at least three categories of work

1. Cleaning
2. Lubricating
3. Adjusting

B. Each category should have columns for listing time when work should be done

1. Daily
2. Weekly/bi-weekly
3. Monthly

C. Each maintenance activity on the chart should have a block for marking the date when maintenance was performed

D. The operator's manual and other manufacturer's guides should be referenced for lubrication and adjustments

E. The back side of the PM chart should provide space to log the date problems occur, what the problems are, and how the problems are solved

(NOTE: The PM schedule presented in TM 1 is a suggested format; in an actual working situation or in the classroom the format may have to be modified to meet the needs of specific equipment in the workplace or the school shop.)

XIV. Sequence of troubleshooting technique

A. Make no assumptions

B. Look for the simple cause and the simple solution

(NOTE: The solution may be as simple as plugging in the power cord.)

C. Identify specific symptoms of the problem

D. List the probable causes

E. List possible solutions for each cause

(NOTE: Refer to operator's or maintenance manuals.)

(CAUTION: Adjustments should be made only with the power off and with the approval of your instructor.)

INFORMATION SHEET

XV. Categories of press troubles

A. Operator

(NOTE: The majority of problems are operator caused; they occur because of lack of knowledge, neglect, or carelessness.)

B. Chemistry and ink

C. Paper stock

D. Image transfer process

E. Mechanical

XVI. Types of emulsification

A. Excess water in ink--Causes ink to pile on rollers, plate and/or blanket producing a grayed image on sheet

(NOTE: Small amounts of water mixing into ink during the run normally cause little harm.)

B. Excess ink in water--Produces overall tint in background area on the printed sheet

XVII. Technique for avoiding emulsification--Ink must be greasy but not too greasy

(NOTE: Ink with a proper greasy quality is determined by the ink vehicle, pigments, compounds, and driers; if the ink is too greasy, the nonimage area of the plate will become ink receptive.)

XVIII. Conditions creating ink drying problems

A. Relative humidity

B. Too much moisture run on the press

C. pH of fountain solution

(NOTE: As pH value drops below 4.0, drying time increases significantly until a pH of 2.0 would take approximately 4 times the drying time on a typical offset paper.)

D. Type of printing paper (absorbency)

E. pH of printing paper

(NOTE: The pH of the paper stock becomes significant when the relative humidity is high (above 60%), especially on coated stock. Inks dry normally on uncoated papers having their pH values above 4.5.)

INFORMATION SHEET

F. Lack of oxygen

(NOTE: When running heavy solids, there may not be enough oxygen between sheets on the delivery pile necessary for drying.)

G. Temperature

XIX. Common ink troubles on the press and their causes

- A. Set-off--Ink is transferred from the front surface of one sheet to the back surface of the sheet above in the delivery pile
- B. Chalking--Ink on the paper turns dry and powdery
- C. Trapping--Ink dries so that succeeding colors will not adhere properly
- D. Tinting--Emulsified ink suspended in the fountain solution on the plate surface appears as a uniform tint on the printed sheet
- E. Scumming--Plate picks up ink in the clear areas and transfers to the clear areas of the sheet
- F. Piling--Ink builds up or piles on rollers, plate, and/or blanket
- G. Picking--Ink tears away part of the paper coating as the sheet is printed; these appear as black spots in the blank areas of the printed sheet and white spots in the solid areas
- H. Misting--Ink flies into atmosphere as fine mist especially at high temperature and speed
- I. Toning--Ink adheres to nonimage area of plate because of lack of dampening and transfers to printed sheet

XX. Guidelines for evaluating good print quality (Transparency 2)

(NOTE: The following is adapted from materials published by the 3M Company.)

- A. Crisp, dark lines and solids
- B. A clean background
- C. Clean halftones, screens, and reverses
- D. Good registration
- E. Each sheet dried completely

XXI. Print quality problems and their causes

(NOTE: The following is adapted from materials published by the 3M Company.)

- A. Scumming--Background dirty because of too much ink, not enough moisture, dirty dampener roll covers, or dampener covers tied too tightly on ends (Transparency 3)

INFORMATION SHEET

- B. Gray, washed out--Not enough ink, too much moisture, wrong color of ink, incorrect dampener form roller pressure, incorrect plate-to-blanket pressure, or incorrect impression-to-blanket pressure (Transparency 4)
- C. Gray, washed out dirty background--Glazed ink rollers, glazed blanket, too much ink form roller pressure, or too much dampener form roller pressure (Transparency 5)
- D. Copy too dark--Too much ink, too much impression-to-blanket pressure, not enough plate-to-blanket pressure, or too many revolutions on blanket without paper going through causing build up on blanket (Transparency 6)
- E. Uneven printing--Incorrect ink distribution, glazed rollers, incorrect dampener form roller parallel pressure, poor paper surface, incorrect ink form roller parallel pressure, incorrect plate-to-blanket parallel pressure, incorrect impression-to-blanket parallel pressure, or dirty impression cylinder (Transparency 7)
- F. Double image (blurred copy)--Loose blanket, too much ink and fountain solution, not enough plate-to-blanket pressure, loose plate, or incorrect impression-to-blanket pressure (Transparency 8)
- G. Weak spots (spotty copy)--Incorrect plate-to-blanket pressure, incorrect impression-to-blanket pressure, low spots in blanket, tacky ink, tacky blanket, dirty impression cylinder, or blind image on plate caused by dried gum or too strong fountain solution (Transparency 9)
- H. Image breakdown during run--Too much dampening form roller pressure, too much ink form roller pressure, too much plate-to-blanket pressure, fountain solution too strong, or end play in form rollers (Transparency 10)
- I. Streaking--Incorrect ink form roller pressure, incorrect dampener form roller pressure, incorrect plate-to-blanket pressure, incorrect impression-to-blanket pressure, improper ink, or loose blanket (Transparency 11)
- J. Improper register--Loose blanket, side guides not set properly, paper not cut straight, or cam band not set (Transparency 12)
- K. No image at all--Not enough ink roller form pressure, not enough plate-to-blanket pressure, not enough impression-to-blanket pressure, too much moisture, glazed blanket, or glazed ink rolls (Transparency 13)
- L. Paper curling in receiver--Too much moisture or a curl in the paper (Transparency 14)
- M. Paper nicking on edge--Paper stop fingers too high, feed rollers not set properly, or paper hitting back stop in receiver too hard (Transparency 15)
- N. Paper missing grippers--Stop fingers incorrectly set or feed rollers out of adjustment (Transparency 16)
- O. Paper wrinkling--Too much moisture, paper damp, too much pressure between blanket and impression cylinder, or register board not set properly (Transparency 17)

INFORMATION SHEET

XXII. Troubleshooting guides for ink and dampening problems

(NOTE: The following is adapted from materials published by the 3M Company.)

PROBLEM	CAUSE	SOLUTION
INK SET-OFF IN DELIVERY PILE	Too much ink on paper	Readjust ink settings
	Too much acid in fountain solution	A low pH retards drying. Test pH of solution. If not between 3.8 and 5.5, adjust accordingly
	Wrong ink for stock	Contact ink supplier
	Not enough drier in ink	Increase drier content. Contact ink supplier for correct drier
	Paper coating of poor quality	Use paper of better quality
	Ink too stiff, causing absorption problems	Add light varnish to ink
	Delivery pile too high	Reduce lift height
	Pressman bends paper pile when removing from press	Use skid under pile and lift paper by skid load only
	Pressroom humidity high	Close windows, increase room temperature
	Running with too much water	Run with minimum ink and water
	Static in the delivery pile is attracting sheets to each other	Increase pressroom humidity. Pre-condition paper to pressroom conditions. Use a tinsel static eliminator across delivery areas so paper contacts it. Use commercial static eliminators
Not enough or improper spray powder	Increase amount of spray powder or increase the particle size of spray powder	

INFORMATION SHEET

PROBLEM	CAUSE	SOLUTION
INK CHALKING	Ink vehicle is absorbed by paper before ink has time to set properly on paper surface	Add a binding base to control absorption by paper
	Not enough drier in ink	Add drier to ink. Check with ink supplier for correct drier
	Job printed with wrong ink for stock used	Over-print with varnish
INK TRAPPING (ink does not adhere to previously printed color)	Ink dries hard before next color	Run all colors as quickly as possible without risking ink set-off
	Ink tack incorrect	Consult ink supplier
	Wrong drier used on first color down	Use different drier on first color. Consult ink supplier
TINTING/CATCH UP (ink can be wiped from plate)	Emulsified ink suspended in the fountain solution appears as a uniform tint on the printed sheet	Smear small amount of ink on glass. Place several drops of fountain concentrate on ink. Rub together with finger. If two mix readily, the ink is faulty. Wash-up and replace ink
	Alkaline or proteinous paper, causing ink emulsification	Adjust fountain pH to needs of paper. Check paper; change if necessary
	Fountain solution	If pH is above 6.0, tinting can result. Readjust pH of fountain. Allow dampeners to become completely wet before printing
	Lack of water	Set top dampener lighter than lower. Ductor not contacting pan roller firmly. Reset. Ductor roller covering compressed and dirty. Clean or replace. Adjust ductor-to-vibrator roller to a firm pressure. Clean and etch pan roller and recover if slimy and dirty. Increase dwell time of ductor roller on pan roller. Check for low spots in dampening rollers --correct. Dirty dampeners--clean

INFORMATION SHEET

PROBLEM	CAUSE	SOLUTION
TINTING/CATCH UP	Excessive ink	Reduce ink level and allow adequate time for adjust to take full effect
	Poor (weak) varnish ink	Replace with better ink
	Breakdown of pigment particles in the ink	Ink may be at fault. Notify the ink manufacturer. May need reformulated ink
	Acid getting into ink from an improperly washed-out plate	Wash up press. Replace ink. Re-process the plate
SCUMMING OR TINTING	Plate or press condition	"Wet hone" plate in problem area. If honed area continues to take ink, the problem is tinting caused by an inking problem on the press. If area stays clean it is scumming caused by plate sensitivity
SCUMMING	Sensitive plate	Desensitized
	Highly bichromated fountain solution	Check solution and re-mix if necessary
	Plate exposed to light after fountain solution allowed to dry on it	Desensitize or re-make plate
	Excessive printing pressure could indirectly cause scum	Check cylinder pressures, adjust as needed
	Paper or ink causing plate sensitivity	Check them out
	Negative plate improperly desensitized or lightstruck	Desensitize or re-make plate
	Positive plate underexposed; water on plate during developing/fixing; improperly desensitized	Re-make plate
Ink form roller setting	Check ink form roller setting to the vibrator roller and to the plate. The vibrator roller should drive the ink form roller and not the plate	

INFORMATION SHEET

PROBLEM	CAUSE	SOLUTION
SCUMMING	Fountain solution too weak or improperly mixed	Increase strength or re-mix
	Ink sensitizing plate background beyond image area	Densensitize with plate cleaner-conditioner
	Glazed offset blanket	Clean all gum, spray, paper sizing, and etc. from blanket with deglazer and pumice
	Low alcohol content	Bring to correct concentration
INK PILING ON ROLLERS	Too much water	Check to adjust all dampener settings
	Ink too short	Add longer varnish
	Coating from paper	Use another stock
TONING	Out of fountain solution	Add fountain solution
	Dampening form roller pressure too light	Increase pressure
	Too little fountain solution being run	Increase quantity
	Dampening form roller cover dirty	Clean cover. Change cover
PICKING AND HICKIES (Defects in printed image caused by dried ink, dirt or paper fibers on plate and blanket.)	Worn or cracked rollers deposit tiny particles of dry ink onto plate	Remove from press and clean thoroughly. Regrind or replace if necessary
	Lint, gum, dried ink skin, etc., in ink fountain	Use lintless dampeners. Clean inking system; use fresh ink
	Dirt or dust on paper	Fan sheets thoroughly. Wipe edges of paper load with glycerin. Vacuum load edges. Be sure slitter knife in paper cutter is sharp. Be sure stock was back-trimmed (cut with correct edge of knife). Inspect sheet cleaning equipment
	Weak paper surface.	Use ink and paper suited to each other

INFORMATION SHEET

PROBLEM	CAUSE	SOLUTION
PICKING AND HICKIES	Dirty plate	Wash plate before resuming the run. Visually check to be sure no specks or particles are still clinging to its surface
	Tacky blanket	Wash blanket. Apply sulfur powder
	High ink tack	Reduce tack slightly. Do not use more than 1/2 oz. reducer per lb. of ink. Do not allow press to stand idle too long allowing tack of ink to increase. Add varnish or lubricant to non-printing areas of rollers
	Excessive blanket to impression pressure	Decrease pressure between the blanket and impression cylinders
	High press speed	Reduce press speed
	Excess water reaching stock	Run with minimum water
	Heavy form	Run light forms first
INK MISTING (flies into atmosphere as fine mist)	Ink too soft	Add heavier varnish to ink
	Ink rollers are nicked or out-of-round	Inspect all rollers and replace defective ones
	Too much ink	Reduce ink fountain settings
	If dots appear on press parts, ink is too thin	Add mixing white and heavy varnish. Use a heavier ink
	If little ink lines appear on press parts, ink is too thick	Add thin varnish
	Ink rollers set too tightly	Re-set ink rollers
	Ink rollers too hard	Replace rollers
	Ink rollers swollen	Use a more volatile press wash. Re-set the rollers
	Ink rollers too soft	Replace the rollers

INFORMATION SHEET

PROBLEM	CAUSE	SOLUTION
INK ROLLER STRIPPING (rollers do not accept ink)	Fountain solution too acid	Test pH of solution. If it is not between 3.8 and 5.5 adjust accordingly
	Glazed form roller	Remove from press and de-glaze and pumice. Rinse thoroughly
	Too much water being run	Cut back water at fountain
	Desensitized metal vibrator rollers	Clean rollers, copperize, wash thoroughly. Then ink rollers and wash again before using

XXIII. Troubleshooting guides for paper stock problems

(NOTE: The following is adapted from materials published by the 3M Company.)

PROBLEM	CAUSE	SOLUTION
PAPER CURLING	Too much water	Run with minimum water
	Paper not properly conditioned	Condition paper to pressroom conditions
	Room humidity not constant	Install proper controls
	Heavy copy at end of form	Reverse plate if possible
	High ink tack	Reduce tack of ink with reducing varnish
	Excess blanket to impression cylinder pressure	Reduce impression setting
PAPER ROLLES INTO DELIVERY TRAY	Short grain stock	Set ejector rollers and rings. Slow press. Change to long grain
	Ejector rollers and rings not set properly	Set ejector rollers near edges of sheet with rings just outside rollers
SHEET WRINKLE (gripper edge to trailing edge)	Excess blanket to impression cylinder pressure	Reduce pressure
	Excess or uneven feed roll pressure (1250 multilith)	Reduce pressure
	Excess sheet edge moisture. Unwrapped stock left in high humidity area	Allow paper stock to adjust to room humidity. Open packages of stock and use immediately

INFORMATION SHEET

PROBLEM	CAUSE	SOLUTION
SHEET WRINKLE	Sheet not fed correctly	Check stack height, sheet guides, air blast and vacuum
SHEET LEAD EDGE CORNER FOLDED	Stack height on feeder not correct (usually too low)	Set stack height to sucker feet for weight of stock being fed
	Sheets not square on feed table	Adjust paper guides to hold sheet square to front plate
	Pullout rollers set too close to sheet edge	Move pullout rollers toward center of sheet
	Paper not square in register position	Set side register guides to hold sheet square
	Uneven feed roll pressure	Check pressure, adjust for equal pressure end to end
PAPER NICKING ON LEAD EDGE	Paper stop fingers too high	Adjust fingers to clear as feed feed roller touches paper
	Feed roller not timed correctly (contacting paper before stop fingers move)	Adjust cam to retard feed roller
	Too much feed roller pressure	Reduce roller pressure
	Paper hitting back stop in receiver too hard	Set paper bail to slow sheet travel. Make sure paper strikes back stop squarely
	Chain delivery grippers not timed correctly with impression cylinder	Set gripper opening on each chain bar, then set chain timing with cylinder

XXIV. Troubleshooting guides for process (image transfer) problems

(NOTE: The following is adapted from materials published by the 3M Company.)

PROBLEM	CAUSE	SOLUTION
PLATE INKS UP SOLID	No fountain solution	Add fountain solution
	Dampening form roller not on	Turn roller on
	Dampening form roller not adjusted properly (too little pressure)	Adjust dampening form roller
	Obstruction holding dampening form roller off plate	Remove or correct obstruction

INFORMATION SHEET

PROBLEM	CAUSE	SOLUTION
PLATE WILL NOT TAKE INK IN IMAGE AREA (blind plate)	Gum not removed from plate surface	Remove gum
	Ink form rollers not on	Turn rollers on
	Incorrect ink form roller pressure	Set rollers to correct pressure
	Too much acid in fountain solution	Keep pH factor between 3.8 and 5.5 (prevents gum from desensitizing plate image)
	Emulsified ink (ink loses its ability to protect image from gum arabic. Often accompanied by roller stripping and/or washed out copy)	Change to better ink, clean rubber rollers, raise pH of fountain, clean metal rollers if stripping
	Too much gum arabic in fountain solution	Gum content should be kept at one ounce or less per gallon of fountain solution
	Detergent in water, sponge, dampeners or ductor reaching plate image	Thoroughly rinse ductor and dampener rollers with one ounce fountain concentrate to a gallon of water before installing on press
	Plate cleaners or scratch removers dried on plate image	Always rinse plate thoroughly immediately after application
PLATE WON'T RUN CLEAN	Ink lacking tack will not adhere to image	Consult ink supplier
	Plate surface oxidized	Clean with scratch remover. Make new plate
	Too much ink	Reduce amount of ink on rollers
	Contaminated fountain solution	Make fresh fountain solution
	Incorrect dampening form roller pressure	Adjust roller pressure
Out-of-date plate or contaminated plate	Make new plate. Open new box of plates	

INFORMATION SHEET

PROBLEM	CAUSE	SOLUTION
PLATE WON'T RUN CLEAN	Bad negative causing background area exposure on plate	Opaque negative, remake negative, make new plate
	Emulsified ink on form rollers	Wash press and reink rollers
PRINTED IMAGE HAS OVERALL FADED APPEARANCE	Plate image blinding (too much acid in fountain solution)	Mix fresh fountain solution
	Too much fountain solution being run	Reduce quantity
	Too little ink being run	Increase ink feed
	Emulsified ink on form rollers	Wash ink system, reink rollers
	Glazed ink rollers	Deglaze, reink
	Glazed blanket	Deglaze blanket
	Ink form roller pressure incorrect (too light)	Set correct pressure--increase
	Dampening form roller pressure incorrect (too heavy)	Set correct pressure--decrease
	Plate to blanket cylinder pressure too light	Increase pressure
	Blanket to impression cylinder pressure too light	Increase pressure
WEAK OR OPEN AREAS IN PRINTED IMAGE	Plate worn	Redevelop plate. Make new plate
	Plate to blanket cylinder pressure too light	Increase pressure
	Blanket to impression cylinder pressure too light	Increase pressure
	Damaged blanket	Apply blanket fix to swell area. Remove blanket and roll out damaged area. Change blanket

INFORMATION SHEET

PROBLEM	CAUSE	SOLUTION
WEAK OR OPEN AREAS IN PRINTED IMAGE	Paper particle buildup on blanket	Clean blanket with blanket wash and water miscible cleaner
	Irregular stock surface	Increase blanket to impression cylinder pressure. Change stock
DOUBLE IMAGE (GHOST IMAGE) ON PRINTED SHEET	Loose plate	Tighten plate tail clamp
	Loose blanket	Tighten blanket (be careful to tighten evenly)
	Too much plate to blanket cylinder pressure	Decrease pressure
	Too much blanket to impression cylinder pressure	Decrease pressure

XXV. Troubleshooting guides for mechanical problems

(NOTE: The following is adapted from materials published by the 3M Company.)

PROBLEM	CAUSE	SOLUTION
PRESS WON'T TURN ON	Disconnected from power source	Plug in cord. Replace fuse. Repair connection
	Power switch not operative	Reattach loose wires. Repair or replace switch
PAPER WILL NOT FEED	Vacuum pump not on	Turn switch on. Repair loose or broken wires. Replace switch
	No vacuum or air blast (pump drive motor on)	Check pump drive belt (replace if broken)
	No vacuum or air blast at feeder (pump is on)	Repair or replace broken or leaking hose. Loosen sticking pump vanes (flush with mixture of oil and solvent)
	Feeder lever not operative	Replace loose or broken spring. Tighten loose screws
	Paper stack too high or too low	Check feed table release. Set stack height for stock being fed. Correct stack height feelers

INFORMATION SHEET

PROBLEM	CAUSE	SOLUTION
PAPER WILL NOT FEED	Paper guides too tight	Set guides to touch sheet edges but not bind
	Sucker feet worn	Replace rubber feet
	Sucker tubes open	Close off tubes not in use
PAPER SKIP FEEDS	Stack height not correct	Set stack height for stock being fed
	Paper guides too tight	Set guides to touch edges of sheet but not bind
	Paper weight too far forward for stock being fed (A. B. Dick)	Move weight back
	Air blast setting not correct	Increase air blast
	Vacuum setting not correct	Increase Vacuum
	Sucker tubes not in use open	Cover tubes not in use
	Heavy paper stock	Increase vacuum. Increase air blast. Loosen trailing edge paper guide
	Paper edges sticking together (dull cutter blade)	Remove stock, fan on all four sides. Restack on feeder
FEEDING TWO OR MORE SHEETS	Stack height not correct	Set stack height for stock being fed
	Too much air blast	Decrease air blast
	Too much vacuum	Decrease vacuum
	Paper weight too far back (A. B. Dick)	Move weight forward
	Paper guides loose (especially trailing edge guide)	Set guides to touch sheet edges but not bind
	Sheet separators bent out of shape	Reshape separators

100

INFORMATION SHEET

PROBLEM	CAUSE	SOLUTION
FEED TABLE WILL NOT LIFT	Lowering release latch not reset	Reset latch
	Stack height control setting incorrect	Set for stock being fed
	Lift adjustment incorrect	Set lift mechanism to engage lift gear
	Obstruction blocking lift mechanism	Locate and remove obstruction

101

Suggested Preventive Maintenance Chart

Preventive Maintenance Schedule																																			
Equipment																																			
Activity	Daily	Weekly/Bi-weekly	Monthly																																
<p>CLEAN Date Performed M T W T H F</p> <table border="1" style="width: 100%; height: 40px;"> <tr><td> </td><td> </td><td> </td><td> </td><td> </td><td> </td></tr> <tr><td> </td><td> </td><td> </td><td> </td><td> </td><td> </td></tr> <tr><td> </td><td> </td><td> </td><td> </td><td> </td><td> </td></tr> <tr><td> </td><td> </td><td> </td><td> </td><td> </td><td> </td></tr> </table>																									<p>Clean ink, oil, lint, and dust from all exposed surfaces of press and work area</p>	<p>Clean total press including side frame surfaces, work area, and floor under press</p> <p style="text-align: right;">Date <table border="1" style="display: inline-table; width: 40px; height: 20px;"><tr><td> </td><td> </td></tr><tr><td> </td><td> </td></tr></table></p>					<p>Remove press side covers, clean oil, grease, lint, and dust from all surfaces; deglaze rollers and blanket</p> <p style="text-align: right;">Date <table border="1" style="display: inline-table; width: 40px; height: 20px;"><tr><td> </td><td> </td></tr><tr><td> </td><td> </td></tr></table></p>				
<p>LUBRICATE Date Performed M T W T H F</p> <table border="1" style="width: 100%; height: 40px;"> <tr><td> </td><td> </td><td> </td><td> </td><td> </td><td> </td></tr> <tr><td> </td><td> </td><td> </td><td> </td><td> </td><td> </td></tr> <tr><td> </td><td> </td><td> </td><td> </td><td> </td><td> </td></tr> <tr><td> </td><td> </td><td> </td><td> </td><td> </td><td> </td></tr> </table>																									<p>Oil friction points of fast moving parts (List points)</p>	<p>Oil friction points of all exposed moving parts (List points)</p> <p style="text-align: right;">Date <table border="1" style="display: inline-table; width: 40px; height: 20px;"><tr><td> </td><td> </td></tr><tr><td> </td><td> </td></tr></table></p>					<p>Remove side covers; oil and/or grease all friction points (List points)</p> <p style="text-align: right;">Date <table border="1" style="display: inline-table; width: 40px; height: 20px;"><tr><td> </td><td> </td></tr><tr><td> </td><td> </td></tr></table></p>				
<p>ADJUST Date Performed M T W T H F</p> <table border="1" style="width: 100%; height: 40px;"> <tr><td> </td><td> </td><td> </td><td> </td><td> </td><td> </td></tr> <tr><td> </td><td> </td><td> </td><td> </td><td> </td><td> </td></tr> <tr><td> </td><td> </td><td> </td><td> </td><td> </td><td> </td></tr> <tr><td> </td><td> </td><td> </td><td> </td><td> </td><td> </td></tr> </table>																									<p>Make adjustments as required for jobs being printed</p>	<p>Make adjustments as required to solve problems</p> <p style="text-align: right;">Date <table border="1" style="display: inline-table; width: 40px; height: 20px;"><tr><td> </td><td> </td></tr><tr><td> </td><td> </td></tr></table></p>					<p>Check and adjust as required all operator controllable settings; form roller parallel, form roller pressure, all cylinders parallel, all cylinders pressure</p> <p style="text-align: right;">Date <table border="1" style="display: inline-table; width: 40px; height: 20px;"><tr><td> </td><td> </td></tr><tr><td> </td><td> </td></tr></table></p>				
Operator's guide or manufacturer's guide(s) to use for determining proper lubrication and adjustments _____																																			
(Back Side of Chart)																																			
Date	Problem	Solution																																	

Guidelines for Evaluating Good Print Quality



Crisp, dark lines and solids • A clean background • Clean halftones, screens and reverses • Good registration • Each sheet dried completely

Scumming



Too much ink • Not enough moisture • Dirty dampener roll covers •
Dampener covers tied too tightly on ends

105

Gray, Washed Out



Not enough ink • Too much moisture • Wrong color of ink • Incorrect dampener form roller pressure • Incorrect plate-to-blanket pressure • Incorrect impression-to-blanket pressure•

197

198

Gray, Washed Out Dirty Background

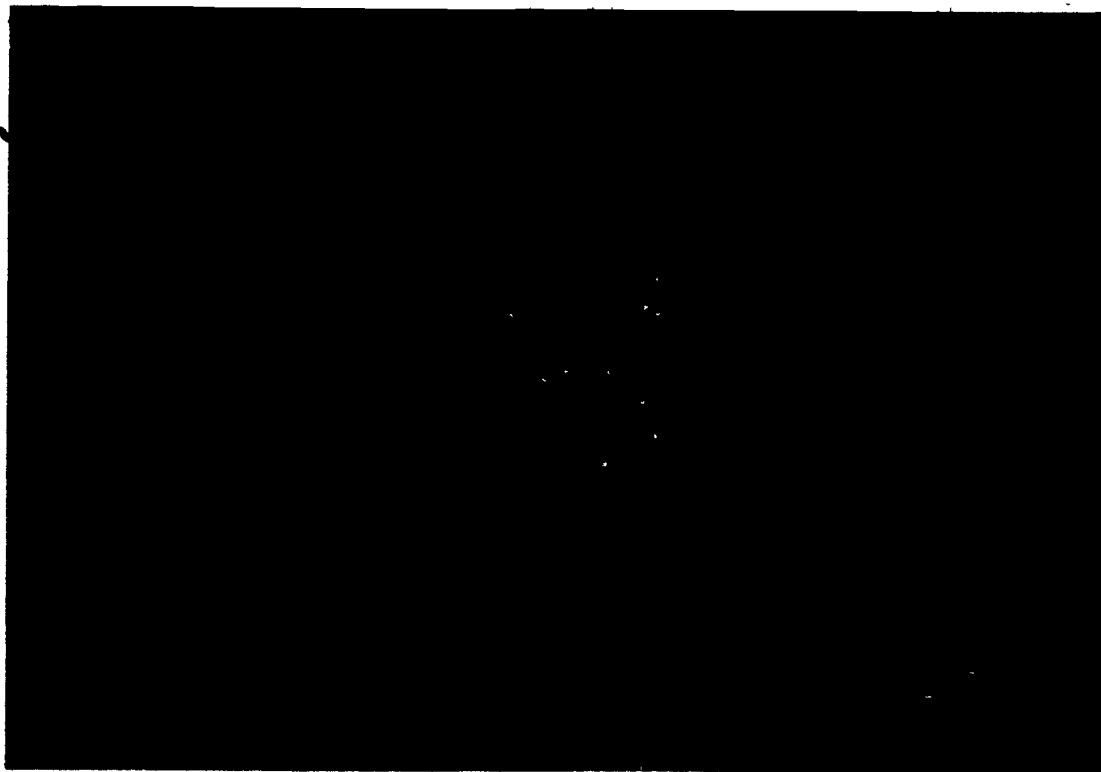

Glazed ink rollers • Glazed blanket • Too much ink form roller pressure • Too much dampener form roller pressure•

199

170

Copy Too Dark

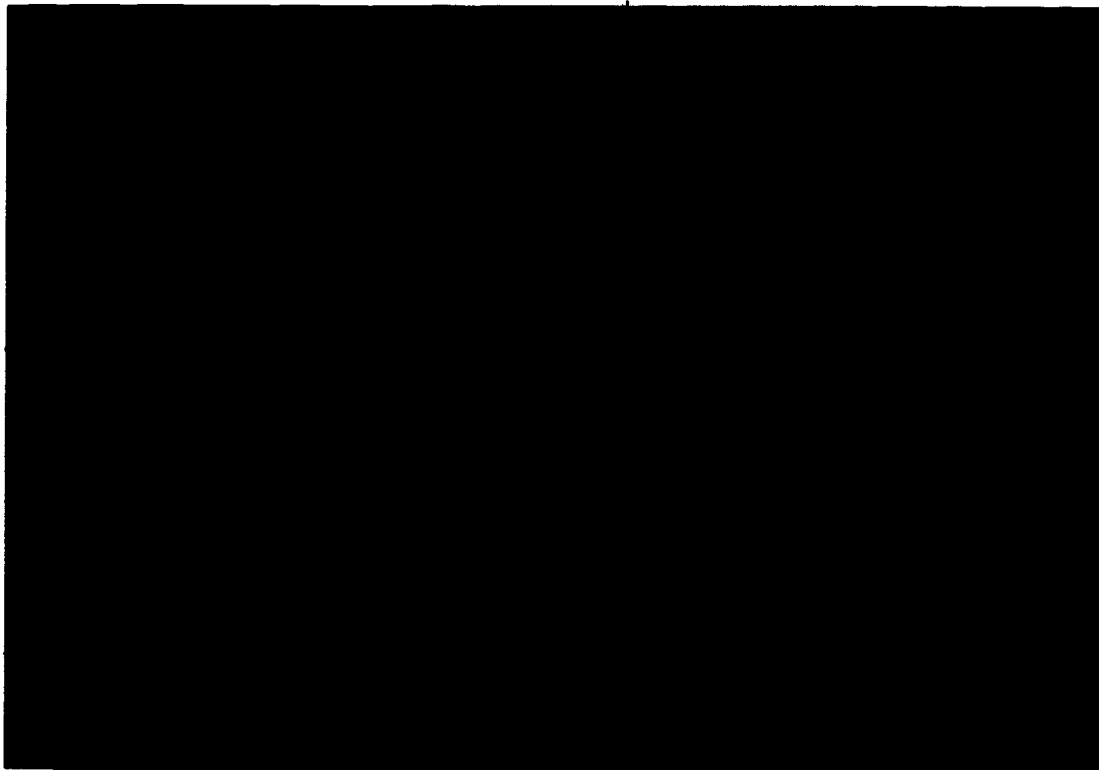

Too much ink • Too much impression-to-blanket pressure • Not enough plate-to-blanket pressure • Too many revolutions on blanket without paper going through (build up on blanket)•

171

172

Uneven Printing



Incorrect ink distribution • Glazed rollers • Incorrect dampener form roller parallel pressure • Poor paper (surface of paper) • Incorrect ink form roller parallel pressure • Incorrect plate-to-blanket parallel pressure • Incorrect impression-to-blanket parallel pressure • Dirty impression cylinders

173

174

Double Image or Blurred Copy



Loose Blanket • Too much ink and fountain solution • Not enough plate-to-blanket pressure • Loose plate • Incorrect impression-to-blanket pressure•

TM

ERIC
Full Text Provided by ERIC

Weak Spots or Spotty Copy



Incorrect plate-to-blanket pressure • Incorrect impression-to-blanket pressure • Low spots in blanket • Tacky ink • Tacky blanket • Dirty impression cylinder • "Blind" image on plate caused by dried gum or too strong fountain solution

TM

177

ERIC
Full Text Provided by ERIC

178

Image Breakdown During Run



Too much dampener form roller pressure • Too much ink form roller pressure • Too much plate-to-blanket pressure • Fountain solution too strong • End play in form roller

Streaking



Incorrect ink form roller pressure • Incorrect dampener form roller pressure •
Incorrect plate-to-blanket pressure • Improper ink • Loose blanket •

191

192

Improper Register



Loose blanket • Side guides not set properly • Paper not cut straight • Cam band not set

193

194

No Image At All

Not enough ink roller form pressure • Not enough plate-to-blanket pressure • Not enough impression-to-blanket pressure • Too much moisture • Glazed blanket • Glazed ink rolls•

195

196

Paper Curling in Receiver



Too much moisture • Curl in paper•

197

199

TM

Paper Nicking on Edge



Paper stop fingers too high • Feed rollers not set properly • Paper hitting back stop in receiver too hard

199

199

Paper Missing Grippers



Stop fingers incorrectly set • Feed rollers out of adjustment•

191

192

Paper Wrinkling



Too much moisture • Paper damp • Too much pressure between blanket and impression cylinder • Register board not set properly•

TM

193

ERIC
Full Text Provided by ERIC

194

GIII - 203-A

PREVENTIVE MAINTENANCE AND TROUBLESHOOTING
UNIT V

ASSIGNMENT SHEET #1--DETERMINE LUBRICATION REQUIREMENTS
FOR A SPECIFIC PRESS

Directions: Your instructor will provide you with a manufacturer's manual and a lubrication chart for a specific press; from this information, and with your instructor's guidance, complete the following information:

- A. List daily lubrication points
- B. List weekly/bi-weekly lubrication points
- C. List monthly lubrication points

(NOTE: Retain your list for use in completing Assignment Sheet #2.)

PREVENTIVE MAINTENANCE AND TROUBLESHOOTING
UNIT V

ASSIGNMENT SHEET #2--SET UP A PREVENTIVE MAINTENANCE
SCHEDULE IN CHART FORM

Directions: Use the suggested format in TM 1 as a guideline and set up a preventive maintenance schedule in chart form for a specific piece of equipment as selected by your instructor and a specific list of items to be checked as assigned by your instructor; information obtained for Assignment Sheet #1 may be used if your instructor so directs.

PREVENTIVE MAINTENANCE AND TROUBLESHOOTING
UNIT V

JOB SHEET #1--ADJUST DAMPENER ROLLERS TO PLATE CYLINDER

- I. Tools and equipment
 - A. 1-inch wide strips of 20-lb bond paper or two .005 3M dampening gauges
 - B. Screwdriver
 - C. Allen wrench, if required
 - D. Box end wrench or adjustable wrench
 - E. Adjustment wrench, if required
 - F. Operator and/or maintenance manual for selected duplicator
- II. Procedure (Figure 1)

FIGURE 1

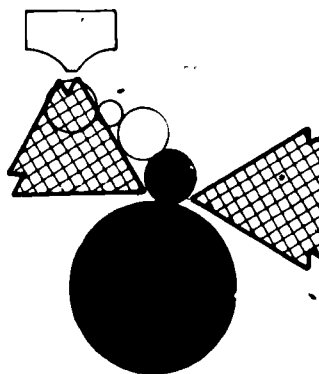

(NOTE: It is important to have equal pressure at all points between the dampening roller and the plate cylinder; depending on the duplicator or duplicators available, your instructor may direct you to complete all or some of the procedures outlined or use the procedures as guidelines for a selected duplicator; these procedures are adapted from materials published by the 3M Company.)

- A. Mount a plate on the plate cylinder
- B. Place two 1-inch wide strips of 20-lb bond paper or two .005 3M dampening gauges between the roller and the plate
- C. Put the roller in the ON position and slowly pull on the strips
- D. Determine if the pull on the strips is uneven; this means the roller is not parallel with the plate cylinder
- E. Determine if the pull on the strips is too heavy or too easy; this means the overall pressure between the roller and plate cylinder must be adjusted

JOB SHEET #1

- F. Adjust the dampener rollers on an ATF Chief 15 with the following procedure (Figure 2):
1. Loosen locking nut (a)
 2. Turn the dampener form roller adjusting screw (b) clockwise if the test strip is too tight or counterclockwise if too loose
 3. Tighten locking nut (a)
 4. Repeat the paper test to make sure that the proper amount of adjustment has been made

FIGURE 2

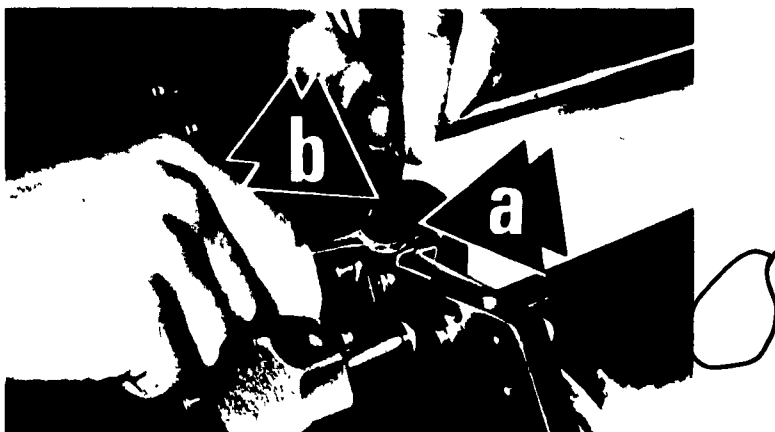

- G. Adjust the dampener rollers on a Davidson Dualith 500 with the following procedure (Figure 3):
1. Loosen lock nuts (a)
 2. Turn screws (b) counterclockwise until the bottom of the screws do not touch the round metal backing stud directly under the dampening form roll brackets
 3. Loosen lock nuts (c)
 4. Turn the adjusting screws (d) until the springs (e) exert an even pressure slightly more than is normally needed for running

JOB SHEET #1

5. Tighten lock nuts (c)

(NOTE: Adjust dampening form roller to metal vibrator roller before adjusting to plate.)

FIGURE 3

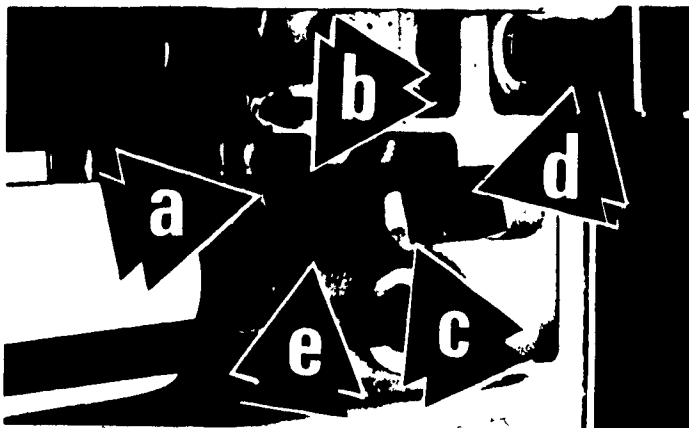

H. Adjust the dampener rollers on an Addressograph-Multilith 1250 with the following procedure (Figure 4):

1. Loosen set screw (a) in the form roller knob
2. Take a screwdriver and turn eccentric shaft (b) counterclockwise until a fairly strong pull can be felt on the strips as they are withdrawn
3. Tighten set screw (a) to lock the adjustment

FIGURE 4

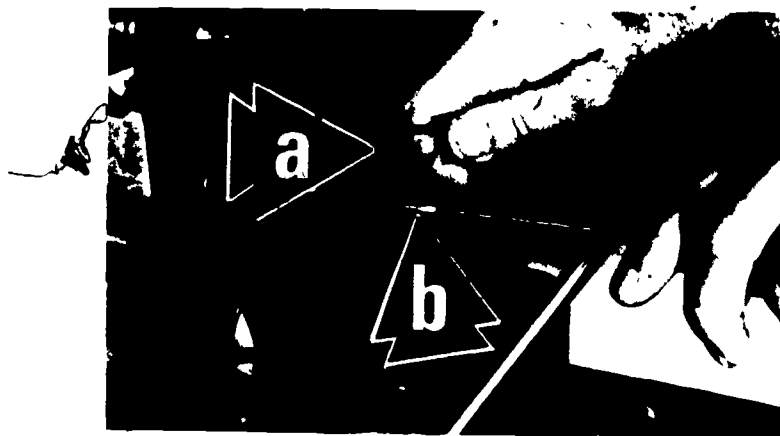

JOB SHEET #1

- I. Adjust the gap between the aquamatic oscillator and the aquamatic ductor roller on an AB Dick 360 only under the careful guidance of your instructor or watch the procedure as it is performed by an A. B. Dick service representative (Figure 5)

FIGURE 5

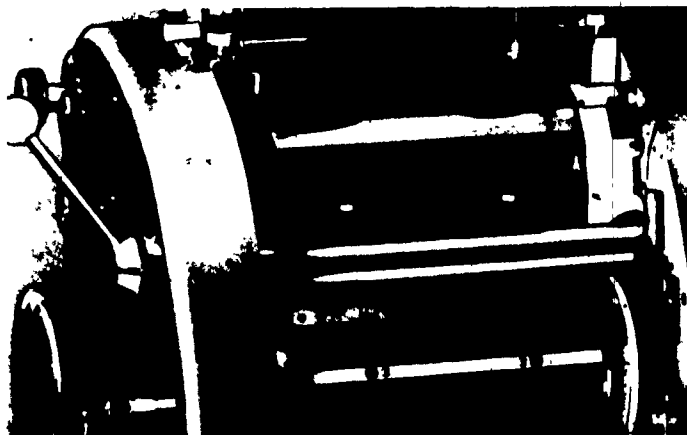

PREVENTIVE MAINTENANCE AND TROUBLESHOOTING
UNIT V

JOB SHEET #2--ADJUST INK FORM ROLLERS TO PLATE CYLINDER

- I. Tools and equipment
 - A. Screwdriver
 - B. Allen wrench, if required
 - C. Box end wrench or adjustable wrench
 - D. Adjustment wrench, if required
 - E. Operator and/or maintenance manual for selected duplicator
- II. Procedure (Figure 1)

FIGURE 1

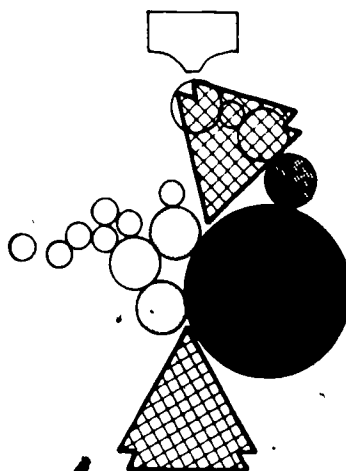

(NOTE: A properly adjusted machine is indicated when an ink roller check gives uniform parallel stripes of ink; irregular stripes indicate either uneven settings or worn rollers; depending on the duplicator or duplicators available, your instructor may direct you to complete all or some of the following procedures or use the procedures as guidelines for a selected duplicator; these procedures are adapted from materials published by the 3M Company.)

- A. Adjust the ink form rollers on a ATF Chief 15 with the following procedures (Figure 2):
 1. Loosen ink form roller lock screw (a) on the side requiring adjustment

JOB SHEET #2

2. Turn the ink form roller adjusting screw (b) clockwise to decrease the width of the stripe or counterclockwise to increase the width of the stripe

(NOTE: Make adjustment on operator's and nonoperator's sides of machine.)

3. Tighten lock screw

FIGURE 2

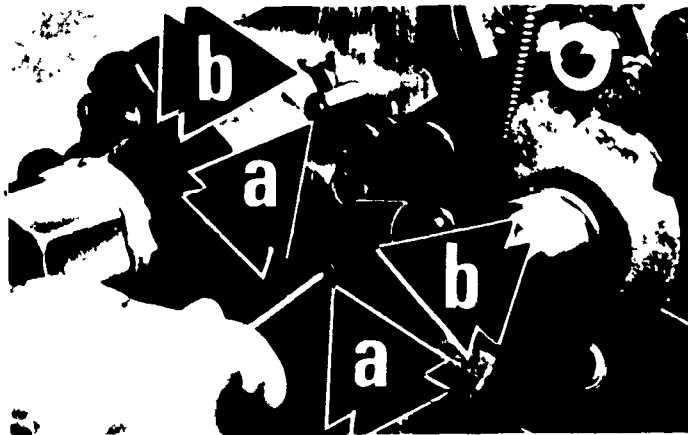

- B. Adjust the ink form rollers on a Davidson Dualith 500 with the following procedures (Figure 3):

1. Loosen lock nuts (a) in the form roll brackets
2. Turn the adjusting screw (b) clockwise to decrease pressure and counterclockwise to increase pressure

(NOTE: Make adjustment on operator's and nonoperator's side of machine.)

3. Tighten the lock nuts (a)

JOB SHEET #2

4. Recheck the pressure until both form roll stripes are exactly 1/8" wide

(NOTE: Adjust ink form roller to vibrator roller before adjusting to plate.)

FIGURE 3

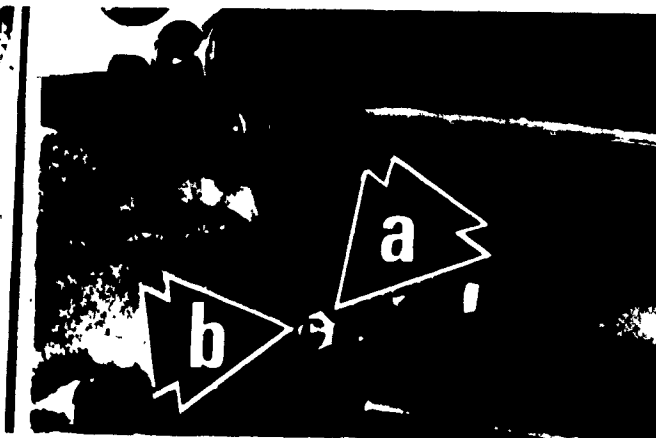

- C. Adjust the ink form rollers on an Addressograph-Multilith 1250 with the following procedure (Figure 4):
 1. Loosen set screw (a) in the form roller knob
 2. Take a screwdriver and turn the eccentric shaft (b) counterclockwise to increase width of the stripe or clockwise to decrease the width of the stripe (should be 1/8" to 3/16")
 3. Tighten set screw (a) to lock the adjustment
 4. If ink stripe is uneven make parallel adjustment on nonoperator side of machine; refer to operation manual or check with instructor

FIGURE 4

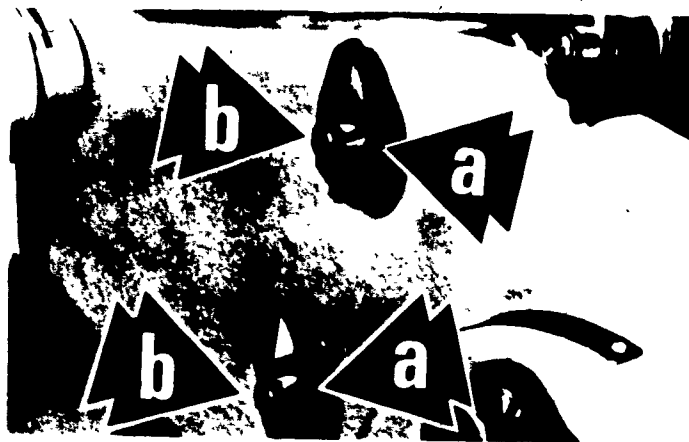

JOB SHEET #2

D. Adjust the ink form rollers on an AB Dick 360 with the following procedures (Figure 5)

1. Loosen lock screws (a) both sides and adjust screws (b) as necessary
2. Upper ink form roller ink stripe should be $1/8$ " wide
 - a) Turn screw (b) on operator side of machine in clockwise direction to increase width of stripe
 - b) Turn screw (b) on the nonoperator side of the machine in a counterclockwise direction to increase width of stripe
3. Lower ink form roller ink stripe should be $5/32$ " wide
 - a) If lower roller is same size as upper roller adjust same as 2.a) and b)
 - b) If lower roller is larger than upper roller
 - 1) Turn screw (b) counterclockwise on operator side of the machine to increase width of stripe
 - 2) Turn screw (b) clockwise on nonoperator side of the machine to increase width of stripe
4. Tighten lock screws

FIGURE 5

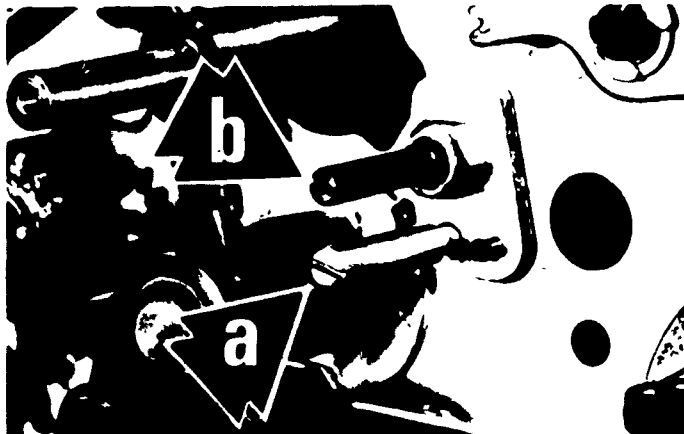

PREVENTIVE MAINTENANCE AND TROUBLESHOOTING
UNIT V

JOB SHEET #3-ADJUST PLATE CYLINDER TO BLANKET CYLINDER

- I. Tools and equipment
 - A. Screwdriver
 - B. Allen wrench, if required
 - C. Adjustment wrench, if required
 - D. Operator and/or maintenance manual for selected duplicator

- ii. Procedure (Figure 1)

FIGURE 1

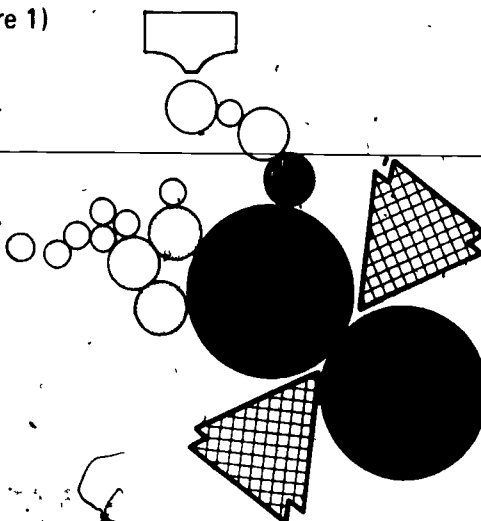

(NOTE: Some of the basic procedures for adjusting plate cylinder to blanket cylinder are common to several duplicators; depending on the duplicator or duplicators available, your instructor may direct you to complete all or some of the following procedures or use the procedures as guidelines for a selected duplicator; these procedures are adapted from materials published by the 3M Company.)

- A. Perform ink stripe checks
- B. Complete adjustments as required
- C. Turn the duplicator on and ink up the rest of the plate
- D. Check to make sure the entire plate is covered, not just the image area; this would not give a proper plate-to-blanket check
- E. Do not turn on the dampener rollers
- F. Turn the duplicator off and then gently lower the plate cylinder to the blanket and raise it immediately

JOB SHEET #3

- G. Rotate the blanket cylinder by the handwheel and inspect the ink stripe (should be 1/8" guide)

(NOTE: The ink stripe should be uniform in width; if it is not, refer to operator manual or maintenance manual for cylinder parallel adjustment or ask instructor to assist.)

- H. Adjust the plate cylinder on an ATF Chief 15 with the following procedure (Figure 2):

1. Loosen the locking screw (a)
2. Turn the plate-to-blanket impression adjusting screw (b) clockwise to increase the width of the stripe or counterclockwise to decrease the width
3. Tighten locking screw (a)

FIGURE 2

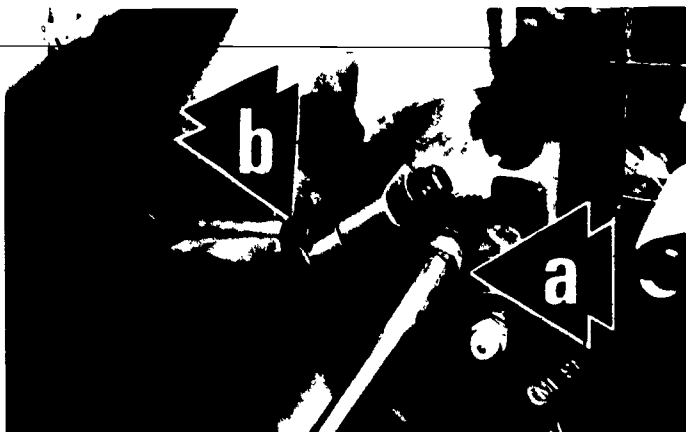

- I. Adjust the plate cylinder on a Davidson Dualith 500 with the following procedure (Figure 3):

1. Loosen the two allen screws (a) in the blanket latch
2. Loosen lock nut (b)
3. Turn the hex-headed screw (c) clockwise to increase pressure and counterclockwise to decrease pressure
4. Tighten the lock nut (b) and the two allen screws (a)

JOB SHEET #3

5. Recheck for correct pressure

FIGURE 3

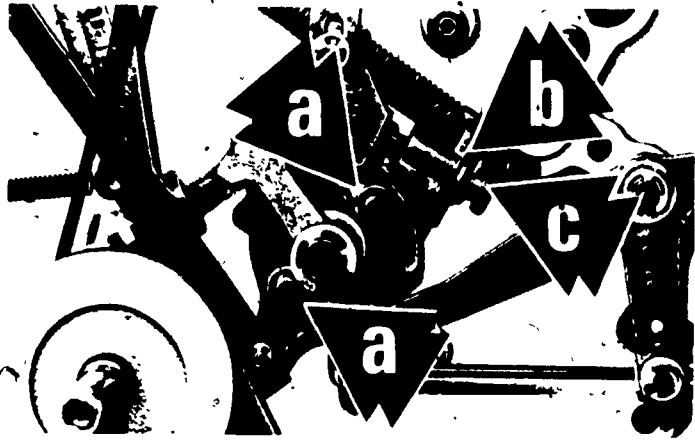

- J. Adjust the plate cylinder on an Addressograph-Multilith 1250 with the following procedure (Figure 4):

1. Loosen lock bolt (a)
2. Move single lever control (b) to left to increase pressure or to the right to decrease pressure
3. Tighten lock bolt (a)

FIGURE 4

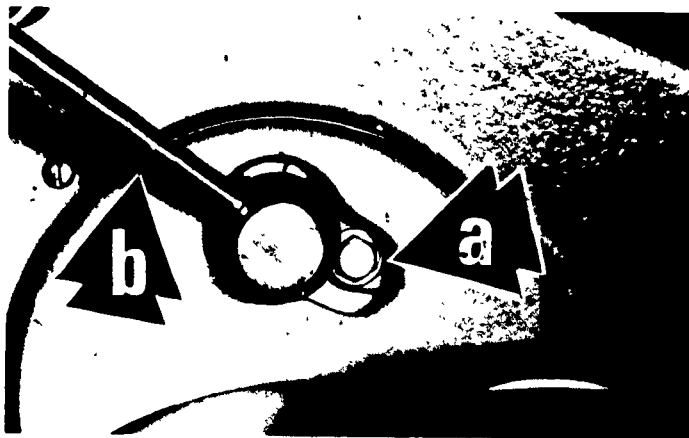

JOB SHEET #3

- K. Adjust the plate cylinder on a AB Dick 360 only under the careful guidance of your instructor or watch the procedure as it is performed by an AB Dick service representative (Figure 5):

FIGURE 5



PREVENTIVE MAINTENANCE AND TROUBLESHOOTING
UNIT V

JOB SHEET #4--ADJUST BLANKET CYLINDER TO IMPRESSION CYLINDER

- I. Tools and equipment
 - A. Screwdriver
 - B. Allen wrench, if required
 - C. Adjustment wrench, if required
 - D. Operator and/or maintenance manual for selected duplicator
- II. Procedure (Figure 1)

FIGURE 1

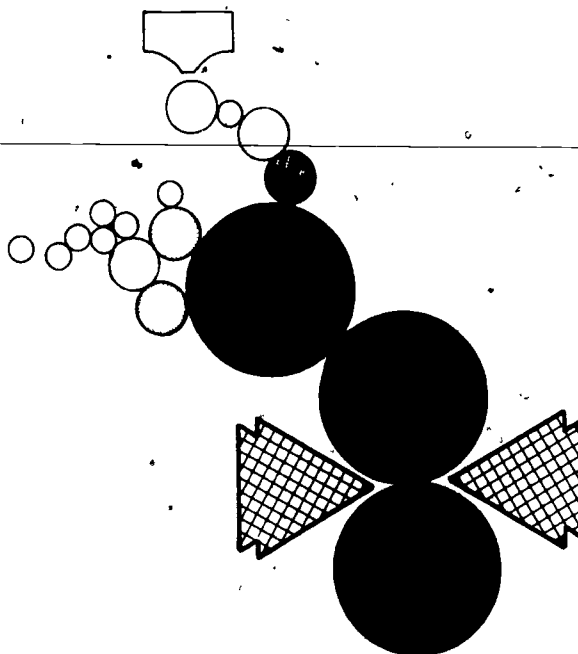

(NOTE: Improper blanket cylinder-to-impression cylinder pressure may result in damaged blankets and poor quality copy, and running heavier than normal stock also requires blanket cylinder-to-impression cylinder adjustment; depending on the duplicator or duplicators available, your instructor may direct you to complete some or all of the following procedures or use the procedures as guidelines for a selected duplicator; these procedures are adapted from materials published by the 3M Company.)

- A. Adjust the blanket cylinder on an ATF Chief 15 with the following procedure (Figure 2):
 - I. Loosen locking screw (a)

JOB SHEET #4

2. Turn the impression adjusting screw (b) toward you until the print obtained is very light
3. Turn the adjusting screw (b) back, away from you, until the desired impression on the paper is obtained
4. Tighten locking screw (a)

FIGURE 2

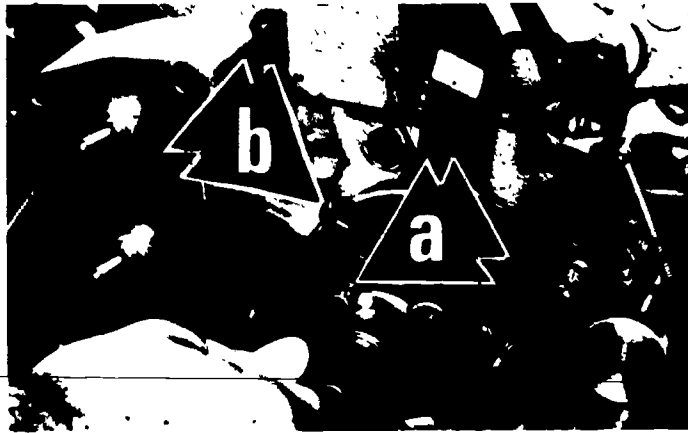

- B. Adjust the blanket cylinder on a Davidson Dualith 500 with the following procedure (Figure 3):
1. Underpack the impression segment with packing sheets under the metal drawsheet
 2. Refer to operator and/or maintenance manual for specific adjustment requirements or ask your instructor to demonstrate the proper procedure

FIGURE 3

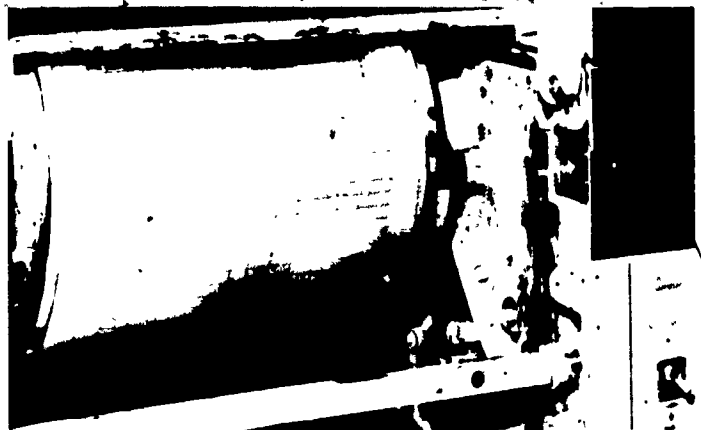

JOB SHEET #4

- C. Adjust the blanket cylinder on an Addressograph-Multilith 1250 with the following procedure (Figure 4):
1. Loosen clamp screw (a)
 2. Turn micrometer adjusting screw (b) clockwise to decrease pressure and counterclockwise to increase pressure
 3. Tighten clamp screw

FIGURE 4

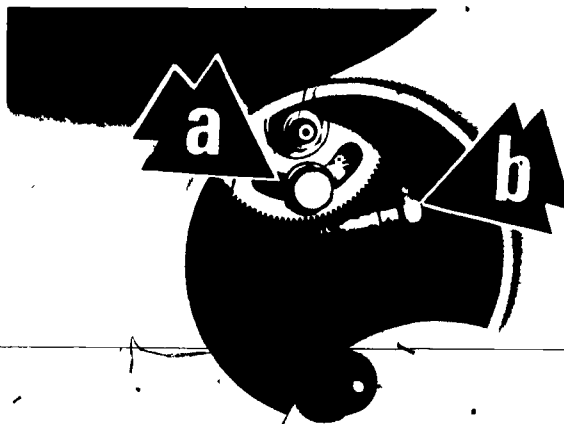

- D. Adjust the blanket cylinder on an AB Dick 360 with the following procedure (Figure 5):
1. Insert allen wrench into the control dial opening
 2. Turn the dial to the lower numbers to increase pressure and to the higher numbers to decrease pressure

FIGURE 5



PREVENTIVE MAINTENANCE AND TROUBLESHOOTING
UNIT V

JOB SHEET #5--CHANGE A MOLLETON COVER

- I. Tools and equipment
 - A. New molleton cover
 - B. Installation sleeve
 - C. Talcum or blanket powder
 - D. Blanket wash
 - E. Roller conditioner-cleaner
 - F. Paper as required
- II. Procedure
 - A. Remove roller from press.
 - B. Split cover for easy removal from roller
(CAUTION: Do not cut roller surface.)
 - C. Clean surface thoroughly with blanket wash and with water and roller conditioner-cleaner to remove all ink and gum
 - D. Complete the change according to one of the following procedures:
 1. If installation sleeve is available
 - a) Slide cover over sleeve
 - b) Insert roller inside sleeve
 - c) Hold end of cover on end of roller as sleeve is removed
 2. If no installation sleeve is available
 - a) Coat roller with blanket or talcum powder
 - b) Prepare a piece of paper 1 1/2 times the length of the roller and wide enough to wrap around the roller two times
 - c) Coat the paper with blanket or talcum powder
 - d) Wrap the paper loosely around the roller, leaving 1/3 the length of the roller exposed
 - e) Slide the cover over the rolled paper onto the roller until the cover just overlaps the exposed end of the roller

JOB SHEET #5

- f) Grasp the cover and roller on the exposed end and pull the rolled paper from between the cover and roller
- E. Secure cover by pulling draw strings to overlap cover ends over roller ends
- F. Soak new cover with fountain solution
- G. Remove excess moisture from cover by rolling with open palms on top of paper towels on a flat surface

PREVENTIVE MAINTENANCE AND TROUBLESHOOTING
UNIT V

JOB SHEET #6-DEGREASE PLATE AND IMPRESSION CYLINDERS

I. Tools and equipment

- A. Chrome cylinder cleaner
- B. Degreaser
- C. Clean cotton pads
- D. Plate etch

II. Procedure

- A. Wipe the entire surface of the cylinder being cleaned with chrome cylinder cleaner or degreaser, using a saturated cotton pad
- B. Apply three coats to the cylinder and rub each coat vigorously
- C. Wash chrome cylinder cleaner or degreaser off, using a clean cotton pad saturated with water
- D. Wipe dry
- E. Wipe the entire surface of the cylinder with a clean cotton pad saturated with etch
- F. Remove excess etch with a clean, dry cotton pad

(CAUTION: Cleaners may cause skin irritation; avoid prolonged skin contact and wash hands with soap and a generous quantity of water after using a cleaner.)

PREVENTIVE MAINTENANCE AND TROUBLESHOOTING
UNIT V

JOB SHEET #7--DEGLAZE INK ROLLERS AND BLANKET

I. Tools and equipment

- A. Deglazer
- B. Blanket powder
- C. Roller conditioner-cleaner
- D. Water miscible cleaner
- E. Shop towels

II. Procedure

(CAUTION: Keep deglazer and roller conditioner-cleaner away from heat or open flame because they are highly flammable; these solvents can also cause skin irritation, so after using them wash hands immediately with soap and a generous quantity of water.)

- A. Apply deglazer on both surfaces to be cleaned; be sure to use only a deglazer recommended by manufacturer or supplier
- B. Follow deglazer with an ink roller conditioner to clean water soluble particles from rollers and blanket as recommended by manufacturer or supplier
- C. Clean rollers with roller cleaner and blanket wash to remove active ingredients in the deglazer
- D. Apply blanket powder to the blanket surface, and if an abrasive cleaner is applied
 - 1. Use a soapy cleaner such as Ajax or Comet with water
 - 2. Thoroughly rinse the rollers with water until all traces of the cleaner are gone

(NOTE: To get maximum life from blankets, it is recommended that they be rotated each week, conditioned with blanket powder, and allowed to rest a week before being put back in service; when repeated cleaning of the blanket is necessary, changing the blanket daily is recommended; blankets on or off the cylinder should be kept away from heat and sunlight, and when they are stored, it should be in a dark, cool place out of direct sunlight and protected from dirt and damage.)

PREVENTIVE MAINTENANCE AND TROUBLESHOOTING
UNIT V

JOB SHEET #8-CHANGE BLANKET

- I. Tools and equipment
 - A. Allen wrench or specific tool recommended by manufacturer
 - B. New or spare blanket
 - C. Cleaner
 - D. Deglazer
 - E. Blanket powder
 - F. Shop towels
 - G. Cotton pads
- II. Procedure
 - A. Unplug power supply to the press
 - B. Clean blanket thoroughly using a standard deglazing procedure
 - C. Remove blanket from cylinder by releasing blanket clamps
 - D. Clean blanket cylinder surface and clamps
 - E. Remove bars, if blanket is attached to cylinder by bars
 - F. Clean bars and attach them to the new blanket
 - G. Wipe surface of old blanket dry
 - H. Apply a liberal quantity of blanket powder to a cotton pad and gently pat the entire surface of the old blanket, adding additional blanket powder to the cotton pad as required
 - I. Rub the powder gently into the entire blanket surface
 - J. Make sure the backing is clean and dry, then roll the old blanket with the rubber side in

(NOTE: Placing a sheet of plain, clean paper over the rubber before rolling will further protect the blanket surface.)
 - K. Place old blanket in its original carton so that when stored it will be in a horizontal position

JOB SHEET #8

- L. Attach new blanket to cylinder in reverse order of removal
- M. Adjust new blanket so that tension is applied uniformly across the entire width and length of the blanket
 - ✓ (NOTE: Over-tightening will cause the blanket surface to become uneven, and if the blanket is too loose, copy quality will suffer, usually causing a ghost image on finished copy; always follow the manufacturer's recommendations for blanket installation.)
- N. After running a few hundred copies, retighten blanket at trailing edge

217

PREVENTIVE MAINTENANCE AND TROUBLESHOOTING
UNIT V

NAME _____

TEST

1. Match the terms on the right with the correct definitions.

- | | |
|--|----------------------------|
| _____ a. The performance of routine inspection, cleaning, adjusting, lubrication, and minor repairs which aid in preventing major equipment failure and process troubles | 1. Piling |
| _____ b. Powdered volcanic rock used for cleaning and scouring surfaces which must be free of oil residue | 2. Troubleshooting |
| _____ c. A cleaner used to dissolve dried ink, solvent, and gum deposits on the surfaces of press rollers and blanket | 3. Ink glaze |
| _____ d. A cleaner used to remove oil and grease residue from the plate and impression cylinder surfaces | 4. Sensitized roller |
| _____ e. A cleaner which mixes with water to remove water soluble particles from press rollers, blanket, and cylinders | 5. Pumice powder |
| _____ f. A thin layer of hardened ink, fountain solution, and blanket wash which forms on press rollers and blanket | 6. Toning |
| _____ g. A thin layer of tiny particles of clay, sizing, lint, and other paper components which forms on the press rollers and blanket | 7. Emulsification |
| _____ h. A powder used on the surface of a rubber offset blanket to protect it during storage and to aid in maintaining the blanket's resilience | 8. Deglazer |
| _____ i. A rubber ink roller which will not hold ink on its surface because of fountain solution, etch, and other chemicals dried in the pores | 9. Misting |
| _____ j. The process of analyzing problems and determining probable causes and applying possible solutions until a problem is solved | 10. Preventive maintenance |
| _____ k. A mixing of ink and fountain solution affecting the separation of image and nonimage areas of the offset plate | 11. Degreaser |
| | 12. Trapping |
| | 13. Water miscible cleaner |
| | 14. Picking |
| | 15. Blanket powder |
| | 16. Set-off |
| | 17. Scumming |
| | 18. Tinting |
| | 19. Chalking |
| | 20. Paper glaze |

- _____ l. Ink is transferred from the front surface of one sheet to the back surface of the sheet above in the delivery pile
- _____ m. Ink on the paper turns dry and powdery
- _____ n. Ink dries so that succeeding colors will not adhere properly
- _____ o. Emulsified ink suspended in the fountain solution on the plate surface appears as a uniform tint on the printed sheet
- _____ p. Plate picks up ink in the clear areas and transfers to the clear area of the sheet
- _____ q. Ink builds up or piles on rollers, plate, and/or blanket
- _____ r. Ink tears away part of the paper coating as the sheet is printed; this appears as black spots in the blank areas of the printed sheet and white spots in the solid areas
- _____ s. Ink flies into atmosphere as fine mist especially at high temperature and speed
- _____ t. Ink adheres to nonimage area of plate because of lack of dampening and transfer to printed sheet

2. List seven advantages of a routine, thorough preventive maintenance program.

- a. _____
- b. _____
- c. _____
- d. _____
- e. _____
- f. _____
- g. _____

3. Name three areas of work in a preventive maintenance program.

- a. _____
- b. _____
- c. _____

4. Match the preventive maintenance schedules on the right with their periodic importance.

- | | |
|--|--|
| <p>_____ a. This is the regular daily cleaning that takes place after a day's run and is the most important of the preventive maintenance schedules</p> <p>_____ b. This usually takes place at the end of the work week and is designed for blanket rotation or protection of other press elements while the press is not in use</p> <p>_____ c. This supplements daily and weekly cleaning and includes a complete cleaning of the total press from the top to the floor</p> | <p>1. Weekly</p> <p>2. Monthly</p> <p>3. Daily</p> |
|--|--|

5. Select true statements concerning preventive maintenance procedures for daily cleanup after a daily run by placing an "X" in the appropriate blanks.

(NOTE: For a statement to be true, all parts of the statement must be true.)

- _____ a. Ink system
- 1) Use the blanket wash normally used for cleaning the blanket during press run to clean ink rollers
 - 2) Clean only other parts that seem to need cleaning
- _____ b. Dampening system
- 1) Wipe ink particles from roller cover using a cotton pad dampened with fountain solution, or
 - 2) Remove covered rollers from press and loosen ink with blanket wash, then flush blanket wash from cover with running water
 - 3) Remove excess moisture from cover by rolling the roller with open palms on top of paper towels on a flat surface
 - 4) Clean metal dampening rollers with plate cleaner or a water miscible cleaner, or pumice powder and water to remove all ink, oil, or residue which repels water
 - 5) A coating of gum arabic solution may be applied to metal rollers after cleaning
 - 6) Change dampening roller cover if enough ink has been trapped on the surface to form an ink glaze that appears shiny

c. Cylinders

- 1) Plate cylinder--Use plate cleaner or nonabrasive water miscible cleaner, then coat with plate etch
- 2) Blanket cylinder--Thoroughly clean blanket with blanket wash and water, then clean cylinder ends and dry blanket
- 3) Impression cylinder--Wipe ink from surface with plate etch, or remove ink with blanket wash or deglazer, then clean with plate cleaner, degreaser, or water miscible cleaner, then coat with etch

 d. Press

- 1) Use a shop towel dampened with water
- 2) Wipe ink, paper lint, dust, and oil from side covers, side frames, support bars, cam shafts, and gear shafts

 e. Work station

- 1) Clean work table surface
- 2) Clean chemical shelf; wipe containers
- 3) Place dirty shop towels in safety can
- 4) Place all waste paper somewhere out of the way
- 5) Arrange work station in orderly manner

6. Complete the following list of preventive maintenance procedures for weekly cleanup.

- a. Deglaze ink rollers and offset blanket
- b. Change blanket if rotation plan is followed
- c. Desensitize noncovered dampening rollers
- d. Degrease plate and impression cylinder surfaces
- e. Clean ink ductor cam truck or follower

f. _____

g. _____





h. _____

7. Complete the following list of preventive maintenance procedures for monthly clean-up.
- _____
 - _____
 - _____
 - Clean oil, ink, paper particles, and dirt from vacuum and drive motors, side frames, cams, gears, levers, shafts, cylinder ends, and all hard-to-reach areas of the press
 - Flush press vacuum pump with a mixture of solvent and oil
 - Clean vacuum and air blast filters, hoses, and air passages
 - Clean upper and lower paper pull-out rollers or forwarding rollers
 - Clean upper and lower paper feed rollers
8. Select procedures for daily, weekly, and monthly lubrication by placing an "X" beside statements that apply.
- _____ a. Unplug the power supply; never lubricate a press while it is running
 - _____ b. Use whatever lubricants are available
 - _____ c. The best time for daily lubrication is at the end of the day's run
 - _____ d. All friction points of all exposed moving parts should be lubricated weekly
 - _____ e. Monthly lubrication should follow monthly cleanup before covers are replaced
9. Complete the following list of daily and weekly adjustment procedures.
- _____
 - Adjustments should be made as necessary to make-ready for each job order and should be made at will as needed
 - Weekly adjustments should be those necessary to troubleshoot and solve problems
10. List three monthly adjustment requirements.
- _____
 - _____
 - _____

11. Arrange in order the steps in making an ink form roller check by placing the correct sequence number in the appropriate blank.

- _____ a. Uniform stripes of ink $1/8''$ to $3/16''$ wide indicate proper adjustment
- _____ b. Irregular ink stripes indicate either uneven settings or worn rollers, and adjustments should be made to correct the problem
- _____ c. Ink up the press
- _____ d. Gently drop the ink form rollers to the plate cylinder, then lift them
- _____ e. Turn the handwheel to bring the plate around for inspection

12. Identify the ink strip configurations in the illustrations that follow by matching them with the definitions on the right.

- | | | |
|----------|---|---------------------------|
| _____ a. |  | 1. Setting uneven |
| _____ b. |  | 2. Ideal setting |
| _____ c. |  | 3. Roller swollen at ends |
| _____ d. |  | 4. Low area in center |
| _____ e. |  | 5. Roller worn at ends |

13. Select true statements concerning requirements for a preventive maintenance schedule in chart form by placing an "X" in the appropriate blanks.

(NOTE: For a statement to be true, all parts of the statement must be true.)

- _____ a. A preventive maintenance chart should include at least three categories of work
- 1) Cleaning
 - 2) Lubricating
 - 3) Adjusting

- _____ b. Each category should have columns for listing time when work should be done
- 1) Daily
 - 2) Weekly/bi-weekly
 - 3) Monthly
- _____ c. Each maintenance activity on the chart should have a block for marking the date when maintenance was performed
- _____ d. The operator's manual and other manufacturer's guides should be referenced for lubrication and adjustments
- _____ e. The back side of the PM chart should provide space to log the date problems occur, what the problems are, and how the problems are solved
14. Arrange in order the sequence of troubleshooting technique by placing the correct sequence number in the appropriate blank.
- _____ a. Identify specific symptoms of the problem
 - _____ b. List the probable causes
 - _____ c. List possible solutions for each cause
 - _____ d. Make no assumptions
 - _____ e. Look for the simple cause and the simple solution
15. Complete the following list of categories of press troubles.
- a. _____
 - b. _____
 - c. Paper stock
 - d. Image transfer process
 - e. Mechanical
16. Distinguish between the two types of emulsification by placing an "X" beside the statement that reflects what happens when there is excess water in ink.
- _____ a. Causes ink to pile on rollers, plate and/or blanket producing a grayed image on sheet
 - _____ b. Produces overall tint in background area on the printed sheet
17. Describe the technique for avoiding emulsification.
- _____
- _____

18. Complete the following list of conditions creating ink drying problems.

- a. Relative humidity
- b. Too much moisture run on the press
- c. pH of fountain solution
- d. Type of printing paper
- e. pH of printing paper
- f. _____
- g. _____

19. Match common ink problems on the press with their causes.

- | | |
|---|-------------|
| _____ a. Ink is transferred from the front surface of one sheet to the back surface of the sheet above in the delivery pile | 1. Piling |
| _____ b. Ink on the paper turns dry and powdery | 2. Misting |
| _____ c. Ink dries so that succeeding colors will not adhere properly | 3. Scumming |
| _____ d. Emulsified ink suspended in the fountain solution on the plate surface appears as a uniform tint on the printed sheet | 4. Chalking |
| _____ e. Plate picks up ink in the clear areas and transfers to the clear areas of the sheet | 5. Toning |
| _____ f. Ink builds up or piles on rollers, plate, and/or blanket | 6. Picking |
| _____ g. Ink tears away part of the paper coating as the sheet is printed; this appears as black spots in the blank areas of the printed sheet and white spots in the solid areas | 7. Tinting |
| _____ h. Ink flies into atmosphere as fine mist especially at high temperature and speed | 8. Set-off |
| _____ i. Ink adheres to nonimage area of plate because of lack of dampening and transfers to printed sheet | 9. Trapping |

20. List four guidelines for evaluating good print quality.

- a. _____
- b. _____
- c. _____
- d. _____

21. Match print quality problems with their causes.

- | | |
|---|---|
| <p>_____ a. Background dirty because of too much ink, not enough moisture, dirty dampener roll covers, or dampener covers tied too tightly on ends</p> <p>_____ b. Not enough ink, too much moisture, wrong color of ink, incorrect dampener form roller pressure, incorrect plate-to-blanket pressure, or incorrect impression-to-blanket pressure</p> <p>_____ c. Glazed ink rollers, glazed blanket, too much ink form roller pressure, or too much dampener form roller pressure</p> <p>_____ d. Too much ink, too much impression-to-blanket pressure, not enough plate-to-blanket pressure, or too many revolutions on blanket without paper going through causing build up on blanket</p> <p>_____ e. Incorrect ink distribution, glazed rollers, incorrect dampener form roller parallel pressure, poor paper surface, incorrect ink form roller parallel pressure, incorrect plate-to-blanket parallel pressure, incorrect impression-to-blanket parallel pressure, or dirty impression cylinder</p> <p>_____ f. Loose blanket, too much ink and fountain solution, not enough plate-to-blanket pressure, loose plate, or incorrect impression-to-blanket pressure</p> <p>_____ g. Incorrect plate-to-blanket pressure, incorrect impression-to-blanket pressure, low spots in blanket, tacky ink, tacky blanket, dirty impression cylinder, or blind image on plate caused by dried gum or too strong fountain solution</p> <p>_____ h. Too much dampening form roller pressure, too much ink form roller pressure, too much plate-to-blanket pressure, fountain solution too strong, or end play in form rollers</p> <p>_____ i. Incorrect ink form roller pressure, incorrect dampener form roller pressure, incorrect plate-to-blanket pressure, incorrect impression-to-blanket pressure, improper ink, or loose blanket</p> <p>_____ j. Loose blanket, side guides not set properly, paper not cut straight, or cam band not set</p> | <p>1. Gray, washed out dirty background</p> <p>2. Gray, washed out</p> <p>3. Image breakdown during run</p> <p>4. Paper curling in receiver</p> <p>5. Scumming</p> <p>6. Weak spots</p> <p>7. Double image</p> <p>8. Streaking</p> <p>9. No image at all</p> <p>10. Copy too dark</p> <p>11. Paper missing grippers</p> <p>12. Paper nicking on edge</p> <p>13. Paper wrinkling</p> <p>14. Uneven printing</p> <p>15. Improper register</p> |
|---|---|

- k. Not enough ink roller form pressure, not enough plate-to-blanket pressure, not enough impression-to-blanket pressure, too much moisture, glazed blanket, or glazed ink rolls
- l. Too much moisture or a curl in the paper
- m. Paper stop fingers too high, feed rollers not set properly, or paper hitting back stop in receiver too hard
- n. Stop fingers incorrectly set or feed rollers out of adjustment
- o. Too much moisture, paper damp, too much pressure between blanket and impression cylinder, or register board not set properly

22. To the following problem concerning troubleshooting guides for ink and dampening problems, find the best solution by placing an "X" in the appropriate blank.

Problem: Ink set-off in delivery pile caused by too much ink on paper

- a. Contact ink supplier
- b. Contact paper supplier
- c. Readjust ink setting

23. To the following problem concerning troubleshooting guides for paper stock problems, find the best solution by placing an "X" in the appropriate blank.

Problem: Paper curling because of too much water

- a. Contact paper supplier
- b. Slow press
- c. Run with minimum water

24. To the following problem concerning troubleshooting guides for process problems, find the best solution by placing an "X" in the appropriate blank.

Problem: Plate inks up solid because of no fountain solution

- a. Contact fountain solution supplier
- b. Adjust cam to retard feed roller
- c. Add fountain solution

25. To the following problem concerning troubleshooting guides for mechanical problems, find the best solution by placing an "X" in the appropriate blank.

Problem: Paper skip feeds because air blast setting is not correct

- _____ a. Increase air blast
- _____ b. Decrease air blast
- _____ c. Increase vacuum
26. Determine lubrication requirements for a specific press.
27. Set up a preventive maintenance schedule in chart form.
28. Demonstrate the ability to:
- Adjust dampener rollers to plate cylinder.
 - Adjust ink form rollers to plate cylinder.
 - Adjust plate cylinder to blanket cylinder.
 - Adjust blanket cylinder to impression cylinder.
 - Change a molleton cover.
 - Degrease plate and impression cylinders.
 - Deglaze ink rollers and blanket.
 - Change blanket.

(NOTE: If these activities have not been accomplished prior to the test, ask your instructor when they should be completed.)

PREVENTIVE MAINTENANCE AND TROUBLESHOOTING
UNIT V

ANSWERS TO TEST

- | | | | |
|----------|-------|-------|-------|
| 1. a. 10 | f. 3 | k. 7 | p. 17 |
| b. 5 | g. 20 | l. 16 | q. 1 |
| c. 8 | h. 15 | m. 19 | r. 14 |
| d. 11 | i. 4 | n. 12 | s. 9 |
| e. 13 | j. 2 | o. 18 | t. 6 |
2. Any seven of the following:
- a. Prevents time loss due to press breakdown
 - b. Lengthens life of rollers and blanket
 - c. Aids in delivering a clean product
 - d. Prevents excessive wear on moving parts
 - e. Insures longer periods of trouble-free press operation
 - f. Increases production
 - g. Insures good image transfer
 - h. Provides opportunity to locate and correct potential problems on a scheduled basis rather than during a production breakdown
 - i. Helps operator to be aware of potential problems
 - j. Helps operator to become more familiar with press mechanical functions
 - k. Helps operator to identify and correct troubles
 - l. Presents an impressive, organized work station for view by the employer, customers, or visitors
3. a. Cleaning equipment and work area
b. Lubricating equipment
c. Adjusting operator controllable settings on equipment
4. a. 3
b. 1
c. 2
5. b, c
6. f. Clean plate clamps
g. Clean delivery stripping rollers and rings or chain delivery clamps and paper turning wheels
h. Wipe oil and dirt off floor area under press
7. a. Unplug the power supply
b. Remove all safety and dust covers
c. Begin at the top of the press and work to the bottom of the press to remove all paper lint and dust from the total press
8. a, d, e
9. a. Student should not make adjustments until approved as an operator by the instructor

10. Any three of the following:
- Make an ink form roller check
 - Adjust dampener rollers to plate cylinder
 - Adjust ink form rollers to plate cylinder
 - Adjust plate cylinder to blanket cylinder
 - Adjust blanket cylinder to impression cylinder
11. a. 4
b. 5
c. 1
d. 2
e. 3
12. a. 2
b. 5
c. 4
d. 3
e. 1
13. a, b, c, d, e
14. a. 3
b. 4
c. 5
d. 1
e. 2
15. a. Operator
b. Chemistry and ink
16. a
17. Description should include: Ink should be greasy but not too greasy
18. f. Lack of oxygen
g. Temperature
19. a. 8 f. 1
b. 4 g. 6
c. 9 h. 2
d. 7 i. 5
e. 3
20. Any four of the following:
- Crisp, dark lines and solids
 - A clean background
 - Clean halftones, screens, and reverses
 - Good registration
 - Each sheet dried completely
21. a. 5 e. 14 i. 8 m. 12
b. 2 f. 7 j. 15 n. 11
c. 1 g. 6 k. 9 o. 13
d. 10 h. 3 l. 4

22. c
23. c
24. c
25. a
26. Evaluated to the satisfaction of the instructor
27. Evaluated to the satisfaction of the instructor
28. Performance skills evaluated to the satisfaction of the instructor

**OTHER PRINTING PROCESSES
UNIT I****UNIT OBJECTIVE**

After completion of this unit, the student should be able to match terms associated with reproduction processes with the correct definitions and select true statements concerning thermography, flexography, microfilming, and stamping. The student should also be able to distinguish between characteristics of gravure and engraving. This knowledge will be evidenced by scoring 85 percent on the unit test.

SPECIFIC OBJECTIVES

After completion of this unit the student should be able to:

1. Match terms associated with other printing processes with the correct definitions.
2. Match types of copiers and duplicators with their characteristics.
3. Select true statements concerning thermography, flexography, microfilming, and stamping.
4. Distinguish between hand-cut film stencils and photographic stencils.
5. Distinguish between characteristics of gravure and engraving.
6. Match terms associated with types of letterpresses with the correct descriptions.

OTHER PRINTING PROCESSES UNIT I

SUGGESTED ACTIVITIES

- I. Provide student with objective sheet.
- II. Provide student with information sheet.
- III. Discuss unit and specific objectives.
- IV. Discuss information sheet.
- V. Make a bulletin board display of different types of copies.
- VI. Have students find different types of printing that have been produced by different types of processes covered in this unit.
- VII. Arrange a field trip to observe as many processes as possible.
- VIII. Tour school and observe processes used.
- IX. Give test.

INSTRUCTIONAL MATERIALS

- I. Included in this unit:
 - A. Objective sheet
 - B. Information sheet
 - C. Test
 - D. Answers to test
- II. References:
 - A. Brockhuizen, Richard J. *Graphic Communications*. Bloomington, IL 61701: McKnight Publishing Company, 1973.
 - B. Hawkinson, Bruce. *Graphic Arts-A Curriculum Manual*. Santa Fe, NM 87503: Vo-Tech Division of NM State Department of Education, 1975.
 - C. Shapiro, Charles. *The Lithographer's Manual*. Pittsburg, PA 15213: Graphic Arts Technical Foundation, Inc., 1968.

OTHER PRINTING PROCESSES
UNIT I

INFORMATION SHEET

I. Terms and definitions

- A. **Electrostatic duplication**--A copying process produced by electrostatic forces causing a powder (toner) to adhere to the charged image area of the copy
- B. **Spirit duplication**--A copying process utilizing a paper spirit master with a carbon image transferring the image to paper when the master is moistened by vapors of duplicating fluid
- C. **Mimeograph duplication**--A direct-plate copying process that employs a typed- or handdrawn stencil mounted on a cylinder filled with ink which flows through the holes (image area) onto the paper
- D. **Diazo process**--Utilizes a light-sensitive dye in the copy paper which is deactivated by ultra-violet light and then developed by passing through ammonia vapors
- E. **Thermography**--A process involving freshly printed sheets dusted with resinous powder, which are heated, causing the powder to fuse and creating a raised surface on the print
- F. **Flexography**--A form of letterpress printing using a rubber plate to print material such as paper bags and boxes, plastic foils, cellophane, and metal foils, in web form
- G. **Microfilm**--Greatly reduced photographic image of a copy used basically for compact storage of large quantities of copies, which can be enlarged and printed back to original size
- H. **Microfiche**--A 4" x 6" microfilm negative that can store as many as sixty 8 1/2" x 11" pages
- I. **Stamping**--Specially cut dies utilized to directly contact the copy and create an image that may be grained, embossed, foil or ink

Example: A common type of stamping is rubber stamps
- J. **Web**--Paper fed to a press from a roll rather than in sheet sizes
- K. **Screen printing**--Printing directly from a stencil through a finely woven screen
- L. **Engraving**--Printing directly from a metal plate that has the image scribed, or scratched, below the surface
- M. **Numbering**--Imprinting consecutive numbers, usually with letter press, on forms or copies being printed

INFORMATION SHEET

- N. Gravure-Printing directly from a metal or plastic plate that has a screened image etched, using acid, below the surface
 - O. Letterpress-Printing directly from raised letters, inked and pressed against paper surface
- II. Types of copiers and duplicators and their characteristics
- A. Electrostatic copiers
 - 1. Method of operation (Figure 1)
 - a. Positive charge of selenium-coated plate
 - b. Image projected through lens onto charged plate
 - c. Toner powder, with negative charge, sticks to plate
 - d. Paper, with positive charge, receives toner in image area

FIGURE 1

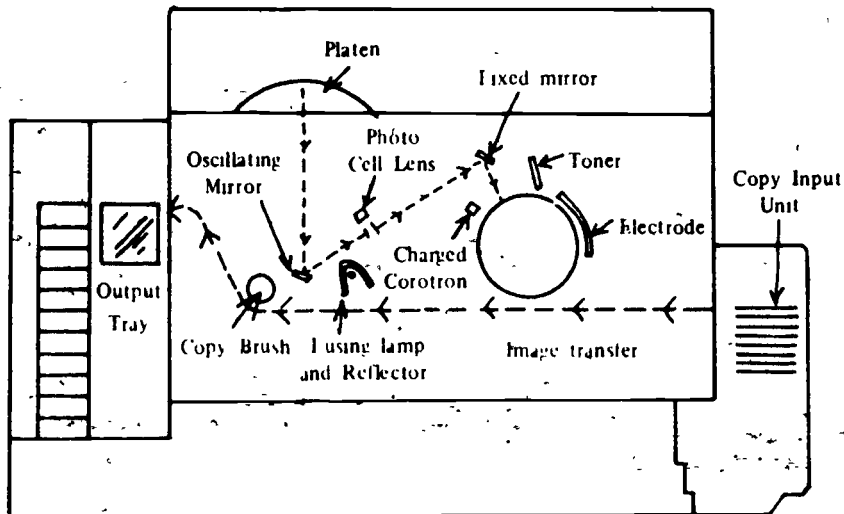

Schematic of a Typical Electrostatic Copier

INFORMATION SHEET

2. Advantages

- a. Small quantities of copies produced at lower cost than by printing
- b. Copies produced with little preparation time
- c. Copies produced by semi-skilled operators

3. Disadvantages

- a. Quality of copies is inferior to printing
- b. Cost is prohibitive for large quantities of copies
- c. Most copiers produce copies in same size only
- d. Different brands of copiers require special paper, chemicals, and other supplies

(NOTE: Electrostatic copies can usually be identified by toner, or a light coating of gray tint, in the nonimage area.)

B. Spirit duplicators

1. Method of operation (Figure 2)

- a. Paper spirit master with carbon image is placed on cylinder
- b. Paper moistened by vapors of duplication fluid when it is fed into machine
- c. Carbon from master is dissolved upon contact with paper, making copy.

FIGURE 2

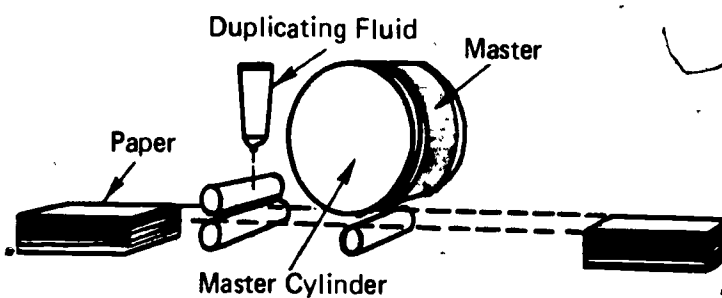

INFORMATION SHEET

2. Advantages

- a. Small quantities of copies produced at smaller cost than by printing
- b. Master, or image carrier, prepared by hand typewriter
- c. Inexpensive paper and supplies

3. Disadvantages

- a. Very small quantity of copies produced from each master (usually 25-50)
- b. Very poor quality of copies produced
- c. Machines use friction feed, which often causes paper jams

(NOTE: Spirit duplicator copies can easily be identified by the blue-purple color, filled and blurred image, and distinct odor.)

C. Mimeograph duplicators

1. Method of operation (Figure 3)

- a. A stencil, which may be typed or written, is placed on the cylinder
- b. Ink, which is stored in the cylinder, flows through the stencil
- c. Paper, when fed through machine, is pressed against the stencil by the impression roller
- d. The ink is transferred from the image areas of the stencil onto the paper

FIGURE 3

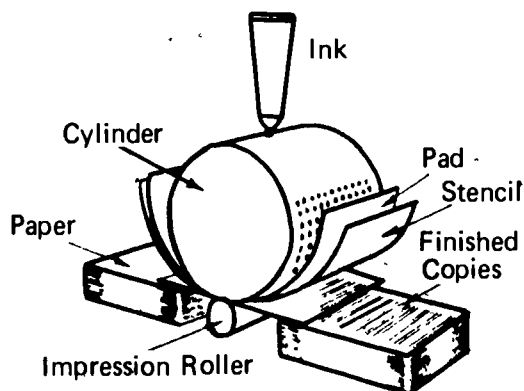

INFORMATION SHEET

2. Advantages

- a. Copies produced at smaller cost than by printing
- b. Master, or image carrier, prepared by hand or by typewriter
- c. Inexpensive method, when compared to other copiers

3. Disadvantages

- a. Quality of copies is inferior to printing
- b. Machines use friction feed, which often causes paper jams
- c. Operation and clean-up usually messy
- d. Large image areas can not be adequately inked

D. Diazo copiers

1. Method of operation

- a. Paper coated with light-sensitive dye
- b. When the original is fed into the machine, ultra-violet light deactivates the dye that is not covered by the image area
- c. The exposed paper is then automatically developed by passing the copy through ammonia fumes

2. Advantages

- a. Used for reproducing copies from drawings on tracing paper
(NOTE: Also known as white-print copying machines.)
- b. Machines available for large size drawings

3. Disadvantages

- a. Quality of copy is dependent on original tracing
- b. Copies produced in same size only
- c. Ammonia odor usually present on copies

III. Thermography, flexography, microfilming & stamping

A. Thermography

- 1. Printing is accomplished with letterpress or offset

INFORMATION SHEET

2. Copies are sprayed with resinous powder while ink is still wet
3. Copies continue on conveyer through a heating unit which causes the powder to fuse
4. The fusion of the ink and powder creates a raised image

(NOTE: This type of printing is an inexpensive imitation of engraving.)

B. Flexography

1. Uses molded rubber or plastic relief plates that are flexible
2. Prints on nontraditional materials, such as thin plastic, in web form
3. Uses extremely fluid ink

C. Microfilming

1. Photographic process of reproduction
2. Negative image of copy that is greatly reduced
3. Copies feed automatically into rapid frame camera using black and white roll film
4. Copies may be reproduced back to the same size on machine called reader-printer

D. Stamping

1. Hot stamping uses foil to transfer type on die; images can be placed on wood, plastic, cloth, paper and leather
2. A rubber stamp is a relief printing image that is cast or molded in rubber, and is used to transfer an inked image to paper manually
3. Embossing is a form of stamping accomplished with letterpress equipment pressing the image area, with no ink, into the sheet

IV. Types of stencils used in screen printing and their characteristics

A. Hand-cut film stencils

1. Thin film of gelatinous material on a waxed paper or plastic backing
2. Design is cut into gelatinous material and peeled away
3. The film is applied to the silk, and water is sprayed on, which softens the gelatinous material and sticks it to the screen

INFORMATION SHEET

4. Corners of the frame are masked, if needed, and prints made
- B. Photographic stencils
1. Indirect method (Figure 4)
(NOTE: This is also referred to as transfer method.)
 - a. Photographic film of desired image is processed in normal manner
 - b. A film positive is made from the negative
 - c. This image is exposed to the presensitized emulsion of a film stencil by exposure to a carbon arc or similar light
 - d. The film stencil is then washed which leaves the image area clear and free of emulsion
 - e. Stencil placed under screen and copies prepared

FIGURE 4

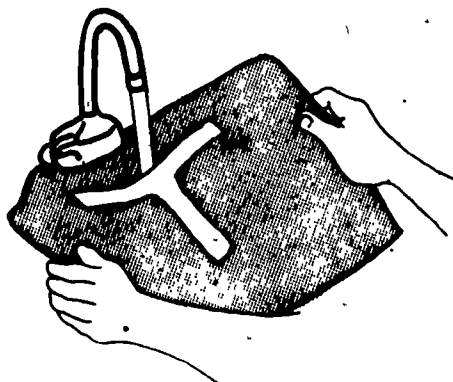

2. Direct method (Figure 5)
 - a. Sensitized emulsion is placed directly on screen
 - b. Exposure is made from positive directly on screen

INFORMATION SHEET

- c. The screen is then washed which leaves the image area clear and free of emulsion
- d. Copies prepared

FIGURE 5

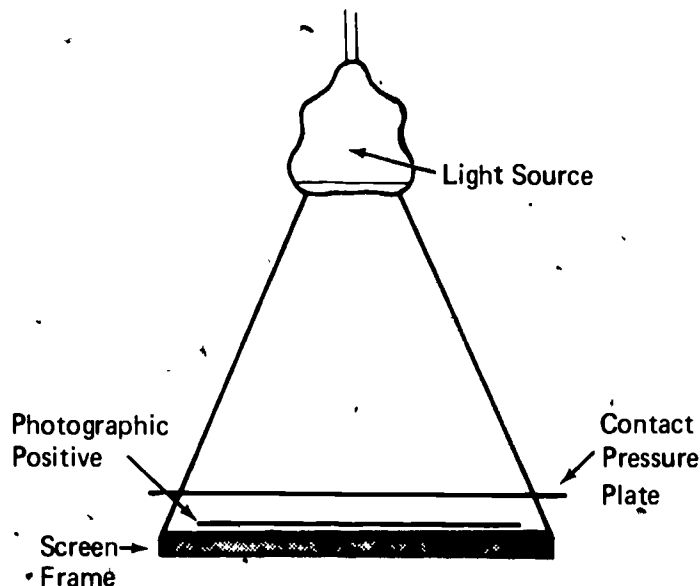

V. Characteristics of gravure and engraving

A. Gravure

1. Also called intaglio, pronounced "in-tal-yo"
2. Opposite of relief printing as image is below the surface of the plate
3. Plates, either metal or plastic, have the images etched, with acid, into the surface
4. Ink is rolled over the plate to fill image areas, and ink on nonimage area is scraped off by a doctor blade
5. When the plates are attached to cylinders for printing, it is called "photogravure"
6. Image is usually screened

B. Engraving

1. Slow and costly process, but very elegant because of dense black type, and raised surface

INFORMATION SHEET

2. Engraving of copper plates is done largely by hand
3. Ink is rolled over the plate to fill cut-out lines of image and ink on nonimage area is scraped off by a doctor blade
4. Paper is then pressed against plate, transferring image
5. Also called intaglio

VI. Letterpresses

(NOTE: Numbering and die-cutting are performed primarily by these machines.)

A. Platen press

1. Prints all of the type form at one time
2. Hand fed speeds to 3,500 impressions per hour, automatic-fed speeds up to 5,000

B. Cylinder press

1. Press prints 1/8" to 1/4" of the form at one time
2. As cylinder turns, the form advances with it
3. Prints one sheet with every second revolution of impression cylinder
4. Cylinder presses use a flat plate

C. Rotary press

1. Uses curved plate on a cylinder
2. Impression is transferred when the two cylinders contact

D. Letterset presses

1. Also known as "dry offset"
2. Uses an intermediate blanket cylinder
3. A shallow-etched relief plate is placed around the plate cylinder

OTHER PRINTING PROCESSES
UNIT I

NAME _____

TEST

1. Match the terms on the right with the correct definitions.

- | | |
|--|------------------------------|
| <p>_____ a. A copying process produced by electrostatic forces causing a powder to adhere to the charged image area of the copy</p> | 1. Microfiche |
| <p>_____ b. A copying process utilizing a paper spirit master with a carbon image transferring the image to paper when the master is moistened by vapors of duplicating fluid</p> | 2. Engraving |
| <p>_____ c. A direct-plate copying process that employs a typed or handdrawn stencil mounted on a cylinder filled with ink which flows through the holes onto the paper</p> | 3. Flexography |
| <p>_____ d. Utilizes a light-sensitive dye in the copy paper which is deactivated by ultra-violet light and then developed by passing through ammonia vapors</p> | 4. Web |
| <p>_____ e. A process involving freshly printed sheets dusted with resinous powder, which are heated, causing the powder to fuse and creating a raised surface on the print</p> | 5. Electrostatic duplication |
| <p>_____ f. A form of letterpress printing using a rubber plate to print material such as paper bags and boxes, plastic foils, cellophane, and metal foils, in web form</p> | 6. Diazo process |
| <p>_____ g. Greatly reduced photographic image of a copy used basically for compact storage of large quantities of copies, which can be enlarged and printed back to original size</p> | 7. Screen printing |
| <p>_____ h. A 4" x 6" microfilm negative that can store as many as sixty 8 1/2" x 11" pages</p> | 8. Letterpress |
| <p>_____ i. Specially cut dies utilized to directly contact the copy and create an image that may be grained, embossed, foil or ink</p> | 9. Mimeograph duplication |
| | 10. Spirit duplication |
| | 11. Thermography |
| | 12. Microfilm |
| | 13. Gravure |
| | 14. Stamping |
| | 15. Numbering |

- _____ j. Paper fed to a press from a roll rather than in sheet sizes
- _____ k. Printing directly from a stencil through a finely woven screen
- _____ l. Printing directly from a metal plate that has the image scribed, or scratched, below the surface
- _____ m. Printing directly from a metal or plastic plate that has a screened image etched, using acid, below the surface
- _____ n. Printing directly from raised letters, inked and pressed against paper surface
- _____ o. Imprinting consecutive numbers, usually with letterpress, on forms or copies being printed

2. Match the types of copiers and duplicators on the right with their characteristics.

- | | |
|---|----------------------|
| _____ a. Ink, which is stored in the cylinder, flows through the stencil | 1. Electrostatic |
| _____ b. Carbon from master is dissolved upon contact with paper, making copy | 2. Spirit duplicator |
| _____ c. Image projected through lens onto charged plate | 3. Mimeograph |
| _____ d. Paper coated with light-sensitive dye | 4. Diazo |
| _____ e. Quality of copies is inferior to printing | |
| _____ f. Copies produced with little preparation time | |
| _____ g. Used for reproducing copies from drawings on tracing paper | |
| _____ h. Very small quantity of copies produced from each master | |

3. Select true statements associated with thermography, flexography, microfilming, and stamping by placing an "X" in the appropriate blanks.

- _____ a. In the flexography process, there is a fusion of ink and powder
- _____ b. Microfilming is a photographic process of reproduction
- _____ c. A rubber stamp is a form of stamping
- _____ d. In thermography, the copies are sprayed with resinous powder

4. Distinguish between hand-cut film stencils and photographic stencils by placing an "H" before descriptions of hand-cut film stencils and a "P" before descriptions of photographic stencils.

- _____ a. These stencils have an indirect and a direct method
- _____ b. Corners of the frame are masked, if needed, and prints made
- _____ c. Design is cut into gelatinous material and peeled away
- _____ d. Film positive is made from the negative
- _____ e. Sensitized emulsion is placed directly on screen

5. Distinguish between characteristics of gravure and engraving by placing the appropriate number in the blank.

(NOTE: Answers may be used more than once.)

- | | |
|--|--------------|
| _____ a. Plates, either metal or plastic, have the images etched, with acid, into the surface | 1. Gravure |
| _____ b. Slow and costly process, but very elegant because of dense black type, and raised surface | 2. Engraving |
| _____ c. Also called intaglio printing | |
| _____ d. Image is usually screened | |
| _____ e. Opposite of relief printing as image is below the surface of the plate | |

6. Match the types of letterpresses on the right with the correct descriptions.

- | | |
|---|--------------------|
| _____ a. Also known as "dry offset" | 1. Platen press |
| _____ b. Uses curved plate on a cylinder | 2. Cylinder press |
| _____ c. Prints all of type form at one time | 3. Rotary press |
| _____ d. As cylinder turns, the form advances with it | 4. Letterset press |

OTHER PRINTING PROCESSES
UNIT I

ANSWERS TO TEST

- | | | | | | | |
|----|---------|--------|----|----|----|----|
| 1. | a. | 5 | f. | 3 | k. | 7 |
| | b. | 10 | g. | 12 | l. | 2 |
| | c. | 9 | h. | 1 | m. | 13 |
| | d. | 6 | i. | 14 | n. | 8 |
| | e. | 11 | j. | 4 | o. | 15 |
| 2. | a. | 3 | e. | 3 | | |
| | b. | 2 | f. | 1 | | |
| | c. | 1 | g. | 4 | | |
| | d. | 4 | h. | 2 | | |
| 3. | b, c, d | | | | | |
| 4. | a. | P | | | | |
| | b. | H | | | | |
| | c. | H | | | | |
| | d. | P | | | | |
| | e. | P | | | | |
| 5. | a. | 1 | d. | 1 | | |
| | b. | 2 | e. | 1 | | |
| | c. | 1 or 2 | | | | |
| 6. | a. | 4 | | | | |
| | b. | 3 | | | | |
| | c. | 1 | | | | |
| | d. | 2 | | | | |

**COST AWARENESS
UNIT II****UNIT OBJECTIVE**

After completion of this unit, the student should be able to list major components which determine printing job costs and distinguish between cost awareness factors of school and commercial shops. The student should also be able to estimate costs of printing jobs in school and commercial shops. This knowledge will be evidenced by correctly performing the procedures outlined in the assignment sheets and by scoring 85 percent on the unit test.

SPECIFIC OBJECTIVES

After completion of this unit, the student should be able to:

1. Match terms related to cost awareness with the correct definitions.
2. List major components which determine printing job costs.
3. List cost items considered when giving an estimate on printing jobs.
4. Distinguish between cost awareness factors in a commercial shop and a school shop.
5. Estimate costs of school shop printing jobs.
6. Estimate costs of commercial shop printing jobs.

COST AWARENESS
UNIT II

SUGGESTED ACTIVITIES

- I. Provide student with objective sheet.
- II. Provide student with information and assignment sheets.
- III. Make transparencies.
- IV. Discuss unit and specific objectives.
- V. Discuss information and assignment sheets.
- VI. Give test.

INSTRUCTIONAL MATERIALS

- I. Included in this unit:
 - A. Objective sheet
 - B. Information sheet
 - C. Transparency masters
 1. TM 1--Sample Estimate Sheet
 2. TM 2--Sample Material Cost Sheet
 - D. Assignment sheets
 1. Assignment Sheet #1--Estimate Costs of School Shop Printing Jobs
 2. Assignment Sheet #2--Estimate Costs of Commercial Shop Printing Jobs
 - E. Answers to assignment sheets
 - F. Test
 - G. Answers to test
- II. References:
 - A. Silver; Gerald A. *Printing Estimating*. Chicago: American Technical Society, 1970.
 - B. *Franklin Offset Catalog*. Salt Lake City: Porte Publishing Co., 1979.

COST AWARENESS
UNIT II

INFORMATION SHEET

- I. Terms and definitions
 - A. Labor--That part of the cost which is an hourly wage rate paid employees working on the job
 - B. Materials--The consummable materials required for the printing job
 - C. Estimate--A detailed estimate of all costs and charges related to a printing job
 - D. Fixed costs--Any cost which does not change with production volume, such as rent and utilities
 - E. Variable costs--Any cost which increases or decreases directly with volume of production, such as paper, ink, and film
 - F. Markup--A predetermined percentage added to job price to recover combined expenses and profit
 - G. Gross profit--The amount of revenue left after direct printing costs have been paid
 - H. Net profit--The amount of revenue left after all costs, fixed and variable, have been paid
 - I. Quotation--The actual selling price of the printing job, quoted and recorded
 - J. Invoice--The bill for the customer's printing job
- II. Major components which determine printing job costs
 - A. Fixed costs
 1. Insurance
 2. Advertising
 3. Taxes
 4. Building rental
 5. Utilities
 6. Maintenance

INFORMATION SHEET

- B. Variable costs
 - 1. Labor
 - 2. Paper
 - 3. Ink
 - 4. Plates
 - 5. Film

- III. Cost items considered in giving estimates on printing jobs (Transparencies 1 and 2)
 - A. Composition
 - B. Line negatives
 - C. Halftone negatives
 - D. Plates
 - E. Press runs
 - F. Ink
 - G. Bindery charges
 - H. Paper stock
 - I. Labor

- IV. Cost awareness factors in commercial and school shops
 - A. Commercial shop
 - 1. Net profit is a key factor
 - 2. Markup designed to produce required net profit
 - 3. Wages and salaries
 - 4. Material waste at specified percentage level
 - 5. Cost of equipment depreciated annually
 - 6. Sales essential factor.
 - 7. Production quality required

INFORMATION SHEET

B. School shop

1. Per pupil cost of training is key factor
2. Markup designed to cover waste
3. No wage or salary cost considered in printing rates
4. No depreciation rate on equipment
5. Higher percentage of waste expected
6. Sales not a factor
7. Production quality desired

Sample Estimate Sheet

Estimate Sheet

Customer _____

Job Title _____

Quantity _____ of _____ Size _____

Talked to: _____ Phone _____

	Est. Hrs.	Est. Cost
Typesetting - Text		
Display		
Negatives		
Line: No. _____ Size _____		
Halftone: No. _____ Size _____		
PMT: No. _____ Size _____		
Plates: 10x15 @		
11x17 @		
18x24 @		
Stock:		
Cover		
Press Run: 10x15 @		
11x17 @		
18x24 @		
Washup. Color		
Bindery: Cut-Trim		
Collate		
Fold		
Pad Punch		
Staple		
Other.		
Cost		
Tax		
Date Est _____ Mark-Up		
Bring In _____ Total		
Date Wanted _____		

Sample Material Cost Sheet

Film Prices	Plate Prices	Contact Prints
9 x 12 or Less \$1.50	10 x 15 'E' \$1.50	Less Than 10 x 12 . . . \$1.00
Larger Than 9 x 12 . . \$3.00	10 x 15 'M' \$2.00	10 x 12 \$1.50
12 x 18 \$3.50	11 x 18 'M' \$2.50	
	11 x 18 1/2 'M' . \$2.50	
Composition	(Simple) (Complex)	Reprints (Plate on File)
5 1/2 x 8 1/2	\$ 4.00 \$ 6.00	\$3.50 + Stock + 30%
8 1/2 x 11	7.50 11.00	Stock Furnished
Business Cards	3.00 3.50	Add all Charges + %
Letterheads	4.00 5.50	Then Subtract Stock Cost.
Envelopes	3.00 4.00	Colors
Ruled Forms (5 1/2 x 8 1/2)	9.00 11.00	Add \$3.50 for Second Color
Ruled Forms (8 1/2 x 11)	12.00 15.00	Add \$9.00 for Additional Colors
Collating		* A Special Reduced Rate is Provided For:
\$.50 Per Hundred Sheets		School Newspapers
\$.25 Per Hundred Sheets (Over 1M)		Student Projects
Folding		* Outside printing is priced at material cost
\$.10 Per Hundred Sheets		plus 30%
Stitching		* Charge Posters, Handbills on Basis of
\$.02 Per Book or Set		Simple Composition
Padding		
\$.10 Per Pad		
Pictures		
Halftones 5 x 7 or Less \$.50		
Halftones Larger Than 5 x 7 . . . \$1.00		

Paper Prices

Bond	8 1/2 x 11	8 1/2 x 14
20 Lb. White	\$1.20 Per Hundred	\$1.40 Per Hundred
20 Lb. Colors	1.50 Per Hundred	1.70 Per Hundred
(2 Reams or More)	4.80 Per Ream	5.20 Per Ream
Colors	5.00 Per Ream	
Index	8 1/2 x 11	8 1/2 x 17
110 Lb. White	\$1.70 Per Thousand	\$2.10 Per Thousand
110 Lb. Colors	1.80 Per Thousand	2.30 Per Thousand
Carbonless	8 1/2 x 11	8 1/2 x 14
2-Part	\$ 9.50 (500 Sets)	\$11.00 (500 Sets)
3-Part	12.00 (500 Sets)	14.00 (500 Sets)
4-Part	15.00 (500 Sets)	17.00 (500 Sets)
Scott Offset	8 1/2 x 11	11 x 17
70 Lb. White	\$1.40 Per Thousand	\$1.80 Per Thousand
70 Lb. Colors	1.70 Per Thousand	2.10 Per Thousand
60 Lb. White	1.30 Per Thousand	1.60 Per Thousand
60 Lb. Colors	1.70 Per Thousand	1.90 Per Thousand

COST AWARENESS
UNIT II

ASSIGNMENT SHEET #1--ESTIMATE COSTS OF SCHOOL SHOP PRINTING JOBS

Directions: Using the sample material cost sheet provided (TM 2), calculate the jobs below.

1. Calculate the total charge for 1,000 handbills $8\frac{1}{2} \times 11$, on colored 20 lb. bond, simple composition, black ink only, and markup percentage for outside work.

Answer: \$ _____

2. Calculate the total charge for printing 500 letterheads, $8\frac{1}{2} \times 11$, 20 lb. bond white, simple composition, in two colors.

Answer: \$ _____

3. Calculate the total charge of 2,000 sets of invoices, $5\frac{1}{2} \times 8\frac{1}{2}$, using the complex ruled form, 2-part carbonless paper, printing two-up on $8\frac{1}{2} \times 11$.

Answer: \$ _____

COST AWARENESS
UNIT IIASSIGNMENT SHEET #2--ESTIMATE COSTS
OF COMMERCIAL SHOP PRINTING JOBS

Directions: Using the Franklin Offset Catalog provided by the instructor, calculate the commercial shop prices of the jobs below.

1. Calculate the total charge of 2,000 letterheads, 8 1/2 x 11, white medium quality, one color ink.

Answer: \$ _____

2. Calculate the total charge of 5,000 handbills (circulars), 6 x 9, medium quality, black ink on white 60 lb. offset.

Answer: \$ _____

COST AWARENESS
UNIT II

ANSWERS TO ASSIGNMENT SHEETS

Assignment Sheet #1

1. \$26.65
2. \$21.45
3. \$43.55

Assignment Sheet #2

1. \$46.50
2. \$69.85

COST AWARENESS
UNIT II

NAME _____

TEST

1. Match the terms related to cost awareness on the right with the correct definitions.

- | | |
|--|---|
| <p>_____ a. That part of the cost which is an hourly wage rate paid employees working on the job</p> <p>_____ b. The consummable materials required for the printing job</p> <p>_____ c. A detailed estimate of all costs and charges related to a printing job</p> <p>_____ d. Any cost which does not change with production volume, such as rent and utilities</p> <p>_____ e. Any cost which increases or decreases directly with volume of production, such as paper, ink, and film</p> <p>_____ f. A predetermined percentage added to job price to recover combined expenses and profit</p> <p>_____ g. The amount of revenue left after direct printing costs have been paid</p> <p>_____ h. The amount of revenue left after all costs, fixed and variable, have been paid</p> <p>_____ i. The actual selling price of the printing job, quoted and recorded</p> <p>_____ j. The bill for the customer's printing job</p> | <p>1. Markup</p> <p>2. Fixed costs</p> <p>3. Labor</p> <p>4. Net profit</p> <p>5. Estimate</p> <p>6. Materials ✓</p> <p>7. Invoice</p> <p>8. Gross profit</p> <p>9. Quotation</p> <p>10. Variable costs</p> |
|--|---|

2. List major components, three fixed costs and three variable costs, which determine printing job costs.

a. Fixed costs

- 1) _____
- 2) _____
- 3) _____

b. Variable costs

- 1) _____
- 2) _____
- 3) _____

3. List six cost items considered in giving estimates of printing job.

- a. _____
- b. _____
- c. _____
- d. _____
- e. _____
- f. _____

4. Distinguish between cost awareness factors in school shops and commercial shops by placing a "S" next to school shop factors and a "C" next to commercial shop factors.

- ____ a. Net profit is a key factor
- ____ b. Per pupil training cost is key factor
- ____ c. Markup is designed to produce required net profit
- ____ d. Markup is designed to cover waste
- ____ e. Wages and salaries are factors
- ____ f. Cost of equipment depreciated annually
- ____ g. Higher percentage of waste expected
- ____ h. Sales an essential factor
- ____ i. Production quality required
- ____ j. Production quality desired

5. Estimate costs of school shop printing jobs.

6. Estimate costs of commercial shop printing jobs.

(Note: If these activities have not been accomplished prior to the test, ask your instructor when they should be completed.)

COST AWARENESS
UNIT II

ANSWERS TO TEST

1.

a. 3	f. 1
b. 6	g. 8
c. 5	h. 4
d. 2	i. 9
e. 10	j. 7

2. Answer should include any three of the following in each group:
 - a. Fixed Costs
 - 1) Insurance
 - 2) Advertising
 - 3) Taxes
 - 4) Building rental
 - 5) Utilities
 - 6) Maintenance

 - b. Variable Costs
 - 1) Labor
 - 2) Paper
 - 3) Ink
 - 4) Plates
 - 5) Film

3. Any six of the following:
 - a. Composition
 - b. Line negatives
 - c. Halftone negatives
 - d. Plates
 - e. Press runs
 - f. Ink
 - g. Bindery charges
 - h. Paper stock
 - i. Labor

4.

a. C	f. C
b. S	g. S
c. C	h. C
d. S	i. C
e. C	j. S

5. Evaluated to the satisfaction of the instructor

6. Evaluated to the satisfaction of the instructor

**BINDING AND FINISHING
UNIT III****UNIT OBJECTIVE**

After completion of this unit, the student should be able to select true statements concerning binding techniques, list major folding styles, and list processes associated with finishing activities. The student should also be able to pad both bond and carbonless papers and drill paper stock for 3-ring binders. This knowledge will be evidenced by correctly performing the procedures outlined in the job sheets and by scoring 85 percent on the unit test.

SPECIFIC OBJECTIVES

After completion of this unit, the student should be able to:

1. Match terms related to binding and finishing with the correct definitions.
2. Select true statements concerning binding techniques.
3. List major folding styles.
4. List processes associated with finishing activities.
5. Demonstrate the ability to:
 - a. Pad 20 lb. stock.
 - b. Pad carbonless paper.
 - c. Drill paper stock for 3-ring binders.

BINDING AND FINISHING UNIT III

SUGGESTED ACTIVITIES

- I. Provide student with objective sheet.
- II. Provide student with information and job sheets.
- III. Make transparency.
- IV. Discuss unit and specific objectives.
- V. Discuss information sheet.
- VI. Demonstrate and discuss the procedures outlined in the job sheets.
- VII. Give test.

INSTRUCTIONAL MATERIALS

- I. Included in this unit:
 - A. Objective sheet
 - B. Information sheet
 - C. Transparency Master 1--Folding Styles
 - D. Job sheets
 1. Job Sheet #1--Pad 20-lb. Stock
 2. Job Sheet #2--Pad Carbonless Paper
 3. Job Sheet #3--Drill Paper Stock for 3-Ring Binder
 - E. Test
 - F. Answers to test
- II. References:
 - A. Prust, Z. A., *Photo-Offset Lithography*. South Holland, IL: Goodheart-Willcox, Co. Inc., 1977.
 - B. Cogoli, John E. *Photo-Offset Fundamentals*. Bloomington, IL: McKnight Publishing Co., 1980.

BINDING AND FINISHING
UNIT III**INFORMATION SHEET**

- I. Terms and definitions
- A. Scoring--To crease a sheet mechanically or manually so it will fold easily
 - B. Perforating--To partially cut a sheet with a broken line cut so it can easily be torn away, like ticket stubs
 - C. Tipping--Applying a small amount of adhesive to the edge of sheet so it can be attached to another
 - D. Collating--Gathering and checking several sheets to make a book
 - E. Inserting--Inserting one signature or sheet, or folded sheet, inside another
 - F. Stitching--Binding pages of a book together using wire stitches or staples
 - G. Trimming--Last major operation in book binding, i.e., trimming the edges on a paper cutter
 - H. Padding--Binding a booklet or multi-page job using an adhesive padding compound
 - I. Binding--To secure pages together by means of wire, thread, adhesive, plastic, etc.
 - J. Finishing--Final bindery work, such as die cutting, varnishing, flocking, laminating or embossing
 - K. Jogging--Vibrating paper by machine or by hand to make sure all sheets line up evenly at the edges
 - L. Marrying sets--When collating, if number of pages exceeds collator capacity, sets must be joined
- II. Binding Techniques
- A. Edition binding
 - 1. Books which must stand hard usage and thus require hard cloth covers
 - 2. Books made up of several signatures, a case, or cover and end sheets
 - 3. The signatures sewed together with thread and the back heavily coated with glue

INFORMATION SHEET

4. Top quality books given additional support by adding a muslin backing cloth over the glue
 5. Involves the term "casing in," which means the assembling of the book and the cover
- B. Adhesive binding
1. Used when less durable, inexpensive binding is preferred
 2. In the simplest form called padding
 3. Paperback books use a form of it
- C. Perfect binding
1. The signatures sawed off, or skived, at the folded edge, leaving a rough back edge
 2. A flexible type glue applied to the rough back edge, and the cover attached while the glue is wet
- D. Plastic binding
1. The units are called combs, and used to assemble the books
 2. Rectangular slots punched in the sheets by a row of metal fingers on the plastic binding unit
 3. The booklet is placed over the fingers of the plastic binder, which is cut to the desired length
 4. Tension released on the binding unit closes the plastic fingers in the slotted sheets of the booklet
 5. Advantages include a booklet that opens flat and the flexibility that allows easy removal of the binder to add or change pages
- E. Looseleaf binding
1. The ring binder is an example
 2. Sheets gathered, punched and placed in the binder, which can be opened and closed manually
- F. Stitching
1. ~~Side~~ stitching--Putting wire staples or stitches through sides of sheets to bind into book form
 2. Saddle stitching--Putting wire staples or stitches through the folded, gathered sheets to bind into book form

INFORMATION SHEET

III. Major paper folding styles (Transparency 1)

- A. Accordion fold
- B. Gate fold
- C. Letter fold
- D. Map fold
- E. French fold
- F. Broadside fold

IV. Processes associated with finishing activities

- A. Die cutting--A letterpress operation using a sharp die cut to cut a design in the finished piece
- B. Embossing--Uses two dies, one raised and one lowered, which the sheet is pressed between to form a raised or embossed image
- C. Laminating--Applying a protective plastic coating over the finished piece
- D. Varnishing--Putting a protective varnish coating over the finished piece
- E. Flocking--Forcing tiny fibers into a wet ink image to add an unusual texture to image area

Folding Styles

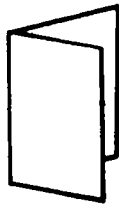

4 Page

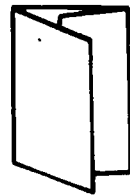

6 Page

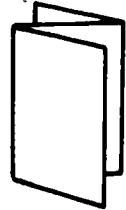

6 Page Accordion



8 Page
(French Fold)



8 Page
Accordion

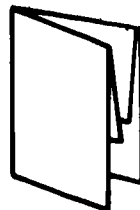

8 Page
Short Fold

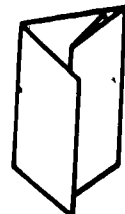

8 Page
Parallel (3 Folds)

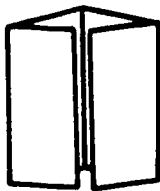

8 Page
Gate Fold



8 Page
Map Fold



8 Page
Reverse Map

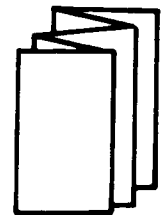

10 Page
Accordion



12 Page
Letter Fold

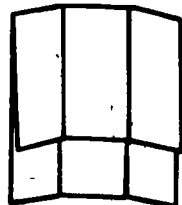

12 Page
Broadside

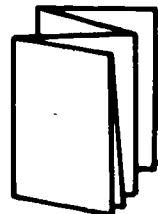

16 Page
Broadside

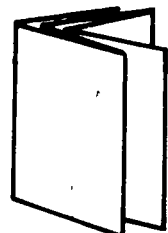

16 Page
Booklet

(Courtesy A. B. Dick Company)

BINDING AND FINISHING
UNIT III

JOB SHEET #1--PAD 20-LB. STOCK

- I. Tools and materials
 - A. One hundred sheets of scrap 20-lb. stock (to be provided by instructor)
 - B. Two pieces of chipboard (provided by instructor)
 - C. Padding compound
 - D. Padding brush
 - E. Jogger
 - F. Padding press
- II. Procedure
 - A. Trim paper and chipboard to same size
 - B. Count 50 sheets of 20-lb., and insert chipboard divider, then count another 50 sheets and insert second divider
 - C. Place entire stack into jogger, turn on jogger until all sheet and divider edges are even
 - D. Place stack in padding press with top edge of sheets lined up with front edge of padding press
 - E. Put clamp or weight on stack and lock in place
 - F. Using brush, apply thin even coat of padding compound to exposed edge; brush from the middle of sheet to outside edges
 - G. Allow sufficient drying time, then apply second coat, heavier than first
 - H. When dry, remove from press and turn in to instructor for evaluation

BINDING AND FINISHING
UNIT III

JOB SHEET #2--PAD CARBONLESS PAPER

- I. Tools and materials
 - A. Twenty five two-part sets of carbonless paper (provided by instructor)
 - B. Padding press
 - C. Jogger
 - D. Padding brush
 - E. Padding compound (for carbonless paper)
- II. Procedure
 - A. Place paper in jogger and jog until edges are even
 - B. Place stack in padding press and line top edge with front of padding press
 - C. Put clamp or weight on stack and lock in place
 - D. Using brush, apply several soaking coats of padding compound to exposed edge, brushing from middle out
 - E. Allow sufficient dry time, feeling edge with fingers, until completely dry
 - F. Take stack out of padding press and holding opposite edge from padded end, fan apart with hand

(NOTE: Sets should stick together, but each set should be free from the adjoining sets.)
 - G. Turn in to instructor for evaluation

207

BINDING AND FINISHING
UNIT III

JOB SHEET #3-DRILL PAPER STOCK FOR A 3-RING BINDER

- I. Tools and materials
 - A. Paper drill
 - B. Twenty five sheets of 8 1/2 x 11 paper (provided by instructor)
 - C. Punched or marked guide for 3-ring binder
- II. Procedure
 - A. Set back stop on paper drill for depth of holes on inside edge of sheet
 - B. Set guide stops on paper drill, using marked or punched guide for 3-ring binder, to set distance between holes
 - C. Jog sheets to be drilled and position on paper drill for first hole
 - D. Set left side guide and make first hole
 - E. Reset left side guide and line up with back stop setting for second hole
 - F. Drill second hole
 - G. Reset left side guide and line up with back stop setting for third hole
 - H. Drill third hole
 - I. Turn in sheets to instructor for evaluation

BINDING AND FINISHING UNIT III

NAME _____

TEST

1. Match terms related to binding and finishing on the right with the correct definitions.

- | | |
|--|--------------------------|
| <p>_____ a. To crease a sheet mechanically or manually so it will fold easily</p> | <p>1. Trimming</p> |
| <p>_____ b. To partially cut a sheet with a broken line cut so it can easily be torn away, like ticket stubs</p> | <p>2. Stitching</p> |
| <p>_____ c. Applying a small amount of adhesive to the edge of sheet so it can be attached to another</p> | <p>3. Scoring</p> |
| <p>_____ d. Gathering and checking several sheets to make a book</p> | <p>4. Jogging</p> |
| <p>_____ e. Inserting one signature or sheet, or folded sheet, inside another</p> | <p>5. Finishing</p> |
| <p>_____ f. Binding pages of a book together using wire stitches or staples</p> | <p>6. Perforating</p> |
| <p>_____ g. Last major operation in book binding, i.e., trimming the edges on a paper cutter</p> | <p>7. Inserting</p> |
| <p>_____ h. Binding a booklet or multi-page job using an adhesive padding compound</p> | <p>8. Binding</p> |
| <p>_____ i. To secure pages together by means of wire, thread, adhesive, plastic, etc.</p> | <p>9. Padding</p> |
| <p>_____ j. Final bindery work, such as die cutting, varnishing, flocking, laminating or embossing</p> | <p>10. Tipping</p> |
| <p>_____ k. Vibrating paper by machine or by hand to make sure all sheets line up evenly at the edges</p> | <p>11. Collating</p> |
| <p>_____ l. When collating, if number of pages exceeds collator capacity, sets must be joined</p> | <p>12. Marrying sets</p> |

2. Select true statements concerning various binding techniques by placing an "X" in the appropriate blanks.

- a. Books which must stand up to hard use require edition binding
- b. In edition binding, several signatures are sewn together and glued
- c. The term "casing in" means putting the books in a case after they are finished
- d. Adhesive binding is used for less expensive books
- e. Paperback books use a form of adhesive binding
- f. In perfect binding, the back or folded edge of the book is sawed off, or skived
- g. A flexible glue is used to attach the cover in perfect binding
- h. In plastic binding, rectangular slots are punched in the sheets
- i. Pages cannot be added or changed in plastic bound books
- j. The ring binder is an example of looseleaf binding

3. List four major styles of folding.

- a. _____
- b. _____
- c. _____
- d. _____

4. List four processes associated with finishing activities.

- a. _____
- b. _____
- c. _____
- d. _____

5. Demonstrate the ability to:

- a. Pad 20 lb. stock.
- b. Pad carbonless paper.
- c. Drill paper stock for 3-ring binders.

(NOTE: If these activities have not been completed prior to the test, ask your instructor when they should be completed.)

BINDING AND FINISHING
UNIT III

ANSWERS TO TEST

1.

a.	3	e.	7	i.	8
b.	6	f.	2	j.	5
c.	10	g.	1	k.	4
d.	11	h.	9	l.	12
2. a, b, d, e, f, g, h, j
3. Any four of the following.
 - a. Accordion fold
 - b. Gate fold
 - c. Letter fold
 - d. Map fold
 - e. French fold
 - f. Broadside fold
4. Any four of the following:
 - a. Die cutting
 - b. Embossing
 - c. Laminating
 - d. Varnishing
 - e. Flocking
5. Performance skills evaluated to the satisfaction of the instructor

CALCULATING PAPER CUTTING UNIT IV

UNIT OBJECTIVE

After completion of this unit, the student should be able to state and use the formula for cutting paper stock, for determining the number of sheets to be cut for a printing job, and for making a combination cut. The student should also be able to draw a cutting diagram. This knowledge will be evidenced by correctly performing the procedures outlined in the assignment sheets and by scoring 85 percent on the unit test.

SPECIFIC OBJECTIVES

After completion of this unit, the student should be able to:

1. Match terms related to calculating paper cutting with the correct definitions.
2. List kinds of pulp used in papermaking.
3. Name the four tests and procedures for determining grain direction.
4. Define base size and base weight.
5. List base sizes of paper.
6. Match major families of fine paper with the correct definitions.
7. Match commercial envelope number sizes with their dimensions.
8. State the formula for cutting paper stock.
9. State the formula for determining the number of sheets to be cut for a printing job.
10. State the formula for making a combination cut.
11. Use formula for cutting paper stock.
12. Use formula to determine how many sheets will be required.
13. Make a combination cut using stock cutting formula.
14. Draw a cutting diagram.

CALCULATING PAPER CUTTING UNIT IV

SUGGESTED ACTIVITIES

- I. Provide student with objective sheet.
- II. Provide student with information and assignment sheets.
- III. Make transparencies.
- IV. Discuss unit and specific objectives.
- V. Discuss information and assignment sheets.
- VI. It is suggested that the instructor show the film strip-cassette series entitled "Paper Cutting Calculations," available from the McKnight Publishing Company.
- VII. Give test.

INSTRUCTIONAL MATERIALS

- I. Included in this unit:
 - A. Objective sheet
 - B. Information sheet
 - C. Transparency masters
 1. TM 1--Types of Envelopes
 2. TM 2--Business Papers Family
 - D. Assignment sheets
 1. Assignment Sheet #1--Use Formula for Cutting Paper Stock
 2. Assignment Sheet #2--Use Formula to Determine How Many Sheets Will Be Required
 3. Assignment Sheet #3--Make a Combination Cut Using Stock Cutting Formula
 4. Assignment Sheet #4--Draw a Cutting Diagram
 - E. Answers to assignment sheets
 - F. Test
 - G. Answers to test

II References

- A Schabel, Adolph J *Practical Problems in Mathematics-Printing Trades*. Albany, NY: Delmar Publishing, 1956
- B Cogoli, John E *Photo-Offset Fundamentals* Bloomington, IL 61701 McKnight Publishing Company, 1980.
- C Spence, Dr. William D. and Dr. David G. Vequist. *Graphic Reproduction*. Peoria, IL 61615: Charles A. Bennett Co., Inc., 1980.
- D Prust, Z.A. *Photo-Offset Lithography* South Holland, IL: The Goodheart-Willcox Co., Inc., 1977.

CALCULATING PAPER CUTTING UNIT IV

INFORMATION SHEET

I. Terms and definitions

- A. ~~Fiber~~—Wood pulp reduced to wood or cellulose fibers, the basic ingredient of paper
- B. Grain—The direction the fiber runs in the finished sheet of paper
- C. Calendaring—Coated papers polished on calendar rollers after coating and drying
- D. Loading—The addition of clay to wood pulp giving paper better opacity and smoother finish
- E. Sizing—Rosin used as sizing to give paper better ink holdout and to keep paper from shredding
- F. Felt side—The smoother side of the paper that was on the felt blanket of the papermaking machine
- G. Wire side—The side of paper next to the screen on the papermaking machine
- H. Sheet—What paper is purchased in, cut into pieces, then a sheet again on the press
- I. Piece—The job-size which is cut from the full-size sheet
- J. Ream—Consists of 500 sheets; most business papers are packaged as such
- K. Caliper—The thickness of a sheet of paper measured in thousandths of an inch
- L. Carbonless paper—Coated with chemicals so it will yield an image when pressure is applied
- M. Substance—Also known as the basis weight of paper
- N. Combination cut—A second cut, made in stock cutting, when grain direction is not a factor; and additional pieces can be cut from waste of first cut

II. Kinds of pulp used in papermaking

- A. Mechanically ground wood pulp
- B. Recycled paper pulp

INFORMATION SHEET

- C. Chemical wood pulp
 - D. Rag pulp
 - E. Cotton pulp
- III. Four tests and procedures for determining grain direction
- A. Bending--Hold sheet first at one edge, then the other; the side producing the greatest sag is direction of the grain
 - B. Tearing--Tear sheet from the end and from the side; cleanest tear is with the grain direction
 - C. Folding--Fold and crease paper sharply in both directions; the smoothest crease is with the grain
 - D. Wetting--Wet sheet; paper rolls with the direction of grain
- IV. Definition of base size and base weight
- A. Base size--Determined by paper's common use size

Example: Bond paper has a base size of 17 x 22, since it is commonly cut into 8 1/2 x 11 (4 x 8 1/2 x 11 = 17 x 22)
 - B. Base weight--Always the weight of one ream (500 sheets) of the base size
- V. Base size of papers
- A. Bond--17" x 22"
 - B. Book--25" x 38"
 - C. Cover--20" x 26"
 - D. Bristol--22 1/2" x 28 1/2"
- VI. Major families of fine paper (Transparency 1)
- A. Book--The largest family; includes coated and uncoated papers for books and publications
 - B. Cover--The most colorful and fanciest family; includes coated and uncoated paper for covers of books, brochures, menus, etc.
 - C. Business--Second largest family; includes bond, ledger, safety and writing paper for business correspondence
 - D. Bristol papers--Primary card stock; includes index and wedding bristols
 - E. Blanks and paperboards--Includes heavy, thick posterboard and paperboards which are sometimes made in layers

INFORMATION SHEET

- F. Thin papers--Really members of book and business paper families; includes bible, manifold, and onionskin
- G. Print papers--Includes newsprint paper for newspapers and is in a soft, non-durable, highly absorbent finish

VII. Commercial envelopes number sizes and dimensions (Transparency 2)

- A. 6 1/4 size--Dimensions 3 1/2 x 6
- B. 6 3/4 size--Dimensions 3 5/8 x 6 1/2
- C. 7 size--Dimensions 3 3/4 x 6 3/4
- D. 7 3/4 size--Dimensions 3 7/8 x 7 1/2
- E. Monarch size--Dimensions 3 7/8 x 7 1/2
- F. Check size--Dimensions 3 5/8 x 8 5/8
- G. 9 size--Dimensions 3 7/8 x 8 7/8
- H. 10 size--Dimensions 4 1/8 x 9 1/2
- I. 11 size--Dimensions 4 1/2 x 10 3/8
- J. 12 size--Dimensions 4 3/4 x 11
- K. 14 size--Dimensions 5 x 11 1/2

(NOTE: The two most common business envelope sizes are #6 3/4 business envelopes and #10 business envelopes.)

VIII. Formula for cutting paper stock--

$$\frac{\text{Dimensions of sheet}}{\text{Dimensions of piece to be cut}} = \text{Number of pieces cut from sheet.}$$

Example: How many 8 1/2 x 11 pieces can be cut from a 17 x 22 sheet?

- a. $\frac{17 \times 22}{8 \frac{1}{2} \times 11}$ $\frac{\text{Dimensions of sheet}}{\text{Dimensions of piece}}$
- b. Divide vertically 8 1/2 into 17 = 2
- c. Divide 11 into 22 = 2
- d. Multiply the two answers from steps b and c

Answer: 2 x 2 = 4

INFORMATION SHEET

IX. Formula for determining number of sheets to be cut for a printing job--

$$\frac{\text{Desired number of pieces}}{\text{Number of pieces obtained from one sheet}} = \text{Total number of sheets needed}$$

Example: How many 17 x 22 sheets will be needed to cut 1,000 pieces 8 1/2 x 11?

a. $\frac{1000}{4}$ desired number of pieces
number of pieces cut from one sheet

b. Divide 4 into 1,000 = 250

$$\begin{array}{r} 250 \\ 4 \overline{) 1,000} \end{array}$$

Answer: 250 sheets will need to be cut to produce 1,000 pieces.

(NOTE: An extra sheet must be cut any time there is a remainder when dividing number of pieces into number of sheets.)

X. Formula for making a combination cut

(NOTE: A combination cut is made when additional pieces can be cut from the waste of the first cut, and when grain direction is not a factor.)

A. $\frac{\text{Dimensions of sheet}}{\text{Dimensions of piece to be cut}} = \text{Number of pieces cut from sheet}$

B. After measuring waste, calculate

$$\frac{\text{Waste portion}}{\text{Dimension of piece to be cut}} = \text{Number of pieces obtained}$$

Example: a. (5) Waste (8) Waste

$$3 \times 3 = 9$$

$$\frac{23 \times 35}{6 \times 9}$$

b. (5) Waste (5) Waste

$$2 \times 5 = 10$$

$$\frac{23 \times 35}{9 \times 6}$$

273

INFORMATION SHEET

- c. Examining the two possible cuts in a. and b. note that one of the waste portions in cut a. is large enough to accommodate one of the dimensions of our piece size, 6 x 9 (Figure 1)

FIGURE 1

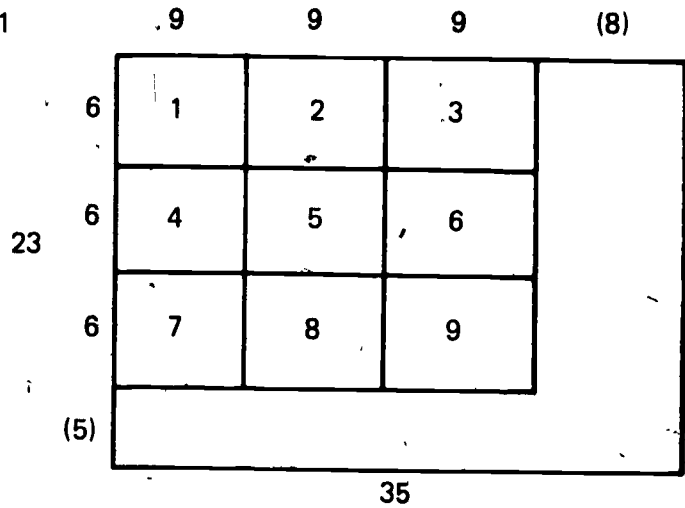

- d. Thus, dividing 6 x 9 in to the waste portion, 8 x 23, we find two more pieces can be obtained (Figure 2)

$$1 \times 2 = 2$$

$$\frac{8 \times 23}{6 \times 9}$$

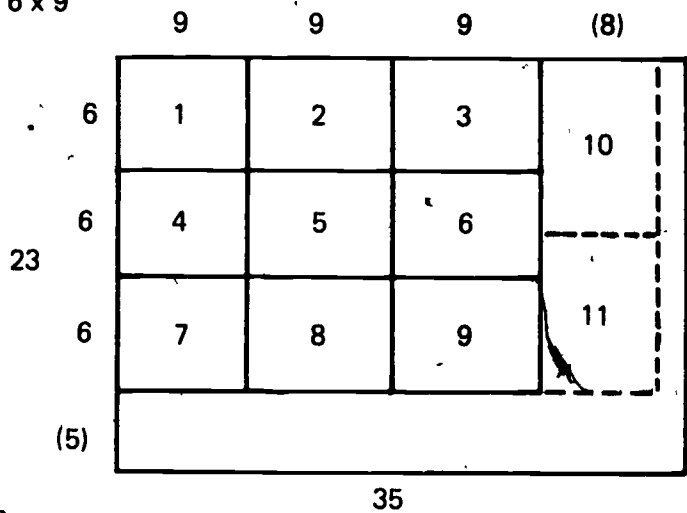

FIGURE 2

INFORMATION SHEET

- e. By using the combination cut, 11 pieces of 6 x 9 are obtained from the 23 x 35 sheet (Figure 3)

(NOTE: If grain direction was a factor, cut b. producing 10 pieces would have been the best cut.)

FIGURE 3

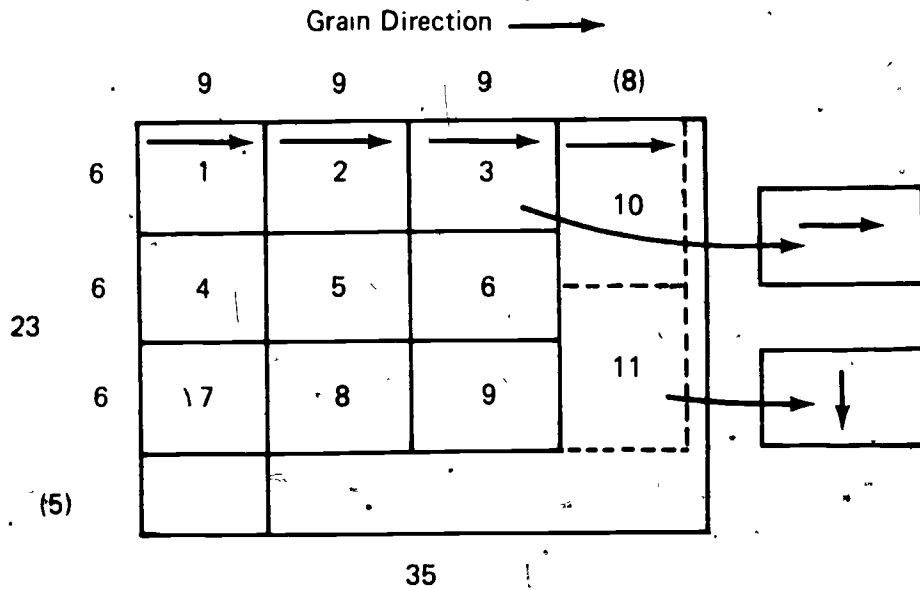

Types of Envelopes



Air Mail

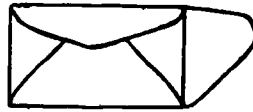

Postage Saver

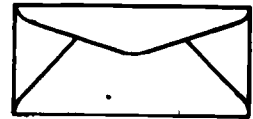

Official



Commercial



Booklet



Dot-A-Gum Postage Saver



Coin



Transparent Window



Pay



Baronial

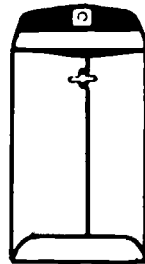

Clasp



Drug



Theater



Policy

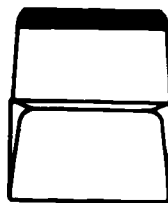

Remittance

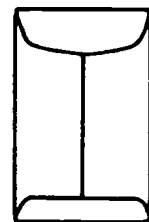

Catalog

(Courtesy Carpenter Paper Company, Oklahoma City)

Business Papers Family

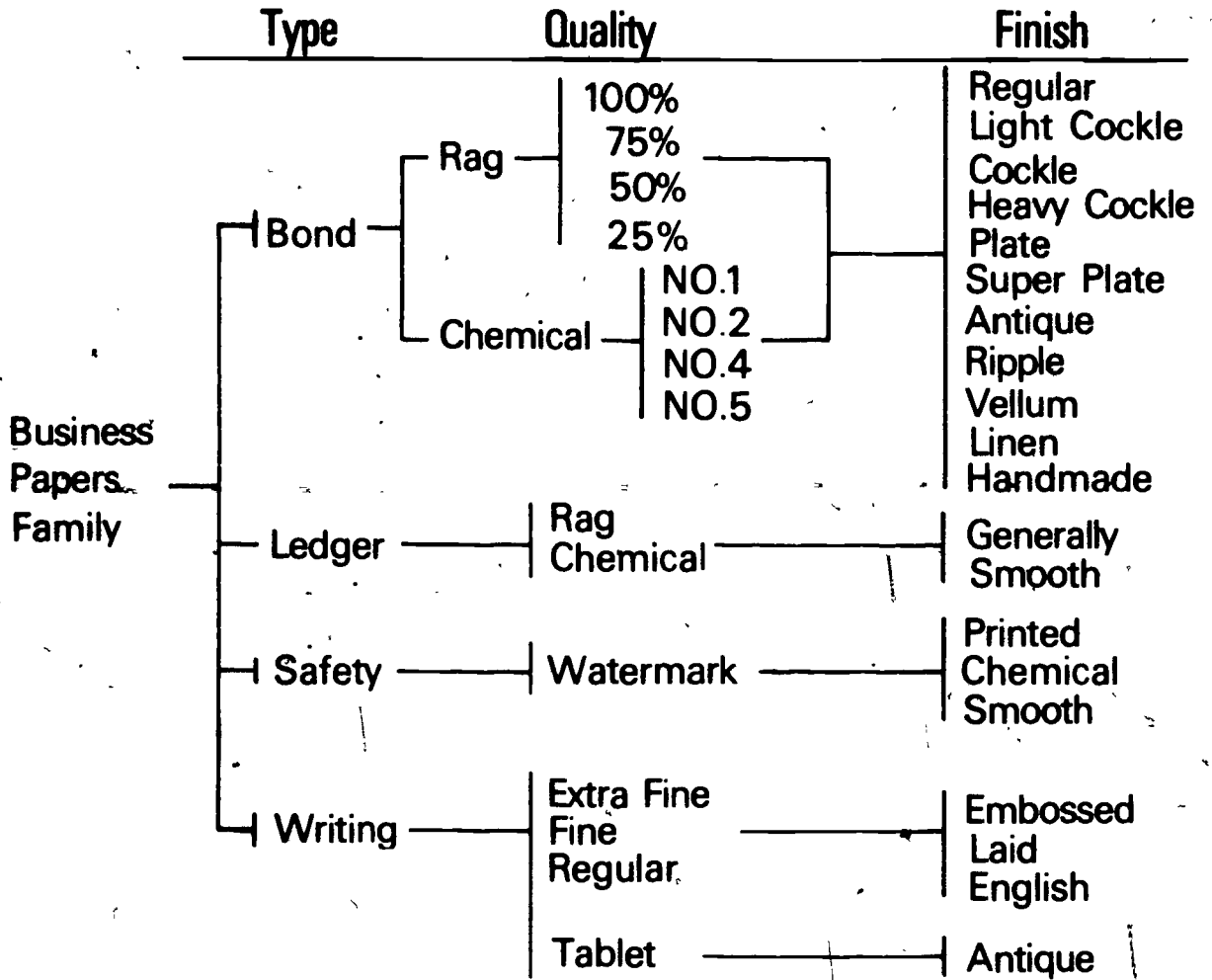

Reprinted from GRAPHIC REPRODUCTION, Copyright 1980 by William P. Spence and David G. Vequist. Used with permission of the publisher Bennett Publishing Company, Peoria, IL 61615. All rights reserved.

CALCULATING PAPER CUTTING UNIT IV

ASSIGNMENT SHEET #1--USE FORMULA FOR CUTTING PAPER STOCK

1. Using the formula for cutting paper stock, find out how many 6 x 9 pieces can be cut from a 35 x 38 sheet. Show two answers and draw the cutting diagram for the best of the two.

a. _____

b. _____

c. Diagram of best:

2. Using the formula when sheet size has fractions, determine how many 4 x 6 pieces can be cut from a $20 \frac{1}{2} \times 24 \frac{3}{4}$ sheet and show cutting diagram.

(NOTE: When fractions are part of only the sheet size, this fraction simply becomes part of the waste, and need not be calculated.)

a. Number of pieces = _____

b. Diagram:

3. Using the formula when piece size has fractions, find out how many $2 \frac{1}{2} \times 5 \frac{1}{2}$ pieces can be cut from a 23 x 35 sheet.

(NOTE: When piece size has fractions, convert to decimals and calculate.)

Number of pieces = _____

CALCULATING PAPER CUTTING
UNIT IVASSIGNMENT SHEET #2--USE FORMULA TO DETERMINE HOW MANY
SHEETS WILL BE REQUIRED

4 Directions: Use the formula for how many sheets will be required in the following:

- 1 First determine how many $3 \frac{1}{2} \times 5 \frac{1}{2}$ pieces can be cut from a sheet 22×28 .

Answer _____

2. Now determine how many sheets will need to be cut up to produce 1000 pieces.

Answer. _____

CALCULATING PAPER CUTTING
UNIT IV

ASSIGNMENT SHEET #3--MAKE A COMBINATION CUT
USING STOCK CUTTING FORMULA

Directions: Find out how many 4 x 6 pieces can be cut from a 23 x 35 sheet. Draw cutting diagrams for both cuts and determine how many additional pieces can be cut from waste of first cut, assuming grain direction is not a factor.

1. Number of pieces = _____

2. Cutting diagrams:

a.

b.

3. Additional number of pieces = _____

CALCULATING PAPER CUTTING
UNIT IV

ASSIGNMENT SHEET #4--DRAW A CUTTING DIAGRAM

Directions Using a sheet of $20 \frac{1}{2} \times 24 \frac{3}{4}$ index sheet, a t-square, a ruler or pica line gauge, and a No. 2 pencil, calculate the following.

1. Determine how many 4×6 pieces can be cut from the $20 \frac{1}{2} \times 24 \frac{2}{4}$ sheet.

Answer: _____

2. Draw the exact cutting diagram on the $20 \frac{1}{2} \times 24 \frac{3}{4}$ sheet, showing where each cut will be made.
3. Number the pieces to be obtained on the diagram.

296

CALCULATING PAPER CUTTING
UNIT IV

ANSWERS TO ASSIGNMENT SHEETS

Assignment Sheet #1

- 1 a. 20
b. 18
c.

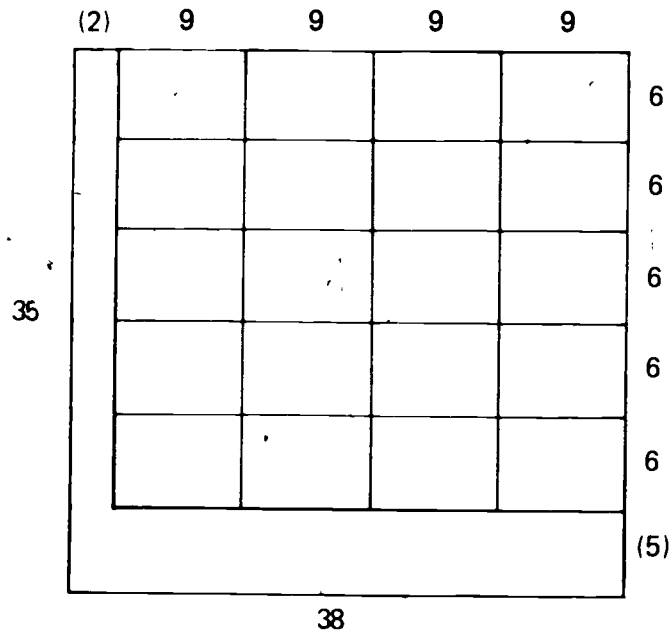

- 2 a. 20
b.

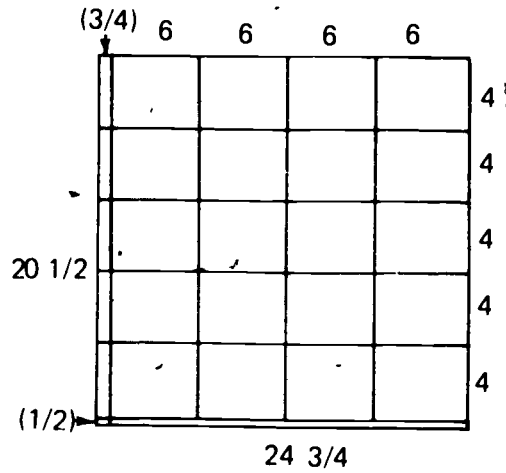

3. 56

ANSWERS TO ASSIGNMENTS SHEETS

Assignment Sheet #2

1. 32
2. 32

Assignment Sheet #3

1. 24
2. a.

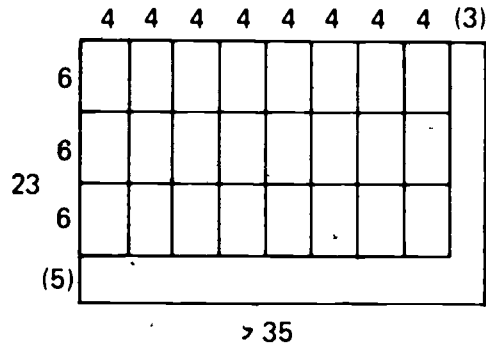

b.

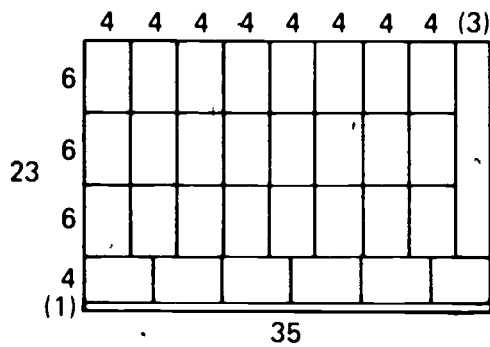

c. 5

ANSWERS TO ASSIGNMENT SHEETS

Assignment Sheet #4

1. 20
2. Answer to 2 and 3 included in the following diagram:

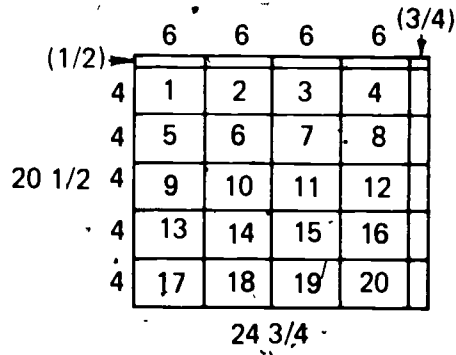

CALCULATING PAPER CUTTING UNIT IV

NAME _____

TEST

1. Match the terms on the right with the correct definitions.

- | | |
|---|----------------------------|
| <p>_____ a. Wood pulp reduced to wood or cellulose fibers, the basic ingredient of paper</p> | <p>1. Sheet</p> |
| <p>_____ b. The direction the fiber runs in the finished sheet of paper</p> | <p>2. Ream</p> |
| <p>_____ c. Coated papers polished on calendar rollers after coating and drying</p> | <p>3. Fiber</p> |
| <p>_____ d. The addition of clay to wood pulp giving paper better opacity and smoother finish</p> | <p>4. Grain</p> |
| <p>_____ e. Rosin used as sizing to give paper better ink holdout and to keep paper from shredding</p> | <p>5. Piece</p> |
| <p>_____ f. The smoother side of the paper that was on the felt blanket of the papermaking machine</p> | <p>6. Carbonless paper</p> |
| <p>_____ g. The side of paper next to the screen on the papermaking machine</p> | <p>7. Wire side</p> |
| <p>_____ h. What paper is purchased in, cut into pieces, then a sheet again on the press</p> | <p>8. Substance</p> |
| <p>_____ i. The job-size which is cut from the full-size sheet</p> | <p>9. Sizing</p> |
| <p>_____ j. Consists of 500 sheets; most business papers are packaged as such</p> | <p>10. Felt side</p> |
| <p>_____ k. The thickness of a sheet of paper measured in thousandths of an inch</p> | <p>11. Loading</p> |
| <p>_____ l. Coated with chemicals so it will yield an image when pressure is applied</p> | <p>12. Caliper</p> |
| <p>_____ m. Also known as the basis weight of paper</p> | <p>13. Calendaring</p> |
| <p>_____ n. A second cut, made in stock cutting, when grain direction is not a factor, and additional pieces can be cut from the waste of the first cut</p> | <p>14. Combination cut</p> |

2. List four kinds of pulp used in making paper.

- a. _____
- b. _____
- c. _____
- d. _____

3. Name the four tests and procedures for determining grain direction.

- a. _____
- b. _____
- c. _____
- d. _____

4. Define base size and base weight.

- a. Base size-- _____
- b. Base weight-- _____

5. List the base sizes of paper.

- a. Bond--
- b. Book--
- c. Cover--
- d. Bristol--

6. Match the major families of fine paper with the correct definitions.

- | | |
|--|---------------------------|
| _____ a. The largest family; includes coated and uncoated papers for books and publications | 1. Thin papers |
| _____ b. The most colorful and fanciest family; includes coated and uncoated paper for covers of books, brochures, menus, etc. | 2. Business |
| _____ c. Second largest family; includes bond, ledger, safety, and writing papers for business correspondence | 3. Book |
| _____ d. Primarily card stock; includes index and wedding bristols | 4. Print papers |
| _____ e. Includes heavy, thick, posterboard and paperboards which are sometimes made in layers | 5. Cover |
| | 6. Bristol papers |
| | 7. Blanks and paperboards |

_____ f. Really members of book and business paper families; includes bible, manifold, and onion-skin

_____ g. Includes newsprint paper for newspapers, and is in a soft, non-durable, highly absorbent finish

7. Match commercial envelope number sizes with their dimensions.

- | | |
|------------------|-------------------|
| _____ a. 6 1/4 | 1. 3 3/4 x 6 3/4 |
| _____ b. 6 3/4 | 2. 4 1/8 x 9 1/2 |
| _____ c. 7 | 3. 3 5/8 x 6 1/2 |
| _____ d. 7 3/4 | 4. 5 x 11 1/2 |
| _____ e. Monarch | 5. 4 1/2 x 10 3/8 |
| _____ f. Check | 6. 3 1/2 x 6 |
| _____ g. 9. | 7. 3 7/8 x 7 1/2 |
| _____ h. 10 | 8. 3 5/8 x 8 5/8 |
| _____ i. 11 | 9. 3 7/8 x 7 1/2 |
| _____ j. 12 | 10. 4 3/4 x 11 |
| _____ k. 14 | 11. 3 7/8 x 8 7/8 |

8. State the formula for cutting paper stock.

9. State the formula for determining the number of sheets to be cut for a printing job.

10. State the formula for making a combination cut.

11. Use formula for cutting paper stock.

12. Use formula to determine how many sheets will be required.

13. Make a combination cut using stock cutting formula.

14. Draw a cutting diagram.

(NOTE: If these activities have not been accomplished prior to the test, ask your instructor when they should be completed.)

CALCULATING PAPER CUTTING
UNIT IV

ANSWERS TO TEST

1.

a. 3	f. 10	k. 12
b. 4	g. 7	l. 6
c. 13	h. 1	m. 8
d. 11	i. 5	n. 14
e. 9	j. 2	

2. Any four of the following:
 - a. Mechanically ground wood pulp
 - b. Recycled paper pulp
 - c. Chemical wood pulp
 - d. Rag pulp
 - e. Cotton pulp

3. Answer should include the following:
 - a. Bending--Hold sheet first at one edge, then the other; the side producing greatest sag is direction of the grain
 - b. Tearing--Tear sheet from the end and from the side; cleanest tear is with grain direction
 - c. Folding--Fold and crease paper sharply in both directions; the smoothest crease is with the grain
 - d. Wetting--Wet sheet; paper rolls with direction of grain

4.
 - a. Base size--Determined by paper's common use size
 - b. Base weight--Always the weight of one ream of the base size

5.
 - a. 17" x 22"
 - b. 25" x 38"
 - c. 20" x 26"
 - d. 22 1/2" x 28 1/2"

6.

a. 3	e. 7
b. 5	f. 1
c. 2	g. 4
d. 6	

7.

a. 6	e. 7 or 9	i. 5
b. 3	f. 8	j. 10
c. 1	g. 11	k. 4
d. 7 or 9	h. 2	

8. $\frac{\text{Dimensions of sheet}}{\text{Dimension of piece to be cut}} = \text{Number of pieces cut from sheet}$

9. $\frac{\text{Desired number of pieces}}{\text{Number of pieces obtained from one sheet}} = \text{Total number of sheets needed}$

10. a. $\frac{\text{Dimensions of sheet}}{\text{Dimension of piece to be cut}} = \text{Number of pieces cut from sheet}$

b. $\frac{\text{Waste portion}}{\text{Dimension of piece to be cut}} = \text{Number of pieces obtained}$

11. Evaluated to the satisfaction of the instructor

12. Evaluated to the satisfaction of the instructor

13. Evaluated to the satisfaction of the instructor

14. Evaluated to the satisfaction of the instructor