

DOCUMENT RESUME

ED 219 651

CE 033 508

AUTHOR Farajollahi, Karim; And Others
 TITLE Graphic Arts: Book Two. Process Camera, Stripping, and Platemaking.
 INSTITUTION Mid-America Vocational Curriculum Consortium, Stillwater, Okla.
 PUB DATE 81
 NOTE 222p.; For related documents see CE 033 507-509.
 AVAILABLE FROM Mid-America Vocational Curriculum Consortium, 1515 West Sixth Avenue, Stillwater, OK 74074.

EDRS PRICE MF01 Plus Postage. PC Not Available from EDRS.
 DESCRIPTORS Competency Based Education; Criterion Referenced Tests; *Graphic Arts; Instructional Materials; Learning Activities; *Photographic Equipment; *Photography; Postsecondary Education; *Production Techniques; *Reprography; *Technical Education

ABSTRACT

The second of a three-volume set of instructional materials for a course in graphic arts, this manual consists of 10 instructional units dealing with the process camera, stripping, and platemaking. Covered in the individual units are the process camera and darkroom photography, line photography, half-tone photography, other darkroom techniques, overview of the process of color photography, continuous tone film processing and printing, introduction to stripping, stripping techniques, introduction to platemaking, and platemaking techniques. Each unit contains some or all of the following: performance objectives, suggested activities for teachers, information sheets, assignment sheets, job sheets, visual aids, tests, and test answers. Instructional materials in the publication are written in terms of student performance using measurable objectives. (MN)

 * Reproductions supplied by EDRS are the best that can be made *
 * from the original document. *

ED219651

GRAPHIC ARTS: BOOK TWO
PROCESS CAMERA, STRIPPING, AND PLATE MAKING

by

Karim Farajollahi

Gary Ogle

William Reed

Kenneth Woodcock

Developed by the

Mid-America Vocational Curriculum Consortium, Inc.

Board of Directors

Merle Rudebusch, Nebraska, Chairman
David Poston, Louisiana, Vice Chairman
Jim Dasher, Arkansas
Bill Barnes, Colorado
Ed Hankins, Kansas
Amon Herd, Missouri
Alan Morgan, New Mexico
Larry Barnhardt, North Dakota
Bob Patton, Oklahoma
Dan Elwood, South Dakota
Pat Lindley, Texas
Ann Benson, Executive Director

U.S. DEPARTMENT OF EDUCATION
NATIONAL INSTITUTE OF EDUCATION
EDUCATIONAL RESOURCES INFORMATION
CENTER (ERIC)

- ✓ This document has been reproduced as received from the person or organization originating it.
- Minor changes have been made to improve reproduction quality.
- Points of view or opinions stated in this document do not necessarily represent official NIE position or policy.

• "PERMISSION TO REPRODUCE THIS
MATERIAL IN MICROFICHE ONLY
HAS BEEN GRANTED BY

S. DEAN

TO THE EDUCATIONAL RESOURCES
INFORMATION CENTER (ERIC) "

COPYRIGHT - 1981

Mid-America Vocational Curriculum Consortium, Inc.

Printed by

**State Department of Vocational and Technical Education
Stillwater, Oklahoma 74074**

TABLE OF CONTENTS

Section A--Process Camera

UNIT I	The Process Camera and Darkroom Photography	G II - 1-A
UNIT II	Line Photography	G II - 27-A
UNIT III	Halftone Photography	G II - 61-A
UNIT IV	Other Darkroom Techniques	G II - 95-A
UNIT V	Overview of Process Color Photography	G II - 125-A
UNIT VI	Continuous Tone Film Processing and Printing	G II - 143-A

Section B--Stripping and Platemaking

UNIT I	Introduction to Stripping	G II - 1-B
UNIT II	Stripping Techniques	G II - 23-B
UNIT III	Introduction to Platemaking	G II - 51-B
UNIT IV	Platemaking Techniques	G II - 81-B

FOREWORD

The Mid-America Vocational Curriculum Consortium (MAVCC) was organized for the purpose of developing instructional material for the eleven member states. Priorities for developing MAVCC material are determined annually based on the needs as identified by all member states. One of the priorities identified was graphic arts or offset printing. This publication is the second of three books designed to provide the needed instructional material for this area.

The success of this publication is due, in large part, to the capabilities of the personnel who worked with its development. The technical writers have numerous years of industry as well as teaching experience. Assisting them in their efforts were representatives of each of the member states who brought with them technical expertise and the experience related to the classroom and to the trade. To assure that the materials would parallel the industry environment and be accepted as a transportable basic teaching tool, organizations and industry representatives were involved in the developmental phases of the manual. Appreciation is extended to them for their valuable contributions to the manual.

This publication is designed to assist teachers in improving instruction. As these publications are used, it is hoped that the student performance will improve and that students will be better able to assume a role in their chosen occupation; graphic arts.

Instructional materials in this publication are written in terms of student performance using measurable objectives. This is an innovative approach to teaching that accents and augments the teaching/learning process. Criterion referenced evaluation instruments are provided for uniform measurement of student progress. In addition to evaluating recall information, teachers are encouraged to evaluate the other areas including process and product as indicated at the end of each instructional unit.

It is the sincere belief of the MAVCC personnel and all those members who served on the committees that this publication will allow the students to become better prepared and more effective members of the work force.

Merle Rudebusch, Chairman
Board of Directors
Mid-America Vocational
Curriculum Consortium

PREFACE

For many years those responsible for teaching graphic arts and offset printing have felt a need for better quality materials to use in this area. A team of teachers, industry representatives, and trade and industrial education staff members accepted this challenge and have produced three manuals which will meet the needs of many types of courses where students are expected to become proficient in the area of printing. This publication, *Graphic Arts: Book Two--Process Camera, Stripping, and Platemaking*, is designed to teach the information related to camera and plate work. Content for paste up and composition has been written in Book One and information related to press and bindery will be presented in Book Three.

Every effort has been made to make this publication basic, readable, and by all means usable. Three vital parts of instruction have been intentionally omitted from this publication: motivation, personalization, and localization. These areas are left to the individual instructors and the instructors should capitalize on them. Only then will this publication really become a vital part of the teaching-learning process.

In addition, we would appreciate your help. We check for content quality, spelling, and typographical errors many times in the development of a manual. It is still possible, however, for an error to show up in a publication.

We are trying to provide you with the best possible curriculum materials and will certainly appreciate your help in detecting areas where possible corrections are needed to maintain the quality you want and deserve.

Ann Benson
Executive Director
Mid-America Vocational
Curriculum Consortium, Inc.

ACKNOWLEDGEMENTS

Appreciation is extended to those individuals who contributed their time and talents to the development of *Graphic Arts: Book Two--Process Camera, Stripping, and Platemaking*.

The contents of this publication were planned and reviewed by:

Mid-America Vocational Curriculum Consortium Committee

Bill Braun	Springer, New Mexico
James Brown, Jr.	Greeley, Colorado
Sandra Devall	Texas City, Texas
Willard Gore	Shreveport, Louisiana
David Hinkley	Grand Forks, North Dakota
Karim Farajollahi	Stillwater, Oklahoma
John Koonce	Emporia, Kansas
Warren Lyon	Lincoln, Nebraska
Eugene Shaver	Aberdeen, South Dakota
William D. Reed	Tulsa, Oklahoma
Tom Presley	Little Rock, Arkansas
Phyllis Miller	Columbia, Missouri

Thanks are extended to Don Ruby of Northeastern State University in Tahlequah, Oklahoma for representing teacher education on this committee and to Ray Merritt for representing state supervisory personnel.

Special thanks are extended to Noel Wilcoxson, foreman of the Print Shop located at the Oklahoma State Department of Vocational-Technical Education, for his representation of industry on the committee and to the numerous other companies who provided references and technical materials.

Gratitude is expressed to Joan Dolan for editing and to the Graphics Division of the Oklahoma State Department of Vocational and Technical Education for typing and art work.

Special appreciation goes to Bill Braun for designing the cover of this publication.

The printing staff of the Oklahoma State Department of Vocational and Technical Education is deserving of much credit for printing this publication.

USE OF THIS PUBLICATION

Instructional Units

The *Graphic Arts: Book Two--Process Camera, Stripping, and Platemaking*, includes ten units. Each instructional unit includes some or all of the basic components of a unit of instruction: performance objectives, suggested activities for teachers and students, information sheets, assignment sheets, visual aids, tests, and answers to the test. Units are planned for more than one lesson or class period of instruction.

Careful study of each instructional unit by the teacher will help to determine:

- A. The amount of material that can be covered in each class period
- B. The skills which must be demonstrated
 1. Supplies needed
 2. Equipment needed
 3. Amount of practice needed
 4. Amount of class time needed for demonstrations
- C. Supplementary materials such as pamphlets or filmstrips that must be ordered
- D. Resource people who must be contacted

Objectives

Each unit of instruction is based on performance objectives. These objectives state the goals of the course, thus providing a sense of direction and accomplishment for the student.

Performance objectives are stated in two forms: unit objectives, stating the subject matter to be covered in a unit of instruction; and specific objectives, stating the student performance necessary to reach the unit objective.

Since the objectives of the unit provide direction for the teaching-learning process, it is important for the teacher and students to have a common understanding of the intent of the objectives. A limited number of performance terms have been used in the objectives for this curriculum to assist in promoting the effectiveness of the communication among all individuals using the materials.

Following is a list of performance terms and their synonyms which may have been used in this material:

<u>Name</u>	<u>Identify</u>	<u>Describe</u>
Label	Select	Define
List in writing	Mark	Discuss in writing
List orally	Point out	Discuss orally
Letter	Pick out	Interpret
Record	Choose	Tell how
Repeat	Locate	Tell what
Give		Explain

Order
Arrange
Sequence
List in order
Classify
Divide
Isolate
Sort

Distinguish
Discriminate

Construct
Draw
Make
Build
Design
Formulate
Reproduce
Transcribe
Reduce
Increase
Figure

Demonstrate
Show your work
Show procedure
Perform an experiment
Perform the steps
Operate
Remove
Replace
Turn off/on
(Dis) assemble
(Dis) connect

Additional Terms Used
Evaluate
Complete
Analyze
Calculate
Estimate
Plan
Observe
Compare
Determine
Perform

Prepare
Make
Read
Tell
Teach
Converse
Lead
State
Write

Reading of the objectives by the student should be followed by a class discussion to answer any questions concerning performance requirements for each instructional unit.

Teachers should feel free to add objectives which will fit the material to the needs of the students and community. When teachers add objectives, they should remember to supply the needed information, assignment and/or job sheets, and criterion tests.

Suggested Activities for the Instructor:

Each unit of instruction has a suggested activities sheet outlining steps to follow in accomplishing specific objectives. Duties of instructors will vary according to the particular unit; however, for best use of the material they should include the following: provide students with objective sheet, information sheet, assignment sheets, and job sheets; preview filmstrips, make transparencies, and arrange for resource materials and people; discuss unit and specific objectives and information sheet; give test. Teachers are encouraged to use any additional instructional activities and teaching methods to aid students in accomplishing the objectives.

Information Sheets

Information sheets provide content essential for meeting the cognitive (knowledge) objectives in the unit. The teacher will find that the information sheets serve as an excellent guide for presenting the background knowledge necessary to develop the skill specified in the unit objective.

Students should read the information sheets before the information is discussed in class. Students may take additional notes on the information sheets.

Transparency Masters

Transparency masters provide information in a special way. The students may see as well as hear the material being presented, thus reinforcing the learning process. Transparencies may present new information or they may reinforce information presented in the information sheets. They are particularly effective when identification is necessary.

Transparencies should be made and placed in the notebook where they will be immediately available for use. Transparencies direct the class's attention to the topic of discussion. They should be left on the screen only when topics shown are under discussion.

Job Sheets

Job sheets are an important segment of each unit. The instructor should be able to and in most situations should demonstrate the skills outlined in the job sheets. Procedures outlined in the job sheets give direction to the skill being taught and allow both student and teacher to check student progress toward the accomplishment of the skill. Job sheets provide a ready outline for students to follow if they have missed a demonstration. Job sheets also furnish potential employers with a picture of the skills being taught and the performances which might reasonably be expected from a person who has had this training.

Assignment Sheets

Assignment sheets give direction to study and furnish practice for paper and pencil activities to develop the knowledges which are necessary prerequisites to skill development. These may be given to the student for completion in class or used for homework assignments. Answer sheets are provided which may be used by the student and/or teacher for checking student progress.

Test and Evaluation

Paper-pencil and performance tests have been constructed to measure student achievement of each objective listed in the unit of instruction. Individual test items may be pulled out and used as a short test to determine student achievement of a particular objective. This kind of testing may be used as a daily quiz and will help the teacher spot difficulties being encountered by students in their efforts to accomplish the unit objective. Test items for objectives added by the teacher should be constructed and added to the test.

Test Answers

Test answers are provided for each unit. These may be used by the teacher and/or student for checking student achievement of the objectives.

GRAPHIC ARTS: BOOK TWO
PROCESS CAMERA, STRIPPING, AND PLATEMAKING

INSTRUCTIONAL/OCCUPATIONAL ANALYSIS

JOB TRAINING: What the
Worker Should Be Able to Do
(Psychomotor)

RELATED INFORMATION: What
the Worker Should Know
(Cognitive)

SECTION A--UNIT I: THE PROCESS CAMERA AND DARKROOM EQUIPMENT

1. Definition of a process camera
2. Types of process cameras
3. Parts of process cameras
4. Functions of process cameras
5. Darkroom equipment uses
6. Darkroom cleanliness
7. Darkroom safety
8. Describe safety practices

UNIT II: LINE PHOTOGRAPHY

1. Terms and definitions
2. Materials used to develop line photography
3. Film characteristics
4. Types of bases
5. Types of emulsion
6. Degrees of density
7. Density values
8. Parts of a lens assembly
9. Characteristics of an aperture
10. Functions of filters
11. Poor copy and problem copy
12. Prepare a darkroom
13. Set up a process camera and determine basic exposure

JOB TRAINING: What the Worker Should Be Able to Do (Psychomotor)

14. Construct an exposure chart

RELATED INFORMATION: What the Worker Should Know (Cognitive)

UNIT III: HALFTONE PHOTOGRAPHY

1. Terms and definitions
 2. Types of contact screens
 3. Care of contact screens
 4. Kinds of halftone dots
 5. Characteristics of Kodak Autoscreen film
 6. Procedures for avoiding moires
-
7. Program a Q12 Exposure Computer and make a halftone negative
 8. Program a Q15 Exposure Computer and make a halftone negative
 9. Make a duotone
 10. Make a fake duotone
 11. Rescreen a halftone illustration

UNIT IV: OTHER DARKROOM TECHNIQUES

1. Terms and definitions
 2. Care of diffusion transfer processor
 3. Materials and equipment for diffusion transfer
-
4. Determine basic exposure and make a diffusion transfer line print
 5. Make a diffusion transfer transparency
 6. Program a Q12 Exposure Computer for diffusion transfer halftones and make a halftone print
 7. Posterize with diffusion transfer materials
 8. Make a PMT paper litho plate
 9. Make a duplicate negative and a film positive

JOB TRAINING: What the Worker Should Be Able to Do (Psychomotor)

10. Make a spread, a choke, a spread outline, and a choke outline

RELATED INFORMATION: What the Worker Should Know (Cognitive)

UNIT V: OVERVIEW OF PROCESS COLOR PHOTOGRAPHY

1. Terms and definitions
 2. Additive and subtractive colors
 3. Functions of inks
 4. Color separation
 5. Color corrections
6. Make a set of unmasked direct screen separation negatives

UNIT VI: CONTINUOUS TONE FILM PROCESSING AND PRINTING

1. Terms and definitions
 2. Equipment and devices in processing a roll of film
 3. Equipment and devices in make a contact sheet and enlargement
4. Mix developer, stop bath, and fixer
 5. Process a roll of 35mm film
 6. Make a contact sheet
 7. Make an enlargement

SECTION B--UNIT I: INTRODUCTION TO STRIPPING

1. Terms and definitions
 2. Stripping tools and uses
 3. Stripping materials and uses
 4. Parts on a layout
 5. Emulsion and base side of a negative
6. Lay out an unruled flat
 7. Strip an unruled flat
 8. Strip a ruled flat

**JOB TRAINING: What the
Worker Should Be Able to Do
(Psychomotor)**

**RELATED INFORMATION: What
the Worker Should Know
(Cognitive)**

UNIT II: STRIPPING TECHNIQUES

1. Terms and definitions
2. Methods of combining line and halftone work
3. Combination printing
4. Stripping register marks and pins
5. Strip for step-and-repeat
6. Combine line and halftone work
7. Strip for combination or surprinting
8. Strip complementary flats for multi-color printing
9. Strip signature flats for multi-page or book printing
10. Use masking films in stripping
11. Use the pin register system in stripping for a two-color job

UNIT III: INTRODUCTION TO PLATEMAKING

1. Terms and definitions
2. Types of plate ends
3. Offset plate characteristics
4. Plate exposure devices
5. Advantages and disadvantages of offset plate processes
6. Presensitized plate characteristics
7. Gumming plates
8. Handling and storing plates
9. Handling plates and chemicals properly
10. Match plates with specific jobs

JOB TRAINING: What the Worker Should Be Able to Do (Psychomotor)

11. Develop a plate using a two-step method
12. Determine correct plate exposure

RELATED INFORMATION: What the Worker Should Know (Cognitive)

UNIT IV: PLATEMAKING TECHNIQUES

1. Terms and definitions
2. Platemaking materials and uses
3. Determine correct exposure and process an additive plate
4. Determine correct exposure and process a subtractive plate
5. Make corrections on a plate
6. Expose a step-and-repeat plate
7. Expose for a screen tint
8. Make plates for a two-color job
9. Expose a photo-direct plate

TOOLS AND EQUIPMENT

Acetic acid
Additive plate
Black-and-white photograph
Black felt tip pen
Blank sheets of paper
Bright light duplicating film
Cardboard
Clear tape
Color proofing material and developer
Contact proofer
Contact screen
Containers
Continuous tone copy
Cotton pads
Darkroom timer
Developer
Developing sink
Diffusion sheet
Diffusion transfer activator
Diffusion transfer gray contact screen
Diffusion transfer negative paper
Diffusion transfer processor
Diffusion transfer receiver paper
Enlarger
Exposure factor chart
Film clips
Film developer
Film register marks
Filter holder
Filters
Fixer
Fixer solution part A
Fixer solution part B
Flash lamp
Flats
Funnel
Gallon jugs
Glass cleaner
Graduated cylinder
Gray contact screen
Gray scale
Gum arabic
Halftone film
Halftone illustration
Halftone negative
Hone
Illustration board
Indicator stop bath
Ink
Kodak Color Separation Guide
Kodak Q12 Graphic Arts Exposure Computer
Kodak Q15 Graphic Arts Exposure Computer
Lead pencil
Light table
Line copy
Line negatives
Litho developer part A
Litho developer part B
Litho film
Lithographers tape
Magnifying glass
Masking film
Masking sheets
Masking tape
Mixing paddle
Negative
Negative preserver
Opaque brush and solution
Panchromatic film
Paper cutter
Paper towels
Platemaker
Plates
Plate sink
Preangled chipboard
Print easel
Print tongs
Process camera
Process gum
Proofing material
Protractor
Reflection densitometer
Register pins
Register punch
Resin coated photographic paper
Rubber eraser
Ruler
Screen tint
Sheet of chipboard
Sixteen ounce containers
Sponges
Squeegees
Stop bath
Stripping knife
T-square
Tape dispenser
Template
35mm tank
Transparent tape
Trays
Triangle
Water
Wetting agent
Zero inch type ruler

REFERENCES

- Bentley, R. G.; Olson, J. C.; Strandberg, C. E.; and Wiper, R. E. *Graphic Communications Series: Transparency Originals*. Chicago: A. B. Dick Company, 1970.
- Cogoli, John E. *Photo-Offset Fundamentals*. Bloomington, IL 61701: McKnight Publishing Company, 1980.
- Eastman Kodak. *Basic Color for the Graphic Arts*. Rochester, NY 14650: Eastman Kodak Company, 1972.
- Eastman Kodak. *Basic Developing, Printing, Enlarging in Black-and-White*. Publication AJ-2 (Revised). Rochester, NY 14650: Eastman Kodak Company, 1979.
- Eastman Kodak. *Basic Photography for the Graphic Arts*. Rochester, NY 14650: Eastman Kodak Company, 1974.
- Eastman Kodak. *Camera Back Silver Masking*. Rochester, NY 14650: Eastman Kodak Company, 1973.
- Eastman Kodak. *Contact Screens, Types, and Applications*. Rochester, NY 14650: Eastman Kodak Company, 1973.
- Eastman Kodak. *Copy Preparation and Platemaking Using Kodak PMT Materials*. Rochester, NY 14650: Eastman Kodak Company, 1975.
- Eastman Kodak. *Halftone Methods for the Graphic Arts*. Rochester, NY 14650: Eastman Kodak Company, 1974.
- Eastman Kodak. *Kodak Darkroom Dataguide*. Publication No. R20. Rochester, NY 14650: Eastman Kodak Company, 1979.
- Eastman Kodak. *Making Halftones with Kodalith Autoscreen*. Rochester, NY 14650: Eastman Kodak Company, 1971.
- Eastman Kodak. *Reference Chart for Diffusion Transfer Prints*. Rochester, NY 14650: Eastman Kodak Company, 1980.
- Eastman Kodak. *Silver Masking of Transparencies*. Rochester, NY 14650: Eastman Kodak Company, 1974.
- Platemaker's Guide*. Sixth edition. St. Paul, MN 55101: 3M Company, Printing Products Division, 1970.
- Spence, William P., and Vequist, David G. *Graphic Reproduction*. Peoria, IL 61615: Chas. A. Bennett Co., Inc., 1980.
- Walker, John R. *Graphic Arts Fundamentals*. South Holland, IL 60473: Goodheart-Willcox Company, Inc., 1980.

THE PROCESS CAMERA AND DARKROOM EQUIPMENT UNIT I

UNIT OBJECTIVE

After completion of this unit, the student should be able to identify types of process cameras and match parts of process cameras with their functions. The student should also be able to select true statements regarding darkroom cleanliness and safety, and describe safety practices. This knowledge will be evidenced by correctly performing the procedures outlined in the assignment sheet and by scoring 85 percent on the unit test.

SPECIFIC OBJECTIVES

After completion of this unit, the student should be able to:

1. Define a process camera.
2. Identify types of process cameras.
3. Identify the parts of process cameras.
4. Match parts of process cameras with their functions.
5. Match darkroom equipment with their uses.
6. Select true statements concerning darkroom cleanliness.
7. Select true statements concerning darkroom safety.
8. Describe safety practices.

THE PROCESS CAMERA AND DARKROOM EQUIPMENT
UNIT I

SUGGESTED ACTIVITIES

- I. Provide student with objective sheet.
- II. Provide student with information and assignment sheets.
- III. Make transparencies.
- IV. Discuss unit and specific objectives.
- V. Discuss information and assignment sheets.
- VI. Take students on a tour of the darkroom.
- VII. Have students label items in a darkroom by completing a plan of a darkroom.
- VIII. Discuss the advantages and disadvantages of vertical and horizontal cameras.
- IX. Give test.

INSTRUCTIONAL MATERIALS

- I. Included in this unit:
 - A. Objective sheet
 - B. Information sheet
 - C. Transparency masters
 1. TM 1--Types of Process Cameras
 2. TM 2--Parts of a Process Camera
 3. TM 3--Parts of a Process Camera (Continued)
 - D. Assignment Sheet #1--Describe Safety Practices
 - E. Test
 - F. Answers to test
- II. References
 - A. Bentley, R.G., Olson, J.C., Strandberg, C.E., and Wiper, R.E. *Graphic Communications Series: Transparency Originals*. Chicago: A.B. Dick Company, 1970.
 - B. Cogoli, John E. *Photo-Offset Fundamentals*. Bloomington, IL: McKnight Publishing Company, 1980.

THE PROCESS CAMERA AND DARKROOM EQUIPMENT
UNIT I

INFORMATION SHEET

- I. Definition of a process camera--A large, sturdy camera used for photographing flat surfaces
- II. Types of process cameras (Transparency 1)
 - A. Vertical camera
 - B. Horizontal camera
 1. Gallery camera
 2. Darkroom camera
- III. Parts of process cameras (Transparencies 2 and 3)

A. Copyboard	H. Vacuum pump
B. Camera lights	I. Timer
C. Lens board	J. Shutter
D. Bellows	K. Diaphragm
E. Ground glass	L. Lens
F. Film back	M. Tapes
G. Focusing controls	
- IV. Parts of a process camera and their functions
 - A. Copyboard--A flat surface used to hold copy, equipped with a hinged glass cover to hold copy in place
 - B. Camera lights--Attached to the copyboard and used to illuminate copy
 - C. Lens board--Holds the lens, diaphragm, and shutter
 - D. Bellows--A light-tight accordion-like chamber between the front case and camera back
 - E. Ground glass--A piece of ground or frosted glass that is positioned on the back of the camera to aid in focusing
 - F. Film back--A hinged gate that holds the film in place, usually by means of a vacuum

INFORMATION SHEET

- G. Focusing controls--Knobs or cranks which change the position of the copy-board or lens board for a focused image
 - H. Vacuum pump--A vacuum cleaner-like device, with the hose attached to camera back
 - I. Timer--A timing device that is linked to the shutter
 - J. Shutter--A device that controls the duration of light striking the film.
 - K. Diaphragm--A device that controls the quantity of light striking the film
(NOTE: A diaphragm is also referred to as an aperture.)
 - L. Lens--One or more pieces of optical glass designed to collect and focus rays of light to form a sharp image on film
(NOTE: Some cameras may have filter holders which are attached to the lens mount and hold the filter in place; others may be incorporated into the lens shade.)
 - M. Tapes--Two narrow strips of thin flexible steel or plastic marked off in percentage units
(NOTE: One tape is attached to front case and the other to the copyboard to show the exact ratio of enlargement or reduction of the copy.)
- V. Darkroom equipment and their uses
- A. Darkroom timer--Used to indicate elapsed time during processing or to operate or control darkroom equipment
 - B. Thermometer--A device used to measure the temperature of liquids
 - C. Graduate--A container used for mixing and measuring chemicals
 - D. Safelight--An enclosed darkroom lamp fitted with a filter to screen out light rays to which film and paper are sensitive
 - E. Film--A sensitized material with clear base used for reproduction processes
 - F. Paper--A sensitized material with opaque base used for reproduction processes
 - G. Developer--A solution used to turn the latent image into a visible image on exposed films or photographic paper
 - H. Stop bath--A weak solution of acetic acid, used in processing black and white film or paper; it stops development, prevents stains on paper, and makes the fixer last longer

INFORMATION SHEET

- I. Fixer--A solution that removes any light-sensitive material not acted upon by light or developer, leaving a black and white negative or print that can no longer be affected by action of light
- J. Temperature control sink--A source of running water with a built-in unit that cools or heats the water to desired temperature
- K. Viewing table--A water-tight light table equipped with ortho safe and white light; may be used for film inspection during processing with ortho, or after processing with white light (Figure 1)

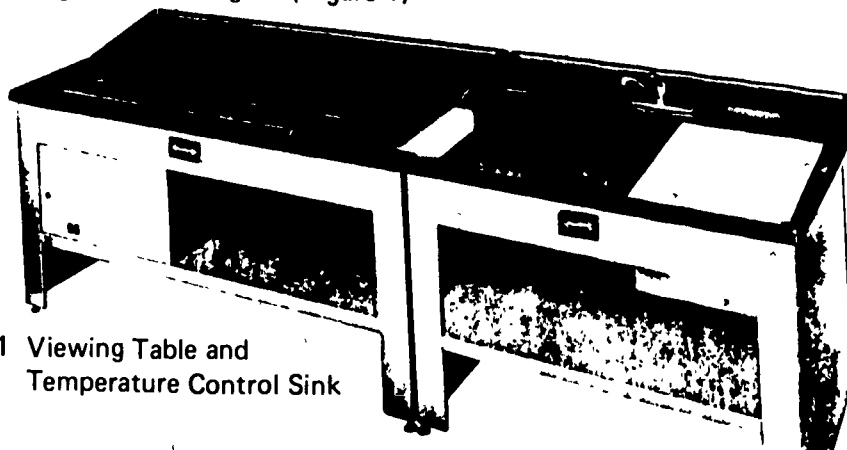

FIGURE 1 Viewing Table and
Temperature Control Sink

- L. Film cutter--A device used to cut or trim large sheets of film or paper to desired size
(CAUTION: Keep fingers away from cutting edges.)
- M. Contact printing frame--Used to make same size reproduction from a negative or any other transparent or translucent material (Figure 2)

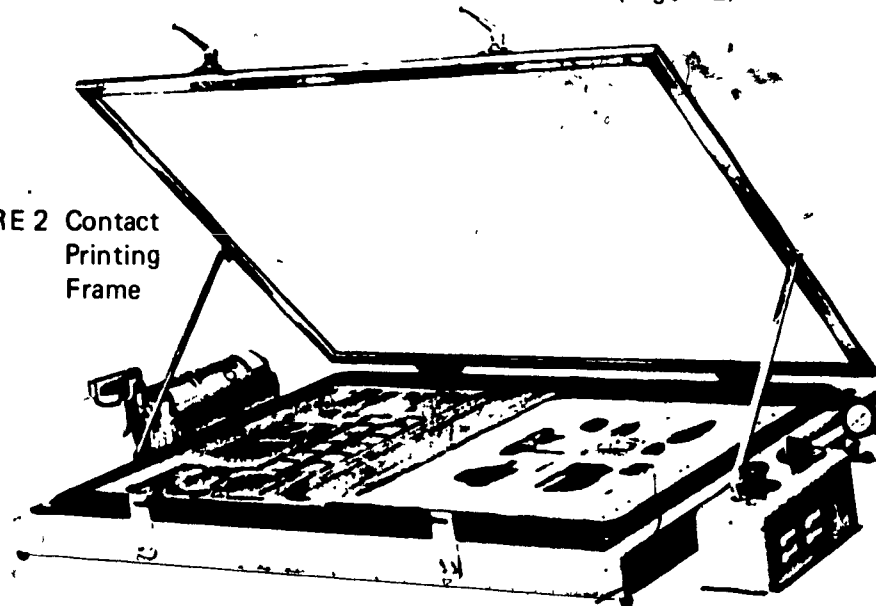

FIGURE 2 Contact
Printing
Frame

INFORMATION SHEET

- N. Film dryer--An instrument that supplies heat and air to speed drying time on films and papers
- O. Light trap--Method of providing entrance and exit from a darkroom without allowing light to enter the darkroom; the most common type is the revolving door
- P. Diffusion transfer processor--A device that contains an activator and used primarily for processing diffusion transfer materials

VI. Darkroom cleanliness

(NOTE: Dirt and dust in a darkroom can lower the quality of the developing and printing work done there. It is important to keep the darkroom clean.)

- A. Keep as much equipment as possible off the floor where dust is likely to collect
- B. Mop the floor frequently
- C. If possible, install a ventilator with a dust filter, and replace or clean the filter often
- D. Wash all working surfaces before and after use
- E. Clean up spilled chemicals immediately

(NOTE: Dried chemicals are a source of dust.)

- F. Set up and follow a regular cleanup routine

VII. Darkroom safety

(CAUTION: Working with chemicals and electrical equipment in total darkness can be dangerous.)

- A. Always keep supplies and equipment labeled and stored in the same location, and be quite familiar with each location
- B. Do not mix chemicals unless white room lights are on
- C. Allow eyes to adjust to the darkness before beginning work
- D. If skin is irritated by any chemicals, wear rubber or plastic gloves
- E. Avoid splashing chemicals into eyes
- F. Wash hands carefully after touching chemicals

INFORMATION SHEET

- G. Clean up moisture on floors and working surfaces immediately to avoid slips and falls
- H. Store darkroom chemicals in plastic and steel containers, if possible, for they are less likely to break than glass
- I. Ground all electrical equipment
- J. Never handle electrical equipment with wet hands or when standing on a wet floor

Types of Process Cameras

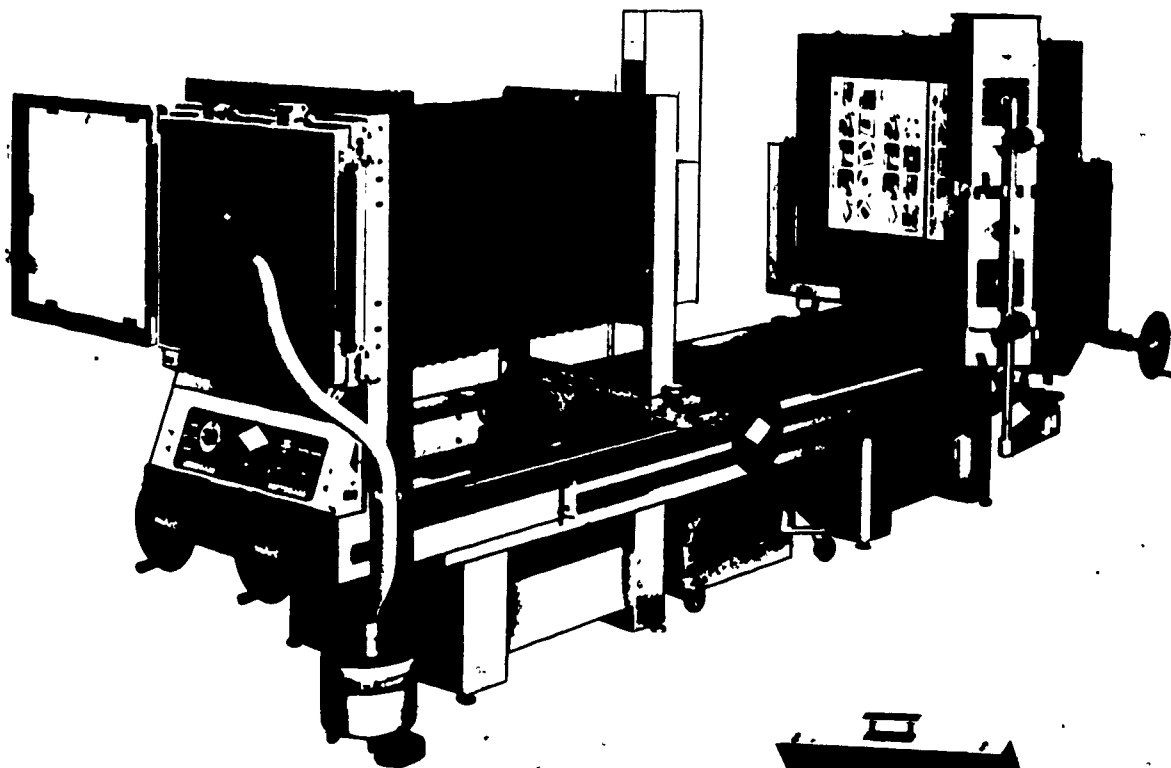

Horizontal Camera

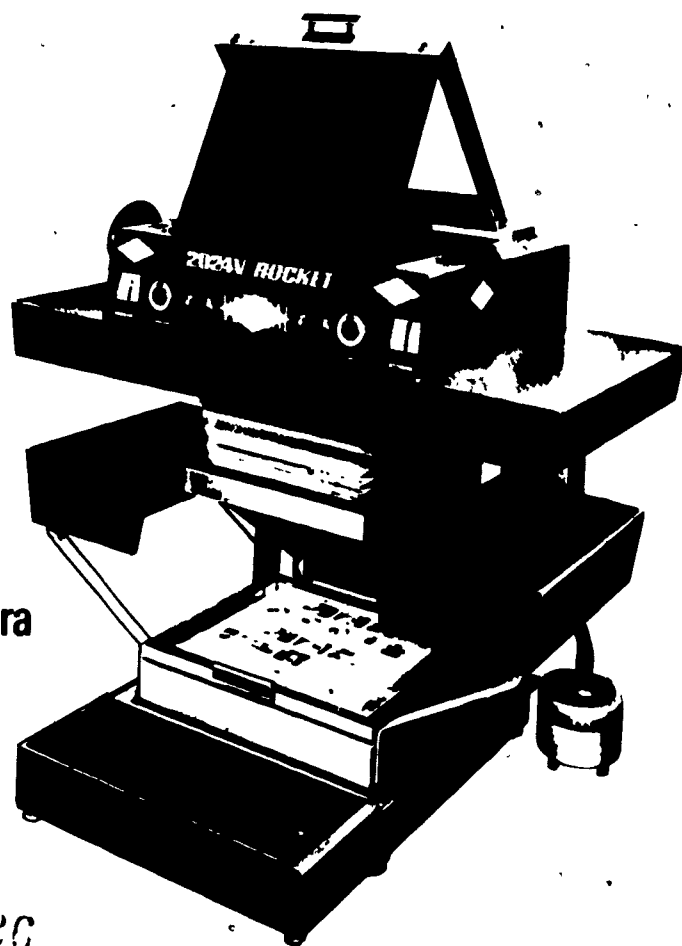

Vertical Camera

Parts of a Process Camera

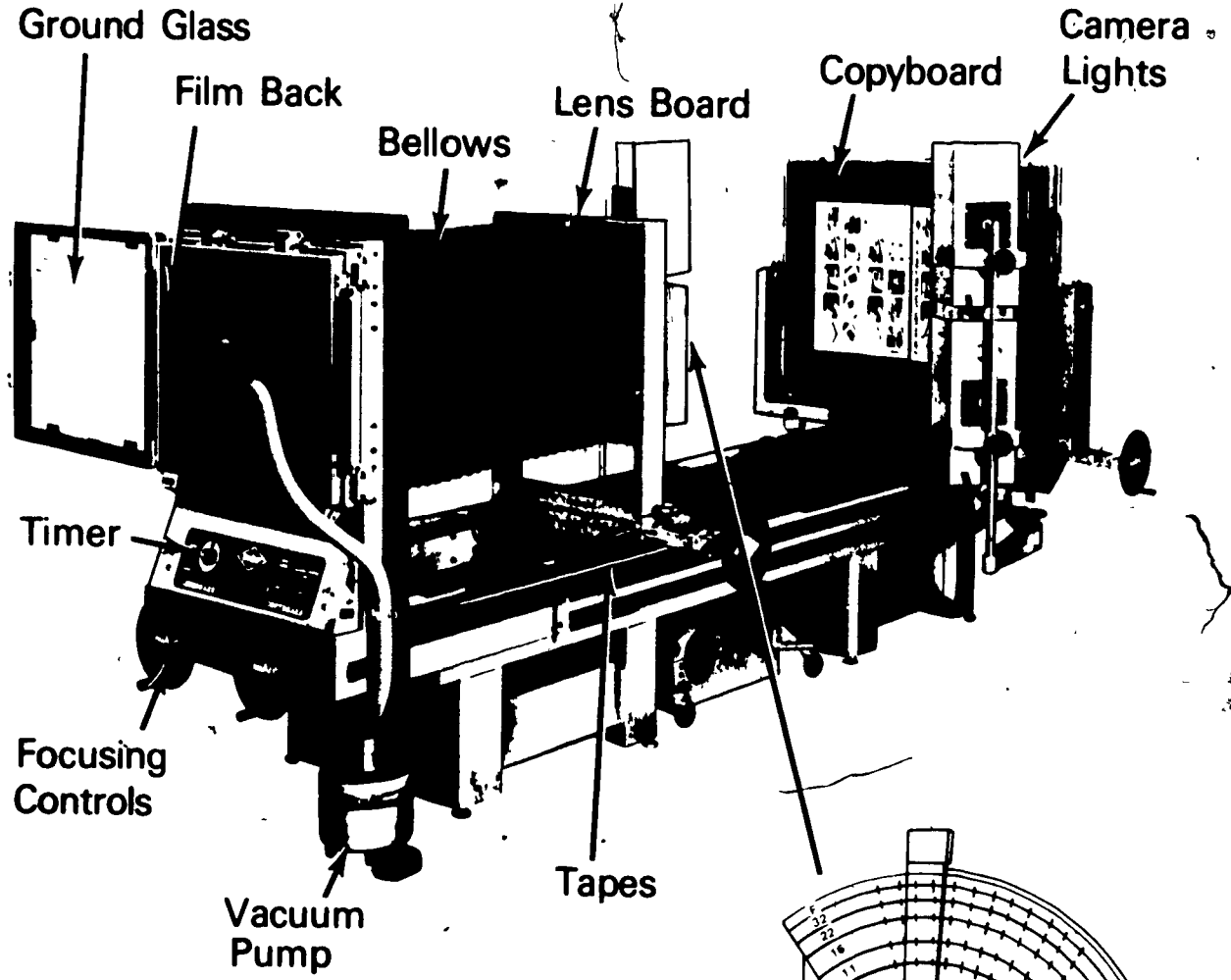

Horizontal Process Camera

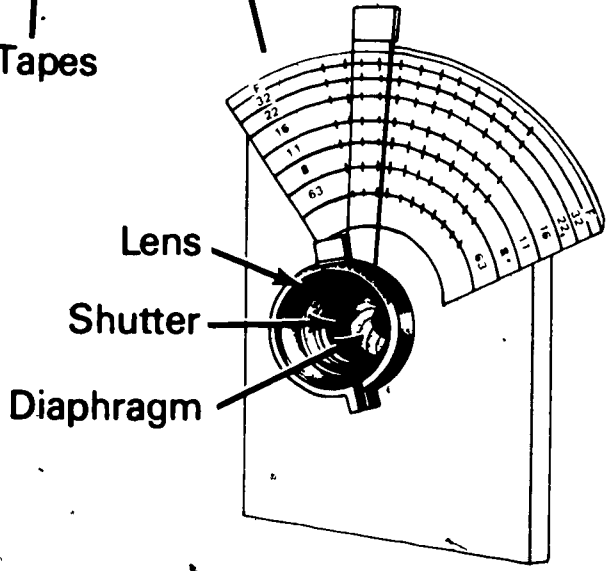

Parts of a Process Camera

(Continued)

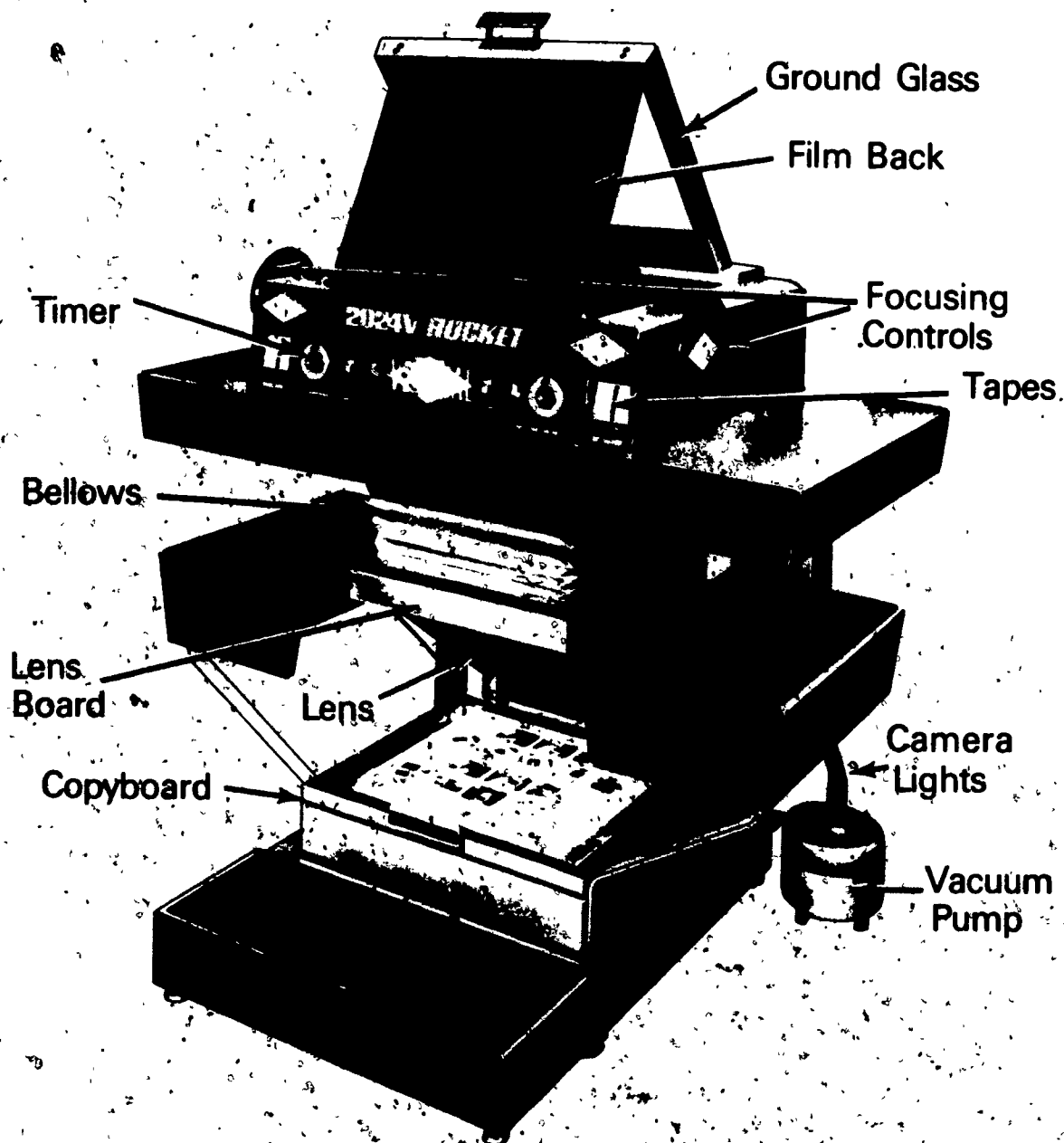

Vertical Process Camera

THE PROCESS CAMERA AND DARKROOM EQUIPMENT
UNIT I

ASSIGNMENT SHEET #1--DESCRIBE SAFETY PRACTICES

Directions: Given the situations below, describe a safety practice to follow. Give a different practice for each situation.

1. A student's skin is irritated by the developer solution. The student should _____

2. Some stop bath solution is spilled on the floor. One should _____
3. A student is ready to mix chemicals in a totally dark darkroom. The student should _____

4. A student is ready to plug in the film dryer immediately after touching wet film. He should first _____

THE PROCESS CAMERA AND DARKROOM EQUIPMENT UNIT I

NAME _____

TEST

1. Define a process camera. _____

2. Identify the types of process cameras below by writing their names in the appropriate spaces.

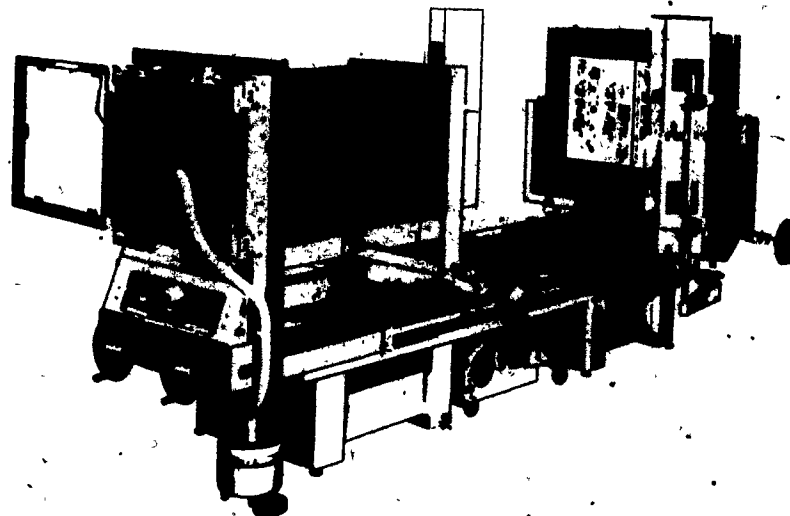

a. _____

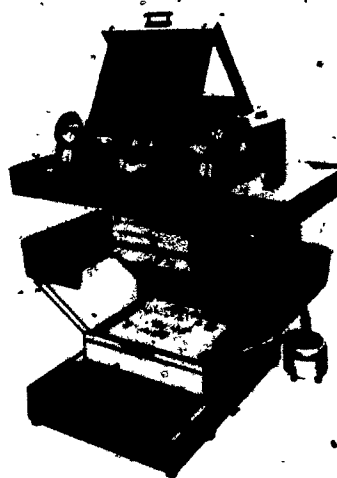

b. _____

3. Identify the parts of the process cameras below and on the next page by completing the blanks with the words on the right.

(NOTE: Answers may be used more than once.)

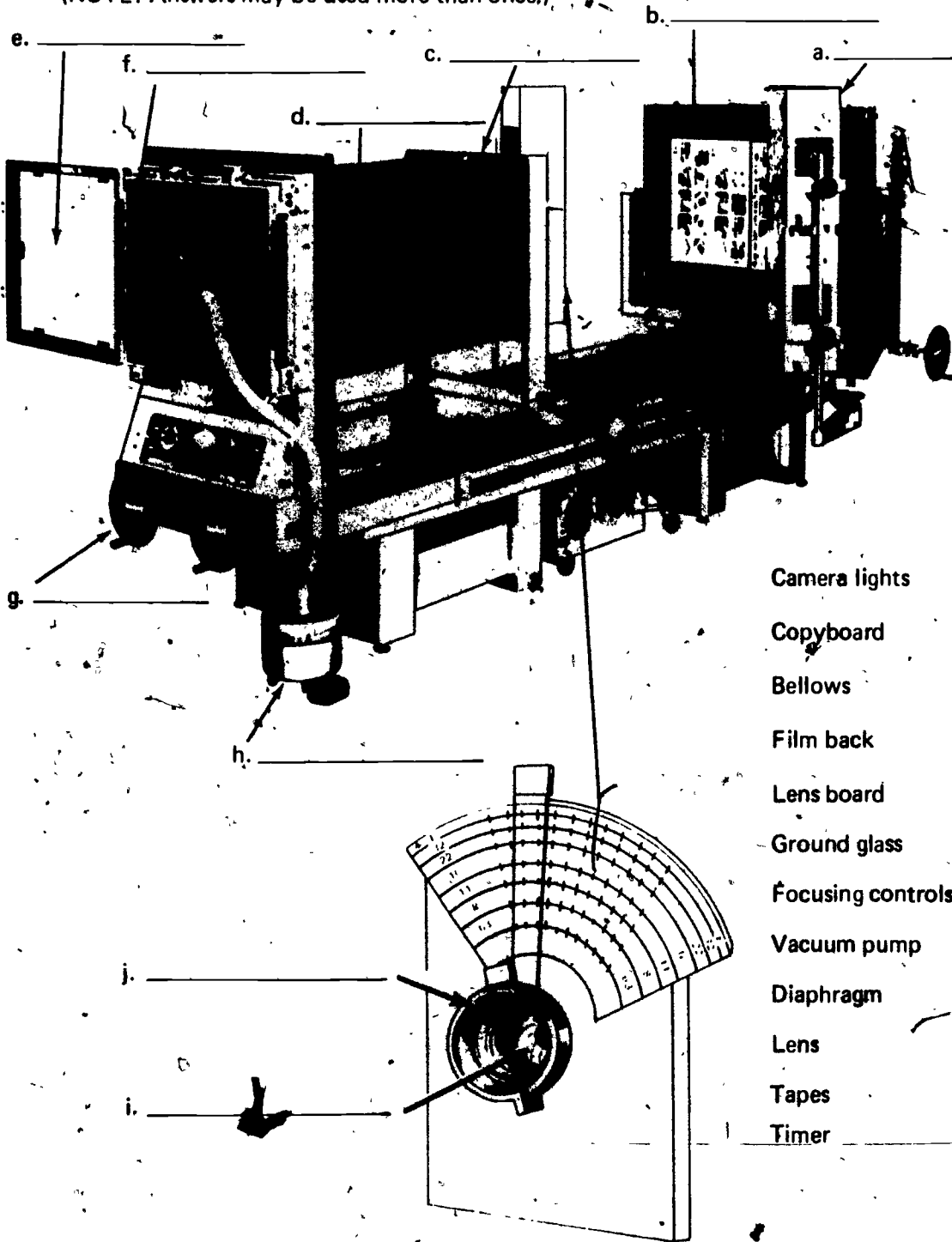

- Camera lights
- Copyboard
- Bellows
- Film back
- Lens board
- Ground glass
- Focusing controls
- Vacuum pump
- Diaphragm
- Lens
- Tapes
- Timer

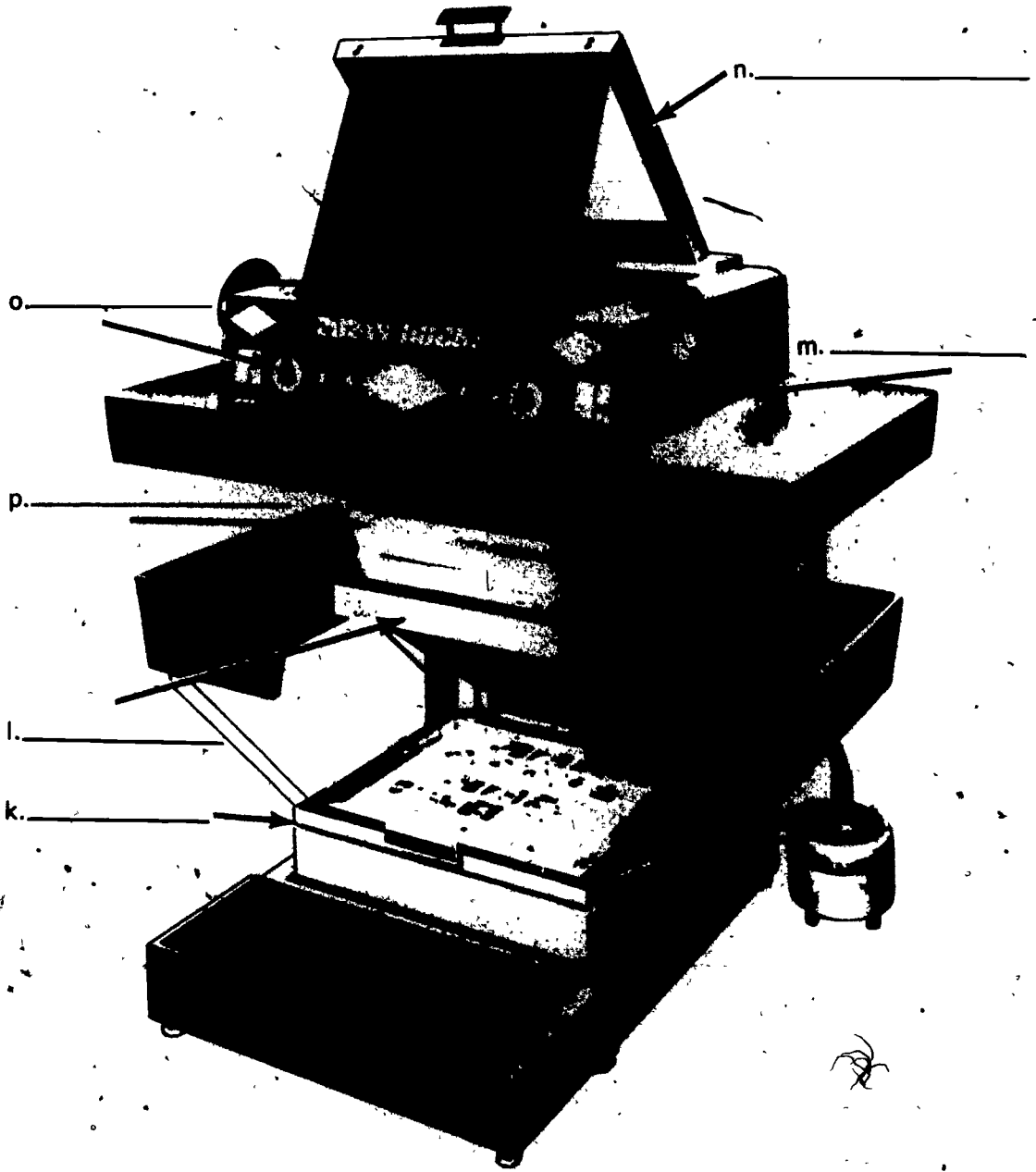

4. Match the parts of a process camera on the right with their correct functions.

- | | |
|---|----------------------|
| _____ a. A hinged gate that holds the film in place, usually by means of a vacuum | 1. Copyboard |
| _____ b. Attached to the copyboard and used to illuminate copy | 2. Lens board |
| _____ c. Knobs or cranks which change the position of the copyboard or lens board for a focused image | 3. Ground glass |
| _____ d. A flat surface used to hold copy, equipped with a hinged glass cover to hold copy in place | 4. Camera lights |
| _____ e. Holds the lens, diaphragm, and shutter | 5. Film back |
| _____ f. A light-tight accordion-like chamber between the front case and camera back | 6. Bellows |
| _____ g. A piece of ground or frosted glass that is positioned on the back of the camera to aid in focusing | 7. Focusing controls |
| _____ h. A vacuum cleaner-like device, with the hose attached to the camera back | 8. Tapes |
| _____ i. A timing device that is linked to the shutter | 9. Diaphragm |
| _____ j. A device that controls the duration of light striking the film | 10. Shutter |
| _____ k. A device that controls the quantity of light striking the film | 11. Vacuum pump |
| _____ l. One or more pieces of optical glass designed to collect and focus rays of light to form a sharp image on film. | 12. Timer |
| _____ m. Two narrow strips of thin flexible steel or plastic marked off in percentage units | 13. Lens |

5. Match the darkroom equipment on the right with their uses.

- _____ a. A container used for mixing and measuring chemicals
- _____ b. A solution that removes any light-sensitive material not acted upon by light or developer, leaving a black and white negative or print that can no longer be affected by action of light
- _____ c. Used to indicate elapsed time during processing or to operate or control darkroom equipment

- | | |
|---|----------------------------------|
| _____ d. A device used to measure the temperature of liquids | 1. Darkroom timer |
| _____ e. An enclosed darkroom lamp fitted with a filter to screen out light rays to which film and paper are sensitive | 2. Graduate |
| _____ f. A sensitized material with clear base used for reproduction processes | 3. Thermometer |
| _____ g. A sensitized material with opaque base used for reproduction processes | 4. Paper |
| _____ h. A solution used to turn the latent image into a visible image on exposed films or photographic paper | 5. Film |
| _____ i. A weak solution of acetic acid, used in processing black and white film or paper; it stops development, prevents stains on paper, and makes the fixer last longer | 6. Developer |
| _____ j. A source of running water with a built-in unit that cools or heats the water to desired temperature | 7. Stop bath |
| _____ k. Used to make same size reproduction from a negative or any other transparent or translucent material | 8. Fixer |
| _____ l. An instrument that supplies heat and air to speed drying time on films and papers | 9. Safelight |
| _____ m. Method of providing entrance and exit from a darkroom without allowing light to enter the darkroom; the most common type is the revolving door | 10. Film dryer |
| _____ n. A device used to cut or trim large sheets of film or paper to desired size | 11. Diffusion transfer processor |
| _____ o. A water-tight light table equipped with ortho safe and white light; may be used for film inspection during processing with ortho, or after processing with white light | 12. Light trap |
| _____ p. A device that contains an activator and used primarily for processing diffusion transfer materials | 13. Viewing table |
| | 14. Film cutter |
| | 15. Temperature control sink |
| | 16. Contact printing frame |

6. Select true statements concerning darkroom cleanliness by placing an "X" in the appropriate blanks.

- a. Mop floors frequently
- b. Clean up spilled chemicals once a day
- c. Store equipment on or near the floor
- d. Keep the darkroom totally air tight

7. Select true statements concerning darkroom safety by placing an "X" in the appropriate blanks.

- a. Know storage locations so that chemicals can be mixed in total darkness
- b. Allow eyes to adjust to darkness before beginning work
- c. Glass containers are preferable to plastic or steel for storing darkroom chemicals
- d. Never handle electrical equipment with wet hands or when standing on a wet floor
- e. Clean up moisture on floors immediately

8. Describe safety practices.

- (NOTE: If this activity has not been accomplished prior to the test, ask your instructor when it should be completed.)

**THE PROCESS CAMERA AND DARKROOM EQUIPMENT
UNIT I**

ANSWERS TO TEST

1. A large, sturdy camera used for photographing flat surfaces
2. a. Horizontal
b. Vertical
3. a. Camera lights
b. Copyboard
c. Lens board
d. Bellows
e. Ground glass
f. Film back
g. Focusing controls
h. Vacuum pump
i. Diaphragm
j. Lens
k. Copyboard
l. Lens board
m. Tapes
n. Ground glass
o. Timer
p. Bellows
4. a. 5 e. 2 i. 12 m. 8
b. 4 f. 6 j. 10
c. 7 g. 3 k. 9
d. 1 h. 11 l. 13
5. a. 2 f. 5 k. 16 p. 11
b. 8 g. 4 l. 10
c. 1 h. 6 m. 12
d. 3 i. 7 n. 14
e. 9 j. 15 o. 13
6. a
7. b, d, e
8. Evaluated to the satisfaction of the instructor

**LINE PHOTOGRAPHY
UNIT II****UNIT OBJECTIVE**

After completion of this unit, the student should be able to prepare a darkroom, set up a process camera and determine basic exposure, and construct an exposure chart. This knowledge will be evidenced by correctly performing the procedures outlined in the job sheets and by scoring 85 percent on the unit test.

SPECIFIC OBJECTIVES

After completion of this unit, the student should be able to:

1. Match terms related to line photography with the correct definitions.
2. Name materials used to develop line photography.
3. Match film characteristics with their functions.
4. Distinguish between types of bases.
5. Distinguish between types of emulsion.
6. Select degrees of density.
7. Label density values on a reflection gray scale.
8. Identify the parts of a lens assembly.
9. Select true statements concerning the characteristics of an aperture.
10. Select true statements concerning the functions of filters.
11. Distinguish between poor and problem copy.
12. Demonstrate the ability to:
 - a. Prepare a darkroom.
 - b. Set up a process camera and determine basic exposure.
 - c. Construct an exposure chart.

LINE PHOTOGRAPHY
UNIT II

SUGGESTED ACTIVITIES

- I. Provide student with objective sheet.
- II. Provide student with information and job sheets.
- III. Make transparency.
- IV. Discuss unit and specific objectives.
- V. Discuss information sheet.
- VI. Demonstrate and discuss the procedures outlined in the job sheets.
- VII. Show slides on line photography. The film "Line Photography" is available on a short term loan basis at no cost from:

Eastman Kodak Company
343 State Street
Rochester, New York 14650

- VIII. Give test.

INSTRUCTIONAL MATERIALS

- I. Included in this unit:
 - A. Objective sheet
 - B. Information sheet
 - C. Transparency Master 1--Parts of the Lens Assembly
 - D. Job sheets
 1. Job Sheet #1--Prepare a Darkroom
 2. Job Sheet #2--Set Up a Process Camera and Determine Basic Exposure
 3. Job Sheet #3--Construct an Exposure Chart
 - E. Test
 - F. Answers to test

II. References

- A. Eastman Kodak. *Basic Photography for the Graphic Arts*. Rochester, NY 14650: Eastman Kodak Company, 1974.
- B. Cogoli, John E. *Photo-Offset Fundamentals*. Bloomington, IL 61701: McKnight Publishing Co., 1980.

-LINE PHOTOGRAPHY
UNIT II

INFORMATION SHEET

I. Terms and definitions

- A. Line copy--Any image composed of solid dark areas against light background
- B. Phototype--Black characters printed on white photographic paper by means of phototypesetting equipment
- C. Developer--A solution used to turn the latent image into a visible image on exposed films or photographic paper
- D. Stop bath--A weak solution of acetic acid, used in processing black and white film or paper; it stops development, prevents stains on paper, and makes the fixer last longer
- E. Fixer--A solution that removes any light-sensitive material not acted upon by light or developer, leaving a black and white negative or print that can no longer be affected by action of light
- F. Exposure--The quantity of light that is allowed to reach a sensitized material
- G. Density--A numerical measure of the lightstopping ability of a photographic image
- H. Opaque--Where the density is sufficient in the film background to prevent light from passing through
- I. Translucent--Where the density is insufficient to block out all light
- J. Transparent--Where there is no density; clear areas of the film allow light to pass through
- K. Reflection gray scale--A commercially produced strip of photographic paper stepped (usually 12) in increasing density values of .15 in each step
- L. Densitometer--An instrument for reading densities
- M. Resolving power--The ability of a lens or emulsion to record fine details
- N. Emulsion--The light-sensitive coating on photographic materials
- O. Q12 Exposure Computer--An instrument designed to calculate exposure

(NOTE: This instrument is made by Eastman Kodak.)

INFORMATION SHEET

- P. Lens--One or more pieces of optical glass designed to collect and focus rays of light to form a sharp image on film
 - Q. Color copy--A copy where the background and/or the image is in a color other than black on white
 - R. Filter--A colored device made commonly of gelatin or glass placed in front of the lens to reduce or eliminate light of certain colors and allow the light of other colors to pass through
 - S. Filter factor--A number indicating the exposure increase necessary when using a filter
 - T. F-stop--A camera lens aperture setting indicated by an f-number
- II. Materials used to develop line photography
- A. Developer
 - B. Stop bath
 - C. Fixer
 - D. Water
- III. Film characteristics and their functions
- A. Base--A sheet of flexible plastic that supports emulsion and backing
 - B. Emulsion--The light-sensitive coating on photographic materials
 - C. Antihalation backing--A coating that absorbs light rays during exposure so they cannot reflect back to the emulsion
- IV. Types of bases
- A. Acetate--An inexpensive base suitable for most line work
 - B. Polyester--A very stable base generally used for halftones and other critical work requiring image stability
- V. Types of emulsion
- A. Orthochromatic--Sensitive to all colors of light except red
 - B. Panchromatic--Sensitive to all colors of light

INFORMATION SHEET

VI. Degrees of density

- A. Opaque
- B. Translucent
- C. Transparent

VII. Density values on the reflection gray scale. (Figure 1)

.00	1
.15	2
.30	3
.45	4
.60	5
.75	6
.90	7
1.05	8
1.20	9
1.35	10
1.50	11
1.65	12

FIGURE 1 Density Values on Reflection Gray Scale

VIII. Parts of the lens assembly (Transparency 1)

- A. Lens elements
- B. Aperture

(NOTE: The aperture is also called a diaphragm or f-stop.)

- C. Shutter
- D. Lens shade and filter holder

INFORMATION SHEET

IX. Characteristics of an aperture

- A. Located inside lens barrel with several metal blades that form a circular opening (Figure 2)
- B. Controls quantity of light striking the film
- C. A change in an f-stop number will change the aperture

Example: Changing the f-stop to the next higher number will reduce the light by exactly one half. Changing the f-stop to the next lower number will double the amount of light.

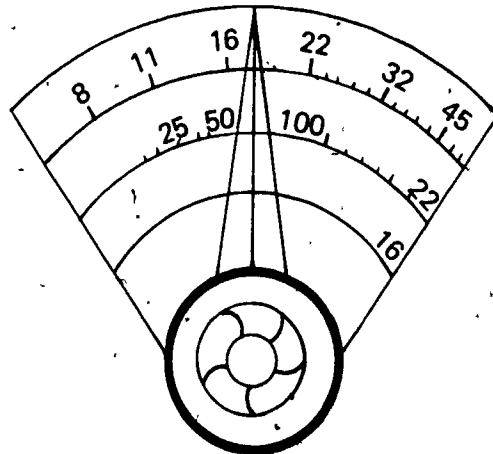

FIGURE 2 Aperture

X. Functions of filters

- A. Used to drop color and therefore photograph as white
- B. Used to hold color and therefore photograph as black

(NOTE: The following table is a suggested film and filter combination for photofaphing color copy.)

To Hold A Color		Color of Copy	To Drop A Color	
Orthochromatic	Panchromatic		Orthochromatic	Panchromatic
Orange (16)	Green (61, 58)	Magenta	Blue (47B)	Red (25)
Blue (47B)	Blue (47B)	Red or Orange	N/R	Red (29)
Blue (47B)	Blue (47B)	Yellow	Orange (16)	Red (29)
Blue (47B)	Magenta (30)	Green	Orange (16)	Green (58)
N/R	Red (25)	Cyan	No Filter Needed	Blue (47B)
Orange (16)	Green (58)	Blue	Magenta (30)	Blue (47B)

Table 1

INFORMATION SHEET

XI. Poor copy and problem copy

- A. Poor copy--An original that has grayed black, broken type, and/or poor contrast

(NOTE: At normal exposure details will be lost. Shorten the exposure.)

- B. Problem copy--An original that has extremely fine detail

(NOTE: Shorten the exposure and use "still development" procedure. To still develop a piece of film, agitate the film until the image appears, then leave it absolutely motionless for a total development time of 2 1/4 minutes.)

Parts of the Lens Assembly

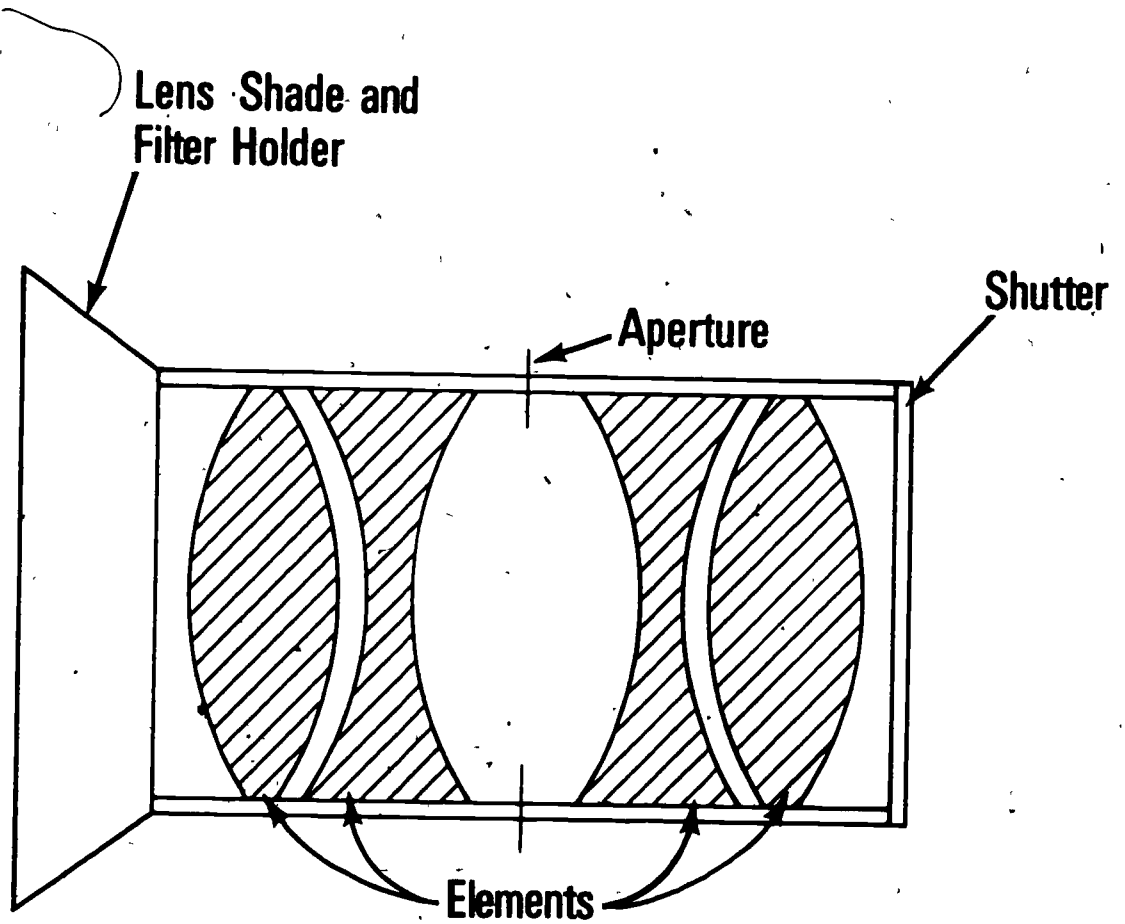

Schematic cross section of a typical process lens.

LINE PHOTOGRAPHY
UNIT II

JOB SHEET #1--PREPARE A DARKROOM

- I. Equipment
 - A. Trays (3)
 - B. Graduate
 - C. Thermometer
 - D. Containers
- II. Supplies
 - A. Litho developer part A
 - B. Litho developer part B
 - C. 28% acetic acid or indicator stop bath
 - D. Fixer solution part A
 - E. Fixer solution part B
 - F. Hot and cold running water
- III. Procedure

(NOTE: Read manufacturer's instruction sheet for the proper procedure.)

 - A. Mix litho developer part A, pour it in a container, and mark the container "DEVELOPER A"

(NOTE: If liquid developer is used, disregard this step.)
 - B. Mix litho developer part B, pour it in a container, and mark the container "DEVELOPER B"

(NOTE: If liquid developer is used disregard this step.)
 - C. Mix fixer by following instructions on the fixer carton

(NOTE: When mixing powder fixer, use a dust mask.)
 - D. Place a tray in the sink on right side next to wash basin (Figure 1)

(NOTE: If the wash basin is located on the left side of the sink, another tray of water should be placed on the right side of fixer tray.)

JOB SHEET #1

- E. Pour fixer into tray
- F. Place another tray on the left side of the fixer tray (Figure 1)
- G. Mix short stop (stop bath) and pour it into this tray

(NOTE: Stop bath is prepared by mixing 8 ounces of 28% acetic acid into a gallon of water.)

(CAUTION: Always add acid to the water.)

- H. Place the last tray on the left side next to stop bath tray (Figure 1)
- I. Mix litho developer and pour it into this tray

(NOTE: If powder developer was used to prepare the A and B solutions, mix equal amounts of A and B and pour it into this tray. If concentrated liquid developer is used, it must be further diluted by mixing one part Developer A with three parts of water, and one part Developer B with three parts water. Since the quantity of developer is dependent on the size of tray being used, ask your instructor how much to mix.)

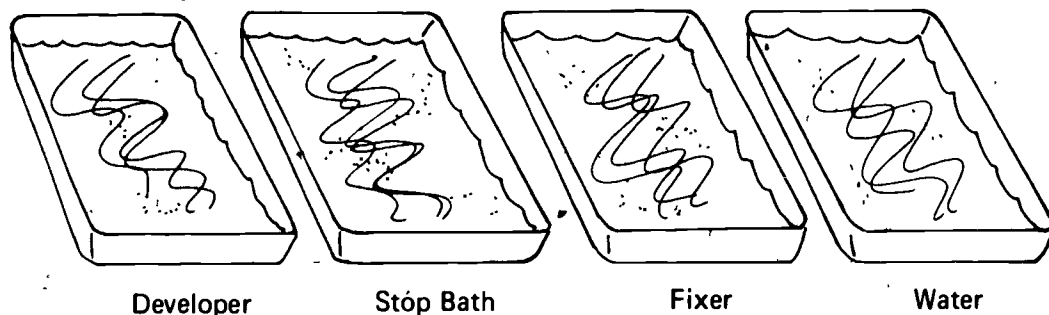

FIGURE 1

- J. Place drain stopper of the sink in place and pour approximately one inch of water into the sink
- K. Place a thermometer in the sink
- L. Set the temperature control unit at 68°F and turn the unit on

(NOTE: If the sink is not equipped with a temperature control unit, cold or hot water may be used to lower or raise the water temperature of the sink. Never add ice to developer to reduce temperature, as this will dilute the developer.)

JOB SHEET #1

- M. Check the thermometer often until it reaches the temperature of 68° and stabilizes at that mark

(NOTE: At this point the temperature of chemicals may not be the same as the water in the sink. Wash the thermometer, place it in the developer, and check the temperature of the developer. Additional time may be required to stabilize the temperature of the developer.)

- N. Turn on safelights and turn off all white lights

LINE PHOTOGRAPHY UNIT II

JOB SHEET #2--SET UP A PROCESS CAMERA AND DETERMINE BASIC EXPOSURE

(NOTE: The instructor may also use this job sheet to illustrate examples in the areas of filters, reductions, enlargements, and problem copy.)

I. Equipment and materials

- A. Process camera
- B. Q12 Graphic Arts Exposure Computer
- C. 12-step reflection gray scale
- D. 10-power magnifier
- E. Darkroom timer
- F. Squeegee
- G. Litho film

II. Procedure

A. Set up the camera

1. Make sure the copyboard is clean

(NOTE: Use common household glass cleaner if necessary.)

2. Make sure the lens is clean by visual observation

(NOTE: DO NOT ATTEMPT TO DISASSEMBLE or clean the lens. If it is necessary to clean the lens, ask your instructor.)

3. Position camera lights to give more illumination to the four corners of the copyboard than to the center (Figure 1)

(NOTE: The angle formed by an imaginary line from lens to copyboard and the camera lights will vary on cameras, but will generally fall between 45 and 60 degrees.)

FIGURE 1

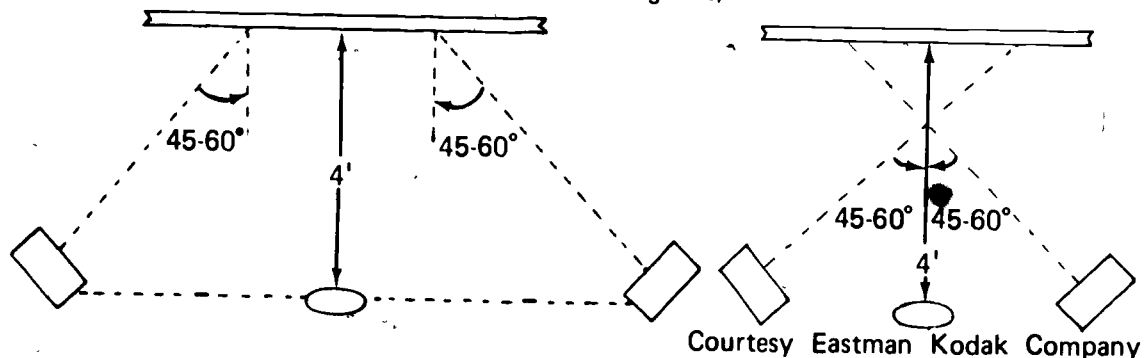

JOB SHEET #2

4. Adjust camera lights to avoid any direct reflection from the glass of the copyboard
5. Make sure the lens is not reached by any source other than camera lights

(NOTE: The lens and film must be protected from lights that are not part of the image, such as room light, window light, reflected light from bright objects, or misplaced copy lights. These nonimage lights will cause flare and degrade the quality of negative. A lens hood is usually effective.)

B. Determine basic exposure

1. Set up darkroom

(NOTE: See Job Sheet #1.)

2. Select samples of the following line copies:
 - a. Phototypeset
 - b. Typewriter
 - c. Line illustrations
3. Fasten small strips of the line copies on a cardboard
4. Place copyboard in the horizontal position and raise the glass cover
5. Place the sample copies on the center copyboard
6. Place a 12-step reflection gray scale next to the copy on the copyboard and close the copyboard
7. Return copyboard to vertical position
8. Open the lens to two complete stops smaller than wide open

(NOTE: If the maximum lens opening is f/11 use f/22. Lenses have their best resolving power at midrange.)
9. Set the camera controls on 100% (same size) reproduction
10. Set the camera timer to make a 20 second exposure

JOB SHEET #2

11. Place a sheet of litho film on the center of the camera back with the emulsion side up
(NOTE: Always handle the film by the edges.)
12. Turn on the vacuum and close the camera back
13. Make an exposure by starting the timer
14. Turn the vacuum off and remove the film
15. Set the darkroom timer to 2 minutes and 45 seconds (2:45)
16. Start the timer and drag the film emulsion side down through the developer and then quickly flip it over
(NOTE: Agitate the developer continuously by raising the left side of the tray and lowering it, then raising the right side of the tray and lowering it, then raising the front of the tray and lowering it. Continue this procedure until the time has elapsed.)
17. Remove film from developer and hold it on top of tray to drain for approximately 5 seconds
18. Place film in stop bath quickly and agitate vigorously for approximately 15 seconds
19. Place film in fixer and agitate for approximately 2 minutes, or until the film appears to be clear in the image area
20. Wash film for recommended time
(NOTE: For this test exposure, simple rinsing will be sufficient.)
21. Squeegee the film and hang it to dry
22. Place the negative on a light table and examine the gray scale

(NOTE: A black step 4 indicates that the negative is probably good. The negative area is either clearly transparent or densely opaque. The edges of the letters are sharp and details are true to the original. See Figure 2.

A black step 3 or lower indicates that the negative is underexposed. Although the clear areas are transparent, the opaque areas have low density and many pinholes, and details are thicker than the original. See Figure 2.

A black step of 5 or higher indicates that the negative is overexposed. Although dense areas are opaque, density appears in some areas that should be clear and the type shows loss of fine details. See Figure 2.

JOB SHEET #2

If the film is under or overexposed, exposure must be altered to achieve a black step 4. A Kodak Q12 Exposure Computer is used to compute the correct exposure.

FIGURE 2

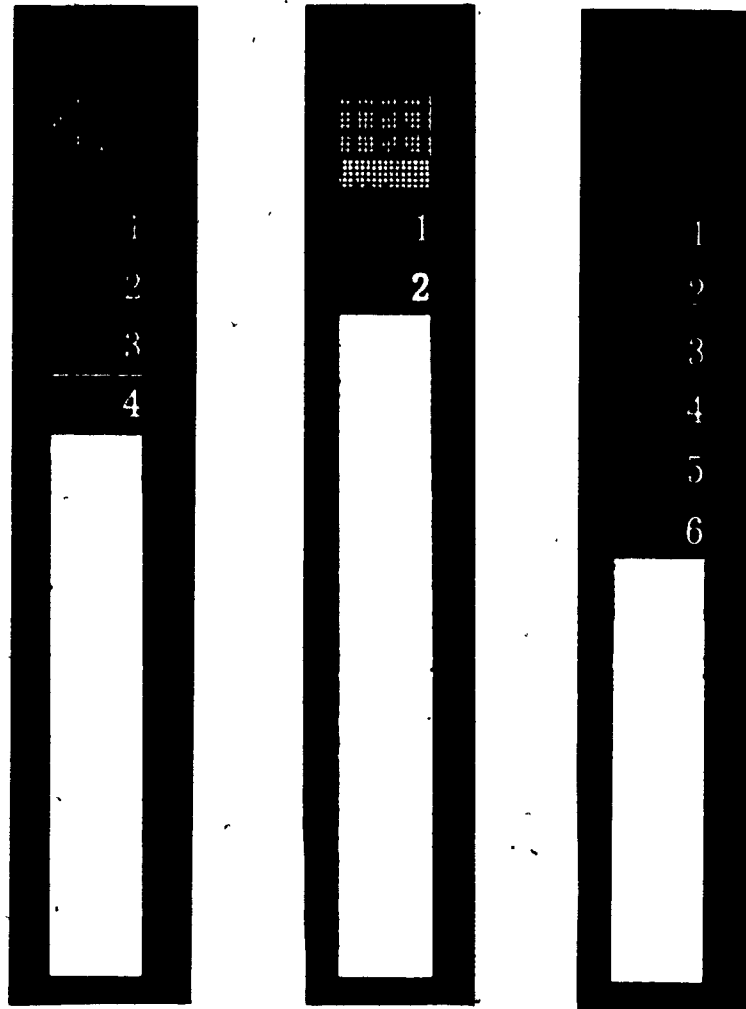

Correctly Exposed

Underexposed

Overexposed

Courtesy Stouffer Graphic Arts Equipment Company

If a step lower than step 4 is black (underexposed, and we assume it is step 2), go to procedure step 23.

If a step higher than step 4 is black (overexposed, and we assume it is step 6), go to procedure step 27.)

23. Rotate the lens aperture dial (clear) of the exposure computer until f/22 is in the line with 100 percent

JOB SHEET #2

24. Rotate the density dial (red) until .15 density is in line with 20 seconds
(NOTE: Step 2 of the gray scale has an approximate density of .15)
25. Read exposure in seconds that is in line with .45 density
(NOTE: Step 4 of the gray scale has an approximate density of .45. In this example the correct exposure will be 40 seconds.)
26. Make a new exposure with the new exposure time (40 seconds) and process the film by repeating steps 11 through 22
(NOTE: This negative should be a normal negative and have a black step 4; if not, a minor alteration should be made to correct it and the computer should be adjusted.)
27. Rotate the lens aperture dial (clear) of the exposure computer until $f/22$ is in line with 100 percent
28. Rotate the density dial (red) until .75 density is in line with 20 seconds
(NOTE: Step 6 of the gray scale has an approximate density of .75.)
29. Read exposure in seconds that is in line with .45 density
(NOTE: Step 4 of the gray scale has an approximate density of .45. In this example the correct exposure will be 10 seconds.)
30. Make a new exposure with the new exposure time (10 seconds) and process the film by repeating steps 11 through 22
(NOTE: This negative should be a normal negative and have a black step 4. If not, a minor alteration should be made to correct it and the computer should be adjusted.)

LINE PHOTOGRAPHY
UNIT II

JOB SHEET #3--CONSTRUCT AN EXPOSURE CHART

I. Equipment and materials

- A. Process camera
- B. Q12 Graphic Arts Exposure Computer
- C. 12-step reflection gray scale
- D. 10-power magnifier
- E. Darkroom timer
- F. Squeegee
- G. Litho film

II. Procedure

- A. Set up the process camera for 1:1 reproduction (100%)
- B. Set up the darkroom
- (NOTE: Refer to Job Sheets #1 and 2.)
- C. Place a 12-step reflection gray scale on the copyboard
- D. Set the f-stop on f/22 and the timer on 30 seconds

(NOTE: This is a hypothetical exposure setting; any other f-stop or timer setting may be used.)

- E. Make an exposure
- F. Process and dry the film
- G. Place the negative on the light table and examine

(NOTE: In this example we assume the gray scale step 4 is black. By using this information and the Q12 computer, we can determine the f-stop and the exposure time to achieve any black step on the gray scale.)

H. Program the Q12 Computer

1. Rotate the lens aperture dial (clear) until f/22 is in line with 100%

C11

JOB SHEET #3

2. Rotate the density dial (red) until .45 density is in line with 30 seconds
3. Use a piece of clear tape and fasten the density dial (red) to the lens aperture dial (clear)
4. Check to make sure the settings are still in line (f/22 with 100% and .45 with 30 seconds)
5. Read and record the exposure times that are in line with the densities of the steps of the gray scale (Figure 1)

(NOTE: In this example, to achieve a black step 1 (.00 density) the exposure time is 11 seconds. Step 2 (.15 density) is 15 seconds. Step 3 (.30 density) is 21 seconds. Step 5 (.60 density) is 42 seconds. Step 6 (.75 density) is 60 seconds.)

6. Rotate the lens aperture dial until f/16 is in line with 100%
- (NOTE: DO NOT REMOVE THE TAPE that fastens the density dial to lens aperture dial.)
7. Read and record the exposure times that are in line with the densities of the steps of the gray scale (Figure 1)
 8. Rotate the lens aperture dial until f/32 is in line with 100%
 9. Read and record the exposure times that are in line with the densities of the steps of the gray scale (Figure 1)
 10. Rotate the lens aperture dial until f/45 is in line with 100%
 11. Read and record the exposure times that are in line with the densities of the steps of the gray scale (Figure 1)

Gray Scale Densities	Gray Scale Step	f/16	f/22	f/32	f/45
.00	1	Sec. <u>5.5</u>	Sec. <u>11</u>	Sec. <u>22</u>	Sec. <u>44</u>
.15	2	Sec. <u>7.5</u>	Sec. <u>15</u>	Sec. <u>30</u>	Sec. <u>60</u>
.30	3	Sec. <u>11</u>	Sec. <u>22</u>	Sec. <u>44</u>	Sec. <u>88</u>
.45	4	Sec. <u>15</u>	Sec. <u>30</u>	Sec. <u>60</u>	Sec. <u>120</u>
.60	5	Sec. <u>21</u>	Sec. <u>42</u>	Sec. <u>84</u>	Sec. <u>168</u>
.75	6	Sec. <u>30</u>	Sec. <u>60</u>	Sec. <u>120</u>	Sec. <u>240</u>

FIGURE 1

JOB SHEET #3

12. Using the test negative, re-program the Q12 Computer and complete the exposure times in the chart (Figure 2)

(NOTE: Read the absolute densities of the steps 1-6 of the gray scale with an accurate reflection densitometer. If you do not have a densitometer, use densities that are given in Figure 1 and enter in the chart. Have your instructor check your results for accuracy. You now have a very important instrument. SAVE THIS CHART. As long as the dark-room conditions stay the same, and the same film is used, you may use this chart to increase or decrease the density of a negative, to enlarge or reduce copy, and to change an f-stop and/or exposure time without further testing. See Figure 2.)

EXPOSURE CHART

Gray Scale Densities	Gray Scale Steps	f/16	f/22	f/32	f/45
	1	Sec. _____	Sec. _____	Sec. _____	Sec. _____
	2	Sec. _____	Sec. _____	Sec. _____	Sec. _____
	3	Sec. _____	Sec. _____	Sec. _____	Sec. _____
	4	Sec. _____	Sec. _____	Sec. _____	Sec. _____
	5	Sec. _____	Sec. _____	Sec. _____	Sec. _____
	6	Sec. _____	Sec. _____	Sec. _____	Sec. _____

FIGURE 2

LINE PHOTOGRAPHY
UNIT II

NAME _____

TEST

1. Match the terms on the right with the correct definitions.

- | | |
|--|---------------------------------|
| <p>_____ a. Any image composed of solid dark areas against light background</p> | <p>1. Density</p> |
| <p>_____ b. Black characters printed on white photographic paper by means of phototypesetting equipment</p> | <p>2. Emulsion</p> |
| <p>_____ c. A solution used to turn the latent image into a visible image on exposed films or photographic paper</p> | <p>3. Developer</p> |
| <p>_____ d. A weak solution of acetic acid, used in processing black and white film or paper; it stops development, prevents stains on paper, and makes the fixer last longer</p> | <p>4. Reflection gray scale</p> |
| <p>_____ e. A solution that removes any light-sensitive material not acted upon by light or developer, leaving a black and white negative or print that can no longer be affected by action of light</p> | <p>5. Filter</p> |
| <p>_____ f. The quantity of light that is allowed to reach a sensitized material</p> | <p>6. Line copy</p> |
| <p>_____ g. A numerical measure of the lightstopping ability of a photographic image</p> | <p>7. Q12 Exposure Computer</p> |
| <p>_____ h. Where the density is sufficient in the film background to prevent light from passing through</p> | <p>8. Resolving power</p> |
| <p>_____ i. Where the density is insufficient to block out all light</p> | <p>9. Phototype</p> |
| <p>_____ j. Where there is no density; clear areas of the film allow light to pass through</p> | <p>10. Densitometer</p> |
| <p>_____ k. A commercially produced strip of photographic paper stepped in increasing density values of .15 in each step</p> | <p>11. Filter factor</p> |
| <p>_____ l. An instrument for reading densities</p> | <p>12. Lens</p> |
| | <p>13. Translucent</p> |
| | <p>14. Transparent</p> |
| | <p>15. Fixer</p> |
| | <p>16. Color copy</p> |
| | <p>17. Stop bath</p> |
| | <p>18. Exposure</p> |
| | <p>19. Opaque</p> |
| | <p>20. F-stop</p> |

- _____ m. The ability of a lens or emulsion to record fine details
- _____ n. The light-sensitive coating on photographic materials
- _____ o. An instrument designed to calculate exposure
- _____ p. One or more pieces of optical glass designed to collect and focus rays of light to form a sharp image on film
- _____ q. A copy where the background and/or the image is in a color other than black on white
- _____ r. A colored device made commonly of gelatin or glass placed in front of the lens to reduce or eliminate light of certain colors and allow the light of other colors to pass through
- _____ s. A number indicating the exposure increase necessary when using a filter
- _____ t. A camera lens aperture setting indicated by an f-number

2. Name three materials used to develop line photography.

- a. _____
- b. _____
- c. _____

3. Match the film characteristics on the right with their functions.

- | | |
|--|-------------------------|
| _____ a. The light-sensitive coating on photographic materials | 1. Base |
| _____ b. A coating that absorbs light rays during exposure so they cannot reflect back to the emulsion | 2. Emulsion |
| _____ c. A sheet of flexible plastic that supports emulsion and backing | 3. Antihalation backing |

4. Distinguish between types of bases by placing an "X" to the left of the description of the polyester base.

- _____ a. An inexpensive base suitable for most line work
- _____ b. A very stable base generally used for halftones and other critical work requiring image stability

5. Distinguish between types of emulsion by placing an "X" to the left of the description of orthochromatic emulsion.

a. Sensitive to all colors of light except red

b. Sensitive to all colors of light

6. Select degrees of density by placing an "X" in the appropriate blanks.

a. Opaque

b. Translucent

c. Transmission

d. Transparent

7. Label the density values where appropriate on the reflection gray scale below.

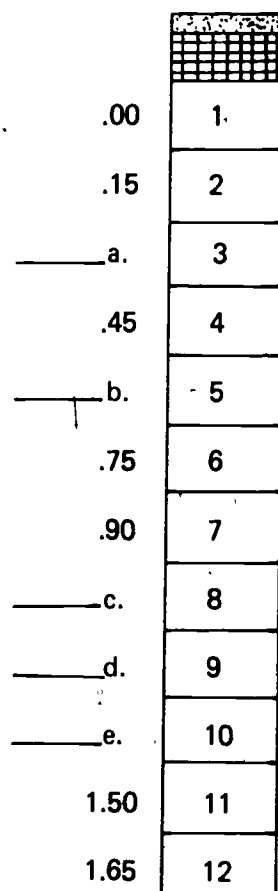

8. Identify the parts of a lens assembly by labeling the picture below.

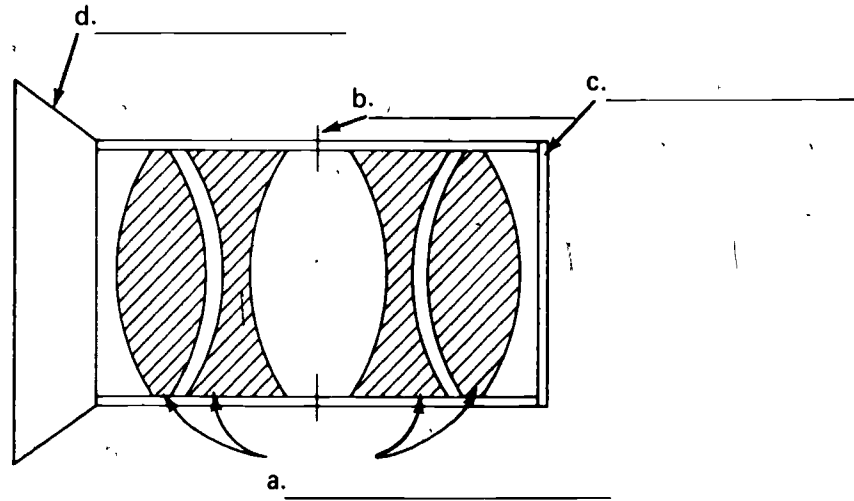

9. Select true statements concerning the characteristics of an aperture by placing an "X" in the appropriate blanks.
- a. The aperture is located inside lens barrel with several metal blades that form a circular opening
- b. A change in an f-stop number will not affect the aperture
- c. A change in an f-stop number will change the aperture
- d. The aperture does not affect the quantity of light striking the film
10. Select true statements concerning the functions of filters by placing an "X" in the appropriate blanks.
- a. Filters are used to drop color and therefore photograph as black
- b. Filters are used to hold color and therefore photograph as white
- c. Filters are used to drop color and therefore photograph as white
- d. Filters are used to hold color and therefore photograph as black
11. Distinguish between poor copy and problem copy by placing an "X" to the left of the description of a problem copy.
- a. An original that has extremely fine detail
- b. An original that has grayed black, broken type, and/or poor contrast

12. Demonstrate the ability to:

- a. Prepare a darkroom
- b. Set up a process camera and determine basic exposure
- c. Construct an exposure chart

(NOTE: If these activities have not been accomplished prior to the test, ask your instructor when they should be completed.)

64

LINE PHOTOGRAPHY
UNIT II

ANSWERS TO TEST

- | | | | | | | | | | |
|-------|----|----|----|----|----|----|----|----|----|
| 1. a. | 6 | e. | 15 | i. | 13 | m. | 8 | q. | 16 |
| b. | 9 | f. | 18 | j. | 14 | n. | 2 | r. | 5 |
| c. | 3 | g. | 1 | k. | 4 | o. | 7 | s. | 11 |
| d. | 17 | h. | 19 | l. | 10 | p. | 12 | t. | 20 |

2. Any three of the following:

- a. Developer
- b. Stop bath
- c. Fixer
- d. Water

3. a. 2
b. 3
c. 1

4. b

5. a

6. a, b, d

7. a. .30 d. 1.20
b. .60 e. 1.35
c. 1.05

- 8. a. Lens elements
- b. Aperture
- c. Shutter
- d. Lens shade and filter holder

9. a, c

10. c, d

11. a

12. Performance skills evaluated to the satisfaction of the instructor

HALFTONE PHOTOGRAPHY UNIT III

UNIT OBJECTIVE

After completion of this unit, the student should be able to identify kinds of halftone dots and select true statements concerning procedures for avoiding moires in rescreening. The student should also be able to program Q12 and Q15 computers, make halftone negatives, make a duotone, make a fake duotone, and rescreen a halftone illustration. This knowledge will be evidenced by correctly performing the procedures outlined in the job sheets and by scoring 85 percent on the unit test.

SPECIFIC OBJECTIVES

After completion of this unit, the student should be able to:

1. Match terms related to halftone photography with the correct definitions.
2. Match types of contact screens with their descriptions.
3. Select true statements concerning the care of contact screens.
4. Identify kinds of halftone dots.
5. Select true statements concerning the characteristics of Kodak Autoscreen film.
6. Select true statements concerning procedures for avoiding moires in rescreening.
7. Demonstrate the ability to:
 - a. Program a Q12 Exposure Computer and make a halftone negative.
 - b. Program a Q15 Exposure Computer and make a halftone negative.
 - c. Make a duotone.
 - d. Make a fake duotone.
 - e. Rescreen a halftone illustration.

HALFTONE PHOTOGRAPHY UNIT III

SUGGESTED ACTIVITIES

- I. Provide student with objective sheet.
- II. Provide student with information and job sheets.
- III. Discuss unit and specific objectives.
- IV. Discuss information sheet.
- V. Show the slides entitled "Halftones and Other Tones."

(NOTE: This presentation includes 89 slides [Catalog No. ED 10-2] and a narrated tape [Catalog No. ED 10-2T] available for purchase [\$10] from:

Department 454
Eastman Kodak Company
343 State Street
Rochester, NY 14650.)

- VI. Demonstrate and discuss the procedures outlined in the job sheets.

(NOTE: Advanced techniques for halftone and duotone are not discussed in this unit. It is recommended that job sheets be written by the instructor for advanced students to cover these areas.)

- VII. Give test.

INSTRUCTIONAL MATERIALS

- I. Included in this unit:
 - A. Objective sheet
 - B. Information sheet
 - C. Job sheets
 1. Job Sheet #1--Program a Q12 Exposure Computer and Make a Halftone Negative
 2. Job Sheet #2--Program a Q15 Exposure Computer and Make a Halftone Negative
 3. Job Sheet #3--Make a Duotone

4. Job Sheet #4--Make a Fake Duotone

5. Job Sheet #5--Rescreen a Halftone Illustration

D. Test

E. Answers to test

II. References:

A. Eastman Kodak. *Contact Screens, Types, and Applications*. Rochester, NY 14650: Eastman Kodak Company, 1973.

B. Eastman Kodak. *Halftone Methods for the Graphic Arts*. Rochester, NY 14650: Eastman Kodak Company, 1974.

C. Eastman Kodak. *Basic Photography for the Graphic Arts*. Rochester, NY 14650: Eastman Kodak Company, 1974.

D. Eastman Kodak. *Making Halftones with Kodalith Autoscreen*. Rochester, NY 14650: Eastman Kodak Company, 1971.

HALFTONE PHOTOGRAPHY
UNIT III

INFORMATION SHEET

I. Terms and definitions

- A. Halftone--A converted image of a continuous tone copy that consists of solid dots of equal density but varying sizes
- B. Halftone screen--Used in the light path between the lens and film to break the continuous tone copy into a dot pattern for reproduction

(NOTE: There are two classifications of halftone screens, glass screens and contact screens, but only the contact screen will be discussed and used in this section.)

- C. Contact screen--A precision pattern of vignettted dots on a flexible support used in direct contact with the film
- D. Screen ruling--The number of lines per inch on a halftone screen

(NOTE: Higher number screen rulings will reproduce finer details. Screen rulings range from 65 to 300 lines, with the most common rulings being 65, 85, 100, 120, 133, and 150 lines.)

- E. Density--A numerical measure of the blackening or light-stopping ability of a photographic image
- F. Densitometer--An instrument for making density measurements
- G. Main exposure--A detail exposure made through the lens of the camera, with the contact screen in place only with the camera lights
- H. Flash exposure--A nonimage exposure made through the contact screen to the film
- I. No-screen exposure--An exposure made by exposing the film to the copy without the contact screen

(NOTE: The no-screen exposure is also called highlighting or bump exposure.)

- J. Neutral density filter--A gray-colored filter used to uniformly reduce all colors of light

(NOTE: Neutral density filters are also referred to as ND filters.)

INFORMATION SHEET

- K. Duotone--A two-impresion reproduction using two halftones of the same original

(NOTE: One halftone is normally black and the other is another color. However, both halftones may be black. The screen angle of the halftones must be 30° apart.)

- L. Fake duotone--A two-impresion reproduction, with a halftone which is overprinted on a color block

(NOTE: A fake duotone is also called a duograph.)

- M. Moire--An objectionable wavy effect produced when screens are overprinted at an incorrect angle

- N. Rescreening--Screening of a printed halftone illustration

II. Types of contact screens and their descriptions

- A. Gray contact screen--A silver emulsion screen that does not require magenta color for control of tone reproduction

(NOTE: This is the most popular and easiest screen to use. A controlled flash exposure is recommended for adjusting halftone contrast.)

- B. Magenta contact screen--A dyed screen whose tone reproduction characteristics can be altered with the use of magenta and yellow filters

- C. Conventional dot screen--A screen that produces square middletone dots that join all four corners as the dots reach 50 percent (Figure 1)

FIGURE 1

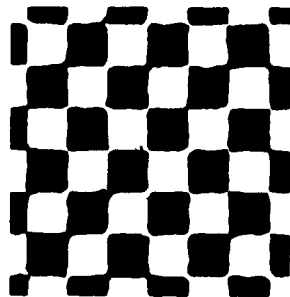

Conventional (square) dots

Courtesy Eastman Kodak Company

INFORMATION SHEET

- D. Elliptical dot screen--A screen that produces football-shaped middletone dots that join only two opposite corners as the dots reach 50 percent (Figure 2)

FIGURE 2

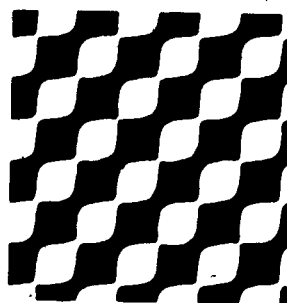

Elliptical dots

Courtesy Eastman Kodak Company

III. Care of contact screens

- A. Protect from dirt, dust, fingerprints, scratches, and other damage
- B. Keep the screen flat and in its original folder when not in use
- C. Dust the screen when necessary by wiping it lightly with a clean dry photo chamois
- D. Clean water spots only with film cleaner

IV. Kinds of halftone dots

- A. Highlights--The densest part of the negative containing small clear openings in an otherwise solid area (Figure 3)

FIGURE 3

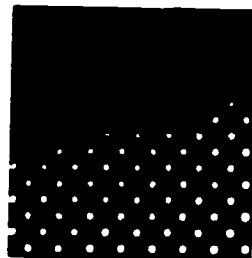

Highlights

Courtesy Eastman Kodak Company

INFORMATION SHEET

- B. Shadow areas--Have the least density in the halftone negatives (Figure 4)

(NOTE: These are the transparent areas of the negative that have small black dots.)

FIGURE 4

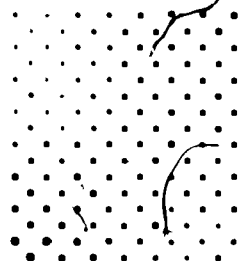

Shadow areas

Courtesy Eastman Kodak Company

- C. Middletones--The tones between highlight and shadow (Figure 5)

(NOTE: The halftone dots from 30 to 70 percent comprise the middle-tones.)

FIGURE 5

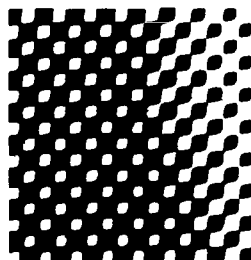

Middletones

Courtesy Eastman Kodak Company

V. Characteristics of Kodak Autoscreen film

- A. A halftone film with a 133 line screen ruling built into the film emulsion
- B. Does not require a halftone screen
- C. Requires a shorter exposure time than conventional method
- D. A no-screen (bump) exposure can not be made with this film

INFORMATION SHEET

VI. Procedures for avoiding moires in rescreening

(NOTE: Making a halftone negative from a printed halftone illustration may cause a moire.)

- A. Angle the contact screen or copy 30°
- B. Use a screen which has a screen ruling of 50 lines coarser or finer than the copy
- C. Hold a clean piece of glass in front of the lens, and tilt back and forth during exposure
- D. Original may be reduced to less than 40%

HALFTONE PHOTOGRAPHY
UNIT III

JOB SHEET #1--PROGRAM A Q12 EXPOSURE COMPUTER AND
MAKE A HALFTONE NEGATIVE

I. Tools and materials

- A. Kodak Q12 Exposure Computer
- B. Kodak 24 Step Reflection Density Guide, Q16
- C. Reflection densitometer (optional)
- D. Magnifier (10X)
- E. Contact screen
- F. Litho film (8 x 10 or 10 x 12)
- G. A continuous tone copy with normal contrast (a good black and white photograph)
- H. Process camera and other darkroom equipment

II. Procedure

A. Make the test negative

- 1. Set up darkroom and stabilize temperature
- 2. Set up camera for a 100% reproduction
 - a. Set f-stop on f/16
 - b. Set timer

(NOTE: Use an exposure of approximately three times the normal exposure for line. In this example we will use 30 seconds.)

- 3. Place a Kodak Reflection Density Guide (24 step) on the camera copyboard
- 4. Place a sheet of 8 x 10 or 10 x 12 inch film that is normally used for halftone on the camera back
- 5. Cover up approximately one inch of the film widthwise with a piece of cardboard and tape it down

JOB SHEET #1

6. Place a contact screen, emulsion side down, over the film

(NOTE: To insure good contact, the screen must be at least 1/2 inch larger than the film on all four sides.)

7. Wipe the contact screen lightly with a lint free cloth or rubber roller to work air bubbles out

(NOTE: Air bubbles and dust will create hot spots on the negative.)

8. Make an exposure and open the camera back

(NOTE: DO NOT TURN THE VACUUM OFF.)

9. Uncover the covered area and cover the exposed area of the film with the contact screen in place

10. Make a series of flash exposures

(NOTE: Use a second piece of cardboard to step off a series of at least five 5 second exposures by moving the cardboard 1/2 inch each time.)

11. Remove the contact screen and place it in its original container

12. Process the test negative

(NOTE: All processing must be kept absolutely consistent.)

13. Place the negative on a light table and examine the dot structure with a magnifier

(NOTE: The normal highlight dots should fall on step .00 or higher density of the gray scale. If they do not, another exposure must be made by doubling the exposure. Ask the instructor what the normal highlight dots should be. There will be no dots in the area of the negative that represent the darkest steps of the gray scale, but dots do appear in lower density steps (shadow dots). Select the normal highlight and shadow dot, and note the density of the corresponding steps. In this example we will use hypothetical numbers of .30 for highlight and 1.20 for shadow. Student should use the actual steps that produced the normal highlight and shadow dots. Subtracting highlight density (.30) from shadow density (1.20), we arrive at a Basic Density Range (BDR) of .90. If the original copy has a BDR of .90, a single exposure (main) will reproduce a good halftone negative. The BDR will remain the same in any darkroom as long as the same equipment, materials, and techniques are used.)

JOB SHEET #1

B. Program the computer

1. Rotate the lens aperture dial of the computer so that f/16 is in line with the 100% mark on the magnification scale
2. Hold the lens aperture dial down and rotate the density dial (red) so that the highlight density (.30) is in line with the exposure time (30 seconds)
3. Tape the density dial to the lens aperture dial, thus programming the computer for main exposure

C. Determine basic flash exposure

1. Examine the series of flash exposures on the test negative
2. Select the exposure time that produced the most suitable dots

(NOTE: These dots should be the same size as the shadow dots. In this example we assume the 20 second step has the most suitable dots. Student should use the actual step that produced the most suitable dots. This is the basic flash exposure. Mark the basic flash exposure on flash exposure table.)

D. Use the computer

1. Obtain the density range of the furnished copy

- a. Use a Kodak Reflection Density Guide or a reflection densitometer and read the highlight density and shadow density of the copy
- b. Subtract the highlight density of the copy from the shadow density

(NOTE: In this example we assume a highlight density of .10 and a shadow density of 1.60. The density range of the copy will be 1.50 ($1.60 - .10 = 1.50$.)

2. Determine the main exposure

- a. Rotate the dial of the computer so that the magnification or reduction is in line with the lens aperture to be used
- b. Read off the exposure time that is in line with the highlight density of the copy

(NOTE: In this example the highlight density of the copy was .10, so the main exposure will be 19 seconds.)

JOB SHEET #1

3. Determine the flash exposure

- a. Calculate the excess density range by subtracting the basic density range from the density range of copy

(NOTE: In this example $1.50 - .90 = .60$; .60 is excess density.)

- b. Locate the basic flash exposure and excess density on the flash exposure table

- c. Read off flash exposure time

(NOTE: Flash exposure time in seconds will be found where the proper line and column intersect. In this example flash exposure will be 15 seconds.)

4. Use the above procedures and make a halftone

5. Evaluate the negative and show it to the instructor

HALFTONE PHOTOGRAPHY
UNIT III

JOB SHEET #2--PROGRAM A Q15 EXPOSURE COMPUTER AND
MAKE A HALFTONE NEGATIVE.

- I. Tools and materials
 - A. Kodak Q15 Exposure Computer
 - B. Kodak 24 Step Reflection Density Guide, Q16
 - C. Reflection densitometer (optional)
 - D. Magnifier (10X)
 - E. Contact screen
 - F. Litho film (8 x 10 or 10 x 12)
 - G. A continuous tone copy with normal contrast (a good black and white photograph)
 - H. Process camera and other darkroom equipment
- II. Procedure
 - A. Make the test negative
 1. Set up darkroom and stabilize temperature
 2. Set up camera for a 100% reproduction
 - a. Set f-stop on f/16
 - b. Set timer

(NOTE: Use an exposure of approximately three times the normal exposure for line 1. In this example we will use 30 seconds.)
 3. Place a Kodak Reflection Density Guide (24 step) on the camera copyboard
 4. Place a sheet of 8 x 10 or 10 x 12 inch film that is normally used for halftone on the camera back
 5. Cover up approximately one inch of the edge of the film widthwise with a piece of cardboard and tape it down

JOB SHEET #2

6. Place a contact screen, emulsion side down, over the film
(NOTE: To ensure good contact, the screen must be at least 1/2 inch larger than the film on all four sides.)
7. Wipe the contact screen lightly with a lint free cloth or rubber roller to work air bubbles out
8. Make an exposure and open the camera back
(NOTE: DO NOT TURN THE VACUUM OFF.)
9. Uncover the covered area and cover the exposed area of the film with the contact screen in place
10. Make a series of flash exposures
(NOTE: Use a second piece of cardboard to step off a series of at least five 5 second exposures by moving the cardboard 1/2 inch each time.)
11. Remove the contact screen and place it in its original container
12. Process the test negative
(NOTE: All processing must be kept absolutely consistent.)
13. Place the negative on a light table and examine the dot structure with a magnifier
(NOTE: The normal highlight dots should fall on step .00 or higher density of the gray scale. If they do not, another exposure must be made by doubling the exposure. Ask your instructor what the normal highlight dots should be. There will be no dots in the area of the negative that represent the darkest steps of the gray scale, but dots do appear in lower density steps (shadow dots). Select the normal highlight and shadow dot, and note the density of the corresponding steps. In this example we will use the hypothetical numbers of .20 for highlight and 1.30 for shadow. Students should use the actual steps that produced the normal highlight and shadow dots.)
14. Examine the flash exposures on the edge of the test negative, and select the step which produced a normal shadow dot
(NOTE: These dots should be the same size as the shadow dot on the gray scale.)

JOB SHEET #2

15. Record the exposure time which produced this dot

(NOTE: This flash time becomes the basic flash exposure. If none of the steps show acceptable dot sizes, change the flash lamp distance and/or size of the bulb and repeat the process. In this example we will assume the 20 second step produced a normal shadow dot.)

B. Program the computer

1. Select the quadrant of the basic flash dial (clear) that corresponds with the basic flash exposure

(NOTE: In this example it is 20 seconds.)

2. Cover all but the correct quadrant with the mask wheel

3. Rotate the main exposure dial (M) until it is in line with the density of copy that produced the highlight dot

(NOTE: In this example it is .20.)

4. Set "zero" of the basic flash quadrant opposite the density of gray scale that produced the shadow dots

(NOTE: In this example it is 1.30.)

5. Secure the basic flash dial, mask wheel, and main exposure dial with a piece of tape, making sure the alignment has not changed

6. Rotate the main exposure calibration tab so that the test negative exposure time appears in the window and is in line with the density that produced the highlight dots

(NOTE: In this example it is 30 seconds.)

7. Fasten the tab to the base of the computer; the computer is now programmed

C. Use the computer, with gray contact screen and Kodalith Autoscreen

1. Obtain the highlight and shadow densities of the copy

(NOTE: Use a Kodak Reflection Density Guide or a reflection densitometer. In this example we will use a highlight density of .25 and shadow density of 1.55. Student should use the actual densities of the copy.)

2. Rotate M to the highlight density of the copy

3. Set pointer F at the shadow density of the copy

JOB SHEET #2

4. Select the red correction arrow which is closest to pointer F
5. Move pointer F to the head of the correction arrow
6. Rotate the flash quadrant dial the length of the arrow
7. Reset F at the copy shadow density
8. Read the main exposure time in the window
9. Read the flash exposure time at pointer F

(NOTE: In this example, the main exposure is 33 seconds and the flash exposure is 6 seconds.)

D. Use the computer with a magenta contact screen

1. Obtain the highlight and shadow density of the copy
2. Rotate M to the highlight density of the copy
3. Set pointer F at the shadow density of the copy
4. Read the main exposure time in the window
5. Read the flash exposure time at pointer F

(NOTE: Do not use correction arrows when using magenta contact screens.)

E. Program the computer for no-screen (bump) exposure

1. Make a second test negative with the same contact screen, same film, and same exposure

(NOTE: Do not turn the vacuum off.)

2. Remove the contact screen

(NOTE: This should be done carefully so the film does not move.)

3. Make a second exposure on the same piece of film

(NOTE: If a gray contact or magenta negative screen is used, the exposure time should be 5 percent of the exposure for the first test negative. If a magenta positive screen is used, the exposure time should be 10 percent. In this example we assume 5 percent. The first test negative had a 30 second exposure. Five percent of 30 seconds is 1 1/2 seconds. If the process camera is not equipped with an accurate timer, a neutral density filter should be used. Ask the instructor for the proper value.)

JOB SHEET #2

4. Process and dry the negative
5. Locate the step on the gray scale that produced a suitable highlight dot only

(NOTE: The highlight dot will be in a higher density step; assume it is .45.)

6. Determine the difference between the density of the step that produced the highlight dot in test negative No. 1 and test negative No. 2

(NOTE: In this example $.45 - .20 = .25$.)

7. Refer to the no-screen calibration table on the back of the computer

(NOTE: For convenience, the numbers from one of the vertical columns of the table will be transferred to the no-screen scale of the computer. To determine which column to use, read down the left-hand side of the table to the density difference. Read across to the percentage of no-screen exposure that was used.)

8. Read down the left-hand side of the table (highlight difference) to the density difference (Figure 1)

9. Read across to the percentage of no-screen exposure that was used (Figure 1)

(NOTE: Where these two figures intersect (Figure 1), transfer the numbers from this column to the front of the computer opposite their density equivalents on the no-screen scale (Figure 2). The computer is now calibrated for no-screen exposure.)

FIGURE 1

NO SCREEN CALIBRATION TABLE									
Highlight Difference	Percentage No-Screen Exposure								
.15	2	2	1	1	1	1	1	1	0
.20	4	3	3	2	2	2	2	2	1
.25	7	5	4	4	3	3	3	2	
.30	10	8	7	5	4	4	3		
.35	15	10	8	7	6	5	4		
.40	20	13	10	8	7	6	6	5	
.45		16	12	10	8	7	7	6	5
.50		20	15	13	10	8	8	7	6
.55			18	15	13	10	9	8	7
.60			20	18	15	13	10	9	8
.65				20	19	18	15	13	10
.70					20	19	18	15	13
.75						20	19	18	15
.80							20	19	18

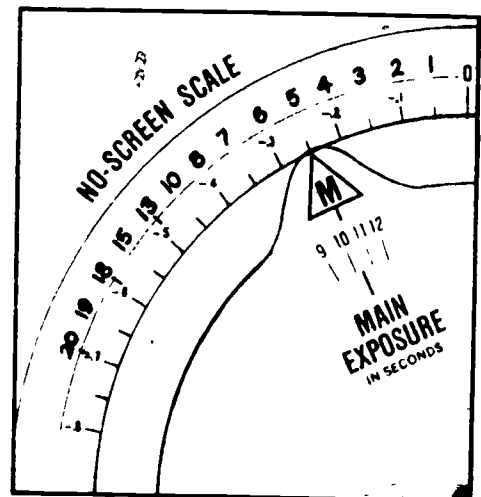

FIGURE 2

Courtesy Eastman Kodak Company

JOB SHEET #2

F. Use the computer for no-screen exposures

1. Select the areas of the copy where a highlight and shadow dot should be placed

(NOTE: In this example we assume a highlight density of .10 and shadow density of 1.65.)

2. Rotate M to the percentage of no-screen exposure to be used for that copy (Figure 2)

(NOTE: In this example it is 5.)

3. Rotate M clockwise the distance of the highlight density of the copy (Figure 3)

(NOTE: Do not rotate M if the highlight density of the copy is .00.)

FIGURE 3

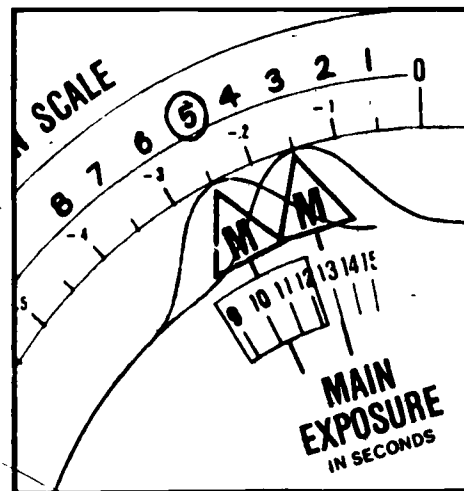

Courtesy Eastman Kodak Company

4. Read the main exposure in the window (Figure 3)

(NOTE: In this example it is 13 seconds.)

5. Set Pointer F at the shadow density

(NOTE: Correction arrows are not used. The exposure times for this copy will be:

Main exposure--13 seconds
 No-screen exposure--13 seconds with a 1.30 ND filter
 Flash exposure--17 seconds.)

6. Using the above procedures, make a halftone negative
7. Evaluate the negative and show it to the instructor

HALFTONE PHOTOGRAPHY
UNIT III

JOB SHEET #3--MAKE A DUOTONE

- I. Tools and materials
 - A. Process camera
 - B. Darkroom equipment
 - C. Contact screen
 - D. Continuous tone copy
 - E. Halftone film
 - F. Register marks
 - G. A sheet of index or chipboard (larger than copy)
 - H. Masking tape
 - I. Litho paper (or photographic paper and Dektol developer)
 - J. Color key or other proofing material and developer
 - K. Protractor and ruler
- II. Procedure
 - A. Make a template for angling copy on the index or chipboard (Figure 1)
 1. Draw a vertical line through the center of chipboard, and mark this line 0°
 2. Place zero line of the protractor on this line and mark off 45° , 75° , 90° , and 105°
 3. Draw lines from this point through the center of zero line to the edge of the chipboard

(NOTE: Only 45° and 75° lines will be used in this job sheet. However, this template should be saved for use in rescreening and in the color separation unit, later in this section.)

JOB SHEET #3

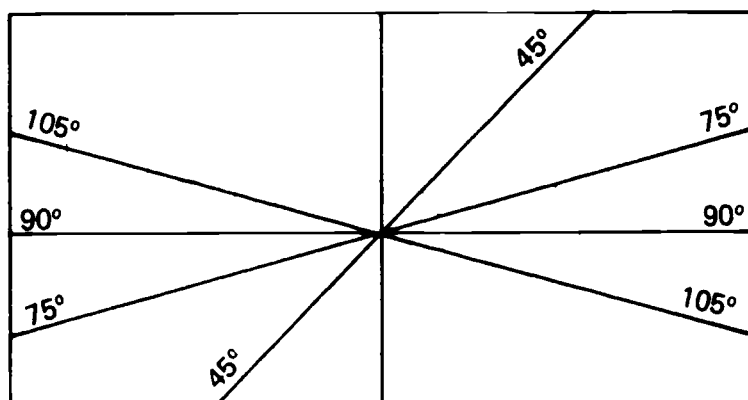

FIGURE 1

- B. Place register marks on the copy

(NOTE: Place at least two of them at opposite ends of the copy. If they can not be placed on the copy, mount the copy on a larger board.)

- C. Mark the centerline of the copy at both top and bottom

(NOTE: These lines will be used to line up the copy with the lines on the chipboard.)

- D. Tape the copyboard mat down securely to the metal copyboard frame
- E. Tape the chipboard securely to the center of copyboard mat
- F. Place the copy in the center of chipboard, and line it up with the 45° line
- G. Tape the copy down securely
- H. Set the camera to required size
- I. Position the contact screen as straight as possible on the vacuum back where it would normally go
- J. Place strips of masking tape as guides at the corner edges of the screen
- K. Determine what size film is needed

(NOTE: Since the copy is angled on the copyboard, a larger sheet of film is required.)

- L. Place tape guides on the vacuum back to guide the film in position

JOB SHEET #3

- M. Make the exposure and process the film

(NOTE: Refer to Job Sheet #1 or #2 in this unit and Job Sheet #2 in Unit II. This should be basically a normal negative. A 15 percent flash exposure is added to keep shadows from printing solid black. If a magenta positive screen is used, a 10 percent no-screen (bump) exposure is needed.)

- N. Open the copyboard slowly and rotate the copy to line up with the 75° line

- O. Tape the copy down securely and gently close the copyboard

- P. Place another sheet of film in the same position as before

- Q. Position screen in exactly the same position as before

- R. Expose and process the film

(NOTE: Reduce the main exposure by 25 percent and eliminate the flash. The result should be a flat-looking halftone in the highlight area, and little or no dots in the shadows.)

- S. Register the two negatives

(NOTE: If the negatives can not be registered, or if there is evidence of a moire, carefully review the steps and ask the instructor for help. If the negatives do register and have no evidence of moire, ask the instructor if it should be proofed. To proof a duotone continue with steps below.)

- T. Make a contact print of the black negative (45°) on a sheet of litho paper

- U. Process the contact print and dry

- V. Make a contact proof of the color negative on a sheet of color key or other proofing material

- W. Process the proof, wash, and dry

- X. Register the color proof to the contact print and tape it down

HALFTONE PHOTOGRAPHY
UNIT III

JOB SHEET #4- MAKE A FAKE DUOTONE

- I. Tools and materials
 - A. Process camera
 - B. Darkroom equipment
 - D. Contact screen
 - E. Halftone film
 - F. Register marks
 - G. Illustration board
 - H. Masking film
 - I. Paste-up and stripping equipment
 - J. Masking tape
- II. Procedure
 - A. Mount the copy to the illustration board using masking tape
 - B. Cut a piece of masking film large enough to extend 1/2 inch beyond the copy on all four sides
 - C. Cut a straight line 1/2 inch down from the top of the masking film
(NOTE: Do not cut through the support base.)
 - D. Remove the emulsion from the top strip
 - E. Apply two register marks in diagonal corners of the copy on the illustration board
 - F. Place the masking film on the copy and fasten down with a strip of masking tape across the top
(NOTE: Make sure the clear part of the masking film extends into the copy about 1/16" or less.)
 - G. Draw the masking film down tightly and fasten the two lower corners
 - H. Cut around the edge of the copy just inside the borders

JOB SHEET #4

- I. Peel off the masking film from all areas of the copy except the area covering the illustration
- J. Slide a sheet of white opaque paper under the masking film to cover the copy but not the register marks
- K. Set the camera to the required size and photograph this as a line copy
(NOTE: Use the same type of film that is to be used for halftone. The dimensional stability of film bases vary. Using two types of film could result in lack of registration.)
- L. Process the film
(NOTE: This negative will be used for the solid or tint block to be laid under the halftone.)
- M. Open the copyboard slowly, being careful not to jar the camera out of focus
- N. Remove the two pieces of masking tape from the lower corners of the overlay
- O. Swing the overlay back exposing the copy
(NOTE: Make sure the register marks are not covered and leave the overlay attached to the illustration board.)
- P. Carefully close the copyboard
- Q. Place a sheet of halftone film on the vacuum back
- R. Position the screen as straight as possible on top of the film
- S. Make a normal halftone negative
(NOTE: Refer to Job Sheets #1 and 2.)
- T. Register the two negatives to see if they fit properly
(NOTE: If a tint screen is used for second color, it must be angled 30° away from the angle of the contact screen to prevent moire.)

HALFTONE PHOTOGRAPHY
UNIT III

JOB SHEET #5--RESCREEN A HALFTONE ILLUSTRATION

I. Tools and materials

- A. Process camera
- B. Darkroom equipment
- C. Contact screen
- D. Halftone illustration
- E. Halftone film
- F. Magnifier
- G. Template for angling copy (refer to Job Sheet #3)

II. Procedure

(NOTE: Several methods are used for rescreening. In this job sheet the copy will be angled at 30°. Ask the instructor if other methods should also be used.)

1. Find the screen angle of the illustration
(NOTE: Use a screen angle finder or magnifier.)
2. Place the template on the copyboard
(NOTE: This template was made in Job Sheet #3.)
3. Place the illustration on the center of the template
4. Angle the illustration 30° from its screen angle and fasten it to the template
5. Make a normal halftone
(NOTE: Make sure the contact screen is straight on the vacuum board.)
6. Process and dry the negative
7. Examine the negative for the presence of moire

(NOTE: If there is moire in the negative, check the procedures and remake the negative.)

HALFTONE PHOTOGRAPHY UNIT III

NAME _____

TEST

1. Match the terms on the right with the correct definitions.

- | | |
|--|----------------------------------|
| <p>_____ a. A converted image of a continuous tone copy that consists of solid dots of equal density but varying sizes</p> | <p>1. No-screen exposure</p> |
| <p>_____ b. Used in the light path between the lens and film to break the continuous tone copy into a dot pattern for reproduction</p> | <p>2. Halftone screen</p> |
| <p>_____ c. A precision pattern of vignettted dots on a flexible support used in direct contact with the film</p> | <p>3. Density</p> |
| <p>_____ d. The number of lines per inch on a halftone screen</p> | <p>4. Rescreening</p> |
| <p>_____ e. A numerical measure of the blackening or light-stopping ability of a photographic image</p> | <p>5. Duotone</p> |
| <p>_____ f. An instrument for making density measurements</p> | <p>6. Halftone</p> |
| <p>_____ g. A detail exposure made through the lens of the camera, with the contact screen in place only with the camera lights</p> | <p>7. Flash exposure</p> |
| <p>_____ h. A nonimage exposure made through the contact screen to the film</p> | <p>8. Neutral density filter</p> |
| <p>_____ i. An exposure made by exposing the film to the copy without the contact screen</p> | <p>9. Fake duotone</p> |
| <p>_____ j. A gray-colored filter used to uniformly reduce all colors of light</p> | <p>10. Contact screen</p> |
| <p>_____ k. A two-impression reproduction using two halftones of the same original</p> | <p>11. Densitometer</p> |
| <p>_____ l. A two-impression reproduction, with a halftone which is overprinted on a color block</p> | <p>12. Moire</p> |
| | <p>13. Screen ruling</p> |
| | <p>14. Main exposure</p> |

- m. An objectionable wavy effect produced when screens are overprinted at an incorrect angle
- n. Screening of a printed halftone illustration

2. Match the types of contact screens on the right with the correct descriptions.

- | | |
|--|---|
| <ul style="list-style-type: none"> <input type="checkbox"/> a. A dyed screen whose tone reproduction characteristics can be altered with the use of magenta and yellow filters <input type="checkbox"/> b. A screen that produces square middletone dots that join all four corners as the dots reach 50 percent <input type="checkbox"/> c. A screen that produces football-shaped middletone dots that join only two opposite corners as the dots reach 50 percent <input type="checkbox"/> d. A silver emulsion screen that does not require magenta color for control of tone reproduction | <ul style="list-style-type: none"> 1. Elliptical dot screen 2. Magenta contact screen 3. Gray contact screen 4. Conventional dot screen |
|--|---|

3. Select true statements concerning the care of contact screens by placing an "X" in the appropriate blanks.

- a. Clean water spots only with blanket wash
- b. Dust the screen by wiping it with a clean shop towel
- c. Keep the screen flat and in its original folder when not in use
- d. Protect from dirt, dust, fingerprints, scratches, and other damage

4. Identify the kinds of halftone dots pictured below.

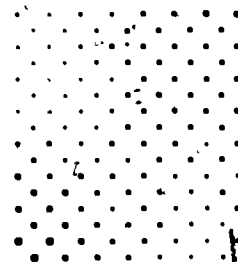
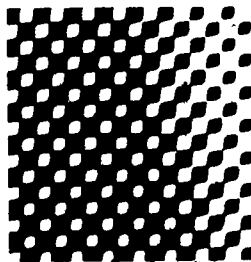
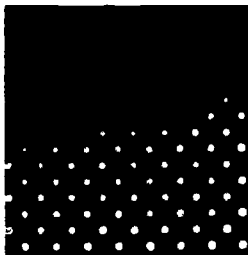

- a. _____ b. _____ c. _____

5. Select true statements concerning the characteristics of Kodak Autoscreen film by placing an "X" in the appropriate blanks.
- a. It is a halftone film with a 133 line screen ruling built into the film emulsion
 - b. It requires a halftone screen
 - c. It requires a shorter exposure time than the conventional method
 - d. A no-screen exposure must be made when using this film
6. Select true statements concerning procedures for avoiding moires in rescreening by placing an "X" in the appropriate blanks.
- a. Use a screen which has a screen ruling that is the same as the copy
 - b. The original may be greatly enlarged
 - c. Hold a clean piece of glass in front of the lens, and tilt back and forth during exposure
 - d. Angle the contact screen or copy 30°
7. Demonstrate the ability to:
- a. Program a Q12 Exposure Computer and make a halftone negative
 - b. Program a Q15 Exposure Computer and make a halftone negative
 - c. Make a duotone
 - d. Make a fake duotone
 - e. Rescreen a halftone illustration

(NOTE: If these activities have not been accomplished prior to the text, ask your instructor when they should be completed.)

HALFTONE PHOTOGRAPHY
UNIT III

ANSWERS TO TEST

- | | | | | | | |
|----|----|----|----|----|----|----|
| 1. | a. | 6 | f. | 11 | k. | 5 |
| | b. | 2 | g. | 14 | l. | 9 |
| | c. | 10 | h. | 7 | m. | 12 |
| | d. | 13 | i. | 1 | n. | 4 |
| | e. | 3 | j. | 8 | | |
2. a. 2 c. 1
 b. 4 d. 3
3. c, d
4. a. Highlights
 b. Middletones
 c. Shadow areas
5. a, c
6. c, d
7. Performance skills evaluated to the satisfaction of the instructor

OTHER DARKROOM TECHNIQUES UNIT IV

UNIT OBJECTIVE

After completion of this unit, the student should be able to make a diffusion transfer line print, a transparency, a screened print, posterize, and make a PMT paper litho plate. The student should also be able to make a duplicate negative, a film positive, a spread, a choke, a spread outline, and a choke outline. This knowledge will be evidenced by correctly performing the procedures outlined in the job sheets and by scoring 85 percent on the unit test.

SPECIFIC OBJECTIVES

After completion of this unit, the student should be able to:

1. Match terms related to other darkroom techniques with the correct definitions.
2. Select true statements concerning the care of a diffusion transfer processor.
3. List materials and equipment necessary to make a diffusion transfer.
4. Demonstrate the ability to:
 - a. Determine basic exposure and make a diffusion transfer line print.
 - b. Make a diffusion transfer transparency.
 - c. Program a Q12 Exposure Computer for diffusion transfer halftones and make a halftone print.
 - d. Posterize with diffusion transfer materials.
 - e. Make a PMT paper litho plate.
 - f. Make a duplicate negative and a film positive.
 - g. Make a spread, a choke, a spread outline, and a choke outline.

OTHER DARKROOM TECHNIQUES UNIT IV

SUGGESTED ACTIVITIES

- I. Provide student with objective sheet.
- II. Provide student with information and job sheets.
- III. Discuss unit and specific objectives.
- IV. Discuss information sheet.
- V. Demonstrate and discuss the procedures outlined in the job sheets.

(NOTE: Job Sheet #7 discusses manual methods of making a spread, a choke, and an outline. If a style modifier system is available, it is recommended that job sheets be written by the instructor.)
- VI. Demonstrate the proper procedures to:
 - A. Set up the diffusion transfer processor.
 - B. Set up the contact frame.
 - C. Use the platemaker.
 - D. Use the register punch.
 - E. Use the register pins or strip.
 - F. Use a densitometer.
- VII. It is suggested that the instructor contact the manufacturers/suppliers of various types of diffusion transfer materials and obtain in-depth information on them for the students.
- VIII. Give test.

INSTRUCTIONAL MATERIALS

- I. Included in this unit:
 - A. Objective sheet
 - B. Information sheet
 - C. Job sheets

1. Job Sheet #1--Determine Basic Exposure and Make a Diffusion Transfer Line Print
2. Job Sheet #2--Make a Diffusion Transfer Transparency
3. Job Sheet #3--Program a Q12 Exposure Computer for Diffusion Transfer Halftones and Make a Halftone Print
4. Job Sheet #4--Posterize with Diffusion Transfer Materials
5. Job Sheet #5--Make a PMT Paper Litho Plate
6. Job Sheet #6 -Make a Duplicate Negative and a Film Positive
7. Job Sheet #7--Make a Spread, a Choke, a Spread Outline, and a Choke Outline

D. Test

E. Answers to test

II. References:

- A. Eastman Kodak Co. *Copy Preparation and Platemaking Using Kodak PMT Materials*. Rochester, NY 14650: Eastman Kodak Company, 1975.
- B. Eastman Kodak Co. *Reference Chart for Diffusion Transfer Prints*. Rochester, NY 14650: Eastman Kodak Company 1980.

III. Additional materials:

Kodak Publication Q-170, Special Effects
Eastman Kodak Company
343 State Street
Rochester, NY 14650

OTHER DARKROOM TECHNIQUES
UNIT IV

INFORMATION SHEET

- I. Terms and definitions
 - A. Diffusion transfer--A photographic process characterized by exposing a sheet of sensitized paper, processing the paper in contact with a receiver sheet, and peeling the two apart after a short waiting period to produce a usable image on the receiver
 - B. PMT (Photo-mechanical transfer)--Trade name of diffusion transfer material marketed by the Eastman Kodak Company
 - C. Diffusion transfer negative paper--A light-sensitive camera speed paper designed for use in a process camera
 - D. Diffusion transfer receiver paper--A non-light-sensitive, but chemically sensitive paper that accepts the transferred image as a positive print
 - E. Diffusion transfer transparent receiver sheet--A non-light-sensitive, but chemically sensitive material with a transparent base
 - F. Activator--A one-step, ready-to-use processing chemical used in diffusion transfer processor
 - G. Copy dot--Making a line negative of a previously screened halftone illustration
 - H. Posterizing--The practice of compressing a full range of tones in a picture into a few flat tones
 - I. Bright light positive duplicating film--A contact speed, thin base duplicating film that can be handled in room light; used to produce a duplicate
 - J. Bright light negative duplicating film--A contact speed, thin base duplicating film that can be handled in room light; used to produce a reverse
 - K. Spread--A method of enlarging line copy to create a heavier line
 - L. Choke--A method of reducing line copy to create a lighter, smaller line
 - M. Spread outline--An outline image that is larger than the original
 - N. Choke outline--An outline image that is smaller than the original

INFORMATION SHEET

- II. Care of a diffusion transfer processor
 - A. Clean the processor daily
 - B. Drain activator into the storage container.
 - C. Remove and wash the tray with warm water
 - D. Clean the processor rollers
 - E. Dry and reassemble the processor

- III. Materials and equipment necessary to make a diffusion transfer
 - A. Diffusion transfer negative paper
 - B. Diffusion transfer receiver paper
 - C. Activator
 - D. Camera
 - E. Processor

OTHER DARKROOM TECHNIQUES
UNIT IV

JOB SHEET #1--DETERMINE BASIC EXPOSURE AND MAKE
A DIFFUSION TRANSFER LINE PRINT

- I. Equipment and materials
 - A. Process camera
 - B. Diffusion transfer processor
 - C. Diffusion transfer activator
 - D. Diffusion transfer negative paper
 - E. Diffusion transfer receiver paper
 - F. Kodak Q12 Graphic Arts Exposure Computer
 - G. 12-step reflection gray scale
 - H. Sample copies of phototype, typewriter copy, and line illustrations
- II. Procedure
 - A. Determine basic exposure
 1. Set up the camera
(NOTE: See Job Sheet #2 in Section A, Unit II)
 2. Set up the diffusion transfer processor
(NOTE: Refer to instruction manual.)
 3. Fasten small strips of the sample line copies on a cardboard
 4. Place copyboard in the horizontal position and raise the glass cover
 5. Place the sample copies on the center of the copyboard
 6. Place the 12-step reflection gray scale next to the copy on the copyboard and close the copyboard
 7. Return copyboard to vertical position
 8. Open the lens to two complete stops smaller than wide open
(NOTE: If the maximum lens opening is f/11 use f/22. Lenses have their best resolving power at midrange.)

JOB SHEET #1

9. Set the camera controls on 100% (same size) reproduction
 10. Set the camera timer to make a 10 second exposure
 11. Place a sheet of diffusion transfer negative paper on the center of the vacuum back with emulsion side up
- (NOTE: Always handle the negative by the edges.)
12. Turn on the vacuum and close the vacuum back
 13. Make an exposure by starting the timer
 14. Turn the vacuum off and remove the exposed negative
 15. Position the exposed diffusion transfer negative paper with its emulsion side up in contact with the coated side of the diffusion transfer receiver sheet

(NOTE: The dark side of the diffusion transfer negative is the emulsion side. The coated side of the receiver sheet has no visible marks or printing.)

16. Align the negative and receiver combination on the feed tray of the diffusion transfer processor

(NOTE: Follow processor manufacturer's recommendation on proper method of feeding the paper.)

17. Feed negative and paper into the processor

(NOTE: Make sure the negative paper goes under the separator fin and receiver sheet over the fin. When they exit, hold them in contact for 30 to 60 seconds. This operation must be done under red safelight.)

18. Peel the negative paper away from the receiver paper and discard the negative

(NOTE: The remaining steps should be done in normal room light.)

JOB SHEET #1

19. Examine the print and gray scale

(NOTE: A white step 4 on the gray scale indicates that the print is probably good, the print areas either clearly white or densely black. The edges of the letters are sharp and details are true to the original. See Figure 1. A white step 3 or lower indicates that the print is underexposed, the white areas are not clean, and details are thicker than the original. See Figure 2. A white step of 5 or higher indicates that the print is overexposed. Although the white areas are white and clean, the dense areas are gray, and copy shows less of fine details. See Figure 3. If the print is under or overexposed, exposure must be altered to achieve a white step 4. A Kodak Q12 Exposure Computer is used to compute the correct exposure.)

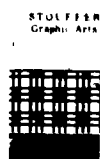

1

2

3

4



FIGURE 1



1

2



FIGURE 2

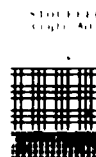

1

2

3

4

5

6



FIGURE 3

Courtesy Stouffer Graphic Arts Equipment Company

JOB SHEET #1

B. Program the computer

(NOTE: If a step lower than step 4 is white [underexposed, and we assume it is step 2] go to procedure step 1; if a step higher than step 4 is white [overexposed, and we assume it is step 6], go to procedure step 4.)

1. Rotate the lens aperture dial (clear) of the exposure computer until f/22 is in line with 100 percent

2. Rotate the density dial (red) until .15 density is in line with 10 seconds

(NOTE: Step 2 of the gray scale has an approximate density of .15.)

3. Read the exposure in seconds that is in line with .45 density

(NOTE: Step 4 of the gray scale has an approximate density of .45. In this example the correct exposure will be 20 seconds. The computer is now programmed, and it can be used to determine exposure if the copy is enlarged or reduced, or if the f-stop is changed.)

4. Rotate the lens aperture dial (clear) of the exposure computer until f/22 is in line with 100 percent

5. Rotate the density dial (red) until .75 density is in line with 10 seconds

(NOTE: Step 6 of the gray scale has an approximate density of .75.)

6. Read the exposure in seconds that is in line with .45 density

(NOTE: In this example, the correct exposure will be 5 seconds.)

7. Make a new diffusion transfer with the corrected exposure

(NOTE: Record the information from the test exposure and final print and hand them in to the instructor.)

7

OTHER DARKROOM TECHNIQUES
UNIT IV

JOB SHEET #2--MAKE A DIFFUSION TRANSFER TRANSPARENCY

I. Equipment and materials

- A. Process camera
- B. Diffusion transfer processor
- C. Diffusion transfer activator
- D. Diffusion transfer negative paper
- E. Diffusion transfer transparent receiver
- F. Kodak Q12 Graphic Arts Exposure Computer
- G. Line copy

II. Procedure

- A. Set up the process camera
- B. Set up the diffusion transfer processor
- C. Place the copy on the copyboard of the camera
- D. Set the exposure time and f-stop

(NOTE: The exposure time for diffusion transfer negative paper is 15 percent less when used with a diffusion transfer transparent receiver sheet than a diffusion transfer receiver sheet. Use the exposure time that gave the best result in Job Sheet #1 less 15 percent. If the exposure in Job Sheet #1 was 10 seconds, this exposure will be 8.5 seconds.)

- E. Place a sheet of diffusion transfer negative paper on the center of the vacuum back with the emulsion side up
- F. Turn on the vacuum and close the vacuum back
- G. Make an exposure and remove the exposed negative
- H. Position the exposed diffusion transfer negative with its emulsion side up in contact with the coated side of the diffusion transfer transparent receiver sheet

(NOTE: The coated side of the transparent receiver sheet is up if the notch is in the upper right hand corner.)

- I. Align the negative and receiver sheet combination on the feed tray of the diffusion transfer processor

JOB SHEET #2

- J. Feed the negative and the receiver sheet into the processor

(NOTE: Make sure the negative paper goes under the separator fin and the receiver sheet over the fin. When they exit, hold them in contact for 90 seconds. This operation must be done under red safelight.)

- K. Peel the negative paper away from the receiver sheet and discard the negative

- L. Rinse the transparent receiver sheet under warm running water

- M. Hang to dry

101

OTHER DARKROOM TECHNIQUES
UNIT IVJOB SHEET #3--PROGRAM A Q12 EXPOSURE COMPUTER FOR
DIFFUSION TRANSFER HALFTONES AND MAKE A HALFTONE PRINT

I. Tools and materials

- A. Kodak Q12 Exposure Computer
- B. Kodak 24 Step Reflection Density Guide Q16
- C. Reflection densitometer (optional)
- D. Magnifier (10X)
- E. Diffusion transfer gray contact screen
- F. Diffusion transfer negative material
- G. Diffusion transfer receiver paper
- H. Diffusion transfer activator
- I. Diffusion transfer processor
- J. Process camera
- K. Black-and-white photograph
- L. Masking tape

II. Procedure

- A. Make a test screen print
 1. Set up the diffusion transfer processor
 2. Set up the camera for 1:1 (100%) reproduction
 - a. Set f-stop on f/22
 - b. Set timer

(NOTE: Use an exposure of approximately three times the normal exposure for line. In this example a 30 second exposure is used.)

3. Place a Kodak Reflection Density Guide (24-step) on the copyboard
4. Place a sheet of 8 x 10 or 10 x 12 inch diffusion transfer negative material on the vacuum back with the emulsion side up
5. Cover up approximately one inch of the edge of the diffusion transfer negative widthwise with a piece of cardboard and tape it down

JOB SHEET #3

6. Place the diffusion transfer gray contact screen, emulsion side down, over the film

(NOTE: To insure a good contact, the screen must be at least 1/2 inch larger on all four sides than the diffusion transfer negative.)

7. Wipe the contact screen lightly with a lint-free cloth or rubber roller to work air bubbles out

8. Make an exposure and open the camera back

(NOTE: Do not turn the vacuum off.)

9. Uncover the covered area and cover the exposed area of the diffusion transfer negative with contact screen in place

10. Make a series of flash exposures

(NOTE: Use a piece of cardboard to step off a series of at least five 5-second exposures by moving the cardboard 1/2 inch each time.)

11. Remove the contact screen and place it in its original container

12. Place the negative on a sheet of receiver paper and process

13. Examine the dot structure of the print with a magnifier

(NOTE: The normal highlight dots should fall on step .00 or higher density of the gray scale. If they do not, another exposure must be made by reducing the exposure. Ask the instructor what the normal highlight dots should be. There will be no dots in the area of the print that represents the darkest steps of the gray scale, but dots do appear in lower density steps (shadow dots). Select the normal highlight and shadow dot, and note the density of the corresponding steps. In this example we will use hypothetical numbers of .30 for highlight and 1.20 for shadow. Student should use the actual steps that produced the normal highlight and shadow dots. Subtracting highlight density (.30) from shadow density (1.20), we arrive at a Basic Density Range (BDR) of .90. If the original copy has a BDR of .90, a single exposure (main) will reproduce a good halftone print. The BDR will remain the same in any darkroom as long as the same equipment, materials, and techniques are used.)

- B. Program the computer

1. Rotate the lens aperture dial of the computer so that f/22 is in line with the 100% on the magnification scale
2. Hold the lens aperture dial down and rotate the density dial (red) so that the highlight density (.30) is in line with the exposure time (30 seconds)
3. Tape the density dial to lens aperture dial; the computer is now programmed for main exposure

JOB SHEET #3

C. Determine basic flash exposure

1. Examine the series of flash exposures on the test print
2. Select the exposure time that produced the most suitable dots

(NOTE: These dots should be the same size as the shadow dots. In this example we assume the 20 second step has the most suitable dots. Student should use the actual step that produced the most suitable dots. This is the basic flash exposure. Mark the basic flash exposure on the flash exposure table.)

D. Using the computer

1. Obtain the density range of the furnished copy

- a. Use a Kodak Reflection Density Guide or a reflection densitometer and read the highlight density and shadow density of the copy
- b. Subtract the highlight density of the copy from the shadow density

(NOTE: In this example we assume a highlight density of .10 and a shadow density of 1.60. The density range of the copy will be 1.50 [$1.60 - .10 = 1.50$].)

2. Determine the main exposure

- a. Rotate the dial of the computer so that the magnification or reduction is in line with the lens aperture to be used
- b. Read off the exposure time that is in line with the highlight density of the copy

(NOTE: In this example the highlight density of the copy was .10, so the main exposure will be 19 seconds.)

3. Determine the flash exposure

- a. Calculate the excess density range by subtracting the basic density range from the density range of copy

(NOTE: In this example $1.50 - .90 = .60$; .60 is excess density.)

- b. Locate the basic flash exposure and excess density on the flash exposure table
- c. Read off flash exposure time

(NOTE: Flash exposure time in seconds will be found where the proper line and column intersect. In this example flash exposure will be 15 seconds.)

OTHER DARKROOM TECHNIQUES
UNIT IV

JOB SHEET #4-POSTERIZE WITH DIFFUSION TRANSFER MATERIALS

I. Tools and materials

- A. Diffusion transfer processor
- B. Process camera
- C. 40 percent screen tint
- D. Diffusion transfer activator
- E. Diffusion transfer negative material
- F. Diffusion transfer receiver paper
- G. Continuous tone copy

II. Procedure

- 1. Set up diffusion transfer processor
- 2. Set up camera for diffusion transfer line copy
- 3. Place continuous tone copy on copyboard
- 4. Place a sheet of the diffusion transfer negative on vacuum back with emulsion side up
- 5. Turn on the vacuum and make a line exposure
- 6. Open the vacuum back
- (NOTE: Do not turn the vacuum off.)
- 7. Place the 40 percent screen tint over the exposed diffusion transfer negative with the emulsion side down
- 8. Reset the camera timer to approximately three times the normal line exposure
- 9. Close the vacuum back and make the exposure
- 10. Place the diffusion transfer negative on a sheet of receiver paper and process

(NOTE: This print with burned out highlights, a tint in the middletones, and solid shadows is called a three tone posterization print. Posterizing techniques are subjective and can be varied to produce diverse effects. Ask the instructor for other screen tints and exposure times.)

OTHER DARKROOM TECHNIQUES
UNIT IV

JOB SHEET #5--MAKE A PMT PAPER LITHO PLATE

I. Tools and materials

- A. Process camera
- B. Diffusion transfer processor
- C. PMT activator
- D. PMT litho negative paper
- E. PMT paper litho plate
- F. PMT paper plate fixer

II. Procedure

- A. Set up the diffusion transfer processor
- B. Expose the negative
 - 1. Place the mechanical on the copyboard of the process camera

(NOTE: To insure proper alignment of the mechanical and the negative, a pin register system or template is recommended.)
 - 2. Place a sheet of PMT litho negative paper on the vacuum back with the emulsion side up

(NOTE: The PMT litho negative paper must be handled under a red safelight.)
 - 3. Make an exposure

(NOTE: Refer to manufacturer's suggested recommendation for trial exposure or ask the instructor.)
- C. Process the negative and plate
 - 1. Place the exposed negative on a PMT litho plate with the emulsion side of the negative in contact with the printing side of the plate

(NOTE: The printing side of the PMT litho plate is the dull side which also has a rougher feel. The negative and plate must be aligned accurately to insure proper transfer of image.)

JOB SHEET #5

2. Run the negative and plate through the diffusion transfer processor

(NOTE: A special plate processor is recommended; however, any diffusion transfer processor may be used if set up properly. Make sure the negative paper goes under the separator fin and the plate goes over the fin.)

3. Hold the negative and plate combination in contact for 30 to 60 seconds after they exit

4. Peel the negative away from the plate and discard the negative

(NOTE: The remaining steps should be done in a lighted room.)

D. Fix the plate

1. Pour a liberal amount of PMT paper plate fixer onto the plate surface

(NOTE: Pour approximately 1/4 ounce of fixer per square foot of plate surface.)

2. Work the plate fixer evenly across the plate surface with a clean cotton pad for a minimum of 30 seconds

(NOTE: The plate should still be wet with the fixer at the end of 30 seconds.)

3. Remove excess fixer from the plate with a clean pad dampened with water or fountain solution

(NOTE: The plate is now ready for the press. If the plate is to be run at a later date, it should be washed in running water for approximately 15 seconds and hung to dry. Store the plate in a clean and dry area. For making deletions, additions, and press runs refer to manufacturer's instruction sheet.)

OTHER DARKROOM TECHNIQUES
UNIT IV

JOB SHEET #6--MAKE A DUPLICATE NEGATIVE AND A FILM POSITIVE

- I. Equipment and materials
 - A. Platemaker
 - B. Basic darkroom equipment and chemicals
 - C. Bright light duplicating film (positive and negative)
 - D. Negative
- II. Procedure
 - A. Make a duplicate negative
 1. Set up darkroom
 2. Clean the glass of the platemaker
 3. Place a masking sheet on the rubber matt of the platemaker
 4. Cut a sheet of duplicating film into desired size

(NOTE: The film should be the same size or larger than the negative.)
 5. Place the duplicating film on the masking sheet with the emulsion side down
 6. Place the negative on top of the duplicating film with emulsion side down

(NOTE: For faithful reproduction of an original, contacting should be done emulsion to emulsion. In this case the loss of extremely fine details will not be noticeable because of the thin film base. However, for uniformity of the finished product, the original should not be used with the duplicate. It is recommended that more duplicates be made.)
 7. Turn on the vacuum

(NOTE: Pull as high a vacuum as possible, preferably in the range of 22 PSI on the indicator.)

JOB SHEET #6

8. Make an exposure

(NOTE: If the platemaker is a flip top, it must be flipped before exposing. If it is not, or if using a contact frame with point-source light, it is ready to be exposed. If the exposure time has not been determined prior to this job sheet, it should be done at this time. To determine the exposure time, step off a series of five second exposures. Process and dry the negative. Examine the negative and select the step that is the same as the original. The exposure time that was used for this step will be the exposure time for this film.)

9. Process the film

(NOTE: Process this film following the same procedures used for line or halftone films, except that this film can be developed in normal room light. If this was a test negative, make another duplicate negative and turn it in to the instructor.)

B. Make a film positive

(NOTE: There are several methods of making film positives. One method is using a diffusion transfer transparent sheet, which was discussed in Job Sheet #2 of this unit. Another method is using line film and the contact printer or bright light duplicating film negative and the platemaker or contact printer. The procedure is the same as when making a duplicate negative. Ask the instructor which film and method should be used, remembering that the line film must be used in the darkroom under red safelight.)

OTHER DARKROOM TECHNIQUES
UNIT IV

JOB SHEET #7--MAKE A SPREAD, A CHOKE,
A SPREAD OUTLINE, AND A CHOKE OUTLINE

I. Equipment and materials

- A. Platemaker
- B. Register punch and pins
- C. Bright light duplicating film (negative and positive)
- D. Line negative
- E. Basic darkroom equipment
- F. Chemicals (developer, stop bath, fixer)
- G. Diffusion sheet

II. Procedure

A. Produce a spread

1. Set up the darkroom
2. Place a masking sheet on the rubber matt of the platemaker
3. Punch a sheet of positive duplicating film with register punch
4. Punch a sheet of clear plastic with a thickness of approximately .004"

(NOTE: A fixed, washed, and dried sheet of unexposed film may be used.)

5. Punch the line negative
6. Place the sheet of punched duplicating film on the platemaker with the emulsion side down

(NOTE: Use register pins.)

7. Register the spacer sheet on top of the film

(NOTE: The spacer sheet is the sheet of plastic or film base that was punched earlier. Different thicknesses of the spacer sheet will produce different results.)

JOB SHEET #7

8. Register the line negative on top of the spacer sheet with the emulsion side down (Figure 1)

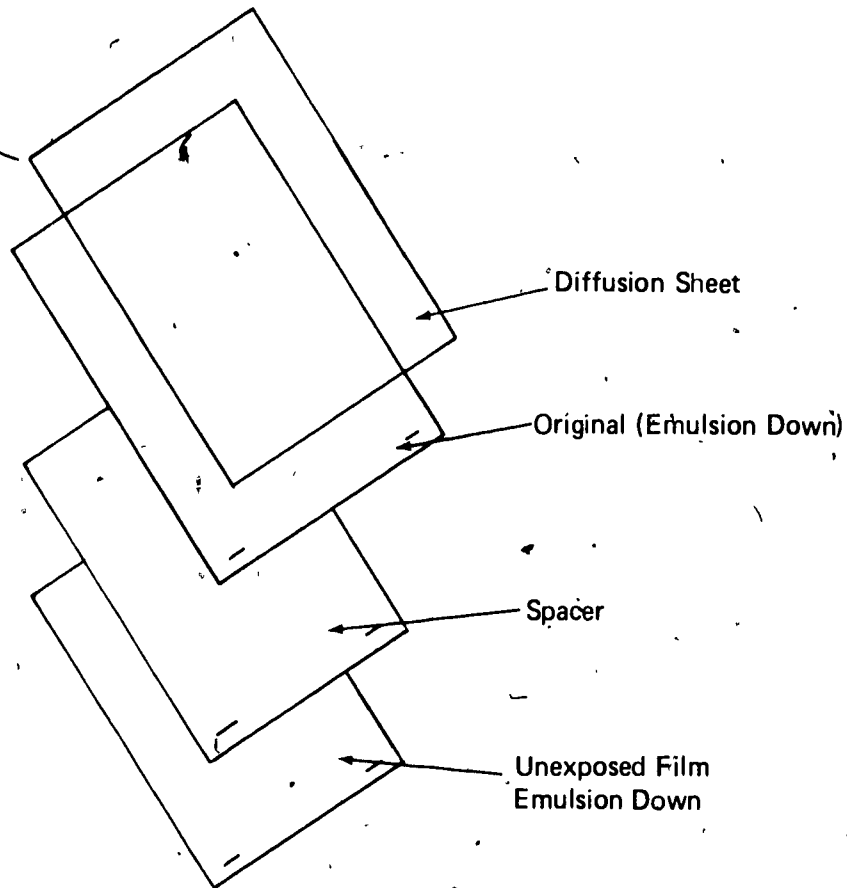

FIGURE 1

9. Place a diffusion sheet on top of the line negative
10. Turn the vacuum on
11. Expose and process the film

(NOTE: Refer to Job Sheet #6 for exposure time.)

JOB SHEET #7

12. Process, wash, and dry the negative

(NOTE: The result is a negative that is somewhat larger, the lines heavier. This is a spread negative. If a positive spread is required, use the same procedures outlined except use negative duplicating film in place of positive duplicating film.)

B. Produce a choke

(NOTE: Procedures for producing a choke are identical to producing a spread, except a film positive is used in place of a line negative. Refer to Job Sheet #6 for making a film positive.)

C. Produce an outline

1. Spread outline

- a. Make a film positive
- b. Make a spread negative
- c. Register the film positive over the spread negative with emulsion to emulsion
- d. Contact this assembly on a sheet of positive duplicating film

(NOTE: If a reverse outline is required, use negative duplicating film.)

2. Choke outline

- a. Make a line negative
- b. Make a choke positive
- c. Register the choke positive over the line negative with emulsion to emulsion
- d. Contact this assembly on a sheet of positive duplicating film

(NOTE: If a reverse outline is required, use negative duplicating film.)

OTHER DARKROOM TECHNIQUES
UNIT IV

NAME _____

TEST

1. Match the terms on the right with the correct definitions.

- | | |
|---|--|
| <p>_____ a. A photographic process characterized by exposing a sheet of sensitized paper, processing the paper in contact with a receiver sheet, and peeling the two apart after a short waiting period to produce a usable image on the receiver</p> | <p>1. Diffusion transfer receiver paper</p> |
| <p>_____ b. Trade name of diffusion transfer material marketed by the Eastman Kodak Company</p> | <p>2. Choke</p> |
| <p>_____ c. A light-sensitive camera speed paper designed for use in a process camera</p> | <p>3. Bright light negative duplicating film</p> |
| <p>_____ d. A non-light-sensitive, but chemically sensitive paper that accepts the transferred image as a positive print</p> | <p>4. Diffusion transfer</p> |
| <p>_____ e. A non-light-sensitive, but chemically sensitive material with a transparent base</p> | <p>5. PMT</p> |
| <p>_____ f. A one-step, ready-to-use processing chemical used in a diffusion transfer processor</p> | <p>6. Choke outline</p> |
| <p>_____ g. Making a line negative of a previously screened halftone illustration</p> | <p>7. Spread</p> |
| <p>_____ h. The practice of compressing a full range of tones in a picture into a few flat tones</p> | <p>8. Bright light positive duplicating film</p> |
| <p>_____ i. A contact speed, thin base duplicating film that can be handled in room light; used to produce a duplicate</p> | <p>9. Copy dot</p> |
| <p>_____ j. A contact speed, thin base duplicating film that can be handled in room light; used to produce a reverse</p> | <p>10. Diffusion transfer negative paper</p> |
| <p>_____ k. A method of enlarging line copy to create a heavier line</p> | <p>11. Spread outline</p> |
| <p>_____ l. A method of reducing line copy to create a lighter, smaller line</p> | <p>12. Diffusion transfer transparent receiver sheet</p> |
| | <p>13. Posterizing</p> |
| | <p>14. Activator</p> |

- _____ m. An outline image that is larger than the original
- _____ n. An outline image that is smaller than the original
2. Select true statements concerning the care of a diffusion transfer processor by placing an "X" in the appropriate blanks.
- _____ a. Clean processor once a month
- _____ b. Remove and wash the tray with warm water
- _____ c. Clean the processor rollers
- _____ d. Dry and reassemble the processor
- _____ e. Drain and discard activator daily
3. List the materials and equipment necessary to make a diffusion transfer.
- a. _____
- b. _____
- c. _____
- d. _____
- e. _____
4. Demonstrate the ability to:
- a. Determine basic exposure and make a diffusion transfer line print.
- b. Make a diffusion transfer transparency.
- c. Program a Q12 Exposure Computer for diffusion transfer halftones and make a halftone print.
- d. Posterize with diffusion transfer materials.
- e. Make a PMT paper litho plate.
- f. Make a duplicate negative and a film positive.
- g. Make a spread, a choke, a spread outline, and a choke outline.

(NOTE: If these activities have not been accomplished prior to the test, ask the instructor when they should be completed.)

OTHER DARKROOM TECHNIQUES
UNIT IV

ANSWERS TO TEST

- | | | | | | |
|-------|----|----|----|----|----|
| 1. a. | 4 | f. | 14 | k. | 7 |
| b. | 5 | g. | 9 | l. | 2 |
| c. | 10 | h. | 13 | m. | 11 |
| d. | 1 | i. | 8 | n. | 6 |
| e. | 12 | j. | 3 | | |
2. b, c, d
3. a. Diffusion transfer negative paper
b. Diffusion transfer receiver paper
c. Activator
d. Camera
e. Processor
4. Performance skills evaluated to the satisfaction of the instructor

OVERVIEW OF PROCESS COLOR PHOTOGRAPHY UNIT V

UNIT OBJECTIVE

After completion of this unit, the student should be able to distinguish between additive and subtractive primary colors and select true statements concerning color separation and the functions of inks. The student should also be able to make a set of unmasked direct screen separation negatives. This knowledge will be evidenced by correctly performing the procedures outlined in the job sheet and by scoring 85 percent on the unit test.

SPECIFIC OBJECTIVES

After completion of this unit, the student should be able to:

1. Match terms related to the overview of process color photography with the correct definitions.
2. Distinguish between additive and subtractive primary colors.
3. Select true statements concerning the functions of inks.
4. Select true statements concerning color separation.
5. Name methods for making color corrections.
6. Demonstrate the ability to make a set of unmasked direct screen separation negatives.

OVERVIEW OF PROCESS COLOR PHOTOGRAPHY
UNIT V

SUGGESTED ACTIVITIES

- I. Provide student with objective sheet.
- II. Provide student with information and job sheets.
- III. Discuss unit and specific objectives.
- IV. Discuss information sheet.
- V. Demonstrate and discuss the procedures outlined in the job sheet.
- VI. Give test.

INSTRUCTIONAL MATERIALS

- I. Included in this unit:
 - A. Objective sheet
 - B. Information sheet
 - C. Job Sheet #1--Make a Set of Unmasked Direct Screen Separation Negatives
 - D. Test
 - E. Answers to test
- II. References:
 - A. Eastman Kodak. *Basic Color for the Graphic Arts*. Rochester, NY 14650: Eastman Kodak Company, 1972.
 - B. Eastman Kodak. *Camera Back Silver Masking*. Rochester, NY 14650: Eastman Kodak Company, 1973.
 - C. Eastman Kodak. *Silver Masking of Transparencies*. Rochester, NY 14650: Eastman Kodak Company, 1974.
 - D. Walker, John R. *Graphic Arts Fundamentals*. South Holland, IL 60473: Goodheart-Willcox Company, Inc., 1980.

OVERVIEW OF PROCESS COLOR PHOTOGRAPHY
UNIT V

INFORMATION SHEET

I. Terms and definitions

- A. Color separation--A process of separating the color original into three black-and-white negatives
- B. Color correction--The process of compensating for ink deficiencies in making separation negatives
- C. Code notch--One or more notches on one corner of a sheet of film used to identify the emulsion and emulsion side of the film

(NOTE: Notches are primarily used on panchromatic film and transparent materials.)
- D. Complementary color--The color that is opposite another color on a color wheel
- E. Cyan--A blue-green color that is used in color separation and color printing
- F. Magenta--A dark pink color that is used in color separation and color printing
- G. Mask--A black-and-white photographic image of a color original used for color correction
- H. Moire--An undesirable pattern on a halftone negative created by the improper angling of the contact screen
- I. Neutral density filter (ND)--A gray-colored filter used to add density with no change in color
- J. Panchromatic film--Film that is sensitive to all colors of light
- K. Primary colors--Colors which cannot be produced by mixing other colors
- L. Separation negative--The negative that represents one of the primary colors from a color original

II. Primary colors

- A. Additive primary colors
 - 1. Additive primary colors--Blue, green, and red

178

INFORMATION SHEET

2. When the three additive primary colors are added together, they will form white light (Figure 1)

FIGURE 1

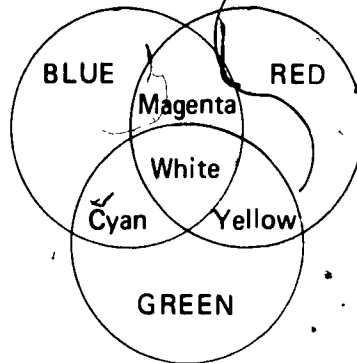

3. When one color is subtracted, the remaining two will form another color which is complementary of the subtracted color

(NOTE: If the blue light is subtracted, the red and green will form yellow, which is complementary to blue. See Figure 2.)

FIGURE 2

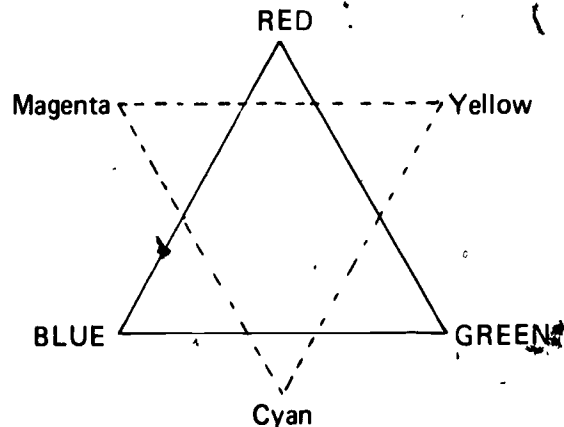

B. Subtractive primary colors

1. Subtractive primary colors—Cyan, magenta, and yellow
2. The complementary colors of additive primary colors
3. When the cyan, magenta, and yellow inks are mixed together in various proportions, they produce a full range of colors
4. Cyan, magenta, and yellow inks are also called process colors

INFORMATION SHEET

5. When solid layers of the process colors are printed on a white sheet, they produce black (Figure 3)

FIGURE 3

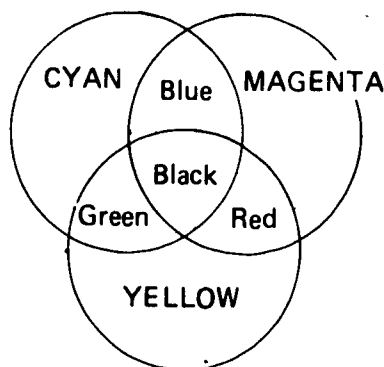

III. Functions of inks

- A. Absorb light
- B. Used to control the light that is permitted to strike the paper and to be reflected from it
- C. Each of the three primary colored printing inks absorbs one of the three component colors of white light and leaves the other two components to be reflected

1. Cyan ink absorbs the red part of white light

(NOTE: Where cyan ink is printed, only green and blue light can be reflected from it. This combination of green and blue light appears cyan in color.)

2. Magenta ink absorbs the green part of white light

(NOTE: Where magenta ink is printed, only red and blue light can be reflected from it. This combination of red and blue light appears magenta in color.)

3. Yellow ink absorbs the blue part of white light

(NOTE: Where yellow ink is printed, only red and green light can be reflected from it. This combination of red and green light appears yellow in color.)

4. Black ink absorbs all components of white light

(NOTE: Its only function in four color printing is to increase the contrast of the reproduction.)

IV. Color separation

- A. Three plates used for printing the three-colored inks

(NOTE: Four plates will be necessary if a black printer is also used.)

INFORMATION SHEET

- B. Each plate a record of either the cyan, magenta, or yellow ink
- C. Three separate negatives needed, each one representing one of the primary colors

(NOTE: To avoid moire, each separation negative is made at a different screen angle, i.e., cyan printer at 105°, yellow printer at 90°, magenta printer at 75°, and black at 45°.)

- D. Negatives made by photographing the color original three times through three different filters on black-and-white panchromatic film
- E. Cyan printer separation negative is made by exposing through a red filter
- F. Magenta printer separation negative is made by exposing through a green filter
- G. Yellow printer separation negative is made by exposing through a blue filter

V. Methods for making color corrections

(NOTE: Printing three color images [cyan, magenta, and yellow] with one on top of the other in perfect register will not reproduce a faithful image of the original. The problem is not in faulty craftsmanship, filters, or the process, but rather in the inks. Process inks are not pure absorbers. Each of the inks absorbs some of the other two colors in addition to its complementary color. The result is a low contrast and muddy reproduction. The correction is achieved by printing less of the inks of certain colors in specific areas. There are three popular methods of color correcting which are described below.)

A. Photographic masking

1. Photographic mask--A weak image of the color original on photographic film
2. Mask--Used with either the color copy or the negative when making separation negatives

B. Electronic scanning

C. Localized dot etching

(NOTE: Photographic masking is the most popular method of color correcting. There are several methods of masking: positive masking, negative masking, camera back masking, using an enlarger, using a contact frame, single stage masking, two stage masking, etc. Although a very important part of process photography, masking procedures will not be discussed in this unit due to the time-consuming nature of the process in a typical school shop. However, a job sheet on unmasked direct screen color separation is included. Unmasked separations are extensively used in newspaper reproduction. Masking is strongly recommended if time permits.)

OVERVIEW OF PROCESS COLOR PHOTOGRAPHY
UNIT V

JOB SHEET #1--MAKE A SET OF UNMASKED DIRECT
SCREEN SEPARATION NEGATIVES

- I. Equipment and materials
 - A. Process camera
 - B. Standard darkroom equipment

(NOTE: See unit on halftone photography in this section for the listing of equipment.)
 - C. Flash lamp with 7 1/2 watt frosted bulb and ND No. 96 (1.30 density) filter
 - D. Preangled chipboard

(NOTE: This chipboard was made in the unit entitled "Halftone Photography.")
 - E. Kodak Color Separation Guide with A, M, B Patch, Q13
 - F. Color illustration (photograph)

(NOTE: Instant color prints are suitable for this process.)
 - G. Filter holder
 - H. Filters (PM23A, PM58, PM47B, K2)

(NOTE: These filters may be substituted with the following: No. 25 for PM23A, and PM47 for PM47B.)
 - I. Masking tape
 - J. Transparent tape
 - K. Gray contact screen
 - L. Panchromatic film
 - M. Magnifying glass
 - N. Color proofing material and developer
- II. Procedure
 - A. Set up the process camera
 - B. Set up the darkroom and stabilize the temperature

JOB SHEET #1

- C. Set up flash lamp for making flash exposure

(NOTE: A conventional flash lamp filter is not suitable for the separation process. A neutral density filter No. 96 [1.30 density] over a 7 1/2 watt frosted tungsten bulb 7 feet from the camera back is recommended.)

- D. Place the preangled chipboard on the copyboard and fasten it down (Figure 1)

FIGURE 1

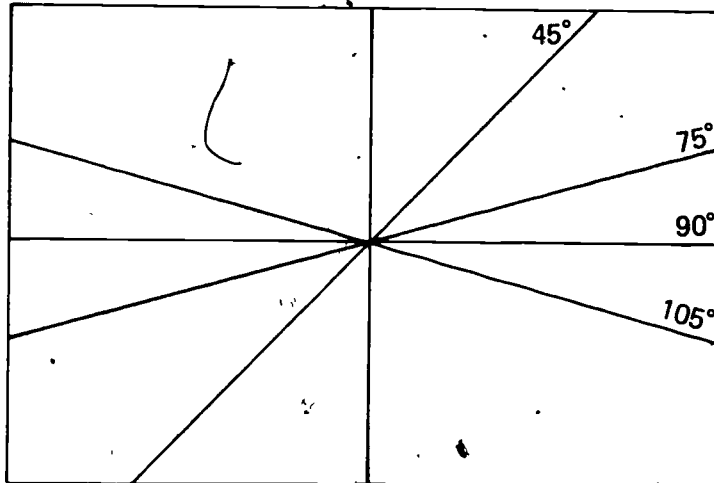

- E. Place a Kodak Color Separation Guide (A, M, B Patch) next to the original color illustration
- F. Fasten these two pieces on a mounting board that is approximately the same size as the two pieces (Figure 2)

FIGURE 2



JOB SHEET #1

- G. Draw two short lines on the center of the mounting board, one on the top and one on the bottom (Figure 2)
- H. Place the copy on the center of the preangled chipboard and line up the short lines of the copy with the 105° line
- I. Place a PM23A or number 25 (red) filter in the filter holder of the camera
- J. Set the lens at f/16 and timer at 25 seconds
- K. Set the flash exposure at 20 seconds
- L. Set the darkroom timer to 2 minutes and 45 seconds (2:45)

(NOTE: A timer with a buzzer is recommended to signal the end of the developing time.)

- M. Place reference marks on the camera back

(NOTE: Place two pieces of masking tape at right angles to each other on the camera back to aid in the positioning of the film in total darkness. Since the copy is angled on the copyboard, a much larger sheet of film must be used to cover the entire copy. A 10 x 12 sheet of film is recommended for a 4 x 5 copy.)

- N. Turn all lights off

(NOTE: Before doing so, remember where everything is [for example, the film, screen, developer, and fixer].)

- O. Place a sheet of pan film on the camera back with the emulsion side up

(NOTE: The emulsion side is up when the code notch is above the lower right hand corner of the film.)

- P. Place the contact screen on the top of the film with the emulsion side down

(NOTE: Make sure the screen is parallel with the camera back and is placed at the same position for all four separation negatives. To ensure this, the contact screen may be fastened to the camera back with masking tape.)

- Q. Rub the screen with the palm of your hand or a rubber roller to ensure a good contact

- R. Expose for main and flash

- S. Develop, fix, and wash the film

(NOTE: Refer to the unit on halftone photography in this section for the proper methods of film processing.)

JOB SHEET #1

- T. Examine the negative on a light table with a magnifying glass

(NOTE: Check the dot sizes in A, M, and B Patch. The aim points for this negative [cyan printer] are: A-step-98% \pm 1%, M-step-50% \pm 4%, and B-step-14% \pm 4%. If these percentages are not present, remake the negative. Use a Q12 Exposure Computer and alter the exposure until the desired dot structure is achieved. Keep a record of the exposures of all four separation negatives; it will help reduce the remaking of future separation negatives.)

- U. Turn the copy on the copyboard and line up the short lines of the copy with the 75° line

- V. Place a PM58 (green) filter in the filter holder of the camera

- W. Set the lens at f/16 and timer at 70 seconds

- X. Set the flash exposure at 20 seconds

- Y. Repeat procedure steps L through T

(NOTE: The aim points for this negative [magenta printer] are: A-step-99% \pm 1%, M-step-63% \pm 4%, and B-step-23% \pm 4%. Remake if necessary.)

- Z. Turn the copy on the copyboard and line up the short lines of the copy with the 90° line

- AA. Place a PM47B (blue) filter in the filter holder of the camera

- BB. Set the lens at f/11 and timer at 130 seconds

- CC. Set the flash exposure at 20 seconds

- DD. Repeat procedure steps L through T

(NOTE: The aim points for this negative [yellow printer] are the same as magenta printer: A-step-99% \pm 1%, M-step-63% \pm 4%, and B-step-23% \pm 4%. Remake if necessary.)

- EE. Turn the copy on the copyboard and line up the short lines of the copy with the 45° line

- FF. Place a K2 filter (yellow) in the filter holder of the camera

- GG. Set the lens at f/16 and timer at 20 seconds

- HH. Repeat procedure steps L through T

(NOTE: DO NOT FLASH THIS NEGATIVE. The aim points for this negative [black printer] are: A-step-no dots, M-step-99% \pm 1%, and B-step-61% \pm 4%. Remake if necessary.)

JOB SHEET #1

- II. Proof all four separation negatives on their respective color proofing materials

(NOTE: Ask the instructor for the proper procedures to be used with the material that is available in the shop.)

- JJ. Assemble the proofs

(NOTE: Place yellow printer proof on the light table and secure it temporarily to the light table. Next, place the magenta printer on top of the yellow printer and, with the aid of a magnifying glass, register it to the yellow. Secure the magenta proof to the yellow proof by using clear tape on one side only. Repeat the procedure for the blue printer and black printer and tape them down on the same side.)

- KK. Place the assembly on the stock it is to be printed on and turn in the proofs and separation negatives to the instructor

OVERVIEW OF PROCESS COLOR PHOTOGRAPHY
UNIT V

NAME _____

TEST

1. Match the terms on the right with the correct definitions.

- | | |
|--|-----------------------------------|
| <p>_____ a. A process of separating the color original into three black-and-white negatives</p> | <p>1. Complementary color</p> |
| <p>_____ b. The process of compensating for ink deficiencies in making separation negatives</p> | <p>2. Moire</p> |
| <p>_____ c. One or more notches on one corner of a sheet of film used to identify the emulsion and emulsion side of the film</p> | <p>3. Panchromatic film</p> |
| <p>_____ d. The color that is opposite another color on a color wheel</p> | <p>4. Color separation</p> |
| <p>_____ e. A blue-green color that is used in color separation and color printing</p> | <p>5. Primary colors</p> |
| <p>_____ f. A dark pink color that is used in color separation and color printing</p> | <p>6. Color correction</p> |
| <p>_____ g. A black-and-white photographic image of a color original used for color correction</p> | <p>7. Code notch</p> |
| <p>_____ h. An undesirable pattern on a halftone negative created by the improper angling of the contact screen</p> | <p>8. Cyan</p> |
| <p>_____ i. A gray-colored filter used to add density with no change in color</p> | <p>9. Mask</p> |
| <p>_____ j. Film that is sensitive to all colors of light</p> | <p>10. Magenta</p> |
| <p>_____ k. Colors which cannot be produced by mixing other colors</p> | <p>11. Separation negative</p> |
| <p>_____ l. The negative that represents one of the primary colors from a color original</p> | <p>12. Neutral density filter</p> |

2. Distinguish between additive and subtractive primary colors by placing an "A" before descriptions of additive primary colors and an "S" before descriptions of subtractive primary colors.

- _____ a. These primary colors are blue, green, and red
- _____ b. These primary colors are cyan, magenta, and yellow

- _____ c. When these colors are mixed together in various proportions, they produce a full range of colors
- _____ d. These are also called process colors
- _____ e. When these colors are added together, they form white light
3. Select true statements concerning the functions of inks by placing an "X" in the appropriate blanks.
- _____ a. One function of ink is to control the light that is permitted to strike the paper and to be reflected from it.
- _____ b. Magenta ink absorbs the blue part of white light
- _____ c. Yellow ink absorbs the green part of white light
- _____ d. Cyan ink absorbs the red part of white light
- _____ e. Black ink absorbs all components of white light
4. Select true statements concerning color separation by placing an "X" in the appropriate blanks.
- _____ a. Three plates are used for printing three-colored inks
- _____ b. The yellow printer separation negative is made by exposing through a blue filter
- _____ c. The magenta printer separation negative is made by exposing through a red filter
- _____ d. The cyan printer separation negative is made by exposing through a green filter
- _____ e. Three separate negatives are needed for color separation, each one representing one of the primary colors
5. Name two methods for making color corrections.
- a. _____
- b. _____
6. Demonstrate the ability to make a set of unmasked direct screen separation negatives.

(NOTE: If this activity has not been accomplished prior to the test, ask your instructor when it should be completed.)

OVERVIEW OF PROCESS COLOR PHOTOGRAPHY
UNIT V

ANSWERS TO TEST

1. a. 4 g. 9
 b. 6 h. 2
 c. 7 i. 12
 d. 1 j. 3
 e. 8 k. 5
 f. 10 l. 11
2. a. A
 b. S
 c. S
 d. S
 e. A
3. a, d, e
4. a, b, e
5. Any two of the following:
 a. Photographic masking
 b. Electronic scanning
 c. Localized dot etching
6. Performance skills evaluated to the satisfaction of the instructor

**CONTINUOUS TONE FILM PROCESSING AND PRINTING
UNIT VI****UNIT OBJECTIVE**

After completion of this unit, the student should be able to identify equipment and devices used in processing a roll of film and in making a contact sheet and enlargement. The student should also be able to mix developer, stop bath, and fixer, process a roll of film, make a contact sheet, and make an enlargement. This knowledge will be evidenced by correctly performing the procedures outlined in the job sheets and by scoring 85 percent on the unit test.

SPECIFIC OBJECTIVES

After completion of this unit, the student should be able to:

1. Match terms related to continuous tone film processing and printing with the correct definitions.
2. Identify equipment and devices used in processing a roll of film.
3. Identify equipment and devices used in making a contact sheet and enlargement.
4. Demonstrate the ability to:
 - a. Mix developer, stop bath, and fixer.
 - b. Process a roll of 35mm film.
 - c. Make a contact sheet.
 - d. Make an enlargement.

CONTINUOUS TONE FILM PROCESSING AND PRINTING
UNIT VI

SUGGESTED ACTIVITIES

- I. Provide student with objective sheet.
- II. Provide student with information and job sheets.
- III. Make transparencies.
- IV. Discuss unit and specific objectives.
- V. Discuss information sheet.
- VI. Demonstrate and discuss the procedures outlined in the job sheets.
- VII. Show the following slides:
 - "Processing Black and White Film"--74 slides with narrated tape (18 min.)
 - "Beginning Black and White Printing"--80 slides with narrated tape (17 min.)
 - "Advanced Black and White Printing"--80 slides with narrated tape (24 min.)

These presentations are available on a loan basis at no charge from:

Eastman Kodak Company
343 State Street
Rochester, NY 14650
- VIII. Develop an area of instruction on camera operations.
- IX. Show students types of processing tanks.
- X. Show students methods of loading tanks.
- XI. Give test.

INSTRUCTIONAL MATERIALS

- I. Included in this unit:
 - A. Objective sheet
 - B. Information sheet
 - C. Transparency masters
 1. TM 1--Equipment and Devices Used in Processing a Roll of Film

2. TM 2--Equipment and Devices Used in Making a Contact Sheet and Enlargement

D. Job sheets

1. Job Sheet #1--Mix Developer, Stop Bath, and Fixer
2. Job Sheet #2--Process a Roll of 35mm Film
3. Job Sheet #3--Make a Contact Sheet
4. Job Sheet #4--Make an Enlargement

E. Test

F. Answers to test

II. Additional materials

- A. Eastman Kodak. *Kodak Darkroom Dataguide*. Publication No. R20. Rochester, NY 14650: Eastman Kodak Company, 1979.
- B. Eastman Kodak. *Basic Developing, Printing, Enlarging in Black-and-White*. Publication AJ-2 (Revised). Rochester, NY 14650: Eastman Kodak Company, 1979.

CONTINUOUS TONE FILM PROCESSING AND PRINTING
UNIT VI

INFORMATION SHEET

I. Terms and definitions

- A. Developer--A solution used to turn the latent image into a visible image on exposed films or photographic papers
- B. Stop bath--A weak solution of acetic acid used in processing black-and-white film or paper; it stops development, prevents stains, and makes the fixer last longer
- C. Fixer--A solution that removes any light-sensitive material not acted upon by light or developer, leaving a black-and-white negative or print that can not be affected by further action of light
- D. Agitation--Keeping the developer, stop bath, or fixer in gentle motion while processing film or paper; helps to speed and ensure even development and prevent spotting or staining
- E. Emulsion--A thin coating of light-sensitive material, usually silver halide in gelatin, in which the image is formed on film and photographic paper
- F. Negative--The developed film that contains a reversed tone image of the original scene
- G. Enlarger--A device consisting of a light source, a negative holder, and a lens, and a means of adjusting these to project an enlarged image from a negative onto a sheet of photographic paper
- H. Lens--One or more pieces of optical glass or similar material designed to collect and focus rays of light to form a sharp image on the film, paper, or projection screen
- I. F-numbers (f-stops)--Numbers used to indicate the light-passing ability of the lens opening
- J. Safelight--An enclosed darkroom lamp fitted with a filter to screen out light rays to which film and paper are sensitive
- K. Exposure--The quantity of light allowed to act on a photographic material; controlled by f-stop and timer or shutter speed
- L. Contact sheet--A print made by exposing photographic paper while it is held tightly in contact with the negative

(NOTE: Images in the print will be the same size as those in the negative.)

INFORMATION SHEET

- M. Enlargement--A print that is larger than the negative
- N. Cropping--Using only a part of the image that is in the negative
- II. Equipment and devices used in processing a roll of film (Transparency 1)
 - A. Processing tank
 - B. Graduated cylinder
 - C. Thermometer
 - D. Darkroom timer
- III. Equipment and devices used in making a contact sheet and enlargement (Transparency 2)
 - A. Enlarger
 - B. Easel
 - C. Contact proofer
 - D. Trays
 - E. Print tongs
 - F. Graduated cylinder
 - G. Thermometer
 - H. Darkroom timer

Equipment and Devices Used in Processing a Roll of Film

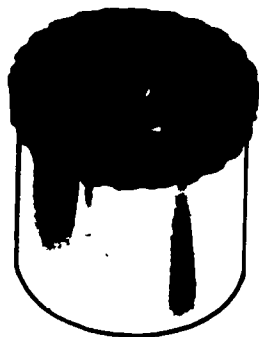

Processing Tank

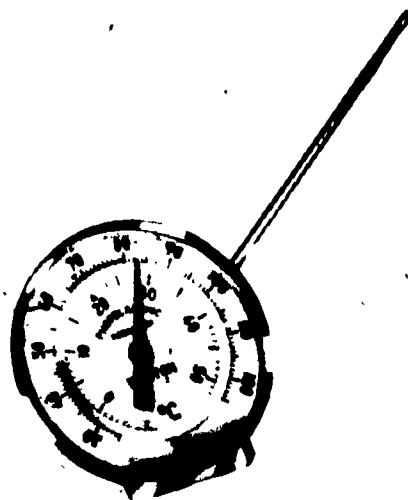
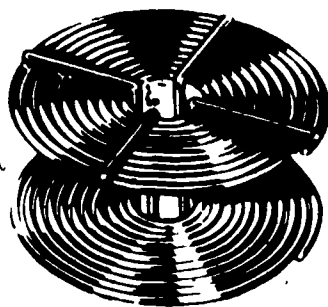

Thermometer

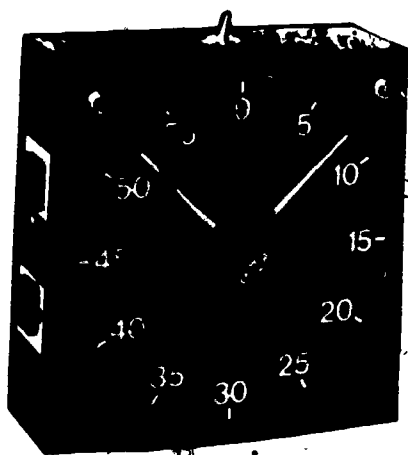

Darkroom Timer

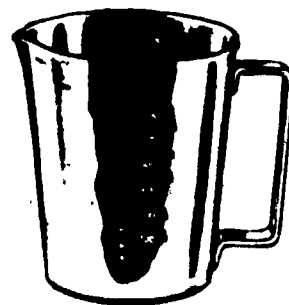

Graduated Cylinder

Equipment and Devices Used in Making a Contact Sheet and Enlargement

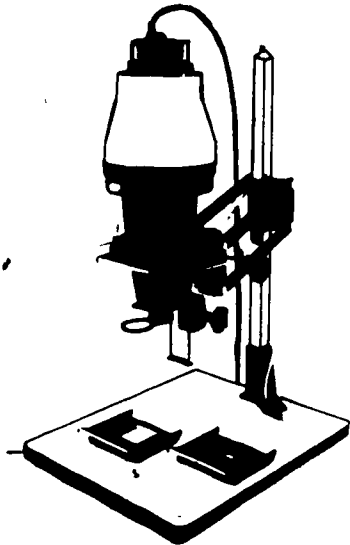

Enlarger

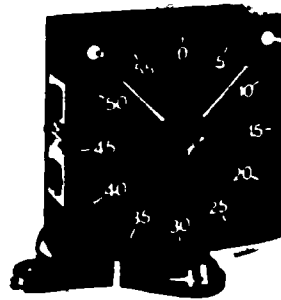

Darkroom Timer

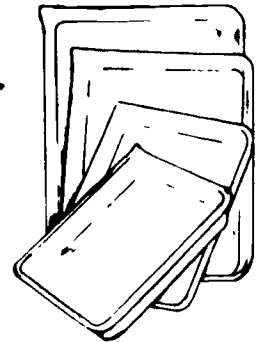

Trays



Print Tongs

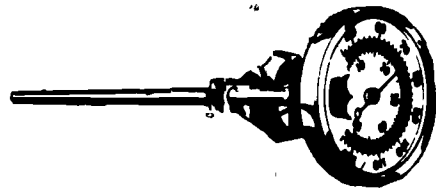

Thermometer

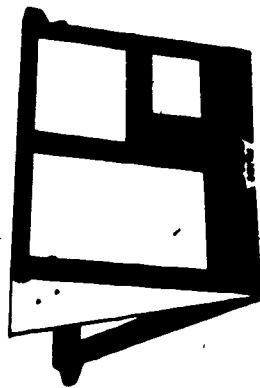

Easel

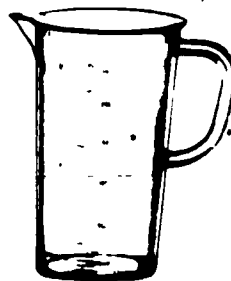

Graduated Cylinder

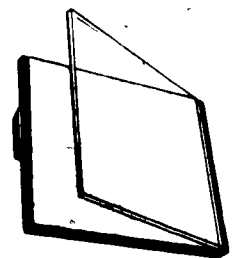

Contact Proofer

CONTINUOUS TONE FILM PROCESSING AND PRINTING
UNIT VI

JOB SHEET #1--MIX DEVELOPER, STOP BATH, AND FIXER

I: Equipment and materials

A. Equipment

1. Gallon jugs (two)
2. Graduated cylinder (graduate)
3. Mixing paddle
4. Funnel
5. 16 ounce containers

B. Materials

1. Developer (one gallon)
2. Acetic acid (or indicator stop bath)
3. Fixer

II. Procedure

A. Mix developer

(NOTE: Liquid developers are also available.)

1. Clean a gallon jug, graduated cylinder, and mixing paddle
2. Pour about 30 ounces of warm water into the graduated cylinder
3. Pour about 1/4 of the developer into the graduated cylinder slowly while constantly stirring with mixing paddle until all the developer is dissolved
4. Place funnel on the jug and pour the dissolved mixture into the jug
5. Repeat steps 3 and 4 three more times so that all of developer is dissolved and is in the jug
6. Put the cap back on the jug and shake the jug for approximately one minute
7. Label the jug appropriately, i.e., "STOCK FILM DEVELOPER" or "STOCK PAPER DEVELOPER"

JOB SHEET #1

B. Mix stop bath

1. Pour approximately five drops of 28% acetic acid per 8 ounces of water
2. Pour this solution into one of the 16 ounce containers
3. Label the container "STOP BATH"

(NOTE: Mix just enough stop bath for one time use since it will be discarded after use.)

C. Mix fixer

(NOTE: There are two types of fixers. Instructions for mixing both types are given below.)

1. Mix powder fixer

(NOTE: Use a dust mask when mixing powder fixer.)

- a. Follow the same procedure for mixing developer (A)
- b. Label the jug "Fixer"

2. Mix liquid fixer

- a. Clean a gallon jug and place a funnel on the jug
- b. Open a one gallon size carton of liquid fixer
- c. Pour the contents of large container marked "Fixer" or "Fixer Part A" into the gallon jug
- d. Pour approximately 64 ounces of warm water into the jug
- e. Replace cap and shake the jug for approximately two minutes

(NOTE: If the fixer is not totally mixed with water at this step, it will crystallize during the next step.)

- f. Pour the contents of small container marked "Fixer Part B" or "Hardener" into the jug
- g. Add enough water to the jug to bring the volume up to approximately one inch from the top
- h. Replace cap and shake the jug for approximately two minutes, or until the mixture is totally mixed
- i. Label the jug "Fixer"

CONTINUOUS TONE FILM PROCESSING AND PRINTING
UNIT VI

JOB SHEET #2-PROCESS A ROLL OF 35MM FILM

I. Equipment and materials

A. Equipment

1. 35mm tank loaded with exposed film
2. Graduated cylinder (graduate)
3. Thermometer
4. Timer
5. Film clips or clothes pin
6. Funnel

B. Materials

1. Film developer
2. Stop bath
3. Fixer
4. Wetting agent
5. Negative preserver

II. Procedure

- A. Pour proper quantity of developer into a graduated cylinder

(NOTE: Refer to tank manufacturer's recommendation on the capacity of the processing tank.)

- B. Check the temperature of the developer with an accurate thermometer
- C. Cool or heat the developer to desired temperature (usually 68°F) by placing the graduated cylinder in a pan of cold or hot water

- D. Set the timer for proper developing time

(NOTE: The recommended developing time and the type of developer is usually found in the fact sheet that is packed with the film.)

- E. Pour the developer into the tank through the opening in the top
- F. Start the timer

JOB SHEET #2

- G. Tap the tank a few times on a table to release the air bubbles
- H. Agitate the tank by rotating it back and forth for 5 seconds every 30 seconds during the entire processing time
- I. Pour the developer back into the developer jug
- J. Pour stop bath into the tank
(NOTE: Use the same quantity as developer.)
- K. Agitate for 30 seconds
- L. Discard stop bath
- M. Pour fixer into the tank
(NOTE: Use the same quantity as developer.)
- N. Agitate every minute for approximately five minutes
- O. Pour fixer back into the fixer jug
- P. Remove the tank cover and place the tank under running water for 30 minutes
- Q. Turn the water off and place four or five drops of wetting agent (such as Kodak Photo-Flo) into the tank
- R. Agitate by turning the reel inside of the tank
- S. Remove the film from reel and hang it up to dry in a dust free area with a film clip or clothes pin at each end
(NOTE: The film emulsion at this stage is very soft and should not be touched.)
- T. Cut the roll of negatives into desired number of frames and place them in the negative preserver
(NOTE: Desired number of frames is how many frames will fit in each section of the negative preserver.)

CONTINUOUS TONE FILM PROCESSING AND PRINTING
UNIT VI

JOB SHEET #3--MAKE A CONTACT SHEET

I. Equipment and materials

A. Equipment

1. Enlarger
2. Contact proofer
3. Graduated cylinder (graduate)
4. Thermometer
5. Three 8 X 10 trays
6. A sheet of cardboard
7. Print tongs
8. Paper cutter

B. Materials

1. Negatives
2. Photographic paper (resin coated)
3. Paper developer
4. Stop bath
5. Fixer
6. Water

II. Procedure

A. Set up processing sink

1. Pour 32 ounces of diluted paper developer in a tray and place it in the sink on the left side

(NOTE: Almost all stock solution of the paper developers require dilution. Refer to manufacturer's recommendation on the ratio of dilution. The temperature of the developer should be 68°F.)

2. Pour 32 ounces of stop bath in another tray and place it on the right side of the developer tray

JOB SHEET #3

3. Pour 32 ounces of fixer in the third tray and place it on the right side of the stop bath tray

B. Set up enlarger

1. Turn off all the white lights in the darkroom
2. Turn on the enlarger and open the lens
3. Raise the enlarger head until the light illuminates a 10" X 12" area
4. Close the enlarger lens down to approximately f/8 and turn it off

C. Make a test print

1. Open the package of photographic paper

(NOTE: This should be done only under safelight filters that are designed for that paper. Any other light will expose the paper.)

2. Cut a small strip of photographic paper (approximately 1" x 8")
3. Place the small strip of photographic paper under the glass of contact proofer with emulsion side up (usually glossy side) (Figure 1)
4. Place a strip of the negative on top of the proofer with the emulsion side down on the paper (dull side) (Figure 1)
5. Place the glass of the contact proofer on top of the negative (Figure 1)

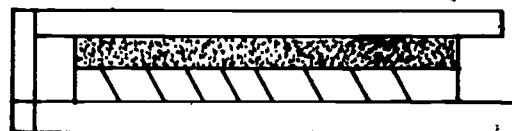

Contact Proofer
Negative
Photo Paper

FIGURE 1

6. Set the enlarger timer on 2 seconds
7. Place a piece of cardboard on top of the plate glass to cover all frames except one
8. Start the timer and expose for 2 seconds
9. Move the cardboard back and uncover another frame

(NOTE: Now there are two frames uncovered.)

JOB SHEET #3

10. Expose for two more seconds
11. Repeat steps 8, 9, and 10 until the last frame has been exposed

(NOTE: If there were 5 frames on this strip of film, the first frame has now been exposed for 10 seconds, the second frame for 8 seconds, the third frame for 6 seconds, the fourth frame for 4 seconds, and the fifth frame for 2 seconds.)

12. Remove the small strip of paper and with tongs place it in the developer tray and agitate for one minute
13. Remove the paper and hold it on top of the tray to drain the developer
14. Place the paper in the stop bath for about 30 seconds, then remove the paper and drain
15. Place the paper in fixer and agitate for one minute, then remove the print and drain

(NOTE: This paper with the image is called the test print.)

16. Rinse the test print in water and examine under white light

(NOTE: The frame with the 10 second exposure will be the darkest and the frame with the 2 second exposure will be the lightest. One of these five frames should look right, but if not, proceed as follows: If the frame with the 10 second exposure is too light, set the enlarger timer to 4 seconds and repeat steps 2 through 16. If the frame with the 2 second exposure is too dark, set the enlarger lens at f/11 and repeat steps 2 through 16. The number of seconds and the f-stop that was used to print the frame that looked the best is the exposure for making the contact sheet.)

17. Place a full sheet of photographic paper under the glass of the contact proofer with the emulsion side up
18. Place all of the negative strips on the paper, emulsion side down
19. Place the glass of the contact proofer on top of the negatives
20. Set the timer and f-stop as it was determined in step 16 and expose the print
21. Repeat steps 12 through 16
22. Wash the print for approximately five minutes
23. Use a clothes pin and hang the print to dry

(NOTE: Forced hot air may be used to speed drying.)

CONTINUOUS TONE FILM PROCESSING AND PRINTING
UNIT VI

JOB SHEET #4--MAKE AN ENLARGEMENT .

I. Equipment and materials

A. Equipment

1. Enlarger
2. Graduated cylinder (graduate)
3. Thermometer
4. Three 8" X 10" trays
5. Sheet of cardboard
6. Print tongs
7. Paper cutter
8. Print easel

B. Materials

1. Negative
2. Resin coated photographic paper
3. Paper developer
4. Stop bath
5. Fixer
6. Water

II. Procedure

A. Set up processing sink

1. Pour 32 ounces of diluted paper developer in a tray and place it in the sink on the left side

(NOTE: Almost all stock solution of the paper developers require dilution. Refer to manufacturer's recommendation on the ratio of dilution. The temperature of the developer should be 68°F.)

2. Pour 32 ounces of stop bath in another tray and place it on the right side of the developer tray

JOB SHEET #4

3. Pour 32 ounces of the fixer in the third tray and place it on the right side of the stop bath tray
- B. Set up the enlarger
1. Turn off all the white lights in the darkroom
 2. Remove the negative carrier from the enlarger and place it on the counter
 3. Place negative in the carrier, emulsion side down
 4. Put carrier back into the enlarger
 5. Turn enlarger on and open the lens to its maximum opening
 6. Place an easel under the enlarger with the desired opening on top
 7. Position the image inside the opening of the easel
(NOTE: The enlarger head may be raised to enlarge the image or lowered to reduce the image.)
 8. Focus the image by turning the focusing knob
(NOTE: If the image is not cropped properly, the head may be raised or lowered again to obtain the best composition. If the enlarger head is moved, it must be focused again.)
 9. Bring the enlarger lens down to mid range (approximately f/8) and turn the enlarger off
- C. Make a test print
1. Place an appropriate size of photographic paper in the easel with the emulsion side up
 2. Set the enlarger timer on 1 second
 3. Cover the paper with a piece of cardboard so that only about 1/2" of paper is exposed
 4. Make an exposure by starting the timer
 5. Move the cardboard back and uncover another 1/2" of paper
 6. Expose for another second
 7. Repeat steps 4 and 5 until all of the paper has been exposed
 8. Remove the paper and with print tongs place it in the developer tray and agitate for one minute

JOB SHEET #4

9. Remove the paper and hold it on top of the tray to drain the developer
10. Place the paper in the stop bath for 30 seconds, then remove the paper and drain
11. Place the paper in the fixer and agitate for one minute, then remove the print and drain

(NOTE: This paper with the image is called the test print.)

12. Rinse the test print in water and examine it under white light

(NOTE: Assuming that the print was exposed six times, the darkest strip has a 6 second exposure and the lightest 1 second. The exposure of the strip that looks best in density will be the exposure for final print.) (Figure 1)



Test Print



Final Print

D. Make a print

1. Set the timer and f-stop as it was determined in step 12
2. Place an appropriate size of photographic paper in the easel with the emulsion side up
3. Make the exposure by starting the timer
4. Process the print by repeating steps 8 through 11, but leave the print in fixer for five minutes
5. Wash the print in running water for five minutes

JOB SHEET #4

6. Use a clothes pin and hang the print to dry or use forced hot air to speed drying

(NOTE: A good quality print should have light and clean highlight areas and dark shadow areas. If the print does not have these qualities, ask the instructor for information on how to use polycontrast filters to increase the contrast in the print.)

CONTINUOUS TONE FILM PROCESSING AND PRINTING
UNIT VI

NAME _____

TEST

1. Match the terms on the right with the correct definitions.

- | | |
|--|--------------------------|
| <p>_____ a. The quantity of light allowed to act on a photographic material; controlled by f-stop and timer or shutter speed</p> | <p>1. Developer</p> |
| <p>_____ b. The developed film that contains a reversed tone image of the original scene</p> | <p>2. Agitation</p> |
| <p>_____ c. A solution used to turn the latent image into a visible image on exposed films or photographic papers</p> | <p>3. Stop bath</p> |
| <p>_____ d. Using only a part of the image that is in the negative</p> | <p>4. Fixer</p> |
| <p>_____ e. A print made by exposing photographic paper while it is held tightly in contact with the negative</p> | <p>5. Emulsion</p> |
| <p>_____ f. A weak solution of acetic acid used in processing black-and-white film or paper; it stops development, prevents stains, and makes the fixer last longer</p> | <p>6. Negative</p> |
| <p>_____ g. A thin coating of light-sensitive material, usually silver halide in gelatin, in which the image is formed on film and photographic paper</p> | <p>7. Enlarger</p> |
| <p>_____ h. A print that is larger than the negative</p> | <p>8. Lens</p> |
| <p>_____ i. A device consisting of a light source, a negative holder, and a lens, and a means of adjusting these to project an enlarged image from a negative onto a sheet of photographic paper</p> | <p>9. F-numbers</p> |
| <p>_____ j. Keeping the developer, stop bath, or fixer in gentle motion while processing film or paper; helps to speed and ensure even development and prevent spotting or staining</p> | <p>10. Safelight</p> |
| <p>_____ k. One or more pieces of optical glass or similar material designed to collect and focus rays of light to form a sharp image on the film, paper, or projection screen</p> | <p>11. Exposure</p> |
| | <p>12. Contact sheet</p> |
| | <p>13. Enlargement</p> |
| | <p>14. Cropping</p> |

- _____ l. Numbers used to indicate the light-passing ability of the lens opening
- _____ m. A solution that removes any light-sensitive material not acted upon by light or developer, leaving a black-and-white negative or print that can not be affected by further action of light
- _____ n. An enclosed darkroom lamp fitted with a filter to screen out light rays to which film and paper are sensitive

2. Identify the equipment and devices below that are used in processing a roll of film.

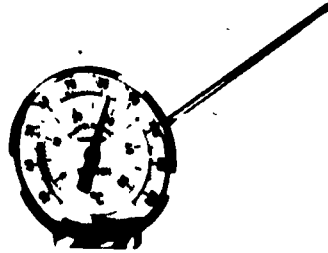
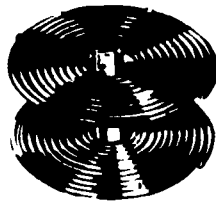

a. _____

b. _____

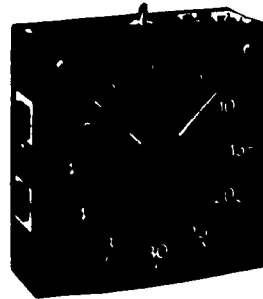
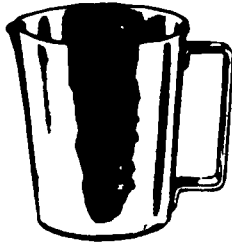

c. _____

d. _____

3. Identify the equipment and devices below that are used in making a contact sheet and enlargement.

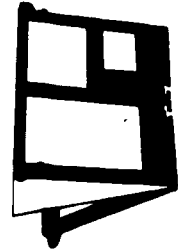
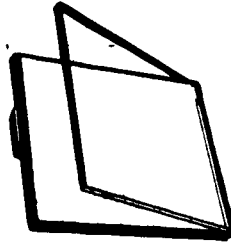
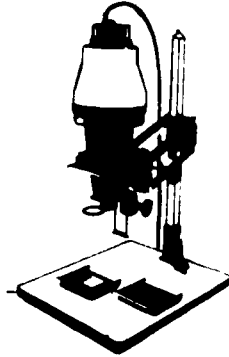

a. _____

b. _____

c. _____

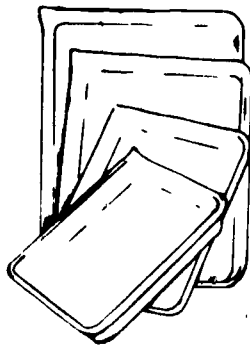

d. _____

e. _____

4. Demonstrate the ability to:

- a. Mix developer, stop bath, and fixer
- b. Process a roll of 35mm film
- c. Make a contact sheet
- d. Make an enlargement

(NOTE: If these activities have not been accomplished prior to the test, ask your instructor when they should be completed.)

CONTINUOUS TONE FILM PROCESSING AND PRINTING
UNIT VI

ANSWERS TO TEST

- | | | | | | |
|-------|----|----|----|----|----|
| 1. a. | 11 | f. | 3 | k. | 8 |
| b. | 6 | g. | 5 | l. | 9 |
| c. | 1 | h. | 13 | m. | 4 |
| d. | 14 | i. | 7 | n. | 10 |
| e. | 12 | j. | 2 | | |
2. a. Processing tank
b. Thermometer
c. Graduated cylinder
d. Darkroom timer
3. a. Enlarger
b. Contact proofer
c. Easel
d. Trays
e. Print tongs
4. Performance skills evaluated to the satisfaction of the instructor

INTRODUCTION TO STRIPPING UNIT 1

UNIT OBJECTIVE

After completion of this unit, the student should be able to match terms related to the introduction to stripping with the correct definitions and match stripping tools and materials with their proper uses. The student should also be able to lay out an unruled flat and strip an unruled and ruled flat. This knowledge will be evidenced by correctly performing the procedures outlined in the job sheets and by scoring 85 percent on the unit test.

SPECIFIC OBJECTIVES

After completion of this unit, the student should be able to:

1. Match terms related to the introduction to stripping with the correct definitions.
2. Match stripping tools with their proper uses.
3. Match stripping materials with their proper uses.
4. Identify the parts on a layout of a typical flat.
5. Select true statements concerning the emulsion side and the base side of a negative.
6. Demonstrate the ability to:
 - a. Lay out an unruled flat.
 - b. Strip an unruled flat (wrong-reading).
 - c. Strip a ruled flat (right-reading).

INTRODUCTON TO STRIPPING UNIT I

SUGGESTED ACTIVITIES

- I. Provide students with objective sheet.
- II. Provide students with information and job sheets.
- III. Make transparency.
- IV. Discuss unit and specific objectives.
- V. Discuss information sheet.
- VI. Demonstrate and discuss the procedures outlined in the job sheets.
- VII. Have students-practice laying out a flat by using ruled masking sheets.
- VIII. Give test.

INSTRUCTIONAL-MATERIALS

- I. Included in this unit:
 - A. Objective sheet
 - B. Information sheet
 - C. Transparency Master 1--Parts on a Layout of a Typical Flat
 - D. Job sheets
 1. Job Sheet #1--Lay Out an Unruled Flat
 2. Job Sheet #2--Strip an Unruled Flat (Wrong-Reading)
 3. Job Sheet #3--Strip a Ruled Flat (Right-Reading)
 - E. Test
 - F. Answers to test
- II. Reference--Cogoli, John E. *Photo-Offset Fundamentals*. Bloomington, IL 61701: McKnight Publishing Co., 1980.

INTRODUCTION TO STRIPPING UNIT I

INFORMATION SHEET

I. Terms and definitions

- A. Stripping--The process of fastening negatives to masking sheets to produce a flat
- B. Flat--Negative or negatives attached to masking sheet from which the offset plate is made
- C. Masking sheet--Special opaque paper or plastic sheet used to make the flat

(NOTE; Masking sheets can be either ruled or unruled.)
- D. Goldenrod--Another name for masking paper; yellow or orange in color
- E. Windows--Openings in the masking sheet that expose image areas onto the offset plate
- F. Opaque--To prevent light from passing through a material
- G. Emulsion side--The side of the film coated with light-sensitive material
- H. Pinholes--Small clear areas in the negative which would allow light to pass through if not detected and opaqued
- I. Lithographers tape--Red tape; opaque in nature
- J. Rule--A line scribed or scratched on a negative

II. Stripping tools and uses

- A. Stripping knife--A single-edged, pointed razor blade, affixed to a handle, used to cut masking sheets and windows
- B. Opaque brush or pen--A fine-pointed artist tool used to apply opaquing solution to a negative
- C. T-square--Instrument, usually stainless steel or plastic, used to square work on a light table
- D. Straight edge ruler--Instrument, usually stainless steel or plastic, used to measure, rule, and cut along an edge

INFORMATION SHEET

- E. Tape dispenser--Holds rolls of tape and contains attached cutting edge
 - F. Triangles--Metal or plastic 45- or 30-60-90 degree triangles used to rule and cut along specific lines
 - G. Scribing tool--A shaped, sometimes looped point with handle for scribing lines on negatives
 - H. Light table--A table with a frosted glass top and a light underneath to view flats and negatives
 - I. Magnifier (linen tester)--Magnifying glass mounted on a small frame used to detect negative flaws
 - J. Register pins and punches--Used to secure flats and plates for close registration
 - K. Scissors--Cutting instrument used in trimming
 - L. Line-up table--Light table with built-in vertical and horizontal straight edges, calibrated for accuracy
- III. Stripping materials and uses
- A. Goldenrod (masking sheets)--Used to prevent light from reaching the plate
 - B. Clear plastic tape--Used to tape masking sheets
 - C. Lithographers tape--Used to fasten negatives to the masking sheet and cover large pinholes
 - D. Opaque solution--Used to cover pinholes and scratches
 - E. Acetate (clear plastic)--Used in stripping positives and overlays
- IV. Parts on a layout of a typical flat (Transparency 1)
- A. Position of cut-out for gray scale
 - B. Size of press sheet
 - C. Final trim size
 - D. Image positions laid out
 - E. Image limit

155

INFORMATION SHEET

- F. Sheet gripper margin
 - G. Leading edge of plate
 - H. Wedge cut-out to indicate leading edge of plate
 - I. Leading edge of press sheet
- V. The emulsion side and base side of a negative
- A. Emulsion side
 1. Coating which carries the image
 2. If scratched, the emulsion comes off, leaving only the clear base, thus allowing light to pass through the negative
 3. Backward or wrong-reading (Figure 1)

FIGURE 1



Emulsion Side Up

- B. Base side
 1. Made of a polyester or acetate (plastic) base
 2. Coated with a dye which absorbs light and prevents reflection
 3. Also called the antihalation back
 4. Right-reading (Figure 2)

FIGURE 2

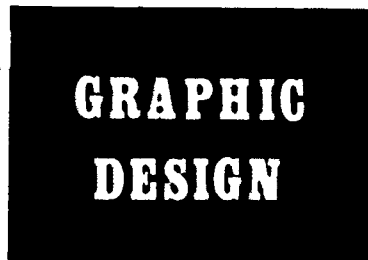

Emulsion Side Down

Parts on a Layout of a Typical Flat

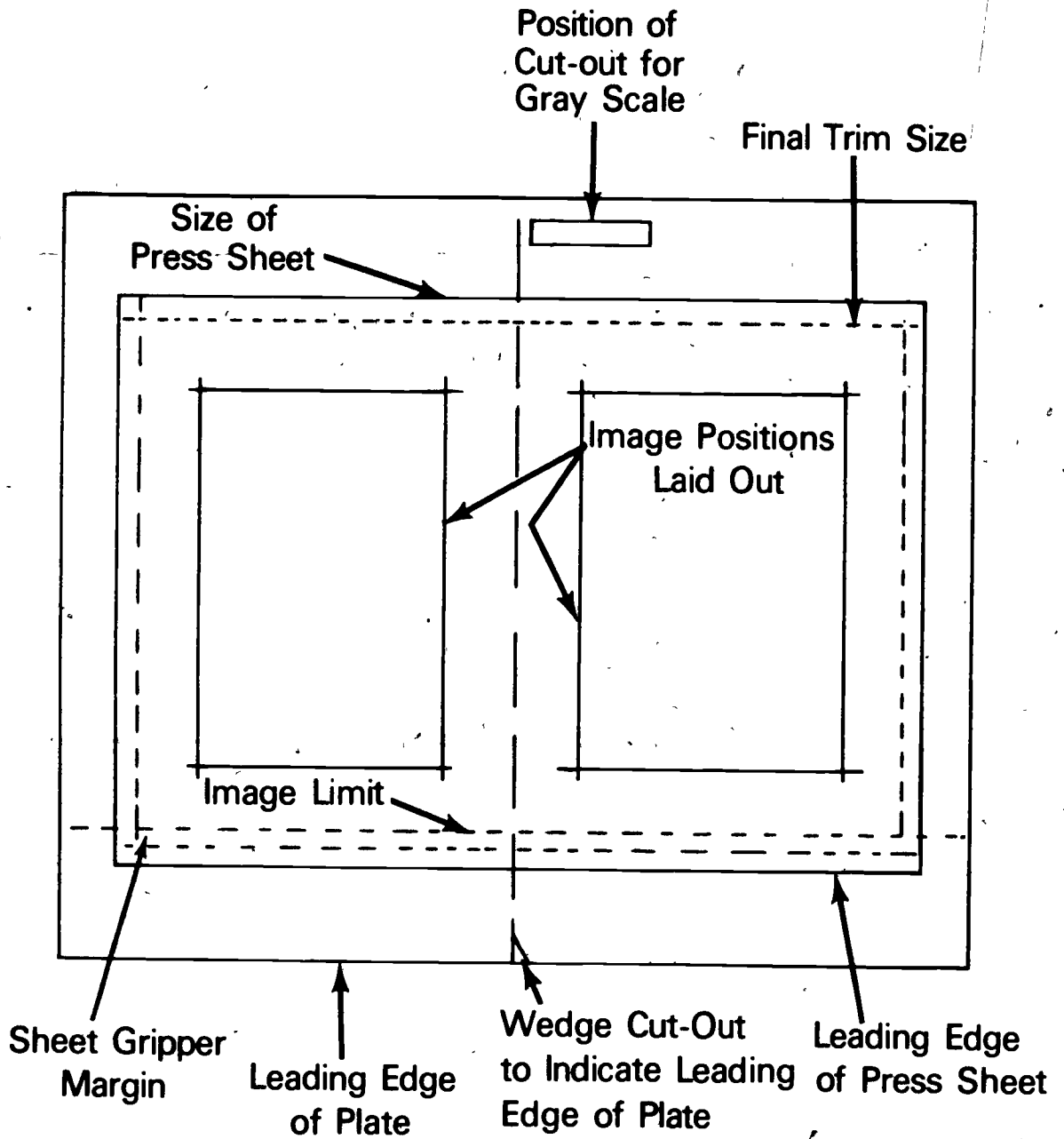

INTRODUCTION TO STRIPPING
UNIT I

JOB SHEET #1--LAY OUT AN UNRULED FLAT

I. Tools and materials

- A. Unruled masking sheet (goldenrod)
- B. Tape dispenser
- C. Clear tape
- D. Lithographers tape
- E. Pen
- F. T-square
- G. Zero inch type ruler
- H. Triangle

II. Procedure

- A. Determine the size of the masking sheet needed for the press
- B. Position the masking sheet on table so that the shorter side is immediately in front of you
- C. Using the T-square, butt the T-square on the left side of the table and make sure the sheet is square with the table
- D. Tape down the top left and right hand corners of the sheet

(NOTE: Make sure the top edge of sheet is still square with table after taping.)

- E. Determine the plate bend and measure down from the top of the sheet
- F. Rule across on the bend mark with pen

(NOTE: This line represents the top edge of the printed sheet.)

- G. Measure down from plate bend line made in Step F and rule line across with pen

JOB SHEET #1

- H. Check for the maximum image size of the press
- I. Measure down 11" (if using an 8 1/2 x 11 sheet) from line drawn in Step F and draw another rule across the sheet
- (NOTE: This line represents the bottom edge of the sheet.)
- J. Using the ruler, find the center point on the top edge of the sheet, or the line drawn in Step F
- K. Using the triangle and the T-square, rule vertically from top to bottom on the center line mark
- L. Measure 4 1/4" (if using an 8 1/2 x 11 sheet) on each side of center line and make a mark
- M. Using the triangle and T-square, draw vertical rules on both 4 1/4" marks
- (NOTE: These two vertical lines represent the left and right edge of the printed sheet.)
- N. Turn in the completed job sheet for evaluation by the instructor
- (NOTE: The completed sheet will be used for Job Sheet #2.)

INTRODUCTION TO STRIPPING
UNIT I

JOB SHEET #2--STRIP AN UNRULED FLAT (WRONG-READING)

- I. Tools and materials
 - A. Tape dispenser
 - B. Clear tape
 - C. Lithographers tape
 - D. T-square
 - E. 12-inch ruler
 - F. Stripping knife
 - G. Opaque brush and opaque solution
 - H. Light table
 - I. Unruled masking sheet

(NOTE: Use the ruled flat completed in Job Sheet #1.)

- J. 5 x 7 line negative
- K. Soft lead pencil

II. Procedure

- A. Using the T-square, position unruled masking sheet square with table with gripper edge at the top
- B. Measure the masking sheet, find the horizontal center, and draw a center line on the sheet
- C. Select dominant line of types on negative and using rule, mark center of negative by scratching with stripping knife at top edge on emulsion side
- D. Using straight edge ruler and stripping knife, find the base of the same line of type in Step C and scratch reference marks at the right and left edge of negative
- E. Position negative on flat so center mark on negative lines up with center line on flat

JOB SHEET #2

- F. Fasten top of negative to flat by placing small strip of lithographers tape over center mark on negative

(NOTE: Position negative vertically so top line of type on negative is 1/4" below gripper margin on flat.)

- G. Using T-square, line up marks on right and left edge of negative so base line of type is square with light table
- H. Finish taping down negative by fastening small strips of lithographers tape over the marks at each edge of film
- I. Check base line of type on negative with T-square to make sure it did not get off square while taping
- J. Remove tape from top corners of flat and turn flat over so negative faces down on light table
- K. Turn on light table so image area of negative can be seen through the flat
- L. Using the stripping knife, cut away masking sheet to expose all of the image area
- (NOTE: Cut no closer than 1/8" of any part of type or image.)
- M. Using opaque brush, opaque (cover) any pinhole or scratches that might allow light to pass through negative in non-image area
- N. Give completed flat to instructor for evaluation

INTRODUCTION TO STRIPPING
UNIT I

JOB SHEET #3--STRIP A RULED FLAT (RIGHT-READING)

- I. Tools and materials
 - A. Tape dispenser
 - B. Clear tape
 - C. Lithographers tape
 - D. T-square
 - E. 12-inch ruler
 - F. Stripping knife
 - G. Opaque brush and opaque solution
 - H. Light table
 - I. Ruled masking sheet
 - J. 5 x 7 line negative

- II. Procedure
 - A. Using T-square, position masking sheet with gripper margin at stripper's left and square with light table
 - B. Tape masking sheet to light table by placing two strips of clear tape at the horizontal edge away from the stripper and keeping corners clear
 - C. Position line negative under masking sheet, and line up dominant type line with rule on masking sheet
 - D. Hold negative in aligned position with left hand and secure lower right corner to masking sheet with lithographers tape
 - E. Hold negative and masking sheet in aligned position with right hand and secure lower left corner of negative to masking sheet with lithographers tape
 - F. Leave top edge of masking sheet taped to light table, and flip flat over to tape remaining two corners of negative
 - G. Flip flat back over and use stripping knife to open image area by cutting masking sheet

(NOTE: Do not cut closer than 1/8" to the image.)
 - H. Use opaque brush and opaque solution to cover any pinholes or scratches in exposed negative area
 - I. Give completed flat to instructor for evaluation

INTRODUCTION TO STRIPPING
UNIT I

NAME _____

TEST

1. Match the terms on the right with the correct definitions.

- | | |
|---|------------------------------|
| <p>_____ a. The process of fastening negatives to masking sheets to produce a flat</p> | <p>1. Flat</p> |
| <p>_____ b. Negative or negatives attached to masking sheet from which the offset plate is made</p> | <p>2. Emulsion side</p> |
| <p>_____ c. Special opaque paper or plastic sheet used to make the flat</p> | <p>3. Windows</p> |
| <p>_____ d. Openings in the masking sheet that expose image areas onto the offset plate</p> | <p>4. Rule</p> |
| <p>_____ e. Another name for masking paper; yellow or orange in color</p> | <p>5. Stripping</p> |
| <p>_____ f. To prevent light from passing through a material</p> | <p>6. Pinholes</p> |
| <p>_____ g. The side of the film coated with light-sensitive material</p> | <p>7. Opaque</p> |
| <p>_____ h. Small clear areas in the negative which would allow light to pass through if not detected and opaqued</p> | <p>8. Goldenrod</p> |
| <p>_____ i. Red tape; opaque in nature</p> | <p>9. Lithographers tape</p> |
| <p>_____ j. A line scribed or scratched on a negative</p> | <p>10. Masking sheet</p> |

2. Match the stripping tools on the right with their proper uses.

- | | | |
|----------|--|-------------------------------|
| _____ a. | A single-edged, pointed razor blade, affixed to a handle, used to cut masking sheets and windows | 1. Triangles |
| _____ b. | A fine-pointed artist tool used to apply opaquing solution to a negative | 2. Opaque brush or pen |
| _____ c. | Instrument, usually stainless steel or plastic, used to square work on a light table | 3. Scribing tool |
| _____ d. | Instrument, usually stainless steel or plastic, used to measure, rule, and cut along an edge | 4. Magnifier |
| _____ e. | Holds rolls of tape and contains attached cutting edge | 5. T-square |
| _____ f. | Metal or plastic 45- or 30-60-90 degree triangles used to rule and cut along specific lines | 6. Tape dispenser |
| _____ g. | A shaped, sometimes looped point with handle for scribing lines on negatives | 7. Light table |
| _____ h. | A table with a frosted glass top and a light underneath to view flats and negatives | 8. Line-up table |
| _____ i. | Magnifying glass mounted on a small frame used to detect negative flaws | 9. Straight edge ruler |
| _____ j. | Used to secure flats and plates for close registration | 10. Scissors |
| _____ k. | Cutting instrument used in trimming | 11. Register pins and punches |
| _____ l. | Light table with built-in vertical and horizontal straight edges, calibrated for accuracy | 12. Stripping knife |

3. Match the stripping materials on the right with their proper uses.

- | | | |
|----------|--|-----------------------|
| _____ a. | Used to prevent light from reaching the plate | 1. Opaque solution |
| _____ b. | Used to tape masking sheets | 2. Acetate |
| _____ c. | Used to fasten negatives to the masking sheet and cover large pinholes | 3. Lithographers tape |
| | | 4. Goldenrod |
| | | 5. Clear plastic tape |

- ___ d. Used to cover pinholes and scratches
- ___ e. Used in stripping positives and overlays

4. Identify the parts on a layout of a typical flat.

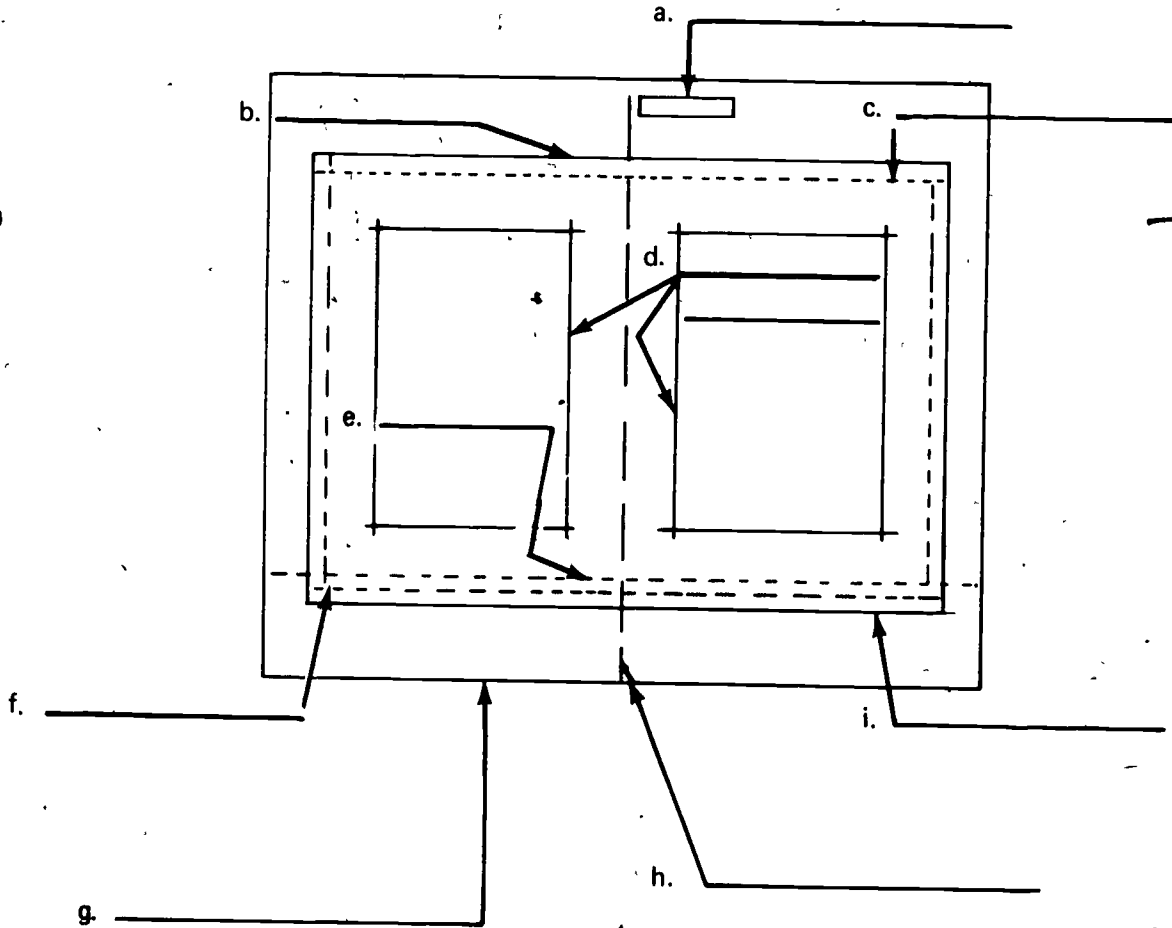

5. Select true statements concerning the emulsion side and the base side of a negative by placing an "X" in the appropriate blanks.

- a. The emulsion side of the negative can be scratched to allow light to pass through
- b. The base of the negative carries the image
- c. The base of the negative is right-reading
- d. The emulsion side of the negative is backward or wrong-reading
- e. The emulsion side of the negative is coated with a non-reflective dye
- f. The emulsion side of the negative is made of polyester or acetate base
- g. The base of the negative is also called the antihalation back

6. Demonstrate the ability to:

- a. Lay out an unruled flat
- b. Strip an unruled flat (wrong-reading)
- c. Strip a ruled flat (right-reading)

(NOTE: If these activities have not been accomplished prior to the test, ask your instructor when they should be completed.)

100

INTRODUCTION TO STRIPPING
UNIT I

ANSWERS TO TEST

1. a. 5 f. 7
 b. 1 g. 2
 c. 10 h. 6
 d. 3 i. 9
 e. 8 j. 4
2. a. 12 f. 1 k. 10
 b. 2 g. 3 l. 8
 c. 5 h. 7
 d. 9 i. 4
 e. 6 j. 11
3. a. 4
 b. 5
 c. 3
 d. 1
 e. 2
4. a. Position of cut-out for gray scale
 b. Size of press sheet
 c. Final trim size
 d. Image positions laid out
 e. Image limit
 f. Sheet gripper margin
 g. Leading edge of plate
 h. Wedge cut-out to indicate leading edge of plate
 i. Leading edge of press sheet
5. a, c, d, g
6. Performance skills evaluated to the satisfaction of the instructor

STRIPPING TECHNIQUES UNIT II

UNIT OBJECTIVE

After completion of this unit, the student should be able to match terms related to stripping techniques with the correct definitions, and select true statements concerning the methods of combining line and halftone work. The student should also be able to strip flats for step-and-repeat, combination printing, multi-color work, signature printing, and use masking films and the pin register system in stripping. This knowledge will be evidenced by correctly performing the procedures outlined in the job sheets and by scoring 85 percent on the unit test.

SPECIFIC OBJECTIVES

After completion of this unit, the student should be able to:

1. Match terms related to stripping techniques with the correct definitions.
2. Select true statements concerning the methods of combining line and halftone work.
3. Name two types of combination printing.
4. Identify stripping register marks and pins.
5. Demonstrate the ability to:
 - a. Strip for step-and-repeat.
 - b. Combine line and halftone work.
 - c. Strip for combination or surprinting (double burn).
 - d. Strip complementary flats for multi-color printing.
 - e. Strip signature flats for multi-page or book printing.
 - f. Use masking films in stripping.
 - g. Use the pin register system in stripping for a two-color job.

STRIPPING TECHNIQUES UNIT II

SUGGESTED ACTIVITIES

- I. Provide student with objective sheet.
- II. Provide student with information and job sheets.
- III. Discuss unit and specific objectives.
- IV. Discuss information sheet.
- V. Demonstrate and discuss the procedures outlined in the job sheets.
- VI. Show a film-cassette on stripping techniques, such as the one from the McKnight Career Education Series called "Stripping and Platemaking--Basic Procedures."
- VII. Demonstrate the use of pins and tabs.
- VIII. Instructor may wish to amend the job sheets provided by having the students perform all the procedures using the pin method of stripping.
- IX. Give test.

INSTRUCTIONAL MATERIALS

- I. Included in this unit:
 - A. Objective sheet
 - B. Information sheet
 - C. Job sheets
 1. Job Sheet #1--Strip for Step-and-Repeat
 2. Job Sheet #2--Combine Line and Halftone Work
 3. Job Sheet #3--Strip for Combination or Surprinting (Double Burn)
 4. Job Sheet #4--Strip Complementary Flats for Multi-Color Printing
 5. Job Sheet #5--Strip Signature Flats for Multi-Page or Book Printing
 6. Job Sheet #6--Use Masking Films in Stripping
 7. Job Sheet #7--Use the Pin Register System in Stripping for a Two-Color Job

D. Test

E. Answers to test

II. References:

A. Spence, William P., and Vequist, David G. *Graphic Reproduction*. Peoria, IL 61615: Chas. A. Bennett Co., Inc., 1980.

B. Cogoli, John E. *Photo-Offset Fundamentals*. Bloomington, IL 61701: McKnight Publishing Co., 1980.

STRIPPING TECHNIQUES
UNIT II

INFORMATION SHEET

- I. Terms and definitions
 - A. Step-and-repeat--The procedure of repeating the exposure of a flat several times on an offset plate

(NOTE: The step-and-repeat method of stripping is used for press-run economy by burning a single image on the plate several times to produce many images on each press sheet.)
 - B. Register--To print the image in the exact same position on each sheet of paper
 - C. Register marks--Small crosses, guides, or patterns placed on originals and flats to aid registration
 - D. Pin register--Accurate system of registration using punched negatives, flats, plates, and positioned register pins
 - E. Main flat--Flat containing the key negatives of a multi-color job
 - F. Complementary flat--A flat containing negatives for only one color or part of a multi-color job
 - G. Combination printing--Printing line copy on top of a halftone

(NOTE: Combination printing is also called surprinting.)
 - H. Signatures--Usually two, four, eight, or sixteen pages printed on a single sheet to be folded and trimmed as a book or part of a book

(NOTE: Signatures may run from 2 to 128 pages.)
 - I. Imposition guide--A sheet marked to show the page positions

(NOTE: This is commonly referred to as a dummy.)
 - J. Surprinting--Printing one image on top of another

(NOTE: This is also called combination printing.)
 - K. Double burn--Exposing a plate twice using two complementary flats
- II. Methods of combining line and halftone work
 - A. Halftone windows cut from red or black material such as paper or masking film, and window positioned on paste-up
 1. Line negative developed so halftone window remains clear

INFORMATION SHEET

2. Halftone negative stripped into clear window (Figure 1)

FIGURE 1

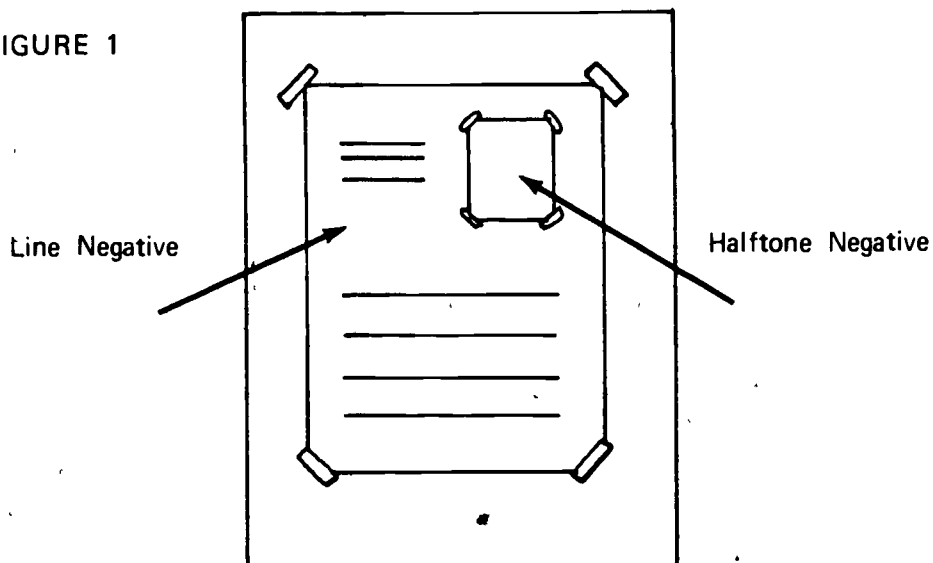

- B. Line and halftone negatives stripped separately to the same flat

1. Negatives trimmed and taped into position on the flat
2. Windows cut for halftone and line copy in the flat (Figure 2)

FIGURE 2

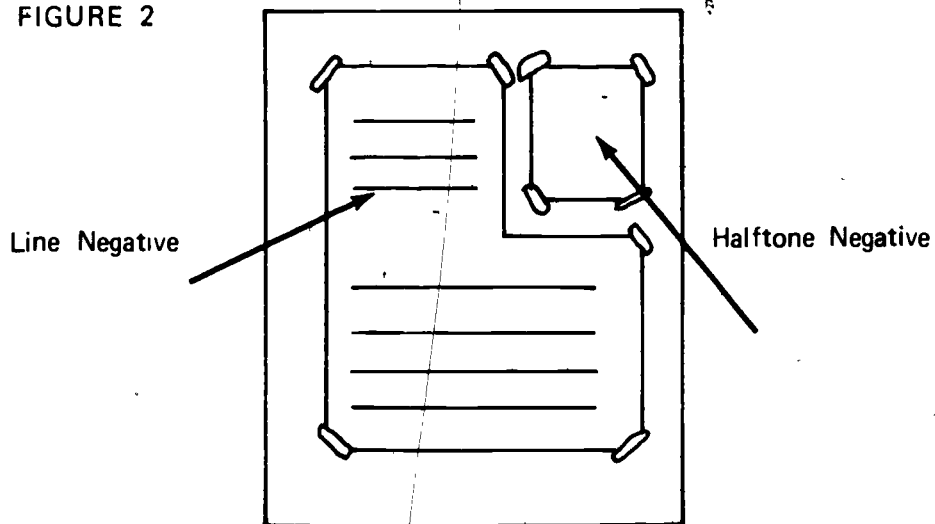

INFORMATION SHEET

C. Negatives stripped and exposed on separate flats

1. Line negative positioned carefully on flat and plate burned
2. Halftone negative positioned carefully on second flat and second burn made on plate (Figure 3)

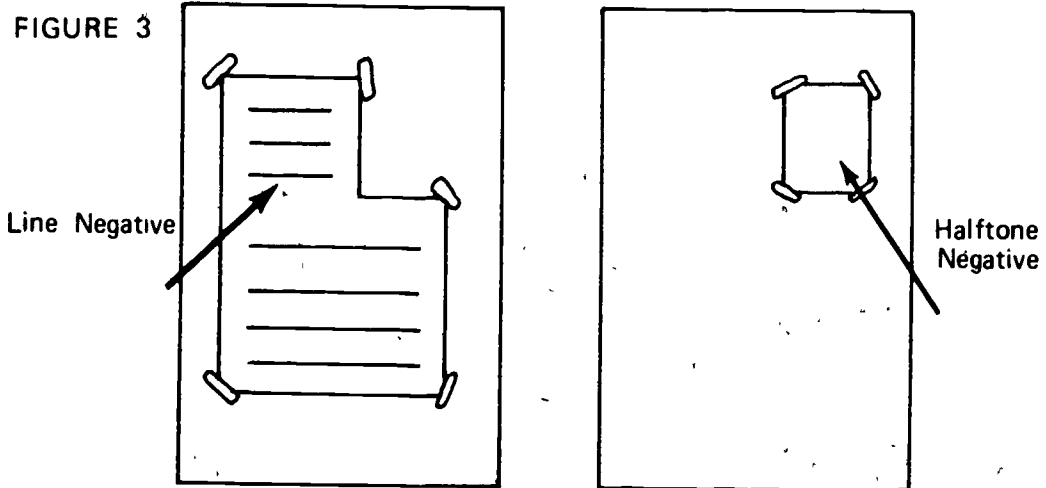

III. Two types of combination printing (surprinting)

- A. Positive lettering printed on top of halftones
- B. Reversed lettering printed on top of halftones (single burn)

IV. Stripping register marks and pins (Figures 4, 5, and 6)

- A. Alignment marks

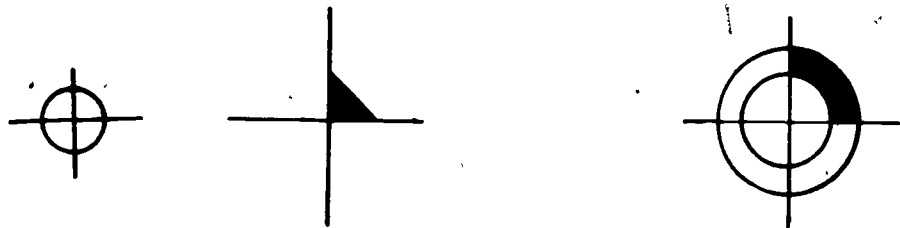

FIGURE 4

Common Register Marks Used
For Alignment or Single Runs

INFORMATION SHEET

B. Multiple printing marks

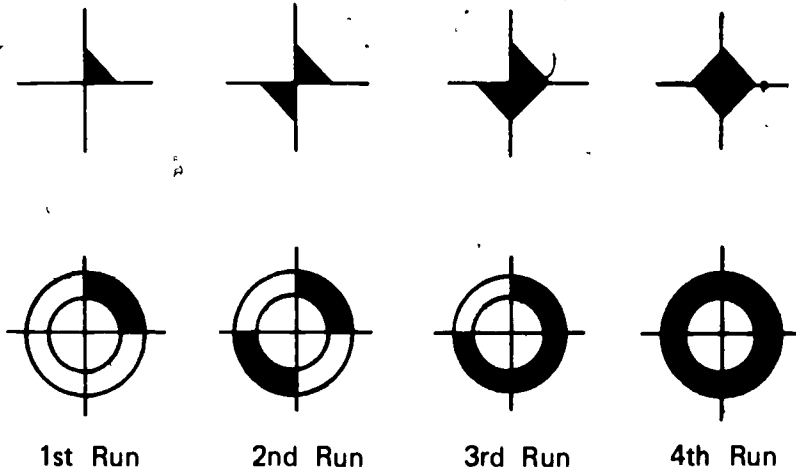

FIGURE 5 Register Marks for Multiple Printings

C. Register pins

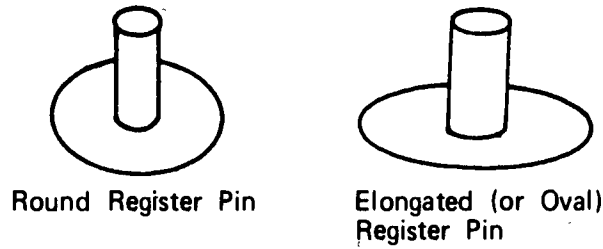

FIGURE 6 Register Pins

171

STRIPPING TECHNIQUES
UNIT II

JOB SHEET #1--STRIP FOR STEP-AND-REPEAT

I. Tools and materials

- A. Light table
- B. T-square
- C. Tape dispenser (with clear tape and lithographers tape)
- D. Stripping knife
- E. Opaque brush and opaque solution
- F. 10 x 15 ruled masking sheet
- G. 2" x 3" trimmed line negative
- H. Spare 10 x 15 masking sheet

II. Procedure

- A. Using T-square, position 10 x 15 masking sheet square on light table with gripper margin at the top

(NOTE: If this position of the gripper edge at the top is maintained throughout the stripping/platemaking process by all personnel, consistent image positioning is better achieved.)
- B. Position negative and strip negative in center line position 1/4" below gripper margin
- C. Check dominant line on negative with T-square to make sure image is square on flat
- D. Line up T-square with ruled line on masking sheet which represents the top edge of the finished printed sheet

JOB SHEET #1

- E. Using the stripping knife, cut a 1/4" V-shaped notch in the right side of the masking sheet on the line representing the top edge of the printed finished piece (See Figure 1)

FIGURE 1

Gripper Margin

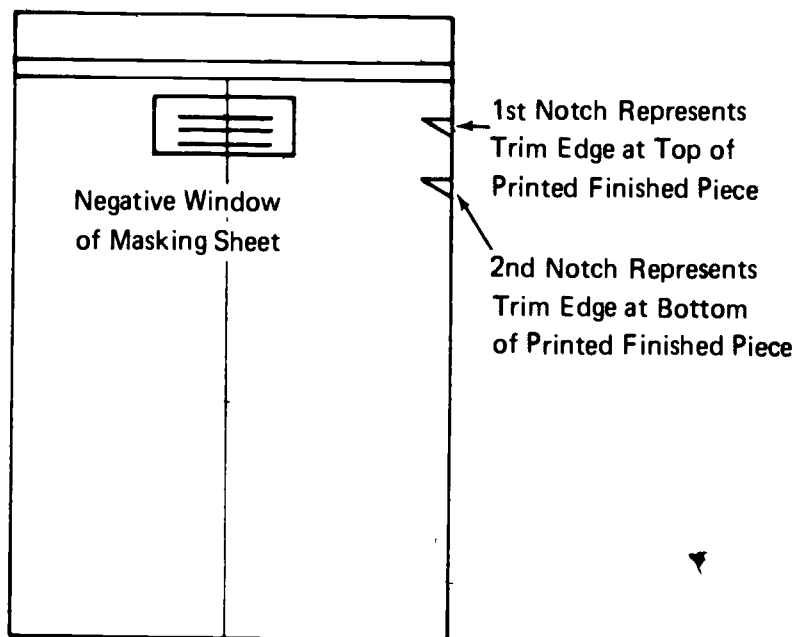

- F. Move the T-square down (or to your right on the masking sheet) and line up with the ruled line on the masking sheet representing the bottom edge of the finished printed sheet
- G. Cut a second 1/4" notch on the same right edge of the masking sheet along position of T-square in Step F (See Figure 1)
- (NOTE: If the negative is opaqued, the flat is now ready for the first exposure (burn) of the step-and-repeat process.)
- H. When the first exposure (burn) is completed, the flat is repositioned by matching the #1 notch on the flat with the exposure mark left by Notch #2 during the first exposure (Figure 1)
- I. Place the additional masking sheet over the previously exposed part of the plate for each additional exposure
- (NOTE: A slight change of color will be noticed where the notch openings were exposed to light during the first burn.)
- J. Steps H and I may be repeated for as many images as are desired
- K. Remove notch image with deletion fluid or eraser
- L. Give to instructor for evaluation

STRIPPING TECHNIQUES
UNIT II

JOB SHEET #2--COMBINE LINE AND HALFTONE WORK

- I. Tools and materials
 - A. Light table
 - B. T-square
 - C. Stripping knife
 - D. Tape dispenser (clear tape and lithographers tape)
 - E. 5" x 7" line negative with 2" x 3" halftone window
 - F. 2 1/4" x 3 1/4" halftone negative
 - G. 10 x 15 masking sheet
- II. Procedure
 - A. Strip line negative to masking sheet 1/4" below gripper margin and center on center line
 - B. Turn masking sheet over and position halftone negative over window so 1/8" of negative laps over edge of window on all four sides
 - C. Make sure the emulsion sides of both the line and halftone negatives are facing up
 - D. Secure four overlapping corners of the halftone negative to the line negative with small strips of lithographers tape

(NOTE: Use as little tape as possible, and avoid wrinkles or double thickness.)
 - E. Cut away masking sheet to expose all images
 - F. Opacify any pinholes or scratches on line negative
 - G. Turn in completed flat to instructor for evaluation

STRIPPING TECHNIQUES
UNIT II

JOB SHEET #3--STRIP FOR COMBINATION OR
SURPRINTING (DOUBLE BURN)

- I. Tools and materials
 - A. Light table
 - B. T-square
 - C. Stripping knife
 - D. Tape dispenser (clear tape and lithographers tape)
 - E. Halftone negative, 3" x 4"
 - F. Line negative, 3" x 4"
 - G. Two 10 x 15 masking sheets
 - H. Four film register marks
- II. Procedure
 - A. Strip halftone negative to masking sheet 1/4" below gripper margin and center on center line
 - B. Tape film register marks at two diagonal corners 1/2" outside halftone negative
 - C. Cut away masking sheet exposing halftone negative and register marks
 - D. Strip line negative on second masking sheet 1/4" below gripper margin and center on center line
 - E. Place line flat on top of halftone flat and register position of two flats
 - F. Tape film register marks on line flat while lined up with register marks on halftone flat
 - G. Burn halftone flat on plate
 - H. Burn line flat on plate
 - I. Give to instructor for evaluation

STRIPPING TECHNIQUES
UNIT IIJOB SHEET #4--STRIP COMPLEMENTARY FLATS FOR
MULTI-COLOR PRINTING

I. Tools and materials

- A. Light table
- B. T-square
- C. Stripping knife
- D. Tape dispenser (clear tape and lithographers tape)
- E. 5" x 7" line negative with four display lines plus body type
- F. Three 10" x 15" masking sheets
- G. Black felt tip pen

II. Procedure

- A. Strip 5" x 7" line negative to masking sheet 1/4" below gripper margin and center on center line
- B. Using stripping knife, cut away masking sheet exposing all lines of type on negative
- C. Using black pen, mark which lines of type are to be printed in first and second colors
- D. Tape second masking sheet over stripped flat and cut away masking sheet to expose all lines to print in first color
- E. Identify masking sheet cut in Step D as first color (name color)
- F. Tape third masking sheet to first flat and cut away masking sheet to expose all lines of second color
- G. Identify third masking sheet cut in Step F as second color (name color)
- H. Identify first flat as main flat
- I. Burn the first plate by placing the first mask over the main flat
- J. Burn the second plate by placing the second mask over the main flat
- K. Turn in main and complementary flats and finished plate to instructor for evaluation

STRIPPING TECHNIQUES
UNIT II

JOB SHEET #5--STRIP SIGNATURE FLATS FOR
MULTI-PAGE OR BOOK PRINTING

(NOTE: Instructor may enlarge on this job sheet to include 16 or 32 signatures and either saddle stitch or side bound formats.)

- I. Tools and materials
 - A. Light table
 - B. T-square
 - C. Stripping knife
 - D. Tape dispenser (clear tape and lithographers tape)
 - E. Blank sheet of paper, size 11 x 17
 - F. Two 11 x 17 masking sheets
 - G. Black felt tip pen
- II. Procedure
 - A. Fold the 11 x 17 sheet in half and then into a quarter fold
 - B. Holding folded edges at left and top, number lower right corner of sheets from 1 through 8 (Figure 1)

FIGURE 1

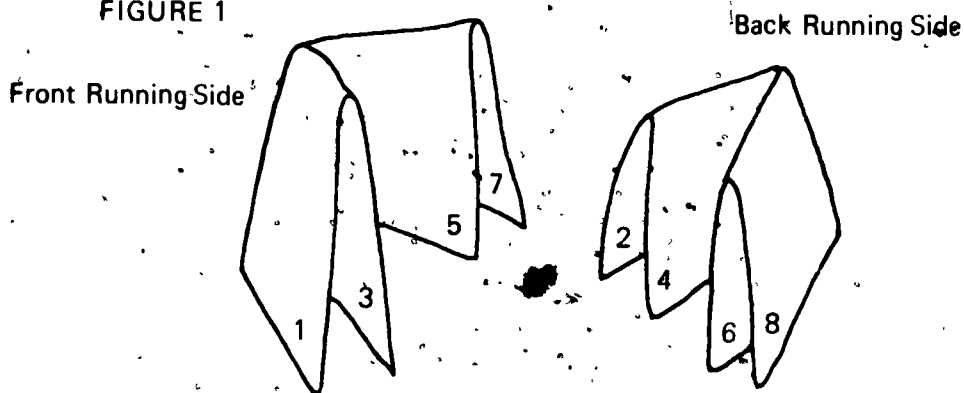

- C. Unfold the marked sheet, now called an imposition guide

JOB SHEET #5

- D. Mark the two masking sheets using the imposition guide (See Figure 2)

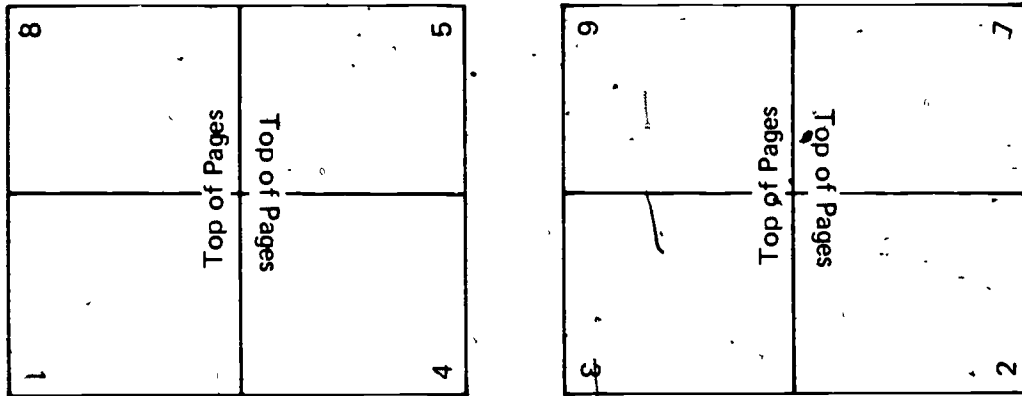

FIGURE 2

- E. Turn in the imposition guide and marked masking sheet to the instructor for evaluation.

151

STRIPPING TECHNIQUES
UNIT II

JOB SHEET #6--USE MASKING FILMS IN STRIPPING

I. Tools and materials

- A. 10 x 15 flat with suitable areas for color dropouts (flat to be provided by instructor)
- B. Sheet of masking film (amber)
- C. Stripping knife with round-edged blade
- D. Film register marks

II. Procedure

- A. Tape masking film over image area
- B. Using sharp edge of stripping knife, cut outline of area to be "dropped" out as second color, cutting through only top layer of the film

(NOTE: The masking material is a gelatin film with a clear acetate base.)

- C. Peel away the amber film from the area outside the "dropped" or outline area, leaving this area masked from plate exposure by the amber mask
- D. Add register marks to the masking film to ensure close register when plate exposures are made
- E. Position "dropped" masking film into flats for plate exposure
- F. Give to instructor for evaluation

STRIPPING TECHNIQUES
UNIT II

JOB SHEET #7--USE THE PIN REGISTER SYSTEM
IN STRIPPING FOR A TWO-COLOR JOB

- I. Tools and materials
 - A. Register punch (two or three hole)
 - B. Two 1/4" (1/16" height) register pins
 - C. Two masking sheets
 - D. Negatives for two-color job (provided by instructor)
 - E. Light table (stripping table)
- II. Procedure
 - A. Using register punch, punch both masking sheets on gripper edge of sheet
(NOTE: Punch should position two 1/4" diameter holes an equal distance on either side of center line of masking sheet.)
 - B. Place first flat in position on stripping table and strip negative into exact position
 - C. Fit register pins into holes punched in first flat
 - D. Tape tabs of register pins in first flat to glass top of stripping table
 - E. Remove first flat from pins and position for registration of second color
 - F. Turn in flats to instructor for evaluation

**STRIPPING TECHNIQUES
UNIT II**

NAME _____

TEST

1. Match the terms on the right with the correct definitions.

- | | |
|---|--------------------------------|
| <p>_____ a. The procedure of repeating the exposure of a flat several times on an offset plate</p> | <p>1. Surprinting</p> |
| <p>_____ b. To print the image in the exact same position on each sheet of paper</p> | <p>2. Step-and-repeat</p> |
| <p>_____ c. Small crosses, guides, or patterns placed on originals and flats to aid registration</p> | <p>3. Register</p> |
| <p>_____ d. Flat containing the key negatives of a multi-color job</p> | <p>4. Combination printing</p> |
| <p>_____ e. A flat containing negatives for only one color or part of a multi-color job</p> | <p>5. Imposition guide</p> |
| <p>_____ f. Printing line copy on top of a halftone</p> | <p>6. Main flat</p> |
| <p>_____ g. Usually two, four, eight, or sixteen pages printed on a single sheet to be folded and trimmed as a book or part of a book</p> | <p>7. Register marks</p> |
| <p>_____ h. A sheet marked to show the page positions</p> | <p>8. Complementary flat</p> |
| <p>_____ i. Printing one image on top of another</p> | <p>9. Signatures</p> |
| <p>_____ j. Accurate system of registration using punched negatives, flats, plates, and positioned register pins</p> | <p>10. Double burn</p> |
| <p>_____ k. Exposing a plate twice using two complementary flats</p> | <p>11. Pin register</p> |

2. Select true statements concerning the methods of combining line and halftone work by placing an "X" in the appropriate blanks.

- _____ a. To strip halftone negatives into windows of a line negative, the window must be clear
- _____ b. Halftone windows are cut from any color material for paste-up
- _____ c. When line and halftone negatives are stripped separately to the same flat, windows must be cut in the flat

- _____ d. When line and halftone negatives are stripped separately to the same flat, both negatives must be trimmed
- _____ e. Stripping and exposing negatives on separate flats requires only a single plate burn
- _____ f. Stripping and exposing negatives on separate flats requires careful positioning on flats and burn plates

3. Name two types of combination printing.

- a. _____
- b. _____

4. Identify the stripping register marks and pins below.

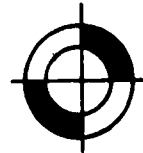
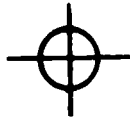

a. _____

b. _____

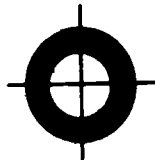

c. _____

d. _____

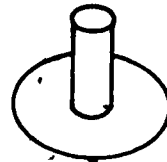

e. _____

5. Demonstrate the ability to:

- a. Strip for step-and-repeat
- b. Combine line and halftone work
- c. Strip for combination or surprinting (double burn)
- d. Strip complementary flats for multi-color printing
- e. Strip signature flats for multi-page or book printing
- f. Use masking films in stripping
- g. Use the pin register system in stripping for a two-color job.

(NOTE: If these activities have not been accomplished prior to the test, ask your instructor when they should be completed.)

STRIPPING TECHNIQUES
UNIT II

ANSWERS TO TEST

- | | | | | | |
|-------|---|----|----|----|----|
| 1. a. | 2 | f. | 4 | k. | 10 |
| b. | 3 | g. | 9 | | |
| c. | 7 | h. | 5 | | |
| d. | 6 | i. | 1 | | |
| e. | 8 | j. | 11 | | |
2. a, c, d, f
3. a. Positive lettering on top of halftones
b. Reversed lettering on top of halftones
4. a. Alignment or single run
b. Second run
c. Fourth run
d. Third run
e. Elongated register pin
5. Performance skills evaluated to the satisfaction of the instructor

INTRODUCTION TO PLATEMAKING UNIT III

UNIT OBJECTIVE

After completion of this unit, the student should be able to identify types of plate ends and plate exposure devices, and match plates with specific jobs. The student should also be able to develop a plate using a two-step method and determine correct plate exposure. This knowledge will be evidenced by correctly performing the procedures outlined in the assignment and job sheets and by scoring 85 percent on the unit test.

SPECIFIC OBJECTIVES

After completion of this unit, the student should be able to:

1. Match terms related to the introduction to platemaking with the correct definitions.
2. Identify types of plate ends.
3. Match types of offset plates with their correct characteristics.
4. Identify plate exposure devices.
5. Match offset plate processes with their advantages and disadvantages.
6. Match types of presensitized plates with their characteristics.
7. Select true statements concerning the gumming of plates.
8. Select true statements concerning the handling and storing of plates.
9. Select true statements related to the dos and don'ts for handling plates and chemicals properly.
10. Match plates with specific jobs.
11. Demonstrate the ability to:
 - a. Develop a plate using a two-step method (additive process).
 - b. Determine correct plate exposure.

INTRODUCTION TO PLATEMAKING UNIT III

SUGGESTED ACTIVITIES

- I. Provide student with objective sheet.
- II. Provide student with information, assignment, and job sheets.
- III. Make transparencies.
- IV. Discuss unit and specific objectives.
- V. Discuss information and assignment sheets.
- VI. Demonstrate and discuss the procedures outlined in the job sheets.
- VII. Show a slide-tape demonstration on the two-step plate developing procedure.
- VIII. Give test.

INSTRUCTIONAL MATERIALS

- I. Included in this unit:
 - A. Objective sheet
 - B. Information sheet
 - C. Transparency masters
 1. TM 1--Four Types of Plate Ends
 2. TM 2--Plate Exposure Devices
 - D. Assignment Sheet #1--Match Plates with Specific Jobs
 - E. Answers to assignment sheet
 - F. Job sheets
 1. Job Sheet #1--Develop a Plate Using a Two-step Method (Additive Process)
 2. Job Sheet #2--Determine Correct Plate Exposure
 - G. Test
 - H. Answers to test

II. References:

- A. Spence, William. D. and Vequist, David G. *Graphic Reproduction*. Peoria, IL 61615: Chas. A. Bennett, Inc., 1980.
- B. Cogoli, John E. *Photo-Offset Fundamentals*. Bloomington, IL 61701: McKnight Publishing Co., 1980.
- C. *Platemaker's Guide*. Sixth edition. St. Paul, MN 55101: 3M Company, Printing Products Division, 1970.

INTRODUCTION TO PLATEMAKING

UNIT III

INFORMATION SHEET

I. Terms and definitions

- A. Grained plate--A plate where tiny pits or indentations in the surface of the plate allow it to carry water
- B. Smooth plate--A plate whose surface is grainless
- C. Process gum/desensitizer--A solution used to desensitize the plate

(NOTE: Manufacturers have different processes. Use recommended chemistry with plate.)
- D. Diazo--A light-sensitive dye
- E. Gum arabic--Solution used to preserve plate and protect surface from oxidation
- F. Surface plate--A plate in which the image and non-image areas are level
- G. Deep-etch plate--A plate in which the image is etched slightly below the surface
- H. Squeegee--A smooth rubber blade used to wipe moisture from plate surface
- I. Ink-receptive--Areas which accept and hold ink and reject water
- J. Ink-repellent--Areas which accept and hold water and reject ink
- K. Gray scale (sensitivity guide)--A commercially produced sensitivity guide with a 12-step negative representing the various tones from white to black; used by platemakers to determine plate exposure

II. Types of plate ends (Transparency 1)

- A. Serrated/loop
- B. Straight cut
- C. Pinbar
- D. Slotted/oval

INFORMATION SHEET

III. Types of offset plates and characteristics

A. Surface plates

1. Direct-image--No sensitized coating; image accomplished by typing or hand lettering

(NOTE: The direct-image plates are often called "masters.")

2. Presensitized--Light-sensitive coating applied during plate manufacturing
3. Photo-direct--Made directly in automatic platemakers making intermediate step (flat) unnecessary

(NOTE: These commonly come in roll form.)

4. Wipe-on--Light-sensitive coating applied in shop immediately before exposure
5. Electrostatic--Image produced on plate surface by an electrostatic charge

- B. Deep-etch--Image area chemically etched to a depth slightly below non-printing area; common types are single metal and multimetal

IV. Plate exposure devices (Transparency 2)

- A. Vacuum frame--Holds flat and plate in close contact

B. Light sources

1. Carbon arc
2. Pulsed-xenon
3. Mercury-vapor light bulb

C. Manual/automated processing units

V. Advantages and disadvantages of offset plate processes

A. Direct-image and electrostatic

1. Advantages

- a. Quickly generated
- b. Lower cost than others

2. Disadvantages

- a. Limited on quality of line work

INFORMATION SHEET

- b. Will not reproduce halftones
- c. Difficult to make corrections
- d. No original
- e. Make a maximum of 500 impressions

B. Presensitized**1. Advantages**

- a. High quality
- b. Meet all printing requirements
- c. Can be stored for repeat use
- d. Make a maximum of 2,000 to 250,000 impressions

2. Disadvantages

- a. High cost
- b. Require substantial amount of production time

C. Photo-direct**1. Advantages**

- a. Moderately priced
- b. Can (usually) change original sizes
- c. Make a maximum of 1000 impressions

2. Disadvantages

- a. Plates can not be stored or repeated
- b. Require exact and specific chemistry for plate and press

D. Wipe-on**1. Advantage--Good quality at moderate price****2. Disadvantages**

- a. Require substantial amount of production time
- b. Require larger inventory

INFORMATION SHEET

E. Deep-etch

1. Advantage--Good quality at moderate price
2. Disadvantages
 - a. Require great amount of production time
 - b. Require great amount of care and production control

VI. Types of presensitized plates and characteristics

- A. Additive-working--A special ink-holding coating added during plate developing process
- B. Subtractive-working--A synthetic lacquer applied at the factory over entire surface; the synthetic lacquer coating removed during development
- C. Negative-working--Produce an image area in all places on the plate that are struck by light during exposure
- D. Positive-working--Produce an image area in all places on the plate not struck by light during exposure

VII. Gumming of plates

- A. After applying gum arabic to plate, surface should be buffed damp-dry
- B. Both sides of plate should be buffed damp-dry before hanging up to dry
- C. Hang up plates in such a way so that one plate does not lie against another
- D. If plate has been run, clean both sides before gumming

VIII. Handling and storing plates

(NOTE: Do not contaminate the plates with any foreign matter.)

A. Handling

1. Pick up plates at ends using only thumb and index finger
(CAUTION: Avoid sliding fingers along plate edges as they are sharp.)
2. Avoid touching plate surfaces with fingers before and after processing
3. Lift large plates by opposite corners to avoid crimping or scratching

INFORMATION SHEET

B. Storing

1. Be certain all plates are clean and dry before storing
2. Should be stored in vertical hanging envelopes if possible
3. Can be stored in flat drawers if protected by folders
4. Store unexposed presensitized plates in cool, dry area away from light and do not remove until ready for exposure

IX. Dos and don'ts for handling plates and chemicals properly

- A. Do handle sharp edged plates carefully
- B. Do raise, rotate, and close vacuum frame slowly and carefully
- C. Do shake chemicals well before using
- D. Do pour chemicals slowly
- E. Do store chemicals in properly marked, tightly closed containers
- F. Do not handle electrical platemaking equipment with wet hands
- G. Do not lean on glass-topped vacuum frame
- H. Do not breathe chemical fumes
- I. Do not look directly at light sources

(CAUTION: Do not wear contact lenses when working in arc platemaking area.)

Four Types of Plate Ends

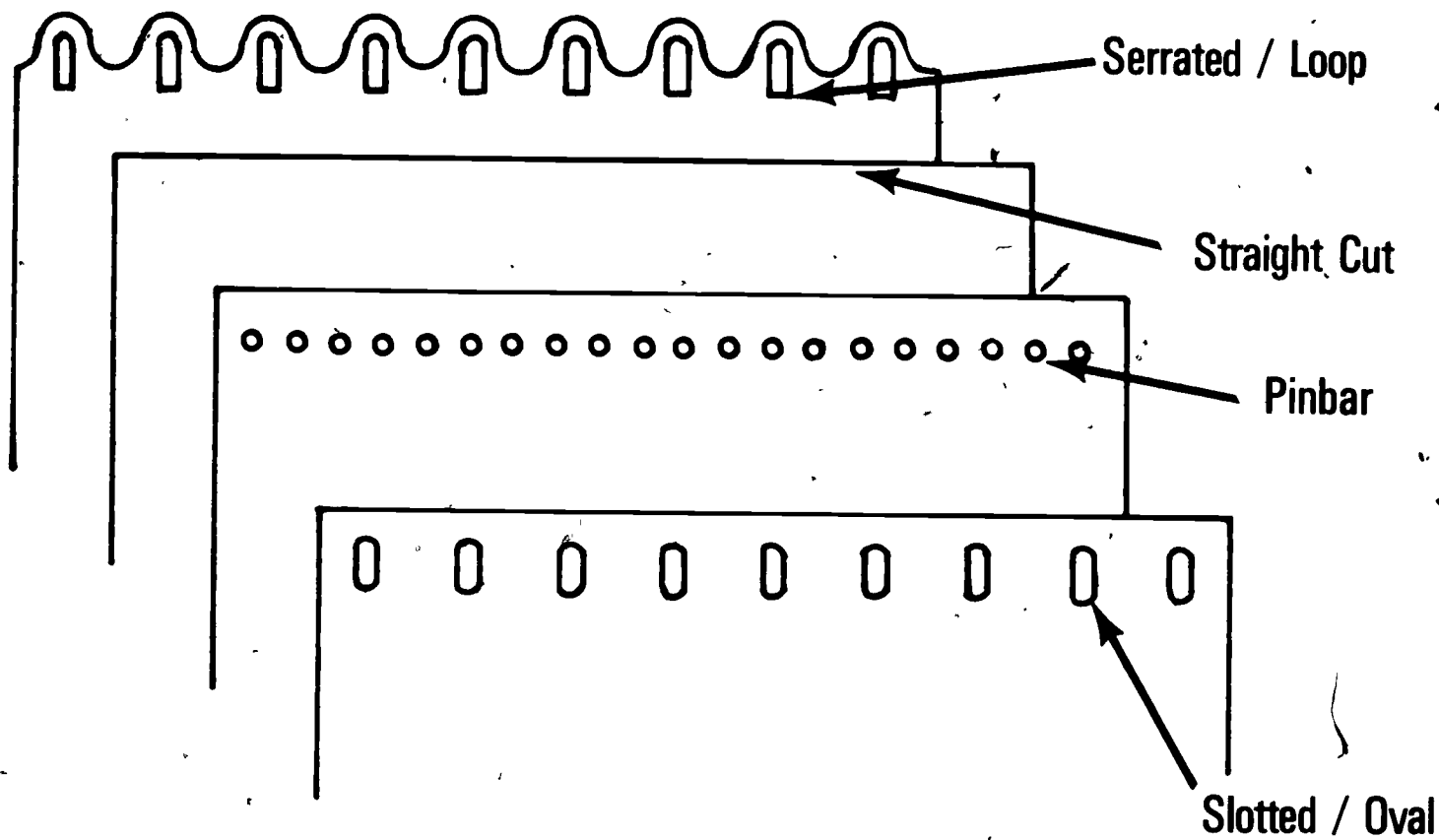
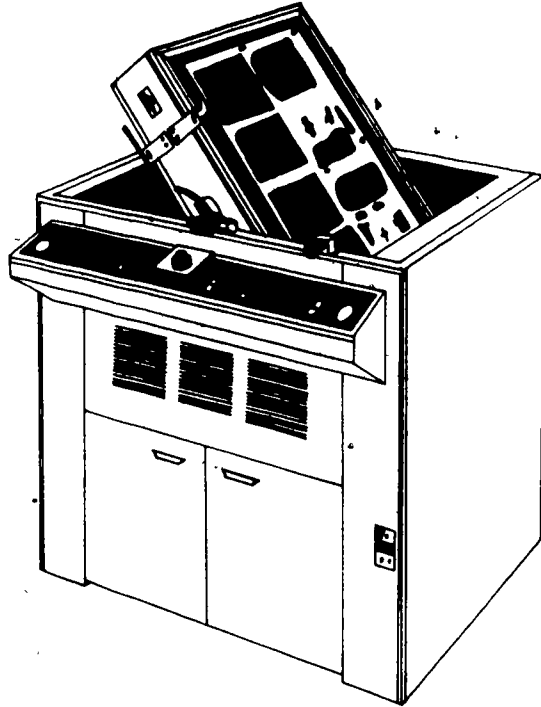
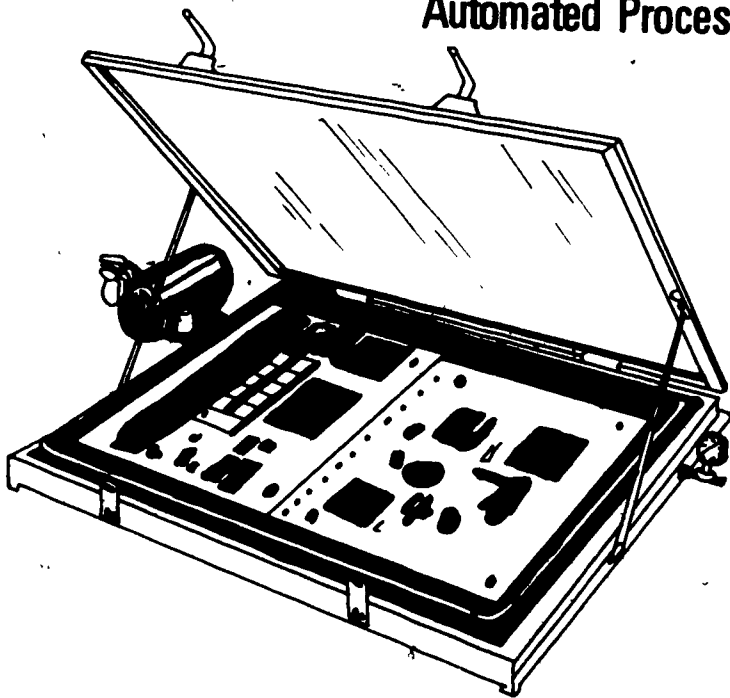

Plate Exposure Devices



Automated Processing Unit



Vacuum Frame

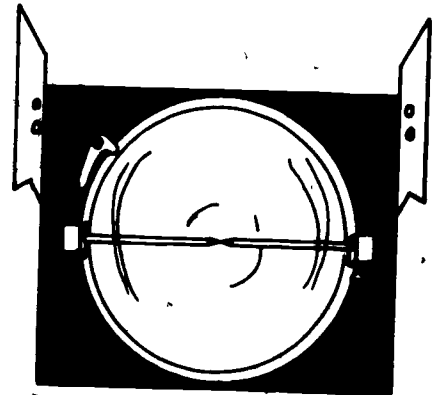

Carbon Arc Light Source

INTRODUCTION TO PLATEMAKING
UNIT III

ASSIGNMENT SHEET #1--MATCH PLATES WITH SPECIFIC JOBS

Directions: From the list of offset plates below, select the plate best suited for each printing job specified.

<u>PRINTING JOB</u>	<u>PLATES</u>
___ 1. 5000 letterheads	a. Direct-image
___ 2. 100 copies of typed sheet	b. Photo-direct
___ 3. 1000 handbills (heavy type)	c. Presensitized
___ 4. 1000 sheets, line copy and halftone	
___ 5. 50 handbills, light type	
___ 6. 500 posters with line illustrations	
___ 7. 100 reprints of newspaper photo	
___ 8. 1000 charts with large solid image areas	
___ 9. 5000 brochures, art and halftones	
___ 10. 500 ruled forms	

INTRODUCTION TO PLATE MAKING
UNIT III

ANSWERS TO ASSIGNMENT SHEET #1

1. c
2. a
3. b
4. c
5. a
6. a
7. b
8. c
9. c
10. ~~A~~

200

INTRODUCTION TO PLATEMAKING
UNIT III

JOB SHEET #1--DEVELOP A PLATE USING A TWO-STEP
METHOD (ADDITIVE PROCESS)

(NOTE: Procedures may have to be altered to adapt to equipment from various manufacturers.)

- I. Tools and materials
 - A. Developing sink
 - B. Process gum
 - C. Developer
 - D. Gum arabic
 - E. Three clean sponges
 - F. Squeegee
 - G. Plate (exposed and provided by instructor)
- II. Procedure
 - A. Make sure sink is clean and damp but not wet
 - B. Make sure all sponges are clean and damp but free of excess moisture
 - C. Shake all chemical containers
 - D. Place plate, exposed side up, in sink
 - E. Pour enough process gum on plate to cover and desensitize entire plate
 - F. Wipe process gum over entire plate surface
 - G. Using side of sponge, wipe excess moisture from plate and surrounding area
 - H. While plate is still moist, pour small pool of developer (half dollar size) and wipe over entire plate surface
 - I. Continue rubbing developer on plate with quick, soft sponge motion until uniform image appears on plate
 - J. Flush plate with water to clean off excess developer
 - K. Squeegee excess moisture from plate surface and surrounding sink area
 - L. Apply thin coat of gum arabic to plate surface and wipe on with clean sponge

JOB SHEET #1

- M. Wring out sponge and continue to buff plate damp-dry
- N. Turn in plate to instructor for evaluation

INTRODUCTION TO PLATEMAKING
UNIT III

JOB SHEET #2--DETERMINE CORRECT PLATE EXPOSURE

I. Tools and materials

- A. 10 x 15 flat
- B. 10 x 15 presensitized plate
- C. Platemakers sensitivity guide (gray scale)
- D. Stripping knife
- E. Tape dispensers with clear tape and lithographers tape
- F. Light table
- G. Platemaker
- H. Plate sink and developing chemicals

II. Procedure

- A. Cut out area of flat in margin the same size as platemakers gray scale
- B. Turn flat over and tape gray scale into window of flat cut in step A
- C. Position flat on offset plate in vacuum frame of platemaker with plate emulsion or coated side up and emulsion side of flat down
- D. Close vacuum frame, lock, and turn on vacuum pump
- E. When vacuum pressure is at sufficient level, check flat and gray scale for total contact
- F. Expose plate according to plate manufacturer's recommendation, e.g., 2 minutes, 45 seconds
- G. Develop plate

(NOTE: If step 6 is open on plate and step 7 is closed, exposure is correct. If not, consult instructor for second exposure.)

- H. Turn in plate for instructor evaluation

INTRODUCTION TO PLATEMAKING
UNIT III

TEST

NAME _____

1. Match the terms on the right with the correct definitions.

- | | |
|--|--|
| <p>_____ a. A plate where tiny pits or indentations in the surface of the plate allow it to carry water</p> <p>_____ b. A solution used to desensitize the plate</p> <p>_____ c. A light-sensitive dye</p> <p>_____ d. Solution used to preserve plate and protect surface from oxidation</p> <p>_____ e. A plate in which the image and non-image areas are level</p> <p>_____ f. A plate in which the image is etched slightly below the surface</p> <p>_____ g. A smooth rubber blade used to wipe moisture from plate surface</p> <p>_____ h. Areas which accept and hold ink and reject water</p> <p>_____ i. Areas which accept and hold water and reject ink</p> <p>_____ j. A commercially produced sensitivity guide with a 12-step negative representing the various tones from white to black; used by platemakers to determine plate exposure</p> <p>_____ k. A plate whose surface is grainless</p> | <p>1. Diazo</p> <p>2. Ink-repellent</p> <p>3. Squeegee</p> <p>4. Process gum/desensitizer</p> <p>5. Grained plate</p> <p>6. Gray scale</p> <p>7. Ink-receptive</p> <p>8. Gum arabic</p> <p>9. Deep-etch plate</p> <p>10. Surface plate</p> <p>11. Smooth plate</p> |
|--|--|

2. Identify the types of plate ends below.

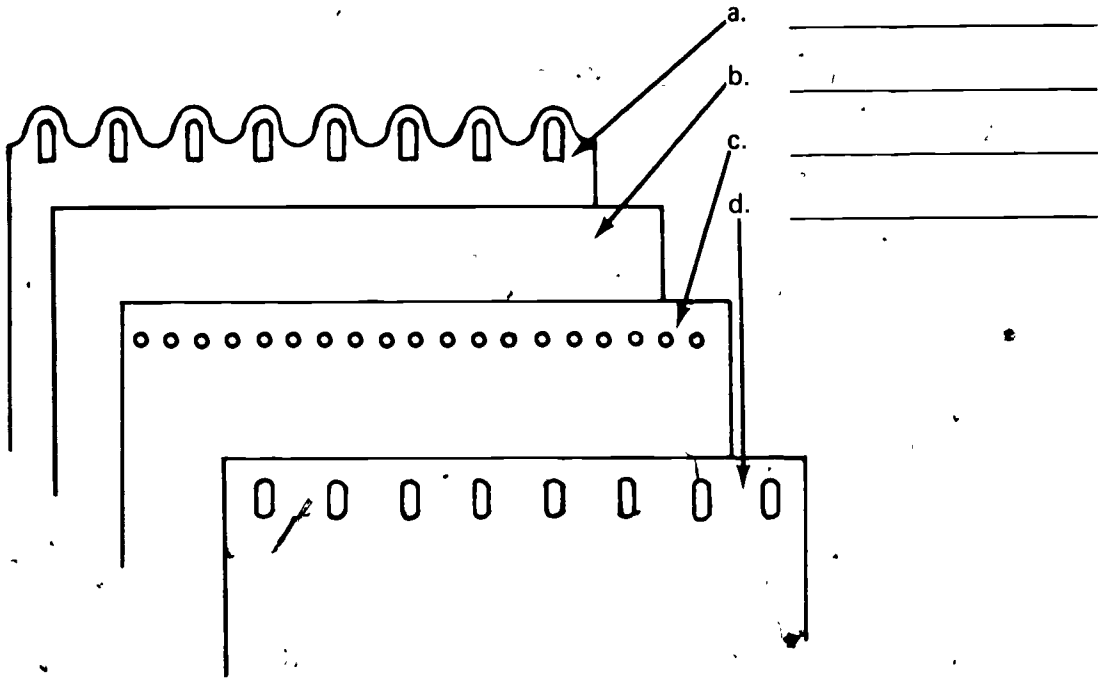

3. Match the types of offset plates on the right with the correct characteristics.

- | | |
|---|------------------|
| <input type="checkbox"/> a. No sensitized coating; image accomplished by typing or hand lettering | 1. Wipe-on |
| <input type="checkbox"/> b. Made directly in automatic platemakers making intermediate step unnecessary | 2. Electrostatic |
| <input type="checkbox"/> c. Light-sensitive coating applied in shop immediately before exposure | 3. Direct-image |
| <input type="checkbox"/> d. Light-sensitive coating applied during plate manufacturing | 4. Photo-direct |
| <input type="checkbox"/> e. Image produced on plate surface by an electrostatic charge | 5. Presensitized |
| <input type="checkbox"/> f. Image area chemically etched to a depth slightly below nonprinting area; common types are single and multimetal | 6. Deep-etch |

4. Identify the plate exposure devices below.

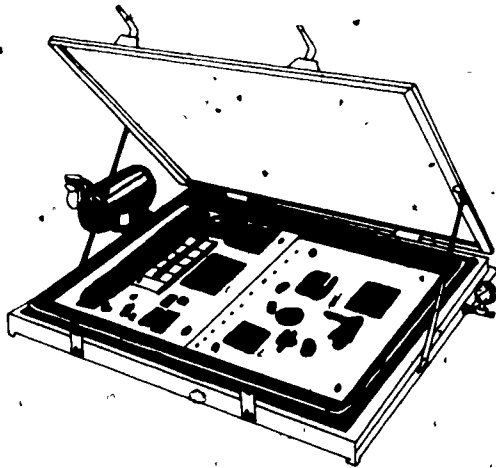

a. _____

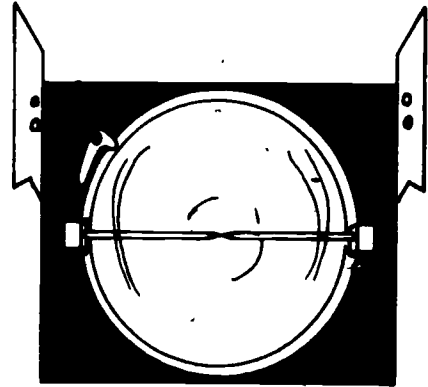

b. _____

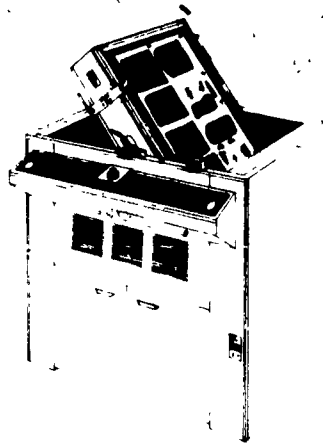

c. _____

5. Match the offset plate processes on the right with their advantages and disadvantages.

- _____ a. 1) Advantages
- a) Quickly generated
 - b) Lower cost than others
- 2) Disadvantages
- a) Limited on quality of line work
 - b) Will not reproduce halftones
 - c) Difficult to make corrections
 - d) No original
 - e) Make a maximum of 500 impressions

- _____ b. 1) Advantages
- a) High quality
 - b) Meet all printing requirements
 - c) Can be stored for repeat use
 - d) Make a maximum of 2000 to 250,000 impressions

- 2) Disadvantages
- a) High cost
 - b) Require substantial amount of production time

- _____ c. 1) Advantages
- a) Moderately-priced
 - b) Can change original sizes
 - c) Make a maximum of 1000 impressions

- 2) Disadvantages
- a) Plates can not be stored or repeated
 - b) Require exact and specific chemistry for plate and press

- _____ d. 1) Advantage--Good quality at moderate price

- 2) Disadvantages
- a) Require substantial amount of production time
 - b) Require larger inventory

- _____ e. 1) Advantage--Good quality at moderate price

- 2) Disadvantages
- a) Require great amount of production time
 - b) Require great amount of care and production control

1. Photo-direct
2. Deep-etch
3. Presensitized
4. Direct-image and electrostatic
5. Wipe-on

6. Match the types of presensitized plates on the right with their characteristics.

- _____ a. A special ink-holding coating added during plate developing process

- _____ b. A synthetic lacquer applied at the factory over entire surface; the synthetic lacquer coating removed during development

- _____ c. Produce an image area in all places on the plate that are struck by light during exposure

1. Additive-working
2. Negative-working
3. Positive-working
4. Subtractive-working

- _____ d. Produce an image area in all places on the plate not struck by light during exposure
7. Select true statements concerning the gumming of plates by placing an "X" in the appropriate blanks.
- _____ a. After applying gum arabic to plate, plate should be immediately hung up to dry
- _____ b. If plate has been run, clean both sides before gumming
- _____ c. Hang up plates in such a way so that plates lie against each other
8. Select true statements concerning the handling and storing of plates by placing an "X" in the appropriate blanks.
- _____ a. Lift large plates by opposite corners to avoid crimping or scratching
- _____ b. Avoid touching plate surfaces with fingers before and after processing
- _____ c. Pick up plates at center using only thumb and index finger
- _____ d. Plates should be stored in vertical hanging envelopes
9. Select true statements related to the dos and don'ts for handling plates and chemicals properly by placing an "X" in the appropriate blanks.
- _____ a. Do shake chemicals well before using
- _____ b. Do look directly at light sources
- _____ c. Do not lean on glass-topped vacuum frame
- _____ d. Do not breathe chemical fumes
10. Match plates with specific jobs.
11. Demonstrate the ability to:
- a. Develop a plate using a two-step method
- b. Determine correct plate exposure

(NOTE: If these activities have not been accomplished prior to the test, ask your instructor when they should be completed.)

INTRODUCTION TO PLATEMAKING
UNIT III

ANSWERS TO TEST

1. a. 5 f. 9 k. 11
 b. 4 g. 3
 c. 1 h. 7
 d. 8 i. 2
 e. 10 j. 6
2. a. Serrated/loop
 b. Straight cut
 c. Pinbar
 d. Slotted/oval
3. a. 3
 b. 4
 c. 1
 d. 5
 e. 2
 f. 6
4. a. Vacuum frame
 b. Carbon arc light source
 c. Automated processing unit
5. a. 4
 b. 3
 c. 1
 d. 5
 e. 2
6. a. 1
 b. 4
 c. 2
 d. 3
7. b
8. a, b, d
9. a, c, d
10. Evaluated to the satisfaction of the instructor
11. Performance skills evaluated to the satisfaction of the instructor

PLATEMAKING TECHNIQUES
UNIT IV

UNIT OBJECTIVE

After completion of this unit, the student should be able to determine correct exposures and process additive and subtractive plates. The student should also be able to expose for a screen tint, make corrections on a plate, make plates for a two-color job, and expose step-and-repeat and photo-direct plates. This knowledge will be evidenced by correctly performing the procedures outlined in the job sheets and by scoring 85 percent on the unit test.

SPECIFIC OBJECTIVES

After completion of this unit, the student should be able to:

1. Match terms related to platemaking techniques with the correct definitions.
2. Match platemaking materials with their proper uses.
3. Demonstrate the ability to:
 - a. Determine correct exposure and process an additive plate.
 - b. Determine correct exposure and process a subtractive plate.
 - c. Make corrections on a plate.
 - d. Expose a step-and-repeat plate.
 - e. Expose for a screen tint.
 - f. Make plates for a two-color job.
 - g. Expose a photo-direct plate.

PLATEMAKING TECHNIQUES
UNIT IV

SUGGESTED ACTIVITIES

- I. Provide student with objective sheet.
- II. Provide student with information and job sheets.
- III. Discuss unit and specific objectives.
- IV. Discuss information sheet.
- V. Demonstrate and discuss the procedures outlined in the job sheets.
- VI. Show the film strip-cassette from the McKnight's career education series entitled "Stripping and Platemaking-Basic Procedures."
- VII. Give test.

INSTRUCTIONAL MATERIALS

- I. Included in this unit:
 - A. Objective sheet
 - B. Information sheet
 - C. Job sheets
 1. Job Sheet #1--Determine Correct Exposure and Process an Additive Plate
 2. Job Sheet #2--Determine Correct Exposure and Process a Subtractive Plate
 3. Job Sheet #3--Make Corrections on a Plate
 4. Job Sheet #4--Expose a Step-and-Repeat Plate
 5. Job Sheet #5--Expose for a Screen Tint
 6. Job Sheet #6--Make Plates for a Two-Color Job
 7. Job Sheet #7--Expose a Photo-Direct Plate
 - D. Test
 - E. Answers to test

II. References:

- A. Spence, William P. and, Vequist, David G. *Graphic Reproduction*. Peoria, IL 61615: Chas. A. Bennett, Co., Inc., 1980.
- B. Cogoli, John E. *Photo-Offset Fundamentals*. Bloomington, IL 61701: McKnight Publishing Co., 1980.
- C. *Platemaker's Guide*. Sixth edition. St. Paul, MN 55101: 3M Company, Printing Products Division, 1970.

PLATEMAKING TECHNIQUES
UNIT IV

INFORMATION SHEET

- I. Terms and definitions
 - A. Halo--A shadow around the edge of a halftone
 - B. Dot--The individual element of a halftone
 - C. Dot loss--Disappearance of a dot from the plate
 - D. Dot spread--Dot enlargement on the plate
 - E. Broken image--An incomplete image on the plate
 - F. Blind--An imaged plate surface that will not accept ink
- II. Platemaking materials and their uses
 - A. Asphaltum--Substance from gum arabic and petroleum base used to preserve plates
 - B. Hone--An abrasive stone used to remove unwanted marks on the plate surface
 - C. Lacquer--Solution base used for hardening image in platemaking
 - D. Tusche--A liquid chemical used to repair broken images on plate surface
 - E. Deletion fluid--Solution used to eliminate plate flaws

PLATEMAKING TECHNIQUES
UNIT IV

JOB SHEET #1--DETERMINE CORRECT EXPOSURE AND PROCESS
AN ADDITIVE PLATE

I. Tools and materials

- A. Flat (provided by instructor)
- B. Additive plate
- C. Platemakers gray scale (10-step sensitivity guide)
- D. Platemaker
- E. Stripping knife
- F. Lithographers tape
- G. Exposure factor chart

II. Procedure

- A. Cut small window and strip gray scale into non-printing margin area of flat
- B. Position flat and plate in vacuum frame of platemaker
- C. Set exposure time (light units for integrator platemakers) and expose plate
- D. Check developed plate to see if a solid step 6 on the gray scale was produced

(NOTE: If the scale develops to a higher numbered step, the exposure time is too long; changes in the exposure can be determined by using a exposure factor chart.)

PLATEMAKING TECHNIQUES
UNIT IV

JOB SHEET #2--DETERMINE CORRECT EXPOSURE AND PROCESS
A SUBTRACTIVE PLATE

I. Tools and materials

- A. Flat (provided by instructor)
- B. Subtractive plate
- C. Platemakers gray scale (10-step sensitivity guide)
- D. Platemaker
- E. Stripping knife
- F. Lithographers tape
- G. Exposure factor chart

II. Procedure

- A. Cut small window and strip gray scale into non-printing margin area of flat
- B. Position flat and plate in vacuum frame of platemaker
- C. Set exposure time (light units for integrator platemakers) and expose plate
- D. Check developed plate to see if a solid step 7 on the gray scale was produced

(NOTE: If the scale develops to a higher numbered step, the exposure time is too long; changes in the exposure can be determined by using the exposure factor chart.)

PLATEMAKING TECHNIQUES
UNIT IV

JOB SHEET #3--MAKE CORRECTIONS ON A PLATE

- I. Tools and materials
 - A. Plate with broken image and spots in the nonimage area (plate provided by instructor)
 - B. Sharpened hone
 - C. Rubber eraser
 - D. Process gum
 - E. Stripping knife
 - F. Cotton pads
 - G. Small ink supply on wet cotton pad
- II. Procedure
 - A. Lay plate on well-lighted table covered with scrap newsprint paper
 - B. Using stripping knife, scratch area of broken image to join broken lines
 - C. Use wet hone to remove larger spots in nonimage area
 - D. Use wet pencil eraser to remove smaller spots near image area
 - E. Cover plate with thin layer of process gum and rub with cotton pad
 - F. Flush and clean plate with water and cotton pad
 - G. Ink up plate with wet cotton pad and small amount of ink
 - H. Inspect plate to see if flaws are still picking up ink
 - I. Turn in plate for instructor evaluation

PLATEMAKING TECHNIQUES
UNIT IV

JOB SHEET #4-EXPOSE A STEP-AND-REPEAT PLATE

- I. Tools and materials
 - A. Flat (provided by instructor)
 - B. Presensitized plate
- II. Procedure
 - A. Position flat on presensitized plate (refer to Job Sheet #1 of "Introduction to Stripping" in this section)
 - B. Make first exposure
 - C. Reposition flat for second exposure, matching first notch on flat with second notch burn mark on plate
 - D. Make second exposure
 - E. Repeat procedure until number of desired images are on plate

(NOTE: Make certain edge of plate and flat are aligned perfectly for each exposure.)

PLATEMAKING TECHNIQUES
UNIT IV

JOB SHEET #5--EXPOSE FOR A SCREEN TINT

- I. Tools and materials
 - A. Flat (provided by instructor)
 - B. Screen tint (percentage optional)
 - C. Light table
 - D. Tape dispenser
 - E. Offset plate
 - F. T-square
- II. Procedure
 - A. Tape flat to light table, emulsion side up, using a T-square to make sure flat is square with table
 - B. Use screen tint for selected window in flat to be screened, 1/4" larger than window
 - C. Tape screen over window, making sure of total coverage with 1/8" overlap on all sides
 - D. Place plate in platemaker vacuum frame and position flat on plate with screen tint in contact with plate surface
 - E. Close vacuum frame and make normal plate exposure
 - F. Develop plate and gum plate
 - G. Give finished plate to instructor for evaluation

PLATEMAKING TECHNIQUES
UNIT IV

JOB SHEET #6--MAKE PLATES FOR A TWO-COLOR JOB

I. Tools and materials

- A. Main flat
- B. Complementary flat-1st color
- C. Complementary flat-2nd color
- D. Two offset plates
- E. Tape dispenser with lithographers tape
- F. Stripping knife
- G. Platemaker
- H. Developing sink
- I. Plate developing chemicals
- J. Three clean sponges
- K. Squeegee

II. Procedure

- A. Cut 1/4" triangle in all three masking sheets in area above gripper margins
- B. Cover triangle openings with small strips of lithographers tape
- C. Position main flat and register first color flat over it on the first plate
- D. Make first plate exposure
- E. Position main flat and register second color flat over it on the second plate
- F. Make second plate exposure
- G. Develop plates
- H. Turn in to instructor for evaluation

PLATEMAKING TECHNIQUES
UNIT IV

JOB SHEET #7--EXPOSE A PHOTO-DIRECT PLATE

- I. Tools and materials
 - A. Photo-direct platemaker
 - B. Photo-mechanical copy (paste-up or original)
 - C. Glass cleaner
 - D. Paper towel
- II. Procedure
 - A. Clean copy frame glass
 - B. Position photo-mechanical (paste-up or original) in copy frame
 - C. Set percentage (100%) on copy frame
 - D. Set percentage (100%) on control panel
 - E. Set plate length (13-14")
 - F. Set exposure dial S x10 and 1.5 = 15 seconds
(NOTE: Assume this is the normal exposure.)
 - G. Press exposure button
 - H. When plate comes out (approximately 90 seconds) check to make sure entire image is on plate
(NOTE: Compare plate with original copy.)
 - I. Check contrast between image and background
 - J. Check for flaws, scratches, and spots
 - K. Correct exposure
 1. If copy and background are dark, lengthen exposure by 2 seconds
 2. If copy is light, shorten exposure by 2 seconds
 - L. Turn in final plate to instructor for evaluation

PLATEMAKING TECHNIQUES
UNIT IV

NAME _____

TEST

1. Match the terms on the right with the correct definitions.

- | | |
|---|-----------------|
| _____ a. A shadow around the edge of a halftone | 1. Blind |
| _____ b. The individual element of a halftone | 2. Broken image |
| _____ c. Disappearance of a dot from the plate | 3. Dot |
| _____ d. Dot enlargement on the plate | 4. Halo |
| _____ e. An incomplete image on the plate | 5. Dot spread |
| _____ f. An imaged plate surface that will not accept ink | 6. Dot loss |

2. Match the platemaking materials on the right with their proper uses.

- | | |
|---|-------------------|
| _____ a. Substance from gum arabic and petroleum base used to preserve plates | 1. Tusche |
| _____ b. An abrasive stone used to remove unwanted marks on the plate surface | 2. Lacquer |
| _____ c. Solution base used for hardening image in platemaking | 3. Asphaltum |
| _____ d. A liquid chemical used to repair broken images on plate surface | 4. Hone |
| _____ e. Solution used to eliminate plate flaws | 5. Deletion fluid |

3. Demonstrate the ability to:

- a. Determine correct exposure and process an additive plate
- b. Determine correct exposure and process a subtractive plate
- c. Make corrections on a plate
- d. Expose a step-and-repeat plate
- e. Expose for a screen tint
- f. Make plates for a two-color job
- g. Expose a photo-direct plate

(NOTE: If these activities have not been accomplished prior to the test, ask your instructor when they should be completed.)

PLATEMAKING TECHNIQUES
UNIT IV

ANSWERS TO TEST

- | | | | | |
|----|----|---|----|---|
| 1. | a. | 4 | d. | 5 |
| | b. | 3 | e. | 2 |
| | c. | 6 | f. | 1 |
- 2.
- | | |
|----|---|
| a. | 3 |
| b. | 4 |
| c. | 2 |
| d. | 1 |
| e. | 5 |
3. Performance skills evaluated to the satisfaction of the instructor.