

DOCUMENT RESUME

ED 217 298

CE 032 991

**AUTHOR** Brown, James M.; Kayser, Terrence F.  
**TITLE** The Transition of Special Needs Learners into Postsecondary Vocational Education.  
**INSTITUTION** Minnesota Univ., Minneapolis. Research and Development Center for Vocational Education.  
**SPONS AGENCY** Minnesota State Dept. of Education, St. Paul. Div. of Vocational and Technical Education.  
**PUB DATE** Jun 82  
**NOTE** 99p.

**EDRS PRICE** MF01/PC04 Plus Postage.  
**DESCRIPTORS** \*Articulation (Education); \*Disabilities; Dropout Prevention; Educational Planning; High Risk Students; Individual Needs; \*Mainstreaming; Models; Postsecondary Education; \*Program Development; Special Education; Statewide Planning; \*Transitional Programs; \*Vocational Education  
**IDENTIFIERS** Minnesota

**ABSTRACT**

A developing concern in Minnesota for the fact that a greater percentage of special needs students than non-special needs students tends to drop out of postsecondary vocational education prompted a project to promote articulation--transition--for these students into postsecondary education. A statewide survey was conducted to determine current articulation efforts aimed at facilitating the entry of special needs students into postsecondary vocational institutions, and a national survey was carried out to determine the availability of formal articulation programs and/or efforts. The results of these activities clearly demonstrated that additional efforts must be focused on this topic. A third activity was the assembly of a national symposium that focused on several aspects of the articulation question, such as development of a sound transition model, school policies and information needs, preparation of vocational educators to implement transition efforts, and development of formal, flexible transition policies and practices. The final project activity was the development of a conceptual model of articulation. The model employs ideas from various disciplines, including health care services delivery, vocational rehabilitation, and vocational psychology. It is based on the concept that the needs and resources of students and institutions must correspond; without this correspondence, students are likely to leave the program. The model developed through this project presents a rationale for helping educators to determine how to select transition services and how to provide them, based on the strategies of correction, compensation, and circumvention. (Author/KC)

\*\*\*\*\*  
 \* Reproductions supplied by EDRS are the best that can be made \*  
 \* from the original document. \*  
 \*\*\*\*\*



ED217298

# The Transition of Special Needs Learners into Postsecondary Vocational Education

By  
James M. Brown and  
Terrence F. Kayser



U.S. DEPARTMENT OF EDUCATION  
NATIONAL INSTITUTE OF EDUCATION  
EDUCATIONAL RESOURCES INFORMATION  
CENTER (ERIC)

✓ This document has been reproduced as  
received from the person or organization  
originating it.  
Minor changes have been made to improve  
reproduction quality.

• Points of view or opinions stated in this docu-  
ment do not necessarily represent official NIE  
position or policy.

JUNE 1982

"PERMISSION TO REPRODUCE THIS  
MATERIAL HAS BEEN GRANTED BY

G. Coyle

TO THE EDUCATIONAL RESOURCES  
INFORMATION CENTER (ERIC)."

This project was jointly supported by  
Minnesota Research and Development Center For Vocational Education  
Department of Vocational & Technical Education  
College of Education, University of Minnesota

and the  
Vocational-Technical Division  
Minnesota State Department of Education

CE032991

## ACKNOWLEDGEMENTS

The authors wish to thank the many people who helped make this report possible. Without Hal Birkland's commitment to the special needs learners, present and future, in Minnesota's vocational education programs, this project might never have been conducted. Hal and Lloyd Petri of the Vocational-Technical Division at the Minnesota Department of Education have also been most gracious with their time and advice, without which many project activities would not have been feasible. Special thanks are offered to Brandon Smith and George Copa for their guidance that made this project a meaningful experience that, hopefully, will contribute to the technology of serving special needs populations in a wide variety of programs and institutions. We also express our gratitude to Howard Anderson and the other staff at Pine Technical Institute for their advice and indulgence as we explored the "real world" tasks of serving a wide range of special populations in an actual postsecondary vocational education institution. Certainly we thank the many people throughout Minnesota and across the country who donated their time and efforts to provide the crucial survey data that laid the groundwork upon which this project is based. Finally, we applaud the perseverance and patience of Mary Gupta and Judy Schletty whose typing and word processing skills were used to create this document and the numerous earlier drafts.

## ABSTRACT

This research report originated from a developing concern with the fact that a greater percentage of special needs students than of non-special needs students tend to drop out of postsecondary vocational programs. This project was, therefore, initiated based upon the belief that these students were not being adequately "articulated" into postsecondary institutions.

This report summarizes the following project activities: (a) a state-wide survey to determine current articulation efforts aimed at facilitating the entry of special needs students into postsecondary vocational institutions and (b) a national survey to determine the availability of formal articulation programs and/or efforts. The results of these activities clearly demonstrated that additional efforts must be focused on this topic.

A third activity was the assembly of a national symposium that focused on several aspects of the articulation question. The results of that symposium are described briefly in this report, but the complete presentations can be found in the Special summer issue of Career Education for Exceptional Individuals, 1981.

The final activity was the development of a conceptual model of articulation, now referred to in terms of the more concise concept of "transition". The rationale and development of this transition model are presented in Part Two of this report. This model employs ideas from various disciplines including health care services delivery, vocational rehabilitation, and vocational psychology. The model is, thus, based upon the concept that the needs and resources of students and institutions must "correspond". If this level of correspondence diminishes to a critical level, the student in question is likely to drop out of school, transfer to another program, or be terminated.

One problem educators have had when attempting to provide effective and appropriate services to special needs students may have been not knowing how to select these services. The model for transition presented here develops a rationale for determining how to select those services and how to provide them, based on the strategies of correction, compensation, and circumvention.

# TABLE OF CONTENTS

	Page
ACKNOWLEDGEMENTS . . . . .	iii
ABSTRACT . . . . .	iv
TABLE OF CONTENTS . . . . .	vi
LIST OF TABLES . . . . .	viii
LIST OF FIGURES . . . . .	ix
PART ONE . . . . .	1
Articulation: Current State of the Art . . . . .	1
Introduction . . . . .	1
Statement of the Problem . . . . .	2
Project Activities . . . . .	3
Literature Review . . . . .	5
Telephone Survey of Articulation Practices in Minnesota . . . . .	7
Sample . . . . .	7
Findings . . . . .	8
Summary . . . . .	21
National Survey of Current Articulation Efforts . . . . .	22
Sample . . . . .	22
Findings . . . . .	23
Summary . . . . .	26
Limitations . . . . .	26
National Articulation Symposium . . . . .	27
Symposium Results . . . . .	27
Symposium-Related conclusions . . . . .	30
Conclusions . . . . .	32
Recommendations . . . . .	32
The Future of the Articulation Model . . . . .	37
PART TWO . . . . .	38
Articulation/Transition: Designing a Procedural Model . . . . .	38
General Factors in the Transition <u>Process</u> . . . . .	39
Flexibility . . . . .	40
Compatibility . . . . .	41
Specificity . . . . .	41
Timeliness . . . . .	42
Measurability . . . . .	42
Information Exchange as a Facilitator of Transition . . . . .	43
National Symposium Topics . . . . .	45

The Information Record and Potential Barriers to Gathering Student Data . . . . .	47
Legal requirements . . . . .	47
Lapse of time . . . . .	48
Usefulness . . . . .	48
Use of Information . . . . .	49
Measurement Units Related to the Transition Process . . . . .	50
A Broad Picture of Transition . . . . .	51
The Concept and Characteristics of Continuity Accessibility . . . . .	53
Comprehensiveness . . . . .	54
Coordination . . . . .	54
Pre-Enrollment Requirements . . . . .	55
Post-Enrollment Requirements . . . . .	57
Environmental Elements of the Transition Model . . . . .	58
Monitoring Transition Through the Post-Enrollment Phase . . . . .	61
Record Contents . . . . .	61
Administrative input . . . . .	62
Instructor input . . . . .	62
Student-reported information . . . . .	62
Special needs staff and other information . . . . .	63
Monitoring timeline . . . . .	63
Monitoring recorders . . . . .	64
An Educational Adjustment Model: A Strategy to Facilitate Postsecondary Transition . . . . .	65
The Model . . . . .	65
A Theoretical Perspective of Transition Correspondence: The Central Issue . . . . .	67
Special Needs Services . . . . .	68
The Environment: Institutions and their Staff . . . . .	39
Student characteristics in the learning process . . . . .	71
Enhancing institutional accommodation of student's needs . . . . .	72
Enhancing Student Accommodation of institutional needs . . . . .	74
Assembling the Transition Model . . . . .	75
Conclusions and Recommendations . . . . .	83
REFERENCES NOTES . . . . .	85
REFERENCES . . . . .	86

## LIST OF TABLES

	Page
1. Telephone Survey Respondents . . . . .	9
2. Respondent Job Titles Reported in the National Survey . . . . .	23
3. Key Variables in Educational Environments . . . . .	71
4. Variables in the Instructional Process . . . . .	73



## LIST OF FIGURES

	Page
1. Initial long-term goals for the articulation project . . . . .	4
2. Recommended activities to minimize articulation-related problems . . . . .	32
3. Required attributes of an articulation model . . . . .	36
4. A categorization of factors impacting conceptual models of the transition process . . . . .	44
5. Services and Service Agencies Involved in Transition . . . . .	53
6. The pre-enrollment phase of postsecondary vocational education . . . . .	60
7. A model of the basic learning process . . . . .	71
8. The relationship of transition-enhancing processes to the overall educational process . . . . .	76
9. Relationships between major components in the educational process and transition-enhancing processes . . . . .	78
10. A model of transition into and through postsecondary vocational education models . . . . .	80

## PART ONE

### Articulation: Current State of the Art

This report represents the results of a two year effort to examine the *articulation* of special needs learners into Minnesota postsecondary vocational education institutions. The report's initial section focuses on the current status of articulation processes while the second section examines potential means by which current articulation processes could be improved and formal procedures established.

### Introduction

The decade of the 1970's was a period when America's educational institutions were influenced by societal changes in the form of federal legislation mandating improved and expanded educational services and opportunities for populations with special learning needs. Now that vocational educators are seriously involved in the delivery of program activities for special needs populations, the 1980's must become a time for serious evaluation of the effectiveness of these programs.

Vocational educators can realistically expect that students, who have previously received special and/or support services in elementary and secondary schools, will become an increasingly larger proportion of the enrollment in postsecondary vocational education programs. Many of these special needs students must now begin to compete with "regular" students. Many may find less extensive special assistance or program and instructional modifications than were previously provided to them in elementary and secondary schools. Thus, articulation procedures and policies must be developed which will permit the intra- and inter-institutional transmission of educationally pertinent information about special needs students enrolled in postsecondary vocational institutions (Brown & Kayser, 1981).

## Statement of the Problem

Presently, there is no standardized, well accepted model applicable to the transition of special needs students into and through postsecondary vocational education programs (Wright, 1980). These students enter from a variety of sources: secondary schools, unemployment, employment, and social service agencies. The following definition of articulation is presented and will be used throughout this report unless otherwise specified:

The student-oriented process, formal and/or informal, designed to guide the transition of students into and through postsecondary educational programs. This process is intended to maximize the students' performance in those programs, while maintaining awareness of their interests, aspirations, educational needs, and availability of appropriate programs. The foundation of this process is the use of established policies that coordinate available resources to insure cost-effective [humane, equitable, responsive, job-related, and/or interesting] educational activities. (Brown & Kayser, 1981, p. 3)

As a result of inconsistent or nonexistent articulation efforts, many special needs students in postsecondary vocational institutions are currently "falling between the cracks", i.e., they drop out of school before staff members discover that these students have special learning needs. In other cases they may also fall so far behind in their class work that they are hopelessly unable to catch up and become competitive, regardless of how much special assistance is provided at that point in their educational program.

When the special needs staff in the Vocational-Technical Division of the Minnesota Department of Education identified this problem, the Minnesota Research and Development Center for Vocational Education (MRDC) submitted a research grant proposal for funds to investigate this "articulation problem" in Minnesota's Area Vocational Technical Institutes (AVTIs). After the MRDC was selected to receive the grant, funding was

initiated for a research program expected to continue four or five years in order to thoroughly explore the ideas and to develop an extensive/effective description of ways in which articulation procedures could be designed and established in one or more Minnesota AVTIs (See Figure 1). However, due to decreased levels of federal funding for vocational education, this project was supported with grant funds for only 18 months. Therefore, the contents of this report reflect the abbreviated efforts of the Articulation Project's staff to understand the state-of-the-art of articulation and to determine if and how ideal articulation efforts should be designed.

### Project Activities

The Articulation Project has accomplished a broad variety of activities which contributed to the understanding of what articulation is, what it ideally should be, what issues are involved, and how the process might be evaluated. The following is a list of the major activities undertaken during this project:

1. A thorough review of the literature related to articulation;
2. A survey of current articulation practices, policies, and preferences within Minnesota;
3. A national survey of the availability and desirability of articulation models in other states;
4. A national symposium with speakers, from across the country, who discussed selected topics related to articulation issues;
5. The publication of a special issue of the journal, Career Development for Exceptional Individuals, containing the proceedings of the articulation symposium; and
6. The design of an articulation model for student transition into and through postsecondary vocational programs.

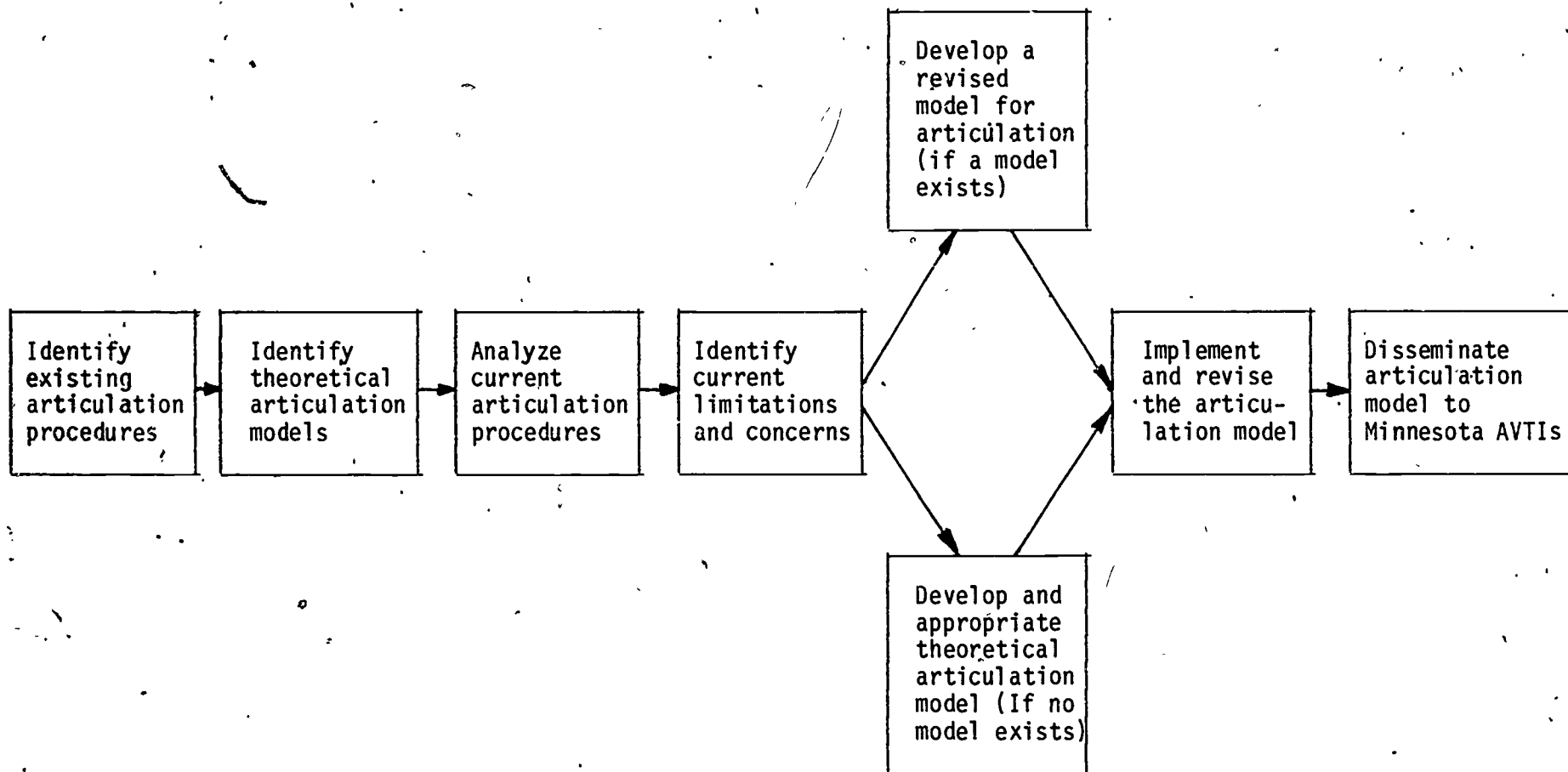

Figure 1. Initial Long-Term Goals for the Articulation Project.

## Literature Review

An extensive search effort failed to identify a wide array of materials in the literature which focus on the transfer of education records containing useful information about students' specific learning needs or on appropriate educational strategies which can enhance students' transitions into postsecondary vocational institutions. Most materials identified in the literature focused only on the articulation of curricula, not on the unique instructional needs of individual students. One of the few references applicable to this study contained a suggested guide to "serve secondary and postsecondary administrators, program faculties, admissions officers...to alleviate articulation problems experienced by students in making the transition from secondary to postsecondary educational programs" (McKinnerney, Thomas, & Todd, 1974, p. 1). In addition to discussing several problems identified in this area, McKinnerney et. al. enumerated 11 different operational procedures and methods of implementation. The guide's contents reinforced the fact that articulation is a complex problem. However, while the guide superficially addressed both the needs of the individual student and the instructional procedures used by an educational institution's staff, the major emphasis centered on curriculum organization.

In 1977, Strom reported the results of a study which examined selected dimensions of the articulation of industrial education programs between the secondary and postsecondary levels. The articulation attributes examined were information, communication, and interaction as they related to administrators, counselors, and industrial education teachers at the secondary and community college levels. He listed the following conclusions: "[a] little coordination now exists between administrative levels for purposes of vertical articulation, [(b)] a lack of vertical articulation exists between counselors at community colleges and public secondary schools, and [(c)] vertical articulation was not apparent

between industrial education teachers at the two educational levels studied" (p.26).

Strom also concluded that: "[a] professionals who are not directly involved in the delivery of industrial education instruction in the classroom have different perceptions of vertical articulation than do teachers, and [b] industrial education faculty at both the community college level and public secondary school do not agree that program interaction exists between the two levels" (p.26). Thus, there clearly is now a void that could be filled by an effective articulation model which would interconnect the efforts of vocational staff in both secondary and postsecondary level institutions.

Wright (1980) focused on articulation as "the process of communication... [which] provides for continuity throughout the student's educational experience. This allows the student to complete occupational training more quickly, at less cost, because repetition of learning experiences could be minimized" (p.47). The following were listed as areas to be articulated: (a) funding, (b) legislation, (c) curriculum, (d) postsecondary policies and procedures, and (e) student needs. Wright also noted that administrators, faculty, support services personnel, and students and their parents contribute valuable input in the development of vocational programs' communication networks. However, the needs of special populations often mandate input from additional groups which are external to postsecondary educational institutions. These may include: (a) federal agencies, (b) state agencies, (c) local education institutions, (d) local human resource agencies, (e) medical and psychological services, and (f) business and industry. Wright also acknowledged that no nationally known model for articulation existed for meeting the needs of handicapped vocational education students. However, she assumed that the variations in articulation efforts from one educational system to another may preclude the use of a preconceived articulation model for all educational agencies (Wright, 1980).

Wright's hypothesis denies the possibility of identifying articulation concepts and processes which are applicable to many educational institutions. The hypothesis assumes that articulation processes are too complex to permit useful commonalities to be identified, analyzed, and used as the basis for developing generalizable articulation models. This assumption appears to have been reached without adequate efforts to identify commonalities among articulation processes in a variety of institutional settings. The efforts of the MRDC's articulation project have focused on identifying key processes and resources and on attempting to understand the dynamics of how they can best be enhanced to maximize the effectiveness and efficiency of the articulation process. Unfortunately, the literature contains little additional material that reflects specific efforts to understand and/or enhance articulation processes focused on students' educational needs.

#### Telephone Survey of Articulation Practices in Minnesota

In order to determine the articulation state-of-the-art in Minnesota, persons knowledgeable of such processes were surveyed by telephone. This survey focused on the following key questions:

1. What types of articulation efforts were currently in place?
2. What form(s) should articulation take?
3. What information should be included?
4. Who should be involved in articulation efforts?

Sample. The articulation survey collected information from: (a) secondary vocational educators, counselors, and special educators; (b) postsecondary vocational educators; (c) counselors for the Division of Vocational Rehabilitation (DVR); (d) parents/advocates for special needs students; and (e) postsecondary vocational special needs students (see Table 1). Parents were selected via announcements in newsletters of



advocate organizations and special needs students were selected by support services managers at two AVTIs. However, unlike all other participants, the students were interviewed anonymously and in person. Vocational educators and DVR counselors in the sample were randomly drawn from State personnel directories. These educators and DVR counselors were initially contacted by means of letters which described the purposes of the articulation project and requested participants to indicate the time(s) and date(s) which would be most desirable for a phone contact. Respondents were asked for their candid reactions to a series of questions relevant to the articulation process.

Findings. The key questions were addressed in a telephone interview survey by means of a series of open-ended questions. These questions assumed that personnel in high schools and community agencies were the major sources of student-related information which would be of value to postsecondary vocational educators seeking to enhance the successful transition of special needs students. Likewise, postsecondary vocational staff were considered to be the direct or indirect recipients of that student-related information. The results of this survey were aggregated and analyzed and are reported in the following section in outline form.

Table 1  
Telephone Survey Respondents

<u>Respondent Group</u>	<u>Number</u>
Secondary*Administrators/Supervisors	32
Postsecondary Students*	21
Postsecondary Staff	15
DVR Counselors	13
Secondary Teachers/Coordinators	9
Parents of Special Needs Students	2

\*Students were interviewed in person.

I. Question: "What is being done in your school system/program regarding articulation?"

A. Major issues identified:

1. Services now being provided?

- a. Very little similarity exists between the efforts provided in schools of different sizes and in varying regions of the state.
- b. The greatest range of services is provided by secondary personnel, followed closely by DVR counselors.

2. Respondent comments about articulation efforts.

a. Secondary:

- 1) There is genuine concern about vocational special needs students desiring to go on to the postsecondary level.
- 2) Little imagination has been used to assist the articulation process.

b. Postsecondary:

- 1) Some school districts provide extensive help in the articulation process (typically those AVTIs serving large numbers of special needs students).
- 2) Existing procedures are probably the result of trial and error (in terms of strategies and personnel utilized).
- 3) Some AVTIs provide little or no special services that would assist special needs students to be successfully articulated. There are strong feelings of uncertainty about what should be done. These persons seem fearful about the implications of potential new responsibilities and demands.
- 4) Thus, some persons are resisting any attempt to offer an expanded range of services.

B. Conclusions:

1. The current range of articulation services is great -- from nothing to extensive with no apparent consistency from one geographic region to another.
2. Various job titles are involved in this effort (at least eleven agencies or job titles assist in articulation efforts).
3. There is a need to standardize the articulation process, regardless of the person/agency delivering services.
  - a. To assure complete service to student.
  - b. To minimize the burden on the deliverer of the service(s).

II. Question: "What information about students should be transferred?"

A. Major issues identified:

1. Various forms of information are needed by AVTI staff, depending on students' type and degree of

special needs (e.g., disadvantage, mental, physical).

2. Can the admission application form be used to identify the information needed to help the students or their teachers?
3. DVR personnel were reluctant to release anything but basic information, yet most felt it is important to share information to avoid duplication of time and costs.
4. Students tended to feel that their past records should be available to their current teachers *as long as that information was up-to-date*-- e.g., still appropriate.
5. Transferring various bits of student information to unknown persons in postsecondary institutions poses a potential for abuse: indiscriminate use to screen applicants, to bias staff expectations, etc. Thus, only general information is often transmitted, such as student transcripts and course descriptions.
  - a. Many respondents indicated their willingness to verbally communicate with AVTI staff, thus giving additional information directly to specific staff who they feel can correctly use that information.
  - b. No effective/efficient standardized articulation "systems" were found to be formally operating in Minnesota.
6. What are the advantages/disadvantages of written versus verbal information exchange?
7. How can the probability of misinterpretation of data be reduced?
8. How do postsecondary staff determine what information to ask for while not knowing what is available?

B. Conclusions:

1. Most of the persons who were concerned about information transfer were at the sending end.
2. Postsecondary special needs students were less concerned than educators about controlling or limiting information transfer.

3. Most potential "information suppliers" wanted to maximize the information available at the postsecondary level but many were concerned about potential misinterpretation of the data and/or improper use of it.

III. Question: "Who should collect and transfer information to be articulated from the secondary school?"

A. Major issues identified:

1. Twelve job titles were suggested.
  - a. They ranged from individual students - to teachers - to support staff - to counselors - to principals.
2. Counselors did not want additional work.
3. Since several people would probably have important information to contribute, combinations of various job titles should be involved, depending on the needs of specific students in question.

B. Conclusions:

1. A staff member should be designated "Articulation Manager" and assigned the responsibility of requesting student-related information from specific sources on students with sufficient knowledge of the student to provide useful suggestions.

IV. Question: "Who should receive articulated information?"

A. Major issues identified:

1. Three recipients at the postsecondary level (noted consistently), are believed to be appropriate:
  - a. Admissions office staff.
  - b. Counselors for the vocational area in which students plan to enter or the special needs coordinator/director.
  - c. The instructors who will teach the student.

B. Conclusions:

1. Persons receiving student information must be aware of the support services available for them in order to use that information most effectively.
2. Educational information about students is not always sent to the appropriate persons.
3. Several respondents felt that additional training for postsecondary staff should be provided regarding the interpretation of students' academic, intellectual, or social data as it applies to their specific programs and the students' interests.

V. Question: "Is it legal to request information about special needs students exceeds that required for regular students?"

A. Major issues identified:

1. Answers given - Both YES and NO
2. Key determinant - Respondents' knowledge of the Buckley Amendments or Family Educational Rights and Privacy Act (Public Law No. 93-380) (Educational Amendments of 1974).
  - a. Most respondents stated that they provided nothing in the way of written data without the written permission of the client or their guardian.
  - b. Some school districts follow the same procedures used with regular students and, thus, do nothing extra.
  - c. Many felt it is legal to provide additional information since they felt the material was necessary for the student's chance to succeed in the program.
  - d. Several persons felt that any information which is released must be relevant to the student's educational program.
  - e. Cost effectiveness a major consideration. The information often exists at the secondary level but it must be officially requested by postsecondary level staff.
    - 1) This additional step increases costs, time, and effort that could be spent elsewhere.

- 2) The process of requesting information can delay the availability of valuable information by several months.
- 3) Information is often limited because the request must be for specific data and postsecondary schools often are not aware of what data currently exists and what does not.

B. Conclusions:

1. Many of Minnesota's vocational educators do not adequately understand the legal issues which impact the dissemination of information about students after those students enroll in other educational institutions.
2. Misinterpretations of the laws impacting the release of student information sometime inhibit and/or reduce the efficiency of other educators' efforts to properly educate special needs learners.

VI. Question: "Other concerns not of a legal nature?":

NOTE: This question was inserted to provide the respondents an opportunity to think about and determine additional constraints, barriers, or reservations associated with articulation, primarily from their individual perspectives.

A. Major issues identified:

Generally the responses can be loosely clustered into two major categories: (1) *procedural* in nature and (2) *individual* in nature.

1. Procedural concerns:
  - a. Extra time and funds may be required when implementing articulation processes.
  - b. There is a possibility of gathering duplicate information.
  - c. Secondary schools often assume the responsibility to promote special needs persons' aspirations to go to college, but not to other forms of post-secondary training such as vocational education.

d. The perceived burden of increased "paperwork" (record keeping/communications) is genuinely feared by many respondents.

2. Individual concerns:

a. The fear of burdening students with stigmatizing labels while enrolled at the postsecondary school.

b. The potential transfer of biases and prejudices.

c. A commitment to the valid interpretation/use of test data and student files.

d. The need to use only up-to-date data, reflecting only the present status of the student.

e. How many people will have access to this information, and will it be released indiscriminately?

f. Not every postsecondary program has a person trained and qualified to select or provide appropriate services for special need students.

B. Conclusions:

1. Articulation efforts have little chance of being accepted if they consume substantial amounts of school resources or replicate existing procedures.

2. The typical emphasis in secondary institutions on "college preparation" is currently a higher priority than successfully articulating special needs students into AVTIs.

3. There are currently no safeguards to assure that articulated student data will be properly interpreted by qualified persons or that instructors will be told how to prescribe modified instruction.

4. An articulation model must contain safeguards to avoid perpetuating biases and misunderstandings about a special needs student.



VII. Question: "What student information is currently being sent to vocational program?"

A. Major issues identified:

1. Trends from the sending end:

- a. Traditional forms of information - grade transcripts attendance records and course descriptions.
- b. Less typical forms of information - health, IEP-related, psychological and behavioral, staffing reports, successful instructional methods for student, and competency check lists.
- c. Modes of communication:
  - 1) Written
  - 2) Verbal

2. Trends from the receiving end:

- a. Information typically received - transcripts, admission application data, plus some IEPs and a few agency and medical records.
- b. Source of discrepancies about information sent:
  - 1) Postsecondary staff may not have been totally aware of all types of information received.
  - 2) Secondary staff may have embellished their efforts by listing all forms of information ever sent, however, many types of information are probably only rarely sent.

B. Conclusions:

1. It appears that many inconsistencies exist in the ability of current informal articulation systems to transmit or use useful student information.
2. If data transferral processes could be formalized, both sending and receiving educators could serve the needs of special needs students more effectively.

- a. School personnel will know what information is available to expect or what to ask for.
- b. Special needs students will have better opportunities to successfully complete their vocational training.

VIII. Question: "Who receives the information and who has access to it?"

A. Major issues identified

- 1. Two major groups tend to receive student information.
  - a. The admissions office
  - b. Counselors
- 2. Beyond these responses - no consistent trends existed.
- 3. Low incidence responses:
  - a. Work experience coordinators
  - b. Special needs coordinators
  - c. Remedial teachers
  - d. Case managers
  - e. Content area teachers
- 4. Major concerns expressed by respondents.
  - a. After going through official channels, information may not find its way to persons who need it and can make use of it.

B. Conclusions:

- 1. There seems to be a need to provide inservice training to at least one person at each post-secondary vocational institution to receive, interpret, and synthesize student information for distribution to other staff members who have a "need to know".

IX. Question: "What is being done with the information that has been articulated to the AVTIs?"

A. Major issues identified:

1. Persons outside the postsecondary institutions -
  - a. Didn't know how articulated student information was being used at the postsecondary level.
  - b. They hoped it was being used in a professionally responsible manner.
2. Persons within the postsecondary institutions noted various uses for student information -
  - 1) Planning and counseling
  - 2) Students with weak scores on various tests (unspecified) were referred to support services counseling.
3. Due to the lack of standardization or even an awareness of current information-use practices, it was impossible to evaluate the effectiveness of information supplied to postsecondary programs.

B. Conclusions:

1. Cooperation by educators in secondary institutions is inhibited since they currently have no safeguards that student data which they release to other institutions will be used in ways that will benefit students.
2. Minnesota's AVTIs are not consistent in their efforts to use student data to assure the effective articulation of special needs students.

X. Question: "What information must be received?"  
(Answered only by postsecondary respondents)

A. Major issues identified:

1. Types of information identified (aggregated, NOT necessarily selected by all respondents)
  - a. Skill levels
  - b. Aptitudes

- c. Strengths and weaknesses
- d. Mathematics and reading data
- e. Health information
- f. Medications used
- g. Interpersonal problems
- h. Psychological test data
- i. Individualized Education Program (IEPs) details
- j. High school grade records
- k. Vocational evaluation/assessment
- l. Information related to student safety concerns (e.g., equipment usage limitations)
- m. Learning abilities
- n. Learning needs
- o. Personal interview results
- p. Personal contact with high school personnel

NOTE: This list goes far beyond what is now typically provided by secondary schools.

- 2. It does not appear that all of these forms of information will be necessary for each student, nor for each program.
- 3. Perhaps this list would be useful as a guideline for an "articulation" specialist.
  - a. Staff members could then request specific information about any of their students, which would be more cost-effective in terms of timeliness of receiving the information and the need to duplicate such information.

B. Conclusions:

- 1. Although a great variety of forms of student data are released by secondary institutions, there is little consistency in the dissemination

of anything other than school grade reports and course descriptions. Thus, the comprehensive range of data required for effective articulation efforts exceeds that currently provided by most Minnesota secondary schools and social service agencies.

2. The initiation of an articulation system will require postsecondary institutions to have an "articulation manager" who can interpret student data and provide special needs students' teachers with instructionally-related information that will enhance the success of articulation efforts.

XI. Question: "Would you use an articulation system, model, or procedures?"

A. Major issues identified:

1. Most responses were affirmative.
  - a. This was probably in reaction to the belief that current data communication efforts are ineffective and that too many special needs students are failing in postsecondary programs.
2. There were many indications of concerns among respondents.
  - a. An articulation system must be flexible.
    - 1) To accommodate varying school enrollment/size/natures.
    - 2) Different geographic considerations, i.e., urban, suburban, and rural.
  - b. We must avoid biasing teacher expectations.
  - c. Potential increases in costs and the requirement for additional staff must be avoided or minimized.
  - d. Increased "paperwork" must be avoided or minimized.
  - e. The system must improve services and avoid duplication or gaps in school and agency efforts to supply needed information.

- f. The major focus must be on helping the student, not necessarily the institution.
3. There seems to be substantial support and agreement for standardization and delineation of articulation processes.
  - a. However, as with any suggestions for new processes/procedures, skepticism does exist and must be dealt with when implementing a formal articulation system.

B. Conclusions:

1. There is strong and consistent interest in the belief that an appropriately designed articulation system could enhance the efficiency with which special needs students in Minnesota's AVTIs are educated.
2. For an articulation system to function successfully, it must be based on a conceptual model which adequately accounts for variations in institutional, community, and student population characteristics.
3. Even though all respondents believed that the hypothetical formal articulation system is an acceptable concept, implementation will be inhibited or precluded if initial efforts are not carefully managed in order to focus on students' educational needs, not simply on the needs of institutions.

Summary. The current diversity of informal articulation activities in Minnesota is extensive. However, formal articulation processes are essentially nonexistent. Existing articulation activities lack consistency, their validity is questionable and impact is limited. Unfortunately, most vocational educators are unable and/or unwilling to launch a comprehensive offensive on this problem.

Formal articulation efforts must be designed that can function effectively in spite of the severe financial limitations now prevalent in most educational institutions. In addition, special needs students must be articulated without stigmatizing them with labels and without jeopardizing the

privacy of their educational record files. Efforts to establish formal articulation process can be initiated in Minnesota by selecting qualified staff members in each AVTI to serve as "articulation managers". These persons will assume the responsibility of protecting the privacy of student data while promoting the dissemination of educationally-related student information to those educators with a "need to know." However, these and numerous other complex problems currently associated with educating special needs students in Minnesota's AVTIs require a comprehensive effort which must be coordinated by means of a valid conceptual model, (e.g., formal articulation model). Having established the need for an articulation model, the task of generating such a model remains to be accomplished.

#### National Survey of Current Articulation Efforts

After examining the status and desirability of articulation efforts in Minnesota, it was also judged appropriate to investigate the nature of articulation efforts elsewhere. Otherwise the articulation process could not safely be assumed to be of equal importance, or that similar conditions exist, elsewhere in the country. In order to collect this information without consuming extensive amounts of time and resources, a mailed questionnaire strategy was selected to examine the following key questions:

1. How important is the articulation process, perceived to be?
2. How many states have numerous articulation efforts currently in operation?
3. Are educators interested in improving their understanding of the articulation process?

Sample. This survey utilized a questionnaire which was mailed to staff members in all 50 state departments of education. The sample population selected consisted of persons designated as "supervisors" of vocational special needs programs (see Table 2 for respondents' specific job titles).

Completed questionnaires were received from 36 states, representing a 72% response rate. However, it must be noted that although only one questionnaire was mailed to each of the states, two responses were received from six states and three responses were received from one state. Since no follow-up procedures were conducted to enhance the response rate, the multiple responses from certain states and the relatively high response rate both tend to support the belief that articulation is an issue perceived to be of high interest and significant importance by respondents.

Table 2

Respondent Job Titles Represented In the National Survey

Job Title	Number (N=43)	Percent of Total
Special Needs Supervisor	15	35%
Special Needs Consultant	10	23%
Director of Special Needs Programs	9	21%
Program Specialist	5	12%
Coordinator	4	9%

Findings. The key questions noted above were examined by means of a multiple choice questionnaire containing four questions. The results of this survey were aggregated and analyzed and are presented as follows:

Question 1. "Rate the need in your state to assist special needs students through articulation efforts, including information exchanged between secondary and postsecondary vocational programs."



Level of Need for Articulation Efforts

1	2	3	4	5
None	Little	Some	Much	Great

I. Statistical results:

- A. Mean score = 4.2
- B. Standard deviation = 1.0

II. Conclusions:

- A. With very few exceptions, all respondents indicated that they perceived a very substantial need to assist the articulation efforts of special needs students in their states. Apparently, articulation is consistently believed to be crucial to attempts to effectively serve special needs students. Therefore, it is likely that attempts to systematize and/or to better understand articulation processes will almost certainly be strongly supported by most state special needs supervisors.

Question 2. "Would you be interested in examining an articulation model for possible use in your state's vocational schools?"

I. Statistical results:

- A. Yes = 81%
- B. Maybe = 19%
- C. No = 0%

II. Conclusions:

- A. It is unusual that all respondents expressed positive interest in examining an articulation model, e.g., no one chose the "no" response. To examine any concept where no one responds negatively, is indeed a unique situation and suggests the extent of interest and strong support which state supervisors expressed for articulation. This was later substantiated by the results of question four (see discussion presented later in this report).

Question 3. "Do you have schools in your state which are already engaged in articulating special needs students between the secondary and postsecondary levels?"

I. Statistical results:

A. Yes = 37%

B. No = 63%

C. Of those responding in the affirmative:

1. Only 11 could identify one articulation example in their state.

2. Only 3 could identify two examples of articulation in their state.

3. Only 2 could identify three examples of articulation in their state.

II. Conclusions:

A. Very few states, if any, have readily visible articulation efforts in operation. In fact, almost two-thirds (63%) of the states had no articulation activities which were sufficiently well organized, documented, or publicized to have come to the attention of the state department of education personnel most likely to know of such activities. In the absence of any states with four or more known articulation efforts, it seems safe to assume that formal and/or well-established articulation activities are rare in all areas of the country. It is suspected that even those examples of articulation which do exist are probably of a limited, informal nature and that they are not based on a sound conceptual understanding of the key factors or influences involved. Given such an informal approach, it is essentially impossible to evaluate the impact or effectiveness of such efforts or to identify their strengths and weaknesses. Clearly, a more thoroughly developed conceptual model for articulation does not exist but is greatly needed.

Question 4. "Would you like to be kept informed of the results of this articulation project?"

I. Statistical results (N = 43)

A. Yes = 100%

B. No = 0%

II. Conclusions:

- A. Even though this questionnaire contained only a brief discussion of articulation related concepts, respondents were absolutely consistent in their desire to know more about the topic. Therefore, articulation is assumed to be not only an emerging topic in the special needs area, but also is deemed to be of high interest among state department of education special needs supervisors. Efforts to conceptualize and develop a formal articulation model are, thus, concluded to be worthy of the time and resources necessary to improve vocational educators' understanding of this topic.

Summary. It is apparent that the national trend among vocational educators is to support the concept of articulation. However, few efforts of that nature are being formally pursued at this time. The unanimous response of all respondents was one of interest in the details of a formal articulation model/system, if and when it has been developed and validated. Seldom has such universal support for a prospective educational process for special needs learners ever been encountered.

Limitations. The information derived from the Minnesota telephone survey and the nationally mailed questionnaire is assumed to reflect the opinions of the respondents in each study. The telephone survey respondents described were from a sample of randomly selected school districts in Minnesota while the state vocational special needs supervisors represented the total national population of such persons. The methods used in this study represent an informal approach to research and the data should be re-examined by means of more rigorous methods in order to establish the validity of this study's findings and conclusions. However, in the absence of any other articulation-related data with known validity and reliability, this project is believed to have realistically verified the existence of a variety of articulation problems and to have identified many of the issues and processes related to this issue. Clearly, articulation represents a problem worthy of additional investigation.

## National Articulation Symposium

Based upon a preliminary review of the literature and project staff discussions with a wide variety of educators involved in the education of vocational special needs learners, it became apparent that specific articulation issues should be systematically examined. This was accomplished by conducting a national symposium in October 1980 at the University of Minnesota's St. Paul campus. This symposium systematically examined five areas which are believed crucial to the articulation concept: (a) the impact of vocational special needs legislation, (b) current and emerging special needs-related legal issues, (c) the role of the recently formed Department of Education, (d) the role of individualized education programs (IEP) in the articulation process, and (e) research priorities which may impact future articulation efforts.

Symposium contributors were selected to present papers on each of the five areas listed above. These presenters were instructed to identify major issues within their assigned topic areas, to explore the background of the issues, and to examine potential avenues/methods of resolving these articulation-related issues.

The papers discussed by each presenter were also provided to reviewers. For each paper, one reviewer was asked to: (a) respond to all issues identified by the presenter, (b) critique the presenter's position statements, and (c) evaluate proposed articulation-related problem solutions.

Symposium results. Each of the symposium papers was edited and published in a special issue of Career Development for Exceptional Individuals (CDEI) during the summer of 1981. Copies of the CDEI journal were distributed to regular CDEI subscribers as well as to the following audiences: (a) all symposium participants and presenters/reactors, (b) all persons listed in the National Association of Vocational Education Special Needs Personnel

(NAVESNP) national directory of special needs teacher educators, (c) representatives of selected school and agency libraries across the country, (d) selected secondary and postsecondary vocational administrators/supervisors in Minnesota, (e) NAVESNP's executive board, and (f) the various persons who requested copies of the CDEI issue directly from the MRDC. In addition to the publication of the articulation major symposium proceedings in CDEI, the following discussion highlights the issues identified during the symposium.

The legislative discussion by Michael Brustein provided new insights into the "excess costs" problem as it impacts the funding of vocational special needs programming. Brustein concluded that the excess costs may have actually had a negative effect upon special needs students (Brustein, 1981). Reactor Gary Meers expanded the discussion of federal legislation's influence on vocational education's services for special needs persons. He primarily focused on exploring the relationships between vocational legislation and other socially stimulated legislation which was designed to improve the quality of life for special populations (Meers, 1981).

The legal issues were examined by presenter Frank Laski, who identified four major concerns related to legal arguments for educating the handicapped: (a) exclusion from services, (b) integration with nonhandicapped persons, (c) the availability of appropriate program and support services, and (d) the application of state-of-the-art technology in education. This presentation focused not only on applicable legislation, but also on the results of related court decisions involving the service of handicapped persons (Laski, 1981).

Bruce Balow tended to disagree with Mr. Laski's emphasis on the use of state-of-the-art technology in education. Balow noted that the research literature has failed to provide any supporting evidence that one educational technology is significantly superior to others for the handicapped. Thus, it was suggested that insufficient knowledge currently exists

which would allow the selection and application of high technology approaches to the education of the handicapped with the assurance that the most appropriate educational technology was being used (Balow, 1981).

Jane Razeghi's presentation, in collaboration with William Halloran, provided a national perspective of problems faced by vocational and special educators. Ms. Razeghi's presentation focused on the following major issues: (a) the attitudes of vocational educators towards handicapped people, (b) disparities among funding allocations from state and local educational agencies, (c) the lack of coordinated efforts among agencies, (d) the lack of clear definitions and identification procedures for special needs students, and (e) the absence of mandates or policies that would make postsecondary training more readily available to handicapped persons (Halloran & Razeghi, 1981).

Gordon Krantz responded by noting some of the paradoxes which impact vocational educators attempting to serve special needs students. He suggested that a "caseload management" strategy, as modified only slightly from similar methods used successfully in vocational rehabilitation, would provide a potential solution to the problems associated with delivery of vocational education to special populations (Krantz, 1981).

Maynard Reynolds examined the use of the IEP as a facilitating tool for the articulation process. He proposed that IEPs may prove to be useful in admission processes, the modification of educational programs, financial assistance decisions, and the assessment of instructional needs. However, before these actions can become feasible, Reynolds believes that a variety of potential problems must be explored and/or resolved. Among those issues are the following: (a) the ownership of personal records as specified by the Buckley Amendments (P.L. 93-380) (Education Amendments of 1974), (b) accountability for services delivered, (c) the individualization of instruction, (d) professional development

of staff, and (e) a variety of factors or relationships related to the articulation context (Reynolds, 1981).

Carole Johnson's reaction to Reynold's presentation stressed the importance of fostering more efficient cooperative working relationships between various agencies serving special needs clients. Articulation activities, however, will not automatically emerge or produce far-reaching benefits unless adequate time and efforts are spent to develop and implement articulation processes (Johnson, 1981).

Recommendations regarding desirable areas of articulation-related research were provided in Rodney Riffel's presentation. Riffel noted his belief that articulation is, by nature, an undertaking involving multiple agencies. Therefore, he argued that articulation research must focus on the personal concerns and changes experienced by individuals during transition processes, as well as the development of agency linkages (Riffel, 1981).

The final presentation of the symposium was Nancy Hartley's response to Riffel. Hartley focused primarily on the importance of including needs assessment among the initial stages of efforts to provide postsecondary vocational education to handicapped students. Finally, she asserted her belief that effectively designed research efforts can "help us identify the best methods to bring these changes more effectively, how to use information that has already been developed, and how to expand areas that have been considered atypical in vocational education" (Hartley, 1981, p. 98).

Symposium-related conclusions. Admittedly, the articulation symposium produced more new questions than answers about the articulation process. However, it is now clear that effective, efficient articulation processes could comprise a significant aspect of efforts to reduce the losses in productivity which result from an inadequately trained citizenry (Brown, 1981). The following factors have been proposed to be indicative of issues which will significantly

impact efforts to provide postsecondary vocational education opportunities to special needs learners during the 1980's and beyond:

First, American educational institutions are diverse and not always compatible in terms of philosophies and procedures. Second, many vocational educators are inadequately prepared to serve special needs students. Third, the federal mandate to better serve special needs populations involves complex interactions among a wide array of institutions and agencies in an emotionally charged social environment. Finally, potential methods and systems for attacking these problems are now merely speculative and have yet to be proven acceptable or effective (Brown, 1981, p. 108).



## Conclusions

The surveys of Minnesota educators and a sample of special needs supervisors in states across the country consistently provided evidence of the value of formal articulation activities and procedures. In addition, there is a strong belief that a model or system should be developed that could be effectively implemented in order to improve the ability of special needs students to make the transition into and through postsecondary vocational education programs.

## Recommendations

As initial efforts are undertaken to establish a formal articulation model in hopes of enhancing the transition of special needs students, the issues depicted in Figure 2 must be considered in order to minimize problems and to maximize success;

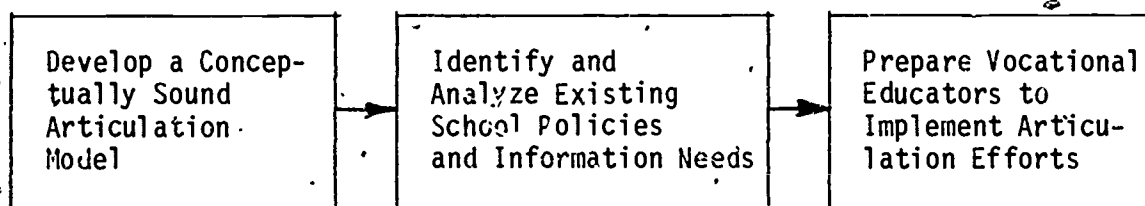

Figure 2. Recommended activities to minimize articulation-related problems.

### I. DEVELOP A CONCEPTUALLY SOUND ARTICULATION MODEL:

- A. A functional model or system must be developed and adopted to guide the articulation efforts for serving postsecondary special needs students.

II. IDENTIFY AND ANALYZE RELATED SCHOOL POLICIES AND INFORMATION NEEDS:

- A. Before implementing an articulation model or system, special needs staff members in the AVTIs should do the following: (a) identify specific program-related instructional needs which apply to special needs students; (b) examine and interpret district policies, if any, which apply to articulation activities; and (c) determine the nature of the school's special needs population, i.e., handicapped, disadvantaged, limited English-speaking.

III. PREPARE VOCATIONAL EDUCATION TO IMPLEMENT ARTICULATION EFFORTS:

- A. Many educators fear being overwhelmed by the seemingly immense nature of an articulation effort. This fear tends to be particularly intense in secondary and postsecondary schools where few or no articulation efforts have occurred previously.
- B. Each person involved in the articulation process should be able to understand and effectively use educationally relevant information which is applicable to that person's effort to serve special needs students' educational needs.
- C. In spite of the problems and fears associated with implementing articulation efforts, many such negative factors can probably be overcome by providing appropriate training experiences for and to the educators directly and indirectly involved in articulation. Thus, some form(s) of inservice training should be provided to articulation-related

educators. One of the goals of these inservice programs must be to improve the skills of educators to better analyze and utilize applicable student data.

The articulation process is conducted within complex, ever-changing environments. However, key attributes have been identified which must be accommodated when designing a formal articulation model. Those attributes are noted in Figure 3 and further elaborated as follows:

I. INTER- AND INTRA-INSTITUTIONAL NATURE:

- A. Articulation efforts must cut across discipline, agency, and institution boundaries in order to identify and access numerous sources of information and services. That is, information must then be effectively communicated to appropriate persons within the AVTI.
- B. Cooperative agreements to transfer and/or release information must be established between AVTIs and other schools, institutions, or agencies which can provide articulation-related services and/or information.

II. APPROPRIATE ASSIGNMENT OF PERSONNEL DUTIES:

- A. An articulation "contact person" must be established at each applicable referring secondary school or agency.
- B. An "articulation manager" must be established within each AVTI, who would have prime responsibility for implementing articulation-related efforts.

### III. PRE-INSTRUCTIONAL ORIENTATION OF STUDENTS:

- A. New students entering vocational programs should attend orientation meetings where the following items will be discussed: typical activities and requirements in each vocational program, related employment opportunities and their typical geographic location available to students, the type of counseling and support services available within the postsecondary institution, and the nature of other training programs available within the institution.

### IV. EFFECTIVE IDENTIFICATION AND ASSESSMENT OF SPECIAL NEEDS STUDENTS

- A. Informal assessment of all new postsecondary students by their instructors in terms of their performance in the vocational program. This will require inservice activities to assure the instructors' ability to collect useful data.

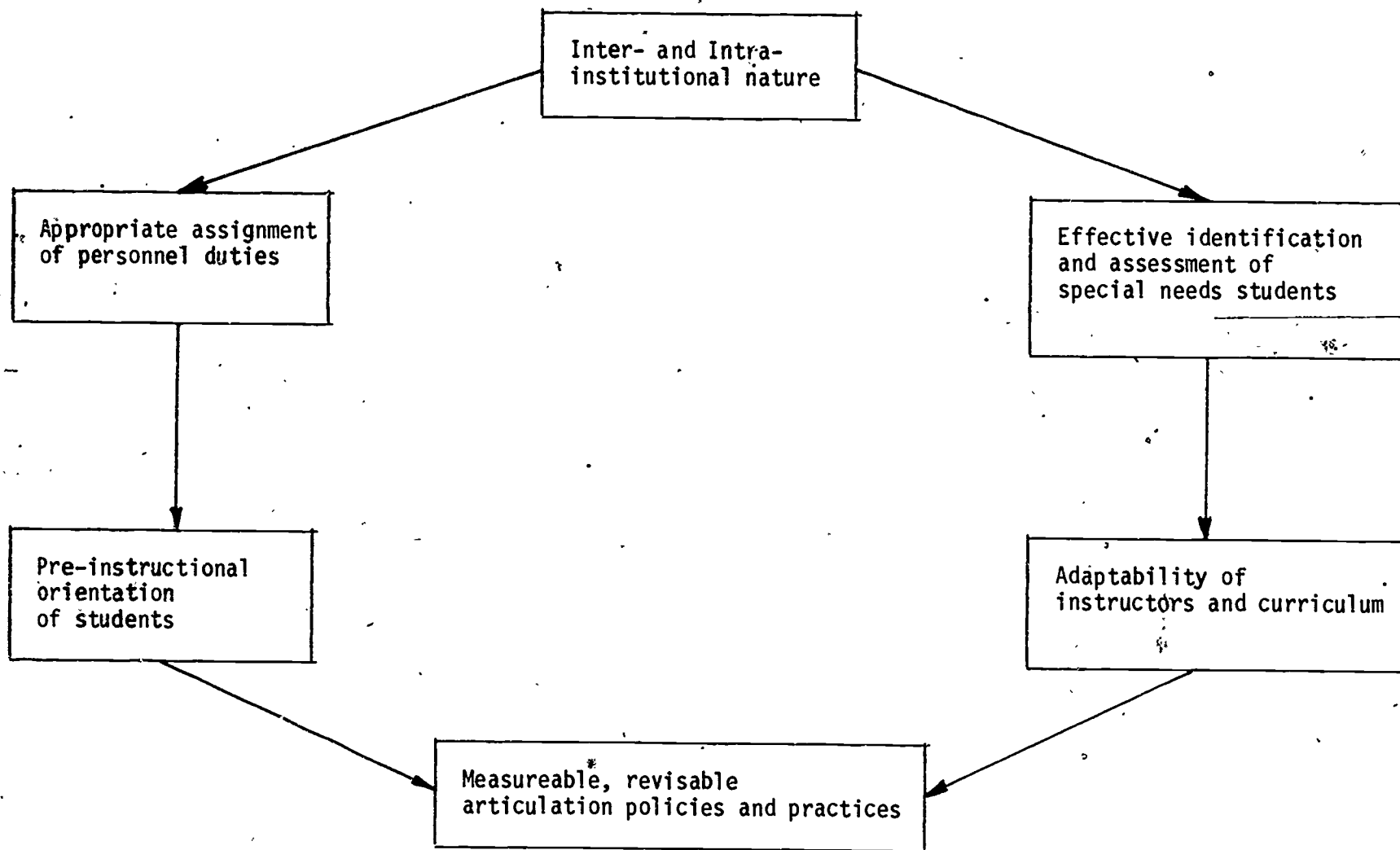

Figure 3. Required attributes of an articulation model.

- B. Formal assessment of special needs students' abilities, e.g., reading and mathematics skills, by postsecondary support services staff. This could include assessment data drawn from testing in a "performance sample" which simulates the students' chosen training programs.

#### V. ADAPTABILITY OF INSTRUCTORS AND CURRICULA:

- A. Instructors and instructional programs which can adapt to the unique educational needs identified among special needs students.

#### VI. FORMAL, REVISABLE ARTICULATION POLICIES AND PRACTICES.

- A. A monitoring system should be established to evaluate the effectiveness and validity of each stage of the transition process. Program stages found to be functioning poorly should then be revised to better serve special needs students.

#### The Future of the Articulation Model

This concludes the discussion of issues related to the need for developing articulation model for Minnesota's AVTIs. Part Two of this report will focus on identifying and analyzing potential components and forces which must be accommodated by a formal articulation model.

Note: The term "articulation" has been found to have too wide a variety of applications/ definitions and, thus, is confusing and misleading. Therefore, during the remainder of this report the term "transition" will be used instead.

## PART TWO

### Articulation/Transition: Designing a Procedural Model

The first part of this report elaborated on the need to develop a transition model, based on the belief that too many special needs students have failed to successfully complete postsecondary vocational education programs. In addition, the five project activities that were accomplished during the 18 month duration of State Department of Education funding were identified and discussed in detail. (See page 3) The sixth activity, the actual design of a transition model (referred to previously as "articulation") to improve student movement into and through postsecondary vocational programs, will be the central focus of the remainder of this report.

The development of a conceptual model of the student transition process, understandably, represents a difficult task. Many of the variables that must be considered are readily apparent, while others must be drawn from the literature or by analyzing appropriate research data. For example, five general transition factors were identified as a result of the telephone survey and will be discussed in the next section. After the relationships of these variables to the model are examined, the framework of a transition model will be discussed. At the current stage of this investigation, it is important to recognize that it is feasible to develop only the framework for such a conceptual model. The development of a more precise, i.e., measurable, model would require additional work, including the development of a means to empirically test the effectiveness of transition processes. Such work will necessitate an iterative process of model building, data collection, and then model revision, etc. Although the proposed framework may not resolve the immediate problem of excessive termination rates among special needs students in Minnesota's AVTIs, this report should serve as a basis for future

development and refinement of the transition process. Let us begin by examining the five general factors identified by staff in postsecondary vocational programs.

### General Factors in the Transition Process

The statewide telephone survey of secondary education, postsecondary education, and vocational rehabilitation personnel as described in detail in Part One of this report, identified three critical factors related to current transition efforts. These factors are:

1. Many different persons are involved in helping the special needs student make the transition into postsecondary programs.
2. There were many different procedures currently in use to assist in this transition, and their effectiveness is unknown in many cases.
3. Information related to the transitioning student was often not shared with all appropriate parties in the transition process.

While survey respondents indicated that current transition practices have exhibited limited effectiveness, they were also dissatisfied with the overall results of the transition process. There appeared to be agreement among these respondents that a more standardized procedural model is needed, and desired, to make their work easier and to improve special needs students' transition into postsecondary vocational education programs.

Several issues are related to the three factors listed above. First, because many different job titles were involved in the transition process, attempts to provide either preservice or inservice training to staff must, by necessity, be given to a wide range of persons. These persons serve in a variety of staff and administrative capacities and, thus, may not equally acknowledge or understand the importance of this problem.



Second, because the respondents identified a wide variety of transition procedures, it may be assumed that without a more "standardized" process, the results of any one individual's efforts are likely to be hit-and-miss. However, one important question that should be answered in subsequent research efforts is what type and amount of information best facilitates the transition of the special needs student.

The third issue deals with student information. In addition to questions about the nature and extent of information about the student, questions relating to who should provide this information and how can it be best used to enhance the transition both into and through the postsecondary vocational programs must also be answered. In conclusion, there appears to be definite concern both at the administrative and practitioner level with excessive numbers of special needs student non-completers. These vocational educators recognize the need to change the procedures involved in the transition process and the basic nature of that process.

Despite the apparent interest expressed by respondents about the development of a model of transition that would benefit special needs students, they expressed concerns about the possible form such a model should take. These concerns were discussed in Part One and listed in Figure 3. Concepts and issues identified during this project have been synthesized from responses into five general factors. These factors help establish the form and boundaries of a transition model and are: (a) flexibility, (b) compatibility, (c) specificity, (d) timeliness, and (e) measurability. The following discussion will elaborate on meanings of each of these needs.

Flexibility. The respondents in the statewide survey represented professional educators from different population centers - rural, urban, and suburban - and from institutions with varied enrollments levels and transition-related staff functions. It became apparent during the interviews that any model proposed must accommodate the needs of individual

educational institutions. A model developed specifically for an urban vocational program cannot be assumed to also be appropriate for use in a small, outstate, rural AVTI. Therefore, any model developed to facilitate transition efforts must be sufficiently general to allow it to be adapted to all AVTIs, while still being capable of serving the unique needs of each institution.

Endeavoring to simultaneously achieve flexibility while maintaining some degree of standardization that will facilitate measurement and monitoring of students' progress is, indeed, an ambitious but desirable goal. However, it should be apparent that the more flexible the model, the more difficult it will be to monitor transition-related processes.

Compatability. This factor emerged from efforts to identify the wide range of persons and agencies with potential involvement in transition processes. Any model proposed, therefore, should consider all prospective institutions and agencies, as well as their varied perspectives on client needs. The two agencies most likely to work with AVTIs are the Division of Vocational Rehabilitation (DVR) and the Comprehensive Employment and Training Act (CETA) offices. These agencies, however, have somewhat different goals for their clients than does Vocational Education. These differences highlight the need for interagency compatability. Two basic areas that need to be addressed here are the procedures that clients or students are exposed to and agency terminology or jargon. The development of a mutual awareness and understanding of the goals, procedures, and languages of these different agencies will be an important step toward achieving effective transition processes.

Specificity. This characteristic suggests that a model must be capable of measuring an individual's progress through the transition process. In addition, the model should be capable of guiding efforts to determine the overall effectiveness of total programs, as well as specific courses.

Individual students' performances must be routinely evaluated in terms of transition into and through the various phases of postsecondary vocational education. Since numerous factors may be associated with the success or failure of both individual students and specific institutional programs, determination of which works the best for individual students must often be made on a case-by-case basis. It must be stressed, however, that both student and program-related measures are necessary due to the interdependence of students and programs.

Timeliness. This characteristic refers to the transition model's ability to identify students who need special or supplemental services early in their postsecondary program experience. Special needs students are often not identified when they enter postsecondary programs and it thus becomes critical that AVTI staff identify students with special learning needs as early as possible. It is assumed that appropriate educational and non-educational services either are available within the institution or can be procured to meet the transition-related needs of a wide range of students. However, timeliness refers not only to the process of identifying these needs prior to instruction, but also includes on-going efforts to identify and provide appropriate services, as needed, for students during their entire educational experience.

Measurability. Although last to be examined, this factor is very critical in a transition model and was alluded to in the other four general factor areas. If the impact the model or of any of its components cannot be measured, their effectiveness cannot be determined. Hence, it is impossible to determine which problem areas contribute to the excessively high dropout rates of special needs students. The model must be equally measurable in all AVTIs state-wide: those with open-entry, open-exit programs as well as those with more traditional admissions policies. Individual students could possibly be assessed in relation to their past performances as well as in comparison to performance levels "typically" achieved by

students in given phases of vocational education programs. Therefore, the discrepancy levels between typical and actual performance which can be tolerated before special assistance is prescribed must be determined. When a student's performance is monitored in this manner, staff can more effectively identify problem areas in programs and provide appropriate remedial assistance when needed.

These five factors provide guidelines for conceptualizing the framework upon which the transition model will be built. However, these characteristics may be difficult to attain simultaneously. The problem is exaggerated by the fact that there are, literally, no existing models addressing this topic. Thus, any proposed model must be treated as tentative until pilot-tested in a variety of postsecondary vocational institutions and preliminary analyses have been made to determine its utility for promoting transition processes. Figure 4 contains the critical transition model features that have been identified by this project thus far.

#### Information Exchange As a Facilitator of Transition

Social service agencies at the federal and state levels are currently interested in exploring the potential usefulness of interagency agreements. For a small percentage of the students enrolled in Minnesota's AVTIs, such interagency agreements among local and regional social agencies may facilitate the transition process. The agencies referred to here are DVR, CETA, and local school districts. It may be possible, for example, for some form of information record to act as a unifying force of common agreement among agencies at this level. While policy and procedural agreements tend to be formal and abstract, the exchange of specific, pertinent client/student information could readily be seen as concrete evidence of such agreement and cooperation.

Similar Groups of Transition Model Characteristics/Issues

General Factors

Measurability

Timeliness

Specificity

Compatibility

Flexibility

Survey Identified Factors

Measurable, revisable transition policies

Effective identification and assessment of special needs students

Appropriate assignment of duties to specific personnel

Intra- and inter-institutional focus on transition processes

Adaptability and flexibility of staff and curricula

Pre-instructional orientation of students entering the institution

Figure 4. A categorization of factors impacting conceptual models of the transition process.

However faddish the concept of interagency agreements is, relatively little information is available to suggest that actual procedures are in place at local levels of service. For example, Phelps (1981) reports in a compendium of interagency agreements that the most common activity or procedure (used in 90% of states reporting) was the development of an interagency task force comprised of state agency staff. Only 8% of the states reported having policy guidelines for local agencies to follow. However, since multiple agencies often serve the same client, it is important that the content of shared client records be readily and accurately understood by the different agencies' personnel. Thus it appears that interagency agreements at a local or regional level are critically important and that they should include provisions for information exchange if more special needs students are to surmount the barriers in the transition process.

#### National Symposium Topics

One of the topical presentations at the National Symposium on Articulating Special Needs Students into Postsecondary Vocational Education Programs held at the University of Minnesota in October 1980 focused on the use of the IEP to facilitate this transition. Reynolds (1981) stated that the use of the IEP would provide pertinent information about handicapped students and their previous educational programs. He believed this information would be very useful during the transition into postsecondary vocational programs. This assumption seems rational in light of the fact that such information is gathered over an extended time period at substantial costs, and by specially trained professionals in the field of education.

However, Johnson (1981) cautioned us about being too optimistic when using the IEP. She stated that the only group of persons now routinely having this information record available are the handicapped who comprise a small proportion of the

postsecondary special needs enrollment. (Lee, [1975] reported that approximately 13% of the postsecondary vocational population were specified as handicapped and received special services in Fiscal Year 1974). Johnson further stated that additional problems may be encountered in obtaining current IEPs containing information that is usable or adaptable to a vocational education program. Finally, it should be noted that other special needs individuals and handicapped persons not receiving special education or rehabilitation services are not required to have IEPs to guide their educational programs. Thus, AVTI personnel cannot expect to have available to them complete, up-to-date records on all special needs persons entering their institution.

For handicapped individuals, usually adults, receiving vocational rehabilitation services, the standard document is the Individual Written Rehabilitation Plan (IWRP) which is similar to the IEP. However, this document is generally constructed without input from postsecondary vocational educators. Principal contributors to this document are the vocational rehabilitation counselor, the client, and possibly the vocational evaluator, if such an evaluation has taken place. Even in the case of CETA clients, specific training or education plans for each individual client are to be developed before services are provided, but seldom include input from vocational educators. It is apparent that a demand for an existing information record prevails for special needs students entering postsecondary vocational programs. However, there are also many special needs students for whom this information is not available upon their entry and must, therefore, be developed after their enrollment. Despite the possibility that student information records may already exist, there are serious questions about the role these information records serve in the transition process.

## The Information Record and Potential Barriers to Gathering Student Data

It is apparent that any transition model will necessitate an information record, for individuals who have special needs which specifies the services previously provided to meet those needs and the impact of those services. Although this record is important, several barriers exist that may restrict the acquisition of existing records or the development of new ones. Among these barriers are: legal requirements, lapse of time, use of information, and usefulness of information to postsecondary staff. Each of these potential barriers will be discussed individually.

Legal requirements. The transfer of personal information related to an individual is a controversial subject. Consequently, there are federal and state laws regulating this information flow. A broad piece of legislation, commonly referred to as the Buckley Amendment and which applies to all students, is the Family Educational Rights and Privacy Act of 1974 (Public Law No. 93-380) (FERPA). A law specifically applicable to handicapped students is Public Law 94-142, the Education for All Handicapped Children Act of 1975. For special needs student other than the handicapped, only FERPA applies to their records. In general, these laws prohibit the dissemination of student information without the students' consent when they are 18 or older, or parental consent when student are younger than 18. However, for handicapped students, where such information was gathered specifically to develop the IEP as required in P.L. 94-142, such records may be disseminated only if the parents, or the student, give their permission. FERPA, on the other hand, states that secondary schools may transfer student records to postsecondary schools to which the student has applied, without parent or student release when other conditions are met. [See Sec. 99.31 and 99.34 (a)(1)(ii)]. Most often this procedure is carried out



routinely, simply because the secondary school has an existing and published policy to share this information. However, this procedure is not allowed in the transfer of data for handicapped students. Even after satisfying the procedural requirements of these laws, there remains an additional possibility that complete, currently valid, and useful information may not be available to postsecondary staff.

Lapse of time. Many enrollees in postsecondary vocational programs do not enter directly from high school (Johnson, 1981). A potential problem arises in this situation since only outdated and/or incomplete information may be available from previous school records. An excellent example is the student's attitude in secondary school as reflected by a poor attendance record. It is possible that after a period of employment (or unemployment) this person may have developed more positive attitudes toward work and school, but this change would not be reflected in their past records. A variation on this theme also includes the student who has been out of high school for several years, that school was located in another state, and the student has received no prior vocational training. Under such circumstances, any attempt to secure school records may be ineffective. These examples help illustrate the potential problems related to obtaining current records of information about students.

Usefulness. This potential barrier refers to the content of materials that may be transferred from a secondary school, DVR, CETA, or other agencies to the AVTI. If these agencies release typical data such as transcripts, attendance records, and general information, the educational usefulness of that data is limited. Much of the student data that would be helpful to vocational instructors and remedial support staff has been generated by teachers, psychologists, social workers, and counselors but under the current laws (FERPA and P.L. 94-142) is unavailable through routine record exchanges. Given the questionable usefulness of routine data that may be legally

exchanged, it may be more practical and/or effective to generate current information within the AVTIs in order to meet the specific information needs of AVTI personnel.

Use of information. The last potential barrier regarding student records is the use of the information provided. If records are forwarded from a secondary school or social service agency, such as DVR or CETA, an assumption is often made that the information will be of use to the receiving institution and will be used effectively by that institution's staff. This assumption may not always be correct. Two factors impact this assumption: who has access to the records, and what is their expertise in interpreting and integrating the information into appropriate instructional strategies that will serve the students' educational needs. One of the reservations reported by counselors from secondary schools and DVR offices during the Minnesota Telephone Survey was that they did not know which postsecondary instructors and other staff would have access to this information. In addition, several counselors expressed a concern over the confidentiality of information and the potential damage this information could cause when improperly used. These counselors were unsure of the postsecondary instructors' ability to properly use test scores or other assessment data to modify their instructional strategies and contents. Underlying their concerns was the perception that additional data beyond the standard transcripts and attendance reports might actually be detrimental to entering special needs students. The student information record may be viewed as an important aspect of the transitional process in that its content summarizes the students needs, the prior educational strategies used, and the results of those strategies. Such a record could promote continuity of services for the individual, since the contents would contribute to achieving the goals of the transition process. However, as it was pointed out, the probability that complete and useful student/client records are available to postsecondary vocational staff may be slight

indeed. Thus, the generation of valid, up-to-date student information is a necessary and realistic means to facilitate the transition of students with special needs.

The effect on the transition process, of student information that may not be used, has limited usefulness, or is unavailable, is not presently known. The telephone survey noted that this exchange is haphazard and it may be assumed that the ease of students' transitions may be directly related to the identification and communication of their special needs. Yet, at this time little is known about what types of information would best facilitate this transition and what information would be of no value. In the context of a postsecondary vocational program, any information supplied or otherwise generated about a special needs student should have some utility. Perhaps the most valuable aspect of students' information records is not the individual classes taken or grades achieved, but the identification of instructional strategies that were successfully used to remediate any of the students' special needs.

#### Measurement Units Related to the Transition Process

One of the most effective and reliable means of determining the effectiveness of a process is to measure the outcomes resulting from that process. The Termination Report from the Minnesota Vocational Education Data System VEDS data base for 1979-80 reports that 9,183 (38%) AVTI students enrolled in that school year, dropped out of Minnesota AVTIs. While this figure represents a reliable estimate of the transition related problems in these institutions, lack of specificity limits its usefulness as a measure of the transition process. Similarly, knowing that 1,800 of these students dropped out because of "unsatisfactory program performance" does not represent an effective means of monitoring this transition process.

Despite this lack of specificity, the need for such an information record seems to be well established if the

transition is to be facilitated. To hope that such useful information may be available to AVTI staff at the time the student applies for enrollment is another issue. If this past information record provided the only data available during the students' enrollment, it would soon prove to be useless. Thus, for the development of our transition framework, we must take a broader view of the whole process of transition, including the role of the information record, which will encompass both entering into and moving through the postsecondary vocational program.

### A Broad Picture of Transition

Transition should not be thought of as only the process of moving between two different educational levels such as secondary and postsecondary programs. This research has been based on the fact that students already enrolled in postsecondary programs were dropping out. A perceived reason for these dropouts was that these students were not being adequately articulated to the next higher program level. Hence, it is apparent that transition "failures" occur along a continuum of time beginning with the admissions process and ending at a time prior to graduation and placement in a related occupational area. Since these students are on a time continuum, it may be convenient to view the services they require as being related to the concept of continuity. To present a broad picture of transition, three additional areas will now be explored. These are: (a) the concepts of continuity especially as they relate to transition, (b) pre-enrollment requirements; and (c) post-enrollment requirements.

#### The Concept and Characteristics of Continuity

The concept of continuity as it applies to social services can be traced to recent applications in the medical field, specifically as it applies to the delivery of primary medical

care (Davidson & Ferloff, 1981). The unique educational services required by special needs students are often analogous to medical treatments. This concept, therefore, with slight modifications, appears to be conducive to the development of a transition model. A definition of continuity, modified to fit educational situations, is stated as follows:

Continuity of services can be defined as the extent to which all educational and non-educational services are received by the student as a coordinated and uninterrupted succession of events, consistent with the individual's unique educational needs.

There are two basic assumptions made by this definition: First, the educational needs of the student are known by someone who can do something about them; and second, services which meet those needs are available within reasonable limits. Furthermore, it is clear that the use of a complete and accurate information record may be a critical feature of continuity as described above. Continuity may be described more fully by examining the characteristics of this concept including: accessibility, comprehensiveness, and coordination. To assist in discussing these characteristics, a diagram of potential services is shown in Figure 5. The services and service agencies in this figure should not be viewed as an exhaustive list, only the most typical ones are included.

Accessibility. This characteristic refers to an educational institution's responsibility to assist each student to overcome the temporal, spatial, economic, and psychological barriers to appropriate vocational programs. Any and all services must first be made accessible to all students, even those with special needs. This includes general services such as outreach, recruitment, and admissions prior to entry into an instructional program. For students already enrolled in vocational programs, accessibility would be observed in the individual's opportunity to make use of such program elements as counseling, program selection, remediation, and non-

educational social services, as well as job placement and follow-up services.

Comprehensiveness. This refers to an institution's ability to provide a wide variety of services, such as those listed under accessibility, that would resolve the majority of the educational problems that students might experience. This characteristic may be constrained by institution size and geographic location. Usually the smaller, more isolated settings tend to be less comprehensive. However, the degree to which related educational and non-educational services must be obtained from outside the primary educational setting, often increases the time lapse between identification and delivery of required services, thus diminishing continuity.

Coordination. When the primary educational agency cannot provide all services required by a special needs student or when numerous services are available from different departments within an institution, coordination becomes a significant factor. Coordination for postsecondary vocational special needs students may explicitly include other social agencies as well as internal services. For example, a physically handicapped student in a technical drafting program may require the financial assistance of DVR to assist in the purchase of a special drafting table. Or a disadvantaged mother may require day care support through CETA for her child so she can pursue her training program.

Other examples, too numerous to relate, exist. However, the thread of coordination running through them acknowledges two basic assumptions. First, individuals with special needs who enter AVTI programs are likely to have numerous needs that will require coordination either between different internal services or between the AVTI and other specialized social service agencies. The second assumption is that all social service agencies which coordinate services are unique and provide basic services to specified types of individuals. These individuals usually have unique basic needs, which is why they

applied for services and were accepted at a specific agency. They may also have additional needs for which the other agencies offer the more appropriate services and, thus, services must be coordinated.

When AVTIs exemplify these three characteristics of accessibility, comprehensiveness, and coordination, they are said to possess continuity of services. Under such conditions, a student can access a wide variety of services that are designed and managed to meet their specific and often individual needs. In addition, these services are available within a reasonable time after they have been requested by students or prescribed by the staff in order to maintain students' transition into and through their vocational programs. Continuity of services relates primarily to procedures and services in postsecondary institutions. However, it should be obvious that a timeframe must be considered for these transition activities. In order to expand upon the view that transition must be examined more broadly, it is necessary to consider the requirements of the transition process from a pre-enrollment versus post-enrollment perspective.

#### Pre-Enrollment Requirements

The pre-enrollment period includes the timeframe and related activities prior to the point at which the individual selects a specific vocational program to pursue. Several of the activities identified above in the discussion of accessibility and coordination directly relate to this time period. In these activities, the exchange of information is highlighted, which means that the vocational program is providing information about its offerings while trying to secure information about students who make application to these programs. For all students, the information going out to them must be clear and completely understandable in order to avoid gross misinterpretation of programs' requirements and potential benefits. This may be even more critical for those special

needs students who may be less mature and more easily impressed by the "glamor" or "macho" associated with the image of some vocational programs.

The information about special needs students coming into the vocational program is highly critical at this point. Unfortunately, it appears that the vast majority of special needs students do not indicate their need for special needs services on AVTI enrollment application forms, suggesting that other needs identification methods must be used. Several problem areas related to student records were identified previously in this section and it is assumed that students with special needs will profit more from improved methods of early identification. Therefore, the time needed to identify special needs students is critical to their successful transition into and through the vocational program of their choice.

In the pre-enrollment phase, information related to potential and actual enrollees may be acquired through several processes. For example, if useful, up-to-date, reliable, and valid information already exists and is available to AVTI staff, this will facilitate counseling, program selection, and later, the scheduling of regular or routine remedial assistance for the student. In addition such information may tell the staff which educational and training techniques or processes work best for the student. Although this information may be subject to continuous verification as the student proceeds through their vocational program, its presence enhances continuity of the transition process.

On the other hand, when such information is not available, students are more likely to experience slow and uneven progress which may eventually result in their withdrawal from the AVTI. In the absence of useful information, additional interviewing and counseling may be required. If evaluation services are available, such services may also be recommended prior to program selection. Even with this information available to both counselor and student, program selection may take additional



time. When previously generated information is not available to the staff, additional time will be required to generate that information if effective pre-enrollment services are to be provided. Thus, when additional time is consumed, continuity will be reduced.

#### Post-Enrollment Requirements

One of the concerns noted at the national level is that the average postsecondary vocational student is approximately 26 years of age. Other important concerns are related to the fact that numerous AVTI students have not completed high school but may have a General Equivalency Diploma (G.E.D.) and that the special needs group is comprised of more disadvantaged persons than handicapped or limited-English proficient (LEP) persons. These facts have a direct impact on pre-enrollment information such as: (a) information available from a secondary school may be outdated; (b) many incoming students may not have complete secondary school records available; and (c) the majority of entering special needs learners do not have any formal information record other than standard data on prior courses, grades, and attendance. Thus, useful information records may only be obtained if they are generated upon entrance into the postsecondary institution.

Special needs students may pass through the pre-enrollment process without being detected as needing special services for a variety of reasons. When this occurs, it becomes imperative that students' educational, and sometimes non-educational needs, are quickly determined. The purpose of early needs identification is to prescribe services that will assist students in their day-to-day activities. There are increasing numbers of students who were not identified early and who continued unnoticed in classes for several weeks without comprehending much of the content and finally stopped attending or dropped out formally -- all without ever being contacted by a support services staff member. Where did the continuity of

services break down for these students? This is a critical research question that must be thoroughly examined. Second, other key questions must also be addressed as well: How useful is an information record for students making the transition into postsecondary settings? What type of data is most useful to the staff? What procedures must be carried out by the staff to monitor students' transition progress? What remedial procedures are needed to assist in this process and how should these services be administered?

Because federal and state laws prohibit discrimination against special populations entering vocational programs, the characteristics of AVTI enrollees are likely to vary greatly. In other words, variations in students' ability levels, backgrounds, performance levels, and educational needs will continue to increase. As a result of this increased variation, instructors and support staff will be responsible for earlier and increasingly more comprehensive monitoring of their students.

Based on these legal restrictions and student needs, successful transition will require an increased effort by AVTI staff during the post-enrollment phase. In addition to taking the pre-enrollment and post-enrollment phases into consideration, it will also be necessary to attend to environmental elements which influence transition. These environmental elements will be discussed in the next section.

#### Environmental Elements of the Transition Model

This section will discuss environmental elements of the transition model in order to focus on the basic organizational framework of students' transition into and through postsecondary programs. These elements fit into the concept of continuity presented earlier. Furthermore, they are factors which either facilitate transition or enhance the tendency to drop out. As Datta (1980) observed, "knowing what to change to improve retention requires considerable examination of the

reasons for non-retention" (p. 70). An examination of these elements will identify areas where the transition process can potentially break down.

The purpose of articulating special need students into postsecondary vocational education programs is "...to guide the transition of students into and through postsecondary education programs... and to ...maximize the student's performance in those programs, ...while insuring... cost-effective educational activities" (Brown & Kayser, 1981, p. 3). Special needs students may enter AVTIs from a variety of sources or perspectives (Figure 6). Although their approaches may differ somewhat, they are likely to encounter the same processes as other students, i.e., outreach, application, counseling, and finally admission to a program of instruction. These steps or activities, are recognized as the pre-enrollment phase.

Even though these activities may be difficult to monitor in terms of effectiveness, they should somehow be included in any evaluation of transition processes. Datta (1980) discusses this concern by identifying several possible reasons for ineffective programs. She states that although certain outcome measures such as enrollment, completion, and employment figures may be commonly used at the national level, there is a need for more meaningful criteria to be used to improve local programs. Discriminating criteria, such as those of the pre-enrollment phase can lead to improving the transition process.

Sources of Incoming Students

Pre-Enrollment Phases at AVTI's

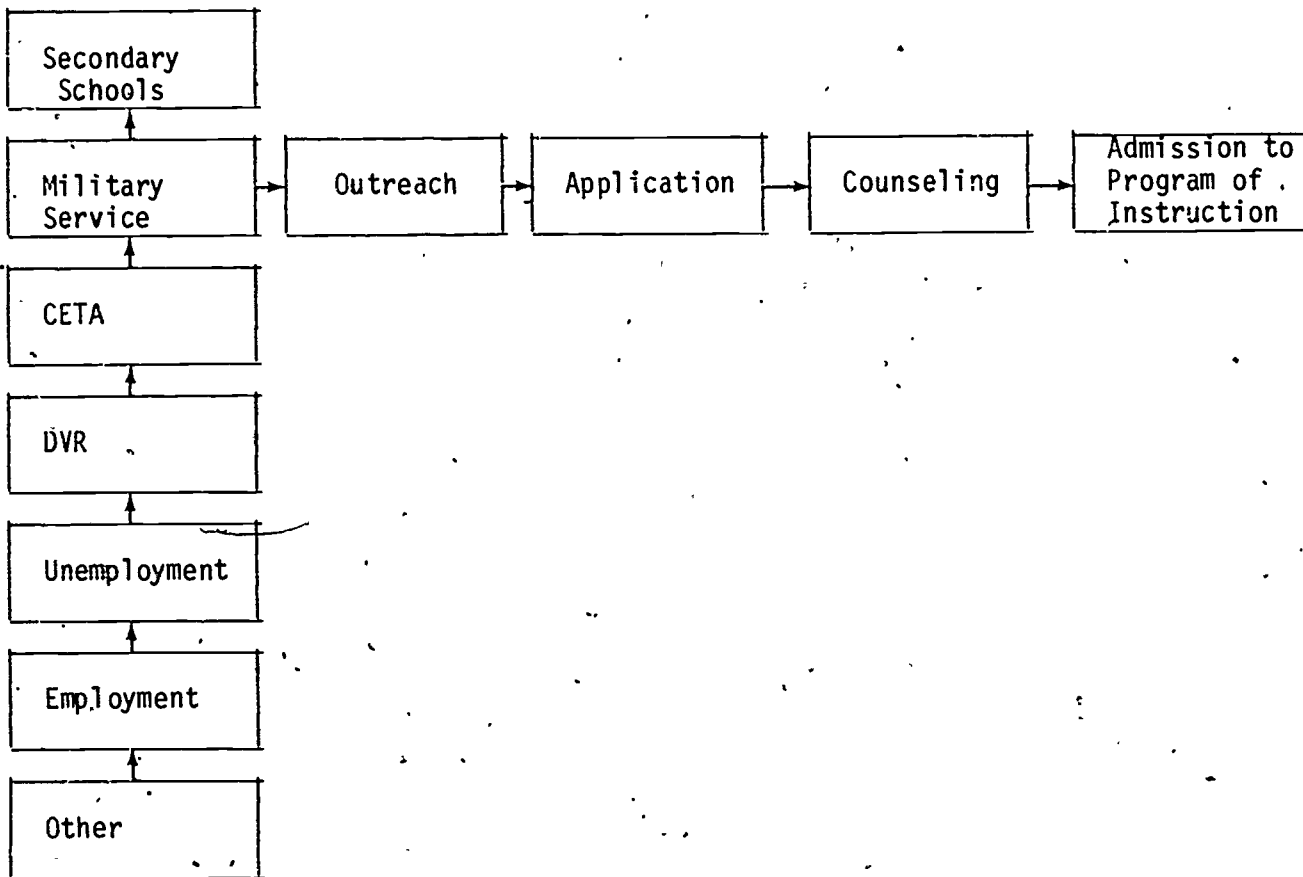

Figure 6. The pre-enrollment phase of postsecondary vocational education.

Efforts to monitor these pre-enrollment processes have not received high priority in program evaluations. Similarly, few evaluation designs and instruments have focused on this stage of the educational process. Yet, the quality of the transition process in these early stages may influence students' ability to progress successfully through their vocational education programs. However, the fact that there may be numerous moderating variables in this phase that cannot be controlled by

AVTIs, suggests that efforts to improve activities in the post-enrollment phase may be very effective. The post-enrollment time period seems to be the time period in which data can be most successfully collected to monitor the internal transition process. Thus, monitoring activities implemented during the post-enrollment phase may prove to be critical to enhancing the transition of special needs students through their postsecondary vocational programs.

#### Monitoring Transition Through the Post-Enrollment Phase

Initial efforts to examine the problem of special needs students dropping out of AVTI programs have concluded that a means to monitor students' progress, or lack of it, should be the focal point of the transition process. The transition mechanism is composed of a record, the recorder, and a timeframe in which the records are established and maintained. This discussion, will focus on an idealistic view of efforts to monitor transition rather than attempt to describe what is realistically possible at the present.

It is clear that an information record must be established and maintained as special needs students progress through their vocational programs. This is certainly not a revolutionary thought, since this procedure is now occurring with handicapped students in elementary and secondary schools. However, the structure of this record, the procedure for establishing it, and the purpose of it, are all slightly different than for the IEP in the lower educational levels.

Record contents. The content of this record must reflect three forms of information: (a) identification of the special educational or non-educational needs of the student, (b) identification of services selected to accommodate these needs, and (c) the outcome of the specified services. This record should be established shortly after students are enrolled in vocational program. This record should contain input from a minimum of four sources:

1. Administrative input. This input should include pertinent information from transcripts of earlier educational/training experiences. This will include demographic data, information from other postsecondary schools, and data which are included in commonly used admissions forms. Additional information related to students' experiences prior to enrollment including exposure to recruitment information, program options, and counseling discussions may be pertinent.
2. Instructor input. Instructors can provide information about students that is directly related to classroom and laboratory activities. Individual instructors can also develop assignments and class activities that identify students' present ability levels in areas such as reading, writing, and computation since these skills relate directly to course objectives as well the broad goals and requirements of specific vocational education programs. Hands-on activities in classes would also establish additional insights into students' psychomotor performance levels. Formal and informal discussions with the students may also generate information about students' interest areas and motivation levels.
3. Student-reported information. While students may be one of the best sources of information about themselves, they may not always provide accurate interpretations of their abilities and needs. They must, none the less, be given the opportunity to provide input. Techniques for collecting these data may include open-ended questionnaires, checklists, or structured interviews. Since the reliability of these processes is unknown, it will be necessary to determine that characteristic. Once these techniques

have been field-tested and revised, more practical, streamlined data gathering techniques may emerge.

4. Special needs staff and other sources. The special needs staff at an AVTI may have very limited information to contribute to the evaluation process immediately after the student has enrolled unless contact has been successfully established with secondary schools, DVR programs, and CETA agencies. Information obtained from special needs staff and other support service personnel will be generated during the time in which students are enrolled in the AVTI programs. Subsequently, this information could comprise the major portion of special needs students' information records.

All four above mentioned sources will provide information that the AVTI staff can use to monitor the transition of students through the institutions' programs. This monitoring process is a critical aspect of transition. Furthermore, this monitoring process must be applied over the course of several weeks to be as effective as possible. The next section discusses this time element of the monitoring process.

Monitoring timeline. One major difference between dropout identification and transition monitoring is that the latter process requires more than one measurement point, despite the fact that much of the information that is gathered will be redundant. The purpose of continuously monitoring of student performance is to identify patterns of change and stability. The time periods selected for monitoring can be arbitrarily selected. However, the interval between enrollment and initial monitoring efforts should be brief enough to include future dropouts but long enough for instructors to have sufficient time to become acquainted with their students' needs and abilities. Following the first data gathering period, subsequent monitoring sessions will gather similar information. At this time no specific time intervals can be recommended to record

these measurements but this issue should be examined empirically.

Monitoring recorders. The third element in the transition monitoring process consists of the people who record students' progress or status. These persons were referred to in the previous description of information record contents and include the class or laboratory instructor, the student, special needs support services staff, and counselors who potentially could contribute personal insights as well as useful data related to pre-enrollment concerns.

The type of data supplied by these four sources may change from the first to the second and subsequent monitoring periods. That is, not all of the data supplied in the first round may be required in subsequent efforts. For example, most demographic student data obtained from administrative records will not change during this time, nor will some measures of academic performance. Math ability, for instance, should not change very greatly in a 3 to 4 week time span.

Two observations must be made regarding the previously described elements that comprise the framework of the transition model.

1. It is very important that the validity of these elements, i.e., the record and the monitoring timeframe, be examined in realistic institutional settings.
2. The effectiveness of the transition model will be contingent upon the use of data collected during the monitoring process to appropriately modify the instructional processes to which students are exposed. These instructional processes could include special needs support services and others such as counseling and financial aid, in addition to classroom and laboratory activities.

The preceding material has focused on the parameters of transition and factors believed to influence the dynamics of



transition processes. The process of regularly monitoring students has been examined. Finally, it is now necessary to examine transition from a more theoretical point of view with the idea of trying to conceptualize transition problems to meaningfully assimilate the numerous concepts and issues discussed thus far.

### An Educational Adjustment Model:

#### A Strategy to Facilitate Postsecondary Transition

The special needs learner may be classified as an individual who has difficulty successfully achieving any or all of the required objectives in a vocational education program. Consequently, this person may typically require a variety of educational interventions in order to succeed in a vocational education program. On the other hand, the educational system must be relatively comprehensive for the transition model to function effectively. This comprehensiveness determines the nature and extent of instruction and support services that are available to assure "correspondence" among the following: (a) the institution's resources versus the educational needs of special needs learners and (b) the institution's requirements, e.g., program prerequisites, versus students' characteristics. In other words, a comprehensive educational system enhances the probability that the institution will be able to effectively serve unique student needs and that students will be able to comply with institutional needs.

#### The Model

A transition model is perceived to be a system by which educational programs can readily adapt to the unique educational needs of individual learners by modifying: (a) the response potential of learners, (b) the content or standards of educational programs, and/or (c) the teaching/learning environment. Such an educational system could enhance the

0

flexibility of the total instructional environment in unique educational situations. Applying a combination of these modifications would generate a variety of benefits. First, these modifications would have the potential to increase learners' abilities to tolerate the educational environment. Second, these modifications could also reduce levels of frustration/anxiety which students and educators experience within educational environments by modifying the nature of content and standards in the teaching/learning process. To the extent that educational systems successfully accomplish these modifications, the percentage of students successfully completing all or most of the requirements in instructional programs will increase while the percentage of students who drop out of training programs before they are able to acquire useful skills, will be reduced.

The proposed transition model is drawn from a synthesis of four different but related sources of information: (a) Theory of Work Adjustment (TWA) (Dawis, England, & Lofquist, 1969), (b) theory of health services delivery (Davidson & Perloff, 1981), (c) theory of instruction (Smith & Currey, Note 1), and (d) an approach to selecting rehabilitation practices (the "3 Cs") (Krantz, 1981). Many of ideas and variables referred to by these four sources have been reconceptualized to serve as the basis of the transition model.

It is assumed that underlying all human behavior are existing or potential theories that help explain the foundations of individual behavior. Thus far, no one has attempted to develop a theory to explain the transition process of special needs students or the converse, their failure to successfully make the transition into and through postsecondary vocational education programs, i.e, dropping out. Participants in the National Articulation Symposium (reviewed earlier in this report) addressed only a few of the general factors involved in transition. The final segment of this report will discuss theoretical aspects of transition and examine related

issues, with the intent of presenting a clearer picture of the total transition process.

Correspondence: The central issue. The central issue of transition is believed to be "correspondence" - the relationship between the abilities of students and of the educational institution to cope with the various factors that determine whether or not the students will successfully continue through an educational program. It is assumed that when correspondence levels are within such limits, students will tend to remain in their educational environment, i.e., educational transition will be maintained. When correspondence levels diminish, students will consciously or subconsciously seek to change environments, i.e., they drop out of school or change to another program.

This conceptualization is similar to that of the Minnesota Theory of Work Adjustment (TWA), (Dawis, et al, 1969). In TWA, workers may either continue to work at their jobs or leave the immediate work environment. In either case, factors which influence whether the person remains or leaves are measures of the relationship between the individual (performance and needs) and their work environment (work requirements and reinforcers). The same may be said of transition in an educational setting. Factors related to individual students' characteristics and to the instructional environment in which students must function, may be viewed as forces which influence students' transition efforts. Continued transition through the educational environment is a function of a student's performance level and their ability to correspond to the needs and resources of an educational program. When the "input" (curriculum, instructor, school policies, and procedures) or the "output" (student's ability to attain or maintain acceptable performance levels) result in non-corresponding conditions that cannot be tolerated by either the environment (school/program managers) or by the student, such a condition may result in a situation where the student is terminated or chooses to exit (drop out) from the educational environment.

However, by definition special needs learners are those persons who cannot, or will not, succeed in a regular vocational program unless additional support services are provided to individual students, as needed. Smith (Note 2) noted that in the educational process, learners must have the ability to perceive (receive, encode, decode, and assimilate the stimuli contents that constitute the course curriculum. These attributes influence an individual's ability to participate in the learning process and may be observed in terms of the student's psychomotor, cognitive, and/or affective behavioral responses. Smith has developed an "instructional model" based upon these concepts and states that the instructional implications will vary from one individual student to another, based on the influence of these attributes. However, special needs learners can be assumed to be deficient in one or more of these attributes. Thus, such persons will require "special needs" services in order to succeed in the vocational education program (continue in the transition process) to the maximum extent of their potential.

Special needs services. A growing variety of educationally-related services are provided for postsecondary vocational students including those identified as having special needs. Support services of this nature typically include remedial reading, remedial math, and counseling. These services can be referred to as "corrective" measures (Krantz, 1981). But in order to apply corrective measures, it is first necessary to determine the nature and extent of students' educational needs. Much of the data collected during in the monitoring process, described earlier, should satisfy this requirement.

In addition to "correction," Krantz (1981) identified two other procedures as options for working with special needs learners: "compensation" and "circumvention". These make up the "3 Cs". The latter two options are usually applied to the educational environments. not to the students. All three

options have the same purposes in mind: (a) to increase individuals' abilities to function in their educational environment and/or (b) to expand the range of students' abilities and actions which will be served in an educational setting. Both of these options may be applied individually or in combination as determined by the flexibility, creativity, and skill of an educational institution's staff.

Smith, Brown, and Kayser (in press) proposed a psychological model for designing and managing instruction for special needs learners. They argue that given the right circumstances, "all learners may be, to some extent, handicapped or disadvantaged in terms of one or more of the following variables: (a) their physical or mental capabilities, (b) the nature or form of the content presented [to them], or (c) the nature of the behavioral responses/standards to be produced". Improved educational technology based upon this model should permit increasing numbers of special needs learners to be more effectively identified and educated. Examples of procedures deemed appropriate to help various categories of special needs students to succeed in vocational education programs are suggested in the article by Smith, et al. However, the broad concepts of compensation, correction, and circumvention of special learning problems are not discussed in that article. Before the "3 Cs" can be applied to students and their educational environments, student characteristics and the major environmental components must be examined.

#### The Environment: Institutions and their Staff

Students in AVTIs are confronted daily with institutional and staff variables. They are illustrated in terms of broad categories in Table 3.

Table 3

Key Variables in Educational Environments

<u>Institutional Variables</u>	<u>Staff-Related Variables</u>
Curriculum offerings	Personality
Physical plant and location	Training/experience
Resources available	Motivation
Policies/procedures	

The institutional variables listed in Table 3 vary extensively throughout Minnesota's AVTI system, but within any one institution these variables tend to be relatively stable. For example, auto mechanics programs are offered in more than 20 AVTIs, while gunsmithing is offered at only one location and this distribution of programs is unlikely to change substantially during a student's training period. The physical plant and its location cannot be changed readily but have a substantial impact on students. Institutional resources include services available within the AVTI, such as support services and counseling, as well as those available within the local community, such as DVR services and chemical dependency support groups. Institutional policies and procedures serve as guidelines designed to facilitate the day-to-day operation of an institution and its programs. Variables in this last category can be modified or changed at times, such as when the system acknowledges the need to modify its approach to facilitating transition or the need to intervene to assist potential dropouts.

The staff-related category contains three components. Personality traits among the instructional staff vary from person to person within an institution and changes in this category will occur primarily as instructors join or depart from the institution. The other two variables, training/experience and motivation, also vary as the nature of the staff changes but can be modified through a variety of methods.

The environmental variables define the limits that students can tolerate during their attempts to successfully complete vocational education programs. These tolerance limits are based upon students' perceptions of their abilities to achieve program goals. For example, a student enrolled in a particular auto mechanics course may perceive the combined influences of curriculum, physical resources, institutional policies/practices, and instructors' personalities to be more than he/she is able or willing to tolerate. Fortunately, these variables can be modified with instructional strategies based on the "3 Cs". This process must also take into consideration the psychological characteristics of students, which will now be explored.

#### Student Characteristics in the Learning Process

Based on a synthesis of literature which examined the student characteristics required to succeed in educational settings, Smith (Note 2) identified several basic processes related to sensory input, information processing, as well as the three behavior output responses (see Figure 7).

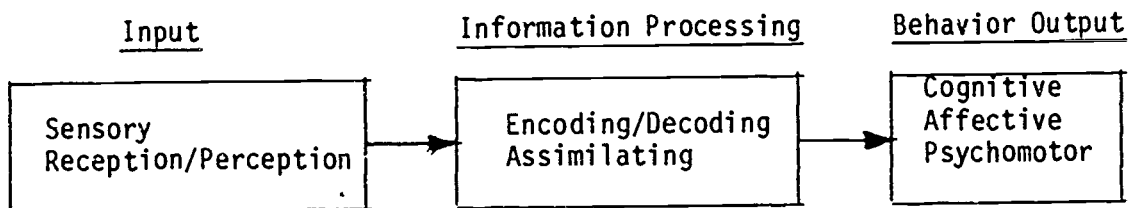

Figure 7. A model of the basic learning process.

Special needs students may be viewed as having limited capacities in the stimulus input, information processing, and/or behavior output stages of the learning process. Thus, unless effective support services can be applied to enhance the appropriate stages of students' learning process within educational programs, such students are likely to drop out. Unfortunately, many special needs students are not identified in time to prevent them from dropping out of AVTI programs. This means that the "3 Cs" have not been effectively used to aid students' to meet institutional demands or to help institutions adequately accommodate students' needs.

It seems logical, therefore, to assume that if students are weak in one of the stages of the learning process under normal conditions when no special instructional assistance is provided, the resulting poor performances of such students may often cause them to become frustrated with themselves and their educational programs. The strategies of correction, compensation, and circumvention can be used to accommodate students' needs within educational institutions. Transition procedures are meant to provide timely, effective services to students and, thereby, retain increased numbers of students in the system by keeping their frustration levels within limits which can be tolerated by both the student and the institution.

#### Enhancing Institutional Accommodations of Students' Needs

The transition process must seek to optimize conditions for the institution and for the student. The basic strategies of correction, compensation, and circumvention can be applied in terms of key variables in the instructional process (Smith, Note 2) (see Table 4).



Table 4

Variables in the Instructional Process

Planning

1. Readiness
2. Structure/Organization
3. Goals/Objectives/Standards
4. Sequence

Implementation

1. Rates of Presentation
2. Frequency/Contiguity/Practice
3. Reinforcement/Rewards
4. Knowledge of Results/Feedback.

Stimulus Content

1. Enactive - Trial and Error Hands-on Experiences
2. Iconic - Graphic/Pictorial representation
3. Symbolic - Spoken and Written Communication

Numerous educational tasks require many trial-and-error efforts. For "regular" students, these are often difficult tasks; to special needs students these tasks may seem impossible. To apply the circumvention strategy, a variety of options might be used. A vocational education training program's structure could be modified to avoid the need to learn some hands-on skills. Also, the use of written instructions could be reduced or eliminated in order to avoid generating frustrations that could inhibit the performance of students with limited reading ability. Correction can be applied to students' psychomotor skills by closely monitoring activities and providing feedback to students when skills are being developed, thus, correcting inappropriate behaviors immediately after they appear.

Compensation can be applied by a wide variety of options. For instance, instructors could inform students that each task represents only one of many activities contained in a course and that weaknesses in one area can often be offset by strengths in other areas. In addition, students must understand that some tasks are inherently more difficult than others and they cannot expect to achieve success immediately. The rate and frequency

for presenting course materials may be altered (compensation) to extend over segments of several class periods, not just during a single, brief discussion. Reinforcement may also be increased, especially during the early stages of intervention, and feedback can be provided more frequently than would be typical under normal circumstances. Although many tasks are essentially psychomotor, the provision of additional types of stimuli (designed to focus not only on "how to", but the "why" of tasks) may compensate for existing special needs and, thus, increase students' performance levels. These correction, compensation, and circumvention strategies can enhance students' success rates and reduce feelings of frustration that could otherwise cause them to drop out of school, to be terminated, or to fail to successfully complete graduation requirements. Methods of reducing students' levels of frustration with the educational system should also be undertaken and is discussed next.

#### Enhancing Student Accommodations of Institutional Needs

Strategies that maximize students' abilities to accommodate institutional needs will also decrease the likelihood that they will be non-completers. For example, if data were collected that indicated that a student had a reading ability below a level required for a given program of instruction, remedial reading services could be employed to enhance the student's ability to function within that program (correction strategy). If, however, the student's reading performance in the training program approaches a point where dropping out or termination is being considered, a circumvention strategy might be applied to reduce the reading-related demands placed upon the student. Another example of circumventing this problem would be to utilize the counseling process to explore the possibility of transferring the student to an alternate training program with reduced reading requirements.

## Assembling The Transition Model

The transition model, simply stated, describes the processes that impact all students enrolled in postsecondary vocational education programs. The model also reflects the scope of activities designed to enhance the successful flow of special needs students into and through vocational education programs. The relationship between these two areas of activities (depicted in Figure 8) is one in which transition-enhancing activities supplement the typical educational processes. The typical educational process contains three stages: (a) input, (b) process, and (c) output. Likewise, transition-enhancing activities can be sequenced into the four steps of the "educational cycle": (a) assessment, (b) planning, (c) implementation, and (d) evaluation. Clearly, transition-enhancing activities are associated with the "process" stage of the educational experience.

Typical Educational Processes

Transition-Enhancing Processes

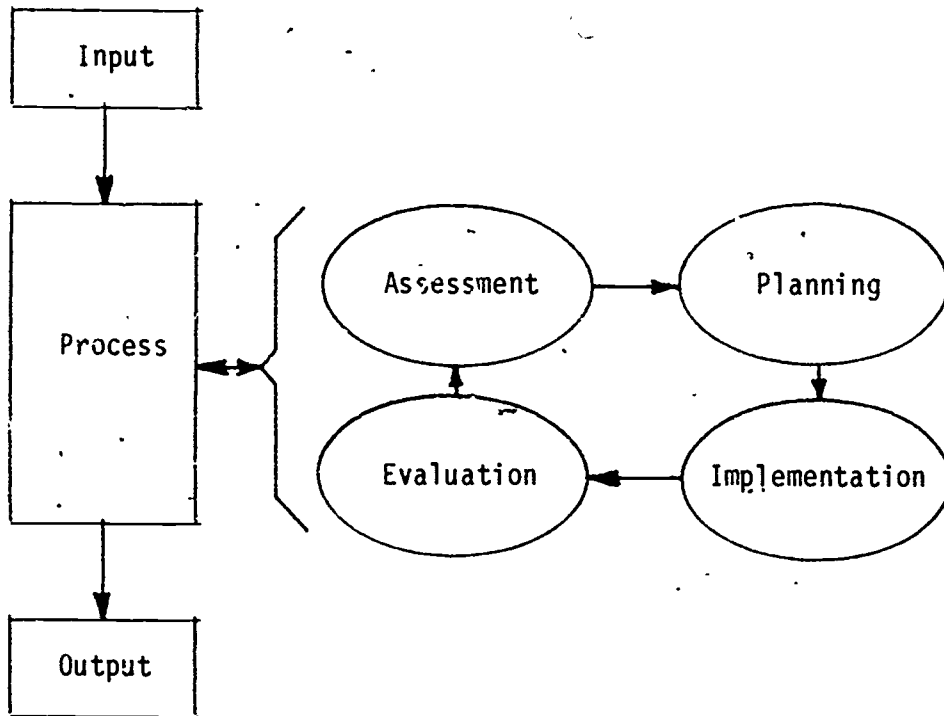

Figure 8. The relationship of transition-enhancing processes to the overall educational process.

To understand the transition process it is necessary to closely examine the components from both sides of the relationship depicted in Figure 8. Figure 9 lists, in greater detail, the following attributes of typical educational processes: (a) outreach ("input"), (b) application ("input"), (c) counseling ("process"), (d) admission to a program of instruction ("process"), (e) instruction ("process"), and (f) completion/non-completion ("output"). The process-oriented components in Figure 9 interact with the following transition-enhancing activities: (a) formal and informal assessment of the correspondence between students' and institutions' needs and resources; (b) the planning of strategies (the "3 Cs") which will help students meet institutional demands and help institutions meet students' needs; (c) the implementation of strategies using the "3 Cs"; and (d) evaluation of the effectiveness of efforts using these strategies to increase the level of correspondence between students' and institutions' needs and resources, e.g., enhance the likelihood that students will successfully complete their programs of study.

This transition-enhancement process represents an ongoing cycle of events which continues for each student until they complete the program, drop out, or are terminated. Most students are evaluated only by their teacher(s) during the instructional stage (informal assessment). Their problems, if any exist, are usually resolved by the instructor and the student. However, special needs students often exhibit problems which must be examined by more thorough (formal) procedures. These students may have unique educational needs which exceed the ability or resources of classroom instructors. In such cases the assistance of support services staff and/or social services agency personnel may be required.

Typical Educational Processes

Transition-Enhancing Processes

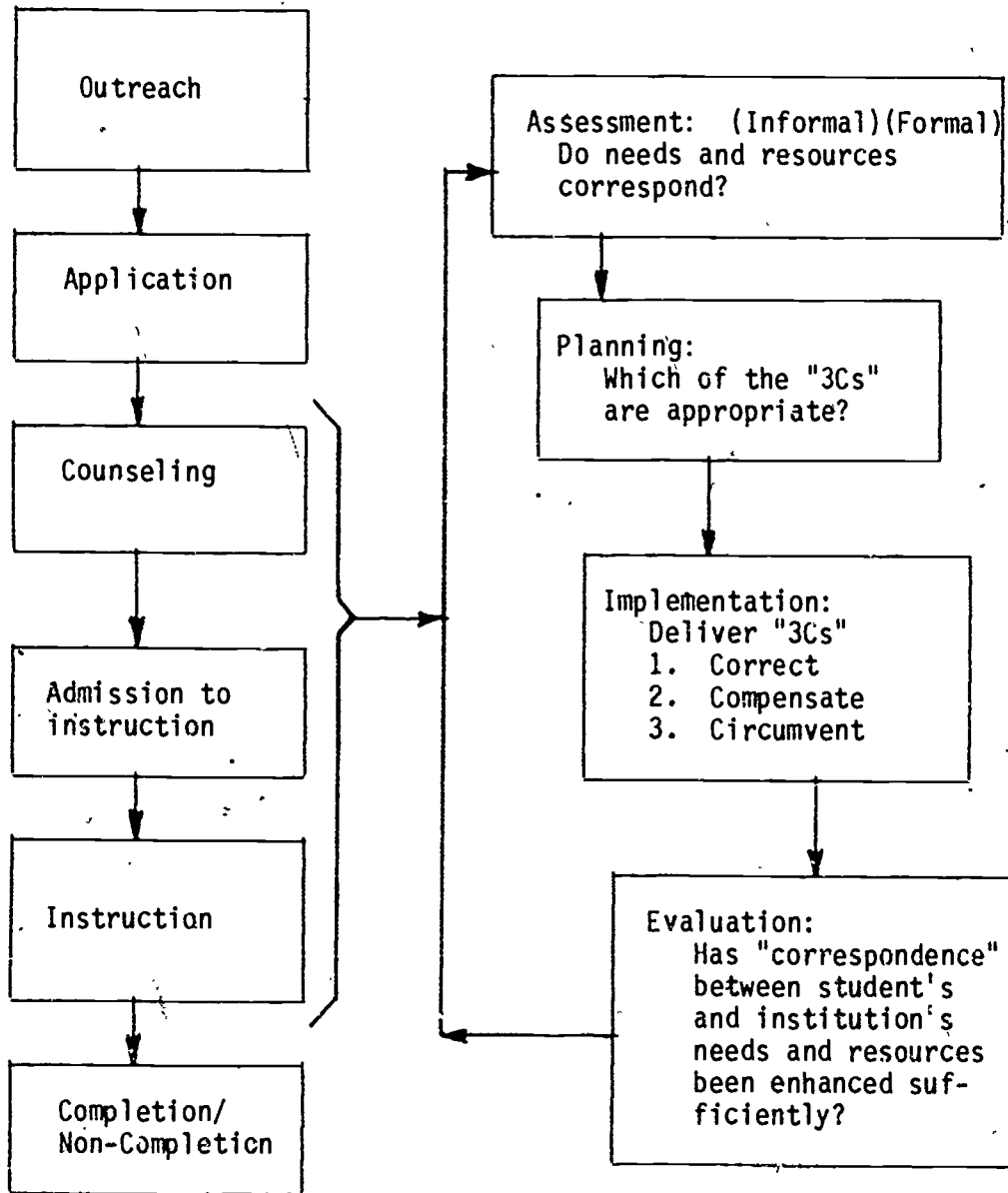

Figure 9. Relationships between major components in the educational process and transition-enhancing processes.

A wide variety of factors, ranging from the simple to the complex, have been described as components or factors in the articulation process. The concept of transition is complex and requires the creation and validation of a conceptual model before related research and development efforts can be effectively and efficiently pursued. Figure 10 provides a model of the significant activities available to be employed by a hypothetical postsecondary vocational institution which is committed to maintaining transition-enhancing conditions. Perhaps the model can best be illustrated by means of a scenario in which a student is followed through the transition-enhancing process.

The effort begins when the student enters the "outreach" stage, during which the student seeks out and/or is recruited by the AVTI which the student will eventually select. During the "application" stage the student obtains, completes, and submits an application form for the selected AVTI. After that point the student meets with an AVTI counselor in order to review the range and nature of institutional programs available within the institution. When the student expresses interest in one or more programs, the counselor examines the student's qualifications in terms of interview-generated information, data obtained from the application form, and any relevant student records which may have been transmitted to the AVTI. If the student's interests, abilities, unique educational needs, and other characteristics fail to correspond adequately with the content, requirements, and resources available within the desired training program, those potential conflicts are discussed with the applicant. If, at that point, the applicant acknowledges the importance of these discrepancies, three options are open. The student may elect to choose an alternate program and continue the counseling process to determine if additional problems will exist if enrolled in that program. The applicant can also choose to terminate their plans to enroll at the AVTI and, thus, seek training elsewhere or enter the pool of workers available for

TYPICAL EDUCATIONAL PROCESSES

TRANSITION-ENHANCING PROCESSES

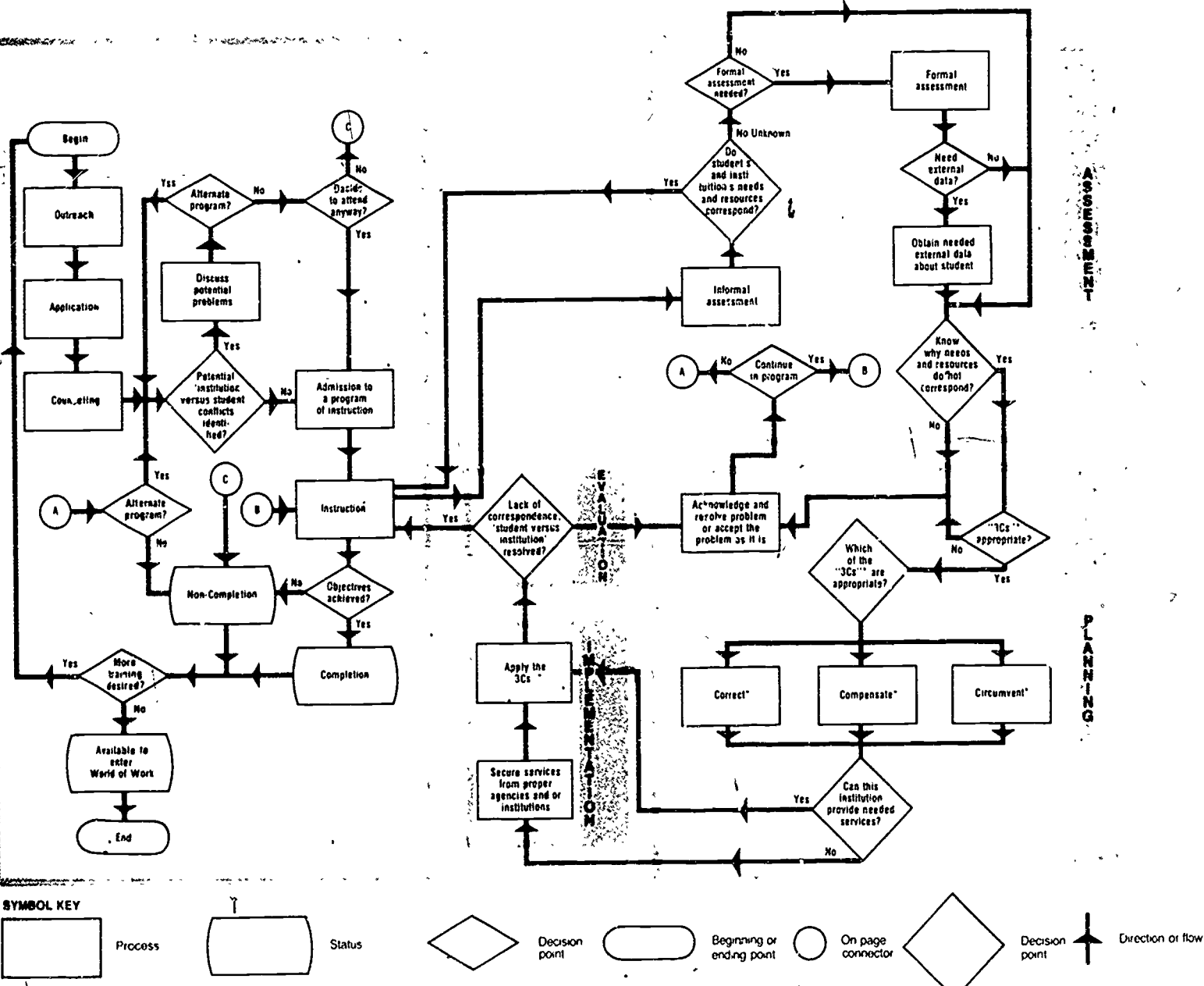

Figure 10. A model of transition into and through postsecondary vocational education programs

\*Students with special needs are defined by this model as those persons who have needs and resources (abilities) which do not correspond adequately with the educational institution's needs (requirements) and resources (the educational environment). As this failure to correspond becomes more severe, the student's satisfaction with their educational experience will decrease and the student's "satisfactoriness," from the institution's perspective, will become less. Thus, it becomes likely that the student will drop out of school, transfer to another program, or be terminated.



employment. They may also choose to enter a program of instruction in spite of having been advise about potential problems which are likely to emerge.

Once instruction has begun, the instructor will continually assess (informally) the performance of this student, as well as others, in order to determine if the student's and the institution's needs and resources are corresponding adequately. If the student's needs and abilities and institution's resources and requirements seem to be conflicting with one another, the instructor and/or other AVTI staff who monitor the student's progress can elect to "formally" assess the student. If this formal assessment process does not adequately identify the sources/causes of the mismatch between the student and the educational environment, it may be possible to obtain other educationally pertinent information from external sources, e.g., DVR, CETA, or previously attended educational institutions, if such information is available.

If formal assessment activities and cooperative information transfer efforts involving external agencies/institutions are exhausted but the problem(s) remains unresolved, an AVTI's staff may choose to continue seeking additional ways to resolve the problem. They may also accept the problem as it exists and continue instructional efforts if the student chooses to remain in the program. If the student elects to leave the program, she/he then has the option of transferring to an alternate program or of entering the labor market.

When assessment procedures identify the source(s) of a student's educationally-related problem(s), those issues are examined to determine if the "3 Cs", i.e., correction, compensation, and circumvention, represent appropriate strategies to bring the student's and the institution's needs and resources into agreement (to establish "correspondence"). Should this prove feasible, the appropriate "3 Cs" strategies are selected and those services, if any, which must be obtained

outside the AVTI, are contracted. Once the appropriate "3 Cs" strategies have been applied, their effectiveness must be evaluated in terms of the revised level of correspondence between student and institutional needs and resources. If the issue(s) has (have) been satisfactorily resolved or if satisfactory progress is being achieved, the student is encouraged to continue in the instructional program. However, if no progress has been made toward alleviating the problem(s), an important decision must be made. Again, the AVTI's staff may either accept the problem as it exists or search for additional strategies by which the problem might be alleviated. If the student decides to leave the program at this point, they may seek out alternate programs or enter the labor market. Should the student choose to continue in the same program of instruction, formal and informal assessment efforts can be continued, as well as logical applications of any of the "3 Cs" strategies, in hopes that the student will eventually successfully complete all, or most of the instructional program's learning objectives.

If the student and/or the institution acknowledge that the student cannot complete the program's learning objectives, the student may drop out or be terminated. At that point the student may seek an alternate training program or become available to enter the labor market. The institution may offer certificates to these non-completers, verifying the knowledge and skills that have been mastered, in order to enhance their employability.

Those students who successfully complete their program's instructional objectives are eligible to enter advanced or alternate training programs or they may choose to enter the labor market. At this point, the circuit through typical educational and transition-enhancing processes has been completed and it should be apparent that the transition model seeks to maximize the opportunity for *all* individuals, regardless of prior special needs labels, to successfully

complete training in postsecondary vocational educational programs. The model also maximizes the institution's ability to serve special needs students while efficiently and effectively providing services to *all* students enrolled. Admittedly, this is an idealistic, hypothetical situation. However, the model seems to represent a viable concept which is believed to be applicable to all postsecondary vocational students, regardless of the program or institution in which they are enrolled.

### Conclusions and Recommendations

The transition concept is a relatively new and different approach to looking at the continuing problem of dropouts or early leavers/non-completers of educational programs. This report has presented the concept of transition in terms of key persons, processes, and corresponding needs and resources that apply to students as well as to their educational environments. The idea of "correspondence", as it relates to special needs students, was also examined in terms of three strategies which could be applied to: (a) modify conditions which are difficult to tolerate and (b) enhance students' ability to avoid or overcome frustrations. These strategies are labeled correction, compensation, and circumvention. Examples of how these strategies may be applied were also briefly examined. The task of determining how well the transition model functions in reality must now be undertaken.

In order to better understand transition processes and to implement valid/reliable transition policies and practices, the following issues must be examined in greater detail:

1. What factors, if any, can be used to predict which students are likely to drop out (i.e., excessive lack of correspondence between student and institutional needs and resources)?
2. If dropout-related predictors exist, which, if any, can be utilized to prescribe the "3 Cs" within the range of services available at the AVTIs?

3. Which additional transition-related activities/services should be made available within AVTIs?
4. How can teachers, administrators, and support services personnel communicate and interact more effectively in their efforts to identify and service special needs students?
5. How can interagency cooperation with representatives from other educational institutions and social services agencies contribute to transition efforts in AVTIs?
6. What purposes can microcomputers serve in record-keeping, student needs identification efforts, and other transition-related activities?
7. Are transition processes, concerns, and limitations in Minnesota's AVTIs similar to those found in other Minnesota educational institutions, as well as in postsecondary vocational education programs in other states?
8. How should the transition model be modified to become more valid and, if possible, more generalizable?
9. What is the relative importance of the various components of transition model?
10. What forms of research methodology should be developed and/or applied to future transition-related investigations?
11. How and to whom should these findings be disseminated?
12. How can educators best be trained to implement and administer new transition activities, who should receive this training, and who can best deliver it?

The proposed model of transition presented in this report is a unique approach to reducing the problem of unacceptably high dropout rates found in most schools today. If this model is found to exceed the accuracy and effectiveness of previous efforts to predict and, thus, help prevent potential dropouts, the model may offer educators an effective process with which the needs of these students can be served.

## REFERENCES NOTES

1. Smith, B. B. & Currey, J. A. A generalizable learning/teaching model: A bibliography of teaching and instructional concepts for vocational education. Manuscript in progress - St. Paul, MN: University of Minnesota, Minnesota Research and Development Center for Vocational Education, 1982.
2. Smith B. B. A rationale for designing and managing technical training programs. Paper presented to the meeting of the American Vocational Association, Atlanta, December 1981.

## REFERENCES

- Balow, B. Comments on vocational education and the law: A response to Frank Laski's paper. Career Development for Exceptional Individuals, Special Summer Issue 1981, 4(1), 45-47.
- Brown, J. M. A national symposium on articulation: Examining issues and potential goals for the next decade. Career Development for Exceptional Individuals, Special Summer Issue 1981, 4(1), 100-109.
- Brown, J. M. & Kayser, T. F. Articulation: Enhancing special needs students' transition from secondary to postsecondary vocational education programs. Career Development for Exceptional Individuals, Special Summer Issue (1981), 4(1), 1-7.
- Brustein, M. Does the federal vocational education framework hinder the delivery of programs for special needs populations? Career Development for Exceptional Individuals, Special Summer Issue 1981, 4(1); 8-22.
- Datta, L. E. Inside the black box: Process evaluation as a part of cost effectiveness/benefit analysis. Journal of Vocational Education Research. Fall, 1980, 5,(4), p. 63-74.
- Davidson, S. M. & Perloff, J. D. Continuing care: The concept and the research issue. Department of Health and Human Services. Health Care Financing Administration, Office of Research, Demonstration, and Statistics. Baltimore, MD: 1981. (HCFA Pub. No. 03100)
- Dawis, R. V., England, S.W. & Lofquist, L. H. Minnesota studies in vocational rehabilitation: XV. A theory of work adjustment. Minneapolis: Industrial Relations Center, University of Minnesota, 1964.
- The Education For All Handicapped Children Act of 1975, Pub. L. No. 94-142, 89 Stat. 775, 20 U.S.C.A. Sec. 1401 et. seq. (Nov. 29, 1975).
- Education Amendments of 1974 (the Buckley amendment), Pub. L. No. 93-380, Sec 513-515, 20 U.S.C. Sec. 12132(g). Protection of the rights and privacy of parents and students. (See also, Title 45, Sub. A., Part 99. Fed. Reg. 24662, June 17, 1976).

- Halloran W. & Razeghi, J. A. Problems associated with handicapped individuals' accessing education, training, and employment programs: A national perspective. Career Development for Exceptional Individuals, Special Summer Issue 1981, 4(1), 48-59.
- Hartley, N. Articulating secondary special needs groups into postsecondary programs: A reaction to directions for future research. Career Development for Exceptional Individuals, Special Summer Issue 1981, 4(1), 89-99.
- Johnson, C. Using the IEP for postsecondary vocational programs: A reaction. Career Development for Exceptional Individuals, Special Summer Issue 1981, 4(1), 78-82.
- Krantz, G. C. Paradoxes, basics, and proposals about impact on articulation. Career Development for Exceptional Individuals, Special Summer Issue 1981, 4(1), 59-67.
- Laski, F. Some future legal issues for special needs populations. Career Development for Exceptional Individuals, Special Summer Issue 1981, 4(1), 32-44.
- Lee, A. M. Earning a living across the nation. Volume IV, Parts 1 and 2. Project Baseline, Fourth National Report Baseline Year 1973-74 (Fiscal Year 1974). Flagstaff: Northern Arizona University, 1975. (ED 120470 and 120471).
- McKinnerney, B. R., Thomas R., & Todd, H. R. Student articulation between secondary and postsecondary education: A suggested guide. College Station, TX: June 1974.
- Meer's, G. Articulating special needs students into postsecondary vocational programs: A reaction to Michael Brustein. Career Development for Exceptional Individuals, Special Summer Issue 1981, 4(1) 22-31.
- State of Minnesota, Department of Education, Division of Vocational/Technical Education, Termination Report. Minnesota Vocational Education Data System. 1981.
- Phelps, L. A. A compendium of interagency agreements: Vocational education, special education and vocational rehabilitation policy research and resource series: Document 5. Leadership Training Institute/Vocational Education and Special Education. College of Education, University of Illinois, Urbana-Champaign, 1981.

Reynolds, M. C. IEPs as articulation facilitators. Career Development for Exceptional Individuals, Special Summer Issue 1981, 4(1), 68-78.

Riffel, R. Articulating secondary special needs groups into postsecondary programs: Some directions for future research. Career Development for Exceptional Individuals, Special Summer Issue 1981, 4(1), 83-89.

Smith, B. B., Brown, J. M., & Kayser, T. F. A psychological model for special needs instruction and research. Journal for Vocational Special Needs Education 1982, 4(3), 29-32.

Strom, L. H. A study of articulation practices in selected industrial education programs in public secondary schools and community colleges in California. California Articulation Research Project Final Report, May 1977. (ERIC Document Reproduction Service No. ED 145 168)

Wright, D. Articulation in postsecondary vocational education for handicapped learners. In J. P. Greenan (Ed.), Postsecondary vocational education for the handicapped. Urbana, Illinois: Leadership Training Institute, University of Illinois, 1980. (Policy Paper Series: Document 3)