

DOCUMENT RESUME

ED 213 904

CE 031 578

**AUTHOR** Brath, Ed  
**TITLE** Plumbing. Pre-Apprenticeship Phase 2 Training. Student Training Modules.  
**INSTITUTION** Lane Community Coll., Eugene, Oreg.  
**SPONS AGENCY** Employment and Training Administration (DOL), Washington, D.C.; Oregon State Dept. of Education, Salem.  
**PUB DATE** 81  
**NOTE** 394p.; For related documents see CE 031 561-579.  
**EDRS PRICE** MF01/PC16 plus Postage.  
**DESCRIPTORS** Behavioral Objectives; \*Building Trades; Check Lists; Job Skills; Learning Activities; Learning Modules; Pacing; \*Plumbing; Postsecondary Education; Sanitary Facilities; Tests; \*Trade and Industrial Education; Two Year Colleges; Vocabulary  
**IDENTIFIERS** \*Preapprenticeship Programs

**ABSTRACT**

These 26 Student Training Modules on plumbing comprise one of nine sets of self-paced learning modules developed for Pre-Apprenticeship Phase 2 Training. (A companion instructor's guide is available separately as CE 031 577.) The modules are designed to impart trade knowledge and skills to the student. Each module contains some or all of the following: cover sheet listing module title, goals, and performance indicators; study guide/checklist with directions for module completion; introduction; vocabulary listing and defining new trade or technical terms; supplementary references; information sheet(s) providing information and graphics covering the module topic(s); self-assessment; self-assessment answers; assignment sheet(s); job sheet(s) listing materials and tools necessary to complete tasks designed to develop manipulative skill; post assessment; and post assessment answers. Topics covered in the module include pipe materials; fittings; plumbing valves; adhesives; cutting of pipe materials; reaming, cleaning, and threading; attaching pipes and fittings with solder and cement; attaching threaded pipe and fittings; plumbing systems; soil system; waste system; vent system; water system; gas piping system; plumbing tests and inspection; tub and shower; lavatory; water closet; kitchen sink, garbage disposal, and dishwasher; laundry tub; water heater; repair; sewer cleaning and tools; and specialty buildings. (YLB)

\*\*\*\*\*  
 \* Reproductions supplied by EDRS are the best that can be made \*  
 \* from the original document. \*  
 \*\*\*\*\*

ED213904



# PRE-APPRENTICESHIP PHASE 2 TRAINING Student Training Modules

## Plumbing

U.S. DEPARTMENT OF EDUCATION  
NATIONAL INSTITUTE OF EDUCATION  
EDUCATIONAL RESOURCES INFORMATION  
CENTER (ERIC)

This document has been reproduced as received from the person or organization originating it. Minor changes have been made to improve reproduction quality.

Points of view or opinions stated in this document do not necessarily represent official NIE position or policy.

"PERMISSION TO REPRODUCE THIS MATERIAL HAS BEEN GRANTED BY

C. Horstrup

TO THE EDUCATIONAL RESOURCES INFORMATION CENTER (ERIC)"

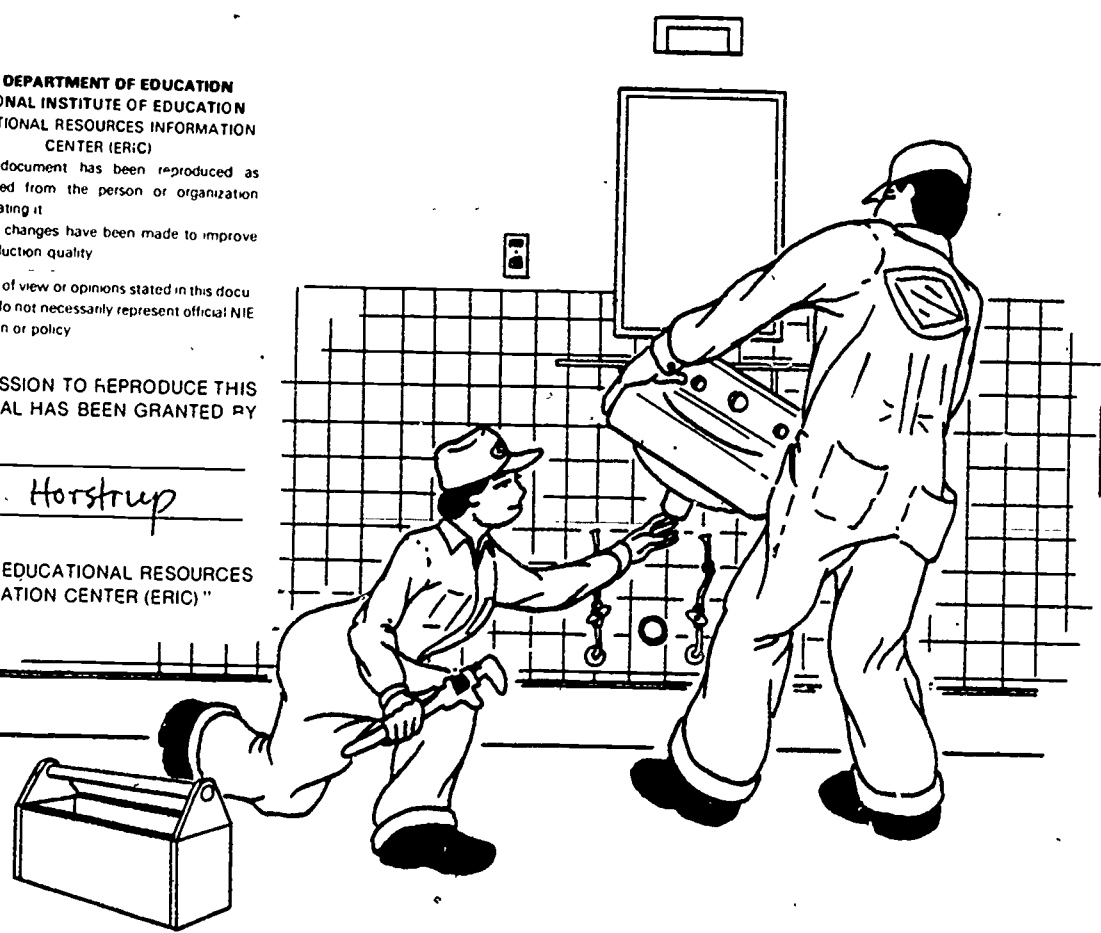

CE031578

Plumbing Module Writer:

Ed Brath

Technical Assistance:

Ken Browne

Graphics: Ralph Bentley

Editorial, Proofreading and Pasteup:

Debi Carroll, Ron Hamblen

Typing:

Strandlien Typing Service

This project was developed under a sub-contract for the Oregon Department of Education by Lane Community College, Community Education Division, Eugene, Oregon. Funds were provided by the Governor of Oregon from the Educational Linkages Component of the CETA Governor's Grant.

#### **STATEMENT OF ASSURANCE**

It is the policy of the Oregon Department of Education that no person be subjected to discrimination on the basis of race, national origin, religion, sex, age, handicap or marital status in any program, service or activity for which the Oregon Department of Education is responsible. The Department will comply with the requirements of state and federal law concerning non-discrimination and will strive by its actions to enhance the dignity and worth of all persons

# Lane Community College

4000 E. 30th Avenue  
Eugene, Oregon 97405  
(503) 726-2200

Office of the President

July 27, 1981

On behalf of Lane Community College, I wish to express our pride and gratitude for the opportunity to participate in the development of the Pre-Apprenticeship training materials. We also wish to commend the Oregon Department of Education for its original concept and continued support; and, the Educational Linkages Component of the CETA Governor's Grant for funding.

The goals of this project are many, but none are more important than that of producing valid, understandable vocational curriculum material. We congratulate the tradespeople and production staff for their accomplishments.

Finally, I recommend this material to anyone exploring Pre-Apprenticeship as an entry into the vocational work world, with the hope and belief that it will go a long way toward producing skilled craftspeople who are dedicated to their work.

Sincerely,

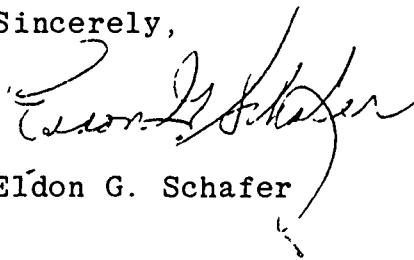

Eldon G. Schafer

HISTORY AND DEVELOPMENT OF PLUMBING

**Goal:**

The student will be able to explain the history and development of plumbing.

**Performance Indicators:**

The student will successfully complete a Self Assessment and a Post Assessment.

# Study Guide

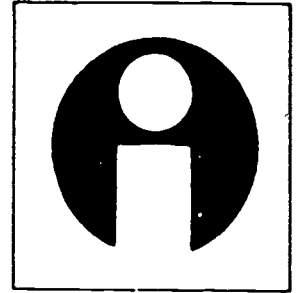

In order to finish this module, do the following tasks. Check each item off as you complete it.

1.  Read the Goal and Performance Indicators on the cover of the module. This will tell you what you will learn by studying the module, and how you will show you've learned it.
2.  Read the Introduction. The Introduction will tell you why the module is an important part of the plumbing trade.
3.  Study the Vocabulary section. Vocabulary words are important for a good understanding of the trade. After you have studied the vocabulary, ask your teacher to quiz you on the words and their meanings.
4.  Study the Information section. This section will give you the information you need to understand the subject.
5.  Take the Self Assessment exam. This is a test for you to prove to yourself that you have learned the material you have studied. Compare your answers with the answers on the Self Assessment Answer Sheet, which is on the page following the Self Assessment. If you scored poorly, re-study the Information section or ask your teacher for help.
6.  Take the Post Assessment exam. Give the exam to your teacher after you have completed it. Your teacher will grade it for you.

# Introduction

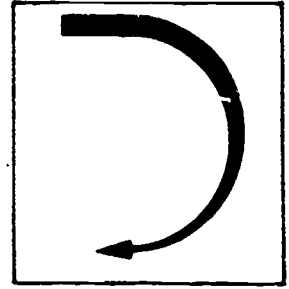

Plumbing goes back into ancient times; only recently has it been perfected. All the modern conveniences of today--hot and cold running water and a plumbing system designed to eliminate raw sewage--are a couple of examples.

Plumbing is the art, trade and business involved in the design, installation and maintenance of the plumbing in a building.

# Vocabulary

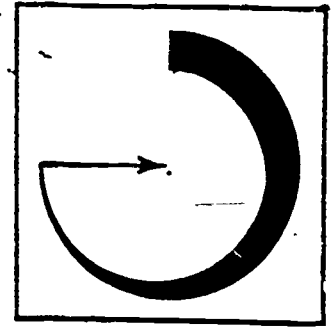

Trade terms are very important for a good understanding of the trade. Study these words and meanings. When you have learned them, ask your teacher to quiz you on the words and their meanings.

**PLUMBING SYSTEM**--In a building it consists of water piping, waste piping, soil, waste and vent piping, sewer piping and plumbing fixtures.

**CODE**--When used alone shall rule and regulate as set forth by an administrative authority.

**DRAINAGE SYSTEM**--All piping within public or private premises which conveys sewage to a public sewer or private disposal system.

**NON-POTABLE WATER**--Water not safe for drinking.

**POTABLE WATER**--Is satisfactory for drinking, cooking and which meets the requirements of the board of health.

**WATER CLOSET**--A water flushing fixture that receives human waste.

**STORM WATER**--Water that comes from rain.

**VENT**--A pipe that is run from the top of the drain pipe and out to the atmosphere.

**SANITATION**--The neutralizing or removal of conditions injurious to health.

**PLAGUE**--A disease that was found in ancient times due to unsanitary conditions.



WATER PIPING SYSTEMS--Are designed to bring potable water to the fixture to which they serve.

PERSONAL HYGIENE--The act of cleanliness for ones own body.

CISTERN--A holding tank designed for water.

TRAP--A device that provides a water seal to prevent sewer odors from entering the building.

# Supplementary References

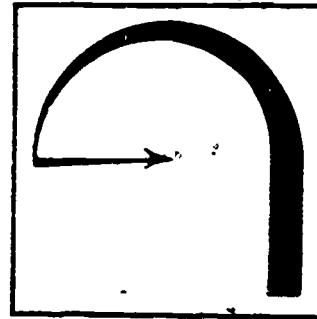

1. Colliers Encyclopedia, Volume 19. MacMillan Educational Committee, 1977.
2. Encyclopedia Americana, Volume 22. Americana Corporation, 1979.

# Information

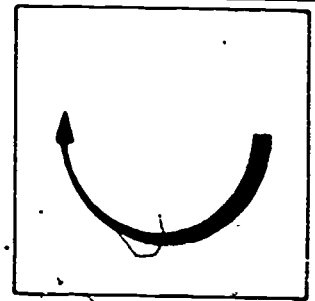

History tells us that in ancient times (about 6000 years ago) the difference between barbarism and civilization was related to the installation of piping systems. These systems provided them with a supply of potable drinking water and a system for disposing of storm water. It was a proven fact that the civilized people outlived the barbaric people.

Through archeological diggings and written material, it was found that in Egypt sections of copper water pipe served palace apartments some 5000 years ago.

In India 3000 to 6000 years ago the ruins of a plumbing system were found. In the city of Kish on the Euphrates River in the country that we now call Iraq, they found 4500-year-old ruins of cemented tile drains and swimming pools.

Later, around 2800 B.C., bathrooms and pottery pipes, tapered so that they fit end to end, were used. Their sewerage systems were vented as required now in our code. Even their toilets could be flushed and sealed so no sewer gas could escape.

But along with the ancient culture that created them, all these things and the related ideas of sanitation vanished. If they had not, the many plagues of history might not have occurred. Of all ancient civilizations, the Romans brought the highest degree of civilization with huge underground sewer systems, public and private baths, lead and bronze water piping systems, marble fixtures with gold and silver fittings and cast lead underground public water supply systems.

Following 1000 years of rule, the Roman Empire fell to the Vandals and Goths, who were barbaric tribes from the north of Europe. They destroyed everything

in their path, including metals and public works. The Roman civilization decayed and sanitary conditions vanished.

The following 1000 years were called the Dark Ages. Then, people in general paid little or no attention to personal hygiene or sanitary conditions. Plumbing fixtures, including water closets, which were developed around 400 to 500 A.D. in Rome, were non-existent during the Dark Ages. They did not reappear until 1200 A.D., and then very little.

In 1300 A.D. Europe was ravaged by a disease called the Bubonic Plague, because of the lack of sanitation. The plague caused the death of 25 million people.

Even in 1700 A.D. the European cities had not been equipped with sanitary sewer facilities. The death rate was greater than the birth rate.

In the latter part of the 1700s, Europe started to provide sanitary sewer facilities. They built public sewers and people began to use the sanitary sewer facilities and developed higher sanitary standards. These facilities were mostly troughs which both men and women used.

Among the early settlements in America, the sewage disposal was very primitive. As the settlements became major cities on the East Coast, they progressed and developed sanitary methods.

The first water closet that had a trap was proposed in the 1500s by Sir John Harrington. This invention was taken very lightly and over 200 years passed before a patent was issued for an improved water closet in 1775 A.D. It became widely accepted with the development of public water supplies.

The first fixture in America was the kitchen sink. If a public water supply was not available, water was pumped from a cistern or well to the kitchen. Bathtubs were the next fixtures available. They were made from wood boxes lined with lead, tin or copper.

The 1900s have been the most progressive in plumbing. We have a uniform code to act as our guide. Each year new fixtures are being developed. The fixtures will be covered in later modules.

## GENERAL USE

Plumbing systems are designed and constructed using materials such as plastic pipe and fittings, galvanized steel pipe and fittings, copper pipe with copper or brass fittings, black steel pipe and fittings, cast iron pipe and fittings, concrete pipe with concrete fittings.

These plumbing systems are composed of many different parts: pipes, fittings, valves and fixtures. They are then assembled into a safe and sanitary plumbing system.

To make sure that the safety and health of the people is insured, we have developed a standard for quality and correct workmanship which is called the code. The code was developed for some of the following reasons:

1. To prevent diseases from entering into our plumbing systems.
2. To provide for proper sizing of drainage for the sewer system.
3. To provide enough water for the sewer system to drain properly.
4. To provide potable drinking water.
5. To provide a water seal at all fixtures to prevent sewer gasses (odors) from entering the room.
6. To provide a vent pipe to extend to the atmosphere for each fixture, which allows air to circulate freely into the drainage system.

The plumber is responsible for the public health and sanitation. The plumber must provide a safe or potable supply of water into a building, distributed to the correct fixture.

The plumber is also responsible for the repair and maintenance of all water and waste pipes.

The plumber can work at many levels: apprentice, journeymen, foreman, superintendent and master plumber. Master plumbers in some states are plumbers with business licenses issued to them by the administrative authority. A plumbing superintendent is the person who oversees all foremen, journeymen and apprentices who work for him or her.

The plumbing foreman oversees journeyman plumbers and apprentices on a specific job or project. The journeyman plumber oversees the apprentice and guides him or her in everyday work.

# Self Assessment

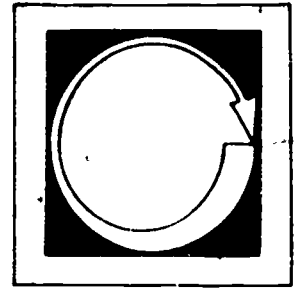

LISTED BELOW ARE SEVERAL STATEMENTS. IF THE STATEMENT IS TRUE, PLACE A "T" IN THE BLANK PROVIDED. IF THE STATEMENT IS FALSE, PLACE AN "F" IN THE BLANK.

1. \_\_\_\_ A plumbing system is designed to provide a clean and safe way of depositing solid and water-borne wastes.
2. \_\_\_\_ There were plumbing systems as far back as 3000 years ago.
3. \_\_\_\_ The disease that struck Europe in the 1300s was called Bubonic Plague.
4. \_\_\_\_ One reason the code was developed was to provide proper sizing of plumbing systems.
5. \_\_\_\_ A water seal at all fixtures is provided to make sure no leaking occurs.
6. \_\_\_\_ The plumbers's responsibility is to provide a safe and clean potable water system.
7. \_\_\_\_ There are three levels of plumbers.
8. \_\_\_\_ Code means the rules and regulations to which all plumbing systems must comply.
9. \_\_\_\_ Non-potable water is safe for drinking.
10. \_\_\_\_ A water closet is a fixture that receives human waste.
11. \_\_\_\_ The city of Kish was located in Greece.

12. \_\_\_\_ A cistern is a tank holding human waste.
13. \_\_\_\_ Rubber piping is used for water lines.
14. \_\_\_\_ The master plumber in some states is the highest grade of plumber.

# Self Assessment Answers

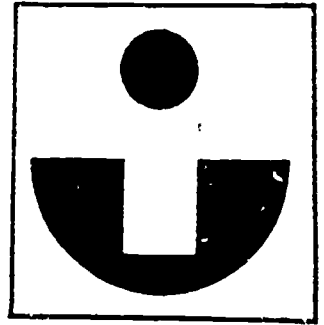

1. T
2. T
3. T
4. T
5. F
6. T
7. F
8. T
9. F
10. T
11. F
12. F
13. F
14. T



# Post Assessment

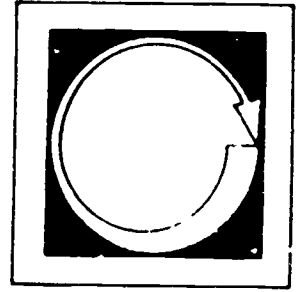

Write a short report (one page) on the history of plumbing.

## IDENTIFICATION OF PIPE MATERIALS

### **Goal:**

The student will be able to identify the different pipes used in plumbing and will be able to select the proper pipe and explain its use in the plumbing system.

### **Performance Indicators:**

The student will successfully complete a Self Assessment, an Assignment and a Job Sheet.

# Study Guide

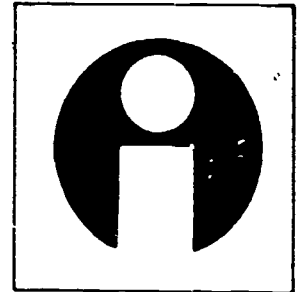

In order to finish this module, do the following tasks. Check each item off as you complete it.

1.  Read the Goal and Performance Indicators on the cover of the module. This will tell you what you will learn by studying the module, and how you will show you've learned it.
2.  Read the Introduction. The Introduction will tell you why the module is an important part of the plumbing trade.
3.  Study the Vocabulary section. Vocabulary words are important for a good understanding of the trade. After you have studied the vocabulary, ask your teacher to quiz you on the words and their meanings.
4.  Study the Information section. This section will give you the information you need to understand the subject.
5.  Take the Self Assessment exam. This is a test for you to prove to yourself that you have learned the material you have studied. Compare your answers with the answers on the Self Assessment Answer Sheet, which is on the page following the Self Assessment. If you scored poorly, re-study the Information section or ask your teacher for help.
6.  Do the Assignment page. Follow the instructions at the top of the Assignment page.
7.  Do the Job Sheet. Follow the instructions at the top of the Job Sheet. The tasks listed on the Job Sheet will help you develop skills which will be helpful to you.

# Introduction

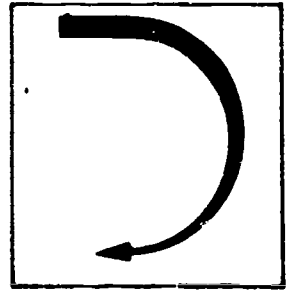

Pipe for plumbing dates back to ancient times when only lead pipe was used.

In modern times, the pipe in plumbing has been perfected to make sure the correct pipe for the particular system is used.

A modern system needs pipe with improved design and strength to increase the load-bearing capacity.

All pipe from 1/8" through 12" is measure by its inside diameter (I.D.); 14" and larger is measured by its outside diameter (O.D.).

Today, pipe is made from all types of material, the most common of which are discussed in this module. They include copper, plastic, steel and cast iron.

# Vocabulary

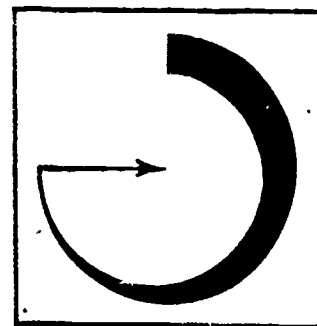

Trade terms are very important for a good understanding of the trade. Study these words and meanings. When you have learned them, ask your teacher to quiz you on the words and their meanings.

ABS--Acrylonitrile-Butadiene-Styrene.

ACRYLONITRILE-BUTADIENE-STYRENE--A thermoplastic compound.

ABS PIPE--Is made from thermoplastic.

DWV--Drainage-waste-vent.

BUILDING SEWER--The part of the horizontal piping of a drainage system that conveys it to the sewer, private or individual sewage disposal system.

STORM DRAIN--Part of horizontal piping, and its branches which convert subsoil and/or surface drainage from roofs or yards to the storm sewer.

BUILDING DRAINAGE SYSTEM--The part of the lowest piping of the drainage system which conveys soil, waste and other drainage pipes inside the building to the building sewer.

ASTM--American Society of Testing Materials.

NSF--National Sanitation Foundation.

IAPMO--International Association of Plumbing and Mechanical Officials.

NON-PRESSURIZED--At least one end that is open to the atmosphere.

PRESSURIZED--A closed system.

UNDERGROUND PIPING--Pipe that is buried in sand, gravel or earth fill.

PVC--Polyvinyl Chloride.

POLYVINYL CHLORIDE--Man-made plastic used in making pipe, fittings and valves.

PVC--Man-made plastic pipe, fittings and valves.

SCHEDULE 40--The thickness of the wall of pipe.

BELL--That portion of a pipe large enough to accept the spigot end of a pipe the same size.

ABOVE GROUND PIPING--Pipe that does not touch soil, concrete and gravel or land fill.

SPIGOT--The end of a pipe that is fit into the bell.

SCHEDULE 80--Wall thickness of pipe, thicker than schedule 40.

CLASS 200 PVC PLASTIC PIPE--Pipe with a wall thickness thinner than schedule 40.

COPPER--A tough, reddish brown, metallic chemical element that resists rust and is easily shaped, also used in making brass and bronze.

HARD TEMPERED--Treated to make tubing rigid.

CAST BRASS--An alloy, mostly copper with a base metal of zinc, poured into a mold.

SOFT TEMPERED--Treated for tubing to be bent or rolled.

GALVANIZED--To coat iron or steel with a coating of zinc as an aid against rust; silver in color.

NPT--National Pipe Threads.

RIGID--Stiff or firm. Cannot be bent without proper tools.

DURHAM--Recessed drainage fittings, tapped for grade and tar-dipped.

BLACK STEEL PIPE--Uncoated pipe, called black pipe because of the oxide scale which forms on steel.

CAST IRON PIPE--A commercial alloy of iron, carbon and silicon cast in a mold.

DOUBLE HUB--Pipe that has a bell on both ends.

SINGLE HUB--Pipe that has a bell on one end and a spigot on the other end.

SERVICE WEIGHT--Cast iron pipe having the thinnest wall thickness.

WALL THICKNESS--Size of thickness of walls in pipe.

EXTRA HEAVY--Cast iron pipe having a wall thickness thicker than service weight, but thinner than double extra heavy.

DOUBLE EXTRA HEAVY--Cast iron pipe having the thickest wall thickness.

TAR--A black, sticky substance that comes from coal or peat.

NO HUB--Cast iron pipe on which both ends are plain.

LOAD-BEARING CAPACITY--The amount of weight or pressure a pipe can hold without cracking or leaking.

DRAINAGE--Includes all the piping which conveys sewage to a point outside the building.

WASTE--Piping in a building receiving liquids and discharging into the drainage system.

Vent--A pipe or opening used for insuring free air to circulate throughout the plumbing system.

# Supplementary References

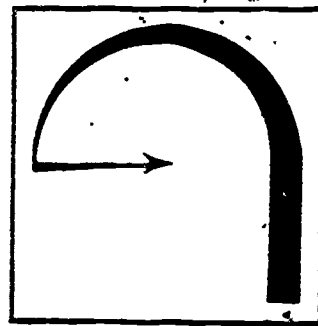

1. McConnell, Charles. Audels Plumbers & Pipefitters Library. Howard W. Sams & Co. Inc., Indianapolis, Indiana, 1977. pp. 9-31.
2. Daniels, George. Home Guide to Plumbing, Heating and Air Conditioning. Popular Science Publishing Co., 1967. pp. 12, 23-36.



# Information

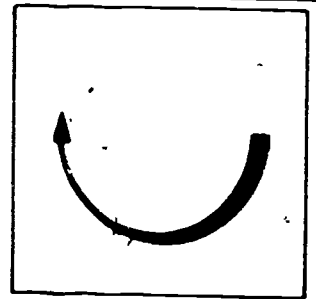

## ABS PLASTIC PIPE

1. ABS pipe trade standard is that it be schedule 40.
2. It comes in black and white.
3. It comes in 20-foot lengths with plain ends.
4. It will be used only for drainage, waste vent, building sewer, storm drains, building drainage system.
5. It is made in these sizes: 1½" - 1½" - 2" - 3" - 4" and 6" I.D.
6. It is manufactured to meet or exceed ASTM requirements.
7. It is approved by the NSF and the IAPMO.
8. It has continuous lettering throughout its length. It tells the diameter of pipe, the schedule of pipe and its manufacturer.
9. All ABS pipe is to be used with ABS fittings only.
10. Non-pressurized use only.

## PVC PLASTIC PIPE

1. PVC pipe trade standard is that if it is used for DWV; the pipe must be schedule 40.
2. Its color is white.
3. It comes in 20-foot lengths, with either both plain ends or one end with a bell.
4. It can be used on all plumbing systems, including potable water, except inside a building.
5. PVC pipe schedule 40 comes in sizes from ½" I.D. through 8" I.D.
6. It is manufactured to meet or exceed ASTM requirements.
7. It is approved by NSF and the IAPMO.
8. It has continuous lettering throughout its length, denoting the diameter of pipe, the schedule of pipe and its manufacturer.
9. Only PVC schedule 80 is recommended for threading.

10. Class 200 PVC plastic pipe can be used for storm drains also, but to a limited use.
11. All PVC plastic pipe is to be used only with PVC plastic fittings.

## COPPER TUBING

### DWV.

1. DWV copper tubing has the thinnest wall thickness of all copper tubing.
  - a. comes in 20-foot lengths.
  - b. it is hard tempered.
  - c. it is to be used only with DWV copper or DWV cast brass fittings.
  - d. has continuous lettering throughout its length, telling its size manufacturer, ASTM and DWV.
  - e. the lettering is in yellow ink.
  - f. is recommended for above ground use only.
  - g. is to be used in a non-pressurized plumbing system only.
  - h. comes in sizes from 1½" through 6".

### Type M Copper Tubing

1. Type M copper tubing has the thinnest wall thickness of copper tubing allowed for potable water.
  - a. it is hard tempered and comes in 20-foot lengths.
  - b. it also comes soft tempered in coils.
  - c. it is used only with copper or cast brass fittings designed for the potable water supply system.
  - d. it has continuous lettering throughout its length, listing its size, manufacturer ASTM and type M.
  - e. this lettering is in red ink.
  - f. it is to be used above ground and in a building only.
  - g. it comes in sizes from ½" through 12".

### Type K Copper Tubing

1. Type K copper tubing has the thickest wall thickness of all copper tubing.
  - a. it comes in 20-foot lengths and is hard tempered.
  - b. it also comes in coils and is soft tempered.
  - c. it may be used in a building plumbing, drainage system with DWV fittings.

- d. it may be used also in a water supply system with copper or cast brass fittings designed for potable water.
- e. it may be used underground as well as above ground.
- f. it has continuous lettering throughout its length, listing its manufacturer, size, ASTM and type K.
- g. this lettering is in green ink.

#### Type L Copper Tubing

- 1. Type L copper tubing wall thickness is thinner than type K and thicker than type M.
  - a. it comes hard tempered in 20-foot lengths.
  - b. it comes also soft tempered in coils.
  - c. it may be used with DWV fittings in a building drainage system, or with copper or cast brass fittings in a water supply system.
  - d. it has continuous lettering throughout its length, listing its size, manufacturer, ASTM and type L.
  - e. this lettering is in blue ink.

#### GALVANIZED STEEL PIPE

- 1. Galvanized steel pipe schedule 40 may be ordered with NPT on both ends, or plain ends.
- 2. It comes in approximately 21-foot lengths and it is rigid.
- 3. It may be used only with galvanized fittings for potable water above ground.
- 4. It has continuous lettering denoting its size, schedule and manufacturer.
- 5. Galvanized steel pipe may be used in the DWV system, with proper Durham fittings. Above ground only.
- 6. It may be used in a non-pressurized system as well as a pressurized system.
- 7. It is manufactured in sizes from 1/8" through 12".
- 8. Galvanized steel pipe schedule 40 is used the most throughout the plumbing trade.

#### BLACK STEEL PIPE

- 1. Black steel pipe schedule 40 may be ordered with NPT on both ends, or plain ends.

2. It comes in approximately 21-foot lengths and it is rigid.
3. Black steel pipe may be used with black fittings only; above or below ground.
4. It has continuous lettering listing its size, schedule and manufacturer.
5. It may be used for gas piping and steam piping, in a pressurized system.
6. Black steel pipe comes in sizes from 1/8" throughout 12".

#### CAST IRON SOIL PIPE (BELL AND SPIGOT)

1. Cast iron soil pipe comes in various lengths: 5-foot single hub, 10-foot single hub and 5-foot double hub.

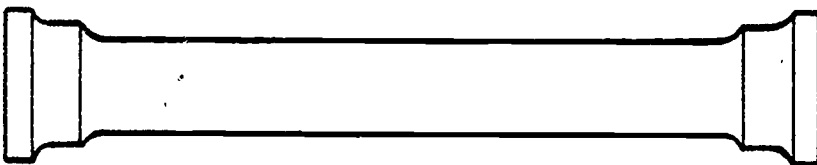

DOUBLE HUB  
CAST IRON PIPE



SINGLE HUB  
CAST IRON PIPE

2. It may be used throughout the DWV plumbing system, above or below ground.
3. It is identified with the size and weight, plus the manufacturer. It is put on the pipe when it is cast.
4. There are three grades of cast iron soil pipe, they are service weight, extra heavy and double extra heavy.
5. It is to be used in a non-pressurized DWV plumbing system only.

6. Cast iron soil pipe comes in sizes 1½" throughout 12".
7. Service weight is used the most throughout the plumbing trade.
8. Cast iron soil pipe bell and spigot can be used only with cast iron bell and spigot fittings.
9. The pipe is dipped in tar so the inside and outside get an even coat for longer life.

#### CAST IRON SOIL PIPE (NO HUB)

1. Cast iron no hub pipe usually comes in 10-foot lengths.
2. It may be used above or below ground throughout the plumbing system.
3. The pipe is identified with the size and weight and manufacturer. It is usually done with silver paint.
4. It comes in two grades, service weight and extra heavy.
5. The pipe shall be used in a non-pressurized DWV plumbing system only.
6. The pipe comes in sizes 1½" through 8".
7. Service weight is used the most throughout the plumbing industry.
8. Cast iron no hub pipe is to be used with cast iron no hub fittings.
9. The pipe is dipped in tar so the inside and outside get an even coat for a longer life.

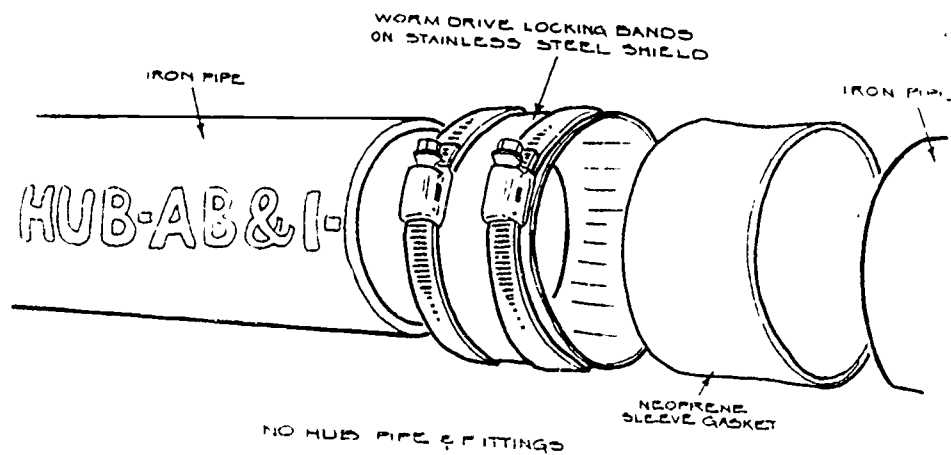

The chart on the following page is to serve as a guide in measuring the size of pipe from 1/2" through 2".

Listed in the chart are the inside diameter and outside diameter.

CHART

| Nominal Size | Pipe Material                | O.D. IN. | I.D. IN. |
|--------------|------------------------------|----------|----------|
| 1/2"         | Copper Tubing Type K         | .625     | .527     |
| 1/2"         | Copper Tubing Type L         | .625     | .545     |
| 1/2"         | Copper Tubing Type M         | .625     | .569     |
| 1/2"         | Galvanized Steel Schedule 40 | .840     | .622     |
| 1/2"         | Black Steel Schedule 40      | .840     | .622     |
| 1/2"         | PVC Plastic Schedule 40      | .840     | .622     |
| 3/4"         | Copper Tubing Type K         | .875     | .745     |
| 3/4"         | Copper Tubing Type L         | .875     | .785     |
| 3/4"         | Copper Tubing Type M         | .875     | .811     |
| 3/4"         | Galvanized Steel Schedule 40 | 1.050    | .824     |
| 3/4"         | Black Steel Schedule 40      | 1.050    | .824     |
| 3/4"         | PVC Plastic Schedule 40      | 1.050    | .824     |
| 1"           | Copper Tubing Type K         | 1.125    | .995     |
| 1"           | Copper Tubing Type L         | 1.125    | 1.025    |
| 1"           | Copper Tubing Type M         | 1.125    | 1.055    |
| 1"           | Galvanized Steel Schedule 40 | 1.315    | 1.049    |
| 1"           | Black Steel Schedule 40      | 1.315    | 1.049    |
| 1"           | PVC Plastic Schedule 40      | 1.315    | 1.049    |
| 1 1/4"       | Copper Tubing Type K         | 1.375    | 1.245    |
| 1 1/4"       | Copper Tubing Type L         | 1.375    | 1.265    |
| 1 1/4"       | Copper Tubing Type M         | 1.375    | 1.291    |
| 1 1/4"       | Galvanized Steel Schedule 40 | 1.660    | 1.380    |
| 1 1/4"       | Black Steel Schedule 40      | 1.660    | 1.380    |
| 1 1/4"       | PVC Plastic Schedule 40      | 1.660    | 1.380    |
| 1 1/4"       | ABS Plastic Schedule 40      | 1.660    | 1.380    |
| 1 1/2"       | Copper Tubing Type K         | 1.625    | 1.481    |
| 1 1/2"       | Copper Tubing Type L         | 1.625    | 1.505    |
| 1 1/2"       | Copper Tubing Type M         | 1.625    | 1.527    |
| 1 1/2"       | Galvanized Steel Schedule 40 | 1.900    | 1.610    |
| 1 1/2"       | Black Steel Schedule 40      | 1.900    | 1.610    |
| 1 1/2"       | PVC Plastic Schedule 40      | 1.900    | 1.610    |
| 1 1/2"       | ABS Plastic Schedule 40      | 1.900    | 1.610    |
| 1 1/2"       | Copper Tubing Type DWV       | 1.625    | 1.583    |
| 2"           | Copper Tubing Type K         | 2.125    | 1.959    |
| 2"           | Copper Tubing Type L         | 2.125    | 1.985    |
| 2"           | Copper Tubing Type M         | 2.125    | 2.009    |
| 2"           | Copper Tubing Type DWV       | 2.125    | 2.083    |
| 2"           | Galvanized Steel Schedule 40 | 2.375    | 2.067    |
| 2"           | Black Steel Schedule 40      | 2.375    | 2.067    |
| 2"           | PVC Plastic Schedule 40      | 2.375    | 2.067    |
| 2"           | ABS Plastic Schedule 40      | 2.375    | 2.067    |
| 2"           | Cast Iron Standard Weight    | 2.375    | Varies   |

# Self Assessment

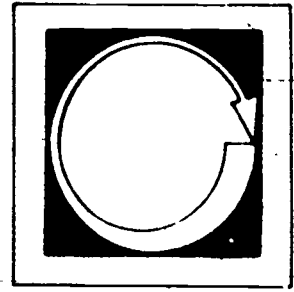

LISTED BELOW ARE SEVERAL STATEMENTS. IF THE STATEMENT IS TRUE, PLACE A "T" IN THE BLANK PROVIDED. IF THE STATEMENT IS FALSE, PLACE AN "F" IN THE BLANK.

1. \_\_\_ All pipe from 1/8" through 12" is measured by I.D.
2. \_\_\_ ABS pipe comes in 15-foot lengths.
3. \_\_\_ ABS pipe is used for potable water.
4. \_\_\_ ABS pipe is schedule 40.
5. \_\_\_ ABS pipe can be used in a pressurized system.
6. \_\_\_ PVC is made of steel.
7. \_\_\_ PVC water piping can only be used outside a building.
8. \_\_\_ PVC piping used for DWV must be schedule 80.
9. \_\_\_ PVC piping comes with plain ends or one end with a bell.
10. \_\_\_ DWV copper tubing is marked with blue ink.
11. \_\_\_ Type K copper tubing is marked with green ink.
12. \_\_\_ DWV copper pipe may be used in a pressurized plumbing system.
13. \_\_\_ Galvanized steel pipe comes only with plain ends.
14. \_\_\_ Black pipe must be used with black fittings only.
15. \_\_\_ No-hub cast iron pipe is used for potable water.

# Self Assessment Answers

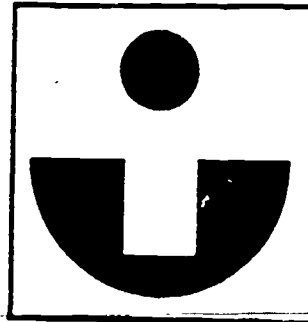

1. T
2. F
3. F
4. T
5. F
6. F
7. T
8. F
9. T
10. F
11. T
12. F
13. F
14. T
15. F



# Assignment

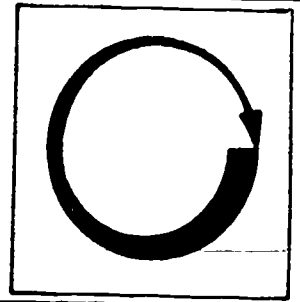

COMPLETE THE ASSIGNMENT BELOW.

Visit plumbing shops and plumbing wholesale distributors and ask for written material on piping used in the plumbing industry.

Return these pamphlets and/or books to the instructor and explain what piping material you have seen.

# Job Sheet

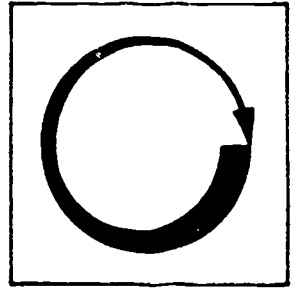

COMPLETE THE FOLLOWING TASKS.

1. Identify and explain the different types of copper tubing and their uses in the plumbing system.
2. Identify and explain PVC plastic pipe and its uses in the plumbing system.
3. Explain the use for cast iron no-hub cast iron pipe.

IDENTIFICATION OF FITTINGS

**Goal:**

The student will be able to identify the different fittings and match them to pipe, and will be able to explain the different materials found in fittings.

**Performance Indicators:**

The student will successfully complete a Self Assessment, an Assignment, a Job Sheet and a Post Assessment.

# Study Guide

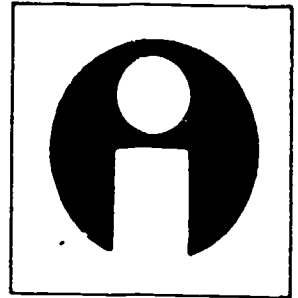

In order to finish this module, do the following tasks. Check each item off as you complete it.

1.  Read the Goals and Performance Indicators on the cover of the module. This will tell you what you will learn by studying the module, and how you will show you've learned it.
2.  Read the introduction. The Introduction will tell you why the module is an important part of the plumbing trade.
3.  Study the Vocabulary section. Vocabulary words are important for a good understanding of the trade. After you have studied the vocabulary, ask your teacher to quiz you on the words and their meanings.
4.  Study the Information section. This section will give you the information you will need to understand the subject.
5.  Take the Self Assessment exam. This is a test for you to prove to yourself that you have learned the material you have studied. Compare your answers with the answers on the Self Assessment Answer Sheet, which is on the page following the Self Assessment. If you scored poorly, re-study the Information section or ask your teacher for help.
6.  Do the Assignment page. Follow the instructions at the top of the Assignment page.
7.  Do the Job Sheet. Follow the instructions at the top of the Job Sheet. The tasks listed on the Job Sheet will help you develop skills which will be helpful to you.
8.  Take the Post Assessment exam. Give the exam to your teacher after you have completed it. Your teacher will grade it for you.

# Introduction

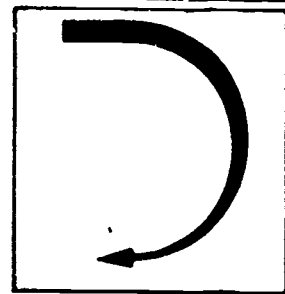

Throughout the plumbing system there is a large amount of pipe fittings and each fitting has a special purpose in the plumbing system. This is to make sure of a safe and clean system.

In a DWV system the fittings have more turn to them to ensure an even gravity flow since the DWV system is not a pressurized system.

# Vocabulary

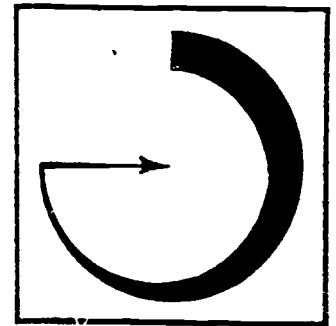

Trade terms are very important for a good understanding of the trade. Study these words and meanings. When you have learned them, ask your teacher to quiz you on the words and their meanings.

MALLEABLE--Fittings made by special-heat treated cast iron.

FITTING--Used to connect piping or for a change in the direction of pipe.

SOLDER--A metal or metallic alloy used, when melted, to join metallic surfaces.

VENT--A pipe or opening to make sure there is a circulation of air in the plumbing system.

NO-HUB COUPLING--A rubber connector with a stainless steel band, used with no-hub pipe and fittings.

OAKUM--A twisted nemp or fiber inserted with tar and used for packing before pouring lead.

LEAD--A metallic element, soft and bluish grey in color.

PVC PRIMER--A cleaning agent for PVC pipe and fittings.

PVC CEMENT--A clear liquid used to glue PVC pipe and fittings.

GROUND JOINT--A mechanical metal joint that fits tightly without gasket or packing.

CROSS--A four-directional fitting with little or no slope.

NATURAL GAS--A highly explosive gas that is odorless and colorless.

SEWER MACHINE--A machine used to unplug unwanted waste materials in a sewer or other waste pipe.

SLOPE--The direction of gravity flow.

GASKET--Is used to give a watertight joint.

SWEEP--The arc of the fitting.

# Supplementary References

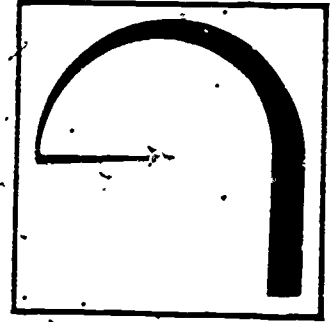

1. McConnel, Charles. Audel Plumbers and Pipefitters Library. Theodore Audel & Co., Division of Howard W. Sams & Co., Indianapolis, Indiana, 1977. pp. 63-79, 93-97..
2. Babbitt, Harold E. Plumbing. McGraw-Hill Book Co., New York, 1960. pp. 18-35.



# Information

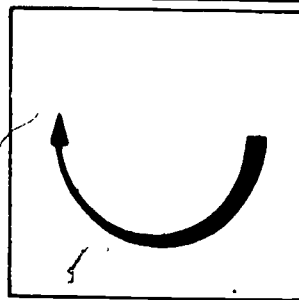

The pipe fittings most commonly used in plumbing include:

- (a) ABS, used with ABS pipe for the DWV system.
- (b) PVC, used with PVC pipe for the water supply system.
- (c) Copper DWV fittings, used with copper DWV tubing for the DWV system.
- (d) Copper fittings, used with copper tubing; designed for the water supply system.
- (e) Galvanized malleable fittings, used with galvanized steel pipe, which may be used in the water supply system.
- (f) Durham fittings, used with galvanized steel pipe, which may be used in the DWV system.
- (g) Cast iron bell and spigot fittings, used with cast iron bell and spigot pipe, which may be used in the DWV system.
- (h) Black malleable fittings, used with black steel pipe, which may be used for the natural gas piping system.

All pipe fittings have a name and a size. There is a correct way to describe each fitting. See the following examples.

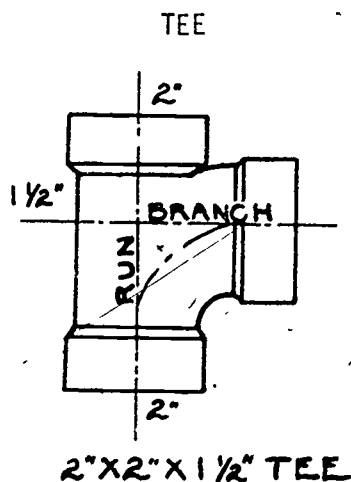

The steps and the proper way to read a tee:

1. Largest opening of the run = 2".
2. Other size of the run = 2".
3. The branch is always last = 1½".

Therefore we have a:

2" x 2" x 1½" tee.

90 DEGREE ELBOW

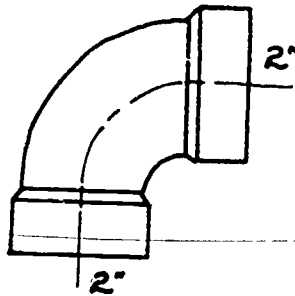

90° ELBOW

1. In a 90 degree elbow, both outlets in most cases are the same size. If one opening has a different size, it is read with the larger opening first.

There is no run or branch on this fitting.

CROSS

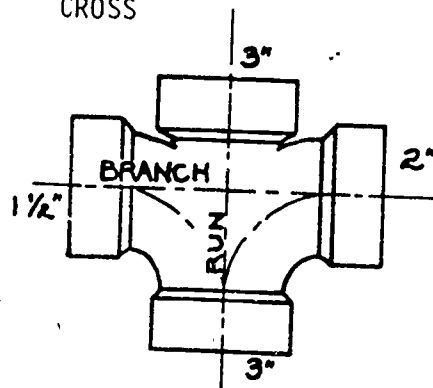

3X3X2X1½ CROSS

Proper way to read a cross.

1. Largest opening of the run = 3".

2. Other opening of the run = 3".
3. Largest opening of the branch = 2".
4. Other opening of the branch = 1½".

Therefore, we have a:

3" x 3" x 2" x 1½" Cross.

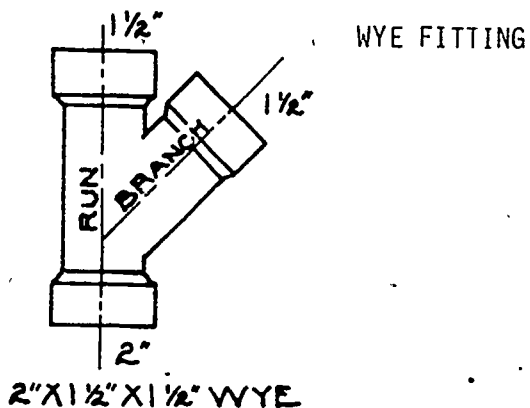

The proper way to read a wye.

1. Largest opening of the run = 2".
2. Other opening of the run = 1½".
3. The branch is last = 1½".

Therefore, we have a:

2" x 1½" x 1½" wye.

45 DEGREE ELBOW

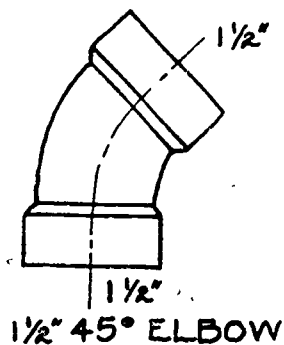

1. On all 45 degree elbows both openings are the same size.

Therefore, we have a:

1½" 45 degree elbow.

## DWV COPPER AND PLASTIC FITTINGS

The DWV fittings which follow are for use only in the DWV system. These fittings have shapes which are very much alike.

In all DWV systems a 90 degree elbow is called a 1/4 bend, a 45 degree elbow is called a 1/8 bend.

Plastic fittings are joined with plastic pipe with cement.

Copper fittings are joined with copper pipe with solder.

Galvanized threaded fittings and galvanized threaded pipe are joined together by tightening the fitting onto the pipe.

Cast iron bell and spigot fittings are joined with cast iron bell and spigot pipe by lead and oakum.

Cast iron no-hub fittings and pipe are joined together with no-hub couplings.

LONG SWEEP 1/4 BEND

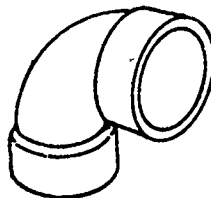

A long sweep 1/4 bend is used for changing direction on a drainage and waste system. Its sweep is twice as long as a regular 1/4 bend.

1/4 BEND

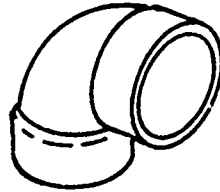

A 1/4 bend is used for changing direction in venting.

SANITARY TEE

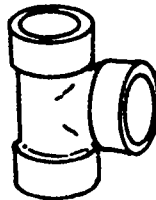

A sanitary tee is used in the drainage, waste and vent system.

WYE

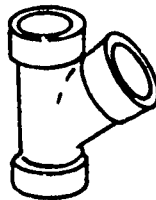

A wye's branch outlet is at a 1/8 bend angle. It is used mostly in the drainage and waste system.

1/8 BEND

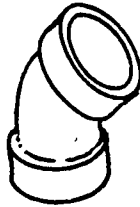

A 1/8 bend may be used throughout the DWV system.

COUPLING

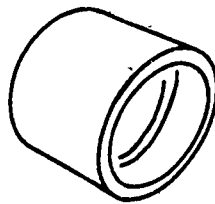

A coupling is used to extend the pipe's length.

TEE-WYE OR COMBINATION

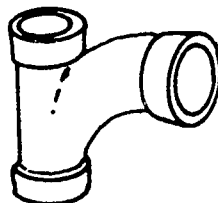

A tee-wye or combination is a combination of a wye and 1/8 bend and used mostly in the drainage and waste system.

## WATER CLOSET FLANGE

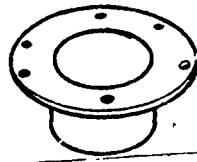

A water closet flange is used to secure the water closet to its drainage system.

## P-TRAP

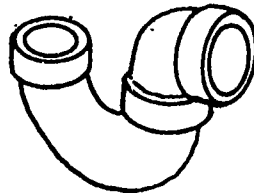

The purpose of a P-trap is to keep sewer odors from entering the building through a water seal.

## TWO-WAY CLEANOUT FITTING

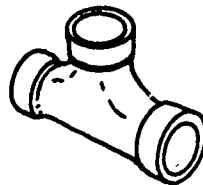

A two-way cleanout is installed within 5 feet from the building to allow a sewer machine to get in the system in case of clogged pipes.

## CAST IRON NO-HUB FITTINGS

The following cast iron no-hub fittings are to be used only with cast iron no-hub pipe.

### NO-HUB COUPLING

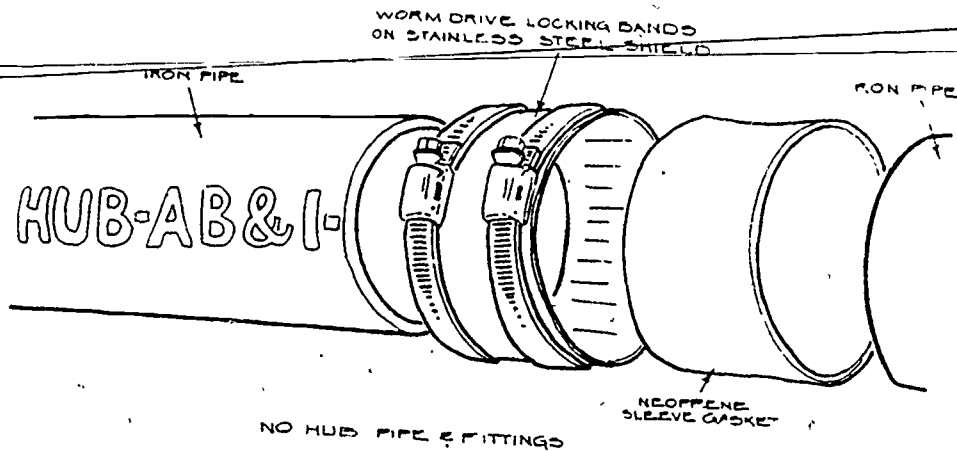

A no-hub coupling is used to join cast iron no-hub fittings to no-hub pipe or other fittings. They come in various sizes.

### CLOSET BEND

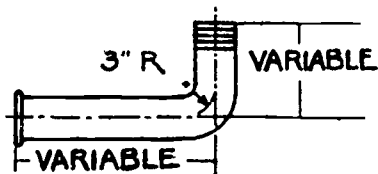

A cast iron closet bend may be used to connect the closet flange and the vertical piping to a water closet.



SANITARY CROSS

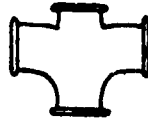

A cast iron sanitary cross may be used in the venting system.

DOUBLE COMBINATION

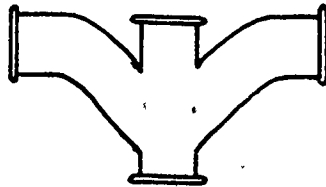

A double combination may be used in the horizontal and vertical position throughout the DWV system.

DOUBLE Y

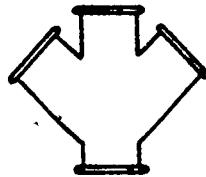

A double y may be used in the horizontal and vertical position throughout the DWV system.

## CAST IRON BELL AND SPIGOT FITTINGS

Cast iron bell and spigot fittings are to be used with bell and spigot pipe. They are joined together with oakum and lead.

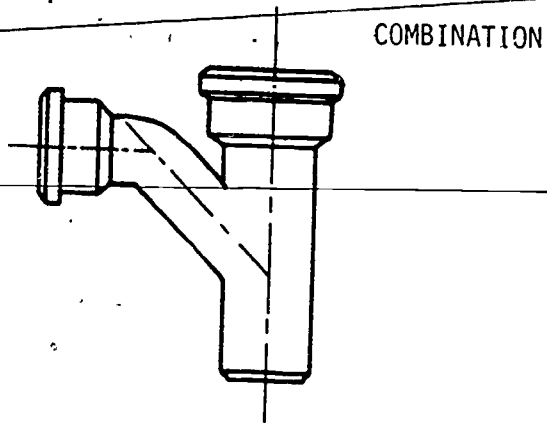

A cast iron bell and spigot combination is used throughout the DWV plumbing system.

1/4 BEND

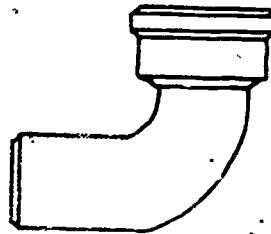

A 1/4 bend may be used throughout the DWV plumbing system.

WYE

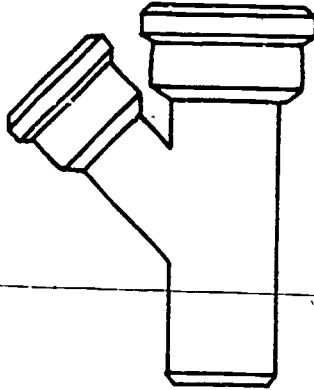

A wye may be used throughout the DWV plumbing system.

SANITARY TEE.

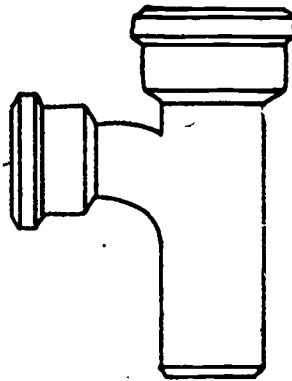

A sanitary tee may be used in the DWV plumbing system.

## DURHAM FITTINGS

Durham drainage fittings are threaded recessed and the threads are tapped to a grade of 1/4" to the foot. They are dipped in tar for resistance to rust and a longer life.

The fittings which follow are to be used with galvanized threaded pipe only. They may be used in the DWV plumbing system.

DURHAM P-TRAP

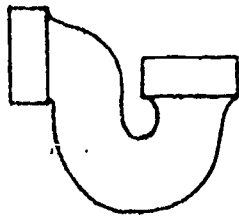

45° DOUBLE DURHAM WYE

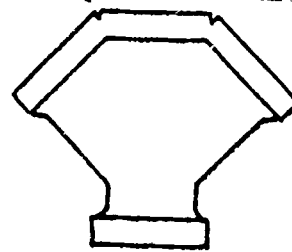

45° DURHAM WYE

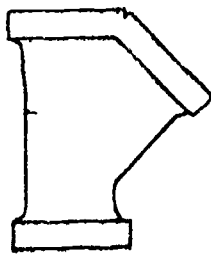

45° DURHAM ELL



DURHAM COMBINATION

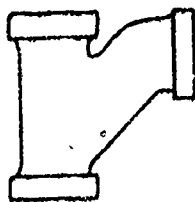

DURHAM SANITARY TEE

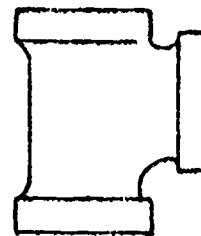

## COPPER WATER PIPE FITTINGS

The copper fittings which follow are for use in the potable water system. They may be used with type K, L and M copper soft and hard-tempered tubing.

The pipe and fittings are joined together by soldering.

COUPLING



A coupling is used to increase the length of pipe being used.

90 DEGREE ELBOW

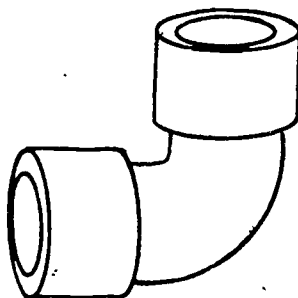

A 90 degree elbow is used in making a 90 degree change of direction.

TEE

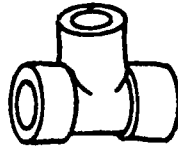

A tee is used to make a change of direction and still continue on in a straight line with the piping.

45° ELBOW

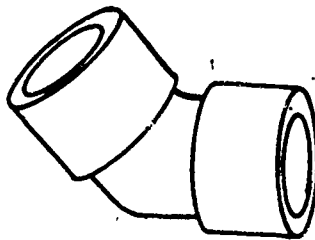

A 45 degree elbow is used to make a 45 degree directional turn of the pipe.

MALE ADAPTER

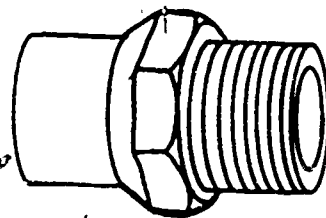

A male adapter is a copper solder connection on one end to male pipe thread on the other.

UNION

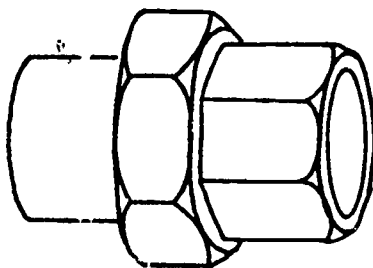

A union is a ground joint connection to copper connection and used to make quick disconnects or connections.

#### PVC WATER PIPE FITTINGS

The PVC plastic water pipe fittings which follow are for use in the potable water system. They may be used with PVC water pipe. The fittings and pipe are joined together with PVC cement and primer.

TEE

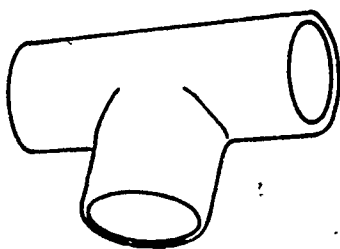

REDUCING TEE

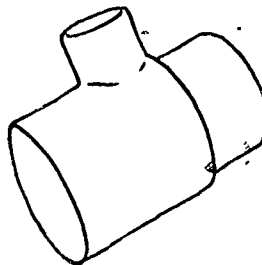

A reducing tee is used when you want to change the size of pipe in either direction.

#### BLACK MALLEABLE AND GALVANIZED FITTINGS

Galvanized and black malleable fittings are the same, but galvanized fittings can be used to pipe water. These fittings are joined with pipes by means of threads which are tightened to make a tight joint.

REDUCER

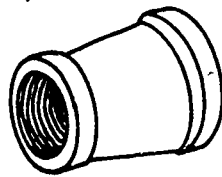

A reducer is used when you wish to change sizes of pipe.

PLUG

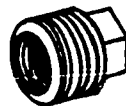

A plug is used to close off one side of a fitting. It can be removed and the fitting can be used at a later date.



CAP

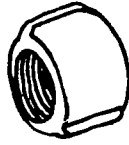

A pipe cap is used to close off the end of a pipe.

STREET 45°

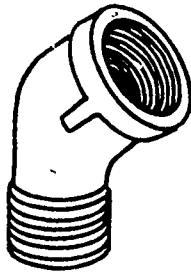

A street 45° is used to make a change of direction.

# Self Assessment

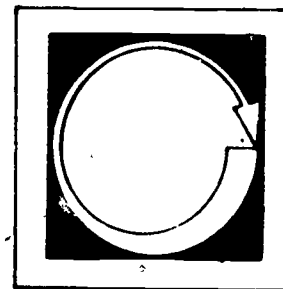

COMPLETE THE FOLLOWING STATEMENTS BY WRITING THE CORRECT WORD OR WORDS IN THE BLANK(S) PROVIDED.

1. \_\_\_\_\_ is used to clean PVC pipe and fittings.
2. A \_\_\_\_\_ pipe is used to insure free air circulation in the plumbing system.
3. A \_\_\_\_\_ is a four-directional fitting.
4. Only \_\_\_\_\_ may be used with cast iron no-hub fittings.
5. \_\_\_\_\_ is used to connect copper pipe and fittings.
6. \_\_\_\_\_ fittings may be used in gas piping.
7. The \_\_\_\_\_ is the last part of a fitting to be read.
8. The \_\_\_\_\_ of the run is read first.
9. A \_\_\_\_\_ is half the directional turn of a 1/4 bend.
10. A \_\_\_\_\_ is equal to a 90 degree elbow.
11. A \_\_\_\_\_ 1/4 bend has twice the sweep as a regular 1/4 bend.
12. \_\_\_\_\_ and \_\_\_\_\_ is used to join cast iron bell and spigot pipe and fittings.

13. A \_\_\_\_\_ is used to extend the pipe's length.
14. A \_\_\_\_\_ is used to prevent sewer odors from entering the building.
15. A \_\_\_\_\_ is used to unclog wastes in the plumbing system.
16. A \_\_\_\_\_ is used to connect cast iron no-hub pipe and fittings.
17. \_\_\_\_\_ may be used with galvanized pipe in the DWV plumbing system only.
18. \_\_\_\_\_ copper tubing has the thickest wall thickness of all copper tubing.
19. \_\_\_\_\_ copper fittings may be used with copper DWV pipe only.
20. A \_\_\_\_\_ is used to change sizes of pipe.

# Self Assessment Answers

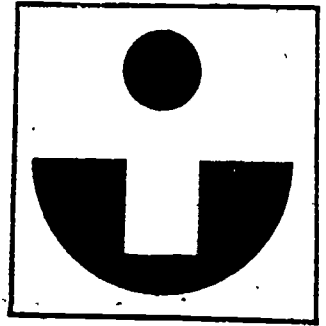

1. PVC Primer
2. Vent
3. Cross
4. Cast Iron No-Hub Pipe
5. Solder
6. Black Malleable
7. Branch
8. Largest Size
9. 1/8 Bend
10. 1/4 Bend
11. Long Sweep
12. Oakum-Lead
13. Coupling
14. P-Trap
15. Sewer Machine
16. No-Hub Coupling
17. Durham Fittings
18. Type K
19. DWV
20. Reducer

# Assignment

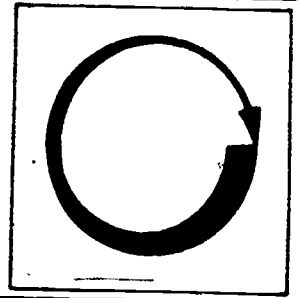

COMPLETE THE ASSIGNMENT BELOW.

Visit plumbing wholesale distributors and bring the written material you were able to obtain back to your instructor.

# Job Sheet

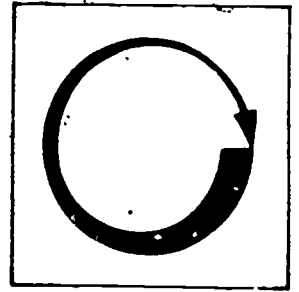

COMPLETE THE FOLLOWING TASKS.

1. Identify and explain the different types of fittings and where in the plumbing system they are used.
2. Identify the correct fitting with the pipe used. This will be asked by the instructor.

# Post Assessment

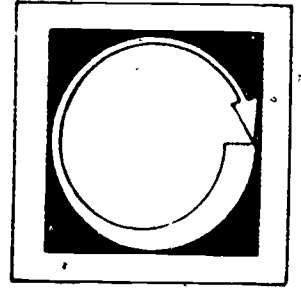

COMPLETE THE FOLLOWING STATEMENTS WITH A SHORT ANSWER.

1. The material used to connect PVC pipe with PVC fittings is:
2. Galvanized pipe in the water system is used with:
3. Type M copper tubing is:
4. Type L copper tubing is marked with:
5. The proper way to read a tee is:

# ● Instructor Post Assessment Answers

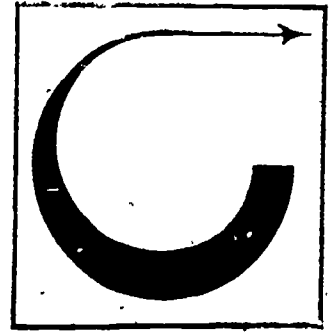

1. PVC Cement
2. Galvanized Fittings
3. The thinnest wall thickness of copper tubing allowed in the water system.
4. Blue Ink
5. (1) Largest size of the run, (2) Other size of run, (3) Size of the branch.



IDENTIFICATION OF PLUMBING VALVES

**Goal:**

The student will be able to identify, explain the use of and assemble the different valves used in the plumbing industry.

**Performance Indicators:**

The student will successfully complete the Self Assessment and will identify the valves presented in this module and their use in the plumbing system by completing the Job Sheet.

# Study Guide

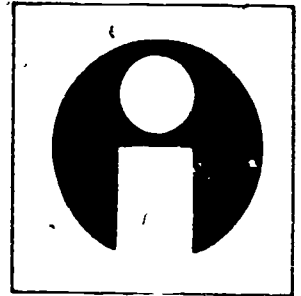

In order to finish this module, do the following tasks. Check each item off as you complete it.

1.  Read the Goal and Performance Indicators on the cover of the module. This will tell you what you will learn by studying the module, and how you will show you've learned it.
2.  Read the Introduction. The Introduction will tell you why the module is an important part of the plumbing trade.
3.  Study the Vocabulary section. Vocabulary words are important for a good understanding of the trade. After you have studied the vocabulary, ask your teacher to quiz you on the words and their meanings.
4.  Study the Information section. This section will give you the information you need to understand the subject.
5.  Take the Self Assessment exam. This is a test for you to prove to yourself that you have learned the material you have studied. Compare your answers with the answers on the Self-Assessment Answer Sheet, which is on the page following the Self Assessment. If you scored poorly, re-study the Information section or ask your teacher for help.
6.  Do the Job Sheet. Follow the instructions at the top of the Job Sheet. The tasks listed on the Job Sheet will help you develop skills which will be helpful to you.

# Introduction

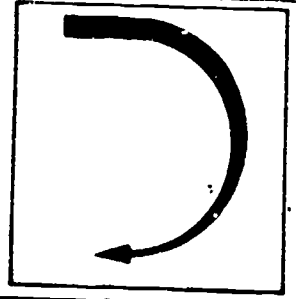

Throughout the plumbing industry there are many different valves. Each valve has a specific use. In this module you will be studying the most common valves and their use in residential plumbing.

A number of engineering and manufacturing associations have established minimum standards for valves. Chief among these organizations are: ANSI, MSS, API, ASTM, and ASME.

In addition, the federal government has established minimum standards for valves. The valves that are used in residential buildings are made mostly from cast brass.

The valve's main purpose is to control the amount and direction in which the liquids will flow. Cast brass valves may be used above or below ground.

# Vocabulary

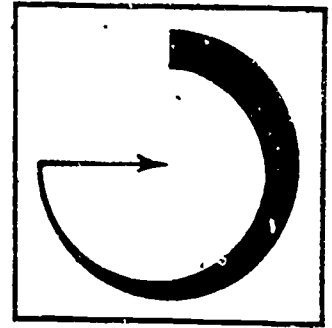

Trade terms are very important for a good understanding of the trade. Study these words and meanings. When you have learned them, ask your teacher to quiz you on the words and their meanings.

A.N.S.I.--American National Standards Institute.

M.S.S.--The Manufacturers Standardization Society of the Valves and Fittings Industry.

A.P.I.--American Petroleum Institute.

A.S.T.M.--American Society for Testing Materials.

A.S.M.E.--American Society of Mechanical Engineers.

I.P.S.--Iron Pipe Size.

P.R.V.--Pressure Regulating Valve.

CAST--Is a mold into which metal is poured.

# Information

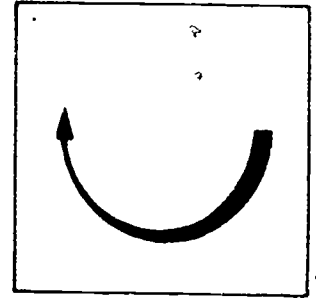

valves are used to control the flow of liquids in plumbing systems. The most common valves used in residential plumbing systems are:

1. Gate Valve
  - a. solder type, cast brass
  - b. screw type, cast brass
  - c. PVC cement type
  
2. Globe Valve
  - a. solder type, cast brass
  - b. screw type, cast brass
  - c. PVC cement type
  
3. Ball Valve
  - a. solder type, cast brass
  - b. screw type, cast brass
  - c. PVC cement type
  
4. Check Valve
  - a. solder type, cast brass
  - b. screw type, cast brass
  - c. PVC cement type
  
5. Temperature and Pressure Relief Valve
  - a. IPS only, cast brass
  
6. Pressure Regulating Valve
  - a. IPS to union IPS connection, cast brass

7. Hose Bibb

- a. solder type, cast brass
- b. screw type, cast brass

8. Gas Cock

- a. cast brass screw type w/lever handle
- b. cast brass screw type w/ square head

Gate Valve

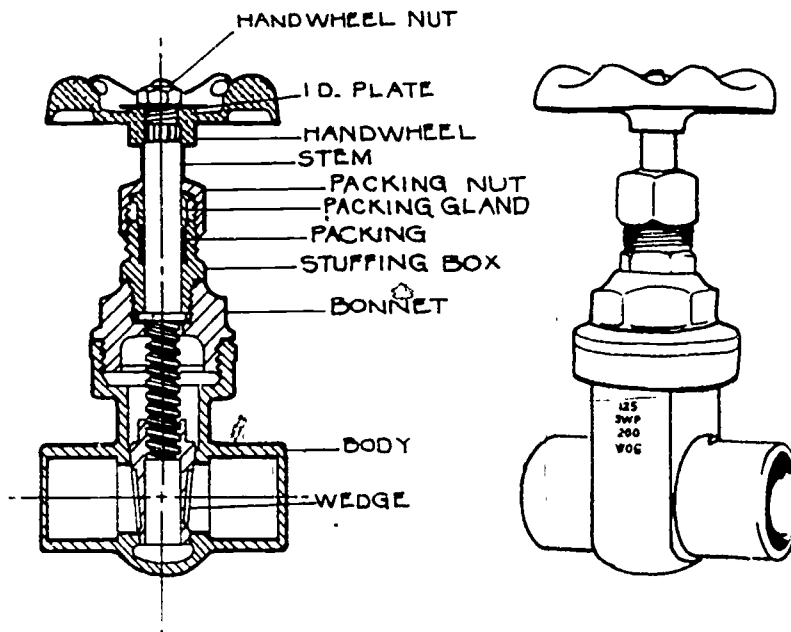

A gate valve is always used in the full open position or fully closed position. It is best suited in the full open position for a full flow of liquid in a straight line.

It is used as a main shut off at the water meter location, and also on the cold water piping to the water heater.

## Globe Valve

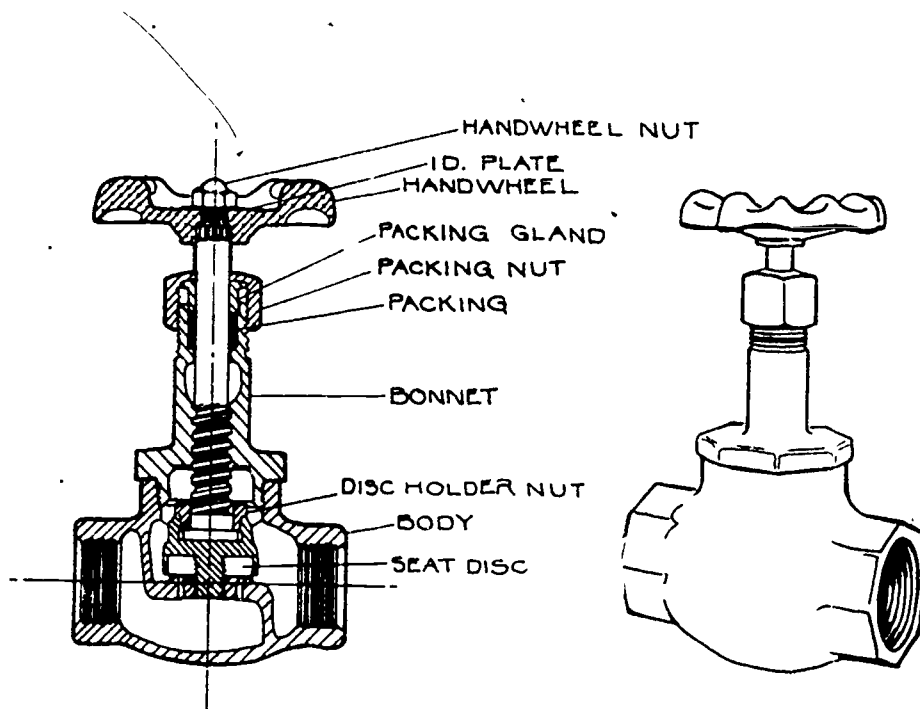

Bronze Globe Valve

A globe valve is used primarily as a control valve; as the valve disc is closed, the pressure and volume of flow decrease.

When installing a globe valve, the pressure should be on top of the disc, as shown in the illustration.

Ball Valve (See illustration at the top of the following page.)

A ball valve is a full open-and-close valve. It is best suited in the full open or closed position for a full flow of liquids in a straight line.

Check Valve (See illustration at the bottom of the following page.)

A check valve is used in many different places that liquid flows. Its main purpose is to permit an unrestricted forward flow while at the same time not allowing any backflow of water or unwanted materials.

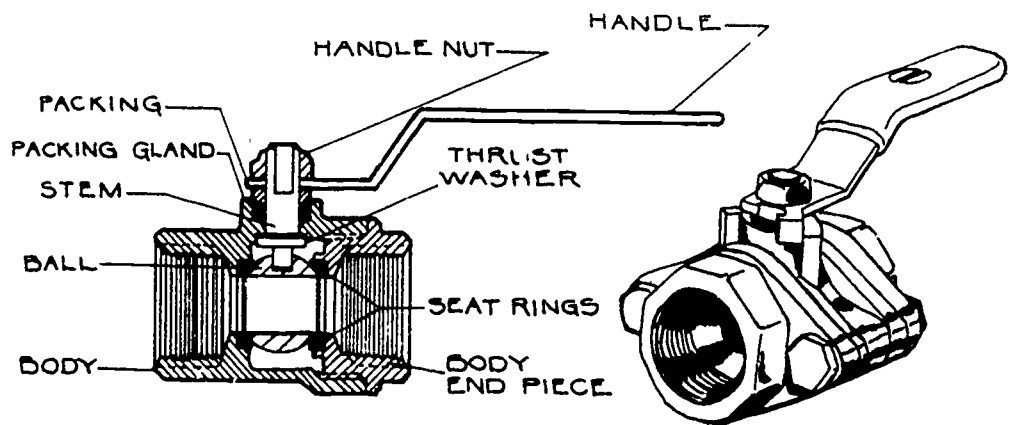

Internal working parts of a ball valve

Ball Valve

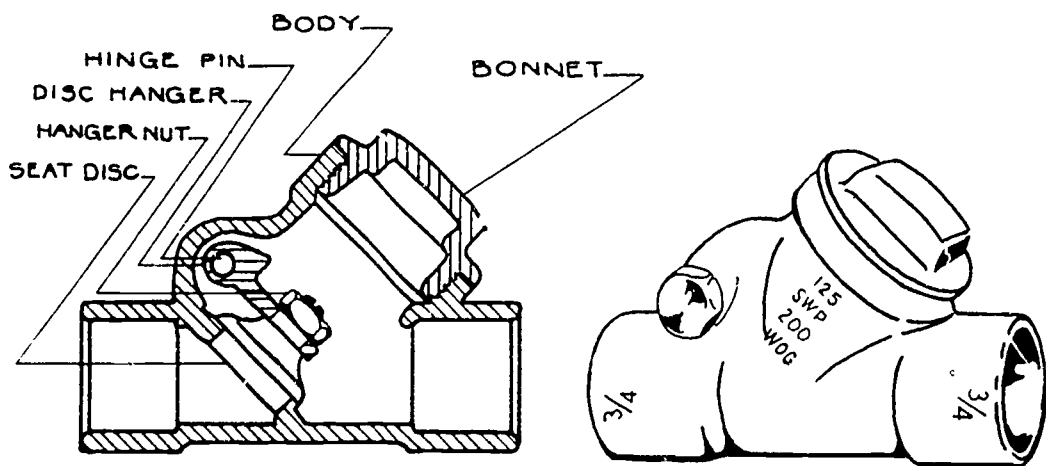

Check Valve



## Temperature and Pressure Relief Valve

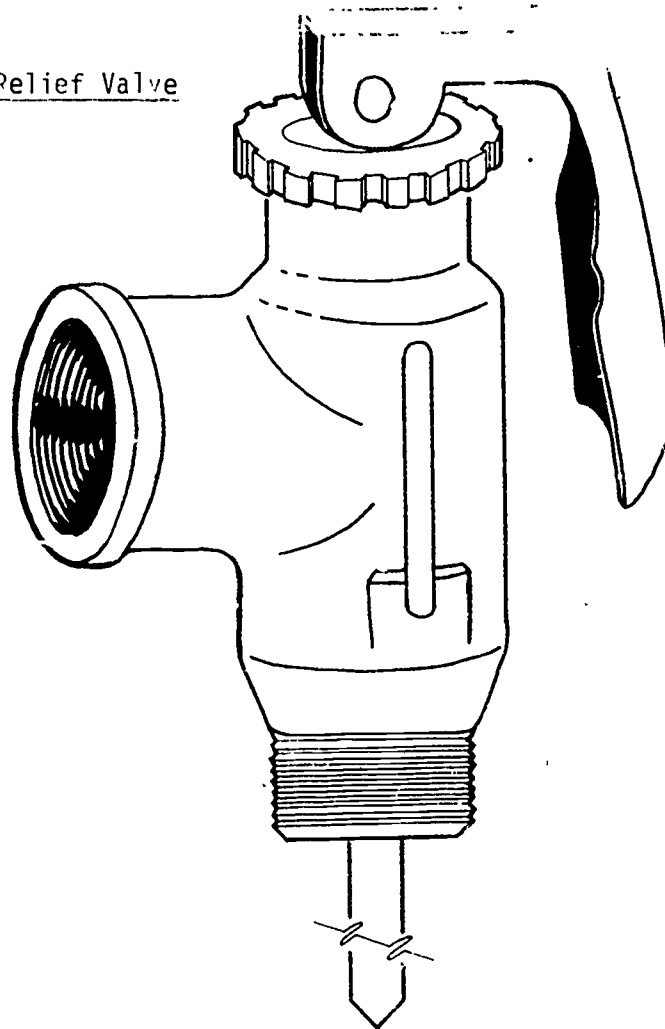

Temperature and pressure relief valves are specifically designed to control excess temperature and pressure. All T & P valves have a temperature setting of 210°F. Pressure settings may vary from 125 PSI to 150 PSI. When either pressure or temperature exceeds these settings, the valve will relieve itself by melting the solder in the tube or by pressure forcing the solder out of the tube.

Pressure Regulating Valve (See illustration at the top of the following page.)

A pressure regulating valve's purpose is to lower the water pressure in a building if the water main pressure is too high.

Hose Bibb (See illustration at the bottom of the following page.)

A hose bibb is equipped with a hose connection on the outlet side. This allows a hose to be connected and water used outside the building.

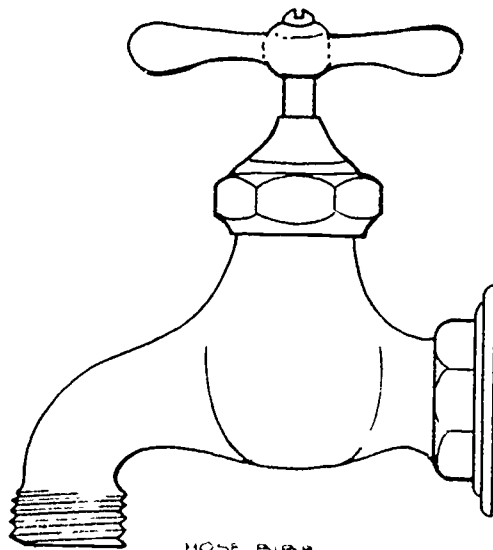
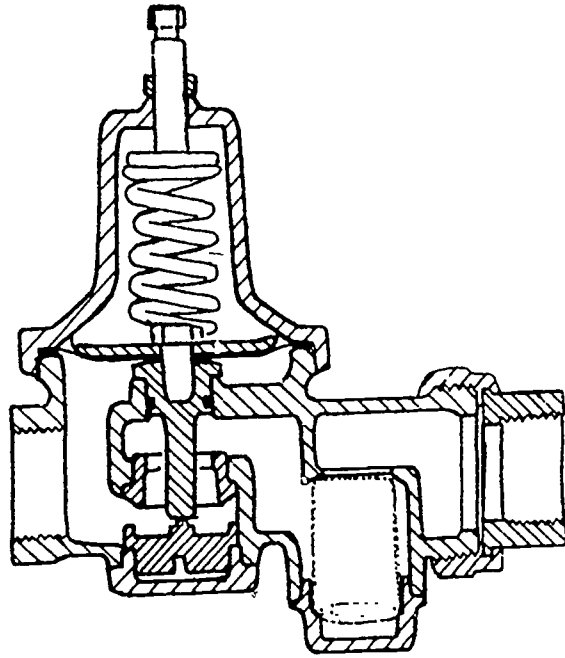

HOSE BIBB  
HOSE BIBB FAUCET

Gas Cock

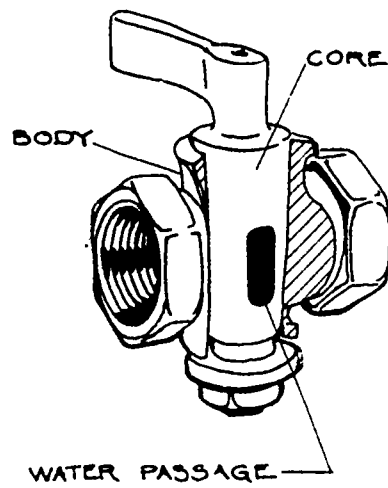

A gas cock is used mainly on gas lines to control the flow to a fixture. It must be located so it can be turned off quickly.

# Self Assessment

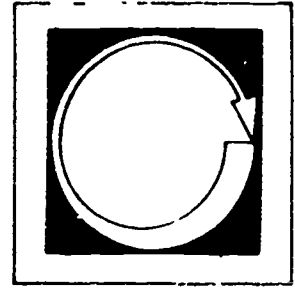

LISTED BELOW ARE QUESTIONS OR STATEMENTS FOLLOWED BY A NUMBER OF POSSIBLE ANSWERS OR COMPLETIONS. SELECT THE ANSWER OR COMPLETION WHICH ANSWERS THE QUESTION OR COMPLETES THE STATEMENT CORRECTLY AND PLACE THE LETTER IN THE BLANK PROVIDED.

1. \_\_\_ What is the purpose of a pressure regulating valve?
  - a. Reduce water pressure in building
  - b. Increase water pressure in building.
  - c. None of the above.
  
2. \_\_\_ A gate valve is used for:
  - a. Cold water at the water heater.
  - b. Main shut off valve to the building.
  - c. All of the above.
  
3. \_\_\_ A globe valve is used to:
  - a. Check unwanted objects from entering the water system.
  - b. Regulate the amount of water in the water system.
  - c. None of the above.
  
4. \_\_\_ Temperature and pressure relief valve is used to:
  - a. Make sure no hot water escapes from the water heater.
  - b. Control the cold water entering the water heater.
  - c. Open when the temperature exceeds 210°F.
  
5. \_\_\_ A ball valve is used:
  - a. As a check.
  - b. As a full open and closed valve.
  - c. As a float in the water system.

# ● Self Assessment Answers

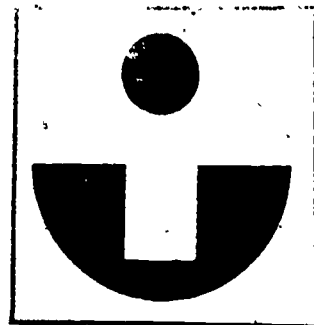

1.   a  

2.   c  

3.   b  

4.   c  

5.   b

# Job Sheet

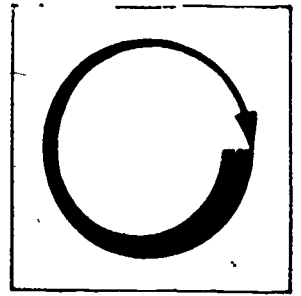

COMPLETE THE TASKS BELOW IN THE PRESENCE OF YOUR INSTRUCTOR.

1. Identify and explain the use of each valve mentioned in this module.
2. With the help of your teacher take three valves apart. Identify each part of the valve.
3. Assemble the valves back to their original condition.

## ADHESIVES

### **Goal:**

The student will be able to explain the use of solvents, adhesives and lubricants as they are used in the plumbing trade.

### **Performance Indicators:**

The student will demonstrate an understanding of the subject by successfully completing a Self Assessment and a Post Assessment.

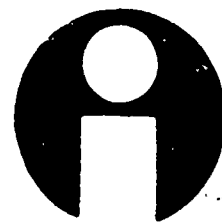

# Study Guide

In order to finish this module, do the following tasks. Check each item off as you complete it.

1.  Read the Goal and Performance Indicators on the cover of the module. This will tell you what you will learn by studying the module, and how you will show you've learned it.
2.  Read the Introduction. The Introduction will tell you why the module is an important part of the plumbing trade.
3.  Study the Vocabulary section. Vocabulary words are important for a good understanding of the trade. After you have studied the vocabulary, ask your teacher to quiz you on the words and their meanings.
4.  Study the Information section. This section will give you the information you need to understand the subject.
5.  Take the Self Assessment exam. This is a test for you to prove to yourself that you have learned the material you have studied. Compare your answers with the answers on the Self Assessment Answer Sheet, which is on the page following the Self Assessment. If you scored poorly, re-study the Information section or ask your teacher for help.
6.  Take the Post Assessment exam. Give the exam to your teacher after you have completed it. Your teacher will grade it for you.



# Introduction

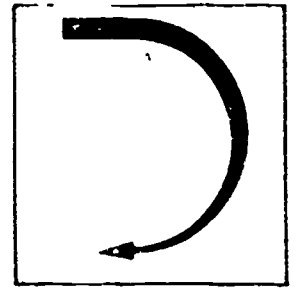

There are many different types of sealants, adhesives, lubricants and cements used in the plumbing system and each is used only for a special purpose.

# Vocabulary

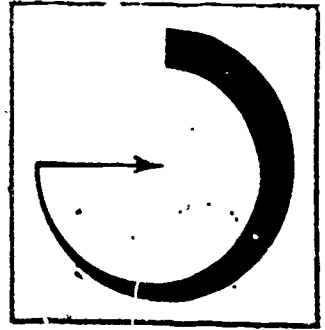

Trade terms are very important for a good understanding of the trade. Study these words and meanings. When you have learned them, ask your teacher to quiz you on the words and their meanings.

SEALANT--A sealing agent, used to seal.

ADHESIVE--A material used to join pipes together.

LUBRICANT--A material used to make something slippery.

BOILED LINSEED OIL--Amber (yellowish) colored oil that comes from flax seed.

CHLORIDE--A compound of chlorine

ZINC--A blue-white metallic element.

FLUX--A substance used to aid the flow of solder.

AMMONIUM--A chemical with a strong odor.

# Supplementary References

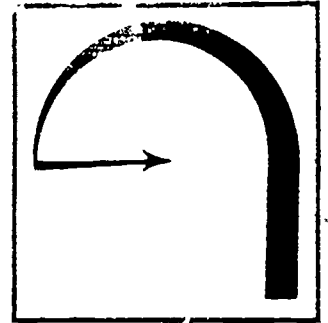

Ripka, L. V. Plumbing Installation and Design. American Technical Society,  
1978. pp. 102-104, 108-109.

# Information

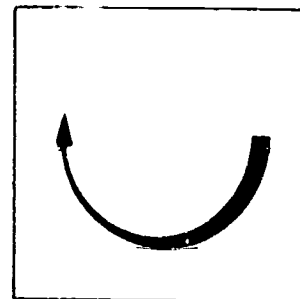

## THREADED PIPE JOINTS

Threaded pipe joints are joined together by using pipe joint compound or teflon tape. When applied to the male threads, the compound acts as a lubricant and a sealer. Pipe joint compounds should not be used on plastic pipe or fittings as they both are oil-based products. (A chemical reaction occurs when these oil-based products are joined together--the plastic threads become soft and the pipe erodes.)

Most all pipe joint compounds have a lead-base powder which is mixed with boiled linseed oil to form a liquid. The compound is applied to the male threads by the use of a small paint brush or dauber before using the pipe wrench to make up pipe and fitting.

## COPPER TUBING JOINTS

The 3 most common methods of joining copper tubing in plumbing are:

1. The solder joint with capillary fittings.
2. The flared joint.
3. The compression joint.

Solder joints are used on water and drainage lines.

The flared joints are used mostly on equipment that require quick disconnections. A special tool called a flaring tool is used with flared fittings to form a flared joint. No pipe joint compound or teflon tape is needed to lubricate these threads. (See the illustration at the top of the following page.)

The compression joint is most commonly used on the exposed water pipe supply to plumbing fixtures. A compression nut and ring are applied on the smooth end of the tubing and inserted into the compression fitting. The nut and ring are then tightened to form a sealed joint. (See the 2nd illustration on the next page.)

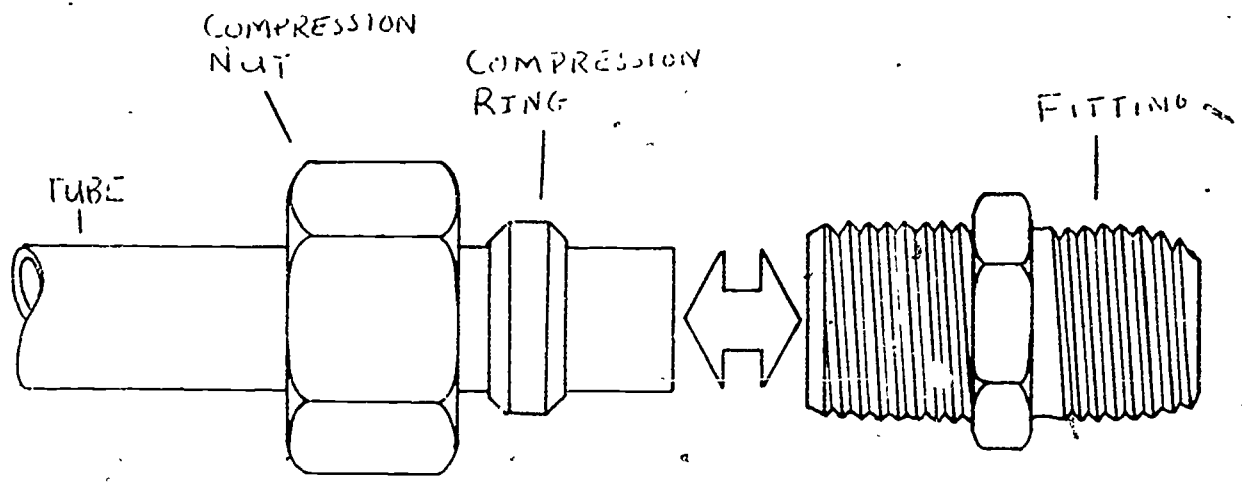
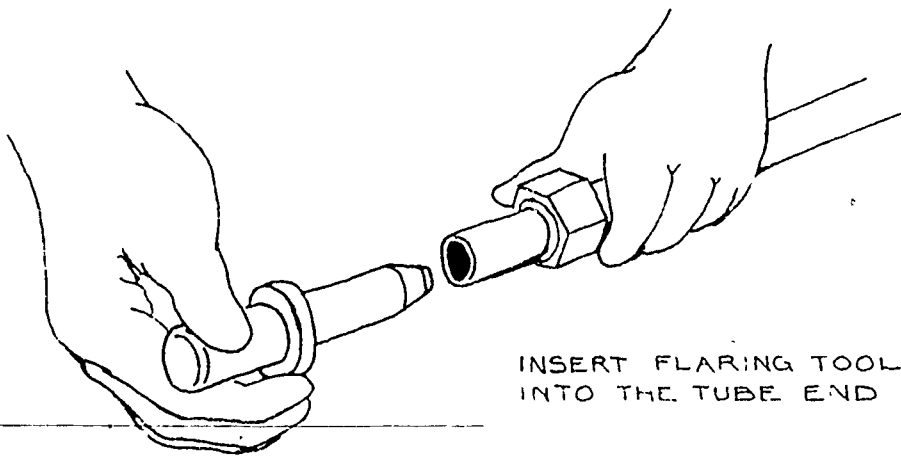

Solder joints depend on capillary action drawing free-molten (melted) solder into the gap between the fitting and tubing. The illustration below shows this capillary space.

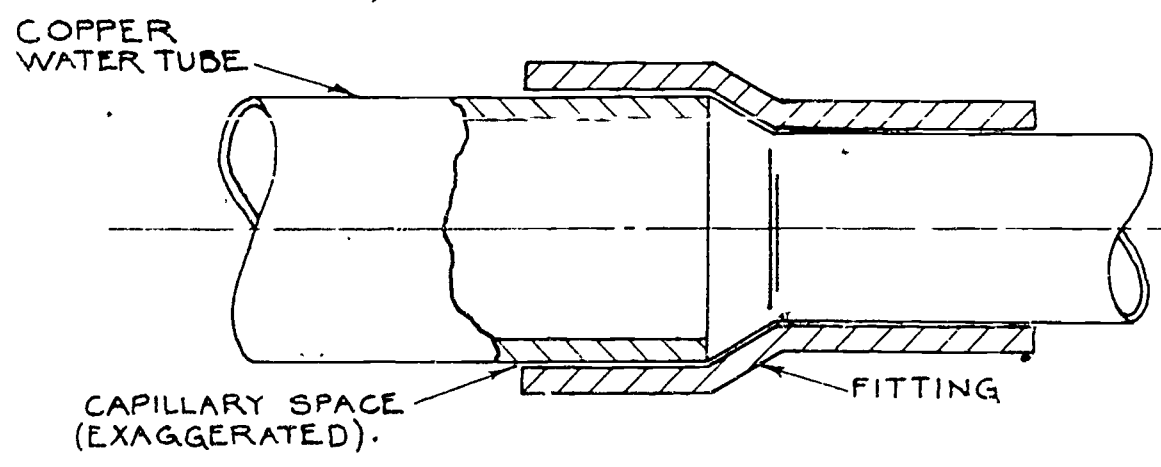

Flux is applied and acts as a wetting agent. (When properly applied, flux permits uniform spreading of the molten solder over the surfaces to be fastened.) Most fluxes have acid in them and should be used sparingly and carefully.

The type of solder to use depends on the operating heat and pressure in the plumbing line. The two types of wire solder mainly used by plumbers are 50-50 and 95-5. (The 50-50 solder is made of 50% tin and 50% lead. The 95-5 solder is made of 95% tin and 5% antimony.)

In most common systems, 50-50 wire solder is used. In hot water heating systems and high pressure piping, 95-5 wire solder is used.

The fluxes best suited to the 50-50 and 95-5 solders are mildly-corrosive liquid or petroleum-based pastes containing chlorides of zinc and ammonium.

Most liquid fluxes are self-cleaning fluxes, and their use involves a risk. Some paste-type fluxes are also identified by their manufacturers as "self-cleaning", and there is a similar risk in their use. There is no doubt that a strong corrosive flux can remove some oxides and dirt films. However, when highly-corrosive fluxes are used this way, there is always a concern as to whether uniform cleaning has occurred and whether corrosive action continues after the soldering has been completed.

#### PLUMBER'S PUTTY

Plumber's putty is a stretchable compound for setting toilet bowls, fixtures, faucets, strainers and for other sealing applications. Plumber's putty will not harden, since a part of the compound is boiled linseed oil. (Do not use glazier's putty for plumbing and do not use plumber's putty for glass.)

#### SOLVENT WELD JOINTS

Solvent weld joints are made by solvent bonding, producing a welded system much like a metal welded system. The primer and solvent actually soften the material to be joined together. When joined together under the proper conditions, the two surfaces actually run together and fuse, creating one solid piece of material that is as strong as the pipe itself.

The correct primer and solvent must be used with the proper plastic pipe and fittings to be used.

To assure a good solid weld with PVC and CPVC plastics, priming is essential, not optional. Priming cleans the surface, takes away the glaze, and starts the softening process:

With ABS however, you need only use ABS solvent to weld the joint. No primer is needed. Be sure all plastic pipe and fitting is free of dirt and foreign obstacles.

---

#### CAULKING COMPOUND

Caulking compound is made from plastics and contains a hardening agent. It is used for the rims of sinks, tubs, showers and water closets to prevent water leaking into cabinets or under the floor.

#### LIQUID TAR

Liquid tar is used around and on the roofjacks to prevent water from entering around a vent pipe and seeping into the building.

# Self Assessment

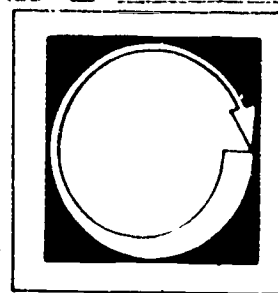

LISTED BELOW ARE SEVERAL STATEMENTS. IF THE STATEMENT IS TRUE, PLACE A "T" IN THE BLANK PROVIDED. IF THE STATEMENT IS FALSE, PLACE AN "F" IN THE BLANK.

1. \_\_\_ Pipe joint compound containing oil may be used on plastic pipe threads.
2. \_\_\_ Pipe joint compound should be applied to the female threads.
3. \_\_\_ There are only two common methods of connecting copper tubing.
4. \_\_\_ 50-50 wire solder is the most common solder used by a plumber.
5. \_\_\_ When connecting ABS pipe and fittings, only a solvent needs to be used.



# Self Assessment Answers

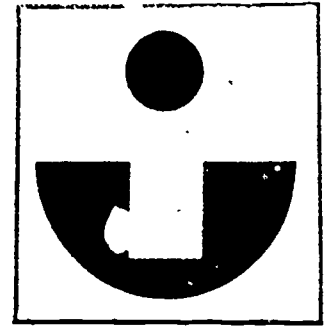

1. F
2. F
3. F
4. T
5. T

# Post Assessment

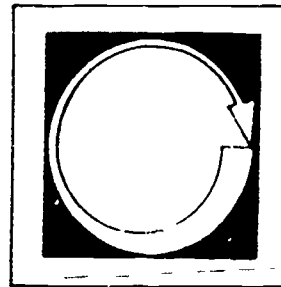

COMPLETE THE FOLLOWING STATEMENTS BY WRITING THE CORRECT WORD OR WORDS IN THE BLANKS PROVIDED.

1. The two most common types of solder used by plumbers are 50-50 and \_\_\_\_\_.
2. 50-50 wire solder is composed of 50% tin and 50% \_\_\_\_\_.
3. 95-5 wire solder is composed of 95% \_\_\_\_\_ and 5% \_\_\_\_\_.
4. Plumber's putty has within its compound \_\_\_\_\_.
5. Only a \_\_\_\_\_ may be used when welding plastic ABS pipe and fittings together.
6. A \_\_\_\_\_ and a \_\_\_\_\_ must be used when welding PVC and CPVC pipe and fittings.
7. The primer and solvent actually \_\_\_\_\_ the material to be joined together.
8. \_\_\_\_\_ is used around and on the roofjack to prevent water from entering the building.
9. Pipe joint compounds should be applied to the \_\_\_\_\_ threads only.
10. There are \_\_\_\_\_ common methods of connecting copper tubing.

# Instructor Post Assessment Answers

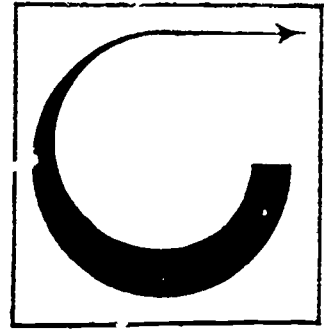

1. 95-5
2. lead
3. tin, antimony
4. boiled linseed oil
5. solvent
6. primer, solvent
7. soften
8. liquid tar
9. male
10. three

---

CUTTING OF PIPE MATERIALS

**Goal:**

The student will be able to identify, select, and demonstrate the appropriate tools used in the cutting of pipe and other materials.

**Performance Indicators:**

The student will successfully complete a Self Assessment and Job Sheet.

# Study Guide

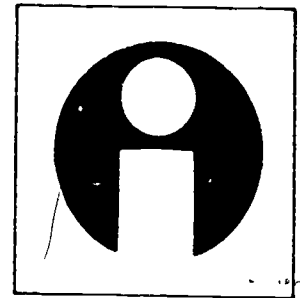

In order to finish this module, do the following tasks. Check each item off as you complete it.

1.  Read the Goal and Performance Indicators on the cover of the module. This will tell you what you will learn by studying the module, and how you will show you've learned it.
2.  Read the Introduction. The Introduction will tell you why the module is an important part of the plumbing trade.
3.  Study the Vocabulary section. Vocabulary words are important for a good understanding of the trade. After you have studied the vocabulary, ask your teacher to quiz you on the words and their meanings.
4.  Study the Information section. This section will give you the information you need to understand the subject.
5.  Take the Self Assessment exam. This is a test for you to prove to yourself that you have learned the material you have studied. Compare your answers with the answers on the Self Assessment Answer Sheet, which is on the page following the Self Assessment. If you scored poorly, re-study the Information section or ask your teacher for help.
6.  Do the Job Sheet. Follow the instructions at the top of the Job Sheet. The tasks listed on the Job Sheet will help you develop skills which will be helpful to you.

# Introduction

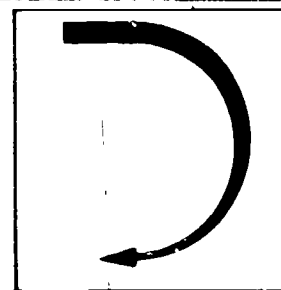

There are quite a few different materials used in the plumbing industry. So there are different tools and methods to cut these materials.

# Vocabulary

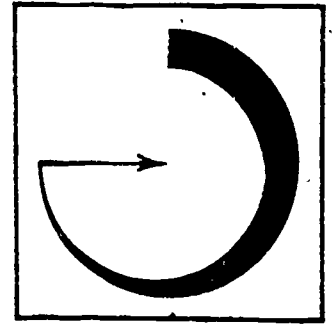

Trade terms are very important for a good understanding of the trade. Study these words and meanings. When you have learned them, ask your teacher to quiz you on the words and their meanings.

**TAPE MEASURE**--A rule or narrow strip of strong, but limp or flexible cloth or steel, marked off in  $1/16$  of an inch and usually carried in a reel.

**FOLDING RULE**--A ruler usually made of wood, marked off in  $1/16$  of an inch; has hinges every 6 inches so that it may be folded.

**PIPE VISE**--A gripping device for holding pipes while they are being cut, reamed and threaded. They have two V-shaped jaws that apply pressure to the pipe and hold it firm.

# Supplementary References

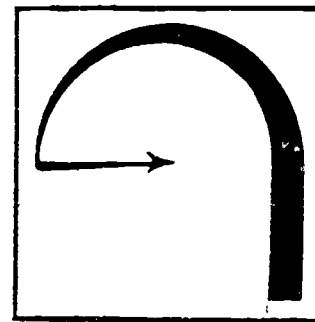

1. McConnell, Charles. Audel Plumbers and Pipefitters Library. Theodore Audel & Co., Division of Howard W. Sams & Co. Inc., Indianapolis, Indiana.
2. Babbitt, Harold E. Plumbing. McGraw Hill Book Co. Inc., New York, Toronto, London, 1960.



# Information

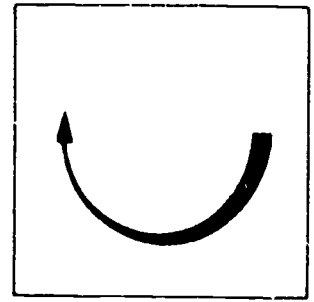

The first tools that you should know are a tape measure and folding wood rule. No material should ever be cut until you have figured out the correct length or width.

## TAPE MEASURE AND 6-FOOT FOLDING RULE

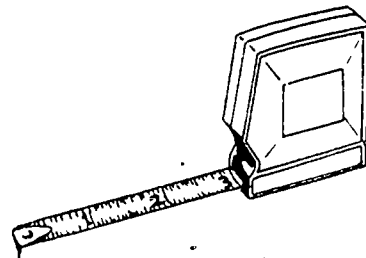
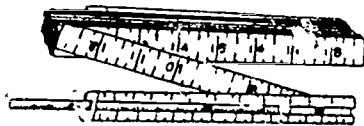

A tape measure is made of flexible steel so it may be coiled up in a case. The tape measure is made in various lengths: 6', 8', 10', 12', 16', 20', 50' and 100 feet.

A folding ruler is made of wood. It has hinges every 6 inches so it may be folded and kept in the worker's pocket.

There are basically three ways to measure pipe. They are:

- a. Center to center, which means the center of one fitting to the center of the other fitting. (See illustration on the top of the following page.)

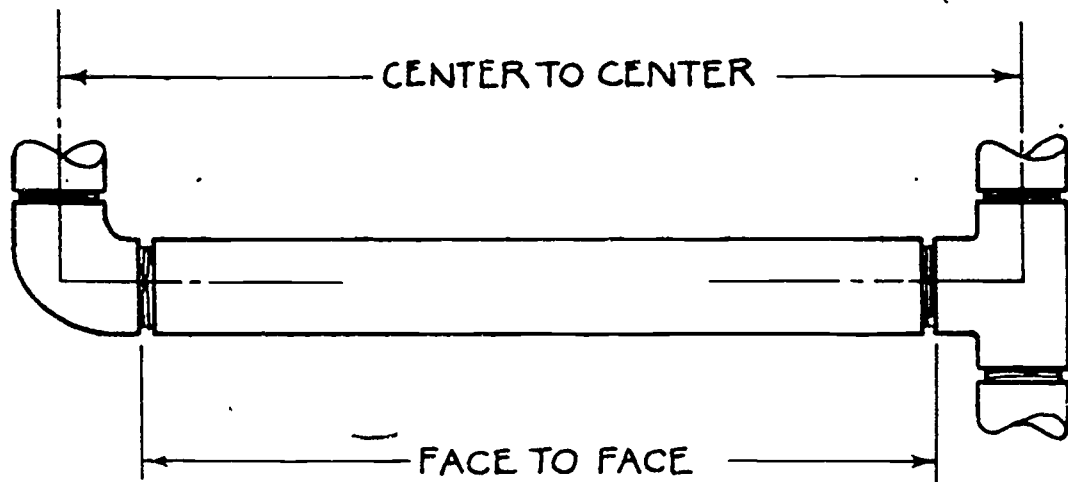

- b. Center to end, which means the center of one fitting to the end of pipe.

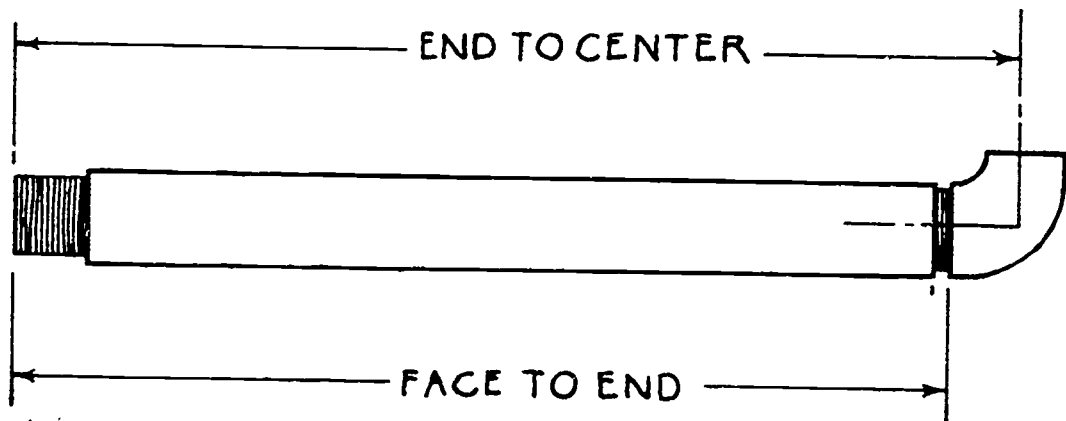

- c. End to end, which means one end of the pipe to the other end of the pipe.

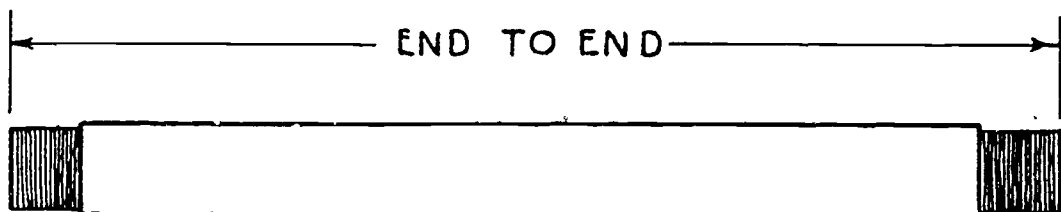

In using center to center measurement, subtract the difference between the distance the pipe goes into the fitting and the exact center on both fittings.

In using end to center measurement, subtract the difference between the distance the pipe goes into the fitting and the exact center of one fitting only.

In using end to end measurement, there are no take offs from a fitting or fittings. With this type of measuring, all you have to do is cut the pipe or material to its desire length.

Following are the tools used in cutting plastic pipe.

- a. Tubing cutter: is made of lightweight aluminum alloy, in sizes to cut from 1/2" to 1" pipe, 1" through 2", and 2" through 4".
  - (1) Insert the pipe between the rollers and the cutting wheel.
  - (2) Apply pressure by turning the handle clockwise and at the same time, turning the tubing cutter around the pipe.

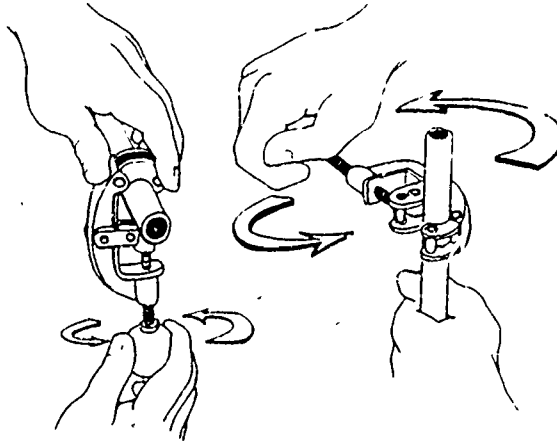

- b. Hacksaw: comes in two sizes, 10" and 12". The most common is 12", with 18 teeth per inch. When installing the blade, insert the blade with the saw teeth pointing forward. The cutting begins as you apply pressure to the pipe with the hacksaw blade, while pushing forward. Continue back and forth in a straight line until you have cut the pipe to the desired length.

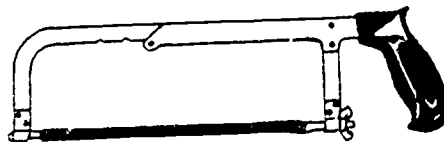

- c. Handsaw: a good all-around handsaw for plumbers has 12 teeth per inch. It is used to saw wood, as well as to cut plastic pipe. It is used like the hacksaw is used.

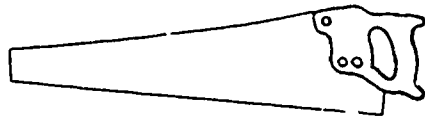

Following are the tools used in cutting copper tubing.

- a. Tubing cutter: is used the same as in cutting plastic pipe. The difference being a different type of cutting wheel is used for copper tubing.
- b. Hacksaw: is used the same way as in cutting plastic pipe and with the same type of cutting blade.

Following are the tools used in cutting steel pipe.

- a. Pipe cutter: is to be used the same way as a tubing cutter described under plastic pipe.

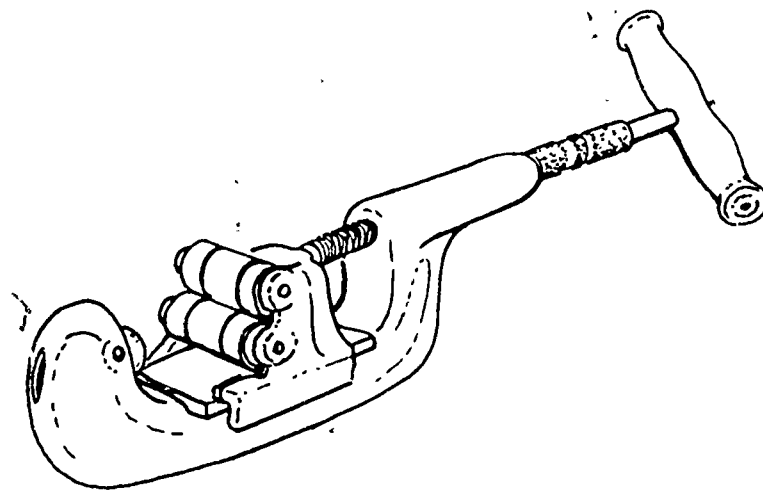

- b. Hacksaw: is to be used the same way as described under plastic pipe.
- c. Pipe vise: There are basically two types of pipe vises. Bench vise and a tripod vise.

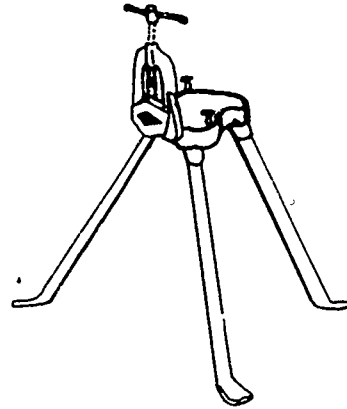
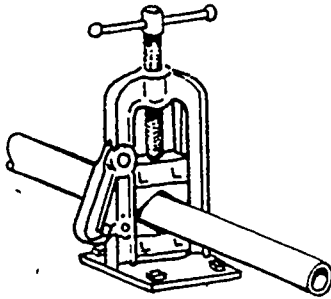

Following is the tool used in cutting cast iron. The cast iron pipe is actually snapped off.

- a. Cast iron snap cutter: it is a ratchet type cutter with their cutter wheels close together and, as the ratchet is tightened, the pressure from the cutter wheels force the pipe to snap.

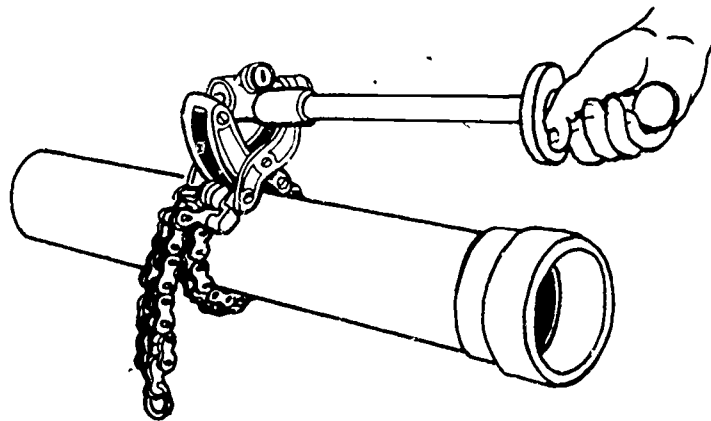

# Self Assessment

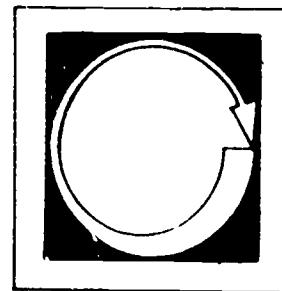

LISTED BELOW ARE SEVERAL STATEMENTS. IF THE STATEMENT IS TRUE, PLACE A "T" IN THE BLANK PROVIDED. IF THE STATEMENT IS FALSE, PLACE AN "F" IN THE BLANK.

1. \_\_\_ A folding rule coils up in a case.
2. \_\_\_ A hacksaw may be used to cut plastic pipe.
3. \_\_\_ Flexible means to be rigid.
4. \_\_\_ Center to center measurement means center of one fitting and the center of another.
5. \_\_\_ A tubing cutter is used to cut galvanized steel pipe.
6. \_\_\_ A snap cutter is used to cut cast iron pipe.
7. \_\_\_ A handsaw may be used to cut copper tubing.
8. \_\_\_ Copper tubing may be cut by a tubing cutter.
9. \_\_\_ The teeth of a hacksaw lean to the front of the hacksaw.

# Self Assessment Answers

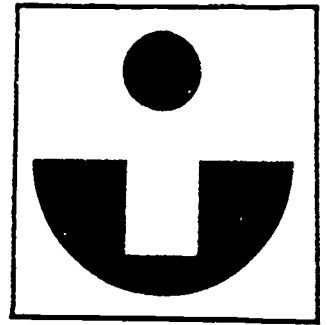

1. F

2. T

3. F

4. T

5. F

6. T

7. F

8. T

9. T

# Job Sheet

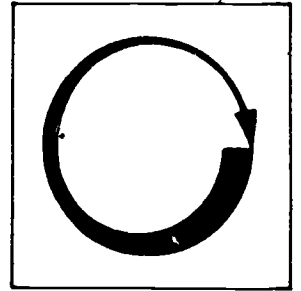

COMPLETE THE FOLLOWING TASKS.

1. Identify all the tools illustrated in this module.
2. Explain the purpose of each tool listed in this module.
3. The instructor will give the student materials to complete this task.  
The student will then measure and cut the pipe from the measurements given by the instructor.
  - a. One pipe cut from a center to center measurement.
  - b. One pipe cut from a center to end measurement.
  - c. One pipe cut from an end to end measurement.



REAMING & CLEANING, THREADING

**Goal:**

The student will be able to identify, select and demonstrate the use of the different tools.

**Performance Indicators:**

The student will successfully complete a Self Assessment, and will clean and ream copper and plastic pipe. The student will also ream and thread galvanized and black pipe.

# Study Guide



In order to finish this module, do the following tasks. Check each item off as you complete it.

1. \_\_\_ Read the Goal and Performance Indicators on the cover of the module. This will tell you what you will learn by studying the module, and how you will show you've learned it.
2. \_\_\_ Read the Introduction. The Introduction will tell you why the module is an important part of the plumbing trade.
3. \_\_\_ Study the Vocabulary section. Vocabulary words are important for a good understanding of the trade. After you have studied the vocabulary, ask your teacher to quiz you on the words and their meanings.
4. \_\_\_ Study the Information section. This section will give you the information you need to understand the subject.
5. \_\_\_ Take the Self Assessment exam. This is a test for you to prove to yourself that you have learned the material you have studied. Compare your answers with the answers on the Self Assessment Answer Sheet, which is on the page following the Self Assessment. If you scored poorly, re-study the Information section or ask your teacher for help.
6. \_\_\_ Do the Job Sheet. Follow the instructions at the top of the Job Sheet. The tasks listed on the Job Sheet will help you develop skills which will be helpful to you.

# Introduction

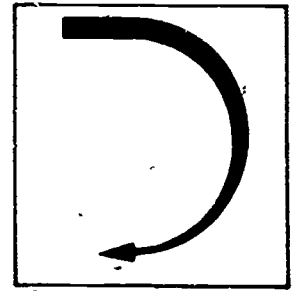

In the previous module, you learned how to cut different pipes. This module covers the next step toward a complete assembly of pipe and fitting: cleaning, reaming and in some cases threading of pipe.

# Vocabulary

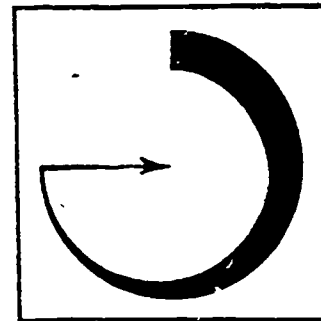

Trade terms are very important for a good understanding of the trade. Study these words and meanings. When you have learned them, ask your teacher to quiz you on the words and their meanings.

BURRS--A rough edge remaining on metal.

EMERY CLOTH--A fine grained stone used for shining or polishing.

DISCOLORATION--A stain.

FITTING BRUSH TOOL--Tool used to clean and shine copper fittings.

REAMING--To make larger. The reamer is the tool used to make pipes larger.

BEVEL--An angle or incline of a line or surface of not more than 90 degrees.

DEBURRING TOOL--Tool which is used to remove burrs.

TAPERED--Gradual increase or decrease in size.

DIE--Stronger metal that imprints softer metal.

DIE HEAD--Holder of a die.

THREAD CUTTING OIL--Special oil used for threading pipes, bolts, rods.

THREADS--Grooves imprinted on or cut into pipes.

N.P.T.--National Pipe Thread.

THREADING MACHINE--Machine used to produce threads on pipes, bolts and rods.

RATCHET-- A tool with sloping gears so it may move in one direction only.

CONE--A round object tapered to a point.

HAND STOCK AND DIES--A hand-held tool which produces a thread when you apply pressure. Its parts are:

1. Die head
2. Die
3. Ratchet
4. Handle

# Information

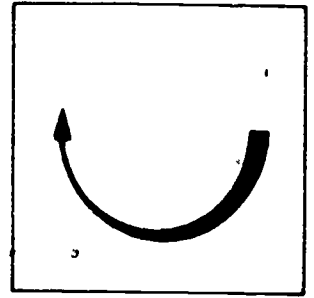

There are different ways to prepare a piece of pipe and a fitting to make a joint.

## REAMING AND CLEANING OF COPPER TUBING AND COPPER FITTINGS

You have already made a fine even cut, using a tubing cutter or hacksaw.

If you have used a hacksaw you will find rough burrs of copper on the edges of the pipe.

Use a half round bastard file and, with the flat side of the file, file the burrs off. With the half round side of the file, file the inner edge of the tubing until it is smooth.

Clean the inside of the fitting with emery or sand cloth, then clean the part of the tubing that will enter the fitting.

The tubing is cleaned by cupping a 12-inch strip of emery or sand cloth in your hand. While putting pressure with your hand to the pipe, clean the pipe until it is shiny and polished. There should be no dirt or discoloration.

Fitting brushes are used to clean the inside of fittings. They are available in the sizes of copper fittings used.

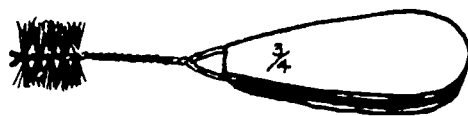

Copper Fitting Brush

On the tubing cutter there is a built in reamer that slides into the body of the tubing cutter. This is used by inserting the pointed end into the pipe and applying pressure on the pipe while turning the reamer back and forth until the inside is even all around.

#### REAMING AND CLEANING OF PLASTIC PIPE

After you have cut the plastic pipe with a tubing cutter (leaving a clean and even cut), take a pocket knife and trim a slight bevel around the outer edge of the pipe. ~~This allows the pipe to slide into the fitting.~~

With a clear rag wipe all dirt and foreign materials off the pipe and fitting. No further cleaning of the fitting is necessary.

If you have used a hacksaw to cut the pipe, remove the burrs on the pipe as it is done for copper tubing. A deburring tool may be used to clean the inside or outside of pipe.

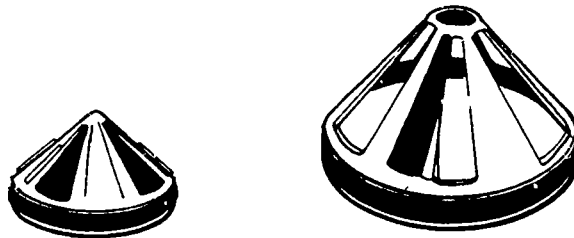

#### GALVANIZED AND BLACK STEEL PIPE

After you have cut the pipe to its desired length, leave the pipe in the vise.

Insert the cone part of the reamer in the pipe. By applying pressure to the reamer with your body, turn the handle of the reamer clockwise until the inner edge of the pipe is completely smooth.

#### THREADING OF GALVANIZED AND BLACK STEEL PIPE

Threads may be cut on the pipe in one of two ways.

1. Hand stock and dies.
2. Pipe threading machines.

Ratchet  
Pipe  
Reamers

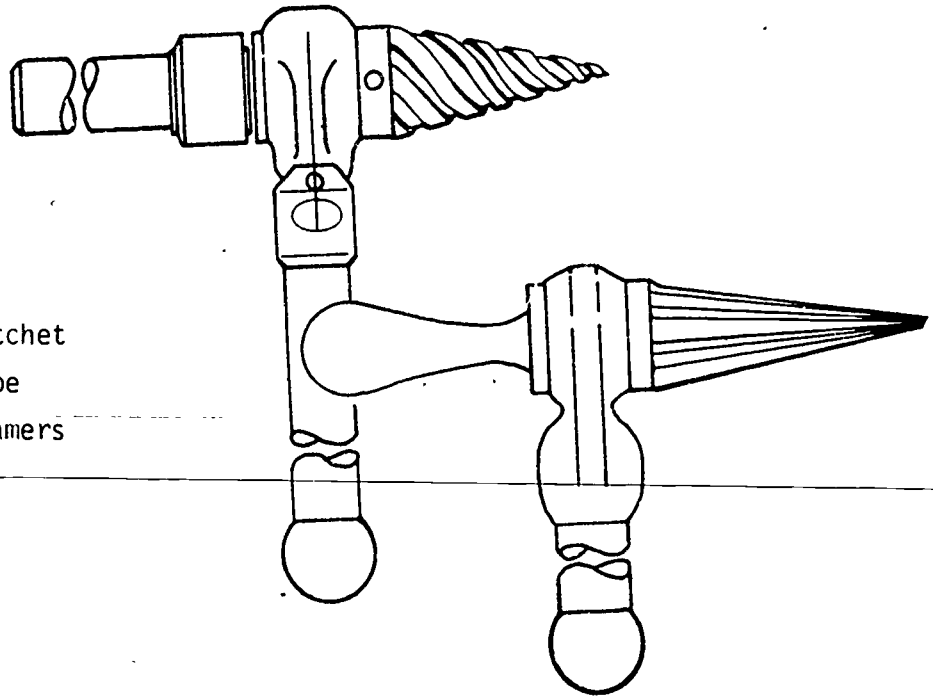

Hand Stock

Pipe threads are tapered. Be sure the die is placed on the pipe in the right direction. The die will stay on the pipe (when it is in the proper direction) without being held.

Ratchet

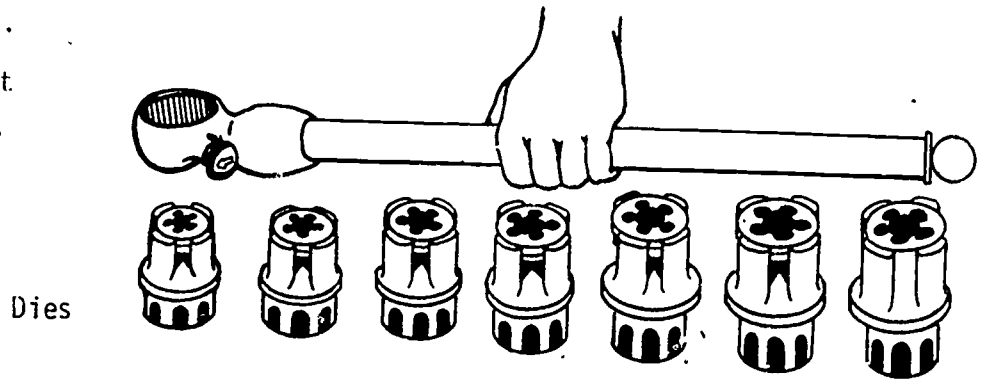

Dies

Die is inserted  
in ratchet head

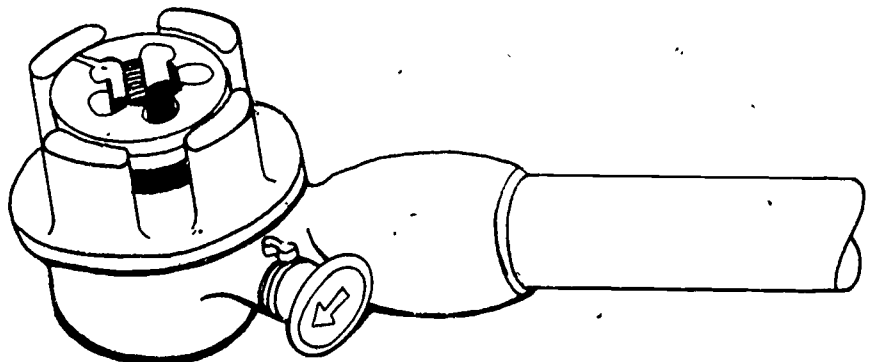



Wear safety eye protection. Place the die over the pipe.

1. With one hand, hold pressure against the die head. Turn the handle clockwise with the other hand.
2. Continue doing this until the die has started to make an even cut on the pipe.
3. Apply thread cutting oil. Use a lot of oil.
4. Continue cutting threads and using plenty of oil.

---

5. After 3 or 4 threads have been cut on the pipe, clean out the metal chips that have built up in the die head with a small brush. Cleaning should be done three or four times until the thread has been finished.
6. Threading is complete when 1 or 2 threads appear beyond the die head.
7. Reverse the die head by pulling out the ratchet (have the arrow pointing in the opposite direction).
8. Reverse the pressure on the handle, and turn the handle until the die can be taken off the pipe. Don't use oil.
9. Clean the oil off the pipe with rags. Wipe off all metal chips.
10. Reverse the die head with the ratchet.

The dies are now ready for the next thread to be cut. There is no other necessary preparation such as reaming, filing, threading or cleaning.

# Self Assessment

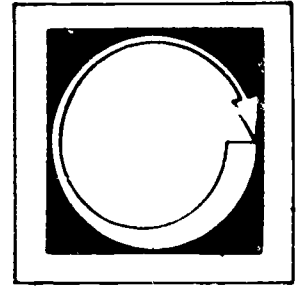

LISTED BELOW ARE SEVERAL STATEMENTS. IF THE STATEMENT IS TRUE, PLACE A "T" IN THE BLANK PROVIDED. IF THE STATEMENT IS FALSE, PLACE AN "F" IN THE BLANK.

1.  Emery cloth is used to clean plastic pipe.
2.  A cone is square.
3.  A die is the tool that cuts threads.
4.  The deburring tool is used to remove burrs from cast iron pipe.
5.  Sand cloth is used to clean copper tubing.
6.  When threading pipe, the pipe thread should go beyond the die at least four threads.
7.  A pocket knife may be used to remove burrs from plastic pipe.
8.  A half round bastard file may be used to remove burrs on all pipes.

# Self Assessment Answers

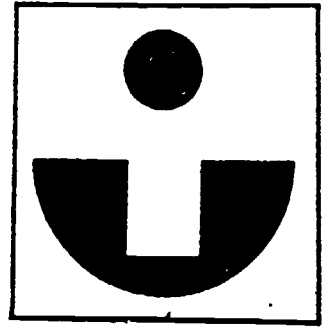

1. F

2. F

3. T

4. F

5. T

6. F

7. T

8. T

# Job Sheet

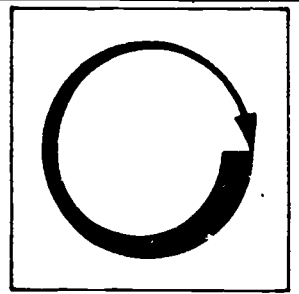

COMPLETE THE FOLLOWING TASKS.

1. Identify the tools illustrated in this module.
2. Explain the use of these tools.
3. The instructor will furnish the materials to complete this task.
4. The student will cut, ream and thread three pieces of pipe six inches long of black or galvanized steel pipe.
5. The student will cut, ream and clean three pieces of copper and plastic pipe.

## ATTACHING PIPES AND FITTINGS WITH SOLDER

### Goal:

The student will be able to:

1. Identify and select different materials and tools used in making a copper soldering joint.
2. Demonstrate the ability to join copper pipe and fitting with different types of solder and flux.

### Performance Indicators:

The student will successfully complete a Self Assessment, Job Sheet and Post Assessment.

# Study Guide

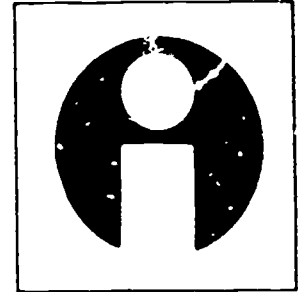

In order to finish this module, do the following tasks. Check each item off as you complete it.

1. \_\_\_ Read the Goal and Performance Indicators on the cover of the module. This will tell you what you will learn by studying the module, and how you will show you've learned it.
2. \_\_\_ Read the Introduction. The Introduction will tell you why the module is an important part of the plumbing trade.
3. \_\_\_ Study the Vocabulary section. Vocabulary words are important for a good understanding of the trade. After you have studied the vocabulary, ask your teacher to quiz you on the words and their meanings.
4. \_\_\_ Study the Information section. This section will give you the information you need to understand the subject.
5. \_\_\_ Take the Self Assessment exam. This is a test for you to prove to yourself that you have learned the material you have studied. Compare your answers with the answers on the Self Assessment Answer Sheet, which is on the page following the Self Assessment. If you scored poorly, re-study the Information section or ask your teacher for help.
6. \_\_\_ Do the Job Sheet. Follow the instructions at the top of the Job Sheet. The tasks listed on the Job Sheet will help you develop skills which will be helpful to you.
7. \_\_\_ Take the Post Assessment exam. Give the exam to your teacher after you have completed it. Your teacher will grade it for you.

# Introduction

---

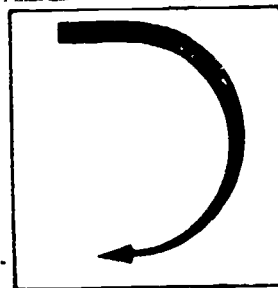

The most common method of joining copper tubing and fittings is soldering. Soldered joints are used in plumbing for water lines and for sanitary drainage.

Brazed joints are used where greater strength is required or where service temperatures are as high as 350° Fahrenheit.

# Vocabulary

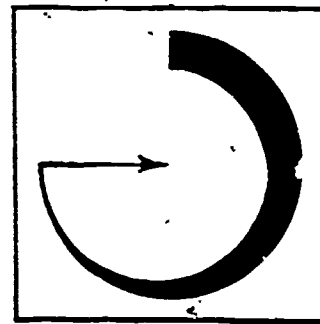

Trade terms are very important for good understanding of the trade. Study these words and meanings. When you have learned them, ask your teacher to quiz you on the words and their meanings.

FAHRENHEIT--Measurement of heat.

IGNITE--To light a flame.

PROPANE--A flammable gas.

REGULATOR--A device used to adjust the flow of liquids and gases.

STRIKER--Used to make a spark.

BRAZE--To unite metals with copper and zinc at a high melting point.

CHLORIDE--A salt acid made of chlorine and sodium.

ZINC--A metallic element resembling magnesium.

AMMONIUM--Performs as a metal in a salt when ammonia reacts with an acid.

LEAD--A heavy, soft, flexible metal.

TIN--A soft metal.

ANTIMONY--A brittle, white-metallic element used in alloys.



CORROSIVE--Having the quality to "melt" or "burn" something.

PETROLEUM--An oily, thick, flammable substance.

CAPILLARY ACTION--An attraction that occurs with heat.

MOLTEN--Melted.

FLUX--A substance used to clean impurities from metals.

# Supplementary References

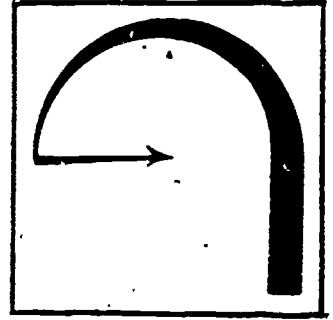

1. Daniels, George. Home Guide to Plumbing Heating & Air Conditioning. Popular Science Publishing Co., 1967. pp. 24-25.
2. McConnell, Charles. Audels Plumbers & Pipefitters Library. Howard W. Sams Co., 1977. pp. 161, 163 and 164.

# Information

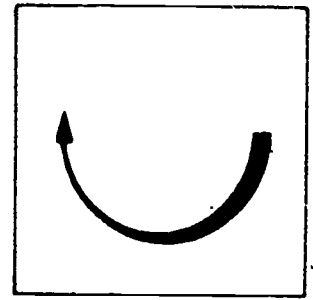

Soldered joints depend on capillary action drawing free-flowing molten solder into the gap between the fitting and tubing.

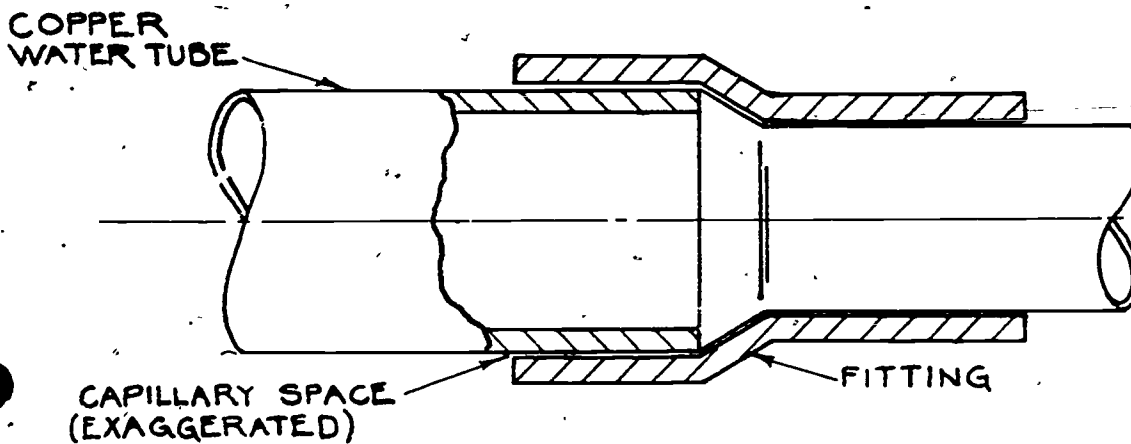

Flux is applied first. It acts as a cleaning and wetting agent and permits uniform spreading of the molten solder over the surfaces to be soldered.

The two most common solders used are:

1. 50-50 solder which is made with 50 percent lead and 50 percent tin.
2. 95-5 solder which is made with 95 percent tin and 5 percent antimony. They both come in 1 lb. coils.

The fluxes best suited to the 50-50 and 95-5 solders are mildly corrosive liquid or petroleum-based pastes containing chlorides of zinc and ammonium.

Most liquid fluxes are self-cleaning. There is no doubt that a strong corrosive flux can remove some oxides and dirt. It is not certain whether the corrosive action continues after the soldering has been completed.

The handiest tool for heating the joint for 50-50 or 95-5 solder is a propane torch. A propane torch kit (illustrated below) has the following parts:

1. A propane tank.
2. A handle and valve assembly.
3. A 2-tip burner assembly--the smaller tip used for copper tubing up to 1" in diameter.
4. A hose assembly, usually 15 feet in length.
5. A regulator assembly.
6. A striker.

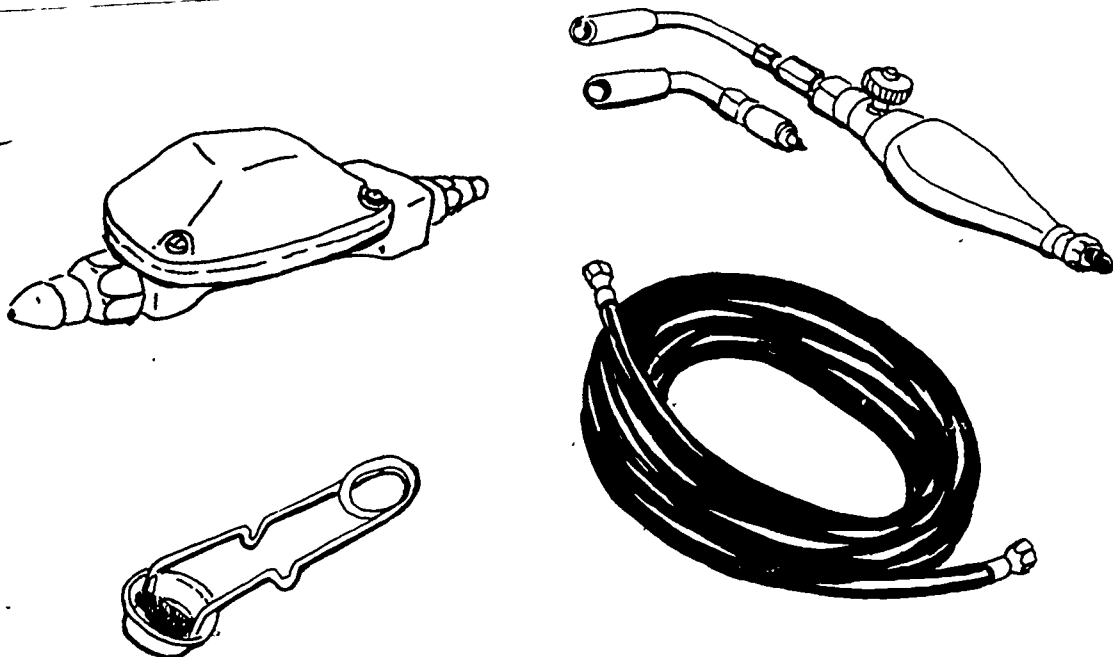

Surfaces to be joined must be clean from oil, grease and dirt. As soon as the fitting and tubing are clean, a coating of flux is applied to the outside of the pipe. It will enter the fitting.

Then the pipe is put into the fitting and given a slight twist to make sure that the pipe is all the way in. It is a common practice to prepare as many as 10 joints at a time before soldering.

Listed below is the proper procedure for lighting the propane torch:

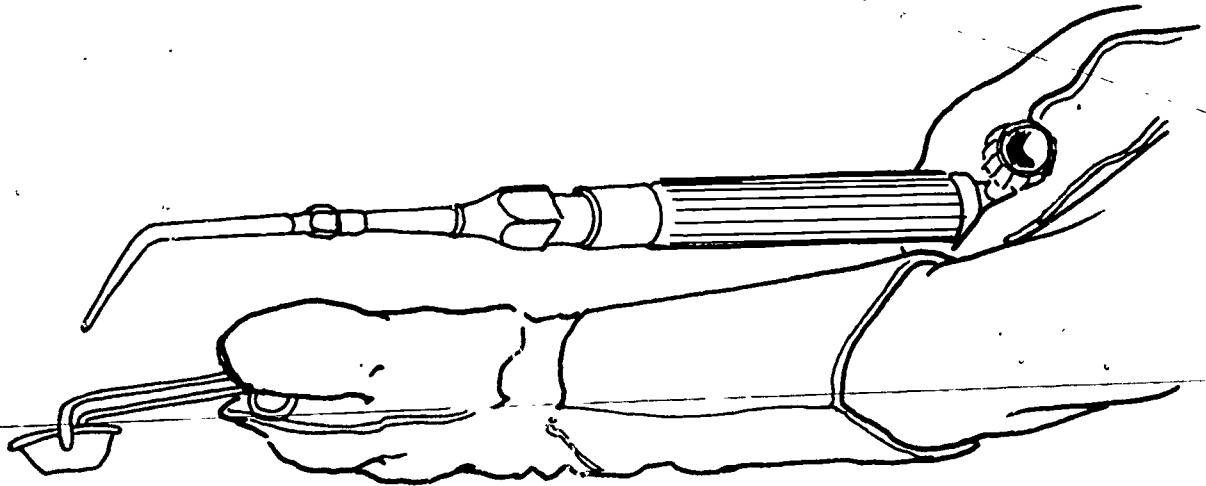

1. The valve on the handle assembly must be closed and the hoses and regulator must be tight.
2. The valve on the tank is opened a full turn to allow the propane to enter the regulator and hose up to the valve on the handle assembly.
3. With striker in one hand and valve handle assembly in the other, the valve is opened just enough to allow the propane to come through. A striker is used to ignite a spark at the tip to cause a flame.
4. The flame is adjusted with the valve until the flame is blue in color and is about 2 inches long.
5. With the solder in one hand, heat is applied to the back of the fitting and all around the joint to be soldered.
6. Solder is applied from the bottom to the top in an up-swing motion. The heat is removed as soon as the solder flows freely all the way around the fitting and the solder has been drawn all the way back in the fitting.
7. Excess solder is removed with a clean rag. The joint should be cooled off before handling.

#### Silver Soldering.

This procedure is identical to soldering with the exception of the type of flux, solder and torch used. Since silver solder has a higher melting point (1100 Fahrenheit to 1500 Fahrenheit), a different torch and equipment are used. These are:

1. Oxygen and acetylene tanks.

2. Oxygen and acetylene regulators with gauges.
3. A green oxygen hose connection with a right-hand thread.
4. A red acetylene hose connection with a left-hand thread.
5. A handle with two adjusting valves.
6. Assorted tips to be used on different sizes of copper tubing.

Silver solder used for water piping has 5 percent silver and the balance in copper. Silver solder comes in 18" long sticks. All copper piping passing under ground is silver soldered. When copper fitting and tubing are properly cleaned no flux is needed.

Before striking a flame, gauges should be checked and set as follows:

1. Oxygen set at 20 lbs.
2. Acetylene set at 8 lbs.

The acetylene valve should be cracked open, a flame struck and the oxygen valve immediately cracked open. Both valves should be opened slowly until 1½ inches high. The acetylene valve should be opened some more until a slight white flame is at the tip of the blue flame.

Heat to pipe and fitting should be applied with the tip of the flame. The tip should not be left in one spot, but moved around throughout the soldering process. Solder won't melt until tubing and fitting are cherry red.

As the heat draws the solder to the back of the fitting it will make a bead at the end of the fitting. This is a complete joint.

# Self Assessment

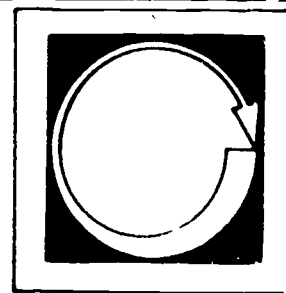

LISTED BELOW ARE SEVERAL STATEMENTS. IF THE STATEMENT IS TRUE, PLACE A "T" IN THE BLANK PROVIDED. IF THE STATEMENT IS FALSE, PLACE AN "F" IN THE BLANK.

1. \_\_\_ 50-50 solder is made from 50 percent lead and 50 percent tin.
2. \_\_\_ Silver solder is used on all underground piping that is soldered.
3. \_\_\_ 95-5 solder is made up of 95 percent antimony and 5 percent tin.
4. \_\_\_ Flux is needed when soldering with 50-50 solder.
5. \_\_\_ The oxygen gauge is set at 8 lbs. when silver soldering.
6. \_\_\_ Oxygen hoses are red.
7. \_\_\_ An acetylene hose connection has a left-handed thread.
8. \_\_\_ When soldering, the heat is applied to the front of the fitting.

# Self Assessment Answers

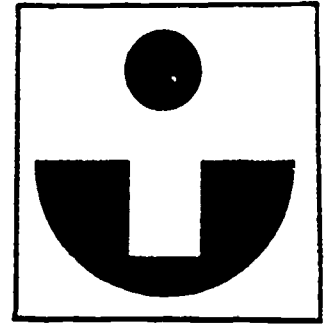

1. T

2. T

3. F

4. T

5. F

6. F

7. T

8. F



# Job Sheet

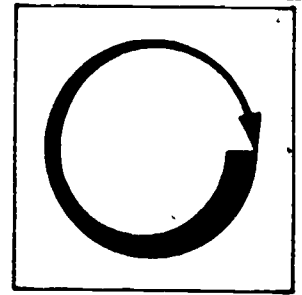

COMPLETE THE FOLLOWING TASKS.

1. Explain and demonstrate the proper way of connecting the regulators, hoses and valve handle assembly on oxygen and acetylene tanks.
2. Demonstrate how to connect the regulator, hose and valve handle assembly to the propane tank.

3. Material and Tools

2--3/4" X 6" pieces of copper tubing, type M

1--3/4" piece of 90-degree elbow copper

1 can solder flux

A 1 coil of 50-50 and 95-5 solder

- a. Following the steps in this module, solder the 2 pieces of 3/4" tubing into the 3/4" 90-degree elbow copper.
- b. After the tubing and fitting cool, re-heat them and, with a pair of pliers, take pipes out of fitting.
- c. Examine both tubing and fitting to see that the solder has flowed completely onto them.
- d. Re-clean tubing and fitting and re-solder them together.
- e. Repeat this procedure five times.
- f. Show the fitting and tubing to the instructor after each process.
- g. Repeat the above with new tubing and fitting, using 95-5 solder.

4. Material and Tools

3--1" X 8" copper tubing, type L

1--1" tee copper piece

1 stick silver solder

- a. Follow the steps explained in this module for silver soldering. Solder the 3 pieces of tubing into the tee.
- b. Let the fitting cool until it can be handled.
- c. Show fitting to the instructor for his or her remarks, to make sure it was done properly.
- d. With a hacksaw cut one-half the way into the fitting on all sides. Take pipe and fitting apart to see if the solder has been pulled into the fitting.
- e. Repeat this procedure with new tubing and fitting until the solder has been pulled into the fitting.

# Post Assessment

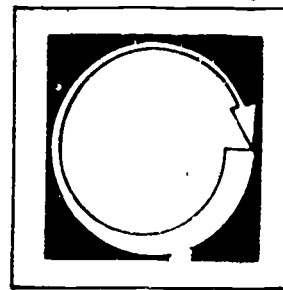

COMPLETE THE FOLLOWING STATEMENTS BY WRITING THE CORRECT WORD OR WORDS IN THE BLANKS PROVIDED.

1. A regulator is used on oxygen and acetylene lines to \_\_\_\_\_  
\_\_\_\_\_.
2. A striker is used to \_\_\_\_\_.
3. A(n) \_\_\_\_\_ pressure is set on the acetylene gage.
4. A \_\_\_\_\_ colored hose is used on oxygen lines.
5. Acetylene thread connection has a \_\_\_\_\_ thread.

# Instructor Post Assessment Answers

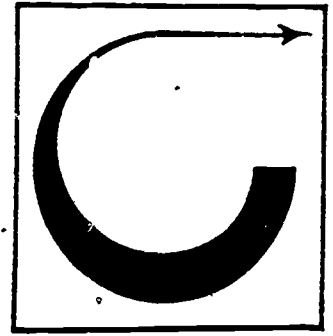

1. adjust the pressure
2. ignite a flame
3. 8-1b.
4. green
5. left-hand

---

ATTACHING PLASTIC PIPE AND FITTINGS WITH CEMENT

---

**Goal:**

The student will be able to: (1) identify and select the proper materials and tools used in making a PVC and ABS pipe joint; (2) demonstrate the ability to join plastic pipe and plastic fitting together with plastic solvent cement.

**Performance Indicators:**

The student will successfully complete a Self Assessment, a Job Sheet and a Post Assessment.

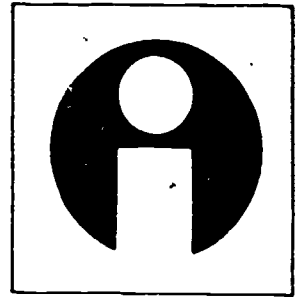

# Study Guide

In order to finish this module, do the following tasks. Check each item off as you complete it.

1.  Read the Goal and Performance Indicators on the cover of the module. This will tell you what you will learn by studying the module, and how you will show you've learned it.
2.  Read the Introduction. The Introduction will tell you why the module is an important part of the plumbing trade.
3.  Study the Vocabulary section. Vocabulary words are important for a good understanding of the trade. After you have studied the vocabulary, ask your teacher to quiz you on the words and their meanings.
4.  Study the Information section. This section will give you the information you need to understand the subject.
5.  Take the Self Assessment exam. This is a test for you to prove to yourself that you have learned the material you have studied. Compare your answers with the answers on the Self Assessment Answer Sheet, which is on the page following the Self Assessment. If you scored poorly, re-study the Information section or ask your teacher for help.
6.  Do the Job Sheet. Follow the instructions at the top of the Job Sheet. The tasks listed on the Job Sheet will help you develop skills which will be helpful to you.
7.  Take the Post Assessment exam. Give the exam to your teacher after you have completed it. Your teacher will grade it for you.

# Introduction

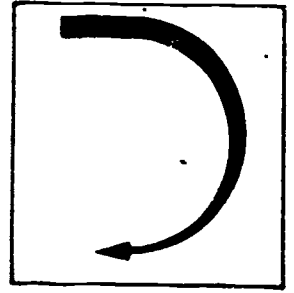

Plastic pipe in residential construction is fairly new, about 10-years old.

Local codes throughout the country are slow to approve any new materials. The advantage of plastic pipe is its low cost and lightweight. Also, it is easy to assemble.

# Vocabulary

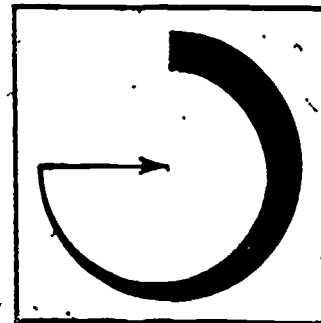

Trade terms are very important for a good understanding of the trade. Study these words and meanings. When you have learned them, ask your teacher to quiz you on the words and their meanings.

**SOLVENT WELDING**--The skill of joining plastic together using a liquid.

**SOLVENT CEMENT**--The liquid which is used to join plastic pipe and fitting together.

**WELDING**--The skill of joining metals or plastic by heat or liquid to flow together as one.

**FUSING**--The action that occurs when metals or plastics are welded together.

**APPLICATOR**--A tool used to apply a liquid or a paste onto a surface.

**PRIMER**--A liquid cleaning agent applied to PVC pipe and fittings before applying plastic solvent cement.



# Supplementary References

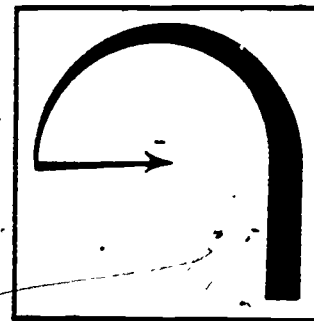

1. McConnell, Charles. Plumbers and Pipefitters Library. Howard W. Sams & Co. Inc., 1977. pp. 20-23.
2. Ripka, L. V. Plumbing Installation and Design. American Technical Society, 1978. pp. 108-109.

# Information

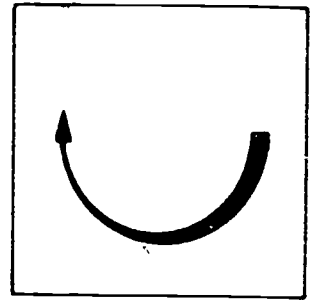

In this module we will be attaching two kinds of plastic pipe and fittings:

1. ABS pipe and fittings.
2. PVC pipe and fittings.

The cement process used in this method is called solvent welding.

## ABS

When connecting ABS pipe and ABS fittings together, use only the solvent cement recommended for ABS. When the proper solvent cement is used it forms a weld or a fusing action between pipe and fitting.

As the solvent cement is applied to both pipe and fitting it softens the material in both pipe and fitting. When they are joined they become one. ABS solvent cement comes in two colors:

1. Black.
2. Milky.

Either one may be used.

## Process

After you have cut and reamed the plastic pipe, with a clean cloth remove all dirt and moisture in the fitting and where the pipe will enter the fitting.

With the applicator or brush that comes in the top of the can:

1. Apply a generous amount of solvent cement to the fitting and to the amount of pipe that will enter the fitting.
2. Immediately put the fitting over the pipe, applying pressure so the pipe is all the way in the fitting.
3. Hold fitting for 10 seconds to make sure that the cement has dried.  
(See illustrations on the following page.)

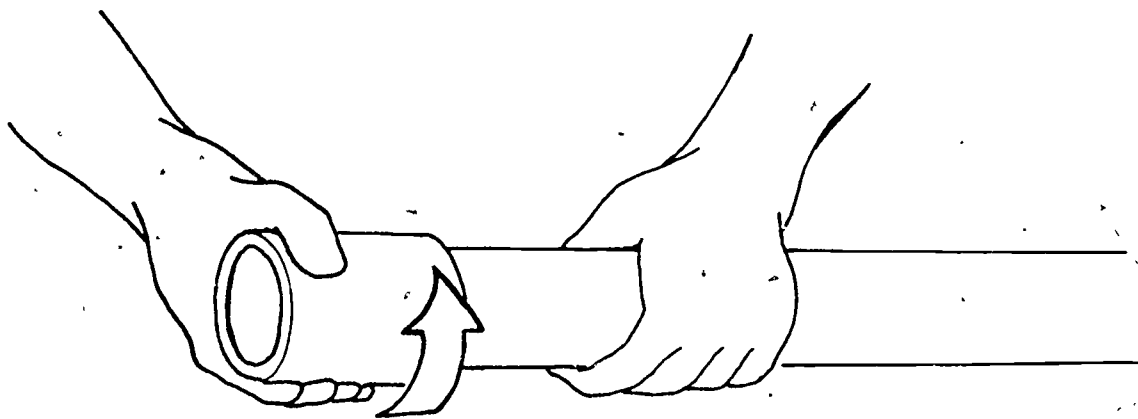
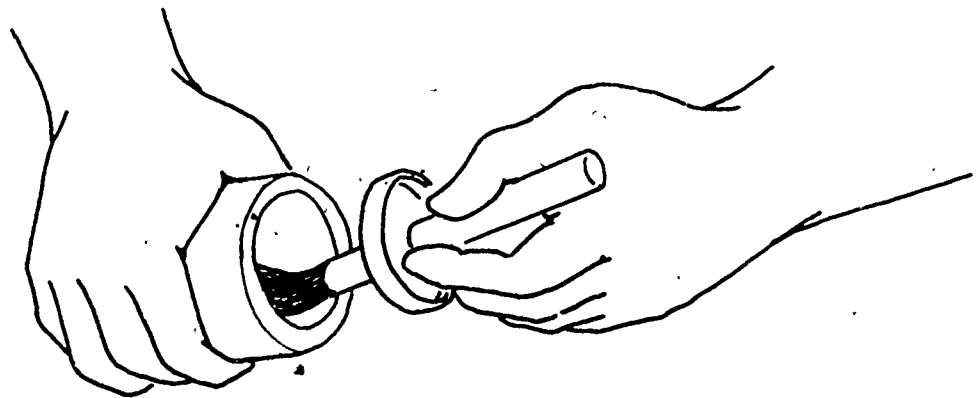
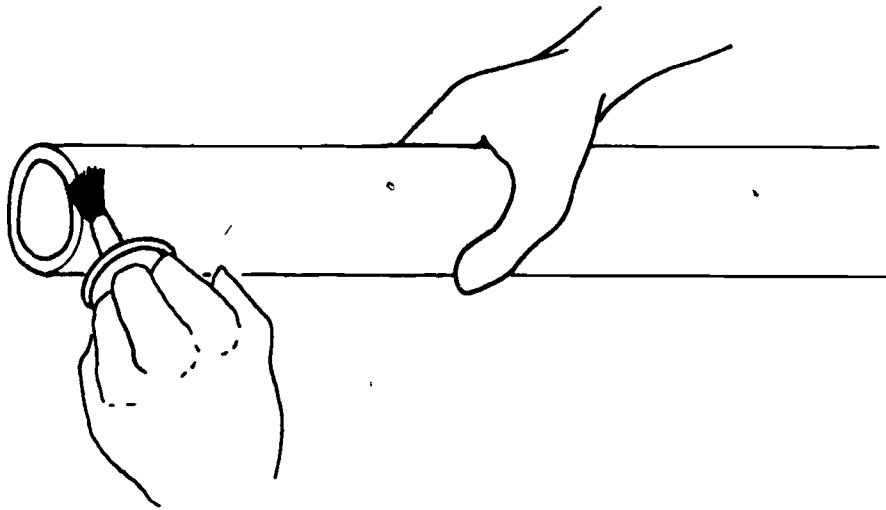

### PVC

PVC solvent comes in clear only.

### Process

1. Make sure that pipe and fitting are clean, free from dirt and moisture.
2. Before applying PVC solvent cement, a primer must be used.

3. PVC primer is purple in color. When you apply PVC primer, do not allow the primer to dry before applying the PVC solvent cement.
4. When applying the PVC solvent cement, follow the same instructions used for connecting ABS pipe and fitting.

# Self Assessment

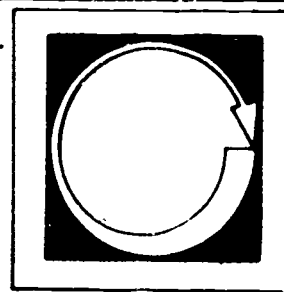

LISTED BELOW ARE SEVERAL STATEMENTS. IF THE STATEMENT IS TRUE, PLACE A "T" IN THE BLANK PROVIDED. IF THE STATEMENT IS FALSE, PLACE AN "F" IN THE BLANK.

1. \_\_\_\_ ABS solvent cement comes in two colors.
2. \_\_\_\_ PVC solvent cement is black.
3. \_\_\_\_ PVC primer is purple in color.
4. \_\_\_\_ PVC primer is used on ABS pipe.
5. \_\_\_\_ One advantage of using plastic pipe and fittings, is that it is light in weight.

# Self Assessment Answers

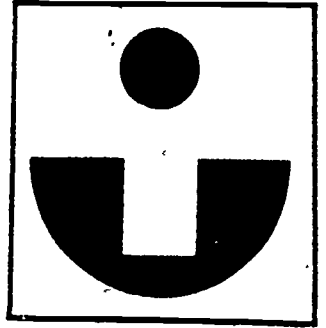

1. T
2. F
3. T
4. F
5. T

# Job Sheet

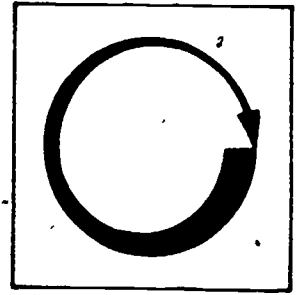

COMPLETE THE FOLLOWING TASKS.

## Materials and Tools

- 1 - 3/4" PVC Tee
- 2 feet - 3/4" PVC Pipe
- 1 can PVC Primer and Brush
- 1 can PVC Solvent Cement and Brush

1. Explain to your instructor:
  - a. The proper solvent cements to use with their pipe and fittings.
  - b. The proper application of solvent cements to the pipe and fitting.
  
2. Do the following steps.
  - a. Cut 2 pieces of PVC pipe end to center of a tee 9" long.
  - b. Cut 1 piece of PVC pipe end to center of the branch on the tee 6" long.
  - c. Cement the two pieces of pipe on the runs of the tee.
  - d. Cement the other piece of pipe on the branch of the tee as illustrated.

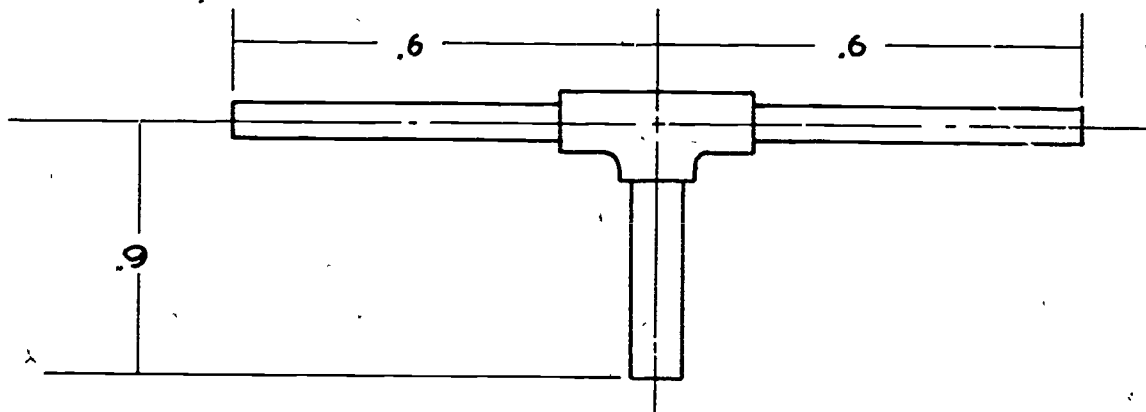

14C

143

# Post Assessment

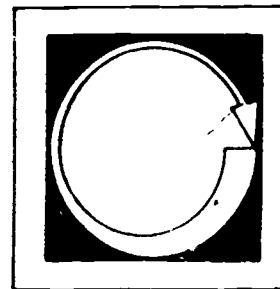

COMPLETE THE FOLLOWING STATEMENTS BY WRITING THE CORRECT WORD OR WORDS IN THE BLANKS PROVIDED.

1. The color of solvent cement used with PVC is \_\_\_\_\_.
2. \_\_\_\_\_ and \_\_\_\_\_ colored solvent cement is used on ABS.
3. PVC primer is \_\_\_\_\_ in color.
4. PVC plastic pipe is \_\_\_\_\_ in color.
5. \_\_\_\_\_ plastic pipe may be used for water piping.



# ● Instructor Post Assessment Answers

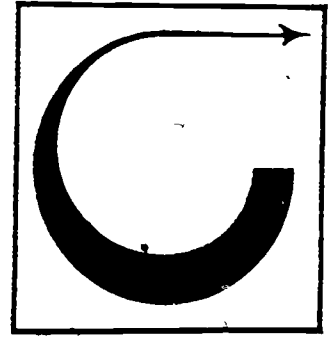

1. clear
2. black and milky
3. purple
4. white
5. PVC

---

ATTACHING THREADED PIPE AND FITTINGS

**Goal:**

The student will be able to identify and select the materials and tools that are used in the final process of making a pipe joint, and will demonstrate the ability to join pipe and fitting.

**Performance Indicators:**

The student will successfully complete a Self Assessment, a Job Sheet and a Post Assessment.

# Study Guide

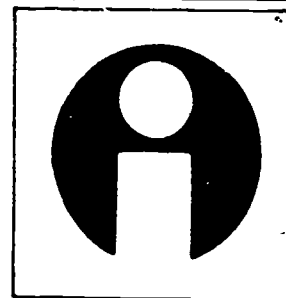

In order to finish this module, do the following tasks. Check each item off as you complete it.

1.  Read the Goal and Performance Indicators on the cover of the module. This will tell you what you will learn by studying the module, and how you will show you've learned it.
2.  Read the Introduction. The Introduction will tell you why the module is an important part of the plumbing trade.
3.  Study the Vocabulary section. Vocabulary words are important for a good understanding of the trade. After you have studied the vocabulary, ask your teacher to quiz you on the words and their meanings.
4.  Study the Information section. This section will give you the information you need to understand the subject.
5.  Take the Self Assessment exam. This is a test for you to prove to yourself that you have learned the material you have studied. Compare your answers with the answers on the Self Assessment Answer Sheet, which is on the page following the Self Assessment. If you scored poorly, re-study the Information section or ask your teacher for help.
6.  Do the Job Sheet. Follow the instructions at the top of the Job Sheet. The tasks listed on the Job Sheet will help you develop skills which will be helpful to you.
7.  Take the Post Assessment exam. Give the exam to your teacher after you have completed it. Your teacher will grade it for you.

# Vocabulary

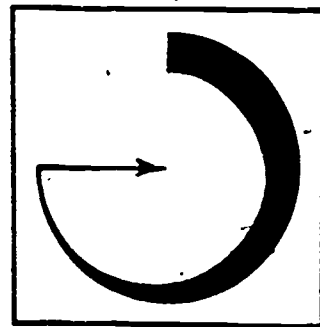

Trade terms are very important for a good understanding of the trade. Study these words and meanings. When you have learned them, ask your teacher to quiz you on the words and their meanings.

• PIPE JOINT COMPOUND--Material used to lubricate pipe threads and to make a water tight seal. It contains boiled linseed oil.

• TEFLON TAPE--Plastic or resin noted for its slippery, non-sticking properties.

• MALE THREADS--Threads on the outside wall of pipe or fittings.

• FEMALE THREADS--Threads on the inside wall of fittings.

• ROUGH PIPING--Pipe that does not have a finish texture to it, such as galvanized steel, black steel and cast iron.

• BOILED LINSEED OIL--A drying oil made from flaxseed.

# Supplementary References

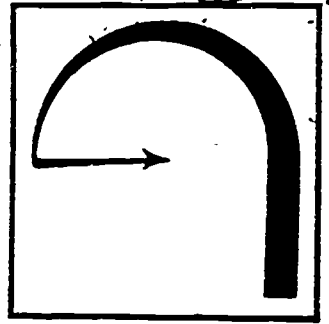

1. Daniels, George. Home Guide to Plumbing, Heating and Air Conditioning. Popular Science Publishing Co., Harper and Row, New York. pp. 16-18.
2. McConnell, Charles. Plumbers and Pipefitters Library. Division of Howard W. Sams & Co. Inc., Indianapolis, Indiana. pp. 38-54.

# Information

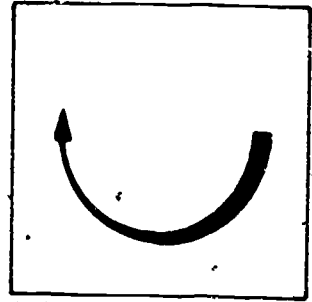

You have learned to cut, ream and thread pipe. The last step is in the making of a watertight screwed joint. A good thread sealer and lubricant is a must because:

1. It lubricates the joint, making it easier to tighten with wrenches.
2. It forms a watertight seal.

The two types of thread sealer and lubricant most often used are:

1. Pipe joint compound.
2. Teflon tape.

When applying pipe joint compound, apply it to the MALE threads of the pipe. If applied to the female threads of the fitting, it will get pushed up into a valve, and cause the valve to get plugged up.

When applying teflon tape to pipe threads, apply it clockwise so it won't unravel the tape as the fitting is put on. Two wraps around the pipe is sufficient.

For tightening the fitting onto the pipe it is necessary to use the proper wrench. Only a pipe wrench should be used on rough piping and fitting. The wrench's jaws have grooves in them and they will leave teeth marks on both pipe and fittings.

To select the proper pipe wrench for the size of pipe and fittings, refer to this guide:

|              |                   |                           |
|--------------|-------------------|---------------------------|
| 1/4 inch -   | 1/2 inch pipe =   | 10 or 12 inch pipe wrench |
| 3/4 inch -   | 1 inch pipe =     | 12 or 14 inch pipe wrench |
| 1 inch -     | 1 1/4 inch pipe = | 18 inch pipe wrench       |
| 1 1/4 inch - | 1 1/2 inch pipe = | 18 or 24 inch pipe wrench |
| 1 1/2 inch - | 2 inch pipe =     | 24 inch pipe wrench       |

The size of the pipe wrench (in inches) is cast on the end of the wrench.

When setting the pipe wrench on the pipe or fitting, open the jaws of the wrench as shown below.

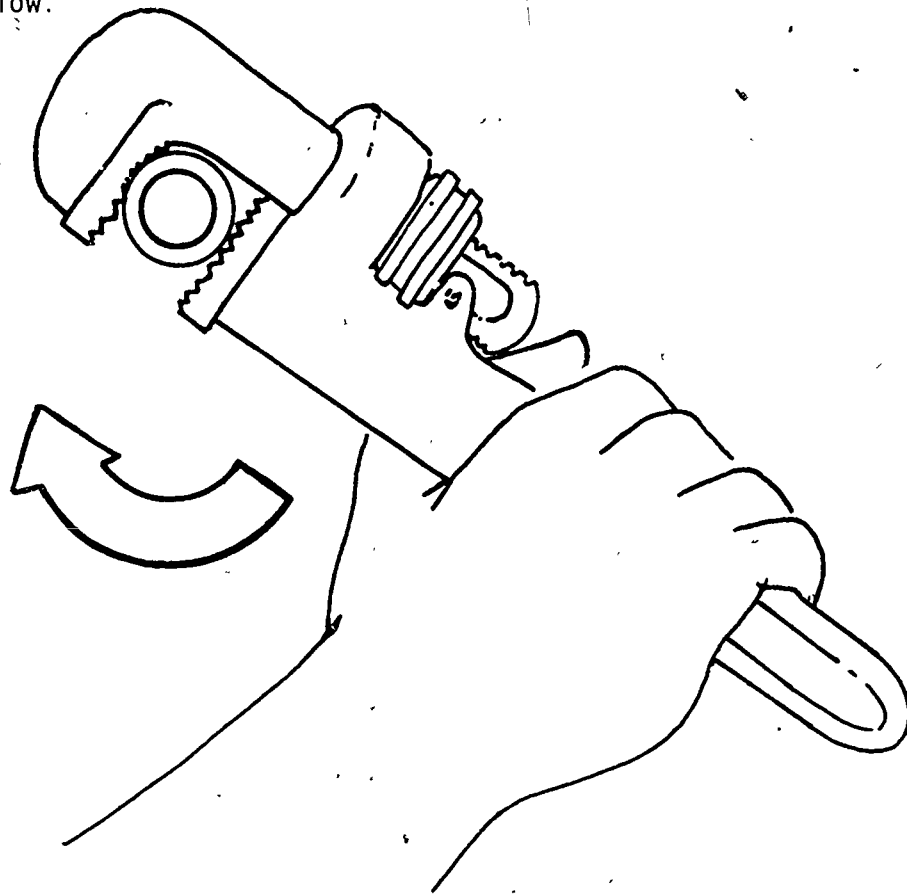

The upper jaw of the pipe wrench may seem wobbly. There is a spring in the body of the pipe wrench, to allow the jaw to "give" a little.

In making up pipe and fitting together at a workbench with a pipe vise:

1. Put the wrench around the fitting so the handle is pointing at 1 o'clock and push down on the handle until it is pointing at 5 o'clock. Continue doing this until the fitting is a little tighter than snug, and it becomes an effort to apply more pressure.
2. When making a pipe joint overhead, put the pipe wrench on the fitting with the handle at 4 o'clock and apply pressure until handle is at 6 o'clock. Continue on as explained in step 1.

When making up fitting onto pipe, do not go extremely fast since you will cause friction. Friction is heat, and the pipe or fitting, when heated, will

expand. When the pipe or fitting has cooled after tightening, it will shrink back to the normal size.

Leaks are usually caused when the material expands, then contracts.



# Self Assessment

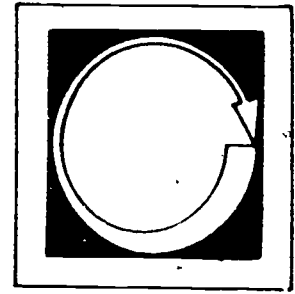

COMPLETE THE FOLLOWING STATEMENTS BY WRITING THE CORRECT WORD OR WORDS IN THE BLANK(S) PROVIDED.

1. A \_\_\_\_\_ pipe wrench may be used on 2-inch pipe.
2. One reason pipe joint compound is used on pipe threads is to \_\_\_\_\_  
\_\_\_\_\_.
3. Teflon tape is made from \_\_\_\_\_.

LISTED BELOW ARE SEVERAL STATEMENTS. IF THE STATEMENT IS TRUE, PLACE A "T" IN THE BLANK PROVIDED. IF THE STATEMENT IS FALSE, PLACE AN "F" IN THE BLANK.

4. \_\_\_\_\_ Pipe joint compound should be applied to female threads of a pipe fitting.
5. \_\_\_\_\_ A pipe wrench should be used only on rough pipe and fittings.
6. \_\_\_\_\_ Pipe wrench size is cast on the end of the wrench.

# Self Assessment Answers

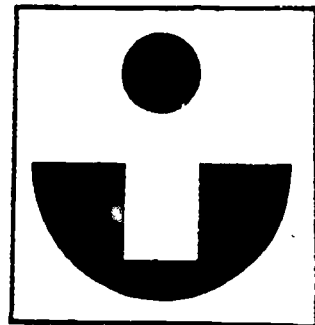

1. 24-inch
2. Reduce friction, watertight seal
3. Non-stick slippery substance
4. F
5. T
6. T

# Job Sheet

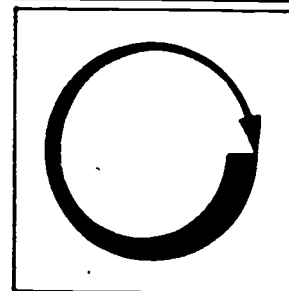

COMPLETE THE FOLLOWING TASKS.

1. Explain to your instructor:
  - a. the proper size of pipe wrench to be used with the size of pipe and fitting.
  - b. the proper method in applying teflon tape on pipe.
2. Materials & Tools
  - 2--1/2" 90° elbow black malleable fittings
  - 18"--1/2" schedule 40 black pipe
  - 1 roll teflon tape
  - a. Cut 2 pieces of pipe end to center of a 90 degree elbow 6" long. Thread one end only.
  - b. Cut 1 piece of pipe center to center of a 90 degree elbow 6" long. Thread both ends.
  - c. On the piece of pipe with threads on both ends, make up both 90 degree elbows.
  - d. Center to center of the 90 degree elbows should be 6".
  - e. If that measurement is not correct, repeat the process until you have the center to center measurement correct.
  - f. Make up the 2 pieces of pipe with threads on one end into both 90 degree elbows.
  - g. You should be able to stand this pipe and fittings makeup on end.
  - h. They should now stand straight up by themselves. (See illustration on following page.)

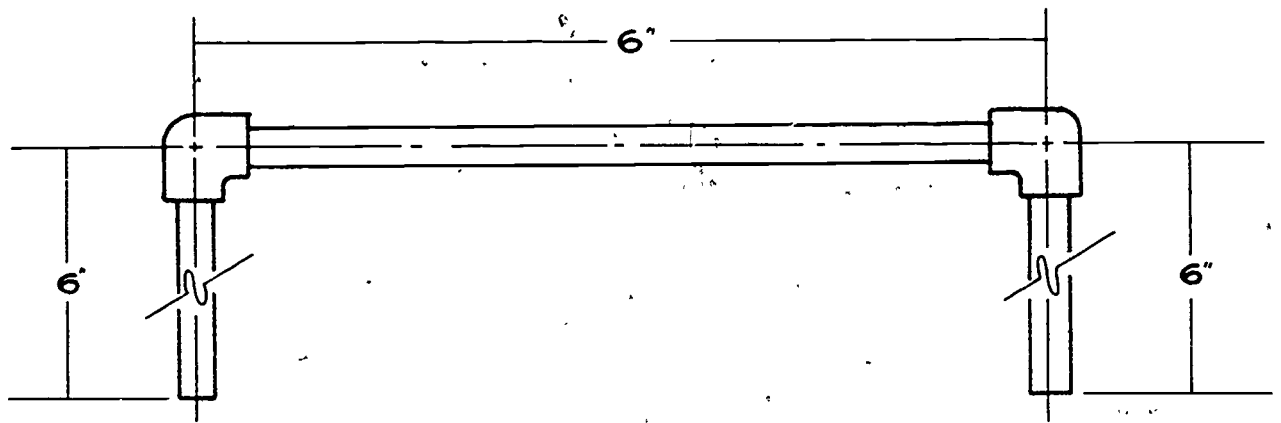

Threaded Pipe

# Post Assessment

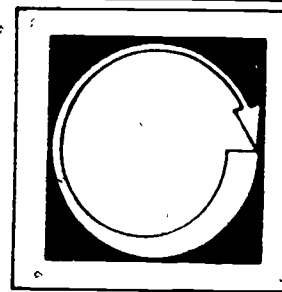

LISTED BELOW ARE STATEMENTS FOLLOWED BY A NUMBER OF POSSIBLE COMPLETIONS. SELECT THE COMPLETION WHICH COMPLETES THE STATEMENT CORRECTLY AND PLACE THE LETTER IN THE BLANK PROVIDED.

1. \_\_\_\_ The take off of a 1/2" 90 is:
  - a. 3/8 inch
  - b. 1/2 inch
  - c. 3/4 inch
  - d. 1 inch
  
2. \_\_\_\_ Thread makeup for a 1/2 inch pipe is:
  - a. 3/8 inch
  - b. 1 inch
  - c. 1/2 inch
  - d. 3/4 inch
  
3. \_\_\_\_ The proper procedure after the pipe has been cut is:
  - a. thread and ream
  - b. ream and thread
  - c. thread and apply fitting
  - d. none of the above
  
4. \_\_\_\_ The proper pipe wrench used on 2" galvanized pipe is:
  - a. 24 inch
  - b. 12 inch
  - c. 14 inch
  - d. all of the above

# Instructor Post Assessment Answers

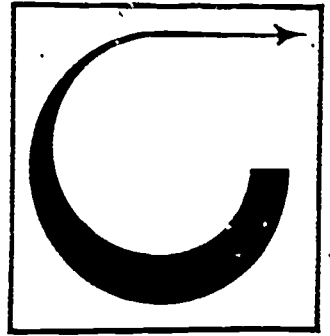

1. b

2. c

3. b

4. a

---

PLUMBING SYSTEMS IN BUILDINGS

---

**Goal:**

The student will be able to identify and explain the proper procedure of installing pipe in the plumbing system.

**Performance Indicators:**

The student will demonstrate an understanding of the subject by successfully completing a Self Assessment and a Post Assessment.

# Study Guide



In order to finish this module, do the following tasks. Check each item off as you complete it.

1.  Read the Goal and Performance Indicators on the cover of the module. This will tell you what you will learn by studying the module, and how you will show you've learned it.
2.  Read the Introduction. The Introduction will tell you why the module is an important part of the plumbing trade.
3.  Study the Vocabulary section. Vocabulary words are important for a good understanding of the trade. After you have studied the vocabulary, ask your teacher to quiz you on the words and their meanings.
4.  Study the Information section. This section will give you the information you need to understand the subject.
5.  Take the Self Assessment exam. This is a test for you to prove to yourself that you have learned the material you have studied. Compare your answers with the answers on the Self Assessment Answer Sheet, which is on the page following the Self Assessment. If you scored poorly, re-study the Information section or ask your teacher for help.
6.  Take the Post Assessment exam. Give the exam to your teacher after you have completed it. Your teacher will grade it for you.



# Introduction

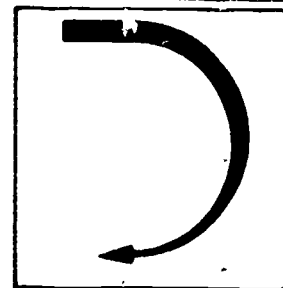

The design and installation of drainage, waste, vent, potable water and gas-piping systems depend on the type of building. The local codes and type of occupancy will tell you about the acceptable piping materials, installation and inspection. These are the first requirements for a safe and clean job.

# Vocabulary

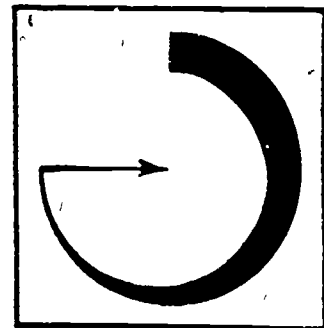

Trade terms are very important for a good understanding of the trade. Study these words and meanings. When you have learned them, ask your teacher to quiz you on the words and their meanings.

**PUBLIC SEWER**--A common sewer directly controlled by public authority.

**PRIVATE SEWER DISPOSAL SYSTEM**--A septic tank which discharges wastes into one or more seepage pits.

**DRAINAGE SYSTEM**--All the piping within public or private premises which convey sewage or other liquid wastes to a legal point of disposal.

**BUILDING SEWER**--Piping that takes sewage and other liquid wastes out of any building and into the public sewer.

**BUILDING DRAIN**--Piping inside a building that takes sewage to the building sewer.

**SEPTIC TANK**--A tank in which sewage is separated and purified by bacterial action.

**ARTERY**--The main channel.

**SOIL STACK**--A vertical pipe carrying sewage and liquid wastes.

**VERTICAL**--Up and down.

BRANCH--A part of the piping system other than a main, riser, or stack.

VENT--An air opening used to ensure free air circulation in the plumbing soil and waste system.

FLASHING--A word used to mean water-tight, as around the pipes through the roof.

B.T.U.--British Thermal Unit.

WATER CLOSET--(W.C.) Term used for toilet in the plumbing industry.

WATER METER--A mechanical device that measures volume of water.

FLUE--A passageway used to allow gases to escape to the open air.

V.T.R.--Vent Through Roof.

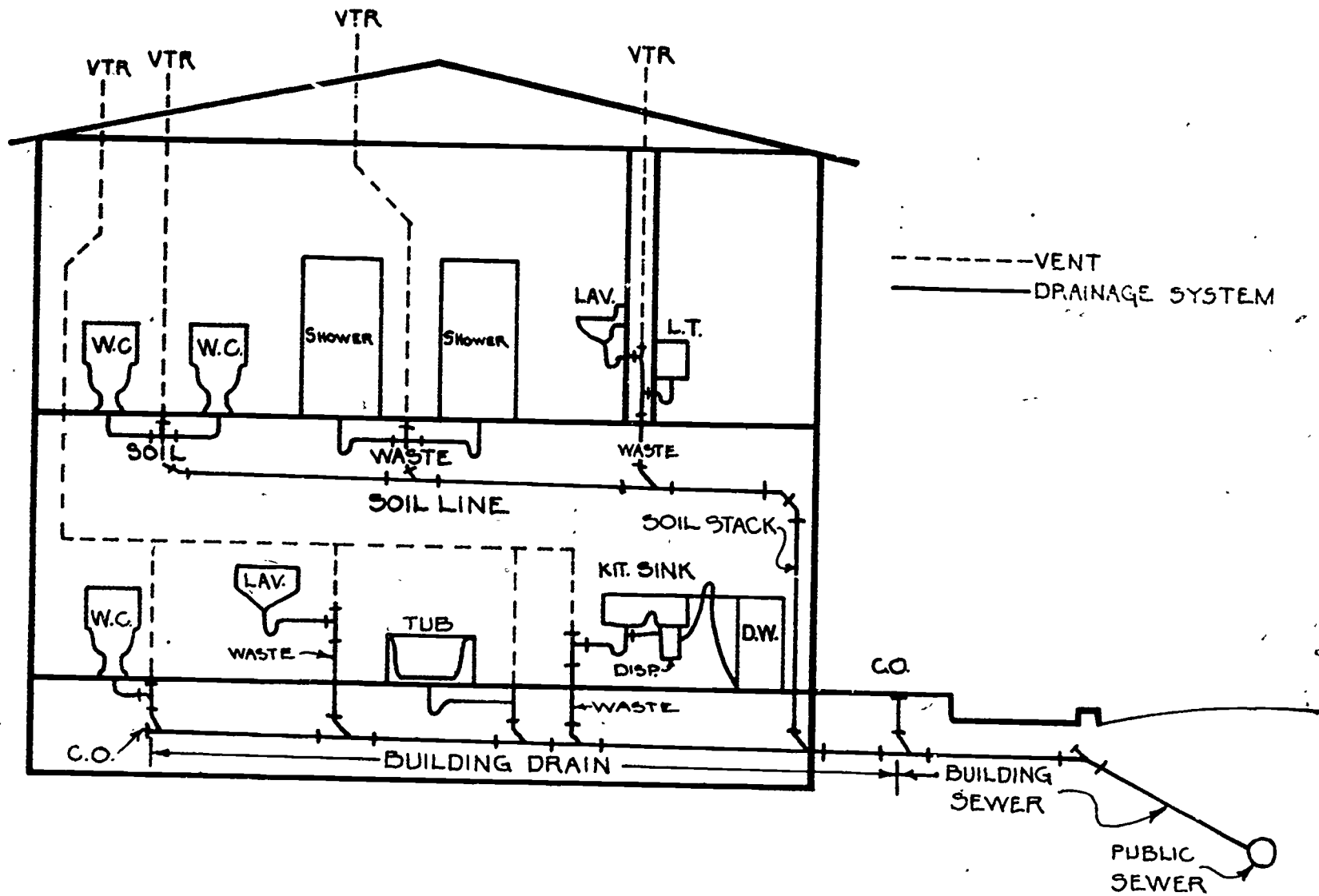

161

165

164

# Supplementary References

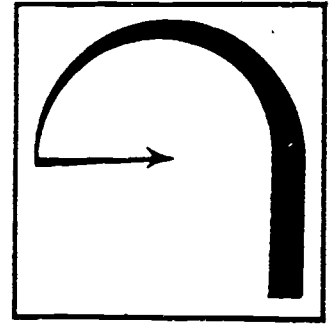

1. Uniform Plumbing Code Illustrated Training Manual. 1979, International Association of Plumbing and Mechanical Officials. Chapter 2 and pp. 126 and 177.
2. Daniels, George. Plumbing Heating and Air Conditioning. Popular Science Publishing Co., 1967. p. 12.

# Information

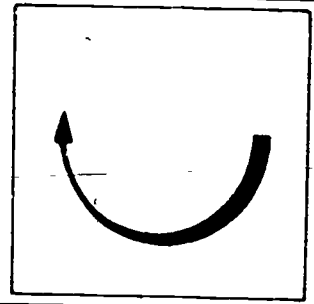

The order in which plumbing is installed in a building is:

1. Underground
  - a. Drainage piping
  - b. Gas piping
  - c. Water piping
  - d. Test and inspection
2. Above ground and through the roof
  - a. drainage, waste and vent
  - b. gas piping
  - c. water piping
  - d. flue piping
  - e. test and inspection
3. Finish
  - a. Setting of fixtures
  - b. Test and inspection

## DRAINAGE SYSTEM

The purpose of the drainage system is to provide a way of taking sewage and liquid waste from the plumbing fixture to the public sewer or a private sewer disposal system. The part of the drainage system under a building in a crawl space or under a concrete floor to a point of 5 feet outside the building is called the building drain. The building sewer starts at this point and ends at the public sewer or a private sewer disposal system such as a septic tank.

The main artery of the drainage system is the soil stack which is a vertical pipe receiving sewage and liquid waste from its branches. All branches from the soil stack receiving liquid wastes only are called the waste system, such as kitchen sinks, bathtubs, wash basins, washing machines and showers.

All plumbing fixture soil, waste and vent-piping is sized according to the code. Each fixture must be vented and connected with other vents. All vents have to be at least 6 inches above the rim of the highest fixture. The vents are taken through the roof at least 6 inches.

The vents will have an approved flashing around them to prevent moisture from entering the building.

At this stage all piping shall be capped, plugged, strapped and secured, except for the vent outlet on the roof. A water hose is put into this opening to fill the entire system with water.

Check the system for leaks, cracked fittings and pipe. Make necessary repairs. Remove cracked fittings and pipe and replace them. Re-test the system. If there are no leaks, call for inspection.

#### GAS PIPING

Gas piping is done next with threaded pipe. Cut as few threads as possible to make the best job.

Locate the gas meter outside the building. This meter is provided by the local gas company and used to record the amount of gas used.

Starting at the gas meter, piping is installed to each gas fixture, such as: water heater, furnace, stove, dryer and log lighter. These fixtures are also sized to code and are measured by B.T.U. To finish, cap pipe and plug all lines. With a gauge and valve on one outlet, use a tire pump to pump up a pressure of 10 pounds. If the gauge holds the air pressure for 15 minutes, call for a gas inspection.

While waiting for the inspector, start on the hot and cold water piping. The soil and waste line outlets that you have provided must have potable water piped to each outlet.

The toilet, or W.C., shall only have cold water. The water heater must have hot and cold water.

The kitchen sink must have an extra hot water outlet provided for the dishwasher. Shower and tub valves are installed in the walls along with the tub and shower.

After there is hot and cold water, cap all lines and connect the water service piping from the water meter to the building's potable water supply.

Turn on the water meter, check for leaks and remove air from the water lines. Install the flue from the water through a point in the roof. Call for inspection.

After the inspector has given his or her approval in writing, a sticker is put on the gas piping for the underground and rough plumbing and the water service.

The rough plumbing is complete and the plumbing fixtures may be connected after painting and tile floors and cabinets are installed.



# Self Assessment

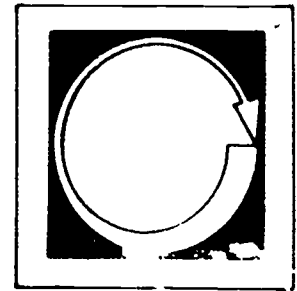

LISTED BELOW ARE SEVERAL STATEMENTS. IF THE STATEMENT IS TRUE, PLACE A "T" IN THE BLANK PROVIDED. IF THE STATEMENT IS FALSE, PLACE AN "F" IN THE BLANK.

1. \_\_\_ A drainage system is all the piping which conveys sewage or liquid wastes to a legal point of disposal.
2. \_\_\_ An artery is the main channel.
3. \_\_\_ Soil stack is the horizontal waste line.
4. \_\_\_ Flashing is used to seal around pipes at the roof level.
5. \_\_\_ Vertical is up and down.
6. \_\_\_ A vent is used for an air-tight plumbing system.
7. \_\_\_ Water closet (W.C.) is used to store water.
8. \_\_\_ A flue is used to allow unwanted gases to escape to the open air.
9. \_\_\_ V.T.R. means Vent Top Roof.
10. \_\_\_ There are normally three inspections to one job.
11. \_\_\_ The building sewer ends where the public sewer begins.
12. \_\_\_ A kitchen sink is part of the waste system.
13. \_\_\_ A vent shall extend through the roof at least 6 inches.

# ● Self Assessment Answers

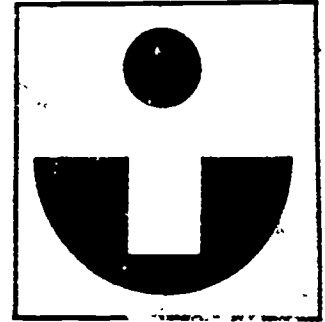

1. T
2. T
3. F
4. T
5. T
6. F
7. F
8. T
9. F
10. T
11. T
12. T
13. T

# Post Assessment

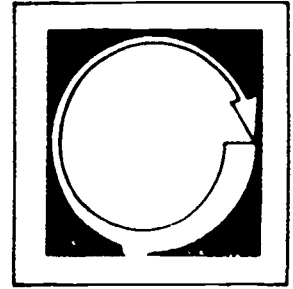

COMPLETE THE FOLLOWING STATEMENTS BY WRITING THE CORRECT WORD OR WORDS IN THE BLANKS PROVIDED.

1. \_\_\_\_\_ is a tank in which sewage is separated and purified by \_\_\_\_\_.
2. A \_\_\_\_\_ is part of the piping system other than a main, riser, or stack.
3. A \_\_\_\_\_ is a mechanical device used to measure the volume of water.
4. The pipe used to allow free air to circulate in the soil and waste system is called a \_\_\_\_\_.
5. A gas water heater must have a \_\_\_\_\_ to allow unwanted gases to escape through the roof.
6. After the underground piping is installed, a(n) \_\_\_\_\_ and \_\_\_\_\_ are required.
7. A private sewer disposal system shall have a(n) \_\_\_\_\_.
8. All piping is sized according to the \_\_\_\_\_.
9. \_\_\_\_\_ pipe is used in the gas system.
10. When testing the drainage system, all cracked fittings and pipe must be \_\_\_\_\_.

11. A(n) \_\_\_\_\_ is used to record the amount of gas used.
12. The air pressure used to test gas piping is \_\_\_\_\_.
13. Only \_\_\_\_\_ water is supplied to the W.C.
14. The \_\_\_\_\_ are installed after the painting, tile floors and cabinets are installed.
15. A \_\_\_\_\_ is the common sewer directly controlled by public authority.
16. Testing of the drainage system shall be for a minimum period of \_\_\_\_\_ minutes.
17. B.T.U. means \_\_\_\_\_.
18. V.T.R. means \_\_\_\_\_.
19. Kitchen sinks are a part of the \_\_\_\_\_ system.
20. Vents may be connected together at a point no lower than \_\_\_\_\_ above the rim of the highest fixture.

# Instructor Post Assessment Answers

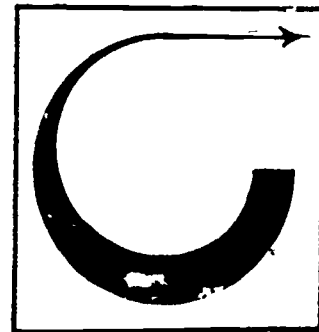

1. septic tank, bacteria
2. branch
3. water meter
4. vent
5. flue
6. Test, inspection
7. septic tank
8. code
9. threaded
10. replaced
11. gas meter
12. 10 pounds
13. cold
14. plumbing fixtures
15. public sewer
16. 15
17. British Thermal Unit
18. Vent Through Roof
19. Waste
20. 6 inches

..SOIL SYSTEM

**Goal:**

The student will be able to identify and explain the different types of pipe used in the soil system, and their connections.

**Performance Indicators:**

The student will demonstrate an understanding of the subject by successfully completing a Self Assessment and a Post Assessment.

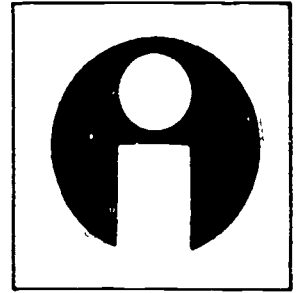

# Study Guide

In order to finish this module, do the following tasks. Check each item off as you complete it.

1.  Read the Goal and Performance Indicators on the cover of the module. This will tell you what you will learn by studying the module, and how you will show you've learned it.
2.  Read the Introduction. The Introduction will tell you why the module is an important part of the plumbing trade.
3.  Study the Vocabulary section. Vocabulary words are important for a good understanding of the trade. After you have studied the vocabulary, ask your teacher to quiz you on the words and their meanings.
4.  Study the Information section. This section will give you the information you need to understand the subject.
5.  Take the Self Assessment exam. This is a test for you to prove to yourself that you have learned the material you have studied. Compare your answers with the answers on the Self Assessment Answer Sheet, which is on the page following the Self Assessment. If you scored poorly, re-study the Information section or ask your teacher for help.
6.  Take the Post Assessment exam. Give the exam to your teacher after you have completed it. Your teacher will grade it for you.

# Introduction

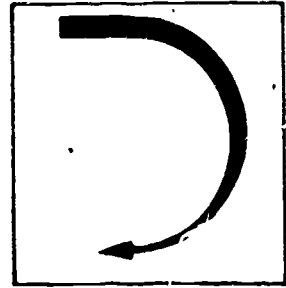

There are many types of piping material used from the tap of the public sanitary or storm sewer to the connection at the building sewer.

This module discusses plastic, cement and cast iron pipe.



# Vocabulary

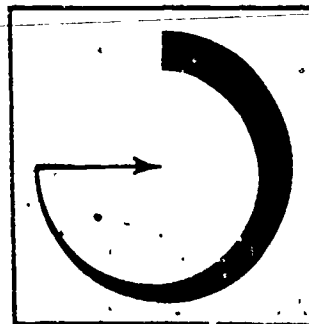

Trade terms are very important for a good understanding of the trade. Study these words and meanings. When you have learned them, ask your teacher to quiz you on the words and their meanings.

**MANHOLE**--An opening constructed to permit a person to gain access to the sewer system.

**DETRIMENTAL**--Causes damage or harm.

**CORE-DRILLING**--A specially designed cutting tip mounted with diamonds.

**BACKFLOW**--Reverse of direction in the sewer system.

**NOXIOUS**--Injurious to health, like some gases.

# Supplementary References

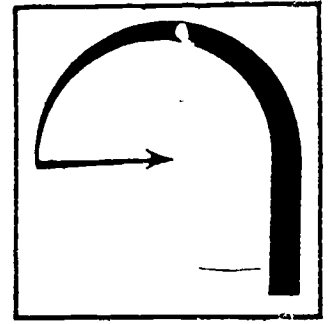

Ripka, L. V. Plumbing Installation and Design. American Technical Society,  
1978. pp. 91-93.

# Information

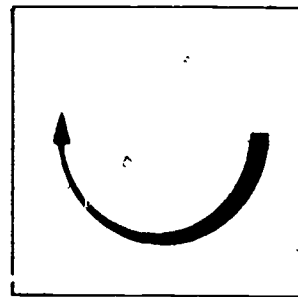

A plumber's basic skill is the ability to install and join the various kinds of pipe to complete the plumbing systems of a building. The plumber must know what kind of a joint to use for each piping material and be able to make this joint watertight, and, in the case of sewer gas, airtight.

Imperfect joints allow the liquid content of pipes to escape. If this happens, property damage can result.

Soil and waste pipe lines are often concealed in partitions or under the floor. If a joint fails for any reason, finished walls and ceilings can be damaged.

The plumbing drainage systems contain many noxious sewer gases, which are detrimental to health if they are permitted to enter an occupied building.

A leaking joint on a sewer or drain installed below the surface of the soil would allow sewage to enter the subsoil and could contaminate the drinking water. A leaky joint of this kind might also allow soil to enter the drain and cause stoppage of the drain line. Leaky underground pipe joints in yard areas allow the entrance of tree roots. Once these roots have entered the pipe, they spread quickly until they have filled the entire inside of the pipe. A drain blocked with tree roots usually requires mechanical cleaning of the drain line, and sometimes the pipe can be opened only by digging up the drain and replacing it with a new one.

## CAST IRON SOIL PIPE BELL AND SPIGOT

Bell and spigot cast iron soil pipe joints--either caulked joints or mechanical joints--are made with pre-formed, molded neoprene rubber compression gaskets. No-hub soil pipe is joined by a stainless steel clamp assembly surrounding a sealing sleeve of neoprene rubber.

A caulked joint in soil pipe is made with molten lead and oakum; caulked with caulking irons to make the joint is watertight (shown on next page).

Oakum is hemp that has been treated with pitch to make it waterproof and resistant to the elements in the sewer and soil piping.

The lead is heated on a lead furnace and poured with a ladle. The lead should be heated up to the point of not sticking to the ladle and not turning red hot, forming a residue on top of the molten lead. Follow the steps in the illustration for making a watertight lead caulking joint. (See illustration on following page.)

#### COMPRESSION GASKET SOIL PIPE JOINT

Compression gaskets are made from neoprene rubber.

The compression gasket soil pipe joint is made by:

1. Cleaning the hub and spigot so they are free from dirt, mud and other material.
2. Inserting the gasket into the hub.
3. Lubricating the gasket and installing the pipe into the hub.

Most public sewer piping is made from concrete and installed below the street or ground. The manholes that you see in the streets are installed every 300 feet. A manhole is used at every turn of direction in the sewer system.

When a private sewer connection is made to the public sewer, it is generally made by core-drilling the concrete pipe as close to the top as possible. This also prevents the possibility of backflow of the public sewer into the private sewer system.

Plastic sewer piping or ABS plastic pipe may be connected from the tap into the public sewer system with a specially designed fitting that is used only for this purpose. The fitting is then connected to the building sewer. This is done by means of a neoprene gasket with stainless steel bands and is called a Caulder Coupling.

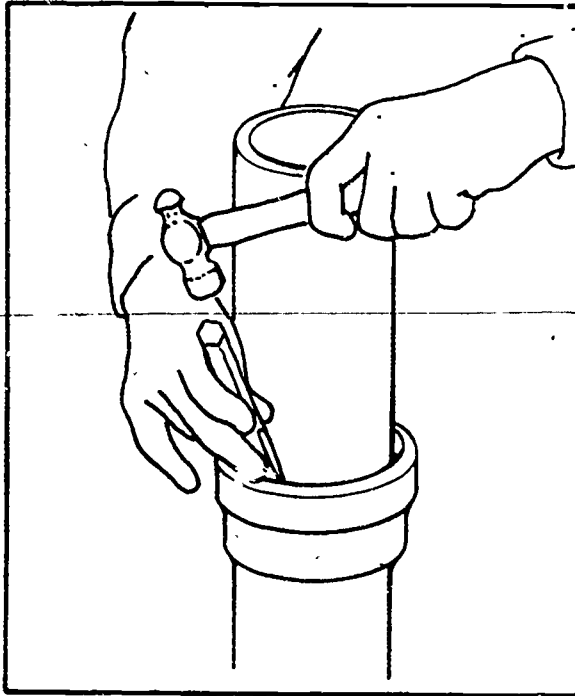

PACKING OAKUM



YARNING OAKUM

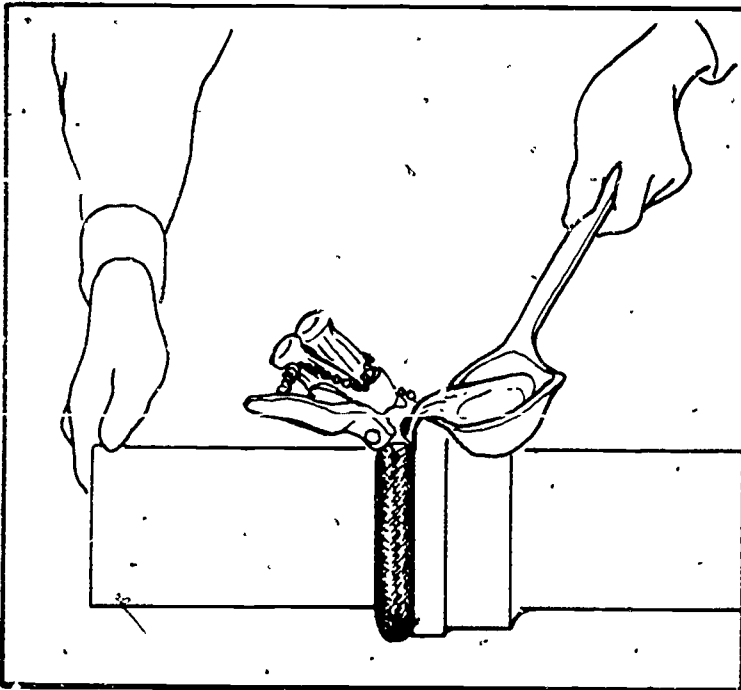

POURING MOLTEN LEAD INTO A HORIZONTAL SOIL PIPE JOINT

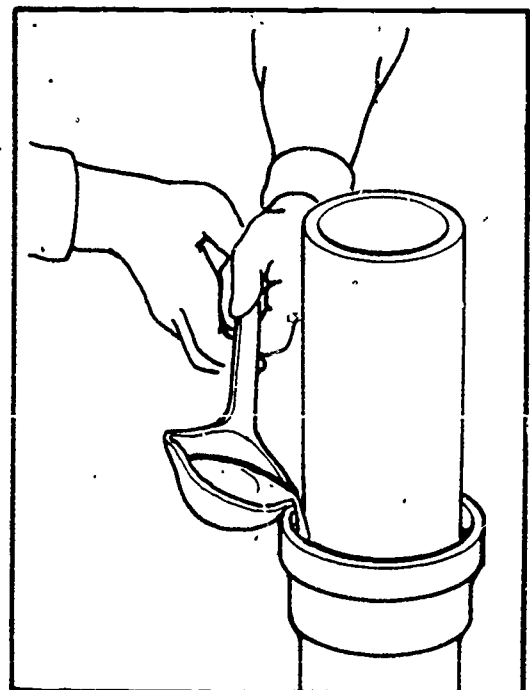

POURING MOLTEN LEAD

# Self Assessment

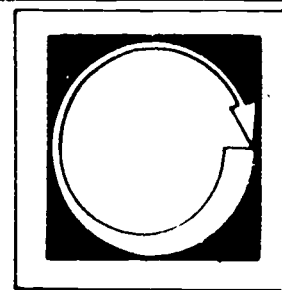

LISTED BELOW ARE SEVERAL STATEMENTS. IF THE STATEMENT IS TRUE, PLACE A "T" IN THE BLANK PROVIDED. IF THE STATEMENT IS FALSE, PLACE AN "F" IN THE BLANK.

1. \_\_\_ There are various types of piping used in the sewer system.
2. \_\_\_ The word "detrimental" means anything that causes damage or harm.
3. \_\_\_ All sewer piping must be watertight and airtight.
4. \_\_\_ A caulked joint is made by using oakum and concrete.
5. \_\_\_ Manholes are installed every 200 feet.

# Self Assessment Answers

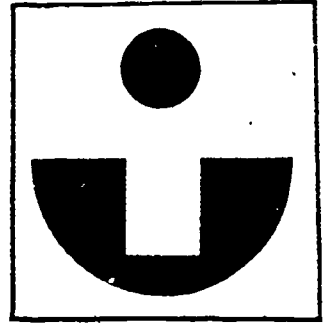

1. T

2. T

3. T

4. F

5. F

# Post Assessment

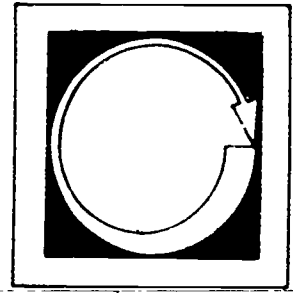

COMPLETE THE FOLLOWING STATEMENTS BY WRITING THE CORRECT WORD OR WORDS IN THE BLANKS PROVIDED.

1. A caulked joint is made by using \_\_\_\_\_ and \_\_\_\_\_.
2. Manholes are installed every \_\_\_\_\_ feet.
3. All sewer piping must be watertight and \_\_\_\_\_.
4. The plumbing drainage systems contain many noxious \_\_\_\_\_.
5. Oakum is made of \_\_\_\_\_.
6. Compression gaskets are made from \_\_\_\_\_.
7. Private sewer connections should be made near the \_\_\_\_\_ of the public sewer.



# ● Instructor Post Assessment Answers

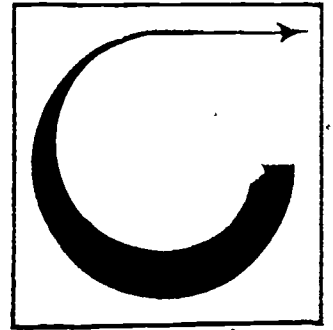

1. oakum, lead
2. 300
3. airtight
4. sewer gases
5. hemp
6. neoprene rubber
7. top

## WASTE SYSTEM

### **Goal:**

The student will be able to identify and explain:

1. The proper sizing of the fixtures.
2. Proper support of the piping.
3. The proper use of a trap.

### **Performance Indicators:**

The student will demonstrate an understanding of the subject by successfully completing a Self Assessment, a Post Assessment and by memorizing the table for waste pipe sizing.

# Study Guide

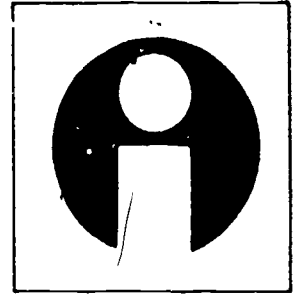

In order to finish this module, do the following tasks. Check each item off as you complete it.

1. \_\_\_ Read the Goal and Performance Indicators on the cover of the module. This will tell you what you will learn by studying the module, and how you will show you've learned it.
2. \_\_\_ Read the Introduction. The Introduction will tell you why the module is an important part of the plumbing trade.
3. \_\_\_ Study the Vocabulary section. Vocabulary words are important for a good understanding of the trade. After you have studied the vocabulary, ask your teacher to quiz you on the words and their meanings.
4. \_\_\_ Study the Information section. This section will give you the information you need to understand the subject.
5. \_\_\_ Take the Self Assessment exam. This is a test for you to prove to yourself that you have learned the material you have studied. Compare your answers with the answers on the Self Assessment Answer Sheet, which is on the page following the Self Assessment. If you scored poorly, re-study the Information section or ask your teacher for help.
6. \_\_\_ Take the Post Assessment exam. Give the exam to your teacher after you have completed it. Your teacher will grade it for you.

# Introduction

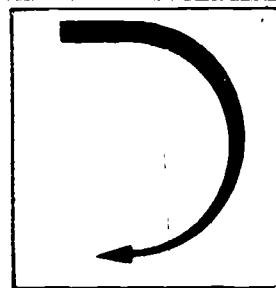

The purpose of the waste system is to provide a way of disposing liquid waste from the plumbing fixture to the soil and sewer piping system of a public or private sewer system.

To insure that this is accomplished in a manner which provides for protection of public health, safety and welfare, the code regulates the design, construction, installation and quality of materials for the entire drainage system.

# Vocabulary

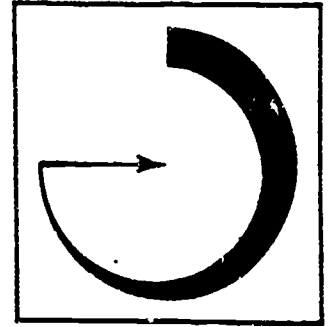

Trade terms are very important for a good understanding of the trade. Study these words and meanings. When you have learned them, ask your teacher to quiz you on the words and their meanings.

VERTICAL--Straight up and down.

HORIZONTAL--Flat, running from left to right.

SCOURING--A cleaning action in the pipe.

OVERFLOW RIM--The upper most part of a fixture or pipe before it spills.

HANGER--A metal frame hung from the ceiling which carries the weight of pipe.

RISER CLAMP--A metal device used to support the weight of a vertical pipe.

CLEANOUT--A plug or cover joined to a pipe which can be removed for cleaning or inspection of the pipe.

STOPPAGE--The plugging up of solids in the plumbing system.

# Supplementary References

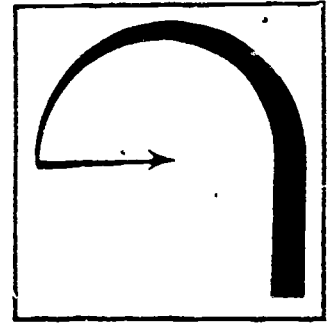

1. Uniform Plumbing Code Illustrated Training Manual. International Association of Plumbing and Mechanical Officials, 1979. pp. 177, 183, 184, 185, 188, 189.
2. Ripka, L. V. Plumbing Installation and Design. American Technical Society, 1978. pp. 113-116, 119-121, 123, 124.

# Information

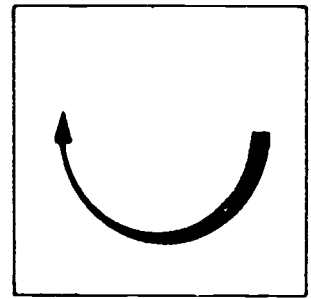

The waste pipe system contains all vertical and horizontal piping that receives the discharge of all liquid wastes.

In a home the fixtures that are a part of this system are:

1. Kitchen sink.
2. Wash basins or lavatory.
3. Tub.
4. Shower.
5. Washing machine.
6. Laundry sink.
7. Bar sink.

Before any waste piping can be installed on a job it must be sized correctly according to code.

A lavatory or wash basin, being a smaller fixture, discharges through its waste outlet approximately 7 1/2 gallons of water in a one-minute interval. This volume was so close to 1 cubic foot of water that it was established as the basis of the drainage fixture unit system adopted by most plumbing codes throughout the country.

Based on the above value of one drainage fixture unit being equal to 7 1/2 gallons of water per minute of waste discharge, and tests of various plumbing fixtures, waste water discharge rates have been established.

The table shown below has the drainage fixture unit values for various plumbing fixtures. In addition to listing the individual plumbing fixtures and their drainage fixture unit values, the table also lists the minimum size trap and waste pipe for each fixture. This is the smallest size pipe into which this fixture may drain.

| Fixture                | Drainage<br>Fixture Unit<br>Value | Trap Size | Waste<br>Pipe Size |
|------------------------|-----------------------------------|-----------|--------------------|
| Clothes Washer         | 2                                 | 2"        | 2"                 |
| Bath tub               | 2                                 | 1 1/2"    | 2"                 |
| Shower                 | 2                                 | 2"        | 2"                 |
| Lavatory or Wash Basin | 1                                 | 1 1/4"    | 1 1/4"             |
| Kitchen Sink           | 2                                 | 1 1/2"    | 2"                 |
| Laundry Sink           | 2                                 | 1 1/2"    | 2"                 |
| Bar Sink               | 1                                 | 1 1/2"    | 1 1/2"             |

Many plumbers believe that increasing the pipe size of a horizontal drainage pipe one size will increase its efficiency. This is not true. Scouring action is lost when the size of the drain is increased. As the waste water travels down the drainage pipe it swirls in a clockwise circular motion, carrying all liquid wastes with it. It also helps clean the pipe as it travels to the building sewer and city sewer or septic tank.

Proper sizing of piping in the plumbing systems helps to prevent stopped-up branch and main piping.

All horizontal piping must have grade of 1/4 inch to the foot. Only on special occasions where the architectural design has made this impossible will 1/8 inch grade to the foot be used.

In making a change in direction from the vertical to the horizontal, only a combination, wye-fitting, 45° (1/8 bend) 90° long turn (1/4 bend) may be used.



In going from the horizontal to the vertical, a sanitary tee, 45° (1/8 bend) code 90° (1/4 bend) and a wye fitting may be used.

Material used in the waste drainage system in residential use is mostly ABS schedule 40. Cast Iron, DWV, galvanized threaded pipe with Durham fittings and PVC pipe and fittings may also be used.

Two fixtures back-to-back, having the same height overflow rim, may discharge into an approved sanitary cross or sanitary double tee. The inside of the fitting on both sides must have a curve directing the flow directly into the pipe.

All vertical piping extending more than two stories in height must be supported at each floor level by means of a hanger or riser clamp. (See below.)

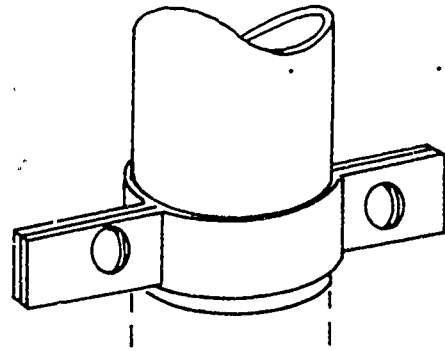
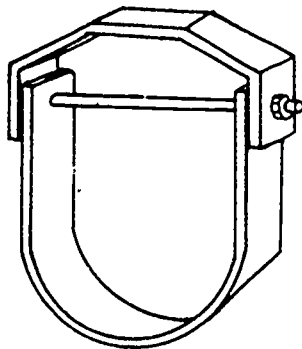

All horizontal plastic waste piping must be strapped or placed in hangers every four feet. Since plastic pipe is somewhat flexible, being strapped at four-foot intervals guarantees the pipe won't buckle or sag.

When using cast iron in 10-foot lengths, the pipe has to be strapped or in hangers only at the coupling where the two pipes join. Common sense is used where there are fittings joined together with the no-hub couplings as to how close and how many hangers or straps are to be used.

A cleanout is a fitting installed at the base of the drainage stack. In case of a stoppage it may be opened and properly cleaned out and cleared. It is also installed in the crawl space under a house when a change of direction

exceeds 135 degrees. (This means one 90° elbow and one 45° elbow, or three 45° elbows.)

In a typical home, when installing the waste system for showers, tubs and washing machines, a trap is installed in the wall or under the floor at the outlet indicated. A trap is installed under the floor at the center of the shower. The tub trap is set under the floor at a distance prescribed by the manufacturer.

The washing machine trap is installed in the wall and an extension piece is installed in the inlet side upward with a 45° elbow or a 60° elbow connecting at the top and coming out of the wall. This allows the hose from the washer to be put right into the fitting after the wall has been covered up and finished.

The kitchen sink, lavatory and laundry sink traps are installed when the plumbing fixtures are installed.

When installing the waste pipe for these fixtures a pipe of the proper size and height from the finished floor sticks out from the concealed wall.

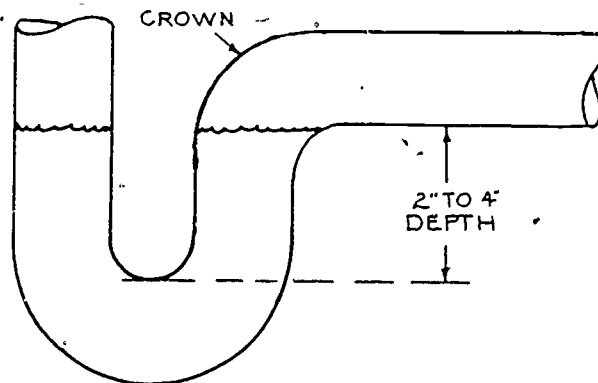

The illustration above is a trap that has a minimum and maximum water seal of two and four inches. This trap is needed to prevent sewer gases, rodents and bugs from entering the building or home.

The illustration shown at the top of the following page is a typical cast iron no-hub soil, waste and vent system suspended from the upper floor. The pipe hangers keep the pipe and fittings in a line and properly graded toward the vertical stack to which they will flow.

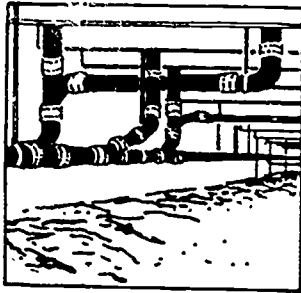

Suspended System

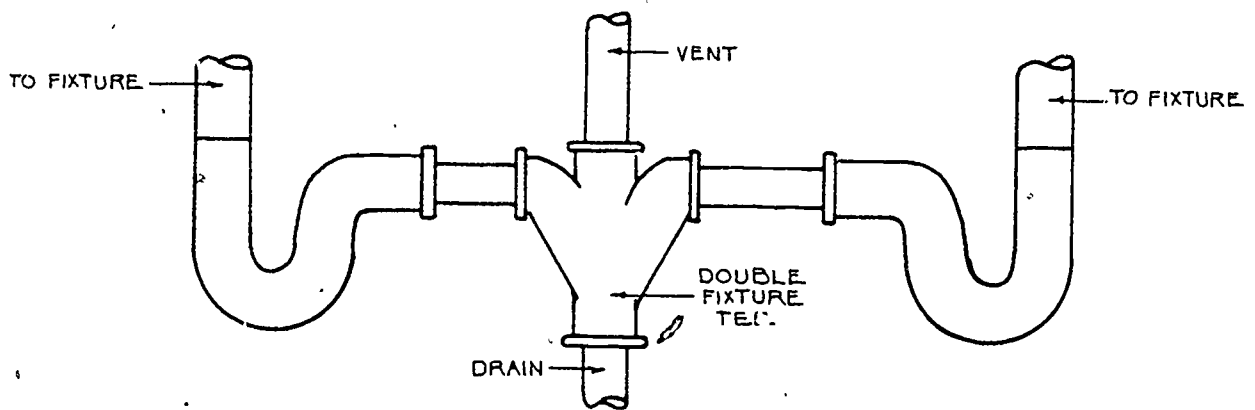

The illustration (directly above) shows the proper fittings and pipe used in a back-to-back situation where the overflow rims are the same height.

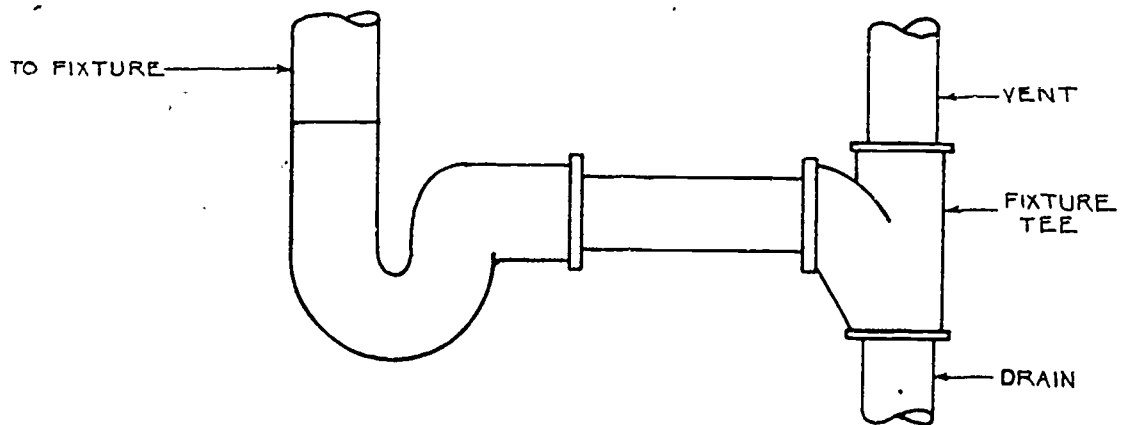

The illustration above shows the typical single fixture connection as explained earlier. Sometimes the fittings and trap are installed under the floor, in the wall, or when the plumbing fixture is installed.

The illustration below shows a typical bathroom layout. This layout is very common and may be in the home where you live.

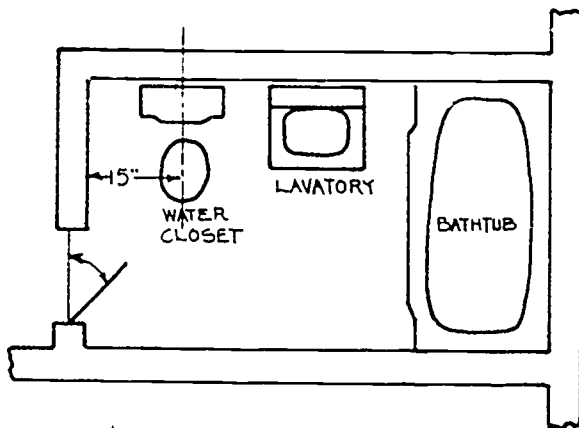

Fig. G

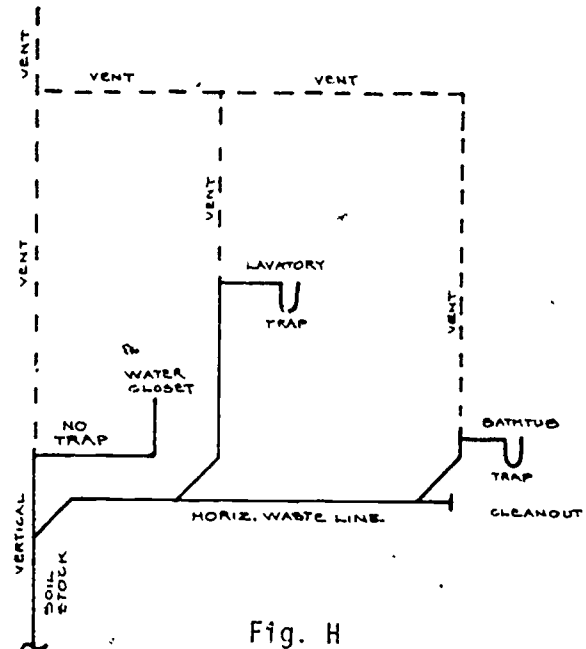

Fig. H

Figure G is a plan view that is in the blueprints you receive before you are asked to install the plumbing. The minimum distance between the center of the water closet and the finish wall is 15 inches. Notice that the distance between the outer edge of the tub and the outer edge of the toilet tank is the same. When laying out the waste piping the plumber must know the sizes of the fixtures so they may be centered properly and look even when it is time to set the plumbing fixture.

Figure H shows the typical in-wall and under-floor piping for Figure G.

The pipe at the water closet has no trap. All water closet traps are built in the water closets.

# Self Assessment

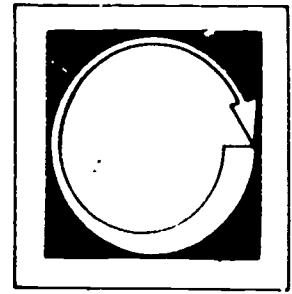

LISTED BELOW ARE SEVERAL STATEMENTS. IF THE STATEMENT IS TRUE, PLACE A "T" IN THE BLANK PROVIDED. IF THE STATEMENT IS FALSE, PLACE AN "F" IN THE BLANK.

1. \_\_\_ All waste pipe systems can be installed without regard to code.
2. \_\_\_ The overflow rim is where the waste pipe is connected to the trap.
3. \_\_\_ A cleanout is used to clean and inspect the pipe.
4. \_\_\_ A typical plumbing fixture found in the home is a urinal.
5. \_\_\_ Another typical fixture found in the home is a lavatory.
6. \_\_\_ A lavatory discharges approximately 7 1/2 gallons of water per minute.
7. \_\_\_ The drainage fixture unit for a lavatory is 2.
8. \_\_\_ The drainage fixture unit for a bathtub is 2.
9. \_\_\_ The trap size for a shower is 2 inches.
10. \_\_\_ The trap size for a bathtub is 2 inches.
11. \_\_\_ The waste pipe size of a lavatory is 1 1/4 inches.
12. \_\_\_ The waste pipe size of a kitchen sink is 2 inches.
13. \_\_\_ The waste pipe receives solids as well as water wastes.

- 2
14. \_\_\_ In going from the horizontal to the vertical, a code 90 may be used.
  15. \_\_\_ All vertical piping 2 or more stories in height may be supported at every other floor.
  16. \_\_\_ Cast iron no-hub pipe may be supported every 10 feet.
  17. \_\_\_ A cleanout may be installed in the crawl space.
  18. \_\_\_ A cleanout must be used when the change of directions exceeds  $135^{\circ}$ .
  19. \_\_\_ A washing machine trap is installed under the floor.
  20. \_\_\_ The shower trap is installed under the floor.

# Self Assessment Answers

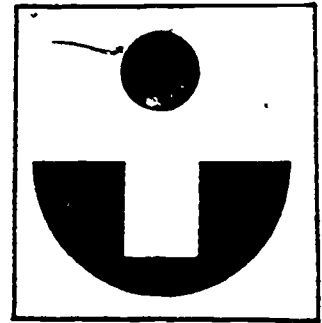

1. F
2. F
3. T
4. F
5. T
6. T
7. F
8. T
9. T
10. F
11. T
12. T
13. F
14. T
15. F
16. F
17. T
18. T
19. F
20. T

# Post Assessment

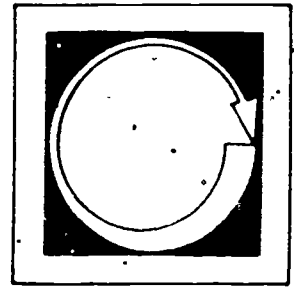

COMPLETE THE FOLLOWING STATEMENTS BY WRITING THE CORRECT WORD OR WORDS IN THE BLANKS PROVIDED.

1. The trap for a shower is located \_\_\_\_\_.
2. The trap for a washing machine is installed \_\_\_\_\_.
3. The minimum size water seal in a trap is \_\_\_\_\_.
4. The maximum size water seal in a trap is \_\_\_\_\_.
5. The minimum distance that a water closet may be installed from a finish wall is \_\_\_\_\_.
6. All water closets have a built-in \_\_\_\_\_.
7. The swirling action in a drain pipe goes in a \_\_\_\_\_ direction.
8. The normal grade for a waste pipe on the horizontal is \_\_\_\_\_.
9. Approximately \_\_\_\_\_ of water per minute discharges from a lavatory.
10. A clothes washer drainage fixture unit is \_\_\_\_\_.
11. A \_\_\_\_\_ size trap is needed for a shower.



12. A \_\_\_\_\_ size trap is needed for a lavatory.
13. A \_\_\_\_\_ size trap is needed for a kitchen sink.
14. The waste pipe size for a bathtub is \_\_\_\_\_.
15. The waste pipe size for a lavatory is \_\_\_\_\_.
16. The horizontal waste pipe has a grade of \_\_\_\_\_ per foot except under architectural conditions.
17. All horizontal plastic waste piping is strapped every \_\_\_\_\_.
18. All horizontal waste pipe exceeding \_\_\_\_\_ has a cleanout.
19. All vertical waste pipe is supported on \_\_\_\_\_ floor when it exceeds 2 stories.
20. The fixture drainage unit of a shower is \_\_\_\_\_.

# Instructor Post Assessment Answers

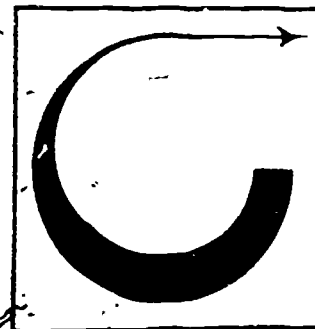

1. under floor
2. in the wall
3. 2 inches
4. 4 inches
5. 15 inches
6. trap
7. clockwise
8. 1/4 inch per foot
9. 7 1/2 gallons
10. 2
11. 2-inch
12. 1 1/4-inch
13. 1 1/2-inch
14. 2 inch
15. 1 1/4 inch
16. 1/4 inch
17. 4 feet
18. 135 degrees
19. every
20. 2

## VENT SYSTEM

### Goal:

The student will be able to identify and explain:

1. The reason for venting a plumbing drainage system.
2. The difference between a vent pipe and waste pipe.
3. The proper installation of vent piping.
4. The table showing the fixture, trap size and vent size.

200

### Performance Indicators:

The student will demonstrate understanding of the subject by successfully completing a Self Assessment and Post Assessment and by memorizing the table for vent pipe sizing.

204

# Study Guide

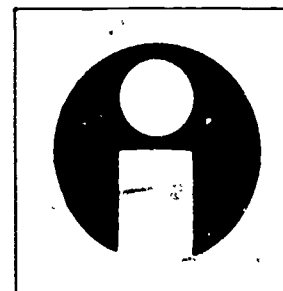

In order to finish this module, do the following tasks. Check each item off as you complete it.

1.  Read the Goal and Performance Indicators on the cover of the module. This will tell you what you will learn by studying the module, and how you will show you've learned it.
2.  Read the Introduction. The Introduction will tell you why the module is an important part of the plumbing trade.
3.  Study the Vocabulary section. Vocabulary words are important for a good understanding of the trade. After you have studied the vocabulary, ask your teacher to quiz you on the words and their meanings.
4.  Study the Information section. This section will give you the information you need to understand the subject.
5.  Take the Self Assessment exam. This is a test for you to prove to yourself that you have learned the material you have studied. Compare your answers with the answers on the Self Assessment Answer Sheet, which is on the page following the Self Assessment. If you scored poorly, re-study the Information section or ask your teacher for help.
6.  Take the Post Assessment exam. Give the exam to your teacher after you have completed it. Your teacher will grade it for you.

# Introduction

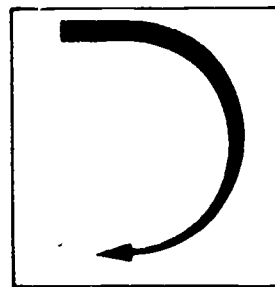

Ventilation of the plumbing system is accomplished by one or more vent pipes connected to the drainage system and terminating outside of the building.

The system must be designed to maintain atmospheric pressure within it, prevent retardation of flow and trap seal loss, and preventing sewer gas from entering the building.

Good sanitation practice demonstrates that rooms in which plumbing fixtures are located be well-lighted, ventilated and free of sewer gas.

Water seals in fixture traps provide the means to prevent gases and odors from entering into the building's air.

# Vocabulary

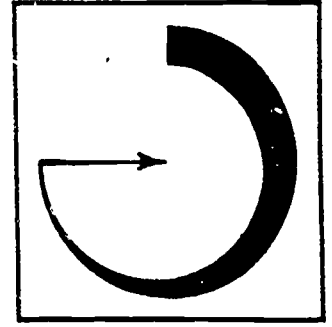

Trade terms are very important for a good understanding of the trade. Study these words and meanings. When you have learned them, ask your teacher to quiz you on the words and their meanings.

ATMOSPHERIC PRESSURE--A unit of pressure equal to 14.7 pounds per square inch.  
The pressure exerted by the air on the earth's surface at sea level is about one atmosphere.

RETARDATION--Any substance that can slow down the speed of a given reaction.

TRAP SIPHONAGE--A suction causing the trap to lose its water seal.

BACK PRESSURE--A reverse pressure greater than the flow of its normal direction.

# Supplementary References

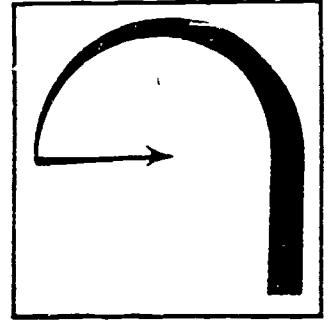

1. Uniform Plumbing Code Illustrated Training Manual. International Association of Plumbing and Mechanical Officials, 1979. pp. 199, 204, 205, 207, 208, 213.
2. Ripka, L. V. Plumbing Installation and Design. American Technical Society, 1978. pp. 131-133, 135, 137, 139, 141.

204

208

# Information

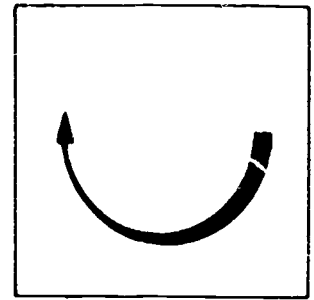

Vent pipes are extensions of the waste and soil pipe and are installed at the same time.

A vent pipe is any pipe provided to ventilate a building drainage system and to prevent trap siphonage and back pressure. This means that every plumbing fixture has a water seal trap, and every trap should have a vent to protect its water seal.

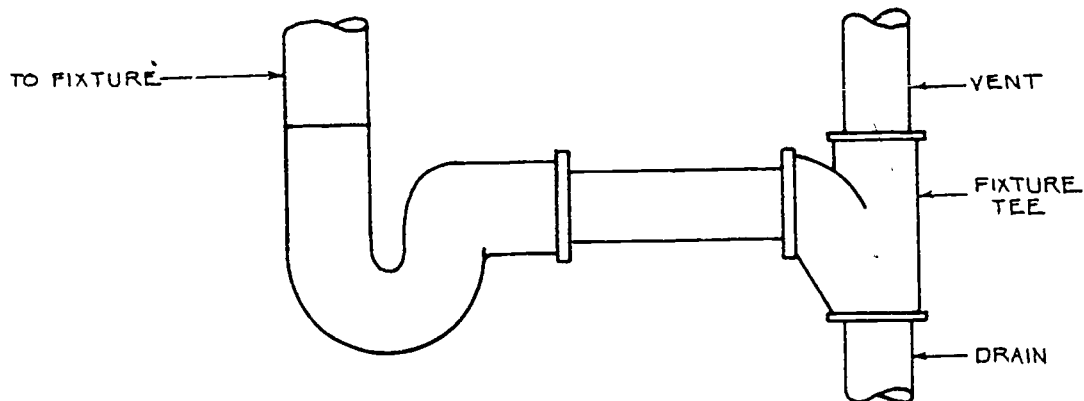

A properly installed system of vent pipes provides free circulation of air within the sanitary system and assures that at no time should the traps lose their water seal. This free circulation of air within the drainage system allows the liquid waste to drain freely through the pipes.

The vent piping system also removes unwanted gases from the drainage system.

Improper venting can result in slow drainage and, again, loss of water trap seal.

In some cases the size of the trap is the same size as the vent.



Vent pipes may be connected together at a point no less than 6 inches above the overflow rim of the highest fixture served as long as they are properly sized according to the code. All vents going through the roof will extend at least 6 inches above the roof and be properly sealed around the pipe where it goes through the roof.

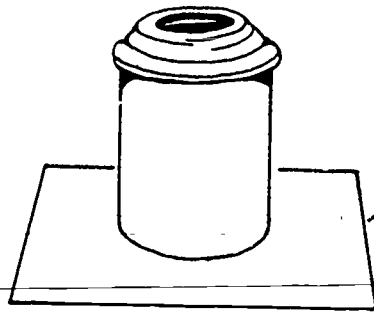

Roof Jack

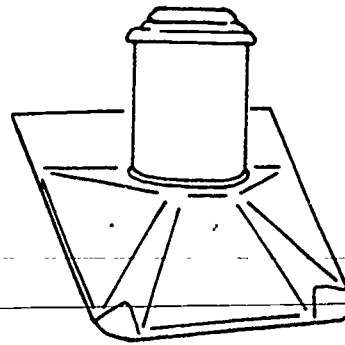

Roof Flashing

The proper material to use is a roof jack or roof flashing nailed to the roof and tared to protect water from entering the building around the vent pipe. All vertical pipes are installed straight and plumb. All horizontal pipes may be run flat or at a slight grade upward toward the roof.

The illustrations on the following page list the vent sizing and total amount of fixture units allowed on each size of drainage pipe and the vertical and horizontal distances allowed.

The smallest size vent allowed is 1 1/4 inches as that is the smallest waste pipe allowed in the plumbing drainage system. The total sizing of vent pipes through the roof equals the size of the building sewer and soil pipe to which it serves.

Vent openings must be at least 10 feet from a window or opening in the building.

If the roof is used as a sun deck the minimum height of the vent pipe is 7 feet.

(See the Vent Table following the illustrations.)

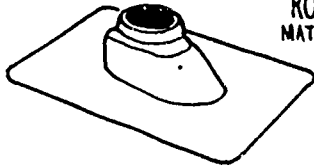

ROOF FLASHING  
MATERIAL; NEOPRENE

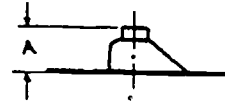

| PART NO. | SIZE           | DESCRIPTION | A     |
|----------|----------------|-------------|-------|
| 3891     | 1 1/4 or 1 1/2 |             | 2 3/4 |
| 3892     | 2              |             | 2 3/4 |
| 3893     | 3              |             | 3 3/4 |
| 3894     | 4              |             | 3 3/4 |

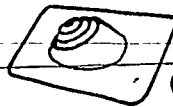

ROOF FLASHING  
(NO CRACK)  
Galvanized w/Neoprene Collar

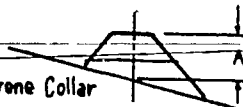

| PART NO. | SIZE           | DESCRIPTION | A     |
|----------|----------------|-------------|-------|
| 3887     | 1 1/4 or 1 1/2 |             | 2 1/2 |
| 3888     | 2              |             | 2 1/2 |
| 3889     | 3              |             | 2 1/2 |
| 3890     | 4              |             | 3     |

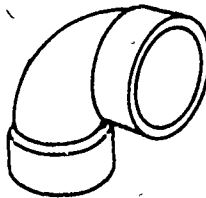

Vent Ell

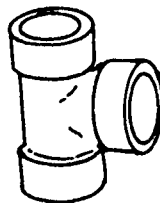

Vent Tee

## VENT TABLE SIZE

| Fixture                           | Drainage Fixture |  | Trap Size         | Vent Size         |
|-----------------------------------|------------------|--|-------------------|-------------------|
|                                   | Unit Value       |  |                   |                   |
| Clothes Washer                    | 2                |  | 2"                | 1 1/2"            |
| Bathtub                           | 2                |  | 1 1/2"            | 1 1/2"            |
| Shower                            | 2                |  | 2"                | 1 1/2"            |
| <del>Lavatory or Wash Basin</del> | <del>1</del>     |  | <del>1 1/4"</del> | <del>1 1/4"</del> |
| Kitchen Sink                      | 2                |  | 1 1/2"            | 1 1/2"            |
| Laundry Sink                      | 2                |  | 1 1/2"            | 1 1/2"            |
| Bar Sink                          | 1                |  | 1 1/2"            | 1 1/2"            |
| Water Closet                      | 4                |  | 3"                | 2"                |

The different types of vents are:

1. Vent Stack--Vertical pipe extending through the roof.
2. Branch Vent--Horizontal pipe receiving the vents from fixtures and connecting to the vent stack.
3. Single Vent--Pipe from a plumbing fixture that extends through the roof by itself.
4. Common Vent--Single pipe serving back-to-back plumbing fixtures.

The fittings often used in the vent system are vent tees--vent short-turn 90° elbows. The reason for the use of these fittings only in the vent system is that they have no curve inside the fitting.

The illustration on the following page is a 2-story building with the waste piping, soil piping and vent piping which will be concealed in the walls. This is typical in most multi-story buildings.

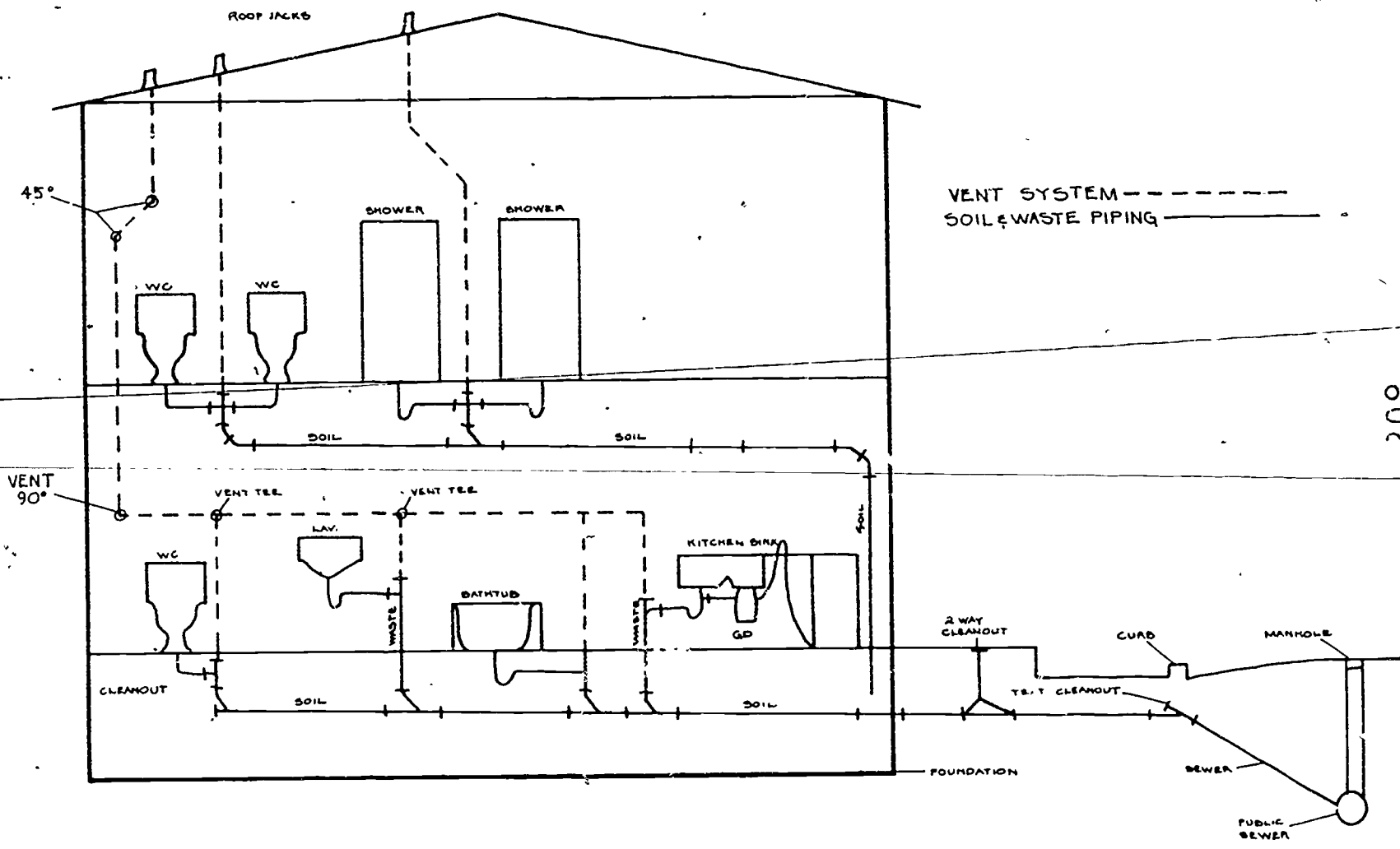

# Self Assessment

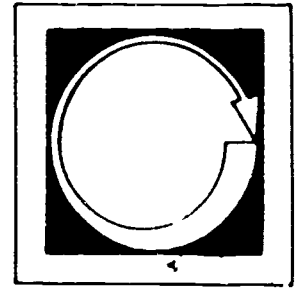

LISTED BELOW ARE SEVERAL STATEMENTS. IF THE STATEMENT IS TRUE, PLACE A "T" IN THE BLANK PROVIDED. IF THE STATEMENT IS FALSE, PLACE AN "F" IN THE BLANK.

1. \_\_\_ Vent pipes are the extensions of water pipes.
2. \_\_\_ One reason for installing vent piping is to prevent trap siphonage.
3. \_\_\_ All plumbing fixtures are required to have a vent.
4. \_\_\_ A vent pipe is installed in the plumbing system to allow free air to circulate in that system.
5. \_\_\_ The vent pipe must go through the roof at least one foot.
6. \_\_\_ A roof jack is installed over the vent pipe in the wall.
7. \_\_\_ A roof jack is installed to make sure no water enters the building around the vent pipe.
8. \_\_\_ All horizontal vent piping may be run flat.
9. \_\_\_ The smallest size vent pipe that may be used is 1 1/2 inches.
10. \_\_\_ The size of the vent piping must equal the size of the building sewer according to code.
11. \_\_\_ The vent stack is the horizontal vent in a building.
12. \_\_\_ A common vent is two vent pipes serving back-to-back fixtures.

# Self Assessment Answers

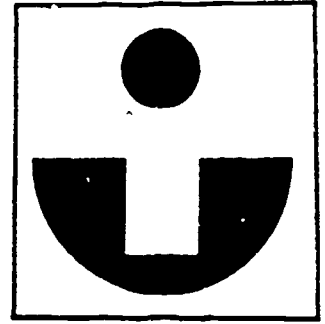

1. F
2. T
3. T
4. T
5. F
6. F
7. T
8. T
9. F
10. T
11. F
12. F

# Post Assessment

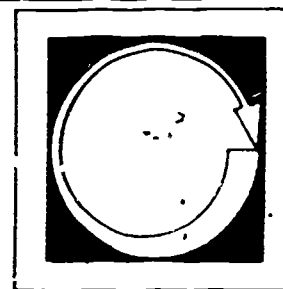

COMPLETE THE FOLLOWING STATEMENTS BY WRITING THE CORRECT WORD OR WORDS IN THE BLANKS PROVIDED.

1. \_\_\_\_\_ piping is the extension of waste and soil piping.
2. All plumbing fixtures are required to have a \_\_\_\_\_.
3. The vent pipe must extend through the roof at least \_\_\_\_\_.
4. A \_\_\_\_\_ is installed on the vent pipe to prevent \_\_\_\_\_ from entering the building.
5. The smallest vent pipe size allowed by the code is \_\_\_\_\_.
6. The minimum size vent pipe allowed for a bathtub is \_\_\_\_\_.
7. The smallest size vent pipe allowed for a kitchen sink is \_\_\_\_\_.
8. The smallest size vent pipe allowed for a water closet is \_\_\_\_\_.
9. A vent is installed to prevent a trap from losing its \_\_\_\_\_.
10. List the trap size and vent size for the following.

| <u>Fixture</u>    | <u>Trap Size</u> | <u>Vent Size</u> |
|-------------------|------------------|------------------|
| A. Clothes Washer | _____            | _____            |
| B. Bathtub        | _____            | _____            |
| C. Shower         | _____            | _____            |

- D. Lavatory or Wash Basin
- E. Kitchen Sink
- F. Laundry Sink
- G. Bar Sink
- H. Water Closet

|  |  |
|--|--|
|  |  |
|  |  |
|  |  |
|  |  |
|  |  |
|  |  |



# Instructor Post Assessment Answers

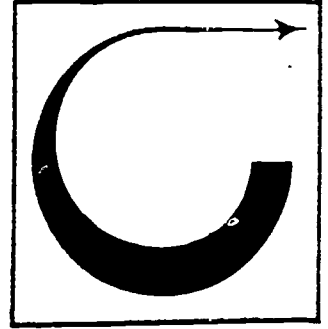

1. vent
2. vent
3. 6 inches
4. roof jack, water
5. 1 1/4 inches
6. 1 1/2 inches
7. 1 1/2 inches
8. 2 inch
9. water seal
10.
 

|           |        |
|-----------|--------|
| A. 2"     | 1 1/2" |
| B. 1 1/2" | 1 1/2" |
| C. 2"     | 1 1/2" |
| D. 1 1/4" | 1 1/4" |
| E. 1 1/2" | 1 1/2" |
| F. 1 1/2" | 1 1/2" |
| G. 3"     | 2"     |

## WATER SYSTEM

### Goal:

The student will be able to identify and explain:

1. The importance of a safe and clean potable water supply.
2. The reason for the proper pipe sizing.
3. The proper materials used in the water pipe system.

### Performance Indicators:

The student will demonstrate an understanding of the subject by successfully completing a Self Assessment and a Post Assessment and by memorizing the water pipe sizing table.

# Study Guide

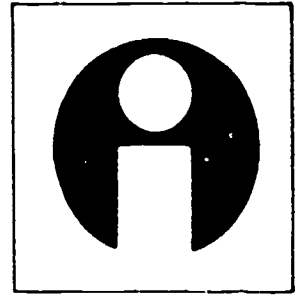

In order to finish this module, do the following tasks. Check each item off as you complete it.

1.  Read the Goal and Performance Indicators on the cover of the module. This will tell you what you will learn by studying the module, and how you will show you've learned it.
2.  Read the Introduction. The Introduction will tell you why the module is an important part of the plumbing trade.
3.  Study the Vocabulary section. Vocabulary words are important for a good understanding of the trade. After you have studied the vocabulary, ask your teacher to quiz you on the words and their meanings.
4.  Study the Information section. This section will give you the information you need to understand the subject.
5.  Take the Self Assessment exam. This is a test for you to prove to yourself that you have learned the material you have studied. Compare your answers with the answers on the Self Assessment Answer Sheet, which is on the page following the Self Assessment. If you scored poorly, re-study the Information section or ask your teacher for help.
6.  Take the Post Assessment exam. Give the exam to your teacher after you have completed it. Your teacher will grade it for you.

# Introduction

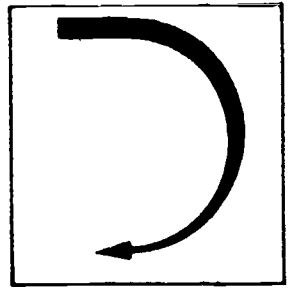

In the beginning wells, lakes, springs and rivers were used as a source of water. But as the population grew and communities enlarged, water became more difficult to come by.

As various wastes from rainwater, privies, dish and clothes washing and bathing were being disposed of on the surface of the ground, shallow wells and springs became polluted. So a better system of water supply was needed for distribution and sanitation.

The first water supply in the United States was in 1776 where the water was obtained from public wells and ponds through wooden pipes. In 1830 New York City installed its first public water works for use against night fires.

It wasn't until the early 1900s that laws were enacted in many areas of the country regulating the water piping system.

# Vocabulary

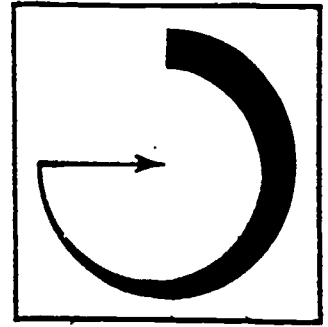

Trade terms are very important for a good understanding of the trade. Study these words and meanings. When you have learned them, ask your teacher to quiz you on the words and their meanings.

**HYDROGEN**--A colorless, odorless, flammable gas that is mixed with oxygen to make water.

**OXYGEN**--A colorless, odorless gas that is mixed with hydrogen to produce water.

**IRRIGATE**--To supply land with water.

**CONTAMINATE**--To make unsafe and not clean.

**TOXIC**--Having the effect of a poison.

**VACUUM BREAKER**--Used to prevent back siphonage.

**SUBMERGED**--To be below the surface of water or any liquid.

**POLLUTE**--To make unclean, especially with waste materials.

**DEVICE**--Something made for a special purpose.

**CROSS CONNECTION**--Any connection of piping between the potable water supply system and any plumbing fixture or any device that will allow any impure material from entering the potable water system.

**BACKFLOW PREVENTION DEVICE**--An assembly of valves that prevents any back siphonage to occur.

# Supplementary References

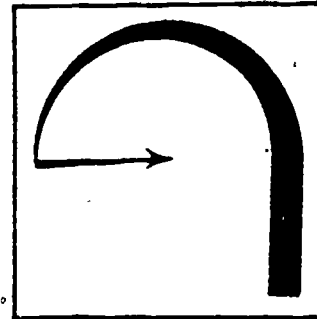

1. Uniform Plumbing Code Illustrated Training Manual. International Association of Plumbing and Mechanical Officials, 1979. pp. 253, 254, 255, 269.
2. Ripka, L. V. Plumbing Installation and Design. American Technical Society, 1978. pp. 181, 183, 185, 186, 187.

# Information

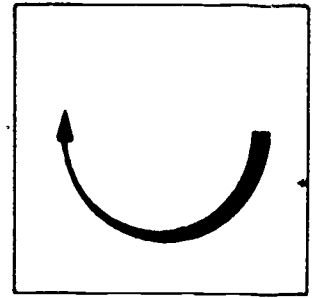

Water is composed of two gases: Hydrogen and oxygen. The chemical symbol is  $H_2O$ --two parts hydrogen to one part oxygen.

Pure and wholesome potable water from a source approved by the health authority having jurisdiction should be available at all times on the premises of every building in which plumbing fixtures are installed.

The potable water supply of a building should be connected to a public potable water supply system when available. However, where a public system is not available, a private source of potable water following the regulations of the health authority may be used.

Private systems usually serve a single- or multi-family building or a small community's needs.

For safety and sanitation, each plumbing fixture is supplied with potable water. This water is used for drinking, bathing, food preparation, medical products and irrigation.

Buildings' potable water supply systems should not be subject to contamination from any source. Chemicals that could produce toxic conditions in the systems should not be introduced into any part of the piping without the approval of the health authority.

There is no direct connection between a private water supply system and a public potable water supply, except by the approval of the health authority.

Potable water supply piping, water outlets and vacuum breakers can't be installed where there is a possibility that they may be submerged.

The code prohibits any connection that might introduce polluted or contaminated water, mixtures, or any substance from entering the potable water supply system.

No plumbing fixture, device, or construction is installed, maintained, or connected to a domestic water supply when there is a possibility of a cross connection. This can occur between the fixture, device, or construction and the domestic potable water distribution system unless an approved backflow prevention device is installed.

All potable water supply outlets should terminate at sufficient height above the flood level rim. This means tub spouts and faucet outlets should be installed so they are above the flood level rim at least one inch.

Any device installed in the water supply system for the prevention of backflow or backsiphonage shall be approved and maintained in good working condition.

#### INSTALLATION

Materials used inside a building for water pipe and fittings are made of brass, copper, cast iron, galvanized wrought iron, galvanized steel, lead, or other approved materials. Fittings for the above piping are made of the same quality.

All materials used in the water supply system, except valves and similar devices, are made of the same materials.

Valves and similar devices used in the home are cast brass or copper. This is to make sure they will not rust and will be in good working condition except for minor repair.

Changes in direction are made with approved fittings (except with copper tubing, which may be bent according to code).

Water service piping can't run in the same trench with the building sewer or drainage unless the pipe used is approved for inside building use.

All water piping going through or resting on concrete is protected with approved insulation against corrosion and settlement of the building concerned.



Whenever the water pressure to any plumbing fixture is not 15 P.S.I., a device is installed to correct it.

When water pressure exceeds 80 P.S.I., a pressure regulating valve (PRV) is installed to prevent it from going that high again. It may be adjusted to any pressure that the owner desires.

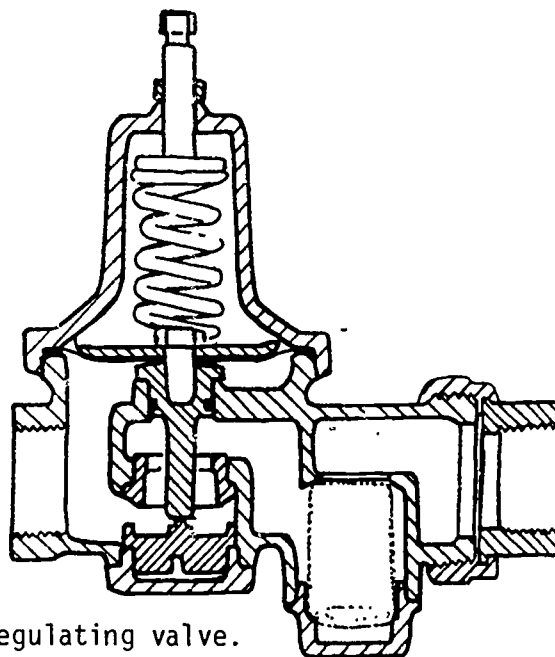

Figure A shows a typical pressure regulating valve.

Before the water system can be installed, three things must be known:

1. Water pressure at the water meter.
2. The farthest fixture's length and height from the water meter.
3. Total fixture units.

Once these items are known, the water piping system may be installed.

The pressure that is lost due to the height of the highest plumbing fixture from the water meter is .433 per ft. But to keep it simple, the plumber just figures a loss of five pounds per square inch every ten feet in height.

The fixture count in the water sizing table for a home is as follows:

|                 | <u>Fixture Units</u> | <u>Pipe Size</u> |             |
|-----------------|----------------------|------------------|-------------|
|                 |                      | <u>Hot</u>       | <u>Cold</u> |
| 1. Bathtub      | 2                    | 1/2"             | 1/2"        |
| 2. Shower       | 2                    | 1/2"             | 1/2"        |
| 3. Kitchen Sink | 2                    | 1/2"             | 1/2"        |

|                      | <u>Fixture Units</u> | <u>Pipe Size</u> |             |
|----------------------|----------------------|------------------|-------------|
|                      |                      | <u>Hot</u>       | <u>Cold</u> |
| 4. Water Closet      | 3                    | --               | 1/2"        |
| 5. Lavatory or Basin | 1                    | 1/2"             | 1/2"        |
| 6. Dishwasher        | 2                    | 1/2"             | --          |
| 7. Washing Machine   | 2                    | 1/2"             | 1/2"        |
| 8. Laundry Sink      | 2                    | 1/2"             | 1/2"        |

All water heaters have a minimum of 3/4" cold water supply pipe from the water meter.

A trouble-free water supply system starts at the city or private water main.

The private or city water department taps into its water main and extends its supply to a water meter which it installs on the property that it serves.

The size of the water meter and its water supply depends on the needs of the building according to the code. Figure B shows a typical water meter.

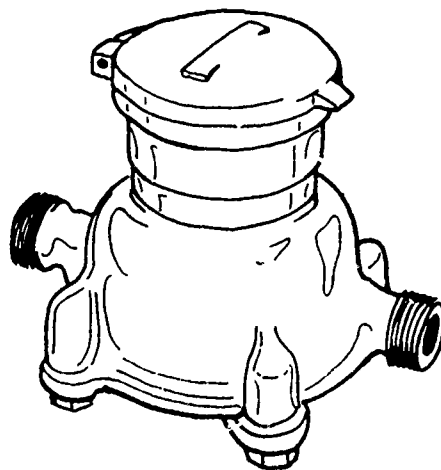

The plumber sizes all the water piping according to the table in the plumbing code.

All water piping in the ground is embedded in sand or soft dirt and compacted to protect it. The pipe has a cover of dirt 6" below the freezing level of the ground.

There is a gate valve or a ball valve for a shutoff device on the customer's side of the water meter. (See Figure C.)

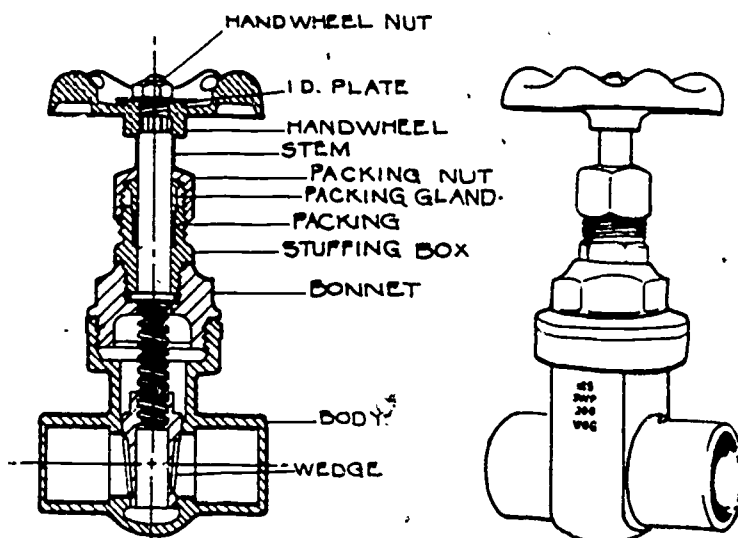

After the water pipe is put below freezing level and insulated against any friction caused by the movement of pipe, it is secured with insulated straps or J hooks. (See Figure D.)

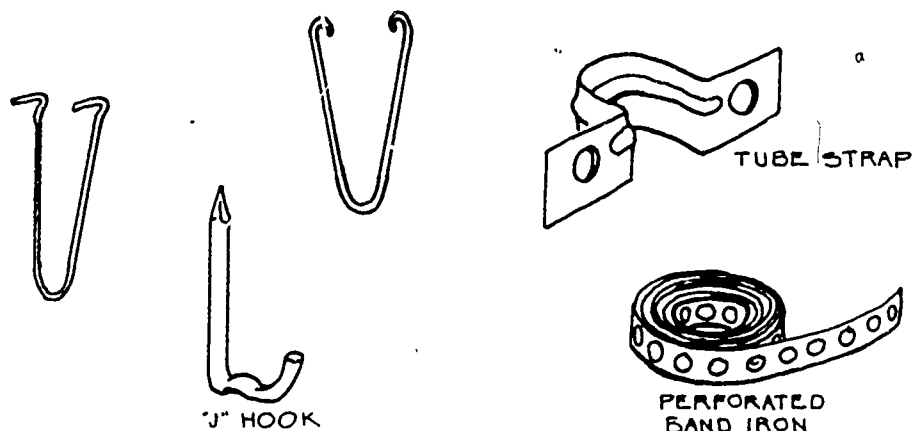

This is a typical hot and cold water piping system in a single-family home. (See Figure E.)

BT = BATH TUB  
 LV = LAVATORY  
 WC = WATER CLOSET  
 HD = HOSE BIB  
 GV = GATE VALVE  
 WH = WATER HEATER  
 KS = KITCHEN SINK  
 LT = LAUNDRY TRAY

——— COLD WATER  
 - - - - - HOT WATER

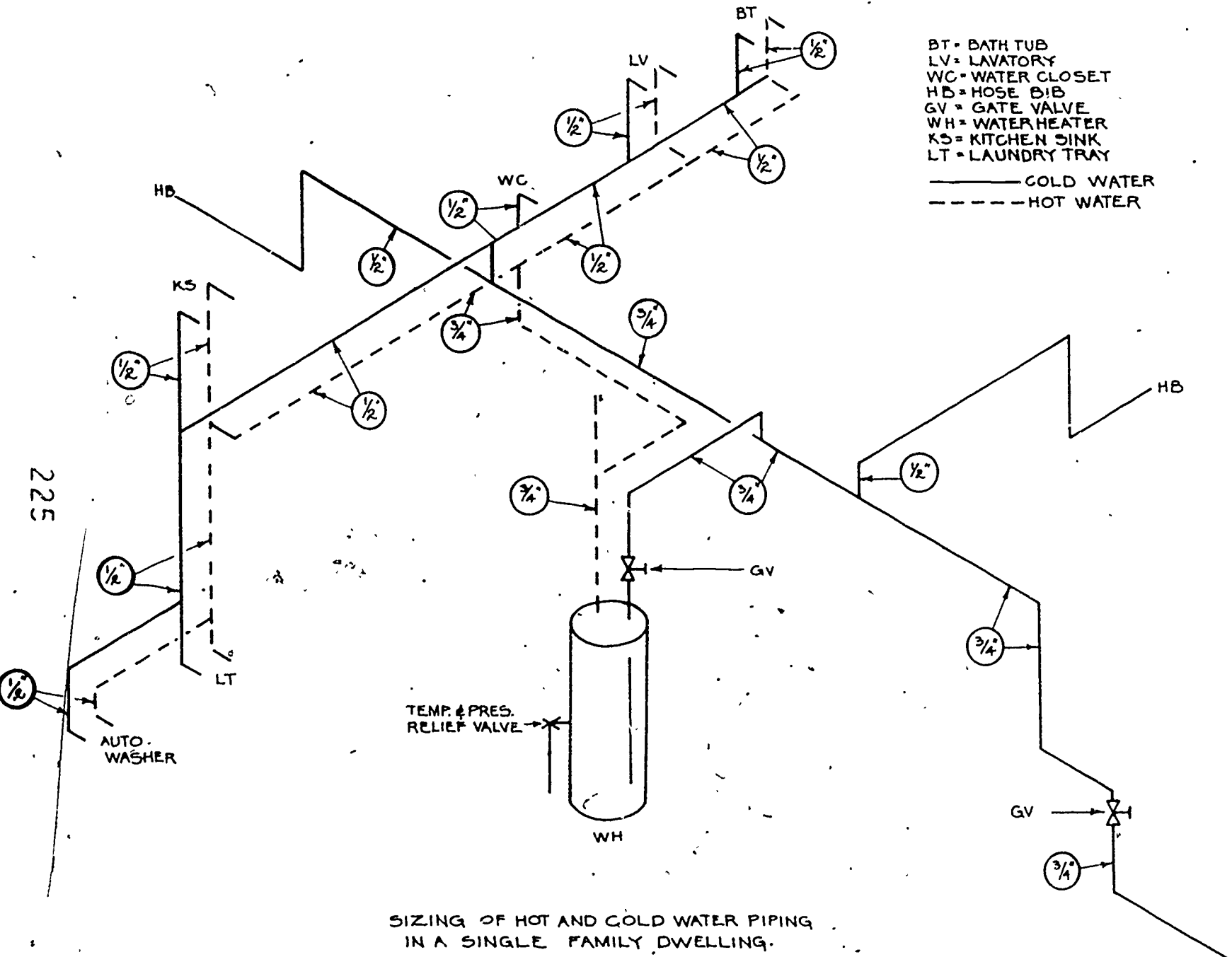

225

SIZING OF HOT AND COLD WATER PIPING  
 IN A SINGLE FAMILY DWELLING.

# Self Assessment

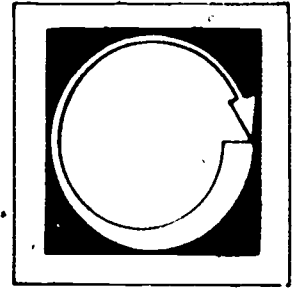

LISTED BELOW ARE SEVERAL STATEMENTS. IF THE STATEMENT IS TRUE, PLACE A "T" IN THE BLANK PROVIDED. IF THE STATEMENT IS FALSE, PLACE AN "F" IN THE BLANK.

1. \_\_\_ Water is composed of two gases: Nitrogen and oxygen.
2. \_\_\_ Only pure and wholesome potable water are used in a building with plumbing fixtures.
3. \_\_\_ Water piping may be installed submerged.
4. \_\_\_ A cross connection may be used in the potable water supply.
5. \_\_\_ Tub spouts may be installed below the flood level rim of a plumbing fixture.
6. \_\_\_ All devices installed for the prevention of back siphonage are approved by the administrative authority.
7. \_\_\_ All valves are cast brass or copper that are used in the home.
8. \_\_\_ Only pipe and fittings made from the same material are used in the water supply system.
9. \_\_\_ Changes in direction with copper tubing may be bent according to code.
10. \_\_\_ All water piping in, or resting on, concrete is insulated.
11. \_\_\_ The minimum water pressure to each plumbing fixture is 10 P.S.I.

12. \_\_\_\_ The maximum water pressure allowed into a home is 80 P.S.I.
13. \_\_\_\_ A pressure regulating valve is installed at each plumbing fixture.
14. \_\_\_\_ Three things must be known before installing water piping.
15. \_\_\_\_ The minimum size of cold water pipe to a water meter is 3/4 inch.
16. \_\_\_\_ The plumber installs the water meter.

# Self Assessment Answers

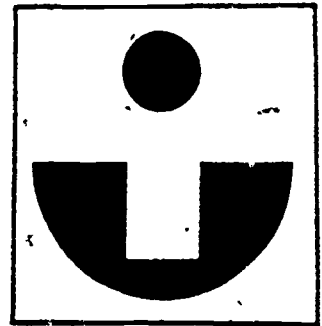

1. F
2. T
3. F
4. F
5. F
6. T
7. T
8. T
9. T
10. T
11. F
12. T
13. F
14. T
15. T
16. F

# Post Assessment

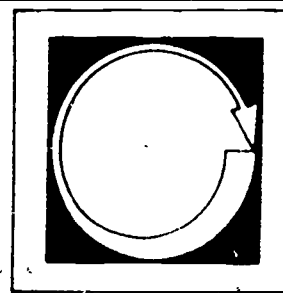

COMPLETE THE FOLLOWING STATEMENTS BY WRITING THE CORRECT WORD OR WORDS IN THE BLANKS PROVIDED.

1. Only \_\_\_\_\_ and wholesome potable water shall be used in a building with plumbing fixtures.
2. Water is composed of \_\_\_\_\_ gases.
3. A \_\_\_\_\_ valve may be used as a shutoff valve at the water meter.
4. All water piping going through concrete is \_\_\_\_\_.
5. \_\_\_\_\_ and \_\_\_\_\_ are the two gases that make water.
6. There is \_\_\_\_\_ connection between any private water supply and a public potable water supply system.
7. All tub spouts and faucet outlets are above the flood level rim by at least \_\_\_\_\_ inch.
8. All valves installed in a home must be \_\_\_\_\_ or \_\_\_\_\_.
9. When using copper tubing, instead of fittings for a change of direction, the pipe may be \_\_\_\_\_.
10. A pressure reducing valve is installed when the water pressure exceeds \_\_\_\_\_.



11. The minimum water pressure allowed at each plumbing fixture is \_\_\_\_\_.
12. The pipe size for the hot water supply to a bathtub is \_\_\_\_\_.
13. The minimum size pipe for the cold water supply to a water heater is \_\_\_\_\_.
14. The cold water supply to a kitchen sink pipe size is \_\_\_\_\_.
15. All water pipe is strapped and \_\_\_\_\_.

# Instructor Post Assessment Answers

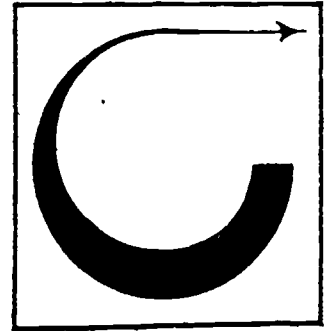

1. pure
2. two
3. gate or ball
4. insulated
5. hydrogen, oxygen
6. no, direct
7. one
8. cast brass, copper
9. bent
10. 80 P.S.I.
11. 15 P.S.I.
12. 1/2 inch
13. 3/4 inch
14. 1/2 inch
15. insulated

## GAS PIPING SYSTEM

### **Goal:**

The student will be able to identify and explain the proper installation of the gas system, and its materials.

### **Performance Indicators:**

The student will demonstrate an understanding of the subject by successfully completing a Self Assessment and a Post Assessment.

232

238

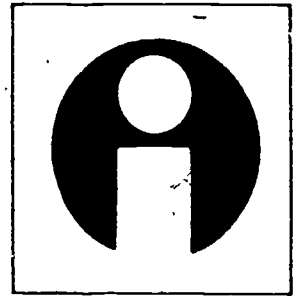

# Study Guide

In order to finish this module, do the following tasks. Check each item off as you complete it.

1.  Read the Goal and Performance Indicators on the cover of the module. This will tell you what you will learn by studying the module, and how you will show you've learned it.
2.  Read the Introduction. The Introduction will tell you why the module is an important part of the plumbing trade.
3.  Study the Vocabulary section. Vocabulary words are important for a good understanding of the trade. After you have studied the vocabulary, ask your teacher to quiz you on the words and their meanings.
4.  Study the Information section. This section will give you the information you need to understand the subject.
5.  Take the Self-Assessment exam. This is a test for you to prove to yourself that you have learned the material you have studied. Compare your answers with the answers on the Self Assessment Answer Sheet, which is on the page following the Self Assessment. If you scored poorly, re-study the Information section or ask your teacher for help.
6.  Take the Post Assessment exam. Give the exam to your teacher after you have completed it. Your teacher will grade it for you.

# Introduction

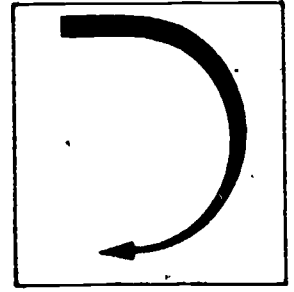

In many homes, people who use gas for heat and cooking instead of electric power, have switched from liquid fuels to natural gas. This is a cleaner burning and more reasonably priced fuel.

# Vocabulary

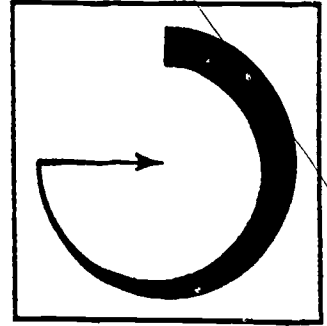

Trade terms are very important for a good understanding of the trade. Study these words and meanings. When you have learned them, ask your teacher to quiz you on the words and their meanings.

ORIFICE--An opening.

FLUE--A passage for fumes and smoke to escape to the outside air.

COMBUSTION AIR--A low and high opening to allow air to freely circulate.

COMBUSTIBLE--Capable of catching on fire and burning.

BRITISH THERMAL UNIT--The amount of heat required to raise the temperature of one pound of water.

# Information

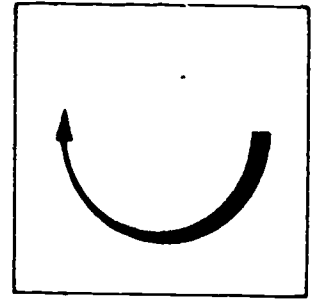

All gas-fired water heaters, stoves and furnaces must have an approved flue through the roof to allow excess gas and exhaust fumes to escape to the outside air.

They need combustion air, require clearances for combustible material, and are not permitted in any sleeping area, bathroom, clothes closet or under stairways.

The approval agency for gas-fired appliances is the American Gas Association (AGA). AGA tests gas-fired appliances for compliance to a product standard and, if found acceptable, the "AGA approved" label is displayed on the appliance.

All gas-fired appliances are measured by British Thermal Units (BTU). The "BTU" requirements are stamped on each appliance.

All home service gas piping may be either black steel schedule 40 with black malleable fittings or galvanized steel with galvanized malleable fittings. (Home service gas piping means from the gas meter outside the building to the gas cock.) The piping from the exposed gas cock to the appliances may be a flexible connector designed for gas only and must have an approved sticker on the flexible connector.

In the home, all gas piping is threaded, but in larger buildings where pipe is larger than 2", it is usually welded.

All gas piping when installed should be sloped or graded downward back to the meter to prevent unwanted particles from clogging the orifice of the appliance.

All gas piping installed underground should be wrapped with a material that will prevent the gas piping from rusting.

No unions may be used in any concealed area or between the gas cock and the piping to the gas meter.

After the gas piping has been installed an air test is required. The piping is pumped with 15 lbs. of air and must hold this pressure for 10 minutes.

The inspector will then place a sticker on the pipe at the location of the gas meter. This sticker tells the gas supplier that the gas piping has been tested and approved. Only then will the gas supplier install the gas meter.

When all appliances have been connected to the gas piping and the gas meter has been connected to the pipe, the appliances may be ignited.

To test the piping from the gas cock to the appliance, mix liquid soap and water and apply at each joint. If bubbles occur, there is a leak at that joint. Turn off the gas and make the necessary repairs.



# Self Assessment

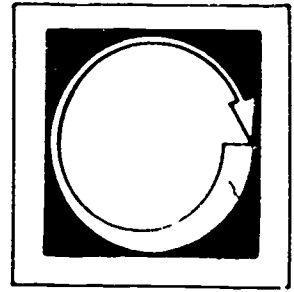

LISTED BELOW ARE SEVERAL STATEMENTS. IF THE STATEMENT IS TRUE, PLACE A "T" IN THE BLANK PROVIDED. IF THE STATEMENT IS FALSE, PLACE AN "F" IN THE BLANK.

1. \_\_\_ "BTU" means British Temperature Unit.
2. \_\_\_ All gas piping is subject to testing.
3. \_\_\_ Natural gas provides a cleaner burning system.
4. \_\_\_ All gas appliances must have an approved flue.
5. \_\_\_ A gas-fired water heater may be installed under the stairs.
6. \_\_\_ An orifice is an opening.
7. \_\_\_ Combustible means that something can burn.
8. \_\_\_ Copper tubing "soldered" may be used for gas piping.
9. \_\_\_ Unions may be used in a concealed area.
10. \_\_\_ Gas piping must slope toward the appliance.

# Self Assessment Answers

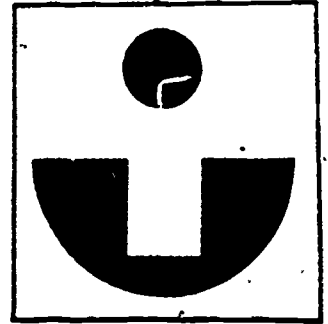

1. F
2. T
3. T
4. T
5. F
6. T
7. T
8. F
9. F
10. F

# Post Assessment

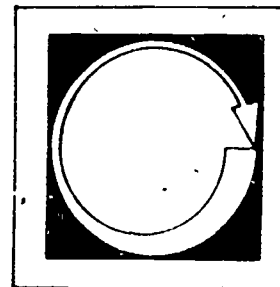

COMPLETE THE FOLLOWING STATEMENTS BY WRITING THE CORRECT WORD OR WORDS IN THE BLANKS PROVIDED.

1. "BTU" means \_\_\_\_\_.
2. \_\_\_\_\_ provides a cleaner burning system.
3. A gas-fired appliance may be connected with an approved \_\_\_\_\_.
4. All gas piping is subject to \_\_\_\_\_.
5. An \_\_\_\_\_ is an opening.
6. Gas piping should be sloped to the \_\_\_\_\_.
7. \_\_\_\_\_ means capable of catching fire and burning.
8. All underground gas piping should be \_\_\_\_\_.
9. Gas pipe testing must be for a period of \_\_\_\_\_  
at \_\_\_\_\_.
10. The gas supplier will install the gas meter only after it has been  
\_\_\_\_\_ and \_\_\_\_\_.

# Instructor Post Assessment Answers

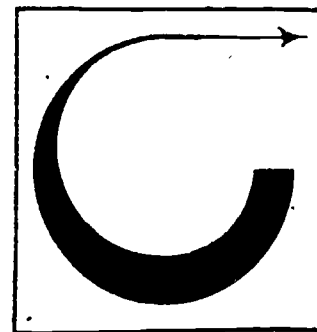

1. British Thermal Unit
2. natural gas
3. flexible connector
4. testing
5. orifice
6. gas meter
7. combustible
8. wrapped
9. 10 minutes, 15 pounds
10. tested, approved

PLUMBING TESTS AND INSPECTION

**Goal:**

The student will be able to identify and select the proper testing method for each part of the plumbing system.

**Performance Indicators:**

The student will demonstrate an understanding of the subject by successfully completing a Self Assessment, an Assignment and a Post Assessment.

# Study Guide

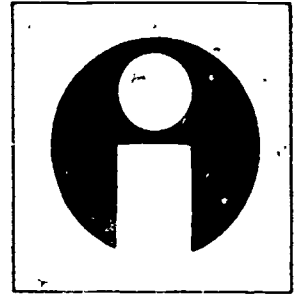

In order to finish this module, do the following tasks. Check each item off as you complete it.

1. \_\_\_\_ Read the Goal and Performance Indicators on the cover of the module. This will tell you what you will learn by studying the module, and how you will show you've learned it.
2. \_\_\_\_ Read the Introduction. The Introduction will tell you why the module is an important part of the plumbing trade.
3. \_\_\_\_ Study the Vocabulary section. Vocabulary words are important for a good understanding of the trade. After you have studied the vocabulary, ask your teacher to quiz you on the words and their meanings.
4. \_\_\_\_ Study the Information section. This section will give you the information you need to understand the subject.
5. \_\_\_\_ Take the Self Assessment exam. This is a test for you to prove to yourself that you have learned the material you have studied. Compare your answers with the answers on the Self Assessment Answer Sheet, which is on the page following the Self Assessment. If you scored poorly, re-study the Information section or ask your teacher for help.
6. \_\_\_\_ Do the Assignment page. Follow the instructions at the top of the Assignment page.
7. \_\_\_\_ Take the Post Assessment exam. Give the exam to your teacher after you have completed it. Your teacher will grade it for you.

# Introduction

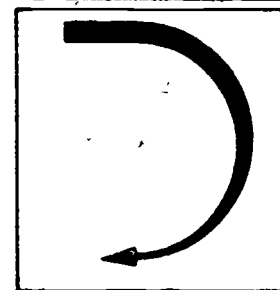

All new plumbing work and such parts of the existing plumbing system that may be affected by new work or changes shall be tested and inspected by the Administrative Authority. All requests shall be made 24 hours in advance either in writing or by phone.

The holder of the permit is responsible for all testing and inspections. All notices of corrections by the inspector shall be posted at the job site or delivered to the permittee. The permittee has 10 days in which to make corrections. After that, a penalty may be assessed.

# Vocabulary

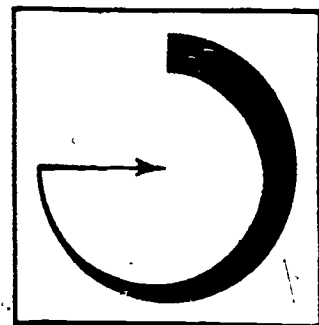

Trade terms are very important for a good understanding of the trade. Study these words and meanings. When you have learned them, ask your teacher to quiz you on the words and their meanings.

**ADMINISTRATIVE AUTHORITY**--The individual official, board, department, or agency authorized by city, county or state by law to enforce the plumbing code as adopted or amended.

**TESTED**--Checked for quality.

**INSPECTED**--Approved or disapproved by the official of the Administrative Authority.

**PERMITEE**--Person to whom a permit is issued.

**PERMIT**--A written order allowing the work to begin.

**ENTIRETY**--All at once.

**SECTION**--A part of.

**MERCURY GAUGE**--A gauge using liquid mercury for measuring pressures.

**GAUGE**--A standard of measuring.

**MERCURY**--A heavy silver-white poisonous metallic element used in thermometers and barometers.

**P.S.I.**--Pounds per Square Inch.



# Supplementary References

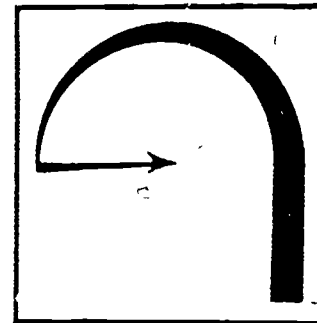

Uniform Plumbing Code Illustrated Training Manual. 1979 Edition, International Association of Plumbing and Mechanical Officials. pp. 292, 306, 307, 404.

# Information

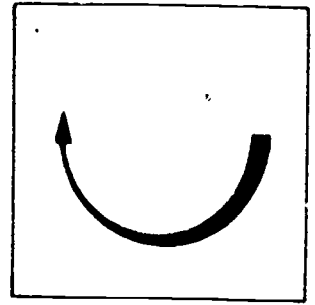

The two most common ways of testing a complete plumbing system are:

1. Water Test.
2. Air Test.

## DWV SYSTEM

The water test may be done in its entirety or in sections. If the system is tested in sections, all openings shall be plugged or capped except for the highest opening of the section to be tested. Each section shall be filled with water and will have a 10-foot head of water pressure above the highest fixture outlet. This is to make sure a pressure of approximately 5 PSI is at the highest fixture outlet.

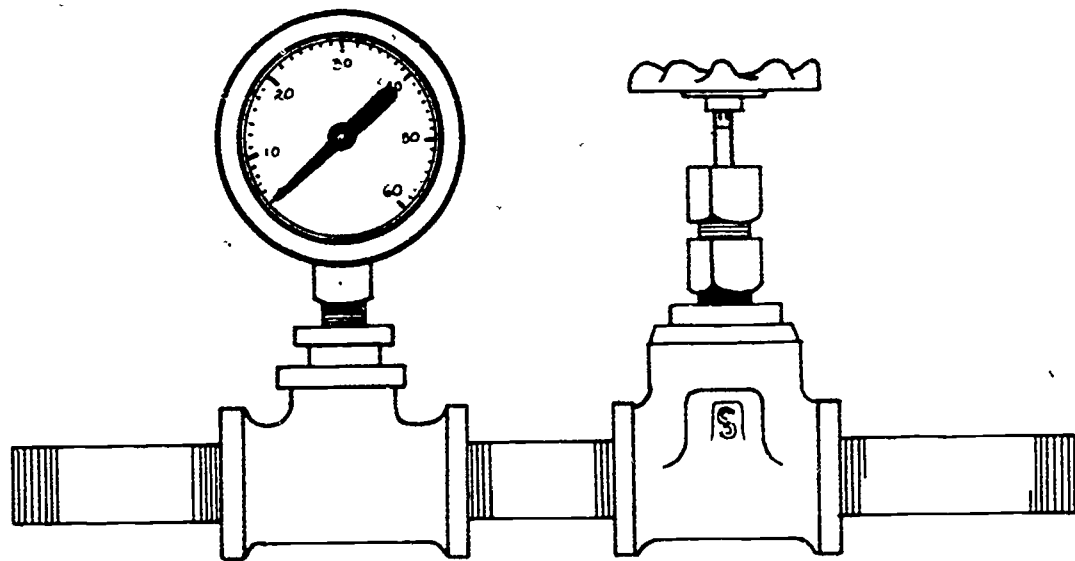

Test plugs are shown below. These are used to plug the outlets in the DWV system. They are inserted in the openings and with a tire pump, pumped to 30 PSI. Test plugs come in all sizes for the plumbing system.

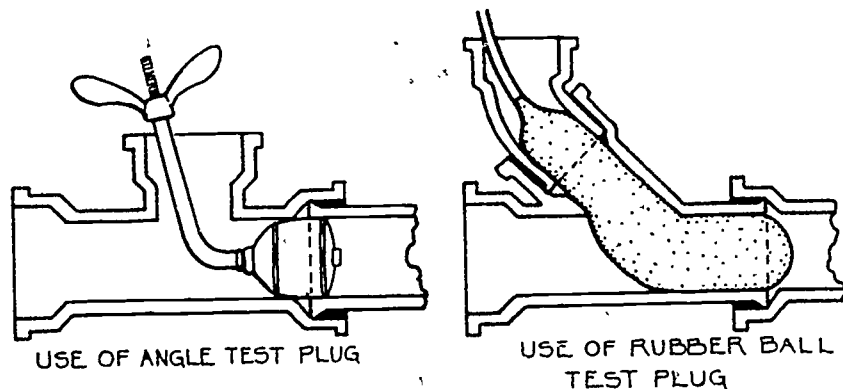

The water shall be kept in the system at least 15 minutes before the inspection is started. If the building is to be tested in its entirety, all outlets below the roof level shall be plugged or capped and water-filled up to the vent outlet on the roof.

On a tire pump, all openings are plugged or capped except one opening which will have a gauge put on, and air is pumped into the system until there is an air pressure of 5 PSI. Inspection will start after the system holds this pressure for 15 minutes.

In testing of the water piping system with water or air, all openings are plugged or capped except for one which shall have a gauge. The system shall maintain a pressure of 50 PSI for 15 minutes before inspection begins.

When testing this system with water, make sure that all outlets have been opened until water has appeared to allow all air to escape. The water used for all testing should come from a potable water supply.

After the permittee has the testing done with water or air, the inspector proceeds, making sure that:

- a. Proper sizing, strapping and use of pipe and fittings are according to code.
- b. No holes or cracks are in the pipe and fittings.
- c. No piping or fitting are covered up until accepted.
- d. If the inspection fails its test, a notice of corrections and violations shall be given.
- e. The permittee will then call for re-inspection after the corrections are made.
- f. A notice of acceptance shall be placed on the job site and signed by the inspector.

#### GAS PIPING

All testing of gas piping shall be made with air pressure in the presence of the inspector. The piping and fittings shall hold air pressure of 10 pounds for a minimum of 15 minutes.

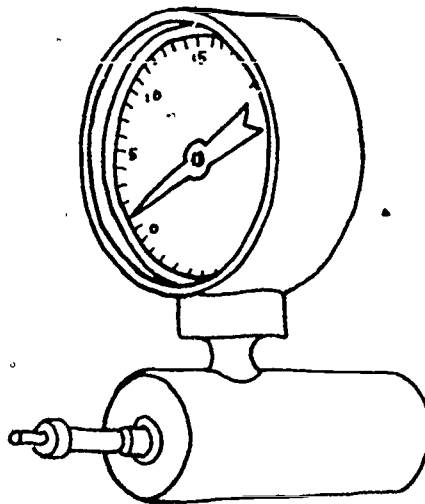

Gas Test Pressure Gauge

The testing device below is a mercury gauge.

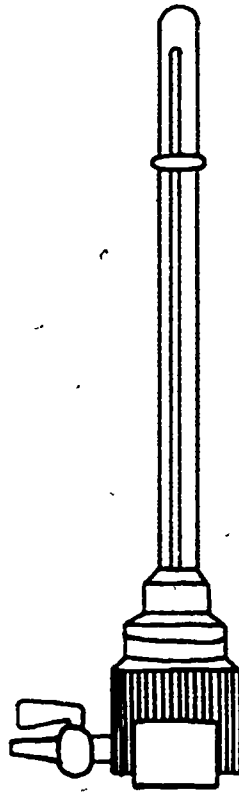

This may be used instead of an air gauge and it must be pumped up until there is a rise of a 6-inch column of mercury. It must stand for at least 15 minutes. The top of the mercury has a half-rounded head in the tube.

# Self Assessment

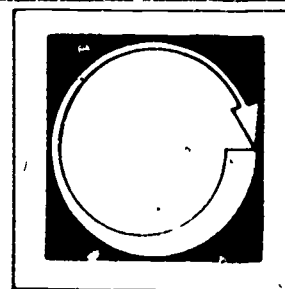

LISTED BELOW ARE SEVERAL STATEMENTS. IF THE STATEMENT IS TRUE, PLACE A "T" IN THE BLANK PROVIDED. IF THE STATEMENT IS FALSE, PLACE AN "F" IN THE BLANK.

1. \_\_\_ All inspection notices shall be made 24 hours in advance.
2. \_\_\_ There are three ways of testing a plumbing system.
3. \_\_\_ The plumber is responsible for all inspections.
4. \_\_\_ The inspector shall put in writing, or deliver in person, all violations seen on the job.
5. \_\_\_ A sticker of approval shall be placed on the job site.
6. \_\_\_ A permit is given when work is completed.
7. \_\_\_ A mercury gauge is used to test the water piping system.
8. \_\_\_ DWV means drainage, water and vent.
9. \_\_\_ Each section or the DWV system shall be tested with a 10-ft. head of pressure.

# Self Assessment Answers

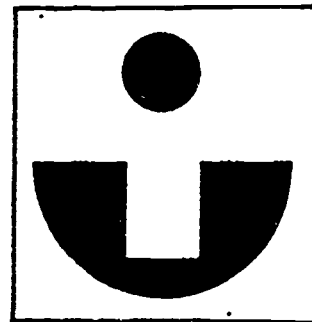

1. T

2. F

3. F

4. T

5. T

6. F

7. F

8. F

9. T

# Assignment

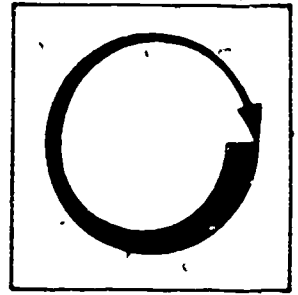

COMPLETE THE ASSIGNMENT BELOW.

Write a report of 250 words on the duties of the inspector.



# Instructor Post Assessment Answers

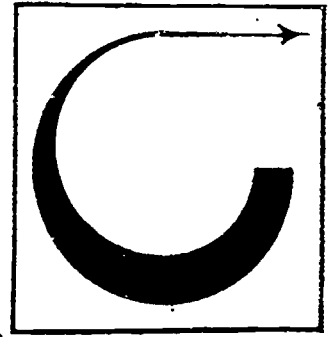

1. 10 days
2. gauge
3. water and air
4. ten
5. 50 PSI
6. Pounds Square Inch
7. mercury
8. 10-foot
9. 15 minutes
10. 6-inch

# Post Assessment

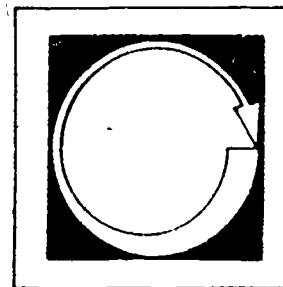

COMPLETE THE FOLLOWING STATEMENTS BY WRITING THE CORRECT WORD OR WORDS IN THE BLANKS PROVIDED.

1. The permittee has \_\_\_\_\_ in which to make corrections before a penalty may be assessed.
2. A \_\_\_\_\_ is used as a standard of measuring.
3. The two most common ways of testing a complete plumbing system are \_\_\_\_\_ and \_\_\_\_\_.
4. Testing gas pipe and fittings shall last for at least \_\_\_\_\_ minutes.
5. The minimum pressure allowed in testing a water piping system is \_\_\_\_\_.
6. PSI means \_\_\_\_\_.
7. The heavy silver-white poisonous metallic element used to test gas piping is called \_\_\_\_\_.
8. A \_\_\_\_\_ head is required for inspection on a section of the DWV system.
9. Inspection starts after the pressure has been in the water piping system for \_\_\_\_\_.
10. A mercury test gauge shall have a \_\_\_\_\_ column of mercury in its tube.

---

TUB AND SHOWER

---

**Goal:**

The student will be able to identify and explain the different types of tubs and showers, and will demonstrate the proper installation of these fixtures.

**Performance Indicators:**

The student will demonstrate an understanding of the subject by successfully completing a Self Assessment, a Job Sheet and a Post Assessment.

# Study Guide

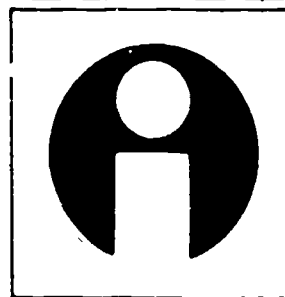

In order to finish this module, do the following tasks. Check each item off as you complete it.

1.  Read the Goal and Performance Indicators on the cover of the module. This will tell you what you will learn by studying the module, and how you will show you've learned it.
2.  Read the Introduction. The Introduction will tell you why the module is an important part of the plumbing trade.
3.  Study the Vocabulary section. Vocabulary words are important for a good understanding of the trade. After you have studied the vocabulary, ask your teacher to quiz you on the words and their meanings.
4.  Study the Information section. This section will give you the information you need to understand the subject.
5.  Take the Self Assessment exam. This is a test for you to prove to yourself that you have learned the material you have studied. Compare your answers with the answers on the Self Assessment Answer Sheet, which is on the page following the Self Assessment. If you scored poorly, re-study the Information section or ask your teacher for help.
6.  Do the Job Sheet. Follow the instructions at the top of the Job Sheet. The tasks listed on the Job Sheet will help you develop skills which will be helpful to you.
7.  Take the Post Assessment exam. Give the exam to your teacher after you have completed it. Your teacher will grade it for you.

# Introduction

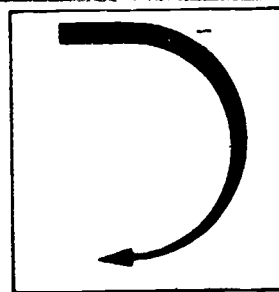

Bathtubs are identified as right-hand or left-hand, depending on the location of the tub waste opening from the finished front of the tub.

A shower bath is a bath in which the bathing water is showered on the user's body from above. There are right- and left-hand showers also, depending on the design of the shower.

# Instructor Post Assessment Answers

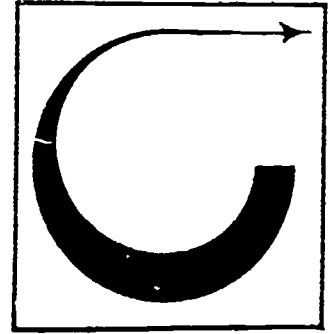

1. 10 days
2. gauge
3. water and air
4. ten
5. 50 PSI
6. Pounds Square Inch
7. mercury
8. 10-foot
9. 15 minutes
10. 6-inch

# Vocabulary

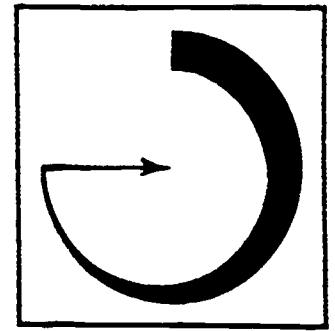

Trade terms are very important for a good understanding of the trade. Study these words and meanings. When you have learned them, ask your teacher to quiz you on the words and their meanings.

GLAZED CERAMIC TILE--A thin, coated piece of clay.

RECESSED--Set into, below the surface.

TERRAZZO--A combination of marble chips and cement.

MEMBRANE--A thin layer.

DIVERTER--To change direction from.

RECEPTACLE--A container or holder.

# Supplementary References

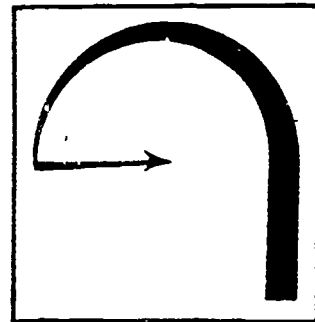

Ripka, L. V. Plumbing Installation and Design. American Technical Society,  
1978. pp. 218-221.



# Information

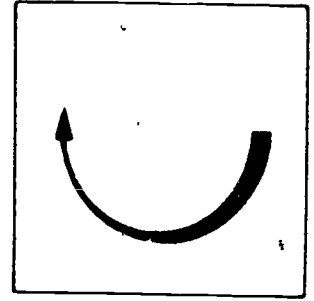

Bathtubs and showers come in a variety of sizes, shapes and colors. The two most common types of bathtubs are the recessed bathtub and the tub and shower combination.

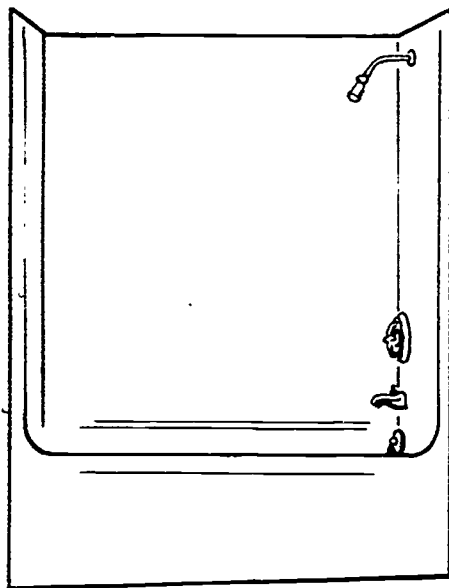

BATH-SHOWER

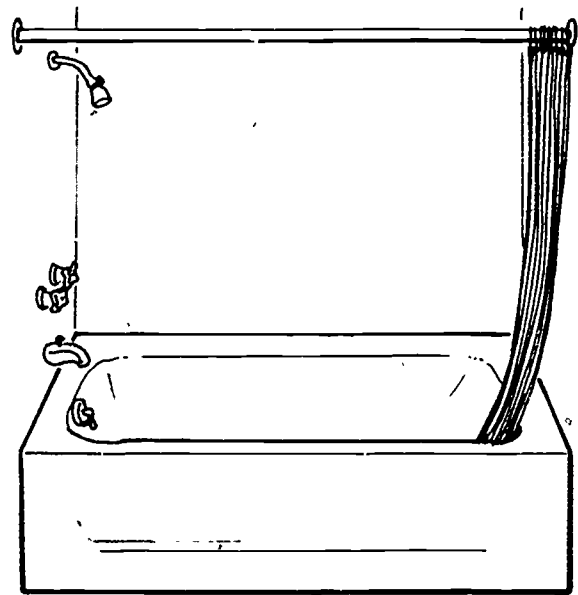

RECESSED BATHTUB

There are two distinct types of residential shower-baths. One consists of a shower enclosure; and the other is built of glazed ceramic tile.

A recessed or built-in bathtub is permanently attached or built into the walls and floor of the bathroom. Recessed bathtubs are made from enameled cast iron or enameled pressed steel.

A bath-shower combination is a bathtub and shower wall made from fiberglass. This type of bathtub is very popular in residential construction because the

fiberglass shower walls eliminate the need for ceramic tile in the shower area.

A shower enclosure is built of fiberglass in one piece to completely waterproof the shower bath area. Other shower enclosures of this type are manufactured in fiberglass and painted steel; the walls and base come as separate units that the plumber assembles on the job site.

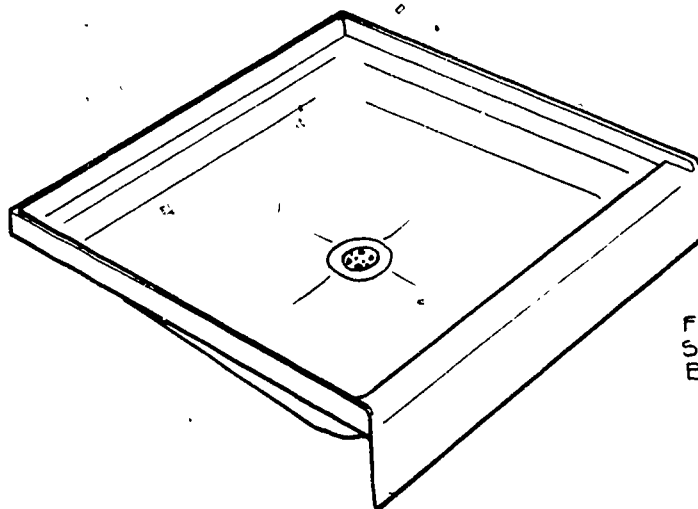

FIBERGLASS  
SHOWER  
BASE

Ceramic tile shower baths may be built in almost any shape to fit the available space within the bathroom.

In a ceramic tile shower, the plumber installs either a shower base (constructed of fiberglass or terrazzo) or a waterproof membrane. The tile setter then completes the installation of the shower enclosure after the shower valves are installed during the "rough plumbing" stage.

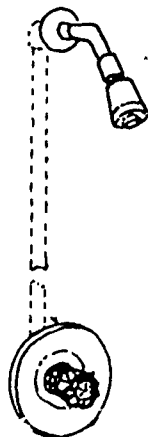

PORT CONTROL  
SINGLE HANDLE  
SHOWER VALVE

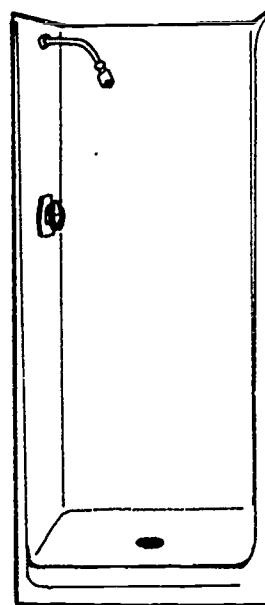

ONE-PIECE  
FIBERGLASS  
SHOWER  
ENCLOSURE

## BATHTUB VALVE FITTING

Water is supplied to a bathtub through an overrim bathtub fitting. The overrim bathtub fitting consists of a faucet assembly and a mixing spout. These are mounted in the wall on the drain end of the bathtub, with the spout placed above the flood level rim of the bathtub.

The bathtub fitting, like the lavatory fittings, may be either a combination compression faucet or a single-handle faucet.

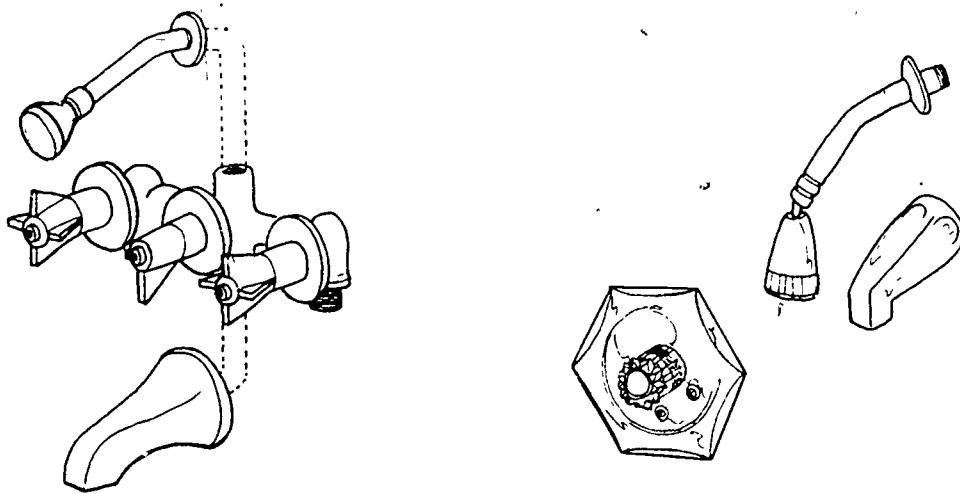

In many plumbing installations, the bathtub is used both as a bathtub and as a shower bath. In these installations, the plumber installs a combination bath and shower fitting. On this fitting, the bathtub mixing spout has a diverter attached to an external knob. This knob is raised to divert the flow of water from the bathtub spout to the shower head.

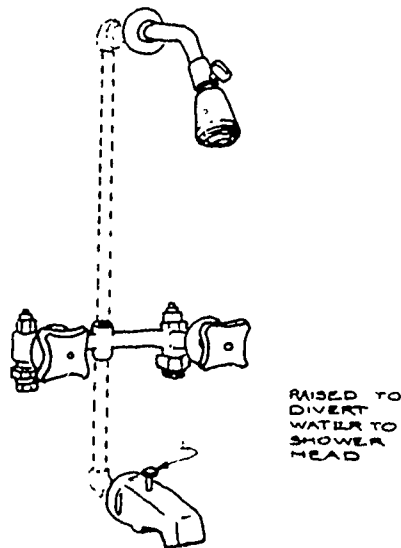

COMPRESSION FAUCET FITTING

The bathtub drain fitting used on bathtubs is a combination waste and overflow fitting. This fitting provides the outlet for the bathtub drain and also an overflow to allow excess water to drain from the tub before it spills over onto the bathroom floor.

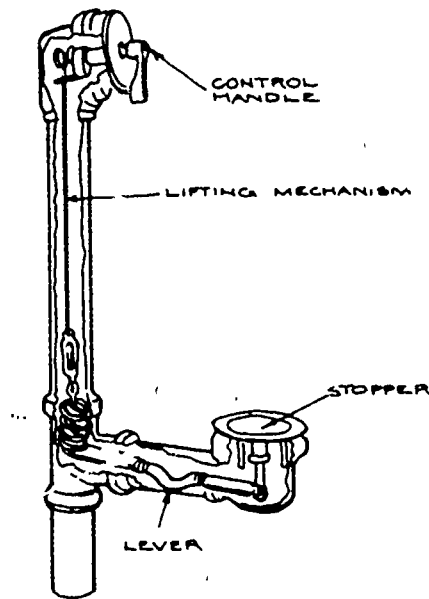

The illustration (above) is a combination waste and overflow fitting commonly installed on bathtubs. Inside the overflow tube of this fitting is a lifting device. A lever connects the device to the stopper in the outlet of the tub. Turning the handle will either lift or lower the device to fill or discharge water from the tub.

Unlike the bathtub shower combination valve, the shower valve does not have a diverter spout. All that is needed is a shower head opening that is usually installed six feet above the finish floor.

When installing the shower-bath drain, plumbers' putty is placed between the plastic or chrome-plated drain and the shower base. The assembly is attached by tightening the large nut and rubber washer (as was done in connecting the drain to the lavatory). The size of waste pipe and p-trap is 2-inch. The trap is connected directly under the shower drain.

When connecting the waste and overflow to the tub, the trap should be located under the overflow tube that connects with the bathtub drain under the floor.

When connecting the drain to the overflow, plumbers' putty is used between the drain fitting and the bathtub. (Between the tub and the shoe a rubber washer is used to guarantee a water-tight seal.)

# Self Assessment

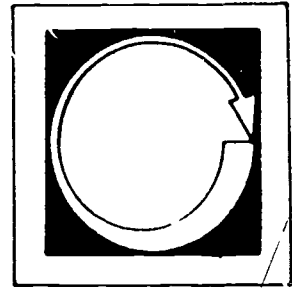

LISTED BELOW ARE SEVERAL STATEMENTS. IF THE STATEMENT IS TRUE, PLACE A "T" IN THE BLANK PROVIDED. IF THE STATEMENT IS FALSE, PLACE AN "F" IN THE BLANK.

1. \_\_\_ Bathtubs are identified as right and left foot.
2. \_\_\_ There are right and left foot showers also.
3. \_\_\_ There are three types of tubs that are common.
4. \_\_\_ Most bath and shower combinations are made from fiberglass.
5. \_\_\_ Ceramic tile shower baths may be built in almost any shape.
6. \_\_\_ The tub and shower valves are installed during the rough plumbing stage.
7. \_\_\_ Hose bibs are used to fill a bathtub.
8. \_\_\_ A diverter spout is used on the waste and overflow.
9. \_\_\_ A lifting device in the waste and overflow changes the water from the shower head to the tub spout.

# Self Assessment Answers

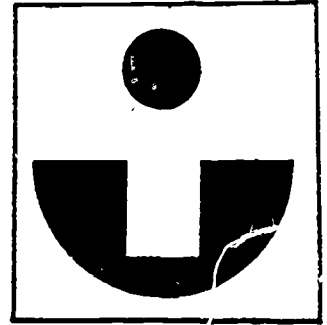

1. F

2. F

3. F

4. T

5. T

6. T

7. F

8. F

9. F

# Job Sheet

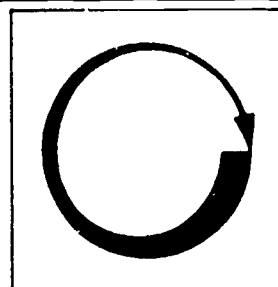

COMPLETE THE FOLLOWING TASKS:

Materials and Tools

recessed tub

waste and overflow unit

shower base

shower drain

putty

tools

1. With the information given in this module:
  - a. Connect the waste and overflow to a recessed bathtub.
  - b. Connect a shower drain to a shower base.

# Post Assessment

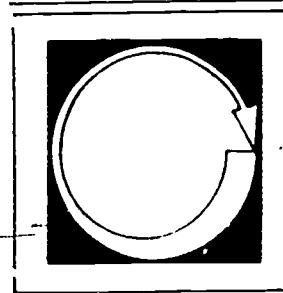

COMPLETE THE FOLLOWING STATEMENTS BY WRITING THE CORRECT WORD OR WORDS IN THE BLANKS PROVIDED.

1. Bathtubs are identified as right and \_\_\_\_\_.
2. Most bath and shower combinations are made from \_\_\_\_\_.
3. The tub and shower valves are installed during the \_\_\_\_\_ plumbing stage.
4. A \_\_\_\_\_ device in the waste and overflow releases the water from the tub.
5. A bathtub is constructed to fit the shape of the \_\_\_\_\_.
6. There are \_\_\_\_\_ and \_\_\_\_\_ hand showers, also.
7. All baths drain through a \_\_\_\_\_ and overflow.
8. The two most common types of bathtubs are the \_\_\_\_\_ and the tub and shower combination.
9. \_\_\_\_\_ is a combination of marble chips and cement.
10. A membrane is a thin \_\_\_\_\_.
11. A \_\_\_\_\_ is used to change the direction of water flow.
12. Glazed ceramic tile is a thin coated piece of \_\_\_\_\_.



# Instructor Post Assessment Answers

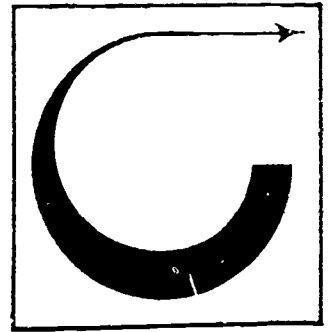

1. left hand
2. fiberglass
3. rough
4. lifting
5. human body
6. right and left
7. waste
8. recessed
9. terrazzo
10. layer
11. diverter
12. clay

## LAVATORY

### Goal:

The student will be able to identify and explain:

1. The different types of lavatories.
2. The proper installation of the lavatories and valves with trim.

### Performance Indicators:

The student will demonstrate understanding of the subject by successfully completing a Self Assessment, a Job Sheet and a Post Assessment.

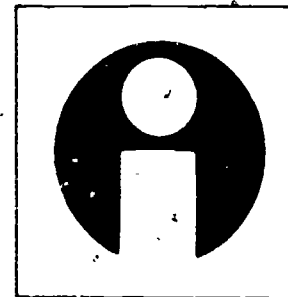

# Study Guide

In order to finish this module, do the following tasks. Check each item off as you complete it.

1.  Read the Goal and Performance Indicators on the cover of the module. This will tell you what you will learn by studying the module, and how you will show you've learned it.
2.  Read the Introduction. The Introduction will tell you why the module is an important part of the plumbing trade.
3.  Study the Vocabulary section. Vocabulary words are important for a good understanding of the trade. After you have studied the vocabulary, ask your teacher to quiz you on the words and their meanings.
4.  Study the Information section. This section will give you the information you need to understand the subject.
5.  Take the Self Assessment exam. This is a test for you to prove to yourself that you have learned the material you have studied. Compare your answers with the answers on the Self Assessment Answer Sheet, which is on the page following the Self Assessment. If you scored poorly, re-study the Information section or ask your teacher for help.
6.  Do the Job Sheet. Follow the instructions at the top of the Job Sheet. The tasks listed on the Job Sheet will help you develop skills which will be helpful to you.
7.  Take the Post Assessment exam. Give the exam to your teacher after you have completed it. Your teacher will grade it for you.

# Introduction

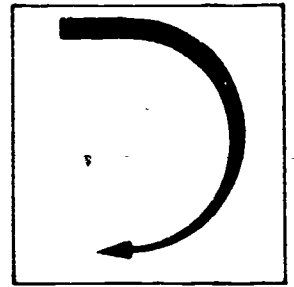

A lavatory is a plumbing fixture designed for washing the hands and face. It is commonly found in bathrooms and restrooms. Lavatories are also called wash basins or vanity lavatories.

The lavatory has the most variety of any plumbing fixture in terms of color, size and shape. They are made of vitreous china, enameled cast iron, enameled pressed steel, stainless steel, marble and plastic.

# Vocabulary

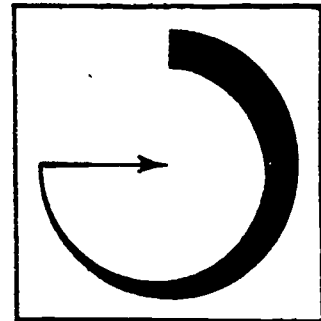

Trade terms are very important for a good understanding of the trade. Study these words and meanings. When you have learned them, ask your teacher to quiz you on the words and their meanings.

VITREOUS--Any porcelain ware.

COMPRESSION--To force together.

DISK--Flat, circular plate.

CARTRIDGE--A cylinder designed to fit into a special place.

# Supplementary References

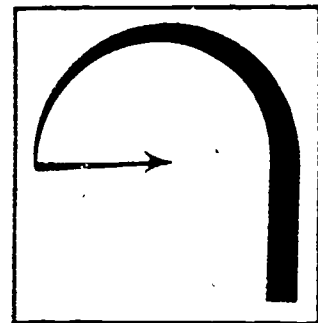

Ripka, L. V. Plumbing Installation and Design. American Technical Society,  
1978. pp. 214-218.

# Information

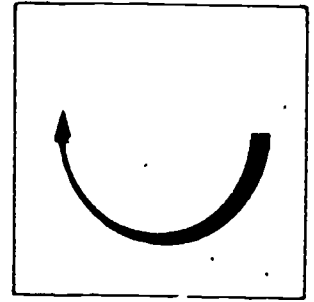

A wall-hung lavatory is a lavatory that is supported by a stamped steel or cast iron bracket fastened to the wall. This bracket is supplied with the lavatory by the plumbing fixture manufacturer.

A wall-hung lavatory is normally installed with its flood level rim 31" above the floor. This height permits the user of the fixture to stand, slightly bent over the basin, so that water used for washing tends to drain from the arms back into the basin.

LAVATORY WITH  
RAISED BACK

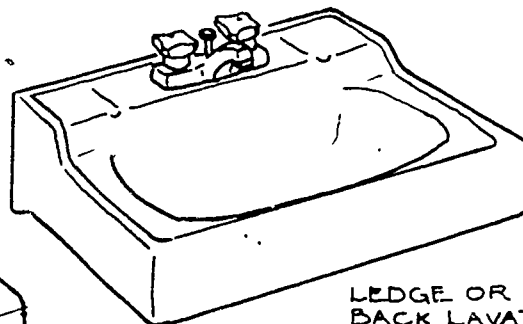
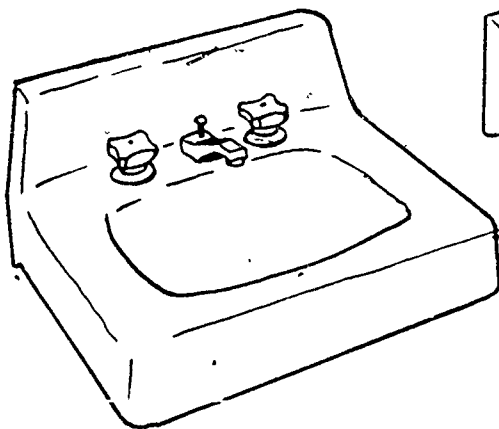

LEDGE OR SHELF  
BACK LAVATORY

A vanity is a bathroom fixture consisting of a lavatory set into the top of a cabinet. Vanity lavatories are also called counter top lavatories. They are

manufactured from enameled cast iron, vitreous china, enameled pressed steel, marble, stainless steel and plastic.

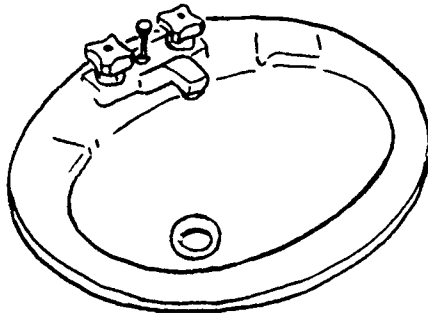

SELF-RIMMING  
VANITY  
LAVATORY

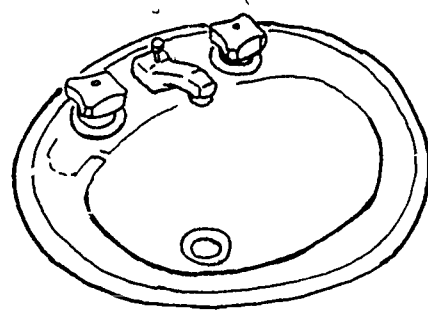

RIM-TYPE  
VANITY  
LAVATORY

Lavatory trim consists of:

1. A faucet (or lavatory fitting) which controls the supply of cold and hot water to the lavatory, and,
2. The lavatory drain fitting through which the water drains from the lavatory.

Lavatory faucets may be either compression faucets or port control faucets.

A compression faucet is a faucet in which the flow of water is shut off by means of a washer that is forced down onto the seat.

Most lavatory compression faucets are combination faucets, consisting of the hot and cold water compression valves joined together in one faucet body with a common mixer spout. This faucet permits people to mix hot and cold water to the desired temperature.



A port control faucet is a single-handle, non-compression faucet that contains ports for both hot and cold water, and some method of opening and closing these ports. This control may be either a disk or a cartridge. The disk or cartridge opens or closes one or both ports in the faucet body to mix the water to the desired temperature and volume.

Lavatory drain fittings are installed in the bottom of the lavatory. The most common type of lavatory drain fitting is the pop-up waste fitting. This fitting consists of a brass waste outlet into which a sliding metal or plastic stopper is fitted. A lever that goes through the side of the drain fitting is connected to a lift rod on top of the lavatory. This rod is lifted to lower the stopper and allow the lavatory to fill. It is lowered to raise the stopper and drain the lavatory.

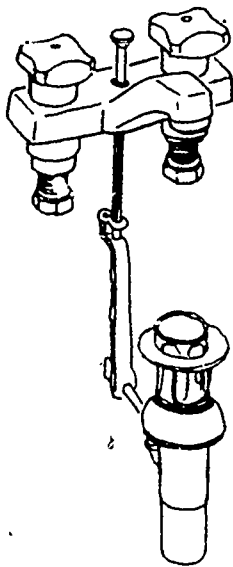

CENTERSET FITTING

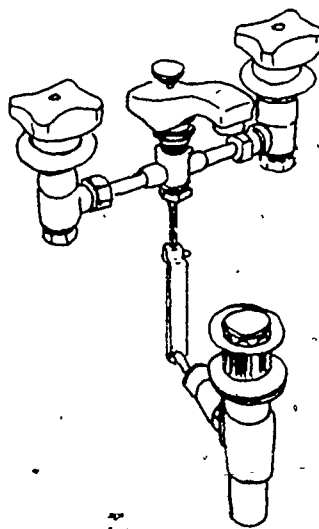

CONCEALED FAUCET

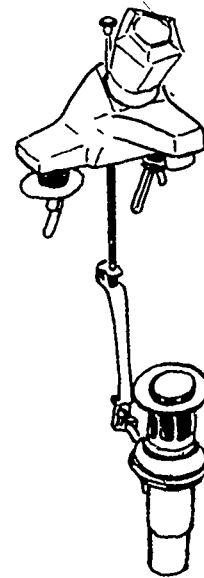

SINGLE HANDLE FAUCET

The illustration shows 3-different lavatory fittings.

The center-set fitting is the most common type of lavatory fitting. This faucet is a combination compression faucet. It is used on lavatories that have been drilled on 4" centers.

The concealed faucet or bottom-mounted faucet, is also a compression type faucet. This faucet fits lavatories on which the faucet mounting holes are drilled on 8" or 12" centers. It is installed on the lavatory with the faucet body below the fixture, with only the handles and spout on top of the lavatory.

The single-handle faucet and drain assembly is also used on lavatories that are drilled on 4" centers.

### INSTALLATION

When installing the hot and cold water rough plumbing you have hot and cold water pipes sticking out of the wall.

1. Install on these pipes either a compression or IPS chrome-plated angle stop. These stops control the water to one fixture only.
2. For wall hung lavatories, using wood screws, install the bracket on the wall. Use a builder's level to make sure the bracket is level.
3. Install the lavatory fitting on the lavatory by using plumbers' putty only between the lavatory fitting and lavatory. Tighten the nuts with the washers (not too tight). Make sure the faucet is even with the lavatory.
4. Place putty under the drain and tighten the large nut with the rubber washer. (Not too tight.)
5. Hang the lavatory on the bracket. Make sure the lavatory is level.
6. With the supply tubing that comes with the angle stops, connect the hot to the hot and the cold to the cold.
7. The center outlet is the waste outlet and must be connected to the tail piece from the drain in the lavatory by a chrome-plated or ABS, PVC p-trap.
8. When installing the p-trap you are allowed slip joint nuts and washers on the fixture side of the trap only. The outlet side of the trap may have a ground joint connection, which consists of a slip nut and a tapered brass slip ring. (A slip joint is considered to be a slip nut and a rubber washer.)

(See the illustration at the top of the following page.)



SLIP  
JOINT  
NUT



| PART NO. | SIZE          | A      |
|----------|---------------|--------|
| 3930     | 1 1/4         | 1 1/32 |
| 3931     | 1 1/2         | 1 1/32 |
| 3932     | 2             | 1 1/32 |
| 3933     | 1 1/2 x 1 1/4 | 1 1/32 |

When installing a lavatory in a counter top, a water protection sealant is put between the counter top and the lavatory. This sealant is generally a plastic liquid which is squeezed from a tube and hardens to make the seal waterproof.

With the lavatory comes a set of special screws and clips that are used to mount the lavatory to the counter top.

# Self Assessment

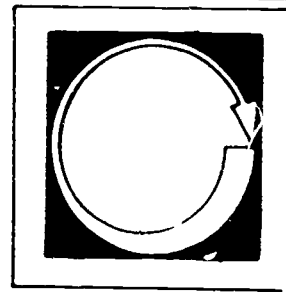

LISTED BELOW ARE SEVERAL STATEMENTS. IF THE STATEMENT IS TRUE, PLACE A "T" IN THE BLANK PROVIDED. IF THE STATEMENT IS FALSE, PLACE AN "F" IN THE BLANK.

1.  A lavatory is a plumbing fixture used to wash dishes.
2.  Lavatories are also called wash basins.
3.  Some lavatories are made of plastic.
4.  A bracket is needed to install a vanity-type lavatory.
5.  Wall-hung lavatories are usually installed 31 inches above the finish floor.
6.  Lavatory trim consists of a lavatory fitting.
7.  A compression faucet is shut off by means of a washer.
8.  Lavatory drain fittings are installed at the bottom of the lavatory.
9.  The lift rod is used to raise and lower the stopper.
10.  The location of the hot water piping is located on the right side.

1. F

2. T

3. T

4. F

5. T

6. T

7. T

8. T

9. T

10. F

● **Self Assessment  
Answers**

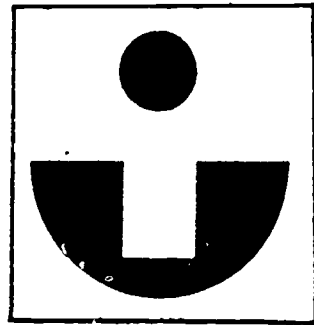

# Job Sheet

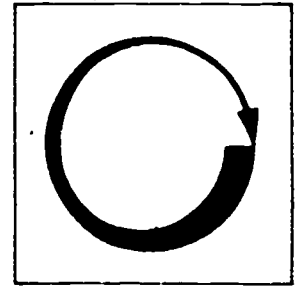

COMPLETE THE FOLLOWING TASK.

Materials and Tools

wall-hung lavatory unit

fittings

tool box

putty

With the information supplied in this module, install a wall-hung lavatory with all its trim just as it is in your home.

# Post Assessment

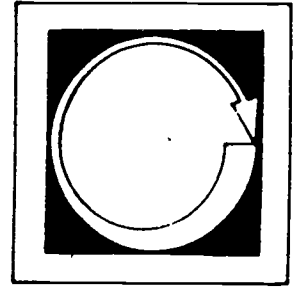

COMPLETE THE FOLLOWING STATEMENTS BY WRITING THE CORRECT WORD OR WORDS IN THE BLANKS PROVIDED.

1. Cold water is located on the \_\_\_\_\_ side of a lavatory fitting.
2. A \_\_\_\_\_ is used to control the water supply to the lavatory fitting.
3. A bracket is used to hang a \_\_\_\_\_ lavatory.
4. A compression faucet is shut off by means of a \_\_\_\_\_.
5. Hot water piping is located on the \_\_\_\_\_ side.
6. Wall-hung lavatories are usually installed \_\_\_\_\_ above the finish floor.
7. Lavatory faucets may be classified as either compression faucets or \_\_\_\_\_ faucets.
8. Lavatory drain fittings are installed at the \_\_\_\_\_ of the lavatory.
9. A lift rod is used to lift and lower the \_\_\_\_\_.
10. \_\_\_\_\_ is used to seal between the lavatory and the lavatory fitting.
11. \_\_\_\_\_ are used to install the bracket.



12. A chrome plated or \_\_\_\_\_ p-trap may be used to connect the lavatory to the waste pipe from the wall.
13. The outlet side of the trap may have a \_\_\_\_\_ connection.
14. Lavatories are also called \_\_\_\_\_.
15. The main purpose of a lavatory is to \_\_\_\_\_.

# Instructor Post Assessment Answers

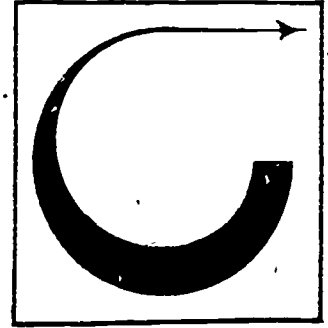

1. right
2. angle stop
3. wall-hung
4. washer
5. left
6. 31 inches
7. port control
8. bottom
9. stopper
10. plumbers' putty
11. wood screws
12. plastic
13. ground joint
14. wash basins
15. wash hands and face.

## WATER CLOSET

### **Goal:**

The student will be able to identify and explain the different types of water closets and the proper installation of these fixtures.

### **Performance Indicators:**

The student will demonstrate an understanding of the subject by successfully completing a Self Assessment, a Job Sheet and a Post Assessment.

# Study Guide

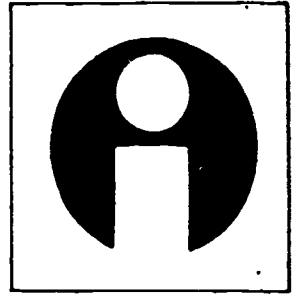

In order to finish this module, do the following tasks. Check each item off as you complete it.

1.  Read the Goal and Performance Indicators on the cover of the module. This will tell you what you will learn by studying the module, and how you will show you've learned it.
2.  Read the Introduction. The Introduction will tell you why the module is an important part of the plumbing trade.
3.  Study the Vocabulary section. Vocabulary words are important for a good understanding of the trade. After you have studied the vocabulary, ask your teacher to quiz you on the words and their meanings.
4.  Study the Information section. This section will give you the information you need to understand the subject.
5.  Take the Self Assessment exam. This is a test for you to prove to yourself that you have learned the material you have studied. Compare your answers with the answers on the Self Assessment Answer Sheet, which is on the page following the Self Assessment. If you scored poorly, re-study the Information section or ask your teacher for help.
6.  Do the Job Sheet. Follow the instructions at the top of the Job Sheet. The tasks listed on the Job Sheet will help you develop skills which will be helpful to you.
7.  Take the Post Assessment exam. Give the exam to your teacher after you have completed it. Your teacher will grade it for you.

# Introduction

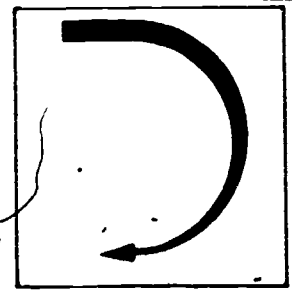

A water closet is a water-flushed plumbing fixture we normally call a toilet.

Water closets require a 3" waste pipe and a 2" vent.

Water closets are usually made of vitreous china. They are installed either directly on the floor or are suspended from a wall.

# Vocabulary

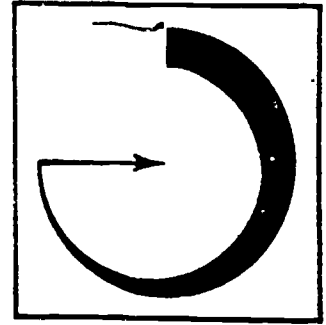

Trade terms are very important for a good understanding of the trade. Study these words and meanings. When you have learned them, ask your teacher to quiz you on the words and their meanings.

**SIPHON JET CLOSET**--A toilet which empties and flushes with a volume of water, assisted by a jet stream of water to aid the built-in siphon of the toilet bowl that is located in the drainage passageway.

**ELONGATED PATTERN BOWL**--Oval shaped.

**BALL COCK**--The flushing device inside a toilet tank.

**BOLWAX RING**--Round shape, made from beeswax.

# Supplementary References

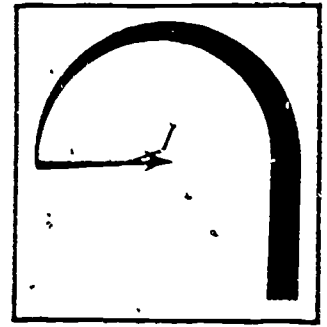

Plumbing Installation and Design. American Technical Society, 1978. pp. 201-207.

# Information

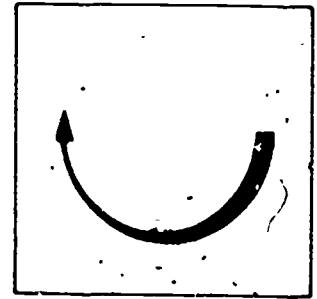

There are many models of water closets presently manufactured for residential use. The illustration below shows some of the more commonly used models.

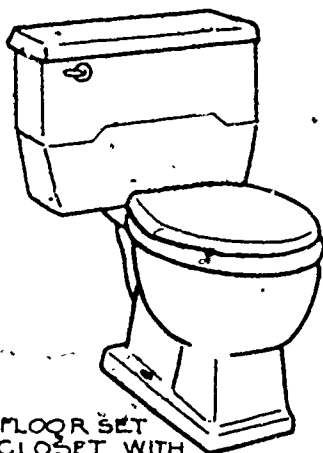

FLOOR SET  
CLOSET WITH  
CLOSE-COUPLED  
TANK AND BOWL

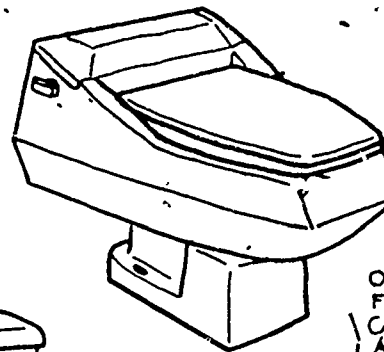

ONE-PIECE  
FLOOR SET  
CLOSET TANK  
AND BOWL  
COMBINATION

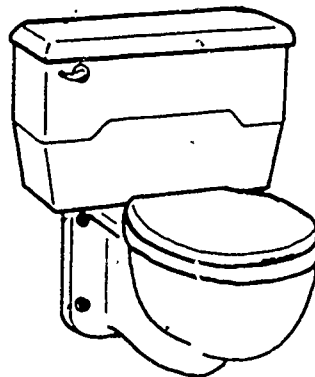

WALL-HUNG SIPHON JET WATER CLOSET  
WITH A CLOSE-COUPLED TANK AND BOWL

The type most often used in residential construction is an inexpensive, floor-set water closet with a close-coupled flush-tank and bowl combination. This closet has a siphon jet flushing action. (Water closets of this type are also available in water-saving models. The flushing action of water-saving closets has been designed to ensure a positive flush with 3 1/2 gallons of water, compared with the 5 1/2 gallons required to flush other water closets.)

A second type is the modern, one-piece water closet flush tank and bowl combination. This floor-set closet has an elongated pattern bowl. Since the



water height in the flush tank is not adequate to give a proper rim flush, a connection is made from the ball cock assembly directly to the flushing rim. This closet requires a minimum of 35 to 40 pounds of water supply pressure for proper operation.

The third type is a wall-hung siphon jet water closet with a close-coupled tank and bowl. The closet is anchored to the wall with a concealed supporting carrier.

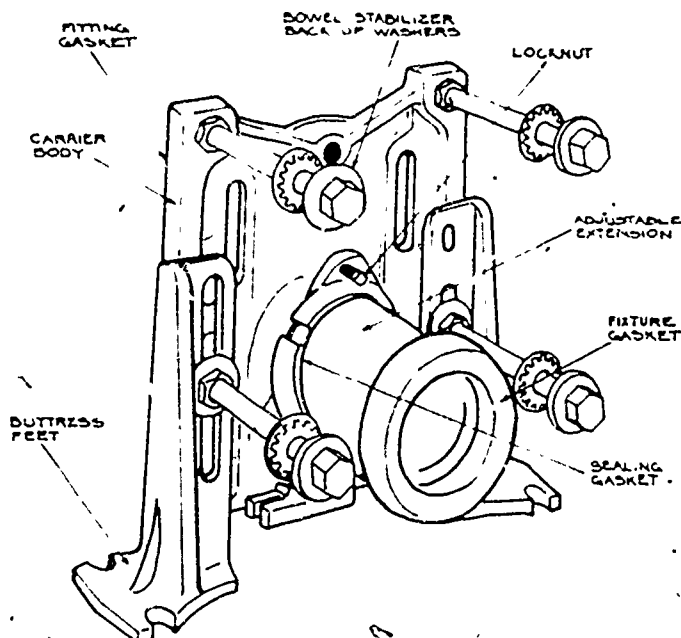

The off-the-floor design of this closet makes cleaning the fixture and the floor much easier.

#### SIPHON JET WATER CLOSET OPERATION

The flushing action of a siphon jet water closet goes through many stages:

Figure 1 shows a typical front-jet siphon jet water closet.

Figure 2 shows how water starts to enter the closet. Water enters the closet by way of the rim holes and jet. It rises in the bowl and flows over the dam, but no siphon or flushing action has started.

Figure 3--More water enters the passageway. As soon as the water is accelerated, it will be directed over the dam to the other side of the passageway, and then re-directed to the opposite side where it will create a curtain through the passageway. This curtain prevents air from entering the passageway.

Figure 4--The passageway water level begins to rise. As the water in the down leg of the passageway rises, air from the passageway mixes with the water leaving the closet.

Figure 5--When the passageway is completely filled with water, a good flush or siphon jet action is created.

Figure 6--The siphon is broken as soon as the level of the water in the bowl drops to the level where air is again introduced into the passageway. When the siphon is broken, the flush stops.

Figure 7--Possibility of sewer gas entering the room if the seal is not restored with refill water.

(See Figures 1-7 on the following page.)

In addition to the siphon jet water closet, plumbing fixture manufacturers offer water closets with reverse trap, washdown, and blowout flushing actions.

#### FLUSHING DEVICES FOR WATER CLOSETS

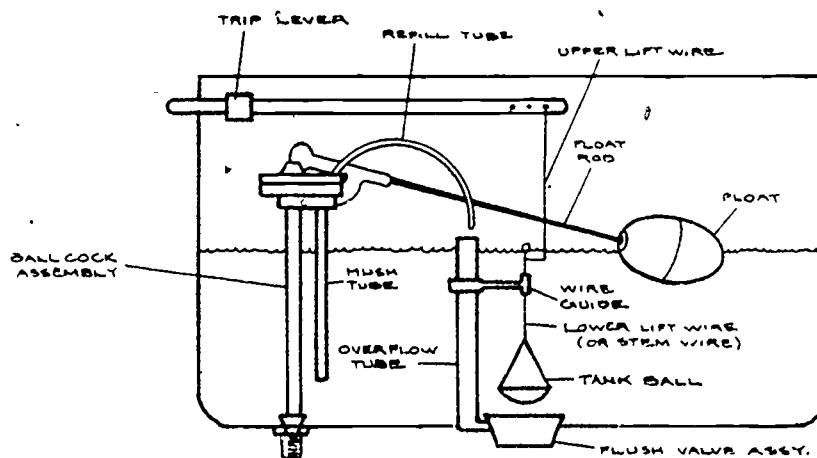

Flush tanks are commonly used on water closets in residential construction. In addition to being less expensive than the flushometer, the flush tanks have the advantage of a quieter operation, and they use less water pressure and less water.

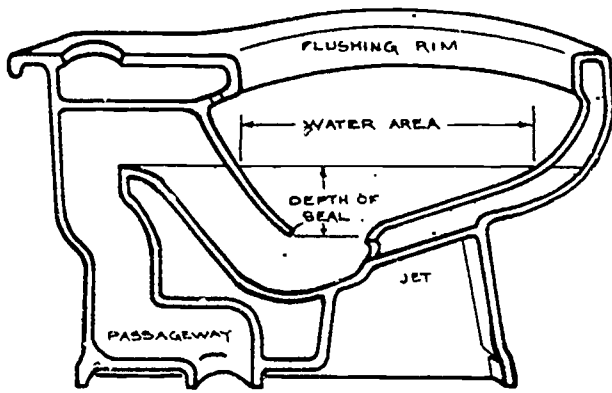

FIG. 1.

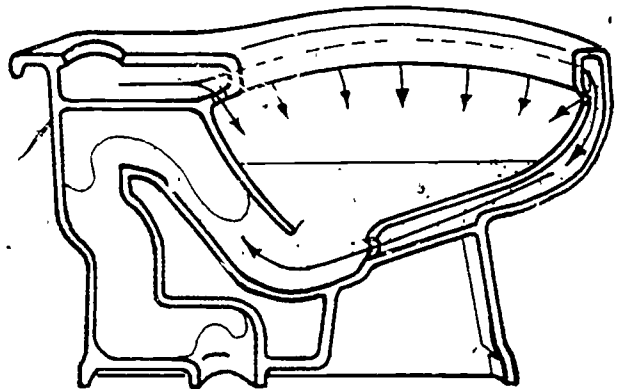

FIG. 4

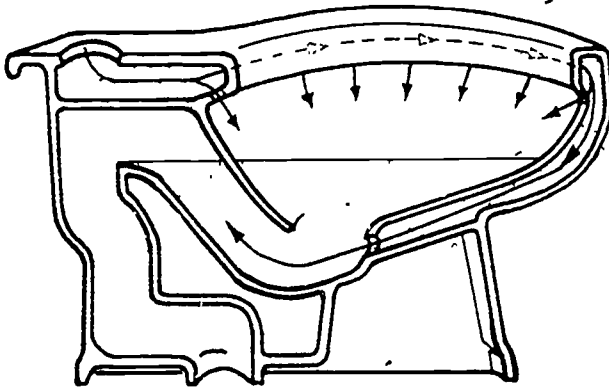

FIG. 2

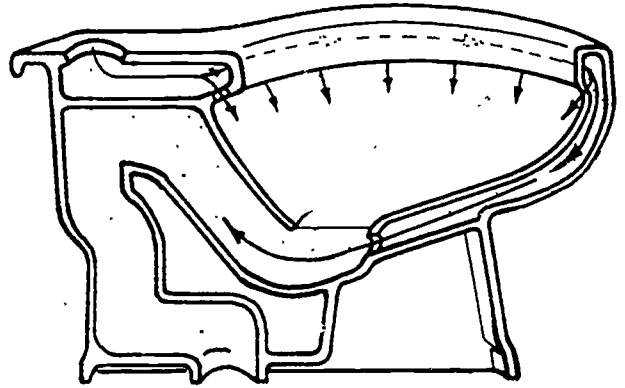

FIG. 5

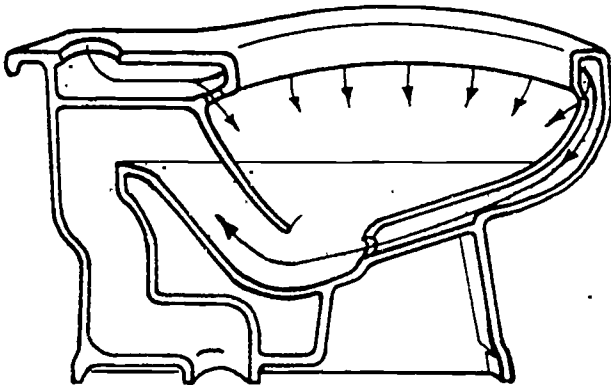

FIG. 3

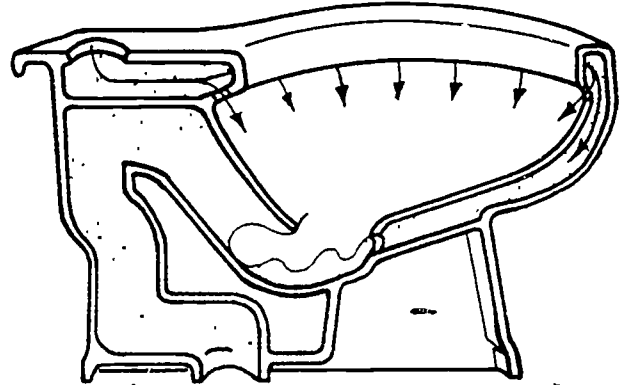
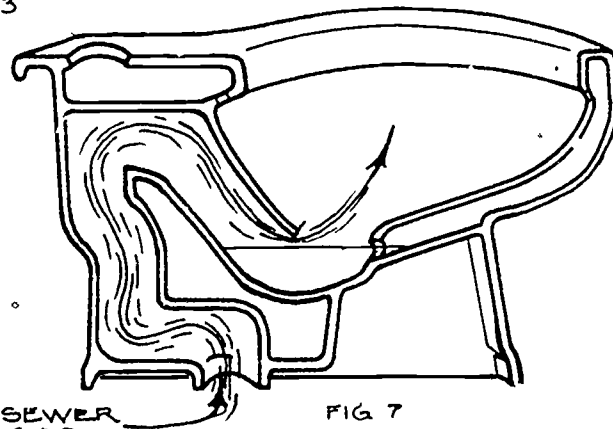

FIG. 6



SEWER  
GAS

FIG. 7

A flushometer valve requires a minimum of a 1" size water supply, while a flush tank may be supplied with a 1/2" pipe, which lowers the cost of installation.

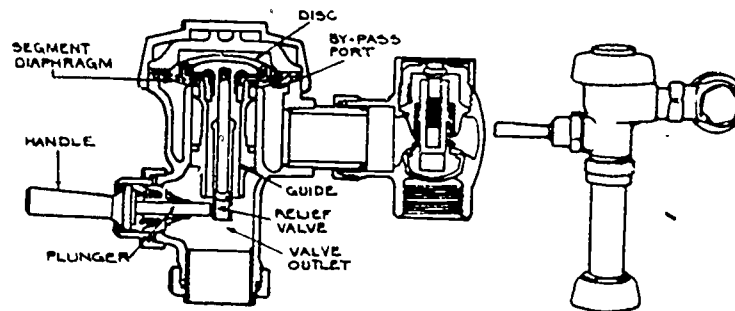

Flushometer valves used on commercial plumbing installations have lower maintenance cost and rapid flushing action uses more water than a flush tank.

#### OPERATION OF A WATER CLOSET FLUSH TANK

The working parts of a water closet flush tank are:

1. A float valve or ball cock assembly connected to the water supply.
2. The flush valve assembly consisting of an overflow tube, valve seat, and a rubber tank ball that is attached to the trip lever with lift wires. (Refer to illustration C.)

The flush tank gets its supply of water by means of a ball cock assembly. This contains a seat, faced by a soft rubber compression washer. The rubber washer, which is fastened to the float valve plunger, moves up and down over the brass seat. The plunger is connected to the brass float rod.

Pressure on the trip lever starts the tank in operation. The float drops in the tank as the water level lowers. When it reaches a certain point, this lifts the plunger from the seat, and the water enters the closet tank through the hush tube. When the water reaches the proper height, the plunger is forced onto the ball cock and the flow of water is shut off. The water level in the tank is controlled by the setting of the float.

To flush the closet bowl, the trip lever on the outside of the flush tank is pressed. This action raises the rubber tank ball from the flush valve seat. Gravity makes the water stored in the tank flow into the water closet bowl with such speed that a siphon flushing action occurs in the bowl. The tank ball floats down on the water. It is drawn onto the seat of the flush valve by the action of the water passing into the closet bowl. When the tank ball has seated itself, the flush is stopped, and the water closet tank again becomes watertight and refills with water.

Although nearly every plumbing fixture manufacturing company has its own design of internal parts, the operating principles of all flush tanks are the same.

## INSTALLATION

### Step 1

When the rough plumbing was installed, you fastened a closet flange to the soil pipe and secured it to the floor with corrosive resistant wood screws.

### Step 2

Install 2 closet bolts (also corrosive resistant) into the slots of the closet flange.

### Step 3

Place a bolwax ring around the collar of the bottom of the water closet bowl.

### Step 4

Lift the water closet bowl up, holding on to both sides of the rim. Gently lower the water closet until the bolts stick through the holes in the water closet bowl.

### Step 5

Screw a washer and nut (both chrome-plated) on to the bolts. Screw one turn more than hand tight.

### Step 6

(Tank installation.) Most water closet tanks are supplied with another set of bolts and rubber washers, and a cone-shaped washer.

1. Put the cone-shaped washer on the large opening that leads to the bowl.
2. Put the bolts through the holes from the tank to the bowl.
3. Make sure the rubber washer is installed inside the tank between the head of the bolt and the tank.
4. Tighten the closet bolts more firmly as the weight of the tank and bowl cause the bolwax ring to compress.

Step 7

Connect the water supply to the water closet and check for leaks.

# Self Assessment

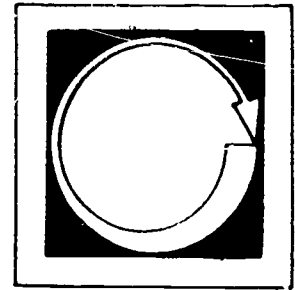

LISTED BELOW ARE SEVERAL STATEMENTS. IF THE STATEMENT IS TRUE, PLACE A "T" IN THE BLANK PROVIDED. IF THE STATEMENT IS FALSE, PLACE AN "F" IN THE BLANK.

1. \_\_\_ A water closet is designed to receive human wastes.
2. \_\_\_ The minimum waste discharge of a water closet is 2".
3. \_\_\_ Some water closets are made to be suspended from a wall.
4. \_\_\_ The most common water closet used in a home is a close-coupled flush tank and bowl combination.
5. \_\_\_ A siphon jet water closet delivers 5 1/2 gallons of water for flushing.
6. \_\_\_ Another feature of some water closets is a washdown.
7. \_\_\_ The flush tank device used in water closets in residences costs less.
8. \_\_\_ The flush tank uses more pressure to operate.
9. \_\_\_ The flush tank uses more water to operate.
10. \_\_\_ Flushometer valves in commercial use have a higher maintenance cost.
11. \_\_\_ There are two main components in the operation of a flush tank.
12. \_\_\_ The float in the tank drops as the water level lowers.
13. \_\_\_ Only corrosive-resistant wood screws and bolts should be used when installing a water closet.

1. T

2. F

3. T

4. T

5. F

6. T

7. T

8. F

9. F

10. F

11. T

12. T

13. T



INDIVIDUALIZED LEARNING SYSTEMS

● **Self Assessment  
Answers**

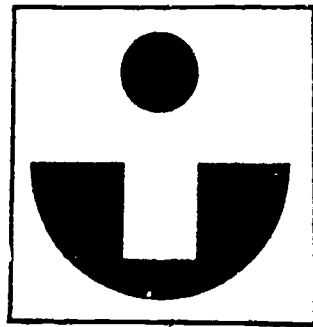

# Job Sheet

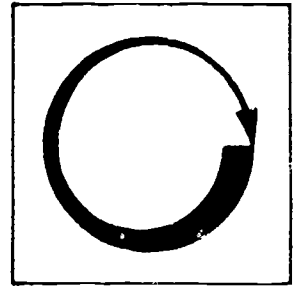

COMPLETE THE FOLLOWING TASKS.

Materials and Tools

rough plumbed room  
water closet assembly  
tools

With the information given in this module:

1. Follow the steps and connect the water closet bowl to the floor.
2. Connect the tank to the bowl and connect the water supply.

# Post Assessment

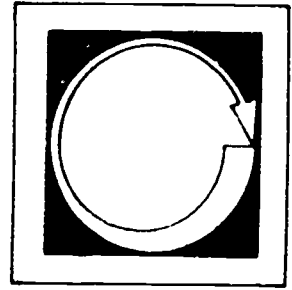

COMPLETE THE FOLLOWING STATEMENTS BY WRITING THE CORRECT WORD OR WORDS IN THE BLANKS PROVIDED.

1. Minimum size drainage pipe for water closets is \_\_\_\_\_ inch.
2. A water closet requires a minimum \_\_\_\_\_ inch vent.
3. Water closets are usually made of \_\_\_\_\_.
4. The most commonly used water closet has a \_\_\_\_\_ flushing action.
5. Water-saving toilets have been designed to deliver \_\_\_\_\_ gallons of water.
6. \_\_\_\_\_ are commonly used on water closets in residential areas.
7. A flush tank requires a cold water supply of \_\_\_\_\_ inch.
8. A \_\_\_\_\_ or \_\_\_\_\_ assembly is connected to the water supply.
9. Only \_\_\_\_\_ wood screws or bolts may be used in the installation of water closets.
10. A \_\_\_\_\_ ring is used to connect the water closet to the closet flange.

# ● Instructor Post Assessment Answers

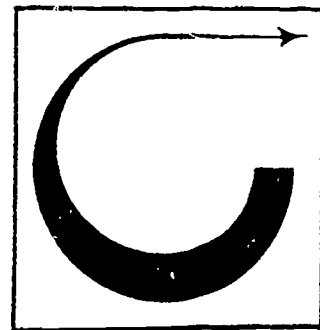

1. 3
2. 2
3. vitreous china
4. siphon jet
5. 3 1/2
6. flush tanks
7. 1/2
8. float valve, ball cock
9. corrosive resistant
10. bolwax

KITCHEN SINK--GARBAGE DISPOSAL--DISHWASHER

**Goal:**

The student will be able to identify and explain the types of kitchen sinks and related fixtures and the proper installation of the fixtures and valves.

**Performance Indicators:**

The student will demonstrate an understanding of the subject by successfully completing a Self Assessment, a Job Sheet and Post Assessment.

303

310

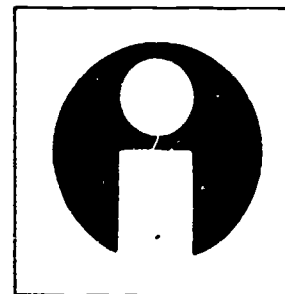

# Study Guide

In order to finish this module, do the following tasks. Check each item off as you complete it.

1.  Read the Goal and Performance Indicators on the cover of the module. This will tell you what you will learn by studying the module, and how you will show you've learned it.
2.  Read the Introduction. The Introduction will tell you why the module is an important part of the plumbing trade.
3.  Study the Vocabulary section. Vocabulary words are important for a good understanding of the trade. After you have studied the vocabulary, ask your teacher to quiz you on the words and their meanings.
4.  Study the Information section. This section will give you the information you need to understand the subject.
5.  Take the Self Assessment exam. This is a test for you to prove to yourself that you have learned the material you have studied. Compare your answers with the answers on the Self Assessment Answer Sheet, which is on the page following the Self Assessment. If you scored poorly, re-study the Information section or ask your teacher for help.
6.  Do the Job Sheet. Follow the instructions at the top of the Job Sheet. The tasks listed on the Job Sheet will help you develop skills which will be helpful to you.
7.  Take the Post Assessment exam. Give the exam to your teacher after you have completed it. Your teacher will grade it for you.

# Introduction

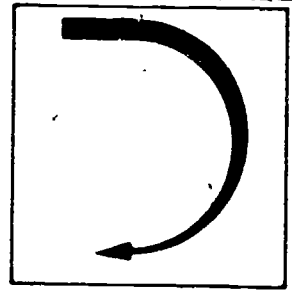

A kitchen sink requires a 2" waste pipe, 1 1/2" p-trap and a 1 1/2" vent pipe.

Kitchen sinks are made with enameled cast iron, enameled pressed steel, stainless steel and plastic.

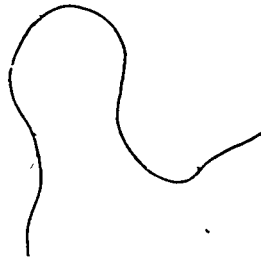

# Vocabulary

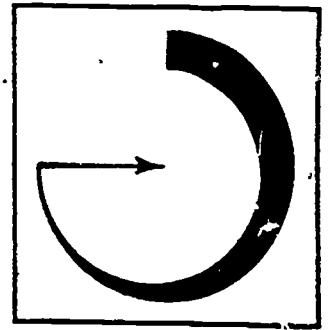

Trade terms are very important for a good understanding of the trade. Study these words and meanings. When you have learned them, ask your teacher to quiz you on the words and their meanings.

17 gage--Wall thickness of metal. Abbreviation is "ga."



# Supplementary References

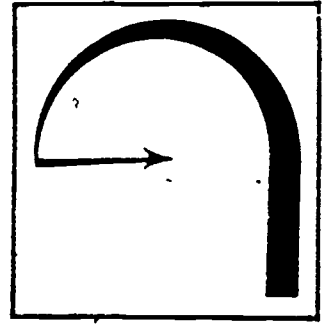

Plumbing Installation and Design, American Technical Society, 1978. pp. 222-226.

# Information

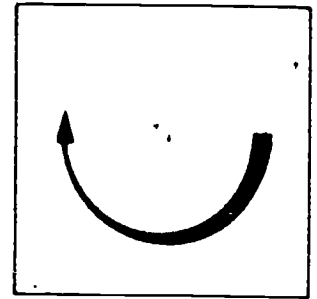

Kitchen sinks are available in a large variety of sizes and shapes. The most popular is the double compartment sink installed on a kitchen cabinet counter top.

The illustration (below) shows three types of double compartment kitchen sinks: A self-rimming enameled cast iron sink, a rim-type enameled cast iron sink, and a stainless steel sink. (Enameled pressed steel sinks are not shown, but they are very similar to the enameled cast iron sink.)

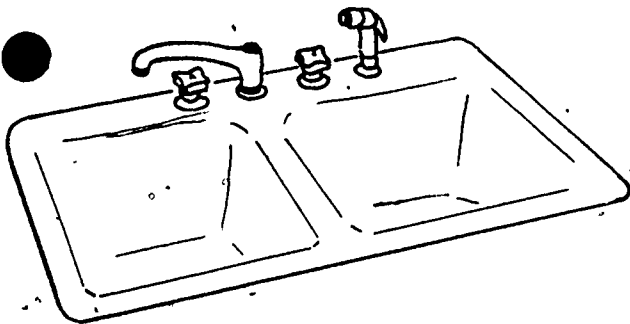

SELF RIMMING ENAMELED  
CAST IRON SINK

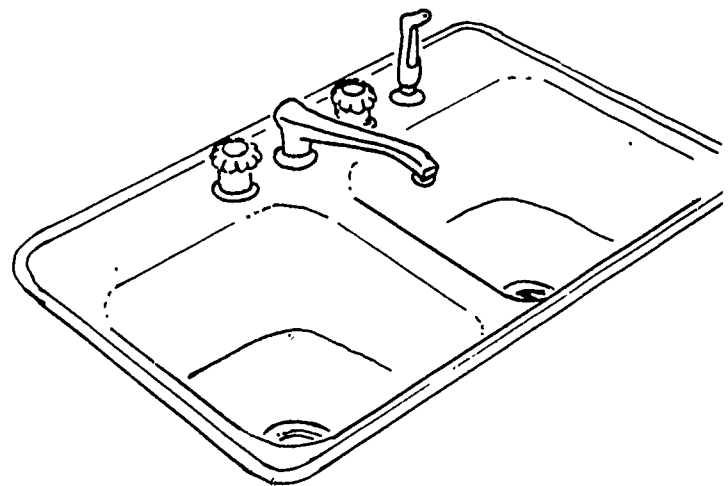

RIM-TYPE ENAMELED  
CAST IRON SINK

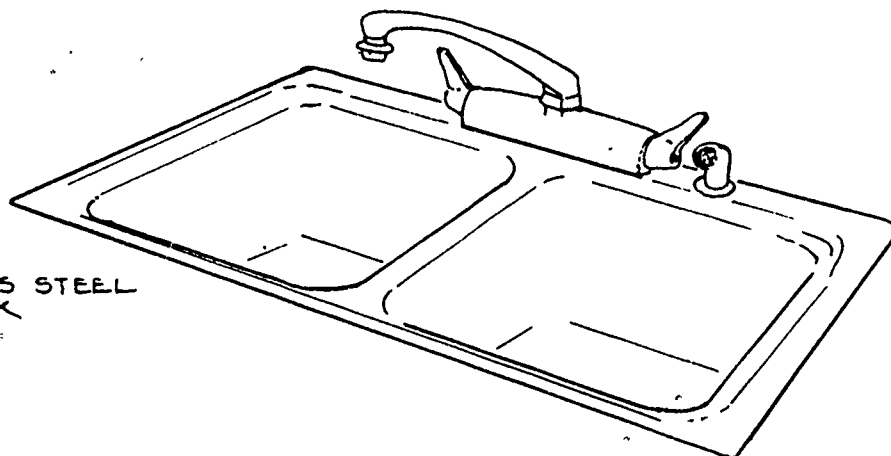

STAINLESS STEEL  
SINK

## KITCHEN SINK FAUCETS

Kitchen sink faucets are available either as combination compression faucets or as port control faucets with swing spouts. Another common feature of kitchen sink faucets is the flexible hose and spray attachment, which is used for rinsing dishes.

COMPRESSION  
VALVE SINK  
FAUCET

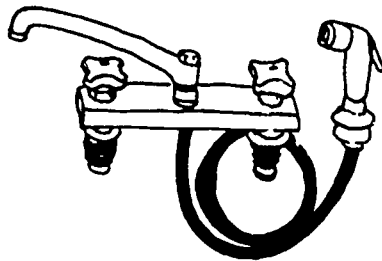

PORT CONTROL,  
ON SINGLE HANDLE  
SINK FAUCET

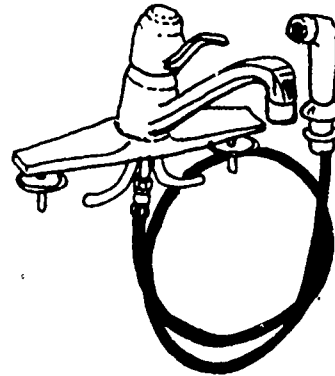

## KITCHEN SINK DRAIN FITTINGS

Since kitchen sinks are used for cleaning dishes and in the preparation of food, the plumber installs a special drain fitting in each compartment of the sink to keep the solid food waste particles out of the drainage piping. This fitting is called a basket strainer.

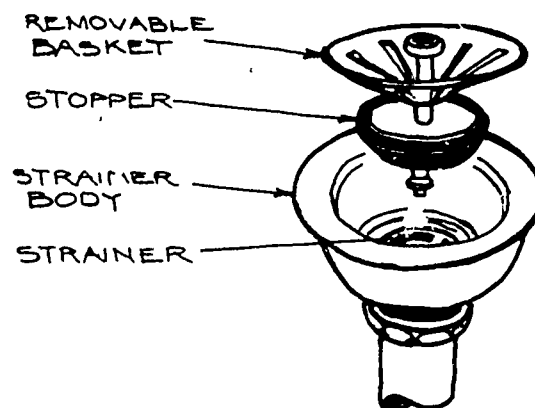

It consists of a strainer body attached to the drain opening at the bottom of the sink compartment and a removable basket. The strainer body has a strainer across its waste outlet opening. The basket is also the stopper, and is used to retain water in the sink compartment.

There are two methods of connecting the waste outlets from the basket strainers in a double compartment kitchen sink to the drainage piping.

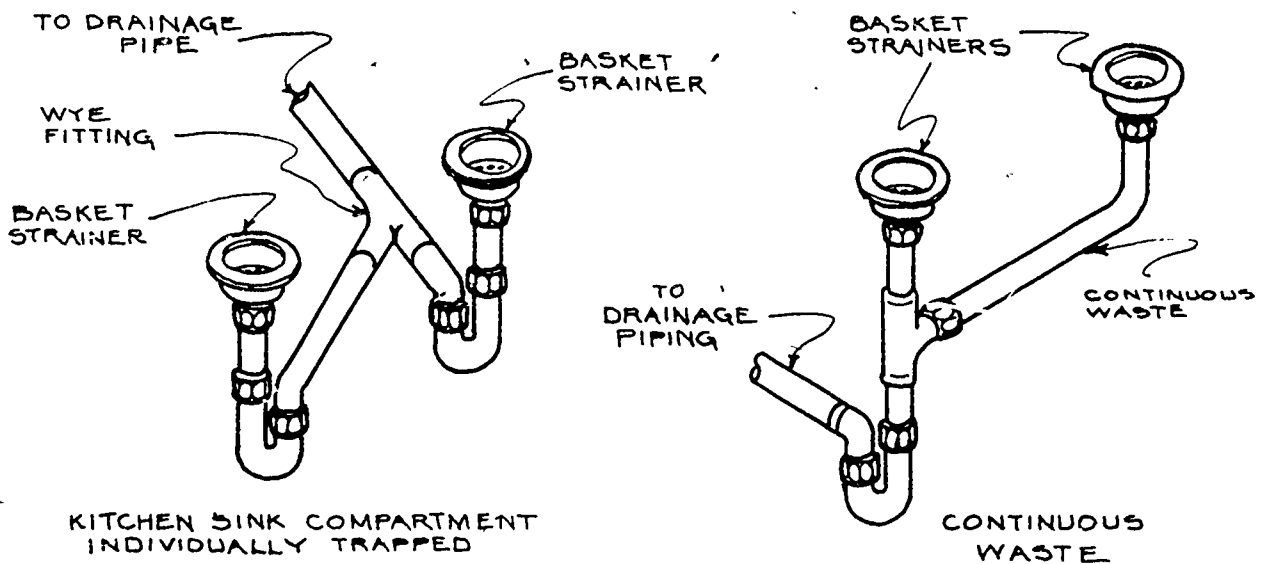

In one method, each basket strainer waste is individually trapped. The two traps then connect to a wye fitting, which in turn connects to the drainage piping.

In the other method, the basket strainer wastes are tied together with a continuous waste fitting. This continuous waste fitting discharges into a single p-trap, which drains into the drainage piping. The size of the piping is 1 1/2" O.D., which enables it to be connected inside a 1 1/2" pipe sticking out of the wall. The material used in this piping must be plastic ABS, DWV or chrome plated. The chrome plated p-traps must be made of 17 ga. metal. The continuous waste may be 20 ga. metal.

#### GARBAGE DISPOSALS

A garbage disposal, also called a food waste disposer, is an electric grinding device, used with water, to grind food wastes into pulp and discharge the wastes into the drainage system. The illustration on the following page shows a typical

domestic garbage disposal, which is mounted beneath one compartment of the kitchen sink in place of the basket strainer assembly.

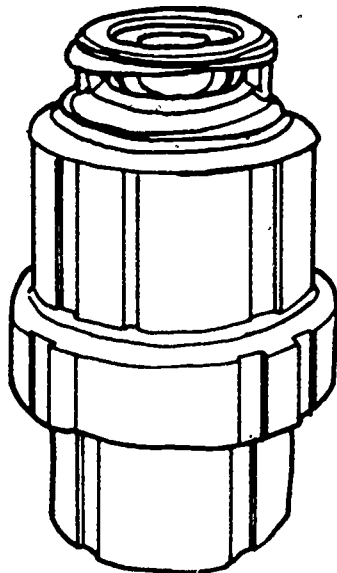

A garbage disposal may discharge its waste into a separate p-trap.

A garbage disposal may also discharge its waste into a continuous waste fitting.

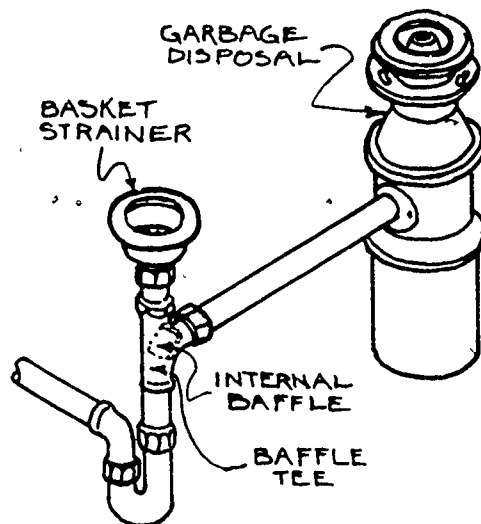

When a disposal drains into a continuous waste fitting, the tee connection joining the disposal waste and the waste for the other sink compartment must contain an internal baffle to prevent the disposal waste from backing up into the other sink compartment.

The plumber should remind the homeowner that it is very important to run a large quantity of cold water into the garbage disposal when using it, so that the food waste pulp will be washed through the drainage piping (and avoid a stoppage of the drain pipe).

## DOMESTIC DISHWASHERS

A domestic dishwasher is an electric appliance for washing dishes.

The waste from a domestic dishwasher is pumped out of the machine into the side outlet of a garbage disposal or a specially designed fitting called a dishwasher wye (installed directly under the basket strainer). The hose connection must have a high loop strapped at the highest point under the counter top before it discharges into the garbage disposal or the dishwasher wye. (See the illustration below.)

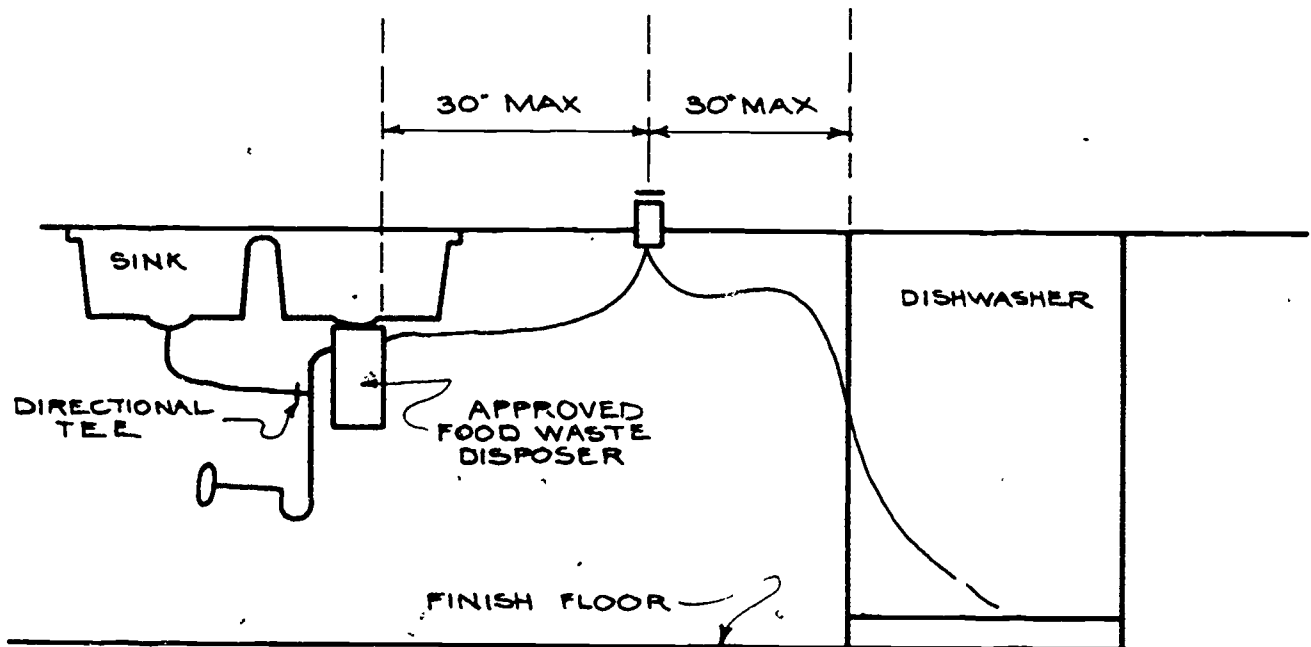

The purpose of this loop is to allow the dishwasher to drain properly and to prevent wastes from the kitchen sink and/or garbage disposal from backing up into the dishwasher.

### INSTALLATION

#### Step 1

Install the kitchen faucet on the sink. (Explained in the module titled "Lavatory".)

### Step 2

Install the basket strainer on one end and strainer from the garbage disposal on the side nearest the dishwasher.

### Step 3

Put caulking completely around the outer edge of the underside of the sink. Place sink down on the top of counter top.

### Step 4

From underneath, insert the clips and tighten the nuts. The sink is in place now and secured to the counter top.

### Step 5

Since the water supplies are furthest away from you, connect the hot and cold water to the faucet.

### Step 6

Drill two 3/4" holes in the cabinet between the dishwasher and the sink as far back and as low as possible. Drill one above the other.

### Step 7

1. Bring 3/8" copper tubing through the bottom hole and connect to the hot water inlet on the dishwasher.
2. Push through the top hole the rubber 5/8" O.D. hose supplied with the dishwasher.
3. Slide the dishwasher into the cabinet.
4. Level the dishwasher so that the metal plate inside the dishwasher is against the top of the under side of the cabinet.
5. With the wood screws provided, secure the dishwasher to the cabinet.

### Step 8

To the other hot water supply, connect the 3/8" copper tubing from the dishwasher. Connect the 5/8" rubber hose to the air gap which is provided. Use a stainless steel clamp for the connection.

### Step 9

1. Install the bottom part of the garbage disposal.

2. Knock out the metal plug in the side outlet of the garbage disposal.
3. Connect the 1/8" O.D. rubber hose from the air gap to the garbage disposal. Use stainless steel clamps.

Step 10

Install the continuous waste pipe from the outlet of the garbage disposal into the baffle tee that comes with the continuous waste pipe. Connect to the waste pipe sticking out of the wall.

Connect electricity to the dishwasher and garbage disposal.

Turn water on and test for leaks.



# Self Assessment

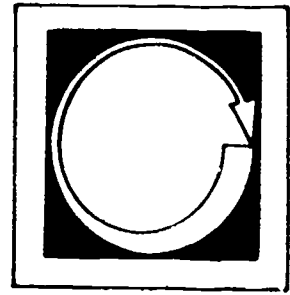

LISTED BELOW ARE SEVERAL STATEMENTS. IF THE STATEMENT IS TRUE, PLACE A "T" IN THE BLANK PROVIDED. IF THE STATEMENT IS FALSE, PLACE AN "F" IN THE BLANK.

1. \_\_\_ A kitchen sink requires a 2" p-trap.
2. \_\_\_ Some kitchen sinks are made from stainless steel.
3. \_\_\_ Most kitchen sink faucets have a swing spout.
4. \_\_\_ The drain fitting used to keep particles from entering the drainage piping is a basket strainer.
5. \_\_\_ One method of connecting a double compartment sink is with a continuous waste.
6. \_\_\_ A garbage disposal is used to grind up food.
7. \_\_\_ 5/8" rubber hose is used to connect the water supply to the dishwasher.
8. \_\_\_ Caulking is used to seal the kitchen sink to the counter top.
9. \_\_\_ A dishwasher should be made level.

# Self Assessment Answers

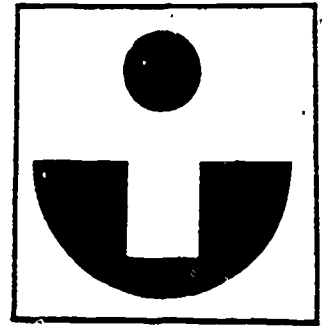

1. F

2. T

3. T

4. T

5. T

6. T

7. F

8. T

9. T

# Job Sheet

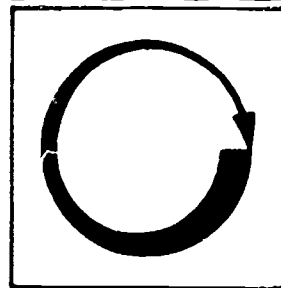

COMPLETE THE FOLLOWING TASKS.

Materials and Tools

double compartment kitchen sink

faucet

garbage disposal

pipng

caulking

tools

With the information given in this module, connect a faucet, garbage disposal and dishwasher to a double compartment sink. Connect all piping needed for a complete kitchen sink hook-up.

# Post Assessment

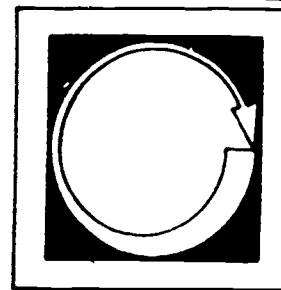

COMPLETE THE FOLLOWING STATEMENTS BY WRITING THE CORRECT WORD OR WORDS IN THE BLANKS PROVIDED.

1. \_\_\_\_\_ copper tubing is used to connect the water supply from the dishwasher.
2. All dishwashers should be made \_\_\_\_\_.
3. \_\_\_\_\_ rubber hose is used to connect the waste from the dishwasher.
4. A \_\_\_\_\_ clamp is used to secure the hose to the garbage disposal.
5. A kitchen sink requires a \_\_\_\_\_ waste pipe.
6. A kitchen sink requires a \_\_\_\_\_ vent pipe.
7. Most kitchen faucets have \_\_\_\_\_ spouts.
8. A \_\_\_\_\_ may also be used to connect a dishwasher hose to the waste system.
9. The tee connection of a continuous waste has an internal \_\_\_\_\_ in it.

# Instructor Post Assessment Answers

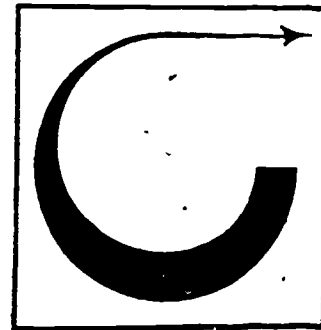

1. 3/8 inch
2. level
3. 5/8 inch O.D.
4. stainless steel
5. two inch
6. 1 1/2 inch
7. swing
8. wye fitting
9. baffle

## LAUNDRY TUB

### Goal:

The student will be able to identify and explain:

1. The different types of laundry tubs and connections.
2. The proper installation of these fixtures and valves.

### Performance Indicators:

The student will demonstrate an understanding of the subject by successfully completing a Self Assessment, a Job Sheet and a Post Assessment.

# Study Guide

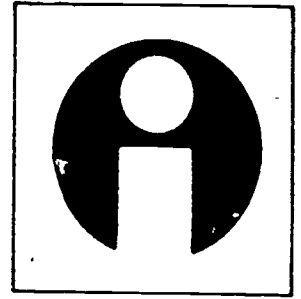

In order to finish this module, do the following tasks. Check each item off as you complete it.

1.  Read the Goal and Performance Indicators on the cover of the module. This will tell you what you will learn by studying the module, and how you will show you've learned it.
2.  Read the Introduction. The Introduction will tell you why the module is an important part of the plumbing trade.
3.  Study the Information section. This section will give you the information you need to understand the subject.
4.  Take the Self Assessment exam. This is a test for you to prove to yourself that you have learned the material you have studied. Compare your answers with the answers on the Self Assessment Answer Sheet, which is on the page following the Self Assessment. If you scored poorly, re-study the Information section or ask your teacher for help.
5.  Do the Job Sheet. Follow the instructions at the top of the Job Sheet. The tasks listed on the Job Sheet will help you develop skills which will be helpful to you.
6.  Take the Post Assessment exam. Give the exam to your teacher after you have completed it. Your teacher will grade it for you.

# Introduction

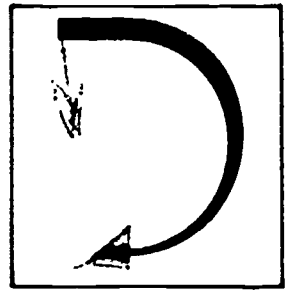

A laundry tray is a fixed tub, installed in the laundry room of a home, that is supplied with cold and hot water and a drain connection. The laundry tray is used for washing clothes and other household items. It is also used to receive the waste from the automatic clothes washer.

Laundry trays (sometimes called tubs) require a 2" waste pipe, 1 1/2" P-trap and a 1 1/2" vent pipe.

A washing machine requires a 2" waste pipe, 2" P-trap, with a 2" pipe between (18" minimum to 30" maximum), to which the washing machine is connected. It also requires a 1 1/2" vent pipe.

Laundry trays are manufactured of plastic or fiberglass. They are available in single or double compartment, wall-hung and floor-set models.



# Supplementary References

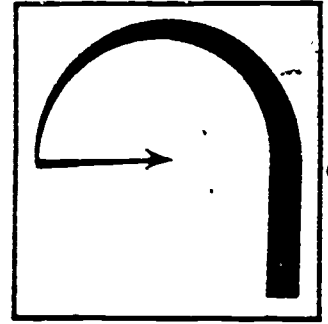

Plumbing Installation and Design. American Technical Society, 1978. pp. 226-227.

# Information

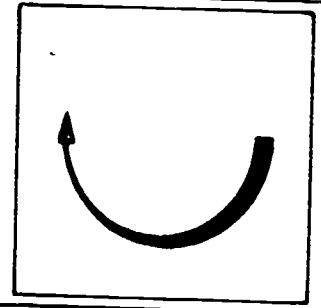

The illustration below shows a wall-hung and a floor model double compartment laundry tray. These are available in single compartments also.

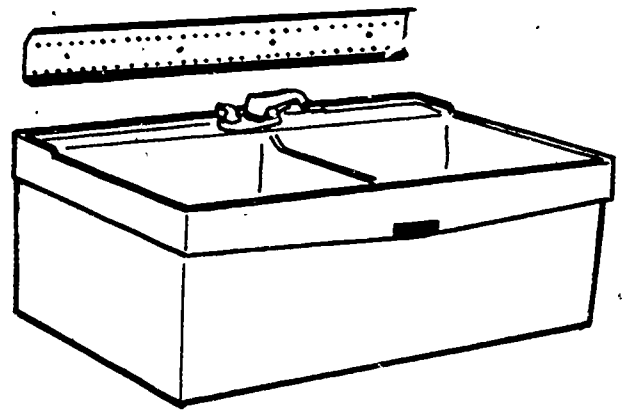
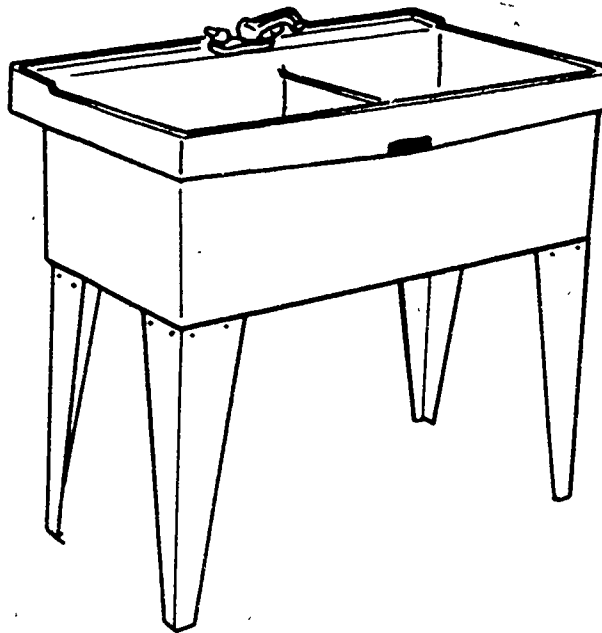

## LAUNDRY TRAY FAUCETS

The faucet used on laundry trays is a two-handle compression faucet with a swing spout. The laundry tray faucet is mounted on the back ledge of the fixture. Water is supplied from under the laundry tray. (Another type is mounted on the wall, and water is supplied through the wall.) (See the illustration on the top of the following page.)

## LAUNDRY TRAY DRAIN FITTINGS

Waste water from the laundry tray flows through a strainer fitting. A rubber stopper is placed in the strainer fitting to retain water in the tub. This

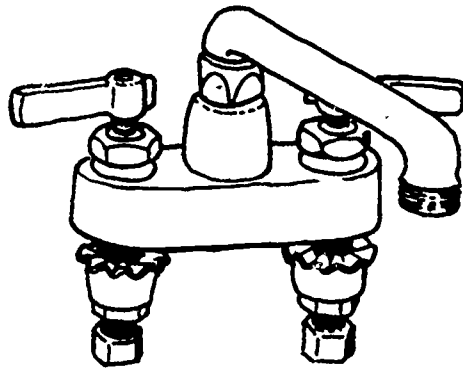

fitting is supplied with the laundry tray by the manufacturer.

A single strainer fitting is used on a single compartment laundry tray. A double compartment laundry tray uses a wye fitting that ties the two compartments of the laundry tray together into a common waste opening that discharges into a single P-trap.

## INSTALLATION

### Step 1

Attach the mounting bracket on the wall with wood screws, making sure the bracket is level.

### Step 2

Install the laundry tray faucet and hang fixture on bracket.

### Step 3

Connect the water supplies (hot and cold) to the laundry tray faucet and connect the waste pipe to the outlet from the wall.

# Self Assessment

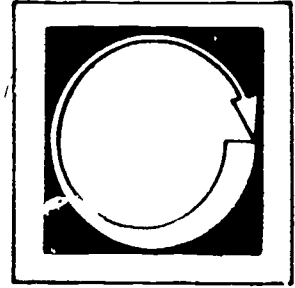

LISTED BELOW ARE SEVERAL STATEMENTS. IF THE STATEMENT IS TRUE, PLACE A "T" IN THE BLANK PROVIDED. IF THE STATEMENT IS FALSE, PLACE AN "F" IN THE BLANK.

1. \_\_\_ The laundry tray is used to soak your body in.
2. \_\_\_ Laundry trays require a 2" waste pipe.
3. \_\_\_ Laundry trays require a 2" vent pipe.

1. F

2. T

3. F

327

● **Self Assessment  
Answers**

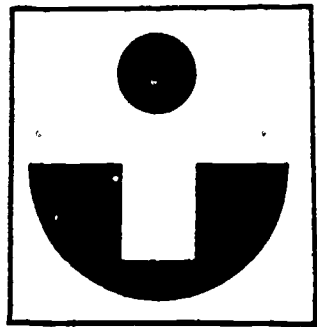

# Job Sheet

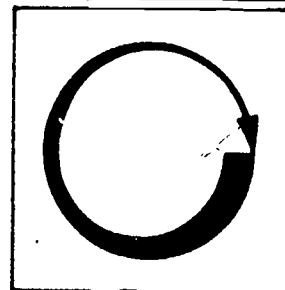

COMPLETE THE FOLLOWING TASK.

Materials and Tools

laundry tray and fixtures

plumbing tools

1. Assemble and install a laundry tray as explained in the information section of this module.

# Post Assessment

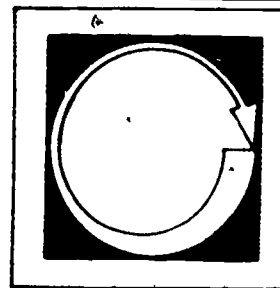

COMPLETE THE FOLLOWING STATEMENTS BY WRITING THE CORRECT WORD OR WORDS IN THE BLANKS PROVIDED.

1. Laundry trays require a \_\_\_\_\_ vent pipe.
2. Laundry trays require a \_\_\_\_\_ waste pipe.
3. Double compartment laundry trays drain through a \_\_\_\_\_.
4. Washing machine drains require a \_\_\_\_\_ P-trap.
5. The maximum length of pipe from the P-trap up is \_\_\_\_\_.



# ● Instructor Post Assessment Answers

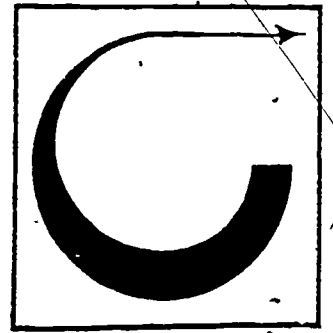

1. 1 1/2 inch
2. 2 inch
3. wye fitting
4. 2 inch
5. 30 inches

## WATER HEATER

### **Goal:**

The student will be able to identify and explain:

1. The different types of water heaters.
2. The safe connection and operation of water heaters.

### **Performance Indicators:**

The student will demonstrate understanding of the subject by successfully completing a Self Assessment, an Assignment and a Post Assessment.

# Study Guide

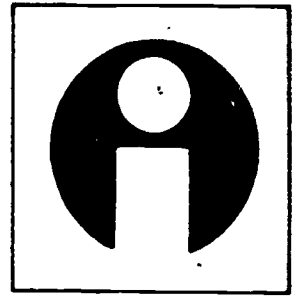

In order to finish this module, do the following tasks. Check each item off as you complete it.

1.  Read the Goal and Performance Indicators on the cover of the module. This will tell you what you will learn by studying the module, and how you will show you've learned it.
2.  Read the Introduction. The Introduction will tell you why the module is an important part of the plumbing trade.
3.  Study the vocabulary section. Vocabulary words are important for a good understanding of the trade. After you have studied the vocabulary, ask your teacher to quiz you on the words and their meanings.
4.  Study the Information section. This section will give you the information you need to understand the subject.
5.  Take the Self Assessment exam. This is a test for you to prove to yourself that you have learned the material you have studied. Compare your answers with the answers on the Self Assessment Answer Sheet, which is on the page following the Self Assessment. If you scored poorly, re-study the Information section or ask your teacher for help.
6.  Do the Assignment page. Follow the instructions at the top of the Assignment page.
7.  Take the Post Assessment exam. Give the exam to your teacher after you have completed it. Your teacher will grade it for you.

# Introduction

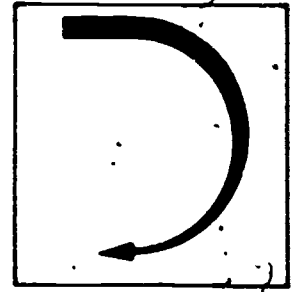

A water heater is an appliance that heats and supplies the hot water that is used in a building for bathing, washing clothes and washing dishes.

The two most common types used in a building are the automatic gas storage and the automatic electric storage tank water heaters.

An automatic storage tank water heater--whether gas or electric--heats and stores hot water at a thermostatically controlled temperature for delivery on demand.

# Vocabulary

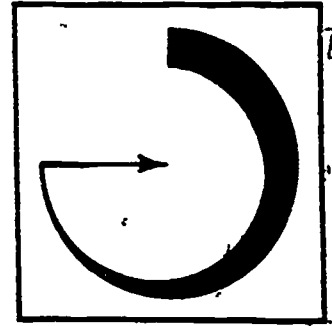

Trade terms are very important for a good understanding of the trade. Study these words and meanings. When you have learned them, ask your teacher to quiz you on the words and their meanings.

**ANODE ROD**--A rod installed in water heaters to prevent the deterioration of water heaters.

**IMMERSED**--Placed into a liquid.

**COMBUSTION**--The act or process of burning.

**INSULATION**--To cover, for protection against heat loss.

**FLUE**--A passage or duct for smoke or unwanted gases.

**MAGNESIUM**--Silver white metallic element.

**SEDIMENT**--Loose solid matter that settles to the bottom of a liquid.

**THERMOSTAT**--A device that turns a heating and cooling system on and off.

**SENSING BULB**--A delicate device used to "tell" the thermostat to be on or off.

**STORAGE TANK**--A cylinder used to store liquid.

**RETARD**--To delay the progress of, to slow down.

**FUSED**--Combine by melting together.

# Supplementary References

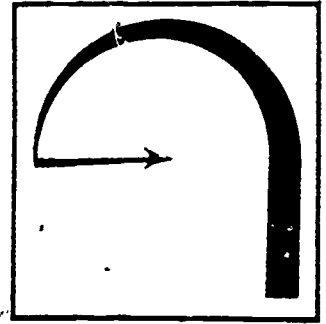

Ripka, L. V. Plumbing Installation and Design. American Technical Society,  
1978. pp. 235-237.

# Information

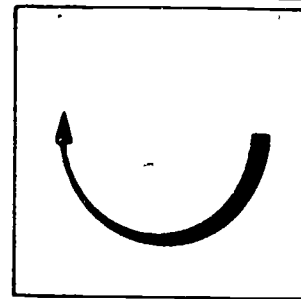

## AUTOMATIC GAS STORAGE TANK WATER HEATER

An automatic gas storage tank water heater uses the heat produced by the burning of gas (natural or liquid petroleum) and transfers this heat to the cold water in the storage tank through the tank bottom and flue.

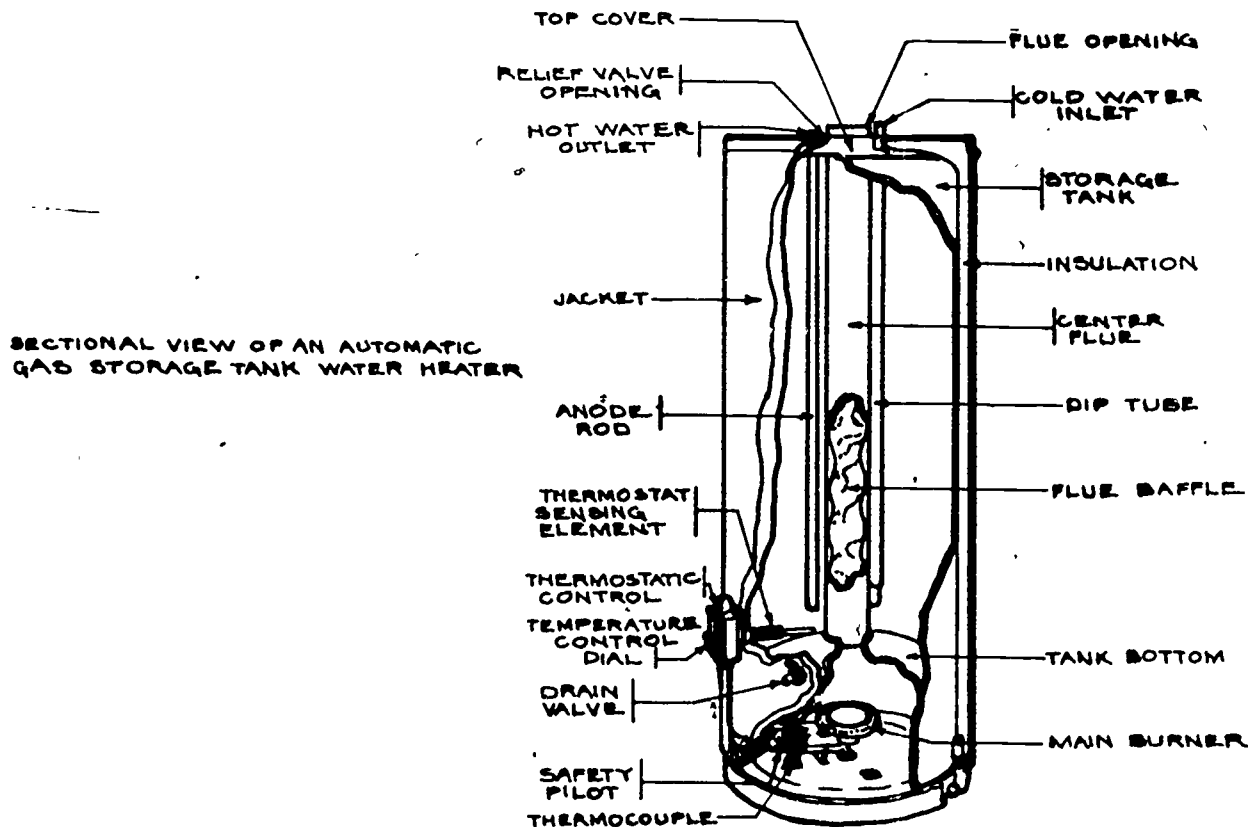

The illustration shows the parts that make up a typical gas storage tank water heater.

Water heaters are made of the following parts:

### Jacket and Top Cover

The jacket and top cover form the outer shell of the water heater. Both pieces are made of steel, finished in baked enamel.

### Insulation

To prevent the water in the tank from losing heat, a layer of insulation is provided between the tank and outer shell.

### Storage Tank

The design of this type of water heater storage tank allows the heated flue gases to cover the entire bottom of the tank before they enter the vertical flue inside the tank. This flue is fitted with a flue baffle to retard the flow of the hot combustion gases and so allow the most heat transfer to take place.

To protect the water heater from the corrosive effects of the hot water it contains, the inside surfaces of the tank are covered with a glass coating. This coating is fused to the steel tank. Water heaters with this glass coating are known as glass-lined.

The top of the water heater has three openings.

1. Cold water inlet. The cold water enters here and through the dip tube. It goes to the bottom, forcing the hot water to the fixture when a hot water faucet or valve is opened.
2. Hot water outlet. The hot water supply for the building is connected here. In this model of water heater, a magnesium anode rod is set into the hot water outlet fitting.
3. Relief valve opening. This opening is placed in water heaters to provide for the installation of a temperature-pressure relief valve.

The side of the water heater has two openings, one of which takes the water heater control and the other, the tank drain valve. The drain valve opening is located as close to the bottom as possible. Draining the tank at least twice a year will prevent any sediment build-up from forming. Build-up will result in discoloration of the water.

The operation of an automatic gas storage tank water heater is regulated by a thermostatic control sensing element immersed in the water which is in the storage tank. This control has a temperature dial which permits the selection of the desired hot water temperature.



When hot water is drawn from the storage tank, it is replaced with cold water. This cools the sensing element, which then turns on the gas to the main burner to heat the water. This same thermostat also shuts off the gas to the main burner when the temperature of the water in the tank reaches the right temperature.

Anytime the water in the tank cools down below the selected temperature, the thermostat will light up the main burner. The main burner is a device for the final delivery of fuel gas or a mixture of fuel gas and air to the combustion chamber, where it is burned to produce heat.

The safety pilot ignites the gas at the main burner when the thermostat turns it on. It is called a safety pilot because if it goes out, the gas supply to the water heater is automatically shut off.

The safety pilot also generates electricity because its flame heats a device called a thermocouple. A thermocouple is a tiny electric generator made of two different metals jointed together firmly. When these metals are heated, a small electric current is created. Although the electric energy is small, it is enough to hold the safety shut-off gas valve open. If the pilot flame becomes too small, or if it goes out, the thermocouple does not produce enough electricity and a spring closes the gas valve. Because of this device, the gas water heater is entirely safe.

#### AUTOMATIC ELECTRIC STORAGE TANK WATER HEATER

An automatic electric storage tank water heater uses the heat produced by the flow of electricity through a resistance wire placed in the heating elements, which are in the storage tank. The illustration at the top of the next page shows a typical electric storage tank water heater.

The following parts are identical to those used in a gas water heater.

1. Jacket and top cover.
2. Insulation.
3. Dip Tube.
4. Anode rod. (Hot water inlet.)
5. Storage tank.

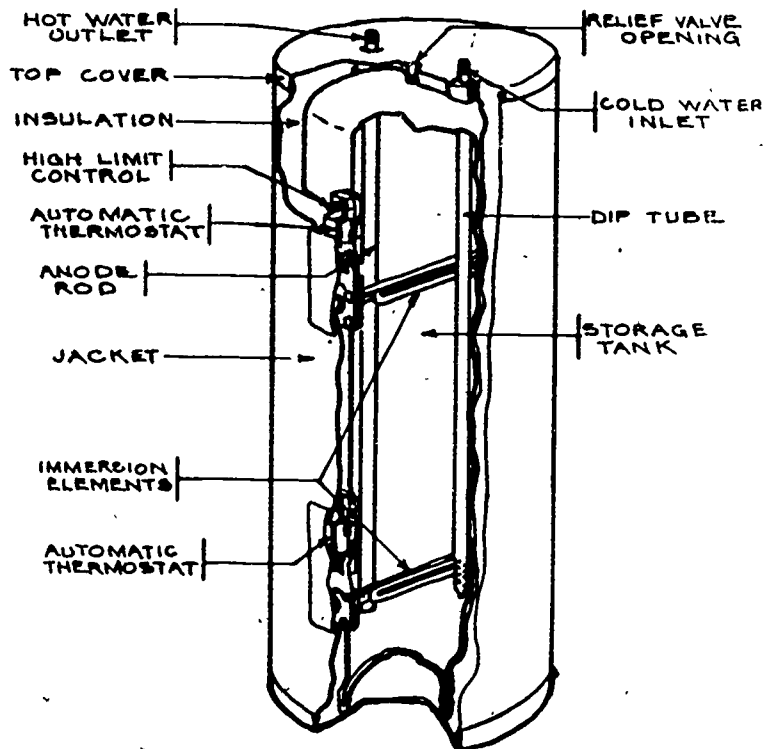

SECTIONAL VIEW OF AN AUTOMATIC  
ELECTRIC STORAGE TANK  
WATER HEATER

Immersion elements are electric heating elements that are exposed to the water for fast heat transfer.

The water heater must be full of water before turning on the electric switch to the heater.

The automatic thermostat is the main device that starts and stops the flow of electricity to the heating elements. Some heaters have a sensing bulb located in the water of the water heater.

Each electric water heater has a high limit control. The purpose of this control is to stop the flow of electricity to the heating element circuit. It is a safety device used to protect against excessive (too high) water temperatures.

A water heater is a potentially dangerous plumbing appliance, if either high temperature or high pressure occurs in the tank. Because of that, a device must be installed to protect the water heater from bursting. (See the illustration at the top of the following page.)

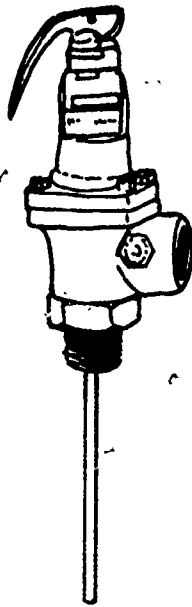

The illustration above is a temperature-pressure relief valve. The heat setting on this valve is 210° Fahrenheit (2° less than the boiling point). The pressure can be either 125 P.S.I. or 150 P.S.I. When the pressure or temperature exceeds this, the tube opens, allowing the pressure and heat to escape through a pipe (that has been installed during the rough plumbing installation)-to the outside of the building.

All water heaters, when installed, must have a full opening valve on the cold water side; also, unions or flex connectors must be installed on the water heaters.

On gas water heaters a gas cock must be installed on the gas supply outlet. Follow the manufacturers suggested starting-up procedure for gas and electric water heaters.

# Self Assessment

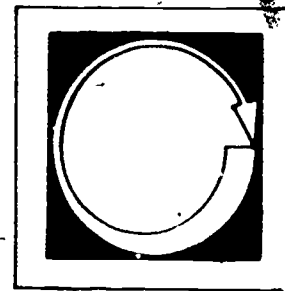

LISTED BELOW ARE SEVERAL STATEMENTS. IF THE STATEMENT IS TRUE, PLACE A "T" IN THE BLANK PROVIDED. IF THE STATEMENT IS FALSE, PLACE AN "F" IN THE BLANK.

1. \_\_\_ A water heater is used to heat water for washing dishes.
2. \_\_\_ There are two types of water heaters used in homes.
3. \_\_\_ All water heaters are thermostatically controlled.
4. \_\_\_ The dip tube on a water heater is installed on the hot water outlet.
5. \_\_\_ The anode tube is installed on the cold water inlet.
6. \_\_\_ The insulation is installed between the tank and the outer shell.
7. \_\_\_ The heated flue gases cover the entire top of the tank.
8. \_\_\_ A flue baffle in a gas-fired water heater is used to slow the flow of hot combustion gases.
9. \_\_\_ A union-type connection must be used on all water heaters.
10. \_\_\_ All water heaters must have a full opening valve on the hot water side.

1. T
2. T
3. T
4. F
5. F
6. T
7. F
8. T
9. T
10. F

342

349

● **Self Assessment  
Answers**

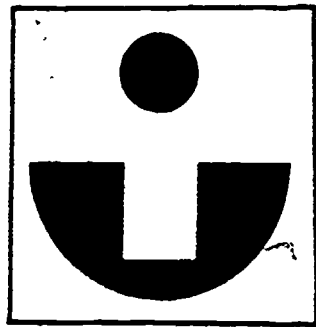

# Assignment

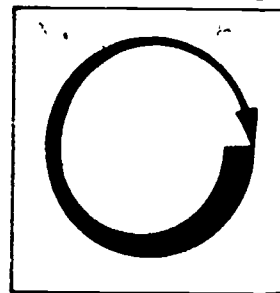

COMPLETE THE FOLLOWING ASSIGNMENT.

Examine the water heater in your home. Study the identification plate which is mounted on the outer shell of the water heater.

Bring back the following information to your instructor.

1. Type of water heater.
2. Amount (in gallons).
3. Where is the temperature-pressure relief valve?
4. Size of hot and cold water storage?
5. What type connections are there from the water supply to water heater?

# Post Assessment

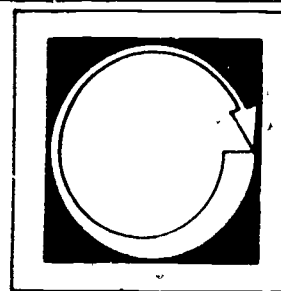

COMPLETE THE FOLLOWING STATEMENTS BY WRITING THE CORRECT WORD OR WORDS IN THE BLANKS PROVIDED.

1. The dip tube is installed on the \_\_\_\_\_ water side.
2. All water heaters are \_\_\_\_\_ controlled.
3. There are \_\_\_\_\_ types of water heaters used in the home.
4. A \_\_\_\_\_ connection must be installed on all water heaters.
5. A \_\_\_\_\_ must be installed on all gas-fired water heaters.
6. The temperature setting on the temperature pressure relief valve is \_\_\_\_\_°.
7. A \_\_\_\_\_ is installed in water heaters to prevent deterioration.
8. \_\_\_\_\_ is used to protect against heat loss.
9. \_\_\_\_\_ enters through the dip tube.
10. \_\_\_\_\_ is provided in water heaters for the installation of a temperature-pressure relief valve.



11. The drain valve is located as \_\_\_\_\_ as possible.
12. The water heater should be drained at least \_\_\_\_\_ a year.
13. When \_\_\_\_\_ water is drawn, \_\_\_\_\_ water takes its place.
14. The \_\_\_\_\_ is a device for the final delivery of fuel gas.
15. The \_\_\_\_\_ ignites the gas at the main burner when the thermostat turns it on.
16. Electric water heaters must be \_\_\_\_\_ of water before turning on the \_\_\_\_\_.

# Instructor Post Assessment Answers

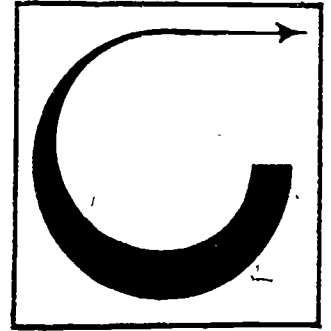

1. cold
2. thermostatically
3. two
4. union type
5. gas cock
6. 210°
7. anode rod
8. insulation
9. cold water
10. relief valve opening
11. low
12. twice
13. hot, cold
14. main burner
15. safety pilot
16. full, switch

---

REPAIR

---

**Goal:**

The student will be able to identify and explain different types of repair to valves, water closets and water heaters.

**Performance Indicators:**

The student will demonstrate understanding of the subject by successfully completing a Self Assessment, a Job Sheet and a Post Assessment.

# Study Guide

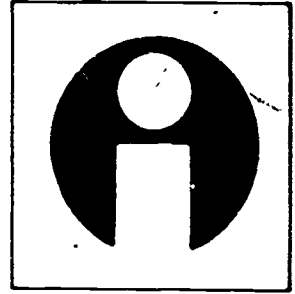

In order to finish this module, do the following tasks. Check each item off as you complete it.

1.  Read the Goal and Performance Indicators on the cover of the module. This will tell you what you will learn by studying the module, and how you will show you've learned it.
2.  Read the Introduction. The Introduction will tell you why the module is an important part of the plumbing trade.
3.  Study the Vocabulary section. Vocabulary words are important for a good understanding of the trade. After you have studied the vocabulary, ask your teacher to quiz you on the words and their meanings.
4.  Study the Information section. This section will give you the information you need to understand the subject.
5.  Take the Self Assessment exam. This is a test for you to prove to yourself that you have learned the material you have studied. Compare your answers with the answers on the Self Assessment Answer Sheet, which is on the page following the Self Assessment. If you scored poorly, re-study the Information section or ask your teacher for help.
6.  Do the Job Sheet. Follow the instructions at the top of the Job Sheet. The tasks listed on the Job Sheet will help you develop skills which will be helpful to you.
7.  Take the Post Assessment exam. Give the exam to your teacher after you have completed it. Your teacher will grade it for you.

# Introduction

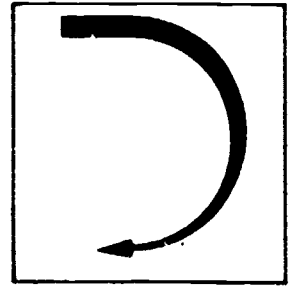

Maintenance and repair problems requiring the attention of the plumber include:

1. Stoppage of fixture outlets and of drain pipes.
2. Burst or leaking pipes.
3. Leaking faucets and other valves.
4. Low water supply pressures.
5. Frozen pipes.
6. No hot water.
7. No cold water.
8. Dirty water.
9. Bad odors.

To detect the causes and to make repairs will require knowledge, ingenuity and equipment. In this module we will concentrate on the repair of valves, water closets and water heaters.

# Vocabulary

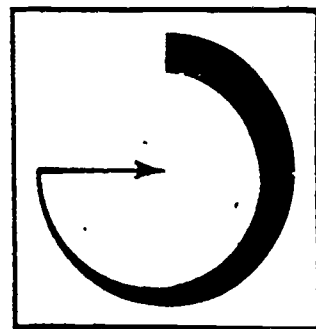

Trade terms are very important for a good understanding of the trade. Study these words and meanings. When you have learned them, ask your teacher to quiz you on the words and their meanings.

THREADED SPINDLE--A valve stem.

PACKING--A substance packed around the top of a valve stem to prevent water from escaping.

THERMOSTAT--Used to control the temperature.

THERMOCOUPLE--Device to carry gas to the pilot light.

# Supplementary References

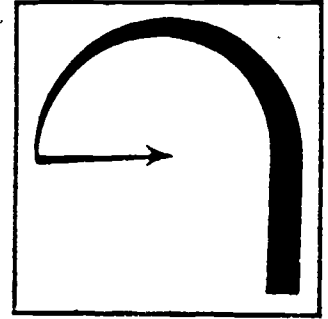

Plumbing. McGraw-Hill, 1976. pp. 465, 472-473.

# Information

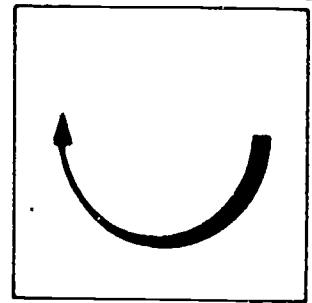

Through the years, plumbing fixtures have gone through many stages of design. Parts made for one faucet or fixture seldom fit another. The key to repair is simple: Just replace each part with a duplicate. Learning which part is required is more than half the task of repair.

The first step is to find the manufacturer and model number. Washers that "almost fit" seldom work. Get the exact size, as well as the right kind--rubber, fiber, nylon, leather, etc.

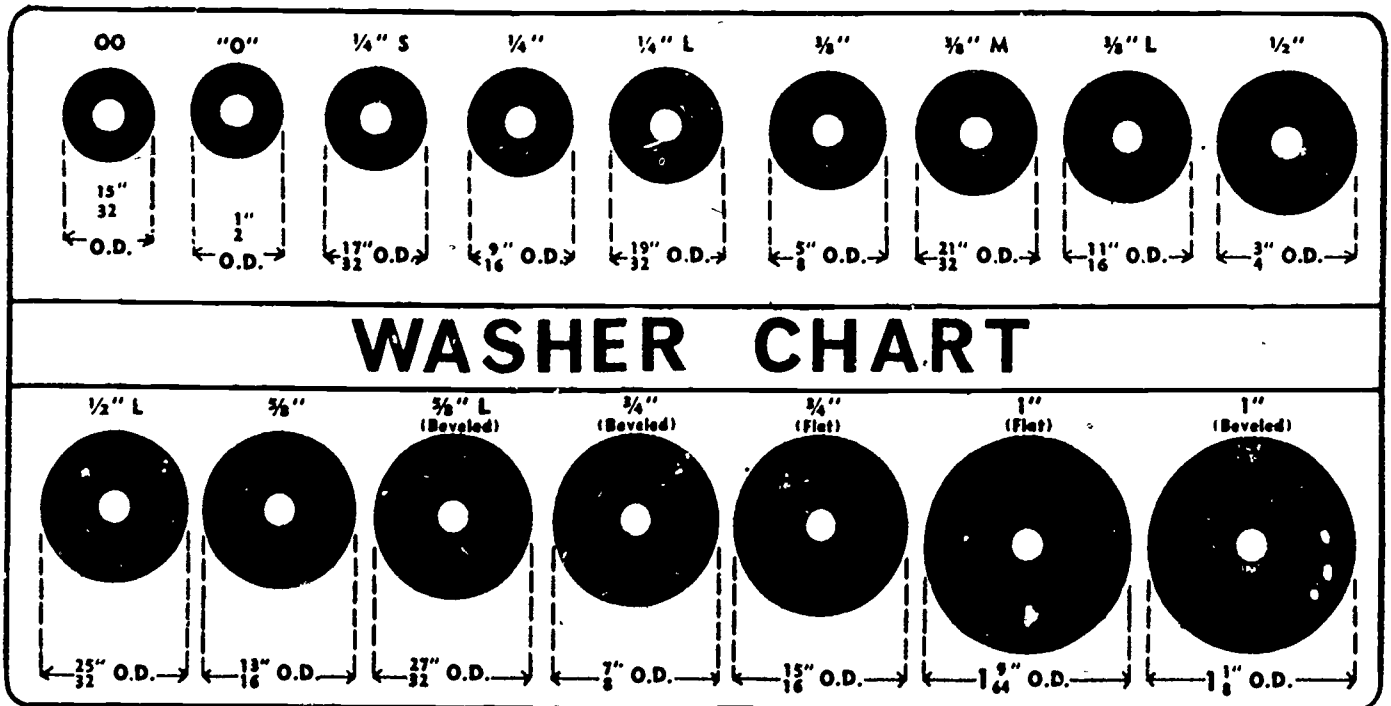

Faucet washer sizes have been standardized. The illustration (above) shows the size and number. (This makes it easier when ordering or buying.)



## FAUCET REPAIR

A compression faucet is the faucet found at the end of most of the hot and cold water piping in our homes, offices and factories. (It is called a compression faucet because when you turn the handle to shut off the flow of water, the stem moves down into the body of the faucet, and a washer is compressed against the opening that passes water from one end of the faucet to the other.)

The illustration below shows the parts of the compression faucet and their relation to one another. When the threaded spindle or valve stem is turned, the washer on the bottom end moves down and seals itself against the top of the seat, stopping all flow of water. When the faucet is open and the spindle or valve stem is in its raised position, the water can slip past the threaded spindle, up along the stem until it reaches the packing. The packing stops water moving in this direction: Instead, the water goes out the spout.

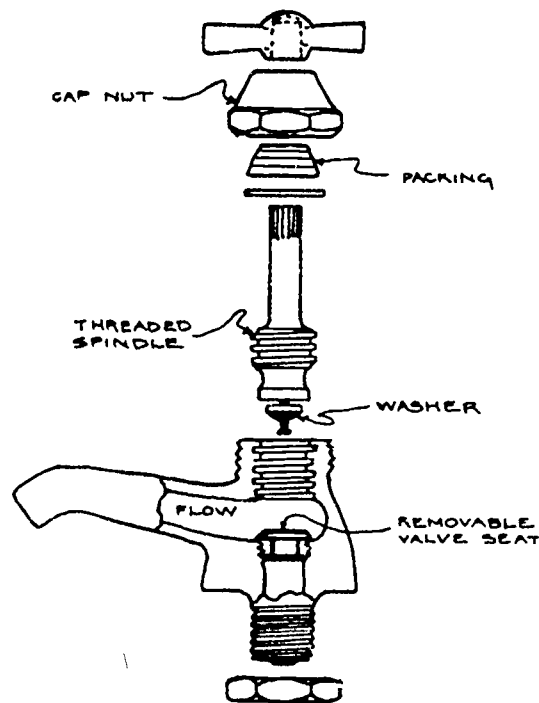

There are several major points of wear in a faucet of this type.

1. The washer wears as it is repeatedly tightened against the valve seat.
2. The packing wears as the spindle is turned.

3. The seat wears as the washer rubs against it and as the water flows over its edge.
4. The spindle itself wears along its thread and along the area in contact with the packing.

A faucet in proper working condition will shut off the flow of water completely with little more than light finger pressure on its handle. A faucet in proper working condition does not leak water at its stem when it is opened.

1. Leakage through the faucet spout is due to wear at the washer and/or seat.
2. Leakage past the stem is due to a worn stem and packing.

These are two independent problems. A leak at the washer does not affect a leak at the stem, and vice versa.

When heavy pressure is required in order to completely close a faucet, its washer and/or seat will soon become defective and need to be replaced or repaired. If a repair is not made, the washer will be chewed up very quickly and the water will leak out badly no matter how much pressure is applied.

The following steps show how to remove the stem and repair the faucet.

1. Pry off cap which covers the screw that holds handle in place.

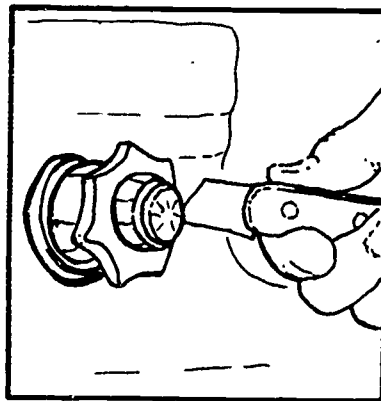

2. Remove screw.

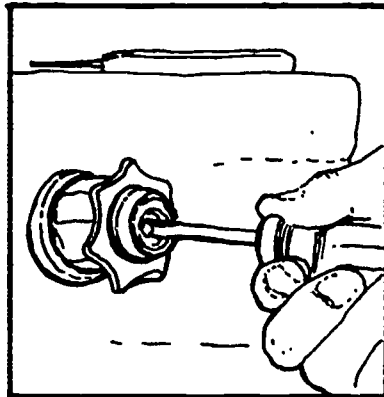

3. Use wrench to loosen valve assembly.

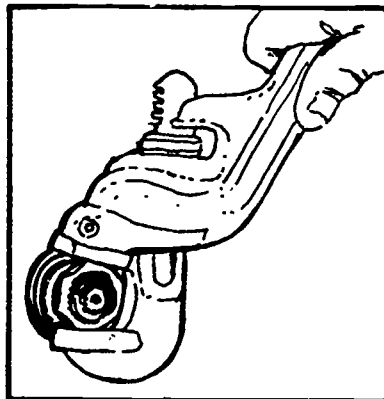

4. Remove valve assembly.

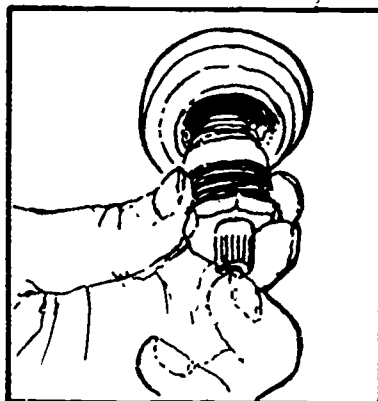

5. Use seat-removal tool and wrench to remove seat. (Turn counter-clockwise.)

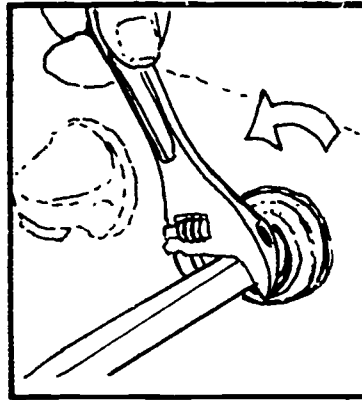

6. Match seat size of old seat with new seat.

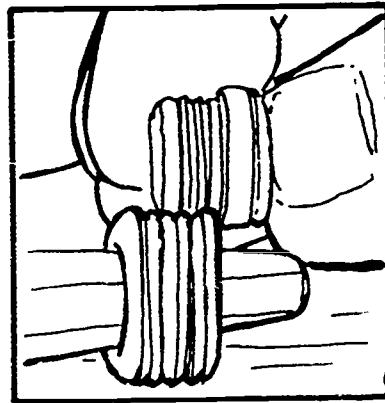

7. Slip new seat on end of seat-removal tool and replace. Put the rest together.

#### TOILET REPAIR

If water keeps running, remove the top of the water tank. If the water level is above the overflow pipe, the ballcock valve (the valve that admits water to the tank) has not closed.

1. The valve washer and/or seat may be worn.
2. Check by lifting the float. If the water flow stops, you can assume for the moment that the valve is okay.

3. Check the float by unscrewing it and shaking it. If you hear water inside, it has a leak and must be replaced.
4. If there is no leak, its position in relation to the ballcock valve may be too high.
  - a. Check the rod that holds the ball. It may be loose and may have turned on its axis. Usually it is screwed into the ballcock valve mechanism, but in some valves it is held in place by a thumb screw.
  - b. Tighten the screw.
  - c. Lift the stopper ball (by hand) to let some water out of the tank.
  - d. Push it down to stop the flow. Water will now enter the tank. The float will rise.
  - e. If the inflow of water stops about 1" below the top of the overflow pipe or at the level mark inside the tank, operate the handle a few times to make certain the parts do not touch each other.
  - f. If the water goes above the overflow tube, bend the rod downward to the point that, when you fill it again, the water stays below the overflow tube by about 1 inch.
5. When the handle must be held down, it is due to a ruptured stopper ball.
  - a. Replace the ball by unscrewing the brass rod from the ball and screwing it into the new stopper ball.
6. If the tank lever arm has to be jiggled to operate, open the tank cover and see that nothing is touching the brass rods. The rods may need to be bent or replaced.

#### WATER HEATER REPAIR

Since there are not many parts in a water heater, the need for repair is limited.

In electric and gas water heaters, the dip tube that is inserted in the cold water inlet may be replaced if more cold water is coming from the hot water outlet than hot. This is due to the overworking of the thermostat.

1. Simply disconnect the union on the cold water inlet and lift the fill tube out; replace it with a new one.

Tanks may be replaced if they are leaking. In most instances, it is cheaper to replace the water heater than the tank.

In electric water heaters, the heating element may need to be replaced if the temperature of the hot water has not reached the temperature desired.

1. Turn the electricity off.
2. Drain the tank through the drain valve at the bottom.
3. Unbolt the electrical heating element and replace it with a new heating element.
4. Bolt the element to the tank.
5. Fill tank with water.
6. Turn the electricity back on at the panel. (NEVER, NEVER turn on the electricity unless the water heater is full of water.)

Gas-fired water heaters have a thermostatic control valve that is inserted in the tank (much like the electric water heater). This valve needs replacing when the thermostat won't give the temperature that is desired.

1. The valve is a single unit. It is removed and replaced after the water heater is drained. It merely screws into the tank wall.

When the pilot refuses to stay lit, the thermocouple should be replaced. To replace the thermocouple:

1. Unscrew the old one from the thermostatic controlled valve.
2. Replace the thermocouple with the same type and length.

# Self Assessment

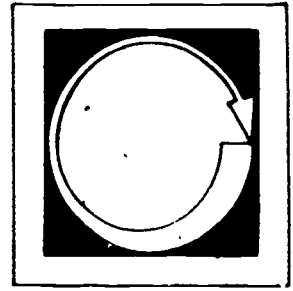

LISTED BELOW ARE SEVERAL STATEMENTS. IF THE STATEMENT IS TRUE, PLACE A "T" IN THE BLANK PROVIDED. IF THE STATEMENT IS FALSE, PLACE AN "F" IN THE BLANK.

1.  Most parts that fit one valve will fit another.
2.  One of the first things in repair is to look for the manufacturer's name.
3.  Washers should be replaced with washers of the same material.
4.  The valve stem is sometimes called a threaded spindle.
5.  The faucet washer wears or erodes as it is tightened against the valve seat.
6.  Leakage through the faucet spout is due to too much wear of the washer or seat.
7.  The ballcock is the valve in a lavatory.
8.  The stopper ball, when lifted, will supply water to a water closet.
9.  A thermocouple is used in an electric water heater.
10.  There is a dip tube in both gas and electric water heaters.

# Self Assessment Answers

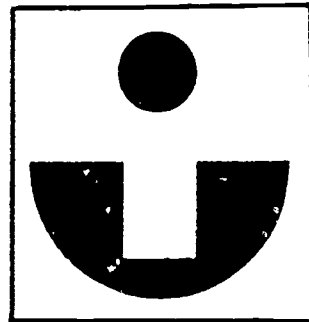

1. F
2. T
3. T
4. T
5. T
6. T
7. F
8. T
9. F
10. T



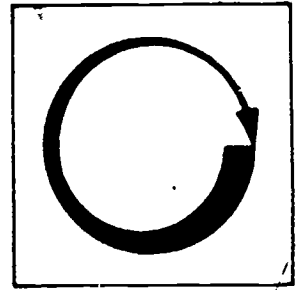

# Job Sheet

COMPLETE THE FOLLOWING TASKS.

Materials and Tools

faucet assembly

tools

washer

valve seat and tool

Take a faucet apart and put it back together--both hot and cold water.

# Post Assessment

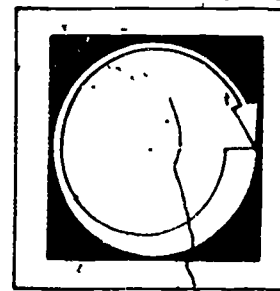

COMPLETE THE FOLLOWING STATEMENTS BY WRITING THE CORRECT WORD OR WORDS IN THE BLANKS PROVIDED.

1. The first thing to look for in repair is the \_\_\_\_\_.
2. The valve stem is sometimes called a \_\_\_\_\_.
3. The \_\_\_\_\_ supplies water to the toilet tank.
4. A thermocouple is used in a \_\_\_\_\_ water heater.
5. Both gas and electric water heaters have a \_\_\_\_\_.
6. The drain valve is located on the \_\_\_\_\_ of a water heater.
7. Replace washers with the same \_\_\_\_\_.
8. The faucet washer wears as it is tightened against the \_\_\_\_\_.
9. Electricity to the water heater should not be turned on until the tank \_\_\_\_\_.

# Instructor Post Assessment Answers

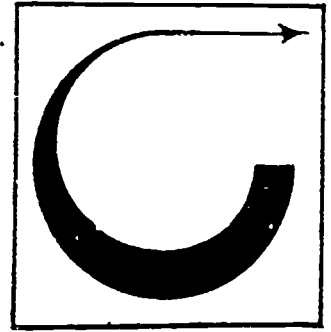

1. manufacturer's name
2. threaded spindle
3. ballcock
4. gas
5. dip tube
6. bottom
7. material
8. valve seat
9. is full of water

SEWER CLEANING AND TOOLS

**Goal:**

The student will be able to identify and explain the different types of cleaning methods and types of sewer cleaning equipment.

**Performance Indicators:**

The student will demonstrate an understanding of the subject by successfully completing a Self Assessment and a Post Assessment.

# Study Guide

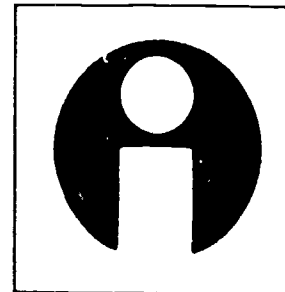

In order to finish this module, do the following tasks. Check each item off as you complete it.

1.  Read the Goal and Performance Indicators on the cover of the module. This will tell you what you will learn by studying the module, and how you will show you've learned it.
2.  Read the Introduction. The Introduction will tell you why the module is an important part of the plumbing trade.
3.  Study the Information section. This section will give you the information you need to understand the subject.
4.  Take the Self Assessment exam. This is a test for you to prove to yourself that you have learned the material you have studied. Compare your answers with the answers on the Self Assessment Answer Sheet, which is on the page following the Self Assessment. If you scored poorly, re-study the Information section or ask your teacher for help.
5.  Take the Post Assessment exam. Give the exam to your teacher after you have completed it. Your teacher will grade it for you.

# Introduction

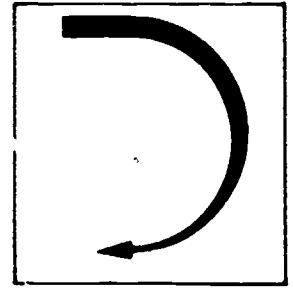

Sewer stoppages are due mostly to carelessness in flushing things down the toilet and sinks.

Paper towels, feminine napkins, toys, paper and plastic cups, grease, bits of food, hair or roots from trees all create plumbing problems.

# Supplementary References

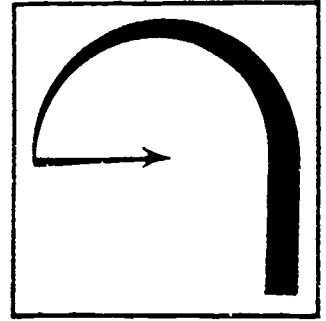

Plumbing (Third Edition), McGraw Hill. 1960. pp. 472-473.

# Information

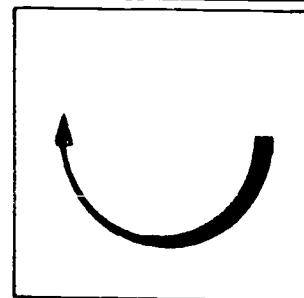

To repair stoppage of lavatories and similar fixtures:

1. Fill the fixture with water and push up and down with the plunger to unplug the stoppage and force it down the drain.
2. Covering the overflow will help to concentrate the pressure produced on the drain.

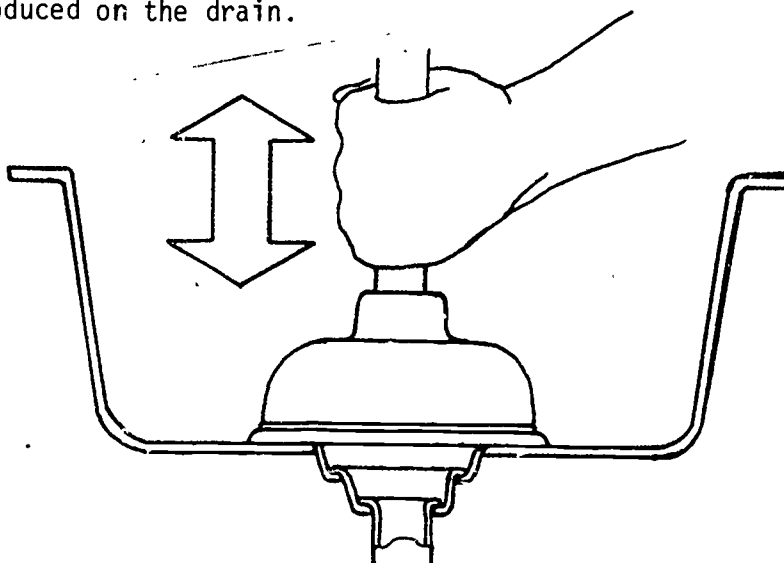

3. If this does not clear the stoppage, remove the water and disconnect the P-trap. (Place a bucket under the P-trap to receive the excess water.)
4. After the P-trap has been disconnected, insert the drain cleaner or (top snake) cable into the waste outlet, pushing the cable all the way in. (See the illustration on the top of the following page for an example of the tools.)
5. When it stops, pull the trigger on the top snake and push and pull gently back and forth until the stoppage unplugs.
6. Re-connect the P-trap and run the hot water to make sure that it has unplugged. If it has, when the fixture is filled, the water should have a swirling action to it as it drains.



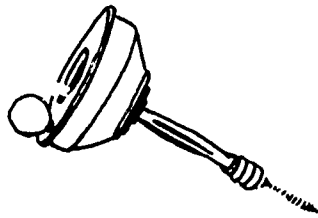

HAND SPINNER

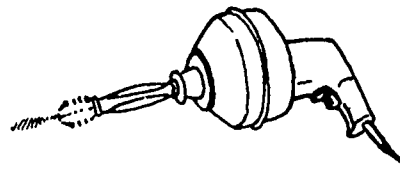

PORTABLE ELECTRIC

7. If it has not cleared the stoppage, repeat the clearing procedure.

#### STOPPAGE OF A WATER CLOSET

The water closet plunger should be used first. If this doesn't work, a closet auger (below) should be used.

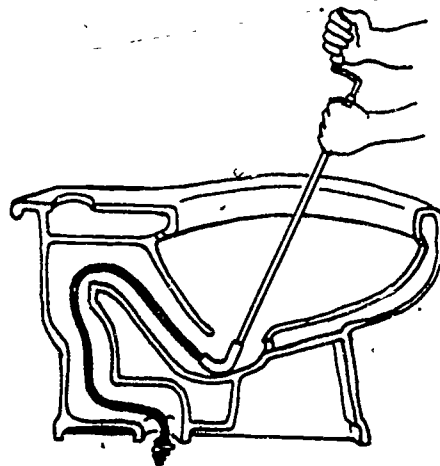

▲  
CLOSET  
AUGER

This is used by letting the heel (made of plastic) rest on the bottom of the water closet. Push down and turn the handle at the same time. If stoppage is caused by paper or cloth, it may wrap around the cable so that it can be pulled out of the pipe.

Cakes of soap, soap brushes, and other hard objects may become lodged in the trap, making it necessary to disconnect the fixture at its base. Care must be

replacing the fixture make sure the seal between the fixture and the drain pipe is sewer gas-tight. A new bolwax should always be used after a water closet has to be pulled up and repaired or replaced.

#### STOPPAGE OF DRAIN PIPES WITHIN THE BUILDING

Through a cleanout (provided when the rough plumbing was installed) insert a flexible wire or small sewer cleaning machine into the clogged pipe.

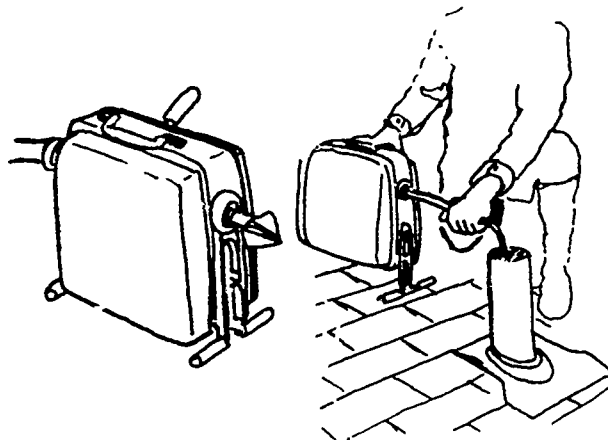

Try to push the object along the pipe or to entangle it on the wire and pull it out.

If the pipe is only partially closed and water will still flow, flush it with hot water and a drain pipe solvent or substance that creates enough heat in the drain pipe to cause grease to turn into a liquid. Continue until the stoppage is cleared.

#### STOPPAGE OF THE BUILDING SEWER

Access to the sewer may be gained through the cleanout (usually located in the basement) or through a two-way cleanout outside the building (within 5 feet).

Stoppage of the building sewer is usually caused by roots, grease or hard objects. All stoppages must be pushed or washed into the public sewer or other outlet, such as a septic tank.

Tree roots, particularly those of the poplar, willow and elm, will enter a sewer through tiny holes in the joints and grow in the sewer. Fungus growths occasionally cause trouble in sewers by forming and building a barricade across the sewer.

The illustration (below) shows a sewer cleaning machine used in clearing the stoppages in the building sewer.

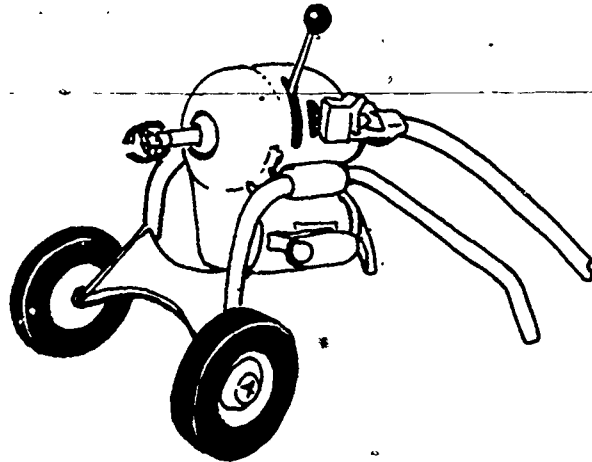

Most machines use 7/8" cable and each section is 75 or 100 feet in length. Additional sections may be connected. A cutter is attached to the end.

The first cutter used is the spade cutter. It will bore a hole through the stoppage or push it through. If the spade cutter does not clear the stoppage entirely, it usually means that there are roots in the sewer pipe. Use the "H" cutter for roots. Work it back and forth. (This usually takes much longer.) After the roots have been cut, attach the expanding finish cutter. This cutter enables the inside walls of the sewer pipe to be cleared.

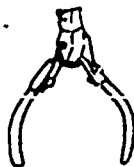

At all times, when using the sewer machine, keep water running in the pipe to push and clean as the cable is clearing the stoppage.

# Self Assessment

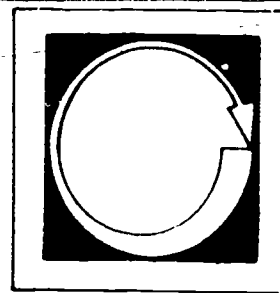

LISTED BELOW ARE SEVERAL STATEMENTS. IF THE STATEMENT IS TRUE, PLACE A "T"  
IN THE BLANK PROVIDED. IF THE STATEMENT IS FALSE, PLACE AN "F" IN THE BLANK.

1.  A closet auger is used to clear the stoppage in a lavatory.
2.  Covering the overflow will help to clear the stoppage in a lavatory.
3.  The draining water should have a swirling action after the stoppage has been cleared.
4.  The old bolwax should be used when replacing a water closet.

# Self Assessment Answers

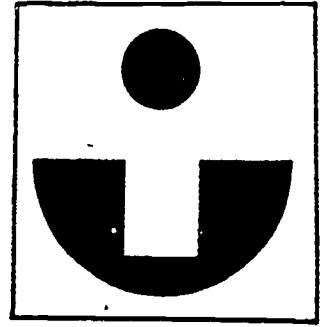

1. F

2. T

3. T

4. F

373

350

# Post Assessment

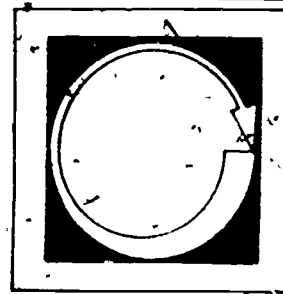

COMPLETE THE FOLLOWING STATEMENTS, BY WRITING THE CORRECT WORD OR WORDS IN THE BLANKS PROVIDED.

1. The water should have a \_\_\_\_\_ after the stoppage has been cleared.
2. A new \_\_\_\_\_ should be used when replacing a water closet.
3. A \_\_\_\_\_ is used to clear a stoppage of a water closet.
4. The \_\_\_\_\_ should be the first cutter used when using the sewer machine.
5. Access to the sewer is made through the \_\_\_\_\_.

# Instructor Post Assessment Answers

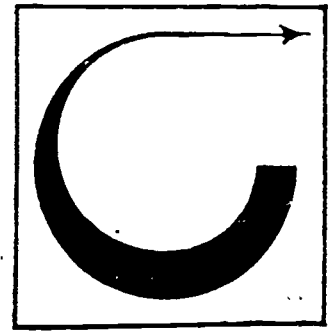

1. swirling action
2. bolwax
3. toilet auger
4. spade cutter
5. cleanout

## SPECIALTY BUILDINGS

### Goal:

The student will be able to identify and explain the different types of equipment, fixtures and piping used in hospitals, restaurants and schools.

### Performance Indicators:

The student will demonstrate an understanding of the subject by successfully completing a Self Assessment and a Post Assessment.



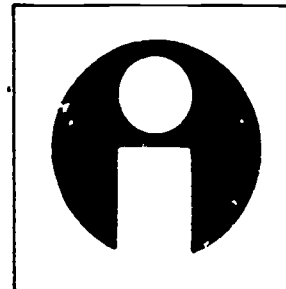

# Study Guide

In order to finish this module, do the following tasks. Check each item off as you complete it.

1.  Read the Goal and Performance Indicators on the cover of the module. This will tell you what you will learn by studying the module, and how you will show you've learned it.
2.  Read the Introduction. The Introduction will tell you why the module is an important part of the plumbing trade.
3.  Study the Vocabulary section. Vocabulary words are important for a good understanding of the trade. After you have studied the vocabulary, ask your teacher to quiz you on the words and their meanings.
4.  Study the Information section. This section will give you the information you need to understand the subject.
5.  Take the Self Assessment exam. This is a test for you to prove to yourself that you have learned the material you have studied. Compare your answers with the answers on the Self Assessment Answer Sheet, which is on the page following the Self Assessment. If you scored poorly, re-study the Information section or ask your teacher for help.
6.  Take the Post Assessment exam. Give the exam to your teacher after you have completed it. Your teacher will grade it for you.

# Introduction

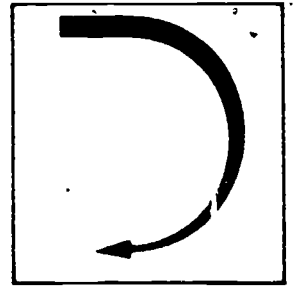

This module will give a brief explanation of the piping, fixtures, equipment, and the safety precautions used in the connecting of plumbing equipment in schools, restaurants and hospitals.

# Vocabulary

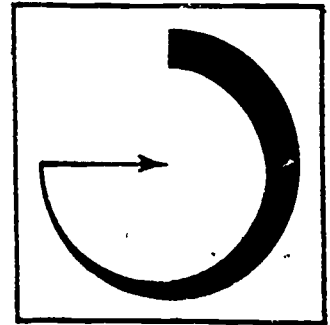

Trade terms are very important for a good understanding of the trade. Study these words and meanings. When you have learned them, ask your teacher to quiz you on the words and their meanings.

**INDIRECT WASTE**--A pipe that does not connect directly with the drainage system but conveys liquid wastes by discharging into a plumbing fixture by means of an air break.

**AIR BREAK**--A separation between the drain pipe, from an indirect waste to a floor drain or floor sink.

**VACUUM BREAKER**--Used to prevent waste water from entering the potable water supply through back siphonage.

# ● Supplementary References

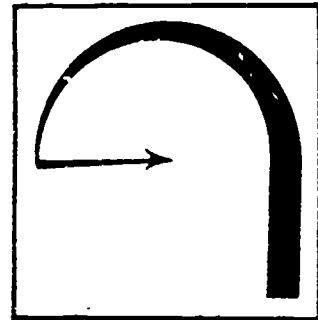

Uniform Plumbing Code Illustrated Training Manual. International Association  
of Plumbing and Mechanical Officials, 1979. pp. 216-219, 330-332.

# Information

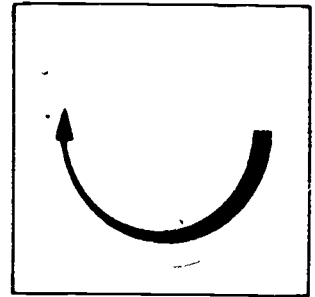

## RESTAURANTS

The most common equipment and fixtures used in restaurant kitchens are:

1. Commercial dishwasher.
2. Commercial garbage disposal.
3. 3-compartment pot sinks.
4. Ice makers.
5. Grease traps.
6. Floor drains and floor sinks.
7. Walk-in coolers.
8. Salad bars.
9. Bar sinks.
10. Fruit and vegetable preparatory sink.

Commercial dishwashers come completely piped, including a vacuum breaker installed on the hot water inlet and 6" above the top of the dishwasher. A vacuum breaker is installed when the water inlet is located lower than the overflow rim for which it serves, so that no back siphonage may occur and cause liquid waste to enter the potable water supply.

Like all plumbing fixtures, this must also be trapped and vented.

A commercial garbage disposal must be trapped independently of the other fixtures.

## INDIRECT WASTES

The illustration on the top of the following page shows a typical indirect waste from a food preparation sink (vegetables, meat, and fruit). The reason for the indirect waste is that in a case of a stoppage, it will back up over the floor drain or floor sink.

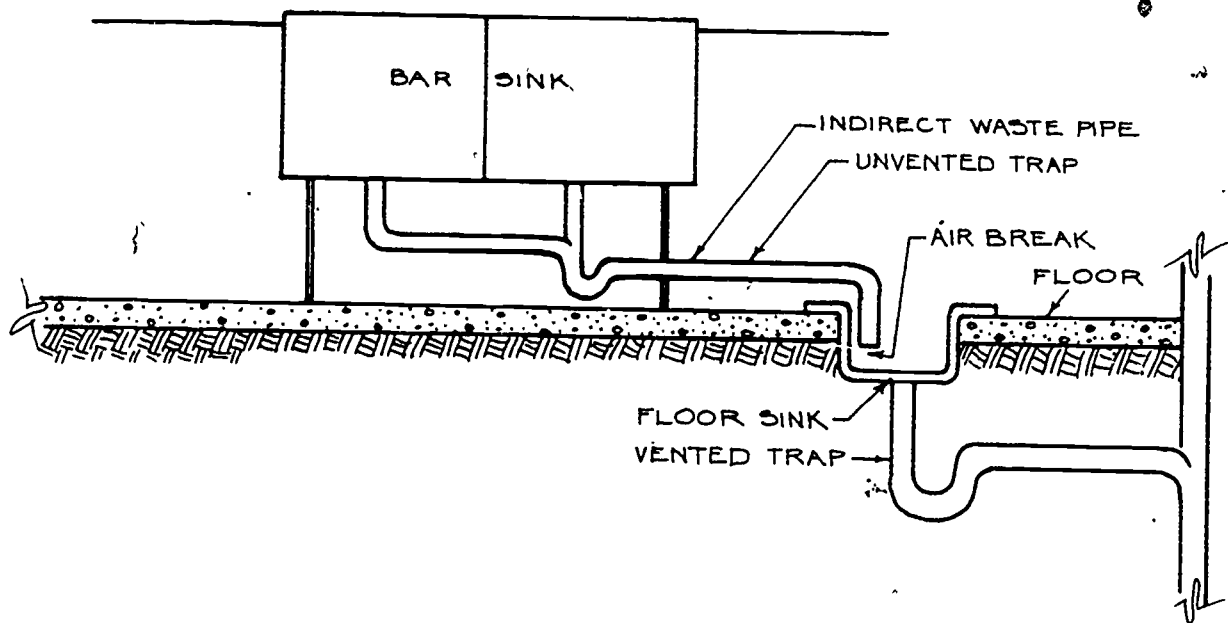

Other fixtures that must be connected by an indirect waste are ice-makers, walk-in coolers, salad bars and others.

Three-compartment pot sinks are piped to a "grease interceptor" through a flow control valve that is located between the grease interceptor and the sink. The flow control valve is needed to make sure that the solids will stay in the grease interceptor and only liquids will drain into the sanitary sewer system. No stoppages will occur in the drainage system if only liquid is allowed to drain.

When solids fill a grease interceptor they are disposed of in special containers and processed for other uses.

A different type of interceptor is used in gas stations, veterinary clinics, morgues, hospitals and dental clinics. They all have the same purpose, and that is to retain the solids while allowing the liquids to escape into the sanitary sewer system.

## HOSPITALS AND DENTAL CLINICS

There is a large variety of piping and specialty plumbing fixtures that are installed in hospitals and dental clinics. Air, oxygen and vacuum piping (copper type "L" pipe) is used a lot. The inside of the pipe goes through a special cleaning process to remove any oil or dirt particles. The pipe and fittings are connected by brazing with silver solder. To assure cleanliness in the pipe and fittings during installation, nitrogen, a non-combustible gas, is allowed to flow freely throughout the pipe from an opening during the brazing process.

X-ray developing tanks are usually made of lead. This equipment is also connected to the sanitary sewer separately.

## SCHOOLS

For the most part, the plumbing in schools is the same as in hospitals and restaurants.

The cafeteria has the same type of plumbing fixtures that are used in restaurants.

In chemistry classrooms, as in hospitals, there is oxygen, air and gas piping. The gas piping is either black or galvanized screwed-type pipe and fittings. The waste piping used in chemistry classrooms must be acid resistant.

An example of this is pyrex glass piping. Its ends are formed by using heat until the ends are flared (like the shape of a copper flared fitting). A special band and gasket made for acid resistance is then used to connect pipe and fitting together. The fittings are all flared when they are formed.

Another type of acid-resistant piping is corrosiron. Corrosiron is made in a cast from cast iron, fiberglass and other non-corrosive and acid-resistant materials. This piping comes with bell and spigot and is assembled the same way as bell and spigot cast iron piping. Lead is used and pipe is caulked the same way as in regular bell and spigot cast iron. The difference is in the oakum. An acid-resistant hemp coated with plaster and cement is used instead of oakum.

Corrosiron pipe has a very thick wall and is brittle. It must be handled with a lot of care when it's installed. It is probably one of the most expensive piping systems to install.

# Self Assessment

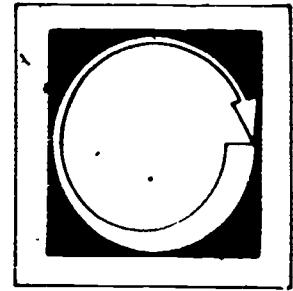

LISTED BELOW ARE SEVERAL STATEMENTS. IF THE STATEMENT IS TRUE, PLACE A "T" IN THE BLANK PROVIDED. IF THE STATEMENT IS FALSE, PLACE AN "F" IN THE BLANK.

1. \_\_\_ A vacuum breaker installed on a commercial dishwasher must be 6" above the unit.
2. \_\_\_ A vacuum breaker is needed when the potable water inlet is below the overflow rim.
3. \_\_\_ A commercial garbage disposal may be connected to another plumbing fixture before it is trapped.
4. \_\_\_ An indirect waste may be connected to the sink.
5. \_\_\_ Ice makers must be connected by means of an indirect waste.
6. \_\_\_ Pot sinks may be connected directly to the drainage system.
7. \_\_\_ Oxygen piping must have gone through a special cleaning process before installation.
8. \_\_\_ Oxygen piping may be soldered with 50-50 solder.



# Self-Assessment Answers

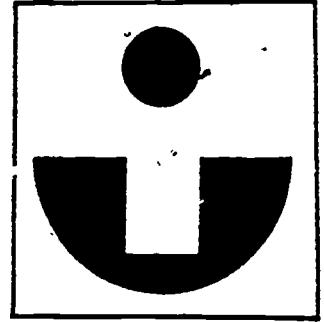

1. T

2. T

3. F

4. F

5. T

6. F

7. T

8. F

# Post Assessment

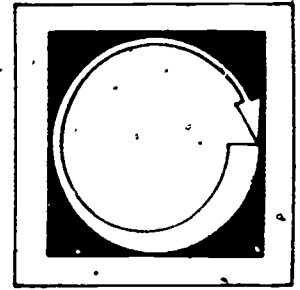

COMPLETE THE FOLLOWING STATEMENTS BY WRITING THE CORRECT WORD OR WORDS IN THE BLANKS PROVIDED.

1. Nitrogen is a \_\_\_\_\_ gas.
2. X-ray developing tanks are usually made of \_\_\_\_\_.
3. Chemistry classroom piping must be \_\_\_\_\_.
4. Corrosion piping comes with \_\_\_\_\_ and \_\_\_\_\_.
5. A commercial garbage disposal must be independently \_\_\_\_\_.
6. A vacuum breaker is needed when the potable water inlet is below the \_\_\_\_\_.
7. An indirect waste must be connected to a \_\_\_\_\_ or a \_\_\_\_\_.
8. A food preparation sink must be connected to the drainage system by means of an \_\_\_\_\_.

# Instructor Post Assessment Answers

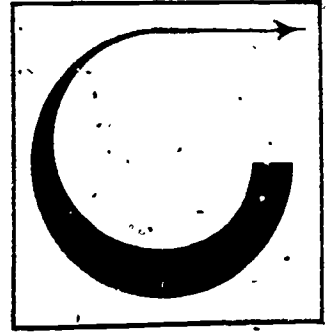

1. non-combustible
2. lead
3. acid resistant
4. bell, spigot
5. trapped
6. overflow rim
7. floor sink, floor drain
8. indirect waste