

DOCUMENT RESUME

ED 210 506

CE 030 778

TITLE Energy Production Systems. Energy Technology Series.

INSTITUTION Center for Occupational Research and Development, Inc., Waco, Tex.; Technical Education Research Centre-Southwest, Waco, Tex.

SPONS AGENCY Office of Vocational and Adult Education (EI), Washington, D.C.

BUREAU NO 498AH80027

PUB DATE Sep 81

CONTRACT 300-78-0551

NOTE 260p.; For related documents see CE 030 771-789 and ED 190 746-761.

AVAILABLE FROM Center for Occupational Research and Development, 601 Lake Air Dr., Waco, TX 76710 (\$2.50 per module; \$17.50 for entire course).

EDRS PRICE MF01 Plus Postage. PC Not Available from EDRS.

DESCRIPTORS Adult Education; Behavioral Objectives; Course Descriptions; Courses; *Energy; Energy Conservation; Engines; *Fuel Consumption; *Fuels; Glossaries; Laboratory Experiments; Learning Activities; Learning Modules; Nuclear Energy; Postsecondary Education; *Power Technology; Solar Radiation; *Technical Education; Two Year Colleges

IDENTIFIERS Energy Consumption

ABSTRACT

This course in energy production systems is one of 15 courses in the Energy Technology Series developed for an Energy Conservation-and-Use Technology curriculum. Intended for use in two-year postsecondary technical institutions to prepare technicians for employment, the courses are also useful in industry for updating employees in company-sponsored training programs. Comprised of seven modules, the course is an in-depth technical study of the processes and equipment used to convert fuels and energy resources into useful energy forms (electricity, heat, motion). The first four modules emphasize fuels and energy sources, examine their properties, and describe how they are used to produce steam and hot water. The final three modules emphasize how energy is used. Written by a technical expert and approved by industry, each module contains the following elements: introduction, prerequisites, objectives, subject matter, exercises, laboratory materials, laboratory procedures (experiment section for hands-on portion), data tables (included in most basic courses to help students learn to collect or organize data), references, and glossary. Module titles are Generation of Steam and Hot Water Using Solid Fuels; Generation of Steam and Hot Water Using Liquid and Gaseous Fuels; Generation of Steam, Hot Water, and Hot Air Using Solar Collectors; Generation of Steam and Hot Water Using Nuclear and Experimental Power Sources; Combustion Engines; Turbines; and Production of Electricity. (YLE)

ED210506

ENERGY
PRODUCTION
SYSTEMS

CENTER FOR OCCUPATIONAL RESEARCH AND DEVELOPMENT

601 LAKE AIR DRIVE
WACO, TEXAS 76710

U.S. DEPARTMENT OF EDUCATION
NATIONAL INSTITUTE OF EDUCATION
EDUCATIONAL RESOURCES INFORMATION
CENTER (ERIC)

This document has been reproduced as
received from the person or organization
originating it.

Minor changes have been made to improve
reproduction quality.

Points of view or opinions stated in this docu-
ment do not necessarily represent official NIE
position or policy.

"PERMISSION TO REPRODUCE THIS
MATERIAL IN MICROFICHE ONLY
HAS BEEN GRANTED BY

D. M. Hull

TO THE EDUCATIONAL RESOURCES
INFORMATION CENTER (ERIC) "

SEPT. 81'

82050378



P R E F A C E

ABOUT ENERGY TECHNOLOGY MODULES

The modules were developed by CORD for use in two-year postsecondary technical institutions to prepare technicians for employment and are useful in industry for updating employees in company-sponsored training programs. The principles, techniques, and skills taught in the modules, based on tasks that energy technicians perform, were obtained from a nationwide advisory committee of employers of energy technicians. Each module was written by a technician expert and approved by representatives from industry.

A module contains the following elements:

Introduction, which identifies the topic and often includes a rationale for studying the material.

Prerequisites, which identify the material a student should be familiar with before studying the module.

Objectives, which clearly identify what the student is expected to know for satisfactory module completion. The objectives, stated in terms of action-oriented behaviors, include such action words as operate, measure, calculate, identify, and define, rather than words with many interpretations such as know, understand, learn, and appreciate.

Subject Matter, which presents the background theory and techniques supportive to the objectives of the module. Subject matter is written with the technical student in mind.

Exercises, which provide practical problems to which the student can apply this new knowledge.

Laboratory Materials, which identify the equipment required to complete the laboratory procedure.

Laboratory Procedures, which is the experiment section, or "hands-on" portion, of the module (including step-by-step instruction) designed to reinforce student learning.

Data Tables, which are included in most modules for the first year (or basic) courses to help the student learn how to collect and organize data.

References, which are included as suggestions for supplementary reading/viewing for the student.

Test, which measures the student's achievement of pre-stated objectives.

CONTENTS

Preface

Table of Contents

Introduction to Course

- MODULE EP-01 Generation of Steam and Hot Water Using Solid Fuels
- MODULE EP-02 Generation of Steam and Hot Water Using Liquid and Gaseous Fuels
- MODULE EP-03 Generation of Steam, Hot Water and Hot Air Using Solar Collectors
- MODULE EP-04 Generation of Steam and Hot Water Using Nuclear and Experimental Power Sources
- MODULE EP-05 Combustion Engines
- MODULE EP-06 Turbines
- MODULE EP-07 Production of Electricity

R

ENERGY PRODUCTION SYSTEMS

INTRODUCTION

Energy Production Systems is an in-depth technical study of the processes and equipment used to convert fuels, such as coal and natural gas, and energy resources, such as sunlight, into useful energy forms: electricity, heat, or motion. This course will enable energy technicians to select optimum energy sources and equipment for maximum economy, availability, efficiency, and/or environmental quality. The course consists of the following seven modules:

1. "Generation of Steam and Hot Water, Using Solid Fuels."
2. "Generation of Steam and Hot Water, Using Liquid and Gaseous Fuels."
3. "Generation of Steam, Hot Water, and Hot Air, Using Solar Collectors."
4. "Generation of Steam and Hot Water, Using Nuclear and Experimental Power Sources."
5. "Combustion Engines."
6. "Turbines."
7. "Production of Electricity."

The first four modules of the course emphasize fuels and energy sources, examine their properties, and describe how they are used to produce steam and hot water. These modules extend information as far as the boiler in the system. The final three modules emphasize how energy is used: to produce motion, to drive a turbine, or to produce electricity. Thus, steam that is produced by the combustion of a fuel, as described in Modules EP-01 or EP-02, is used in processes that are described in later modules.

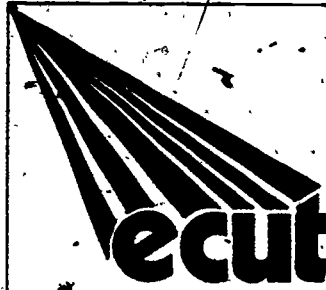

ENERGY TECHNOLOGY

CONSERVATION AND USE

ENERGY PRODUCTION SYSTEMS

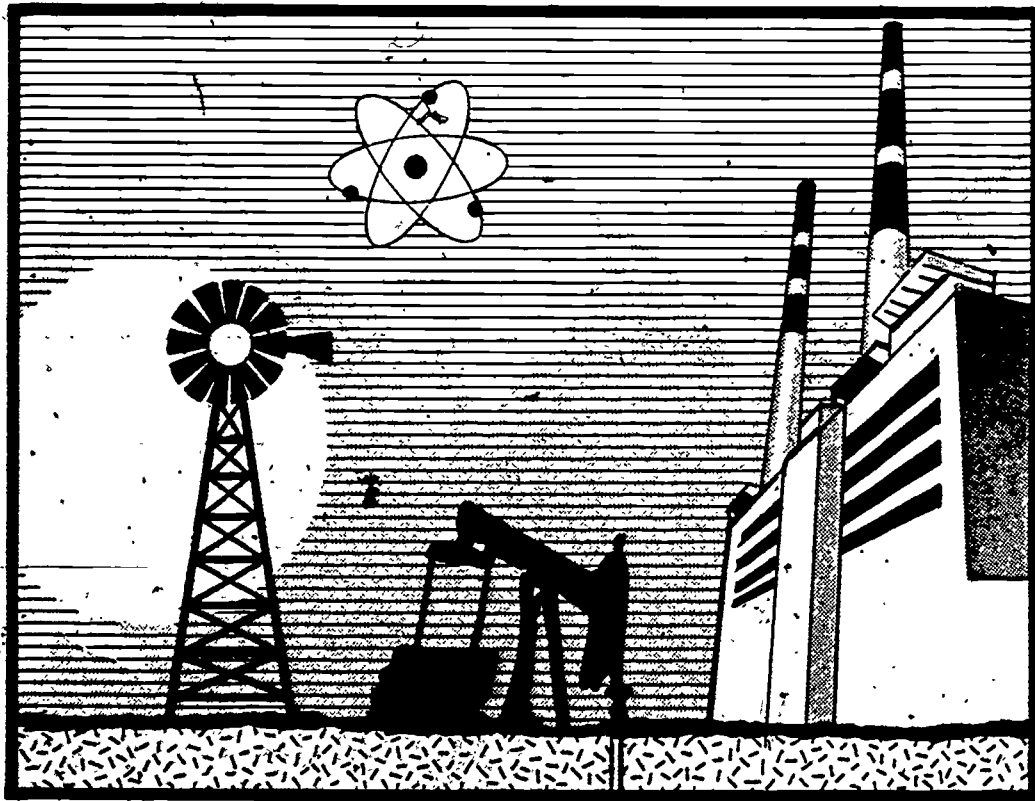

MODULE EP-01

GENERATION OF STEAM AND HOT WATER,

USING SOLID FUELS



CENTER FOR OCCUPATIONAL RESEARCH AND DEVELOPMENT

© Center for Occupational Research and Development, 1981

This work was developed under a contract with the Department of Education. However, the content does not necessarily reflect the position or policy of that Agency, and no official endorsement of these materials should be inferred.

All rights reserved. No part of this work covered by the copyrights hereon may be reproduced or copied in any form or by any means — graphic, electronic, or mechanical, including photocopying, recording, taping, or information and retrieval systems — without the express permission of the Center for Occupational Research and Development. No liability is assumed with respect to the use of the information herein.



CENTER FOR OCCUPATIONAL RESEARCH AND DEVELOPMENT

INTRODUCTION

As the title suggests, this first module deals with generation of hot water or steam using solid fuels such as coal, wood, and waste products. Production of steam and hot water by burning solid fuels is an important step in applications such as heating of buildings, generation of electricity, and processing of materials in agriculture and industry. Various solid fuels and their heat contents are discussed, as well as advantages and uses of each. Coal, the most important of solid fuels, is emphasized, with discussions concerning composition, burning characteristics, and handling techniques. Included also are discussions that involve types of burners and boilers associated with the use of solid fuels and the characteristics of steam production systems.

PREREQUISITES

The student should have completed the Fundamentals of Energy Technology course.

OBJECTIVES

Upon completion of this module, the student should be able to:

1. List and describe each of the fuels discussed.
2. Describe the importance of each fuel used for the generation of steam and hot water.
3. Cite the relative advantages of each fuel.
4. List the four major classifications of coal.
5. Define the following terms:
 - a. Combustion
 - b. Complete combustion
 - c. Stoichiometric combustion
 - d. Excess air
 - e. Ash
 - f. Mineral matter
6. Given information about the chemical composition of a sample of coal, calculate the heating value. In addition, calculate the amount of air needed for complete combustion.

7. Describe the procedures for handling coal and preparing it for burning.
8. Describe firing methods for coal burning systems and discuss their relative advantages.
9. Describe ash disposal methods for a coal burning system.
10. Describe the construction of a water-tube boiler and a fire-tube boiler. Discuss the applications for each type.

SUBJECT MATTER

TYPES AND PROPERTIES OF SOLID FUELS

There are a number of materials used as solid fuels, including coal, wood, coke, peat, and solid waste products from industry and agriculture. Of these materials, coal is the most widely used and most important in the production of steam and hot water.

COAL

Coal is the combustible, carbon-containing remains of prehistoric vegetable matter. It is not considered to be a rock or a mineral. Chemically, coal is mostly carbon; however, it also contains hydrogen, oxygen, nitrogen, and sulfur. Coal often contains other minerals in varying percentages, depending on the type.

Chemical composition alone does not specify the fuel properties of coal. In fact the uses and classifications for coal are determined by the content of the following components:

- Moisture
- Volatile matter
- Ash
- Fixed carbon
- Sulfur

Moisture can be an important component in some types of coal since the amount of moisture affects its use. Moisture, which is measured in a standardized test, represents the amount of "free water" in the coal (that is, water that can be removed by drying); it does not necessarily represent all the water contained in the coal. Water that is chemically bound in the coal is not counted in the moisture content. Only "free water" is counted as moisture.

Volatile matter is defined as "the portion of the coal that can be driven off as gas during the process of heating the coal in a standardized test." Volatile matter consists of organic oils and tars, organic hydrocarbons, and gases such as carbon monoxide, carbon dioxide, hydrogen, and methane. All of these materials can be removed in gaseous form by heating the coal under controlled conditions.

Ash is the nonburnable mineral material that remains after coal is burned. Ash consists of certain materials that were present in the coal, such as clay and mud, and of various minerals, such as calcium sulfate and iron sulfide. To determine ash content, coal may be ignited with an electrically heated wire and completely burned under conditions of carefully controlled atmosphere and temperature. The material that remains is ash.

Fixed carbon is the solid residue — other than ash — that remains after the volatile matter is driven off. The composition of coal is expressed on the basis of dry, ash-free samples. For such samples, the moisture and ash are neglected. Fixed carbon (FC) and volatile matter (VM), expressed as percentages, are related by Equation 1:

$$FC + VM = 100\% \quad \text{Equation 1}$$

where: FC = Fixed carbon (%)
VM = Volatile matter (%)

Thus, fixed carbon (in a sample of coal) is the burnable solid material that remains after the moisture and volatile material have been removed. Ash is not considered. The fixed carbon primarily consists of elemental carbon, but not necessarily pure carbon. There may be contributions from some other solid, burnable materials.

Sulfur is an undesirable component in coal. When coal is burned, sulfur oxides contained in the coal contribute to air pollution. There are laws that place a maximum sulfur content on coals burned in certain locations.

Another important property is heating value, also called "calorific value." Heating value is the amount of heat energy produced by the combustion of a unit mass of coal. Heating value is generally expressed in Btu/lb.* Although Btu/lb is not a metric unit, most standards that characterize coal are expressed in this unit. To convert to metric units (kilo-joule/kilogram), the number of Btu/lb should be multiplied by 2.328.

The analysis of properties in a sample of coal is conducted by using a series of carefully standardized tests. Standards for measurement of the

*The Btu (British thermal unit) is defined as "the amount of heat needed to raise the temperature of one pound (lb) of water by one degree Fahrenheit (°F)."



content of coal have been developed by the American Society for Testing and Materials (ASTM). Such standardized ASTM tests for quantities such as moisture, volatile material, fixed carbon, ash, heating value, and so forth, provide methods by which workers can make measurements on a consistent basis.

As an example, the ASTM standard for measuring heating value specifies burning a pulverized sample of coal in a bomb calorimeter. The bomb is a pressurized vessel, into which the coal and a known amount of oxygen are admitted. The coal is ignited by an electrically heated wire and allowed to burn. The pressurized bomb (contained in a jacket) is then immersed in water. The burning of the coal heats the water, and, at the same time, the water is stirred to ensure temperature equilibrium. The temperature of the water is then measured, and the known specific heat of water is used to calculate the energy released in the burning. In the process, the bomb and jacket also become heated, and the amount of energy needed to heat them must be known. Thus, the calorimeter is calibrated by burning a substance that has a known heat of combustion — usually benzoic acid.

There is a further distinction — one that depends upon whether water vapor produced in the burning of the fuel is allowed to condense or to remain as a vapor. If the water vapor is allowed to condense, the heat of condensation will be included in the observed thermal energy. In this case, the heating value will be higher than if the water remained as vapor. The ASTM test described previously measures the heating value with the condensation of water vapor. This value is called the high heating value. The lower value obtained without the condensation of water vapor is called the low-heating value. In the United States, the high heating value is usually used for boiler calculations; however, in Europe, the low heating value is often used. For the purposes of this module, it will be assumed that the term "heating value" refers to the high heating value.

The analysis of a sample of coal may be presented in two ways:

1. Ultimate analysis: Specifying the content in terms of the chemical elements present.
2. Proximate analysis: Specifying the content in terms of the components (such as volatile matter and fixed carbon) which affect its use.

Table 1 shows an example of these two types of analyses as applied to a sample of coal taken from the Pittsburgh bed located in West Virginia. The

analyses are applied to the coal in its "as-received" condition, and moisture and ash appear as components in both analyses. The percentage of elemental carbon in the ultimate analysis is higher than the percentage of fixed carbon in the proximate analysis — which indicates that some of the elemental carbon was removed as a constituent of the gas in the volatile matter.

TABLE 1. ANALYSES OF A COAL SAMPLE.

Proximate Analysis		Ultimate Analysis	
Moisture	2.3%	Moisture	2.3%
Volatile Matter	36.5%	Carbon	76.6%
Fixed Carbon	56.0%	Sulfur	0.8%
Ash	5.2%	Hydrogen	5.3%
	100.0%	Nitrogen	1.5%
		Oxygen	8.3%
		Ash	5.2%
			100.0%
Heating Value: 14040 Btu/lb			

The results of these analyses are used as the basis of a classification scheme for coal. To be classified systematically, coal must be referred to some standard condition. Two standard conditions are as follows:

1. Dry, mineral-matter free: This condition refers to the composition of coal after it has been dried. Ash content is neglected.
2. Moist, mineral-matter free: This condition refers to the composition of coal with its natural bed-moisture still present, but with no visible water on the surface. Ash content is neglected.

There are two sets of formulas used to specify coal content in the two preceding conditions. Measurements are made on the coal in a moist condition (that is, with natural bed-moisture present, but with no visible surface water) and with ash present in the coal. Then, the formulas are employed to convert to the reference conditions. The first set of formulas are called Parr formulas. The second set of formulas, called approximation formulas, are approximate forms of the Parr formulas, but they are somewhat easier to apply.

PARR FORMULAS

$$\text{Dry Mm - free FC} = 100 \frac{\text{FC} - 0.15 \text{ S}}{100 - (\text{M} + 1.08 \text{ A} + 0.55 \text{ S})} \quad \text{Equation 2}$$

$$\text{Dry Mm - free VM} = 100 - \text{Dry Mm - free FC, \%} \quad \text{Equation 3}$$

$$\text{Moist Mm - free Btu} = 100 \frac{\text{Btu} - 50 \text{ S}}{100 - (1.08 \text{ A} + 0.55 \text{ S})}, \text{ Btu/lb} \quad \text{Equation 4}$$

APPROXIMATION FORMULAS

$$\text{Dry Mm - free FC} = 100 \frac{\text{FC}}{100 - (\text{M} + 1.1 \text{ A} + 0.1 \text{ S})}, \% \quad \text{Equation 5}$$

$$\text{Dry Mm - free VM} = 100 - \text{Dry Mm - free FC, \%} \quad \text{Equation 6}$$

$$\text{Moist Mm - free Btu} = 100 \frac{\text{Btu}}{100 - (1.1 \text{ A} + 0.1 \text{ S})}, \text{ Btu/lb} \quad \text{Equation 7}$$

- where:
- Mm = Mineral water.
 - Btu = Heating value, in Btu/lb.
 - FC = Fixed carbon (%).
 - VM = Volatile matter (%).
 - M = Moisture (%).
 - A = Ash (%).
 - S = Sulfur (%).

All of the preceding quantities are measured for coal in a moist condition with mineral matter present.

EXAMPLE A: CALCULATION OF COAL CONTENT.

Given: The Parr formulas and the approximation formulas.

Find: The calculation for the coal of Table 1:

Dry, Mm - free FC.

Dry, Mm - free VM.

Moist, Mm - free Btu.

Solution: Using the Parr formulas, the following can be calculated:

$$\begin{aligned} \text{Dry, Mm - Free FC} &= 100 \frac{56 - 0.15 \times 0.8}{100 - (2.3 + 1.08 \times 5.2 + 0.55 \times 0.8)} \\ &= 60.98\%. \end{aligned}$$

Example A. Continued.

$$\text{Dry, Mm - free VM} = 100 - 60.98 = 39.02\%$$

$$\begin{aligned} \text{Moist, Mm - free Btu} &= 100 \frac{14040 - 50 \times 0.8}{100 - (1.08 \times 5.2 + 0.55 \times 0.8)} \\ &= 14902 \text{ Btu/lb.} \end{aligned}$$

Using the approximation formulas, the following can be calculated:

$$\begin{aligned} \text{Dry, Mm - free FC} &= 100 \frac{56}{100 - (2.3 + 1.1 \times 5.2 + 0.1 \times 0.8)} \\ &= 60.94\% \end{aligned}$$

$$\text{Dry, Mm - free VM} = 100 - 60.94 = 39.06\%$$

$$\begin{aligned} \text{Moist, Mm - free Btu} &= 100 \frac{14040}{100 - (1.1 \times 5.2 + 0.1 \times 0.8)} \\ &= 14904 \text{ Btu/lb.} \end{aligned}$$

The results obtained from these formulas are used as the basis of a classification for coal of various types and compositions. Coal is classified into four broad classes, as follows:

- Anthracite
- Bituminous
- Subbituminous
- Lignite

As one might progress upward in this ranking from lignite (listed last) to anthracite (listed first), the coal is farther along in each step in its natural development from compressed vegetation to relatively pure carbon. Thus, lignite is said to be "young" coal and anthracite is said to be "old" coal.

Anthracite coal is a hard, dense coal with a black, metallic-looking luster. It is difficult to ignite because it lacks volatile matter to begin the burning. Once ignited, though, it burns well and does not produce smoke.

Bituminous coal is less hard and contains more volatile matter than anthracite coal. It ignites easily and burns freely with a smoky flame. The term "bituminous coal" includes a wide range of different coals with different compositions and burning properties. It may vary in color from dark brown to black.

Subbituminous coal is relatively high in moisture content and tends to break up easily. It is black in color and burns easily, producing relatively little smoke.

Lignite coal is a brownish-black coal with a woodlike structure. It is moist and subject to disintegration and breakup. Because of the moisture, it is hard to ignite; but once dried, it burns well. Lignite is distinguished by having a relatively low heating value, as compared to other types of coal.

Within each of these classes, there are a number of different groups. For the ASTM classification commonly used in the United States, the important parameter for old coals (anthracite and bituminous, with a high fixed-carbon content) is fixed carbon. For younger coals, which have a lower fixed-carbon content, the important parameter is calorific value. These coals include some coals classified as bituminous, subbituminous, and lignite. The ASTM classification for coal is presented in Table 2. This classification does not include a few types of coal that contain unusual properties. The classification in Table 2 is called a classification by rank, that is, a classification according to the degree of progression in the natural change of coal from lignite to anthracite.

There are other types of classifications for the more complex and varied nature of coal, but the ASTM classification shown in Table 2 is probably the most widely used in the United States.

TABLE 2. ASTM CLASSIFICATION FOR COAL.

Class	Group	Fixed Carbon Limits (%) (Dry, Mm-free)	Calorific Value Limits (Btu/lb) (Moist, Mm-free)
Anthracite	Methanthracite	>98	--
	Anthracite	92 - 98	--
	Subanthracite	86 - 92	--
Bituminous	Low Volatile	78 - 86	--
	Medium Volatile	69 - 78	--
	High Volatile A	<69	<14000
	High Volatile B	--	13000 - 14000
	High Volatile C	--	11500 - 13000
Subbituminous	Subbituminous A	--	10500 - 11500
	Subbituminous B	--	9500 - 10500
	Subbituminous C	--	8300 - 9500
Lignite	Lignite A	--	6300 - 8300
	Lignite B	--	<6300

OTHER SOLID FUELS

Solid fuels other than coal include the following:

- Wood
- Waste products from industry and agriculture
- Coke
- Peat

At present, these fuels are much less important than coal for the production of steam and hot water.

Wood has been used as a fuel for centuries. Wood-burning stoves and home-heating systems were common in the United States into the 20th century, but the use of wood to heat homes declined as oil and natural gas furnaces became more common. Then the use of wood in the home was confined mainly to fireplace use. In recent years, however, as oil and natural gas prices have risen, supplemental wood-burning furnaces are being used again.

Wood is being used in industry for the production of steam and hot water; but, for this use, it usually is not burned as logs. Bark and other scrap from wood-processing operations are usually employed. In a location where wood is being processed and scrap is readily available, wood can serve as a convenient fuel for both space-heat and industrial process steam or hot water. This also provides a useful method for disposing of scrap.

The usual measurement for wood used as fuel is the cord. A cord is a pile of wood eight feet long, four feet wide, and four feet high. This is the equivalent of 128 cubic feet of wood.

The heating value of wood depends on the type of wood and its moisture content. The heating value of dry pine can be as high as 9000 Btu/lb. Dry wood burns extremely well. Even with a moisture content of 50%, wood will burn reasonably well. However, if the moisture content is above 65%, too much heat is required to evaporate the water. If the moisture content is 80%, the heating value is less than 2000 Btu/lb; and the heat needed to evaporate the water is so high that combustion may not even occur.

Table 3 presents properties of some wood fuels that could be used for steam or hot water production. The values presented are based on a dry condition. (The percentages refer to the material after moisture is removed.) The definitions of the terms are the same as for coal; however, in contrast to coal, volatile matter is greater than fixed carbon.

TABLE 3. PROPERTIES OF SOME WOOD FUELS.

	Pine Bark	Oak Bark	Redwood Bark
Fixed Carbon	24.2%	18.7%	27.0%
Volatile Matter	72.9%	76.0%	72.6%
Ash	2.9%	5.3%	0.4%
Heating Value (Btu/lb)	9030	8370	8350

Presently, the primary use of wood as a fuel is for wood stoves and residential heating systems. Only in industries where wood scraps and bark are readily available is wood widely used as a fuel. (For example, approximately 50% of the energy in pulp and lumber industries comes from burning wood.) However, there are a few, small wood-fired electrical generators planned or operating in several states.

The use of wood as a fuel will probably increase as costs of other fuels increase. Wood represents a renewable energy source; and in the near future, it will probably account for a large percentage of this country's total energy use as a supplemental energy source.

A number of waste products from agricultural and industrial operations are used as fuels, and most are used in the industry that produces them. One advantage is that this eliminates the need to dispose of the waste. The total energy contributed by fuels that come from waste products is only a small percentage of the total energy consumed by industry. However, for a processing plant that produces suitable wastes, the wastes usually provide a significant fraction of the plant's fuel needs.

One example is bagasse, which is the fiber that remains after juice is pressed from sugarcane. The waste is ground up and burned to produce steam in sugar mills. If the sugar is not being refined at the plant, the bagasse may satisfy the fuel requirements of the plant.

Other waste products frequently burned at plants that produce them include the following: coffee grounds left over from the production of instant coffee, corn cobs, straw and hulls of various grains, and municipal refuse. The heating values of some waste materials used as fuels are given in Table 4. These heating values are based on dried material; however, the materials listed often contain a large amount of moisture. Bagasse, for example, may contain more than 50% moisture; therefore, much of the heat may be required simply to vaporize the moisture.

TABLE 4. HEATING VALUES OF DRIED WASTE PRODUCT FUELS.

Material	Heating Value (Btu/lb)
Bagasse	8390
Corn cobs	9300
Cottonseed cake	9500
Rice straw	6000
Wheat straw	8500

Coke is the residue produced when coal is heated in the absence of air, or with little air. Coal is heated to a temperature of 1200-1400°C (but not burned), and much of the volatile matter is driven off. The residue that remains is coke. Coke is mostly carbon, along with mineral matter and some remaining volatile matter. It is a cellular mass, having greater strength than the original coal.

Bituminous coals are rated as coking or non-coking, according to their capacity for being converted into coke. If the coal has too little carbon or too much ash, it will produce a coke that crumbles too easily.

The volatile matter that is driven off in the production of coke is a complex mixture of materials. It is collected and used in the production of many substances, including cosmetics, perfumes, and pharmaceutical products. One ton of average coal will yield about 0.7 ton of coke, 1150 cubic feet of gas, 50 gallons of benzene, 27 pounds of ammonium sulfate (used for fertilizers), and several pounds of mixed organic chemicals.

The residual solid coke is very high in carbon content (at least 86%) and contains very little moisture. Coke is used in blast furnaces for the production of pig iron. Because of its strength, it can be used as a bed for a heavy charge of metal. This use accounts for most of the coke produced in the United States. Very little coke is used for the production of steam and hot water.

Peat is an early stage in the development of coal from vegetable matter. The structure of the original vegetable matter can sometimes be seen in peat. Peat, which is found in swamps and bogs, has a very high moisture content at least 75%. However, when peat is dried, the moisture can be reduced to

about 55%. In this condition, peat burns well, with a heating value of approximately 4000 Btu/lb.

In many countries, peat is often used as a fuel for household heating. In the United States, peat is not used for this purpose, because coal, which has a higher heating value, is readily available. Peat is not an important fuel for production of steam and hot water.

The following briefly summarizes some of the relative advantages, disadvantages and uses of each of the solid fuels previously discussed:

- Coal is a high-grade fuel with high heat content. It is abundantly available throughout the United States and is the most widely used solid fuel. However, the high sulfur content of many types of coal causes air pollution. The majority of the coal burned in the United States is used by electric utility companies for generating electricity.
- Wood has the main advantage of being a renewable resource. When dry, it has high heating value; but often it is wet, and some of the energy must be used for vaporizing moisture. It is used most often in industries where it is available as a by-product (such as bark). Examples are pulp and lumber industries.
- Waste products are attractive sources of energy in industries where they are readily available and will not have to be disposed of in some manner. Advantages include high heating value (when dry) and elimination of the disposal problem. However, waste products are often wet. Fuels from waste products are limited in availability, so they are not widely used as an energy source, except in industries that produce suitable wastes. An example of usage is bagasse in sugar mills.
- Coke is a high-grade fuel with a high heat content. Its preparation yields other products of value, such as perfumes and cosmetics. Because coke is more costly than coal, it is not widely used in the routine production of hot water and steam. It is used mainly in applications that require its special characteristics (for example, smelting, which requires higher purity than coal).
- Peat is a low-grade fuel that is readily available in some areas and is relatively inexpensive. However, because peat has low heating value, and is wet, it normally is used only for residential heating.

HANDLING OF SOLID FUELS

The following section of the module emphasizes the handling of coal since it is the most widely used solid fuel. The discussion includes the following steps: transportation, unloading, storage, sizing, and preparation for burning.

TRANSPORTATION

Coal may be transported by a variety of methods, including the following:

- Railroad
- Truck
- Barge
- Conveyor belt
- Pipeline (in a liquid slurry)

The shipping method depends on the geographical relationship of the mine and the user. Because transportation costs can represent an important part of the total cost of coal, large, coal-burning electrical plants are often located where access to coal is easy (for example, near a mine or along a river where coal can be barged in).

Railroads ship as much as 75% of the coal transported in the United States. To cut costs, railroads often use unit trains. The concept of unit trains involves moving an entire trainload of a single commodity. The unit train moves directly from the mine to the user, without any intermediate terminals or switching. A unit train may have as many as 100 to 200 cars that are semi-permanently coupled. Shipping time and costs are much reduced in this manner, as compared to conventional railroad shipment.

Of course, many users will just need one or two carloads of coal. This operation involves collecting empty cars at the terminal and delivering them to the mine where they are loaded. After loading, the cars are returned to the user's location. After several terminals and several switchings, the car eventually arrives at the user's facility. Thus, the single carload moves on an irregular schedule, depending on the availability of freight trains. The costs involved in single carload delivery are the highest in the railroad industry.

Other methods of transportation by rail include the multiple carload volume and the trainload volume. In trainload service, a complete train moves directly from the mine to the user, but the full range of concepts of the unit train are not employed.

Cars used for railroad transportation of coal carry their load "in-capacity," with most modern cars having capacities that range from 100 to 125 tons. Cars designed for carrying coal are open-topped, and they are either the hopper-type, with the floor sloping to one or more hinged doors, or the gondola-type, with a flat bottom and fixed sides.

Due to the expense involved, coal generally is shipped by truck only for short distances. Coal can be shipped by truck to a user located near the coal field, or it can be moved by truck to the user from a local distribution point where it has been delivered by rail or barge.

Coal is very often moved by barge. Barges have capacities of approximately 1400 tons, and fleets of as many as 20 barges are possible; therefore, they are capable of delivering large amounts of coal. In addition, barge costs are lower than those of truck or rail transportation.

Most barges move on the inland waterway system of the United States, that is, the Mississippi-Ohio Rivers and their tributaries, and the Great Lakes. The regions covered by these systems include many important industrial regions of the United States, as well as many important coal-mining areas in the eastern part of the country. When the user is not located near a waterway, coal is usually shipped by barge to a distribution point and then moved by truck or rail.

Conveyer belts can be used for the delivery of coal when the user is within a few miles of the mine. Conveyer belts are also used for movement of coal within the user's plant.

Coal can also be moved in pipelines in the form of a liquid slurry. The slurry, which is a soupy mixture of pulverized coal and water, is pumped through a pipeline from a mine to a large volume user. The first coal pipeline operated in 1914, and this technique has continued to develop, particularly in recent years. Although pumping coal through pipelines represents only a small fraction of the total amount of coal that is transported, this method will probably become more important in the future. An example of pipeline transportation of coal is the Black Mesa Pipeline, which carries coal for 273 miles, from

northeastern Arizona to a generating station in southern Nevada. This 18-inch diameter pipeline is capable of delivering 4.8 million tons of coal per year. As stated previously, pipelines are only suitable for large volume users of coal; but when pipeline transportation is appropriate, it can be the most economical method available.

UNLOADING

Unloading coal from a train at the user's facility is an important operation. For economy's sake, it is essential that the coal be unloaded quickly since it is expensive to tie up a large number of railroad cars for prolonged unloading.

In the bottom of many coal cars are doors that can be opened to drop the coal between the rails or at the side of the rails. Car shaker systems are sometimes used to speed up the discharge of the coal.

For small plants, portable belt conveyers can be used to move the coal after it is unloaded; but for large plants, complete mechanical handling equipment is needed. Coal is often discharged into a pit, from which it is moved by a conveyor system. Rotary dump systems are sometimes used. In this system, the car is moved inside the rotary dumper, and the dumper turns the entire car upside down, allowing the coal to fall out. Some rotary dumpers are capable of accommodating two cars at a time.

Motion unloading is also popular. In this method, the cars proceed slowly over the dumping area, and the doors on the bottom of the car are opened as the car moves into position, discharging the coal.

The trade-off between the two systems is based on economics. The rotary dumper is expensive, but it can accommodate cars with no doors and no moving parts. Motion unloading requires more expensive cars, but less elaborate facilities. With motion unloading, a 100-car train can be unloaded in approximately one hour, as compared to the 4 to 6 hours required for a rotary dump system. The economic trade-off decision must be made on the basis of the total amount of coal to be received, the number of cars involved, and so forth.

Another factor that must be considered is that coal may arrive frozen since open coal cars are exposed to the weather. In winter, coal can freeze into a solid, unmanageable lump. In this case, it must be thawed or broken up. Thawing methods include steam, radiant heaters, and oil-fired thawing

pits. If breakup is required, heavy metal bars approximately the size of the coal car can be lifted by a hoist and dropped on the coal. Or, at small plants, hand labor (with pry bars and portable torches) can be used.

STORAGE

Storage of large amounts of coal may be necessary to ensure continuous supplies. However, coal in storage can degrade through oxidation. Even more seriously, oxidation can heat the coal and lead to spontaneous ignition of the coal pile. A fire in a coal pile can be difficult and dangerous to extinguish.

To minimize the possibility of spontaneous ignition, coal should be stored in a firm, clean, well-drained base. It should be piled in layers from one to two feet high, with each layer compacted before the next layer is added. Then a 12-inch-thick layer of fine coal should be added over the top and sloping sides of the coal pile to seal it against moisture. The coal should be dry, because damp conditions favor self-ignition of coal in storage. Anthracite coal is much less susceptible to self-ignition than is bituminous coal. Coal that has been screened so that the lumps are of uniform size is less susceptible to self-ignition than unsized coal.

Coal piles can be arranged into a variety of shapes, including conical, wedge-shaped, or kidney-shaped, and can be as high as the available coal-handling equipment can manage. In storage, the coal should be monitored by both regular, visual inspection and temperature-measuring devices located in the pile. If the coal heats above 66°C, it should be dug out and repiled. If a fire has ignited, the recommended procedure is smothering. This can be done in a variety of ways: by compacting with a bulldozer, by sealing the top of the pile with asphalt, and by the use of carbon dioxide (supplied as blocks of dry ice).

SIZING

Establishment of the size of coal is important since various uses require different sizes of coal. Furthermore, a particular method of feeding coal to the furnace can be designed in order to use certain sizes of coal lumps.

Sizes for anthracite coal are well standardized according to the size of a round hole through which the lumps of coal will pass. The larger sizes

are used for domestic heating and for gas production! Smaller sizes are used in equipment having mechanical feeds. The size standards for anthracite coal are given in Table 5.

TABLE 5. SIZE STANDARDS FOR ANTHRACITE COAL.

Size	Diameter of Hole (inches)	
	Coal Lumps Pass	Do Not Pass
Broken	4 3/8"	3 - 3 1/4"
Egg	3 - 3 1/4"	2 7/16"
Stove	2 7/16"	1 5/8"
Nut	1 5/8"	13/16"
Pea	13/16"	9/16"
Buckwheat	9/16"	5/16"
Rice	5/16"	3/16"

Sizing of bituminous coal is less standardized. Table 6 presents various sizes and descriptions of bituminous coal. Again, the larger sizes tend to be used for domestic heating and for gas production, and the smaller sizes to be used in mechanized, industrial stokers.

TABLE 6. SIZES FOR BIUMINOUS COAL.

Name	Description
Run of Mine	Coal as it comes from mine
Run of Mine (8") Lump (5")	Run of mine with oversize lumps broken up Will not go through 5" round hole
Egg (5" x 2")	Goes through 5" hole but not 2" hole
Nut (2" x 1 1/4")	Goes through 2" hole but not 1 1/4" hole
Stoker (1 1/4" x 3/4")	Goes through 1 1/4" hole but not 3/4" hole
Slack (3/4" and under)	Goes through 3/4" hole

PREPARATION FOR BURNING

Several operations are important in preparing coal for burning, including the following:

- Cleaning
- Crushing

• Sulfur removal

Cleaning methods are employed to remove some noncombustible products from coal. Because many common impurities are more dense than coal, they can be separated by mechanical methods. Particles of different density settle at different rates in a fluid. Heavier impurities sink to the bottom faster in water and, thus, can be separated from the coal.

Another method involves placing the coal on a screen and blowing either air or water through the bed of coal. The heavier particles fall downward through the holes in the screen more easily and can be separated.

A method called froth flotation is applicable to coal that is small in size. The coal is agitated in a mixture of water and reagents, thereby producing a froth on the surface. The coal particles float in the froth, whereas the heavier particles sink and can be separated.

Crushing is employed to produce the sizes needed for various types of burners. (Sizing standards have already been described.) Crushers use toothed rollers, rotating hammers, or rings that strike the coal and break it up. In conjunction with the crushers, screens or gratings of appropriate spacing are used to control the size of the crushed coal.

Sulfur is an undesirable element in coal because it leads to air pollution. Sulfur that is in the form of pyrites (iron sulfide) is removed by the operation of crushing, washing, gravity separation, or froth flotation. Sulfur that is present in the form of organic compounds cannot be removed by these methods. Experimental methods, such as magnetic separation, are under development for improved removal of pyrites.

COMBUSTION OF SOLID FUELS

Combustion is defined as "the burning of a material." It is a chemical reaction in which the chemical constituents of a material combine with oxygen and produce heat. The usual source of oxygen is the oxygen that is present in air. For some specialized applications, oxygen can be supplied from some other chemical; but for production of steam and hot water, air is the source of oxygen.

STAGES OF COMBUSTION

Combustion of solid fuels occurs in stages. First the volatile matter is driven out of the fuel. The volatile matter mixes with air and burns as a gas. This process heats the solid residue, which is mostly carbon. The residue must be heated to the point where combustion can continue at the surface. Air moves to the hot surface, and the oxygen combines with carbon there. In this stage, combustion will cease if the temperature drops because the combustion reaction cannot be sustained.

Because of the manner in which solid fuels burn, bituminous coal is relatively easy to ignite. If heated slightly, it releases volatile material such as hydrocarbons, which burn easily in the air. Burning the volatile matter heats the residue to the point where it also will burn.

Anthracite coal is more difficult to ignite because it contains very little volatile matter. Because of this, the first stage of combustion does not provide much heat, making it more difficult for the solid residue to become hot enough to burn.

Any fuel containing much moisture is limited by the fact that some of the heat must be used to vaporize the moisture. Because this keeps the temperature lower than it would be otherwise, combustion may cease.

CHEMICAL REACTIONS IN COMBUSTION

The principal chemical reactions that occur in burning an organic material that contains carbon, hydrogen, and sulfur are the following:

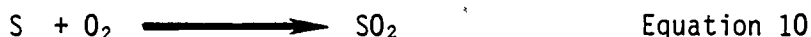
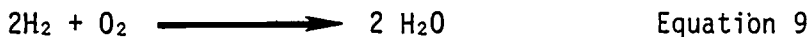
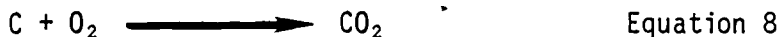

If not enough oxygen is available to burn the carbon completely, carbon monoxide may be formed in the following reaction:



The preceding reactions describe the end result of burning an organic solid material such as coal. If the coal primarily consists of carbon and hydrogen, the end products of combustion (with adequate air) are primarily

carbon dioxide (CO₂) and water (H₂O).

Equations 8-11 are simplifications. The reactions actually occur in stages with intermediate steps. The net final processes are represented adequately by these reactions.

In complete combustion of fuels containing carbon, hydrogen, and sulfur, all of these materials are oxidized completely to CO₂, H₂O, and SO₂. This process of complete combustion is represented by Equations 8 and 10. The end products will no longer react with oxygen. Complete combustion of a hydrocarbon fuel can be defined as "combustion that carries the chemical components to the final end products which cannot burn further."

A contrast is incomplete combustion, represented by Equation 11. This reaction produces an end product of carbon monoxide (CO), which will burn further according to the following reaction:

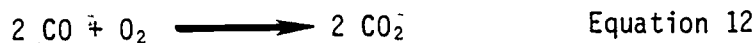

Incomplete combustion, as represented by Equation 11, is undesirable because (1) carbon monoxide (CO) is a dangerous poison and (2) it represents an inefficient use of the fuel.

Stoichiometric combustion is defined as "combustion of a fuel with the exact amount of oxygen needed to oxidize it completely," according to the preceding reactions (Equations 8 and 11). In stoichiometric combustion, the fuel is completely burned to produce CO₂, H₂O, and SO₂, and there is no oxygen remaining after the combustion. In practice, it is difficult to achieve stoichiometric combustion. The flow of air and its mixture with the fuel are variable enough that stoichiometric combustion usually is not assured.

Therefore, more air is usually supplied — more than is needed for stoichiometric combustion. The amount of air supplied above the amount for stoichiometric combustion is called excess air. Excess air usually is provided in the production of steam and hot water. It is provided both for safety and for maximum fuel utilization. The amount of excess air cannot be too great, because the air that goes up the smokestack is heated. If too much air is supplied, it will represent a loss to the efficiency of the heating process. The amount of excess air supplied will vary. It depends on the type of fuel, the expected variations in the fuel, and the type of furnace being used.

In common practice, the amount of excess air beyond the amount needed for stoichiometric combustion can vary from about 15-40% for combustion of coal.

Table 7 presents the amount of air needed for stoichiometric combustion of some chemical substances. It is presented in terms of the weight of air needed to burn one pound of fuel in stoichiometric combustion. If the chemical composition of fuel is known, the required amount of air can be determined. The amount of air listed in the table is sometimes called theoretical air.

Table 7 also presents the heating value for various chemical constituents. If the chemical composition of the fuel is known, the heating value of the fuel can be calculated by adding the contributions from the different combustions.

TABLE 7: THEORETICAL AIR AND HEATING VALUES OF SOME MATERIALS.

Material	Combustion Reaction	Theoretical Air (lb/lb of Fuel)	Heating Value (Btu/lb)
Carbon	$C + O_2 \longrightarrow CO_2$	11.51	14447
Carbon monoxide	$2 CO + O_2 \longrightarrow 2 CO_2$	2.47	4344
Hydrogen	$2 H_2 + O_2 \longrightarrow 2 H_2O$	34.28	60958
Sulfur	$S + O_2 \longrightarrow SO_2$	4.31	3980

EXAMPLE B: CALCULATION OF HEATING VALUE.

Given: The ultimate analysis of a sample of coal from the Pocahontas #3 bed in West Virginia is as follows:

- a. Carbon: 80.7%
- b. Hydrogen: 4.5%
- c. Sulfur: 0.8%
- d. Nitrogen: 1.3%
- e. Oxygen: 4.6%
- f. Ash: 5.2%
- g. Moisture: 2.9%

Find: The heating value and the amount of air needed for stoichiometric combustion.

Example B. Continued.

Solution: The last four components do not burn and do not contribute to the heating value. If the heating values in Table 7 are used, the following is obtained for each pound of coal:

$$\begin{array}{rcl} \text{Carbon:} & 0.807 \times 14447 & = 16,659 \text{ Btu} \\ \text{Hydrogen:} & 0.045 \times 60958 & = 2,473 \text{ Btu} \\ \text{Sulfur:} & 0.008 \times 3980 & = \underline{32} \text{ Btu} \\ & & 14,434 \text{ Btu.} \end{array}$$

Thus, the calculated heating value is 14,434 Btu/lb. The amount of air required for one pound of fuel is determined as follows:

$$\begin{array}{rcl} \text{Carbon:} & 0.807 \times 11.51 & = 9.29 \text{ lb} \\ \text{Hydrogen:} & 0.045 \times 34.28 & = 1.54 \text{ lb} \\ \text{Sulfur:} & 0.008 \times 4.31 & = \underline{0.03} \text{ lb} \\ & & 10.86 \text{ lb.} \end{array}$$

Thus, 10.86 pounds of air are needed for stoichiometric combustion of one pound of this coal.

BURNING OF SOLID FUELS

Fuels are burned inside an enclosure that confines the products of the combustion. This enclosure, the furnace, must be capable of withstanding the high temperatures produced by burning. The furnace walls are constructed of materials that are chemically nonreactive and can survive temperatures in the furnace. Such materials are called refractory materials. One example is firebrick.

In modern boiler furnaces, the walls are usually water-cooled to keep the wall temperature low enough so that the wall materials are resistant to oxidation and will retain their mechanical strength.

Inside the furnace, solid fuel can be burned on a hearth or grate, which allows air to rise through the bed of burning fuel. Often the grate moves in some way to provide even distribution of fuel throughout the furnace.

Furnaces are designed to provide complete combustion of the fuel. This means that the fuel must remain in the furnace for a long enough time and at a high enough temperature so that it burns completely. There are many different furnace designs, depending on the type of fuel being burned, the rate

of heat generation, and the method of feeding fuel into the furnace.

The delivery of fuel into the furnace is called firing. The firing method should provide continuous delivery of fuel to the furnace and distribute it within the furnace. Modern furnaces can be described on the basis of the firing method.

There are a number of methods for firing solid fuels. Again, coal is emphasized. The oldest method, of course, is hand firing. In this, a person shovels coal into the burner. Hand firing is obsolete, and, in any case, would not be useful in a large plant that uses thousands of tons of coal each day.

Mechanical stokers that feed coal into the burner were developed a short time after the invention of the steam engine. Mechanical stokers remained as the leading method for many years.

In the 1920s, a major advance occurred with the development of pulverized coal systems. The coal is pulverized and delivered to the furnace in a continuous process. This procedure provides significant advantages as compared to stoker firing.

In the 1940s, a further advance occurred with the development of the cyclone furnace. The cyclone furnace provides additional advantages over the pulverized coal systems. Many modern coal burners are of this type.

STOKERS

Mechanical stokers were originally developed as an improvement over hand-firing methods. Stokers move coal into the furnace, and they can also remove the ash. Stokers have been well-developed and continue to be suitable for many small and medium-sized boilers. They offer a continuous feed of coal in a mechanized system of reasonable efficiency.

There are a number of different types of stokers in use. Perhaps the most important is the spreader stoker, which uses traveling chains to spread fuel uniformly into the furnace. Heavy pieces of coal rest on the grate where they burn. Lightweight, small pieces of coal are suspended in the rising, hot gas flow; then they are rapidly consumed. Coal is fed from the hopper onto the moving chain by a rotor. Figure 1 shows a schematic diagram of a spreader stoker with a traveling grate.

Such stokers can effectively burn many types of coal. In addition, they can accommodate coals with a wide range of burning characteristics, including all types of lignites and bituminous coal. However, anthracite coal is not satisfactory for spreader stokers.

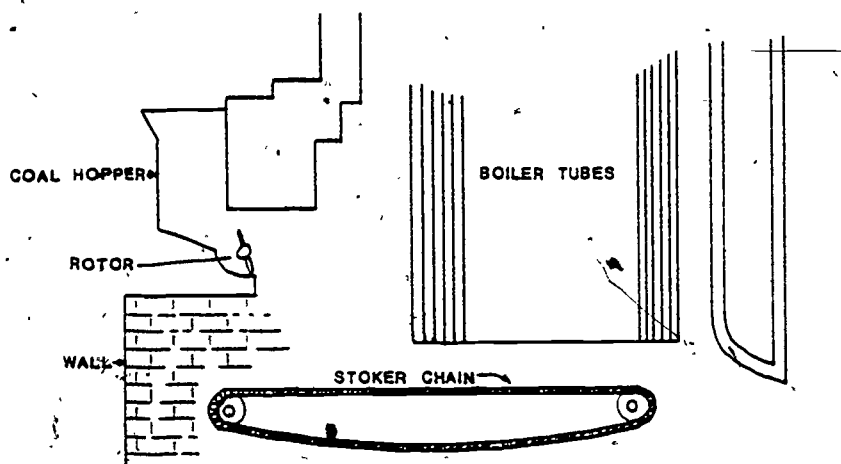

Figure 1. Schematic Diagram of a Spreader Stoker.

Several other stoker designs are in use: the underfeed stoker; the water-cooled, vibrating, grate stoker; and the traveling-grate stoker.

There is a maximum burning rate possible with each type of stoker. The highest value is 750,000 Btu/ft²/h. Because of this limitation, the boiler size must be increased in large plants. Therefore, stokers are not so widely used as they previously were. Pulverized coal systems or cyclone furnaces are used in most new installations. When stokers are installed now, it is generally, in smaller plants. Many stokers do remain in operation on older equipment.

Very large, modern furnaces are capable of burning rates up to 165,000,000 Btu/h. With the limitation imposed by the maximum burning rates of stokers, the combustion chamber would become unreasonably large for stoker firing. Pulverized coal systems provide higher burning rates and, thus, are more compatible with large plants.

PULVERIZED COAL SYSTEMS

A large percentage of the coal that is burned in large, steam generating facilities is burned in pulverized form. Pulverized coal burning was a major advancement developed in the 1920s. As boilers grew larger, stoker systems were no longer able to provide the required combustion rates. The development of pulverized coal systems was the solution.

In a pulverized coal system, the coal is pulverized to very small particles. The particles of coal are carried into the furnace on a stream of air. Because of their small size, the particles burn rapidly. Pulverized coal systems are capable of producing high heating rates. Thus, pulverized coal burning is compatible with large plants that generate large quantities of steam. Pulverized coal systems usually are not used in small installations for which stokers are more economical. Pulverized coal systems probably are the best means of burning the higher-ranking coals.

An important characteristic of coal for pulverized coal systems is "grindability." Grindability is expressed as a number relative to a standard coal which is assigned a grindability index of 100. The grindability index is measured by a standard ASTM procedure. A coal is more difficult to grind if its grindability index is less than 100; a coal is easier to grind if its grindability index is greater than 100. Obviously, the grindability index is an important factor for pulverized coal systems. As the grindability index of the coal increases, the capacity of a pulverizer increases. Thus, a system with pulverizers of a certain type will need a coal supply with a minimum value of the grindability index.

Originally, pulverized coal burners used a bin system. The coal was first pulverized in a pulverizer, and then it was transported to a bin where it was stored until used. There are many plants still in operation that use the bin system. Newer installations use direct firing, in which the pulverized coal is transported directly from the pulverizer to the furnace. The direct-firing system is simpler, safer, and less expensive than the bin system. It superseded the bin system as soon as pulverizing equipment became reliable enough to ensure uninterrupted operation of the plant.

A simplified drawing of a direct-firing, pulverized coal system is shown

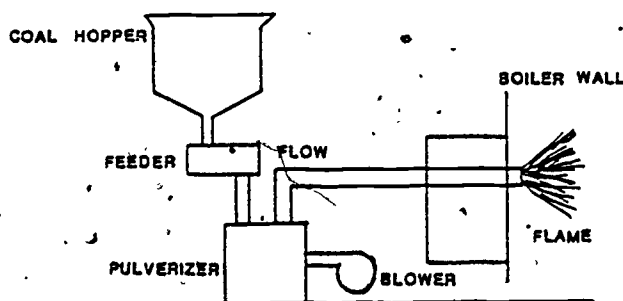

Figure 2. Schematic Diagram of a Direct-Firing System for Pulverized Coal.

in Figure 2. Coal is fed from a hopper into the pulverizer. After it is pulverized, it is blown directly through pipes and into the burner. The air used to transport the coal is part of the air used for combustion. This air is called

primary air. The remainder of the air needed for burning is introduced into the burner. It is called secondary air. Primary air provides about 15-20% of the total air needed for burning.

Pulverizers generally can be considered as being of three types: slow speed, medium speed, and high speed. Slow-speed pulverizers use a rotating drum with tumbling steel balls. Medium-speed pulverizers can use a ball-and-race construction, with steel ball bearings between an upper and lower race. The coal is crushed under pressure between the grinding surfaces. High-speed pulverizers have hammer-like beaters revolving inside a chamber.

The pulverized coal passes through a screen that ensures that the coal is of the required fineness. The fineness depends on the type of coal and on the design of the furnace. A typical requirement is that it must pass through a screen with openings the size of 0.0029 inch. Thus, the pulverizing operation results in very small coal particles. This is needed to allow transportation into the burner on a stream of air.

Two other divisions applying to burners for pulverized-coal systems are front firing and tangential firing.

Front firing simply means that the fuel is fed into the front of the burner.

In tangential firing, the fuel is fed into the corners of the chamber (Figure 3). Some large, modern installations tend to be of the tangential type.

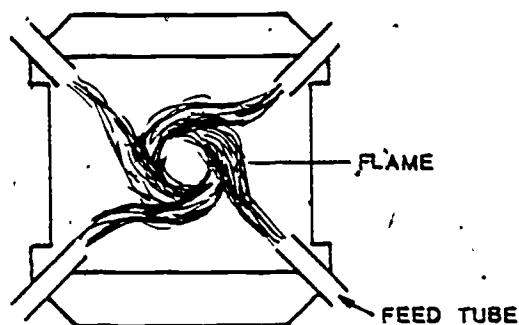

Figure 3. Corner-Fired Tangential Burning.

CYCLONE FURNACES

The cyclone furnace, which is a further advancement in coal-burning technology, was developed in the early 1940s. The cyclone furnace allowed economic use of low ranks of coal and improved combustion performance. Many large power plants now employ coal-burning cyclone furnaces.

The cyclone furnace is a horizontal cylinder. Coal, which is crushed in a simple crusher, is fed into the burner. Parts of the air (about 20% of

what is needed for combustion) enters in the same part of the burner in a direction parallel to the outside of the cylinder. This is called primary air. Primary air causes the coal to whirl about in a tangential direction. Figure 4 shows the operation of the cyclone furnace, with the coal and primary air entering the primary burner portion of the furnace.

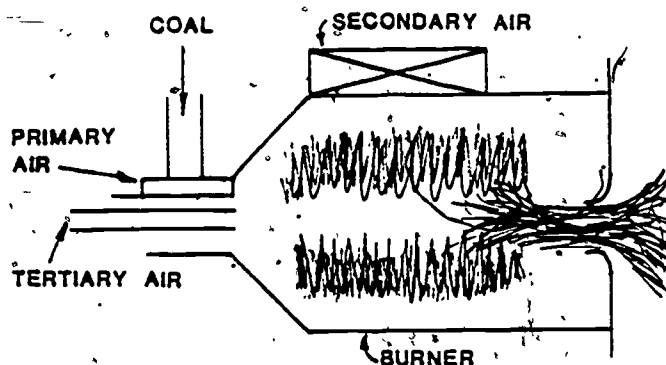

Figure 4. Diagram of Cyclone Furnace.

The burning coal is carried into the main chamber of the furnace. The secondary air enters the main chamber of the furnace. The secondary air enters the

main chamber, tangentially to the roof of the cylinder. The secondary air (about 75% of the total) also causes the coal to whirl about in the main chamber. A small, additional amount (approximately 5%) of air, called tertiary air, enters the center of the burner.

The combustion occurs efficiently, with high heat release. The temperatures are high enough to melt the ash into a liquid called slag. The slag coats the walls of the burner. Pieces of coal entering the burner are whirled to the wall where they stick in the slag. They burn rapidly in the fast-flowing secondary air.

The cyclone furnace generates a high rate of heat release in a small volume. It can burn a wide variety of coal types ranging from lignite to low-volatile bituminous. The ash characteristics of coal are important. To form a liquid-slag coating on the walls of the burner, there should be at least 6% ash in the coal. The chemical content of sulfur and iron are also important. Figure 5 shows a range of coals suitable for burning in a cyclone furnace, as based on the sulfur content and the ratio of iron to calcium and magnesium in the ash. Coals lying outside the suitable range have a high tendency to form iron sulfide, which is undesirable in a cyclone furnace.

To summarize the applications in which various firing methods are used, Table 8 shows the furnace sizes (in terms of rate of heat release) for which the various firing methods are applicable.

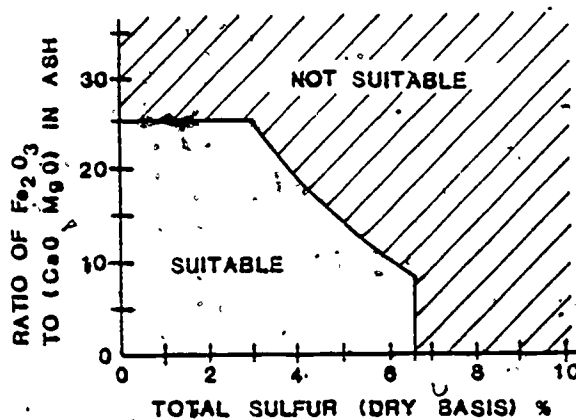

Figure 5. Suitability of Coal for Cyclone Furnaces.

TABLE 8. HEAT RELEASE RATES FOR VARIOUS FURNACES.

Firing Method	Heat Release (Million Btu/h)
Hand-fired	0.5 - 5
Stokers, small	2 - 50
Stokers, large	50 - 200
Pulverized coal	25 - 2000
Cyclone furnace	200 - 2000

FLUIDIZED BEDS

A new development in the burning of coal is combustion in fluidized beds. This process, which is under development in the United States and England, is being hailed as a major advance in combustion technology.

In fluidized bed combustion, air is blown upward through the bottom of the burner. The finely divided coal is suspended in the rising current of air. The particles of coal are lifted slightly so they are no longer resting on each other, but, rather, are floating in the rising air stream. More surface area is exposed to the air than in conventional burning where air moves over the surface of the bed of coal. Thus, efficient combustion is possible. Another result is that heat transfer to the boiler is more efficient; therefore, smaller boilers can be used. The fluidized bed also allows for lower-grade coals to be burned effectively.

It appears that the development work of fluidized bed combustion of coal is now complete. An experimental, electrical generating station using this process is being constructed in Yorkshire, England, and should be operational in 1979. This may become an important factor in coal combustion in the future.

EXCESS AIR

Excess air was defined as "the amount of air that is supplied to the combustion process in excess of the theoretical amount required for stoichiometric combustion." It is supplied to ensure complete combustion of fuel without production of carbon monoxide. The amount of excess air varies with the method of firing. Table 9 gives the amounts of excess air that are commonly supplied for various firing methods. It can be seen that the cyclone furnace is operated with the smallest amount of excess air.

TABLE 9. USUAL AMOUNTS OF EXCESS AIR FOR VARIOUS COAL-BURNING METHODS.

Method	Excess Air (Weight Percentage)
Stokers	
Spreader	30 - 60
Underfeed	20 - 50
Water-cooled vibrating grate	30 - 60
Chain grate and traveling grate	15 - 50
Pulverized coal systems	15 - 40
Cyclone furnaces	10 - 15

BOILERS

The boiler is an important part of steam production. The boiler consists of structures that are in contact with hot gases on one side and with water, or a mixture of water and steam, on the other. Sometimes the term "boiler" is used to refer to the entire structure, including the furnace. In this module, the term "boiler" means the surfaces that transfer heat from the hot gases to the water and the structures that contain water and steam. The boiler is essentially a closed vessel containing water that is converted to steam by heat.

Four types of boilers — fire-tube, water-tube, straight water-tube and bent water-tube — are described as follows:

1. Fire-tube boiler. In the fire-tube boiler, the hot gases from the combustion circulate through tubes and heat water that surrounds the tubes. The tubes and water are contained in a cylindrical drum. Steam collects above the water

level and is withdrawn through a pipe. A safety valve is necessary, because if the pressure rises too high, the boiler can explode. A

diagram of a fire-tube boiler is shown in Figure 6.

In current practice,

fire-tube boilers are used in small installations. Water-tube boilers offer greater safety and are used in large, modern installations. Fire-tube boilers are used in steam-heating systems in apartment buildings, small factories, and hotels.

2. Water-tube boiler. Water-tube boilers use small tubes in which water is contained. Hot gases are on the outside of the tubes. The tubes, which have outside diameters in the range of 1 to 3 inches, are connected to steam and water drums. The drums are shielded from the hot gases. Steam is formed in the tubes and circulates to the steam drum, from which it is extracted through a pipe. Water-tube construction provides greater safety than the fire-tube type. The only boiler parts exposed to hot gases are small diameter tubes. If there is a failure, the release of energy is small and there is a reduced hazard of explosion.

In addition, boiler capacity can be increased. In the fire-tube boiler, increase of pressure requires an increase in thickness and strength in the drum. The drum of the water-tube boiler is smaller and better able to withstand high pressure. The capacity of the water-tube boiler

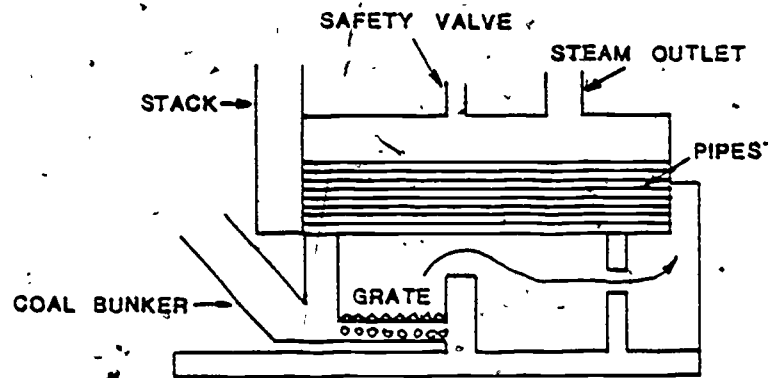

Figure 6. Schematic Diagram of a Fire-Tube Boiler with an Underfeed Coal Stoker. (Arrows show direction of gas flow.)

can be increased by increasing the number and length of the tubes. Thus, water-tube boilers are used for large installations: large, electrical generating plants; steel mills; paper mills; oil refineries; and large manufacturing plants.

There are many designs of water-tube boilers, but the most common are the straight-tube type and the bent-tube type.

3. Straight water-tube boilers. Straight water-tube boilers have straight tubes connected to headers that carry water and steam. The headers lead to one or more drums located above the boiler tubes. Water moves downward in the downcomer header. The circulation is powered by the difference in density between the water in the downcomer and the water-steam mixture in the riser. As in all water-tube boilers, the hot gases circulate around the tubes, transfer heat through the tube walls, and boil water inside the tubes. A drawing showing a design of a straight water-tube boiler is shown in Figure 7. The straight-tube boiler is also called the header-type boiler.

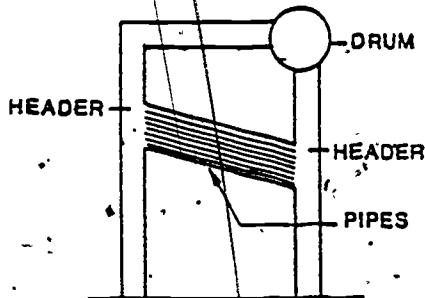

Figure 7. Schematic Diagram of a Straight Water-Tube Boiler With Inclined Tubes.

4. Bent water-tube boiler. Bent water-tube boilers offer more capability of higher pressure than straight-tube types. Straight-tube boilers have limitations imposed by the headers. Thus, modern boilers for large plants are usually the bent-tube type.

There are many possible designs of this type. A typical example is shown in Figure 8. The bent-tube type is also called the drum-type boiler. The boiler tubes end in upper and lower drums. The tube may be vertical so that formation of steam pockets is less likely. The steam drum, with

Straight water-tube boilers were widely used in the late 1800s; however, modern boilers are usually the bent water-tube type.

its pipe outlet, is at the top.

Modern, bent water-tube boilers are capable of delivering several million pounds of steam per hour. A typical design for a large, steam-generating unit is shown in Figure 9. The scale size is represented by the mark at the right, which represents the height of an adult human. The figure shows an example of a steam generator powered by a pulverized coal furnace.

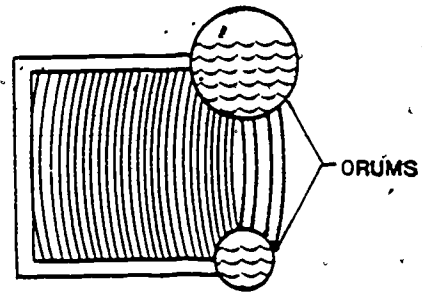

Figure 8. Schematic Diagram of Bent Water-Tube Boiler.

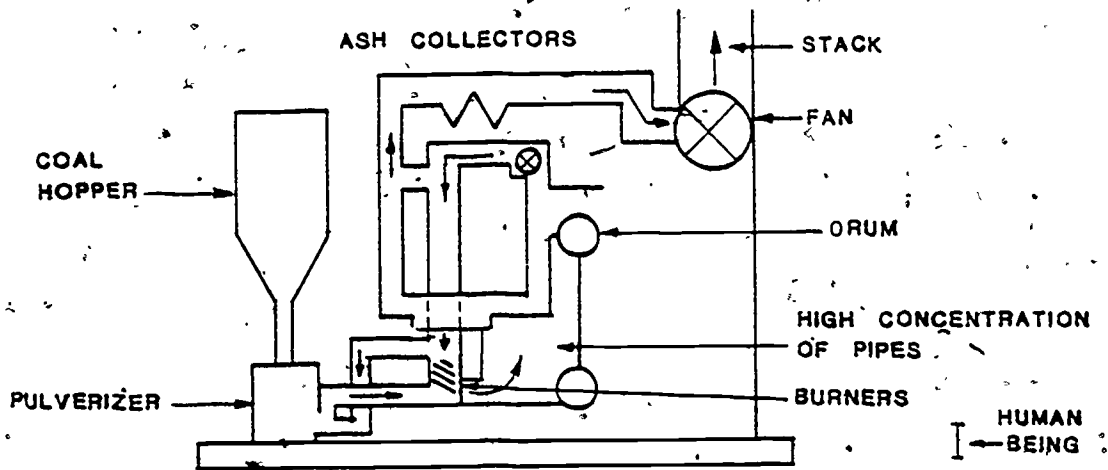

Figure 9. Steam-Generating Facility Powered by Pulverized Coal.

The flow of air through the system is indicated by arrows. Such a boiler would be suitable for a large, electrical-power generating station.

REMOVAL OF ASH

Ash is present in all types of coal. It remains as a residue after coal is burned. The furnace design must account for the fact that ash will remain after the burning of coal; otherwise, ash will deposit on the furnace walls

and floor. Even more importantly, ash will deposit on the surface of the boiler, reducing the capability of the boiler surfaces to transfer heat from the hot gases to the water inside the boiler tubes. This will limit the efficiency of the plant.

The method of removal of ash depends on a characteristic called ash-fusion temperature. If the temperature of the ash is above the ash-fusion temperature, the ash will melt and become a liquid. The ash-fusion temperature can be determined by a standard ASTM test. The ash-fusion temperature is important because it determines whether the ash will remain as a solid or whether it will melt in a furnace that operates at a specified temperature.

If the ash remains solid, the furnace will have a hopper bottom. Part of the ash will be carried up the smokestack as solid particles. Part will fall to the bottom of the hopper as dry, solid material and will be removed from the hopper in this form.

Dry ash removal is often used in stoker firing. The ash particles fall through the grate and can be removed manually with rakes, hoes, or by means of conveyer belts.

If the coal has a low ash-fusion temperature, it will melt or become sticky. It will then become difficult to remove, and it may accumulate on the walls and bottom of the furnace. In this case, the slag-tap method of removal is used. The slag drops as a liquid onto a floor where there is a pool of liquid slag. The liquid slag is drained through an opening in the furnace floor called the slag tap. The slag is then collected in a tank that contains water. Liquid slag collection is applicable for cyclone furnaces.

The characteristics of the furnace and its ash collection method determine the properties of the coal that can be burned. If the furnace operates at high temperature and is designed for liquid slag collection, the coal should have low ash-fusion temperature. Conversely, if the furnace is designed for dry ash collection, the coal used in it must have high ash-fusion temperature.

ECONOMIC AND ENVIRONMENTAL ASPECTS OF SOLID FUEL SYSTEMS

Coal is currently being called "the once and future king," a phrase that was used in the popular musical "Camelot." In the musical, this phrase refers to King Arthur of England, with implications that King Arthur will return

someday to rule over a prosperous kingdom. As the phrase is applied to coal, it means that coal was once the most widely used fuel and, now that its use is increasing, it may once again become the king of fuels. However, as coal once again becomes a dominant energy source, certain economic and environmental considerations will become even more important.

ECONOMIC CONSIDERATIONS

Coal was once used more widely than any other fuel. However, as other fuels (particularly natural gas and petroleum) were developed, the use of coal declined. This was due in part to the relatively greater cleanliness of natural gas and petroleum. It was also due to lower costs of oil and natural gas in some regions of the United States. For example, in the Gulf Coast states, oil and natural gas were plentiful, and along the East Coast, imported oil was less expensive. Hence, the percentage of the total energy output supplied by coal declined in the United States. Some of the traditional markets such as railroads and space heating — all but disappeared. Most of the coal used in the United States was for electrical generation. In that usage, the efficiency made possible by improvements in coal technology (for example, advances in burners, unit trains, and improved mine productivity) made coal attractive for use in large, electrical-generating plants. Nevertheless, the percentage of the total energy supplied by coal declined. By 1973, only about 18% of the total energy used in the United States came from coal as a primary source.

The situation has changed in recent years. The costs of oil and natural gas have risen sharply since 1973, and there is great concern about the future availability of oil and natural gas. Under these conditions, the use of coal should again increase rapidly. It is probable that coal will again become the dominant energy source, both as a primary solid fuel and as a source of other fuels through coal gasification and coal liquification. Once again, there may be a "King Coal."

The use of other solid fuels will also increase. As the price of conventional fuels continues to increase, the economic justification for burning industrial and agricultural waste products with low heat content will improve. Wood, as a renewable resource, will be more attractive. Already many small users are considering wood as a viable, alternative fuel.

Solid fuels can be burned with high efficiency. For large, modern coal-burning systems, about 90% of the energy stored in the coal can be converted into useful heat.

ENVIRONMENTAL CONSIDERATIONS

Coal has also declined in use because of undesirable emissions from the smokestack, primarily flyash and oxides of sulfur. Both of these emissions contribute to air pollution. Flyash (particulate material) dirties the surrounding neighborhood, and sulfur oxides contribute to smog and to nose and throat irritations. In some cases, sulfur dioxide contributes to a so-called "acid rain," which contains sulfuric acid. Such acid rains are believed to have destroyed fish life in some lakes in New York, and they are threatening lakes in Canada. Hence, removal of the polluting factors is important, particularly with the expected increase in the use of coal.

The United States Environmental Protection Agency and most of the individual states have imposed limits on the amount of sulfur-dioxide emission. The technology for effective removal of the undesirable components from smokestack emission is under intensive development.

Flyash may be removed by electrostatic precipitators and by liquid scrubbers. Electrostatic precipitators impart an electrical charge to the particles and then collect them at an electrode. Scrubbers bring the gas into contact with a liquid to remove the particles of flyash.

Reduced sulfur-dioxide emission can be achieved by burning coal with low sulfur content; however, such coal is in limited supply and is more expensive. Thus, most methods emphasize removal of the sulfur, before, during, or after combustion. Cleaning of the coal before burning can remove part of the sulfur (see the section headings "Handling of Solid Fuels" and "Preparation for Burning"). Burning coal in a bed containing limestone combines some of the sulfur as calcium sulfate — which is removed as a dry ash. Sulfur removal from the gases produced by combustion is also possible. The gases are passed through scrubbers containing liquid solutions that contain materials such as calcium or magnesium. The sulfur is removed by chemical reaction with these materials.

Much research and development is being conducted in the search for processes of sulfur removal with good technical performance and reasonable cost.

This remains an important challenge for future use of coal as a large-scale replacement for other fuels.

REFERENCES

ASHRAE Handbook, 1977 Fundamentals. New York: American Society of Heating, Refrigerating, and Air-Conditioning Engineers, Inc., 1977.

Baumeister, T., ed. Mark's Standard Handbook for Mechanical Engineers. New York: McGraw-Hill Book Co., 1978.

Considine, D.M., ed. Energy Technology Handbook. New York: McGraw-Hill Book Co., 1977.

Steam, Its Generation and Use. New York: Babcock and Wilcox, 1972.

Weight, S.J. Combustion of Coal in Fluidized Bed, Physics in Technology. November, 1972. p. 244.

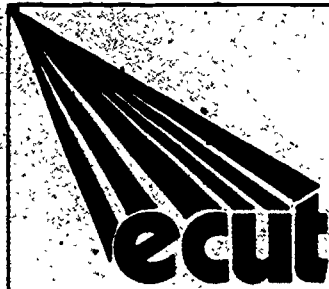

ENERGY TECHNOLOGY

CONSERVATION AND USE

ENERGY PRODUCTION SYSTEMS

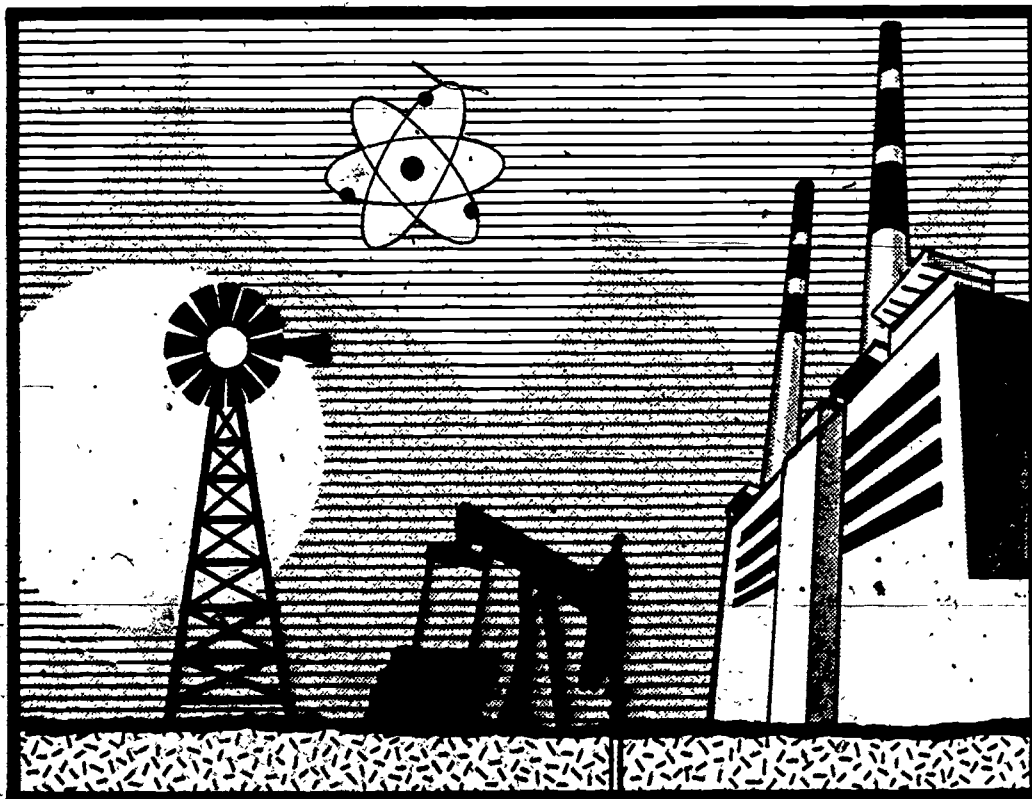

MODULE EP-02

GENERATION OF STEAM AND HOT WATER,
USING LIQUID AND GASEOUS FUELS



CENTER FOR OCCUPATIONAL RESEARCH AND DEVELOPMENT

INTRODUCTION

This module presents an overview of the generation of steam and hot water using liquid and gaseous fuels such as fuel oil, natural gas, and products derived from coal and biomass. The various fuels and their Btu content and impurities are discussed, as well as burning procedures and handling techniques which are used in association with these fuels. The variations in burner design and operation are described, and the entire steam production system is discussed. Included also is a discussion of each fuel, as well as the extent of their use.

PREREQUISITES

The student should have completed Fundamentals of Energy Technology and Module EP-01 of Energy Production Systems.

OBJECTIVES

Upon completion of this module, the student should be able to:

1. List and describe each of the fuels discussed.
2. Describe the importance of each fuel and how they are used.
3. Describe handling and preparation procedures used in burning fuel oil and natural gas.
4. Describe the burners used with fuel oil and natural gas.
5. List the grades of fuel oil and briefly describe their characteristics.
6. Describe the relative advantages and disadvantages of each fuel.
7. Given the necessary information about the chemical composition of a fuel, calculate the heating value and the amount of air needed for complete combustion.
8. Discuss the characteristics of liquid and gaseous fuel-fired systems for generation of steam and hot water.

SUBJECT MATTER

TYPES AND PROPERTIES OF LIQUID AND GASEOUS FUELS

Liquid and gaseous fuels generally burn cleaner and produce less ash than coal. There is also the convenience of being able to deliver them through pipelines. Because of these advantages, liquid and gaseous fuels gradually displaced coal as the primary source of energy in the United States. In the early 1900s, coal provided most of the energy used; but by 1970, liquid petroleum fuels and natural gas provided about 75% of the energy. In more recent years, however, rising costs and concerns about depletion of the supply of these fuels have caused their use to decrease somewhat. The result is that the use of coal has again increased and alternate energy sources are under development. Yet, liquid and gaseous fuels continue to be important.

Fuel oil and natural gas are emphasized in this module because they are the most widely used of the liquid and gaseous fuels. These fuels, which are extracted from reservoirs in nature, are fossil fuels. Because of the increased costs and diminished supply of the main fossil source of liquid and gaseous fuels, efforts have increased to derive such fuels from coal, a supply that is still abundant. In addition, there are developmental efforts being made to supply liquid and gaseous fuels from the decomposition of waste and agricultural products (biomass).

LIQUID AND GASEOUS FOSSIL FUELS

The liquid and gaseous fossil fuels described in this section of the module are obtained from oil and gas fields located in many different parts of the United States and other areas of the world. These fuels have been formed by the decay of living organisms over time periods of millions of years. The fuel stored in these oil and gas fields is, thus, an exhaustible resource that cannot be renewed.

The following paragraphs emphasize the fossil fuels that are used for production of steam and hot water. The two most important examples of such fuels are fuel oil and natural gas. Liquified petroleum gas and some manufactured gases are also discussed. However, a number of important liquid fuels of fossil origin are not used to produce steam or hot water and, therefore, will not be treated in this module. An example is gasoline, which is used mainly for transportation.

Fuel Oil

Fuel oil is derived from petroleum or crude oil. Petroleum is an oily, flammable liquid formed from organic material contained in seabed sediments. The exact process of formation is unknown, but the formation has taken millions of years. Petroleum is found in many different areas of the world. Sometimes it is found oozing from the ground, but more often it must be pumped from below the ground. In some cases, the deposits are several miles deep. The composition of petroleum varies widely from one source to another.

Generally crude oil is not used directly as a fuel. Rather, it is refined to produce a variety of products. The products of the refining process include gasoline, kerosene, jet fuels, diesel fuels, lubricating oils, and fuel oils; but it is the fuel oil fraction that is of primary interest here.

Part of the refining process involves distillation of the oil and condensation of the products. Fuel oils that have been distilled and recondensed are called distillate oils. Distillate oils tend to be cleaner and more free of sediment and other impurities; they are composed of relatively light molecules. The portion of the oil that is not vaporized and condensed in the refining process is called residual oil. Residual fuel oils are thicker and heavier than distillate fuel oils; they are composed of heavier molecules and contain more impurities and sediment.

Fuel oils are classified into a number of different grades specified properties. The grades now in use are as follows:

- Grade No. 1 is a light distillate used in vaporizing burners. It must vaporize easily.
- Grade No. 2 is a heavier distillate, commonly used in general purpose domestic oil burners.
- Grade No. 4 is a heavier oil, but one for which preheating usually is not required.
- Grade No. 5 (Light) is an oil for burners capable of handling heavier oils than Grade No. 4. Preheating may be needed for some types of burners and some climates.
- Grade No. 5 (Heavy) is intended for similar service to Grade No. 5 (Light). Preheating is usually needed for burning and, in cold climates, for handling.

• Grade No. 6 (sometimes called Bunker C) is a high viscosity oil used for commercial and industrial heating. It requires preheating for both handling and burning.

Grades No. 1 and 2 are distillate fuel oils. This means that they are the condensed products of a distillation process. Grades No. 4, 5, and 6 are residual fuel oils. This means that they are left over after distillation. The oils grow more viscous — that is, they are thicker and more resistant to flow — as one proceeds from Grade No. 1 to Grade No. 6. Notice that Grade No. 3 is not defined.

The American Society for Testing and Materials (ASTM) specifies standards that the various grades of oil must meet. There are a number of characteristics that determine grade classification and suitability for various applications. A few of the properties specified in the ASTM standard for fuel oils are given in Table 1 in order to illustrate how the properties change from grade to grade, but this is only a partial list. The flash point is defined as "the maximum temperature at which an oil can be stored and handled." Minimum values for flash point may be prescribed by state and local laws. The pour point can be defined as "the lowest temperature at which an oil can be stored and still flow."

TABLE 1. ASTM STANDARD SPECIFICATIONS FOR FUEL OIL GRADES (PARTIAL LIST).

Grade	Minimum Flash Point (°C)	Maximum Pour Point (°C)	Maximum Water and Sediment (Volume %)
No. 1	38	-18	Trace
No. 2	38	-7	0.1
No. 4	55	-7	0.5
No. 5 (Light)	55	—	1.0
No. 5 (Heavy)	55	—	1.0
No. 6	65	—	2.0

Some typical properties of oils in the different grades are listed in Table 2. These values are not defining standards for each grade, as the values in Table 1 are. Rather, the values in Table 2 are values that one might expect

to obtain in fuel oil of the specified grade. These are not exact values; they will vary somewhat with the source of the oil.

TABLE 2. TYPICAL VALUES OF PHYSICAL PROPERTIES OF FUEL OIL.

Grade	Pour Point (°C)	Heating Value (Btu/gal)	Density		
			lb/gal	gm/cm ³	deg API
No. 1	-37	135,000	6.8	0.82	42
No. 2	-21	139,000	7.2	0.87	32
No. 4	-7	145,000	7.6	0.9	20
No. 5 (Light)	-1	148,000	7.8	0.94	18
No. 5 (Heavy)	-1	151,000	8.0	0.95	16
No. 6	-	153,000	8.3	0.97	14

Heating value is an important property of oil. It specifies how much heat is produced when a gallon of oil is burned. Heating value is not specified by an ASTM standard, but it does tend to increase as the grade number increases.

Table 2 also lists the density of the different grades of oil in three different units: lbs per gallon, grams per cubic centimeter, and a scale called degrees API. This last unit of measure, which is specified by the American Petroleum Institute (API), is measured on a hydrometer. (Note: Density of water is about 1 gm/cm³; therefore, the information given in Table 2 shows that oil is less dense than water.)

Because the heavier grades of fuel oil are used most often for large installations such as electric generating plants, the value of 150,000 Btu/gal can be adopted as the heating value of fuel oils used in industry. Table 2 shows that this approximates the heating value of the heavier grades of fuel oil to within a few percent of their exact value.

Table 2 has presented information about the density of fuel oil. The density of fuel oil, of course, changes with temperature. Because fuel oils are sold on a volume basis, the delivered volume is generally corrected by a factor that depends on temperature. The delivered volume is corrected to what it would have been at 60°F. The correction factor depends on the density

of the oil, and on the temperature. The volume at 60°F is equal to the volume at the given temperature multiplied by the correction factor. Figure 1 shows the correction factor appropriate for oils having different values of API gravity.

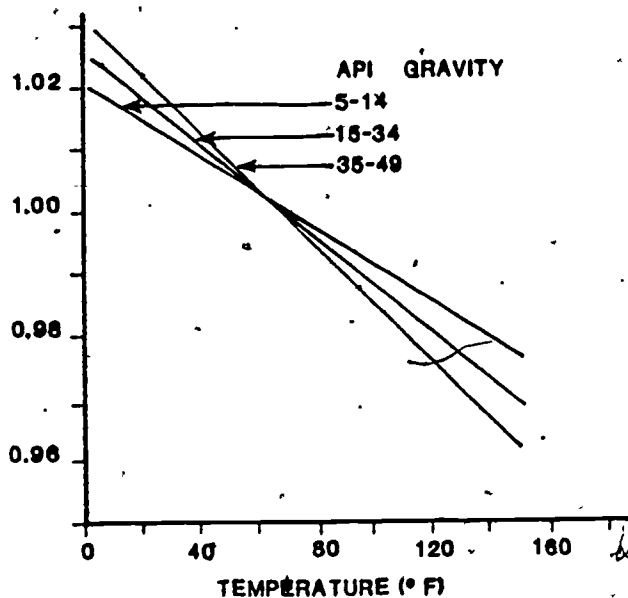

Figure 1. Temperature Dependent Correction Factor for Fuel Oil Volume.

EXAMPLE A: USING CORRECTION FACTOR TO CALCULATE VOLUME.

Given: One thousand gallons of No. 6 fuel oil at a temperature of 18°F.
Find: How many gallons one would be charged for.
Solution: From Figure 1, the appropriate correction factor at 18°F is 1.015. This value is obtained by using the curve for the API gravity in the range of 5 to 14. One would be charged for 1,000 x 1.015, or 1,015 gallons.

Table 3 presents information about the chemical analysis of some grades of fuel oil. These can be considered as approximations rather than exact values for all cases. The chemical composition will vary somewhat according to the source of the fuel oil. Generally, the percentage of carbon does not change greatly through the different grades. The percentage of hydrogen decreases somewhat as one goes from Grade 1 to Grade 6. The amount of impurities, especially sulfur, increases as one goes to the higher numbered grades.

TABLE 3. TYPICAL CHEMICAL COMPOSITION OF FUEL OILS.

Grade	Weight Percent					
	Hydrogen	Carbon	Sulfur	Nitrogen	Oxygen	Ash
1	13.8	86.1	0.1	0	0	0
2	12.5	87.2	0.3	0.02	0	0
4	11.8	87.4	0.8	—	—	0.03
5	11.2	87.8	1.0	—	—	0.03
6	9.7	85.9	2.3	2		0.12

EXAMPLE B: CALCULATING HEATING VALUE OF FUEL-OIL.

Given: The data in Table 3.

Find: The heating value of No. 6 fuel oil. (Note: Heating values given in Table 7 of Module EP-01 will be useful.)

Solution: From Table 7, Module E0-01, the heating values of carbon, hydrogen, and sulfur are 14,447, 60,958, and 3,980 Btu/lb, respectively. For one pound of oil, the heating value due to carbon will be as follows:

$$0.859 \times 14,447 = 12,410 \text{ Btu.}$$

This uses the percentage of carbon specified in Table 3. The heating value due to hydrogen will be as follows:

$$0.097 \times 60,958 = 5,913 \text{ Btu.}$$

The heating value due to sulfur will be as follows:

$$0.023 \times 3,980 = 92 \text{ Btu.}$$

Adding these contributions gives 18,415 Btu/lb. Since the density of No. 6 oil is about 8.3 lb/gal (Table 1), the heating value can be expressed as follows:

$$18,415 \text{ Btu/lb} \times 8.3 \text{ lb/gal} = 152,845 \text{ Btu/gal.}$$

This figure is in reasonable agreement with the heating value in Table 2.

The cost of fuel oil decreases as one goes from lower grade numbers to higher ones. The complexity of handling and burning the oil also increases as one goes to the higher grade numbers. Thus, domestic and small commercial space-heating applications usually employ Grade No. 2, which is easy to handle and to burn. Grade numbers 4, 5, and 6 are used for larger industrial and commercial installations. They are appropriate for use in large, costly furnaces where large quantities of oil are used. Because of its relatively low cost, Grade No. 6 oil is often used for generation of steam and hot water in industry.

In summary, fuel oil is a major source of heat energy for producing steam and hot water. It is an important energy source for space heating in homes, offices, and industry; for industrial process heat; and for electrical power generation.

Natural Gas

Natural gas is a term applied to gases commonly found in the same geological formations as petroleum. It is often in contact with crude oil. Natural gas is a fossil fuel, formed over millions of years through decomposition of organic material. It is a highly desirable fuel because it is clean, easy to burn, and easily deliverable by pipeline. Natural gas is by far the most widely used gaseous fuel in the United States. In 1970, it supplied about 30% of the primary energy consumed in the United States.

Natural gas is combustible, but it can contain nonburnable components such as carbon dioxide and nitrogen. There is no single composition for natural gas. It consists mostly of methane, with the chemical composition CH_4 . However, the composition can vary widely, with the exact composition depending on the geographical source. Table A lists some of the constituent gases commonly found in natural gas, along with typical ranges for their percentages.

TABLE 4. COMPOSITION OF TYPICAL NATURAL GAS.

Gas	Chemical Composition	Percentage
Methane	CH ₄	70-96%
Ethane	C ₂ H ₆	1-14%
Propane	C ₃ H ₈	0-4%
Butane	C ₄ H ₁₀	0-2%
Pentane	C ₅ H ₁₂	0-0.5%
Hexane	C ₆ H ₁₄	0-2%
Carbon dioxide	CO ₂	0-2%
Oxygen	O ₂	0-1%
Nitrogen	N ₂	0.4-17%
Hydrogen	H ₂	0-2%
Hydrogen sulfide	H ₂ S	0-0.2%
Helium	He	0-2%

The heating value of natural gas can vary from about 900 to 1,200 Btus per cubic foot, but delivered gas is usually in the range of 1,000 to 1,050 Btus per cubic foot. The supplier can adjust the composition somewhat in order to keep the heating value of the delivered gas reasonably constant.

The ultimate chemical composition of natural gas taken from some different sources in the United States is given in Table 5. The ultimate chemical composition is the composition by chemical elements (carbon, hydrogen, and so forth), regardless of how these elements are combined in CH₄, C₂H₆, and so on. Heating values are also specified.

TABLE 5. ULTIMATE CHEMICAL COMPOSITION OF NATURAL GAS FROM DIFFERENT SOURCES.

Source of Gas	Density (lb/ft ³)	Ultimate Chemical Composition (Weight Percent)				Heating Value (Btu/cubic foot)
		Carbon	Hydrogen	Sulfur	Nitrogen and Oxygen	
Pennsylvania	0.048	75.25	23.53	-	1.22	1129
Southern California	0.048	74.72	23.30	-	1.98	1116
Ohio	0.043	69.12	23.20	0.34	7.24	964
Louisiana	0.046	69.26	22.68	-	8.06	1002
Oklahoma	0.048	64.84	20.85	-	14.31	974

Because most natural gas is odorless, compounds containing sulfur are usually added for safety purposes. Enough of the compound will usually be added so that the average person will be able to smell the presence of the natural gas when it reaches a concentration of 1% in the air. This is well below the percentage at which a mixture of natural gas and air will burn. The addition of the odorous compounds does not significantly increase sulfur content.

EXAMPLE C: CALCULATING AIR NEEDED FOR COMBUSTION.

Given: One thousand cubic feet of natural gas of the composition specified for the Pennsylvania sample shown in Table 5.

Find: The amount of air needed for complete combustion.

Solution: Use the values from Table 7 of Module EP-01 for the theoretical air. To burn one pound of the natural gas, the air needed to burn the carbon is as follows:

$$0.7525 \times 11.51 = 8.66 \text{ lb.}$$

And the air needed to burn the hydrogen is as follows:

$$0.2353 \times 34.28 = 8.06 \text{ lb.}$$

The total air needed is $8.66 + 8.06 = 16.72$ pounds per pound of natural gas. Because 1,000 cubic feet of the natural gas weighs 48 lb ($1,000 \times 0.048 = 48$), the total amount of air is $48 \times 16.72 = 803$ lb. At a density of 0.0793 lb/ft^3 (at 60°F and one atmosphere of pressure), this will require the following:

$$\frac{803}{0.0793} = 10,216 \text{ cubic feet of air.}$$

A mixture of natural gas and air is flammable only within certain limits for the percentage of natural gas in the mixture. The lower limit is about 5%; the upper limit is about 15%. If the percentage of natural gas lies between 5 and 15%, it is flammable. If the percentage of natural gas lies outside these limits, a flame will not propagate and the mixture will not burn.

Natural gas is a desirable fuel and an easy-to-use fuel; but, it is a limited resource. Thus, the known reserves of natural gas in the United States are declining. Moreover, natural gas is delivered by pipeline, and it is

difficult and uneconomical for it to meet the needs during peak demand periods. Natural gas is widely used for space heating in homes and businesses and for steam generation in boilers of the size that produce as much as 250,000 pounds of steam per hour. In many cases, this industrial service is "interruptible" — which means that during periods of peak demand (as on a very cold winter day), the supply of natural gas to the industrial customers might be cut off. These customers must then rely upon fuel oil or coal. This practice ensures continued delivery of natural gas for heating of homes and small businesses.

Natural gas is an important fuel for industrial use (generation of steam and electrical power). Its major use, however, is for space heating. Because of considerations described previously, the use of natural gas for steam generation is largest in summer and other periods of relatively low total demand for gas.

Liquefied Petroleum Gas

Liquefied petroleum gas (commonly called LP gas) is a mixture of gases of several types. It usually consists mainly of propane (C_3H_8) or butane (C_4H_{10}), or a mixture of these two gases. LP gas can easily be liquefied with a moderate amount of pressure. It is transported and stored as a liquid and burned as a gas. The gas can be obtained by venting it through pipes directly from the storage vessel to the burner. When a valve in the pipe is opened, the gas will flow because of the pressure in the storage vessel.

Commercial liquid propane and liquid butane are also available. They are obtained by either the removal of the specified gas from natural gas or as a by-product of the refining of petroleum. Some of the properties of liquid propane and liquid butane are listed in Table 6. Mixtures of propane and butane are also available. Their properties lie between those of the unmixed products.

TABLE 6. PROPERTIES OF LP GAS.

Gas Type	Propane	Butane
Boiling point at 1 atm pressure (°F)	-40	+32
Vapor pressure at 100°F, Maximum (psig)	210	70
Typical other gases	5-10% Propylene	5% Butylene
Heating value (Btu/ft ³)	2500	3200
Flammability limits in air mixture (%)	2.1-9.5	1.8-8.4

The boiling point is an important factor that affects their use. Because of its low boiling point, liquid propane can be used in winter without additional handling. Liquid butane will solidify (freeze) in cold weather. It has a higher boiling point and cannot be used in cold conditions unless heating is supplied.

The heating value of LP gas is high, more than twice as high as that of typical natural gas. In an air mixture, LP gas is flammable at lower concentrations than natural gas (which has a lower flammability limit around 5%). Thus, care must be taken to avoid small leaks of LP gas.

LP gas is an important energy source. It supplies about 2% of the total energy used in the United States. It is used to heat homes and trailers, especially in places where natural gas is not available. Some small cities use LP gas instead of natural gas. It is rarely used as the primary source of energy for producing steam and hot water in industry. However, it is often used as a back-up fuel at times when the natural gas supply is interrupted because of high demand. Thus, LP gas is significant in its use as a fuel for production of steam and hot water.

Manufactured Gas

Manufactured gas is fuel gas made from some other starting material, such as oil or coal. The manufactured gases produced from coal are described later in the section on coal gasification.

One type of gas manufactured from oil is called oil refinery gas. Oil refinery gases are by-products of the processing of oil in an oil refinery.

They are the result of the thermal breakup of large molecules into smaller gaseous molecules. This type of gas was once used for heating purposes in urban areas until natural gas became more popular in this application. Today, oil refinery gas is used mainly for heating purposes in the refinery in which it is produced.

Most oil-based manufactured gases are used for specialized operations in industrial plants; or they are used as specialty fuels (such as acetylene) that are used in welding. The use of manufactured gases to produce steam and hot water is unusual, except in some cases for in-plant operations in the facility where the gas is produced.

Shale Oil

Shale oil is obtained from a type of sedimentary rock that contains an organic material called kerogen. If the rock is heated to a temperature around 875°F in the absence of air, the kerogen decomposes to produce an oily liquid that can be used as a fuel. Thus, shale oil is not a true petroleum product; rather, it is the result of a chemical breakup of the molecules that compose kerogen.

Rocks capable of yielding shale oil are distributed widely, including the western United States. Shale oil can be refined to produce gasoline, jet fuel, and fuel oil. However, the economic prospects for development of shale oil are uncertain since it requires a major investment to produce appreciable quantities of it. Even at the current prices for petroleum, shale oil does not appear to compete economically. Thus, shale oil is not a current energy source in the United States, although plants for the production of shale oil are being constructed in other parts of the world. If the price of petroleum continues to increase, the situation may change and shale oil may become an important energy source in the future.

LIQUID AND GASEOUS FUELS DERIVED FROM COAL

Liquid and gaseous fuels can be produced from coal by chemically combining hydrogen with the carbon in the coal so as to produce a liquid or gaseous hydrocarbon compound. In one sense, such fuels can be considered as being of fossil origin, since coal is a fossil fuel. This module previously considered that the fossil gaseous and liquid fuels are normally found in nature

as gases or liquids. Production of gaseous or liquid fuels from coal involves a different technology and, therefore, will be treated separately.

The purpose of producing gaseous and liquid fuels from coal is to supplement or replace natural gas and fuel oil, which are in increasingly short supply. Coal, on the other hand, is relatively abundant. Gaseous and liquid fuels are cleaner to burn than coal; they also are adaptable for use in vehicles. Solid coal, of course, is not a convenient fuel for vehicles. In order to supplement supplies of oil and natural gas, a method of producing gaseous and liquid fuels from coal is desired.

Three categories of gaseous and liquid fuels made from coal will be considered: manufactured gases, coal gasification, and coal liquefaction. Manufactured gases provide fuel for the production of steam and hot water in industry. Coal gasification and coal liquefaction are still under development and do not yet provide significant amounts of fuel, although they probably will become important in the future.

Manufactured Gases

There are several types of fuel gases that have been manufactured from coal. Such gases were popular in the early 1900s until natural gas became widely used around 1940. After this, coal-derived gases fell into disuse, except for specialty applications.

Producer gas is made when coal or coke is burned with a deficiency of air. Air and steam are blown through the coal. The resulting gas has a low heating value — approximately 140 Btu/ft³ — and contains about 23% carbon monoxide. Because of the low heating value, producer gas is not economical to transport for any distance; therefore, it is used within the plant where it is produced. Its applications include production of steam and hot water.

Blast-furnace gas is produced as a by-product during the manufacture of pig iron. It has a low heating value — approximately 90 Btu/ft³ — and is used within the factory where it is produced. Typically, blast furnace gas is used for producing steam. It contains about 25% carbon monoxide, which is its most important combustible gas.

Coke-oven gas is obtained in the production of coke from coal. It is produced from the volatile products contained in the coal. Coke-oven gas has a heating value of approximately 560 Btu/ft³. It is a by-product of the pro-

duction of coke in steel factories, where coke is to be used in the blast furnace; and it is used entirely within the steel factory where it is produced, typically for the production of steam. Coke-oven gas contains a high fraction of hydrogen and methane.

Water gas is manufactured by passing steam through hot coke. It contains free hydrogen and carbon monoxide as the burnable fractions and can be enriched with oil to make "carbureted" water gas. The oil molecules are broken up by heat to provide hydrocarbons in the gas mixture. Carbureted water gas has a heating value of approximately 530 Btu/ft³ and is used within industry for steam production. It has sometimes been piped short distances for home heating, but this use has largely been replaced by natural gas.

These four gases (producer gas, blast-furnace gas, coke-oven gas, and water gas) are gases that are manufactured from coal. They share two common characteristics: they are used mainly inside the factory where they are made and their heating values are much lower than that of natural gas.

The technology of manufacturing these gases from coal has been known for years, and they are currently being used in modern industry for producing steam and hot water. However, a technology capable of producing (from coal) a gas that has a higher heating value is desired. Such a gas could serve as a substitute for natural gas. This possibility is considered in the next section of this module that discusses coal gasification.

Coal Gasification

The techniques of producing manufactured gas from coal should be considered to be coal gasification. The term "coal gasification," as commonly used now, implies attempts to produce a substitute for natural gas that could replace many applications of natural gas. It also implies more advanced technology than was used for the older manufactured gases.

The process of coal gasification involves reacting coal, which is largely carbon, with some material containing hydrogen under conditions of high temperature and pressure. The result should be a light hydrocarbon, such as methane, CH₄.

For simplicity, this discussion considers coal as consisting mostly of carbon. Coal can be converted to methane gas according to the following chemical reaction:



This reaction can proceed at elevated temperatures as an exothermic reaction (that is, it proceeds with a net release of energy). It produces a gas that has a high heating value and that is similar to natural gas, which has high methane content. However, it needs free hydrogen, which requires large quantities of energy to produce. Therefore, most coal gasification procedures use multi-step processes, with water (in the form of steam) supplying the hydrogen. A possible series of reactions of steam with coal is as follows:

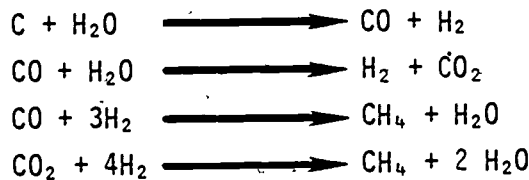

This series of reactions will have the net effect of producing methane when coal and water are reacted. These reactions are all endothermic (that is, they require heat to make the reactions occur). The heat can be produced by supplying some oxygen along with the steam. Partial combustion of the coal will provide the needed heat. In addition, some of the reactions may require the use of catalysts to make them proceed efficiently.

A variety of different processes for coal gasification are under development. Perhaps the most familiar is the so-called "Lurgi process," which was first developed in 1936. In the Lurgi process, lump coal travels on a grate through the reaction chamber. Steam and oxygen are also fed into the chamber from the bottom so that they pass upward through the coal. The chamber itself is a water-cooled cylindrical shell. The pressure inside the chamber can be as high as 450 pounds per square inch. The following set of reactions is believed to occur:

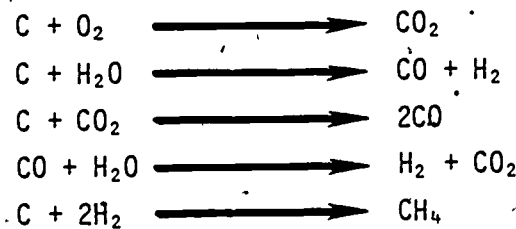

The top reaction provides the heat necessary to drive the other reactions, heating the bed of coal to a temperature around 2000°F. The bottom reaction provides the fuel gas, methane. It uses hydrogen that was released in the second and fourth reactions. The top reaction occurs only in a thin layer near the bottom of the coal. The other reactions occur higher in the coal bed, which may be about seven feet deep. In this part of the bed, there is no oxygen available; so the fuel gas is not oxidized.

The efficiency of the conversion of energy stored in the coal to energy stored in the fuel gas may be around 77%. The fuel gas is extracted from the top of the reaction vessel and is cooled in a waste-heat boiler to produce most of the steam needed for the process. The gas is then passed through an absorber to remove sulfur. The result is a fuel gas with a heating value of approximately 400 Btu/ft³ — less than half that of methane.

The Lurgi process has been described in some detail because it represents some of the typical ideas encountered in coal gasification. There are a few Lurgi gas procedures operating in the world, but this process is not likely to be economically competitive in the United States — at least in its simple form. There are many other coal gasification procedures under development. The following are a few: the BIGAS process, the COGAS process, the HYGAS process, the Hydrane process, the Consolidated Synthetic Gas (CGS) process, and the Synthane process. It is not appropriate here to describe details of all these processes, although some of them have reached the status of pilot plant construction. Thus, the technology for production of substitutes for natural gas is being developed. However, it appears that a large investment in capital may be the major obstacle to the scaled-up technology of coal gasification that can produce a useful substitute for natural gas.

At present there is no fuel gas being produced by coal gasification in the United States, except for a few small pilot plants. As natural gas becomes more scarce in the future, a substitute produce by coal gasification should become important.

Coal Liquefaction

Coal can be processed in a variety of ways to produce synthetic crude oil. The first liquefaction of coal was demonstrated in 1914. It was used in Germany during World War II to produce synthetic gasoline. —A commercial—

plant in South Africa has been in operation for over 20 years. Although coal liquefaction is not a new idea, it still needs further development to become an economical source of synthetic crude oil in the United States. As with coal gasification, there are great needs for capital investment.

Coal liquefaction can be illustrated by the so-called "Fischer-Tropsch process," named after the German chemists who developed it. Coal is gasified by using a mixture of oxygen and steam in a manner similar to the Lurgi process. The resulting gas is rich in carbon monoxide and hydrogen. This gas is passed through a bed of iron-based catalysts at a temperature around 450°F and at a pressure around 360 psi. The catalyst encourages chemical reactions that lead to liquid products. The process can be directed by the choice of the catalyst to make different types of products, such as methyl alcohol, motor fuels, or heavy oils. The Fischer-Tropsch process is the one used in the South African coal liquefaction plant.

The economics of the Fischer-Tropsch process appear to be debatable, but the common opinion is that this process will not be economical in the United States. A number of other processes are under development, and some pilot plants have been established. Some of the names of these projects include the following: the Char Oil Energy Development (COED) process, the Synthol Process, the H-coal process, the Coalcon process, the Solvent Refined Coal (SRC) process, and the Donor Solvent Liquefaction process. These various processes approach the problem of coal liquefaction in a number of different ways. It is not appropriate at this time to discuss them all; however, it can be noted that pilot plants capable of producing a few hundred tons of oil per day have been established in order to demonstrate several of the processes. It is probable that coal liquefaction will lead to an economical substitute for crude oil, especially as world oil prices continue to rise. At present, there is no liquid fuel available from coal liquefaction, except for the relatively small output of the pilot plants.

GASEOUS AND LIQUID FUEL FROM BIOMASS

Organic materials decay and decompose. Under proper conditions, the decay can produce liquids and gases useful for fuels. In fact, the decay of organic materials produced the fossil fuels, crude oil, and natural gas that are widely used today.

Fuels can also be produced by the decay and processing of waste organic materials that are the by-products of farming, gardening, and everyday living. These waste products include such materials as corn stalks, weeds, harvest stubble, grass clippings, leaves, sugarcane, kitchen garbage, and manure from farm animals. These waste products are readily available in extremely large quantities. In fact, the disposal of these wastes poses a problem. Collectively, these products often are called biomass.

This section describes how gaseous fuels and liquid fuels can be produced from biomass. In practice, these fuels are not used for production of steam in the United States.

Gaseous Products

The decay of organic products in the absence of oxygen is called anaerobic decay. Anaerobic decay, in the presence of certain bacteria called anaerobic bacteria, yields methane gas (CH_4). Methane, the main component of natural gas, is useful as a fuel. Anaerobic decay occurs underwater — in stagnant ponds, for example — and bubbles of methane gas can be observed as they rise to the surface. Anaerobic decay that leads to methane can also be produced in airtight tanks, called methane digesters.

In contrast, decay in the presence of oxygen leads to a different mixture of gaseous products — including ammonia and carbon dioxide — that are not useful for fuel production.

Methane digesters can include the "batch" type, which are loaded, sealed, and later emptied when the gas has been produced. "Continuous" digesters are loaded with smaller amounts of material on a regular basis, and gaseous fuel can be extracted regularly. Continuous digesters are more useful for providing a continuous supply of fuel.

The output of the digester, in addition to the gas, produces a solid sludge and liquid products called supernatant liquid. Both the sludge and the supernatant liquid are used as fertilizers. Also, a material called scum is produced. Scum is a coarse, fibrous, and essentially useless material that can clog the digester. The gas, called biogas or dungas, accumulates at the top of the tank.

The process proceeds rapidly at a temperature around 95°F . In hot climates, the temperature can be easily maintained without assistance. Methane digesters

have long been used in India, for example. In colder climates, insulation of the digester and auxiliary heating will be needed. Some of the gas produced can be used for heating.

One possible design for a methane digester is shown in Figure 2. The input material is mixed in a small tank and delivered by pipe to the bottom of the digester. Partially digested material passes over the top of the dividing wall into the second compartment. This arrangement prevents the withdrawal of material at too early a stage. Gas is collected at the top, and the solids and liquids are collected in the discharge tank.

Another popular design is the horizontal displacement system. Material is inserted at one end of a horizontal cylindrical tank and is withdrawn from the other end.

The heating value of the biogas varies, but often it falls in the range of 580-750 Btu/ft³. Methane digesters can convert 60-70% of the energy content of the input materials to energy that is available as fuel.

Methane digesters in the United States are usually small units, and they are often used on farms. The gas normally is used for cooking and heating and for powering machinery. The sludge and liquid are useful as fertilizer. A few municipal sewage plants utilize biogas — typically for driving turbines.

Only a very small fraction of the easily collectable biomass is now used to produce fuel gas. The biogas produced from biomass is not used for producing steam or hot water in industry on any practical scale. However, for

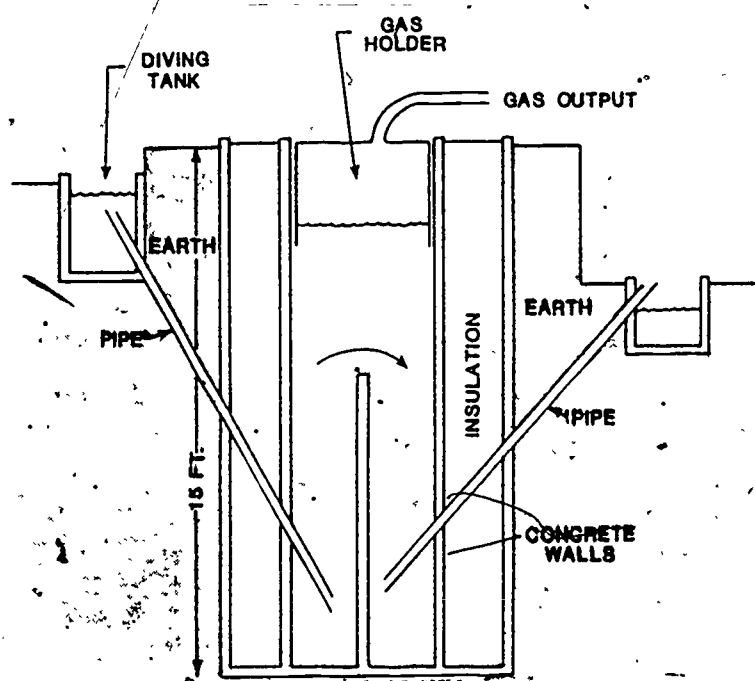

Figure 2. Diagram of System for Production of Biogas.

the future, biomass could be a valuable renewable source of fuel.

Liquid Products

The main emphasis on production of liquid fuels from biomass is the production of alcohol which is intended for use as vehicular fuel. Alcohol can be used by itself (with an altered carburetor) as an automotive fuel, or it can be mixed with gasoline and used in unaltered automobiles. The mixture, called gasohol, is being produced and marketed — at least on a limited scale — in the United States. It is most common in the midwestern part of the country where corn products are abundant.

Brazil has adopted a program intended to produce fuel for vehicles in a large scale agricultural program. Alcohol is produced from sugarcane and from a plant called manioc, which is specially grown for this purpose. This represents the largest program for production of liquid fuel from plant materials.

The United States has a few commercial facilities and many experimental programs for producing liquid fuel from biomass. The process basically involves fermentation, which converts sugars in the plants into alcohol. Further development of the process is needed to make it economical on a large scale.

The liquid fuel (alcohol) produced from biomass is used as a substitute for gasoline in vehicles. It is not used for producing steam and hot water.

FUEL HANDLING

This section of the module describes some of the factors involved in the handling of liquid and gaseous fuels, including transportation, storage, preparation for burning, and waste disposal. Generally, liquid and gaseous fuels are easier to handle than coal. They can be shipped long distances by pipeline, need little preparation for burning, and produce less waste than coal. The discussion in this section emphasizes the two most widely used gaseous and liquid fuels: fuel oil and natural gas.

TRANSPORTATION

Oil is transported by several methods. Very large oil tankers carry crude oil from outside the United States, especially from the Middle East and South

America. Tankers also carry oil from the Gulf Coast of the United States to the East Coast. Barges deliver oil from the Gulf Coast to the ports of the United States that are accessible from the Mississippi River and its tributaries.

Pipelines deliver oil to most of the sections of the United States that are not accessible by water. Pipeline shipping of oil is probably the most common method of delivery inside the country.

Relatively small amounts of oil are shipped by truck and rail since the costs are much higher than shipping by water or pipeline.

The final delivery to the user is usually made by truck or rail. This involves only a short distance from a central storage point to which the oil was delivered by pipeline.

Delivery of natural gas within the United States is almost all done by pipeline. A large network of pipelines covers most of the country. Natural gas is shipped long distances through the pipeline system and is delivered to the customer through smaller pipes.

Natural gas coming into the United States from abroad is delivered by ship. These large vessels capable of carrying natural gas are becoming quite commonplace.

STORAGE

Storage of fuels is needed to meet the changes in seasonal demand for fuels. In recent years, the use of large oil tankers has increased the need for storage facilities near places where the tankers load and unload.

Storage in most parts of the United States is provided by large cylindrical steel tanks. For safety, the tanks are usually surrounded by earthen dikes capable of containing the contents. The assemblies of oil tanks are known as tank farms. In California, large concrete-lined reservoirs are used to store oil. For longer-term storage, underground storage in caverns and in salt formations has been used.

The user may also provide storage at the facility where the oil is to be used. This offers a reserve for periods of high demand for fuel. This type of storage is usually in the form of steel tanks.

Pipeline companies and utilities store natural gas near the users in order to provide a continuous supply during periods of high demand. Storage of natural gas is accomplished above ground in tanks sealed with a water seal. Inflatable plastic domes are also being used.

The preferred method for the storage of natural gas is underground. Underground storage offers the most economical method of storing such large volumes of natural gas. Depleted oil or gas wells can be filled in the summer and emptied in the winter. In areas where such depleted wells are not available, storage in geological formations which can trap the gas is used. The trap can consist of a dome-shaped layer of dense rock on the top, with water-filled sand below. The sand is pushed back by gas pressure to provide room for the gas.

Storage of natural gas is not usually provided by the user of the gas. The fact that it is easily distributed through pipes makes this unnecessary.

Liquefied natural gas is stored at locations near where tankers load and unload. It also is stored to provide supplies for periods of peak demand. It can be stored in insulated metal tanks or in buried concrete tanks. In some cases, excavation in frozen earth has been used.

PREPARATION FOR BURNING

Compared to coal, the preparation for burning of oil and natural gas is relatively simple. The processing of crude oil to provide suitable grades of fuel oil has been performed at the refinery. The user has to do very little preparation. The lighter grades of fuel oil can be burned directly. Heavier grades of fuel oil, Grades 4-6, must be heated. Grade No. 4 may need to be preheated in cold weather. Grade No. 6 must always be preheated.

Thus, to make heavier grades of oil flow freely through pipes and to provide preheating for burning, heating equipment is provided in the storage tanks and along the piping for heavy grades of fuel oil.

Natural gas is delivered through pipes to the user in a condition suitable for burning. It needs no preparation for burning. This fact helps to make natural gas a desirable fuel.

WASTE DISPOSAL

Fuel oil and natural gas are much cleaner fuels than coal and offer fewer problems with waste disposal. The ash content of fuel oil — even in the heaviest fuel oil — is usually below 0.2%. Since this is a very small value compared to that of coal, there is no problem of disposing large amounts of ash, as there is with coal.

However, oil contains some corrosive elements, such as vanadium, nickel, sodium, and sulfur. These substances can lead to fouling and corrosion of the surfaces of the burner and the superheaters in the furnace. The removal of sulfur or the use of oil with low sulfur content is helpful. Control of the temperature of the steam so that the maximum steam temperature is below 1050°F reduces the production of troublesome corrosive materials. Additives such as aluminum oxide and magnesium oxide also help prevent corrosion. Control of the excess air to low values (around 1-2%) also will reduce formation of corrosive materials.

In addition, sludge can accumulate in the storage tanks and piping for heavy oils. Periodic cleaning may be required.

Essentially, natural gas contains no ash, and waste disposal is not a problem with natural gas. The combination of easy handling, clean burning, and negligible ash problems makes natural gas an extremely desirable fuel.

COMBUSTION SYSTEMS FOR LIQUID AND GASEOUS FUELS

The most important liquid and gaseous fuels for steam and hot water production are oil and natural gas. This section of the module discusses how these two fuels are burned. The equipment may have to be modified somewhat when other fuels are used. The low heating value of manufactured gases, as compared to natural gas, would require a different flow rate when a manufactured gas is used.

The combustion system for coal was described in detail in Module EP-01. The system included a firing method for delivery of the coal, a furnace in which the fuel is burned, and a boiler in which water is heated. Generally, the furnace and boiler are similar for coal and for oil and for gas. In fact, some systems can burn pulverized coal, oil, or natural gas, depending on which fuel is available at the time. Since these components have already been described, this module will not emphasize furnace enclosures or boilers.

However, it will emphasize the burner part of the system — which is the distinctive feature for gaseous and liquid fuels.

The solid fuel coal had to be delivered by fairly complicated systems — for example, the stokers and pulverized coal systems discussed in Module EP-01. Delivery of oil and gas is much simpler. They are delivered to the furnace through pipes, possibly with the aid of pumps and fans. For fuel oil Grade Nos. 4, 5, and 6, the pipes may have to be heated — at least in cold weather, so the oil will flow freely.

BURNERS

The burner is a device for producing a burnable mixture of fuel and air and for introducing it into the furnace. Fuels will burn only when the fuel-air mixture is proper. For example, natural gas will burn only when its percentage in an air mixture lies between 5-15%.

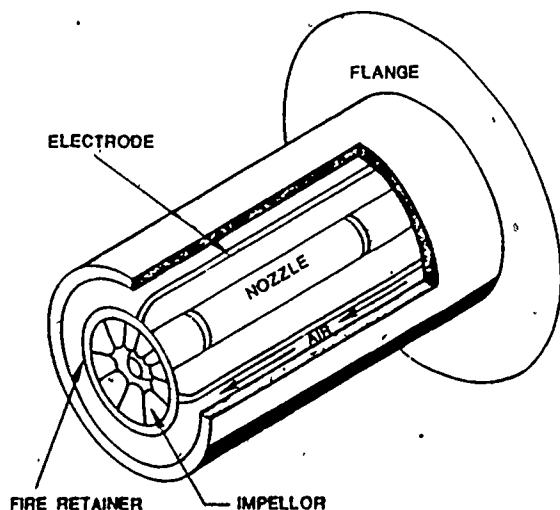

Figure 3. Cut-Away View of Burner for Gaseous or Liquid Fuels.

Because natural gas is already gaseous, it can simply be injected through the nozzle of the burner directly. Fuel oil must be atomized or broken up into tiny droplets. The droplets are carried as a fine mist in a stream of steam or air. This mixture is pumped through the nozzle at pressures up to 300 psi. Thus, the fuel oil is turned into a form suitable for injection through the nozzle.

Figure 3 shows a typical example of a modern burner. The fuel is injected in gaseous form and under pressure through the nozzle. Fuel oil must be "atomized" into gaseous form, as discussed below. The impellor thoroughly mixes the air and the fuel. Ignition is provided by a spark from the electrodes. The fire retention ring tends to stabilize the base of the flame so that it remains at the end of the nozzle. The burners are mounted on the vertical walls of the furnace. The flame then extends into the furnace.

The most common method of atomizing the oil is the use of the steam (or air) atomizer. Steam (or air) atomizers have coaxial barrels inside the nozzle. One barrel carries oil, and the other carries steam (or air). The two streams are combined near the end of the nozzle where they strike a sprayer plate. This mixes the oil and the steam (or air). When the mixture escapes from the nozzle, it expands, and the oil is atomized into small droplets. These atomizers can be used with either steam or air as the mixing gas. Steam provides more efficient operation of the atomizer. It does not have to be supplied from the steam produced in the boiler and, thus, represents some loss in the total steam production.

The heavy grades of oil atomize properly when they are heated. This is performed with either electric or steam heaters. Grade No. 4 fuel oil should be heated to about 135°F for good atomization; Grade No. 5 fuel oil should be heated to about 185°F; and Grade No. 6 fuel oil should be heated to about 210°F.

THE COMPLETE COMBUSTION SYSTEM

The complete system for producing steam or hot water with liquid or gaseous fuels consists of the following:

- Delivery portion
- Burners
- Furnace
- Boiler

The delivery portion of the system contains piping, pumps, and, in the case of heavy oil, heaters. This part of the system delivers the fuel to be burned.

The previous subsection of the module described the burners used for fuel oil and natural gas.

The furnace is the enclosure within which the fuel is burned. It confines the products of the burning. The burners for fuel oil and natural gas are located in the vertical walls of the furnace. The walls must withstand the high temperatures of the combustion and must also resist corrosion. In most modern furnaces the walls are water-cooled.

The design of boilers for coal-fired systems was described in Module EP-01. The boilers in systems that use fuel oil or natural gas are similar.

Modern systems usually are the water-tube type, with small tubes containing the water to be heated and heat being applied to the outside. However, the boilers may be the straight-tube or bent-tube types, as discussed in Module EP-01. Most modern boilers are designed to operate in the temperature range of 1000-1015°F. Higher temperatures are avoided to minimize corrosion problems.

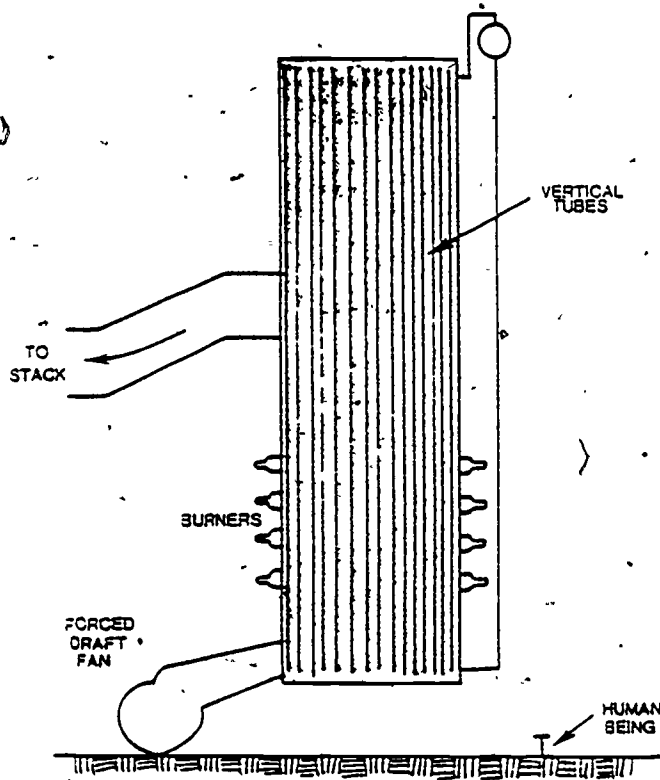

Figure 4. Schematic Diagram of a Combustion System for Gaseous or Liquid Fuels.

A schematic diagram of a system designed to be fired by either fuel oil or natural gas is shown in Figure 4. The system uses vertical tubes and is capable of producing 4.2 million pounds of steam per hour at a steam temperature of 1005°F. The height of a human being is indicated for comparison.

Table 7 shows typical performances of furnaces and boilers used with fuel oil and natural gas and, for comparison, pulverized coal. These are systems for steam production, not for applications like home heating. The largest systems of each size are comparable. The smallest systems tend to be oil or gas, rather than coal. In some cases, a system can be designed to be fired

by all three: coal, fuel oil, or natural gas. The fuel used depends on the price and availability of the different fuels. Therefore, even though a user may prefer to use natural gas because of cleanliness, when the supply of natural gas is cut off to the industrial user in times of high demand, the user may switch to fuel oil or pulverized coal.

TABLE 7. PERFORMANCE OF FURNACES AND BOILERS.

Fuel	Heat Production (Thousands of Btu per hour per cubic foot)	Excess Air (%)	Furnace Size (Millions of Btu per hour)	Boiler Efficiency (%)	Stack Temperature (°F)
Natural Gas	20-40	5-15	10-2000	86	300-600
Fuel Oil	20-50	15-30	10-2000	87	300-600
Pulverized Coal	15-35	15-30	25-2000	88	250-500

RELATIVE ADVANTAGES OF LIQUID AND GASEOUS FUELS

The following section summarizes the relative advantages of gaseous and liquid fuels, including costs and environmental considerations. Comparisons with coal are included for completeness.

ECONOMICS

The costs of using the different fuels described varies widely, depending on location and availability. In addition, the costs for all fuels have been increasing steadily since 1973, the time of the Arab oil embargo. Cost increases have affected oil and natural gas more than coal, because much of the United States crude oil is imported and because of concerns about decreasing supplies of oil and natural gas. Any comments concerning costs must necessarily include generalizations. For example, for a user located close to a supply of a particular fuel, the relative cost of that fuel is lower. Table 8 presents approximate costs of various fuels (given in dollars per million Btus of energy).

TABLE 8. APPROXIMATE COSTS OF VARIOUS FUELS.
(Given in Dollars per Million Btus of Energy.)

Fuel	Year		
	1968	1976	2010*
Natural Gas	0.30-0.37	2.00	9.41-18.83
Fuel Oil	0.29-0.35	2.95	3.34-16.05
Coal	0.31-0.41	2.21	0.96- 3.86
Synthetic natural gas from coal	—	6.2	—
Liquid fuel from biomass	—	1.4-4.8	—

*Expressed in terms of 1978 dollars.

In the late 1960s, the price of oil and gas tended to be similar for steam generation and tended to be slightly lower, on the average, than for coal. The range of prices, however, shows that coal could have been the least expensive fuel in many individual cases.

By 1976, the world price of oil had increased enough that oil was more expensive than coal or natural gas. (Government regulation had kept the price of natural gas from increasing as much as oil.) The 1976 numbers for oil, gas, and coal (shown in Table 8) are expressed in averages, and no ranges are given. Because supplies of natural gas to industrial users are limited and can be interrupted, the relatively low price of natural gas did not completely lead to replacement of coal or fuel oil for steam production.

Two approximate prices for synthetic liquid fuels are included for comparison. As of 1976, they were not economically competitive. Such fuels should become more economically attractive in the future.

An estimated range of prices for the year 2010 is included in Table 8. The prices are expressed in terms of 1978 dollars. Of course, there are many uncertainties in such projections. This is expressed by the wide ranges for the prices. In general, though, it seems that early in the 21st century, coal will be the least expensive, oil will be next, and natural gas will be highest. The relative cost of synthetic liquid fuels will depend on many uncertain factors, including governmental policies and the rate of capital investment.

ENVIRONMENTAL CONSIDERATIONS

Generally, liquid and gaseous fuels are cleaner to burn and have less environmental impact than coal. They release less sulfur and ash into the atmosphere than coal. Sulfur produced by coal-fired electrical generating plants can lead to acidic rains downwind from the plants. Such rains are destructive to ecological systems, especially lakes. Fish life in many lakes is threatened by such rains.

Natural gas is clean to burn and produces relatively little environmental effects. Many fuel oils, especially the heavier grades, do contain some sulfur and ash. The stack gases do require cleaning to remove these products.

Considerations of environmental impact and the cost of sulfur removal can change economic analyses. Thus, coal may be the cheapest fuel on an as-received basis, but the costs of cleanup of the stack gases might make it less

so than fuel oil or natural gas.

Fuels manufactured by gasification or liquefaction of coal must have the sulfur content removed. Scrubbing of the product to remove sulfur is an important step in these processes.

Fuels manufactured by gasification of biomass would have little environmental impact. However, large-scale production of liquid fuel from biomass may have undesirable environmental effects. It could require conversion of valuable farmland to growth of the plants needed for alcohol production. The burning of the alcohol itself is relatively clean and would produce fewer undesirable combustion products than the burning of gasoline.

SUMMARY OF ADVANTAGES AND USES

For summary purposes, Table 9 compares the relative advantages and disadvantages of the gaseous and liquid fuels that have been discussed. It also summarizes the importance of each fuel used in the United States. The comments are derived from the discussion of each of the fuels.

TABLE 9. COMPARISON OF GASEOUS AND LIQUID FUELS.

Fuel	Advantages	Disadvantages	Application in U.S.
Fuel Oil	Clean and easy to burn compared to coal. Easy to deliver.	Nonrenewable resource. Supply decreasing and price increasing.	Very widely used, often used for steam production.
Natural Gas	Cleanest of common fuels, no ash, very easy to deliver, handle, and burn.	Nonrenewable resource. Supply decreasing and price increasing.	Very widely used, often used for steam production.
LP Gas	Very clean. High heating value.	Nonrenewable resource. Supply decreasing and price increasing.	Important energy source. Mainly used for space heating.
Manufactured Gas	Can be made from coal.	Low heating value. May contain carbon monoxide.	Used mostly in plant where it is made. Used for steam production.
Gas from Coal Gasification	Coal in good supply.	No current production. Capital investment needed.	Very small.
Liquid Fuel from Coal	Coal in good supply.	No current production. Capital investment needed.	Very small.
Gas from Biomass	Renewable source.	No large supply available. Large investment needed.	Small supplies. Used on site of production.
Liquid from Biomass	Renewable source.	No large supply available. Large investment needed.	Small supplies. Intended as vehicle fuel.

REFERENCES

- ASHRAE Handbook, 1977 Fundamentals. Chapter 14. New York: American Society of Heating, Refrigerating and Air-Conditioning Engineers, Inc.; 1977.
- Baumeister, T., ed. Marks' Standard Handbook for Mechanical Engineers. Chapter 7. New York: McGraw-Hill Book Co., 1978.
- Cochran, N.P. "Oil and Gas from Coal," Scientific American. p. 24 (May 1976).
- Considine, D.M., ed. Energy Technology Handbook. Sections 2 and 3: New York: McGraw-Hill Book Co., 1977.
- Hammond, A.L. "Photosynthetic Solar Energy, Rediscovering Biomass Fuels," Science 197, p. 745 (August 19, 1977).
- Hottell, H.C. and Howard, J.B. New Energy Technology - Some Facts and Assessments. Chapter 3. Cambridge, MA: The MIT Press, 1971.
- Just, J. and Love, L. "Review of Scenarios for Future U.S. Energy Use," Annual Review of Energy. Hollander, J.M., ed., pp. 501-536. Palo Alto, CA: Annual Reviews, Inc., 1979.
- Lovins, A.B. "Soft Energy Technologies," Annual Review of Energy. Hollander, J.M., ed. pp. 477-517. Palo Alto, CA: Annual Reviews, Inc., 1978.
- Mann, W.C. "Biomass Refinery Turns Crop Wastes into Fuel," Popular Science. p. 78 (April 1979).
- Steam/Its Generation and Use. Chapters 5 and 7. New York: Babcock and Wilcox Company, 1972.
- Stoner, C.H. Producing Your Own Power. Section IV. Emmaus, PA: Rodale Press, Inc., 1974.



ENERGY TECHNOLOGY

CONSERVATION AND USE

ENERGY PRODUCTION SYSTEMS

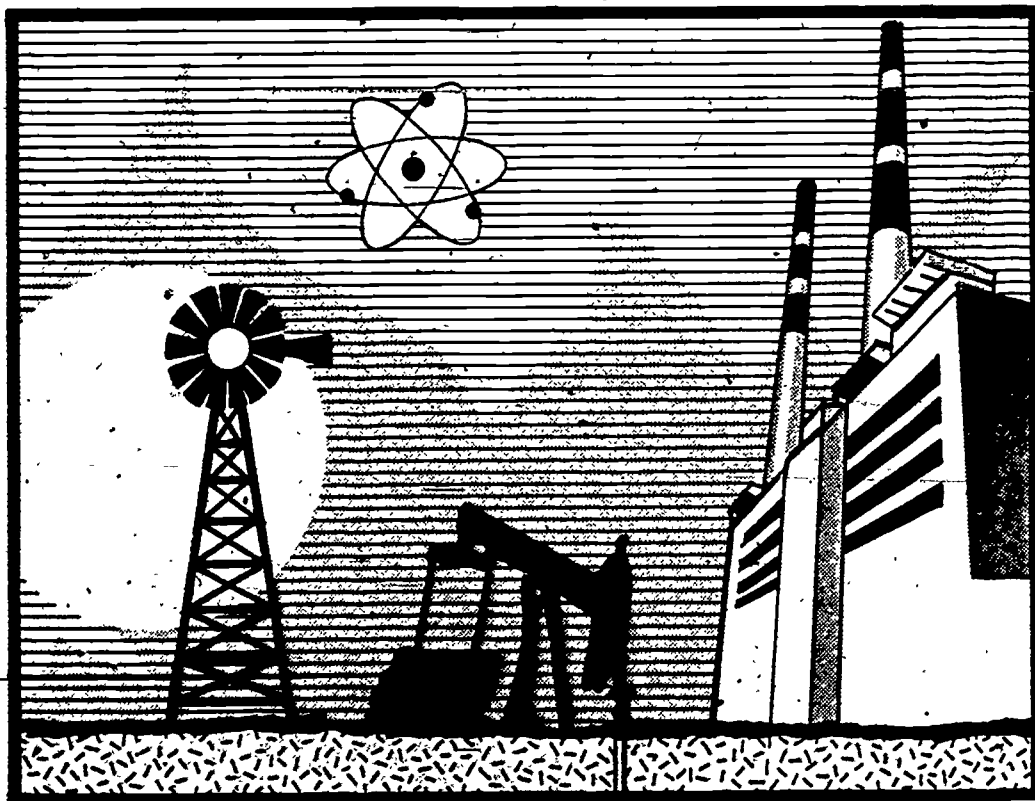

MODULE EP-03

GENERATION OF STEAM, HOT WATER, AND HOT AIR,
USING SOLAR COLLECTORS



CENTER FOR OCCUPATIONAL RESEARCH AND DEVELOPMENT

INTRODUCTION

This module discusses the generation of steam, hot water, and hot air, using thermal energy taken from solar collectors. On a clear day, when the sun is directly overhead, the sun delivers energy to the earth's surface at a rate of approximately 1000 watts on each square meter of surface. Solar collectors can harness this energy for space heating, water heating, cooling, industrial processing, and generation of electricity. This module describes the principles of operation and the types of equipment involved in the utilization of solar energy for these applications. The module also discusses system designs, including their relative advantages, limitations, and practical uses.

PREREQUISITES

The student should have completed Fundamentals of Energy Technology and Modules EP-01 and EP-02 of Energy Production Systems.

OBJECTIVES

Upon completion of this module, the student should be able to:

1. Define the term "solar constant" and state its numerical value.
2. Given the necessary information, calculate the maximum efficiency for a solar energy system.
3. Describe flat-plate collectors and concentrating collectors, and include the following information for both: the method of operation, the relative temperatures and efficiencies, the relative advantages and disadvantages, and the practical applications.
4. Compare air-based solar energy systems and water-based solar energy systems. Include similarities and differences in the collectors and storage systems. Describe the relative advantages and typical applications for both types.
5. Describe methods for producing high temperature steam. Include the axial tower and the parabolic collector.

SUBJECT MATTER

SOLAR RADIATION

The sun delivers electromagnetic radiation to the surface of the earth. This electromagnetic radiation is mainly present in the infrared, visible, and ultraviolet portions of the spectrum.

Electromagnetic radiation is radiant energy that travels at the velocity of light (3×10^{10} cm/s). It has a wavelike character since the waves are rapidly oscillating electric and magnetic fields. The waves can be characterized by the frequency of oscillation of the field or by the wavelength (that is, the distance between peak values of the electric or magnetic fields). The wavelength, λ and frequency f are related by Equation 1 below:

$$\lambda f = c \quad \text{Equation 1}$$

where: λ = Wavelength.
f. = Frequency.
c = Velocity of light.

Light is the green portion of the visible spectrum, with $\lambda = 0.5 \times 10^{-4}$ cm. It has a frequency equal to $f = 3 \times 10^{10} / 0.5 \times 10^{-4} = 6 \times 10^{14}$ Hz.

The word "radiation" is sometimes interpreted as meaning nuclear radiation — with unpleasant connotations. But in the broader sense, electromagnetic radiation includes things such as radiowaves and visible light, which are regarded as beneficial. Figure 1 shows the range covered by electromagnetic radiation, with some familiar types of electromagnetic radiation indicated. The wavelength and frequency scales are also indicated. When solar energy

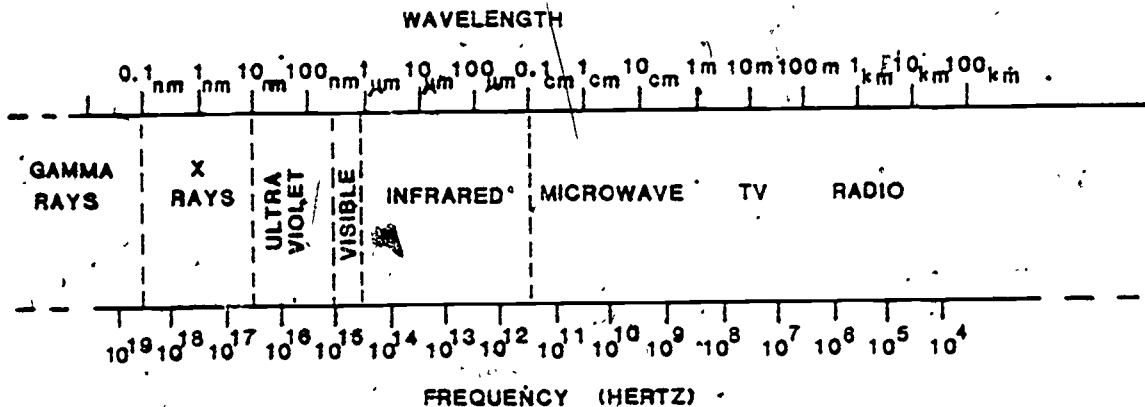

Figure 1. The Electromagnetic Spectrum.

arrives at the surface of the earth, it lies in the wavelength region from about 0.3 to 2 micrometers (μm).

Everyday, large amounts of energy arrive at the surface of the earth. Without the energy delivered by sunlight, there would be no life on earth. Sunlight provides the heat energy that keeps the earth's temperature in a habitable range. Sunlight also causes plants to grow, thereby providing the initial source of energy for all the food chains on earth. The energy stored in all fossil fuels (coal, oil, natural gas) was originally provided by sunlight. For example, coal is derived from plants that lived during prehistoric times. These plants died, and the dead plants decayed and became the carbon-containing material that is now mined and burned in the form of coal. With only a few exceptions, sunlight has provided most of the energy used on earth.

The energy that arrives from the sun heats the atmosphere and the oceans and causes circulation of air and ocean water. Thus, energy from the sun is the cause of weather on earth. The amount of sunlight reaching the earth's surface varies slightly as the earth travels around the sun in its yearly journey. These relatively small changes lead to the change of seasons.

Besides growing plants, the energy from sunlight can be used more directly to satisfy needs of human beings. This energy can be used to heat air for space heating of homes, office buildings, and factories. It can also heat water, giving hot water and steam for space heating and for industrial processes. The sun's energy can also be used to produce electricity directly. This last use cannot be duplicated by other fuels, such as coal or oil.

Thus, it is established that sunlight is an abundant source of energy. All that is needed is a "bucket" to catch it. A major portion of this module is devoted to descriptions of a suitable bucket — the design of which is neither simple nor obvious.

SOLAR CONSTANT (INSOLATION)

How much energy from the sun arrives at the earth? The amount of solar energy that reaches the neighborhood of the earth is called the solar constant, or insolation. "Insolation" is a term that describes the delivery of energy from the sun to the earth. The value of the solar constant is specified as the energy arriving at the top of the earth's atmosphere. Because of absorption by the atmosphere, the energy actually arriving at the earth's surface is somewhat less.

The numerical value of the solar constant (or insolation) is 1350 watts per square meter. (This means that a flat surface facing the sun and outside the atmosphere could collect 1350 watts for each square meter of surface area.) The value of the solar constant varies slightly during the year since the distance from the earth to the sun changes somewhat. However, 1350 watts per square meter represents an average value for the solar constant.

FACTORS AFFECTING INCIDENT SOLAR RADIATION

The solar constant defines the amount of solar energy that would strike a flat surface that is facing the sun and is located outside the earth's atmosphere. The amount of energy that reaches the ground is less because of factors such as absorption in the atmosphere, cloudiness, location on the surface of the earth, time of day, and seasons of the year. The last three factors are related to the height of the sun above the horizon.

Absorption in the Atmosphere

Even on a clear day, part of the incident solar energy is absorbed by the atmosphere. The effect of absorption by the atmosphere is shown in Figure 2, which shows the distribution of solar energy as a function of the wavelength. The top curve shows the distribution over the wavelength at the top of the atmosphere. The second curve shows the distribution on the ground at sea level, and on a clear day when the sun is directly overhead. Some of this energy is not penetrating to the ground, however. Regions of very high absorption (such as 1.4 and 1.8 μm) are present. The absorptions are caused by specific molecules in the atmosphere, such as CO_2 and H_2O . When the sun is close to the horizon, the sunlight must pass through a longer path of atmosphere, and the energy reaching the ground is still lower, as the lower curve shows.

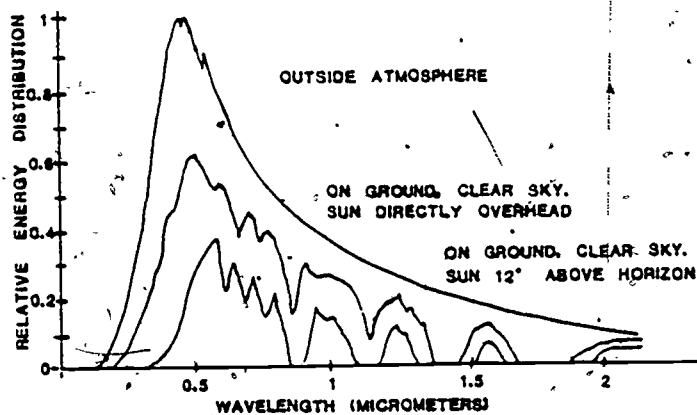

Figure 2. Wavelength Distribution of Solar Energy.

Although exact values depend on atmospheric conditions — the amount of CO_2 , the amount of dust present, and so forth — Figure 2 does demonstrate how solar energy is reduced in the atmosphere.

Even in the best of conditions — with the sun directly overhead in a clear atmosphere — incident insolation will be reduced to about 1000 watts per square meter on the ground. Under poor conditions — with clouds or haze — solar energy may be reduced much more. During daylight hours, some light will always reach the surface of the earth; but with heavy clouds or haze, it will not come directly from the sun but will be diffused (come to the surface from all directions because of scattering and reflection in the atmosphere). This factor is important because some types of collectors can accept diffuse light, whereas other types of collectors need light in a collimated beam directly from the sun. The first type of collector can operate to some extent on a cloudy day, whereas the second type will operate only under clear conditions.

Figure 2 is important, too, because it defines the necessary properties of the collector. The collector must be capable of absorbing energy at the wavelengths that solar energy reaches the ground.

Solar Altitude

The amount of solar energy reaching the surface of the earth is also dependent upon where the sun is located above the horizon. This is called solar altitude, and is expressed in degrees above the horizon. For a solar altitude of 90° , the sun is located directly overhead.

Solar altitude varies with several factors: location of the earth (latitude), time of day, and season of the year.

Solar altitude changes during the course of each day. Figure 3 shows the amount of solar energy striking a horizontal surface as related to the time of day. The figure is relevant to a latitude of 40° N . Curves are shown for June 21 and December 21. The change is due to the change in solar altitude during the day.

Figure 4 shows how the solar energy that reaches the earth's surface on a clear day varies with solar altitude. Curves are shown for both a horizontal surface and a surface that faces directly toward the sun. The maximum influx of solar energy occurs when the sun is directly overhead (solar altitude = 0°). It is also beneficial to have a collecting surface that faces toward the sun.

When the sun is directly overhead on a clear day, solar energy arrives at a rate of approximately 1000 watts per square meter. The rate of energy arrival rapidly decreases as the sun approaches the horizon.

The axis of the earth's rotation is tilted with respect to the orbit of its yearly revolution around the sun. Therefore, the amount of sunlight reaching the earth's surface varies both with latitude and with the season of the year. Because of the tilt of the earth's axis, the sun can be directly overhead at some time of the year at latitudes between $23\frac{1}{2}^\circ$ north latitude and $23\frac{1}{2}^\circ$ south latitude.

Outside of this range, the sun can never be directly overhead. The only part of the United States that falls within this range is Hawaii. At Minneapolis, Minnesota (latitude 45°), the sun is $68\frac{1}{2}^\circ$ above the horizon at noon on

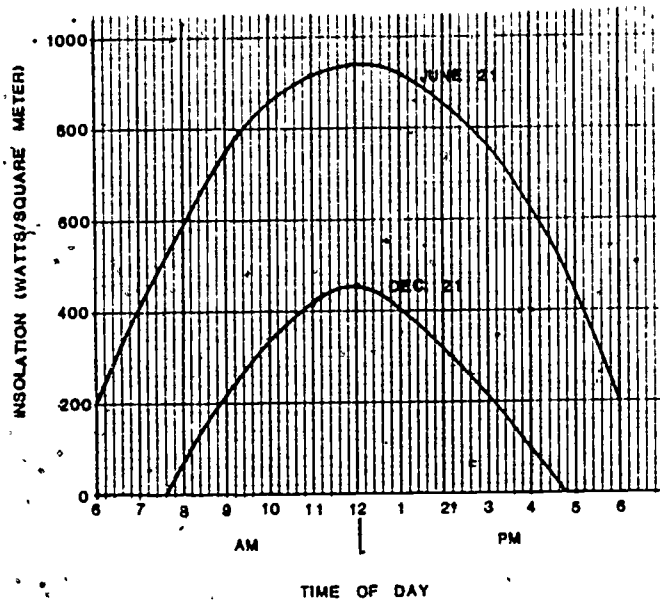

Figure 3. Insolation on a Horizontal Surface for 40° North Latitude.

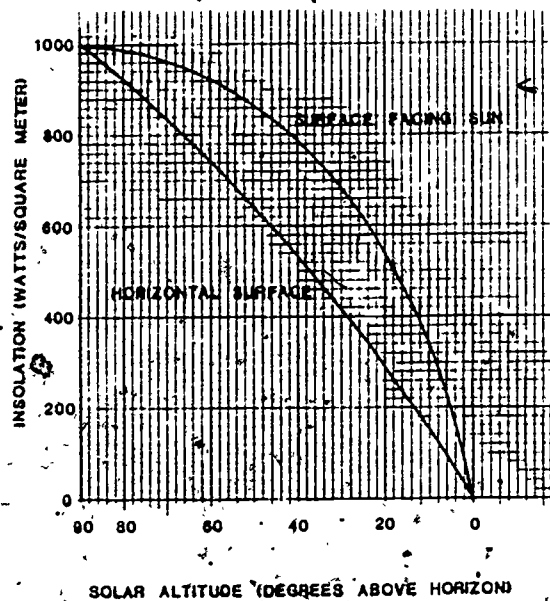

Figure 4. Insolation on Flat Surfaces on a Clear Day.

June 21 — which is the highest that it ever gets at that location.

In addition to latitude, another factor that affects the amount of solar energy reaching the earth is the amount of cloudiness that is present. In the southwestern United States, where most days are clear and cloudless, there is a great deal of solar energy available. However, along the coasts of Oregon and Washington, where many days are cloudy, the arrival of solar energy is reduced.

Figures 5 and 6 show how solar energy varies with geographical locations and the seasons of the year. Figure 5 shows the total daily solar energy (in kWh/m²) that strikes the United States in the summer. The curves are

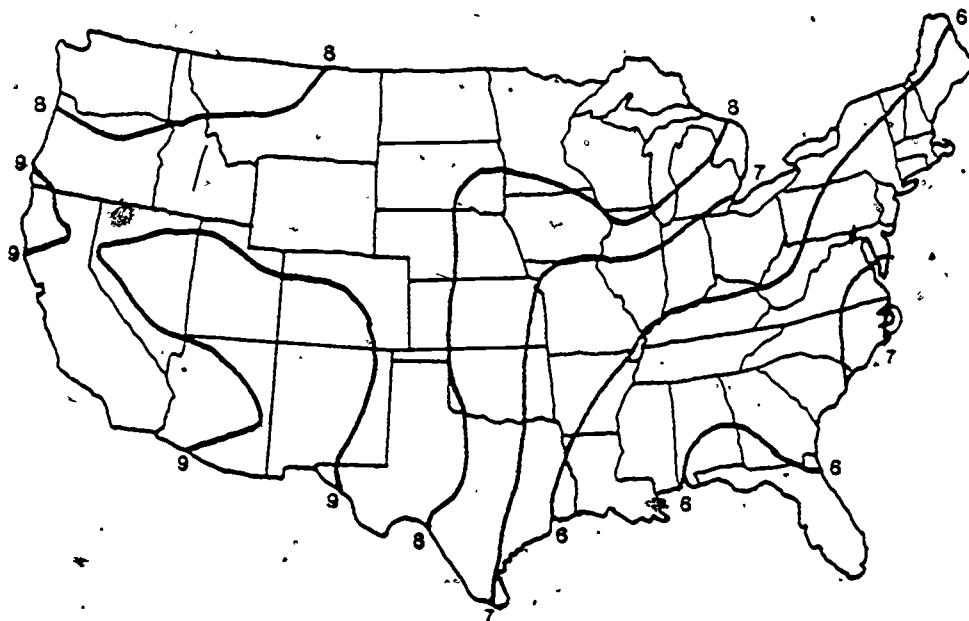

Figure 5. Contours of Total Daily Solar Energy Striking a Surface Directly Facing the Sun in Summer. (Units are in kWh/m².)

relevant to a surface facing toward the sun. Figure 6 shows similar curves for the winter. The southwest part of the United States receives a large input of solar energy, whereas the northeast part of the United States and the Pacific Northwest receive relatively low amounts of solar energy. For a given location, the amount of solar energy that strikes the earth is much less in winter than in summer.

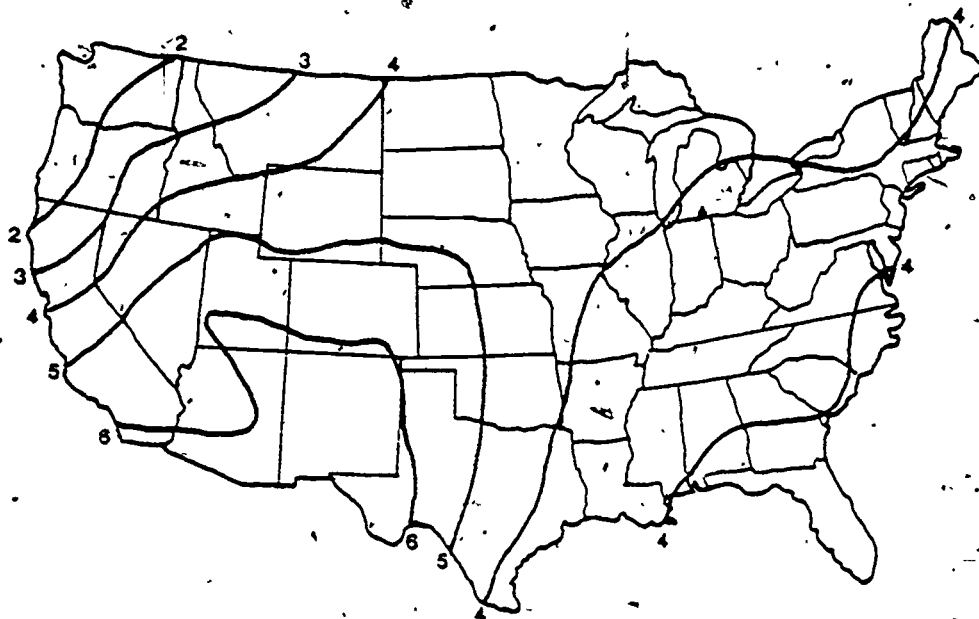

Figure 6. Contours of Total Daily Solar Energy Striking a Surface Directly Facing the Sun in Winter. (Units are in kWh/m².)

Figure 7 shows the total solar energy that reaches the United States in a year. The total amount of solar energy that reaches the earth's surface is great; particularly in the Southwest. Even in the Northeast, solar energy is a primary source of energy. If all the solar energy that is available were collected and used for heating purposes alone, it would provide a significant source of energy and would reduce the demands on other sources.

EXAMPLE A: DETERMINATION OF COLLECTOR SURFACE.

Given: A homeowner in Columbia, Missouri, uses 600 kWh of electricity each month in the winter, with the solar collectors operating at 10% efficiency.

Find: How many square meters of collector surface that would be needed to provide this amount of electrical energy.

Solution: For a month of 30 days, the homeowner will use $600/30 = 20$ kWh/day (d). At 10% efficiency, this means that 200 kWh must be incident each day. From Figure 6, at Columbia, Missouri, 4 kWh of energy are incident on each square meter of surface that faces directly

Example A. Continued.

toward the sun. This is the average daily value in the winter. Thus, on the average, the collector should have an area of $200/4 = 50 \text{ m}^2$.

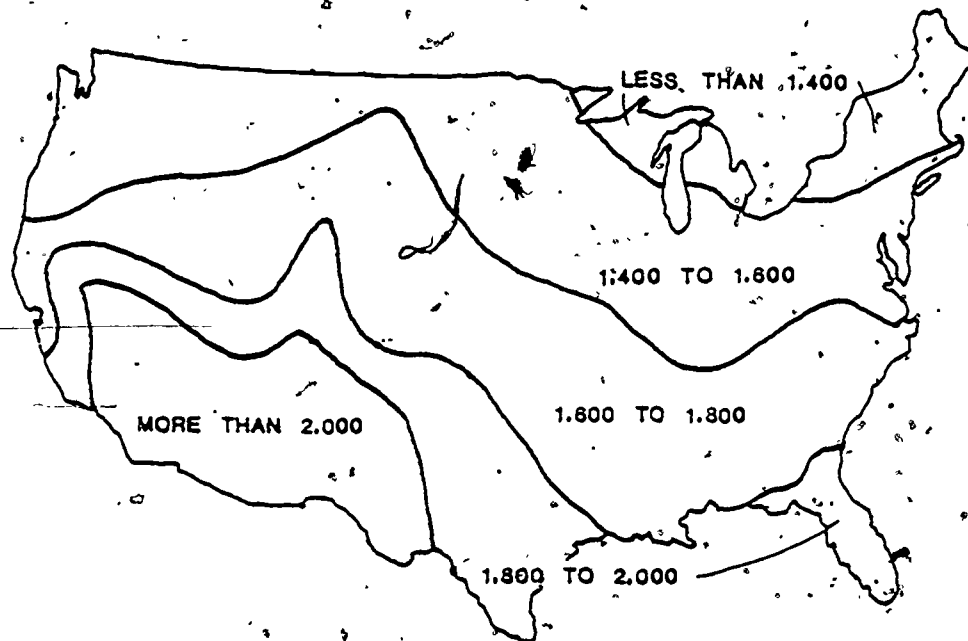

Figure 7. Annual Insolation in the U.S.
(Numbers indicate kWh/m².)

ABSORPTION BY VARIOUS MATERIALS

The material that forms the collector must be absorbing at the wavelengths of the radiation that the sun delivers. If the material is not absorbing, the incident energy will be reflected from the surface and lost for any purposes of useful energy. Figure 2 defined how incident solar energy is distributed with respect to wavelength. The wavelength region of interest is approximately 0.3 to 2 μm .

Figure 8 shows the wavelength dependence on absorption for several materials. For both aluminum foil and white paint, absorption is low in the spectral region of interest. These materials would not make good surfaces for solar collectors. Black paint, on the other hand, is high in absorption in the important spectral range. On solar collectors, black paint can be used

for absorption as the outer layer. In fact, it has been used in some simple collectors.

Other, more sophisticated coatings are employed to provide high absorption for solar radiation. For example, an electrolytic coating called a Tabor selective surface provides about 90% absorption in the region of interest. In addition, the Tabor selective coating has low absorption at long infrared wavelengths and around 10 μm . This is important since low absorption in that region reduces reradiation of energy from the surface — which helps reduce losses of the absorbed energy. For this reason, a coating such as Tabor is superior to black paint.

Other similar coatings are available. For example, a coating of black copper oxide on copper metal has an absorption of approximately 91% in the region of interest for absorption, but a low absorption (approximately 16%) in the long wave-

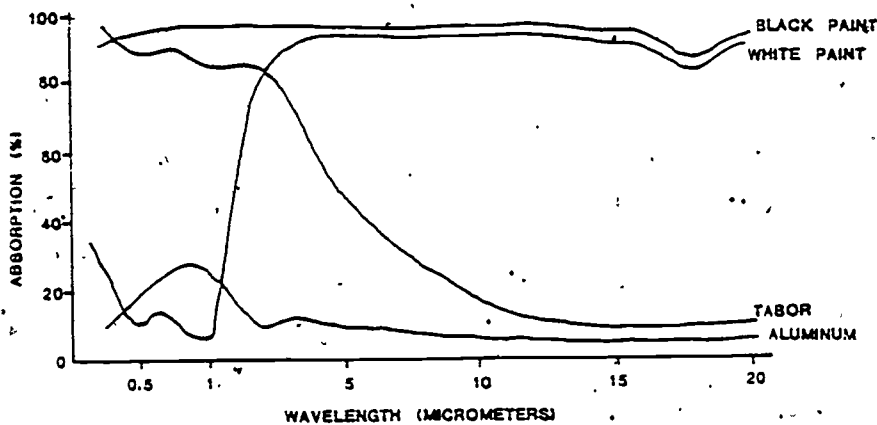

Figure 8. Absorption vs. Wavelength for Several Materials.

length region. Thus, oxide type coatings with properties such as black copper oxide are well-suited for the absorbing surface.

The basic idea is that the outer surface of the absorber should have a high absorption in the spectral region where the sunlight is and should have low absorption in the longer wavelength region where there is little solar energy. Suitable coatings with the desired properties have been developed.

EFFICIENCY OF CONVERSION OF SOLAR ENERGY TO USEFUL HEAT

Conversion of solar energy to useful heat does not occur with 100% efficiency. The total efficiency of the solar collector system, η , is the product of two factors: the so-called collector efficiency, η_c , and the cycle efficiency, η_e .

$$\eta = \eta_c \eta_e$$

Equation 2

where: η = Total efficiency of the solar collector system.

η_c = Collector efficiency.

η_e = Cycle efficiency.

The collector efficiency, η_c , is the efficiency for absorption of the insolation by the surface of the collector. As previously stated, there are materials available with surfaces that can absorb solar radiation with high efficiency over the wavelength region covered by the solar radiation. Collector efficiency greater than 90% is possible.

The cycle efficiency, η_e , depends on the temperature of the working fluid. The working fluid (usually water or air) circulates through the collector and is heated to a temperature T_1 . Then the heated fluid is used to perform some function, such as space heating or driving a turbine. After it has performed that function — with the heat extracted from it — the fluid is then at a lower temperature T_2 and is circulated back to the collector.

Both temperatures, T_1 and T_2 , must be expressed as absolute temperatures, that is, in degrees Kelvin. (The relation between a temperature in degrees Celsius and a temperature in degrees Kelvin should be remembered. Add 273° to Celsius temperature to obtain Kelvin temperature.)

The maximum possible cycle efficiency is given by Equation 3 below:

$$\eta_e = \frac{T_1 - T_2}{T_1}$$

Equation 3

where: η_e = Cycle efficiency.

T_1 = Fluid initial temperature.

T_2 = Fluid final temperature.

This value, called the Carnot efficiency, is an idealized value that represents a theoretical maximum. This maximum value can never be achieved in practice; there are inevitable losses of heat energy that always reduce the practical cycle efficiency below its theoretical maximum value.

Figure 9 shows the maximum cycle efficiency (from Equation 3) as a function of fluid initial temperature T_1 . (It is presented for several values of fluid final temperature T_2 .) Ideally, in order to achieve high cycle efficiency, high values of the initial temperature must first be achieved.

The final temperature T_2 should be as low as possible, since a low final temperature means that the heat energy stored in the fluid has been extracted efficiently. In practice, a final temperature T_2 lower than about 300 K (27°C) is unusual. This is usually the value that is approximately equal to the ambient temperature.

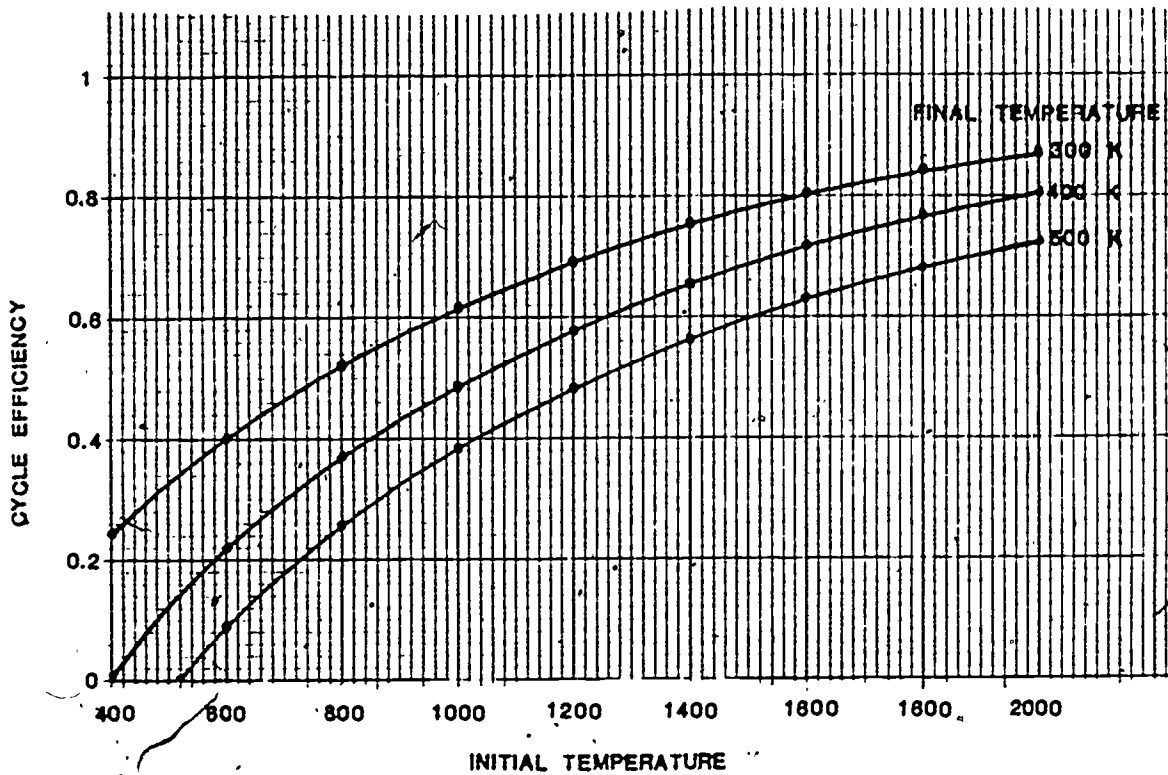

Figure 9. Maximum Cycle Efficiency Vs. Initial Temperature for Several Different Values of Final Temperature.

EXAMPLE B: MAXIMUM EFFICIENCY.

Given: A solar collecting surface has an efficiency of 95% for collecting sunlight. Air circulating through the collector is heated to 160°C. The air is used for space heating and, then, it is rejected at a temperature of 27°C.

Find: The maximum possible efficiency of the system.

Solution: The collector efficiency η_c is given as 0.95. The maximum cycle efficiency is as follows:

$$\eta_e = (T_1 - T_2)/T_1,$$

Example B. Continued.

$$\text{where: } T_1 = 160 + 273 = 433 \text{ K}$$

$$\text{and, } T_2 = 27 + 27 = 300^\circ\text{C.}$$

$$\text{Thus, } \eta_e = \frac{433 - 300}{300} = \frac{133}{300} = 0.443.$$

The maximum system efficiency is, as follows:

$$\eta = \eta_c \eta_e = 0.95 \times 0.443 = 0.421 \text{ or } 42.1\%.$$

HOT WATER SYSTEMS

In solar energy systems, sunlight is collected by being absorbed at some surface. There is some fluid contained within pipes or channels under the surface. The fluid is warmed by the sunlight; then it circulates to the place where heat is needed, for example, for space heating or hot-water heating. Heat is extracted from the fluid, cooling it to a lower temperature; then the fluid is circulated back to the collector.

In this section of the module, systems are described in which the working fluid is water. Water has the advantages of being inexpensive and readily available. It also has a relatively high value of specific heat, so a large amount of thermal energy can be stored in the water. In practice, pure water is almost never used because water is subject to freezing. In almost every section of the United States, the temperature drops below freezing at night sometime during the year. This would cause water in the collector to freeze and possibly rupture the pipes. Therefore, a mixture of water and antifreeze (usually ethylene glycol) is used. However, these systems will be considered as water systems. In water systems, another factor to consider is corrosion. The water must circulate through pipes, pumps, and heat exchangers; and it is important that no corrosion of these components occurs. Thus, chemicals that inhibit corrosion may also be added to the water.

In some systems, heat transfer oils are used instead of water. These oils are more expensive than water. But, with a proper choice of oil for a given geographical location, the freezing problem can be eliminated. However, the viscosity of the oil may change with temperature, causing the oil to flow more slowly through the pipes at low temperatures. The change in viscosity sometimes causes problems. The basic design of systems that use

heat transfer oils is similar to that of water systems; therefore, the discussion of water-filled systems will also be adequate for oil-filled systems.

The following paragraphs describe the basic components used in water-filled systems. The types of collectors are emphasized, including flat-plate collectors and concentrating collectors. The design of an entire system is discussed. Alternate designs are possible, but the description leads to an understanding of important components that are commonly used.

FLAT-PLATE COLLECTORS

The use of solar energy begins with an absorbing surface upon which sunlight falls and is absorbed. The simplest type of collector is a flat-plate collector. In contact with the flat-plate collector's surface are tubes, pipes, fins, through which the water moves. A typical design is shown in Figure 10.

At the front of the flat-plate collector is a transparent material that allows sunlight in but reduces heat loss.

The transparent material is usually

glass or plastic. Plastic is less expensive than glass, but it is less durable and weathers less well than glass. Glass is usually used in well-developed commercial systems. Often, two layers of the transparent material will be used to provide protection from heat loss.

The absorbing surface must have high absorption for the wavelength region in which the sunlight falls. Black paint is sometimes used in homemade collectors. The more sophisticated coatings (such as oxide-coated metals) are used in commercial systems. Such coatings provide better performance, but at increased cost.

The backing layer of insulation is needed to reduce heat loss. Any heat conducted out through the back of the structure is lost and will result in reduction of the collector efficiency.

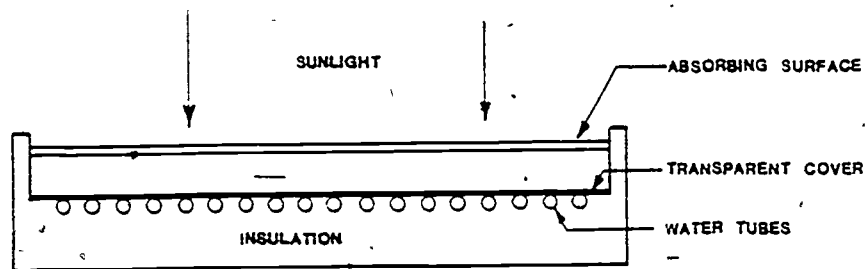

Figure 10. Schematic Diagram of a Basic Flat-Plate Collector.

Tubing can take a variety of forms. For relatively inexpensive systems, aluminum plates bent into V-grooves have been used. The water channels are simply the spaces in the Vs between the aluminum and the insulation. In more sophisticated systems, metallic tubing is bonded directly to the absorbing surfaces.

There are several possible designs, construction methods, and materials for flat-plate collectors. Currently there is much experimentation underway to provide a good compromise between cost and performance. For instance, many enterprising amateurs have devised flat-plate collectors that can be constructed from inexpensive materials by a reasonably handy homeowner. At the other extreme, packaged collectors are being offered by a number of companies. The development of flat-plate solar collectors is far from complete, with many experimental designs still being evaluated.

Table 1 presents a summary of some of the materials that have been used in flat-plate collectors. There is no one standard way of constructing flat-plate solar collectors; therefore, a variety of materials are being used.

TABLE 1. MATERIALS USED IN FLAT-PLATE COLLECTORS.

Transparent materials	<ol style="list-style-type: none"> 1. Glass (single layer or multilayer) 2. Plastic (single layer or multilayer) 3. Combinations of glass and plastic 4. Transparent honeycombs of glass or plastic
Absorbing materials	<ol style="list-style-type: none"> 1. Metal surfaces 2. Plastics 3. Metal screening 4. Cloth gauze 5. Porous foam 6. Dark liquids 7. Dark glass
Coatings on absorbing materials	<ol style="list-style-type: none"> 1. Flat black paints 2. Oxide coatings 3. Electrolytic coatings 4. Roughened surfaces
Fluid containers	<ol style="list-style-type: none"> 1. Tubes welded, soldered, or roll-bonded to metal absorbers 2. Channels in absorbing surfaces 3. Fins in absorbing surfaces
Insulation	<ol style="list-style-type: none"> 1. Fiber mat 2. Plastic or glass foam 3. Reflective layers in combination with above materials 4. Vacuum (in glass tube)

The flat-plate collector has a maximum temperature for the water in the system. Thus, according to Equation 3, the cycle efficiency is also limited. Cycle efficiencies of approximately 30% are possible with current flat-plate collector technology.

With current technology, temperatures up to 400 to 450 K can be produced with flat-plate collectors. These temperatures are above the boiling point of water (373 K), so the tubes must be pressurized to prevent boiling. The temperatures that can be produced with flat-plate collectors are adequate for many applications, including the following:

- Space heating in residences
- Hot-water heating in residences
- Air conditioning in residences
- Space heating, hot-water heating, and air conditioning in small buildings (such as schools, medium-sized office buildings, and factories)
- Industrial process heat and industrial process steam at reasonably low temperatures

Because the maximum water temperature is limited, flat-plate collectors are not suitable for some applications, including the following:

- Generation of electricity
- Generation of industrial process heat and industrial process steam at high temperature
- Cooking
- Heating and air conditioning of large buildings, especially multi-story buildings that have relatively small roof areas in comparison to the volume of the buildings

CONCENTRATING COLLECTORS

The maximum temperature and, hence, the maximum cycle efficiency that can be achieved with flat-plate collectors are relatively low. Concentrating collectors are used when higher temperatures are required. Such collectors use mirrors of various shapes to focus solar radiation onto an absorbing surface. The area of the absorber is much smaller than the area of the reflecting surface; thus, energy from a large area is moved to a small area. This

allows production of much higher temperatures than those that are possible with simple flat-plate collectors.

One possible design of a concentrating collector — the focusing collector — is shown in Figure 11. This figure shows a cylindrical reflecting mirror with a parabolic cross section. The sunlight is focused on the pipe,

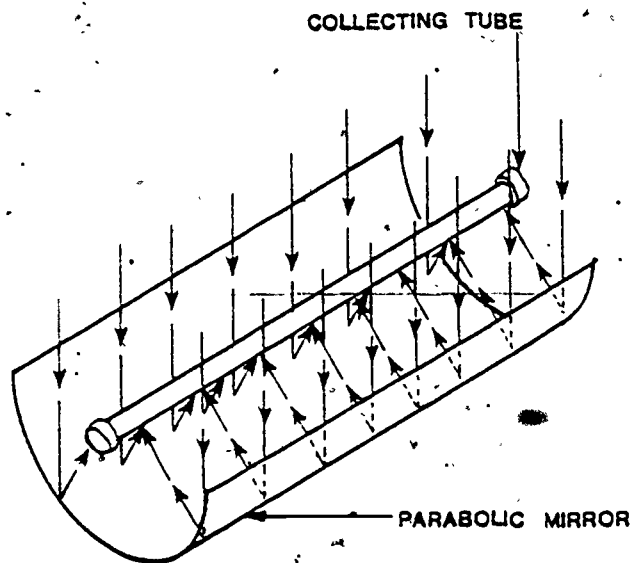

Figure 11. Example of Focusing Collector.

which has an absorbing surface. The pipe is filled with fluid (usually not water because of the high temperatures that can be achieved). Molten salts or liquid metals such as sodium and potassium are sometimes used as the fluid. The pipe may be surrounded with a glass tube to help reduce heat loss.

The temperatures that can be reached in the working fluid can be as high as 550 K for a simple, cylindrical collector (Figure 11). However, cylindrical collectors with more sophisticated absorbers that utilize selectively-coated evacuated glass tubes around the absorbing pipe have produced temperatures as high as 850 K. In some research designs of concentrating collectors, temperatures up to a few thousand degrees Kelvin have been attained.

Table 2 presents a summary of some designs that have been used for reflectors in concentrating collectors. Although this list is not complete, it gives an idea of the variety of shapes that are possible. Figure 12 illustrates a few of the designs mentioned in Table 2.

TABLE 2. SELECTED DESIGNS FOR CONCENTRATING COLLECTORS.

Designs with multiple flat reflectors	Flat side boosters V-trough Array of sun-following flats
Cylindrical reflectors	Circular cylinders Parabolic cylinders
Double-curvature reflectors	Paraboloids Spheres Array focused on a receiver
Lenses	Cylindrical Circular Fresnel
Others	Fresnel reflectors Truncated cones Sun-following flats with fixed paraboloid

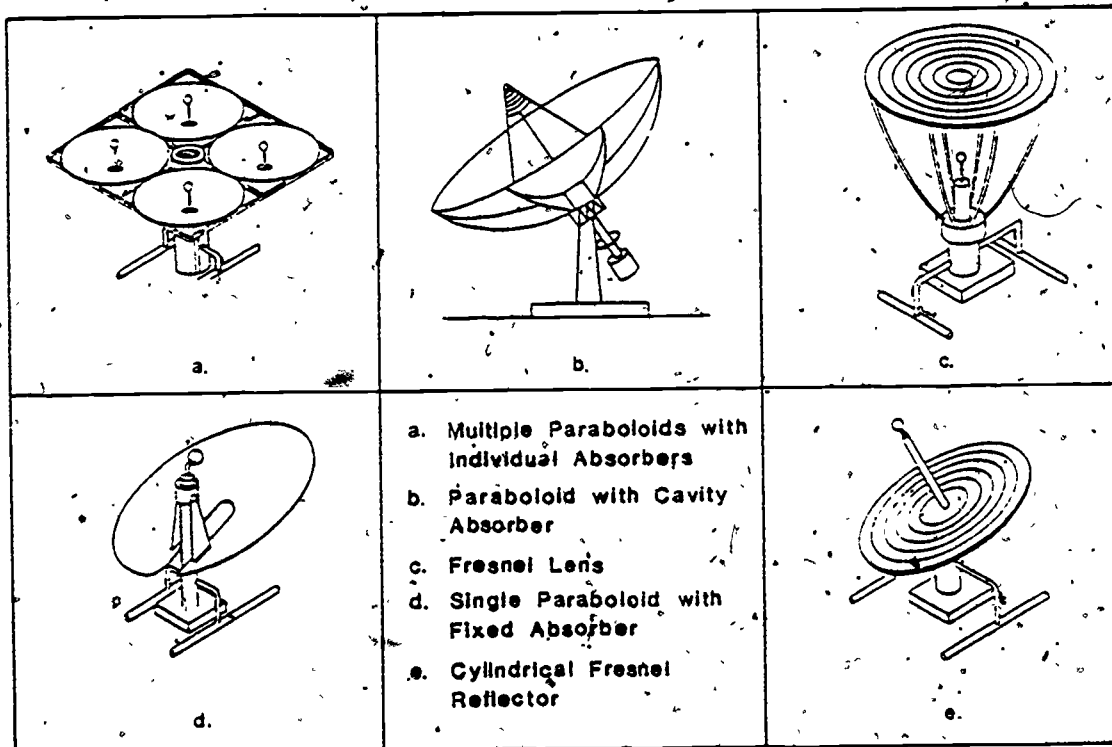

Figure 12. Examples of Concentrating Collectors.

An important parameter for concentrating collectors is the concentration ratio. The concentration ratio is defined as "the ratio of the area of the reflector to the area of the absorber." For cylindrical collectors, concentration ratios in the range from 10 to 50 are possible. For large paraboloids, concentration ratios up to a few thousand are possible.

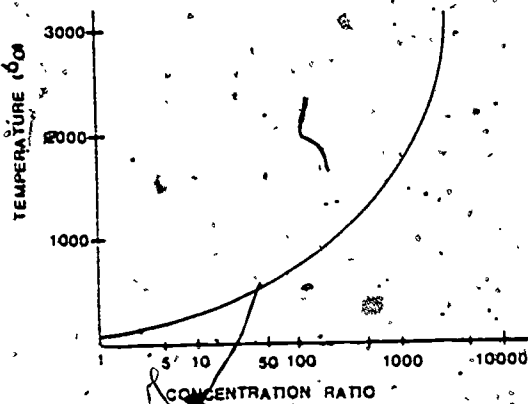

Figure 13. Fluid Temperature Vs. Concentration Ratio for Concentrating Collectors, for Insolation of 1000 W/m^2 .

The concentration ratio defines the maximum temperature that can be reached by the working fluid. Figure 13 shows the temperature that can be produced by concentrating collectors as a function of the concentration ratio. The figure is relevant to the insolation of $1000 \text{ watts per square meter}$.

The concentration ratio for a flat-plate collector is one, and the maximum temperature is only 100° or so. But, as the concentration ratio rises, the fluid temperature rises rapidly.

Because of the higher temperatures, cycle efficiency for a system with a concentrating collector can also be higher. Cycle efficiency can range up to 75%; therefore, for a given required output, a smaller total surface can be used if the collector is of the concentrating type.

A disadvantage of concentrating collectors is that an image of the sun must be imaged accurately by the reflector on the absorber. Thus, concentrating collectors must track the sun. To do this, they are supported on movable mounts with solar position sensors to track the sun across the sky. This, of course, correctly implies that systems with concentrating collectors are more complicated and costly than systems with flat-plate collectors.

Concentrating collectors need a well-defined solar image; therefore, on a cloudy or hazy day they will be almost completely ineffective. However, flat-plate collectors will receive the diffuse radiation from the cloudy sky and will deliver some output:

In order to compare the properties of flat-plate collectors and concentrating collectors, Table 3 summarizes the relative advantages and disadvantages of both types.

TABLE 3. COMPARISON OF FLAT-PLATE COLLECTORS AND CONCENTRATING COLLECTORS.

Advantages	
Flat-Plate	Concentrating
Simple construction and low cost No tracking systems Uses diffused sky radiation, hence giving some output on cloudy days	Higher efficiency Higher water temperatures Smaller areas needed
Disadvantages	
Flat-Plate	Concentrating
Lower efficiencies Lower water temperatures Larger area needed	Higher cost and more complicated construction Almost no output on cloudy days

Because of their higher cost and complexity, concentrating collectors are not used for space and hot-water heating for homes. Their higher temperatures and efficiencies render them useful for applications such as the following:

- Generation of electricity (to be described later)
- Generation of industrial process heat and steam at high temperature
- Cooking
 - Hot water and hot air for large buildings, especially multistory buildings where smaller areas of collectors may be important
 - Drying in industry and agriculture.

Solar cooking is accomplished with a metallized, parabolic concentrating collector. Cooking vessels are placed in the focal area of the paraboloid. Solar cooking is used in North Africa, Israel, and other sunny areas, but it has not been popular in the United States.

EFFECT OF ADJUSTING ORIENTATION OF COLLECTOR FOR MAXIMUM COLLECTION EFFICIENCY.

A solar collector, either flat-plate or concentrating, operates best when it is aimed directly at the sun. Concentrating collectors need the well-defined focused image of the sun on the absorber. Both types collect solar radiation more efficiently when they are pointed at the sun. Table 4 shows the average total amount of solar radiation that arrives in June and in

December for both a fixed surface and a tracking surface. The tracking surface is driven so that it always faces the sun directly. The fixed surface is oriented so that it is south-facing and tilted at 45° from the horizontal. For a fixed surface, the orientation is close to optimum for much of the United States. Values are shown for a number of selected cities.

In each case the tracking collector receives more total energy each day. This is true even though the fixed surface is oriented near the optimum position. For example, in Albuquerque, in December, a tracking surface receives about 20% more energy each day than a fixed surface.

The tracking surface is more complicated and expensive than the fixed surface; but it requires a detailed system analysis to decide whether its improved energy collection justifies the cost.

TABLE 4. TOTAL DAILY SOLAR RADIATION ON FIXED SURFACES AND TRACKING SURFACES IN JUNE AND DECEMBER FOR SEVERAL CITIES.
(Values are in kWh/m²/d.)

City	Fixed Surface - Tilted at 45° from Horizontal and Facing South		Tracking Surface - Always Facing Sun	
	June	December	June	December
Albuquerque, NM	6.7	6.1	10.8	7.3
Boston, MA	5.0	3.3	7.3	3.8
Brownsville, TX	5.1	3.9	8.4	4.5
Columbia, MO	5.7	3.9	8.5	4.5
Madison, WI	6.2	4.0	9.3	4.8
Nashville, TN	5.1	3.4	7.6	3.9
New York, NY	4.7	3.2	6.5	3.6
Phoenix, AZ	6.1	5.6	9.9	6.6
Seattle, WA	5.9	1.8	9.0	2.1
Washington, DC	5.2	3.8	7.5	4.5

TOTAL SYSTEM CONFIGURATION

The collector is an important component in a solar energy system, but the system requires many other components to make it complete. Pipes, valves, heat exchangers, sensors, thermostats, pumps, fans, and storage devices are

also needed. This section of the module discusses some of these components and their uses in a total system for solar energy.

Storage Devices

Storage devices are needed in solar energy systems because the sun does not shine at night and because a series of cold, cloudy days may cut off the output of energy just when the need is greatest.

Heat-storage units may be incorporated in the system. The heat-storage unit is usually a tank of water, with a heat exchanger that extracts heat from the water after it is heated by the solar collector. Water is used because it is inexpensive, is easily stored and handled, and has a high heat capacity. Hot water from the solar collector enters the heat exchanger and warms the water in the storage tank. Later, when the sun is not shining, the thermal energy from the storage tank may be used for heating.

Other alternatives for thermal storage include rocks that may be used in addition to water. Some systems using molten salts have also been developed; however, these are more sophisticated and costly and are not well-suited for residential heating.

Figure 14 shows how a solar collector could be used to provide both space and water heating for a home. The collector is placed on the roof, facing south and tilted so that it faces the sun as much of the time as possible. The water in the collector

is heated to a high temperature and is pumped to the hot-water heater and the storage tank. In both the hot-water tank and the storage tank, the collector exchanges

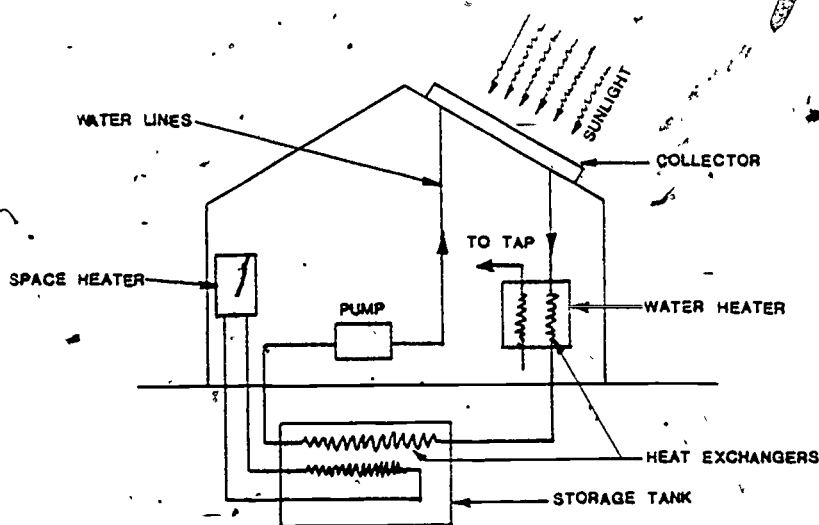

Figure 14. Sample System for Solar Space and Water Heating.

its energy to the water in these tanks. Then, water for use in the home is drawn directly from the hot water tank. The hot water in the storage unit is circulated through radiators — as it is needed — to provide space heating.

A conventional heating system is usually installed parallel to the solar system. This system is needed to provide heat when the sun is not shining and when there is not enough energy stored in the storage system.

Solar air conditioning has previously been mentioned as a possible use of solar thermal energy. The system is similar to a refrigerator. A refrigerant fluid is vaporized; then the heat of vaporization is extracted from the space to be cooled. The solar energy drives a compression cycle so the fluid is recompressed to liquid. The heat released in the recompression is released to the outdoors.

Control Considerations

The system must be under the control of temperature sensors and thermostats. Figure 15 shows the flow through a system of valves under the control

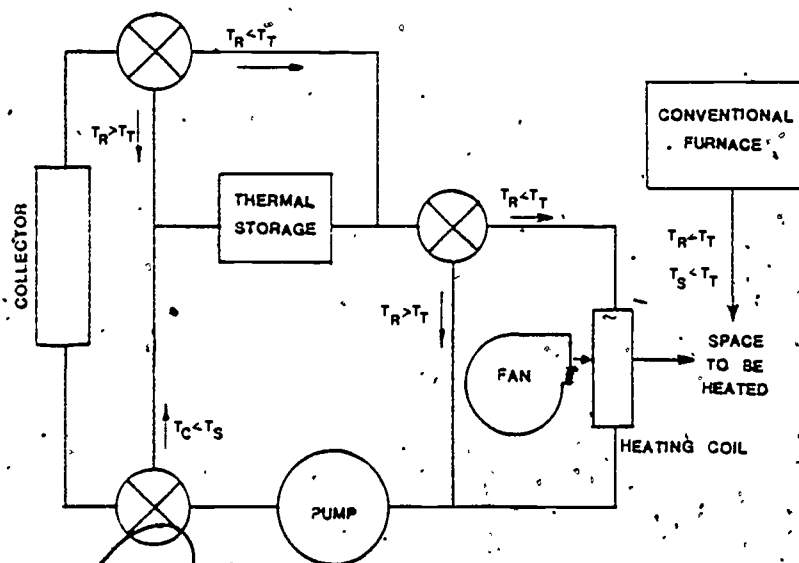

Figure 15. Control Circuit.

When the room has warmed to the desired temperature ($T_R > T_T$), the flow from the collector goes through the storage unit, and thermal energy is stored in the collector.

When the collector temperature drops ($T_C < T_S$) — as at night — energy is extracted from the storage unit to heat the room. If there is insufficient

of a thermostat set at temperature T_T , with temperature sensors to monitor collector temperature T_C , storage temperature T_S , and room temperature T_R .

When the room needs heat ($T_R < T_S$), the heat from the collector is delivered directly to the room.

energy in the storage unit. ($T_S < T_T$), then the conventional furnace is switched on.

Comparison of Efficiency for Various Configurations

Several considerations concerning the different types of collectors are summarized below. Although some characteristics and components have been discussed earlier, a summarization is needed for explicit comparison.

Table 5 presents data on the properties of flat-plate collectors, concentrating collectors of medium concentration, and concentrating collectors of high concentration. The table also presents typical values for the temperature of the fluid and the efficiency. The actual temperature depends on the properties of the absorbing surface, the reflectance of the reflectors in a concentrating collector, and the accuracy of the solar tracking. Efficiency depends on heat loss in the system and on the final temperature of the working fluid after it has performed its heating function.

TABLE 5. TYPICAL PROPERTIES OF SOME COLLECTOR TYPES.

Collector Type	Construction	Concentration Ratio	Typical Temperature (K)	Typical Efficiency
Flat-plate	Blackened surface	1	350-450	~30%
Concentrating (medium)	Parabolic cylinder	10-50	500-850	~50%
Concentrating (high)	Paraboloid	Up to several thousand	1000-2000	~70%

HOT-AIR SYSTEMS

Systems using hot air (or another hot gas) as the working fluid are very similar to hot-water systems; they tend to use the same type of collectors, and system designs are conceptually similar.

PASSIVE SYSTEMS

A passive solar energy system is a term that refers to architectural features that use the natural transfer of solar energy for heating. In this

context, it could be nothing more than a south-facing window or windows. A passive solar system generally means a deliberate architectural design that will maximize the transfer of thermal energy. There can be some storage system, but the transfer of energy into and out of storage is by natural conduction or convection, rather than by pumps and fans.

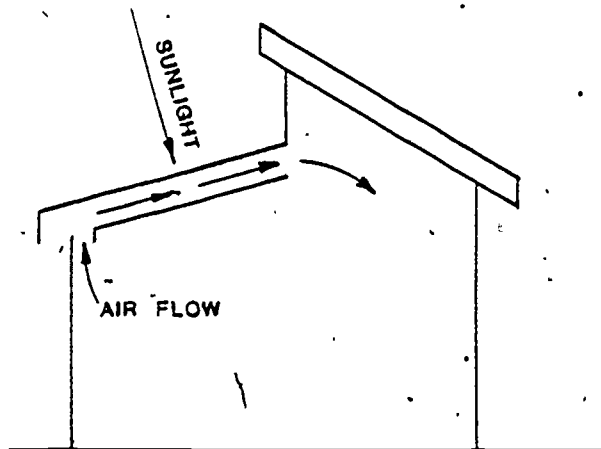

Figure 16. Schematic Diagram of a Thermosyphoning Roof.

the windows and the roof in the winter. The design will also provide for minimal heat gain during the summer.

COLLECTORS

Active systems are systems in which air is pumped, heated in a collector, then pumped through the other system components. The types of collectors used are the same as those already described for hot-water systems. They include flat-plate collectors and concentrating collectors.

The advantages of hot air as the working fluid are more obvious for concentrating collectors. The temperature of the gas can be raised to very high temperatures, higher than would be feasible for water-based systems. Thus, hot-air systems can be used for concentrating collectors intended to operate at high temperature. The working fluid may be air or some other gas, such as helium.

The use of air in flat-plate collectors is less common than the use of water as the working fluid, simply because of the difference in energy storage between the two fluids. For a given volume of fluid and a given temperature

rise, water will store approximately 1,000 times as much energy as air. Thus, flat-plate collectors, with their limited maximum temperatures, are limited in the capacity to store and transfer energy if air is used instead of water.

The flat-plate collectors that do use air tend to be those at the low end of the cost-and-performance range. Simple, inexpensive channels made from corrugated metals are used instead of bonded tubes in the collector, and the fluid is transferred through metal ductwork rather than pipes.

Figure 17 shows an example of a design for a flat-plate collector to be used with air as the working fluid. This can be compared to Figure 10, which shows a typical design for a flat-plate collector to be used with water.

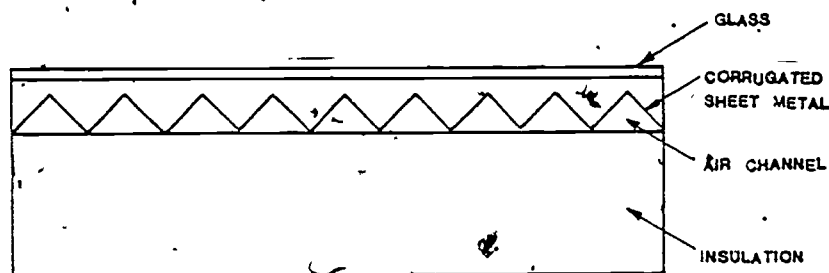

Figure 17. Typical Design for Flat-Plate Collector, Using Air as the Working Fluid.

STORAGE

Storage reservoirs are needed with hot-air solar systems, just as with water-filled systems, and for the same reasons. The storage reservoirs for hot-air systems are often heated rocks. Hot air passes through the interstices between the rocks and warms them. Later, when heat is needed from the reservoirs, cool air circulates through the warm rocks and is heated.

In contrast, hot-water systems usually use water tanks for storage. However, hot air cannot exchange its heat as well with water. On the other hand, it is probable that water circulating through the small openings in a rock pile soon would lead to clogging and circulation problems, whereas hot air can circulate well through the rocks.

COMPARISON TO WATER-BASED SYSTEMS

There are many applications where air is a better fluid for heat transfer in a solar collector. Advantages are as follows:

- Air does not freeze
- Air-based systems are less subject to corrosion and to blockage than are water-based systems

- Air leaks are less serious than water leaks in a system
- Air-based systems can be used at higher operating temperatures than water systems.

However, the low-specific heat of air (and of other gases) is a drawback. Not as much energy can be stored in the gas as in water; thus, the ducts that carry the heated air must be much larger than the pipes that carry water.

Nevertheless, both types are used in solar energy systems. Because of better heat storage of water, water-based systems are used most often in relatively low temperature systems, such as for residential space and water heating. Air-based systems, with their capabilities of operating at very high temperatures — and, therefore, at high efficiencies — are used in concentrating collectors with high concentration ratios.

Table 6 summarizes some of these considerations in a comparison of air-based and water-based solar energy systems.

TABLE 6. COMPARISON OF AIR-BASED AND WATER-BASED SYSTEMS.

Air-based	Water-based
Advantages	
No freezing Less corrosion Higher temperatures and efficiencies possible	Larger heat capacity Smaller piping needed
Typical Applications	
Low cost flat-plate collectors High temperature concentrating collectors	High capacity flat-plate collectors Low temperature concentrating collectors

SOLAR FURNACES FOR STEAM GENERATION

Concentrating collectors can be used to superheat water and produce steam, which in turn can be used to drive turbines and produce electricity. There are two principal approaches to steam generation: the axial tower and the parabolic concentrator.

AXIAL TOWER

With the axial tower approach to steam generation, many flat mirrors are placed over a large land area (field). Each flat mirror individually reflects sunlight onto a boiler, which is at the top of a tower located in the center of the field. The large area involved means that a large amount of energy is delivered to the tower. Many megawatts can be collected if the area is large enough. The high temperature steam that is produced in the boiler can drive a turbine and produce electricity. Thus, the axial tower could provide a pollution-free, central electrical-generating station that operates only on solar energy. Figure 18 shows a schematic diagram.

The individual mirror elements, called heliostats, are driven by electrical or hydraulic servomechanisms that are controlled individually by solar-positioned sensors. Suitable sensors are available in the form of four-element phototubes.

When the image of the sun is off-center in the phototube, one element is illuminated

more than the others. This generates an electrical signal that is used to reposition the solar image. When the solar image falls equally on the four elements, there is no net output signal, and the heliostat remains stationary.

Heliostats can be square mirrors, with approximate dimensions between 4 to 10 meters. The mirror surfaces can be silvered glass or thin, metallic films. Heliostats are positioned over a field with a radius perhaps 2 to 3 times greater than the height of the tower, which may be a few hundred meters. This positioning eliminates problems with shading on one heliostat by another.

The solar tower concept eliminates many heat transfer problems because all the energy is brought to a central point in the form of light. The separate mirrors can be mass produced and, thus, be relatively inexpensive. The smaller mirrors are less subject to damage by wind than a single, large collector of comparable size.

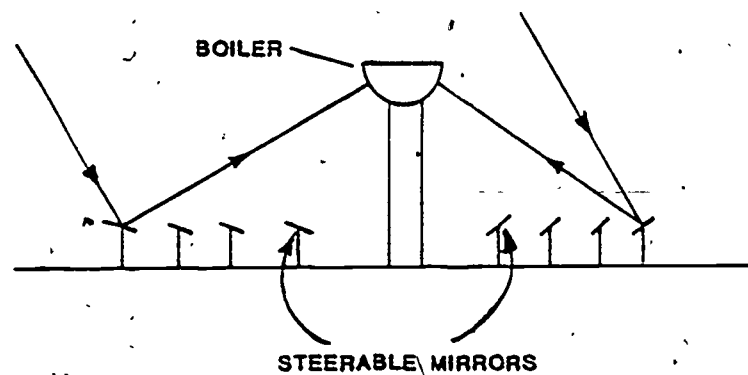

Figure 18. Tower Concept for Solar Power Generation.

The surface of the heliostats must be kept clean or loss of efficiency will result. Accumulation of dust, sand, or other contaminants on the surface would create problems. Two alternatives for solving this problem include automatically turning the heliostats upside down and using electrostatic methods to drive off dust.

Of course, the axial tower concept depends on a focused image of the sun being reflected to the boiler, so the output of the axial tower would be very low on a cloudy or hazy day.

One prototype of an electrical-generating station based on the axial tower concept is being constructed on a site near Barstow, California. This is an area of high insolation and a location where there are many clear days. The entire site covers 72 acres and contains 1760 heliostats. The boiler is located on a tower 250 feet above the ground. Cold water is pumped up the tower and is heated to produce steam at a temperature of more than 500°C. The steam, in turn, is used to generate electrical power. This plant is expected to produce 10 megawatts of power.

PARABOLIC COLLECTORS

The parabolic collector (or paraboloid) has been discussed briefly in the section on concentration collectors (Figure 12). The paraboloid is an important type of concentrating collector because of its capability for producing very high temperatures.

The parabolic concentrator is the most efficient of the concentrating collectors. It produces the highest temperatures, and, therefore, is suitable for generating steam, among other applications.

A parabola is a mathematical curve that can be expressed in mathematical form by the following equation:

$$y = ax^2 \quad \text{Equation 4}$$

where: x and y = The spatial coordinates.

a = A constant.

The value of "a" determines the exact shape of the parabola. Examples of several parabolas, with different values of "a," are shown in Figure 19. Because of the dependence on the square of x , the parabola is symmetric about

its axis (that is, the value of y is the same for x equal to plus or minus the same value).

If a parabola is rotated about its axis, it generates a three-dimensional surface called a paraboloid.

The paraboloid is an extremely efficient collector of sunlight. The paraboloid reflector has the following characteristic: All light rays that enter the paraboloid parallel to its axis are reflected so they pass through a common point, called the focus. Thus, an absorber located at the focus will receive

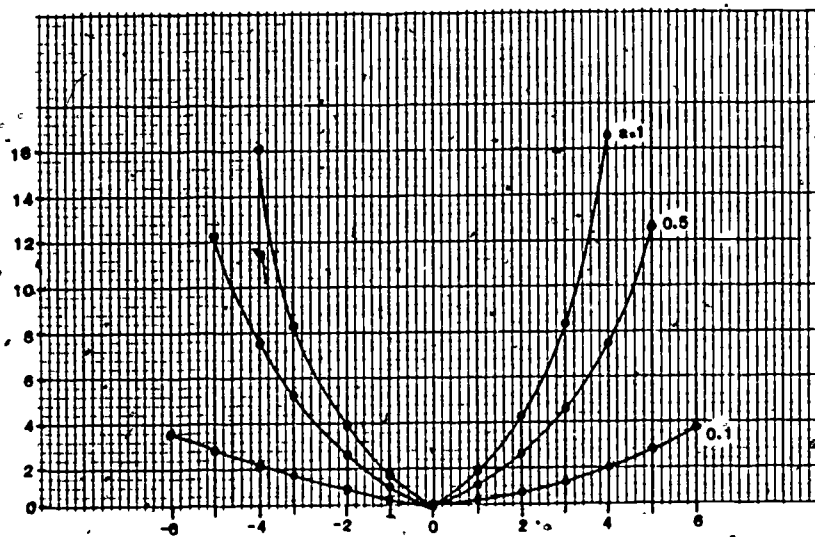

Figure 19. Examples of Parabolas.

all the solar energy incident on a paraboloid pointed at the sun. Extremely high temperatures can be produced at the focus. Figure 20 shows this focusing characteristic of a paraboloid.

The paraboloid must be used in a tracking system so the sunlight is parallel to the axis of the paraboloid. For small systems, the paraboloid itself can be mounted on a movable platform that tracks the sun. For larger systems, it becomes too difficult to move the paraboloid accurately. A large paraboloid will often be stationary, and will be used with an array of smaller flat mirrors, each of which tracks the sun and reflects the sunlight toward the paraboloid along its axis.

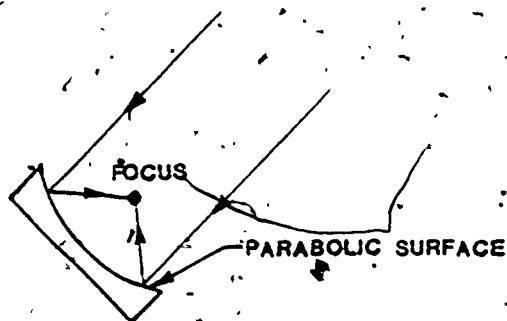

Figure 20. Parabolic Collector.

Because of the nature of the parabolic surface, it is more expensive than other types of concentrating collectors. It is more difficult to form an accurate paraboloidal surface than it is to form a flat or spherical surface. A paraboloid is difficult to machine or to polish as a single piece; therefore, large paraboloids are constructed of many smaller mirror elements that are positioned to approximate the desired paraboloidal surface.

Paraboloidal concentrating collectors have been designed with concentration ratios above 10,000 and with operating temperatures of several thousand degrees Celsius. Because of the high operating temperature, the cycle efficiency can also be high. Total thermal efficiencies up to approximately 70% have been demonstrated.

One of the largest paraboloidal solar collectors is located in the Pyrenees mountains in southern France at an altitude of 5900 feet. There is a large amount of solar radiation at this location. The paraboloid is 130 feet high and 175 feet wide. It is constructed of 9500 mirrors, each 17.7 inches square. The paraboloid is capable of producing temperatures above 3800°C at its focus. Radiation is delivered to the stationary paraboloid by 63 heliostats, each of which measures approximately 25 x 20 feet in dimension and tracks the sun. The system is capable of delivering 1000 kilowatts of power.

This preceding description shows that large paraboloidal solar collectors are complex, expensive systems that are still primarily in a research stage. Since they are capable of producing very high temperatures, metals and high temperature ceramic materials have melted at the focus of a paraboloidal collector.

In addition to research that is performed with larger parabolic concentrators, some smaller parabolic systems have been used for industrial processing — such as for melting high temperature materials (such as alumina and zirconia) and for providing heat for drying in industrial and agricultural processes.

The role of paraboloidal concentrators for producing steam is still being evaluated. It is uncertain whether using high temperature steam from such collectors for electric power generation will be economical. Further development work to optimize the design of heliostats, concentrator, and boiler is in progress.

INSTALLATION AND MAINTENANCE OF SYSTEMS

The next few paragraphs describe some of the practical factors relative to location, reduction of heat loss, and maintenance of solar energy systems.

LOCATION

The maximum collection of solar energy occurs with tracking systems that move the collector during the course of the day so it is always facing the sun directly. A tracking system is much more expensive than a fixed system, and a fixed system can collect a considerable fraction of the available energy. As Table 4 shows, a fixed collector that is facing south and tilted at 45° can receive 70-80% as much radiation per area (for many cities in the United States) as a tracking collector. Thus, an optimally placed, fixed collector, with an area approximately 20-30% larger than a tracking collector can collect as much energy as the tracking collector. Moreover, the fixed collector would probably be less expensive to install.

The optimum orientation of the fixed collector can be specified by its angle of tilt (measured from the horizontal) and by the direction that it faces. The following rules summarize the optimum tilt angle:

In the winter, the tilt angle should be equal in degrees to the latitude + 15° .

In the summer, the tilt angle should be equal in degrees to the latitude - 15° .

Because of the summer-winter difference, some solar collectors are designed so the tilt can be adjusted several times a year. However, this adjustment makes relatively little difference. The use of a tilt angle, which varies from the optimum by 10- 15° , has only a slight effect on the amount of solar energy that can be collected.

The optimum direction for the collector surface to be facing is toward the south. However, the performance is not degraded as much if the surface faces in a direction within 15 degrees east or west of direct south.

REDUCTION OF HEAT LOSS

Heat loss from any part of the system will reduce the amount of energy available and will reduce the efficiency of a solar energy system. Already

mentioned is the fact that the back side of the collector should be adequately insulated to reduce heat loss from the collector.

Two other sources of heat loss are the storage tanks and the pipes that carry the heated fluid. The storage tanks must be adequately insulated since this insulation can make the difference between a system that performs poorly and one that performs well. Moreover, all hot-water and hot-air piping should be insulated, including the pipes leading to and from the collectors.

Another source of heat loss is reradiation of the collected energy. The surface of the collector should have high absorption in the wavelength region in which the solar energy occurs (approximately $1 \mu\text{m}$), and it should have low emission at the wavelength region in which reradiation of heat energy occurs (approximately $10 \mu\text{m}$). The selective coatings described in the section entitled "Absorption by Various Materials" have the desired properties to reduce heat loss due to reradiation, although they will increase the cost of the system.

The reflection of solar energy at the surfaces of the glass cover plate can amount to 8% of the incident energy. Anti-reflection coatings are available for glass plates. However, although such coatings can reduce the reflection loss, they also will add to the cost.

MAINTENANCE

The most sensitive part of the solar energy system is the surface of the absorber. This surface must absorb the incident energy efficiently and must maintain this high absorption over a period of years. The surface is exposed to an environment of high solar-radiation flux and will tend to bleach and lose its absorption over a period of time.

The absorption of the surface must be checked periodically. When the surface absorptivity has degraded, the absorber will have to be recoated or repainted.

In systems with reflecting heliostats, such as the axial tower, the reflectivity of the mirror surfaces must remain high. In the environment of intense sunlight, these reflectors can also become degraded. Repolishing or recoating of the reflecting surfaces may be necessary. For example, in the large paraboloid in France, the mirror surfaces are recoated with aluminum once a year.

Of course, any coating of dust or dirt on the collector will reduce its efficiency. For a homeowner, simply washing off the collectors outer surface with a hose will help keep them clean. However, the absorbing surfaces of some solar collectors require cleaning with a solvent such as turpentine.

Finally, solar energy systems often depend on fluids circulating through pipes. Over a period of time, corrosion can partially block circulation and reduce the system's efficiency. Periodic checking to make sure the fluid is circulating freely is important.

FACTORS AFFECTING SYSTEM OPERATION

Effective operation of a solar-energy system is dependent upon several factors, including the architectural aspects of the building, the size of the system installed, and the initial investment.

ARCHITECTURAL FACTORS

The questions involving installation of a solar energy system can be very different, depending on whether the building is new or old. On a building just being constructed, the entire building design can be adjusted to take advantage of the incident sunlight. Factors that can be changed include choice of materials, placement of the building on the site, number and placement of windows, ratio of surface area to floor space, and orientation of walls and roof surfaces. These factors can be included in the design to take advantage of the available solar energy.

On existing buildings, the feasibility of solar energy systems has to be evaluated on an individual basis since the building was designed without considering any of the needs of a solar energy system.

The tilt angle and orientation of the collectors are important. (These factors were considered in the section entitled "Location.") To summarize briefly: The collector should be oriented approximately toward the south. Furthermore, it should be tilted from the horizontal at an angle approximately equal to the latitude. For solar space heating, an angle equal to the latitude, plus 10°, is about optimum. For water heating alone, a tilt angle equal to the latitude is best.

The collectors should be placed where they will not be shaded by trees, other buildings, and so on. It must be remembered that in winter the sun

may be very low on the horizon. This fact may lead to unexpected problems in shading of the collectors.

Collectors can often be placed effectively on the flat roofs of factories, offices, and commercial buildings or on south-facing sloping roofs of homes.

The question of "sun rights" may become important. If someone installs a solar collector, and then the owner of the adjacent property builds a tall structure that shades the collector, the value of the collector will be reduced considerably. Laws are being passed in some states to govern the rights of access to sunlight; however, the development of such laws is still in a very early stage.

SYSTEM SIZE

Before a solar energy system is installed, it is important to estimate the size of the system that is required. Many factors affect the required size, including the following:

- The climate at the particular location
- The design and amount of insulation in the building
- The amount of solar energy available
- The efficiency of the chosen solar energy system
- The percentage of the heat load that must be provided

The amount of solar energy required will vary from place to place according to the climate. A building in San Diego will need less heating than the same building in Boston.

The climatic effects can be estimated with reference to the number of degree-days in a heating season at the particular location. The number of degree-days is defined as "the difference between the average temperature during the day (midnight to midnight) and 65°F." Thus, if the average temperature for the day is 40°F, there will be 25 degree-days. In a heating season in Minneapolis, there will be a total of more than 8000 degree-days.

The number of degree-days for a given location may be obtained from weather records. In some places, it is published in the daily newspaper.

In a given climate, the heat load of different buildings varies according to size, design, type of construction, and amount of insulation. Perhaps the best method for estimating the requirements of a particular building is

to refer to the utility records. For instance, the following question can be answered: How many kilowatt-hours (or Btus) of energy were used in previous heating seasons? It should also be determined that the heating season is typical -- not unusually mild, for example. Again, reference to the weather records is required.

Next, what fraction of the heat load is to be supplied by solar energy? In most cases, it is not practical to supply 100% because the size and cost of the collecting system and storage systems become unreasonable. A more practical range is perhaps 50-70%.

Analysis of the preceding factors should give the total solar energy that must be supplied. Next, one must determine how much solar energy is available at the particular location. This was presented earlier in the module in the discussion concerning insolation at various places in the United States.

Of course, not all the energy can be used. The system efficiency must be considered. The following example shows how all the factors discussed can be combined to yield an estimate of the total collector area needed.

EXAMPLE C: DETERMINATION OF COLLECTOR AREA.

Given: Determine from old utility bills that a home uses 24,000,000 Btus of heat energy in January. Suppose that 50% of this energy is supplied with a solar collector in a location where the sun delivers 30,000 Btus/ft² of solar energy in January. A system will be used with a total system efficiency of 25%.

Find: How large the collector should be.

Solution: Needed is a total of $24,000,000 \times 0.5 = 12,000,000$ Btus. Each square foot of collector area will yield $30,000 \times 0.25 = 7,500$ Btus.

Thus, the collector area should be $12,000,000 / 7,500 = 1600$ ft².

As rough rules of thumb that are applicable for a reasonable range of climatic conditions, the following estimates are presented:

For a well-insulated home, the collector area needed to supply approximately 70% of the heating requirements will be approximately 17-25% of the floor space in the home.

For the storage system, there should be approximately 1.5-2.5 gallons of water for each square foot of collector area in a water-based system. In an air-based system, there should be approximately 40-70 pounds of rock per square foot of collector area.

ECONOMIC FACTORS

The economics of solar energy systems are strongly affected by two factors:

- Initial costs tend to be high, and it takes a rather long time to recover the initial investment.
- In almost all cases, the solar system must be backed up by a conventional heating system.

The costs of materials and installation for a solar energy system represent an initial investment that is recovered gradually through reduced costs for conventional fuels. Although sunlight is essentially free, and operating costs for a solar system are relatively low, the initial costs may make the system of doubtful economic value. The time that it takes to recover the initial investment (the payback period) may be unacceptably long — perhaps longer than the expected life of the system. Even for relatively inexpensive systems installed by a do-it-yourself homeowner, payback periods may be 10 years or more at 1979 fuel prices.

Because the sun does not shine all the time, a conventional back-up heating system is required. The alternative would be an unreasonably large and expensive storage system. Although it is practical to provide storage large enough to cover a period of two consecutive cloudy days, beyond this, storage size and heat loss from the storage tank would probably be excessive. In most areas of the United States, it is not unusual to have cloudy periods lasting much longer than two days.

Because a conventional heating system is still needed, the entire cost of the solar system must be regarded as an extra cost and not as being partially offset by replacing other equipment.

A solar space and hot-water heating system for a typical home in a typical climate can cost somewhere in the range of \$4,000 to \$8,000. This range is based on use of commercial components and commercial installation. The costs could be reduced considerably by use of designs that can be constructed and installed by the homeowner. Some designs for flat-plate collectors are available at costs of less than \$1 per square foot for materials only, with all construction done by the do-it-yourself homeowner. This cost compares well to the cost of commercially installed flat-plate collectors — which is in the range of \$15-\$20 per square foot, as of 1979. However, the inexpensive,

do-it-yourself designs will probably be less efficient and require more square footage. The materials cost for a do-it-yourself solar energy project is still likely to be in the \$2,000 range.

It takes a long time to recover this amount of investment on fuel savings at 1979 fuel prices, especially when the conventional furnace and hot water heat must still be used part of the time.

As of 1979, the best economic case can be made for solar water heating since hot water is needed all year and space heating is only needed a few months out of the year.

The cost analysis for a solar energy system becomes complicated because it includes the cost of money (the interest rate on the money needed for installation), tax considerations, and estimates on possible future costs of conventional fuels. The best estimate — as of 1979 — appears to be that solar space heating can be compared economically to electric heating. However, it is not economical when compared to natural gas or fuel oil. One advantage is that the federal government and some state governments offer tax credits for installation of solar systems, so the initial investment can be partially offset by tax rebates. These tax considerations can change the economic considerations considerably.

Furthermore, the cost of conventional fuels almost certainly will escalate rapidly in the future. If solar systems are still of marginal economic attractiveness in the next year or two, the increased prices of other fuels will make solar systems increasingly more attractive in the future.

REFERENCES

Baumeister, T., ed. Mark's Standard Handbook for Mechanical Engineers. New York: McGraw-Hill Book Company, 1978.

Boes, E.C. and others. Availability of Direct, Total, and Diffused Solar Radiation to Fixed and Tracking Collectors in the USA. Sandia Laboratories Energy Report, SAND 77-885. Albuquerque, NM: Sandia Laboratories, 1977.

Collins, T. Solar Energy: Four Sites Demonstrate Potential IEEE Spectrum (April 1979): p. 60.

Heister, N.K. and Tangney, C.A. Renewable Energy Sources. Stanford Research Institute Report Number 563. Menlo Park, CA: Stanford Research Institute, 1975.

Hottel, H.C. and Howard, J.B. New Energy Technology. Cambridge, MA: MIT Press, 1971.

Annual Review of Solar Energy, Report Number SERI/TR-54-066. Golden, CO: Solar Energy Research Institute, 1978.

Williams, Jr.R. Solar Energy: Technology and Applications. Ann Arbor, MI: Ann Arbor Science Publishers, 1974.

116

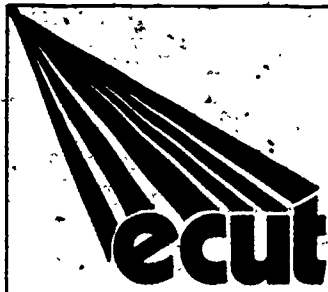

ENERGY TECHNOLOGY

CONSERVATION AND USE

ENERGY PRODUCTION SYSTEMS

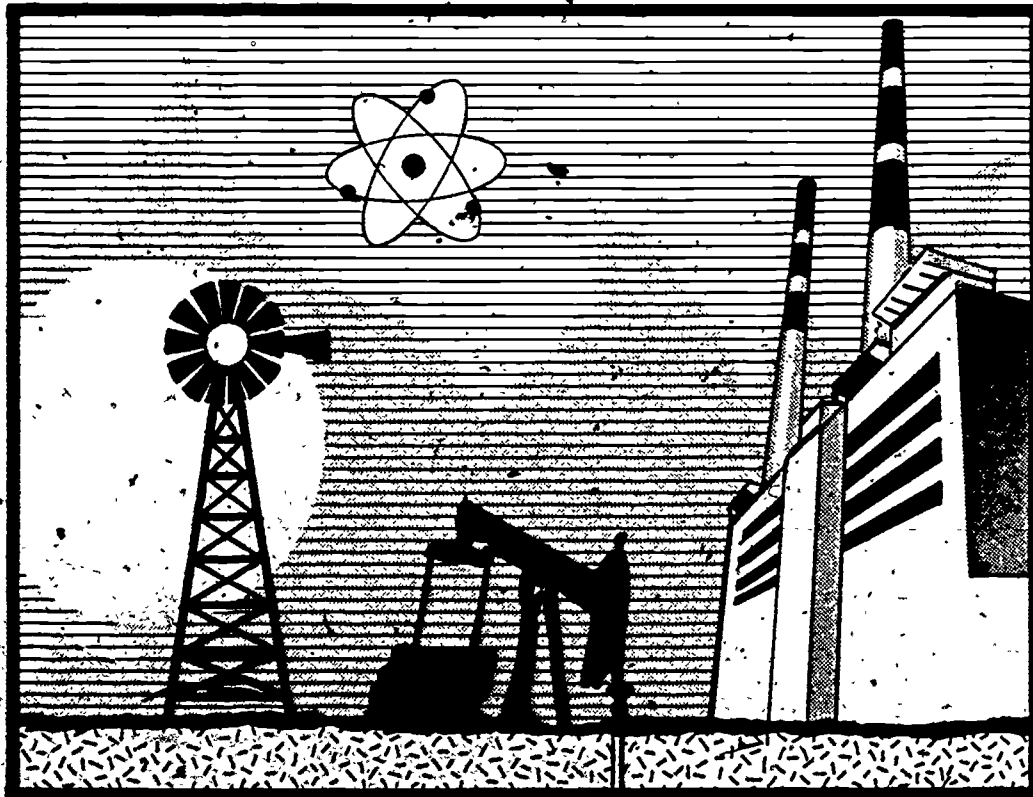

MODULE EP-04

GENERATION OF STEAM AND HOT WATER USING NUCLEAR
AND EXPERIMENTAL POWER SOURCES



CENTER FOR OCCUPATIONAL RESEARCH AND DEVELOPMENT

INTRODUCTION

This module discusses the generation of steam and hot water, using thermal energy from nuclear reactors. The various types of nuclear reactors are described, as well as experimental energy sources which include nuclear fusion devices, geothermal energy supplies, and ocean thermal supplies. Included in the discussion of the principles of operation of these energy sources are the following: the types of equipment employed; the variations in system design; the relative advantages, and the practical uses.

PREREQUISITES

The student should have completed Fundamentals of Energy Technology and Module CH-11, "Nuclear Chemistry," of the course Chemistry for Energy Technology II.

OBJECTIVES

Upon completion of this module, the student should be able to:

1. Define the following terms:
 - a. Fuel rod
 - b. Fuel assembly
 - c. Reactor core
 - d. Reactor vessel
 - e. Moderator
 - f. Control rod
2. Describe the heat generation and collection systems that were discussed.
3. Describe the basic principles of operation for each system.
4. Describe the status of practical usage for each system.
5. Discuss the relative advantages, disadvantages, and applications of each system.
6. Describe the different types of nuclear reactors that were described, including the types of materials used in their construction, the advantages, the disadvantages, and the degree of usage of each type.

SUBJECT MATTER

NUCLEAR REACTORS (FISSION)

Nuclear reactors based on nuclear fission form an important energy source. The principles of nuclear fission described in Module CH-11, "Nuclear Chemistry," of the course Chemistry for Energy Technology II should be reviewed by the student, since this module emphasizes how those principles are employed to generate steam in a nuclear reactor. The design features of nuclear reactors are discussed, and the various types of nuclear reactors are described.

Nuclear reactors are large structures that are suitable for the generation of steam for a large, central electrical generating station or for the propulsion of large ships. Thus, nuclear reactors are used almost exclusively for the generation of steam — which is in contrast to some of the other fuels described earlier. Fuel oil, for example, is widely used for space heating — in addition to steam generation.

Although public debate continues concerning the question of whether or not the use of nuclear power is wise, this module does not discuss the social implications of the use of nuclear power. Instead, the discussion involves the design and applications of available nuclear reactor technology. It also includes a description of the various types of reactors, with the main emphasis on the so-called "light water reactor," the type most widely used in the United States.

In the terminology of nuclear reactors, "light water" refers to ordinary water (H_2O), where the hydrogen is the isotope 1H , with an atomic weight of one. "Heavy water," in contrast, means water in which the hydrogen is the isotope 2H , with an atomic weight of two. The isotope 2H , called deuterium, is sometimes represented by the symbol D ; therefore, heavy water is D_2O . Deuterium is not really a separate chemical element, but simply a heavy isotope of hydrogen.

In order for nuclear fission to proceed in a chain reaction, it is necessary that more neutrons be produced in the fission process than are absorbed by the nucleus in other nuclear reactions. Only three isotopes satisfy this condition: ^{235}U , ^{233}U , and ^{239}Pu . Of these three isotopes, only ^{235}U occurs in nature. It comprises about 0.7% of the uranium in natural uranium, with the rest being the nonfissionable isotope ^{238}U . The other two isotopes do not occur naturally, but they can be produced by the following two reactions:

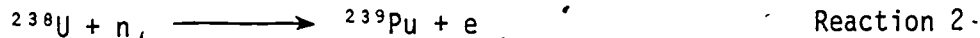

Reaction 2 occurs in the ${}^{238}\text{U}$ component of the uranium in a reactor. Thus, fissionable plutonium can be extracted from fuel rods that have been used in a reactor and could be used as a nuclear fuel. In practice, however, the use of ${}^{239}\text{Pu}$ as a nuclear fuel is still in the early stages of development. The nuclear fuel presently in use in electrical generating plants in the United States is the isotope ${}^{235}\text{U}$.

Nuclear reactors are considered to be either "thermal" reactors or "fast" reactors. In the nuclear fission reaction, neutrons are emitted with relatively high energy — approximately 2 million electron volts (2 MeV). One electron volt (eV) is the kinetic energy gained by an electron when it is accelerated through an applied voltage of one volt. Numerically, 1 eV is equal to 1.6×10^{-12} ergs. The energies of the atomic particles involved in nuclear reactions are commonly expressed in electron volts.

The 2 MeV neutrons produced in nuclear fission are considered to be "fast" neutrons. If they are allowed to react at this energy, the reactor is called a fast reactor. In most reactors, the neutrons are allowed to slow down by collisions with atoms of some material called a moderator. When the neutrons have slowed down to a low energy — around 0.025 eV — they have a much greater probability of interacting with a fissionable nucleus (such as ${}^{235}\text{U}$) to produce a fission reaction. Neutrons with energy around 0.025 eV are called thermal neutrons. A nuclear reactor that employs a moderator to slow neutrons down to thermal energies is called a thermal reactor. Most operating reactors today use a moderator and, therefore, are in the thermal category.

The moderating materials should be materials of low atomic weight. Neutrons slow down more quickly when they collide with atoms with low atomic weight. Thus, moderators are materials that contain light elements, such as hydrogen, carbon, or beryllium. Water is a convenient hydrogen-containing material, and an additional advantage is that it can be used as a coolant. The energy from slowing down the neutrons is transferred directly to heat in the water. The heated water can then be circulated and used to generate steam. The water can be ordinary light water, or it can be heavy water; but reactors using light water have been emphasized in the United States.

The following paragraphs contain information concerning several different types of reactors, with most of the emphasis on light water reactors. Other reactors included in the discussion are water reactors, gas cooled reactors, and breeder reactors. The breeder reactor is an example of a fast reactor, whereas the other three types are thermal reactors.

LIGHT WATER REACTORS

Most of the nuclear reactors currently in use for steam generation in the United States are light water reactors. They use ordinary water both as the moderator to slow down neutrons and as the coolant for the reactor. This water is heated and then used to generate steam.

The reasons for using light water involve three advantages: convenience, economy, and availability. Heavy water, in contrast, is expensive. Water, both heavy and light, has good thermal characteristics for cooling purposes.

The uranium used in light water reactors must be enriched so that the ^{235}U component is increased above its naturally occurring concentration of 0.7%. The uranium must be enriched so that it contains 2-3% of ^{235}U .

The enrichment is accomplished by gaseous diffusion of a uranium compound, uranium hexafluoride, which has the chemical formula UF_6 . Molecules of $^{235}\text{UF}_6$ are slightly lighter than those of $^{238}\text{UF}_6$ and diffuse slightly faster. This fact allows partial separation of ^{235}U from ^{238}U . The process consumes a large amount of energy; therefore, it requires the use of very large and expensive separation facilities.

In summary, light water reactors allow use of an inexpensive and convenient moderator and coolant, but it requires extra expense and loss of energy for processing the fuel.

Reactor Design

The heart of the reactor, where the nuclear fuel is present and the nuclear reactions occur, is called the core. The fuel is in the form of pellets, or uranium dioxide (UO_2), which is a ceramic-like material. The uranium has been enriched to contain about 2-3% of ^{235}U . The pellets are contained in long, thin rods called fuel rods. A schematic diagram showing the typical structure for a fuel rod is presented in Figure 1. The dimensions illustrated in the figure are typical, but they vary among different reactors. The pellets are contained in

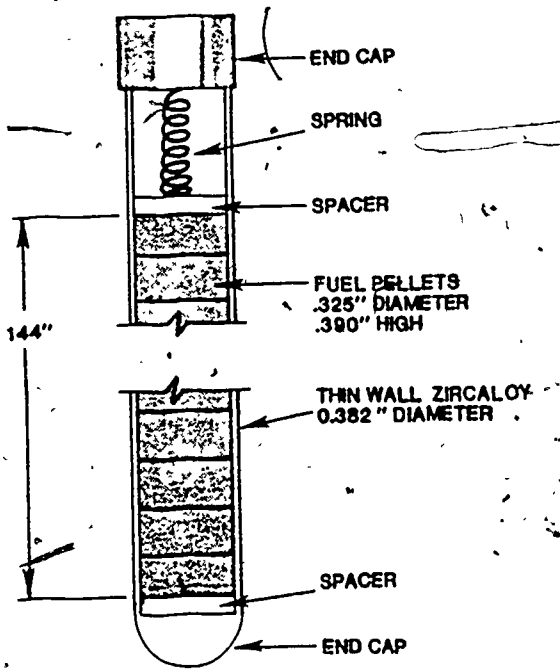

Figure 1. Schematic Diagram of a Typical Fuel Rod Structure.

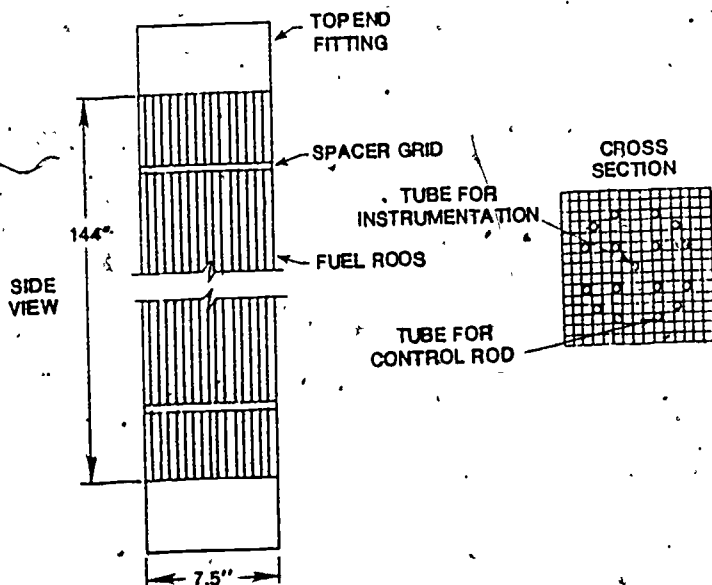

Figure 2. Schematic Diagram of Fuel Assembly Composed of 15 x 15 Array of Fuel Rods.

a thin-walled metal tube made of the alloy "zircaloy." This is an alloy that contains zirconium metal. It is chosen because it is relatively resistant to corrosion in the environment of the reactor and has very low interaction with the neutrons.

A number of fuel rods are grouped together into what is called a fuel assembly. Figure 2 shows a fuel assembly consisting of a square array of 15 x 15 rods. This is a typical type of assembly with typical dimensions; but the number and the dimensions may vary for different reactors. The fuel rods, with diameters of 0.382 inches, are held about 0.124 inches apart by spacers. This allows the flow of water between the rods. Thus, the total width of the 15-rod-wide assembly is about 7.5 inches.

The total array of 15 x 15 spaces would have room for 225 fuel rods. However, only 208 spaces are filled with fuel rods. The central space has a tube into which instrumentation can be inserted to measure conditions inside the core. The other 16 spaces have tubes into which control rods can be inserted.

The control rods are made of materials that strongly absorb neutrons, such as boron. The 16 control rods that would fit into this fuel assembly are all top-mounted together as an assembly. Therefore, the control rods move up and down together. When they are moved into their down position, they provide enough absorption to shut down the chain reaction. When they are raised, the nuclear reaction is allowed to proceed. The power output of the reactor is controlled by moving the control rods up and down. Control rods also provide a quick way of shutting down the reactor. The prompt shutdown of the reactor with the control rods is called a scram.

A number of fuel assemblies are packed together to form the core of the reactor. The core is contained inside a reactor vessel, usually conical in shape with rounded ends. A schematic diagram of the reactor vessel with the core is shown in Figure 3. One fuel assembly and one control rod are shown. The wall of the reactor vessel is steel, with a stainless steel lining to resist corrosion. The thermal shield absorbs radiation in order to reduce the amount of radiation reaching the reactor vessel wall. The main function of the reactor vessel is to contain the coolant.

A cross section of a reactor vessel and the core is shown in Figure 4. This particular core is made up of 177 square fuel assemblies. The diameter of the structure is approximately 10 feet.

In the reactor vessel, the cooling water flows upward through the core. It flows through the spaces between the fuel rods and acts as the moderator to slow down neutrons. It also cools the assembly. Absorption of heat by the water generates steam. There are two major approaches to the generation of steam in light water reactors: the boiling water reactor and the pressurized water reactor. Both will be described in the next two subsections of the module.

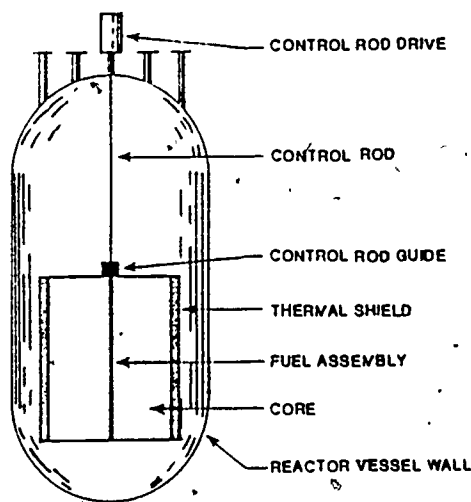

Figure 3.
Schematic Diagram of
Reactor Vessel.

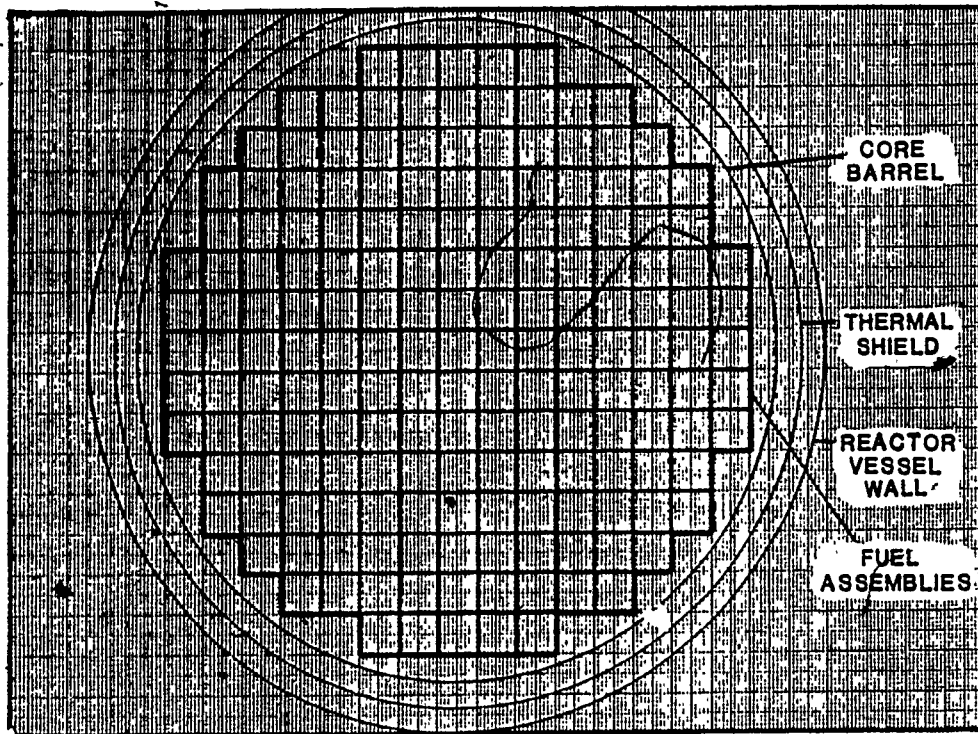

Figure 4. Schematic Diagram of Cross Section of Reactor Vessel and Core Comprised of 177 Fuel Assemblies.

Boiling Water Reactors

In a boiling water reactor, the water heated by removal of heat energy from the core is allowed to boil inside the reactor vessel. The steam is piped to the turbines, which are used to drive the electric generators. After passing through the turbines, the steam is condensed, and the water is pumped back to the reactor vessel.

A schematic diagram of a boiling water reactor system is shown in Figure 5. The water flows through the core and is heated to about 550°F. The water flows through the piping to drive the turbines. (The piping shown in Figure 5 is oversimplified; there are many pumps, valves, and so forth, in the circulation system.) The steam carries radioactivity because it has passed through the reactor core.

The water in the condenser is cooled by heat exchange with water from the cooling towers that are located outside the reactor building. These large cooling towers, which have become familiar as a symbol of nuclear power, allow dissipation of waste heat from the reactor. Most reactors are located

near a large body of water — a lake or river — to provide a good supply of coolant. The cooling towers are used to avoid thermal pollution of the body of water.

Pressurized Water Reactors

In pressurized water reactors, the core coolant water is kept under pressure so that it does not boil. The hot water is piped into a steam generator where it exchanges heat with water in the generator and causes that water to boil. The steam is used to drive turbines and to generate electricity. This part of the system is similar to the boiling water system. A diagram of a pressurized water reactor system is shown in Figure 6.

The steam generator itself is a large vessel that is several stories tall. The pressurized water flows through a maze of metal tubes, typically having diameters of around seven-eighths of an inch. These metal tubes, heated by the pressurized water inside, boil the water from the steam part of the system. There are two separate water supplies in the steam generator: the core coolant and the water that is boiled to make steam. These two water supplies do not mix.

Both boiling water reactors and pressurized water reactors are used in the United States, and neither type appears to have a clear advantage over the other.

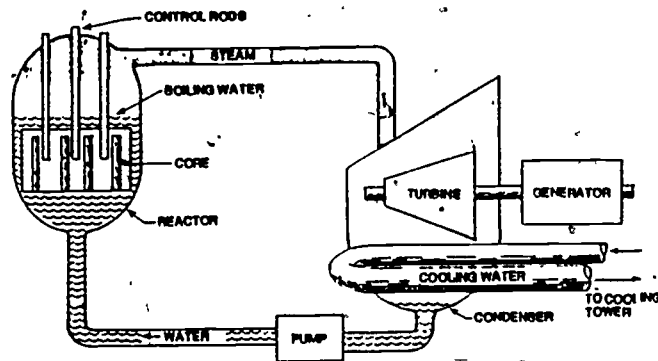

Figure 5. Diagram of a Boiling Water Reactor System.

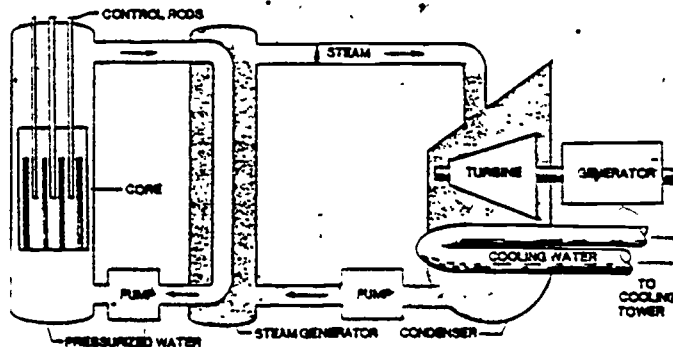

Figure 6. Diagram of a Pressurized Water Reactor System.

Boiling water reactors require less equipment and less plumbing. They do not have a steam generator, for example. There are fewer components to maintain and fewer things to go wrong. They also are somewhat more stable and easier to control.

Pressurized water reactors produce somewhat more thermal energy per unit of fuel, and the separation of the core cooling water from the steam in the steam generator means that radioactive steam does not reach the turbines — which makes maintenance of the turbines easier.

Status of Light Water Reactors

As of 1979, there are 68 nuclear reactors in operation in the United States that generate electrical power. These reactors are capable of generating more than 5×10^{10} watts of electrical power. Of these 68 reactors, all but two are light water reactors. Clearly, light water reactors are dominant in the United States. Slightly more than one-third of these light water reactors are boiling water reactors; almost two-thirds are pressurized water reactors. Three additional reactors are in the process of start-up.

For the future, 121 reactors are under construction or on order. The construction cycle for a nuclear reactor can be quite lengthy. Some of the reactors that have been ordered are not expected to be in operation before 1994. It is probable, too, that some of these planned reactors will be canceled.

These planned reactors are almost all light water reactors, with only a few exceptions. More than 70% of the total number are pressurized water reactors.

The output of nuclear reactors can be rated in terms of the electrical output or the thermal energy output. The electrical output (in megawatts) is denoted as "MW(e)." The thermal output (in megawatts) is denoted as "MW(th)." The thermal efficiency is defined as "MW(e)/MW(th)." For both pressurized light water reactors and boiling light water reactors, the thermal efficiency is typically around 33%. This is a relatively low value, lower than that available from fossil-fuel electrical generating plants. It is low because the temperature of the steam produced is lower than that for fossil-fuel plants. Steam temperature in a light water reactor is only about 550°F, as compared to temperatures up to 1050°F in fossil-fuel plants.

Because of the relatively low thermal efficiency, large amounts of waste heat are produced by reactors. This heat must be dissipated without heating up.

lakes or rivers. Heat is detrimental to fish and plant life (thermal pollution). Hence, large cooling towers are a familiar accessory to nuclear plants.

The cost of electrical power generation is dependent on many factors, such as price and availability of fuel at a particular location, age and efficiency of the generating plant, and others. Thus, only general comparisons can be made between the cost of electrical power from nuclear facilities and that from fossil-fuel plants. It appears that in the late 1970s the rising costs of fossil-fuels has made electrical power generation from nuclear sources more economical. One 1977 estimate, relevant to newly constructed facilities, indicated that the cost of electricity from a nuclear plant would be 0.86¢/kWh. The cost from a coal-fired plant would be 0.94¢/kWh. Construction of the nuclear plant would be more expensive, but the impact of fuel prices would make nuclear power less expensive.

As of 1979, civilian reprocessing of spent fuel elements is not being carried out in the United States. The fuel assemblies removed from reactors are being stored in pools of water by the utility companies that operate the reactors. Storage of these fuel assemblies is becoming a significant problem.

At present, the United States lacks a policy concerning the storage of the spent fuel and its reprocessing. The fuel assemblies are simply being stored, awaiting decisions by the government about their disposal.

The Nuclear Fuel Cycle

Uranium is obtained by mining ores that contain uranium. The ores are chemically treated to remove the uranium. The uranium is converted to UF_6 , which is used in the gaseous diffusion process to yield a material enriched in ^{235}U . The enriched material is then converted to uranium dioxide (UO_2), which is used in the fuel rods. The fuel rods are incorporated in fuel assemblies and used in an operation reactor.

After a fuel assembly has been used in an operation reactor for about three years, it is replaced with a fresh fuel assembly. In an average reactor, approximately one-fourth to one-third of the fuel assemblies are replaced each year. Replacement is needed because either the fissionable ^{235}U has been depleted or physical and chemical changes have occurred in the fuel rods.

The replaced fuel rods contain unused ^{235}U . They also contain ^{239}Pu , a fissionable isotope that could also be used as a reactor fuel. The ^{239}Pu is

produced by the following reaction:

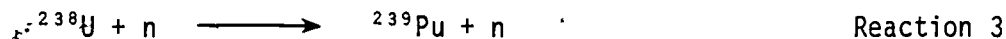

Recovery of these isotopes can provide additional fuel. The ^{235}U can be reprocessed into fresh fuel rods. The ^{239}Pu could also be used as a reactor fuel, although it has not been used in the United States.

The recovery of the fissionable isotopes can be performed by cutting up the spent fuel elements, dissolving the fuel in a dilute solution of nitric acid, and chemically separating the uranium. One suitable chemical process is the so-called Purex process. In the Purex process, a mixture of organic chemicals (kerosine and tributyl phosphate) is used to collect the uranium. It is estimated that one new fuel assembly can be produced by the reprocessing of three spent assemblies — which could increase the available supply of uranium considerably.

Safety of Nuclear Reactors

Safety issues involving nuclear reactors are complicated, and there are no general agreements about them. Although it is not within the scope of this module to consider all facets of this complex subject, a few of the more significant ones will be discussed.

First, a light water nuclear reactor cannot explode like a nuclear bomb. Nuclear bombs require highly enriched uranium with high content of ^{235}U . The maximum ^{235}U content in fuel for light water reactors is around 3%. There is no possibility of a nuclear explosion in a light water reactor.

However, there are a number of other concerns about the safety of nuclear reactors, including the following:

- Possibility of a large accident involving release of radioactivity into the environment
- Release of small amounts of radioactivity into the environment
- Storage of the radioactive wastes from reactor operation for thousands of years
- Possible diversion of nuclear fuel by saboteurs or terrorists

Disposal of nuclear power plants at the end of their useful life (assumed to be about 30 years)

In the event of a large-scale loss of coolant to the reactor core, the core could overheat and melt. The very hot molten mass could melt through the containment vessel and begin to melt through the crust of the earth. This would involve the release of large amounts of radioactivity and could result in the death of hundreds or thousands of people. The radioactivity could contaminate large areas, possibly including large cities or major fractions of a state so that the areas could not be used for many years. This event (or the possibility of this event occurring) is called the China syndrome. It is so named because the molten reactor core would begin melting through the earth, traveling in the general direction of China.

In order to reduce the possibility of such an event, emergency core cooling systems have been added to reactors. These systems allow the core to be flooded with large amounts of water in the event of a loss of coolant. However, no one is completely sure that the emergency core cooling system will prevent the type of accident that could be caused by a loss of coolant and result in the large release of radioactivity.

A risk analysis study of reactors was commissioned by the Atomic Energy Commission (which has been superseded by the Department of Energy). The result of this study was a report referred to as WASH-1400. This report forms the basis for much of the discussion on nuclear safety.

The WASH-1400 report calculated the probability of various events that could lead to loss of human life. (The nuclear reactor calculations were based on the fact that 100 nuclear reactors would be in operation in the 1980s.) The report concluded that the probability of deaths resulting from a large nuclear reactor accident is much smaller, — in fact, orders of magnitude smaller — than the probability of the same number of deaths caused by many other types of events, such as air crashes, dam failures, hurricanes, and earthquakes. Advocates of nuclear power hailed the report as an indication that nuclear power is relatively safe compared to other types of risks.

Critics of nuclear power claimed that the statistical methods used to obtain the results of the WASH-1400 report were flawed. It is difficult to assess the risk of an event that is rather improbable but which could cause great numbers of deaths and great damage if it did occur.

Even without a major nuclear accident, the low-level release of radioactive materials into the environment could lead to cancer in people exposed to the radioactivity. However, other methods of producing electrical power are responsible for the release of radioactive substances into the atmosphere — particularly the burning of coal. Therefore, the relative social risks of nuclear power and coal generated power are hotly debated.

Storage of the radioactive wastes that build up during reactor operation is a continuing problem. The spent fuel assemblies are currently being stored in water pools. The United States government has not developed a policy concerning disposal of such waste. Critics of nuclear power point out that such wastes must be stored for thousands of years — a longer time than social systems endure, and a longer time than people in this generation can guarantee safe storage. Advocates of nuclear power point out that there are underground salt reservoirs into which radioactive wastes can be deposited. These salt reservoirs are encased in rock, are impervious to water, and have been stable for millions of years.

As nuclear power becomes more widely used, there will be more installations where nuclear fuel or nuclear waste is stored and fabricated, and there will be many more shipments of material made between such locations, making it virtually impossible to prevent a determined band of terrorists from taking over a plant or from stealing a shipment of fuel. The problem would be particularly acute for breeder reactors (to be discussed later), for which the stolen fuel could possibly be fashioned into nuclear bombs.

Nuclear reactors are expected to have a maximum operating lifetime of approximately 30 years. After that time, the reactor would be taken out of service, but the site would still contain much radioactivity. This radioactivity must either be disposed of or sealed off safely from human access and environmental contamination. The dismantling of a reactor in Elk River, Minnesota, is often pointed out as a significant test case. The reactor was completely disassembled and the pieces removed. The land is now being used for other purposes.

In summary, there are many complex issues involving safety of nuclear reactors. Public doubts and fears have been sharpened because of the accident at Three Mile Island, Pennsylvania, early in 1979. Although no one was killed, the accident did show that accidents could occur in ways that had not been

predicted and that human error could be an important factor in accidents.

This subsection has pointed out some of the concerns involving safety of nuclear power. It has not provided definite answers to these concerns because these concerns and their possible answers are currently being debated. The future of nuclear power in the United States will be determined by the manner in which these issues are resolved.

HEAVY WATER REACTORS

The use of heavy water as a moderator and coolant — instead of light water — leads to significant changes in reactor design. Light water absorbs some of the neutrons produced in the fission reactions, representing a loss for the system. In order to provide enough neutrons to keep the chain reaction going, the uranium fuel must be enriched in ^{235}U above the natural percentage of 0.7%. Heavy water has much lower absorption for neutrons. With their reduced losses for neutrons, heavy water reactors can use natural uranium without enrichment, making the fuel costs for a heavy water reactor much lower and providing better usage of the available uranium resources.

On the other hand, heavy water, which is present in natural water in a very small percentage, must be separated from the natural water. Heavy water is expensive; therefore, a heavy water reactor is more expensive than a light water reactor. Moreover, heavy water is in short supply. This lack of availability has limited the development of heavy water reactors.

Heavy water reactors have been emphasized in Canada, and a number of electrical generating stations based on heavy water reactors are currently in operation there. The reactors being used in Canada are sometimes called Candu reactors (which stands for Canadian and deuterium).

A schematic diagram of a heavy water reactor is shown in Figure 7. The approach has been to encase fuel rods in individual pressurized tubes with the cooling water flowing through them. The tubes, fuel rods, and coolant that flows through the core are all horizontal. This arrangement contrasts with the light water reactor, in which the fuel rods are in a single large vessel, through which the water flows vertically.

The heavy water core coolant flows through a steam generator, and there it transfers its heat to light water in the generator. The light water is transformed to steam, which is used to drive turbines. From that point on,

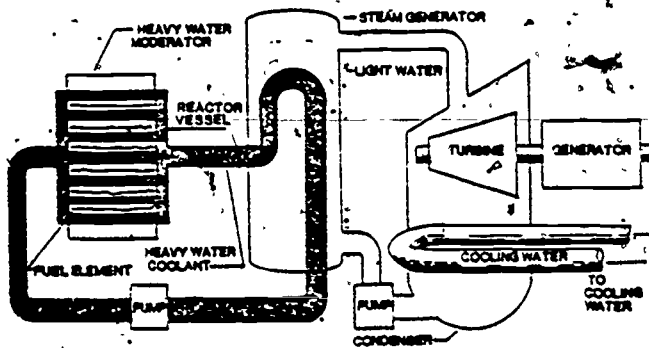

Figure 7. Diagram of a Heavy Water Reactor.

the system is similar to a light water pressurized water reactor.

In one variation of the Candu reactors, heavy water is used only as the moderator, and light water is used as the core coolant. This design requires less heavy water, but the variation is less developed than the original design which uses heavy water as

both moderator and core coolant.

The costs of electrical power generation with heavy water reactors appear comparable to that of generation with light water reactors. Decreased costs for fuel are compensated by the high price of heavy water.

GAS COOLED REACTORS

Gas cooled reactors offer some advantages as compared to liquid cooled reactors. In particular, the high temperature gas cooled reactor (HTGR) offers higher efficiency and better use of nuclear fuel. In addition, the HTGR uses less water to carry away waste heat.

The fuel in a HTGR is a mixture of uranium and thorium. The thorium interacts with neutrons according to the following reaction:



This reaction produces the fissionable isotope ${}^{233}\text{U}$. The fission of the ${}^{233}\text{U}$ produced right in the reactor contributes additional energy. The use of this fuel cycle in the HTGR means that relatively abundant thorium can be used to stretch the supply of fissionable uranium fuel.

Furthermore, the HTGR appears to be immune to accidents involving loss of coolant of the type that have been worrisome in relation to liquid cooled reactors.

The HTGR does have some drawbacks. The initial cost of the reactor is higher than that of light water reactors, and the HTGR requires highly enriched uranium. The uranium must be enriched so that it contains about 93% of ^{235}U .

The development of the HTGR was pioneered in Great Britain, but it is now being developed in the United States. It is not as widely used as liquid cooled reactors because its development began later. In 1979 only one HTGR was used for electrical generation in the United States; however, a number of HTGRs are on order or planned. The HTGR, with the attractive features mentioned above, appears to have considerable promise for future use.

The fuel itself consists of small spheres containing a mixture of thorium and enriched uranium. The spheres are coated with carbon compounds. The carbon, an element of low atomic weight, acts as the moderator. The use of carbon as a moderator material is another significant difference attributed to the HTGR.

The fuel elements are graphite blocks that have hexagonal cross sections. The graphite blocks have holes for insertion of the fuel and for coolant flow. The graphite (carbon) also acts as a moderator. Fuel elements are stacked to form the reactor core.

Figure 8 shows a schematic diagram of a HTGR. Helium, which is used as the gaseous coolant, is chemically inert, has very good heat transfer properties, and has very low absorption for neutrons.

The steam is generated by the heated helium flowing through the steam generator. The helium reaches a temperature around 1366°F . The steam is used to drive turbines in a configuration similar to that of the other reactor systems that have been discussed.

Most HTGRs use steam generation, as illustrated in Figure 8. However, a few systems are under development that directly use the heated helium to drive gas turbines.

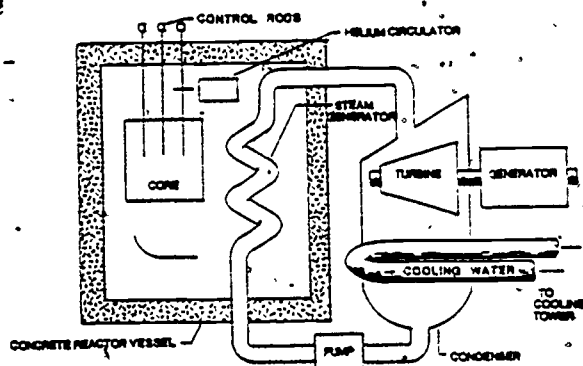
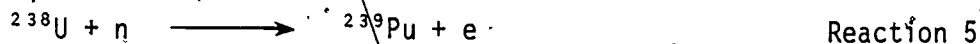

Figure 8. Diagram of a High Temperature Gas Cooled Reactor (HTGR).

BREEDER REACTORS

A reactor using fission of ^{235}U in a fuel mixture that also contains ^{238}U can have the following reaction occur:



The ^{239}Pu is itself a fissionable isotope. In a light water reactor, the ^{239}Pu will build up in the core, undergoing fission reactions and contributing some of the energy release.

After the fuel assembly is used up, the ^{239}Pu could be extracted during the reprocessing and used to make fuel rods. The isotope ^{239}Pu has not been used as a fuel for reactors in the United States.

It is possible to design a reactor so that the buildup of ^{239}Pu will be more rapid than the depletion of ^{235}U . Such a reactor will breed more fissionable material than it consumes. Hence, it is called a breeder reactor.

Breeder reactors are attractive because they can produce additional nuclear fuel and, thus, stretch the available natural supply of uranium. Drawbacks include the following: (1) plutonium is extremely toxic, (2) ^{239}Pu , if released into the environment, would be an effective cancer-causing agent, and (3) the reprocessing facilities to reclaim the plutonium would be an attractive target for terrorists, particularly since plutonium could be used to make nuclear bombs.

For effective breeding of additional nuclear fuel, the neutrons released in the fission should not be slowed down. Reaction 5 occurs best with fast neutrons. Thus, breeder reactors are fast reactors, using fast neutrons. This is in contrast to the other types of reactors that have been discussed, all of which are thermal reactors and use a moderator to slow down the neutrons. Breeder reactors do not use a moderator material.

The coolant for a breeder reactor must not interact with the neutrons to slow them down. The most promising materials that appear useful as coolants are liquid metals. The leading designs for breeder reactors utilize liquid metal coolants; therefore, these reactors are often called liquid-metal fast breeder reactors (LMFBR).

The liquid metal that appears most favorable is sodium. It has excellent heat transfer characteristics and good nuclear properties, including low absorption for neutrons. Sodium has a high boiling point and relatively low vapor

pressure. Thus, it can be heated to very high temperatures without generating too much pressure.

Sodium is highly reactive when exposed to water or air. However, if it is shielded from oxygen and water, it is neither excessively reactive nor corrosive. It does become radioactive in a reactor, yielding the isotope ^{24}Na . Fortunately, this isotope has a short half-life, and most of the radioactivity decays in a few days. Sodium, a solid at room temperature, must initially be heated before it can act as an effective coolant.

One design for a LMFBFR is illustrated in Figure 9. There are two separate sodium loops in this design. Sodium in the primary loop cools the core and heats the sodium in the secondary loop. The sodium in the secondary loop gives up its heat in a heat exchanger to produce steam. The remainder of the system is similar to what has been described before. The purpose of the two separate sodium loops is to provide safety and shielding for the radioactive sodium in the reactor core.

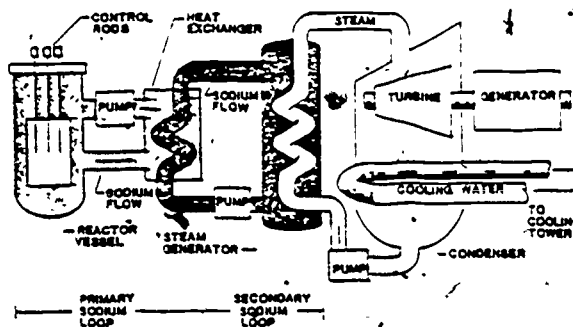

Figure 9. Diagram of Liquid-Metal Fast Breeder Reactor (LMFBFR).

The fuel in a typical LMFBFR would consist of a "core" region containing the fissionable material, surrounded by a "blanket" region of ^{238}U . The core would be about 10-15% ^{239}Pu , with the rest ^{238}U . As the reactor operates, the original ^{239}Pu is used up. However, the ^{238}U , both in the core and in the blanket, is converted to ^{239}Pu . A breeder reactor can produce more ^{239}Pu than it started with. This material can be reprocessed and used to fuel other reactors. The effect would be to greatly increase the supply of nuclear fuel.

The technology of LMFBFRs is being vigorously pursued in Great Britain, France, and the Soviet Union. The United States has proceeded more slowly because of concerns about the hazards of plutonium and its possible misuse. There is one LMFBFR project located in the United States (in Clinch River, Tennessee). This reactor, intended as a demonstration of breeder reactor technology while producing commercial electricity, is scheduled for operation in 1986.

NUCLEAR FUSION

In nuclear fission reactors a heavy nucleus splits apart, yielding lighter fragments with a net release of energy. In nuclear fusion, two nuclei combine to produce a heavier nucleus — also with a net release of energy. All the nuclei suitable for nuclear fusion reactions are light nuclei, including the isotopes of hydrogen, lithium, and possibly boron. Nuclear fusion reactors are still in an experimental stage, but they represent a potentially abundant energy source for the future.

PRINCIPLES

The most promising reactions involve the heavy isotopes of hydrogen, namely deuterium (^2H) and tritium (^3H). Deuterium, a stable, naturally-occurring isotope, is present in water in small amounts. Tritium is a radioactive isotope with a half-life of 12.3 years. Because of its short half-life, tritium is not found in nature. Any scheme involving tritium must provide for some way of generating tritium within the fuel cycle.

There are many cycles of reactions among the light elements that yield a net release of energy. For example, the following set of reactions —

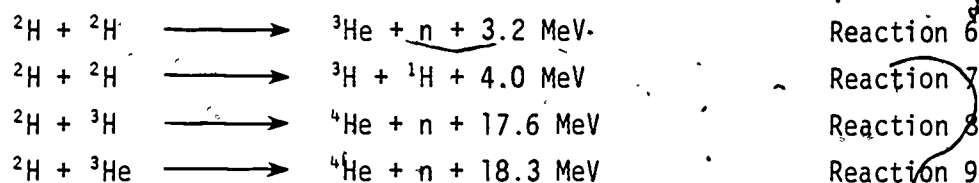

has the following reaction as its sum:

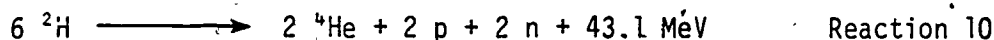

The ^3H needed in Reaction 8 is generated in Reaction 7. The energy release per gram of deuterium amounts to about 10^5 kWh. Thus, the deuterium present in the world's oceans can supply an enormous amount of energy. It is estimated that, at today's rate of energy consumption, the deuterium in the oceans could supply the world's energy needs for 10 billion years.

An alternate fuel cycle could be described by the following reactions:

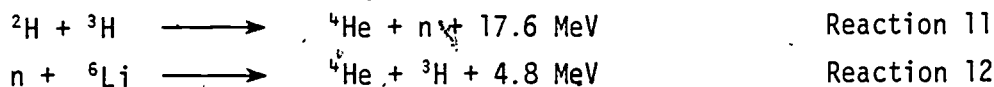

The net effect of the above two reactions is as follows:

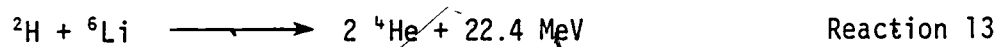

The ${}^3\text{H}$ needed for the first reaction is provided by the second. This set of reactions is complicated by the need for lithium in addition to deuterium. As an ultimate source of energy, it is probably less desirable than that represented by Reactions 6 through 10. However, the threshold conditions for Reactions 11 through 13 are easier to meet. Thus, current research is emphasizing the fuel cycle of Reactions 11 through 13.

There is great interest in nuclear fusion because of the practically inexhaustible supply of fuel it would afford. In addition, the generation of energy by nuclear fusion has the advantage of being relatively clean compared to nuclear fission. Other advantages are as follows: (1) the buildup of radioisotopes and the problem of storage of radioactive waste are much reduced, (2) there is no plausible catastrophic release of radioactive elements into the environment, (3) the environmental impact of obtaining the deuterium fuel is negligible, and (4) the problem of possible theft of nuclear materials for weapons production is virtually eliminated. In summary, power from nuclear fusion offers many extremely attractive features.

In order to make a set of nuclear fusion reactions proceed, certain conditions must be met. The conditions include high temperature and containment of the reacting materials. Because of the need for very high temperatures (10^8 to 10^9 K), the fusion process is often referred to as thermonuclear fusion.

In order to extract a net gain of energy, the fuel must be heated to the required temperature; then it must be confined long enough for the energy output to exceed the needed energy input. At the required temperatures, the atomic particles have high velocity, and the fuel tends to fly apart before the reaction proceeds very far. Thus, there is a need to confine the materials at high density for a reasonable amount of time.

The quantitative expression of the threshold is given by the Lawson criterion. The Lawson criterion is a greatly simplified statement of the needs for net energy production. The Lawson criterion is stated in terms of a product

$n\tau$, where n is the particle density (atoms per cubic centimeter) of the fuel and τ is the time for which the fuel must be confined at that density. The product $n\tau$ must exceed a value that depends on the temperature and on the set of reactions.

Figure 10 shows the Lawson criterion for the two sets of reactions discussed above. The required value of $n\tau$ is shown as a function of temperature.

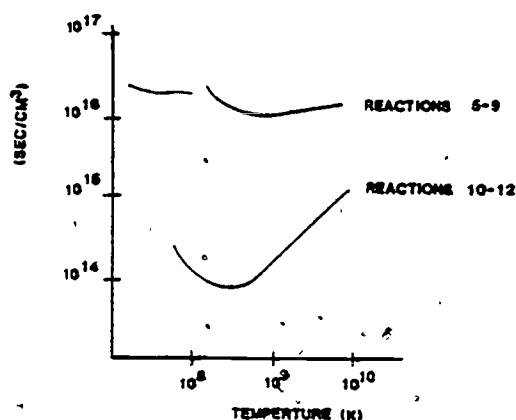

There is a particular temperature for each set of reactions for which the confinement requirements are easiest. For Reactions 11 through 13, the minimum occurs for $n\tau$ about 10^{14} sec/cm³ at a temperature around 3×10^8 K. Sometimes the Lawson criterion is simply stated by the following equation:

Figure 10. The Lawson Criterion.

$$n\tau > 10^{14} \text{ sec/cm}^3 \quad \text{Equation 1}$$

where:

n = The particle density (atoms per cubic centimeter) of the fuel.

τ = The time for which the fuel must be confined at density n .

The assumption of the above equation is that the temperature is the value for which the required $n\tau$ is minimum.

The set of Reactions 6 through 10 has more stringent requirements on the required value of $n\tau$. Thus, present research is concentrating on achieving the easier goal of meeting the Lawson criterion for Reactions 11 through 13.

The criterion, as expressed by Equation 1, can be satisfied by appropriate combinations of n and τ . Thus, if the material can be confined for only one nanosecond (10^{-9} seconds), the particle density will have to exceed $10^{14}/10^{-9} = 10^{23}$ atoms/cm³. If the fuel could be confined for one microsecond, the required particle density would drop to 10^{20} atoms/cm³.

At the temperatures of interest, the atoms are completely stripped of their electrons. Thus, one has the fuel in the form of an ionized plasma, that is, a gas composed of positive ions and electrons.

The quest for practical generation of power from controlled thermonuclear reactions is still in an experimental stage. It will be decades before commercial power is derived from thermonuclear fusion. Because of its great potential, however, research programs are underway in many countries, including the United States, the Soviet Union, Great Britain, France, Germany, and Japan. The main thrust is to provide a method of confinement that satisfies the Lawson criterion. Two main approaches are being pursued: magnetic confinement and inertial confinement. These approaches will be described in the next sections of the module.

MAGNETIC CONFINEMENT FUSION

A charged atomic particle, moving in a magnetic field, experiences a force perpendicular to the direction of its motion. The result of the force is that the particle will spiral around the magnetic field line. The resultant motion is illustrated in Figure 11. The particle is confined in one dimension, the direction perpendicular to the magnetic field line. It does travel along the direction of the magnetic field line.

Because the thermonuclear fuel is in the form of a plasma of charged particles, magnetic fields offer the possibility of containment of the plasma. Obviously, a simple linear magnetic field will not confine the plasma well. Particles would simply diffuse along the magnetic field lines and escape. Hence, closed loop magnetic field configurations have been devised.

Research on magnetic field confinement of plasmas for thermonuclear fusion began in the early 1950s. Many ingenious configurations of magnetic fields have been designed. This module will not describe all the configurations. The experiments have been plagued by instabilities in the interaction between the magnetic field and the plasma. The plasma would bulge out in some direction, carrying the magnetic field lines with it. These instabilities have made it much more difficult to

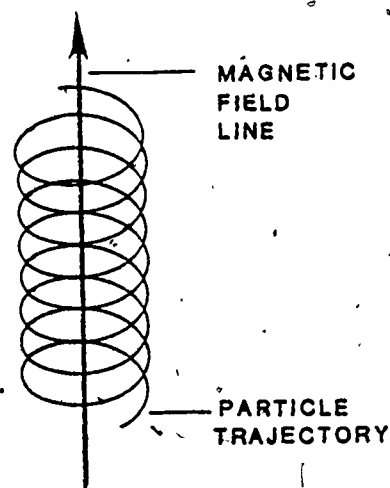

Figure 11. Trajectory of Charged Particle in a Magnetic Field.

achieve confinement than had been expected. Nevertheless, considerable progress has been made. In the late 1970s, the lower edges of the region of interest for magnetic confinement fusion were being reached. Critical experiments to define the potential of magnetic confinement fusion will be performed in the near future.

The leading configuration of magnetic field for magnetic confinement fusion is the "tokamak." The tokamak was originally developed in the Soviet Union, but now it is also being used in the United States program on magnetic confinement fusion.

The tokamak is a torus-shaped device. (A torus has the shape of the surface of a doughnut.) A schematic diagram of a tokamak is shown in Figure 12.

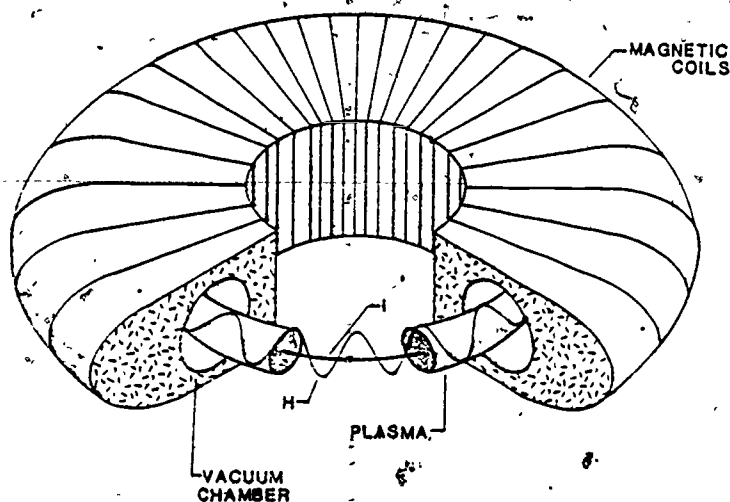

Figure 12. Cutaway Diagram of a Tokamak.

The plasma is contained within a vacuum chamber, which is torus-shaped. Because of the magnetic confinement, the plasma is confined in the center of the torus, away from the walls. This prevents cooling of the plasma by contact with the walls. The plasma acts as the secondary winding of a large external transformer (not shown), causing a large current to flow in the plasma (indicated as I in the figure). The current heats the plasma to the desired high temperatures.

In a tokamak, the magnetic field winds around in a helical path (indicated by H in Figure 12). The magnetic field is partly produced by the wedge-shaped magnets surrounding the torus and partly by the current in the plasma itself. The magnetic field closes back on itself; therefore the charged particles cannot escape down the length of the field. This configuration of magnetic field shows the ability to confine the plasma with good stability.

In a tokamak, the particle densities are expected to be around $10^{14}/\text{cm}^3$. Thus, to satisfy the Lawson criterion, confinement times would have to be around one second, at temperatures around 10^8 K. In experiments in a tokamak at

Princeton University in 1979, plasma densities around 4.5×10^{13} were produced at a temperature around 5.5×10^8 K and were confined for about 0.02 seconds. This represents a product $n\tau$ of 9×10^{11} sec/cm³, or approximately a factor of 100 lower than the Lawson criterion. Still, the values of these parameters are approaching the range that is of interest for thermonuclear fusion. Improved tokamaks are under construction, and it is expected that the Lawson criterion can be exceeded in the early 1980s.

It is possible that improved design will continue through the 1980s, and that, in the 1990s, the technology of power generation with magnetic confinement fusion could be tested on pilot plants. Commercial generation of power could begin in the early 21st century.

INERTIAL CONFINEMENT FUSION

There is a competing approach for controlled thermonuclear fusion — inertial confinement fusion. In this approach, a tiny target is compressed and heated in a very short time, less than one billionth of a second. The fusion energy is produced very rapidly, before the fuel has a chance to fly apart. The fuel is said to be "confined" by inertial forces.

A method must be used for heating the fuel very rapidly. One approach is to use lasers, which are capable of producing very high power pulses with extremely short duration. Laser-assisted thermonuclear fusion was first suggested in the early 1950s, and large programs directed at laser fusion are underway in the United States, the Soviet Union, and several other countries.

The discussion of inertial confinement fusion in this section emphasizes the use of lasers for heating the fuel. Other heating methods are also under investigation — such as the use of electron beams or ion beams. It should be remembered that there are competing approaches for inertial confinement fusion.

Because the confinement time is short ($\geq 10^{-9}$ seconds), the particle density must be high ($\geq 10^{23}$ /cm³) in order to satisfy the Lawson criterion. Since deuterium-tritium (the fuel) is gaseous, it must be compressed considerably to achieve the required density (which is higher than the density in solid materials). The approach to heating and confinement is illustrated in Figure 13. The gaseous fuel is contained in a spherical glass shell. The spherical targets being used in current experiments have diameters of approximately 0.01 cm. A number of laser beams (or electron beams or ion beams) strike the target from

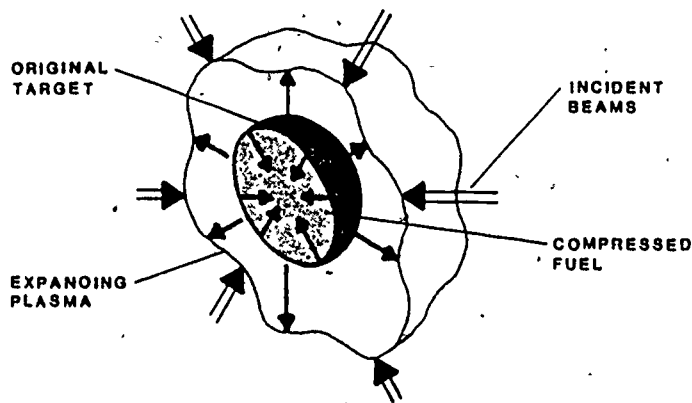

Figure 13. Diagram of Processes in Inertial Confinement Fusion.

several different directions, as shown. The beams vaporize the surface of the target and produce a hot, expanding plasma. The expanding plasma reacts on the fuel, compressing it and driving it inward. This process, called an implosion, can produce the required high temperatures and high particles needed to satisfy the Lawson criterion.

The approach of inertial confinement fusion offers many simplifications, as compared to magnetic confinement fusion. For instance, it removes the need for large magnets and it bypasses all the problems of plasma instabilities which have troubled magnetic confinement fusion. At the same time, inertial confinement fusion creates many problems, one of the most significant being the development of suitable high power lasers.

Initial experiments on inertial confinement fusion involved using infrared lasers — particularly neodymium-glass lasers or carbon dioxide lasers. These lasers were chosen because they are the only ones that are well enough developed to begin experiments. However, many experts believe that these lasers can never be developed to drive a thermonuclear generator. They feel that the required laser must have an output in the ultraviolet or in the blue part of the visible spectrum. There are no suitable high power blue or ultraviolet lasers available today, yet large programs are underway to develop such lasers.

Some milestones on the energy release in laser-assisted thermonuclear fusion are shown in Figure 14. This figure shows the program at the Lawrence Livermore Laboratory which uses neodymium-glass lasers. The figure shows the pellet gain, defined as "the ratio of thermonuclear energy output to the laser energy input." The names (Janus, Cyclops, and so on) refer to particular lasers, the powers of which are indicated. One terawatt (TW) is 10^{12} watts.

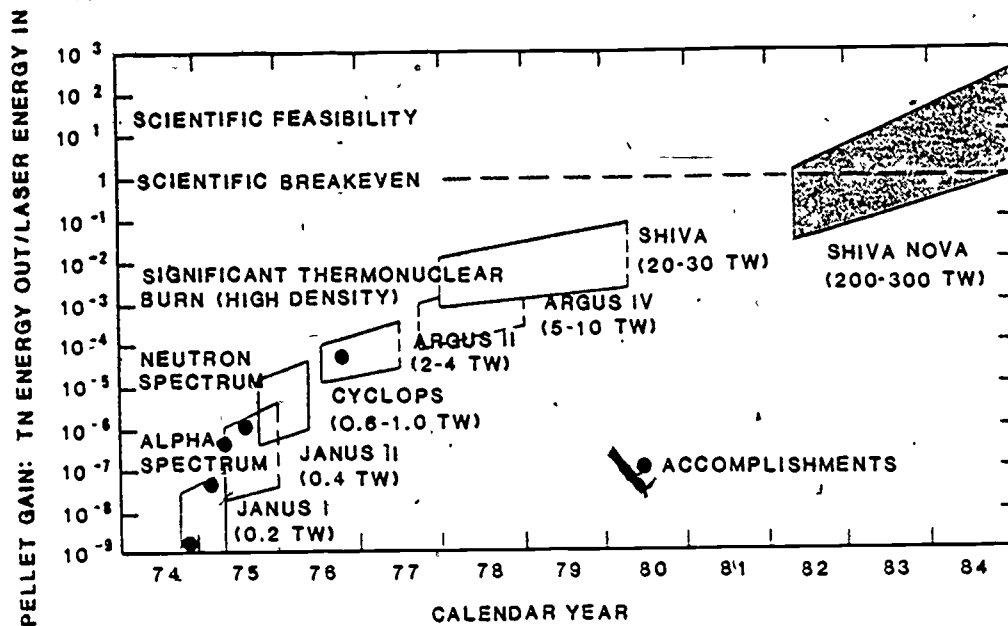

Figure 14. Laser Fusion Energy Yield Projections.

In 1979, the SHIVA laser was in operation, delivering 10 to 15 kilojoules of energy to a target in approximately one nanosecond and producing thermonuclear reactions that release about 3×10^{10} neutrons. It is hoped that this laser will produce significant thermonuclear burn, defined as "pellet gain greater than 0.01."

Construction of a larger laser, the SHIVA-NOVA, has begun. This laser should produce over 100 kilojoules of energy in a pulse 1 to 3 nanoseconds long. It is hoped that this will demonstrate scientific breakeven (pellet gain greater than one) in the early 1980s.

FUSION REACTORS

Controlled thermonuclear fusion (either magnetic confinement or inertial confinement) will need a reaction chamber to contain the products of the reaction and to harness the energy released. The energy will be converted to heat which will be used to produce steam. The steam, in turn, can be used to drive generators which will produce electrical power.

There are difficult requirements for the reactor. It must withstand the shock, and debris and particle bombardment from the small thermonuclear

explosions. It will be bombarded by neutrons, gamma rays, and charged particles. The reactor must also provide entry ports for laser beams entering from many different directions and a method for collecting the energy release of the fusion reaction.

One concept concerning a suitable reactor involves using a layer of liquid lithium on the inside wall of the chamber. Lithium protects the wall from the particle bombardment. It also produces the tritium needed for the fuel, according to Reaction 12, and serves as a heat transfer medium to drive the steam generating system. The development of a good reactor remains as one of the requirements for successful exploitation of controlled thermonuclear fusion:

PROJECTED TECHNOLOGY

The current status of controlled thermonuclear fusion is experimental. Systems are now being constructed which should demonstrate scientific feasibility (that is, satisfying the Lawson criterion) in the early 1980s. This applies to both magnetic confinement and inertial confinement fusion. The demonstration of scientific feasibility should be followed by some years of continued development of the various technologies to improve designs and to increase energy yields. By the late 1980s, decisions could be reached concerning the feasibility of one of the systems, but the decisions will have to involve choices about the driver for inertial confinement fusion (laser, electron, or ion beams) and a choice between inertial and magnetic confinement fusion.

By the 1990s, the technology could be sufficiently developed to construct a pilot plant for production of electric power. With the experience gained from operation of the pilot plant, it might be possible to construct commercial electrical generating plants based on fusion in the early 21st century.

GEOHERMAL ENERGY SUPPLY

The temperature inside the earth increases with depth below the surface. The temperature rises about 20-30°C per kilometer of depth. Because of the temperature gradient, heat is conducted from the hot interior of the earth to the surface. Most of the heat is too diffuse to be useful. In some geologically active regions, the heat flow is much larger than the average value.

In these areas, flows of steam or hot water can emerge from the surface of the earth — for example, the hot springs and geysers of Yellowstone National Park.

The extraction of useful energy from the stored heat energy of the earth is called geothermal energy. Geothermal energy has long been used for space heating in some areas. The city of Reykjavik, Iceland, supplies much of its heating from geothermal energy. In addition, geothermal energy is used to produce electrical power in a few locations.

GEOTHERMAL ENERGY RESOURCES

Geothermal energy has many attractive features. Systems using geothermal energy are simple because they do not require furnaces, boilers, and so forth. The steam is delivered directly from the earth. Once the capital installation for generating power is in place, the operation is essentially free — in the sense that no fuel is required. The operation is clean and has very little environmental impact. In some cases, hydrogen sulfide (H_2S), an odorous gas, may be released into the atmosphere. However, because this occurs in areas where hydrogen sulfide is already being released naturally, the release is usually not significant. Another advantage of using geothermal energy is that it would conserve fossil fuels.

The disadvantage of geothermal energy is that it is available only in certain areas of the world, areas associated with movements of the earth's crust, volcanic activity, and so forth. Such areas are often located far from large population centers.

Regions of intense geothermal activity include the western portions of the North and South American continents, the western part of the Pacific Ocean basin, parts of central Asia (the Himalaya Mountain area), the basin of the Mediterranean Sea, and Iceland. The area covers parts of thirteen states in the western United States, including Hawaii and Alaska.

Current geothermal electric generating capacity provides only a small fraction of 1% of the electrical needs of the United States. Yet the capability exists for much greater utilization. Intense geothermal activity is known to be available in many areas, and it is possible for geothermal energy to supply up to 25% of the electrical power needed in the western United States.

Geothermal energy sources are divided into two general types: vapor dominated and liquid dominated. The vapor dominated systems produce steam, typically at temperatures around 250°C and pressures of several hundred pounds per square inch. The steam is suitable for driving turbines and producing electrical power.

The liquid dominated systems produce either hot water or a mixture of steam and hot water. Some liquid dominated systems are suitable for power generation; however, for this application, the steam must be separated from the water. Thus, vapor dominated systems are usually desired for power generation, and many liquid dominated systems are better suited for space heating applications.

PRESENT GEOTHERMAL TECHNOLOGY

The generation of electrical power from vapor dominated geothermal sources is straightforward. Wells are drilled to the underground reservoirs containing the steam. The depths of the reservoirs can range from a few hundred to a few thousand feet. Steam is piped out of the reservoir under its own pressure and is delivered directly to steam turbines which drive electric generators.

The exhausted steam is condensed with cooling water; therefore, cooling towers may be needed. It is possible for the steam to contain corrosive gases, such as hydrogen sulfide. This possibility of corrosion makes it necessary for stainless steel to be used for the turbine blades and the pipes.

The only operating geothermal generating plant in the United States is located at The Geysers, California, north of San Francisco. At this location, wells have been drilled to depths up to 9000 feet to reach steam reservoirs. Steam is delivered to the turbines in pipes up to three feet in diameter, at a pressure around 115 pounds per square inch and a temperature of 348°F. The steam contains about 1% of gases such as carbon dioxide, methane, and hydrogen sulfide. The gases are released to the atmosphere, but it is possible to remove the hydrogen sulfide. After driving the turbines, the steam is condensed by cooling water from a cooling tower. The condensed steam is then returned to the ground in a disposal well. Because of its simplicity (that is, because it requires no boiler, no boiler controls, and so forth), the installation does not require continuous operator attendance.

The Geysers' geothermal plant has been in operation since 1960. In 1976 it was capable of generating 908 megawatts of power. Furthermore, it is estimated that it might ultimately be capable of producing up to 5000 megawatts of power.

Geothermal generating stations are in operation in a number of other countries, including Italy, New Zealand, Japan, and Mexico. Geothermal generating plants operate at relatively low thermal efficiency because the steam temperatures are low compared to those in fossil-fuel plants. The efficiency of conversion of thermal energy in the steam to electrical energy is only around 16%.

Costs of geothermal energy include the costs of exploration, drilling, and installation of the piping and generating equipment. A detailed cost comparison between geothermal energy and other energy sources is difficult. It appears that the cost of electrical power from geothermal sources should be comparable to or lower than that from other sources, except for hydroelectricity. As the cost of fossil fuels continues to rise, more development in the area of geothermal energy sources can be expected.

OCEAN THERMAL ENERGY

Great amounts of thermal energy are stored in the oceans of the world. This section of the module describes attempts to harness some of this energy. Although most of the emphasis contained in this module and in other modules of this course has been placed on production of steam and hot water, this section of the module discusses ocean thermal energy systems, for which the working fluid is usually something other than water.

PRINCIPLES

Large temperature differences exist between the cold deep layers of the ocean and the warm surface waters, especially in tropic areas. This temperature difference can be used to run a heat engine — which is a concept known for some time. A primitive power plant using this concept was demonstrated as early as 1930, but the technology is still in an experimental state.

Basically, the operation of an ocean thermal energy conversion (OTEC) system involves extraction of heat from the warmer surface water at a temperature perhaps around 25°C in order to vaporize some fluid, such as ammonia,

which has a low boiling point. The vapor is used to drive a turbine, which, in turn, can generate electricity. Cold water, at a temperature around 4°C, is piped up from the ocean depths and is used to condense the fluid. The use of floating stations is usually envisioned.

In a sense, this is also a use of solar energy, because the temperature difference in the ocean is maintained by solar energy.

Ocean thermal energy conversion systems require a suitable temperature difference between the top surface and the deep waters — preferably, a temperature difference of around 20°C. And, since it may be difficult to pump the water from depths greater than about 2000 meters, a temperature difference of 20°C in water that is not too deep is needed. Only certain parts of the oceans are suitable, and most are located in tropic or subtropic areas.

The energy created in an ocean thermal energy system could be used directly by transmitting it to the land via cable. This use is applicable mainly for areas that are reasonable close to suitable parts of the ocean. Examples could be Hawaii, Puerto Rico, and parts of the Gulf Coast of the United States.

For ocean thermal energy conversion systems located in parts of the ocean far removed from land, direct transmission of electricity to the shore may not be feasible. However, it might be possible to use the energy to produce a fuel, such as hydrogen, which could be transported to shore by barge.

Ocean thermal energy systems would require no fuel, would use a renewable energy resource, and would have very little environmental impact. These systems are presently in a developmental stage because there are difficult problems to overcome — for instance, in mooring of the conversion stations, in possible corrosion and fouling by seawater, and in transmission of the generated power. The costs of setting up an ocean thermal energy conversion system are likely to be higher than those of fossil-fuel or nuclear plants of similar capacity.

BASIC PLANT DESIGN

There are a number of possible designs for ocean thermal energy conversion systems. A schematic diagram of what is probably the most common type of system is shown in Figure 15. The long pipe extends to depths perhaps thousands of feet below the ocean surface. Cold water, which is raised by pumps, is used to cool condensers; then the water can be exhausted directly back into

the ocean. Warm surface water is pumped into evaporators, where it vaporizes a fluid with a low boiling point. Ammonia has been used as the fluid in most tests. At a pressure of one atmosphere, ammonia is a gas at ordinary temperatures; however, it can be liquefied by pressure. The system is pressurized so that the change from vapor to liquid occurs at a temperature between that of the warm and cold waters. The expanding vapor from the evaporator passes through a turbine which drives a generator. The vapor is recondensed to a liquid in the condenser.

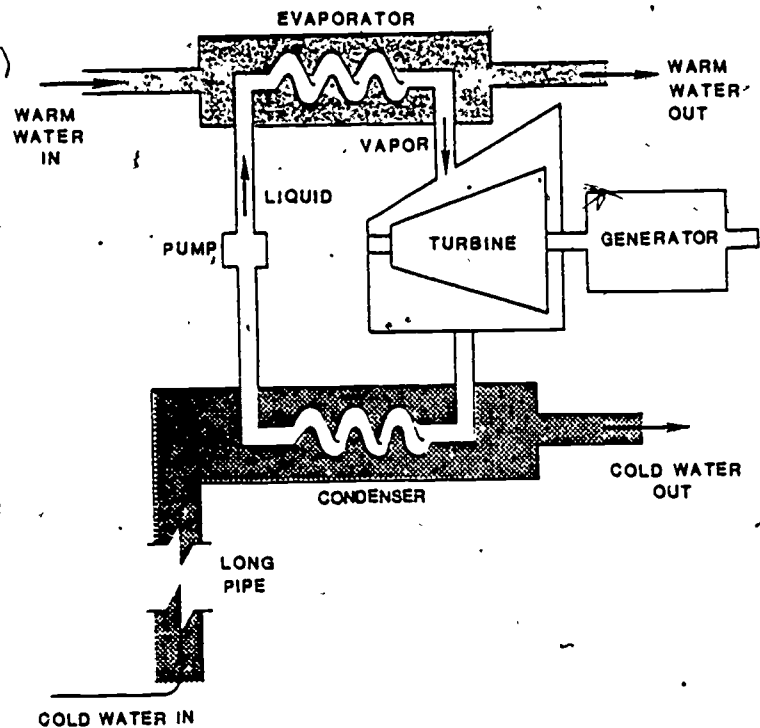

Figure 15. Diagram of Ocean Thermal Energy Conversion.

Because the temperature of the working fluid is low, the thermal efficiency of the system is low. The thermal efficiency is around 2.5% (that is, only 2.5% of the available thermal energy is extracted) — which is an efficiency much lower than that of other power plants. Because there is such a large reservoir of thermal energy in the oceans, useful power generation may be possible despite the low efficiency.

A number of possible platforms are under investigation, including ships; submarines; and tubular, roughly cylindrical structures, of which only a small portion shows above water.

PRESENT TECHNOLOGY

Ocean thermal energy conversion systems are currently in a conceptual phase; however, a number of detailed designs have been developed, and the United States government is funding several programs. As of the late 1970s, there apparently were no operating systems in existence. A modified tanker being prepared as an engineering test facility is expected to begin operation in 1980.

This facility, which will generate one megawatt of electrical power, will provide data about ocean thermal energy conversion systems that can be used in the design of other facilities.

A larger pilot plant, capable of generating about 10 megawatts, is planned for the middle 1980s. It is possible that commercial electrical power could be generated by ocean thermal energy conversion in the late 20th century.

REFERENCES

- Anonymous. "Shiva Moves Closer to Laser Fusion," Physics Today, p. 20 (November 1979).
- Babcock and Wilcox Co. Steam, Its Generation and Use. Chapters 19, 21 and 23. New York: The Babcock and Wilcox Co., 1972.
- Considine, D. M., ed. Energy Technology Handbook. Chapters 5 and 7. New York: McGraw-Hill Book Co., 1977.
- Coppi, B. and Rem, J. "The Tokamak Approach in Fusion Research," Scientific American, p. 65 (July 1972).
- Emmett, J. L.; Nuckolls, J.; and Wood, L. "Fusion Power by Laser Implosion," Scientific American, p. 24 (June 1974).
- Foster, A. L. and Wright, R. L. Basic Nuclear Engineering. Chapters 1 and 13. Boston: Allyn and Bacon, Inc., 1972.
- Kruger, P. "Geothermal Energy," Annual Review of Energy, p. 159. Hollander, J. M., ed. Palo Alto, CA: Annual Reviews, Inc., 1976.
- McIntyre, H. C. "Natural-Uranium Heavy Water Reactors," Scientific American, p. 17 (October 1975).
- Pease, R. S. "The Potential of Controlled Nuclear Fusion," Physics in Technology 8, 144 (1977).
- Post, R. F. "Nuclear Fusion," Annual Review of Energy, p. 213. Hollander, J. M., ed. Palo Alto, CA: Annual Reviews, Inc., 1976.
- Ready, J. F. Industrial Applications of Lasers. pp. 572-576. New York: Academic Press, Inc., 1978.
- Rubinstein, E. "Nuclear Power in the United States," IEEE Spectrum, p. 46 (November 1979).
- Rumbaugh, J. H.; Garrity, T. F.; Cohen, R.; and Sullivan, R. L. "Thermal Energy Conversion: Tapping the Sea Depths," IEEE Spectrum, p. 42 (August 1979).

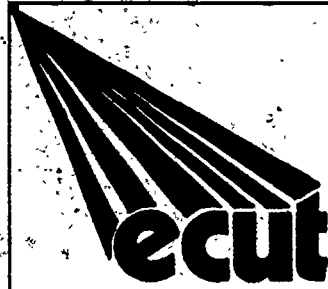

ENERGY TECHNOLOGY

CONSERVATION AND USE

ENERGY PRODUCTION SYSTEMS

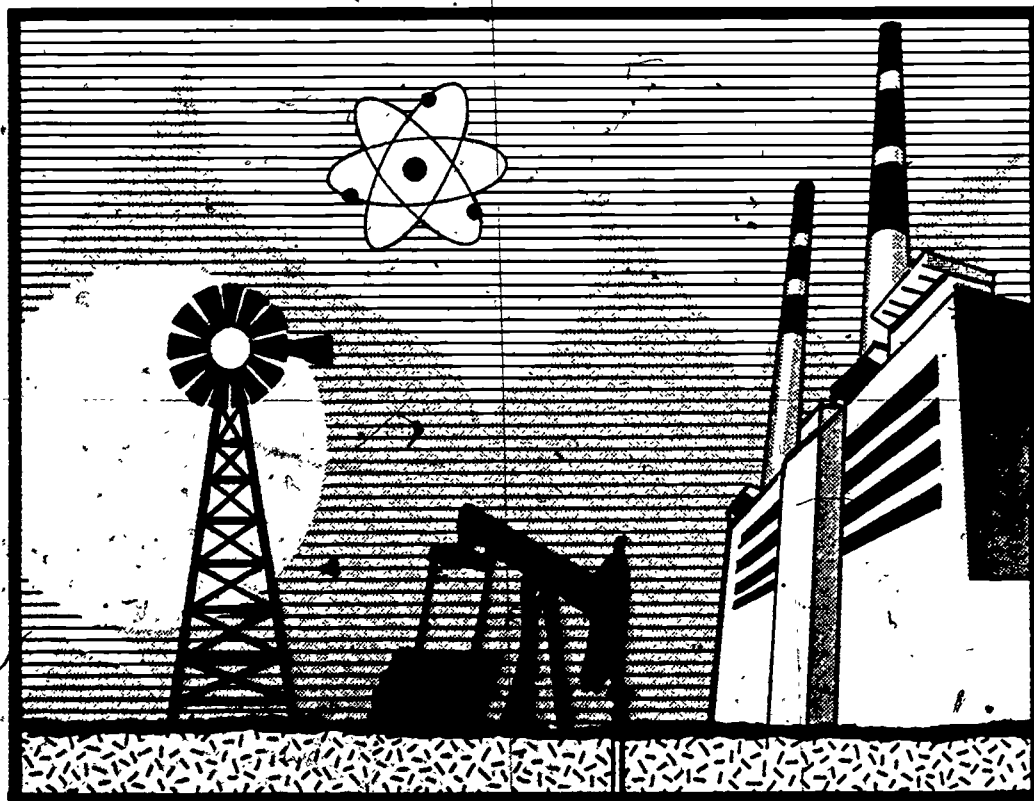

MODULE EP-05

COMBUSTION ENGINES



CENTER FOR OCCUPATIONAL RESEARCH AND DEVELOPMENT

INTRODUCTION

A combustion engine is a device that burns a fuel to produce heat energy and converts a portion of that heat energy into mechanical output energy. Very little has changed the course of history as much as the combustion engine. It has taken farmers out from behind the horse and placed them on farm machines where their output has increased manyfold. It has freed a portion of the agriculture work force to move to the urban areas and has given industry the capability to absorb the newcomers' talents.

Combustion engines are the power sources for vehicles that transport food, raw material, finished products, and people. Stationary combustion engines are used for the following purposes: (1) in production machinery to drive pipeline pumps and (2) for the production of electricity in power plants up to 10,000 kW.

This module presents all major types of combustion engines — except turbines, which are described in Module EP-06, "Turbines." Because of the importance of reciprocating internal combustion engines that use gasoline or diesel fuel, this engine type is discussed in detail.

PREREQUISITES

The student should have completed Fundamentals of Energy Technology.

OBJECTIVES

Upon completion of this module, the student should be able to:

1. Discuss the following classifications of combustion engines and give examples of engines in subdivisions within each classification:
 - a. Place of combustion
 - b. Means of energy conversion
 - c. Type of mechanical cycle
 - d. Type of cooling system
 - e. Arrangement of cylinders

2. Describe the operation of the following engines:
 - a. Two-stroke, compressing-ignition reciprocating engine (diesel)
 - b. Four-stroke, spark-ignition reciprocating engine (gasoline)
 - c. Rotary internal combustion engine
 - d. Stirling engine
 - e. Steam engine
3. Discuss the function and characteristics of the following major components of an internal engine:
 - a. Cylinder block
 - b. Cylinder head
 - c. Mainfolds
 - d. Valve train
 - e. Piston and connecting rod assembly
 - f. Crankshaft assembly
4. List four types of lubrication systems and briefly explain the function of each.
5. Draw a diagram of a full-flow oil filter system and discuss the function of each component.
6. List and discuss four types of fuel injection systems.
7. List the components of a carburetion fuel system.
8. List and explain three types of air cleaners.
9. Draw and label a diagram of a simple carburetor and explain its functions.
10. Identify and discuss the function of each component in the following sub-systems of the electrical system of a spark-ignition engine:
 - a. Ignition system
 - b. Starting system
 - c. Charging system
11. Replace the breaker points, rotor, and condenser of a spark-ignition engine and time the engine.

SUBJECT MATTER

CLASSIFICATION OF ENGINES

There are many ways to classify engines. They can be classified by the following engine parameters:

- Place of combustion (internal or external)
- Means of energy conversion (reciprocating or rotary)
- Type of mechanical cycle (two-stroke or four-stroke)
- Type of cooling system (water or air)
- Arrangement of cylinders (in-line, V-type, opposed, radial)

Each of these classifications will be discussed in detail in the following sections of the module.

PLACE OF COMBUSTION

Every engine relies on heat to produce mechanical energy. In combustion engines, heat is provided by the burning of a fuel. In order to burn the fuel, a place of combustion must be provided. Thus, the first classification of combustion engines involves where the combustion takes place. The burning of the fuel can take place inside the engine, in which case the engine is classified as an "internal combustion engine." Or, the fuel can be ignited in a place remote to the engine. This type of engine is classified as an "external combustion engine."

Internal Combustion Engines

Internal combustion engines are divided into two groups according to the type of ignition used: spark-ignition or compression-ignition.

In a spark-ignition engine, a vaporized fuel-air mixture is compressed with a piston in a cylinder inside the engine. At or near the point of maximum compression (called "top dead center"), a spark is introduced into the cylinder and the fuel-air mixture is ignited. The combustion causes heat and increased pressure inside the cylinder. The pressure pushes the piston downward in the cylinder, thus producing the force necessary to generate work. By attaching the piston to a crankshaft, rotational energy is generated.

In a compression-ignition engine, air is highly compressed by a piston in a cylinder. This compression forces the molecules of the air closer together and causes the air to heat to a higher temperature. At or near the point of

maximum compression and highest temperature, an atomized fuel is sprayed into the cylinder. The fuel ignites (because of the high temperature in the combustion chamber) and burns, driving the piston outward in the cylinder and producing work.

Table 1 shows some of the applications for internal combustion engines. As shown in the table, spark-ignition engines are used in situations where lightweight and higher horsepower engines are required. Because compression-ignition (diesel) engines withstand higher temperatures and pressures, they are bulkier and heavier. These characteristics limit diesel application to heavier machinery and stationary usage.

TABLE 1. APPLICATIONS OF INTERNAL COMBUSTION ENGINES.

Class	Service	Approximate hp Range (one engine)	Predominant Type		
			D or SI	Cycle	Cool- ing
Road vehicles	Motorcycles, scooters	1-50	SI	2,4	A
	Small passenger cars	20-100	SI	4	A-W
	Heavy passenger cars	100-500	SI	4	W
	Light commercial	50-200	SI-D	4	W
	Heavy (long distance) commercial	150-500	D	4	W
Off-road vehicles	Light vehicles (factory, airport, etc.)	2-20	SI	2,4	A-W
	Agricultural	4-200	SI-D	2,4	A-W
	Earth moving	50-1000	D	2,4	W
	Military	50-2500	D	2,4	A-W
Railroad	Rail cars	200-500	D	2,4	W
	Locomotives	500-4000	D	2,4	W
Marine	Outboard	1/2-100	SI	2	W
	Inboard motorboats	5-1000	SI-D	4	W
	Light naval craft	40-3000	D	2,4	W
	Ships	5000-30,000	D	2,4	W
	Ships' auxiliaries	100-1000	D	4	W
Airborne vehicles	Airplanes	65-3500	SI	4	A
	Helicopters	65-2000	SI	4	A
Home use	Lawn mowers	1-4	SI	2,4	A
	Snow blowers	3-6	SI	2,4	A
	Light tractors	3-10	SI	4	A
Stationary	Building service	10-500	D	2,4	W
	Electric power	50-30,000	D	2,4	W
	Gas pipe line	1000-5000	SI	2,4	W
Special for racing	Vehicles and boats	100-2000	SI	4	W

SI = Spark-ignition; D = Diesel.

Internal combustion engines have become important in this century because of the automotive application. However, they are relatively inefficient (35% general efficiency as compared to turbine efficiency of higher than 90%) and

are highly dependent on petroleum products which are becoming scarce and costly. Because of these facts, efforts are being made to find substitutes for the internal combustion engines. Two substitutes which have gained recent attention are the battery-powered engines and the Stirling engine. The Stirling engine is discussed below.

External Combustion Engines

One of the substitutes for internal combustion engines is the external combustion engine. The primary advantage in using the external combustion engine is that it can burn any type of fuel; not just gasoline or diesel fuel as in internal combustion engines. In most cases, the combustion heats either air or steam. The two most important types of external combustion engines are the Stirling engine and the steam engine.

Stirling engines use hot air to heat the pistons that produce rotational motion. As shown in Figure 1, air is heated and allowed to pass around the outside of an expansion chamber. As the hot air passes, it heats the air inside the chamber. As the internal air heats, it expands, causing the piston to move downward in the cylinder. This piston is linked

to an output shaft that makes the linear motion become rotational energy. Once the piston starts moving, then the Stirling engine is similar to an internal combustion engine. The Stirling engine has three major characteristics: (1) air is heated and passed around an expansion chamber, (2) this hot air heats air that is inside the chamber, and (3) heating the air inside the chamber causes the air to expand and move a piston.

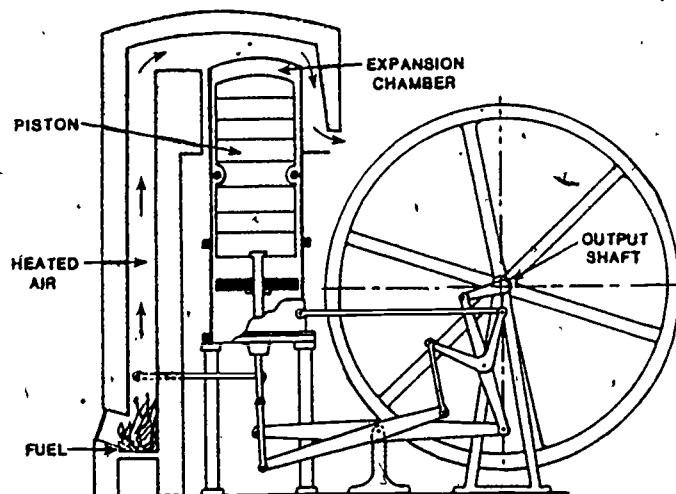

Figure 1. Early Stirling Engine.

Stirling engines have been used in the past as refrigerating machines, heat pumps, and pressure generators; and they are presently being tested for use in transportation devices. These engines have several advantages to offer, such as running without noise or vibration and having low air pollution rates and high thermal efficiency. But, the major advantage is that they use any type of combustible material as fuel. However, despite these advantages they are costly and complex, two factors which have contributed to the major problem concerning Stirling engines today — that they are relatively untested in many applications.

The steam engine, another type of external combustion engine, has a "double-acting" piston (Figure 2). A double-acting piston uses the force of

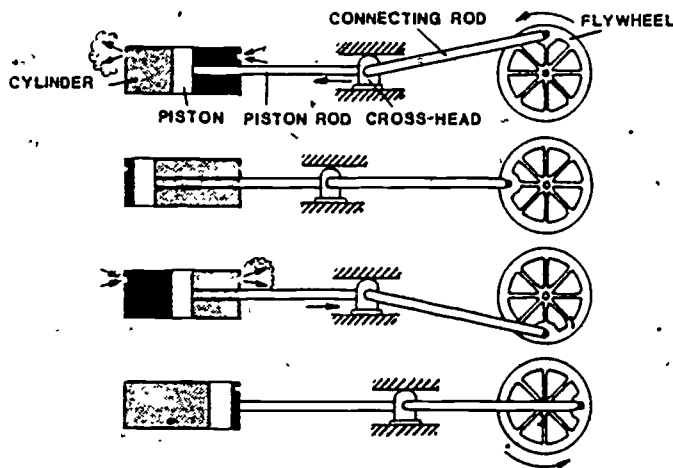

Figure 2. Schematic of a Steam Engine.

the steam alternately applied to each side of the piston, causing the piston to move back and forth and generating rotational mechanical power at the flywheel. The steam can be generated in a boiler at any location and piped to the steam engine. Steam engines were used in early railroad locomotives before diesel engines became popular.

Historically, external combustion engines have been used on a limited basis. However, due to increasing petroleum fuel costs, they are becoming options to internal combustion engines since — as stated previously — external combustion engines can use any type of fuel for the heat generating process.

MEANS OF ENERGY CONVERSION

Combustion engines can also be classified by means of energy conversion. Engines operate by producing heat and pressure. This pressure must be exerted against some movable object in order to produce mechanical motion. The

pressure must be contained in some sealed device in order to keep the pressure from dissipating in directions other than the one desired. There are two standard methods used in engines for enclosing high pressure and for producing rotary motion and mechanical work from pressure: the reciprocating engine and the rotary engine.

Reciprocating Engine.

The reciprocating engine encloses the high pressure gas in a cylinder in which there is a movable piston (Figure 3). The pressure pushes against the top of the piston and forces it downward. The piston is attached to a crankshaft with a connecting rod. The connecting point on the crankshaft is offset from the center line of the shaft, thus allowing the shaft to turn as the piston goes up and down. The reciprocating engine converts thermal energy into linear motion, which is then converted to rotary motion.

Reciprocating engines are the oldest of the two types of internal combustion engines. As such, a large amount of time and money has been spent in perfecting them and in making them more sophisticated. However, because linear motion has to be transformed to rotational motion in these types of engines, they are fairly complicated, have a large number of internal parts, and depend heavily on their lubrication and cooling systems for efficiency. A more recent design for internal combustion engines has been made available by the introduction of the rotary engine.

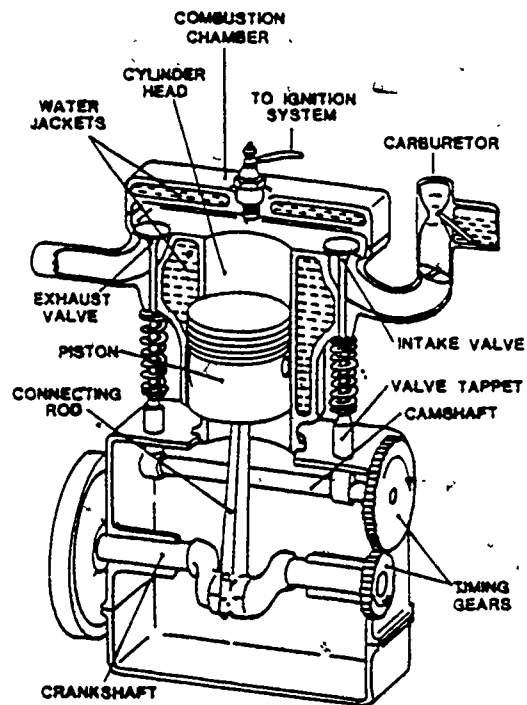

Figure 3. Schematic of a Reciprocating Engine.

Rotary Engine

The rotary engine omits the linear motion step in producing mechanical energy from thermal energy. The most common rotary engine is the turbine; however, in recent years, the Wankel spark-ignition rotary engine was developed

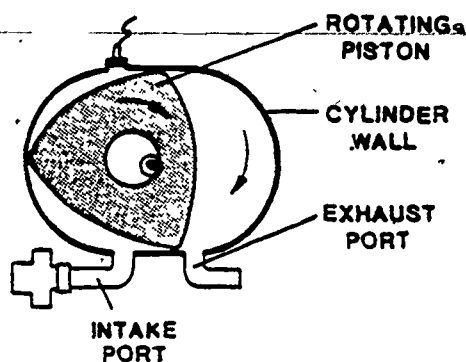

Figure 4. Rotary Engine.

for use in the automotive field. This rotary engine uses a "rotating" piston to produce rotary motion (Figure 4). This piston is connected directly to the output shaft of the engine, thus eliminating the connecting rod. The piston has seals at its three corners that divide the combustion chamber into three distinct sections. Thus, the engine can simultaneously be taking in and compressing a fuel-air mixture; burning a second, already-compressed mixture; and exhausting a third, completely burned gas.

Since there are no oscillating pistons that require rapid change of directions, the engine can operate at higher speeds of rotation than reciprocating engines. The major problems with rotary engines in recent years involve their excessive fuel consumption and exhaust pollution.

TYPE OF MECHANICAL CYCLE

Reciprocating internal combustion engines are classified according to their mechanical cycles. Mechanical cycle refers to the entire process of producing power from combustion. This process is as follows: (1) air, or a fuel-air mixture, is brought into the combustion chamber and compressed; (2) combustion occurs and power is transmitted to the piston; and (3) the spent gases are exhausted from the cylinder. These functions can be done either with one revolution of the crankshaft and two strokes of the piston (up and back down) or with two revolutions of the crankshaft and four strokes of the piston. Each of these mechanical cycles is discussed in more detail in the following paragraphs.

Two-Stroke Cycle

The two-stroke cycle generates one power stroke for each revolution of the crankshaft (Figure 5). Since diesel fuel is frequently used with the type of engine that uses this mechanical cycle, the two-stroke diesel engine will be discussed. In a two-stroke diesel engine, intake and exhaust valves are not used. Instead, the movement of air and exhaust gases occur through ports, or openings, in the cylinder walls. At the beginning of the first stroke, the

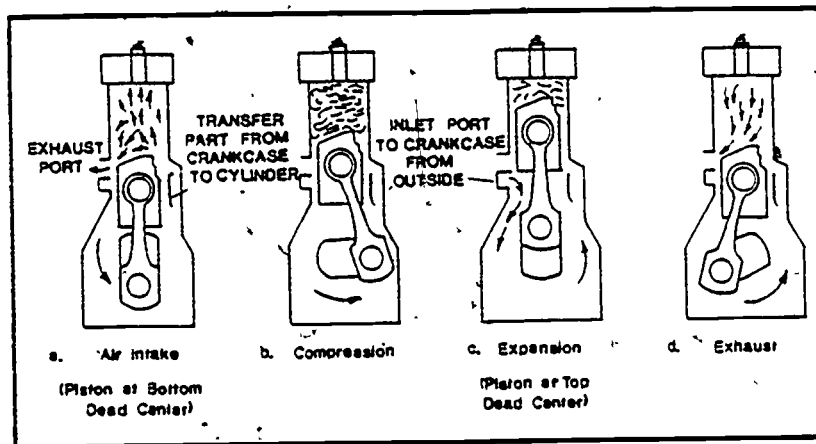

Figure 5. Two-Stroke Cycle:—One Power Stroke Out of Each Revolution.

exhaust and transfer ports are open, allowing spent gases of the previous stroke to exhaust on one side of the cylinder and fresh air to enter the cylinder from the crankcase through the transfer port (Figure 5a). In the two-stroke engine, the piston head is designed to channel air flow within the cylinder to keep air and spent gases moving in the proper direction. On the compression stroke (Figure 5b), the piston rises in the cylinder, compressing the air and causing the rising piston to seal both the cylinder and the crankcase. As the piston compresses the air in the cylinder, it also causes a partial vacuum in the crankcase. Before the piston reaches top dead center (TDC), fuel injection starts. The third, or expansion stroke (Figure 5c), begins with fuel combustion already in progress. With the piston at TDC, the crankcase inlet port is open, allowing outside air to be sucked into the crankcase. With fuel combustion occurring, the piston is forced downward, sealing the crankcase,

inlet port. As it moves further down toward bottom dead center (BDC), it opens the exhaust port (Figure 5d), allowing the exhaust gases to be pushed from the high pressure area in the cylinder to the lower pressure outside the cylinder. As the piston reaches BDC (Figure 5a), the transfer port is opened and the cycle is complete. All of these functions — air intake, compression, expansion, and exhaust — are performed in one revolution of the crankshaft.

Although the two-stroke cycle engine is not as popular as the four-stroke cycle engine, it is used where high power is needed in a smaller engine. Two-stroke cycle diesel engines are used in a variety of small generators and in off-road vehicles such as earth moving equipment. Two-stroke cycle gasoline (spark-ignition) engines are used in such items as lawn mowers, motorcycles, and chain saws.

Four-Stroke Cycle

In the four-stroke cycle, the mechanical cycle is completed in four strokes of the piston or two revolutions of the crankshaft (Figure 6). Since the four-stroke gasoline engine is the one most often used, it will be the one

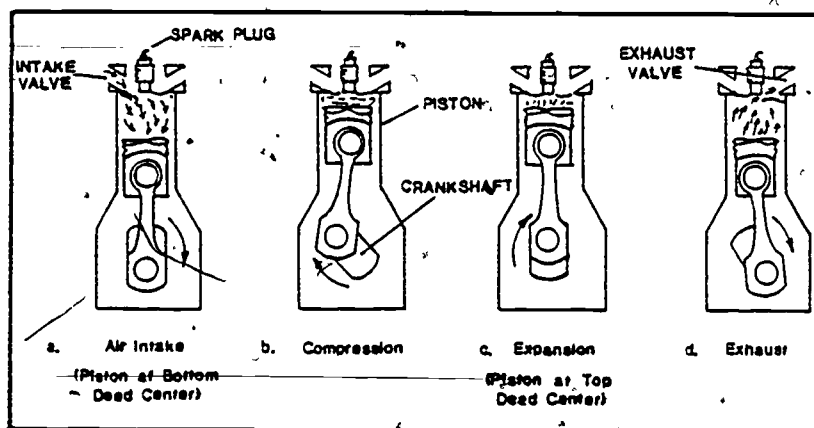

Figure 6. Four-Stroke Cycle: One Power Stroke Out of Two Revolutions.

discussed. On the first, or air intake stroke (Figure 6a), the intake valve is opened and the downward motion of the piston creates a low pressure area in the cylinder, thus sucking the fuel-air mixture into the cylinder from the

intake manifold. At the end of the first stroke and the beginning of the second (compression stroke), the intake valve is closed and the piston is at BDC. During compression (Figure 6b), the piston moves upward, compressing the trapped fuel-air mixture inside the cylinder. This heats the air into a superheated condition (approximately 1000°F). As the piston reaches the end of the stroke, a spark is introduced into the cylinder. At the end of the second stroke, the crankshaft has made one complete revolution. The third, or expansion stroke (Figure 6c), starts with the piston at TDC and the combustion of the fuel-air mixture already in progress. During this stroke, the burning gas expands, pushing the piston down and creating a turning force on the crankshaft through the connecting rod. At the beginning of stroke four, the exhaust stroke (Figure 6d), the piston is again at BDC. The exhaust valve is opened and the piston moves upward, carried by the momentum of the crankshaft. This movement forces the spent gases out of the cylinder through the open exhaust valve. The stroke finishes with the piston at TDC. The four-stroke cycle is completed after two complete revolutions of the crankshaft.

The four-stroke cycle is typically used in larger, multiple-cylinder engines. Although these engines generally are more efficient in fuel consumption and smoother during operation, they are more complicated and bulkier than their two-stroke counterparts. Automotive vehicles use the four-stroke cycle almost exclusively.

TYPE OF COOLING SYSTEM

Engine operation depends upon converting thermal energy into mechanical energy. If an engine were 100% efficient, all of the thermal energy would be converted into useful power. In reality, however, only about one-fourth of the thermal energy is used to produce power (Figure 7). The rest is lost through friction of engine parts, heat in exhaust gases, or heat conduction to parts of the engines. The energy that is transmitted to the engine parts must be removed or the temperatures inside the engine could reach

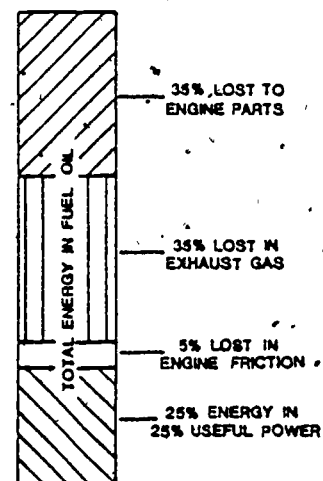

Figure 7. Energy Utilization in an Engine.

2000°F. Temperatures in this range would break down lubricating oil and damage the engine. Two major methods are used to cool internal combustion engines: water cooling and air cooling.

Water Cooling Systems

Water cooling systems for internal combustion engines are segregated into open or closed systems. In the open water cooling system, water passes through the water jackets inside the engine and is returned to a river, lake, ocean, or central reservoir. It can also be returned to a cooling tower or a spray pond where it is cooled for reuse. Open water cooling systems are mainly used to cool stationary diesel power plants.

In the closed water cooling system, the same coolant is continuously recirculated through the engine water jackets by a water pump. The water jackets surround the cylinders in the engine block and are adjacent to valves in the engine head (Figure 3). The coolant continues to circulate through the engine until it reaches a certain temperature, at which time a thermostat opens and the coolant circulates through a radiator (Figure 8) where it releases heat energy to the air.

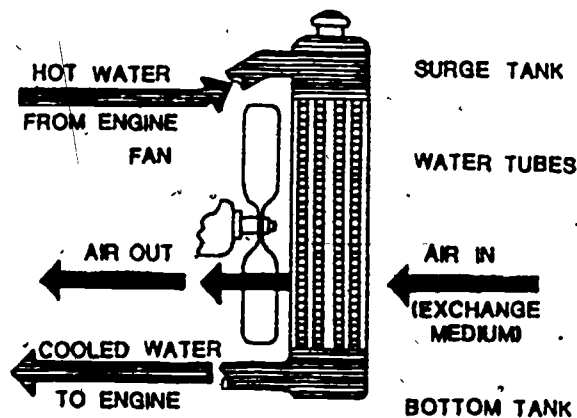

Figure 8. Radiator.

The thermostat, located on the engine block, controls the flow of the cooling liquid to the radiator.

When the engine is started, the thermostat blocks the flow to the radiator and keeps the coolant circulating through the engine only. This rapidly raises the temperature of the coolant. At some preset temperature, the thermostat opens and allows flow to the radiator, thus allowing cooling to occur.

When an engine is started in cold temperatures, its thermal efficiency is low. The reduced efficiency is caused by the following: condensation of fuel on cold cylinder walls, excess heat transfer from the combustion chamber to the cylinder walls, and increased viscosity of cold lubricating oil. Thus, the

thermostat is essential to increased efficiency. The thermostat is designed to open and to allow cooling to take place at some prescribed temperature, a temperature which should be as close as possible to the operating limits of the fuel and oil. Hotter running engines, which are generally tighter due to thermal expansion of internal parts, suffer less compression losses.

Coolant is another critical part of the cooling system. Some liquid-cooled engines use water; however, most engine manufacturers recommend using some other liquid, such as ethylene glycol (antifreeze), which heats up more quickly, allows the engine to reach its normal operating temperature faster, and still provides protection from overheating in hot weather.

Air Cooling Systems

Air cooling is primarily used on small engines. Air is used as the heat exchange medium and is routed around the outside of the cylinder wall by cooling fins. Size and spacing of the fins are dependent on the amount of heat to be disbursed, as are the material of which the fins are made, the spacing or pitch of the fins, the diameter of the cylinder, and the speed and temperature of the cooling air. An air-cooled system reduces engine weight by about 10% and makes the engine more compact. Wear rate on engine parts compares favorably with that of water-cooled systems, and maintenance costs are somewhat less due to the fewer number of moving parts. However, air-cooled engines are normally longer and noisier than their water-cooled counterparts.

ARRANGEMENT OF CYLINDERS

Reciprocating internal combustion engines usually have 1, 2, 4, 6, 8, 12, or 16 cylinders. The number of cylinders varies with engine size, type, and application.

Just as there are engines of different cylinder numbers, there are also various cylinder configurations. The overriding factor in choosing a cylinder configuration is to design an engine to optimize or fit a particular space. The following cylinder arrangements are used in internal combustion engines:

- In-line
- V-type
- Opposed
- Radial

In-Line Cylinder Configuration

As many as 16 cylinders can be placed in line. However, this number of cylinders is an upper limit due to crankshaft stress and vibration of longer engine designs. Advantages of in-line design include mechanical simplicity and ease of maintenance. The in-line six-cylinder engine is very popular in the automotive field. In-line engines in excess of six cylinders offer disadvantages such as (1) being excessively long in comparison to their other dimensions and (2) experiencing excessive crankshaft vibration. Yet, despite these factors, in-line engines with as many as 12 cylinders are still used for large ships, primarily because their shape fits well into hull design.

V-Type Cylinder Configuration

Another popular cylinder arrangement in automotive engines is the V-type engine (Figure 9). (To classify as a V-type engine, the axes of the two banks of cylinders must make an angle with each other of less than 180° .) Length in these engines is reduced by almost half in comparison with in-line engines. V-type engines have advantages of having excellent balance and reduced vibration. Because the engine is shorter than the in-line engine, it fits reasonably well in smaller automotive engine spaces. This cylinder configuration was introduced in the 1930s with the popular flathead V-8 engine. However, the automotive industry has since produced V-6 and even V-4 engines in an effort to reduce fuel consumption and to make smaller engine packages.

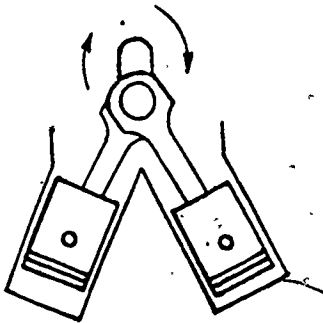

Figure 9. V-Type Engine.

Opposed Cylinder Configuration

Cylinders can be arranged so that they are opposite from one another. When they are arranged in this fashion, the engine is considered to be an opposed cylinder engine (Figure 10). This cylinder configuration lends itself

well to air cooling since there is space for many cooling fins around the cylinder. It is generally used in smaller aircraft; however, the automotive industry has also used the opposed cylinder, air-cooled engine (Volkswagen beetle).



Figure 10. Opposed Cylinder Engine.

Radial Cylinder Configuration

A lesser used, but still important, cylinder configuration is the radial engine, in which all the cylinders are arranged radially around the axis of the crankshaft. This type of engine is easily air cooled and is convenient for servicing. Because it gives the lowest unit weight per cylinder displacement, it is mainly used for larger aircraft.

COMPONENTS OF AN INTERNAL COMBUSTION ENGINE

The most common type of combustion engine is the reciprocating internal combustion engine, using either gasoline or diesel fuel. This type of engine has the following major components:

- Cylinder block
- Cylinder head
- Manifolds (intake and exhaust)
- Valve train
- Piston and connecting rod assembly
- Crankshaft assembly

CYLINDER BLOCK

The cylinder block is the basic framework of a combustion engine (Figure 11). All other parts are either assembled within it or attached to it. In the block are holes, or cylinders, in which the pistons move. In addition, inside the block are passages for cooling water (in water-cooled engines) or fins that help dissipate heat (in air-cooled engines). The block is normally made from cast iron, a cast iron alloy, or aluminum.

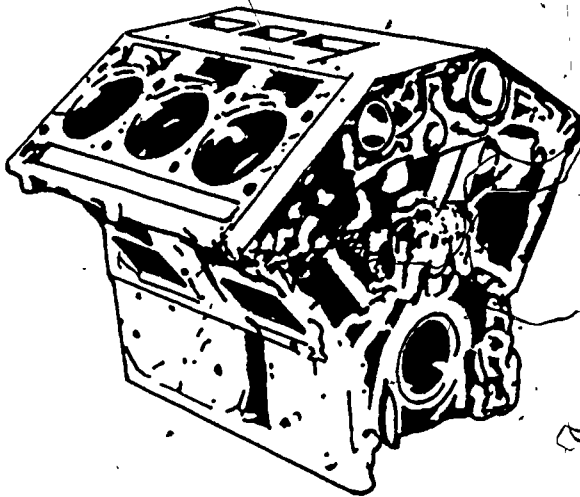

Figure 11. V-6 Cylinder Block.

CYLINDER HEAD

The cylinder head is another stationary part of the engine; it is bolted to the block to form a "cap" over the cylinder. There is a head for each bank of cylinders. In-line cylinder configuration engines have only one bank (since all of the cylinders are grouped together) and, thus, have only one head. For a V-type engine, there are two heads. Radial engines do not have cylinders that are grouped together; therefore, they require a head for each cylinder.

The head contains combustion chambers, valve ports, spark plug or fuel nozzle holes, coolant passages, and passages that connect the valves to the manifolds. Because it must withstand the same heat and pressure as the block, the cylinder head is normally constructed of the same metal.

Before the head is bolted to the block, a gasket is placed between these two parts to form a gastight seal. This gasket, called the head gasket, is made of ~~terneplated~~ sheet steel which covers asbestos board or sheet steel. If the gastight seal is broken, the engine loses compression and power. Fuel consumption also increases. Normally, head gasket leaks make the engine exhaust "pop" because of the improper seal on the exhaust valve. In addition, oil droplets can be seen in the coolant in the radiator, and water droplets show up on the oil. Head gasket leaks can only be corrected by replacing the head gasket.

MANIFOLDS

There are two types of engine manifolds: intake and exhaust. Intake manifolds bolt to the head of the engine and must route air or a fuel-air mixture to the combustion chamber. In a diesel engine, only filtered air flows through the intake manifold; in the spark-ignition engine, a fuel-air mixture must be routed. In a spark-ignition engine, the carburetor is mounted on top of the manifold. The carburetor (discussed later in the module) meters the fuel so that the proper fuel-air ratio is provided to the engine. The intake manifold then delivers the mixture to the cylinders to produce combustion.

The exhaust manifold provides the means of removing the exhaust gases from the engine. It connects to the exhaust ports in the cylinder head and routes the exhaust to the exhaust pipe. One of the most important factors in exhaust manifold design is that, by minimizing back pressure, it increases engine efficiency. A special method to increase the efficiency of exhaust manifolds is called exhaust turning. This method is accomplished by selecting the proper length of exhaust pipe to reduce the back pressure in the exhaust system.

VALVE TRAIN

A valve train (Figure 12) is used to open and close the intake and exhaust valves at the proper time in the mechanical cycle of internal combustion engines. The valve train consists of the following parts:

- Camshaft
- Tappet (valve lifters)
- Push rod
- Rocker arm assembly
- Valve springs
- Valves

There are two valves for each cylinder, one intake and one exhaust valve. They work as a pair and are timed for maximum efficiency.

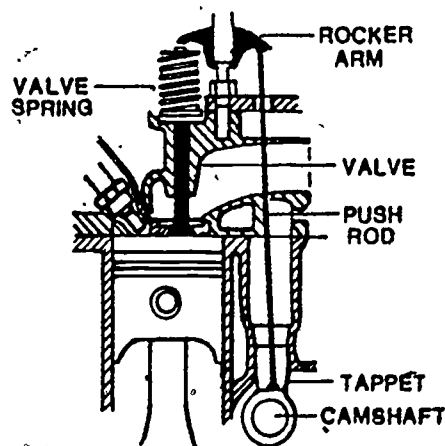

Figure 12. Valve Train.

Camshaft

The camshaft (Figure 13) is used to force open the valves. In conventional combustion engines, the camshaft is mounted in the crankcase and is gear driven.



Figure 13. Camshaft of a V-8 Engine.

As the camshaft rotates, the cam lobes turn. By their shape, they apply force to the remaining parts of the valve train. Camshafts are usually forgings, that is, machined out of a metal bar; but in some cases they are castings, that is, formed in the final shape when the liquid metal is poured. To reduce wear, the cam surface is hardened.

Tappet (Valve Lifter)

Resting on the cam lobe is the tappet, or valve lifter. As the cam lobes rotate, they force the valve lifter up, thus changing the rotary motion of the camshaft into a reciprocating motion that opens the valves. As the cam continues to rotate past its raised surface, the valve spring forces the tappet down, thus holding it against the cam surface.

Push Rod

In a conventional engine, the valve lifter, or tappet, is connected to a push rod. The function of the push rod is to transmit the reciprocating motion of the valve lifter to one end of the rocker arm assembly. Overhead cam engines eliminate the need for push rods.

Rocker Arm Assembly

The rocker arm assembly (Figure 14) changes the direction of the motion of the push rod and transmits it to the valves. The rocker arms oscillate through small angles about the rocker arm shaft. A rocker arm usually operates only one valve, but it can operate two valves by using a bridge, as shown in Figure 14.

Figure 14. Push Rod, Rocker Arm, and Bridge for Actuating Two Valves.

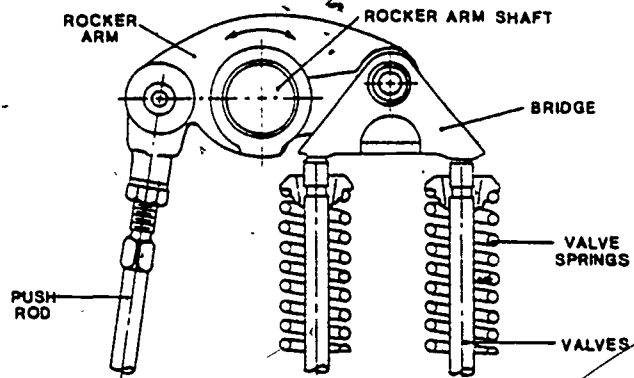

Valve Springs

In order to close the engine valves after they are opened and to keep the valve lifter riding on the camshaft, valve springs are provided. These springs are made of a special alloy steel to withstand heat, corrosion, and continued flexing.

Valves

The last parts of the valve train assembly are the valves (Figure 15). Each cylinder has two valves: intake and exhaust. Valves perform two functions. First, they open and allow gases in and out of the cylinder. Second, they form a gastight seal during the compression and power strokes. Valves attach to the rocker arm assembly and ride in valve guides, which limit their lateral motion. Both intake and exhaust valves are exposed to high temperatures of combustion — which range from 1200° to 1500° in spark-ignition engines and to 2000°F in diesel engines. To withstand these temperatures, they are normally constructed of steel alloy.

If valves do not form a gastight seal, the engines lose compression and, thus, power. Leaks around the exhaust valve allow unburned fuel to be emitted from the engine. Therefore, the valves must be adjusted to seat properly.

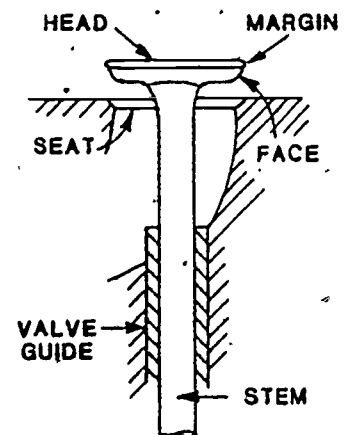

Figure 15. Valve.

PISTON AND CONNECTING ROD ASSEMBLY

The piston and connecting rod assembly (Figure 16), along with the crankshaft assembly, actually converts the thermal energy of combustion in the cylinder to mechanical energy at the output shaft of the engine.

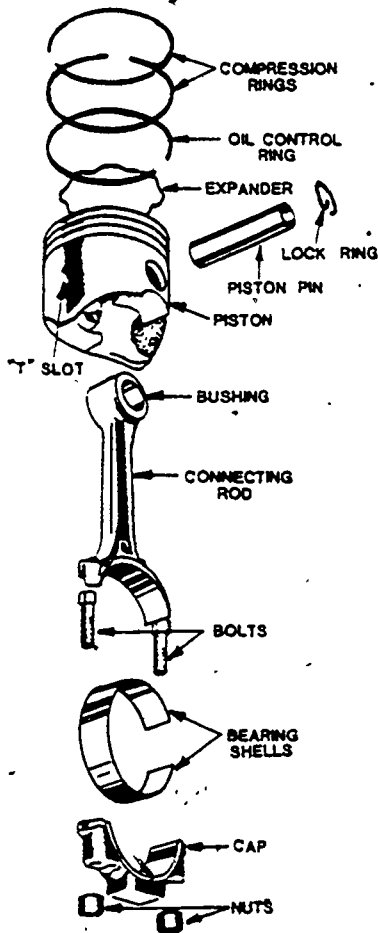

Figure 16. Exploded View of Piston and Connecting Rod Assembly.

Piston

Pistons and their rings seal the cylinder and transmit gas pressure to the connecting rod. A piston normally has three or four rings mounted in grooves on the outside of the piston. The top two rings, called compression rings, form a gastight seal around the sides of the piston. One or two oil control rings are mounted below the compression rings. These rings scrape a controlled amount of oil from the cylinder wall and return it to the center of the piston or the crankcase. Piston rings are normally constructed of gray cast iron.

Pistons convert thermal energy to reciprocating mechanical energy in the cylinder. They are subjected to severe heat and pressures, as well as extreme inertial forces, as they are accelerated and decelerated in the cylinder. Pistons are normally constructed of aluminum or alloyed cast iron. Aluminum has several advantages over cast iron. First, it has excellent heat conductivity, thus making it easier to cool. Second, it is lightweight, thus reducing the load on the bearings and the crankshaft.

Connecting Rod

The connecting rod is attached to the piston with a piston pin. At its other end, it is connected to the crankshaft by a combination of a bearing shell, bearing cap, nuts, and bolts. The connecting rod converts the reciprocating motion of the piston to the rotating motion of the crankshaft. Thus, the end of the connecting rod that attaches to the piston has an up-and-down motion, whereas the end attached to the crankshaft has a circular motion. It is either being pushed or pulled at all times; therefore, it is subjected to alternating compression and tension loads. To withstand these loads, connecting rods are normally made of medium or alloy steel by the drop forge method.

Bearings

The bearing is the part of the connecting rod that is subjected to the most wear. For this reason, proper lubrication of the bearing is important. When bearings wear out, the engine is subject to excessive vibration and power loss. Replacing connecting rod bearings is a difficult procedure normally accomplished by an experienced mechanic during a major engine overhaul.

CRANKSHAFT ASSEMBLY

A crankshaft assembly has two major parts: the crankshaft itself and the flywheel.

Crankshaft

The crankshaft (Figure 17) is a rotating member of the engine proper and is supported by main bearings. On smaller engines, the main bearings are located on each end of the crankshaft. On larger engines, main bearings are also located at intermediate points along the crankshaft. The connecting rods connect to the offset points on the crankshaft. These points are called throws. The number and arrangement of the throws along the crankshaft is determined by the number of

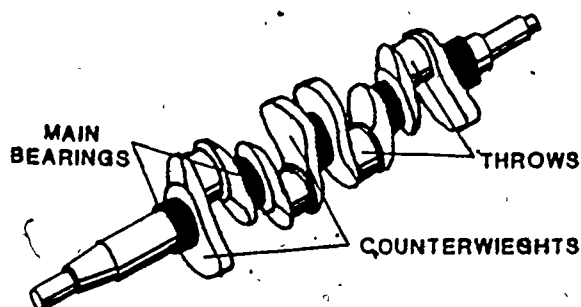

Figure 17. Crankshaft.

cylinders and the desired firing order. Figure 18 shows the different configurations for different engines. Crankshafts are balanced with counterweights to more evenly distribute the forces operating on the shaft. Crankshafts are normally forged or cast out of medium carbon steel.

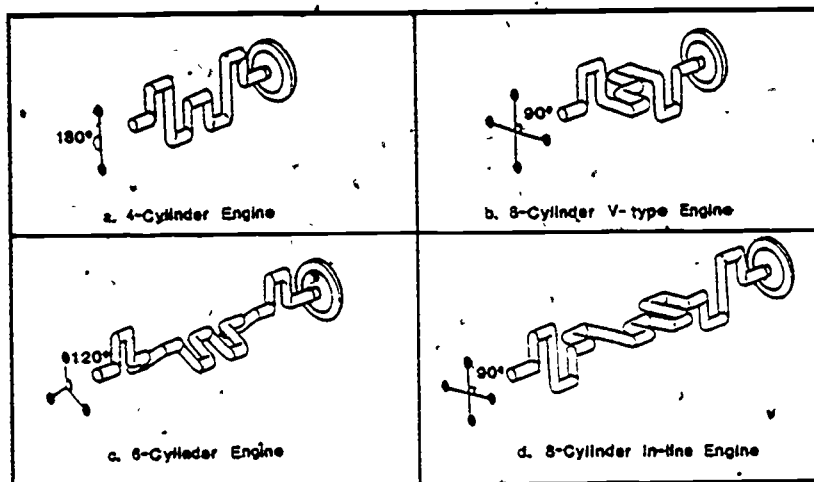

Figure 18. Crankshaft Configurations for Various Types of Engines.

Flywheel

The flywheel is a heavy disc attached to the rear of the crankshaft. It has two functions:

1. It controls the speed fluctuations of the crankshaft. Without it, the engine would run roughly.
2. Using the outside edge of the flywheel (normally called the ring gear), it gives the starter the capability of rotating the crankshaft in order to start the engine.

ENGINE LUBRICATION SYSTEMS

The job of an engine's lubrication system is to reduce friction, to aid in cooling engine parts, and to keep engine parts clean. Several systems have been devised to perform the job of lubrication, such as the following:

- Splash system
- Barrel-type pump system
- Oil slinger system
- Pressure-feed system

SPLASH SYSTEM

The splash system (Figure 19) uses a dipper on the end of the connecting rod to scoop up oil from the crankcase and to sling it into the engine bearings and cylinder walls.

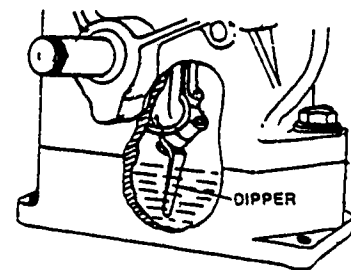

Figure 19. Splash Lubrication System.

BARREL-TYPE PUMP SYSTEM

The barrel-type lubrication system (Figure 20) is a second type of system. It uses a pump driven by the camshaft of the engine. The pump draws oil into its central passage on its intake stroke and discharges it onto engine parts on the compression stroke.

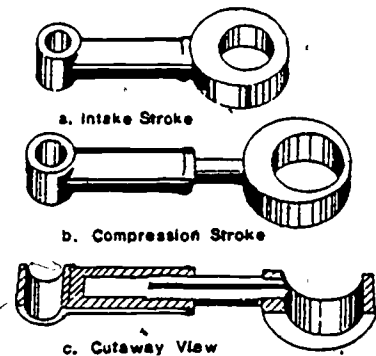

Figure 20. Barrel-Type Lubrication Pump.

OIL SLINGER SYSTEM

An oil slinger is used on some Briggs and Stratton engines. The slinger is partially submerged in the oil supply in the crankshaft. As the engine operates, a cam gear turns the slinger, thus providing lubrication to engine parts.

PRESSURE-FEED SYSTEM

The most effective lubrication system, the one used in most larger engines, is the pressure-feed system. System parts include a pump for oil storage, a pump to supply pressure, an oil cooler to remove excess heat from the oil, and oil conditioning equipment to remove impurities from the oil. Each of these parts will be discussed in detail in the following paragraphs.

Oil Pan

The oil pan at the bottom of the crankcase performs two functions. First, it acts as a pump, or reservoir, for the oil. Second, it performs the function of a heat exchanger. Air that flows through the crankcase absorbs some of the heat of the oil as the air flows over the oil supply. The outer side of the pan is exposed to the environment. Heat transfer occurs through the pan into the atmosphere.

Oil Pump

The most important part of the lubrication system is the oil pump. In automotive engines, two types of pumps are used: the gear-type and the rotor-type (Figures 21a and 21b). The gear-type pump makes use of a pair of meshing gears to force oil out through the outlet. The rotor-type pump has an inner

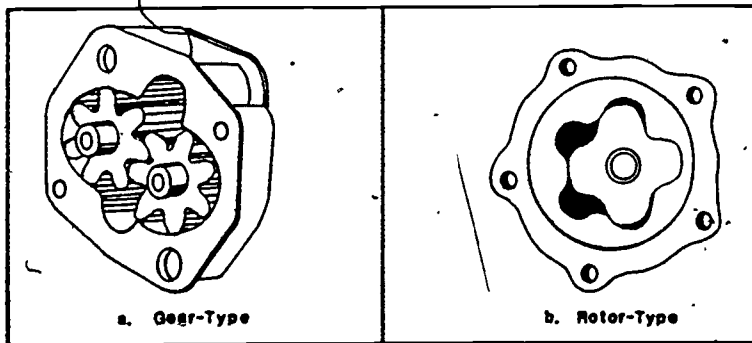

Figure 21. Oil Pumps.

and outer rotor. As the lobes of the inner rotor move into spaces in the outer rotor, oil is squeezed through the outlet. These pumps force oil through oil lines to various part of the engine.

Oil Filter

As the oil moves through the engine, it picks up dirt, carbon, and small pieces of metal. The oil filter performs the function of removing these impurities from the oil. The following are the three types of filtration systems:

- By-pass filter
- Shunt filter
- Full-flow filter

In a by-pass filter, only a portion of the oil supplied by the pump to the engine bearings goes through the filter. The oil is returned to the crankcase after filtration. In a shunt-type oil filter, only a portion of the oil is filtered, as in the by-pass system. However, in a shunt system, the filtered oil is delivered to the engine bearings rather than returned to the crankcase. In the full-flow oil filter system (Figure 22), the oil filter cleans the entire volume of oil as it passes from the pump to the bearings. This latter system is the most effective filtration system of the three because it filters all of the oil before it reaches the bearings. It is the one used in most automotive engines.

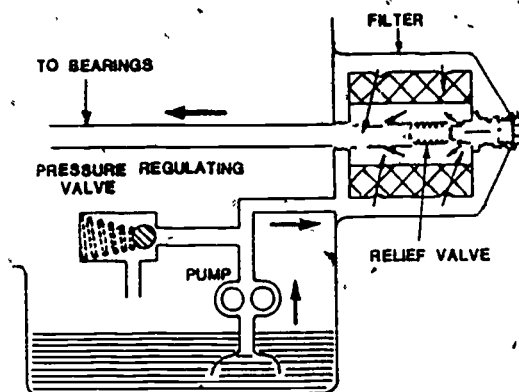

Figure 22. Full-Flow Oil Filter.

As with cooling systems, combustion engines are heavily dependent on their lubrication systems to operate properly. If there is a malfunction in the system, the engine will overheat and, possibly, will stop running completely. In addition, proper lubrication system operation can minimize engine wear by reducing friction.

Because oil pressure is important to engine operation, most engines have gauges that monitor oil pressure inside the engine. These gauges are normally calibrated with just high and low readings. If the gauge indicates a low reading, the engine should be stopped immediately to prevent damage to the engine, and the problem should be corrected before the engine is restarted.

Engine oil level should be checked periodically and/or during scheduled maintenance activities. In order to prevent an incorrect reading of the oil level, the engine should be stopped while the level is being checked. Engine oil and oil filters should be checked on a regular basis since extended use of

the same oil and filter can result in a clogged filter or a breakdown of the lubricating capability of the oil. The proper weight of oil should be used to achieve maximum engine efficiency.

FUEL SYSTEMS

Fuel systems for internal combustion engines are divided into two groups: (1) compression-ignition engines, which can only use fuel injection and (2) spark-ignition engines, which can use either fuel injection or carburetion. Both of these systems will be discussed in detail in the following paragraphs.

FUEL INJECTION

The diesel fuel system employs fuel injection to introduce fuel into the cylinder. The fuel injection system must perform the following five essential tasks:

- Deliver fuel from storage to the fuel nozzle
- Raise fuel pressure to the level needed for atomization
- Measure and control the amount of fuel injected during each cycle
- Control the time of injection
- Spray fuel into the cylinder in an atomized form for mixing and burning

Types of Injection Systems

Pumps and nozzles form the basic elements of every fuel injection system. They monitor the fuel, raise the fuel's pressure, and spray the fuel into the cylinder at the right time. These elements are combined in many ways, but most diesel fuel systems fall into the following four categories:

- Common rail
- Pump injection
- Distributor
- Unit injection

Common-rail systems (Figure 23) feature a controlled pressure pump that takes the fuel from the storage tank and places it under a constant pressure. The fuel under pressure is moved to an accumulator which is joined with fuel lines to each cylinder. As the fuel enters the fuel line, it goes to a pressure.

relief and timing valve which measures and controls the injection time. This operation is performed by means of a control level that rides on a camshaft. As the cam rotates, it depresses the control level and opens the pressure relief and timing valve to allow the right amount of fuel under pressure to pass on through the system to the spray valve. The spray valve then pushes the fuel through the nozzle and into the cylinder in an atomized form. The common-rail system is not well adapted for small bore, high-speed engines, as it is difficult to accurately control the small quantity of fuel injected at each power-stroke. However, it works well in large diesel engines such as those used in stationary power generation plants.

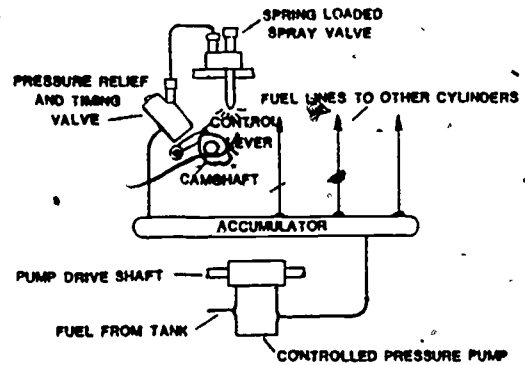

Figure 23. Common-Rail Fuel Injection System.

Pump-injection systems (Figure 24) depend heavily on a pump to carry out the bulk of the controlling and metering job. The pump is responsible for taking the fuel from the fuel tank, pressurizing it, and then metering it out through the fuel lines to the nozzles where it is injected into the individual cylinders.

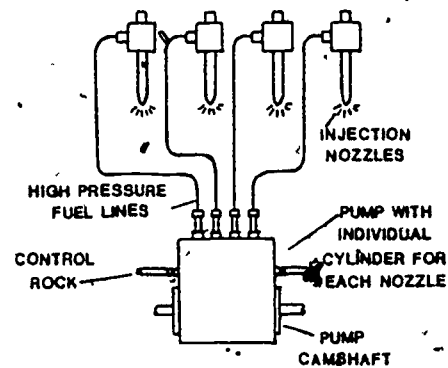

Figure 24. Pump-Injection Fuel System.

Pump-injection systems must be capable of producing high pressures and measuring small quantities of fuel with a high degree of precision. Most operate with a constant stroke, although variable-stroke pumps are available.

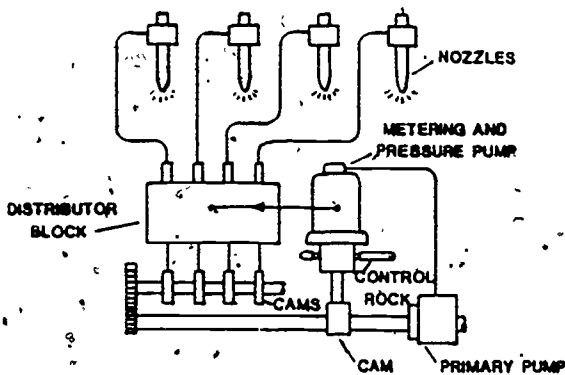

Figure 25. Distributor Fuel Injection System.

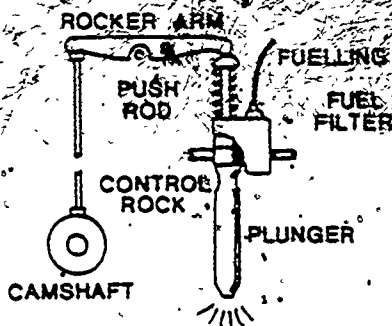

Figure 26. Unit-Injection Fuel

The pressure of the plunger moving down through the supply chamber meters the fuel and pressurizes it. The pressure activates a needle valve, allowing the fuel to be forced through an orifice and into the cylinder as atomized fuel. Unit-injection systems greatly reduce the distance between the pump and the nozzle, making them useful in small, high-speed engines.

Each of the four fuel systems has a number of valves and one nozzle per cylinder. The valves and nozzles open and close passage to cylinder space and convert high pressure diesel fuel into a spray with a desired pattern. Typical common-rail injection systems are mechanically-operated needle valves. A spring holds the valve closed against fuel pressure (normally 5000 to 8000 psi)

Distributor pumps (Figure 25) meter fuel at a central point and then direct it to the cylinders in the proper order. This process is accomplished by using a metering and pressure pump, which measures and pressurizes the fuel and sends the metered fuel to a distributor. The distributor - usually cam-actuated - then sends the fuel to the proper cylinder for injection. The metering pump is designed so that the quantity of fuel sent to the distributor can be adjusted by the engine governor. Although this type of fuel injection system is still in use, it has largely been superseded on newer engines.

The unit-injection systems (Figure 26) combine pump, fuel valve, and nozzle in a single housing, thus eliminating the use of high pressure fuel lines. As the fuel enters the injector through the fuel line, it enters into a supply chamber in the center of the unit. The motion of the injector rocker arm moves a plunger downward at one end of the supply chamber.

until the rocker, actuated by push rods from the camshaft, lifts the valve in proportion to the amount and duration of the injection needed.

Nozzles

Most fuel valves consist of a nozzle holder, or body, that contains the valve mechanism and a nozzle tip that atomizes the fuel. The nozzle and holder are designed to carry the high pressure fuel from the fuel line through the cylinder head into the combustion chamber. The fuel is delivered as a fine spray by the nozzle tip. Nozzle tips can be divided into the following three categories:

- Single-hole nozzles
- Multiple-hole nozzles
- Pintle nozzles

Single-hole nozzles (Figure 27) offer the advantages of a fairly large opening, even in small, high-speed engines — which usually means fewer clogging problems. Efficient fuel filtration is less of a problem with this type of nozzle. Multiple-hole nozzles are designed to distribute fuel spray to all parts of a wide, shallow chamber. The more spray openings built into the design, the smaller each opening becomes — a fact which makes keeping the fuel clean a critical factor. Either type of nozzle is used to produce a spray of uniform and compact pattern.

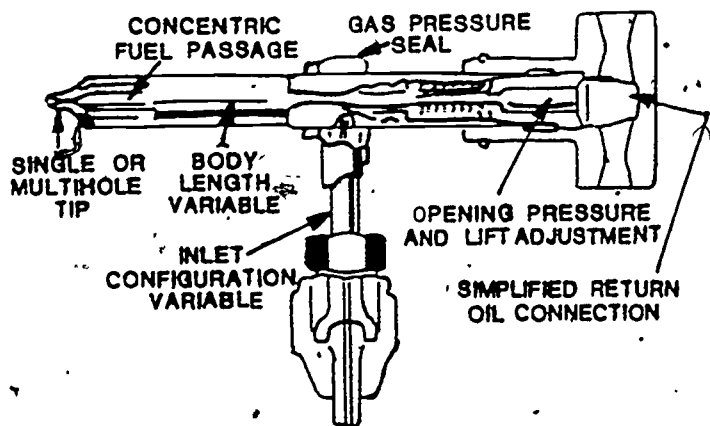

Figure 27. Single-or Multiple-Hole Nozzles.

Pintle nozzles are fitted with tips that are shaped to form the spray pattern desired. By shaping the tip, spray patterns can range from a hollow, cylindrical jet of fuel to a tapered spray with an angle up to about 60°.

CARBURETION

Most spark-ignition engines introduce a fuel-air mixture into the cylinder for combustion. Thus, the fuel system on this type of engine must bring the fuel from the fuel tank, and it must vaporize it, mix it with an air supply, and move it into the intake manifold for delivery to the cylinder. To accomplish these tasks, the spark-ignition engine fuel system has the following parts:

- Fuel pump
- Fuel filter
- Air cleaner
- Carburetor
- Fuel tank
- Fuel lines

Fuel Pump

The fuel pump (Figure 28) performs the function of keeping a constant supply of gasoline flowing to the carburetor. As shown in Figure 28, the fuel pump is cam-actuated. As the cam turns, the pump arm moves up and down. The

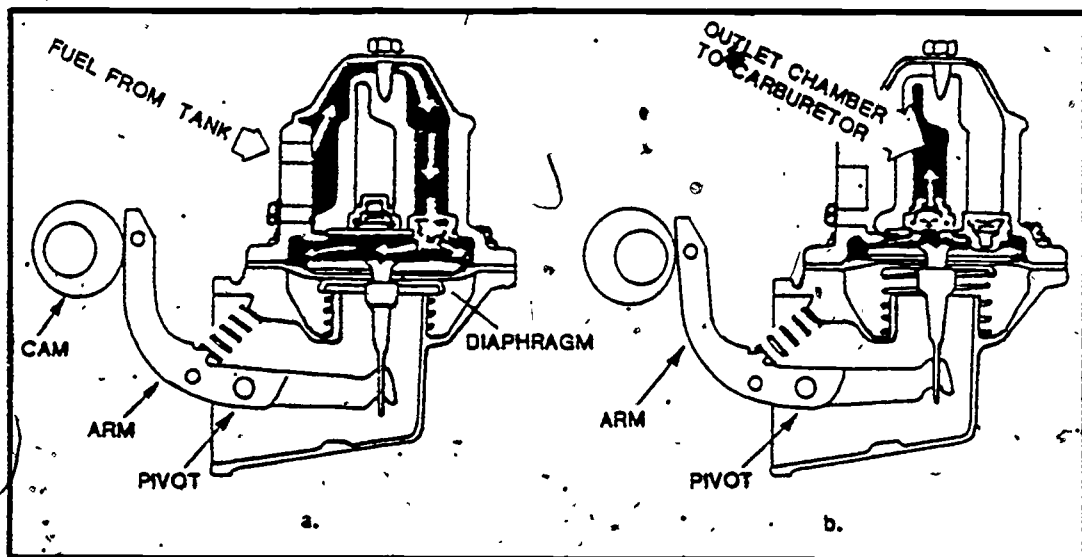

Figure 28. Typical Gasoline Fuel Pump.

arm, in turn, moves a diaphragm up and down in the bottom of the pump. As the diaphragm moves down, a valve on the right side of the pump opens to allow fuel into the bottom chamber (Figure 28a). As the diaphragm returns to the UP position, it closes the valve. The movement of the diaphragm, also forces the fuel that is in the bottom chamber to go through the center valve and into the outlet to the carburetor (Figure 28b).

Fuel Filter

Most spark-ignition engines have a fuel filter between the fuel pump and the carburetor. These filters contain a fine screen to filter out impurities in the gasoline. Some fuel systems also use an in-tank filter, which is nothing more than a screen placed over the fuel outlet of the tank.

Air Cleaner

As the fuel is being filtered and pumped to the carburetor (the other element of the combustible mixture), air is being cleaned — a task which is accomplished by the air cleaner. The three types of air cleaners are listed below and shown in Figure 29.

- Oil-wetted
- Oil-bath
- Dry filter.

The oil-wetted cleaner (Figure 29a) has an element of metal fibers that are wetted with oil. As the air from the atmosphere passes through the cleaner,

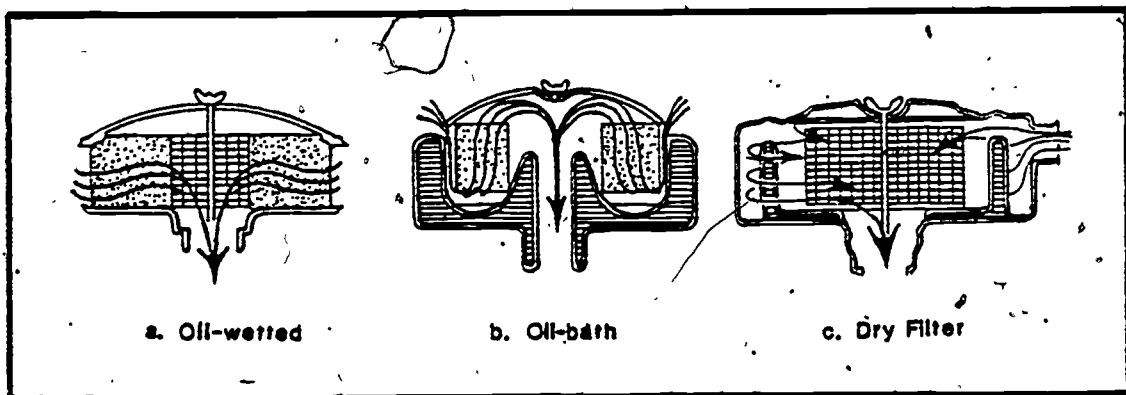

Figure 29. Three Types of Air Cleaners.

the dust and small particles of dirt are caught by the oil. The oil-bath cleaner (Figure 29b) makes the incoming air turn a corner inside the cleaner. Heavier-than-air particles fall out of the air and are trapped by the oil. The air then passes through a metal filter to extract the dust out of the air. The dry-type air cleaner (Figure 29c) uses a porous paper that allows the air to pass freely but filters out the dust and dirt. After the air has been cleaned, it flows into the carburetor.

Carburetor

The carburetor receives clean air and gasoline, mixes it to the right proportion, and supplies it to the engine. The principle of carburetion is similar to the principle used in a common insecticide spray gun (Figure 30). In the latter, air is blown over the top of a small tube, the bottom of which is immersed in a liquid. This rapidly moving air creates a partial vacuum in the tube, causing the liquid to rise in the tube. As the liquid rises to the top, it is drawn out into the air stream and is atomized.

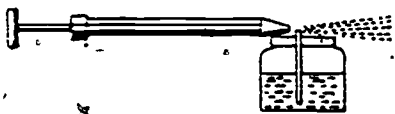

Figure 30. Insecticide Spray Gun.

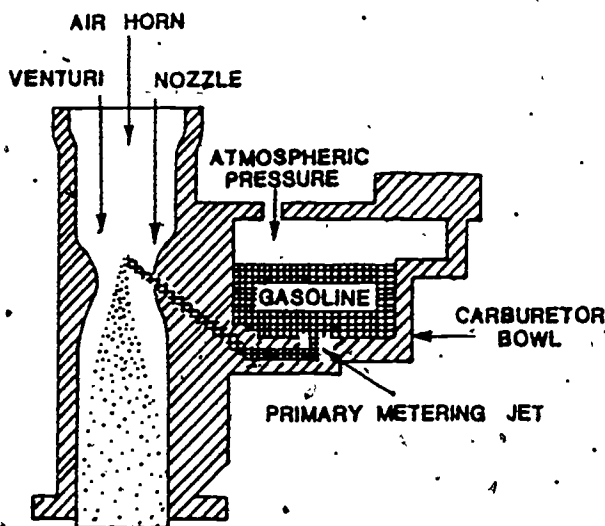

Figure 31. Simplified Carburetor.

A simple carburetor (Figure 31) works in the same way. Air is drawn into the air horn by the vacuum created by the piston moving downward in the cylinder. At the center of the air horn is an area of restricted space called a venturi. The venturi speeds up the air just as the air passes over the nozzle. This rapid flow of air allows a partial vacuum to build up inside the nozzle. The gasoline is sucked out of the carburetor bowl and into the

nozzle; then, as it reaches the end of the nozzle, it is atomized. The fuel-air mixture then flows through the intake manifold and into the cylinder.

Fuel Tank

The fuel tank is used to store the gasoline for the fuel system. It is normally made of a material - such as galvanized steel - which keeps the fuel clean and which does not react with the organic compounds in the fuel.

Fuel Lines

Fuel lines connect the fuel tank, fuel pump, fuel filter, and carburetor in the order listed. These lines - like the fuel tank - must not react with the fuel.

EFFICIENCY OF FUEL SYSTEM

The internal combustion engine will not operate without proper operation of the fuel system. Therefore, monitoring instrumentation (other than a fuel level gauge) is not required. However, the carburetor or fuel nozzle can be adjusted to change the amount of fuel that is introduced into the combustion chamber. Gasoline or diesel fuel needs about 15 pounds of air to burn one pound of fuel efficiently. This produces a fuel-air ratio of 15:1. If the ratio is increased to 16:1 or 17:1, the mixture is said to be "lean"; if it is adjusted below 15:1, it is said to be "rich." Figure 32 shows how changing the fuel-air ratio affects both power and economy.

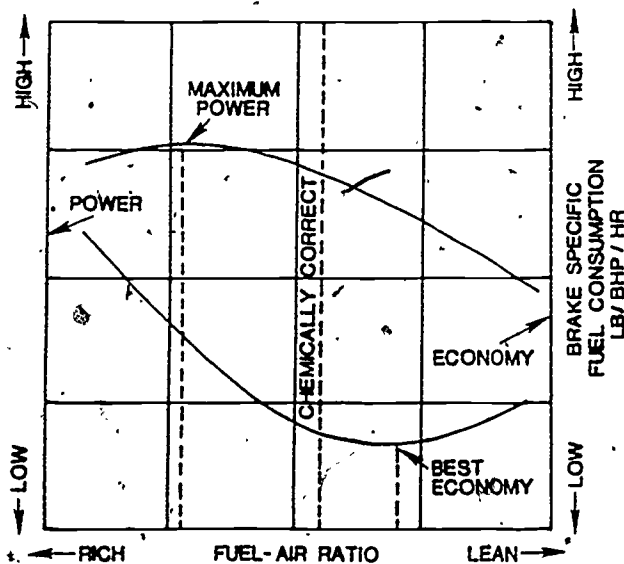

Figure 32. Economy Vs. Power in Internal Combustion Engines.

ELECTRICAL SYSTEM

The electrical system of internal combustion engines has the three following primary functions:

- Igniting the fuel-air mixture
- Starting the engine
- Charging the battery

Each one of these functions has its own components (which will be discussed in detail). However, there are two components of the electrical system that are in each subsystem: the battery and the ignition/starting switch. Rather than discuss these two components under each subsystem, this module will discuss them in the following paragraphs.

Battery

The battery is the storage facility for electrical power in internal combustion engines. Most automotive batteries are the lead-acid type; however, nickel-cadmium batteries are also widely used. Lead-acid batteries use lead plates which act as positive and negative cells. The two groups of plates are joined to separate poles: positive and negative. The number of plates used in a battery determine the voltage of the battery; however, most automotive batteries are 12 volts. Some 6-volt batteries are used in smaller internal combustion engines. Another component of lead-acid batteries is electrolyte, a combination of sulphuric acid and water. The acid reacts with the plates, producing electrical energy.

Nickel-cadmium batteries rely on chemical reactions that can be reversed, that is, the reactants can be changed back to their original chemical state. Because of this fact, there are no by-products of the reaction. Nickel-cadmium batteries have the advantage of a long life (10-15 years); however, their initial cost is higher than lead-acid batteries.

IGNITION/STARTING SWITCH

The ignition/starting switch is a simple electrical switch that has at least three, and sometimes four, positions. The OFF position disengages all electrical circuits on the engine. Once the proper key is inserted into the

the switch, it can be turned to the ON and START positions. To start the engine, the key is turned to the START position. This position activates the starting circuit, allowing the starter to turn the engine flywheel and the ignition circuit to allow the cylinders to fire. Once the engine is started, the switch is turned to the ON position, allowing the starter circuit to be disengaged. The ignition circuit remains closed, allowing the spark plugs to continue to fire and the engine to operate. A fourth position, an ACCESSORY position, allows accessory switches to be activated when the engine is not operating. Thus, accessories such as the radio and windshield wipers can be operated off of the battery power without draining the power of the battery by activating the other circuits.

IGNITION SYSTEM

Compression-ignition engines' fuel-air mixtures combust spontaneously due to the high heat of the larger compression ratios. However, to operate spark-ignition engines, some way must be found to ignite the compressed fuel-air mixtures. Therefore, spark-ignition engines are provided with electrical ignition systems. These ignition systems (Figure 33) consist of the following parts:

- Coil
- Distributor
- Spark plugs

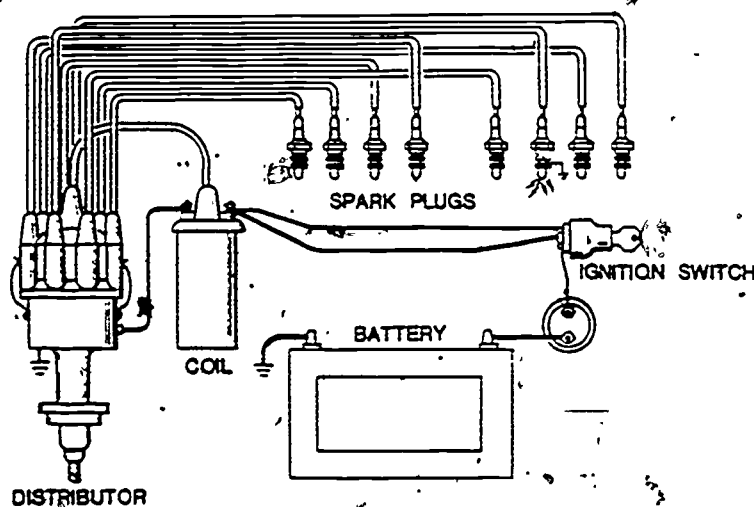

Figure 33. Schematic of a Typical Ignition System.

Coil

The action of the coil is the same as that of a transformer. The coil takes the voltage that is produced by the battery — normally 12 volts — and transforms it to a voltage that will produce a spark across the spark gap of the spark plugs, approximately 24,000 volts. The coil accomplishes this requirement with two sets of internal windings: the primary and the secondary. The primary winding usually has 200 turns of wire, whereas the secondary has as many as 20,000 turns.

Distributor

The purposes of the distributor are to open and close the primary circuit of the coil and to distribute the high voltage of the coil's secondary winding to the spark plugs in the proper sequence.

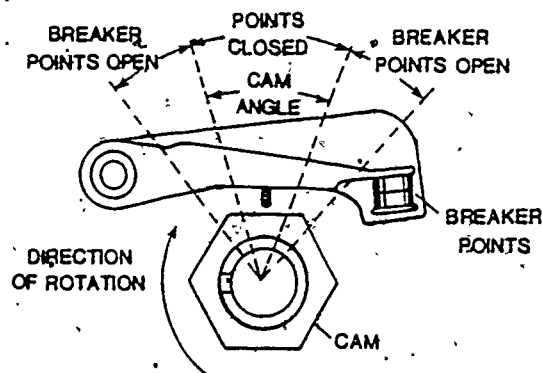

Figure 34. Distributor Cam and Breaker Points.

To open and close the primary circuit of the coil, the distributor uses a cam and a set of breaker points (Figure 34). The cam is geared to the engine camshaft and turns at the same speed as the crankshaft. As the distributor cam rotates, a set of breaker points is opened and closed. With the points closed, electrical energy gradually builds in the primary windings of the coil. As the points are forced open, the primary circuit is broken and the required high voltage is induced into the secondary windings.

To distribute this high voltage of the coil's secondary winding to the spark plug, the distributor uses a rotary switch consisting of a rotor and a cap (Figure 35). The rotor is electrically attached to the secondary winding of the coil and is also attached to the distributor camshaft. It rotates as the engine operates; and as it turns, the tip of the rotor touches the electrical contacts embedded in the distributor cap. As it touches each contact

in turn, the rotor transmits the high voltage to a wire leading to a spark plug.

A condenser is placed between the coil and the breaker points in the distributor to prevent arcing across the points.

This arc would burn and pit the points and would change the clearance distance between them.

Changing the clearance affects the timing and causes the engine to operate less efficiently.

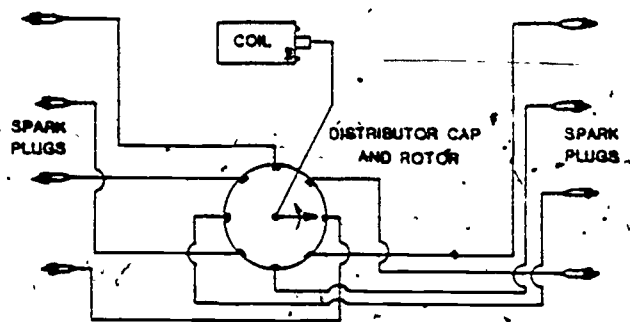

Figure 35. Schematic of High Voltage Ignition Circuit.

Spark Plugs

The function of the spark plug is to produce a spark in the combustion chamber of the engine to ignite the compressed fuel-air mixture. The high voltage pulse from the distributor produces an arc across the gap between the center electrode of the plug and the ground electrode. Normal plug gaps vary from 0.12 to 0.135 inch; however, electronic-ignition systems require a larger gap of approximately 0.15 inch.

Repair and Timing of the Ignition System.

The breaker points, condenser, and rotor of the distributor are often replaced when the engine is tuned. By removing the distributor cap carefully, so as not to dislodge the spark plug wires from the cap, one can observe these items inside the distributor and remove them. The rotor is normally removed by simply lifting it off of the distributor shaft. The points can then be removed by unscrewing the retaining screws. To remove the condenser, one must first unsnap the lead coming from the coil from the lead going to the condenser. Then the screws holding the condenser in place can be removed and the condenser can be separated from the distributor base.

Replacing the components is accomplished in a manner that is just the reverse of that described above. Once the points are in place, they must be gapped with a point gapper to the opening prescribed by the manufacturer. This

is normally accomplished by turning the engine over and inserting the gapper between the points as the distributor cam rotates. Careful attention should be made to ensure that the lead from the coil to the condenser is disconnected; otherwise an electric shock will be suffered by the mechanic. Once the points are gapped, the rotor and distributor cap can be replaced.

Spark plugs are another component of the electrical system that is frequently replaced due to corrosion on electrodes. When spark plugs are replaced, they must be gapped with a spark plug gapper (or "feeler gauge") to the specification recommended by the manufacturer.

Timing of the ignition system is normally accomplished by rotating the distributor until timing marks on the block and on the harmonic balancer (front end of the crankshaft) are aligned. Since engine rotation precludes seeing the mark on the harmonic balancer, a timing light (which is a simple stroboscope) is inserted between the distributor and the spark plug in the number one cylinder. Inserting the timing light in the circuit causes the light to operate at a specified time. By shining the light at the harmonic balancer, the timing mark can be seen. Rotating the distributor causes this mark to move in relation to the mark on the block. Once the two lines are aligned, the engine is timed.

STARTING SYSTEM

Small internal combustion engines are normally hand cranked; however, larger engines require some type of electrical starting system. In addition to a battery and an ignition/starting switch, these systems (Figure 36) consist of a solenoid and a starting motor.

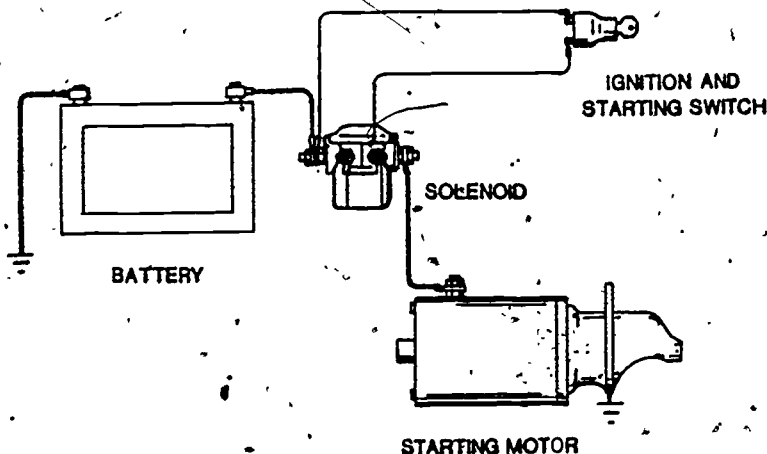

Figure 36. Schematic of a Typical Starting System.

Solenoid

The function of the solenoid is (1) to provide the magnetic force required to engage the starter pinion gear with the flywheel ring gear and (2) to close the electrical circuit between the battery and the starter motor (Figure 37).

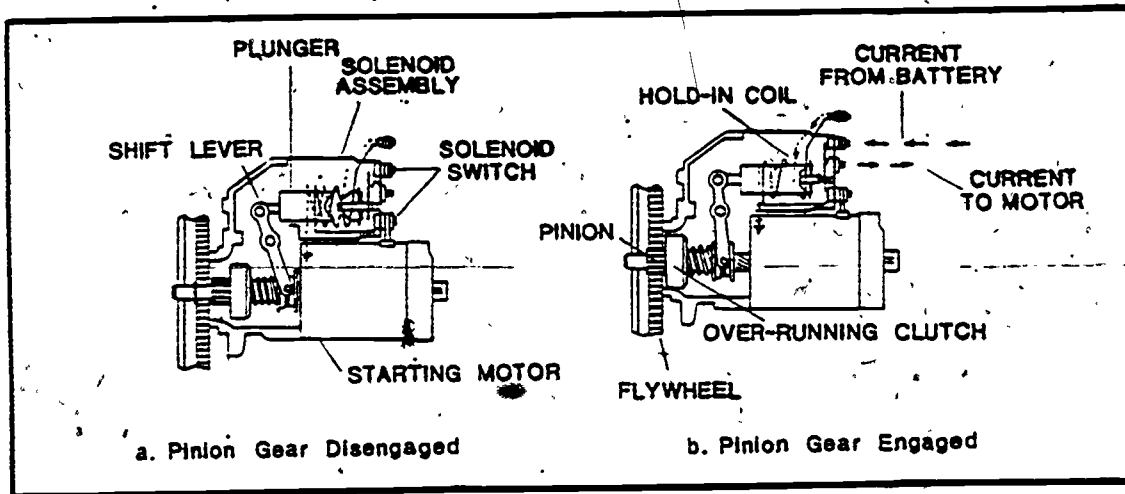

Figure 37. Operation of the Solenoid.

When the starter switch is activated, a small current flows from the battery to the solenoid. The magnetic field produced by this current pulls the solenoid plunger into the coil, engaging the pinion gear and closing the solenoid switch.

Starter Motor

The starter motor is a series-d.c. motor that converts electrical energy into mechanical energy to turn the flywheel. It must produce high torque in order to overcome inertial forces of the engine and to withstand high rpm once the engine is started and before the starter is disengaged. In order to achieve the high torque requirements, a high gear ratio of approximately 16:1 is used between the starter pinion gear and the ring gear on the flywheel. Normal engine starting rpm is approximately 200; therefore, a starter motor with a gear ratio of 16:1 must turn at 3200 rpm to start an engine. This speed represents no problem to the starter motor. However, once the engine starts, it idles at about 800 rpm. This speed drives the starter motor to 12,800 rpm unless the

pinion gear is quickly disengaged. Thus, the starter motor must be more durable than the average electric motor in order to withstand the higher rpms. Most starter motors require about 350 A.

CHARGING SYSTEM

The function of the charging system on internal combustion engines is to provide the electrical power required to operate engine accessories and to replenish the battery's electrical power. To accomplish these functions, the charging system has the following parts (Figure 38) in addition to the ignition/starting switch and the battery discussed previously:

- Alternator/generator
- Voltage regulator
- Ammeter

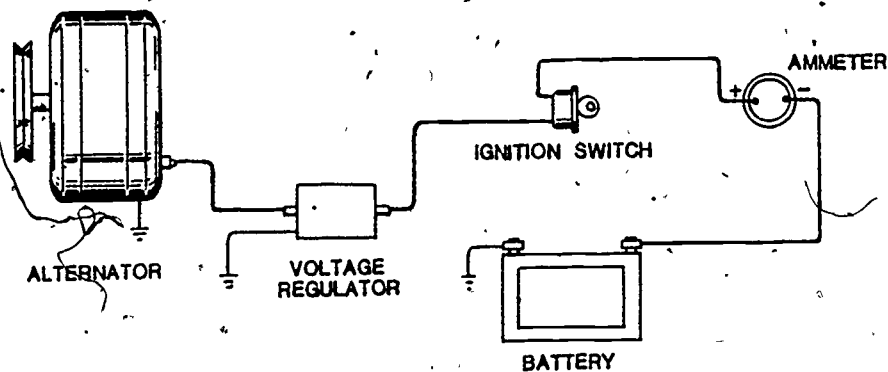

Figure 38. Schematic of a Charging System.

Alternator/Generator

The function of the alternator or generator is to produce electrical power for operating accessories or charging the battery. Either unit is normally mounted on the front of the engine and is belt driven by the crankshaft. A generator produces direct current; an alternator produces alternating current which is rectified to produce d.c. current. Generators have largely been replaced by alternating systems because alternators produce more electrical power at all engine speeds. This fact is especially important in the automotive

field due to the increase in electrically powered accessories and to the requirements of powering these accessories while the engine is idling or running at a low rpm.

Voltage Regulator

The output voltage of an alternator or generator varies with engine speed, but a constant voltage is required for operation of the engine electrical system. The voltage regulator is an electronic circuit that regulates the varying alternator or generator voltage to deliver a constant voltage to the engine electrical system.

Ammeter

The ammeter is used to monitor the operation of the charging system, and it measures the current flowing through the system. Often it is calibrated only with charging, discharging, and neutral positions. If the system is highly charging immediately after the engine is started, then the ammeter indicates that the battery electrical power used to start the engine is being replenished. After the engine has been operating for a short period of time, the ammeter should show a reading closer to the neutral point. If the ammeter continues to show a large charge being transmitted to the battery after the engine has been running for a considerable length of time, there is some fault in the charging circuit — either with the voltage regulator or with the battery. After the engine is warmed up and operational, the desired ammeter reading is one that is slightly closer to the charging side of the neutral point. If, for some reason, the ammeter should show a discharge reading, there is some problem in the system. Either the voltage regulator or alternator/generator could be faulty.

EXERCISES

1. Explain the advantages and disadvantages of Stirling engines.
2. Explain the advantages and disadvantages of the Wankel rotary engine.
3. Explain the function of the rings on the piston of a reciprocating engine.

4. Explain the operation of the following electrical subsystems in a spark-ignition engine (include the function of each component):
 - a. Ignition system
 - b. Starting system
 - c. Charging system
5. Explain the operation of the valve train of a reciprocating engine.
6. Explain the operation of the thermostat in a water-cooled engine. Why is controlling engine temperature important?

LABORATORY MATERIALS

Spark-ignition engine with at least four cylinders.

Set of breaker points that fits the engine.

Condenser that fits the engine.

Rotor that fits the engine.

Feeler gauge for breaker points.

Timing light.

Set of wrenches.

Screwdriver set.

LABORATORY PROCEDURES

1. Remove the distributor cap.
2. Remove the rotor, condenser, and breaker points from the distributor.
3. Replace old parts with new points, a condenser, and a rotor. Do not connect the coil wire to the condenser.
4. Gap the points to prescribed measurement with the feeler gauge.
5. Connect the coil wire to the condenser.
6. Replace the distributor cap.
7. Insert the timing light between the number one cylinder and the corresponding spark plug wire.
8. Time the engine.

9. In the Data Table, list the steps that were performed in gapping the points and timing the engine. Then, discuss any problems encountered and how they were solved.

DATA TABLE

DATA TABLE.

Steps in Gapping the Points:

Steps in Timing the Engine:

REFERENCES

- Ansdale, R.F. The Wankel RC Engine. New York: A.S. Barnes and Company, 1969.
- Atteberry, Pat H. Power Mechanics. Homewood, IL: The Goodheart-Willcox Co., Inc., 1968.
- Bushnell, Charles H. Diesel Engine Operation, Maintenance and Repair. New York: John Wiley and Sons, Inc., 1930.

- 1
- Degler, Howard E. Diesel Engines: Theory and Design. Chicago: American Technical Society, 1943.
- Faires, Virgil Moring. Applied Thermodynamics. New York: The MacMillan Company, 1949.
- Gill, Paul W.; Smith, James H., Jr.; and Zuirys, Eugene J. Internal Combustion Engines. Annapolis, MD: United States Naval Institute, 1969.
- Lewitt, E.H. Thermodynamics Applied to Heat Engines. London: Sir Isaac Pitman and Sons, Ltd., 1951.
- Skrotzki, B.G.A., associate editor. "Oil and Gas Engine," Power, New York: McGraw-Hill. December 1964.
- Taylor, Charles Fayette. The Internal-Combustion Engine in Theory and Practice. Volume I. Cambridge, MA: The MIT Press, 1966.
- Taylor, Charles Fayette. The Internal-Combustion Engine in Theory and Practice. Volume II. Cambridge, MA: The MIT Press, 1968.
- The Way Things Work. Volume I. New York: Simon and Schuster, 1967.
- The Way Things Work. Volume III. New York: Simon and Schuster, 1971.
- Toboldt, William K. Diesel: Fundamentals, Service, Repair. South Holland, IL: The Goodheart-Willcox Company, Inc., 1977.
- Waltz, R.W., Maj., ed. Automotive Engineering. Volume I. West Point, NY: U.S. Military Academy, August 1978.
- Walker, G. Stirling-Cycle Machines. Oxford: Clarendon Press, 1973.

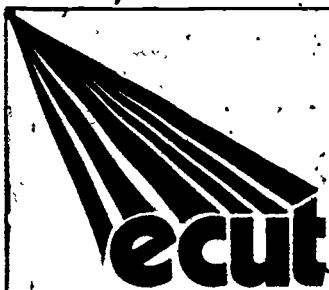

ENERGY TECHNOLOGY

CONSERVATION AND USE

ENERGY PRODUCTION SYSTEMS

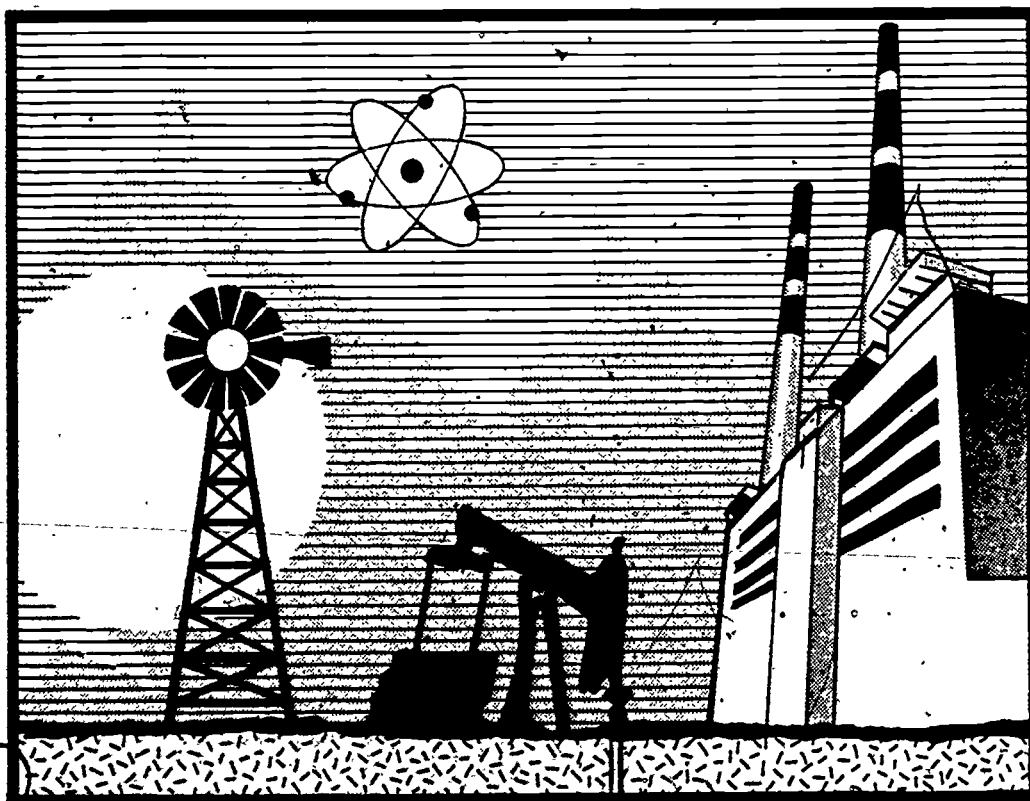

MODULE EP-06

TURBINES



CENTER FOR OCCUPATIONAL RESEARCH AND DEVELOPMENT

INTRODUCTION

A turbine is an energy converter that changes the kinetic energy of a moving fluid to the mechanical energy of a rotating shaft. Most turbines use steam, air, or water as working fluids. Steam turbines are used to power ships and most large electrical generators. Gas turbines power jet aircraft and medium-sized generators. The energy of falling water is converted to electrical energy by hydraulic turbines.

This module discusses the design, operation, and application of the above types of turbines. Major emphasis is placed on steam turbines because of their major role in electrical power production. In the laboratory, the student will operate a small hydraulic impulse turbine.

PREREQUISITES

The student should have completed Fundamentals of Energy Technology.

OBJECTIVES

Upon completion of this module, the student should be able to:

1. List the three major components of a simple steam turbine and state the purpose of each.
2. Sketch the shape of the nozzle vanes and rotor buckets that are components of the following types of steam turbines:
 - a. Impulse turbine
 - b. Reaction turbine
3. Draw side views of the nozzles and rotor and stator blades that are components of the following types of turbines:
 - a. Single-stage impulse turbine
 - b. Velocity-stage impulse turbine
 - c. Pressure-stage impulse turbine
 - d. Combination pressure- and velocity-stage impulse turbine
 - e. Reaction turbine
 - f. Combination impulse reaction turbine

4. Explain the operation of the following steam turbine components:
 - a. Diffuser nozzle
 - b. Blade seals
 - c. Carbon ring seal
 - d. Labyrinth seal
 - e. Steam chest
 - f. Extraction port
 - g. Turning gear
5. Explain the advantage of a double-flow turbine over a single-flow turbine.
6. Explain the differences in operation, efficiency, and application of condensing turbines and non-condensing turbines.
7. Explain the operation and application of the following turbine systems:
 - a. Mixed pressure turbine
 - b. Extraction turbine
 - c. Reheat turbine
8. Draw and label a diagram showing the basic components of a gas turbine and explain the purpose of each component.
9. Explain the design and operation of the two common types of combustors.
10. Describe characteristics of gas turbines that make them suited for the following applications:
 - a. Jet aircraft power plants
 - b. Stand-by electrical power for peak loads
 - c. Rural voltage booster stations
11. List four types of hydraulic turbines and state the approximate head height used with each type.
12. List the two major classes of wind turbines.

SUBJECT MATTER

STEAM TURBINES

A steam turbine is a form of heat engine in which the thermal energy of high temperature, high pressure steam is converted to kinetic energy by allowing the steam to expand through a nozzle. The steam jet is directed at blades connected to a rotating shaft. The force of the steam against the blades produces torque that turns the shaft.

Steam turbines are the most efficient devices available for converting thermal energy to mechanical energy on a large scale. They are widely used in the production of electricity and as the power source for large ships. The turbines used in these systems are designed to extract the maximum energy from the steam that passes through them. They are called condensing turbines because they condense the steam back into liquid water.

In many industrial power systems, steam is used as a medium of heat transfer — that is, the purpose of the power system is to deliver steam, not to do mechanical work. Such systems require mechanical energy to drive pumps, fans, auxiliary generators, and other support equipment. This energy is often supplied by non-condensing steam turbines that convert a portion of the thermal energy of the steam to mechanical work. The steam leaving such a turbine still contains sufficient heat energy to be used in heating processes.

THE SIMPLE STEAM TURBINE

The three basic components of a simple steam turbine are as follows:

- A nozzle for expanding the steam and directing it toward the blades of the turbine rotor.
- A rotor with blades that change the direction of the steam jet and, thus, produce output torque.
- A casing to contain the expanding steam and to direct it through the rotor blades.

Figure 1 is a simple steam turbine called a solid-wheel turbine. The rotor of this turbine is a cast wheel with circular cups located around the rim. A nozzle directs expanding steam into one side of the circular cup. The steam swirls through the cup and the depressions in the turbine casing. Only a portion of the casing is shown in Figure 1. The escaping steam is actually contained

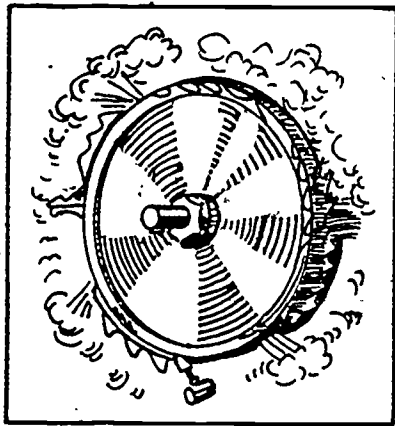

Figure 1. Solid-Wheel Turbine.

inside the casing and is piped away to perform other work.

The solid-wheel turbine converts only a fraction of the input thermal energy into mechanical work; but this fraction is converted efficiently, and the energy remaining in the steam is used elsewhere. The solid-wheel turbine is one of the simplest and most durable and dependable energy converters ever devised. It has been widely used to drive auxiliary equipment in steam heating systems for much of this century.

The rotor of a more efficient, modern steam turbine consists of a series of blades or vanes connected radially to a central shaft. Two shapes of rotor blades are commonly used. Modern turbines are classified, according to rotor blade shape, as either impulse turbines or reaction turbines.

IMPULSE TURBINES

The shape of the nozzle vanes and rotor buckets of an impulse turbine are shown in Figure 2. The steam expands through the nozzle vanes, reducing steam

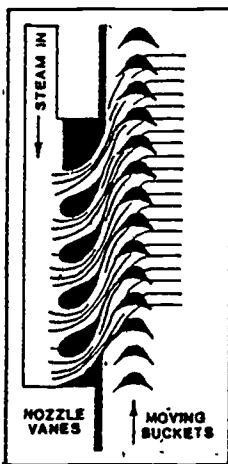

Figure 2. Schematic of Impulse Stage Blading.

pressure and increasing steam velocity. The concave surfaces of the half-moon-shaped buckets change the direction of flow of the steam and are forced upward, as shown in Figure 2. All impulse steam turbines have this characteristic rotor blade shape. Pressure drops and velocity increases occur in impulse turbines only in the nozzles.

Single-Stage Impulse Turbine

Figure 3 shows top and side views of the steam nozzles and buckets of a single-stage impulse turbine. This non-condensing turbine is used for the same applications as the solid-wheel turbine, but it converts a greater percentage of the input thermal energy to mechanical work. Single-stage impulse turbines can have efficiencies as high as 60%. Forty percent of the original thermal energy remains in the steam for future use.

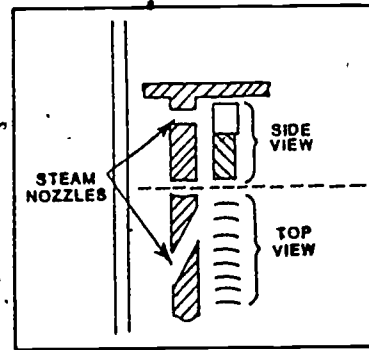

Figure 3. Top and Side Views of Single-Stage Impulse Turbine.

Velocity-Stage Impulse Turbine

Greater turbine efficiency can be achieved by adding a set of fixed blades and another set of moving blades to the single-stage turbine to produce the velocity-stage impulse turbine shown in Figure 4.

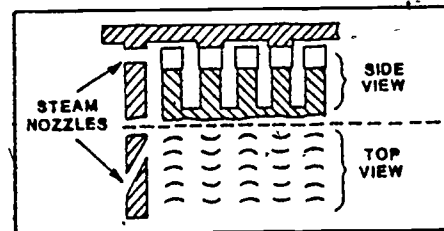

Figure 4. Top and Side Views of Velocity-Stage Impulse Turbine.

Figure 5 shows the steam flow through such a turbine. The fixed blades following the first set of moving blades redirect the steam to produce force on the second set of moving blades. In the velocity-stage turbine, the steam pressure is converted to velocity at a single nozzle. This constant velocity steam is then used to drive two or more sets of turbine blades.

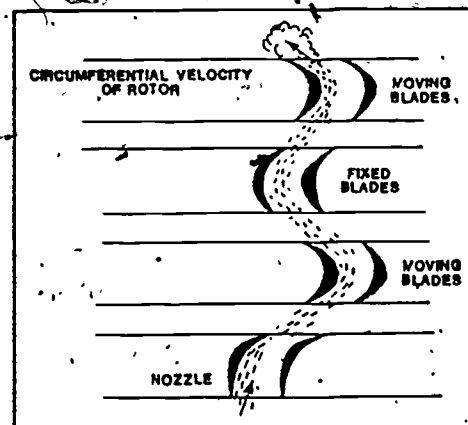

Figure 5. Double-Row Curtis Turbine (Velocity Staging).

Pressure-Stage Impulse Turbine

Figure 6 shows a pressure-stage impulse turbine, which, essentially, is two or more complete single-stage turbines, connected in series in a single casing.

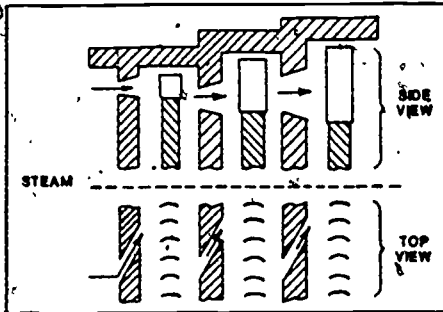

Figure 6. Top and Side Views of Pressure-Stage Impulse Turbine.

The stages are separated by nozzles that reduce the steam pressure in steps, with a lower pressure in each succeeding stage. The volume of each stage is larger than the last in order to allow for steam expansion, and the rotor blades are larger in the lower pressure stages in order to maximize efficiency.

Combination Pressure- and Velocity-Stage Turbine

Figure 7 shows a turbine that combines both pressure staging and velocity staging in order to achieve maximum turbine efficiency.

Velocity-stage, pressure-stage, and combination-stage impulse turbines are used in electrical power production and marine power. In most systems, several turbines are connected on a single shaft and operate in principle as a combination pressure- and velocity-stage turbine, even though individual turbine units may have a different design. The high pressure sections of such systems operate as non-condensing turbines, passing steam on to the lower pressure sections. The last turbine section is usually a condensing turbine. The output from this stage consists of liquid water and water vapor at pressures below atmospheric pressure. Such turbines can be constructed with efficiencies of 90%.

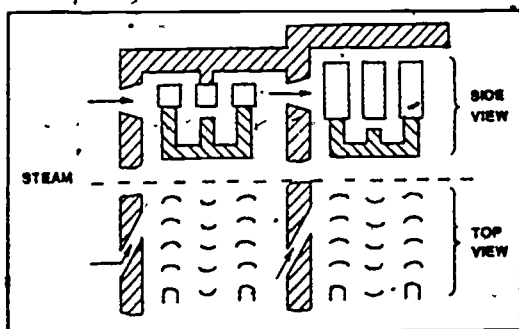

Figure 7. Top and Side Views of Combination Pressure- and Velocity-Stage Turbine.

REACTION TURBINES

Figure 8 shows the nozzle vanes and moving buckets of a reaction turbine. The moving buckets of this turbine have the same shape as the nozzle vanes. A completed reaction turbine consists of several alternating sets of fixed and moving vanes, as shown in Figure 9. Each set of vanes is larger and longer than the preceding set.

In impulse turbines, pressure drops and velocity increases occur only at the nozzles. In the reaction turbine, they occur at each set of blades, both fixed and moving. Each set of vanes acts as an expanding nozzle for the next set. Reaction turbines are the most efficient type, with peak efficiencies of slightly over 90%.

Figure 10 shows a combination impulse-reaction turbine. Most of the thermal energy is converted to mechanical energy in the impulse section of the turbine. The remaining thermal energy is converted to mechanical energy by the highly efficient reaction turbine. In this system, the reaction turbine usually acts as a condensing turbine. The impulse reaction turbine is the most popular configuration for electrical power production, but multistage impulse turbines are also used.

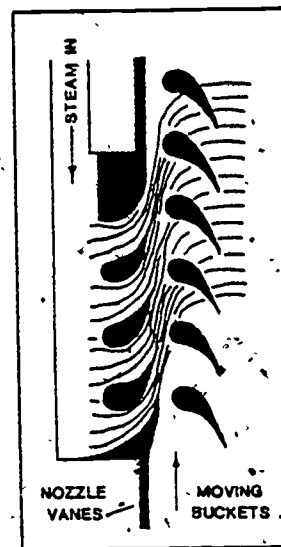

Figure 8. Schematic of Reaction-Stage Blading.

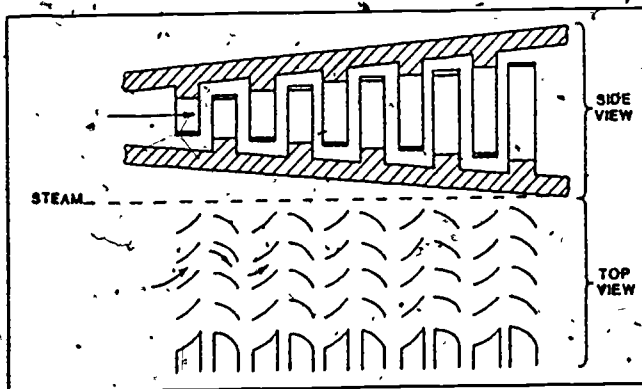

Figure 9. Top and Side View of Reaction Turbine.

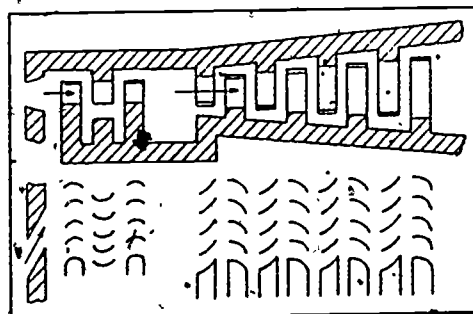

Figure 10. Combination Impulse-Reaction Turbine.

STEAM TURBINE DESIGN FEATURES

Impulse and reaction turbines differ only in the shape of their rotor blades. The following descriptions of construction details apply to both types.

Nozzles

Figure 11 shows two nozzle designs used in steam turbines. The converging nozzle (Figure 11a) constricts the flow of steam to produce a jet steam at high pressure. The diffusing nozzle (Figure 11b) includes a diffuser section that results in more expansion of the steam, greater pressure drop, and higher steam velocity. Figure 12 is a diagram showing the inlet, throat, and diffuser of a typical nozzle.

Most nozzles are the diffuser type, since higher steam velocity produces greater torque. Constricting nozzles are often used in the high pressure stage of multistage steam turbines and in gas turbine jet engines.

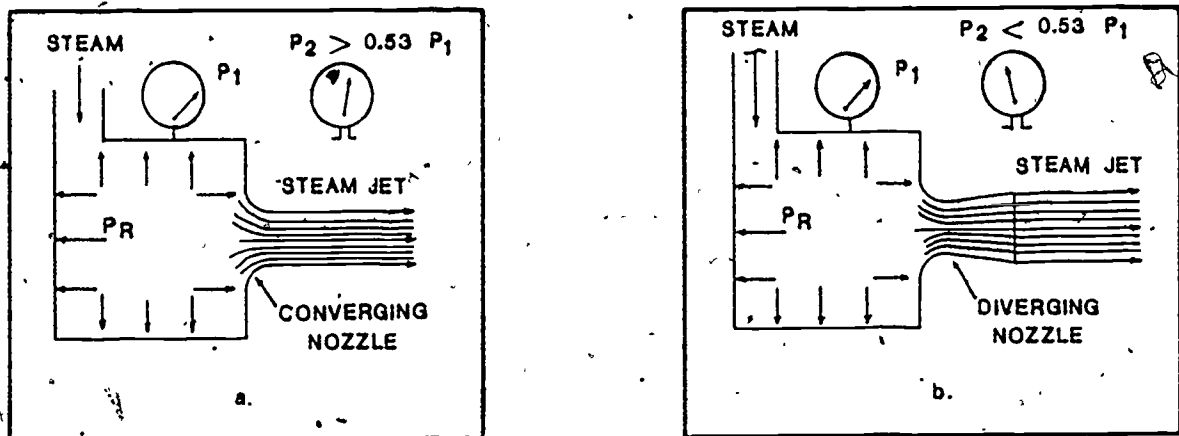

Figure 11. Two Types of Nozzles Used in Steam Turbines.

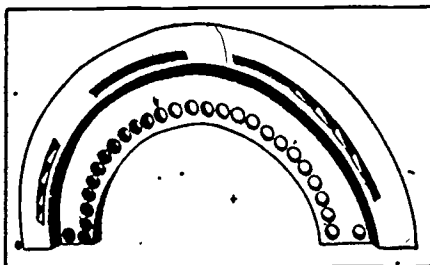

Figure 12. Typical Nozzle Block with Three Groups of Converging Nozzles.

Figure 12 shows the nozzle block of a steam turbine. The individual nozzles are arranged around the nozzle block in order to distribute steam continually to most of the turbine blades.

Rotor

Figure 13 shows a single rotor blade of a steam turbine. The blade root fits into a slot in the rotor wheel, as shown in Figure 14. The tenon on the other end of the blade fits into a slot in a circular shroud around the blades.

The blades in the initial stages of a turbine come into contact with superheated steam and must withstand high temperatures without warping or deterioration. These blades are made of high strength steel alloys. The blades in the condensing section of the turbine are in contact with wet steam and water and are made of corrosion resistant steel alloys.

The centers of the rotor wheels are keyed to the turbine shaft. Rotors are often constructed by simply stacking the assembled rotor wheels and spacers on the shaft.

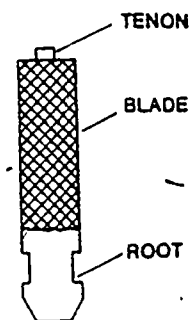

Figure 13.
Parts of a
Rotor Blade.

Casing

The turbine casing encloses the rotor and holds the nozzle blocks, stators (stationary blade rings), bearings, and other stationary parts. High-pressure turbine casings are constructed of specially alloyed steel to withstand the high pressures and temperatures of the steam. Low pressure turbine casings can be made of either cast iron or low-carbon steel. Casings are constructed in halves, with the casing split horizontally - which allows access to the interior of the turbine by lifting off the top casing half. In larger turbines and some smaller ones, the casing contains a separate cylinder that supports the stator rings and nozzle blocks. In these turbines, the cylinder is also split in half, and the top half lifts off with the casing.

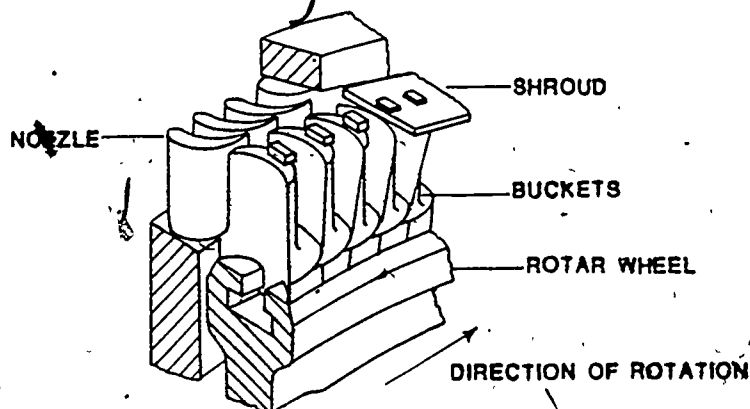

Figure 14. Parts of a Rotor.

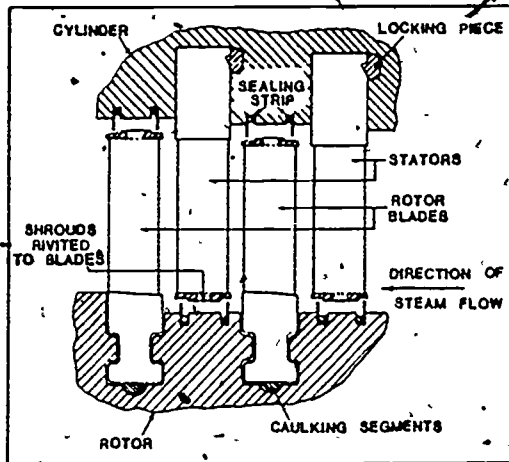

Figure 15. Positioning and Mounting of Stator Blading.

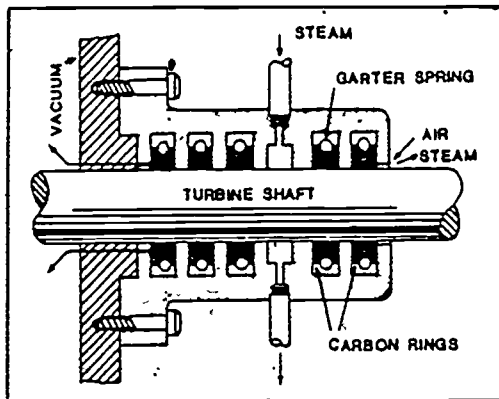

Figure 16. Carbon Rings

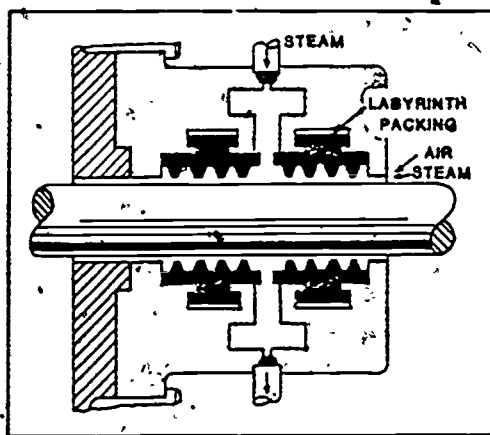

Figure 17. Labyrinth Gland.

Blade Seals

Figure 15 shows the blade seals between adjacent blade sets in a reaction turbine or a velocity-stage turbine. The sealing strips for the rotor blades extend from the cylinder walls almost to the shrouds of the rotor. The strips for the stator blades are located on the rotor shaft. As shown in Figure 15, there is some space between the shrouds and sealing strips that allows for uneven expansion and contraction of the rotor and cylinder during operation.

Shaft Seals

Two types of shaft seals are commonly used on steam turbines. Smaller models employ the ring seals shown in Figure 16. The rings are usually made of carbon, but other materials can be used. Each ring is split into three equal segments, which are held against the turbine shaft by garter springs. In Figure 16, steam is introduced between two of the rings to prevent air from entering the turbine; but this is not always done.

Figure 17 shows the labyrinth seals used on larger steam turbines. The labyrinth packing is made of soft white-metal and fits the shaft flosely. Steam introduced between the two labyrinth sections prevents air from entering the turbine. Some labyrinth seals also have vacuum sections that keep steam from escaping into the air.

Bearings

The turbine shaft is supported by bearings mounted on the casing external to the shaft seals. All large turbines use pressure-lubricated journal bearings of either the plain or self-aligning type. Packing in the bearings and shaft seals assures that no oil from the bearing can enter the turbine and contaminate the steam.

Thrust bearings are designed to resist the shaft end thrust produced by the steam pressure differential across the turbine blading. Several common types of thrust bearings can be used.

Steam Chest

The steam chest is the intake manifold of the turbine which receives steam from the boiler and routes it to the appropriate nozzle block. It contains the throttling valve for the turbine.

Extraction Ports

Many steam turbines have extraction ports (Figure 20) which are located between stages and which can be used to extract steam at a desired temperature and pressure for some external purpose. In some cases, these ports are also used to reintroduce steam from an external process into the turbine so its remaining energy can be extracted.

Turning Gear

All large turbines and many smaller ones are equipped with a motor-driven turning gear. This gear is used to bring the turbine up to about 60% of its running speed before steam is applied. When an operating turbine is shut down, the turning gear keeps the rotor turning while the turbine cools.

Steam Flow Paths

Figure 18 shows four possible steam flow paths for multistage turbines. Single-flow turbines (Figure 18a) have a single casing with all stages in line. The steam enters one end and leaves the other.

Double-flow turbines (Figure 18b) split the input steam between two identical paths. Each of the identical turbine halves has a high pressure section at

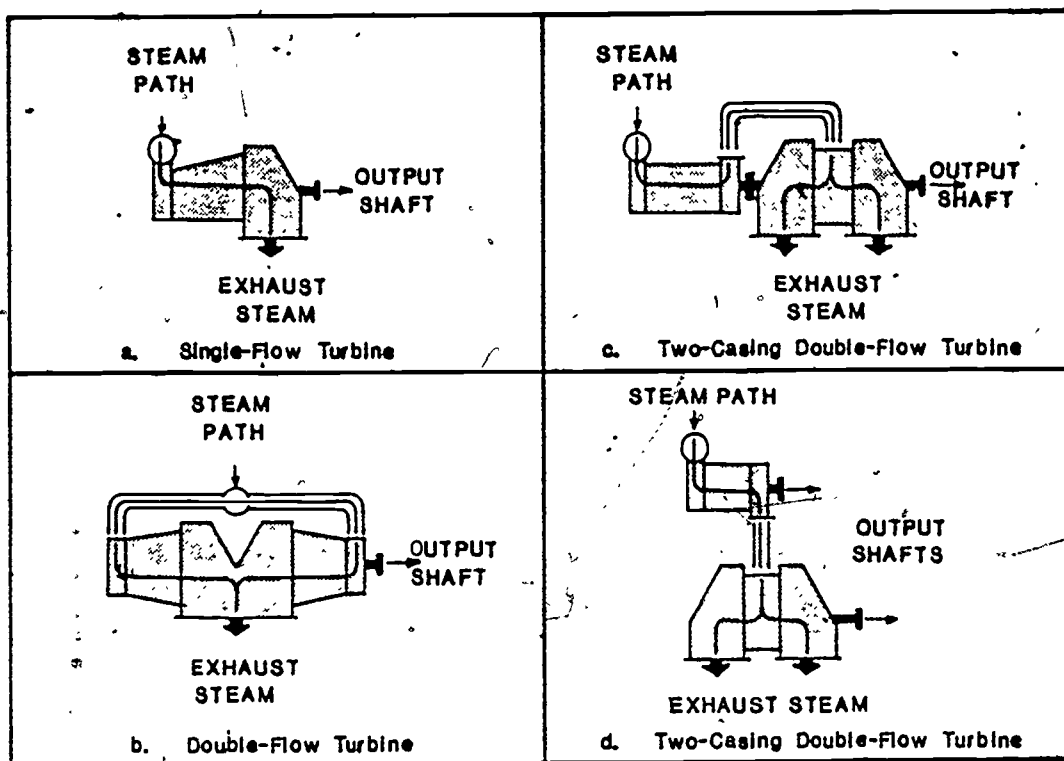

Figure 18. Steam Flow Paths for Multistage Turbines.

the outer end and a low pressure section in the center. Most of the largest steam turbines (up to 1,000,000 kW) are designed in this manner because the axial thrust of the two turbine halves offset each other.

Figures 18c and 18d show two possible configurations of two-casing, double-flow turbine systems.

STEAM TURBINE SYSTEMS AND APPLICATIONS

Steam turbines are commercially available in a large number of configurations in sizes from a few horsepower to a million horsepower. Turbines are classified according to their size (power rating) and to the conditions of their input and output steam. Most turbine systems fall into one or more of the following categories.

Condensing Turbines

Condensing turbines are designed to extract the maximum thermal energy from the input steam. The output of such turbines is liquid water and low pressure water vapor. The output port of the turbine is connected to a condenser that maintains an exhaust pressure of less than atmospheric pressure in order to increase turbine efficiency. Condensing turbines can be designed to operate at high (more than 400 psig), intermediate (150-450 psig), or low (less than 150 psig) input steam pressures. Most electrical generating stations are powered by high pressure condensing turbines. Most marine turbines are intermediate or low pressure condensing turbines.

Non-Condensing Turbines

The output of a non-condensing turbine is steam which contains sufficient thermal energy for other uses. Most auxiliary steam turbines are this type. Large non-condensing turbines are used in applications requiring both electrical energy and steam. The output steam from the turbine can be used for environmental or industrial heating.

Mixed Pressure Turbines

Figure 19 shows the steam flow in a mixed pressure turbine. This turbine has a high pressure inlet connected directly to a boiler. Boiler steam is also used for some other process which lowers its temperature and pressure but leaves recoverable energy in the steam. This used steam is introduced into a lower pressure stage of the turbine.

Extraction Turbine

In the extraction turbine (Figure 20) all the input steam enters from the boiler and passes through the high pressure section of the turbine. A portion of the cooler, lower-pressure steam is extracted for external use, and the remainder

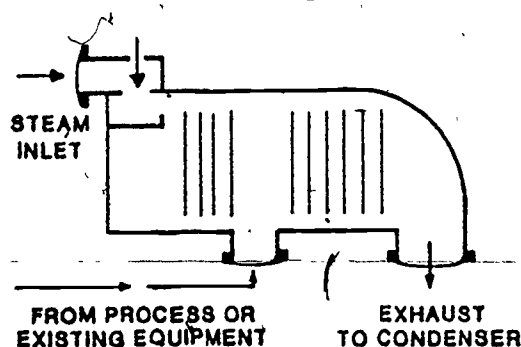

Figure 19. Mixed Pressure Turbine.

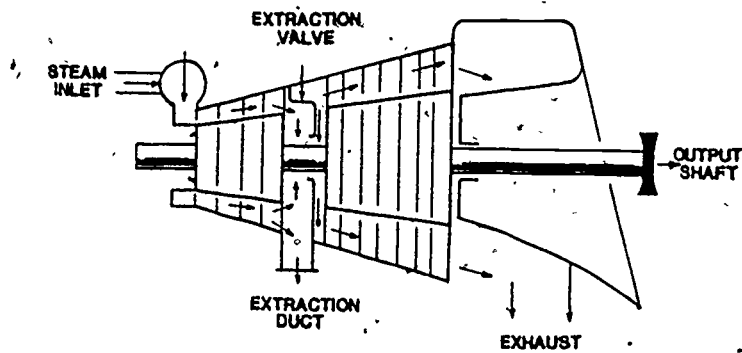

Figure 20. Single Automatic Extraction Turbine.

continues through the low pressure section of the turbine.

Both extraction and mixed pressure turbines are widely used to achieve maximum efficiency in steam driven power systems. Most are the condensing type.

Reheat Turbines

Figure 21 shows a reheat turbine. After the high pressure steam has expanded through a high pressure turbine stage, it is extracted, reheated to approximately its original temperature, and introduced into the next turbine stage. Reheat turbines provide the most efficient system of electrical power production.

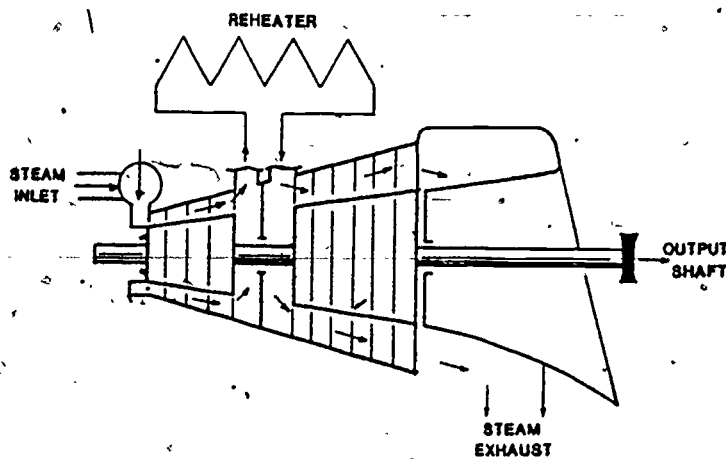

Figure 21. Single-Reheat Turbine.

GAS TURBINES

Gas turbines are designed to produce shaft rotation by compressing and heating air and, then, expanding the air through a turbine. The mechanism by which the shaft is turned is the same as that in the steam turbine, but the working medium is air. The major difference in the operation of a gas turbine and a steam turbine is the source of heat energy. The steam turbine receives heat energy in the form of steam from an external boiler. The gas turbine burns a liquid or gas fuel internally to produce the required heat energy.

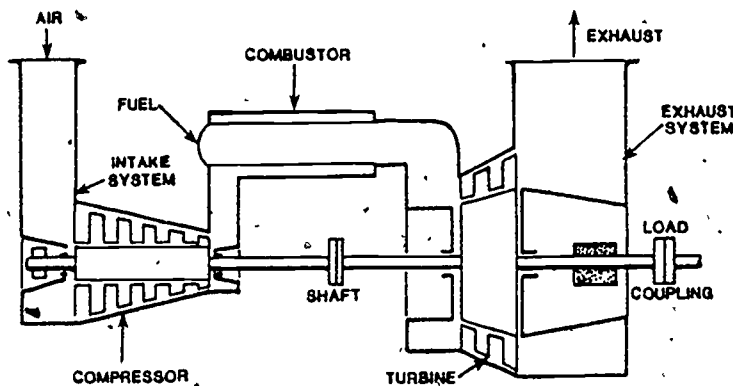

Figure 22. Schematic of a Simple Gas Turbine.

Figure 22 shows the major components of a gas turbine. Air enters the intake system, is compressed by the compressor, and is forced into the combustor where fuel is added and ignited. The heated air expands through the turbine, producing rotational motion; then it is exhausted through an exhaust system. The rotational motion of the turbine drives the compressor.

Gas turbines used for electrical power production are designed to convert most of the thermal energy of the air to mechanical energy. They exhaust low velocity air at atmospheric pressure. Gas turbines used to power aircraft produce only enough mechanical energy to run the compressor. Most of the energy leaves the turbine in the form of high velocity exhaust which pushes the aircraft forward.

GAS TURBINE DESIGN FEATURES

As shown in Figure 22, the five major components of a gas turbine are the following:

- Air intake system
- Compressor
- Combustor
- Turbine
- Exhaust system

Air Intake System

The air intake system of a gas turbine performs one or more of the following functions:

- Air filtration
- Air cooling (for greater compressor efficiency)
- Sound muffling (to protect personnel)
- Anti-icing protection and weather insulation

Compressor

After environmental air leaves the air intake system, it enters the compressor. The compressor increases the air pressure to approximately 50-75 psig. Two types of compressors are commonly used.

Figure 23a shows the rotor of a centrifugal compressor. Air enters the center of the impeller and is forced through the outside slots by centrifugal action. Since the outside area of the air passage is smaller, the air is compressed.

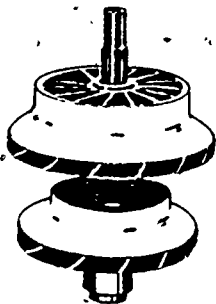

a. Centrifugal

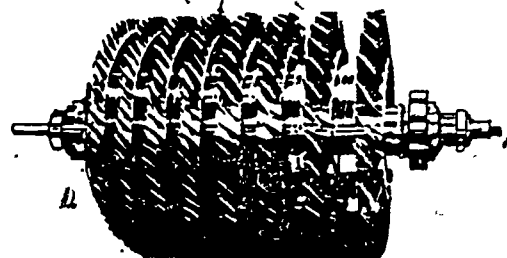

b. Axial

Figure 23. Rotors for Two Types of Compressors.

Figure 23b shows the rotor of an axial compressor. This is a reaction turbine with the curve of its rotor blades reversed. Instead of allowing the gas passing through it to expand and speed up, it reduces velocity and increases pressure.

Axial compressors are more efficient than centrifugal compressors, but they are also heavier and larger. Both types have been used for aircraft plants and electrical power production.

Combustor

After the pressurized air leaves the compressor, it enters the combustor where fuel is added and burned. Normal combustion occurs with 15 parts of air (by weight) to one part of fuel. In gas turbines, the mixture is closer to 70 or 80 parts of air to one part of fuel. This mixture is required to cool the air entering the turbine blades, but it is also difficult to ignite and will not sustain even combustion. The combustor solves this problem by mixing the fuel with only a portion of the air before combustion. Two types of combustors are in common use.

Figure 24 shows the flame-tube combustor, commonly used on stationary gas turbines. The combustor tube is filled with small holes that allow some air to enter it and to mix with the fuel inside. The remainder of the air flows around the tube and cools it. Combustion takes place continuously inside the flame tube, and the gases mix before they reach the turbine.

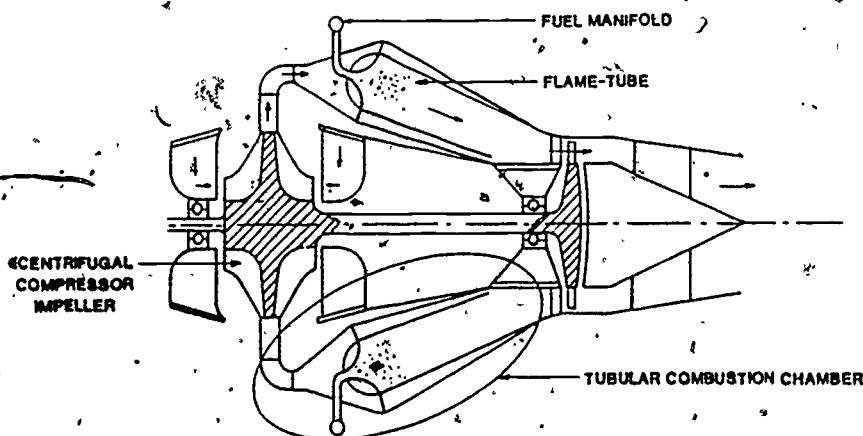

Figure 24. Cross Section of Turbine with Tubular Combustor and Centrifugal Compressor.

Figure 25 shows the annular combustor after it is used in aircraft gas turbines. The annular combustion chambers are rings around the outside of

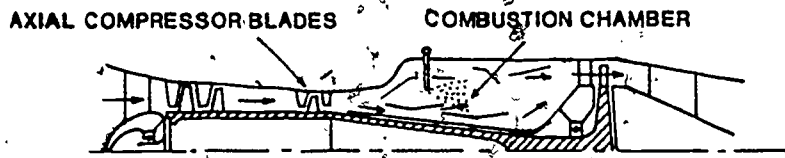

Figure 25. Cross Section of an Annular Combustion Chamber.

the compressor-to-turbine air passage. The entire flow of air moves through the combustion chamber, but it is split so only a small portion of the air enters the immediate area of combustion.

Turbine

The heated gas (650-1700°F, depending on turbine design) leaves the combustor and expands through the turbine. Several designs have been used for gas turbines, but most are reaction turbines with three or four rotor wheels.

Exhaust System

The exhaust system returns the exhaust gases to the atmosphere or introduces them into another heating system. Figure 26 shows a recuperative exhaust system that uses exhaust gases to heat input air after it has been compressed. Since the exhaust gas still contains 80% of its original free oxygen content, it can be used as the air input to the furnace of a steam boiler.

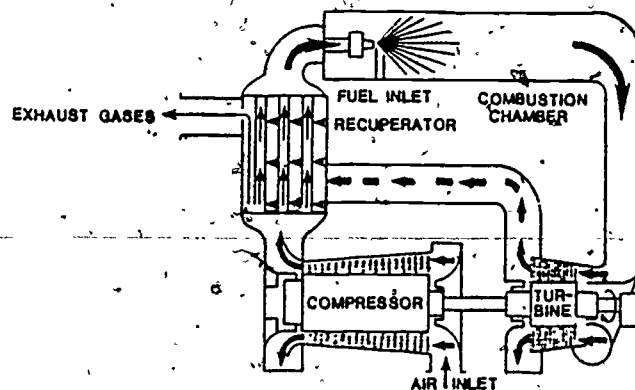

Figure 26. Schematic of Gas Turbine with Recuperative Exhaust System.

GAS TURBINE CHARACTERISTICS AND APPLICATIONS

The gas turbine delivers greater output power per pound of weight than any other convertor. It is dependable, portable in small sizes, and requires no elaborate cooling systems. Gas turbines are simpler to operate and easier to maintain than most other power sources. They can be brought from a standstill to full power in less than a minute, and they can be adapted to burn a variety of fuels. For these reasons, gas turbines are the most widely used power sources for aircraft (including turboprop), and they have also been used in marine vehicles and large trucks. But, they are not used in automobiles because they are less efficient than reciprocating engines and more costly.

Gas turbines cannot be used for large scale electrical power generation, but gas turbine generators are in common use in the following applications:

- The overall efficiency of a fossil-fuel fired generating station can be improved as much as 3% by using gas turbine exhaust air as furnace input air.
- At peak load periods, stand-by gas turbine generators can be brought into operation quickly to meet rising electrical demands. Such generators can be used only for a few hours a day or during extreme weather conditions when electrical demands are highest. Low maintenance, high reliability, and rapid start-up make the gas turbine the ideal auxiliary power source.
- Gas turbine generating stations can be used to increase line voltage at the extremes of long distribution systems. They also serve as auxiliary local power in rural areas when the power distribution network is broken. Some systems of this type require no external cooling water and can be operated by remote control.

HYDRAULIC TURBINES

A hydraulic turbine uses water as the working medium to turn a rotor, called a runner, which is attached to an electrical generator. Several turbine designs can be used, depending upon the height of the input water above the turbine.

HYDRAULIC IMPULSE TURBINE

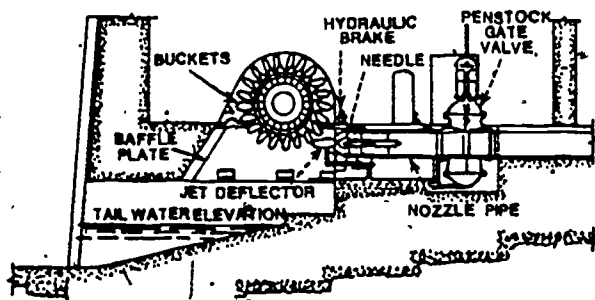
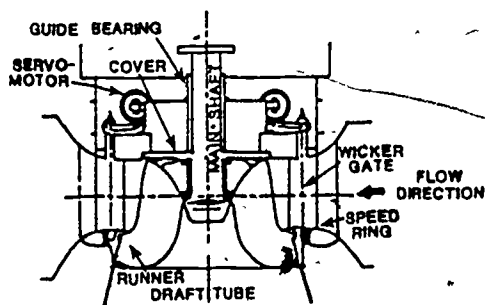

Figure 27. Impulse-Type Hydraulic Turbine.

Figure 27 shows a hydraulic impulse turbine used when the water depth is 1000 feet or more. A jet nozzle directs water into the buckets on the rotor wheel. Only a few hydroelectric sites have sufficient head pressure to allow the efficient use of hydraulic impulse turbines.

HYDRAULIC REACTION TURBINES

Several types of hydraulic reaction turbines are used for heads of a few feet to a few hundred feet in size. Figure 28a shows a Francis-type reaction turbine used for water depths of 100 to 1000 feet.



a. Francis-Type

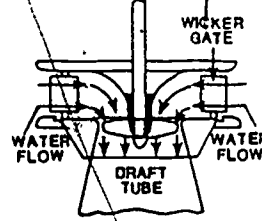

b. Propeller

Figure 28. Hydraulic Reaction Turbines.

Dams with low heads (100 to 400 feet) usually use propeller turbines similar to the one shown in Figure 28b. Fixed-blade propeller turbines have blades which are set at a specific angle of 16 to 20 degrees and cannot be adjusted. Kaplan turbines are propeller turbines with blades that can be adjusted from 10° to 32° to provide maximum efficiency with varying loads.

Figure 29 shows an axial-flow propeller turbine used for extremely low heads.

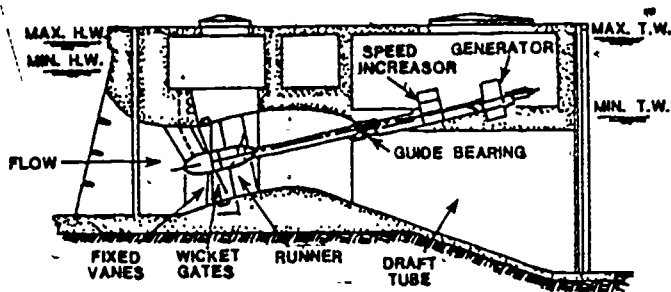

Figure 29. Axial-Flow Propeller Turbine.

WIND TURBINES

Windmills have long been used in many parts of the world to pump water. The search for alternative energy sources has focused renewed attention on wind power. Two types of wind-driven electrical generating systems are now being tested at several locations.

Figure 30a shows a vertical axis wind turbine under investigation at Sandia Laboratories and other sites. Figure 30b is a horizontal axis wind turbine. Small models of this type are commercially available. An experimental generating station using a horizontal axis turbine with two 97½ foot blades is being built on a 4400-foot mountain near Boon, North Carolina. While such systems will never produce a significant portion of our national energy needs, they may meet local needs in some areas.

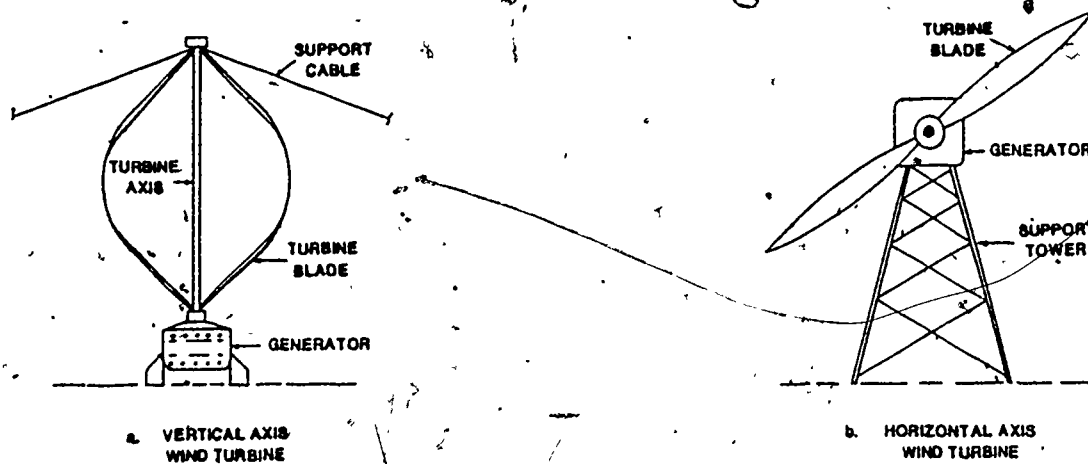

Figure 30. Wind Turbines.

EXERCISES

1. Explain where pressure drops and velocity increases occur in the following types of steam turbines:
 - a. Velocity-stage impulse turbines
 - b. Pressure-stage impulse turbines
 - c. Reaction turbines
2. Explain the application and chief advantage of a solid-wheel turbine.
3. Draw and label a diagram showing the parts of a turbine blade. Explain the function of each part.
4. Explain the advantages of gas turbines over steam turbines for emergency electrical power.
5. Explain how a gas turbine can increase overall steam plant efficiency.

LABORATORY MATERIALS

Impulse water motor with pressure gauge and prony brake
(Sargent-Welch #1101 or equivalent).

Water source.

Collection container, calibrated in ft^3 .

Timer.

LABORATORY PROCEDURES

1. Set up the experimental apparatus, as shown in the Figure, with the collection container removed.
2. Turn on the water supply and adjust the flow for low-speed operation of the water motor. Record the difference in the spring scale readings in Trial 1 of the Data Table (in pounds): Next, record the water pressure in lb/in^2 and convert this value to lb/ft^2 .
3. Place the collection container to catch the expelled water and simultaneously start the timer and revolution counter.

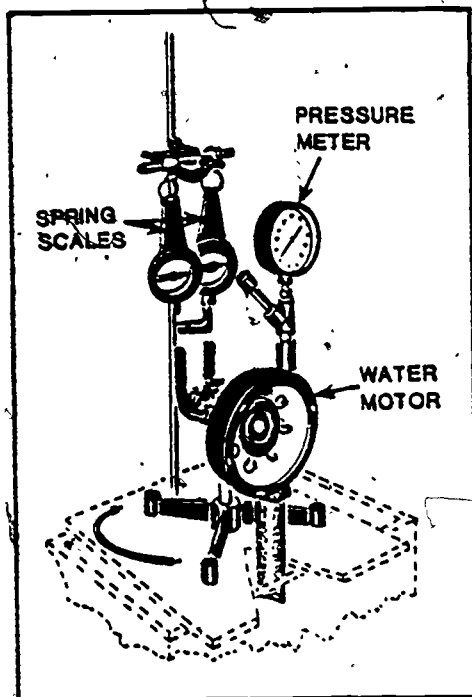

Laboratory Setup.

4. When a predetermined volume of water has passed through the turbine, read and record the values of the revolution counter and timer; then record the volume of water.
5. Turn off the water supply.
6. Record the circumference of the pulley (in feet).
7. Calculate and record turbine input power from the following equation:

$$\text{Input Power} \left[\frac{(\text{ft} \cdot \text{lb})}{\text{s}} \right] = \frac{\text{Pressure (lb/ft}^2) \times \text{Volume (ft}^3)}{\text{Time (s)}}$$

8. Calculate and record the turbine output power from the following equation:

$$\text{Output Power} \left[\frac{(\text{ft} \cdot \text{lb})}{\text{s}} \right] = \frac{\text{Revolutions}}{\text{Time (s)}} \times \text{Scale difference (lb)} \times \text{Pulley circumference (ft)}$$

9. Calculate and record turbine efficiency.
10. Repeat the steps for two higher water-flow rates and complete Trials 2 and 3 of the Data Table.

DATA TABLE

DATA TABLE:

Trial	Scale Difference		Water Pressure		Number of Revolutions	Time	Volume of Water	Input Power	Output Power	Efficiency
	oz	lb	lb/in ²	lb/ft ²						
1										
2										
3										

Pulley circumference = _____ in = _____ ft

REFERENCES

- Elonka, Steve. Standard Plant Operators' Manual. New York: McGraw-Hill Book Co., 1975.
- Gartmann, Hans, ed. De Laval Engineering Handbook. 3rd ed. New York: McGraw-Hill Book Co., 1970.
- Stanjar, William, ed. Prime Movers. New York: McGraw-Hill Book Co., 1966.
- The American Society of Manufacturing Engineers. Loss Prevention in Rotating Machinery. New York, 1971.

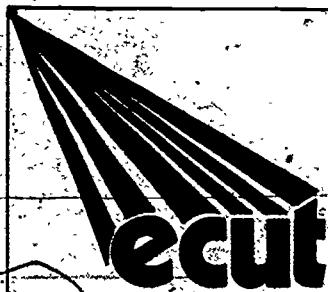

ENERGY TECHNOLOGY

CONSERVATION AND USE

ENERGY PRODUCTION SYSTEMS

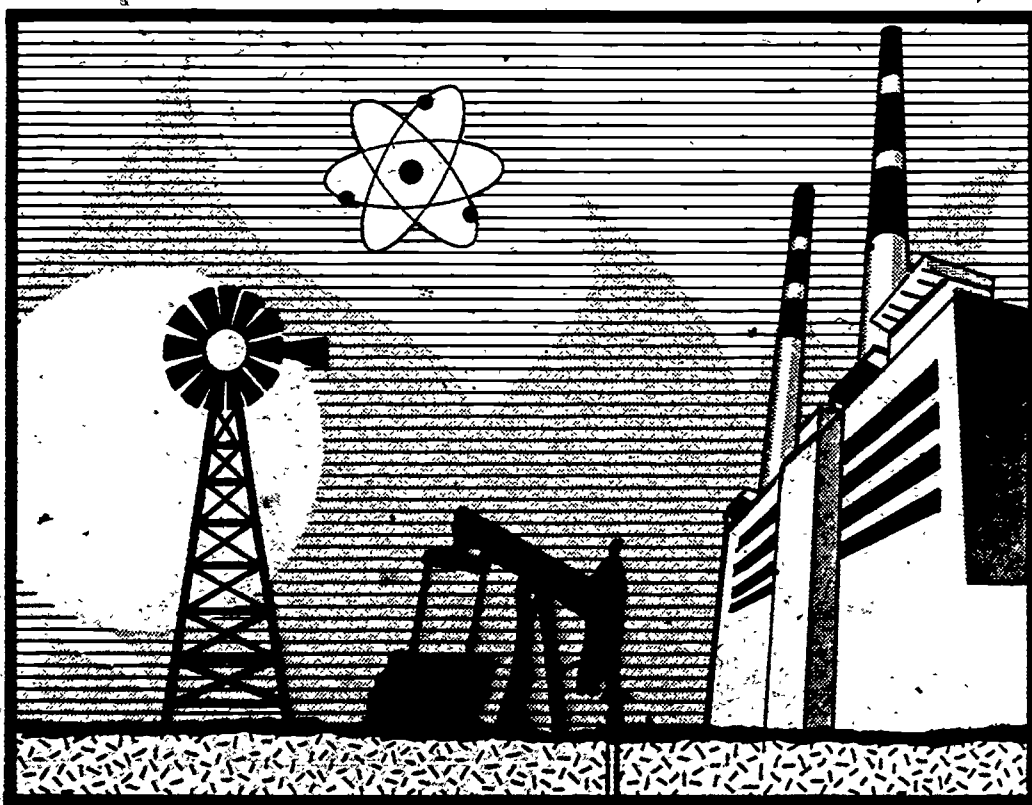

MODULE EP-07

PRODUCTION OF ELECTRICITY



CENTER FOR OCCUPATIONAL RESEARCH AND DEVELOPMENT

INTRODUCTION

This module discusses various methods for production of electricity and describes conventional generation of electrical power, electrochemical methods, and photovoltaic generation. The discussion includes the principles, practicality, and degree of use for each method, as well as the major problems that must be overcome by the new technologies.

This module emphasizes systems for producing electrical power. Specifically, it describes electrical power plants using steam turbines that produce commonly encountered alternating electrical current. It also discusses the generation of electrical power with internal combustion engines and the generation of d.c. electrical power.

The discussion then covers electrochemical methods of generating electricity - including fuel cells and batteries (both conventional batteries, such as automotive batteries, and experimental batteries). Finally, the module describes photovoltaic generation of electricity.

PREREQUISITES

The student should have a basic understanding of physics, as it relates to electric generators and photovoltaic materials, and should have completed Fundamentals of Energy Technology.

OBJECTIVES

Upon completion of this module, the student should be able to:

1. List each of the methods described for production of electricity.
2. Describe the basic operation of each device or system described.
3. Describe the degree to which each technology is used in practical usage.
4. Describe the relative advantages of each technology.
5. Describe the major problems that must be overcome in the new technologies.

SUBJECT MATTER

ELECTRICAL POWER PLANTS USING STEAM TURBINES AND COMBUSTION ENGINES

This section of the module emphasizes the generation of large amounts of electrical power for residential and industrial use. It covers the conventional technology for production of the a.c. electrical power that is distributed by electric utilities. Electrical energy is produced by electrical plants which convert energy from coal, fuel oil, natural gas, nuclear reactions, or falling water. Most of the electricity is generated by steam turbines which drive electrical generators; however, smaller amounts are produced by hydraulic turbines in hydroelectric plants or by turbines driven by internal combustion engines. For completeness, the following sections also discuss generation of d.c. electrical power.

STEAM TURBINE PLANTS

Electric power production for commercial distribution implies production in large-scale stationary generating plants. Approximately 85% of the commercial electrical power in the United States is derived from plants using steam turbines. The steam can be produced by energy from the burning of coal, fuel oil, or natural gas, or by energy derived from nuclear reactors. This is regarded as the standard, conventional method of producing electrical power.

Advantages of generating electricity by this method include the following:

- Availability of highly developed technology
- Availability of large components (turbines, generators, and so forth) for very large generating stations (greater than 100 megawatts)
- High conversion efficiency

Compared to hydroelectric plants, steam turbine plants have the advantages of not being dependent on water flow, of more flexible site selection, and of closer proximity to users.

Disadvantages of steam turbine plants include the following:

- Air and water pollution
- Radioactivity and disposal of waste for nuclear plants
- Rising costs of fossil fuels

- Depletion of supplies of fossil fuels
- Vulnerability to widespread blackouts in the event of a system failure

Although this portion of the module emphasizes the function of generating electricity, it does not discuss the transmission and distribution of electricity to the users.

Steam Cycles and Efficiency

In a steam turbine electrical generating plant, the water is boiled in a boiler, cycled through the turbine, condensed, and then conveyed back to the boiler.

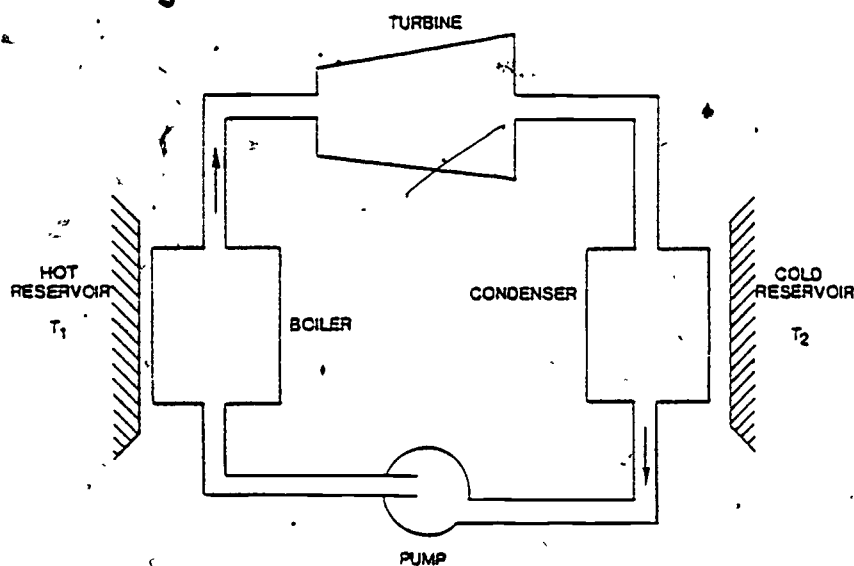

Figure 1. Elementary Steam Power Plant.

This process is illustrated in Figure 1. The steam is produced at a high temperature T_1 and condensed at a lower temperature T_2 . These temperatures are to be regarded as absolute temperatures.

According to Figure 1, the process can be regarded as being a cycle. The performance of a steam plant can be analyzed in terms of the properties of the steam as it goes through the cycle.

One common steam cycle is the Rankine cycle, which is illustrated in Figure 2. Figure 2 shows a plot of the pressure and volume of a unit mass of water as it goes through the cycle. From point 1 to point 2 in the cycle, water is compressed to the pressure of the boiler. Practically no temperature increase occurs in this step. From point 2 to point 3, heat is added to the

water, converting it to steam and superheating the steam. From point 3 to point 4, the steam is allowed to expand and to drive the turbine. Then, from point 4 to point 1, the steam is condensed, completing the cycle. There are other steam cycles, but the Rankine cycle is an important, frequently used example.

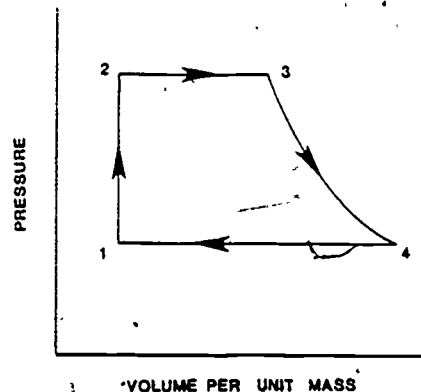

Figure 2. The Rankine Cycle.

During the cycle, work is extracted from the steam; but it is impossible to extract as useful work all of the energy that is supplied by the fuel that heats the steam. The efficiency of the cycle can be defined as "the ratio of the useful work output of the cycle to the heat energy supplied." The maximum possible efficiency of a heat engine working in a cycle is given by Equation 1:

$$E_{\max} = \frac{T_1 - T_2}{T_1} \quad \text{Equation 1}$$

where: T_1 and T_2 = The temperatures at which the steam is produced and condensed, respectively.

Remember that the temperatures T_1 and T_2 are absolute temperatures.

Equation 1 shows that the thermal efficiency becomes higher as the initial steam temperature T_1 is increased. Thus, it is desirable to work at high values of steam temperature. As was learned in Module EP-04, nuclear reactor steam cycles with maximum steam temperatures around 550°F have maximum efficiencies of approximately 32%. Cycles based on the burning of fossil fuels produce steam temperatures around 1000°F, and have maximum efficiencies of approximately 66%.

It must be emphasized that the efficiency given by Equation 1 is a maximum value set by the laws of thermodynamics. It cannot be exceeded under any conditions. If the system design is poor, or if there are heat losses, the value given by Equation 1 cannot be reached.

EXAMPLE A: DETERMINING MAXIMUM POSSIBLE EFFICIENCY.

Given: A coal-fired steam generating plant produces superheated steam at 550°C. After passing through the turbine, it is condensed at a temperature of 37°C.

Find: The maximum possible efficiency.

Solution: The absolute temperature T_1 in Equation 1 is 823°K (550 + 273). The absolute temperature T_2 is 310°K (37 + 273). Hence, the maximum possible efficiency is the following:

$$\frac{823 - 310}{823} = \frac{513}{823} = 0.623 = 62.3\%$$

System Configuration

The basic configuration for steam-turbine-based electrical power generation consists of a boiler (heated either by a combustion furnace or by a nuclear reactor), a steam turbine driven by steam from the boiler, and an alternating current generator. A schematic diagram of the system based on a light water nuclear reactor is shown in Figure 3, illustrating the essential features of the electrical generation. In a fossil-fuel power station, the reactor is replaced by a furnace, with its attendant fuel processing and delivery system.

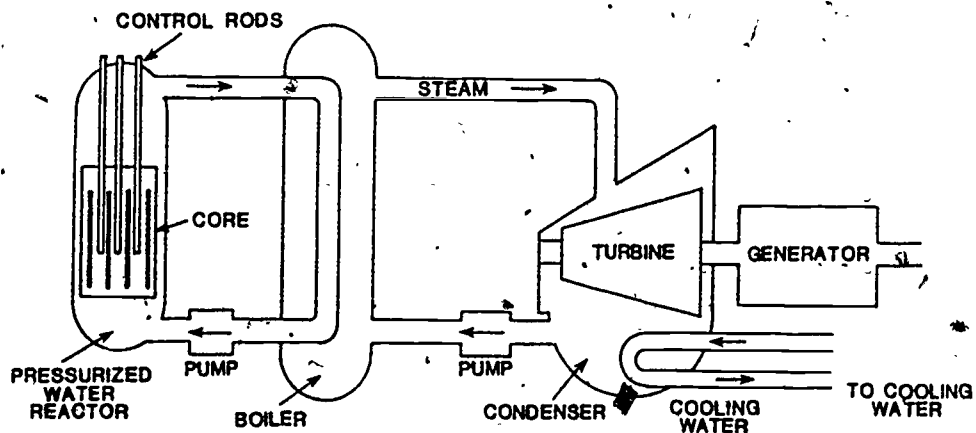

Figure 3. Schematic Diagram of Electrical Generating System.

Many of the components were described in earlier modules of this course. Modules EP-01 and EP-02 described furnaces and boilers using fossil fuels. Module EP-04 described nuclear reactors and their applications. Module EP-06 discussed turbines.

Heat is produced by the nuclear reactions in the reactor core. The heat is carried to the boiler by circulating, pressurized water; and in the boiler it exchanges heat with the water in the boiler, producing superheated steam. The steam drives a steam turbine, which in turn drives an alternating current generator. The steam is condensed and is returned to the boiler.

The alternating current generator (also called an a.c. generator or an alternator) converts the mechanical rotation energy supplied by the turbine into alternating current electrical power. The student should remember the principles of operation of the alternating current generator from prior physics courses; but for completeness, this type of operation is briefly reviewed in the following paragraphs.

Basically, an alternating current generator consists of a coil of wire rotating in a magnetic field — a metallic conductor moving through a magnetic field, having induced a voltage in it. If the conductor is wound into a complete circuit, an electric current will flow. The direction of the current depends on the relative orientation of the motion and the direction of the magnetic field.

The configuration of the generator is sketched in Figure 4. The top part of the figure (Figure 4a) shows a soft iron core that rotates in the

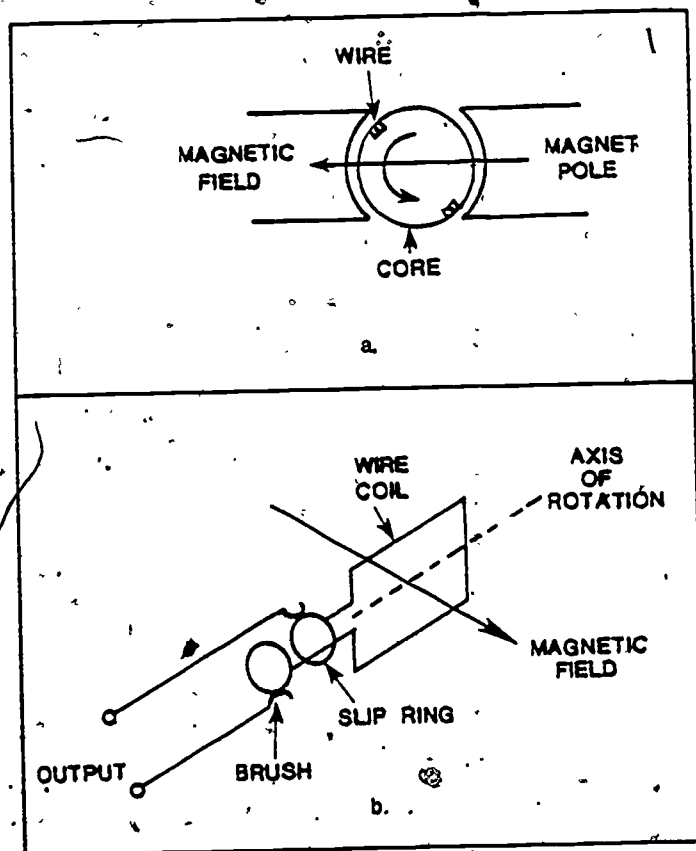

Figure 4. Configurations of an Alternating Current Generator.

direction indicated by the arrow. A coil of wire is wound in many loops. The combination of core and wire coil is called the armature. The coil of wire is embedded in slots on the surface of the core. There are many loops in the coil of wire, although only one is indicated in the figure. The magnetic field in large generators is usually supplied by an electromagnet. For small generators, or for cases in which very high reliability is needed, a permanent magnet can be used.

The bottom part of the figure (Figure 4b) shows the operation in another way. The coil of wire is indicated as being rectangular. Again, only one loop is shown. The ends of the coil are connected to slip rings which rotate with the coil. The slip rings are insulated from each other, but each are in contact with a stationary brush that is connected to the external circuit. At a particular point in the rotation, electric current is produced in one direction. One-half cycle later, the relative orientation of the motion of the coil and the magnetic field is reversed; hence, the direction of current flow is also reversed. Thus; this generator produces alternating current. For the first half of the cycle rotation, the current flows in one direction; in the other half of the cycle, the current flows in the opposite direction.

In the most common type of a.c. generator, the system frequency is proportional to the rotation speed. This type of generator is called a synchronous generator. The frequency f (in hertz) is given by Equation 2:

$$f = N R / 120 \quad \text{Equation 2}$$

where: N = The number of magnetic field poles (usually either two or four).
 R = The rotation speed of the armature, in rpm.

Thus, a generator with two magnetic poles will rotate at 3600 revolutions per minute to produce alternating current at a frequency of 60 Hz. This high rotation rate is compatible with high speed steam turbines which operate most economically at high rotation rates.

Very large alternating current generators are now in use for commercial electrical power generation. Individual units with capacities exceeding 1000 megawatts have been installed. The common system frequency in the United States and Canada is 60 Hz; in Europe, it is 50 Hz.

Generation of Three-Phase A.C. Power

The generation process previously described produces an electrical voltage V which varies with time t as a sine wave. Consider Equation 3:

$$V = V_0 \sin 2\pi \cdot f \cdot t \quad \text{Equation 3}$$

where: V_0 = The maximum voltage.

f = The frequency of the system.

This function is sketched in Figure 5a. In one cycle, which takes an amount of time equal to $1/f$, the voltage rises from zero to a maximum positive value, falls through zero to a minimum negative value, and then increases back to zero.

There may be more than one sine wave, with the waves oscillating nonsynchronously. Thus, one wave may be at its positive maximum when the second wave is at a different part of its cycle. In this case, the waves are said to be "out of phase." The phase difference between the waves is defined as "the fraction of a cycle by which one wave leads, or lags, behind the other."

Figure 5b shows three sine waves which are out of phase by one-third cycle. These three waves may be expressed by the following:

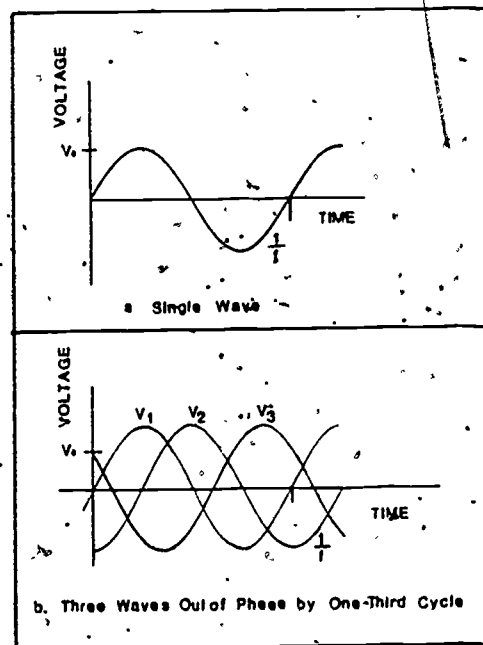

Figure 5. Sine Waves.

$$V_1 = V_0 \sin 2\pi f t$$

$$V_2 = V_0 \sin (2\pi f t - 2\pi/3)$$

$$V_3 = V_0 \sin (2\pi f t - 4\pi/3)$$

Equation 4

The phase difference between the waves is $2\pi/3$ radians, or 120° .

In the discussion so far, it has been assumed that the generator produces a voltage that is represented by a single sine wave. This requires two wires, one carrying the voltage and the second acting as a return. This system, called single-phase alternating current, is the type of alternating current most often used in domestic applications.

For delivering large amounts of electrical power and for many industrial applications, three-phase systems are used. These systems use three sine waves that are out of phase by 120° , as illustrated by Figure 5b. Although one might think that such a system would require six wires (two for each phase), this is not the case. If the currents in each phase are properly balanced, only three wires are needed. The individual currents for the three phases may be flowing in either a positive or a negative sense. In a properly balanced system, the net total current at any instant of time is zero. Thus, no return wires are needed. Such a system, with each of the three wires carrying current 120° out of phase with the other two wires, is called a three-phase system. Each phase of the three-phase system carries current and delivers net electrical power. Such a three-phase system, with three wires, can deliver as much power as three separate single-phase systems, which would require six separate wires. Of course, it is impossible to balance the three phases so perfectly in a practical system that the net current is exactly zero. Thus, there is usually a small return current. It is common practice to return this current to ground and to let the earth act as the return conductor.

In order to generate three-phase electrical power, three separate coils of wire are wound on the armature of the alternating current generator. Each coil generates one phase of the three-phase power. It is possible to connect the coils in two different ways, as illustrated in Figure 6. The configuration in Figure 6a is called a wye (Y) configuration because of its shape. It is also sometimes called a star configuration. In this configuration, the line voltage V_L (which is the voltage between any two of the wires) is related to the phase voltage V_p (which is the voltage between any wire and ground) by the following equation:

$$V_p = V_L / \sqrt{3}$$

Equation 5

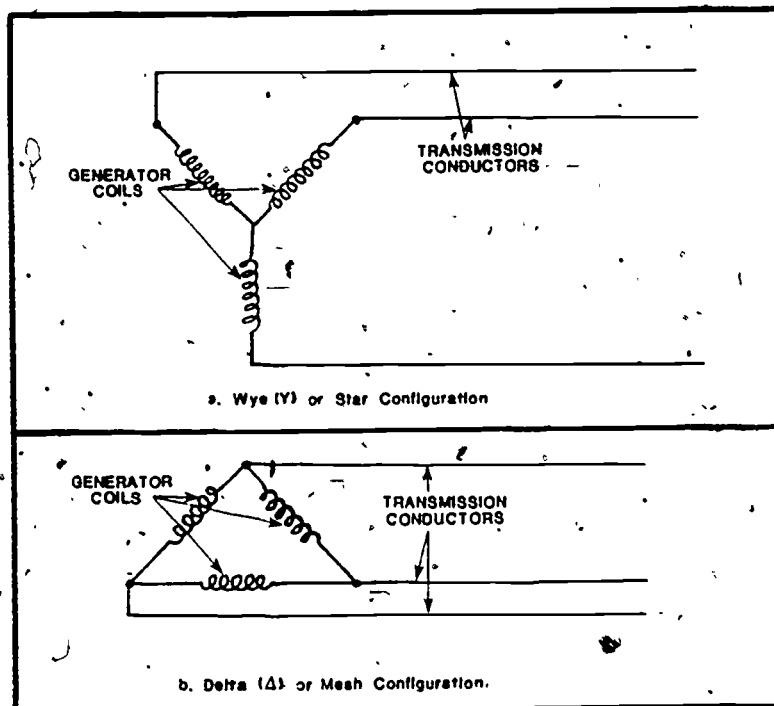

Figure 6. Connections for Three-Phase Alternating Current.

A common line voltage for distribution of three-phase electrical power is 220 V. The phase voltage is then $220/\sqrt{3} = 127$ V. Thus, single-phase electricity for domestic use at 127 V may be obtained by tapping one wire of a 220-V three-phase 220-V distribution system. For many industrial applications — especially for large motors — all three phases are used. The wye configuration for distribution of electricity from a three-phase generator is commonly used in the United States.

The other possible arrangement, shown in Figure 6b, is less often encountered in the United States. This arrangement is called the delta- (Δ) or mesh-connected system. For the delta connection, the line voltage and phase voltage are equal.

Three-phase systems have several advantages over single-phase systems. The flow of power is more constant, so the motors operate more smoothly. And, three-phase motors start more easily because of interaction between the phases. For distribution of equal amounts of power, there is a savings in the amount of wire needed for three-phase systems.

Comparison of Plant Costs

The cost of generating electrical power is an extremely complex issue. Two contributions to the cost must be considered: the initial capital investment and the operating costs (including fuel). In a period of rapidly increasing fuel prices, any cost estimates rapidly become outdated.

The cost of the capital investment per unit generating capacity depends on the plant size. This cost decreases for large plants. For a kilowatt of generating capacity, a small (50 megawatt) steam plant can be 20% more expensive to build than a large (1000 megawatt) steam plant. The cost will vary from one part of the country to another because of differences in labor rates, tax incentives, and local laws on control of emissions. Addition of pollution control equipment can substantially increase the cost of a generating plant.

The operating costs for steam plants are dominated by fuel costs. It is difficult to compare fuel costs because there is considerable variation from one part of the country to another. Table 1 shows some utility prices for various fossil fuels in different localities. These are 1975 prices, which, of course, have changed. However, the figures do show that fuel costs can vary considerably according to location.

TABLE 1. UTILITY PRICES FOR FOSSIL-FUELS IN 1975
(Dollars per million Btus).

Region	Natural Gas	Fuel Oil	Coal
New England	1.13	2.04	1.35
Middle Atlantic	0.85	2.05	1.05
West (north central)	0.44	1.85	0.58
West (south central)	0.63	1.83	0.21
Mountain	0.67	1.98	0.31
Pacific	0.84	2.35	0.58

The prices shown are expressed in terms of dollars per million Btus of thermal energy in the fuel - which is a widely used measure of fuel cost.

Fuel prices tend to be high in New England and relatively low in the Western United States. Natural gas, for example, varies over the range of 0.44 to 1.13 dollars per million Btus - almost a factor of three.

In many areas, natural gas is the least expensive fuel; but because of supply limitations, it generally is not used in large electrical generating plants. Supplies of natural gas to large customers are often interruptible, that is, they can be cut off when the demand for natural gas is large. For these reasons, coal may still be used — even in areas where natural gas is cheaper than coal.

In virtually all areas, fuel oil is more expensive than coal. In the southwestern central region, it is as much as eight times as expensive. Moreover, since 1975, there have been many increases in the world price of oil. This makes oil even less attractive as a fuel for large electrical plants. Thus, coal is favored over oil, and most large generating plants are coal-fired plants.

Basically, the comparison of plant costs becomes a comparison between coal-fired plants. A coal-fired plant may have a furnace that can burn other fuels (such as natural gas) when they are available at a cost less than coal. Then the plant can switch fuels according to price and availability.

Table 2 shows a comparison of plant costs for a large (940 megawatt) generating plant based on coal and nuclear power. These numbers are estimates and will vary according to location, amount of pollution controls required, and so forth. The estimates in Table 2, taken from 1977 figures, have changed; however they do show some of the general features.

TABLE 2. COMPARISON OF COSTS FOR NUCLEAR AND COAL-FIRED PLANTS (970 Megawatt).

Type of Cost	Coal-Fired Plant	Nuclear Plant
Total cost of plant (\$)	190 x 10 ⁶	240 x 10 ⁶
Cost of electricity (cents/kWh)		
Cost for plant investment	0.50	0.63
Operation and maintenance	0.03	0.04
Fuel	<u>0.41</u>	<u>0.19</u>
Total cost	0.94	0.86

The capital investment for a nuclear plant tends to be higher than that for a coal plant. The operating cost for a nuclear plant tends to be lower, mainly because of lower fuel cost. Thus, the total cost of producing the electrical power, approximately 0.9¢ per kilowatt hour, tends to be comparable.

An exact comparison of whether coal-fired nuclear plants are less expensive depends on exact circumstances, but the estimates in Table 2 show some of the major contributions to the cost of generating electrical power.

HYDROELECTRIC PLANTS

Hydroelectric plants use the energy of falling water as it drops through a vertical distance. The vertical distance is called the head. The head must be reasonably large in order to produce power economically; thus, only certain sites are suitable for hydroelectric plants. Obvious choices are areas near waterfalls, such as Niagara Falls. However, other areas, such as where a river is dropping rapidly, could be suitable even without any waterfall. Dams are often constructed to increase the head and to provide a reservoir of water which can be used to compensate for seasonal variations in water flow.

In the United States, hydroelectric power provided a major portion of the electrical power in the early 1900s - at times supplying more than 40%. In more recent years, the technology of steam turbines and boilers has advanced. The efficiency of steam systems has increased, and very large steam turbine generating systems have been developed. And, many of the most desirable sites for hydroelectric generation have been used. These factors have led to a decrease in the fraction of electrical power that is generated by hydroelectric plants. In the late 1970s, less than 15% of the electrical power in the United States was generated by hydroelectric plants; and it is likely that this fraction of power will decrease further. The fraction of electrical power produced in this way varies widely from one section of the country to another. For instance, hydroelectric power is a major factor in places such as the Pacific Northwest and the Tennessee River Valley area, but it is a very small factor in areas such as New England and Florida.

Hydroelectric power is the major source of electricity in certain countries that have an abundance of good sites. These countries include Norway, Sweden, Switzerland, and Canada. In all these countries, more than 80% of the electrical power is produced by hydroelectric plants.

Hydroelectric generation of electricity has many advantages when compared to fossil-fuel or nuclear generating plants. These advantages include the following:

- No use of fossil fuels
- No radioactive waste
- No air pollution
- Low cost of operation
- Use of a renewable energy source
- Reservoirs having other uses, such as recreation and flood control

Thus, hydroelectric generating plants are used in many parts of the United States to produce electricity at a cost lower than that of electricity from fossil-fuels or nuclear reactors. There are some disadvantages, however, including the following:

- Limited site selection, with most of the best sites already in use
- Tendency for best sites to be remote from population centers so that transmission over greater distances is needed
- Dependence on water flow, with reduced output in times of drought
- High initial construction cost
- Possible loss of farmland or decrease of scenic values

A hydroelectric generating plant is illustrated in Figure 7. This diagram shows a system with a high head, generated by a reservoir behind a high dam. Water is conducted from the upper part of the reservoir through a closed conduit called a penstock. The penstock may be constructed of welded steel plates, and there may be one penstock for each turbine; or there may be a single penstock which splits into branches for the different turbines. Typically, there will be a valve for the penstock so the turbines can be shut down for maintenance.

The power plant will be located at the base of the dam. Water falling through the penstock drives hydraulic turbines — which, in turn, drive electric generators. The hydraulic turbine was described in detail in Module EP-06.

In a variation called the pumped storage hydroelectric plant, water is pumped to higher elevations during periods of low electrical demand. Then,

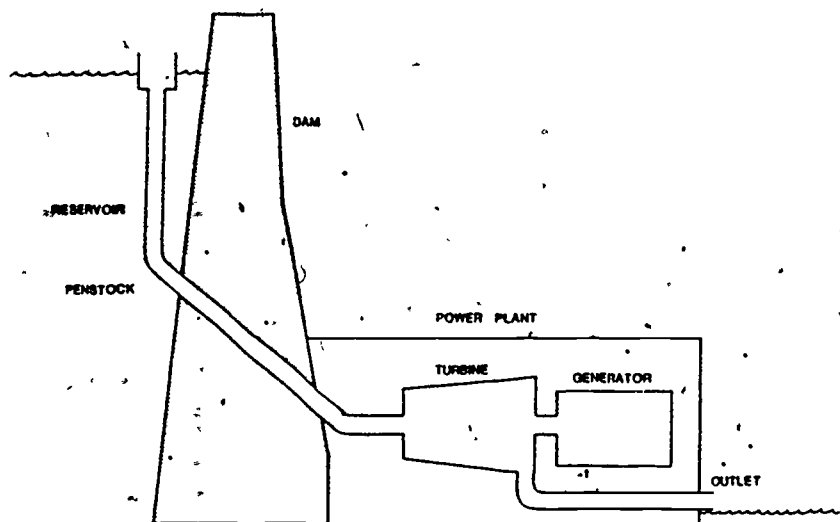

Figure 7. Schematic Diagram of Hydroelectric Generating Facility.

during periods of high demand, the water is released to provide a larger head and more generating capacity.

The cost of generating hydroelectric power depends on the size of dam that is needed. The cost may be less in some mountainous regions where a narrow gorge may be dammed with a relatively small dam.

Because of the cost of the dam, the initial capital expense will probably be higher than for a nuclear reactor system or a fossil-fuel system of the same size.

On the other hand, the operating expenses will be much less, perhaps as low as one-tenth of the operating cost of a nuclear or fossil-fuel system. This is largely because no fuel (uranium or fossil-fuel) is used.

The total effect is that, in most cases, electrical power produced by hydroelectric plants is less expensive than electrical power from nuclear or fossil-fuel plants. The reduced operating costs more than offset the higher charges to pay off the initial investment.

INTERNAL-COMBUSTION ENGINE PLANTS

Another method for generating electricity involves driving the current generator with an internal combustion engine. The internal combustion engine drives a rotating shaft, as in an automobile. The rotating shaft then drives the rotating armature in the current generator. The electrical generator in a system driven by an internal combustion engine is essentially the same as that used in any other electrical plant. It is the source of energy used to drive the generator that is different. The steam turbine, or hydraulic turbine, is replaced by the internal combustion engine.

The internal combustion engine can be either a diesel engine or a gasoline engine. Gasoline engines can be used for electric generation when the requirements are quite small - for example, an individual farm or lake cabin. Most internal combustion electrical generating plants of considerable size use diesel engines. As compared to gasoline driven systems, diesel systems offer higher efficiency and lower fuel cost. For the remainder of this section of the module, it will be assumed that the internal combustion engine is a diesel engine. Diesel engines were described fully in Module EP-05.

The use of diesel engines for electrical power generation in reasonably small systems offers several advantages. Diesel engine systems have shorter start-up times, as compared to steam systems which take a long time to build up to a peak output. Small diesel-based systems that use up to a few thousand kilowatts are more efficient and less expensive than steam-based systems of the same size.

For larger systems, with requirements greater than several thousand kilowatts, steam-based plants reach efficiencies as high as those of diesel-based plants. In addition, the cost of large steam-based plants is less than that of large diesel-based plants.

Thus, internal combustion engine electrical plants are preferable up to a certain maximum size, above which steam-based plants are preferable. This maximum size is in the range of 5000 to 10,000 kilowatts.

Within this size limitation, there are many practical applications for diesel-based electrical plants. For example, they are used for electrical power generation by many small communities in facilities such as hospitals, hotels, and industrial plants. They can be used for reasons of economy or for reasons of reliability. Some large users find it less expensive to generate their own electricity than to buy it from the local utility. And, because diesel generating plants are reliable, some facilities (such as hospitals) prefer to have their own electrical power. In addition, such facilities may have back-up diesel systems which are used for emergency power in the event of a power failure. The short start-up time of diesel-based systems is convenient for this use.

Moreover, large utilities often have diesel systems which are used when the power demands approach the capacity of the steam turbine part of the system.

Steam turbines routinely supply the power under most conditions. When power demand becomes very high, the diesel systems are started and used to supplement the steam turbines until the demand decreases. This application takes advantage of the short start-up time for diesel engine electrical generating systems.

In summary, many internal combustion engine plants are in use for the generation of electricity, some ranging in size up to a maximum size of around 5000 to 10,000 kilowatts. In this size range, they are more efficient and more economical than steam turbine plants.

GENERATION OF DIRECT CURRENT POWER

The methods for generating a.c. electrical power have already been discussed. It is possible to use similar methods to produce d.c. electrical power. A coil of wire rotates in a magnetic field, as illustrated in Figure 8. This

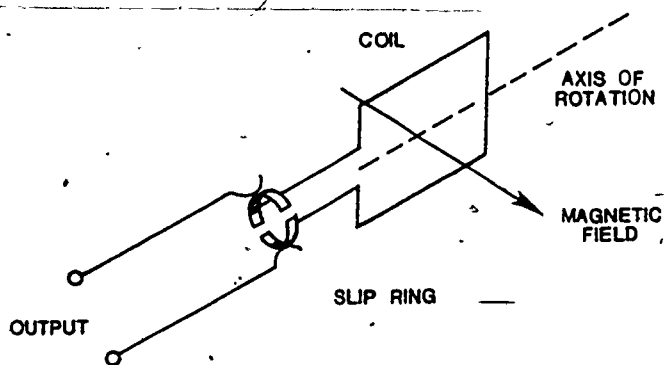

Figure 8. Direct Current Generator.

can be compared to Figure 4b. A sinusoidal alternating voltage is generated in the coil. The coil is attached to a split ring. At the time when the direction of the voltage in the coil changes direction, the connection of the split ring to the external circuit is also reversed.

Thus, the direction of the voltage and current in the external circuit remains the same. In other words, this type of generator produces direct current.

In its construction of coils, rotor, magnets, and so forth, the d.c. generator is very similar to the a.c. generator. The main difference is the use of the split ring, which is called a commutator. The single coil illustrated in Figure 8 will produce direct current in which the power fluctuates. If a number of coils are connected to a number of commutators, the fluctuations can almost be eliminated.

A second method for producing d.c. power is to rectify a.c. power. This is done with rectifiers which pass electrical current in only one direction. For most modern applications, silicon-controlled rectifiers are employed.

Direct current is often used in industry specifically to operate d.c. motors since d.c. motors are capable of operation at precisely controlled speeds — more so than a.c. motors. This is one of the most important modern uses of direct current. The direct current is often generated locally in the industrial plant where it is used.

Some early commercial generation and distribution systems in the 1800s used direct current, but almost all have been supplanted by a.c. systems. A few, small d.c. networks survive, mostly in Europe; and a number of high voltage d.c. systems exist for long distance transmission of electricity. In modern distribution of electricity from the utility to the customer, almost all customers receive a.c. power.

BATTERIES

Batteries are devices that convert chemical energy into electric energy. The term "battery" strictly applies to two or more electrochemical cells that are connected together. But in common usage, the term "battery" is also applied to single electric cells, such as flashlight batteries.

This section of the module first discusses the principles of electrochemical generation of electricity and then the conventional types of batteries that are now in use for many applications requiring a source of electrical power. These batteries are especially adaptable to situations where electrical power would not otherwise be easily available (such as in automobiles). The module concludes with a discussion of developmental and experimental batteries.

PRINCIPLES OF ELECTROCHEMICAL ENERGY GENERATION

An electrical cell consists of two electrodes of dissimilar material which are immersed in an electrically conductive material. The conductive material may be solid or liquid.

At one electrode (the anode, which is the negatively charged electrode), a chemical reaction occurs between the electrode and the electrolyte. In the

chemical reaction, the electrode, which is usually a metal, is oxidized, and electrons are released. For a zinc electrode, a possible reaction would be the following:

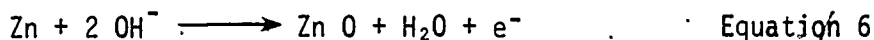

This reaction uses OH^- ions from the electrolyte and releases free electrons.

At the other electrode (the cathode, which is the positively charged electrode), electrons recombine during the chemical reaction. The material of the cathode, which is often a metal oxide, is reduced. A reaction involving a manganese oxide cathode could be the following:

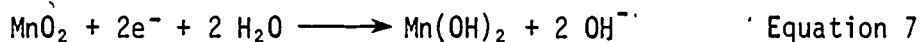

Thus, water is produced at the anode and used up at the cathode. Hydroxyl ions (OH^-) are produced at the cathode and used up at the anode. They migrate through the electrolyte from one electrode to the other. In the reactions, the materials of the electrodes are gradually used up. When the materials are consumed, the chemical reactions cease, and the battery is dead.

If the anode and cathode are connected through a wire, electrons will flow through the wire from the anode to the cathode. In this way, the energy produced in the chemical reactions is transformed into electrical current. A schematic diagram is shown in Figure 9.

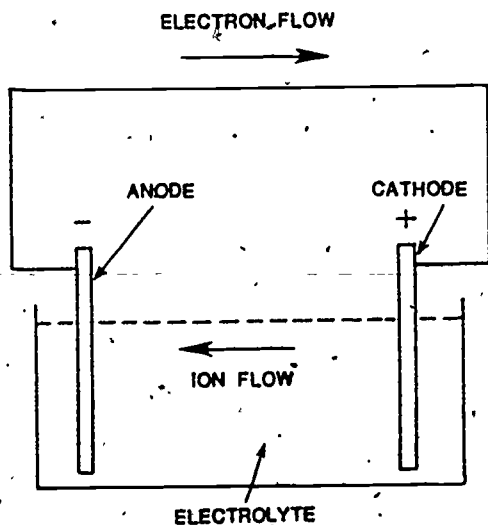

Figure 9. Diagram of Electric Cell.

CONVENTIONAL BATTERIES

There are many types of batteries in use today. Familiar examples are automobile batteries and flashlight batteries. Batteries can be divided into two general classes: primary batteries and secondary storage batteries.

Primary batteries are produced with high energy chemical compounds. The energy is withdrawn later as electrical current. The batteries are sold in a charged state, are used, and then are discarded without recharging. Primary batteries should not be recharged. Attempts to recharge primary batteries will yield poor results, and it may be dangerous to do so. Attempting to recharge a primary battery can possibly produce gas buildup inside the battery and lead to an explosion.

Secondary batteries are intended for recharging. They are constructed of different materials than primary batteries and have different electrode designs to facilitate recharging. These are commonly called storage batteries. Electricity is produced elsewhere (as in a generator) and is stored in the battery until it is to be used.

There are valid applications for both primary and secondary batteries. Primary batteries may be used when the following conditions are applicable:

- Portability and convenience are important (such as a flashlight)
- Electrical power for recharging is not available
- Reserve stand-by power is desirable for long periods of time (such as emergency lights)

Secondary storage batteries are useful under the following conditions:

- The battery is a prime power source and many charge-discharge cycles are needed (such as automotive use)
- Relatively high-power requirements must be supplied
- Long periods of low current operation followed by recharge are needed (such as buoys).

The most familiar type of primary battery is the Leclanche cell. This cell uses a zinc anode, a manganese dioxide cathode, and an electrolyte of ammonium chloride and zinc chloride in a water solution. In addition, a carbon rod is often used as a current collector at the cathode. A schematic diagram is shown in Figure 10. This type of cell is familiar as the common flashlight battery. The relevant reactions by which the electricity is produced were presented in Equations 6 and 7.

Table 3 lists some of the types of primary batteries that are commercially available. The first system is the Leclanche cell. Other systems use an electrolyte consisting of potassium hydroxide in water. These batteries, called

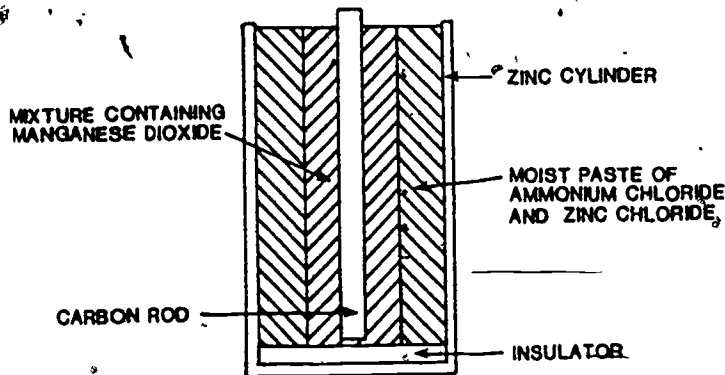

Figure 10. Diagram of Leclanche Cell.

The energy density is also listed. This is the energy that can be extracted from a battery of a given weight. Obviously, high values are desirable. Many experimental and developmental efforts are devoted to increasing the energy density.

alkaline batteries, generally offer higher efficiency and perform better than Leclanche cells. They are more expensive to produce, however..

Table 3 lists the voltages of the cells in commercial primary batteries. All available cell voltages lie within narrow limits. In order to achieve higher voltages, a number of cells are connected in series.

TABLE 3. COMMERCIAL PRIMARY BATTERIES.

Negative Electrode	Positive Electrode	Electrolyte	Voltage Per Cell	Energy Density (Wh/lb)
Zinc	Manganese dioxide	Ammonium chloride-zinc chloride	1.5	5-40
Zinc	Manganese dioxide	Potassium hydroxide in water	1.5	20-40
Zinc	Mercuric oxide	Potassium hydroxide in water	1.35	10-50
Zinc	Silver oxide	Potassium hydroxide in water	1.5	30-60

After primary batteries are discharged, they are discarded. Secondary batteries can be recharged by forcing an electrical current through the battery. The charging current flows in the opposite direction to the current extracted from the battery during use. Rechargeable secondary storage batteries can be

recharged many times, perhaps up to hundreds or thousands of times. They are constructed of different materials than the primary cells. Probably the most familiar of the secondary batteries is the lead-acid battery, which is commonly used for automotive use. This battery often has six cells connected in series to provide an output of 12 volts. The negative electrode is lead, and the positive electrode is lead oxide. The electrolyte is sulfuric acid in water, which dissociates to produce hydrogen (H^+) ions and sulfate ($SO_4^{=}$) ions. At the negative electrode, a porous, or spongy, lead plate is converted to lead sulfate in the following reaction:

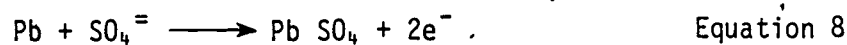

At the positive electrode, lead oxide is converted to lead sulfate in the following reaction:

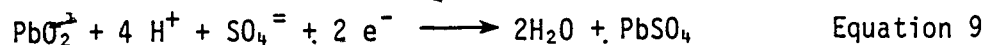

The electrons flow through the wire in an external circuit and provide electrical power. The water produced in Equation 9 dilutes the sulfuric acid solution and lowers its specific gravity. Thus, the specific gravity of the electrolyte can be measured to determine the status of the battery charge.

During recharging, electrical current flows in the opposite direction, and lead sulfate is reconverted into spongy lead by the following reaction:

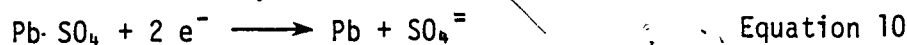

Lead oxide is produced in the following reaction:

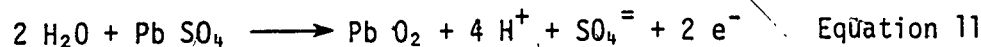

These reactions use up water and strengthen the sulfuric acid solution, increasing its specific gravity.

The common method of construction for lead-acid batteries is to use flat plates of lead and lead oxide, suspended vertically in the liquid electrolyte. Positive and negative plates alternate and are kept apart by insulating separators.

Lead-acid batteries are used in industry for standby power, for emergency lighting, and for powering security alarm systems. The most important application of lead-acid batteries is to provide the power to start internal combustion engines. Typically, such a battery will consist of six cells (six positive plates and six negative plates), all being contained within a common case and providing an output voltage of 12 volts. Lead-acid batteries with capacities in the range of 60 to 100 ampere hours are very common to automotive use. Very large banks of lead-acid batteries (up to millions of watt-hours) have been employed for propulsion of submarines.

Table 4 presents some of the commercially available secondary batteries. The first entry is the lead-acid battery discussed above. The second entry is the nickel-cadmium battery, which is commonly used as a rechargeable battery in electronic calculators and similar applications. The following reactions occur during discharge and are reversed during recharging:

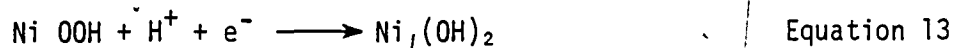
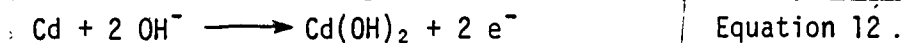

TABLE 4. COMMERCIAL SECONDARY BATTERIES.

Anode	Cathode	Electrolyte	Voltage Per Cell	Energy Density (Wh/lb)
Lead	Lead dioxide	Sulfuric acid in water	2.0	10-15
Cadmium	Nickel hydroxide	Potassium hydroxide in water	1.25	12-20
Iron	Nickel hydroxide	Potassium hydroxide in water	1.2	8-14
Cadmium	Silver oxide	Potassium hydroxide in water	1.4	22-34

The range of voltages for single cells is limited, and cells are connected in series to produce higher voltages. The energy density - watt-hours per pound - is an important characteristic.

DEVELOPMENTAL AND EXPERIMENTAL BATTERIES

Many additional types of electrochemical energy systems are under development. The main emphasis is to provide batteries that have higher values of energy storage density than the conventional batteries described above. Such batteries could store much larger quantities of electrical energy than conventional batteries of the same size and weight. One important application could be electric propulsion of vehicles. They would also be useful for load-leveling by utility companies. (Load-leveling refers to charging storage batteries during periods of low demand for electrical power, and then drawing power from the batteries during periods of high demand.) Improved batteries are also desired for improved portable tools and communications equipment. Conventional batteries are limited to cell voltages in the 1-V to 2-V range. Batteries with higher cell voltage are also desired.

Table 5 lists some of the leading materials that could possibly improve batteries. There are many other experimental electrochemical systems, but the table does show some of the most important types.

The first entry, the air battery, offers high energy density. It has been used in some practical applications for railroad signaling. The cathode material is atmospheric oxygen, which is absorbed at a porous carbon structure. The cathode reaction is as follows:

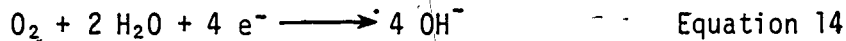

Air batteries with an iron anode are also under development.

Air batteries have been limited by the fact that current can only be drawn from them slowly. Research is underway to increase the discharge rate and provide higher currents. The air battery is a primary battery, whereas most of the other batteries listed in Table 5 are secondary storage batteries.

TABLE 5. DEVELOPMENTAL AND EXPERIMENTAL BATTERY TYPES.

Type	Anode	Cathode	Electrolyte	Voltage Per Cell	Energy Density (Wh/lb)	Status
Air	Zinc	Oxygen	Water, solution of potassium-hydroxide	1.25	80-100	Fairly well developed
Zinc-chlorine	Zinc	Chlorine hydrate	Zinc chloride in water	2.12	High	Not yet practical
Sodium-sulfur	Molten	Sodium polysulfide	Solid membrane of alumina ceramic	2	100-150	Developmental
Lithium-sulfur	Lithium metal alloy	Iron sulfide	Molten salt lithium chloride and potassium chloride	2.3	125	Developmental
Lithium-sulfur dioxide	Lithium	Liquid sulfur dioxide	--	2.8	120	Beginning to reach practical use
Redox	Water solution of $TiCl_3$ - $TiCl_4$	Water solution of $FeCl_2$ - $FeCl_3$	Part of cathode and anode solutions	L	High	Very early development

246

247

The zinc-chlorine battery uses a cathode of chlorine hydrate ($\text{Cl}_2 \cdot 6 \text{H}_2\text{O}$). The chlorine is contained in a porous titanium structure to form the cathode. The electrolyte must be circulated during discharge. Zinc is removed at the anode, and it enters the electrolyte as zinc ions. Chlorine is removed at the cathode, and it enters the electrolyte as chlorine ions. During recharge, zinc and chlorine are redeposited on the electrodes. The zinc-chlorine battery offers considerable promise, but further development is needed to produce more practical batteries.

Most of the batteries described so far use electrolytes which contain water. This fact limits the types of metals that can be used as electrodes. Research is being done on systems with electrolytes that do not contain water. Such systems could use reactive metals such as sodium or lithium. Higher values of cell voltage could then be achieved.

The sodium-sulfur battery uses an anode of molten sodium. The temperature must be maintained around 300°C . Sodium diffuses through the alumina membrane during discharge to form sodium polysulfide. During recharge, the compound is broken up into sodium and sulfur.

Because of its very high energy density, the sodium-sulfur battery is under development for utility load-leveling and vehicle propulsion. It has not reached the stage of practical usage because of its high cost. Research is aimed at reducing the cost. Another problem for vehicle propulsion is the possible release of hot corrosive sodium in an automobile crash.

The lithium-sulfur battery is an example of a system that uses a molten salt as an electrolyte. It offers high energy density and operates at a temperature of 400 to 500°C . This type of battery is potentially useful for vehicle propulsion and for utility load-leveling; but again, the problems are similar to the sodium-sulfur system.

Essentially, the lithium-sulfur dioxide system dispenses with an electrolyte by having the liquid sulfur dioxide cathode in direct contact with the lithium electrode. Development of these cells is aimed at producing small cells similar to flashlight batteries, but with much higher power density.

Redox cells involve two fluids that are circulated by pumps through a cell which has two compartments, one for each fluid. The compartments are separated by a selective membrane which allows passage of selected ions. During discharge,

the Fe^{3+} ions are reduced to Fe^{2+} , and the titanium ion is oxidized (Ti^{3+} to Ti^{4+}). Hence the name "redox" (reduction-oxidation).

During recharge, the reactions are reversed. The solutions are combination electrodes and electrolytes. The redox cell can be useful for storing large quantities of electricity and for utility load-leveling; however, its development is in a very early stage.

This discussion of developmental batteries will give an idea of some of the main thrusts of research and development for producing improved batteries. Useful batteries for storage of large amounts of electricity can be produced if problems can be researched and overcome. Some of the problems include high cost of production; development of suitable materials, containers, and seals for use with corrosive materials (such as sodium and lithium); lack of reproducibility; and relatively short life for some of the systems.

FUEL CELLS

A fuel cell is defined as "a continuous electric cell which uses the chemical combustion of a fuel (such as hydrogen) to generate electricity directly, without the intermediate step of heat generation." The fuel is combined with oxygen, but it does not burn with an open flame. Instead, it reacts chemically at an electrode, which acts as a catalyst to promote the reaction.

Fuel cells, like batteries, convert chemical energy into electrical energy. They rely on chemical reactions that occur at electrodes and liberate free electrons that flow in an external circuit in order to yield an electric current. An electrolyte is also used. In these respects, a fuel cell is very similar to a battery. For some purposes, a fuel cell is sometimes considered to be a type of battery.

In other ways, fuel cells are very different from the batteries that were described earlier. The chemical reaction involves a fuel and an oxidizer (oxygen) which flow into the cell, usually as gases. Essentially, the fuel is burned, and the combustion products are removed. Unlike the electrodes in batteries described earlier, the electrodes are not consumed; rather, they act as catalysts for the chemical reaction.

Because of these significant differences, the fuel cell is usually regarded as a separate type of electrical generating system, rather than as another type of battery.

The fuel cell burns conventional fuels — such as gaseous fossil fuels or hydrogen — by combining them with an oxidizer (air or oxygen). It is a continuous process, operating as long as the fuel and oxidizer are supplied. This process generates low-voltage, d.c. electrical power.

The basic fuel cell reaction is usually the burning of hydrogen, as in the following reaction:



The hydrogen and oxygen are supplied as gases, and the water is usually formed as a liquid. This reaction is also the beginning of the conventional fossil-fuel, steam turbine generating cycle. In that cycle, fuel is burned to produce heat ... which makes steam, which drives a turbine, which drives the generator. In the fuel cell, this process is bypassed: the electrical current is generated directly in the chemical reaction. The advantage of the use of the fuel cell is that the efficiency is higher than if the same fuel were burned to produce heat in a conventional steam cycle.

In a fuel cell, there is an anode at which the hydrogen is oxidized and free electrons are liberated. In addition, there is a cathode at which the oxygen reacts and the free electrons recombine. As in a battery, if a wire connects these electrodes, electrical current will flow in the external circuit. An electrolyte is in contact with the anode and cathode, and ions migrate through the electrolyte.

Specifically, for one type of system that uses an electrolyte that contains carbonate ions (CO_3^-), the reaction (at the anode) is the following:

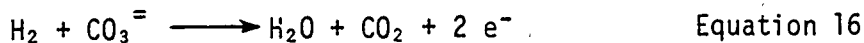

At the cathode, the reaction is as follows:

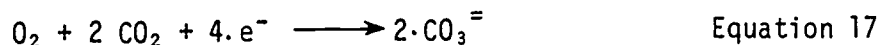

The net effect of these two reactions is to combine hydrogen and oxygen to form water, in accordance with Equation 15.

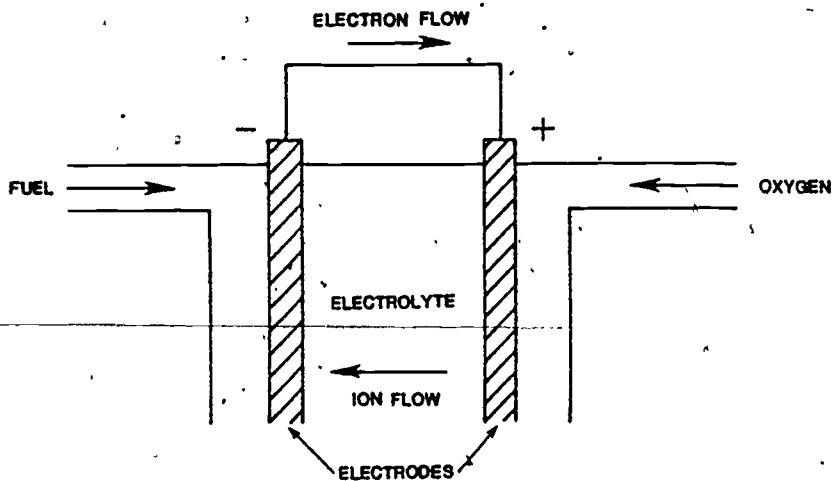

Figure 11. Schematic Diagram of Fuel Cell.

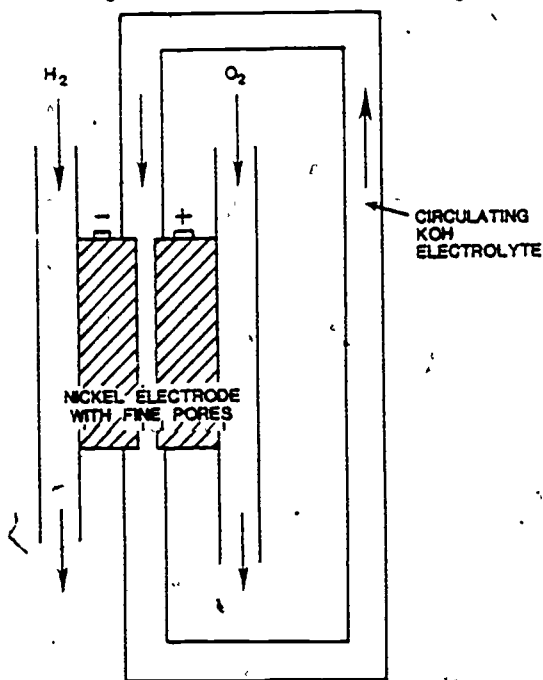

Figure 12. Diagram of Bacon-Type Fuel Cell.

A schematic diagram of a fuel cell is shown in Figure 11. The fuel and oxygen flow into the cell and diffuse through porous electrodes. The reactions occur on the inside surface of the electrodes, where the gas, the electrode, and the electrolyte are all in contact.

The prototype of modern fuel cells is the Bacon cell, which was named after its inventor. This cell operated at a temperature around 200°C and had a liquid potassium hydroxide electrolyte and nickel electrodes with fine pores. A schematic diagram is shown in Figure 12. This cell produced a voltage of approximately 0.7 volt and provided an electrical current of 750 amperes for each square foot of electrode area. The development of this type of fuel cell in the 1950s generated great enthusiasm and led to continued development of fuel cells.

Fuel cells were developed for practical application in the space program. Fuel cells were used with great success on the Gemini and Apollo space missions because they were well suited to providing electrical power for periods of around two weeks under conditions where low weight was important but where cost was not of great importance. The fuel cells for the space program provided a reliable electrical power with high energy storage per unit weight; but the cost was relatively high.

After the successful application of fuel cells in the space program, attention turned to possible uses of fuel cells for terrestrial applications. One desirable application could be for vehicle propulsion. Experimental units have been used to power trucks and automobiles. Fuel cell systems have been developed by many organizations. Some have been demonstrated to produce several kilowatts of power; others have demonstrated lifetimes up to 10,000 hours.

However, despite fairly large efforts, fuel cells have not yet been successful for ground-based applications. The main problem has been the high cost. Cost was not a prime consideration in fuel cells for the space program, but it is extremely important for applications such as vehicle propulsion. Despite intensive efforts, the cost of fuel-cell systems remains too high for them to be economically attractive at this time. There are other improvements that are needed, such as improved lifetime development of units that can produce higher powers and improved catalytic materials for electrodes. For low-cost operation, the fuel cells must use gases that need little purification. For example, air, rather than oxygen, should be the oxidizer. Further advances in this area are also needed. Thus, the status of fuel cells remains as follows: they are still developmental, and practical applications are lacking.

A few types of fuel cells that are being studied are shown in Table 6. This is not a complete list, but rather a sample which shows the types of material that are being studied. The high temperature fuel cell is significant. At high temperatures, the catalyst material can be more simple and less expensive than catalysts needed for lower temperature operation. Because the cost of the catalyst is high, this type of fuel cell can possibly be constructed at a reduced price.

Fuel cells could be desirable energy sources. Fuel cells using hydrogen would conserve fossil-fuels and would be a renewable energy source. They are compatible with many applications, including vehicle propulsion, domestic air conditioning, generation of heat and electricity within a home, and as a supplement to conventional electrical power plants. For generation of electricity, they offer a higher efficiency of conversion of the thermal energy of the fuel to electrical energy, as compared to conventional electrical generation.

TABLE 6. SOME TYPES OF FUEL CELLS UNDER DEVELOPMENT.

Type	Gases Used	Electrolyte	Electrodes	Temperature of Operation (°C)
Aqueous electrolyte	Hydrogen and oxygen	Potassium hydroxide in water	Nickel	25
Aqueous electrolyte	Hydrogen - containing gas and air	Sulfuric acid in water	Tungsten carbide	25
High temperature	Hydrogen - containing gas and air	Molten carbonate salts	Nickel or silver	650
Ammonia	Ammonia and oxygen	Potassium hydroxide	Platinum containing materials	140

PHOTOVOLTAIC GENERATION OF ELECTRICITY

Photovoltaic generation of electricity involves direct conversion of the energy from sunlight into electrical energy. Module EP-03 discussed generation of steam and hot water using solar collectors. High temperature solar collector systems can generate steam which can drive a steam turbine and generate electricity in a conventional cycle. In photovoltaic generation, electricity is produced directly when the light is absorbed in a semiconductor material. There is no need to generate heat or steam.

PRINCIPLES OF OPERATION

The photovoltaic effect in semiconductors is the basis for the direct generation of electricity from sunlight. The photovoltaic effect is described in physics courses that the student has studied; but, for completeness, it will be briefly reviewed here.

The energy states available to electrons in a semiconductor, such as silicon, are not continuous; rather, they have a region called the energy gap in which there are no energy states. The width of the energy gap varies from one semiconductor to another. The presence of the energy gap affects the electrical properties of the material, and is, in fact, what makes them semiconductors.

Electrons in the valence band, which lies below the energy gap, are not free to move and cannot contribute to electrical conductivity. Electrons in the conduction band above the energy gap are free to move and can produce electrical conductivity.

When light is absorbed in a semiconductor, the energy of the light can raise an electron across the energy gap, from the valence band to the conduction band. This produces a current carrier — an electron with a negative charge in the conduction band. This is called a hole. The hole can also be a current carrier that acts as if it had a positive charge. The situation is shown schematically in Figure 13, which shows the energy gap, the conduction and valence bands, and the motion of the charge carriers (electrons and holes) in an applied electric field.

Electrical conductivity can also be produced in a semiconductor by doping the semiconductor with small amounts of impurity elements. In silicon, an element such as phosphorous contributes an electron to the conduction band because the outer electronic shell in phosphorous has five electrons, as compared to four for silicon. Such a semiconductor is called N-type because the current carriers are negative (electrons).

An element such as boron contributes a hole to the valence band because the outer electronic shell in boron has only three electrons. Such a semiconductor is called P-type because the current carriers are positive (holes).

It is possible to dope a semiconductor to produce adjacent regions of P-type material and N-type material. The result is called a P-N junction, which is illustrated in Figure 14. The energy bands in the region of a P-N junction are shown in Figure 14. The junction region itself is only a few micrometers

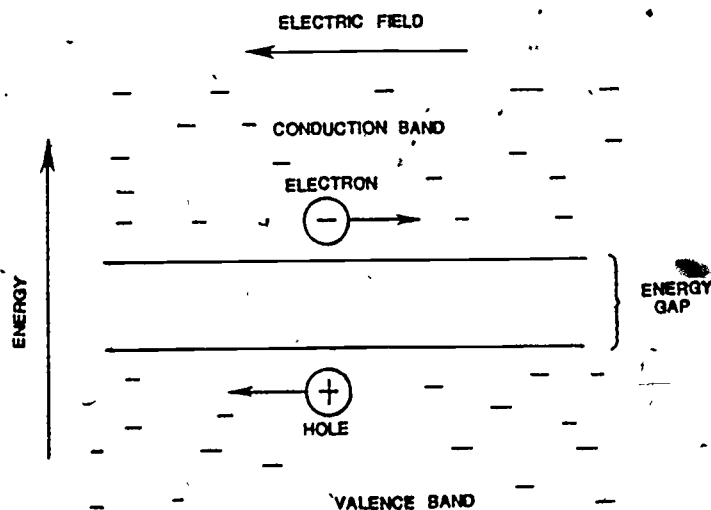

Figure 13. Diagram of Energy Gap, Conduction Band, Valence Band, and Current Carriers in a Semiconductor.

in width. One side is P-type material; the other side is N-type material. The conduction and valence bands change shape through the junction, as indicated. The band gap is denoted by E_g , and the dashed line shows the level to which the electronic states are filled.

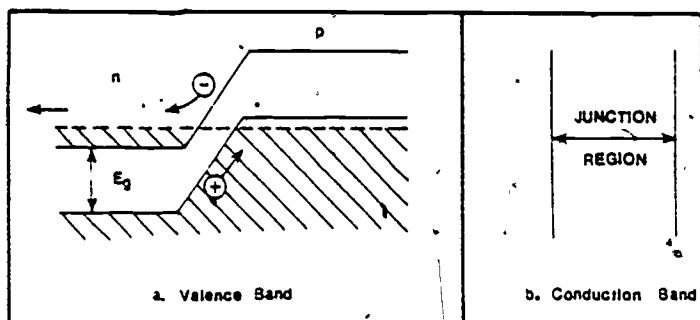

Figure 14. Diagram of P-N Junction in a Semiconductor.

If light is absorbed near the junction region, it will raise an electron from the valence band to the conduction band, producing an electron in the conduction band and a hole in the valence band. The change in shape of the bands near the junction acts like a built-in electrical field and will cause the hole and electron to move,

as indicated in Figure 14. This produces a flow of electrical current.

This is the photovoltaic effect. Light is incident on a P-N junction in a semiconductor. Absorption of the light produces a flow of electrical current directly, a phenomenon that occurs without application of any voltage external to the semiconductor. The energy of the light is turned directly into a flow of electrical current, without any intermediate stages such as production of heat or steam. Electrical current generation, using P-N junctions in semiconductors and the photovoltaic effect, can, thus, convert energy from sunlight into electrical energy.

PHOTOVOLTAIC CELLS

A diagram of a photovoltaic cell is shown in Figure 15. A substrate of P-type semiconductor has a thin layer of N-type semiconductor. The P-type semiconductor may be silicon, doped with a small amount of an element such as boron or indium. The N-type semiconductor may be silicon, doped with a small amount of an element such as arsenic or phosphorous. The narrow region between these two layers is called the junction region. This region is approximately one micrometer thick.

If sunlight is incident on the photovoltaic cell, free electrons and holes (denoted by minus and plus signs respectively) will be produced by absorption of light energy near the junction region. Because of the photovoltaic effect, the carriers will move in the direction of the arrows. Electrical contacts are formed by depositing thin metal films on the surface. The photovoltaic effect will cause electrical current to flow in a wire that connects the contacts. Thus, a photovoltaic cell is a generator of electrical current and electrical power when it is exposed to sunlight.

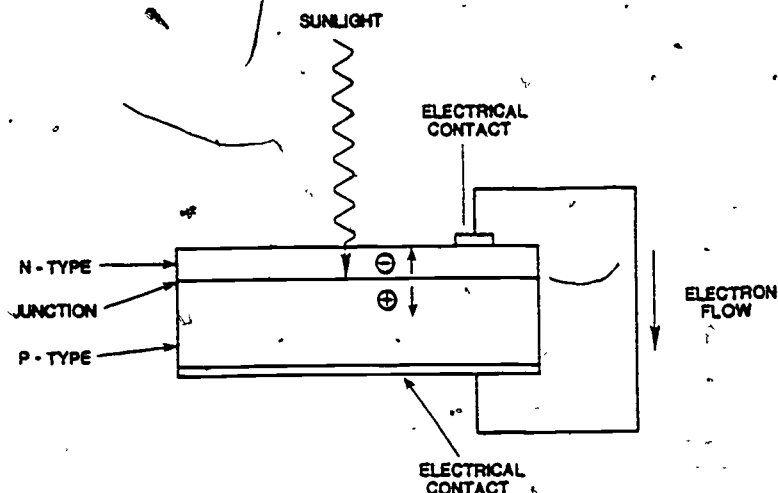

Figure 15. Diagram of Photovoltaic Cell.

The potential efficiency of solar cells is of great importance. Because of the fact that solar radiation is distributed over a wide range of wavelengths, the efficiency of any photovoltaic cell must be less than 100%. The spectral distribution of energy in sunlight was shown in Figure 2 of Module EP-03. Light with long wavelength cannot excite free carriers and, thus, is ineffective in producing photovoltaic electrical power. Light of short wavelength can produce photovoltaic current, but each incoming photon produces one electron-hole pair. Any excess energy above the minimum needed to produce the electron-hole pair is lost. Only light with photon energy nearly equal to the energy gap of the semiconductor is used with high efficiency.

The maximum possible efficiency for conversion of solar energy into electrical energy is a function of the energy gap of the semiconductor. This is a result of the inevitable losses. The situation is illustrated in Figure 16, which shows the maximum possible efficiency for photovoltaic conversion of sunlight versus energy gap. The highest possible value is around 25%, near an energy gap of 1.4 electron volts. This is a theoretical maximum value, set by the losses resulting from the mismatch of the ends of the solar spectrum with the energy gap. If the engineering and construction of solar cells is less

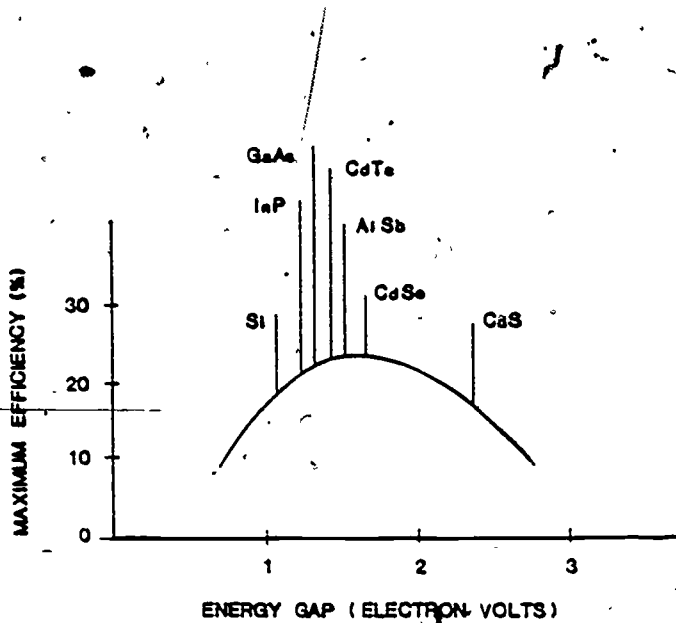

Figure 16. Maximum Photovoltaic Conversion Efficiency Vs. Semiconductor Energy Gap.

than perfect, the conversion efficiency will be even less than the value shown in Figure 16.

Figure 16 shows the energy gaps of a number of semiconductors. The most popular and best developed semiconductor is silicon, having an energy gap around 1.1 eV and a maximum possible efficiency around 20%. Other semiconductors, such as GaAs and CdTe, have energy gaps closer to the

maximum value, and they could have higher conversion efficiency.

Silicon solar cells, which have been the subject of intense development, have been used in the space program. They take advantage of many technological developments involving silicon used in the electronics industry. The leading

candidate for solar photovoltaic energy conversion is silicon, despite the fact that it does not have the highest possible value of efficiency.

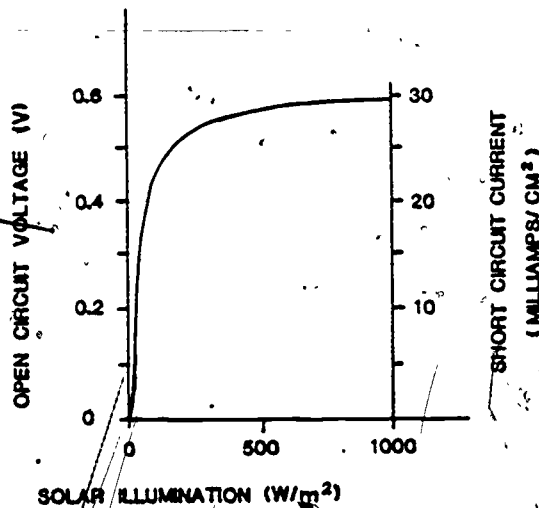

Figure 17. Output of Typical Silicon Photovoltaic Cell Vs. Incident Solar Illumination.

Figure 17 shows electrical characteristics for a typical silicon photovoltaic cell. The top curve is the open circuit voltage, and the lower curve is the short circuit current. These outputs are shown as versus the power per unit area delivered by sunlight. (Remember that solar power has a maximum value around 1000 W/m² on the earth's surface, when the sun is directly overhead.)

Silicon solar cells can be fabricated in large area configurations with efficiencies in the range of 10 to 12%. Higher efficiencies can be obtained in devices with small areas and high cost, but large area devices will be needed for production of large amounts of electrical power.

Development of other types of solar cells is proceeding. In particular, cadmium telluride and gallium arsenide solar cells are of interest because of potentially higher efficiency. Experimental gallium arsenide devices have been made with efficiency around 25%, near the theoretical maximum. However, these types of solar cells are far less developed than silicon devices. The cost is much higher than for silicon devices. The ability to make devices with large areas is much less developed than for silicon; therefore, cadmium telluride and gallium arsenide solar cells must be regarded as experimental devices.

APPLICATION OF PHOTOVOLTAIC ELECTRIC GENERATION

Conversion of solar energy directly into electricity has many attractive features. This method uses no fossil-fuels; rather, it takes advantage of solar energy that is already incident on the earth - thus making it a renewable resource. Photovoltaic electric generation causes no direct environmental damage. It is a flexible technology, compatible with relatively small generating plants; therefore it could serve small communities or even individual buildings. Thus, large distribution networks are not needed, and dangers of large-scale blackouts are eliminated.

The overwhelming problem for large-scale usage of solar photovoltaic cells is their high cost. All of the current materials and manufacturing steps are too expensive to make large-scale electrical generation feasible. Many development programs are attempting to reduce costs. The main advance needed is the ability to produce large area solar cells that have good efficiency at low cost.

A second drawback is the fact that solar power is not constant. Thus, storage facilities are necessary for night, cloudy days, and so forth. Present methods of producing the electrical contacts on the top surface of the cells cover too much area and reduce the useful area of the cell. Advances are needed in the production of electrical contacts. Finally, paving of large areas with silicon may be considered environmentally undesirable. At the currently available conversion efficiency of 10%, about 1.6% of the area of the United States

would have to be covered with solar cells to provide all the energy needs of the country.

Photovoltaic conversion of solar energy to electrical energy has been used successfully for many years in the space program. Silicon solar cells have provided most of the electrical power used on space vehicles. Very large panels with many solar cells on each panel are deployed after launch. These panels have the appearance of sails. Units with capabilities up to 11 kilowatts have been launched into space. Obviously, this has been a successful, practical application of photovoltaic energy conversion.

The use of photovoltaic cells in the space program was compatible with the relatively high cost of the cells. Solar cells used in space cost \$200 or more per watt of electrical power generation, a cost that is far too high for ground-based generation of electrical power.

The U.S. Department of Energy is sponsoring a broad-based program to reduce the cost of solar cells to the point that they will be competitive for terrestrial power generation. It is estimated that, at a cost of 50 cents per peak-watt, ground-based photovoltaic conversion of solar energy would be economically feasible. (In this specification, the cost is expressed in terms of 1975 dollars, and the term "peak-watt" refers to the wattage produced when the solar cell is exposed to the peak insolation of 1000 W/m^2 .) The goal of the Department of Energy program is the capability to produce large area solar cells at a cost of 50 cents per peak-watt by 1986. By the late 1970s, continued developments in silicon growth, coating methods, and cell fabrication had reduced the cost to several dollars per peak-watt. It appears possible that the 1986 cost goal can be met. At that point, electricity generated directly by photovoltaic conversion of solar energy could develop rapidly.

It is likely that photovoltaic electric generating plants will be relatively small compared to conventional electrical generating plants. Fossil-fuel and nuclear reactor plants are not economical unless they are large — 1000 megawatts or more. Generation stations for commercial generation of photovoltaic electrical power would probably be much smaller, serving relatively smaller communities, or perhaps individual buildings. Storage capacity would be required for periods when the sun is not shining.

REFERENCES

- Austin, L.G. "Fuel Cells," Scientific American, p. 72 (October 1959).
- Chalmers, B. "The Photovoltaic Generation of Electricity," Scientific American, p. 34 (October 1976).
- Chang, S.S.L. Energy Conversion. Englewood Cliffs, NJ: Prentice-Hall, Inc., 1963. Chapters 6 and 7.
- Considine, D.M., ed. Energy Technology Handbook. New York: McGraw-Hill Book Co., 1977. Sections 4, 6, and 9.
- Ehrenreich, A.E. and Martin, J.H. "Solar Photovoltaic Energy," Physics Today, p. 25, (September 1979).
- Fink, D.G. and Carroll, J.M. Standard Handbook for Electrical Engineers. 10th ed. New York: McGraw-Hill Book Co., 1968. Sections 8 and 24.
- Hart, A.B. and Womack, G.J. Fuel Cells - Theory and Applications. London: Chapman and Hall, Ltd., 1967.
- Hottel, H.C. and Howard, J.B. New Energy Technology. Cambridge, MA: The MIT Press, 1971. Chapters 5 and 6.
- Javetski, J. "A Burst of Energy in Photovoltaics," Electronics, p. 105 (July 19, 1979).
- Miller, S. The Economics of Nuclear and Coal Power. New York: Praeger Publishers, 1976.
- Neuenschwander, J.R. Modern Power Systems. New York: Harper and Row, 1971.
- Pender, H. and Del Mar, W.A. Electrical Engineers Handbook, Electric Power. New York: John Wiley & Sons, Inc., 1949. Sections 7 and 13.
- Potter, P.J. Power Plant Theory and Design. New York: John Wiley & Sons, Inc., 1959.
- Skrotzki, B.G. and Vopat, W.A. Power Station Engineering and Economy. New York: McGraw-Hill Book Co., 1960.