

DOCUMENT RESUME

ED 208 152

CE 030 181

AUTHOR Ethridge, Jim; And Others
TITLE Core I Materials for Metropolitan Agriculture/Horticulture Programs. Units D-F.
INSTITUTION Illinois Univ., Urbana. Dept. of Vocational and Technical Education.
SPONS AGENCY Illinois State Board of Education, Springfield. Dept. of Adult, Vocational and Technical Education.
PUB DATE Jun 81
CONTRACT R-33-31-D-0542-388
NOTE 351p.; Not available in paper copy due to colored paper. For related documents see CE 030 180-182.

EDRS PRICE MF01 Plus Postage. PC Not Available from EDRS.
DESCRIPTORS *Agricultural Education; *Agricultural Engineering; Agricultural Skills; Behavioral Objectives; Botany; Carpentry; Equipment; Grade 9; Grade 10; Guidelines; Hand Tools; *Horticulture; Instructional Materials; Job Skills; Learning Activities; Machine Tools; Safety; Secondary Education; *Urban Areas; Vocational Education

ABSTRACT

These units of instructional materials and teaching aids are part of a series of 10 units designed for use in metropolitan agriculture/horticulture programs for students in grades 9 and 10. Covered in the unit on horticulture/agricultural mechanics are safety in horticulture/agriculture; identifying, fitting, and using hand tools; using and maintaining selected power tools; and developing carpentry skills. Caring for, handling, and storing herbaceous seeds; seeding in containers; and propagating plants by cutting, layerage, and division or separation are described. Discussed next are identifying and classifying plants and identifying different parts and types of leaves, stems, fruits, flowers, and roots. Each of these units or problem area packets includes some or all of the following components: suggestions to the teacher, a content outline, a teacher's guide, information sheets, student worksheets or assignment sheets and keys, demonstrations, job sheets, transparencies, a discussion guide for transparencies, and sample test questions and a teacher's key. (The remaining seven units are available separately--see note.) (MN)

 * Reproductions supplied by EDRS are the best that can be made *
 * from the original document. *



EP 081-2

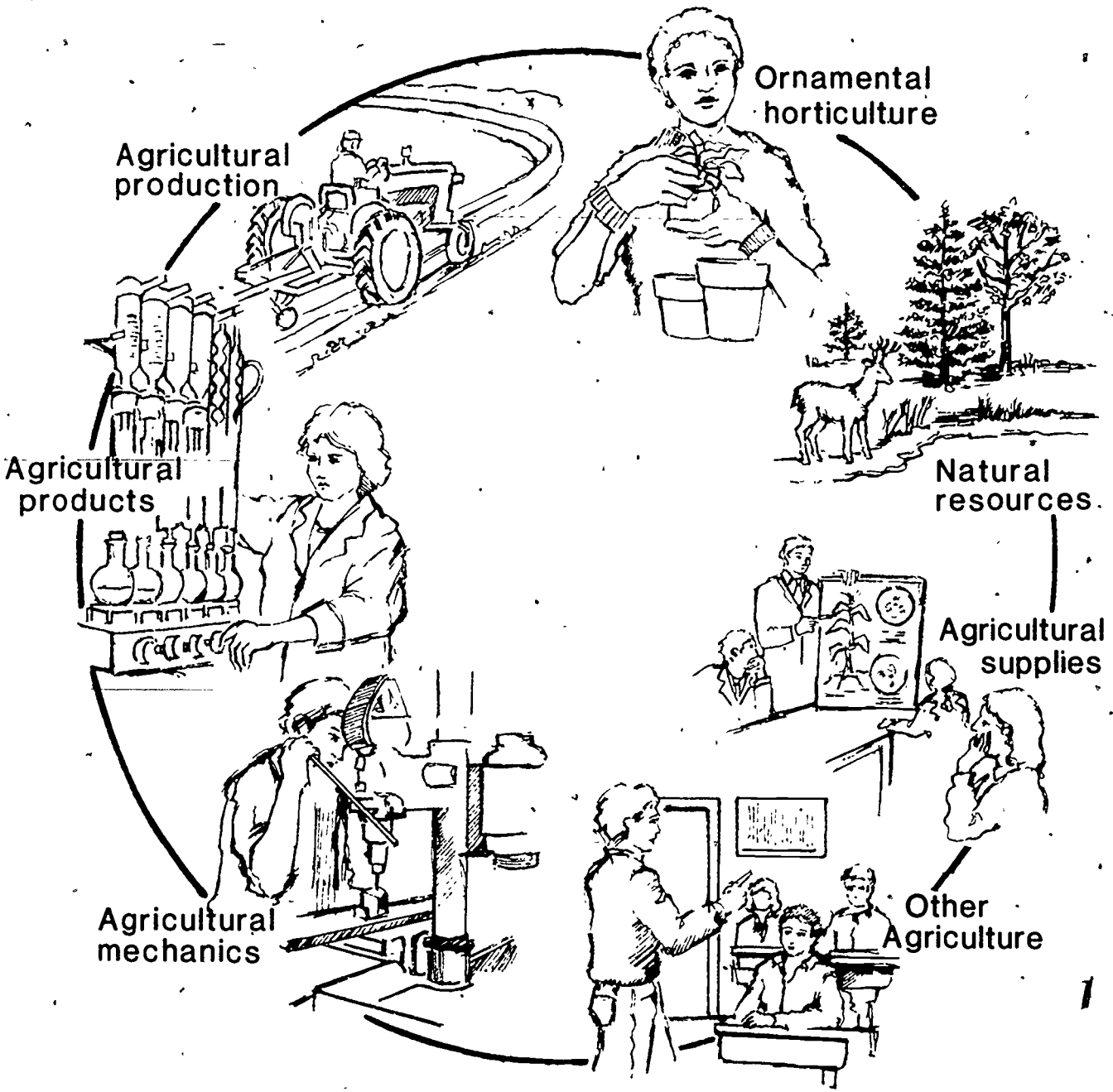

CE 081-2

UNIT D: Horticulture/Agricultural Mechanics

PROBLEM AREAS:

1. Understanding and practicing safety in horticulture/
agriculture
2. Identifying, fitting and using hand tools
3. Using and maintaining selected power tools
4. Developing basic carpentry skills

UNIT D: HORTICULTURAL/AGRICULTURAL MECHANICS

PROBLEM AREA: IDENTIFYING, FITTING AND USING HAND TOOLS

SUGGESTIONS TO THE TEACHER:

This problem area is designed for use with freshman or beginning students enrolled in an agricultural/horticultural occupations program. The recommended time for teaching this problem area is during the early winter. The estimated time for teaching this problem area is 3 to 5 days depending on how much time the teacher wishes to spend on discussion and conducting the suggested exercises. The materials in this problem area were selected and written with the following assumptions:

1. It is important for all agriculture students to be able to identify common hand tools.
2. It is important for students to receive instruction in the proper use and care of hand tools.

The materials included in this problem area include both urban and rural materials. The teacher should adapt this material to his/her local situation.

CREDIT SOURCES:

These materials were developed through a funding agreement, R-33-21-D-1542-388 with the Illinois State Board of Education, Department of Adult, Vocational and Technical Education, Research and Development Section, 100 North First Street, Springfield, Illinois 62777. Opinions expressed in these materials do not reflect, nor should they be construed as policy or opinion of the State Board of Education or its staff.

The teacher's guide, worksheets, transparency discussion guides were developed by Paul Benson, Jerry Pepple, and Jim Ethridge, Department of Vocational and Technical Education, University of Illinois. The transparency masters and suggested test questions were prepared by Vocational Agriculture Service, University of Illinois. The student worksheet on "Sharpening a Knife" was adapted from the Horticultural task sheet "Sharpening a Knife" developed by the Department of Agricultural Education, The Pennsylvania State University, University Park, PA 16802.

Suggestions and guidance in the development of these materials were provided by the pilot test teachers who worked with the Rural and the Urban Core Programs.

TEACHER'S GUIDE

- I. Unit: Agricultural mechanics
- II. Problem area: Identifying, fitting and using hand tools
- III. Objectives: At the close of the problem area students will:
 1. Be able to identify commonly used hand tools.
 2. Be able to sharpen or fit commonly used hand tools.
 3. Be able to use hand tools in a proper and safe manner.
- IV. Suggested interest approaches:
 1. Have various hand tools displayed on a table and ask students to identify the tools by name and use.
 2. Lead into a discussion of hand tools by asking students what hand tools they have at home.
 3. Ask the student to name safe practices and procedures to follow in using certain hand tools.
 4. Ask the students if they have been involved in any accidents when using hand tools.
 5. Ask the students if they know the approximate cost of each tool and then have them figure a total value for their own tools.
 6. Hand out hand tool puzzle sheet "I Tool You So" and challenge students to provide the answers.
- V. Anticipated problems and concerns of students:
 1. Why do I need to know the names of hand tools?
 2. Why do I need to be able to sharpen hand tools?
 3. Why do I need to wear safety glasses when using hand tools?
 4. How do you sharpen certain hand tools?
 5. How do I hold a board when sawing with a hand saw?
 6. Why do I need to be able to recognize hand tools?
 7. What hand tools are sharpened? How often?
 8. How are various hand tools used?
- VI. Suggested learning activities and experiences:
 1. Discuss problems and concerns identified by class or teacher when first starting problem area.

2. Take students into the shop area and identify available hand tools. Use Job Sheet 1 and Student Worksheet 2.
3. Discuss the safety considerations of each group of tools identified. Use Worksheet 6.
4. Visit a local machinery dealership and identify hand tools there.
5. Distribute Worksheet 1, Tool Identification, and have class identify tools.
6. Show transparencies. Identify various parts of each tool and explain the correct procedures for their use.
 - a. Hand Saws
 - b. Types of Hand Planes
 - c. Parts of the Brace and Bit
 - d. Selecting Nail Hammers
7. Have each student demonstrate the proper use of one tool in the shop. For example, for the hand saw and square, provide each student with a board and have them saw one end so it will be square.
8. Have class read VAS Unit 3005, "Sharpening Hand Tools."
9. Distribute Worksheet 4, "Sharpening Hand Tools" and have class fill out.
10. Demonstrate the actual sharpening of certain hand tools in the shop. Use Job Sheet 2 and 3 and Student Worksheet 3.
11. Have each student bring in tools of each type to be sharpened.
12. Have students make 3 by 5 identification cards by cutting out pictures of tools from catalogs.
13. Schedule field trip for horticulture students to visit the ILCA (Illinois Landscape Contractors' Association) field day in August and/or the ILCA winter show to see jobbers display tools available.

VII. Evaluation:

1. Prepare and administer a pencil and paper test covering: identification of hand tools, proper use of hand tools, and sharpening of hand tools.
2. Grade worksheets.
3. Prepare and administer laboratory practical exam on identification, proper use, and sharpening of hand tools.
4. Administer VAS safety test "Safe Practices in the Vocational Agriculture Shop" (section on hand tools).

VIII. References and aids:

1. VAS Unit 3005, "Sharpening Hand Tools," Vocational Agriculture Service, University of Illinois.
2. VAS Safety Test, "Student Test on Hand Tools."

3. VAS Transparencies on Hand Tools.
4. Student Worksheets 1-5.
5. Phipps, Lloyd J., Mechanics in Agriculture, The Interstate Printers and Publishers, Danville, Illinois.
6. Hand tool puzzle sheet "I Tool You So."
7. VAS Slide Set No. 633, "Identifying and Using Horticultural Hand Tools." (Available in fall of 1981.)
8. Job Sheets 1, 2, and 3.

HAND TOOL PUZZLE SHEET

I TOOL YOU SO

Fill in each blank with the name of a tool used in a workshop.

_____ we _____ of you is that you _____ away at the job of having a good time. No other ad _____ is necessary. If you need a new idea, _____ the cobwebs off your brain and _____. You will _____ little _____. That's the _____. _____ up your courage. Don't be as dead as a door _____. Try a new _____ your way through difficulties. If you do, it _____ well for your future. That's _____, isn't it? _____ up! Just tell them that you _____ me at the WORKSHOP PARTY.

THE TOOL CHEST HAS BEEN UPSET, AND WE MUST GET IT BACK IN ORDER. The following is a group of tools with the letters disarranged. Can you straighten them out?

- | | |
|-------------------|------------------------|
| _____ 1. Urel | _____ 14. Itb |
| _____ 2. Aws | _____ 15. Rcsew virder |
| _____ 3. Lnai ets | _____ 16. Cenhrw |
| _____ 4. Memhar | _____ 17. Rusgae |
| _____ 5. Elrwot | _____ 18. Life . |
| _____ 6. Alnep | _____ 19. Shicle |
| _____ 7. Careb | _____ 20. Chunp |
| _____ 8. Law | _____ 21. Rescw |
| _____ 9. 'Exa | _____ 22. Lina |
| _____ 10. Sive | _____ 23. Catk |
| _____ 11. Husbr | _____ 24. Finke |
| _____ 12. Cetthha | _____ 25. Guares |
| _____ 13. Leeend | |

TOOL IDENTIFICATION

Worksheet 1

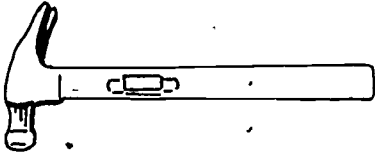

1. _____

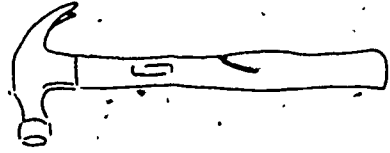

2. _____

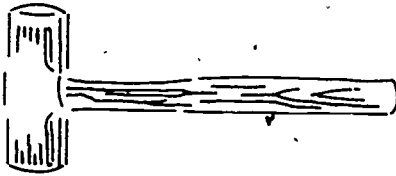

3. _____

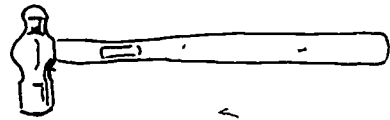

4. _____

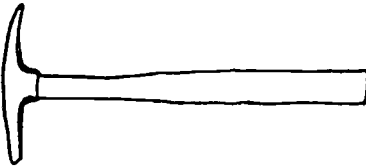

5. _____

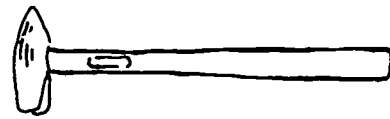

6. _____

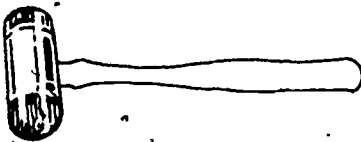

7. _____

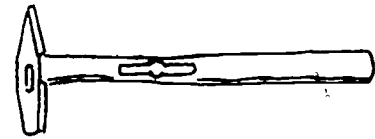

8. _____

9. _____

Worksheet 1, Page 2



9. _____



10. _____



11. _____

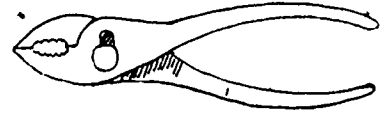

12. _____



13. _____

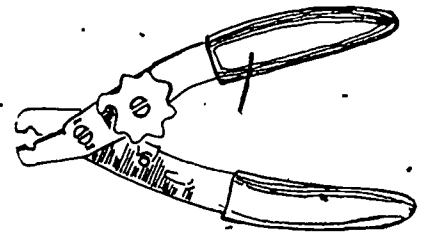

14. _____

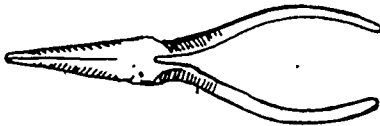

15. _____

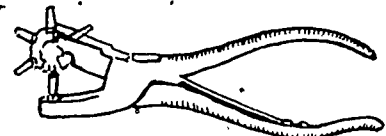

16. _____



17. _____

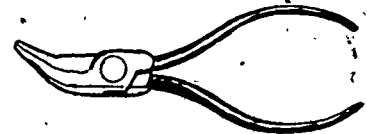

18. _____

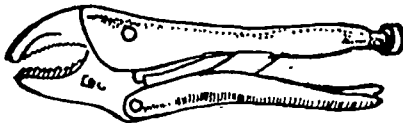

19. _____

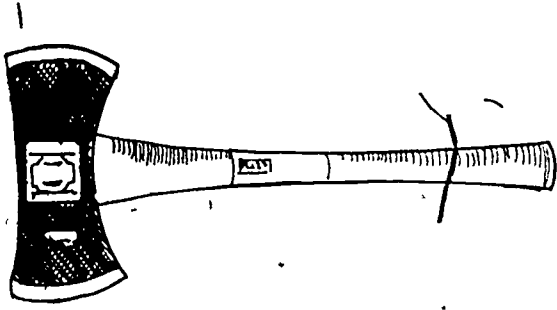

20. _____

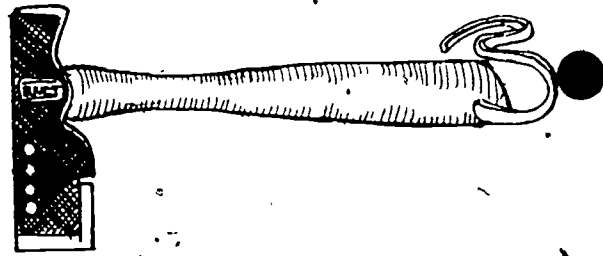

21. _____

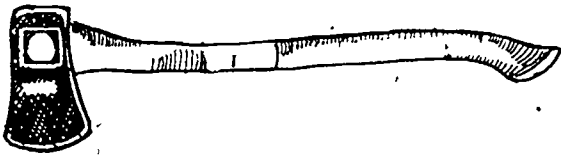

22. _____

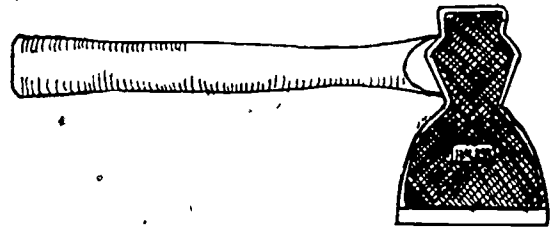

23. _____

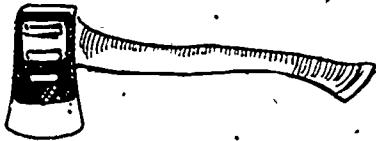

24. _____

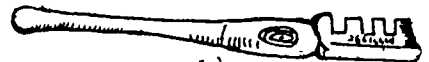

25. _____



26. _____



27. _____

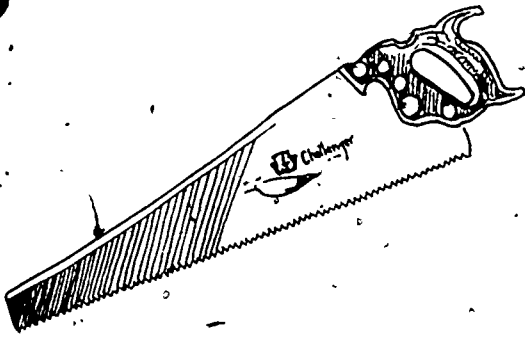

28. _____

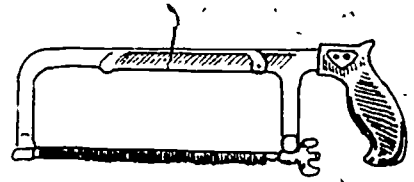

29. _____

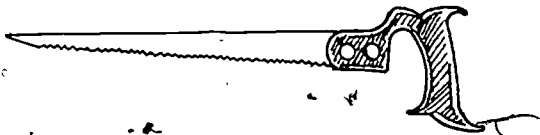

30. _____

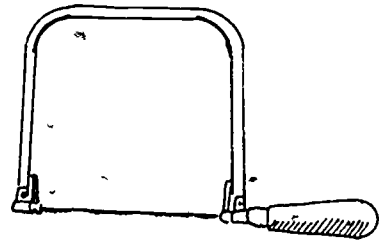

31. _____

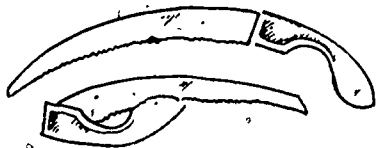

32. _____

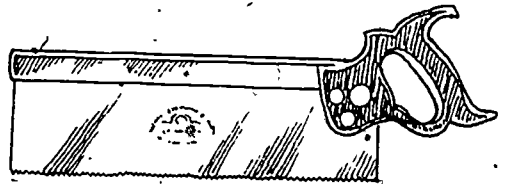

33. _____

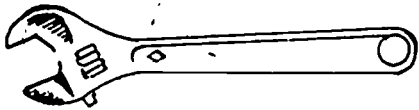

34. _____

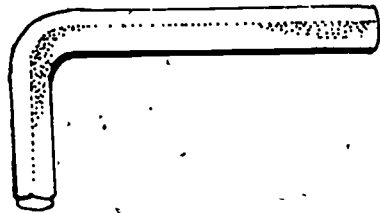

35. _____

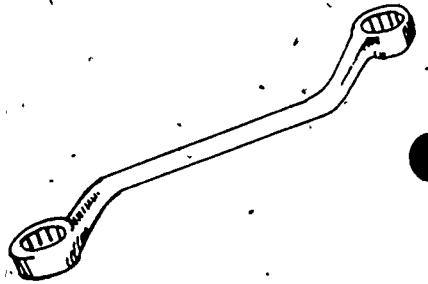

36. _____

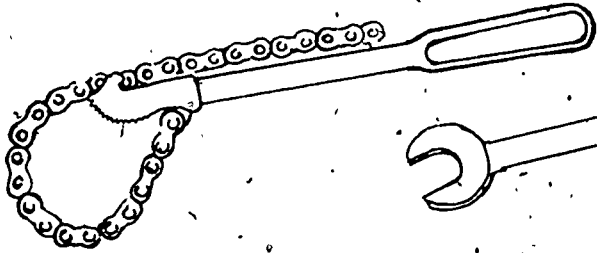

37. _____

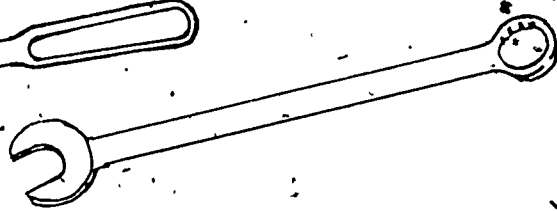

38. _____

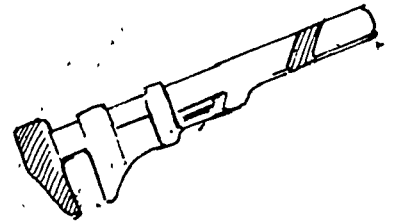

39. _____

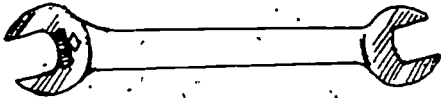

40. _____

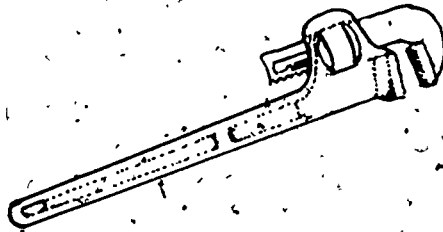

41. _____



42. _____



43. _____



44. _____

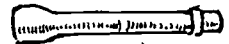

45. _____

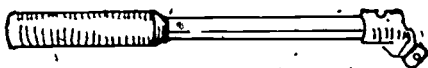

46. _____



47. _____

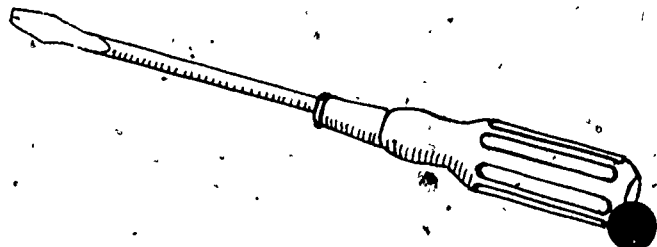

48. _____

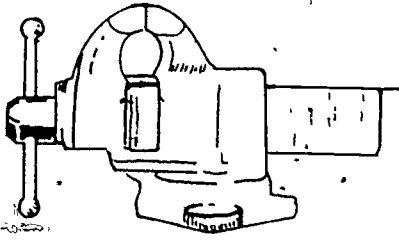

50. _____

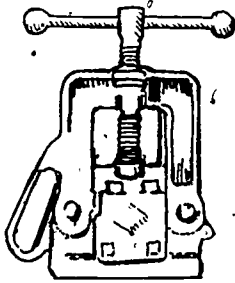

52. _____

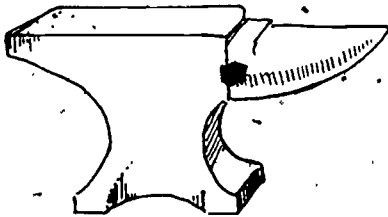

54. _____

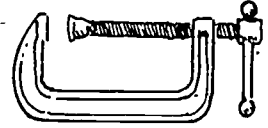

49. _____

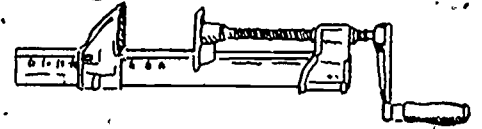

51. _____

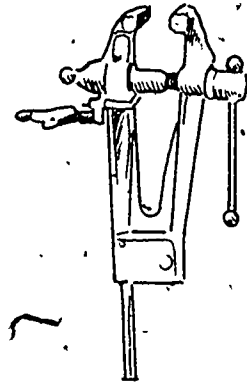

53. _____

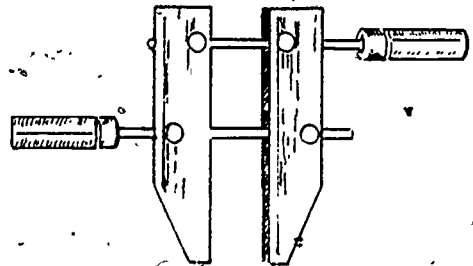

55. _____



56. _____

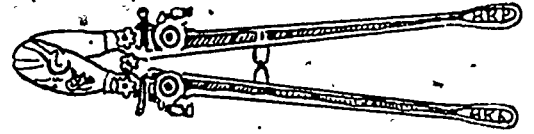

57. _____

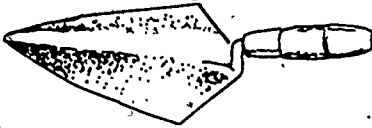

58. _____

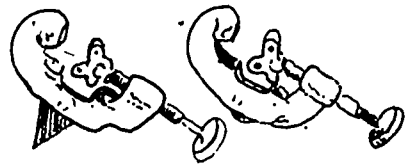

59. _____

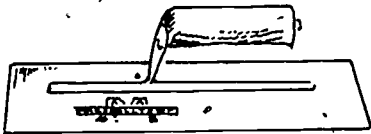

60. _____

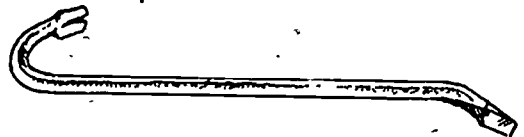

61. _____

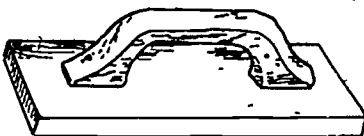

62. _____

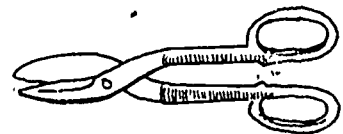

63. _____

15

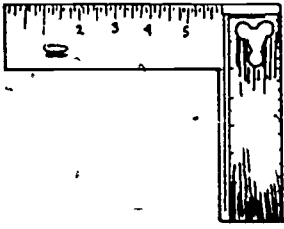

64. _____

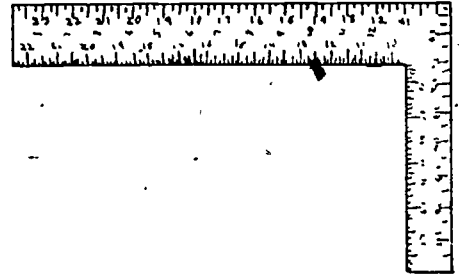

65. _____

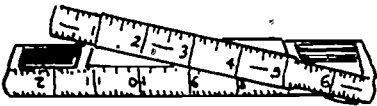

66. _____

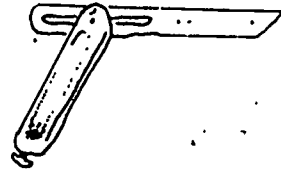

67. _____

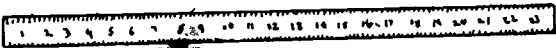

68. _____



69. _____



70. _____

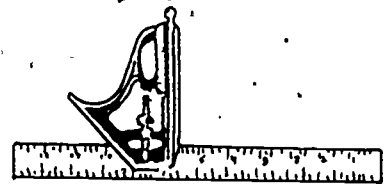

71. _____



72. _____

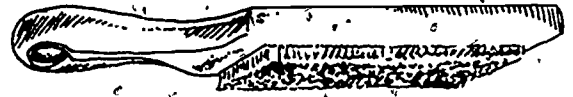

73. _____



74. _____



75. _____



76. _____

77. _____

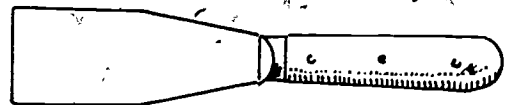
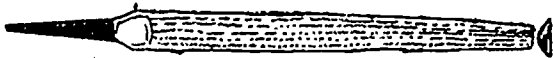

78. _____

79. _____



80. _____

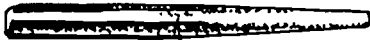

82. _____



84. _____



86. _____



88. _____

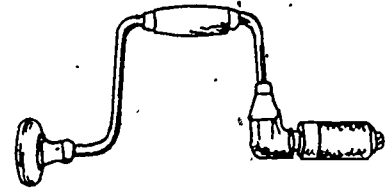

81. _____



83. _____

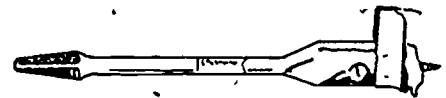

85. _____



87. _____

STUDENT WORKSHEET 2
IDENTIFYING HAND TOOLS

Name _____ Price _____

Give one use: _____

Name _____ Price _____

Give one use: _____

3

Name _____ Price _____

Give one use: _____

Name _____ Price _____

Give one use: _____

Name _____ Price _____

Give one use: _____

Name _____ Price _____

Give one use: _____

STUDENT WORKSHEET 3
HAND TOOL DEMONSTRATION

Questions:

1. Name of tool _____
2. Primary function _____
3. Can this tool be adjusted? _____
If so, how and where? _____

4. Can tool be sharpened? _____ If so, how and where?

Observations:

List step-by-step method of correctly using the tool. Draw and identify the major parts of the tool.

Conclusion:

List safety practices identified and how to properly clean and store the tool.

STUDENT WORKSHEET 4
SHARPENING HAND TOOLS

1. Why shouldn't a wood chisel be sharpened to a longer thinner bevel than what is recommended?

2. When sharpening a tool on a grinder wheel, how should the tool to be sharpened be held?

3. What is meant by keeping a grinding wheel properly dressed? _____

4. What are three safety precautions to take when using a grinding wheel?

a. _____

b. _____

c. _____

5. The standard angle of keenness for wood chisels is about _____ degrees.

6. The length of bevel of a wood chisel should be about twice the _____ of the chisel blade.

7. The cutting edge of a knife differs from a wood chisel in that the knife blade is ground on _____ and usually with a longer _____.

8. How do you joint an axe blade? _____

9. All sharpening of the auger bit is usually done with a _____.

10. Describe the difference between rip-saw teeth and cross-cut saw teeth. _____

11. What does "set of the saw" mean? _____

12. The standard angle of keenness for metal cutting tools, such as a cold chisel, is _____ degrees.

13. What does it mean to fit a screwdriver? _____

STUDENT WORKSHEET 5

DISCUSSION QUESTIONS ON HAND TOOLS

1. When should pliers be used in place of a wrench?
2. Why is a dull chisel more dangerous than a sharp one?
3. What determines if a screwdriver is the proper size?
4. How do you properly start and drive a nail?
5. Why should you not use a claw hammer for metal working?
6. If a hammer head is loose, how should you repair it?
7. Why should you not have anyone standing in front of you when using a hammer?
8. How should edged tools be stored?
9. Why should handles be used on files?
10. How should edged tools be carried?

HAND TOOL PUZZLE SHEET

I TOOL YOU SO

Fill in each blank with the name of a tool used in a workshop.

Awl we axe of you is that you hammer away at the job of having a good time. No other ad vise is necessary. If you need a new idea, brush the cobwebs off your brain and file. You will needle little punch. That's the rule. Screw up your courage. Don't be as dead as a door nail. Try a new tack. Knife your way through difficulties. If you do, it augers well for your future. That's plane, isn't it? Brace up! Just tell them that you saw me at the WORKSHOP PARTY.

THE TOOL CHEST HAS BEEN UPSET, AND WE MUST GET IT BACK IN ORDER. The following is a group of tools with the letters disarranged. Can you straighten them out?

- | | | | |
|-----------------|-------------|---------------------|------------------|
| <u>rule</u> | 1. Urel | <u>bit</u> | 14. Itb |
| <u>saw</u> | 2. Aws | <u>screw driver</u> | 15. Resew virder |
| <u>nail set</u> | 3. Lnai ets | <u>wrench</u> | 16. Cenhrw |
| <u>hammer</u> | 4. Memhar | <u>square</u> | 17. Rusqae |
| <u>trowel</u> | 5. Elrwot | <u>file</u> | 18. Life |
| <u>plane</u> | 6. Alnep | <u>chisel</u> | 19. Shicle |
| <u>brace</u> | 7. Careb | <u>punch</u> | 20. Chunp |
| <u>awl</u> | 8. Law | <u>screw</u> | 21. Rescw |
| <u>axe</u> | 9. Exa | <u>nail</u> | 22. Lina |
| <u>vise</u> | 10. Sive | <u>tack</u> | 23. Catk |
| <u>brush</u> | 11. Husbr | <u>knife</u> | 24. Finke |
| <u>hatchet</u> | 12. Cetthha | <u>augers</u> | 25. Guares |
| <u>needle</u> | 13. Leeend | | |

TEACHER'S KEY
STUDENT WORKSHEET, 1

TOOL IDENTIFICATION KEY

1. Straight Claw or Ripping Hammer
2. Curved Claw Hammer
3. Sledge Hammer
4. Ball Pein or Machinist's Hammer
5. Tack Hammer
6. Blacksmith's Hammer
7. Mallet or Soft Headed Hammer
8. Tinner's Hammer
9. Fence Pliers
10. Water Pump Pliers
11. Battery Pliers
12. Slip Joint Combination Pliers
13. Diagonal Pliers
14. Wire Stripper
15. Long Nose Pliers
16. Revolving or Leather Punch
17. Lineman or Electricians Pliers
18. Curved-needle nose Pliers
19. Lever-Jawed Wrench or Locking Pliers
20. Double Bit Axe
21. Shingler's Hatchet
22. Single Bit Axe
23. Broad Hatchet
24. Hand Axe
25. Glass Cutter
26. Jack Plane
27. Wood Scraper
28. Hand Saw
29. Hack Saw
30. Keyhole or Compass Saw
31. Coping Saw
32. Pruning Saw
33. Back Saw
34. Adjustable or Crescent Wrench
35. Allen or Setscrew Wrench
36. Box End Wrench
37. Chain Wrench
38. Combination End Wrench
39. Monkey Wrench
40. Open End Wrench
41. Pipe Wrench
42. Double Open End S Wrench
43. Phillips Screw Driver
44. Deep Socket
45. Extension Bar
46. Flex Handle
47. Universal Joint
48. Screw Driver
49. "C" Clamp
50. Machinist's Vise
51. Bar Clamp
52. Pipe Vise
53. Blacksmith's or Leg Vise
54. Anvil
55. Hand Screw
56. Non-metallic Cable Ripper
57. Bolt Cutters
58. Brick Trowel
59. Tubing Cutter
60. Concrete Finishing Trowel
61. Wrecking, Ripping, or Pinch Bar
62. Concrete Float
63. Tinner's Shears or Tin Snips
64. Tri Square
65. Carpenter's or Framing Square
66. Folding Rule
67. Sliding "T" Bevel
68. Steel Rule or Bench Rule
69. Carpenter's Level
70. Plumb Bob
71. Combination Square
72. Wood Rasp
73. File Card
74. Single Cut File
75. Cold Chisel
76. Taper or Triangular File
77. Wood Chisel
78. Half Round File
79. Putty Knife
80. Center Punch
81. Bit Brace
82. Drift Punch
83. Auger Bit
84. Nail Set
85. Expansion Bit
86. Pin Punch
87. Straight Shank Twist Drill
88. Prick Punch

TEACHER'S KEY
STUDENT WORKSHEET. 4

SHARPENING HAND TOOLS

1. Why shouldn't a wood chisel be sharpened to a longer thinner bevel than what is recommended?
It is likely to chip, break or dull.
2. When sharpening a tool on a grinder wheel, how should the tool to be sharpened be held?
Hold the tool so wheel turns toward the cutting edge.
3. What is meant by keeping a grinding wheel properly dressed?
Clean and sharpen the wheel to keep clean particles of abrasive material exposed.
4. What are three safety precautions to take when using a grinding wheel?
 - a. wear goggles
 - b. use wheel guards
 - c. adjust tool rest so it is close to the wheel
5. The standard angle of keenness for wood chisels is about 25 - 30 degrees.
6. The length of bevel of a wood chisel should be about twice the thickness of the chisel blade.
7. The cutting edge of a knife differs from a wood chisel in that the knife blade is ground on both sides and usually with a longer bevel.
8. How do you joint an axe blade? Lay blade flat on the tool rest with a light pressure against the wheel. Move handle back and forth as blade is moved across the stone.
9. All sharpening of the auger bit is usually done with a file.
10. Describe the difference between rip-saw teeth and cross-cut saw teeth.
Rip-saw teeth have flat cutting edges. Cross-cut teeth have sharp points.
11. What does "set of the saw" mean?
Bending the teeth so the cutting points are wider than the blade.
12. The standard angle of keenness for metal cutting tools, such as a cold chisel, is 60 degrees.
13. What does it mean to fit a screwdriver?
Grinding the tip so it is square and blunt with straight sides.

JOB SHEET 1

IDENTIFYING AND USING HAND TOOLS

Objectives:

1. To become familiar with the names of hand tools in the school shop.
2. To know the correct uses of selected hand tools.
3. To become familiar with the cost of selected hand tools.

Materials:

1. Provide student access to the shop hand tools.
2. A supply of old hardware shop catalogs.

Procedure:

1. Give students a tour of the shop pointing out the various hand tools and their location.
2. Have each student locate a picture of each selected hand tool in an old catalog, cut it out, tape the picture on the worksheet and complete the necessary information.
3. Duplicate additional worksheet pages according to the number of hand tools the students are to identify.

JOB SHEET 2
HAND TOOL USE AND SAFETY

Objectives:-

1. To develop an interest in hand tools.
2. To develop the ability to correctly use hand tools.
3. To appreciate a satisfactory job of using hand tools.
4. To develop ability to correctly clean, adjust and store hand tools.

Materials:

1. Selected hand tools.
2. Materials which can be used to demonstrate each hand tool (wood, metal, etc).

Procedures:

1. Demonstrate or have students demonstrate the use of selected hand tools.
2. Explain proper methods of using each tool.
3. Determine student knowledge of use and safety of each hand tool by asking students to identify safety practices.
4. Have students complete attached sheet as each hand tool is demonstrated.

127

JOB SHEET 3
SHARPENING A KNIFE

Objective:

Given a florist, nursery, or grafting knife, the student will sharpen the blade on an oil stone and a leather strop to a razor cutting edge in a safe, careful manner. Performance is evaluated by the teacher.

Introduction:

A sharp knife is important in working with plant materials so that all cuts are made in a clean and smooth manner without crushing delicate plant parts. A dull knife is more likely to slip while being used than a sharp one, so injuries are more likely to occur with a dull knife.

The knife blade is sharpened at the original angle, with all nicks carefully removed.

Materials and Tools Needed:

Florists, nursery, or grafting knife
Oil sharpening stone
Filled oil can
Wiping cloth
Leather razor strop

Procedures:

1. Assemble all the needed materials: pocket knife, oil stone, filled oil can, wiping cloth.
2. Under the direct supervision of the instructor, carefully examine the blade to find any nicks in the blade. If it is nicked, use the "coarse" side of the stone to remove them. Put a few drops of oil on the stone. Hold the blade against the stone near one end of the stone, at about a 20° angle, cutting edge in the direction of motion. Move it evenly and smoothly the full length of the stone. Lift the blade and return it to the original position. Repeat 5 to 10 times. Turn the blade over in order to stroke the other side 5 to 10 times. Repeat alternately stroking each side of the blade until the nicks are all removed.
3. After the nicks are removed, (or do this at once if there are no nicks) turn the stone to the "fine" side and repeat the strokes as explained in Step 2.
4. Test the sharpness by attempting to cut a newspaper edge with the blade. Check the tip, middle, and shank parts of the blade. Often only part of a blade may be sharp. Continue sharpening and testing until the entire cutting edge is sharp.
5. When the entire edge is sharp, the next step is to finish (remove burrs) with a leather razor strop. No oil is used. The motions are exactly the same as for using a stone, except that in this case the back of the blade is in the direction of the motion (otherwise, the strop will be cut!) This stropping results in a very fine edge.
6. Clean up all tools and equipment and store them.

Properly used, a stone will last many years; a circular motion in a small space of the stone will soon develop a narrow groove in the stone, ruining it.

HAND SAWS

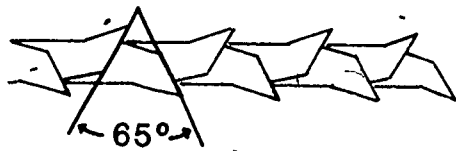
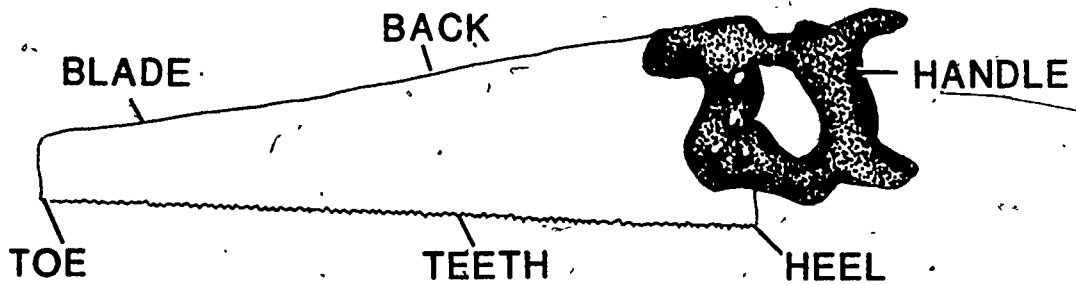

CROSSCUT

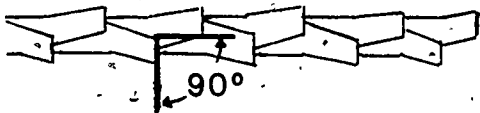
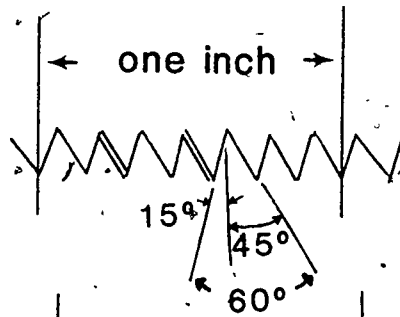

RIP

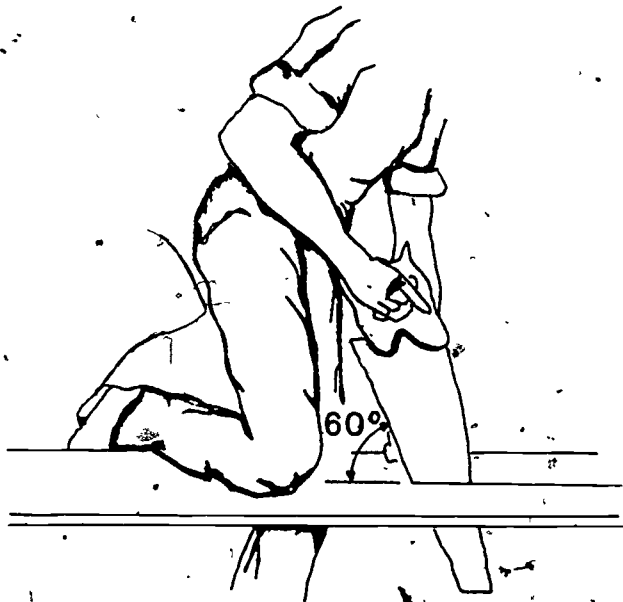
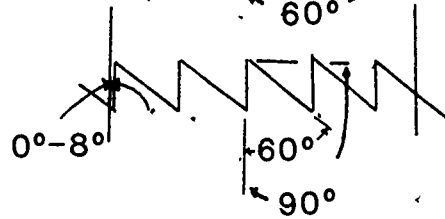

RIP SAW

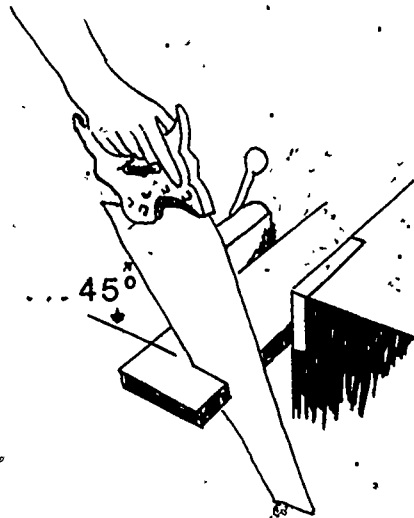

CROSSCUT SAW

TYPES OF HAND PLANES

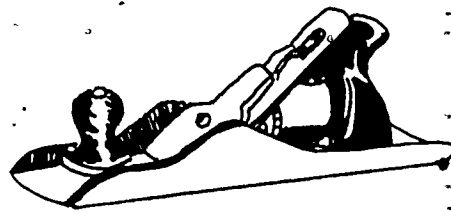

JACK

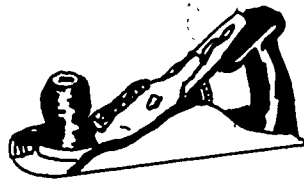

SMOOTH

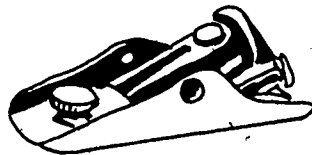

BLOCK

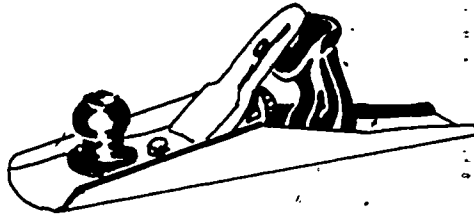

JOINTER

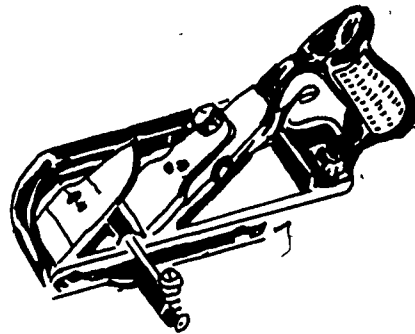

RABBET

PARTS OF THE BRACE

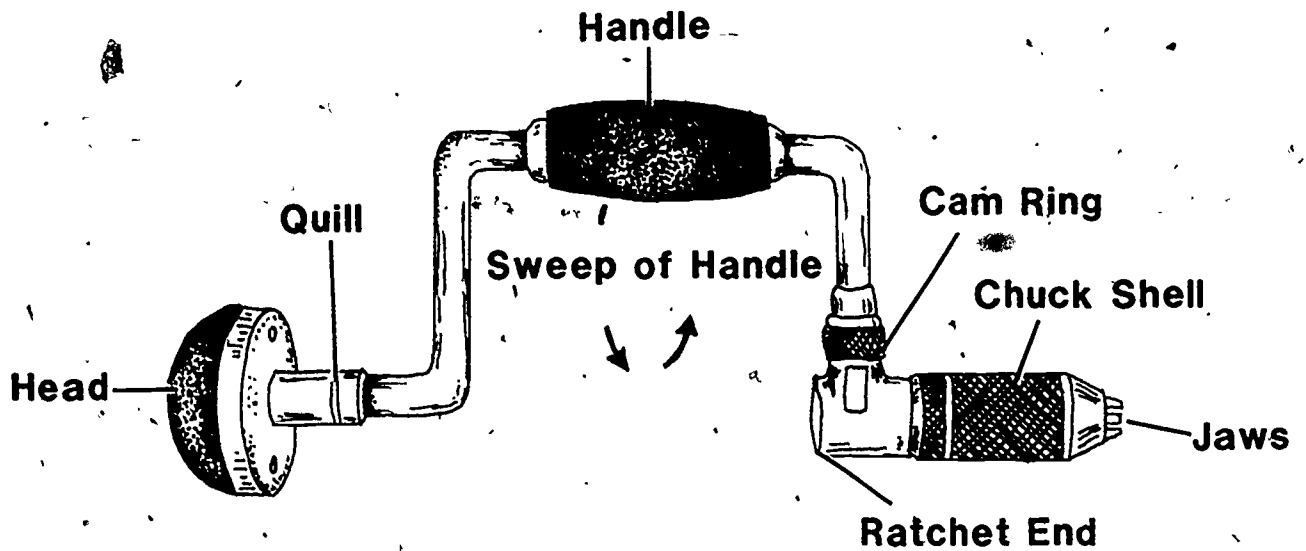

PART OF THE AUGER BIT

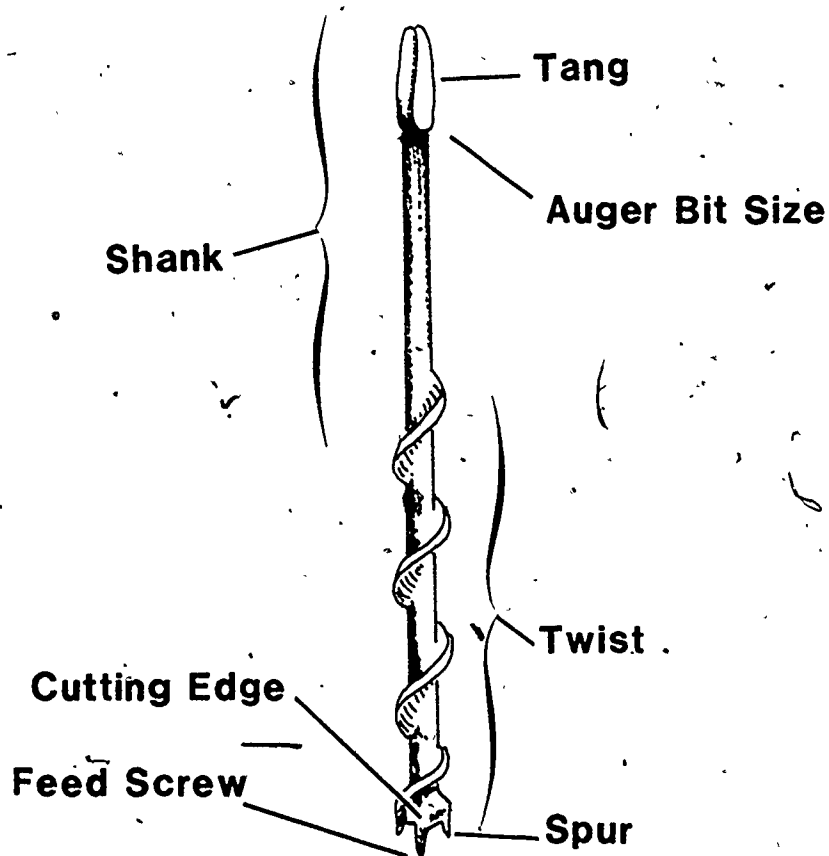

SELECTING NAIL HAMMERS

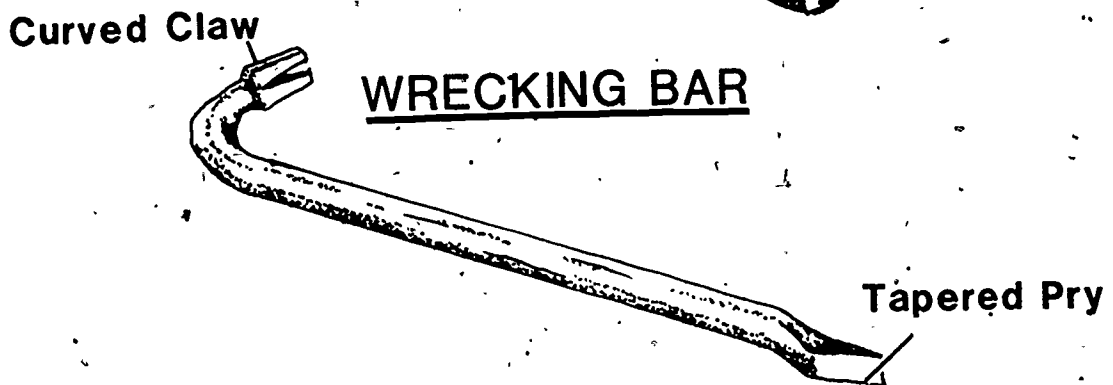
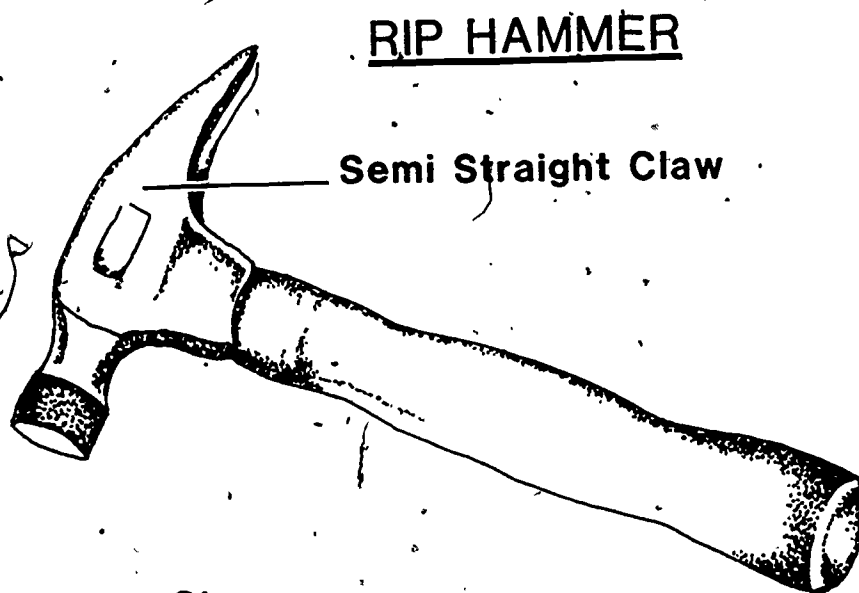
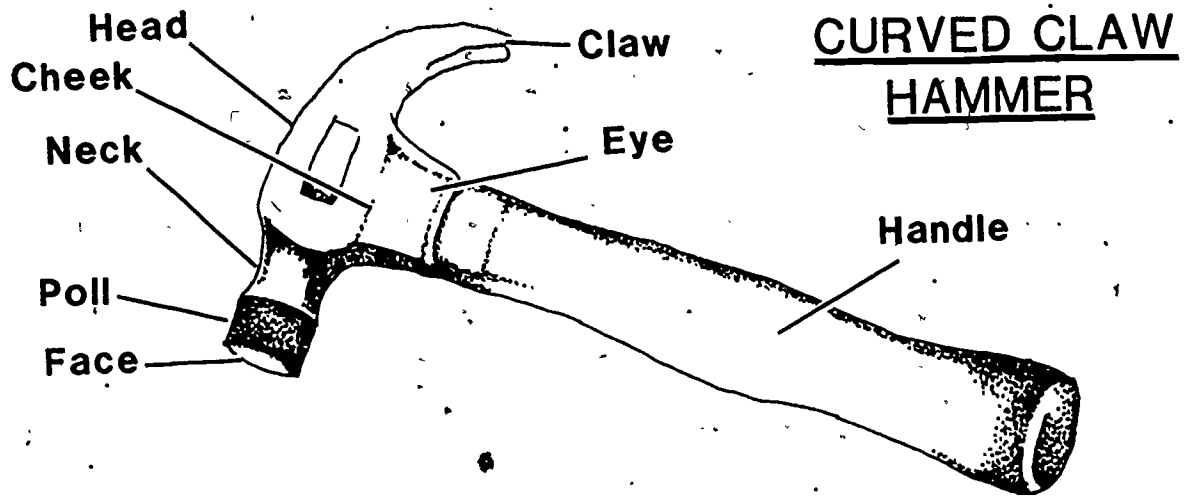

DISCUSSION GUIDE FOR TRANSPARENCIES

HAND TOOLS

I. Transparency: Crosscut and Rip Hand Saw

- A. Explain how hand saws are important to a well-equipped shop.
1. For small or confined work, hand saws are most often better than power tools.
 2. Hand saws are often better for finish work than power saws.
 3. Electricity may not be available or safe in some locations.
 4. Hand saws are often lighter and easier to handle than power tools.
 5. Many times, a job can be completed quicker with a hand saw than with power saws.
- B. It is important to understand how saws differ so the correct saw can be selected and used.
1. Saws can have curved backs or straight backs.
 2. Blade lengths, measured from heel to toe vary from 18" - 26" for commonly used cross-cut saws and rip saws.
 3. Most commonly used cross-cut saws have between 5 and 11 teeth per inch. Rip saws most commonly have between 4 and 7 teeth per inch.
 4. Cross-cut saw teeth are shaped at different angles than rip saw teeth.
 5. Rip saw teeth are perpendicular to the blade and cut like a wood chisel. The front angle can be from perpendicular to 8 degrees forward. The rear angle should be between 52 and 60 degrees.
 6. Cross-cut saw teeth are angled about 65 degrees to the blade and shave the wood like a plane. The front angle is about 15 degrees and the back angle is about 45 degrees.
- C. When purchasing hand saws specify:
1. rip or cross-cut
 2. number of points to the inch, and
 3. length of the saw
- D. Correct use of hand saws:

Rip saw

1. Secure the material to be sawed.
2. Use the thumb on the free hand as a guide when starting a cut.

3. Hold the blade at 60 degrees to the surface of the work.
4. Place the saw on the waste side of the line. Draw the saw back until a groove is formed. Use long, steady strokes with only light pressure on the down stroke.

Cross-cut saws

1. Use the same procedure as the rip saw except change the angle to 45 degrees.

II. Transparency: Types of Hand Planes

- A. Jack Plane — Most commonly used size is 14 inch length with a 2" blade.
 - General purpose plane used for smoothing and jointing lumber.
- B. Smooth Plane — Most commonly used size is 8 inch length with a 1 3/4 inch blade.
 - Use to smooth a surface after a larger plane has been used.
 - It produces a smooth but not always a true surface.
- C. Block Plane — Smallest of all the planes.
 - Used to plane small pieces of wood.
 - Bevels, camfers, and end grain — held in one hand.
- D. Jointer Plane — Largest of the planes. The length is 20 to 24 inches with blade widths of 2 3/8 to 2 5/8 inches.
 - Used on long boards and produces a straight true edge.
 - Will perform the same work as a power jointer.
- E. Rabbit Plane — Most commonly used size is 8 inch length and 1/2 inch blade.
 - A specialty plane which can be used to plane into corners.
 - Primarily used as a finishing plane.
- F. All planes use the same principle for cutting. Their main difference is in the weight, length, width, and type of blade.

III. Transparency: Parts of the Brace and Parts of the Auger Bit

Braces

- A. Braces range in sizes from 6 to 14 inches with the 10-inch being the most common.
- B. The size refers to the sweep of the handle.
- C. Braces can be purchased with or without ratchet. The ratchet brace will permit the drilling of holes in places where a full circle cannot be made with the handle.

Auger bit

- A. Used to bore holes in wood
- B. Most common sizes are from 1/4 inch to one inch and are graduated in sixteenths. The number stamped on the tang is the numerator for the size of bit. A number 7 bit will bore a 7/16 hole.

IV. Transparency: Selecting Nail Hammers, Parts of the Nail Hammer, Rip Hammer

- A. Most commonly used hammer in agriculture is the curved claw hammer. It is best for pulling nails and driving nails.
- B. The second most popular hammer is the rip or semi-straight claw hammer. It is best for taking apart structures and driving nails.
- C. Hammers range in weight from 13 to 20 ounces. The 16 ounce is the most popular weight.
- D. The face of hammers may be bell faced (reducing marking of wood) or flat-faced (easier driving of the nail).
- E. The handles may be made of wood, nylon, or metal. The wood handle is the least expensive and will absorb the shock which reduces tiring of the hand and arm.

Wrecking Bar

- A. Most common size is 24 inch length.
- B. Used to pry boards loose and pull nails.
- C. The wrecking bar is better for pulling large nails and dismantling structures than claw hammers.
- D. The wrecking bar is not a good crow bar: It is not good at prying machinery, beams, or large rocks.

SAFETY RULES WITH HAND TOOLS

1. Use handles on files to avoid injuring your hands.
2. Be sure all machinery is stopped before adjusting.
3. Be sure wrenches fit securely to avoid slipping.
4. Replace broken handles; never repair them.
5. Always work away from your body when using chisels.
6. Do not stand in front of someone using a hammer.
7. Be sure nails are well started before using hard blows.
8. Be sure the hammer heads are tight on the handles before you use them.
9. Never use screwdrivers or files as pry-bars; select the proper tool for the job.
10. Keep edge tools sharp.
11. Use screwdrivers of the proper size.
12. Keep tool handles free from dirt, oil, and grease.
13. Do not carry edged or pointed tools in your pocket.
14. Store tools properly when you finish using them.

SUGGESTIONS TO THE TEACHER REGARDING STUDENT TESTS ON
"SAFE PRACTICES IN THE VOCATIONAL AGRICULTURE SHOP"

1. These tests have been prepared for individual power tools or areas of instruction with each test on a single sheet.
2. Most of the test questions are TRUE-FALSE types. Space has been left between questions for students to explain why the statement is true or false. It may be particularly desirable to explain why a question was marked true or false, thus re-emphasizing correct procedure.
3. A set of correct answers to the test questions is not provided. The correct answers to certain questions depend upon the safety standards adopted by individual teachers.
4. Some teachers may wish to have the students sign the attached statements of safety training and keep them on file.
5. Permission to duplicate any of this material is freely granted. Credit for the material used in this unit is due to many individual teachers. Original drafts were submitted by A. W. Schmidt, D. J. Witt, Loren Mills, and Charles Pearson, Teachers of Vocational Agriculture in Illinois.

Name _____

Date _____

STUDENT TEST
ON
HAND TOOLS

TRUE or FALSE

- _____ 1. A dull edged tool may be more dangerous than a sharp one.
- _____ 2. You should check the condition of any tool, as to its safety, before using it.
- _____ 3. You should always cut toward yourself when using an edged tool to avoid dulling the tool.
- _____ 4. It is all right to use a hammer with a poor handle, if that handle is fastened on tight.
- _____ 5. It is all right to hammer on a wrench with a ball-peen hammer, but not with a claw hammer.
- _____ 6. It is safer to use both hands on a screwdriver.
- _____ 7. It is not safe to use files without handles.
- _____ 8. In using adjustable end wrenches, have the jaws facing the direction of pull.
- _____ 9. You should keep your fingers flat against the board when holding a nail for starting with a hammer.
- _____ 10. If you discover a defective hammer handle in the shop, you should toss it aside and get another hammer.

UNIT D: HORTICULTURAL/AGRICULTURAL MECHANICS

PROBLEM AREA: USING SELECTED POWER TOOLS

SUGGESTIONS TO THE TEACHER:

This problem area is designed for use with freshman or beginning students enrolled in an agricultural/horticultural occupations program. The recommended time for teaching this problem area is during the early winter. The estimated time for teaching this problem area is 3 to 10 days depending on how much time the teacher wishes to spend on discussion and conducting the suggested exercises. The materials in this problem area were selected and written with the following assumptions:

1. It is important for all agriculture students to be able to identify common power tools used in agriculture and their parts.
2. Students need instruction on the safe use and care of power tools at the freshman level.

The instructor is reminded that this problem area includes power tools used on the farm and in urban areas. The items in this problem area are for reference or modification as the teacher adapts this material to his/her local situation.

CREDIT SOURCES:

These materials were developed through a funding agreement, R-33-21-D-1542-388 with the Illinois State Board of Education, Department of Adult, Vocational and Technical Education, Research and Development Section, 100 North First Street, Springfield, Illinois 62777. Opinions expressed in these materials do not reflect, nor should they be construed as policy or opinion of the State Board of Education or its staff.

The teacher's guide, worksheets, transparency discussion guides were developed by Paul Benson, Jerry Pepple, and Jim Ethridge, Department of Vocational and Technical Education, University of Illinois. The transparency masters and suggested test questions were prepared by Vocational Agriculture Service, University of Illinois. Suggestions and guidance in the development of these materials were provided by the Rural and Metropolitan Core Curriculum Pilot Test Teachers.

TEACHER'S GUIDE

- I. Unit: • Agricultural mechanics
- II. Problem area: Using selected power tools
- III. Objectives: • At the close of the problem area, students will:
 1. Be able to identify and list parts of selected power tools.
 2. Be able to use proper procedures in the operation of selected power tools.
 3. Understand the safety instructions for proper use of selected power tools.
- IV. Suggested interest approaches:
 1. Collect an assortment of power tools and have students identify them.
 2. Lead into a discussion by asking students what power tools they have at home.
 3. Ask students how they could get physically hurt with certain power tools.
 4. Ask the students if they have been involved in any accidents when using power tools.
 6. Ask students if they know the approximate cost of each power tool and then have them figure a total value for their home power tools.
 7. Have a display of boards or pieces of metal that have been cut or drilled with power tools.
 8. Prepare a bulletin board display indicating various kinds of power tools used in the agricultural service areas.
 9. Discuss the issues involved in using your own tools as compared to hiring the work done or renting the tools.
 10. Develop a list of power tools found at local businesses and identify the common ones; then have the students learn how to operate these tools.
- V. Anticipated problems and concerns of students:
 1. What power tools are we going to learn to operate?
 2. How are each of these tools used and operated?
 3. What safety precautions should we use in operating these tools?
 4. How should these tools be maintained and stored?
 5. What shop rules should I follow when using power tools?
 6. How do you change a blade on the power saw?
 7. Additional problems and concerns are included in Worksheets 1 – 5. Students could be referred to these worksheets to obtain additional problems and concerns.

VI. Suggested learning activities and experiences:

1. Discuss problems and concerns identified by class or teacher and develop appropriate answers. Have class consider questions on Worksheets 8, 9 and 10.
2. Have class read VAS Unit 3022 "Safety in the Agricultural Mechanics Shop," Sections 7, 8, 11, 13, and 14.
3. Distribute Worksheet No. 1, "Safety Instructions for Operating Power Tools," and have class fill out and discuss. Use Job Sheet 1 and Worksheet 2 to identify additional power tools.
4. Show transparencies. Identify various parts of each power tool and explain the correct procedures for its use.
 - a. Table Circular Saw
 - b. Table Saw Blades
 - c. Bench Model Drill Press
5. Show filmstrips:
 - VAS 461 "Drill Press"
 - VAS 462 "Circular Saw"
 - VAS 463 "Power Grinder"
 - VAS 498 "Using Power Lawn Mowers Safely"
 - VAS 633 "Identifying and Using Horticultural Hand Tools"
6. Have each student demonstrate the proper and safe use for each power tool. For example, for the table saw, provide each student with a board and have them cut one end and one side so they are square. Use Job Sheet 2 and Worksheet 3.
7. Hand out Worksheets 4, 5, 6, and 7. Have students go into the shop and fill out. Discuss their results with the class.
8. Arrange for students to conduct an area survey of businesses using power tools in each of the service areas. Use the information gathered by the students in conducting your instruction. Use Worksheets 11-19 for business survey.
9. Use pictures, films, filmstrips, slides and/or actual power tools in demonstrating or discussing their safe and proper use. Identify occupational activities in which the students would use each power tool.
10. Ask students to demonstrate their ability to safely use and adjust certain power tools.

VII. Application procedures:

1. The main purpose of this problem area is to learn to recognize and use power tools in a proper and safe manner.
2. The students should apply their knowledge and understanding learned in the shop to their own power tools or to those in a place of employment.

VIII. Evaluation:

1. Prepare and administer a pencil and paper test covering the identification of power tools and their parts and the proper use of power tools.
2. Grade worksheets

3. Prepare and administer laboratory practical exam on identification and proper use of power tools.
4. Administer VAS Safety Test. "Safe Practices in the Vocational Shop" (sections on specific power tools)

IX. References and Aids:

1. VAS Unit 3022 "Safety in the Agricultural Mechanics Shop" (Sections 7, 8, 11, 13, 14)
2. VAS Safety Test "Safe Practices in the Vocational Agriculture Shop." Series on power tools.
3. VAS Transparencies on Power Tools.
4. Power Tool Student Worksheets 1 - 19.
5. Job Sheets 1 and 2.
6. VAS Charts on Safety Rules for Power Tools.
7. Phipps, Loyd J., Mechanics in Agriculture, The Interstate Printers, Danville, Illinois.
8. VAS Filmstrip 633 on "Identifying and Using Horticultural Hand Tools."
9. VAS Filmstrip 498, "Using Power Lawn Mowers Safely."
10. VAS Filmstrip 463, "Power Grinder"
11. VAS Filmstrip 462, "Circular Saw"
12. VAS Filmstrip 461, "Drill Press"

STUDENT WORKSHEET 1

SAFETY INSTRUCTIONS FOR OPERATING POWER TOOLS

1. Blade height for a tilting arbor table saw should be just high enough to clear the work by no more than _____ inches.
2. When can more than one person be inside the "safety zone" lines of the table saw?

3. What dress precautions should be taken when using the table saw?

4. When should a push stick be used with a table saw?

5. What are the three main types of sabre saw blades?
 - a. _____
 - b. _____
 - c. _____
6. What should you remember to do before adjusting or repairing any power tool?

7. To stop a portable sander, you should _____ and then turn the switch off.
8. You should have at least _____ inches of leverage before holding any work to be drilled.
9. Check, and if necessary, adjust _____ before starting a grinder.
10. A tool rest should be _____ inches away from the face of the wheel?
11. Grind only on the _____ of the wheel.
12. Use _____ to hold small objects against the wheel.

STUDENT WORKSHEET 2
IDENTIFYING POWER TOOLS

Name _____ Price _____

Give one use: _____

Name _____ Price _____

Give one use: _____

Name _____ Price _____

Give one use: _____

Name _____ Price _____

Give one use: _____

Name _____ Price _____

Give one use: _____

Name _____ Price _____

Give one use: _____

STUDENT WORKSHEET 3
POWER TOOL DEMONSTRATION

Questions:

1. Name of tool _____
2. Primary function _____
3. Can this tool be adjusted? _____
If so, how and where? _____

4. Can tool be sharpened? _____ If so, how and where?

Observations:

List step-by-step method of correctly using the tool. Draw and identify the major parts of the tool.

Conclusion:

List safety practices identified and how to properly clean and store the tool.

STUDENT WORKSHEET 4

TILTING ARBOR SAW INFORMATION SHEET

Manufacturer's Name _____ Model _____ Size _____

1. What type of blade is in the saw?
2. What is the diameter of the saw blade?
3. What is the diameter of the arbor?
4. What other blades are available in the shop?
5. What is the deepest cut possible?
6. How is the blade raised and lowered?
7. How is the arbor tilted?
8. How far will the arbor tilt?
9. On what part are the saw guard and anti-kick-back fingers mounted?
10. How is the rip fence locked?
11. What is the use of the slot parallel to the blade?
12. What is the speed of the blade in RPM?
13. What is the horsepower rating of the motor?
14. What type of switch turns the saw on and off?
15. How many volts are passing through this switch?

STUDENT WORKSHEET 5
POWER GRINDER INFORMATION SHEET

Manufacturer's Name _____ Model _____ Size _____

1. What is the abrasive material from which the wheel is made?

2. What is the diameter of the wheel?

3. What is the width of the wheel's face?

4. What is the diameter of the motor shaft?

5. What is the horsepower rating of the motor?

6. What is the RPM speed of the motor?

7. What type of switch turns the grinder on and off?

8. How many volts are passing through the switch?

47

STUDENT WORKSHEET 6
DRILL PRESS INFORMATION SHEET

Manufacturer's Name _____ Model _____ Size _____

1. What is the largest diameter of the end of a bit that can be held in the chuck?
2. What is the largest size of hole that can be drilled in cast iron?
3. What is the largest size of hole that can be drilled in steel?
4. What is the distance of quill travel (stroke)?
5. What is the horsepower rating of the motor?
6. What is the RPM speed of the motor?
7. What spindle speeds are available?
8. How is the spindle speed changed?
9. What type of switch turns the drill press on and off?
10. How many volts are passing through this switch?

STUDENT WORKSHEET 7
PORTABLE CIRCULAR SAW INFORMATION SHEET

Manufacturer's Name _____ Model _____ Size _____

1. What type of blade is in the saw?
2. What is the diameter of the blade?
3. What other types of blades are available in the shop?
4. Where is the blade wrench kept?
5. What is the maximum depth of cut?
6. How is the depth of cut adjusted?
7. How is the angle of cut adjusted?
8. Does this saw have a brake?
How is it activated?
9. Does this saw have a kick-proof clutch?
10. What is the motor's ampere rating?
11. What is the motor's idle speed in RPM?

STUDENT WORKSHEET 8
DISCUSSION QUESTIONS ON BAND SAWS

1. Who should be allowed within the saw's "safety zone" area?
2. How is the band saw's safety zone marked?
3. Why is loose clothing dangerous when operating a band saw?
4. Why should stock be pushed and not pulled through a band saw?
5. What should be done before you begin to cut stock with a band saw?
6. Why should you not cut round stock on a band saw?
7. How far should the saw guide be from the stock? Why?
8. What adjustments can be made on the band saw?
9. How do you change the blade on the band saw?

10. What problems result from cutting with dull blades?

STUDENT WORKSHEET 9

DISCUSSION QUESTIONS ON PORTABLE JIG SAWS

1. What checks should be made of the work area before you start to use the jig saw?
2. What are the three types of blades which can be used with jig saws?
3. What type of clothing should be worn when using the jig saw?
4. Describe the procedure for attaching the blade to the jig saw.
5. How should the jig saw be cleaned and lubricated?
6. Describe the procedure to follow when metal cutting with jig saws.
7. When should the rip fence be used with jig saws?
8. What adjustments can be made on the jig saw?
9. How can material be secured for cutting with a jig saw?
10. Describe how to make an inside cut with a jig saw.

STUDENT WORKSHEET 10

DISCUSSION QUESTIONS ON ELECTRIC SANDERS

1. Can the motor be locked on for continuous sanding? If so, how?
2. Describe how to change the belt on a belt sander.
3. Describe how to adjust the "tracking" of the belt on a sander.
4. Why should the dust collector be kept clean?
5. Describe how to properly clean a belt sander.
6. Why should you not start and stop the belt sander while it is resting on the stock?
7. Explain how to properly attach sanding paper to a disk sander.
8. Describe how to properly secure and sand small stock.

52

STUDENT WORKSHEET 11

DISCUSSION QUESTIONS ON THE SOIL SHREDDER

1. What will the soil shredder shred?
2. What is the proper clothing to wear when shredding soil?
3. How do I sharpen the hammer flails?
4. How many people does it take to operate a soil shredder?
5. How do I properly operate the soil shredder?
6. How do I properly maintain the soil shredder?
7. What materials should not be put through the soil shredder?
8. How should materials be prepared for shredding?

STUDENT WORKSHEET 12

DISCUSSION QUESTIONS ON THE WEED TRIMMER

1. What guards are provided on the electric weed trimmer?
2. What are the advantages of an automatic line feed trimmer?
3. What hazards are involved in operating a weed trimmer?
4. What is an extension cord connector?
5. At what angle should the electric trimmer be slanted for the most effective trimming?
6. In what direction should the weed trimmer be operated and why?
7. What is the proper method of trimming along fences?
8. How do you rewind and install a nylon line and the disk?
9. What maintenance program should be followed on the weed trimmer?

STUDENT WORKSHEET 13

DISCUSSION QUESTIONS ON THE CONCRETE MIXER (SOIL MIXER)

1. What is the maximum cubic feet that a soil mixer will handle?
2. How do I operate a soil mixer?
3. Why is a concrete mixer used for mixing soil?
4. What maintenance program should be followed on a soil mixer?
5. What adjustments can be made on a soil mixer?
6. What hazards are involved in operating a soil mixer?
7. Can the soil be over-mixed? What is done when the soil is over-mixed?
8. How many people should operate a soil mixer?

STUDENT WORKSHEET 14

DISCUSSION QUESTIONS ON THE ROTARY TILLER

1. What is the correct procedure to use in starting a gasoline rotary tiller?
2. What is the recommended speed for rotary tilling?
3. How deep should the rotary tiller dig?
4. How do I force the rotary tiller into the ground?
5. How do I remove or add on additional cutting blades?
6. What is the drag bar on the rotary tiller?
7. What are the capabilities of an electric rotary tiller?
8. What are the hazards in operating a rotary tiller?
9. How can the electric rotary tiller be adapted to operate as a de-thatcher?

STUDENT WORKSHEET 15

DISCUSSION QUESTIONS ON THE SOIL STERILIZER

1. How is soil media prepared for the soil sterilizer?
2. What precautions should be taken when operating an electric soil sterilizer?
3. What unsafe actions should be avoided when operating a soil sterilizer?
4. What temperatures are required to kill different organisms in a soil sterilizer?
5. How much time is required to sterilize soil?
6. Can a soil sterilizer be filled, turned on, and then left unattended?
7. What hazards can occur if sterilized soil is removed before allowing it to cool?
8. What additional checks can be made to insure that the soil sterilizer is operating correctly?

STUDENT WORKSHEET 16
DISCUSSION QUESTIONS ON THE CHAIN SAW

1. What different sizes of chain saws are available?
2. What size of chain saw should be used for what size of limbs or tree trunk?
3. What type of clothing should be worn when operating a chain saw?
4. How does one prepare a tree for felling?
5. What precautions should be taken before starting the chain saw?
6. How is the chain of the saw lubricated and sharpened?
7. What special safety precautions should be observed when operating an electric chain saw?
8. How is the fuel mixed for chain saws?
9. What safety precautions must be taken when using a chain saw to prune trees?

STUDENT WORKSHEET 17

DISCUSSION QUESTIONS ON THE LAWN EDGER

1. Why must eye protection be used when using a lawn edger?
2. How can "outdoor" extension cords be identified?
3. What is an extension cord retainer?
4. How do I attach a blade to a lawn edger?
5. How do I change the position of the cutting head?
6. What chemicals will cause the blades to corrode? How do I prevent corrosion?
7. How do I clean and lubricate the lawn edger?
8. What hazards are involved in using a lawn edger?

STUDENT WORKSHEET 18

DISCUSSION QUESTIONS ON THE ELECTRIC AND GASOLINE LAWN MOWERS

1. What are the advantages of an electric and gasoline lawn mower?
2. What is the proper dress when operating any lawn mower?
3. How do I sharpen a lawn mower blade?
4. What safety shield should be on the lawn mower?
5. How do I maintain the electric and gasoline lawn mowers?
6. What are the hazards in using each of the lawn mowers?
7. How do I determine when my lawn mower blade needs sharpening?
8. What is the proper method of mowing slopes?
9. How do I determine at what height my lawn should be mowed?
10. How do I adjust the height of my lawn mower?

STUDENT WORKSHEET 19

DISCUSSION QUESTIONS ON THE HEDGE TRIMMER

1. How often does a hedge trimmer need to be sharpened?
2. How should a hedge trimmer be sharpened?
3. How do I operate an energy pack for a hedge trimmer?
4. What should I do if I drop an electric hedge trimmer?
5. How do I properly trim a hedge and operate the hedge trimmer?
6. How do I lubricate the hedge trimmer?
7. How do I clean the hedge trimmer after the work is completed?
8. What are the hazards in operating a hedge trimmer?
9. What is the proper dress for a person operating a hedge trimmer?
10. How many people should it take to operate a hedge trimmer properly?

TEACHER'S KEY
STUDENT WORKSHEET 1

SAFETY INSTRUCTIONS FOR OPERATING POWER TOOLS

1. Blade height for a tilting arbor table saw should be just high enough to clear the work by no more than 1/4 inches.
2. When can more than one person be inside the "safety zone" lines of the table saw?
Instructor has assigned a helper to assist the operator.
3. What dress precautions should be taken when using the table saw?
Do not wear gloves, long loose sleeves, neckties, or rings. Keep shirt tucked in trousers.
4. When should a push stick be used with a table saw?
When board is to be ripped.
5. What are the three main types of sabre saw blades?
 - a. woodcutting
 - b. metal cutting
 - c. knife blade
6. What should you remember to do before adjusting or repairing any power tool?
Disconnect the cord.
7. To stop a portable sander, you should lift it from the work and then turn the switch off.
8. You should have at least 12 inches of leverage before holding any work to be drilled.
9. Check, and if necessary, adjust tool rest before starting a grinder.
10. A tool rest should be 1/8 inches away from the face of the wheel?
11. Grind only on the face of the wheel.
12. Use pliers to hold small objects against the wheel.

JOB SHEET 1
IDENTIFYING AND USING POWER TOOLS

Objectives:

1. To become familiar with the names of power tools in the school shop.
2. To know the correct uses of selected power tools.
3. To become familiar with the cost of selected power tools.

Materials:

1. Provide student access to the shop power tools.
2. A supply of old hardware shop catalogs.

Procedure:

1. Give students a tour of the shop pointing out the various power tools and their location.
2. Have each student locate a picture of each selected power tool in an old catalog, cut it out, tape the picture on the worksheet and complete the necessary information.
3. Duplicate additional worksheet pages according to the number of power tools the students are to identify.

JOB SHEET 2
POWER TOOL USE AND SAFETY

Objectives:

1. To develop an interest in power tools.
2. To develop the ability to correctly use power tools.
3. To appreciate a satisfactory job of using power tools.
4. To develop ability to correctly clean, adjust and store power tools.

Materials:

1. Selected power tools.
2. Materials which can be used to demonstrate each power tool (wood, metal, etc).

Procedures:

1. Demonstrate or have students demonstrate the use of selected power tools.
2. Explain proper methods of using each tool.
3. Determine student knowledge of use and safety of each power tool by asking students to identify safety practices.
4. Have students complete attached sheet as each power tool is demonstrated.

64

SAFETY RULES WITH POWER TOOLS

TILTING ARBOR SAW

1. Keep saw guard in place unless you have instructor's permission to remove it.
2. Do not saw free hand—use the rip fence or miter gauge.
3. Adjust blade to clear work $1/4$ to $1/2$ inch only.
4. Use the push stick.
5. Never allow your fingers to go beyond the orange line when ripping.
6. Never use the fence as a length stop for cross cutting.
7. Never clear away scraps from a turning blade with your fingers.
8. Disconnect power before handling blade.
9. Make no adjustments with saw running.
10. Stand so your face is not in the direct line of cut.

SAFETY RULES WITH POWER TOOLS
PORTABLE ELECTRIC CIRCULAR SAWS

1. Keep blade sharp at all times.
2. Keep guards in place and working at all times.
3. Check regularly for cracked blades.
4. Keep power cord clear of working area.
5. Do not over reach; keep well balanced and have good footing.
6. Do not start or stop saw with the blade in contact with the stock.
7. Keep both hands on the saw and away from the blade and line of cut.
8. Never lay the saw down until it stops turning.
9. Disconnect the power source before making any adjustments.
10. Always wear safety glasses when sawing.
11. Keep other workers at a safe distance from the work area.
12. Always use proper size and type of blade for the work being done.

63

SAFETY RULES WITH POWER TOOLS

GRINDER

1. Wear safety goggles or a face shield when using the grinder.
2. Adjust tool rests to be firm, slightly above wheel center and not over 1/8 inch from wheel.
3. Stand clear and let grinder run a full minute before starting to grind.
4. Grind only on face of wheel—never on the side.
5. Keep grinding wheels properly dressed and trued.
6. Do not hold small pieces in your hand for grinding.
7. Keep fingers away from face and eyes until abrasive dust has been carefully washed off.
8. Make no adjustments with grinder running.
9. Stand so your face is not in direct line with the grinding wheel.
10. Do not leave grinder until it has come to a full stop.

SAFETY RULES WITH POWER TOOLS

DRILL PRESS

1. Keep drills properly ground and sharp.
2. Tighten chuck securely and remove chuck key before starting drill press.
3. Do not hold pieces by hand unless you have at least 12 inches leverage.
4. Keep hair, neckties, sleeves, etc., secured.
5. Keep belt guards always in place.
6. Operate drill press only at speed recommended for the particular job.
7. Avoid forcing a drill, especially just as it cuts through.
8. Keep floor around drill press free from oil and scrap materials.
9. Wear safety goggles or a face shield when drilling at high speeds.
10. Remove shavings and chips from drill press table with brush—not your hands.

SAFETY RULES WITH POWER TOOLS

BAND SAWS

1. Keep other workers outside the saws "safety zone" area.
2. Remove or secure loose clothing, aprons, and ties.
3. Check the blade for free movement and trueness before turning on the power.
4. Keep fingers at least 2 inches from the blade when cutting.
5. Keep fingers away from the direct line of cut with the blade.
6. Use a push stick.
7. Do not pull the stock through from the back of the blade.
8. Keep saw clean and free of oil, grease, and scrap material.
9. Keep saw guide within one-half inch of the stock being cut.
10. Keep all guards in place.
11. Do not saw round stock on a band saw.

SAFETY RULES WITH POWER TOOLS

PORTABLE JIG SAWS

1. Be sure all connections are adequately grounded and are safe.
2. Keep saw clean and dry.
3. Keep all parts and screws tight.
4. Be sure blade is locked securely before starting to work.
5. Be sure work is solidly supported.
6. Keep the saw shoe firmly against the work when operating the saw.
7. Be sure all adjusting keys and wrenches are removed from the saw before turning it on.
8. Move the saw forward rapidly enough to keep the blade cutting; do not force the saw.
9. Use safety glasses when cutting material.
10. Keep hands away from the cutting area.
11. Keep the electrical cord clear of the cutting area.

SAFETY RULES WITH POWER TOOLS

ELECTRIC SANDERS

DISK SANDERS

1. Sand only on the downstroke side of the disk.
2. Do not hold small stock in your hand while sanding.
3. Always stop and unplug the sander to clean, adjust, or repair it.
4. Make sure the sander has stopped before laying it down or leaving it.
5. Never touch a moving sanding disk.
6. Always wear safety glasses when sanding.

BELT SANDERS

1. Check belt for proper adjustment and movement before operating.
2. Secure stock firmly before sanding.
3. Check dust collector and clean, if necessary, before sanding.
4. Do not start or stop the sander while it is resting on the stock.
5. Always wear safety glasses when sanding.
6. Never hold small stock in your hand while sanding.

SAFETY RULES WITH POWER TOOLS

SOIL SHREDDER

1. Do not place dry soil components into the soil shredder.
2. Do not place rocks or coarse bark into a soil shredder.
3. Wear safety goggles while operating a soil shredder.
4. Wear protective shoes, shirt and pants while operating a soil shredder.
5. Keep the free-swinging flail action hammers sharp.
6. Check before each operation, to see that the "Release-On-Impact" shredding mechanism is in operating condition.
7. Check and properly secure the screen attachment before turning on the machine.
8. Adjust the legs of the machine to insure the shredder is firmly secured and balanced.
9. Stand clear and let the soil shredder run a full minute before starting to shred soil media.
10. Keep fingers away from the hammer flails in the machine.
11. Make no adjustments while the soil shredder is running.
12. Stand so your face is not in direct line with the flail hammers.
13. Do not leave the work area until the soil shredder has come to a full stop.

72

SAFETY RULES WITH POWER TOOLS

ELECTRIC WEED TRIMMER

1. Safety glasses or goggles should be worn at all times when trimming.
2. Do not use the weed trimmer without the guard attached.
3. Keep your hands, face and feet clear of the rotating nylon line at all times.
4. Keep bystanders at a safe distance from the work area.
5. Do not carry a plugged in tool with your finger on the trigger.
6. Do not force the tool at a rate faster than the rate it is able to cut effectively.
7. To prevent electric shock hazard, use only with an extension cord suitable for outdoor use.
8. Do not yank the cord from the receptacle. Keep the cord from heat, oil, and sharp edges.
9. Keep the cord away from the rotating nylon cord.
10. Disconnect the weed trimmer when not in use, while lengthening line, prior to cleaning, and when removing or replacing the spool containing the line.
11. Do not operate the trimmer when barefoot or wearing open sandals.
12. Do not operate the weed trimmer in damp or wet locations.
13. Do not use the trimmer in the rain.
14. Store the idle weed trimmer indoors when not in use. The storage should be out of the reach of children or locked up.

SAFETY RULES WITH POWER TOOLS

CONCRETE MIXER

1. Use only grounded outlets when operating a concrete mixer (soil mixer).
2. Do not operate in barefeet or open sandals.
3. Wear safety goggles or glasses when operating the soil mixer.
4. Stand clear and let the soil mixer run a full minute before starting to mix your soil media.
5. Add additional materials to the barrel only when the machine has come to a complete stop.
6. Keep fingers away from all moving parts.
7. Do not wear loose or floppy clothing that might get entangled in the moving parts of the soil mixer.
8. Make no adjustments to the soil mixer while it is running.
9. Always have at least two people operating the soil mixer at a time.
10. Do not leave the soil mixer until it has come to a full stop.

SAFETY RULES WITH POWER TOOLS

ROTARY TILLER

1. Study the operator's manual carefully before operating the rotary tiller.
2. When operating the rotary tiller, give it your undivided attention.
3. Never leave the rotary tiller running unattended.
4. Keep children and pets clear of the rotary tiller.
5. Never allow children or pets to run alongside or in front of the rotary tiller.
6. Keep hands and feet away from cutting blades at all times.
7. Never clean or perform maintenance work on the rotary tiller without first removing the spark plug wire from the plug.
8. If a carburetor adjustment is necessary, disengage the clutch lever and stand to one side, keeping hands and feet away from the cutting blades.
9. When starting the engine make sure the clutch lever is in neutral.
10. Never run the engine in a poorly ventilated place. The exhaust gases contain carbon monoxide which is an odorless and deadly gas.
11. Stop the engine and disengage the clutch if, at any time, it becomes necessary to use hands or feet near the cutting blades.
12. Stop the engine and disengage the clutch when transporting the rotary tiller.

SAFETY RULES WITH POWER TOOLS

SOIL STERILIZER

1. Wear safety goggles or face shield when using the soil sterilizer.
2. Adjust the location of the sterilizer to rest firmly on the floor.
3. Check the temperature gauge to see that the machine is working properly before you put the machine into operation.
4. Do not compact the soil media into the sterilizer.
5. Moisten the soil to ready it for planting before sterilization.
6. Do not place your hand into the sterilizer to check heating elements while it is in operation.
7. Make no adjustments while the machine is plugged into the receptacle or within 15 minutes after the machine has been unplugged and emptied.
8. When opening the lid of the sterilizer, stand so your face is not in direct line of the steam that will escape.
9. Do not leave the sterilizer unattended while in operation.
10. Do not operate the sterilizer in bare feet or with open faced sandals.
11. Do not operate the sterilizer while standing on a wet floor.
12. Allow the soil media to cool before removing it from the soil sterilizer.

SAFETY RULES WITH POWER TOOLS

CHAIN SAW

1. Follow steps in the instructional manual for operation and maintenance of your chain saw.
2. Wear protective clothing.
3. Have a first-aid kit available.
4. Remove nails, wire, etc. from the trunk before sawing.
5. Determine where the tree or limb will fall before you begin sawing.
6. Select a safe place to stand when the tree or limb falls.
7. Clear debris from around the tree.
8. Notch the tree on the side in the direction of the fall, then make your corner cuts and cut back.
9. Yell "Timber!" as the tree falls.

SAFETY RULES FOR ELECTRIC-POWERED CHAIN SAWS

1. Read the manual supplied with your saw.
2. Use a heavy-duty, 3-wire, outdoor extension cord for power tools.
3. Be careful not to trip on the cord.
4. Disconnect the cord while moving from one plant to another.
5. Do not cut through the cord.
6. Do not use this tool while standing in a wet area.

SAFETY RULES WITH POWER TOOLS

ELECTRIC LAWN EDGER

1. Safety glasses or goggles should be worn at all times when using a lawn edger.
2. Do not use the lawn edger without the guard in place.
3. Keep your face, hands and feet away from the cutting area at all times.
4. Wear long pants to protect your legs.
5. Keep all bystanders away and at a safe distance from the work area.
6. Do not carry a "plugged-in" lawn edger with your finger on the trigger. Keep your finger off the trigger when plugging in the machine.
7. Do not force the tool at a faster rate than it is able to edge effectively.
8. Keep a proper footing and balance at all times. Do not over-reach.
9. Do not yank the cord from the receptacle. Keep the cord from heat, oil, and sharp edges.
10. To prevent disconnection of the extension cord during operation, use an extension cord retainer.
11. Keep the lawn edger cord away from the moving blade.
12. Use only 3 wire "outdoor" extension cords.
13. Always connect extension cords to a fused line or one protected by a circuit breaker.
14. Disconnect the lawn edger when not in use, prior to cleaning, or when removing or replacing the blade.
15. Do not operate the lawn edger when bare footed or wearing open sandals.
16. Do not use the electric lawn edger in damp or wet locations.
17. Do not use the lawn edger in the rain.
18. When the lawn edger is not in use, store the lawn edger in a dry locked location, away from children.
19. Do not use the lawn edger for any job except for which it is intended.
20. Follow all cleaning and lubrication instructions as outlined in the operator's manual.

SAFETY RULES WITH POWER TOOLS

LAWN MOWERS

1. Avoid dangerous environment. Do not use the electric lawnmower in damp or wet locations.
2. Keep children away. All visitors should be kept a safe distance from the mowing area.
3. Store idle tools indoors. When not in use, the electric lawn mower should be stored indoors in a dry, high or locked place and out of reach of children.
4. Do not force the tool. The electric lawn mower will do a better job and do it safer at the rate for which it was designed.
5. Dress properly. Do not wear loose clothing or jewelry. They can be caught in moving parts. Shoes must be worn at all times.
6. Never drag the electric mower by the electrical cord or yank it to disconnect it from the receptacle. Keep the cord from heat, oil, and sharp edges.
7. To prevent a shock hazard use only a drop cord suitable for outdoor use.
8. Do not use the electric lawn mower while it is raining.
9. Keep the proper footing and balance at all time. Do not over-reach.
10. Keep the cutting edges sharp and clean for the best and safest performance.
11. Disconnect the electric lawn mower from the power source when not in use, before servicing, and when changing blades.
12. To avoid accidental starting do not carry the lawn mower while it is plugged in and with your finger on the switch.
13. Keep all guards in place and in good condition at all times.
14. Keep hands and feet away from the cutting area.
15. The lawn should always be carefully examined and cleared of all objects prior to each mowing.
16. Never operate the electric mower in a gaseous or explosive atmosphere. Motors in electric lawn mowers spark and these sparks might ignite fumes.
17. Safety glasses should be worn whenever you are operating a lawn mower.
18. Mow across the face of slopes, never up and down. Exercise extreme caution when changing direction on slopes. Do not mow excessively steep slopes.

SAFETY RULES WITH POWER TOOLS

HEDGE TRIMMERS

1. Read the owner's manual before you operate a shrub and hedge trimmer.
2. Do not wear loose clothing. Wear non-skid foot wear and safety glasses when operating a hedge trimmer.
3. Keep your hands away from the blades. Keep both hands on the handles when the power is on.
4. Do not feed twigs into the blades or reach over the blade to clean up cuttings while the blades are in operation.
5. Never grasp the blades when picking up the tool. Caution should be watched as the blades continue after the power has been turned off.
6. Do not use the trimmer in rain, on moist plants, or while standing in wet locations.
7. Use only extension cords marked "suitable for use with outdoor appliance."
8. Never carry the hedge trimmer by the cord.
9. Do not yank the cord to disconnect it from the electrical outlet.
10. Keep the cord away from heat, oil, or sharp edges.
11. Do not permit children to come in contact with the trimmer or the extension cord.
12. Use the hedge trimmer only for the specific tasks for which it was designed.
13. Do not carry the tool with your finger on the trigger switch.
14. Do not leave the switch locked on when the tool is not in operation.
15. Disconnect the trimmer from its power supply when the hedge trimmer is not in use, before servicing, and for cleaning.
16. When the hedge trimmer is not in use store it in a dry and locked location.
17. Before using the hedge trimmer inspect it each time for damaged cords or dull blades.
18. If a guide line is used to trim your hedge, make sure this guide line can be easily cut by the trimmer if it becomes entangled in the blades.

30

TABLE CIRCULAR SAW

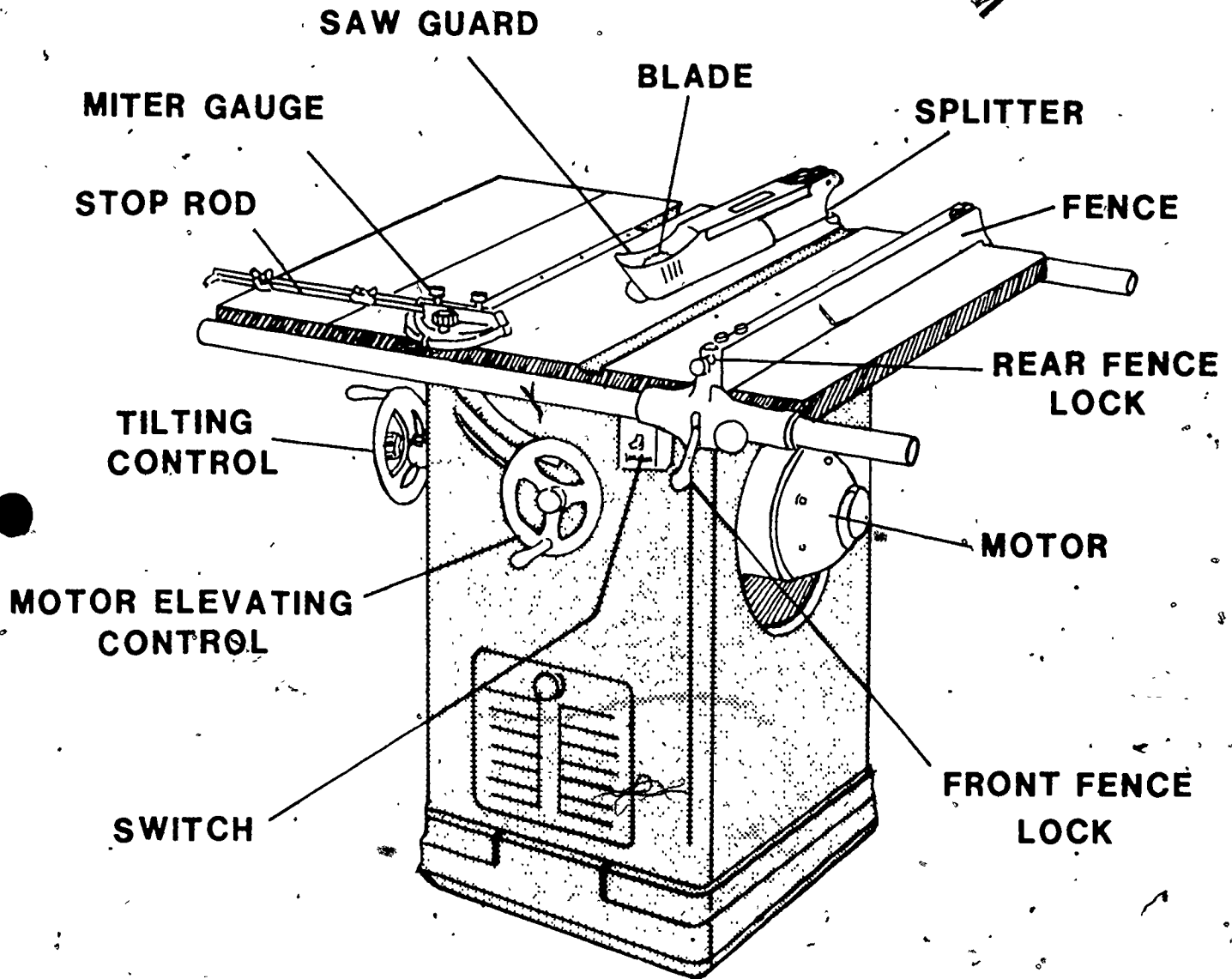
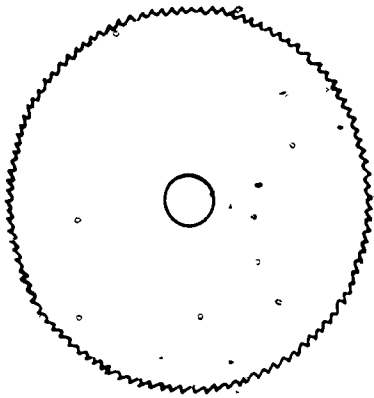
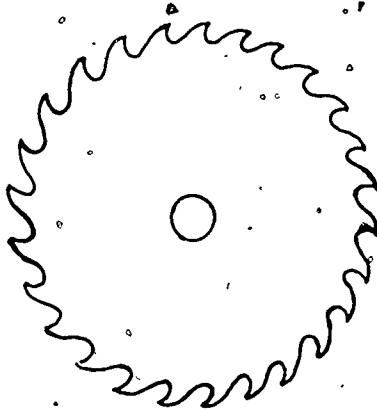
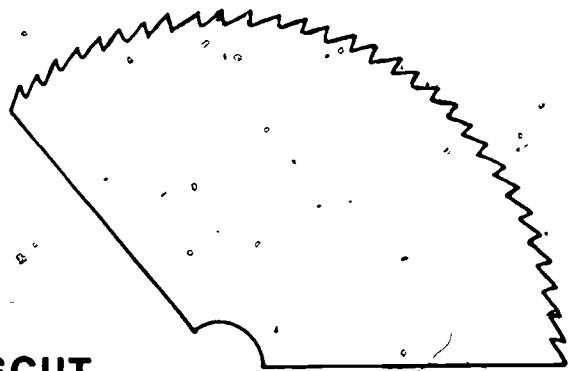

TABLE SAW BLADES



CROSSCUT



RIP

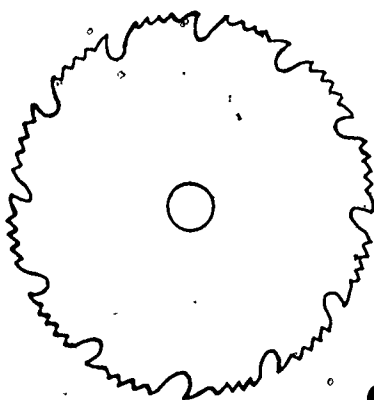
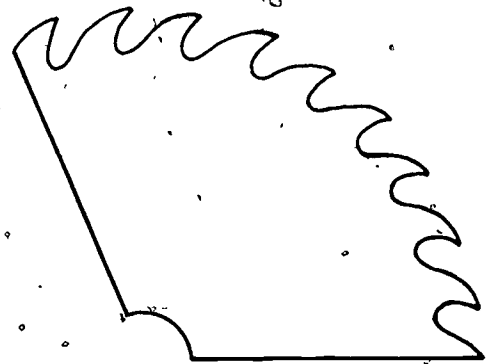

COMBINATION



BENCH MODEL DRILL PRESS

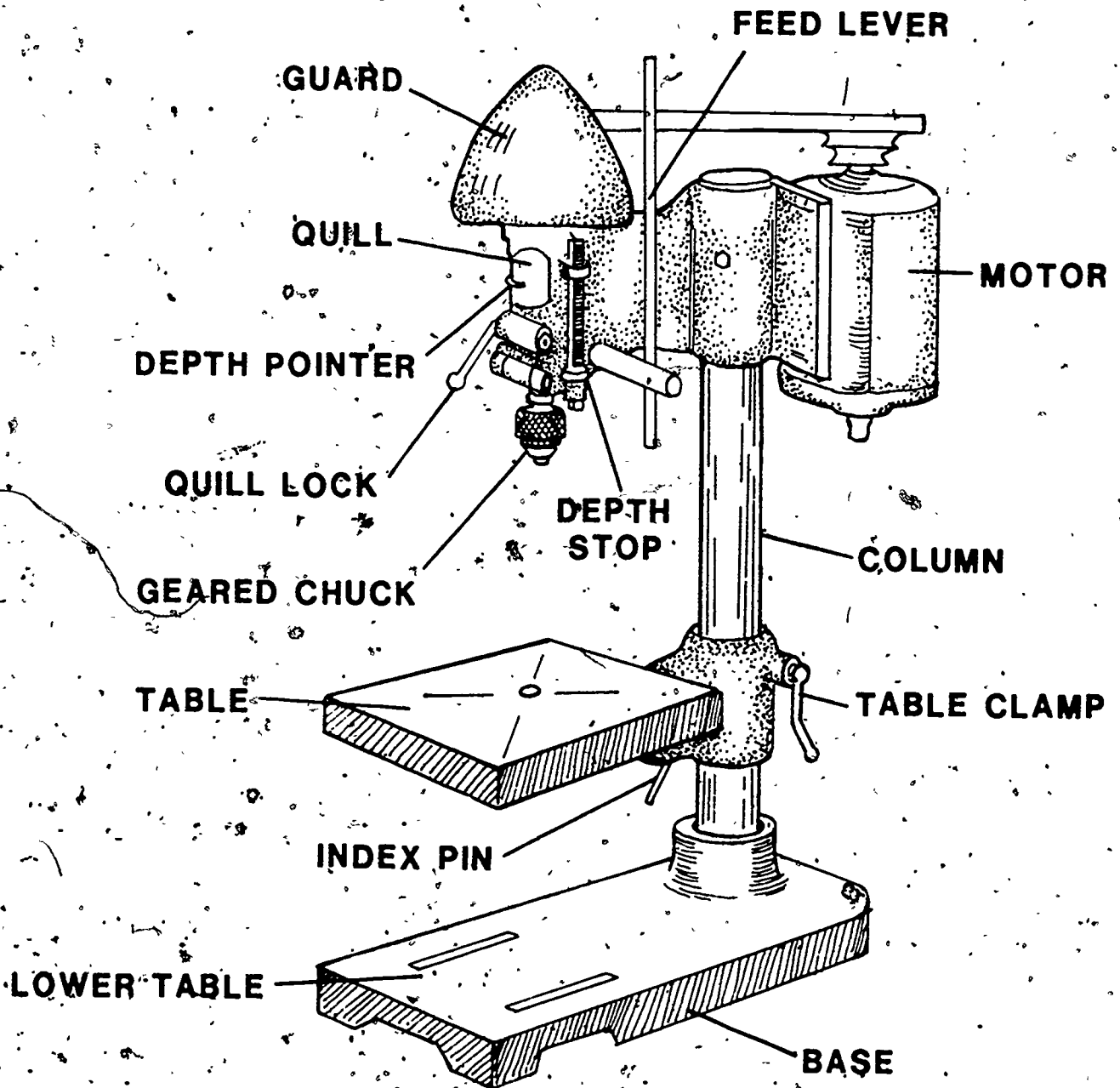

DISCUSSION GUIDE FOR TRANSPARENCIES
USING SELECTED POWER TOOLS

I. Transparency: Table Circular Saw

- A. The table saw is used for many types of straight-edged cuts such as crosscutting, ripping, chamfering, beveling, dadoing, mitering, and rabbeting.
- B. Table saws are classified as:
1. Tilting arbor saw – blade and arbor tilt. This is most commonly used in agriculture shops.
 2. Tilting table saw – table tilts for sawing angles. This type generally costs less than the tilting arbor saw.
- C. Table saws are sized by the maximum diameter blade that will fit on the saw.
- D. Major parts of the table circular saw.
1. Blade – determines the size of the circular saw. An 8 inch blade can square cut 2½ inches deep and 1 3/4 inches deep when angled at 45 degrees.
 2. Saw guard – safety shield which surrounds the blade. Floats on top of work being cut and has anti-kickback fingers for operator protection.
 3. Splitter – keeps cut boards apart and prevents binding of saw blade.
 4. Fence – used for ripping lumber. It is adjustable and should be removed from the table when using the miter gauge.
 5. Rear and front fence locks – used to secure and square the ripping fence.
 6. Motor – generally uses three belts for driving the blade. A commonly used motor would be a 240 volt, 1 H.P. with a 3450 RPM capacitor-start with a built-in overload protector.
 7. Switch – controls power to the motor. The switch should be operated only by the operator and not a by-stander or assistant.
 8. Motor elevating control – used to raise and lower the saw blade.
 9. Tilting control – tilts the blade for cutting angles from 90 to 45 degrees. The blade only tilts in one direction.
 10. Stop rod – attaches to the miter gauge and allows stock to be cut to determined lengths.
 11. Miter gauge – used for pushing and guiding stock when making crosscuts. It is adjustable in both directions to enable crosscutting from 90 to 45 degrees.

II. Transparency: Table Saw Blades

- A. Crosscut — used to cut across the grain. The teeth are shaped like a crosscut hand saw. The teeth are smaller than those on the rip blade. The blade tends to get hot if used for ripping.
- B. Rip — used to rip lumber. The teeth are shaped like those on a hand-rip saw. It is not suitable for crosscutting as it leaves a very rough finish.
- C. Combination — used for both crosscutting and ripping lumber. The teeth are slightly smaller than those on the rip blade and the back of the teeth are beveled. A series of raker teeth are used on the blade which are preceded by a deep groove. The blade produces a smooth cut when crosscutting and ripping.

III. Transparency: Bench Model Drill Press

- A. There are two general types of drill presses —
 - 1. bench press
 - 2. floor press
- B. The primary function is drilling holes; however, with proper attachments the press can be used for sanding, buffing, polishing, routing, shaping, grinding and cutting mortises and rabbets.
- C. Common sizes of drill presses are 11 inch, 15 inch, and 17 inch. The size is determined by the distance from the column to the center of the drill chuck.
- D. Speeds can vary from 400 to 8500 RPM and are changed by the belt-pulley ratio. Slower speeds are used for drilling metal and faster speeds are used for drilling wood.
- E. Parts of the drill press:
 - 1. Feed lever: moves the quill and spindle up and down for drilling. Generally, a spring keeps the quill in its highest position when not in use.
 - 2. Motor — Can be either 120 or 240 volt with 1/3 to 1/2 H.P.
 - 3. Column — Provides support for the head and table.
 - 4. Table clamp — fastens the table to the column. This allows the table to be adjusted up and down and sideways.
 - 5. Base — supports the drill press—some are mounted on benches and some rest on the floor.
 - 6. Lower table — part of the base and serves the same purpose as the movable table when drilling large stock.
 - 7. Index pin — device used to tilt the table for drilling at angles.
 - 8. Table — adjustable support for securing stock for drilling or for other work.
 - 9. Geared chuck — used to attach twist drills and augers to the press. Generally opens to a maximum of 1/2 inch.

10. Depth stop -- used to drill holes to a predetermined depth.
11. Quill lock -- locks the quill in various depth positions.
12. Depth pointer -- indicates depth of hole.
13. Quill -- the sleeve that supports the revolving spindle in a vertical position.
14. Guard -- protective cover over the pulleys and belt.



SUGGESTIONS TO THE TEACHER REGARDING STUDENT TESTS ON
"SAFE PRACTICES IN THE VOCATIONAL AGRICULTURE SHOP"

1. These tests have been prepared for individual power tools or areas of instruction with each test on a single sheet.
2. Most of the test questions are TRUE-FALSE types. Space has been left between questions for students to explain why the statement is true or false. It may be particularly desirable to explain why a question was marked true or false, thus re-emphasizing correct procedure.
3. A set of correct answers to the test questions is not provided. The correct answers to certain questions depend upon the safety standards adopted by individual teachers.
4. Some teachers may wish to have the students sign the attached statements of safety training and keep them on file.
5. Permission to duplicate any of this material is freely granted. Credit for the material used in this unit is due to many individual teachers. Original drafts were submitted by A. W. Schmidt, D. J. Witt, Loren Mills, and Charles Pearson, Teachers of Vocational Agriculture in Illinois.

Name _____

Student Test

Date _____

on

Circular Saws (Tilting Arbor and Radial Arm)

- _____ 1. To make accurate cuts with a circular saw, it is necessary to remove the guard.
- _____ 2. The operator should always use the miter gauge or the ripping fence and not saw freehand.
- _____ 3. The blade should project as far as possible through the work being cut in order to lessen the danger of kickback.
- _____ 4. A push stick should always be used by the person helping you rip long narrow boards on the circular saw.
- _____ 5. It is safer to remove the ripping fence from the saw (entirely) when cross-cutting is being done.
- _____ 6. Scraps should not be removed from the area near the saw blade with the fingers until the saw has come to a dead stop.
- _____ 7. It is not a safe practice to stop the blade from coasting with a piece of scrap lumber after the motor had been turned off.
- _____ 8. A helper used in ripping long boards should support and guide the board being cut.
- _____ 9. You should stand directly in line with the blade when ripping so you can see to follow the line on the work accurately.
- _____ 10. Which of the following is correct direction for ripping with a radial arm saw?

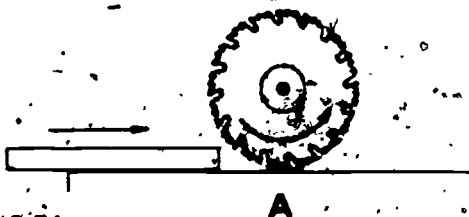

A

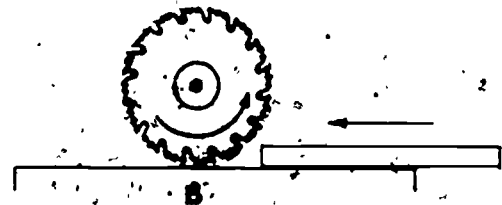

B

Name _____

Date _____

Student Test
on
Power Grinders

- _____ 1. Always use a face shield or goggles when operating a grinder.
- _____ 2. Tool rests should never be set as close as 1/8 inch from the wheel because materials are likely to be caught between the rest and the wheel.
- _____ 3. When grinding, you should stand directly in front of the wheel so you can have better control over the piece you are grinding.
- _____ 4. Keep fingers clear of the wheel when grinding.
- _____ 5. After a new wheel has been installed, you should stand to one side, turn it on, and let it run for at least a minute before starting to grind.
- _____ 6. Grinding on the flat side of the wheel is permissible when the curved surface is out of shape.
- _____ 7. You should wash your hands thoroughly before touching your face or eyes after using a grinder.
- _____ 8. Start the grinder and then adjust the tool rest so that it is slightly above the center of the wheel.
- _____ 9. You are responsible for the safety of others nearby when you are using a portable grinder.
- _____ 10. If anything seems wrong with a grinder, turn it off, and call your instructor.

Name _____

Date _____

Student Test
on
Drill Press and Portable Drills

- _____ 1. When using the drill press, clamp small work in a vise or clamp it to the drill press table.
- _____ 2. When drilling, remove the shavings from the work with a brush, not your hand.
- _____ 3. You should increase the pressure on the drill slightly just as it starts to break through a piece of steel in order to cut a clean hole.
- _____ 4. Keep a light film of oil on the floor around the drill press so that chips will not stick to it.
- _____ 5. Be sure the switch is "off" when making adjustments on the drill press.
- _____ 6. Do not wear loose, floppy clothing when operating a drill press.
- _____ 7. The chuck key should always be left in the chuck after using a drill press so it won't get lost.
- _____ 8. Do not use a 1/2 inch portable electric drill in an "off balance" position.
- _____ 9. Never hold a piece of steel being drilled in one hand and a portable drill in the other.
- _____ 10. Always lock the switch "on" when a portable drill is held in your hands.

Name _____

Date _____

Student Test
on
Portable Electric Saw

- _____ 1. When using a portable electric saw, use one hand to operate the saw and the other to hold the board securely.
- _____ 2. It is not enough to just turn off the portable saw when you wish to change blades, lubricate, or make adjustments.
- _____ 3. When you use a portable electric saw for cross-cutting, start the motor with the saw teeth against the wood to prevent kickbacks.
- _____ 4. The telescoping guard must be held out of the way when starting a pocket cut.
- _____ 5. It is not necessary to ground the frame of a portable electric saw, if the operator is well grounded.
- _____ 6. The portable circular saw is equipped with adjustments which may be made while the saw is running.
- _____ 7. When finishing a cut, you may safely reach around to catch the board to prevent it from falling down and splintering.
- _____ 8. Dull blades cut slower but are safer to use since they would not cut the operator so severely if an accident occurred.
- _____ 9. It is good practice to check the blade guard to see that it works freely and springs back promptly before using a portable electric saw.
- _____ 10. Never lay a portable saw down until you have turned it off and the blade has stopped turning.

Name _____

Date _____

Student Test
on
The Band Saw

- _____ 1. Before using the band saw, always check to see that the blade is centered on the wheels by switching the motor on and off several times.
- _____ 2. It is safest to keep both hands on the same side of the blade when operating the band saw.
- _____ 3. Use a push stick when your fingers might otherwise come closer than 2 inches to the band saw blade.
- _____ 4. It is safest to back a band saw blade out of a blind cut while it is running at full speed.
- _____ 5. Narrow blades are best for cutting sharp curves.
- _____ 6. It is considered a safe practice to follow a line when sawing with the band saw.
- _____ 7. The band saw may be checked for trueness and free blade movement by turning the saw a few revolutions by hand before starting.
- _____ 8. Operating a saw with the blade caked with dust, resin, or gum substances may cause breakage.
- _____ 9. Blade guards should be removed only when changing band saw blades.
- _____ 10. The upper blade guide support should be adjusted to clear the work by (A) no more than; (B) at least; one-half inch.

Name _____

Date _____

Student Test
on
Reciprocating and Sabre Saws

- _____ 1. In operating the sabre saw, it is necessary to apply considerable force to move it through the wood.
- _____ 2. Check the saw often for loose screws and parts.
- _____ 3. Always disconnect the cord when repairing or adjusting the saw or changing blades.
- _____ 4. In making a cut with the sabre saw, hold the stock piece firmly in one hand and the saw in the other hand.
- _____ 5. When cutting metal with the reciprocating saw, fasten the metal securely in a vise before starting to saw it.
- _____ 6. Use the high speed for cutting wood and the low speed for cutting metals.
- _____ 7. It is best to use the lock switch while operating the reciprocating saw.
- _____ 8. The saw may be held at any angle when sawing except when nearing a corner.
- _____ 9. Be sure to keep the saw shoe against the work when sawing.
- _____ 10. If the saw has a tendency to bounce, change to a blade having larger teeth.

Name _____

Date _____

Student Test
on
Electric Sanders

- _____ 1. Portable disk sanders may be equipped for sanding masonry.
- _____ 2. If the disk sander turns clockwise, you should hold the piece being sanded against the right-hand half of the disk.
- _____ 3. It is safe to sand pieces that are too small to be run over the jointer safely.
- _____ 4. After the disk sander is turned off, you should either stand in front of it until it comes to a dead stop or jam a piece of lumber up against the disk to stop it.
- _____ 5. You should empty the dust collector on a portable belt sander each time the sander is used, even if it is only half full.
- _____ 6. Plug in a portable sander and then check to be sure the switch is turned off.
- _____ 7. It is safer to hold small pieces with one hand and the sander with the other than to hold small pieces in a vise and take a chance on sanding the vise.
- _____ 8. Always disconnect the sander from the power before changing the abrasive sheet.
- _____ 9. It is all right to lay a sander down while it is still running if you lay it on its side.
- _____ 10. Stop the sander before making any adjustments.

Name _____

Date _____

Student Test
on
Soil Shredders

- _____ 1. Operate the shredder on a firm level area to prevent tipping.
- _____ 2. Stand away from the discharge area when the machine is running.
- _____ 3. Stand directly in front of the hopper when feeding in the material.
- _____ 4. Wear safety goggles at all times when operating the soil shredder.
- _____ 5. Always wear gloves when operating the soil shredding machine.
- _____ 6. The machine operator should wear loose fitting clothes when operating the soil shredder.
- _____ 7. Never put your hands down into the hopper or discharge opening when the machine is running or when it is plugged into the electrical outlet.
- _____ 8. A soil shredder will grind, shred or pulverize all organic material.
- _____ 9. The shredder will pulverize dry material more easily than moist material.
- _____ 10. If too much material gets into the shredder, press back on the stone ejector lever with your foot.
- _____ 11. Small stones will normally be pulverized when the shredder discharge door is shut.
- _____ 12. You may move a shredder from one area in the greenhouse to another safely without turning off the motor.
- _____ 13. Shredders powered with gasoline may be refilled while the engine is running.

Name _____

Date _____

Student Test
on
Electric Weed Trimmers

- _____ 1. The weed trimmer is designed to cut weeds over 8" tall.
- _____ 2. Cut from left to right whenever possible for maximum cutting power.
- _____ 3. The weed trimmer should be slightly tilted when trimming weeds.
- _____ 4. One can safely trim weeds with an electric trimmer when the weeds are wet.
- _____ 5. Guards are needed on the electric weed trimmer.
- _____ 6. When moving from one area of the lawn to another, leave the trimmer plugged in.
- _____ 7. Never trim weeds with an electric trimmer when it is raining.
- _____ 8. Any extension cord is acceptable to use with an electric trimmer.
- _____ 9. Trimming weeds while wearing sandals is acceptable.
- _____ 10. Never repair the weed trimmer while it is plugged into the receptacle.
- _____ 11. If the casing is cracked and the machine still runs, it is acceptable to operate the weed trimmer.

Name _____

Date _____

Student Test
on
Concrete Mixers (Soil Mixer)

- _____ 1. The barrel or drum of the soil mixer (concrete mixer) can be locked into three different locations.
- _____ 2. Always add water to the amended soil mix before it is placed in the soil mixer.
- _____ 3. It is safe to place your hands in the soil mixer when it is in operation.
- _____ 4. Soil should be placed into the machine before turning the soil mixer "on".
- _____ 5. Keep the barrel rotating, in the down position, in order to dump the soil from the mixer into the wheel barrow.
- _____ 6. Adjusting the cotter pin enables the barrel to be shifted into its three possible positions.
- _____ 7. Never reach across the front of the mixer when turning it off or on.
- _____ 8. It is recommended that the mixer be filled with additional materials while the barrel is rotating, assuming you are using a shovel.
- _____ 9. When cleaning the mixer, keep the barrel rotating and spray water in the barrel to remove any debris.
- _____ 10. For proper adjustment of the belt, it is recommended to keep the machine running while adjustments are made.

Name _____

Date _____

Student Test
on
Rotary Tillers

- ___ 1. The clutch should be in neutral when the machine is being started.
- ___ 2. Never clean the rotary tiller when the machine is running.
- ___ 3. Never change the blade when the rotary tiller is running.
- ___ 4. When the new machine is delivered, oil is included in the tiller drive box.
- ___ 5. It is not dangerous to pull the engine starter cord while the engine is running.
- ___ 6. Full throttle is the best speed for tilling new soil.
- ___ 7. The cutting depth of the tiller is controlled by the height of the drag bar.
- ___ 8. For a deep cut increase the downward pressure on the handles.
- ___ 9. The tiller should be left running if you are moving the tiller in a truck.
- ___ 10. The air filter on the tiller should be checked no more than once every five hours.
- ___ 11. Rotary tiller oil should not be changed.

Name _____

Date _____

Student Test
on
Soil Sterilizers

- _____ 1. When using a soil sterilizer, water should be added to the soil media to aid in the speed of pasteurization.
- _____ 2. When pasteurizing soil, remove the soil media immediately after the automatic switch turns the sterilizer "off".
- _____ 3. Soil media can be left in the pasteurizer for several days after pasteurization.
- _____ 4. The electric soil sterilizer should be unplugged when not in use.
- _____ 5. Be sure to switch "off" the sterilizer when filling the soil sterilizer.
- _____ 6. Never operate the soil sterilizer while standing in mud or water.
- _____ 7. An electric soil sterilizer should be used only on a flat, even surface.
- _____ 8. The lid of a soil sterilizer should be in place before the soil sterilizer is switched "on".
- _____ 9. Never remove the soil sterilizer lid while soil is being pasteurized and the temperature light is still "on".
- _____ 10. Allow the soil media in an electric sterilizer to cool 15 minutes before removing the soil media.

Name _____

Date _____

Student Test
on
Chain Saws

- _____ 1. It is not necessary to read the owner's manual before operating a chain saw.
- _____ 2. It is not necessary to have a guide bar located on the power chain saw.
- _____ 3. All chain saws use the same fuel mixture.
- _____ 4. Most chain saws are designed to use the right index finger to operate the throttle.
- _____ 5. Eye protection is a must when operating any chain saw.
- _____ 6. Stop the engine and do not smoke while refueling your chain saw.
- _____ 7. Shut off your chain saw while carrying it from one tree to another.
- _____ 8. A chain saw should always be carried with the guide bar pointed to the rear.
- _____ 9. Two people are needed when operating a chain saw.
- _____ 10. A chain saw should not be held higher than the operator's waist.
- _____ 11. Trim the limbs from a fallen tree while standing on the opposite side of the trunk.
- _____ 12. A second person is needed to hold the ladder while a person is operating a chain saw while on a ladder.

100

Name _____

Date _____

Student Test
on
Electric Lawn Edgers

- ___ 1. Safety goggles must be worn when using an electric lawn edger.
- ___ 2. Guards must always be in place when operating an electric lawn edger.
- ___ 3. Long pants must be worn when operating an electric lawn edger.
- ___ 4. Never yank the cord from the receptacle.
- ___ 5. Never operate the electric lawn edger when bare-footed or when wearing open sandals.
- ___ 6. Never operate the electric lawn edger in a damp or wet location.
- ___ 7. Never use the electric lawn edger in the rain.
- ___ 8. Never repair the electric lawn edger with the power supply connected.
- ___ 9. Make sure that other persons are at least 100 feet away from the electrical edger while it is in operation.
- ___ 10. Always stand to the left side of the electric lawn edger.

Name _____

Date _____

Student Test
on
Lawn Mowers

- _____ 1. Electric mowers can be used while the dew is still on the lawn.
- _____ 2. When operating "walk behind" mowers, cut across the slopes, never up and down.
- _____ 3. Shut off the motor, disconnect the spark plug, and wait until moving parts have stopped before attempting maintenance.
- _____ 4. On power mowers, do not remove the grass catcher bag before the mower has completely stopped.
- _____ 5. Never remove a safety device or guard on the lawn mower.
- _____ 6. Always refuel the gasoline engine mower outdoor.
- _____ 7. Always refuel only when the motor has stopped.
- _____ 8. Never operate a lawn mower in bare feet or open-faced sandals.
- _____ 9. Children under the age of ten can safely operate a lawn mower.
- _____ 10. Non-grounded extension cords can be used with electric lawn mowers.
- _____ 11. Safety glasses should be used when operating a lawn mower.
- _____ 12. Operate a gasoline engine lawn mower at the slowest speed possible to obtain a satisfactory cutting job.
- _____ 13. Never attempt to adjust the cutting height without first stopping the engine.
- _____ 14. Always set the four wheels of the lawn mower at the same height.
- _____ 15. All lawn mowers are equipped with a shear pin on the rotating blades.
- _____ 16. Always read the owner's manual before operating any lawn mower.

Name _____

Date _____

Student Test
on
Hedge Trimmers

- _____ 1. The owner's manual must be read thoroughly before operating the hedge trimmer.
- _____ 2. Both hands should be on the handles when operating the hedge trimmer.
- _____ 3. Twigs should not be hand-fed into the hedge trimmer.
- _____ 4. The hedge trimmer should never be picked up by the blades.
- _____ 5. Never use the electric trimmers in the rain.
- _____ 6. Children under the age of 10 should not operate a hedge trimmer.
- _____ 7. Hedge trimmers should be operated with groups of people.
- _____ 8. Always disconnect the hedge trimmer from its power source when it is not being used.
- _____ 9. Before using the hedge trimmer, inspect it for a damaged cord and dull blade.
- _____ 10. Hedge trimmer blades must be lubricated for safe use.
- _____ 11. When the hedge trimmer is equipped with a power pack, the tool must be stored in a locked area or out of the reach of children.

UNIT D: HORTICULTURAL/AGRICULTURAL MECHANICS

PROBLEM AREA: DEVELOPING SAFE WORK HABITS IN AGRICULTURAL MECHANICS

SUGGESTIONS TO THE TEACHER:

This problem area is designed for use with freshman or beginning students enrolled in an agricultural/horticultural occupations program. The recommended time for teaching this problem area is prior to the student's shop project work. The estimated time for teaching this problem area is 3 to 5 days depending on how much time the teacher wishes to spend on discussion and conducting the suggested exercises. The materials in this problem area were selected and written with the following assumptions:

1. It is important for students to develop and practice a positive safe work attitude.
2. Students need instruction on the procedures to follow regarding first-aid.

Even though a separate problem area on safety has been included in these Core I materials, teachers should not assume that safety should be taught solely as a separate unit. Instruction in safety should be included in all problem areas where applicable and handled as an integral part of the teaching program.

CREDIT SOURCES:

These materials were developed through a funding agreement, R-33-21-D-1542-388 with the Illinois State Board of Education, Department of Adult, Vocational and Technical Education, Research and Development Section, 100 North First Street, Springfield, Illinois 62777. Opinions expressed in these materials do not reflect, nor should they be construed as policy or opinion of the State Board of Education or its staff.

The teacher's guide, worksheets, and transparency discussion guide were developed by Paul Benson, Jerry Pepple, and Jim Ethridge, Department of Vocational and Technical Education, University of Illinois. The transparency masters, safety charts and suggested test questions were prepared by Vocational Agriculture Service, University of Illinois. Suggestions and guidance in the development of these materials were provided by the Rural and Metropolitan Core Curriculum Pilot Test Teachers.

TEACHER'S GUIDE

I. Unit: Agricultural mechanics

II. Problem area: Developing safe work habits in agricultural mechanics

III. Objectives: At the close of this problem area students will:

1. Understand the value of a positive safety attitude.
2. Understand the value and purposes of sound safety practices.
3. Know and practice proper safety procedures inside and outside of the agricultural mechanics laboratory (shop) or greenhouse.
4. Know the proper steps to take regarding accidents and first aid.

IV. Suggested interest approaches:

1. Demonstrate the results of various hazards that may occur in the shop, and greenhouse, for example:
 - a. Demonstrate the flammability of human hair by collecting some from each student and igniting it at the front of the class.
 - b. Demonstrate the flammability and burning characteristics of various types of clothing, both old and new.
 - c. Demonstrate how a piece of metal in a drill press may catch on the bit and start spinning.
 - d. Demonstrate cutting a board with a hand saw and fake a cut on the hand by using red dye. Yell out and then ask the class what they should do for first aid.
2. Lead into a discussion of safety practices by asking students if they have been involved in any accidents. Then ask them to describe what happened and also how these accidents could have been avoided.
3. Show color filmstrip that illustrates the results of proper and poor safety procedures.
4. Take the class into the laboratory and ask them to list, or point out, the potential hazards.
5. Ask the students to name as many safe operating procedures as they can, and list them on the board.
6. To insure student safety students must demonstrate their knowledge of safety by passing a safety exam before being able to work in the shop.
7. Take the class to a home shop to observe safety procedures and potential hazards.
8. Develop student interest and motivation by asking the following lead questions:
 - a. What type of fire extinguishers do you have at home?
 - b. Where are the fire extinguishers in the lab?

- c. What is a fire blanket made of and how do you use it?
- d. How could a dull power tool cause an accident?
- e. How could safety glasses protect your eyes in the shop?
- f. What are the OSHA safety procedures that are required in a machine shop?
- g. Are safety glasses required by law in a school shop?

V. Anticipated problems and concerns of students:

- 1. Why should I practice good safety procedures?
- 2. What are good safety procedures?
- 3. What are the purposes of good safety procedures?
- 4. Why do I need to dress differently for the lab than for class?
- 5. Do I need to demonstrate all safety procedures before I will be allowed in the shop?
- 6. How will knowing safety practices be beneficial outside the shop?
- 7. Will knowing and following safety procedures count as a part of my grade? How much?
- 8. Where is the first aid kit and what is in it?
- 9. Where is the fire extinguisher and how do you use it?
- 10. What do I do if:
 - a. I get cut?
 - b. I get burnt?
- 11. Do I have to wear safety glasses in the shop? Why?

VI. Suggested learning activities and concerns:

- 1. Have class read VAS Unit 3022, Section 1, 2, and 3, **Safety in the Agricultural Mechanics Shop**, and record tentative answers to the problems and concerns identified by the class or teacher when first starting problem area.
- 2. Distribute Worksheet 1, **Safety in the Agricultural Mechanics Shop**, and have students answer questions.
- 3. Show the following transparencies:
 - a. Safety Hazards
 - b. Types of Fire Extinguishers
 - c. Shop Safety and Hand Tools
- 4. Distribute Worksheet 2, **Checklist of Shop Hazards**, and have class fill out in shop area.
- 5. Conduct or have students conduct fire extinguisher demonstration using Job Sheet 1.
- 6. Show VAS filmstrip, "The Circular Saw and How to Use it Safely," and discuss.

7. Have class read VAS Unit 3044, A Color Code for Shop Safety.
8. Distribute Worksheet 3, Color Code for Shop Safety, and have class fill out.
9. Have class look at FFA record book on Safety and discuss the possibility of a student S.Q.E. program on safety.
10. Have students develop and conduct an FFA Chapter Safety Program.
11. Show film on greenhouse fire hazards and flammability of polyethylene and fiber glass.

VII. Application procedures:

1. The main purpose of this problem area is to develop a positive safety attitude and avoid bodily injury.
2. The students should apply all safety procedures learned in the classroom to working in the shop, at their homes, and at their place of employment.
3. Have students develop an S.O.E. safety project and submit records for sectional competition.
4. Have FFA chapter develop and conduct a safety campaign and submit for sectional competition.

VIII. Evaluation:

1. Prepare and administer a pencil and paper test covering safety procedures.
2. Grade worksheets.
3. Prepare and administer laboratory practical examination on safety procedures.
4. Administer VAS Safety Test "Safe Practices in the Vocational Agriculture Shop" (Section on general shop safety).

IX. References and aids:

1. VAS Unit 3022, "Safety in the Agricultural Mechanics Shop."
2. VAS Unit 3044, "A Color Code for Shop Safety."
3. VAS Safety Test, "General Shop Safety" and "Safety Quiz - Horticulture."
4. VAS Filmstrip, "The Circular Saw and How to Use it Safely."
5. VAS Transparencies on General Safety.
6. Student Worksheets 1, 2, and 3 and Teacher's Key.
7. Job Sheet 1, "Safe Use of Fire Extinguishers."
8. VAS Safety Charts
9. Phipps, Lloyd J., Mechanics in Agriculture, The Interstate Printers and Publishers, Inc., Danville, Illinois.
10. National FFA Chapter Safety Award Handbook.
11. Illinois Foundation FFA Record Book on Safety.

STUDENT WORKSHEET ↓
SAFETY IN THE AGRICULTURAL MECHANICS SHOP

1. Name three ways to dress properly for shop work:

- a. _____
- b. _____
- c. _____

2. List at least one reason why you should:

- a. Keep all edge tools sharp? _____

- b. Use wrenches of the proper kind? _____

- c. Use files with handles? _____

- d. Not use a punch with a mushroomed head? _____

- e. Adjust the jaws of adjustable wrenches? _____

- f. Not use a wrench as a hammer? _____

3. Why should you not use a penny as a substitute for an electrical fuse?

4. List one unsafe way to use the following tools:

- a. Pliers _____
- b. Screwdriver _____
- c. Carpenter's hammer _____

5. List five possible hazards while working with electricity in the shop?

- a. _____
- b. _____
- c. _____
- d. _____
- e. _____

6. What do you think are the most important safety rules for shop work?

- a. _____
- b. _____
- c. _____
- d. _____
- e. _____

100

STUDENT WORKSHEET 2
CHECKLIST OF SHOP HAZARDS

(To be filled out in shop area)

List and give the location of possible safety hazards in the shop.

1. _____
2. _____
3. _____
4. _____
5. _____
6. _____
7. _____
8. _____
9. _____
10. _____

110

STUDENT WORKSHEET 3
COLOR CODE FOR SHOP SAFETY

I. List the purposes of the safety color code as used in agricultural mechanics programs.

- a. _____
- b. _____
- c. _____
- d. _____

II. Match the colors used in the safety color code to the proper descriptions.

- | | | |
|-------------|-------|---|
| 1. Green | _____ | a. Applied to electrical switches, interior surfaces of doors, fuse and electrical power boxes, movable guards and parts, inside of nonmovable guards, traffic lanes, and overhead hazards; used to designate dangerous parts of equipment which may cut, crush shock, or otherwise injure. |
| 2. Aluminum | _____ | |
| 3. Yellow | _____ | |
| 4. Red | _____ | b. Applied to operating levers, wheels, handles, and hazardous areas which may cause stumbling, falling or tripping; used to designate caution. |
| 5. Blue | _____ | |
| 6. Orange | _____ | c. Applied to noncritical parts of equipment and machine surfaces, nameplates, and bearing surfaces; used to designate the location of safety and first aid equipment. |
| 7. Ivory | _____ | d. Applied to tops of tables and work areas to provide contrast with work. |
| | _____ | e. Used to identify the location of fire fighting equipment. |
| | _____ | f. Applied to tabel edges, vise jaws, and edges of tool rests to reflect light and "show the way". |
| | _____ | g. Used as the basic color for designating caution against starting equipment while it is being worked on or against the use of defective equipment. |

111

TEACHER'S KEY
STUDENT WORKSHEET 1

SAFETY IN THE AGRICULTURAL MECHANICS SHOP

1. Name three ways to dress properly for shop work:

- a. Wear appropriate clothes
- b. Keep hair cut
- c. Wear safety goggles

2. List at least one reason why you should:

- a. Keep all edge tools sharp? Dull tools require extra pressure which might result in slippage and injury to the operator
- b. Use wrenches of the proper kind? To avoid slippage and reduce possibility of injury to your knuckles.
- c. Use files with handles? To reduce possibility of an injury from the sharp tang.
- d. Not use a punch with a mushroomed head? Particles may break off and injure the operator.
- e. Adjust the jaws of adjustable wrenches? Wrench may slip or break if not adjusted properly.
- f. Not use a wrench as a hammer? Wrench may break or chip

3. Why should you not use a penny as a substitute for an electrical fuse?

It may result in overheated conductors and appliances and could start a fire.

4. List one unsafe way to use the following tools:

- a. Pliers using them as a wrench.
- b. Screwdriver using it as a cutting tool or punch.
- c. Carpenter's hammer using it to strike a punch or chisel.

5. List five possible hazards while working with electricity in the shop?

a. Using tools with damaged cords or faulty plugs.

b. Using tools without a grounding conductor.

c. Overloading extension cords.

d. Handling electrical cords with wet hands.

e. Placing extension cords in doorways.

6. What do you think are the most important safety rules for shop work?

a. Do not engage in horseplay.

b. Wear safety goggles.

c. Avoid "hurry".

d. Dress properly.

e. Unplug tools before cleaning or adjusting.

113

TEACHER'S KEY
STUDENT WORKSHEET 3.

COLOR CODE FOR SHOP SAFETY

I. List the purposes of the safety color code as used in agricultural mechanics programs.

- a. Reduces glare by diffusing light for better vision.
- b. Reduces eyestrain, tension and fatigue.
- c. Points out critical parts and areas.
- d. Provides a more pleasing environment.

II. Match the colors used in the safety color code to the proper descriptions.

- | | | |
|-------------|----------|---|
| 1. Green | <u>6</u> | a. Applied to electrical switches, interior surfaces of doors, fuse and electrical power boxes, movable guards and parts, inside of nonmovable guards, traffic lanes, and overhead hazards; used to designate dangerous parts of equipment which may cut, crush shock, or otherwise injure. |
| 2. Aluminum | | |
| 3. Yellow | | |
| 4. Red | <u>3</u> | b. Applied to operating levers, wheels, handles, and hazardous areas which may cause stumbling, falling or tripping; used to designate caution. |
| 5. Blue | | |
| 6. Orange | <u>1</u> | c. Applied to noncritical parts of equipment and machine surfaces, nameplates, and bearing surfaces; used to designate the location of safety and first aid equipment. |
| 7. Ivory | <u>2</u> | d. Applied to tops of tables and work areas to provide contrast with work. |
| | <u>4</u> | e. Used to identify the location of fire fighting equipment. |
| | <u>7</u> | f. Applied to tabel edges, vise jaws, and edges of tool rests to reflect light and "show the way". |
| | <u>5</u> | g. Used as the basic color for designating caution against starting equipment while it is being worked on or against the use of defective equipment. |

JOB SHEET 1

SAFE USE OF FIRE EXTINGUISHERS

Objectives:

1. To understand how to properly use fire extinguishers.
2. To be able to control wood, oil and gasoline type fires.
3. To be able to recognize fire hazards in a shop and determine methods to eliminate the identified hazard.

Materials:

1. Each type of fire extinguisher available in the shop and/or school.
2. Metal pan of wood scraps.
3. Metal pan with oil (diesel fuel).
4. Metal pan with sawdust or old rags soaked with gasoline.
5. Water hose.
6. Matches.

Procedures:

1. Carefully select the demonstration area, this should be outside the building yet accessible to the students.
2. Read references and instructions on the fire extinguishers before the demonstration and practice the demonstration.
3. Show and explain how the different types of fire extinguishers should be carried and operated when controlling a fire.
4. Explain how fire extinguisher works by use of fire triangle chart.

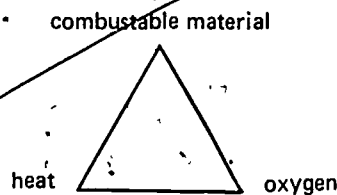

5. Demonstrate each type of fire extinguisher on each type of fire. Discuss why certain types of fire extinguishers were not effective on some of the fires. Could also demonstrate using only water to control oil or gasoline fires.
6. Have students demonstrate how to use fire extinguishers.

7. Summarize as follows:

- a. Keep calm, sound alarm (use good judgement).
- b. Call Fire Department, give your name, complete location of fire.
- c. Select proper fire extinguisher.
- d. Control base of fire,
 - 1) windward and base of horizontal fires
 - 2) base of vertical fires
- e. Do not take chances with your personal safety.

Questions:

1. Which type of fire extinguisher should you use?

Identify the types of fires controlled by:

Type "A" extinguisher _____

Type "B" extinguisher _____

Type "C" extinguisher _____

2. Why do you not use a soda acid extinguisher on an electrical fire?

3. What three things are necessary for a fire? _____

4. What is the local phone number for:

a. Fire Department _____

b. Police Department _____

116

Observation:

Record the location and type of fire extinguisher in the shop and classroom. Also note location of fire alarms.

Conclusions:

Record the results of the fire extinguishers' demonstrations. Note what happens when each type of extinguisher is used on each fire. Develop a list of approved practices to follow in preventing fires.

TYPES OF FIRE EXTINGUISHERS



**PRESSURIZED
WATER**



**SODA-
ACID**



**CARBON
DIOXIDE**



**DRY
CHEMICAL**

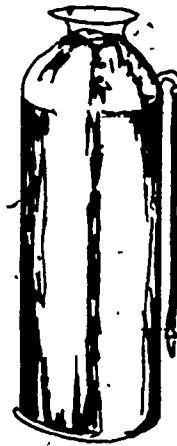

FOAM

SHOP SAFETY HAND TOOLS

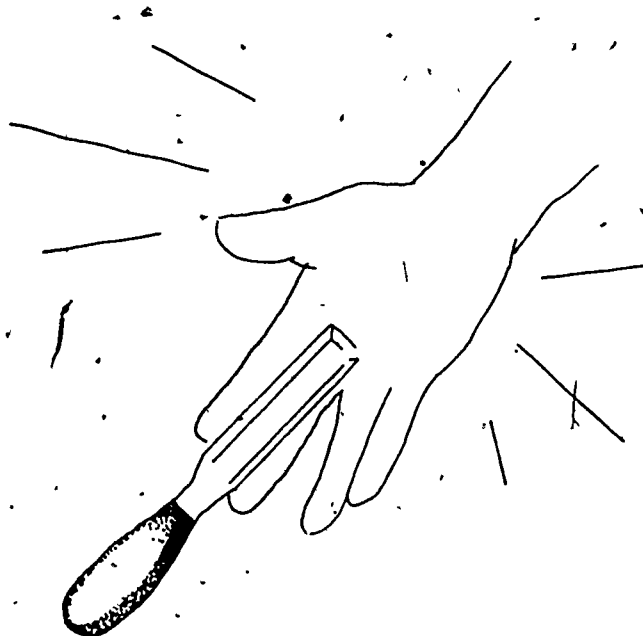

Dull wood chisel slips causing injury

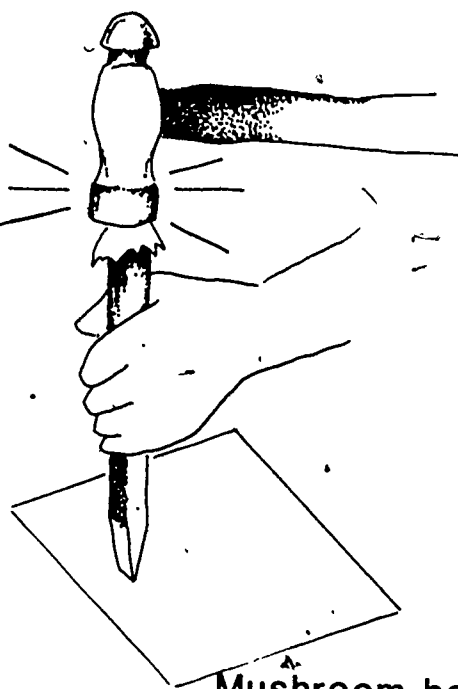

Mushroom head cold chisel--sliver causes injury

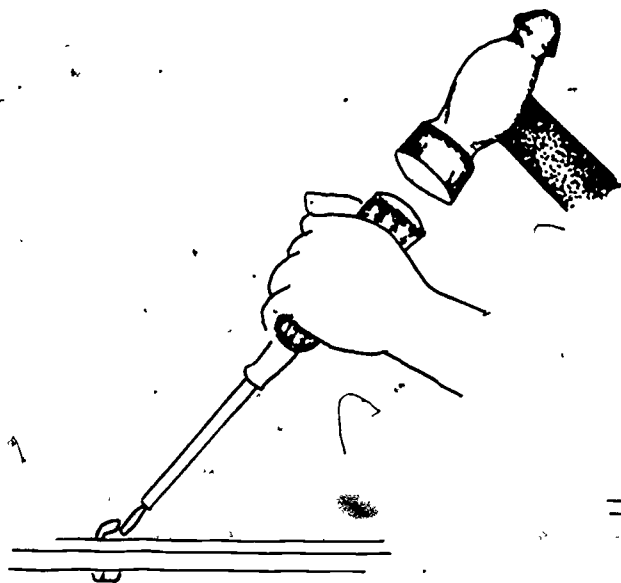

Improper use of hand tool can cause injury

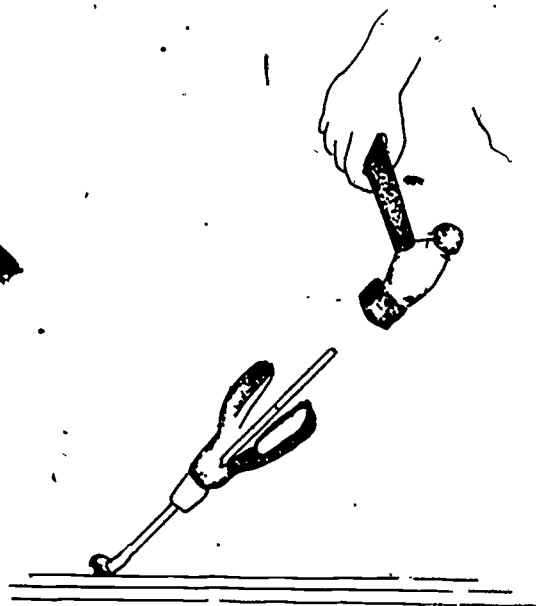

Possible injury to body by improper tool use

SAFETY HAZARDS

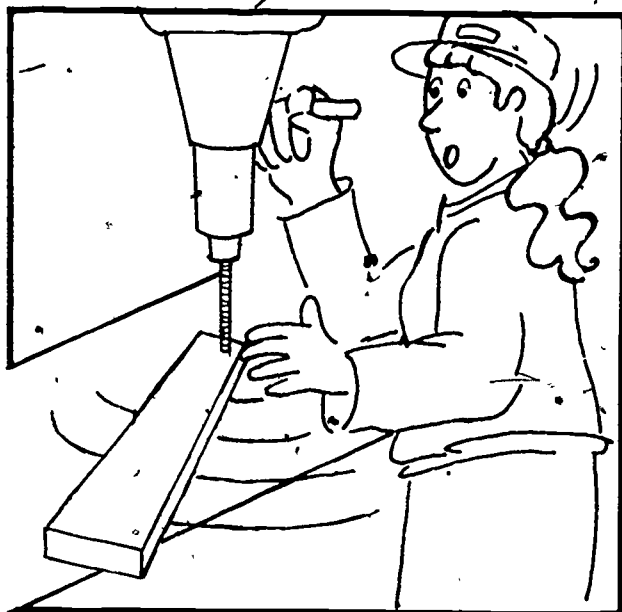

Secure objects to be drilled!

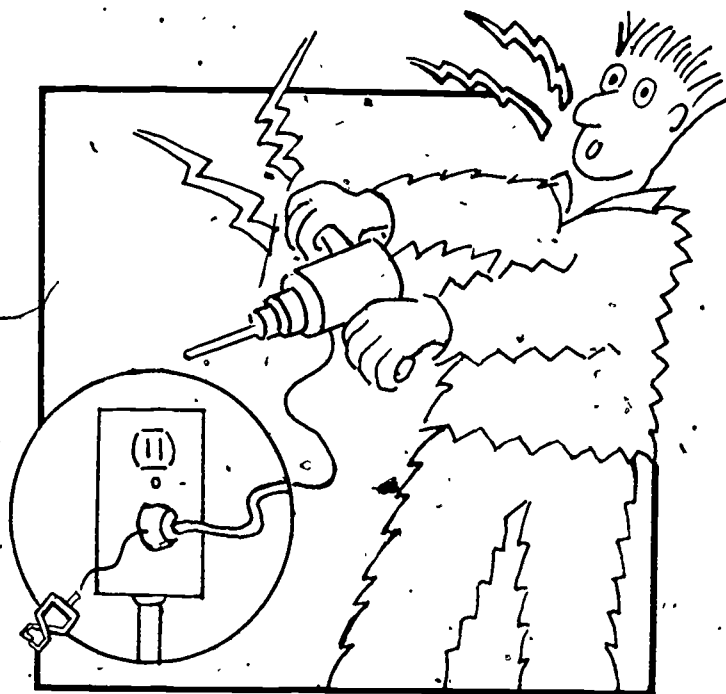

Ground all electrical appliances!

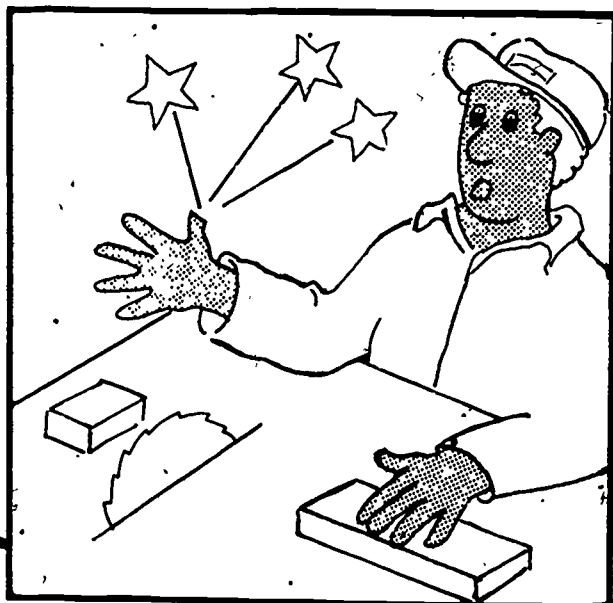

Use a miter gauge when crosscutting

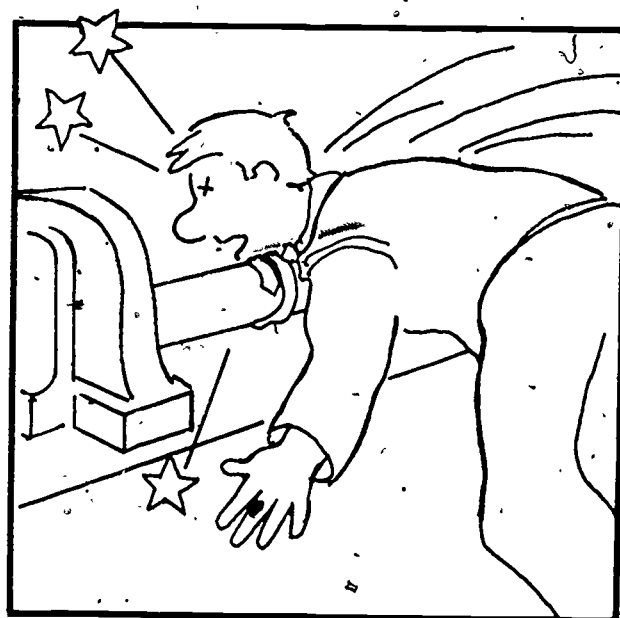

Wear appropriate clothing for the job!

SUGGESTIONS TO THE TEACHER REGARDING STUDENT TESTS ON
"SAFE PRACTICES IN THE VOCATIONAL AGRICULTURE SHOP"

1. These tests have been prepared for individual power tools or areas of instruction with each test on a single sheet.
2. Most of the test questions are TRUE-FALSE types. Space has been left between questions for students to explain why the statement is true or false. It may be particularly desirable to explain why a question was marked true or false, thus re-emphasizing correct procedure.
3. A set of correct answers to the test questions is not provided. The correct answers to certain questions depend upon the safety standards adopted by individual teachers.
4. Some teachers may wish to have the students sign the attached statements of safety training and keep them on file.
5. Permission to duplicate any of this material is freely granted. Credit for the material used in this unit is due to many individual teachers. Original drafts were submitted by A. W. Schmidt, D. J. Witt, Loren Mills, and Charles Pearson, Teachers of Vocational Agriculture in Illinois.

Name _____

Date _____

Student Test
on
General Shop Safety

- _____ 1. It is the responsibility of every student to learn to work in a safe manner.
- _____ 2. Such items as loose neckties, loose sleeves, and loose aprons must be secured or removed before operating a machine.
- _____ 3. When "clean up" time is announced, hurry and get your work finished.
- _____ 4. Students should not operate a machine unless the instructor is in the shop.
- _____ 5. Students, not using proper safety precautions, should not be permitted to operate the equipment.
- _____ 6. Noninterference with others is a good safety rule.
- _____ 7. No student, who has had an accident which has caused the flow of blood, should leave the classroom alone.
- _____ 8. Do you know the location of the fire extinguishers in your shop? (yes) (no)
- _____ 9. Good natured scuffling, pushing, and horseplay in the shop can cause a serious accident.
- _____ 10. Any students not operating a machine should stay out of the machine area.

123

SAFETY QUIZ
HORTICULTURE

Name _____

Date _____

- _____ 1. I will only operate machines in the Horticulture Department at _____ that I have been taught how to operate.
- _____ 2. When operating a piece of equipment, I will do so in a safe manner so as not to jeopardize the safety of myself or any bystanders.
- _____ 3. A machine is not to be left running while unattended.
- _____ 4. A machine in need of repair is to be turned off while repair is being done.
- _____ 5. All breakdowns or malfunctions in equipment are to be reported to the instructor immediately.
- _____ 6. Machines are to be operated only with all safety shields in place.
- _____ 7. I realize being a safe operator of equipment is one of the most important skills I can develop.
- _____ 8. All machines should be operated at the appropriate speed for the job, never at excessive speeds.
- _____ 9. I realize the importance of safety glasses in the operation of certain pieces of equipment.
- _____ 10. Proper clothing and shoes are very important for safe operation of equipment.
- _____ 11. I will only operate a piece of equipment at _____ with the consent of the instructor.

UNIT D: HORTICULTURAL/AGRICULTURAL MECHANICS
PROBLEM AREA: DEVELOPING BASIC CARPENTRY SKILLS

SUGGESTIONS TO THE TEACHER:

This problem area is designed for use with freshman or beginning students enrolled in an agricultural/horticultural occupations program. The recommended time for teaching this problem area is during the early part of spring semester. The estimated time for teaching this problem area is 10 to 15 days depending on how much time the teacher wishes to spend on discussion and conducting the suggested exercises. The materials in this problem area were selected and written with the following assumptions:

1. It is important for students to plan and construct a project to develop their shop skills.
2. Students need to be involved in the "doing" phase of instruction to maximize retention of material learned.

The instructor is reminded that this problem area can be used in either a rural or urban setting. The items in this problem area are for reference or modification as the teacher adapts this material to his/her local situation.

CREDIT SOURCES:

These materials were developed through a funding agreement, R-33-21-D-1542-388 with the Illinois State Board of Education, Department of Adult, Vocational and Technical Education, Research and Development Section, 100 North First Street, Springfield, Illinois 62777. Opinions expressed in these materials do not reflect, nor should they be construed as policy or opinion of the State Board of Education or its staff.

The teacher's guide, suggested content outline and suggested test questions were developed by Paul Hemp, Department of Vocational and Technical Education, University of Illinois. The student worksheets and suggested project plans were prepared by Vocational Agriculture Service, University of Illinois. Suggestions and guidance in the development of these materials were provided by the Rural and Metropolitan Core Curriculum Pilot Test Teachers.

TEACHER'S GUIDE

- I. Unit: Agricultural mechanics
- II. Problem area: Developing basic carpentry skills
- III. Objectives: At the close of this problem area, students will:
 1. Be able to identify and classify the following as softwood or hardwood: white pine, fir, cedar, poplar, oak, yellow pine, ash, elm, maple and hickory.
 2. Be able to list the characteristics and common uses of select, common and dimension lumber.
 3. Be able to identify with 90% accuracy the following hardware items:

a. common nail	g. stove bolts
b. finishing nail	h. machine bolts
c. box nails	i. carriage bolts
d. roofing nails	j. toggle bolts
e. lag screws	k. strap hinge
f. flat-headed wood screw	l. T hinge
 4. Be able to sketch a project showing the top, side and end view.
 5. Be able to read a blueprint and calculate a bill of materials from the blueprint drawing.
 6. Be able to calculate board feet and running feet from a bill of materials supplied by the teacher.
 7. Be able to perform the following skills to the satisfaction of the instructor:
 - a. Measuring and marking a ten feet length of board within 1/8"
 - b. Squaring a board
 - c. Sawing a board
 - d. Smoothing a rough cut on a board
 - e. Joining two boards with nails
 - f. Boring a hole in a 2" board
 8. Be able to plan and construct a wood project which meets the following specifications:
 - a. Plan meets the approval of the teacher and parent.
 - b. Bill of materials is judged to be 95% accurate by the teacher.
 - c. Cutting list is judged to be 95% accurate by the teacher.
 - d. Finished project is square, level and free of splits and hammer marks.
- IV. Suggested interest approaches:
 1. Obtain sample pieces of wood from a lumber yard.
Hold samples up to the class and ask them to identify the wood.
 2. Ask class to identify a variety of nails and other hardware
 3. Explain to the class that they will be building a carpentry project and that before the project is started, basic information and skills must be learned.

4. Ask class to name the trees that grow in the community. Ask them to name the trees that are used for lumber.
5. Conduct a discussion of past experiences of students to see how many class members have done carpentry work.
6. Show class examples of wood projects constructed by previous classes.

V. Anticipated problems and concerns of students:

1. What kind of lumber should I use for my project?
2. What kinds of lumber are available and what are they used for?
3. What is heartwood? sapwood?
4. What causes a knot in lumber?
5. What are the lumber grades and what are the characteristics of each grade?
6. Why does lumber warp? How can this be prevented?
7. What factors should be considered in selecting lumber?
8. What are the different types of nails, screws and bolts and how are they used?
9. What are the various types of hinges and fasteners and how are they used?
10. When should glue be used?
11. How can I drive a nail properly?
12. What do I need to know about a blueprint?
13. What is a bill of material? a cutting list?
14. How is board feet and running feet calculated?
15. How are drawings made to scale?
16. What are isometric, oblique and orthographic projections?
17. What steps are involved in performing basic carpentry skills?

VI. Suggested learning activities and experiences:

1. Select problems and concerns related to VAS Unit 3052 and handle them first. This unit covers nails, wood screws, bolts, hinges, fasteners and glue.
2. Conduct an identification contest to provide class with practice and identifying hardware.
3. Have class make charts showing various types of nails and other hardware.
4. Select problems and concerns related to lumber and wood. Use information included in Chapter 8 of Mechanics in Agriculture to answer questions.

5. Take class on a field trip to a lumber yard to see how lumber is graded, stored and sold.
6. Assign students problems to work on board feet and running feet.
7. Obtain a cross section of an old tree trunk and use it to point out the following to the class:
 - a. Type of tree or wood
 - b. Sapwood
 - c. Heartwood
 - d. Annual rings
8. Have students select a project to build in the shop. Obtain parental approval for all project plans.
9. Have students sketch project plan, calculate a bill of materials and cutting list or have them use one of the sample plans included with this packet.
10. Have students read VAS Unit 3051 and use worksheets or reproduce them for student use.
11. Have students read VAS Unit 3052 on Selecting Fasteners and Hardware.
12. Demonstrate or have students demonstrate the basic carpentry skills such as squaring a board, boring a hole, etc.
13. After projects are completed, have class evaluate each project in terms of criteria listed in VAS Unit 3051.

VII. Application procedures:

1. Encourage students to build additional projects for their S.O.E.P. or for home use.

VIII. Evaluation:

1. Prepare and administer a pencil and paper test using the sample questions included with this problem area.
2. Conduct identification contests on wood samples, hardware and fasteners.
3. Grade each finished project and explain to students why the grade was given.
4. Have class select the best "carpenter" in the class based on safety practices followed, use of time, use of tools, cleanup procedures and carpentry skills.

IX. References and aids:

1. VAS Unit 3051, "Planning a Woodworking Project"
2. VAS Unit 3052, "Selecting Fasteners and Hardware"
3. **Mechanics in Agriculture**, by Lloyd Phipps, The Interstate Printers & Publishers, Danville, IL.
4. Teacher's guide and suggested test questions.
5. Sample plans

SUGGESTED CONTENT OUTLINE
DEVELOPING BASIC CARPENTRY SKILLS

- I. Selecting Lumber
 - A. Classes of lumber
 - B. Types of wood
 - C. Grading lumber
 - D. Selecting and buying lumber

- II. Selecting and Using Hardware and Glue
 - A. Identifying and use nails
 - B. Identifying and using wood screws
 - C. Identifying and using bolts
 - D. Identifying and using other hardware
 - E. Selecting and using glue

- III. Making Sketches and Reading Blueprints
 - A. Importance of using a sketch or plan
 - B. Sketching
 - C. Reading blueprints

- IV. Computing a Bill of Materials
 - A. Defining a bill of materials
 - B. Measuring lumber—board feet and running feet
 - C. Writing out a bill of materials

- V. Developing Basic Woodworking Skills
 - A. Measuring and marking boards
 - B. Squaring a board
 - C. Sawing
 - D. Shaping and smoothing boards
 - E. Joining and fastening boards
 - F. Boring holes

- VI. Constructing a Carpentry Project
 - A. Deciding what to build
 - B. Procedures to follow
 - C. Evaluating the finished project

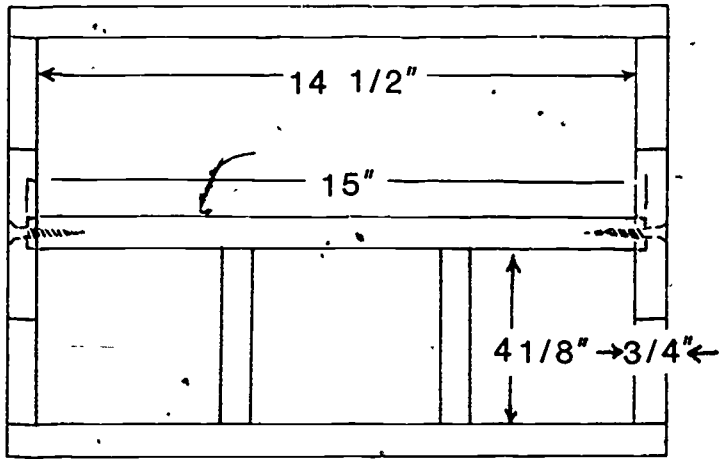
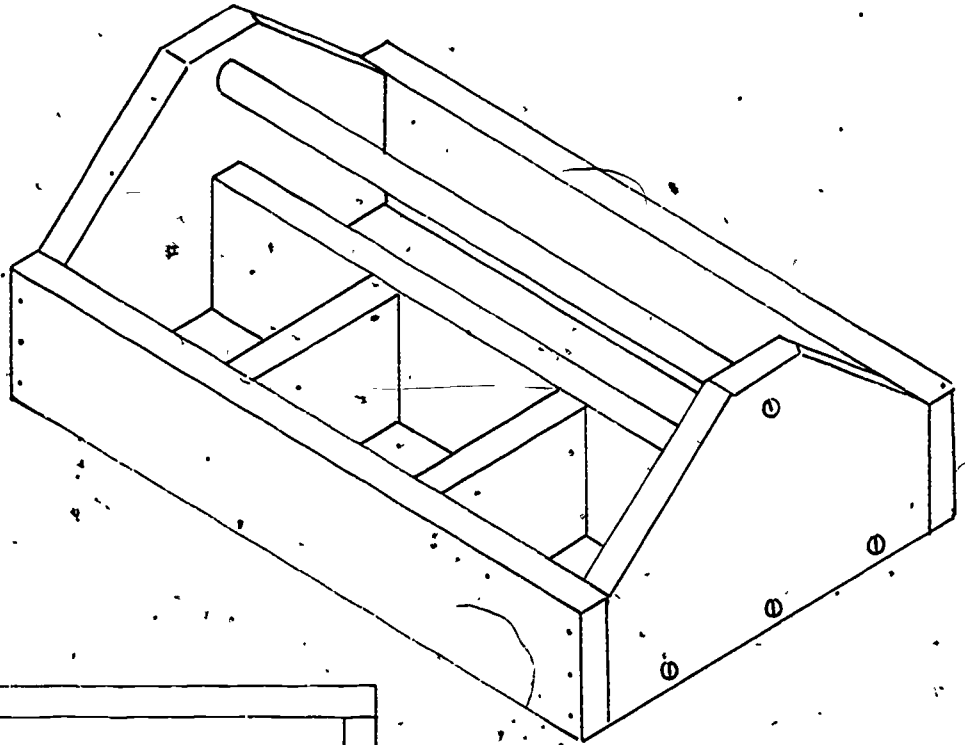

TOP VIEW

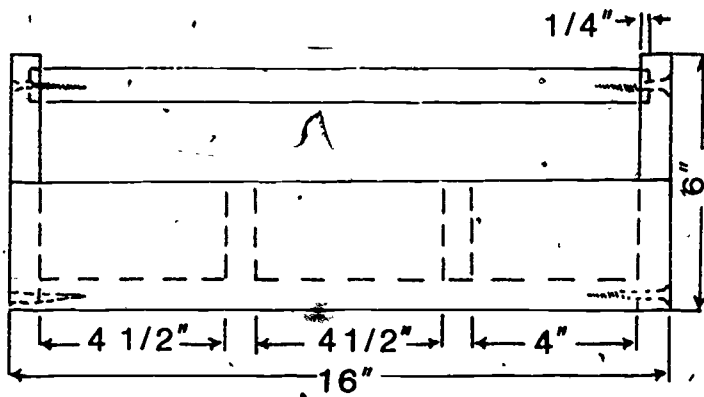

SIDE VIEW

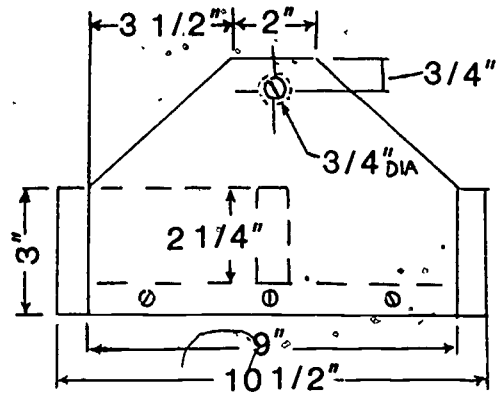

END VIEW

NAIL BOX

BROOM HOLDER

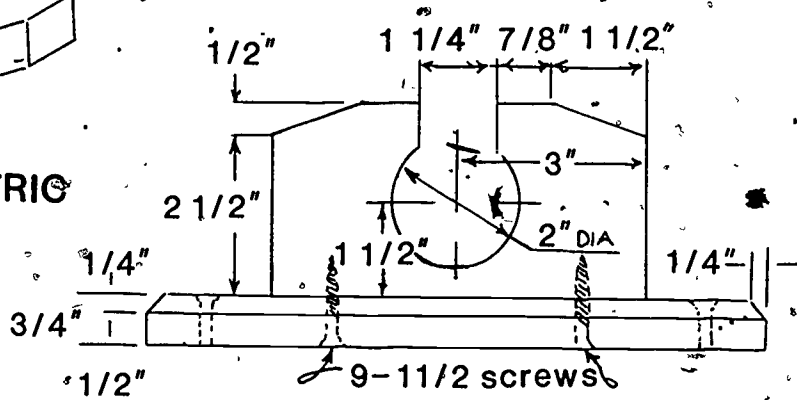
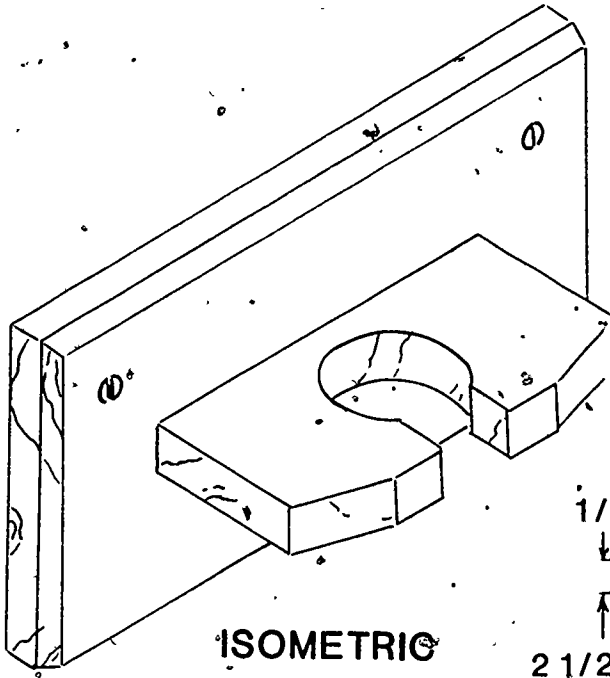

BOTTOM VIEW

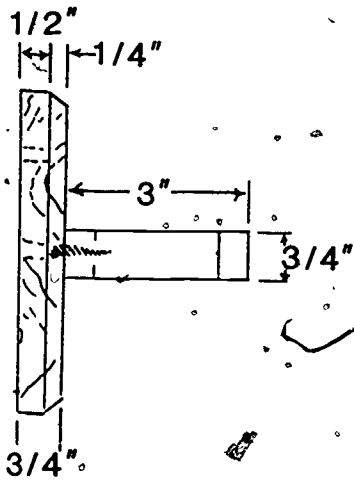

SIDE VIEW

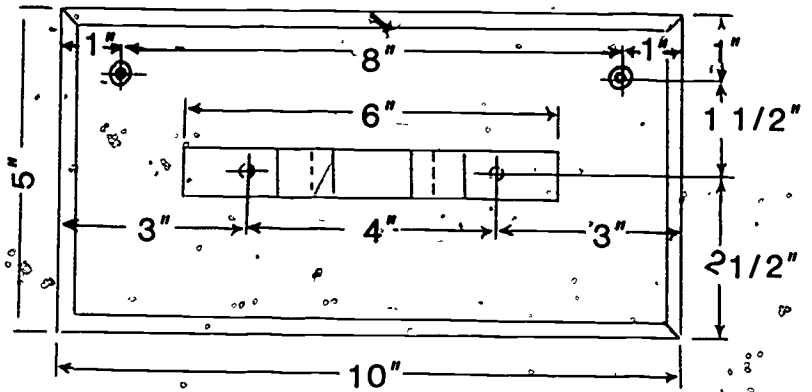

FRONT VIEW

PLANTER BOX

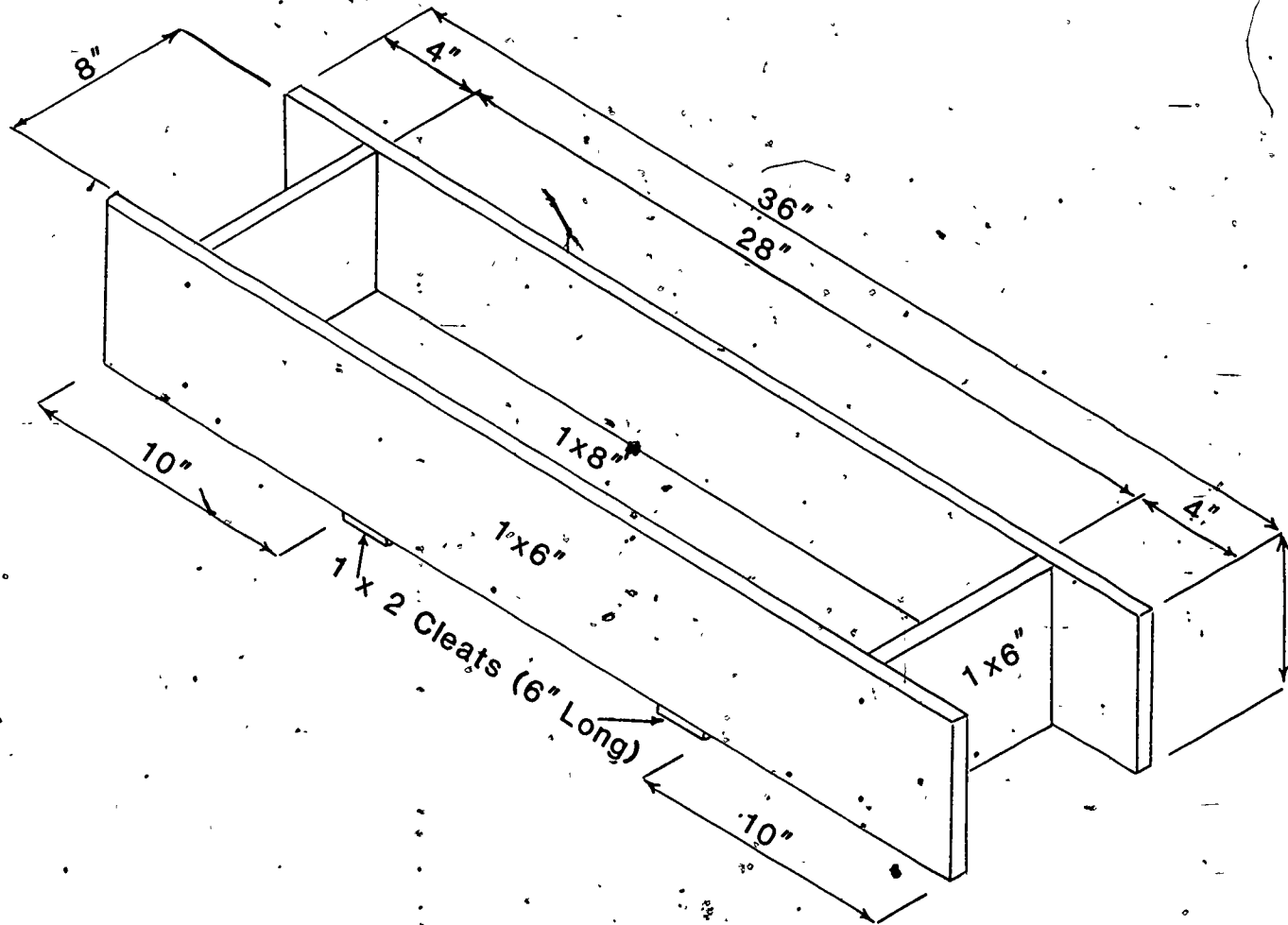

AGRICULTURAL MECHANICS PROJECT

Constructing a Flat

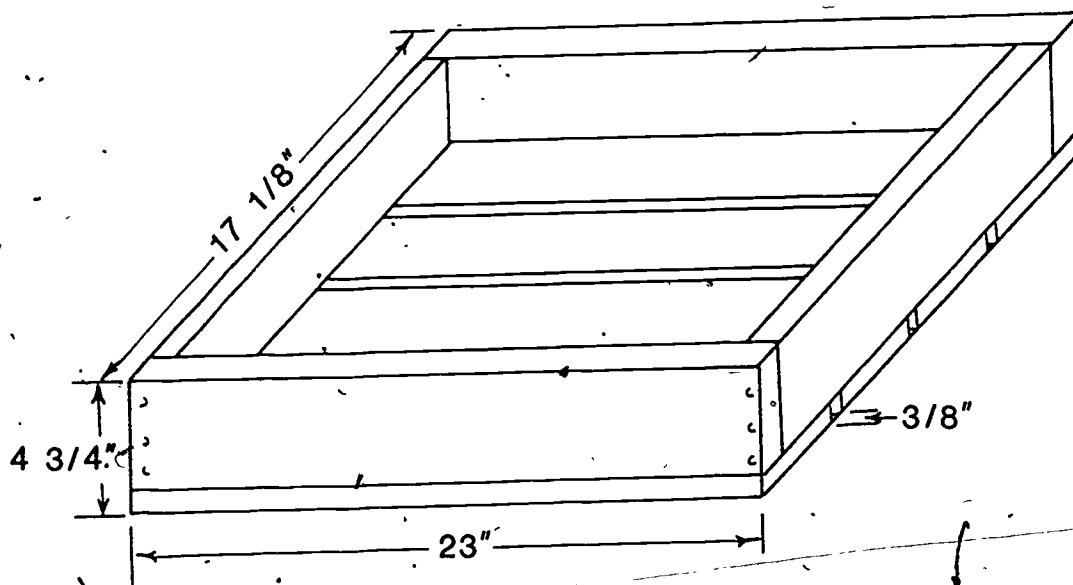

Bill of materials: (Use redwood stock.)

<u>Item</u>	<u>No. of Pieces</u>	<u>Size</u>
Ends	2	3/4" x 4" x 23"
Bottom	4	1/2" x 4" x 23"
Sides	2	1/2" x 4" x 15 5/8"
Nails	1/4 lb.	4d or 6d

Gable roofed birdhouse

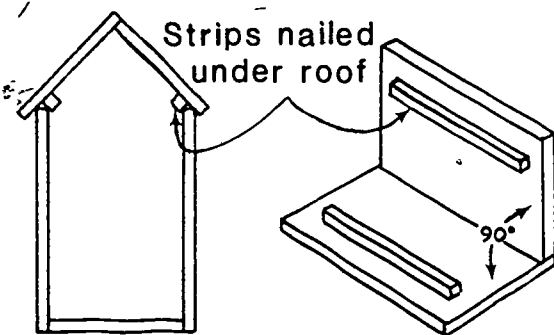
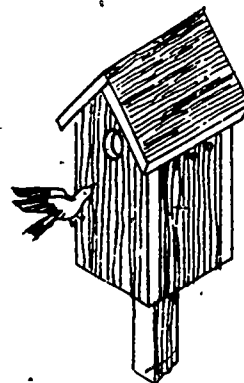
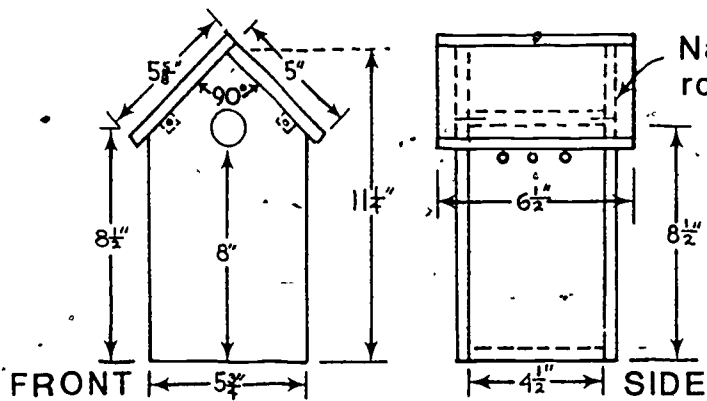

Simple birdhouse

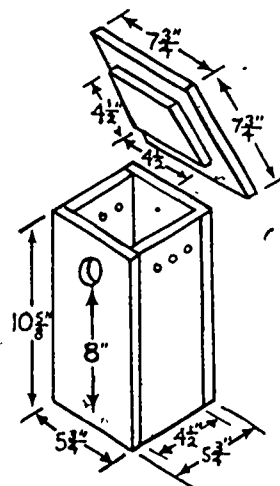
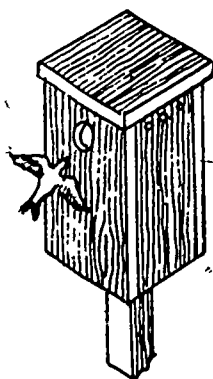

MATERIALS

- 5/8 in. of plywood
- 1- 1" x 6" x 5'
- 2- 3/4" x 3/4" x 4 1/2" strips
- 4d nails (non corroding)

TABLE OF DIMENSIONS

	Diameter of entrance (inches)	Height from ground (feet)
Wren	1	8-18"

MAILBOX PLANTER

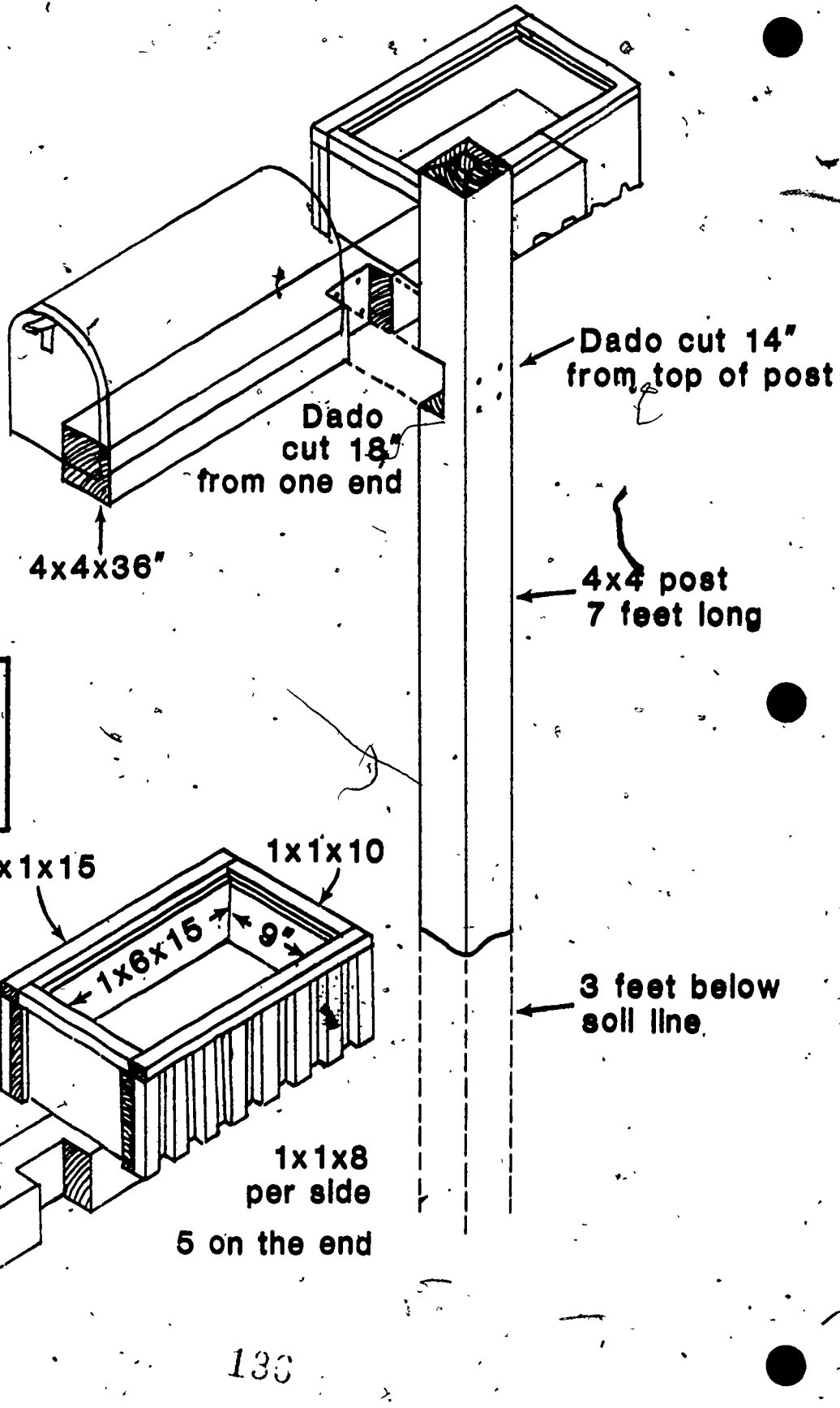

LUMBER LIST

1	10'	4x4
1	6'	1x6 or 2x6
1	18'	1x1

Lumber and Tile Bench

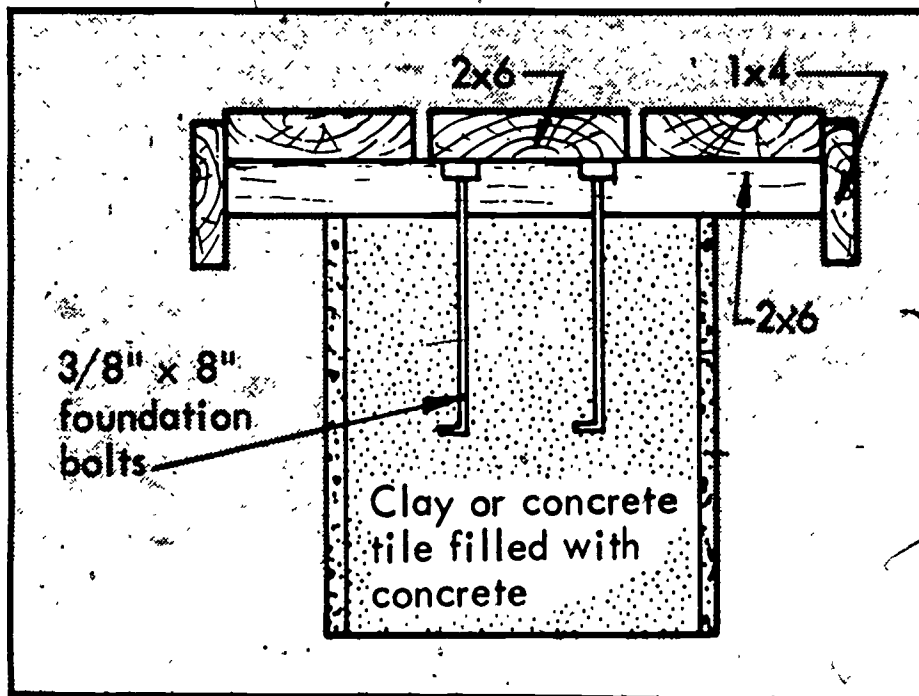
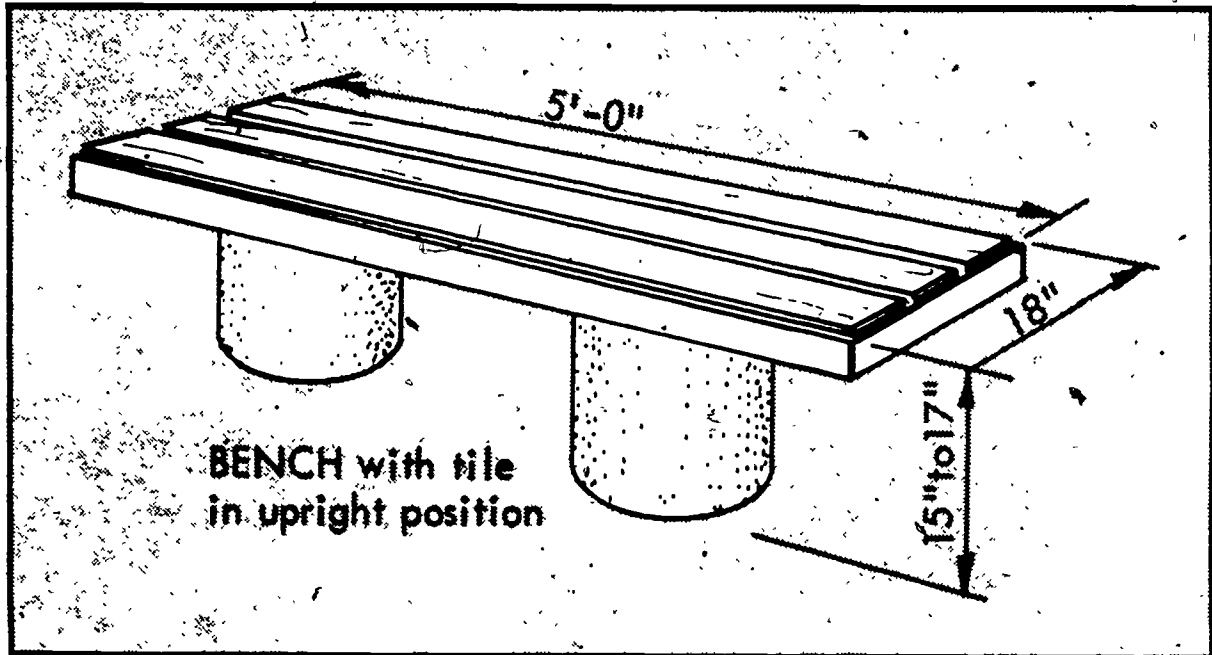

Lawn Chair

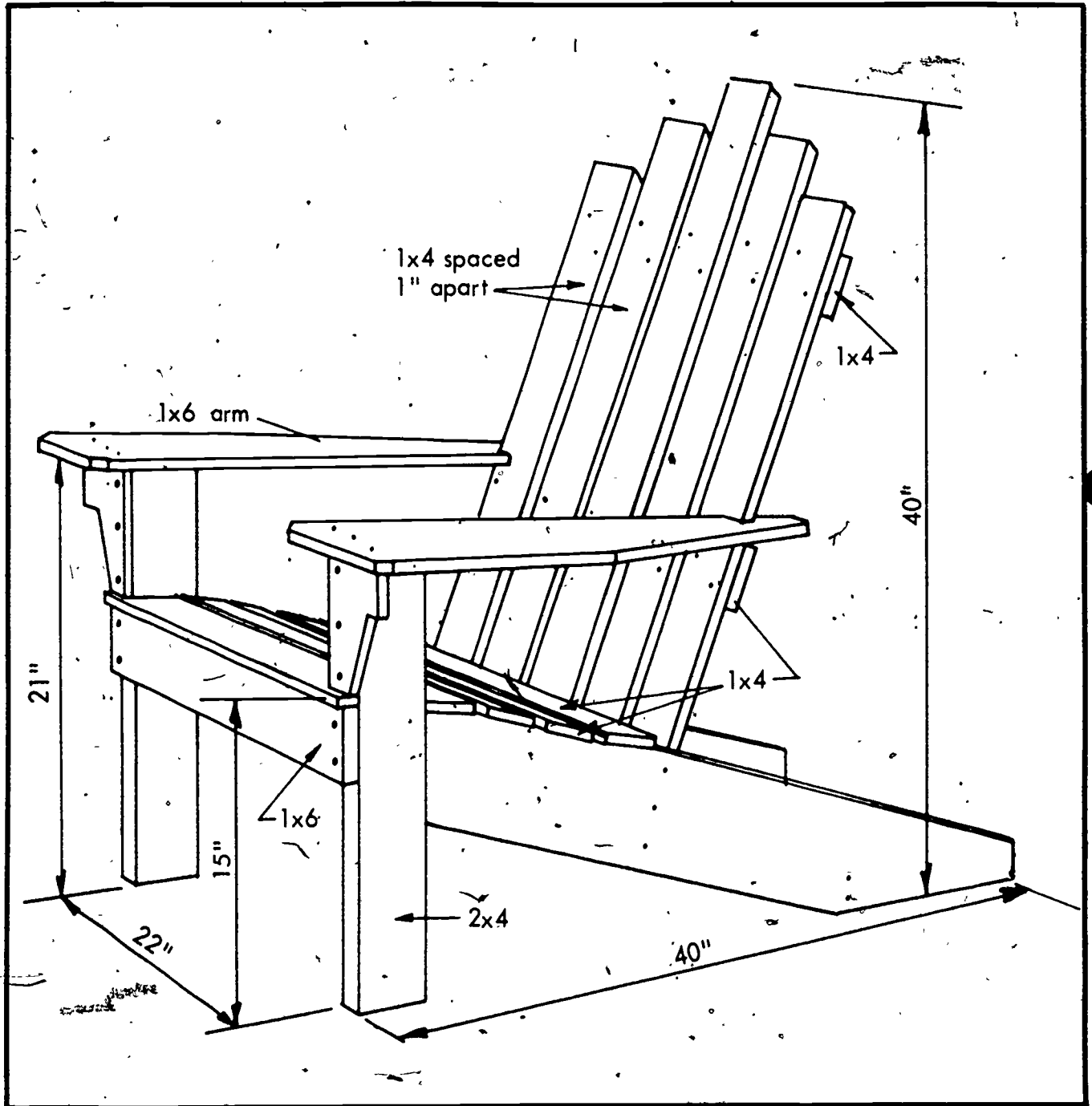

Planter Box with Gravel Tray

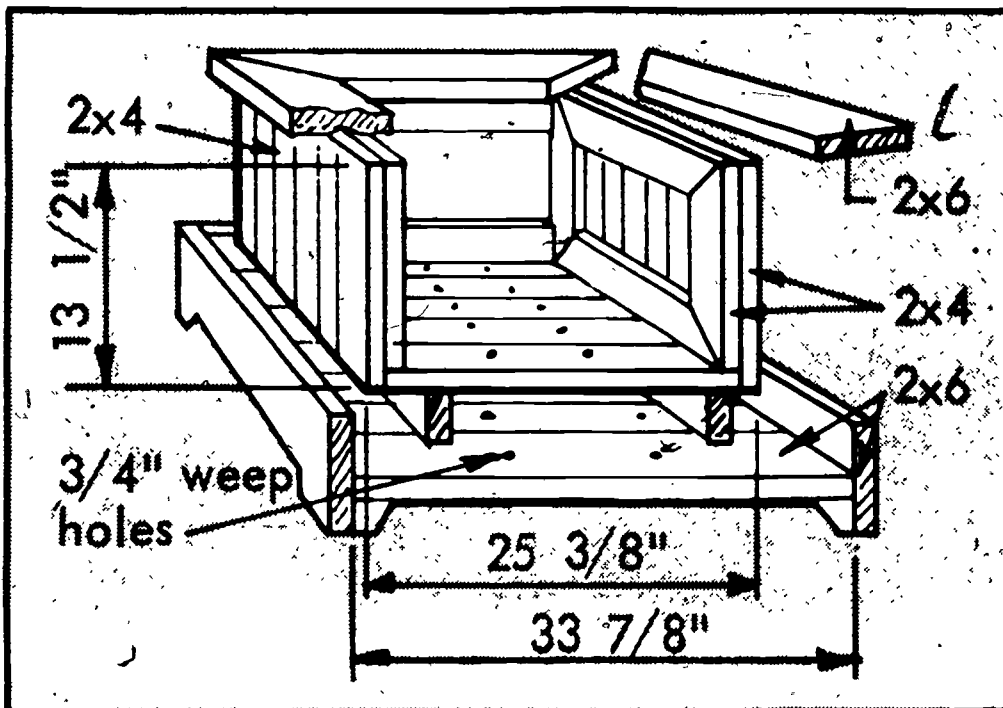
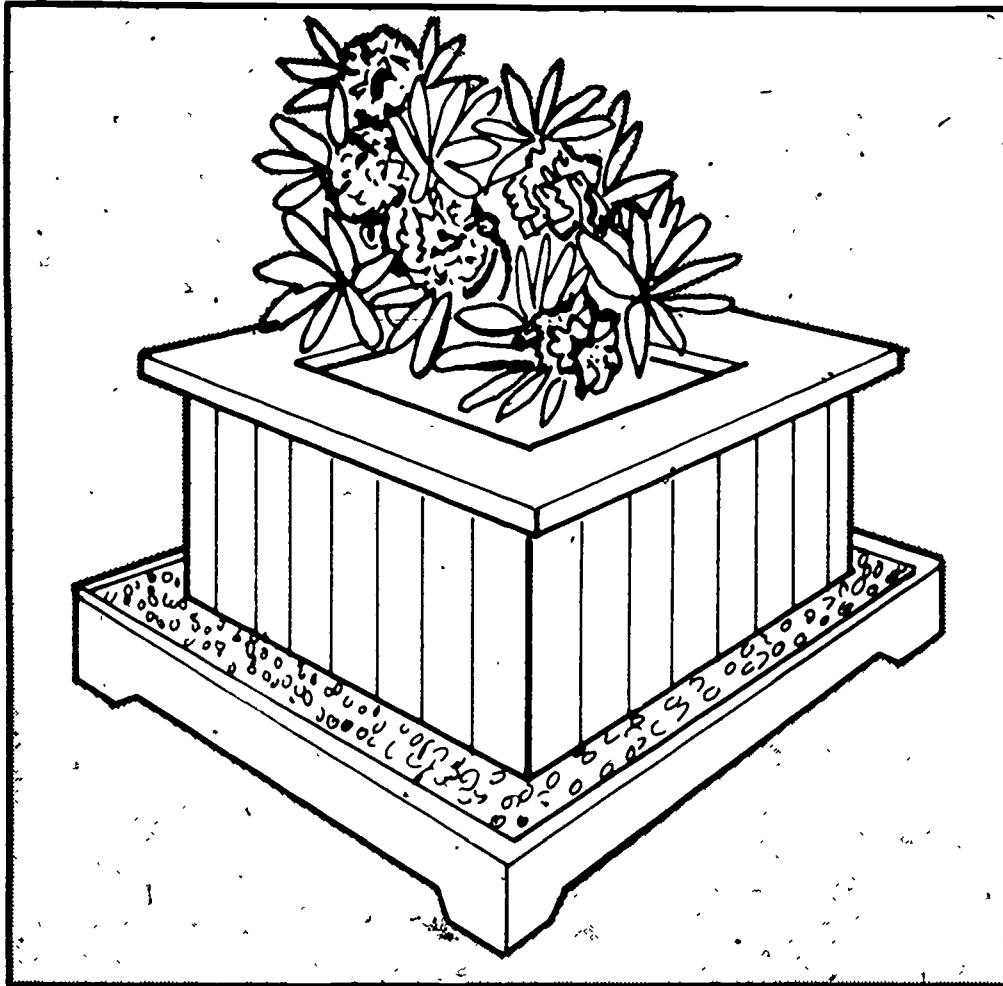

Patio Bench

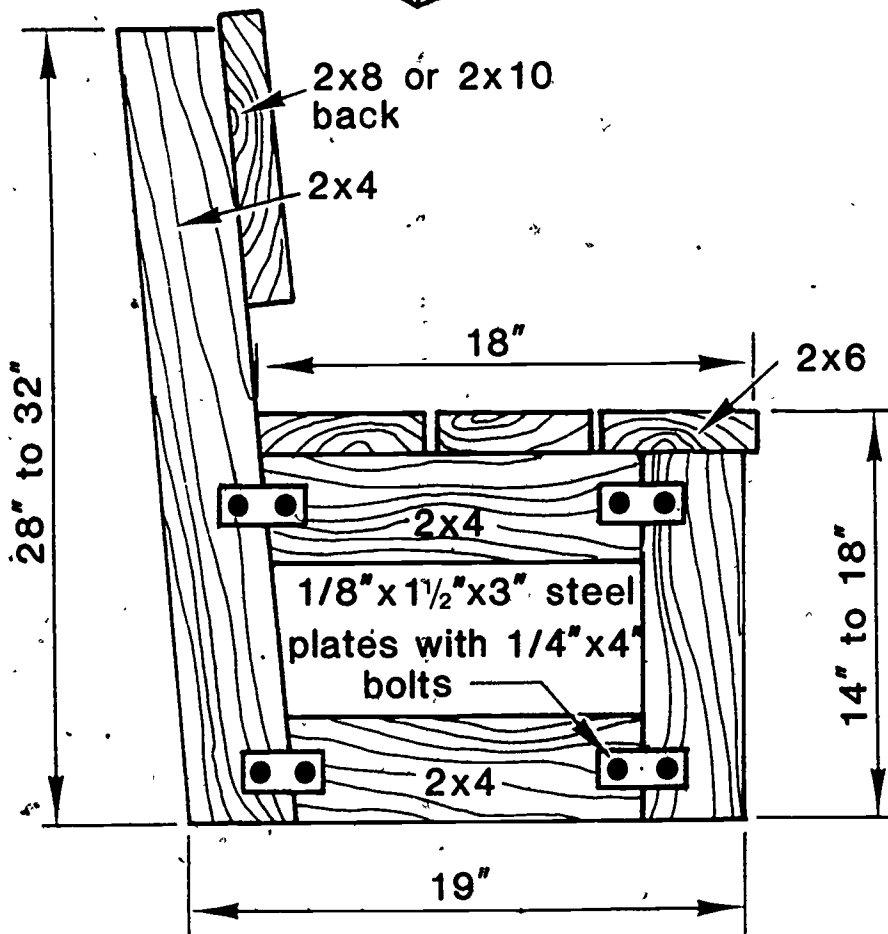
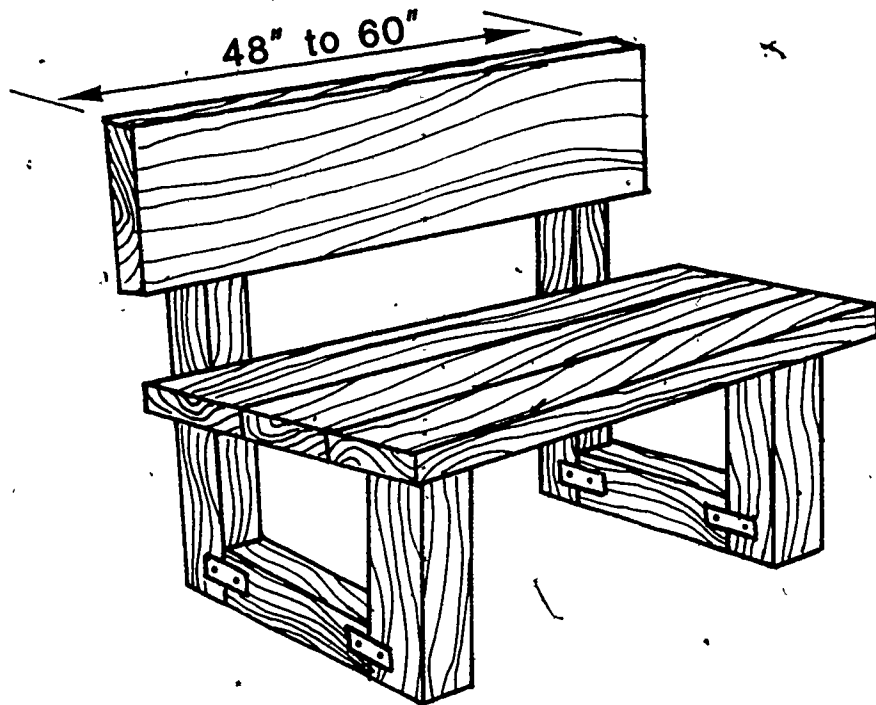

PROJECT PLAN

Name _____ Project _____

Drawings of the project (top, front, and/or side views). Attach photographs, blueprints, etc. if available.

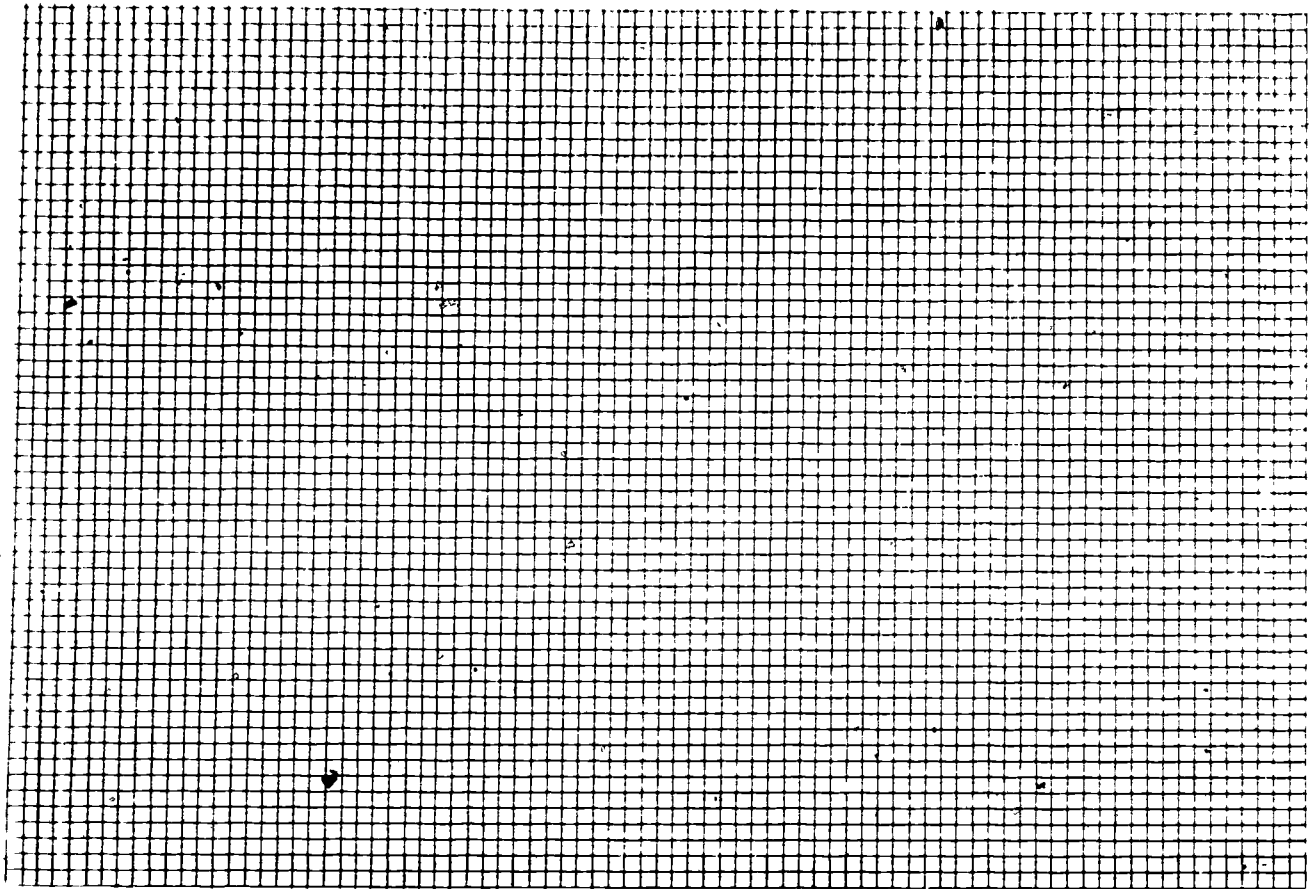

Where did you get the ideas to plan this project _____

CUTTING LIST

<u>Number</u>	<u>Sizes Needed</u>	<u>Purchased dimensions</u>	<u>Use</u>

BILL OF MATERIALS

Lumber

Number Dimensions Grade and Species of Wood Use Cost

Fasteners

Number Size Kind of Fastener Cost

Hardware

Number Size Kind of Hardware Cost

Finish

Number Size of Container Kind of Finish Cost

142



CONSTRUCTION PROCEDURE

(Steps in making the Project)

Lined writing area for notes.



AGRICULTURE MECHANICS DAILY PERFORMANCE REPORT

Name _____ Date _____

- I. Problem Area (project) _____
- A. Job skill performed today: Circle One
1. _____ individual or group
2. _____ individual or group
3. _____ individual or group
- B. Difficulties encountered today:
1. _____ unsolved or solved
2. _____ unsolved or solved
3. _____ unsolved or solved
- C. Plans for tomorrow:
1. _____
2. _____
- D. Today I feel I accomplished the following grade:
- Circle one - A B C D F

..... cutting line.

AGRICULTURE MECHANICS DAILY PERFORMANCE REPORT

Name _____ Date _____

- I. Problem Area (project) _____
- A. Job skill performed today: Circle One
1. _____ individual or group
2. _____ individual or group
3. _____ individual or group
- B. Difficulties encountered today:
1. _____ unsolved or solved
2. _____ unsolved or solved
3. _____ unsolved or solved
- C. Plans for tomorrow:
1. _____
2. _____
- D. Today I feel I accomplished the following grade:
- Circle one - A B C D F

141

STUDENT EVALUATION

(To be filled out when project is completed)

Name _____ Project _____

What do you like about your finished project? _____

How could you have done a better job? _____

What would you change if you were going to make another project like this one _____

What grade do you feel you deserve for this project? _____

INSTRUCTOR EVALUATION

(Based on planning, use of time, and quality of workmanship)

How well was project planned: (drawings, cutting list, bill of materials, and construction procedure) _____

Did the student make good use of shop time? _____

Does the finished project show quality workmanship? (Is it square? Is it level? etc.) _____

How could the project be improved? _____

145

Project Grade _____

M-I-D-4-23

TEACHER'S KEY
SUGGESTED TEST QUESTIONS

DEVELOPING BASIC CARPENTRY SKILLS

Completion Section

1. Two main classes of trees are the needleleaf or softwood and the broadleaf or hardwood.
2. Wood from the inner part of a limb or trunk of a tree is called heartwood and wood from the outer portion is called sapwood.
3. A defect in a board which is actually the cross section of a limb is called a knot.
4. Two general grades of softwoods are select and common.
5. Four types of lumber commonly used in agricultural construction are dimension lumber, common boards, finish lumber and pattern lumber.
6. Finish nails are used wherever you do not want nail heads showing in the completed project.
7. Nails will be less likely to bend if you lubricate the point with soap, wax or oil.
8. To prevent marring project wood when pulling a bent nail, place a wood block under the claws of the hammer.
9. A six penny nail (6d) is two inches long.
10. Box nails are smaller in diameter than common nails.
11. Three commonly shaped screw heads are oval, flat and round.
12. Carriage bolts have a round head.
13. Stove bolts have a flat or round head.
14. A properly glued wood joint is stronger than the wood itself.
15. To hold two boards together while the glue is drying, use clamps if possible.

True-False Section

- T 1. Driving a series of nails in a straight line parallel to the grain may cause splitting.
- T 2. Screws hold wood more securely than nails:
- F 3. Screws are usually cheaper than nails.
- T 4. If you buy a 2" x 4" finished piece at the lumber yard you will find that it measures about $1\frac{5}{8}$ x $3\frac{1}{2}$.
- F 5. When drilling a hole for a wood screw, you should drill a hole equal to the diameter of the screw.
- T 6. Cedar wood is resistant to decay.
- F 7. Oak is very easy to work.
- T 8. A board 1" x 12" x 12' contains 144 board feet.
- F 9. A 6d (six penny) nail is 6" long.
- T 10. Stove bolts are threaded their full length.

Classification Item

1. Classify the following woods as hard or soft by checking the appropriate blank:

Wood	Hard	Soft
Oak	<u> X </u>	<u> </u>
Elm	<u> X </u>	<u> </u>
White Pine	<u> </u>	<u> X </u>
Cedar	<u> </u>	<u> X </u>
Maple	<u> X </u>	<u> </u>
Redwood	<u> </u>	<u> X </u>
Walnut	<u> X </u>	<u> </u>
Ash	<u> X </u>	<u> </u>
Douglas Fir	<u> </u>	<u> X </u>
Cypress	<u> </u>	<u> X </u>
Hickory	<u> X </u>	<u> </u>

Multiple-Choice Section

- b 1. A board one inch thick, six inches wide, and sixteen feet long equals
 - a. four board feet
 - b. eight board feet
 - c. sixteen board feet
- a 2. The symbol for lumber surfaced on one side is
 - a. SIS
 - b. S2S
 - c. S1E
 - d. S2E

147

Multiple-Choice Section (cont.)

- d 3. Machine bolts have
- a. Square holes
 - b. Hexagonal heads
 - c. Round heads
 - d. Square or hexagonal heads
- b 4. Two pieces of wood glued together with a good glue form a bond that is
- a. Weaker than when nailed
 - b. Stronger than when nailed
 - c. The same as a nailed bond
- b 5. The length of an eight penny nail is
- a. 8"
 - b. 2½"
 - c. 2"

UNIT E: Plant Propagation

PROBLEM AREAS:

1. Care, handling and storing herbaceous seeds
2. Seeding containers
3. Propagating by cuttings
4. Propagating by layerage
5. Propagating by division or separation

UNIT E: PLANT PROPAGATION

PROBLEM AREA: CARE, HANDLING AND STORING HERBACEOUS SEEDS

SUGGESTIONS TO THE TEACHER:

This problem area is designed for use with freshmen or beginning students enrolled in a horticultural occupations or an agricultural occupations program. The recommended time for teaching this problem area is during the fall semester for the collecting, cleaning, and storing of seeds and during the spring semester for identification of seed parts, certification, and germination of seeds. The estimated instructional time for this problem area is 10 to 15 days depending on how far the teacher wishes to go in developing sexual propagation skills at the first year level. If the teaching plan is limited to classroom discussion with little or no practice or observation the instructional time can be seven days or less. If the students are to be involved in collecting and cleaning seeds of numerous plants and other activity exercises, the instructional time will need to be increased. The materials in this problem area were selected and written with the following assumptions:

1. All students need to know how plants develop from seed and how to best germinate those seeds even though some of the students will not be commercially involved in seed propagation in the future.
2. The basic principles and procedures included in this problem area will be useful to students who plan to enter an agriculture or horticulture occupation as well as those who do not plan to enter such a vocation.

The instructor is encouraged to conduct a local search to locate other supplementary materials for use with this problem area. The items in this problem area are for reference and modification as the instructors adapt this material to their local situation.

CREDIT SOURCES:

These materials were developed through a funding agreement, R-33-21-D-0542-388 with the Illinois State Board of Education, Department of Adult, Vocational and Technical Education, Research and Development Section, 100 North First Street, Springfield, Illinois 62777. Opinions expressed in these materials do not reflect, nor should they be construed as policy or opinion of the State Board of Education or its staff.

The teacher's guide, student worksheets, and test questions were developed by Jim Ethridge. Transparency masters and the transparency discussion guide were prepared by Vocational Agriculture Service. Suggestions and guidance in the development of these materials were provided by the Metropolitan Core Curriculum Pilot Test Teachers.

TEACHER'S GUIDE

- I. Unit: Plant propagation
- II. Problem area: Care, handling, and starting herbaceous seeds.
- III. Objectives: At the close of this problem area students will be able to--
 1. Identify two major types of propagation.
 2. List two means of sexual plant reproduction.
 3. Demonstrate familiarity with terms that pertain to seeds and seedlings.
 4. Identify reasons why plants are propagated from seeds.
 5. Name factors affecting seed germination.
 6. Demonstrate knowledge of the steps in seed germination.
 7. Identify factors affecting viability.
 8. Identify factors affecting germination.
 9. Develop an ability to propagate plants sexually in the proper germination environment.
 10. Develop the ability to control the external factors so that seeds will germinate successfully.
 11. Develop the ability to make and use newspaper testers and blotter testers and to use commercial seed germinators.
 12. Develop an understanding of the treatments which are effective for inducing germination and emergence.
 13. Develop an understanding of the storage conditions necessary to preserve viability and purity of seeds.
 14. Correctly set up a germination program for five varieties of herbaceous annuals using the information found in VAS Unit 5010 and information covered in class.
 15. Identify four reasons for growing your own seedlings over purchasing seedlings.
- IV. Suggested interest approaches:

1. Display a collection of seeds and have students identify them.
2. Show slide sets showing propagation by seed and selection of varieties by seeds especially slide sets by De Jager and American Rose Society.
3. Bring in a seed catalog and have students discuss in class location of seed sources and how to prepare seed for germination.
4. Demonstrate all propagation techniques including pollination and fertilization of plants.
5. Collect seed for germination testing.
6. Display an apple, peach, tomato and avacado. Cut them in half and show the seeds (number, size shape, etc.).
7. Set up a germination testing examples.
8. Use seed catalogs - showing costs, weight, varieties, etc.

V. Anticipated problems and concerns of students:

1. What factors should be considered when collecting seeds?
2. What is meant by "stratification" of seeds?
3. What is pelleted seed?
4. How do we clean seed?
5. How is seed tested?
6. What are the parts of the seed and their functions?
7. What is the germination process?
8. What is the seed coat and its function?
9. How are seeds produced and where?
10. How can we test seeds for germination?
11. What is a variety?
12. How do varieties originate?
13. What are the requirements for germination?

14. What factors cause delayed germination?
15. What is the difference between germination and emergence?
16. What is the temperature range for the germination of specified seeds?
17. What conditions of storage are best for vegetable seeds? For seeds of fleshy fruits? For oily seeds? For citrus? For conifers?
18. What are the causes of delayed germination of seeds? What can be done to overcome each cause?
19. What treatments are used for diseases borne on the seed coat? Within the seed coat?
20. What are the ways of testing seeds to determine their quality?
21. What are two methods of which plants are propagated?
22. What are the functions of the parts of the seed?
23. How can we provide the conditions necessary for germination?
24. How can we be sure that seed we buy will germinate?
25. What is a seed?
26. What is quality seed?
27. What conditions are necessary for germination?
28. What is meant by segregation?
29. What are reasons for failure of germination?
30. How does a seed germinate?
31. What is germination?
32. What groups of plants are commonly grown from seeds?
33. What treatments do we give seed before planting?
34. Why does one schedule sexual propagation?
35. How does one collect seeds?

36. How does one clean seeds?
37. What is seed dormancy?
38. Why do seeds need dormancy?
39. What is seed stratification?
40. What is seed scarification?
41. What is drilling of seeds?
42. How does one drill seeds?
43. How does one define direct vs. transplant seeding operations?
44. How does one explain seed viability and quality?
45. How does one determine seeding rate?
46. What environment factors affect germination?
47. What uses do seedlings have?

VI. Suggested learning activities and experiences:

1. Compare the sizes and shapes of various seeds.
2. Have each student collect, clean, and store seeds of herbaceous or ornamentals.
 - a. Remove the protective coating and pulp from the seed by squeezing the berry to remove the seed.
 - b. Allow seed pods to dry and break the pods to release the seeds.
 - c. Remove stems and other debris by screening through a wire mesh.
 - d. Store cleaned seed in a dry, cool place until ready to plant.

NOTE: (1) It may be necessary to treat stored seed with a fungicide.

(2) Some seeds will have immature embryos and some hard seed coats that will require special treatment.

3. Have each student collect, clean, and store seeds of herbaceous ornamentals (flowering annuals).

4. Treat seed with a fungicide before storage.
5. See how seeds develop.
6. Clean fleshy seed.
 - a. Soak seeds.
 - b. Loosen and separate seed from the pulp.
 - c. Dry the seed.
 - d. Remove stress and other debris by screening through a wire mesh.
 - e. Store cleaned seed in a dry, cool place until ready to plant.

NOTE: It may be necessary to treat stored seed with a fungicide.

7. Students may be assigned in groups to plant seeds of various sizes. Seeds should be planted at various depths and in various types of soil. Observations of germination and emergence under the various conditions should be observed by each group and recorded in a form for reporting to the class.
8. Students may prepare a report using charts, graphs or other visual materials to describe the effect on germination of storage under different temperature, moisture and aeration conditions. Using the data supplied, students may compute rates of seeding necessary to produce the same plant population when seeds having different germination rates are used.
9. After soaking in water for ten hours, students may look at a cross section of a kernel of corn, a bean and a bulb (onion, hyacinth, etc.). Identify the various parts in three cross sections.
10. While studying dormancy and scarification, the class may be organized in groups to run germination tests on treated and untreated seed to study the effects of scarification. A dormancy test may be run on marigold.
11. Students may be organized into groups to use various germination devices, such as newspaper, blotter, and sand and sawdust. Each group may be assigned to test samples of the same seeds, using a different device. A chart may be developed to show a comparison of the various tests.

12. Label specimens.

- a. Select and secure type of label and marker to be used.
- b. Print name of plant on label. Include color of bloom on annuals, perennials and biennials.
- c. Place labels in flats, packs, pots or trays.
- d. Orderly arrange colors, varieties, and species of plants.

13. Plant seed.

- a. Select seed to be plants.
- b. Prepare soil mixture.
- c. Place soil in flats, packs, pots, or trays.
- d. Prepare soil by smoothing and firming it in the container.
- e. Prepare seed for planting.
- f. Sow seed in rows at the recommended depth and spacing.
- g. Place cheese cloth or other similar material over the top of the seeded container.
- h. Water lightly until medium is moist.
- i. Set recommended germination temperature in germination area.

NOTE: Some seed require stratification or acid treatment.

14. Harvest seed.

- a. Select plants with a crop of mature seed ready to be harvested. (fruits of flowering annuals, pears, apples, honey suckle, roses, yew, ash, honey locust, pines.)
- b. Remove seed from the branches of the plants by cutting or picking seed pods, bunches of berries or individual berries.
- c. Place seed pods, bunches of berries or individual berries in specified containers.

- d. Label and date container with name and location of plant producing the pods or berries.

VII. Application procedures:

1. The main purposes of this problem area are to teach information and develop positive attitudes toward germination of seeds.
2. The application phase should be emphasized in practical experience of sowing seeds and cleaning seeds.

VIII. Evaluation:

1. Prepare and administer an objective pencil-paper test using Sample Test Questions.
2. Collect and evaluate laboratory exercises.
3. Evaluate performance on assigned tasks.

IX. References and aids:

1. Plant Propagation, Principles and Practices, Hartman and Kester, 3rd Edition, Prentice Hall, Inc. Publishers. Read Chapters 3, 5, 6, 7.
2. 50 Laboratory Exercises for Vocational Ornamental Horticulture, Compiled by Paul Hemp, The Interstate Printers and Publishers, Danville, Illinois.
 - A. "Pre-Soaking Seeds" p. 83
 - B. "Effects of Oxygen Deficiency and Excess Oxygen on Germinating Seeds" p. 123
3. University of Illinois, Cooperative Extension Service Circular No. C1077 "Germinating Flower Seeds"
4. Laboratory Exercises on:
 - A. "Types of Seed and Seed Labels"
 - B. "Seed Testing and Germination Percentage"
 - C. "Seed Testing, Germination Percentage, and Seed Scarification"
 - D. "Germinating Seeds and Seedling Development"

- E. "Seed Germination"
- F. "Seed Collection and Extraction"
- G. "Factors Affecting Seed Germination"
5. Transparencies and Transparency Discussion Guide
6. Sample Test Questions

153

LABORATORY EXERCISE

TYPES OF SEED AND SEED LABELS

- I. Materials Needed:
 - A. Seed labels from each seed type

- II. Procedure:

Each student is to identify each seed label and write down the materials found on the label. Discussion is to follow as to why this information is on the label and how it will help the purchaser.

- III. Observations:

- A. Certified Seed Label

- B. Foundation Seed Label

- C. Registered Seed Label

- D. Uncertified Seed Label

LABORATORY EXERCISE

SEED TESTING, GERMINATION PERCENTAGE

I. Materials Needed:

A. Paper Towels

B. Plastic Bag

C. Rye Grass Seed

II. Procedure: Rolled Paper Towel Test

Count out 100 rye grass seeds onto a moistened paper towel. Roll the towel up and place it into a plastic bag. Unroll after germination and compute the germination percentage.

III. Observations:

100

LABORATORY EXERCISE
FACTORS AFFECTING SEED GERMINATION

I. Materials Needed:

- A. Large seeds (sweet corn, pumpkins, beans).
- B. Five large-mouth glass jars.
- C. Peat moss, vermiculite, wood shavings or sawdust.
- D. Paper towels.

II. Procedures:

- A. Line five large-mouth jars with paper towels.
- B. Fill the jars with peat moss, vermiculite, wood shavings, or sawdust.
- C. Place some of the large seeds between the paper and the glass.
- D. Moisten the filling in three jars and add about one inch of water to the jars.
- E. Label one of these jars and place in a warm place.
- F. Label one jar and place in a refrigerator to show the effect of lower temperature.
- G. Label and tightly seal one jar and place it in a warm place to show the effect of lack of air. (Perhaps it would be good to use a jar which had been inverted over a burning candle to exhaust the atmospheric air supply first.)
- H. Fill one jar completely full of water to show the effect of too much water. Label and place in a warm place.
- I. Label and do not add any water to the fifth jar to show the effect of no water. Place in a warm place.
- J. After about ten days, observe what has happened to the seeds in each jar and record your findings.

III. Observations:

LABORATORY EXERCISE

SEED GERMINATION AND SEEDLING DEVELOPMENT

I. Materials Needed:

- A. Bean, peas, squash, onion, corn seed
- B. Sharp Knife
- C. Magnifying lens

II. Procedure:

- A. Four weeks prior to this activity seeds of the recommended plant were planted. Three weeks prior to this activity seeds of the recommended plants were planted. Two weeks prior to this activity seeds of the recommended plants were planted. One week prior to this activity seeds of the recommended plants were placed on moist paper and allowed to germinate.
- B. On the seeds which have been germinating on the moist paper; remove the seed coat and carefully split the seed down the middle to expose the seedling parts. Be sure to label your drawing as you locate each part.
- C. With the magnifying lens, carefully locate the embryo inside the seed. It consists of the cotyledon, root, and growing shoot.
- D. After you have labeled the drawing, have your instructor check it for correctness and then compare the other three stages of development and make your observations.

III. Observations:

162

✓

LABORATORY EXERCISE

SEED GERMINATION

The job of sowing seed and handling seedlings up to the time of transplanting can prove to be a very difficult one. Damping off, a condition caused by a certain fungi, often occur in the early seedling stage and may cause the loss of the entire planting. Fungi, such as Pythium, Rhizoctonia, and Fusarium, frequently attack seedlings by killing the tissue of stems and roots near the ground line. In such cases, the young plants will fall over.

Environmental conditions, such as poor air movement and high temperatures, can lead to the loss of many plants. Therefore, a complete understanding of the methods involved in seed preparation and environmental control before and after seed germination are important. It is not intended that complete understanding will be gained from this demonstration alone, but that an introduction will be provided that will lead to further study of germination.

I. OBJECTIVES:

1. To develop an understanding of the external factors that affect germination.
2. To develop the ability to control the external factors so that seed will germinate successfully.

II. MATERIALS NEEDED:

1. Seeds that have been sown.
2. Sprinkle can or breakers for hose.
3. Source of artificial light and a light meter that measures foot-candles. The most satisfactory sources of artificial light are fluorescent tubes of the cool, white type.
4. Shade cloth.

III. PROCEDURE:

1. Place containers of sown seed in a place where the temperature can be controlled. The temperature requirements for any given seed may be thought of as being maximum, minimum, and optimum. Both temperature and light may affect the percentage of germination. Temperature and light requirements of some of the more common plants are as follows:

Species or Variety	Optimum Temperature	Light Requirement
Petunia	70° F.	1st 24 hours
Saint Paulia	70° F.	1st five days
Impatiens	70-75° F.	Light until germination
Centaurea	60-70° F.	Cover 1st 48 hours

*for others see the information sheet prepared by Vaughn-Jacklim

A good rule of thumb that can be followed is that most seeds will germinate readily at temperatures from 65° to 75° Fahrenheit.

- Each student should have two groups of seeds of the same species and variety. Place one container in an area where the temperature will be constant, as is required for the variety. Place the second container in an environment where the temperature can be altered as follows:

Hold the temperature at the low end of the range for 18 hours and then raise the temperature to the upper level of the range for a period of six hours and continue alternating the temperatures throughout the period of the demonstration. This process can be reversed or changed in other ways if a separate study of this phase is desired.

Alternation of temperatures, rather than keeping the temperature at a constant level, will often speed up germination. Be sure to check the temperatures recommended for each species planted.

- Water the seeds according to the type of planting medium used. If the medium contains loam and sand, the percent of moisture should not be less than 10 percent. With planting medium about to be used, the moisture content should be such that the medium will not ball when compressed in the hand. It should be just slightly drier so that when it is released in the hand, it will crumble slightly.

The correct amount of moisture for the planting medium used can be determined by experimenting with unused portions of medium that is the same as that in which the seeds are planted.

- Make provision for shading the containers of sown seeds. High surface temperatures and the fact that the seeds are planted shallow will make moisture control difficult. The container should be shaded during the bright part of the

day. A mulch may be added to the planting medium to help keep the moisture content at the proper level.

5. Provide an adequate supply of oxygen.

Make sure that the planting medium has good structure. That is, be sure that it will remain firm, but not harden and crust.

Properly ventilate the area. Oxygen is necessary for the respiration that takes place in all viable seeds.

6. Follow the instructions for lighting for the variety of seed used.

Place some containers in natural light and containers with corresponding varieties under artificial light. This light should be from fluorescent tubes. Three hundred to five hundred foot-candles of light are recommended. For a two-tube light bank, the distance above the container should be approximately six inches. A third group may be set aside, if desired, in complete darkness. Place a piece of glass over the container and then cover the glass with several layers of newspaper which acts as a darkener and as insulation.

7. Record the results of your demonstration in a chart similar to the following:

Growth	Name of Seed :		Light Given
	Temperature :		
	Constant Temp.	Alternating	
Days Seeding to Germination			
Growth--week			
Growth--2 weeks			
Growth--3 weeks			

NOTE: Growth may be recorded in inches of height and diameter of main stems. An average of several plants should be used to record the growth.

An alternative method sometimes used by plant scientists, is to use four pluses (++++) for maximum growth and one plus (+) for lowest growth. Of course, two and three pluses would indicate growth in between the minimum and maximum.

IV. APPLICATION:

There are three basic requirements for germination. First, the seed must be viable, or the embryo must be alive. Second, favorable environmental conditions must exist, the main ones being the right combination of oxygen, temperature, light, and water. Once the seeds have germinated and the first leaves have formed and expanded, the watering becomes slightly less critical.

The third requirement, that of overcoming any other conditions of the seed which might prevent germination, should be taken care of through special treatment before the seed is planted. Furthermore, a started fertilizer, applied at the time of germination, will help give a stronger and more even growth.

If production is to be based upon the development of plants from seeds, it is essential that the best environment for maximum germination and growth be provided.

LABORATORY EXERCISE

HERBACEOUS SEED COLLECTION AND EXTRACTION

- I. Materials Needed
 - A. Each student will collect two of the following seeds.
Petunia, Marigold, 4 O'clock, Zinnia, Moss Rose, or Salvia,
Holly Hock, Beans, Peas, Okra, Tomato, Pepper
- II. The student should clean and prepare the seed in the appropriate manner for storage.
- III. Observations:

NOTE: REVIEW THE RULES OF SEED COLLECTION PRIOR TO THE COLLECTION OF THE SEEDS.

TRANSPARENCY DISCUSSION GUIDE

Plant Propagation

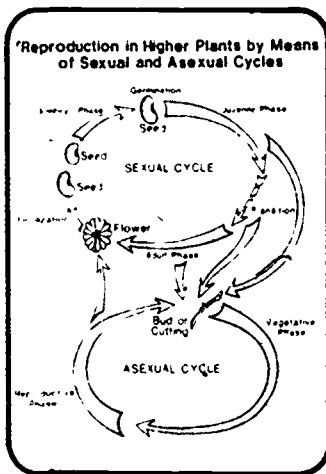

1. The sexual cycle or seed cycle of a plant begins with the flowering of the plant. The vegetative cycle or asexual cycle of a young plant develops into the adult or flowering phase of the plant. The adult plant produces new seeds.

The sexual cycle begins by the taking of a cutting or bud. As the cutting develops roots and grows, the bud develops and fruits. The bud may enter the pre-reproductive phase where it may flower and produce seeds, or remain in the vegetative phase where one may take additional cuttings.

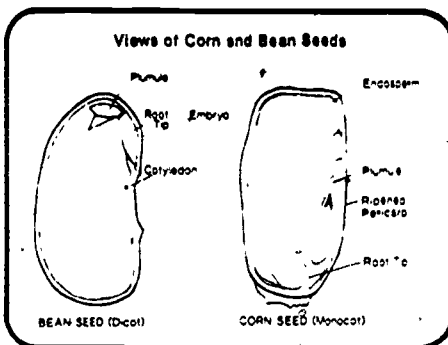

6. Food can be stored in the endosperm or the cotyledons of the embryo. The corn seed is a dry indehiscent fruit. A corn seed coat has a very hard pericarp, which protects the embryo from disease. The cotyledons of the bean seed provide a food source to the young seedling during germination. The plumule becomes the growing tip of the plant.

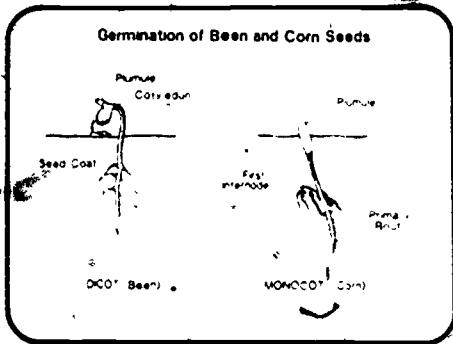

7. Germination of a seed is a process. Water is absorbed by the seed and the seed increases in size. The seed may be living or not. The living seed moves water and food to the growing tips and cell division begins. Growth of the root usually begins first. Many, but not all, dicots have seed leaves (cotyledons) which are pushed above ground by the growing plants. Some monocots have seeds which do not have seed leaves and the seed remains below ground, thus providing nutrients to the young seedling.

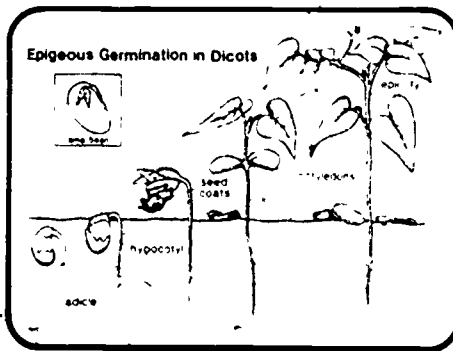

8. Epigeous germination occurs in seeds wherein the endosperm arise above ground. The root develops first for the absorption of water and nutrients. It is important that the soil remain moist after germination and emergence of the seedling from the soil. The seed coat should drop from the cotyledons within the first day or two after emergence. If the soil dries out during emergence, the seed coat can dry, shrink and the cotyledons will not be able to begin photosynthesis. Seedling development can be delayed several days to several weeks.

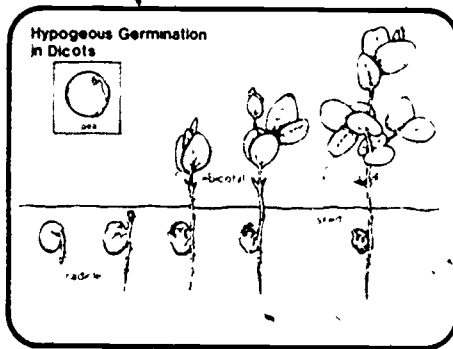

9. Hypogeous germination occurs in those seeds wherein the endosperm remains below ground. These seeds are similar in peas and corn in that the seed (endosperm) remains below ground providing nutrients to the seedling. The root system will develop first.

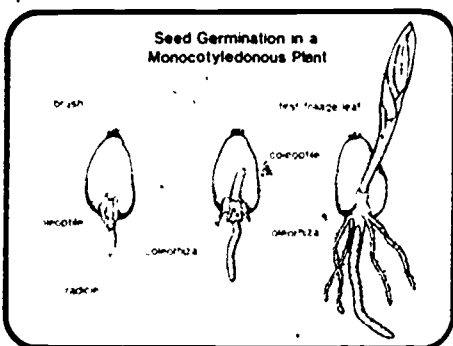

10. In hypogeous seed the emergence of the stem does not move the seed above ground. The coleoptile is the first leaf in the germination of these seeds. The coleorhiza is a sheath which surrounds the root of this seedling through which the young root (radicle) grows.

SAMPLE TEST QUESTIONS AND TEACHER'S KEY

SEXUAL PROPAGATION
SEEDS AND GERMINATION

TRUE-FALSE (+ = True - 0 = False)

- 0 1. Woody ornamental seeds are best collected in the fall.
- + 2. All monocots are epigenous.
- + 3. Viability is the ability of a seed to germinate.
- 0 4. Damping off is not a disease but a cultural problem.
- 0 5. A spotting board or dibble board is not used in planting seeds.
- + 6. Seed scarification involves the breaking of the seed coat.
- 0 7. Most seed can be stored indefinitely under proper conditions.
- X 8. Stratification of seeds involves the cool storage of seeds in a moist media for a given period of time.
- + 9. Flesh on the seed must be cleaned because it might include a chemical that could inhibit germination.
- + 10. Dormancy is defined as given the proper environmental conditions the seed will not germinate.

Indicate the correct sequence of steps in seed germination by placing numerals 1, 2, 3, 4, 5, 6 and 7 in the appropriate blank.

- 3 Seeds swells and splits the seed coat.
- 2 Seed coat softens and gets bigger.
- 4 Primary root emerges through the split and grows downward to form the root.
- 5 Upper part of the epicotyl emerges from the soil.
- 1 Seed absorbs or soaks up water.
- 7 True leaves (plumules) unroll or unfold exposing growth bud and allowing the plant to begin to grow.
- 6 Cotyledon (or cotyledons) open up above the ground.

Which of the following does not affect viability of seeds? (Place a check mark in front of those not affecting viability.)

- | | |
|--|--|
| <input type="checkbox"/> 1. Damaged seeds | <input type="checkbox"/> 6. Disease |
| <input type="checkbox"/> 2. Old seeds | <input type="checkbox"/> 7. Drying out of soil |
| <input type="checkbox"/> 3. Soil too wet | <input type="checkbox"/> 8. Planting too deep |
| <input type="checkbox"/> 4. Temperature too cold | <input type="checkbox"/> 9. Dormancy |
| <input type="checkbox"/> 5. Hard seed | |

Multiple Choice

1. Which of the following chemicals are not used to promote emergence of seeds?
- A.
 - B. (Teacher should supply examples)
 - C.
 - D.
2. Which of the following chemicals are not used to reduce diseases attaching seeds?
- A.
 - B. (Teacher should supply examples.)
 - C.
 - D.
3. Which of the following is not a reason why plants are propagated from seeds?
- A. Some plants will not propagate by any other means
 - B. Cheaper
 - C. Way of obtaining new varieties and strains
 - D. Slower
4. Which of the following is not a part of the seed?
- A. Endosperm
 - B. Seed coat
 - C. Embryo
 - D. Grain
5. Which of the following does not affect germination?
- A. Good quality seed
 - B. Germination medium
 - C. The container
 - D. Air or oxygen

- B 6. That part of the embryo (seed) which forms the primary root is the:
- A. Plumule
 - B. Radicle
 - C. Hypocotyl
 - D. Cotyledon
- A 7. That part of the embryo (seed) which provides nourishment for the corn seedlings is the:
- A. Endosperm
 - B. Plumule
 - C. Hypocotyl
 - D. Radicle
- D 8. That part of the embryo (seed) which forms the stem and leaf structures is:
- A. Radicle
 - B. Endosperm
 - C. Cotyledon
 - D. Plumule
- C 9. That part of the embryo (seed) of monocotyledons which contains the stored food is the:
- A. Cotyledons
 - B. Hypocotyl
 - C. Endosperm
 - D. Plumule
- A 10. That part of the embryo (seed) which forms the base part of the stem is the:
- A. Hypocotyl
 - B. Radicle
 - C. Endosperm
 - D. Plumule
- B 11. Soil texture should be considered along with the soil temperature as a planting guide for early spring planting of crops. Therefore, finely textured clay soils as compared to medium silt loam soils should be:
- A. 10°F warmer
 - B. 3-5° warmer
 - C. 3-5° cooler
 - D. 5-8° cooler

C 12. Checking soil temperature may involve more time and trouble than desired. Air temperature can serve as a substitute. During the early spring season on a silt loam soil, the air temperature is usually:

- A. 5-8° cooler
- B. The same temperature
- C. 2-3°F cooler
- D. 2-3°F warmer

B 13. For germination, the ideal soil condition is:

	<u>Air</u>	<u>Water%</u>	<u>Solid (Soil-%)</u>
A.	50	10	40
B.	25	25	50
C.	50	25	25
D.	25	50	25

A 14. Early spring planted seed as compared to later-planted seed should be planted:

- A. Shallower
- B. Deeper
- C. The same depth

C 15. Seed size, to some extent, should determine planting depth, therefore:

- A. Petunia seed should be planted deeper than marigold.
- B. Marigold seed should be planted deeper than cucumber.
- C. Marigold should be planted deeper than tobacco
- D. Not a problem. All seed should be planted at the same depth.

MATCHING

I. Germination and Seedling Growth

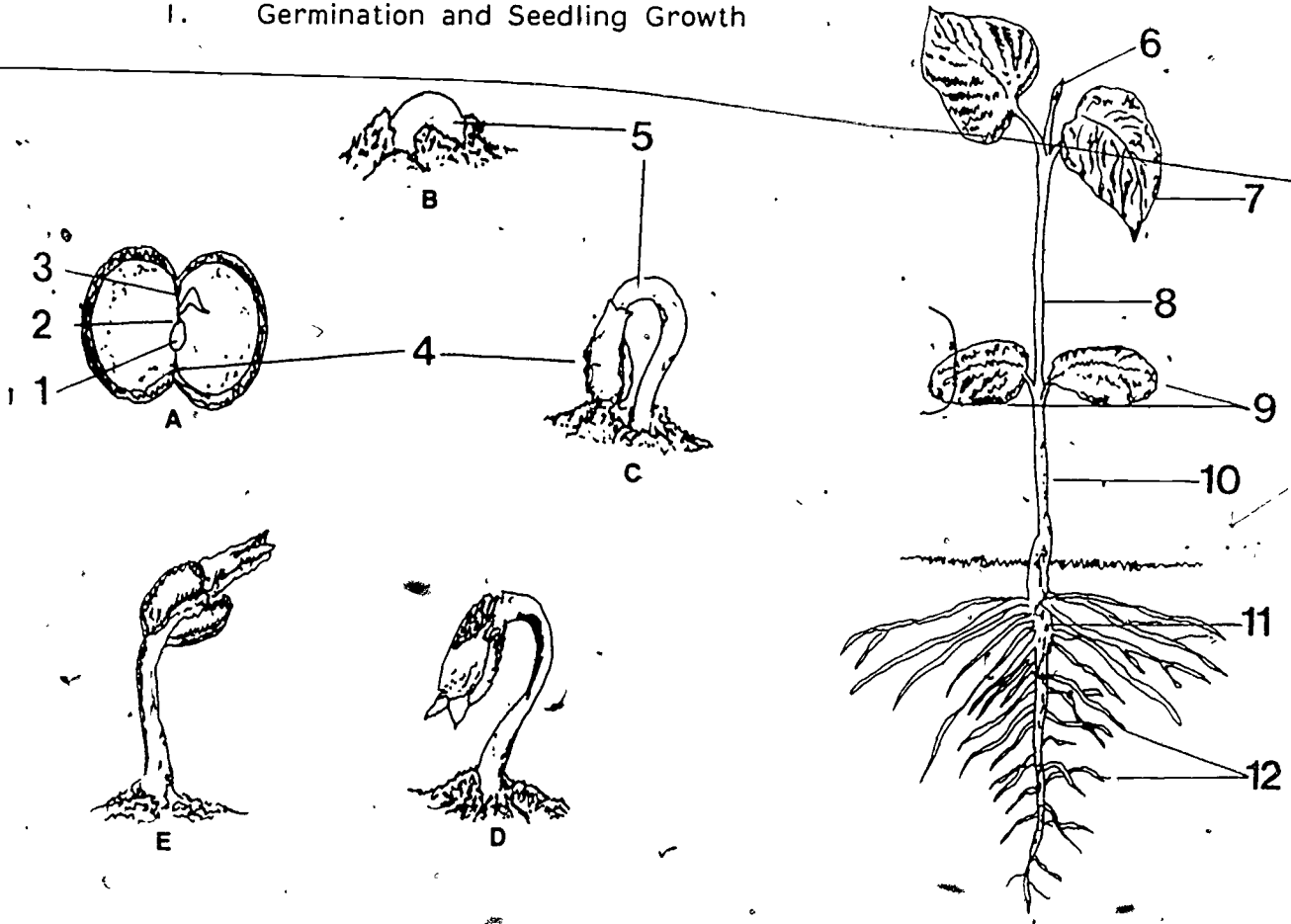

In the blank in Column A, write the appropriate letter from the list of parts in Column B which matches the location of the part in the illustration. Not all parts in Column B are used in Column A.

(NOTE-The same part letter of Column B may be used in more than one blank in Column A)

Column A

- i 1.
- d 2.
- g 3.
- b 4.
- d 5.
- m 6.
- e 7.
- l 8.
- b 9.
- d 10.
- h 11.
- j 12.

Column B

- a. Coleoptile
- b. Cotyledons
- c. Endosperm
- d. Hypocotyl
- e. Leaf
- f. Nodal permanent roots
- g. Plumule
- h. Primary root
- i. Radical
- j. Secondary root
- k. Seminal roots
- l. Stem
- m. Growing point

Germination and Seedling Growth

In the blank in Column A, write the appropriate letter from the list of parts in Column B which matches the location of the parts of the illustrations. Not all parts listed in Column B are used in Column A.

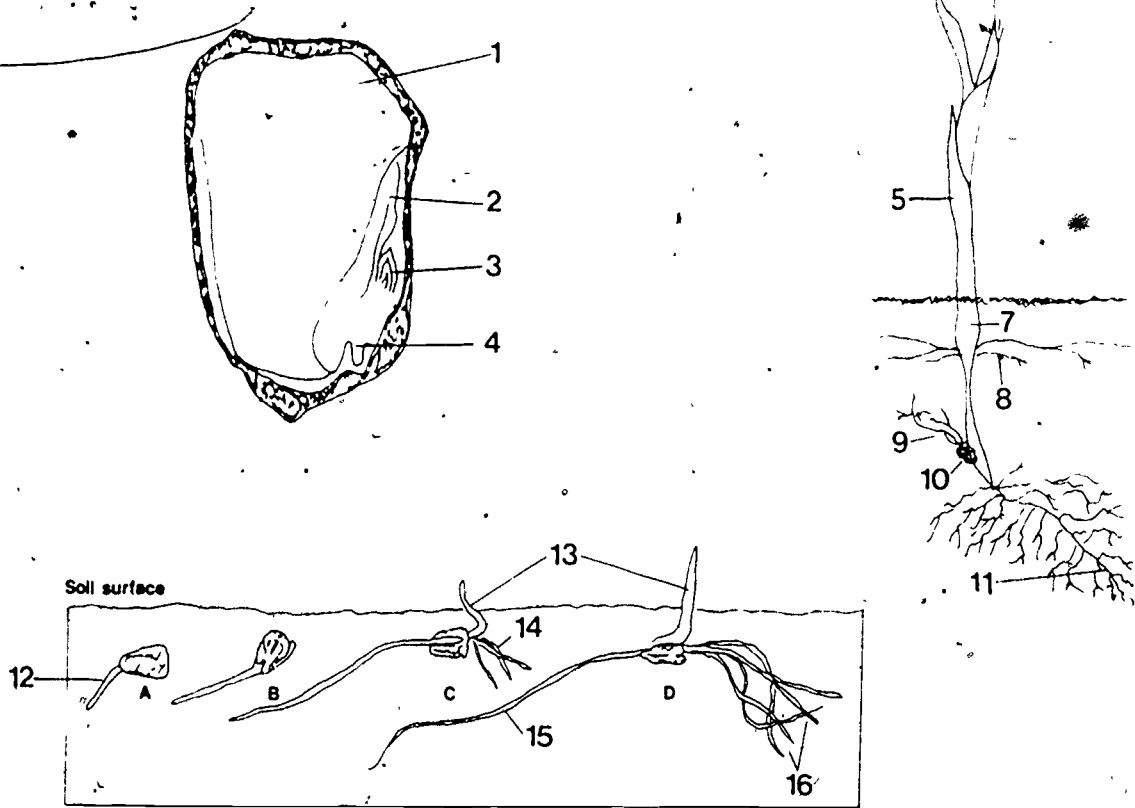

NOTE-The same part letter of Column B may be used in more than one blank in Column A.

Column A

- c 1.
- b 2.
- g 3.
- h 4.
- d 5.
- k 6.
- a 7.
- f 8.
- j 9.
- i 10.
- h 11.
- j 12.
- m 13.
- j 14.
- h 15.
- j 16.

Column B

- a. Growing point
- b. Cotyledon
- c. Endosperm
- d. First leaf
- e. Hypocotyl
- f. Nodal permanent root
- g. Plumule
- h. Radicle
- i. Seed
- j. Seminal roots
- k. Third leaf
- l. Tiller
- m. Coleptile

MATCHING

- | | | | |
|-------------|------------------|----|---|
| <u>E</u> 1. | Viability | A. | Small, dormant plant inside the seed coat |
| <u>F</u> 2. | Variety | B. | A ripened ovule |
| <u>B</u> 3. | Seed | C. | Special food storage area for monocotyledonous seeds |
| <u>A</u> 4. | Embryo | D. | Process in which the embryo resumes growth |
| <u>C</u> 5. | Endosperms | E. | Ability of a seed to be able to germinate |
| <u>D</u> 6. | Seed germination | F. | A group of closely related plants of common origin which have similar characteristics |

ESSAY

1. What is the function of:
 - a. Seed coat
 - b. Embryo
2. Define sexual plant propagation:
3. What is the scarification process? When is it necessary?
4. During what months are herbaceous ornamental plant seeds collected in Illinois?
5. What is the purpose of stratifying seeds?
6. How do monocots and dicots emerge differently from the soil?
7. Define viability.
8. Define optimum temperature for germination.
9. How does light affect seed germination?
10. How does seed coat affect germination?
11. How does one disinfect seeds?
12. What is damping off?

177

UNIT E: PLANT PROPAGATION

PROBLEM AREA: SEEDING IN CONTAINERS

SUGGESTIONS TO THE TEACHER:

This problem area is designed for use with freshman or beginning students enrolled in horticultural or agricultural occupations program. The recommended time for teaching this problem area is during the spring semester prior to the bedding plant season and after a discussion of soil media selection for germinating seeds. This problem area can be taught in the fall semester if the students are growing calceolaria, cineraria, or primula for pot crops or snapdragons as a bench crop. The estimated time for this problem area is 5 to 10 days depending on how far the teacher wishes to go in developing seeding skills at the freshman or beginning student level. If the teacher is limited to classroom discussion with little or no practice the instructional time can be three days or less. If students are to be involved in a bedding plant production enterprise and other activity exercises, the instructional time will need to be increased:

▲ The instructor is encouraged to conduct a local search to locate other supplementary materials for use with this problem area. The items in the problem area are for reference and modification as instructors adapt this material to their local situation.

CREDIT SOURCES:

These materials were developed through a funding agreement, R-33-21-D-0542-388 with the Illinois State Board of Education, Department of Adult, Vocational and Technical Education, Research and Development Section, 100 North First Street, Springfield, Illinois 62777. Opinions expressed in these materials do not reflect, nor should they be construed as policy or opinion of the State Board of Education or its staff.

The teacher's guide, student worksheets and test questions were developed by Jim Ethridge. Transparency masters and the transparency discussion guide were prepared by the Vocational Agriculture Service. Suggestions and guidance in the development of these materials were provided by the Metropolitan Core Curriculum Pilot Test Teachers. The information sheets were prepared by the Vaughn-Jacklin Corporation.

TEACHER'S GUIDE

I. Unit: Plant propagation

II. Problem area: Seeding in containers

III. Objectives: At the close of this problem area students will--

1. Demonstrate skill in the propagation of seedlings in seed flats, and preparing a seed flat.
2. Demonstrate familiarity with terminology pertaining to seeding in flats and the materials involved.
3. Identify advantages of using containers in seeding propagation.
4. State the information necessary on container labels.
5. Understand limitations of sexual propagation.
6. State the steps of care to follow after seeds have germinated.
7. Understand how environmental factors affect sexual propagation.
8. Utilize environmental factors, chemicals, and other tools to overcome germination inhibitors in sexual propagation.

IV. Suggested interest approaches:

1. Show slides of the different containers used in growing seeds.
2. Collect containers used in growing seeds.
3. Prepare a demonstration showing the proper methods of preparing a seed flat and tools used in preparing seed flats.

V. Anticipated problems and concerns of students:

1. What care do seedlings need in the flat?
2. What is viability?
3. What is a seed flat?
4. How does one fill and mark out a seed flat?
5. What kinds of flats are there?

6. How deep do we plant seeds in flats?
7. How do you sow seeds in flats?
8. What are the reasons for starting certain seeds flats and not others?
9. What is broadcast seeding?
10. What media mixes are recommended for seed propagation in containers?
11. What is a seed vibrator?
12. What is seed pelleting?
13. What should be on a seed flat label?
14. Where does the average grower secure good seed?
15. What characteristics does a good growing media possess?
16. What is accelerated-optimal-growth (AOG)?
17. What is the proper temperature to germinate seeds?
18. What happens if you germinate seeds too cool?

VI. Suggested learning activities and experiences:

1. Visit a nursery and observe and record their seed propagating techniques and facilities.
2. Transplant "spot-off" seedlings when they are ready?
3. Identify methods and procedures for sowing seed.
4. Determine spacing for sowing seed.
5. Have students work out a propagation time schedule for a selected group of seeds.
6. Have students sow fine seeds properly in a greenhouse.
7. Have each student plant various types of seeds and keep record of progress (example: germination, emergence, first true leaf, etc.).
8. Plant specific seeds at different and have students record results.

150

9. Make a seed collection and label individual seeds with the common and botanical name.

VII. Application procedures:

1. The main purposes of this problem area are to teach information and develop student's interests in proper seed germination in flats.
2. The application phase should be emphasized in the school greenhouse in the growing of bedding and foliage plants. Spring would seem appropriate for this problem area except for the growing of greenhouse crops of calendula, stocks, snapdragons, and the growing of perennial flowers.

VIII. Evaluation:

1. Prepare and administer a pencil paper test using Sample Test Questions.
2. Collect and evaluate student worksheets and laboratory exercises.
3. Evaluate performance on planting of seed flats.

IX. References and aids:

1. Plant Propagation, Principles and Practices, Hartman and Kester, 3rd Edition Prentice Hall, Inc. Publishers. Read Chapters 5 and 6.
2. 50 Laboratory Exercises for Vocational Ornamental Horticulture, Compiled by Paul Hemp, The Interstate Printers and Publishers, Danville, Illinois.
"Germinating Seeds"p. 50.
3. University of Illinois, Cooperative Extension Service Circular No. C 1077 "An Easy Method for Germinating Seeds".
4. Laboratory Exercises on:
"Testing Seed Viability"
"Starting Seeds in Flats for Transplanting"
"Seed Sowing"
5. Student Worksheet on "Different Types of Seed"
6. Transparencies and Transparency Discussion Guide
7. Sample Test Questions and Teacher's Key

8. Vocational Agriculture Service Unit 5010a
"Growing Flowering Annuals" p. 17 to 19.
9. Seed catalogs.

182

LABORATORY EXERCISE
TESTING SEED VIABILITY

I. Materials needed:

200 corn kernels

Container to soak seeds

Boiling water

.1 percent tetrazolium chloride

Shallow dish

II. Procedure:

1. Soak 100 corn seeds overnight
2. Divide into two equal lots
3. Kill one lot of seeds by boiling for 15 minutes
4. Cut several of the unboiled seeds in half and place in a shallow dish
5. Similarly section several of the boiled seeds and place in a shallow dish
6. Apply tetrazolium to all sectioned seeds and record results

III. Observations:

IV. Discussion questions:

1. Did the embryos of the living or dead seeds change color in the tetrazolium?
2. Why does the seed change color?

3. What is a viable seed?

184

LABORATORY EXERCISE

"STARTING SEEDS IN FLATS FOR TRANSPLANTING"

I. Materials Needed:

- A. Flat
- B. Germination medium
- C. Packet of seeds
- D. One 2" by 4" block that will fit inside of the flat
- E. Fungicide (a chemical that will kill fungus)

II. Procedure:

- A. Fill the flat within $\frac{1}{2}$ " of the top with the germinating medium.
- B. Firm lightly with a 2" x 4" block or brick.
- C. Make rows $\frac{1}{4}$ " deep and $1\frac{1}{2}$ " apart in the germinating medium.
- D. Open the seed packet and put a small amount of fungicide in the packet with the seed. Close the hole and shake so all seeds will be coated with the fungicide.
- E. Sow the seeds in the medium. Cover lightly.
- F. Moisten and place in a warm place. You may cover the flat with glass, burlap or a plastic bag. (Instructor will decide). Check the flat several times and water as needed.
- G. Fill out label.
- H. Apply fungicide.

III. Observations:

LABORATORY EXERCISE

SEED SOWING

I. Objectives:

1. To develop an understanding of the uses of suitable containers, proper medium, and approved methods for seed sowing.
2. To develop the ability to sow seeds in a manner that will allow for successful germination.

II. Materials Needed:

1. Flats (approximately 14 x 10 x 3 inches), regular flowering pots, saucer pots, some milk cartons cut apart lengthwise, a portion of a greenhouse bench and/or a cold frame, if possible.
2. Drainage material for the clay containers or commercial devices designed to permit free drainage.
3. Planting medium mixed as follows:

One-third peat		Two parts sand
One-third sand	or	One part loam
One-third soil		One part peat or leaf mold

Vermiculite or perlite may be used as the sole planting medium or as a 1/4 to 1-inch top layer in the containers.

4. Facilities for pasteurization. If it is necessary to pasteurize the planting medium, it may be done by baking the moistened planting medium in a covered container placed in a pasteurizer at a temperature from 160° to 180° F. for 45 minutes. If there is a source of steam that can be used, this is the best method for pasteurization. If neither of the above methods can be used, Formalin (40 per cent commercial formaldehyde) may be used at the rate of 2 1/1 to 3 tablespoons diluted in 6 parts of water. This is an ample supply for one bushel of planting medium. It should be mixed thoroughly with the planting medium just before the medium is placed in the containers. If Formalin is used, the medium must remain covered for a period of 24 hours and cannot be used for a period of 48 hours. MIX OUTDOORS--THE FUMES ARE POISONOUS TO PLANTS AND PEOPLE.

Equipment can be disinfected with a lysol solution or 10% Clorox solution.

5. Healthy, viable--petunia, snapdragon, marigold or aster seed.

III. Procedure:

1. Have each student prepare one or more of each kind of container to be used. These may include flats, regular flowerpots, saucerpots, milk cartons cut lengthwise, and a portion of greenhouse bench or cold frame. Put the planting medium into the containers and pack it slightly by lightly jarring the container two or three times on the worktable. Level the medium with a flat marking label or ruler-like object.
2. If flats are used, mark the rows across the flat to limit the spread of damping off if it should occur. If the seeds are to be covered with vermiculite or perlite, only shallow marks will be necessary. In the containers other than the flats, the seeds should be broadcast and, therefore, no row marks will be necessary.
3. Some seed is treated when it is purchased, but if the seed has been grown and obtained locally or without going through any of the processing normally done by the dealer, it will be necessary to treat it if good results are expected and if diseases are to be avoided. Not all seed, especially fine seed like petunia, has been treated and the grower should treat this seed prior to sowing. If the seed has not been previously treated, treatment should be done in the following manner:
 - a) There are many commercial seed treatment materials that may be used. These will usually be preferable to treatments prepared by individual growers. Among these are certain zinc and copper fungicides. These should be used according to the directions of the manufacturer.
 - b) A second treatment that may be used is to mix one ounce of bichloride of mercury and 7 1/2 gallons of water. Keep it in a glass container as it is very corrosive. The seeds should be soaked for an hour in water and then for ten minutes in the bichloride of mercury solution.

It should also be noted that there are some seeds, such as the Lupine and Morning Glory, that should be nicked before they are planted. This process simply breaks the hard outer cover on the seed.

4. Have each student study the seed that is to be used and group the seeds into fine, medium, and large size seed groups.
5. If balances are available, students should record the amount of seed sown by each method. They would then be able to determine the number of plants produced in relation to the amount of seed used under each of the methods of seeding. Sow the seed as follows:
 - a) Fine seed. Plant the seed in each of the containers used. When planting in the pots, the best method to use is to broadcast the seed or scatter it randomly over the surface of the soaked medium. Very fine seeds do not need to be covered. Larger fine seeds may be covered with a layer of vermiculite approximately 1/8-inch deep.

When using the flats or milk cartons, it is not necessary to mark rows because of the difficulty in handling the seed. But, in order to make comparisons of the total number of plants produced, sow some of the seed in a marked row approximately 1/8-inch deep. Make another row by merely placing the seed in a line on top of the medium. Cover the marked row lightly.

- b) Medium sized seed. Plant some medium sized seed in each of the containers used. When planting the seed in pots, use the broadcast system. Two methods should be demonstrated here in order to compare the number of plants produced. Randomly broadcast one group of seed and directly sow another group in rows of 1-inch to 1 1/2-inches apart. The latter group should be spaced far enough apart so the plants will not have to be thinned until they are ready to be shifted, potted individually, or transplanted.

In the flats and milk cartons, make the rows 1/8-inch deep and 2 inches apart in the previously moistened medium. Plant one group in the row at close intervals and directly plant a second group as described above. Identify the rows and the seed used and sprinkle lightly a layer of soil or vermiculite.

- c) Large seed. Broadcast the seed in a pot and plant a second pot using the system and the spacing previously described for medium seed. The seeds of this size will require the 1 1/2-inch spacing in the row when planted directly. Cover the seed with a layer of vermiculite at 1/4-inch deep and water slightly with a sprinkling can.

Plant the seeds of this size in flats and milk cartons just as the medium sized seeds were planted. The only difference is that the rows must be marked to a depth of 1/4-inch or more depending on the size of the seed. Again, plant one row randomly and

a second row directly. The seed should be covered to a depth that is equal to twice their width. Sprinkle and label.

If there is a shortage of containers or other materials, it might be desirable to have students form groups because it is likely that seeds of all the different sizes will produce different sized plants and, therefore, undesirable growing conditions may exist for smaller plants. Also, observation will be more difficult if the plants from the various planting methods are mixed. It is recommended that the instructor plan this phase of the demonstration according to the equipment and the facilities available.

6. Maintain a temperature of 65° to 70°F and keep the containers out of the direct sunlight as excess heat will cause drying and eventual damage to the seed. The containers may be placed in greenhouse benches or cold frames.
7. The medium should be moist when the seeds are planted and, in the case of fine seeds, no more watering should be necessary until the seeds have germinated. Water all seeds only when necessary.
8. To control damping off after the germination is complete, lower the temperature approximately 10°F, reduce the moisture slightly and if there are any signs of the damping off, make sure that there is plenty of air circulation after the seeds have germinated. The containers and the seedlings may be dusted with commercial powders that have been developed especially for this condition.

An electric fan, placed so that the main air blast is between 2 and 3 feet above the seedlings, will help in controlling damping off. A glass covered with newspapers placed over the containers in which the seeds are planted will help to reduce temperatures until the seeds have germinated. After germination, the covers should be removed.

9. Such observations as the following may be recorded for the fine, medium, and large seeds:
 - a) Number of plants produced per ounce of seed and per square foot of space used.
 - (1) When broadcast. (2) When sowed in rows.
 - b) Quality of plants.
 - (1) From broadcast seeding. (2) From sowing in rows.
 - c) Amount of handling required such as transplanting. Record +++ for high and + for low.

(1) For broadcast plants. (2) For plants in rows.

- d) Compare the amount of loss caused by disease between those plants originated from broadcast seed, those from seed which was planted closely in rows, and those from seed which was planted directly.

IV. Application:

The beginning of a successful plant production operation is in being able to successfully start the plants. If seeds are to germinate properly, they must be sown in a manner that will allow for the best environmental controls to be applied. What often is believed to be a bothersome task can be accomplished quite easily if the operation is well planned and the correct procedures are used.

100

STUDENT WORKSHEET

SEED TYPES

I. Each student is to visit a local store and copy three labels of three types of seed.

A. Certified Seed

B. Foundation Seed

C. Registered Seed

D. Uncertified Seed

194

M-I-E-2-15

TRANSPARENCY DISCUSSION GUIDE

PLANT PROPAGATION

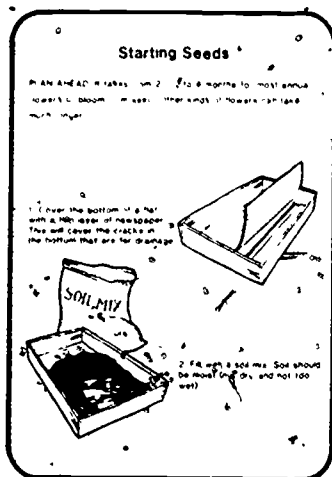

2. It takes from two and one half to four months for most annual flowers to bloom from the seed. If you are using a wood flat, cover the bottom of the flat with a layer of newspaper. This prevents fine soil media from dropping out of the seed flat.

Fill the flat with a moist soil mix appropriate for the type of seed one is planting; different species of seed will require different soil media. The soil media should be about one half inch from the top of the flat when full.

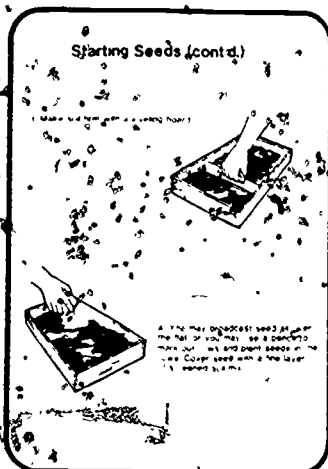

3. The soil should be made firm with a one half inch lumber leveling board, making sure the soil level is at the proper depth from the top of the flat. Each flat size will determine the length of the board used for leveling.

Seed may be either broadcast over the surface or planted in rows. Row planting is usually preferred over broadcast seeding; it reduces the spread of disease in the flat. An average seed flat with average size seeds will contain approximately 500 seedlings at transplanting time. Identify the seed package and determine the germination percentage. Calculate how many seeds to plant for the desired number of seedlings.

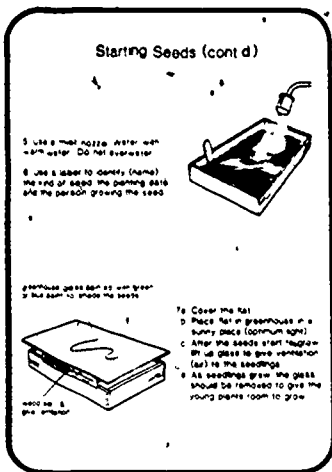

4. When watering newly planted seeds, use a mist nozzle. Make sure the soil is evenly moist and not soggy. The temperature of the water can be a few degrees warmer than the air temperature. Using cold water can shock the seedlings, inhibiting growth and development for several days.

Use a plant label to identify the seed, planting date, and person planting the seed. Identifying the propagator is not common in a commercial business, yet it allows students to identify accomplishments and compare results with other students.

If the location selected in the greenhouse is too cool or drafty for the species planted, cover the flat with a sheet of glass or thin film of plastic. Allow for ventilation by placing a wood slat between the flat and the chosen covering. The wood slats provide ventilation but not excessive draft, and the covering increases air temperature and decreases evaporation. This can be considered a mini-greenhouse. This method is recommended at any time that optimum growing conditions are not available in an existing structure.

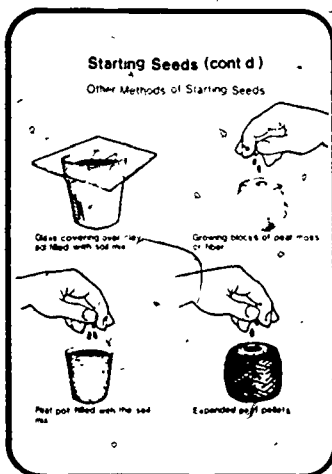

5. Other methods of planting seed include (a) planting seeds in a pot, (b) planting seeds in peat moss blocks or fiber blocks, (c) planting in peat pots and, (d) planting in peat pellets. These seedling containers allow for constant growth without transplanting. Choosing one of these containers as an alternative to planting in flats is determined by quality or quantity desired, cost of the container, and salability. Commercial producers as well as home owners use these alternatives for special crops, preference, and special markets. Usually the container is over seeded and then thinned down to one seedling per container.

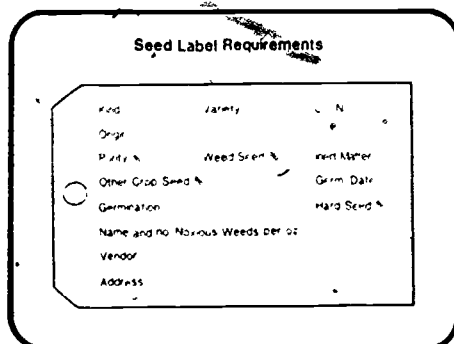

11. A seed label should provide the information presented. Beware of the percentage listing. The percentage may be percent by weight, volume, or number of seed. Other crop seed may be identified individually as well as by percentage.

SAMPLE TEST QUESTIONS AND TEACHER'S KEY

TRUE-FALSE

- 0 1. It is not necessary to sterilize the benches, tools, or soil when germinating seeds.
- + 2. When seeding annuals outside in early spring, it must be remembered that seeds germinate best when soil temperatures are above 60°F.
- 0 3. Vermiculite holds large quantities of water and retains perfect aeration, but it should be remembered that it is not sterile.
- 0 4. It is recommended that watering be done in the daytime when water loss from evaporation will be minimized.
- + 5. When setting started plants, planting too deeply often causes poor root growth.
- 0 6. A good mulch conserves moisture and aids in water penetration but it doesn't hold down the weeds.
- + 7. Keep seeds dry and cool until you plant.
- 0 8. The depth you plant a seed does not depend upon the size of the seed.
- 0 9. When fertilizing the soil it must be dry.
- + 10. When germination is complete the flats should be moved to a cooler location to prevent soft spindly growth.

MULTIPLE CHOICE (Make appropriate choice of A, B, C, or D)

- D 1. A good rule of thumb when spacing plants is to leave a space between them that will be:
- A. Equal to the approximate anticipated height
 - B. Six to eight inches
 - C. Equal to approximately three-fourths their anticipated height
 - D. Equal to approximately one-half of their anticipated height

- D 2. The proper time to transplant seedlings is when:
- A. Seed leaves emerge
 - B. They are full-grown
 - C. The plant is 12 in.
 - D. The first true leaves appear between the seed leaves

- C 3. When sowing seeds, the depth to plant them is equal to:
- A. Diameter of seed
 - B. 6 inches
 - C. 3x the diameter
 - D. 1 inch

- A 4. The germination of seeds in outdoor beds can be improved by:
- A. Covering the seedbed with material such as newspaper or cheesecloth
 - B. Continuous watering
 - C. Applying ample amount of N, P, and K
 - D. Watering carefully

- C 5. For success with flowering annuals the soil must be:
- A. Pulverized as fine as possible
 - B. Have little humus content
 - C. Loose, well aerated
 - D. pH of 5.0

MATCHING (Select the matching answer A through L that most satisfactorily fits the description or word in the left column.)

- | | | | |
|----------|--------------------------|----|--|
| <u>D</u> | 1. Shade-loving plant | A. | Many of these are red |
| <u>E</u> | 2. Mulch | B. | Seed treatment |
| <u>H</u> | 3. Pinching | C. | Growth retardant chemical |
| <u>F</u> | 4. AAS | D. | Impatiens |
| <u>K</u> | 5. F ₁ Hybrid | E. | Peat moss |
| <u>C</u> | 6. B-Nine | F. | Only accepted rating system in North America for new seed-grown flower varieties |
| <u>C</u> | 7. Zinnia | G. | Marigold |
| <u>J</u> | 8. Hardening-off | H. | The removal of a plant's growing tip |
| <u>A</u> | 9. Salvia | I. | Susceptible to mildew and Alternaria Leaf Blight |
| <u>B</u> | 10. Thiram | J. | Plant gradually subjected to cooler temperatures and a more vigorous environmental condition |
| | | K. | Produced by crossing inbred parents |
| | | L. | American Agriculture Society |

Rearrange the following directions for germinating seeds into the correct sequence.

- | | | |
|-----------|----|--|
| <u>2</u> | A. | Pasteurize the soil and container. |
| <u>5</u> | B. | Treat the seed with a protective fungicide. |
| <u>6</u> | C. | Sow the seed thinly along depressions. |
| <u>10</u> | D. | Move the flat to a cooler location. |
| <u>1</u> | E. | Fill the container. |
| <u>8</u> | F. | Place the flat in a draft free location. |
| <u>3</u> | G. | Level and gently firm the soil, then moisten it. |
| <u>9</u> | H. | Water as necessary. |
| <u>7</u> | I. | Cover the seeds except for very small seed. |
| <u>4</u> | J. | Pour vermiculite onto the media. |

COMPLETION (Write appropriate information or words to complete statements.)

1. The purpose of thinning is so plants will have enough light, water, nutrients, and space for them to develop fully.
2. Old seed saved from previous years may have lost much of its vitality under household conditions.
3. To test soil to see if it is capable of absorbing water from rainfall, dig a hole about 10 inches deep and fill the hole with water.
4. The next day, fill the hole again with water and see how long the water remains in the hole. If the water drains away in 8 to 10 hours, the permeability of the soil is sufficient for good growth of annuals.
5. F_1 hybrids are superior to F_2 because they are usually more vigorous.
6. After annual plants have been started, weeding and cultivating at 10 to 14 day intervals is sufficient.
7. One method often used to improve drainage is to "bed-up" the soil.
8. Frequent light waterings of annual plants will result in shallow root formation.
9. Soil fumigation, done well before planting or seeding, is a way to destroy weed seeds, the roots of perennial weeds, certain disease organisms, insects, and nematodes.

ESSAY QUESTIONS:

1. Assess the relative results, successes, or problems you may have with each of the three following methods of starting and growing annual flowers:
 - A. Start your own plants indoors and then replant them where you want them

(See pages 7-14 of VAS subject matter unit 5010a)

B. Seed fresh seed where the plants are to grow,
(See pages 10-14 of VAS subject matter unit 5010a)

C. Buy started plants and replant them where you want them
(See pages 10-14 of VAS subject matter unit 5010a)

2. Discuss the merits of home gardeners saving seed from their annuals to produce and grow next year's plants.

(See page 7 of VAS subject matter unit 5010a)

3. Why is newspaper, sphagnum moss or some other material placed in the bottom of a wooden flat when germinating seeds?

4. Identify three materials that flats are made of.

5. List four advantages of using flats in seed propagation:

6. List five factors involved in seeding in flats.

7. The label on the flat after it has been seeded should contain:

8. The procedure to follow after the seeds have germinated in the flats should be:

9. Identify the steps to care for seedlings after germination.

10. What is damping off?

11. What are the advantages of planting in rows vs broadcasting seeds in flats?

12. What is the difference between vitality and viability?

13. What seeds should not be grown in flats?

14. Why are seeds pelleted?

15. Where are commercial seeds grown in the United States?

16. What is AOG?

17. What are the characteristics of seed grown too warm?

18. Why are seedlings grown and spaced farther apart during summer months than winter months?

UNIT E: PLANT PROPAGATION

PROBLEM AREA: PROPAGATING BY CUTTINGS

SUGGESTIONS TO THE TEACHER:

This problem area is designed for use with freshman or beginning students enrolled in horticultural occupations or agricultural occupations program. The recommended time for teaching this problem area is prior to the production of a crop such as poinsettias, mums, or hanging baskets in which cuttings are used to begin the crop. Coleus and fuschia are also acceptable. The estimated instructional time for this problem area is 7 to 10 days depending on how far the teacher wishes to go in developing the skills of herbaceous cuttings at the freshman or beginning level. If the teaching plan is limited to classroom discussion with little or no practice, the instructional time can be three days or less. If the students are to be involved in producing cuttings commercially (geraniums) and other activity exercises, the instructional time will need to be increased.

The instructor is encouraged to conduct a local search to locate other supplementary materials for use with this problem area. The items in the problem area are for reference and modification as the instructors adapt this material to their local situation.

CREDIT SOURCES:

These materials were developed through a funding agreement, R-33-21-D-0542-388 with the Illinois State Board of Education, Department of Adult, Vocational and Technical Education, Research and Development Section, 100 North First Street, Springfield, Illinois 62777. Opinions expressed in these materials do not reflect, nor should they be construed as policy or opinion of the State Board of Education or its staff.

The teacher's guide, some student worksheets, and test questions were developed by Jim Ethridge. Transparency masters and the transparency discussion guide were prepared by the Vocational Agriculture Service. Suggestions and guidance in the development of these materials were provided by the Metropolitan Core Curriculum Pilot Test Teachers. The student worksheets on "Herbaceous Stem Cuttings," "Removing Cuttings from a Propagation Bench," "Maintaining a Propagation Log" and "Using Root-Promoting Compounds" were adapted from materials developed from Horticulture Task Sheets prepared by the Department of Agricultural Education, the Pennsylvania State University.

TEACHER'S GUIDE

- I. Unit: Plant propagation
- II. Problem Area: Propagating by cuttings
- III. Objectives: At the close of this problem area students will:
 1. Evaluate growing media for cuttings.
 2. Formulate different concentrations of rooting hormones.
 3. Properly select and remove cuttings from stock plants.
 4. Properly maintain stock plants.
 5. Perform steps in taking herbaceous.
 6. Properly store cuttings.
 7. Develop an understanding of cutting propagation and the terminology involved.
- IV. Suggested interest approaches:
 1. Show slides on the different methods of taking cuttings and the proper procedure of each method.
 2. Prepare a demonstration using coleus cuttings using Hormodin 1, 2, and 3, dip a group of coleus in each, place in the propagation bench, and observe which ones root and which die from too high concentration of auxin. Discuss the results.
 3. Take mum cuttings and observe where the cuttings originate. Those on the top of the plant should root faster, those taken from the sides should root slower. Discuss why this happens and the need for trained people to take commercial cuttings.
 4. Demonstrate the taking of root cuttings using herbaceous plants which propagate readily.
- V. Anticipated problems and concerns of students:
 1. How are cuttings classified?
 2. Why produce plants from cuttings?
 3. What environmental conditions are necessary for cuttings to root?

4. What is a callus?
5. What is the relationship between callus and rooting?
6. What is the mother block?
7. What characteristics should a mother block have?
8. How are herbaceous cuttings taken?
9. What are the characteristics of a good cutting?
10. When is the best time of day to take cuttings?

11. What is a rooting hormone?
12. How does one apply a rooting hormone?
13. What is "sticking"?
14. What is asexual plant propagation?
15. What advantages does asexual plant propagation have over sexual plant propagation?
16. What plant parts can be used for asexual propagation?
17. What equipment is used and needed in propagating cuttings?
18. How does one secure foundation stock for taking cuttings?
29. How does one evaluate the quality of cuttings?
20. What is the relationship between variety and quality?
21. What are the economics of using quality stock?
22. How does one determine if a cutting is softwood or hardwood?
23. What are the procedures for making the various cuttings?
24. How do I handle cuttings?
25. Why have uniform cuttings?
26. What portion of the plant makes the "best" cuttings?
27. What rooting hormone should I use?
28. What are the methods of using rooting hormones?

203

29. How does one "clean" a cutting?
30. What environmental conditions affect rooting of cuttings?

VI. Suggested learning activities and experiences:

1. Have students read VAS Unit 5006 for basic information on asexual plant propagation. Follow this reading with a discussion.
2. Show students different types of rooting hormones and identify plants which each could be used for.
3. Demonstrate to the students the correct procedure of making a cutting.
4. Have each student prepare plant cuttings using the steps and procedures you have provided them.
5. Allow the students to take home some rooted cuttings.
6. Ask students to give demonstrations (at grade schools or other sciences classes) on taking cuttings to other civic groups.
7. Demonstrate the use of a double pot home propagator. The instructor may demonstrate cutting preparation from available plant material.
8. Make enough cuttings of various kinds to fill the space allotted. Select one species and treat half your cuttings with auxin and leave half untreated. Compare the results.
9. Plant the cuttings, label them in the bench, and make a diagram of the location and kinds of cuttings.
10. Make diagrams showing leaves, nodes, buds, and position of cuts on the various cuttings. Note any special procedures you used.
11. Record the progress of your cuttings weekly; as they root, pot them up. You may take your rooted cuttings home.
12. Visit a local propagation nursery.
13. Prepare propagation media and root designated types of cuttings.
14. Have students request a supply catalog from a reputable firm and find out what is available in cuttings (study in small groups.)

VII. Application procedures:

1. The main purposes of this problem area are to teach information and create student interest in taking and caring for cuttings.

2. The application phase should be emphasized in the school greenhouse or at home in taking of cuttings for hanging baskets and house plants. Propagation of ground covers should be a high priority for success.

VIII. Evaluation:

1. Prepare and administer a pencil test using Sample Test Questions.
2. Collect and evaluate worksheets and laboratory exercises.
3. Evaluate performance on taking of cuttings and success of rooting.

IX. References and aids:

1. Plant Propagation, Principles and Practices, Hartman and Kester, 3rd Edition Prentice Hall, Inc. Publishers.
2. 50 Laboratory Exercises for Vocational Ornamental Horticulture, Compiled by Paul Hemp, The Interstate Printers and Publishers, Danville, Illinois.
 - A. "Soft Wood Cuttings" pp. 61, 62.
 - B. "Effects of Rooting Compounds on Rooting" pp. 89 to 92.
3. University of Illinois Cooperative Extension Service Circular No. C886 "Plant-Regulators" pp. 3 to 9.
4. Laboratory Exercises on:
 - A. "Asexual Propagation by Leaf Sections"
 - B. "Asexual Propagation by Leaf Bud Cuttings and Leaf Petiole Cuttings"
 - C. "Herbaceous Stem Cuttings"
 - D. "Removing Rooted Cuttings from a Propagation Bench"
 - E. "Maintaining a Propagation Log"
 - F. "Using Root Promoting Compounds"
 - G. "Making Herbaceous Cuttings"
 - H. "Asexual Propagation by Stem-Tip Cuttings and Stem Cuttings"
5. Transparencies and Transparency Discussion Guide.

205

6. Sample Test Questions.

7. Vocational Agriculture Service Units:

A. #5011 "Poinsettia Care and Propagation" pp. 6 & 7

B. #5013 "Producing Poinsettias Commercially" pp. 3 to 7

C. #5006 "Asexual Propagation" pp. 1,2,5,9,10,11.

LABORATORY EXERCISE

ASEXUAL PROPAGATION - LEAF SECTIONS - LAB

I. Materials:

Leaf of mother-in-law plant
Knife
Cell packs with media or propagation bench
Pencil and plant label

II. Purpose: To propagate a plant using sections of a leaf

III. Procedure:

1. Using pen or pencil, draw lines on the leaf, dividing it into equal sections. (at least 4)
2. Draw an arrow on each section pointing downward. Be careful not to puncture the leaf.
3. Slice the leaf on each line.
4. Place half of the leaf sections in the media with the arrow going down. Place the other half of leaf sections in the media with the arrow going up.
5. Place on bench. Water thoroughly.
6. Check daily for root growth.

IV. Observations:

20

IV. Discussion Questions:

1. It is known that the part of a plant nearest the plant crown produces roots more easily while the part of the plant farther from the plant crown, produces shoots more easily. What would cause this? Watch your leaf actions to see what cuttings root first.

2. Where is the crown of a plant? Illustrate in a drawing.

3. By what other asexual methods can the sanseveria be propagated?

4. With the leaf section method, how is the new plant formed? Illustrate with a drawing.

200

LABORATORY EXERCISE

ASEXUAL PROPAGATION - LEAF BUD CUTTINGS AND LEAF PETIOLE CUTTINGS

I. Materials:

Cell packs with soil media or a propagation bench
Plant materials suitable for this method of taking cuttings

- #### II. Purposes:
1. To propagate a plant using the leaf bud portion of the plant.
 2. To propagate a plant using the leaf petiole portion of the plant.

III. Procedure:

1. Remove five leaves with their petioles from a plant and place them in the propagation media about $1\frac{1}{2}$ inches deep.
2. Remove five leaves with the accompanying bud and place these in the propagation media about $1\frac{1}{2}$ inches deep.
3. Write out labels and place them in the appropriate location to identify your cuttings. Be sure to use pencil only.
4. Place in the propagation bench for further observation.

IV. Observation:

V. Discussion Questions:

1. Which technique do you think will produce a rooted geranium plant? Explain.

2. What reason can you give for taking a leaf bud cutting rather than a stem?

3. How will the media affect the rooting process?

4. Did all of your cuttings survive? If not, what do you think happened?

5. Did all cuttings form root systems? Did some cuttings root faster than others?

6. How does the new growth compare on the difference cuttings types.

LABORATORY EXERCISE
HERBACEOUS STEM CUTTINGS

I. Purpose:

Information about the rooting of a cutting gained through personal experimentation will do much to insure the success of your propagation program. The objectives of this exercise are to experimentally determine four useful pieces of information: 1) The correct procedure for making a stem cutting; 2) The position on the stem where roots develop most readily; 3) The relationship between the amount of leaf surface and the rootings of the cutting; and 4) The best position for making the basal cut. This experiment will require fourteen to twenty-one days to complete, depending on plant material used and time of year.

Date begun _____ Date completed _____

II. Materials:

1. Suggested plant material: chrysanthemum, poinsettia, geranium, fuschia, coleus, or Swedish ivy
2. Suggested foliage material: grape ivy, aluminum plant, or wandering jew

III. Procedure:

1. Students should work in assigned teams.
2. Each team should fill two flats with assigned propagating media.
3. Proceed to the school greenhouse and determine the location of the plant material to be used in this exercise. The instructor will assign each team one type of plant to use.
4. Each team member should take twenty-five stem cuttings of the assigned plant material.
5. Each stem cutting should be three to five inches long. All cuttings should be from young, healthy, vegetative growth. The cuttings should be taken from the ends of lateral or terminal shoots.
6. One partner should make all his basal cuts just below the nodes. The other partner will make all his basal cuts just above the nodes.
7. Each partner will remove all but two leaves from ten of his cuttings and leave all the leaves on the other fifteen cuttings (see Fig. 2B).

8. Open a trench in the propagating media approximately one inch wide and two inches deep and place the cuttings into the trench approximately one inch apart.
9. After insertion, the medium should be firmed around the base of each cutting with the fingers.
10. Label each flat with your name, and cut date. Use only waterproof markers.
11. Water the cuttings and set on the propagation bench. Most of the cuttings should be rooted in fourteen to twenty-one days.

IV. Observations:

213

LABORATORY EXERCISE

REMOVING ROOTED CUTTINGS FROM A PROPAGATION BENCH

- I. Purpose: Given labels, flats, pencil, water sprinkler, and cuttings rooted in a bench, move rooted cuttings from bench to a flat without damaging root system and label correctly. Performance is evaluated by teacher.
- II. Note: Certain kinds of plants have very brittle roots that are easily broken in handling. Such broken roots are easily infected, and plants may be killed. Gentle handling of rooted cuttings is important.

Rooted cuttings should be moved from the propagation bench to a flat as soon as they have formed roots from $\frac{1}{4}$ to $\frac{1}{2}$ inch long. Label them clearly. They should be sprinkled with water right after removal from propagation bench. Rooted cuttings should be placed in a shaded area to prevent wilting until they are planted. Planting should be done as soon as possible--a delay of several hours could be harmful.

III. Procedure:

1. Gently pull on the top of cutting. If it seems to "tug back" it is rooted. Use this test on a number of cuttings in the same block; if most are rooted, they are ready to remove from the propagation bench.
2. Clean flat with water hose and put clean paper or plastic film in bottom.
3. Using label ($1\frac{1}{2}$ wide, 12" long- "garden" label), slide under a row of cuttings, and gently lift to loosen the cuttings in the rooting medium.
4. Gently take hold of the tops of the cuttings with the fingers and lift.
5. Place the cuttings in the flat. Repeat Steps 3, 4, and 5 until the flat is filled.
6. Prepare a label ($5/8$ " x 5") by printing the name of the plant on the label in lead pencil (ink would wash away). Copy the name from the label in the propagation bench for this batch of cuttings.
7. Place the new label in the flat with the rooted cuttings.
8. Sprinkle the rooted cuttings in the flat lightly with water.
9. Cover the cuttings with wet paper, wet, clean burlap; or plastic film to keep them from drying.

10. If the flats of cuttings are not to be planted within an hour or two, place them in a refrigerator (40°F).

IV. Observations:

214

LABORATORY EXERCISE
MAINTAINING A PROPAGATION LOG

I. Purpose:

So that you may determine the success of your propagation program, it is important to keep accurate records. A successful propagation program requires excellent records on types of material propagated, propagation methods, number of cuttings rooted, dates of transplant, and special treatment which may have been made during the propagating time. You should record in the master log kept by the teacher all the information that relates to: 1) All plants that you propagate, 2) All cuttings that you remove from the propagation bed and transplant. The following exercise will teach you what information is required to fill out the master log sheets correctly.

II. Procedure:

Note: Every plant propagated by you should have a corresponding log sheet filled out neatly, accurately, and completely. You will be able to fill out only half of the form at a time. The following information should be supplied:

- 1) List the plant name, giving both the common and botanical names.
- 2) Under the section titled: Propagated by, list:

- A) Your name
- B) Today's date
- C) Number of cuttings made
- D) Method of propagation (stem cuttings, leaf cuttings, axillary bud cuttings, or whatever method you are using)
- E) Special consideration given this group of cuttings (root promoting compounds, increased bottom heat, or fungicide application)

- 3) Under the section titled "Transplanted by," list:

- A) Your name
- B) Today's date
- C) Total number of cuttings rooted
- D) The size and kind of container you transplanted into, along with the number of cuttings per container.
- E) Total number of days since the cuttings were made
- F) Any disease, fungus, or insect problems that may be obvious at time of transplanting.

III. Observations:

PROPAGATION LOG SHEET

PROPAGATION LOG SHEET # _____

Plant Name: Common _____

Botanical _____

Propagated By: Transplanted By:

Name _____ Name _____

Date _____ Date _____

of Cuttings _____ # of Cuttings _____

Special Considerations _____ Type _____

_____ Size _____

_____ # of Container _____

_____ Total Days since Cuttings _____

PROPAGATION LOG SHEET # _____

Plant Name: Common _____

Botanical _____

Propagated By: Transplanted By:

Name _____ Name _____

Date _____ Date _____

of Cuttings _____ # of Cuttings _____

Special Considerations _____ Type _____

_____ Size _____

_____ # of Container _____

_____ Total Days since Cuttings _____

LABORATORY EXERCISE

USING ROOT-PROMOTING COMPOUNDS

I. Purpose:

Under good propagating conditions, most greenhouse-grown crops can be propagated without the use of root-promoting compounds. However, there may be times when it becomes necessary to increase either the quality, the speed, or the uniformity of root initiation by applying root-promoting compounds. Therefore, you should be able to identify those commercial root-promoting compounds used in the laboratory and follow the instructions given for the application of these compounds to specific types of plant materials.

II. Procedure:

1. Locate the assigned area you are to work in and the tools and plant material you are to work with.
2. Prepare several (depending on the number of cuttings taken) propagation flats using a standard propagating medium. To avoid brushing off the powder during insertion make a trench in the medium.
3. Locate the plant material; take as many cuttings as instructed by the instructor.
4. If the plant material has been cut for more than one hour, fresh basal cuts should be made.
5. Place a small amount of the root-promoting compound into the plastic container, so there is a thin layer of powder, perhaps one-fourth to one-half inch thick.
6. The base of each cutting is dipped and rotated in the powder.
7. Lightly tap the cutting against the side of the plastic container to remove excess powder.
8. Insert the cuttings into the rooting medium immediately.
9. After all the cuttings have been treated, discard the remaining powder in the plastic container. Do not put this powder back into the original container.
10. Water the flat and place it on the propagation bench.

III. Observations:

LABORATORY EXERCISE

"Using Leaves, Stems and Roots to Reproduce Plants Asexually and the Effects of Polarity on the Propagation of Plants"

This lab is to show how buds, leaves and stems influence the rooting of cuttings. The lab will also acquaint the student with the use of other plant structure besides stems for the propagation of plants. Leaves of some seed plants which contain no meristem can be made to develop meristems which give rise to leaves, stems, and roots. Sometimes a leaf plus a bud is necessary to produce a propagated plant. Root cuttings must initiate adventitious buds instead of adventitious roots as on stem cuttings. Since various transport systems exist in the plant and these systems tend to run in one direction the plant is said to be polarized. The polarity of plants must be maintained for them to root properly.

Experiment No. 1

Prepare 5 groups of 5 cuttings of *Hedera helix* and treat in the following manner and insert in peat and perlite medium under mist.

1. Complete cutting containing buds, stems, leaves
2. Cutting with only stems and leaves, no buds
3. Cutting with buds and leaves, very little stems
4. Cutting with buds and stems, no leaves
5. Leaves only

Experiment No. 2

Take several leaves of plants that show themselves capable of being reproduced in this manner. For small leaved items such as *Peperomia* and *Saintpaulia*, take the whole leaf.

For larger leaved items like *Begonia rex* and *Sanseria*, take only a small piece of the leaf. Try at least one leaf bud cutting of *Camellia* or some other plants that propagate in this manner.

Experiment No. 3

Take several small pieces (1" - 2") of horseradish* root and maintain the proper polarity by marking in some manner. Take two cuttings and stick them vertically and reverse the polarity on one of them. Take one piece 3" - 4" long and cut in three pieces. Lay these pieces out horizontally and reverse one of the ends.

Observations:

210

LABORATORY EXERCISE
MAKING HERBACEOUS CUTTINGS

I. Introduction:

Many ornamental plants can be propagated by cuttings taken from parent plants. A cutting is made by removing a vegetable part of the plant and treating it in such a way that roots will form and thus produce a new plant.

Three types of cuttings are commonly used when propagating plants. There are, however, many variations of these three types and the following demonstrations will provide a basic understanding of some of the various methods. The three common types of cuttings to be used for the demonstration are:

- a. stem cuttings
- b. leaf cuttings
- c. leaf petiole cuttings

Other types that should be recognized by the student and which they may practice making include root cuttings, which are used commercially to propagate garden phlox and oriental poppies, and offset cuttings, which represent a modification of the true cutting propagative method.

It is recommended that a pressure mist system be installed for use with this demonstration and be kept as a permanent part of the plant growing facilities.

II. Objectives:

1. To develop the ability to propagate plants by making soft wood cuttings of different types.
2. To develop an understanding of the practices to be used in propagating plants by means of cuttings.
3. To develop an understanding of the advantages of vegetative propagation by cuttings.

III. Materials:

1. A supply of plants from which the various types of cuttings can be made. Some examples are:

stem cuttings--carnation, coleus, geranium, ivy, chrysanthemum, begonia and philodendron.

leaf cuttings--sansevieria or rex begonia.

leaf petiole cuttings--African violet, gloxinia, tuberous begonia, and peperomia.

2. Rooting medium such as coarse sand, coarse sand and peat, or vermiculite.
3. Material for shading cuttings such as cheesecloth.
4. Pots, growing bench, flats, plots for growing the cuttings.
5. Time clock and interval timer.
6. High pressure mist system.

IV. Procedure:

1. Prepare the area in which the cuttings will be placed. This may involve preparing pots, a greenhouse bench, small area in the greenhouse, or preparing an outdoor plot near the school laboratory.
2. Select the plants to be propagated and determine the kinds of cuttings to be made. If possible, each student should make at least five cuttings of each of the three types. If materials are limited, students may be divided into groups with each group responsible for making a few cuttings of each type.
3. Make the cuttings as follows:
 - a. For stem cuttings, select healthy, rapidly growing stems. Cut the stems in lengths approximately 3-4 inches long, making the base cut just below a node.
 - b. For leaf cuttings, select healthy leaves. Remove the leaves from the stem of the plant. The leaves should lay flat on the growing medium. They should be weighted or pinned to make sure that they will stay in this flattened position. Cut through the veins of the leaf at several different points.

If sansevieria is used, the leaf must be chemically treated with a root inducing hormone and must be placed upright with the base of the leaf in the medium.
 - c. For leaf petiole cuttings, remove a number of healthy leaves with their petioles. Place the petioles in the growing medium the same as you would a stem cutting.
4. Treat the cuttings with a root inducing hormone and stick them into the rooting medium. Be careful not to allow any of the hormone to get on the buds of the stem cuttings.

5. Keep the cuttings moist, but do not saturate the medium. Maintain an even temperature of about 70°F. and shade the plants from direct sunlight.
6. Keep a record of the results of the demonstration as follows, recognizing that details of the record will vary according to the material used and the facilities available:
 - a. Kind of plant used.
 - b. Kind of cuttings made.
 - c. Number of cuttings made.
 - d. Kind of plant hormone(s) used.
 - e. Kind of rooting medium used.
 - f. Temperature at which the cuttings were held.
 - g. Per cent of cuttings rooted.
 - h. Time required for the cuttings to produce one-half inch roots.
 - i. Point or location on the cutting at which roots were produced.

V. Application:

Production of plants from cuttings is a popular hobby for some people. For others who are interested in commercial production of plants, this method of propagation represents a highly desirable means of producing large numbers of plants, all of which will have the same characteristics. The fact that cuttings are made from vegetable parts of the plant assures the producer that the propagated plants will have identical characteristics to those of the parent plant. This method of propagation also offers a means of reducing the amount of time normally required to grow certain plants to maturity or to a salable size.

VI. Observations:

STUDENT WORKSHEET

ASEXUAL PROPAGATION BY STEM-TIP CUTTINGS AND STEM CUTTINGS

I. Purpose: To propagate a plant by division.

II. Materials: Coleus / geranium / wandering jew / or swedish ivy

Sharp Knife
Label
Pencil

III. Procedure:

1. Make a 4 stem-tip cuttings and stick in mist bench $1\frac{1}{2}$ " deep.

A stem-top cutting should.....

- a) be 4-6 inches long
- b) include terminal bud
- c) have lower leaves removed
- d) have flowers removed
- e) be cut close to a side bud to avoid leaving a stub remaining on the original plant.

2. Make 4 stem cuttings and stick in mist bench $1\frac{1}{2}$ " deep.

A stem cutting does not have a terminal bud.

3. Place a label with your name and date, in front of your cuttings in the mist bench.

IV. Observations:

222

V. Discussion:

1. Draw a plant stem and label: terminal bud, side bud

2. Concerning the stem-tip cutting, list:

advantages

disadvantages

3. Concerning the stem cutting, list:

advantages.

disadvantages

4. Describe the environment that is best for rooting plants.

5. How long do you guess it will take the cutting to root?

6. Describe the procedure for sticking cuttings in the mist bench.

TRANSPARENCY DISCUSSION GUIDE

PLANT PROPAGATION

Classification of Cuttings

- I. Root Cuttings
 - A. Sweetwood
 - B. Willow
- II. Stem Cuttings
 - A. Softwood
 - B. Semi-hardwood
 - C. Hardwood
- III. Leaf Cuttings
 - A. Bryophytes
 - B. Ferns
 - C. Flowering plants
- IV. Special Cuttings
 - A. Layering
 - B. Grafting
 - C. Budding
 - D. Tissue Culture

19. Cuttings are made from vegetative portions of the plant. Cuttings can be classified according to the part of the plant from which they are obtained. A ripe wood cutting is more commonly referred to as a semi-hardwood cutting. A leaf bud cutting may also be referred to as a stem cutting, because it is a leaf and a bud with a portion of stem.

Herbaceous Cuttings

A herbaceous plant is a plant that is soft not woody. Herbaceous plants usually grow for only one year. They usually die back to the roots or die completely.



Most herbaceous plants, such as carnations, geraniums, fuchsias, impatiens, and many others, can be rooted easily. Cuttings are usually 3 to 4 inches long. They will root very quickly. Cuttings of these plants can be made any time of the year except for the flowering period of the plants. In the autumn.

20. Herbaceous cuttings are the most common type of cutting taken on house plants. Herbaceous cuttings are the least expensive and easiest method of propagating cuttings. The herbaceous cutting is usually "snapped-off" the plant, or taken by using a sharp knife. Using a pair of pruning shears is not recommended.

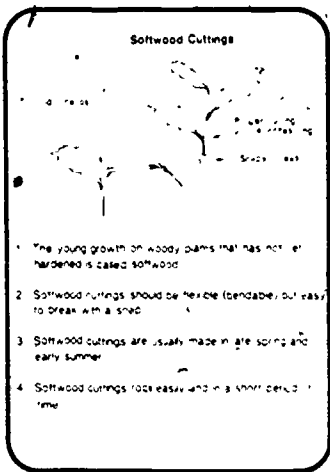

21. The softwood cutting is made with the leaves attached, not allowing them to dry out. Fast growing material with large internodes is undesirable. It is generally recommended to take softwood cuttings early in the day to avoid excessive drying.

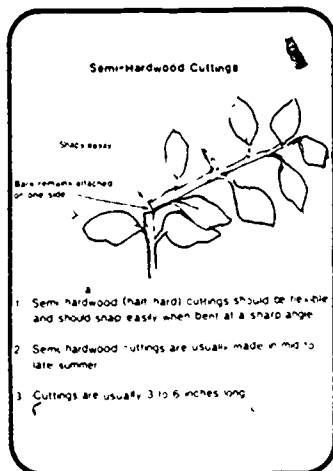

22. Semi-hardwood or ripe wood cuttings are commonly taken on broadleaf evergreens and summer leafy deciduous plants. Leaf size is usually reduced to lower the water loss and allow for a closer spacing of cuttings in the propagation bench. Most semi-hardwood cuttings must be misted if they are to survive.

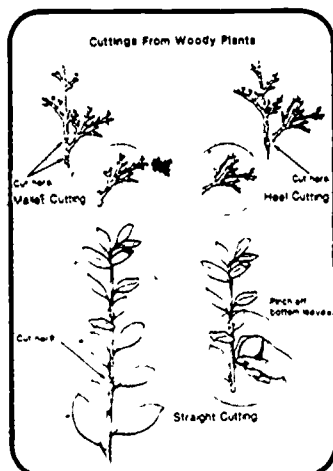

23. Three types of cuttings are usually taken from woody plants. They are the mallet, the heel, and the straight cutting. The ease of rooting the species will determine what cutting is taken. The more difficult the rooting of the species the more "mature" wood to be taken with the cutting.

Mallet cuttings include a short section of the stem of older wood. The heel cutting includes a small piece of older wood. The straight cutting is taken of the current seasons growth.

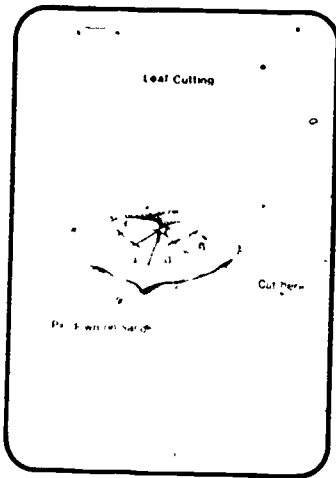

24. In leaf cuttings, adventitious roots and adventitious shoots develop at a vein or at the base of the leaf. The original leaf or part of a leaf does not become part of a new plant. Plants usually propagated in the illustrated manner include begonia, gloxinia, and streptocarpus.

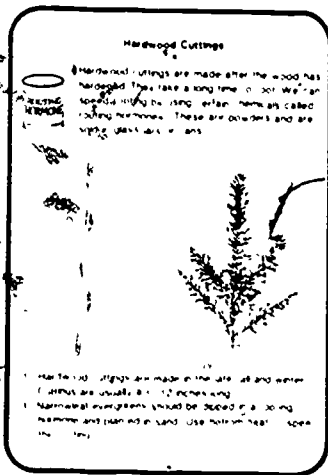

25. Hardwood cuttings are commonly taken on deciduous plants and evergreen plants. The hardwood cutting is taken on the current seasons wood after the plant has gone dormant and the deciduous plant has lost its leaves. Evergreen cuttings require high light intensity, light misting, and bottom heat of 75 to 80° F. Dipping the cuttings in a fungicide helps prevent disease.

Hardwood cuttings of average diameter and internode length, for the species, is the most desirable. The growing tip of the stem is usually low in stored food and should be discarded or propagated separately.

The purpose of a rooting hormone is to increase the percentage of cuttings which form roots, to increase uniformity of rooting, and to increase the quality of roots that do form.

Sample Test Questions & Teachers Key

Multiple Choice (Make appropriate choice of A, B, C, or D)

- A
1. The leaves of herbaceous cuttings should be reduced in number to:
- A. Reduce water loss and economize bench space
 - B. Force growth of the roots
 - C. Reduce possibility of disease on leaves
 - D. Aid in fertilizer and water application
- A
2. In plants with fleshy leaves, leaf cuttings:
- A. Of some varieties may not produce stems unless treated with hormones.
 - B. Will not root. Only plants with enlarged petioles will root from leaf cuttings.
 - C. Develop shoots, followed by root formation.
 - D. Usually produce only one plant at its base
- B
3. Well developed roots should form on a geranium in about:
- A. One week
 - B. Three weeks
 - C. Three days
 - D. Four weeks
- B
4. Chrysanthemums are most commonly propagated:
- A. By hardwood cuttings
 - B. By stem cuttings like geraniums
 - C. By runners
 - D. By leaf cuttings like Rex begonias
- D
5. The type of cutting to be made is determined in part by:
- A. Ease of root or shoot formation
 - B. Availability of skilled labor
 - C. Time of year
 - D. All of the above

Essay Questions

1. Relate what materials should be used as rooting media for herbaceous cuttings. (see page 1)
2. Describe how cuttings should be placed in the media (see pages 1, 2, 3, & 4). UAS Unit 5006
3. List three reasons for producing plants from cuttings.
4. When are herbaceous cuttings usually made?
5. List three common plants which would be considered good specimens? For taking herbaceous cuttings?
6. When are herbaceous cuttings made?
7. What temperature is necessary to root cuttings?
8. List three characteristics of a good cutting?
9. What is the function of the callus on cuttings?
10. When are cuttings ready to transplant?
11. What is the major difference among hormones 1, 2, and 3.
12. Why are tip cuttings and stem cuttings separated before being "struck"?
13. What is the procedure in taking herbaceous cuttings?
14. Identify six types of herbaceous cuttings.
15. Describe a mother block.

UNIT E: PLANT PROPAGATION

PROBLEM AREA: PROPAGATING BY LAYERAGE

SUGGESTIONS TO THE TEACHER:

This problem area is designed for use with freshman or beginning students enrolled in a horticultural occupations or agricultural occupations program. The recommended time for teaching this problem area is during the early spring semester just as plants are beginning their growth. It is recommended that the teacher have available suitable plant materials in the greenhouse or have pussy willow or other willow material available outside for use. The estimated instruction time for this problem area is 3-5 days depending on how far the teacher wishes to go in developing air layering skills at the first year level. If the teaching plan is limited to classroom discussion with little or no practice the instructional time can be two days or less.

CREDIT SOURCES:

The instructor is encouraged to conduct a local search of curriculum materials to locate other supplementary materials for use with this problem area. The items in this problem area are for reference and modification as the instructors adapt this material to their local situation.

These materials were developed through a funding agreement, R-33-21-D-0542-388 with the Illinois State Board of Education, Department of Adult, Vocational and Technical Education, Research and Development Section, 100 North First Street, Springfield, Illinois 62777. Opinions expressed in these materials do not reflect, nor should they be construed as policy or opinion of the State Board of Education or its staff.

The teacher's guide, student worksheets, and test questions were developed by Jim Ethridge. Transparency masters and the transparency discussion guide were prepared by the Vocational Agriculture Service. Suggestions and guidance in the development of these materials were provided by the Metropolitan Core Curriculum Pilot Test Teachers.

TEACHER'S GUIDE

I. Unit: Plant propagation

II. Problem area: Propagating by layerage

III. Objectives: At the close of this problem area students will--

1. Develop their ability to asexually propagate selected plants through air-layering.
2. Identify and describe several different layering techniques.
3. Identify the steps necessary for successful air-layering.
4. Define air layering.
5. Demonstrate air-layering procedures including care before layering and care after layering of the new plant and the mother plant.

IV. Suggested interest approaches:

1. Show VAS Slidefilm 600 on air-layering techniques.
2. Using outdoor plant material such as willow (spring) practice air-layering techniques.
3. If plant material is limited, demonstrate different air layering techniques.
4. Show slides and transparencies of air layering techniques.

V. Anticipated problems and concerns of students:

1. What is layering?
2. What types of layering exist?
3. How does one wound a plant?
4. When should air layering be performed?
5. Why does one air layer plants?

6. How does one care for the plant after layering?
7. What treatments are used to stimulate rooting during layering?
8. How does one estimate the time of layer rooting?
9. What different types of layering exist?

VI. Suggested learning activities and experiences:

1. Show VAS Slidefilm 600 on air layering.
2. Have each student perform each of the layer techniques and observe the results.
3. Have a demonstration set up showing the techniques of air-layering.

VII. Application procedures:

1. The main purposes of the problem area are to teach information and develop interest in layering as an asexual propagation technique.
2. The application phase should be emphasized in the land laboratory. Use beginning apple root stocks for budding, tip layering brambles, serpentine layering vines and air layer house plants from the diffenbachia and ficus group.
3. Have students practice air-layering on overgrown house plants owned by their families.

VIII. Evaluation:

1. Prepare and administer a pencil paper objective test using Sample Test Questions.
2. Collect and grade worksheet.
3. Observe performance of layering techniques.

IX. References and aids:

1. Plant Propagation, Principles and Practices, Hartman and Kester, 3rd Edition, Prentice Hall, Inc. Publishers. Read Chapter 14, p. 455 to 459.

2. 50. Laboratory Exercises for Vocational Ornamental Horticulture, Compiled by Paul Hemp, The Interstate Printers and Publishers, Danville, Illinois.
 - A. "Air-Layering", pp. 65 to 68.
3. Student Worksheet on:
 - A. "Propagation by Air-Layering"
4. Laboratory Exercise on:
 - A. "Propagation by Air-Layering"
5. Transparencies and Transparency Discussion Guide
6. Sample Test Questions
7. Vocational Agriculture Service Unit:
 - A. #5006, "Producing Plants by Asexual Propagation", pp. 19 & 20.
8. Vocational Agriculture Service Slidefilm:
 - A. #600 "Air-Layering"

LABORATORY EXERCISE
PROPAGATION BY AIR LAYERING

I. Materials:

Plant materials
Knife
Toothpicks
Rooting hormone powder
Plastic sheets
2 Twist ties
Moist sphagnum moss

II. Purpose: To root a plant while it is still attached to the mother plant.

III. Procedures:

1. Remove leaves from a 6" area of the Dracaena stem.
2. Make a slanted cut about halfway into the stem. Be careful not to cut entirely through the stem.
3. Prop the cut open, using the toothpicks.
4. Place the rooting hormone powder into the cut.
5. Wrap a handful of wet moss around the stem, making sure some wet moss gets into the cut area.
6. Wrap the moss with the plastic sheet. Be sure all the air is removed.
7. Tie a twist tie at both ends of the plastic sheet to secure the moss around the stem.
8. Place on the bench or area assigned.
9. Observe daily to watch when the first root appears.
10. When 3 roots are visible through the plastic, it is time to plant our air-layered cutting. Remove plastic. Cut through stem below the root moss. Transplant into a new pot. Water thoroughly. Keep out of direct sun until established.

IV. Observations:

STUDENT WORKSHEET
PROPAGATION BY AIR LAYERING

V. Discussion Questions:

1. What purpose does the moss serve?
2. Why do we use the hormone powder?
3. What plants, besides the Dracaena, can be air-layered?
4. Why would we air-layer a plant instead of taking a tip cutting?
5. What are the advantages of using this technique to propagate plants?
6. What are the disadvantages of using this technique to propagate plants?

234

TRANSPARENCY DISCUSSION GUIDE

PLANT PROPAGATION

Classification of Layerages

- I Simple Layering
- II Compound Layering
- III Trench Layering
- IV Mound or Stool Layering
- V Air Layering

16. The five types of layerages are: simple (which includes tip), compound, trench, mound, and air. Simple layering involves the bending of a branch to the ground and covering it partially with soil, leaving the terminal bud exposed. In tip layering, the tip is the portion buried in the soil. Compound layering involves a branch being lateratively covered and exposed along its length. New shoots will arise from the exposed portions. Trench layering involves growing a plant in a trench, and filling in soil around new shoots after the plant has been placed in a horizontal position. Mound layering involves the pruning of a plant to the soil line, and mounding soil over the new shoots as they emerge. Air layering involves the development of roots on the aerial part of the plant where a stem has been wounded.

Plant Propagation by Air Layering

Air layering is usually done in the fall or winter in the greenhouse.

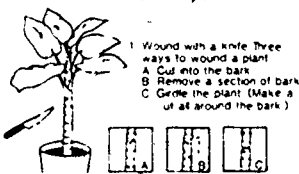

1. Wound with a knife. Three ways to wound a plant:
 - A. Cut into the bark.
 - B. Remove a section of bark.
 - C. Girdle the plant. (Make a cut all around the bark.)

2. Wrap a ball of wet sphagnum moss around the wound.



17. Air layers are usually done on wood that is less than one year old and with actively growing leaves present. The actively growing leaves help promote rooting. Getting moisture content of the sphagnum moss around the air layer too high may cause the stem tissue to decay.

18. It is desirable to remove a layer for transplanting when the plant is not actively growing. Latent buds should grow after the layer is removed to give your tropical plant a new top.

Plant Propagation by Air Layering (cont'd)



2. Wrap plastic around the ball of sphagnum moss. Tie above and below moss with string, using a bow on top to allow addition of moisture at a later time.

4. Within a few weeks, roots will be growing in the sphagnum moss.



5. Cut off with pruners, remove plastic, and pot up the new plant.

6. New growth will start from the stem.

233

SAMPLE TEST QUESTIONS

Rearrange the following directions for air-layering into the correct sequence.

- ___ 1. Place rooting hormone into the cut.
- ___ 2. Observe daily until the first root appears.
- ___ 3. Prop the cut open using toothpicks.
- ___ 4. Make a slanted cut halfway through the stem.
- ___ 5. Wrap a handful of sphagnum moss around the cut, making certain some of the moss is forced into the cut.
- ___ 6. Remove leaves from a 6" area of the dracena stem.
- ___ 7. Place on bench.
- ___ 8. When 3 or 5 roots are visible through the plastic cut through the stem directly below the roots.
- ___ 9. Tie a twistem at both ends of the plastic sheet to secure the moss around the stem.
- ___ 10. Plant the new plant into a suitable pot.
- ___ 11. Wrap the moss with a plastic sheet to secure the moss around the stem.

ESSAY QUESTIONS

1. Why do we wound plants that are to be layered?
2. What type of plants can be layered in a simple way?

3. Why do we layer plants?
4. What materials are used in air-layering?
5. When is the best time to layer most plants?
6. Name 10 plants commonly air-layered and which method is used.
7. What treatments are used to stimulate rooting during layering?

UNIT E: PLANT PROPAGATION

PROBLEM AREA: PROPAGATING BY DIVISION AND SEPARATION

SUGGESTIONS TO THE TEACHER:

This problem area is designed for use with freshman or beginning students enrolled in horticultural occupations or agricultural occupations program. The recommended time for teaching this problem area is during the fall semester. The estimated instructional time for this problem area is 5 to 10 days depending on how far the teacher wishes to go in developing asexual propagation skills at the first year level. If no practice, the instructional time can be four days or less. If the students are to be involved in the production of hanging baskets, the thinning of perennial gardens and other activity exercises, the instructional time will need to be increased.

The instructor is encouraged to conduct a local search of curriculum materials to locate other supplementary materials for use with this problem area. The items in this packet are for reference and modification as instructors adapt this material to their local situation.

CREDIT SOURCES:

These materials were developed through a funding agreement, R-33-21-D-0542-388 with the Illinois State Board of Education, Department of Adult, Vocational and Technical Education, Research and Development Section, 100 North First Street, Springfield, Illinois 62777. Opinions expressed in these materials do not reflect, nor should they be construed as policy or opinion of the State Board of Education or its staff.

The teacher's guide, laboratory exercises, and sample test questions were developed by Jim Ethridge. Transparency masters and transparency discussion guide were prepared by the Vocational Agriculture Service. Suggestions and guidance in the development of these materials were provided by the metropolitan core curriculum pilot test teachers.

TEACHER'S GUIDE

- I. Unit: Plant propagation
- II. Problem area: Propagation by division and separation
- III. Objectives: At the close of this problem area students will --
 1. Identify two types of bulbs, and methods of propagating bulbs, corms, runners, offsets, suckers and viviparous plants.
 2. Demonstrate the ability to propagate given plants by all the above means.
 3. Develop an understanding of how to increase plants by divisions.
 4. Propagate selected plants by division.
 5. Describe the processes of division.
- IV. Suggested interest approaches:
 1. Display an aloe or sanseveria which are over crowded; lead into a discussion as how to improve the situation.
 2. Set up a demonstration and divide the following structures:
 - a. Corms each with a bud.
 - b. Crown (African violet).
 - c. Orchids (pseudo bulbs).
 - d. Rhizomes - lily of the valley, iris.
 - e. Tuberous roots each with 1 or 2 eyes (dahlia).
 3. Take a field trip and visit a propagation nursery demonstrating propagation by division and observe nursery workers dividing plants.
 4. Ask students to relate their experiences to any of the miscellaneous forms of propagation, what plants they used and how they accomplished the propagation.
 5. Discuss the problem of digging up a bulb bed and why one ends up with as many bulbs in the bed after digging up the old ones. Discuss what might happen if you would roto-till a bulb area.

6. Put a strawberry, strawberry begonia, spider plant, boston fern, plant or others with runners and expose them to increasing day length and others with decreasing day length. -What happens with runner formation?
7. Have each student select a plant from an approved list and discover through reading literature how this particular plant is propagated and have the student demonstrate the method to the rest of the class.
8. Have students explore garden centers, the school greenhouse and plants at their homes or in park areas and have them discover names of plants and/or specimens that produce young plantlets on the leaves of the plant.
8. Dig up Glads and Crocus in the fall and examine the young cormels. Package them for storage and line out the cormels in the spring. Also examine the "cool" greenhouse when forcing freshness.
9. Dig up an established lily and examine the young plantlets around the base. Ask the lead question, where all of these young plantlets originate?

V. Anticipated problems and concerns of students:

1. What are bulb scales?
2. What is a laminate bulb?
3. What is a tunicate bulb?
4. Why do we divide plants?
5. How do we divide plants?
6. When does one divide plants?
7. What is polarity in sweet potato tubers?
8. What is a cormel?
9. Why should lily and tulip vegetative growth not be cut off after flowering?
10. What plants are commonly divided?
11. How is division distinct and different from separation?
12. What is a viviparous plant?
13. What are suckers?

14. What are bulbils and bulblets?
15. How are runners formed?
16. Why do sweet potatoes form slips at only one end?
17. What kinds of rhizomes are there?
18. How does one propagate bulbs?
19. How does one propagate runners?
20. How does one propagate stolons?
21. How does one propagate viviparous plants?
22. How does one propagate corms?
23. How does one propagate suckers?

VI. Suggested learning activities and experiences:

1. By using demonstration method of instruction or making this experience a group experience with several members participating do the following:
 - a. Line out glad cormels (or crocus or freshice) in a nursery bed in the spring. This can also be done with canna, iris, daylily etc.
 - b. Size cormels and dig in fall and properly store.
 - c. Line out scales and lily bulbs in flats after planting easter lilies and grow on in the greenhouse. Line outside in spring in propagation area.
 - d. Collect bulbils and bulblets from lilies and perennial onions in fall and line out in fall.
 - e. Collect plantlets from viviparous plants and plant in flat. Take special notice of variegated varieties.
 - f. Using spider, strawberry plants and others with runners propagate plants with runners. This can also be done with Boston Fern.
1. Have each student propagate plants using various methods of division.
2. Have students identify plants that need dividing.
3. Field trips can be used where greenhouses or nurseries are using these propagation techniques.

4. Show slides of the various specialized plant parts and their propagation techniques.

VIII. Application procedures:

1. The main purposes of this problem area are to teach information and develop ability of the student to propagate plants by specialized means and to recognize terms related to these specialized propagation means.
2. The application phase should be emphasized in a controlled laboratory setting first demonstration the propagation techniques and then enabling the students to develop themselves in these propagation skills.

VIII. Evaluation:

1. Prepare and administer a pencil paper test using sample test questions.
2. Collect and grade laboratory exercises.
3. Observe performance in working with these propagation techniques.

IX. References and aids:

1. Plant Propagation, Principles and Practices, Hartman and Kester, 3rd Edition, Prentice Hall, Inc. Publishers. Read Chapter 15 p. 477 to 503.
2. 50 Laboratory Exercises for Vocational Ornamental Horticulture, Compiled by Paul Hemp, by The Interstate Printers and Publishers, Danville, Illinois.
 - A. "Rooting of ²Kalanchoe Pinnata" p. 69 to 70
3. Laboratory Exercises on:
 - A. "Asexual Propagation by Offsets of Offshoots"
 - B. "Asexual Propagation of Tubers"
 - C. "Asexual Propagation of Bulbs"
 - D. "Asexual Propagation by Division"
4. Transparencies and Transparency Discussion Guide
5. Sample Test Questions
6. Vocational Agriculture Service Units:
 - A. # 5014 "Growing Lilies" p 1 to 3
 - B. #5006 "Asexual Propagation of Plants" p 3, 4, 9, 10, 13-18.

LABORATORY EXERCISE

ASEXUAL PROPAGATION - OFFSETS OF OFFSHOOTS

I. Materials:

Suitable plants such as Aloe or Sanseveria Knife
Containers with suitable soil media

II. Purpose:

To propagate a plant by off shoots

III. Procedure:

1. Identify the plant (to be propagated) and materials and return to your station.
2. Tap the plant out of the pot.
3. Locate a plantlet and pull carefully away from the mother plant until you see the main stem connecting the plantlet to the mother plant.
4. Cut the stem between the plantlet and the mother plant so the plantlet has some of its own roots.
5. Repeat steps 3 and 4 until all plantlets are separated from the mother plant.
6. Pot up all the plantlets in the appropriate size pot. (3" - 4" size)
7. Repot the mother plant back in its original pot.
8. Move all plants to the greenhouse bench as designed by the instructor.
9. Water all your plants thoroughly.

IV. Observations:

V. Discussion Questions:

1. Name 2 other plants which could be propagated by offshoots.
2. What is the difference between offshoot and division type propagation?
3. How are the plantlets connected to the mother plant.
4. How can you tell what size pot to place the newly separated plantlets in?
5. What care, if any, needs to be given to the new plantlets for the first week or so?

245

LABORATORY EXERCISE
ASEXUAL PROPAGATION OF TUBERS

I. Materials:

White or red potato tubers.
Cell packs with soil media or a propagation bench
Knife

II. Purpose:

To develop the skill of dividing potato tubers

III. Procedure:

1. Fill a cell pack 1/2" from the top with soil
2. Divide a potato into sections. Each section should have 2 or 3 "eyes". (see demonstration).
3. Plant the sections as deeply as possible in the soil.
4. Record your observations for at least 2 weeks in the space provided below.
5. Take your potato plants home and plant them in a large plastic container. The soil in this container should be loose to provide good drainage.
6. In time, you will enjoy your new potatoes at the dinner table.

IV. Observations:

240

M-1-E-5-9

V. Discussion Questions:

1. What part of the tuber produces new growth?
2. How much time is required for growth to occur?
3. What is the function of the potatoe in the life cycle of the plant?
4. Give two examples of plants similar to the potato.

217

LABORATORY EXERCISE

PROPAGATION OF BULBS

NOTE: In cases where bulb propagation must be encouraged by special processing, it will take three to six years for a bulblet to reach a size which is suitable for flowering. Because of the length of time required for a bulblet to reach flowering size, it is recommended that this demonstration be carried out through Step 5 in the procedure and then if it is desired to continue growing the bulblet to maturity make this step a forced growing period.

I. Objectives:

1. To develop an understanding of the structure of a bulb.
2. To develop an understanding of the principles of propagating bulbs.
3. To develop the ability to process and propagate bulbs.

II. Materials Needed:

1. A supply of large, dormant, disease-free, well-developed hyacinth and onion bulbs. The onion bulbs will be used for identification and practice and the hyacinths for actual processing and propagating.
2. Suitable growing medium or outdoor plots.
3. Potato or melon baller or a sharpened, stainless steel teaspoon.
4. Sharp penknife.
5. Dark, warm storage areas.

III. Procedure:

1. Let each student take an onion bulb and remove a thick scale then identify the buds in the axils of the scales. Cut some of the bulbs vertically so that students may observe the basal plate, the overlapping scales, and the large central bud. Note the other steps in the procedure and let the student practice with onion bulbs, the procedure they will use when working with the hyacinth bulbs.
2. Let each student select one hyacinth bulb for each of the following methods of preparation:

A. Scooping

(1) Lay the bulb on a work table with the basal plate to the right (for right-handed students).

(2) With the bulb remaining on the table, grasp it gently, but firmly, with the left hand.

(3) Take either the melon baller or the sharpened teaspoon in the right hand.

(4) With a minimum of cutting action, scoop out the basal plate in a manner that will just expose the bulb scales. The scooped out portion need not be more than three-eighths-inches deep.

B. Scoring and notching

(1) Hold a bulb on the work table with the basal plate up.

(2) With the sharp penknife, make two or three cuts completely across the basal plate, crossing each other and extending about a third of the way into the bulb.

C. Separating and planting scales

(1) Each student may remove a bulb scale.

(2) Identify the buds in the axils of the scale.

(3) Plant the scale in an upside-down position.

(4) Continue as in Steps 5 and 6 which follow.

3. Place the bulbs that have been scooped or scored in a warm, slightly darkened place for two to three months prior to spring planting. The temperature should be maintained from 70° to 80° F.

4. After storage, plant the bulbs in an upside-down position in plots or cold frames. The bulbs should be placed on planting medium as well as being covered by two to three inches of it. A "rule of thumb" to follow when planting bulbs is to cover them to a depth one-and-one-half times their length.

5. Care for them as you would under normal conditions.

6. After a growing season and the withering of the foliage, dig up the original bulbs and separate the newly formed bulblets.

7. Replant the separated bulblets to continue their growth into bulbs of flowering size.

8. Compare the results of the different methods of processing the bulbs by recording the numbers of bulblets produced and measuring.

IV. Application:

Many bulbs propagate themselves naturally by breaking up into a number of small bulbs. Tulips do this, particularly when planted shallowly. Other bulbs, such as daffodils, will form offsets which are known as slabs. Still others, like the hyacinth, are slow propagators under normal conditions, but by processing a dormant bulb it is possible to greatly increase the number of bulblets produced.

On processed bulbs, more but smaller bulblets will form on scooped bulbs, while fewer but larger bulblets will form on the scored bulbs.

With any type of bulb propagation, several growing seasons are required for the bulblets to acquire a size that is adequate for flowering.

Bulbs are measured by determining the circumference. Grades are assigned in respect to circumference in inches or centimeters. A grade 8-9 would have a circumference of 8-9 inches or centimeters.

It is believed that varietal grades of bulbs may influence the resulting plants. This is true to a point, but it must be remembered that it is important for bulbs to be secured from a reputable firm. While the grade of the bulb is important, the quality of the plant may be greatly influenced by the way in which the parent plant was cared for before the bulb was harvested. It is possible for bulbs to be a good size but lack stored food substances essential for growth of a new plant.

V. Observations:

LABORATORY EXERCISE
ASEXUAL PROPAGATION - DIVISION

I. Materials:

Multi-crowned plants
Knife
Pots appropriate for replanting
Soil media

II. Purpose:

To propagate a plant by division

III. Procedure:

1. Tap plant out of pot.
2. Using thumbs, pull apart the plant where it naturally splits apart.
3. Each new section should include a portion of leaf, stem and root..
4. Repot new sections into pots.
5. Water.

IV. Observations:

251

V. Discussion Questions:

1. How many new plants should result from a plant to be divided?
2. Where is the crown of the plant located?
3. Give three (3) examples of multi-crowned plants.
4. If after dividing a plant, a section does not have any roots, what can be done to help save that particular section?
5. What will happen to the newly potted sections?

LABORATORY EXERCISE

ASEXUAL PROPAGATION BY DIVISION

- I. Purpose: To propagate a plant by division.
- II. Materials: A multi-crowned plant, knife, extra pot and soil.
- III. Procedure:
 - 1) Tap plant out of pot.
 - 2) Using thumbs, pull apart the plant where it naturally splits apart.
 - 3) Each new section should include a portion of leaf stem and root.
 - 4) Repot new sections into pots.
 - 5) Observe carefully.
- IV. Discussion:
 - 1) How many new plants resulted from the plant you divided?
 - 2) Where is the crown of the plant located?
 - 3) Given three (3) examples of multi-crowned plants.
 - 4) If after dividing a plant, a section does not have any roots, what can be done to help save that particular section?

Fern?

Fibrous begonia?

253

LABORATORY EXERCISE

ASEXUAL PROPAGATION BY OFFSETS OR OFFSHOOTS

- I. Purpose: To propagate a plant by offshoots.
- II. Materials: Aloe or Sasevieria
Sharp knife
Clean pots
Sterlized soil mix
- III. Procedure:
 - 1) Tap the plant out of the pot.
 - 2) Locate a plantlet and pull carefully away from the mother plant until you see the main stem connecting the plantlet to the mother plant.
 - 3) Cut the stem between the plantlet and the mother plant so the plantlet has some of its own roots.
 - 4) Repeat steps 3 and 4 until all plantlets are separated from the mother plant.
 - 5) Pot up all the plantlets in the appropriate size pot. (3" - 4" size)
 - 6) Repot the mothe plant back in its original pot.
 - 7) Move all the plants to the greenhouse bench as designated by the instructor.
 - 8) Water all your plants!
 - 9) Observe carefully over a period of time.
- IV. Discussion:
 - 1) Name 2 other plants which could be propagated by offshoots.
 - 2) What is the difference between offshoot and division tyoe propagation?
 - 3) How are the plantlets connected to the mother plant?
 - 4) What care, if any, needs to be given to the new plantlets for the first week or so?

TRANSPARENCY DISCUSSION GUIDE

PLANT PROPAGATION

Separation and Division

- I Tubers
- II Rhizomes
- III Runners, Offsets, Suckers
- IV Corms
- V Bulbs
- VI Viviparous Plants
- VII. Old Plants

26. Specialized stem and leaves require specialized methods of propagation other than by cuttings. This transparency identifies the most common vegetative means reproducing plants Vivipary actually means seeds which germinate while still attached to the plant. "Viviparous" used here refers to primary meristem at the margins and base of leaves which give rise to new plants.

Division of Old Plants

When new growth is about to start cut or pull apart and repot



a. Three crown plant

b. Being divided

African Violet



c. Three repotted divisions

d. Potting in 3 inch pots

27. The African violet develops more than one crown as it matures. Splitting the crown and repotting, results in several new plants plus the mother plant.

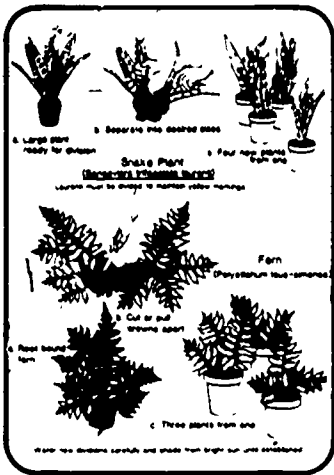

28. The *Sanseveria* develops new underground shoots from underground stems. The variegated varieties can only be maintained by separating the plants, not by leaf cuttings. All scientific names of plants should be underlined and the genus capitalized.

Many ferns produce new plants by underground stems or stems that creep on the soil surface. Cutting and separating the mature plant yields new plants. Pruning the plants will help develop a symmetrical plant.

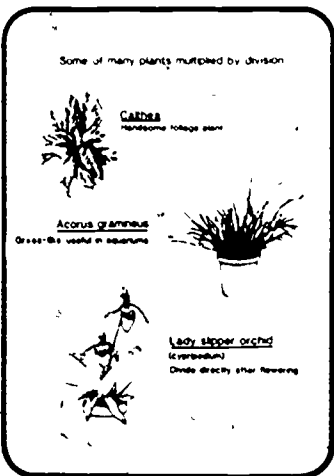

29. *Calthea*, *Acorus*, and *Cypripedium*, as well as many other plants, can be propagated by dividing the mature plant. The dividing of the plant is also the common way of propagating peony, iris, and day lily.

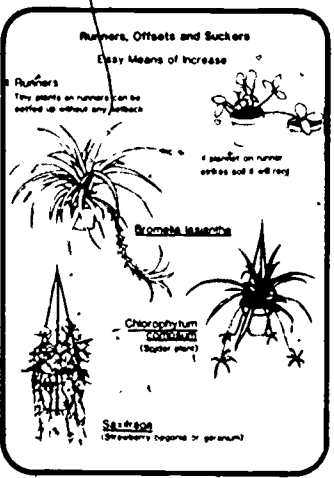

30. Runners, offsets and suckers are specialized plant stems that produce small plantlets at some location of the stem.

Runners are above ground stolons produced by strawberries, strawberry begonias, and spider plants. The runner produces a plant that roots when placed in contact with the soil. These plants are commonly referred to as offsets.

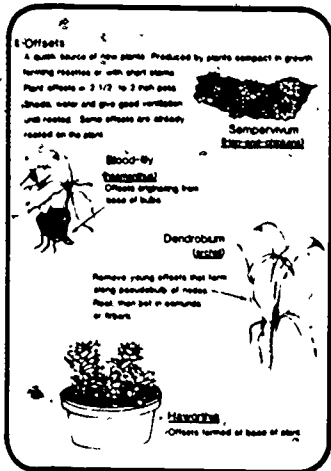

31. Offsets are also found in plants such as hen-and-chicks, bulbs, and orchids. Offsets are also defined as plantlets that develop at the base of the plant.

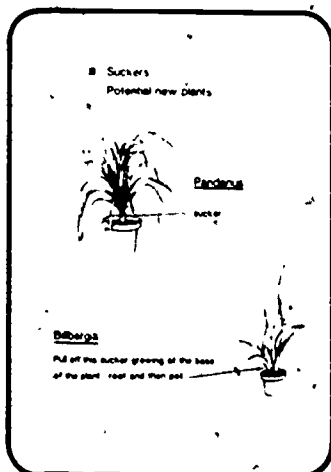

32. Suckers are formed at the base of the plant. Suckers are common in *Pandanus* and *Billbergia* as well as other bromilads. Suckers are also common on apple trees.

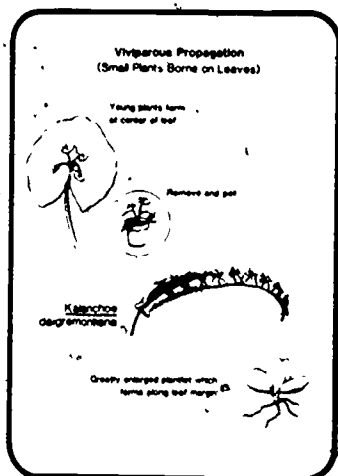

33. Viviparous plants have the seeds of their flowers germinate while the seed is still attached to the flower. The perennial onion is a common example. "Viviparous" refers to primary meristem at the margins and base of leaves which give rise to new plants. The *Kalanchoe*, and the piggy-back plant are common examples.

34. The leaf or leaf cutting will not become part of the new plant that is formed. In many greenhouses and homes these "viviparous" plants become weeds in other flower pots by falling off the mother plant and growing in undesirable locations.

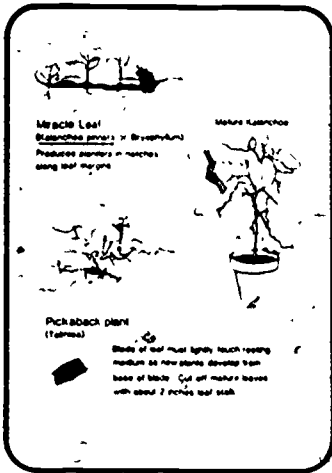

253

SAMPLE ESSAY TEST QUESTIONS

1. What is a basal plate?
2. What are bulb scales?
3. What are bulblets?
4. What are offsets?
5. What are stem bulblets?
6. What are bulbils?
7. What is a daminate bulb or tunicate bulb?
8. What are contractile roots?
9. How do bulbs form?
10. What is a mother bulb?
11. What are pre-cooled bulbs?
12. What are CTF bulbs?
13. What is a tubercles?
14. What is a sweet potato "slip?"
15. What is pre-sprouting treatment?
16. What is a corm?
17. How can you identify a flowering rhizome from a vegetative plant such as the lily-of-the-valley?
18. What are back bulbs?
19. What are green bulbs?
20. List 4 plants that can be propagated by division.
21. When is the best time to divide shrubs?
22. List 2 shrubs that can be divided.
23. Why do we divide perennials?
24. When should one divide perennials?

25. Describe the procedure involved in dividing a:

a. Daylily:

b. ~~Canna~~:

c. Iris:

d. Lilac:

e. Quince:

f. Orchid:

26. Describe the following plant structures:

a. Pseudo bulb:

b. Corm:

c. Tuber:

d. Crown:

e. Rhizomes:

f. Bulb:

200

UNIT F: Plant Identification and Classification

PROBLEM AREAS:

1. Identifying and classifying plants
2. Identifying different parts and types of leaves
3. Identifying different parts and types of stems
4. Identifying different parts and types of fruits
5. Identifying different parts and types of flowers
6. Identifying different parts and types of roots

UNIT F: PLANT IDENTIFICATION AND CLASSIFICATION

PROBLEM AREA: IDENTIFYING AND CLASSIFYING PLANTS

SUGGESTIONS TO THE TEACHER:

This problem area is designed for use with freshman or beginning students enrolled in horticultural occupations or agricultural occupations programs. The recommended time for teaching this problem area is during the fall semester prior to any plant identification. It is important that beginning students have a sound background in terminology before they begin to explore the plants available to the horticulturalist. The estimated instructional time for this problem area is 5-10 days depending on how far the teacher wishes to go in developing identification skills at the beginning student level, to what extent the teaching plan is limited to classroom use of and whether or not students are to be involved in outside activities.

The instructor is encouraged to conduct a local search to locate other supplementary materials for use with this problem area. The materials in this problem area are for reference and modification as instructors adapt the material to their local situation.

CREDIT SOURCES:

These materials were developed through a funding agreement, R-33-21-D-0542-388 with the Illinois State Board of Education, Department of Adult, Vocational and Technical Education, Research and Development Section, 100 North First Street, Springfield, Illinois 62777. Opinions expressed in these materials do not reflect, nor should they be construed as policy or opinion of the State Board of Education or its staff.

The teacher's guide, information sheet, student worksheets, and test questions were developed by Jim Ethridge. Transparency masters and the transparency discussion guide were prepared by Vocational Agriculture Service, University of Illinois. Suggestions and guidance in the development of these materials were provided by the Metropolitan Core Curriculum Pilot Test Teachers.

TEACHER'S GUIDE

- I. Unit: Plant identification and classification.
- II. Problem area: Identifying and classifying plants.
- III. Objectives: At the close of this problem area students will --
 1. Develop the vocabulary needed to describe plants.
 2. Understand how the differences in plants can be used for the purpose of identification.
 3. Understand the use of scientific names in identifying plants.
 4. Develop an interest in plant identification and classification.
 5. Develop the ability to identify and classify plants.
 6. Develop an understanding of some of the problems involved in identifying and classifying plants.

IV. Suggested interest approaches:

1. Use a comparison of a mechanic repairing equipment and knowing his or her tools and equipment and a plant specialist working with plants not knowing their parts, functions, and classification. This example serves to point out that a worker must be able to identify and use correctly the "tools of the trade".
2. One approach to the teaching of plant identification without the use of botanical keys is to use the "learn one-plant-a-day approach." By this method the teacher will bring in one plant a day and discuss it thoroughly by:
 - a. Giving the common name and spelling for the plant under study.
 - b. Pointing out the outstanding characteristics of the plant which will help to recognize or identify it in the future. These characteristics might include the shape and coloration of the leaf, shape of the flower, fragrance or peculiar aroma, color and type of flower, or the general shape of the plant.
 - c. Comparing the plant currently under study with plants studied previously.
Considerable time should be devoted to reviewing the plants previously studied. Keep the instruction cumulative. Review identification of selected plants previously studied before discussing the plant for the day. Repetition is the keynote to teaching by this method.

The students should be made well aware of the goal of learning one new plant a day. Stress the point that if the student can

learn just one new plant a day, then at the end of a 180 school-day year, 180 plants will be known. If the student extends the goal by using the summer months or by learning more than one plant a day, the graduate of the course should be able to identify a considerable number of plants:

If the teacher is to keep up with the goal of identifying one plant per day, some careful pre-planning will be required. It is suggested that frequent trips be made to the school landscape during the nice days of spring and fall in order to use these plants most effectively. During inclement weather, foliage plants, pot plants, and balled and burlapped or potted plants can be brought into the classroom. It may be necessary to work out some arrangements with local florists and nurserymen in order to have an adequate supply of plants for a day-by-day approach to learning the plants of the trade.

3. In order to help the students become more aware of basic plant differences, it is suggested that for the first several classes, the teacher bring in plants which are considerably different and point out in detail the various ways in which the plants differ. The plants should be carefully chosen to exhibit the characteristics to be emphasized in the class discussion.
4. The more able students could learn to identify plants by comparing the plants to be identified with suitable pictures, sketches, or plant specimen mounts.
5. Prepare individual 5 x 7 cards of the various ways in which plants differ using actual plant materials. The students may be actively involved in this project. It would also be desirable to have the students prepare plant specimen mounts or make leaf impressions.

V. Anticipated problems and concerns of students:

1. What are the ways of classifying plants based on life cycles?
2. What is a herbaceous perennial?
3. What is a woody perennial?
4. What is an evergreen plant?
5. What is the classification of plants based on growth habit?
6. Why should a person training in a horticultural occupation be able to identify plants?
7. Why do we classify plants?
8. What is the basis for the classification of plants?

9. What are the methods used for classifying plants?
10. How are plants classified as to function?
11. In what ways is classification of plants of life cycle useful to man?
12. How are plants classified as to structure?
13. What is scientific classification of plants?
14. Why is scientific classification of plants widely used?
15. What are the major criteria for classification?
16. What are the objections to the use of common names for scientific study?
17. How do you define: species, genus?
18. What are the four basic parts of plants?
19. What is classification as applied to plants?
20. Why is it important to have a knowledge of plant parts?*

VI. Suggested learning activities and experiences:

1. Have students read the information sheets and record tentative answers to the problems and concerns identified by the class or teacher.
2. Distribute Student Worksheet 1 and have students complete the blanks.
3. Show transparencies.
4. Take a walking field trip to practice identification.
5. Use crossword puzzles with plant part names and classification terms.
6. Compare a lawn mower with a plant. Emphasize that both mowers and plants have different parts. Give examples and emphasize the need for vocabulary in describing lawn mower parts and plant parts.
7. Use a balled and burlapped, narrow leaf evergreen (taxus), a blooming herbaceous plant, (mum) and a piece of sod. Prepare a series of cards with one plant descriptive term as covered in class per card. Take care of the tree plants and ask to place the card descriptive of the plant.

EXAMPLE

Perennial	Juniper	Evergreen
Woody Plant		Narrow leaf Evergreen
Hardy Plant		Shrub
Nursery Plant		

Considerable repetition will be necessary to help the student learn the vocabulary.

8. Ask the students to turn in a short report describing a plant in which they are particularly interested using the vocabulary being studied.
9. Prepare a series of cards giving a general plant description and ask the student to suggest the name of a plant which fits the description.

EXAMPLE

This plant is a perennial. It is a tender bedding plant and is grown for its foliage. It has no flowers.

VII. Application procedures:

1. The main purposes of this problem area are to teach information and develop favorable attitudes toward plant identifications and classification.
2. The application phase should be emphasized in the problem areas of identifying: (a) perennial flowers, (b) annual flowers, (c) weeds, (d) turf grasses, (e) evergreen trees, (f) evergreen shrubs, (g) deciduous trees (h) deciduous shrubs, (i) ground covers, (j) flowering house plants, (d) foliage house plants, (l) vegetables and (m) fruits.

VIII. Evaluation:

1. Prepare and administer a pencil and paper objective test using the Sample Test Questions as possible test items.
2. Collect and grade worksheets.
3. Performance tests can be given by using the Student Worksheet 1 and have them check appropriate responses.

IX. References and aids:

1. Plant Diary (See Unit on Supervised Occupational Experience, Problem Area: Keeping Records on a SOE Program)
2. Student worksheets on:
 - a. Plant Identification
 - b. Flower and Foliage Plant Find
3. Information Sheet "Terms used in General Identification of Plants."
4. Transparencies available from Vocational Agriculture Service.
5. Transparency Discussion Guide on Plant Identification.
6. Sample Test Questions

INFORMATION SHEET

The following are terms which describe plants based on their life cycles or growth habits.

annual	cool-season plant
biennial	warm-season plant
perennial	genus
tender plant	species
hardy plant	cultivar
herbaceous plant	weed
woody plant	deciduous plant
ground cover	evergreen
vine	narrow leaf evergreen
tree	broad leaf evergreen
small tree	conifer
medium tree	foliage plant
large tree	bedding plant
shrub.	
small shrub	
medium shrub	
large shrub	

Since the beginning of time, man has been classifying plants and animals. By using systems of classification, he has been able to determine the origin, reproductive habits, and other characteristics of living things. The system used to classify plants has made it much easier for the scientist to study plants.

It is essential that the student training for a horticultural occupation understand the classification of plants and how they were given their scientific names. The scientific names of plants are difficult to pronounce, spell, and learn; but it is a sensible, convenient method of studying and identifying plants. Some of the advantages are as follows:

1. Scientific names of plants are used world-wide. The terms (nomenclature) used to describe plants were developed in Vienna in the early 1900's by botanists from many nations. Those attending this meeting developed the International Code of Botanical Nomenclature (a guide to be used in naming plants). It has been revised several times but is still in use today. A publication based on the International Code of Botanical Nomenclature is called "Standard Plant Names" and is the one used by most horticulturists to identify plants today.
2. All plants are classified in the same manner. Their natural relationship is the basis for classification. People who name and classify plants are called taxonomists.

3. The common names of plants may differ from one area to another, but a horticulturist can order a plant by its botanical name and be sure of receiving the plant he or she ordered.
4. Scientific names of plants serve as a basis for standardizing all terminology used by horticulturists.
5. A knowledge of botanical names will help in identifying plants and eliminating confusion.

The scientific name given a plant usually is selected by the discoverer and is normally useful in describing or identifying the plant; however, this is not always true. Some of the names used that indicate the origin of plants are americana (America), koreana (Korea), orientalis (Orient), and virginicus (Virginia). Examples of people are baileyi, wilsoni, and fortunei. Descriptive terms used as names of plants are arborescens (treelike), compactus (compact), and nanus (Dwarf). Some of the names used for plants may refer to the season of the year in which they bloom: autumnale (autumn), praecox (very early), and aestivalis (spring). If the term "flors" is used as a part of the name, it describes something about the flower. The term may refer to quantity (floribund), the size (grandiflora), or many flowers (multiflora).

Many people fail to pronounce the botanical names of greenhouse plants correctly; however, the pronunciation is not as important as the spelling. The botanical name of a plant must be spelled correctly in order for the plant to be properly identified.

The botanical names of plants are not always permanent, as is thought by many people. After gaining additional information about a plant and if a name change is warranted, taxonomists can have the name changed.

The botanical name of a plant is composed of two Latin or Latinized words (for example, Spinacia oleracea). The first word is always capitalized and is the genus or generic name. The second word, called a specific epithet (a word or phrase accompanying or occurring in place of the name of a person or thing), is never capitalized. The words are never used alone in referring to a plant, and both words are required to correctly name the plant.

To designate a small difference in plants in a species, taxonomists often use a third word in the plant name. This is called a varietal name. The third word is often the name of the man who first named or described the plant.

The genus is a relatively small group of plants having similar form and structure. The factors considered by taxonomists in determine the genus of a plant are morphology and genetic factors. Plants in one genus cannot cross with plants in another genus.

A species is a group of plants that are similar in form and structure to each other but are dissimilar to other plants in the genus. Linne established the practice of identifying each species by two names, as previously discussed. The species is subdivided into cenospecies and ecospecies by taxonomists to facilitate the study of plants. The cenospecies are separated into groups genetically.

The variety is broken into several subdivisions under the species. The variety in these statements refers to botanical variety rather than plant variety. A plant in a species that is particularly different in appearance from other members in the species is called a variety, which is designated by three words. For example, common juniper would be *Juniperus communis* Var. *communis*.

A horticultural variety is called a cultivar: these are cultivated plants that have similar characteristics and retain their distinguishing features when reproduced. The three types of cultivars are clones, lines, and individuals. The propagator of horticultural plants is constantly looking for a plant which for some unexplained reason, is a mutation, is attractive and desirable. To reproduce this plant, the propagator develops a clone.

There are several reasons why a person training in a horticultural occupation should be able to identify ornamental plants. Two examples are given: to recognize plants by description (important for those selling plants), and to be able to follow instructions as to the care of plants.

There are a number of ways of identifying plants. A horticulturist familiar with botanical terms may identify plants by using the botanical key; however, many people must learn to identify plants by their different characteristics. A discussion of several ways of identifying plants follows.

Life Cycle Classification

Based on its life cycle, a plant may be classified as either an annual, biennial, or perennial.

An annual is a plant that completes its life cycle in one year. During this period, the plant blooms, produces seeds, and dies. It is said that an annual is a plant that goes "from seed to seed" in one year in one growing season.

A biennial is a plant that requires two years or a part of two years to complete its life cycle. It goes "from seed to seed" in two years.

A perennial is a plant that usually lives for more than two years. They are of two kinds, herbaceous and woody. A herbaceous perennial is a plant that has soft, non-woody stems. Most of the herbaceous plants are annuals. Wood perennials are woody-stemmed plants that live over winter. Some perennials produce stems and leaves the first year and fruit the second year.

Growth Habit Classification

Based upon their growth habits, plants are classified as trees, shrubs, and vines.

A tree is a woody perennial that has one erect or single stem which exceeds twelve feet in height, a trunk at least three inches in diameter at breast height (DBH), and definite crown, when fully grown.

A shrub, referred to by many as a bush, is a woody plant that arises from the ground with more than one stem and is usually very low (attaining not more than twenty feet in height).

A vine is a plant that requires some type of support and climbs by tendrils or some other means, or creeps along the ground. It may be either a woody or herbaceous plant.

Size Classification

Plants are classified according to size into one of seven different classifications:

A climbing vine, is a plant that will climb and grow on some type of a support, such as a trellis, fence, or wall.

A plant classified as ground cover (includes turf) may be either a woody or herbaceous plant. Ground cover attains the height of one foot or less, either trails or creeps, and may form a compact mat.

Dwarf shrubs are woody plants that grow from one to three feet tall. Medium shrubs are plants that grow from six to nine feet tall. Large shrubs (small ornamental trees) are woody plants, and they grow from ten to twenty-five feet high. Standard trees are woody plants that grow to a height of thirty feet or more.

Although size is not considered, another method of classifying plants, which can be helpful in plant identification, is whether they are evergreen or deciduous. An evergreen has leaves throughout the year, while a deciduous plant loses its leaves in the fall.

271

STUDENT WORKSHEET, #1

PLANT IDENTIFICATION

Instructions: Given the plants identified by your instructor, classify them according to the following information. Check the appropriate term which identifies the plant.

Plant No. _____

Common Name _____

Botanical Name: Genus _____ Species _____ Cultivar _____

Tree _____ Shrub _____ Vine _____ Ground Cover _____ Vegetable _____

Annual _____ Biennial _____ Perennial _____

Tender _____ Hardy _____ Herbaceous _____ Woody _____

Deciduous _____ Evergreen _____ Narrow-leaf _____ Broad-leaf _____

Foliage Plant _____ Flowering Plant _____ Bedding Plant _____

Other Observations:

Plant No. _____

Common Name _____

Botanical Name: Genus _____ Species _____ Cultivar _____

Tree _____ Shrub _____ Vine _____ Ground Cover _____ Vegetable _____

Annual _____ Biennial _____ Perennial _____

Tender _____ Hardy _____ Herbaceous _____ Woody _____

Deciduous _____ Evergreen _____ Narrow-leaf _____ Broad-leaf _____

Foliage Plant _____ Flowering Plant _____ Bedding Plant _____

Other Observations:

STUDENT WORKSHEET #2

IDENTIFYING COMMON NAMES OF PLANTS

Words can go anyway -- across, up and down, backwards, forwards, diagonally, etc. The plants are listed in common names. The clues are given below. You are to identify the common names of the plants.

AECHMEA FASCIATA

BOUGAINVILLEA HYBRIDA

CALCEOLARIA HERBEA HYBRIDA

CAPSICUM ANNUUM

CATTLEYA HYBRIDA

CHRYSANTHEMUM MORIFOLIUM

CITRUS MITIS

CYCLAMEN

EUPHORBIA PULCHERRIMA

EXACUM AFFINE

HIBISCUS ROSA-SINENSIS

PELARGONIUM X DOMESTICUM

PRIMULA VERIS ELATIOR

SAINTPAULIA IONANTHA

SCHLUMBERGERA TRUNCATHS

SENECCO CRUENTUS

SININIA SPECIOSA

STREPTOCARPUS X HYBRIDUS

ARAUCARIA EXCELSA

BRASSAIA ACTINOPHYLLA

CHLOROPHYTUM COMOSUM

DIEFFENBACHIA AMOENA

FICUS BENJAMINA

NEPHROLEPIS EXALTATA

SCINDAPSUS AUREUS

CISSUS RHOMBIFOLIA

FISCUS ELASTICA

ASPARAGUS SPRINGERI

PEPEROMIA OBTUSIFOLIA

SAXIFRAGA SARMENTOSA

A Z Q A L O J H E M E O U S L Y C P T U N
S T R A W B E R R Y B E S O N I A E I O E L S
U L M I C U L U S T N A S T H N E E A B B O E S
O M O R T T U S I N I K A Y T T L R E E A B B O S
A A F R I C A N V I O L E K A Y T T L R E E A B B O S
T H R H O R E C O P D E L R I L L O T T I R O N S E
I Y M E R H I Y B A L U E O V C R T T I R O L R Y
C W V A T N T C I E S B O E Y A M U R R F R Y
A A Z E H Z T L T H B U V R E L I O O P F O U T
P S A T B H E M A I U W O G M U R C P O P L T
A H L M O M E R E W O L F A R P A P L A Y
S I E W O S H E I N K C O H A O E B B E K A Y
P N I R U O E N P S R W X A P L P R P I S O W
A G B A S M A U W O E N I T E A R L S O W
R T S C H E F F L E R A N T R R C T A L W T
O U N X C O R C H I D I O S I A P I N N D A
G N B Y M K E F F L U A F I A P I N N D A
U G C H V R D U C G Y C Y O A L P E M P B
S E G I A I M M D A N V E U N A P E M P B
F R E B I R S Y U S L A E K V D E A A I N E U Q
E A P I T K D L O C L R R Y I N D R Y N N E U Q
R N S S T L O Y I D O N I O O D O E R E T E B
N I B C E S V M V O T H G L O M S O T E B
S U F U S H I E A U E M C D F O T N A A U F I
O M Z S N L S U E R M C D F O T N A A U F I
U D L G I P S U T C A C S A M T S I R H C
S A U B O S T O N F E R N R T H E T E O L Y
E X U M P R I M R O S E G R A P E I V Y M
I L U M B C T N A L P R E V E D I P S R S F M
X T H E M C A F L E T A M H E O T T G D N V
P I O A R A A L E T A M H E O T T G D N V
D P F B C R A N L I P A N D N C D F S O R E
E I D L O G D I E C X W I A K T S E Y I O
Q A W E E P I N G F I G N T S I H M C R U

TRANSPARENCY DISCUSSION GUIDE

PLANT IDENTIFICATION

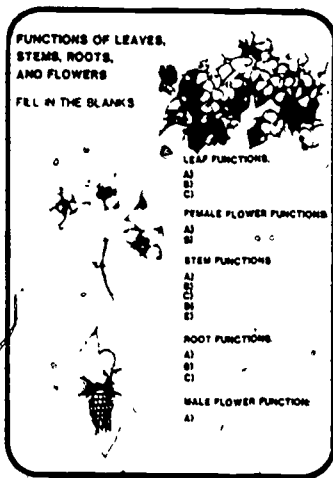

1. The leaf's chief function is to absorb light and manufacture food. Secondary functions are (1) exchange of oxygen and carbon dioxide, (2) food storage, and (3) vegetative propagation. The female flower's chief functions are: (1) production of the egg, (2) attraction of pollinators, and (3) protection of the developing embryo. The main function of the male flower is production of pollen for fertilization of the female flower.

The functions of the stem include: (1) movement of nutrient and water, (2) manufacture of food, (3) conduction of food from leaves to other parts of the plant, (4) the production of leaves, (5) support of leaves and fruit, (6) the storage of food reserves, and (7) vegetative reproduction. Two plants that are grown for their edible stems are the Irish potato and asparagus.

The functions of the root are: (1) anchorage of the plant, (2) absorption of water and nutrients from the soil, and (3) vegetative reproduction. Roots of sugar beets, carrot, radish and sweet potato store food, and are roots which we eat.

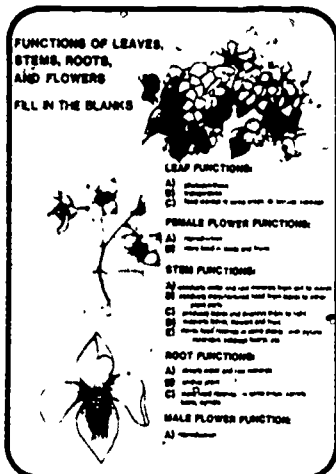

2. Some possible answers to functions of leaves, stems, roots, and flowers are displayed in transparency No. 2.

27

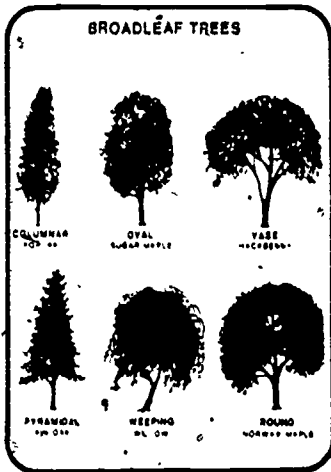

46. The form of a plant is one of the most important design qualities. The form of a plant is also an identification feature used when viewing the plant from a distance. Descriptive outlines or silhouettes of trees can be found in the University of Illinois, College of Agriculture Cooperative Extension Service Circular 858, Chapter 14, "Selected List of Plant Materials," (pages 216 to 246).

Columnar — A slender upright plant.

Oval — egg shaped, elliptical.

Vase — narrow at the base, spreading wider as the vertical increases.

Pyramidal — Angular sides meeting at a point.

Weeping — having pendulous branches, a feature which draws the viewer's eye toward the ground.

Round — shaped like a ball, spherical.

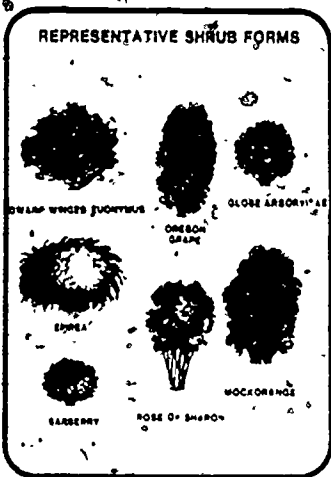

47. Botanical plant classification is only one of many ways to classify or identify plants. Another method of identifying plants is by their natural shape or form as seen in this transparency. Identification of plants by their form is a skill to be acquired by all landscapers and by people who maintain trees and shrubs.

275

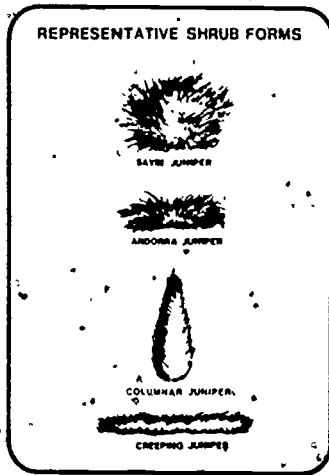

48. The growth habit or form of an evergreen can be categorized into five groups (1) low spreading, prostrate, or creeping forms, (2) conical, pyramidal, (3) columnar forms, (4) spreading or upright spreading forms, and (5) rounded forms. Each form imparts a different visual effect to a landscape.

Low spreading, creeping, or some varieties of andora juniper forms are ideally suited for ground cover use. Conical, pyramidal, and columnar forms are suited for specimen plant materials, but dwarf varieties may make ideal elements for planting beds.

Spreading and upright spreading evergreens are some of the most versatile. These are broad spreading and grow ultimately to about 8 - 12 feet high. Dwarf selections are also available. A number of evergreens naturally retain a round form as they grow, and require no pruning to remain a near perfect globe. (The rounded form is not shown.) Globe arborvitae and mugo pine are examples of the rounded form.

SAMPLE TEST QUESTIONS AND TEACHER'S KEY

TRUE-FALSE

- + 1. A species is a group of plants that are similar.
- + 2. The botanical name of a plant is usually permanent.
- 0 3. The second word used in the scientific names of plants is often capitalized.
- + 4. A specific name of a plant is its genus, and its species.
- 0 5. Not all plants are classified in the same manner.
- + 6. Common names of plants differ from one area to another.
- 0 7. A perennial usually grows from seed to flower in one year.
- + 8. Not all conifers keep their leaves year round.
- 0 9. Bluegrass is not a weed in a petunia bed.

MULTIPLE CHOICE (Make appropriate choice of A, B, C or D)

- D 1. Plants grown for the beautiful appearance they display are classified as:
- A. cover plant
- B. annuals
- C. perennials
- D. ornamentals
- C 2. Plants that start from seed in the autumn, overwinter as a small dormant plant and the following spring grow, produce flowers, seeds and then die are: _____
- A. perennials
- B. summer annuals
- C. winter annuals
- D. biennials

A 3. Plants that require two years to complete their life span are classified as:

- A. biennials
- B. herbaceous perennials
- C. perennials
- D. summer annuals

A 4. New plants which start from seed in the spring and complete their life span by autumn of the same year are:

- A. summer annuals
- B. biennials
- C. winter annuals
- D. herbaceous perennials

C 5. Plants that live for more than two years are classified as:

- A. deciduous
- B. biennials
- C. perennials
- D. annuals

C 6. Which of the following plants is not a vine?

- A. Boston Ivy
- B. Clematis
- C. Pine
- D. Grape

MATCHING

(Select the matching answer A through K that most satisfactorily fits the description or word in the left column)

- | | |
|-------------------------------|--|
| <u>E</u> 1. Annual | A. One which thrives during the fall or spring. |
| <u>F</u> 2. Evergreen | B. Undesirable plant growing with a crop. |
| <u>B</u> 3. Weed | C. Plant that lives more than 1 year but in some cases produces seed the first year. |
| <u>H</u> 4. Cultivar | D. One which grows during the summer and early fall. |
| <u>A</u> 5. Cool season plant | E. Plant which completes its life cycle in one year. |
| <u>C</u> 6. Perennial | F. Trees and shrubs that can retain their green leaves for the entire year. |
| <u>G</u> 7. Deciduous | G. Trees and shrubs that lose their leaves each autumn. |
| <u>D</u> 8. Warm season plant | H. Name used to describe varieties of hybrids developed by plant scientists. |
| | I. Plant family in which plants are capable of using nitrogen from the atmosphere. |
| | J. Plant that produces one seed leaf. |
| | K. Plants that produce true flowers and fruit. |

COMPLETION (Write appropriate information or words in the blanks to complete the following statements)

1. A horticultural variety is called a cultivar.
2. Based on life cycle, a plant may be classified as either a(n) annual, biennial, perennial.
3. Based upon their growth habits, woody plants are classified as shrubs, trees, or vines.
4. Plants are classified according to size into one of seven different classifications: a climbing vine that will grow on some type of support, a ground cover that attains the height of one foot or less.
5. Dwarf shrubs are woody plants that grow from one to three feet tall. Medium shrubs are plants that grow from six to nine feet tall. Larger shrubs are woody plants that grow from ten to twenty-five feet high. Tall or large trees are woody plants that grow to a height of thirty feet or more.
6. Another method of identifying plants is based on whether plants maintain leaves during the winter. A(n) evergreen plant has green leaves or needles throughout the year, while a(n) deciduous plant loses its leaves in the fall.
7. A plant that will not overwinter in a landscape setting is termed tender while other plants which overwinter are termed hardy. Life cycle is not a considering factor.
8. There are two types of evergreens. One group is characterized by the yew and the juniper. They are called narrow leaf evergreens and the second group is characterized by the azalea and the rhododendron. This second group is termed broad leaf evergreens.

23,

UNIT F: PLANT IDENTIFICATION AND CLASSIFICATION

PROBLEM AREA: IDENTIFYING DIFFERENT PARTS AND TYPES LEAVES

SUGGESTIONS TO THE TEACHER:

This problem area should be taught to freshman or beginning students in a horticultural or agricultural occupations program. The recommended time for teaching this problem area is during the fall semester before the leaves of herbaceous and woody plants have been destroyed by frost. This problem area can be taught during the winter months if a greenhouse is available for a plant collection.

The estimated instructional time for this problem area is 4 to 5 days, depending on how far the teacher wishes to go in developing leaf identification skills at the first year level. If the teaching plan is limited to classroom discussion with little or no practice or observation, the instruction can be 3 days or less. If the students are to be involved in other activity exercises, the instructional time will need to be increased.

The instructor is encouraged to conduct a local search to locate other supplementary materials for use with this problem area. The items in this problem area are for reference or modification as the instructors adapt this material to their local situation.

CREDIT SOURCES:

These materials were developed through a funding agreement, R-33-21-D-0542-388 with the Illinois State Board of Education, Department of Adult, Vocational and Technical Education, Research and Development Section, 100 North First Street, Springfield, Illinois 62777. Opinions expressed in these materials do not reflect, nor should they be construed as policy or opinion of the State Board of Education or its staff.

The teacher's guide, student worksheets, and test questions were developed by James Ethridge. Transparency masters and the transparency discussion guide were prepared by the Vocational Agriculture Service, University of Illinois. Suggestions and guidance in the development of these materials were provided by the Metropolitan Core Curriculum Pilot Test Teachers.

TEACHER'S GUIDE

I. Unit: Plant identification and classification

II. Problem area: Identifying different parts and types of leaves

III. Objectives: At the close of this problem area students will--

1. Identify the functions of the leaf and leaf structures, and origin.
2. Name and describe three common types of leaf arrangement.
3. Distinguish between parallel venation and net venation; between simple and compound leaves.
4. Identify specialized leaves and their functions.
5. Identify economic importance of leaves.

IV. Suggested interest approaches:

1. Bring in actual leaves as examples for the class to observe.
2. Take class on a walking tour of the school grounds to observe and study leaves and leaf parts.
3. Ask class to collect examples of each leaf part.
4. Stimulate interest by raising the following questions:
 - a. What types of leaves are there?
 - b. (With sample plants), ask the students to identify plant parts (to show lack of knowledge).
5. This problem area can lead into a discussion of why plants are important and careers which require a knowledge of plants.

V. Anticipated problems and concerns of students:

1. What are the functions of leaves?
2. Where do leaves originate?
3. What types of leaf arrangements exist?
4. What constitutes a common angiosperm leaf?
5. What are stipules? What is their usefulness?
6. What is venation? What types exist?

7. How can one distinguish between simple and compound leaves?
8. What are simple and compound leaves? What are their parts?
9. What is the function of the absciss?
10. What kinds of specialized leaves exist?
11. When is the absciss formed?
12. How do you determine if a structure is a stem or leaf?
13. What is the difference between palmate and pinnate venation?
14. What are the economic importances of leaves?
15. What are sessile leaves?
16. Why is it important to know which plants have leaf modifications?

VI. Suggested learning activities and experiences:

1. Collect and identify types of leaf margins.
2. Collect and identify types of leaf venation.
3. Collect and identify leaf shapes.
4. Collect and identify leaf apices and leaf bases.
5. Have students complete Student Worksheets.
6. Have class read Information Sheet and record tentative answers to problems and concerns.
7. Take a walking field trip for the purpose of leaf identification without the use of aids.
8. Have each student collect and identify 5 each of the following: leaf apex, margin, venation, forms, shapes, bases, arrangements.

VII. Application procedures:

1. The main purpose of this problem area is to teach information and develop skill in identifying leaf parts, functions, and modifications.
2. The application phase of plant identification by leaves should be emphasized in the problem area dealing with specific plants.

VIII. Evaluation:

1. Prepare and administer a pencil and paper test using the Sample Test Questions as possible test items.
2. Collect and grade Student Worksheets. Use worksheet as a leaf collection aid.

IX. References and aids:

1. Information Sheet on: "Identifying Plants by their leaves"
2. Student Worksheets on:
 - a. "Making a Leaf Collection"
 - b. "Making Leaf Comparisons"
 - c. "Leaf Modifications"
3. Transparencies available from Vocational Agriculture Service
4. Transparency Discussion Guide.
5. Sample Test Questions

INFORMATION SHEET
IDENTIFYING PLANTS BY THEIR LEAVES

There are several factors that should be considered when identifying plants by their leaves. Identifying factors included in this discussion are morphology, stem arrangement, venation patterns, complexity of leaf, shape of leaf, leaf apex, leaf base, leaf margins, and leaf surfaces.

Morphology

Possibly, the first identifying factor that should be considered when viewing a plant leaf is its structure (morphology).

The expanded portion of the lamina (blade), the petiole (blade stalk), and the stipules (small leaves or scales) are the morphological factors considered when identifying plants.

The leaf blade contains veins and soft tissue. The vein arrangement varies depending upon the leaf. In dicots, the veins branch several times and are referred to as being netted, while in monocots, the veins usually are parallel to each other.

The petiole is a stalk that supports the leaf and is the area found between the base and bottom of the leaf blade. Not all leaves have a petiole. If the petiole is absent, the leaf is sessile (attached directly to the base of the stem).

All plants do not have stipules. The stipules on many plants serve no useful purpose, but on others they serve as food manufacturing structures.

The most common leaf positions on plant stems are of three types: alternate, opposite, and whorled.

Stems with the leaves ascending in an alternating pattern are referred to as being alternate. When two leaves appear at each node on opposite sides of the stem, they are considered to be opposite. Leaves are also said to have an opposite (subopposite). Leaf pairs growing at a right angle to the pairs growing above and below them are called decussate. Basal is a term used for plants with leaves arising at the base; leaves borne on the aerial stem are called canline. If the bases of the leaves overlap, equitant is the descriptive term used. The leaf pattern "whorled" has three or more leaves at the nodes of the plant. This stem arrangement is common in herbaceous plants.

The leaves of different plants have different venation patterns. The terms used to describe the veins in leaves are parallel, pinnate, and palmate.

The major veins in leaves with parallel veins are about equal in size and are parallel from the base to near to tip.

Leaves with the pinnate venation pattern have one major vein with secondary veins branching from the midrib. Leaves with the palmate pattern have three or more major veins extending from the base of the blade and have secondary veins branching from the main veins.

Complexity of Leaf

There are several different forms of leaves. Simple, compound, pinnately divided, and palmately divided are some of the leaf forms that may be used in plant identification.

A simple leaf has a blade in one segment, or it has one blade. A leaf with the blade divided into several sections and attached to a common stalk is compound. All of the leaflets come from one point at the end of the petiole. They resemble the fingers of the hand.

A compound leaf with the leaflets arranged along both sides of the rachis is pinnately divided. It may be either odd-pinnate or even pinnate.

A palmately divided leaf is one where all the leaflets come from a point at the tip of the petiole.

STUDENT WORKSHEET

LEAF MODIFICATIONS

I. Plant Materials Needed:

- | | |
|-------------------|-------------------------------------|
| 1) Maple | 7) Rose |
| 2) Sweet Pea | 8) Asparagus |
| 3) Elm | 9) Oleander or banana or blue grass |
| 4) Honeylocust | 10) Rubber Plant |
| 5) Horse chestnut | 11) Schefflera |
| 6) Banana | 12) Blue Grass |

(or other suitable substitutes)

II. Introduction:

The purpose of this exercise is to demonstrate some of the typical features and modifications of leaves and to provide practical working knowledge of the basic leaf characteristics.

III. Objective:

At the conclusion of this exercise students will be able to identify terminology used to identify leaves and demonstrate a working knowledge of those terms of correctly identifying the term with the leaf that has the characteristic.

IV. Procedure:

Examine the different leaves provided and record the following particulars:

Common Name:

Scientific Name:

Leaf Type: Simple or Compound:

Leaf Venation: Parallel or Branched (Netted)

Kind of Margin: Smooth, Serrate, or Lobed.

Leaf Arrangement: Alternate, Opposite, Whorled, or Rosulate

Leaf Attachment: Petiolate, Sessile, or Perfoliate

Leaf Venation: Palmate, or Pinnate

Evergreen Conifer Leaf Arrangement: Fascicle, Scale like, or Awl like

V. Discussion Questions:

1. What are the parts of the compound leaf?
2. What is an absciss layer?
3. When and why does the absciss layer form?

283

STUDENT WORKSHEET
MAKING A LEAF COLLECTION...

Overview: The finished project will consist of a booklet containing pressed and labeled selections of 20 leaves, from the list given to you.

Due Date: _____

- Specifics:
1. Begin to collect leaf samples as we walk though the school campus. You can also collect leaves in your own neighborhood.
 2. You may store your leaves, as they are being pressed, in the greenhouse. Add to the collection daily, if possible.
 3. To press a leaf...place it between thick layers of newspaper under pressure for several days or until dry.
 4. Pressed leaves may then be mounted on a paper or a cardboard background. If you wish you may want to cover your leaves with a plastic film which will make your collection more permanent.
 5. Carefully label each leaf with its correct COMMON and SCIENTIFIC name.
 6. Neatly organize all your pages and secure them in some way to form a booklet.

Evaluation: Your efforts will be evaluated in the following way:

Possible Points

- ___ 1. Using a field guide or key, correctly identify 20 species or deciduous trees.
- ___ 2. Press, dry, and mount each leaf on a suitable background.
- ___ 3. Label each leaf (common and scientific names)

___ = total possible points

*Bonus Up to ___ additional points will be given for a particularly well-organized and creative booklet.

STUDENT WORKSHEET
MAKING A LEAF COLLECTION...

Overview: The finished project will consist of a booklet containing pressed and labeled selections of 20 leaves, from the list given to you.

Due Date: _____

- Specifics:
1. Begin to collect leaf samples as we walk though the school campus. You can also collect leaves in your own neighborhood.
 2. You may store your leaves, as they are being pressed, in the greenhouse. Add to the collection daily, if possible.
 3. To press a leaf...place it between thick layers of newspaper under pressure for several days or until dry.
 4. Pressed leaves may then be mounted on a paper or a cardboard background. If you wish you may want to cover your leaves with a plastic film which will make your collection more permanent.
 5. Carefully label each leaf with its correct COMMON and SCIENTIFIC name.
 6. Neatly organize all your pages and secure them in some way to form a booklet.

Evaluation: Your efforts will be evaluated in the following way:

Possible Points

- ___ 1. Using a field guide or key, correctly identify 20 species or deciduous trees.
- ___ 2. Press, dry, and mount each leaf on a suitable background.
- ___ 3. Label each leaf (common and scientific names)

___ = total possible points

*Bonus Up to ___ additional points will be given for a particularly well-organized and creative booklet.

STUDENT WORKSHEET
MAKING A LEAF COMPARISON

Problem: Sketch the two leaves your instructor has given you.

Leaf #1

Leaf #2

Identify 4 ways in which these two leaves are different.

1.

2.

3.

4.

230

TRANSPARENCY DISCUSSION GUIDE

PLANT IDENTIFICATION

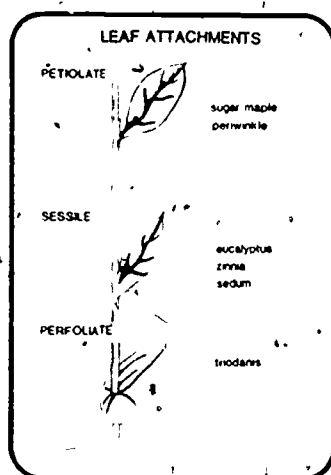

10. A petiole is the stalk of the leaf. There are three common attachments of leaves to stems. **Petiolate** attachment is identified by the leaf having a petiole. **Sessile** is identified by the leaf not having a petiole. **Perfoliate** is identified by the leaf not having a petiole and the stem being totally enclosed by the leaf. Wood merry bells (*Uvalaria perfoliatus*), a herbaceous perennial and the house plant *Crassula perfoliata*, (a member of the jade family), are examples of the perfoliate attachment.

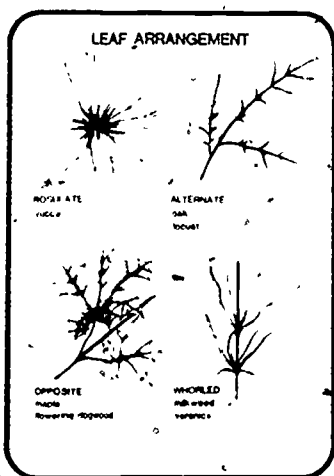

11. There are six basic types of leaf arrangement (four are now shown here). **Rosulate** or **rosette** plants are those that have a cluster leaf arrangement at ground level. This arrangement is common in yucca and dandelion. When rosulate plants are observed from above, no leaf shades another leaf. The **alternate** leaf arrangement is defined as a single leaf at each node. The **opposite** arrangement is defined as two leaves at a node. The **whorled** arrangement is defined as more than two leaves at a node. The herbaceous perennial, veronica is an example of the whorled leaf arrangement. **Fascicled** arrangement (not shown here but in transparency 15) are bundles of two to five needles that are enclosed by a sheath. **Clustered** arrangement (not shown) are false whorls at tips of spurs without a sheath. They are needles like as in larch.

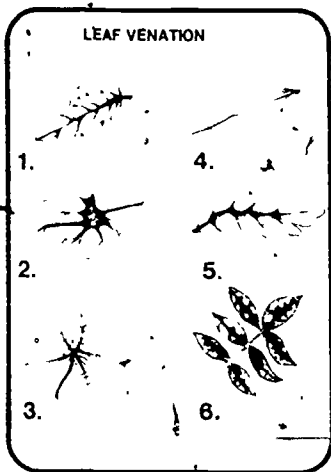

12. This transparency identifies two concepts, venation and simple and compound leaves. A simple leaf is defined as not being branched or divided into parts; not compound. Examples 1, 2, 4, and 5 are simple leaves. Leaves which are branching are compound leaves. Compound leaves can be identified by locating buds. If a bud is not present where the leaf attaches to a stem it is then a compound leaf. Examples 3 and 6 are compound leaves.

Venation is defined as the vein arrangement in the leaf. The arrangement of veins varies in leaves of different genera but usually conforms to one of two types. In **parallel venation** (Example 4), (iris, banana, lilies, and palms) the veins are parallel with each other and arrangement lengthwise in the leaf. In leaves with **net or branched venation**, (maple, ash, and coleus) there is a single midrib from which branches diverge. Example 1, is a net venation called **pinnate venation**. **Pinnate venation** is defined as smaller veins diverging from the midrib like a feather. An elm is an example of a pinnate leaf. **Palmate leaves** (Example 2) are identified by the veins diverging like fingers from the palm of one's hand. Sycamore, American linden and ivy are examples of palmate leaves. Example 3 is an example of a palmate leaf. Example 5 (oak) is an example of a **pinnatifid leaf**. Example 6 (ash) is an example of a **pinnately compound odd leaf**. Separate leaflets (each leaflet having venation like a feather) are arranged on either side of the leaf stalk called the **rachis**. If a single leaf is at its apex the leaf is termed odd.

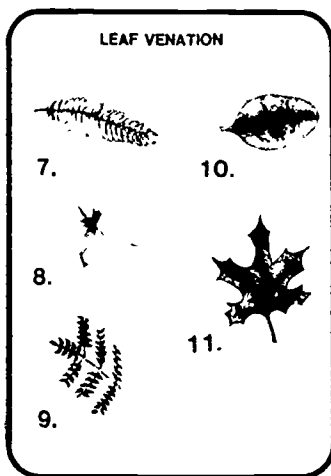

13. Example 7 (Acacia and mesquite) is an example of a **pinnately compound even leaf**. Separate leaflets (each leaf having the venation like a feather) are arranged on either side of a leaf stalk. If a single leaflet does not appear at the apex but rather a pair, the leaf is termed even. Example 8 is an example of a **trifoliate leaf**. Example 9 is an example of a **bi (twice) pinnately compound odd leaf**. Example 10 is an example of a simple leaf. Example 11 is an example of a palmate leaf that is also simple.

LEAF VENATION

- | | |
|--------------------------|---------------------------|
| 1 PINNATE | 7 PINNATELY-COMPOUND EVEN |
| 2. PALMATE | 8. TRIFOLIATE |
| 3 PALMATELY COMPOUND | 9. BI-PINNATELY COMPOUND |
| 4 PARALLEL | 10 SIMPLE |
| 5 PINNATIFID | 11. PALMATE-SIMPLE |
| 6 PINNATELY COMPOUND ODD | |

14. The identification of leaf types and leaf venations are displayed in transparency 14.

SPECIAL LEAF FORMS



A FASCICLE



SCALE-LIKE



AWL-LIKE

15. Special leaf arrangements commonly found in gymnosperms (naked seed plants) include the fascicle (needle-like) which occur in bundles of two to five which are enclosed at the base by a sheath. The sheath is not shown. A bundle of two are common in the jack pine and red pine. Bundles of five are common in the white pine. Scale-like leaves are common to the juniper. In junipers, the scales are opposite in arrangement and almost encircle the stem. Awl-like leaves are common to the cedar family and occur singly around the stem.

PINNATELY COMPOUND

SIMPLE BROAD LEAF



16. In order to identify plant material, using leaves, it is necessary to become familiar with terms used to describe plant leaves. A leaf consists of a more or less flat blade and usually a stalk. Most leaves have a one-piece blade and are therefore called simple leaves. A compound leaf is a leaf, the blade of which is subdivided into several parts, none of which have buds at their base. A leaflet is one of the several blades of a compound leaf, none of which have a bud at their base.

Structures of the leaf and stem are identified and a definition of the plant part is included. **Apex**—the tip, or point of the leaf, **Vein**—vascular tissue in the leaf, **Margin**—the edge of the leaf, **Blade**—the expanded, usually flattish, broad portion of a leaf, **Base**—the portion of the leaf to which the petiole is attached, **Petiole**—the stalk of the leaf, **Stipule**—a leaf-like structure on either side of the petiole, **Node**—the slightly enlarged portion of the stem where buds and leaves arise. **Internode**—the region of the stem between two nodes. **Rachis**—the main axis of the leaf stalk from which leaflets arise.

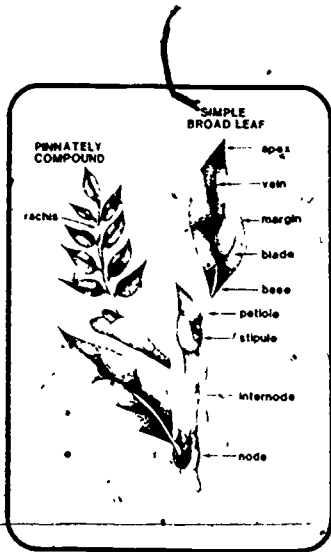

17. Parts of the stem and leaf are identified.

SAMPLE TEST QUESTIONS .

THE LEAF

(FILL IN THE BLANKS)...

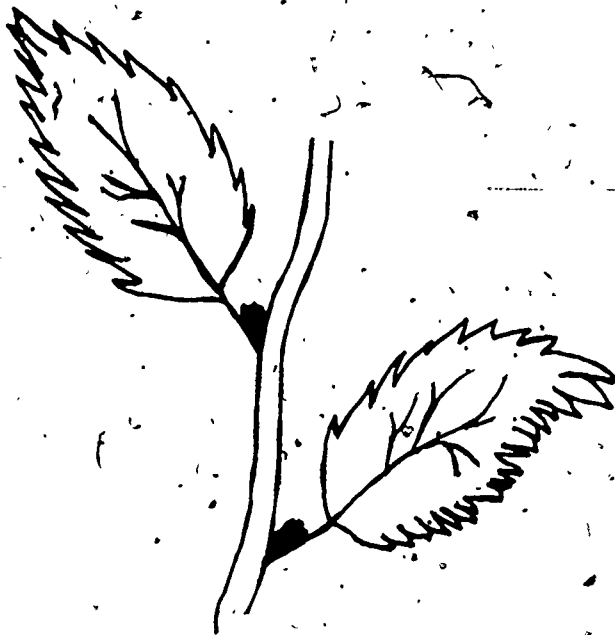

1. The edge of the leaf is called?

2. The vein pattern of the leaf is called:

3. Is this leaf simple or compound?

4. Is this leaf lobed or toothed?

5. Does this branch have an opposite or alternate pattern?

6. Label the bud on one of the leaves.

7. Label a blade on the picture.

8. You can tell leaves from leaflets because there is no _____ at the base of a leaflet.

ON THIS LEAF.....

9. Label a lobe.

10. Label the petiole.

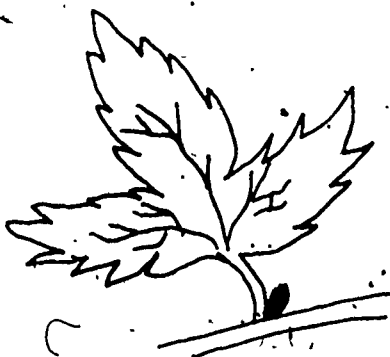

11. Explain the differences between an evergreen and a deciduous plant.

12. Circle the plant which has compound leaves.

Ash Sugar Maple Honeylocust Pin Oak Green

13. A plant that has palmately compound leaves is a _____

~~14. The leaf shape that is distinctively heart-shaped is a _____~~

15. Circle the plants which have simple leaves.

Burr Oak White Ash Norway Maple European Mountain Ash

16. Circle the plants which have leaves that are lobed.

Pin Oak Honeylocust Sugar Maple Ash

17. Circle the plant that have a lopsided leaf base:

Chinese Elm Sugar Maple American Linden Green Ash

293

UNIT F: PLANT IDENTIFICATION

PROBLEM AREA: IDENTIFYING DIFFERENT PARTS AND TYPES OF STEMS
SUGGESTIONS TO THE TEACHER:

This problem area is designed for use with freshman or beginning students in a horticultural or agricultural occupations program. The recommended time for teaching this problem area is during the spring semester.

The estimated instructional time for this problem area is 3 to 4 days, depending on how far the teacher wishes to go in developing twig and stem identification skills at the first year level. If the teaching plan is limited to classroom discussion, with little or no practice or observation, the instruction can be 2 days or less. If the students are to be involved in other activity exercises, the instructional time will need to be increased.

The instructor is encouraged to conduct a local search to locate other supplementary materials for use with this problem area. The items in this problem area are for reference or modification as instructors adapt this material to their local situation.

CREDIT SOURCES:

The materials were developed through a funding agreement, R-33-21-D-0542-388 with the Illinois State Board of Education, Department of Adult, Vocational and Technical Education, Research and Development Section, 100 North First Street, Springfield, Illinois 62777. Opinions expressed in these materials do not reflect, nor should they be construed as policy or opinion of the State Board of Education or its staff.

The teacher's guide, student worksheet, and test questions were developed by Jim Ethridge. Transparency masters and the transparency discussion guide were prepared by Vocational Agriculture Service, University of Illinois. Suggestions and guidance in the development of these materials were provided by the Metropolitan Core Curriculum Pilot Test Teachers.

TEACHER'S GUIDE

- I. Unit: Plant identification and classification
- II. Problem area: Identifying different parts and types of stems
 1. Parts of a herbaceous stem.
 2. Parts of a woody stem.
 3. Stem modification and adaptations.
- III. Objectives: At the close of this problem area students will--
 1. Name and identify major parts of stems.
 2. Demonstrate knowledge of the major functions of the stem.
 3. Demonstrate familiarity with terminology that relates to stem parts.
 4. Identify stem modifications.
- IV. Suggested interest approaches:

See Problem Areas I and II.
- V. Anticipated problems and concerns of students:
 1. What are the functions of stems?
 2. What is meant by the term shoot?
 3. What are aerial stems?
 4. What are subterranean stems?
 5. What are the differences between wood and herbaceous stems?
 6. Are annual stems always herbaceous?
 7. How are trees and shrubs different?
 8. What are: nodes, internodes, leaf axils, terminal buds, axillary buds, and adventitious buds?
- VI. Suggested learning activities and experiences:
 1. Take a walking tour of the school grounds. Using identification sheets, identify the parts of the herbaceous and woody stems.
 2. With examples, slides or pictures, examine modifications of stems.
 3. Divide the class into groups using identification of stems as the competition to encourage the learning of stems.

4. Provide class with samples of various types of stems. Have students fill in Worksheet Plant I.D. Woody #1 External Stem Parts.
5. Have growing in your greenhouse for this unit an Iris, Quack Grass, Strawberry, Onions, Lily, Crocus, Ajuga, Iris Potato, Grass in flower, Hen and Chicks.

VII. Application procedures:

1. The main purposes of this problem area are to teach information and develop skill in identifying plant stems, especially woody stems.
2. The application phase should be emphasized in the program areas: (a) deciduous trees; (b) deciduous shrubs, and; (c) woody ground covers.
3. Interrelate this material with plant careers materials.

VIII. Evaluation:

1. Prepare and administer a pencil and paper test using the Sample Test Questions as possible test items.
2. Collect and grade worksheets.
3. Prepare a laboratory exam and have students identify different types of stems and stem parts.

IX. References and aids:

1. Woody Plants in Winter, Core and Ammons, published by the Boxwood Press, Pacific Grove, California 1973. p. 7 to 9, 199 to 206.
2. Fruit Key and Twig Key to Trees and Shrubs, Harlow, William M. published by Dover Publications, Inc., New York, New York, 1946. p. 1 to 8 (second half of book)
3. Information Sheet on "Stem and Stem like Structures"
4. Transparencies and Transparency Discussion Guide
5. Student Worksheets on:
 - a. "Woody Stems"
 - b. "Modified Stems"
 - c. "Identifying Woody Stem Characteristics"
6. Sample Test Questions

200

INFORMATION SHEET

STEMS AND STEM-LIKE STRUCTURES

Types and Functions of Stems and Stem-like structures

Some principle types of stems and stem-like structures

1. Corn - A bulb-like, solid, fleshy, scale-covered enlargement, usually of the underground stem.
2. Bulb - Any of several underground stems that are comprised of a cluster of thickened, scale-like leaves.
3. Tuber - A short, thickened portion of an underground stem.
4. Crown - Portion of the stem just above and below the ground line (e.g., strawberries and asparagus).
5. Spurs - Compressed stems of woody plants adapted for fruit production (e.g., pears & apples).
6. Rhizome - A stem that grows under the soil surface; like a root. Has well-developed nodes and internodes.
7. Stolon - A stem that grows horizontally above the soil surface (e.g., bermuda grass, zoysia grass).
8. Thorn - A stiff, woody sharp pointed structure which represents a modified branch. (e.g., honey locust, pyracantha)
9. Prickle - A spine like outgrowth of the empidermis. Prickles are not connected to the vascular tissue and may be easily dislodged by pushing them side-wise (e.g., rose).
10. Spine - May form on leaves, at the apex, margin, stipules, or on other parts of the plant. Spines can be distinguished from thorns; the leaf forming the spine is always below a branch or bud.

300

M-I-F-3-5

STUDENT WORKSHEET

WOODY STEMS

I. Plant Materials Needed:

Hickory	Silver Maple
Lilac	Forsythia
Buckeye	

II. Equipment:

Pruners
Hand Lens
Knife

III. Procedure:

This exercise is designed to survey the important structures, functions, and parts of woody stems. Point to be identified are lenticles, buds, leaf scars, bundle scars, and scars of yearly growth. Nodes and internodes should also be identified. Compare three of the above plant materials draw them, diagram them and note their differences.

IV. Note:

Twigs in winter condition is one of many methods of identifying deciduous plant material.

V. Discussion Questions:

1. What is a bud?
2. Identify 3 kinds of buds.
3. During what time of the year are buds formed?
4. What prevents buds on trees from freezing?

STUDENT WORKSHEET

MODIFIED STEMS

I. Plant Materials Needed:

- 1) Runners of strawberry, strawberry begonia, spider plant, or Boston fern
- 2) Rhizomes of quack grass
- 3) Corm of crocus or gladiolus
- 4) Tuber of white Irish potato
- 5) Bulb of tulip or hyacinth
- 6) Bulb of lily

II. Equipment

- 1) Knife

III. Procedure: Identify the plant observed and indicate. Note the external features of these stems. Properly label the features of these stems. Cut open these stems and examine the internal features of these stems.

IV. Observations:

V. Discussion Questions:

1. Define the following:

Runner

Rhizome

Tuber

Corm

Bulb

2. How do each of the above differ?
3. Explain why the popular use of the term bulb is often incorrect.

STUDENT WORKSHEET

IDENTIFYING TWIGS IN WINTER CONDITION

1. Procedure: Given eight woody twigs, identify the twigs according to their woody stem characteristics.

	Name of tree or shrub	Leaf Arrangement	Twig Color	Leaf Scar (sketch)	Other Characteristics (thorns, bud scales; etc.)
1.					
2.					
3.					
4.					
5.					
6.					
7.					
8.					

TRANSPARENCY DISCUSSION GUIDE

PLANT IDENTIFICATION

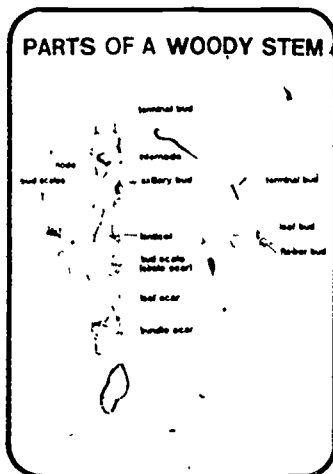

4. Foresters and horticulturalists commonly use woody and herbaceous twig and stem characteristics as their means of plant identification (especially in winter). Leaf scars are usually triangular scars which represent the point of attachment of the petioles of old leaves. The leaf scar occupies a position on the stem called a node. The terminal bud is the large bud at the tip of a branch. Axillary buds are smaller buds located above a leaf or leaf scar. Bud scales are specialized leaves which protect the bud over winter. The bud scale scars are left after the bud scales have dropped off. The node refers to a position where one or more leaves are attached. The portion of the stem or twig between successive nodes is an internode. Lenticles are small openings in the bark.

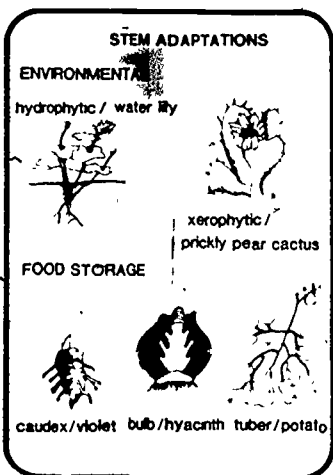

5. To a great extent environmental conditions determine successful plant growth and development in a particular location. The xerophyte (xero = dry, phyte = plant) prickly pear cactus exists in a dry climate because the plant stems have thickened and have a waxy covering. This enables the plant to store moisture for periods when it is dry. The hydrophyte (hydro = water, phyte = plant) has the ability to grow in water. The water lily has the ability to elongate the stems of leaves and flowers, rising above the depth of the water. The vast majority of plants fall between these two extremes.

* The violet, hyacinth, and Irish potato have stem adaptations for underground food storage and vegetative reproduction.

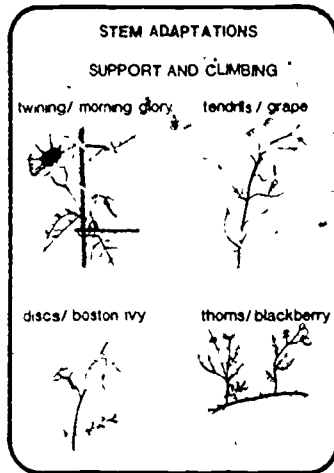

6. Stems of some plants have the ability to aid in climbing, support, or defense. The stem of some plants have the special ability to twine, that is, to twist around some structure for support. Other plants such as the grape have a specialized leaf, the tendril, that wraps around its support as it grows. Prickles develop from tissues that may be easily dislodged by pushing them sideways. The rose is an example of a plant that has prickles. The thorns and prickles protect the plant. The rounded adhesive discs found in Boston ivy are actually tendrils with 5 to 12 branches.

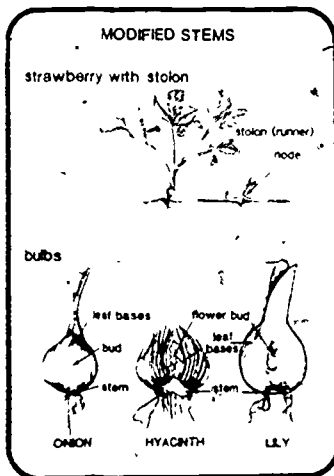

7. Strawberry, strawberry begonia and spider plants are examples of plants that produce above ground stems called stolons (runners). A major function of the stolons is the vegetative reproduction of the plant.

Bulbs are specialized food storage stems usually produced underground. The onion, hyacinth, and lily are common examples. The bulb also has vegetative reproductive capabilities.

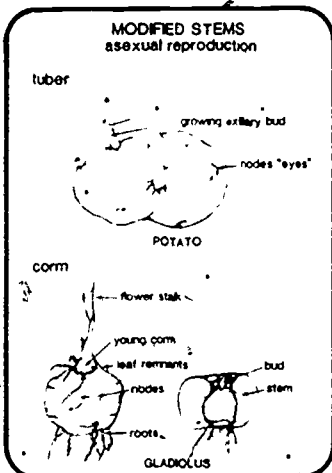

8. The Irish potato is a tuber (underground stem) and not a true root. Only a stem has the ability to produce buds (eyes in potatoes). The corm, another underground stem, is different from a bulb because the corm does not increase in size each year, nor does it live from year to year as does the bulb. When the corm is planted and flowers, a new corm develops on the top or side of the old corm. It is possible for several corms to develop from an old corm.

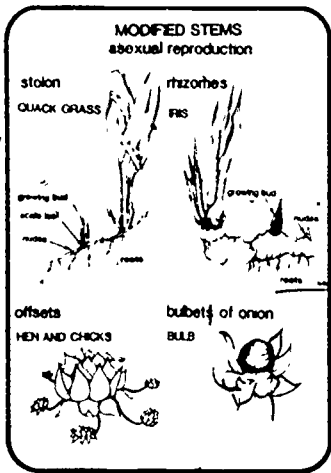

9. Quack grass has underground stems called rhizomes. When this underground stem is cut by a hoe or other cultivation practices, each node cut from the parent plant has the ability to grow into a separate plant. The rhizome can be identified as a stem and not a root because it has buds. An iris and hen and chicks are also examples of rhizomes.

SAMPLE TEST QUESTIONS
AND TEACHERS KEY

TRUE-FALSE (+ = True; 0 = False)

- + 1. A leaf forming a spine is always below a branch or bud.
- + 2. There are two types of aerial stems; herbaceous and woody.
- + 3. There are underground stems.
- + 4. The aerial stems of most plants are erect but some are climbing and some prostrate.
- + 5. The section between two successive nodes is called an internode.
- 0 6. Occasionally, buds arise at places other than in the axils of leaves. These are called terminal buds.
- 0 7. Bud scales are not specialized leaves.
- 0 8. Lenticels function in the woody plant stem are to exchange moisture in the plant.
- 0 9. Woody plants cannot "self-prune" themselves.
- 0 10. A tendril stem and a twiner are the same specialized stem.
- 0 11. Plants do not produce bulbs above ground.

COMPLETION (Write appropriate information or words to complete statements)

1. The point on a stem from which a leaf or bud arises is called a node .
2. Buds that occur at the tips of the stems are terminal .
3. Adventitious buds arise in places other than the axils of leaves or the tips of stems.
4. A covered bud is protected by overlapping protective bud scales that are modified leaves.
5. Herbaceous stems are soft, usually green, with little woody tissue, and usually not much growth in diameter, and are chiefly annual.
6. Woody stems are tough, not usually green after one growing season, show considerable growth in diameter and are mostly perennial.
7. When bud occurs at a node, bud arrangement is called alternate or spiral .
8. When buds occur at a node, bud arrangement is called opposite .

9. When more than two buds occur at a node, the arrangement is called whorled.
10. The point on a stem from which a leaf develops is called a node.

MATCHING (Select the matching answer A through M that most satisfactorily fits the description or word in the left column.)

- | | | | | |
|------------|-----|--------------------|----|-----------------|
| <u>C</u> | 1. | Gladiola | A. | Rhizomes |
| <u>C</u> | 2. | Crocus | B. | Tubers |
| <u>E</u> | 3. | Strawberry Begonia | C. | Corms |
| <u>D</u> | 4. | Sweet Pea | D. | Tendrils |
| <u>B</u> | 5. | Irish potato | E. | Running-Stolons |
| <u>F</u> | 6. | Cactus | F. | Thorns |
| <u>I</u> | 7. | Rose | G. | Twining |
| <u>A</u> | 8. | Iris | H. | Bulb |
| <u>E</u> | 9. | Hen and Chicks | I. | Prickles |
| <u>E-K</u> | 10. | Strawberry | J. | Spines |
| <u>G</u> | 11. | Morning Glory | K. | Crown |
| <u>F</u> | 12. | Blackberry | L. | Spur |
| <u>H</u> | 13. | Tulip | M. | Stoma |
| <u>F</u> | 14. | Firethorn | | |
| <u>J</u> | 15. | Holly | | |
| <u>K</u> | 16. | Asparagus | | |
| <u>F</u> | 17. | Honey-locust | | |
| <u>A</u> | 18. | Quackgrass | | |
| <u>F</u> | 19. | Honeylocust | | |

300

MULTIPLE CHOICE:

- B 1. Which of the following is not a function of the stem?
- A. Food storage
 - B. Anchorage.
 - C. For support and climbing
 - D. For sexual reproduction
- C 2. Which of the following is not reproduced by stolons or runners?
- A. Spider plants
 - B. Strawberry
 - C. Iris
 - D. Strawberry begonia
- A 3. Which of the following is not an underground stem?
- A. Stolon
 - B. Rhizome
 - C. Bulb
 - D. Corm
- D 4. Which of the following is not an above-ground stem?
- A. Twiner
 - B. Tendril
 - C. Bulb
 - D. Corm
- D 5. Above ground spreading runner-like stems are called!
- A. Rhizomes
 - B. Meristems
 - C. Tubers
 - D. Stolons
- B 6. Enlarged, fleshy parts of a rhizome are:
- A. Stolons
 - B. Tubers
 - C. Bulbs
 - D. Rhizomes
- D 7. Underground stems that grow horizontally and contain nodes from which new plants originate are:
- A. Crowns
 - B. Bulbs
 - C. Corms
 - D. Rhizomes

A

8. Plant structures that are short, flattened or disc-shaped and have leaf-like scaly structures are:

- A. Bulbs
- B. Tubers
- C. Corms
- D. Crowns

B

9. A stem modification that is found at the soil surface from which several stems (sometimes called suckers) may grow is:

- A. Tuber
- B. Crown
- C. Rhizome
- D. Spur

310

UNIT F: PLANT IDENTIFICATION

PROBLEM AREA: IDENTIFYING DIFFERENT PARTS AND TYPES OF FRUITS

SUGGESTIONS TO THE TEACHER:

This problem area should be taught to freshman or beginning students enrolled in a horticultural or agricultural occupations program. The recommended time for teaching this problem area is during the spring semester. It is suggested that the teacher, not only identify the botanical features of the fruit but also bring to class different kinds of fruit from the grocery.

The estimated instructional time for this problem area is 3 to 5 days depending on how far the teacher wishes to go in developing fruit identification skills at the first year level. If the teaching plan is limited to classroom discussion with little or no practice or observation, the instructional can be 2 days or less. If the students are to be involved in other activity exercises, the instructional time will need to be increased.

The instructor is encouraged to conduct a local search to locate other supplementary materials for use with this problem area. The items in this problem area are for reference or modification as instructors adapt this material to their local situation.

CREDIT SOURCES:

These materials were developed through a funding agreement, R-33-21-D-0542-388 with the Illinois State Board of Education, Department of Adult, Vocational and Technical Education, Research and Development Section, 100 North First Street, Springfield, Illinois 62777. Opinions expressed in these materials do not reflect, nor should they be construed as policy or opinion of the State Board of Education or its staff.

The teacher's guide, student worksheet, and test questions were developed by Jim Ethridge. Transparency masters and the transparency discussion guide were prepared by the Vocational Agriculture Service, University of Illinois. Suggestions and guidance in the development of these materials were provided by the Metropolitan Core Curriculum Pilot Test Teachers.

TEACHER'S GUIDE

- I. Unit: Plant identification and classification
- II. Problem area: Identifying plants by their fruit
- III. Objectives: At the close of this problem area students will--
 1. Be able to name or identify major parts of fruits.
 2. Be able to demonstrate knowledge of the major types of fruits.
 3. Be able to demonstrate familiarity with terminology that relates to fruits.
 4. Be able to identify genus by fruit characteristics.
- IV. Suggested interest approaches:
 1. Collect the fruit types and have a tasting experience to see if they can identify some by type.
 2. Blindfold several students and have them describe the fruits they touch.
 3. See Problem Areas I and II.
- V. Anticipated problems and concerns of students:
 1. How are fruits classified?
 2. What are the different structures of fruits?
 3. How does the botanical term fruit vary from the common term?
 4. What do we do with fruits besides eat them?
 5. What are simple fruits?
 6. What are aggregate fruits?
 7. What are compound fruits?
 8. What structure terms are involved in identifying fruits?
 9. What are accessory fruits?
 10. What is a carpel? What kinds of carpels exist?

11. What kinds of seeds exist?
12. How are seeds disseminated?
13. What is a stone?
14. What are the parts of the seedling?
15. What are the 3 parts of the pericarp?
16. What is dormancy in seeds?
17. What is a fruit?
18. Why is the tomato fruit a berry?
19. What is a pericarp?

VI. Suggested learning activities and experiences:

1. Provide class with samples of various types of fruits. Have students complete worksheets.
2. To have students bring different groups of fruits to class and identify each type.

VII. Application procedures:

1. The main purposes of this problem area are to teach information and develop skill in identifying plant flowers - especially herbaceous flowers.
2. The application phase should be emphasized in the problem areas: (a) herbaceous annuals (b) herbaceous perennials (c) ground covers.

VIII. Evaluation

1. Prepare and administer a pencil and paper test using the Sample Test Questions as possible test items.
2. Collect and evaluate worksheets.
3. Prepare a laboratory exam and have students identify different types of fruits.

IX. References and aids:

1. Student Worksheet on:
 - a. "Identifying fruit"

b. "Identifying fruits - Discussion Questions"

2. Sample Test Questions and Teacher's Key
3. Transparencies and Transparency Discussion Guide
4. Fruit Key and Twig-Key to Trees and Shrubs, Harlow, William M. Dover Publications, Inc. New York, New York. 1946, p. 1-11. (First half of book)
5. Vocational Agriculture Service Slide Set
 - a. #670.1 Identifying Fruits, Nuts, and Pods

STUDENT WORKSHEET

IDENTIFYING FRUIT

Plant Materials:

1) Fruits: (a) pea or bean pod, (b) milkweed or peony fruit, (c) iris or tulip fruit, (d) maple or ash fruit, (e) clematis, dandelion, or goats beard, (f) acorn, (g) caryopsis of bluegrass, bent grass, brome grass, (h) orange of lemon, (i) cucumber or squash, (j) cherry or peach, (k) apple, pear, or quince, (l) strawberries, or (m) pineapple. Others may also be included.

Equipment:

Knife

Procedure:

Identify each fruit type and a description of that fruit type.

Observations:

Identify the fruit name with the fruit observed in class:

Legume -

Pome -

Follicel -

Aggregate -

Capsule -

Multiple -

Achené -

Hesperidium -

Samara -

Nut -

Caryopsis -

Berry -

Peop -

Drupe -

STUDENT WORKSHEET

~~IDENTIFYING FRUITS - DISCUSSION QUESTIONS~~

1. Identify dry fruits observed in class and fleshy seeded fruits observed in class.
2. Identify simple fruits observed in class and compound fruits observed in class.
3. Identify dry fruits observed in class that split open when dry and dry fruits that do not split open when dry.
4. What is the difference between aggregate fruits and multiple fruits?
5. Name several horticultural plants in your class room, the greenhouse or in the landscape and the type of fruit they have?
6. What is a fruit? and how is it used in the Identification of plant materials?

313

TRANSPARENCY DISCUSSION GUIDE

PLANT IDENTIFICATION

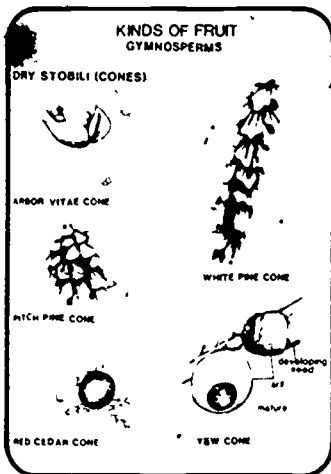

40. The evergreens or conifers and some broad leaf plants belong to a group of plants known as Gymnosperms. The name means "naked seeds." Most gymnosperms produce a fruit called a cone. The "berry" or fleshy cone is common to taxus and juniper. The fleshy seed coats are termed arils. Pines and arborvitae have dry cones. They usually remain upright for their first growing season and then turn down or pendulate.

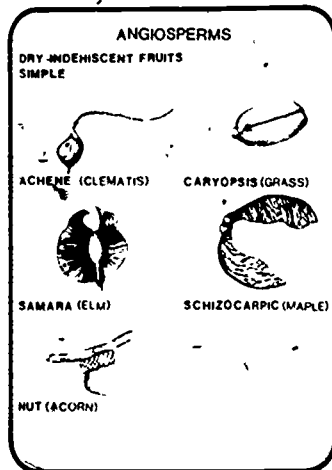

41. Angiosperms are plants that produce their seed within an ovary. The ripened ovary is called a fruit. Angiosperm fruit will be dry or fleshy. A dry fruit is one in which the entire pericarp becomes dry and hard at maturity. The pericarp is composed of three tissues: (1) the **exocarp** is the outer most layer of epidermal cells, (2) the **mesocarp** is the middle layer of tissue and, (3) the **endocarp** is the inner layer. There are two types of dry fruit; the indehiscent and dehiscent types. An **indehiscent** fruit is one which does not split along definite seams when ripe and will usually contain one or two seeds. An **achene** bears only one seed which will separate from the ovary except at the point of attachment. Examples of achenes include sunflowers and dandelions. The **caryopsis** bears only one seed. The **samara** is a one or two seeded fruit with its pericarp flattened into a wing like outgrowth. Ex. maples, elms and ash. A **nut** is a one seeded fruit with a hard pericarp. Ex. acorn, chestnut and hazelnut. The **schizocarpic** fruit splits into two halves. Ex. the maple.

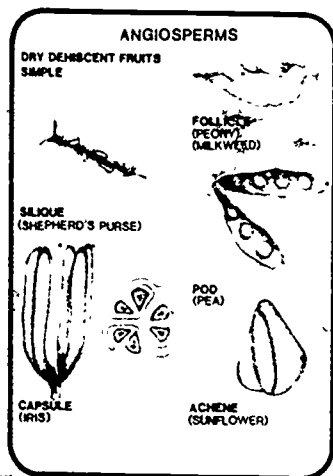

42. A dehiscent fruit is one that splits along definite seams when ripe. The fruit may contain many seeds. The legume consists of one carpel which splits along two seams. Ex. the red bud and honey locust. The follicle consists of one carpel which will split along one seam. Ex. the peony, larkspur, delphinium and columbine. The capsule consists of two or more fused carpels and split in a variety of ways. Ex. the lily, tulip, iris, crocus, and snapdragon. The silique consists of two fused carpels that split at maturity. Ex. cabbage, mustard, and shepards purse.

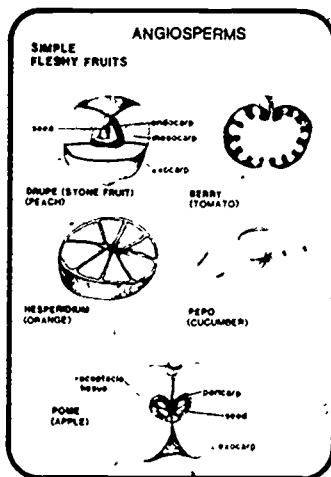

43. A simple fruit consists of a single ripened ovary. A fleshy fruit has all or most of the pericarp fleshy. Seeds are released from the fruit as a result of decomposition or consumption and excretion. In the berry the entire fruit is fleshy. Ex. grapes, tomatoes, oranges, currants watermelons and cucumbers. The hesperidium is a specialized berry. This berry has a hard rind and definite longitudinal sections. All citris are examples of this berry type. The pepo is the specilized berry as exemplified by the cucumber, squash and melon. In drupes the exocarp is a thin skin, the mesocarp is fleshy, and the endocarp is hard and stoney. Common examples include peaches, cherries, apricots, olives and plums.

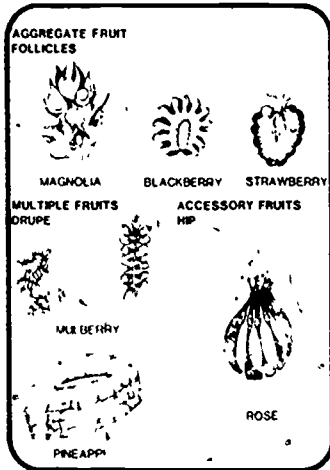

44. An aggregate fruit is a cluster of several ripened ovaries produced by a single flower. The individual ripened ovary may be a follicle as in magnolia, drupes in blackberries or achenes in buttercups.

A multiple fruit is a cluster of several ripened ovaries produced by several flowers crowded on the same inflorescence. Mulberries, orange, and pineapples are examples of multiple fruits.

Accessory fruits are structures that consist of one or more ripened ovaries together with tissues of some other plant part. Strawberries are actually receptacles on which the seed sets. To be defined correctly the strawberry is an aggregate drupe with an accessory receptacle. A pome (apples and pears) are actually ripened ovaries surrounded by an enlarged receptacle and calyx tissue. A rose hip is actually an achene with accessory tissues.

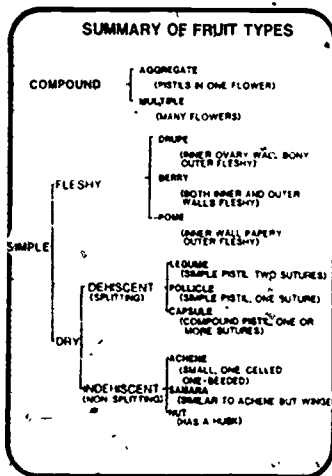

45. The summary of fruit types is only a summary of angio-sperm fruit. A brief description of each fruit type is provided in the transparency.

SAMPLE TEST QUESTIONS AND TEACHERS KEY

TRUE-FALSE (+ = True 0 = False)

- + 1. A fruit is a ripened ovary.
- 0 2. A cucumber is a fruit.
- 0 3. A strawberry is a simple fruit.
- + 4. Wind and water are common methods of seed dissemination.
- + 5. The pericarp is the combined name for the endocarp, exocarp, and mesocarp.
- 0 6. Walnuts and acorns are examples of nuts.
- + 7. A multiple fruit is derived from several flowers.
- 0 8. A blackberry is a multiple fruit.
- + 9. A pod is another name for a legume fruit.
- + 10. When planting a lawn you are planting the fruit of the caryopsis.

MULTIPLE CHOICE (make appropriate choice of A, B, C or D)

- D 1. Which of the fruits listed is not an achene?
- A Rose hip
- B Potentilla
- C Geranium
- D Maple
- C 2. Which of the fruits listed is not a nut?
- A Oak (acorn)
- B Hickory
- C Elm
- D None of the above

- C 3. Which of the fruits listed is not a samara?
- A Elm
 - B Maple
 - C Pine
 - D Ash
- D 4. Which of the fruits listed is not a legume?
- A Garden Peas
 - B Honeylocust
 - C RedBud
 - D None of the above
- A 5. Which of the fruits listed is not a hesperidium?
- A Peach
 - B Orange
 - C Lemon
 - D Lime
- A 6. Which of the following is not a part of the fruit?
- A Alphacarp
 - B Meocarp
 - C Endocarp
 - D Ectocarp
- B 7. Which of the following is not a fleshy fruit?
- A Berry
 - B Follicle
 - C Drupe
 - D Pepo

321

- A 8. Which of the following is not a dehiscent fruit?
- A Pepo
B Legume
C Follicle
D Capsule
- D 9. Which of the following is not an indehiscent fruit?
- A akene
B caryopsis
C nut
D pome
- C 10. Which of the following is not an aggregate fruit?
- A Raspberry
B Strawberry
C Cranberry
D Blackberry

MATCHING (Select the matching answer A through L that most satisfactorily fits the description or word in the left column)

- | | |
|-------------------------|---------------|
| <u>F</u> 1. Cones | A. Cottonwood |
| <u>B</u> 2. Arillike | B. Juniper |
| <u>J</u> 3. Follicle | C. Tomato |
| <u>H</u> 4. Pod | D. Tulip |
| <u>E</u> 5. Achene | E. Dandelion |
| <u>C</u> 6. Berry | F. Pines |
| <u>L</u> 7. Hesperidium | G. Muskmelon |
| <u>G</u> 8. Pepo | H. Locust |
| <u>D</u> 9. Capsule | I. Maple |
| <u>I</u> 10. Samara | J. Peony |
| | K. Acorn |
| | L. Grapefruit |

COMPLETION QUESTIONS:

1. Simple fruit form from a single, simple or compound ovary.
2. Aggregate fruits form from a collection of ovaries of a single flower ripening into a single mass.
3. Multiple fruits form from ovaries of several flowers massed together on or in a common receptacle.
4. Accessory fruits form from ovaries with adjacent parts such as the calyx and the receptacle developing into them.
5. Dehiscent fruits are kinds of fruits and escape by splitting open while indehiscent fruits do not split open.
6. A ripened ovary is termed a fruit.
7. A pericarp may consist of three tissue layers. The outer layer is called the exocarp, the center layer the mesocarp and the inner layer the endocarp.
8. Fruits are important in many ways. Three of these are:
(a) food, (b) drugs (c) dyes waxes
spices
9. Gymnosperms do not produce fruit, but do produce naked bearing seeds in dry strobili commonly called cones as in pines and berries as in ginkgo, junipers and yews.
10. Give one reason why a tomato is termed a vegetable.
(a) -served with or before the main course of a meal
Give one reason why a tomato is termed a fruit.
(a) ripened ovary

UNIT F: PLANT IDENTIFICATION

PROBLEM AREA: IDENTIFYING DIFFERENT PARTS AND TYPES OF FLOWERS

SUGGESTIONS TO THE TEACHER:

This problem area should be taught to freshman or beginning students enrolled in a horticultural or agricultural occupations program. The recommended time for teaching this problem area is during the fall semester when many types or forms of flowers are available.

The estimated instructional time for this problem area is 3 to 5 days. Depending on how far the teacher wishes to go in developing flower identification skills at the first year level. If the teaching plan is limited to classroom discussion with little or no practice or observation, the instruction can be 2 days or less. If the students are to be involved in other activity exercises, the instructional time will need to be increased.

The instructor is encouraged to conduct a local search to locate other supplementary materials for use with this problem area. The items in this problem area are for reference or modification as instructors adapt this material to their local situation.

CREDIT SOURCES:

These materials were developed through a funding agreement, R-33-21-D-0542-388 with the Illinois State Board of Education, Department of Adult, Vocational and Technical Education, Research and Development Section, 100 North First Street, Springfield, Illinois 62777. Opinions expressed in these materials do not reflect, nor should they be construed as policy or opinion of the State Board of Education or its staff.

The teacher's guide, student worksheet, and test questions were developed by James Ethridge. Transparency masters and the transparency discussion guide were prepared by the Vocational Agriculture Service, University of Illinois. Suggestions and guidance in the development of these materials were provided by the Metropolitan Core Curriculum Pilot Test Teachers.

TEACHER'S GUIDE

- I. Unit: Plant identification and classification
- II. Problem area: Identifying different parts and types of flowers
- III. Objectives: At the close of this problem area students will--
 1. Name or identify major parts of flowers.
 2. Demonstrate knowledge of the major functions of the flower.
 3. Demonstrate familiarity with terminology that relates to stem parts.
 4. Classify flowers based on their characteristics.
- IV. Suggested interest approaches:
 1. Have each student or groups of student collect 10 flowers; each group collecting a different plant group. The groups could be (a) weeds; (b) annual flowers; (c) perennial flowers; (d) deciduous trees; (e) deciduous shrubs; (f) ground covers; (g) flowering house plants; (h) broad leaf evergreens; (i) narrow leaf evergreen trees; (j) narrow leaf evergreen shrubs and then identify the specific flowers.
 2. See Problem Area I and II.
- V. Anticipated problems and concerns of students:
 1. What is the difference between complete and incomplete flowers?
 2. What are the names of the organs of a complete flower and what are their functions?
 3. How does one distinguish among carpel, pistil, simple pistil, and compound pistil?
 4. What are the major differences between flowers of monocotyledons and those of dicotyledons?
 5. What is radial and bilateral symmetry? What are some examples?
 6. What is the difference between spiral and cyclic arrangement of flower parts?
 7. What is the difference between superior and inferior ovaries?
 8. What is a composite inflorescence?
 9. How is a grass flower described?
 10. How do primitive and advanced flowers differ?

11. Nursery catalogs frequently advise that a person desiring to have a fruit tree in his/her garden should buy two fruit trees. Why?
12. Why can the quality of a flower be maintained longer by leaving it on the plant?

VI. Suggested learning activities and experiences:

1. Have each student collect flowers from a specific group of plants; annual flowers, perennial flowers, grasses, weeds, woody trees, shrubs, vines, house plants, wholesale florists for studying all the parts, characteristics and functions.
2. Brainstorm how florists use flowers in wedding work (corsage and nosegay) and why specific flowers are favorites in regard to ease of working with them.
3. Dissect a rose on the "bush" by removing sepals and petals - observe how the hip develops, then, after maturing, dissect it. A gladiola works very well as does daisies or curbit flowers.
4. From the flowers collected, dry them in silica sand and borax and make a display using all of the learned terminology. If drying is not appropriate, use pressing method and frame the floral collections. Framing is excellent for very small flowers.

VII. Application procedures:

1. The main purposes of this problem area are to teach information and develop skill in identifying plant flowers.
2. The application phase should be emphasized in these problem areas: (a) annual flowers; (b) perennial flowers; (c) weeds; (d) herbaceous ground covers; (e) deciduous trees; (f) deciduous shrubs.

VIII. Evaluation:

1. Prepare and administer a pencil and paper test using the Sample Test Questions as possible test items.
2. Collect and grade worksheets.

IX. References and aids:

1. Information Sheet on Flowers
2. Student Worksheets on:
 - a. Flower identification
 - b. Flower identification check sheet
 - c. Flower identification check sheet
3. Transparencies and Transparency Discussion Guide
4. Sample Test Questions
5. Vocational Agriculture Slide Set: #670.2 "Identifying Flower and Inflorescences"

INFORMATION SHEET

"FLOWERS"

Characteristics of Flowers

Plant flowers are specialized shoots, with the different flower parts representing specialized leaves. The flower has both sterile and reproductive leaves and is supported by the receptacle. Below the receptacle are internodes and nodes. The first internode below the receptacle is the pedicel, and the second internode is the peduncle. (This term is sometimes used to designate a branch bearing a cluster of flowers.) These two areas may also be referred to as the flower stalk. A specialized leaf, known as the bract, is usually at the base of the pedicel.

A flower may be either complete or incomplete. Each is discussed below:

Complete Flower

All complete flowers have four stem appendages or parts which are a part of the flower. These are the sepals, petals, stamens, and pistils (carpels). The sepals are the outer whorl, while the petals form the inner whorl. Both are sterile leaves and are known collectively as the perianth (floral envelope).

The sepals collectively are known as the calyx and are usually green but may be another color. The sepals prevent the rapid evaporation of plant moisture within the inner part of the flower.

The petals, derived mostly from stamens, are either white or colored; corolla is the term used when referring to the petals collectively. It is not always possible to distinguish between the sepals and the petals, as they look alike on some plants. The lily is an example.

The stamen (male part of the flower) is composed of an anther and a filament (stalk). The anther is the pollen bearing portion of the flower and usually contains four pollen sacs (microsporangia). The pollen is released by the anthers and carried by insects, birds, water, or wind to the carpel (female part of the flower).

The flower may have one or more carpels. If it has only one carpel, it is the pistil (a specialized leaf). If the flower has two or more separate carpels, each is a pistil; two or more united carpels are collectively a pistil. The pistil is composed of an ovary, style, and stigma. The ovary contains ovules which develop into seed after fertilization. The stigma collects pollen, and the style is the passageway through which the pollen is allowed to pass. The pollen grain grows in the ovary cavity.

Incomplete Flower

Many flowers are incomplete and may lack the perianth, a part of the perianth, or either stamens or pistils. Usually, the petals of the perianth are missing, and the calyx is present on an incomplete flower. Sometimes the petals are present and the sepals are absent, but this is unusual.

Flowers that have both stamens and pistils are bisexual, while those lacking either are unisexual. If pistils only are present on the flower, the flower is pistillate; and if the flower has only stamens, it is staminate.

If both pistil and stamen are present on the flower, the plant is monoecious. The plant is dioecious when only the staminate or pistillate is produced. The plant is polygamous when the pistillate and staminate are perfectly formed.

Inflorescence

Inflorescence is the mode of development and arrangement of flowers on an axis. As previously stated, the two different kinds of flower stalks are the peduncle (a stalk bearing a fruit or flower cluster) and the pedicel (a stalk that supports a fruiting or spore bearing organ).

320/

STUDENT WORKSHEET
FLOWER IDENTIFICATION

Materials:

Lily flowers
Gladiola flowers
Carnation flowers
Rose flowers
Staminate and Pistilate flowers of pine or cucumber or squash
Knife
Hand lens

Purpose: The student will identify the major portions of the flower and be able to classify flowers based on their flower parts.

Procedure:

Observations:

1 9-6
STUDENT WORKSHEET
FLOWER IDENTIFICATION

Given some of the following flowers identify them according to the following characteristics (check the appropriate characteristics).

Plant No. _____

Complete Flower _____ Incomplete Flower _____ (identify the parts missing):

Male Flower _____ Female Flower _____

Tubular Flower _____ Bell Flower _____ Rotate Flower _____

Papilionaceous Flower _____ Spadix Flower _____ Catkin Flower _____

Labiata Flower _____ Grass Flower _____

Other Observations: _____

Plant No. _____

Complete Flower _____ Incomplete Flower _____ (identify the parts missing):

Male Flower _____ Female Flower _____

Tubular Flower _____ Bell Flower _____ Rotate Flower _____

Papilionaceous Flower _____ Spadix Flower _____ Catkin Flower _____

Labiata Flower _____ Grass Flower _____

Other Observations: _____

Plant No. _____

Complete Flower _____ Incomplete Flower _____ (identify the parts missing):

Male Flower _____ Female Flower _____

Tubular Flower _____ Bell Flower _____ Rotate Flower _____

Papilionaceous Flower _____ Spadix Flower _____ Catkin Flower _____

Labiata Flower _____ Grass Flower _____

Other Observations: _____

STUDENT WORKSHEET
FLOWER IDENTIFICATION

Discussion Questions:

1. What is the function of the flower?
2. What is a flower cluster?
3. Name two plants that have male and female flowers on the same plant but in different locations?
4. Name two plants that have male and female flowers on different plants?
5. What are the four main parts of the flower?
6. What is a bract?
7. Why do some flowers have colored petals and sepals?
8. Name two plants that have catkins as flower types.

TRANSPARENCY DISCUSSION GUIDE

PLANT IDENTIFICATION

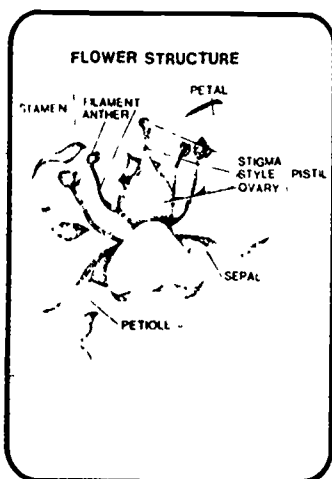

31. A complete flower is composed of: (a) sepals, (b) petals, (c) stamens, and (d) pistil, all attached to one receptacle. The receptacle is not shown. The sepals are usually green and the petals are usually colored. Each stamen has a slender stalk called a filament at the top of which is an anther bearing pollen. A pistil is composed of three parts: (a) the stigma which catches the pollen grains, (b) the style in which the pollen grain grows down to fertilize the egg, and (c) the ovary. Variations in floral structure are some of the methods by which we are able to identify plants. If the flower is missing any one of the sets of floral parts, it is an incomplete flower. Incomplete flowers are common in willow, pumpkins, holly, asparagus, oak and walnut. A perfect flower has both pistils and stamens but may lack other flower parts.

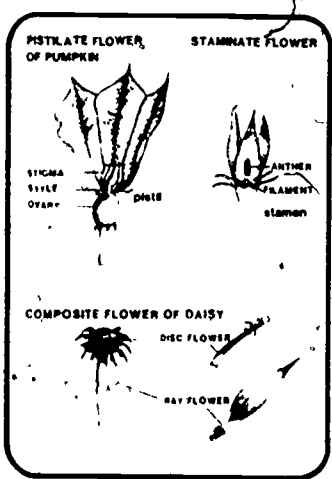

32. Single sex flowers are said to be imperfect while bisexual flowers are termed perfect. Flowers bearing only stamens are termed **staminate** and pistil bearing flowers are termed **pistilate**. When male and female flowers are born on the same plant but in imperfect form as in squash; the plant is termed **monoecious**. When male and female flowers (imperfect) are born on separate plants as in asparagus, willow, and holly the plant is said to be **dioecious**.

In dahlia and sunflower and many other composite flowers there are two distinct types of individual flowers. They are: ray flowers and disc flowers. Some species or varieties have all ray flowers as in the cactus, dahlia, and all disc flowers as in the globe thistle. Ray flowers are frequently sterile of pistils and disc flowers are generally complete.

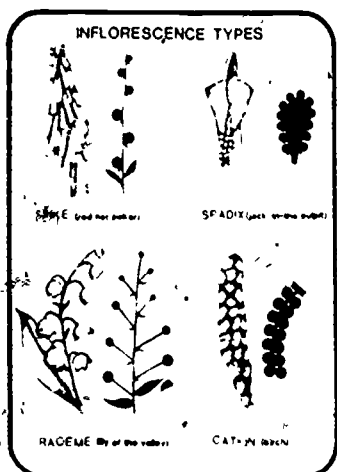

33. An inflorescence is a flower cluster not easily changed by environmental conditions. Four inflorescences are identified with descriptions of their particular characteristics. Examples of the inflorescence are identified.

Spike – main axis is elongated and the flowers are sessile. Ex. red hot poker and plaintain.

Spadix – a spike with fleshy axis, a spathe is the large bract enclosing the inflorescence. Ex. calla lily, jack-in-the-pulpit and anthurium (and the family *Araceae*).

Raceme – the main axis is elongated and the pedicles are about equal in length. Ex. lily-of-the-valley (the flowers are alternate).

Catkin or Ament – a scaly spike generally bearing only male or female flowers, flexible and usually inverted. Ex. male flowers of honey locust and walnut, all flowers of birch.

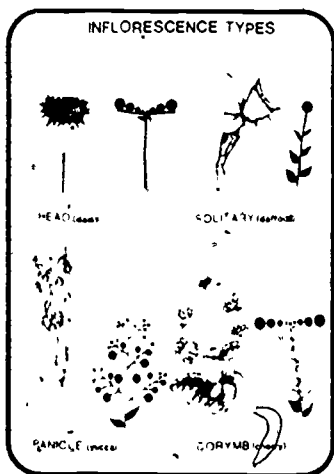

34. Four additional inflorescence forms are identified with descriptions and examples of that particular inflorescence.

Head – a dense cluster of short dense spike of sessile or nearly sessile flowers. A head may be globose as in a globe thistle or flattoped as in a daisy.

Solitary – a spike with only one flower as in most daffodils and tulips.

Panicle – a compound usually loose cluster, longer than broad as a branched raceme or branched corymb. Ex. yucca and clematis.

Corymb – A flat topped or convex flowering cluster with the outer flowers opening first. Ex. cherry, candytuft and viburnum. The example has several clusters of flowers (of the same stem); the outer flower of each cluster opens first.

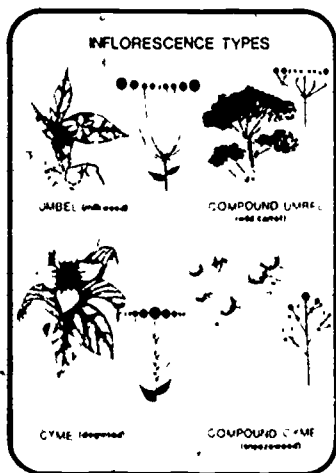

35. Four additional inflorescence forms are identified with descriptions and examples of that particular inflorescence.

Umbel – an inflorescence with pedicles or branches arising at the same point and of nearly equal length. Ex. allium, and members of the milkweed family. The picture of the milkweed looks down on the flower.

Compound Umbel – a branched umbel. Ex. Queen Ann's Lace.

Cyme – an inflorescence consisting of a central rachis bearing pedicelled flowers. Cylindrical cymes have pedicels of nearly the same length. Ex. phlox. Flattopped cymes have pedicels of unequal length. Ex. dogwood (outer flowers).

Compound Cyme – a branched cyme. Ex. sneeze weed.

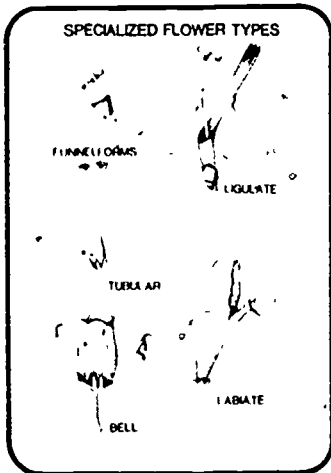

36. Most specialized flowers have fused floral parts for floral structures.

Funneliforms — a corolla with the tube gradually widening upward as in the morning glory.

Ligulate — tongue-shaped, as in ray flowers common to the daisy.

Tubular — tube-shaped, as in the cigar plant.

Labiate — lipped, as in the corolla of most mints, usually two lipped as in snapdragon and perennial salvia.

Bell-campanulate — bell-shaped as in the campanula family.

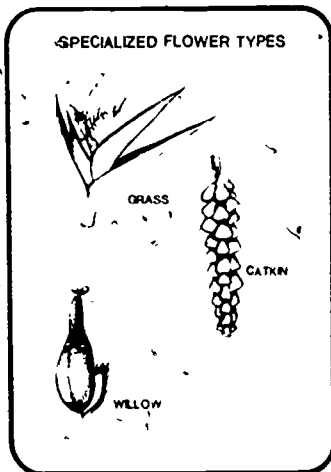

37. Three inflorescence are identified:

Grass Spikelet — (1) a secondary spike (2) one part of a compound inflorescence (3) the floral unit, or ultimate cluster, of a grass inflorescence comprised of flowers and their subtending bracts. Ex. wheat, bluegrass.

Willow — the willow flower shown is an example of female flower while the male will have the form of a catkin. Many plants unisexual flowers will take two separate forms.

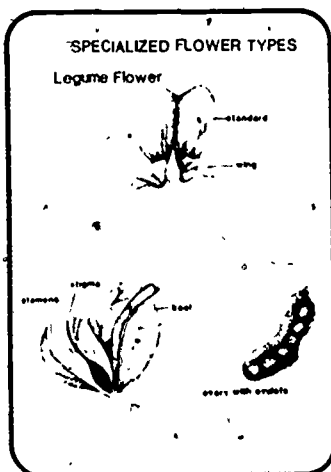

38. The legume flower is called papilionaceous. Papilionaceous flowers have a corolla that is composed of a standard, wings and keel. A close up of the flower and the ovary are included in the transparency.

SAMPLE TEST, QUESTIONS AND TEACHER'S KEY

TRUE-FALSE (+ = true)
(o = false)

- o 1. Clematis has sepals and petals.
- + 2. Squash bear male flowers; female flowers and perfect flowers.
- + 3. A monocot bears its flowers usually in three's or multiples of three's.
- o 4. A bract (the red portion of a poinsettia) is a flower.
- o 5. The stamen is the male part of the flower.
- + 6. The stamen is the male portion of the complete flower.
- + 7. The pistil contains the stigma, style and ovary.
- o 8. Hypogynous flower the ovary is below the other flower parts.
- o 9. Ray flowers and disc flowers are common to tulips.
- + 10. Wings and standards are common to legume flowers.

COMPLETION (Write appropriate information or words to complete statements)

- 1. The main function of the petal is to attract insects.
- 2. The sepals are collectively known as the calyx.
- 3. The function of the sepals is to prevent evaporation.
- 4. The functions of the stigma is to collect pollen.
- 5. A bisexual flower will have stamens and pistils.
- 6. If both pistil and stamen are present on the flower, the plant is monoecious. A plant is termed dioecious when only the staminateae pistillate.
- 7. A flower cluster is called a(n) inflorescence.
- 8. All of the sepals and all of the petals combined is called the perianth.
- 9. Two examples of plants having a catherin inflorescence are a) birch b) willow.

MULTIPLE CHOICE (Make appropriate choice of A, B, C or D)

B 1. The four main parts of a flower are the

- a) pollen, ovary, pistil, and stamen
- b) sepals, petals, stamen, pistil
- c) sepals, pistil, ovary, stigma
- d) none of these

A 2. A flower is actually a specialized

- a) stem-
- b) leaf
- c) root
- d) none of these

C 3. The stamen is composed of

- a) stigma, style, ovary
- b) style, filament, pollen
- c) pollen, anther, filament
- d) pollen, style, stigma

A 4. A flower that has all four of the main parts: sepals, petals, stamens, pistils is called a(n)

- a) complete flower
- b) incomplete flower
- c) pistilate flower
- d) staminate flower

B 5. Which of the following is not a head flower?

- a) daisy
- b) tulip
- c) zinnia
- d) cosmos

B 6. Which of the following is not a spadix?

- a) anthurium
- b) lily of the valley
- c) calla lily
- d) jack-in-the-pulpit

C 7. Which of the following is not an umbel?

- a) milk weed
- b) onion
- c) zinnia
- d) Queen Ann's lace

D 8. Which of the following does not have bracts?

- a) shrimp plant
- b) dogwood
- c) poinsettia
- d) chrysanthemum

A 9. Which of the following is not a spike?

- a) hyacinth
- b) gladiola
- c) plantain
- d) snapdragon

A 10. Which of the following is not a sessile flower?

- a) hyacinth
- b) gladiola
- c) plantain
- d) snapdragon

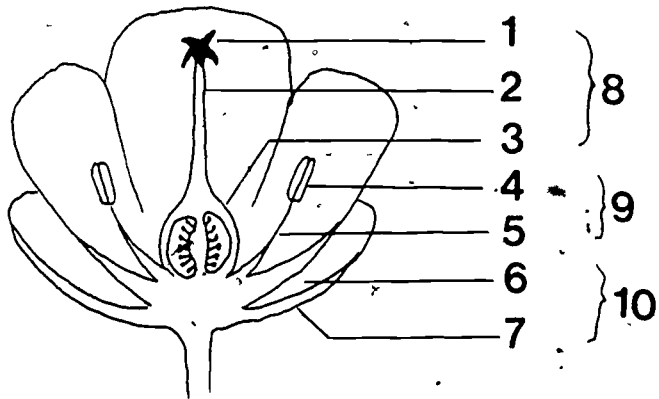

Above is illustrated the complete flower of a plant. In the blank of Column A, write the appropriate letter from the list of parts in Column B which matches the location of the part in the illustration.

Column A

- i 1.
- j 2.
- c 3.
- a 4.
- b 5.
- e 6.
- g 7.
- f 8.
- h 9.
- d 10.

Column B

- a. anther
- b. filament
- c. ovary
- d. perianth
- e. petal
- f. pistil
- g. sepal
- h. stamen
- i. stigma
- j. style

MATCHING

(Select the matching answer that most satisfactorily fits the description or word in the left column)

G 1. Solitary

J 2. Spike

A 3. Raceme

F 4. Panicle

H 5. Corymb

E 6. Cyme

C 7. Umbel

I 8. Spadix-Spathe

D 9. Catkin

B 10. Head

A. Current

B. Black Eye Susan

C. Queen Ann's Lace

D. Willow

E. Phlox

F. Yucca

G. Poppy

H. Candy Tuft

I. Anthurium

J. Plaintain

J 1. The part of the flower that produces the pollen

A 2. The part of the flower that receives the pollen

H 3. The flower part where seed is developed

B 4. A male flower

F 5. A female flower

D 6. The colorful or beautiful part of the flower

I 7. A flower lacking sepals and petals

K 8. The miniature plant within a seed

C 9. The flower part containing the anther and filament

G 10. The flower part containing the stigma, style and ovary

A. Stigma

B. Staminate

C. Stamen

D. Petals

E. Perianth

F. Pistilate

G. Pistil

H. Ovary

I. Incomplete

J. Filament

K. Embryo

L. Corolla

M. Anther

UNIT F: PLANT IDENTIFICATION

PROBLEM AREA: IDENTIFYING DIFFERENT PARTS AND TYPES OF ROOTS

SUGGESTIONS TO THE TEACHER:

This problem area should be taught to freshmen or beginning students enrolled in horticultural occupations or agricultural occupations programs. The recommended time for teaching this problem area is during the fall semester or prior to any plant identification. It is important that beginning students have a sound background in plant terminology before they begin identifying the plants available to the horticulturalist. The estimated instructional time for this problem area is 2-3 days depending on how far the instructor wishes to go in developing identification skills at the beginning students level. If the teaching plan is limited to classroom discussion with little or no practice, the instructional time can be limited to 2 days or less. If the students are to be involved in outside activities the instructional time will need to be increased.

The instructor is encouraged to conduct a local search to locate other supplementary materials for use with this problem area. The items in this problem area are for reference and modification as instructors adapt this material to their local situation.

CREDIT SOURCES:

These materials were developed through a funding agreement, R-33-21-D-0542-388 with the Illinois State Board of Education, Department of Adult, Vocational and Technical Education, Research and Development Section, 100 North First Street, Springfield, Illinois 62777. Opinions expressed in these materials do not reflect, nor should they be construed as policy or opinion of the State Board of Education or its staff.

The teacher's guide, information sheet, student worksheets, and test questions were developed by Jim Ethridge. Transparency masters, and the transparency discussion guide were prepared by Vocational Agriculture Service, University of Illinois. Suggestions and guidance in the development of these materials were provided by the Metropolitan Core Curriculum Pilot Test Teachers.

TEACHER'S GUIDE

- I. Unit: Plant identification and classification
- II. Problem area: Identifying different parts and types of roots
- III. Objectives: At the close of this problem area students will--
 1. Name and identify major parts of the root.
 2. Identify the functions of the root
 3. Demonstrate familiarity with terminology that relates to roots.
 4. Identify root modifications.
 5. Develop the ability to identify root parts.
 6. Identify physiological problems with roots.
- IV. Suggested interest approaches:
 1. Identify selected plants such as: Ragweed Plantain, Dandelions, Corn, Blue Grass, Rye, Carrot, Radish, Sweet Potato, and Rooted Cuttings, Virginia Creeper, English Ivy, and Radish seedlings 48 hours old or Cucumber. Dig them up and identify root parts and characteristics.
 2. Identify adventitious roots in the greenhouse - show Orchid roots, Philodendron roots and other adventitious roots.
 3. Compare functions of roots with the function of the digestive system of humans.
 4. Make a collection of specialized root plants and display these specialized roots.
 5. In order to get the students to become more aware of basic differences of roots, it is suggested that the teacher would bring in plants which are considerably different in root type and point out in detail the various ways in which these root adaptations differ.
 6. Prepare individual 5 X 7 cards of the various root systems using pictures. The students may be actively involved in this project.
 7. A field trip to a commercial greenhouse, and relate the importance of this knowledge and have it relate to growing plants.
- V. Anticipated problems and concerns of students:

1. What is the function of roots?
2. What is a root system?
3. What are the different types of root systems?
4. What are primary roots and secondary roots?
5. What is a hypocotyl?
6. Why do roots have rootcaps?
7. When don't roots have rootcaps?
8. What are root hairs?
9. What relationship exists between roots and soils?
10. How much of a large plant is underground?
11. How long do root hairs live?
12. What is the function of root hairs?
13. What are the adventitious roots?
14. What are aerial roots?
15. What are bare root shrubs?

VI. Suggested learning activities and experiences:

1. Have the students read the information sheet and record tentative answers to the problems and concerns identified by the class or teacher.
2. Distribute worksheet on root systems and specialized roots and have student complete the blanks.
3. Show transparencies.
4. Bring in specialized roots to develop ability in recognition.
5. Prepare a series of cards giving general descriptions of a root and ask the student to suggest a name of that root which fits the description.

VII. Application procedures:

1. The main purposes of this problem area are to teach information and develop ability in using terminology as it relates to roots and their classification.

311

2. The application phase should be emphasized in the problem areas of watering, and transplanting, and digging bare foot woody plant materials.

VIII. Evaluation:

1. Prepare and administer a pencil and paper test using the Sample Test Questions as possible test items.
2. Collect and grade worksheet.
3. Observe transplanting activity to ensure proper handling of roots.

IX. References and aids:

1. Information Sheet on: "External Features of Roots"
2. Student Worksheets on:
 - a. "Roots"
 - b. "Roots - Discussion Questions"
 - c. "Pruning Roots on Shrubs"
 - d. "Pruning Roots on House Plants"
3. Transparencies and Transparency Discussion Guide
4. Sample Test Questions

INFORMATION SHEET
ON
EXTERNAL FEATURES OF ROOTS

Roots are typically underground structures and function mainly for anchorage and absorption. The problem of anchorage becomes acute in large trees and other tall plants. Tremendous stresses and strains are imposed on the roots when large trees are subjected to strong winds. Typical roots have hairlike extensions of the epidermal cells: the root hairs which absorb water from the soil. All of the water lost by a plant during transpiration must enter through the root hairs. Roots differ further from stems since they do not have nodes, never produce leaves, and have a special covering (the root cap) which protects the delicate growing point from injury as it pushes through the soil. Some roots are used for food, and others are sources of important drugs.

A. TAP ROOTS

Examine the tap root system of a young sunflower plant. The central tap (primary) root appears to be an underground extension of the stem shaft. Observe the method of branching, the characteristic tapering of primary and secondary roots. Close examination of suitable material may reveal tertiary and quaternary roots. Ragweed, English, plantain, alfalfa, and dandelion furnish other good examples of tap root systems.

B. FIBROUS ROOTS

Examine the root system of a young corn plant. These roots are characteristically long, cylindrical, and fiber-like in appearance. This is a fibrous root system, sometimes termed a diffuse root system because of the manner in which the roots ramify throughout the soil. Fibrous roots are characteristic of the grasses and are the chief reason why these plants are such efficient soil binders.

C. STORAGE ROOTS

Some tap roots become fleshy and much enlarged for the storage of food. Plants with this type of root are often biennials. Can the biennial habit of plants be correlated with the presence of a storage root? The sugar beet is an example of a commercially important storage root and is unusual because it stores considerable amounts of sugar. Examine mature roots of turnip or carrot, also roots of Dahlia (fasciated roots) and of the cultivated sweet potato (a tuberous root).

D. ADVENTITIOUS ROOTS

Examine cuttings of tradescantia, coleus, willow or geranium which have been naturally rooted in sand. The roots arising from the stems of such cuttings are termed adventitious. What does this term mean? Compare with the adventitious roots of Virginia creeper, English ivy, poison ivy, and the prop roots of an older corn plant. Adventitious roots may also arise from leaves.

E. ROOT HAIRS

Examine seedling of Radish and cuttings of Tradescantia. Examine their root hairs and identify their functions.

311

STUDENT WORKSHEET

ROOTS

I. Materials:

Corn plants 6 to 8 inches tall
Plantain root system
Sunflower root system
Bluegrass root system
Carrots, beets, radishes
Sprouting sweet potato
Rooted cuttings of wandering jew, willow or coleus
Roots of dahlia
Radish, marigold, squash, or cucumber seedlings
Aerial roots of corn, ivy, orchids

II. Purpose:

III. Procedure:

1. Remove radish or similar seedlings from their container and wash any soil media off the roots. (1 seedling per two students) Observe the root systems and draw examples of one or two different plants.
2. Examine the tap root system of the sunflower or dandelion and observe the branching root system of the blue grass.
3. Remove corn seedlings from their containers and wash the roots. Observe the root system noting the fibrous roots system and how similar it is to blue grass roots.
4. Observe the roots of the sweet potato and the dahlia and compare their roots systems. How are they similar and how are they different?
5. Observe root hairs on cucumber seedlings, radish or marigold or similar seedlings. Note your observations in the space provided.

IV. Observations:

STUDENT WORKSHEET

ROOTS

Discussion Questions:

1. What are the functions of roots?
2. What are the major difference between roots and stems?
3. What are the specialized functions of root hairs?
4. How much of the plant you observed were made up of the root system?
5. How long do root hairs live?
6. What plants have you observed, make them good soil binders?

340

STUDENT WORKSHEET

PRUNING OF ROOTS ON SHRUBS

- I. Materials:
 - Tree digging spade
 - Fertilizer
 - Colored plastic strips 6 to 8 inches long for identifying root pruned plants
- II. Purpose: The student will be able to circle and root prune a shrub within a radius of about $\frac{1}{4}$ of the height of the shrub.
- III. Procedure:
 1. Mark a circle around the shrub with a diameter of about $\frac{1}{4}$ the height of the shrub.
 2. Thrust the spade straight down to full depth all round and just outside the circle.
 3. Sprinkle a cupful of fertilizer evenly over the ground just inside the circle.
 4. Tag the shrub to show that it has been root-pruned.

Root-pruning is done only after leaves have fallen from deciduous plants in late fall. In large scale operations, root-pruning is usually done by passing a tractor-drawn, U-shaped blade under the rows of the plants in the field. The roots within the pruned space form branches, giving a strong root system within a confined space.

Roots of shrubs naturally grow well beyond the soil volume that can be moved with B & B plants, or the roots spread exceeds that easily handled with bare root stock. In order to keep most of the roots within a small area, shrubs are pruned in the nursery every 2 or 3 years until they are dug for sale.

- IV. Observations of the work completed:

STUDENT WORKSHEET

PRUNING OF ROOTS ON HOUSE PLANTS

- I. Materials:
Container with appropriate soil mix for transplanting pruned plant
Plant that has over-grown roots and needs root-pruning
A Plant that a home owner wants to keep in the same size container
- II. Purpose: The student will be able to repot root-bound plants and remove the roots correctly.
- III. Procedure:
(see this worksheet) in the Problem Area on Pruning

343

TRANSPARENCY DISCUSSION GUIDE

PLANT IDENTIFICATION

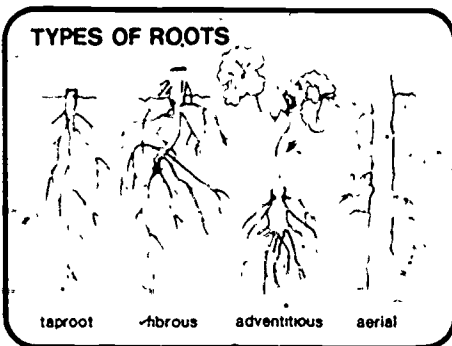

3. Root systems of hackberry, oak, sunflower and dandelion are said to be tap root systems. They have one central root that grows deep into the ground with few side or secondary roots. A fibrous root system is common to many small plants, such as garden flowers or turf grass, and to some large plants, such as the willow. These plants, when pulled up, show a mass of roots near the soil surface arising from the base of the plant.

Adventitious roots usually refer to roots that develop from any portion of the stem, or roots that develop from pruned roots. Adventitious roots are common to stem cuttings and stems that come into contact with the soil. They are especially common in bugle weed, euonymus, and strawberries. Aerial roots (a form of some adventitious roots) are common to orchids, corn, and ivy. Aerial roots have functions similar to other roots.

SAMPLE TEST QUESTIONS AND

TEACHERS' KEY

TRUE OR FALSE

0

1. Plants grown in water are easily transplanted into soil.

0

2. Adventitious roots are uncommon to most rooted cuttings.

0

3. Aerial roots are uncommon to most climbing vines.

+

4. The primary root develops from the seed.

+

5. All secondary roots develop from the primary root.

+

6. Another name for the primary root is the hypocotyl.

+

7. Adventitious roots are developed on all rooted cuttings.

+

8. Root hairs live only a few days.

+

9. Root hairs when exposed to sunlight live a few minutes.

0

10. Tap root plants make excellent soil binders.

0

11. All roots grow underground.

MULTIPLE CHOICE (Make appropriate choice of A, B, C, or D)

D

1. Which of the following is not a function of roots?

- A. Anchorage
- B. Absorption
- C. Food storage
- D. Sexual Reproduction

D

2. Which of the following plants do not have aerial roots?

- A. Ivy
- B. Virginia Creeper
- C. Trumpet Creeper
- D. Pear

D

3. Which of the following plants does not have a tap root?

- A. Carrot
- B. Sunflower
- C. Dandelion
- D. Zinnia

D

4. Which of the following plants does not produce enlarged storage root?

- A. Carrots
- B. Radish
- C. Turnips
- D. Onion

B

5. Which of the following have haustoria?

- A. Pine
- B. Mistletoe
- C. Maple
- D. Willow

C

6. When is the best time to dig bare root shrubs for the nurseryman?

- A. Spring
- B. Summer
- C. Fall
- D. Winter

A

7. When is the best time to plant bare root shrubs for the homeowner?

- A. Spring
- B. Summer
- C. Fall
- D. Winter

COMPLETION (Write appropriate information or words to complete statements.)

1. Roots differ from all stems in lacking INTERNODES and NODES.