

DOCUMENT RESUME

ED 200 440

SE 034 587

**AUTHOR** Steinberg, Florence S.  
**TITLE** Aboard the Space Shuttle.  
**INSTITUTION** National Aeronautics and Space Administration, Washington, D.C. Div. of Public Affairs.  
**REPORT NO** NASA-EP-169  
**PUB DATE** 80  
**NOTE** 40p.; Contains numerous colored photographs and drawings which may not reproduce well.  
**EDRS PRICE** MF01/PC02 Plus Postage.  
**DESCRIPTORS** \*Aerospace Education; \*Aerospace Technology; Astronomy; Elementary School Science; Elementary Secondary Education; Government Publications; Pamphlets; \*Resource Materials; Science Education; Secondary School Science; \*Space Exploration; \*Space Sciences  
**IDENTIFIERS** Space Shuttle

**ABSTRACT**

This 32-page pamphlet contains color photographs and detailed diagrams which illustrate general descriptive comments about living conditions aboard the space shuttle. Described are details of the launch, the cabin, the condition of weightlessness, food, sleep, exercise, atmosphere, personal hygiene, medicine, going EVA (extra-vehicular activity), the manipulator arm or "space crane," spacelab, the space center, and returning home. (CS)

\*\*\*\*\*  
 \* Reproductions supplied by EDRS are the best that can be made \*  
 \* from the original document. \*  
 \*\*\*\*\*

U.S. DEPARTMENT OF HEALTH,  
EDUCATION & WELFARE  
NATIONAL INSTITUTE OF  
EDUCATION

THIS DOCUMENT HAS BEEN REPRO-  
DUCED EXACTLY AS RECEIVED FROM  
THE PERSON OR ORGANIZATION ORIGIN-  
ATING IT. POINTS OF VIEW OR OPINIONS  
STATED DO NOT NECESSARILY REPRESENT  
OFFICIAL NATIONAL INSTITUTE OF  
EDUCATION POSITION OR POLICY.

ED 200740

SE 034 587

2

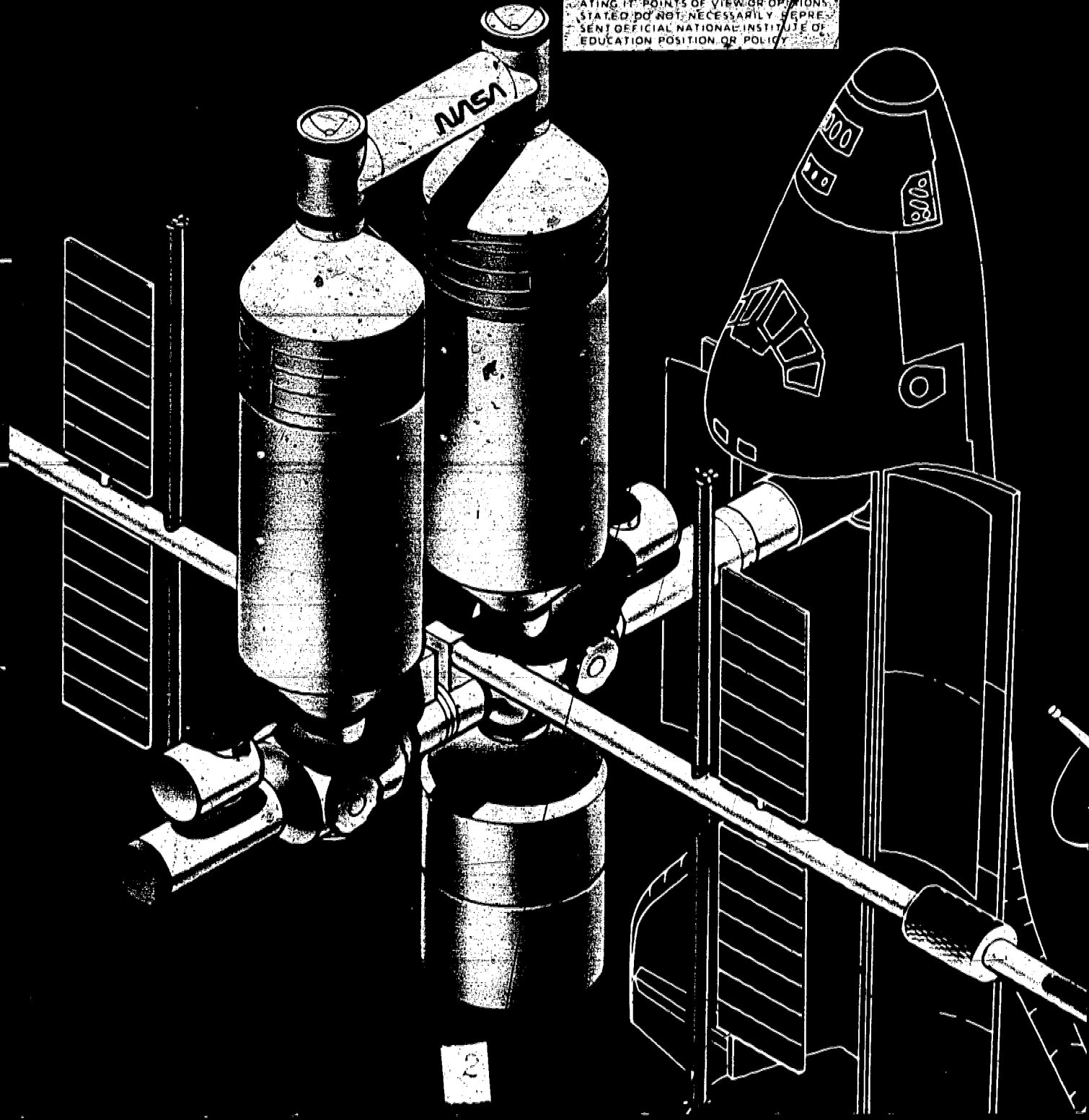

**Cover:**

The cover shows a permanent space operations center that has been freighted piecemeal into low Earth orbit by the Shuttle and assembled by astronauts. The two joined cylinders contain living quarters and a laboratory. Below the cylinders, the service modules supply electrical power, communications, a docking berth, guidance and control instruments and life-support systems, such as air and water. When in operation, the eight-person center will function as the base for a host of space programs to improve the quality of life on Earth. In time, the center could lead to the development of larger stations, which could be used to fabricate mammoth solar power satellites in far space requiring 500-man building crews.

Cover painting courtesy  
Kentron International, Inc.

# Aboard the Space Shuttle

**Florence S. Steinberg**

National Aeronautics and  
Space Administration

Division of Public Affairs  
Washington, D.C.  
1980

*Dedicated to Robert S. Tiemann whose ideas  
provided the inspiration for this project.  
"Bob" Tiemann died November 1, 1978.*

## **Table of Contents**

### **Living in Space**

3

### **Taking a Trip**

4

### **The Launch**

6

### **The Cabin**

8

### **Weightlessness**

12

### **Food**

14

### **Sleep**

18

### **Exercise**

20

### **Sea-Level Atmosphere in Space**

21

### **Personal Hygiene**

22

### **Medicine**

24

### **Going EVA**

24

### **The Helpful Manipulator Arm**

27

### **Spacelab**

28

### **The Space Center**

29

### **Returning Home**

30

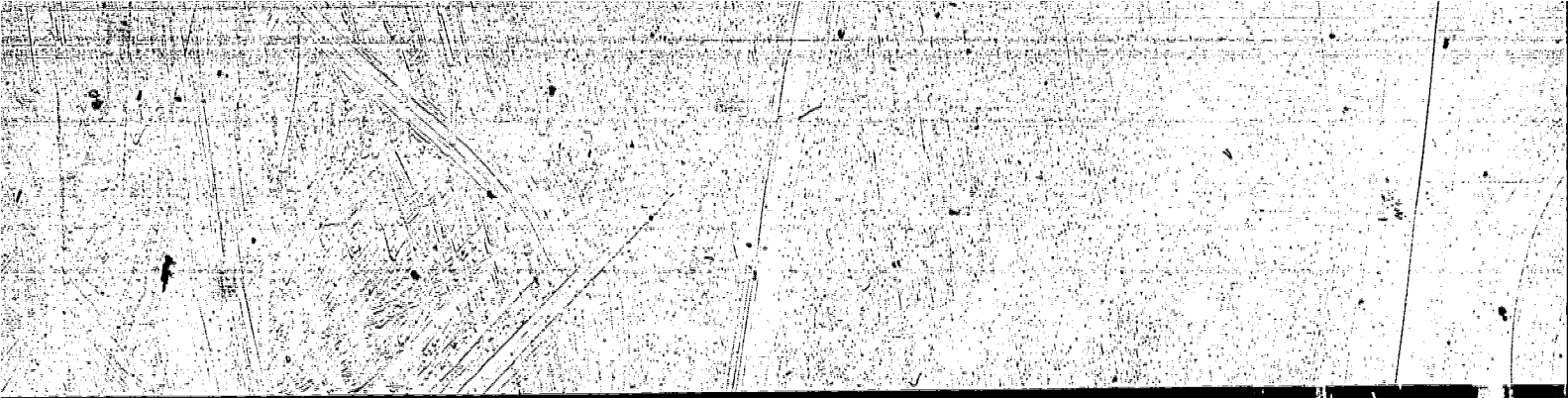

2

5

1



# Living in Space

**The Shuttle Orbiter will lift off like a rocket, orbit like a spacecraft and return to Earth on a landing strip like a glider or airplane.**

In 1962, when John Glenn rocketed spaceward and orbited the Earth, some scientists feared he would be unable to swallow or digest the pureed fruit NASA had supplied him. Their concern was unfounded. From this simple experiment with eating in space, the menu for the coming flights of the Space Shuttle Orbiter has grown larger than that in the average restaurant and provides a variety ranging from shrimp cocktail to steak.

In 1969, when Neil Armstrong, Edwin Aldrin and Michael Collins made their historic trip to the Moon aboard Apollo II, they had their choice of sleeping under the seat, in it, or floating free. In sharp contrast, voyagers on the Space Shuttle will stretch out in sleeping bags secured to bunk beds. They will enjoy the luxury of a light behind their heads for reading in bed and side panels for privacy.

These are merely a few examples of the giant strides that have been made to improve the standard of living in orbit since the space program began only 20 years ago. When the Shuttle lifts off, its designers will have built into its living arrangements all the lessons learned from Mercury, Gemini, Apollo and Skylab, plus their own innovations, to make life as safe and comfortable as possible in weightlessness.

This is especially important because, thanks to the Shuttle, there will be a remarkable increase in manned space travel in the 1980s. So far, 43 Americans have been in space. Now, four Shuttle Orbiters, each with accommodations for up to seven persons, are scheduled to make as many as 60 round

trips a year to low Earth orbit and back. Shaped like an airplane, the 37.2 meter- (122-foot) long Shuttle Orbiter will lift off like a rocket, orbit like a spacecraft on seven to 30-day missions and return to Earth on a landing strip like a glider or airplane.

The livability aboard the Shuttle makes it possible to add other people besides superbly healthy astronauts to the list of travelers. Men and women scientists, technicians and others in reasonably good health will also ride the Shuttle. As for the astronauts, these living arrangements will make it easier for them to handle the heavy workload on Shuttle trips.

The Shuttle will function as a "freight" carrier, delivering and launching satellites in space and bringing some back to Earth within its payload bay. It will also serve as a traveling repair shop for orbiting satellites that are ailing, a science lab for space experiments and observations and as a factory for manufacturing products in zero gravity, such as perfect crystals. In addition, the Shuttle could deliver supplies to Earth orbit to construct future space stations.

# Take a Trip



At a height of 45 m (147 ft.) on the modified launch pad where Saturn V's carrying Apollo spacecraft lifted off for the Moon, you climb through the Shuttle's hatch for a voyage into space. NASA specialists in space medicine have checked to make sure you are healthy, free of conditions that could trigger physical problems or cause you to become disoriented in weightlessness.

You join the others lying down in the seats, strapped in, feet above head, as on the early one-man Mercury, two-man Gemini and three-man Apollo launches. But there the similarity ends. For the Shuttle provides

a shirt-sleeve environment from the start and a sea-level air-mixture atmosphere.

Nobody aboard at lift-off is burdened by the traditional clumsy, heavy space suit. Instead, everyone wears a goodlooking, cobalt blue, soft cotton, lined zipper jacket and pants with a coordinated navy blue, cotton knit, short-sleeve shirt. You were all fitted "from the racks" at NASA's Johnson Space Center near Houston, the jacket by chest size and sleeve length and the pants by waist size and leg length.

These flight suits have built-in safety features. They are fitted to be comfortable

**The Shuttle provides a shirt-sleeve environment from the start and a sea-level air-mixture atmosphere.**



but not sloppy. Loose clothes can turn critical switches on or off by mistake if they brush against them. The material is also treated with a chemical soak to make it fireproof. A dozen closable pockets cover much of the flight suit's exterior for storing small, useful items and to keep them from sailing about dangerously later in weightlessness. Stocked in specific pockets before the flight are felt-tip and pressurized ball-point pens, mechanical pencils, data books, sun glasses, a multi-purpose Swiss Army pocket knife and standard surgical scissors.

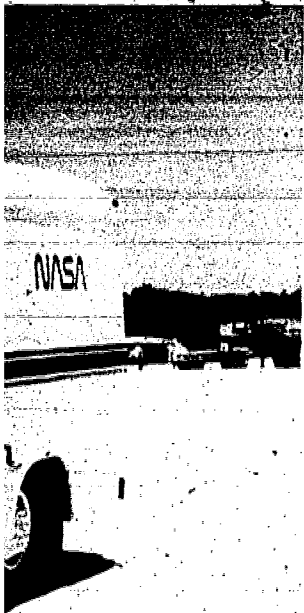

*Left: Transfer van from astronaut headquarters to the launch tower (used on early flights)*

*Right: Mission specialist astronaut Anna L. Fisher, M.D., in flight suit with lift-off communications headgear and helmet*





## The Launch

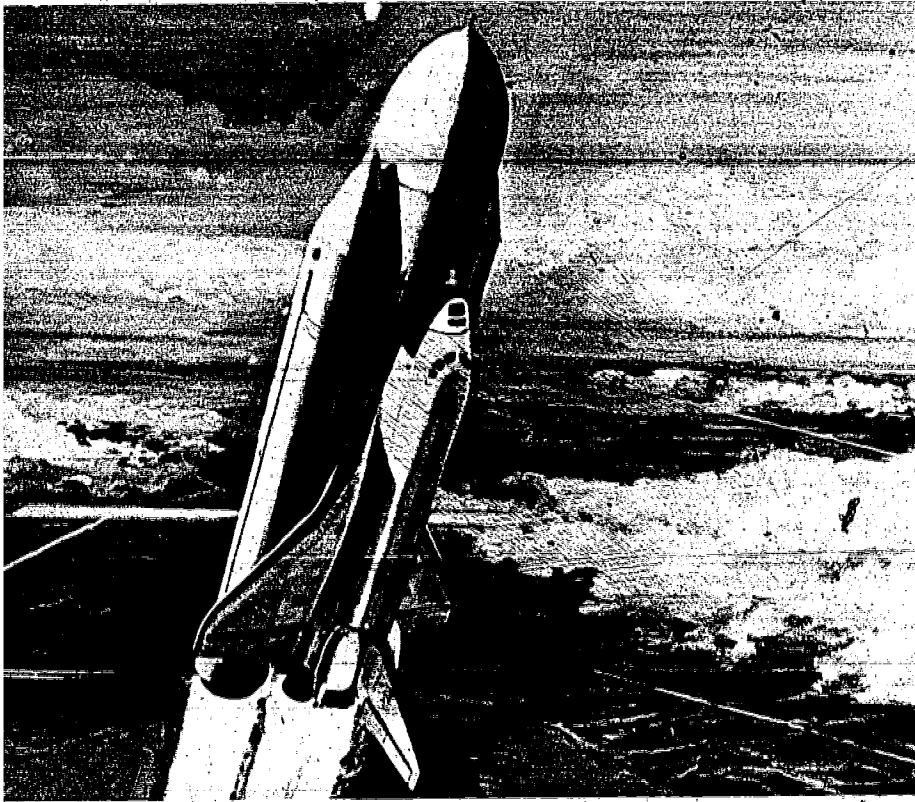

**Less than ten minutes from lift-off, you are in zero gravity and without your restraining straps you will float.**

*The Shuttle roars spaceward*

A major feature of the Shuttle's lift-off is that you will not undergo the unpleasant gravity load which went as high as 8.1 g on earlier manned flights. (A "g" is the weight or pull of Earth's gravity on your body at sea level. Thus 8.1 g would be 8.1 times that force.) After you have listened to the systems checkout and the countdown through the "Snoopy Hat" styled headset under your helmet, ignition of the mighty rocket motors and engines brings a roar and makes the spacecraft shudder for a few seconds while it is still restrained. Powering the lift-off are twin 45.7 m- (150- ft.) long solid fuel rocket boosters, plus the Shuttle's own three rear engines fueled by a huge attached liquid hydrogen and oxygen tank.

These engines can provide an immense, swift thrust. But by design, their acceleration is deliberately reined in to slow them down and make them run for a longer period. This is done for the traveler's benefit, so that the pull of gravity toward Earth, as opposed to the outward thrust of the engines, will not exceed 3 g on the rise into orbit. This is about the same level of discomfort you would feel if you turned a corner much too fast in an automobile.

You will experience 3 g only twice. The first time comes and goes quickly near the two-minute mark, just before the two solid fuel rocket boosters burn out and drop by parachute into the Atlantic for reuse on future Shuttle launchings. The final 3 g load comes five minutes later and lasts for a minute. It occurs about 185 kilometers (105 miles) from Earth, shortly before the liquid fuel tank empties, separates and reenters

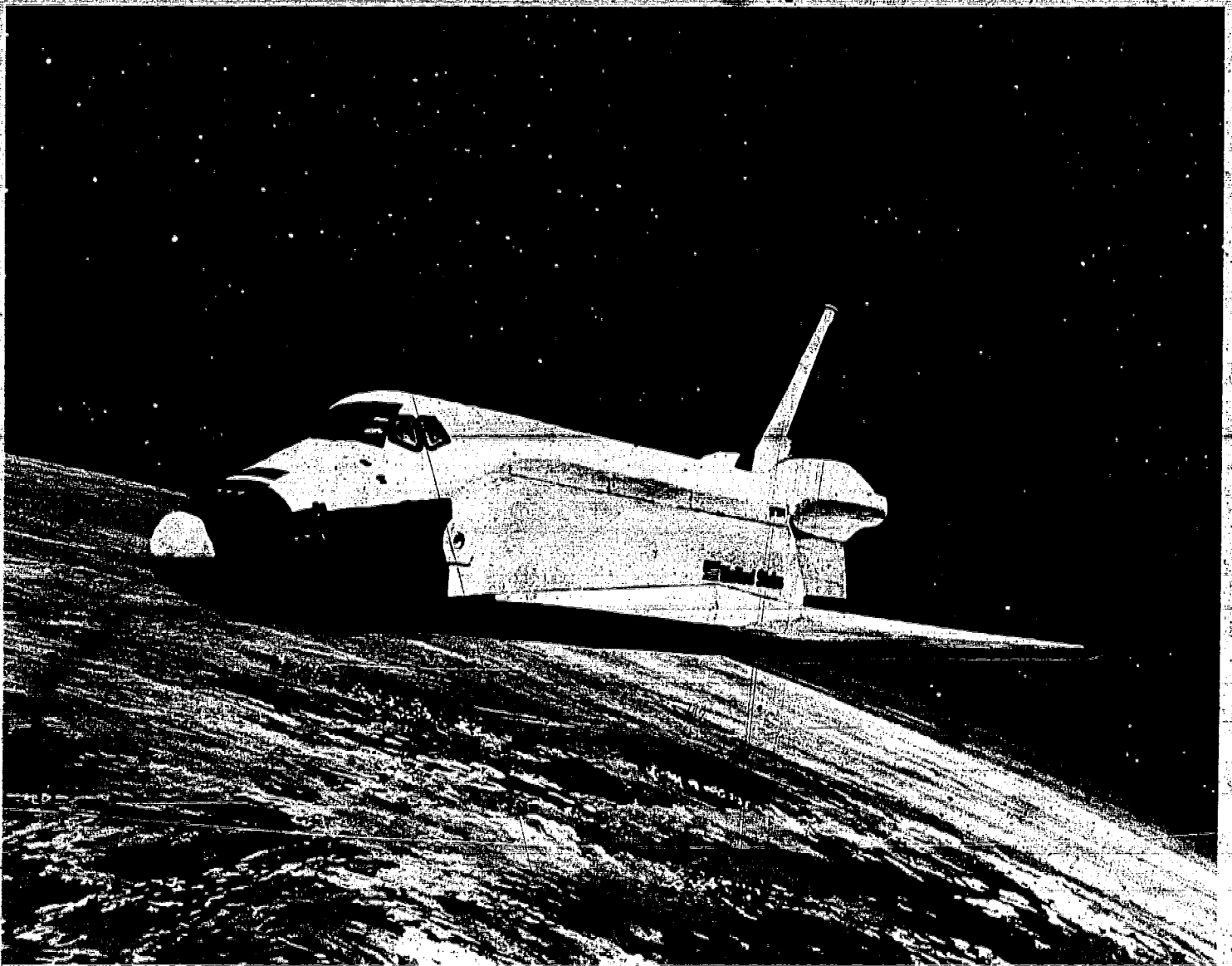

the atmosphere. There it begins to disintegrate and the remainder falls into a remote ocean area. Now two other engines ignite at the rear of the Orbiter, maneuver the spaceship in its further rise and insert it into the desired orbiting path. Less than ten minutes from lift-off, you are in zero gravity, and without your restraining straps you will float.

Once in orbit, you will have time to observe your new surroundings. At 277 km (172 mi.) up and traveling at a speed of

28,160 km (17,500 mi.) per hour, the Shuttle is circling the Earth every 90 minutes. Not quite half that time is spent in darkness, while the Earth is between it and the Sun. Through the window in the hatch, you will watch entire countries speed by. You will see the shape of India, the Australian continent, the California coast. You will race across the United States in just 12 minutes, perhaps notice a hurricane over Cuba, or sight a sandstorm over a desert area.

*Shuttle in orbit,  
minus its two  
solid rocket  
boosters and  
fuel tank*



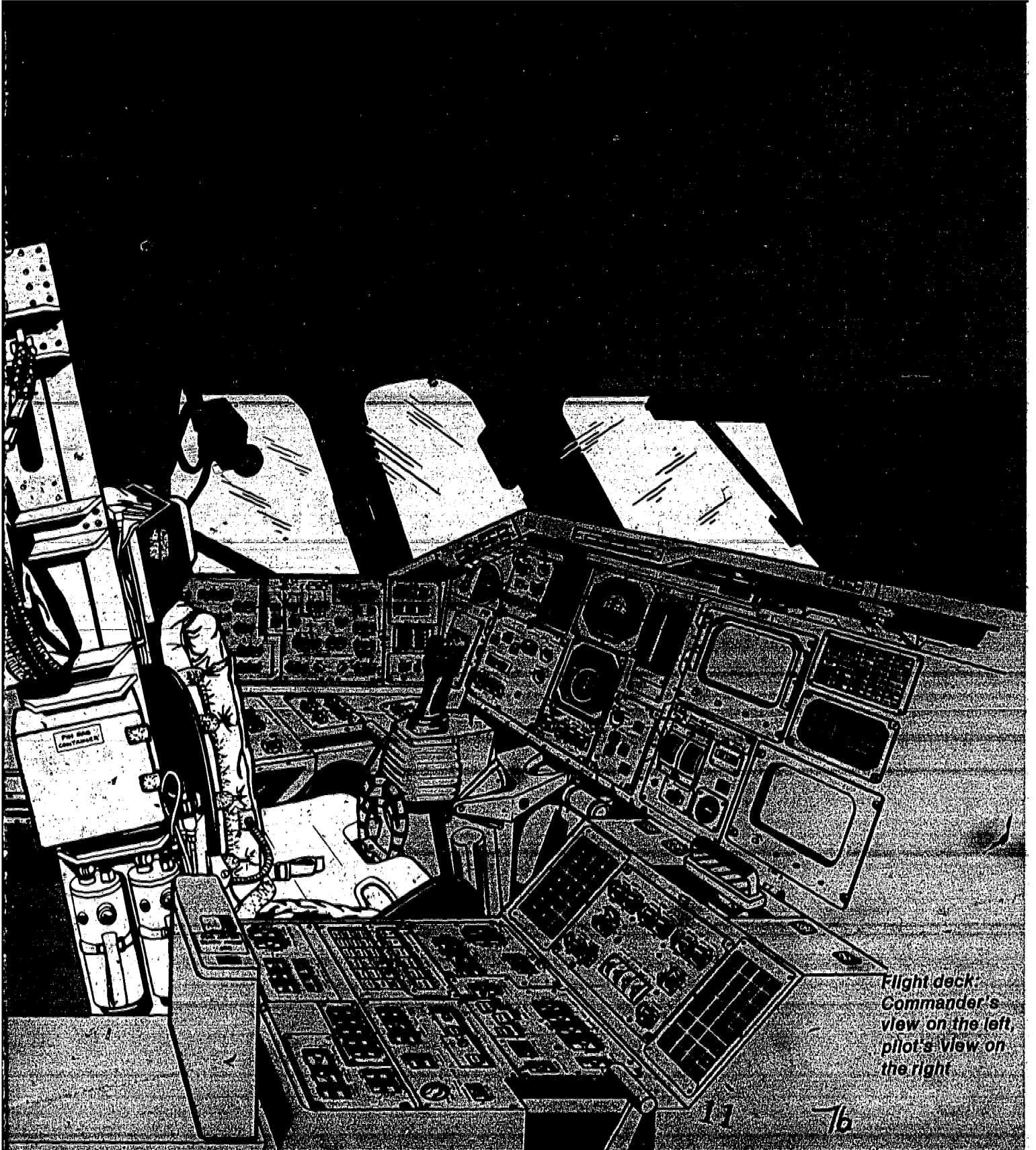

*Flight deck:  
Commander's  
view on the left,  
pilot's view on  
the right*



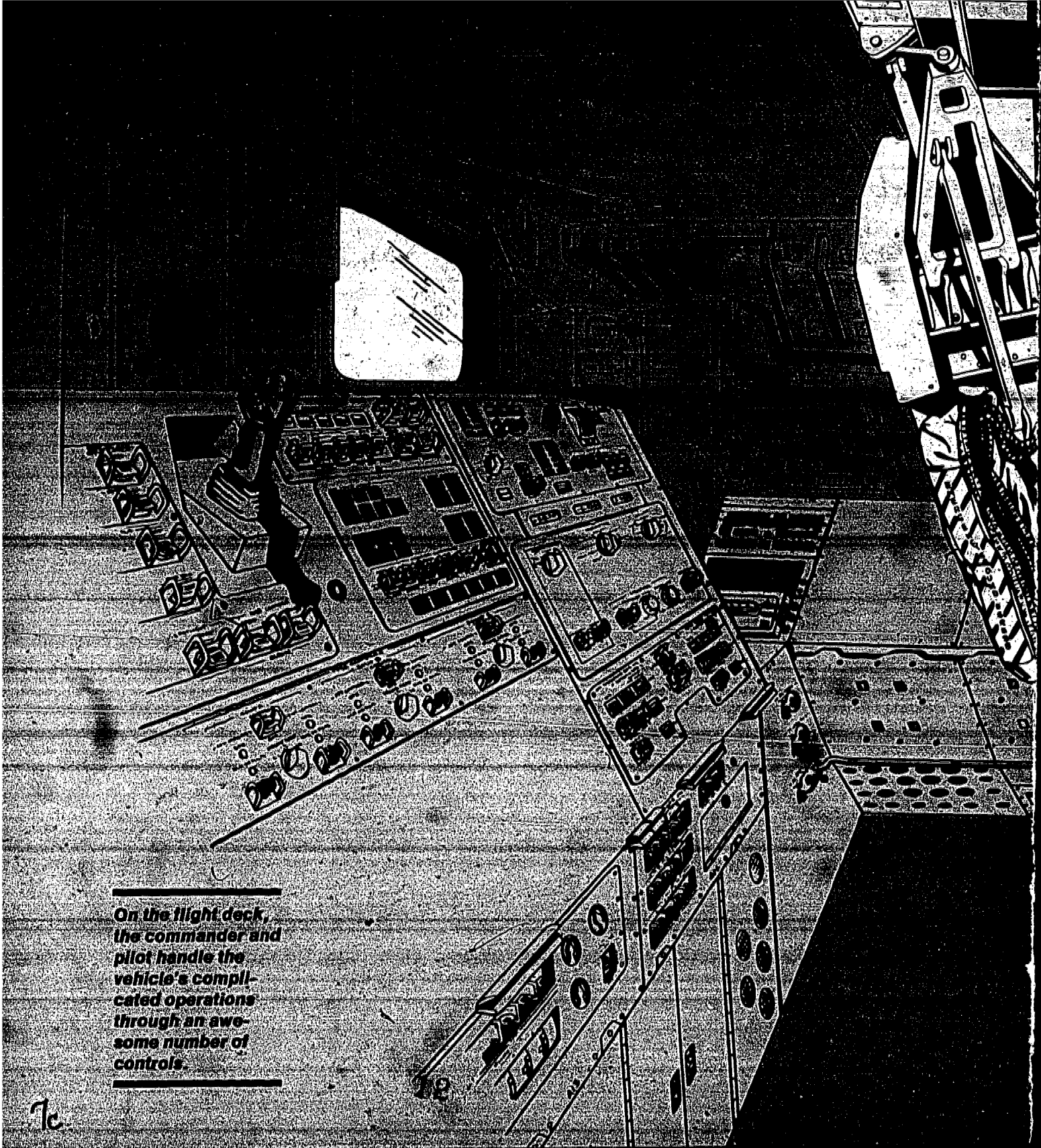

**On the flight deck, the commander and pilot handle the vehicle's complicated operations through an awesome number of controls.**

7c



# The Cabin

*Three levels of the cabin: Flight deck; mid-deck living quarters; and sub-floor life-support and housekeeping equipment*

Your home aboard the Shuttle is the mid-deck of the cabin at the forward end of the spaceship. Below the mid-deck's metal floor are storage containers and ducts that distribute air and water. Directly over the mid-deck is the flight deck with six triple-pane thermal glass windows wrapped around the front and sides for full vision, two more windows overhead and two behind, overlooking the payload, or cargo bay.

Here on the flight deck, the commander and pilot handle the vehicle's complicated operations through an awesome number of controls. It is comforting to know they have

had at least three years of rigorous training, including 600 hours in a Shuttle mission simulator that is an exact copy of the flight deck. Also in the crew are two astronaut-scientists called mission specialists, who are in charge of the payload data and the "housekeeping." They, too, have had extensive training. The primary reason for the vast number of controls is that for safety's sake all critical Shuttle systems are in triplicate. Should the electrical system fail, a second one takes over. If this should also fail, a third electrical system is available.

When it was empty, your mid-deck

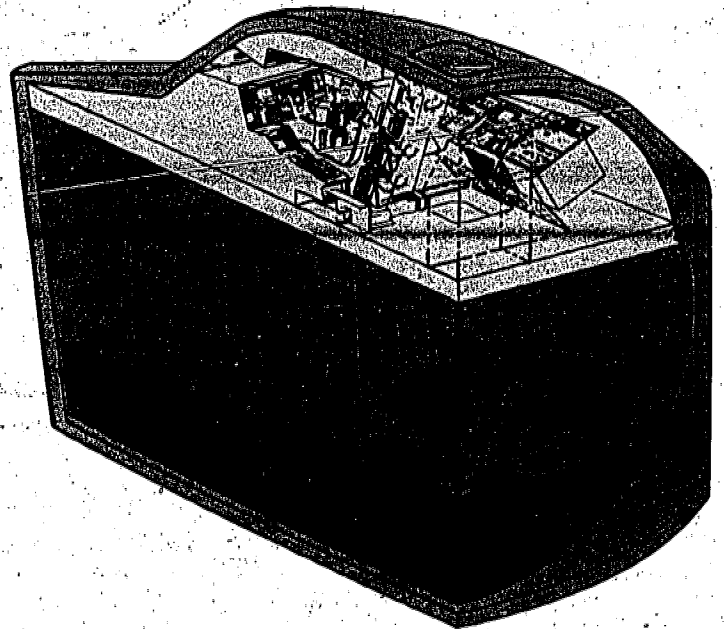
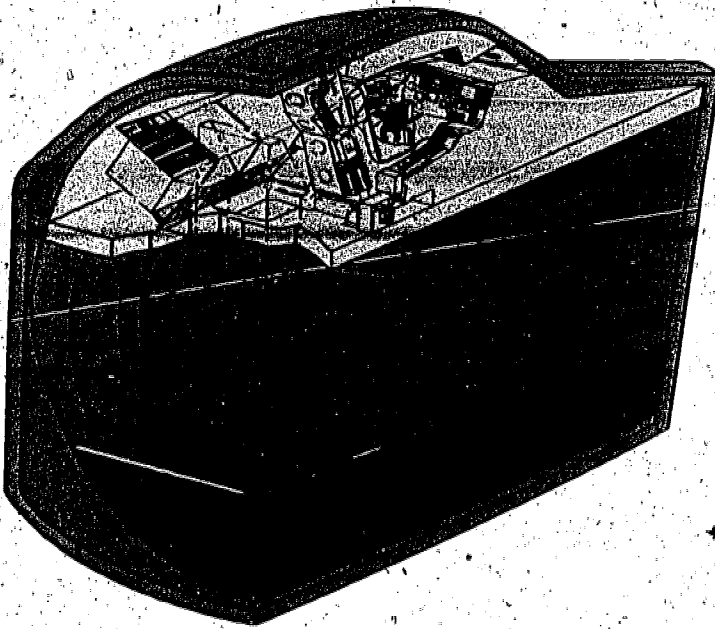

Please open fold-outs at left to see a full display of the Space Shuttle flight deck.

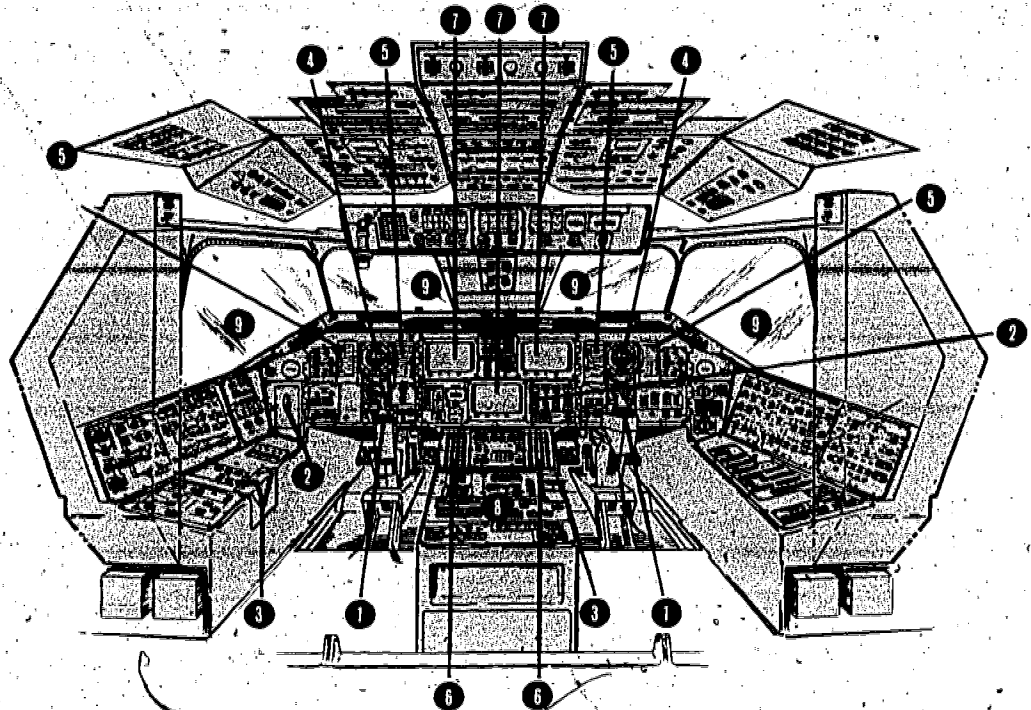

Below: Flight deck seats after the Shuttle's four test flights. Ladder at floor level leads below to mid-deck

Above: Flight deck locations (Duplicate controls)

- 1 Rotational hand controller
- 2 Translational hand controller
- 3 Speed brake
- 4 Attitude direction indicator: An artificial horizon—around black and white ball which tells which way is up.
- 5 Air speed and altitude indicators
- 6 Keyboard: Runs flight computer, which in turn runs automatic pilot
- 7 Cathode ray (TV) tubes provide displays from flight computers
- 8 Radio panel
- 9 Windows

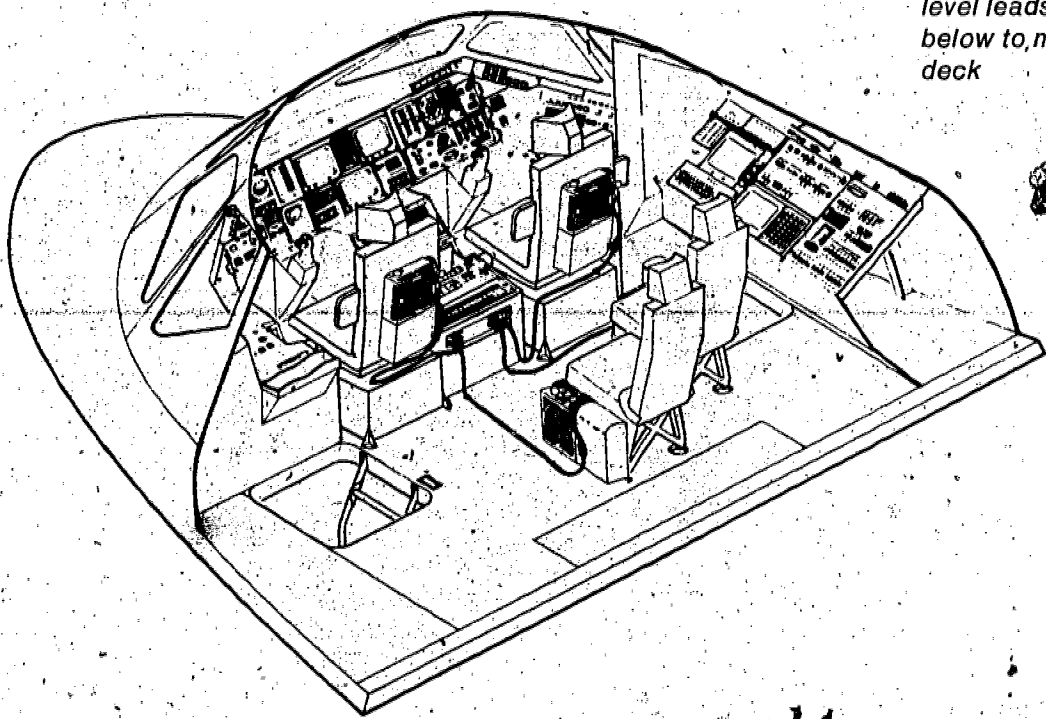



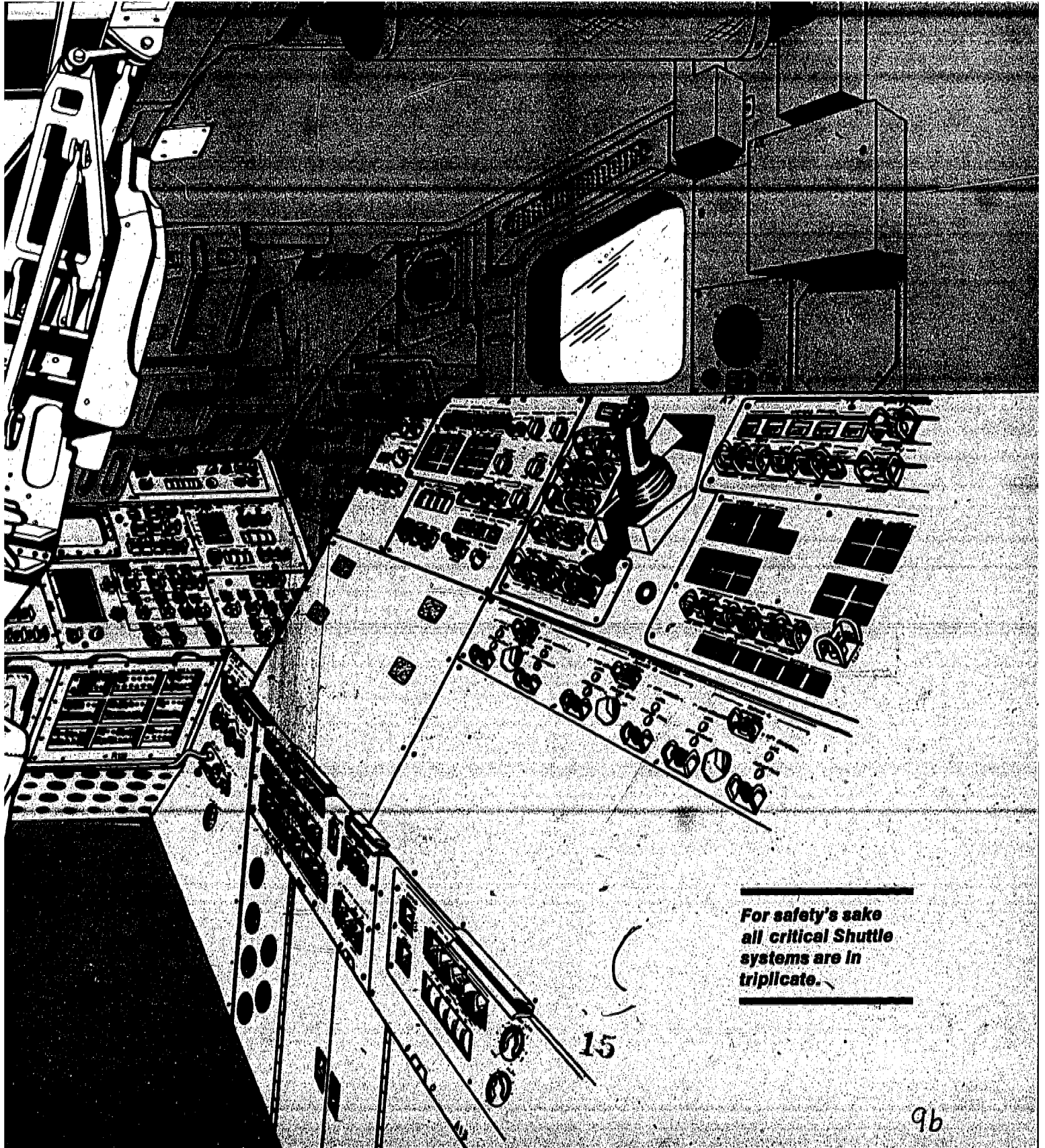

**For safety's sake  
all critical Shuttle  
systems are in  
triplicate.**

15

9b



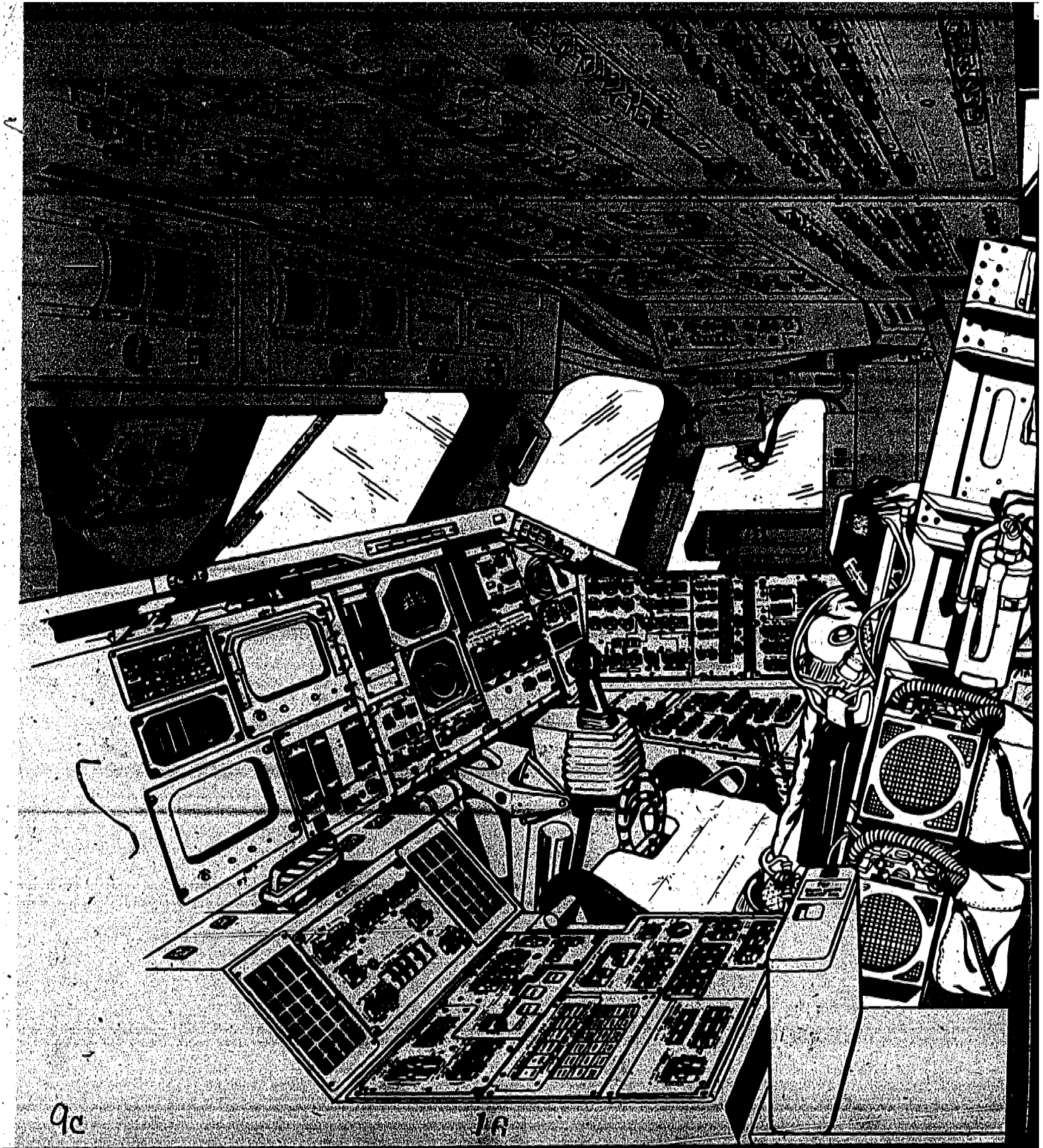

9c

16



Below: Mid-deck floor plan

- |                         |                                |
|-------------------------|--------------------------------|
| 1 Galley                | 10 Sleep station               |
| 2 Hatch                 | 11 Wall of lockers             |
| 3 Toilet                | Floor hatches                  |
| 4 Ladder to flight deck | 12 Lithium hydroxide changeout |
| 5 Airlock               | 13 Lithium hydroxide storage   |
| 6 Avionics bay 1        | 14 Wet trash storage           |
| 7 Avionics bay 2        |                                |
| 8 Avionics bay 3        |                                |
| 9 Lockers               |                                |

**The amount of room in the Shuttle cabin is a compromise between that provided on early spacecraft and Skylab.**

home was a room measuring 4 m (13 ft.) in length, with a 3.7 m-(12-ft.) rear width and a 2.7 m-(9-ft.) front width. But with all the necessary equipment in place, you can hardly see the 2.1 m-(7-ft.) high curved, white-painted aluminum and fiber glass walls. To the left when you face forward is a private toilet, wash basin with mirror and a galley with an oven. To your right are some drawer-size lockers and the bunk beds. Ahead is a wall of more storage lockers, some containing your food supply, arranged by day and meal. Behind you is a metal ladder leading to the flight deck, plus the large airlock that provides passage for the crew into the 18.3 m-(60-ft.) long payload bay and the outside of the Shuttle.

Below: Mid-deck aft

- |                         |
|-------------------------|
| 1 Galley                |
| 2 Hatch                 |
| 3 Toilet                |
| 4 Ladder to flight deck |
| 5 Airlock               |

load bay and the outside of the Shuttle.

The amount of room in the Shuttle cabin is a compromise between that provided on early spacecraft and Skylab, which was the huge third stage of a Saturn rocket. On the first flights, the work and living quarters were so cramped that some described the missions as "man in a can." Skylab, on the other hand, had the dimensions of a small, three-bedroom house. Astronauts in the Apollos that docked with Skylab for 28, 59 and 84 days found the air so thin inside Skylab that they had to shout to communicate across the big area. Even when they did, their voices came out high and squeaky.

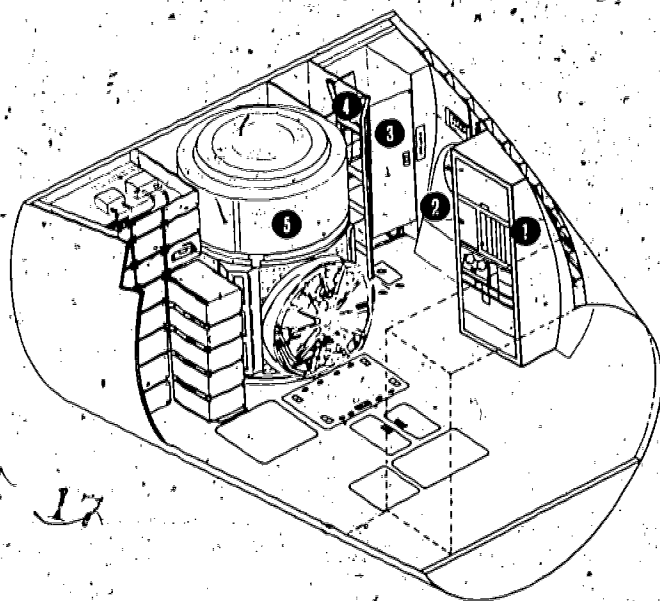
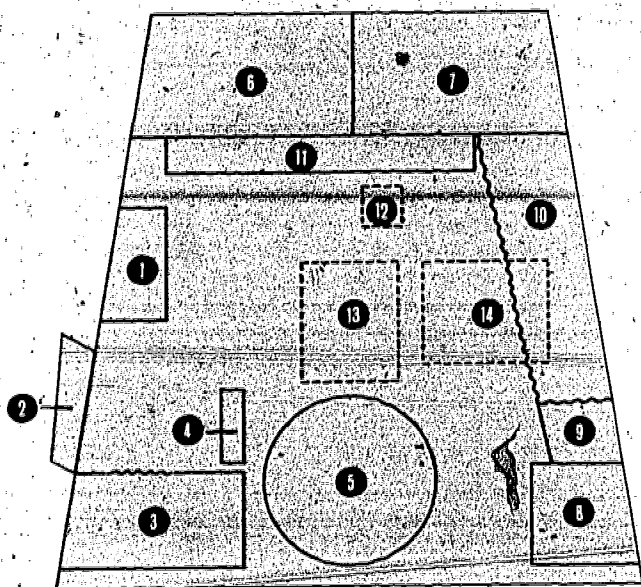

*John W. Young,  
Commander of  
the Shuttle's  
maiden flight,  
checks out  
some mid-deck  
installations*

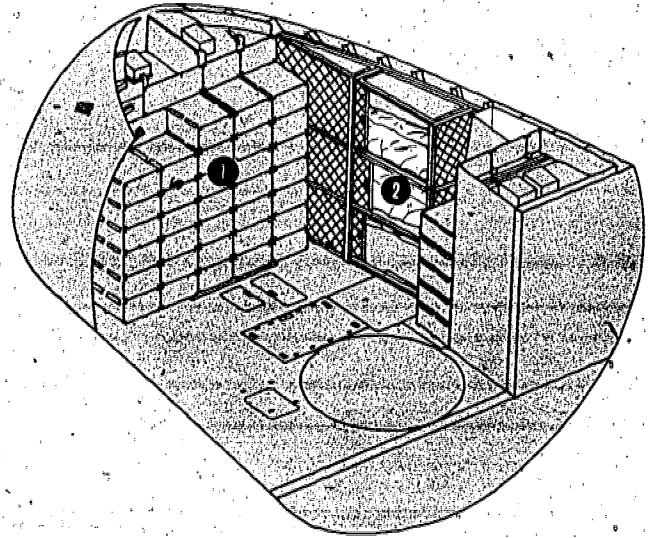

*Mid-deck forward*

- 1 Storage lockers*
- 2 Sleep station*

# Weightlessness

**You will measure 2.5 cm to 5 cm (one to two inches) taller, for the discs between the vertebrae of your backbone no longer have the downward pressure of gravity upon them.**

*Far Right: Skylab astronauts Edward G. Gibson and Gerald P. Carr demonstrate how much fun weightlessness can be*

*Above Right: Comparison of normal Earth posture and weightless posture of space*

On the Shuttle, as on earlier spacecraft, the key word that controls living in space is "weightlessness." There will be many surprises in an existence where you can push away from a solid object with a finger and float. Look in the mirror above the wash basin. Your eyes will seem smaller because your face has grown fuller. This results from the shift of much blood normally in the lower part of your body to the upper part. If you had wrinkles or a double chin on Earth, they will have disappeared. As a result of the blood shift, your waistline has shrunk 2.5 to 5 centimeters (one to two inches), and you must tighten the bands of your pants. Your leather boots have also become too loose, and you will have to tighten the laces.

As for your body, you will measure 2.5 cm to 5 cm (one to two inches) taller, for the discs between the vertebrae of your backbone no longer have the downward pressure of gravity upon them. To handle your new height, the flight jacket was made with elasticized pleats that run up each side of the back and over the shoulders.

Your posture, too, will be different, but not for the better. Joints go to their midpoint in zero gravity so that your hips and knees

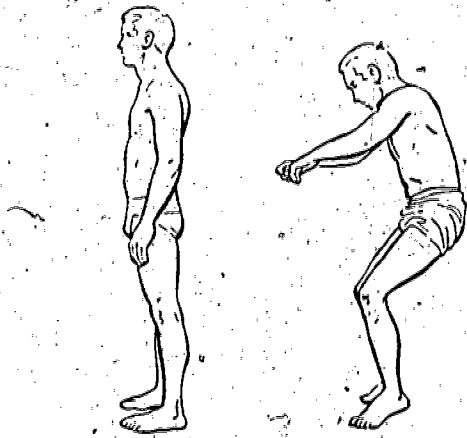

will be bent into a slight crouch. Your arms will tend to float in front of you unless you consciously hold them down. When you sit at a work bench, you will of course have to strap yourself in place. Even so, your seated posture will be to lean back.

The way you handled the most ordinary tasks on Earth must be replaced by new techniques to offset the effects of weightlessness. Eating is a prime example. Forks and spoons will drift off unless they are anchored. When you broke a slice of rye bread at home, you knew the crumbs would drop to your plate. In space, crumbs rise and float, presenting a menace if you inhale them or if they get inside equipment. As a result, bread has to be soft so it will not crumble. Table salt sprinkled toward your meat will scatter instead into the air. Spilled water does not drip down, but moves upward to form fairly stationary, suspended balls. Should these globules hit a solid object, however, they will spread like pancake batter, cling stubbornly to the surface, and be extremely difficult to wipe away.

On Earth you depended on the reacting force of friction to help you do many jobs. In zero gravity, you must do all the work your-

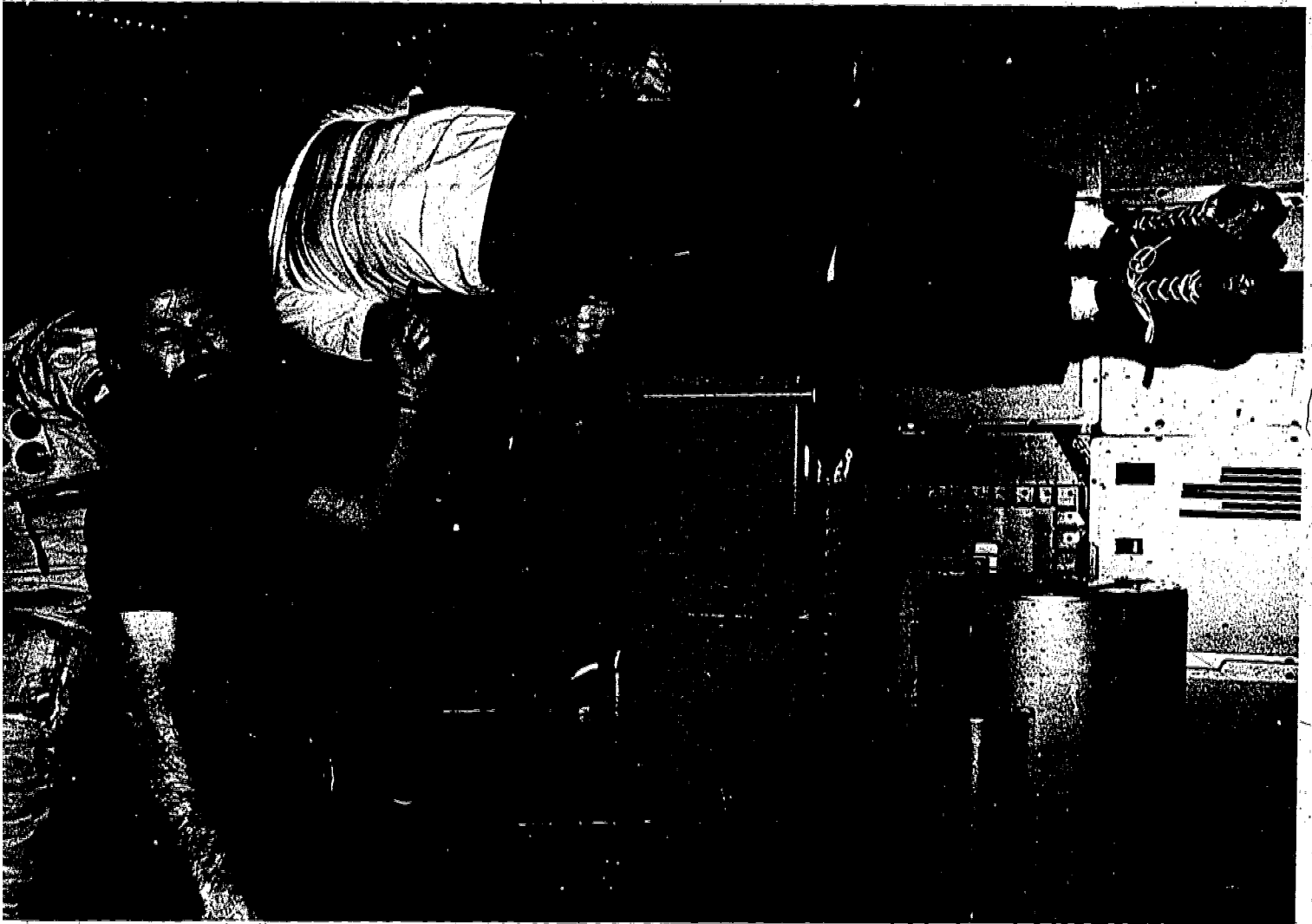

self, with extra steps that consume much energy. Take the simple problem of opening a hinged floor plate in the mid-deck. If the Shuttle were on Earth, you would merely bend down and pull it open. But if you bent down to do this in space, you would continue into endless somersaults until you managed to stop yourself. What you do instead is to go first to stowage and get a portable handhold with suction cups. Then you position your body in a floating headstand, reach down and press the handhold against the floor. With your free hand, you now pinch the opposing springloaded fast-

eners on the floor plate together, and when you succeed it will come open.

Large amounts of energy are often poured into efforts to coordinate the different parts of a job in weightlessness. Describing his frustration in trying to tighten a connector to a plug on the outside of Skylab, astronaut Jack Lousma said, "I would get the tool all hooked up and by that time I would either float loose or the connector had floated loose from the plug. I couldn't seem to get everything all fixed into place at one time."

---

***Spilled water does not drip down, but moves upward to form fairly stationary, suspended balls.***

---



# Food

The four types of food packaging used on the Shuttle are displayed on pages 14-15: Cans; hard plastic containers for rehydration; flex pouches (flexible, aluminum-foil-backed plastic bags); and heavy plastic bags

Your daily food supply on the Shuttle takes into account such excessive use of energy. It will total a high 3,000 calories, plus snacks. Besides this, the meals attempt to compensate for the body's tendency to lose essential minerals in zero gravity. Depletion of potassium, calcium, nitrogen and other minerals can affect muscle tone, bone mass, ability to concentrate and your disposition. So your food will contain ample amounts of these minerals.

Shuttle food must meet other standards as well. Your meals must have a minimum of roughage and items that are hard to digest. The food must also have a shelf life of six months at 37.7° Celsius (100° Fahrenheit), or it will not be taken into orbit. At the same time, the meals must be attractive. Space nutritionists have the memory of the early missions when astronauts had to suck their meals out of plastic bags. Unable to see or smell the food, they had little interest in eating. Bite-size sandwiches and fruit cereal cubes coated with gelatin are also less pleasant relics of a bygone space era. Today, endless experimenting and testing go on to make the food as mouth-watering as possible and allow you to see it and smell its aroma.

To meet weight restrictions for the Shuttle's lift-off, those of the 100-plus different food items that can be dehydrated must go through this process. They are later rehydrated in orbit when ready to be eaten. Included are cereals, vegetables, soups, spaghetti, beef patties, scrambled eggs, bananas, pears, strawberries and shrimp. A freeze-dried strawberry remains full size in outline with its color, texture and quality intact. It can be rehydrated with mouth saliva or by adding water to the package.

Twenty varieties of drinks, including tea and coffee, are also dehydrated. But the list does not include pure orange and grapefruit juice or whole milk. When water is added to the orange crystals, there is no mixture, only orange rocks in water. If whole milk is rehydrated, the milk floats around in lumps and has a disagreeable taste. So skimmed milk and synthetic orange and grapefruit juice are used instead.

Some Shuttle food items are brought aboard in natural form while others are first cooked at moderate temperatures and sealed in cans (thermostabilized), irradiated, or treated to the intermediate moisture process. Natural form Shuttle foods include graham crackers, pecan cookies, almond

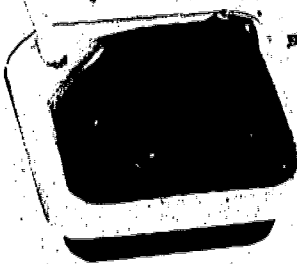

after



before

Orange juice

Hard plastic container for dehydrated food and drink

crunch bars, peanut butter, nuts, hard candy and gum. Thermostabilized foods are canned items on your grocer's shelf, such as tuna fish and canned fruit in heavy syrup. Irradiated foods, or those preserved by exposure to ionizing radiation, include meat and bread. The dried apricots you buy on Earth are an example of the intermediate moisture process. Tobacco and liquor are barred from the Shuttle.

The variety of food carried into orbit is so broad that travelers will enjoy a six-day menu cycle. This means no meal will be repeated until the seventh day. The dinner menu your first evening is an example of the good eating you can expect throughout your trip. It begins with shrimp cocktail in sauce and goes on to beefsteak and gravy, broccoli au gratin, rice pilaf, fruit cocktail, chocolate pudding and grape drink.

With seven persons aboard, there will probably be two shifts of diners. A mission specialist starts the kitchen chores half an hour before the meal. He or she takes the big plastic overwrap marked "Day 1 Meal C," which serves four, from the food lockers and attaches it to the work table that pulls out of the galley. The galley is shaped like a big dispensing machine, but it has an oven, hot

**Meals attempt to compensate for the body's tendency to lose essential minerals in zero gravity.**

**The galley**

- 1 Light
- 2 Mirror
- 3 Wash basin
- 4 Soap dispenser
- 5 Water dispenser
- 6 Food pantry
- 7 Oven
- 8 Meal trays
- 9 Water dispensers
- 10 Wet wipes
- 11 Cups, condiments, hot pads, utensils
- 12 Miscellaneous storage, water heater

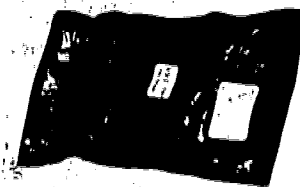
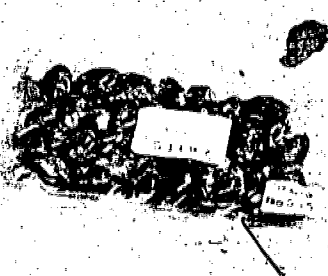
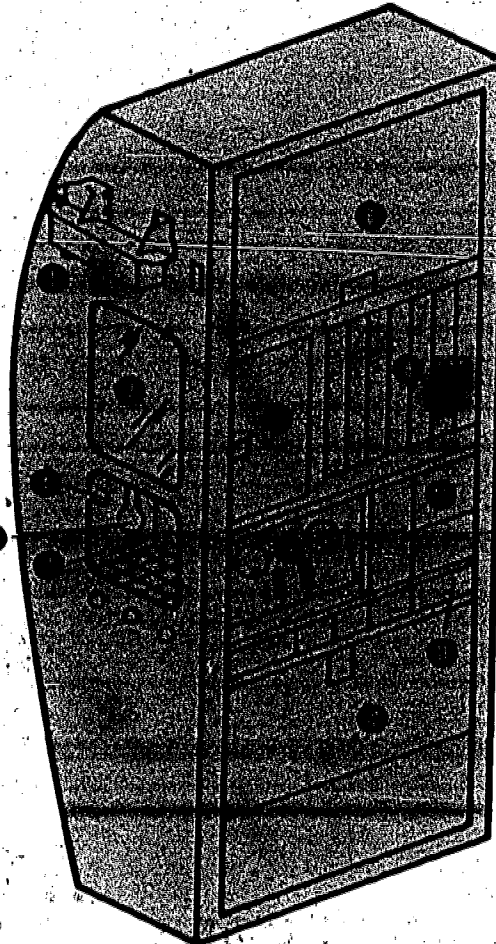

Nine meals for two in overwraps

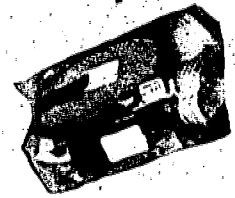
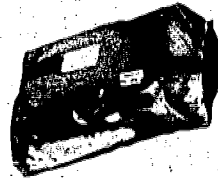
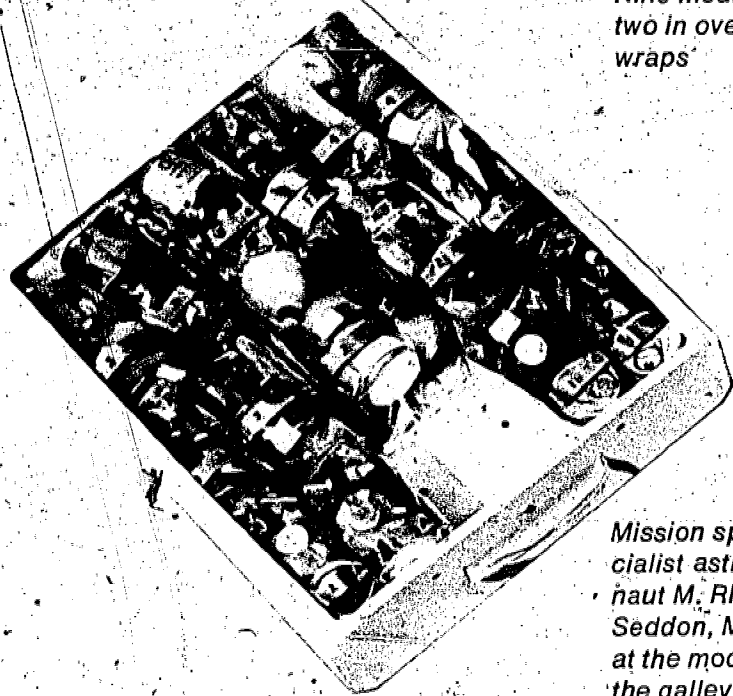

Mission specialist astronaut M. Rhea Seddon, M.D., at the model of the galley

and cold water outlets, trays, hot pads, silverware, wet and dry wipes and a storage section for liquid salt and pepper, catsup, mustard, barbecue sauce, hot pepper sauce and mayonnaise.

Inside the overwrap are four smaller plastic overwraps, each holding a complete meal of seven separate containers. The chef injects the prescribed amount of water through a narrow passageway into the plastic bowls of dehydrated broccoli and rice, using a hollow needle attached to the hot water outlet. He kneads them through their flexible plastic tops and secures them in the oven along with the four pre-cooked steaks. These steaks are packaged in flexible, aluminum-backed plastic bags called "flex pouches." The heat maximum in the oven is 82° Celcius (180° Fahrenheit); which does not harm the plastic containers. A fan circulates the air so that the food is heated evenly.

While these items are warming in the oven, the mission specialist takes four trays from the galley and attaches them by magnets or clamps to a portable dining table hooked to the lockers. He rehydrates the bowls of shrimp, chocolate pudding and grape drink with cold water through the hollow needle, and inserts a plastic straw with a clamp on it into the passageway of the grape drink. These cold items, along with the cans of fruit cocktail, the silverware and a can opener, are then assembled on the trays and restrained by magnets or sticking tape.

When the heated foods are ready, you join the other three diners at the table. You will soon grow accustomed to eating stand-



*Some meal accessories: Can opener, liquid salt*

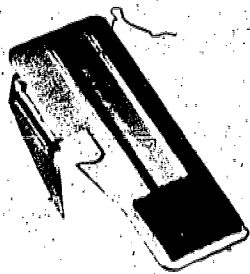

*Below Right: Mission specialist Seddon with food tray*

ing up with suction cup assemblies attached to your boots to keep you in one place. If you sat while you ate, you would lean back and not enjoy the meal.

With the surgical scissors you carry in a leg pocket, you cut off the tops of the food containers and restrain them. The can opener takes care of the fruit cocktail should the easy-open, flip-top lid fail. Early in the space program, it was believed that any food in an open bowl would fly away. It was a happy discovery to find that food in gravy or thick sauce adhered to the container. This made possible the use of spoons and forks because such foods cling to them as well. But if you eat with a regular-size spoon or fork, too large a portion comes to your mouth because the food sticks to the bottom side as well as the top side of silverware. The remedy is to knock the excess off against the inside rim of the food container, or to use a three-quarter size fork. You must also eat slowly and gracefully without sudden starts or stops that could jar food loose. With good food and company, mealtime in space should be a pleasant part of the day.

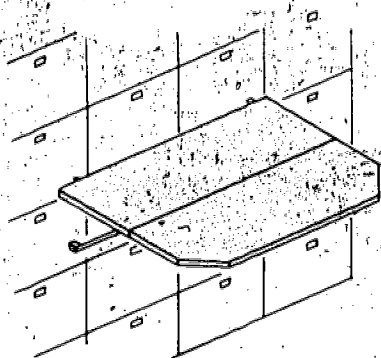

24



### Sleep station

- 1 Top bunk
- 2 Lower bunk
- 3 Bottom bunk on backside of lower bunk
- 4 Vertical bunk
- 5 Movable panels

# Sleep

As with eating, sleeping arrangements aboard the Shuttle must also make peace with weightlessness. Across the mid-deck from the galley is what appears to be a two-tier bunk. Actually, it provides private sleeping accommodations for four persons because zero gravity does not recognize an up or a down. The first person will occupy the top bunk; another the lower bunk. The third sleeper's bed is on the backside of the lower bunk and faces the floor! As for the fourth occupant, this person will sleep vertically in a bunk set against one end of the two-level bunk.

It is time for the first shift of four to get some sleep. The bunks are more than 1.8 m (six feet) long and about .75 m (30 inches) wide. Each bed is a padded board with a fireproof sleeping bag attached to it. The bag has dozens of perforations for ventilation. At-Earth gravity, your body sinks into your mattress. On the Shuttle, your body barely feels the hard bed base. Yet it is enough to give the illusion of mattress and pillow. On past missions, when astronauts slept with nothing behind their sleeping bags, sleep was not restful.

You have the bottom bunk tonight, the one facing downward with your back against the bed base above you. When you grow sleepy, you go to your bunk, put your boots and outer clothing in its personal stowage container and climb into the sleeping bag. It has a long zipper in front that you pull from your legs to your chest, leaving your arms outside. Then you snap together the straps that encircle your waist. If you want privacy, you can shut the side panels. Also

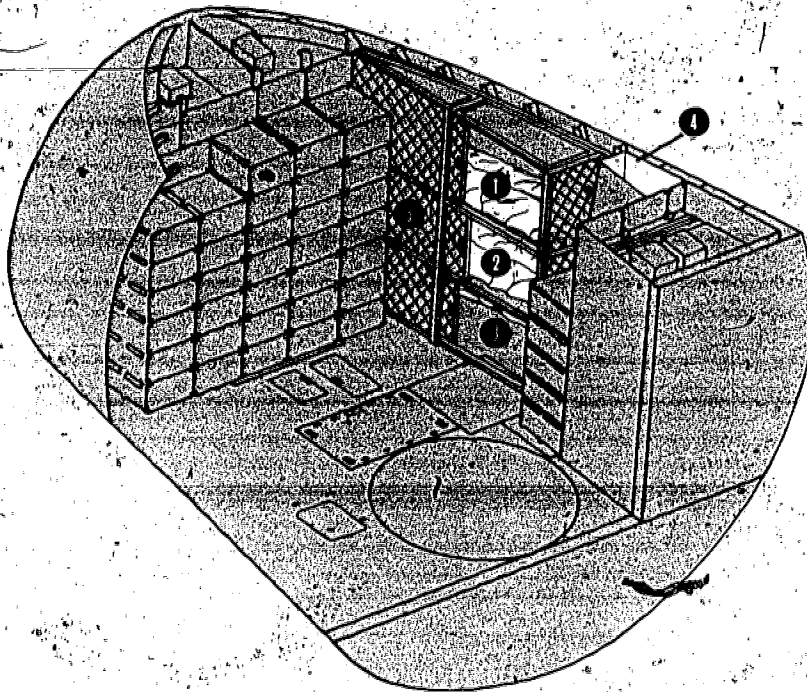

**Should all seven of you decide to sleep at the same time, three of you will be sleeping horizontally (one face down) and four will be vertical.**

25

*Below: The sleeping bag*

*Right: Skylab astronaut Owen K. Garriott ready for bed in his sleeping bag hanging on the wall*

available are eyeshades and earmuffs to reduce outside light and noise. Before you go to sleep, turn off the light behind your head, adjust the airflow duct and slip your hands under the waist straps so your arms won't rise in front of you while you sleep.

Should all seven of you decide to sleep at the same time, two members of the crew must wear communications gear to receive ground calls and alarms. With four of you in the bunks, the other three will have to take sleeping bags from stowage and attach them vertically to the lockers. The hard surface of the lockers will provide the needed feeling of firmness behind the sleepers. So three of you will be sleeping horizontally (one face down) and four will be vertical.





# Exercise

Resistance exercise is as necessary as proper food and sleep to maintain your good health in zero gravity. On past missions, astronauts have suffered some bone and muscle deterioration despite their hard physical exertion in space, because their bodies were not getting the resistance they were accustomed to in gravity.

To help offset this, you will walk a treadmill on the Shuttle. Flight physicians recommend at least 15 minutes daily on the treadmill for missions lasting from seven to 14 days. On 30-day missions, the time should be extended to 30 minutes. In addition to the healthful affect on your bones and muscles, it will help you readjust more quickly to Earth gravity on your return home.

When not in use, the treadmill is kept in a locker. Set it near the hatch window so you can overcome the monotony of the exercise by looking out occasionally on the passing world. Or, turn on some music. The treadmill consists of a teflon-coated aluminum sheet on a roller. Its bottom plugs lock into the holes in the floor to make it secure. Straps come from its base to tie around your waist. The tighter the straps, the greater the resistance encountered during the workout. Other straps attach from a bar in front of you to your waist. This lets you exercise your arms by pushing upward on the bar as you trudge.

Make sure the air is circulating well about you by turning up the duct close to you. Otherwise, when you perspire, you may be creating a nightmare. For the perspiration will cling to your skin just as water always does to a solid surface in zero



gravity. It does not drip off, but only grows thicker. On Skylab, astronauts used a hose blower to get it off their skins. This created a new problem because the moisture came off in sheets. Finally, they were forced to use a vacuum cleaner to suck it out of the air.

*The treadmill in use*

# Sea-level Atmosphere in Space

**The air manufacturing and control system has been working to provide you with a steady supply of unpolluted air.**

In the vacuum of space, there is almost no oxygen, moisture or air pressure. If your body were exposed, your blood would boil and turn to gas. Inside the Shuttle, the air manufacturing and control system has been working to provide you with a steady supply of unpolluted air. Even more, it has been keeping the air at the comfortable sea-level atmosphere of 6.66 kilograms (14.7 pounds) of pressure per square inch, with an air mix of 80 percent nitrogen and 20 percent oxygen.

This pressure is maintained by releasing more nitrogen and oxygen into the cabin atmosphere as they are lost. Nitrogen and oxygen leak overboard. Also, oxygen declines as it is inhaled and used by your body. Should the valve that measures cabin pressure show even the smallest drop from 6.66 kg (14.7 lbs.) to 6.62 kg (14.6 lbs.), it alerts an electronic "smart box." In turn, the "smart box" checks the three oxygen sensors in the cabin. If two agree about the level of oxygen, the "smart box" accepts the majority opinion. It then signals other valves near it to open and supply either more oxygen or nitrogen, or both, from the storage area at the rear of the Shuttle.

To keep the air clean, a fan under the mid-deck floor pulls it constantly through a screen that catches debris, such as lint, hair and crumbs. Then the air moves through canisters of white, granular lithium hydroxide to remove the carbon dioxide you exhale. If it is not removed, it could cause headaches. Large amounts of carbon dioxide are poisonous. The canisters also contain a layer of charcoal to trap odors in the air. Following this, the air passes through another valve that decides how much heat and humidity to subtract, and this is done. Finally the cleaned air is returned to the cabin.

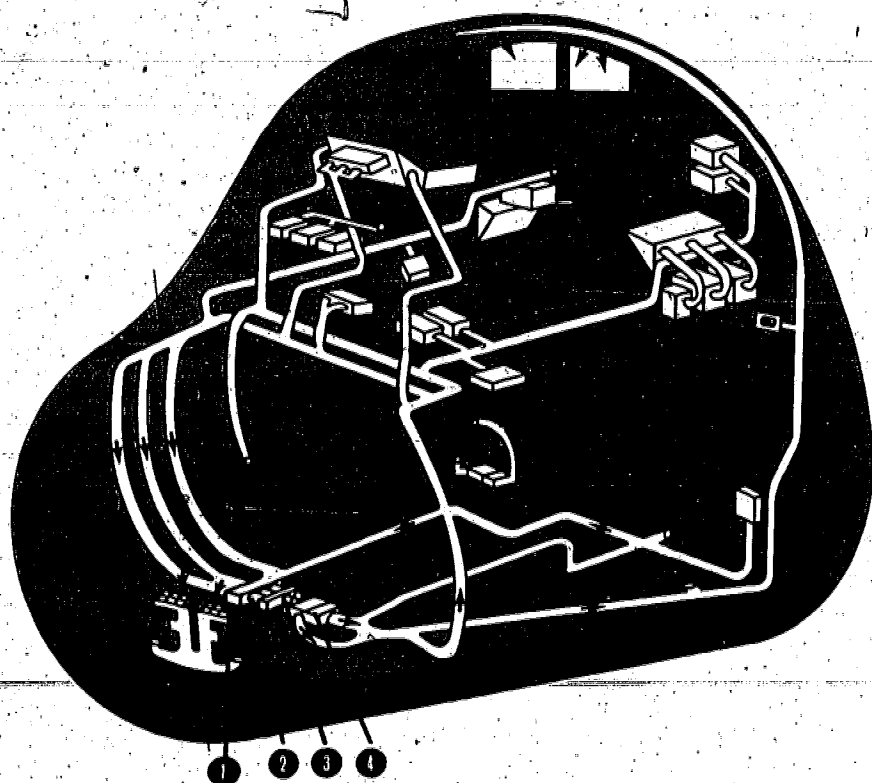

- |                                  |                             |  |
|----------------------------------|-----------------------------|--|
| <b>Air Revitalization System</b> | 4                           | Heat and humidity remover  |
|                                  | 5                           | "Smart Box" and valves that supply more air in ceiling over toilet |
| 1                                | Air-filter screen           |  |
| 2                                | Fan                         |  |
| 3                                | Lithium hydroxide canisters |  |



## Personal Hygiene

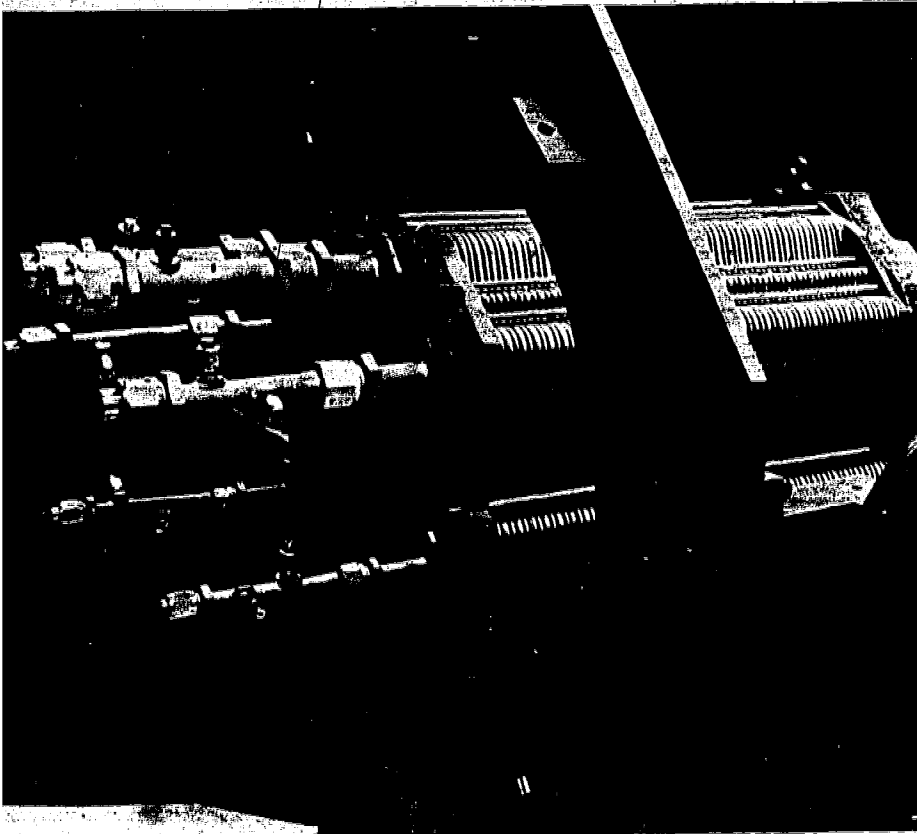

*The fuel cell:  
The battery of  
space that  
makes pure  
water as a by-  
product*

You won't be able to shower on the Shuttle, but not for want of water. The spacecraft's electricity is produced by three fuel cells. Each has 32 plates. When liquid hydrogen is applied to one side of a plate and liquid oxygen to the other side, the plate puts out one volt of electrical power, or 32 volts per fuel cell. The byproduct is water, as pure as distilled, made by the fuel cells at the rate of 6.8 kg. (15 lbs.) an hour. This is four times the estimated amount needed by seven persons on the Shuttle. The excess is dumped overboard.

Skylab, with its larger facilities, had a shower. While standing inside a collapsible, cylindrical cloth bag, an astronaut squirted warm water at himself from a water gun and scrubbed with liquid soap. In theory, the shower was a success; in practice, a failure. The reason: His two fellow astronauts had to spend valuable time vacuuming escaping water from the air and installations.

You will be restricted to sponge baths on the Shuttle. According to training procedures, this should take about ten minutes. For privacy, draw the curtain from the bathroom door to the side of the galley where the wash basin is recessed. Above the basin are a mirror and a light, and on the wall are strips of tape to attach towels, wash cloths and personal hygiene items. The basin provides warm water and a soap dispenser.

There is no need to use much water because it adheres so well to your skin in weightlessness, as do the soapsuds. You use one cloth to wash, another to rinse yourself. At the rear of the basin is a fan



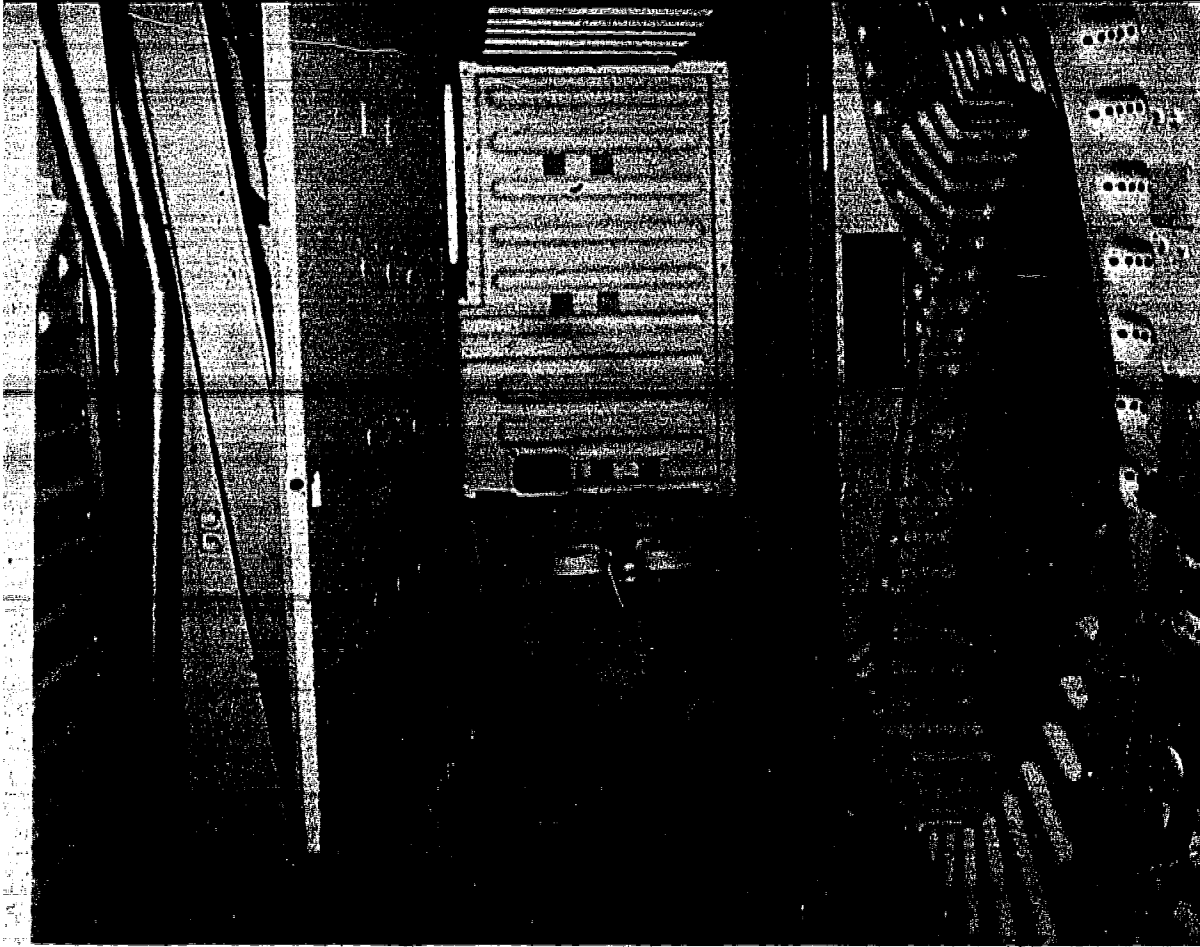

*The toilet in stowed position; ready for use with foot-rest down. Wet trash bag on the door for used wash cloths, towels and garbage*

*The bathroom on the Shuttle reflects the enormous effort made to provide a touch of home in space.*

that pulls the excess water toward a drain that leads to the waste water tank under the floor. When the tank becomes full, an alarm goes off and a mission specialist dumps the water overboard. The wash cloths and towels go into the bag hanging on the bathroom door.

The bathroom on the Shuttle reflects the enormous effort made to provide a touch of home in space. It is a private room when the curtain is drawn, with a regular-appearing toilet, a light over the right shoulder to read by and the hatch window on the left to look down at Earth.

But in important ways the Shuttle's toilet is unique. To remain seated, the user must insert his boots into the toe holds of foot restraints and snap together the seat-belt waist restraints. There are also hand-holds. Instead of water to flush away solid

wastes, this toilet relies on a fan that draws away the wastes from the user and sends it to a compartment below. There it is dried and disinfected. Liquid wastes are drawn into a contoured cup and flexible hose by air flow, and the fluid is pumped into the waste water tank under the floor.

Before this type of toilet was developed, astronauts used an emesis bag. This was much like an aircraft emergency bag, with chemicals inside to disinfect the waste.

The personal hygiene gear in your own locker includes changes of clothes and a kit containing items such as toothpaste and a toothbrush, dental floss, razor and shaving cream, a nail clipper, and a comb and brush. The nail clipper will not be necessary on a short trip. On Earth, fingernails need trimming once a week. In space, they grow so slowly that once a month is enough.



## Medicine

In general, your health will be watched by a mission specialist, some of whom are physicians. Others are astronauts with paramedic training. They have equipment aboard to take electrocardiograms, as well as a medicine chest with first aid kits and drugs for minor ailments, such as sinus congestion or insomnia. In the past, 30 percent of our astronauts suffered from motion sickness with its symptoms of dizziness, nausea, cold sweats, headaches and drowsiness. A drug is available that prevents or ends it. For those who prefer not to take the drug, their motion sickness can be expected to last for three days. On a seven-day flight, this is almost half their trip.



## Going EVA

When the Shuttle moved into its orbit, the huge doors covering the payload bay were opened from the flight deck. But they must be examined to make certain they and the radiators on them are operating properly and can be closed before the return to Earth. The heat shield, which consists of thousands of bonded silica tiles, must also be checked. This tile shield must be intact to protect affected areas of the Shuttle's exterior from heat as high as 1370°C (2,500°F) on reentry.

Only astronauts may go outside the Shuttle to make these inspections and repairs, and handle the mission's scheduled workload in space. Extra-Vehicular Activity, or EVA, begins when an astronaut opens the hatch of the airlock at the back end of the mid-deck and goes inside. Once he closes the airlock hatch behind him, he is inside a large metal drum 1.6 m (63 in.) in diameter and 2.1 m (7 ft.) tall, with lights, handholds and foot restraints and the same air mix and pressure as the mid-deck.

Here in the airlock, he changes into his EVA gear. First, he puts on a pair of longjohns and a urine-collecting device. The longjohns have water-cooling tubes running through them to keep him comfortable during the heavy outside work. Next he rises into the top section of his two-piece space suit hanging on the wall and gets into the lower part. He has to align the many connections between the two parts so that water and air will be able to run from the top to the lower section and return. Then he locks the hard upper area of the bottom to the hard upper torso of the suit. Finally, he puts on the helmet and gloves, and locks

*Left: Astronaut with Manned Maneuvering Unit on his back*

*Below: Upper part of the Extra-Vehicular Activity suit stowed on the wall of the airlock*

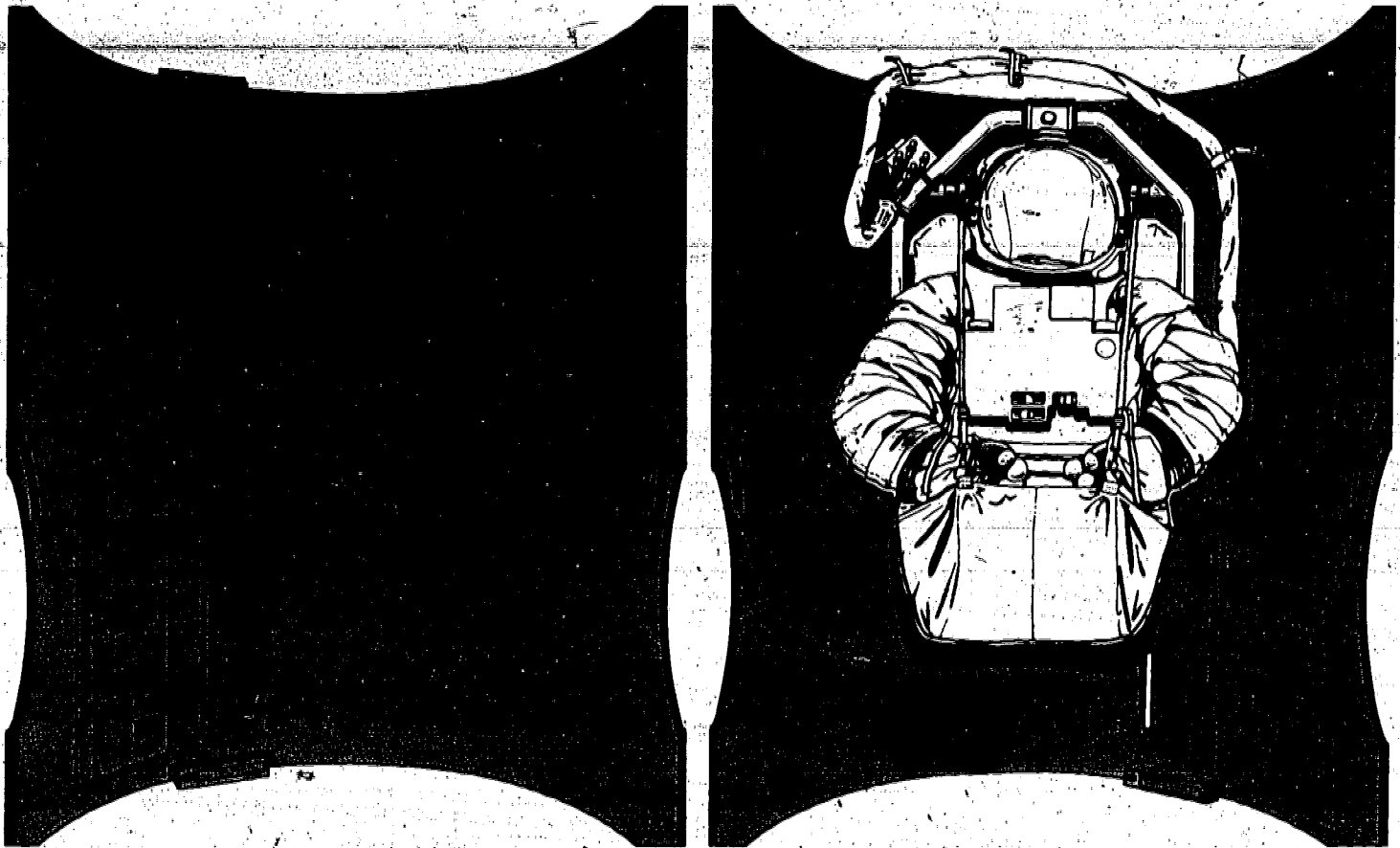

both securely because the smallest exposure of the body when outside the spacecraft would be fatal.

The Shuttle space suit is a remarkable feat of engineering. A built-in backpack in its upper section contains a miniature of the life support system in the Shuttle. In this backpack are oxygen for circulation through the helmet and the inside layer of the space suit, a fan to move the air, a small

lithium hydroxide canister with a layer of charcoal to remove carbon dioxide and gases, water and a pump to dispatch it into the tubes in the longjohns, a unit to cool the water and get rid of the accumulating heat, and batteries to power it. There is even a water purifier, so drinking water can be sipped inside the helmet.

The suit is made in a series of layers. Its basic layer is an inflatable bladder that

---

***Only astronauts may go outside the Shuttle to make inspections and repairs, and handle the workload in space.***

---



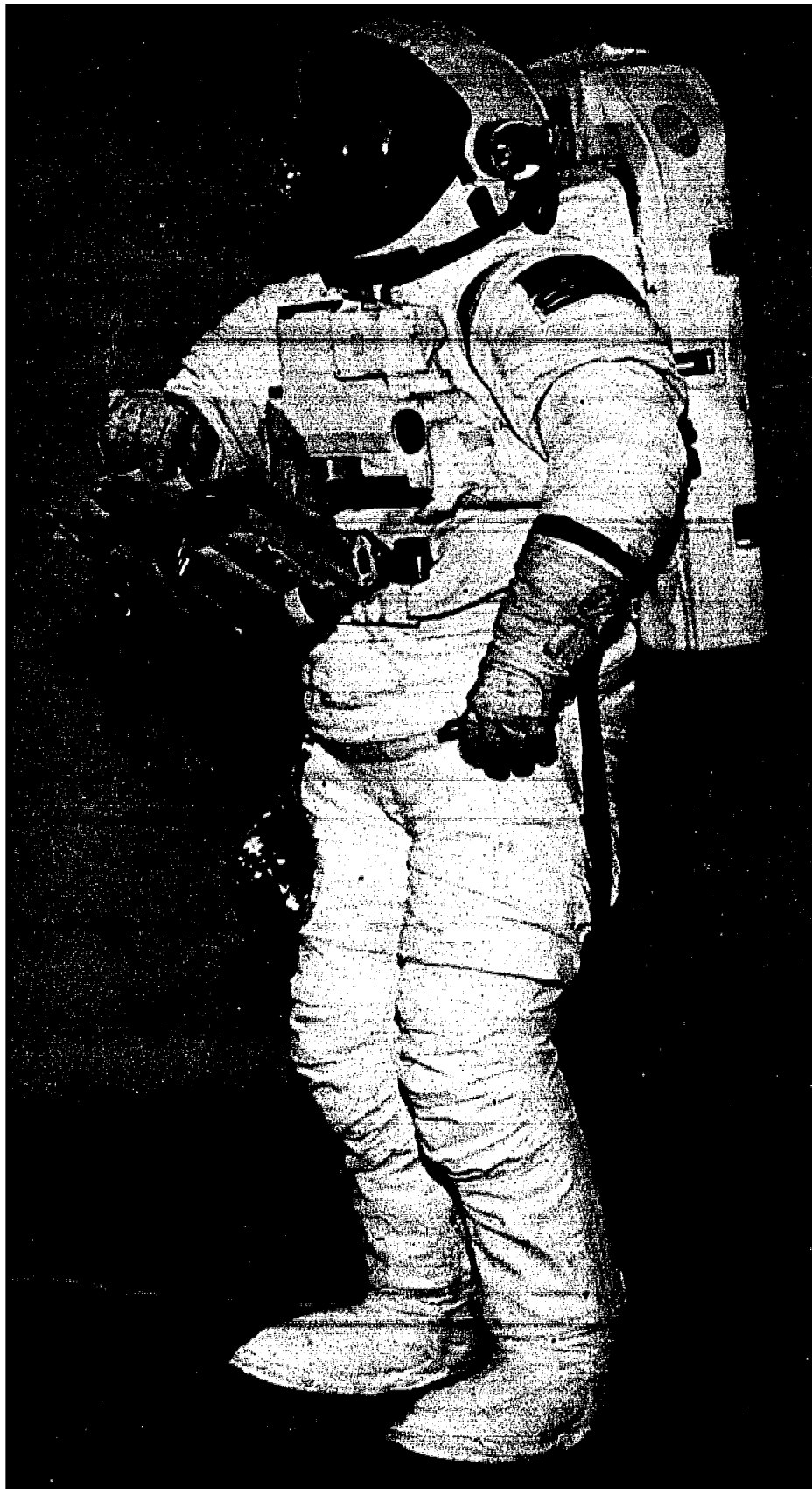

*Astronaut in  
EVA suit ready  
for work out-  
side the Shuttle*

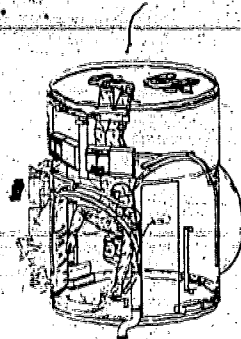

is filled with oxygen to create a steady ring of pressure around the body of 1.58 kg (3.5 lbs.) per square inch. This will prevent the blood from boiling in space. A restraint layer of dacron-polyester over the bladder stops it from ballooning. Next are several layers of fireproof fabric and flexible metal to provide insulation against radiation and temperature variations in space that can range from  $-157^{\circ}\text{C}$  ( $-250^{\circ}\text{F}$ ) to  $+121^{\circ}\text{C}$  ( $+250^{\circ}\text{F}$ ) in a short time span. There is also the layer of hard metal to join the top and bottom sections of the space suit into a unit.

Ready now to exit the spacecraft, the crew member secures his flashlight and tools to his suit, opens the airlock hatch to the outside, tethers himself and leaves for work. The flashlight is a necessity because half of a three-hour stay will be spent in darkness.

## The Helpful Manipulator Arm

Anchored in the payload bay is a 15.2 m - (50-ft.) long metal manipulator arm called the "space crane." The arm has a movable shoulder, elbow and wrist, and a four-claw hand. Without the manipulator arm, astronauts on EVA duty would probably tire themselves unduly trying to handle the Shuttle's heavy schedule of duties.

From the rear of the flight deck, astronauts will operate the arm with a set of controls similar to those in aircraft. The arm is capable of removing a satellite from the payload bay and releasing it into orbit. The arm can also be manipulated to capture satellites needing repairs and return them to the payload bay, to be worked on there or brought back to Earth. Inspection is another function of the crane, or manipulator arm. The TV camera on its wrist, for instance, can easily photograph the payload bay and exterior parts of the Shuttle Orbiter. Two TV receivers on the flight deck have an instant, close view.

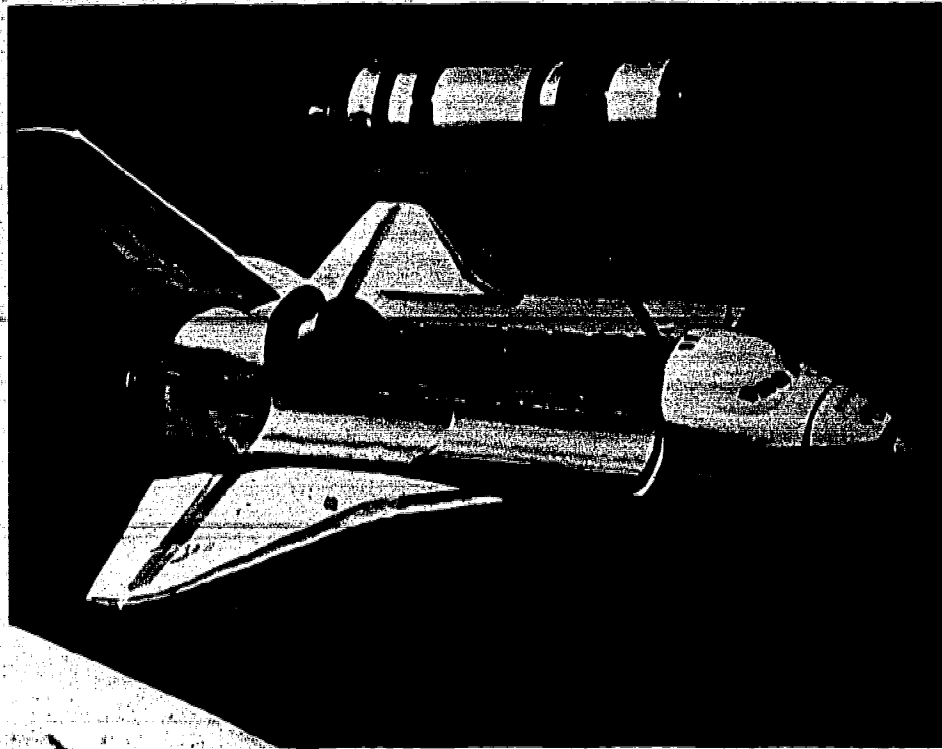

*Above: The Remote Manipulator Arm releasing a satellite from the payload bay for boosting into higher orbit by its attached rocket*

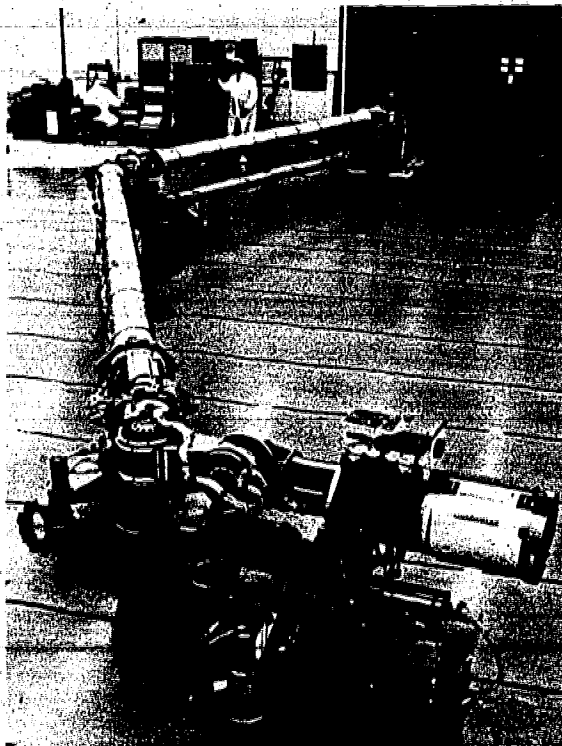

*Left: The 50-foot-long "space crane" in detail, showing "elbow" and "wrist"*

# Spacelab

**Spacelab, financed and built by ten European countries, is a completely furnished laboratory.**

Although the Spacelab is not aboard the Shuttle this trip, it will be carried into space in the payload bay several times each year. Spacelab, financed and built by ten European countries, is a completely furnished laboratory.

It comes in many units that can be assembled in a variety of ways. Part of it can be a sealed, circular laboratory with the same shirt-sleeve environment as the Shuttle cabin. Other parts are outdoor units for work to be done in the vacuum of space.



People who work in Spacelab are called payload specialists. They are not career astronauts, but are chosen by the organizations getting room in Spacelab as authorities on their projects. In their non-working hours, payload specialists will live with the crew and other passengers in the mid-deck, going and coming from Spacelab through a connecting tunnel that also has a shirtsleeve environment.

In their work, the payload specialists will be involved in many kinds of experiments, observations and production that are better done in space than on Earth. For example, some will examine the Earth as a unit from space for data on pollution or the fish population. Others will be able to make observations of celestial bodies without atmospheric interference. Still others will engage in gravity-free manufacturing of new alloys, perfect crystals, and unusually pure vaccines.

*Left: The aft end of the flight deck where Dr. Anna L. Fisher and other mission specialists and payload specialists will receive and control Spacelab data*

*Right: Space Operations Center*



# The Space Center

**Technology is already available to construct a permanent eight-person space center in low Earth orbit.**

When you observe the Shuttle workhorse in action and the skill of the space crane operators and the astronauts on EVA duty, you are prompted to think about the possibilities of broadening human activities in space.

The technology is already available to construct a permanent eight-person space center in low Earth orbit. In turn, this base would become the staging station to support a host of space programs important to humankind.

The Shuttle's role would be to carry into orbit two enormous cylinders and some service units that would be lifted out of the payload bay by the space crane and plugged together. The cylinders, with a connecting passageway, would serve as the command control center, living quarters and laboratory. The service modules would be set below the cylinders and would have the life support systems, power unit, communications apparatus, an airlock and a docking berth for the Shuttle.

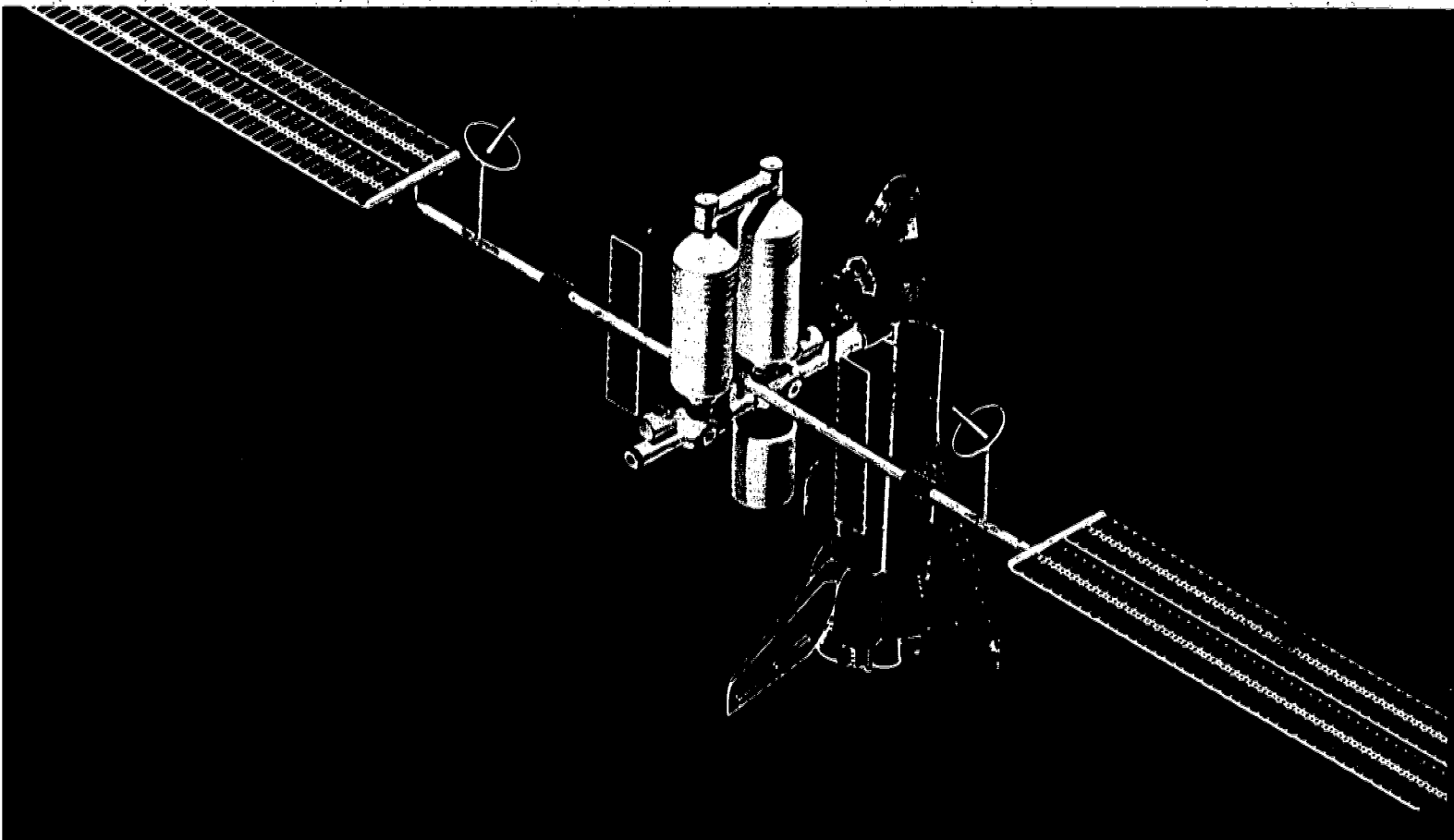

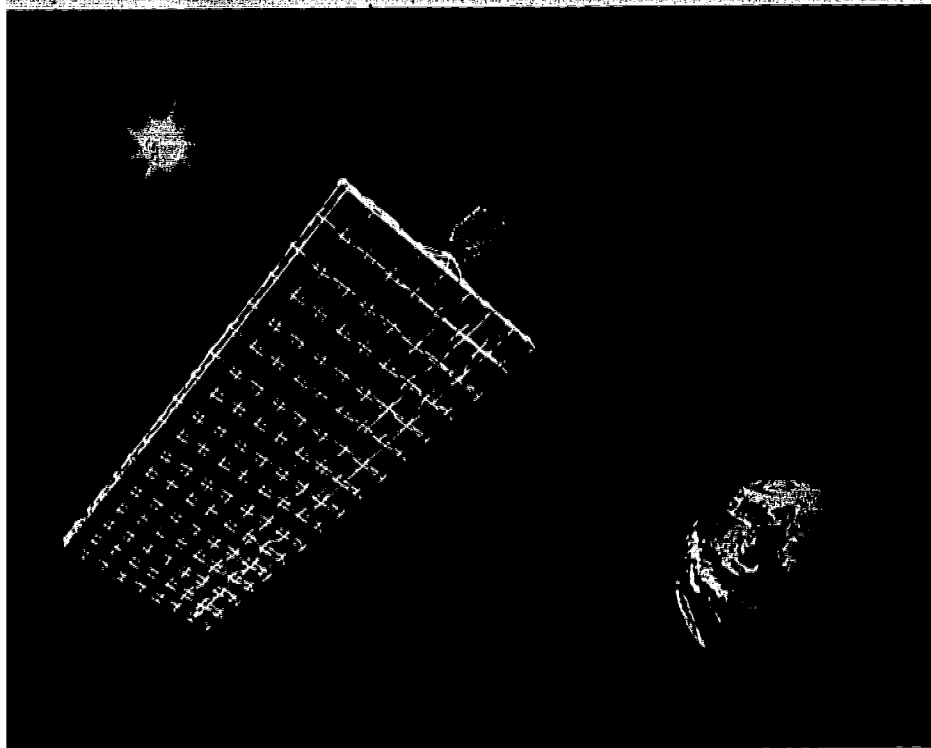

## Returning Home

On day seven of your trip aboard the Shuttle, the time comes to return to Earth. About 6½ hours before the scheduled landing, the crew begins to ready the spacecraft for its reentry with a thorough check of the flight control system. The items not to be used go into stowage, seats come out of storage to be attached to the mid-deck floor, and the payload bay doors are closed.

You have a final snack and put on the special gear for reentry. These are the anti-gravity suit and the helmet with the communications headset. The anti-gravity suit is really an inflatable pair of pants that goes on over your underwear. It has a valve to help you fill it with oxygen from a bottle. Without the A-G Suit, your blood would pool in the lower part of your body on the return from weightlessness to Earth gravity. This could cause you to black out. The pressure of the suit on the legs and abdomen prevents pooling of blood.

Two hours before landing, the crew and passengers strap themselves into their seats. The crew then goes through the preburn checklist, a job that takes 30 minutes. One hour before landing, the descent starts with a reduction in the Shuttle's 28,160 km (17,500 m.p.h.) orbiting speed. The pilot does this by turning the spacecraft around so that it is traveling backward. Now the two small engines with their powerful forward thrust ignite. This burn takes the Shuttle out of its orbit, and it begins to drop. While it falls, the pilot turns it back again into its original direction and pulls its nose up high.

A half hour later, the Shuttle has

As in Skylab, the space center's power will come from inexhaustible solar energy. The Shuttle will provide its initial supply of water. For its air, some of this water will be broken down into oxygen by a reverse process of the fuel cell. Both air and water will be continually cleaned and reused. As for food, the space center is expected to experiment with filling part of its needs from its own soilless hydroponic agriculture.

Another task for the Shuttle will be to transport residents to the space center and return them to Earth at the completion of their stay. No person will be permitted to live on the base for more than three months at a time.

Looking even farther ahead, scientists see the Shuttle-serviced space center as the building block leading to the construction of mammoth solar power stations in far space. They are convinced that shortly into the next century these solar power satellites could be providing Earth with an important share of the energy it will require.

**Scientists see the space center as the building block leading to the construction of mammoth solar power stations in far space.**

*Above: Solar energy being beamed to Earth from far space*

About 6½ hours before the scheduled landing, the crew begins to ready the spacecraft for its reentry.

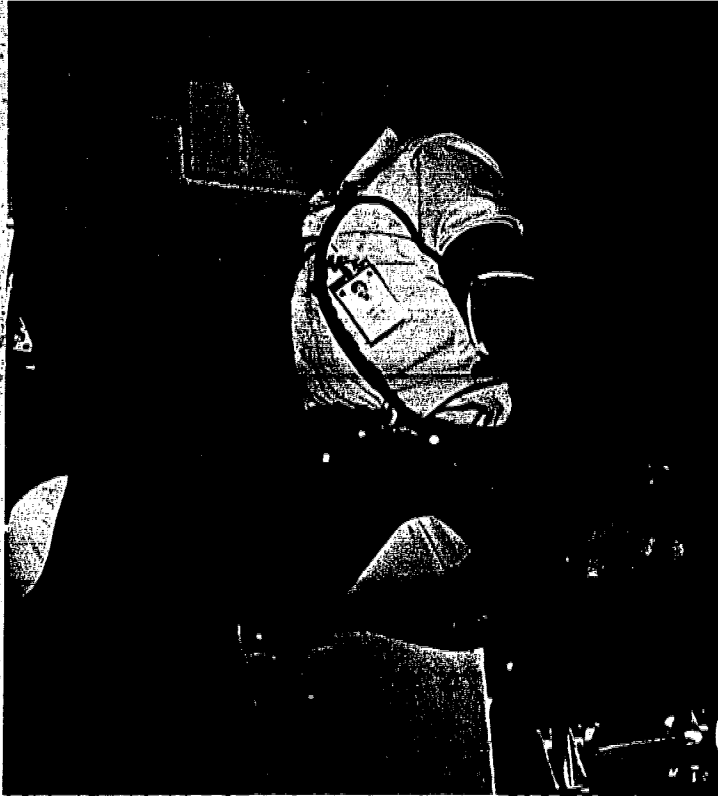

The anti-gravity suit with instrumentation to inflate it



Pivotal points in the Shuttle's return from space

dropped halfway to Earth and enters the rarified atmosphere at an altitude of 121,920 m (400,000 ft.). At this point, the spacecraft is committed by computers to a flightpath that will cover ground distance of 6,400 km (4,000 mi.) horizontally and a drop of about 120 km (75 mi.) during the next 30 minutes to deliver it to a runway at the Kennedy Space Center in Florida.

A communications blackout occurs shortly after the Shuttle re-enters Earth's atmosphere. Intense heat reaching almost +1,650° C (+3,000° F.) hits the protected surfaces of the nose and leading edges of the wings and tail, and temperatures as high as +1,370° C (+2,500° F.) on the heat shield covering the bottom. You do not feel any of it in the mid-deck.

The communications blackout disappears and the heat eases while the Shuttle goes through a series of maneuvers to correct errors in its flight path and speed. At 22,900 m (75,000 ft.) and traveling at 2½ times the speed of sound, the Shuttle should



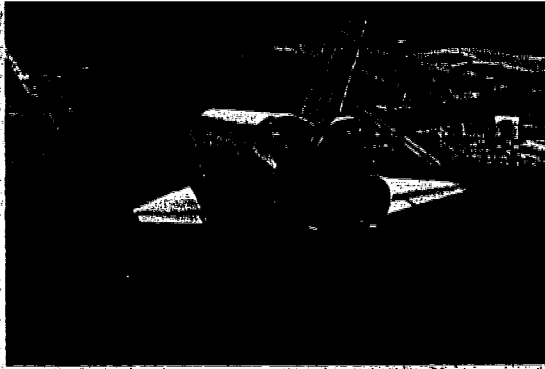

*The Shuttle approaches the runway*

**After about two weeks of inspection, maintenance service and re-equipping, the Shuttle spacecraft will be ready to lift off again.**

now be lined up correctly with the landing site.

The approach starts at about 4,270 m (14,000 ft.) altitude. There has been no motor noise because the Shuttle is landing like a glider, without operating engines. Yet its speed is 530 km (330 mi.) per hour and its descent angle is seven times as steep as that of a commercial airplane. But at 520 m (1,700 ft.), it levels off, the landing wheels come down at an altitude of 90 m (300 ft.), and seconds later you land at about 320 km (200 mi.) per hour.

Almost before you realize you are back on Earth, the mid-deck hatch opens. The ground crew has driven a truck to the Shuttle. The truck has a stairway with an enclosure at the top that is placed against

the side of the Shuttle. You cross into the enclosure and the truck takes you to the nearby medical facility for a physical checkup by flight surgeons. Not until you are lying down do you remove your anti-gravity suit. You will probably remain for a few days in the astronaut living quarters until you have become readjusted to living in gravity.

Meanwhile the Shuttle Orbiter has been towed from the runway to a building resembling an aircraft hangar which is able to handle two Shuttles at one time. After about two weeks of inspection, maintenance service and re-equipping, the Shuttle spacecraft will be ready to lift off again, with a new crew on the flight deck and new passengers in the mid-deck.



*Shuttle exit truck*

### **Astronaut Crew.**

1. *Commander and Pilot.*
2. *Mission Specialists.* Astronaut-scientists responsible for experiment data and housekeeping; also help commander and pilot perform duties outside the Shuttle.

### **Payload Specialists.**

Non-astronauts, experts on specific experiments undertaken in Spacelab during flight of the Shuttle.

### **About the Author:**

Florence S. Steinberg (née Schoenberg) grew up in Minnesota and graduated Phi Beta Kappa from the University of Minnesota. For many years she has collaborated with her husband, Alfred Steinberg, on books and magazine articles. She has a son and two daughters who are a Ph.D. in music, a lawyer and an M.D., respectively. Currently she is writing a pamphlet for NASA on Spacelab, the portable laboratory that will fly in the Shuttle. Her ambition is to be the first "older person (non-astronaut) in reasonable good health" to go into space.