

DOCUMENT RESUME

ED 197 159

CE 027 789

AUTHOR Arneson, F.: And Others
 TITLE Mountain Plains Learning Experience Guide: Electrical Wiring. Course: Electrical Wiring Trim-Out.
 INSTITUTION Mountain-Plains Education and Economic Development Program, Inc., Glasgow AFB, Mont.
 SPONS AGENCY Office of Vocational and Adult Education (ED), Washington, D.C.
 BUREAU NO 498MH90008
 PUB DATE Oct 74
 CONTRACT 300-79-0153
 NOTE 287p.: For related documents, see CE 027 766 and CE 027 788.

EDPS PRICE MF01/PC12 Plus Postage.
 DESCRIPTORS Adult Education; Building Trades; Disadvantaged; Electrical Occupations; *Electricians; Electricity; Family Programs; *Finishing; *Individualized Instruction; Instructional Materials; Learning Activities; Learning Modules; Postsecondary Education; *Vocational Education
 IDENTIFIERS *Electrical Wiring; Mountain Plains Program

ABSTRACT One of two individualized courses included in an electrical wiring curriculum, this course covers electrical materials installation for the trim-out stage. The course is comprised of five units: (1) Outlets, (2) Fixtures, (3) Switches, (4) Appliances, and (5) Miscellaneous. Each unit begins with a Unit Learning Experience Guide that gives directions for unit completion. The remainder of each unit consists of Learning Activity Packages (LAP) that provide specific information for completion of a learning activity. Each LAP is comprised of the following parts: objective, evaluation procedure, resources, procedure, supplemental sheets, study guide, and a LAP test with answers. The course is preceded by a pretest which is designed to direct the student to units and performance activities.

(LRA)

ED197159

MOUNTAIN PLAINS LEARNING EXPERIENCE GUIDE:

Electrical Wiring.

Course: Electrical Wiring Trim-Out.

00 027789

U S DEPARTMENT OF HEALTH,
EDUCATION & WELFARE
NATIONAL INSTITUTE OF
EDUCATION

THIS DOCUMENT HAS BEEN REPRODUCED EXACTLY AS RECEIVED FROM THE PERSON OR ORGANIZATION ORIGINATING IT. POINTS OF VIEW OR OPINIONS STATED DO NOT NECESSARILY REPRESENT OFFICIAL NATIONAL INSTITUTE OF EDUCATION POSITION OR POLICY.

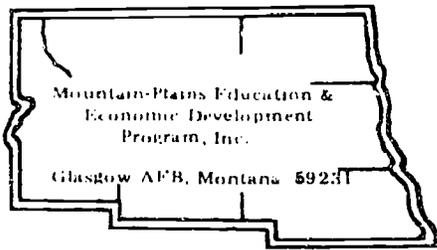

Learning Experience Guide

COURSE: ELECTRICAL WIRING TRIM-OUT

DESCRIPTION:

The Electrical Wiring Trim-Out course contains the information and procedures for completing the electrical requirements for a structure plan. The electrical materials installation for the trim-out stage generally includes fixtures, appliances, and control device. Procedures presented and the information provided are those used for quality work and directed by the National Electrical Codes.

RATIONALE:

Becoming a qualified electrical wireman involves knowledge about determining what is to be done, where to do it, and how to do it. In this course you will become involved with the trimming out stage or completing the electrical requirements for a structure.

OBJECTIVES:

Identify characteristics of symbols, and procedures for electrical trim-out. Given blueprint specifications, National Electrical Codes, tools, building or shop simulation with electrical wiring rough-in, students will list materials required and make installations of electrical wiring in a trim-out mode. Success will be determined by adherence to specifications under controlled conditions and by 80% accuracy on the multiple choice course test.

PREREQUISITES:

Communications skills at the H-level.

Occupational prerequisites course: Electrical Wiring Trim-Out.

RESOURCES:

Electrical Wiring Residential, Ray C. Mullin, Delmar Publishers, 1973.

A variety of electrical supply catalogs.

A variety of manufacturer's electrical products specifications guides.

Principal Author(s):

R. Arneson, L. Leland, T. Ziller

Electrical Wireman's tools.

Film Loops:

Permeability; Magnetic Field; Magnetic Poles; Law of Magnetism; Induced Magnetism;
Permanent Magnets; Poles occur in Pairs; Polarity of Static Charges; Inductive Field;
Electrostatic Induction; Electroscope I and II; Electromagnetic Generator and Alternative;
Moving Coil and Reversing Polarity; Electromagnetic Force and Electromagnetic Polarity;
The Electric Motor I and II; Electric Generator, Fairfield Associates, the Jam Handy
Organization.

Audio Cassette Tapes.

Narrations for each of the film loops listed, Mountain-Plains Education & Economic
Development Program, Inc.

GENERAL INSTRUCTIONS:

This is the second course of the two-course sequence for wireman. A unit guide will be given to you before beginning the activities in that unit. The unit guide describes the assigned unit. After reading the unit guide, you may begin your activities or request a unit test if you believe you have already mastered the unit objectives.

There is a LAP provided for each assigned activity. This LAP gives the procedures to be followed. Upon mastery of an activity objective you will proceed to the next assigned activity until the unit is completed. A LAP test is used to determine mastery of the activity. You will usually work independently. The instructor will assist you when you have problems or questions.

UNIT TITLES:

- .01 Outlets.
- .02 Fixtures.
- .03 Switches.
- .04 Appliances.
- .05 Miscellaneous.

FOLLOW-THROUGH:

After reading this course guide, you are ready for the first assigned unit in this course. Obtain the guide for that unit.

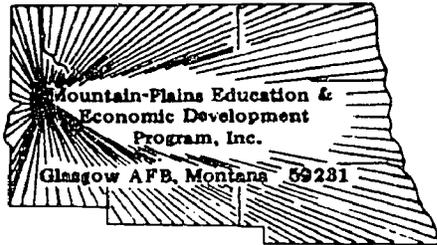

COURSE TEST: ELECTRICAL WIRING TRIM-OUT

72.02.01.01

1. The NEC states that the minimum wire size allowable in a house is:

- a. 10 AWG.
- b. 14 AWG.
- c. 8 AWG.
- d. 12 AWG.

2. Which of the following symbols is a ceiling outlet?

- a. 
- b. 
- c. 
- d. 

3. Where are notations found on an electrical plan?

- a. In the specifications.
- b. On the plan letterhead.
- c. Next to a symbol, usually as abbreviations.
- d. In the plan margin.

4. Each neutral wire entering and leaving a box is counted as:

- a. not counted.
- b. two wires.
- c. one wire.
- d. three wires.

5. What do the letters AWG stand for in electrical terminology?

- a. Advanced Wattage Gauge
- b. American Wire Gauge
- c. Ambient Weather Gauge
- d. Aluminum Wire Gauge

72.02.01.02

6. Which of the following is a symbol for a fan?
- a. 
 - b. 
 - c. 
 - d. 
7. A three wire 115/230 volt branch circuit is the equivalent of how many receptacle branch circuits (115V)?
- a. one
 - b. three
 - c. four
 - d. two
8. Which of the following is a symbol for a thermostat?
- a. 
 - b. 
 - c. 
 - d. 
9. What system is used for the wiring of the receptacles in the kitchen? (see plan)
- a. standard
 - b. compound circuit
 - c. split circuit switched
 - d. split circuit
10. What is the height of the convenience receptacles in the kitchen (see plan)?
- a. 48" to center
 - b. 50" to center
 - c. 36" to center
 - d. 44" to center

72.02.01.03

11. Dash lines on an electrical plan:

- a. always are used to connect outlets.
- b. never are used to indicate switch connections.
- c. always indicate special purpose use.
- d. always are used to indicate switch connections.

12. Boxes are measured:

- a. diagonally.
- b. by inside opening.
- c. by outside opening.
- d. by circumference

13. Which of the following symbols indicates a battery?

- a.  B
- b.  B
- c.  B
- d. 

14. Which of the following is the symbol for a duplex outlet?

- a. 
- b. 
- c.  WP
- d.  GWP

15. What size and larger is the wire beyond which the conductors are no longer standard?

- a. 10 AWG
- b. 8 AWG
- c. 12 AWG
- d. 6 AWG

72.02.01.04

16. Which of the following symbols indicates a lighting panel?

- a. 
- b. 
- c. 
- d. 

17. Which of the following symbols indicates a range outlet?

- a. 
- b. 
- c. 
- d. 

18. Each neutral wire entering and leaving a box is counted as:

- a. not counted.
- b. three wires.
- c. two wires.
- d. one wire.

19. Which of the following is the symbol for a duplex outlet?

- a. 
- b. 
- c. 
- d. 

20. A device mounted in a box is counted as:

- a. three wires.
- b. two wires.
- c. not counted as a wire.
- d. one wire.

72.02.02.01

21. A three wire 115/230 volt branch circuit is the equivalent of how many small appliance branch circuits?
- two
 - one
 - three
 - four
22. A three wire 115/230 volt branch circuit is the equivalent of how many receptacle branch circuits (115V)?
- one
 - three
 - four
 - two
23. Which of the following is a symbol for a thermostat?
- 
 - 
 - 
 - 
24. In the living room, what type of fluorescent fixtures are used for the valance lighting?
- revolving start
 - instant start
 - trigger start
 - rapid start
25. Which of the following symbols indicates a recessed ceiling fixture?
- 
 - 
 - 
 - 

72.02.02.02

26. What is the current rating of a portable heater of 1750 watts 120 volt?
- 14.58 amps
 - 15.63 amps
 - 12.6 amps
 - 13.8 amps
27. According to the code, what is the maximum portable appliance current rating that may be connected to a 15 amp branch circuit?
- 14
 - 13
 - 12
 - 10
28. How are the heaters supplied with electricity at outlets A1 & A2 (see plan)?
- permanently
 - EMT/permanently
 - semi-permanently
 - plug in (portable)
29. What color is the grounded conductor?
- black
 - red
 - white
 - green
30. Using the plan, where is the special purpose receptacle A1 located?
- storage
 - workshop
 - utility
 - recreation

72.02.02.03

31. Which one of the connections is wired correctly so that both ceiling light outlets are controlled from the one single-pole switch. Assume the installation is in cable.

a.

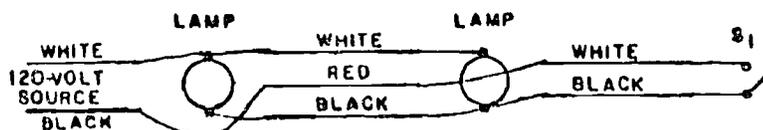

72.02.02.03 (continued)

31. continued

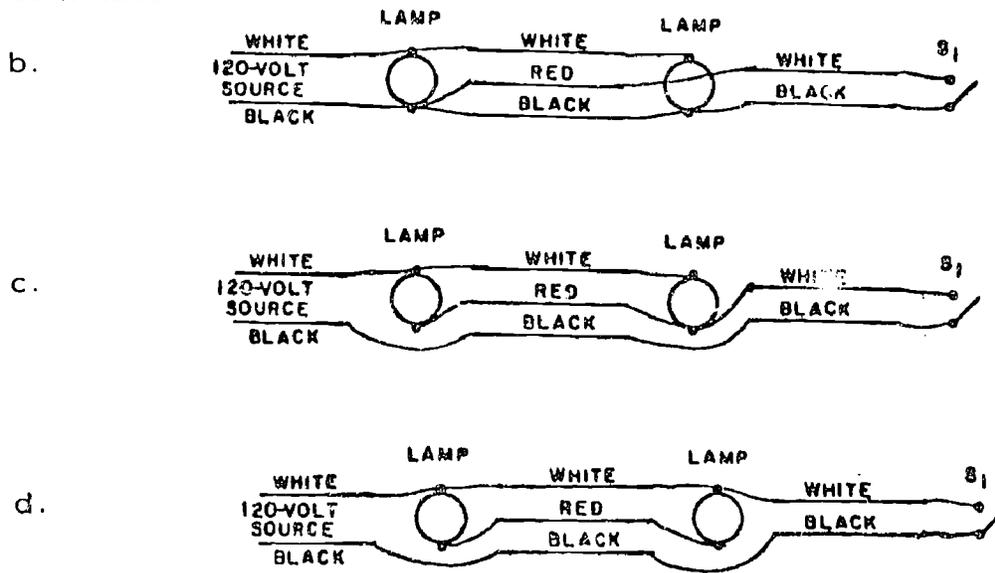

32. To control a group of lights from one location the most practical switch to use is:

- double pole.
- four way.
- single pole.
- three way.

33. The color of the identified conductor is:

- blue.
- white.
- black.
- green.

34. A DPDT switch may be installed:

- in a three way circuit.
- between outlets.
- at the end of a circuit.
- at the beginning of a circuit.

72.02.02.03 (continued)

35. Which one of the connections is wired correctly so that the ceiling outlet may be controlled from either three way switch?

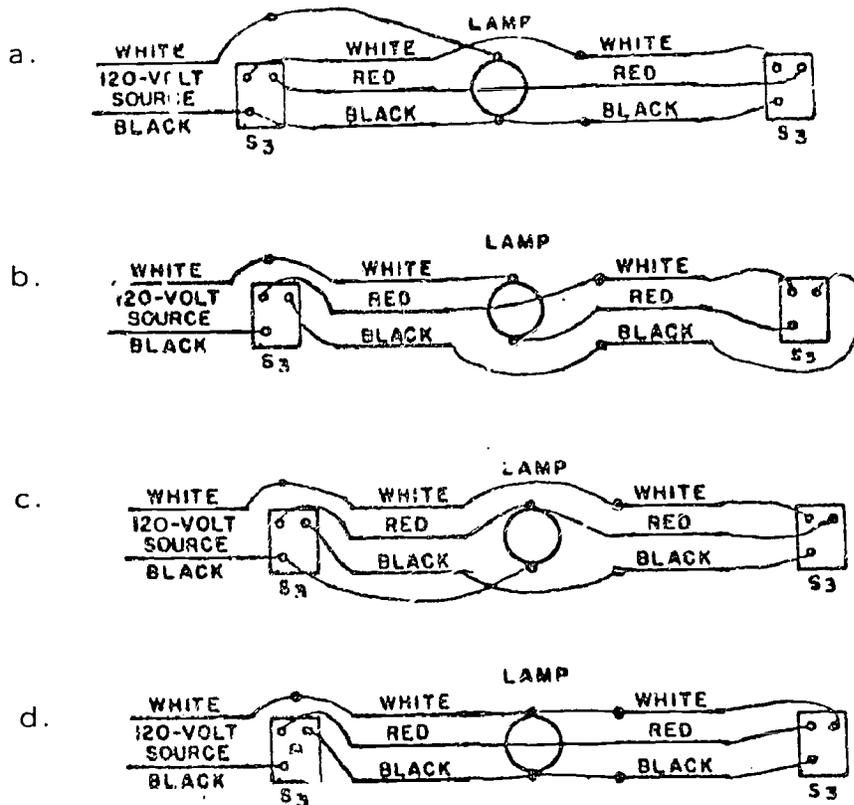
72.02.02.04

36. If a recessed fixture does not have an approved junction box, one must be installed. The code indicates a maximum and minimum distance from the fixture for the raceway to the box. What is it?
- 3 - 4 feet
 - 4 - 6 feet
 - 1 - 2 feet
 - 6 - 8 feet
37. According to the electrical code the area temperature between a recessed fixture and combustible material must not exceed:
- 120 degrees.
 - 90 degrees.
 - 160 degrees.
 - 50 degrees.

72.02.02.04 (continued)

38. If a circuit is rated at 1440 watts and the voltage is 120 volts, what is the size circuit breaker that should be installed in the power panel for this circuit?
- a. 20 amp
 - b. 50 amp
 - c. 30 amp
 - d. 15 amp
39. Exposed noncurrent-carrying metal parts of electrical equipment are installed within which of the following distances of any grounded metal work or fixture in a bathroom?
- a. 8' vertically and 2' horizontally
 - b. 8' vertically and 5' horizontally
 - c. 5' vertically and 8' horizontally
 - d. 4' vertically and 5' horizontally
40. What type of face plates should be used in a bathroom?
- a. metal
 - b. plastic
 - c. copper
 - d. aluminum

72.02.02.05

41. When is it allowable to run branch circuit wiring through an outlet box that is an integral part of an incandescent fixture?
- a. if building codes approve it
 - b. if rated for it
 - c. if U/L approved
 - d. if inspector approves it
42. If a fluorescent fixture has a 40 watt lamp rating and the standard 1.25 factor is used, what is the fixture total load?
- a. 40 watts
 - b. 40 VA
 - c. 45 VA
 - d. 50 watts

72.02.02.05 (continued)

43. What is the size rough-in box used on the switches outside of the shower in the bathroom (see plan)?
- 2" x 2" x 3"
 - 4" x 4" x 1-1/2"
 - 3" x 3" x 2-1/2"
 - 4" x 4" x 2-1/8"
44. According to the code the junction box must be set a minimum distance from the recessed fixture. What is the distance?
- 10"
 - 12"
 - 16"
 - 6"
45. What type of face plates should be used in a bathroom?
- aluminum
 - metal
 - plastic
 - copper

72.02.03.01

46. Which one of the following connections is wired correctly for a ceiling outlet which is controlled from any one of three switch locations? The 120 volt feed is at the light.

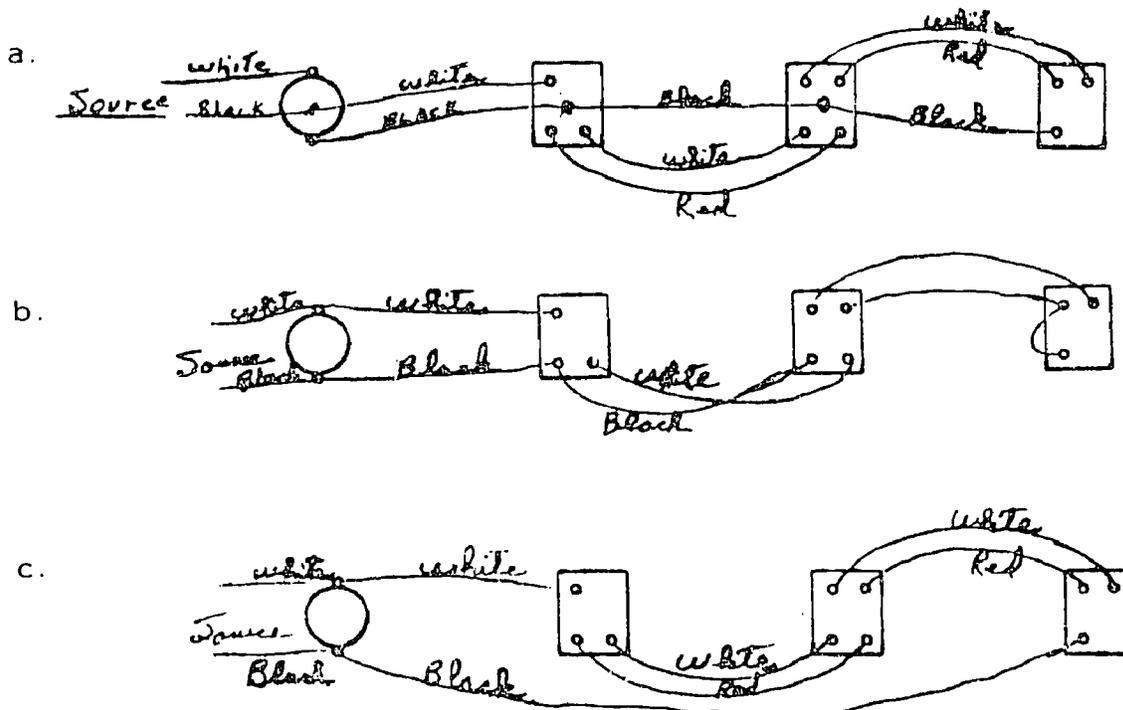

72.02.03.01 (continued)

46. continued

d.

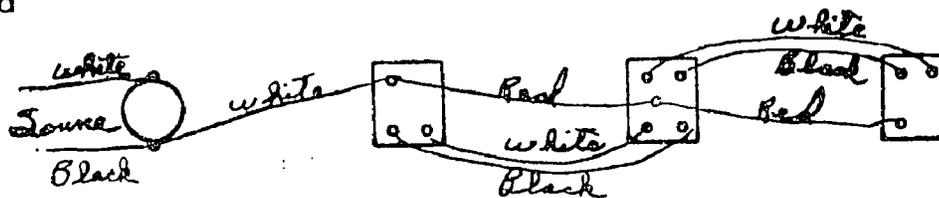

47. In a four way switch configuration, how many three way switches are used?

- a. three
- b. four
- c. one
- d. two

48. Which of the following is not a toggle switch?

- a. double pole
- b. three way
- c. single pole
- d. momentary

49. The identified conductor can be used in a switch loop when the unidentified conductor is:

- a. the source.
- b. the return.
- c. the terminal.
- d. the feed.

50. The unidentified conductor must connect between the switch and the:

- a. white wire.
- b. neutral.
- c. load.
- d. ground.

72.02.03.02

51. In bedroom #1, what is the height from the rough floor to which the switches will be set (see plan)?

- a. 52 5/8"
- b. 48 3/4"
- c. 50 5/8"
- d. 46 1/2"

72.02.03.02 (continued)

52. Approximately how far from the door opening is the first convenience outlet in the bedroom #1 (see plans)?
- 4' 2"
 - 1'
 - 2' 6"
 - 1' 9"
53. How high are convenience outlets usually placed off the finished floor?
- 12" T.C. (To Center)
 - 15" T.C.
 - 20" T.C.
 - 10" T.C.
54. What type of receptacles are used in the bedroom (see plan)?
- switched
 - split
 - universal
 - outlet
55. In electrical terminology the white conductor is considered to be which of the following?
- grounding conductor
 - hot conductor
 - grounded conductor
 - feed conductor

72.02.03.03

56. The four way switch is used in situations to control a load from how many positions?
- all of the below
 - two or more
 - one or more
 - three or more
57. Three way switches control the load from how many positions?
- one
 - two
 - three
 - four

72.02.03.03 (continued)

58. A DPDT switch may be installed:

- a. in a three way circuit.
- b. between outlets.
- c. at the end of a circuit.
- d. at the beginning of a circuit.

59. With the exception of double pole switching and split circuit wiring, the identified conductors can:

- a. always be grounded.
- b. never be grounded.
- c. always be switched.
- d. never be switched.

60. The unidentified conductor must connect between the switch and the:

- a. load.
- b. neutral.
- c. ground.
- d. white wire.

72.02.03.04

61. Which one of the following connections is wired correctly for a ceiling outlet which is controlled from any one of three switch locations? The 120 volt feed is at the light.

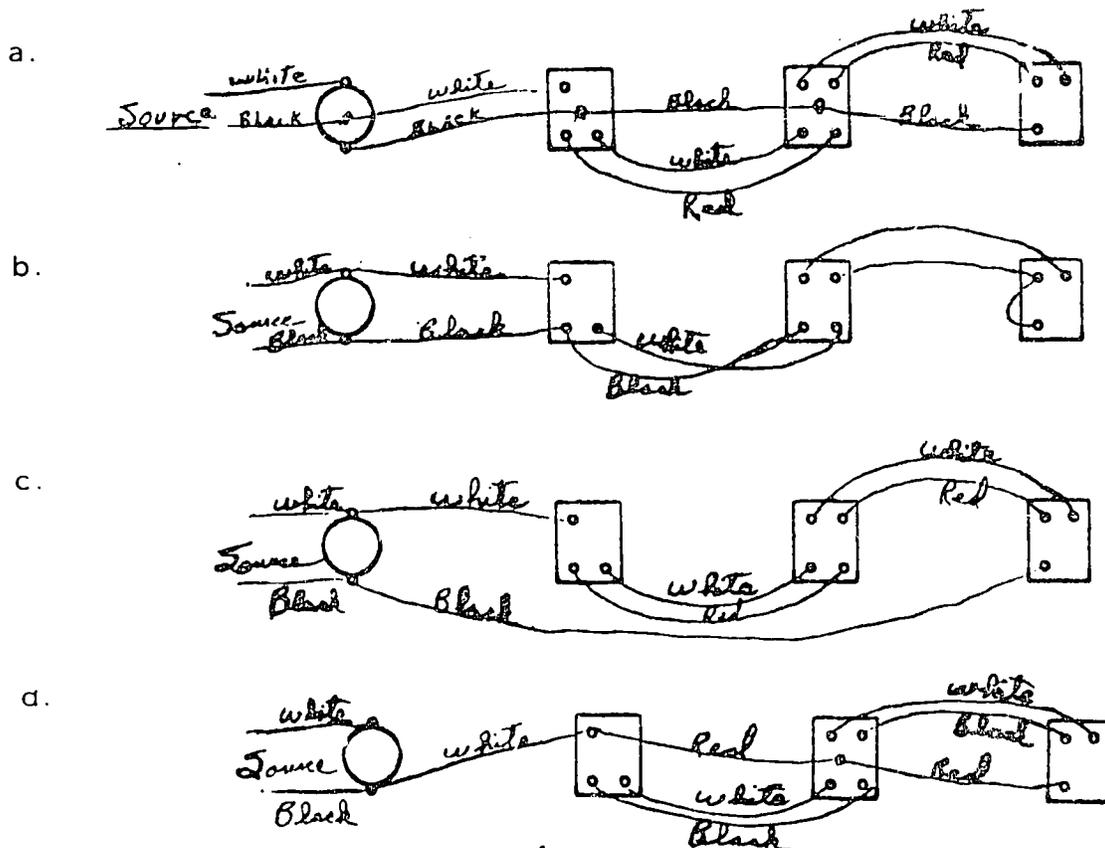

72.02.03.04 (continued)

62. Which of the connections is wired correctly so that both ceiling light outlets are controlled from the one single pole switch? Assume the installation is in cable.

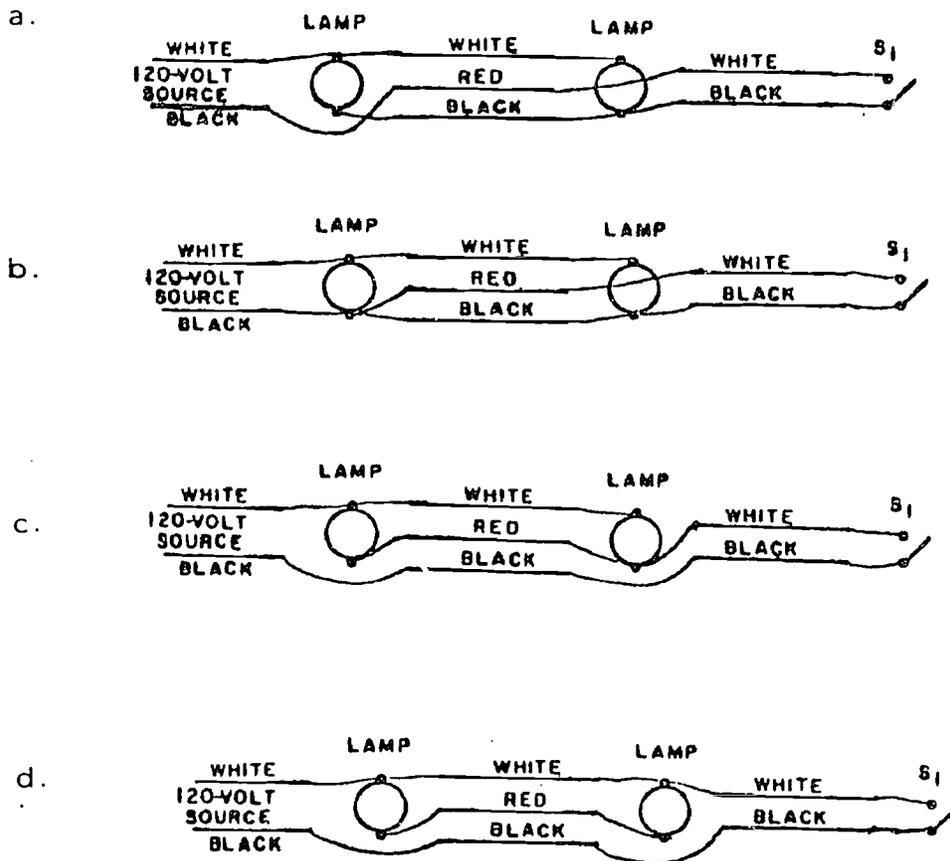

63. In a four way switch configuration the travelers from a four way switch are connected how on the four way switch?

- one on each side
- both on the same side
- by a pigtail
- one on top of one side and one on the bottom of the other side

64. The identified conductor can be used in a switch loop when the unidentified conductor is:

- the source.
- the return.
- the terminal.
- the feed.

72.02.03.04 (continued)

65. The three way switch has how many positions?
- a. two
 - b. three
 - c. four
 - d. one

72.02.04.01

66. Stove heating elements are impacted in what?
- a. aluminum
 - b. magnesium oxide
 - c. aluminum oxide
 - d. nichrome
67. How many appliances are on the circuit supplying  ?
- a. three
 - b. one
 - c. four
 - d. two
68. Where is the special purpose outlet  located (see plans)?
- a. SE wall of kitchen
 - b. SW wall of kitchen
 - c. NW wall of kitchen
 - d. NE wall of kitchen
69. If a stove has a burner switch position circuit that draws 74 ohms 120 volts, what is the power rating?
- a. 195 watts
 - b. 170 watts
 - c. 140 watts
 - d. 255 watts
70. If the voltage is doubled what happens to the power if the resistance is constant?
- a. varies, dependent on amperage
 - b. increases
 - c. remains the same
 - d. decreases

72.02.04.02

71. If a flow switch is installed on a garbage disposal, it is connected in which of the following ways?
- any of the below
 - series parallel
 - parallel
 - series
72. Which sections of the national electrical code cover the grounding of appliances?
- (250-42 through 250-45) (250-57 and 250-59)
 - (260-42 through 260-45) (260-57 and 260-59)
 - (250-60 through 250-65) (250-67 and 250-69)
 - (270-42 through 270-45) (270-57 and 270-59)
73. According to the NEC the motor protector on an appliance must not exceed the rated amperage by what percentage?
- 125%
 - 100%
 - 175%
 - 150%
74. Which of the following would not be on a garbage disposal if an electrician installs a fused box cover unit in a garbage disposal unit?
- fuse
 - ballast
 - thermal protector
 - heat strip
75. To what circuit is the garbage disposal connected (refer to specs)?
- B9
 - B6
 - B7
 - B5

72.02.04.03

76. Using the plan & specs as reference, which of the following symbols indicates a bathroom ceiling heater?
- | | |
|--|--|
| a.  H | c.  K |
| b.  I | d.  M |

72.02.04.03 (continued)

77. Which wall of the bathroom is used to mount the device that controls the baseboard heat for the bath (see plans)?
- NW
 - SE
 - NE
 - SW
78. Which of the following can be used to control a heat-a-vent automatically?
- bi-metal strip
 - fusestat
 - rheostat
 - thermostat
79. Which of the following circuits serves the bathroom heat-a-vent (see specs)?
- A14
 - A17
 - A23
 - A24
80. What is the current rating of a heat-a-vent unit rated at 1475 watts/120 volts?
- 24.29 amps
 - 15.37 amps
 - 12.29 amps
 - 8.29 amps

72.02.04.04

81. Which of the following sections of the code allows a circuit to be used for both heating and cooling (see code book)?
- 175-6 (C)
 - 425-2 (A)
 - 379-4 (B)
 - 220-4 (L)
82. What color is the grounded conductor according to the NEC?
- white
 - red
 - blue
 - black

72.02.04.04 (continued)

83. How many circuits feed the electric heating units in this house (see specs)?
- four
 - nine
 - six
 - two
84. How much current passes through the recreation room thermostat when it's on (see specs)?
- 13.6 watts
 - 8.5 watts
 - 8.5 amps
 - 12.5 amps
85. What color must the identified conductor be rendered if it is to be used as unidentified?
- yellow
 - black
 - green
 - white

77.02.04.05

86. In the code book which table identifies the insulation factor of conductors?
- 220-5
 - 422-17
 - 310-12
 - 310-2 (A)
87. Approximately how many feet of cable will be required to service the wall mounted oven (see plan)?
- 20'
 - 16'
 - 14'
 - 34'
88. What is the maximum insulation rating of type RHH conductor (see code book)?
- 90 degree C
 - 60 degree C
 - 75 degree C
 - 100 degree C

77.02.04.05 (continued)

89. What is the special purpose outlet  G • intended for (see plan)?
- counter top stove
 - garbage disposal
 - garage door opener
 - water heater
90. If type SE cable with an uninsulated grounding conductor is used, where must it originate in a house?
- panel C
 - service entrance panel
 - panel B
 - panel A

72.02.04.06

91. Which of the following circuits are connected to the dryer (see plans and specifications)?
- A17
 - A (9-11)
 - B (17-19)
 - A (13-15)
92. In the code book 220-2 (A), what is the minimum watts rating used to determine the feeder rating of house used in plans?
- 6000 watts
 - 5500 watts
 - 5000 watts
 - 4700 watts
93. What does the symbol  D stand for on the plan (see specs)?
- door opener
 - clothes washer
 - clothes dryer
 - damper
94. What size conductors would be required for a dryer rated 7.5 KW, 240 volts?
- 8 awg
 - 6 awg
 - 12 awg
 - 10 awg

72.02.04.06 (continued)

95. If a dryer is rated at 5000 watts, what is the circuit load at 240 volts?
- 20.83 amps
 - 18.75 amps
 - 30 amps
 - 15 amps

72.02.04.07

96. What is the maximum rating of a non-time delay fuse that should be installed for a motor rated 8 amps?
- 24 amps
 - 22 amps
 - 15 amps
 - 30 amps
97. The number 120/240 V on a motor 01 pump indicates what?
- runs on either
 - runs on U20V
 - runs on 240V
 - runs on between the two
98. Using the code book section 430-52 & table 430-152, what is the maximum protective breaker that should be installed on a motor rated 8 amps?
- 25 amps
 - 20 amps
 - 15 amps
 - 30 amps
99. If a water heater draws 21.2 amps at 236 volts, what would the load be if 220 volts were applied?
- 21.76
 - 20.76
 - 18.76
 - 19.76
100. Why is a 240 volt motor preferable to 120 volt motors for use in the residence described in the plan?
- increased voltage decreases amperage
 - increased voltage increases amperage
 - increased voltage increases resistance
 - increased voltage decreases resistance

72.02.05.01

101. The electrical code requires at least _____ number of outlets for the laundry.
- one
 - three
 - four
 - two
102. Non-metallic sheathed cable may be installed in:
- concealed and exposed places.
 - damp places.
 - inside.
 - outside.
103. In which of the following circumstances can metal clad cable be used?
- through walls and partitions
 - exposed to weather
 - lying in masonry
 - underground
104. According to the electrical code, in the kitchen-dining area a receptacle must be placed at each:
- window.
 - counter.
 - lazy susan.
 - cabinet.
105. NMC cable must not be bent in a radius less than _____ its cable diameter.
- five times
 - twice
 - four times
 - three times

72.02.05.02

106. An element that cuts off short circuits quickly is called which of the following?
- dual element
 - fuse link
 - single element
 - thermal cutout

72.02.05.02 (continued)

107. The NEC identifies a minimum slope of roof for general service entrance installations. What is that minimum slope?
- a. 3/12
 - b. 4/12
 - c. 2/12
 - d. 5/12
108. Type S fuses in cartridge form are labeled how?
- a. SFC
 - b. DSC
 - c. SDFC
 - d. SC
109. If a short circuit occurs, which of the following in a circuit breaker stops the current instantly?
- a. coil
 - b. capacitor
 - c. thermostat
 - d. bi-metal strip
110. Circuit breakers that compensate for room temperature change have how many elements?
- a. three
 - b. two
 - c. one
 - d. four

72.02.05.03

111. How many receptacles are on the circuit that the freezer in the utility room is plugged into? (See Plan)
- a. one
 - b. two
 - c. three
 - d. four
112. What is the rating of each receptacle in the utility room (see plan)?
- a. 20 amp
 - b. standard
 - c. 30 amp
 - d. 15 amp

72.02.05.03 (continued)

113. The plaster cover or raised cover thickness is dependent upon which of the following?
- box construction
 - stud thickness
 - insulation thickness
 - finish material
114. How many wires would be in a box that has a 12/36 terminating in a ceiling light fixture box?
- 2
 - 3
 - 6
 - 5
115. According to the code the receptacles on the terrace must be which of the following (see plan)?
- standard
 - grounding
 - recessed
 - grounding WP

72.02.05.04

116. A panel board used to mount over current devices may not have more than _____ over current devices (384-15).
- 26
 - 32
 - 42
 - 20
117. Where an underground service entrance comes out of the ground, the duct or conduit must have which of the following done to it?
- be fastened to concrete
 - be sealed
 - be embedded in concrete
 - be fastened to an auxiliary post
118. If cable is to run in a raceway under a concrete slab, it must be of what type?
- SEC
 - RHW
 - NM
 - NMC

72.02.05.04 (continued)

119. If a service entrance cable passes over a street, what is the minimum distance required over the street?
- a. 18'
 - b. 12'
 - c. 14'
 - d. 16'
120. If an underground service entrance runs up a pole, it must be protected by conduit to a minimum length of which of the following?
- a. 10'
 - b. 4'
 - c. 8'
 - d. 6'

72.02.05.05

121. A unit that consists of several groups of two different kinds of metal in a furnace is called which of the following?
- a. relay
 - b. thermostat
 - c. thermocoupler
 - d. limit switch
122. Which of the following functions is not performed by the stack switch?
- a. ignite oil burner
 - b. time of ignition
 - c. start oil burner
 - d. stop oil burner
123. Which of the following is easiest to wire?
- a. oil burner (forced air)
 - b. hot water (forced)
 - c. gas fired (forced air)
 - d. self-generated
124. What equipment furnishes the spark for ignition on an oil burner system?
- a. transformer
 - b. circulator
 - c. relay
 - d. stack switch

72.02.05.05 (continued)

125. Which of the following functions does the liquid immersion controller perform on a hydronic oil burner system?
- a. stop oil burner
 - b. give time of ignition
 - c. ignite oil burner
 - d. start oil burner

72.02.05.06

126. Which of the following burners requires a stack switch?
- a. natural gas
 - b. electric
 - c. fuel oil
 - d. propane
127. A gas fired system that does not use an electrical supply is called which of the following?
- a. self-generating
 - b. forced feed
 - c. gravity feed
 - d. hydronic
128. Which of the following systems requires a circulating pump?
- a. hydronic
 - b. gravity feed
 - c. forced feed
 - d. forced air
129. On most gas fired furnaces the high limit control, the safety valve, and the gas valve are connected how?
- a. parallel
 - b. series
 - c. series parallel
 - d. parallel series
130. A unit that consists of several groups of two different kinds of metal in a furnace is called which of the following?
- a. limit switch
 - b. relay
 - c. thermostat
 - d. thermocoupler

COURSE TEST ANSWER KEY: ELECTRICAL WIRING TRIM-OUT

<u>UNIT 01</u>	LAP 01	<u>UNIT 03</u>	LAP 01	<u>UNIT 04</u>	LAP 06
	1. d		46. a		91. c
	2. c		47. d		92. c
	3. c		48. d		93. c
	4. b		49. b		94. a
	5. b		50. c		95. a
	LAP 02		LAP 02		LAP 07
	6. a		51. c		96. a
	7. d		52. d		97. a
	8. c		53. a		98. b
	9. d		54. b		99. d
	10. d		55. c		100. a
	LAP 03		LAP 03	<u>UNIT 05</u>	LAP 01
	11. d		56. d		101. a
	12. b		57. b		102. a
	13. d		58. c		103. a
	14. a		59. d		104. b
	15. b		60. a		105. a
	LAP 04		LAP 04		LAP 02
	16. a		61. a		106. b
	17. c		62. a		107. b
	18. c		63. b		108. d
	19. d		64. b		109. a
	20. d		65. a		110. b
<u>UNIT 02</u>	LAP 01	<u>UNIT 04</u>	LAP 01		LAP 03
	21. a		66. b		111. a
	22. d		67. b		112. a
	23. c		68. a		113. d
	24. b		69. a		114. d
	25. b		70. b		115. d
	LAP 02		LAP 02		LAP 04
	26. a		71. d		116. c
	27. c		72. a		117. b
	28. b		73. a		118. b
	29. c		74. c		119. a
	30. b		75. c		120. c

COURSE TEST ANSWER KEY: (continued)

<u>UNIT 02</u>	LAP 03	<u>UNIT 04</u>	LAP 03	<u>UNIT 05</u>	LAP 05
	31. c		76. c		121. c
	32. c		77. a		122. a
	33. c		78. d		123. d
	34. c		79. c		124. a
	35. b		80. c		125. a
	LAP 04		LAP 04		LAP 06
	36. b		81. d		126. c
	37. b		82. a		127. a
	38. d		83. b		128. a
	39. b		84. d		129. b
	40. b		85. b		130. d
	LAP 05		LAP 05		
	41. b		86. d		
	42. d		87. d		
	43. d		88. a		
	44. b		89. a		
	45. c		90. b		

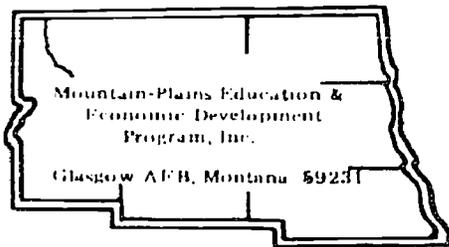

Learning Experience Guide

UNIT: OUTLETS

RATIONALE:

Installation of electrical outlets is a part of the wireman's duties. Knowing how to determine what materials are needed and how to correctly install them is important to your success as a wireman.

PREREQUISITES:

Since this is the first unit in the course, the prerequisites listed in the course guide applies.

OBJECTIVES:

Identify characteristics of and procedures for installation of electrical outlets. Given blueprint specifications, National Electrical codes, tools, building or shop simulation with electrical wiring rough-in, students will estimate materials required and install the specified electrical outlets.

RESOURCES:

Electrical Wiring Residential, Delmar Publisher, 1972.

A variety of manufacturer's electrical products specifications guides.

A variety of electrical supply catalogs.

Set of electrical wireman's tools.

GENERAL INSTRUCTIONS:

Performance activities will be assigned to you for this unit. Carefully follow the procedures on the LAP for each activity. If questions or problems arise, seek help from the instructor.

Principal Author(s): R. Arneson, L. Leland, T. Ziller

PERFORMANCE ACTIVITIES:

- .01 Determine Type of Outlets to be Installed.
- .02 Install Split Circuit Receptacles.
- .03 Install Duplex Outlets.
- .04 Install Special Purpose Outlets.

EVALUATION PROCEDURE:

Success in this unit is determined by identifying 80% of the desired responses to a set of multiple choice test items and obtaining a "satisfactory" for completing each line item on a performance test.

FOLLOW-THROUGH:

After reading the unit guide, begin with the first assigned LAP. Read it and apply the knowledge and skill acquired thus far in doing the activity.

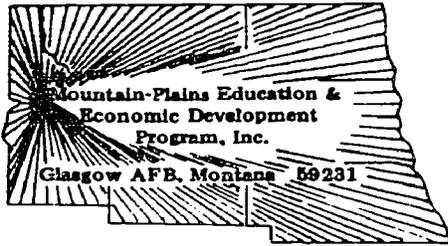

UNIT PRETEST: OUTLETS

72.02.01.01

1. Where are notations found on an electrical plan?
 - a. next to a symbol, usually as abbreviations
 - b. in the plan margin
 - c. in the specifications
 - d. on the plan letterhead

2. Which of the following symbols is a ceiling outlet?
 - a. 
 - b. 
 - c. 
 - d. 

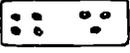
3. Which of the following symbols indicates a power panel?
 - a. 
 - b. 
 - c. 
 - d. 

4. Which of the following is the symbol for a duplex outlet?
 - a. 
 - b. 
 - c. 
 - d. 

72.02.01.01 (continued)

5. Which of the following symbols indicates a single pole switch with pilot?
- S_1p
 - Sp
 - SP
 - S_1

72.02.01.02

6. According to the national electrical code, at least how many branch circuits must be supplied to a kitchen for small appliances?
- two
 - one
 - four
 - three
7. Which of the following is a symbol for a fan?
- 
 - 
 - 
 - 
8. Which of the following symbols indicates a recessed ceiling fixture?
- 
 - 
 - 
 - 
9. A three wire 115/230 volt branch circuit is the equivalent of how many receptacle branch circuits (115V)?
- four
 - two
 - one
 - three

72.02.01.02 (continued)

10. A three wire 115/120 volt branch circuit is the equivalent of how many small appliance branch circuits?
- one
 - three
 - two
 - four

72.02.01.03

11. What advantage does a 4 inch box have over a 3 $\frac{1}{4}$ inch octagonal box?
- costs less
 - has less conductor capacity
 - has more conductor capacity
 - easier to mount
12. A device mounted in a box is counted as:
- two wires.
 - not counted as a wire.
 - three wires.
 - one wire.

13. Which of the following symbols indicates a lighting panel?

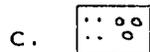

14. Which of the following symbols indicates a battery?

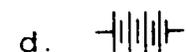
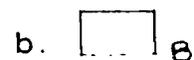
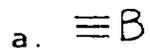

72.02.01.03 (continued)

15. What do the letters AWG stand for in electrical terminology?
- Ambient Weather Gauge
 - American Wire Gauge
 - Aluminum Wire Gauge
 - Advanced Wattage Gauge

72.02.01.04

16. Which of the following symbols indicates a power panel?



17. What advantage does a 4 inch box have over a 3½ inch octagonal box?

- has more conductor capacity
- easier to mount
- has less conductor capacity
- costs less

18. What are offset bar hangers used for?

- to mount boxes
- to mount power panels
- to mount fixtures
- to mount fluorescent lights

19. Which of the following is the symbol for a duplex outlet split circuit?

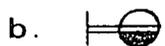
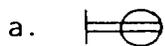

72.02.01.04 (continued)

20. Dash lines on an electrical plan:

- a. always indicate special purpose use.
- b. always are used to indicate switch connections.
- c. always are used to connect outlets.
- d. never are used to indicate switch connections.

UNIT PRETEST ANSWER KEY: OUTLETS

LAP 01

1. a
2. c
3. b
4. c
5. b

LAP 02

6. a
7. a
8. a
9. b
10. d

LAP 03

11. c
12. d
13. b
14. d
15. b

LAP 04

16. a
17. a
18. a
19. b
20. b

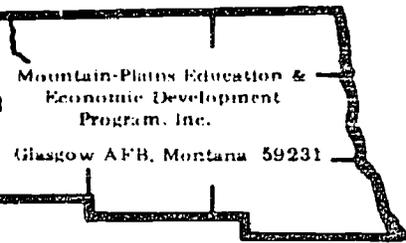

Learning Activity Package

Student: _____

Date: _____

PERFORMANCE ACTIVITY: Determining the Type of Outlet to be Installed

OBJECTIVE:

Given the blueprint and specifications, identify, and record the type, description, and quantity of outlets on a requisition form. Compiled data must correlate to and conform with the listed references and standards established in the industry. Identify the electrical outlet symbols, designations, capacities and requirements for their installation.

EVALUATION PROCEDURE:

Accurate ordering of the parts and supplies needed to complete the specific job listed in the objective and on the blueprint. Complete, score and return a ten-item multiple-choice test about this LAP. Successful completion is eight out of ten items.

RESOURCES:

Electrical Wiring, Ray C. Mullin, pp. 11-25.
Electrical Supply Catalog.

PROCEDURE:

1. Obtain an Electrical Parts Supply Catalog.
2. Using the attached requisition and the blueprint sketch you have completed, order the parts and supplies needed to complete the job indicated in the objective.

NOTE: Parts and supplies must be ordered by quantity, complete description and type.

3. Check the completed requisition with the answer key.
4. Enter the requested data on your Performance Record.
5. Take the test for this LAP.
6. Score the LAP test and return it.
7. If the test is satisfactory, begin the next assigned LAP. If the test is unsatisfactory, proceed as directed by the instructor.

Principal Author(s): R. Arneson, L. Leland, T. Ziller

PURCHASE REQUISITION

72.02.01.01.A2-0

ORIGINATOR'S CONTROL NO.

REQUISITION NO. _____ REQUISITION DATE _____ TIME REQUIRED _____ PURCHASE ORDER NO. _____ PAGE of

<input type="checkbox"/> RESEARCH DEVELOPMENT <input type="checkbox"/> START UP SUGGESTED SOURCE	<input type="checkbox"/> OPERATIONS	ACCOUNTING DATA USING ACTIVITY _____ USED FOR _____	DEPARTMENT <input type="checkbox"/> ADMINISTRATION <input type="checkbox"/> FAMILY LIFE <input type="checkbox"/> INSTRUCTION <input type="checkbox"/> MULTI-PURPOSE <input type="checkbox"/> STATE PROGRAMS <input type="checkbox"/> PLANNING & RESEARCH <input type="checkbox"/> OTHER
--	-------------------------------------	---	--

QUAN.	UNIT	DESCRIPTION OF SUPPLIES / SERVICES	EST. UNIT PRICE	EST. AMOUNT

REMARKS _____ EST. TOTAL AMOUNT 

Title	Signature	Date	Title	Signature	Date
ORIGINATOR			PROPERTY CONTROLLER		
DEPT. HEAD			PROCUREMENT OFFICER		
DIRECTOR			ACCOUNTING OFFICE (To Procurement)		

ACCOUNTING



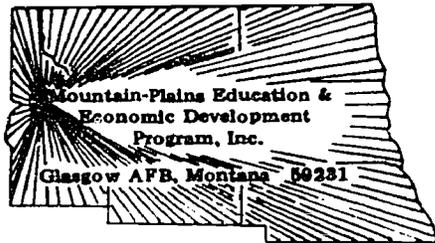

LAP TEST: DETERMINING THE TYPE OF OUTLET TO BE INSTALLED

1. Which of the following is the symbol for a duplex outlet split circuit?

- a.
- b.
- c.
- d.

2. Which of the following symbols indicates a duplex outlet?

- a.
- b.
- c.
- d.

3. A device mounted in a box is counted as:

- a. three wires.
- b. one wire.
- c. not counted as a wire.
- d. two wires.

4. Which of the following symbols indicates a battery?

- a. $\equiv B$
- b.
- c. $\bigcirc B$
- d. $\square B$

5. When counting the number of wires in a box, a wire that originates and terminates within the box is:
- ignored.
 - counted as two wires.
 - not counted as a wire.
 - counted as one wire.
6. Which of the following symbols is a ceiling outlet?
- 
 - 
 - 
 - 
7. Which of the following symbols indicates a single pole switch with pilot?
- S₁P
 - Sp
 - S₁
 - SP
8. What size and larger is the wire beyond which the conductors are no longer stranded?
- 6 AWG
 - 10 AWG
 - 12 AWG
 - 8 AWG
9. Dash lines on an electrical plan:
- always are used to indicate switch connections.
 - always indicate special purpose use.
 - always are used to connect outlets.
 - never are used to indicate switch connections.
10. All ground wires entering and leaving a box are counted as:
- three wires.
 - one wire.
 - not counted.
 - two wires.

LAP TEST ANSWER KEY: DETERMINING THE TYPE OF OUTLET TO BE INSTALLED

1. b
2. c
3. b
4. b
5. c
6. a
7. b
8. d
9. a
10. b

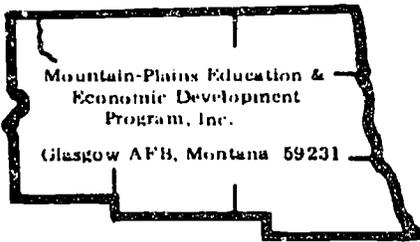

Learning Activity Package

Student: _____

Date: _____

PERFORMANCE ACTIVITY: Installing Split Circuit Receptacles

OBJECTIVE:

Given the necessary tools, equipment, supplies and blueprint, correctly install split circuit receptacles according to: (1) manufacturer's and blueprint specifications; (2) Following procedures and practices accepted in the Industry and outlined in the reference text. Identify components, symbols, and characteristics of a given split circuit plan and requirements for their installation.

EVALUATION PROCEDURE:

Installation meets the criteria listed on the attached checklist. Complete, score and return a ten-item multiple-choice test about this LAP. Successful completion is eight out of ten items.

RESOURCES:

Electrical Wiring, Ray C. Mullin, pp. 88-97.
Manufacturer's Specifications.

PROCEDURE:

1. Read pp. 88-97 in Electrical Wiring.
2. Go to your assigned work station where you will complete the activities listed in the objective. Review the text if necessary.
3. Obtain the necessary tools, equipment and supplies needed to complete the operations listed.
4. Complete the job listed in the objective.
NOTE: Follow safe practices and procedures.
5. Perform all necessary testing and evaluation checks listed in the checklist. If you have any questions or problems, check with the instructor.
6. When you have been checked off on the checklist by the instructor, complete the data requested on your Performance Record and have him initial it.
7. Clean up the area.

Principal Author(s): R. Arneson, L. Leland, T. Ziller

8. Take the test for this LAP.
9. Score the LAP test and return it.
10. If the test is satisfactory, begin the next assigned LAP. If the test is unsatisfactory, proceed as directed by the instructor.

CHECKLIST: INSTALLING SPLIT CIRCUIT RECEPTACLES

- _____ 1. Proper selection and use of tools, equipment and supplies.
- _____ 2. Safe practices and procedures followed.
- _____ 3. Neat and presentable.
- _____ 4. Meets or exceeds standards established in the industry.
- _____ 5. Procedures followed are practiced and accepted in the industry.

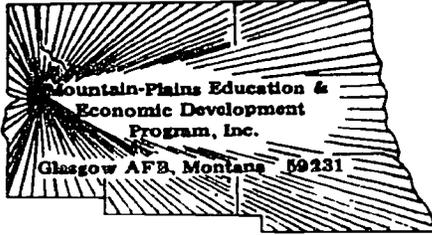

LAP TEST: INSTALLING SPLIT CIRCUIT RECEPTACLES

1. Which of the following is a symbol for a clock?

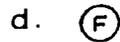
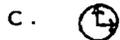
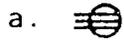

2. Which of the following symbols indicates a recessed ceiling fixture?

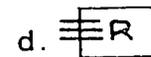

3. A three wire 115-230 volt branch circuit is the equivalent of how many small appliance branch circuits?

- a. three
- b. one
- c. two
- d. four

4. When speaking of fluorescent bulbs, which of the following letters are used to indicate Deluxe Warm White?

- a. WWX
- b. WWD
- c. WWDX
- d. WWFDX

5. Which of the following is a symbol for a fan?

a.  (F)

b. 

c. 

d. 

6. A three wire 115/230 volt branch circuit is the equivalent of how many receptacle branch circuits (115V)?

- a. two
- b. four
- c. three
- d. one

7. What system is used for the wiring of the receptacles in the kitchen (see plan)?

- a. split circuit
- b. compound circuit
- c. standard
- d. split circuit switched

8. In a three wire two circuit system, how can the continuity of the neutral ground be accomplished?

- a. spliced
- b. use a splice and pigtail the device
- c. use a common connection on the device (electrical)
- d. use the electrical device

9. What is the height of the convenience receptacles in the kitchen (see plan)?

- a. 44" to center
- b. 36" to center
- c. 50" to center
- d. 48" to center

10. According to the national electrical outlet code, at least how many branch circuits must be supplied to a kitchen for small appliances?

- a. two
- b. four
- c. three
- d. one

LAP TEST ANSWER KEY: INSTALLING SPLIT CIRCUIT RECEPTACLES

1. c
2. b
3. c
4. a
5. d
6. a
7. a
8. b
9. a
10. a

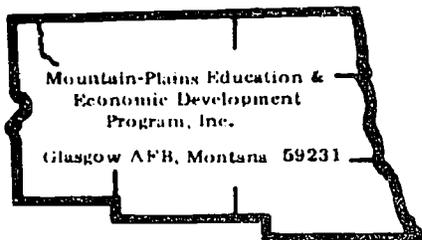

Learning Activity Package

Student: _____

Date: _____

PERFORMANCE ACTIVITY: Installing Duplex Outlets

OBJECTIVE:

Given the necessary tools, equipment, supplies and blueprint, correctly install duplex outlets according to: (1) manufacturer's and blueprint specifications; (2) following procedures and practices accepted in the industry; and outlined in the reference text. Identify the system and their designations and the characteristics of duplex outlets and their installation requirements.

EVALUATION PROCEDURE:

Installation meets the criteria listed on the attached checklist. Complete, score and return a ten-item multiple-choice test about this LAP. Successful completion is eight out of ten items.

RESOURCES:

Electrical Wiring, Ray C. Mullin, pp. 11-25.
 Manufacturer's Specifications.

PROCEDURE:

1. Go to your assigned work station where you will complete the activities listed in the objective. Review the text if necessary.
2. Obtain the necessary tools, equipment and supplies needed to complete the operations listed.
3. Complete the job listed in the objective.
4. NOTE: Follow safe practices and procedures. Perform all necessary testing and evaluation checks listed in the checklist. If you have any questions or problems, check with the instructor.
5. When you have been checked off on the checklist by the instructor, complete the data requested on your Performance Record and have him initial it.
6. Clean up the area.
7. Take the test for this LAP.
8. Score the LAP test and return it.
9. If the test is satisfactory, begin the next assigned LAP. If the test is unsatisfactory, proceed as directed by the instructor.

Principal Author(s): R. Arneson, L. Leland, T. Ziller

CHECKLIST: INSTALLING DUPLEX OUTLETS

- _____ 1. Proper selection and use of tools, equipment and supplies.
- _____ 2. Safe practices and procedures followed.
- _____ 3. Neat and presentable.
- _____ 4. Meets or exceeds standards established in the industry.
- _____ 5. Procedures followed are practiced and accepted in the industry.

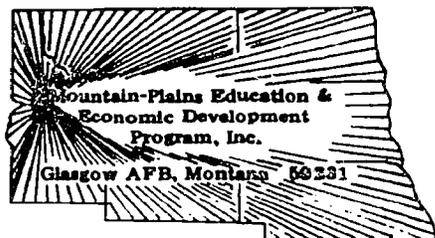

LAP TEST: INSTALLING DUPLEX OUTLETS

1. Boxes are measured:
 - a. diagonally.
 - b. by circumference.
 - c. by outside opening.
 - d. by inside opening.

2. Which of the following is the symbol for a duplex outlet?
 - a.  GWP
 - b. 
 - c. 
 - d.  WP

3. All ground wires entering and leaving a box are counted as:
 - a. not counted.
 - b. three wires.
 - c. two wires.
 - d. one wire.

4. Each neutral wire entering and leaving a box is counted as:
 - a. not counted.
 - b. one wire.
 - c. three wires.
 - d. two wires.

5. Dash lines on an electrical plan:
 - a. always are used to indicate switch connections.
 - b. always are used to connect outlets.
 - c. always indicate special purpose use.
 - d. never are used to indicate switch connections.

6. Which of the following symbols indicates a power panel?

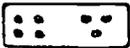
- a. 
- b. 
- c. 
- d. 

7. Which of the following symbols indicates a range outlet?

- a. 
- b. 
- c. 
- d. 

8. What size is the opening of a switch box for a single device?

- a. $1 \frac{1}{2} \times 3$
- b. $1 \frac{1}{2} \times 2 \frac{1}{2}$
- c. $1 \frac{3}{4} \times 2 \frac{3}{4}$
- d. $1 \frac{1}{4} \times 3$

9. Which of the following is the symbol for a duplex outlet split circuit?

- a. 
- b. 
- c. 
- d. 

10. What advantage does a 4 inch box have over a $3 \frac{1}{4}$ inch octagonal box?

- a. easier to mount
- b. costs less
- c. has less conductor capacity
- d. has more conductor capacity

LAP TEST ANSWER KEY: INSTALLING DUPLEX OUTLETS

1. d
2. b
3. d
4. d
5. a
6. a
7. c
8. c
9. b
10. d

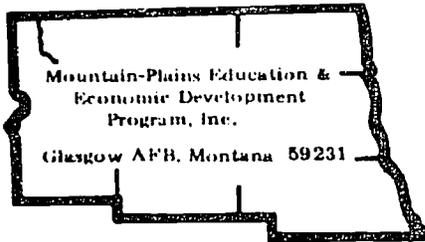

Learning Activity Package

Student: _____

Date: _____

PERFORMANCE ACTIVITY: Installing Special Purpose Outlets

OBJECTIVE:

Given the necessary tools, equipment, supplies and blueprint, correctly install special purpose outlets according to: (1) manufacturer's and blueprint specifications; (2) following procedures and practices accepted in the Industry; and outlined in the reference text. Identify the characteristics of special purpose outlets and requirements for their installation.

EVALUATION PROCEDURE

Installation meets criteria listed on the attached checklist. Complete, score and return a ten-item multiple-choice test about this LAP. Successful completion is eight out of ten items.

RESOURCES:

Electrical Wiring, Ray C. Mullin, pp. 11-25.
Manufacturer's Specifications.

PROCEDURE:

1. Go to your assigned work station where you will complete the activities listed in the objective. Review the text if necessary.
2. Obtain the necessary tools, equipment and supplies needed to complete the operations listed.
3. Complete the job listed in the objective.
NOTE: Follow safe practices and procedures.
4. Perform all necessary testing and evaluation checks listed in the checklist. If you have any questions or problems, check with the instructor.
5. When you have been checked off on the checklist by the instructor, complete the data requested on your Performance Record and have him initial it.
6. Clean up the area.
7. Take the test for this LAP.
8. Score the LAP test and return it.
9. If the test is satisfactory, begin the next assigned LAP. If the test is unsatisfactory, proceed as directed by the instructor.

Principal Author(s): R. Arneson, L. Leland, T. Ziller

CHECKLIST: INSTALLING SPECIAL PURPOSE OUTLETS

- _____ 1. Proper selection and use of tools, equipment and supplies.
- _____ 2. Safe practices and procedures followed.
- _____ 3. Neat and presentable.
- _____ 4. Meets or exceeds standards established in the industry.
- _____ 5. Procedures followed are practiced and accepted in the industry.

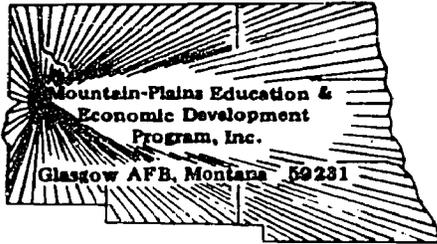

LAP TEST: INSTALLING SPECIAL PURPOSE OUTLETS

1. What size and larger is the wire beyond which the conductors are no longer standard?
 - a. 10 AWG
 - b. 8 AWG
 - c. 12 AWG
 - d. 6 AWG

2. When counting the number of wires in a box, a wire that originates and terminates within the box is:
 - a. counted as one wire.
 - b. counted as two wires.
 - c. not counted as a wire.
 - d. ignored.

3. Dash lines on an electrical plan:
 - a. never are used to indicate switch connections.
 - b. always are used to indicate switch connections.
 - c. always indicate special purpose use.
 - d. always are used to connect outlets.

4. What do the letters AWG stand for in electrical terminology?
 - a. Advanced Wattage Gauge.
 - b. American Wire Gauge.
 - c. Ambient Weather Gauge.
 - d. Aluminum Wire Gauge.

5. What size is the opening of a switch box for a single device?
 - a. $1 \frac{3}{4} \times 2 \frac{3}{4}$
 - b. $1 \frac{1}{2} \times 3$
 - c. $1 \frac{1}{4} \times 3$
 - d. $1 \frac{1}{2} \times 2 \frac{1}{2}$

6. What advantage does a 4 inch box have over a 3 1/4 inch octagonal box?
- has more conductor capacity.
 - easier to mount.
 - costs less.
 - has less conductor capacity.
7. A device mounted in a box is counted as:
- three wires.
 - two wires.
 - not counted as a wire.
 - one wire.
8. Each neutral wire entering and leaving a box is counted as:
- not counted.
 - three wires.
 - two wires.
 - one wire.
9. What are offset bar hangers used for?
- to mount fluorescent lights.
 - to mount boxes.
 - to mount fixtures.
 - to mount power panels.
10. The NEC states that the minimum wire size allowable in a house is which of the following?
- 14 AWG
 - 12 AWG
 - 10 AWG
 - 8 AWG

LAP TEST ANSWER KEY: INSTALLING SPECIAL PURPOSE OUTLETS

1. B
2. C
3. B
4. B
5. A
6. A
7. D
8. C
9. B
10. A

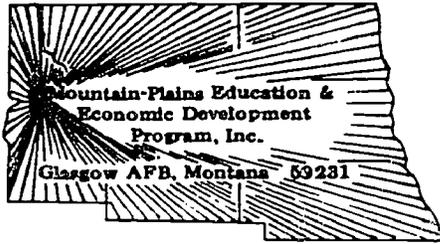

UNIT POST TEST: OUTLETS

72.02.01.01

1. All ground wires entering and leaving a box are counted as:
 - a. one wire.
 - b. three wires.
 - c. not counted.
 - d. two wires.

2. What do the letters AWG stand for in electrical terminology?
 - a. Aluminum Wire Gauge
 - b. American Wire Gauge
 - c. Ambient Weather Gauge
 - d. Advanced Wattage Gauge

3. Each neutral wire entering and leaving a box is counted as:
 - a. two wires.
 - b. not counted.
 - c. one wire.
 - d. three wires.

4. Which of the following symbols indicates a range outlet?
 - a.  R
 - b.  R
 - c.  R
 - d.  R

5. Which of the following symbols indicates a battery?
 - a. 
 - b.  B
 - c.  B
 - d.  B

72.02.01.02

6. How many built-in appliances are there in the kitchen (see plan)?
- eight
 - four
 - six
 - two
7. In a circuit with a breaker of 15 amps 110/120 volts, what is the total wattage allowable for this circuit (approximately)?
- 1240 watts
 - 1040 watts
 - 1540 watts
 - 1440 watts
8. What system is used for the wiring of the receptacles in the kitchen (see plan)?
- split circuit switched
 - compound circuit
 - standard
 - split circuit
9. Which of the following is a symbol for a clock?
- 
 - 
 - 
 - 
10. A three wire 115/230 volt branch circuit is the equivalent of how many small appliance branch circuits?
- three
 - four
 - two
 - one

72.02.01.03

11. Dash lines on an electrical plan:

- a. always are used to indicate switch connections.
- b. never are used to indicate switch connections.
- c. always are used to connect outlets.
- d. always indicate special purpose use.

12. What size is the opening of a switch box for a single device?

- a. $1 \frac{3}{4} \times 2 \frac{3}{4}$
- b. $1 \frac{1}{4} \times 3$
- c. $1 \frac{1}{2} \times 3$
- d. $1 \frac{1}{2} \times 2 \frac{1}{2}$

13. When counting the number of wires in a box, a wire that originates and terminates within the box is:

- a. counted as one wire.
- b. ignored.
- c. counted as two wires.
- d. not counted as a wire.

14. Which of the following is the symbol for a duplex outlet?

- a. 
- b. 
- c. 
- d. 

15. What size and larger is the wire beyond which the conductors are no longer standard?

- a. 12 AWG
- b. 6 AWG
- c. 10 AWG
- d. 8 AWG

72.02.01.04

16. What do the letters AWG stand for in electrical terminology?
- Advanced Wattage Gauge
 - American Wire Gauge
 - Ambient Weather Gauge
 - Aluminum Wire Gauge
17. Which of the following is the symbol for a duplex outlet?
- 
 - 
 - 
 - 
18. What size and larger is the wire beyond which the conductors are no longer standard?
- 6 AWG
 - 12 AWG
 - 8 AWG
 - 10 AWG
19. What is the size opening of a switch box for a single device?
- 1 1/2 x 2 1/2
 - 1 3/4 x 2 3/4
 - 1 1/4 x 3
 - 1 1/2 x 3
20. When counting the number of wires in a box, a wire that originates and terminates within the box is:
- counted as two wires.
 - counted as one wire.
 - ignored.
 - not counted as a wire.

UNIT POST TEST ANSWER KEY: OUTLETS

LAP 01

1. a
2. b
3. a
4. c
5. a

LAP 02

6. c
7. d
8. d
9. c
10. b

LAP 03

11. a
12. a
13. d
14. a
15. d

LAP 04

16. b
17. d
18. c
19. b
20. d

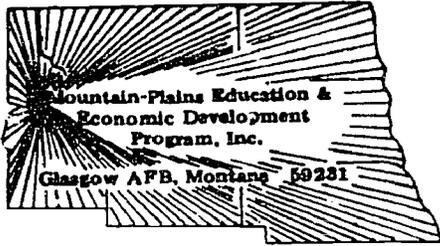

UNIT PERFORMANCE TEST: OUTLETS

OBJECTIVE 1:

Given a blueprint of a floor plan and an electrically roughed-in wood frame construction, simulated or actual, the student will list the electrical outlets to be installed.

OBJECTIVE 2:

Given a blueprint of a floor plan and a roughed-in wood frame construction, simulated or actual, the student will obtain the electrical outlets used in the installation.

OBJECTIVE 3:

Given a blueprint of a floor plan and a roughed-in wood frame construction, simulated or actual, the student will install the electrical outlets in the proper locations.

TASK:

The student will list, obtain, and install various types of electrical outlets using a previously drawn sketch of the installation. The student will install the electrical outlets in an electrically roughed-in wood frame construction. The construction will be simulated or real.

ASSIGNMENT:CONDITIONS:

The student will be tested in a wood frame construction to simulate any specified room of a residence. The student will be given necessary tools and equipment. No assistance may be obtained from another student or the instructor or from unspecified text material.

RESOURCES:

Tools:

High leverage plier
High leverage oblique cutting plier
Long nose cutting plier
Electrician's hammer
Screwdriver slot 3/16 x 4
Screwdriver no. 2 phillips 8"
Screwdriver slot 3/16 x 9
Screwdriver 1/4 x 4
Screwdriver 1/4 x 6
Nutdriver variable size 1/4" x 7/16
Scratch awl
Adjustable Wrench size 8"
Pump plier size 10"
All-purpose tool, wire stripper, crimper and cutter
Tape rule 12' 3/4"
Knife, electricians
Tool pouch, 5 pocket

Equipment:

Simpson 260 VOM or Amprobe

Text:

Electrical Wiring Residential, Ray C. Mullin, Delmar Publishers, 4th Ed., 1973
National Electrical Code

ASSIGNMENT SHEET 1

KITCHEN

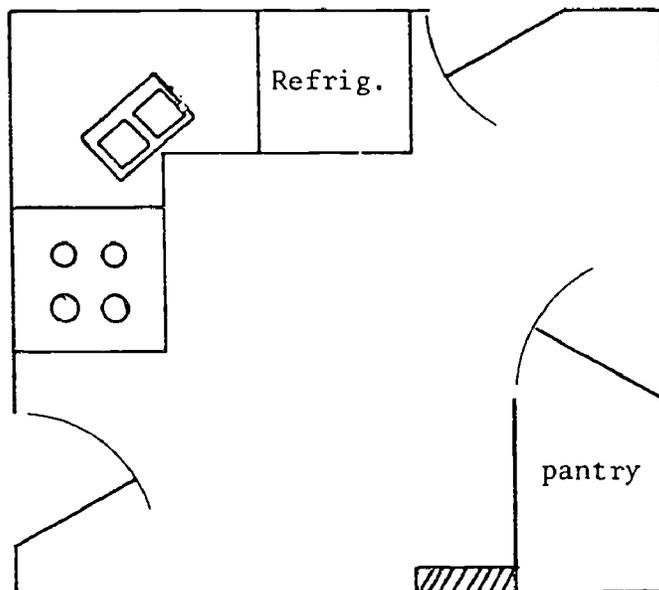

- garbage disposal
- pantry light
- light 2-position control

ASSIGNMENT SHEET 2

LAUNDRY ROOM

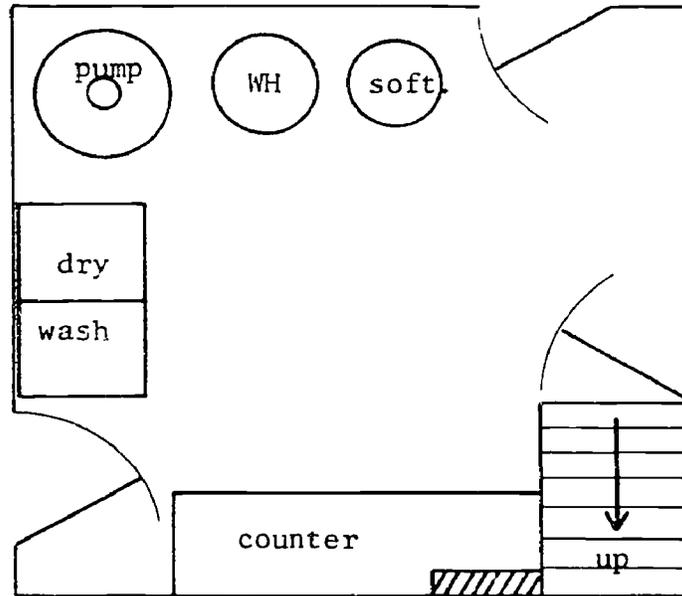

- sub-pump
- water heater
- water softener
- 3-position switch control

ASSIGNMENT SHEET 3

LIVING ROOM

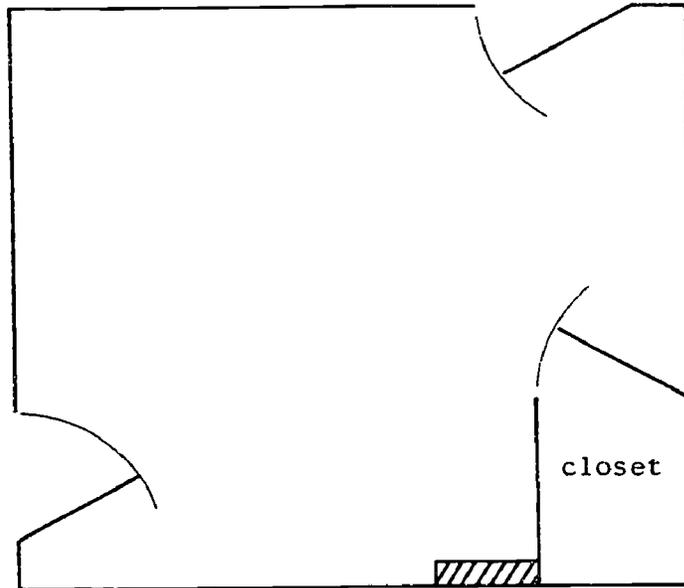

- electric heat
- split receptacles
- 2-position switch control

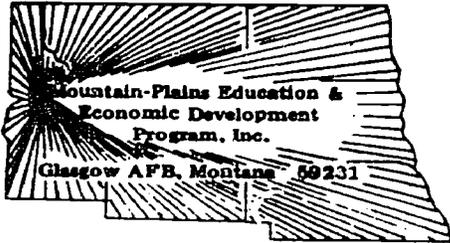

PERFORMANCE CHECKLIST:

OVERALL PERFORMANCE: Satisfactory _____ Unsatisfactory _____

	CRITERION	
	Met	Not Met
Objective 1:		
1. The student determines the type of electrical outlets to be installed.		
2. The student determines the quantity of electrical outlets to be installed.		
3. The student itemizes each type and quantity of electrical outlets to be used.		
Criterion: The physical and electrical dimensions meet National Electrical Code standards and blueprint specifications.		
Objective 2:		
4. The student obtains the electrical outlets to be installed from the electric shop's storage room.		
Criterion: The outlets will be used by the student for installation.		
Objective 3:		
5. The student strips the conductor's insulation to fit the		

(Checklist continued)

	CRITERION	
	Met	Not Met
electrical outlet's connecting device.		
6. The student bends the electrical wire to fit the electrical outlet connecting screw.		
7. The student connects the "hot" black or red conductor to the brass-colored screw on the electrical outlet.		
8. The student connects the "neutral" white conductor to the aluminum-colored screw.		
9. The student connects the bare grounding conductor to the grounding clip on the outlet box.		
10. The student fastens the electrical outlet to the electrical outlet box with appropriate-sized screws.		
11. The student fastens the outlet plate to the outlet with appropriate-sized screw.		
Criterion: The outlet installation meets National Electrical Code Standards and blueprint and manufacturer's specifications.		
12. Task completed in allotted time.		
Criterion: See assignment for time specifications.		
Student must meet criterion on all line items to obtain an overall score of satisfactory.		

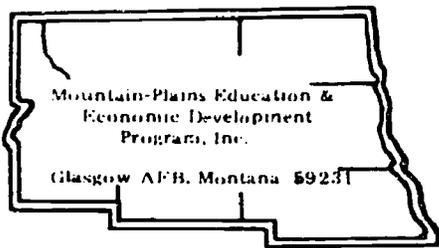

Learning Experience Guide

UNIT: FIXTURES

RATIONALE:

A qualified electrical wireman correctly installs fixtures in a structure. To successfully make these installations requires knowledge about determining the type of fixtures that is needed, how to install it and practice in each installation. This unit directs your activities toward correctly installing the electrical fixtures specified in the structure plan.

PREREQUISITES:

The prerequisites include those for the course and Unit .01: Outlets for this course.

OBJECTIVE:

Identify electrical fixture characteristics, symbols designations, and installation procedures. Given blueprint specifications, National Electrical Codes, tools, building or shop simulation with electrical wiring rough-in, students will estimate materials required and install the specified electrical fixtures.

RESOURCES:

Electrical Wiring Residential, Ray C. Mullin, Delmar Publisher, 1973.

A variety of electrical supply catalogs containing fixtures.

A variety of manufacturer's electrical fixtures specifications guides.

A set of electrical wireman's tools.

Manufacturer's Specifications.

Film Loops:

Permeability, Magnetic Field, Magnetic Poles, Law of Magnetism, Induced Magnetism,

Permanent Magnets, Poles occur in Pairs, Polarity of Static Charge, and Inductive

Principal Author(s): R. Arneson, L. Leland, T. Ziller

Field, Fairfield Associates, Inc., the Jam Handy Organization.

Audio Cassette Tapes.

Narration for each of the film loops listed, Mountain-Plains Education & Economic Development Program, Inc.

GENERAL INSTRUCTIONS:

You are to complete the performance activities assigned for this unit. The LAP will give you the directions and procedures for the activity. Work independently unless directed otherwise. If you need help, ask the instructor.

PERFORMANCE ACTIVITIES:

- .01 Determining the Type of Fixture to be Installed.
- .02 Installing Baseboard Heater.
- .03 Installing Incandescent Fixtures.
- .04 Installing Fluorescent Fixtures.
- .05 Installing Recessed Fixtures.

EVALUATION PROCEDURES:

Success will be determined by adherence to specifications under controlled conditions and by achieving 80% accuracy on the multiple choice unit test.

FOLLOW-THROUGH:

After reading this guide for the Unit: "Fixture", read the first assigned LAP. When performing the activity apply the skills and knowledges that you have acquired.

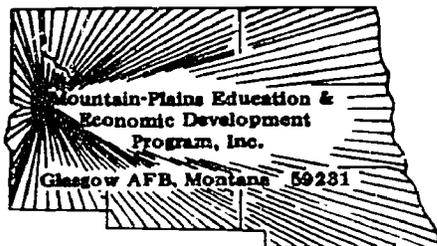

UNIT PRE-TEST: FIXTURES

72.02.02.01.

1. How many wires must be run between an incandescent lamp and its dimmer control?
 - a. two.
 - b. five.
 - c. three.
 - d. four.

2. According to the National Electrical Code, at least how many branch circuits must be supplied to a kitchen for small appliances?
 - a. four.
 - b. two.
 - c. three.
 - d. one.

3. When circuit breakers are thrown from incandescent lamp load surge, what is required to solve the problem other than replacing the switch?
 - a. change conductors.
 - b. replace incandescent lamp.
 - c. replace grounding circuit.
 - d. replace circuit breakers tripping high magnetic

4. In a three-wire two-circuit system, how can the continuity of the neutral ground be accomplished?
 - a. use a splice and pigtail the device.
 - b. splice.
 - c. use a common connection on the device (electrical)
 - d. use the electrical device.

5. A three-wire 115/120 volt branch circuit is the equivalent of how many 115 volt receptacle branch circuits?
 - a. two.
 - b. one.
 - c. four.
 - d. three.

72.02.02.02.

6. What color is the grounded conductor?
- red.
 - white.
 - green.
 - black.
7. What color is the grounding conductor?
- white.
 - red.
 - black.
 - green.
8. According to the code book 210-24, an appliance cannot exceed what percent of the rating of its branch circuit?
- 60%
 - 90%
 - 80%
 - 70%
9. How can receptacles be grounded according to the code?
- strap.
 - TW.
 - washer.
 - NM.
10. How can receptacles be grounded according to the code?
- NMC.
 - washer.
 - NM.
 - grounding clip.

72.02.02.03.

11. Double pole switches are used to control:
- two circuits.
 - one circuit.
 - four circuits.
 - three circuits.

72.02.02.03. continued

12. With the exception of double pole switching the identified conductor can:
- always be switched.
 - always be grounded.
 - never be grounded.
 - never be switched.
13. In a four way switch configuration, how many three way switches are used?
- one
 - two.
 - three.
 - four.
14. The identified conductor can be used in a switch loop when the unidentified conductor is:
- the return .
 - the source.
 - the feed.
 - the terminal
15. The four-way switch is used in situations to control a load from how many positions?
- all of the above.
 - one or more.
 - two or more.
 - three or more.

72.02.02.04.

16. If you find a rating on a fluorescent fixture that says 50 VA, what does the VA mean?
- Volts/Amps
 - Volt + Amps
 - Amp/Volts
 - Volts x Amp

72.02.02.04. continued:

17. Exposed noncurrent-carrying metal parts of electrical equipment are installed within which of the following distances of any grounded metal work or fixtures in a bathroom?
- 8' vertically and 5' horizontally.
 - 8' vertically and 2' horizontally.
 - 5' vertically and 8' horizontally.
 - 4' vertically and 5' horizontally.
18. If a fluorescent fixture has a 40 watt lamp rating and the standard 1-25 factor is used, what is the fixture total load?
- 40 VA
 - 40 watts
 - 45 VA
 - 50 watts
19. According to the code the junction box must be set a minimum distance from the recessed fixture. What is this distance?
- 16"
 - 6"
 - 12"
 - 10"
20. Where is the switch located in the passage hall closet? (See Plan)
- on the wall next to (circle) H.
 - one the door.
 - on the outside wall of closet.
 - in the door jams.

72.02.02.05.

21. Which of the following symbols indicates a special purpose outlet?
- 
 - 
 - 
 - 

72.02.02.05. continued:

22. Where is the electric heater located in the bathroom? (See Plan)
- NE wall
 - NW wall
 - SE wall
 - SW wall
23. According to the code the junction box must be set a minimum distance from the recessed fixture. What is this distance?
- 12"
 - 16"
 - 10"
 - 6"
24. What type of fixture is in the shower? (See Plan)
- recessed WP
 - recessed
 - unidentifiable by plan
 - pendant
25. If a circuit is rated at 1440 watts and the voltage is 120 volts, what is the size circuit breaker that should be installed in the power panel for this circuit?
- 30 AMP
 - 20 AMP
 - 15 AMP
 - 50 AMP

UNIT PRE-TEST answer key: FIXTURES

LAP

- 01 1. A
 2. B
 3. D
 4. A
 5. A
- 02 6. B
 7. D
 8. C
 9. A
 10. D
- 03 11. A
 12. D
 13. B
 14. A
 15. D
- 04 16. D
 17. A
 18. D
 19. C
 20. D
- 05 21. A
 22. C
 23. A
 24. A
 25. C

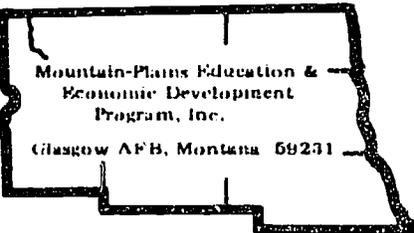

Learning Activity Package

Student: _____

Date: _____

PERFORMANCE ACTIVITY: Determining the Type of Fixture to be Installed

OBJECTIVE:

Given the blueprint and specifications, identify and record the type, description, and quantity of fixtures on a requisition form. Compiled data must correlate to and conform with the listed reference standards established in the Industry.

EVALUATION PROCEDURE:

Accurate ordering of the parts and supplies needed to complete the specific job listed in the Objective and on the blueprint. Complete, score and return a ten-item multiple-choice test about this LAP. Successful completion is eight out of ten items.

RESOURCES:

Electrical Wiring, Ray C. Mullin, pp. 11-25.
Electrical Supply Catalog.
Permeability and Magnetic Field.

PROCEDURE:

1. Listen to tape while viewing films, Permeability and Magnetic Field.
2. Obtain an Electrical Parts Supply Catalog.
3. Using the attached requisition and the blueprint sketch you have completed, order the parts and supplies needed to complete the job indicated in the objectives.

NOTE: Parts and supplies must be ordered by quantity, complete description and type.

4. Check the completed requisition with the answer key.
5. Enter the requested data on your Performance Record.
6. Take the test for this LAP.
7. Score the LAP test and return it.
8. If the test is satisfactory, begin the next assigned LAP. If the test is unsatisfactory, proceed as directed by the instructor.

Principal Author(s): R. Arneson, L. Leland, T. Ziller

PURCHASE REQUISITION

Post Office Box 3078
Glasgow AFB, Montana 59231

ORIGINATOR'S CONTROL NO. _____

REQUISITION NO. _____	REQUISITION DATE _____	TIME REQUIRED _____	PURCHASE ORDER NO. _____	PAGE _____ of _____
<input type="checkbox"/> RESEARCH DEVELOPMENT <input type="checkbox"/> OPERATIONS <input type="checkbox"/> START UP		ACCOUNTING DATA	DEPARTMENT	
SUGGESTED SOURCE		USING ACTIVITY	<input type="checkbox"/> ADMINISTRATION <input type="checkbox"/> FAMILY LIFE <input type="checkbox"/> INSTRUCTION <input type="checkbox"/> MULTI-PURPOSE <input type="checkbox"/> STATE PROGRAMS <input type="checkbox"/> PLANNING & RESEARCH <input type="checkbox"/> OTHER	
		USED FOR		

ITEM NO.	QUAN.	UNIT	DESCRIPTION OF SUPPLIES / SERVICES	EST. UNIT PRICE	EST. AMOUNT

REMARKS _____ EST. TOTAL AMOUNT _____

Title _____	Signature _____	Date _____	Title _____	Signature _____	Date _____
ORIGINATOR			PROPERTY CONTROLLER		
DEPT. HEAD			PROCUREMENT OFFICER		
DIRECTOR			ACCOUNTING OFFICE (To Procurement)		



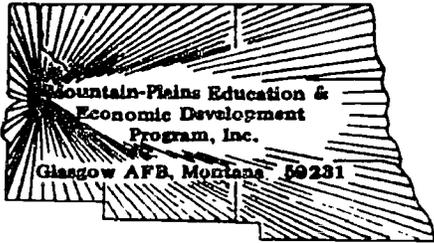

LAP TEST: DETERMINING THE TYPE OF FIXTURE
TO BE INSTALLED

1. How many conductor cables will be required in the kitchen receptacle (small appliance) circuit (s)? (See Plan)
 - a. four.
 - b. one.
 - c. three.
 - d. two.

2. Which of the following is a symbol for a thermostat?
 - a. T
 - b. T
 - c. T
 - d. T

3. A three-wire 115/230 volt branch circuit is the equivalent of how many receptacle branch circuits (115V)?
 - a. two.
 - b. one.
 - c. three.
 - d. four.

4. A three-wire 115/120 volt branch circuit is the equivalent of how many small appliance branch circuits?
 - a. two.
 - b. four.
 - c. three.
 - d. one.

5. In the living room what type of fluorescent fixtures are used for the valance lighting?
- instant start.
 - rapid start.
 - revolving start.
 - trigger start.
6. When circuit breakers are thrown from incandescent lamp load inrush, what is required to solve the problem other than replacing the switch?
- replace the incandescent lamp.
 - replace grounding circuit.
 - change conductors.
 - replace circuit breakers with high magnetic tripping.
7. In a three-wire two circuit system, how can the continuity of the neutral ground be accomplished?
- use a common connection on the device (electrical).
 - use the electrical device.
 - splice.
 - use a splice and pigtail the device.
8. What type of switch is required to compensate for incandescent lamp load inrush?
- P rated switches.
 - Y rated switches.
 - X rated switches.
 - T rated switches.
9. How many wires must be run between an incandescent lamp and its dimmer control?
- two.
 - five.
 - four.
 - three.
10. When speaking of fluorescent bulbs, which of the following letters are used to indicate warm white deluxe?
- WWD.
 - WWDX.
 - WWX.
 - WWFDX.

LAP TEST ANSWER KEY: DETERMINING THE TYPE OF FIXTURE
TO BE INSTALLED

1. D
2. D
3. A
4. A
5. B
6. D
7. D
8. D
9. A
10. C

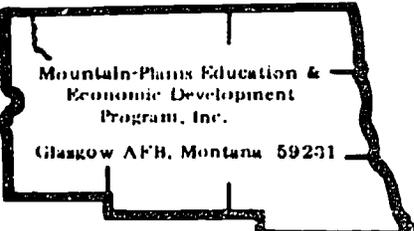

Mountain-Plains Education &
Economic Development
Program, Inc.

Glasgow AFB, Montana 59231

Learning Activity Package

Student: _____

Date: _____

PERFORMANCE ACTIVITY: Installing Baseboard Heaters

OBJECTIVE:

Given the necessary tools, equipment, supplies and blueprint, correctly install a baseboard heater according to: (1) manufacturer's and blueprint specifications; (2) following procedures and practices accepted in the Industry; and outlined in the reference text. Identify the characteristics of a baseboard heater.

EVALUATION PROCEDURE:

Installation meets the criteria listed on the attached checklist. Complete, score and return a ten-item multiple-choice test about this LAP. Successful completion is eight out of ten items.

RESOURCES:

Electrical Wiring, Ray C. Mullin, pp. 144-149.
Manufacturer's Specifications.
Magnetic Poles and Law of Magnetism.

PROCEDURE:

1. Listen to tapes while viewing films, Magnetic Poles and Law of Magnetism.
 2. Read the resource, pp. 144-149 and answer questions on pp. 147-149.
 3. Go to your assigned work station where you will complete the activities listed in the objective. Review the text if necessary.
 4. Obtain the necessary tools, equipment, and supplies needed to complete the operations listed.
 5. Complete the job listed in the objective.
- NOTE: Follow safe practices and procedures.
6. Perform all necessary testing and evaluation checks listed in the checklist, If you have any questions or problems, check with the instructor.
 7. When you have been checked off on the checklist by the instructor, complete the data requested on your Performance Record and have him initial it.
 8. Clean up the area.

Principal Author(s): R. Arneson, L. Leland, T. Ziller

9. Take the test for this LAP.
10. Score the LAP test and return it.
11. If the test is satisfactory, begin the next assigned LAP. If the test is unsatisfactory, proceed as directed by the instructor.

CHECKLIST: INSTALLING BASEBOARD HEATERS

- _____ 1. Proper selection and use of tools, equipment and supplies.
- _____ 2. Safe practices and procedures followed.
- _____ 3. Neat and presentable.
- _____ 4. Meets or exceeds standards established in the industry.
- _____ 5. Procedures followed are practiced and accepted in the industry.

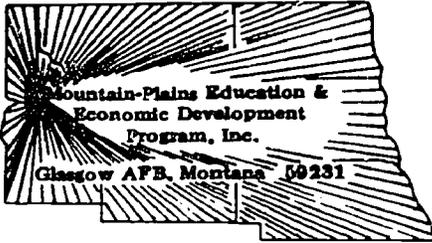

LAP TEST: INSTALLING BASEBOARD HEATERS

1. According to the code, what is the maximum portable appliance current rating that may be connected to a 20 amp branch circuit?
 - a. 17.
 - b. 16.
 - c. 15.
 - d. 18.

2. What is the current rating of a portable heater of 1750 watts 120 volt?
 - a. 12.6 amps.
 - b. 15.63 amps.
 - c. 13.8 amps.
 - d. 14.58 amps.

3. Using the Plan, where is the special purpose receptacle A1 located?
 - a. workshop.
 - b. recreation.
 - c. storage.
 - d. utility.

4. How can receptacles be grounded according to the code?
 - a. NMC.
 - b. washer.
 - c. NM.
 - d. grounding clip.

5. Some manufactures provide three-prong grounding cords with a:
 - a. moveable grounding prong.
 - b. grounding bolt (moveable).
 - c. grounding clip.
 - d. grounding screw (moveable).

6. According to the code book 210-24 an appliance cannot exceed what percent of the rating of its branch circuit?
- a. 90%
 - b. 80%
 - c. 60%
 - d. 70%
7. What color is the grounded conductor?
- a. red.
 - b. white.
 - c. green.
 - d. black.
8. According to the code, what is the maximum portable appliance current rating that may be connected to a 15 amp branch circuit?
- a. 10.
 - b. 12.
 - c. 13.
 - d. 14.
9. What color is the grounding conductor?
- a. red.
 - b. green.
 - c. white.
 - d. black.
10. How can receptacles be grounded according to the code?
- a. NM.
 - b. strap.
 - c. TW.
 - d. washer.

LAP TEST ANSWER KEY: INSTALLING BASEBOARD HEATERS

1. B
2. D
3. A
4. D
5. A
6. B
7. B
8. B
9. B
10. B



Learning Activity Package

Student: _____

Date: _____

PERFORMANCE ACTIVITY: Installing Incandescent Fixtures

OBJECTIVE:

Given the necessary tools, equipment, supplies and blueprint, correctly install incandescent fixtures according to: (1) manufacturer's and blueprint specifications; (2) following procedures and practices accepted in the Industry; and outlined in the reference text. Identify the characteristics of incandescent fixtures and associated switching circuits.

EVALUATION PROCEDURE:

Installation meets the criteria listed on the attached checklist. Complete, score and return a ten-item multiple-choice test about this LAP. Successful completion is eight out of ten items.

RESOURCES:

Electrical Wiring, Ray C. Mullin, pp. 45-53.
 Manufacturer's Specifications.
Induced Magnetism and Permanent Magnets.

PROCEDURE:

1. Listen to tapes while viewing films, Induced Magnetism and Permanent Magnets.
2. Read the resource, pp. 45-53 and answer the questions, pp. 51-53.
3. Go to your assigned work station where you will complete the activities listed in the objective. Review the text if necessary.
4. Obtain the necessary tools, equipment, and supplies needed to complete the operations listed.
5. Complete the job listed in the objective.
NOTE: Follow safe practices and procedures.
6. Perform all necessary testing and evaluation checks listed in the checklist. If you have any questions or problems, check with the instructor.
7. When you have been checked off on the checklist by the instructor, complete the data requested on your Performance Record and have him initial it.
8. Clean up the area.

Principal Author(s): R. Arneson, L. Leland, T. Ziller

9. Take the test for this LAP.
10. Score the LAP test and return it.
11. If the test is satisfactory, begin the next assigned LAP. If the test is unsatisfactory, proceed as directed by the instructor.

CHECKLIST: INSTALLING INCANDESCENT FIXTURES

- _____ 1. Proper selection and use of tools, equipment and supplies.
- _____ 2. Safe practices and procedures followed.
- _____ 3. Neat and presentable.
- _____ 4. Meets or exceeds standards established in the industry.
- _____ 5. Procedures followed are practiced and accepted in the industry.

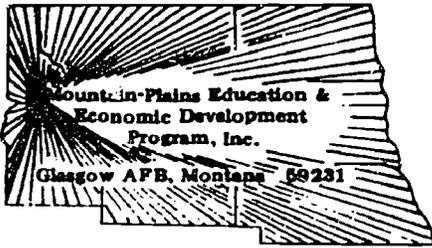

LAP TEST: INSTALLING INCANDESCENT FIXTURES

1. With the exception of double-pole switches, the identified conductor can:
 - a. always be switched.
 - b. never be switched.
 - c. never be grounded.
 - d. always be grounded.

2. The grounded circuit conductor is called a(n):
 - a. potential conductor.
 - b. identified conductor.
 - c. hot conductor.
 - d. unidentified conductor.

3. Double pole switches are used to control:
 - a. three circuits.
 - b. one circuit.
 - c. two circuits.
 - d. four circuits.

4. The third terminal on a three way switch is the:
 - a. cold terminal.
 - b. neutral terminal.
 - c. hot terminal.
 - d. common terminal.

5. In a four way switch configuration, how many three-way switches are used?
 - a. three.
 - b. one.
 - c. two.
 - d. four.

6. The four-way switch is used in situations to control a load from how many positions?
- three or more.
 - two or more.
 - one or more.
 - all of the above.
7. The three-way switch has how many positions?
- two.
 - one.
 - three.
 - four.
8. Which of the following is not a toggle switch?
- momentary.
 - three-way
 - single pole.
 - double pole.
9. A three-way switch has how many terminals?
- three.
 - one.
 - four.
 - two.

10. Which of the following connections is wired correctly for a ceiling outlet which is controlled from any one of three switch location? The 120 volt feed is at the light.

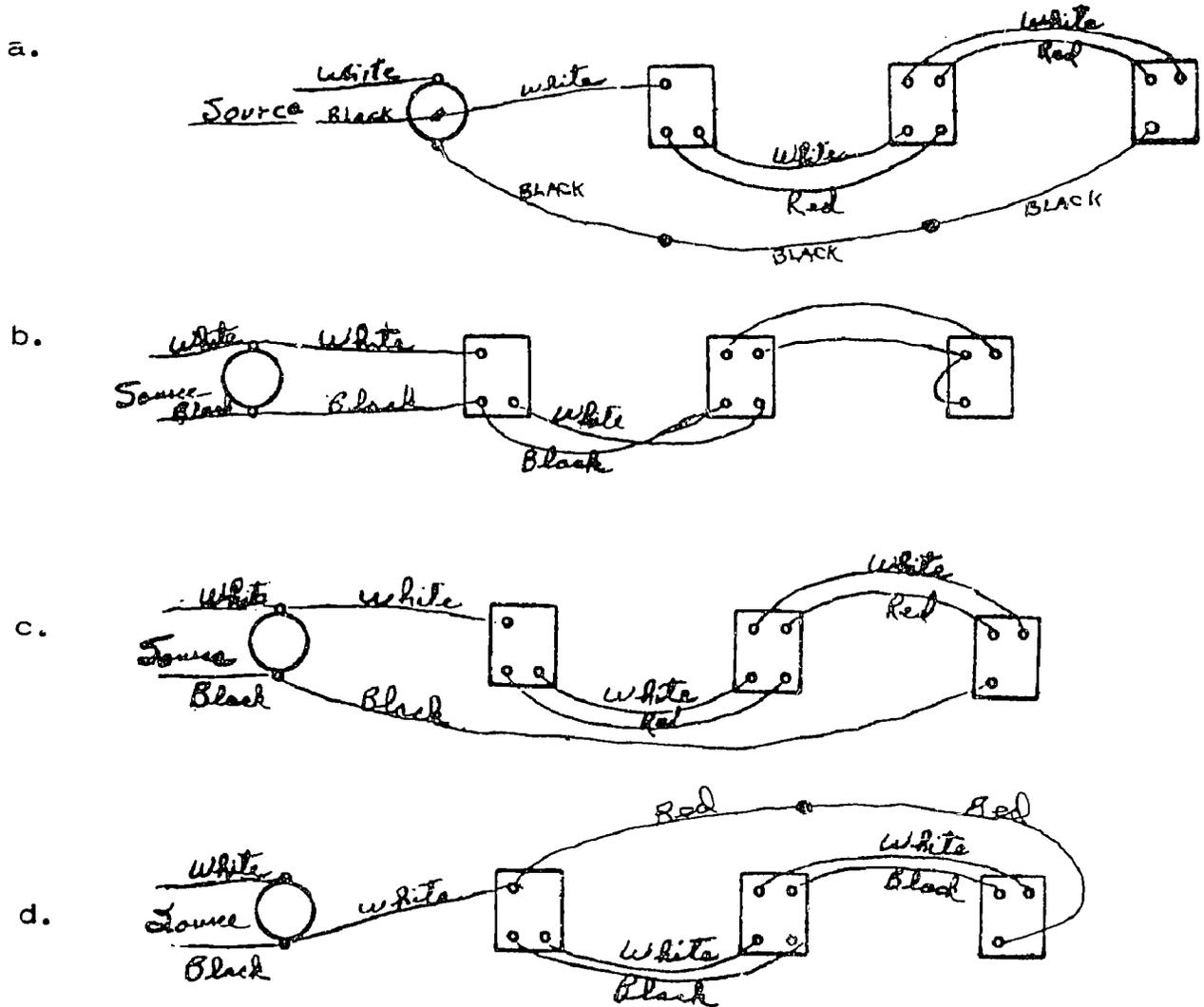

LAP TEST ANSWER KEY: INSTALLING INCANDESCENT FIXTURES

1. B
2. B
3. C
4. C
5. C
6. A
7. A
8. A
9. A
10. A

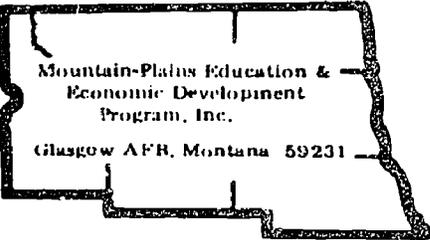

Mountain-Plains Education &
Economic Development
Program, Inc.
Glasgow AFB, Montana 59231

Learning Activity Package

Student: _____

Date: _____

PERFORMANCE ACTIVITY: Installing Fluorescent Fixtures

OBJECTIVE:

Given the necessary tools, equipment, supplies and blueprint, correctly install fluorescent fixtures according to: (1) manufacturer's and blueprint specifications; (2) following procedures and practices accepted in the Industry; and outlined in the reference text. Identify fluorescent fixture circuit characteristics, symbols, and designations.

EVALUATION PROCEDURE:

Installation meets the criteria listed on the attached checklist. Complete, score and return a ten-item multiple-choice test about this LAP. Successful completion is eight out of ten items.

RESOURCES:

Electrical Wiring, Ray C. Mullin, pp. 69-76.

Manufacturer's Specifications.

Poles Occur in Pairs, Polarity of Static Charges, Inductive Field.

The Solenoid, and The Electro-Magnet.

PROCEDURE:

1. Listen to tapes and view films (3), Poles Occur in Pairs, Polarity of Static Charges, Inductive Field.
2. View films while listening to tapes, The Solenoid, and The Electro-Magnet.
3. Read the text, pp. 69-76 and complete the review on pp. 74-76.
4. Go to your assigned work station where you will complete the activities listed in the objective. Review the text if necessary.
5. Obtain the necessary tools, equipment, and supplies needed to complete the operations listed.
6. Complete the job listed in the objective.
NOTE: Follow safe practices and procedures.
7. Perform all necessary testing and evaluation checks listed in the checklist. If you have any questions or problems, check with the instructor.
8. When you have been checked off on the checklist by the instructor, complete the data requested on your Performance Record and have him initial it.

Principal Author(s): R. Arneson, L. Leland, T. Ziller

9. Clean up the area.
10. Take the test for this LAP.
11. Score the LAP test and return it.
12. If the test is satisfactory, begin the next assigned LAP. If the test is unsatisfactory, proceed as directed by the instructor.

CHECKLIST: INSTALLING FLUORESCENT FIXTURES

- _____ 1. Proper selection and use of tools, equipment and supplies.
- _____ 2. Safe practices and procedures followed.
- _____ 3. Neat and presentable.
- _____ 4. Meets or exceeds standards established in the industry.
- _____ 5. Procedures followed are practiced and accepted in the industry.

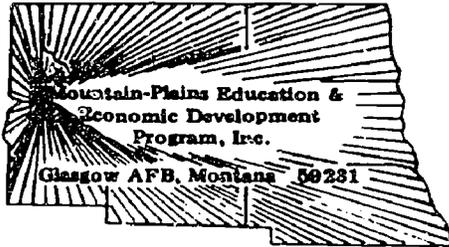

LAP TEST: INSTALLING FLUORESCENT FIXTURES

1. A standard factor of 1.25 is multiplied times 1 amp wattage to compensate for what in a fluorescent fixture?
 - a. conductor voltage drop.
 - b. grounding.
 - c. grounded fixture leakage.
 - d. ballast load.

2. Exposed noncurrent-carrying metal parts of electrical equipment are installed within which of the following distances of any grounded metal work or fixtures in a bathroom?
 - a. 5' vertically and 8' horizontally.
 - b. 8' vertically and 5' horizontally.
 - c. 4' vertically and 5' horizontally.
 - d. 8' vertically and 2' horizontally.

3. If you find a rating on a fluorescent fixture that says 50 VA, what does the VA mean?
 - a. Amp/ Volts
 - b. Volts x Amp
 - c. Volt + Amps
 - d. Volts/Amps

4. According to the electrical code the area temperature between a recessed fixture and combustible material must not exceed:
 - a. 50 degrees.
 - b. 90 degrees.
 - c. 120 degrees.
 - d. 160 degrees.

5. What type of face plates should be used in a bathroom?
 - a. copper.
 - b. aluminum.
 - c. plastic.
 - d. metal.

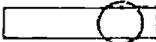
6. When is it allowable to run branch circuit wiring through an outlet box that is an integral part of an incandescent light fixture?
- if U/L approved.
 - if inspector approves it.
 - if rated for it.
 - if building codes approve it.
7. Which of the following is a fluorescent light fixture symbol?
- 
 - 
 - 
 - 
8. According to the code the junction box must be set a minimum distance from the recessed fixture. What is this distance?
- 6".
 - 10".
 - 12".
 - 16".
9. If a circuit is rated at 1440 watts and the voltage is 120 volts, what size is the circuit breaker that should be installed in the power panel for this circuit?
- 15 amp.
 - 50 amp.
 - 30 amp.
 - 20 amp.
10. If a fluorescent fixture has a 40 watt lamp rating and the standard 1.25 factor is used, what is the fixture total load?
- 40 watts.
 - 45 va.
 - 40 va.
 - 50 watts.

LAP TEST ANSWER KEY: INSTALLING FLUORESCENT FIXTURES

1. D
2. B
3. B
4. B
5. C
6. C
7. B
8. C
9. A
10. D

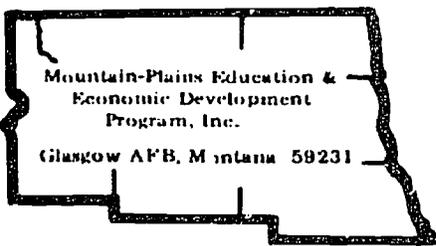

Learning Activity Package

Student: _____

Date: _____

PERFORMANCE ACTIVITY: Installing Recessed Fixtures

OBJECTIVE:

Given the necessary tools, equipment, supplies and blueprint, correctly install recessed fixtures according to: (1) manufacturer's and blueprint specifications; (2) following procedures and practices accepted in the Industry; and outlined in the reference text. Identify circuit symbols for and characteristics of recessed fixtures.

EVALUATION PROCEDURE:

Installation meets the criteria listed on the attached checklist. Complete, score and return a ten-item multiple-choice test about this LAP. Successful completion is eight out of ten items.

RESOURCES:

Electrical Wiring, Ray C. Mullin, pp. 69-76.
Manufacturer's Specifications.

PROCEDURE:

1. Review pages 69-76 in Electrical Wiring.
2. Go to your assigned work station where you will complete the activities listed in the objective.
3. Obtain the necessary tools, equipment, and supplies needed to complete the operations listed.
4. Complete the job listed in the objective.
NOTE: Follow safe practices and procedures.
5. Perform all necessary testing and evaluation checks listed in the checklist. If you have any questions or problems, check with the instructor.
6. When you have been checked off on the checklist by the instructor, complete the data requested on your Performance Record and have him initial it.
7. Clean up the area.
8. Take the test for this LAP.
9. Score the LAP test and return it.
10. If the test is satisfactory, begin the next assigned LAP. If the test is unsatisfactory, proceed as directed by the instructor.

Principal Author(s): R. Arneson, L. Leland, T. Ziller

CHECKLIST: INSTALLING RECESSED FIXTURES

- _____ 1. Proper selection and use of tools, equipment and supplies.
- _____ 2. Safe practices and procedures followed.
- _____ 3. Neat and presentable.
- _____ 4. Meets or exceeds standards established in the industry.
- _____ 5. Procedures followed are practiced and accepted in the industry.

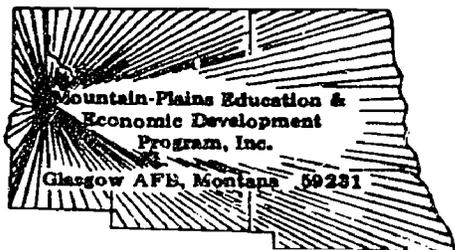

LAP TEST: INSTALLING RECESSED FIXTURES

1. When is it allowable to run branch circuit wiring through an outlet box that is an integral part of an incandescent fixture?
 - a. if building codes approve it.
 - b. if inspector approves it.
 - c. if rated for it.
 - d. if U/L approved.

2. According to the electrical code the area temperature between a recessed fixture and combustible material must not exceed:
 - a. 120 degrees.
 - b. 50 degrees.
 - c. 160 degrees.
 - d. 90 degrees.

3. Exposed noncurrent-carrying metal parts of electrical equipment are installed within which of the following distances of any grounded metal work or fixtures in a bathroom?
 - a. 5' vertically and 8' horizontally.
 - b. 8' vertically and 2' horizontally.
 - c. 8' vertically and 5' horizontally.
 - d. 4' vertically and 5' horizontally.

4. According to the code the junction box must be set a minimum distance from the recessed fixture. What is this distance?
 - a. 6"
 - b. 16"
 - c. 10"
 - d. 12"

5. What size is the rough-in box used on the switches outside of the shower in the bathroom? (See Plan)
 - a. 2 x 2 x 3"
 - b. 4 x 4 x 1 1/2"
 - c. 3 x 4 x 2 1/2"
 - d. 4 x 4 x 2 1/8"

6. Where is the electric heater located in the bathroom? (See Plan)
- SE wall.
 - NE wall.
 - NW wall.
 - SW wall.
7. If you find a rating on a fluorescent fixture that says 50 VA, what does the VA mean?
- Amp/ Volts
 - Volts/Amps
 - Volts \times Amp
 - Volt \div Amps
8. Which of the following symbols indicates a special purpose outlet?
- 
 - 
 - 
 - 
9. A standard factor of 1.25 is multiplied times 1 amp wattage to compensate for what in a fluorescent fixture?
- ballast load.
 - conductor voltage drop.
 - grounded fixture leakage.
 - grounding.
10. If a circuit is rated at 1440 watts and the voltage is 120 volts, what is the size circuit breaker that should be installed in the power panel for this circuit?
- 30 amp.
 - 50 amp.
 - 20 amp.
 - 15 amp.

LAP TEST ANSWER KEY: INSTALLING RECESSED FIXTURES

1. C
2. D
3. C
4. D
5. D
6. A
7. C
8. D
9. A
10. D

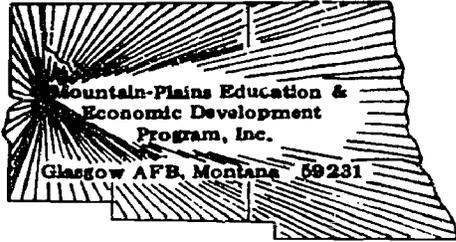

UNIT POST-TEST: FIXTURES

72.02.02.01.

1. Where is the speed control switch for the fan located in the kitchen?
(See Plan)
 - a. right over the counter top.
 - b. part of the range.
 - c. part of the fan.
 - d. part of the stove.

2. When speaking of fluorescent bulbs, which of the following letters are used to indicate Deluxe Warm White?
 - a. WWX
 - b. WWD
 - c. WWDX
 - d. WWFDX

3. Which of the following symbols indicates a recessed ceiling fixture?
 - a. 
 - b. 
 - c. 
 - d. 

4. Which of the following is a symbol for a thermostat?
 - a. 
 - b. 
 - c. 
 - d. 

72.02.02.01. continued:

5. A three-wire 115/230 volt branch circuit is the equivalent of how many receptacle branch circuits (115V)
- three.
 - four.
 - one.
 - two.

72.02.02.02.

6. According to the code, what is the maximum portable appliance current rating that may be connected to a 20 AMP branch circuit?
- 17.
 - 15.
 - 16.
 - 18.
7. According to the code, what is the maximum portable appliance current rating that may be connected to a 15 AMP branch circuit?
- 10.
 - 14.
 - 12.
 - 13.
8. Using the Plan, where is the special purpose receptacle A₁ located?
- utility.
 - workshop.
 - recreation.
 - storage.
9. Some manufactures provide three-prong grounding cords with a:
- grounding screw (moveable).
 - grounding bolt (moveable) .
 - grounding clip.
 - moveable grounding prong.
10. How are the heaters supplied with electricity at outlets A1 & A2 ?
(See Plan)
- semi-permanently.
 - plug in (portable).
 - EMT / permanently
 - permanently.

72.02.02.03.

11. Which of the following connections is wired correctly for a ceiling outlet which is controlled from any one of three switch location? The 120 volt feed is at the light.

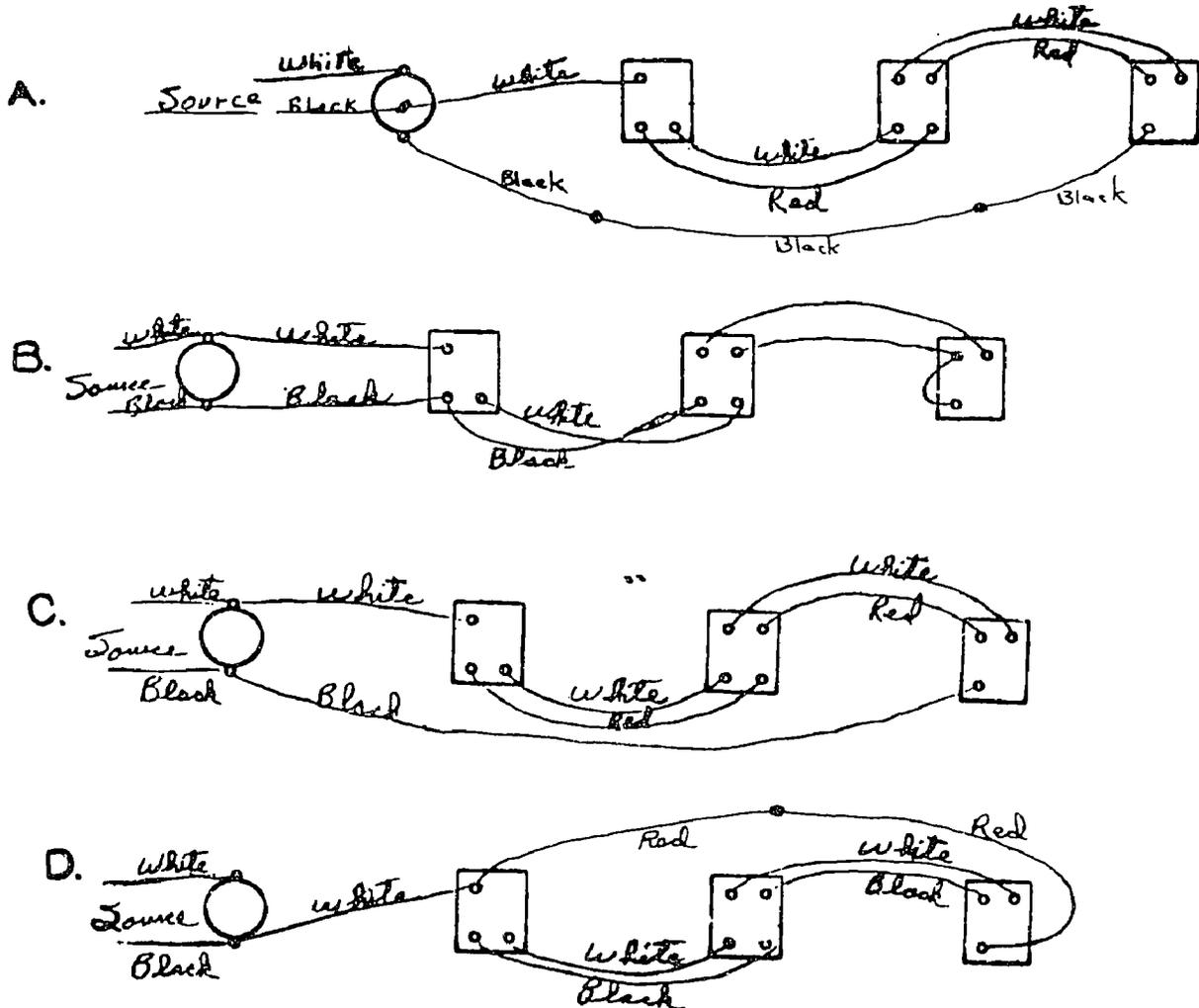

12. The third terminal on a three way switch is the:

- cold terminal.
- neutral terminal.
- hot terminal.
- common terminal.

72.02.02.03. continued:

13. The color of the unidentified conductor is?
- black.
 - green.
 - gray.
 - white.
14. The three-way switch has how many positions?
- one.
 - two.
 - four.
 - three.
15. A DPST switch may be installed:
- at the end of a circuit.
 - in four-way circuits only.
 - between outlets.
 - in a three-way circuit.

72.02.02.04.

16. Which of the following symbols indicates a special purpose outlet?
- 
 - 
 - 
 - 
17. What size is the rough-in box used on the switches outside of the shower in the bathroom? (See Plan)
- 2" x 3"
 - 4" x 1 1/2"
 - 3" x 2 1/2"
 - 4" x 2 1/8"

72.02.02.04. continued:

18. What type of face plates should be used in a bathroom?
- copper.
 - aluminum.
 - plastic.
 - metal.
19. What type of fixture is in the shower? (See Plan)
- pendant.
 - recessed.
 - unidentifiable by plan.
 - recessed WP.
20. If a recessed fixture does not have an approved junction box, one must be installed. The code indicates a maximum and minimum distance from the fixture for the raceway to the box. What is it?
- 1 - 2 feet.
 - 6 - 8 feet.
 - 3 - 4 feet.
 - 4 - 6 feet.

72.02.02.05.

21. If you find a rating on a fluorescent fixture that says 50 VA, what does the VA mean?
- Volt + Amps
 - Volts x Amp
 - Amp/ Volts
 - Volts/Amps
22. Where is the switch located in the passage hall closet? (See Plan)
- on the door.
 - on the outside wall of closet.
 - in the door jams.
 - on the wall next to (circle) H.

72.02.02.05. continued:

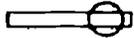
23. A standard factor of 1.25 is multiplied times 1 Amp wattage to compensate for what in a fluorescent fixture?
- ballast load.
 - grounding.
 - conductor voltage drop.
 - grounded fixture leakage.
24. If a recessed fixture does not have an approved junction box, one must be installed. The code indicates a maximum and minimum distance from the fixture for the raceway to the box. What is it?
- 3 - 4 feet.
 - 4 - 6 feet.
 - 1 - 2 feet.
 - 6 - 8 feet.
25. Which of the following is a fluorescent light fixture symbol?
- 
 - 
 - 
 - 

UNIT POST-TEST answer key: FIXTURES

LAP

- | | |
|----|-------|
| 01 | 1. C |
| | 2. A |
| | 3. B |
| | 4. D |
| | 5. D |
| 02 | 6. C |
| | 7. C |
| | 8. B |
| | 9. D |
| | 10. C |
| 03 | 11. A |
| | 12. D |
| | 13. A |
| | 14. B |
| | 15. A |
| 04 | 16. C |
| | 17. D |
| | 18. C |
| | 19. D |
| | 20. D |
| 05 | 21. B |
| | 22. C |
| | 23. A |
| | 24. B |
| | 25. C |

Family Pay Number: _____ Sex: M F (Circle 1)

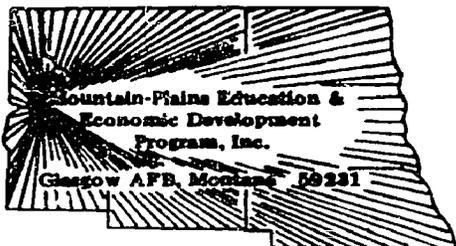

UNIT PERFORMANCE TEST: FIXTURES

OBJECTIVE 1:

Given a blueprint of a floor plan and electrically roughed-in wood frame construction, simulated or actual, the student will estimate the electrical fixtures to be installed.

OBJECTIVE 2:

Given a blueprint of a floor plan and an electrically roughed-in wood frame construction, simulated or actual, the student will itemize the electrical fixtures used in the installation.

OBJECTIVE 3:

Given a blueprint of a floor plan and an electrically roughed-in wood frame construction, simulated or actual, the student will install the electrical fixture in the proper locations.

TASK:

The student will complete a list of electrical fixtures, using blueprints and sketches. The student will obtain the electrical fixtures from the storage room. Then the student will install the electrical fixtures according to the blueprint specifications, manufacturer's specifications, and National Electrical Code standards.

ASSIGNMENT:CONDITIONS:

The student will be tested in a wood frame construction to simulate any specified room of a residence. The student will be given necessary tools and equipment. No assistance may be obtained from another student or the instructor or from unspecified text material.

RESOURCES:

Tools:

High leverage plier
High leverage oblique cutting plier
Long nose cutting plier
Electrician's hammer
Screwdriver slot 3/16 x 4
Screwdriver no. 2 phillips 8"
Screwdriver slot 3/16 x 9
Screwdriver 1/4 x 4
Screwdriver 1/4 x 6
Nutdriver variable size 1/4" x 7/16
Scratch awl
Adjustable Wrench size 8"
Pump plier size 10"
All-purpose tool, wire stripper, crimper and cutter
Tape rule 12' 3/4"
Knife, electricians
Tool pouch, 5 pocket

Equipment:

Simpson 260 VOM or Amprobe

Text:

Electrical Wiring Residential, Ray C. Mullin, Delmar Publishers. 4th Ed., 1973
National Electrical Code

ASSIGNMENT SHEET 1

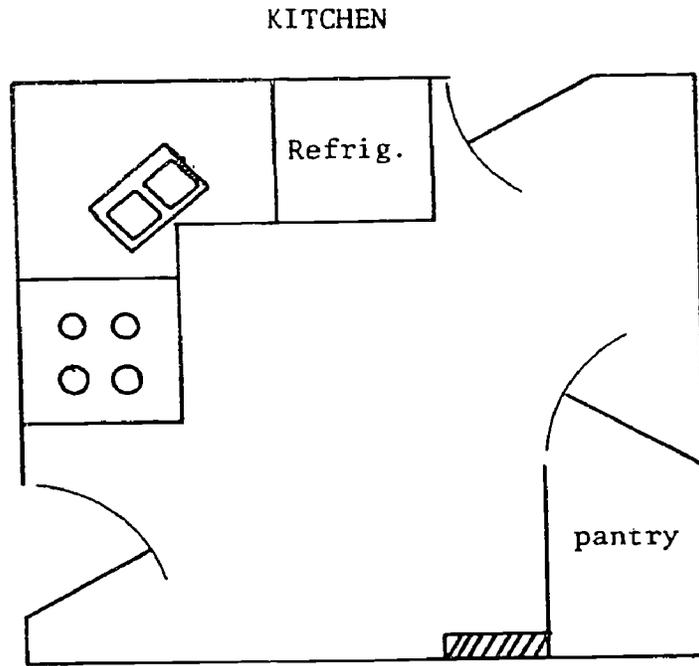

- garbage disposal
- pantry light
- light 2-position control

ASSIGNMENT SHEET 2

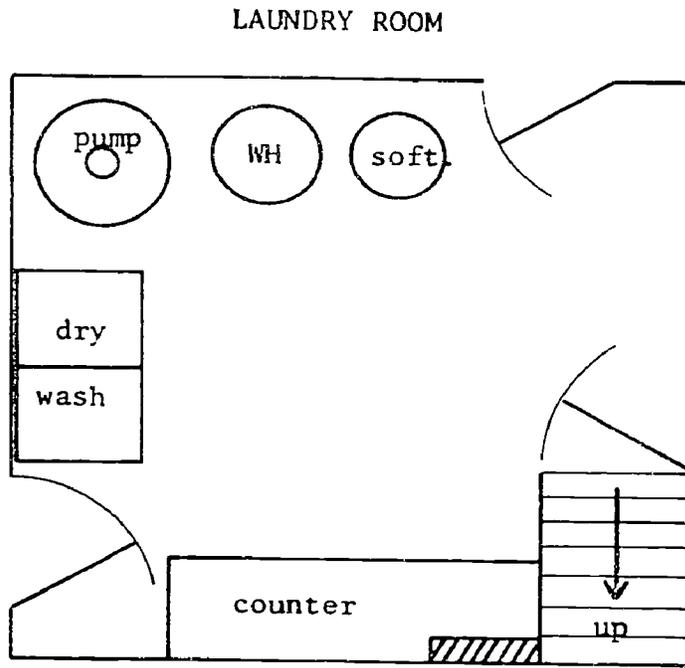

- sub-pump
- water heater
- water softener
- 3-position switch control

ASSIGNMENT SHEET 3

LIVING ROOM

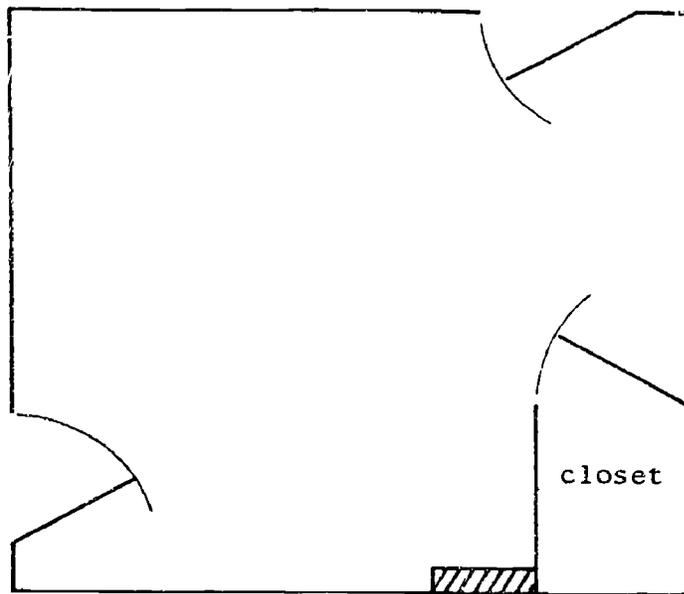

- electric heat
- split receptacles
- 2-position switch control

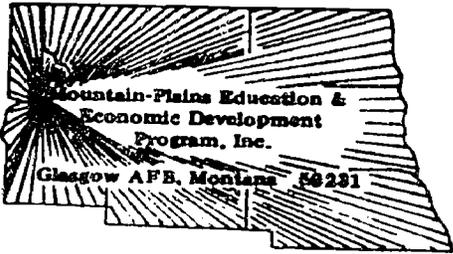

PERFORMANCE CHECKLIST:

OVERALL PERFORMANCE: Satisfactory _____ Unsatisfactory _____

	CRITERION	
	Met	Not Met
Objective 1:		
1. The student determines the type of electrical fixtures to be installed.	"	
2. The student determines the quantity of each electrical fixture to be installed.		
3. The student itemizes each type and quantity of electrical fixture to be used.		
Criterion: The physical and electrical dimensions meet National Electrical Code standards and blueprint specifications.		
Objective 2:		
4. The student obtains the electrical fixtures to be installed from the electric shop's storage room.		
Criterion: The electrical fixtures will be used by the student for installation.		
Objective 3:		
5. The student strips the conductor's insulation with wire		

(Checklist continued)

	CRITERION	
	Met	Not Met
strippers to fit the electrical fixture's connecting device.		
6. The student bends the electrical wire to fit the connecting screw, when appropriate.		
7. The student connects the "hot", black or red, conductor to the brass colored screw on the electrical fixture.		
8. The student connects the "neutral", white, conductor to the aluminum colored screw on the electrical fixture.		
9. The student connects the bare grounding conductor to the grounding clip on the fixture box.		
10. The student connects a grounding strap from the electrical fixture to the grounding clip on the electrical fixture outlet box.		
11. The student fastens the electrical fixture to the electrical fixture outlet box with appropriate sized screws.		
Criterion: The fixture installation meets National Electrical Code standards and blueprint and manufacturer's specifications.		
12. Task completed in allotted time.		
Criterion: See assignment for time specifications.		

(Checklist continued)

CRITERION
Met Not Met

Student must meet criterion on all line items to obtain an overall score of		
satisfactory.		

[Faint text]



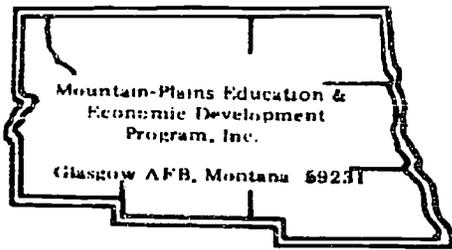

Learning Experience Guide

UNIT: SWITCHES

RATIONALE:

The correct installation of switches is one of the qualifications for an electrical wireman. To successfully install switches requires a knowledge about what type of switch to use, where to install it and installing it correctly. This unit is organized to assist you in qualifying for switch installation.

PREREQUISITES:

Unit titled "Fixtures" and the course prerequisites are needed for this unit.

OBJECTIVES:

Identify characteristics of electrical switches and procedures for their installation. Given blueprint specifications, National Electrical Codes, tools, building or shop simulation with electrical wiring rough-in, students will estimate materials required and install the specified electrical switches.

RESOURCES:

Electrical Wiring Residential, Ray C. Mullin, Publisher, 1973.

An assortment of electrical supply catalogs containing switches.

An assortment of manufacturer's electrical switch specifications guides.

Set of electrical wireman's tools.

Film Loops:

Electrostatic Induction, Electroscopes I and II, Electromagnetic Generator and Alternative, Moving Coil and Reversing Polarity, Fairfield Associates, Inc., the Jam Handy Organization.

Audio Cassette Tapes.

Narration for each of the film loops listed, Mountain-Plains Education & Economic Development Program, Inc.

Principal Author(s): R. Arneson, L. Leland, T. Ziller

GENERAL INSTRUCTIONS:

Each performance activity assigned to you, for this unit, will have a LAP that will give directions. Independently follow the procedures provided in the LAP unless you are directed otherwise. If help is needed, ask your instructor.

PERFORMANCE OBJECTIVES:

- .01 Determining the Type of Switch to be Installed.
- .02 Installing Automatic Door Switches.
- .03 Installing Single-Pole Switches.
- .04 Installing 3-Way and 4-Way Switches.

EVALUATION PROCEDURE:

Success in this unit is determined by identifying 80% of the desired responses to a set of multiple choice test items and obtaining a "satisfactory" for completing each line item on a performance test.

FOLLOW-THROUGH:

When you have finished reading this unit test guide, about electrical switches, obtain the first assigned activity LAP. Follow the directions included in the LAP and apply those skills you have acquired thus far.

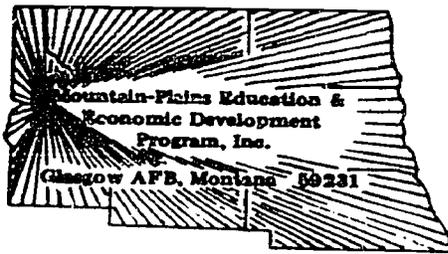

UNIT PRE-TEST: SWITCHES

72.02.03.01.

1. Double pole switches are used to control:
 - a. four circuits.
 - b. three circuits.
 - c. one circuit.
 - d. two circuits.

2. To control a group of lights from one location the most practical switch to use is:
 - a. four way.
 - b. three way.
 - c. single pole.
 - d. double pole.

3. Which of the following is not a toggle switch?
 - a. three way.
 - b. double pole.
 - c. momentary.
 - d. single pole.

4. The four way switch is used in situations to control a load from how many positions?
 - a. at least five.
 - b. one or more.
 - c. two or more.
 - d. three or more.

5. With the exception of double pole switching the identified conductors can:
 - a. always be switched.
 - b. always be grounded.
 - c. never be switched.
 - d. never be grounded.

72.02.03.02.

6. In electrical terminology the green conductor is considered to be which of the following?
- hot conductor.
 - grounded conductor.
 - feed conductor.
 - grounding conductor.
7. What type of receptacles are used in the bedroom? (Use Plan)
- outlet.
 - universal.
 - split.
 - switched.
8. What is the total load in watts allowable for a 15 amp circuit?
- 1440 watts.
 - 1300 watts.
 - 1650 watts.
 - 1800 watts.
9. In electrical terminology the white conductor is considered to be which of the following?
- feed conductor.
 - grounded conductor.
 - grounding conductor.
 - hot conductor.
10. What type of covers are used with 4 inch square outlet boxes?
- flush plaster cover.
 - finish plaster cover.
 - closed plaster cover.
 - a gang raised plaster cover.

72.02.03.03,

11. The identified conductor can be used in a switch loop when the unidentified conductor is:
 - a. the return.
 - b. the terminal.
 - c. the feed.
 - d. the source.

12. The color of the identified conductor is:
 - a. black.
 - b. white.
 - c. blue.
 - d. green.

13. Double pole switches are used to control:
 - a. two circuits.
 - b. one circuit.
 - c. three circuits.
 - d. four circuits.

14. To control a group of lights from one location the most practical switch to use is :
 - a. three way.
 - b. double pole.
 - c. single pole.
 - d. four way.

15. The color of the unidentified conductor is:
 - a. black.
 - b. green.
 - c. white.
 - d. gray.

72.02.03.04.

16. The color of the identified conductor is:
- a. green.
 - b. black.
 - c. white.
 - d. blue.
17. The three way switch has how many positions?
- a. one.
 - b. three.
 - c. four.
 - d. two.
18. The grounded circuit conductor is a(n):
- a. unidentified conductor.
 - b. hot conductor.
 - c. potential conductor.
 - d. identified conductor.
19. To control a group of lights from one location the most practical switch to use is:
- a. double pole.
 - b. three way.
 - c. four way.
 - d. single pole.
20. In a four way switch configuration, how many three way switches are used?
- a. four.
 - b. three.
 - c. one.
 - d. two.

UNIT PRE-TEST answer key: SWITCHES

LAP

- | | |
|----|-------|
| 01 | 1. D |
| | 2. C |
| | 3. C |
| | 4. D |
| | 5. C |
| 02 | 6. D |
| | 7. C |
| | 8. A |
| | 9. B |
| | 10. D |
| 03 | 11. A |
| | 12. B |
| | 13. A |
| | 14. C |
| | 15. A |
| 04 | 16. C |
| | 17. D |
| | 18. D |
| | 19. D |
| | 20. D |

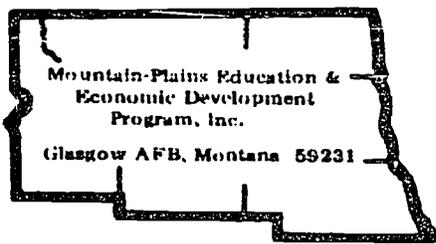

Learning Activity Package

Student: _____

Date: _____

PERFORMANCE ACTIVITY: Determining Type of Switch to be Installed

OBJECTIVE:

Given the blueprint and specifications, identify and record the type, description, and quantity of switches on a requisition form. Compiled data must correlate to and conform with the listed reference standards established in the Industry.

EVALUATION PROCEDURE:

Accurate ordering of the parts and supplies needed to complete the specific job listed in the Objective and on the blueprint. Complete, score and return a ten-item multiple-choice test about this LAP. Successful completion is eight out of ten items.

RESOURCES:

Electrical Wiring, Ray C. Mullin, pp. 45-53.
Electrical Supply Catalog.
Electro-static Induction, and Electro-scope I and II.

PROCEDURE:

1. View films while listening to tapes, Electro-static Induction, and Electro-scope I and II.
2. Review pages 45-53 in Electrical Wiring.
3. Obtain an Electrical Parts Supply Catalog.
4. Using the attached requisition and the blueprint sketch you have completed, order the parts and supplies needed to complete the job indicated in the objective.
NOTE: Parts and supplies must be ordered by quantity, complete description and type.
5. Check the completed requisition with the answer key.
6. Enter the requested data on your Performance Record.
7. Take the test for this LAP.
8. Score the LAP test and return it.
9. If the test is satisfactory, begin the next assigned LAP. If the test is unsatisfactory, proceed as directed by the instructor.

Principal Author(s): R. Arneson, L. Leland, T. Ziller

Post Office Box 3078
Gisgow AFB, Montana 59231

ORIGINATOR'S CONTROL NO. _____

REQUISITION NO. _____ REQUISITION DATE _____ TIME REQUIRED _____ PURCHASE ORDER NO. _____ PAGE _____ of _____

<input type="checkbox"/> RESEARCH DEVELOPMENT <input type="checkbox"/> START UP	<input type="checkbox"/> OPERATIONS	ACCOUNTING DATA _____ USING ACTIVITY _____ USED FOR _____	DEPARTMENT <input type="checkbox"/> ADMINISTRATION <input type="checkbox"/> FAMILY LIFE <input type="checkbox"/> INSTRUCTION <input type="checkbox"/> MULTI-PURPOSE <input type="checkbox"/> STATE PROGRAMS <input type="checkbox"/> PLANNING & RESEARCH <input type="checkbox"/> OTHER
SUGGESTED SOURCE _____			

ITEM NO.	QUAN.	UNIT	DESCRIPTION OF SUPPLIES / SERVICES	EST. UNIT PRICE	EST. AMOUNT

REMARKS _____ EST. TOTAL AMOUNT 

Title	Signature	Date	Title	Signature	Date
ORIGINATOR			PROPERTY CONTROLLER		
DEPT. HEAD			PROCUREMENT OFFICER		
DIRECTOR			ACCOUNTING OFFICE (To Procurement)		

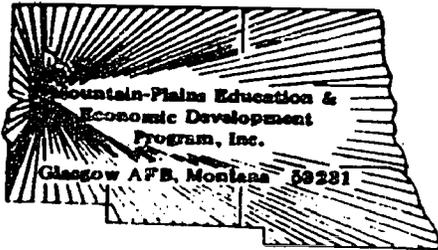
LAP TEST: DETERMINING TYPE OF SWITCH TO
BE INSTALLED

1. A DPST switch may be installed:
 - a. at the beginning of a circuit.
 - b. between outlets.
 - c. at the end of a circuit.
 - d. in a three-way circuit.

2. The third terminal on a three way switch is the:
 - a. cold terminal.
 - b. neutral terminal.
 - c. hot terminal.
 - d. common terminal.

3. The unidentified conductor must connect between the switch and the:
 - a. load.
 - b. white wire.
 - c. ground.
 - d. neutral.

4. The color of the identified conductor is:
 - a. green.
 - b. white.
 - c. black.
 - d. blue.

5. With the exception of double-pole switching the identified conductors can:
 - a. always be grounded.
 - b. always be switched.
 - c. never be grounded.
 - d. never be switched.

6. The four-way switch is used in situations to control a load from how many positions?
- all of the below.
 - two or more.
 - three or more.
 - one or more
7. The grounded circuit conductor is a(n):
- unidentified conductor.
 - potential conductor.
 - hot conductor.
 - identified conductor.
8. The color of the unidentified conductor is:
- green.
 - white.
 - black.
 - gray.
9. Which of the following is not a toggle switch?
- double pole.
 - three way.
 - momentary.
 - single pole.
10. In a four way switch configuration how many three way switches are used:
- two.
 - four.
 - three.
 - one.

LAP TEST ANSWER KEY: DETERMINING TYPE OF SWITCH TO
BE INSTALLED

1. A
2. D
3. A
4. B
5. D
6. C
7. D
8. C
9. C
10. A

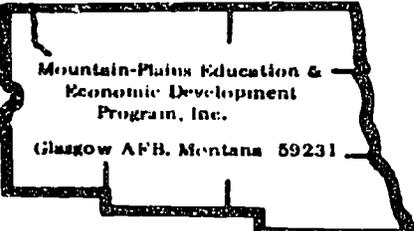

Mountain-Plain Education &
Economic Development
Program, Inc.
Glasgow AFB, Montana 59231

Learning Activity Package

Student: _____

Date: _____

PERFORMANCE ACTIVITY: Installing Automatic Door Switches

OBJECTIVE:

Given the necessary tools, equipment, supplies and blueprint, correctly install an automatic door switch according to: (1) manufacturer's and blueprint specifications; (2) following procedures and practices accepted in the industry; and outlined in the reference text. Identify circuit characteristics of an automatic door switch and procedure for installation.

EVALUATION PROCEDURE:

Installation meets the criteria listed on the attached checklist. Complete, score and return a ten-item multiple-choice test about this LAP. Successful completion is eight out of ten items.

RESOURCES:

Electrical Wiring, Ray C. Mullin, pp. 65-68.
Manufacturer's Specifications.
Electromagnetic Generator and Alternating Circuit.

PROCEDURE:

1. Listen to tapes while viewing films, Electromagnetic Generator and Alternating Circuit.
2. Read the text, pp. 65-68 and complete the review pp. 67, 68.
3. Go to your assigned work station where you will complete the activities listed in the objective.
4. Obtain the necessary tools, equipment and supplies needed to complete the operations listed.
5. Complete the job listed in the objective.
NOTE: Follow safe practices and procedures.
6. Perform all necessary testing and evaluation checks listed in the checklist. If you have any questions or problems, check with the instructor.
7. When you have been checked off on the checklist by the instructor, complete the data requested on your Performance Report and have him initial it.
8. Clean up the area.

Principal Author(s): R. Arneson, L. Leland, T. Ziller

9. Take the test for this LAP.
10. Score the LAP test and return it.
11. If the test is satisfactory, begin the next assigned LAP. If the test is unsatisfactory, proceed as directed by the instructor.

CHECKLIST: INSTALLING AUTOMATIC DOOR SWITCHES

- _____ 1. Proper selection and use of tools, equipment and supplies.
- _____ 2. Safe practices and procedures followed.
- _____ 3. Neat and presentable.
- _____ 4. Meets or exceeds standards established in the industry.
- _____ 5. Procedures followed are practiced and accepted in the industry.

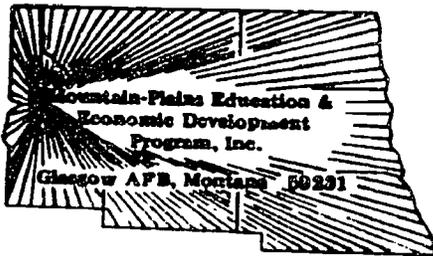

LAP TEST: INSTALLING AUTOMATIC DOOR SWITCHES

1. In bedroom #1, what is the height from the rough floor to which the switches will be set? (See Plan)
 - a. 46 1/2"
 - b. 52 5/8"
 - c. 50 5/8"
 - d. 48 3/4"

2. What type of covers are used with 4 inch square outlet boxes?
 - a. closed plaster cover.
 - b. finish plaster cover.
 - c. a gang raised plaster cover.
 - d. flush plaster cover.

3. Using 12 awg wire as a conductor and a standard 4" square box, what is the maximum number of wires allowable?
 - a. 14.
 - b. 6.
 - c. 8.
 - d. 12.

4. What type of receptacles are used in the bedroom? (See Plan)
 - a. switched.
 - b. outlet.
 - c. split.
 - d. universal.

5. Which of the following is installed first when wiring a bedroom?
 - a. switch boxes.
 - b. cable.
 - c. fixtures.
 - d. outlet boxes.

6. What is the total load in watts allowable for a 15 amp circuit?
- 1650 watts.
 - 1440 watts.
 - 1300 watts.
 - 1800 watts.
7. In bedroom #1 on the set of Plans, what is the height to which the switches will be set from finished floor? (Use Plans)
- 48" T.C. (to center)
 - 46" T.C.
 - 50" T.C.
 - 52" T.C.
8. Approximately how far from the door opening is the first convenience in the bedroom #1? (See Plan)
- 2'6"
 - 1'
 - 4'2"
 - 1'9"
9. In electrical terminology the white conductor is considered to be which of the following?
- grounded conductor.
 - hot conductor.
 - grounding conductor.
 - feed conductor.
10. In electrical terminology the green conductor is considered to be which of the following?
- grounded conductor.
 - grounding conductor.
 - hot conductor.
 - feed conductor.

LAP TEST ANSWER KEY: INSTALLING AUTOMATIC DOOR SWITCHES

1. C
2. C
3. A
4. C
5. D
6. B
7. C
8. D
9. A
10. B

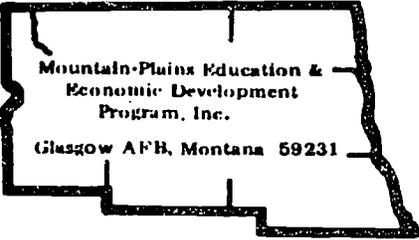

Mountain-Plains Education &
Economic Development
Program, Inc.

Glasgow AFB, Montana 59231

Learning Activity Package

Student: _____

Date: _____

PERFORMANCE ACTIVITY: Installing Single-Pole Switches

OBJECTIVE:

Given the necessary tools, equipment, supplies and blueprint, correctly install single-pole switches according to: (1) manufacturer's and blueprint specifications; (2) following procedures and practices accepted in the Industry; and outlined in the reference text. Identify types and proper installation of a single-pole switching circuit.

EVALUATION PROCEDURE:

Installation meets the criteria listed on the attached checklist. Complete, score and return a ten-item multiple-choice test about this LAP. Successful completion is eight out of ten items.

RESOURCES:

Electrical Wiring, Ray Mullin, pp. 45-53.
Manufacturer's Specifications.

PROCEDURE:

1. See your instructor for Unit I test, Introduction to AC.
 2. Go to your assigned work station where you will complete the activities listed in the objective. Review the text if necessary.
 3. Obtain the necessary tools, equipment, and supplies needed to complete the operations listed.
 4. Complete the job listed in the objective.
- NOTE: FOLLOW SAFE PRACTICES AND PROCEDURES.
5. Perform all necessary testing and evaluation checks listed in the checklist. If you have any questions or problems, check with the instructor.
 6. When you have been checked off on the checklist by the instructor, complete the data requested on your Performance Record and have him initial it.
 7. Clean up the area.
 8. Take the test for this LAP.
 9. Score the LAP test and return it.
 10. If the test is satisfactory, begin the next assigned LAP. If the test is unsatisfactory, proceed as directed by the instructor.

Principal Author(s): R. Arneson, L. Leland, T. Ziller

CHECKLIST: INSTALLING SINGLE POLE SWITCHES

- _____ 1. Proper selection and use of tools, equipment and supplies.
- _____ 2. Safe practices and procedures followed.
- _____ 3. Neat and presentable.
- _____ 4. Meets or exceeds standards established in the industry.
- _____ 5. Procedures followed are practiced and accepted in the industry.

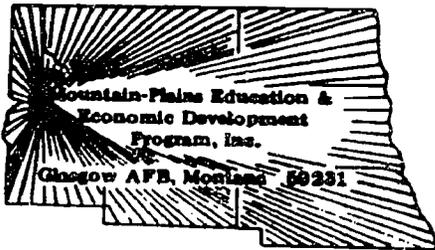

LAP TEST: INSTALLING SINGLE-POLE SWITCHES

1. The unidentified conductor must connect between the switch and the:
 - a. neutral.
 - b. white wire.
 - c. ground.
 - d. load.

2. A three-way switch has how many terminals?
 - a. one.
 - b. four.
 - c. two.
 - d. three.

3. Which one of the connections is wired correctly so that the ceiling outlet may be controlled from either three way switch?

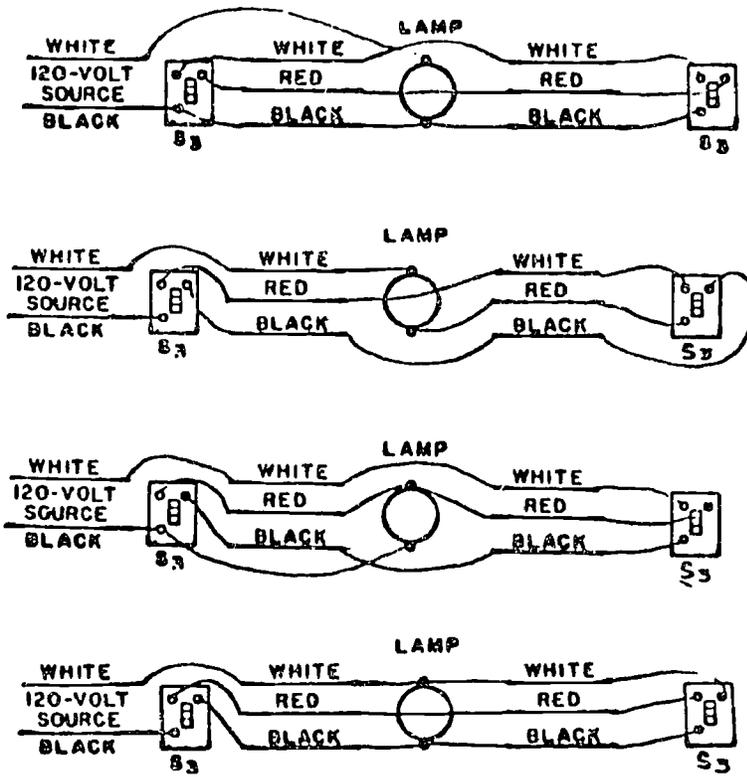

4. Three way switches control the load from how many positions?
 - a. four.
 - b. two.
 - c. one.
 - d. three.

5. Which of the following is not a toggle switch?
 - a. momentary.
 - b. single pole.
 - c. double pole.
 - d. three way.

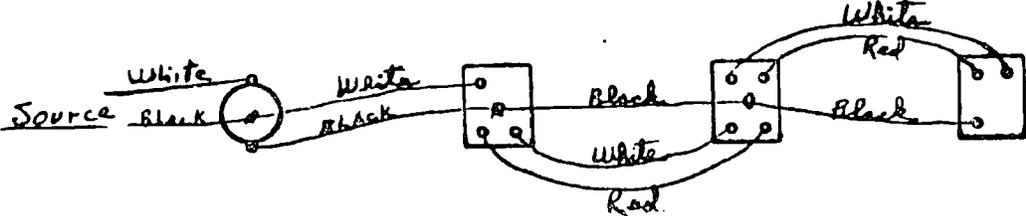
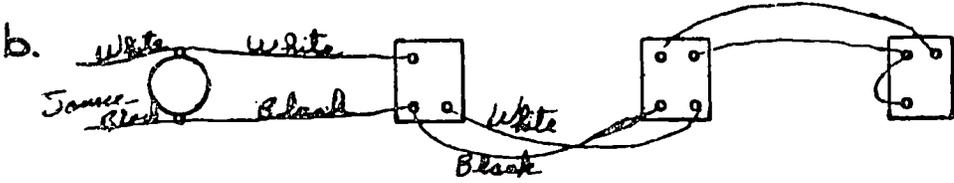
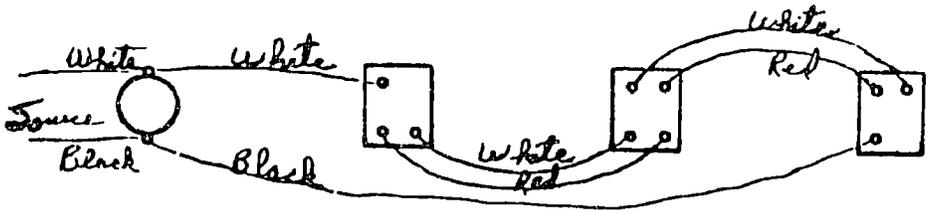
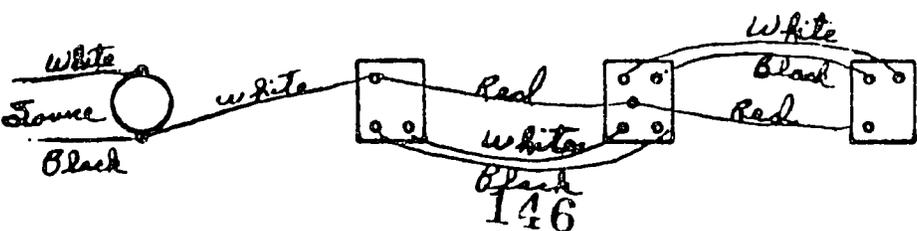
6. Which one of the following connections is wired correctly for a ceiling outlet which is controlled from any one of three switch locations? The 120 volt feed is at the light.
 - a. 
 - b. 
 - c. 
 - d. 

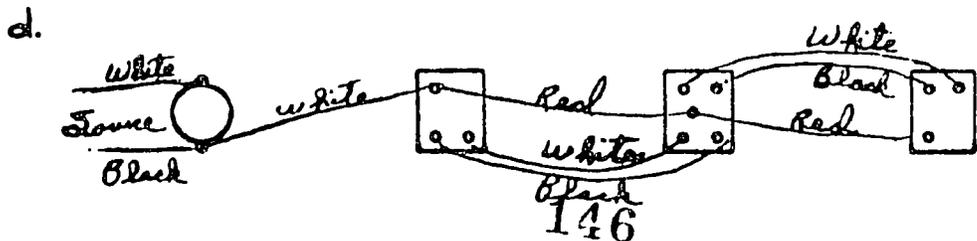
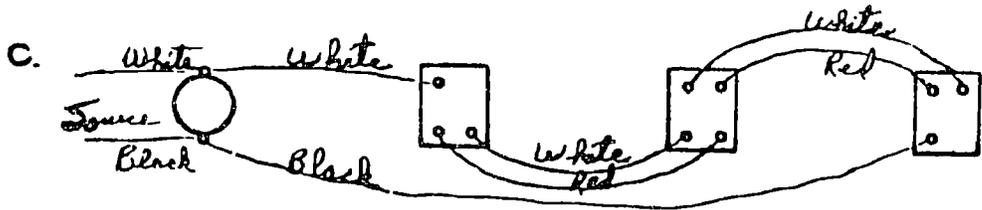
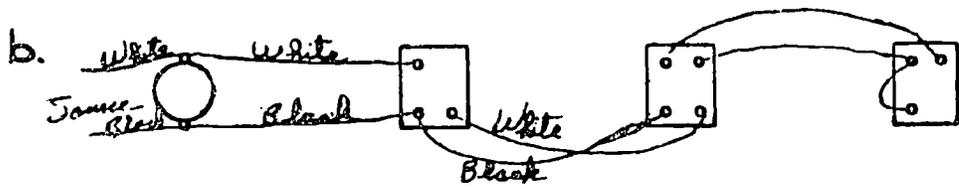
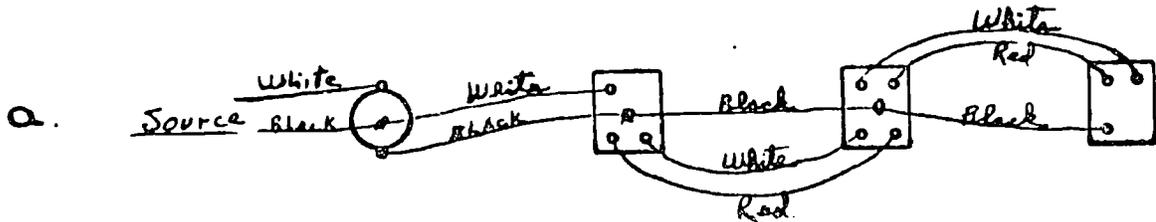

146

7. In a four-way switch configuration, how many three-way switches are used?
- a. four.
 - b. three.
 - c. two.
 - d. one.
8. Double pole switches are used to control:
- a. two circuits.
 - b. one circuit.
 - c. four circuits.
 - d. three circuits.
9. The third terminal on a three way switch is the:
- a. pole terminal.
 - b. neutral terminal.
 - c. hot terminal.
 - d. common terminal.
10. The identified conductor can be used in a switch loop when the unidentified conductor is:
- a. the return.
 - b. the source.
 - c. the feed.
 - d. the terminal.

LAP TEST ANSWER KEY: INSTALLING SINGLE-POLE SWITCHES

1. D
2. D
3. B
4. B
5. A
6. A
7. C
8. A
9. D
10. A

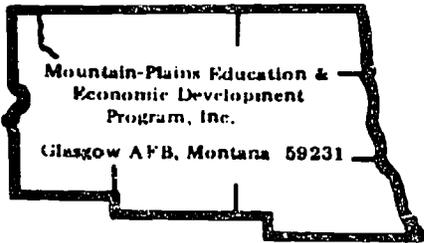

Learning Activity Package

Student: _____

Date: _____

PERFORMANCE ACTIVITY: Installing 3-Way and 4-Way Switches

OBJECTIVE:

Given the necessary tools, equipment, supplies and blueprint, correctly install 3-way and 4-way switches according to: (1) manufacturer's and blueprint specifications; (2) following procedures and practices accepted in the industry; and outlined in the reference text. Compare characteristics of 3-way and 4-way switching circuits.

EVALUATION PROCEDURE:

Installation meets the criteria listed on the attached checklist. Complete, score and return a ten-item multiple-choice test about this LAP. Successful completion is eight out of ten items.

RESOURCES:

Electrical Wiring, Ray C. Mullin, pp. 45-53.
Manufacturer's Specifications.
Moving Coil, and Reversing Polarity.

PROCEDURE:

1. View film while listening to tape, Moving Coil, and Reversing Polarity.
 2. Go to your assigned work station where you will complete the activities listed in the objective. Review the text if necessary.
 3. Obtain the necessary tools, equipment and supplies needed to complete the operations listed.
 4. Complete the job listed in the objective.
- NOTE: FOLLOW SAFE PRACTICES AND PROCEDURES.
5. Perform all necessary testing and evaluation checks listed in the checklist. If you have any questions or problems check with the instructor.
 6. When you have been checked off on the checklist by the instructor, complete the data requested on your Performance Record and have him initial it.
 7. Clean up the area.
 8. Take the test for this LAP.
 9. Score the LAP test and return it.
 10. If the test is satisfactory, begin the next assigned LAP. If the test is unsatisfactory, proceed as directed by the instructor.

Principal Author(s): R. Arneson, L. Leland, T. Ziller

CHECKLIST: INSTALLING 3-WAY AND 4-WAY SWITCHES

- _____ 1. Proper selection and use of tools, equipment and supplies.
- _____ 2. Safe practices and procedures followed.
- _____ 3. Neat and presentable.
- _____ 4. Meets or exceeds standards established in the industry.
- _____ 5. Procedures followed are practiced and accepted in the industry.

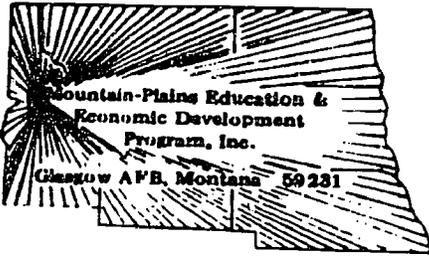

LAP TEST: INSTALLING 3-WAY AND 4-WAY SWITCHES

1. The identified conductor can be used in a switch loop when the unidentified conductor is:
 - a. the feed.
 - b. the terminal.
 - c. the return.
 - d. the source.

2. The color of the unidentified conductor is:
 - a. gray.
 - b. green.
 - c. white.
 - d. black.

3. A double switch may be installed:
 - a. in a three way circuit.
 - b. between outlets.
 - c. at the beginning of a circuit.
 - d. at the end of a circuit.

4. Which of the following is not a toggle switch?
 - a. momentary.
 - b. three way.
 - c. single pole.
 - d. double pole.

5. The third terminal on a three-way switch is the:
 - a. neutral terminal.
 - b. hot terminal.
 - c. common terminal.
 - d. pole terminal.

6. The three-way switch has how many positions?
 - a. one.
 - b. four.
 - c. two.
 - d. three.

7. To control a group of lights from one location the most practical switch to use is:
 - a. double pole.
 - b. single pole.
 - c. four way.
 - d. three way.

8. In a four way switch configuration the travelers from a four-way switch are connected how on the four-way switch?
 - a. one on the top of one side and one on the bottom of the other side.
 - b. one on each side.
 - c. both on the same side.
 - d. by a pigtail.

9. The color of the identified conductor is:
 - a. black.
 - b. white.
 - c. blue.
 - d. green.

10. The grounded circuit conductor is a(n):
 - a. potential conductor.
 - b. identified conductor.
 - c. unidentified conductor.
 - d. hot conductor.

LAP TEST ANSWER KEY: INSTALLING 3-WAY AND 4-WAY SWITCHES

1. C
2. D
3. C
4. A
5. C
6. C
7. B
8. C
9. B
10. B

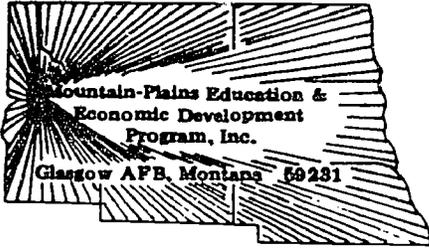

UNIT POST-TEST: SWITCHES

72.02.03.01.

1. A DPST switch may be installed:
 - a. in a three way circuit.
 - b. at the end of a circuit.
 - c. in four-way circuits only.
 - d. between outlets.

2. The unidentified conductor must connect between the switch and the:
 - a. ground.
 - b. load.
 - c. white wire.
 - d. neutral.

3. The color of the identified conductor is :
 - a. green.
 - b. white.
 - c. blue.
 - d. black.

4. Three way switches control the load from how many positions?
 - a. three.
 - b. four.
 - c. one.
 - d. two.

5. In a four way switch configuration how many three way switches are used?
 - a. one.
 - b. four.
 - c. three.
 - d. two.

72.02.03.02.

6. Which of the following is installed first when wiring a bedroom?
- fixtures.
 - switch boxes.
 - cable.
 - outlet boxes.
7. How high are convenience outlets usually placed off the finished floor?
- 10" T.C.
 - 20" T.C.
 - 15" T.C.
 - 12" T.C. (to center)
8. Using 12 AWG wire as a conductor and a standard 4" square box, 2 1/8" deep, what is the maximum number of wires allowable?
- 6.
 - 14.
 - 8.
 - 12.
9. How many receptacles are in bedroom #1? (Use Plan)
- six.
 - eight.
 - four.
 - two.
10. Approximately how far from the door opening is the first convenience in the bedroom #1? (See Plan)
- 2'6"
 - 1'9"
 - 4'2"
 - 1'

72.02.03.03.

11. Which of the connections is wired correctly so that both ceiling light outlets are controlled from the one single pole switch? Assume the installation is in cable.

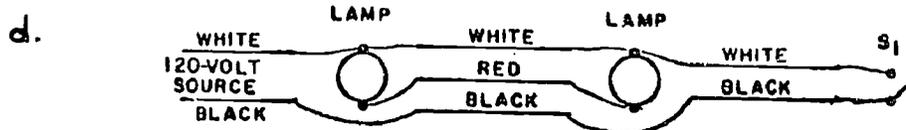
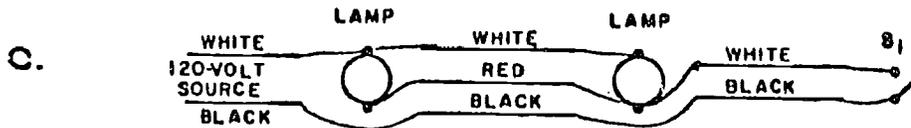

12. The unidentified conductor must connect between the switch and the:
- white wire.
 - ground.
 - load.
 - neutral.

72.02.03.03. continued:

13. A DPST switch may be installed:
- in a three way circuit.
 - in four-way circuits only.
 - at the end of a circuit.
 - between outlets.
14. With the exception of double pole switching the identified conductors can:
- never be grounded.
 - always be switched.
 - always be grounded.
 - never be switched.
15. Which of the following is not a toggle switch?
- double pole.
 - single pole.
 - three way.
 - momentary.

72.02.03.04.

16. A DPST switch may be installed:
- in a three way circuit.
 - between outlets.
 - in four-way circuits only.
 - at the end of a circuit.

72.02.03.04. continued:

17. Which one of the following connections is wired correctly for a ceiling outlet which is controlled from any one of three switch locations? The 120 volt feed is at the light.

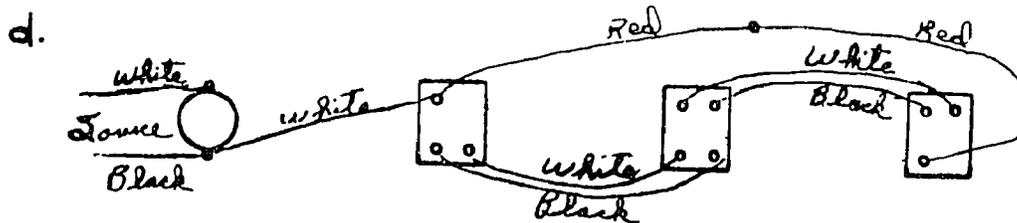
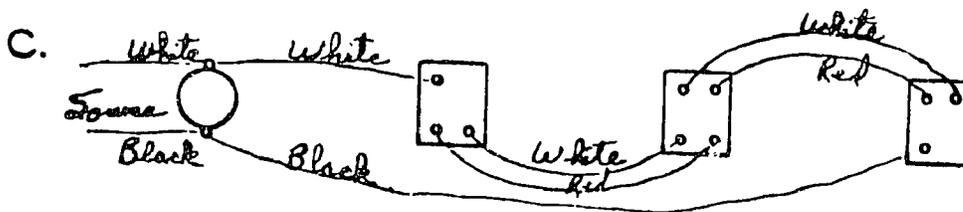
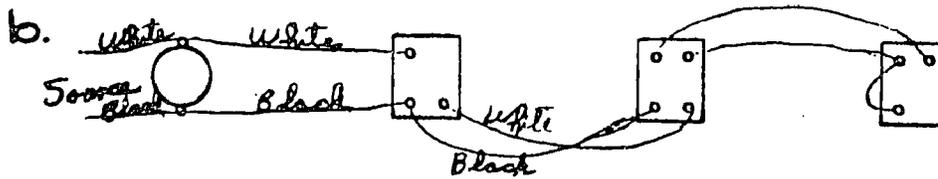
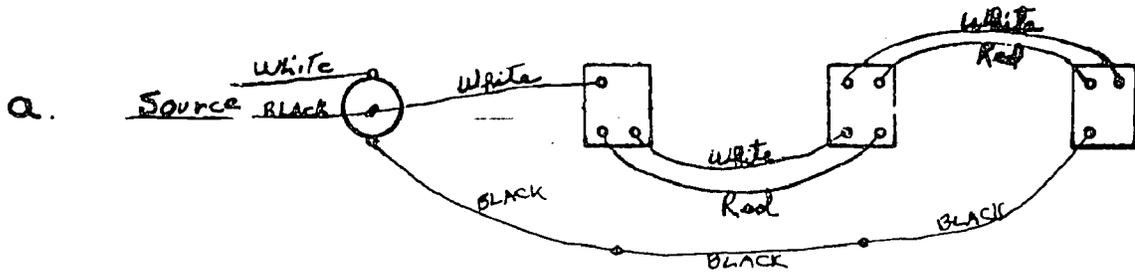

18. The color of the unidentified conductor is:

- white.
- black.
- green
- gray.

72.02.03.04. continued:

19. The unidentified conductor must connect between the switch and the:

- a. load.
- b. white wire.
- c. neutral.
- d. ground.

20. Which of the connections is wired correctly so that the ceiling outlet may be controlled from either three way switch?

a.

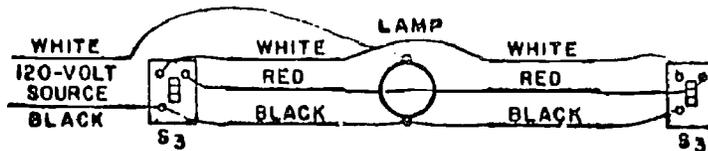

b.

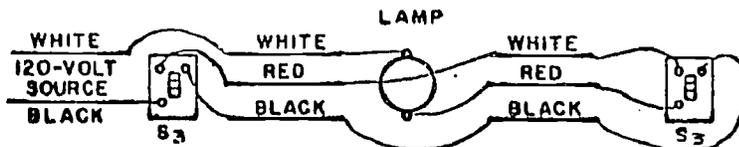

c.

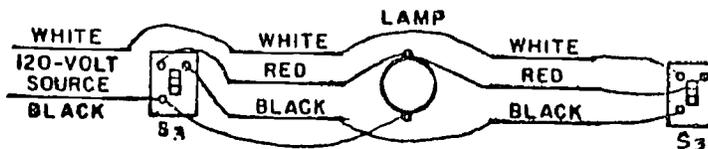

d.

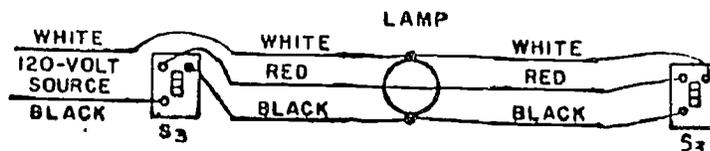

UNIT POST-TEST answer key: SWITCHES

LAP

- | | | |
|----|-----|---|
| 01 | 1. | B |
| | 2. | B |
| | 3. | B |
| | 4. | D |
| | 5. | D |
| 02 | 6. | D |
| | 7. | D |
| | 8. | D |
| | 9. | A |
| | 10. | B |
| 03 | 11. | A |
| | 12. | C |
| | 13. | C |
| | 14. | D |
| | 15. | D |
| 04 | 16. | D |
| | 17. | A |
| | 18. | B |
| | 19. | A |
| | 20. | B |

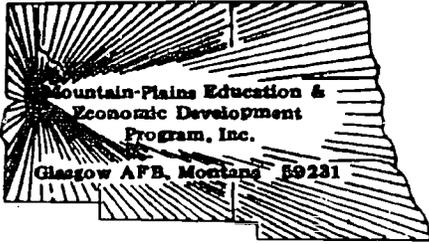

Family Pay Number: _____ Sex: M F (Circle 1)

UNIT PERFORMANCE TEST: SWITCHES

OBJECTIVE 1:

Given a blueprint of a floor plan and an electrically roughed-in wood frame construction, simulated or actual, the student will estimate the electrical switches to be installed.

OBJECTIVE 2:

Given a blueprint of a floor plan and electrically roughed-in wood frame construction, simulated or actual, the student will itemize the electrical switches used in the installation.

OBJECTIVE 3:

Given a blueprint of a floor plan and an electrically roughed-in wood frame construction, simulated or actual, the student will install electrical switches in their proper locations.

TASK:

The student will complete a list of electrical switches, using blueprints and sketches. The student will obtain the electrical switches from the storage room; the the student will install the electrical switches according to blueprint specifications, manufacturer's specifications and National Electrical Code standards.

ASSIGNMENT:CONDITIONS:

The student will be tested in a wood frame construction to simulate any specified room of a residence. The student will be given necessary tools and equipment. No assistance may be obtained from another student or the instructor or from unspecified text material.

RESOURCES:

Tools:

High leverage plier
High leverage oblique cutting plier
Long nose cutting plier
Electrician's hammer
Screwdriver slot 3/16 x 4
Screwdriver no. 2 phillips 8"
Screwdriver slot 3/16 x 9
Screwdriver 1/4 x 4
Screwdriver 1/4 x 6
Nutdriver variable size 1/4" x 7/16
Scratch awl
Adjustable Wrench size 8"
Pump plier size 10"
All-purpose tool, wire stripper, crimper and cutter
Tape rule 12' 3/4"
Knife, electricians
Tool pouch, 5 pocket

Equipment:

Simpson 260 VOM or Amprobe

Text:

Electrical Wiring Residential, Ray C. Mullin, Delmar Publishers, 4th Ed., 1973
National Electrical Code

ASSIGNMENT SHEET 1

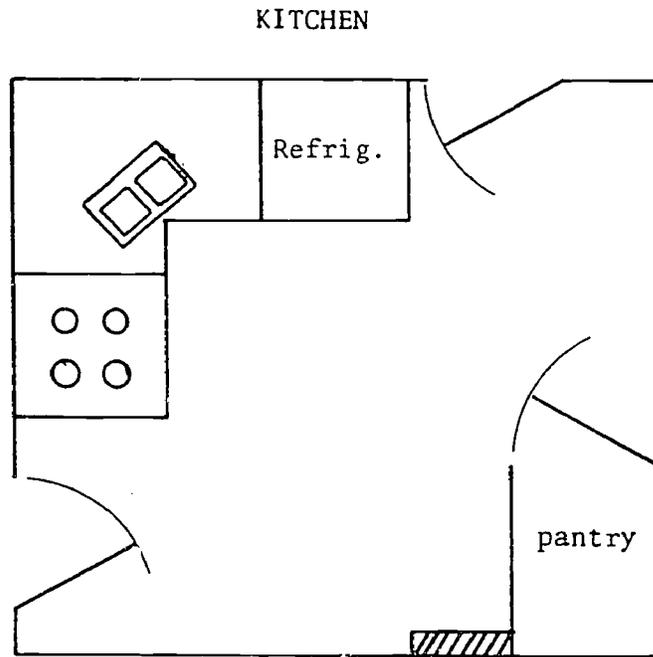

- garbage disposal
- pantry light
- light 2-position control

ASSIGNMENT SHEET 2

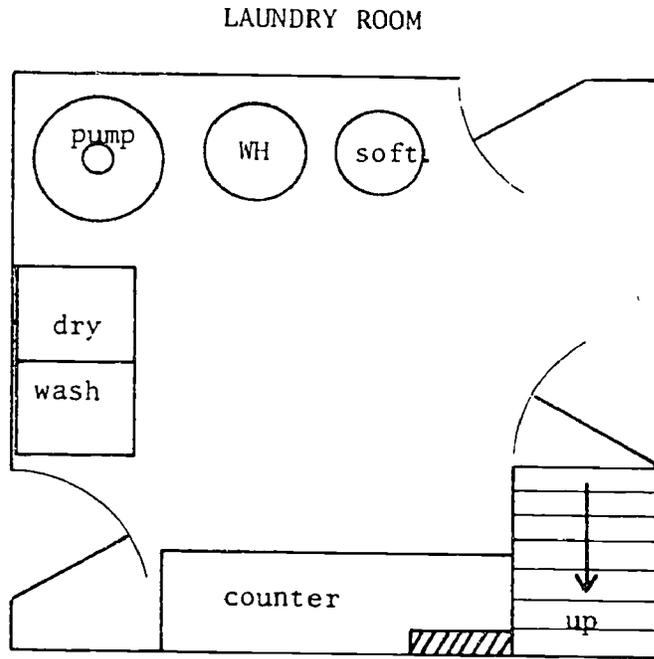

- sub-pump
- water heater
- water softener
- 3-position switch control

ASSIGNMENT SHEET 3

LIVING ROOM

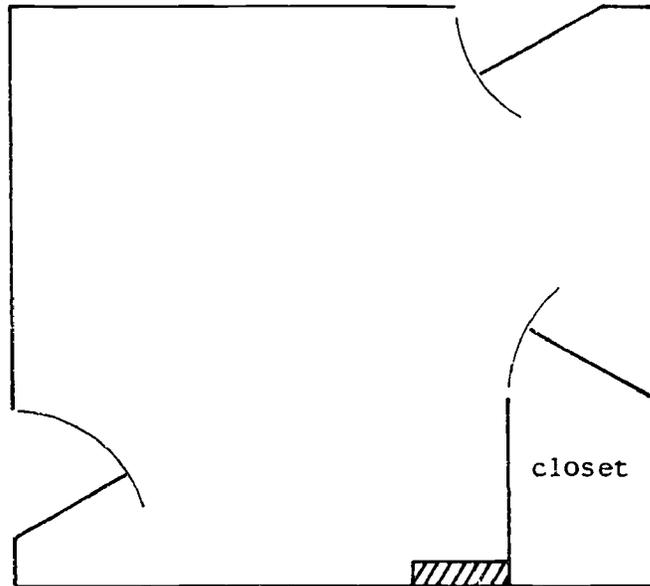

- electric heat
- split receptacles
- 2-position switch control

Family Pay Number: _____ Sex: M F (Circle 1)

PERFORMANCE CHECKLIST:

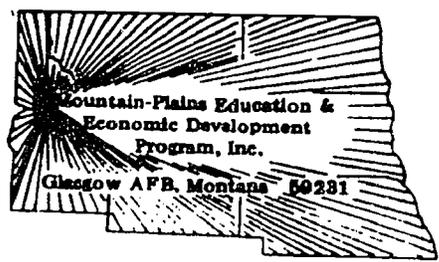

OVERALL PERFORMANCE: Satisfactory _____ Unsatisfactory _____

	CRITERION	
	Met	Not Met
Objective 1:		
1. The student determines the type of electrical switches to be installed.		
2. The student determines the quantity of each electrical switch to be installed.		
3. The student itemizes each type and quantity of electrical switch to be used.		
Criterion: The physical and electrical dimensions meet National Electrical Code standards and blueprint specifications.		
Objective 2:		
4. The student obtains the electrical switches to be installed from the electric shop's storage room.		
Criterion: The electrical switches will be used by the student for installation.		
Objective 3:		
5. The student strips the conductor's insulation with		

(Checklist continued)

	CRITERION	
	Met	Not Met
wire strippers to fit the electrical switch connecting device.		
6. The student bends the electrical wire to fit the connecting screw when appropriate.		
7. The student connects the "hot", black or red, conductor to the brass-colored screw.		
8. The student connects the "neutral", or white, conductor with wire nuts to continue the common conductor in the circuit.		
9. The student connects the bare grounding conductor to the grounding clip on the switch box.		
10. The student connects a grounding conductor from the switch to the grounding clip.		
11. The student fastens the electrical switch to the electrical switch box with appropriate sized screw.		
Criterion: The electrical switch installation meets National Electrical Code standards and blueprint and manufacturer's specifications.		
12. Task completed in allotted time.		
Criterion: See assignment for time specifications.		

(Checklist continued)

	CRITERION	
	Met	Not Met
Student must meet criterion on all line items to obtain an overall score of satisfactory.		

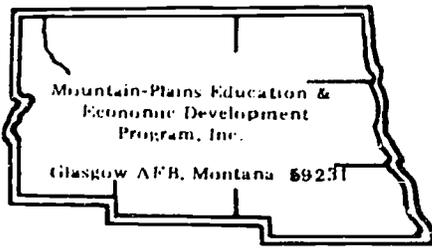

Learning Experience Guide

UNIT: APPLIANCES

RATIONALE:

Many electrical appliances are directly connected to electrical circuits or have circuits installed specifically for them. Electrical appliances like garbage disposals, exhaust fans, clothes dryers and water heaters are examples. The electrical installation of or for appliances is a duty of the electrical wireman. To successfully install an appliance requires determining the type of appliance, where to install it and how to install it.

PREREQUISITES:

Besides the course prerequisites, the unit titled "Switches" is required.

OBJECTIVES:

Identify placement of, characteristics of, and procedures for installing circuits for electrically operated appliances. Given blueprint specifications, National Electrical Codes, tools, building or shop simulation with electrical wiring rough-in, students will estimate materials required and install the specified electrically operated appliances.

RESOURCES:

Electrical Wiring Residential, Ray C. Mullin, Delmar Publisher, 1973.

An assortment of electrical supply catalogs containing appliances.

An assortment of manufacturer's electrical appliance installation specifications guides.

Set of electrical wireman's tools.

Film Loops:

Electromagnetic Force and Electromagnetic Polarity, The Electric Motor I and II,

Electric Generator, Fairfield Associates, the Jam Handy Organization.

Audio Cassette Tapes.

Principal Author(s): R. Arneson, L. Leland, T. Ziller

Narrations for each of the film loops listed, Mountain-Plains Education & Economic Development Program, Inc.

GENERAL INSTRUCTIONS:

Follow the directions in the LAP for each performance activity assigned for this unit. Unless otherwise directed, independently follow the procedures stated in the LAP. The instructor will provide help if you have a problem.

PERFORMANCE ACTIVITIES:

- .01 Determining Types of Appliance to be Installed.
- .02 Installing Garbage Disposals.
- .03 Installing Exhaust Fans.
- .04 Installing Electrical Heaters.
- .05 Installing Electrical Ranges
- .06 Installing Electrical Clothes Dryers.
- .07 Installing Electrical Water Heaters.

EVALUATION PROCEDURES:

Success will be determined by adherence to specifications under controlled conditions and by achieving 80% accuracy on the multiple choice unit test.

FOLLOW-THROUGH:

After reading this guide for the unit "Appliances", read the LAP first assigned. Apply the skills you have acquired in following the procedures given in the LAP.

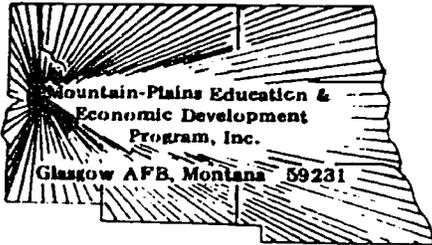

UNIT PRE-TEST: APPLIANCES

72.02.04.01.

1. Stove heating elements are impacted in what?
 - a. aluminum oxide.
 - b. nichrome.
 - c. aluminum.
 - d. magnesium oxide.

2. If type SE cable with an uninsulated grounding conductor is used, where must it originate in a house?
 - a. panel A.
 - b. panel C.
 - c. service entrance panel.
 - d. panel B.

3. What is the maximum insulation rating of type RHH conductor?
(See code book)
 - a. 60 degrees C.
 - b. 75 degrees C.
 - c. 100 degrees C.
 - d. 90 degrees C.

4. What is the height of the special purpose outlet symbol  F?
(See Plan)?
 - a. 18" to center.
 - b. 50" to center.
 - c. 12" to center.
 - d. 42" to center.

5. What size circuit supplies symbol  F?
(see specs)?
 - a. 20 amp.
 - b. 12 amp.
 - c. 30 amp.
 - d. 15 amp.

6. If a flow switch is installed on a garbage disposal, it is connected in which of the following ways?
 - a. parallel.
 - b. series.
 - c. either of the above.
 - d. series parallel.

7. Which sections of the national electrical code cover the grounding of appliances?
 - a. (250-42 through 250-45) (250-57 and 250-59)
 - b. (260-42 through 260-45) (260-57 and 260-59)
 - c. (270-42 through 270-45) (270-57 and 270-59)
 - d. (250-60 through 250-65) (250-67 and 250-69)

8. When a flow switch is installed on a garbage disposal unit, which of the following is the reason for the flow switch?
 - a. thermal protection.
 - b. amperage protection.
 - c. current protection.
 - d. water flow protection.

9. To what circuit is the garbage disposal connected? (Refer to Specs)
 - a. B9
 - b. B6
 - c. E
 - d. E1

10. According to the NEC, when installing a separate box cover unit in a garbage disposal circuit what percentage is allowable for over current protection?
 - a. 150%
 - b. 100%
 - c. 125%
 - d. 175%

11. Which of the following controls the base heater in the bathroom?
(See Specs)
- a. thermostat (independent).
 - b. thermostat (intrical).
 - c. rheostat.
 - d. fusestat.
12. Which of the following circuits serves the bathroom heat-a-vent?
(See Specs)
- a. A14
 - b. A23
 - c. A24
 - d. A17
13. From which panel in the residence does the circuit for the heat-a-vent originate? (See Specs)
- a. C
 - b. D
 - c. A
 - d. B
14. Which of the following letters indicates the grille on the heat-a-vent diagram? (See diagram on next page)
- a. B
 - b. C
 - c. A
 - d. D

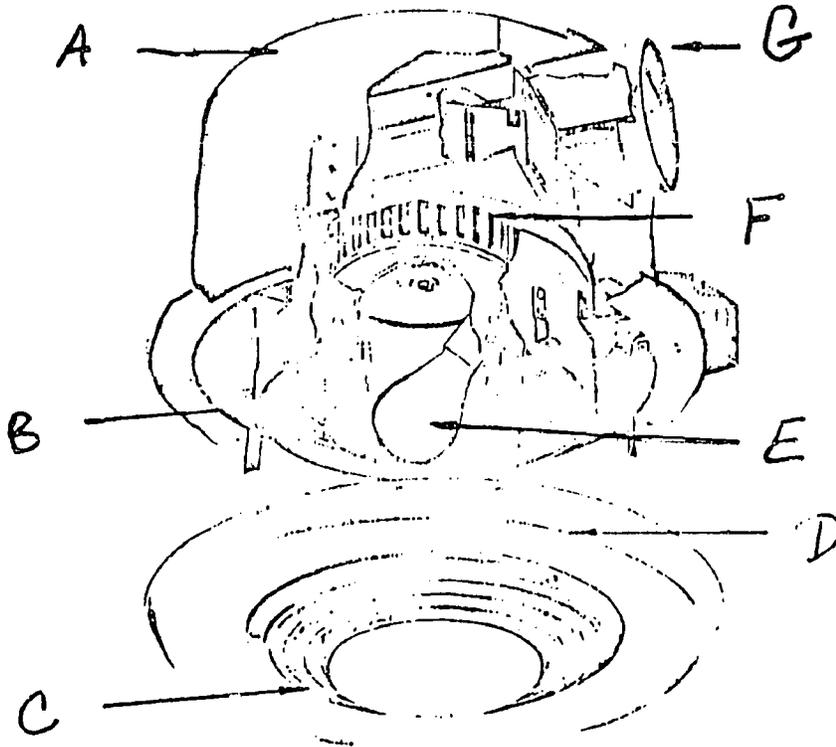

15. Using the Plan and Specs as reference, which of the following symbols indicates a bathroom ceiling heater?

a.  H

b.  J

c.  K

d.  N

16. If the amperage rating of a line thermostat is exceeded by the system, which of the following would be a solution to the problem?
- use a capacitor.
 - use a four wire system.
 - use a low voltage thermostat.
 - use a three wire system.
17. Which of the following sections of the code allows a circuit to be used for both heating and cooling? (See Code Book)
- 424-2(A)
 - 379-4 (B)
 - 222-4 (1)
 - 175-6 (C)
18. How many watts are provided for electric heat for this building? (See Specs)
- 25,500
 - 19,500
 - 17,500
 - 15,500
19. How many pole circuits are the electric heating circuits?
- double.
 - single pole/double throw.
 - single/double.
 - single.
20. What color must the identified conductor be rendered if it is to be used as unidentified?
- black.
 - yellow.
 - green.
 - white.

21. When an electrician uses a non-metallic sheathed cable to connect an appliance such as a range, which of the following would meet the code section 250-60? (See Code Book)
- a. blue conductor.
 - b. red conductor.
 - c. black conductor.
 - d. white conductor.
22. According to section 220-5 how many appliances would two wall-mounted ovens and a counter-top range be figured as? (See Code)
- a. two.
 - b. one.
 - c. four.
 - d. three.
23. What is the power of the counter top unit?
- a. 6600.
 - b. 1475.
 - c. 1750.
 - d. 7450.
24. Approximately how many feet of cable will be required to service the wall-mounted oven? (See Plan)
- a. 16'
 - b. 14'
 - c. 20'
 - d. 34'
25. If the voltage is doubled and the resistance is constant, by how much is the wattage increased or decreased?
- a. four times.
 - b. three times.
 - c. two times.
 - d. one time.

--

72.02.04.06.

26. If a dryer circuit is to have EMT installed, what is the size conduit required?
- a. 3/8" conduit.
 - b. 1/2" conduit.
 - c. 1" conduit.
 - d. 3/4" conduit.
27. The neutral wire of a dryer circuit carries which of the following?
- a. heat elements and thermostat.
 - b. thermostat.
 - c. motor, lights, thermostat and elements.
 - d. motor and lights.
28. Which of the following circuits is connected to the dryer? (See Plans and Specifications)
- a. A (13-15)
 - b. A 17
 - c. A (9-11)
 - d. B (17-19)
29. Which of the following is not an acceptable method of wiring a dryer?
- a. AC.
 - b. EMT-AC.
 - c. cord/receptacle.
 - d. SE noninsulated neutral.
30. On dryer circuit-protector breakers it is assumed the standard rating is which of the following?
- a. 20 amp.
 - b. 50 amp.
 - c. 30 amp.
 - d. 15 amp.

72.02.04.07.

31. The off-peak method of water heater temperature regulation requires the use of which of the following?
- a. fuse stat.
 - b. fuse tion.
 - c. ballast.
 - d. clock timer.

32. For all practical purposes when the voltage is doubled on heating elements, the wattage is increased how many times?

- a. two.
- b. four.
- c. one.
- d. three.

33. The off peak protective device for a water heater system is also called which of the following?

- a. ballast unit.
- b. developmental.
- c. thermo cupler.
- d. feed through unit.

34. How many heating elements does a typical water heater usually have?

- a. one.
- b. four.
- c. three.
- d. two.

35. In a water heater heat elements are compacted into insulators that are made of:

- a. aluminum.
- b. aluminum oxide.
- c. magnesium oxide.
- d. nichrome.

UNIT PRE-TEST ANSWER KEY: APPLIANCES

LAP

01 1. D
2. C
3. D
4. C
5. A

02 6. B
7. A
8. D
9. D
10. C

03 11. A
12. B
13. C
14. B
15. C

04 16. C
17. C
18. D
19. A
20. A

05 21. D
22. B
23. D
24. D
25. A

06 26. B
27. D
28. D
29. D
30. C

07 31. D
32. B
33. D
34. D
35. C

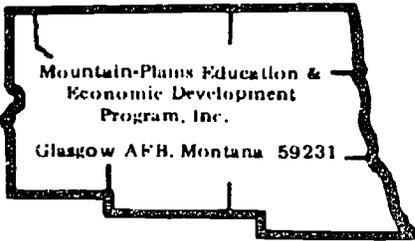

Learning Activity Package

Student: _____

Date: _____

PERFORMANCE ACTIVITY: Determining Types of Appliances to be Installed

OBJECTIVE:

Given the blueprint and specifications, identify and record the type, description, and quantity of fixed electrical appliances on a requisition form. Compiled data must correlate to and conform with the listed reference standards established in the industry. Identify placement of appliance circuits.

EVALUATION PROCEDURE:

Accurate ordering of the parts and supplies needed to complete the specific job listed in the objective and the blueprint. Complete, score and return a ten-item multiple-choice test about this LAP. Successful completion is eight out of ten items.

RESOURCES:

Electrical Wiring, Ray C. Mullin, pp. 273-278.
Electrical Supply Catalog.
Electromagnetic Force and Electromagnetic Polarity.

PROCEDURE:

1. Listen to tape while viewing film, Electromagnetic Force and Electromagnetic Polarity.
2. Review the text. (pages 273-278)
3. Obtain an Electrical Parts Supply Catalog.
4. Using the attached requisition and the blueprint sketch you have completed. Order the parts and supplies needed to complete the job indicated in the objective.
NOTE: Parts and supplies must be ordered by quantity, complete description and type.
5. Hand in the completed requisition for evaluation along with your blueprint sketch.
6. Complete the requested data on your Performance Record.
7. Have the instructor initial it when you have correctly completed the indicated operation.
8. Take the test for this LAP.
9. Score the LAP test and return it.
10. If the test is satisfactory, begin the next assigned LAP. If the test is unsatisfactory, proceed as directed by the instructor.

Principal Author(s): R. Arneson, L. Leland, T. Ziller

PURCHASE REQUISITION

72.02.04.01.A2-0

Development Program, Inc.
 Post Office Box 3078
 Glasgow AFB, Montana 59231

ORIGINATOR'S CONTROL NO. _____

REQUISITION NO. _____	REQUISITION DATE _____	TIME REQUIRED _____	PURCHASE ORDER NO. _____	PAGE _____ of _____
-----------------------	------------------------	---------------------	--------------------------	---------------------

<input type="checkbox"/> RESEARCH DEVELOPMENT <input type="checkbox"/> START UP	<input type="checkbox"/> OPERATIONS	ACCOUNTING DATA USING ACTIVITY _____ USED FOR _____	DEPARTMENT <input type="checkbox"/> ADMINISTRATION <input type="checkbox"/> FAMILY LIFE <input type="checkbox"/> INSTRUCTION <input type="checkbox"/> MULTI-PURPOSE <input type="checkbox"/> STATE PROGRAMS <input type="checkbox"/> PLANNING & RESEARCH <input type="checkbox"/> OTHER
SUGGESTED SOURCE _____			

ITEM NO.	QUAN.	UNIT	DESCRIPTION OF SUPPLIES / SERVICES	EST. UNIT PRICE	EST. AMOUNT

REMARKS _____	EST. TOTAL AMOUNT
---------------	-------------------

Title _____	Signature _____	Date _____	Title _____	Signature _____	Date _____
ORIGINATOR			PROPERTY CONTROLLER		
DEPT. HEAD			PROCUREMENT OFFICER		
DIRECTOR			ACCOUNTING OFFICE (To Procurement)		

PROPERTY CONTROL

MPPEEDP Form PR-1 3805 REV.



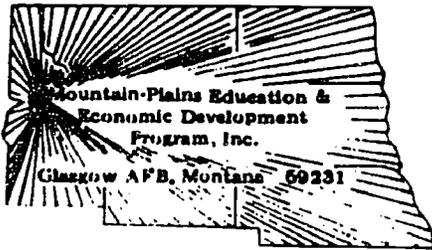

LAP TEST: DETERMINING TYPES OF APPLIANCES
TO BE INSTALLED

1. What is the height of the special purpose outlet  F?
(See Plan)?
 - a. 18" to center.
 - b. 50" to center.
 - c. 42" to center.
 - d. 12" to center.

2. What are most heating elements of a stove made of?
 - a. aluminum.
 - b. silchrome.
 - c. nichrome.
 - d. copper.

3. Where is the special purpose outlet  F?
located? (See Plans)
 - a. SW wall of kitchen.
 - b. NE wall of kitchen.
 - c. SE wall of kitchen.
 - d. NW wall of kitchen.

4. If type SE cable with an uninsulated grounding conductor is used,
where must it originate in a house?
 - a. panel B.
 - b. panel C.
 - c. panel A.
 - d. service entrance panel.

5. If the voltage is doubled and the resistance is constant, by how
much is the wattage increased or decreased?
 - a. four times.
 - b. two times.
 - c. three times.
 - d. one time.

6. What size circuit supplies  F
(See Specs)
- 12 amp.
 - 15 amp.
 - 20 amp.
 - 30 amp.
7. What is the maximum insulation rating of type RHH conductor?
(See Code Book)
- 60 degrees C
 - 90 degrees C
 - 100 degrees C
 - 75 degrees C
8. How many appliances are on the circuit supplying  F
- four.
 - three.
 - one.
 - two.
9. If a stove has a burner switch position circuit that draws 74 ohms
120 volts, what is the power rating?
- 140 watts.
 - 255 watts.
 - 170 watts.
 - 195 watts.
10. If a circuit on a stove is operated on 120 volts and 164 ohm
resistance, what is the power rating?
- 46 watts.
 - 68 watts.
 - 124 watts.
 - 140 watts.

LAP TEST ANSWER KEY: DETERMINING TYPES OF APPLIANCES
TO BE INSTALLED

1. D
2. C
3. C
4. D
5. A
6. C
7. B
8. C
9. D
10. B

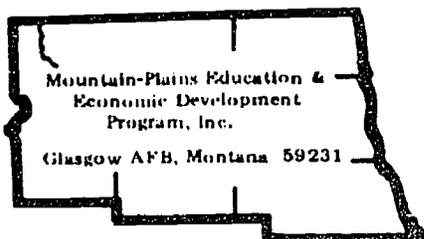

Learning Activity Package

Student: _____

Date: _____

PERFORMANCE ACTIVITY: Installing Garbage Disposals

OBJECTIVE:

Given the necessary tools, equipment, supplies and blueprint, correctly install a garbage disposal according to: (1) manufacturer's and blueprint specifications; (2) following procedures and practices accepted in the industry; and outlined in the reference text. Identify circuit characteristics of a garbage disposal that satisfy the National Electrical Code.

EVALUATION PROCEDURE:

Installation meets the criteria listed on the attached checklist. Complete, score and return a ten-item multiple-choice test about this LAP. Successful completion is eight out of ten items.

RESOURCES:

Electrical Wiring, Ray Mullin, pp. 184-189.
Manufacturer's Specifications.
The Electrical Motor I & II.

PROCEDURE:

1. View film while listening to tape, The Electrical Motor I and II.
2. Read the text pp. 184-189 and complete the review pp. 188-189.
3. Go to your assigned work station where you will complete the activities listed in the objective.
4. Obtain the necessary tools, equipment, and supplies needed to complete the operations listed.
5. Complete the job listed in the objective.
NOTE: FOLLOW SAFE PRACTICES AND PROCEDURES.
6. Perform all necessary testing and evaluation checks listed in the checklist. If you have any questions or problems, check with the instructor.
7. When you have been checked off on the checklist by your instructor, complete the data requested on your Performance Record and have him initial it.
8. Clean up the area.

Principal Author(s): R. Arneson, L. Leland, T. Ziller

9. Take the test for this LAP.
10. Score the LAP test and return it.
11. If the test is satisfactory, begin the next assigned LAP. If the test is unsatisfactory, proceed as directed by the instructor.

CHECKLIST: INSTALLING GARBAGE DISPOSALS

- _____ 1. Proper selection and use of tools, equipment and supplies.
- _____ 2. Safe practices and procedures followed.
- _____ 3. Neat and presentable.
- _____ 4. Meets or exceeds standards established in the industry.
- _____ 5. Procedures followed are practiced and accepted in the industry.

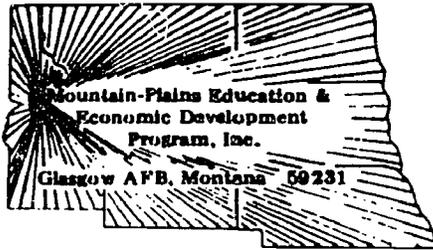

LAP TEST: INSTALLING GARBAGE DISPOSALS

1. If a flow switch is installed on a garbage disposal, it is connected in which of the following ways?
 - a. series.
 - b. series parallel.
 - c. parallel.
 - d. any of the above.

2. In this residence what size wire is used to supply the garbage disposal? (See Specs)
 - a. 8 awg.
 - b. 14 awg.
 - c. 10 awg.
 - d. 12 awg.

3. Which of the following would not be on a garbage disposal if an electrician installs a fused box cover unit in a garbage disposal unit?
 - a. fuse.
 - b. thermal protector.
 - c. heat strip.
 - d. ballast.

4. To what circuit is the garbage disposal connected? (Refer to Specs)
 - a. B 5
 - b. B 7
 - c. B 6
 - d. B 9

5. If a separate circuit supplies the garbage disposal, how many feet of cable will be required to connect the disposal approx; cable may not be exposed in the utility room? (See Plan)
 - a. 20'
 - b. 30'
 - c. 15'
 - d. 25'

6. Which sections of the National Electrical Code cover the grounding of appliances?
- (260-42 through 260-45) (260-57 and 260-59)
 - (250-50 through 250-65) (250-67 and 250-69)
 - (250-42 through 250-45) (250-57 and 250-59)
 - (270-42 through 270-45) (270-57 and 270-59)
7. According to the NEC the motor protector on an appliance must not exceed the rated amperage by what percentage?
- 125%
 - 150%
 - 175%
 - 100%
8. According to the NEC when installing a separate disposal box cover unit in a garbage disposal circuit, what percentage is allowable for over current protection?
- 125 %
 - 100%
 - 175%
 - 150%
9. When a flow switch is installed on a garbage disposal unit, which of the following is the reason for the flow switch?
- water flow protection.
 - current protection.
 - thermal protection.
 - amperage protection.
10. In referring to the specifications provided, what is the amperage rating of the garbage disposal?
- 10 amps.
 - 5.8 amps.
 - 7.2 amps.
 - 8 amps.

LAP TEST ANSWER KEY: INSTALLING GARBAGE DISPOSALS

1. A
2. D
3. B
4. B
5. A
6. C
7. A
8. A
9. A
10. C

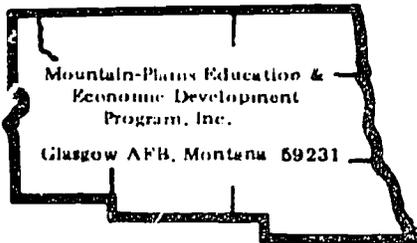

Learning Activity Package

Student: _____

Date: _____

PERFORMANCE ACTIVITY: Installing Exhaust Fans

OBJECTIVE:

Given the necessary tools, equipment, supplies and blueprint, correctly install an exhaust fan according to: (1) manufacturer's and blueprint specifications; (2) following procedures and practices accepted in the industry; and outlined in the reference text. Identify characteristics of exhaust fan circuits and their specification designations.

EVALUATION PROCEDURE:

Installation meets the criteria listed on the attached checklist. Complete, score and return a ten-item multiple-choice test about this LAP. Successful completion is eight out of ten items.

RESOURCES:

Electrical Wiring, Ray Mullin, pp. 190-200.
Manufacturer's Specifications.
Electric Generator.

PROCEDURE:

1. View film while listening to tape, Electric Generator.
 2. Read the text pp. 190-200 and answer the review questions, 198-200.
 3. Go to your assigned work station where you will complete the activities listed in the objective.
 4. Obtain the necessary tools, equipment, and supplies needed to complete the operations listed.
 5. Complete the job listed in the objective.
- NOTE: FOLLOW SAFE PRACTICES AND PROCEDURES.**
6. Perform all necessary testing and evaluation checks listed in the checklist. If you have any questions or problems, check with the instructor.
 7. When you have been checked off on the checklist by the instructor, complete the data requested on your Performance Record and have him initial it.
 8. Clean up the area.
 9. Take the test for this LAP.
 10. Score the LAP test and return it.
 11. If the test is satisfactory, begin the next assigned LAP. If the test is unsatisfactory, proceed as directed by the instructor.

Principal Author(s): R. Arneson, L. Leland, T. Ziller

CHECKLIST: INSTALLING EXHAUST FANS

- _____ 1. Proper selection and use of tools, equipment and supplies.
- _____ 2. Safe practices and procedures followed.
- _____ 3. Neat and presentable.
- _____ 4. Meets or exceeds standards established in the industry.
- _____ 5. Procedures followed are practiced and accepted in the industry.

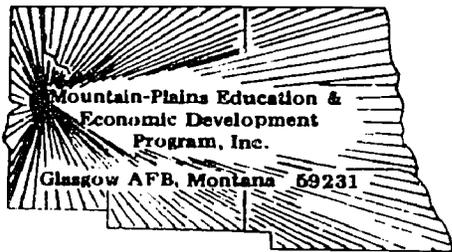

LAP TEST: INSTALLING EXHAUST FANS

1. Which of the following letters indicates the enclosed heating element on the heat-a-vent unit diagram? (See Diagram)
 - a. C.
 - b. B.
 - c. A.
 - d. D.

2. Which of the following controls the base heater in the bathroom? (See Specs)
 - a. rheostat.
 - b. thermostat.
 - c. fusestat.
 - d. thermostat (independent)

3. Which of the following can be used to control a heat-a-vent automatically?
 - a. thermostat.
 - b. rheostat.
 - c. bi-metal strip.
 - d. fusestat.

4. What is the current rating of a heat-a-vent unit rated at 1475 watts /120 volts?
 - a. 8.29 amps.
 - b. 15.37 amps.
 - c. 24.29 amps.
 - d. 12.29 amps.

5. Which of the following letters indicates the blower on the heat-a-vent unit diagram? (See Diagram)
 - a. A.
 - b. D.
 - c. C.
 - d. E.

6. From which panel in the residence does the circuit for the heat-a-vent originate? (See Specs)
- C.
 - B.
 - D.
 - A.
7. Which wall of the bathroom is used to mount the device that controls the baseboard heat for the bath? (See Plans)
- SE.
 - NW.
 - NE.
 - SW.
8. What is the rating of the breaker to be installed on the heat-a-vent circuit? (See Specs)
- 30 amp.
 - 20 amp.
 - 15 amp.
 - 10 amp.
9. Which of the following letters indicates the grille on the heat-a-vent diagram? (See Diagram)
- B.
 - D.
 - A.
 - C.
10. Which of the following letters indicates the discharge duct with louver? (See Heat-a-vent Diagram)
- D.
 - E.
 - B.
 - G.

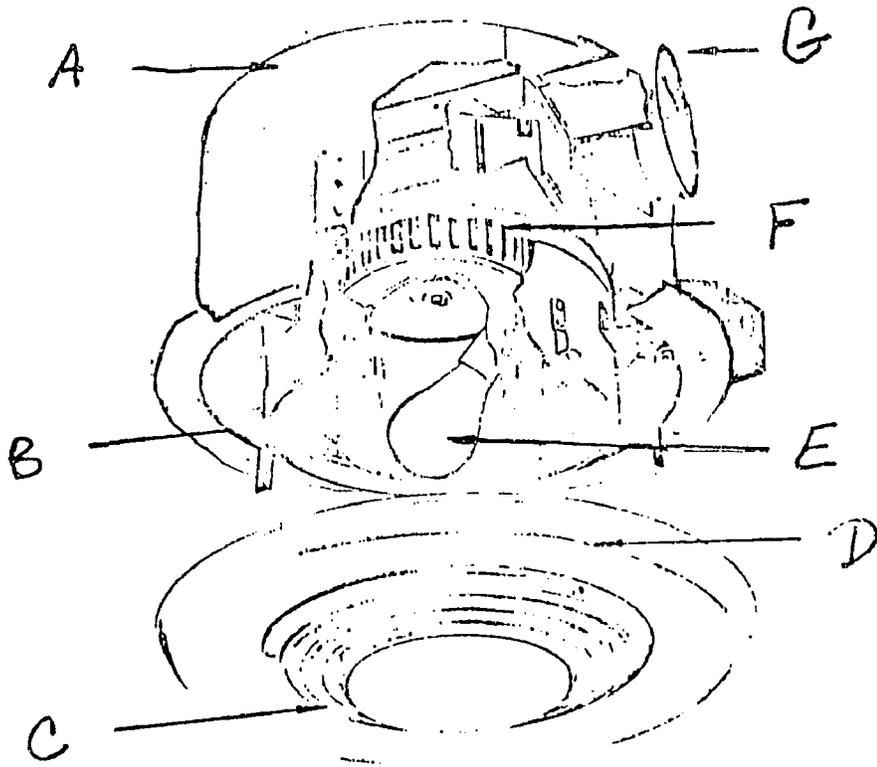

LAP TEST ANSWER KEY: INSTALLING EXHAUST FANS

1. B
2. D
3. A
4. D
5. B
6. D
7. B
8. C
9. D
10. D

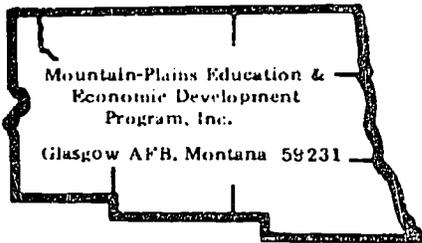

Learning Activity Package

Student: _____

Date: _____

PERFORMANCE ACTIVITY: Installing Electric Heaters

OBJECTIVE:

Given the necessary tools, equipment, supplies and blueprint, correctly install an electric heater according to: (1) manufacturer's and blueprint specifications; (2) following procedures and practices accepted in the industry; and outlined in the reference text. Identify characteristics of an electric heater circuit that meet the National Electrical Code.

EVALUATION PROCEDURE:

Installation meets the criteria listed on the attached checklist. Complete, score and return a ten-item multiple-choice test about this LAP. Successful completion is eight out of ten items.

RESOURCES:

Electrical Wiring, Ray Mullin, pp. 213-219.
Manufacturer's Specifications.

PROCEDURE:

1. Read the text 213-219 and answer the questions pp. 218-219.
2. Go to your assigned work station where you will complete the activities listed in the objective.
3. Obtain the necessary tools, equipment, and supplies needed to complete the operations listed.
4. Complete the job listed in the objective.
NOTE: FOLLOW SAFE PRACTICES AND PROCEDURES.
5. Perform all necessary testing and evaluation checks listed in the checklist. If you have any questions or problems check with the instructor.
6. When you have been checked off on the checklist by the instructor, complete the data requested on your Performance Record and have him initial it.
7. Clean up the area.
8. Take the test for this LAP.
9. Score the LAP test and return it.
10. If the test is satisfactory, begin the next assigned LAP. If the test is unsatisfactory, proceed as directed by the instructor.

Principal Author(s): R. Arneson, L. Leland, T. Ziller

CHECKLIST: INSTALLING ELECTRIC HEATERS

- _____ 1. Proper selection and use of tools, equipment and supplies.
- _____ 2. Safe practices and procedures followed.
- _____ 3. Neat and presentable.
- _____ 4. Meets or exceeds standards established in the industry.
- _____ 5. Procedures followed are practiced and accepted in the industry.

6. At what voltage do the first floor electric heating units operate?
(See Specs)
- 220 V
 - 115 V
 - 110 V
 - 240 V
7. What color is the grounded conductor according to the NEC?
- black.
 - red.
 - white.
 - blue.
8. What color must the identified conductor be rendered if it is to be used as unidentified?
- black.
 - white.
 - yellow.
 - green.
9. At what height are the thermostats mounted in this house? (See Plan)
- 48" to center.
 - 5'6" to center.
 - 5' to center.
 - 50" to center.
10. Which of the following covers the electric heat specs in the NEC?
- 261
 - 424
 - 357
 - 125

LAP TEST ANSWER KEY: INSTALLING ELECTRIC HEATERS

1. A
2. D
3. C
4. D
5. C
6. D
7. C
8. A
9. D
10. B

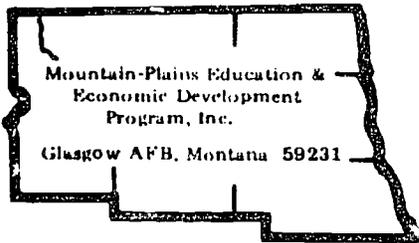

Learning Activity Package

Student: _____

Date: _____

PERFORMANCE ACTIVITY: Installing Electric Ranges

OBJECTIVE:

Given the necessary tools, equipment, supplies and blueprint, correctly install an electric range according to: (1) manufacturer's and blueprint specifications; (2) following procedures and practices accepted in the industry; and outlined in the reference text. Identify characteristics of an electric range circuit and the types of conductors meeting National Electrical Code Standards.

EVALUATION PROCEDURE.

Installation meets the criteria listed on the attached checklist. Complete, score and return a ten-item multiple-choice test about this LAP. Successful completion is eight out of ten items.

RESOURCES:

Electrical Wiring, Ray Mullin, pp. 170-183.
Manufacturer's Specifications.

PROCEDURE:

1. Read the text pp. 170-183 and answer the review questions, pp. 180-183.
 2. Go to your assigned work station where you will complete the activities listed in the objective.
 3. Obtain the necessary tools, equipment, and supplies needed to complete the operations listed.
 4. Complete the job listed in the objective.
- NOTE: FOLLOW SAFE PRACTICES AND PROCEDURES.**
5. Perform all necessary testing and evaluation checks listed in the checklist. If you have any questions or problems check with the instructor.
 6. When you have been checked off on the checklist by the instructor, complete the data requested on your Performance Record and have him initial it.
 7. Clean up the area.
 8. Take the test for this LAP.
 9. Score the LAP test and return it.
 10. If the test is satisfactory, begin the next assigned LAP. If the test is unsatisfactory, proceed as directed by the instructor.

Principal Author(s): R. Arneson, L. Leland, T. Ziller

CHECKLIST: INSTALLING ELECTRIC RANGES

- _____ 1. Proper selection and use of tools, equipment and supplies.
- _____ 2. Safe practices and procedures followed.
- _____ 3. Neat and presentable.
- _____ 4. Meets or exceeds standards established in the industry.
- _____ 5. Procedures followed are practiced and accepted in the industry.

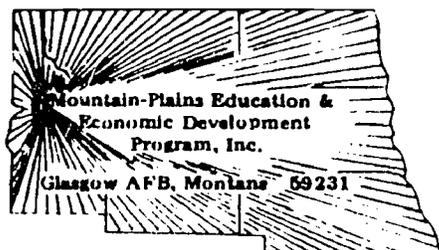

LAP TEST: INSTALLING ELECTRIC RANGES

1. What is the maximum operating temperature of type A conductor?
(See Code)
 - a. 140 degree F
 - b. 60 degree C
 - c. 200 degree C
 - d. 200 degree F

2. When an electrician uses a non-metallic sheathed cable to connect an appliance such as a range, which of the following would meet the code section 250-60? (See Code Book)
 - a. red conductor.
 - b. black conductor.
 - c. white conductor.
 - d. blue conductor.

3. What is the maximum insulation rating of type RHH conductor?
(See Code Book)
 - a. 75 degree C
 - b. 60 degree C
 - c. 90 degree C
 - d. 100 degree C

4. If SE cable is used with a non-insulated conductor to connect a range, where must it originate?
 - a. power panel.
 - b. sub panel.
 - c. load center.
 - d. light panel.

5. Approximately how many feet of cable will be required to service the wall-mounted oven? (See Plan)
 - a. 16'
 - b. 14'
 - c. 20'
 - d. 34'

6. If type SE cable with an uninsulated grounding conductor is used, where must it originate in a house?
- panel A .
 - panel B .
 - service entrance panel .
 - light panel .
7. What are most heating elements of a stove made of?
- aluminium .
 - copper .
 - nichrome .
 - silchrome .
8. What special purpose outlet symbol  H in the plan is intended? (See Specs)
- dryer .
 - stove .
 - range .
 - oven .
9. In the code book which table identifies the insulation factor of conductors?
- 422-17
 - 310-2 (A)
 - 310-12
 - 220-5
10. What is the power rating of the counter top unit? (See Plan)
- 1750
 - 1475
 - 6600
 - 7450

LAP TEST ANSWER KEY: INSTALLING ELECTRIC RANGES

1. C
2. C
3. C
4. A
5. D
6. C
7. C
8. D
9. C
10. D

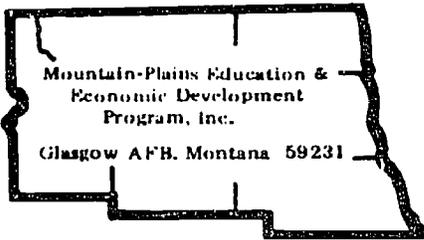

Learning Activity Package

Student: _____

Date: _____

PERFORMANCE ACTIVITY: Installing Electric Clothes Dryers

OBJECTIVE:

Given the necessary tools, equipment, supplies and blueprint, correctly install an electric clothes dryer according to: (1) manufacturer's and blueprint specifications; (2) following procedures and practices accepted in the industry; and outlined in the reference text. Identify characteristics of an electric clothes dryer circuit. Identify circuit symbols and wire types satisfying the National Electrical Code.

EVALUATION PROCEDURE:

Installation meets the criteria listed on the attached checklist. Complete, score and return a ten-item multiple-choice test about this LAP. Successful completion is eight out of ten items.

RESOURCES:

Electrical Wiring, Ray Mullin, pp. 161-169.
Manufacturer's Specifications.

PROCEDURE:

1. Read the text pp. 161-169 and answer the review questions, pp. 168-169.
 2. Go to your assigned work station where you will complete the activities listed in the objective.
 3. Obtain the necessary tools, equipment, and supplies needed to complete the operations listed.
 4. Complete the job listed in the objective.
- NOTE: FOLLOW SAFE PRACTICES AND PROCEDURES.**
5. Perform all necessary testing and evaluation checks listed in the checklist. If you have any questions or problems check with the instructor.
 6. When you have been checked off on the checklist by the instructor, complete the data requested on your Performance Record and have him initial it.
 7. Clean up the area.
 8. Take the test for this LAP.
 9. Score the LAP test and return it.
 10. If the test is satisfactory, begin the next assigned LAP. If the test is unsatisfactory, proceed as directed by the instructor.

Principal Author(s): R. Arneson, L. Leland, T. Ziller

CHECKLIST: INSTALLING ELECTRIC CLOTHES DRYERS

- _____ 1. Proper selection and use of tools, equipment and supplies.
- _____ 2. Safe practices and procedures followed.
- _____ 3. Neat and presentable.
- _____ 4. Meets or exceeds standards established in the industry.
- _____ 5. Procedures followed are practiced and accepted in the industry.

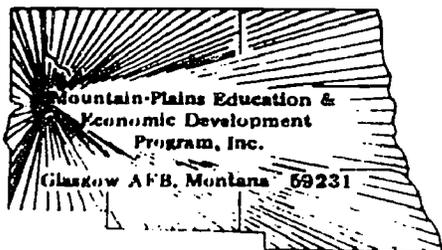

LAP TEST: INSTALLING ELECTRIC CLOTHES DRYERS

1. On dryer circuit protector breakers it is assumed their standard rating is which of the following?
 - a. 15 amp.
 - b. 50 amp.
 - c. 20 amp.
 - d. 30 amp.

2. If a dryer circuit is to have EMT installed, what is the size conduit required? (See Code Book)
 - a. 1/2" conduit.
 - b. 3/8" conduit.
 - c. 3/4" conduit.
 - d. 1" conduit.

3. A dryer is rated at 7.5 kw, 240 volts; what is the amperage rating?
 - a. 27.5 amps.
 - b. 25.2 amps.
 - c. 50.6 amps.
 - d. 31.2 amps.

4. Which of the following is not an acceptable method of wiring a dryer?
 - a. cord/receptacle.
 - b. EMT-AC.
 - c. AC.
 - d. SE non-insulated neutral.

5. What regulates the temperature in a dryer?
 - a. circuit breaker.
 - b. thermal protector.
 - c. thermostat.
 - d. thermo coupler.

6. What size conductors would be required for a dryer rated 7.5 kw, 240 volts?
- 10 awg.
 - 8 awg.
 - 12 awg.
 - 6 awg.
7. In the code book 220-4 (A) what is the minimum watts rating used to determine the feeder rating?
- 6000 watts.
 - 5500 watts.
 - 4700 watts.
 - 5000 watts.
8. All clothes dryers have a thermal protector which protects which of the following?
- motor.
 - thermostat.
 - circuit.
 - elements.
9. What does the symbol  stand for on the Plan? (See Specs)
- i0. a. clothes washer.
b. damper.
c. clothes dryer.
d. door opener.
10. According to section 250-60 code book, what size must the neutral wire be if the neutral is to act as a grounding conductor?
- 14 awg.
 - 10 awg.
 - 12 awg.
 - 8 awg.

LAP TEST ANSWER KEY: INSTALLING ELECTRIC CLOTHES DRYERS

1. D
2. A
3. D
4. D
5. C
6. B
7. D
8. A
9. C
10. B

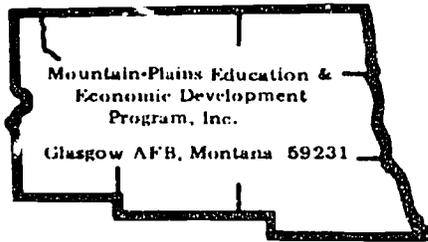

Learning Activity Package

Student: _____

Date: _____

PERFORMANCE ACTIVITY: Installing Electric Water Heaters

OBJECTIVE:

Given the necessary tools, equipment, supplies and blueprint, correctly install an electric water heater according to: (1) manufacturer's and blueprint specification; (2) following procedures and practices accepted in the industry; and outlined in the reference text. Identify types of associated electric water heater equipment. Identify circuit characteristics of electric water heaters meeting National Electrical Code Standards.

EVALUATION PROCEDURE:

Installation meets the criteria listed on the attached checklist. Complete, score and return a ten-item multiple-choice test about this LAP. Successful completion is eight out of ten items.

RESOURCES:

Electrical Wiring, Ray Mullin, pp. 150-160.
Manufacturer's Specifications.

PROCEDURE:

1. Read the text pp. 150-160 and answer the review questions, pp. 158-160.
2. Go to your assigned work station where you will complete the activities listed in the objective.
3. Obtain the necessary tools, equipment, and supplies needed to complete the operations listed.
4. Complete the job listed in the objective.
NOTE: FOLLOW SAFE PRACTICES AND PROCEDURES.
5. Perform all necessary testing and evaluation checks listed in the checklist. If you have any questions or problems check with the instructor.
6. When you have been checked off on the checklist by the instructor, complete the data requested on your Performance Record and have him initial it.
7. Clean up the area.

Principal Author(s): R. Arneson, L. Leland, T. Ziller

8. Take the test for this LAP.
9. Score the LAP test and return it.
10. If the test is satisfactory, begin the next assigned LAP. If the test is unsatisfactory, proceed as directed by the instructor.

CHECKLIST: INSTALLING ELECTRIC WATER HEATERS

- _____ 1. Proper selection and use of tools , equipment and supplies .
- _____ 2. Safe practices and procedures followed .
- _____ 3. Neat and presentable .
- _____ 4. Meets or exceeds standards established in the industry .
- _____ 5. Procedures followed are practiced and accepted in the industry .

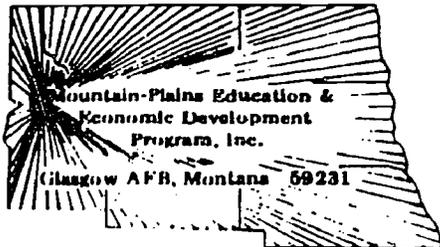

LAP TEST: INSTALLING ELECTRIC WATER HEATERS

1. Why is a 240 volt motor preferable to 120 volt motors for use in the residence described in the Plan?
 - a. increased voltage increase amperage.
 - b. increased voltage decreased resistance.
 - c. increased voltage increases resistance.
 - d. increased voltage decreased amperage.

2. How many thermostats does a typical water heater usually have?
 - a. two.
 - b. three.
 - c. one.
 - d. four.

3. A capacitor start motor is used on most pumps for what reason?
 - a. low cost.
 - b. high starting torque.
 - c. low starting torque.
 - d. high cost.

4. In a water heater what restriction takes place that is called limited demand?
 - a. elements come on at the same time.
 - b. elements are controlled by thermostats.
 - c. elements cannot come on at the same time.
 - d. elements are limited by a protective device.

5. Given a water heater that has heating elements rated at 2000 watts and 3000 watts, what is the maximum load demand if its voltage is of normal rating?
 - a. 16.4 amps.
 - b. 18.6 amps.
 - c. 21.1 amps.
 - d. 12.7 amps.

6. For all practical purposes when the voltage is reduced by one half the wattage is reduced by how much?
- a. 50%
 - b. 80%
 - c. 70%
 - d. 25%
7. What is the maximum rating of a non-time delay fuse that should be installed for a motor rated 8 amps? (See Code, Section 430-52; Table 430-152)
- a. 30 amps.
 - b. 22 amps.
 - c. 24 amps.
 - d. 15 amps.
8. What prevents water from draining back from the equipment into the well in a jet pump system?
- a. gate valve.
 - b. check valve.
 - c. globe valve.
 - d. foot valve.
9. What furnishes the running protection for a jet pump motor?
- a. single pole breaker.
 - b. thermal over load.
 - c. double-pole breaker.
 - d. double-pole single-throw breaker.
10. What is a common speed for jet pump motors?
- a. 1200 rpm.
 - b. 3400 rpm.
 - c. 4200 rpm.
 - d. 2400 rpm.

LAP TEST ANSWER KEY: INSTALLING ELECTRIC WATER HEATERS

1. D
2. A
3. B
4. C
5. D
6. D
7. C
8. D
9. B
10. B

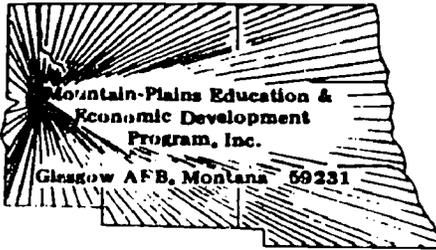

UNIT POST-TEST: APPLIANCES

72.02.04.01.

1. If a circuit on an electric range burner unit is operated on 240 volts and has 16 ohms resistance, what is the power rating?
 - a. 4600 watts.
 - b. 3660 watts.
 - c. 1240 watts.
 - d. 1400 watts.

2. Where is the special purpose outlet symbol  located? (See Plans)
 - a. NE wall of kitchen.
 - b. SW wall of kitchen.
 - c. NW wall of kitchen.
 - d. SE wall of kitchen.

3. What are most heating elements of a stove made of?
 - a. copper.
 - b. silchrome.
 - c. aluminum.
 - d. nichrome.

4. If an electric range burner circuit draws 10 amps 240 volts, what is the power rating?
 - a. 1400 watts.
 - b. 1700 watts.
 - c. 2400 watts.
 - d. 2550 watts.

5. If the voltage is doubled and the resistance is constant, by how much is the wattage increased or decreased?
 - a. three times.
 - b. two times.
 - c. four times.
 - d. one time.

6. In referring to the specifications provided, what is the amperage rating of the garbage disposal?
 - a. 5.8 amps.
 - b. 8 amps.
 - c. 10 amps.
 - d. 7.2 amps.

7. According to the NEC the motor protection on an appliance must not exceed the rated amperage by what percentage?
 - a. 150%
 - b. 175%
 - c. 100%
 - d. 125%

8. If a separate circuit supplies the garbage disposal, how many feet of cable will be required to connect the disposal? Approx cable may not be exposed in the utility room. (See Plan)
 - a. 15'
 - b. 25'
 - c. 30'
 - d. 20'

9. In this residence what size wire is used to supply the garbage disposal? (See Specs)
 - a. 12 awg.
 - b. 14 awg.
 - c. 10 awg.
 - d. 8 awg.

10. Which of the following would not be on a garbage disposal if an electrician installs a fused box cover unit in a garbage disposal unit?
 - a. heat strip.
 - b. thermal strip.
 - c. fuse.
 - d. ballast.

11. Which of the following can be used to control a heat-a-vent?
 - a. thermostat.
 - b. bi-metal strip.
 - c. fusestat.
 - d. rheostat

12. What is the rating of the breaker to be installed on the heat-a-vent circuit? (See Plan)
 - a. 10 amp.
 - b. 30 amp.
 - c. 15 amp.
 - d. 20 amp.

13. The element of heat-a-vent light is similar to the elements in which of the following?
 - a. fluorescent light.
 - b. refrigerator.
 - c. washer.
 - d. electric range.

14. Which wall of the bathroom is used to mount the device that controls the baseboard heat for the bath? (See Plans)
 - a. NW.
 - b. NE.
 - c. SW.
 - d. SE.

15. What is the current rating of a heat-a-vent unit rated at 1475 watts /120 volts?
 - a. 15.37 amps.
 - b. 12.29 amps.
 - c. 8.29 amps.
 - d. 24.8 amps.

16. Which of the following is the type of electric heat used in this house?
(See Plan)
- a. ceiling cable embedded.
 - b. duct heaters.
 - c. central furnace.
 - d. baseboard.
17. What color is the grounded conductor according to the NEC?
- a. black.
 - b. blue.
 - c. white.
 - d. red.
18. At what voltage do the first floor electric heating units operate?
- a. 115 V
 - b. 240 V
 - c. 110 V
 - d. 220 V
19. How many circuits feed the electric heating units in this house?
(See Specs)
- a. six.
 - b. four.
 - c. two.
 - d. eight.
20. If a line thermostat has a rating of 2500 watt at 120 volts, what is its amperage rating?
- a. 19.8
 - b. 20.8
 - c. 16.8
 - d. 24.8

72.02.04.05.

21. If SE cable is used with a non-insulated conductor to connect a range, where must it originate?
- a. load center.
 - b. power panel.
 - c. light panel.
 - d. sub panel.
22. What is the maximum operating temperature of type A conductor? (See Code)
- a. 200 degree F
 - b. 200 degree C
 - c. 140 degree F
 - d. 60 degree C
23. What is the standard temperature rating on conductor insulation?
- a. 60 degree C
 - b. 50 degree C
 - c. 70 degree C
 - d. 80 degree C
24. What section of the code governs grounding of a wall-mounted oven?
- a. 215-7
 - b. 220-5
 - c. 210-19 (C)
 - d. 250-60
25. What is the special purpose outlet symbol  in the plan intended? (See Specs)
- a. dryer.
 - b. oven.
 - c. range.
 - d. stove.

72.02.04.06.

26. What does the symbol  stand for on the plan? (See Specs)
- a. damper.
 - b. door opener.
 - c. clothes washer.
 - d. clothes dryer.

27. In the code book 220-4 (A) what is the minimum watts rating used to determine the feeder rating?
- a. 5500 watts.
 - b. 6000 watts.
 - c. 5000 watts.
 - d. 4700 watts.
28. What regulates the temperature in a dryer?
- a. thermostat.
 - b. circuit breaker.
 - c. thermal protector.
 - d. thermo coupler.
29. When a SE cable has an uninsulated neutral, from which of the following can it originate? (Code 238-3)
- a. service entrance.
 - b. sub panel B
 - c. sub panel C
 - d. sub panel A
30. A dryer is rated at 7.5 KW, 240 volts; what is the wattage rating?
- a. 4250 watts.
 - b. 5000 watts.
 - c. 3400 watts.
 - d. 7500 watts.

72.02.04.07.

31. What is the maximum rating of a non-time delay fuse that should be installed for a motor rated 8 amps?
- a. 30 amps.
 - b. 24 amps.
 - c. 15 amps.
 - d. 22 amps.
32. Given a water heater that has heating elements rated at 2000 watts and 3000 watts, what is the maximum load demand if its voltage is of normal rating?
- a. 12.7 amps.
 - b. 21.1 amps.
 - c. 16.4 amps.
 - d. 18.6 amps.

72.02.04.07. continued:

33. Which of the following, if any, is a moving part below the ground level on a jet pump?
- a. none.
 - b. jet.
 - c. globe valve.
 - d. gate valve.
34. What are the heating elements of a water heater usually made of?
- a. silchrome.
 - b. aluminum.
 - c. copper.
 - d. nichrome.
35. Using the code book section 430-52 and table 430-152, what is the maximum protective breaker that should be installed on a motor rated 8 amps using a time-delay (dual element) fuse?
- a. 20 amps.
 - b. 25 amps.
 - c. 15 amps.
 - d. 30 amps.

UNIT POST-TEST ANSWER KEY: APPLIANCES

LAP

- 01 1. B
 2. D
 3. D
 4. C
 5. C
- 02 6. D
 7. D
 8. D
 9. A
 10. B
- 03 11. A
 12. C
 13. D
 14. A
 15. B
- 04 16. D
 17. C
 18. B
 19. D
 20. B
- 05 21. B
 22. B
 23. A
 24. A
 25. B
- 06 26. D
 27. C
 28. A
 29. A
 30. D
- 07 31. B
 32. A
 33. A
 34. D
 35. C

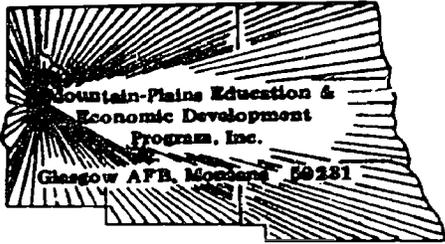

UNIT PERFORMANCE TEST: APPLIANCES

OBJECTIVE 1:

Given a blueprint of a floor plan and an electrically roughed-in wood frame construction, simulated or actual, the student will estimate the electrical appliances to be installed.

OBJECTIVE 2:

Given a blueprint of a floor plan and an electrically roughed-in wood frame construction, simulated or actual, the student will itemize the electrical appliances used in the installation.

OBJECTIVE 3:

Given a blueprint of a floor plan and an electrically roughed-in wood frame construction, simulated or actual, the student will install various electrical appliances in their proper locations.

TASK:

The student will complete a list of electrical appliances, using blueprints and sketches. The student will obtain the electrical appliances from the storage area. Then the student will install the electrical appliances according to blueprint specifications, manufacturer's specifications and National Electrical Code standards.

ASSIGNMENT:CONDITIONS:

The student will be tested in a wood frame construction to simulate any specified room of a residence. The student will be given necessary tools and equipment. No assistance may be obtained from another student or the instructor or from unspecified text material.

RESOURCES:

Tools:

High leverage plier
High leverage oblique cutting plier
Long nose cutting plier
Electrician's hammer
Screwdriver slot 3/16 x 4
Screwdriver no. 2 phillips 8"
Screwdriver slot 3/16 x 9
Screwdriver 1/4 x 4
Screwdriver 1/4 x 6
Nutdriver variable size 1/4" x 7/16
Scratch awl
Adjustable Wrench size 8"
Pump plier size 10"
All-purpose tool, wire stripper, crimper and cutter
Tape rule 12' 3/4"
Knife, electricians
Tool pouch, 5 pocket

Equipment:

Simpson 260 VOM or Amprobe

Text:

Electrical Wiring Residential, Ray C. Mullin, Delmar Publishers, 4th Ed., 1973
National Electrical Code

ASSIGNMENT SHEET 1

KITCHEN

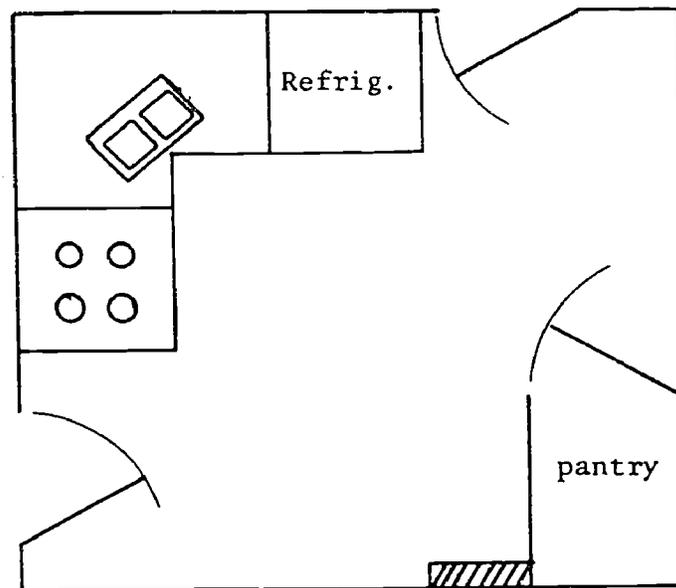

- garbage disposal
- pantry light
- light 2-position control

ASSIGNMENT SHEET 2:

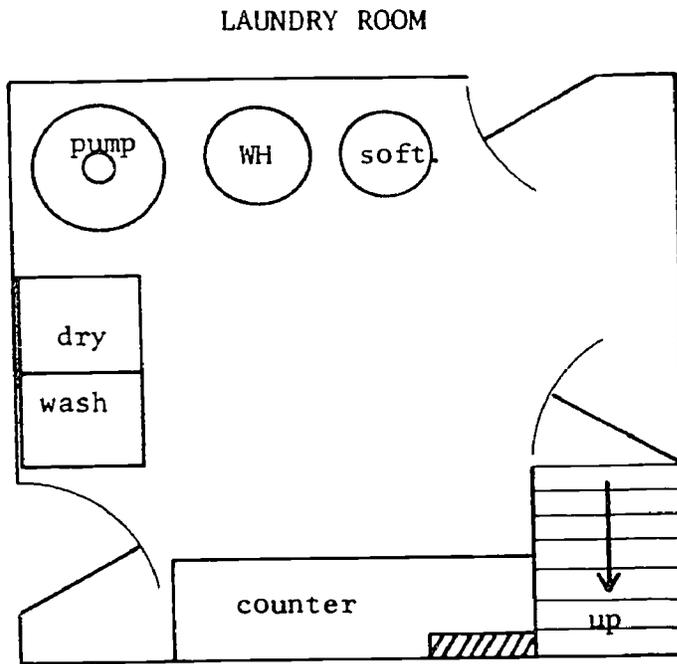

- sub-pump
- water heater
- water softener
- 3-position switch control

ASSIGNMENT SHEET 3

LIVING ROOM

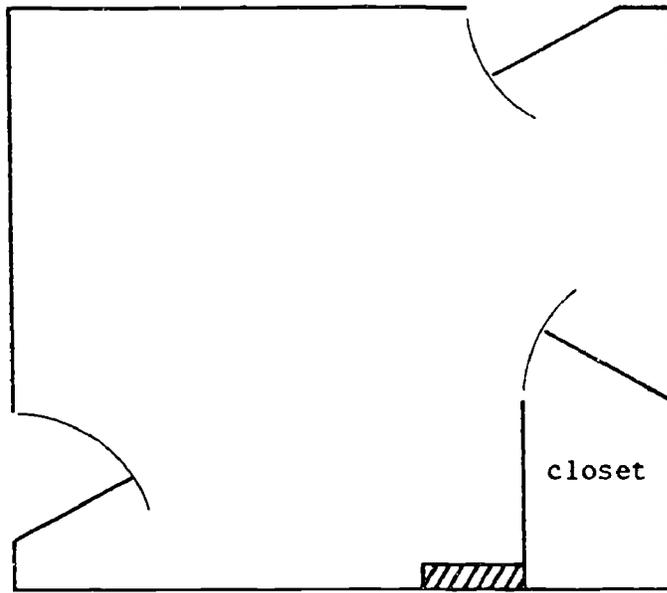

- electric heat
- split receptacles
- 2-position switch control

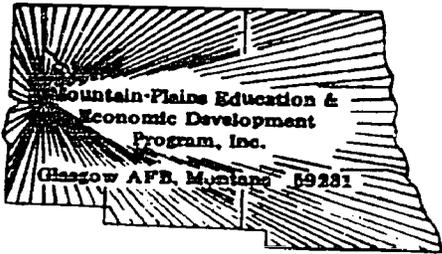

PERFORMANCE CHECKLIST:

OVERALL PERFORMANCE: Satisfactory _____ Unsatisfactory _____

	CRITERION	
	Met	Not Met
Objective 1:		
1. The student determines the type of electrical appliances to be installed.		
2. The student determines the quantity of each electrical appliance to be installed.		
3. The student itemizes each type and quantity of electrical appliance to be installed.		
Criterion: The physical dimensions and the electrical and manufacturing specifications meet the National Electrical Code and blueprint specifications.		
Objective 2:		
4. The student obtains the electrical appliances to be installed from the electric shop's storage room.		
Criterion: The electrical appliances will be used by the student for installation.		
Objective 3:		

(Checklist continued)

	CRITERION	
	Met	Not Met
5. The student strips the conductors insulation with wire strippers to fit the electrical appliance's connecting device.		
6. The student bends the electrical wire to fit the connecting screw, when appropriate.		
7. The student connects the "hot", black and/or red, conductor to the appliance hot terminals identified by the appliance manufacture by a schematic.		
8. The student connects the "neutral", gray or white, conductor to the common terminals identified by the appliance manufacture by a schematic.		
9. The student connects the bare grounding conductor to the appliance grounding terminals or equipment grounding screw, identified by the appliance manufacture by a schematic.		
10. The student connects the equipment ground to the grounding prong on the male receptacle.		
Criterion: The electrical appliance installation meets National Electrical Code standards and blueprint and manufacturer's specifications.		
11. Task completed in allotted time.		

	CRITERION	
	Met	Not Met
Criterion: See assignment for time specifications.		
Student must meet criterion on all line items to obtain an overall score of satisfactory.		

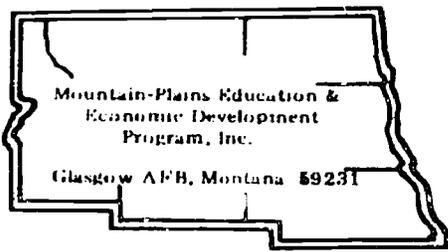

Learning Experience Guide

UNIT: MISCELLANEOUS

RATIONALE:

A qualified electrical wireman must acquire skill in installing the many electrically operated control devices and the circuits between the device and the appliance being controlled. These miscellaneous devices are many in number. They include such devices as circuit breakers, thermostats, thermocouples and humidistats. Success in installation requires skill in determining the type of device, where to install it and how to install it.

PREREQUISITES:

The unit titled "Appliances" and course prerequisites are required.

OBJECTIVE:

Identify characteristics and functions of electric circuit control devices used in service entrances. Given blueprint specifications, National Electrical Codes, tools and supplies building or shop simulation with electrical wiring rough-in, students will estimate materials required and install the specified miscellaneous devices that control electrical energy applied to electrical circuits and devices.

RESOURCES:

Electrical Wiring Residential, Ray C. Mullin, Delmar Publisher, 1973.

An assortment of electrical supply catalogs containing control devices.

An assortment of manufacturer's electrical control installation specifications guides.

Set of electrical wireman's tools.

GENERAL INSTRUCTIONS:

The LAP for each performance activity assigned for this unit is to be read. You are to follow the LAP procedures. Work independently unless otherwise directed. Take any problem or question to the instructor.

Principal Author(s): R. Arneson, L. Leland, T. Ziller

PERFORMANCE ACTIVITIES:

- .01 Determining Types of Miscellaneous Devices to be Installed.
- .02 Determining Types of Circuit Breakers to be Installed.
- .03 Installing Humidistats.
- .04 Installing Circuit Breakers.
- .05 Installing Thermostats Controls and Relays.
- .06 Installing Thermocouples.

EVALUATION PROCEDURE:

Success in this unit is determined by identifying 80% of the desired responses to a set of multiple choice test items and obtaining a "satisfactory" for completing each line item on a performance test.

FOLLOW-THROUGH:

This is the last unit in this course. When you finish this guide, read the LAP for the first assigned performance activity. Apply the skills acquired thus far in performing the procedures for the unit activities. When you master this unit you will have completed occupational preparation here for electrical wireman.

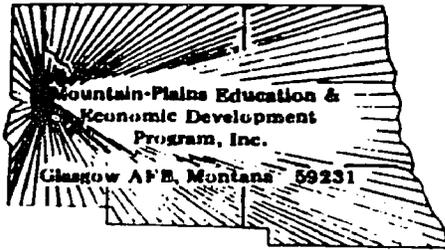

UNIT PRE-TEST: MISCELLANEOUS

72.02.05.01.

1. According to the electrical code, in the kitchen-dining area a receptacle must be placed at each:
 - a. lazy susan.
 - b. counter.
 - c. cabinet.
 - d. window.

2. When stapling NM cable, the intervals must not exceed:
 - a. 4'6"
 - b. 5'
 - c. 3'6"
 - d. 2'

3. Non-metallic sheathed cable may be installed in:
 - a. damp places.
 - b. outside.
 - c. concealed and exposed places.
 - d. inside.

4. Floor receptacles are not considered part of the required number of outlets unless they are:
 - a. placed near the wall.
 - b. placed near a light switch.
 - c. placed near a door.
 - d. placed near an appliance.

5. What is the minimum number of 15 ampere lighting circuits if the dwelling has an occupied area of 4000 square feet?
 - a. 9.
 - b. 7.
 - c. 8.
 - d. 6.

72.02.05.02.

6. Circuit breakers that compensate for room temperature change have how many elements?
 - a. one.
 - b. two.
 - c. three.
 - d. four.

7. Dual element fuses are commonly used on which of the following?
 - a. motors.
 - b. ranges.
 - c. receptacles.
 - d. lights.

8. An element that has a long time lag on low overloads is called:
 - a. thermal element.
 - b. thermal cutout element.
 - c. single element.
 - d. single thermal element.

9. Type S fuses in cartridge form are labeled:
 - a. SFC.
 - b. DSC.
 - c. SDFC.
 - d. SC.

10. Circuit breakers with inadequate rating for some circuits are literally:
 - a. safe.
 - b. acceptable.
 - c. bombs.
 - d. appropriate.

72.02.05.03.

11. How many wires is the fixture in a ceiling counted as?
- three.
 - two.
 - zero.
 - one.
12. According to the code the receptacles on the terrace must be which of the following? (See Plan)
- grounding.
 - grounding WP.
 - recessed.
 - standard.
13. What is the rating of each receptacle in the utility room? (See Plan)
- 30 amp.
 - 20 amp.
 - standard.
 - 15 amp.
14. The plaster cover or raised cover thickness is dependent upon which of the following?
- finish material.
 - box construction.
 - insulation thickness.
 - stud thickness.
15. Which of the following is the accepted symbol for chimes?
- 
 - 
 - 
 - 

72.02.05.04.

16. In general on a service entrance the head is to be in what relation to the connections?
- lower than.
 - any of the above.
 - higher than.
 - level with.
17. If an underground service entrance runs up a pole, it must be protected by conduit to a minimum length of which of the following?
- 4'.
 - 10'.
 - 6'.
 - 8'.
18. Where is panel B located in this house? (See Plan)
- rec room.
 - storage room.
 - work shop.
 - utility room.
19. In an underground service entrance what is the minimum size copper conductor allowable by the NEC?
- 10 awg.
 - 6 awg.
 - 8 awg.
 - 4 awg.
20. If a service entrance cable passes over a street, what is the minimum distance required over the street?
- 14'.
 - 18'.
 - 16'.
 - 12'.

72.02.05.05.

21. Which of the following functions does the liquid immersion controller perform on a hydronic oil burner system?
- ignites burner.
 - gives time of ignition.
 - stops oil burner.
 - starts oil burner.
22. Which of the following systems requires a circulating pump?
- forced air.
 - hydronic.
 - forced feed.
 - gravity feed.
23. What equipment furnishes the spark for ignition on an oil burner system?
- circulator.
 - relay.
 - stack switch.
 - transformer.
24. Section 725-17 of the NEC calls for a special type of cable. Which of the following would meet this code?
- low energy safety control (LESC).
 - (NMC) non-metallic corrosion resistant.
 - UF underground feeder.
 - (NM) non-metallic cable.
25. A self generating system must have which of the following?
- thermostat.
 - thermocoupler.
 - capacitor.
 - relay.

72.02.05.06.

26. The device used on a gas fired heating system to protect against no ignition is called a:
- safety shut off valve.
 - stack switch.
 - coupler.
 - coupling switch.
27. Which of the following burners requires a stack switch?
- propane.
 - electric.
 - natural gas.
 - fuel oil.
28. On most gas fired furnaces the high limit control, the safety valve and the gas valve are connected how?
- parallel series.
 - series.
 - series parallel.
 - parallel.
29. A unit that consists of several groups of two different kinds of metal in a furnace is called which of the following?
- limit switch.
 - thermocoupler.
 - relay.
 - thermostat.
30. Which of the following systems requires a circulating pump?
- forced feed.
 - gravity feed.
 - hydronic.
 - forced air.

UNIT PRE-TEST: MISCELLANEOUS

LAP

- | | | |
|----|-----|---|
| 01 | 1. | B |
| | 2. | A |
| | 3. | C |
| | 4. | A |
| | 5. | B |
| 02 | 6. | B |
| | 7. | A |
| | 8. | B |
| | 9. | D |
| | 10. | C |
| 03 | 11. | D |
| | 12. | B |
| | 13. | B |
| | 14. | A |
| | 15. | A |
| 04 | 16. | C |
| | 17. | D |
| | 18. | D |
| | 19. | B |
| | 20. | B |
| 05 | 21. | C |
| | 22. | B |
| | 23. | D |
| | 24. | A |
| | 25. | B |
| 06 | 26. | A |
| | 27. | D |
| | 28. | B |
| | 29. | B |
| | 30. | C |

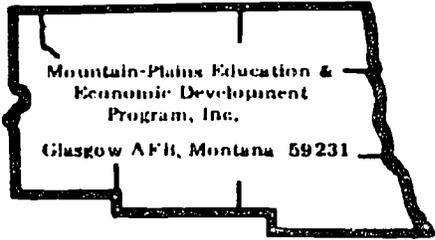

Mountain-Plains Education &
Economic Development
Program, Inc.
Glasgow AFB, Montana 59231

Learning Activity Package

Student: _____

Date: _____

Determining Types of Miscellaneous

PERFORMANCE ACTIVITY: Devices to Be InstalledOBJECTIVE:

Given a blueprint and specifications, identify and record the type, description and quantity of miscellaneous electrical devices on a requisition form. Compiled data must correlate to and conform with the listed reference standards established in the industry. Identify electric circuit characteristics meeting National Electrical Code.

EVALUATION PROCEDURE:

Accurate ordering of the parts and supplies needed to complete the specific job listed in the objective and on the blueprint. Complete, score and return a ten-item multiple-choice test about this LAP. Successful completion is eight out of ten items.

RESOURCES:

Electrical Wiring, Ray C. Mullin, pp. 26-33.
Electrical Supply Catalog.

PROCEDURE:

1. Review the text pages 26-33.
2. Obtain an Electrical Parts Supply Catalog.
3. Using the attached requisition and the blueprint sketch you have completed, order the parts and supplies needed to complete the job indicated in the objective.
NOTE: Parts and supplies must be ordered by quantity, complete description and type.
4. Check the completed requisition with the answer key.
5. Enter the requested data on your Performance Record.
6. Take the test for this LAP.
7. Score the LAP test and return it.
8. If the test is satisfactory, begin the next assigned LAP. If the test is unsatisfactory, proceed as directed by the instructor.

Principal Author(s): R. Arneson, L. Leland, T. Ziller

REQUISITION NO. _____ REQUISITION DATE _____ TIME REQUIRED _____ PURCHASE ORDER NO. _____ PAGE of

<input type="checkbox"/> RESEARCH DEVELOPMENT <input type="checkbox"/> START UP	<input type="checkbox"/> OPERATIONS	ACCOUNTING DATA USING ACTIVITY USED FOR	DEPARTMENT <input type="checkbox"/> ADMINISTRATION <input type="checkbox"/> FAMILY LIFE <input type="checkbox"/> INSTRUCTION <input type="checkbox"/> MULTI-PURPOSE <input type="checkbox"/> STATE PROGRAMS <input type="checkbox"/> PLANNING & RESEARCH <input type="checkbox"/> OTHER
SUGGESTED SOURCE			

ITEM NO.	QUAN.	UNIT	DESCRIPTION OF SUPPLIES / SERVICES	EST. UNIT PRICE	EST. AMOUNT

REMARKS _____ EST. TOTAL AMOUNT

ORIGINATOR	Signature _____	Date _____	PROPERTY CONTROLLER	Signature _____	Date _____
DEPT. HEAD	Signature _____	Date _____	PROCUREMENT OFFICER	Signature _____	Date _____
DIRECTOR	Signature _____	Date _____	ACCOUNTING OFFICE (To Procurement)	Signature _____	Date _____

PROPERTY CONTROL



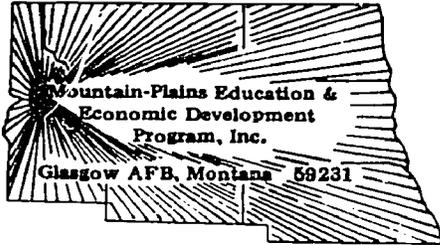

LAP TEST: DETERMINING TYPES OF MISCELLANEOUS DEVICES TO BE INSTALLED

1. NMC cable must not be bent in a radius less than _____ its cable diameter.
 - a. four times.
 - b. twice.
 - c. five times.
 - d. three times.

2. The electrical codes specifies the minimum AWG wire size allowable in a house for lighting circuits as:
 - a. 12 AWG.
 - b. 14 AWG.
 - c. 16 AWG.
 - d. 18 AWG.

3. The electrical code requires at least what number of outlets for the laundry?
 - a. two.
 - b. three.
 - c. one.
 - d. four.

4. Metal clad cable has a rating up to:
 - a. 500 volts.
 - b. 600 volts.
 - c. 400 volts.
 - d. 700 volts.

5. The electrical code states that no point in any room shall be more than how many feet from a receptacle.
 - a. 6 feet.
 - b. 8 feet.
 - c. 4 feet.
 - d. 10 feet.

6. What is the difference between type AC and ACT cable?
 - a. conductor make-up.
 - b. its conductor size.
 - c. conductor use.
 - d. insulation.

7. What is the unit load per square foot for dwellings?
- 3 volts per sq. ft.
 - 3 watts per sq. ft.
 - 20 amps per sq. ft.
 - 20 watts per sq. ft.
8. A mill is defined as:
- .1
 - .001
 - .0001
 - .01
9. In which of the following circumstances can metal clad cable be used?
- through walls and partitions.
 - laying in masonry.
 - underground.
 - exposed to weather.
10. The color code for 3-wire non-metallic cable is:
- white-black-red.
 - black-orange-red.
 - yellow-black-white.
 - black-white-green.

1. c
2. a
3. c
4. b
5. a
6. d
7. b
8. b
9. a
10. a

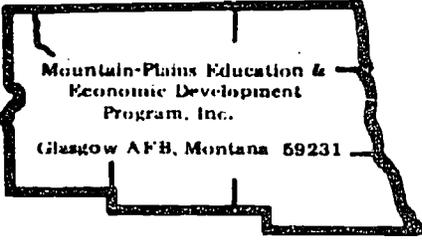

Mountain-Plains Education &
Economic Development
Program, Inc.
Glasgow AFB, Montana 59231

Learning Activity Package

Student: _____

Date: _____

PERFORMANCE ACTIVITY: Determining Types of Circuit Breakers to be Installed

OBJECTIVE:

Given the blueprint and specifications, identify and record the type, description and quantity of circuit breakers on a requisition form. Compiled data must correlate to and conform with the listed reference standards established in the industry. Identify characteristics and nomenclature of current interrupting devices.

EVALUATION PROCEDURE:

Accurate ordering of the parts and supplies needed to complete the specific job listed in the objective and on the blueprint. Complete, score and return a ten-item multiple-choice test about this LAP. Successful completion is eight out of ten items.

RESOURCES:

Electrical Wiring, Ray C. Mullin, pp. 232-255.
Electrical Supply Catalog.

PROCEDURE:

1. Review the text pages 232-255.
2. Obtain an Electrical Parts Supply Catalog.
3. Using the attached requisition and the blueprint sketch you have completed, order the parts and supplies needed to complete the job indicated in the objective.

NOTE: Parts and supplies must be ordered by quantity, complete description and type.

4. Check the completed requisition with the answer key.
5. Enter the requested data on your Performance Record.
6. Take the test for this LAP.
7. Score the LAP test and return it.
8. If the test is satisfactory, begin the next assigned LAP. If the test is unsatisfactory, proceed as directed by the instructor.

Principal Author(s): R. Arneson, L. Leland, T. Ziller

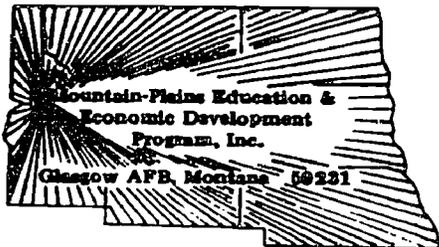

LAP TEST: DETERMINING TYPES OF CIRCUIT BREAKERS
TO BE INSTALLED

1. Which of the following fuses has a rating of 200,000 amperes R.M.S. symmetrical?
 - a. cartridge.
 - b. SDFC.
 - c. SC.
 - d. SFC.

2. If a short circuit occurs, which of the following in a circuit breaker stops the current instantly?
 - a. capacitor.
 - b. bi-metal strip.
 - c. coil.
 - d. thermostat.

3. An element that has a long time lag on low overloads is called?
 - a. thermal element.
 - b. single thermal element.
 - c. single element.
 - d. thermal cutout element.

4. A time delay fuse protects the overload of a circuit up to what percentage of current overload?
 - a. up to 400%.
 - b. up to 300%.
 - c. up to 100%.
 - d. up to 500%.

5. An element that cuts off short circuits quickly is called which of the following?
 - a. dual element.
 - b. thermal cutout.
 - c. fuse link.
 - d. single element.

6. Type S fuses in cartridge form are labeled how?
 - a. SFC.
 - b. SDFC.
 - c. SC.
 - d. DSC.

7. Which of the following type fuses are required on all new installation?
- Type S.
 - Type G.
 - Type X.
 - Type F.
8. In a circuit breaker, which of the following trips the circuit?
- rheostat.
 - bi-metalllic strip.
 - capacitor.
 - thermostat.
9. A transformer with a given KVA Rating and a low impedance rating delivers which of the following in relation to short circuit current of a transformer with a high impedance rating?
- low impedance, less current.
 - high impedance, more current.
 - all of the above.
 - low impedance, more current.
10. If the service entrance drop from the pole passes over the peak of the roof, what is the minimum clearance required over the roof?
- 8 feet.
 - 6 feet.
 - 4 feet.
 - 10 feet.

LAP TEST ANSWER KEY: DETERMINING TYPES OF CIRCUIT BREAKERS TO BE INSTALLED

1. a
2. c
3. d
4. d
5. c
6. c
7. a
8. b
9. d
10. a

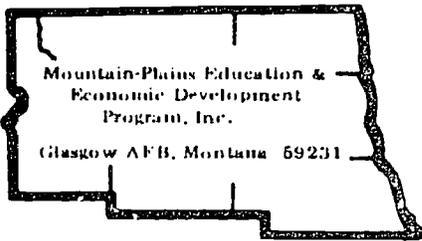

Learning Activity Package

Student: _____

Date: _____

PERFORMANCE ACTIVITY: Installing Humidistats

OBJECTIVE:

Given the necessary tools, equipment, supplies and blueprint, correctly install a humidistat according to: (1) manufacturer's and blueprint specifications; (2) following procedures and practices accepted in the industry; and outlined in the reference text. Determine location of circuits from a given floor plan.

EVALUATION PROCEDURE:

Installation meets the criteria listed on the attached checklist. Complete, score and return a ten-item multiple-choice test about this LAP. Successful completion is eight out of ten items.

RESOURCES:

Electrical Wiring, Ray C. Mullin, pp. 127-135.
Manufacturer's Specification.

PROCEDURE:

1. Read the text, pp. 127-135 and answer the questions pp. 132-135.
2. Go to your assigned work station where you will complete the activities listed in the objective.
3. Obtain the necessary tools, equipment and supplies needed to complete the operations listed.
4. Complete the job listed in the objective.
NOTE: FOLLOW SAFE PRACTICES AND PROCEDURES.
5. Perform all necessary testing and evaluation checks listed in the checklist. If you have any questions or problems check with the instructor.
6. When you have been checked off on the checklist by the instructor, complete the data requested on your Performance Record and have him initial it.
7. Clean up the area.
8. Take the test for this LAP.
9. Score the LAP test and return it.
10. If the test is satisfactory, begin the next assigned LAP. If the test is unsatisfactory, proceed as directed by the instructor.

Principal Author(s): R. Arneson, L. Leland, T. Ziller

CHECKLIST: INSTALLING HUMIDISTATS

- 1. Proper selection and use of tools, equipment and supplies.
- 2. Safe practices and procedures followed.
- 3. Neat and presentable.
- 4. Meets or exceeds standards established in the industry.
- 5. Procedures followed are practiced and accepted in the industry.

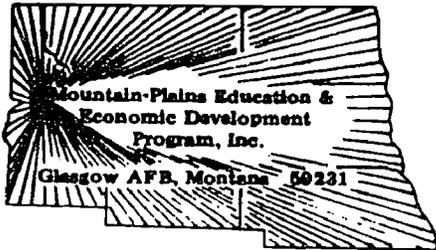

LAP TEST: INSTALLING HUMIDISTATS

1. What type of walls are outside walls of the recreation room (see plan)?
 - a. masonry.
 - b. 2 x 2 fitted.
 - c. cinder block.
 - d. concrete.

2. If a grounding wire enters and leaves a box, it is counted as how many wires?
 - a. one.
 - b. two.
 - c. four.
 - d. three.

3. With the exception of the dryer and washer outlets, what is the height of the switches and convenience receptacles in the utility room (see plan)?
 - a. 18" to center from FF.
 - b. 48" to center from FF.
 - c. 12" to center from FF.
 - d. 50" to center from FF.

4. What is the rating of each receptacle in the utility room (see plan)?
 - a. 15 AMP.
 - b. standard.
 - c. 30 AMP.
 - d. 20 AMP.

5. How many receptacles are on the circuit that the freezer in the utility room is plugged into?
 - a. two.
 - b. three.
 - c. one.
 - d. four.

6. Which section of wiring must be exposed in the recreation room? (See Plan)
 - a. exit door switches.
 - b. box over the fireplace.
 - c. ceiling fixtures.
 - d. convenience receptacles N.E. wall.

7. Which of the following is the accepted symbol for chimes?
- a. 
 - b. 
 - c. 
 - d. 
8. Where is the fan mounted?
- a. between washer and dryer .
 - b. on N.E. utility room wall.
 - c. between studs .
 - d. between joist .
9. The freezer receptacle in the utility room is hooked to which circuit in Panel B?
- a. 6
 - b. 9
 - c. 8
 - d. 7
10. How many speeds does the fan in the utility room have (see plan)?
- a. two.
 - b. four .
 - c. one.
 - d. three.

LAP TEST ANSWER KEY: INSTALLING HUMIDISTATS

1. c
2. a
3. b
4. d
5. c
6. b
7. b
8. d
9. c
10. d

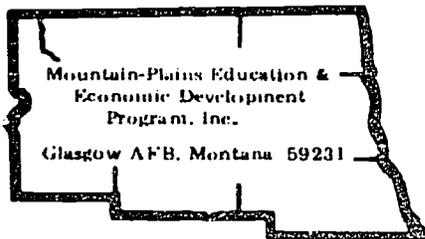

Learning Activity Package

Student: _____

Date: _____

PERFORMANCE ACTIVITY: Installing Circuit Breakers

OBJECTIVE.

Given the necessary tools, equipment, supplies and blueprint, correctly install circuit breakers according to: (1) manufacturer's and blueprint specifications; (2) following procedures and practices accepted in the industry; and outlined in the reference text. Identify service entrance circuit characteristics and nomenclature meeting National Electrical Code Standards.

EVALUATION PROCEDURE:

Installation meets the criteria listed on the attached checklist. Complete, score and return a ten-item multiple-choice test about this LAP. Successful completion is eight out of ten items.

RESOURCES:

Electrical Wiring, Ray C. Mullin, pp. 232-255.
Manufacturer's Specifications.

PROCELURE:

1. Read the text pages 232-255.
 2. Go to your assigned work station where you will complete the activities listed in the objective.
 3. Obtain the necessary tools, equipment and supplies needed to complete the operations listed.
 4. Complete the job listed in the objective.
- NOTE: FOLLOW SAFE PRACTICES AND PROCEDURES.
5. Perform all necessary testing and evaluation checks listed in the checklist. If you have any question or problems check with the instructor.
 6. When you have been checked off on the checklist by the instructor, complete the data requested on your Performance Record and have him initial it.
 7. Clean up the area.
 8. Take the test for this LAP.
 9. Score the LAP test and return it.
 10. If the test is satisfactory, begin the next assigned LAP. If the test is unsatisfactory, proceed as directed by the instructor.

Principal Author(s): R. Arneson, L. Leland, T. Ziller

CHECKLIST: INSTALLING CIRCUIT BREAKERS

- _____ 1. Proper selection and use of tools, equipment and supplies.
- _____ 2. Safe practices and procedures followed.
- _____ 3. Neat and presentable.
- _____ 4. Meets or exceeds standards established in the industry.
- _____ 5. Procedures followed are practiced and accepted in the industry.

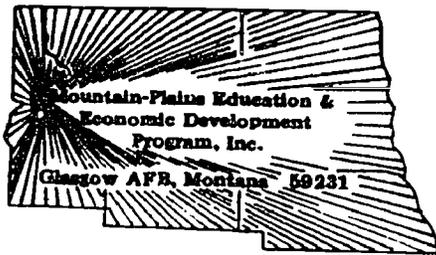

LAP TEST: INSTALLING CIRCUIT BREAKERS

1. If an underground service entrance runs up a pole, it must be protected by conduit to a minimum length of which of the following?
 - a. 8 feet.
 - b. 10 feet.
 - c. 4 feet.
 - d. 6 feet.

2. What type of conductor is to be used in this house (see specs.)?
 - a. UF.
 - b. RH.
 - c. RHW.
 - d. NMC.

3. The service entrance power panel must have a disconnect system that requires no more than how many circuit breakers to shut it off?
 - a. two.
 - b. four.
 - c. one.
 - d. six.

4. A panel board used to mount overcurrent devices may not have more than how many overcurrent devices (384=15)?
 - a. 42.
 - b. 32.
 - c. 26.
 - d. 20.

5. The top of the service entrance mast must be a minimum height from ground finish grade. What is that minimum height?
 - a. 8 feet.
 - b. 14 feet.
 - c. 10 feet.
 - d. 12 feet.

6. What is the voltage rating of the service entrance in this house (see specs.)?
 - a. 115/230.
 - b. 110/220.
 - c. 115/220.
 - d. 120/240.

7. If cable is to run in a raceway under a concrete slab, it must be of what type?
- SEC.
 - RHW.
 - NM.
 - NMC.
8. If service entrance connections are made near doors or windows, what is the minimum distance required between the windows or doors and the connections?
- 2 feet.
 - 3 feet.
 - 4 feet.
 - 1 foot.
9. The NEC code gives an exception to size of conductor if it feeds only one branch circuit such as a small motor. The minimum size conductor allowable in this case is which of the following?
- 8 AWG.
 - 10 AWG.
 - 6 AWG.
 - 12 AWG.
10. If an underground service entrance runs under a building, it must be which of the following?
- larger than 6 AWG.
 - embedded in masonry.
 - larger than 8 AWG.
 - in a raceway.

LAP TEST ANSWER KEY: INSTALLING CIRCUIT BREAKERS

1. a
2. c
3. d
4. a
5. c
6. d
7. b
8. b
9. d
10. d

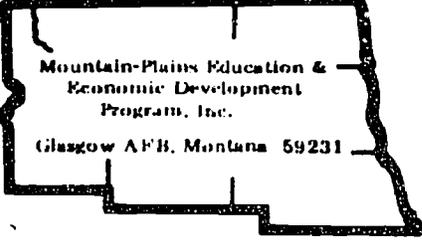

Mountain-Plains Education &
Economic Development
Program, Inc.
Glasgow AFB, Montana 59231

Learning Activity Package

Student: _____

Date: _____

PERFORMANCE ACTIVITY: Installing Thermostat Controls and Relays

OBJECTIVE:

Given the necessary tools, equipment, supplies and blueprint, correctly install a thermostat control and relay according to: (1) manufacturer's and blueprint specifications; (2) following procedures and practices accepted in the industry; and outlined in the reference text. Identify characteristics and functions of controlling circuit devices meeting National Electrical Code Standards.

EVALUATION PROCEDURE:

Installation meets the criteria listed on the attached checklist. Complete, score and return a ten-item multiple-choice test about this LAP. Successful completion is eight out of ten items.

RESOURCES:

Electrical Wiring, Ray C. Mullin, pp. 220-225.
Manufacturer's Specifications.

PROCEDURE:

1. Read the text, pp. 220-225 and answer the questions, pp. 222-225.
 2. Go to your assigned work station where you will complete the activities listed in the objective.
 3. Obtain the necessary tools, equipment and supplies needed to complete the operations listed.
 4. Complete the job listed in the objective.
- NOTE: FOLLOW SAFE PRACTICES AND PROCEDURES.**
5. Perform all necessary testing and evaluation checks listed in the checklist. If you have any question or problems check with the instructor.
 6. When you have been checked off on the checklist by the instructor, complete the data requested on your Performance Record and have him initial it.
 7. Clean up the area.
 8. Take the test for this LAP.
 9. Score the LAP test and return it.
 10. If the test is satisfactory, begin the next assigned LAP. If the test is unsatisfactory, proceed as directed by the instructor.

Principal Author(s): R. Arneson, L. Leland, T. Ziller

CHECKLIST: INSTALLING THERMOSTAT CONTROLS AND RELAYS

- _____ 1. Proper selection and use of tools, equipment and supplies.
- _____ 2. Safe practices and procedures followed.
- _____ 3. Neat and presentable.
- _____ 4. Meets or exceeds standards established in the industry.
- _____ 5. Procedures followed are practiced and accepted in the industry.

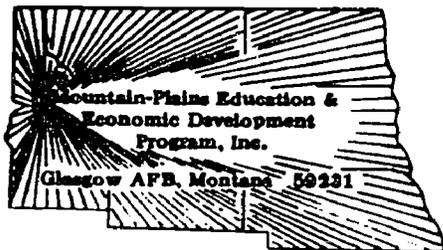

LAP TEST: INSTALLING THERMOSTAT CONTROLS AND RELAYS

1. What piece of equipment does the thermostat on an oil burner control?
 - a. capacitor.
 - b. circulator.
 - c. stack switch.
 - d. the relay.

2. Which of the following systems requires a circulating pump?
 - a. hydronic.
 - b. gravity feed.
 - c. forced air.
 - d. forced feed.

3. Which of the following is easiest to wire?
 - a. gas fired (forced air).
 - b. self generation.
 - c. hot water (forced).
 - d. oil burner (forced air).

4. What equipment furnishes the spark for ignition on an oil burner system?
 - a. circulator.
 - b. relay.
 - c. transformer.
 - d. stack switch.

5. Which of the following functions is not performed by the stack switch?
 - a. ignites oil burner.
 - b. times of ignition.
 - c. starts oil burner.
 - d. stops oil burner.

6. Which of the following functions does the liquid immersion controller perform on a hydronic oil burner system?
 - a. gives time of ignition.
 - b. starts oil burner.
 - c. ignites oil burner.
 - d. stops oil burner.

7. Section 725-17 of the NEC calls for a special type of cable. Which of the following would meet this code?
- (NMC) non-metallic corrosion resistant.
 - (NM) non-metallic cable.
 - low energy safety control (LESC).
 - UF underground feeder.
8. What is the function of the safety shut off on a gas burner?
- works with the low voltage stage.
 - works with the thermostat.
 - works with the line voltage.
 - works with the pilot light.
9. A self-generating system must have which of the following?
- relay.
 - capacitor.
 - thermocoupler.
 - thermostat.
10. A unit that consists of several groups of two different kinds of metal in a furnace is called which of the following?
- thermostat.
 - limit switch.
 - relay.
 - thermocoupler.

LAP TEST ANSWER KEY: INSTALLING THERMOSTAT CONTROLS AND RELAYS

1. d
2. a
3. b
4. c
5. a
6. d
7. c
8. d
9. c
10. d

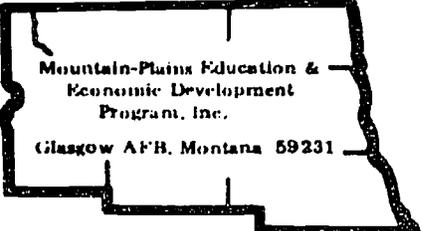

Mountain-Plains Education &
Economic Development
Program, Inc.
Glasgow AFB, Montana 59231

Learning Activity Package

Student: _____

Date: _____

PERFORMANCE ACTIVITY: Installing Thermocouples

OBJECTIVE:

Given the necessary tools, equipment, and supplies, correctly install a thermocouple according to: (1) manufacturer's specifications and (2) following procedures and practices accepted in the industry; and outlined in the reference text. Identify circuit characteristics for and functions of controlling circuit devices meeting National Electrical Code Standards.

EVALUATION PROCEDURE:

Installation meets the criteria listed on the attached checklist. Complete, score and return a ten-item multiple-choice test about this LAP. Successful completion is eight out of ten items.

RESOURCES:

Electrical Wiring, Ray C. Mullin, pp. 226-231.
Manufacturer's Specifications.

PROCEDURE:

1. Read the text, pp. 226-231 and answer the questions, pp. 229-231.
2. Go to your assigned work station where you will complete the activities listed in the objective.
3. Obtain the necessary tools, equipment and supplies needed to complete the operations listed.
4. Complete the job listed in the objective.
NOTE: FOLLOW SAFE PRACTICES AND PROCEDURES.
5. Perform all necessary testing and evaluation checks listed in the checklist. If you have any question or problems check with the instructor.
6. When you have been checked off on the checklist by the instructor, complete the data requested on your Performance Record and have him initial it.
7. Clean up the area.
8. Take the test for this LAP.
9. Score the LAP test and return it.
10. If the test is satisfactory, begin the next assigned LAP. If the test is unsatisfactory, proceed as directed by the instructor.

Principal Author(s): R. Arneson, L. Leland, T. Ziller

CHECKLIST: INSTALLING A THERMOCOUPLE

- 1. Proper selection and use of tools, equipment and supplies.
- 2. Safe practices and procedures followed.
- 3. Neat and presentable.
- 4. Meets or exceeds standards established in the industry.
- 5. Procedures followed are practiced and accepted in the industry.

;

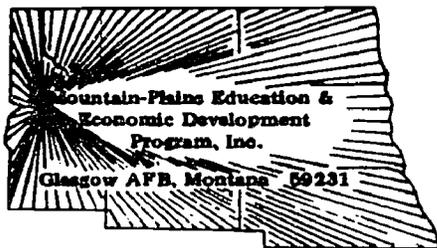

LAP TEST: INSTALLING THERMOCOUPLES

1. Which of the following burners requires a stack switch?
 - a. electric.
 - b. propane.
 - c. natural gas.
 - d. fuel oil.

2. Which of the following is easiest to wire?
 - a. oil burner (forced air).
 - b. hot water (forced).
 - c. gas fired (forced air).
 - d. self-generation.

3. A self-generating system must have which of the following?
 - a. relay.
 - b. thermocoupler.
 - c. thermostat.
 - d. capacitor.

4. Which of the following systems requires a circulating pump?
 - a. forced air.
 - b. hydronic.
 - c. forced feed.
 - d. gravity feed.

5. A gas-fired system that does not use an electrical supply is called which of the following?
 - a. gravity feed.
 - b. forced feed.
 - c. self-generating.
 - d. hydronic.

6. On most gas-fired furnaces the high limit control, the safety valve, and the gas valve are connected how?
 - a. parallel series.
 - b. series parallel.
 - c. parallel.
 - d. series.

7. What is the function of the safety shut off on a gas burner?
- works with the pilot light.
 - works with the thermostat.
 - works with the line voltage.
 - works with the low voltage stage.
8. Section 725=17 of the NEC calls for a special type of cable, which of the following would meet this code?
- (NMC) non-metallic corrosion resistant.
 - (NM) non-metallic cable.
 - low energy safety control (LESC).
 - UF underground feeder.
9. The device used on a gas-fired heating system to protect against no ignition is called?
- coupler.
 - stack switch.
 - safety shut off valve.
 - coupling switch.
10. A unit that consists of several groups of two different kinds of metal in a furnace is called which of the following?
- limit switch.
 - relay.
 - thermocoupler.
 - thermostat.

LAP TEST ANSWER KEY: INSTALLING THERMOCOUPLES

1. d
2. d
3. b
4. b
5. c
6. d
7. a
8. c
9. c
10. c

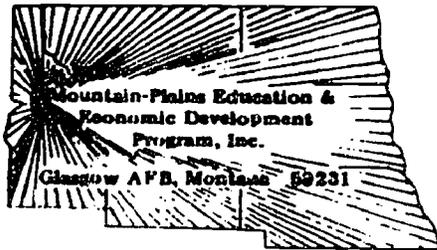

UNIT POST-TEST: MISCELLANEOUS

72.02.05.01.

1. When grounding a house, where ever possible it should be grounded to:
 - a. a 4' pole.
 - b. a 2' pile aster.
 - c. a 2' rod.
 - d. a 10' pipe.

2. Which of the following abbreviations stands for metal clad cable with plastic insulated conductors?
 - a. AC.
 - b. MT.
 - c. MCT.
 - d. ACT.

3. NMC cable must not be bent in a radius less than _____ its cable diameter.
 - a. five times.
 - b. twice.
 - c. three times.
 - d. four times.

4. With the exception of bell wiring and fixture wiring the insulation of most typical house wire is rated at:
 - a. 600 volts.
 - b. 800 volts.
 - c. 400 volts.
 - d. 200 volts.

5. The color code for 3-wire non-metallic cable is:
 - a. white-black-red.
 - b. yellow-black-white.
 - c. black-orange-red.
 - d. black-white-green.

72.02.05.02.

6. Most circuit breakers are made in such a way to contend with changing room temperatures. They are said to be which of the following?
- thermo couplers.
 - top rated.
 - thermo coupled.
 - ambient compensated.
7. If the service entrance comes in on the side of a house, what is the maximum distance it can run up the roof of the house?
- 5'
 - 4'
 - 2'
 - 3'
8. A time delay fuse protects the overload of a circuit up to what percentage of current overload?
- up to 500%
 - up to 100%
 - up to 400%
 - up to 300%
9. A transformer with a given kva rating and a low impedance rating delivers which of the following in relation to short circuit current of a transformer with a high impedance rating?
- low impedance more current.
 - low impedance less current.
 - high impedance more current.
 - all of the above.
10. In a circuit breaker, which of the following trips the circuit?
- capacitor.
 - bi-metallic strip.
 - rheostat.
 - thermostat.

72.02.05.03.

11. What type of walls are outside walls of the recreation room?
(See Plan)
- 2 x 2 fitted.
 - cinder block.
 - masonry.
 - concrete.
12. If a grounding wire enters and leaves a box, it is counted as how many wires?
- two.
 - one.
 - three.
 - four.
13. How many receptacles are on the circuit that the freezer in the utility room is plugged into?
- three.
 - one.
 - two.
 - four.
14. Where is the fan mounted?
- between joist.
 - between washer and dryer.
 - on the utility room wall.
 - between studs.
15. The freezer receptacle in the utility room is hooked to which circuit in panel B?
- 6.
 - 8.
 - 7.
 - 9.

72.02.05.04.

16. Where an underground service entrance comes out of the ground the duct or conduit must have which of the following done to it?
- be fastened to an auxilliary post.
 - be sealed.
 - be fastened to concrete.
 - be embedded in concrete.
17. What is the ampere rating of the service entrance in this house?
(See Specs)
- 150 amp.
 - 200 amp.
 - 250 amp.
 - 125 amp.
18. If the service entrance comes in at a 90 degree angle with the house on the side of the house and the mast is less than 9' from the edge of the roof length, what is the maximum required for mast length above the roof?
- 2'6"
 - 3'
 - 1'6"
 - 2'
19. What type of conductor is to be used in this house? (See Specs)
- RHW
 - RH
 - NMC
 - UF
20. Where is panel A located in this residence? (See Plan)
- storage room.
 - work shop.
 - recreation room.
 - utility room.

72.02.05.05.

21. Which of the following functions is not performed by the stack switch?
- stops oil burner.
 - times of ignition.
 - ignites oil burner.
 - starts oil burner.
22. What is the function of the safety shut off on a gas burner?
- works with the thermostat.
 - works with the low voltage stage.
 - works with the pilot light.
 - works with the line voltage.
23. Which of the following is easiest to wire?
- gas tired (forced air).
 - hot water (forced).
 - oil burner (forced air).
 - self generations.
24. A unit that consists of several groups of two different kinds of metal in a furnace is called which of the following?
- limit switch.
 - relay.
 - thermostat.
 - thermocoupler.
25. What piece of equipment does the thermostat on an oil burner control?
- stack switch.
 - circulator.
 - capacitor.
 - the relay.

72.02.05.06.

26. Which of the following is easiest to wire?
- self generations.
 - hot water (forced).
 - oil burner (forced air).
 - gas fired (forced air)
27. A self-generating system must have which of the following?
- capacitor.
 - thermostat.
 - relay.
 - thermocoupler.
28. What is the function of the safety shut off on a gas burner?
- works with the line voltage.
 - works with the thermostat.
 - works with the low voltage stage.
 - works with the pilot light.
29. Section 725-17 of the NEC calls for a special type of cable. Which of the following would meet this code?
- UF underground feeder.
 - (NM) non-metallic cable.
 - low energy safety control (LESC).
 - (NMC) non-metallic corrosion resistant.
30. A gas fired system that does not use an electrical supply is called which of the following?
- hydronic.
 - self generating.
 - gravity feed.
 - forced feed.

UNIT POST-TEST: MISCELLANEOUS

LAP

- | | | |
|----|-----|---|
| 01 | 1. | D |
| | 2. | D |
| | 3. | A |
| | 4. | A |
| | 5. | A |
| 02 | 6. | D |
| | 7. | B |
| | 8. | A |
| | 9. | A |
| | 10. | B |
| 03 | 11. | B |
| | 12. | B |
| | 13. | B |
| | 14. | A |
| | 15. | B |
| 04 | 16. | B |
| | 17. | B |
| | 18. | C |
| | 19. | A |
| | 20. | B |
| 05 | 21. | C |
| | 22. | C |
| | 23. | D |
| | 24. | C |
| | 25. | D |
| 06 | 26. | A |
| | 27. | D |
| | 28. | D |
| | 29. | C |
| | 30. | B |

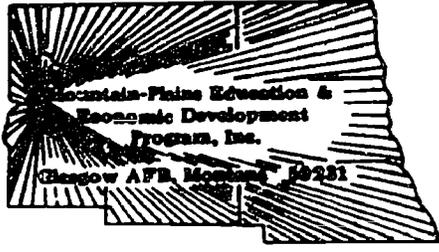

UNIT PERFORMANCE TEST: MISCELLANEOUS

OBJECTIVE 1:

Given a blueprint of a floor plan, and an electrically roughed-in wood frame construction, simulated or actual, the student will estimate the electrical control devices to be installed.

OBJECTIVE 2:

Given a blueprint of a floor plan and an electrically roughed-in wood frame construction, simulated or actual, the student will itemize the electrical control devices to be used in the installation.

OBJECTIVE 3:

Given a blueprint of a floor plan and an electrically roughed-in wood frame construction, simulated or actual, the student will install the electrical control devices.

TASK:

The student will complete a list of electrical control devices using blueprints and sketches. The student will obtain the electrical control devices from the storage room. The student will then install the electrical control devices according to the blueprint specifications and the National Electrical Code.

ASSIGNMENT:

CONDITIONS:

The student will be tested in a wood frame construction to simulate any specified room of a residence. The student will be given necessary tools and equipment. No assistance may be obtained from another student or the instructor or from unspecified text material.

RESOURCES:

Tools:

High leverage plier
High leverage oblique cutting plier
Long nose cutting plier
Electrician's hammer
Screwdriver slot 3/16 x 4
Screwdriver no. 2 phillips 8"
Screwdriver slot 3/16 x 9
Screwdriver 1/4 x 4
Screwdriver 1/4 x 6
Nutdriver variable size 1/4" x 7/16
Scratch awl
Adjustable Wrench size 8"
Pump plier size 10"
All-purpose tool, wire stripper, crimper and cutter
Tape rule 12' 3/4"
Knife, electricians
Tool pouch, 5 pocket

Equipment:

Simpson 260 VOM or Amprobe

Text:

Electrical Wiring Residential, Ray C. Mullin, Delmar Publishers, 4th Ed., 1973
National Electrical Code

ASSIGNMENT SHEET 1

KITCHEN

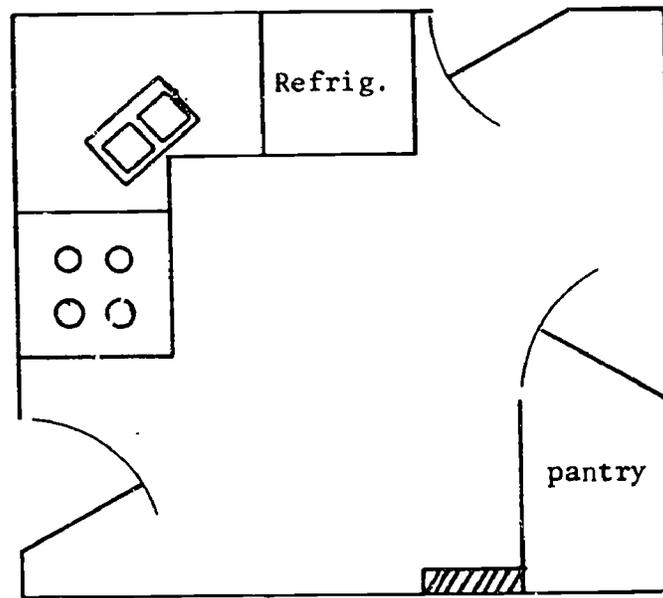

- garbage disposal
- pantry light
- light 2-position control

ASSIGNMENT SHEET 2

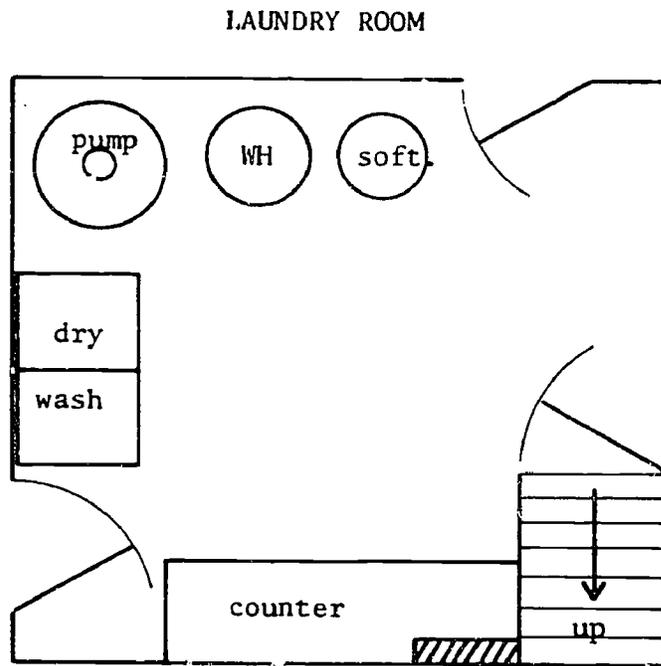

- sub-pump
- water heater
- water softener
- 3-position switch control

ASSIGNMENT SHEET 3

LIVING ROOM

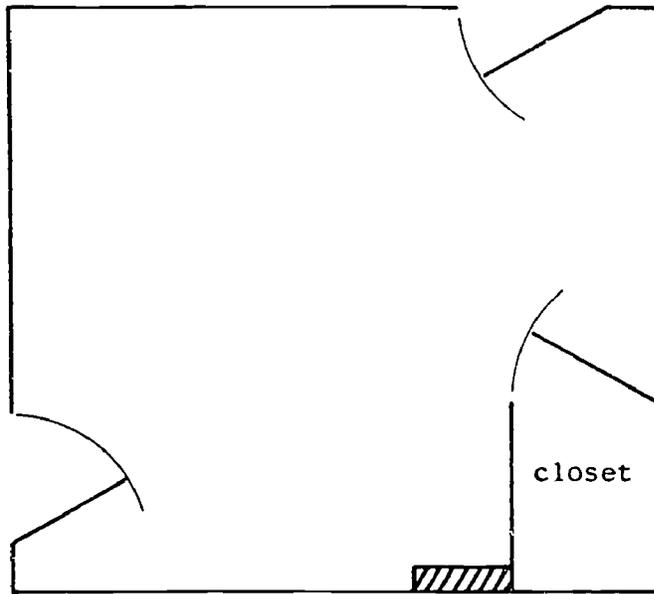

- electric heat
- split receptacles
- 2-position switch control

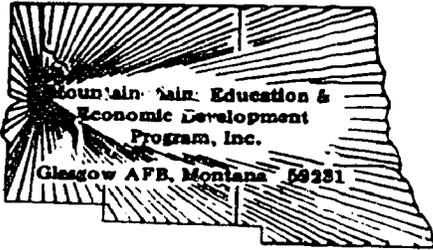

Family Pay Number: _____ Sex: M F (Circle 1)

PERFORMANCE CHECKLIST:

OVERALL PERFORMANCE: Satisfactory _____ Unsatisfactory _____

	CRITERION	
	Met	Not Met
Objective 1:		
1. The student determines the types of electrical control devices to be installed.		
2. The student determines the quantity of each electrical control device to be installed.		
3. The student itemizes each type and quantity of electrical control devices.		
Criterion: The physical and electrical dimensions meet National Electrical Code standards and blueprint specifications.		
Objective 2:		
4. The student obtains the electrical control devices to be installed from the electrical shop's storage room.		
Criterion: The electrical control devices will be used by the student for installation.		
Objective 3:		

(Checklist continued)

	CRITERION	
	Met	Not Met
5. The student strips the conductor's insulation with wire strippers to fit the electrical control device.		
6. The student bends the electrical wire to fit the connecting screw, when appropriate.		
7. The student connects the conductor to the screw, when appropriate.		
8. The student connects the conductors with wire nuts, when appropriate.		
9. The student connects the "hot" lead to appropriate connecting device on the control device.		
10. The student connects the "neutral" lead to appropriate connecting device on the control device.		
11. The student mechanically mounts the control device in the appropriate electrical control box with mounting screws.		
Criterion: The electrical control device installation meets National Electrical Standards and blueprint and manufacturer's specifications.		
12. Task completed in allotted time.		
Criterion: See assignment for time specifications.		

(Checklist continued)

CRITERION
Met Not Met

	Met	Not Met
Student must meet criterion on all line items to obtain an overall score of		
satisfactory,		