

DOCUMENT RESUME

ED 195 719

CE 027 260

AUTHOR Tinnell, Richard W., Ed.
 TITLE Continuing Education for Electrical Power Technicians. Final Report, June 1976-December 1978.
 INSTITUTION Oklahoma State Univ., Stillwater.
 SPONS AGENCY National Science Foundation, Washington, D.C.
 PUB DATE 78
 GRANT SED-76-18811
 NOTE 247p.; Photographs and some pages will not reproduce well.

EDRS PRICE MF01/PC10 Plus Postage.
 DESCRIPTORS Adults; *Continuing Education; *Curriculum Development; *Electricity; *Electronic Technicians; Engineering Technology; Industry; Inservice Education; Instructional Materials; *Mobile Laboratories; Off Campus Facilities; *Technical Education; Technology

ABSTRACT

The objective of this project was to develop and test a method of offering technical education to individuals employed in the electrical power industry. Representatives from industry were invited to an advisory council meeting where attention was focused on the needs of the industry. This information was used to define an extensive curriculum, and selected units were identified for implementation. It was decided that the method of presentation would consist of highly structured criteria-based units using sound-on-slide instruction. A significant part of the program was the use of a traveling laboratory housed in a 35-foot semi-trailer. The units were evaluated through pre- and post-testing and were revised. Once a unit was completed, a student text to accompany the unit was produced. Results of the field testing indicate that the project has been successful in meeting its objectives. Additional work in continuing education for particular areas is suggested. (Appended are the following units--Information Booklet, Introduction to Electric Distribution, Distribution Substations, Power Factor Improvement--a sample certificate, and a typescript for Distribution Substations.) (Author/KC)

 * Reproductions supplied by EDRS are the best that can be made *
 * from the original document. *

ED195719

CE 027 260

FINAL REPORT
GRANT NUMBER SED 76-18811
CONTINUING EDUCATION FOR ELECTRICAL
POWER TECHNICIANS

Perry R. McNeill
Project Director

Russell L. Heiserman
Co-Project Director

U S DEPARTMENT OF HEALTH,
EDUCATION & WELFARE
NATIONAL INSTITUTE OF
EDUCATION

THIS DOCUMENT HAS BEEN REPRO-
DUCED EXACTLY AS RECEIVED FROM
THE PERSON OR ORGANIZATION ORIGIN-
ATING IT. POINTS OF VIEW OR OPINIONS
STATED DO NOT NECESSARILY REPRESENT
OFFICIAL NATIONAL INSTITUTE OF
EDUCATION POSITION OR POLICY

FINAL REPORT

GRANT NUMBER SED 76-18811
CONTINUING EDUCATION FOR ELECTRICAL POWER TECHNICIANS

PRINCIPLE INVESTIGATOR: Perry R. McNeill, Professor and Chairman
of Electrical Engineering Technology, School of Technology, Division
of Engineering, Technology and Architecture, Oklahoma State University.

CO-PROJECT DIRECTOR: Russell L. Heiserman, Assistant Professor,
Electrical Engineering Technology, Division of Engineering, Technology
and Architecture, Oklahoma State University.

SUBMITTED TO: National Science Foundation

ACKNOWLEDGEMENT: The principal investigator and co-project director
gratefully acknowledge NSF for the financial support of this project.
Also we wish to acknowledge the outstanding effort of the project personnel.

PROJECT PERSONNEL: Mr. Jack Burson
Mr. Baily Hanes
Mr. Ken King
Mr. Bob Lager
Mr. Jim Shelton

DURATION OF PROJECT: June 1976 - December 1978

TABLE OF CONTENTS

Introduction..... 1
Planning and Organization..... 2
Implementation..... 8
Field Tests and Evaluations.....13
Public Relations Activity.....16
Results, Conclusions and Recommendations.....19

APPENDIX A

Information Booklet
Introduction to Electric Distribution
Distribution Substations
Power Factor Improvement
Certificate

PLANNING AND ORGANIZATION

N.S.F. notified Dr. Perry McNeill, project director, that the requested grant in continuing education had been funded starting in June, 1976. The first order of business was to organize. Organization was to be followed by planning, implementing the plan, and field testing concepts and products.

The organizational structure was as follows:

Dr. Perry R. McNeill, Project Director

Dr. Russell L. Heiserman, Co-Project Director

Dr. Richard W. Tinnell, Editor and Reviewer

Mr. Jack Burson, Technical Specialist

Mr. Bob Lager, Technical Materials Developer

Mr. James Shelton, Technical Specialist

Mr. Ken King, Technical Education Media Specialist

Secretarial support, as needed

Early duties of the staff were to contact industry and organize an advisory council, review the literature to find reports of effective methods employed in taking technical education off-campus, and to find and equip a suitable mobile laboratory.

The staff used an ERIC search technique with everbroadening discriptors in an attempt to find meaningful reports on successful techniques of taking technical education off-campus. With highly selective discriptors, no reports in the literature were found. At the point where the discriptors were broad enough to yield reports in the literature, the reports were too general to be useful to the project. The project would bring into existance something new.

The staff identified several mailing lists of appropriate industries that should be made aware of the project. Materials were developed and sent to 6000 individuals in industry. The materials were designed to gain information concerning perceived needs for continuing education in electric power and to identify those people willing to become directly involved in the project in a meaningful way. The yield from the mail-out brought three important results: (1) confirmation that an almost desperate need for continuing education in electric power and associated technical areas existed, (2) a list of fairly specific areas that needed the most immediate attention, (3) identification of a few people from industry that were willing to participate in the project in a meaningful way.

A select group of industrial representatives were invited to an advisory meeting held on campus November 18 and 19, 1976. Those in attendance besides the project staff were:

From Industry

Fred Adlam - Oil Industry
 Doug Bursey - Rural Cooperative
 Dick Culbertson - Federal REA Regional Engineer
 Bob Elliot - Rural Cooperative
 Charles Harvey - Urban and Industrial Utility
 Don Howland - Municipal Power Company
 Emmet King - Rural Cooperative
 Wayne Loafman - Rural Cooperative
 Chuck Snowden - Heavy Manufacturing
 Kenneth Thomas - Power Equipment Manufacturing
 J. W. Whitfield - Power Equipment Representative
 W. H. Wilson - Power Generation

Educational Material Specialist

Bill Kennedy - Safety and Job Training Specialist
 A. D. Matlock - Industrial Training Specialist
 Earl Smith - Industrial Training Curriculum Specialist

The Council members shared experiences, needs, and information on available resources. Attention focused on identifying areas of greatest need and in

detailing desirable content. The following is a summary of their recommendations.

Industrial End User Needs

There exists a need to up-grade those technical people in industry responsible for keeping plants in operation on a day-to-day basis. This training should cover:

- A. Magnetic motor starters
- B. Control relays
- C. Reversing starters
- D. Three-phase motors
- E. Applications of sensing devices such as:
 - 1. Thermostats
 - 2. Limit switches
 - 3. Liquid level indicators
- F. Transformers and connections
- G. Interpretation of one-line diagrams
 - 1. How to read
 - 2. How to implement (Use breadboards)
- H. Overview of principles of operation of all the above
- I. Integrate National Electric Safety Code as material is covered
- J. Instruments: selection and use as diagnostic tools
- K. SCR as a control device
- L. Use of capacitors for power factor correction
- M. Voltage surge protection and protection device coordination

It was felt by the industrial end users that the above material should be developed for at least two levels of presentation. One level would be for those working in the non-electric field such as the oil industry and a more advanced level for those now working in electric oriented industries.

Utility/Distribution Needs

Utility representatives identified two specific needs: one involving a large number of people at each installation and more basic materials, and one for highly technical material for few people at each installation.

Basic Needs

A visiting team or traveling lab seemed most appropriate for handling basic needs for many employees at each installation. It was recommended that

the material deal only with that part of the distribution system between the sub-station and the end user. It was also recommended that this system be studied at three levels of complexity:

- A. Single-phase systems
- B. Two-phase systems
- C. Three-phase systems

Each of the above levels of complexity would cover the following topics:

- A. Lines
- B. Transformers and transformer sizing
- C. Estimating user's load
- D. Protective device use and coordination (include fault current)
- E. National Electric Safety Code
- F. Use of instrumentation

This group felt that once these three levels of complexity were completed with their employees, it would be beneficial for them to also receive the instruction outlined by the industrial end users.

Advanced Needs

The advanced needs primarily for engineers and system planners would involve fewer people at each installation and therefore should not include a visiting team or van. It was felt that continuing education for this population would best be served through single subject, practical homestudy materials being prepared and made available on a regular basis, with two or three short, single subject workshops being held at a central location each year.

The idea was advanced that this service could be supported on a subscription basis, once developed and proven effective.

Some of the topics listed that would be of immediate use to this population were:

- A. Load studies
- B. Customer complaints - how to handle
- C. Surveying and staking lines
- D. Load management and peak shaving
- E. Voltage regulators
- F. Power factor correction
- G. Time of day metering
- H. Supervision and management
- I. Developing good communication skills
- J. Evaluating bids
- K. Engineering economics

The Council discussed teaching techniques that could be used with on-sight training. It was felt that a broad use of audio-visual techniques should be tried in determining a most effective delivery system. It was also proposed that if highly structured programs could be produced, then instructors could be found in industry rather than using university professors for these courses. Most felt that this peer approach to developing teachers would improve the chance of success of the Program.

7

During the planning and execution of the industrial advisory conference the staff were also locating a suitable mobile laboratory. A Fruehauf trailer was located through surplus properties and moved to campus. Preliminary planning of the generalized mobile laboratory was also undertaken.

By January 1977, planning and organization were complete. Also a key piece of hardware, the trailer, had been located, evaluated and moved to campus. The project was ready for the implementation phase.

IMPLEMENTATION

After the advisory council meeting, several tasks became defined:

(1) where and how to begin to fill the multiplicity of need cited by the advisory group? (2) What type audio-visual presentation would be most viable for preparing structured presentations? (3) Finalization of mobile laboratory specifications and then finding a way to rework the surplus trailer into the defined facility. These tasks were not dealt with in a serial fashion in real-time, but will be presented in a serial fashion in this report.

A detailed analysis was made of the needs expressed by the advisory council. It was determined that for the distributors of electric power an extensive curriculum could be defined as shown below. Implementation of the entire curriculum was beyond the scope of the project, but selected units within the curriculum could be implemented to test the effectiveness of the delivery system for taking this kind of education off-campus.

CURRICULUM FLOW CHART

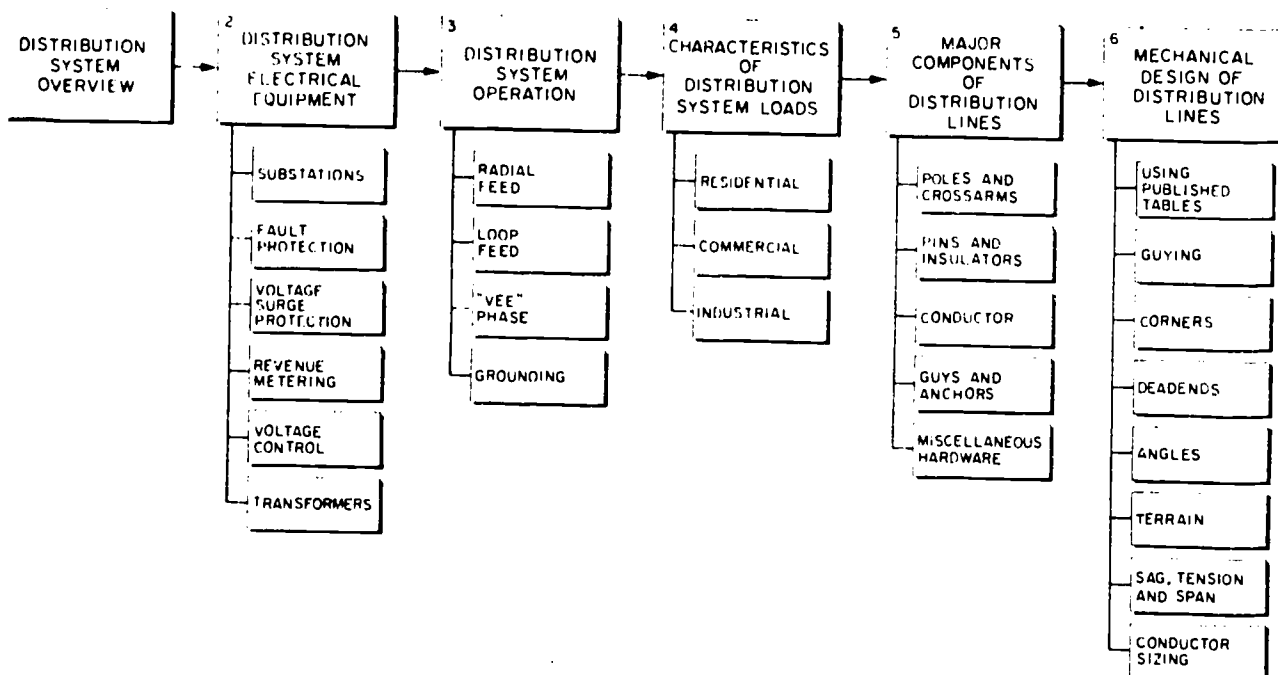

The development group felt that the "Distribution System Overview" module should be the key module to develop and field test. However, it was realized that this module would be instrumental in selling the whole concept and therefore it should reflect our most professional effort.

It was determined that the "substations" module would be relatively short and would include all the development problems that could be visualized. Therefore, this unit was selected for the initial effort that would sharpen development skills prior to attacking the "Distribution System Overview" module.

A review of audio-visual techniques included analyzing the cost-effectiveness of several systems, including: (1) video tape, (2) overhead transparencies, (3) slide-tape, and (4) sound-on-slide presentations. Video tape was discarded because of cost, requirement for specialized technical equipment and operators during production, and the probable necessity for professional actors in the series. Overhead transparencies were discarded because they tend to be dependent on the person making the presentation as to pace and depth of coverage of particular topics. Slide-tape presentations were selected as probably the best final package since an abundance of this type of equipment is in general use, and pace, sequence, and depth of coverage could be controlled. For the development phase, the sound-on-slide system was selected. This system appeared to offer distinct advantages in development in that 35 mm slides could be quickly and inexpensively acquired by moderately trained photographers and artist. The sound-on-slide presentation allowed only 30 seconds of verbal presentation per slide which would lead to strong editing of the voice script and probably improved the quality of presentation. The sound-on-slide system also allowed an easy method of trying material in

different sequences since moving the slide and slide holder moved both the visual and audio presentations.

Once the unit to be developed was selected and the method of presentation determined, work began on defining what the potential student should gain from the experience. These objectives were then translated into pre and post-tests to be administered during field testing to measure effectiveness of the experience.

The pre and post-tests tended to define the unit's content and emphasis. Once module definition was accomplished, a story board was prepared to more clearly define needed audio and visual information for the unit. The technical specialists supervised the preparation of slides for the unit, then edited and re-edited the verbal component to meet the 30 second requirement imposed by the system.

A prototype of the unit was presented to the technical-editor and reviewer representatives from the advisory council and other educational specialists. Their review comments and suggestions were followed in producing a second prototype unit for review.

After modest adjustment following the second review, work progressed in producing the final unit. This work included using a professional voice to record the verbal component and upgrading the quality of the slides. Once the unit was considered finalized, a student text consisting of an expanded story board of the unit was produced.

This finalized unit consisted of 76 sound-on-slide units, pre and post-tests, a student text and a live tour of a substation as the laboratory unit. This unit was ready for field testing.

While the "Substation" module awaited an opportunity for field testing, work began on the "Distribution System Overview" module. Techniques and experience gained in producing the "Substation" module were applied to producing the second module. However, a problem developed. The "Distribution System Overview" module would consist of several hundred slides and would require several hours of viewing time. It was felt that student exposure to the same voice using a descriptive mode of presentation would soon work against a presentation of such length. Two strategies emerged to counter this problem: (1) The use of two voices in a discussion mode that would place the viewer in the position of being an eavesdropper or member of a guided tour; (2) Breaking the presentation into a series of sub modules to allow class discussion and/or work on supporting investigations in the mobile laboratory. Subsequent review sessions supported the use of these techniques for holding student interest.

Paralleling the development of the two audio-visual units for primary use with electric power distribution companies was an effort to produce materials of a more technical nature for seminar presentation. The unit developed for this effort is titled "Power Factor Improvement". The unit was developed, reviewed and field tested before finalization. The seminar presentation using a trained professional also made use of the mobile laboratory for the laboratory portion of the presentation.

While development of the instructional modules were underway, requirements for the mobile laboratory were refined and finalized. The problem was then to bring a surplus trailer in rough condition up to the standards and expectations of development staff at a reasonable cost. Initial interaction with commercial

businesses suggested that few would be willing to accept the project and that the prices quoted by those who would consider the project were too high to be considered.

A solution was found by negotiating with Oklahoma State Tech, a post-high resident vocational school in Okmulgee, Oklahoma. It was determined that by using the rework of the trailer as student projects and assignments in many of the trade areas offered at Tech, the trailer could be reworked at a reasonable cost to the project. Once negotiations were complete the truck driver training department at the Area Vocational School in Drumright, Oklahoma transported the trailer from O.S.U. at Stillwater to Oklahoma State Tech.

Work began on the trailer soon after it arrived at Oklahoma State Tech. Delays in delivery of key items needed to refurbish the trailer and foul weather during the winter months delayed completion of the mobile laboratory and resulted in the request for a six month project extension from N.S.F. The trailer was finally completed and delivered to the O.S.U. campus where final preparations were completed during the spring of 1978 for field testing the instructional modules and mobile laboratory. The whole delivery system would be tested and modified during the summer months of 1978.

FIELD TESTS AND EVALUATIONS

Once the substation module was complete, the development group became interested in field testing the unit prior to completing work on the "Introduction to Electric Distribution" module. The first actual testing of the unit was with students on campus enrolled in Electrical Power Technology. On September 16, 1977 ten students were given a 20 question post-test. A total of 51 questions were missed on the pretest while only 11 questions were missed by the class on the post-test. This group of students also made many excellent suggestions regarding both the instructional module and testing program. Their suggestions improved the final product.

The second testing of this module occurred on December 8, 1977 as part of a lineman training program held at the Payne County Fairgrounds. The test group was made up of 27 linemen from 13 rural electric cooperatives and municipal electric companies. The students ranged in experience from less than one year in the field to several years of on-the-job service. The pretest--presentation--substation tour--post-test format was followed and yielded the following results:

Mean Score	<u>Pretest</u> 45.9%	<u>Post-test</u> 74.8%
------------	-------------------------	---------------------------

These results coupled with the favorable comments of the student group gave the development group confidence that the direction of development was correct and should be followed in subsequent modules being developed.

Work was completed on the "Introduction to Electric Distribution" module and the trailer completely equipped in late May, 1978. Preliminary field testing was arranged in Stillwater at the Municipal Building. Students were

from the small municipal electric power company and from the traffic control department. In addition to presenting the material to 5 students from the city, a peer teacher trainee was sent from Lindsay, Oklahoma to prepare for presenting the program in Lindsay in August, 1978.

During the week of June 18, 1978 these five students were pretested, given the several units of instruction, demonstrations, and laboratory work, and then post-tested with the following results:

	<u>Pretest</u>	<u>Post-test</u>
Mean Score	68.8%	89.6%

These results were encouraging, and again the students offered positive remarks concerning the quality and effectiveness of the module. It was interesting to the developers that even though attendance was completely voluntary, and the training was spread over three days--the student group had 100% attendance.

The second field test was carried out on July 18, 1978 in Blackwell, Oklahoma. We were asked to offer the program in one day rather than over an extended period as in Stillwater. The reason given was that this was the storm season and while men could be freed for one quiet day, there were no guarantees for people being available for two or three days. This group consisted of six students from the city of Blackwell municipal power company. Again, pretesting and post-testing were accomplished, with the presentation being forced into a more intense mode of a one-day presentation.

Results were:

	<u>Pretest</u>	<u>Post-test</u>
Mean	62%	77%

The third and final field test of the "Introduction to Electric Distribution" module was held in Lindsay, Oklahoma during the week ending August 18, 1978. During this field test, a large group of students (39) were used in the one-day presentation mode (13 students per day). In addition, the peer teacher, Mr. Delmar Payne, trained earlier in Stillwater presented the course. O.S.U. project staff members observed, and assisted in only minimal ways. A second or new pretest, post-test was developed and presented to part of the group to compare results to the previously used pretest, post-test. The results were as follows:

Pretest (old), N = 19:	mean 66.0%
Pretest (new), N = 20:	mean = 66.6%
Post-test (old), N = 20:	mean = 78.0%
Post-test (new), N = 19:	mean = 78.5%

In summary, there was little difference noted in using the new tests as compared to using the old or original tests. In every field test experience the group being presented the material improved.

While this field testing was underway, the "Power Factor Improvement" seminar materials had also undergone evaluation. In January, 1978, a seminar was held in Tulsa for plant maintenance supervisors of large manufacturing companies. Again the pretest-post-test technique was used with the following results:

	<u>Pretest</u>	<u>Post-test</u>
Mean	41.2%	68.8%

These results also indicate that materials developed through the project are effective.

PUBLIC RELATIONS ACTIVITY

Public relations activities started soon after notification that the project had been funded and has been maintained as an important aspect of the project. Initial P.R. activities were coordinated with the search for members to serve on the advisory council. Six thousand members of the power industry received an announcement of the new program complete with goals of the program and an offer to keep interested persons informed of the project progress.

The advisory council was also part of the public relations program as additional information was exchanged with members of industry. Council members were asked for additional persons in industry to be contacted about the project. Leads from this meeting led to two additional meetings, one in Oklahoma City and a second in Tulsa. Both of these meetings were with representatives of industrial plants with extensive in-house training programs and with representatives of the oil industry.

It was discovered that the oil industry has an extensive rig-site training need requiring materials similar to those that were implemented by the project. This need, however, is so vast that a separate proposal and project would be required to attempt to serve this industry.

Presentations were also made at three meetings of the Oklahoma Association of Electric Cooperative Engineers. Each presentation gave an update of activities and generated support for the program.

A slide-tape presentation was given at the regional meeting of the American Society of Engineering Education in March, 1977 in Fayetteville, Arkansas. Again, a great deal of interest was generated in the concept of a mobile laboratory for off-campus use.

During the course of the project, several presentations were made to the Municipal Electric Utilities Association and the Oklahoma Association of Electric Cooperatives. The latest presentation to these groups occurred in September, 1978, at both association's managers and supervisors meetings. This presentation included an exposure to the type of materials available and a tour of the mobile laboratory.

Additional coverage of the project throughout Oklahoma was made as part of a three-hour presentation on energy conservation principles and solar basics given at twenty locations across the state during June, 1977. These presentations were attended by an average of 25 individuals at each site. The attendees included representatives of utilities, building contractors and the general public.

A new up-dated slide-tape presentation was prepared and presented at the American Society of Engineering Education College/Industry Education Conference held in San Diego, California, January, 1978. This presentation was followed by a similar presentation at the Industrial and Technical Education Conference sponsored by McGraw-Hill Book Company and Wentworth Institute in Boston, Massachusetts in March 1978.

A similar presentation and tour of the mobile laboratory was part of the Industrial Evaluation Workshop held at Oklahoma State University in May, 1978 and at the Electric Power Technology Curriculum Dissemination Workshop held at Oklahoma State University in August, 1978.

In addition to the above activities, two other areas offered excellent opportunity for public relations. O.S.U. has a center for local government that helps small municipalities deal with technical problems. Our development

group cooperated with the center in training some of their people, helping them prepare technical presentations and in furnishing copies of the project's Information Booklet to interested participants.

The second area involves training Native Americans, informative materials have been supplied to the Council of Energy Resources Tribes. They have shown some interest in the mobile education concept for use at remote sites on Indian Reservations.

Each of the above activities have informed our many publics of the continuing education development activities at O.S.U. The number of requests for more detail information concerning the project led to the printing of the Information Booklet.

RESULTS, CONCLUSIONS AND RECOMMENDATIONS

The results of field testing the material indicate an improvement in each class's understanding of the material as indicated by pretesting and post-testing. An educational consultant in behavioral objectives helped prepare a second set of pretests and post-tests to determine if the test material was tied too closely to the material in the presentations.

The results of testing the revised pretest, post-test as compared to the original set of tests indicates essentially the same improvement in class understanding of the educational materials. It is felt that the pretesting and post-testing procedure used, yield a valid measure of the effectiveness of the materials developed and field tested.

The conclusions that the author draws from his experience with this project are as follows:

- (1) Highly structured audio visual materials can be developed to meet specific, defined needs for continuing education in technical subjects.
- (2) Peer teachers can be used effectively with highly structured audio visual materials with a minimum of teacher training.
- (3) A mobile laboratory is an essential aspect of a worthwhile technical continuing education effort if any meaningful laboratory component is required at a remote site. It is also felt that the mobile laboratory helps sell the program to industry.
- (4) The project has been a success for establishing the three principles outlined above. This success is further indicated by the activity

the mobile laboratory is enjoying. It is currently in use off-campus and is presently scheduled for eleven off-campus visits around the state between January and June of 1979.

Recommendations for further technical continuing education effort also come out the author's experience on this project and through interaction with the project's many publics. Additional work in continuing education should be funded in the following areas:

- (1) To develop materials for rig-site training of oil field personnel.
- (2) To develop additional materials appropriate for the general public in energy conservation practices for the homeowner and small business. This material should include discussions of cost effectiveness, various conservation strategies, and the use of alternate energy sources.
- (3) Materials covering microcomputers. These materials should be developed at both a basic--general level to inform decision makers and at a highly technical level for those that will be dealing with "smart" controllers throughout industry.

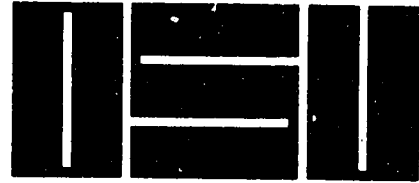
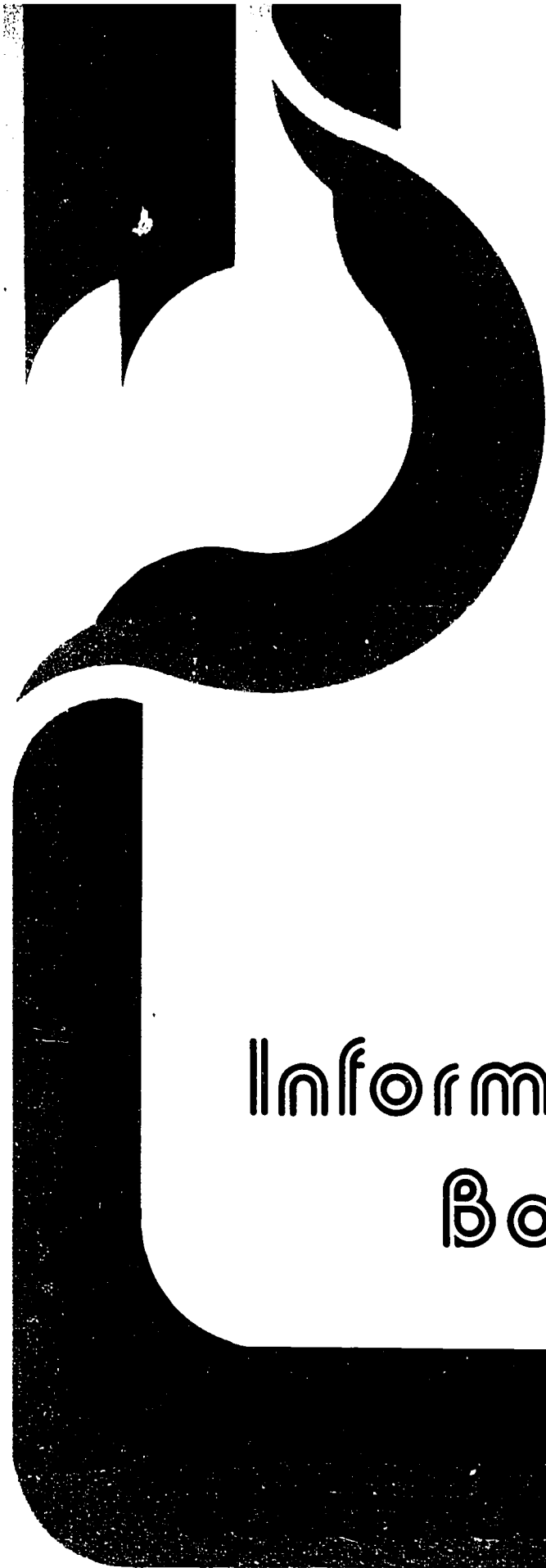

Information
Booklet

Preface

This booklet is intended as a brief information source for those persons interested in the continuing education effort in electric power being developed at Oklahoma State University. This booklet will attempt to inform the reader of the scope, level, and potential of this continuing education program. The reader can then judge how this educational component may be utilized to meet his particular educational needs.

The development work on this continuing education effort was supported through National Science Foundation grant number SED 76-18811. Oklahoma State University was awarded this grant based on a proposal submitted to NSF and because of the successful conclusion of a related on-campus curriculum project to educate electric power technologists.

The proposal initiated at OSU was based on a need expressed by Oklahoma industry. The actual proposal included a number of letters from Oklahoma industrialists citing the need to develop more off-campus programs to help in technical personnel development in a world of changing technology.

Oklahoma State University has traditionally worked with Oklahoma industry through continuing education courses in the following technologies: Business, Construction, Design, Electronics, Health Physics, Mechanical, Petroleum, Radiation, Safety and allied fields. Present delivery systems include semester long credit courses and special single topic seminars. Oklahoma State University has also worked with industry in developing and establishing custom programs to meet specific objectives of in-plant continuing education. These have been offered in a variety of formats from one day programs to complete degree programs spanning several years.



The goals of the electric power continuing education project are to develop and test a method of effectively offering technical education at off-campus locations. A significant component in this program is a traveling laboratory. This laboratory allows on-site use of educationally integrated laboratory work — the hallmark of quality technical education.

The mobile lab is housed in a thirty-five foot semi-trailer with complete environmental conditioning and pleasant furnishings to aid the learning process. The trailer can tow its own power supply so that it may be used at sites without electric power available.

Several library literature searches were made to discover the most effective delivery systems that have been developed for off-campus technical education. The searches revealed no meaningful studies or systems shown to be effective.

The development group at this point opted to develop criteria-based instructional units using highly structured presentations to meet these established criteria. The structuring was accomplished through the use of sound-on-slide instruction units that are content specific.

The effectiveness of these materials is to be measured through pre-testing and post-testing the participants during the field evaluation phase.

The units developed for the evaluation phase were selected after an industrial advisory council meeting where topic areas were identified and prioritized by members of industry. Specific attention was directed towards not duplicating any of the existing programs already in use, such as the Oklahoma Job Training and Safety program and the Oklahoma State Dept. of Vocational and Technical Education's Power Line Technician's Training program.

Introduction

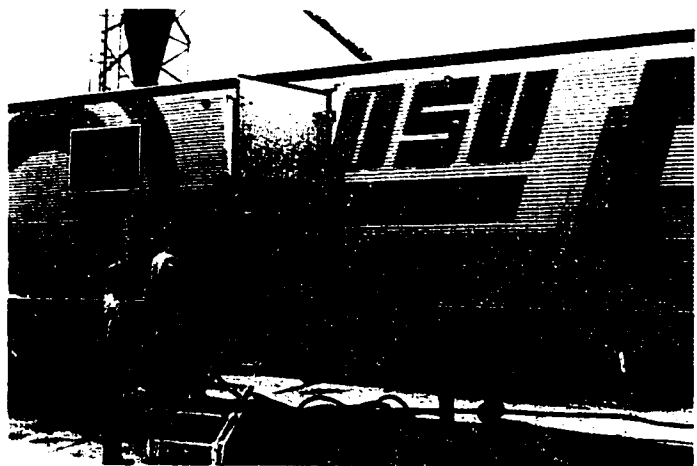

Planning

Planning was begun by forming an on-campus staff and organizing an advisory council to supply ideas and define needs. The on-campus staff consists of:

Dr. Perry R. McNeill, *Director*
Dr. Russell L. Heiserman, *Associate Director*
Mr. Robert Lager, *Technical Specialist*
Mr. Kenneth King, *Materials Development*
Secretarial support as required

In November, 1976, the advisory council was formed and met for two days on the OSU campus. The advisory council represented different aspects of Oklahoma's electric power industry. The attendees at the council meeting were:

Mr. Fred Adlam - *Noble Drilling Corporation - Tulsa*
Mr. Doug Bursey - *People's Electric Cooperative - Ada*
Mr. Dick Culbertson - *Federal REA Regional Field Engineer - Crescent*
Mr. Bob Elliot - *Caddo Electric Cooperative - Binger*
Mr. Charles Harvey - *Public Service Company - Tulsa*
Mr. Don Howland - *Duncan Power and Light - Duncan*
Mr. Emmett King - *Cotton Electric Cooperative - Walters*
Mr. Wayne Loafman - *Rural Electric Cooperative - Lindsay*
Mr. Chuck Snowden - *Oklahoma Steel Castings - Tulsa*
Mr. Kenneth Thomas - *Electric Specialties - Tulsa*
Mr. J. W. Whitfield - *General Electric Co. - Oklahoma City*
Mr. W. H. Wilson - *Grand River Dam Authority - Pryor*

Note: Mr. Bill Kennedy is an informal member of the development staff and member of the advisory council. He helped coordinate the work of this group with the Rural Electric Apprentice Training program to insure that materials are a complementary rather than a duplicating effort.

The advisory council quickly identified two specific groups with a need for technical continuing education. These were:

1. Technical maintenance people within industrial plants.
2. Technical employees in service or utility companies.

The advisory council also identified topic areas that need attention.

It was agreed that the concept of a mobile labora-



tory would lend strength to off-campus continuing education as opposed to lecture only or lecture with demonstration, or make-do laboratory work methods.

The advisory group suggested that materials be organized and structured to allow teaching by other than university professionals. It was felt that in many cases a local, respected supervisor could be more effective than an unknown instructor. The advisory group felt that attractive incentives should be developed, but that college credit was not a particularly attractive incentive for most of the students.

The development staff was further advised by the council to keep aware of other developing programs, such as the Lireman Apprentice program, so that materials would complement rather than duplicate other efforts.

At the conclusion of the advisory conference, work began on identifying the educational modules to be developed and reviewing various delivery systems that would allow easy assimilation of complex material. Also, negotiations began on getting the traveling trailer, mobile laboratory reworked at Oklahoma State University School of Technical Training at Okmulgee.

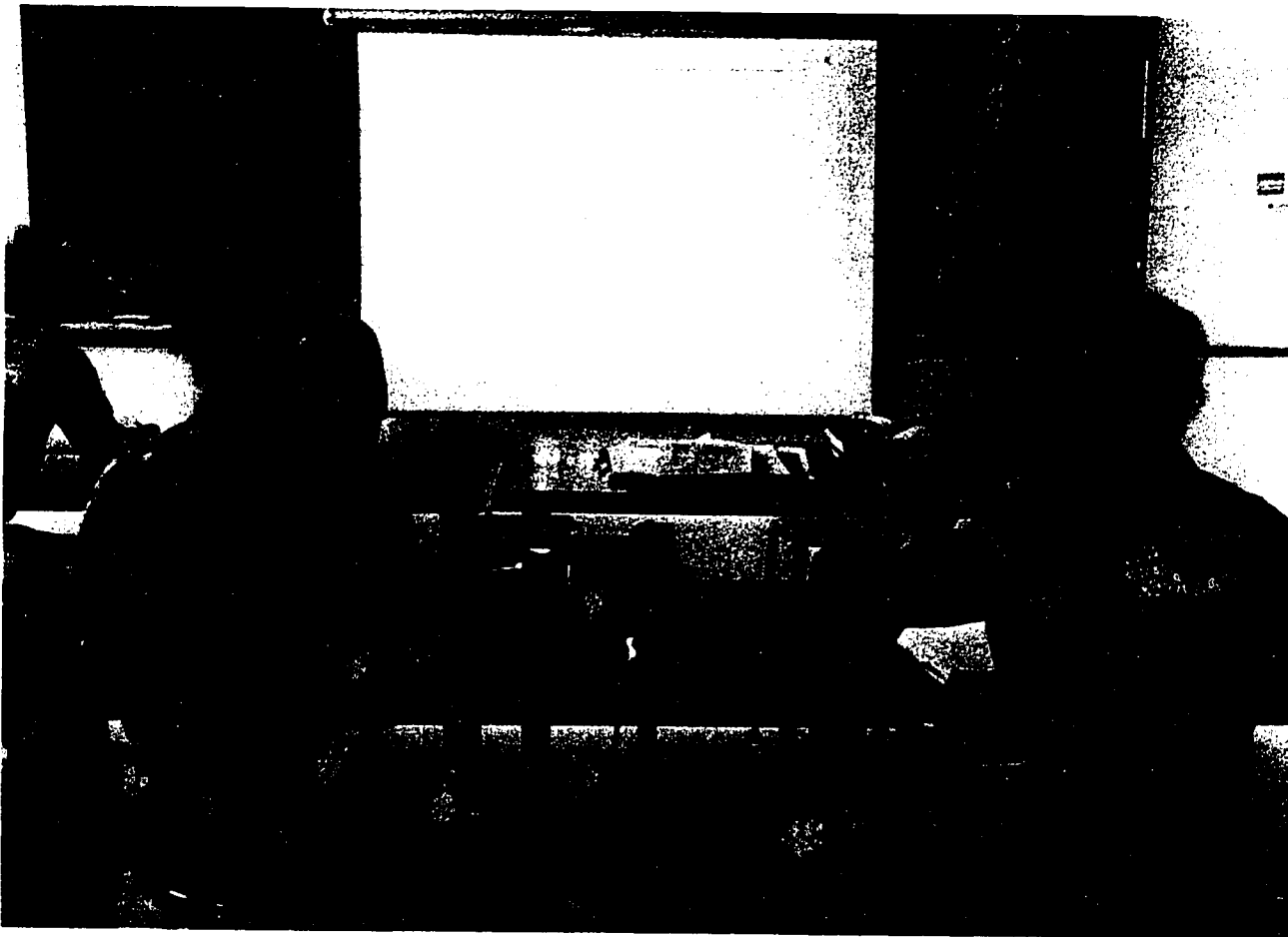

Materials Development

The materials development proceeded along definite lines by detailed evaluation of various delivery systems. The procedure was to:

- (1) identify specific topics to be developed as modules.
- (2) define objectives of each module.
- (3) define criteria for determining if objectives had been achieved.
- (4) develop pre and post tests to measure effectiveness of materials and aid in determining if objectives had been achieved.

The objectives of each module define the contents of the module and level of coverage. Topic sequencing and redundancy of content was dictated by accepted learning strategy and multiple review of each unit by educational specialists.

In general, each distribution electrical component is introduced with a picture of a typical unit. It is then shown in symbolic form and lastly shown symbolically in a typical location on a system. One line diagrams are introduced as the material requires their use.

It was felt that an overview of a complete distribution system from substation to load would be worthwhile to emphasize how components and sub-systems make up the network. Since this overview could become tedious, it was decided to use a female voice in dialogue to make the material more interesting. The viewer is thus eavesdropping on a conversation between two people touring and discussing the complete system. Reviews indicate that this device has achieved the desired effect.



CURRICULUM FLOW CHART

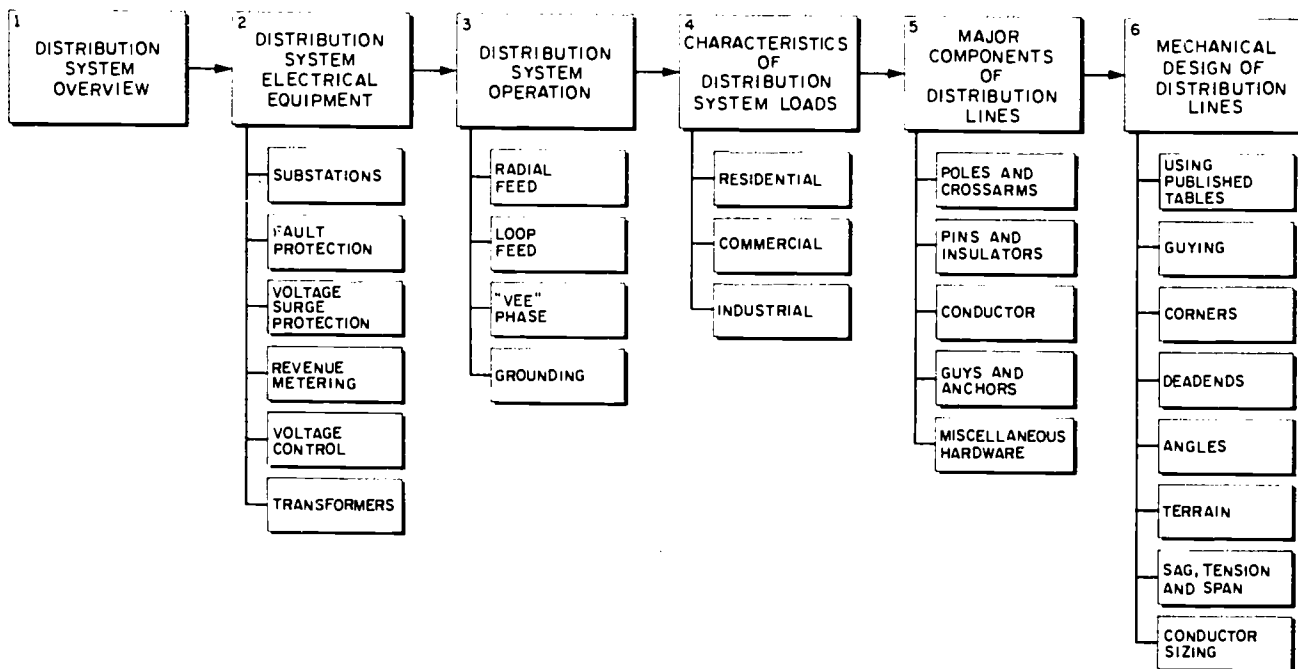

The Distribution Substation is typical of the units that could be developed from the major elements of study in an overall distribution system. The unit covers the essential functions of a substation, the non-essential functions and those functions often physically located in a substation yard without actually being part of the distribution substation.

The Distribution Substation unit begins with a pre-test for students, a student text and several trays of sound-on-slides. Following the sound-on-slide presentation is the laboratory exercise. For the Distribution Substation unit, this consists of a guided tour through a real distribution substation. The goal of this tour is to show the students that the pieces that make up a substation are actually organized in a specific way to perform certain desired jobs.

After the lab exercise, the students are given a post-test to evaluate the immediate effectiveness of the unit.

All through the unit, emphasis is placed on function, organization and relation of actual components to symbols in a one-line diagram. Care has been taken to insure that the familiar aspects of a substation that may be part of the student's background are used to bridge from the physical to the symbolic as represented by one-line presentations. In this way, the unit complements other training efforts that the student has been through.

Typical Unit

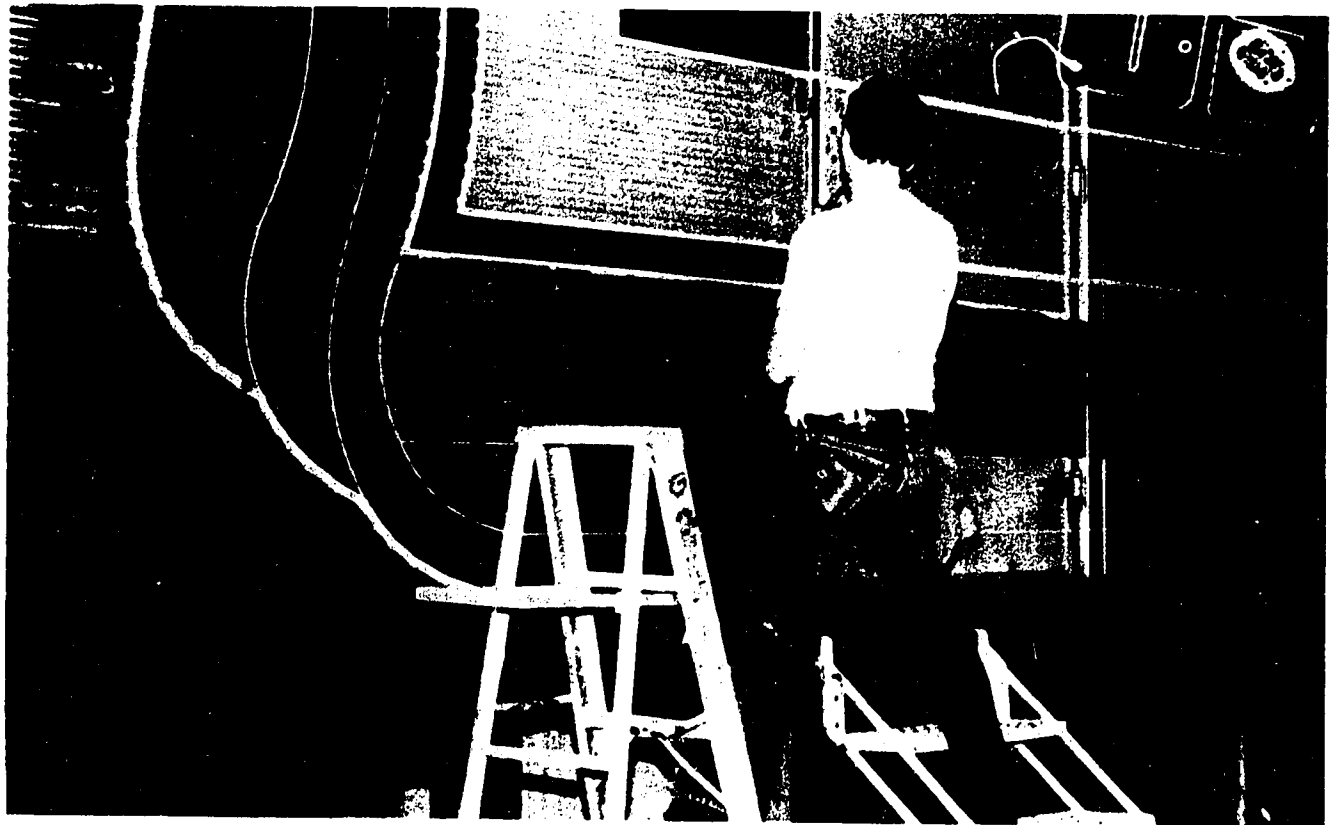
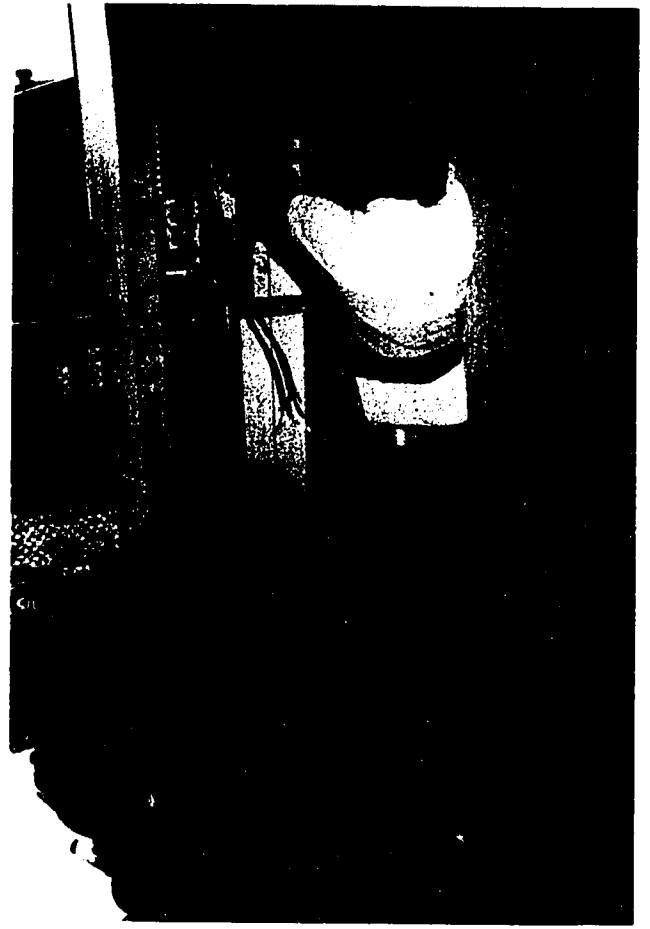

The need for a traveling laboratory was recognized by the Industrial Advisory Council and the OSU development group was encouraged to develop this unique training component. "Hands-on" is the necessary ingredient often missing from off-campus continuing education in technical subjects.

The trailer obtained was a 35-foot surplus unit in less than desirable shape. The students and staff at OSU School of Technical Training at Okmulgee undertook the difficult task of transforming the ugly duckling into a first class educational tool. The results were astounding.

The unit can accommodate from twelve to sixteen students at two-man lab stations in attractive air-conditioned or heated space. Lighting in the trailer has been devised to give a broad range of lighting levels as required.

The trailer electrical system is 208Y/120 volts with a maximum capacity of 100 amps and can be monitored to become part of the laboratory experience in demonstrating the relationship between volts, amps, watts and VAR's. Power Factor Improvement can also be demonstrated using the trailer's actual electric system.

Ideally the trailer can connect to existing electric service when at remote sites. However, to insure that this feature does not limit the application of the mobile laboratory, a portable diesel generator is being acquired that can be towed to remote sites and furnish the power required.

Traveling Laboratory

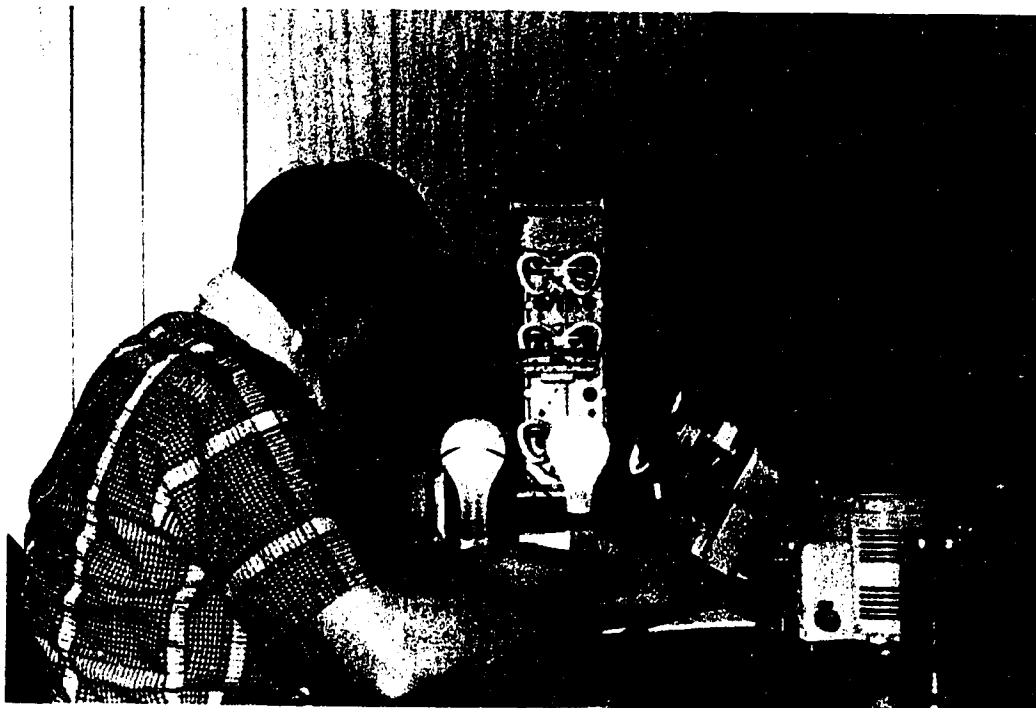

On The Road

The mobile laboratory and two units of instruction are in the field-test phase. This important period of development determines how well the instructional components work together to get results. It also determines how this form of education is accepted by students in the field. All costs to students and employers are absorbed by the project during the field-test phase. After the testing phase, costs for the service will be charged to users on a break-even basis.

It is important that Oklahoma industry support the concept of making the state our campus. Continuing education will become an increasingly important form of education as technology makes rapid changes and energy becomes a managed resource.

Oklahoma State University will be better able to supply educational assistance to Oklahoma Industry if close cooperation is maintained and expenses shared to develop needed programs. This close cooperation is a significant challenge to both industry and education as Oklahoma accelerates its development during the last two decades of this century.



Electric Power Continuing Education Advisory Committee

Mr. Fred Adlam - *Noble Drilling Corporation - Tulsa*
Mr. Doug Burse - *People's Electric Cooperative - Ada*
Mr. Dick Culbertson - *Federal REA Regional Field Engineer - Crescent*
Mr. Bob Elliot - *Caddo Electric Cooperative - Binger*
Mr. Charles Harvey - *Public Service Company - Tulsa*
Mr. Don Howland - *Duncan Power and Light - Duncan*
Mr. Emmett King - *Cotton Electric Cooperative - Walters*
Mr. Wayne Loafman - *Rural Electric Cooperative - Lindsay*
Mr. Chuck Snowden - *Oklahoma Steel Castings - Tulsa*
Mr. Kenneth Thomas - *Electric Specialties - Tulsa*
Mr. J. W. Whitfield - *General Electric Co. - Oklahoma City*
Mr. W. H. Wilson - *Grand River Dam Authority - Pryor*

This publication prepared by
Russell L. Heiserman
Electrical Power Technology Department
School of Technology
Oklahoma State University
Stillwater, Oklahoma 74074
1978

As part of National Science Foundation Grant SED 76-18811
Continuing Education for Electrical Power Technicians

Robert J. Lager, Photographic Specialist

Permission is granted to duplicate any part or all of this publication for educational purposes.

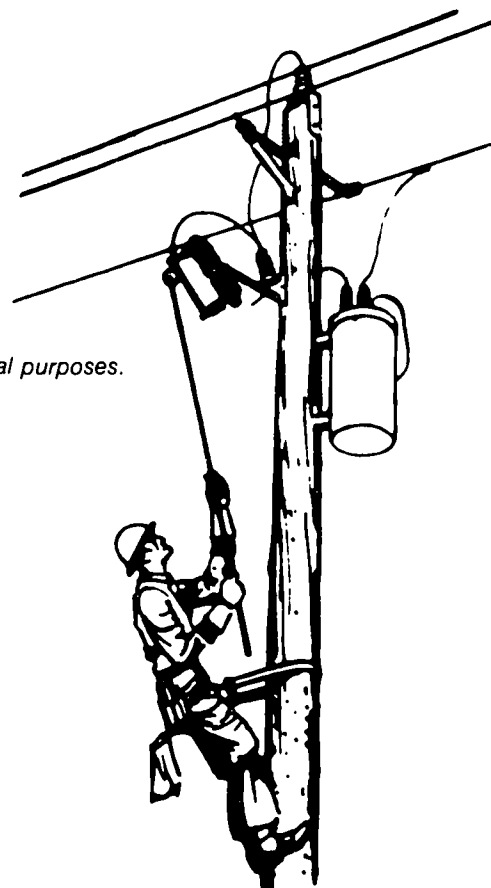

**Electric Power Technology 207 CR
Oklahoma State University
Stillwater, Oklahoma 74074**

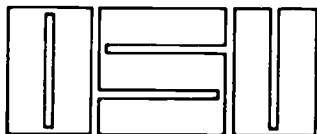

The State Is Our Campus

34

Phone (405) 624-5720

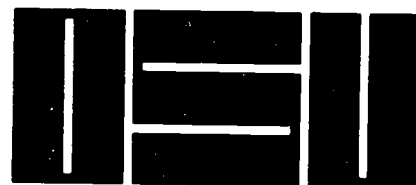

Introduction to Electric Distribution

Table of Contents

Distribution Lines	2
Fuses	6
Reclosers	8
Line Switches	14
Lightning Arresters	20
Transformers	26
Autotransformers	32
Voltage Regulators	35
Capacitors	41
Meters	48
Glossary	60
Laboratory Procedures	70

Introduction to Electric Distribution

This publication prepared by
R. Kenneth King and Robert J. Lager
Electrical Power Technology Department
School of Technology
Oklahoma State University
Stillwater, Oklahoma 74074
1978

As part of National Science Foundation Grant SED 76-18811
Continuing Education for Electrical Power Technicians

Bailey F. Hanes, Educational Program Consultant

Permission is granted to duplicate any part or all of this publication for educational purposes.

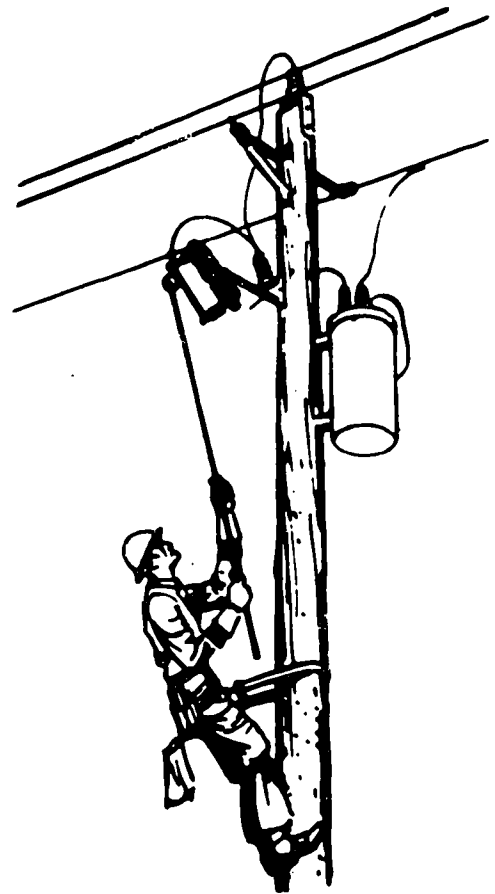

Distribution Lines

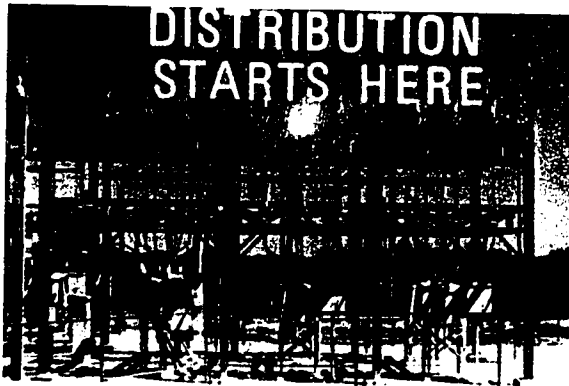

The substation is usually considered the beginning of the distribution system.

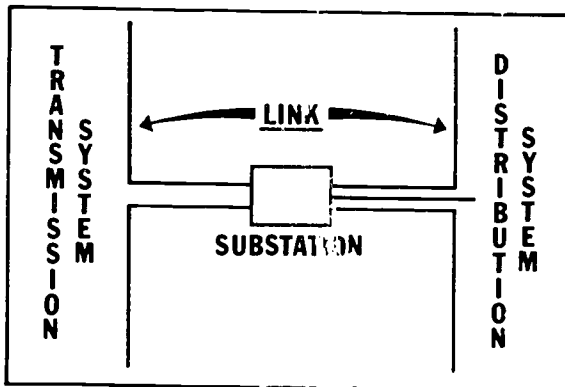

The substation ties the transmission system from which the power company obtains bulk power to the distribution lines that spread the power to the consumers.

Three Essential Functions

1. Voltage Change
2. Disconnect Station
3. Protection From Distribution System

A substation performs several functions to fulfill its purpose as a link between the transmission system and the distribution system. The *essential functions* in providing this link are: *voltage change*, *disconnecting the station from the transmission system*, and *protecting the station from the distribution system*.

In this substation, the equipment that performs these functions can be seen: the disconnect switch that is used to de-energize the station when necessary, the transformer that provides the change in voltage, and the reclosers that protect the station from the distribution system.

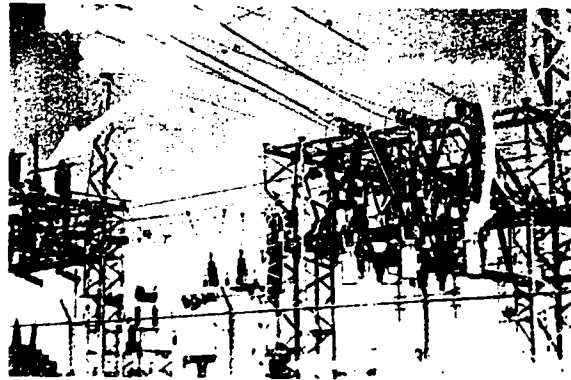

Each of these pole lines leaving the substation carries a complete distribution circuit.

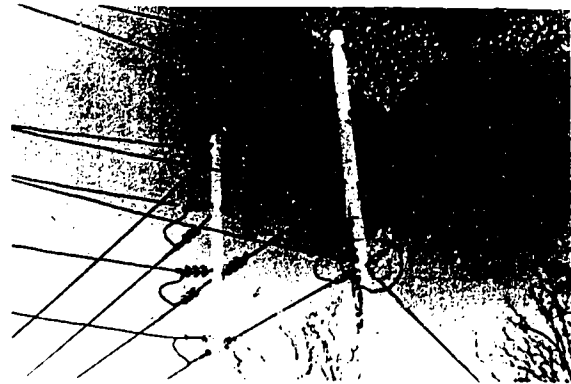

The circuits leaving the substation are *three-phase circuits*. There are three wires supplying power and one returning it, instead of *only* one supply wire and one return wire as in single-phase circuits in houses.

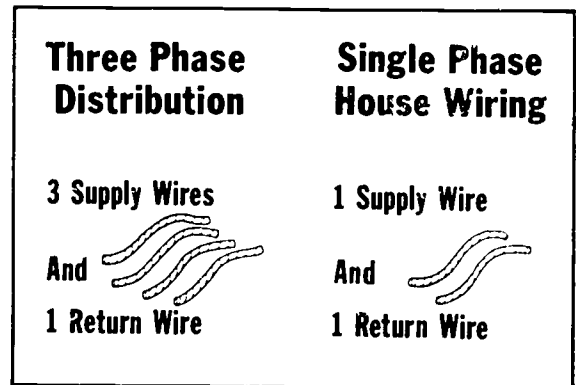

Some of the characteristics of three-phase power are pretty complex, so for right now think of that three-phase line as three separate single-phase lines, but all sharing a common return wire. The common return wire is mounted on the side of the pole by itself and is called the *neutral*. It is electrically connected to the white return wires in housing wiring.

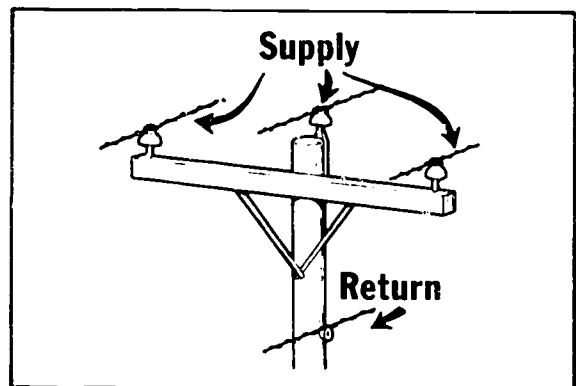

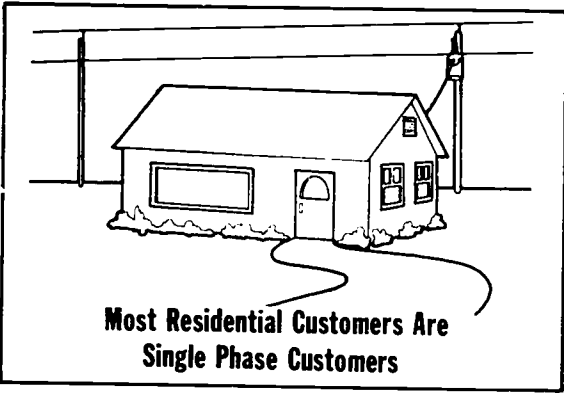

With very rare exceptions, all residential customers are single-phase. However, there are advantages to a three-phase power system over a single-phase system. These advantages have to do with the construction and operation of electric motors and the economics of transmission over long distances.

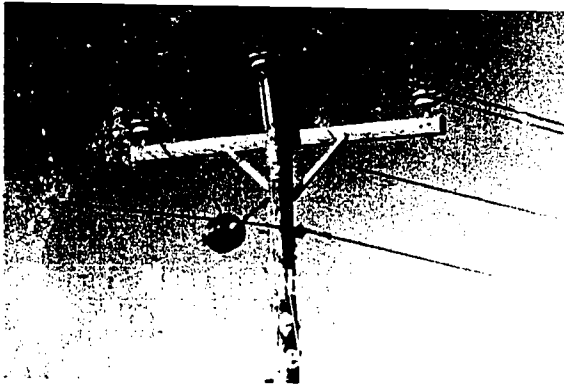

Most distribution lines are single-phase taps from the three-phase feeders, or circuits. These taps consist of *one* of the three supply wires from the main feeder and the neutral.

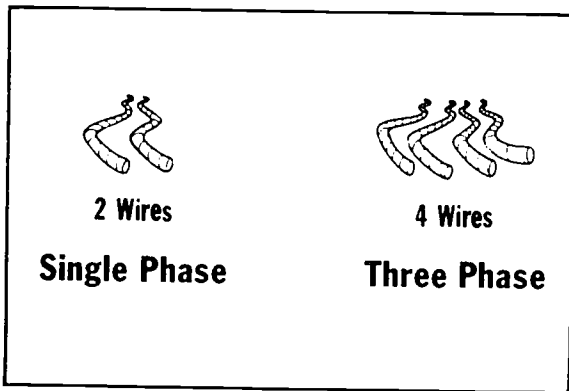

It is generally easier to learn about distribution systems by ignoring the three-phase parts until later, and concentrating on the single-phase relations, since there are only half as many wires to worry about.

Probably the most obvious items that go into a distribution system are the poles, conductors, and other hardware. It might seem that it's easy enough to stick a bunch of poles in the ground and drape some wire over them, but a well designed and built line has a great deal more thought put into it than that.



For example, the proper size wire must be chosen. Not only does the wire have to be big enough to carry today's load economically, it has to be big enough to allow for some growth. Whether to build a line with lots of room for growth, or build one with only a little room for growth and plan on building more lines later, is one of the decisions the engineer must make.

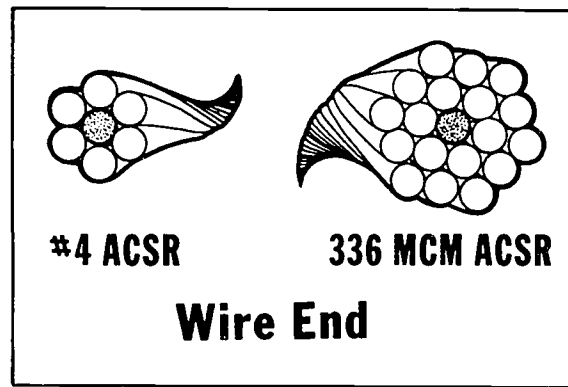

Of course, the wire size chosen affects the entire mechanical design of the line, including span lengths, pole size, guying and anchoring, conductor hardware, and crossarm size. The terrain has a big effect on all these things, too!



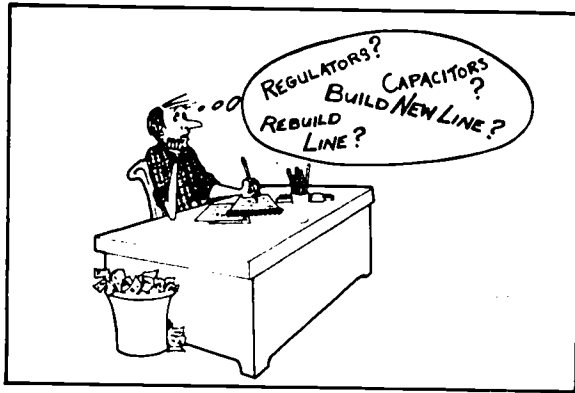

In addition, the engineer must consider the electrical design of a line and the economics of various designs as well as the mechanical aspect. So even before a line is built, a lot of planning goes into it.

Fuses

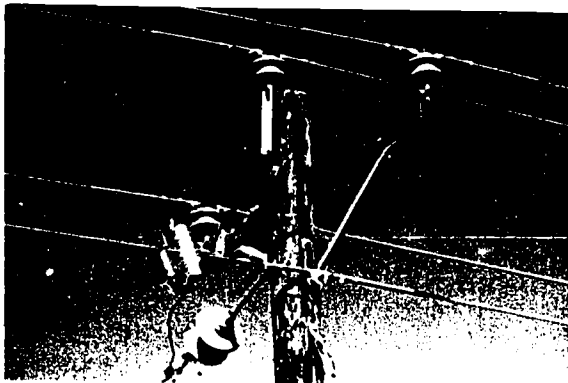

This pole has a single-phase tap from the three-phase main line. Notice the device on the crossarm near the insulator at the left end of the arm. That is a *cutout*, which is nothing more than a fuseholder. When too much current flows through the fuse, it gets hot and melts the link, thus opening the circuit.

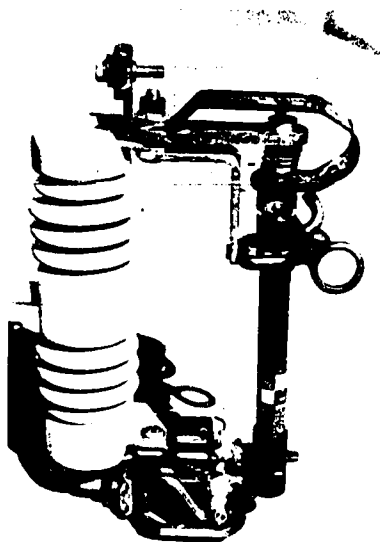

The type of *cutout* used here is called an *open cutout*, since all the parts are out in the open. The small tube, supported by the two metal arms, is the fuseholder or fuse barrel and holds a replaceable fuse link. When too much current flows through the fuse, it melts the link inside the fuseholder, which produces an electric arc and heat. The heat boils off some of the tube material and helps snuff out the arc.

The barrel is spring loaded, so that after the fuse melts, the barrel swings down and hangs from the lower arm. That indicates the fuse has blown.

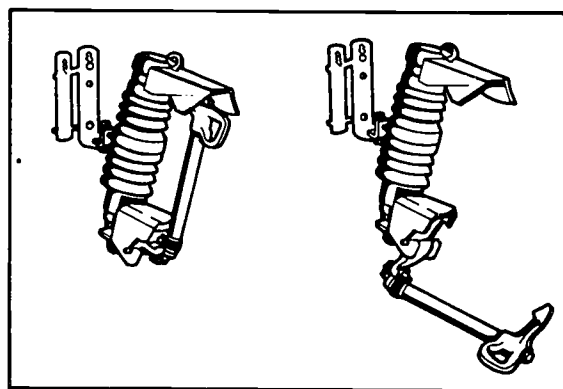

Lots of electrical equipment is fused, including power systems. If there is a fault—a short circuit—on that tap, then that fuse should blow and disconnect the tap from the main line *before* any damage is done to any part of the system, or before another fuse or breaker somewhere else opens. This keeps the number of consumers without power down to a minimum.

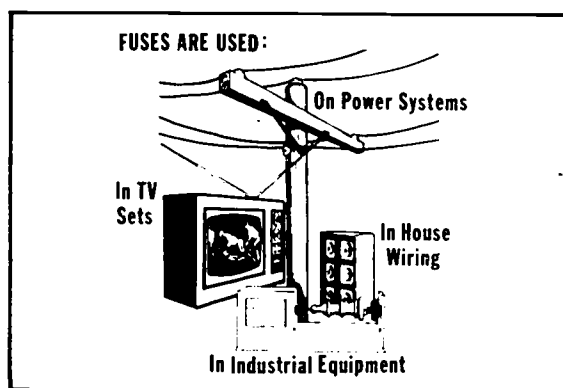

It also makes finding the cause of the problem much easier, since it has got to be on the portion of the line that is off. This saves a lot of time that would otherwise be spent looking at miles of line trying to find the trouble, and that can make a lot of difference to a lineman on a trouble call on a cold, rainy night.

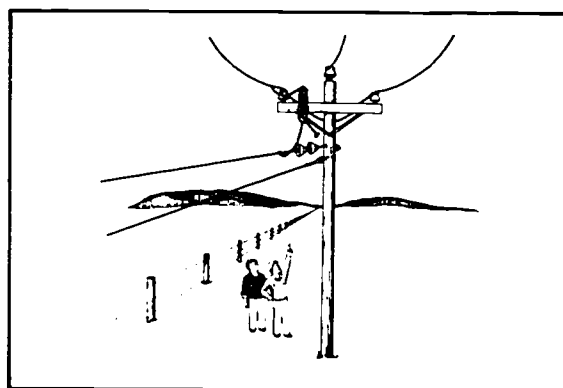

Reclosers

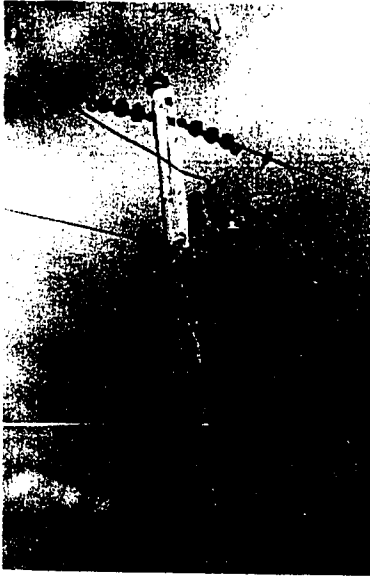

An *oil circuit recloser* is an important device used on distribution systems. It is often referred to simply as a recloser or by its abbreviation, OCR.

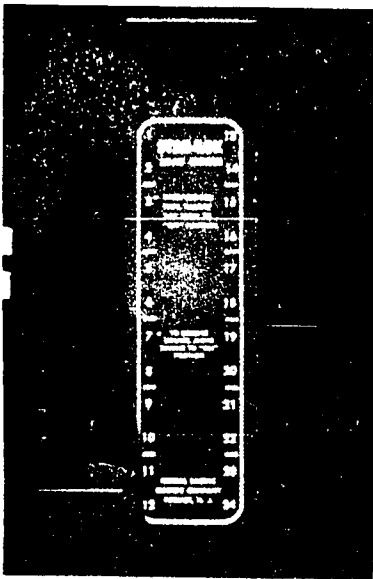

A recloser is used to protect the system against short circuits on the lines, much like a circuit breaker in the electric panel in a house. It disconnects power from a line when a short circuit, or *fault*, is on it.

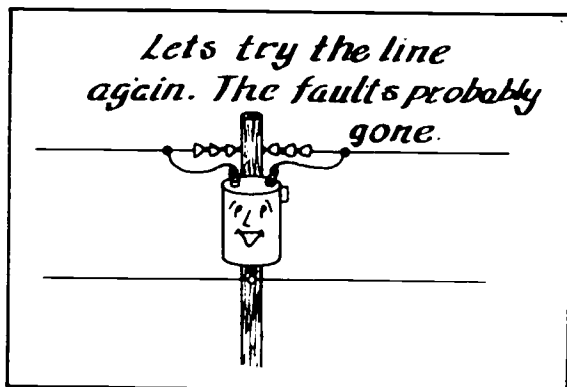

About 70% to 80% of all the faults on a distribution system are temporary. Once they're gone, or cleared, the line can be reconnected. The OCR is able to do this.

If the fault is still on the line when the recloser turns the power back on, the recloser will open the line again, wait a short time, and try to again turn the power on, or *re-energize*, the line. After a limited number of tries, the recloser will not re-energize the line, but it *locks out*. This leaves the line dead. A fault that causes a recloser to lock out is a *permanent* fault.

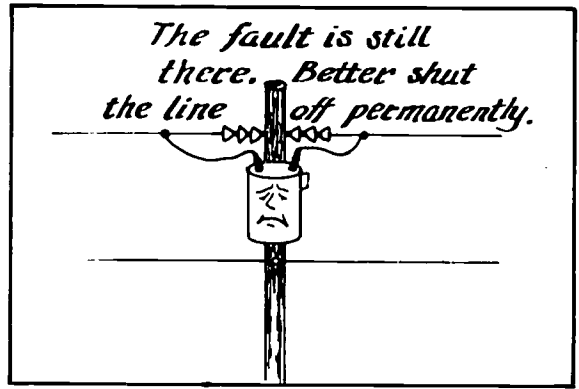

Fuses and OCR's are used together on a distribution system.

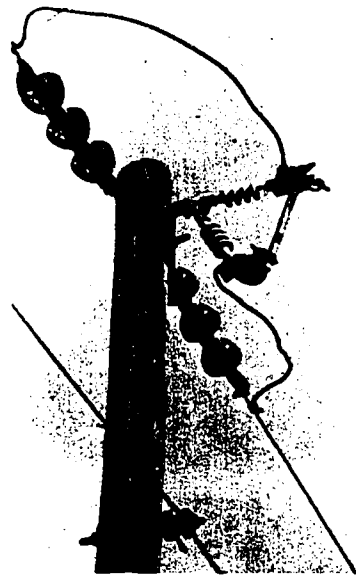

Assume a three-phase line with recloser protection on each phase and a long single phase tap connected to it as shown.

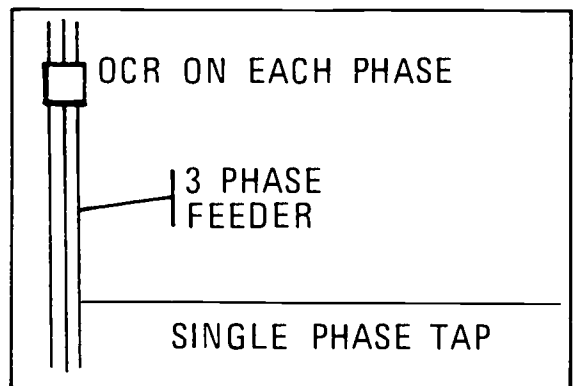

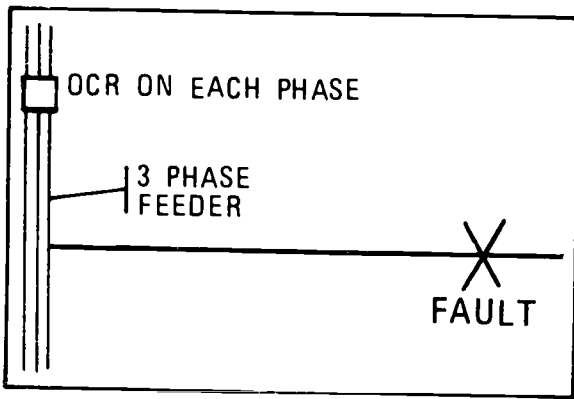

Now suppose a permanent fault happens at the end of the single-phase line. The recloser will sense it and open the line. It will then try to re-energize the line several times. Since the fault is permanent, the OCR will leave the line open after its last try.

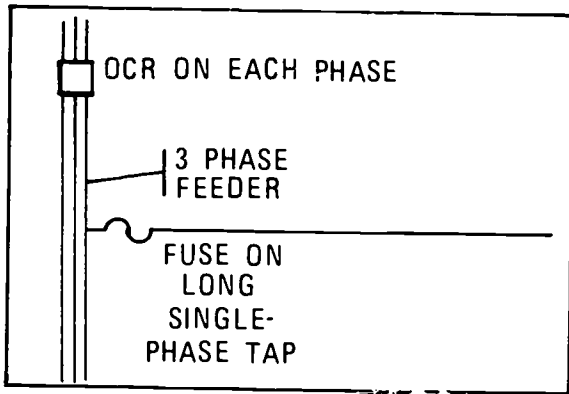

Now put a fuse in the single-phase tap where it connects to the main line.

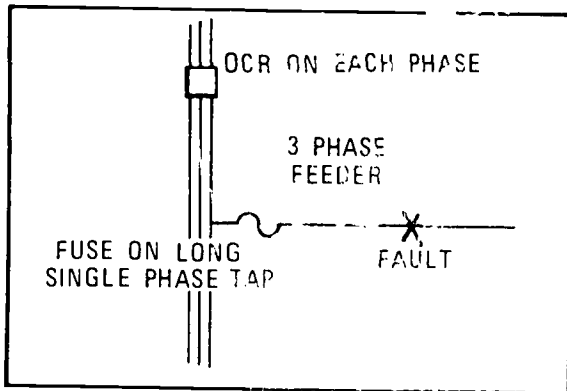

If a fault occurs at the end of the single-phase line, the fuse will blow on the recloser's last attempt to re-energize the line. Of course, this only happens if the right size fuse is used. Picking fuse sizes is another job for the engineer.

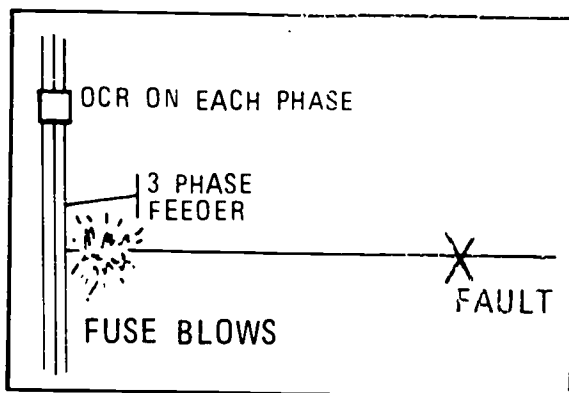

The blown fuse isolates the piece of faulted line from the OCR. The OCR is then able to successfully re-energize the remaining line. The counter inside the OCR then resets, making it ready for the next fault.

By using fuses with OCR's the amount of line that is de-energized because of a fault is much less than the amount that would be de-energized if only OCR's were used.

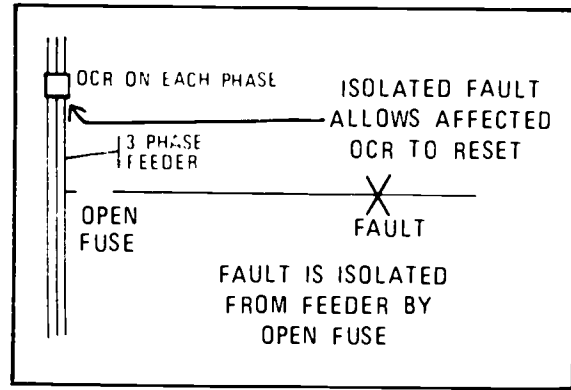

Reclosers, like all electrical equipment, have ratings. One important rating is the *coil size*. This is the continuous load current the recloser can carry without causing operating difficulty. It generally is stenciled on the OCR tank. Sizes range from a few amps to several hundred amps.

RECLOSER RATINGS

COIL SIZE
RATING OF FULL
LOAD CURRENT
CAPACITY

The fault current has to be at least twice the coil rating for the recloser to operate. A 50 amp recloser, for example, will not operate on a fault unless the fault current is at least 100 amps. This is called the *minimum trip point*.

RECLOSER RATINGS

COIL SIZE

RECLOSER WILL NOT OPERATE
UNLESS FAULT CURRENT IS
TWICE COIL RATING. IT TAKES
A 100 AMP FAULT TO TRIP
A 50AMP OCR.

The other important current rating is the *interrupting rating*. This is the amount of current the OCR contacts can safely interrupt without damaging the OCR. For some smaller types, this is 25 times the coil size rating. In larger OCR's there is no direct relation between the interrupting rating and coil size rating. When a recloser is installed, the highest fault current that recloser will see at that location must be less than its interrupting rating.

RECLOSER RATINGS

INTERRUPTING RATING

MAXIMUM FAULT CURRENT
THAT THE OCR CAN INTERRUPT
WITHOUT DAMAGE. IS AT
LEAST 25 TIMES COIL SIZE

RECLOSER RATINGS

INTERRUPTING RATING VS COIL SIZE

<p>LARGE ENOUGH OCR TO INTERRUPT THE LARGEST POSSIBLE FAULT AT ITS LOCATION.</p>	<p>SMALL ENOUGH OCR TO SENSE THE SMALLEST POSSIBLE FAULT AT THE END OF THE PROTECTED AREA.</p>
--	--

The recloser coil has to carry the load current, without thinking it sees a fault and operating. False tripping occurs when a recloser trips and there isn't a fault on the line. Also, the coil size must be small enough that the recloser can detect the smallest possible fault on the portion of the line it's supposed to protect.

RECLOSER RATINGS

VOLTAGE

1. OPERATING VOLTAGE
2. BIL VOLTAGE

Obviously, a recloser must withstand the operating voltage and the surge voltages on the systems. Reclosers have both an *operating voltage* rating and a *basic impulse insulation level* rating, abbreviated as BIL. BIL is a rating of surge voltage insulation inside the recloser.

A RECLOSER MAY BE USED
ON ANY SYSTEM OPERATING AT
OR BELOW ITS RATED
OPERATING VOLTAGE

While the various *current* ratings are the ratings that are most often of concern, the *voltage* ratings are important, too. If an OCR is used on a system with voltages higher than its ratings, it's sure to cause problems—the worst of which is having the recloser explode. For example, an OCR which is rated for 14,400 volts can be used on a 7200 volt system because the recloser voltage rating is higher than the system voltage.

FAULT CURRENT
VARIES
WITH MANY
CONDITIONS.

The highest and lowest possible fault currents at any point on the system can be calculated. The recloser doesn't always see the same size fault since the size of the fault depends on a number of conditions. One of these conditions is the *type* of fault.

With several wires making up a power line, there are many ways in which they can be involved in faults. For example, if the phase conductor on a single-phase line breaks and falls on the ground, that produces a line-to-ground fault. If a tornado wraps all the wires on a three-phase line together, that produces a three-phase fault. In each case, the amount of fault current that flows is different.

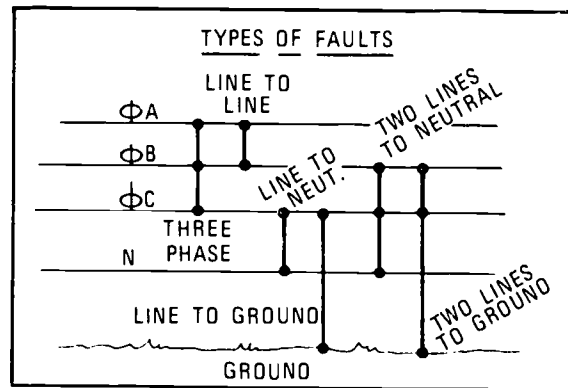

Other important factors that influence the amount of fault current are the wire size used in the line and the distance from the substation to the fault. Other things that affect fault currents include the number of generators running at any particular time, and the way the transmission system is being operated.

WIRE SIZE AND DISTANCE		
#8	?	25 MILES
#6		20 MILES
#4		15 MILES
#2		10 MILES
#1/0		5 MILES
#4/0		
336 MCM		

The engineer calculates the possible values of fault current at many points on the system, taking into account all these factors. Then he decides where to put the reclosers. Sometimes these locations aren't too practical. From an operating standpoint, locations that are easy to get to are best, so a truck could be backed up to the pole even in bad weather.



Line Switches

SWITCHES ARE USED
WITH FUSES AND RECLOSERS
TO MAKE
TROUBLE-SHOOTING EASIER

In conjunction with reclosers and fuses, various kinds of switches are used in the distribution system. Switches make it easy to connect and disconnect lines. This makes trouble-shooting line problems easier, since the line can be isolated in short sections.

The simplest switch is a hot line clamp. It is designed to carry *low* currents, usually 10 amps or less. It is very useful as a connector for distribution transformers.

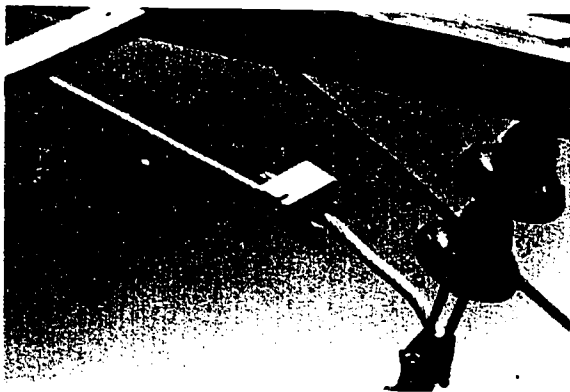
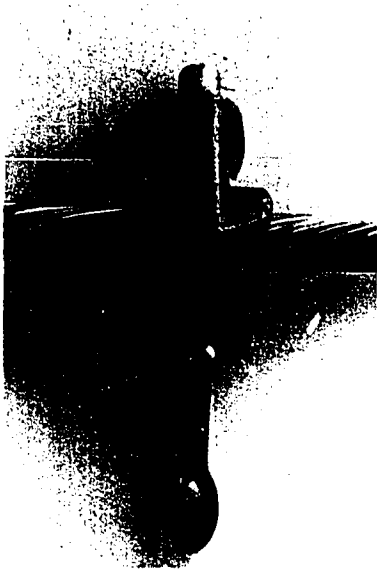

Hot line clamps cause line trouble when they are misused. Often, they are misused on high capacity lines to make jumper connections. Hot line clamps make cheap switches, but connectors or line switches designed for these high currents should be used instead. This also applies to regulators and reclosers used in these heavy lines.

50

The area of contact between the hot line clamp and the wire is small and can't carry much current without overheating. This is why hot line clamps don't work well at higher currents. Inside this clamp is a small, shiny stripe. This is the only area in which the wire and clamp actually had contact to conduct current.

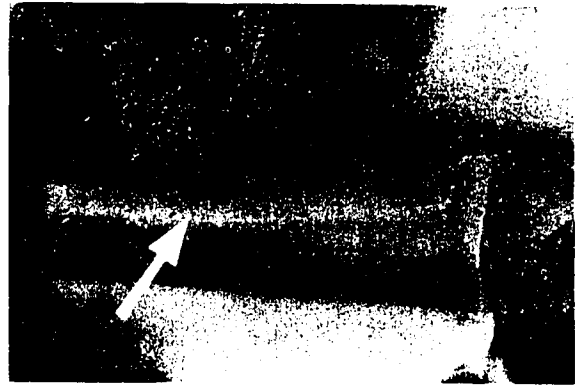

Corrosion sometimes occurs between a hot line clamp and the wire it's clamped on, particularly if the two metals are different. Making sure the clamp is tightly installed reduces this problem.



Loose hot line clamps can also cause radio noise. Since the power system acts as a big antenna, radios can pick up this noise for miles. It is very difficult to locate the source of such noise.

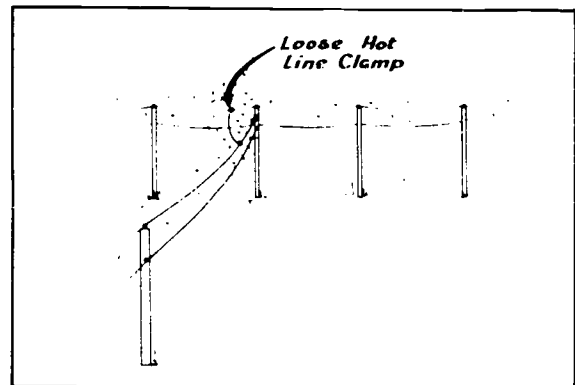

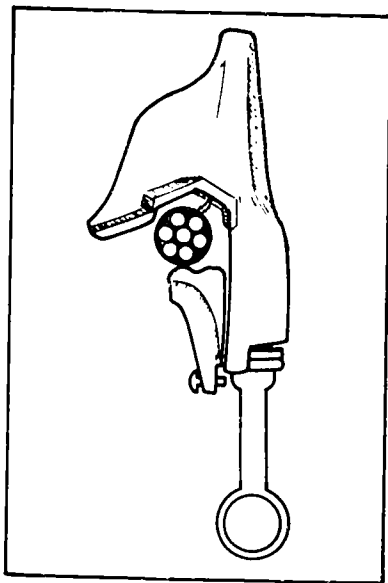

Like any switch, a hot line clamp draws an arc when connected or disconnected. This arc can damage the line conductor.

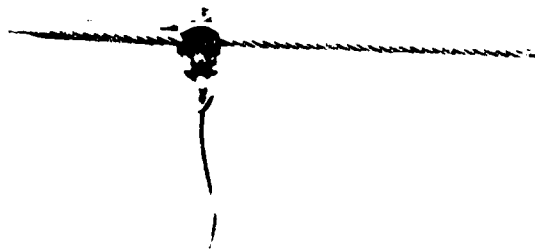

To prevent arcing damage, a set of armor rods are wrapped around the conductor. Armor rods are normally used for mechanical protection at line insulators, but can be used to make a place to connect a hot line clamp. When the hot line clamp is placed on the armor rods, all the arcing damage then occurs to the rods, so the line conductor is not weakened by the arcing.

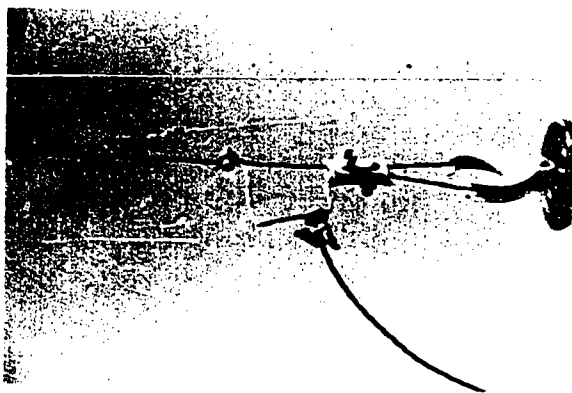

Another way to prevent damage to line conductors is to use a basket for the hot line clamp to connect to. A basket is a loop of wire attached to the conductor. Sometimes, at the end of a line, the wire end is folded back on itself to make the basket.

Another type of basket used on aluminum conductors is made of aluminum rod and bolts on the conductor.



This hot line clamp should be *connected to the basket* instead of the main conductor.

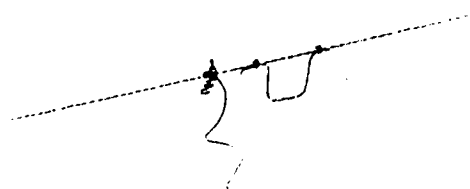

Cutouts can be used as switches, either with the regular fuse barrel and fuse link installed or with a solid blade. They generally are not load-break rated. *Load-break* means that the switch can be opened while current is flowing through it, and *non-load-break* means that the switch shouldn't be opened while current is flowing through it.





This in-line tension switch is essentially a single-phase switch, although it is often used in threes on three-phase lines. These switches are easier to install in an existing line than switches on crossarms because they don't require rebuilding the pole top. They are operated with hot line tools. It's important to install these near the pole; otherwise, it's hard for the lineman to reach them. The further from the pole they are, the more they bounce around in the wind.

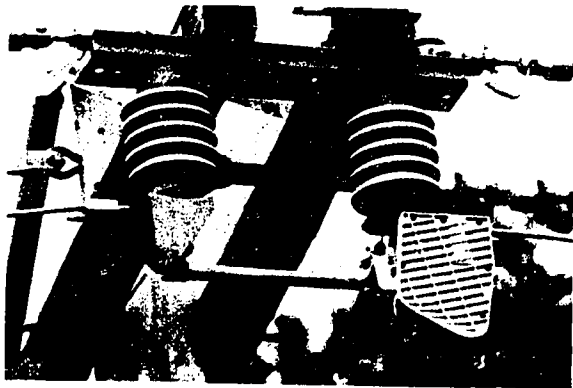

These are single-phase switches which are designed to be pole mounted. They are more expensive than the in-line type, and require a more expensive pole top structure, but are easier to work and are heavier duty. Both load-break and non-load-break models are available. This particular switch is a load-break switch. The white ears on the right end of the switch help put out the arc caused by switching heavy load currents.

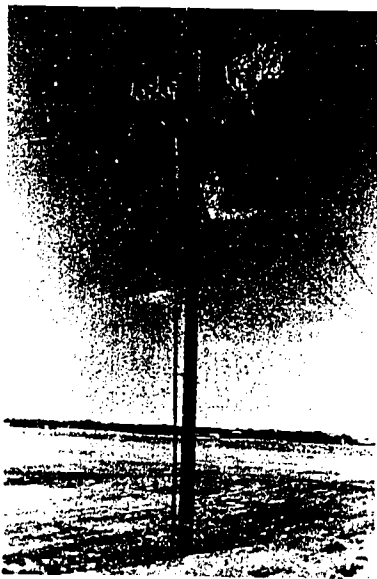

Another common switch is a three-phase ganged-air-break switch. Generally, these are manually operated, although some are motorized. If these switches are used to switch line carrying normal load current, a load-break rated switch is necessary. Some uses of these switches may not require the load-break rating, particularly if an established standard operating procedure is *always* followed.

Even though switching procedures can be established that never require these switches to interrupt load current, some utilities always use load-break switches as a safety precaution. Then, if the switching procedure is not followed for some reason, interrupting the load with a load-break rated switch will not cause damage to the switch or create a dangerous situation for the lineman.

LOAD BREAK VS NON-LOADBREAK	
COST MORE	CHEAPER
LESS CHANCE FOR ERROR	REQUIRE SPECIFIC SWITCHING PROCEDURE

If necessary, OCR's can be operated manually as switches. The handle on the side allows manual operation as well as showing whether the OCR is opened or closed.



The oil switch is similar to an OCR in that its contacts are under oil, and the handle used to operate the contacts is similar. The contacts are load-break rated, but they are *not* designed for fault current interruption. The mechanism is operated either by a mechanical linkage, as in this case, or by an electric motor.



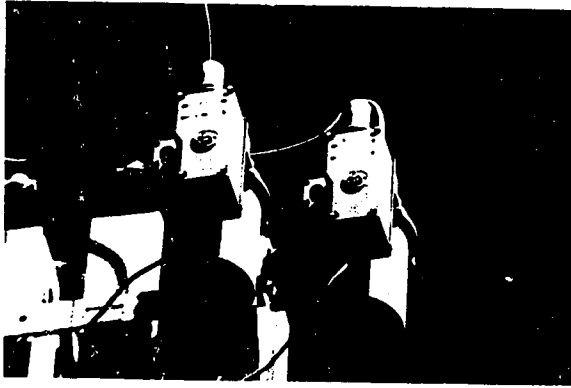

Oil switches were designed to switch capacitors. In this case, the oil switch is operated by an electric motor, which is inside a square box on the side of the switch. Capacitor switching is severe duty for any switch. It's much easier to switch capacitors if the switch contacts are under oil rather than in open air. An arc in oil goes out much easier than one in air.

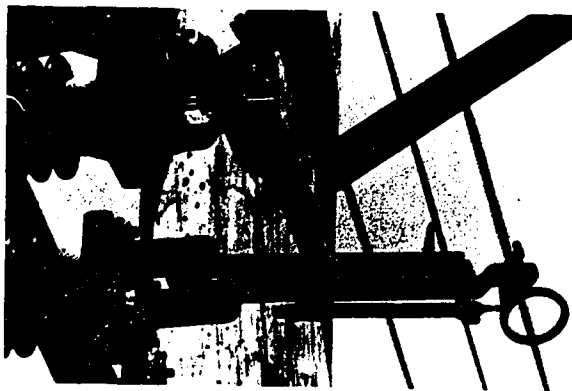

A special kind of switch is the bypass switch, which is used mostly to bypass voltage regulators to remove them from service for maintenance or repair. A bypass switch replaces three ordinary switches. It has the advantage of operating its three component switches in the proper sequence to bypass a piece of equipment without an outage. It eliminates possible human error that can occur when three separate switches are used.

Lightning Arresters

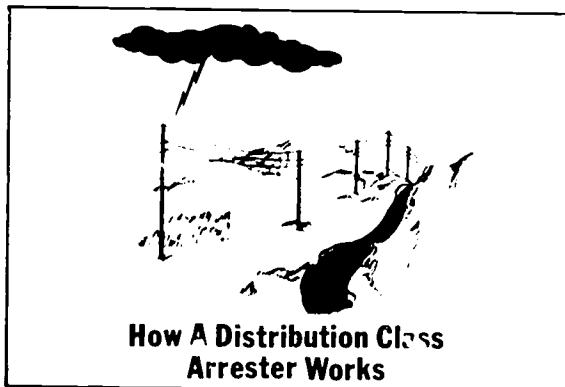

A small but very important piece of equipment is the lightning arrester. Its job is to control surge voltages on the line, whether caused by lightning or other system disturbances. Properly used, arresters prevent damage to transformers and other equipment.

The thing that looks like an extra long insulator on the side of the pole is a lightning arrester. It looks simple, but its internal operation is complex.

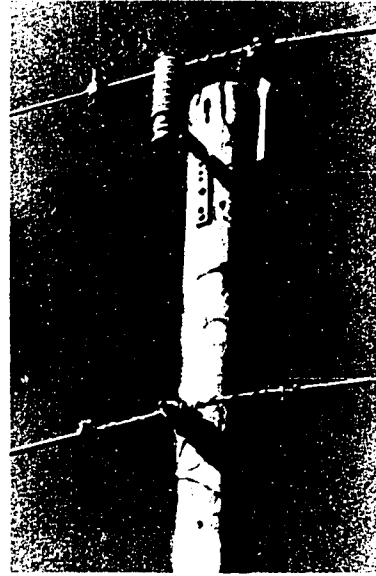

Basically, it's a spark gap that arcs over when the voltage applied to it gets too high. Holding a spark plug wire near the block of an engine to see if it produces a spark is an example of a spark gap arcing over.

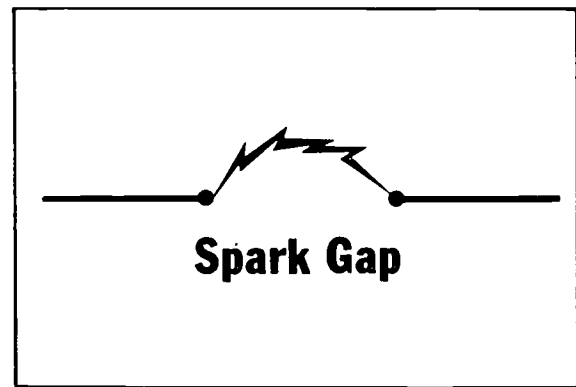

When a spark gap fires from lightning, it sets up a path for electricity to follow. The 60 cycle power flows across the gap along with the lightning. The lightning is only momentary and soon goes away, but the power current keeps flowing. This is a short circuit and is called *power follow current*.

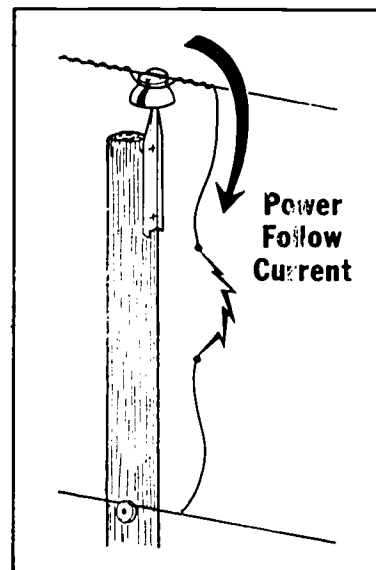

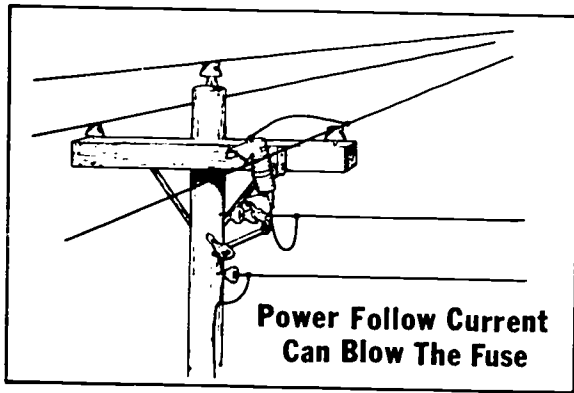

Remember, a fuse is supposed to blow if there's a short circuit on a fused line. So even though a simple spark gap can be used to protect equipment, it can't be used when there are fuses on the system. Each time a spark gap fired, the fuse on that line would blow and cause an outage.

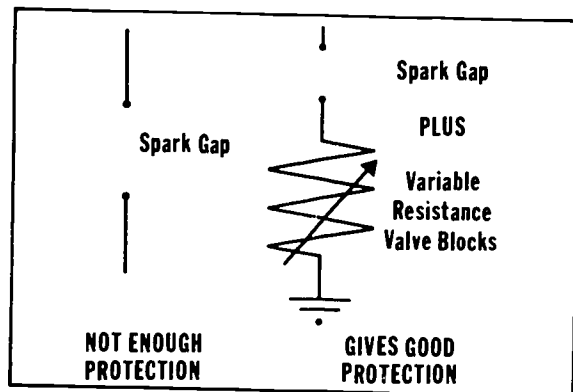

The important thing to remember is that a spark gap alone won't do an adequate job of protecting against lightning. To make it work better, *valve blocks* are added in line with the spark gap.



Here is a disassembled lightning arrester. The black pieces are the valve blocks and are in line with the white discs, which are spark gaps. The valve blocks let high voltage surges pass easily through the arrester to ground. Then these valve blocks react to the lower voltage of the power follow current by reducing the power follow current to a low level so that the spark gaps can interrupt it.



Lightning arresters do occasionally fail. When they fail, they usually short circuit. This either blows a fuse, causing an outage, or the arrester blows up.

Basically there are two ways to prevent a failed arrester from causing an outage. One way is to put a second, external air gap between the arrester and the line. Unfortunately, it takes a higher surge voltage to fire the arrester and gap combination than it would to fire an arrester alone. The gap and arrester combination provides less protection than the arrester alone.

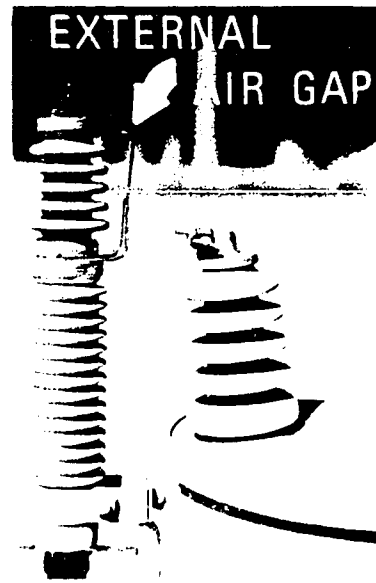

Once the external gap fires, the arrester works the same as one without the external gap. But, if the arrester has failed, a recloser or fuse must operate to make the arc in the external gap go out. Since the failed arrester is not causing any obvious problems, no one goes out to replace it. It probably couldn't be found anyway, since there is no visual indication that the arrester has failed.

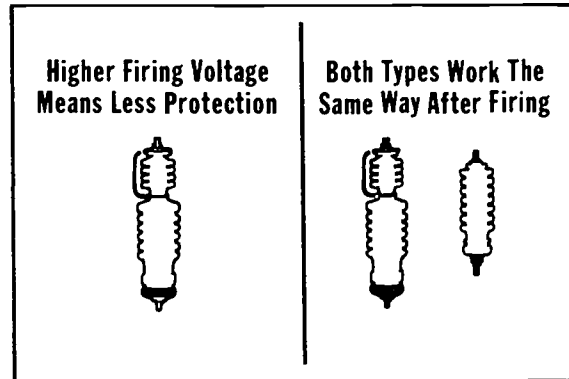

Even though it takes a higher surge voltage to fire an externally gapped arrester, it still provides basic protection to line transformers. The arrester must be mounted close to the transformer, either on the same pole or on the transformer tank.

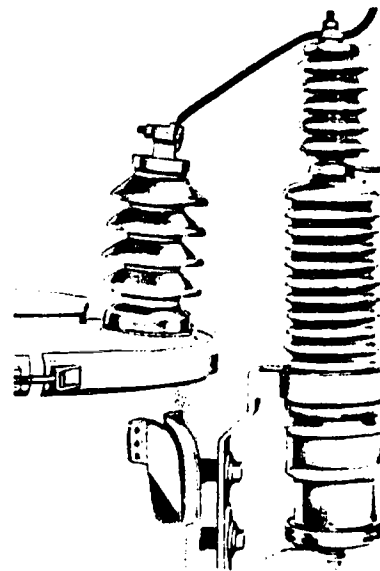

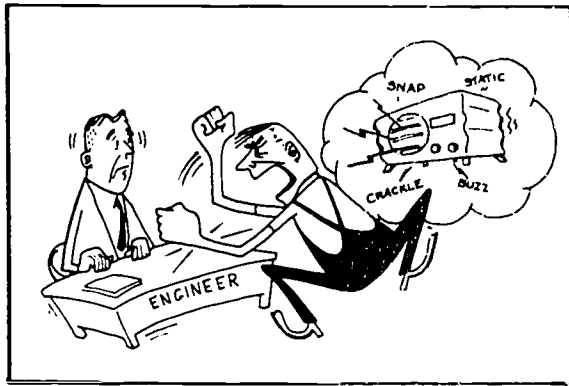

The external gap only provides protection *when properly set*. Too small a gap leads to radio noise. It can also cause the arrester to operate falsely when there is no lightning. Too big a gap raises the firing voltage so high that the arrester doesn't provide any protection.

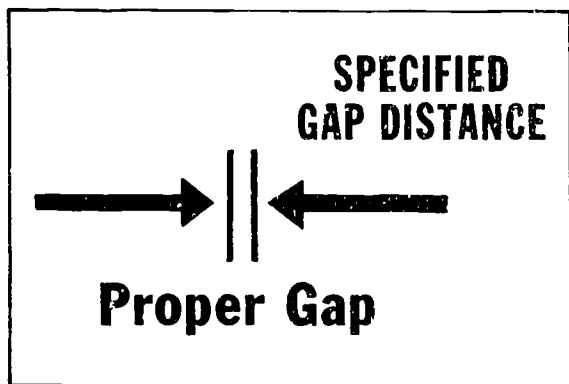

Setting the gap properly is something which can't be emphasized enough *Make sure* that the gap is set right. Make a feeler gauge from a piece of wood, or use a ruler, but *don't guess*! The gap should be set *after* the arrester is in place on the line. This is to prevent accidentally changing the gap setting by knocking the arrester around during installation.

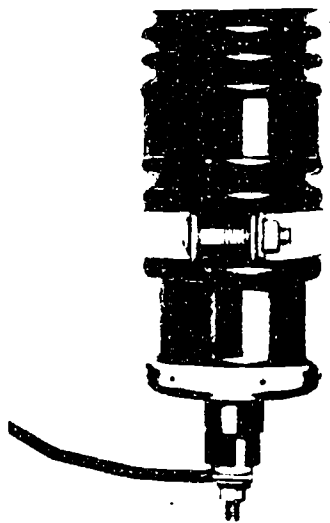

This arrester uses the second method to disconnect itself from the line if it should fail. On the bottom of the arrester is a *ground lead isolator*. There is a small explosive charge built into the base of the arrester.

Normally, this explosive charge has no effect on the arrester. If the arrester fails due to short circuiting, the current flowing through it builds up enough heat so that the explosive fires. This blows off the bottom terminal. Since the ground lead can be seen dangling in the air, it is easy to find a failed arrester of this type.

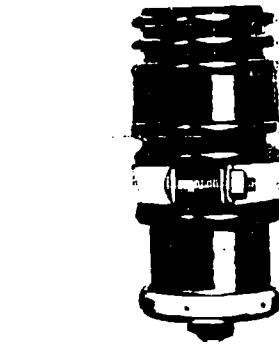

One characteristic of wire is inductance. Because of inductance, lightning arrester leads do not pass surges well. It is necessary to keep the leads as short as possible to minimize the effects of inductance. This helps the arrester do its job properly.

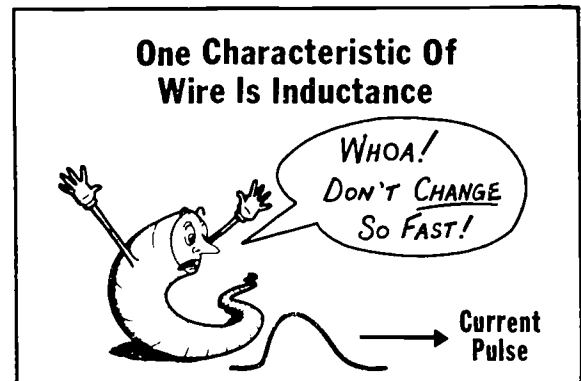

The inductance of the wire lead adds about 2000 volts, or 2 KV per foot of wire to the *spark-over voltage* of the arrester. The spark-over value must be kept as low as possible to provide maximum protection.

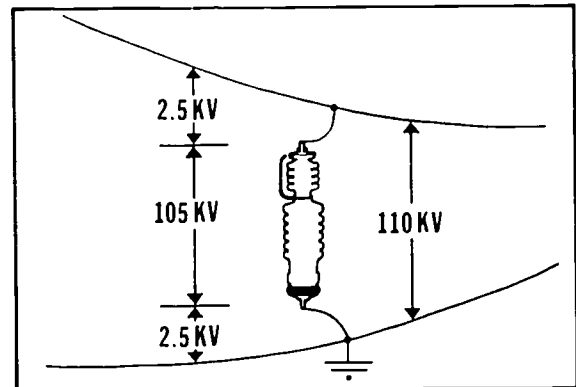

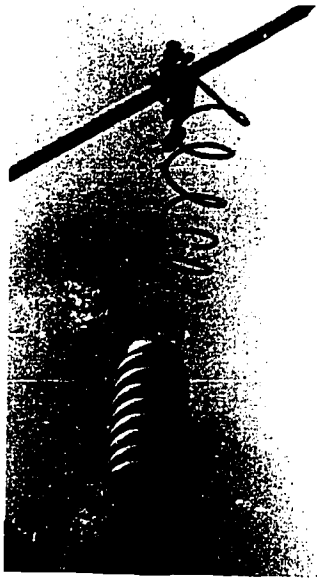

Here's a good example of how not to install arresters. Coiling the lead wire adds to the inductance. Coiled leads are often ten times longer than they need to be. This really reduces the effectiveness of the arresters.

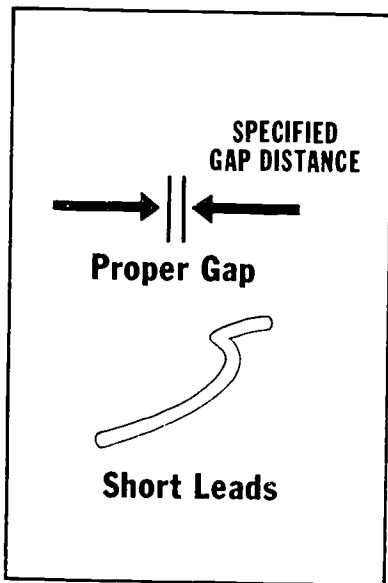

Arresters have to be installed correctly, especially the ones with external gaps, before they can do their important job of protecting the distribution system from lightning and voltage surges.

Transformers

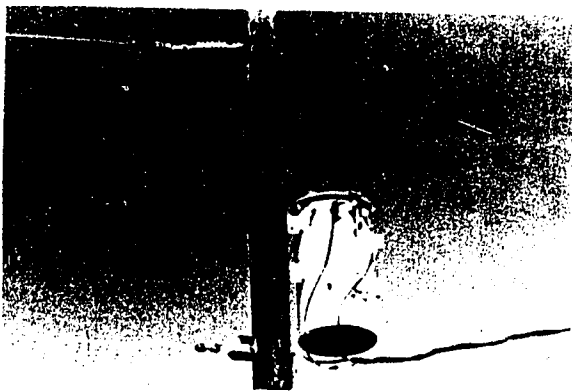

The distribution transformer is probably the most widely used equipment item on a distribution system. Distribution transformers are used to change the high level distribution voltage to the voltage level used by the consumer. This is a typical three wire service used to supply single-phase consumers.

It would seem that two transformers are needed to do that, but it can be done with one. A nifty trick is used to avoid using two transformers which saves money.

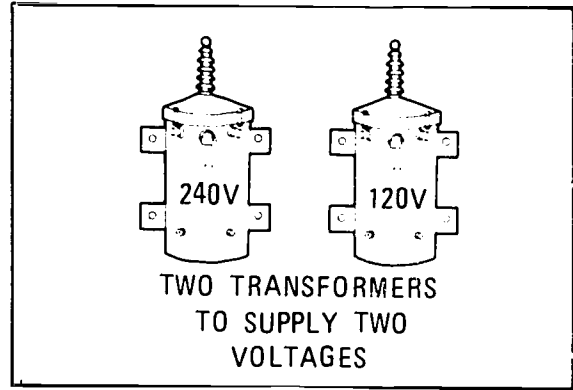

The secondary side of the transformer looks like this. Don't worry about the primary side for now. If the proper transformer is used, 240 v can be measured across the secondary terminals, which are connected to the ends of the secondary winding.

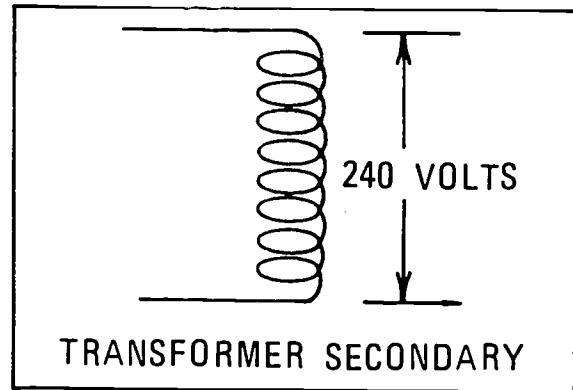

If a third wire is connected in the middle of the winding, 240 v can still be measured across the ends of the winding.

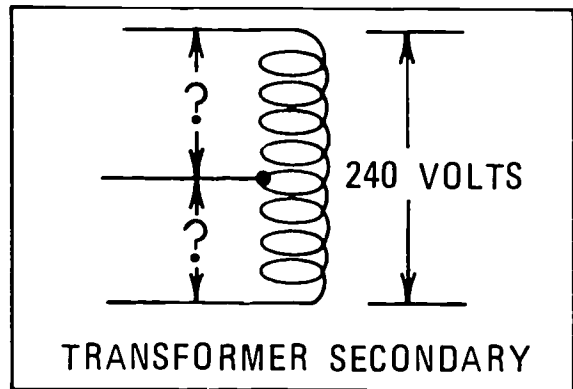

In addition, 120 v can be measured from the center wire to the upper end and also from the center wire to the bottom wire.

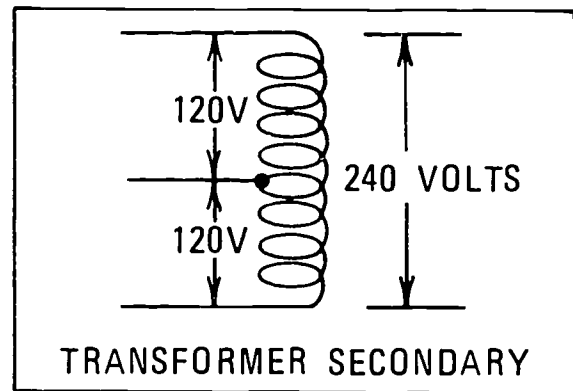

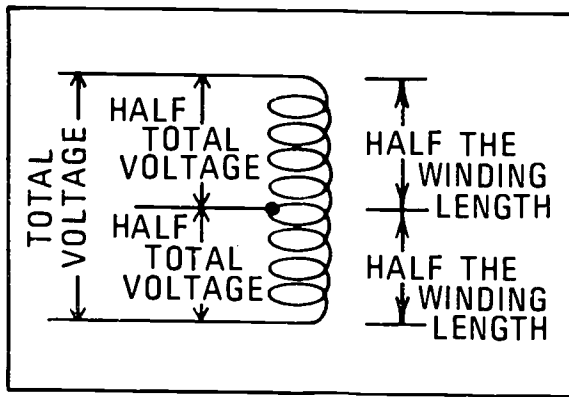

Notice that when the transformer coil is tapped at the halfway point, half the voltage can be measured each way from the center tap to the ends.

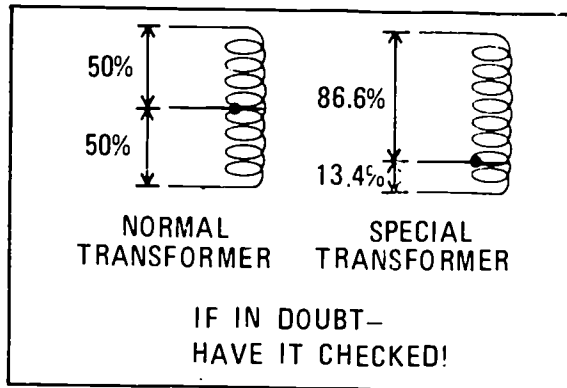

The vast majority of distribution transformers are *center-tapped* which means tapped in the middle. A few are not tapped in the center of the winding. These are designed for special connections.

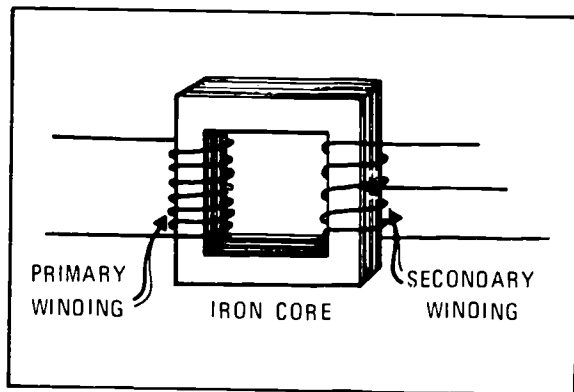

In addition to the secondary winding, there is a primary winding. The two windings are linked by a magnetic core made of iron, which is called the *transformer core*. The primary and secondary are not normally connected to each other within the transformer.

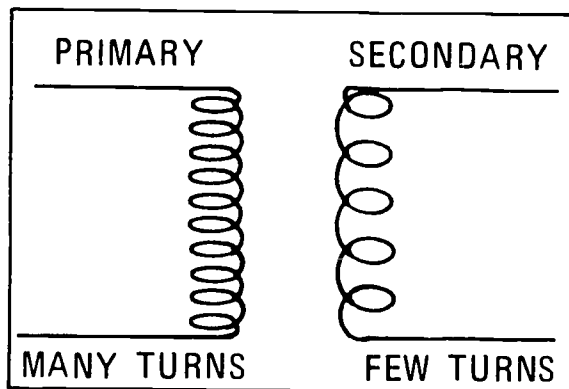

In a distribution transformer, the primary winding has many turns of wire, but the secondary has considerably fewer.

If the turns are counted on both windings and the number of primary turns is divided by the number of secondary turns, the *turns ratio* is obtained.

$$\text{TURNS RATIO} = \frac{\text{NUMBER OF TURNS IN PRIMARY}}{\text{NUMBER OF TURNS IN SECONDARY}}$$

The turns ratio is exactly the same as the *voltage ratio* of the transformer. The voltage ratio is the *primary voltage* divided by the *secondary voltage*. In this example, the voltage ratio is 7200 v divided by 120 v, or 60. This is the same as the turns ratio.

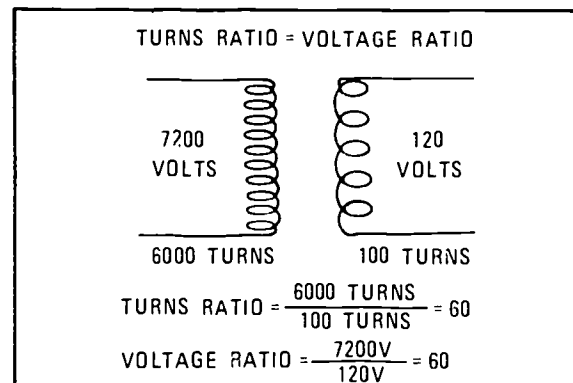

The current flow is different on each side of the transformer, just as the voltage is different, except the currents are related to each other in the opposite way voltages are related. The primary side is connected to the high voltage distribution system. It operates at high voltage, but draws low current.

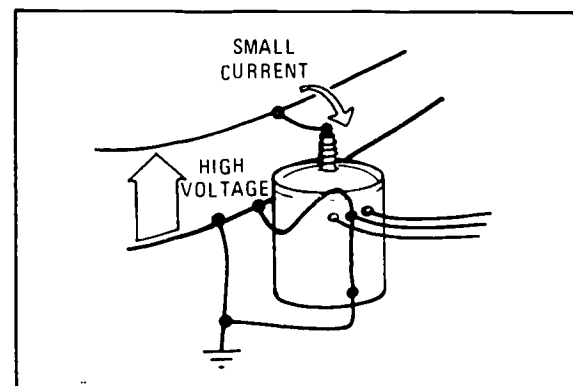

On the secondary side, the voltage is much lower, but the current makes up for that by being much higher (low voltage, high current).

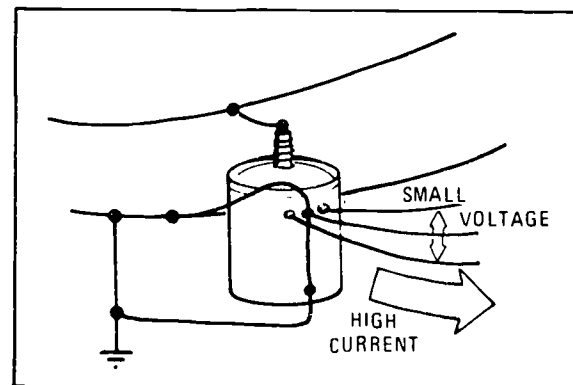

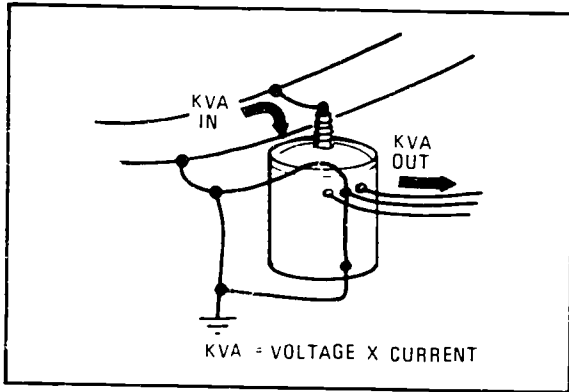

The size of a transformer is rated in KVA. This is the rated voltage times the maximum rated current. The voltage is measured in KV or kilovolts, which is thousands of volts. 7200 v, for example, is 7.2 kilovolts. A transformer rated for 10,000 v or 10 KV and 10 amps can handle 10 KV x 10 amps, or 100 KVA.

$$\text{KVA} = \text{VOLTAGE} \times \text{CURRENT}$$

If the primary voltage in kilovolts is multiplied by the primary current in amps, the product is the KVA going into the transformer. If the secondary voltage in kilovolts is multiplied by the secondary current in amps, the product is the KVA coming out of the transformer. Both of these are the same—the KVA going in equals the KVA coming out.

<u>WHY USE:</u>		
69,000 V	4800 V	161 KV
14,400 V		
7200 V	345 KV	138 KV
<u>WHY NOT JUST:</u>		
120 V		

There are many reasons for using voltages higher than 120 v or 240 v for power systems.

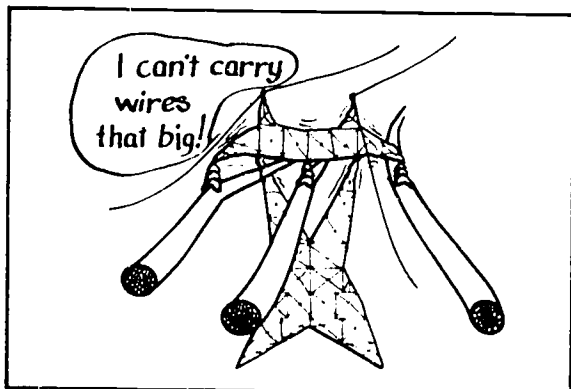

Using only 120 v would eliminate the transformers, but the power system would have to be built with huge wires to transmit the power required by the consumers.

There would also be problems if only high voltage was used in the system and in buildings. Suppose 7200 v was used for house wiring. Each insulated conductor would be about an inch in diameter. It would cost 15 to 20 times as much as the wire used for 120 v wiring. It would cost a lot more to install, too, since it's harder to handle.

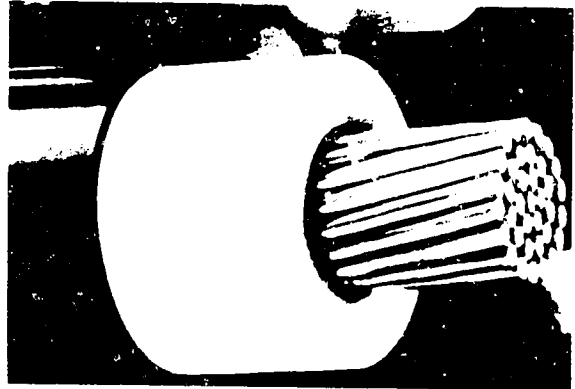

Connections couldn't be made by simply stripping back the insulation and clamping the bare wire under a screw. Special terminators designed to prevent electrical stresses from damaging the insulation would have to be used.

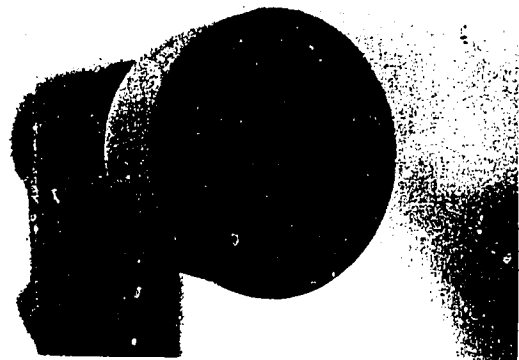

Wall plugs and switches would be monstrous affairs and hard to operate. The total cost to wire such a house could easily be half the cost of the house. High voltage building wiring is an impossibility from both a convenience and economic viewpoint.

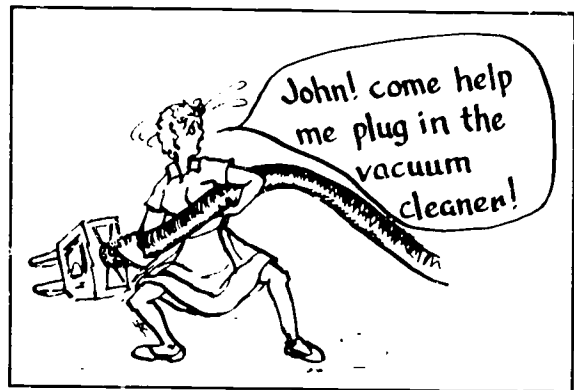

Using high voltages for transmission and distribution and low voltages for building wiring, makes sense economically, even though many, many transformers are used.

POWER TRANSMISSION	
HIGH VOLTAGE LOW CURRENT	LOW VOLTAGE HIGH CURRENT
REASONABLY SIZED WIRES	IMPOSSIBLY LARGE WIRES
MANY TRANSFORMERS	NO TRANSFORMERS

67

Autotransformers

An autotransformer is another device that is often found on systems that use more than one operating voltage or are converting their distribution voltage from one voltage to another.

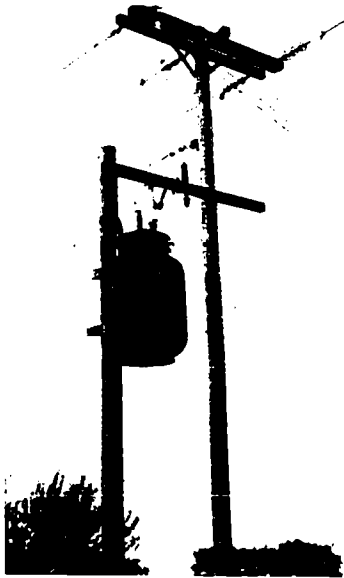

AUTOTRANSFORMERS	
ADVANTAGES	DISADVANTAGES
1. LOWER COST	1. LACK OF ISOLATION BETWEEN CIRCUITS
2. LOWER LOSSES	2. LESS FAULT CURRENT WITHSTAND ABILITY
3. LOWER WEIGHT	

Autotransformers have several advantages and disadvantages when compared to conventional two winding transformers. Advantages of the autotransformer include lower initial cost, lower losses, and lower weight. Disadvantages are: no electrical isolation between primary and secondary, and a higher susceptibility to damage from fault currents.

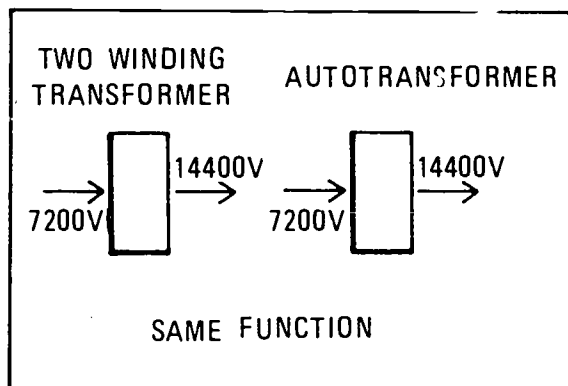

The autotransformer does the same thing as a regular transformer—it provides a voltage change from one side to the other. Like a regular two winding transformer, the KVA flowing in equals the KVA flowing out.

An example will be used to compare an autotransformer and a two winding transformer from the standpoint of coil sizes needed to build each of them. As an example a 500 KVA autotransformer is connected as a 7200 v, to 14,400 v step-up transformer. A step-up transformer produces a higher voltage at its secondary terminals than is applied at its primary terminals. In this example, 7200 volts is stepped up to 14,400 volts.

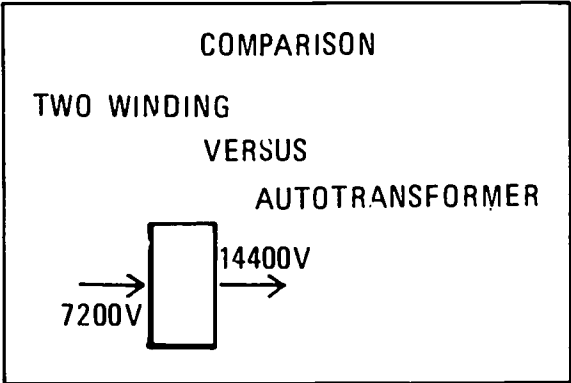

The autotransformer has two coils just as the two winding transformer does, but they are wired up differently. One coil is connected across the line, and is called the *shunt coil*. The other coil is connected in line between the primary and secondary terminals and is called the *series coil*.

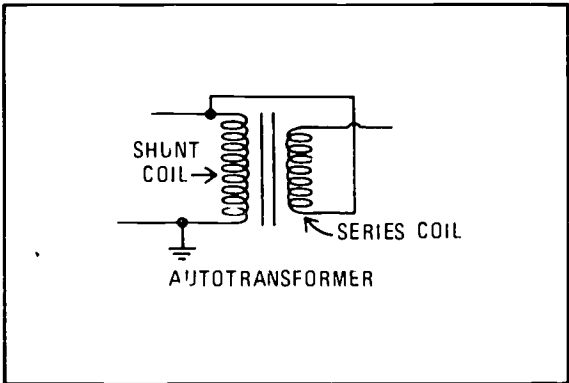

Redrawing the autotransformer with the series coil stacked on top of the shunt coil makes it easier to visualize the voltage relationships. There is 7.2 KV applied to the connections on the left, and 14.4 KV comes out of the connections on the right. The series coil has 7.2 KV across it alone, which appears because of the transformer coupling action between the two coils. This 7.2 KV is *added* to the input 7.2 KV, to give 14.4 KV on the output.

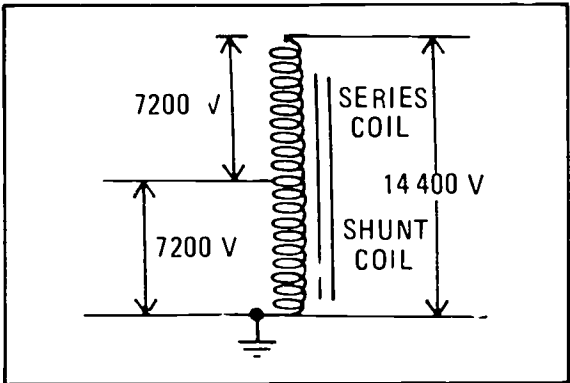

The shunt and series coils only need to be rated at 250 KVA each. Each coil only carries *one half* of the input current and has only half of the full 14.4 KV output voltage across it. So neither coil carries the full transformer rating of 500 KVA. On the other hand, in the two winding transformer, the coils each carry the full current and voltage for their respective sides, so each coil must be able to handle 500 KVA.

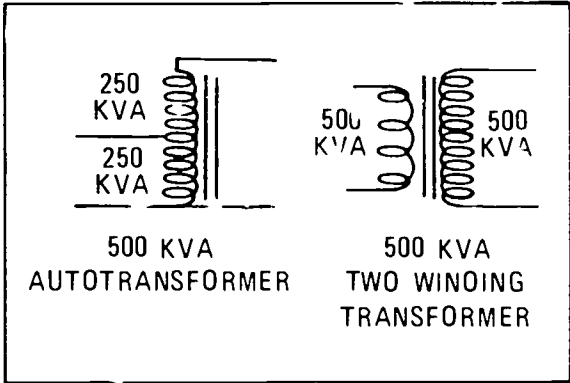

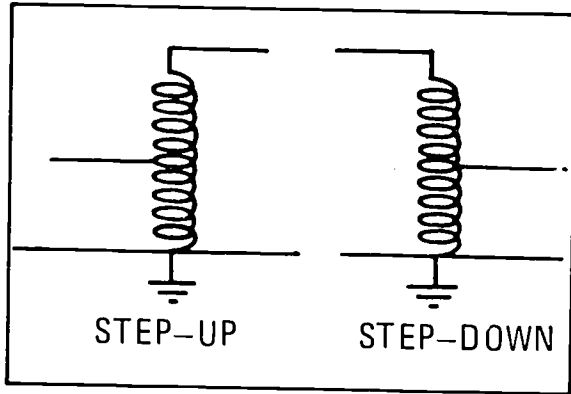

An autotransformer can be used either as a step-up or as a step-down transformer, just as a two winding transformer can. However, with larger turns ratios, the economic advantage of using an autotransformer decreases.

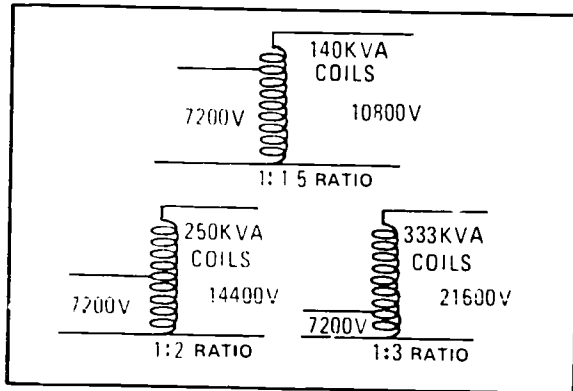

As an example, here are several autotransformers, all with a 7.2 KV primary, and all with a 500 KVA rating. Notice that at the higher turns ratios, the individual coil ratings are higher too. As a result a 1:3 (or 3:1) turns ratio is about the highest ratio that is economically feasible.

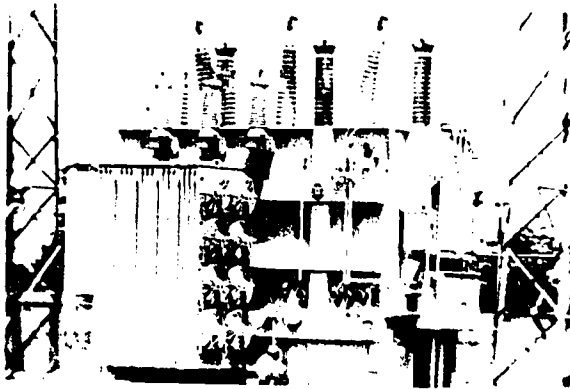

Changing the voltage levels on a distribution system is not the only thing autotransformers are used for. They're used other places, too. Large three-phase units are used to tie together different voltage levels on transmission systems—say a 345 KV system and a 500 KV system. Smaller ones are used in buildings to provide 240 volts from 208 volts.



Autotransformers are also used as ballasts in fluorescent and mercury vapor lights to provide a high enough voltage to make the light work.

Voltage Regulators

The voltage regulator is a device that automatically controls the voltage level on a distribution system. It is an expensive device but well worth the price, since it is a pretty sophisticated piece of equipment, and lasts many years.

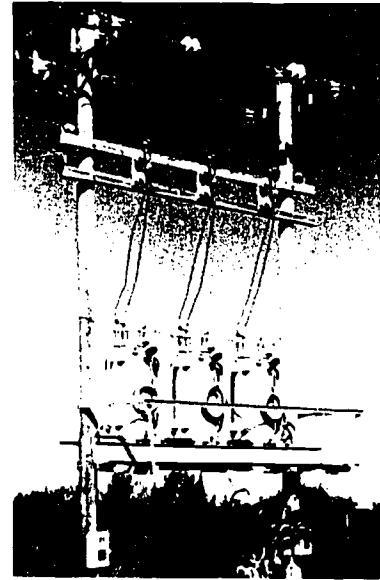

The voltage regulator senses that the incoming voltage is low or high, and by how much, and then adjusts the outgoing voltage to whatever value its been set to hold.

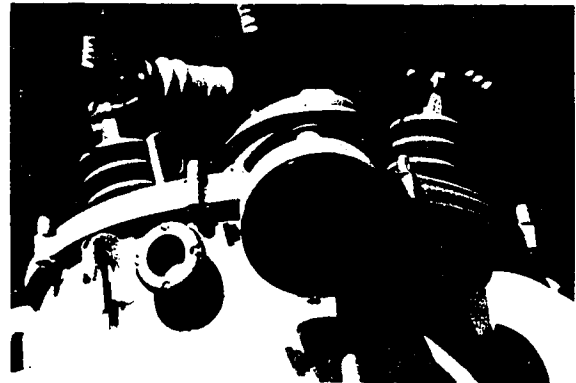

Essentially, the voltage regulator is an autotransformer in which the turns ratio can be adjusted by switching parts of one winding in or out.

VOLTAGE REGULATOR
A SPECIAL TRANSFORMER
THAT AUTOMATICALLY ADJUSTS
ITS TURNS RATIO TO HOLD A NEARLY
CONSTANT OUTPUT VOLTAGE

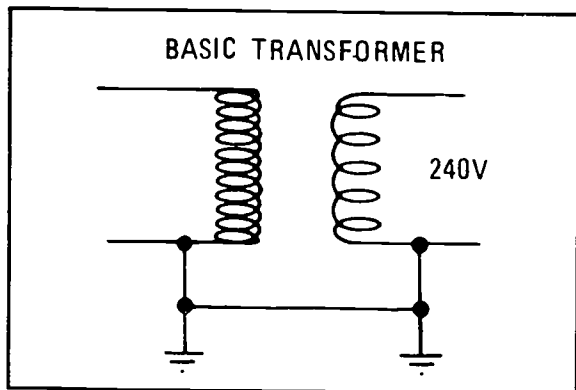

Here is a regular two winding transformer such as those normally used for services, but without a center tap. As an example, let this transformer have a 7200 v primary and a 240 v secondary.

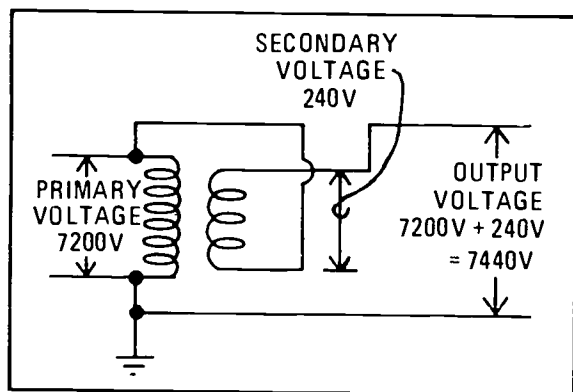

If 7200 v is applied to the primary, and the secondary voltage is 240 v, 7440 is obtained from the output to the ground.

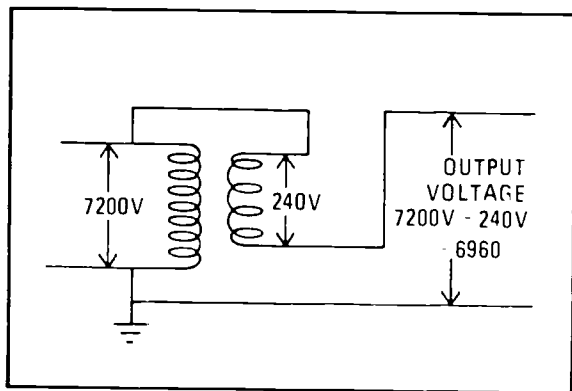

If the secondary is hooked up as shown, the two voltages subtract. If 7200 v is put in, 6960 v would come out.

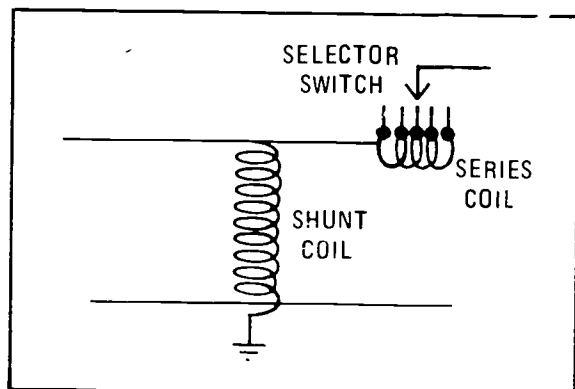

If several taps are brought out from the series winding, the amount of voltage change can be varied by using a selector switch to connect the proper tap.

The reversing switch is used to make the series coil either add or subtract voltage from the incoming voltage.

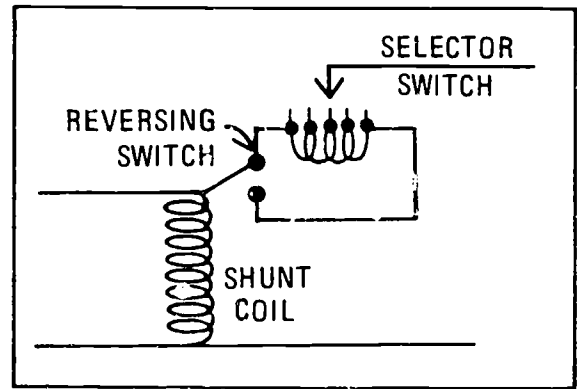

This box mounted on the pole is the control for the regulator. Sometimes, the control box is mounted on the side of the regulator instead of on the pole.

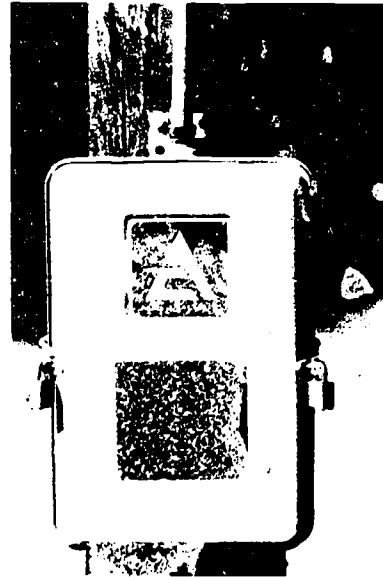

This is an electronic control which is typical of the type being manufactured today. There are still many electromechanical controls around, but both kinds do the same things and generally have the same controls on the panel.

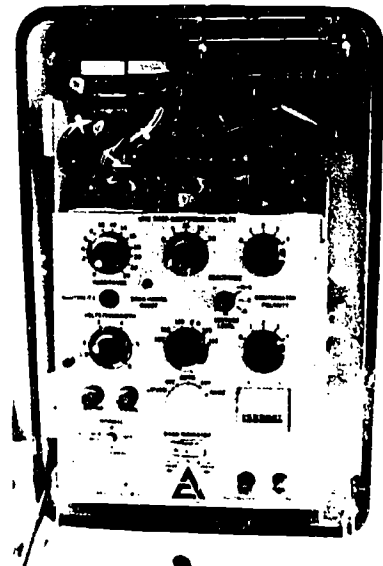

73

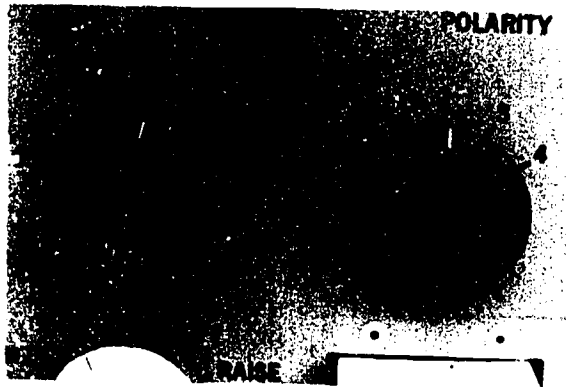

An advantage of the electronic controls is that they are factory calibrated. This control is set to give 122 v output, and that is what the regulator will produce. Mechanical controls have to be checked periodically using an *accurate* volt meter and a trial and error method, since the control calibration drifts with age.

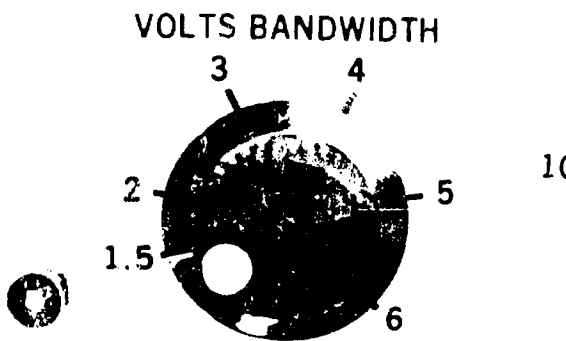

This control is the *bandwidth*, which is the *range* that the output voltage may vary before the regulator operates. The narrower the bandwidth, the more effectively the regulator holds a constant output voltage. The newer regulators with electronic controls are usually set to 1.5 v or even 1 v bandwidth. Older regulators that have mechanical bandwidth controls can't be set accurately to a bandwidth any smaller than two volts.

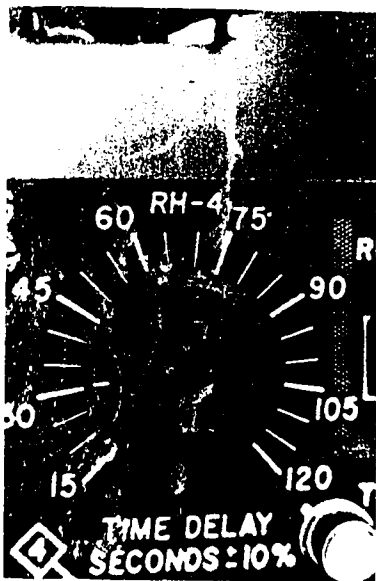

All regulators have a time delay control. This one is inside the panel, on the circuit board. The time delay makes the regulator wait a preset time from when it senses the need to adjust the voltage until it is allowed to do so.

This time delay prevents the regulator from trying to correct momentary voltage fluctuations, such as those caused by loads coming on or off the line. The usual setting for the time delay is 30 seconds, although other settings may be used if required.

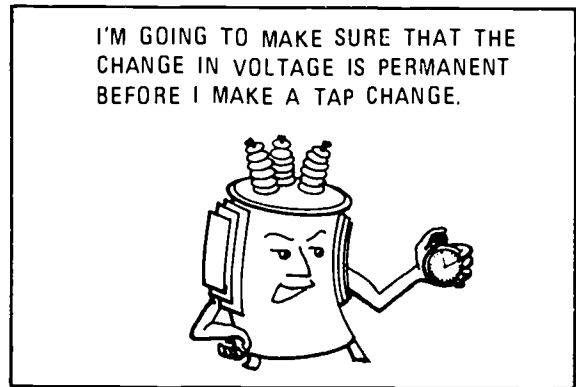

Regulators commonly have a *range of regulation* of plus or minus 10%. That means the output voltage can be up to 10% higher or 10% lower than the incoming voltage. The yellow hand (which appears as gray on this picture) on the step indicator dial shows which step the regulator is on. The white hands show how many steps each side of neutral the regulator has been. These drag hands are reset periodically. Notice that there are 16 steps in each direction.

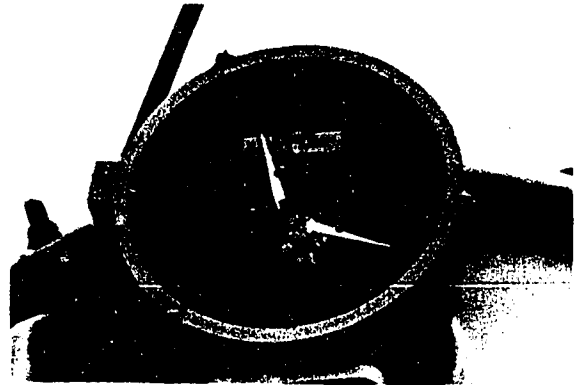

A 10% regulation range in 16 steps gives 5/8% change in voltage for each step. Figured on a base of 120 v, that's 3/4 v per step.

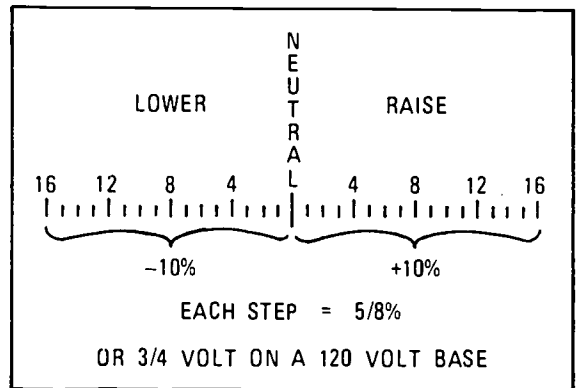

If the regulator is consistently up to 16 steps in either direction, it is trying to control a voltage swing outside the range that it can handle. When this happens, the cause should be determined and then fixed.

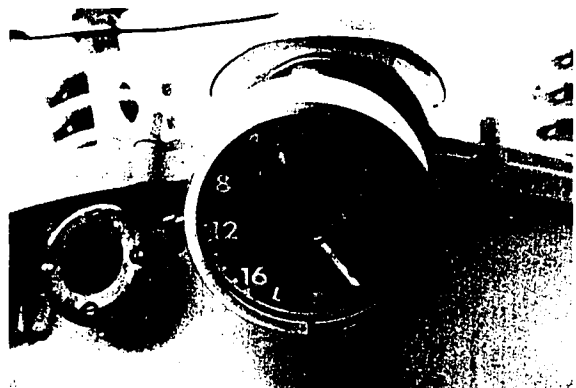

75

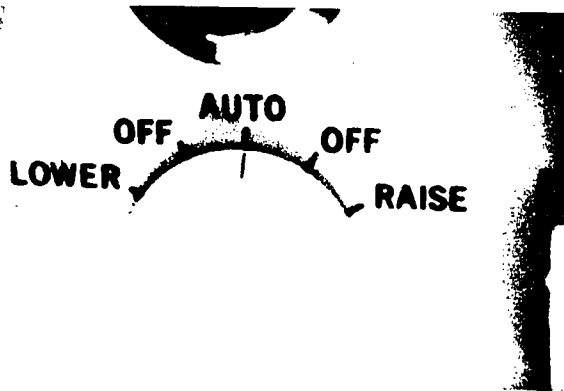

There are some other controls and indicators on the lower part of the panel. One of these is a selector switch that allows automatic control, manual raise or lower, or turning the control off. This control is used for testing the regulator in operation and to bring it to neutral when it is to be de-energized.

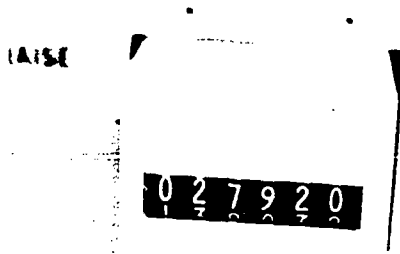

The operations counter shows how many operations the regulator has accumulated, much as the odometer in a car shows accumulated mileage.

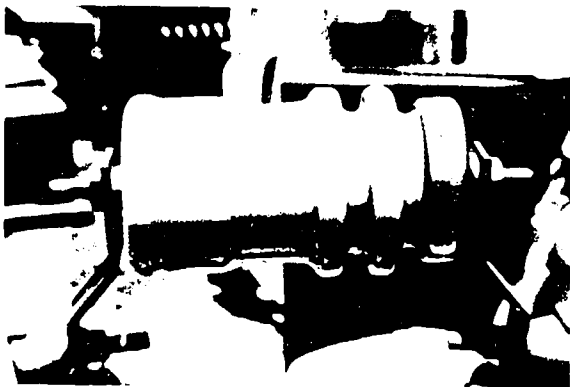

Another important item is the surge arrester across the series coil. This is necessary to help protect the regulator from lightning and switching surges. Some manufacturers put the surge arrester inside the tank so it can't be seen, but it is still there.

In addition, distribution valve type arresters should be used on both the load and source bushings. These should be mounted on the regulator tank to get them as close as possible to the regulator bushings to provide maximum protection to the regulator. Most manufacturers provide lugs on the regulator tank to use for mounting these arresters.

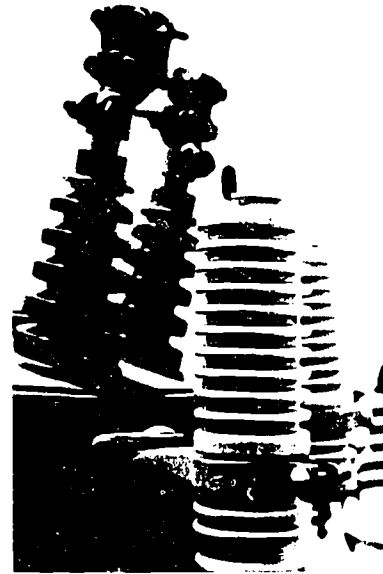

Although voltage regulators can solve lots of the voltage problems on a distribution line, there are other types of voltage problems that are better handled in other ways.

Capacitors

Under the right conditions, the power flow in power lines can be lowered and line losses reduced by using *capacitors* instead of regulators.

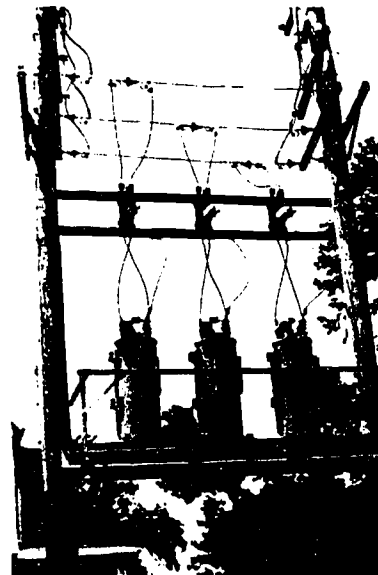

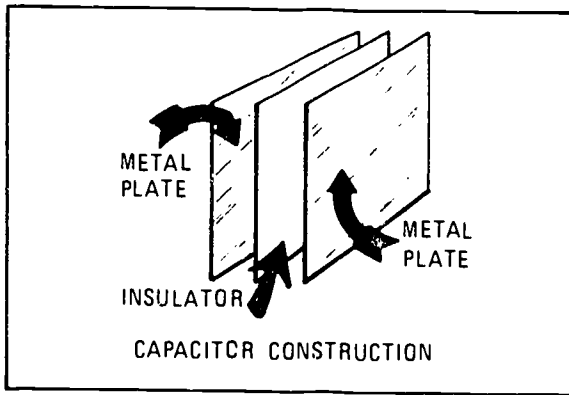

Essentially, a capacitor is two metal plates with an insulator sandwiched in between.

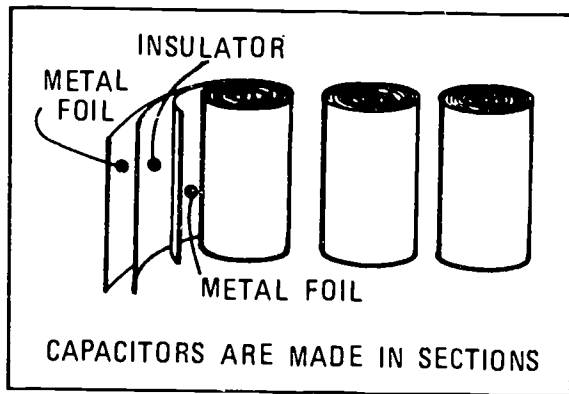

To get a capacitor big enough, power capacitors are made of several sections of foil and oil impregnated paper or plastic film rolled up—much like several rolls of paper towels.

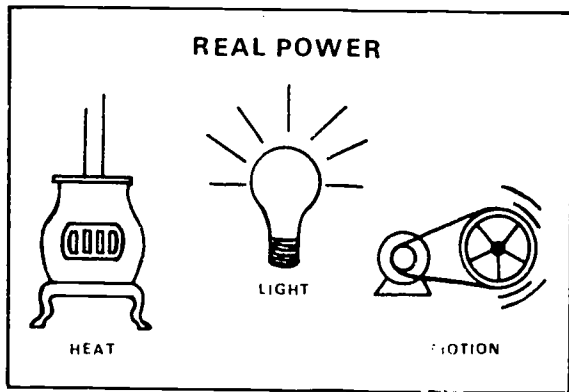

To understand how capacitors reduce power flow in the lines, some background information is needed. All electric devices draw *real* power from the electric system. This power is called *real* because it can be converted into heat, light or motion, which is what's needed to do various jobs such as cooking, running a mill, and so on.

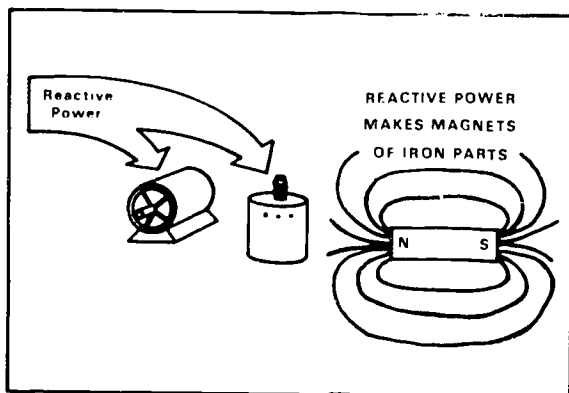

In addition to real power, some electric devices also draw *reactive* power from the electric system. Motors and transformers are the most common users of reactive power. The reactive power is used to magnetize the iron parts of these devices in order to make them work. It is *not* real power, because none of it is ever converted to heat, light, or motion.

A motor will draw reactive power when it is energized, even though it is not powering anything. If a mechanical load is connected to this motor it will draw real power to run that mechanical load. The amount of reactive power it draws will stay nearly the same regardless of the mechanical load.

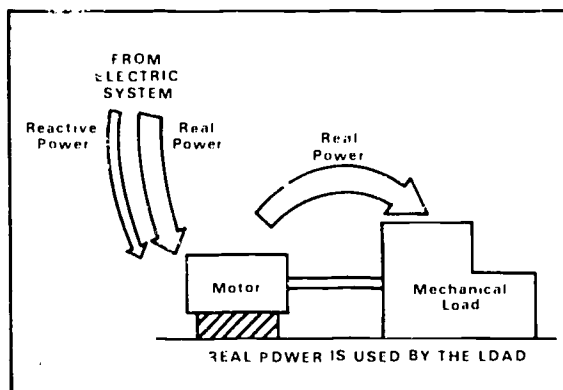

A transformer will also draw reactive power when it is energized, even with no load on it. If a load requiring only *real* power is connected to it, the transformer will draw real power to supply that load. As in a motor, the amount of reactive power the transformer draws will stay nearly constant regardless of the load.

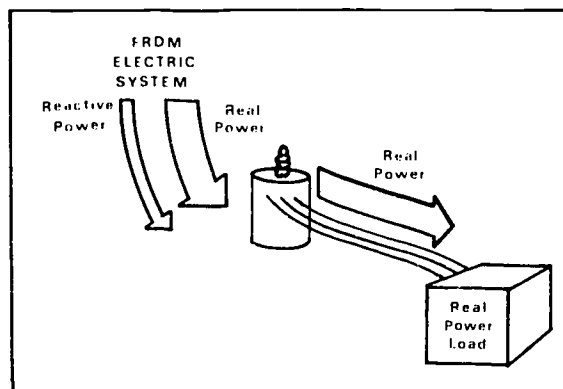

If a load that requires *both* real and reactive power is connected to a transformer, the transformer will draw enough of each of them to pass along to the load. In addition, the transformer still draws reactive power to supply its own needs. The transformer's own need for reactive power to magnetize its core is nearly constant, regardless of the requirements of the load connected to it.

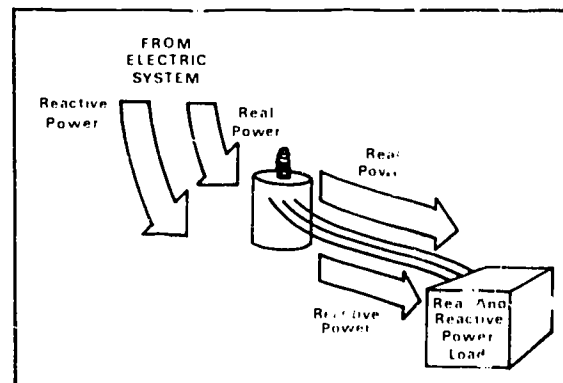

Reactive power, like real power, can be supplied by the generators in a power plant. In this case, it has to flow through the transmission system, the substation, and the distribution system to get to the load needing it. Since the lines and equipment used are not perfect, both the real and reactive power flowing through them will cause losses. If power could be supplied closer to the load, line losses could be reduced, because the power wouldn't have to flow through so much line and so many pieces of equipment.

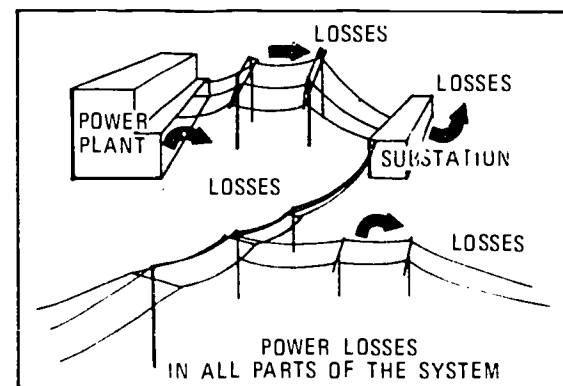

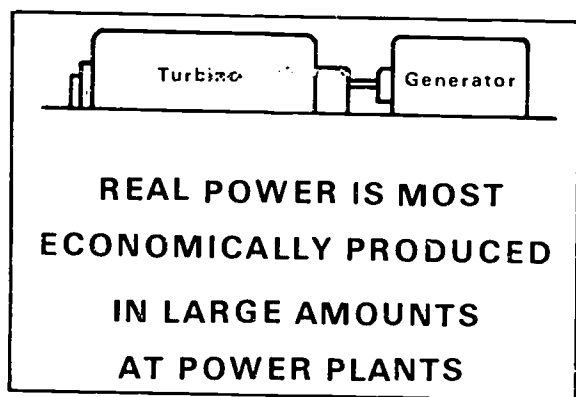

Unfortunately, the only way to supply *real* power economically is by running large generators and shipping the power out over transmission and distribution systems. But reactive power *can* be supplied close to the load by using capacitors.

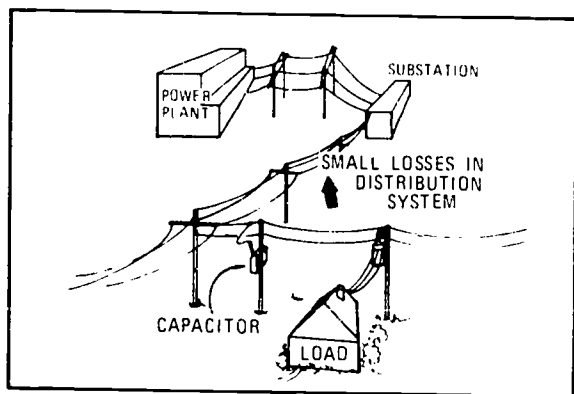

Capacitors can be considered as sources of the reactive power used by motors and other magnetically operated devices. With capacitors on the line, the power plant has to supply less reactive power, since some of it is supplied locally by capacitors.

KVAR
KILOVOLT-AMPERES REACTIVE
A MEASURE OF
REACTIVE POWER

To determine how many capacitors are needed to supply the reactive power required by the load, the amount of reactive power needed must first be determined. Reactive power is measured in KVAR's. Like transformer KVA, KVAR's are kilovolts times amperes. The "R" on the end of KVAR means this is reactive power only.

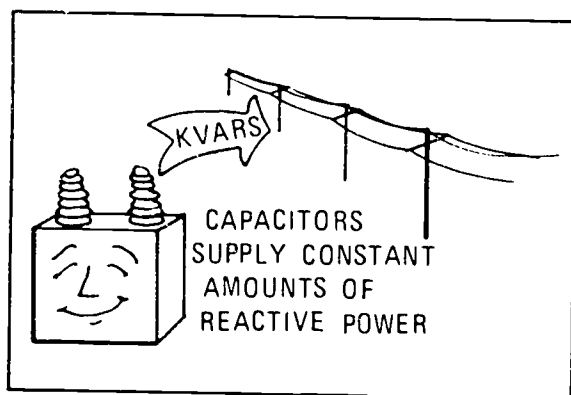

Capacitors are rated by how many KVAR's of reactive power they can supply. After the reactive power required by the load is determined the necessary capacitors can be bought. Typical ratings of distribution capacitors are: 50, 100, and 200 KVAR.

Capacitors also have a voltage rating. This rating *must* be matched to the operating voltage. If too high a voltage is applied to a capacitor, it can shorten its life dramatically. Too low a voltage won't hurt the capacitor, but it will supply a lot less reactive power (KVAR's) than it's designed to.

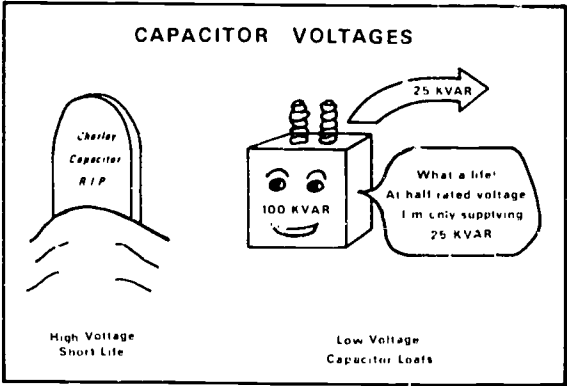

Electrified oil fields and industrial areas require a relatively large amount of reactive power. This requirement is year round.



Air conditioning is another load that requires reactive power. Since it's only used during the hot part of the year, the need for reactive power is seasonal. In addition, it also has a daily cycle since it runs a bit less at night.

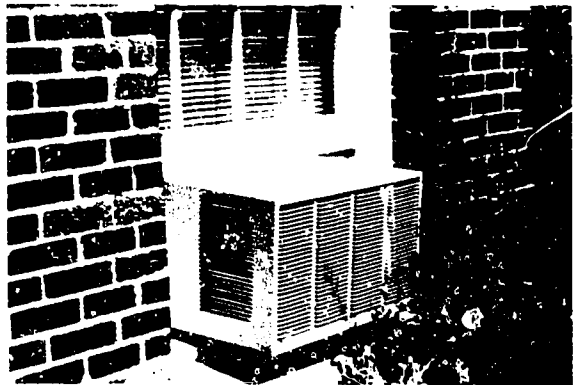

Many residential loads use motors or transformers. Even gas heating systems use transformers to produce the 24 v used in the thermostat circuits. Washing machines, refrigerators, vacuum cleaners and many other household devices use motors which must be supplied with reactive power. Household requirements for reactive power vary with the time of the day.

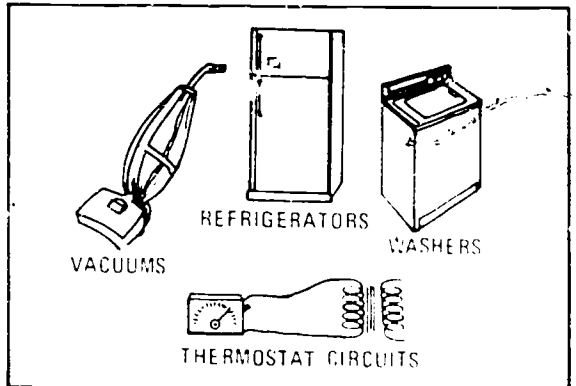

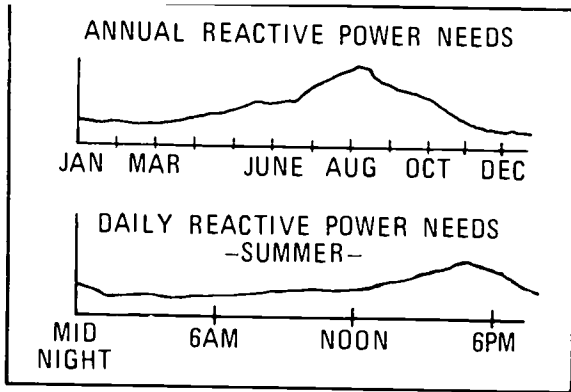

Because some of these loads have varying needs for reactive power, some of the capacitors have to be turned on and off at various times. They can't just be left connected because if there are more capacitors on the line than needed, they supply too much reactive power, or *capacitive* power. As far as line and equipment losses are concerned, this condition is just as bad as not having enough capacitors. In addition to causing higher line losses, too many capacitors on a line *can* cause high voltage towards the end of the line. Therefore, the capacitors must be switched on and off.

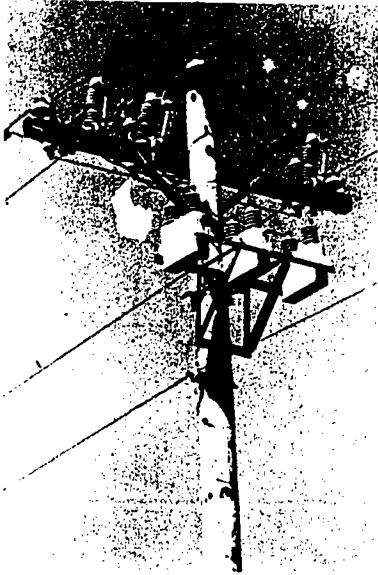

Usually, enough capacitors are left permanently connected to the line to supply the least amount of reactive power needed. This is the reactive power that supplies motors, transformers and other magnetic devices that run all the time.



Then additional capacitors are switched on in the spring and off in the fall. This switching is done manually. These capacitors take care of most seasonal changes in reactive load, most of which is caused by air conditioning and irrigation pumps.

To compensate for the changing requirements during the day, the remainder of the capacitors are switched automatically using oil switches.

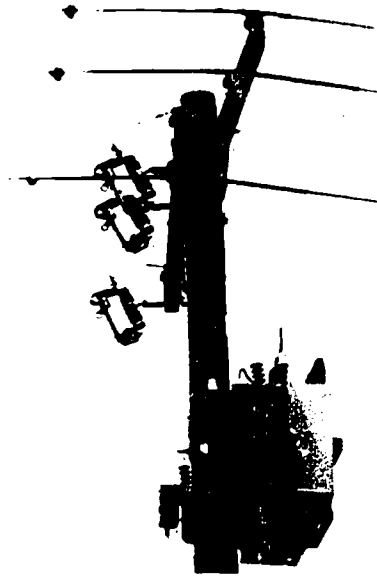

Many types of controls are available to operate the capacitor oil switches. One of the least expensive is a simple thermostat. This works well when daily air conditioning load is causing the reactive power demand. Other more accurate methods can be used to control switched capacitors, too. Some of these are pretty sophisticated and also expensive.

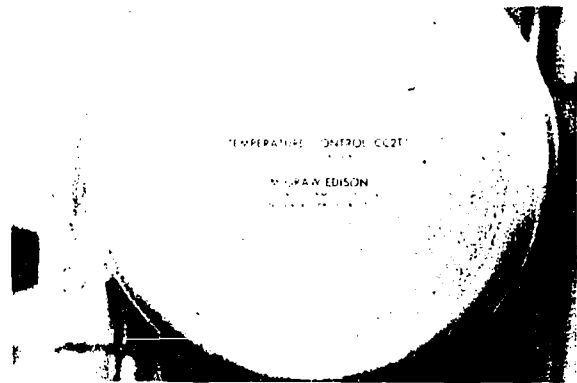

The two basic devices for voltage control on distribution systems are regulators and capacitors. The regulators control voltage directly by changing the turns ratio in a transformer, and the capacitors control it indirectly by supplying reactive power to magnetically operated devices on the system.

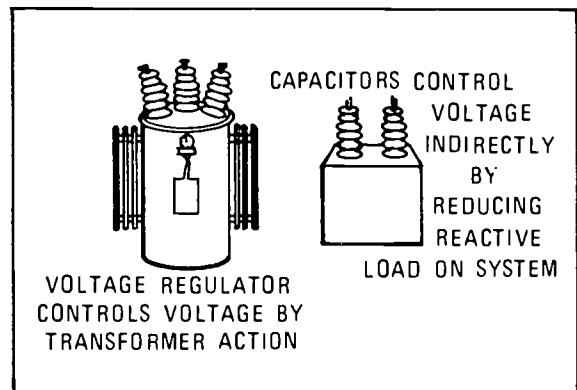

CAPACITORS HELP KEEP THE WHOLESALERE POWER BILL DOWN. SINCE REACTIVE POWER DOES NOT NEED TO BE BOUGHT FROM THE POWER SUPPLIER.



By using capacitors to control reactive current, the power supplier is being helped, yet it doesn't cost him anything. But, the power supplier bills its customers for excessive use of reactive power. In addition to metering the real power demand at the substation, the supplier meters the reactive power demand also. If the reactive power gets too high compared to the real power a penalty must be paid on the monthly power bill. Capacitors are very useful on power systems in a variety of ways.

Meters

The most common, and probably the most important kind of meter used on a power system is the watt-hour meter. A watt-hour meter measures the amount of electrical *energy* flowing through it. The amount of electrical energy a consumer uses is the basis for his monthly bill. Since the power company's revenue depends on accurate metering, proper use and maintenance of them becomes extremely important.

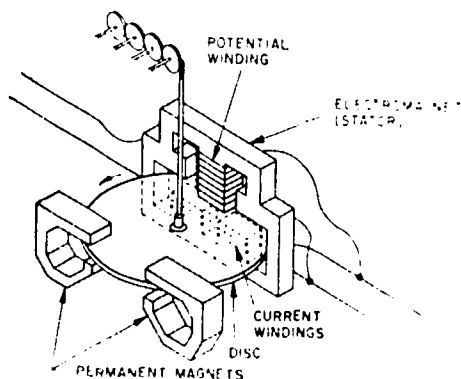

Basically, all watt-hour meters are electric motors whose speed of rotation depends on the amount of power flowing through the meter.

The moving part of the meter is called the *meter disc*.

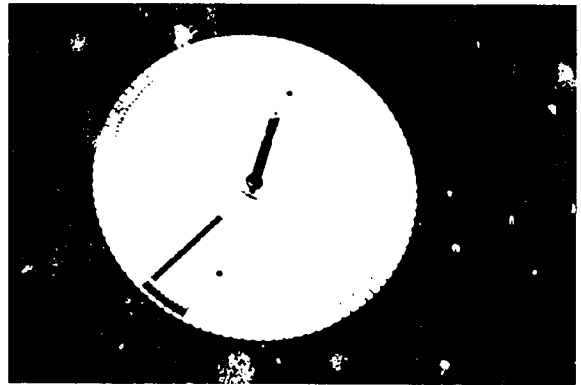

The disc drives a series of gears connected to a *register*.

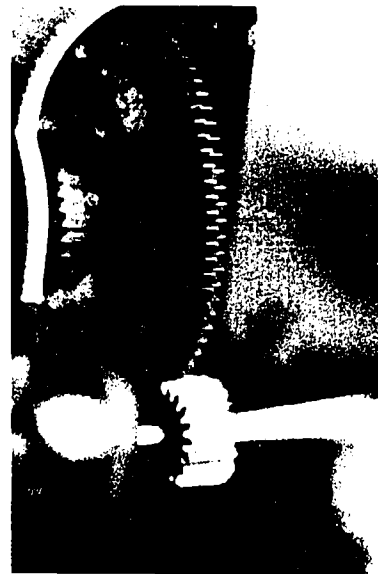

There are two types of registers in common use. One is a *clock type*, which has a series of dials that look like clocks. It's easy to make a mistake reading a meter like this.



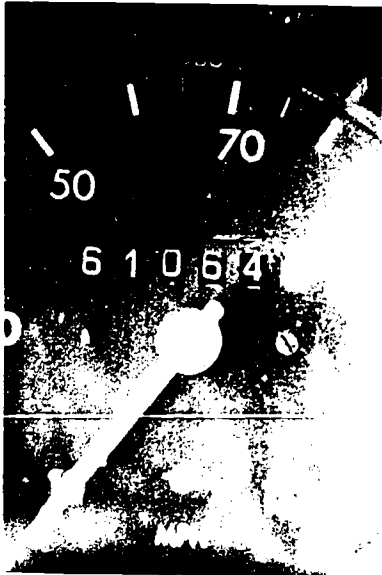

The other type is a *cyclometer* type. The numbers are direct reading, like the odometer of a car.

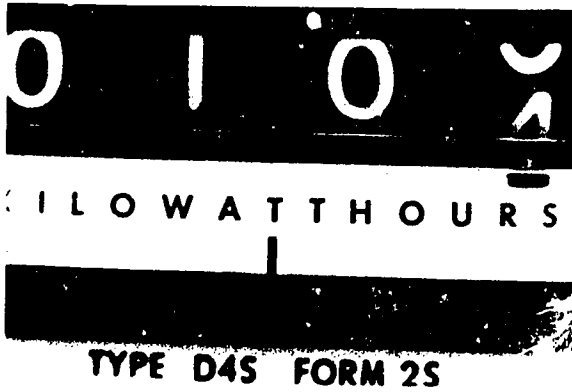

The watt-hour meter register totals up the number of times the disc has turned completely around. The number of disc revolutions is reduced by the gear ratio of the gear train. Totaling the reduced disc revolutions in this way gives a reading of energy consumed, which is measured in *kilowatt-hours*.

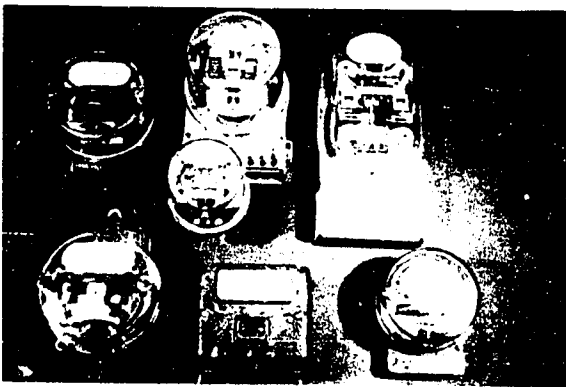

The hardest part of metering is the wide variety of meter types. If only one type of meter was used it would be pretty easy.

Different types of meters were developed either as improved designs or to meter different kinds or sizes of loads.

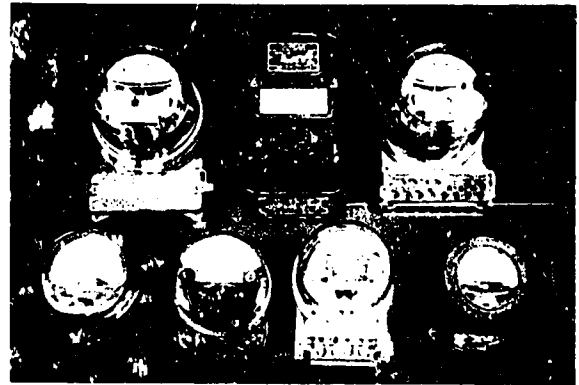

For example, a single-phase meter used for metering residential loads has only one disc. But if a three-phase load is to be metered, this single-phase meter won't work.

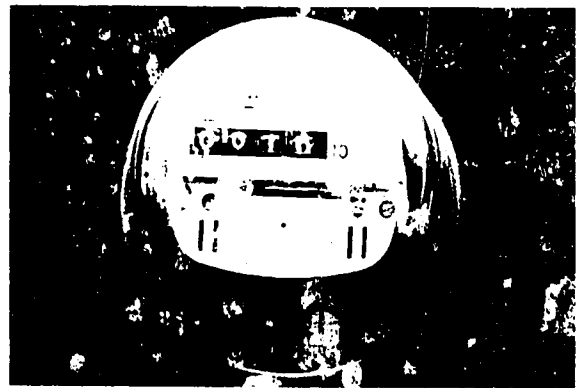

The most straight forward way to measure a three-phase circuit is with three separate single-phase meters. It's the most expensive way, but it's also the most accurate. The three meters can be built in a single unit with the three meters sharing a common shaft and register.

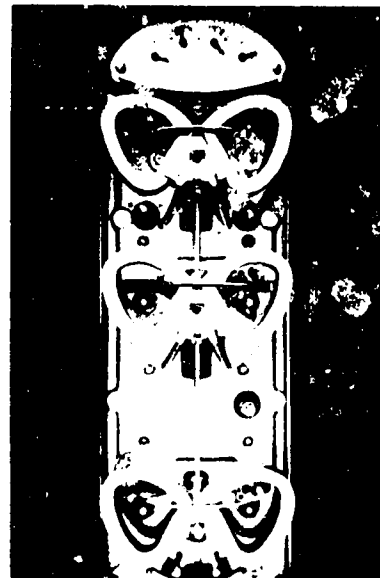

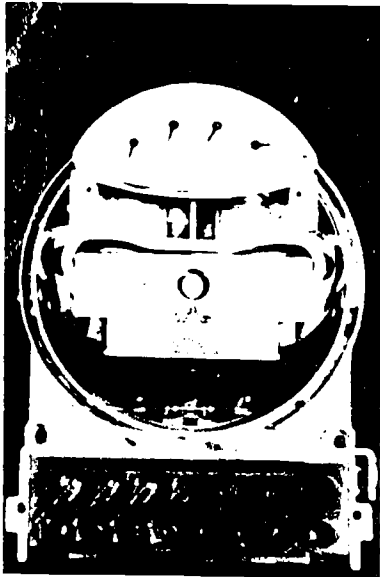

Where a bit less accuracy is allowable, some *compromise* methods can be used. These involve doing wiring tricks inside the meter with the different phase voltages and currents. A meter designed for compromise metering is generally cheaper because it has fewer internal parts.

Most customers are billed for the energy they use.

central rural electric cooperative

RETURN POSTAGE GUARANTEED

Previous Reading	Present Reading	KWH Multiplier	KWH Used	Amount \$	c
8055090580	1	10030	31078		
DEMAND CHARGE			14.5	3553	
CONTRACT CHARGE OFF				34630	

POWER COST FACTOR .0001000
DUE BY 15th OF MONTH

In addition to the energy charges, some commercial and most industrial consumers are billed for a charge related to the fastest speed the disc turned during the month. This is called *demand*.

central rural electric cooperative

RETURN POSTAGE GUARANTEED

Previous Reading	Present Reading	KWH Multiplier	KWH Used	Amount \$	c
8055090580	1	10030	31078		
DEMAND CHARGE			14.5	3553	
CONTRACT CHARGE OFF				34630	

POWER COST FACTOR .0001000
DUE BY 15th OF MONTH

Demand is a measurement of the peak power, or maximum power, the consumer's load demanded during the month. From a practical standpoint, it's a measure of how big a service is needed to supply a consumer—the service wire size and transformer size in particular.

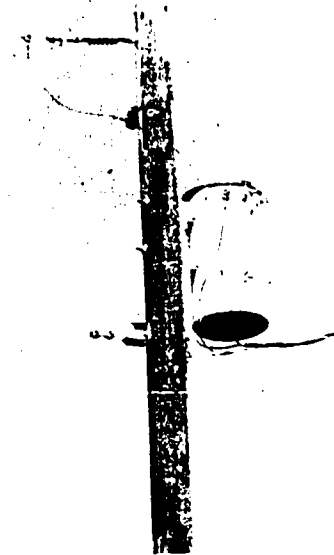

Demand measurement does not take an extra meter. A special register is substituted for the normal register on a regular kilowatt-hour meter.

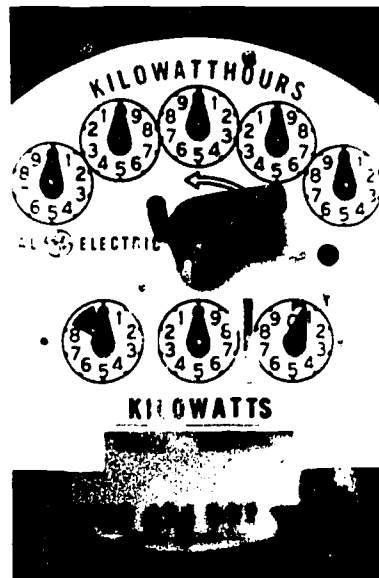

This demand register records the energy used, in *kilowatt-hours* just as a regular meter does.



ELECTRIC

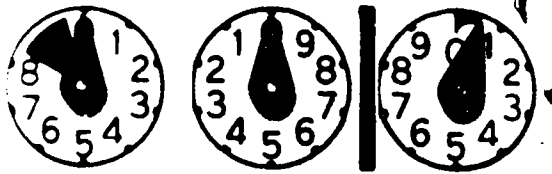

KILOWATTS

In addition, the demand register has another set of dials or a pointer that records the peak power demanded (the demand) in kilowatts.

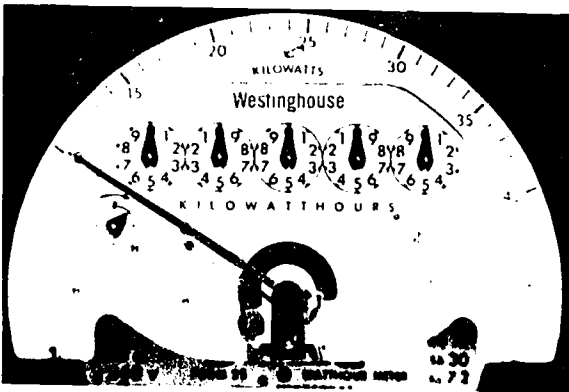

Some demand meters use a scale around the edge of the face plate and a long pointer to record the demand.

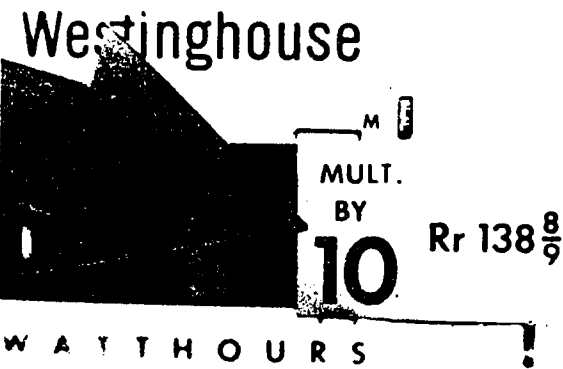

Not all registers show kilowatt-hours and kilowatts directly. Sometimes a multiplier is shown next to the dials. This means the reading must be multiplied by this value. On this meter the multiplier is ten. Generally on demand meters, the same multiplier applies to both sets of dials.

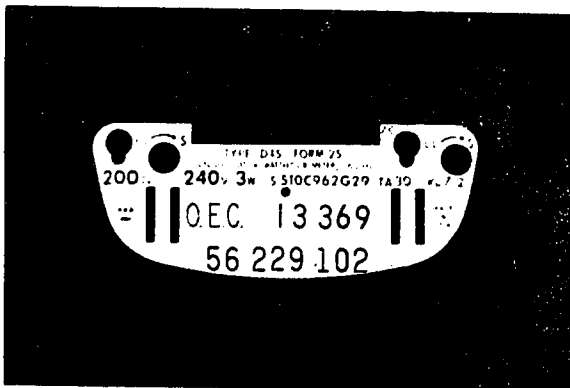

Each number on the face plate is there for a reason.

This big number at the bottom is the manufacturer's serial number.

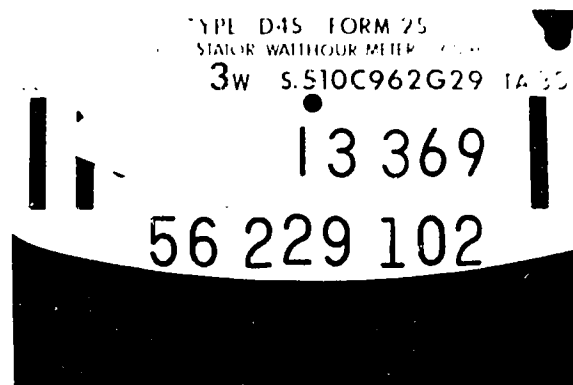

This number is designated by the power company for each meter. These assigned numbers simplify record keeping since it is hard to arrange a file using various manufacturers' serial numbers.

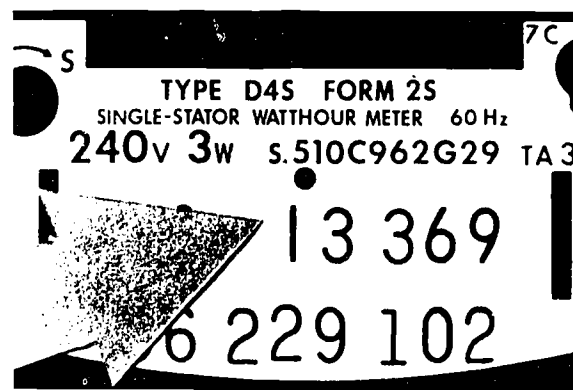

This is the *class* of the meter. It is the maximum load current the meter can carry, in this case, 200 amps.

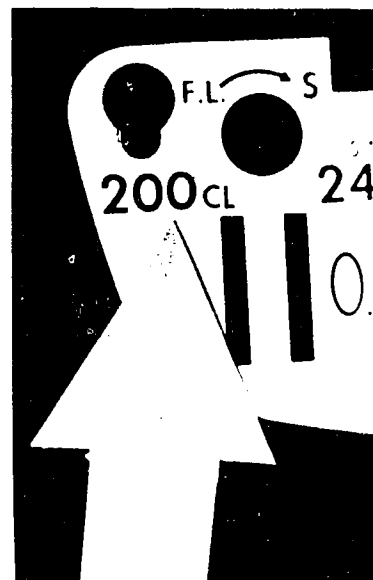

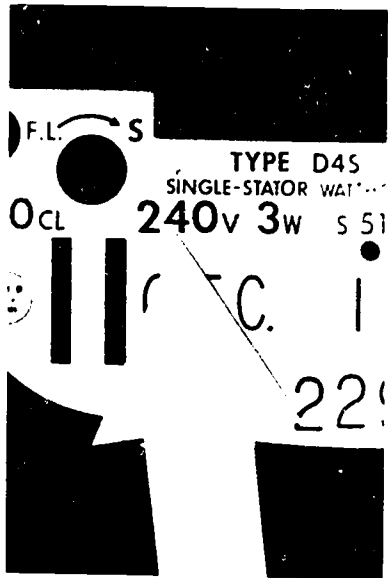

Here are the voltage and circuit type ratings. This meter is a 240 v meter designed to be used on a three wire circuit. Above that are the words, "single stator". This means that this meter is to be used on single-phase.

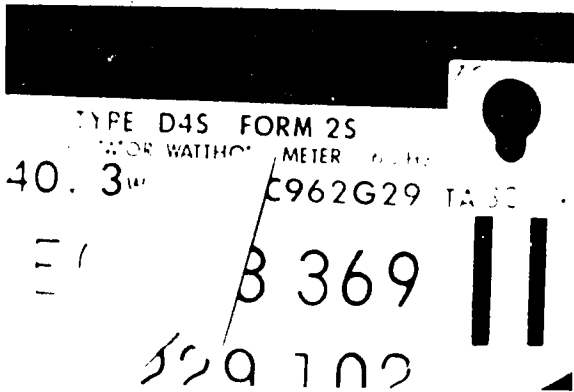

This is a very important number—the *form* number. Form numbers tell how the meter is wired inside. *All* meters with the same form number are wired the same inside. If two meters have the same *class rating*, *voltage rating* and *form number*, they are direct replacements for each other.

SANGAMO
FORM 6A WA

The letter at the end of the form number indicates the type of base the meter has. An "S" means a socket type meter. An "A" means a meter with a terminal block on its bottom side.

This group of numbers is important for testing meters. TA means *test amps*. Test amps is the current applied to the meter for initial adjusting. K_h tells how many times the disc turns completely around for each watt-hour of energy that flows through the meter.

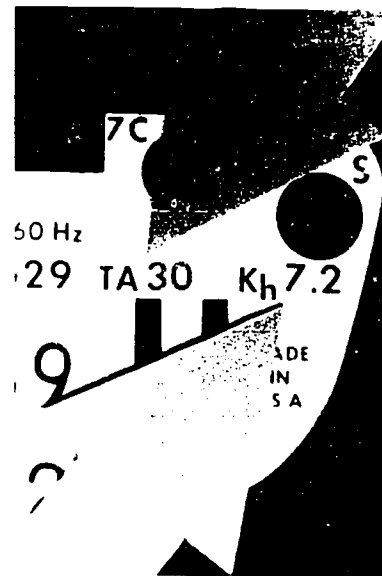

R_r is the register ratio. It is the gear ratio of the gear train in the register.

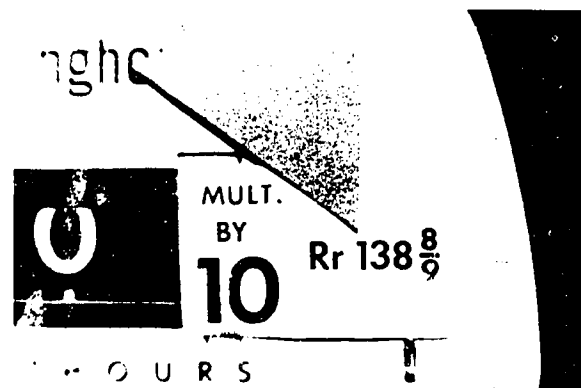

Self contained meters, which are the kind that have been covered so far, usually are not rated above 200 amps full load current, or 480 v. If currents or voltages *higher* than that are to be metered, transformer rated meters are used.



JJDA S 
 20 CL
 120 v 4
 4 w Y 60 Hz

Transformer rated meters are almost always rated class 10 or class 20 and 120 v. They are connected to the load to be metered through special metering transformers, which reduce the current and voltage to these levels.

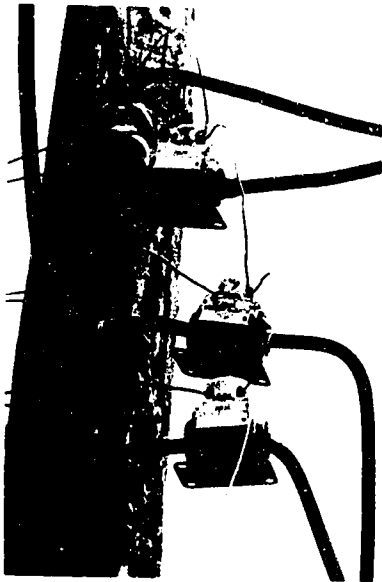

These *instrument* transformers are made in many different sizes to allow metering a wide range of loads.

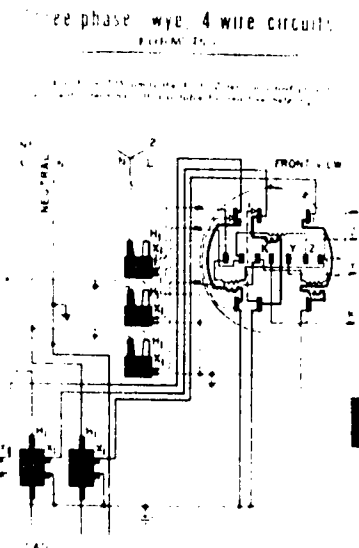

Properly connecting some of these meters can get pretty complicated. Making a mistake can give results from making the meter read wrong, to causing a short circuit and a fire. No one can become an overnight expert on metering since there are so many details.

Since a power company's revenue depends directly on correct and accurate metering, there are a few points that should be remembered. The first is that *all* kilowatt-hour meters measure the electrical energy that the consumers are buying to produce heat, light and mechanical motion.



Secondly, *some* kilowatt-hour meters measure electrical demand, or power, in addition to measuring energy. The demand register indicates how fast a customer used energy since the last time the meter was reset.



The many details of metering stem from the large number of meter types in use. Metering can't be simplified by eliminating any types of meters since each was developed for a particular use. Sooner or later, everyone runs across each of these metering schemes.

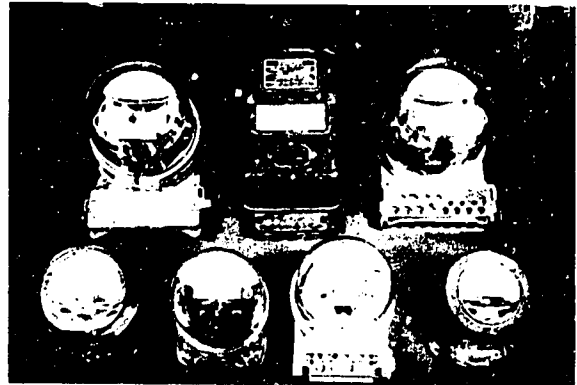

Glossary

Ampere: The unit of electrical current.

Arc: An intense discharge of electric current between two electrodes or two conductors.

Armor Rods: Small rods which are wrapped around a conductor to increase its mechanical strength at that point. They are sometimes used to create a place to connect hot line clamps.

Autotransformer: A single coil (winding) transformer. All the primary and secondary connections are made to this one coil. Often used where the voltage ratio is 1:3 or less, since in these ratios, it is cheaper and lighter than a two winding transformer.

Bandwidth: The upper and lower limits of a condition. As long as the condition remains within these limits, no corrective action is required. When used with respect to a voltage regulator, bandwidth is the number of volts, centered around the voltage setting, that the line voltage can vary without the regulator operating. For example, a bandwidth of 2 volts and a voltage setting of 123 volts allows the voltage to be between 121 volts and 125 volts without the regulator operating.

Basic Impulse Insulation Level (BIL): BIL is the voltage level at which insulation will begin to break down.

Basket: A loop of wire connected to a conductor so a hot line clamp can be attached to or disconnected for the basket without damaging the conductor itself.

Bulk Power: Electrical power transmitted over transmission lines in large quantities.

Bushing: An insulated support for a terminal.

By-Pass Switch: A switch which is used to jumper around a device in the system, thus allowing maintenance to be performed on the bypassed equipment.

Capacitor: A device basically consisting of two metal

plates separated by an insulator. Such a device is used in a power system to provide reactive power.

Capacitor Switching: The act of switching capacitors in or out of a circuit.

Capacitive Power: A type of power which is drawn by capacitors. Capacitive power is opposite to inductive power and these tend to cancel each other when both flow in the same line.

Circuit Breaker: A device that will open a circuit if too much current is flowing through it. Once it opens it can be manually reset.

Clock Type Meter: A meter which has a set of dials that look like clocks. These dials record the accumulated kilowatthours of energy that flow through the meter.

Coil Size, Coil Size Rating: 1. The full load current rating of a recloser. This rating is expressed in amperes.
2. The full load KVA rating of a transformer.

Coiled Lead: A piece of wire connecting a piece of equipment to a power line and formed into a coiled shape. They are to be AVOIDED on lightning arrester installations, as they severely reduce the arrester's effectiveness.

Compromise Metering: The idea of using a metering method less accurate than the best that can be obtained in exchange for lower cost. Compromise metering is accomplished by special wiring connections either in the meter or in the external connections.

Connector: A device used to join two wires electrically and physically.

Continuous Load Current: The amount of current which a device can handle continuously without damaging the device.

Control Calibration: The calibration or adjustment of a control circuit.

Corrosion: A non-conducting substance formed (particularly on connectors and hot line clamps) by the chemical reaction of 2 dissimilar metals being in contact with each other, often with moisture present.

Cutout: A fuse holder designed for use on distribution circuits. Open cutouts provide visual indication of a blown fuse. However, enclosed cutouts may not provide this advantage.

Enclosed Cutout: A cutout containing a fuse in a closed box. Such devices may not provide visual indication of a blown fuse.

Open Cutout: A cutout consisting of exposed parts which can give visual indication of a blown fuse.

Cyclometer: A type of meter register, consisting of rows of numbered wheels, such as found in a car odometer or the operations counter on a voltage regulator. This particular type of register is easier to read accurately than the earlier type using dials and pointers.

Demand: The measurement of the peak power or maximum power which a load requires. The demand gives an indication of how close a power system is being operated to its maximum capacity. See also-PEAK POWER.

Demand Register: A meter register that records both energy (kilowatt-hours) and demand (kilowatts) that flow through the meter. The energy (kilowatt-hours) is recorded on a set of dials as on a regular register. A second set of dials or a pointer records the demand (kilowatts).

Distribution Circuit: A distribution line beginning at a distribution substation and which serves all the consumers in an area. The circuit contains all smaller lines connected to the main line from the substation. A substation usually supplies several distribution circuits.

Distribution System: The part of the power system that delivers power from the substation to the consumer.

Drag Hands: An auxiliary set of pointers on a register which records the highest and lowest points reached by the main pointers. These are used primarily on the position indicator of a voltage regulator.

Electromechanical Control: A device dependent upon electrically induced mechanical motion to perform its function. Such devices can be used to control equipment such as voltage regulators.

Electronic Control: An electronic circuit designed to control a piece of equipment such as a voltage regulator or recloser.

External Gap: An external spark gap used on some lightning arresters in addition to the internal gap.

False Tripping: A recloser operation that is not caused by a fault. The most common causes of false tripping are load current greater than the recloser's minimum trip point, and lack of periodic maintenance.

Fault: A short circuit on the line.

Fault Current: The amount of current that flows in the system when a fault, or short circuit, occurs.

Line To Ground Fault: A short circuit (fault) involving one phase, or hot conductor and the earth. The

neutral (if present) is not involved (this would be called a line to neutral fault).

Permanent Fault: A fault that does not correct itself. For example, a transformer winding could short and would remain on the line until it was removed by the lineman.

Self-Clearing Fault: A fault that corrects itself. For example, a tree limb might slap against a line and cause a momentary short circuit.

Three-Phase Fault: A short circuit (fault) involving all three phase wires of a circuit. If the circuit has a neutral, it may or may not be involved.

Feeler Gauge: A measuring device used to measure the gap between two contacts. The gauge is slipped between the contacts and the gap is adjusted to the point that the contacts *just* touch the gauge.

Fuse: A device placed in a circuit to protect it from over current. When too much current flows through a fuse, the fuse melts or burns up and opens the circuit.

Fuse Holder: A device used to hold a fuse.

Fuse Link: A replaceable fuse such as used in a cut-out.

Gear Ratio: In a kilowatt-hour meter, it is the ratio between the speed of the disc and the right hand (fastest moving) dial on the register. This term relates to the number of revolutions which the meter disc makes for every single revolution made by the right hand pointer on the register. (See Gear Train)

Gear Train: An assembly consisting of a system of interconnected gears. Such an assembly is used in meters to convert the number of disc revolutions to a numerical reading on the meter register.

Ground Lead: The wire connection between a piece of equipment and ground, or neutral.

Ground Lead Isolator: A protective device used on a lightning arrester. If the arrester short circuits, a small explosive charge in the base heats up and fires. This explosion blows off the bottom terminal and remove the arrester from the circuit. This gives a visual indication that the arrester is bad.

High Current Feeder: A three phase line built with relatively large conductors, and generally used to carry power to various smaller taps branching off from it.

Hot Line Clamp: A connecting clamp used for low current connections (usually 1; Amps or less) which can be operated with hot line tools.

Hot Line Tools: Heavily insulated tools which are used

to work on hot (energized) lines.

Incoming Voltage: The voltage coming into a device. The voltage applied to the source side of a piece of equipment.

Inductance: A characteristic of wire. This characteristic causes the conductor to oppose any *sudden* change in current flow. Coiling a wire increases its inductance many times.

Initial Adjusting: The first adjustment or calibrations made on a device.

In-Line Tension Switch: A line switch which is mounted in the line itself and not on a pole. They are easier to install in an existing line than pole top switches. They can be operated by hot line tools.

Interrupting Rating: The amount of current which can be interrupted by a device. If the current exceeds the rating, the device may not be able to interrupt it. This can damage the device and other equipment on the power system.

Jumper Connection: A short wire used to connect the conductors of two lines together electrically. Usually the lines cross each other on a pole, but occasionally mid-span connections are used.

Kilowatt-hour: A measure of electrical energy. One kilowatt-hour is the amount of energy necessary to power a one kilowatt (1000 watts) load for one hour.

K_n : A number that tells how many times the disc in a kilowatt-hour meter turns completely around for each watt hour of energy that flows through the meter. It is called the WATTHOUR CONSTANT.

KVA: A measure of combined real and reactive power called APPARENT power. The voltage in thousands of volts is multiplied by the current in amps to give the KVA. All transformers have a KVA (apparent power) rating. This is the maximum apparent power a transformer can handle continuously without damaging the transformer.

KVAR: A unit of measurement for reactive power. It is determined the same way as KVA. However, only reactive, or magnetizing, current is included in the current measurement (see KVA).

Lightning Arrester: A more common name for a surge arrester.

Line Insulator: A non-conducting device (usually porcelain or glass) used to hold wires on a pole or crossarm.

Line Switch: A manually operated switch used on a distribution line to break it into smaller sections to make

trouble shooting easier.

Load Break: A name given to devices which are designed to open circuits which are carrying load current (energized).

Load Break Rated: Refers to a device designed to safely interrupt a specified load current.

Lock-Out: Occurs when a recloser has been tripped the maximum number of times and then it locks-out or remains open until it is manually reset after the fault has been cleared.

Magnetic Core: The laminated steel structure inside a transformer. Both the primary and secondary coils are wound on the core. The core forms the magnetic circuit within the transformer.

Main Conductor: As used in this book, refers to the conductor to which a basket is attached.

Main Feeder: A main distribution line usually beginning at the distribution substation.

Maximum Rated Current: The maximum current a device can handle continuously without damaging the device.

Mechanical Load: The load driven by an electric motor.

Mechanical Protection: Protection from physical damage.

Meter Disc: The round flat part of a meter which revolves as energy flows through the meter. The speed of the disc's rotation is in proportion to the amount of power flowing through the meter. This disc is connected to the meter's register through a gear train assembly.

Minimum Trip Point: The minimum current necessary to trip a recloser. It is twice the coil size rating in hydraulic reclosers. Its setting is variable in electronic units.

Multiplier: A multiplying factor found on the face of some meters. The reading on the register is multiplied by this factor to obtain the actual kilowatt-hours.

Neutral: A return wire common to all three phases.

Non-Load Break: A name given to devices which are not designed to be opened while carrying load or fault current.

Oil Circuit Recloser: An automatic circuit recloser that uses oil for both insulation and timing by hydraulic methods.

Oil Switch: A switch which has its contacts under oil. The oil provides insulation and arc interruption. The oil

switch is particularly suited to switching capacitors.

Operating Voltage: The voltage level at which a piece of equipment or a system is normally operated.

Operating Voltage Rating: The voltage level at which a device or system can operate continuously without damage. The voltage level at which the equipment or system was designed to operate.

Operation Counter: A mechanical counter which records the total number of times a device has operated.

Outgoing Voltage: The voltage coming out of a device; the output voltage.

Output Voltage: The voltage present at the load terminals of an electric device.

Peak Power: The maximum power a load demands. Sometimes, as in demand meters, power is averaged over 15 or 30 minute intervals. The highest power in one of these intervals is then called peak power. Averaging the power in short intervals more closely approximates the heating effect of loads on the power system. See also DEMAND.

Phase Conductor: A conductor normally energized at a voltage above ground.

Power Capacitor: See Capacitor

Power Follow Current: The 60 cycle power which maintains its flow across a spark gap of a lightning arrester after the lightning has been discharged.

Primary Voltage: The input voltage of a transformer, whether used as a step-up or step-down transformer.

Primary Winding: The input winding of a transformer.

Radio Noise: Electrical interference generated by loose electrical connections, loose hardware, improperly adjusted spark gaps and other conditions. This interference causes noise or static on radios.

Reactive Power: Magnetizing power which is necessary for the operation of such devices as motors and transformers.

Real Power: Electric power which can be converted into heat, light or motion.

Recloser: A device that senses the current flowing through a line and opens if the current exceeds a specified amount. It will, after a short delay, close again for another try. It will give two or three chances for the trouble to clear before remaining open.

Register: A gear train on a kilowatt-hour meter arranged to count the number of disc revolutions. The

register gives the number of kilowatt-hours, however, instead of the actual disc revolutions. The register reading is recorded either on a set of clock-like dials or on a set of odometer-like number wheels.

Regulator: See Voltage Regulator.

Regulator Range: A specified range of voltage which a regulator can correct. Usually this is plus or minus 10% of the nominal, or rated, output voltage (*not* the output voltage set on the control panel).

Return Wire: A common wire which returns current to the source and is usually grounded.

Reversing Switch: In a regulator, a switch used to reverse the connections of the series coil. This controls whether the regulator produces an output voltage which is lower or higher than the incoming voltage.

R_r: Stands for register ratio. It is the gear ratio of the gear train in the register of a meter.

Secondary Side: The output side of a transformer.

Secondary Terminals: The connecting terminals that are used to make a connection to the secondary winding of a transformer.

Secondary Voltage: The output voltage of a transformer, whether used as a step-up or step-down transformer.

Secondary Winding: The output winding of a transformer.

Selector Switch: A switch used in a regulator to choose the amount of voltage to add or subtract from the incoming voltage.

Series Coil: In an autotransformer or regulator, the coil or winding connected between the incoming (source) terminal and the outgoing (load) terminal. No part of the series coil is connected to ground, or neutral.

Short Circuit: A very low resistance connection between hot lines or hot lines and neutral. It is also referred to as a fault. Excessive current flows through the lines that feed a short circuit and can damage these lines if not quickly corrected or properly protected with fuses or oil circuit reclosers.

Shunt Coil: In an autotransformer or regulator, the coil or winding connected across the line (from the hot or phase wire to neutral).

Single-Phase Circuit: A power line that uses one hot wire and one return wire. Sometimes, a service has *three* wires—two hot wires and a neutral. This is still considered single phase since it is derived from only

one phase of the distribution system.

Single-Phase Meter: A meter which is designed to meter a single-phase system load. As single-phase loads can be either two wire or three wire, different meters are made to measure two wire and three wire circuits.

Single-Phase Tap: A connection to one of the hot wires and the return wire of a three-phase circuit to form a single-phase circuit.

Sixty Cycle Power: The frequency most commonly used in the United States for power generation, transmission and distribution. 50 cycle and 25 cycle are two other standard power frequencies.

Spark Gap: A space between two electrodes.

Spark-Over Voltage: The voltage level necessary for a spark gap to fire, or arc over.

Standard Operating Procedure: A set of rules established by a power utility that set forth a step by step method of performing certain recurring jobs. These rules are designed to make the work safe and to minimize disturbances to the power system.

Substation: The group of equipment that interconnects the transmission system to the distribution system. A substation has 3 essential functions (voltage change, disconnecting the station from the transmission system, and protecting it from the distribution system).

Surge Arrester: A device which discharges voltage surges to ground to prevent damage to any devices or equipment on the line. These voltage surges may be caused by switching operations or lightning.

Surge Voltage: A sudden pulse of voltage occurring on a power system. The peak voltage of the pulse is usually several times the normal operating voltage.

System Voltage: The voltage level at which a system normally operates.

Terminator: Special connector designed to minimize electrical stresses caused by power system voltages at the ends of wires.

Test Amps (TA): The current which is applied to a meter for initial adjusting.

Three-Phase Circuit: A system which uses three wires to carry current and which may also have a neutral or return wire.

Three-Phase Ganged-Air-Break Switch: Three single switches, one in each phase of a three-phase line, mechanically connected to operate together, and

using air as the insulating and arc interrupting material.

Thermostat: A temperature controlled switch which usually provides an on-off function. The switching occurs at preselected temperatures.

Time Delay: A waiting period from the time a condition is sensed until the control circuit takes corrective action.

Transformer: A device which changes the voltage level that is applied to it.

Center Tapped Transformer: A transformer which has a tap (connection) at the center of the secondary winding. The voltage at the center tap to either end of the secondary is one half the voltage from end to end of the secondary.

Distribution Transformer: A transformer used to reduce the voltage from that used on the distribution system to the voltage level which is used by the consumer.

Step Down Transformer: A transformer which gives an output voltage that is lower than the input voltage.

Step Up Transformer: A transformer which gives an output voltage higher than that applied to the input.

Transformer Core: See MAGNETIC CORE.

Transmission System: The part of the power system that moves power from the generating plants to the substations and has no other loads along the way.

Turns Ratio: A ratio which represents the number of turns in the primary winding of a transformer divided by the number of turns in the secondary winding.

Valve Block: The part of a lightning arrester which limits the power follow current through a lightning arrester to a point that the spark gap can interrupt it.

Voltage Change: A process occurring in a transformer which converts voltage from one level to another.

Voltage Fluctuation: A change in voltage level.

Voltage Rating: A voltage level that a device is designed to withstand. Most devices have several voltage ratings, each for different conditions.

Voltage Ratio: A ratio of the primary voltage of a transformer divided by the secondary voltage.

Voltage Regulator: A device used to correct the voltage level on a distribution system to maintain some predetermined level.

Watt-hour Meter: A meter which measures the amount of electrical energy flowing through it.

Laboratory Procedures

Reclosers and Fuses

Introduction, Lab One

Both reclosers and fuses are used on distribution systems as protection against faults, or short circuits. Reclosers are "smart" circuit breakers that make several attempts to reset before locking out and leaving a line dead. Fuses, used with reclosers, can minimize the amount of line affected by a fault. Making fuses and reclosers work together properly is called "coordination."

Objectives

After completion of this lab, the student will understand:

1. Recloser trip point and sequence of operations before lock-out.
2. The size of the fuse used with an OCR is important for proper recloser-fuse coordination.

Equipment Required

- 1 AC ammeter
- 1 5 amp OCR
- 1 fused cutout (wall mounted)
- 1 variac

Part I: Demonstration of Recloser Trip Point

To demonstrate the trip point of an OCR, connect the following circuit.

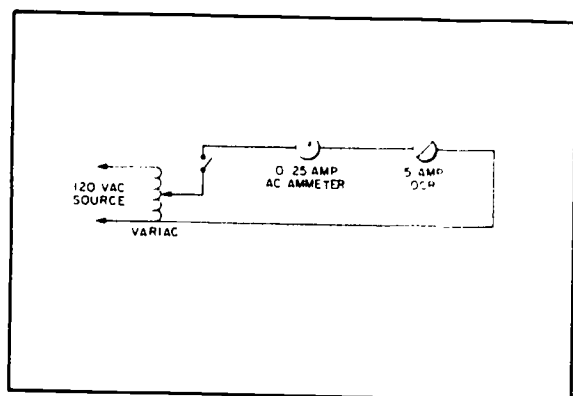

Schematic Diagram

Procedure

Caution—Before energizing circuit, set variac to minimum voltage (full counter-clockwise) position. The instructor will help you determine this position *if you ask him*.

After the circuit is connected to the power supply, slowly rotate the variac control. As you do so, watch the ammeter and listen to the OCR. As soon as the OCR clicks, stop turning the variac and answer the following questions.

1. What was the ammeter reading just before the OCR clicked? _____
2. Did the OCR click more than once? _____
How many times? _____
3. What is the ammeter reading now? _____
Has the OCR locked out? _____

Procedure

If the OCR has not locked out, continue rotating the variac control until the recloser goes through several clicks in a row. After it stops, check the ammeter. If it shows zero, the recloser has locked out. After the recloser locks out, answer the following questions.

Questions

1. What was the ammeter reading just before the recloser locked out? _____
2. What is the coil rating of your OCR? _____
3. What should be the OCR's trip point? _____
4. What was the OCR's trip point? _____

Part II: Demonstration of Recloser-Fuse Coordination

To demonstrate coordination of fuses and OCR's, connect the following circuit.

Procedure

CAUTION—Before energizing circuit, set variac to minimum voltage as in first part. **Note**—Since it is necessary to know on **which** recloser operation the fuse operates, close attention must be paid to both the ammeter and the recloser clicks.

From the three fuse links given, install the smallest

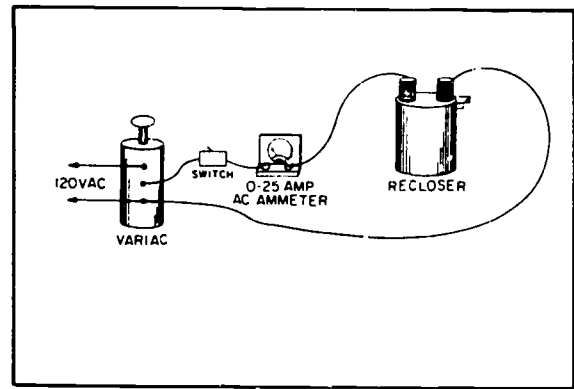

Pictorial Diagram

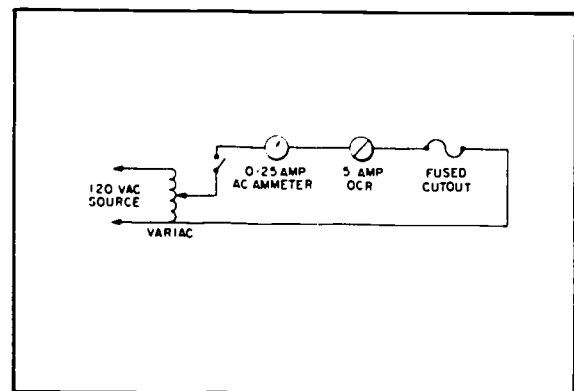

Schematic Diagram

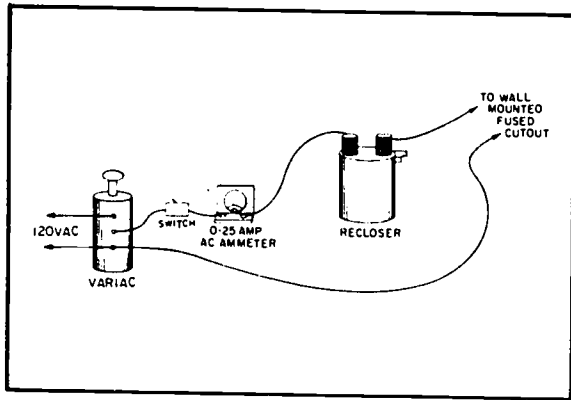

Pictorial Diagram

one in the cutout. Energize the circuit and slowly increase the variac until the recloser begins to operate. **Count the number of recloser operations until the fuse blows.** Repeat for the medium size fuse and the largest size.

Questions

- For each size fuse link, write the number of operations of the recloser and the current read from the ammeter when the OCR began to operate before the fuse blew. Use the table below.

<i>Fuse Size</i>	<i>Number of OCR Operations</i>	<i>Highest Current</i>
Smallest	_____	_____
Medium	_____	_____
Largest	_____	_____

- Based on the table above, what fuse sizes do not coordinate with this OCR?

Lightning Arrester Protection Demonstration

Introduction, Lab Two

Lightning arresters are used to protect distribution lines and equipment from excessive voltages.

Due to the high voltages used in the procedure, this lab will be a demonstration only.

Objective

After the demonstration, the student will understand how lightning arresters protect a distribution line from overvoltage.

Equipment List

- 1 0-50 KV Test Transformer and Induction Regulator Set-Up
- 1 Model of Distribution Line
- 1 Lightning Arrester

Demonstration Procedure

Caution—Voltages up to 50 KV are present in this demonstration. All personnel **must** be clear of the apparatus **before** it's energized.

1. At the end of the model line, bend the two wire ends that form the spark gap **away** from each other so the ends are at least a foot apart.
2. Starting at zero, increase the line voltage until insulator flashover occurs. The maximum voltmeter reading is the insulation breakdown or flashover point. When arcing begins, immediately decrease voltage to about $\frac{3}{4}$ of the flashover level. Note that the ammeter showed no current flow until flashover. Begin decreasing voltage towards zero. Note the voltage at which the arc goes out. Decrease voltage to zero.
3. Discussion Points:
 - a. What made arcing stop?
.....
 - b. Could arcing cause damage to the pole and/or insulator? To the conductor?
 - c. What does the ammeter show?
4. Set spark gap wires at a $\frac{3}{4}$ " **gap**. Starting at zero voltage, increase line voltage until spark gap fires. Maximum voltmeter reading is **sparkover voltage**. Immediately decrease the voltage to about $\frac{3}{4}$ of the flashover level. Note that the ammeter showed no current until flashover. Continue decreasing voltage, noting point at which arc goes out.
5. Discussion Points:
 - a. Did the spark gap prevent arcing across the insulator? Would this prevent pole, insulator and conductor damage?
 - b. What made the arcing in the spark gap stop?
.....
6. Bend spark gap wires at least a foot apart again. Connect lightning arrester to circuit. Begin increasing voltage. When the ammeter shows current flow, arrester has fired. Note the voltage. Begin decreasing voltage. When the ammeter drops back to zero current the arrester has stopped conducting. Note the voltage.
7. Discussion Points:
 - a. What did the ammeter show?
 - b. Was line damaged at all?
 - c. Was there any visible arc?

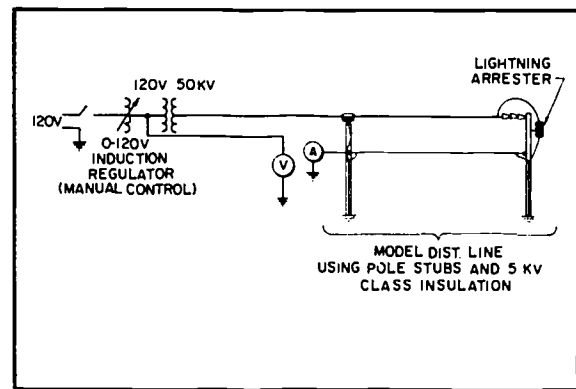

Pictorial Diagram

Transformers and Autotransformers

Introduction, Lab Three

Transformers and autotransformers are used on power systems whenever a change in voltage level is required. The side of a transformer that is connected to the source is called the primary and the side supplying the load is called the secondary.

Objectives

After completion of this lab, the student will understand:

1. Voltage relations among the three leads on the secondary side of a distribution transformer.
2. That transformers can be used either as step-down or step-up.
3. That the voltage **ratio** doesn't depend on the voltage applied.
4. Step-up and step-down operation of an autotransformer.

Equipment List

- 1 12 VCT transformer, 5 connections
- 1 12 VCT autotransformer, 3 connections
- 1 0-120 Volt Variac
- 1 VOM

Procedure

Note: 12 volt transformers are used in this lab to model distribution transformers to avoid working with high voltages. However, 120 volts is being used. **Be Careful.** 120 volts can be as lethal as 7200 volts.

1. Using the transformer with five terminals, connect the side which has only two terminals to the variac output. To make the following measurements, flip the variac control switch to the 120V position (up). The red pilot light indicates the variac is connected to the 120V supply. Increase the variac control to the 100% position (fully clockwise).
2. Measure the voltage across the two outside posts of the secondary. What is it?
3. If you measured the voltage from the center post to

Steps 1, 2, 3 and 4

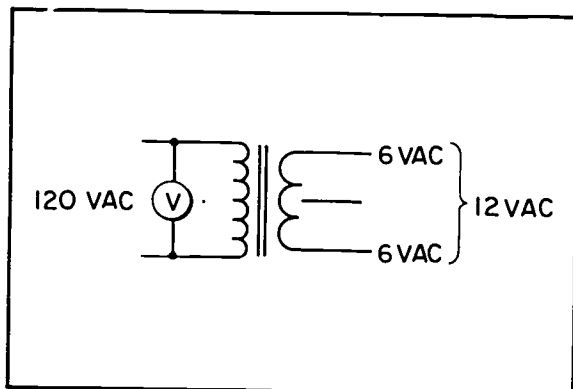

Schematic Diagram

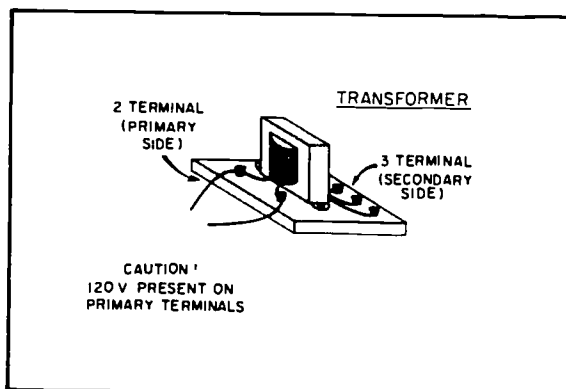

Pictorial Diagram

one of the outside terminals, what do you think it would be? _____

What do you think the voltage would be from the center post to the *other* outside terminal? _____

4. Measure the voltage from the center post to one of the outside posts. _____

Measure the voltage from the center post to the other outside post. _____

Are these voltages the same as your prediction? _____

If the above measurements are added, is the sum the same as the measurement in step 2? _____

Measure the input voltage _____

What is the voltage ratio of this transformer? _____

Decrease the variac control to 0% and flip switch to "off" position.

5. The variac is a variable transformer. It will be used here to provide a variety of voltages to be applied to the output side of the "distribution transformer." Wire up the following circuit, but do not turn on the variac.
6. Turn the variac all the way down (to the left). Set the VOM to the 100 volt scale and connect it across the transformer secondary (VOM Position 1). Flip the variac control switch to the 6 VAC position (amber pilot light) and adjust the variac so the meter reads 45 volts. Disconnect the VOM, set it to the 10 VAC scale and connect it to the transformer primary (VOM Position 2). Record the voltage reading in table I below.
7. Repeat step 6, but with a secondary voltage of 60 volts.
8. Repeat step 6, but with a secondary voltage of 75 volts. Decrease the variac control to 0 and turn switch off.

Table 1

SECONDARY VOLTAGE	PRIMARY VOLTAGE	VOLTAGE RATIO
45	_____	_____
60	_____	_____
75	_____	_____

9. What conclusion can you make about the voltage ratio of a transformer with respect to the voltage applied to it? _____

10. What conclusions can you make about the voltage

Steps 5 through 10

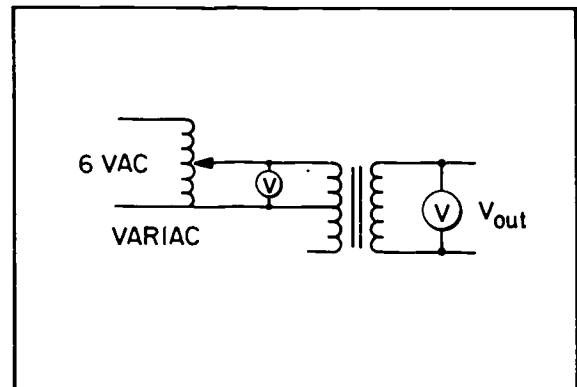

Schematic Diagram

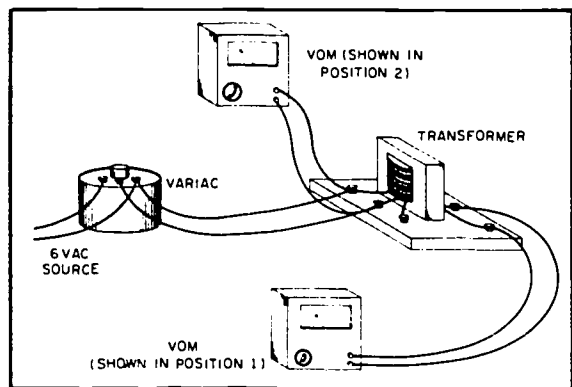

Pictorial Diagram

Step 11

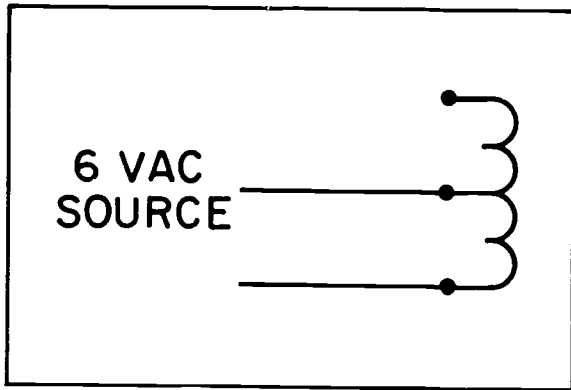

Schematic Diagram

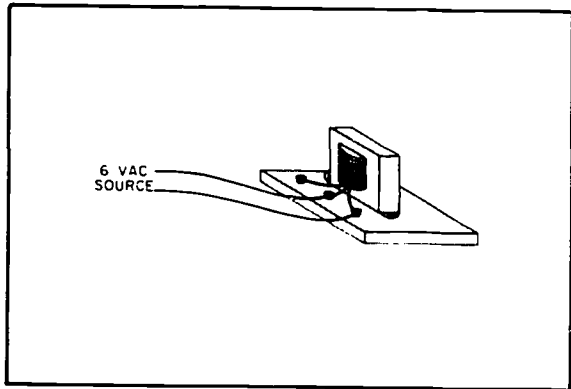

Pictorial Diagram

Step 12

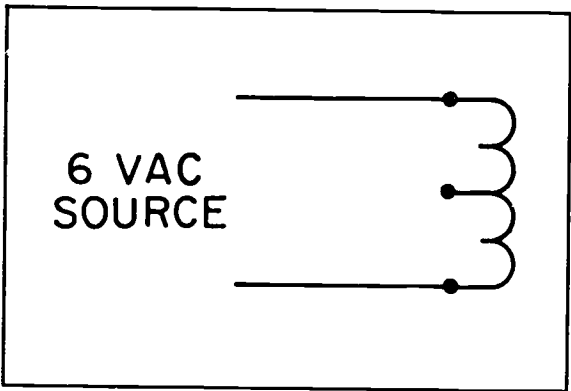

Schematic Diagram

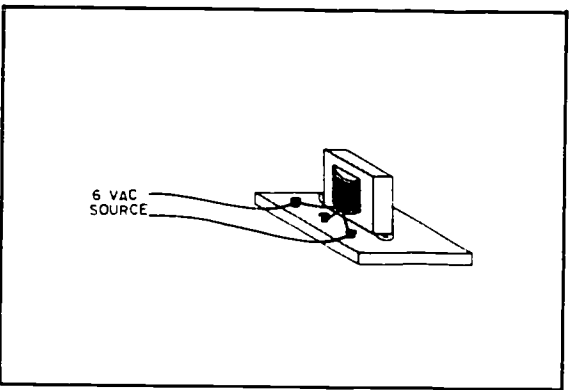

Pictorial Diagram

ratio of a transformer in respect to its use as a step-up or step-down transformer? _____

- Using the transformer with only 3 terminals (auto-transformer), connect the center terminal and one of the other terminals to the 6 VAC source as shown:

With the VOM, measure the exact voltage across the 2 terminals connected to the 6 VAC source (input voltage). Record the reading in table II below. Now measure the voltage across the two **outside** terminals (output voltage) and record it in the table below. What is the voltage ratio? Record it in the table. Is this autotransformer connected step-up or step-down? _____

- Reconnect the autotransformer with the two outside terminals to the 6 VAC source. With the VOM, measure the exact voltage across these two terminals (input voltage) and record in the table below. Now measure the voltage from the center terminal to one of the outside terminals and record the reading in the table below. What is the voltage ratio this time? Record it in the table. Is the autotransformer connected step-up or step-down? _____

Table II

STEP	INPUT VOLTAGE	OUTPUT VOLTAGE	VOLTAGE RATIO
11	_____	_____	_____
12	_____	_____	_____

Distribution Voltage Regulators

Introduction, Lab Four

Step type voltage regulators are widely used on distribution systems to correct improper voltage levels that occur during normal operation of a power system.

Objectives

After completion of this lab, the student will understand the function of various controls on a voltage regulator. **Caution**— This lab uses 120 volts.

Equipment List

- 1 32 Step Distribution Voltage Regulator (modified)
- 2 VOMs
- 1 10 Amp Variac which must have an output range ability above incoming voltage.

Procedure

Set controls as follows:

Voltage	122
Bandwidth	1.5
Time Delay	30
Line Drop Compensation, R	0
Line Drop Compensation, X	0
Voltage Source	External
Function	Auto

1. Plug in variac and adjust its output to 115 volts. Be ready to time the regulator from energization to operation. Now energize the regulator. After the regulator stops operating, record the time delay in Table 1. Also, record the regulator output voltage in Table 1.
2. Reset the variac to 127 volts. Then repeat the procedure in Step 1.
3. Reset the regulator bandwidth to 5 volts. Reset the variac to 123 volts. Repeat the procedure in Step 1.
4. Reset the variac to 131 volts. Repeat the procedure in Step 1.

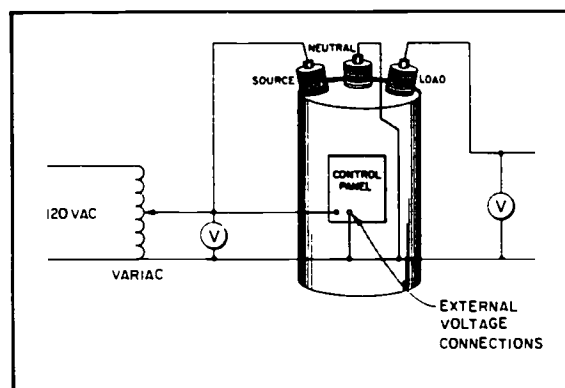

5. Reset the variac to 120 volts. Again repeat the procedure in Step 1.
6. Reset the regulator bandwidth to 1.5 volts. Set the variac to 100 volts. Repeat the procedure in Step 1.

Questions

1. How important is the bandwidth setting to good voltage regulation? _____
2. Can a voltage regulator correct **any** amount of voltage error? _____

Table I

Incoming Voltage	Bandwidth	Voltage Control	Time Delay Control	Actual Time Delay	Output Voltage after regulator operates
115	1.5	122	30	_____	_____
127	1.5	122	30	_____	_____
123	5.0	122	30	_____	_____
131	5.0	122	30	_____	_____
120	5.0	122	30	_____	_____
100	1.5	122	30	_____	_____

Distribution Line Capacitors

Introduction, Lab Five

Distribution capacitors are used as local sources of reactive power. This relieves power plants of having to supply reactive power over long distances, thus reducing line losses.

Objectives

After completion of this lab, the student will understand the effect of capacitors on the voltage levels of distribution circuits.

Equipment

- 1 AC milliammeter
- 1 VOM
- 1 "Model" distribution line
- 2 "Model" distribution capacitors
- 1 "Model" load

114

Procedure

1. Connect the circuit shown:

This represents a distribution line serving a reactive load.

2. Set the switches on both capacitor boards to "OFF". Connect the circuit to the 6 volt source. Read the ammeter and the voltmeter and write down the readings in the table below.
3. Turn on the capacitor labeled number 1.
4. Read the ammeter and voltmeter again and record both readings. Did the current increase or decrease?

5. Turn on the other capacitor also.
6. Read the ammeter and the voltmeter again and record. Did the current increase or decrease?

7. Disconnect the voltmeter from the load and measure the source voltage. Is it higher or lower than the load voltage? _____

Table 1

CIRCUIT	CURRENT	LOAD VOLTAGE
No capacitors	_____	_____
One capacitor	_____	_____
Two capacitors	_____	_____

Questions

1. Were the changes in current and voltage what you expected when only one capacitor was turned on?

2. When the second capacitor was turned on the current and voltage changed again. Did they change in the way you expected? _____
3. Would you expect line losses to be higher or lower with both capacitors on the line instead of with just one? _____
4. With both capacitors on the line the source voltage was (higher or lower) _____ than the load voltage. Did you expect this? _____

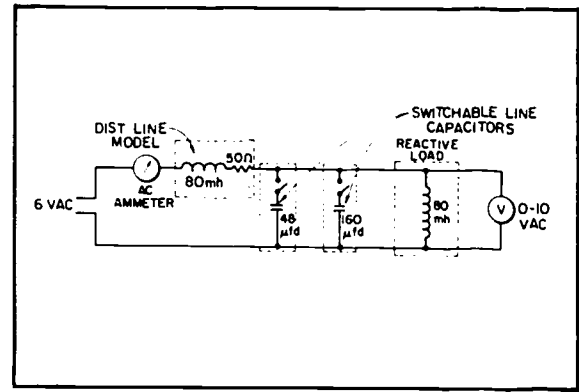

Schematic Diagram

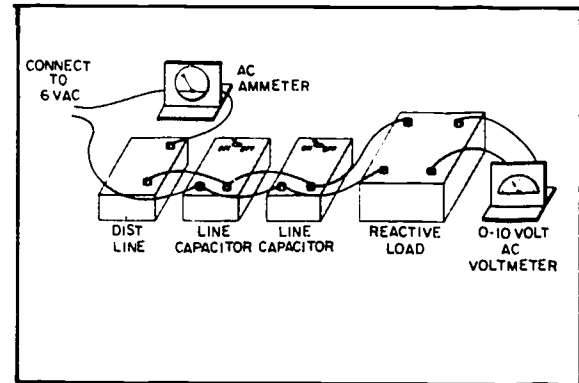

Pictorial Diagram

Watt-hour Meters

Introduction, Lab Six

Watt-hour meters are used on power systems to meter the flow of power and energy in a circuit. All revenue billing is based on the amounts of power and energy recorded by these meters. Accuracy, then, is very important in power system metering.

Objectives

Upon completion of this lab, the student will be able to predict a watt-hour meter's response to various types of loads. **Caution**—This lab uses 120 volt AC in its procedures.

Equipment List

- 1 Demo board
- 1 GE I-50-S Cat. #720X13G34 (2.5a, 120 volt, $R_1 = 1/3$) meter
- 1 Line cord
- 1 300W Lamp
- 1 Capacitor 2uf NP
- 1 Inductor 80 millihenries

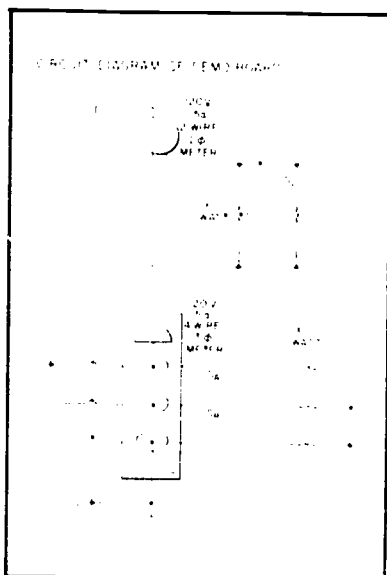

Demonstration Procedure

1. Make sure all switches on the demo board are in their off position.
2. Apply power to the demo board by plugging it into the 3 phase receptacle.
3. Turn on S_1 and observe the speed of rotation of the single phase meter disc.
4. Turn on S_2 and observe the speed of rotation of the single phase meter disc.
5. Turn off S_1 and S_2 .
6. Turn on S_A and observe the speed of rotation of the discs in the three phase meter.
7. Turn on S_B and observe the speed of rotation of the discs in the three phase meter.
8. Turn on S_C and observe the speed of rotation of the discs in the three phase meter.
9. Turn off S_A , S_B , and S_C .

Student Procedure

Connect the light bulb to the load side of the meter as shown:

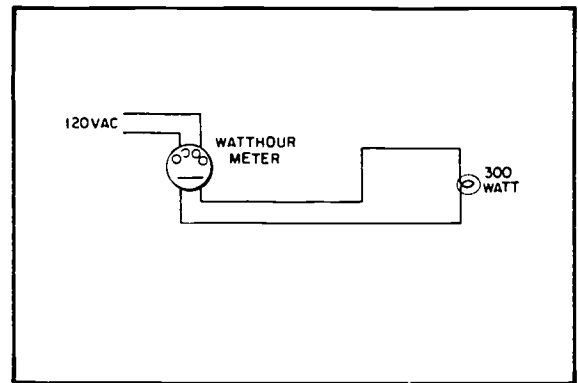

Schematic Diagram

Plug in the power cord. Does the meter disc rotate?

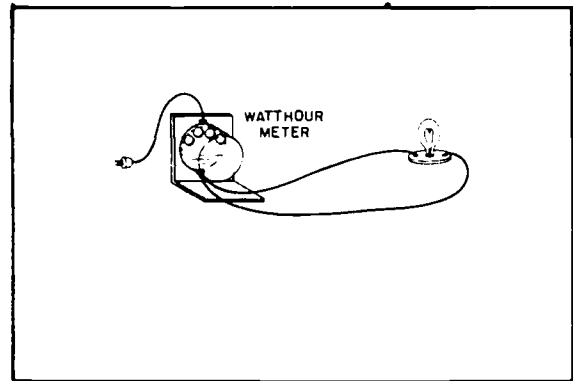

Pictorial Diagram

Unplug the power cord. Remove the light bulb and connect the capacitor.

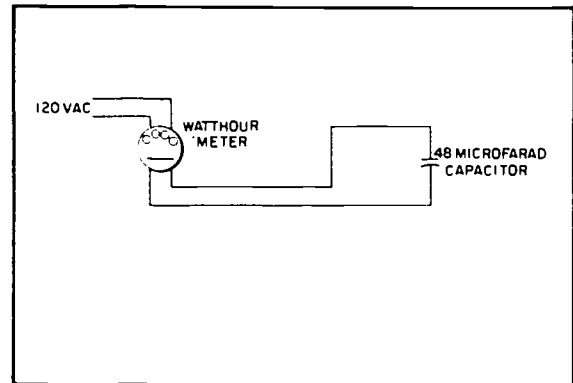

Schematic Diagram

Plug in the power cord. Does the meter disc rotate?

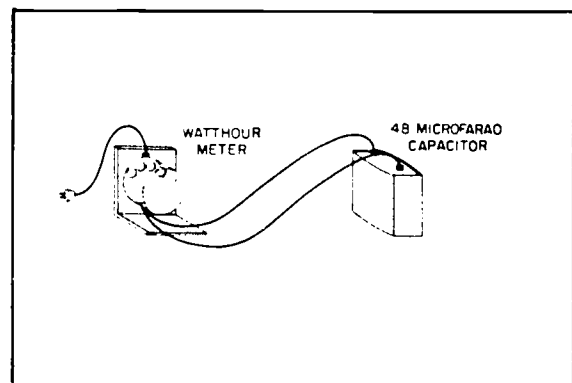

Pictorial Diagram

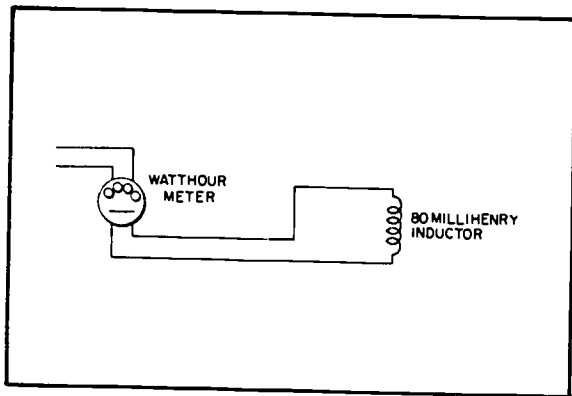

Schematic Diagram

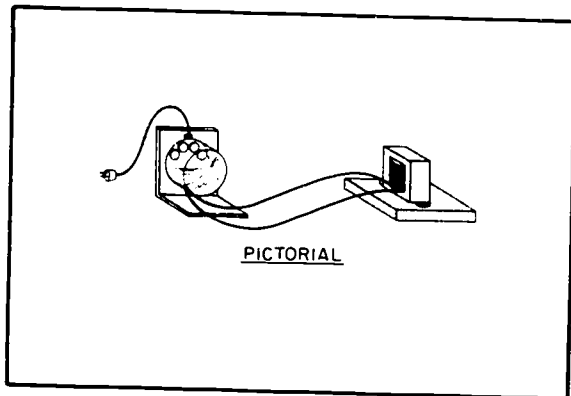

Pictorial Diagram

Unplug the power cord. Remove the capacitor and connect the inductor.

Plug in the power cord. Does the meter disc rotate?

Questions

The light bulb consumes **real** power.

Can the wathour meter measure real power? ___

The capacitor consumes **capacitive** reactive power.

Can the wathour meter measure capacitive power? _____

The inductor consumes inductive **reactive** power.

Can the wathour meter measure reactive power?

NOTES

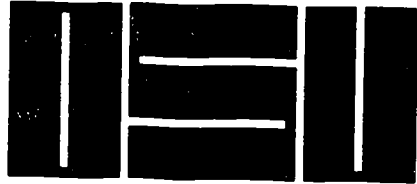

Distribution
substations

Distribution Substations

This publication prepared by
R. Kenneth King and Robert J. Lager
Electrical Power Technology Department
School of Technology
Oklahoma State University
Stillwater, Oklahoma 74074
1978

As part of National Science Foundation Grant SED 76-18811
Continuing Education for Electrical Power Technicians

Permission is granted to duplicate any part or all of this publication for educational purposes.

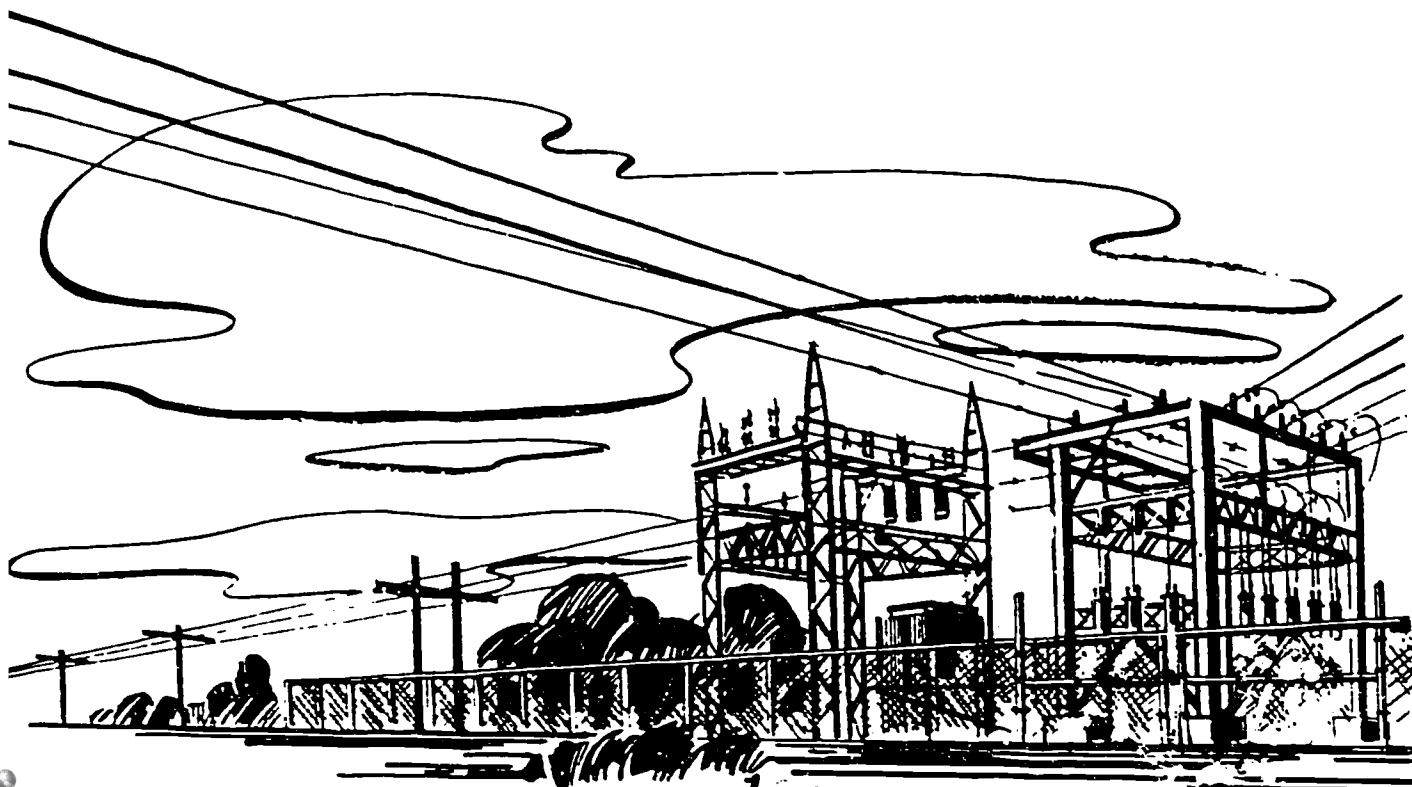

Distribution Substations

This unit of instruction deals with substations. It shows the equipment used in them, explains its functions, and shows how it is depicted on a one line diagram. Upon completion of this program, you should know the purpose of a substation, its essential and non-essential functions, and be able to read and draw a simple one line diagram of a substation.

Power systems are built up of 3 main parts: generation, which is the production of power; transmission, which moves power from the generating stations to the substations; and distribution, which delivers the power from the substations to the customers.

The generating plants are usually close to the concentrated load (cities or industrial areas), so that large amounts of power don't have to be transmitted long distances.

Distribution Substations

SCHOOL OF TECHNOLOGY
CONTINUING EDUCATION

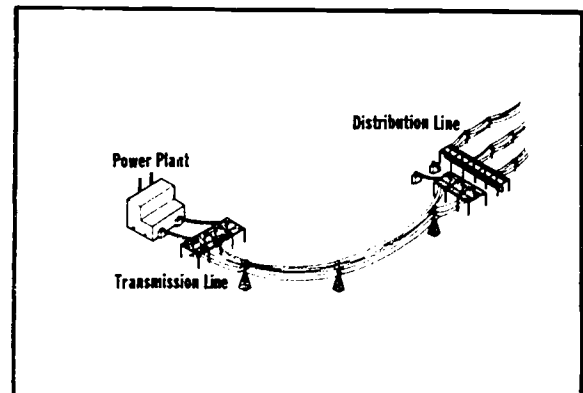

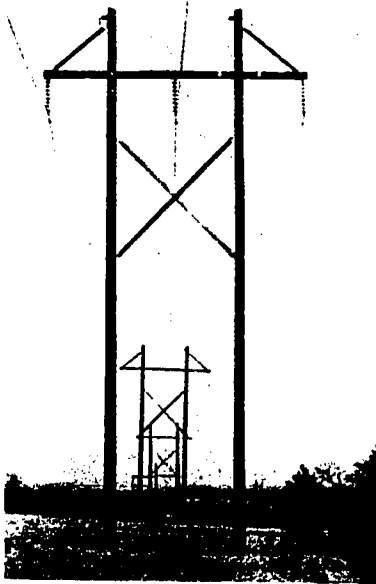

The transmission system is the part of the power system that moves large blocks of power from the generating plants to the substations, from which it is distributed to the consumers.

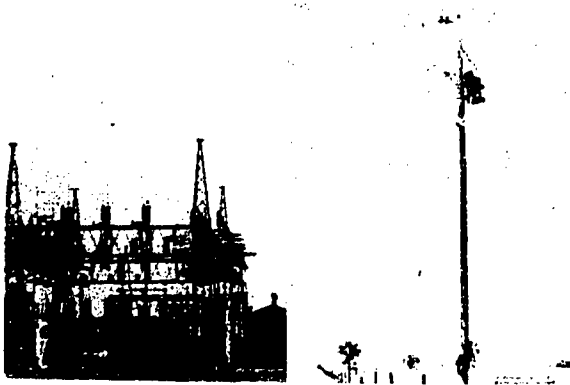

The distribution system is generally considered to start at the substation, which is pictured on the left, and extends to each customer, as shown on the right. As a matter of practice, the voltage used on a distribution system will usually range between 2,400 volts and 35,000 volts.

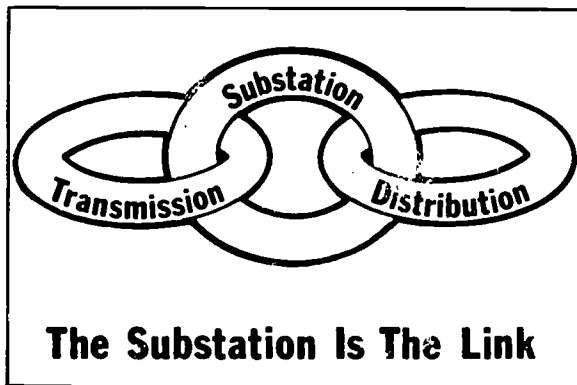

The purpose of a substation is to interconnect or link the transmission system to the distribution system which has individual loads.

A substation performs several functions to fulfill its purpose as a link between the transmission system and the distribution system. The functions which are essential in providing this link are voltage change, disconnecting the station from the transmission system and protecting the station from the distribution system.

- ### Three Essential Functions
1. Voltage Change
 2. Disconnect Station
 3. Protection From Distribution System

Let's look at voltage change first.

1. Voltage Change

The main *function* of a substation is to change the voltage level from that used on the transmission system to the voltage level used for distribution. One or more *transformers* are used to accomplish this.

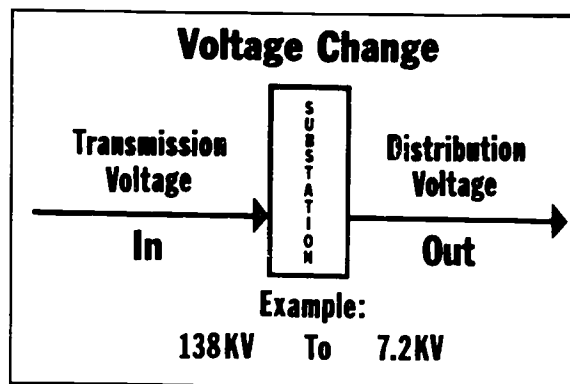

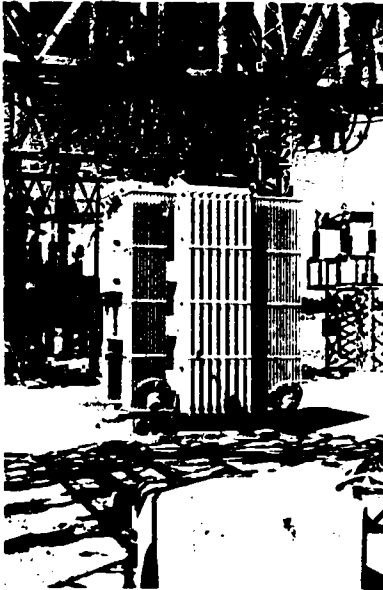

The transformer is usually the largest piece of equipment in a substation. In principle, it works exactly like distribution transformers, but can handle much larger amounts of power. This change in voltage level performed by the transformer is an *essential function* of a substation.

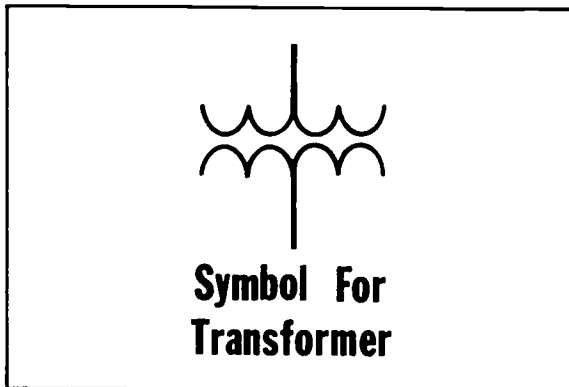

This is the symbol commonly used to represent a transformer.

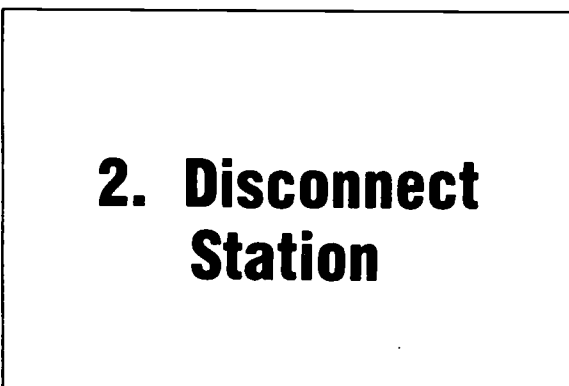

Now let's look at disconnecting the substation from the transmission system.

The ability to disconnect the substation from the transmission system is also an essential function of the substation. This is a typical switch used for this application. If any work is necessary on the substation, then these switches can be opened to de-energize the station while the work is being done.

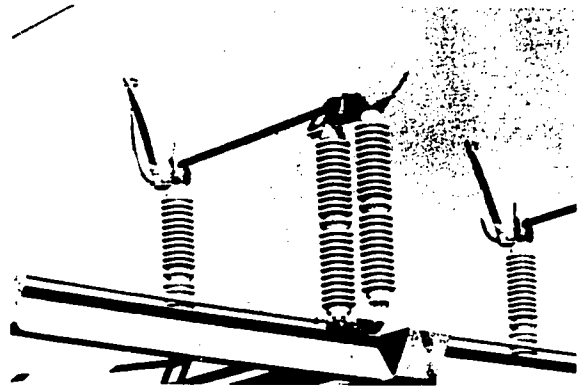

This is the symbol for a switch. This symbol is used for many types of switches. The station disconnect switch is one type.

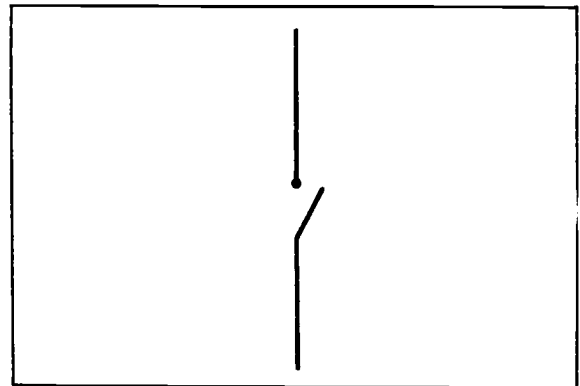

The third essential function of a substation is to protect itself from the distribution lines connected to it.

3. Protection from Distribution System

The substation must be protected from a variety of abnormal current conditions on the distribution lines. Most of these conditions are short circuits on the line called FAULTS or system overloads or equipment failures.

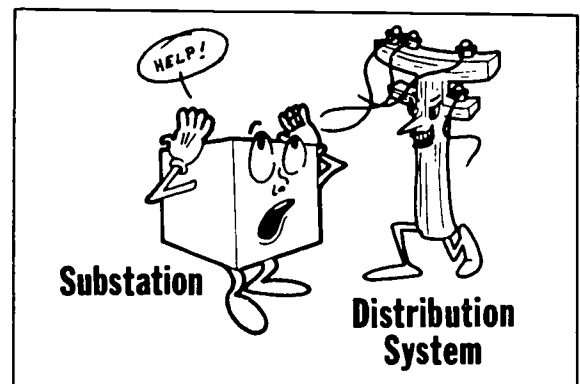

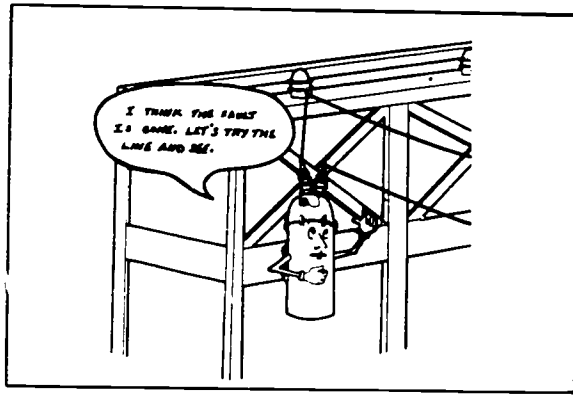

If a problem occurs on a feeder from the station, we'd like to disconnect that line from the substation before station equipment is damaged. Since almost all faults on a distribution system are temporary, or self-clearing, it would save a lot of time, money and trouble if the disconnected line could be re-energized automatically after the fault clears itself.

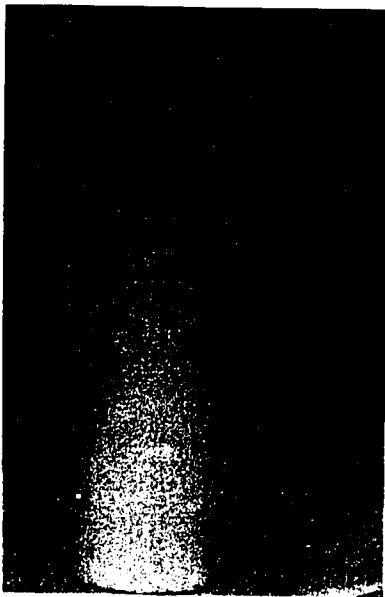

The device commonly used to do this is the OIL CIRCUIT RECLOSER. These are oil-filled devices that have their contacts under oil, and also use the oil for hydraulic control. They are often called C.R.'s. Nowadays, electronic controls and vacuum enclosed contacts are used so the more general name of AUTOMATIC CIRCUIT RECLOSER, or ACR, is coming into use.



The recloser can be set to give 2 or 3 chances for the fault to clear before it "locks out" the line. The line is then off until the fault is manually cleared and the recloser manually reset. Usually, each circuit leaving a substation will have its own recloser.

A recloser is a special kind of circuit breaker. The general symbol for an oil type breaker of any type is shown. "OCR" or "ACR" should be written near this to differentiate it from other devices.

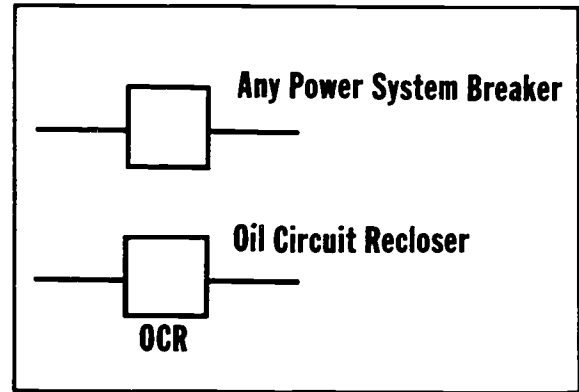

One-line diagrams are often used to show how equipment in a substation is interconnected. On a one-line diagram, a single line represents a complete circuit, regardless of how many phases or conductors are actually used. A one-line diagram of a substation having only the three essential functions—disconnecting the station, changing the voltage, and protecting the station from the distribution system—would look like this.

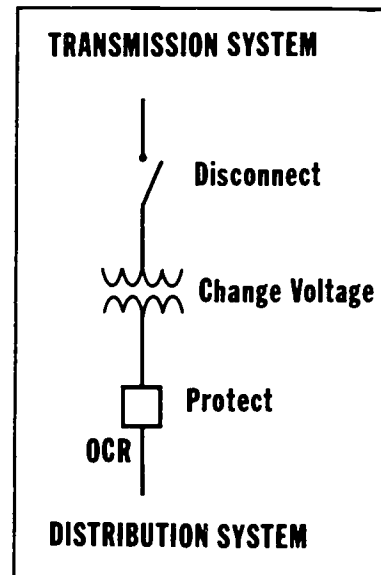

Other functions of the substation are of secondary importance, but are performed to improve reliability or operational ease. These include voltage regulation, metering, additional fault protection, voltage surge protection, and bypass switching.

- Non-Essential Functions**
- 1. Voltage Regulation**
 - 2. Metering**
 - 3. Additional Fault Protection**
 - 4. Voltage Surge Protection**
 - 5. Bypass Switching**

1. Voltage Regulation

The first of these non-essential functions is voltage regulation.

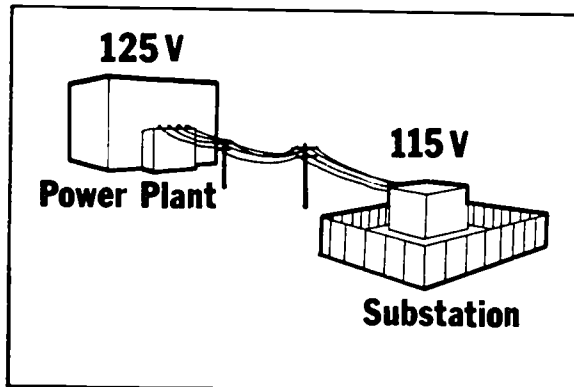

Because the conductors used in transmission systems are not perfect, there are losses associated with them. Some of these losses show up as a voltage difference between the generating plant and the substation. The voltage at the substation is lower than at the generating plant. This is called **VOLTAGE DROP**.

Time	Incoming Voltage
5am	124
6am	122
7am	119
8am	115
9am	116

One way to correct voltage drop is to choose a substation transformer that gives a higher voltage on the distribution side than normal. Unfortunately, the voltage drop varies from hour to hour. It varies with the amount of load on the substation.

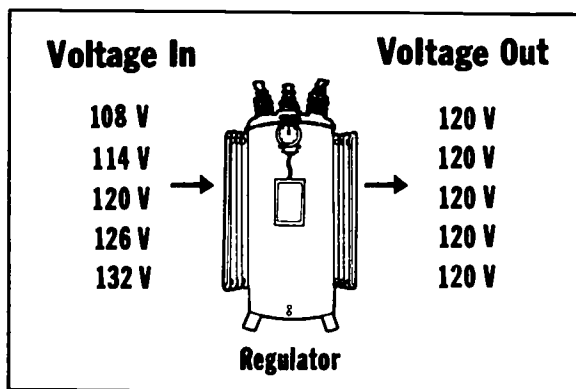

What is needed is a device that will automatically keep the distribution voltage at a constant level. The voltage regulation function is often, but not always, performed in a distribution substation.

In newer equipment, the regulator is often built as part of the transformer, which saves money, but lacks some flexibility. Older stations usually have the regulator separate from the transformer.



The symbol used on a one line diagram for a regulator is shown on the left. If the regulator is built into the transformer, the transformer symbol is changed to become the one on the right. This right hand symbol includes both the transformer and the regulator.

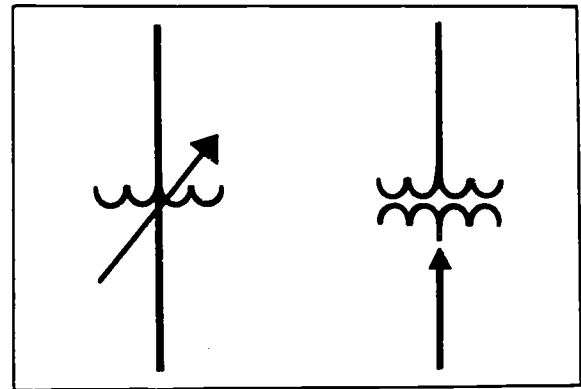

Both the energy and power flowing through a substation are normally metered.

2. Metering

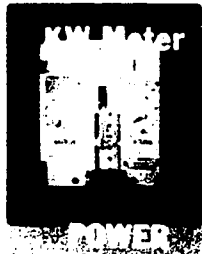

There are several reasons for doing this. First, the station equipment has a limit on how much power it can safely handle.

WHOLESALE BILLING	
Energy Charge	\$9,000
500,000 KWH	
Demand Charge	\$2,295
1,350 KW	
Total Bill	\$11,295

By keeping track of load increases on the station over a period of time, a power system planner can predict when the equipment will be fully loaded. Then he can plan when to upgrade the station.

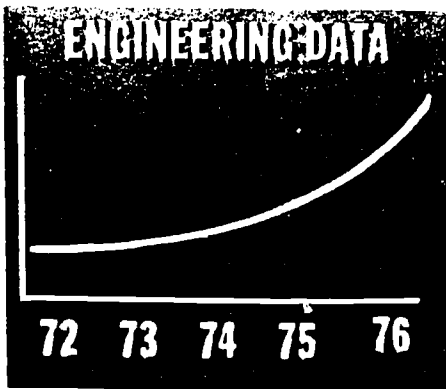

Secondly, the substation may be a point of wholesale power delivery, and the energy and demand over a given period (usually a month) are used to bill the purchaser.

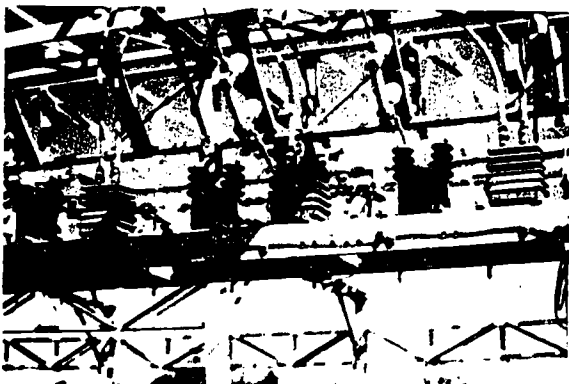

Since it would be too costly to build a meter capable of carrying the hundreds of amps and thousands of volts normally metered, two types of INSTRUMENT TRANSFORMERS are used to reduce the current and voltage to low levels.

One of these instrument transformers is called the *potential transformer* and is similar to the distribution transformer, in that the voltage it supplies is proportional to the voltage applied to it. Since metering must be very accurate for proper billing, potential transformers are designed to give a very accurate voltage ratio.

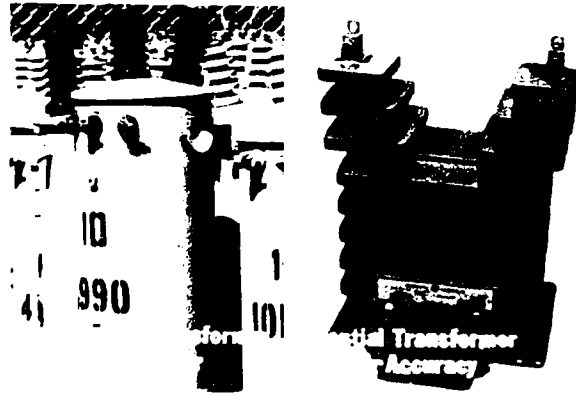

The output or secondary of almost all potential transformers or P.T.'s is 120 volts. The input or primary of the potential transformer is designed for whatever voltage is to be metered.

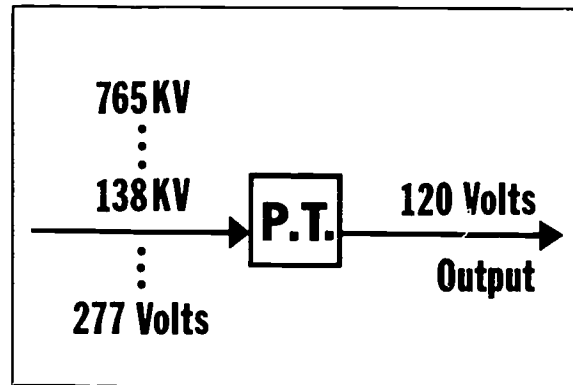

The current transformer is the device that senses the current flowing in a conductor. It provides a much lower current as output to the meter. The current transformer is generally designed to provide 5 amps of current when a full-load current is flowing in its primary.

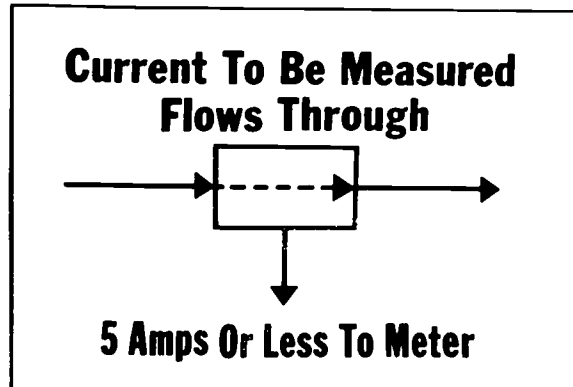

The symbols for potential transformers and current transformers are shown. Note that P.T. stands for "potential transformer", and C.T. stands for "current transformer".

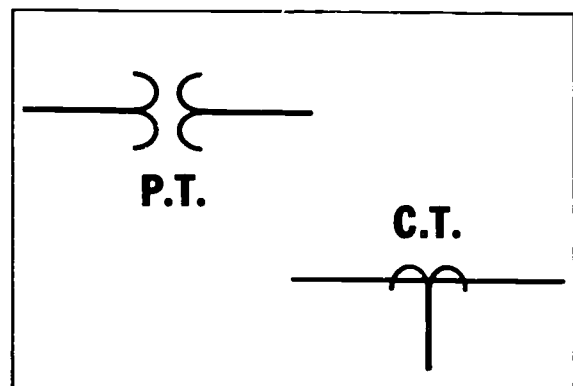

3. Additional Fault Protection

It would be a good idea to protect the transmission system from faults inside the substation.

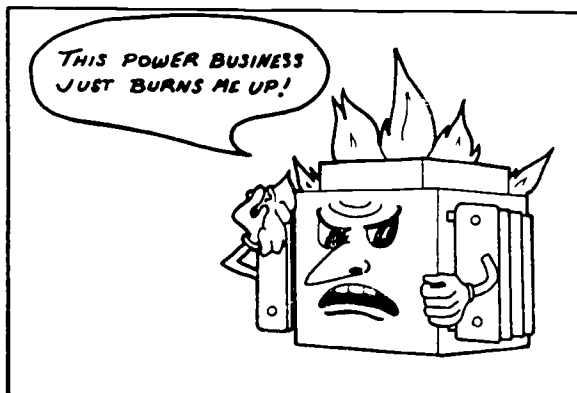

Most of these faults will be permanent faults, such as a transformer winding shorting out, or a truck crashing into the station. Since automatic resetting is not needed, a simple fuse will do to disconnect the station from the transmission system.



This is a typical fuse used to protect the transmission system from the substation.

This symbol is usually used to represent a fuse.

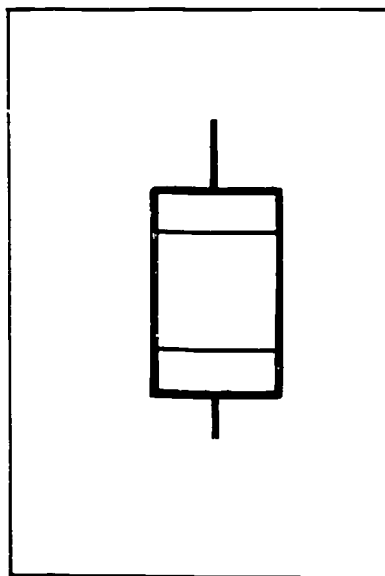

So far, we've looked at protection against too much current. Too much voltage can be a problem too.

4. Voltage Surge Protection

Lightning is the usual source of overvoltage. Surges caused by switching operations are second on the list.

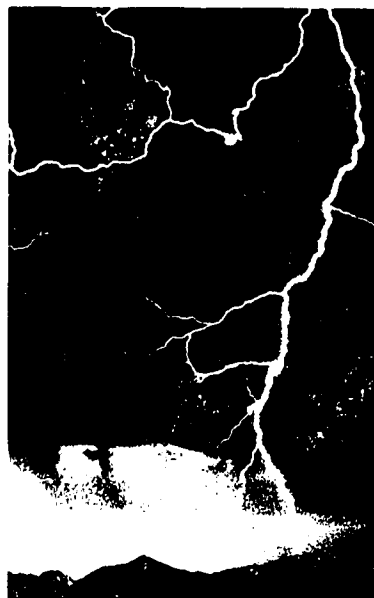

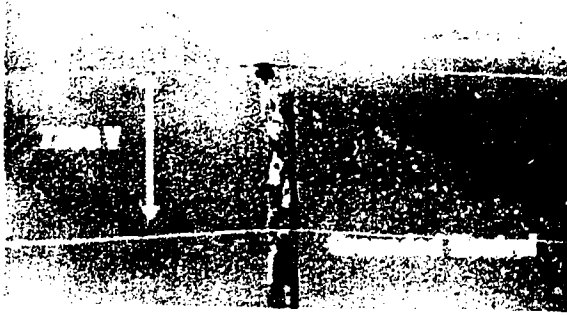

In a normally operating system, there has to be a voltage between the hot phase conductor and ground (including a grounded neutral) so that current will flow through a load when it is placed across this voltage (between phase and ground). An insulator is made of material that will not pass electric current, and is used to keep the phase conductor electrically away from ground.

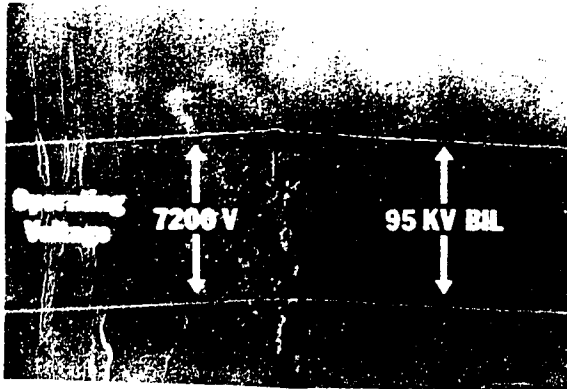

Normally, the system is insulated to withstand steady voltages much higher than the normal operating voltages. This higher level is called the basic impulse insulation level or BIL.

Operating Voltage (Single Phase)	Standard Bil Level
2,400	60 KV
4,800	75 KV
6,900 } 7,200 } 7,620 }	95 KV
13,200 } 13,800 } 14,400 }	125 KV
19,900	150 KV

This chart shows the standard BIL levels for several common distribution system operating voltages. Notice that the BIL level is many times the operating voltage. Even so, many surges will exceed the BIL level.

It is much too expensive to raise the BIL level high enough to prevent all surges from damaging the insulation. SURGE ARRESTERS (or LIGHTNING ARRESTERS) are installed to limit these overvoltages.



In order to limit these surges repeatedly, without causing service interruptions, arresters must discharge the energy of the surge, limit and interrupt the system fault current that will flow through the arrester following the surge; and return to an insulating state ready for the next surge.

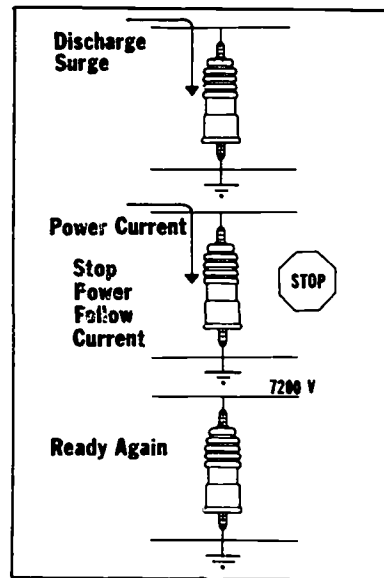

Surges arriving on either the transmission or distribution lines encounter the arresters before they can reach station equipment. The surges are discharged before they can do any damage.

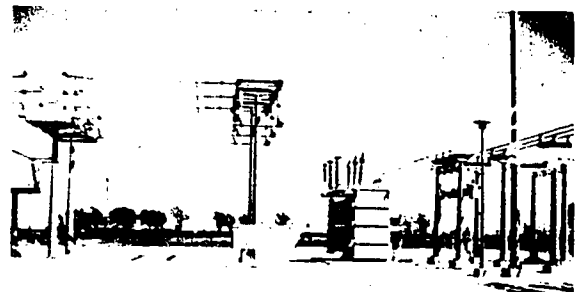

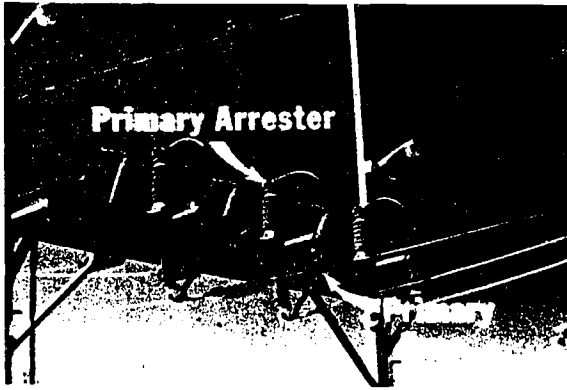

The primary arrester is normally placed ahead of the primary fuse to protect the station and reclosers from surges starting on the distribution system.

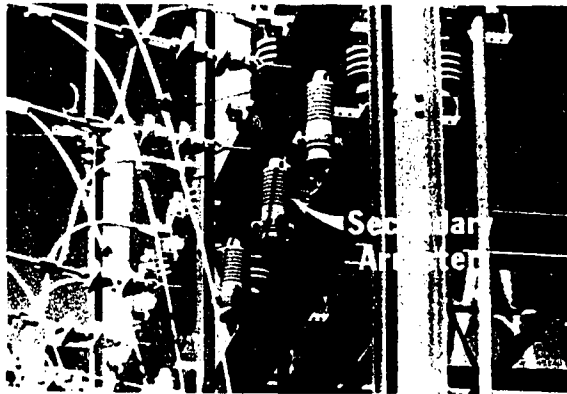

The secondary arresters are usually placed on the load side of the circuit reclosers to protect both the station and reclosers from surges starting on the distribution system.



In addition to arrester on the incoming lines, many utilities put them on the transformer bushings too.

The symbol used for lightning arresters represents a simple spark gap or space between two electrodes. A spark gap will function as an arrester, but has several limitations. Modern arresters are more complex in order to overcome these limitations but the symbol has remained the same.

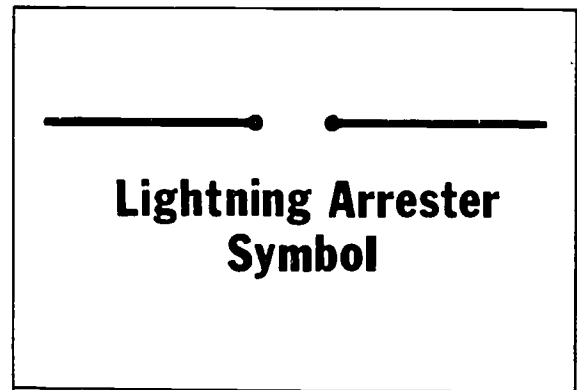

One side of the arrester is normally connected to the ground. An arrester connected to ground on one side is drawn on a one line diagram as shown.



Several pieces of equipment in the substation need to have periodic maintenance. In order to remove these from service without an outage, a bypass switching scheme is employed.

5. Bypass Switching

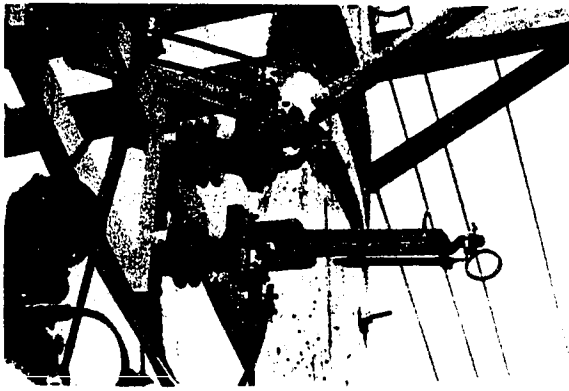

Normally, bypass switching is only used with regulators and reclosers. Before a piece of equipment can be bypassed, the voltages on both sides of it must be the same. The voltages on the two sides of a transformer are always different so transformers cannot be bypassed. Regulators can be bypassed *only* when they are set on neutral, which is the *only* time that the voltage on each side is equal. The voltages on each side of a recloser are the same, so that bypassing a recloser is not a problem.

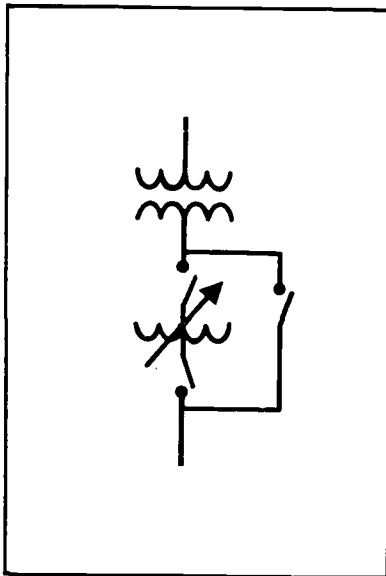

This picture shows a typical bypass scheme applied to a regulator. The two switches in line with the regulator are the disconnect switches, while the one to the side is the bypass switch. To remove the regulator from service, it is first set to neutral, the bypass is then closed and the disconnect switches are opened. This completely removes the regulator from the circuit without interrupting service.

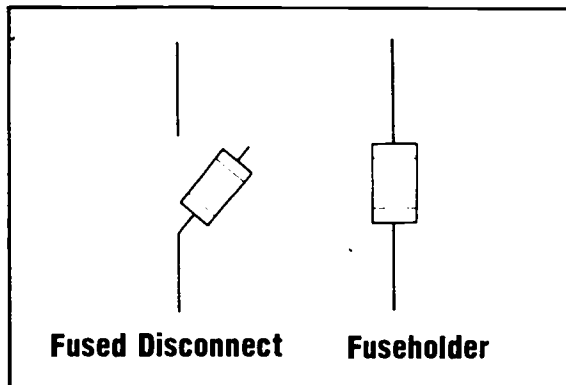

This same scheme can be applied to reclosers. However, in this case the bypass switch is often replaced with a combination fuse and switch. The fused switch performs the essential function of protecting the substation from the distribution system while the recloser is out of service. The symbol for a combination fuse and switch, often called a fused disconnect, is shown at left.

Now let's look at a one line diagram to see how these five nonessential substation functions fit together with the three essential functions.

- Non-Essential Functions**
- 1. Voltage Regulation**
 - 2. Metering**
 - 3. Additional Fault Protection**
 - 4. Voltage Surge Protection**
 - 5. Bypass Switching**

Starting out with only the three essential elements of a substation, we add voltage regulation to keep the distribution voltage at a constant level.

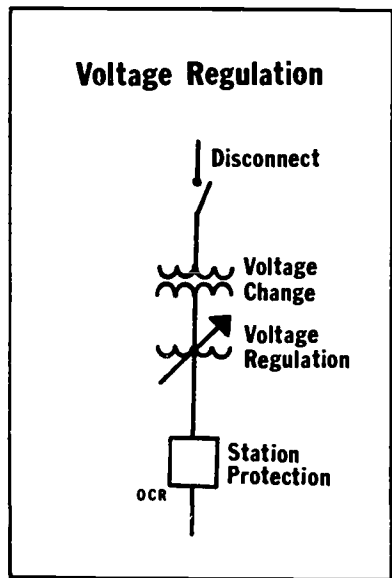

Next we add metering to monitor the energy and power flowing through the substation.

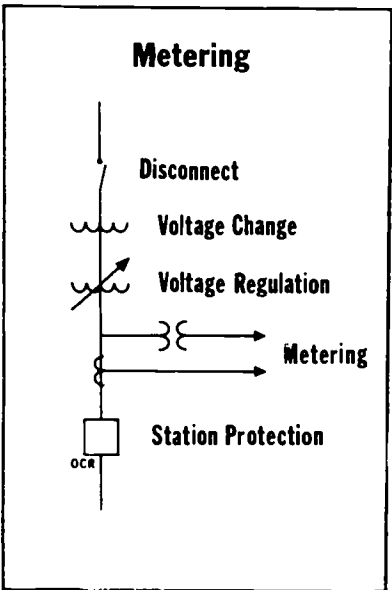

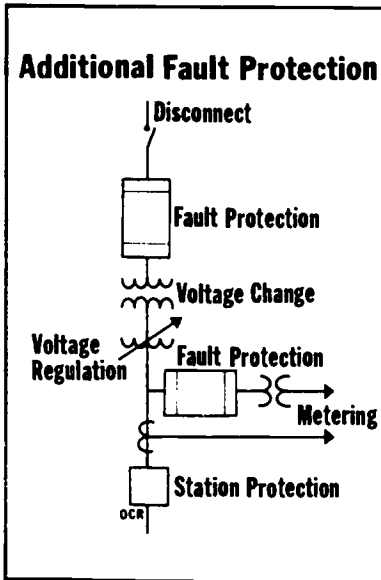

Additional fault protection is normally added right after the station disconnect to protect the transmission system. Also protection is added in the primary of the potential transformer to avoid shutting down the entire substation in case the P.T. fails.

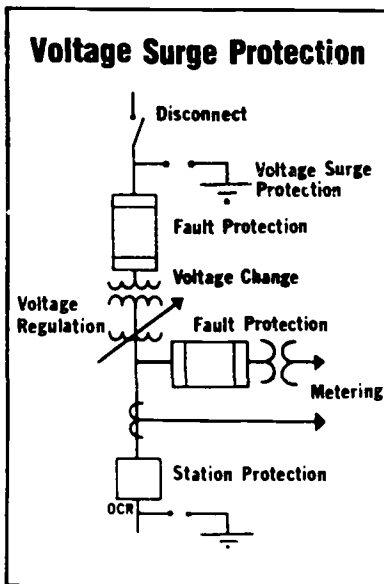

Adding lightning arresters on each end of the station protects it from voltage surges on either the transmission or distribution system.

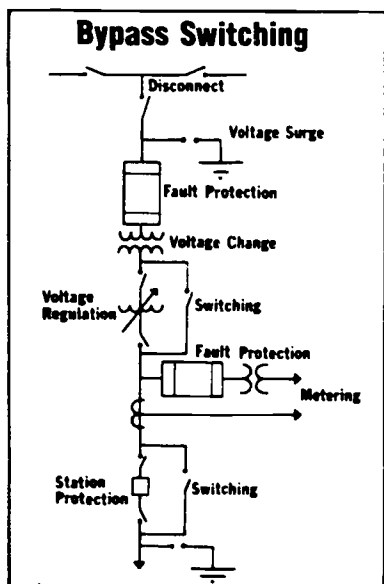

Bypass switching is added on the voltage regulator and station protection so these elements can be serviced without shutting down the entire station. This is a one line diagram of a typical substation that might be found in a rural or suburban area.

An operation that is normally found in a substation, but is not really part of the substations functions is transmission switching. Combining a transmission switching station with a distribution substation is a lot less expensive than building a transmission switching station separate from a distribution substation.

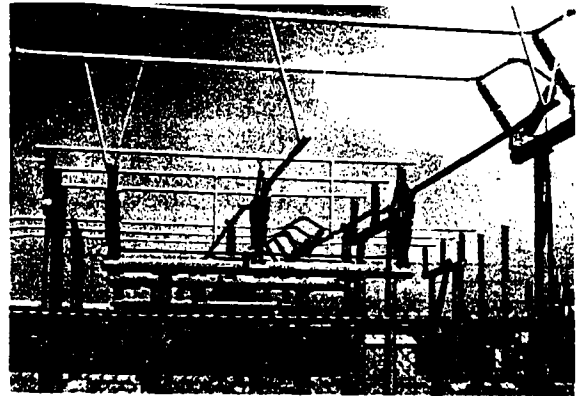

A system map might look like this. This is another type of a one-line diagram. Notice that the transmission lines, which are shown as white lines, are between the generating plants, represented by white hexagons, and the substations, which are represented by white squares.

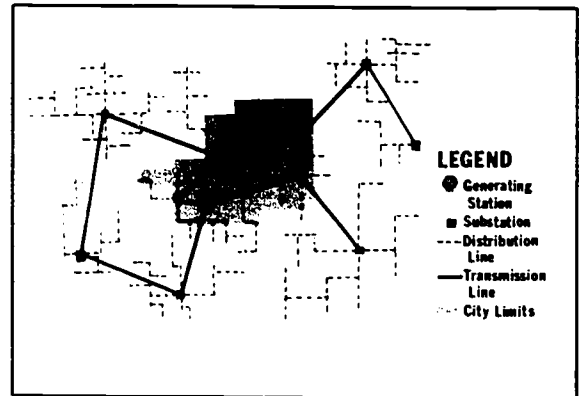

Generally, the transmission lines form loops. The line leaves the generating station, goes to several substations one after another, and returns to the generating station. This type of looping improves the reliability for the entire system. The broken lines represent the distribution lines which run from the substation to the consumers.

Here is an example of a looped power system with three substations and one generating plant. The substation at the bottom is now receiving power from the west. If a fault occurs on the transmission line between the bottom substation and the west substation, then this line can be disconnected at both ends to isolate the fault. After the fault is disconnected then the open switch can be closed to allow the bottom substation to receive power from the east.

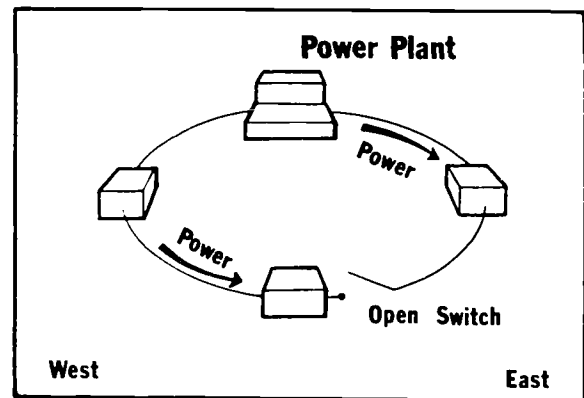

By isolating the fault on the transmission line then closing the switch that was open, the bottom substation is back in service because it can now receive power from the other side of the loop. In this way the customers served from the bottom substation will have only a short outage.

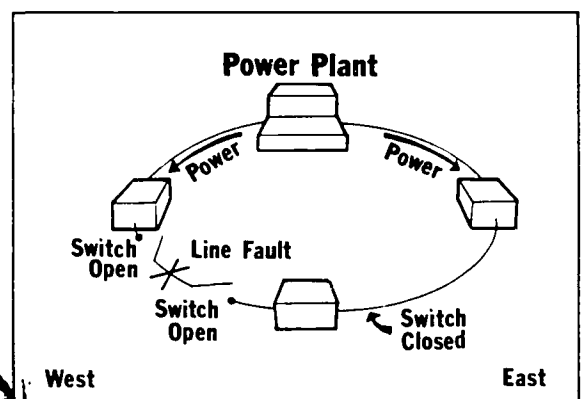

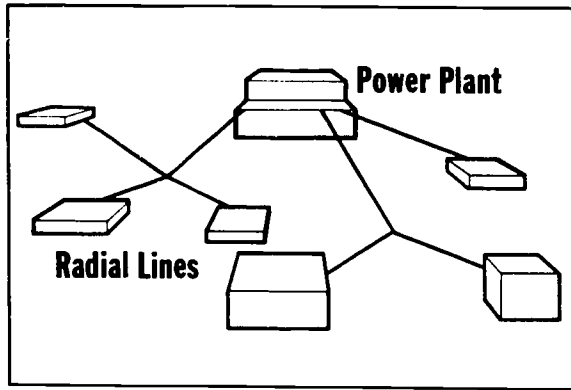

It's not always economical to build transmission loops if the substations are a long distance apart, or don't have much load on them. In some areas, only one line goes to each substation. When a station can be fed from only one direction, it is fed by a radial line.

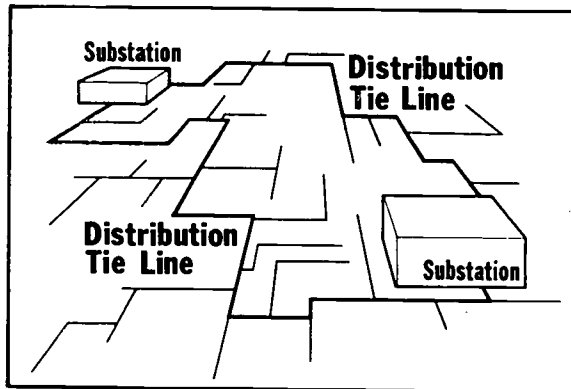

In city areas many of the distribution lines that leave a substation wind up going into another substation. These are similar to transmission loops and aid reliability on the distribution system by providing emergency tie lines. Again, it's not always economical to build distribution loops in suburban and rural areas because the distance between stations makes the extra lines required too expensive for the benefits gained.

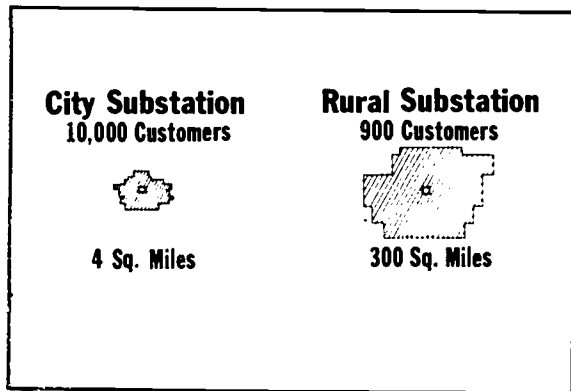

In city areas the load density is much greater than in rural or suburban areas. Each station handles a smaller area (maybe only 1 square mile or so) but many more customers. If there is an outage that affects the entire station, perhaps thousands of customers are without power.

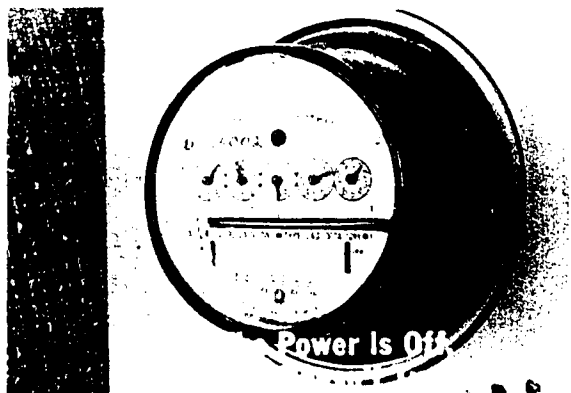

Not only is this bad public relations, but more importantly, it means *lost revenue*, since these customers are not using *any* electricity during the outage. If the substation's reliability could be improved, it would decrease the probability of an outage and save money in the long run.

To improve reliability, more transmission lines can be brought into the station, with automatic switching among them. Also, parallel transformers and duplicated primary and secondary fuses can be used.

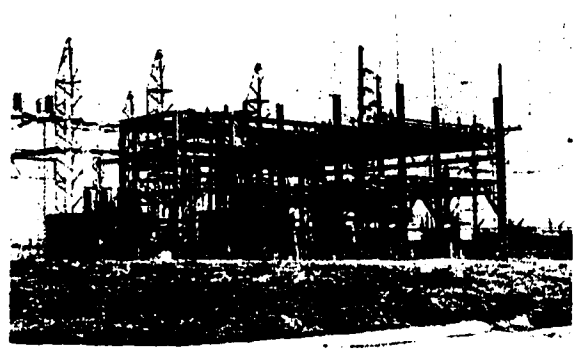

All of this costs money, and savings from reduced outages are usually not great enough to justify the expense unless the station serves a large number of densely packed customers, as it would in a city.

Higher = **Higher**
Reliability = **Cost**

This series has been about the substation and how it links transmission and distribution systems.



Glossary

Arrester: A device used to discharge surges on a power system.

Lightning Arrester: A more common name for a surge arrester.

Primary Arrester: An arrester located at the input of a substation to protect it from surges starting on the transmission system.

Secondary Arrester: An arrester connected to the output side or distribution side of a substation to protect the substation from surges starting on the distribution system.

Surge Arrester: A device which protects the power system from high voltage surges (or pulses) which are caused by switching operations or by lightning.

Basic Impulse Insulation Level: BIL is the voltage level at which insulation will begin to break down.

Bypass Switch: A switch which is used to jumper around a device in the system, thus allowing maintenance to be performed on the bypassed equipment.

Circuit Breaker: A device that will open a circuit if too much current is flowing through it. Once it opens it can be manually reset.

Conductor: Anything that will pass electricity, for example, a copper wire.

De-energize: To disconnect or remove the electrical source.

Demand: A measure of how fast electrical energy is used.

Distribution: The delivering of power to all customers. It is usually considered to start at the substation.

Distribution System: The part of the power system that delivers power from the substation to the consumer.

Electrical Energy: The ability to cause heat, light or mechanical motion.

Fault: A short circuit on the line, or equipment failures.

Permanent Fault: A fault that does not correct itself. For example a transformer winding could short and would remain on the line until it was removed by the lineman.

Self-clearing Fault: A fault that corrects itself. For example, a tree limb might slap against a line and cause a momentary short circuit.

Feeder: A main distribution line.

Fuse: A device placed in a circuit to protect it from over current. When too much current flows through a fuse, the fuse melts or burns up and opens the circuit.

Primary Fuse: The fuse placed at the input of a substation. Its job is to protect the transmission system from short circuits in the substation.

Fused Disconnect: A switch which has a fuse built into it.

Generation: The production of power.

Insulator: Material which will not conduct or pass electricity.

Load: Something that uses electricity.

Load Density: The concentration of customers.

Lock-out: Occurs when a recloser has been tripped the maximum number of times. The recloser locks-out or remains open until it is manually reset after the fault has been cleared.

Losses: Electric energy unavoidably wasted as heat in lines and equipment.

Metering: A method of monitoring a circuit. Meters are used to show the quantities monitored.

One-line Diagram: A drawing often used to show how equipment in a system is inter-connected. One line represents a complete circuit, regardless of how many phases or conductors are actually used.

Overvoltage: A voltage higher than which a system is designed for.

Power: The rate at which electrical energy is used to produce heat, light or mechanical motion.

Primary: Input side of a transformer.

Recloser: A device that senses the current flowing through a line and opens if the current exceeds a specified amount. It will, after a short delay, close again for another try. It will give two or three chances for the trouble to clear before remaining open.

Automatic Circuit Reclosers: A self-contained device that can sense overcurrents, interrupt and time the overcurrent, and reclose automatically to re-energize cleared circuits.

Oil Circuit Reclosers: An automatic circuit recloser that uses oil for both insulation and timing by hydraulic methods.

Reliability: A measure of how dependable a system is.

Secondary: The output side of a transformer.

Spark Gap: A space between two electrodes.

Station Disconnect Switch: The switch that is used to disconnect the transmission system from the substation.

Substation: The group of equipment that interconnects the transmission system to the distribution system. A substation has 3 essential functions (voltage, change, disconnecting the station from the transmission system, and protecting it from the distribution system).

Surge: A sudden high voltage pulse on a line, usually caused by lightning or switching operations.

Switch: A device used to open or close a circuit.

Transformer: A device which changes the voltage level that is applied to it.

Current Transformer: A transformer that gives an output that is proportional to the current that is flowing in the circuit it is connected to. The output is a low level for use in a meter.

Distribution Transformer: A transformer used to reduce the voltage from that used on the distribution system to the voltage level which is used by the consumer.

Instrument Transformer: A transformer that reduces voltage and current levels to a level that can be hooked to a meter; either a current transformer or a potential transformer.

Potential Transformer: An instrument transformer that gives an output which is proportional to the input voltage. This output is low enough to be applied to a meter.

Transformer Bushing: The insulator for the terminals of the transformer.

Transmission Loop: A method of looping several substations to the generating plant. They are connected in a manner which will allow substations to be supplied from more than one direction or one line.

Transmission Switching: A method used to open and close transmission lines to allow power to be supplied from different lines. Switching done on a transmission system.

Transmission System: The part of the power system that moves power from the generating plants to the substations, and has no other loads along the way.

Voltage Drop: The losses in conductors give a voltage difference between the source and the end of a line. This voltage difference is called voltage drop.

Voltage Regulator: A device which senses the input voltage on a line and adjusts the output voltage level automatically to maintain a constant output.

Voltage Surge: A sudden rise in voltage. It is usually produced on a line by lightning or switching operations.

One Line Diagram

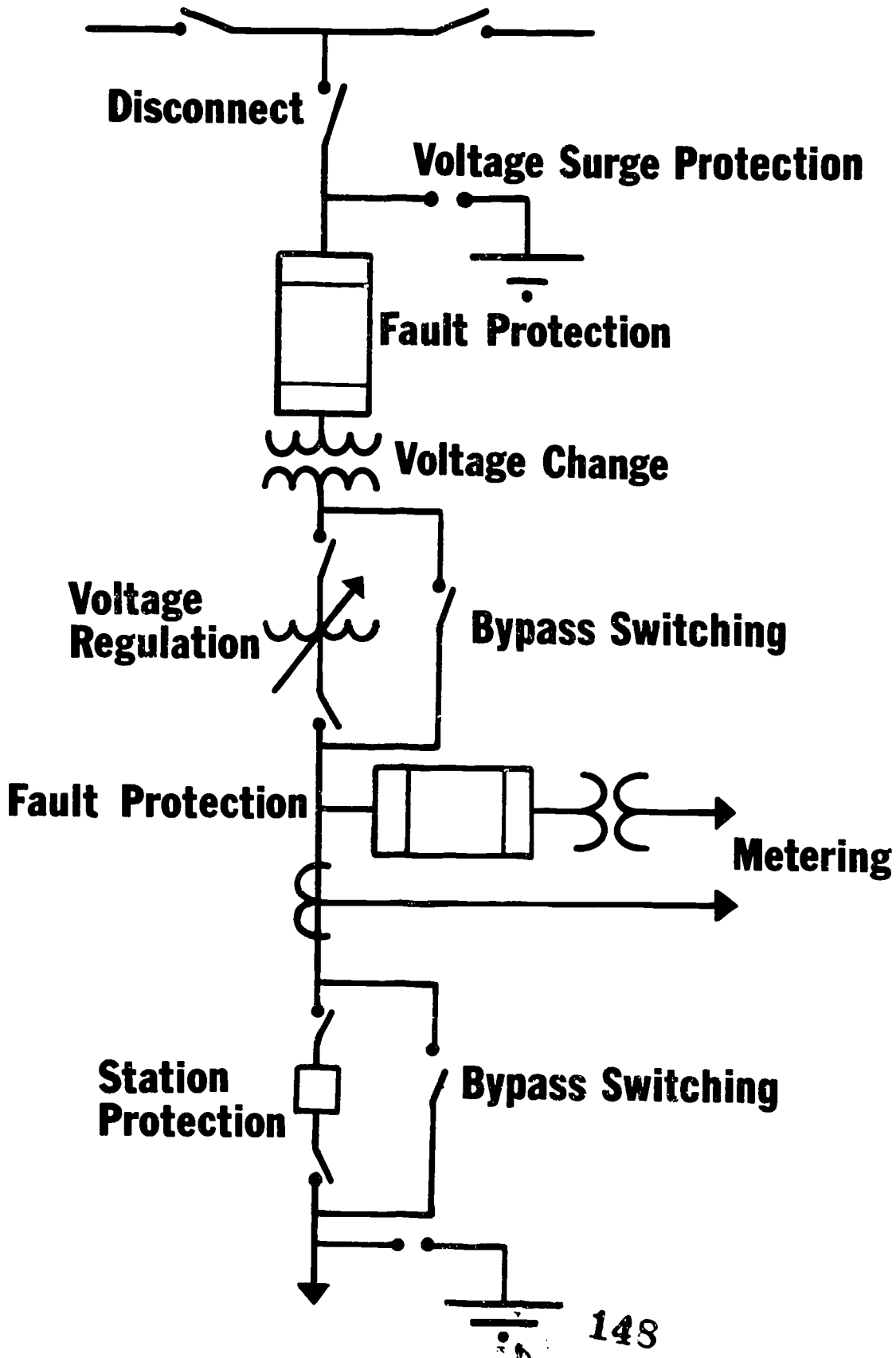

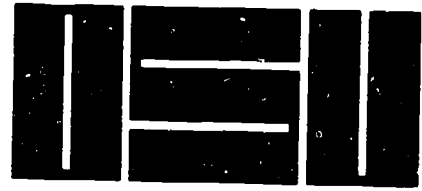

Power Factor Improvement

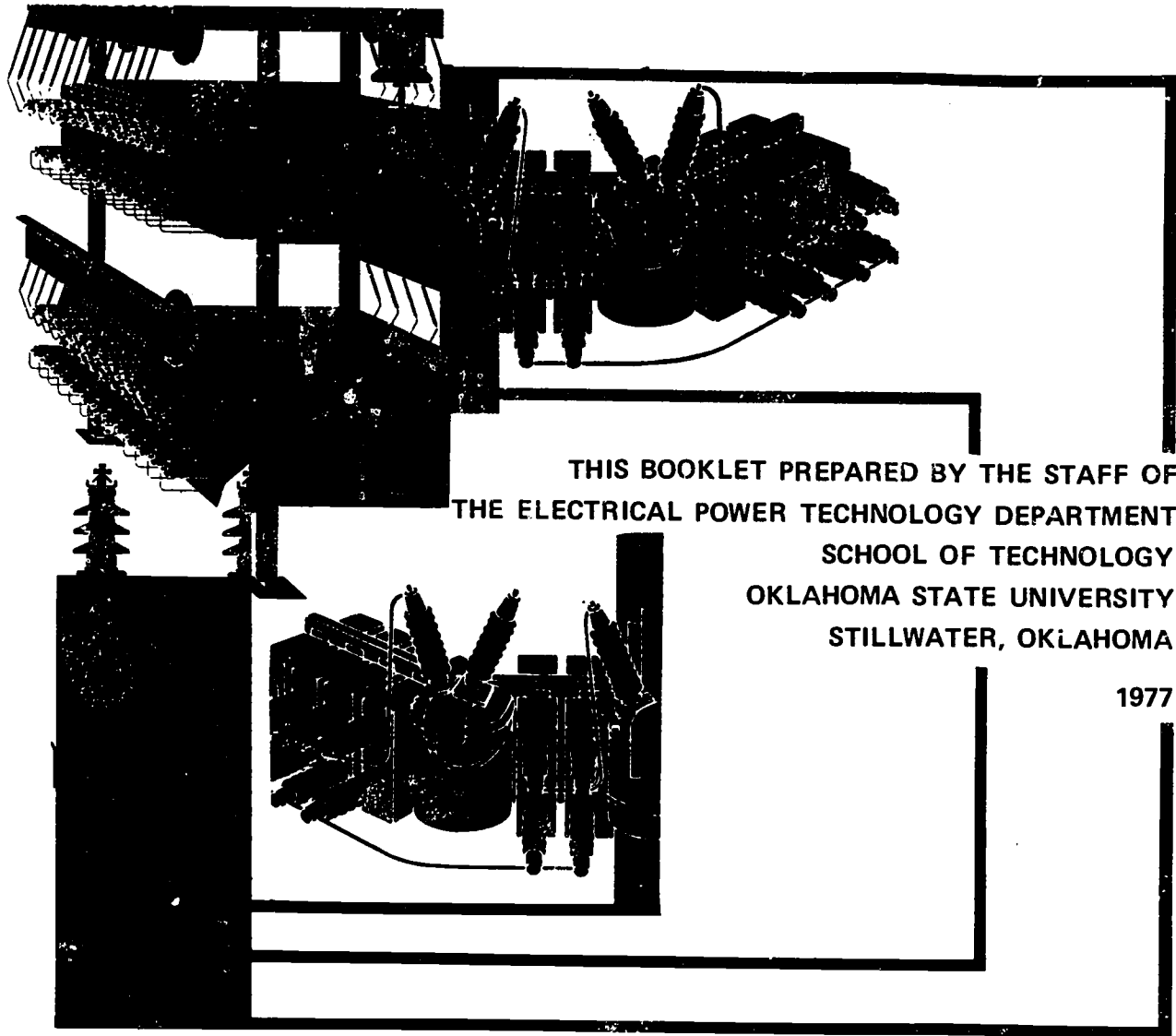

THIS BOOKLET PREPARED BY THE STAFF OF
THE ELECTRICAL POWER TECHNOLOGY DEPARTMENT
SCHOOL OF TECHNOLOGY
OKLAHOMA STATE UNIVERSITY
STILLWATER, OKLAHOMA

1977

As part of National Science Foundation Grant SED 76-18811
Continuing Education for Electrical Power Technicians

*Permission is granted to duplicate any part or a'l of this booklet
for educational purposes.*

i

CREDITS:

General Electric – *Industrial Power Systems Data Book*

Westinghouse – *Westinghouse Industrial Capacitors (SA-10023)*

Fundamentals of Power-factor Improvement

Why are power engineers interested in plant power factor, what causes low power factor, and how can it be improved? The objectives of this section are to briefly answer these questions and to include handy application information for power-factor problems.

In summary, the effects of low plant operating power factor may be any or all of the following: overloaded cables, transformers, etc.; increased copper losses; reduced voltage level, resulting in sluggish motor operation; reduced illumination from lighting, especially where incandescent lamps are used; and increased power costs where a power-factor clause, or its equivalent, is part of the rate structure and is enforced.

Generally, low power factor is due to partially loaded induction motors. Frequently drives are "over-motored," i.e., the motor is selected to handle the largest load but usually operated at less than full load.

There are also other factors contributing to lower power factor, such as replacement of incandescent lamps with fluorescent lamps; use of rectifiers instead of synchronous motor-generator sets for d-c power supply; and increased installation of various induction devices, electronic equipments, air-conditioning units, etc. Most of these changes or replacements are in the interest of worker comfort and

efficiency, lower manufacturing cost, and technological advances; the fact that they contribute to lower plant power factor is of secondary importance.

As plants become motorized it can be expected that the plant power factor will become poorer unless some corrective measures are taken.

Improvement of power factor can reduce power costs, release electrical capacity of the power-distribution system, raise the voltage level, and reduce the system losses. However, the two main reasons for improving the power factor are (a) to reduce the power bill when there is a power-factor incentive in the rate clause and (b) to increase or release electrical capacity of the power-distribution system. Although the first is still of primary importance the second is becoming more important as engineers recognize the economics. This is especially true when capacitors are used for power-factor improvement because the electrical capacity released is valued at several times the cost of capacitors.

The two most common methods for improving power factor are shunt capacitors or synchronous motors. Each has its own application; usually the capacitor method is most economical and practical for existing plants while the synchronous motor finds its main application when a new and large motor drive is added.

POWER-FACTOR FUNDAMENTALS

The usual definition of power factor in terms of the phase relationship of voltage and current in a sine wave is intentionally avoided because it is abstract and difficult to translate into a simple physical concept. The concept used here – based on the fact that there are two types of current in an a-c circuit – is particularly helpful in understanding the effect of power factor on system operation and understanding capacitor applications.

Although the following discussion on fundamentals is written around the use of capacitors because they generally are the most practical and economical means for improving the power factor, these fundamentals also apply to other methods, such as synchronous motors and condensers.

The current required by induction motors, transformers, fluorescent lights, induction heating furnaces, resistance welders, etc., may be considered to be made up of two separate kinds of current: magnetizing current and power-producing current. Some loads, such as incandescent lights require only power-producing current.

Power-producing Current

Power-producing current (or working current) is that current which is converted by the equipment into useful work such as turning a lathe, making a weld, or pumping water. The unit of measurement of the power produced is the *kilowatt* (kw).

Magnetizing Current

Magnetizing current (also known as wattless, reactive or nonworking current) is that current which is required to produce the flux necessary to the operation of induction devices. Without magnetizing current, energy could not flow through the core of a transformer or across the air gap of an induction motor. The unit of measurement of magnetizing volt-amperes is the *kilovar* (kvar).

Total Current

Total current is the current that is read on an ammeter in the circuit. It is generally made up of both magnetizing current and power-producing current. The unit of measurement of total volt-amperes or "apparent power" is the *kilovolt-ampere* (kva). Most a-c power systems require both kilowatts and kilovars.

2 + 2 Does Not Equal 4!

The arithmetic applicable to everyday life follows the simple rule that $2 + 2 = 4$. It is unfortunate that instead of following such a simple rule the addition of kilovar current and kilowatt current follows a principle of geometry. If the kilowatt and kilovar components of current are each 2 amperes, Fig. 1, the total current may be found from the right-triangle relationship as follows:

$$(\text{Kilovar current})^2 + (\text{Kilowatt current})^2 = (\text{Total current})^2$$

$$2^2 + 2^2 = (\text{Total current})^2$$

$$4 + 4 = (\text{Total current})^2$$

$$\text{Total current} = \sqrt{8} = 2.83 \text{ amperes}$$

Therefore, $2 + 2$ does not equal 4.

The following useful formulas apply when kw, kvar, and kva are substituted for their respective currents:

$$\text{kva} = \sqrt{(\text{kw})^2 + (\text{kvar})^2} \quad (1)$$

$$\text{kw} = \sqrt{(\text{kva})^2 - (\text{kvar})^2} \quad (2)$$

$$\text{kvar} = \sqrt{(\text{kva})^2 - (\text{kw})^2} \quad (3)$$

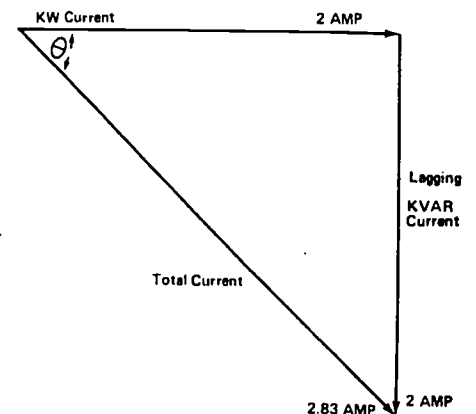

Figure 1. Diagram showing component currents in a-c circuits

WHAT IS POWER FACTOR?

Power factor may be expressed as the ratio of power-producing current in a circuit to the total current in that circuit. Another definition of power factor, which is generally more useful, is the ratio of kw or working power in the total kva or apparent power. Thus:

$$\text{Power factor} = \frac{\text{kw}}{\text{kva}} \quad (4)$$

$$\text{kw} = \text{kva} \times \text{pf} \quad (5)$$

$$\text{kva} = \frac{\text{kw}}{\text{pf}} \quad (6)$$

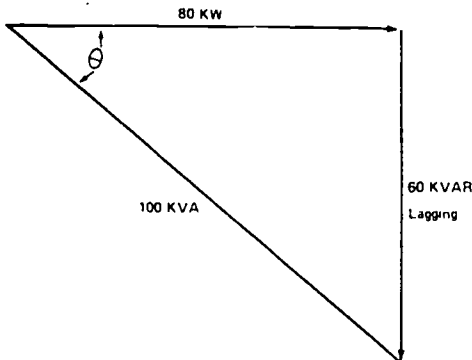

Figure 2. Right-triangle relationship for calculations in an a-c circuit where power producing current is the reference phasor

Stated another way, the power factor is that factor by which the apparent power must be multiplied in order to obtain the working power.

For the case illustrated in Fig. 2 the power factor is $\frac{80}{100}$, or 0.8, or, as it is commonly expressed, 80 percent. The angle included between the kva and the kilowatt components is called the power-factor angle and is designated by the symbol θ . The cosine of this angle ($\cos \theta$) is the power factor.

The actual calculation of power factor is illustrated by the following example.

EXAMPLE 1

What is the power factor of the load on a 460-volt, 3-phase system if the ammeter indicates 100 amperes and the wattmeter reads 62 kw?

Since in a 3-phase circuit:

$$\begin{aligned} \text{kva} &= \frac{\sqrt{3} \text{ volts} \times \text{amperes}}{1000} \\ &= \frac{1.73 \times 460 \times 100}{1000} = 79.6 \end{aligned} \quad (7)$$

Power factor = $\frac{\text{kw}}{\text{kva}} = \frac{62}{79.6} = 0.78$. or, as it is often expressed, 78 per cent.

LEADING AND LAGGING POWER FACTOR

The terms "leading" and "lagging" power factor are apt to be confusing, and they are meaningless unless the direction of both kilowatt and kilovar flow is known. Generally, however, in industrial plants only the load power factor is considered, in which case the following rule may be helpful in differentiating between leading and lagging power factor: "The power factor is lagging if the load requires kilovars and leading if the load furnishes kilovars." Thus, an induction motor has a lagging power factor because its magnetizing requirements must be supplied by the power source or other sources. On the other hand, an overexcited synchronous motor can supply kilovars (from the motor d-c field action), so such a synchronous motor has a leading power factor.

Fig. 3 indicates the power factor for common operating conditions for both loads and supply sources based on the direction of kilowatt and kilovar flow. It is obvious from this table that the terms "leading" and "lagging" are apt to be confusing. In order to avoid this confusion, varmeters are replacing power-factor meters. The varmeter has a zero center point with scales on either side, one labelled "in" and the other "out." In most industrial circuits the kilowatt flow is in only one direction; e.g., to a motor load, so single-scale wattmeters are customarily used. However, in a tie line or transfer circuit a wattmeter with a center scale should be used.

Kilovar readings are generally more useful than power-factor readings as they indicate the actual magnitude of the magnetizing components. However, if the power-factor value is needed it can be computed from the kilowatt and kilovar values.

Figure 3. Power factor of load and source

		Direction of Flow					
		At Load			At Generator		
		Kw	Kvar	P-f*	Kw	Kvar	P-f†
3(a)	Induction	In	In	Lag	Out	Out	Lag
3(b)	Synchronous motor (overexcited)	In	Out	Lead	Out	In	Lead
3(c)	Synchronous motor (underexcited)	In	In	Lag	Out	Out	Lag

* Power factor measured at the load.

† Power factor measured at the generator.

(Figure 3. continued from page 5)

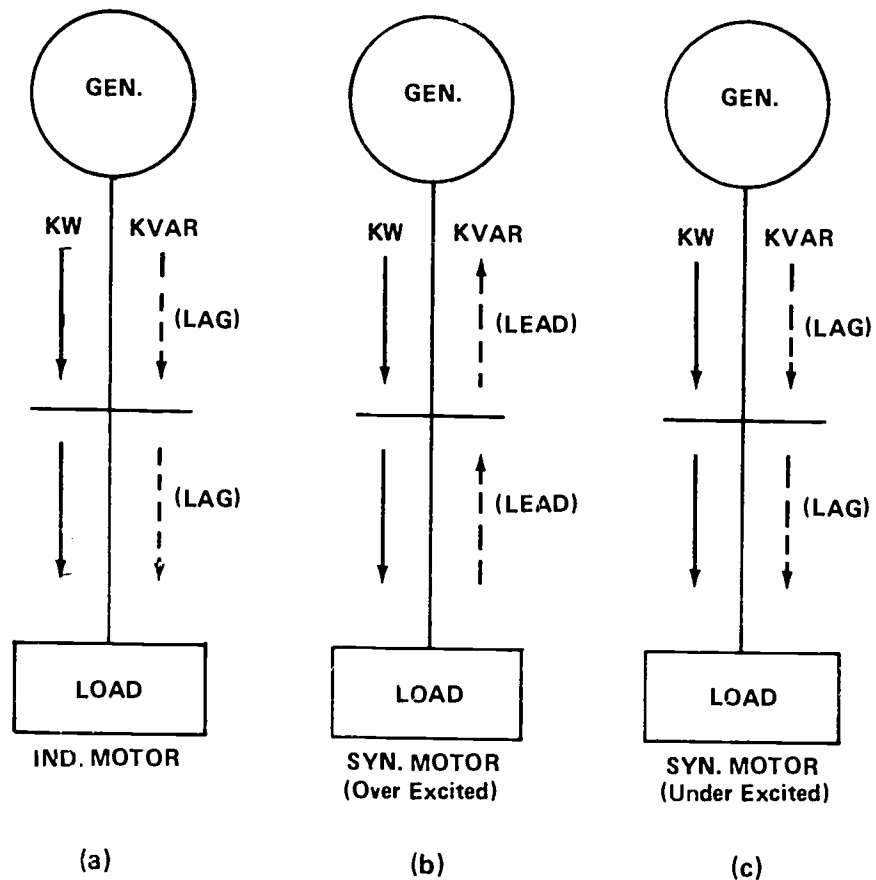

POWER FACTOR OF A GROUP OF LOADS

The power factor of an individual load is generally known or can be estimated quite closely. The power factor of a group of different loads should generally be calculated. This can be done quite simply by means of the relations explained previously.

EXAMPLE 2

Fig. 4 shows a substation supplying three different kinds of loads: incandescent lights, synchronous motors, and induction motors. The substation power factor is obtained from the total kilovars and kilowatts of the various loads, and from these the total substation kva and power factor may be found as follows:

1. Find kilowatts and kilovars of each load.

a. 50-kva lighting load:

Since incandescent lights are primarily a unity power-factor load, all the current is kilowatt current, so kva = kw.

- b. 300 hp of connected induction motor loads:
 Assume kva load = 0.75 x (connected motor hp) with an operating power factor of 80 per cent lagging.

$$kva = 0.75 \times 300 = 225$$

$$kw = (0.75 \times 300) \times 0.8 = 180 \quad (5)$$

$$kvar = \sqrt{(225)^2 - (180)^2} = \sqrt{50,625 - 32,400} = \sqrt{18,225} = 135 \quad (3)$$

- c. 75 hp of 0.8 leading pf synchronous motor:
 At full load assume kva = motor-hp rating = 75 kva

$$kw = 75 \times (0.8) = 60 \quad (5)$$

$$kvar = \sqrt{(75)^2 - (60)^2} = \sqrt{5625 - 3600} = \sqrt{2025} = 45 \quad (3)$$

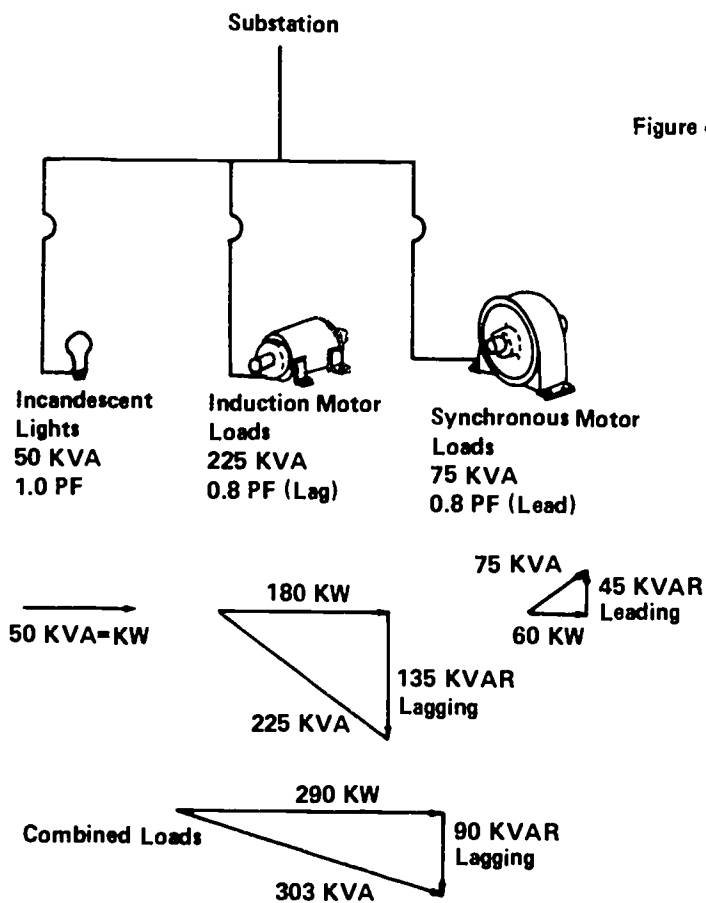

Figure 4. Construction of load diagram for Example 2

2. Find the kilowatts and kilovars that the substation must supply.

a. Kilowatts:

Lights	=	50
Induction motor load	=	180
Synchronous motor	=	60
Total		<u>290 kw</u>

b. Kilovars:

Lights	=	0
Induction motor load	=	135
Subtotal		<u>135 kvar</u>

(Since an overexcited synchronous motor has the ability to supply kilovars, the net kilovars that must be supplied by the substation is therefore the difference between the kilovars supplied by the synchronous motor and the kilovars required by the induction motor loads.)

Induction motor loads require	135 kvar
Synchronous motor supplies	<u>45</u>
Substation must supply	<u>90 kvar</u>

3. Find substation kva and power factor.

$$\begin{aligned}
 \text{Kva} &= \sqrt{(\text{kw})^2 + (\text{kvar})^2} & (1) \\
 &= \sqrt{(290)^2 + (90)^2} \\
 &= \sqrt{84,100 + 8100} \\
 &= \sqrt{92,200} = 303
 \end{aligned}$$

$$\text{Power factor} = \frac{290}{303} = 0.956 \text{ lagging} \quad (4)$$

Since the substation must supply some of the kilovar requirements (the synchronous motor is not large enough to supply all the load kilovar requirements), the over-all power factor is lagging. The various loads are added diagrammatically as shown in Fig. 4. The directions of the kilovar component (down) for lagging power factor and (up) for leading power factor as shown are in accordance with accepted practice.

HOW TO IMPROVE POWER FACTOR

When the kilovar current in a circuit is reduced, the total current is reduced. If the kilowatt current does not change, as is usually true, the power factor will improve as kilovar current is reduced. When the kilovar current becomes zero, all the current is kilowatt current and

therefore the power factor will be 1.0 (unity) or 100 per cent. For example, in Fig 2, if a capacitor is installed to supply the total or 60 kvar, the line power factor will be 1.0. Thus, the power factor may be improved by supplying the load kilovar requirements by a capacitor.

This is shown pictorially in Fig. 5 (a) and (b). The working load requires 80 amperes, but because of the motor-magnetizing requirements of 60 amperes, the supply circuit must carry 100 amperes. After a capacitor is installed to supply the motor magnetizing requirements, the supply circuit needs to deliver only 80 amperes to do exactly the same work. The supply circuit is now carrying only kilowatts, so no system capacity is wasted in carrying non-working current.

From the right-triangle relationship the following important fact can be drawn: *the simple subtraction of kilowatts from total kva never equals the kilovars except at unity power factor.*

In actual practice, it is generally not necessary or economical to improve the power factor to 100 per cent; capacitors or synchronous motors are used to supply part of the load kilovar requirements and the supply system the remainder.

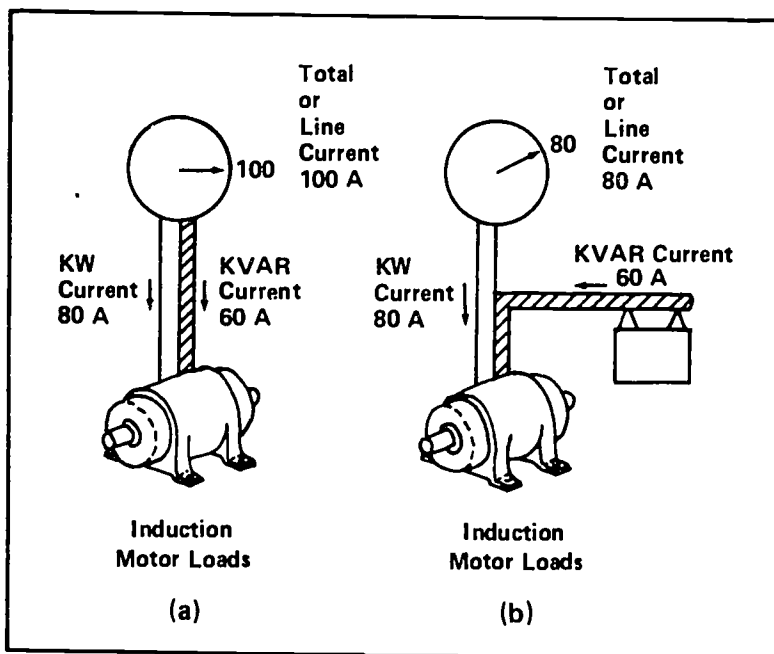

Figure 5. Schematic arrangement showing how capacitors reduce total line current by supplying magnetizing requirements locally

EXAMPLE 3

In the example of Fig. 2, suppose that the power factor is to be improved from 80 to 90 per cent with capacitors. How much of the load magnetizing requirements is furnished by capacitors? (See Fig. 6 for Diagram construction.)

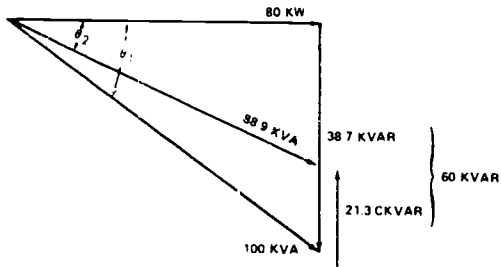

Figure 6. Diagram for Example 3

Without capacitors at 0.8 pf

$$kw = 80$$

$$kvar = 60$$

With capacitors and 0.9 pf

$$kw = 80 \text{ same}$$

$$kva = \frac{80}{0.9} = 88.9 \quad (6)$$

$$\begin{aligned} \text{Line kvar} &= \sqrt{(88.9)^2 - (80)^2} \\ &= \sqrt{7903 - 6400} \\ &= 38.7 \end{aligned} \quad (3)$$

Since the line supplies 38.7 kvar and the load requirement is 60 kvar, the capacitor supplies the difference, or $60 - 38.7 = 21.3$ kvar.

CONVENIENT CALCULATION METHODS FOR POWER- FACTOR IMPROVEMENT

The calculating method described previously was primarily intended to show how kilovars influence the power factor and that in a-c circuits the total kva is obtained by using the right-triangle relationship and not just by arithmetical addition of the kilowatts and kilovars. It is evidence from these calculations that the right-triangle method is rather laborious for power-factor calculations.

From the right-triangle relationship several simple and useful mathematical expressions may be written:

$$\cos \theta = pf = \frac{kw}{kva} \quad (4)$$

$$\tan \theta = \frac{kvar}{kw} \quad (8)$$

$$\sin \theta = \frac{kvar}{kva} \quad (9)$$

Because the kilowatt component usually remains constant (the kva and kvar components change with power factor), expression 8 involving the kilowatt component is the most convenient to use. This expression may be rewritten as:

$$kvar = kw \times \tan \theta \quad (10)$$

For example, assume that it is necessary to determine the capacitor rating to improve the load power factor.

$$\begin{aligned} \text{kvar at original pf} &= \text{kw} \times \tan \theta_1 \\ \text{kvar at improved pf} &= \text{kw} \times \tan \theta_2 \end{aligned}$$

Therefore, the capacitor rating required to improve the power factor is:

$$\text{ckvar}^* = \text{kw} \times (\tan \theta_1 - \tan \theta_2) \quad (11)$$

For simplification $(\tan \theta_1 - \tan \theta_2)$ is often written as $\Delta \tan$. Therefore,

$$\text{ckvar} = \text{kw} \times \Delta \tan \quad (12)$$

All tables, charts, and curves which have a "kw multiplier" for determining the capacitor on synchronous motor kilovars are based on the above expression.

Table 1 lists the "kw multiplier" values for a wide range of operating conditions.

Determine the capacitor rating for Example 3 by using Table 1.

EXAMPLE 4

The "kw multiplier" or $\Delta \tan$ as read from the table is 0.266. Substituting in equation 12,

$$\text{ckvar} = 80(0.266) = 21.3$$

Capacitors

The concept of a capacitor as a kilovar generator is helpful in understanding its use for power-factor improvement. A capacitor may be considered a kilovar generator because it supplies the magnetizing requirements (kilovars) of induction devices.

KILOVAR GENERATORS

This action may be explained in terms of the stored energy. When a capacitor and an induction device are installed in the same circuit, there will be an exchange of magnetizing current between them, i.e.,

*The prefix "c" in ckvar is used to designate the capacitor kvar in order to differentiate it from load kvar.

the leading current taken by the capacitor neutralizes the lagging current taken by the induction device. Because the capacitor relieves the supply line of supplying magnetizing current to the induction device, the capacitor may be considered to be a kilovar generator, since it actually supplies the magnetizing requirements of the induction device.

Synchronous Motors and Synchronous Condensers

Synchronous motors and synchronous condensers may also act as kilovar generators. They generate kilovars in the same manner as a conventional generator does. Their ability to generate kilovars is a function of excitation, and, in the case of synchronous motors, it is also a function of load. When underexcited they do not generate sufficient kilovars to supply their own needs and consequently must take additional kilovars from the system. When overexcited (normal operation), they can supply all their own kilovar requirements and in addition can supply kilovars to the system. Thus, they may be considered as kilovar generators.

Synchronous motors are widely used for power-factor improvement. The kilovar output that they are capable of supplying to the line is a function of excitation and motor load. The curves of Fig. 7 show the kilovars that a synchronous motor is capable of

Figure 7. Curves showing approximate kilovars supplied by synchronous motors with rated excitation

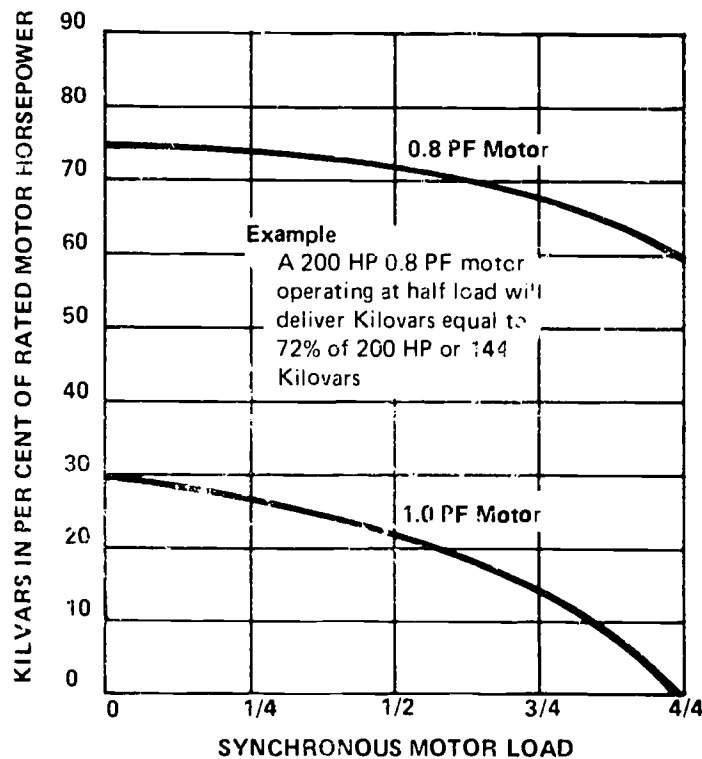

delivering under various load conditions with normal excitation. At high overloads (not shown on these curves) a synchronous motor may take magnetizing current from the line.

The two power-factor ratings of synchronous motors most commonly used in industry are unity pf and 0.8 pf. These ratings refer to the operating power factor at full load and with normal field excitation. In the case of the 0.8-pf motor, this always means 0.8 pf *leading*.

Synchronous condensers are rarely economical for industrial plants, so no further reference will be made to them.

Although maximum over-all operating benefits obtained when capacitors are located at the load, it is not always practical or economical to locate capacitors at each load.

Most industrial plants contain a number of small loads; since capacitors are made in standard sizes it would be impractical to apply the correct capacitor kilovars at each load. Then, too, in the general case all these loads are not on all the time, so it is possible to take advantage of the diversity by installing a single capacitor equipment at some central location. For example, if only 50 percent of the total motor load is in operation at one time, then a group capacitor need be only half the kilovar rating of the total number of kilovars connected at individual loads.

The system operating voltage influences the economic considerations associated with location of capacitors and motors. For example, 230-volt equipments cost more than twice as much, as 460- or 575-volt equipments. Also, economic comparisons should include a suitable switching device. For example, although 2400-volt capacitor units are the most economical, yet these equipments with the proper switching device usually cost more than 460- or 575-volt equipments for practically all industrial applications because of the higher cost of switching devices for 2400-volt service.

ECONOMIC CONSIDERATIONS

Power Billing Savings

The main use of capacitors in industrial plants, and often a deciding factor in the selection of synchronous motors is to reduce purchased power costs when the tariff contains a power-factor clause or its equivalent. Generally, the return on these investments is many, many times the return obtained from straight business investments.

This section stresses capacitors because of their wide application in either existing or new plants. However, attractive savings can also be realized with synchronous motors; the principles of application are similar.

The main purpose of this section is to give some of the background for power-factor clauses, list the more common types of clauses, and show, by means of examples, the procedure for determining the capacitor kilovars required and the annual rate of return on the capacitor investment. In most cases sufficient information for such a study is given in the power bill.

Power-factor clauses have not been standardized and they contain many types of bonuses and penalties. These clauses do not follow general trends, however, and the following types include most of those that are favorable to the improvement of power factor by capacitors or synchronous motors.

TYPES OF POWER-FACTOR CLAUSES

a. Kilowatt-demand charge based on so-called "billing" or "contract" demand, where billing demand is dependent upon the ratio of base to actual power factor, such as:

$$\text{Billing kw demand} = \text{Actual kw demand} \left(\frac{\text{Base power factor}}{\text{Actual power factor}} \right)$$

The base power factor is usually 80 or 85 percent.

b. Same as (a) with a billing kilowatt-demand charge plus an energy (kilowatt-hour) charge dependent upon billing demand. (With this type of rate structure, improvement in power factor becomes very attractive since both the demand and energy charges are reduced.)

c. Billing demand based on *actual kva* with energy charges either dependent on independent of billing demand.

d. Flat percentage increase or decrease to the power bill, depending upon the amount the average power factor is less or more than the base power factor.

e. Independent charges for kilowatt and kilovar demands. A modification of this is the two-rate structure with independent charges for kilowatt-hours and kilovar-hours.

RATE OF RETURN ON CAPACITOR INVESTMENT

The rate of return on the capacitor investment varies widely because of the difference in power-factor clauses. However, it is common for capacitors to pay for themselves in 1/2 to 3 years. This represents an annual gross return of 200 to 33 1/3 percent. The estimated mean return is in the neighborhood of 65 percent. This figure is based on a study of the power-factor clauses of a number of utilities distributed throughout the country.

The rate of return will depend upon the cost of capacitors, which in turn depends somewhat upon the voltage class. However, the above figures are applicable to most industrial installations, the major exception being 230-volt installations, for which the return will be about half of the above values.

HOW FAR CAN THE PLANT POWER FACTOR BE IMPROVED?

The amount of power-factor improvement depends upon the original power factor and the type of rate structure, and each case should be studied individually. However, it is generally economical to improve the power factor to take advantage of the full amount of the

penalty and bonus. A rough rule that has been used is improvement to 90 to 95 percent.

The best way to determine the capacitor kilovars to use is to calculate the rate of return and actual dollar savings for various final power-factor values as in Fig. 8, which is for an actual case study. It should be noted that the final power factor is not necessarily limited to the one corresponding to the maximum rate of return. Generally, the power factor can be improved beyond this value because even though the rate of return is less it is still economically attractive and additional system power capacity is released.

However, there is a limit where the incremental saving for each capacitor kilovar added may not be economically attractive; this can be quickly determined in each case by a few calculations.

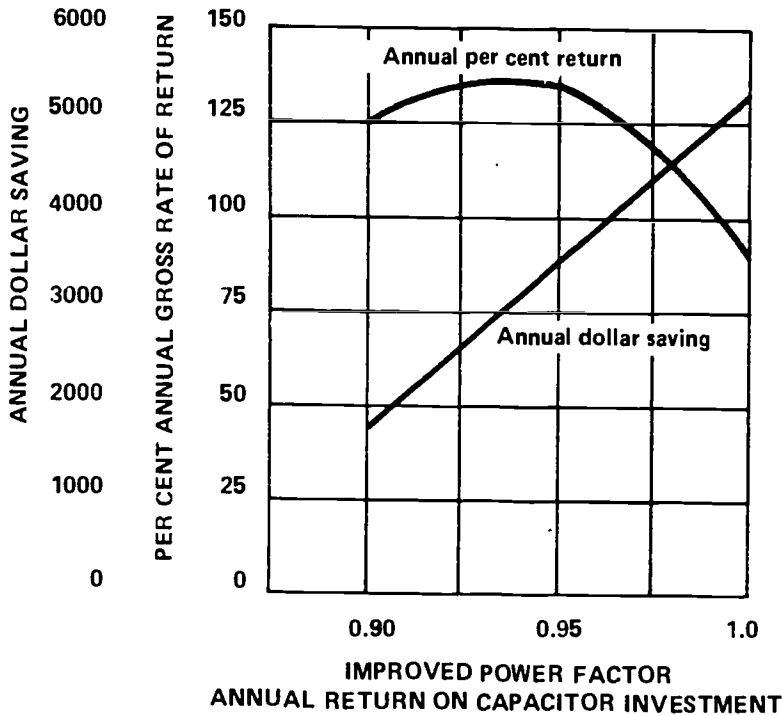

Figure 8. Actual dollar saving and gross annual rate of return on capacitor investment for various values of final power factor for an actual case.

Practically every size of plant having the usual type of power-factor rate structure can justify capacitors. It is the rate of return on the capacitor investment which is the important factor.

WHAT SIZE PLANT CAN JUSTIFY CAPACITORS?

Actually, the rate of return will usually be greater for small plants because of the higher demand and energy charges for small loads.

WHAT INDUSTRIES OR PROCESSES HAVE LOW POWER FACTOR?

In general, those industries having manufacturing processes involving partly loaded induction motors will have a low operating power factor ("low" for this purpose is assumed to be less than 80 percent). Typical of such loads are small pumps, fans, and compressors, and machine tools such as lathes and grinders.

SAMPLE CALCULATIONS OF THE RATE OF RETURN ON CAPACITOR INVESTMENTS

Fig. 9 shows a representative daily load pattern of an industrial plant in which kilowatts, kilovars, and power factor are plotted against time. Actually, any two of these quantities determine the third quantity, but all three are plotted for convenience. Not shown are the kilowatt-demand peaks, which reach 125 kw at infrequent intervals. Power factor at peak demand is 0.8. Although week-end loads are not shown, they are assumed to be the same as "after-hours" weekday loads.

The rate of return on a capacitor investment will depend not only on the rate structure of the utility but also on the method of measuring power factor. To illustrate this point, several examples are included. The same rate structure is used for all cases, but the method of measuring power factor is different in each.

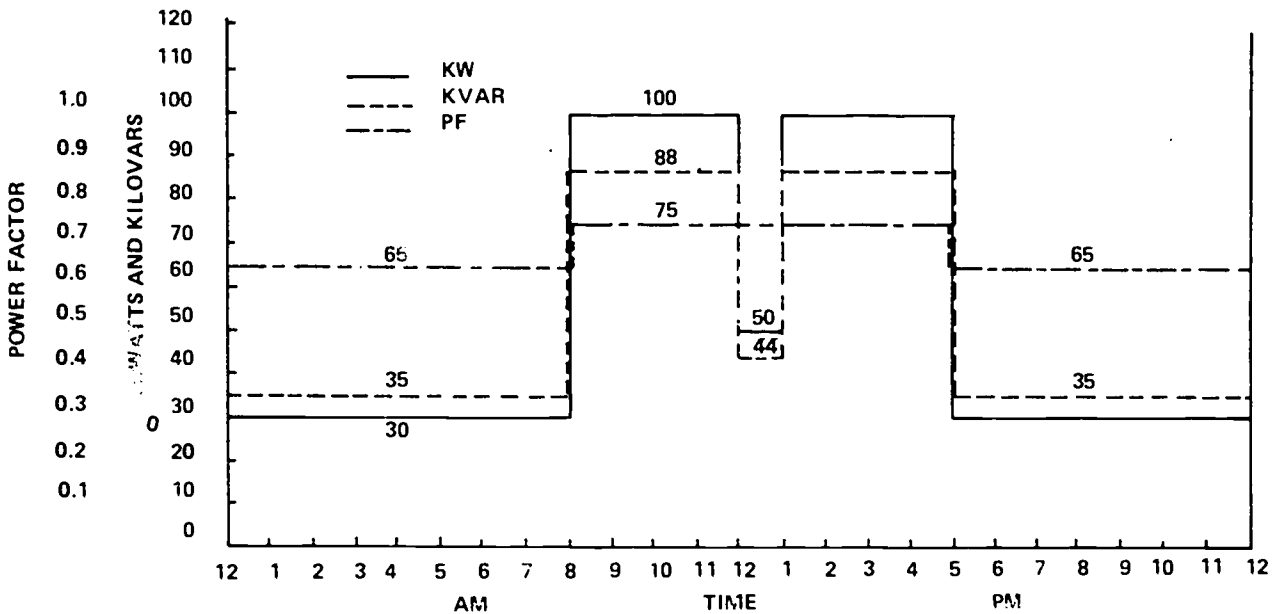

INFREQUENT PEAK KW DEMAND IS 125 AND POWER FACTOR 80 PER CENT.
WEEK-END LOAD SAME AS AFTER-HOURS LOAD.

Figure 9. Representative daily load pattern used in Examples 5 to 8 inclusive

Reference	Type of Rate Clause
Example 5	Power factor is measured at time of maximum kilowatt demand.
Example 6	Power factor is measured during normal load periods.
Example 7	Power factor is the average monthly power factor.
Example 8	Energy charges are affected by power factor.

Demand charge:

\$2.00 per kw.

RATE STRUCTURE

Energy charge:

Usually the energy charge is independent of power factor and so does not enter into the rate of return on a capacitor investment. However, there are some rates in which the cost of energy is affected by the "billing" demand and, therefore, power factor. This type of rate schedule is included in Example 8.

Power-factor clause:

The kilowatt demand for billing purposes shall be adjusted by multiplying the measured demand by the ratio of 0.85 to the power factor.

$$\text{Billing demand} = \text{Measured Kw demand} \times \frac{85}{\text{Actual power factor}}$$

1. Monthly demand charge without capacitors.

Power factor at peak demand is 0.80.

Peak demand is 125 kw.

EXAMPLE 5 (Power factor is measured at the time of maximum kilowatt demand.)

$$\begin{aligned} \text{Billing demand} &= \text{Peak demand} \times \frac{0.85}{\text{Power factor at peak demand}} \\ &= 125 \times \frac{0.85}{0.80} = 132.8 \text{ kw} \end{aligned}$$

$$\text{Demand charge} = 132.8 \times \$2.00 = \$265.60$$

2. Selection of capacitors required for power-factor improvement.

In general, it is desirable to improve power factor to between 0.90 and 0.95. For this example assume that the power factor is improved to approximately 0.90.

$$\text{ckvar required} = \text{kw} (\Delta \tan) \quad (12)$$

From Table 1 *

$$\text{kw multiplier} = 0.266$$

$$\text{ckvar} = 125(0.266) = 33.3$$

A value of 125 kw is used since the power factor is measured at the time of peak kilowatt demand.

A 33.3-kvar capacitor equipment is not of standard rating; therefore, select 30 kvar, which is the nearest standard rating. The final power factor with a 30-kvar capacitor may be obtained as follows:

$$\text{ckvar} = \text{kw}(\tan\theta_1 - \tan\theta_2) \quad (11)$$

where ckvar = 30

$$\text{kw} = 125.$$

$$\tan\theta_1 = 0.75.$$

$$30 = 125 (0.75 - \tan\theta_2)$$

$$30 = 93.75 - 125 \tan\theta_2$$

$$\tan\theta_2 = 63.75.$$

$$\tan\theta_2 = \frac{63.75}{125} = 0.51.$$

From Table 2 the improved power factor = 0.891.

3. Monthly demand charge at 0.891 power factor.

$$\text{Billing demand} = 125 \times \frac{0.85}{0.891} = 119.2 \text{ kw}$$

$$\text{Demand charge} = 119.2 \times \$1.96 = \$238.40$$

4. Annual rate of return on capacitor investment.

The installed cost of 460-volt capacitors including switches is approximately \$11 per ckvar.

$$\text{Capacitor investment} = \$11 \times 30 = \$330$$

$$\text{Monthly saving on power bill} = \$265.60 - \$238.40 = \$27.20$$

$$\text{Annual saving on power bill} = \$27.20 (12) = \$326.40$$

$$\text{Annual percent gross return} = \frac{\text{Annual saving}}{\text{Capacitor cost}} \times 100 = \frac{\$326.40}{\$330.00} \times 100 = 98.9$$

*All tables are in Section A of the Appendix.

The rate of return varies with the extent to which the power factor is improved. This is illustrated in Fig. 10 which applies to this example.

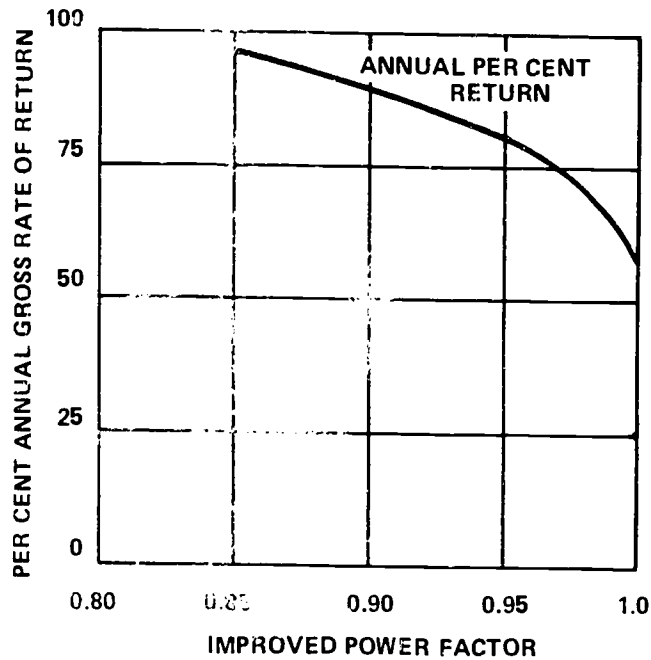

Figure 10. Graph showing how rate of return on capacitors is influenced by the final value of power factor (data for Example 5)

1. Monthly demand charge without capacitors.

Power factor during normal load periods = 0.75.

Demand during normal load is 100 kw.

$$\text{Billing demand} = 100 \times \frac{0.85}{0.75} = 113.3 \text{ kw}$$

$$\text{Demand charge} = 113.3 \times \$2.00 = \$226.60$$

EXAMPLE 6 (Power factor is measured during normal load periods.)

2. Selection of capacitors required for power-factor improvement.

Assume that the power factor is improved to 90 percent.

$$\text{ckvar} = \text{kw} (\Delta \tan\theta) \quad (12)$$

From Table 1

kw multiplier = 0.398

$$\text{ckvar} = 100(0.398) = 39.8 \text{ (use 40)}$$

3. Monthly demand charge at 0.90 power factor.

$$\text{Billing demand} = 100 \times \frac{0.85}{0.90} = 94.4 \text{ kw}$$

$$\text{Demand charge} = 94.4 \times \$2.00 = \$188.80$$

4. Annual rate of return on capacitor investment.

$$\text{Capacitor investment} = \$11 \times 40 = \$440$$

$$\text{Monthly saving on power bill} = \$226.60 - \$188.80 = \$37.80$$

$$\text{Annual power-bill saving} = \$37.80 \times 12 = \$453.60$$

$$\text{Annual percent gross return} = \frac{\$453.60}{\$440} \times 100 = 103$$

It will be noted from comparing Examples 5 and 6 that the rate of return on the capacitor investment is influenced by the time of the power-factor measurement as stipulated by the rate structure.

EXAMPLE 7 (Power factor is the average monthly power factor, but no credit is given for leading power factor.)

1. Monthly demand charge without capacitors.

a. Present average monthly power factor.

There are numerous methods for obtaining average monthly power factor. In this example power factor will be obtained from the total monthly kw-hr and kvar – hr readings.

The average month contains 22 working days and 8 week-end days. The kw-hr and kvar-hr for each week-day and each week-end day can be obtained from the load pattern diagram of Fig. 9.

kw-hr per working day:

$$15 \text{ hours at } 30 \text{ kw} = 450 \text{ kw-hr}$$

$$8 \text{ hours at } 100 \text{ kw} = 800 \text{ kw-hr}$$

$$1 \text{ hour at } 50 \text{ kw} = 50 \text{ kw-hr}$$

$$\underline{1300 \text{ kw-hr}}$$

kw-hr per week-end day:

$$24 \text{ hours at } 30 \text{ kw} = 720 \text{ kw-hr}$$

$$\begin{aligned} \text{Total monthly kw-hr} &= 22(1300) + 8(720) \\ &= 28,600 + 5760 \\ &= 34,360 \end{aligned}$$

kvar-hr per working day:

$$\begin{aligned} 15 \text{ hours at } 35 \text{ kvar-hr} &= 525 \text{ kvar-hr} \\ 8 \text{ hours at } 88 \text{ kvar-hr} &= 704 \text{ kvar-hr} \\ 1 \text{ hour at } 44 \text{ kvar-hr} &= 44 \text{ kvar-hr} \\ \hline &1273 \text{ kvar-hr} \end{aligned}$$

kvar-hr per week-end day:

$$24 \text{ hours at } 35 \text{ kvar} = 840 \text{ kvar-hr}$$

$$\begin{aligned} \text{Total monthly kvar-hr} &= 22(1273) + 8(840) \\ &= 28,006 + 6720 \\ &= 34,726 \end{aligned}$$

$$\text{Tangent (for average monthly power factor)} = \frac{\text{kvar-hr}}{\text{kw-hr}} \quad (8)$$

$$\tan\theta = \frac{34,726}{34,360} = 1.01$$

From Table 2 power factor = 0.704.

b. Demand charge based on normal load conditions.

$$\text{Billing demand} = 100 \times \frac{0.85}{0.704} = 120.5 \text{ kw}$$

$$\text{Demand charge} = 120.5 \times \$2.00 = \$241.00$$

2. Selection of capacitors for power-factor improvement.

Assume the power factor is to be improved to approximately 90 percent, as in the two previous examples.

The permissible kilovar-hours at 90 percent power factor is:

$$\begin{aligned} \text{kvar-hr} &= \text{kw-hr} \times \tan\theta_2 \\ &= 34,360 \times 0.484 \\ &= 16,630 \end{aligned} \quad (10)$$

Therefore, the number of kilovar hours to be eliminated is $34,726 - 16,630 = 18,096$.

Since one kilovar of capacitors will supply 720 kvar-hr per month, the required capacitor rating is:

$$\text{ckvar} = \frac{18,096}{720} = 25.1 \text{ (use 25)}$$

If this value were more than the light-load requirements of 35 kvar, then the rating would be reduced because the rate structure specifies that no credit is given for kilovars supplied above the plant requirements. In other words, no credit is given for leading plant power factor. In this example, however, the full output of the capacitor can be utilized at all load conditions.

Some kilovar-hour meters are provided with a detent device to prevent them from running backwards and reducing the kvar-hr registration for leading power-factor loads. Some utilities do give credit for leading power factor, and where that is the case the rate of return on the capacitor investment is usually very attractive.

The importance of the kilovar requirements during light-load periods varies with the total hours per month that the plant operates at light load. For example, if this plant works 3 shifts per day, 5 days a week, the light-load periods are relatively unimportant because they represent only a small portion of the total kw-hr and kvar-hr. The capacitor kilovars should then be selected primarily on the basis of kilovar requirements during normal load periods.

Find the improved power factor after installing 25 ckvar.

Monthly kw-hr = Same as before = 34,360

kvar-hr per working day:

$$\begin{aligned} 15 \text{ hours at } (35-25) \text{ kvar} &= 150 \text{ kvar-hr} \\ 8 \text{ hours at } (88-25) \text{ kvar} &= 504 \text{ kvar-hr} \\ 1 \text{ hour at } (44-25) \text{ kvar} &= 19 \text{ kvar-hr} \\ &= \underline{673 \text{ kvar-hr}} \end{aligned}$$

kvar-hr per week-end day:

$$24 \text{ hours at } (35-25) \text{ kvar} = 240$$

$$\text{Monthly kvar-hr} = 22(673) + 8(240) = 16,726$$

$$\text{Tangent of power-factor angle} = \frac{\text{kvar-hr}}{\text{kw-hr}} = \frac{16,726}{34,360} = 0.487$$

From Table 2 power factor = 0.899.

3. Monthly demand charge at 0.899 power factor.

$$\text{Billing demand} = 100 \times \frac{0.85}{0.899} = 94.6 \text{ kw}$$

$$\text{Demand charge} = 94.6 \times \$2.00 = \$189.20$$

4. Annual rate of return on capacitor investment.

$$\begin{aligned} \text{Capacitor investment} &= \$11 \times 25 = \$275. \\ \text{Monthly saving on power bill} &= \$241 - \$189.20 = \$51.80 \\ \text{Annual saving on power bill} &= \$51.80 \times 12 = \$621.60 \\ \text{Annual percent gross return} &= \frac{\$621.60}{275} \times 100 = 226 \end{aligned}$$

(In some rate structures the power-factor clause affects both the demand charge and the energy charge. This increases the rate of return on the capacitor investment.)

EXAMPLE 8 (Same as Example 5 except that the energy charge is also affected by power factor.)

Demand charge:

\$2.00 per kw

Energy charge:

5 cents per kw-hr for first 50 kw-hr per kw billing demand

3.8 cents per kw-hr for next 100 kw-hr per kw billing demand

2.9 cents per kw-hr for all over 150 kw-hr per kw billing demand

1. Monthly power bill without capacitors.

From Example 5, power factor = 0.80.

$$\text{Billing demand} = 125 \times \frac{0.85}{0.80} = 132.8 \text{kw}$$

Demand charge:

$$132.8 \times \$2.00 = \qquad \qquad \qquad \$265.60$$

Energy charge:

(Total kw-hr = 34,360, as in Example 7)

First block = 50 x 132.8 = 6640 kw-hr

$$6640 \times \$0.05 = \qquad \qquad \qquad \$332.00$$

Second block = 100 x 132.8 = 13,280 kw-hr

$$13,280 \times \$0.038 = \qquad \qquad \qquad \$504.64$$

Last block

Total kw-hr = 34,360

Total kw-hr of first and second blocks =

$$6640 + 13,280 = 19,920$$

Net kw-hr of last block = 34,360 - 19,920 = 14,440

$$14,440 \times \$0.029 = \qquad \qquad \qquad \$418.76$$

$$\text{Total energy charge} = \qquad \qquad \qquad \underline{\underline{\$1521.00}}$$

$$\begin{aligned} \text{Monthly power bill} &= \text{Demand charge} + \text{Energy charge} = \$265.6 \\ &+ \$1255.40 = \$1521 \end{aligned}$$

2. Selection of capacitors required for power-factor improvement.
From Example 5, 30 ckvar improved the power factor to 0.891.

3. Monthly power bill at 0.891 power factor.

$$\text{Billing demand} = 125 \times \frac{0.85}{0.891} = 119.2 \text{ kw}$$

Demand charge:

$$119.2 \times \$2.00 = \$238.40$$

Energy charge:

$$\begin{aligned} \text{First block} &= 50 \times 119.2 \text{ kw} = 5960 \text{ kw-hr} \\ 5960 \times \$0.05 &= \$298.00 \end{aligned}$$

$$\begin{aligned} \text{Second block} &= 100 \times 119.2 \text{ kw} = 11,920 \text{ kw-hr} \\ 11,920 \times \$0.038 &= \$452.96 \end{aligned}$$

Last block

$$\text{Total kw-hr} = 34,360$$

$$\begin{aligned} \text{Total kw-hr of first and second blocks} &= 5960 \\ &+ 11,920 = 17,880 \end{aligned}$$

$$\text{Net kw-hr of last block} = 34,360 - 17,880 = 16,480$$

$$16,480 \times \$0.029 = \$477.92$$

$$\text{Total energy charge} = \underline{\underline{\$1228.88}}$$

$$\begin{aligned} \text{Monthly power bill} &= \text{demand charge} + \text{energy charge} = \\ \$238.40 + \$1228.88 &= \$1467.28 \end{aligned}$$

4. Annual rate of return on capacitor investment.

$$\text{Capacitor investment} = \$11 \times 30 = \$330$$

$$\text{Monthly saving on power bill} = \$1521.00 - \$1467.28 = \$53.72$$

$$\text{Annual saving on power bill} = \$53.75 \times 12 = \$644.64$$

$$\text{Annual percent gross return} = \frac{\$644.64}{\$330.00} \times 100 = 195.35$$

176

The increase in the annual gross return over that obtained in Example 5 is due to the reduction in monthly energy charge since the demand charge has not changed. Energy is billed in "blocks" of power, and the size of the blocks is determined by the kilowatt demand. The first blocks of power are the most costly in dollars per kilowatt-hour. By reducing the kilowatt demand, the number of kilowatt-hours in these first blocks is reduced and consequently the power bill is reduced.

Lab

LABORATORY PROCEDURES # 1

Purpose: To demonstrate the reduction on current drawn from source equipment when shunt capacitors are connected to terminals of a loaded polyphase squirrel-cage induction motor.

Equipment List:

- Three-phase, 208 v grounded wye source
- Full voltage motor starter (Hickok)
- Three-phase, squirrel-cage induction motor (Hickok)
- Capacitor bank
- D C generator (Hickok)
- VOM Simpson 265
- Three AC ammeters 0–2A FSD (Hickok)
- One, dc ammeter 0-2A FSD (Hickok)
- One, three-phase wattmeter (Hickok)

CAUTION: DANGEROUS VOLTAGES ARE PRESENT DURING THIS PROCEDURE. DO NOT MAKE ANY CIRCUIT CONNECTIONS WITH POWER SOURCE ENERGIZED.

1. Connect circuit as shown in connection diagram. AC motor should be wye connected for operation at 208 v. It is not necessary to carry the neutral conductor for this procedure since no single-phase loads will be used. The capacitor bank should be connected “delta” for Part I of the procedure. The dc generator should be connected for self-excitation with the field circuit being in series with an adjustable rheostat in order to provide a means of adjusting the generator excitation.
2. Short circuit the current coils of the wattmeter and ammeters # 1 and # 2. Set in full resistance on the field rheostat in the dc generator field circuit.
3. Energize the 208 volt source unit and check for proper output voltages using the VOM.

MEASURING SOURCE CURRENT REDUCTION WHEN SHUNT CAPACITORS ARE CONNECTED TO IMPROVE POWER FACTOR ON AN INDUCTION MOTOR CIRCUIT

PROCEDURE PART I:

CIRCUIT CONNECTION DIAGRAM

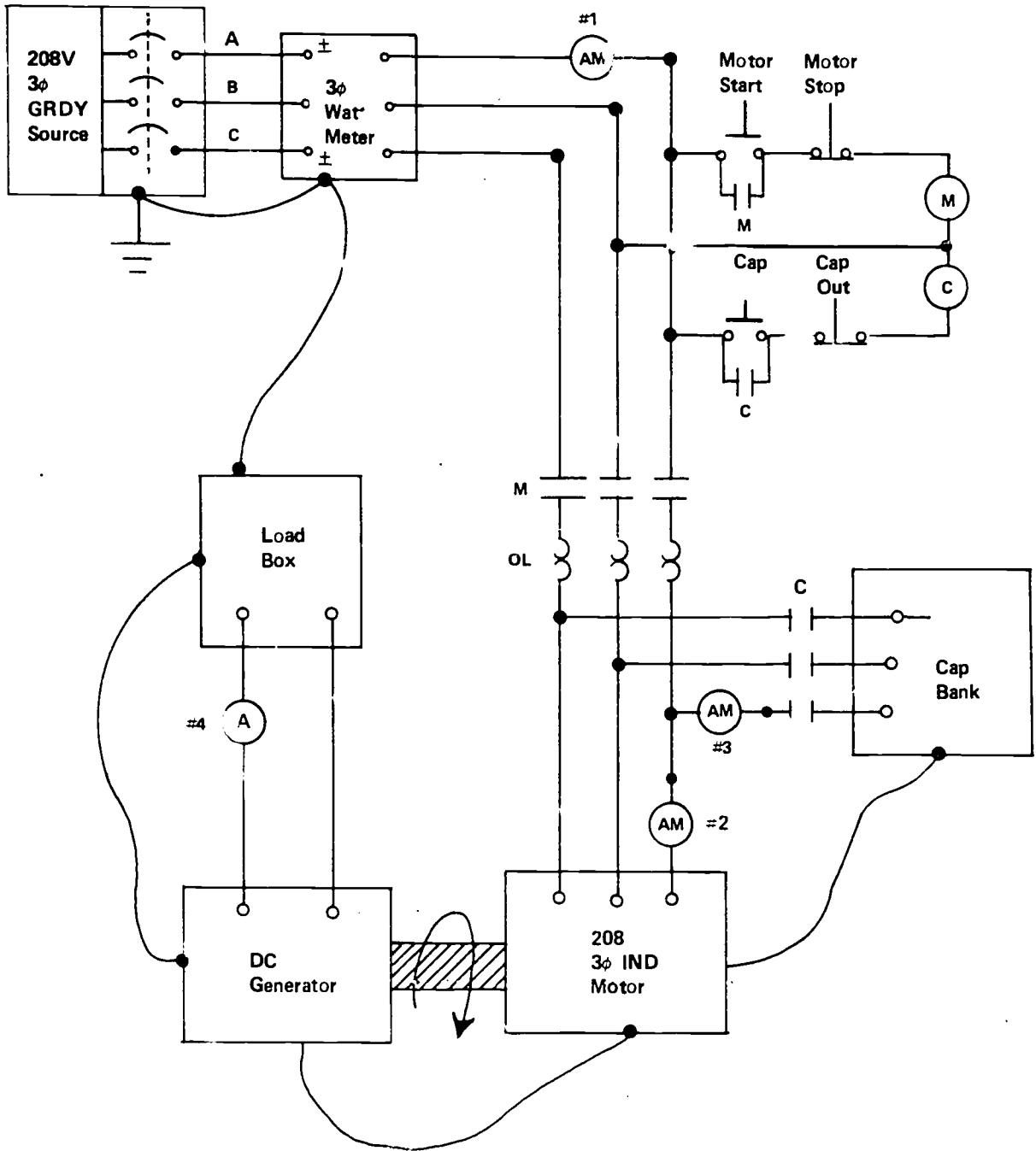

4. Start the induction motor and remove the shorting connection from the wattmeter and the ammeters once the motor is up to speed (about 1800 rpm). Allow 10 minutes warm up period.
5. Set the VOM on the appropriate dc voltage scale and connect it to the generator armature terminals.
6. Flash the generator field circuit by quickly decreasing the field rheostat resistance. Watch the VOM and see the generator terminal voltage begins to rise. Adjust the rheostat for 100 Vdc at the generator terminals. (NOTE: If the generator fails to excite, stop the motor, 208 volt source supply off, and reverse the generator field leads.) Repeat steps 2 through 6.
7. Switch in one 100 watt light bulb across the dc generator armature circuit and readjust the generator terminal voltage for 100 Vdc.
8. Read and record the three-phase wattmeter reading and the line current reading on the ammeter # 1. Ammeter # 1 and # 2 should read the same value of line current.
9. Switch in $1\mu\text{F}$ of capacitance in each leg of the delta connected capacitor bank and connect the bank to the motor circuit by depressing the CAP IN push button.
10. Read and record the three-phase wattmeter reading and ammeters # 1, # 2 and # 3.
11. Disconnect the capacitor bank from the motor circuit and switch in the necessary capacitors such that there are $2\mu\text{F}$ in each leg of the delta connected capacitor bank.
12. Repeat step 10.
13. Repeat step 11 with $3\mu\text{F}$ per leg and continue repeating steps 11 and 10 in $1\mu\text{F}$ steps until finally each leg of the capacitor bank has $10\mu\text{F}$ total.
14. Disconnect the capacitor bank from the motor circuit, stop the motor and de-energize the 208 v source unit.

1. Reconnect the capacitor bank in "wye" and repeat Part I procedure.

PROCEDURE PART II

DATA

DELTA CONNECTED CAPACITOR BANK

CAPACITANCE μ F PER LEG	3 ϕ WATTMETER WATTS W208 V LINE TO LINE	AMMETER #1 SOURCE LINE CURRENT	AMMETER #2 MOTOR AMPERES LINE CURRENT	AMMETER #3 CAPACITOR AMPERES LINE CURRENT
0 No Capacitor	Connected			0
1				
2				
3				
4				
5				
6				
7				
8				
9				
10				

DATA

WYE CONNECTED BANK

CAPACITANCE μ F PER LEG	3 ϕ WATTMETER WATTS W208 V LINE TO LINE	AMMETER #1 SOURCE AMPERES LINE CURRENT	AMMETER #2 MOTOR AMPERES LINE CURRENT	AMMETER #3 CAPACITOR AMPERES LINE CURRENT
0 No Capacitor Connected				0
1				
2				
3				
4				
5				
6				
7				
8				
9				
10				

Analysis:

1. What is the power factor of the motor circuit before any capacitors are connected to the motor circuit?
2. At what value in μF per leg is the power factor of the motor circuit closest to unity when the capacitor bank is delta connected? Wye connected?
3. What is the total reactive volt-amperes supplied by the capacitor bank for the conditions in step 2 above for both the delta and wye connected capacitor bank?
4. Did the addition of capacitors change the amount of power being drawn from the ac source by the motor? Why or why not?
5. At what value of capacitance in μF per leg does the motor circuit power factor become leading for both the delta and wye connected capacitor banks.
6. Make a plot of source current, as read on ammeter # 1, vs. motor circuit power factor for each $1\mu\text{F}$ per leg addition for the delta connected capacitor bank. Label the vertical axis of your graph in amperes and the horizontal axis in % power factor.
7. What is the value of the full load magnetizing current required by the motor?
8. Show that for each different value of capacitance connected to the motor circuit, the total motor current as read on ammeter # 2 is the *vector* sum of the source current as read on ammeter # 1 and the capacitor current as read on ammeter # 3. Do this for the delta connected capacitor bank only.
9. Explain why $5\mu\text{F}$ per leg in a delta connected capacitor bank causes a lower source current than $5\mu\text{F}$ per leg in a wye connected capacitor bank.

LABORATORY PROCEDURE # 2

Suppose that the following loads are all connected to a motor control center in an industrial facility.

Motor A: 200 hp 460 V 1800 rpm
 full load power factor - 85% lagging
 full load efficiency -- 91%

CALCULATING THE COMBINED POWER FACTOR OF SEVERAL LOADS ON A CIRCUIT

Motor B: 150 hp 460 V 1200 rpm
full load power factor – 82% lagging
full load efficiency – 90%

Motor C: 500 hp 460 V 900 rpm
full load power factor – 86% lagging
full load efficiency – 93%

Incandescent

Lighting: 1000 watt 120 V

Lumped Motor

Load: 100 hp 460 V
average full load power factor – 80% lagging
average full load efficiency – 88%

Assume that all the motors are operating at rated voltage and are working full load. Calculate the following:

1. The total power being drawn by the combined motor and lighting load.
2. The total reactive power required for the combined motor load.
3. The combined full load power factor of the motor and lighting load.

Suppose that it is desired to improve the overall power factor of the combined motor and lighting load to 95% lagging using shunt capacitors. Calculate the following:

1. The total capacitive kvar required to improve the power factor to 95% lagging.
2. Given that motors A, B, and C are totally enclosed, NEMA design B, post 1955 motors and it is desired to connect the maximum allowable capacitor to each of these motors and to switch the capacitor and motors as a unit. Using the tables in the appendix, determine what the kvar rating for the capacitor bank for each motor will be.
3. What will be the overall combined load power factor after the capacitors are added to motors A, B, and C?
4. What kvar rating for a capacitor bank to be connected directly to the motor control center bus is required to bring the overall combined load power factor to the desired 95% lagging?
5. What is the magnitude of the line current being drawn by the combined motor and lighting load after the power factor has been corrected to 95% lagging?

6. What was the minimum kva rating of the source equipment required to serve the combined load before the power factor was improved? After the power factor was improved?

LABORATORY PROCEDURES # 3

Suppose that the following electric utility rate structure is in effect for the XYZ Manufacturing Company.

A CASE STUDY IN POWER FACTOR ECONOMICS

Average Demand Rate = \$2.00/kw up to 1000 kw

Demand Interval = 30 minutes

Billing Demand = Maximum monthly 30 minute demand $\times \frac{0.90}{\text{Power Factor at Max. Demand}}$

The XYZ Manufacturing Company has gathered the following data by reviewing the electric utility billing statements over the past year:

Average monthly maximum demand over the 12 month study period is 975 kw.

Average power factor at maximum demand over this period is 0.820 lagging.

Calculate the following:

1. The average monthly demand charge paid by the XYZ Manufacturing Company.
2. The annual demand charge paid by the company.
3. What per cent of the annual demand charge is directly attributable to lower power factor.
4. Above what power factor would the XYZ Manufacturing Company receive an effective "credit" toward their demand charge for power factor improvement?

The XYZ Company has decided to undertake a power factor improvement study. The first step in this study is to decide the most economically advantageous power factor at which the facility should operate. The company economic experts have analyzed the problem and have submitted the following economic guidelines to the facilities electrical department:

The facilities power factor should be improved to that value which will maximize annual savings in utility billing and yield a pay back period that is not to exceed one year.

$$\text{Pay back period} = \frac{\text{Initial capacitor investment}}{\text{annual savings}}$$

The facilities electrical department must find a power factor which recovers the initial capacitor investment within a one year period and yields the maximum annual dollar savings.

Given that the initial capacitor investment will be \$10/kvar, find the facilities power factor and corresponding ckvar requirement which will satisfy the economic constraints given.

One procedure which will lead to the selection of the required power factor is to make the calculations necessary to complete the table below.

PROPOSED POWER FACTOR	CAPACITOR REQUIRED (KVAR)	CAPACITOR COST (\$)	ANNUAL SAVINGS (\$)	PAYBACK (YEARS)
0.83 lagging				
0.84 lagging				
0.85 lagging				
0.86 lagging				
0.87 lagging				
0.88 lagging				
0.89 lagging				
0.90 lagging				
0.91 lagging				
0.92 lagging				
0.93 lagging				
0.94 lagging				
0.95 lagging				
0.96 lagging				
0.97 lagging				
0.98 lagging				
0.99 lagging				
1.00				

Appendix

...A

...B

...C

...D



TABLE 1
KW Multipliers for Determining the Capacitors Kilovars Required for Power-factor Improvement

Original Power Factor (cos θ ₁)	Desired Improved Power Factor (cos θ ₂)																				
	0.80	0.81	0.82	0.83	0.84	0.85	0.86	0.87	0.88	0.89	0.90	0.91	0.92	0.93	0.94	0.95	0.96	0.97	0.98	0.99	1.0
0.50	0.982	1.008	1.034	1.060	1.086	1.112	1.139	1.165	1.192	1.220	1.248	1.276	1.306	1.337	1.369	1.403	1.440	1.481	1.529	1.589	1.732
0.51	0.937	0.962	0.989	1.015	1.041	1.067	1.094	1.120	1.147	1.175	1.203	1.231	1.261	1.292	1.324	1.358	1.395	1.436	1.484	1.544	1.687
0.52	0.893	0.919	0.945	0.971	0.997	1.023	1.050	1.076	1.103	1.131	1.159	1.187	1.217	1.248	1.280	1.314	1.351	1.392	1.440	1.500	1.643
0.53	0.850	0.876	0.902	0.928	0.954	0.980	1.007	1.033	1.060	1.088	1.116	1.144	1.174	1.205	1.237	1.271	1.308	1.349	1.397	1.457	1.600
0.54	0.809	0.835	0.861	0.887	0.913	0.939	0.966	0.992	1.019	1.047	1.075	1.103	1.133	1.164	1.196	1.230	1.267	1.308	1.356	1.416	1.559
0.55	0.769	0.795	0.821	0.847	0.873	0.899	0.926	0.952	0.979	1.007	1.035	1.063	1.093	1.124	1.156	1.190	1.227	1.268	1.316	1.376	1.519
0.56	0.730	0.756	0.782	0.808	0.834	0.860	0.887	0.913	0.940	0.968	0.996	1.024	1.054	1.085	1.117	1.151	1.188	1.229	1.277	1.337	1.480
0.57	0.692	0.718	0.744	0.770	0.796	0.822	0.849	0.875	0.902	0.930	0.958	0.986	1.016	1.047	1.079	1.113	1.150	1.191	1.239	1.299	1.442
0.58	0.655	0.681	0.707	0.733	0.759	0.785	0.812	0.838	0.865	0.893	0.921	0.949	0.979	1.010	1.042	1.076	1.113	1.154	1.202	1.262	1.405
0.59	0.619	0.645	0.671	0.697	0.723	0.749	0.776	0.802	0.829	0.857	0.885	0.913	0.943	0.974	1.006	1.040	1.077	1.118	1.166	1.226	1.369
0.60	0.583	0.609	0.635	0.661	0.687	0.713	0.740	0.766	0.793	0.821	0.849	0.877	0.907	0.938	0.970	1.004	1.041	1.082	1.130	1.190	1.333
0.61	0.549	0.575	0.601	0.627	0.653	0.679	0.706	0.732	0.759	0.787	0.815	0.843	0.873	0.904	0.936	0.970	1.007	1.048	1.096	1.156	1.299
0.62	0.516	0.542	0.568	0.594	0.620	0.646	0.673	0.699	0.726	0.754	0.782	0.810	0.840	0.871	0.903	0.937	0.974	1.015	1.063	1.123	1.266
0.63	0.483	0.509	0.535	0.561	0.587	0.613	0.640	0.666	0.693	0.721	0.749	0.777	0.807	0.838	0.870	0.904	0.941	0.982	1.030	1.090	1.233
0.64	0.451	0.477	0.503	0.529	0.555	0.581	0.608	0.634	0.661	0.689	0.717	0.745	0.775	0.806	0.838	0.872	0.909	0.950	0.998	1.058	1.201
0.65	0.419	0.445	0.471	0.497	0.523	0.549	0.576	0.602	0.629	0.657	0.685	0.713	0.743	0.774	0.806	0.840	0.877	0.918	0.966	1.026	1.169
0.66	0.388	0.414	0.440	0.466	0.492	0.518	0.545	0.571	0.598	0.626	0.654	0.682	0.712	0.743	0.775	0.809	0.846	0.887	0.935	0.995	1.138
0.67	0.358	0.384	0.410	0.436	0.462	0.488	0.515	0.541	0.568	0.596	0.624	0.652	0.682	0.713	0.745	0.779	0.816	0.857	0.905	0.965	1.108
0.68	0.328	0.354	0.380	0.406	0.432	0.458	0.485	0.511	0.538	0.566	0.594	0.622	0.652	0.683	0.715	0.749	0.786	0.827	0.875	0.935	1.078
0.69	0.299	0.325	0.351	0.377	0.403	0.429	0.456	0.482	0.509	0.537	0.565	0.593	0.623	0.654	0.686	0.720	0.757	0.798	0.846	0.906	1.049
0.70	0.270	0.296	0.322	0.348	0.374	0.400	0.427	0.453	0.480	0.508	0.536	0.564	0.594	0.625	0.657	0.691	0.728	0.769	0.817	0.877	1.020
0.71	0.242	0.268	0.294	0.320	0.346	0.372	0.399	0.425	0.452	0.480	0.508	0.536	0.566	0.597	0.629	0.663	0.700	0.741	0.789	0.849	0.992
0.72	0.214	0.240	0.266	0.292	0.318	0.344	0.371	0.397	0.424	0.452	0.480	0.508	0.538	0.569	0.601	0.635	0.672	0.713	0.761	0.821	0.964
0.73	0.186	0.212	0.238	0.264	0.290	0.316	0.343	0.369	0.396	0.424	0.452	0.480	0.510	0.541	0.573	0.607	0.644	0.685	0.733	0.793	0.936
0.74	0.159	0.185	0.211	0.237	0.263	0.289	0.316	0.342	0.369	0.397	0.425	0.453	0.483	0.514	0.546	0.580	0.617	0.658	0.706	0.766	0.909
0.75	0.132	0.158	0.184	0.210	0.236	0.262	0.289	0.315	0.342	0.370	0.398	0.426	0.456	0.487	0.519	0.553	0.590	0.631	0.679	0.739	0.882
0.76	0.105	0.131	0.157	0.183	0.209	0.235	0.262	0.288	0.315	0.343	0.371	0.399	0.429	0.460	0.492	0.526	0.563	0.604	0.652	0.712	0.855
0.77	0.079	0.105	0.131	0.157	0.183	0.209	0.236	0.262	0.289	0.317	0.345	0.373	0.403	0.434	0.466	0.500	0.537	0.578	0.626	0.686	0.829
0.78	0.052	0.078	0.104	0.130	0.156	0.182	0.209	0.235	0.262	0.290	0.318	0.346	0.376	0.407	0.439	0.473	0.510	0.551	0.599	0.659	0.802
0.79	0.026	0.052	0.078	0.104	0.130	0.156	0.183	0.209	0.236	0.264	0.292	0.320	0.350	0.381	0.413	0.447	0.484	0.525	0.573	0.633	0.776
0.80	0.000	0.026	0.052	0.078	0.104	0.130	0.157	0.183	0.210	0.238	0.266	0.294	0.324	0.355	0.387	0.421	0.458	0.499	0.547	0.609	0.750
0.81		0.000	0.026	0.052	0.078	0.104	0.131	0.157	0.184	0.212	0.240	0.268	0.298	0.329	0.361	0.395	0.432	0.473	0.521	0.581	0.724
0.82			0.000	0.026	0.052	0.078	0.105	0.131	0.158	0.186	0.214	0.242	0.272	0.303	0.335	0.369	0.406	0.447	0.495	0.555	0.698
0.83				0.000	0.026	0.052	0.079	0.105	0.132	0.160	0.188	0.216	0.246	0.277	0.309	0.343	0.380	0.421	0.469	0.529	0.672
0.84					0.000	0.026	0.053	0.079	0.106	0.134	0.162	0.190	0.220	0.251	0.283	0.317	0.354	0.395	0.443	0.503	0.646
0.85						0.000	0.027	0.053	0.080	0.108	0.136	0.164	0.194	0.225	0.257	0.291	0.328	0.369	0.417	0.477	0.620
0.86							0.000	0.026	0.053	0.081	0.109	0.137	0.167	0.196	0.230	0.264	0.301	0.342	0.390	0.450	0.593
0.87								0.000	0.027	0.055	0.083	0.111	0.141	0.172	0.204	0.238	0.275	0.316	0.364	0.424	0.567
0.88									0.000	0.028	0.056	0.084	0.114	0.145	0.177	0.211	0.248	0.289	0.337	0.397	0.540
0.89										0.000	0.028	0.056	0.086	0.117	0.149	0.183	0.220	0.261	0.309	0.369	0.512
0.90											0.000	0.028	0.058	0.089	0.121	0.155	0.192	0.233	0.281	0.341	0.484
0.91												0.000	0.030	0.061	0.093	0.127	0.164	0.205	0.253	0.313	0.456
0.92													0.000	0.031	0.063	0.097	0.134	0.175	0.223	0.283	0.426
0.93														0.000	0.032	0.066	0.103	0.144	0.192	0.252	0.395
0.94															0.000	0.034	0.071	0.112	0.160	0.220	0.363
0.95																0.000	0.037	0.079	0.126	0.186	0.329
0.96																	0.000	0.041	0.089	0.149	0.292
0.97																		0.000	0.048	0.108	0.251
0.98																			0.000	0.060	0.203
0.99																				0.000	0.143
1.00																					0.000

EXAMPLE

Find the ckvar required to improve the power factor of a 500-kw load from 0.7 to 0.95.

$$\begin{aligned}
 \text{ckvar} &= \text{kw} \times \text{multiplier} \\
 &= 500 \times 0.691 \\
 &= 345.5
 \end{aligned}$$

137

TABLE 2
Power-factor Table

Power Factor	Tangents Corresponding to Power Factor (cos θ)									Power Factor	Tangents Corresponding to Power Factor (cos θ)										
	0	1	2	3	4	5	6	7	8		9	0	1	2	3	4	5	6	7	8	9
1.00	0	0	0	0	0	0	0	0	0	0	0.55	1.519	1.515	1.511	1.507	1.503	1.499	1.495	1.491	1.487	1.483
0.99	0.143	0.135	0.127	0.119	0.110	0.100	0.090	0.078	0.063	0.045	0.54	1.559	1.555	1.551	1.547	1.542	1.538	1.534	1.530	1.526	1.523
0.98	0.203	0.198	0.192	0.187	0.181	0.175	0.169	0.163	0.156	0.150	0.53	1.600	1.596	1.592	1.588	1.583	1.579	1.575	1.571	1.567	1.563
0.97	0.251	0.246	0.242	0.237	0.233	0.228	0.223	0.218	0.213	0.208	0.52	1.643	1.638	1.634	1.630	1.626	1.621	1.617	1.613	1.608	1.604
0.96	0.292	0.288	0.284	0.280	0.276	0.272	0.268	0.264	0.259	0.255	0.51	1.687	1.682	1.677	1.673	1.669	1.665	1.660	1.656	1.651	1.647
0.95	0.329	0.325	0.322	0.318	0.314	0.310	0.307	0.303	0.299	0.296	0.50	1.732	1.727	1.723	1.718	1.714	1.709	1.705	1.700	1.696	1.691
0.94	0.363	0.360	0.356	0.353	0.350	0.346	0.343	0.339	0.336	0.332	0.49	1.779	1.774	1.770	1.765	1.760	1.755	1.751	1.746	1.741	1.737
0.93	0.395	0.392	0.389	0.386	0.383	0.379	0.376	0.373	0.370	0.366	C. 48	1.828	1.823	1.818	1.813	1.808	1.803	1.798	1.794	1.789	1.784
0.92	0.426	0.423	0.420	0.417	0.414	0.411	0.408	0.405	0.402	0.398	0.47	1.878	1.873	1.868	1.863	1.858	1.853	1.848	1.843	1.838	1.833
0.91	0.456	0.453	0.450	0.447	0.444	0.441	0.438	0.435	0.432	0.429	0.46	1.930	1.925	1.920	1.914	1.909	1.904	1.899	1.894	1.888	1.883
0.90	0.484	0.482	0.479	0.476	0.473	0.470	0.467	0.464	0.461	0.459	0.45	1.985	1.979	1.974	1.968	1.963	1.957	1.952	1.946	1.941	1.936
0.89	0.512	0.510	0.507	0.504	0.501	0.498	0.496	0.493	0.490	0.487	0.44	2.041	2.035	2.030	2.024	2.018	2.012	2.007	2.001	1.996	1.990
0.88	0.540	0.537	0.534	0.532	0.529	0.526	0.523	0.521	0.518	0.515	0.43	2.100	2.094	2.088	2.082	2.076	2.070	2.064	2.058	2.052	2.047
0.87	0.567	0.564	0.561	0.559	0.556	0.553	0.551	0.548	0.545	0.543	0.42	2.161	2.155	2.148	2.142	2.136	2.130	2.124	2.118	2.112	2.106
0.86	0.593	0.591	0.588	0.585	0.583	0.580	0.577	0.575	0.572	0.569	0.41	2.225	2.218	2.212	2.205	2.199	2.192	2.186	2.180	2.173	2.167
0.85	0.620	0.617	0.615	0.612	0.609	0.607	0.604	0.601	0.599	0.596	0.40	2.291	2.285	2.278	2.271	2.264	2.258	2.251	2.244	2.238	2.231
0.84	0.646	0.643	0.641	0.638	0.636	0.633	0.630	0.628	0.625	0.622	0.39	2.361	2.354	2.347	2.340	2.333	2.326	2.319	2.312	2.305	2.298
0.83	0.672	0.669	0.667	0.664	0.662	0.659	0.656	0.654	0.651	0.649	0.38	2.434	2.427	2.419	2.412	2.405	2.397	2.390	2.383	2.375	2.368
0.82	0.698	0.695	0.693	0.690	0.688	0.685	0.682	0.680	0.677	0.675	0.37	2.511	2.503	2.495	2.488	2.480	2.472	2.464	2.457	2.449	2.442
0.81	0.724	0.721	0.719	0.716	0.714	0.711	0.708	0.706	0.703	0.701	0.36	2.592	2.583	2.575	2.567	2.559	2.551	2.543	2.535	2.527	2.519
0.80	0.750	0.747	0.745	0.742	0.740	0.737	0.734	0.732	0.729	0.727	0.35	2.676	2.668	2.659	2.651	2.642	2.633	2.625	2.617	2.608	2.600
0.79	0.776	0.774	0.771	0.768	0.766	0.763	0.760	0.758	0.755	0.753	0.34	2.766	2.757	2.748	2.739	2.730	2.721	2.712	2.703	2.694	2.685
0.78	0.802	0.800	0.797	0.794	0.792	0.789	0.787	0.784	0.781	0.779	0.33	2.861	2.851	2.841	2.832	2.822	2.813	2.803	2.794	2.784	2.775
0.77	0.829	0.826	0.823	0.821	0.818	0.815	0.813	0.810	0.808	0.805	0.32	2.961	2.950	2.940	2.930	2.920	2.910	2.900	2.890	2.880	2.870
0.76	0.855	0.853	0.850	0.847	0.845	0.842	0.839	0.837	0.834	0.831	0.31	3.067	3.056	3.045	3.034	3.024	3.013	3.002	2.992	2.981	2.971
0.75	0.882	0.879	0.877	0.874	0.871	0.869	0.866	0.863	0.861	0.858	0.30	3.180	3.168	3.157	3.145	3.134	3.122	3.111	3.100	3.089	3.078
0.74	0.909	0.906	0.904	0.901	0.898	0.895	0.893	0.890	0.887	0.885	0.29	3.300	3.288	3.275	3.263	3.251	3.239	3.227	3.215	3.203	3.191
0.73	0.936	0.934	0.931	0.928	0.925	0.923	0.920	0.917	0.914	0.912	0.28	3.429	3.415	3.402	3.389	3.376	3.363	3.351	3.338	3.325	3.313
0.72	0.964	0.961	0.958	0.956	0.953	0.950	0.947	0.945	0.942	0.939	0.27	3.566	3.552	3.538	3.524	3.510	3.496	3.483	3.469	3.455	3.442
0.71	0.992	0.989	0.986	0.983	0.981	0.978	0.975	0.972	0.970	0.967	0.26	3.714	3.699	3.683	3.668	3.653	3.639	3.624	3.610	3.595	3.580
0.70	1.020	1.017	1.015	1.012	1.009	1.006	1.003	1.000	0.997	0.995	0.25	3.873	3.857	3.840	3.823	3.808	3.792	3.776	3.761	3.745	3.729
0.69	1.049	1.046	1.043	1.040	1.037	1.035	1.032	1.029	1.026	1.023	0.24	4.045	4.027	4.019	3.993	3.975	3.957	3.940	3.923	3.906	3.890
0.68	1.078	1.075	1.072	1.069	1.067	1.064	1.061	1.058	1.055	1.052	0.23	4.231	4.212	4.193	4.174	4.155	4.136	4.118	4.099	4.081	4.063
0.67	1.108	1.105	1.102	1.099	1.096	1.093	1.090	1.087	1.084	1.081	0.22	4.434	4.413	4.392	4.372	4.351	4.330	4.310	4.291	4.270	4.251
0.66	1.138	1.135	1.132	1.129	1.126	1.123	1.120	1.117	1.114	1.111	0.21	4.656	4.632	4.610	4.587	4.565	4.542	4.520	4.499	4.477	4.456
0.65	1.169	1.166	1.163	1.160	1.157	1.154	1.151	1.148	1.144	1.141	0.20	4.899	4.873	4.848	4.824	4.799	4.775	4.750	4.726	4.703	4.679
0.64	1.201	1.197	1.194	1.191	1.188	1.185	1.182	1.179	1.175	1.172											
0.63	1.233	1.230	1.226	1.223	1.220	1.217	1.213	1.210	1.207	1.204											
0.62	1.266	1.262	1.259	1.256	1.252	1.249	1.246	1.243	1.239	1.236											
0.61	1.299	1.296	1.292	1.289	1.286	1.282	1.279	1.275	1.272	1.269											
0.60	1.333	1.330	1.326	1.323	1.320	1.316	1.313	1.309	1.306	1.302											
0.59	1.369	1.365	1.361	1.358	1.354	1.351	1.347	1.344	1.340	1.337											
0.58	1.405	1.401	1.397	1.394	1.390	1.386	1.383	1.379	1.376	1.372											
0.57	1.442	1.438	1.434	1.430	1.427	1.423	1.419	1.416	1.412	1.408											
0.56	1.480	1.476	1.472	1.468	1.464	1.460	1.457	1.453	1.449	1.445											

EXAMPLE:

Find the c kvar required to improve the power factor of a 300-kw load from 0.712 to 0.937.

$$c \text{ kvar} = \text{kw} \times (\tan \theta_1 - \tan \theta_2)$$

$\tan \theta_1$ = Tangent corresponding to 0.712 pf. From table, $\tan \theta_1 = 0.986$.

$\tan \theta_2$ = Tangent corresponding to 0.937 pf. From table, $\tan \theta_2 = 0.373$.

$$c \text{ kvar} = 300 \times (0.986 - 0.373) = 300 \times 0.613 = 183.9.$$

The set of tables on the following pages is a comprehensive list of recommendations published by the Institute of Electrical and Electronics Engineers, IEEE Publication No. 141, Copyright October, 1964.

INDUCTION-MOTOR/CAPACITOR APPLICATION TABLES FOR MOTORS MANUFACTURED PRIOR TO 1956 ONLY

TABLE 3

Suggested maximum capacitor rating when an induction motor and capacitor are switched as a unit for normal starting torque, normal starting current, and NEMA Classification Design "B" motors.

Induction motor horsepower rating	Nominal motor speed in rpm and number of poles											
	3600 2		1800 4		1200 6		900 8		720 10		600 12	
	kvar†	% AR‡	kvar	% AR	kvar	% AR	kvar	% AR	kvar	% AR	kvar	% AR
3	1.5	14	1.5	15	1.5	17	2	23	2.5	35	3.5	41
5	2	12	2	13	2	17	3	25	4	32	4.5	37
7.5	2.5	11	2.5	12	3	15	4	22	5.5	30	6	34
10	3	10	3	11	3.5	14	5	21	6.5	27	7.5	31
15	4	9	4	10	5	13	6.5	19	8	23	9.5	27
20	5	9	5	10	6.5	12	7.5	17	9	21	12	25
25	6	9	6	10	7.5	11	9	15	11	20	14	23
30	7	8	7	9	9	11	10	14	12	18	16	22
40	9	8	9	11	10	12	13	15	14	20	20	20
50	12	8	11	9	13	10	15	12	19	15	24	19
60	14	8	14	8	15	10	18	11	22	15	27	19
75	17	8	17	8	18	10	21	10	24	14	31	18
100	22	8	21	8	25	9	27	10	32.5	13	41	17
125	27	8	26	8	30	9	32.5	10	40	13	47.5	16
150	32.5	8	30	8	35	9	37.5	10	47.5	12	52.5	15
200	40	8	37.5	8	42.5	9	47.5	10	55	12	65	14
250	50	8	45	8	52.5	8	57.5	9	65	11	77.5	13
300	57.5	8	52.5	8	60	8	65	9	80	11	87.5	12
350	65	8	60	8	67.5	8	75	9	92.5	10	95	11
400	70	8	65	8	75	8	85	9	95	10	105	11
450	75	8	70	8	80	8	90	9	100	9	110	11
500	77.5	8	72.5	8	82.5	8	92.5	9	102.5	9	115	10

NOTE: For 50-cycle operation the following representative data may be used:

- For Standard 60-cycle motors operating at 50 cycles:
kvar = 1.4 to 1.7 of the kvar values listed.
Percent AR = 1.35 to 1.8 of the percent AR values listed.
- For Standard 50-cycle motors operating at 50 cycles:
kvar = 1.1 to 1.4 of the kvar values listed.
Percent AR = 1.05 to 1.4 of the percent AR values listed
(The larger multipliers apply to motors having the higher speeds.)

For standard 60-cycle wound-rotor motors operating at 60-cycles, the following representative data may be used:

- kvar = 1.1 of the kvar values listed.
Percent AR = 1.05 of the percent AR values listed.

TABLE 4

Suggested maximum capacitor rating when an induction motor and capacitor are switched as a unit for high starting torque, low starting current, and NEMA Classification Design "C" motors.

Induction motor horsepower rating	Nominal motor speed in rpm and number of poles									
	1800 4		1200 6		900 8		720 10		600 12	
	kvar†	% AR‡	kvar	% AR	kvar	% AR	kvar	% AR	kvar	% AR
3			2	26	3	31	4	40	4.5	51
5	2	15	2.5	21	4	29	5	36	6.5	46
7.5	2.5	13	3.5	18	5	27	6.5	34	8	41
10	3.5	13	4	16	6	25	8	32	9.5	39
15	5	12	5.5	14	8	21	10	28	13	31
20	6	12	6.5	13	9.5	19	12	25	17	35
25	7.5	12	8	12	11	17	14	24	20	33
30	8.5	12	9	12	13	17	16	23	23	32
40	11	11	12	13	16	16	20	22	30	30
50	13	11	15	11	20	16	25	21	35	29
60	16	11	19	11	23	15	27.5	20	40	27
75	21	11	24	11	27.5	14	35	19	45	25
100	28	11	32.5	11	35	13	42.5	19	55	24
125	35	11	40	11	42.5	13	50	19		
150	42.5	11	45	11	50	13	55	19		
200	50	11	55	11	60	13				

These data are representative for 3-phase, 60-cycle, general-purpose open or splashproof-type motors of 220-, 440-, 550-, or 2300-volt rating.

The operating power factor, for capacitor ratings as listed, will range from 95 to 98 percent at full load and 95 to 100 percent at partial loads.

†kvar is the rating of the capacitors in kilovars. This value is approximately equal to the motor no-load magnetizing kilovars.

‡Percent AR is the percent reduction in line current due to capacitors and is helpful for selecting the proper motor-overload relay. If a capacitor of lower kilovar rating is used, the actual percentage reduction in the line current (percent AR) will be approximately proportional to

$$\frac{\text{actual capacitor rating}}{\text{kvar value in tables}}$$

The relay selection should be based on the motor full-load nameplate current reduced by the percent AR value.

INDUCTION-MOTOR/CAPACITOR APPLICATION TABLES FOR MOTORS MANUFACTURED IN 1956 OR LATER

TABLE 5*

Suggested capacitor rating when induction motor and capacitor are switched as a unit. 220-, 440-, and 550-volt motors, enclosure open — including drip-proof and splash-proof, NEMA Design "B" and larger motors of similar design.

Induction-motor horsepower rating	Nominal motor speed in rpm and number of poles											
	3600 2		1800 4		1200 6		900 8		720 10		600 12	
	kvar	% AR	kvar	% AR	kvar	% AR	kvar	% AR	kvar	% AR	kvar	% AR
2	1	16	1	20	1	23	1	24				
3	1	10	1	16	1	17	2	21				
5	1	9	2	16	2	21	2	24				
7½	1	8	2	13	2	15	4	21	5	29		
10	2	8	2	13	4	15	5	21	5	25	5	30
15	4	8	4	13	5	15	5	13	5	25	5	21
20	4	7	5	9	5	12	5	13	10	25	10	25
25	4	7	5	9	5	11	5	11	10	25	10	25
30	5	7	5	7	5	11	10	11	10	15	10	19
40	5	5	5	7	10	11	10	11	10	15	10	19
50	5	5	10	7	10	9	15	11	20	15	25	19
60	5	5	10	7	10	9	15	11	20	15	30	19
75	10	5	10	7	15	9	15	9	30	15	40	19
100	15	5	10	7	25	9	30	9	40	15	45	17
125	15	5	20	7	30	9	30	9	45	15	50	17
150	15	5	25	6	30	9	40	9	50	13	60	17
200	40	5	40	6	45	8	50	9	70	13	75	17
250	45	5	50	6	50	9	70	9	75	12	90	17
300	50	5	50	6	70	8	70	9	75	11	105	17
350	50	5	50	5	70	8	80	9	80	11	105	17
400	60	5	50	5	70	8	100	9	100	11	110	17
450	60	5	50	5	70	6	100	9	100	11	110	17
500	70	5	90	5	90	6	110	9	120	11	120	17

TABLE 6*

220-, 440-, and 550-volt motors, totally enclosed, fan cooled, normal starting torque, normal starting current, NEMA Design "B" and larger motors of similar design.

Induction-motor horsepower rating	Nominal motor speed in rpm and number of poles											
	3600 2		1800 4		1200 6		900 8		720 10		600 12	
	kvar	% AR	kvar	% AR	kvar	% AR	kvar	% AR	kvar	% AR	kvar	% AR
2	1	17	1	20	1	23	1	24				
3	1	11	1	16	1	19	2	24				
5	1	9	2	15	2	19	2	20				
7½	1	6	2	13	4	19	4	20				
10	2	6	2	11	4	16	5	15	5	17	5	21
15	4	6	4	11	4	13	5	15	5	17	5	21
20	4	6	5	11	5	13	5	15	10	17	10	21
25	5	6	5	8	5	9	5	15	10	17	10	18
30	5	6	5	8	5	9	10	15	10	15	10	18
40	5	6	10	8	10	9	10	15	10	15	15	17
50	5	6	10	8	10	9	15	12	15	12	20	17
60	10	6	10	8	10	9	15	12	20	12	25	17
75	15	6	15	8	15	9	20	11	25	12	30	17
100	15	6	20	8	25	9	25	11	40	12	45	17
125	20	6	25	7	30	9	30	11	45	12	45	15
150	25	6	30	7	30	9	40	11	45	12	50	15
200	35	6	40	7	60	9	55	11	55	11	60	13
250	40	5	40	6	60	9	80	11	60	11	100	13
300	45	5	45	6	80	8	80	10	80	10	120	13
350	60	5	70	6	80	8	80	9				
400	60	5	80	6	80	6	80	6				
450	70	5	100	6			160					
500	70	5										

*These data are representative for three-phase, 60-hertz, general-purpose induction motors.

For standard 60-hertz wound-rotor induction motors operating at 60-hertz, the following data should be used:

$$\text{kvar} = 1.1 \text{ of the kvar values listed.}$$

$$\text{Percent AR} = 1.05 \text{ of the percent AR values listed.}$$

The listed kvar values give the rating of the capacitors in kilovars. This value is approximately equal to the motor no-load magnetizing kilovars.

Percent AR is the percent reduction in full-load line current due to capacitors. A capacitor located on the motor side of the overload relay reduces current through the relay. Therefore, a smaller relay may be necessary. The motor-overload relay should be selected on the basis of the motor full-load nameplate current reduced by the percent reduction in line current (percent AR) due to capacitors. If a capacitor of lower kvar rating is used, the actual percent AR will be approximately proportional to

$$\text{listed percent AR} \times \frac{\text{actual capacitor rating}}{\text{kvar value in tables}}$$

INDUCTION-MOTOR/CAPACITOR APPLICATION TABLES FOR MOTORS MANUFACTURED IN 1956 OR LATER

TABLE 7*

220-, 440-, and 550-volt motors, enclosure open — including dripproof and splashproof, high starting torque and normal starting current, NEMA Design "C" and larger motors of similar design.

Induction motor horsepower rating	Nominal motor speed in rpm and number of poles							
	1800 4		1200 6		900 8		720 10	
	kvar	% AR	kvar	% AR	kvar	% AR	kvar	% AR
3			2	19	2	30		
5	1	15	2	19	4	26		
7.5	2	15	2	15	4	22		
10	2	12	4	12	5	15		
15	4	12	4	12	5	15		
20	4	12	5	12	5	15		
25	5	9	5	9	10	15		
30	5	9	5	9	10	15		
40	10	9	10	9	10	13		
50	10	9	10	9	15	13		
60	10	9	15	9	20	13	20	18
75	15	9	15	9	20	12	30	18
100	20	7	25	9	30	12	40	18
125	20	7	30	8	30	12	50	18
150	35	7	35	8	45	12		
200	40	7	50	8	70	12		
250	50	7	50	8	80	12		
300	60	7	60	8	90	10		
350	60	7	80	8	80	9		

TABLE 8*

220-, 440-, and 550-volt motors, totally enclosed, fan cooled, high starting torque, normal starting current, NEMA Design "C" and larger motors of similar design.

Induction motor horsepower rating	Nominal motor speed in rpm and number of poles									
	1800 4		1200 6		900 8		720 10		600 12	
	kvar	% AR	kvar	% AR	kvar	% AR	kvar	% AR	kvar	% AR
3			2	20	2	27				
5	2	10	2	19	2	21				
7.5	2	10	2	17	4	21				
10	2	9	4	17	5	21				
15	4	9	5	14	5	16				
20	5	9	5	11	5	15				
25	5	9	5	10	10	15	10	15	10	18
30	5	9	5	9	10	15	10	15	10	18
40	10	9	10	9	10	12	15	15	15	18
50	10	9	10	9	15	12	15	15	25	18
60	15	9	15	9	20	12	30	15	30	18
75	15	7	15	8	20	11	30	15	40	16
100	20	7	25	8	25	11	40	15	40	16
125	25	7	35	8	30	11	50	15	50	15
150	35	7	35	7	50	11	50	14	50	13
200	40	7	45	7	50	10	70	14	70	13

*These data are representative for three-phase, 60-hertz, general-purpose induction motors.

For standard 60-hertz wound-rotor induction motors operating at 60-hertz, the following data should be used:

$$\text{kvar} = 1.1 \text{ of the kvar values listed.}$$

$$\text{Percent AR} = 1.05 \text{ of the percent AR values listed.}$$

The listed kvar values give the rating of the capacitors in kilovars. This value is approximately equal to the motor no-load magnetizing kilovars.

Percent AR is the percent reduction in full-load line current due to capacitors. A capacitor located on the motor side of the overload relay reduces current through the relay. Therefore, a smaller relay may be necessary. The motor-overload relay should be selected on the basis of the motor full-load nameplate current reduced by the percent reduction in line current (percent AR) due to capacitors. If a capacitor of lower kilovar rating is used, the actual percent AR will be approximately proportional to

$$\text{listed percent AR} \times \frac{\text{actual capacitor rating}}{\text{kvar value in tables}}$$

191

INDUCTION-MOTOR/CAPACITOR APPLICATION TABLES FOR MOTORS MANUFACTURED IN 1956 OR LATER

TABLE 9*

2300- and 4000-volt motors, enclosure open – including dripproof and splashproof, normal starting torque and current, NEMA Design "B" and larger motors of similar design.

Induction-motor horsepower rating	Nominal motor speed in rpm and number of poles											
	3600 2		1800 4		1200 6		900 8		720 10		600 12	
	kvar	% AR	kvar	% AR	kvar	% AR	kvar	% AR	kvar	% AR	kvar	% AR
100	20	7	25	10	25	11	25	11	30	12	45	17
125	30	7	30	9	30	10	30	10	30	11	45	15
150	30	7	30	8	30	8	30	9	30	11	60	15
200	30	7	30	6	45	8	60	9	60	10	75	14
250	45	7	45	5	60	8	60	9	75	10	90	14
300	45	7	45	5	75	8	75	9	75	9	90	12
350	45	6	45	5	75	8	75	9	75	9	90	11
400	60	5	60	5	60	6	90	9	90	9	90	10
450	75	5	60	5	75	6	90	8	90	8	90	8
500	75	5	75	5	90	6	120	8	120	8	120	8
600	75	5	90	5	90	5	120	7	120	8	135	8
700	90	5	90	5	90	5	135	7	150	8	150	8
800	90	5	120	5	120	5	150	7	150	8	150	8

TABLE 10*

2300- and 4000-volt motors, totally enclosed, fan cooled, normal starting torque, normal starting current, NEMA Design "B" and larger motors of similar design.

Induction-motor horsepower rating	Nominal motor speed in rpm and number of poles											
	3600 2		1800 4		1200 6		900 8		720 10		600 12	
	kvar	% AR	kvar	% AR	kvar	% AR	kvar	% AR	kvar	% AR	kvar	% AR
100	20	5	20	8	20	8	30	11	30	12	30	11
125	20	5	25	7	30	8	30	11	30	11	45	14
150	20	5	30	7	30	8	45	11	45	11	60	14
200	30	5	45	7	45	8	45	11	45	11	75	14
250	30	5	45	7	60	8	60	9	75	11	75	14
300	45	5	45	7	60	8	75	9	90	11	90	14
350	60	5	60	7	90	8	90	9	90	11	135	14
400	60	5	75	7	90	8	90	9	90	11	135	13
450	60	5	90	7	90	8	90	9	90	10	135	13
500	75	5	120	7	135	8	135	9	135	10	150	13

TABLE 11*

2300- and 4000-volt motors, enclosure open – including dripproof and splashproof, high starting torque and normal starting current, NEMA Design "C" and larger motors of similar design.

Induction-motor horsepower rating	Nominal motor speed in rpm and number of poles							
	1800 4		1200 6		900 8		720 10	
	kvar	% AR	kvar	% AR	kvar	% AR	kvar	% AR
100	30	11	30	11	30	11	30	11
125	30	11	30	11	30	11	45	11
150	30	9	30	9	45	9		
200	45	9	45	9	45	9		
250	45	8	60	9	60	9		
300	45	6	75	9	75	9		
350	60	6	75	8	75	9		

TABLE 12*

2300- and 4000-volt motors, totally enclosed, fan cooled, high starting torque, normal starting current, NEMA Design "C" and larger motors of similar design.

Induction-motor horsepower rating	Nominal motor speed in rpm and number of poles							
	1200 6		900 8		720 10		600 12	
	kvar	% AR	kvar	% AR	kvar	% AR	kvar	% AR
75	15	10.9	20	10.0	30	15.7		
100	25	8.7	30	9.8	30	13.1	50	11.9
125	30	9.6	30	8.9	60	21.4	60	18.1
150	30	8.8	60	13.4	30		60	16.9
200			45	9.3	75	15.6	75	14.5

*These data are representative for three-phase, 60-hertz, general-purpose induction motors.

For Standard 60-hertz wound-rotor induction motors operating at 60-hertz, the following data should be used:

$$\text{kvar} = 1.1 \text{ of the kvar values listed}$$

$$\text{Percent AR} = 1.05 \text{ of the percent AR values listed.}$$

The listed kvar values give the rating of the capacitors in kilovars. This value is approximately equal to the motor no-load magnetizing kilovars.

Percent AR is the percent reduction in full-load line current due to capacitors. A capacitor located on the motor side of the overload relay reduces current through the relay. Therefore, a smaller relay may be necessary. The motor-overload relay should be selected on the basis of the motor full-load nameplate current reduced by the percent reduction in line current (percent AR) due to capacitors. If a capacitor of lower kilovar rating is used, the actual percent AR will be approximately proportional to

$$\text{listed percent AR} \times \frac{\text{actual capacitor rating}}{\text{kvar value in tables}}$$

B.

WHERE CAPACITORS SHOULD BE INSTALLED

The primary purpose of power-factor correction, namely reduction of the power bill, simply requires that the capacitors be connected on the load side of the metering point. But intelligent location of the capacitors can pay extra dividends for the careful planner.

The capacitors may be installed at any of several points in the plant distribution system. However, maximum benefits are obtained when the capacitors are located as near to the load as possible, especially in the case of induction motors.

1. By locating the capacitors near the load, the kilovars are confined to the smallest possible segment of the system.
2. The motor starter can be used to switch the capacitor as well as start the motor, thereby eliminating the cost of an extra switch for the capacitor.
3. In addition, switching through the motor starter provides semi-automatic control of the capacitors and a separate control is not required. The capacitors are in the circuit only when they are required . . . when the motor is operating.

However, in some cases it may be more practical and economical to install the capacitors in groups or banks at power centers or on feeders.

THE ADVANTAGES OF GROUP INSTALLATIONS ARE TWOFOLD:

1. Diversity — when several motors or loads are not on the line at the same time or are running intermittently, a capacitor bank at a power center permits the purchase of smaller total amounts of kvac than if capacitors were located at each of the motor loads.
2. When many small motors are operating simultaneously, it is considerably more economical to purchase larger blocks of kvac in banks or groups rather than have many small capacitors installed at each motor.

Fig. 1 illustrates several typical locations where capacitors can be installed for power-factor correction. The most effective location is at the load, as shown by capacitor C_1 . The next choice would be C_2

or C_3 , both of which would ordinarily require some type of switch or circuit breaker. Finally, C_4 is shown on the primary side of the stepdown transformer connected to the system by means of a high-voltage breaker.

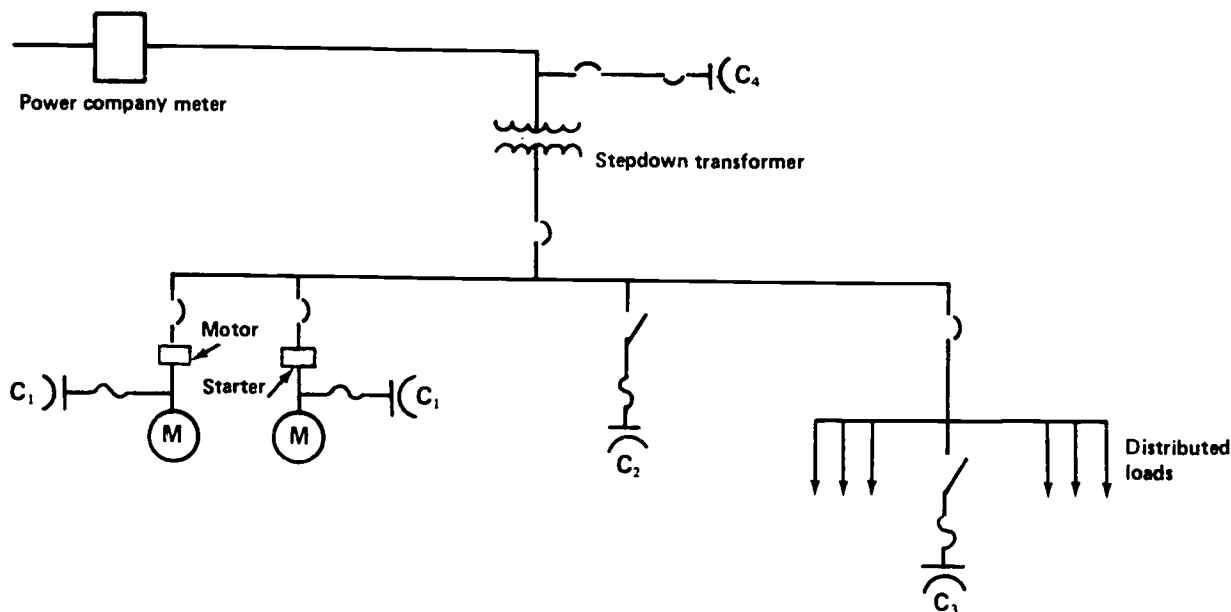

Figure 1.

There are several accepted methods of connecting capacitors to induction motors. Three of the most preferred are shown below.

CONNECTING CAPACITORS TO INDUCTION MOTOR CIRCUITS

1 Position "A" is recommended for new installation only, since a reduced size of thermal protector is required. The capacitors are connected on the motor side of the thermal protector, thus only motor watts flow through the protector. The kvar's are supplied directly to the motor by the capacitor. Therefore, the selection of the thermal protector must be based on the reduced line current.

2 Position "B" shows the capacitors connected on the line of the protector, but also switched with the motor. As in position "A," the capacitors are energized only when the motor is in operation.

3 Position "C" shows the capacitors permanently connected to the circuit, but with the operation of a fusible safety switch or circuit breaker.

In both "B" and "C," full motor current flows through the thermal protector.

Whenever a motor and a capacitor are to be switched as a unit, the capacitor should be sized carefully. If the kvac rating of the capacitor is appreciably greater than the no-load magnetizing kvar of the motor, damaging overvoltages or transient torques can occur. For this reason, most motor manufacturers specify the maximum kvac rating capacitor to be applied to a specific motor.

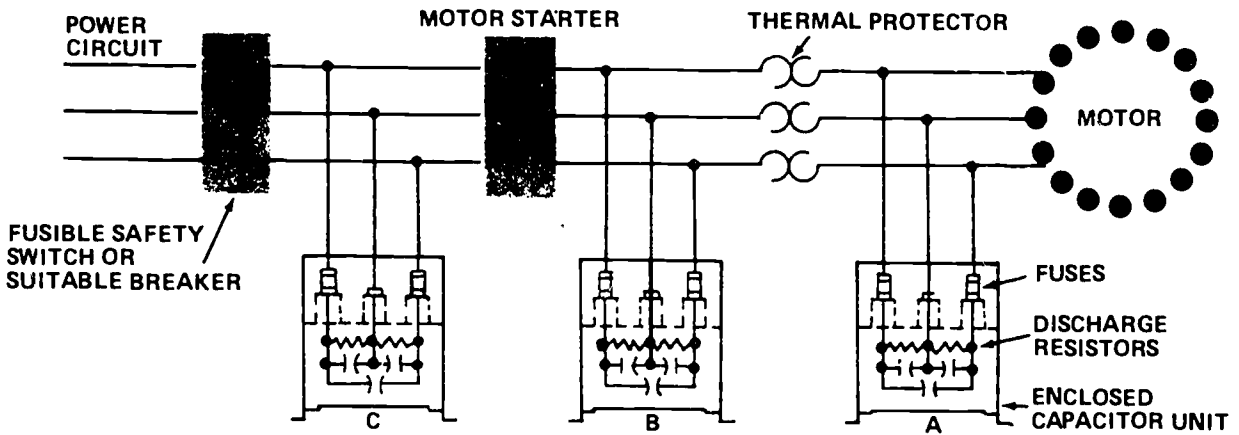

Figure 2.



SELECTION OF SWITCHES AND BREAKERS

Recommended switching devices¹

Volts	Capacitor rating		Amperes			Capacitor rating		Amperes			
	Kvar	Capacitor rated current	Safety switch fuse rating	AB-1 breaker trip rating	DB breaker trip rating	Volts	Kvar	Capacitor rated current	Safety switch fuse rating	AB-1 breaker trip rating	DB breaker trip rating
240	2 1/2	6.0	15	15	15	600	5	4.8	15	15	15
	5	12.0	20	20	20		7 1/2	7.2	15	15	15
	7 1/2	18.0	30	30	30		10	9.6	20	15	15
	10	24.1	40	40	40		15	14.4	25	30	20
	15	36.1	60	70	50		20	19.2	35	30	30
	20	48.1	80	90	70		25	24.1	40	40	40
	25	60	100	100	90		30	28.9	50	50	40
	30	72.2	125	125	100		35	33.6	60	50	50
	45	108	200	175	150		40	38.5	70	70	70
	50	120	200	200	175		45	43.3	80	70	70
	60	144	250	225	200		50	48.1	80	100	70
	75	180	300	275	250		60	57.8	100	100	90
	90	217	400	350	300		75	72.2	125	125	100
	100	240	400	400	350		80	77.0	150	125	125
	120	289	500	500	400		100	96.2	175	150	150
	125	301	500	500	450		120	115	200	175	175
	135	325	600	500	500		125	120	200	200	175
	150	361	600	600	500		150	144	250	225	200
	180	433	800	700	600		160	154	300	250	225
	200	480	800	800	700		180	173	300	300	250
	225	541	900	900	800		200	192	350	300	300
	240	578	1000	900	800		225	217	400	350	300
	250	602	1000	900	900		240	231	400	350	350
	270	650	1200	1000	1000		250	241	400	400	350
300	720	1200		1200	300	289	500	500	400		
360	866	1600		1200	320	306	600	500	500		
375	903	1500		1200	360	347	600	600	500		
480	2	2.41	15	15	15	375	361	600	600	500	
	5	6.01	15	15	15	400	385	700	600	600	
	7 1/2	9.0	15	15	15	450	433	800	700	600	
	10	12.0	20	20	20						
	15	18.0	30	30	30						
	20	24.0	40	40	40						
	25	30.0	50	50	50						
	30	36.1	60	70	50						
	35	42	70	70	60						
	40	48.1	80	100	70						
	45	54	90	100	80						
	50	60.1	100	100	90						

Circuit breakers and switches for use with capacitors must have a current rating in excess of rated capacitor current to provide for overcurrent from overvoltages at fundamental frequency and harmonic currents. The following percent of the capacitor-rated current should be used:

- Fused and unfused safety switches 165%
- Type AB-1 De-ion ® breakers or equivalent 150%
- Air circuit breakers, type DB 135%
- Contactors:
- Open type 135%
- Enclosed type 150%

(1) Switching device ratings are based on percentage of capacitor-rated current as indicated (Above). The interrupting rating of the switch must be selected to match the system fault current available at the point of capacitor application.

Whenever a capacitor bank is purchased with less than the ultimate kvar capacity of the rack or enclosure, the switch rating should be selected based on the ultimate kvar capacity — not the initial installed capacity.



D.

FORMULAS FOR APPLICATION OF CAPACITORS

NOMENCLATURE

- C = Capacity in microfarads.
 X_c = Reactance in ohms.
 f = Frequency in cycles per second.
 Kvar = Reactive kilovolt-amperes
 E = Line-to-line voltage.
 Kv = Line-to-line voltage in kilovolts.
 I = Amperes.
 Kva = Kilovolt amperes.

$$Kva = \frac{\sqrt{3} E \times I}{1000} \quad (3 \text{ phase})$$

$$= \sqrt{3} \times (Kv) \times I$$

$$Kva = \frac{EI}{1000} \quad (1 \text{ phase})$$

$$= (Kv) I$$

FORMULAS

Capacitor connected in parallel.

$$C = C_1 + C_2 + C_3 + \dots$$

Capacitor connected in series.

$$C = \frac{1}{\frac{1}{C_1} + \frac{1}{C_2} + \frac{1}{C_3} + \dots}$$

$$X_c = \frac{10^6}{(2\pi f)C}$$

$$X_c = \frac{2653}{C} \text{ at 60 cycles}$$

(1 mfd = 2653 ohms)

$$X_c = \frac{1000(Kv)^2}{Kvar}$$

$$C = \frac{10^6}{(2\pi f)X_c}$$

$$C = \frac{1000 Kvar}{2\pi f (Kv)^2}$$

$$Kvar = \frac{2\pi f C (Kv)^2}{1000}$$

$$Kvar = \frac{1000 (Kv)^2}{X_c}$$

CAPACITOR CONSTANTS

a. Single-phase capacitors:

Rated Volts	Microfarads per Kvar	Ohms for One Kvar*
230	50.14	52.9
460	12.54	211.6
575	8.02	330.6
2400	0.4605	5760
4160	0.1534	17,300
4800	0.1151	23,040
7200	0.05118	51,840
7960	0.04187	63,361
12,470	0.0106	155,500
13,800	0.01393	190,400

*To find ohms for other kvar values divide by the number of kvar.

b. For three-phase banks, divide the bank capacity by three and proceed with single-phase data, using line-to-line voltage for delta connected banks, and line-to-neutral voltage for wye connected banks.

CONVERSION FORMULAS

The following are *approximate* values.

Horsepower--

- Induction motors:
Kva = Horsepower
- 0.8 pf synchronous motors:
Kva = 1.0 x Horsepower rating
- 1.0 pf synchronous motors:
Kva = 0.80 horsepower

OKLAHOMA STATE UNIVERSITY
School of Technology, Continuing Education

Awards this

CERTIFICATE of TRAINING

To _____

For Completion of _____

Date _____



COURSE DESCRIPTION

- 1-1 This is the first session of a course to briefly cover the broad topic of electrical power distribution. It is not intended to make engineers of you. It is intended to give you an overall picture of what goes on in a distribution system and in each of its components.
- 1-2 It will describe the operating fundamentals of each piece of hardware likely to be encountered on a distribution system, and explain how they interact. All of this is designed to help you solve daily operating problems quickly and directly; to help provide your customers with good, reliable electric service and to keep the time spent on each trouble call to a minimum, hopefully to the satisfaction of all involved - you, your boss and your customers.
- 1-3 Mathematics in this course has been kept to a minimum. Arithmetic and problem solving will be used sometimes.
- 1-4 There will be labs, to give you first-hand knowledge of the inter-relationships of electrical quantities, and hands-on appreciation of the operation of the hardware you deal with daily. Basic safety rules and precautions will be stressed during the labs.
- 1-5 There will be a variety of short reviews, both to help you see if you're learning the material, and to help us see if we're

teaching it in a way that makes it easy to learn. Some of you already know portions of this material, but please, don't shut us out. Hopefully, we can give you a good review, or maybe present it from a different angle.

- 1-6 The first thing this course looks at is an overall view of the electrical distribution system, starting with the substation.
- 1-7 Then, it looks briefly at the major components that go into a distribution system.
- 1-8 Next, it looks at distribution line components, such as transformers, voltage regulators, and lightning arresters.
- 1-9 Fourth, it looks at the characteristics of the loads served by the system.
- 1-10 And lastly, it looks at the design of distribution systems. So sit back and relax, and watch as Tom Thornton, a new man on the job is given the 10¢ tour by his supervisor.

SUBSTATION AND BASIC LINES

- 1-11 Susie: Tom let's start our tour here, at one of our substations.
Tom: What's a substation?
Susie: That's where the distribution lines start. We'll work our way along it to the end. I'll point out the various pieces of equipment you'll be working with, and explain what they are, how they work, and how it relates to the rest of the system.
- 1-12 The substation is usually considered the beginning of the distribution system. It ties the transmission system, from which we buy bulk power, to the distribution lines, that spread the power to our consumers.
- 1-13 A substation performs several functions to fulfill its purpose as a link between the transmission system and the distribution system. The functions which are essential in providing this link are voltage change, disconnecting the station from the transmission system, and protecting the station from the distribution system.
- 1-14 In this substation, we can see the equipment that performs these three functions: The disconnect switch that is used to de-energize the station when necessary, the transformer that provides the change in voltage, and the reclosers that protect the station from the distribution system.
- 1-15 Susie: Each of these pole lines leaving the station is a distribution circuit.

1-16 Tom: I've got a question about these lines.
Susie: Alright.
Tom: A couple of years ago, my dad added a room to our house. I helped him wire it. Each outlet had two wires going to it, one to supply current, and the other to return it to the circuit breaker box. But on these pole lines, I see four wires. Why is that?

1-17 Susie: The reason you see four wires, Tom, is that this is a three phase circuit. There are three wires supplying power, and one returning it, instead of only one supply and one return as in single phase circuits like you have in your house.

1-18 Some of the characteristics of three phase power are pretty complex, so for right now, I'd like for you to think of that three phase line as three separate single phase lines, but all sharing a common return wire. The common return wire is mounted on the side of the pole by itself and is called the 'neutral'. It is electrically connected to those white return wires you worked with when you wired that room.

1-19 Tom: Aren't most of the services we supply single phase? Why bother with three phase?
Susie: You're right, Tom. With very rare exceptions, all of our residential customers are single phase. However, there are advantages to a three phase power system over a single phase

system. These advantages have to do with the construction and operation of electric motors and the economics of transmission over long distances.

1-20

As soon as we get away from the substation, you'll see that most of our lines are single phase taps from the three phase feeders or circuits. These taps consist of one of the three supply wires from the main feeder, and the neutral.

1-21

It is generally easier to learn about distribution systems by ignoring the three phase parts until later, and concentrating on the single phase relations, since there are only half as many wires to worry about.

Tom: That sounds okay to me. I'm sure two wires are easier to keep track of than four.

1-22

Susie: Probably the most obvious items that go into a distribution system are the poles, conductors, and other hardware. It might seem that it's easy enough to stick a bunch of poles in the ground and drape some wire over them but a well designed and built line has a great deal more thought put into it than that.

1-23

Tom: Well, from having done that house wiring, I know that wires come in different sizes. Is that one of the things considered in the design of distribution lines?

Susie: It certainly is. Not only does the wire have to be big enough

to carry today's load economically it has to be big enough to allow for some growth. Whether to build a line with lots of room for growth, or build one with only a little room for growth and plan on building more lines later, is one of the decisions that the engineer must make.

1-24

Of course, the wire size chosen affects the entire mechanical design of the line, including span lengths, pole size, guying and anchoring, conductor hardware, and crossarm size. The terrain has a big effect on all these things, too!

Tom: Whew! That's quite a list!

Susie: Yes, but that's just the mechanical part

1-25

In addition the engineer must consider the electrical design of a line and the economics of various designs as well as the mechanical aspect. So you see, even before a line is built, a lot of planning goes into it.

FUSES

1-26 Susie: Tom, this pole has a single phase tap from the three phase main line. Before we follow out the tap, I want you to notice the device on the crossarm near the insulator at the end of the arm.

Tom: Yes, I see it.

Susie: That is a cutout, which is nothing more than a fuseholder. Do you know how a fuse operates?

Tom: Sure. When too much current flows through it, it gets hot and melts, and opens the circuit.

1-27 Susie: The type of cutout used here is called an open cutout, since all the parts are out in the open. The small tube supported by the two metal arms is the fuseholder or fuse barrel, and holds a replaceable fuse link. When too much current flows through the fuse, it melts the link inside the fuseholder, which produces an electric arc, and heat. The heat boils off some of the tube material, and helps snuff out the arc.

1-28 The barrel is spring loaded, so that after the fuse melts, the barrel swings down and hangs from the lower arm. That tells you the fuse has blown.

1-29 Tom: I know a lot of electrical equipment is fused, but I never realized that a power system is too.

Susie: Very definitely, if there is a fault - a short circuit - on that tap, we want that fuse to blow, and disconnect the tap from

the main line before any damage is done to any part of the system, or before another fuse or breaker somewhere else opens. This keeps the number of consumers without power down to a minimum.

1-30

It also makes finding the cause of the problem much easier, since it's got to be on the portion of the line that's off. This saves a lot of time that would otherwise be spent looking at miles of line hunting for the trouble.

Tom: That sure could make a lot of difference to the lineman on a trouble call on a cold, rainy night.

Susie: You bet it does.

1-31

Are there any questions from the audience about fuses?

RECLOSERS

- 2-1 Susie: Here's an important device used on distribution systems. It is an oil circuit recloser. It is often referred to by its abbreviation, OCR or simply as a recloser.
- 2-2 Tom: What does a recloser do?
- Susie: It's used as protection against short circuits on the lines, much like a circuit breaker in the electrical panel in your house. It disconnects power from a line with a short circuit, or fault on it.
- 2-3 Almost all the faults on a distribution system are temporary. Once they're gone, or cleared, the line can be reconnected. The OCR is able to do this.
- 2-4 Tom: Suppose the fault is still on the line when the recloser turns the power back on?
- Susie: The recloser will open the line again, wait a short time, and try to again turn the power on, or re-energize the line. After a limited number of tries, the recloser will not re-energize the line, but locks out. This leaves the line dead. When this happens, we have a permanent fault.
- 2-5 Tom: Back near the substation you showed me a fuse. Do we use reclosers in some areas and fuses in tohers?
- Susie: No, we use them together. Let me explain how fuses and OCR's work together.

- 2-6 Suppose we have a three phase line with recloser protection on each phase and a long single phase tap connected to it.
- 2-7 Now suppose a permanent fault happens at the end of the single phase line. The recloser will sense it, and open the line. It will then try to re-energize it several times. Since the fault is permanent, the OCR will leave the line open after its last try.
- 2-8 Let's put a fuse in the single phase tap where it connects to the main line.
- 2-9 Now if a fault occurs at the end of the single phase line, the fuse will blow on the recloser's last attempt to re-energize the line. Of course, this only happens if the right size fuse is used.
- Tom: I suppose that's another job for the engineer.
- Susie: Generally yes.
- 2-10 The blown fuse isolates the piece of faulted line from the OCR. The OCR is then able to successfull- re-energize the remaining line. The counter inside the OCR then resets, readying it for the next fault.
- 2-11 By using fuses with OCR's the amount of line that is de-energized because of a fault is much less than the amount that would be de-energized if only OCR's were used.

- 2-12 Reclosers, like all electrical equipment, have ratings. One important rating is the coil size. This is the continuous load current the recloser can carry without causing difficulty. It generally is stenciled on the OCR tank. Sizes range from a few amps to several hundred amps for single phase reclosers.
- 2-13 The fault current has to be at least twice the coil rating for the reclosers to operate. A 50 amp recloser, for example, will not operate on a fault unless the fault current is at least 100 amps. This is called the minimum trip point.
- 2-14 The other important current rating is the interrupting rating. This is how much current the OCR contacts can safely interrupt without damaging the OCR. For some smaller types, this is 25 times the coil size rating. In larger OCR's there is no direct relation between the interrupting rating and coil size rating. When we install a recloser we have to make sure that the highest fault current that recloser will see is less than its interrupting rating.
- 2-15 The coil has to be large enough to carry the load current, without thinking it sees a fault and operating which is called false tripping. We also need a coil size small enough that the recloser can detect the smallest possible fault on the portion of line its supposed to protect.
- 2-16 Obviously, we also want to use a recloser that can withstand the

operating voltage and the surge the voltages on our system.

Reclosers have both an operating voltage rating and a basic impulse insulation level rating, abbreviated as BIL, which is a rating of surge voltage insulation inside the recloser.

2-17

While the various current ratings are the ratings we are most often concerned with, the voltage ratings are important, too. If an OCR is used on a system with voltages higher than its ratings, it's sure to cause problems - the worst of which is having the recloser explode. For example, we can use OCR's rated for 14,400 volts on a 7200 volt system because the recloser voltage rating is higher than the system voltage.

2-18

Tom: How do you know what the fault currents are?

Susie: This is another job for the engineer. The highest and lowest possible fault currents at any point on the system can be calculated.

Tom: Doesn't a recloser always see the same size fault?

Susie: No. The size of the fault depends on a number of conditions. One of these is the type of fault.

2-19

With several wires making up a power line, there are many ways in which they can be involved in faults. For example, if the phase conductor on a single phase line breaks and falls on the ground, we have a line to ground fault. If a tornado wraps all the wires on a three phase line together, we have a three phase fault. In each case, the amount of fault current that flows is different.

2-20

Other important factors are wire size used in the line and the distance from the substation to the fault. Things that affect fault currents that we have no control over include the number of generators running at any particular time, and the way the transmission system is being operated.

2-21

The engineer calculates the possible values of fault current at many points on the system, taking into account all these factors. Then he decides where to put the reclosers. Sometimes his locations don't seem too practical. From an operating standpoint, we want locations that are easy to get to. We'd like to be able to back a truck up to the pole even in bad weather.

Tom: Yeah. I'd hate to have to swim to the pole before climbing it.

Susie: Now, are there any questions about reclosers?

LINE SWITCHES

- 3-1 In conjunction with reclosers and fuses, we use various kinds of switches in the distribution system. Switches make it easy to connect and disconnect lines. This makes trouble-shooting line problems easier, since the line can be broken down into small pieces.
- 3-2 The simplest switch is a hot line clamp. It is designed to carry low currents, say less than 10 amps or so. It is very useful as a connector for distribution transformers.
- 3-3 Hot line clamps cause line trouble when they are mis-used. Often they are mis-used on high current feeders to make jumper connections. Connectors or line switches designed for these high currents should be used instead. This also applies to regulators and all but the smallest reclosers.
- 3-4 Tom: Why don't hot line clamps work at higher currents?
Susie: The area of contact between the clamp and the wire is small, and can't carry much current without overheating. If you look inside this clamp, you can see a shiny stripe. This is the only area in which the wire and clamp actually had contact and conducted current.
- 3-5 Corrosion sometimes occurs between a hot line clamp and the wire it's clamped on, particularly if the two metals are different. Making sure the clamp is tightly installed reduces this problem.

- 3-6 Loose hot line clamps can also cause radio noise. Since the power system acts as a big antenna, this noise can be heard for miles. It is very difficult to locate the source of such noise.
- 3-7 Like any switch, a hot line clamp draws an arc when connected or disconnected. This arc can damage the line conductor
- 3-8 To prevent this damage, a set of armor rods is wrapped around the conductor. Armor rods are normally used for mechanical protection at line insulators, but can be used to make a place to connect a hot line clamp. When the hot line clamp is placed on the armor rods, all the arcing damage occurs to them, so the line conductor is not weakened by the arcing.
- 3-9 Another way to prevent damage to line conductors is to use a basket for the hot line clamp to connect to. A basket can be a loop of wire attached to the conductor. Sometimes, at the end of a line the wire end is folded back on itself to make the basket.
- 3-10 Another type of basket used on aluminum conductor is made of aluminum rod and bolts on the line.
- 3-11 Tom: Isn't this hot line clamp supposed to be connected to the basket instead of to the main conductor?
- Susie: Yes, and somebody is going to hear about it before the day is out. It embarrasses me that any of our linemen would do that.
- 3-12 Cutouts can be used as switches, either with the regular fuse barrel and fuse link installed, or with a solid blade. They generally are not load break.

3-13

This switch is essentially a single phase switch, although it is often used in threes on three phase lines. These in-line tension switches are easier to install in an existing line than switches on crossarms because they don't require rebuilding the pole top. They are operated with hot line tools. It's important to install these close to the pole; otherwise, it's hard for the lineman to reach them from the pole. Also, the further out they are, the more they bounce around in the wind.

3-14

These are 1Ø single phase switches which are designed to be mounted under the crossarm. They are more expensive than the in-line type, and require a more expensive pole top structure, but are easier to work and are heavier duty. Both load-break and non-load-break models are available.

Tom: What are those white "ears" on the right hand end of the switch?

Susie: This particular switch is a load-break switch; the ears help put out the arc caused by switching heavy load currents.

3-15

Another common switch is a three phase ganged air break switch. Generally, these are manually operated, although some can be motorized. If these switches are used to switch line carrying normal load current, a LOAD BREAK rated switch is necessary. Some uses of these switches may not require the load break rating, particularly if an established standard operating procedure is always followed.

3-16

Even though switching procedures can be established that never require these switches to interrupt load current, some utilities always use loadbreak switches as a safety precaution. If the switching procedure is not followed for some reason, interrupting load with a load break rated switch will not cause damage to the switch or create a dangerous situation for the lineman.

Tom: I guess it's better to be safe than sorry.

3-17

OCR's can be operated manually as switches, if necessary. The handle on the side allows manual operation as well as showing whether the OCR is opened or closed.

3-18

The oil switch is similar to an OCR in that its contacts are under oil, and the handle used to operate the contacts looks the same. The contacts are load break rated; but they are not designed for fault interruption. The mechanism is operated either by a mechanical linkage as in this case, or by an electric motor.

3-19

Oil switches were designed to switch capacitors. Capacitor switching is severe duty for any switch, because the capacitors cause a lot of arcing when they're switched on or off. In an oil switch, the arc is in oil instead of in air. An arc in oil goes out much easier than one in air. The square box on the side of the oil switch houses an electric motor that operates the switch.

3-20

A special kind of switch is the bypass switch, which is used mostly to bypass voltage regulators to remove them from service for maintenance or repair. A bypass switch replaces three ordinary switches. It has the advantage of operating its three component switches in the proper sequence to bypass a piece of equipment without an outage. It eliminates possible human error that can occur when three separate switches are used.

3-21

Susie: Are there any questions about the line switches?

LIGHTNING ARRESTERS.

- 4-1 Susie: Now I'd like to tell you about a small but very important piece of equipment, the lightning arrester. Its job is to control surge voltages on the line, whether caused by lightning or other system disturbances. Properly used, arresters prevent damage to transformers and other equipment.
- 4-2 Tom: All I see is what looks like an extra long insulator on the side of the pole.
- Susie: That is a lightning arrester. It looks simple, but its internal operation is complex.
- 4-3 Basically, it's a spark gap that arcs over when the voltage applied to it gets too high. If you've ever held a spark plug wire near the engine block of a car to see if it would produce a spark, then you've seen the basis for lightning arrester operation.
- Tom: That's easy enough to understand.
- 4-4 Susie: There's more to it than that. When a spark gap fires from lightning, it sets up a path for electricity to follow. The 60 cycle power flows across the gap along with the lightning. The lightning is only momentary, and soon goes away, but the power current keeps flowing. This is a short circuit, and is called power follow current.

- 4-5 Do you remember the fuse back at the corner?
- Tom: Yes, it's supposed to blow if there's a short circuit.
- Susie: That's right. So even though a simple spark gap might be used to protect equipment, it can't be used if fuses are used on the system. A fuse would blow to stop the power follow current each time a spark gap fired. This would cause an unnecessary outage.
- 4-6 Susie: The important thing to remember is that a spark gap alone won't do an adequate job of protecting against lightning. So, to make it work better we add some more parts called valve blocks in line with the spark gap.
- 4-7 Here is a disassembled lightning arrester. The black pieces are the valve blocks and are in line with the white discs, which are spark gaps. The valve blocks let high voltage surges pass easily through the arrester to ground. Then these blocks react to the lower voltage of the power follow current. They reduce the follow current to a low level so that the spark gaps can interrupt it.
- 4-8 Tom: Do lightning arresters ever wear out?
- Susie: Yes, they do occasionally fail. Usually when this happens they short circuit. This either blows a fuse, causing an outage, or the arrester blows up.
- Tom: I'll bet they usually do that during a lightning storm.
- Susie: Yes, it's most likely to occur then. Basically there are two ways to prevent a failed arrester from causing an outage.

- 4-9 One way is to put a second, external, air gap between the arrester and the line. The penalty of this is that it takes a higher surge voltage to fire the arrester and gap combination than it would to fire that arrester alone. This means less protection.
- 4-10 Once the external gap fires, the arrester works the same as one without the external gap. If the arrester has failed, a recloser or fuse must operate to make the arc in the external gap go out. Since the failed arrester is not causing any obvious problems, no one goes out to replace it. They probably couldn't find it anyway, since there is no visual indication that the arrester is bad.
- 4-11 Even though it takes a higher surge voltage to fire an externally gapped arrester, it still provides basic protection to line transformers. The arrester must be mounted close to the transformer either on the same pole or on the transformer tank.
- 4-12 That external gap only provides protection WHEN PROPERLY SET. Too small a gap leads to radio noise. It can also cause the arrester to operate falsely when there is no lightning. Too big a gap raises the firing voltage so high that the arrester doesn't provide protection.
- 4-13 Setting the gap properly is something I can't emphasize enough MAKE SURE that the gap is set right. Make a feeler gauge from a piece of wood, or use a ruler, but DON'T GUESS. The gap should be set after the arrester is in place on the line. This is to prevent accidentally changing the gap setting by knocking the arrester around during installation.

- 4-14 Tom: I see another arrester over here, but it doesn't have an external gap.
- Susie: This arrester uses the second method to disconnect itself from the line if it should fail. On the bottom of the arrester is a ground lead isolator. This is a small explosive charge built into the base of the arrester.
- 4-15 Normally, this explosive charge has no effect on normal arrester operation, but if the arrester fails due to short circuiting, the current flowing through it builds up enough heat so that the charge fires. This blows off the bottom terminal. Since the ground lead can then be seen dangling in the air, it is easy to find a failed arrester of this type.
- 4-16 One characteristic of wire is inductance. Because of inductance, lightning arrester leads do not pass surges as well as we would like. Therefore, we try to keep the leads as short as possible so that the lightning arrester can do its job properly.
- 4-17 The inductance of the wire leads adds about 2000 volts, or 2KV per foot of wire to the spark-over voltage of the arrester. The spark-over value must be kept as low as possible to provide maximum protection.
- 4-18 Here's a good example of how not to install arresters. Coiling the lead wires adds to the inductance. I've seen some coiled leads on our system that have leads almost ten times longer than they need to be. This really reduces the effectiveness of the arresters.

4-19 Tom: So arresters have to be installed correctly, especially the one's with external gaps before they can do their important job of protecting the distribution system.

Susie: Yes, and it is a lot more important than many people realize.

4-20 Are there any questions about lightning arresters?

TRANSFORMERS

- 5-1 Susie: The distribution transformer is probably the most widely used equipment item on a distribution system. We're going to take a look at how they work and why we use them. We use distribution transformers to change the high level distribution voltage to 120 v and 240 v. This is a typical three wire service used to supply single phase consumers.
- Tom: Seems like you'd need 2 transformers to do that.
- 5-2 Susie: It can be done that way, but we pull a nifty trick to avoid that and save money.
- 5-3 Let's draw the secondary side of the transformer like so: We won't worry about the primary side for now. If the proper transformer is used, we can measure 240 v across the secondary terminals, which are connected to the ends of the secondary winding.
- 5-4 Now, let's connect a third wire right in the middle of the winding: What voltage will we have across the ends of the winding?
- Tom: Why, the same as before - 240 volts?
- Susie: Right. What about from our center wire to the upper end?
- 5-5 Tom: I'll guess. 120 volts?
- Susie: Right. How about from the middle wire to the bottom end?
- Tom: 120 volts again?

- 5-6 Susie: Right again. Notice that when we tap the transformer coil at the halfway point, we get half the voltage each way from the center tap to the ends.
- 5-7 Susie: The vast majority of distribution transformers are center - tapped, which means tapped in the middle. A few designed for special connections have oddball taps. So, if you run across one that you're not sure of, have the shop test it.
- 5-8 Susie: In addition to the secondary winding, there is a primary winding. The two windings are linked by a magnetic core made of iron. This is called the transformer core. The primary and secondary are not normally connected to each other within the transformer.
- 5-9 The primary winding has lots of turns of wire, but the secondary has considerably fewer.
- 5-10 If you count the turns on both windings and divide the number of primary turns by the number of secondary turns you get the turns ratio.
- 5-11 The turns ratio is exactly the same as the voltage ratio of the transformer. The voltage ratio is the primary voltage divided by the secondary voltage. In this example, the voltage ratio is 7200 volts divided by 120 volts, or 60. This is exactly the same as the turns ratio.

- 5-12 Tom: I see. But is the current different on each side of the transformer just as the voltage is different.
- Susie: Yes, except in the opposite way voltages are related. The primary side is connected to the high voltage distribution system. It operates at high voltage, but draws low current. For instance, in a 7200V system, the current drawn by the primary is about 10 amps or less for commonly used transformer sizes.
- 5-13 On the secondary side, the voltage is much lower, but the current makes up for that by being much higher. Low voltage, high current. The secondary current might be as much as several hundred amps for the same transformer sizes that draw only a few amps on the primary.
- 5-14 The size of a transformer is rated in KVA. This is the rated voltage times the maximum rated current, but the voltage is measured in KV or kilovolts, which is thousands of volts. 7200 volts, for example, 7.2 kilo volts. A transformer rated for 10,000 volts or 10 KV, and 10 amps, can handle 100 KVA.
- 5-15 If you multiply the primary voltage in kilovolts, and current in amps, together you get the KVA going into the transformer. Both of these are the same - the KVA going in equals the KVA coming out.
- 5-16 Tom: Why do we bother with high voltages on power systems? Why don't we just use 120 volts everywhere? That would eliminate the transformers.
- 5-17 Susie: Yes, it would, if we used 120 volts we'd have to have tremendously high currents to transmit the power required by our customers. This would require huge wires to carry those currents. Physically and economically, it just couldn't be done.

- 5-18 Tom: Well, then why not use a high voltage and just wire houses and other buildings to use it?
- Susie: Suppose we used 7200 volts for house wiring. Each insulated conductor would be about an inch in diameter. It would cost 15 to 20 times as much as the wire used for 120 v wiring. It would cost a lot more to install, too, since it's harder to handle.
- 5-19 Connections couldn't be made by simply stripping back the insulation and clamping the bare wire under a screw. Special terminators designed to prevent high electrical stresses from damaging the insulation would have to be used.
- 5-20 Wall plugs and switches would be monstrous affairs, and hard to operate. The total cost to wire such a house could easily be half the cost of the house. High voltage building wiring is an impossibility from both a convenience and economic viewpoint.
- 5-21 So you see, using high voltages for transmission and distribution and low voltages for building wiring, makes sense economically, even though we have to use many, many transformers. (Pause)
Are there any questions about transformers?

AUTOTRANSFORMERS

5-22 Susie: This is another device that is often found on systems that use more than one operating voltage or are converting their distribution voltage from one voltage to another. This autotransformer does the same thing as a regular transformer - it provides a voltage change from one side to the other. Like a regular two winding transformer, the KVA flowing in equals the KVA flowing out.

5-23 Autotransformers have several advantages and disadvantages when compared to conventional two winding transformers. Advantages of the autotransformer include lower initial cost, lower losses, and lower weight. Disadvantages are: no isolation between the primary and the secondary circuits and a higher susceptibility to damage from fault currents.

5-24 Tom: Why can't you use an ordinary two winding transformer to do the same thing?

Susie: You can. But we use an autotransformer because of its lower weight, lower cost, and lower power losses.

5-25 Let's look at an autotransformer and a two winding transformer from the standpoint of the size of the coil used to build it. As an example, we will use a 500 KVA unit connected as a step up transformer. A step up transformer produces a higher voltage at its secondary terminals than is applied at its primary terminals. In our example, we'll use 7200 volts stepped up to 14,400 volts.

- 5-26 The autotransformer has two coils just as the two winding transformer does, but they are wired up differently. One coil is connected across the line and is called the SHUNT COIL. The other coil is connected in line between the primary and secondary terminals, and is called the SERIES COIL.
- 5-27 Redrawing the autotransformer with the series coil stacked on top of the shunt coil makes it easier to visualize the voltage relationships. There is 7.2 KV applied to the connections on the left. The series coil has only 7.2 KV across it, which appears because of the transformer coupling action between the two coils. This 7.2 KV is added to the input 7.2 KV, which gives 14.4 KV on the output.
- 5-28 Each of these coils only needs to be rated at 250 KVA, since each coil carries only one-half of the input current and has only half of the full 14.4 KV output voltage across it. So neither coil carries the full transformer rating of 500 KVA. On the other hand, in the two winding transformer, the coils each carry the full rated current and voltage, so both coils must be able to handle 500 KVA.
- 5-29 An autotransformer can be used either as a step-up or as a step-down transformer, just as a two winding transformer can. However, with larger turns ratios, the economic advantage of using an autotransformer decreases.

5-30 As an example, here are several autotransformers, all with a 7200 V primary, and all with a 500 KVA rating. Notice that at higher turns ratios, the coil ratings are higher too. As a result a 1:3 (or 3:1) turns ratio is about the highest ratio that is economically feasible.

5-31 Tom: Is this the only thing autotransformers are used for - to change voltage levels on a distribution system?

Susie: No, they're used other places, too. Large three phase units are used to tie together different voltage levels on transmission systems - say a 345 DV system and a 500 KV system. Smaller ones are used in buildings to provide 240 volts from 208 volts.

5-32 They're also used as ballasts in flourescent and mercury vapor lights to provide a high enough voltage to make the light work.
(PAUSE) Are there any questions about autotransformers?

VOLTAGE REGULATORS

6-1 We also use equipment which automatically regulates the distribution voltage. The voltage regulator is the device which performs this function.

Tom: Looks pretty impressive.

Susie: Yes, and expensive, too, but well worth the price. The voltage regulator is a pretty sophisticated piece of equipment, and lasts nearly forever.

6-2 The voltage regulator not only senses that the incoming voltage is low or high, but by how much, and then adjusts the outgoing voltage to whatever value we've told it to hold.

6-3 Tom: That's pretty neat. Now does it adjust the voltage?

Susie: Essentially, it's an autotransformer in which we can adjust the turns ratio by switching parts of one winding in or out. I'll make some sketches to show you how this works.

6-4 Susie: Here is a regular two winding transformer like we use for services, except we won't use a center tapped one. As an example, let's use a 7200 volt primary and a 240 V secondary. If we put 7200 volts here at the primary, and the secondary voltage is 240 volts, what would we have from the output to ground?

Tom: Well, adding them up would be (pause) 7440 volts.

Susie: That's right.

6-6 Now suppose I hooked up the secondary this way - backwards so to speak.

Tom: Would they still add?

Susie: No, now they subtract. If we put in 7200 volts we will get out 6960 volts.

6-7 Now, if we bring out taps from the series winding like so, and provide a selector switch, we can pick the amount of voltage we get from the series coil.

6-8 We put in another switch, called a reversing switch. This allows us to choose whether the series coil adds to or subtracts from the incoming voltage.

6-9 Susie: The box mounted here on the pole is the control for the regulator. Let's look inside.

6-10 This is an electronic control which is typical of the type being manufactured today. There are still many electromechanical controls around, but, both kinds do the same things, and generally have the same controls on the panel.

6-11 An advantage of the electronic controls is that they are factory calibrated. So, when you set a control knob to a number, what you see is what you get. Mechanical controls, however, have to be checked periodically using an accurate volt meter and a trial and error method, since the control calibration drifts with age.

- 6-12 This control is the bandwidth, which is the range that the output voltage may vary before the regulator operates. The narrower the bandwidth, the more effectively the regulator holds a constant output voltage. The newer regulators with electronic controls are usually set to 1.5 volts or even 1 volt bandwidth. Older regulators have mechanical bandwidth controls. They can't be set accurately to a bandwidth smaller than two volts.
- 6-13 All regulators have a time delay control. This one is inside the panel, on the circuit board. The time delay makes the regulator wait a preset time from when it senses the need to adjust the voltage until it is allowed to do so.
- 6-14 This time delay prevents the regulator from trying to correct momentary voltage fluctuations, such as these caused by loads coming on or off the line. The usual setting for the time delay is 30 seconds, although other settings are used if required.
- 6-15 Regulators commonly have a range of regulation of plus or minus 10%. That means the input voltage can be up to 10% higher or 10% lower than the desired output voltage. The yellow hand on this dial shows which step the regulator is on. The white hands show how many steps each side of neutral the regulator's been. Notice that there are 16 steps in each direction
- 6-16 A 10% regulation range in 16 steps gives 5/8% change in voltage for each step. Figured on a base of 120 volts, that's 3/4 volt per step.

- 6-17 We try to reset the white hands, called drag hands, about once per month. If the regulator is consistently up to 16 steps in either direction then we're giving the regulator a voltage outside the range that it can handle. When this happens we try to determine the cause and fix it.
- 6-18 There are some other controls and indicators on the lower part of the panel. One of these is a selector switch that allows automatic control, manual raise or lower, or turning the control off. This is used for testing the regulator in operation and to bring it to neutral when it is to be de-energized.
- 6-19 The operations counter shows how many operations the regulator has accumulated, much as the odometer in your car shows accumulated mileage.
- 6-20 Another important item is the surge supressor across the series coil. This is necessary to help protect the regulator from lightning and switching surges. Some manufacturers put the suppressor inside the tank, so you can't see it, but it's still there.
- 6-21 In addition, distribution valve type arresters should be used on both the load and source busings. These should be mounted on the regulator tank to get them as close as possible to the regulator bushings to provide ~~maximum~~ maximum protection to the regulator.

6-22 Tom: It seems that voltage regulators can solve all of the voltage problems on a distribution line.

Susie: They go a long ways towards it, but there are other types of voltage problems that are better handled in other ways. (PAUSE) Are there any questions about regulators?

CAPACITORS

7-1 Under the right conditions, we can lower the power flow in our lines and reduce line losses, without regulators, by using capacitors instead.

Tom: What's a capacitor?

7-2 Susie: Essentially, it's two metal plates with an insulator sandwiched in between.

7-3 To get a capacitor big enough, power capacitors are made of several sections of foil and oil impregnated paper, or plastic film rolled up -- much like several rolls of paper towels.

Tom: Okay, but how do they help reduce power flowing in the lines?

7-4 All electric devices draw real power from the electric system. This power is called real because it can be converted into heat, light or motion, which is what we want in order to do various jobs such as cooking, running a mill, and so on.

7-5 In addition to real power, some electric devices also draw reactive power from the electric system. Motors and transformers are the most common users of reactive power. This reactive power is used to magnetize the iron parts of these devices in order to make them work. It is not real power, because none of it is ever converted to heat, light or motion.

- 7-6 A motor will draw reactive power when it is energized, even though it is not powering anything. If a mechanical load is connected to a motor it will draw real power to run that mechanical load. The amount of reactive power it draws will stay nearly the same regardless of the mechanical load.
- 7-7 A transformer will also draw reactive power when it is energized, even with no load on it. If a load requiring only real power is connected to it, the transformer will draw real power to supply that load. As in a motor, the amount of reactive power the transformer draws will stay nearly constant regardless of the load.
- 7-8 If a load that requires both real and reactive power is connected to a transformer, the transformer will draw enough of each of them to pass along to the load. In addition, it still draws reactive power to supply its own needs. The transformer's own need for reactive power to magnetize its core is nearly constant, regardless of the requirements of the load connected to it
- 7-9 Reactive power, like real power, can be supplied by the generators in a power plant. In this case, it has to flow through the transmission system, the substation, and the distribution system to get to the load needing it. Since the lines and equipment used are not perfect, some of both real and reactive power flowing through them will cause losses. If we could supply power closer to the load, we could reduce our losses, because the power wouldn't have to flow through so much line and so many pieces of equipment.

- 7-10 Unfortunately, the only way to supply real power economically, is by running large generators and shipping the power out over transmission and distribution systems. But, reactive power can be supplied close to the load, and easily, too.
- Tom: I'll bet that's what capacitors are used for!
- Susie: Yes, they are.
-
- 7-11 Susie: Capacitors can be considered as sources of the reactive power used by motors and other magneticly operated devices. With capacitors on the line, the power plant has to supply less reactive power, since most of it is supplied locally by capacitors.
-
- 7-12 Tom: How do you know how many capacitors are needed to supply the reactive power required by the load?
- Susie: First we determine the amount of reactive power needed. The reactive power is measured in Kay-Vee-Ay-Ars, or KVAR's. Like transformer KVA, KVAR'S are kilovolts times amperes. The 'R' on the end of KVAR means we're dealing only with reactive power.
-
- 7-13 Capacitors are rated by how many KVAR'S of reactive power they can supply. So once we know the reactive power required by the load, we can buy the necessary capacitors. Typical ratings are 50, 100, or 200 KVAR.
-
- 7-14 Capacitors also have a voltage rating. This rating must be matched to the operating voltage. If too high a voltage is applied to a capacitor, can shorten its life dramatically. Too low a voltage won't hurt the capacitor, but it will supply a lot less reactive

power than it's designed to.

7-15 Electrified oil fields and industrial areas require a relatively large amount of reactive power. This requirement is year-round.

7-16 Air conditioning is another load that requires reactive power. Since it's only used during the hot part of the year, the need for reactive power is seasonal. But, it also has a daily cycle, since it runs a bit less at night.

7-17 Many residential loads use motors or transformers. Even gas heating systems use transformers to produce the 24 volts used in the thermostat circuits. Washing machines, refrigerators, vacuum cleaners and many other household devices use motors which must be supplied with reactive power. Household requirements for reactive power vary with the time of the day.

7-18 Susie: If there are more capacitors on the line than needed to supply the reactive power, they draw capacitive power. As far as line and equipment losses are concerned, this condition is just as bad as not having enough capacitors. In addition to causing higher line losses, too many capacitors on a line can cause high voltage towards the end of the line. Because some of these loads have varying needs for reactive power, we have to turn some of our capacitors on and off at various times.

- 7-19 Tom: How do we turn line capacitors on and off?
- Susie: Usually, enough capacitors are left permanently connected to the line to supply the lowest amount of reactive power needed. This is the reactive power that supplies motors, transformers and other magnetic devices that run all the time.
- 7-20 Then, additional capacitors are switched on in the spring and off in the fall. This switching is done manually. These capacitors take care of most of the seasonal changes in reactive load.
- 7-21 To compensate for the changing requirements during the day, the remainder of the capacitors are switched automatically, using oil switches.
- 7-22 Many types of controls are available to operate the capacitor oil switches. One of the least expensive is a simple thermostat. This works well when air conditioning load is causing the reactive power demand. Other more accurate, methods can be used to control switched capacitors, too. Some of these are pretty sophisticated, but also expensive.
- 7-23 Tom: So the two basic devices for voltage control on distribution systems are regulators and capacitors. The regulators control voltage directly by changing the turns ratio in a transformer, and the capacitors control it indirectly by supplying reactive power to magnetically operated devices on the system.

7-24 Tom: By using capacitors to control reactive current, we're helping the power supplier, yet it doesn't cost him anything. That doesn't seem fair.

Susie: It costs us in our power bill if we don't control the reactive power. In addition to metering the real power demand at the substation, our supplier meters the reactive power demand also. If the reactive power gets too high compared to the real power we pay a penalty on the monthly power bill. So capacitors are very useful to us in a variety of ways. What other questions do you have about capacitors?

METERS

- 8-1 Susie: A piece of equipment with which you need to become familiar is the WATT-HOUR meter. A watt-hour meter measures the amount of electrical energy flowing through it. The amount of electrical energy a consumer uses is the basis for his monthly bill. Since our revenue depends on accurate metering, proper use and maintenance of them becomes extremely important.
- 8-2 Tom: Meters must be pretty complicated inside.
- Susie: Basically, all watt-hour meters are electric motors whose speed of rotation depends on the amount of power flowing through the meter.
- 8-3 The moving part of the meter is called the meter disc.
- 8-4 The disc drives a series of gears connected to a register.
- 8-5 There are two types of registers in common use. One is a clock type. It has a series of dials that look like clocks. It's easy to make a mistake reading one of these if you're not careful.
- 8-6 The other type is a cyclometer type. The numbers are direct reading like the odometer of a car.
- 8-7 The register is much like the odometer of a car, that records the mileage traveled. The watt-hour meter register totals

up the number of times the disc has turned completely around, but reduced by the gear ratio of the gear train. (Pause) Totalling the disc revolutions in this way gives a reading of energy consumed, which is measured in kilowatt-hours.

8-8 Tom: That's not too hard to understand.

Susie: No, it isn't. The hardest part of metering is the wide variety of meter types. If we only had one type of meter, it would be pretty easy.

8-9 Tom: Why are there so many types?

Susie: Different types were developed either as improved designs or to meter different kinds or sizes of loads.

8-10 For example, a single phase meter used for metering residential loads has only one disc. But if we want to meter 3 ϕ load, this meter won't work.

8-11 The most straight forward way to measure a 3 ϕ circuit is with three separate 1 ϕ meters. It's the most expensive way, but it's also the most accurate. The three meters can be built in a single unit with the three meters sharing a common shaft and register.

8-12 Where a bit less accuracy is allowable, some compromise methods can be used. These involve doing wiring tricks inside the meter with the different phase voltages and currents.

A meter designed for compromise metering is generally cheaper because it has fewer internal parts.

8-13 Most consumers are billed for the energy they use, which is directly related to the number of disc revolutions between monthly readings.

8-14 In addition to the energy charges, some commercial and most industrial consumers are billed a charge related to the fastest speed the disc turned during the month. This is called DEMAND.

8-15 Tom: What does the demand tell us?

Susie: DEMAND is a measurement of the peak power, or maximum power, the consumer's load demanded during the month. From a practical standpoint, it's a measure of how big a service we need to supply a consumer - the service wire size and transformer size in particular.

8-16 Tom: Does that take an extra meter?

Susie: No, it doesn't. A special register, called a DEMAND register is substituted for the normal register.

8-17 This demand register records the energy used, in kilowatt hours, just as a regular meter does.

- 8-18 In addition, the demand register has another set of dials or a pointer that record the peak power demanded - the DEMAND, in kilowatts.
- 8-19 Some demand meters use a scale around the edge of the face plate and a long pointer to record the demand.
- 8-20 Not all registers show kilowatt hours and kilowatts directly. Sometimes a multiplier is shown next to the dials. This means the reading must be multiplied by this value. On this meter, the multiplier is ten. Generally on demand meters the same multiplier applies to both sets of dials.
- 8-21 Tom: What do all these numbers on the face plate mean?
Susie: Let's take them one at a time.
- 8-22 This big number at the bottom is the manufacturer's serial number.
- 8-23 This number is the company number. All our records are keyed to it.
- 8-24 This is the CLASS of the meter. It is the maximum load current the meter can carry in this case, 200 amps.
- 8-25 Here are the voltage and circuit type ratings. This meter is a 240 V meter designed to be used on a three wire circuit. Above that are the words "single strator". This means that this meter is to be used on single phase.

- 8-26 This is a very important number - the FORM number. Form numbers tell how the meter is wired inside. All meters with the same form number are wired the same inside. If two meters have the same class rating, voltage rating and form number, they are direct replacements for each other.
- 8-27 The letter at the end of the form number indicates the type of base the meter has. An "S" means a socket type meter. An "A" means a meter with a terminal block on its bottom side.
- 8-28 This group of numbers is important for testing meters. TA means test amps. Test amps is the current applied to the meter for initial adjusting. K_h tells how many times the disc turns completely around for each watt-hour of energy that flows through the meter.
- 8-29 R_r is the register ratio. It is the gear ratio of the gear train in the register.
- 8-30 Tom: What's the largest load that can be metered?
Susie: Self contained meters, which are the kind we've been talking about, are usually not rated above 200 amps full load current, or 480 volts. If currents or voltages higher than that are to be metered, transformer rated meters are used.

- 8-31 Tom: What are transformer rated meters?
- Susie: These meters are almost always rated class 10 or class 20 and 120 volts. They are connected to the load to be metered through special metering transformers, which reduce the current and voltage to these levels.
- 8-32 These instrument transformers are made in many different sizes to allow us to meter a wide range of loads.
- 8-33 Properly connecting some of these meters gets pretty complicated. Making a mistake can have results - from making the meter read wrong, to causing a short circuit and a fire.
- Tom: I guess I won't be an overnight expert on metering!
- Susie: Nobody becomes an overnight expert on metering, Tom. because there are so many details.
- It is a very important subject, however, since our revenue depends so directly on correct and accurate metering.
- 8-34 Susie: There are a few points I'd like you to remember about metering, however. The first is that all kilowatthour meters measure electrical energy. Electrical energy is what our customers are buying to produce heat, light and mechanical motion.
- 8-35 Secondly, some kilowatthour meters measure electrical demand, or power, in addition to measuring energy. The Demana register tells us how fast a customer used energy since the last time the meter was reset.

The many details of metering stem from the large number of meter types in use. We can't simplify metering by eliminating any, since each was developed for a particular use. Sooner or later, everyone runs across each of these metering schemes. (Pause)

Are there any questions about meters?