

DOCUMENT RESUME

ED 186 620

CE 024 651

AUTHOR Banathy, Bela H.; And Others  
 TITLE Native American Career Education Staff/Community Training Workshop. Coordinator's Manual. Native American Career Education Demonstration Project.  
 INSTITUTION Far West Lab. for Educational Research and Development, San Francisco, Calif.  
 SPONS AGENCY Office of Education (DHEW), Washington, D.C.  
 PUB DATE [79]  
 GRANT G007802031  
 NOTE 270p.; For related documents see CE 024 649-652, ED 147 593-607, ED 163 226, and ED 167 775.

EDRS PRICE MF01/PC11 Plus Postage.  
 DESCRIPTORS Administrator Guides; \*American Indian Education; \*American Indians; Background; \*Career Education; Counselors; Demonstration Programs; Educational Objectives; Educational Resources; Guides; \*Multicultural Education; Program Development; Program Guides; \*Program Implementation; Teachers; Teaching Methods; Transparencies; Units of Study; \*Workshops  
 IDENTIFIERS Education Amendments 1974

ABSTRACT

This staff/community training workshop handbook was written for teachers, counselors, career education specialists, administrators, and other educational staff; for parents, and Indian community representatives; and for any others who will be providing support for a native American career education program, or who will be actively engaged in developing and implementing it. The workshop consists of four sessions. The first session is devoted to providing participants with a general background in career education content and goals, and helping them begin to identify career education resources which are already available. The second session describes the various groups of people who can be involved in developing and implementing career education. The third session describes methods for teaching career education to native American students, beginning with a series of transparencies illustrating traditional Indian education methods, and goes on to introduce the twelve units in the native American career education program. The fourth session focuses on the pros and cons of strategies which have been used to implement career education in various settings, the basic tasks and stages of development for such a program, the most promising sources of funding, and some basic proposal development skills. Readings for each of the sessions are appended. (LRA)

\*\*\*\*\*  
 \* Reproductions supplied by EDRS are the best that can be made \*  
 \* from the original document. \*  
 \*\*\*\*\*

ED186620

**Native American Career Education**  
**Staff/Community Training Workshop**  
**Coordinator's Manual**

Native American Career Education  
Demonstration Project

Bela H. Banathy, Principal Investigator  
Diana P. Studebaker, Project Coordinator  
Diana L. Celestine, Development Intern

U S DEPARTMENT OF HEALTH,  
EDUCATION & WELFARE  
NATIONAL INSTITUTE OF  
EDUCATION

THIS DOCUMENT HAS BEEN REPRO-  
DUCED EXACTLY AS RECEIVED FROM  
THE PERSON OR ORGANIZATION ORIGIN-  
ATING IT. POINTS OF VIEW OR OPINIONS  
STATED DO NOT NECESSARILY REPRESENT  
OFFICIAL NATIONAL INSTITUTE OF  
EDUCATION POSITION OR POLICY

FAR WEST LABORATORY FOR EDUCATIONAL RESEARCH AND DEVELOPMENT  
1855 Folsom St., San Francisco, California 94103

## DISCRIMINATION PROHIBITED

Title VI of the Civil Rights Act of 1964 states: "No person in the United States shall, on the ground of race, color, or national origin, be excluded from participation in, be denied the benefits of, or be subjected to discrimination under any program or activity receiving Federal financial assistance." Title IX of the Education Amendments of 1972, Public Law 92-318, states: "No person in the United States, shall, on the basis of sex, be excluded from participation in, be denied the benefits of, or be subjected to discrimination under any education program or activity receiving Federal financial assistance." Therefore, ~~career education projects supported under Sections 402 and 406 of~~ the Education Amendments of 1974, like every program or activity receiving financial assistance from the U.S. Department of Health, Education, and Welfare, must be operated in compliance with these laws.

## DISCLAIMER

The material in this publication was prepared pursuant to a grant from the Office of Education, U.S. Department of Health, Education, and Welfare. However, points of view or opinions expressed do not necessarily represent policies or positions of the Office of Education.

## THE NATIVE AMERICAN CAREER EDUCATION PROGRAM

This document is one of a series of materials dealing with Native American Career Education. The titles of all individually available documents in this series appear below:

The Native American Career Education Staff/  
Community Training Workshop

Implementing Career Education for Native  
American Students-- A Guide

Native American Career Education, A Curriculum  
Guide

### Career Awareness Units

"Part of the Whole World"

"Cooperation"

"From Idea to Product"

"The Community"

"The Community in Transition"

### Career Orientation Units

"Putting Your Money to Work"

"Living with the Land"

"Working for the People"

### Career Exploration Units

"Planning"

"Putting It All Together"

"Getting Ready for Jobs"

"The Career Fair"

# Foreword

The thing that may be most noticeable about career education designed to serve as a bi-cultural fulcrum for Native Americans within the schools is its absence.

One conclusion that may be drawn from this is that public service agencies, specifically public schools, do not effectively meet the needs of Indian people; the absence of services contributes significantly to the disproportionately high rates of underachievement, educational attrition, and unemployment, as well as the extreme poverty of the Indian people. The underlying justification for categorical funding for programs supplementing the regular public school curriculum is derived from the low achievement levels of minorities within these systems.

The extreme and often irrevocable example of low achievement is when students drop out. Indian students and parents and personnel involved in special Indian programs reveal that the main reason students give for dropping out of school is that they can discern no compelling reason for staying in a place they feel is hostile to them. Career Education has a definite place in the process of reversing the tendency to drop out resulting from this cause.

The cultural element in this Native American Career Education Training Workshop and other materials in this series is beneficial both to the students, by crystallizing awareness of Indian identity, and to the schools, by influencing the attitudes of school personnel. This last aspect is the most important, since it can be reasonably assumed that if the school systems were adequately sensitized to minority problems, categorical funding would not be necessary. This last fault justifies continued attention to careful inservice training of school personnel, with which the Coordinator and Participant materials in this Staff/Community Training Workshop deals most effectively.

Admittedly, this Workshop will not miraculously resolve the problems confronting Indian secondary students, but it will help them to cope with the realities of life while engendering a productive sense of self-determination. I highly recommend the use of the Native American Career Education approach because of the positive awareness it can generate in participating school and community personnel who work with Native American students.

Mark G. Mellon (Hupa),  
Education Manager,  
Tri-County Indian Development  
Council, Inc.

## ACKNOWLEDGEMENTS

The Staff/Community Training Workshop was prototype tested at the four sites which participated in the Native American Career Education Demonstration project. These sites were: the Tri-County Indian Development Council's Indian Career Education project at the Yreka Indian Center, Yreka, California; McDermitt Combined School, McDermitt, Nevada; the American Indian Project (Title IV) of the San Francisco Unified School District, San Francisco, California; and Sherman Indian High School, a Bureau of Indian Affairs School, in Fiverside, California.

We would like to express our gratitude to key personnel from these sites who worked with us in setting up the workshops and in implementing the program, especially Mark Mellon, Susan Jacks and Felice Pace of Tri-County Indian Development Council; Peggy L. Bowen of McDermitt Combined School; Jim Swinney of San Francisco's American Indian Project; and Joy Martin of Sherman Indian High School.

We would also like to thank our Project Advisory Committee:

Dr. Louise Miller (Yurok) Education Specialist, Sacramento Area Office, BIA  
Robert Grant (Karuk), Yreka Indian Center  
Harold Abel (Paiute), McDermitt Combined School  
Israel Alcentar (Papago), American Indian Project, San Francisco  
Peter Soto (Cocopa), Acting Assistant Area Director, Education, Phoenix Area Office, BIA

Some of the information on Career Education in Session I was based on material in the 1978 Annual Career Education Handbook for Trainers, by Palo Verde Associates. Exercises in Session II were adapted from the Interaction curriculum, and the proposal writing guidelines in Session IV were adapted from those produced by the Women's Educational Equity Proposal Development project (both by Far West Laboratory).

# Contents

Foreword	i
Contents	iii
Introduction	v
<hr/>	
Session I: Career Education	1.0
Session II: The School and the Community	2.0
Session III: Native American Career Education Methods	3.0
Session IV: Career Education Program Development	4.0
Information Summaries for the Four Sessions	1
Bibliography	86

## INTRODUCTORY MATERIALS

The following list of topics will help you locate specific information.

<u>Introduction:</u> Workshop Audience	page v
Workshop Purpose	v
Workshop Structure	vi
<u>Guidelines:</u> The Coordinator's Role	vi
Preparing for the Workshop	vii
Meeting Space Required	vii
Equipment Required	vii
Organization of the Coordinator's Manual	viii
Organization of the Participant's Handbook	viii
Options for Scheduling Sessions	viii
Recruiting Participants	ix
Using the Workshop in a Multi-Cultural Setting	x



# Introduction

The NATIVE AMERICAN CAREER EDUCATION STAFF/COMMUNITY TRAINING WORKSHOP is part of a series of materials which are intended to serve as tools for schools, Title IV projects, and other agencies which desire to provide career education for Native American students. With some adaptations, it can be used in a multi-cultural setting as well. Other materials in this series include twelve instructional units in career awareness, orientation, and exploration, the Native American Career Education Curriculum Guide, and Implementing Career Education for Native American Students. The materials used in the workshop consist of a Participant's Handbook, transparencies, and this Coordinator's Manual.

## Who should participate in the workshop?

The Staff/Community Training Workshop was written for teachers, counselors, career education specialists, administrators, and other educational staff; for parents, and Indian community representatives; and for any others who will be providing support for the career education program, or who will be actively engaged in developing and implementing it.

## What is the purpose of the workshop?

The Staff/Community Training Workshop is intended to provide a basic orientation to career education, and specific skills needed to work with others in developing a career education program, including selecting, adapting, and developing materials, program planning, and seeking funding. Specifically, at the end of the workshop, participants should:

- be able to define career education and tell why it is especially important for Native American students;
- be familiar with some career education resources in their area
- understand some ways in which Indian community members can work with school staff on a career education program;
- be familiar with culture-based methods for teaching career education;
- be able to adapt career education materials for use with a given student group;
- know what a comprehensive career education program for their area might be like;
- have begun planning a career education program; and
- know where to look for funding and support for career education.

These materials will not provide users with a comprehensive description of the "right" way to develop a career education program; rather, the purpose is to give workshop participants the background and skills they will need to develop

a program which is based on local needs, resources, and culture, and which reflects the career education goals of the Indian community to which the students belong.

### Structure of the Workshop

The workshop consists of four sessions of two to three hours each, which can be arranged in a number of ways (see pp. viii-ix).

The first session is devoted to providing participants with a general background in Career Education content and goals, and helping them begin to identify career education resources which are already available to them.

The second session describes the various groups of people who can be involved in developing and implementing a career education program, employs a simulation exercise to give participants a 'feel' for what happens when members of these groups try to work together, and presents useful cooperative group interaction skills.

The third session describes methods for teaching career education to Native American students, beginning with a series of transparencies illustrating traditional Indian educational methods, and goes on to introduce the twelve units in the Native American Career Education program and the basic methods and concepts which were used to develop them.

In the fourth session, participants learn about the pros and cons of different strategies which have been used to implement career education in various educational settings, the basic tasks and stages of development for such a program, the most promising sources of funding, and some basic proposal development skills.

Sessions feature a mixture of activities, including lecture/discussion, small group and individual use of worksheets, a simulation, viewing transparencies, and reading supplementary material. The readings are not required for participation in the workshop, but participants should be encouraged to refer to them later.

## Guidelines

### The Role of the Coordinator

As coordinator, you are responsible for leading the participants through the activities in the workshop. A background in career education and Indian culture, or in working with Indian communities, will be of great help, and it would be useful if you have taken the workshop yourself first. However, the materials are designed so that a person with limited knowledge in those areas can lead the sessions and learn with the participants, as long as he or she is familiar with conditions and needs in the setting from which the participants come.

The Coordinator's Manual contains instructions for the activities and guidelines for group discussions and use of the worksheets. In some cases, discussion will be coordinated with use of transparencies. Since so much of the material is provided, your primary job will be to facilitate logical thinking and exploration on the part of the participants, rather than being a content expert yourself.

## Preparing for the Workshop

It is important that the workshop be presented in a relaxed, unpressured setting, and preceded by careful planning. Because arrangements for substitutes, schedule, release time, etc., substantially influence the kind of experience the participants have, allow plenty of time for organization before the first session. We suggest at least a month.

Experience has shown that arrangements for four to eight teachers, administrators, etc. in one school require ten to fifteen hours before the program begins, the time actually spent conducting the workshop, and two to five hours afterwards for closure and evaluation. For a larger number of participants from several schools, more time would be needed. Potential participants should be encouraged to attend all 4 sessions, as the benefit to everyone will be increased if the group has gone through the same experiences together.

## Meeting Space

To run the training sessions you will need a room large enough to accommodate all the participants in one discussion group, but with movable seating so that they can subdivide into workgroups for some of the activities and sit far enough apart so that they will not disturb each other. An ideal situation is a room with three tables which can be pushed together or moved apart as the activities require.

## Equipment and Materials

The following materials are needed for all sessions:

- Coordinator's Manual for yourself;
- Set of transparencies;\*
- Participant's Handbook for each participant;
- Extra pencils and paper;
- Chairs and writing surface for each participant
- Overhead projector and screen (or blank wall)

Career Education checklists\* will be needed for each participant for use at the beginning of Session I. Name tags will also be needed for the first session if participants do not already know each other, and for the second session even if they do. A copy of the local telephone book will also be useful for Session I.

Session II will require as many sets of role playing instructions as there are workgroups. For Session III, examples of career education materials from the counselor's office, library, or career center, and a set of the Native American Career Education units will be needed. For the fourth session, examples

\*Masters for transparencies and handouts appear with the instructions for each session.

of proposals developed by the school or project holding the workshop might be useful. Copies of the Evaluation Questionnaire will be needed at the end of the workshop. It is desirable, though not of course obligatory, to provide coffee and refreshments for participants at the breaks. Lists of items for each Session also appear in the Session instructions.

### Organization of this Manual

This manual contains guidelines, directions and background information for the coordinator; discussion outlines for use in each session; and reproductions of materials from the Participant's Handbook. These excerpts will be printed in Letter Gothic type face like this.

### Timing of sessions

Each session has been designed to occupy between two and three hours. Suggestions for adjusting the timing are included in the guidelines for each session, and approximate times for each activity are given. The activities to watch most closely are the discussions and the coffee breaks. If a discussion lags, begin presenting the commentary suggested in this Manual, but be prepared for your comments to spark the discussion again.

### The Participant's Handbook

Each participant will have a handbook containing:

- introductions to each session, including goals and activity summaries;
- worksheets;
- background material for the simulation (Session II):
- follow-up readings

Relevant materials from the handbook are included in this manual for your reference as you conduct the workshop. Although the follow-up readings can be done individually before or after the workshop, the Handbook is intended for use in a training group rather than for self-study. The readings appear following each Session in the Participant's Handbook, and all together at the end of this manual.

### Scheduling

The Staff/Community Training Workshop is divided into four sessions. Depending on the needs and constraints of the group, these sessions can be scheduled in a number of ways which are described below.

#### 1. Two full days

This arrangement allows four sessions to be presented consecutively as an intensive training experience. The time is sufficient for three hours to be allowed for each session if needed, although participants will

have less time to do the supplementary readings during the workshop. With this approach, the workshop can be scheduled for two school days or a weekend, or possibly on two consecutive Saturdays.

## 2. Four afternoons or evenings

If the four sessions are presented after school or in the evening, it will not be necessary for participants to miss work time. Holding the workshop on successive days provides for more carry-over from one session to another. If sessions are separated, continuity is lessened, but participants will have more time to prepare and study.

## 3. One day and one evening

If absolutely necessary, one could begin the workshop on one evening and continue all the next day. This scheduling is likely to place a strain on participants' energies, however, and their ability to focus on and retain the material being presented will suffer.

## 4. Other options

After you have become thoroughly familiar with the materials, you may find it possible to shorten or otherwise adapt the workshop to the needs of a specific group by presenting some information in lecture form rather than allowing participants to work through it themselves, or by skipping some of the activities. This should be done, however, only after careful thought.

## Recruiting Participants

You may have been called in to coordinate the workshop by a representative of a group which is already organized and interested in learning how to develop a career education program, or you may yourself be responsible for setting up the workshop as well as conducting it. Even if someone else is making the arrangements, it may be useful to discuss the following ideas with him or her.

In order for the workshop to be most successful, it should be given for a participant group which is at least interested in the idea of working together as a group to develop a coordinated program. It will still be useful, but less effective, if presented to teachers who will be working separately.

A conscious effort should be made to recruit representatives of all those groups which should be involved in the career education program--principals or vice-principals, counselors, and librarians as well as teachers; and teacher aides; parents, members of the Parent Advisory Committee for Title IV or Johnson O'Malley projects, and other community members; and business people from the area. It might even be desirable to invite one or more students to attend. Drawing participants from more than one school in the area can be useful in beginning to build regional or district cooperation.

Someone who is familiar with people from these groups will probably be able to suggest those who would benefit most from attending the workshop, but it should be announced publicly as well in order to give others the chance to attend. This may be done through articles in the school or faculty newspaper, parent committee newsletter or Indian center or other newspaper, and/or by posting announcements on bulletin boards. The workshop organizer may want to

prepare personal letters inviting individuals whose participation would be particularly valuable.

If it is possible to arrange with a local community college or other institution of higher education to give graduate credit for the workshop as a part of its continuing education or extension program, the attractiveness of the experience to teachers in particular will be vastly increased.

### Using the Workshop in Settings with a Multi-Cultural Student Population

Although the Native American Career Education program (as its name implies) was developed for use in settings with primarily Indian student populations, the materials and the approach which they exemplify, can also be used in a multi-cultural context. In testing the instructional units, it was discovered that even reservation schools include some non-Indian students, and that, furthermore, the cultural differences between Indians from different tribes or areas are often almost as great as those between Indians and students from other ethnic groups. The predominance of non-Indian teachers introduces a bi-cultural element from the beginning.

For this reason, the approach to career education embodied in the units and taught in this workshop can easily be expanded from multi-tribal to multi-ethnic, or used as a model for developing career education programs for other cultural groups.

The examples given in the instructional units and in this workshop are taken from Native American culture and educational settings; however, the activity guidelines in this Manual will also include suggestions for adjusting them to the needs of a multi-cultural situation.

# Session 1:

## Career Education

# Introduction

## Goals

Session I of the Staff/Community Training Workshop introduces the participants to career education and begins the process of helping them to identify and use career education resources around them. Specifically, Session I focuses on the following goals:

- participants will understand the goals and structure of the training workshop;
- participants will become familiar (or more familiar) and at ease with each other;
- participants will have a general understanding of career education content and goals, and an awareness of the strengths and weaknesses of their own knowledge of it;
- participants will have begun thinking about developing a career education program in their own setting;
- participants will be able to list a number of career education resources available in their school and community.

## Activities

This section lists the major activities in the first session along with estimated time allowances for each:

1. Getting off the Ground--participants put on name tags and fill out questionnaires (optional). Coordinator announces times and places for workshop sessions, sets up projector, and arranges facilities (if this has not been done). Latecomers arrive... 30 min.
2. Introducing Workshop Goals and Activities--Coordinator shows transparency of goals and discusses their meaning, and introduces approach to be used. 5 min.
3. Getting to Know You (optional if group already knows each other)--Coordinator introduces him/herself and conducts participants through Interview activity. 20 min.
4. Career Education Checklist--Coordinator passes out copies of checklist and instructs participants how to fill them out, then discusses possible answers, illustrating with transparencies. 30 min.
5. Break 15 min.



6. Career Education Resource Survey--participants divide into small groups and do worksheets I.1 through I.4. They then reunite, and communicate their findings through a spokesperson while Coordinator comments. 30 min.
7. Conclusion--Coordinator summarizes what has been covered in the session. 15 min.

### Materials

Coordinator's Manual  
 Transparencies (pp. 1.15, 1.19, 1.24, 1.27)  
 Copies of Staff and Community\* Questionnaires }  
 Copies of Checklist } masters appear on pp. 1.3  
 Extra pencils and paper  
 Name tags  
 Sign in sheet  
 Local telephone book

### Preparation

Familiarize yourself with the material covered in this session before the session begins. It is particularly important that you run through the discussion of the Career Education Checklist, with transparencies, ahead of time. The overhead projector should be positioned and tested before the session starts to save time and confusion.

If you are not already familiar with the setting in which you will be giving the workshop, it is highly desirable to talk with the people who have invited you or to arrive at the site enough ahead of time to get a 'feel' for the situation, look at the facilities and resource collection, and gather any other information that may help you understand and assist the people with whom you will be working.

Supplementary readings for this Session appear on pp. 1-9 at the end of this manual.

\*If you prefer, develop other questionnaires which will reflect your own information needs.

QUESTIONS FOR SCHOOL STAFF PARTICIPATING IN NATIVE AMERICAN CAREER EDUCATION  
STAFF/COMMUNITY TRAINING WORKSHOP

Name (optional): \_\_\_\_\_

School: \_\_\_\_\_

Grade(s)/age levels and subject(s) taught or other school functions: \_\_\_\_\_

\* \* \*

1. How long have you lived in this region? (months or years) \_\_\_\_\_

2. How long have you held your present position? \_\_\_\_\_

3. How long have you been working in education? \_\_\_\_\_

4. How many Indian students are in your class(es)? \_\_\_\_\_

5. Do you feel that your school's program provides an appropriate and effective education for Indian students?  yes  no

Comment: \_\_\_\_\_

6. What (if anything) do you think Indian students should be learning that they aren't now?

\_\_\_\_\_

What (if anything) should Indian students not have to learn that they are required to take now?

7. How would you define Career Education? (check as many of the following as apply)

job training;  economic awareness;  job-finding skills;  work habits and other employment skills;  training for productive living, including use of leisure time; other (explain) \_\_\_\_\_

8. Do you think Career Education could be valuable to your students?  yes,  no

9. How do you think Career Education should be presented?  separate elective;  infused into school curriculum;  individual counselling;  work-study program;  job training after graduation; other (explain) \_\_\_\_\_

10. Do you present information on careers or economic awareness as part of your job?  
 often;  sometimes;  never;  not appropriate
11. How relevant do you think the subject(s) you teach is/are to a student's later career success?  
 very;  somewhat;  valuable for other reasons
12. Would you feel able to teach Career Education if you had the chance?  yes,  no  
 If so, what training or experience has prepared you to do this?  
 \_\_\_\_\_
13. What kind of background do you think would be most useful in preparing someone to teach Career Education?  
 college course;  broad work experience;  inservice workshop;  
 self-instructional guide with student materials; other \_\_\_\_\_
14. Who do you think should be responsible for educating Indian students about Indian tribal or community government and culture?  
 school;  Title IV or other special projects;  community center or tribal government;  family
15. Is information on Indian culture provided at your school or project?  
 yes,  no. If so, by whom? \_\_\_\_\_  
 Can non-Indian students participate? \_\_\_\_\_
16. Do you ever teach about or refer to Indian culture or history in your classes?  
 often;  sometimes;  never;  not appropriate
17. How do you think teachers should be prepared to present Indian cultural materials?  
 college course;  lectures by Indian community members and/or cultural experts;  inservice workshop;  texts and instructional guides; other (explain) \_\_\_\_\_
18. Does your project, school or district have a community-based Indian parent group in addition to the PTA or an advisory committee?  
 yes,  no  
 If so, what is it? \_\_\_\_\_
19. Have you had a chance to meet the parents of your Indian students?  yes;  no  
 Have you worked with Indian parents or community people on any projects?  
 yes;  no

1.

20. How would you rate the degree of contact and cooperation between your projection school and the Indian community?

high;  moderate;  sporadic;  nonexistent

What forms (if any) does this cooperation take? \_\_\_\_\_

21. In your opinion, what is the local non-Indian attitude towards Indian people, and especially towards Indian students?

positive;  neutral;  hostile;  snobbish; other \_\_\_\_\_

How do you feel this attitude affects student performance?

helps;  no effect;  causes hostility;  causes poor self-image

22. How much information on the background of your Indian students do you have access to?

comprehensive record;  some information;  sketchy;  variable

23. How much information is available to you about what other classes and activities your students are involved in now?

goals and content of other classes;  class content and other school-based activities;  class-titles only;  variable

24. Would you like to learn more about Career Education for Indian students?

yes;  no;  later

25. Would you be interested in working with a group of other staff members and Indian community members to develop a Career Education program?

yes;  no;  I'd like more information

QUESTIONS FOR COMMUNITY MEMBERS PARTICIPATING IN NATIVE AMERICAN CAREER  
EDUCATION STAFF/COMMUNITY TRAINING WORKSHOP

Name (optional) \_\_\_\_\_

School or Project: \_\_\_\_\_

Job: \_\_\_\_\_

Tribe: \_\_\_\_\_

\* \* \*

1. How long have you lived in this region? (months or years) \_\_\_\_\_

2. Do you have children? \_\_\_\_\_ Ages? \_\_\_\_\_

3. Have you ever worked in education? \_\_\_\_\_ What job? \_\_\_\_\_

4. Do you feel that the local school provides an appropriate and effective  
education for Indian students? \_\_\_\_\_ yes \_\_\_\_\_ no

Comment: \_\_\_\_\_

5. What (if anything) do you think Indian students should be learning that  
they aren't now?

\_\_\_\_\_

What (if anything) should Indian students not have to learn that they are  
required to take now?

6. How would you define Career Education? (check as many of the following as  
apply) \_\_\_\_\_ job training; \_\_\_\_\_ economic awareness; \_\_\_\_\_ job-finding skills;  
\_\_\_\_\_ work-habits and other employment skills; \_\_\_\_\_ training for productive  
living, including use of leisure time; other (explain) \_\_\_\_\_

7. Do you think Career Education could be valuable to students in your  
community? \_\_\_\_\_ yes \_\_\_\_\_ no

8. How do you think Career Education should be presented? \_\_\_\_\_ separate elective;  
\_\_\_\_\_ infused into school curriculum; \_\_\_\_\_ individual counseling; \_\_\_\_\_ work-study  
program; \_\_\_\_\_ job training after graduation; other (explain) \_\_\_\_\_

9. How relevant do you think school work is to a student's later career success?

very;  somewhat;  not at our school

10. Would you feel able to help plan a Career Education program?  yes,  no  
If so, what training or experience has prepared you to do this?

11. Who do you think should be responsible for educating Indian students about Indian tribal or community government or culture?

school;  Title IV or other projects;  community or tribal center;  
 family

12. Is Indian culture taught at your school?  yes,  no. If so, by whom?

Do non-Indian students participate? \_\_\_\_\_

13. Do you teach about or refer to Indian culture and history at home?

often;  sometimes;  never

14. How do you think teachers should be prepared to present Indian cultural materials?

college course;  lectures by Indian community members and/or cultural experts;  inservice workshop;  books; other (explain) \_\_\_\_\_

15. Does your project, school or district have a community-based Indian parent group or advisory committee?

yes,  no; what? \_\_\_\_\_

16. Have you had a chance to meet teachers or other staff at the school or project?

yes,  no

Have you had the opportunity to work with the school or project on any programs or committees?

yes;  no

17. How would you rate the degree of contact and cooperation between your school or project and the Indian community?

high;  moderate;  sporadic;  nonexistent

What forms, (if any) does this cooperation take? \_\_\_\_\_  
\_\_\_\_\_

18. In your opinion, what is the local non-Indian attitude towards Indian people, and especially towards Indian students?

positive;  neutral;  hostile;  snobbish; other \_\_\_\_\_

19. How do you feel this attitude affects student performance?

helps;  no effect;  causes hostility;  causes poor self-image

20. How much do you think most teachers at the school know about their Indian students?

a lot;  some information;  sketchy;  it varies

21. Would you like to learn more about Career Education for Indian students?

yes;  no;  later

22. Would you be interested in working with a group of other school staff members and Indian community members to develop a Career Education program?

yes;  no;  I'd like more information.

\*\*\*

2j

## CAREER EDUCATION FOR NATIVE AMERICANS--A CHECKLIST

You may know more about Career Education than you think--look at the following statements and check the phrases that correctly complete them. In some cases you may feel all the completions are right, and in some cases you may feel that none of them apply. Put a + in the spaces to indicate agreement, a - to indicate disagreement, and a ✓ mark if you think the phrase is correct sometimes, but not always.

1. A career   a.   is the same thing as a job.  
  b.   influences the way you live.  
  c.   is full-time, paid, employment.  
  d.   is a life-time commitment.
  
2. Career Education   a.   continues throughout life.  
  b.   requires the individual to make an early career choice.  
  c.   should be different for each individual
  
3. Vocational Education   a.   comes before Career Education.  
  b.   teaches specific job skills.  
  c.   is an alternative to Career Education.
  
4. Career Awareness   a.   means understanding how the economic system works.  
  b.   means knowing the names of a lot of careers.  
  c.   should be taught in the primary grades.  
  d.   provides a foundation for more specific career information.
  
5. A Career Education Program   a.   should involve parents and community members  
  b.   is best carried out by a vocational school.  
  c.   is best carried out by a school in collaboration with business/and industry.



6. Career Education activities a. \_\_\_\_\_ should take place in a special class.
- b. \_\_\_\_\_ should continue from the primary grades through higher education.
  - c. \_\_\_\_\_ should be infused into subject classes.
  - d. \_\_\_\_\_ should take place in job settings.
7. Counselors a. \_\_\_\_\_ should be involved in the Career Education program.
- b. \_\_\_\_\_ should direct the Career Education program.
  - c. \_\_\_\_\_ should take over after students have completed Career Education.
8. Career Education curricula a. \_\_\_\_\_ should include role models from both sexes and different ethnic groups.
- b. \_\_\_\_\_ should deal with work values as well as information
  - c. \_\_\_\_\_ should encourage students to look for high prestige jobs.
  - d. \_\_\_\_\_ should be developed by professionals.
9. Most American schools a. \_\_\_\_\_ prepare students for the kinds of jobs now available.
- b. \_\_\_\_\_ focus on preparing students for higher education.
  - c. \_\_\_\_\_ present equal career options for both sexes and all ethnic groups.
  - d. \_\_\_\_\_ tend to imply that academic education is "better" than vocational training.
10. The future job market a. \_\_\_\_\_ will be smaller than it is today.
- b. \_\_\_\_\_ will include many jobs not in existence today.
  - c. \_\_\_\_\_ will probably be much like today's.
11. A college education a. \_\_\_\_\_ is required for an increasing number of jobs.
- b. \_\_\_\_\_ is necessary for a high-paying job.
  - c. \_\_\_\_\_ is required for certain professions.
  - d. \_\_\_\_\_ is most valuable when acquired early.

12. Most students a. would like help with career planning by the eighth grade.
- b. feel they receive adequate career information and help.
  - c. prefer to delay career choice until they reach maturity.
  - d. have a pretty accurate idea of the kinds of jobs available.
13. Career Education activities a. require a lot of extra time.
- b. require the purchase of expensive new materials.
  - c. distract from other subjects.
  - d. require the cooperation of the whole school staff.
14. The best way to get Career Education to students is a. to require everyone to take a Career Education class in high school.
- b. to offer Career Education as an elective during the secondary years.
  - c. to offer Career Education activities at various points from Kindergarten through college.
  - d. to develop a Career Education program tailored to local needs and resources.
15. In traditional Indian societies, Career Education a. was not available.
- b. was provided by parents and others as the child grew.
  - c. was unnecessary, since there were no careers.
16. Career Education should a. make students into productive and motivated workers.
- b. teach students acceptable work habits and job behavior.
  - c. help students understand how businesses are managed and what alternatives are possible.
17. Indian students want to know a. how to get off the reservation.
- b. how to make money while staying home.
  - c. how to make a living without losing their culture.

18. Career Education for their children can help Indian communities a. \_\_\_\_\_ develop their own economic base.

b. \_\_\_\_\_ improve their standard of living.

c. \_\_\_\_\_ fill jobs that serve Indians with Indian workers.

d. \_\_\_\_\_ increase political and economic self-determination.

19. Career Education resources

a. \_\_\_\_\_ come from the community.

b. \_\_\_\_\_ come from the school.

c. \_\_\_\_\_ come from the teacher's experience.

20. My knowledge of Career Education is a. \_\_\_\_\_ extensive.

b. \_\_\_\_\_ not as much as I need.

c. \_\_\_\_\_ greater than I thought.

2;

# Introduction

The purpose of the first session of the Workshop will be to introduce you to the other participants (if you don't already know them) and to career education as a subject area. At the end of the session, you should:

- understand the goals and structure of this workshop;
- know the other participants;
- be familiar with career education content and goals;
- be starting to think about how career education activities could be done in your school or project; and
- be able to list career education resources available to you now and suggest how to get them.

Workshop activities will include lecture and discussion, self-evaluation, and working with a group of other participants to share information.

Note: This sheet is reproduced from the Participants' Handbook. Relevant participant's materials will appear in this Manual as they are used in the sessions, and may be identified by the different typeface.

# Guidelines

## Activity 1. --GETTING OFF THE GROUND

The purpose of this 'activity' will be to allow participants to settle into the workshop setting and to take care of any administrative or logistical problems that have not yet been dealt with.

Arrange the sign-in sheet, name tags, and stack of questionnaires at some convenient place in the room, preferably near the entrance. It is helpful to have someone sitting by them to explain to newcomers what to do, or a sign with directions can be placed there. The welcomer, or the sign, should tell participants to do the following:

1. Sign your name and address and whether you want to take the workshop for college credit (if that is an option).
2. Fill out and pin on a name tag (unless participants and coordinator already know each other well enough to make this unnecessary).
3. Take a copy of the Questionnaire and fill it out.

If the Coordinator already knows the participants, the questionnaire may be omitted; however, answering the questions will start participants thinking along certain lines, and may elicit information the Coordinator would not otherwise have known. Give the "Community Questionnaires" to those Native Americans in the group who are attending as representatives of the Indian Community. Native Americans on the educational staff should fill out the "Staff Questionnaire".

Allow time for participants to arrive, find places, and complete the questionnaire. Suggest that if they have finished the questionnaire, they can read the introduction to Session I in their Handbooks. When most of them have finished, begin to welcome them and announce where and when the four workshop sessions will take place.

## Activity 2. -- WORKSHOP GOALS AND ACTIVITIES

When all questionnaires have been collected, show Transparency #1 (p.1.15) on the screen. Slowly read the goals. In this first session, participants will be addressing the first two goals listed:

- to define career education and tell why it is especially important for Native American students; and
- to be familiar with some career education resources in their area.

Explain that in this session and in the rest of the workshop the group will be involved in a variety of kinds of activities, both individual and small group, featuring the viewing of transparencies, using worksheets to organize knowledge, and engaging in discussions. The role of the Coordinator will be to act as a facilitator rather than as an instructor.

Your task as Coordinator will be to help participants identify and organize the knowledge they already have, and work together to develop new skills. The Coordinator (especially if he or she has been imported from outside) cannot

## WORKSHOP GOALS

AT THE END OF THIS WORKSHOP YOU WILL:

- BE ABLE TO DEFINE CAREER EDUCATION AND TELL WHY IT IS ESPECIALLY IMPORTANT FOR NATIVE AMERICAN STUDENTS;
- BE FAMILIAR WITH SOME CAREER EDUCATION NEEDS AND RESOURCES IN YOUR AREA;
- UNDERSTAND SOME WAYS IN WHICH INDIAN COMMUNITY MEMBERS CAN WORK WITH SCHOOL STAFF ON A CAREER EDUCATION PROGRAM;
- BE FAMILIAR WITH SOME CULTURE-BASED METHODS FOR TEACHING CAREER EDUCATION;
- BE ABLE TO ADAPT CAREER EDUCATION CURRICULA FOR USE WITH LOCAL STUDENTS;
- KNOW WHAT A COMPREHENSIVE CAREER EDUCATION PROGRAM FOR YOUR DISTRICT WOULD BE LIKE;
- HAVE BEGUN PLANNING A CAREER EDUCATION PROGRAM;
- KNOW WHERE TO LOOK FOR FUNDING AND SUPPORT FOR CAREER EDUCATION.

1.15

presume to tell local people how to handle local problems, but the workshop (and your own experience) will help participants develop solutions to their problems themselves.

By doing this, you, the Coordinator, will also be serving as a role model for teachers who will be using the instructional units, since many of the activities in the units are intended for student workgroups assisted by a teacher-facilitator.

### Activity 3. --GETTING TO KNOW YOU

If you are not known to the participant group already, here is where you should tell them something about yourself, covering the same kinds of information you are asking for in the Questionnaire, such as where you are from, your educational history, and relevant experience in developing and implementing career education and/or education for Native Americans.

When participants know each other well, or time is short, you can simply ask them to go around the circle, saying their own names and functions (7th grade English teacher, parent committee representative, etc.).

If you have more time, the activity presented on the back of this page can help people learn more about each other and serve as a useful lead-in to the career education content.

### Activity 4. --THE CAREER EDUCATION CHECKLIST

This is perhaps the most important activity in this session. Its purpose is to introduce some basic information about career education, and at the same time to make participants aware of their own knowledge and attitudes. It has an additional use as a pre-test, if you will be formally evaluating the workshop.

Pass out copies of the checklist and ask participants to respond to each phase with a minus, a plus, or a checkmark. The minus will mean that they definitely disagree with the statement, a plus that they definitely agree or think it is true. A checkmark will indicate that the statement may be true sometimes but not others, is only partly true, etc. Participants should not worry over their responses, but should rather go down the list fairly swiftly, leaving spaces blank if they really cannot make up their minds.

Point out that there are no absolutely 'right' or 'wrong' answers. Each one of these completions has been considered true by someone, somewhere. The definition of career education in any given location will have to result from a consensus of local opinion.

When participants have finished filling out their checklists, work through the questions using the discussion guidelines beginning on the next page.\* You can simply run down the list, asking for hands to indicate how many put a check, plus, or minus in a given blank, ask for people to volunteer their answers, or follow group discussions of possible answers with the comments from the guidelines, depending on how secure you, and the group, feel. Have the next 3 transparencies ready and show them as indicated in the discussion guidelines.

If you will be collecting the checklists for evaluation purposes, instruct participants not to change their answers even if they now feel they were wrong, and to sign their checklists. If they like, they can add their corrected answers with circles around them and you can return the checklists after you have tallied them.

\*discussion suggestions are boxed.

## Interview Game

Divide participants into pairs. If there are an uneven number, you can have several pairs and one trio. Ask the members of each pair to interview each other about their job history.

Possible questions include:

- . what are some of the different jobs you have held?
- . what do you like about your present job?
- . what don't you like about your present job?
- . would you recommend your job to a student for consideration as a career choice?

Give the pairs about ten minutes to interview each other, then reassemble them into the large group (if your group includes more than eight people, divide the larger group into several small groups for this purpose).

Ask each participant to introduce his or her partner to the rest and summarize the results of the interview.



## CAREER EDUCATION FOR NATIVE AMERICANS--A CHECKLIST

You may know more about Career Education than you think--look at the following statements and check the phrases that correctly complete them. In some cases you may feel all the completions are right, and in some cases you may feel that none of them apply. Put a + in the spaces to indicate agreement, a - to indicate disagreement, and a ✓ mark if you think the phrase is correct sometimes, but not always.

Example: This workshop   +   will teach participants about career education.

1. A career   a.-   is the same thing as a job.
  - b.+   makes a difference to the way you live.
  - c.✓   is full-time, paid employment.
  - d.✓   is a life-time choice.

A "career" as defined by Ken Hoyt (Director of the Office of Career Education), is a broad concept (which includes volunteer employment as well as full-time jobs.) It is integrated with a person's life style, and may involve many "jobs" over the years. The Career Education Goals in this transparency were also written by Dr. Hoyt. (Put on Transparency #2 -- next page).

2. Career Education   a. +   continues throughout life.
  - b. -   requires the person to make an early career choice.
  - c. +   should be different for each person.

The individual does not necessarily have to make an early choice of a specific occupation. Certainly the career education of each individual will be as different as his/her life experiences.

3. Vocational Education   a. -   comes before Career Education.
  - b. +   can be a part of Career Education.
  - c. +   teaches specific job skills.
  - d. -   is an alternative to Career Education.

The specific job skill training which is the province of Vocational Education should take place within the context of a broader career education program which will prepare students to make best use of what they learn.

## THE TEN LEARNER GOALS OF CAREER EDUCATION

CAREER EDUCATION TRIES TO PRODUCE PEOPLE WHO WILL LEAVE SCHOOL (AT ANY AGE OR AT ANY LEVEL) WITH:

1. THE BASIC ACADEMIC SKILLS NEEDED TO ADAPT IN OUR RAPIDLY CHANGING SOCIETY.
2. GOOD WORK HABITS.
3. WORK VALUES THAT MEAN SOMETHING TO THEM AND MAKE THEM WANT TO WORK.
4. CAREER DECISION-MAKING SKILLS, JOB-HUNTING SKILLS, AND JOB-GETTING SKILLS.
5. SKILLS NEEDED FOR SPECIFIC JOBS, ENOUGH ABILITY TO GET ALONG WITH OTHERS TO GET THOSE JOBS AND SUCCEED IN THEM.
6. ENOUGH SELF-UNDERSTANDING AND UNDERSTANDING OF EDUCATIONAL-VOCATIONAL OPPORTUNITIES TO MAKE SOUND CAREER DECISIONS.
7. AWARENESS OF WAYS THEY CAN CONTINUE OR GO BACK FOR MORE EDUCATION.
8. A JOB THEY WANT, FURTHER EDUCATION, OR PLAN FOR SEEKING A JOB.
9. AN ABILITY TO FIND MEANING AND MEANINGFULNESS THROUGH WORK AND TO USE LEISURE PRODUCTIVELY.
10. AWARENESS OF WAYS TO CHANGE CAREER CHOICES AND OF THINGS IN THEMSELVES AND IN SOCIETY THAT AFFECT THEIR CHOICE.

(ADAPTED FROM A PRIMER FOR CAREER EDUCATION BY KENNETH B. HOYT)

4. Career Awareness
- a. + means understanding how the economic system works.
  - b. ✓ means knowing the names of a lot of careers.
  - c. + should be taught in the early grades.
  - d. + provides a base for more specific career information.

Teaching Career Awareness means much more than familiarizing students with job titles. Awareness provides the foundation for career orientation and exploration. It should begin in the primary grades and continue through high school at increasing levels of sophistication.

5. A Career Education Program
- a. + should involve parents and community members.
  - b. ✓ is best carried out by a vocational school.
  - c. ✓ is best carried out by a school working together with business and industry.

No matter who carries on the Career Education program, it should involve the parents whose children it serves and enable students to explore the world of work. Who will do it "best" depends on local needs and resources.

6. Career Education Activities
- a. ✓ should take place in a special class.
  - b. + should continue from the early grades through higher education.
  - c. + should be done within subject classes.
  - d. + should take place in job settings.

The same point should be made when deciding who in a school should take responsibility. Career Education can be successfully presented in all of these settings.

7. Counselors a. + should be involved in the Career Education program.

b. - should direct the Career Education program.

c. - should take over after students have completed Career Education.

It is important to involve everyone with appropriate expertise in planning and implementing the program from start to finish. No one group should control it, or be limited to a minor position.

8. Career  
Education

Materials a. + should include role models from both sexes and different cultural groups.

b. + should deal with work values as well as information.

c. - should encourage students to look for popular jobs.

d. - should be developed by professionals.

If available materials do not provide ethnic role models, additional illustrations will have to be developed. Teachers and community leaders with knowledge of local needs can often do this better than commercial publishers. Speakers should prepare material before visiting classes. If individuals are not aware of their own values, whether personal or cultural, they may be uncomfortable with Career Education materials or in jobs whose values are shaped by the dominant culture, without understanding why. Students should be encouraged to seek jobs that will satisfy them.

9. Most American Schools
- a. - prepare students for the kinds of jobs now available.
  - b. + mostly prepare students for higher education.
  - c.  present equal career choices for both sexes and all cultural groups.
  - d.  suggest that academic education is "better" than vocational training.

Many American school programs still seem to assume that a college degree is the way to get ahead. However, the number of jobs requiring a 4 year degree has declined. Many of the highest paying jobs now require advanced technical training rather than a degree. College can be an enriching experience later in life. By the year 2000, 2/3 of today's children will fill jobs not even in existence now. Schools must become more responsive to economic developments and more flexible and imaginative in their programming. As you develop your career education program, check with the local employment office about the current job picture.

10. The future job market
- a. - will be smaller than it is today.
  - b. + will include many jobs not in existence today.
  - c. - will probably be much like today's.
11. A college education
- a. - is required for an increasing number of jobs.
  - b. + is necessary for a high-paying job.
  - c. + is required for certain professions.
  - d. - is most valuable when acquired early.

12. Most students
- a. + would like to help with career planning by the eighth grade.
  - b. - feel they get enough career information and help.
  - c. - prefer to delay career choice until they grow up.
  - d. - have a pretty good idea of the kinds of jobs available.

In a recent study, 3/4 of 8th graders and 11th graders wanted career planning help. They would like to learn how to achieve economic independence early, but students from economically deprived areas in particular often have little knowledge of choices available.

13. Career Education activities
- a. - require a lot of extra time.
  - b. - distract from other subjects.
  - c. ✓ require the cooperation of the whole school staff.

Ideally, career education will enhance rather than distract from the existing program. Many commercial materials are available, but perhaps the best are developed by teachers and classes from local materials. For maximum effect, the entire school should contribute to and support the program.

14. The best way to get Career Education to students is
- a. ✓ to require everyone to take a Career Education class in high school.
  - b. ✓ to offer Career Education as an elective during the secondary years.
  - c. + to offer Career Education activities at various points from Kindergarten through college.
  - d. + to develop a Career Education program tailored to local needs and resources.

The best way to implement Career Education depends on the needs of the school involved. All of these ways can work, though the 3rd is probably the best choice. Ideally, basic CE concepts will be addressed several times during school years, at increasing levels of sophistication, as students progress through Career Awareness, Orientation, Exploration, and, finally, preparation for jobs. (Put on Transparency 3 - next page)

### THE SPIRAL CONCEPT OF CAREER EDUCATION

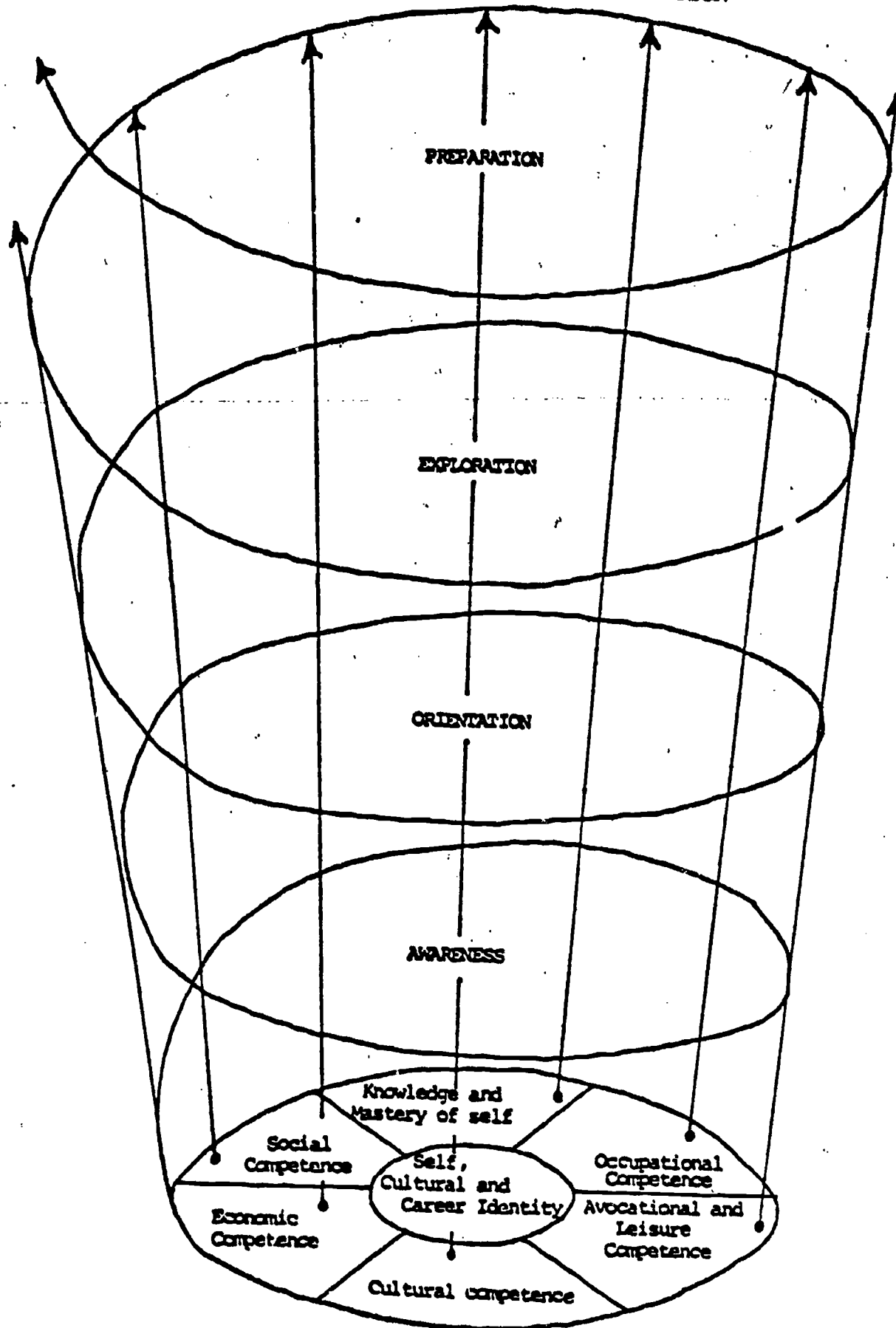

15. In traditional Indian societies, Career Education
- a. - was not available.
  - b. + was provided by parents and others as the child grew.
  - c. - was unnecessary, since there were no careers.

Once, all education was Career Education. Children learned life skills and roles from watching those around them. We will be talking about how this was done in some detail in Session III.

16. Career Education should
- a.  make students into productive and motivated workers.
  - b.  teach students acceptable work habits and job behavior.
  - c.  help students understand how businesses are managed and what alternatives are possible.

Career Education is not intended to turn students into cogs in the industrial machine. They must be able to perform effectively, but they should understand what they are doing and why. If they have the option of starting their own businesses, they may want to run them according to values more in line with their own culture.

17. Indian students want to know
- a.  how to get off the reservation.
  - b.  how to make money while staying home.
  - c. + how to make a living without losing their culture.

Indian students differ in their wants and needs. The Career Education program should provide facts on which to base decisions, not tell them what their decision should be. Sometimes, young Indians drop out or refuse job training opportunities because they are afraid that if they leave home and learn other ways they will not be accepted as Indians when they return. They need to understand the relationship between careers and culture and develop pride in the past and present ability of Indians to meet basic human needs.



18. Career Education for their children can help Indian communities

a. + improve their standard of living.

b. + fill jobs that serve Indians with Indian workers.

c. + increase political and economic self-determination.

All of these, if the program is supported by the community and responsive to its needs. (Put on Transparency # 4 -- next page).

This poem expresses one Native American's attitude towards career development. It is included in all of the NACE units as well as in the Participants' Handbooks.

19. Career Education resources

a. ✓ come from the community.

b. ✓ come from the school.

c. ✓ come from the teacher's experience.

In the next activity, participants will be exploring some of the sources of information you can use in a Career Education program.

20. My knowledge of Career Education is

a. \_\_\_\_\_ not as much as I need.

b. \_\_\_\_\_ greater than I thought.

WE SHALL LEARN ALL THESE DEVICES  
THE WHITE MAN HAS,

WE SHALL HANDLE HIS TOOLS  
FOR OURSELVES.

WE SHALL MASTER HIS MACHINERY,  
HIS INVENTIONS,  
HIS SKILLS,  
HIS MEDICINE,  
HIS PLANNING;

BUT WE'LL RETAIN OUR BEAUTY  
AND STILL BE INDIAN.

"NEW WAY, OLD WAY"  
DAVID MARTIN NEZ

## Activity 5. --COFFEE BREAK

The break will provide participants with an opportunity to relax after working through the checklist, but be careful not to let it stretch out too long. When you let participants go, tell them that they should be back in fifteen minutes, and state what time that will be. Also, tell them that they will be meeting in small groups for the second part of the session, and decide who will be in each group and where it will meet before they break. The break time can then be used for making necessary changes in the physical arrangements of the room.

A group may be subdivided in various ways--by letting people decide who they want to work with; having people who already happen to be sitting together form a workgroup; or dividing them according to the school or area from which they come (if different communities are represented), by grade level, or by some other point of similarity. Each group should have an uneven number of members--five or seven people makes a manageable group--and all groups should be approximately equal in size. If at all possible, each group should include both teachers and other educational staff and Indian community members.

It is probably best if participants do small group activities in the same workgroups throughout the workshop.

A form for noting names of workgroup members is included on the next page.

WORKGROUPS

Group I: location \_\_\_\_\_

1. \_\_\_\_\_
2. \_\_\_\_\_
3. \_\_\_\_\_
4. \_\_\_\_\_
5. \_\_\_\_\_
6. \_\_\_\_\_
7. \_\_\_\_\_
8. \_\_\_\_\_
9. \_\_\_\_\_

Group II: location \_\_\_\_\_

1. \_\_\_\_\_
2. \_\_\_\_\_
3. \_\_\_\_\_
4. \_\_\_\_\_
5. \_\_\_\_\_
6. \_\_\_\_\_
7. \_\_\_\_\_
8. \_\_\_\_\_
9. \_\_\_\_\_

Group III: location \_\_\_\_\_

1. \_\_\_\_\_
2. \_\_\_\_\_
3. \_\_\_\_\_
4. \_\_\_\_\_
5. \_\_\_\_\_
6. \_\_\_\_\_
7. \_\_\_\_\_
8. \_\_\_\_\_
9. \_\_\_\_\_

Group IV: location \_\_\_\_\_

1. \_\_\_\_\_
2. \_\_\_\_\_
3. \_\_\_\_\_
4. \_\_\_\_\_
5. \_\_\_\_\_
6. \_\_\_\_\_
7. \_\_\_\_\_
8. \_\_\_\_\_
9. \_\_\_\_\_

## Activity 6. --CAREER EDUCATION RESOURCE SURVEY

The purpose of this activity is to start participants thinking about program development, and to convince them that they already have some resources that they can use.

When participants have returned from their break and settled into their workgroups, explain that their task will be to discuss the questions or headings on the four worksheets. (in Session I of their handbooks), and fill in answers as far as possible. Worksheet I.1 should be omitted in boarding school settings. Participants should appoint one member of each group to act as recorder and later report their findings to the reunited group.

If you have copies of the local phone book or other information on local economic resources, distribute it to the workgroups for use in filling out the worksheets. Tell the groups that after a half hour, they will be joining together again to report their results. As the groups work, circulate among them and stimulate their thinking with suggestions as needed.

If you must shorten this session, instead of having participants work through the sheets in groups, simply ask them to look over the worksheets individually as they sit together in the larger group, and lead a general discussion of possible responses based on the guidelines which follow. You may also save time by allowing the groups to skip worksheet I.4. Help participants work more quickly by reminding them of the time every seven or eight minutes, perhaps by saying something like --"You should be completing worksheet I.2 and beginning I.3 about now."

When the groups have completed the worksheets or the half hour has passed, bring them together again for discussion. Note--if one group finishes earlier than the rest, refer them to the supplementary readings at the end of the materials for the Session in their Handbook, and at the end of this Manual. This is a useful suggestion at any point in the workshop when an individual or group is done with an activity ahead of time.

Ask the 'recorder' from each group to read off their responses to worksheet I.1, and when all the workgroups are done, ask participants to comment on each other's ideas. Add your own suggestions and ideas from those inserted in italics on the copy of the worksheet that follows. Repeat this process for worksheets I.2, I.3, and I.4. Allow considerable freedom to participants in discussion. Often, one person's comment will suggest a new idea to someone else, but don't let things lag.

If you are dealing with a multi-cultural area, instruct participants to add information on other ethnic communities to the data on Indian groups requested in worksheet I.1.

## WORKSHEET I.1: Jobs for which Career Education is Needed

Where can you find information on jobs that are available now, or that will be available in the future? What tribal jobs are now held by non-Indians? On this sheet, list all possible sources of information about the economic structure and potential of your region in general, and of the Indian or other cultural communities in particular. Where sources are suggested, locate names and addresses of people or organizations to contact for information.

Is there a tribal government in your area? *True mostly of areas near reservations.*

Has the tribe done a needs assessment? *This will give you information on what career areas would be useful.*

Does it have a tribal economic development plan? *If so, the career ed. program should be coordinated with it.*

Who can be contacted for this information? *Try the tribal council or business committee. Some tribes have economic development offices as well. It is very important that the career education program be coordinated with whatever planning is going on at the tribal level. When the career education program development committee is formed, a representative of the tribe should be asked to join it. If no planning is being done, development of the career education program may help inspire some. However, non-Indian career educators can only suggest--leadership in Native American economic development must come from the community.*

Is there a local Indian center? *In a multi-cultural community, are there other ethnic community groups?*

Has the center done a community needs assessment?

Has the center written proposals or reports with information about community needs? *All of the above documents can provide information on community needs which might be met by the development of small businesses, clinics or other projects at the community center, or the training of Indian young people in specific careers.*

Who can be contacted for this information?

*Try the director of the Center or the director of any CETA or other training programs being administered there. Someone from the Center should also become a member of the career education committee.*

Where is the nearest seat of city or regional government?

Is there a regional office of the U.S. Department of Commerce? *Source of information on regional economic structure?*

Can we obtain any state or regional surveys or reports? *Look for projections on economic opportunities, changing population structure, etc.*

Who can be contacted for this information?

*Try the Census Bureau for figures on employment for various ethnic groups, and the Bureau of Labor Statistics of the U.S. Department of Labor for employment projections. Unless you are in a large city, you may have to phone or write to the county seat or state Capitol for this kind of information. A local Chamber of Commerce or the publicity offices of large industries may also be good sources.*

## WORKSHEET 1.2: Career Education Resources in the School

What do you have to work with? List as many resources as you can from each of the following places. Include books, pamphlets, A-V materials, speakers, field trip sites, etc.

*If people from the counselor's office, library, etc. are not at the workshop, the group should decide to consult them for this information.*

### Career Center

*How many teachers or community members have actually visited the career center (if the school has one)? Get the career specialist (if any) to describe what they are doing, and discuss how he or she might work with teachers.*

### Office of Pupil Personnel Services

*Often the counselors are involved with the rest of the program only when its time to advise students on courses. If they are too busy to go to teachers to find out what they are actually teaching that might be relevant to students' career choices, teachers should go to them. They often have quantities of job information that could be displayed in classrooms.*

### Library

*The library is an underrated career education resource. Almost any work of fiction or non-fiction portrays careers in some respect. If librarians encounter books relevant to various subjects with career implications, they should tell teachers.*

### Business or Vocational Education departments

*These classes are the most conscious of preparing students for careers. They might also serve as resources for other classes, however, (e.g., typing and English, shop and physics) in demonstrating the application of some of the principles being learned.*

### District media collection

*Most districts have some kind of resource collection, though it is often not conveniently catalogued, or teachers have long waits for items ordered. The career education committee should try to make a friend of the person in charge of the collection, delegate someone to go down and see what's there, etc.*

**WORKSHEET 1.3: Career Education Resources in the Community**

The community can provide lots of career information if you know where to look. Business, Industry, and public service agencies can all help you. Identify the nearest branches of each of the following and indicate what kind of resources they can provide (speakers, field trip sites, job information, economic analyses, informational brochures, etc.)

Organization

Kind of Information

State Human Resource Development Office

*economic analyses, job opportunities, how to apply for a job*

Address:

Information:

Employment agencies

*job opportunities, how to apply, speakers*

Address:

Information:

Economic development office

*training programs, speakers, brochures*

Address:

Information:

Businessmen's service organizations  
(Lions, Elks, Optomists, etc.)

*economic analyses, brochures, speakers, field trip sites*

Address:

Information:

Chamber of Commerce

*economic analysis, brochures on region, speakers, field trip sites*

Address:

Information:

Labor Unions

*training programs, speakers, field trip sites*

Addresses:

Information:

Public relations departments of local industries or businesses

*brochures, speakers, field trip sites*

Addresses:

Information:



WORKSHEET I.3 (Cont'd)

Organization

Names and addresses:

Career areas:

Tribal government

Address:

Information:

Indian community center

Address:

Information:

Youth Organizations such as:

4-H, FFA, Future Homemakers,

church groups, Scouts

Addresses:

Information

Kind of Information

*speakers, field trip sites*

*economic analyses, speakers,  
information on support for  
training*

*CETA or other job training,  
speakers*

*access to career information,  
access to businesspeople in  
the community. Also, such  
groups may do projects which  
provide work-experience.*

## WORKSHEET #4: Resource Needs

Now that you have surveyed the resources available to you, you can consider what else you may need. Needs might include:

### Need

### Possible Sources?

#### Information

*Teachers may feel that raw information is not very useful if it is not already in the form of teaching materials. Point Out that part of the purpose of this workshop is to teach participants how to take information and turn it into career education activities.*

#### Materials

*Materials on specific career areas may be missing. The librarian or people in various government offices may be able to suggest materials, or look through catalogues from major publishing houses, write the State Office of Career Education, etc. However, teachers should be prepared to work with community and business people to develop materials which will be suited to their students geographically and culturally.*

#### Speakers and field trip sites for certain career areas

*If some important career areas are not already represented in your region, it may be necessary to import people, go on longer field trips, or make do with films or slide-tapes. The State Career Education people would be helpful here as well.*

## Activity 7. CONCLUSION

You should use the last few minutes of the session to review what has gone on and provide a lead-in to Session II. Cover the following points:

- the group has now gone through the introductory activities, and should be more comfortable with each other as individuals, and with the idea of career education;
- career education as an area of study includes not only information about specific jobs and training for them, but the relationship of careers to the culture and economic system within which they exist. Career choice is also affected by lifestyle and personal values;
- career education resources are all around us, although it may require some legwork to identify and obtain them. Later sessions will go into the skills needed to transform these resources into usable career education activities.

Strongly suggest that participants read the Information Summary included in their handbooks at the end of the worksheets for Session I (all the summaries are bound together at the end of this manual). If time allows, they should do this before the next session. In any case, it will be available to them to review or refresh their memories later. This is probably the most important reading for them.

Before ending the session, remind participants at what time and place Session II will begin. If possible, you should look through the participants' questionnaires and checklists before Session II, so that you will have a better idea of their background and interests. If Session II is being presented the next day or later, you may turn to the directions on p. 2.10 and ask participants to choose roles before the next meeting. This will help speed things up for Session II.

# **Session II:**

## **The School and the Community**

# Introduction

## Goals

Session II of the Staff/Community Training Workshop focuses on the interaction of the various groups who must cooperate in order to develop and implement a career education program for Native American students. It has the following objectives:

- participants will be able to list the major groups of people who should be involved in a career education program and describe their roles;
- participants will have had the (simulated) experience of trying to work with others who have differing opinions and goals on a career education committee, and will be able to identify the kinds of interpersonal problems that can occur;
- participants will be able to identify some group interaction skills that can be useful when working on a committee, and will be aware of exercises that can help them to develop these skills;
- participants will be able to describe the relevance of interaction skills to career education.

## Activities

Major activities in this Session and average time allowances for each are as follows:

1. Review of Session I--Coordinator summarizes main points 5 min.
2. Who Does Career Education?--Coordinator uses transparency to introduce and describe the major groups and individuals who should be involved. 10 min.
3. Simulation--A Career Education Program for Happy Valley--Participants read or hear about simulation setting, read role descriptions and choose roles. They then simulate the meeting of a career education committee as instructed, while Coordinator observes. 60 min.
4. Coffee break 15 min.

5. How are things in Happy Valley?--The group reconvenes and participants report on results of simulation. Coordinator reports own observations and helps them identify kinds of problems that occurred. 10 min.
6. Cooperative Group Interaction Skills--Coordinator introduces and describes eight basic interaction skills, then leads participants through as many of the exercises on the skills as time and interest allow. Times for exercises vary and are given individually with the directions. 5 to 30 min.  
each
7. Conclusion--Coordinator reviews material covered in session. 5 min.

### Materials

Coordinator's Manual  
 Transparencies (pp. 2.7, 2.13, 2.34, 2.36, 2.37, 2.46)  
 Overhead projector  
 Extra paper and pencils  
 Name tags  
 Copies of 'secret instructions' for role players  
 Tapes of simulation background materials and cassette recorder  
 Three (or four) puzzle sets and scoresheets for "Cooperation" exercise (optional)

### Preparation

Become familiar with the material for this session ahead of time. Unless your group of participants is entirely composed of fast readers, you may want to tape some of the background materials for the simulation (see directions) and play them, or practice reading them aloud. You should also make a set of copies of the 'secret instructions' for each workgroup and cut them apart ahead of time. If you are not experienced in facilitating simulations, read the discussion on the next 3 pages carefully.

### Role playing

Role playing is well known as a psychological technique. In this workshop it is being used to increase the effectiveness of the simulation rather than for its own sake. Role playing requires people to assume roles other than their own, relinquishing their usual patterns of behavior for the roles and patterns of other people. In its classical form it takes place under conditions that resemble (i.e., simulate) a "real" situation; instead of subjecting a person to an actual "crisis," the social situation and psychological crisis is simulated in a model of a specific problem.

Role playing focuses upon the conflicts, problems, dilemmas, and crises that occur within the framework of the simulation. In other words, role playing follows through on the simulated experience by exploring its many facets of feeling and reacting behavior, of defining alternatives, of

exploring consequences, and finally, choosing a course of action in decision making.

Thus, role playing represents an in-depth exploration of specific problems and conflicts within a simulated experience. It allows for systematic digressions from the simulation: alternatives can be acted out and their consequences compared.

Time constraints will probably limit the extent to which conflicts can be explored and fully resolved. As coordinator, you should be familiar with the guidelines for role playing given below, but once the role playing has started, you should not intrude unless the group has difficulties which threaten to destroy the simulation. Although role playing is widely used as a technique for bringing out personal feelings and resolving interpersonal difficulties, in this workshop role playing is used primarily as a device for exploring content.

If you discover that a particular group is having trouble getting into the role playing, you may want to encourage participants to approach the activity in terms of the attitudes and interpersonal relationships of their roles, but keep in mind that the primary objective of each session is to discuss the informational content.

### Leading group discussions

The extent to which learning takes place in the simulation and role playing enactments depends largely upon your skill in guiding the discussions which follow each session. Discussion guidelines are provided for maximizing instructional 'payoff' to you (as coordinator of the workshop) and to the training group.

A good rule to observe in guiding group discussions of the simulation and role playing sessions is that lengthy discussions follow enactments rather than precede them. Another is that, in the early phases of a session, anything that can be explored through enactments rather than through lengthy discussions should be so managed. Thus, when a participant says, "I don't think the group will give Bob a chance to lead," invite the person to enact what he thinks will happen rather than discuss this opinion.

Experience has shown that the process of role playing evokes real feelings, expresses the interactions and further delineates situations. After such enactments, discussion can be encouraged.

To emphasize, the Coordinator's role is to guide, not to direct, the discussion. To do this you:

1. Listen carefully to what each person is trying to say. When someone hesitates, try to reflect his/her feelings or thoughts. You may say, "You're angry at this group..." and wait to see if this is what the person means. If he/she does not respond to this suggestion, you may say, "Or, are you thinking about something else?" Such statements may help the person to bring to a verbal level feelings or thoughts he/she has been unable to express.

2. Keep your responses in line with what each person is trying to say. Respond with a nod or comment that shows that his/her contribution is genuinely accepted. Do not turn away and call on some other person if a contribution is trivial; try to find meaning in each effort.
3. Select some comments for immediate consideration if they hook onto the action or elaborate on a previous contribution. As the group throws out ideas, help discussion stay in focus. You may say, "Let's help Mary work out her idea. What did she convey to us in her role playing? What do you think about it?" Or, you may suggest, "Bill, tell Leroy your opinion," in order to stimulate the participants to talk to each other.
4. Certain questions help lift the participants out of preoccupation with their own immediate problems to wider considerations. Ask:

"Do you know someone who would have handled this situation differently?"

"Why does \_\_\_\_\_ behave the way he or she does?"

"Why were our ways of solving this situation different from the way the actual evaluation team did it?"

"Why do you suppose problems like this arise?"

Some people respond to such questions and move to analogies, speculation, or some level of generalization. Others remain able only to cope with the specifics of the problem. This tells you that much more experience with confronting problem situations is needed and much more comparison and speculation should be encouraged in other role playing sessions.



# Introduction

The main activity in this session will be a simulation exercise whose purpose is to give you all some 'experience' in serving on a career education committee, and an understanding not only of some of the problems that may come up, but of some ways to solve them.

At the end of the session, you should be able to:

- list the major groups of people who should be involved in a career education program and tell what they would contribute;
- describe some of the problems that may occur when people from different backgrounds try to work together;
- list and define cooperative group interaction skills which people can use to solve problems; and
- describe why group interactions skills are important in career education.

In this session, you will be reading background material, choosing roles, and participating in the simulation; and doing some individual and/or group exercises in various group interaction skills.

# Guidelines

## Activity 1.--REVIEW OF SESSION I

Before launching into the second session, remind participants of the following points:

- Career education, broadly defined, is a life-long process, in which the individual learns things that will enable him or her to make a living, satisfy personal needs, and be a productive member of society.
- Career education should be adapted to the needs and cultural values of the people being educated;
- Career education can be divided into overlapping phases of Awareness, Orientation, Exploration, and Job Preparation;
- Career education can be implemented in a number of ways, depending on the needs and resources of the school or project. One of the most popular ways is infusion, in which career education content of activities are used to enrich or present the content of other subjects; and
- Career education resources are all around us.

## Activity 2.--WHO DOES CAREER EDUCATION?

A career education program doesn't 'just grow'--a number of different people need to work together to provide all the information and resources that will be needed to make it work. Put Transparency #5 (p.2.7) on the screen as you describe the following groups. Be sure and refer to any representatives of the groups who are present in the training group as examples and pay special attention to their potential contribution.

You will probably be presenting the workshop in either a school or project setting. If the former, spend the most time on describing the roles of school personnel and skip lightly over projects. If the latter, reverse the emphasis. Do not omit either entirely as they often end up working together.

The school includes several kinds of people who can be involved:

- a. Administrators are very important because they provide moral and material support for the program, authorize expenditures of time and money, etc. They can also make contacts with the business community, and coordinate career education activities throughout a school or district.

GROUPS INVOLVED IN A CAREER EDUCATION PROGRAM

The Economic Community

- Government ● Business ● Industry ● Labor

The Educational Community

- School or Project Administration
- Career Ed. Specialists
- Teachers, Aides, Tutors
- Counselors
- Other Staff

The Indian Community

- Advisory Committees
- Parents
- Community Leaders



The Student

- b. Career Education Specialists, when available, are extremely valuable, since they have specific training in career education and are mandated to gather resources and conduct activities. However they cannot be everywhere at once, therefore they must work with others.
- c. Teachers and teacher aides, who actually manage learning experiences for students, provide students with information, collect and organize career education resources (sometimes develop them), and evaluate the results.
- d. Counselors should be integral parts of the program. They can provide information and career education materials, make contacts with the business community and training institutions, and advise students on career and educational planning. It is important that teachers keep counselors informed on what they are teaching students about careers, so that they will know how much knowledge they can assume counselees have.
- e. Librarians can identify career education resources already available, and assist students and teachers to identify and obtain others.
- f. Other school staff can serve as career role models, especially in rural areas where field trips are hard to arrange.

A PROJECT, such as Title IV or other project sponsored by an Indian tribe, center, or agency to provide educational services to Indian students, may function much as a school would in developing a career education program. Personnel who might be involved include:

- a. Administrators, such as the Project Director, who provide the same kind of support a principal would in a school. In the smaller project context they may also be working directly with students.
- b. Career Education Specialists, if the project has them, may travel to a number of schools, working with Indian students individually or in small groups at each one. The specialist may also serve as a resource to teachers in the classrooms.
- c. Counselors or Tutors are the project's equivalents of teachers, and work directly with the Indian students individually or in small groups.
- d. Other staff at the project's sponsoring agency (such as people in a tribal government or involved in other projects at an Indian Center) can be extremely useful as career models, contacts with businesses, and general sources of information and materials.

#### INDIAN COMMUNITY MEMBERS

- a. A Parent Advisory Committee (PAC) already established for a school's Title IV or Johnson O'Malley project, or a Tribal Education Committee can delegate a member to represent it on a career education

committee or project and inform the community about what the career education program is doing and vice versa. The PAC is often the group with the most authority to guide Indian Educational Policy.

- b. Parents of students to be served by the career education program should be included if possible, since they are most directly concerned with their children's needs. They can also serve as career role models themselves and contacts with Indian and non-Indian businesses.
- c. Other Indian Community Members can serve as career role models and contacts with businesses, as well as providing information on the community's economic goals. When information on traditional Indian culture would enrich the program, community members should be asked whether discussing such material in the school is all right, and if so, whether they would like to present it themselves or train teachers to do it.

BUSINESS and INDUSTRY is obviously a valuable partner in a career education program if its support can be obtained. A Business representative for a career education committee might come from a chamber of commerce, industry publicity office, trade union, or be a parent of a present or former student at the school. Even if Business has no representative on the committee, it should make contacts with people who will be able to provide information on local economic needs and opportunities, speakers on various careers, and sites for field trips and job experience or training.

STUDENTS themselves should not be forgotten in planning since the goal of the whole operation is to benefit them! A student representative on the committee might be very useful, to tell career education planners not what students 'ought' to like, but what kinds of activities and content will actually interest and involve them.

The difficulty is to get all of these groups together, and to provide a common ground on which they can all work. Successful interaction requires members of the group to be motivated, tolerant of others' differences, and willing to try and communicate with each other. Problems may include: different perceptions of what students need, different approaches to career education or to program development, different values, and different communication styles. Historical factors such as local politics or past conflict may also affect the group's interaction.

### Activity 3.--A CAREER EDUCATION PROGRAM FOR HAPPY VALLEY

#### Background

If school/community cooperation in developing and implementing a career education program is to be more than nominal, both groups must learn to understand each other, and to appreciate the reasons behind their opinions and attitudes. In many places a backlog of hostility or suspicion must first be overcome. The purpose of the simulation is to give participants a chance to 'walk in the other man's moccasins' for a little while, and hopefully to

begin to understand each other. It will also give them some more information about implementing and evaluating a career education program.

In any training group, there may be one or two people who are so uncomfortable with the idea of role playing that they would not benefit themselves or the group by trying to do it. If any of the participants object too strongly to the idea, suggest that they act as recorders for their groups instead of participating in the simulation. In rare cases, a whole group may refuse to play. If this happens, you can simulate the simulation by having them speculate on what is likely to happen if the people whose roles are described try to work together. This, however, is obviously inferior to having participants play the roles themselves.

Participants must absorb a fair amount of background material in order to simulate the characters effectively. If your training group includes individuals with widely varying reading rates, you may find it advisable to read "Career Education for Native Americans in Happy Valley," the "Superintendent's Memo to Committee Members," and the "Evaluation Report" aloud. Even more effective would be to prepare ahead of time a cassette tape of these pieces, using people with appropriate voices. Or if you know some of the participants to be good readers, you may ask them to do this for the group.

Be sure and copy enough sets of the secret instructions for the number of workgroups you have. You should also have blank nametags so that people can put on the names of their characters.

### Facilitating the Simulation

Begin by having participants split up into the same workgroups they formed during the first session, with adjustments for absent or added members. When they are settled, place the transparency with the Information Summary and Map on the projector (transparency #6 p. 2.13) and read, play, or have participants read "Career Education for Native Americans in Happy Valley" in their Handbooks (pp. 2.14 - 2.16 of this manual).

When they have finished, ask them to read carefully through the Role Descriptions on pp. 2.17 - 2.21 of their Handbooks, and select roles. The starred roles must be taken. The others are optional. Roles marked "Indian" or "non-Indian" must be played that way, but can be taken by anyone. Encourage participants to take roles that are different from their own characters. When they have chosen roles, they should write their new names on name tags and put them on.

Now that they know who they are, read, play, or have them read the "Superintendent's Memo on Committee Members," and the "Evaluation Report." (pp. 2.23-2.27) Meanwhile, you or an assistant should pass out the Secret Instructions for each character to the persons wearing those characters names. Make sure participants realize that the other players are not to see these instructions.

Read or have them read the "Role Playing Instructions" in their Handbooks (p. 2.22 of this Manual), and ask the person in each group who is playing the role of Paul or Pauline Partridge, the chairperson, to read the opening remarks

on p. 2.28 of the Handbook to the others in his/her group and begin the simulation, reminding them that they will have 30 minutes for their meeting.

During the simulation, you should circulate among the groups. If interaction bogs down, or conflicts develop, use some of the techniques described in the introduction to this session to ease things along. Participants are more likely to throw themselves into their roles, however, with such dramatic results that your main problem will be to keep a straight face as you listen. If the equipment is available and participants are not too self-conscious, taping or video-taping the simulations could provide a valuable record of what went on. Do remind the groups to appoint a member as recorder so that they will be able to present their conclusions to the others at the end of the simulation.

As the end of the half-hour approaches, move from group to group, announcing yourself as a messenger from the Superintendent. Inform them that the Superintendent has just been summoned to a meeting with community groups, and that he must have the committee's specific suggestions on what to do about the career education program immediately. This is not only good for a laugh, but it will help the group focus its discussion during the last minutes of the simulation.

When the allotted time is over, inform participants, announce the coffee break, and ask them to be ready to discuss the simulation afterwards. If they can act as a large group while still sitting in their workgroup areas, it will save logistical trouble in later activities.

#### Activity 4.--BREAK

This will give participants an opportunity to 'unwind' before trying to look objectively at the results of the simulation. Pages 2.29 - 2.31 are the 'secret instructions' which you are to copy for participants, followed by the simulation materials from the Participants Handbook. Coordinator's directions resume on p. 2.32.

64

**SIMULATION EXERCISE:  
A CAREER EDUCATION PROGRAM FOR HAPPY VALLEY**

**Introduction**

In this simulation exercise you will have a chance to explore attitudes and problems of people involved in planning and implementing career education, etc., resulting in a better understanding and knowledge of career education and of your own feelings.

**Activities**

- Read or Listen to "Career Education for Native Americans in Happy Valley".....2.3\*
- Look at the Information Summary and Map.....2.6
- Read Role Descriptions and Choose Roles.....2.7-11
- Read or Hear the Superintendent's Memo to Committee Members, and the Evaluation Report.....2.13-17
- Read the Role Playing Instructions (Coordinator will hand them out).....
- Hear: Ms./Mr. Partridge's Opening Remarks.....2.18
- Simulate The First Meeting of the Evaluation Committee.....
- Decide What the Committee Should Advise the Superintendent to do!

\*page numbers refer to Participant's Handbook



INFORMATION SUMMARY

1. Location: Rural area with 3 small towns, one industry, and one large city 115 miles away.
2. Economics: Mainly timber, some agriculture, cattle raising, industry, small businesses, recreation, tract housing development increasing.
3. Population: Timbermen, farmers, businessmen; middle class commuters; "summer people"; resident Native Americans, Latinos, minority workers, migrant workers.
4. Student Population in District: 5% blacks, 15% Latinos, 35% Native Americans, and 45% others.
5. Schools: 2 high schools (one in Tyler Heights and one in Alto Groves) grades 9-12 population 800, 1 combined school population 250 (high school and elementary school) and 3 elementary schools population 1,200.
6. School Board: 5 members, one Indian American professional, new resident and 4 long time resident, one of whom is a former teacher interested in helping Indian children prepare to meet college entrance requirements.

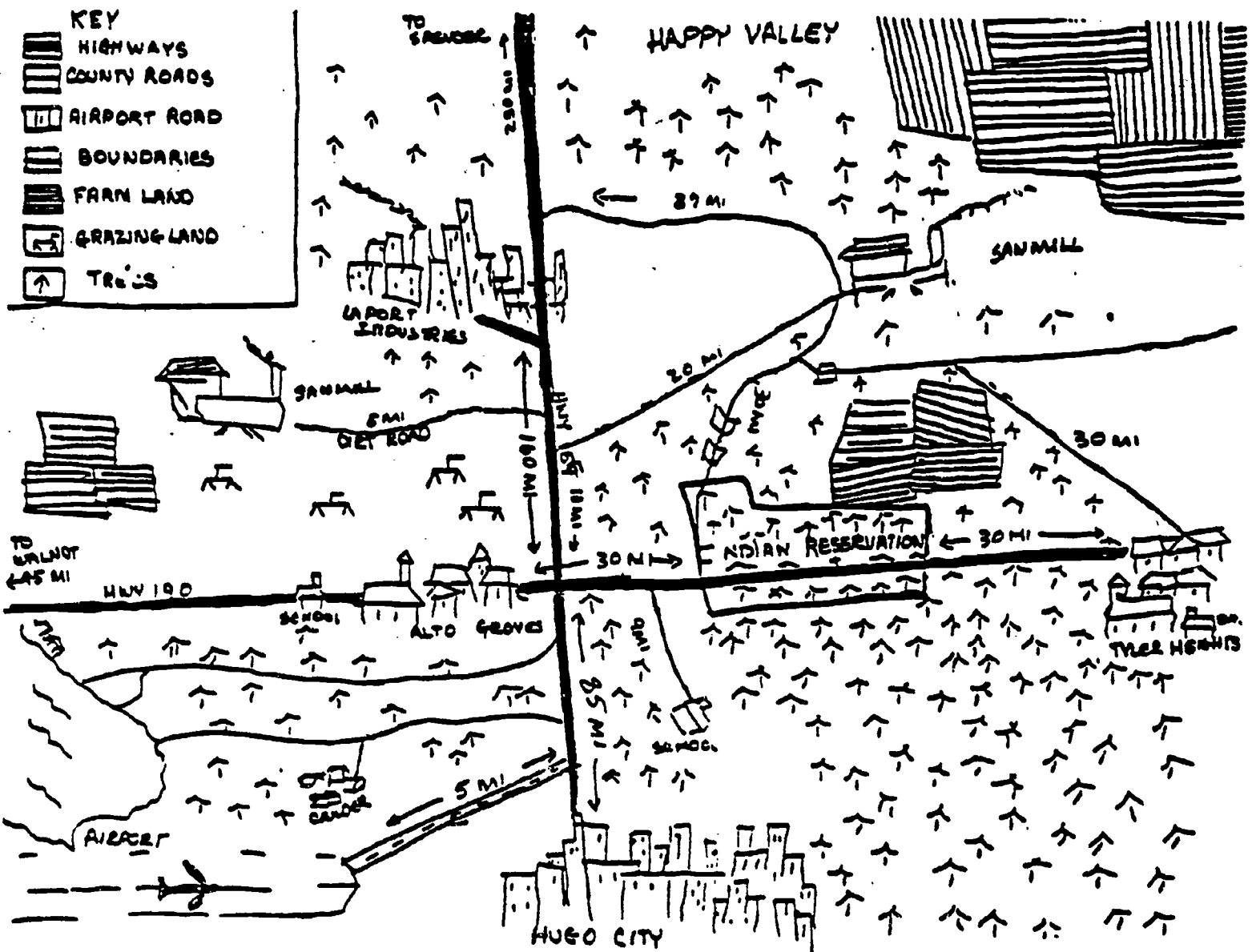

Reading: CAREER EDUCATION FOR NATIVE AMERICANS IN  
HAPPY VALLEY, A SHORT HISTORY

Happy Valley is a large valley which includes an Indian reservation. However, some of the Indians live in the nearby communities of Alto Groves and Tyler Heights. Indian students make up a third of the district's school population.

Many people in these communities show hostility or lack of respect for Indian people there. The problems of Indian students include alcoholism, truancy, and a high drop out rate. Failure begins in kindergarten. Indian people both on and off the reservation have a poor self-image as well as low income and unemployment.

The Indian people feel that their culture is just as valuable as that of the non-Indians, but it is not equally valued in the schools. If students are forced to choose between being 'successful' and being Indian, they are bound to suffer. The result is a very difficult relationship between the Indian community and the school.

The Indian community feels that the Career Education program is not reaching their children and that the community should be involved in planning it. They see the administrators as the prime source of their problem--the administrators want to help, but are blind to the real problem. The community feels that the schools are trying to make the Indians invisible. The parents and community members would like to have better communication with the schools in order to improve the situation.

The administrators, on the other hand, feel that the problem lies with the Indian people. They complain about the high drop out rate and blame the parents for not participating in the larger community. They are not aware of

any racial barriers or acts of prejudice towards the Indian students, and say that a high drop out rate among the poorer students is characteristic of most school districts--nothing they can do will solve the problem.

When the Indian parents suggested having a Career Education program specifically for Indians, the administrators replied that this was a minor problem, and that the existing Career Education program was good enough. They considered special programs that do not benefit all the students as a waste of money, and said they did not have time to revise the budget anyway. They felt that if the parents wanted an Indian career education class for their children then the Indian community should provide one. Finally, they said that counselors are available to help individual Indian students with their problems. The administration has to do what is best for the school as a whole.

Contributing to the complexity of the situation are the teachers, whose views are as varied as the population of the community. Some teachers feel that the Indian children are the most neglected of all the students, and that special efforts should be made to lower their drop out rate and help them retain their Indian identity. Others feel that the administrators are right, that all students should work together and no one should get special treatment since any change in the curriculum and school would bring about trouble with the students. They believe that the Indian students should learn about their culture at home. The purpose of education for all students is to turn them into good Americans.

The current career education program requires elementary school teachers to present units on careers in the 2nd, 4th, and 6th grades. In the secondary schools, the business teachers include information on job hunting in their classes, and some subject teachers refer to relevant careers in theirs. Once

a year the district hosts a Career Fair, and juniors and seniors can participate in a work-study program. Career education activities are developed by teachers or use commercially available materials, except for the Career Fair, which is put on by the Tyler Heights Chamber of Commerce.

60

## ROLE DESCRIPTIONS

Read through the following character descriptions and choose one. Each of the starred roles must be taken by someone in your group. Sexes of characters may be changed if needed. Roles marked (Indian)--must be played as Indian. Roles marked (non-Indian) are to be played as non-Indian. Roles marked (Indian or non-Indian) can be played as either. Any role can be played by a participant of any ethnic background. Write "your" name on the back of your name tag and reserve it. You are encouraged to take roles unlike your own character. Your coordinator will advise you on how to form simulation groups.

### Roles

- \* Paul or Pauline Partridge, 9th grade Business and English teacher, chairperson
- \* Laura or Larry Eaglenose, Johnson O'Malley parent committee president
- \* Donald or Donna Rand, 10th grade history teacher
- \* Jane or Jim Pierson, counselor
- \* Arnie or Anne Ingalls, biology teacher
- \* Ramona or Richard Springbird, president, Indian Student Association
- \* Bob or Barbara Fernandez, Indian PTA member and business person
- \* Floyd or Flo Wing, Vocational Education specialist
- \* Abbey Holloway, 6th grade teacher

\* PAUL OR PAULINE PARTRIDGE

You have been designated as chairperson by Superintendent Haynes. You are a 9th grade English and Business teacher. You have been teaching for 10 years at Happy Valley High School. You are married to a leader in the local business community, and you are active in the Tyler Heights community improvement program and civic groups. You were chosen as chairperson because of your experience working with committees. You feel a need for a change in the Career Education curriculum and feel that many improvements are needed. You feel they should be adapted to fit individual needs. You think your students are much too sophisticated for the present materials. You feel the cost of changing the program would be a problem and that responsibility for a program for Indian students should be shared with the Title IV Program. You realize that as chairperson, you will have to reconcile opposing points of view.

(Indian or non-Indian)

\* LAURA OR LARRY EAGLENOSE

You are President of the JOM Parent Committee and have been selected by the Indian Community to sit on the Evaluation Committee. You have lived in the community of Alto Groves all your life. Your children go to its schools and you are a volunteer at the Happy Valley Indian Educational Center.

You feel that the Evaluation Committee is not likely to fulfill its goal of helping the Career Education program meet Indian needs. You feel that culture is important, you express these ideas to the other committee members, but you suspect that the committee is going to be one of those promises that were never kept. You feel that the curriculum in the schools is not relevant to Indian culture. You state that because of lack of Indian culture in the school curriculum, many Indian children will do poorly in school and furthermore, even attending school will handicap the Indian child.

You want to change Career Education program to include cultural materials for Indians, you push for this change to benefit the Indian children. You would like to see a total change in program. You are very negative toward curriculum improvement if it does not include cultural materials. You will not budge from this idea.

(Indian)

\* DONNA OR DONALD RAND

You were chosen for this committee by the chairperson of the Evaluation Committee, who feels you can be helpful in the decision making because of your knowledge of Indian History and cultural materials. At present you are teaching 10th grade history at Happy Valley High. You are active at the Tyler Heights Historical Society. You are a foster parent of an Indian child.

You feel that the school has a lot to offer the Indian child and vice versa. You would like to see more cultural materials in the schools for the Indian students and you feel that what little materials the school does have should be examined more closely for bias. You know that many Indian resource materials can be obtained free or at a minimal cost.

You don't know much about Career Education, and have not been involved in the program itself, but you know that the Indian community thinks it's important. You would like to learn more about how Career Education can be targeted to meet Indian needs.

(Indian or non-Indian)

\* JIM OR JANE PIERSON

You were chosen by the chairperson because you are a counselor at Blue Springs Combined School. She feels you can tell the committee what career objectives most students have in mind. You have a lot of experience dealing with youth. You are an advisor on the Commission of Youth Programs and active with youth groups in Tyler Heights. You have been working at the school for 5 years. You feel that the Indian students aren't any different than other students. You feel that if you give them special treatment other students will want the same. You want to have a strong influence on the committee because you feel you know what the school needs. You do not think Career Education should be presented from a cultural point of view.

(non-Indian)

\* ANNE OR ARNIE INGALLS

You have volunteered to be on this committee because you feel that biological and earth sciences should be emphasized in the Career Education Project. You have been teaching Biology and Earth Science for many years. You spend your free time working with Indian children in a science awareness project in the Happy Valley Community Service Center and are active with various youth groups.

You feel a need for cultural awareness in the Career Education curriculum, but you have mixed feelings about its appropriateness in the science class. You feel it should be tested within your own class, you would like it also to be tested at the Science Awareness Project. You realize its potential as a tool and you would like to give it a chance. You are enthusiastic and are interested.

(Indian or non-Indian)

\* RICHARD OR RAMONA SPRINGBIRD

You are President of the Native American Indian Student Association at Alto Grove High School. You have volunteered to be on this evaluation committee. You will be graduating next year, and plan to go to Law School eventually.

You want to help improve the Career Education program for your fellow students. You feel that Career Education is especially important to Indian students because so many are poor. You will point out that many of the students do not make an effort to do well in school or to stay in school, because they don't see how school will help them get a job, or they don't want to be part of the White man's system. You feel that the school does not try to reach these Indian students with special needs. You feel that this is the teacher's fault as well as the student's. You think the program should be changed, but you want the school and the community to get together to decide what should be done.

(Indian)

70



\* BOB OR BARBARA FERNANDEZ

You are a parent representative, selected by the PTA. You have not been active in Indian community activities for a number of years. You run an Indian craft store. You were selected by the PTA because you are an Indian and because the evaluation committee chairperson specified that such a person should be included. You feel uneasy about being asked to represent the community. You want to help in any way you can. You feel that all points being made are good, but you cannot decide on which of the suggestions are the best.

(Indian)

\* FLOYD OR FLORENCE WING

You were selected by the chairperson because you are a specialist in Vocational Education. You have been with the school for three years and teach a job orientation course for the local community college. You feel that career education should be taught as an individual course and not integrated into the curriculum. You feel that in a school context, the Career Education program would lose value for the students that it is supposed to help. You would like to see more on-the-job training. You feel that Indian children should have to compete on equal terms with the others as your ancestors did. Only those who have proved themselves serious should receive extra help. You have always had trouble working with parents.

(non-Indian)

\* ABBEY HOLLOWAY

You have volunteered to be on the committee. You teach sixth grade at Kenney Elementary School. You feel that the school is doing a good job and that the parents do not know what really goes on in the school. You feel that the parents should not try to make school policy because of their lack of experience. You would like to tell those parents how hard you work to educate their children.

(non-Indian)

## THE SIMULATION

When you have chosen your roles, the Coordinator will hand each of you specific instructions for this meeting which the other participants should not see. Read the Superintendent's memo on the next page and the other background materials to the committee, then listen while the chairperson reads his/her opening remarks.

Remember, the role descriptions and private instructions are just starters — use them to build your own interpretation of the character. Bring in your own ideas about career and Indian education. Don't be shy — everyone else is in the same boat!

TO : Evaluation Committee

---

FROM : John Haynes, Superintendent, Happy Valley School District

---

SUBJECT: Evaluation of the Career Education Programs, its effect on Indian students

Thank you for agreeing to serve as the NACE evaluation committee. As you know our present Career Education program was implemented last year. Its purpose is to attempt to prepare students to function in the contemporary work world and adapt to the future. It will assist them in developing goals so they can eventually make sound career choices which are not only relevant to their own interests but which will qualify them for existing jobs. By providing students with information and decision-making skills, career education encourages the development of realistic career goals and career plans.

Each student is unique, therefore the program should be different for each individual student. The program should be designed with enough flexibility and include enough options so that it can be tailored to fit the particular needs and abilities of every learner.

As stated in the implementation plan, career education differs in a number of ways from vocational education. Rather than providing training for a specific vocation, it emphasizes a broad orientation to the world of work by fostering an understanding of the socio-economic structure of our society. But, more important, it helps the individual student to know himself or herself, and to view the future and his or her options in light of this self knowledge. In this context, it also stresses clarification of personal values regarding preferred life styles.

Career education also differs from vocational education in that it is useful for all students, not just those who are headed for trade school. Finally, ideally it should be coordinated with and integrated into the rest

of the school's curriculum,

During the past year we have received complaints that the program is not meeting the needs of our Indian students. Our main goal is to present career education in the best way possible, and it should address the problem of dealing with Indian children and their particular needs as well as those of other student groups. To do this, one of the things we need to consider is the relationship between culture and career success. We therefore feel that the program should be evaluated from the Indian point of view. In order to do this we are forming an evaluation committee which will consist of community members, parents, and teachers of the Indian students. This will help us to evaluate the program's effectiveness and to involve the community in which the student lives.

Career opportunities for Indians have been limited in the past. However economic development is a pre-requisite for self determination on either a personal or tribal level. Indians are beginning to realize they must assess their own needs and choose careers rather than have them chosen for them. This is true for both reservation and urban Indians. To do this, they must have a positive self-image. They must believe in the validity of their own culture, and in the possibility of functioning successfully in the dominant society without losing their own cultural identity.

The goals which have been suggested for Indian students in the program are to provide: 1) Knowledge of careers, the socio-economic system, and their relationship to Native American culture; 2) Skills in working with others, planning, decision-making, and information gathering; 3) Attitudes which are positive with regards to the student's self-image as a person and as an Indian, and positive feelings about his or her ability to deal with life.

I would like your opinions on whether the present career education program is achieving these goals, and if it is not, what we can do to improve it.

## EVALUATION SUMMARY

### Effects of the Career Education Program on Native American students

#### Background

Two years ago, a Career Education program for all students was implemented in the Happy Valley schools. Since then questions have been raised about the appropriateness of the program for students with minority backgrounds--specifically, for Native American students attending Happy Valley schools.

At a recent Indian community meeting, Indian parents expressed mixed feelings about the Career Education curriculum. They were very concerned about their children's futures, but they didn't like the idea that they would have to leave the community and reservation to get occupational training. Mainly, they want a quality education for their children. They would like to see them learn as much as possible, but also retain their culture.

They suggested several alternatives for improving the program's ability to meet the needs of Native American students. One would be to hire an educated Native American to relate Native American culture to careers in a special class for Indians. Another would be to train someone already in the school to teach cultural materials, assisted by a teacher aide from the community. Whatever is done, they feel that the community should be consulted about student needs and goals, and have an opportunity to express an opinion on whatever changes the school decides to make. They indicated that they would like to work with the school district in evaluating the Career Education curriculum.

## The Career Education Questionnaire

The questionnaire which has been used in all the schools was revised to include questions identified as specifically relevant to Native American students and administered to all Native American twelfth graders in Alto Groves and Happy Valley Schools at the beginning and ending of the last school year.

Students showed a marked improvement in answering questions related to Career Education content, especially with regard to different careers available to them. They also seemed to have improved in terms of self-concept, and attitude towards school.

## Teacher Observations

Teachers with classes including 15% or more of Native American students were interviewed about the reactions of those students to the Career Education curriculum. They reported that some students were beginning to take the initiative in looking for information about careers and demonstrated an understanding of the kinds of jobs available in the areas.

Including Career Education activities in subject classes seems to have made the subjects more interesting to the Indian students, as well as to the others in the classes. However some of the Indian students, still express negative feelings about their own ability to train for or get good jobs. In essays written on career goals, several have written that they don't want to take jobs that would require them to move to big cities, or where they would have to obey all kinds of strict office rules. They worry about getting so well-trained to do jobs in a non-Indian world that they will forget how to be Indian.

Even those who are hopeful about the future, don't really know what to do next to prepare for it. Teachers have suggested that better counseling

might help, or having counselors sit in on some of the Career Education discussions. They would also like to get better outside speakers--many don't know how to explain their jobs in terms students will understand, or are too self-conscious to speak well.

## CHAIRPERSON'S OPENING REMARKS

At the request of Superintendent Haynes, I will be happy to act as chairperson of the committee meetings. I was chosen specifically because I have worked on committees before. I feel that with this evaluation committee we will be able to make the Career Education program function more smoothly than in the past and better meet the needs of our Indian students.

Often people think of evaluation as nothing more than measuring how effectively the program is meeting its goals and objectives. Actually there are many considerations besides effectiveness. Perhaps the goals themselves should be changed.

Since this evaluation is to be used in revising and improving the Career Education program, you people are in the best possible position to decide what information should be collected. Generally the staff involved in implementing an instructional program will be cooperative if the people doing the evaluation are close to the program and sympathize with the people involved.

In order to decide whether to keep the program the way it is, start over from scratch, or change it in some way, we need to list the information we will need. Program development and improvement requires the cooperation of people in many different positions in the school and community. It looks to me as if we have a good representative group at this meeting. The Superintendent wants information. I think we need to decide:

- 1) Is the career education program satisfactory?
- 2) How can we tell?
- 3) What information do we need?
- 4) What choices do we have if changes are necessary--what would time, money, resources allow us to do?



SECRET INSTRUCTIONS

Coordinator - Cut these slips apart and give to appropriate participants.

PAUL OR PAULINE PARTRIDGE

You are chairperson of the evaluation committee. You will interject your own feelings about the needs of the Indian people and the problems that you face personally. Use your own experiences in dealing with Indian students to make your decisions. You think the committee should find out what evaluation data is available and how dependable it is before proceeding further.

LAURA OR LARRY EAGLENOSE

You are the community representative. You feel that the community should have been asked who should be on the committee, but will try and do your best. You wonder if a totally separate program for Indian students might be a good idea. One of your children had a lot of trouble at school last year. Do not be afraid to express your personal feelings about the school and community relations. You think the committee should consult the community about what students need.

DONNA OR DONALD RAND

Express your own feelings about the situation at your school with regards to Indian Education. If you have any negative feelings express them and vice versa. You are aware that there is a communication gap between the school and the community and you feel that your input could be vital to improving it. You think the committee should find out how Indian culture is related to careers.

BOB OR BARBARA FERNANDEZ

You are also an Indian parent, but you are hesitant to express strong opinions because you weren't chosen by the community. Base your comments on needs assessments you have seen, or your own personal experiences as a parent. You feel the committee should find out more about job opportunities in the area. Your family doesn't get along with the Eaglenose family, but you try not to let that affect your reactions.

FLOYD OR FLORENCE WING

If you have experience in Vocational Education for Indians, use your experience as a basis for comment. If you feel that there is no problem, say so. You feel the committee should get proof that Indian students need special help before changing anything.

ABBEY HOLLOWAY

You feel that the other committee members don't really care about the problems of teaching Career Education at the Elementary level and tell them so. You want to make sure that all parts of the program are coordinated. You once got reprimanded by your principal because a (non-Indian) parent made an unjustified complaint about you, so you tend to be hostile to parent representatives.

JIM OR JANE PIERSON

If you have no counseling experience, use your other experience with students as a guide. You will be representing the school's point of view. You don't feel that the chairperson is exercising enough control. You feel the committee should find out how having a Career Education program for Indians would affect non-Indian students at the school.

ANNE OR ARNIE INGALLS

Express your feelings about the Career Education program. You tend to be very sympathetic with the concerns of the Indian community, and will probably agree with Eaglenose. Like Rand, you want to learn more about the relevance of Career Education to your subject.

RAMONA OR RICHARD SPRINGBIRD

To play this role, act like a student you know or the way you yourself would have acted when you were in school. This character tends to be somewhat radical politically, but is aware that being on this committee is a special privilege. Suggest that students be consulted about their needs.

## Activity 5.--HOW ARE THINGS IN HAPPY VALLEY?

Get participants back together promptly when the time allowed for the coffee break is over. Ask the person who acted as 'secretary' for each group, in turn, to describe how the group answered the questions at the end of the Chairperson's Opening Remarks--

1. Is the career education program in Happy Valley satisfactory (for Native American students)?
2. How can the committee tell whether it is satisfactory or not?
3. What information would the committee need in order to make that decision?
4. If they do decide that the program needs help, what kinds of changes could they make with the resources available?

You should encourage the secretary or other members of each group to talk about how they felt about the role playing and the simulation--what interpersonal problems the characters had and how they tried to deal with them, or what problems were inherent in the situation itself.

Many groups may feel that they could have used more information, that the committee was not clear on what it was supposed to do, etc. Ask participants to comment on how that situation relates to their own real-life experiences with committees. What effects does this kind of confusion have on committees' ability to function?

Remind participants that the purpose of the simulation was to give them some realistic experience of dealing with a career education program. If they know what kinds of problems are likely to occur, they may be able to anticipate and solve them. At least they should be comforted by the knowledge that they are not the only ones who have difficulties.

Guide the discussion to allow participants to indicate whether they felt that the experience helped them to understand the feelings of other kinds of people (community members of school people) better, but do not push them for answers.

Encourage group members to answer each other's questions, and comment on the experiences of other simulation groups, so that the debriefing becomes a full group discussion rather than a dialogue between you and them. One result of this may be that different groups will give parts of their reports together instead of consecutively. Let this happen, but make sure that each group does eventually get a chance to report on all aspects of its experience.

When everyone has had a chance to express his or her feelings, move on to the next activity.

## Activity 6.--COOPERATIVE GROUP INTERACTION SKILLS

Simply becoming aware of the existence of problems will have the effect of discouraging people unless they are also offered some tools for solving them. Explain that just because people often need to improve their interaction skills, industrial psychologists and others have been working on identifying the skills that are needed and developing ways to train people to use them. Put transparency #7 (next page) on the screen.

These skills are discussed at length in the Information Summary for Session II. You will be talking about each of them briefly, and leading the group through simple exercises for as many as time allows (probably one to two). Most of the exercises are adapted from the Interaction curriculum book developed by Far West Laboratory which consists of instructional units on each skill for use at the secondary level.

First describe each of the skills as defined on this page and the next, lead participants through the exercises you have selected. Directions for the exercises are included on pp. 2.35 - 2.50.

### a. COMMUNICATION

Communication skills include being able to give, receive, and retain information; and understanding how the receiver's interpretation affects communication between individuals or in a group.

### b. COOPERATION

Cooperation skills include harmonizing activities of individuals or groups, observing group action and identifying problems, figuring out the causes of problems identified, sensing and expressing a group's standards and goals, stimulating other group members to work well, and setting a good example.

### c. CONFLICT RESOLUTION

Skills needed to resolve conflicts include: finding out what caused the conflict, figuring out different ways to deal with conflicts, recognizing beliefs and goals shared by group members which can be used to resolve conflicts, understanding and respecting individual and group differences, and using the resolution of conflicts to increase group unity and productivity.

### d. SHARING LEADERSHIP

Skills include: seeking leaders who help the group stay together and get its job done, have valid sources of authority, and can create an atmosphere in which others are enabled to contribute (rather than manipulating them); and, being willing to let different group members direct the group in when their skills or experience make them the best person to lead it.

80

Relationships Among the Cooperative  
Group Interaction Skills

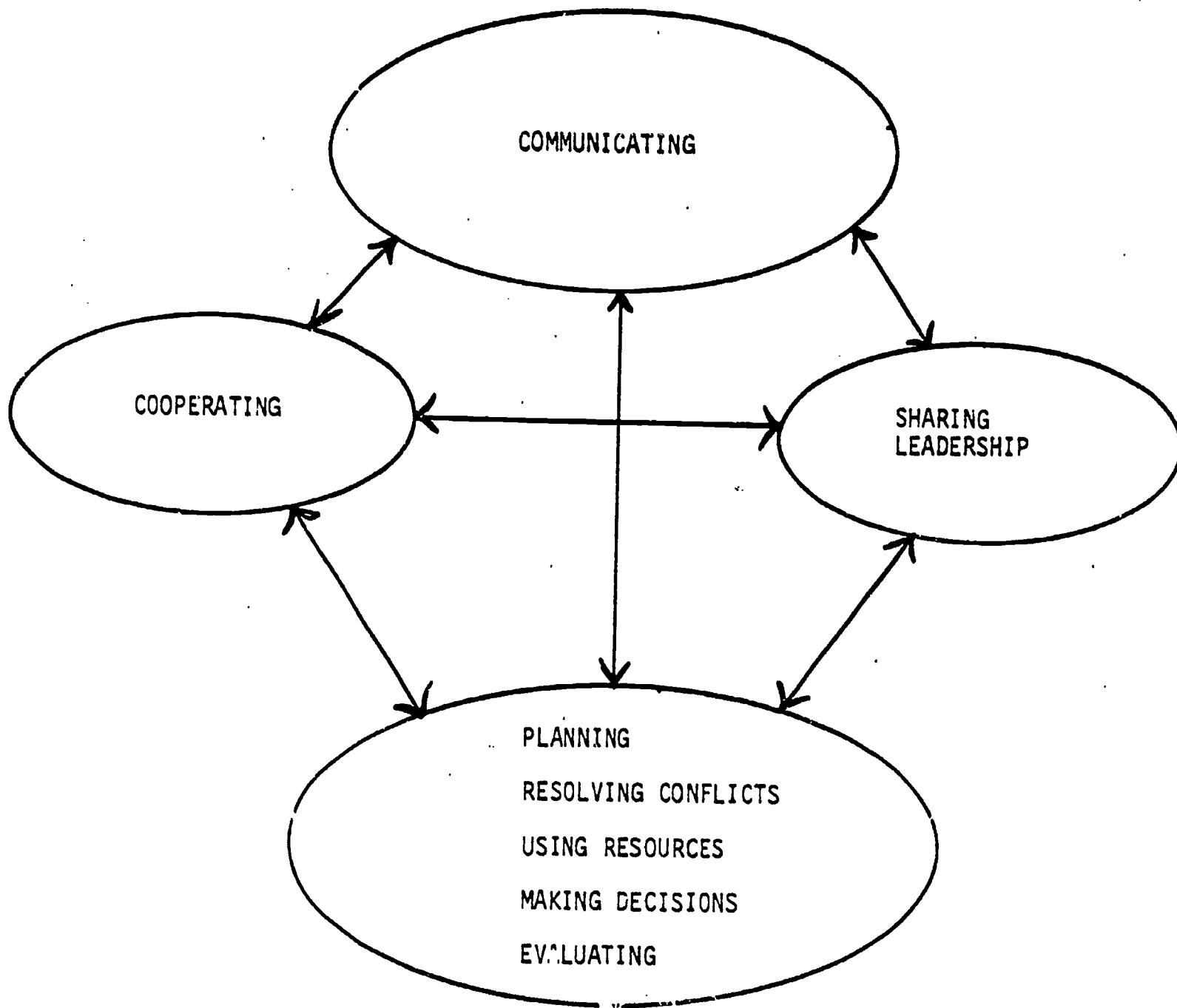

e. **PLANNING**

Planning skills are those needed to:

decide what must be done, where, when, why and by whom;

determine what resources are available and what obstacles may get in the way;

consider alternative ways to accomplish the task, decide criteria for choosing among them, and make the choice;

work out details of the plan;

evaluate the planning process.

f. **USING RESOURCES**

To use resources well you need to be able to: identify what is needed to do the job, what is available, how you can do the job with what you've got, and how you can get resources you don't have. Note that resources can include both physical items, such as paper, and knowledge or abilities, such as knowing how to type.

g. **MAKING DECISIONS**

Decision-making skills include understanding and being able to use different ways of deciding things, and knowing when to use each one.

h. **EVALUATING**

Evaluation skills range from figuring out what should have happened in a situation, what actually did happen, and the similarities and differences between the two, to find out the reasons, and deciding how to avoid the same problems in the future.

Directions for Interaction Exercises

a. **COMMUNICATION (10 min.)**

Activity: Place transparency #8 on the screen. Ask participants what they see. Count hands to find out how many see a young girl, how many see an old woman, and how many see something else entirely. Ask participants to look at the picture again and see how it can be both at the same time.

Place transparency #9 on the screen. Ask participants which line is longer. After discussion, point out that both lines are the same length. The position of the arrows creates the illusion of a difference.

Ask what principles this exercise demonstrates with regard to the reasons why people's opinions may differ and they may misunderstand each other.





TRANSPARENCY 9

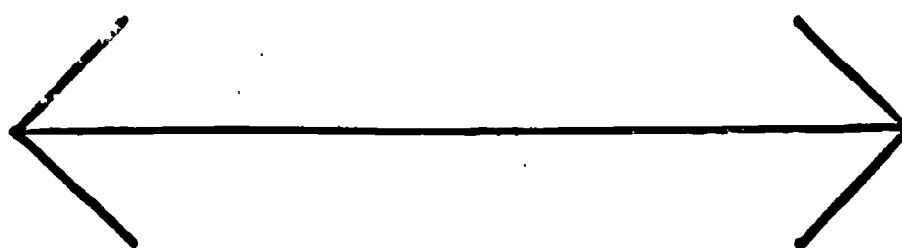
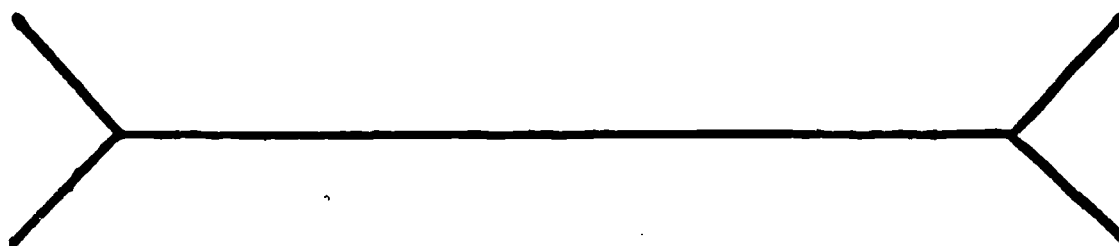

b. COOPERATION (30 min.)

Activity: Hand out puzzle sets to each group of six people. These puzzles should be made up previously according to the directions on the page 2.39. Ask each group to choose one member as 'watcher' and give a copy of the scoresheet (p.2.40) to them, or simply ask the 'watcher' to make notes on how it goes.

The object of the game is to combine the pieces into five squares, all of the same size. The rules are: no one in the group may speak or write anything to anyone else, no one may take a piece from anyone else, but they may give them to each other, and all members of the group must help. They will have fifteen minutes to do this.

Directions for doing the puzzle are included in the Participants' Handbooks as Worksheet II.1.

When participants have finished, ask the 'watchers' to give the points for each group. Ask how people felt while doing the puzzle -- was it easy or hard, and why?

Cooperation Exercise-Directions

To prepare a puzzle set:

1. Cut out 5 squares of the same color of construction paper. Each square should measure 6" x 6".
2. Draw a different pattern on each group. (Suggested patterns are on the next page.) The patterns should divide each square into three parts.
3. On each part, mark a small letter *in light pencil* so that it can be easily erased later.
4. Cut out the parts of each square. Distribute these parts so that they match 5 numbered envelopes this way:

Envelope 1: *i, h, e*  
Envelope 2: *a, a, a, c*  
Envelope 3: *a, j*  
Envelope 4: *d, f*  
Envelope 5: *g, b, f, c,*

5. Carefully erase the small letters which you marked in pencil. Use a pen and write the envelope number on each part which matches that envelope. For example, parts *i, h,* and *e* (above) would each be renamed as 1. Parts *a, a, a,* and *c* would each be renamed as 2, and so on. This system will make it easy for you and the participants to determine which parts belong in which envelope at the beginning of each play.

PATTERNS FOR SQUARES....

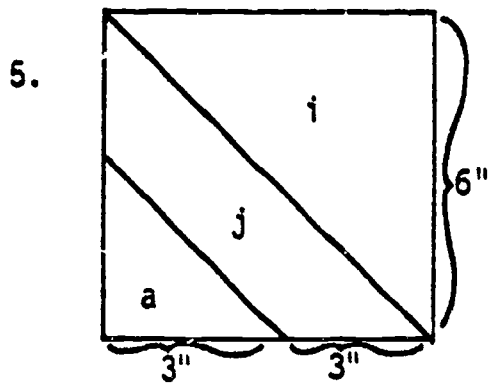
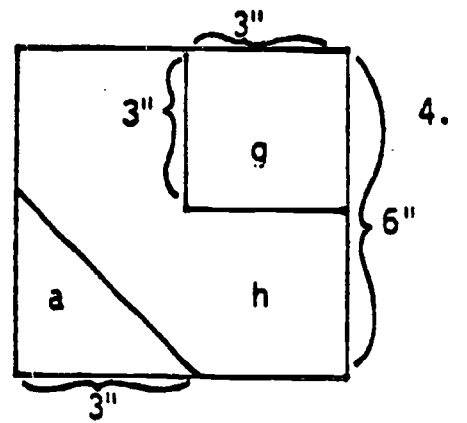
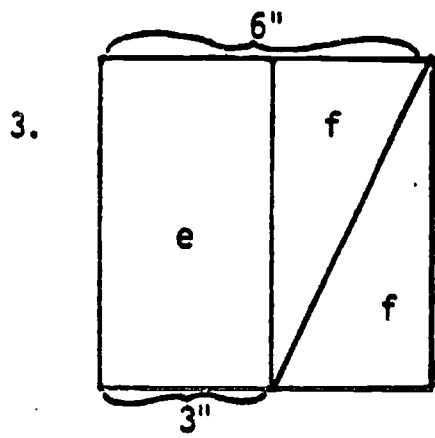
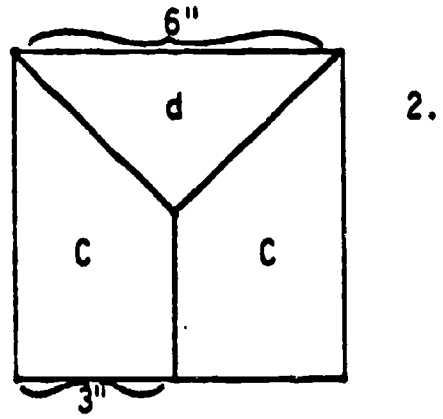
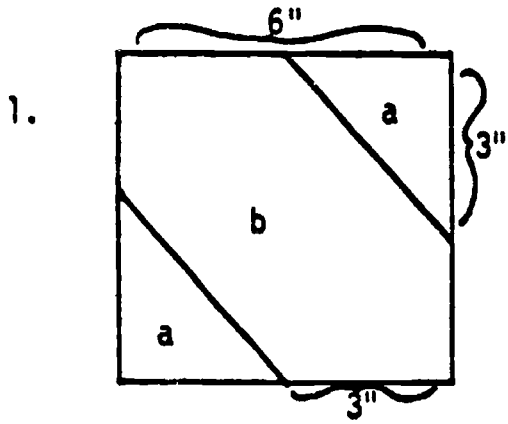

92

THE WATCHER'S SCORESHEET

Name of Group Members	Penalty Points for Talking	Penalty Points for Grabbing	Penalty Points for Not Trying	TOTAL POINTS LOST
1.				
2.				
3.				
4.				
5.				

TOTAL POINTS  
AGAINST THE GROUP

WHAT THE WATCHER SHOULD DO

1. Watch how the group works together.
2. Use the Score Sheet to keep track of what you see. Put one check ( ) each time someone talks, grabs, or does not try to play.
3. If the group solves the puzzle, write down how much time it took.
4. If the group does not solve the puzzle in 15 minutes, write *not enough time*.

**Puzzle Directions:**

1. Pick a Watcher for your group.
2. Take an envelope with 2, 3, or 4 puzzle pieces.
3. When the Coordinator signals you to start, work with others in your group to use all the puzzle pieces to make five squares that are all the same size.

**Rules:**

1. No one in the group may speak or write anything to anyone else. NO TALKING.
2. No one may take a puzzle piece from anyone else.
3. But you may give one or more of your puzzle pieces to others in the group.
4. You will have approximately 15 minutes to do this.
5. Each member of the group must help put the puzzle together.

c. CONFLICT RESOLUTION (15 min.)

To do this exercise, have participants turn to Worksheet II.2 in their Handbooks. (p. 2.43 of this Manual) Read the directions, and give participants a few minutes to classify problems.

To save time, you may then simply ask for a hand count on how many put problem #1 under "the job" etc. And then use the two or three on which the total group was in the most agreement as a basis for discussion of possible solutions. Point out that knowing the cause of a problem can lead to its solution.

d. SHARING LEADERSHIP (15 min.)

Have participants turn to worksheet II.3 in their Handbooks, and briefly fill in each box. Tell them not to worry if they don't know some of the information requested. If they are sitting in workgroups, they can also confer on the answers.

When they have finished, ask participants to volunteer answers for each box. Discuss the answers, using the examples written into the worksheet in this Manual (p. 2.44) as a guide. Further points to discuss include:

- what conditions in a culture or situation affect the kind of leadership that works best?
- is the same kind of leadership 'best' in all situations?
- do different countries or cultures have different definitions of what a 'good' leader is?

This interaction skill is closely related to Decision-Making.

Causes of Conflict

1. By yourself, decide which cause on the chart is usually responsible for each of the problems listed in the box below and write the number of the problem in the appropriate column on the chart. For example, if you decide that hurt feelings are often caused by personality differences, write "2" in the second column. Remember there are no right or wrong answers.
2. Discuss your answers with the others in the group. You will probably find out that they have classified the problems in other ways. As a group, decide the best way to classify each problem. Show the group's decisions on the bottom half of the chart.
3. Pick one problem under each column on the chart. Brainstorm a solution to it. Although you have no details about the problem, do your best to come up with some kind of general solution. One person should record the group's ideas. Be ready to discuss these ideas later with the whole group.

**PROBLEMS**

- |                          |                      |                             |
|--------------------------|----------------------|-----------------------------|
| 1. screaming and yelling | 6. giving up         | 11. "the cold shoulder"     |
| 2. hurt feelings         | 7. last minute panic | 12. inefficiency            |
| 3. helplessness          | 8. racial tension    | 13. constant complaints     |
| 4. boredom               | 9. fault finding     | 14. poor working conditions |
| 5. being behind schedule | 10. bad attitudes    | 15. feeling trapped         |

	THE JOB	PERSONALITY DIFFERENCES	THE GROUP SET UP	PERSONAL PROBLEMS	SOCIETY
<b>YOUR CHOICES</b>					
<b>THE GROUP'S CHOICES</b>					

Fill in the indicated information for each of these situations.

<u>Individual</u>	<u>How was the Leader chosen?</u>	<u>How does he/she enforce decisions?</u>	<u>Who has right to fire him or her?</u>
1. The reigning Queen of a medieval country.	<i>inheritance</i>	<i>legal decisions enforced by subjects thus protecting own rights.</i>	<i>in extreme cases, hereditary or elected representatives of people.</i>
2. The governor of this state.	<i>election</i>	<i>elected or appointed officials</i>	<i>people, by referendum, for legal cause</i>
3. The leader of a group of people shipwrecked on an island.	<i>personal charisma or ability--group consensus</i>	<i>force of personality, group agrees and acts</i>	<i>consensus of group</i>
4. A sachem representing one of the tribes in the Iroquois League (18th century).	<i>consensus of tribal matriarchs (clan mothers)</i>	<i>if tribe agreed, it enforced decisions</i>	<i>tribal matriarchs</i>
5. The chairperson of a Parent Advisory Committee.	<i>election</i>	<i>group agrees and acts</i>	<i>members of committee or body committee represents</i>
6. The "leader" of an artistic movement.	<i>informal consensus of other artists</i>	<i>voluntary agreement of others</i>	<i>others stop following</i>
7. A school principal.	<i>appointed</i>	<i>legal sanctions can fire, reprimand</i>	<i>School Board</i>
8. The owner/boss of a small business.	<i>develops own position</i>	<i>can fire employees who disagree</i>	<i>public, by not patronizing government, for illegal acts.</i>
9. The chief of an Indian tribe on the Plains (19th century).	<i>tribal council, inheritance</i>	<i>consensus of respected members</i>	<i>tribal council, consensus of members</i>
10. The captain of a school sports team.	<i>election or appointment</i>	<i>rules of game, can refuse to let dissidents play</i>	<i>team, coach</i>
	2.44	9	



e. PLANNING (15-20 min.)

Put transparency #10 (p. 2.46) on the screen, with a paper covering all but the step you are discussing. As you review each of these basic steps, uncover it.

1. decide what must be done, where it can be done, when, why, and who will do it;
2. identify the resources that are available to accomplish the task, and what obstacles may get in the way;
3. consider several different ways to get the task done, decide what factors should guide your choice, and choose;
4. work out the details of the plan;
5. evaluate your planning process to see if you missed anything.

Ask participants to turn to worksheet II.4. As individuals or with others in their workgroups, they should look over the planning activities listed, decide in what order they ought to be done, and number them accordingly.

When they have done, they can compare their choices, discuss differences and try to agree on an order of procedure. Ask them if they think there are any other factors that the committee in the exercise could, or would probably, want to consider in their planning (one example might be determining student interest in having a career day!).

The copy of the worksheet on p.2.47 of this Manual has the individual planning activities marked according to the planning 'step' to which they belong. Therefore, a participant could put either the decision to hold the event in the gym or the discussion of when to hold it as the second activity, since they belong to the same 'step,' but should not put the chairperson's listmaking in that position.

# STEPS IN GOOD PLANNING

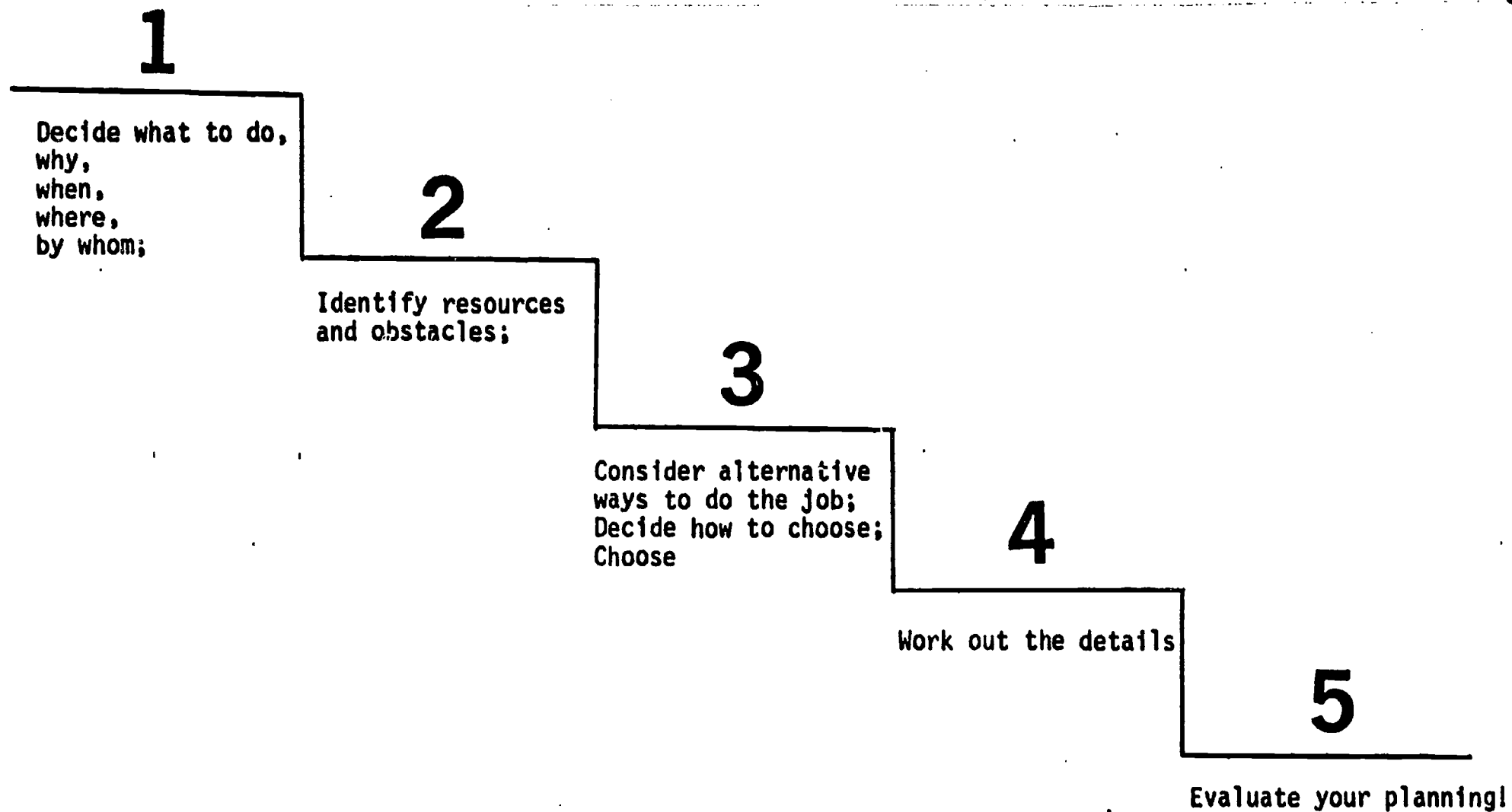

2.46

9.1

10.1

Planning

The Career Education committee at Sandstone School is discussing ways of informing the community about their program. In the spaces to the left of each action, place numbers indicating in what order they should be done for a Career Day at your school. If you think 2 or more of the tasks listed should be done at the same time, you may give them the same number.

- 1 The counselor suggests that having a Career Day at the school would be a good thing.
- 2 The Vice Principal says she knows an Indian lawyer from the state capital who would be a good speaker.
- 1 The committee agrees that they could hold the event in the school gym.
- 1 They discuss when during the school year would be the best time to hold the event.
- 2 The English teacher points out that some of the subject teachers will resent the time and effort being spent on the project.
- 4 The committee decides what sorts of things will have to be covered to put on the event, (publicity, contacting speakers, setting up displays, etc.).
- 2 The shop teacher says he and his class can build display boards and booths.
- 1 The committee settles on early May as the best time to hold the event.
- 4 Group members volunteer to form subcommittees to do the work.
- 1 The committee works out a list of local people in various career areas who might be willing to appear.
- 4 The chairperson starts making a detailed list of things to do.
- 2 The journalism teacher says that businesses who advertise in the school paper would probably like to participate.
- 3 After discussing pros and cons of various dates, the committee decides on May 13-14.
- 3 The committee debates whether to have a group of speakers, a series of displays in booths, or both.
- 2 One of the parent representatives says the Indian community will be preparing for its annual Pow Wow the first week of May.
- 5 The chairperson leads the committee through a review of their planning process to make sure they have covered everything.

f. USING RESOURCES (10-15 min.)

People usually think of resources as being physical things, like oil or timber. However even natural resources are useful only when people have the skills to use them. The exercise on Worksheet II.5 of the participant's Handbook (p. 2.49 of this Manual) will help participants become aware of people as resources.

Ask participants to look at the worksheet and quickly jot down the names of the people in their workgroups or in the group as a whole who come closest to possessing the qualities listed. If they want to, they may use the back of the sheet to list other qualities which can be resources and the people who have them. If time allows, participants can show each other their worksheets and compare choices. Doing this may show them something about their verbal and non-verbal communication as well as about using resources!

g. MAKING DECISIONS (15-20 min.)

Have participants turn to Worksheet II.6. Read aloud the kinds of decision-making described in the directions, and ask participants to put the number of one of them in each of the boxes next to the examples. When they have finished, lead a group discussion of their choices and the reasons for them.

- In the first example, the three teachers will probably have to do a lot of discussing before they can agree on how to write the proposal. Since they are all experienced, none of them is the obvious leader. Numbers 4 or 7 are the most likely answers here.
- In the second case, the answer could be 1 or 2, depending on whether the driver (the 'leader' here) participated in the argument about which way to go. When there is a time limitation on decision-making, an arbitrary choice must sometimes be made.
- The school should let its typewriter experts make the decision on what kind of machine to buy (#3), however in practice, the decision would probably be made by the majority (#6).
- When the effects of the decision will affect the entire group as strongly as the one given in the next example, the choice should be made by everyone (#7). Often, however, only the majority is legally required to agree (#6).
- The last example is a case where the minority will probably make the decision (#5), because they are the only ones who really know what they want. There should be an eighth way of decision-making-- each individual makes up his or her own mind--to cover this.

WHO'S WHO

Below is a chart which you can use to show how the resources of your group are divided. On the right, there is a list of phrases describing different resources which your group might need to work productively. Think about each resource carefully. On the basis of your interaction so far decide which member of the group is most likely to be able to provide that resource. Write his or her name in the blank space at the left. When you have finished the chart, you should have written every group member's name—including your own—at least once.

Name	Resource
	is a hard worker.
	knows a lot about Indian culture.
	helps others settle arguments.
	is a good writer.
	knows a lot about educational theory.
	has a great imagination.
	is very artistic.
	helps others relax and enjoy themselves.
	knows a little bit about a lot of things.
	knows a lot about different jobs.
	is a good manager.
	knows how to use words wisely.
	is full of new ideas.
	is the quiet, effective type.
	really understands how others feel.
	is easy to talk to.
	knows how to get everyone interested.
	doesn't give up easily.
	knows how to handle money.

Below are some situations in which decisions need to be made. What is the best way to make each of these decisions? As a group, decide which of the seven ways of decision-making best matches each situation. Write the appropriate number in the box before the situation. The seven ways of decision-making are:

1. The leader makes the decision without talking to group members.
2. The leader makes the decision after talking to group members.
3. The most expert member in the group makes the decision.
4. Group members give opinions, one by one, and the most popular opinion is followed.
5. A minority of the group makes the decision.
6. A majority of the group makes the decision.
7. Everyone in the group makes the decision.

4

Three teachers get together to write a proposal. They are all equally experienced teachers, and all have written proposals before-- but they have very different ideas about how the proposal should be written.

2

A group of friends are driving to a Pow Wow, all in the same car. There are two ways to get there, both taking about the same amount of time. The people in the car are arguing about which way would be best to take. In order to go by one of them, the driver must take the next exit from the freeway-- if he passes it, they will have to take the other way. They are now passing the first signs for the exit and they are still arguing.

3

An elementary school must decide which of three kinds of typewriter it will purchase for its office. One of the three kinds is of much better technical quality than the other two, but only a few members of the group realize this. The other two kinds have been better advertised, and most of the staff will probably vote for one or the other of these.

7

An Indian tribe must decide whether to lease a tract of its land to a coal mining company.

5

Mary, Gordon, and Ruth are good friends. They usually think alike and support each other at meetings. They spend a lot of time with five or six other teachers who are less well-trained and experienced than they are. The whole group is thinking of joining a teacher's union. Mary's sister is already in the union, so she and Gordon and Ruth think all of them should join. Most of the other teachers are suspicious of the union's officers and do not really want to join. However they are not very good at putting their feelings into words.

h. EVALUATING (10-20 min.)

This exercise can serve as a useful review of the simulation before ending the session, since it requires participants to think back and evaluate what they did. It can either be done in the same workgroups that participated together in the simulation, or you might use it as an opportunity for individuals to make their personal assessments of what went on. (If groups are filling the worksheets out together, allow more time.)

Have participants turn to Worksheet II.7 in their Handbooks, and ask them to briefly indicate their answers to each question. When everyone, or all the groups, have finished the worksheet, lead a general discussion of what happened and why. Ask participants if they have been involved in other situations in which this kind of an evaluation process might have been useful. Ask them if they foresee any opportunities to use it in their immediate futures.

Activity 7.--CONCLUSION

Briefly review what went on during this second session of the Workshop. After considering what kinds of people might be involved in developing and implementing a career education program for Native American students, and what roles they might play, participants had an opportunity to simulate the experience of actually being on such a committee. Hopefully, this experience gave them a better 'feel' for the problems involved in setting up such a program, and in working with the other people involved. The session finished with a discussion of cooperative group interaction skills which would be useful to help such a group function effectively, and some exercises to start participants thinking about and developing those skills.

If possible, participants should read the material in the Information Summary for Session II which covers issues in community participation in education, and discusses the interaction skills in much more detail.

In Session III they will learn about some methods for developing career education activities for Native Americans and students in other ethnic groups, and will get some hands-on experience in using them.

**Worksheet II.7 - Evaluating the Simulation**

**Evaluation  
Exercise**

Returning to the point of view of the characters in the simulation exercise, discuss with other members of your group the answers to the following questions:

1. What was supposed to happen in the situation? (the meeting of the Career Education Evaluation committee)
  
  
  
  
  
  
  
  
  
  
2. What did happen in the situation?
  
  
  
  
  
  
  
  
  
  
3. What are the points of difference between what should have happened and what did happen? What are the similarities?
  
  
  
  
  
  
  
  
  
  
4. Why did things happen that way?
  
  
  
  
  
  
  
  
  
  
5. If the "committee" were to meet again with the same purpose, how could they improve the way they worked together?

100



**Session III:**  
**Native American Career Education**  
**Methods**

107

# Introduction

## Goals

Session III of the Staff/Community Training Workshop builds on the career education background participants acquired in Session I and the understanding of factors affecting career education programs for Native American students acquired in Session II to introduce a culture based approach to teaching career education. Specifically, Session III focuses on the following objectives:

- participants will describe major characteristics of the education process in a traditional Indian setting and relate them to teaching methods they have used;
- participants will identify characteristics of the work place which suggest teaching techniques for career education;
- participants will be able to describe the goals, content and approach/methods of the Native American Career Education units;
- participants will be able to use the Native American Career Education approach to plan adaptation or development of a career education activity for a specific group of students and settings.

## Activities

This section lists the major activities in the third session along with estimated time allowances for each:

1. Reviewing Session II--coordinator summarizes main points 5 min.
2. Traditional Indian Educational methods 15 min.
3. Educational methods from the World of Work 10 min.
4. The Native American Career Education Program 20 min.
5. Break 15 min.
6. Developing career education activities for Native American students 45 min.
7. Conclusion--coordinator summarizes what has been covered in the session 10 min.

## Materials

Coordinator's Manual

Transparencies (3.8-3.19, 3.25, 3.26, 3.29)

Participants Handbook

Overhead projector and screen

1 or more sets Native American Career Education units

Examples of career education or guidance materials put out by commercial publishers, business, etc.

Extra paper and pencils.

## Preparation

Familiarize yourself with the material for this session ahead of time. If you have never used the Native American Career Education units, you should read through as many of them as you can. Try doing activity #6 ahead of time by yourself to get a feel for the kinds of questions participants may have.

If at all possible, contact leaders of the local Indian tribe or community ahead of time to discuss their preferences with regard to how Indian cultural material should be presented in the school and how to find local cultural resources. Invite cultural leaders to attend the workshop, especially this session.

10,

# Introduction

In this session you will come to grips with the actual process of teaching career education within a cultural context. You will learn about appropriate teaching methods and materials using them, and have a chance to put what you have learned into practice.

Specifically, at the end of this session you will:

- be able to describe traditional Indian educational methods;
- be able to identify characteristics of work situations which suggest teaching methods for career education;
- be familiar with the goals, content and approach used in the Native American career education units;
- be able to use this approach to adapt or develop a career education activity for a specific group of students.

Session activities will include lecture and discussion, viewing illustrations of Indian learning methods, and an application exercise.

# Guidelines

## Activity 1--REVIEW AND INTRODUCTION

### Review

The purpose of this activity is to refresh participants' memories of the main points made in the previous session. The amount of time spent here should depend on how long it has been since Session II.

Point out that the second session's purpose was to give participants a feeling for the kind of interactions involved in managing a career education programs. Representatives from the following groups should be included:

administrators	parents and community members
teachers	business people
support staff	students

However a group trying to do a job may run into problems, both external and internal. Interaction skills needed to function effectively may be classified:

communication	planning
cooperation	using resources
conflict resolution	making decisions
sharing leadership	evaluation

The information summary for Session II discusses these skills in detail, and the Interaction curriculum developed by Far West Laboratory presents exercises I for practicing them.

## Rationale for a culturally based career education program

If you are giving this workshop at a Bureau of Indian Affairs contract school, Indian Center, or other Indian-run program, you may skip this section. However in any workshop group with a majority of non-Indians, it is particularly important to make them understand the rationale behind the approach being taught in this session, whether or not they agree with it (the average group of teachers is likely to include at least one individual who is honestly convinced that the purpose of education is to assimilate students from other cultures into the American mainstream as quickly as possible).

The basic reasoning behind the Native American Career Education approach is as follows:

- Everyone needs 'Roots'--knowledge of a heritage in which they can take pride. Knowing where you came from helps you understand where you are now. (This is true for non-Indians too.)
- Cultural background conditions an individual's perceptions, priorities and values, often subconsciously. One culture is not inherently 'better' than another, but all are different. No one likes to be stereotyped.
- The contemporary American political and economic systems were evolved primarily by men from northern Europe, and reflect their cultural values and assumptions. Most educational curricula (and career education materials in particular) express the values of these systems.
- The more people's cultural backgrounds differ from the 'American mainstream,' the more they will have to adapt to succeed in it. This pressure to adapt may produce psychological stress (symptoms of stress caused by this or other factors include dropping out, alcohol or drug abuse, crime, and suicide). People's identities as individuals, members of an ethnic group, and workers in a given profession cannot be separated.
- Although the major influence on 'American' culture has been northern Europe, the richness of that culture comes from its incorporation of multicultural elements. As in genetics, cultural cross-fertilization produces stronger offspring. The vision of America as a pluralistic society into which different cultural elements are integrated rather than being absorbed is gaining acceptance rapidly.
- Even if this was not so, American Indians, as the only ethnic group which had European American culture thrust upon it rather than immigrating into it, have both a moral and a legal right to retain their own land, language and way of life.
- Indian students therefore have a right to career education which will help them achieve economic self determination without losing their identities as Indians.

## Activity 2--TRADITIONAL INDIAN EDUCATIONAL METHODS

This activity will give participants an opportunity to discover for themselves some of the ways in which Indian children have been educated without the intervention of a formal school system. They didn't write texts in teaching methods, but there are ways of figuring out how the children learned. You will be using one of them in this activity.

Have participants turn to Worksheet III.1 in their handbooks. Explain that as you show each picture, they should note in the appropriate box what is being learned and how.

You can choose to show all the transparencies and then discuss them, or to show and discuss participants' interpretation one by one, using the suggested answers on p. 3.7 as a guide. If participants have trouble, start out by discussing the first transparency yourself to give them an example of what they are supposed to do. Move through the pictures fairly quickly.

The suggested responses to the worksheet and copies of the transparencies appear on the following pages. Activity #3 begins on page 3.20.

Show transparencies 11-22 (pp. 3.8-3.19).

When you have finished presenting and discussing the pictures, summarize characteristics of Indian education:

- observation--children had plenty of opportunity to watch or to listen and absorb information at one's own pace, process was repeated until information/skill was mastered.
- supervised participation--children worked with others in tasks, gradually increasing the difficulty level of their parts.
- unsupervised practice--children were self-motivated to practice skills they had been taught or had observed.
- self-evaluation--the "test" was the child's successful accomplishment of a task at a self-chosen time and place.

It should also be noted that the usefulness of everything being taught was obvious to both teacher and learner.

Ask participants for examples of instructional methods they have heard about or used which show any of the above characteristics (Example - dividing students into small groups to work together on learning tasks).

## Worksheet III.1 - Native American Education

Scene	Learning Method
Boys listen to old man explain pictures (Plains)	audio-visual presentation of history teacher as role model
Daughter helps mother plant corn (Iroquois)	observation, supervised practice, lecture with demonstration teacher as role model
Dancers act out legend (Pacific N.W.)	multi-media presentation- religion socialization through group experience
Boy practices archery (Paiute)	unsupervised practice of previously observed/instructed skill*
Girls learn basketweaving from old woman (California)	supervised group practice, observation
Girl imitates corn grinding (Pueblo)	unsupervised practice-- simulation motivated by observation
Family builds hogan (Navajo)	observation, supervised participation cooperative group interaction
Boys practice shooting through hoop (Woodland)	unsupervised group practice through a learning game
Young man gives robe to arrowhead maker (Pawnee)	payment for individual instruction in specialized craft
Sequoyah explains his alphabet (Cherokee)	lecture with A-V aid**
Tribe listens to story teller (S.W. Desert)	lecture and observation, use of nature as aid, socialization
Young man salutes the rising sun (Plateau)	individual learning via observation, meditation, interpretation

- \* the "test" will be when the boy shoots a rabbit and brings it home for dinner.
- \*\* Sequoyah took the idea of an alphabet and invented a script which would express the previously unwritable Cherokee language. After initial suspicion, the tribe became enthusiastic and within a year a majority were literate. This is an excellent example of how Indians can adapt European techniques to meet their own needs.







113.9

11

116



3.10

115

120

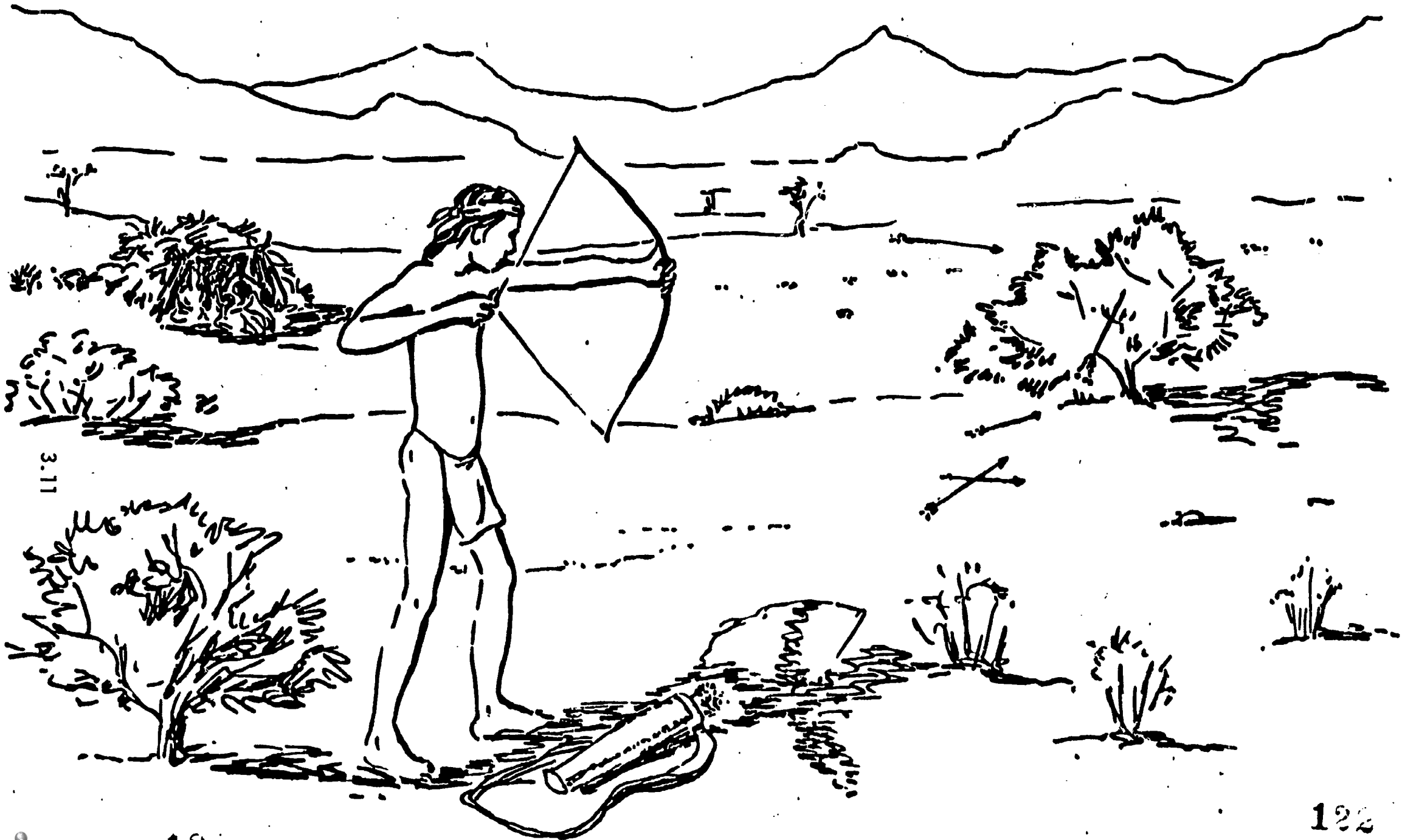

3.11



3.12

123

124

3.13

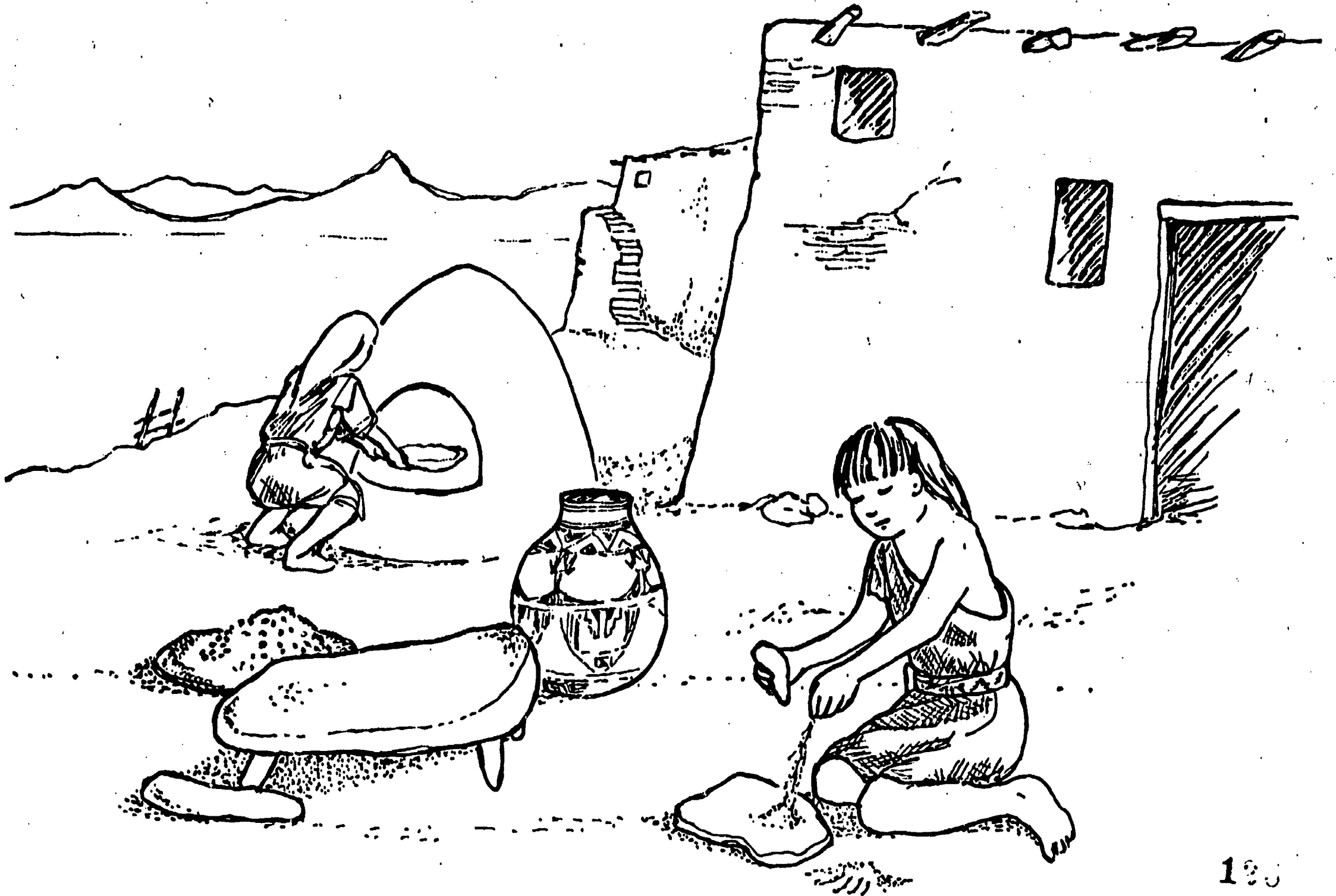

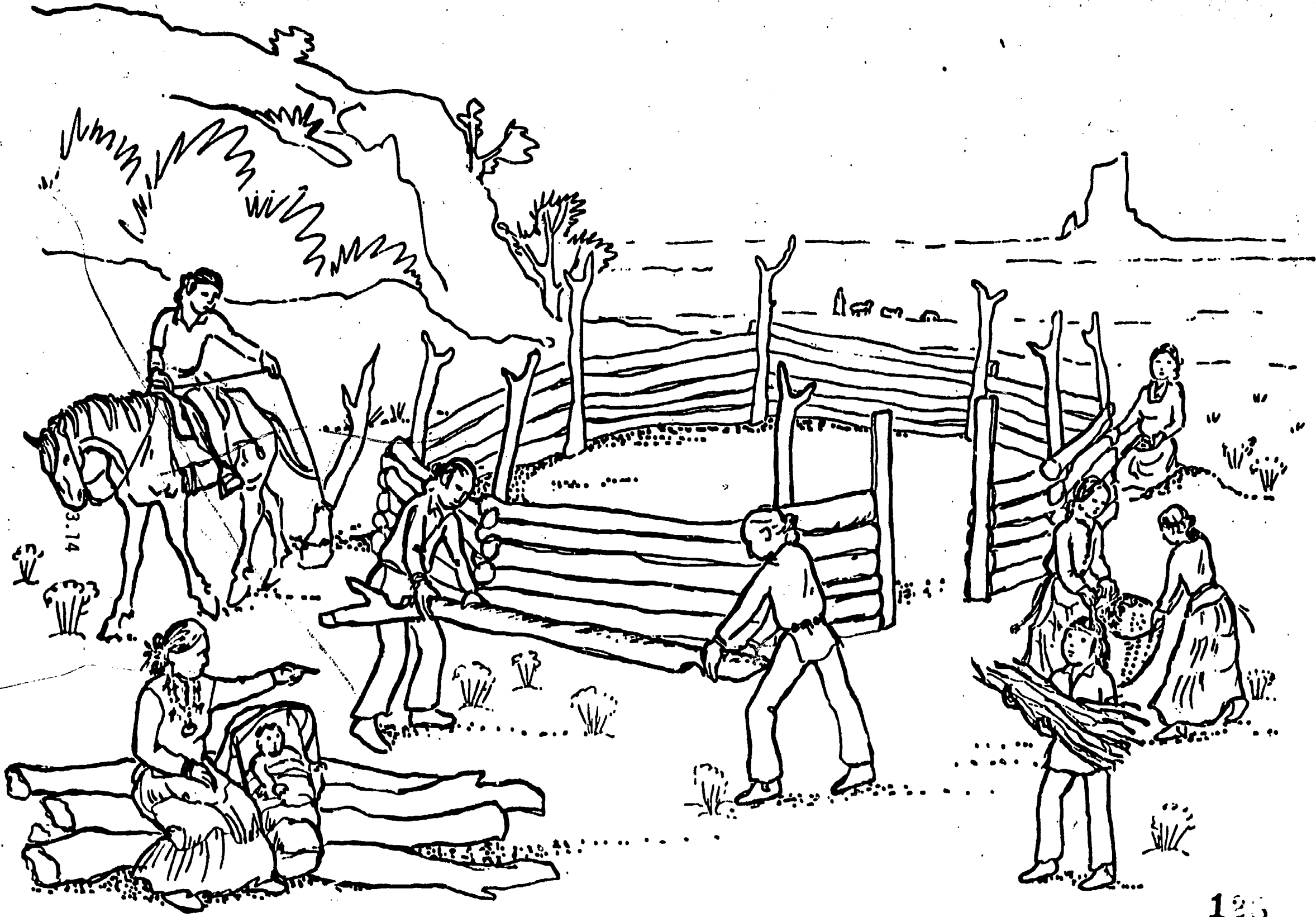

3.14

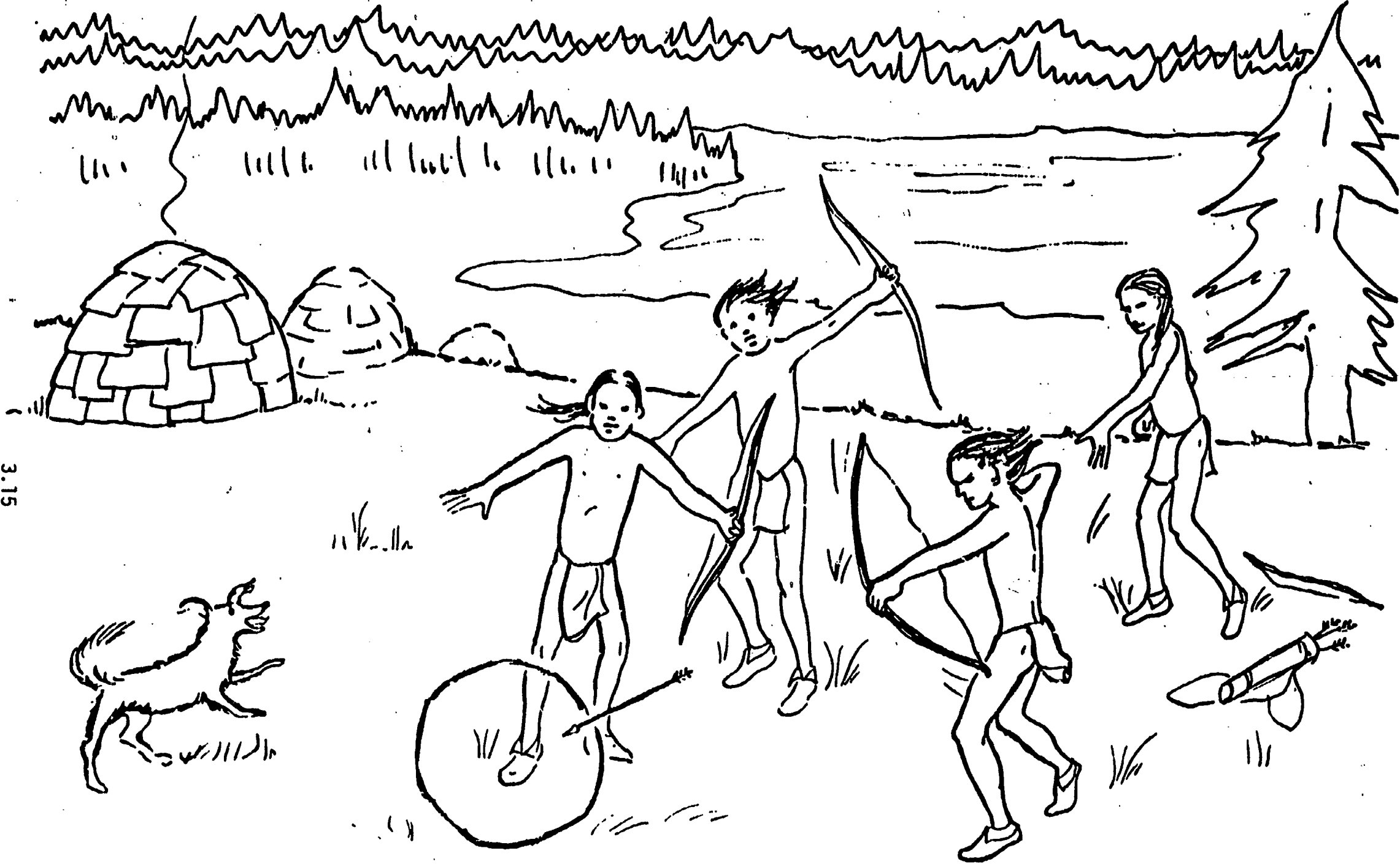

3.15

120

130





3.16



3.17



3.18

135

135



3.19

### Activity 3.--EDUCATIONAL METHODS FROM THE WORLD OF WORK

Explain that the methods chosen for Native American Career Education must be appropriate not only to the culture of the students, but to the content. It is logical to look for inspiration in the world of work. This inspiration falls in three major areas, resources, enrichment, and models for classroom organization.

#### Resources

Using the World of Work as a source of resources is the best known approach to teaching career education. The following activities have been used:

- bringing business people into the classroom as speakers (this works best if both speaker and class have been prepared--The Native American Career Education Curriculum Guide includes suggestions and sample interview sheets).
- having students go into the business community to interview people, observe, get hands-on experience or on-the-job training. One popular activity is 'shadowing' in which a student simply follows an adult through his/her working day.
- writing to companies or associations for literature on various jobs or career areas.
- doing research and setting up simulation exercises where real situations are inaccessible, or setting up school-based versions of adult jobs, such as running a student store.

#### Enrichment

One of the easiest and least time-consuming ways of infusing career content into the curriculum is to become aware of the career relevance of whatever is being taught and comment appropriately when presenting or discussing material. For example:

A class is studying American history and arrives at the invention of the locomotive and development of railroads. In addition to other effects of this development, point out that it changed the relationship between where people lived and worked. Ask students to compare ways people got to work before and after trains, street-cars, and buses. How did this affect distance, commute time, urban population patterns, amount of people who could work in one place, etc.? The discussion could also cover the numbers of new jobs created by the railroads, what jobs are (or are no longer) available with railroads today, and how new forms of transportation may create new jobs.

In discussing literature, comment on the many different jobs writers take to support themselves while they are making a reputation, how their lifestyle deals with that, how it contributes to their understanding of the world, etc. Composition exercises can also be set up as inter-office memos, advertising, business reports, etc. to stress importance of clear communication.

## Classroom Organization

The world of work can also serve as a source of ways of organizing students to do their own work. Success in a career depends as much on being able to function effectively in the work environment as on knowledge of the specific job skills involved. Therefore it is important to give students the individual and group work skills they will need. Not all kinds of classroom organization are appropriate for all parts of the curriculum, but the following should be considered as options:

- the arts--individuals work alone, an individual designs something which others execute
- the factory--jobs are split into repetitive tasks on an assembly line, groups of workers are supervised hierarchically
- the office--small groups work together doing one or more jobs to achieve a single result
- service industries--individuals work alone (which may involve meeting the public) on an assigned task and report regularly to a supervisor
- construction--work crews carry a project through to completion

Ask participants to suggest other examples of ways in which the world of work can inspire career education teaching methods. Encourage them to answer each other's questions. Ask whether they think their students could learn effectively in small, task-oriented groups, or whether they would need some training in group interaction to do so. The INTERACTION curriculum (available from Far West Laboratory) which provided inspiration for the interaction exercises in Session II, includes a variety of student activities which can be used to train students in these skills.

Have participants turn to Worksheet III.2 in their handbooks. You may have them fill the sheets out individually before discussing them, or take the activities listed one by one and discuss them as a group. If participants differ in their answers, encourage them to explore the reasons for their disagreement by citing examples from their own experience.

**Worksheet III.2 - NACE and Degree of Teaching Methods**

Classify the following contemporary teaching methods or classroom management techniques according to their relevance to traditional Indian culture and to Career Education: (highly appropriate = +, appropriate = ✓, inappropriate = —).

Teaching method	Indian culture?	Career education?
Lecture to large group	—	—
Simulation of actual situation	+	+
Field trips	+	+
Reading texts or other materials	—	✓
Teacher questions individual students in front of class	—	—
Small group discussion	+	+
Speakers talk about their experience	+	✓
One-to-one tutoring	+	+
Small groups of students work on projects	+	+
Teaching with audio-visual aids	+	✓
Individual students do research	+	+
Students participate in community events	+	+
Students do self instructional exercises	+	✓
Computer assisted learning	—	✓
Learning games	+	✓
Teams of students compete with others	+	+
On-the-job training	+	+

#### Activity 4.--THE NATIVE AMERICAN CAREER EDUCATION PROGRAM

Have the stack of Native American Career Education units set on the table where participants can reach it.

Start out by explaining that the content and methods which have been presented in this workshop have already been used to develop a career education curriculum for Native American students in grades 7-10--the units they see on the table. These units are not the only materials they should use, but they represent the NACE approach most fully. Although they will be learning how to adapt and develop career education activities of their own, the developers of this program still recommend starting out by using some of the activities or units in the NACE curriculum to become really familiar with the method.

##### Concepts

The units are built around a set of concepts which can also be used to guide development of new activities. Suggest that participants write these down as you discuss them, and allow time for questions after each one. They are:

(1) Cultural Relevance--essential when a program is aimed at any specific ethnic group. Its purpose is to reinforce or instill positive self-image and cultural identity. Methods for achieving this include:

- bring Native American speakers to the classroom
- buy or make posters about noteworthy past or present Native Americans
- set up a student project to photograph local Native Americans in different jobs and make posters for display
- include positive references to Indian culture (whether career-related or not) in classroom discussions--wherever possible, give Indian as well as non-Indian examples
- collect accurate and positive materials about Native Americans and make them available in the classroom (ask the Parent Committee or other Indian community group for advice on what materials are 'accurate').

Refer to the discussion of resources in Session I, which offered suggestions on where and how to find information on Indian culture. Specifically ask any Native American participants in the group how they would suggest that a teacher who wanted to incorporate Indian cultural material in the classroom should proceed. Some Indian communities are simply happy that a teacher is saying something positive about Indians, others see inclusion of this material as just another way of stomping in and telling Indians about themselves. Some communities may prefer that a teacher be trained by community members, or invite a community member into the classroom to present material about traditional Indian ways. Information about contemporary Indians in jobs is generally acceptable, however, as long as the people concerned have given permission to be talked about and the information is accurate.



When you have finished this discussion, work with participants to make a list of places and procedures for finding Indian cultural materials in the community in which the workshop is being given.

## (2) Basic Needs

One of the basic parts of career awareness is understanding why different jobs exist--how they fit into the economic system, and what an economic system is. One way of doing this is to introduce the concept of basic needs which all human groups must meet. These are: something to eat; shelter from the elements; protection from dangers of every kind; and physical and non-physical tools to help people meet the other three needs.

Show transparency #23.

Everything we use or do, and the jobs involved, can be related to one of these areas--for example, we place Education in the area titled 'Aids' because it gives us skills we can use to meet other needs.

Ask participants for names of various jobs, and discuss with the group which need area those jobs might belong to.

Show transparency #24.

This transparency shows how the 15 career areas defined by the Department of Labor match up with the four basic needs. Many jobs and employment materials are organized on this system.

The concept of basic needs provides a foundation for understanding of the next two concepts.

## (3) Traditional and Technological Lifestyles

In order to give students as many options as possible in planning their futures and choosing a way of life, the teacher must present information about careers and culture without making value judgments. The concept is stated as traditional and technological because many students have the option of choosing a lifestyle that incorporates many traditional elements.

If the cultural information discussed under 'cultural relevance' is available, the teacher may find it useful to introduce a career area by first identifying the basic need it meets, and then discussing how that need is/was met in a traditional setting. If the class is multi-tribal or multi-ethnic examples of ways of meeting that need should be taken from all the cultures (including the teacher's) which are represented. This will not only clarify the concept, but establish the idea that different cultures are equally valid, and that all peoples have to solve the same problems in making a living.

Example: A teacher in a coastal community wishes to introduce a unit on the fishing industry. The classroom includes children of Indian, north European, and Vietnamese descent. The teacher begins by talking about how her English ancestors fished in the English Channel. She then has parents from the Indian and Vietnamese communities come to the class to talk about their fishing methods (or has the children

# things a community needs...

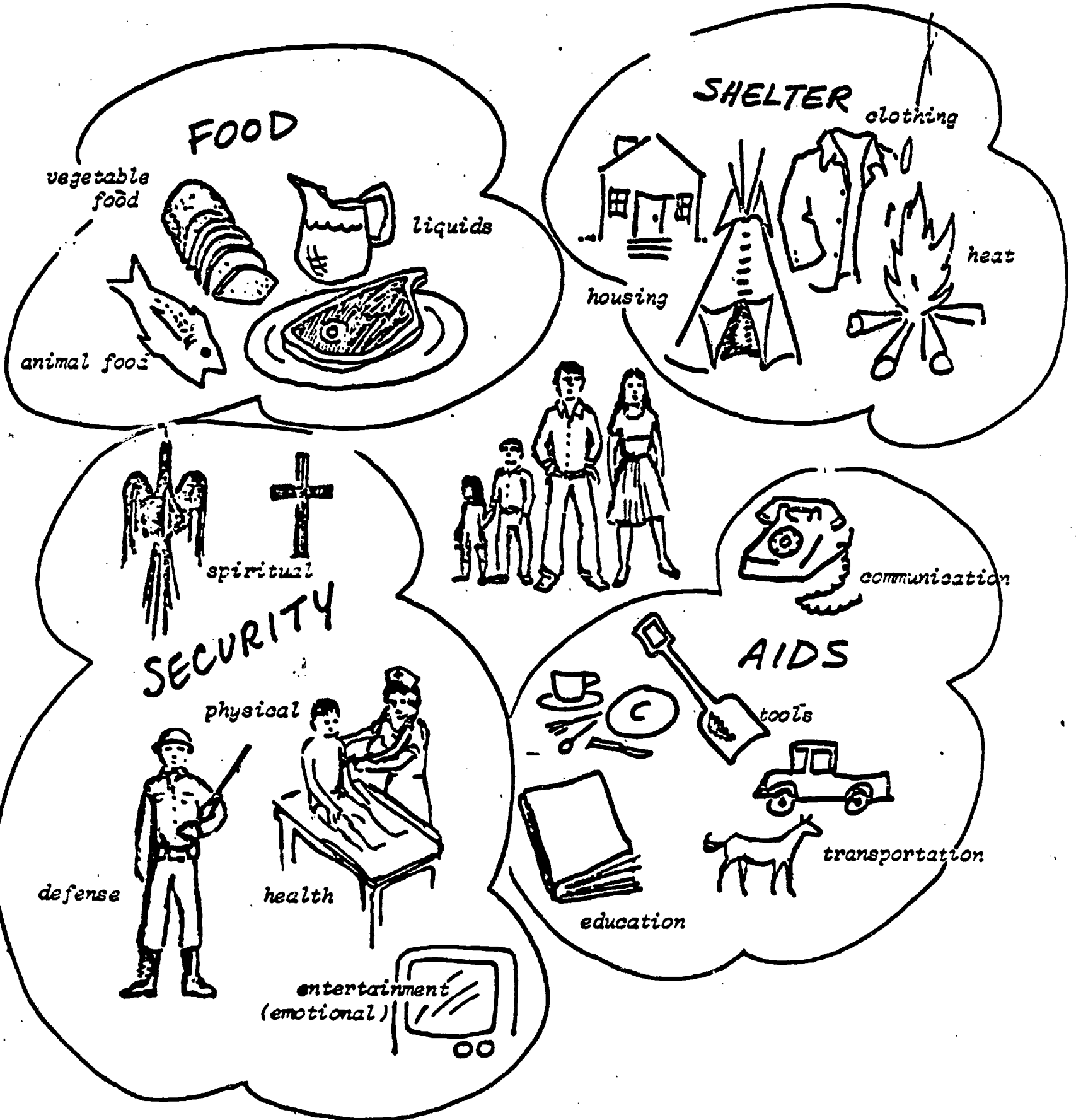

### CAREER CLUSTERS AND BASIC NEEDS

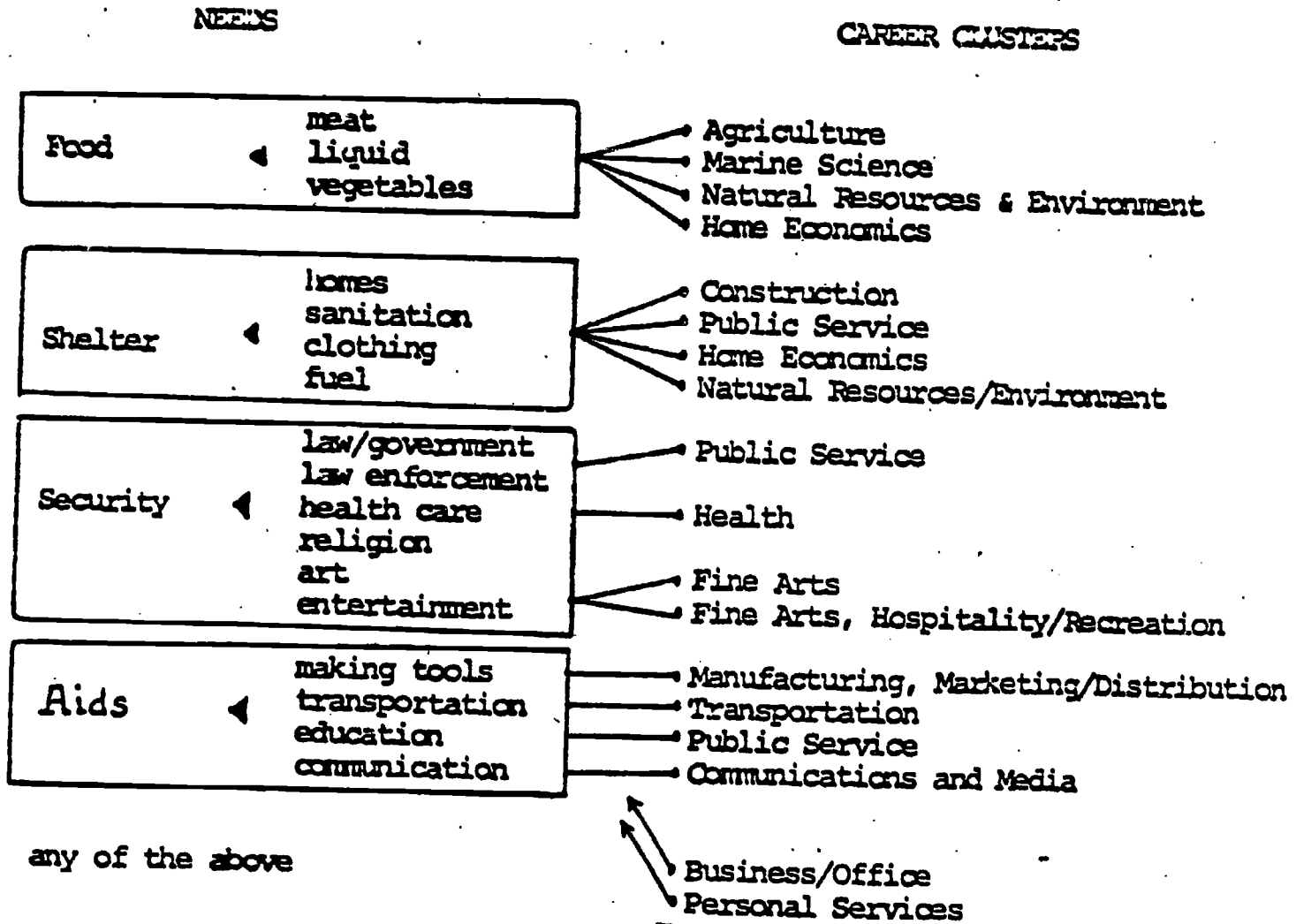

do research, or shows films, or lectures on the basis of previous research). Once the class has compared several ways of fishing, noting the similarities and the differences, it is ready to study the local fishing industry using field trips, films, interviews, etc.

#### (4) Career Clusters

As shown by Transparency #24, basic needs can also be related to career clusters. Grouping jobs this way is a convenient method of dealing with a large and sometimes confusing mass of information. It has two main advantages:

- students who have a general idea of what they want to do with their lives--example, 'to make things' --can be pointed towards the need area and career areas within it, such as Aids (transportation/car designer).
- studying a whole cluster enables one to include jobs at all levels, from laboratory assistant to surgeon. Someone with an interest in the medical field can choose the job most consistent with his/her aptitudes and lifestyle preference.

#### (5) Community

Ask participants to define the word 'community'. Bring out of the discussion the ideas that it can mean both the economic community--the group of people who depend on each other to meet their basic needs; or the social community of those who depend on each other to meet their psychological and emotional needs. Ask for examples of both kinds.

Examples: Economic community--an Iroquois village, a small western town, a medieval castle, an urban neighborhood

Social community--the families who meet at an urban Indian center, families who attend the same church in a small town

Sometimes, of course, the two may be the same.

#### (6) Cooperation and Management

Ask participants to think about their own jobs and note what parts of it require them to coordinate their efforts with other people's, and what parts of it require them to direct their own actions or those of others. Compare notes. Discuss cooperation and management skills required within a career cluster such as the construction industry, i.e., those needed by the boss of a construction company and the workers in it.

Point out that in cultures where self-management is stressed, cooperation has to be voluntary. In cultures where obedience to the leader or the law is valued, some people must learn to manage the cooperation of others. People need to learn to be leaders and followers: The degree to which one prefers one or the other will help one choose a career.

The above ideas can serve as a useful foundation for any career education program.

The Native American Career Education units use a variety of learning activities, many of which we have already discussed. Several approaches to classroom management have been found particularly useful. Specific directions for them are found in the units themselves. In summary they are:

- the use of student workgroups in which groups of 3-7 students work together on learning tasks;
- flexible presentation--recommendations for alternative media if the first choice is unavailable or inappropriate;
- reinforcement and feedback--regular practice exercises, immediate confirmation of success, and the opportunity to correct failure.

### The Units

Have the Native American Career Education units handy so that you can hold each one up as you describe it and pass it to any participant who is interested. Explain that these units can be used wholly or in part within a variety of subject classes and situations. Activities from different units can also be recombined to form new sequences.

The units consist of guidelines for the teacher and masters for student worksheets. The guidelines include suggestions for adapting the worksheets. Teachers should make whatever changes they find useful, reproduce and distribute the worksheets as needed. The chart on page 3.29 indicates which units are relevant to which subject areas.

Put on Transparency #25 and leave it there while you present the units.

The Career Awareness Units provide students with a general understanding of the role careers play in the economic system and the cultural factors involved. They are:

- Cooperation--often given first to train students in group interaction, covers cooperation, conflict resolution, causes of problems such as conflicting values or personal difficulties, and opportunities for students to practice working together. Features a simulation set in an Urban Indian Health Center.
- Part of the Whole World-- moves from consideration of individual identity through individual as member of community, tribe, Indian ethnic group, American, resident of a geo/cultural area, inhabitant of planet Earth; compares ways in which people in different places meet their needs, with a strong emphasis on Indian culture and its contribution to the world; helps students consider how they are the same and how different from others.
- From Idea to Product--Students learn simple charting as a first step in planning, and also as a non-verbal way of describing a process; students learn and compare steps taken to make something in a traditional and in a technological setting, in this case a cradle-board and a playpen (these steps can be applied

3.29

<p>CULTURAL COMPETENCE AND CAREERS</p> <p>KNOWLEDGE AND MASTERY OF SELF</p> <p>OCCUPATIONAL AND ECONOMIC COMPETENCE</p> <p>SOCIAL COMPETENCE AND CAREERS</p>	<p><b>AWARENESS</b></p> <p>Unit : "Part of the Whole World: (Cultural awareness, economy aspect of culture)</p> <p>Unit : "Cooperation" (values, conflict resolution, preparation for group work)</p> <p>Unit : "From Idea to Product" (analysis of tasks, basic stages in product manufacture)</p> <p>Unit : "The Community" (how community economy meets basic needs)</p> <p>Unit : "The Community in Transition" (cultural and economic changes and survivals as technology and resources change)</p>	<p><b>ORIENTATION</b></p> <p>Unit : "Putting Your Money to Work" (Managing financial resources for family and small business, money-handling skills)</p> <p>Unit : "Living with the Land" (Managing natural resources to meet community needs, and associated careers)</p> <p>Unit : "Working for the People" (U.S. &amp; Indian government structures and careers, and how governments manage community resources to meet needs)</p>	<p><b>EXPLORATION</b></p> <p>Unit "Planning" (self-analysis, group and personal planning)</p> <p>Unit : "Putting It All Together" (Career clusters and their relationships, values, aptitudes, and career choice)</p> <p>Unit : "Getting Ready For Jobs" (levels within job areas, identifying training requirements)</p> <p>Unit : "The Career Fair" (researching specific jobs and career clusters, working with group to plan and put on career fair)</p>

to any product). This knowledge should help students understand how the many different jobs in our economic system are related to each other.

- The Community--Students compare the economic structures of a traditional plains village, a contemporary small town through a simulation, their own community; consider the effects of adding a new industry; then consider what new industries or businesses might be started in their own community.
- The Community in Transition--follows historical development of an imaginary southwestern tribe from hunter/gatherer way of life through life in an agricultural village, on a reservation, and planning a new community; demonstrates the relationship between resources and technology and lifestyle and roles; shows how some things change as environment changes, but some things in a culture can stay the same.

The Orientation Units - only three of these were developed, to serve as models for users to develop more aimed at career areas of local importance. For instance, at McDermitt, Nevada, teachers developed a unit on uranium mining.

- Putting your Money to Work--managing financial resources on a personal and business level, and some of the careers in which people deal with money; covers practical skills like budgeting, check-writing, etc.
- Living with the Land--managing natural resources, ecology, conservation, use of materials, waste disposal and pollution; presents an environmental problem facing an Indian tribe, asks what jobs would help people deal with it; describes numerous environmentally related careers.
- Working for the People--government and public service careers (managing social resources) at various levels, including tribes and Indian organizations; asks what government does for people, and what kind of government meets which kinds of needs.

### The Exploration Units

Present some of the knowledge and skills students will need to explore careers on their own and understand the information career counsellors can provide.

- Planning--develops skill in planning ahead which can be used in personal development and career planning; promotes self-analytical skill (also planning is useful skill in job situations).
- Putting it all together--presents career clusters, the needs they meet, and how different career clusters may contribute to a product; also considers the relation between interest and aptitudes and job choice; uses planning and cooperation skills.

UNIT RELEVANCE TO SUBJECT AREAS

	Unit	Social Studies	Language Arts	Fine or Industrial Arts	Math	Life Science	Social Development*
AWARENESS	Cooperation		X			x	X*
	Part of the Whole World	X*	x	x			
	From Idea to Product	x		x			
	The Community	X*					
	The Community in Transition	X*				x	
ORIENTATION	Putting Your Money to Work				X*		x
	Living with the Land					X*	
	Working for the People	X*					
EXPLORATION	Planning		X*	x	x		
	Putting It All Together	X*		x			x
	Getting Ready for Jobs	x	X*		x		
	The Career Fair			x			X*

X = primary relevance  
 x = secondary relevance

\*this class could also be "family living" or a similar class, homeroom, or a special career education class.



- Getting Ready for Jobs--discusses the education and training needed for different kinds of jobs, so that educational planning will be realistic; students also learn how to find out about available jobs and decide whether they would be interested.
- Career Fair--this is the culminating group exercise in which students plan a career day. It could unite students from different classes and levels, and is a good way of involving community members.

When you have finished discussing the units and participants have had a chance to glance through them, ask the teachers in the group which units they think might be useful in their classes. You may need to lead them a little--use the chart on the previous page for suggestions on which units would be most relevant to which classes. If teachers feel the units would be too advanced or too simple for their students, discuss ways of adapting them.

For instance, a 4th grade teacher at McDermitt adapted the unit, 'Cooperation' by having her students do the puzzle game and the first simulation (set in a school situation), and discuss questions from some of the worksheets orally. A teacher at Oakland Technical High School, added research activities to the unit 'Part of the Whole World' to make it more challenging. Her class used what it had learned from the unit as research on which to base an Indian Heritage Assembly.

The same teacher took planning activities from 'Planning,' budgeting exercises from 'Putting Your Money to Work,' and the Introductory activities from 'Living with the Land' and combined them to help her class plan, supply, and conduct a group camping trip. A teacher at Hoopa Elementary School in northern California made 'Living with the Land' the foundation of his 7th grade science class, alternating activities from the unit with other work.

It should be possible to identify some activity from some unit which could be used by any teacher in the group--even if it is only general skills such as cooperation or planning. It is possible to utilize the NACE approach without using the units, but the developers feel that a teacher's ability to adapt and develop NACE activities will be increased if he or she has had experience with the units.

#### Activity 5.--BREAK

Give participants a 15 minute break, during which they can look at the units, talk to you about specific questions, etc.

#### Activity 6.--DEVELOPING CAREER EDUCATION ACTIVITIES FOR NATIVE AMERICAN STUDENTS

When participants have returned from their break, divide them into groups for the application activity. Each group should include a teacher, a community person, and a counselor or administrator, if possible. If participants from more than one district or school are present, divide them according to where they are from.

After participants have settled into their groups, ask them to turn to Worksheet III.3 on p. 3.4 of their handbooks. Using this worksheet as a guide, their goal is to write a lesson plan for a career education activity lasting one class period. The lesson plan should specify objectives, class activities, resources needed and sources, and some way of evaluating the results.

The lesson should also be adapted to the needs of a specific class, whose ethnic and economic characteristics, grade level, etc., should be stated. Groups may choose an activity from one of the units to adapt, take something from one of the other career education materials available, or invent an activity based on the NACE concepts they have just learned. (It would be advisable to review the concepts at this point: cultural relevance, basic needs, traditional and technological lifestyles, career clusters, community, and cooperation and management.)

The lesson plans will be critiqued on the basis of the following questions:

- Is the activity feasible?--suited to the students' age and interest levels, based on accessible resources, etc.?
- Has it been made culturally relevant?--does it include Indian role models, or supporting background that will provide a cultural context?
- Are the objectives clear and can they be evaluated? What exactly will the students do, and how will you know if they have done it?

An example of an adaptation from a commercial career education guide appears at the end of Session III in the Participant Handbook, and on pp. 3.35 - 3.38.

As the groups work, circulate among them, listen to their discussion, ask how things are going, etc. If groups seem to be stuck or sidetracked, offer suggestions on alternative approaches. When groups have had between a half-hour to 45 minutes, give them 5 minutes to wind up their discussion and reconvene the entire group for the discussion.

Have each group choose a speaker to describe its lesson plan. Repeat the three questions to be used in critiquing the plans, and lead the group in a discussion of each group's activity.

If participants are taking the workshop for credit, they may want to use this lesson plan as the basis for an implementation project.

#### Activity 7.--REVIEW OF THIS SESSION

To wrap up the session, summarize the basic points covered as follows:

- Important characteristics of traditional Indian educational methods were observation, supervised participation, unsupervised practice, and self-evaluation. The survival relevance of each skill learned was obvious to the learner.

- The World of Work can provide resources, enrichment, and models for classroom organization, including the idea of organizing students into small workgroups to address learning tasks.
- The Native American Career Education program consists of twelve units in career awareness, orientation, and exploration. These units are based on the following concepts: cultural relevance, basic needs, traditional and technological lifestyles, career clusters, community, and cooperation and management. These units can be adjusted for a variety of cultural/economic settings and grade levels.
- Career Education activities can be adapted from NACE units or other materials or developed from scratch. They should be feasible, culturally relevant, and able to be evaluated.

**ADAPTED ACTIVITIES FOR NATIVE AMERICAN CAREER EDUCATION**  
**(Career Education Infused into Energy Education)**

**Objective #1**

**ORIGINAL OBJECTIVE:** Each student will list five reasons why the demand for energy increases as the civilization advances.

**SUMMARIZED PROBLEM:** The objective is not specific enough when speaking of civilization--particular groups of people advance in different degrees and ways. A general statement like this does not give a clear understanding of any one group of people.

**REVISED OBJECTIVE:** Each student will list five reasons why Native Americans lifestyles change as the demand for energy increases.

**SUGGESTED ACTIVITIES:**

1. By means of group discussion the students will share their ideas about the meaning of energy resources. The ideas and meanings could be written on the board or recorded by a student.
2. Have students list the types of energy used at home and at school. Then compare the energy available to them with that available to their parents when they were their age. Then also make a comparison of the energy available to their grandparents or elders. Ask what industries and jobs exist now that weren't possible then, and vice versa.
3. The student will paint/draw a mural depicting scenes of Native American lifestyles from earlier times to the present, with special emphasis on ways of meeting basic needs.
4. Have students discuss the relationship between resources, values, and ways of living.

\* Adapted from the CAREER ORIENTATION Curriculum Supplement for Grades 7-8, produced by the Ohio Department of Education, Columbus, Ohio (1974)

5. Show films about careers in energy production.

Objective #2

ORIGINAL OBJECTIVE: Each student will give reasons why Columbia Gas of Ohio will not allow builders to place natural gas lines in new homes in Franklin County area after October 1, 1972.

SUMMARIZED PROBLEM: The location of the city, name of the company and year should be changed to familiarize the student with local problems or problems that are widespread.

REVISED OBJECTIVE: Each student will give reason why the 1975 Environmental Protection Agency will not allow mining companies to deposit mineral waste near residential areas, or, choose an environmental problem discussed in a recent issue of your local newspaper.

SUGGESTED ACTIVITIES:

1. Have students write letters to mining companies inquiring of each how the company takes care of its mineral waste. Find out what jobs are included in this aspect of resource production.
2. Have students research in the local library for information in periodicals, newspapers, and media coverage that will provide information on energy development. Have students define the 1975 Environmental Protection Act.
3. Invite guest speaker's from various environmental agency groups to talk about what they do.
4. Show relevant films.

### Objective #3

ORIGINAL OBJECTIVE: Each student will be able to identify Kuwait as the world's leading producer of oil, Russia as the world's leading producer of coal, and Canada as the world's leading producer of natural gas.

SUMMARIZED PROBLEM: The objective is written well, but students should also know about natural resources here in the U.S., especially those on Indian lands.

REVISED OBJECTIVE: The students will be able to identify the natural resources available in the United States and the rest of the world. Each student will be able to classify the resources according to their quantity, usage, and location.

### SUGGESTED ACTIVITIES:

1. Students could be divided into groups to find out about natural resources in different states and reservations. When information is gathered design a pictorial map of natural resources.
2. Plan a field trip to a local company that processes a natural resource in your area, find out what jobs it offers and how one prepares for them.
3. Develop a resource file that could be donated to local people needing information about local companies involved in development of natural resources.
4. Write to tribes owning rich natural resources and find out whether they have hired people to locate resources on the reservation and advise them about how to develop them. What background and experience did these people have? Were they Indian or non-Indian? Ask them to list what natural resource-related jobs they would encourage Indian young people to train for.
5. Show films about Indian tribes whose natural resources are being developed productively or destructively.

**Session IV:**  
**Career Education**  
**Program Development**

# Introduction

## Goals

Session IV should be the culmination of the workshop, in which participants draw on what they have learned in the first three sessions in order to understand the process of career education program development and become involved in it. Specifically, Session IV focuses on the following objectives:

- participants will be able to list pros and cons of alternative career education implementation strategies;
- participants will be able to describe a fully developed career education program, and be able to summarize the three basic stages in its development;
- participants will be able to identify potential funding sources for Native American career education programs, and describe the basic steps in writing a proposal; and
- participants will be able to outline a plan for participating in career education program development for their school or project.

## Activities

This section lists the major activities in the first session along with estimated time allowance for each:

- |  |        |
|--|--------|
| 1. Review of Session III                         | 5 min  |
| 2. Career Education Implementation Strategies    | 20 min |
| 3. Career Education Program Development          | 20 min |
| 4. Paying for the program--proposals and funding | 20 min |
| 5. This time next year--planning for development | 30 min |
| 6. Workshop wrap up                              | 20 min |



## Materials

Coordinator's Manual

Transparencies (4.7, 4.8, 4.10)

Participant's Handbooks

Examples of proposals (optional)

Copies of Evaluation Questionnaire

Overhead projector and screen

Extra pencils and paper

## Preparation

Familiarize yourself with the material covered in this session before it begins. This is your last chance to reach participants, so you may want to note any points that may need reiteration for the workshop wrapup.

# Introduction

In the first three sessions of this workshop you have been introduced to the basic concepts of career education, had a taste of working with others on a career education planning committee, and practiced developing career education curriculum for Native American students. In the fourth session, you will learn about the process of developing a career education program from seeking funding to becoming a model for others.

Specifically, at the end of this session you will be able to:

- list the pros and cons of several ways of implementing a career education program;
- describe the three basic stages in developing a career education program, and know what form the completed program might take;
- identify funding potential sources for different kinds of career education program; and describe basic steps in writing a career education proposal;
- outline a plan for beginning or extending career education program development in your school or project during the coming year.

Session activities will include lecture and discussion and use of worksheets.

# Guidelines

## Activity 1.-- REVIEW AND INTRODUCTION

### Review

This review will refresh participants' memories of the main points made in Session III. If you are continuing from the previous session with only a brief break, you may choose to omit the review.

Ask participants to summarize the main characteristics of traditional Indian education or do so yourself, indicating that learning methods included:

- observation
- supervised participation
- unsupervised practice
- use of A-V aids
- self-evaluation
- simulation
- small group activities
- hands-on activities

Ideas for teaching methods suitable for career education can also be drawn from the world of work. They include:

- organization of students into small, task-oriented groups
- individual projects
- use of teacher as a facilitator/coordinator
- direct exposure to job situations, on-the-job training

Many career education resources are available, including the twelve units in career awareness, orientation, and exploration developed by the Native American Career Education project. The approach used to develop these units can be used to adapt other materials or to develop new ones which are adjusted to the needs and resources of a specific setting and student group. The approach emphasizes:

- cultural relevance
- basic needs
- traditional and technological lifestyles
- career clusters
- community
- cooperation and management

The information summary for Session III discussed these points in more detail. Relevant information can also be found in the NACE Curriculum Guide.

## Activity 2.--CAREER EDUCATION IMPLEMENTATION STRATEGIES

Ask participants to describe the kinds of career education programs or activities they have seen or been involved in. Make notes on these so that you can use them as examples in the discussion that follows. When everyone who wants to has spoken, explain that approaches to most career education fall into one of three groups. Each of these approaches has advantages and disadvantages. Ask participants to turn to worksheet IV.1 in their books. As you describe each approach, ask participants to list pros and cons on the worksheet.

### 1. Career education as a separate program

The first way schools developed to present career education was to make it a separate program. If vocational education classes are considered an aspect of career education, they would fall into this area. Separate career education classes or counselling programs also belong here. Student activities include reading about careers, learning to fill out job applications and other job-seeking skills, etc., field trips and speakers, simulating work activities. If a class is set up in which career education is treated as a separate subject, it may be required of all students at a given grade level, or offered as an elective. At some schools, such a class may be the only way to provide career education targeted towards a specific group, such as Native Americans. Career education programs may also be offered by Indian centers. Sometimes the career education program can be used as a vehicle for education in various subject areas, such as reading, math, science, etc.

### 2. Career education infused into the school curriculum

Infusion has been the method of career education most widely promoted in recent years, particularly by the Office of Career Education. It features presentation of career education content and activities in the context of subject classes. The career oriented material is closely related to the objectives of the subject being taught, and is intended to enrich it and motivate student interest in it.

Teaching methods include: references in the course of lectures--the use of comments, career examples and illustrations; posters and pictures in the classroom; reading assignments with career as well as subject relevance; word problems with career settings; essay topics; simulations addressing basic skills in a career setting; speakers and field trips in career areas related to the subject. The career education activities may be completely integrated into the presentation of the subject, or may be used as occasional enrichment.

### 3. Career education and academic learning via work-experience

One of the newest approaches to career education, developed by Experience-based Career Education programs and others, has been to make arrangements for students to earn school credit for on-the-job experience. An earlier version

of this idea was job-experience programs such as the R.O.P.E. program in which a student works for 6 weeks for a local employer, then switches to another for a second "unit" and so forth.

The EBCE model involves setting up an alternative school organization in which learning coordinators work with students to develop plans, for projects in which they use or develop academic skills while working for employers. The program works out a set of equivalencies so that students can meet legal graduation requirements, and provides self-instructional materials or small-group classes to help students improve basic skills where needed. Modified forms of this approach in which the work-experience program is managed by the school have also been used.

### Pros and Cons

When you have finished discussing each approach, ask participants what pros and cons they found in the first approach. After they have started talking, put transparency 26 (p. 4.7) on the projector with a piece of paper covering the second and third rows. Discuss the pros and cons of separate career education classes as indicated on the transparency.

When you have exhausted the possibilities of row one, ask participants about the pros and cons of infusing career education into the curriculum, and move the covering paper to reveal the second row of the transparency. The same procedure should be followed for the discussion of work-experience programs.

In concluding, make it very clear that a school does not necessarily have to make a choice among the three approaches to career education. In fact, the most flexible and effective method may be to combine them, selecting the type of career education that is most suitable for use in each educational level and setting.

### A comprehensive program

Put transparency 27 (p. 4.8) on the projector.

Point out that career education, like any other subject, needs to be presented gradually, moving from simple concepts and skills to more complex ones. Therefore a completely developed career education program should start in kindergarten and continue through high school and beyond. The transparency shows what kinds of content and activities might be appropriate at each level. Such a comprehensive program might feature infused career education through the elementary years, a career education class in junior high, and work-experience opportunities in high school, while infusion into subject classes continued at increasing levels of sophistication.

The scope of a career education program will depend on the nature of the educational system involved. Depending on the setting and organizational arrangements, a career education program might be developed by an academic department, such as Vocational Education; a single school, such as a BIA boarding school or a rural combined school; a school district which includes

Implementation Strategies	Advantages	Disadvantages
<p>CAREER EDUCATION AS A SEPARATE CLASS OR CLUB</p>	<ul style="list-style-type: none"> <li>. can address special populations</li> <li>. can provide intensive exposure</li> <li>. make sure everyone gets same experiences</li> <li>. address CE systematically</li> <li>. focus CE resources of talent and materials</li> </ul>	<ul style="list-style-type: none"> <li>. transfer students may miss out</li> <li>. learning may be transitory</li> <li>. CE may seem less relevant both to academic program and life</li> <li>. requires special teacher and resources</li> </ul>
<p>CAREER EDUCATION INFUSED INTO SCHOOL PROGRAM</p>	<ul style="list-style-type: none"> <li>. demonstrates relevance of all subjects to careers</li> <li>. can be implemented by regular school staff</li> <li>. reinforce and revisit concepts at higher levels</li> <li>. all students get some CE</li> <li>. encourages staff to communicate</li> <li>. coordinates total school curriculum</li> </ul>	<ul style="list-style-type: none"> <li>. exposure of individual student to CE less predictable</li> <li>. impact may be diffuse</li> <li>. some teachers may be unwilling or unable to address CE</li> <li>. Other goals/pressures may cause CE to be slighted</li> </ul>
<p>WORK-EXPERIENCE- BASED CAREER EDUCATION</p>	<ul style="list-style-type: none"> <li>. provides high student motivation</li> <li>. learning is highly relevant to eventual career needs</li> <li>. develops independence, maturity in students</li> <li>. direct career preparation</li> <li>. provides alternative for those disillusioned with regular school program</li> </ul>	<ul style="list-style-type: none"> <li>. requires flexibility in school programming</li> <li>. requires extra staff time, possibly separate facilities</li> <li>. requires close cooperation and coordination with community, business, etc.</li> <li>. credit may be hard to arrange</li> </ul>

AN IMAGE OF A COMPREHENSIVE CAREER EDUCATION PROGRAM

EDUCATIONAL SETTING	ELEMENTARY			SECONDARY			COLLEGE			EMPLOYED					
	1	2	3	4	5	6	7	8	9	10	11	12	AA	BB	grad. career ladder
LEVEL	← (Individual) AWARENESS →			(Societal) AWARENESS			← PREPARATION →								
	← ORIENTATION →						← EXPLORATION →								
	basic human needs			the purpose and nature of specific career areas, careers, and career requirements			career and leisure			how abilities and interests affect job choice			skills and knowledge for specific jobs		
	job titles in the community			business organization			economics			job markets and hunting skills			staff development		
SAMPLE ACTIVITIES	jobs and roles in other communities			social and economic factors affecting community structure, careers, and roles			self-directed group projects			job training requirements			career change information		
	cooperation games			interviewing job-holders			career counseling			job counseling			on-the-job training		
	role playing			simulations			individual research			jobs and lifestyles			preserve training and certification		
	speakers and trips			films, tapes, books			visits to businesses			internships and projects in a job setting			summer and part-time employment		
films and stories about jobs												night and special courses			
												mid-life career change counselling			

transparency 27

elementary, middle or junior high schools, and high schools; or a region in which several districts cooperate to share goals and resources.

Ask participants to describe the educational unit in their own setting which is most likely to be able to plan and develop a coordinated career education program.

### Activity 3.--CAREER EDUCATION PROGRAM DEVELOPMENT

So far you have discussed different approaches to career education and what a completely developed program might look like. The big question is-- "How do we get there?" Whether or not a school already has some kind of career education going on, it probably does not have a full program for Native American students. Therefore, you should discuss the process of program development as if the participants are going to have to start from scratch.

Put transparency 28 (p. 4.10) on the projector.

The drawing on the transparency may seem rather humorous, but it reflects the actual stages of program development pretty well. Point out that in addition to the stages themselves, the drawing features a 'launching pad'--a period when the resources, support, and skills necessary for program development are being gathered.

The following factors need to be present in order to develop a new program--if they are not already apparent in a situation, they will have to be developed:

- access to students--a setting in which large enough numbers of the students whose needs will be addressed can be gathered together;
- administrative support--as indicated in Session II, administrators must be in favor of the program, and if possible, actively pushing it;
- community support--the community must be aware of a need for career education for its children and willing to send representatives to work with the school or project;
- school/community communication--by means of some established group such as a Title IV or Johnson O'Malley Parent Advisory Committee or a tribal Indian Education Committee.

Ask participants to comment on which of these factors exist in their school or project settings, which are missing, and how they might be developed, or have them note this on Worksheet IV.2.

#### Stage I: INITIATION

Once the ground work has been laid, actual program development can begin. This should proceed in several steps. These and later steps are presented in more detail in the Implementation Guide.



GETTING OFF THE GROUND

Stable Orbit

Program serves as a model for replication elsewhere.

Third Stage: Refinement

Summative evaluation of program effects may take place. Staff employ regular monitoring and maintenance procedures and make necessary adjustments.

Second Stage: Expansion

A majority of staff and administrators are trained. Broad-scale community support is developed. Needed materials are written. The program is expanded to all levels of the system and formal evaluation takes place.

First Stage: Initiation

Specific information on Career Ed. needs is collected. A pilot project is begun and formative evaluation takes place.

Launching Pad

General awareness of problems and interest in Career Ed. as possible solution. Willingness to work for improvement.

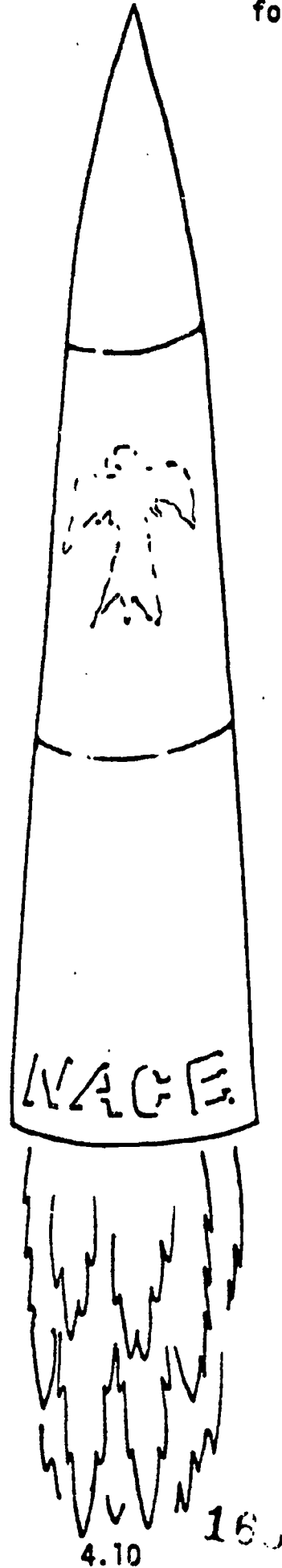

### 1. Form a Career Education Committee (CEC)

This committee should include representatives from all the major groups described in Session II, although it may choose two or three people to spearhead the effort. If the school/project has a career education specialist, he or she should play an important role.

### 2. Do a community needs assessment

In order to involve the community from the beginning and collect accurate information on desires and needs, the CEC should do a community needs assessment, or analyze needs assessments which have been recently made. Several guidebooks and training materials for use in needs assessment are described in the information summary for Session IV.

### 3. Develop career education goals and objectives

The CEC should analyze the needs assessment and investigate career education goals set out by the State, the district, and the NACE Curriculum Guide in order to derive a sample set of goals which can then be broken down into objectives for each grade and class to be included in the total program. Training materials for setting goals and objectives are also described in the information summary.

### 4. Plan and implement a pilot program

In order to build support for the career education program, the first implementation should be small scale, with a sufficient investment of resources and support to give it the best chance of success. The pilot project could involve a single class, grade level, career area, etc. Personnel involved should receive training such as this workshop, the project should be carefully evaluated, and the results should be widely disseminated in the community. The goal is to have everyone else clamoring to become involved.

The Hopi Health Careers project is an example of a career education program that started with a concentration on one career area and gradually extended into other areas and levels until a complete program had been established.

Ask participants to comment on the most promising approaches to developing a pilot project in their schools, or have them note this on Worksheet IV.2, (on page 4.2 of their handbooks).

### Stage II: EXPANSION

Based on information gathered during the initiation phase, the CEC will then coordinate the expansion of the program--this will probably take several years. Things which must be accomplished include:

1. Train educational staff and community people

As the program extends into different classes and grade levels, the teachers to be involved must be trained. As more and different community people become interested in the program, they should be trained along with the educational staff. If this workshop is used, trainees from one year can coordinate the workshop for others later on.

2. Establish cooperative relationships with resource people

It will probably take some time to build relationships with local businesses and industries so that they will be willing to provide speakers, work-experience and field trip sites, etc. More detailed information on how to do this is included in the Implementation Guide, and some further resources are described in the Information Summary.

3. Develop curricula

As the Committee, teachers, etc. become more familiar with the needs and resources of the program, needs for original curriculum materials specifically developed for use in your own situation will become apparent. The principles and methods presented in Session III can be used to do this.

4. Evaluate and revise the program

As the program continues, evaluation should become an integral part of its operation with the specific purpose of contributing to program improvement. Materials, methods, and organizational arrangements should be examined regularly to make sure they are working well. The programs goals should also be periodically re-examined to make sure that changing conditions do not require changes there as well. As the program goes on special care should be taken to keep its various parts balanced and coordinated.

Ask participants to comment verbally or on their worksheets on what they think a fully developed career education program in their setting might look like.

### Stage III: REFINEMENT AND REPLICATION

Once program development is complete, the program will have to be maintained at maximum effectiveness. Activities which take place during this stage include:

1. Implement a communication/monitoring system

The evaluation procedures and communications network developed during program expansion should be refined and extended. After

the excitement of doing something new has died down it is very easy for people to slack off and for communication to break down. Monitoring procedures should include ways of noting changes in community needs which the program should respond to.

## 2. Perform Summative Evaluation

When a program has reached this stage, enough data should be available for a summative evaluation on its effectiveness to be performed. This evaluation will identify any major and some minor problems, and will also provide information to other schools interested in following your example.

## 3. Serve as a model for program replication

Once a positive summative evaluation has taken place, the program should take steps to let other schools, etc. know what it is doing and establish ways for them to learn about it. This includes making arrangements for visits by observers, sending people to educational conferences to talk about the program, writing articles for state or regional career education newsletters, etc.

Ask participants to turn to Worksheet IV.3 in their handbooks and read the capsule case histories there. They should note any problems they see in the space provided, and suggest solutions.

When everyone has had a chance to do this, lead a discussion of problems and solutions. The sample answers on p. 4.14 may be used to start and guide discussion.

### Activity 4.--PAYING FOR THE PROGRAM

The question participants should be asking by now is 'Who's going to pay for all this?' The ideal eventual solution is for career education to be included by the school district, tribe, or Indian Center with the rest of its educational goals and budgeted accordingly. This will have to happen if the program is to become permanent. However external funding can be very helpful in getting a program going.

Funding sources which have or could provide money for Native American career education include:

- The Office of Indian Education Title IV program (for Indian organizations)
- Johnson O'Malley
- State Career Education Offices through CE Incentive Act
- Bureau of Adult, Occupational and Adult Education
- Department of Labor (CETA, etc.)

## Worksheet IV.3

### ONCE UPON A TIME...

Read the following 'case histories' and in the spaces below make some notes on what you think will happen. How do you think the actions in the stories will affect students, school staff, the community, or the program itself?

Miss Meanwell, a 6th grade teacher at Willow Elementary School, felt that Career Education had a lot of potential for motivating her students. She got some activity books, made a lot of references in class about how the skills being taught are used in jobs, and took the kids on a visit to a local sawmill. That June she got an offer of a better job in another town.

*Students may benefit, but are likely to forget quickly without follow-up. The 'program' will last only as long as the interested teacher is working on it. In order for it to continue, she should orient one or more other teachers in the school and show them what she learned, and hopefully get a group of school/community people working on developing a more durable program.*

Dr. Willing, superintendent of the Blue Rock School District, wanted to start a Career Education program. He attended some Career Education conferences and purchased several sets of materials. The next semester he sent a memo to all the teachers telling them that the materials were available and inviting them to use them.

*It is unlikely that busy teachers will take advantage of his invitation without more encouragement than that. He should arrange for staff training, and if possible, provide some other inducements. He should also meet with community leaders and work with them to adapt Career Ed concepts and materials to meet local needs.*

The Turkey Feather Indian center wanted to include Career Education in their after-school youth program but were unable to find suitable materials. Two parents and a staff member volunteered to write some. The completed materials featured illustrations and examples from several Plains tribes.

*Most urban Indian centers include people from tribes all over the U.S. The plains people may be happy with the materials, but the others are likely to object. The curriculum developers should seek the input of others when they are designing the materials.*

### Worksheet IV.3 Cont'd.

Jackson High School serves a rural student population that is 65% Indian, 15% Chicano, and 20% other. The faculty became very enthusiastic about Career Education and attended a workshop on it at the State Capital. Then they got together to plan a program that would introduce students to the newest, most exciting, careers.

*The teachers' perceptions of what careers will be exciting to these students may or may not be correct. They are unlikely to seem very relevant to what students see around them. Before planning the program, the school should involve community members, and gather information on local career education interests and needs.*

The Solidarity Indian Center got a Title IV project funded which included hiring a Career Education specialist who went into local schools to conduct Career Ed. activities for the Indian students. The program worked well, but in the third year the Center had some organizational difficulties and didn't get its proposal in.

*The problem with depending on outside funding for a Career Education program is that if funding fails, the program goes too. Sometimes factors unconnected with the program itself can make it fail. One alternative might be to try and get the school district to fund the career education specialist.*

Petitpoint High School, one of several in a semi-rural area, developed a good Career Education program and wanted to expand it with a work-experience program in cooperation with local business. Business leaders replied that the school could not supply enough students to make the effort of setting up a program worthwhile.

*Two possibilities here would be to work with one business on a pilot basis, and/or to persuade other schools in the area to develop Career Education programs so that together they might provide the required number of students for a work-experience program.*

A Tribal Education Committee conducted a needs assessment and found that most parents felt Career Education would be useful to their children. They presented the results of the survey to the local school superintendent.

*The superintendent may or may not listen. They may have to bring pressure, or start planning and ask the school's input.*

- The School Improvement Program
- Foundations, such as Rockefeller, Ford, etc.
- Local businesses and industries

Ask how many of the participants have ever been involved in writing proposals--get details of what kinds of proposals, who they were submitted to, whether they were funded, and what problems the proposal writers faced.

Proposal writing is a skill which can be developed--a workshop developed to teach women's organizations to write proposals is described in the information summary. It could easily be adapted for use by a group working on Native American Career Education. You will be covering a few of the main points here in order to introduce them.

To start off, ask participants to turn to Worksheet IV.4 in their books. They should consider each 'project' described and number in order of the three funding agencies most likely to be interested in the proposal. Discuss participants' answers. Sample answers are provided on the next page.

#### Things to remember when writing a proposal

1. Choose a workable idea--the project you propose should respond to a documented need, be somewhat original (not what others have tried a thousand times before), be feasible in the setting and with the staff and other resources you will have available, and be the sort of thing funding agencies can support.
2. Choose an appropriate funding source--gather information on what kinds of projects various funding agencies are interested in, when their deadlines are, etc. Submit your proposal to someone who is likely to support your kind of project.
3. Get organized--find out if your funding agency requires a pre-application (a letter of intent, prospectus, etc.) before it will receive your proposal; gather information that will establish your credibility, such as resumes of staff, documentation of previous projects, etc.; decide if you will need consultants and recruit some; prepare a proposal checklist to make sure you cover everything. (see the example in the Information Summary of the Handbook.)
4. Write the Proposal--analyze the applicable Federal Rules and Regulations, the Instructions in the Request for Proposal, and the Evaluation criteria given, in the Program Announcement or other material from the funding agency to find out what information they want and how important it is. This will help you to develop your proposal outline.

Most proposals will have the following parts: a statement of need, a summary of supporting literature or documentation, and a statement of goals and objectives of the proposed project; a description of your group's approach to accomplishing a project, and the

Funding Sources  
(number in order of probability)

<u>Project</u>	Title IV	JOM	State Career Ed.	Bureau of Voc. Educ.	School Improv.	Business	District Budget
Indian tribe wants to give members vocational training for jobs in local timber industry.	1			2		3	
Public school on reservation with good CE program wants to have other schools observe it and send speakers to them.			2				3
Urban public school district wants to develop a multi-cultural CE program.			1		1	3	2
Indian center wants to provide special CE counselling services for local Indian students.	1	1	3				2
Small-town school wants to set up work-study program for Indian kids with local business.	3	1	3			2	3
Tribal Ed. Committee wants to develop elementary level units on tribal members in different jobs.	1	1				2	
Indian center wants to include CE in its teenage tutorial program.	1	1					
Rural district wants to hire an Indian CE specialist to assist teachers at several schools.	$\frac{2}{IV}$ A		?		1		1



specific tasks that will have to be performed to do this one; an evaluation plan for the project; a management plan that will indicate who will do the work, how they will be organized, and a chart scheduling the time involved for each task; a description of your organization, its previous work in this area, and the resources it can provide for the project (facilities, experience, access to other resources, etc.); a budget which is prepared on forms provided by the funding agency; and miscellaneous pieces such as tables of content, a cover letter, etc.

5. Submit the proposal--do a final review, make sure the proposal gets to the funding agency by the deadline, wait patiently to find out if it will be funded. If the funding source wants more information, provide it. If the proposal is rejected, contact them to find out why, so that you can succeed next year.

#### Activity 5.--BREAK

Use this opportunity to answer any questions participants may have on proposal ideas for their own settings.

#### Activity 6.--THIS TIME NEXT YEAR

The longest journey starts with the first step. The purpose of this activity is to get participants actually started doing something concrete--initiating momentum that may carry them into actual program development. If the workshop is being offered for college credit, this activity should produce a preliminary statement of what each participant intends to do to apply what he or she has learned and fulfill the requirements. It may be altered later, but at least they will have started thinking about what to do.

Explain to participants that the major activity for the second part of this session is to outline a one semester implementation plan for a Native American Career Education (or multi-cultural career education) pilot program. If participants are from different schools, they should do this individually, otherwise they should be grouped according to project, district, school, or department. This plan may incorporate and build on the career education activity they outlined in Session III and/or it may be based on the NACE units.

They should use Worksheet IV.5 (p. 4.7 of their handbooks) as a guide, and cover the following points:

- who and where the students are
- goals and objectives
- nature of the activities and how they will fit into the school program
- resources needed and/or available
- what will be evaluated and how

Give participants fifteen minutes or so to work on this, then warn them that time is getting short. Circulate among the groups as they work, making sure they are on course, offering suggestions, or answering questions as needed. After another five minutes, have them break off and ask someone from each group to summarize their plan. The larger group should comment on strengths and weaknesses, offer suggestions for improvement or enrichment, etc. If you have longer than two hours for this session, you can extend the time allowed for this activity. Participants who are taking the workshop for credit should hand in their plans now or send them to you or to whoever is coordinating credit arrangements as soon as they are finished.

#### Activity 7.--WORKSHOP WRAP-UP

Briefly summarize the content of this Session of the Workshop, pointing out that participants have covered the following topics:

- the three main approaches to implementing career education--separate, infusion, and work-experience;
- the basic stages in development of a comprehensive career education program--establishing readiness, initiation, expansion, and refinement and replication;
- potential funding sources for a NACE program or activities include--Title IV, JOM, State CE Incentive funding, the Bureau of Adult and Vocational Education, The School Improvement Program, CETA, and private sources such as foundations or business;
- things to remember in writing a proposal are--choose a workable idea, choose an appropriate funding source, get organized, write the proposal (including all essential parts), and submit it.

#### Evaluation

Administering the evaluation form is optional, but it will give participants a sense of closure, serve as way of reviewing the content of the workshop, and provide useful information on their mastery of content if they are taking the workshop for credit.

Pass out the evaluation forms, advise the participants to go through it at their own pace. Encourage them to add comments about the content or format of the workshop in the empty space on page three.

Close the workshop by collecting the evaluation forms, and making some statement summarizing the workshop experience. Try to find something positive to say, even if there were problems--focus on the factors revealed by the discussions which could provide the basis for a good career education program, such as experienced people, community resources, commitment to the idea of career education, etc. In most workshops, participants will have established

contact with people from other schools or projects for the first time, or may have learned new things about the people they already knew. The mutual enrichment that results from this kind of communication is one of the advantages of holding such a workshop, and should be commented upon.

End by expressing a sincere hope that participants will use the workshop as a foundation upon which to build their own programs, and that they will take definite steps in that direction soon.

If you wish to use the checklist (Session I) and the Evaluation form as a pre-/posttest, the following items in the checklist and the form cover the same content and can be used for comparison:

<u>Checklist</u>	<u>Evaluation Form</u>
1. a - d .....	2
2. a .....	1
2. c .....	3 (negative)
3. b .....	4
4. c, d .....	5
5. a, b, c (all positive).....	7
6. a, b .....	5
6. c .....	6
6. d .....	8 (negative)
7. a (b, c negative) .....	9
8. a .....	13
8. b .....	10
8. c (negative) .....	12
8. d .....	11
9. b .....	12
9. c .....	13
9. d .....	12
11. c .....	12
12. a, b, c .....	14 (negative)
13. a, b .....	15 (negative)
14. ....	5, 6, 8
15. a, c (negative) b (positive).....	16 (negative)
16. ....	10
17. ....	17
18. ....	17, 18
19. ....	19

173

Name (optional) \_\_\_\_\_

Place \_\_\_\_\_

Date \_\_\_\_\_

### WORKSHOP EVALUATION

The purpose of this form is to give you, and us, a better idea about how you feel about Career Education for Native Americans now that you have completed the workshop. The following pages contain a number of statements. Please show the degree to which you agree or disagree with the statements by circling one of the numbers from one to five in the column at the right. If you circle ①, it will mean that you definitely agree with the statement. If you circle ⑤, it will mean that you don't believe that at all. A circled ③ means you are still making up your mind.

Example: This workshop was about Career Education.      ①   2   3   4   5

	YES!										NO!
I. <u>Native American Career Education Content</u>											
1. Career Education includes all the experiences through which one learns about and prepares to work as part of one's life.	1	2	3	4	5						
2. A "career" includes a person's way of life, and may involve many "jobs" over the years.	1	2	3	4	5						
3. Career Education should be the same for everyone.	1	2	3	4	5						
4. Vocational Education may be an important part of Career Education.	1	2	3	4	5						
5. The teaching of Career Awareness should be repeated in more detail at several times in the curriculum to provide a good foundation for other parts of Career Education.	1	2	3	4	5						
6. "Infusion" into the entire curriculum is always the best way to implement Career Education.	1	2	3	4	5						
7. Career Education program planning should include both school people and parents and community members.	1	2	3	4	5						
8. The best Career Education materials stick to presenting information about jobs, only.	1	2	3	4	5						
9. A Career Education program should be directed by the counselling staff or a Career Ed. specialist.	1	2	3	4	5						
10. Career Education should teach students to accept the values of the business world.	1	2	3	4	5						
11. A professionally developed Career Education program will be equally appropriate for any school.	1	2	3	4	5						
12. Career Education should encourage students to go straight to college and prepare for professional careers.	1	2	3	4	5						



workshop Evaluation, p. 2

- |  |   |   |   |   |   |
|--|---|---|---|---|---|
| 13. Career Education materials should include as examples and role models workers of the same ethnic background(s) as the students.            | 1 | 2 | 3 | 4 | 5 |
| 14. Most students do not really want career information until they are finishing their educations and are ready to decide on further training. | 1 | 2 | 3 | 4 | 5 |
| 15. A school that wants to implement Career Education should be prepared to make a considerable investment in time and resources.              | 1 | 2 | 3 | 4 | 5 |
| 16. "Career Education" for Indian students is a modern invention.  | 1 | 2 | 3 | 4 | 5 |
| 17. Career Education has the potential to help Indian students learn to make a good living without losing their cultural identity.             | 1 | 2 | 3 | 4 | 5 |
| 18. The Native American Career Education program should be linked to the economic development planning of the Indian tribe or community.       | 1 | 2 | 3 | 4 | 5 |
| 19. The students' own community can be an excellent source of Career Education resources.  | 1 | 2 | 3 | 4 | 5 |
| 20. The presentations of Career Education speakers should be spontaneous, without any special preparation.                                     | 1 | 2 | 3 | 4 | 5 |
| 21. Groups involved in Career Education planning need to develop their own interaction skills.   | 1 | 2 | 3 | 4 | 5 |
| 22. Several contemporary teaching methods are similar to traditional Indian learning styles.   | 1 | 2 | 3 | 4 | 5 |
| 23. Indian students tend to prefer self- or group-directed learning rather than teacher-directed.  | 1 | 2 | 3 | 4 | 5 |
| 24. Each of the "career clusters" can be related to one or more basic human needs.   | 1 | 2 | 3 | 4 | 5 |
| 25. Development of a comprehensive Career Education program will go through several stages and take a number of years.                         | 1 | 2 | 3 | 4 | 5 |

Workshop Evaluation, p. 3

II. Personal Reactions

- |  |   |   |   |   |   |
|--|---|---|---|---|---|
| 1. Career Education could be helpful to students with whom I am involved (teaching, advising, parenting).                        | 1 | 2 | 3 | 4 | 5 |
| 2. Choosing a career is part of developing a personal and cultural identity.   | 1 | 2 | 3 | 4 | 5 |
| 3. Our school and community should work together on the Career Education program.  | 1 | 2 | 3 | 4 | 5 |
| 4. The cultures of the various ethnic groups in the school should be taught by their communities, not by the school.             | 1 | 2 | 3 | 4 | 5 |
| 5. I would like to contribute to the development of a culturally appropriate career education program in our school or district. | 1 | 2 | 3 | 4 | 5 |

# Information Summaries

Readings for:

Session I	p. 1
Session II	p. 10
Session III	p. 38
Session IV	p. 61

## SESSION I

### Why Native American Students Need Career Education

Economic status (and access to educational opportunities needed to change that status) has historically been lower for racial and ethnic minorities in America than for the Caucasian Protestant majority and those groups who were physically and culturally most easily absorbed by the majority. Among these minorities, American Indians have retained both a separate identity and a second class status (Indians living on reservations were not assured of citizenship until 1924) longer than any. As late as the 1960's Indian families on reservations had a median income of only \$1500.; unemployment rates often exceeded 50% and 90% of reservation housing was sub-standard.<sup>1</sup>

Two hundred years of effort to make the Indian into a white American have had little effect. Low cultural status has contributed to poor economic and educational status as well. Today, the growing appreciation of ethnic diversity in America, and the emergence of cultural pluralism as a value, suggest that the time has come for Native Americans to take their place as full cultural and economic participants in American society.

The policy statement of the Native American Career Education Project's Indian Advisory Committee stated this problem and desired solution very well:

...the needs of the Native American communities differ greatly from the greater American society, language and cultural beliefs. Governmental systems are separate and different from surrounding states and the non-Indian community. Conditions in Indian communities and reservations might best be identified as comparable to conditions in many underdeveloped countries. These countries, as do Indian communities, have many common problems such as high illiteracy, health problems which result in short life spans, high unemployment, and lack of economic development to support the livelihood of the people. In these countries, as in Indian communities, the problem is not due to a lack of natural resources, but a lack of meaningful development of human resources in order to begin the process of economic development. Many Tribal groups have realized the need to develop long range economic plans that will lead toward self-determination and independence, but there is now a need to develop their human resources that will make the economic plans of the Tribal group a reality. With this in mind there is a need to identify the various professions, skills and trades that will be needed to fulfill the long-range economic plans of the Tribal groups or to accommodate the economic trends of Indian communities.<sup>2</sup>

---

<sup>1</sup> F. McKinley, G. Nimnicht, S. Bayne. Who Should Control Indian Education? San Francisco: Far West Laboratory, 1970, p. 7.

<sup>2</sup> B. Ganathy and D. Studebaker. The Native American Career Education Project, Final Report. San Francisco: Far West Laboratory, 1976, p. 2.



In the long history of legal interaction between the U.S. Government and Indian tribes, the Indians have consistently requested that education for their children be part of the compensation they were to receive for the loss of their land. What they have asked for has not been education that will turn their children into white men and women, but education that will give them the tools to survive in the white man's world. The government's attempts to meet that need have met with limited success.

Throughout the latter part of the nineteenth century and the first half of this one, Indian education in the boarding schools attended by most Indian students who went to school was

...characterized by harsh discipline, military drill, use of cast-off army clothing, self-support from farm and herd, rural vocational training unrelated to employment on the reservations or in the cities. and purposeful separation of the children from home and family.<sup>3</sup>

This is not surprising, since the stated goal of these schools was to "...provide the needed development and supply the lacks caused by a faulty environment...The task is changing a way of living."<sup>4</sup>

However, the products of this approach to Indian education were men and women who were neither prepared for life on the reservations nor off them. Those few who did succeed in agriculturing did so by denying their Indian heritage and suffered the consequent psychological stress.

Only in recent years has the dominant culture come to recognize the strength and value of that heritage, and only recently have those responsible for the education of Indians been willing to ask Indian tribes and communities what they believe Indian education should be.

McKinley, Bayne, and Nimnicht described the problem very accurately in their classic study, Who Should Control Indian Education?

The American Indian child differs from his white counterpart in many ways other than skin color. Cultural differences are more complex, more difficult to understand, and far more difficult to deal with than physical differences. Yet educators and administrators on reservations must have an understanding of these cultural differences and their origins in order to develop an appropriate educational program.<sup>5</sup>

This is also true, of course, in city schools with Indian students.

<sup>3</sup>F. McKinley, G. Nimnicht, S. Bayne. Who Should Control Indian Education? San Francisco: Far West Laboratory for Educational Research and Development 1970, p. 7.

<sup>4</sup>Ibid

<sup>5</sup>F. McKinley, G. Nimnicht, S. Bayne. Op. Cit., p. 10.

Indian students are understandably unwilling or unable to learn from materials that deny their existence or worth. Too often, they are caught between two cultures and are unable to profit from a curriculum designed for non-Indian children. As a result, they conclude that they are at fault, or begin to accept the stereotypes of the non-Indian majority.

If economic development is to occur, appropriate education must be provided. However, for any ethnic group, and for Native Americans in particular, effective education must be based on the students' own culture.

In recent years, Indian communities have taken an increasingly active role in the education of their children. Indian school boards are being elected. Tribal governments and urban Indian centers have established educational programs and developed bicultural (and sometimes bilingual) curricula designed to meet their children's needs. But while this development has addressed such areas as tribal culture and reading, there has been little development in an area that both Indian parents and students identify as being of overwhelming importance--Career Education.

The Navajo tribe has recently completed a needs assessment of its people in which preparation for jobs was identified as a primary goal. Similar studies have been conducted by other tribes. The schools are trying to respond to this need by starting Career Education programs, but they are often hampered by lack of materials, or more specifically, by lack of materials which will be meaningful to their students.

This concern is shared by the students themselves. In a group of essays about future plans, Indian students indicated that good jobs were one of their primary goals.<sup>6</sup> A study by H. Thompson showed that American Indian adolescents were twice as concerned as other adolescents about learning what jobs are available and how to get them.<sup>7</sup> A study on the Apache reservation indicated that children are deeply disturbed by the conflict between their desire to find a good job and their desire to stay on the reservation, where jobs are scarce.<sup>8</sup>

It is particularly important that such a crucial area as Career Education is presented in culturally relevant ways so that young people can learn to deal with the cultural conflicts American Indians might face in earning a living in the 1970's.

### The Career Education Concept

During the past two decades, career education has been emerging as an educational movement. During that time it has been defined in a number of

---

<sup>6</sup>E.E. Hoyt, "An Approach to the Mind of the Young Indian," Journal of American Indian Education, January, 1961.

<sup>7</sup>H. Thompson, et al. Education for Cross-Cultural Enrichment. Lawrence, KN: Haskell Institute, 1964.

<sup>8</sup>L.C. Bernardoni, "Apache Parents and Their Vocational Choice," Journal of American Indian Education, August, 1968.

ways, with varying emphasis on education (the means), the career (the goal), or the individual (the subject).

As defined by Hoyt, Career Education is the totality of experiences through which one learns about and prepares to engage in work as part of his or her way of living.<sup>9</sup>

According to Banathy, Career Education is conceived as education for one's progress through life. It is the aggregate of involvements by which an individual acquires and develops knowledge, attitudes, and skills needed to engage in meaningful vocational, avocational, leisure, social, and personal pursuits.<sup>10</sup>

Dr. Lorraine Sundal Hansen, in an examination of definitions and concepts of career education, identified four different philosophical focuses for career education. These are:

- work or the individual
- content or process
- work roles or multiple roles
- training for employability or educating for life

The stages may also be classified as to how work is defined:

- limited to paid employment, or
- all significant goal directed activities

They may also be examined as to whether the emphasis is on:

- job
- self
- work
- life

FOCUS ONE: Job Skills as a Focus for Career Education--This is the most narrow conceptualization and is often equated with occupational training. Employability skills and matching the person to the job is foremost. This view comes mainly from those with vocational education orientation.

FOCUS TWO: Work as a Focus for Career Education--Some see work as the focus of career education with emphasis on occupational information and preparation. This approach stresses occupational information through occupational clusters combined with skill training. Emphasis is on income and

---

<sup>9</sup> Kenneth B. Hoyt. An Introduction to Career Education. U.S. Government Printing Office, 1975, p. 10.

<sup>10</sup> B. Banathy. "Employer Based Career Education," Career Education. Vocational Association, 1973.

production and consumer orientation. The words career and occupation are often used synonymously with focus on paid employment. Career is defined as the sum total of that paid work experience.

**FOCUS THREE: Self Development as a Focus for Career Education**--This stage suggests that the person and the self-development of the individual is or should be the major focus. Work, paid or unpaid, is one major way the individual interacts with environment. Exploratory activities in work and the community are seen as a vehicle to help individuals clarify their values, needs, and goals in fashioning a meaningful life. Career is a process internal to the individual, which people have, not something they choose. However, through that career, the individual makes choices and holds a sequence of positions in a lifetime of which occupation may be one.

**FOCUS FOUR: Life as a Focus for Career Education**--Some people see career education as a way of looking at total education--for life and living. Career is synonymous with life. These people say all education is, or should be, career education.\*

Kenneth Hoyt, Commissioner of Career Education for the Office of Education, has had a major influence on the definition of this area of education. He has provided definitions for six of the most commonly used words used in discussing Career Education in order to establish common understanding of the concept. They are: work, career, vocation, occupation, leisure, and education.\*\*

1. Work--"...conscious effort aimed at producing benefits for oneself and/or for oneself and others. As such, it is unimportant whether such effort is paid or unpaid in nature. What is important is that it represents the basic need of all human beings to achieve--to accomplish--to do something productive that allows the individual to discover both who he/she is and why he/she is. With this definition, work is properly viewed as a human right--not a societal obligation."
2. Career--"the totality of work one does in his or her lifetime." Thus, any person can have only one career. That career typically begins prior to entering kindergarten and continues well into the retirement years.
3. Vocation--"...one's primary work role at any given point in time. Vocations include paid employment, but they also extend to unpaid work roles. For example, we can speak of the 'vocation' of the student, the full-time volunteer worker, or the full-time homemaker just as easily as we can speak about the 'vocation' of the plumber, the physician, or the engineer."

\*Adapted directly from Hansen, Lorraine Sundal. An Examination of the Definitions and Concepts of Career Education. National Advisory Council for Career Education, June, 1977. U.S. Government Printing Office, pages 23 through 32 by the 1978 Annual Career Education Handbook for Trainers.

\*\*Hoyt, Kenneth B. Career Education, Vocational Education, and Occupational Education: An Approach to Defining Differences. Washington, DC: Office of Career Education, USOE, 1975.

4. Occupation--"...one's primary work role in the world of paid employment. Economic returns are always considered among the work values of persons engaged in occupations although these might not be considered at all by persons in certain vocations. The occupations of many persons will be synonymous with their vocations. One can never have an occupation without having a vocation, although, of course, one can have a 'vocation' without being engaged in an 'occupation.'"
5. Leisure--"...activities, other than sleeping, in which one engages when not performing in his or her vocation. Thus, leisure holds possibilities for both 'work' and 'play.'"
6. Education--"...all those activities and experiences through which one learns. As such, it is obviously a lifelong process and considerably broader in meaning than the term 'schooling.'"

In the Career Education Trainer's Handbook, Palo Verde Associates define the career education concept as being one which:

is

- person-centered and takes into account the changing nature of both individuals and the environment and the concurrent need for flexible and adaptable human beings.

is

- a humanistic and developmental concept which integrates into its basic aims the twin goals of human development and experience. This implies a view of development as positive growth and builds on a solid rationale and conceptual framework of the best knowledge available in career development theory and research.
- identifies a sequential, kindergarten-to-adult set of objectives from the empirical literature in developmental psychology as a basis for exposing all individuals through curriculum, counseling, and community experiences to a wide spectrum of career knowledge, information, skills, and attitudes.

continues to

- provide for a wide range of two-way community involvements, paid and unpaid, including alternative education-to-work linkages, business/industry/labor/government internships and exchanges, parent and worker involvement in community;

recognizes

- the need for individuals to know a great deal about the occupational and educational world in order to manage it, and an acknowledgement that many occupational clustering systems and career information systems can be utilized to assist in acquiring, knowing, and processing information;

- recognizes the central place of counseling and guidance as part of its delivery system and the unique historical and contemporary contributions of vocational and career guidance to the career development of children, youth, and adults;
- recognizes the importance of role integration--the need for individuals to examine and prepare for work roles in relation to other life roles in family, community, and leisure--and to clarify their values with respect to the meaning of work in their lives;
- reaffirms the importance of helping individuals in the transition from school to work, school to further education and school to other alternatives, and to the need for educational institutions and agencies to more adequately fulfill the placement functions in assisting individuals to take the next step or reach the next stage;
- stresses the importance of attending to special needs of bypassed and underserved populations, especially women, the handicapped, ethnic minorities, and those in poverty;
- is a time-oriented concept which recognizes that it can help individuals not only to prepare for the future but to see the relationship of the future to the past and present.\*

The two major views of Career Education tend to be that which defines it in terms of specific job preparation, and that which sees it as part of the development of life-skills, in which it contributes to the individual's self-realization and decision-making. In this workshop we will tend to the latter view, since it is our feeling that education should deal with the person as a whole, including his or her culture and environment, and that no aspect of education can be successfully addressed without taking that whole into consideration.

The question of the relationship between cultural background and career choice has rarely been touched on in the literature. Many Career Education materials are pervaded by unvoiced (and perhaps unconscious) assumptions about the values of those who will use them. Although many publishers are now making an effort to balance their illustrations and examples in terms of sexual and ethnic identification, this representation rarely extends to cultural attitudes toward work.

Given that in order to succeed in the business world, the employee must conform to the employer's requirements with regard to dress, personal habits, promptness, it is important for the person coming from an ethnic background which is not that of the dominant society to recognize that it is possible to 'play the game' by the employer's rules without necessarily changing one's own values. And when members of an ethnic group are able to start their own business (as in the case of tribal industries or community centers) they can be managed and run on principles more in harmony with the worker's culture.

---

\* The 1978 Annual Career Education Handbook for Trainers. Tempe, AZ: Palo Verde Associates, 1978.

We would therefore add to the definition of the Career Education the idea that it should recognize the individual's need to understand the value systems attached by different cultures to the process of making a living, and be able to work within these systems without necessarily adopting them. The poem reproduced on the next page expresses this concept.

The relationship between Career Education and Native American culture will be explored further in later sessions of this workshop.

### The Phases of Career Education

The content of Career Education falls into three general areas: Awareness, Orientation, and Exploration. These constitute the first three phases of career development. They also reflect the basic structure of the Native American Career Education program, which includes units in each of the three areas. Development in these areas is normally followed by Career Preparation, in which the learner trains for the career he or she has learned how to choose intelligently.

The Awareness part of the curriculum, corresponding to the first stage of career development, provides information and experiences by which the learner will:

- become more self-aware;
- become more (and more positively) aware of his or her own culture;
- become more socially aware;
- become more aware of the world of work and its economic implications; and,
- develop wholesome attitudes toward work, including respect and appreciation for those who do it.

The Orientation part of the curriculum builds upon the development of awareness and provides information and experiences by which the learner will:

- gain an understanding of himself/herself and his/her relationship to career roles;
- understand the value of a culture to society and to the individuals participating in it;
- understand the individual's responsibility toward others and toward society;
- become familiar with occupational classifications and clusters, labor market conditions, and educational and training requirements; and
- understand the economic and lifestyle implications of various career paths.

The Exploration part of the curriculum, corresponding to the third stage of career development, leads the learner directly into the world of careers and provides information and experiences by which he or she will:

- use information about self in career path planning and in assessing career relevance and career satisfaction;
- explore his or her place and future in the cultural community;
- develop social competence in cooperating with others while accomplishing tasks;
- explore selected occupational clusters and develop competence in occupational planning and decision-making skills; and,
- gain competence as a consumer and in handling economic affairs.

A period of career preparation, which is not part of our curriculum, normally follows the exploration stage. In this period the individual should acquire occupational skills and the knowledge needed to enter a selected field or career.

In a program employing these successive changes in emphasis, the same content can be revisited several times at varying levels of complexity and from different points of view. This results in a spiral sequence of instruction into which all available resources may be fitted.



## SESSION II

### Problems in School/Community Relations

#### Community Power\*

Schools are microcosms of the society they serve. They have the task of preparing youth to function in society. Where environmental pressures lessen the authority of family, church, or tribe, the educational system is expected to step in and fill the gap. Schools should be catalysts for social development, not guardians of the status quo.

The structure and function of schools in all societies meet the particular needs of these societies, and their roles are determined by the dominant philosophy. They must maintain social continuity and promote social change. Urban schools are under a greater pressure to provide equal education opportunity to students from many ethnic groups and adjust to social and technological change without being determined by them. Rural schools are more likely to retain the same ways of educating a consistent school population.

As society changes, people need to ask who shall be educated and what kind of education should be offered. The increasing complexity of and interdependence of modern society demand different skills and attitudes. This is even more crucial when the students being educated belong to a minority group which has not previously exercised an influence on social development.

However the school cannot be expected to completely prepare the child for adult life, at least not without parental participation in the process. The average child is in school only 3% of his/her life to age ten. On the other hand, what happens in school can seriously affect a child's belief in his/her ability to function successfully in the larger society.

If a school is to be responsive to the needs of minority students, it must have some way of receiving information in what those needs are and how they can be met effectively. Usually this requires that the minority community be organized and self-aware. Increased input into educational policy may be only part of a group's drive for increased political or economic power and self-determination.

Often, issues do not start as issues. They may start as vague desires for increased status or power. Changes in material or social conditions create clashes of interest between groups.

When a group seeking to improve its position finds a need felt at a gut level by masses of its members, it tries to present it in terms which will highlight characteristics of the ideology or values of the dominant culture. The dominant group then uses these elements as symbols of its authority. The clash between groups becomes an "issue".

---

\*Based on Community Control in Education: A Study in Power Transition, by Thomas E. Glass and William D. Sanders, Pendell Publishing Co., Midland, Michigan, 1978.

One such issue is "accountability" — the requirement that schools prove that money spent be justified by student achievement. In Indian education, this becomes important most often when school use of money for Indian programs (Title IV, Johnson O'Malley, etc.) is examined.

Power can be defined as the ability to move things, people, and institutions in desired directions. Power does not effect social change until it is exercised by members of a group in influential positions within institutions. In a school system, serving Indians, power may be exercised by teacher groups, boards of education, school-community councils, administrator groups, parent groups, and tribal education committees.

The measure of how much a minority group can trust a school system to educate their children is how much actual control they have over that system. One indication of this control is whether they can set goals for their children's education and require schools to address them, or whether professional educators should use their training and experience to decide what should be taught and how.

The problem of power is similar whether Indian students are a minority in a school staffed by non-Indians, or whether non-Indian staff and school board run a school with an Indian majority. In either case, the goals and methods of the school are likely to be those of the dominant culture.

#### The School and the Community\*

The most significant obstacle to developing a system of education appropriate for American Indians seems to be the substantial differences which exist between the cultural values and attitudes of the Indian child and those of the traditional white American school. The Indian child, however, cannot be separated from the Indian community, nor can the white school be separated from the white society of which it is a part. We are convinced that the relationship between whites and Indians—a relationship that is basically paternalistic—is the heart of the problem. Over a number of years, this relationship has demeaned the Indians, destroyed their self-respect and self-confidence, developed and encouraged apathy and a sense of alienation from the educational process, and deprived Indians, as a community, of the opportunity to develop the ability and experience to control their own affairs. As a result, Indians today distrust the white man and his system but see themselves as unable to develop a system of their own. White administrators and educators see the Indian as disinterested and unwilling to participate in the education of his children.

Since a program of formal education for Indians was first initiated by the Federal Government, there has been almost no attempt by the schools to establish communication with the parents and relatives of Indian children, much less any attempt to understand their attitudes or to adapt curricula to their culture. Murray and Rosalie Wax found that on the Pine Ridge Reservation,

---

\*Excerpted from Who Should Control Indian Education, by Francis McKinley, Stephen Barne, and Glen Nimnicht, 1970, Tempe, Arizona: National Indian Training and Research Center.

... the parents rarely entered the school and never saw what went on in the classrooms; whereas the teachers on their part never visited the parents or attended any of the local Indian social events. . . . Indian elders were not permitted to use the school for gatherings or entertainment, lest they dirty the floors and destroy government property. Around each consolidated school was a compound in which the teachers lived and kept to themselves. . . . Sioux elders, faced with the power of the education establishment, simply withdrew. In this tactic they were encouraged by the education administrators, who found the absence of the parents convenient and proper, since the parents would have no background for understanding the operations of the school and "could only have interfered." \*

Bayne found the same situation to be prevalent on the Navajo and Papago reservations in Arizona.

Interviews with Indian parents at all sites confirmed that they have little or no contact with the schools educating their children. They will visit the school only when their children have been accused of some wrongdoing or misbehavior. When asked about major school problems, Indian parents will mention disagreements among students either at the school playground or on the school bus. Lax discipline and breakdown of parental authority are cited by parents as the main factors contributing toward failure in school. Many parents feel that the easy familiarity between boys and girls encouraged by relaxed moral standards among Americans has influenced the Indian younger generation to go beyond the sanctions of their own society, and has resulted in a breakdown of morality and in promiscuous behavior. Even though Indian parents believe that everyone should have a good education, they tend to rate education below concerns for better housing, sanitation, adequate water supply, income, and transportation. They view the goal of education as obtaining "a good job."

At each of the sites we visited, only limited interaction took place between the Indian parents and the teachers. On one reservation, the houses of Indian families are physically separated from the school and the houses of BIA families by a deep ditch. Roads lead into the community on either side of the ditch, and no roads cross it. Few parents have ever visited the school and none of the teachers has ever been in an Indian home. Several of the teachers interviewed at other sites (and particularly the public school teachers) complained that they were never invited into Indian homes and that, during their rare home visits, they were met in the front yard. When asked about this complaint, some of the parents said that this was true in a great many cases and primarily because the Indians were ashamed of their homes. Also, the Indian parents did not want to provide any material for teacher gossip. The Tribal Chairman on another reservation told us that "the only time the schools contact me is when the kids are in real trouble and the school wants me to get the probation offices in contact with the parents."

Yet administrators at the schools never articulated the schools' problems in terms of cultural differences or lack of communication between school and community. They spoke instead of attendance and language problems and displayed a basic lack of understanding of and respect for people for whom time is not measured by the minutes of an inflexible schedule, and for whom the ability to speak their native language is not a "deficiency." (Few of the teachers, of course, can speak more than a few words of the language of their students.)

---

\*Max, Murray and Rosalie: Enemies of the People. Unpublished Manuscript, 1966.

Attitudes of school administrators and teachers are uncertain and ambiguous toward more Indian involvement and assumption of more decision-making powers in school affairs. It is generally agreed that Indians should assume more active roles in the educative process; however, educators are skeptical about how much Indians can actually contribute to the school. If Indian culture encourages non-competition, does not stress strong time orientation, emphasizes sharing, restrains aggressiveness, and places the group needs above those of the individual, then the culture is at cross purposes with schools' goals and objectives that stress competitiveness, aggression, strong time and structural orientation, rigid work habits, and individual success and achievement in a mobile society. In other words, educators tend to view the school positively as a middle-class institution, dispensing middle-class values and attitudes, and to view the Indian children as products of a deprived, non-middle-class environment, who must somehow overcome their handicaps.

Indian life and environment are still commonly viewed as somehow immoral, uncivilized, primitive, and a great handicap to anyone who wants to find his niche in the American society. A teacher at the Phoenix Indian school said in an interview, "These children are intelligent and capable of learning. We work hard all year and get them to a point where we think we are teaching them proper attitudes, good habits, and a desire to know; then they go home for the summer and forget in three months everything that we have taught them." Another teacher at the same school said, "It is our responsibility to bring these children back to normal--to civilize them." An Indian teacher in one of the Oklahoma BIA boarding schools said that the only way to assure good education for Indian children was to take them away from their reservation environment. The Director of the Chilocco Indian school said that the trouble with the students in his school were the "cronies" back home and that if the students could be separated from these "cronies" they could become motivated to achieve in school. He stated that these "cronies" were beyond redemption.

The principal at the Bent-Mescalero school informed our interviewer that the greatest handicap of the Mescalero Apache students was their inability to understand and communicate in English. The principal wanted to assume control of the Head Start school operated by the Mescalero Apache Tribe because he felt that English was not being stressed enough and that the teachers (mostly Indian) were untrained and unqualified.

If the educators view Indian life with distaste and misgivings, it follows that they would be very reluctant to see Indians taking control of the schools. Many of the educators' attitudes may seem justified when one views the life of many Indians today, rife with factionalism, squalor, drunkenness, broken homes, lack of pride, and loss of self-esteem. However, in part, this very situation is engendered by the demeaning and denigrating attitudes held not only by educators but by others who come in contact with American Indians.

Another factor impeding communication between the school and the Indian community is that well meaning local administrators and field workers are often insensitive to the desires of the community in which they are working. In "Enemies of the People," the Waxes described the process by which idealistic but untrained Vista workers and social service professionals inaugurated and firmly controlled a Head Start program on a reservation, completely ignoring the wishes of the reservation communities.

We visited many Head Start projects for Indian cultures, and in most of them we found that the programs had been funded, planned, staffed, and put into operation with virtually no involvement of the children's parents. At several of the schools the parents had subsequently approached the directors and teachers with complaints and suggestions concerning the operations of the schools. But in every case, the professional staff regarded this parental interest with distress. . . . as if it reflected a failure either in planning or procedure. Parental involvement was defined as the parents complying with the suggestions of the teachers.\*

Our own observations of Head Start projects on the Hopi and Fort Berthold Reservations do not, however, confirm the Waxes' experience. Both programs were marked by real parental pride and involvement. Although the Bureau of Indian Affairs is officially on record as encouraging and supporting control of the schools by local school boards composed of Indians from the community, one still encounters the old attitudes: a BIA Area Director for Education told us that "We cannot allow a board of illiterates to run the schools"; a second BIA official told a group of Indian leaders, in our presence, "The best thing you can do about Indian education is to leave the decisions to us. The Bureau schools have been good for you—look where you are now."

#### Experiments in Community Control

As previously indicated, American Indian parents and communities today have little control over their affairs and the education of their children. Yet viable American Indian communities do exist, although they have been deprived of their normal functions by a reservation system which has controlled most aspects of community life. These communities have remained alive for over 30,000 years, including over 400 years of intensive internal colonialism, and it would appear that they will continue to exist for a long time to come. During the last decade, national experience has shown that healthy, functioning communities are an essential part of any effective program to eradicate poverty from our country. Should not American Indian communities as well be allowed to redevelop responsibility for their own welfare and progress? More "benevolent colonialism" of the form described above by the Waxes has not been an effective solution, and it will never supplant control by the community itself.

If a community is to control its own destiny, it must have control over the education of its children. Indeed, it can be argued that the only solution to the educational problems of the American Indian is for education to be placed back within the culture and community in which the children are raised. Indian children will not become less prepared for life in the larger American society by attending Indian schools—Indian parents are too strongly concerned with the economic and social welfare of their children (if not with their formal education) to allow that to happen. Each Indian community will not approach the problem in the same manner, but neither would all non-Indian communities across the country. Rough Rock, an isolated Navajo community, has already initiated one program in community control of education. While the Rough Rock approach would not be suitable for all Indian communities, it does appear to be highly successful and it does indicate the potential effectiveness of control by Indian communities.

\*Wax, M. & R., Ibid.

By way of introduction, it should be noted that the operation of a Western formal education system by American Indian communities is not a completely new phenomenon. Throughout most of the nineteenth century, the Cherokees and the Choctaws operated their own school systems, at first in their native lands in Georgia and Alabama, and later in the Oklahoma "Indian Country" after their removal to Oklahoma in 1832. School was taught in English and their native languages. Both native languages were oral as well as written. The Choctaw school system included a central board of education with elected district trustees, who appointed local trustees. The trustees were in charge of selecting teachers (both white and Choctaw), examining teachers, visiting the schools, and encouraging school attendance within the community. The system included boarding schools, community day schools, Sunday school literacy classes, and college scholarships. Angie Debo writes that "as a result of its excellent public school system the Choctaw Nation had a much higher proportion of educated people than any of the neighboring states; the number of college graduates one encounters in any contemporary record is surprising, and the quality of written English used by the Choctaws both in their official and private correspondence is distinctly superior to that of the white people surrounding them."\*

The most widely publicized of the new ventures in community control is the school at Rough Rock, an isolated community in the north-central part of the Navajo Reservation. After the failure in 1965 of an attempt to create an experimental school at Lukachukai by superimposing an OEO team of community-development professionals on the BIA teaching staff, both OEO and the BIA contributed money toward the funding of a community-oriented experimental school at Rough Rock. Over \$600,000 was turned over to a private, non-profit organization composed of Navajos from the Tribal Council, and a new \$3½ million school was given to the project by the BIA.

The people of Rough Rock elected one woman and four men to the school board. "All were middle-aged Navajo and only two had ever had as much as a day of formal education."\*\* Complete control of the school was immediately given to this board. The school board, the principal, and his staff were jointly responsible for the operation of the school. Daily meetings between the school board and the staff determined the nature of the curriculum and gave a decidedly "Navajo cast" to the school. Today, Navajo children are involved in an integrated bilingual educational program which begins in kindergarten.

Navajo motifs are mixed freely with other classroom decorations. The library has a Navajo corner. Recordings of Navajo music and rituals are played during the school day. In the evening, old men, the historians and medicine men of the tribe, come to the dormitories and tell Navajo folk tales and legends.\*\*\*

Since its initiation, the Rough Rock community has continued to be strongly involved in the operation and use of the school. School facilities are open to anyone in the community who wants to use them. The school sponsors fairs, movies, and sports events; parents are always welcome in the school and at school board meetings, and are hired (eight every month on a rotating basis) to mend clothes, tell stories, and perform other tasks in the dormitories. Rough Rock staff members visit the homes of their pupils at least twice a year. An extensive adult-education program is operated by the school, with adults choosing the type of instruction to be offered.

\*A. Debo, The Rise and Fall of the Choctaw Republic, 1934.

\*\*R.A. Roessel, Jr., Handbook for Indian Education, Los Angeles, Amerindian Publishing Co., 1967.

\*\*\*Roessel, Ibid.

Critics have pointed out, however, that the Rough Rock School cannot be considered a model for other schools because the community did not initiate the school nor could the school exist without the extraordinary financial support of the Office of Economic Opportunity and the Bureau of Indian Affairs. Yet, the people of the community call the school din'e biol'ta (the Navajo's school), and in its daily operation, it is their school. Although Rough Rock's unique financial status does limit its transferability as a model for other schools, Rough Rock does demonstrate that control of a school by an Indian community is feasible and can be effective. Whether Rough Rock will become an organizational pattern for other Indian community schools is yet to be seen.

### Working Together

Although Indian communities and the schools that serve their children may have had a troubled relationship in the past, or no relationship at all, nonetheless, community involvement in education is essential if the school is to understand the needs of its Indian students. It is even more crucial when the kind of education involved is directly related to the student's future role as a community member.

Since both schools and community share the basic goal of providing an education that will help students become happy and productive adults, they should both be motivated to learn to work together towards this goal.

Often people who want to work together end up in conflict without quite realizing why. Training in the basic skills of cooperative group interaction will help people understand how problems can occur and how groups can get moving productively again.\*

These basic skills are: communication, cooperation, conflict resolution, sharing leadership, planning, using resources, decision-making and evaluation.

Communication within a group requires members to: know and trust each other; give, receive, and interpret information, influence and help each other, and constructively resolve problems (the impact of communication in groups, the impact of interpretation upon the group communication process).

In order to establish good communication, group members must know how to react in helpful, nonthreatening ways.

- 1) React to what people do, not what they are ("John talked a lot," rather than "John is talkative").
- 2) React to what you see or hear rather than what you think was meant. What, not why.
- 3) Think in terms of "more" or "less" rather than "bad" or "good" (low or high participation rather than bad or good participation).

---

\*Adapted from materials in the Instructional Leadership Program in Generic Work Skills, Far West Laboratory, San Francisco, California, 1978.

- 4) React to something as soon as possible after it happened.
- 5) Share ideas rather than giving advice. If you share, others will feel free to use ideas in their own ways. If you tell them, they can only accept or reject.
- 6) Explore different ways of solving a problem before deciding on final answers.
- 7) Explain things in ways and with the right amount of detail so that the other person will understand you, rather than the way that will be easiest for you.

Communication in a group or between groups means giving, receiving, and keeping information. Although you may try to give, receive, and keep information, it is possible that communication may not happen. One thing that blocks communication is interpretation.

Each one of us carries a "filtering system" in our heads through which a bit of information may have to pass several times. Do both the giver and receiver consider the information to be important? If the communication is not important to one of them, the giver may do a poor job or the receiver may not listen well.

Or, opposite messages may be sent at the same time. For example, the giver may be talking about the importance of planning ahead while he is, at the same time, running a meeting that is very poorly planned. Remember, we can communicate in many ways (with words and without words) at the same time.

Or, those involved in the communication may have different sets of experiences. One person may view a campaign as a challenge or opportunity while another may see it as a threat.

What the giver and receiver think of each other can affect how the information is presented or accepted. If the giver thinks that the receiver is not smart enough to understand him, he may not try too hard to make himself understood.

Finally, either the giver or the receiver may be distracted so that the flow of communication is interrupted. Either physical discomfort or personal problems could cause such distractions. It is the job of both the giver and the receiver to make sure that they are both "hearing the same thing."

Cooperating is more than just "getting along": If a group is to operate as one, each member should be able to explain what the group is trying to do, and should have useful information or resources. Each group member should be able to interpret communication from the others, and should understand the importance of courtesy. One of the chief causes of non-cooperation in a group is apathy.

Bradford, et al. (1974) have identified some useful symptoms of apathy in a task group. These may range from obvious indifference to the job and boredom, to a more subtle lack of enthusiasm, energy, persistence, or work standards. Some common signs of apathy are:



- a) frequent yawns, people dozing off
- b) members lose the point of the discussion
- c) low level of participation
- d) conversation drags
- e) members come late; are frequently absent
- f) slouching and restlessness
- g) overquick decisions
- h) failure to follow through on decisions
- i) ready suggestion for adjournment
- j) failure to consider necessary arrangements for the next meeting
- k) reluctance to assume any further responsibility

The behaviors listed below may have a variety of causes, but when they occur together the cause is most likely to be the one suggested.

1. If

- questions may be raised about what's really our job, what does the leader want us to do,
- members fail to follow through on decisions,
- there's no expectation that members will contribute responsibly, and confused, irrelevant statements are allowed to go by without question,
- members wonder about the reason for working on this problem,
- suggestions are made that we work on something else,
- the attitude is expressed that we should just decide "on anything, the decision doesn't really matter,
- members seem to be waiting for a respectable amount of time to pass before referring the decision to the leader, or to a committee,
- members are inattentive, seem to get lost and not to have heard parts of the preceding discussion,
- suggestions frequently "plop," are not taken up and built on by others,
- no one will volunteer for additional work,

Then

- the group goal may seem unimportant to the members.

2. If

- there are long delays in getting started, much irrelevant preliminary conversation,
- the group shows embarrassment or reluctance in discussing the problem at hand,
- members emphasize the consequences of making wrong decisions, imagine dire consequences which have little reference to ascertainable facts,
- members make suggestions apologetically, are over-tentative, and hedge their contributions with many if's and but's,
- solutions proposed are frequently attacked as unrealistic,
- suggestions are made that someone else ought to make the decision-- leader, an outside expert, or some qualified person outside the group,

--members insist that we haven't enough information or ability to make a decision, and appear to demand an unrealistically high level of competence,

--the group has a standard of cautiousness in action,  
--numerous alternative proposals are suggested, with the group apparently unable to select among them,

--members probably fear working toward the group goal.

3. If

--no one is able to suggest the first step in getting started toward the goal,

--members seem to be unable to stay on a given point, and each person seems to start on a new task,

--members appear to talk fast, to misunderstand one another, and the same points are made over and over,

--the group appears to be unable to develop adequate summaries, or restatements of points of agreement,

--there is little evaluation of the possible consequences of decisions reached, and little attention is given to fact-finding or use of special resources,

--members continually shift into related, but off-target tasks,  
--complaints are made that the group's job is an impossible one,

--subgroups continually form around the table, with private discussion held off to the side,

--there is no follow-through on decisions or disagreement in the group about what the decisions really were,

--complaints are made that you can't decide things in a group anyway, and the leader or somebody else should do the job,

Then

--the group may have inadequate problem-solving procedures.

4. If

--the view is expressed that someone else with more power in the organization should be present in the meeting, that it is difficult to communicate with him at a distance,

--unrealistic decisions are made, and there is an absence of sense of responsibility for evaluating consequences of decisions,

--the position is taken that the decision doesn't really matter because the leader or someone outside the group isn't really going to listen to what we say,

--there is a tendency to ignore reaching consensus among members, the important thing being to get the leader to understand and listen,

--the discussion is oriented toward power relations, either within the group, jockeying to win over the leader, or outside the group, with interest directed toward questions about who really counts in the organization,

- doubts are voiced about whether we're just wasting our efforts in working on this program,
- members leave the meeting feeling they had good ideas which they didn't seem to be able to get across,

Then

- members feel powerless about influencing final decisions.

5. If

- two or three members dominate all discussion, but never agree,
- conflict between strong members comes out no matter what is discussed,
- dominant members occasionally appeal to others for support but otherwise control conversation,
- decisions are made by only two or three members,

Then

- a conflict among a few members is creating apathy in the others.

Conflict Resolution. Interpersonal conflict is an inevitable part of the way a group functions in accomplishing a task. The ability to resolve conflict indicates that the group is becoming a working team. Group members need conflict resolution skills in order to maintain the group once it is working. Group maintenance is the process of keeping the group's internal relationships satisfying enough to its members that they will remain in the group and contribute to it. The problems of one member can upset the entire group.

There are five general causes of group conflicts: (1) goals and tasks; (2) personality conflicts; (3) organizational structure; (4) personal problems; and (5) societal conditions.

The group task may be a source of conflict: Its goals may not be in tune with the goals of individual members; the task may be difficult or impossible to complete; the time schedule for completion may be unrealistic or the group may be unable to meet the deadline; the task may require skills and/or resources not available; individual members may be incompetent or inefficient in accomplishing the task; failure at task completion may involve firing, or at least negative evaluation, of individuals; the task may be defined or structured so loosely, or so tightly, as to cause job dissatisfaction and/or lack of productivity; the nature of the task components and the division of roles (sub-tasks) may be a source of destructive competition among the individuals in the group.

Group interpersonal relations may be a source of conflict: value and goal differences may hinder cooperative effort, individual adjustment; lack of communication, miscommunication, and labelling or stereotyping can aggravate individual and group relationships; personality differences may result in attitudes and behaviors that disrupt the group's work and/or the group's working relationship; gossiping, back-biting, fault-finding, aggressive confrontation, bad or hurt feelings, childishness, lack of sensitivity, anger,

"game-playing," aloofness, mistrust, suspicion, exaggeration of differences, manipulation of others, vindictiveness, favoritism, petty jealousies and rivalries are all symptoms of poor human relations.

The group environment and the organizational structure may be a source of conflict: an overly hierarchical structure may contribute to lack of input in goal definition, goal attainment from subordinate members of the group; an overly permissive structure may leave the group and its members without clear goals, adequate direction, and standards for efficiency and productivity; both hierarchical and laissez-faire structures may impair the group and/or the organization's ability to react swiftly to external pressures, to discern what the situation is, and may negatively affect the motivation of group members to perform adequately and to maintain the group's unity; lack of communication between assigned leaders and other group members as well as with other levels or branches of the larger organization may cause unnecessary confusion, frustration, alienation, resentment, and failure to air opinions, feelings, constructive criticism and suggestions for improvement; the division of labor may cause boredom, promote a sense of powerlessness and may stifle creativity and the full utilization of human resources; policies and procedures may hinder rather than facilitate affective communication, healthy interpersonal relationships, decision-making and problem-solving, and needed input from all members; inadequate or oppressive working conditions and facilities may adversely affect productivity, individual development and satisfaction; impersonal environments may depress job outcomes as well as lessen commitment; promotion procedures may not reward members adequately and may hold back or fail to recognize individuals whose talents are being wasted; policies and procedures may reward conformity and merely adequate performance while discouraging innovations and independent thinking.

Personal problems of individuals may also be a source of conflict in groups: the individual's lack of self-confidence and self-worth may affect his or her ability to contribute to the job and to interpersonal harmony. Personal conflict may be reflected in attitudes and behaviors characterized by poor self-concept, anxiety, withdrawal, a sense of failure and inadequacy, depression, discontent, inefficiency, a feeling of oppression, lack of flexibility, a general lack of motivation and/or cooperation, and chronic tardiness and/or absenteeism.

Societal conditions may be another source of conflict: racial, religious, ethnic, political and sexual discrimination in attitudes and practices within larger society may inhibit or exclude individuals or groups from participating in the work group through hiring practices, stereotyping, prejudiced statements and behaviors, unequal treatment; tensions and resentments may flare up into aggressive, divisive confrontations; separatist cliques and intolerant individuals may disrupt the accomplishment of tasks and the unity of the group.

In making these five distinctions, it must be kept in mind that often the distinctions are not useful in a given situation. It may be that a "conflict" that arises within a group setting may be the result of more than one of these factors.

Resolution of group conflict must be an objective for all task groups. The most appropriate approach is to plan for such conflicts to occur. The allowance of adequate time has already been mentioned. Another objective is

to strengthen the time allowed for group members to get to know each other and the task.

Bradford, Stock, and Horwitz (1974) identify the following symptoms of conflict in a group:

- a) members are impatient with one another
- b) ideas are attacked before they are completely expressed
- c) members take sides and refuse to compromise
- d) members disagree on plans or suggestions
- e) comments and suggestions are made with a great deal of vehemence
- f) members attack one another on a personal level in subtle ways
- g) members insist that the group doesn't have the know-how or experience to get anywhere
- h) members feel that the group can't get ahead because it's too large or too small
- i) members disagree with the leader's suggestions
- j) members accuse one another of not understanding the real point
- k) members hear distorted fragments of other members' contributions

Some of these symptomatic behaviors and attitudes form patterns that can be associated with certain causes. For instance:

1. If

- every suggestion made seems impossible for practical reasons,
- some members feel the committee is too small,
- everyone seems to feel pushed for time,
- members are impatient with one another,
- members insist the group doesn't have the know-how or experience to get anywhere,
- each member has a different idea of what the committee is supposed to do,
- whenever a suggestion is made, at least one member feels it won't satisfy the larger organization,

Then

- the group may have been given an impossible job and members are frustrated because they feel unable to meet the demands made of them, or the task is not clear or is disturbing.

2. If

- ideas are attacked before they are completely expressed,
- members take sides and refuse to compromise,
- there is no movement toward a solution of the problem,
- the group keeps getting stuck on inconsequential points,
- members attack one another on a personal level in subtle ways,
- there are subtle attacks on the leadership,
- there is no concern with finding a goal or sticking to the point,
- there is much clique formation,

Then

*--the main concern of members may be in finding status in the group. The main interest is not in the problem. The problem is merely being used as a vehicle for expressing interpersonal concerns.*

When a group has this sort of problem, one cause that should be investigated is the "hidden agenda." Leland Bradford (1968) defines hidden agendas as "...all of the conflicting motives, desires, aspirations, and emotional reactions held by group members, subgroups, or the group as a whole that cannot be fitted legitimately into the accepted group task." In order for a group to proceed with its work, hidden agendas must either be settled or suppressed. If the latter occurs, then any hitch the group runs into with its task may cause all the hidden problems to surface again.

Hidden agendas can exist for members of the group, the facilitator, or the group itself. For example, group members may have preconceived ideas about how to perform the task. They will either try to impose these ideas at the beginning, or simply wait until the time seems ripe. In the latter case, they will not be really listening to what the others are saying. Sometimes a proposed group decision is threatening to one or more of its members, but they are not willing to voice or sometimes even to recognize their fears. When this happens, they will try to change the direction of the group process.

Bradford (1968, p. 68) suggests the following guidelines for dealing with hidden agendas:

1. *Look for hidden agendas that are present. Recognition of the possibility of hidden agendas on individual and group levels is the first step in diagnosis of group difficulty. Diagnosis is the necessary first step before intelligent action can be taken.*
2. *Remember that the group is continuously working on two levels at once. Consequently it may not move so fast on the surface task as the leader might wish.*
3. *Sometimes the leader can make it easier for a group to bring its hidden agenda to the surface. The leader may say, for example: "I wonder if we have said all we feel about the issue. Maybe we should take time to go around the table so that any further thoughts can be opened up."*
4. *When hidden agendas can be laid on the table and talked about, they are easier to handle. But many hidden agendas would hurt the group more if they were talked about openly. A leader or group member needs to be sensitive to this point and should try to recognize what a group can and cannot face at a given point.*
5. *Don't scold or pressure the group because it has hidden agendas. They are present and legitimate and need to be worked on as much as the surface task.*
6. *Help the group to remove feelings of guilt about hidden agendas. As groups are aided to bring out into the open some of the hidden*

agendas and treat them legitimately, there will be a lessening of feelings of guilt about them and a tendency to lay more of them on the table. The leader might say: "We certainly could expect that each of us might see things somewhat differently and we certainly shouldn't feel guilty about wanting different things accomplished. That is all part of the many differences that make up a group."

7. Help the group work out methods of solving their hidden agendas just as they develop methods of handling their surface agenda. Such methods may vary, but basically they call for opening up the problem, collecting as many relevant data as possible, and seeking a solution based on such data. Obviously, data relating to the individual's feelings and problems are as important as more logical data. In the last analysis, problem-solving methods are needed for solving hidden agendas.
8. Help the group evaluate its progress in handling hidden agendas. Each experience should indicate better ways of more openly handling future hidden agendas. As groups grow in maturity and strength, the number of hidden agendas that remain hidden is definitely reduced. Short evaluation sessions, either the last fifteen minutes of a group meeting, or one meeting out of a series of meetings, can be very profitable to a group. In such sessions a group can look back to see how many more problems it was able to talk freely about and how much more confidence the group had in its members.

This discussion of hidden agendas relates also to the problem identified by the following symptoms:

3. If

- the goal is stated in very general, non-operational terms,
- members take sides and refuse to compromise,
- each member is pushing his own plan,
- suggestions don't build on previous suggestions, each member seeming to start again from the beginning,
- members disagree on plans or suggestions,
- members don't listen to one another, each waiting for a chance to say something,

Then

- each member is probably operating from a unique, unshared point of view, perhaps because the members are loyal to different outside groups with conflicting interests.

If hidden agendas are causing severe conflicts, it may be useful to have students work through activities in the Interaction module on Resolving Conflicts. On the other hand, not all evidence of conflict is negative. Sometimes a group which appears to be having a lively argument is actually accomplishing a great deal.

Symptoms of productive conflict include the following:

4. If

- there is a goal which members understand and agree on,
- most comments are relevant to the problem,
- members frequently disagree with one another over suggestions,
- comments and suggestions are made with a great deal of vehemence,
- there are occasional expressions of warmth,
- members are frequently impatient with one another,
- there is general movement toward some solution of the problem,

Then

- probably, members feel involved and are working hard on a problem. The fight being expressed is constructive rather than destructive in character and reflects real interest on the part of members.

Spending time on the resolution of group conflict is the price that must be paid for group maintenance, and consequently for group productivity. Conflict is a predictable occurrence that can be dealt with by employing sound methods. The tendency to react to conflict rather than to respond in a rational manner is something all group members must be aware of. Once conflict occurs, its resolution becomes an interim objective for which the group must allocate time until the conflict comes under control. To attempt to remove the conflict is unnecessary, to control it is necessary. The best criteria for determining when a conflict has been controlled is whether or not the group can start up again and proceed toward its terminal objective. Highly effective task groups can reach their objectives even if they end up with many more conflicts at the end than they had at the beginning of their effort.

Sharing Leadership. Some of the indicators that a group is maturing include:

- greater balance in exchange of information by members
- greater equity in the contributions of members to group efforts
- greater flexibility in sharing leadership functions among group members

A well-balanced group is characterized by (1) an ability to complete its tasks in an appropriate amount of time; (2) quality products; and (3) active involvement by all members. A group can be expected to accomplish a task in less time if it is balanced. Students (and adults) involved in learning CGI skills may believe that balance requires group members to display equal participation, equal skills, and equal abilities. This would be unrealistic, and might even be counterproductive. Instead, the ideal task group balance should be related to the demands of the task. Certain tasks will require group members to either possess appropriate skills before they start or to develop them as they go along. The latter situation is most common, even among adult task groups.



The skill most necessary for group balance is effective communication; and the precondition most necessary for ensuring group balance is satisfactory prior experience related to the task.

The concept of equity in contribution to the task can provide a useful indicator of task group development. To ensure harmonious operation, it is essential that each member feel that all the others are doing their share. Mature task groups can assess the contribution of a member — in the form of information or a product — both in terms of its utility to the group and the degree to which it represents the known ability of the contributor. A comparatively poor piece of work may be well-received by the group if it knows that the producer is working as hard as he or she can, whereas something a talented group member has "just dashed off" may seem unsatisfactory, even if it meets the need at hand.

The degree of equity present can be assessed by observing a task group. The following responses serve as excellent feedback.

- "Great idea, John — we will need that!"
- "Aw, Come on, Nancy — that's good, but you can do better than that..."

It is evident that the group considers John's contribution equitable, but not Nancy's. In a mature group, Nancy will be given the chance to defend her work. In an undeveloped group, her attempt to do so might cause group conflict.

Equity is perhaps the most difficult growth indicator to isolate. It involves more than the amount of labor, courtesy, or positive relations one has with others. Its existence is a practical necessity if the group is to become an effective unit that will fulfill the demands and expectations of its members. Teachers should help students recognize that equity is as essential to group achievement as it is to political justice.

Probably one of the most highly researched areas of social interaction is leadership. The development and training of future leaders has long been considered one of the primary goals of education. However, the nature of leadership is difficult to define without reference to a specific situation and group of followers.

Five basic qualities of leadership have been defined by the literature of behavioral science. These leadership qualities are embodied in different people; and, different qualities are important at different times. These points lead to the idea of shared leadership: that is, each member of the group has some leadership characteristics, and each member should be a leader at one time or another, depending on the requirements of the situation. No one person has a monopoly on leadership characteristics and no one person should be the leader all the time.

A good leader helps the group's work by starting, giving direction to, setting standards for, and organizing the group's action. He or she helps the group communicate by encouraging others to take part in discussion, by listening carefully, by explaining group members' points of view to one

another, and by seeking and giving information and opinions.

The "good listener" type might sound like the ideal follower, but there are many situations in which it is more important for the leader to be able to listen than to be able to talk. This quality is particularly necessary for keeping all the group interested in and participating in a project. A leader with this quality not only listens, but actively draws out other members' opinions and ideas. He or she also gives information when needed and helps group members understand each other by "translating" opposing or unclear points of view.

A good leader helps to resolve group conflicts by relieving tension, building trust, working out disagreements between group members, blending together the work of different members, and finding compromises between opposing points of view.

There are times when the best leader for a group is the peacemaker. These times come when the group has hit an impasse or deadlock between two opposing, strongly-held points of view. The person likely to emerge as the leader during this stage is the one who can somehow reconcile the two opposing camps, both in terms of ideas and in terms of emotions. This involves having the trust of both sides, so that the leader can lead them to trust one another. It also involves skill at relieving tension and cooling tempers and the imaginative ability to see possible plans which encompass elements of both "opposing" views.

A good leader helps bring together the results of the group's work by watching, studying, and explaining the actions, ideas, and decisions of the group.

Sometimes the best leader is the one who has the most complete and precise knowledge of what is happening—and what has been happening—and who can clearly express that knowledge. This quality is often most useful in the later stages of a project, either when a report or summary must be given to some outside party (teacher, class, board of directors) or when the group itself wants to know what and how it is doing. It might be especially valuable if the group has been working mainly as individuals or as small subgroups on different parts of a project. Note that the "summary and review" function may include describing not only the progress of the work itself but also the emotional, group-interaction side of what has been going on. Unlike the evaluation, the summarizer usually does not make judgments about the events described.

A good leader helps to evaluate group performance by studying how well the group ideas work, helping others see the value of different solutions to problems, and finding good ways for the group to carry out its decisions and reach its goals.

The role of evaluator is likely to be a particularly important one at the end of a project or at the end of some definite stage in a project, but it may become important at any time. Whenever it does, the person with good evaluation skills is likely to become the leader of the group. This quality of leadership involves not only knowing what is happening (the evaluator may build on the work of the summarizer) but what should be happening. More than just crit-

icism is involved, however. A good evaluator also suggests alternate methods or approaches to replace the flawed ones he or she sees.

The most central of these qualities is the ability to provide group cohesion. Cohesion can be defined as the inter-relatedness of a group. In a task group, cohesion is an essential precondition for growth. The most dependable indicator of group cohesion is its response to stress. The more developed the group, the more easily it can deal with stress while continuing to work toward its goal. If a specific type of stress can be predicted, a single leader can function well. For example, in combat situations, where everyone knows what kinds of dangers to expect, an officer makes an effective leader.

In student task groups, however, several kinds of stress may occur:

- The information being presented is too complex for students to understand.
- The group has insufficient resources for the task.
- The group is subjected to external distractions, such as shortened class periods, fire drills during work sessions, etc.
- The group members do not have all the skills needed for the task.

As the group tries to deal with various stresses, leadership should shift among those individuals who can best serve the group at each point. Observation of groups that have developed into functioning work units indicates that it may be difficult to tell who is providing leadership at any given time. Yet if one interviews group members, they have no difficulty identifying the person who acted as leader for a certain task.

In planning implementation, teachers should assign tasks that will allow stresses to occur. It is only through encountering difficulties that one develops the ability to surmount them. Insulating task groups from stress will deprive them of one of the chief benefits of training in CGI.

The concept of shared leadership is central to the functions of group maintenance and growth, since stress may cause a group to abandon its task while it works on maintaining its integrity. The leader of a task group needs to help the group maintain itself as well as helping it grow.

Power is the ability to get someone to do a certain thing or behave in a certain way. Everyone has and uses power over others to some degree. Each member of a group has the power to influence or change the other group members in some way. Power in itself is not good or bad. Whether power will have good or bad effects depends upon how it is gained (what it is based on) and how it is used.

Power in a group can come from one or more of several sources, or bases. Some of these bases of power are more legitimate than others. Legitimate power bases can help a person gain a lot of group support without a lot of group resentment.

## FIVE BASES OF POWER

**Reward** A group member may have power because he or she can reward other members—for instance, by giving them money, material goods, or high positions within the group.

**Punishment** A group member may have power because he or she can punish other members—for instance, by throwing them out of the group, taking away some special privilege, or even physically hurting them.

**Position** A group member may have power because he or she has a high position in the group—for instance, the leader or president.

**Personal influence** A group member may have power because he or she has such an outstanding personality that the other members respect him or her and want to do what he or she says—for instance, if he or she is especially friendly, kind or honest.

**Expertise** A group member may have power because he or she has some special knowledge or skill which the group needs for completing a certain project.

Power in a group may be distributed in different ways. Most of it may be in the hands of one person or of a small part of the group, or power may be shared among group members as the situation develops.

**Planning.** In order to be able to plan effectively, a group needs to be able to determine the nature of the task, identify resources available and obstacles that may hinder its accomplishment, generate alternative approaches to accomplishing it and choose the best one, work out the details, and evaluate their planning. This process may be broken down into a series of steps.

The first step in good planning is to understand the job that has to be done. Before the group actually begins planning, all members should understand the task be committed to it. In considering the nature of the task to be done, the group should ask itself:

1. What is the job? Does everyone understand it?
2. Does everyone agree to go along with it?

An understanding of the task can be developed by investigating and deciding the following:

- What has to be done?
- When? Is there a special time limit?
- Who must do it? The entire group, individual group members, someone outside the group?
- Where must it be done? Is there a special place?
- Why must it be done? How does it relate to the group's goals and purposes? Is there a special reason for doing the job that will make a difference in planning?

Once the job is understood, then the group can agree about whether it wants to do the job. It is essential that all the group members understand the task, however, before they make this decision.

If one or two members or even a large minority of the group can't agree about going on with the task, here are some things the group might do to resolve the problem:

- Ask for other ideas.
- Bargain for changes.
- Refuse the task.
- Try to change the minds of the minority.
- Insist on a majority decision.

In any case, the group must realize that it cannot go any further until it has reached a decision about committing itself to the task.

When the first step in the planning process is completed, the group should have decided on the nature of the task and its commitment to it.

The second step in good planning is for the group to know what resources it will be able to use. Some of the questions the group should ask itself when considering its resources are:

1. What skills do group members have that might be used in this job? We have explored our personal resources in past activities, and we each have an idea of some of the ways in which each member of our group is a resource for the group. Think of ways in which we could use these varied resources to accomplish this job.
2. Has anyone in the group ever done this type of work before? What experiences do individuals or the group have that might be related to the job? These past experiences can be an important resource for our group. How could we build on them or use them in this job?
3. What equipment, supplies, and money does our group have? The availability of these may determine whether the group can do the job at all.
4. How much time is available and when is it available? Time is a very important resource. Do we have enough time to do this job?

When the available resources have been considered, the group will have determined the potentials of its members, the experience, the equipment, the supplies, the money, and the time available for accomplishing its task. Consideration of the resources may suggest or eliminate possible plans for accomplishing the task.

The third step the group should take in order to plan well is to think about the problems that lie ahead. This step will help the group to identify obstacles to avoid or to overcome in the accomplishment of its task. Questions the group should ask are:

1. What things about the job itself might make it hard for us to do it?
2. What things about the group might make it hard for us to do the job?
3. What things about the situation might make it hard for us to do the job?

In answering these questions, the group should decide what effects such problems and obstacles might have on its ability to do the job. The group may also wish to discuss how to solve the problems or avoid the obstacles it has foreseen.

When the third step in the planning process has been completed, the group will have considered as many as possible of the obstacles that might lie ahead of it in accomplishing its task.

The fourth step in planning is to think about different ways to do the job. The three preceding steps in the planning process comprise the fact-finding and information-gathering phases of planning. Identifying alternatives is the first part of the creative part. Some strategies for generating alternative plans are:

1. Get suggestions from all group members. Do not judge the worth of any alternatives at this point.
2. Try brainstorming ideas. Have someone record the ideas on paper so they can be judged later.
3. Try to decide what the group might do in case of unforeseen changes of plan. How might such changes affect the group's ability to do the job?
4. What are the most likely changes in plan that might occur? How would they affect the group's ability to do the job? Thinking about such changes now and trying to make the plan flexible enough to include them will make the completed plan more effective.

When the group has finished generating alternatives, it will have produced a set of alternatives from which it can choose a final plan of action.

The fifth step is to study the different ways, which is the reflective step in the process. The decisions that the group has already made about the nature of the task, the resources of the group, and the obstacles that may hinder the accomplishment of the task will generate criteria for selecting an alternative to follow. It is important that the group review the decisions made about the task, resources, and obstacles before deciding on a plan of action. This step ensures consistency between the plan and the nature of the task, the resources of the group, and the avoidance of obstacles to the group's action. When this step is completed, the group will have determined formally the criteria for selecting a plan.

The next step is to choose the best plan of action. Based on all previous steps, the group now decides on a plan of action. If none of the alternatives generated in the previous step seems to be acceptable, the group should consider one of two actions:

1. Combining two or more alternatives;
2. Brainstorming more alternatives.

If the group is still unable to decide, it should consider going back to the first step and re-thinking the task, its understanding of the job and its commitment to it

When this step in the planning process is completed, the group will have decided on a plan of action. The plan of action which the group decides to pursue should be the alternative that is most consistent with the task, the resources, and avoidance of the expected obstacles.

Now the group can work out the details of its plan. It must agree on the specific details of its plan. It should determine the answers to the following questions:

1. What exactly will be done?
2. Who will do it?
3. Where and when will it be done?
4. How will it be done (what are the procedures to follow)?

As these details are decided on, they should be recorded on paper and copies should be made for all those involved. Recording the plan makes it formal and ensures that details and assignments are not forgotten. When this step is completed, all details of the plan will have been worked out and recorded.

*Stop and think about how well you have done the first seven steps.* When all decisions have been made and the plan is ready to be carried out, the group should consider the process it followed in devising the plan and ask itself:

1. How well did we think about the job?
2. How well did we think about our resources?
3. How well did we think about possible problems?
4. How well did we list different ways to do the job?
5. How well did we study those different ways to decide which was best?  
How good were the standards we used in deciding?
6. How well did we choose a plan?
7. How well did we work out the details of the plan?
8. How can we improve our planning?

When this step is completed, the group will have evaluated its work on the previous seven steps of the planning process. Members should be aware that evaluating their planning will lead to improved planning in the future.

Hopefully, a group of adults involved in planning a career education or other educational programs will not need to consciously follow this process step-by-step. However, it will be useful to understand the process, and to use this understanding to guide them as they go along. If planning is done carefully at the beginning, and paired with evaluation processes, many problems and mistakes can be avoided or minimized.

Using Resources. The second of the steps in the planning process involved assessment of the resources available to the group for use in doing a job. It is important to understand that there are many kinds of resources. Resources can include any person, thing, skill, information, experience, attitude, or even available time which will help the group accomplish its task or maintain group cohesion, as well as the more familiar categories of money and materials.

In relation to group interaction, the most important resources to be aware of are those possessed by the group members themselves. The group will find it useful to initiate discussions that might bring to light talents and background in members

which would not come up in ordinary conversation. People may also have abilities which they themselves do not realize might be valuable. Doing personality inventories may help in identifying these traits.

Kinds of personal resources which might be useful in a task group include:

1. physical skills-- building things, clerical skills, sports, transportation,
2. social skills-- decision-making, empathizing, making jokes, keeping calm in a crisis, spreading enthusiasm, peace-making, thinking logically, etc.
3. experience/background-- experience in a variety of jobs, educational experience, youth-work, management, etc.
4. contacts-- friends or connections in local business/industry
5. knowledge-- Native American culture, language,

However in comparing individual assessments of abilities, it may happen that an individual's self-analysis varies widely from the opinion of his/her abilities held by the rest of the group. This variance may be in the person's favor, or quite the contrary. There may also be differences of opinion as to what personal resources could be useful to the group. If possible, the group should explore the reasons for these differences of opinion, trying to identify the actions or evidence that have been used by group members as a basis for their opinions. In the final analysis, a person's ability to use a skill in a given situation will be the determinant of truth in this area.

There are other kinds of resources which the group will also need. These include physical materials and information. Time is also an important factor, and the funds to get materials, pay for people's time, etc. To some extent, Time, Talent, and aspects of the Task at hand can be traded off to get a job done. For instance, if there is little time for a job, getting more people in to help may solve the problem whereas if staff is small, the task may still be accomplished given enough time. When both time and talent are limited, the task itself may have to be modified. It is important that a group be able to analyze available resources with relation to the demands of the task so that adjustments may be made if necessary.

There are times when resources may be so inadequate that the job cannot be done, but human beings generally find themselves in a position of having fewer resources than they think they need. When enough determination and imagination are used, a surprising amount may be done with surprisingly little.

Decision-Making. In any situation requiring the efforts of a task group, there will probably be a number of decisions to be made. The ways in which these decisions are taken will depend on a number of factors, including the importance of the thing to be decided to the task and to the group members, the time available to make it, the potential consequences if the decision is wrong, the cultural values and traditional leadership styles of group members, and any political or legal constraints on the decision-making process.

Before a decision can be made, a group must determine who should make it and how it should be made in the situation at hand. If this is not done, even a theoretical appropriate decision may have unfortunate results. There are several different ways in which a decision in a group may be made.

One of the simplest is for the group leader to make the decision alone with no input from the rest of the group. This may work well if the decision is so simple or routine that it would be a waste of the group's time to sit around and talk about it. For instance, if a group of house painters usually used a certain brand of paint,



although another brand was known to be just as good, the person sent to get supplies would be justified in ordering the second brand if the first was out of stock without consulting the other painters. Unilateral decision-making is also desirable in an emergency. If there is a fire in the building, one person should call the fire department and the others should leave without discussing the matter.

However decision-making by a single person does not work well if the decision is an important one or if it will require group support to be successfully implemented. For instance, the head of a company would be ill-advised to simply design a new product and then order the others in the company to produce it, since the design may have flaws the leader did not see, or the workers' skills may not be appropriate. People will often not support or work to implement a decision in which they were not involved. They may feel that the leader is acting as a 'dictator' if they are not consulted.

A modification of this style of decision-making is for the group leader to ask the advice of his/her group before making the decision. This may seem fairer than making the decision alone, and does involve the group to some extent. But the leader still has the final 'say-so', and may or may not choose to abide by the wishes of the rest. If the leader makes a different decision, the group has no power to change it, and thus may not support the decision even though it was involved in it.

The effectiveness of this method of making decisions depends on the personality of the leader. If he or she listens carefully and tries to express the group's consensus in the decision, they will support it. If the leader pays no attention to what group members say, the discussion might as well not have happened. In cases where the leader's authority is extremely high, or he or she has special expertise in the area involved, the group may be willing to accept the decision whether or not they agree with it. The danger when the leader has all the power is that members of the group will compete to impress him/her or say only what they think the leader wants to hear rather than expressing their real opinions. Unresolved conflicts between group members and leader or among members themselves may remain to act as a hidden agenda and undermine subsequent implementation of the decision.

Sometimes the most expert member of the group makes the decision. This person is not necessarily the leader, but has recognized expertise relevant to the problem at hand. For instance, if a company is thinking about buying one of several complex new machines, it might ask its mechanical or engineering expert to make a final choice of which machine to buy.

This approach to decision-making works well if everyone in the group agrees on which person is the expert. If this is not clear, however, someone may be called an "expert" because he or she is popular or has some other basis of power whether he or she actually knows any more about the subject than the others or not.

An expert decision also works well in situations where implementation of the decision will not require a great deal of support from the group. Sometimes group members feel that the expert is a 'know-it-all.' Even if they respect the expert's advice, they may not be very interested in a decision to which they did not contribute. So if the whole group is going to have to carry out the decision, it may work better for the expert to give advice rather than making the decision alone.

A fourth way of making a decision is to have everyone in the group give an opinion separately and then to follow the plan or opinion that the greatest number of the group members want. Opinions can be collected verbally or by formal voting.

This approach does give everyone a chance to state his or her opinion, but it does not necessarily involve any discussion, and so conflicts of opinion are not worked out. If there are many different options, the one that wins may represent the choice of only a small part of the group.

This way of deciding works well in situations where it is hard for members of a group to get together, for instance, if their homes are far apart. It also works well if there is enough time to take a vote but not really enough for discussion. It does not work well if some of the group members are more knowledgeable or qualified to make the decision than others, because the 'poor' opinions may cancel out the 'good' ones. It also does not work well if strong group support will be needed to implement the decision.

Sometimes a minority of group members makes the decision. This may come about in several ways. Sometimes it is deliberate, as when the leader or the group names a committee to study some issue and make a decision on it. Sometimes it seems to happen without having been planned, as when two or three people in a group agree quickly on a decision, present it to the others, and then say, "Don't you agree?... All right, we'll do it that way," without really waiting to find out what the other group members think. This kind of minority decision-making is often called 'railroading.'

How well a minority decision will work depends on who the minority is and how it gained its power. If the minority was chosen by the group or by the leader with the group's permission, then its decision may gain group support. This is especially true if the minority is made up of people who are especially qualified to make this particular decision (a group of experts) or if they are known in the group for their careful consideration of problems and of group needs. On the other hand, if a minority decision is made by railroading, the rest of the group may feel resentful and refuse to help carry it out.

A minority decision is useful in situations where the group is very large and cannot easily meet to make every decision, or where having a great many people try to decide would be confusing. In this kind of situation, the leader or larger group may want to appoint committees to handle certain kinds of decisions. Decisions that can be handled well by a minority include those which are routine and less important, and those which affect small parts of the group or do not require much group support. A minority decision usually does not work well if the decision is very important or will require work from the entire group.

Sometimes a majority makes the decision, as when candidates are elected to political office in the United States. The majority decision may or may not involve group discussion. The group may talk until it arrives at a decision which more than half its members can support, or someone may make a motion and have the group vote 'yes' or 'no' on it immediately.

A majority decision works well in many situations. After all, it must have the support of more than half the group. It is most useful when decisions are not too important or must be made quickly so that there is no time for an extended group discussion. However a majority decision can leave many unresolved conflicts. The minority may feel that its rights and ideas have been ignored. If it is a large minority, this resentment may make it very hard for the group to implement a decision requiring support from everyone. The majority may also not be the best-informed, most intelligent, or most active part of the group.

Sometimes everyone in the group contributes to making the decision. A decision of this kind is called a consensus. It may not be a decision which everyone in the group agrees upon (unanimous decision), but it is a decision which everyone in the group understands, and it has been reached after a group discussion in which everyone has had a chance to present his or her views. It will be at least tried and temporarily supported even by group members who disagree with it.

A decision which has been reached by consensus has the best chance of effectiveness for the whole group. If everyone understands the decision and feels that he or she has had a chance to express ideas or feelings about it, the decision is most likely to have group support. The decision is also most likely to represent the group's real wishes and to fit with its goals. Thus, it has a much higher chance than other kinds of being successfully implemented.

However, a consensus decision is the hardest kind to make. It often takes a great deal of time for a group to reach a decision which really represents everyone's feelings. Many possibilities need to be tried out and discarded before the right one is found. A consensus decision also requires high level group interaction skills. If each person or subgroup blindly argues for a separate position without listening to what anyone else says, for instance, discussion could go on almost forever without any agreement being reached. If everyone is too willing to give up or compromise for the sake of peace, resentments may stay hidden and conflicts remain unresolved.

A consensus decision is the best kind when the decision is complicated, or important, or both, and when it will affect everyone in the group. This approach will not work well if a decision must be reached quickly or if a group lacks the necessary skills to reach such a decision in a practical length of time. A consensus decision is usually unnecessary if the matter to be decided is fairly routine or unimportant--the time necessary to have a full group discussion on such a matter might be better spent in doing something else.

Evaluation.\* In a world where choices must be made, evaluation is an important part of our everyday lives. Decisions ranging from what time to get up in the morning to what profession to choose are made by evaluating alternative courses of action. These evaluations may be split-second, based on intuition or past experience, or they may be detailed, involving research and careful analysis of information. The extent and complexity of an evaluation are often determined by the importance of the decision to be made in terms of consequences and related costs. It is generally in a situation where the decision is important and the evaluation is inadequate that people become apprehensive about evaluation.

A small group evaluating its performance of a task can ask some simple questions to help it identify problems and learn how to do better in the future. These include asking what should have happened in the situation, what actually did happen, reasons for the ways things happened, and how performance can be improved.

An individual or a group involved in evaluating the work of others, such as a school program, should focus their activities on providing information that will be useful for making a specific decision. This information must be logically relevant to the decision and factually accurate. The decision must be specified in terms of its

\*Adapted from: Evaluation for Program Improvement, San Francisco, CA: Far West Laboratory, 1975

nature, who is to make it, and when it is to be made. The alternative courses of action which may result from different decisions must also be specified in terms of comparative benefits and feasibility.

Evaluation involves more than the simple collection of objective information, however. The information must be incorporated with the values, interests, and motivations of all those who participate in choosing a course of action-- in making the final decision. Many of these other considerations are subjective and cannot be specified by those involved. Much difficulty in evaluation stems from a failure to separate the process of collecting and organizing relatively objective information from the subjective considerations surrounding the process.

In spite of this difficulty, people are constantly evaluating situations and making decisions. They may or may not be able to get good information which can be balanced with the subjective factors entering into the decision. Since very few decisions of any importance can be classified as completely right or wrong, the most we can expect to do is to increase the probability that a given decision will contribute to an ultimately positive effect.

The function of an educational evaluation is to supply decision makers with the best possible information, thus increasing the likelihood that a good decision will be made. To be of the greatest value, this information must be identified, collected, and interpreted in a way that will allow for incorporation of the subjective considerations important to the decision makers.

To be most useful, evaluation activities should begin at the same time as the rest of the group's tasks. Procedures may be very simple, but the group should establish some way of monitoring its progress, and periodically compare its actions with its plan, account for any differences, and adjust either the activities or the plan as needed. If the group knows at the beginning that certain kinds of information will be needed for a decision, its plans to collect that information should be incorporated into its regular functioning procedures so that it will not have to be collected hastily and inadequately at the last minute.

Once information has been collected and analyzed, it should be presented in a way which will be useful to those who must make decisions dependent on it, and which will be clear to other elements in the school and community who are interested in the activities being evaluated.

## SESSION III

### Native American Career Education Methods

In developing materials specifically for Indian students, it is essential to try to find out as much as possible about what teaching methods were and are used by the Indians themselves, what cultural factors condition the Indian child's approach to learning, and how this information can be used in the classroom. Unfortunately, comparatively little research in this area has been done, and that little is difficult to locate.

As late as 1969, the Senate Subcommittee report on Indian Education could state--"...the typical school feels that it is its responsibility not to teach skills, but to impress the 'alien' Indian with values of the dominant culture..."\* so perhaps it is not surprising that so little information on the Indian learner exists. Organization and dissemination of existing information, and additional research to fill in the gaps, is one of the crucial needs of Indian Education.

### Traditional Indian Teaching Methods\*\*

One point which should be emphasized at the beginning of this discussion is that in a traditional Indian setting there are no "schools." Nonetheless, for several thousand years, Indian children have learned what they needed to know in order to survive and transmit their culture to subsequent generations. Obviously, formal schooling is not required for learning to take place. What then are the means by which Indian children are taught in a traditional setting?

In a paper based on research done on the Warm Springs reservation in Oregon, Susan U. Philips summarizes them as follows:

The context...in which learning takes place can be perceived as a sequence, idealized, of three steps: (1) observation, which of course includes listening; (2) supervised participation; and (3) private, self-initiated self-testing.\*\*\*

These characteristics appear to be typical of most American Indian tribes. Let us consider them in a little more detail.

---

\* Special subcommittee on Indian Education, Indian Education: A National Tragedy--a National Challenge, op. cit.

\*\* Excerpted from, Native American Career Education: A Curriculum Guide, San Francisco, CA: Far West Laboratory for Educational Research and Development, 1976.

\*\*\* Susan U. Philips, "Acquisition of Rules for Appropriate Speech" in, Function of Speech in the Classroom, ed. C. Cazden, V. John, D. Hymes, Teacher's College Press: 1972.

Observation. Philips reports that older women on the Warm Springs reservation reminisced about being required to watch their elder relatives tan hides when they were very young, rather than being allowed to play. In a society where there was no separation between work and family life, just as there was no separation between family life and education, children had ample opportunity to observe how necessary tasks were done.

History, religion, and ethics were transmitted to the young by story tellers, or by the great spoken and danced dramas of the ceremonial cycles among tribes such as the Hopi or the Pawnee. In these instances, too, the child was required to watch or listen, but not to participate. A participant at the National Indian Bilingual Education conference in 1973 commented, "The Indian style for teaching is to tell a story to illustrate the points to be taught to the child...the child is not told to do this or that to the story."\*

Supervised participation. Philips defines this as "...the segmentation of a task by an older relative, and the partial carrying out of the task or one of its segments by the child." This begins at a very early age, and tasks would be suited to a child's strength and comprehension, such as collecting firewood, pounding clay for making pottery, etc. "Such activities involve a small amount of verbal instruction or direction from the older relative, and allow for questions on the part of the child. Gradually the child comes to learn all of the skills involved in a particular process, consistently under the supervision of an older relative who works along with him." This mode of instruction is particularly convenient in an extended family situation, where grandparents or other older relatives are available and have close relationships with the young children. Children also learn from older siblings and other children, and by participating in games which simulate life tasks.

Unsupervised practice. Two comments from the bilingual conference are of interest here-- "...an Indian child learns by trial and error (they are) expected to learn to cope with things by themselves...", and "You just repeat the process until it comes out right. You must have a positive, forward-looking approach. This is really a cultural approach to acquiring a skill."

For instance, a little boy may want to learn to be a hunter. He listens to his father tell hunting stories. He watches his older brothers playing shooting games. His grandfather makes him a little bow and shows him how to hold it. Then he goes out by himself and practices, and practices, until at last he is able to bring a rabbit home for supper. That is his examination. The point here is that the learner is self-motivated, he goes at his own pace, he practices where no one else will be able to see his failures, and the only "test" that counts is the one he passes. Carried into the religious area, this pattern is typical of many Plains and Great Basin tribes, where individuals spent long periods in isolated vision-quests, returning when they had acquired spiritual power, new skills, or new songs or ceremonies.

---

\* National Indian Bilingual Education Conference, 1973 Proceedings, National Indian Bilingual Education Conference, BIA Indian Education Resources Center, Box 1788, Albuquerque, New Mexico. pp. 25, 30.

Another characteristic of learning in a traditional Native American setting is that the practical value of the knowledge being presented is immediately obvious to the student, and all instruction is illustrated by personal reference or observation of the environment. A painting entitled "Sioux teacher," by Oscar Howe, shows a warrior explaining the exploits painted on his tepee to two boys. Even more typical would be references to incidents which had taken place at various spots a child and older person might be passing, or comments on the characteristics and use of different plants or animals which they see.

To conclude this summary of traditional learning styles, we would like to refer to the report of McKinley, Bayne, and Nimnicht:

"Our field data indicate that Indian children prefer the style of learning characteristic of their native culture. Generally, the learner initiates an extended period of observation and attempts performance only when he feels fairly certain of his ability. Premature, bungling attempts are met with teasing, and successful attempts with quiet acceptance. ...American Indian children...prefer self-directed and self-initiated projects, ungraded curricula, and learning activities which can be completed with minimal interaction between students and teacher, except when the interaction involves friendly help on an individual basis."\*

## The Indian Learner

### Values

In addition to exploring the methods of instruction favored by Indian societies, it is important to consider what cultural values may affect the Indian child's approach to learning. A.D. Fisher contrasts the differences between Indian and modern American values in the list on the next page.\* The list is fairly extensive, and it becomes easy to see how in many cases the classroom "...becomes a place where a single adult representing white American cultural values attempts to impose these values on a group of children to whom those values are intolerable."\*\*

The two places where these value differences are most likely to cause problems are in curriculum materials and standard classroom organization. We have already considered curriculum problems under the heading of Cultural Relevance (pages 25-26). Classroom organization and instructional strategies present a more subtle problem.

---

\* A.D. Fisher, "White Rites versus Indian Rights," Transaction (New Brunswick, November, 1969), p. 32.

\*\* McKinley, Bayne, Nimnicht, op. cit., p. 16.

## Indian Cultural Background Stresses

---

cooperation  
wisdom  
protection of environment  
sharing  
sharing  
"present" rather than "future"  
oriented  
independence of tribal groups  
respect for tradition  
old age as a time of reverence  
food gathering, hunting, fishing  
observation  
close ties to homeland and the  
extended family  
group status actively pursued  
(inappropriate to work for  
individual status)  
restitution  
peace and politeness  
happy human relationships  
endurance  
intense and highly personal  
relationships  
character as a source of status

## Modern American Values and Goals Incorporated into and Reinforced by the Educational System

---

competition  
technology  
manipulation of environment  
commercialization  
amassing capital  
delayed gratification  
national interdependence  
modernism  
youth as the "golden age"  
industrialization  
science  
nobility and the nuclear family  
striving for increased individual  
status  
punishment  
confrontation  
individual achievement  
devotion to the "new"  
casual impersonal relationships  
educational degrees as a source  
of status



One of the most common assumptions in American education is that individual, competitive achievement is good in itself and is a useful method of motivating students to do their best. This is in considerable contrast to the Indian values of cooperation, sharing, and putting the group first. As Bradshaw and Renaud point out, "In trying to be a good and successful Indian, the Indian student must often be a bad and unsuccessful student."\*\*\*

However, competition, when used properly, is not necessarily a bad thing. Foerster and Little Soldier state:

Contrary to what many uninformed non-Indians believe, the Indian student is competitive. One has only to look at the successes which Native American students enjoy in athletics to disprove this myth. But the type of competition in the traditional classroom which singles out individuals and puts one student against another is contrary to what many Indian students are taught at home and may only serve to embarrass these students and create negative feelings toward school and teacher. Competition in the open classroom, on the other hand, in which the student vies with himself and which encourages healthy small group competition, offers a more satisfactory alternative which allows the Native American student to compete within the framework of his own value system.\*

The solution offered by Foerster and Little Soldier is "open education," which features a flexible use of space, furniture, and equipment, student-initiated activity, and small group work. This approach allows students to share equipment, and it encourages them to share themselves as well. Open education also gets the teacher out of the role of the authoritarian leader who imposes his will on others and controls all activity in the classroom. Students, who are treated as competent individuals at home, are given the same respect and responsibility at school.

When students control and direct the interaction in small group projects...there is again a marked contrast between the behavior of Indian and non-Indian students. It is in such contexts that Indian students become more fully involved in what they are doing, concentrating completely on their work until it is completed, talking a great deal to one another within the group, and competing, with explicit remarks to that effect, with the other groups.\*\*

---

\*\*\* Theckla Bradshaw and Andre Renaud, The Indian Child and Education (The Canadian Home and School and Parent-Teacher Federation, Mid-west Litho, Ltd., Canada).

\* Leona M. Foerster, and Dale Little Soldier, "Open Education and Native American Values," Educational Leadership (October, 1974).

\*\* Philips, op. cit., p. 84.

Cultural difference in attitudes toward individual responsibility and scheduling may also cause problems. In Indian culture the same rules are applied to both children and adults. It is assumed that the child is a competent individual, with rights and responsibilities, who has his own contribution to make to the community. Kluckhorn and Leighton write: "Children and adults do not belong to two separate worlds. The same set of standards prevails in most things for all ages, from the child to very old people."\* This is in considerable contrast to the assumption in many schools that the child (especially the Indian child) is an inferior being who must be controlled for his own good, and who can have nothing worthwhile to say that is not elicited by the teacher.

Another important value difference between the two cultures is in their attitudes toward time. In a traditional setting, life is governed by the sun and the seasons, not by the clock. All individuals are expected to set their own schedules and work voluntarily with others. For example, Wax and others point out that "within Sioux culture all individuals, including children, are free to set their own schedule of activities. Thus, the Indian child, when he enters school, is accustomed to an environment in which interference with plans is minimal. To such a child, normal schooling is excessively and disturbingly regimented."\*

What alternatives to the familiar lecture/discussion approach to teaching exist? The "open education" concept has already been discussed. McKinley, Bayne, and Nimnicht have some other suggestions:

Another theme which emerged from our data is that Indian students are most enthusiastic about learning when it is an integral part of creative activities which let the student express himself in diverse ways. Creative writing, drawing, model making, and drama are all popular when integrated into classroom projects...Instructional methods which emphasize creative activities appear to be more effective than those which are based on programmed learning...However, both approaches seem to work and to yield far more satisfactory results than lectures and oral classroom drill.\*

### The Problem of Language

Related to the problem of cultural conflicts is the fact that perhaps the most obvious cause of learning difficulties among Indian students is unwillingness or inability to communicate in English, either written or verbal. This problem may exist even when English is the students' only language.

---

\*\*Kluckhorn, C., and Leighton, D., The Navajo (Revised Edition). Garden City, New York: Doubleday, 1962.

\*Wax, R., "The Warrior Dropouts," Transaction (April, 1967), pp. 40-46

Philips believes that the difficulty with speech is caused by the fact that "the social conditions governing or determining when it is appropriate for a student to speak in the classroom differ from those which govern verbal participation and other types of communicative performance in the... community's social interactions.\*\*

The unwillingness of Indian students to talk in class is a common complaint of non-Indian teachers, especially as students grow older. There is some evidence that this problem can be mitigated if the teacher is able to create a warm, flexible classroom environment and build rapport with students. Philips analyses the problem as follows:

(students) show less willingness to perform or participate verbally when they must speak alone in front of other students. Second, they are relatively less eager to speak when the point at which speech occurs is dictated by the teacher, as it is during sessions when the teacher is working with the whole class or a small group. They also show considerable reluctance to be placed in the 'leadership' play roles that require them to assume the same type of dictation of the acts of their peers.\*

Reading problems among Indian students are equally well documented. For example, the Senate report includes the information that--

21 of 28 Indian students in a Washington 8th grade class were non-readers; one-third of the 123 Yakima Indians enrolled in 8th grade of a Washington public school were reading two to six grades below the median level...

Lest this be interpreted as reflecting on Indian intelligence, it should be pointed out that when Havighurst administered two non-verbal performance tests to Indian children in the 1940's, he found that the Indians did as well or better than similar groups of white children.\*\*\*

---

\*\* Philips, op cit., p. 78.

\* Philips, ibid., p. 85.

\*\*\* Havighurst, R.J., M.K. Gunther, & E. Pratt, "Environment and the Draw-a-man Test: The Performance of Indian Children." Journal of Abnormal and Social Psychology, 41, 1946, pp. 50-63.

There is some evidence that the bilingual programs now being instituted in the primary grades in many Indian schools are helping Native American children to master English as well as promoting their positive self-image as Indians. Also, there are a number of remedial reading programs in use which allow the student to progress at his own pace and many Indian students seem to enjoy and profit from these. However, as any teacher of teen-agers or adults with reading problems has undoubtedly noticed, finding material which is written at a level which students can handle, but which is conceptually sophisticated enough to hold their interest, is a constant challenge. It is certainly no less so with Indian students.

In conclusion, we would like to present the following suggestions for non-Indians who are teaching Indian students. The suggestions are taken from a guide for teachers and librarians put out by the Oklahoma State Department of Education.

1. Non-Indians should make the first move toward cooperation with the Indians. There will be very little communication with Indian children unless the teacher has the trust of the students.
2. Smile--be friendly but not aggressive. Respect the child's right to privacy.
3. Criticize constructively, never destructively. Accent the positive.
4. Praise in private, not before the class.
5. Be consistent in your treatment of your students. Understand that much of Indian culture is non-competitive.
6. Establish and maintain a warm climate where each child is recognized by himself and others as a worthy individual. Children recognize rejection when regarded as unworthy or hopeless. Each child has intrinsic worth. Each is unique.
7. Children tend to see themselves as others see them--good, smart, talented, etc., or the opposite.
8. Establish individual goals which are within his grasp for each child. Use positive reinforcement for desired behaviors immediately.
9. Let him reinforce his own learning by his success in reaching each goal, no matter how short the step it takes to reach that goal. Frustration will lower efficiency.
10. Many different experiences must be provided to stimulate all or some of the senses as no two children learn in exactly the same manner. Activity is basic to learning. The known experiences of a student should serve as a springboard for all new learning. Self determined goals are more effective than teacher directed activities. Use many methods. Remember behavior is caused.

11. An Indian child may not be quick to respond individually. At first he will perform best in groups. Individual response is often gradual.
12. Do not expect eye-contact when talking to an Indian child. Lowered eyes and head show respect.
13. The Indian child may not talk freely about himself before you first talk freely about yourself.
14. Indian children at home learn much by observation and are not always allowed to ask questions. Therefore, an Indian student may not ask questions if he is not urged.
15. It is possible that the Indian child is not being raised by his natural parents, but this does not mean he is not receiving the love he needs. The extended family members are very important to an Indian.
16. Discipline from Indian parents is often not the same type as from non-Indian parents. Many Indian parents believe a child is only frustrated by "corrective" measures.
17. Recognize the child who thinks in another language and allow him sufficient time to translate both the question and the answer from his native tongue to English. This is very important.
18. Some English idioms are foreign to Indian students. Be careful how you say what you say. Use explicit directions and give instructions one at a time. Don't assume the child knows the meaning of all the words you use. Indian students traditionally do not ask questions even if they don't understand.
19. Indians, adult and young, are sometimes slow in developing a concept of time and this fact must be acknowledged and allowed.
20. Indians are not "Vanishing Americans." Indian population is increasing.
21. The term non-Indian rather than white should be used.
22. Most Indians consider themselves members of a tribe, rather than as individuals in a community.
23. Become familiar with local tribes' culture, i.e., subsistence, housing, clothing, crafts, social organizations, political system, religion and mythology, language and values, and respect them as valuable contributions to the class.

In the workgroup system, the teacher's task is often easier than in traditional systems, since he or she can allow students to manage themselves rather than having to be "in control" of all students at all times. Instead of acting as class dictator, the teacher functions as resource and guide. The teacher moves from group to group and provides information and advice on an individual level, rather than dealing with students publically and making them come to him or her. It is also true that in many cases one student who understands the material will be much more successful in communicating it to another than the teacher could be. The student, after all, not only shares language and background, but is more likely to understand what the problem is, since he has just finished solving it himself.

It should also be noted that the workgroup approach is particularly appropriate for teaching about careers, since a significant majority of jobs are done by teams or small groups of people working together. Very few work situations consist of thirty-five people all working separately under the direction of a single boss. Furthermore, in a job situation, the idea that one is competing against a co-worker and must under no circumstances give him information or help is likely to be counter-productive.

If possible, the teacher is encouraged to establish a Career Education bulletin board in the classroom. This will provide an opportunity to display the products of the various workgroups where all students can see and learn from them. Other relevant material can also be posted there.

### Selecting Workgroups

The benefits of using the workgroup approach are many, however, groups should be selected and managed carefully, particularly if students are not use to this kind of arrangement. There can be no single rule for guiding selection of group members, since differences among students, school communities, and teaching styles inevitably affect interpersonal relationship. However, there are several points which should be noted, and which may be useful as guidelines:

1. In some schools, boys and girls (7th graders in particular) may be extremely self-conscious about working together. Although it would be highly desirable to use this opportunity to try and get them to relate to each other as people rather than social targets, the social pressures within a school may make this impossible. In this case, it might be better to segregate the sexes for workgroup activities.
2. In those activities in which students are asked to do research on their own tribal cultures, it is obviously most efficient to group students by tribe. However, there are times when this may not be the best approach. For instance, if two tribes have a traditional hostility, such a grouping could revive old tensions. If very little information on one of the tribes in the class is available, members of it might equate lack of information with lack of value in comparison to more thoroughly studied tribes, with negative psychological effect.

When there are non-Indians or mixed-bloods as well as Indian students in a class, grouping should be handled especially carefully. Recognition of racial or cultural differences should always be used in a positive manner (Vive le difference!). Students may be very sensitive about their background, and should never be put in a position where they will have to choose between parts of their heritage, or made to feel inferior. If handled badly, grouping students by background may make racial tensions stronger, rather than decreasing them. This is especially important since some students, encountering materials which present Indian culture from a positive point of view for the first time, may overreact, and begin denigrating other cultures.

When these kinds of problems seem possible, the best approach to selecting workgroups would probably be to mix students as thoroughly as possible. However you handle it, keep in mind the necessity to constantly stress the positive characteristics of the different tribes or races involved.

The unit "Cooperation" is recommended as the students' first experience with these materials because it deals with conflict resolution, understanding of values and interpersonal relationships and other aspects of working in groups. The first Activity from this unit, and Activity 4 from the unit "Part of the Whole World" (which deals with ethnic stereotypes), could be used separately if necessary.

### Alternatives and Substitutions

The goals of the units are to get certain skills and concepts across to the student, not to test his ability to learn particular facts. The assumption is made that exposure to and mastery of a series of concrete pieces of information will enable the student to understand an often rather abstract idea. But neither the particular activities included nor, in some cases, the information presented is essential to the units. They are included, of course, because they seem very likely ways to help students achieve the unit goals; however, where necessary, other activities or illustrations can be substituted-- and should be.

For instance, although all examples and illustrations are drawn from Native American tribal groups and individuals, in some cases this may not be sufficient to assure cultural relevance. An example from a tribe which has a very different culture and environment from the one to which the students belong may be almost as alien as a non-Indian illustration. The teacher should become familiar enough with the culture of the children he or she is teaching to add or substitute a local example. In any case, the teacher should try to insert local cultural material at appropriate points in the units, even if it only consists of adding a comparison of the way something is done in the illustration and the way the local tribe does it. Wherever possible, the teacher should follow the Indian practice of using the immediate environment as a resource for instruction.

Use of alternative activities is also encouraged. In general, audio-visual materials are a more attractive and effective way of conveying information than lectures or reading; however, availability of such resources varies widely from school to school. Each unit includes a list of resources which would be appropriate for use with various activities. It is by no means complete, or applicable to all schools, but at least it should serve as a guide to the kinds of material to look for. All materials should be previewed by the teacher before being shown to the class; however, you should note that even poor materials can sometimes provide a basis for rewarding discussion and critique.

Audio-visual materials are by no means the only alternatives available. Where length of readings causes problems for students, the teacher may want to summarize the material in lecture form or assign different students to read parts of it and communicate the information to each other. The complete reading will still be available in student workbooks for review purposes. Another possibility is for the teacher to read material onto tape and set up a "listening post" in the classroom.

In the workbooks, response is generally requested in written form. However, depending on student feelings about writing and speaking, the teacher may wish to have students discuss the questions in their workgroups instead of writing down the answers. Another possibility, at least with some materials, would be to have students draw pictures illustrating the concepts involved.

A list of optional activities is included at the end of the Teacher Suggestions for each Activity in each unit. These include activities which will probably not be possible for all school settings, and which, therefore, cannot be made essential parts of the unit. However, they can be of considerable value in enriching the unit, and they may in some cases be substituted for regular exercises. Any activities which will involve the community are particularly desirable.

### Reinforcement and Feedback

It is an established premise of learning theory that repeated exposure to information, and practice of an action, and immediately confirmation of success or failure, contribute dramatically to mastery of the material or skills involved. For this reason, in the program, student activities which involve presentation of concepts or skills are generally followed by review questions or some other exercise which will lead students to reconsider the material just presented.

Where appropriate, units also include a "Feedback" section, containing sample answers or suggestions of what acceptable answers might be like. The student is encouraged to turn to the Feedback pages and check his own answers as soon as he has finished a reinforcement exercise. This is intended to approximate the period of unsupervised practice characteristic of Native American learning. If the student corrects his own answers, he will not be displaying his knowledge until it is correct.



The fact that this feedback is provided should underline the idea that the object of the exercises is not to test the students' ability to learn. Answering the review questions forces the student to reconsider, and hopefully review, the material he has just encountered. Checking his answers with the Feedback section insures that he is exposed to the relevant information at least one more time.

Teachers should explain this system to students and explain the advantages of using the Feedback section. They should also make sure students understand that their answers do not have to be phrased in exactly the same way as those in the Feedback section. Any answer that expresses the same ideas or concepts as those expressed in the sample answers is correct.

Discussion and sharing of information with other workgroup members also serves to take the student over the material again, and so it is to be encouraged. In many units, concepts are repeated and built upon from Activity to Activity, so that material which may not have been very clear at the beginning will be understood by the time the unit has been completed.

### Simulation Exercises and Learning Games

The recent realization that learning is more effective if it is enjoyed has encouraged the development of a great many learning games in the past few years. Such games are extremely useful to introduce material, review material that has been presented, show students how to use information they have learned, and generally involve and motivate them in an unobtrusive manner. At the very least, learning games provide a change from usual classroom activities and allow students to return to them refreshed. The only difficulty may be that students will assume that if it is fun it can't be valid, or it is "kid stuff" etc. They should be assured that learning games are being used not only in public schools all over the country, but in colleges, business, and the military.

Games used in the program fall into three main types: monopoly-style board games, card games, and simulations. Some of these games have been adapted from games developed and tested by the R-3 Program at the San Jose Unified School District, San Jose, California, others are original, or are adapted from other sources. To avoid burdening the program with expensive supplementary materials, "master" for all game boards, score sheets, and game cards are included in the Teacher's Guide. These sheets can be detached and xeroxed or transferred to ditto masters. Students can then cut, paste, and otherwise help prepare materials for use. Many of the game materials can be re-used after they have been put together.

Simulation, although it has assumed some very sophisticated forms, is in essence the same thing children are constantly doing in play--"You be the hunter and I'll be the bear, and you see if you can track me..I'll be Superman and they can be the bad guys and I'll rescue you..." A simulation is a scaled-down imitation of real life.

As Robert E. Horn describes the process--

...simulations are working models of reality. In a basic sense, simulation means "simplified." Not all of reality, but the important part is symbolized or modeled by a combination of words, mathematical formulae, computer programs, roleplays, rules, etc. The learner who plays a simulation game begins to form verbal/non verbal models of reality in his head...as play progresses, he modifies and enlarges the model..Any past, present, or future situation in which humans working in a society find themselves making decisions and taking action to change the course of events around them can be the subject of a simulation game.\*

As such, simulation exercises are particularly well-suited to getting students to deal with attitudes and values, to helping them understand why people react the way they do, and to recreating in the classroom certain aspects of the world to which they would not otherwise have access.

Simulation is one of the best in-class methods of teaching Career Education. Ideally, of course, students would learn about careers by visiting offices and factories, and observing what goes on there, or by serving internships. However, when it is impossible for one reason or another, students can attempt to recreate the work environment in the classroom through simulations.

It should be pointed out, however, that simulation exercises, particularly when they involve role-playing by students, may encounter student resistance. Sometimes, instead of feeling challenged and interested by the idea of pretending to be someone else, students feel threatened. They may fear that they are going to be judge on the basis of their acting ability; they may be afraid to speculate on what another person would do; or they may simply not be able to relax enough to throw themselves into their roles.

The teacher should be careful and supportive in the presentation of the simulation exercise. He or she should encourage students to think of it as a drama, and assure them they they will not be judged. However, if too much resistance is encountered, in most cases it will be possible simple to have students discuss what they think would happen in a certain situation, given the problem and the people involved.

students take well to the simulation idea, on the other hand, they can be encouraged to develop the simulation, work out new simulations on their own, etc. The Guide to Simulations/Games by Horn and Zuckerman includes guidelines on do-it-yourself simulations as well as a survey of available simulation games.

---

\* Horn, Robert E., and D.W. Zuckerman, The Guide to Simulations/Games for Education and Training (Lexington, Massachusetts, Information Resources, Inc., 1973), p. 439.

## Native American Sources of Material on Culture

In addition to the general sources of information identified in Section 1, the following organizations or materials may be useful. Additional materials and sources are listed in the Curriculum Guide, and at the end of each of the NACE units.

Akwesasne Notes  
Mohawk Nation  
via Rooseveltown  
New York 13683

Ford Foundation  
320 East 43rd St.  
New York, NY 10017

Office of Academic Studies,  
Room 356  
Smithsonian Institution Building  
Smithsonian Institution  
Washington, DC 20560

The Library Project of National Indian  
Education Association  
Archives  
National Indian Education Association  
3036 University Ave, S.E.  
Minneapolis, MN 55414

American Indian Historical Society  
1451 Masonic Ave.  
San Francisco, CA 94117  
(Listing of books, bibliographies, periodicals about Native Americans)

## REFERENCE MATERIALS

American Indians, an Annotated Bibliography of Selected Library Resources  
Minnesota Department of Education, 1970  
444 Centennial Building  
St. Paul, MN 55101

Books About the American Indians  
The Indian Historian  
1451 Masonic Ave.  
San Francisco, CA 94117

Textbooks and the American Indian  
The Indian Historian Press, Inc.  
1451 Masonic Ave.  
San Francisco, CA 94117 (\$4.25)

Books About Indians and Reference Materials  
Idaho State Department of Education 1968  
Indian Education  
Boise, ID

Indian Bibliography  
Bureau of Indian Affairs  
Division of Instructional Services  
Brigham City, UT

Native American Materials  
Center for In-Service Education  
P.O. Box 754  
Loveland, CO 80537

ISAM (Information System for Native American Media)  
National Indian Education Association  
3036 University Ave., S.E.  
Minneapolis, MN 55414

## BOOKS

Brown, Dee, Bury My Heart at Wounded Knee. New York: Holt, Rinehart, & Winston, 1971.

Deloria, Vine, Jr., Custer Died for Your Sins. New York: Macmillan Co., 1969.

Deloria, Vine, Jr., We Talk, You Listen. New York: Macmillan Co., 1970.

Josephy, Alvin, The Indian Heritage of America. New York: Alfred A. Knopf, 1968.

La Farge, Oliver, The American Indian. Racine, WS: Western Publishing Co., 1970.

Vogel, Vergil J., This Country Was Ours. New York: Harper and Row, 1972.

Indians of the United States (a series of 14 booklets about Indians of different states)

---

Superintendent of Documents  
U.S. Government Printing Office  
Washington, DC

Audio-Visual Materials

American Visual Communication  
P.O. Box 26392  
Tucson, AZ 85726

Phone: (602)623-2565

Poetry of American Indians	\$225.00 set
NAP-1, NAP-2, NAP-3, NAP-4	62.50 ea.
Cheyenne Sundance NASD	25.00
Baskets of California NABC	35.00
Pueblo Architecture NAPA	25.00
American Indian Design Element NADE	50.00
Costumes and Masks of the Southwest Tribes NASCM	27.00
Costumes and Masks of the Northwest Coast Tribes NANCM	25.00
Pueblo Indians of New Mexico NANM	100.00
The Hopi Indians of Arizona NAH	100.00
The Navajo Indians NAN	100.00
The Sioux NAS	100.00

## Strategies for Identifying and Using Community Resources\*

In addition to incorporating the cultural resources of the Indian community into the Native American Career Education program, planners and teachers should consider marshalling any resources available in local business and industry to enrich the program. This is a traditional approach to Career Education, and can be very effective. Ideally, the Indian community's economic planning will tie in with the region's present and projected business and industrial development, and the Career Education program can be planned to complement both. If the program makes good use of the world of work in its Awareness and Orientation phases, it will be easier to find work-sites for Exploration and later preparation in the form of work-experience and on-the-job training programs.

The amount and kind of interaction between the school and the business/industrial community can vary widely. In some programs, business people may serve on the Career Education committee and play an active part in developing the program, supervising work experiences, etc. In others, they may simply serve as resources, coming into the schools or being visited by students on an irregular basis.

Things which business community resource people can do include:

- actually teaching parts of the curriculum;
- discussing ways in which the curriculum relates to the world outside the classroom;
- providing actual information about jobs related to the subject area;
- verifying information students have collected, points brought up in class discussion, or conclusions of individual experiments;
- demonstrating ways in which people are dependent and interdependent on products and services provided by others;
- describing their own experiences as a worker, and factors involved in their own career development.

One of the major purposes of career education is to bring increased meaning to what is taught in the classroom so that students will be motivated to learn better and will be better prepared for life outside of school. One way of demonstrating to students the need for skills such as reading, writing, and arithmetic is to have people who are already employed explain how they use these things in their work.

Teachers are often reluctant to approach people outside of the classroom, not only because they fear a negative response, but because they are not aware how community resource people can assist in the teaching-learning process. A list of the ways community resources might be used by students would include:

---

\*Based on materials in the 1978 Annual Career Education Handbook for Trainers, Tempe, AZ: Palo Verde Associates, 1978.

- bussed field trips;
- walking field trips;
- career observation/interview site trips;
- work experience sites;
- telelectures;
- career speakers;
- service by community people as career advisors, technical advisors in subject areas or recruiters of other resource people.

In order to make most effective use of community resources, teachers should plan the experience carefully, and ask and answer the following questions:

1. what will students learn from the person or experience?
2. where and when (including time of day) will this experience take place?
3. how long should it take?
4. should a question and answer session be included?
5. how will this experience relate to what other things students are learning in this class and in the career education program as a whole?
6. what preparatory and follow-up activities can you plan?

The ability of a resource person to provide an interesting and useful learning experience for students will be increased if he or she is given some preparation by the teacher. Resource people need to know what their audience will be like--ages, interests and abilities of the students, and what background, if any, they have in the area to be discussed--so that they can adjust their presentation to the students' level of attention and comprehension. The teacher should also indicate any specific items the resource person should cover. The teacher will also need to know the resource person's educational and occupational background and qualifications in the topic area to introduce him or her to the class. This information might include the resource person's name and job title, training and work experience, honors and awards, and any special achievements.

Some things which should be determined ahead of time include:

- whether the resource person wishes to conduct a question-and-answer session for the students and, if so, whether he/she would like to receive a list of questions in advance.
- In the case of a guest speaker, whether any special equipment is required--filmstrip, slide, or movie projector, tape recorder, record

player, miscellaneous demonstration materials, etc. These items must be arranged for in advance and should be tested to see that they are in good working order.

- In the case of a field trip, whether any safety precautions will be necessary. Students need to be made aware of this ahead of time.
- Whether the resource person has any media--brochures, posters, or pictures, for instance--that can be given to the students to reinforce what they have learned.

Here are some other things which should be done:

- Confirm the date and time that students will be meeting with the resource person.
- If taking a field trip, be sure you have complete directions to the destination.
- In the case of guest speakers in the classroom, tell the individual how to reach the school and where he/she will be met. Prepare a map of the school which indicates the parking area, office, restrooms, and classroom, then mail it to the speaker.
- Prior to the actual day, discuss matters of etiquette with students, especially courteous listening techniques. Encourage them to decide what their responsibilities to the resource person are, including such items as appropriate advance preparation, attentiveness, participation in discussion, and mature evaluation of the experience.
- Remind students of the purpose of the experience, how it relates to the regular curriculum, and discuss the nature and purpose of any observation/interview tools, etc. they are going to use.

While the resource person is speaking, the teacher should position himself/herself so that he/she will be able to observe both the students and the resource person. This strategy generally elicits good behavior from the students, and in the event that any disciplinary action becomes necessary, permits the teacher to act quickly and unobtrusively. The teacher should request clarification of complicated information if students are becoming confused. A timely interruption may prevent lack of understanding and, therefore, lack of interest.

The teacher should also see that formal appreciation is expressed at the conclusion of the resource experience. Later on, a thank you note, perhaps signed by the entire class, would be a nice gesture. The teacher should assist students in analyzing the significance of what has been learned. Make appropriate concluding assignments that will help them relate what the resource person has told them to the work being carried on in the classroom. Finally, evaluate the experience. This will assist teachers and planners in continuing efforts to improve the quality of these experiences from the point of view of the resource person, the teacher, and the students.



Arranging experiences with community resources for students is a very useful teaching strategy. Direct contact between the school and the community can be extremely beneficial to all concerned, and educators should take advantage of the willingness of these individuals and organizations to donate their time and talents toward the education of our young people.

### Developing Community Resources

The school is an integral part of the community, and with the importance of career education, the school is increasing its participation with the community. Community, especially business, industry, and service groups, are offering increasing help to schools in furthering students' career development. Intentions are good, but there are some apprehensions and a definite lack of experience in collaboration. To effect meaningful collaboration, views must be exchanged about involving the different societal institutions in student career development.

One way to begin developing a business community resource base is to assemble a panel of representatives from business, industry, labor, professions, and service groups. Discuss what they can offer to school people and the concerns they have in becoming involved in student career development.

Introduce the panel and invite each representative to describe his or her company's or agency's career education services only. Ask the participants to delay their questions until every panel member completes his or her presentation. Have a set of questions ready for the panel to answer. These could be distributed to participants to pose.

Invite additional participant questions and moderate to insure full panel participation. During the course of questions encourage multiple panel members to answer the questions.

Some of the following issues could be considered:

- Can the individual teacher or counselor contact your agency or business directly and what is the best way to make contact?
- What materials and personnel will your company/agency provide?
- What mechanism is available for the educator to use in giving constructive feedback on the performance of a representative of your company or agency?
- What coordination or preparation by the school does your agency or business expect?

Next, have panel members join small educator groups to ask questions of the educators. Two way dialogue is important in this session.

## Using the School as a Career Education Resource

One of the most accessible agencies which includes a variety of workers as well as working situations is the school district itself. Examples include:

- secretaries
- custodians
- electricians
- counselors
- grounds people
- warehouse people
- teachers
- nurses

Schools have many resources (people, materials, and equipment) which are, or can be, used for students' career development. One step in preparing yourself for using resources is to identify the resources that are available or could be available in the school or school district.

## Families as Career Resources

Within the walls of any classroom or for that matter any time a group of people gather, there is an excellent opportunity for discovering much about the world of work. Not necessarily a traditional study of occupations, although this can result and be profitable, but developing some recognition of the interdependence of society through work.

If a class has 30 students enrolled, there could be as many as 60 different kinds of work done by the families of the class members. This is a tremendously fertile area. All families have essentially the same needs. The society in which we live is certainly the most interdependent society that individuals have known. Now this can be shown within a classroom, any classroom.

Determine the occupations, the kinds of work performed by these families, and point out the work contributions by one family to all the others in the class. Without thinking, we all automatically accept the performance of that work in our daily lives. It seems rather obvious that youngsters will feel better about themselves and their family when classmates pointedly recognize that their families make an important contribution.

To find out how many occupations are represented within the group of participants, have students fill out the Vocational Information Form (follows immediately). (Remind individuals that Homemaker is a vocation.) Have students discuss how they personally are dependent on the products or services represented by the workers on their lists.

It will be rather surprising to see how many different occupations are represented right in the group. It should be easy to recognize that the products and services represented in the group are absolutely necessary to humans to maintain present standards or styles of living. Even very young students can develop this same recognition.

How the occupations are classified depends on developmental level of the students (see "Graduated Classifying" after the next page). If students are sophisticated enough to deal with the concept of career cluster, the teacher

Pages 59a and 59b were removed due to copyright.

can hand out the cluster definitions at the end of this section, and write them on the board, and tally occupations of students' family members under the appropriate headings.

Children at the K-3 level and possibly higher may not know their family's work background. It is amazing how many children do not know what kind of work is done by members of their family. In order to start gathering occupational information for a class, it will be necessary to determine the occupations, or kinds of work, done by the families of the students. With small children, it will probably be necessary to develop an appropriate cover letter and include an information form to be completed. If students are encouraged to talk with their families about the content of the forms, the students will become more knowledgeable. Once the forms are returned, they can be retained in the classroom and used for reference at other times during the year, whenever a need arises. If a career speaker is needed, look within the class first. Possibly the person might not be able to come to the school, but a cassette recorder could be used by the student to interview a family member for the class; again helping students to learn more about careers.

A sample letter that could be used to gather this data (see "Questionnaire for Resource Parents") is presented at the end of this section.

Instead of starting the school year by having students write a theme about what they did during their summer vacation, one could start the year by having students discover all of the different kinds of work done by the families of their classmates. This would help them see that the way they live requires work done by families of their classmates and that their classmates depend on work done by their own family. This interdependence theme can contribute much to an internal concept of classroom organization. It is rather startling to seriously consider the vastness of the human resource potential that is housed within a group of 30 or so human beings.

## SESSION IV: Relevant Training Materials

### NEEDS ASSESSMENT MANUAL: ALAMEDA COUNTY NEEDS ASSESSMENT MODEL (ACNAM)

Alameda County Schools  
Hayward, California

#### INTENDED USERS

Elementary school personnel.

#### TYPE OF EVALUATION ADDRESSED

Needs assessment (preformative evaluation).

#### APPROACH TO EVALUATION

Needs assessment is defined as being a systematic way of identifying discrepancies between existing conditions and desired conditions in a school's program.

#### FORMAT

"How-to" manual.

#### PRODUCT COMPONENTS

User's manual, statistical summary and data forms, staff survey, parent survey, student survey answer sheets, student survey tape for administration (English, Spanish, Cantonese, and Tagalog).

#### CONTENT EMPHASIS

The manual deals with: populations to be assessed; determining existing conditions; using statistical summary and data forms; using surveys; sampling; interpreting data; determining priorities; making decisions; and taking action.

#### PRODUCT PURPOSE OR GOALS

The user's manual is designed to help school personnel collect the necessary data for decision-making in the process of planning the educational program at the school level for elementary schools (K-8).

#### CONTENT ORGANIZATION OR USER ACTIVITIES

Guided by a management checklist, users go through the stages of a needs assessment. Survey instruments are provided, and a decision matrix, action forms, and other aids are provided to assist users in organizing their activities and ideas.

#### REQUIREMENTS

Personnel: Assistance from ACNAM staff (including workshops) is available but not required.

Resources: Survey forms, etc. as indicated under COST, below.

Length: Variable, depending on user needs.

Conditions of Use: Data processing is handled by CTB/McGraw-Hill in Monterey, Ca.

#### ADAPTABILITY

The model is particularly applicable to schools using consolidated applications for state and/or federal funding (A-127ES), but can be used by anyone involved in needs assessment.

#### RELATED PRODUCTS

None.

#### COST

User's Manual, one per school, \$4.00.  
Statistical summary forms, one per school, \$2.50.  
Staff survey, package of 20, \$5.00.  
Parent survey, 35 per package, \$8.75.  
Student survey answer sheets, 35 per package, \$6.00.  
Student survey tape, one or two per school, \$3.00 each.

#### AVAILABILITY

Alameda Superintendent of Schools  
Alameda County Education Center  
685 "A" Street  
Hayward, CA 94541

#### HISTORY AND EVALUATION

This model was developed under an ESEA Title I grant under the direction of Dr. Belle Ruth Witkin. The current edition is a product of two earlier experimental models. The procedures and techniques presented are based on extensive research into the state of the art, and use testing by over 650 California schools. Users are encouraged to release group data to ACNAM for research purposes.

#### COMMENT

This model is the result of an extensive research and development process. The user materials have been refined for maximum convenience and clarity. Directions are straightforward, and procedures are adapted to the needs and abilities of elementary schools staff. This is an attractive, well-designed package.

215

**THE SCHOOL AND COMMUNITY:**  
**PARTNERS IN EDUCATION**

Fresno County  
Department of  
Education  
Fresno, California

**INTENDED USERS**

Steering committees composed of community members and school personnel.

**TYPE OF EVALUATION ADDRESSED**

Goal setting and needs assessment.

**APPROACH TO EVALUATION**

The purpose of using this procedure to state needs and goals is to give decision-makers (the school board) the opportunity to select educational goals which will express the community's perceptions, desires, and priorities.

**FORMAT**

Conference guide.

**PRODUCT COMPONENTS**

Booklet.

**CONTENT EMPHASIS**

This booklet covers the following topics: deriving the statement of needs, writing the statement of goals, the problem-solving cycle and accountability, how to modify the conference structure, and deriving district goals from school goals.

**PRODUCT PURPOSE OR GOALS**

The purpose of this booklet is to enable community members to identify needs and set goals that will be practical, readable, and readily understood.

**CONTENT ORGANIZATION OR USER ACTIVITIES**

The entire community is invited to participate in the conference by a school-based steering committee. At the first meeting participants divide into sub-groups and work on defining school problems. At the second session, groups define goals. These ideas are sifted and synthesized by the steering committee, which converts the needs statements to goals statements, and presents them to the school board for approval and implementation. A series of flow charts guides activities.

**REQUIREMENTS**

**Personnel:** Someone from the district staff to serve as project director; community members to serve on steering committee; consultants.

**Resources:** Clerical time, meeting space, etc.

Length: Time spent on the project by various people varies. Averages are:  
School, two hours;  
Community members at conference, five hours;  
Steering Committee, 12-15 hours;  
Administrators or Project Director; 20-30 hours;  
Consultants, 40-60 hours.

Conditions of Use: Strong commitment to the idea of school-community cooperation from all involved.

#### ADAPTABILITY

By changing the focus of the questions asked at the conference, this approach can be used by/for churches, college departments of education, trainees of school counselors, providers of student health services, PTAs, and city governments.

#### RELATED PRODUCTS

None indicated.

#### COST

\$3.75.

#### AVAILABILITY

Fresno County Department of Education  
Division of Instruction  
2314 Mariposa St.  
Fresno, CA 93721  
(209) 488-3311

#### HISTORY AND EVALUATION

The Community Conference procedure was developed by Dr. Bob King, then Director of Elementary Education for the Fresno County Department of Education, and was widely used by school communities in Fresno and elsewhere. The present version was revised and edited by Dr. Wayne N. Jordan of the Division of Instruction.

#### COMMENT

This booklet presents an exciting and original approach to involving the community in educational planning. This procedure could probably be incorporated into a formative or summative evaluation effort as well. The material is clearly written, and the directions appear to be complete and comprehensive.



EDUCATIONAL GOALS AND OBJECTIVES: PHASE I  
A MODEL PROGRAM FOR COMMUNITY AND PROFES-  
SIONAL INVOLVEMENT

Program Development  
Center of Northern  
California and  
Phi Delta Kappa, Inc.

**INTENDED USERS**

Administrators, teachers, students, community members, and AB 65 School Site Councils.

**TYPE OF EVALUATION ADDRESSED**

Process, goal-setting and prioritization, perceived need assessment.

**APPROACH TO EVALUATION**

Developers feel that this approach to goal-setting will provide the educational community with important decision-making information. The approach is process-oriented and will provide outcomes of educational goals, listed in order of importance, and the perceived needs of the district as viewed by the community, the teachers, and the students.

**FORMAT**

Community meeting, activity- and process-oriented with group interaction.

**PRODUCT COMPONENTS**

Community Kit for Goal Ranking includes Administrator's Manual, all necessary worksheets, and materials for conducting a meeting with 60 community members.

**CONTENT EMPHASIS**

Ranking of educational goals in order of their importance, and assessment of the degree to which the educational programs are meeting these goals.

**PRODUCT PURPOSE OR GOALS**

The purpose of the strategies presented is to enable the school district, including educators and community members, to work together to develop community-ranked goals and determine perceived needs.

**CONTENT ORGANIZATION OR USER ACTIVITIES**

The process begins with the ranking of educational goals (in order of their importance) by a cross-section of the community. A determination is then made as to how well the educational programs of the district are meeting these goals. While the goals are ranked by a cross-section of the community, the determination of how well the educational programs are meeting the goals is done not only by the community but also by the teaching staff and by students.

## REQUIREMENTS

- Personnel: School and community people to serve on committees, task force leaders and administrators.
- Resources: Limited clerical assistance, possible small group monitors, meeting space.
- Length: Program can be completed in six months to one year.
- Conditions of Use: Administrators must play an active role in securing community participants. Recommended procedures in the Administrator's Manual should be followed as closely as possible. (Program is intended to be quite flexible and may vary from school district to school district.)

## ADAPTABILITY

All goals materials are available in Spanish. Phi Delta Kappa also has them in French (for use in Canada).

## RELATED PRODUCTS

Educational goal-attainment tests are available from Phi Delta Kappa. These are validated tests which determine the degree to which goals are being met in a particular school district.

## COST

Community Kit for 60 participants, \$70.00 (includes all materials necessary to conduct community meetings).

## AVAILABILITY

Phi Delta Kappa  
Box 789  
Bloomington, IN 47401

## HISTORY AND EVALUATION

This program was developed by the Northern California Program Development Center in Chico, California (Butte County Superintendent of Schools), under the direction of Dr. B. Keith Rose. It was originally field tested in many California school districts and has been successfully used in schools throughout the United States and Canada for the past five years. It is now being distributed through Phi Delta Kappa. Phi Delta Kappa can furnish potential users with the names of school districts that have used the materials in the past.

**EDUCATIONAL GOALS AND OBJECTIVES:**  
**PHASE II, WRITING PERFORMANCE OBJECTIVES**

Program Development  
Center of Northern  
California and  
Phi Delta Kappa, Inc.

**INTENDED USERS**

Teachers and administrators.

**TYPE OF EVALUATION ADDRESSED**

Process, but outcomes will include completed curriculum based on performance objectives and sequences.

**APPROACH TO EVALUATION**

Performance objectives provide an effective, efficient way of analyzing curriculum, assisting teachers in planning, assuring program continuity, helping district articulation, helping both teachers and students be more accountable, and assisting teachers to report to parents.

**FORMAT**

Workshop, and a series of teacher meetings.

**PRODUCT COMPONENTS**

Writing Performance Objectives, Instructor's Manual, and Programmed Course for the Writing of Performance Objectives.

**CONTENT EMPHASIS**

Participants will learn the difference between performance objectives and goals, and how to write them for the cognitive, affective, and psychomotor domains. The purpose is to analyze and develop curriculum based on critical skills in a sequential manner. Outcomes are a completed, sequenced curriculum for any selected content area.

**PRODUCT PURPOSE OR GOALS**

By termination of instruction the participants will be able to write instructional-level objectives for critical skills in a subject of individual choice. The accuracy will be determined by teams of teachers developing the curriculum.

**CONTENT ORGANIZATION OR USER ACTIVITIES**

The workshops consist of a series of meetings. After an introduction and overview, the learners complete assigned frames from the programmed text, review answers, and discuss them. Learners will also complete objectives writing assignments, which will be critiqued by other participants. The Instructor's Manual includes directions and discussion ideas.

## REQUIREMENTS

Personnel: Instructor with skill in writing performance objectives and experience in staff training.

Resources: Overhead projector.

Length: Eight hours of instruction.

Conditions of Use: It is recommended that a selected cadre of instructors be trained first so that they can then train others. A ratio of 20 teachers to each instructor is recommended.

## ADAPTABILITY

The workshop can be used to train teachers to write objectives as the final phase of the community/professional involvement process described in Educational Goals and Objectives: A Model Program for Community and Professional Involvement.

## RELATED PRODUCTS

None.

## COST

A Programmed Course for the Writing of Performances Objectives, \$1.00.  
Instructor's Manual, \$1.00.

## AVAILABILITY

Phi Delta Kappa, Inc.  
Commission on Education Planning  
Box 789  
Bloomington, IN 47401

## HISTORY AND EVALUATION

This program was developed by the Northern California Program Development Center in Chico, California (Butte County Superintendent of Schools), under the direction of Dr. B. Keith Rose. It was originally field tested in many California school districts and has been successfully used in schools throughout the United States and Canada for the past five years. It is now being distributed through Phi Delta Kappa.

## COMMENT

These materials provide a professional and comprehensive approach to teaching the writing of performance objectives, which are invaluable in evaluating educational programs as well as planning them. The programmed approach is very strict, and may require some extra motivation on the part of the teachers. Introductory sections do not make clear that these materials are packages with the Administrators Manual for Educational Goals and Objectives, A Model Program for Community and Professional Involvement, because they are intended to train teachers to implement the final phase of the process.

## COMMENT

This manual offers a variety of strategies for selecting a committee and managing the process of goal setting and implementations. Instructions for arranging and conducting activities are quite detailed but more introductory material outlining the process, and the use and relationship of product components, would be helpful. The role of the "administrator" or project coordinator, is not clear.

DEVELOPING COMPREHENSIVE CAREER  
GUIDANCE PROGRAMS: MODULES 3-12

American Institutes  
for Research (AIR)  
Palo Alto, California

INTENDED USERS

Preservice and inservice guidance personnel.

TYPE OF EVALUATION ADDRESSED

Preformative, formative, and summative evaluation.

APPROACH TO EVALUATION

The model for developing career guidance programs which is presented here is heavily evaluation-oriented. The modules feature repeated cycles of formative evaluation and decision-making at each phase.

FORMAT

Workshop materials.

PRODUCT COMPONENTS

Twelve module and coordinator guides.

CONTENT EMPHASIS

The program consists of ten modules, which cover orientation (Modules 1-2) and four phases of program development. Phase I teaches users how to answer the question "What should the program goals and objectives be?" (Module 3: Assessing Desired Outcomes; Module 4: Assessing Current Status; Module 5: Establishing Program Goals). Phase II asks "What strategies should be followed to meet these goals?" (Module 6: Specifying Student Performance Objectives; Module 7: Selecting Alternate Program Strategies). Phase III deals with the question "Do these strategies work, and what changes are needed?" (Module 8: Specifying Process Objectives; Module 9: Developing Program Staff; Module 10: Trying Out and Monitoring). The last phase (IV), asks "Did the program meet its goals?" (Module 11: Conducting Product Evaluations, and Module 12: Communicating Evaluation Results).

PRODUCT PURPOSE OR GOALS

Users of the various modules will benefit in the following ways.

Module 3: Assessing Desired Outcomes--Acquire the skills needed to assess the desired outcomes of a career guidance program.

Module 4: Assessing Current Status--Acquire the tools to assess the current status of a career guidance program.

- Module 5: Establishing Program Goals--Be able to define a comprehensive set of goals for a career guidance program using the results of the desired outcomes assessment and current status assessment performed in Modules 3 and 4.
- Module 6: Specifying Student Performance Objectives--Acquire the knowledge and skills needed to write student performance objectives for a career guidance program.
- Module 7: Selecting Alternative Program Strategies--Acquire the knowledge and skills to select appropriate strategies for agreed upon objectives of a program.
- Module 8: Specifying Process Objectives--Understand what process objectives are, and why they are written, and acquire the skills to develop and use them.
- Module 9: Developing Program Staff--Acquire the skills necessary to carry out a staff development program in a school or district.
- Module 10: Trying Out Activities and Monitoring Early Implementation Efforts--Appreciate the value of the empirical approach to product development and acquire certain skills required to conduct and measure the effects of activity tryouts and early implementation efforts.
- Module 11: Conducting Product (Summative) Evaluations--Understand the importance of summative evaluation and acquire the basic skills needed to design and carry out an evaluation.
- Module 12: Communicating Evaluation Results--Develop the skills needed to produce an effective evaluation report appropriate to the setting.

#### CONTENT ORGANIZATION OR USER ACTIVITIES

Modules follow a standard pattern. They begin with an introduction which presents the module's goals and objectives, an outline, and its relationship to the model. The text consists of readings and practice activities for each objective. This is followed by a postassessment section (end-of-module-test), an application exercise, and an appendix with references.

#### REQUIREMENTS

Personnel: Instructor

Resources: Reference materials.

Length: Module 3--9 hours; Module 4--5 hours; Module 5--5 1/2 hours; Module 6--6 hours; Module 7--4 hours; Module 8--6 1/2 hours; Module 9--6 hours; Module 10--5 hours; Module 11--8 1/2 hours; Module 12--7 1/2 hours.

Conditions of Use: These materials are very specific to the career guidance subject area, and should be used as a series.

## ADAPTABILITY

These modules could probably be used self-instructionally as well as in a workshop setting.

## RELATED PRODUCTS

Catalog summarizing existing competency-based staff development programs in the U.S.

## COST

Modules 3-12, \$33.50. Whole set (1-12), \$39.50. Coordinator's Guides (Modules 3-12), \$4.00. Coordinator's Guides (whole set), \$5.00 (California residents add 6% sales tax).

## AVAILABILITY

Publications Office  
American Institutes for Research  
P.O. Box 1113  
Palo Alto, CA 94302

## HISTORY AND EVALUATION

These modules were one of the outcomes of the AIR project titled A Validated Program Development Model and Staff Development Prototype for Comprehensive Career Guidance, Counseling, Placement, and Follow-up, conducted during 1974-75. Development began with a national search for and analysis of staff development materials, and module content was derived from a variety of sources. The first versions of the modules were tested with fifteen school counselors and other staff. After an extensive revision, field testing took place at two school districts, involving a dozen schools and approximately 75 people. The materials were also tested as curricula for an undergraduate counseling program at the University of Missouri.

## COMMENT

This is a very attractive set of materials, including interesting examples and amusing illustrations. They are written in a colloquial style which should be appreciated by users. Although they would probably be of limited use instructionally to personnel outside of career guidance, the modules provide an excellent model for a formative evaluation approach to program development which could be adapted to other subject areas.



**VOCATIONAL EDUCATION CURRICULUM  
SPECIALIST (VECS) PROGRAM:  
MODULES 9, 13, 15**

American Institutes  
for Research (AIR)  
Palo Alto, CA.

**INTENDED USERS**

Preservice and inservice vocational education curriculum specialists.

Type of evaluation addressed.

Preformative and formative evaluation.

**APPROACH TO EVALUATION**

Evaluation is defined as a systematic, formal process for identifying and collecting data on educational phenomena to assist in the decision-making process.

**FORMAT**

Teaching/Learning modules, study guides.

**PRODUCT COMPONENTS**

Twenty-two modules in program.

**CONTENT EMPHASIS**

The VECS program consists of 22 modules designed to train vocational education curriculum specialists in various content areas and skills. The modules most relevant to evaluation are: Module 9--Testing Instructional Objectives; Module 13--Basic Concepts in Education Evaluation; and Module 15--Procedures for Conducting Evaluations of Vocational Education.

**PRODUCT PURPOSE OR GOALS**

**Module 9: Testing Instructional Objectives**

Goal 9.1: Understand the concept of criterion-referenced measurement within the framework of educational evaluation.

Goal 9.2: Select approaches/techniques for assessing student achievement of instructional objectives in the three domains of learning.

Goal 9.3: Develop an evaluation plan and construct test instruments for measuring student achievement of instructional objectives.

### Module 13: Basic Concepts in Educational Evaluation

- Goal 13.1: Be aware of the social, political, and economic factors that have contributed to the development of the educational evaluation movement.
- Goal 13.2: Be familiar with the terminology used in educational evaluation.
- Goal 13.3: Be aware of the similarities and differences between educational research and educational evaluation.
- Goal 13.4: Be aware of the qualities and knowledge that educational evaluators must possess and the roles they must play.
- Goal 13.5: Be aware of the different conceptions of educational evaluation and the purposes for which it is conducted.
- Goal 13.6: Be aware of the criteria used in a decision-making context to evaluate vocational education programs and instructional interventions.

### Module 15: Procedures for Conducting Evaluations of Vocational Education

- Goal 15.1: Know the various purposes and components of decision-facilitation evaluations.
- Goal 15.2: Analyze and interpret the roles that evaluators are required to assume when conducting decision-facilitation evaluations.
- Goal 15.3: Develop or use appropriate criteria and methodology for decision-facilitation evaluations.
- Goal 15.4: Know the methods for preparing decision-facilitation evaluation plans and reports.

### CONTENT ORGANIZATION OR USER ACTIVITIES

Each module has five major sections. Part I, Organization and Administration, contains an overview and rationale, educational goals and performance objectives, recommended learning materials, and suggested reference materials. Part II, Content and Study Activities, contains the content outline arranged by goals. Study activities for each goal and its corresponding objectives follow each section of the content outline. Content focus follows the goals listed above. Part III, Group and Classroom Activities, suggests classroom or group activities and discussions keyed to specific content in the outline and to specific materials in the list of references. Part IV, Student Self-Check, contains questions directly related to the goals and objectives of the module, which may be used as pretest or posttest. Part V, Appendix, contains suggested responses to the study activities from Part II and responses to the student self-checks.

## REQUIREMENTS

Personnel: Instructor, if modules are used in a workshop or classroom setting.

Resources: Optional reference materials.

Length: Approximately 30 hours of class study is required to complete each module.

Conditions of Use: Most relevant in vocational education setting.

## ADAPTABILITY

These modules are designed for flexible installation. They may be used effectively by both instructors and students in a variety of educational environments, including independent study, team teaching, seminars and workshops, as well as in non-conventional classroom settings. Modules can be used individually or as part of the series. They can also be used by personnel not involved in vocational education.

## RELATED PRODUCTS

Other modules in VECS program.

## COST

ERIC microfiche, \$0.83 each.  
ERIC hardcopy--Module 9, \$4.67; Module 13, \$3.50, plus postage;  
Module 15, \$6.01, plus postage.

## AVAILABILITY

These modules are available from ERIC:

Module 9 - ED 132 411.  
Module 13 - ED 132 414.  
Module 15 - ED 132 415.

Modules and Installation Guide  
U.S. Government Printing Office  
Washington, D.C. 20402

These modules are also on file with each state Occupational Education Curriculum Center. Copies in quantity may be obtained at a discount by writing:

Dr. James A. Dunn  
Director, Institute for Occupational  
Education  
Department of Education  
Stone Hall  
Cornell University  
Ithaca, NY 14853

## HISTORY AND EVALUATION

The VECS project was a comprehensive development and evaluation effort involving project staff, curriculum consultants, a national advisory panel, and a number of cooperating colleges and universities. Modules were field tested at the California State Universities in Long Beach, Sacramento, San Diego, San Francisco, San Jose, and Los Angeles; at California Polytechnic State University, San Luis Obispo; The University of California at Los Angeles; Iowa State University; and the University of Northern Colorado. Principal Investigator was Dr. James A. Dun and the Project Director was Dr. John E. Bowers.

## COMMENT

These materials are extremely well-developed. Although examples and illustrations are drawn from Vocational Education, the evaluation principles and procedures being taught are readily generalizable to other fields.

25,

THE EVALUATION IMPROVEMENT PROGRAM  
(EIP)

California Evaluation  
Improvement Project  
Sacramento California

INTENDED USERS

Administrators, teachers, specialists at state, district, or building level.

TYPE OF EVALUATION ADDRESSED

Formative and summative evaluation.

APPROACH TO EVALUATION

The project feels that evaluation should be user-directed, and an integral part of program-planning. It should provide useful, timely information to people who can use it.

FORMAT

Workshop.

PRODUCT COMPONENTS

Program Evaluator's Guide; Workbook on Program Evaluation; Evaluation Trainer's Guide; transparencies, orientation slide/tape; audio cassettes.

CONTENT EMPHASIS

The workshop divided evaluation into the following steps: determine the evaluation purposes and requirements; develop an evaluation plan; determine evaluation in design and do the sampling; select or develop assessment instruments; collect the data; analyze evaluation data; report evaluation results; apply evaluation findings.

PRODUCT PURPOSE OR GOALS

Workshop participants will:

- sharpen skills in setting program objectives;
- increase knowledge of program planning;
- improve understanding of evaluation design;
- gain ability in selecting and developing instruments;
- learn new techniques in data collection and analysis;
- learn ways to use data and report results.

After participating, users will be able to help their districts gain:

- better evidence with which to discuss programs with school boards and communities;
- more objective and accurate information on anticipated and unanticipated program results;
- greater sensitivity to aspects of programs that need refinement;
- more certainty that changes will mean improvements;
- greater assurance that resources will be allocated in the best possible way.

## CONTENT ORGANIZATION OR USER ACTIVITIES

The Program Evaluator's Guide is a study guide and learning tool for use in inservice training workshops for program evaluators. The Workbook can be used as a learning aid during the workshop, or as a working notebook for recording plans and activities during program evaluation. The Trainer's Guide supplies background and supporting materials for use by workshop instructors.

## REQUIREMENTS

Personnel: Two trainers for each group of 30 participants.

Resources: Conference room and table space for up to six groups of five persons each; screen, blank acetates, and marking pens.

Length: Three days.

Conditions of Use: Trainers should have some background in evaluation.

## ADAPTABILITY

These materials can be used in any educational setting. The needs survey could be revised and utilized for assessing the status of evaluation services in any state.

## RELATED PRODUCTS

CEVAL Elementary School Simulation Game, \$20.00.

Resource Notebook of Information for Assessment and Evaluation (New Jersey State Department of Education) is a useful companion volume. Available from ETS at \$5.50 each.

## COST

Workbook, \$8.00 each for 1-24; \$6.25 each for 25 or more.  
Evaluator's Guide, \$12.00 each for 1-24; \$10.00 for 25 or more.  
Trainer's Guide, \$9.50.

## AVAILABILITY

Dr. Wesley W. Walton  
Evaluation Improvement Program  
Educational Testing Service (ETS)  
Box 2845  
Princeton, NJ 08541

## HISTORY AND EVALUATION

These materials are the result of an extensive development effort involving school districts all over California. Development and testing of the workshop materials began in 1975, following an initial needs survey. The cycle of revision and re-testing continued during two additional years of development involving administrators, teachers, and educational specialists. The workshops were well received and users have expressed a desire for more. Project staff are now involved in developing follow-up and support services, documenting program effects, and preparing additional products. Users are requested to provide developers with information on their experience and reactions.

## COMMENT

These materials have been very carefully developed. They cover all stages of evaluation clearly and comprehensively, and provide users with examples, references, and practice in applying what has been learned. User reaction to the workshops conducted in California by project staff have been very good. It will be interesting to see how they are used elsewhere, and what the long-term effects will be on schools whose staffs have gone through this training.

## EVALUATION FOR PROGRAM IMPROVEMENT (Unit 5: Educational Management Training Series)

### INTENDED USERS

District level curriculum specialists, building level administrators, teachers, parents and others who might be involved in a program evaluation effort.

### TYPE OF EVALUATION ADDRESSED

Formative evaluation, evaluation planning, instrumentation, interpretation of results

### APPROACH TO EVALUATION

The purpose of evaluation is seen as being to help educational managers make decisions about program improvement.

### MAIN EMPHASIS

Evaluation for Program Improvement is concerned with improving school/community attitudes towards evaluation, and providing those involved in it with an understanding of what evaluation can and cannot do, and the basic procedures and techniques used. It is not intended to turn people into expert evaluators, but rather provide them with a working knowledge of evaluation skills which they can use to plan and implement evaluation of their own programs.

### GOALS AND OBJECTIVES

The goal of this workshop is to help instructional program managers develop the knowledge or skills necessary to identify, collect, organize, and analyze useful information in making decisions about program modification. A further goal is to bring about an understanding of the process of program evaluation and how it relates to specific roles in the school community.

### MAIN ACTIVITIES

The workshop is divided into five sessions, which follow a basic pattern which involves reading about a stage of evaluation; participating in a simulation exercise in which given participants are provided with all necessary information to take the roles of members of an evaluation project in an imaginary school and community; reading selections from a case study which describes what evaluators in a similar school actually did at this point; and discussing what went on. Worksheets and reference lists are provided.

### PROVISIONS FOR USE

- A. Format: Workshop
- B. Personnel needed: Between five and thirty participants and a coordinator. The Coordinator will guide participants through the activities. He or she need not be a specialist in evaluation, or have participated in the workshop previously, but about 15 hours of advance preparatory reading



may be required in addition to time needed to make arrangements for the workshop.

- C. Product components: A Coordinator's Handbook and one Participant's Handbook for each participant, are required. The Coordinator's Handbook contains a diagnostic questionnaire. A slide-tape and set of overhead transparencies are available and recommended. However, the Coordinator's Handbook suggests alternatives if the necessary audio-visual equipment is not available.
- D. Resources needed: The workshop is self-contained, but the Coordinator is encouraged to assemble as many of the books in the annotated bibliography as possible so they will be readily available to participants.
- E. Time needed: The workshop consists of five three hour sessions which can be presented in a variety of configurations, ranging from once a week for five weeks, to every day for five days, to two consecutive week-ends. The Coordinator's Handbook also contains suggestions for compressing it into 12 hours of meeting time or expanding it. Ideally time should be allowed between sessions for reading supplementary material in the Participants' Handbook and other recommended readings.
- F. Conditions of Use: If the workshop has more than eleven participants, the Coordinator will have to divide the group and may need an assistant. Although the five sessions have been conducted in one weekend (evening and two days), it is clearly preferable to space the sessions over a longer period of time.

#### ADAPTABILITY

The workshop has been used as a five week segment of a semester course in educational evaluation. The principles and materials in the unit could probably be extended to treat summative evaluation issues if desired.

#### RELATED PRODUCTS

Other units in the Educational Management series; CSE Evaluation Workshops and kits.

#### COST

Coordinators' Handbook, transparencies, and slide-tape--\$34.95  
Participant's Handbooks, \$7.95 per copy

#### AVAILABILITY

To order, write: Far West Laboratory for Educational Research and Development  
1855 Folsom St., San Francisco, Ca. 94103

#### HISTORY AND EVALUATION

Specialists in evaluation have reviewed this unit and responded favorably to questions posed by program staff. A total of 64 participants, including district

administrators, teachers, principals and school counselors used all or parts of the materials in four field test sites. Thirty-nine of these participants responded to overall judgment questions at the conclusion of the workshop, of whom 80% said they had learned what they expected to from the workshop, 10% said they had not, and 10% had mixed reactions. No one has reported that the unit is physically, psychologically, or sociologically harmful, and user reactions have been generally positive. The material does not appear to display any social, ethnic, or sexual bias or stereotyping.

#### COMMENT

Test results for this unit appear to be somewhat inconclusive, which may be due to the fact that the unit leans more in the direction of creating understanding of evaluation purposes and procedures than towards mastery of evaluation skills, although exercises are provided. Role playing, on which much of the unit depends, may be difficult for some participants. The materials themselves are convenient and self-contained. The Participant's Handbook in particular is attractive and easy to use, although the Coordinator's Handbook appears a little crowded. The information provided seems to be complete enough for the unit to be used without the assistance of a consultant.

## DEVELOPING SUCCESSFUL PROPOSALS

Far West Laboratory for Educational Research and Development, San Francisco, California and

## INTENDED USERS

Leaders in Women's Educational Equity, i.e., project staff and volunteers at Women's Centers, etc., interested in writing proposals.

The Center for the Study of Contemporary Rural Women, University of Mississippi

## FORMAT

Self-instructional guide--can be used as basis for a workshop.

## PRODUCT COMPONENTS

Developing Successful Proposals, The Supplement, and the Swipe File.

## CONTENT EMPHASIS

The guide covers procedures and guidelines for the pre-proposal phase, the proposal-writing phase, the post-writing phase, and starting up the project.

## PRODUCT PURPOSE OR GOALS

The purpose of these materials is to prepare present or prospective workers in the field of women's educational equity to write their first proposal. Specific section objectives include teaching users:

### Part I:

- how to develop an idea through brainstorming;
- how to assess an idea in terms of need, feasibility and fundability;
- how to find information about federal, state and local funding agencies, foundations, corporations, and professional organizations;
- how to select a funding source;
- how to make initial contact with a funding agency;
- how to increase your organization's credibility; and
- how to find, develop and use checklists.

## Part II:

- how to write a needs statement;
- how to write a literature review;
- how to write objectives;
- how to write a statement of procedures (scope of work);
- how to design an evaluation plan;
- how to design a management plan, including organizational charts;
- how to design PERT charts, timelines and jobs descriptions;
- how to construct a budget;
- how to write an abstract;
- how to write appendices; and,
- how to complete federal and state forms.

## Part III:

- how to do a final review of your proposal;
- how to get organizational approval of your proposal;
- how to submit your proposal to the funding agency;
- how funding sources review your proposal;
- what to do if your proposal is accepted for funding; and
- what to do if your proposal is rejected.

## Part IV:

- how to structure a project; and
- how to set the wheels in motion.

## CONTENT ORGANIZATION OR USER ACTIVITIES

Sections of the Guide feature narrative discussions of each step in preparing a proposal, and copious examples of checklists, annotated sections from proposal regulations, and sections from actual proposals.

## REQUIREMENTS

Personnel: None

Resources: None, though examples of proposals would be useful.

Length: Guide is 158 pp.

Conditions of Use: None stated.

## ADAPTABILITY

The procedures described would be useful for writing a proposal addressing the needs of any special groups, including Native Americans, although the information on funding and information sources would have to be replaced with something more appropriate. However this gives the user a good idea of what kinds of information to look for.

## COST

Developing Successful Proposals - \$2.50

The Supplement - \$6.50

The Swipe File - \$6.00

(all orders must  
be prepaid)

## AVAILABILITY

Ann Sarmento  
Far West Laboratory  
1855 Folsom Street  
San Francisco, California 94103

(415) 565-3100

## HISTORY AND EVALUATION

The Guide and other materials were used as a basis for a series of Proposal Development Workshops presented by Far West Laboratory during 1978-79, and were revised on the basis of user feedback. Procedures described were based on the successful proposal-writing experience of project staff.

## COMMENT

This is an excellent and comprehensive practical guide to developing a proposal, from getting the idea to starting the project. A group which has thoroughly absorbed this information should be able to write a clear, feasible, and fundable proposal (assuming it has the required resources and staff and a good idea to start with). Although the examples and specific information given are directed towards Women's Equity, anyone with a general knowledge of funding sources, etc. in a different field of interest could easily substitute relevant information.

# Bibliography

- B. Banathy, "Employer Based Career Education," Career Education, Vocational Association, 1973.
- B. Banathy, et al., Interaction--A Curriculum in Generic Work Skills, San Francisco: Far West Laboratory, 1976.
- B. Banathy, et al., Instructional Leadership Development for Generic Work Skills Curriculum, Modules 1, 2, San Francisco: Far West Laboratory, 1979.
- B.H. Banathy and D.P. Studebaker, Native American Career Education, A Curriculum Guide, San Francisco: Far West Laboratory, 1976.
- B.H. Banathy and D.P. Studebaker, The Native American Career Education Project, Final Report, San Francisco: Far West Laboratory, 1976.
- Far West Laboratory for Educational Research and Development, The Native American Career Education Unit, Seaside, CA: National Teaching Systems, 1976.
- T.E. Glass and W.D. Sanders, Community Control in Education: A Study in Power Transition, Midland, MI: Pendell Publishing Co., 1978.
- L.S. Hansen, An Examination of the Definitions and Concepts of Career Education, National Advisory Council for Career Education, U.S. Government Printing Office, 1977.
- K.B. Hoyt, Career Education, Vocational Education, and Occupational Education: An Approach to Defining Differences, Washington, D.C.: Office of Career Education, 1975.
- K.B. Hoyt, An Introduction to Career Education, U.S. Government Printing Office, 1975.
- L. Hunter, et al., Developing Successful Proposals, San Francisco: Far West Laboratory, 1979.
- F. McKinley, G. Nimmicht, S. Bayne, Who Should Control Indian Education? San Francisco: Far West Laboratory, 1970.
- National Indian Bilingual Education Conference, 1973 Proceedings, National Indian Bilingual Education Conference, Albuquerque, NM: BIA Indian Education Resources Center, 1973.
- C. Raymond, ed., Career Education Trainers' Handbook, Tempe, AZ: Palo Verde Associates, 1978.

Special Sub-committee on Indian Education, Indian Education: A National Tragedy--a National Challenge, Washington, D.C.: U.S. Government Printing Office.

H. Thompson, et al., Education for Cross-Cultural Enrichment, Lawrence, KN: Haskell Institute, 1964.

R. Watkins, et al., Evaluation for Program Improvement, San Francisco: Far West Laboratory, 1975.