

DOCUMENT RESUME

ED 182 437

CE 023 744

AUTHOR Lillo, Robert E.; Soffiotto, Nicholas S.
 TITLE Industrial Education. Electricity/Electronics Curriculum Guide, Phase II. Instructional Modules, Level I (18 Week).
 INSTITUTION California State Dept. of Education, Sacramento. Bureau of Industrial Education.
 PUB DATE Oct 79
 NOTE 215p.; For related documents see CE 023 743-746.

EDRS PRICE MF01/PC09 Plus Postage.
 DESCRIPTORS Career Exploration; Course Content; Curriculum Guides; *Electricity; *Electronics; Energy; *Industrial Arts; *Industrial Education; Learning Activities; Learning Modules; Natural Resources; Safety; Secondary Education; Teaching Guides; Tests; Units of Study
 IDENTIFIERS California

ABSTRACT

Designed for students in grades 7 and 8, this electricity/electronics curriculum guide contains instructional modules for twelve units of instruction: (1) orientation; (2) understanding electricity; (3) safety; (4) methods to generate electricity; (5) wiring tools and wire; (6) soldering; (7) magnetism and electromagnetism; (8) circuits, symbols, and component identification; (9) resistors and identification systems; (10) small appliance repair; (11) available sources of the Earth's energy; and (12) exploring occupations. Each instructional module is divided into two sections. The first section is an instructor's guide which enables the instructor to have a lesson plan overview to the unit. This overview includes the title of the unit, time allocation, unit goal, unit objectives, evaluation, instructor references, unit overview, suggested presentation hints/methodology, supplemental activities and demonstrations, and instructional module contents listing. Section 2 of the module contains the packet of materials to be utilized in the classroom. Each packet includes the following parts: unit outline/transparency master, pre-post test, vocabulary enrichment activities, student informational handouts, related quest activities, and answer keys. (IRA)

 * Reproductions supplied by EDPS are the best that can be made *
 * from the original document. *

ED182437

CE 023 744

INDUSTRIAL EDUCATION

ELECTRICITY / ELECTRONICS

CURRICULUM GUIDE PHASE II

INSTRUCTIONAL MODULES LEVEL I (18 WEEK)

U.S. DEPARTMENT OF HEALTH,
EDUCATION & WELFARE
NATIONAL INSTITUTE OF
EDUCATION

THIS DOCUMENT HAS BEEN REPRODUCED EXACTLY AS RECEIVED FROM THE PERSON OR ORGANIZATION ORIGINATING IT. POINTS OF VIEW OR OPINIONS STATED DO NOT NECESSARILY REPRESENT OFFICIAL NATIONAL INSTITUTE OF EDUCATION POSITION OR POLICY.

PERMISSION TO REPRODUCE THIS MATERIAL HAS BEEN GRANTED BY

Robert E. Lillo
Nicholas S. Saffiatto

TO THE EDUCATIONAL RESOURCES INFORMATION CENTER (ERIC)

STATE OF CALIFORNIA

INSTRUCTIONAL MODULES

A set of 12 technical units which were specifically designed to support Electricity/Electronics instructors in the planning and presentation of their course materials.

THE AUTHORS:

Robert E. Lillo, has taught Electricity/Electronics for 14 years in industry, college, and at Mt. Pleasant High School, San Jose, California.

Nicholas S. Soffiotto, has taught Electricity/Electronics for 6 years at Yerba Buena High School, San Jose, California.

DEDICATION:

To the youth of California in an effort to improve their technical preparation for the world beyond the classroom.



© R.E. Lillo and N.S. Soffiotto 1979,
All Rights Reserved.
Printed in the United States.

TABLE OF CONTENTS

	<u>Page</u>
ACKNOWLEDGEMENTS	ii
Project Staff	ii
Special Contributors	ii-iii
Other Contributors	iii
PREFACE	iv
Industrial Education	iv
INTRODUCTION	v
Philosophical Background	v
Project Purpose Phase I	v-vii
Project Purpose Phase II	vii
ORIENTATION	viii
Rationale	viii
Scope	viii-ix
Support Systems	ix-x
MODULE LISTING	xi

ACKNOWLEDGEMENTS

The development of the California State Electricity/
Electronics Curriculum Guide Phase II was a result of the
valuable contributions of the following people.

Project Staff

Robert Lillo, Project Coordinator/Curriculum Development
Nick Soffiotto, Project Staff Leader
Kirk Harmon/Ben Gonzales, Project Illustrators
Penny Morgan, Project Secretary and Typist
Kevin Merrill, Project Assistant
Ken Beron, Project Staff Member
Mark Torres, Project Promotional Illustrator
Keith Bush, Project Director/Administration

Special Contrubutors

Chris Almeida
Special Consultant
Bureau of Industrial Education
State Department of Education
Sacramento, California

Dr. Lois W. Bennett
Vocational Education Department
University of Northern Colorado
Greeley, Colorado

Alex Bentley
District Manager
Mc-Graw-Hill Book Company
Novato, California

Thomas Collins
Assistant Superintendent
East Side Union High School
District
San Jose, California

Wilbur Concklin
Principal
Mt. Pleasant High School,
San Jose, California

Bob Crates
Director of Planning and
Development
C.T.I. Education Products, Inc.
Mt. Pleasant, South Carolina

Charles Elkind
Vice President
American Electronics Association
(WEMA)
Los Angeles, California

Frank Fiscalini
Superintendent
East Side Union High School
District
San Jose, California

Max Hartdegen
Administrative Assistant
East Side Union High School
District
San Jose, California

Merl K. Miller
Publisher
Dilithium Press
Portland, Oregon

Chuck Moomau
Career Services Supervisor
East Side Union High School
District
San Jose, California

D.W. Nurse
President
Schlumberger Products
St. Joseph, Michigan

George Oliver
Manufacturing's Representative
Fremont, California

Larry Tribett
Marketing Representative
Bobbs-Merrill Educational Company
Pasadena, California

A special thanks is extended to the public schools, industries, and publishers whose input contributed greatly to the completion of this curriculum project. Thanks is also extended to James Herman, Chief (retired), Bureau of Industrial Education, California State Department of Education, and James Allison, acting Chief, Bureau of Industrial Education, California State Department of Education.

Other Contributors

An additional acknowledgement of gratitude must be extended to the California Council of Electronics Instructors, whose 400 Statewide membership actively provided valuable input towards the creation of the Instructional Modules.

PREFACE

Industrial Education, in the public schools of California, is a generic term which applies to all levels of education and training which relate directly to industrial occupations. Industrial Education includes the major subject matter fields of industrial arts, trade and industry, and technical and health careers and services. A comprehensive and reflective Industrial Education curriculum will assist and support students in selecting, preparing, and advancing in occupations or careers which currently exist or which are emerging.

Industrial Education programs are also those educational programs which pertain to the body of related subject matter organized for the development of understanding about the technical, consumer, occupational, recreational, organizational, managerial, social, historical, and cultural aspects of industry and technology.

In essence, Industrial Education curriculum is concerned with aiding the individual to respond and react sensitively to technological developments and to cope efficiently and effectively with the consequences in one's personal life.

In order to provide skills for students to meet their employment needs in the future, the educational system must meet its curriculum challenges today. One means of solving this problem was the development of the State Electricity/Electronics Curriculum Guide Phase I, that centered on a competency-based cluster approach to derive curriculum. Phase II provides the necessary Instructional Learning Modules including classroom materials for a realistic curriculum foundation which will assist in developing student competencies for entry level occupations and/or technical specialization. Statewide application of these materials will allow for student mobility because of standardization and it avoids duplication of high cost instruction.

It is sincerely hoped that the educational materials contained in this curriculum project will serve as the foundation for improving instruction in the area of Electricity/Electronics within the school systems of California.

INTRODUCTION

Philosophical Background

One of the primary purposes of the public schools in our society is to acquaint the young with the nature of the culture within which they live and operate. The American culture is distinctly technological; therefore, it is the responsibility of our educational system to acquaint our youth with the nature of this technological culture. The tremendous acceleration of industrial technology has had and will continue to have an overwhelming impact on society.

One fundamental concept behind Industrial Education in our educational system is that technical experiences, curriculum, instruction, and guidance assist the student in preparation for economic independence and an appreciation for the dignity of work. Another main thrust is to prepare students for a successful life of work by increasing their options for occupational choice, by eliminating barriers to attaining job skills, and by enhancing learning achievement in all subject areas.

Irrespective of what the future may hold, individuals living in our present day environment will be handicapped unless they are reasonable well informed concerning the vast Electrical/Electronic technological applications in our daily living. Our present civilization is scarcely conceivable without the applications of Electricity/Electronics which have become identified with the industrial growth of our country and our thousands of everyday conveniences. The Electricity/Electronics subject field is an integral part of the Industrial Education curriculum, and this field provides employment for millions of individuals annually.

The total impact of Electricity/Electronics on human life is of such magnitude that it necessitates a comprehensive technical program in our schools to produce informed individuals capable of effective and meaningful functioning in our society.

Project Purpose Phase I

During the Industrial Revolution, Industrial Education focused on primary or single skill development, and this approach was viable in an era that required the mastery of one skill for initial employment. However, present technological developments in the labor market have necessitated that individuals within the labor force have a multiplicity of skills to meet the needs of the nation's trade and technological communities.

In order to facilitate methods for students to meet their employment needs in the future, the educational system must meet its curriculum challenges today. One means of solving this problem is the development of an Electricity/Electronics instructional program that centers on a competency-based cluster approach to derive curriculum. Utilizing this approach, the student will have a realistic curriculum foundation which will provide access to the necessary competencies for entry level occupations and/or technical specialization.

The basic intent of the State Electricity/Electronics Curriculum Guide was to provide educators within Industrial Education a competency-based guide that can be adapted or adopted to any existing or new program without major cost expenditures. Hopefully, the guide will act as a catalyst for educators who desire a revision or restructuring of their Electricity/Electronics curriculum, yet the guide format provides the flexibility for teacher-based modifications related to methodology, instructional resources, textbooks, equipment, laboratory systems, etc. For the educator, the heart of this guide was the curriculum outlines that were an outgrowth of the occupational tasks and/or competencies identified through various occupational needs assessments and tasks analysis inventories.

The following is a brief synopsis of each outline in terms of level of instruction and duration.

1. Curriculum Outline Level I - Grades 7-8
 - a. 9 week unit outline
 - b. 18 week unit outline
2. Curriculum Outline Level II - Grade 9
 - a. 36 week unit outline
3. Curriculum Outline Level III - Grade 10
 - a. 36 week unit outline
4. Curriculum Outline Level IV (Specialization Level) - Grades 11-14
 - a. 36 week unit outline at each grade level

The contents of the curriculum outlines were generated to increase the efficiency of the Electricity/Electronics programs in the schools of this State, and the competency based structure was established for the students so that their complex and confusing world begins to take on order and their learning tasks are more relevant and readily attained.

Project Purpose Phase II

The State Electricity/Electronics Curriculum Guide was proposed as a comprehensive educational guide designed to eliminate the dichotomy between formal school and the world of work. Basically Phase II allowed the development of Learning Modules for the Guide, in an effort to improve the preparation of California's youth for their future in the world beyond the classroom.

Phase II also addressed itself to the development and use of Instructional Modules within the classroom as a vehicle to implement the Curriculum Outlines presented in Phase I.

Instructional Modules were based on each major unit topic within Levels I, II and III of the State Curriculum Guide for Electricity/Electronics. Approximately sixty Instructional Modules or packets were created for teacher/student use. Each module contains basically the following:

1. Goals and Objectives (unit)
2. Outline
3. Pre-Post Test (keyed)
4. Instructor References
5. Suggested Methodology
6. Demonstrations and Quest Activities
7. Student Handouts--Informational
8. Vocabulary Enrichment List
9. Student Worksheets
10. Related Instructional Activities and Graphical Illustrations

ORIENTATION

Rationale

The Instructional Modules in this level were specifically designed to assist the electronics instructor in the planning, organization, and presentation of course materials. Care and emphasis throughout the modules has been given to the needs of technical instructors who must motivate and guide California's youth through the educational system. At the same time the authors of the Instructional Modules were fully cognizant of the need to present fundamental competencies, yet, not in the traditional dry fashion but with an eye towards:

- Marketing the Subject Matter
- Innovative Assignments
- Eye Appeal
- Constant Reinforcement
- Educational Games
- Doing Activities
- Immediate Unit Evaluation
- "State of the Art" Subject Matter
- Diversity in Teaching Methodology

Scope

The Instructional Modules are generally divided into two sections, as follows:

Section I (Instructor's Guide)

This section is presented first in the module to enable the instructor to have a lesson plan overview to the unit. This overview includes;

1. Title of Unit
2. Time Allocation
3. Unit Goal
4. Unit Objectives
5. Evaluation
6. Instructor References
7. Overview (unit)
8. Suggested Presentation Hints/Methodology
9. Supplemental Activities and Demonstrations
10. Instructional Module Contents Listing

All of the suggestions in this section were designed to enhance the unit presentation and provide the most effective learning environment for utilization of all instructional materials. The contents of each module have been carefully prepared and scrutinized in order to establish a solid technical foundation for the student.

Section II (Instructional Module Materials)

This section contains the packet of materials to be utilized in the classroom. When appropriate each module includes;

1. Unit Outline/Transparency Master
2. Pre-Post Test (keyed)
3. Vocabulary Enrichment Activities
4. Student Informational Handouts
5. Related Quest Activities
6. Answer Keys

The Instructional Modules have been constructed and packaged so that the deletion of certain materials or the addition of pertinent information can be inserted or removed with minimal difficulty. Individual courses and instructors are not identical hence provision for flexibility is necessary in order to achieve a curriculum that is compatible with the instructor.

In the event a training program requires a radical change in the content of material presented within a module, the instructor may easily cut, insert, and paste masters to achieve the desired results which are tailored to the instructors specific needs.

Support Systems

No amount of planning or preparation can guarantee success in the classroom, because learning is such an intangible quality, yet, the lack of these ingredients in any program immediately guarantees dismal educational results. The most indispensable support system within the educational process is the teacher, who must have the expertise and enthusiasm that can propel students into the world of learning.

The instructor must also possess the drive and ambition to continuously improve and update the program, especially in this area, due to dramatic technological innovations.

The classroom should contain the necessary furniture to allow the course to be taught in a satisfactory manner. Good lighting is absolutely essential in terms of the activities that occur. Power outlets are of paramount concern for obvious reasons,

and their location should allow for room flexibility. Tables, benches, and/or desks should contain locks to insure inventory control, and storage facilities for projects, equipment, parts, etc., must be readily available. Chalkboards and bulletin boards should be mounted for easy access within the classroom.

The field of Electricity/Electronics seems to be a natural interest area to many students and the laboratory portion can be used as the vehicle to generate a vast amount of enthusiasm along with necessary technical concepts. Whether an instructor utilizes individual experiments, project construction, training systems, or a combination approach in their laboratory is not critical; what is vital is that their selection reflects the goals and objectives that they want to attain within the course.

An individual school may have the best physical facility, equipment, instructional materials, and administration, but in the final analysis it is the teacher who must promote, coordinate and maintain the program.

MODULE LISTING

Curriculum Guide Phase II

Level I Instructional Modules* (18 weeks)

- Unit 0 Orientation
- Unit I Understanding Electricity
- Unit II Safety
- Unit III Methods to Generate Electricity
- Unit IV Wiring Tools and Wire
- Unit V Soldering
- Unit VI Magnetism and Electromagnetism
- Unit VII Circuits, Symbols, and Component Identification
- Unit VIII Resistors and Identification Systems
- Unit IX Small Appliance Repair
- Unit X Available Sources of the Earth's Energy
- Unit XI Exploring Occupations

*Instructional Module contents are coordinated with the California Industrial Education Electricity/Electronics Curriculum Guide, Level I, Curriculum Outlines.

ELECTRICITY / ELECTRONICS

CURRICULUM GUIDE INSTRUCTIONAL MODULE

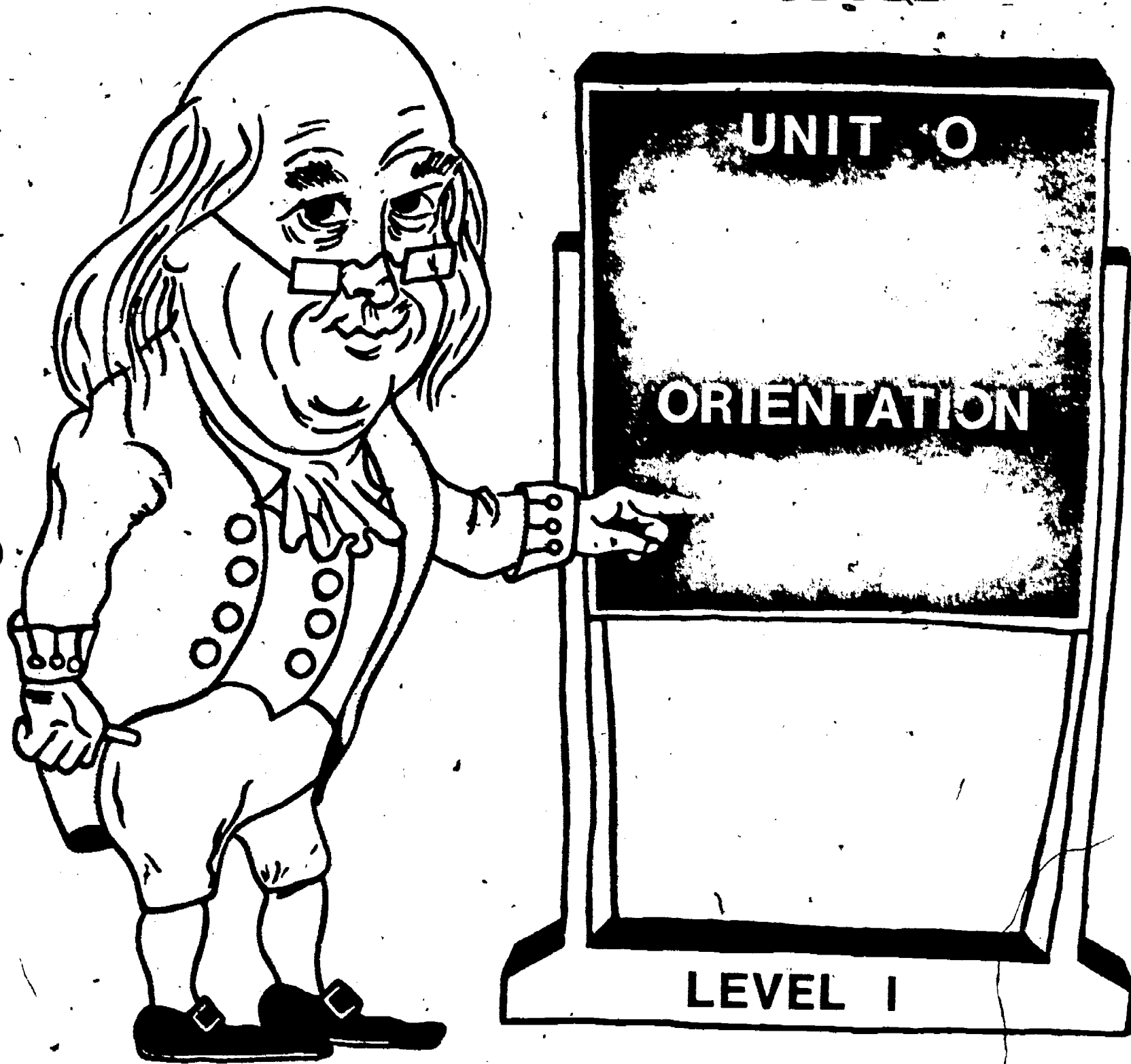

STATE OF CALIFORNIA
DEPARTMENT OF EDUCATION

NAME _____

DATE STARTED _____

DATE COMPLETED _____

BY
R. E. LILLO
N. S. SOFFIOTTO

ELECTRICITY / ELECTRONICS

CURRICULUM GUIDE INSTRUCTIONAL MODULE

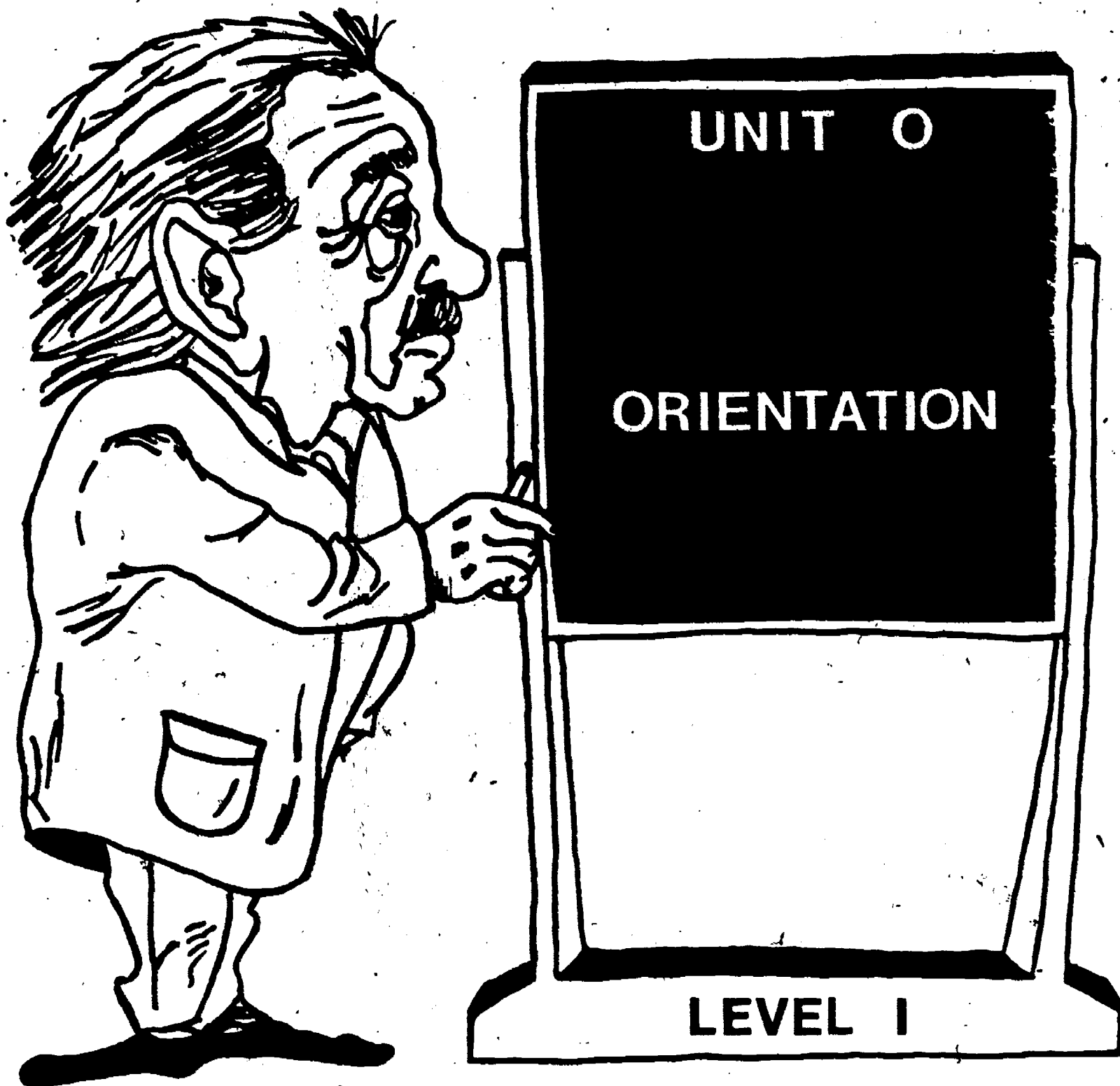

STATE OF CALIFORNIA
DEPARTMENT OF EDUCATION

NAME _____

DATE STARTED _____

DATE COMPLETED _____

BY

R. E. LILLO

N. S. SOFFIOTTO

Title of Unit: Orientation

Time Allocation: Several Days

Unit Goal:

To communicate those competencies which will allow an awareness of course goals, objectives, and basic requirements.

Unit Objectives:

The student will be able to:

1. describe examples of the technical nature of our modern society, and the need for technical instruction in the area of Electricity/Electronics.
2. explain basic course requirements and the system of student evaluation.
3. demonstrate an awareness of the general course objectives and verify the significance of each within this educational program.

Evaluation:

The student will demonstrate his/her competence in terms of these measurable objectives based upon individual instructors acceptable performance criteria, which may utilize a combination of oral, or written testing procedures.

Instructor References:

Industrial Education Electricity/Electronics Curriculum Guide Grade Levels 7-14. Published by the State of California, 1977.

Innovative Programs In Industrial Education. Leslie H. Cochran, McKnight and McKnight Co., 1970. Chapters 5, 6, and 7.

Planning and Organizing Instruction. Ralph C. Bohn and Harold Silvius, McKnight and McKnight Co., 1976.

Overview:

This unit should be introduced by examining the course goals and objectives, not merely an instructor/student exercise in reading, but a brief discussion in reference to each item while also highlighting their overall significance.

Basic school or classroom rules and regulations, or operating procedures require attention early and this may be a good opportunity to present those to the class.

The next topic should emphasize specific course requirements and the method for student evaluation. Time should be allocated in such a manner that it will allow extensive descriptions as needed.

This unit will not conclude with an examination as will other modules, because of the length and nature of the subject matter presented.

Suggested Presentation Hints/Methodology:

Follow the instructional module unit outline as a basic skeleton for curriculum presentation, however, note the following:

1. This unit can afford the instructor an unusual opportunity to learn about important qualities the student possesses. The Student Questionnaire for example can act as a means to discover a wealth of information, so read through it carefully upon completion, then file all student forms by periods in one notebook for a handy reference.
2. The handout labeled "Student Performance Record" can serve several functions as desired. First, it can be placed at the front of the students' notebook as a title page, or it can be graded periodically to indicate unit performance as evaluated by instructor. Finally, this handout could be a quick Table of Contents for students in terms of specific course content and/or subject matter chronology.
3. When introducing the Informational Handout - Electricity/Electronics, (area description) have each student read out loud a small portion. This will immediately draw your attention to those students who might need special attention.
4. Remember detailed Rules for Conduct and Procedure are located in the safety unit and will be taught at a later time. This unit is only concerned with basic classroom conduct and procedures.

Supplemental Activities and Demonstrations:

1. Initial room impressions are important so if possible have the bulletin boards adequately displayed, materials stored properly, safety signs posted, etc. These kinds of things such as shop appearance develop student attitudes that will affect their own craftsmanship or performance.
2. During the first week of school many students can be disenchanted with the "paper shuffling" so try to demonstrate a technical device that can catch their imagination. If a strobe light, color organ, or even a microcomputer is available use it to generate enthusiasm about the program.

Instructional Module Contents:

1. Unit Outline (overhead)
2. Informational Handout (Course Goals and Objectives)
3. Informational Handout (Electricity/Electronics Area Description)
4. Informational Handout (Student Questionnaire)
5. Informational Handout (Student Performance Record)
6. Informational Handout (Student Evaluation System)
7. Exam Answer Sheet (Master)

0. Orientation

A. Course Objectives and Goals

B. Rules of Conduct and Procedures

C. Course Requirements

Name: _____

Date: _____

Period: _____

INFORMATIONAL HANDOUT

COURSE GOALS AND OBJECTIVES

This Electricity/Electronics program is a technical school program designed to make sure that all individuals are prepared with "entry" level skills to enter either the world of work or to continue their education.

Listed below are some general objectives that will be accomplished with the successful conclusion of this course!

An appreciation of the influence the Electricity/Electronics area has on our life.

The ability to select, care for, and utilize electronic products equipment and tools.

An awareness of safe habits and attitudes regarding materials, tools, and equipment.

Opportunities to explore leisure-time activities within this subject field.

An appreciation of design, construction techniques, and craftsmanship.

An understanding of the occupational families in the Electricity/Electronics area.

The ability to problem-solve by utilizing sound judgements based on knowledge and experience.

An awareness in regards to energy conservation and its significance.

An understanding of consumer products and their technical operation and application.

Demonstrations of basic technical skills that apply to a range of jobs in Electricity/Electronics.

The recognition of specific training essential for employment in a job area and the basic formation of occupational goals.

Name: _____

Date: _____

INFORMATIONAL HANDOUT Period: _____

ELECTRICITY/ELECTRONICS

Our grandparents would never recognize the world in which we live or many of the gadgets which are so common to us. Hundreds of electronic wonders which we readily accept in our society were unknown sixty years ago, and have become familiar objects only through the development of a new industry that is called electronics. This industry is now one of the largest in the United States, and a major portion of its research and production plants are located in California.

This school has recognized that present technology and consumer demands offer a special opportunity for students who want occupations which are interesting and challenging and where the chance for advancement and salary are unlimited. The electronics field is one in which continuous research is always adding new products to be made, tested, marketed, and operated. There will be a steady increase in the number of persons employed in this industry according to statistics developed by the State of California.

The student in Electricity/Electronics studies basic electrical theory, laboratory techniques, use of test instruments, care and use of hand tools, shop safety, circuits, and construction or project building. The skills which one can develop may be applied to the areas of communication, transportation computers, research and development, etc.. If the student is deeply interested in his/her work, has abilities, and is willing to study and learn, s/he can progress to an entry level occupation or to continue further technical training.

Basically, electronics is a field that is a combination of the study of mathematics and physical science, and its principles can be understood by the individual who is willing to **WORK!**

Name: _____

Date: _____

Period: _____

INFORMATIONAL HANDOUT
STUDENT QUESTIONNAIRE

PLEASE PRINT

1. Name _____ Phone _____

2. Address _____
Last First Middle Grade in School

3. Age _____ Birthdate _____
Month Day Year

4. Father or Guardian's name _____
Last First Middle

5. Occupation _____

6. Mother or Guardian's name _____
Last First Middle

7. Occupation _____

8. What are your hobbies? _____

9. Do you have a job? _____ What? _____

10. What occupation would you like to follow? _____

11. What type of education do you think is required for this occupation? _____

12. Previous shop courses	School	Grade level	Letter Grade
A. General Shop	_____	_____	_____
B. Drafting	_____	_____	_____
C. Woodwork	_____	_____	_____
D. Auto Shop	_____	_____	_____
E. Metal Shop	_____	_____	_____
F. Electricity	_____	_____	_____

13. List machines you have used in school or at home _____

Name: _____

14. List hand tools you have used in school or at home _____

15. Why are you enrolled in this class? _____

16. Whom to contact in case of an accident _____

Address _____ Phone _____

17. School Activities (athletic teams, clubs, etc.) _____

18. School Attended last year _____

19. List classes taken last year and letter grade for last semester.

	Class	Teacher	Grade
1.			
2.			
3.			
4.			
5.			
6.			

20. Class schedule this year.

Period	Class	Teacher	Room
1.			
2.			
3.			
4.			
5.			
6.			

21. Counselor _____

22. Write a brief autobiography, include where you were born, schools attended, interest, goals etc..

SCORE:

GRADE:

Name: _____

Date: _____

Period: _____

ELECTRICITY / ELECTRONICS

STUDENT PERFORMANCE RECORD

Name of Student _____
Last First Middle

UNIT

Unsatis- Satis- Excel-
factory factory lent

- 0. Orientation
- I. Understanding Electricity
- II. Safety
- III. Methods to Generate Electricity
- IV. Wiring Tools and Wire
- V. Soldering
- VI. Magnetism and Electromagnetism
- VII. Circuit, Symbol, and Component Identification
- VIII. Resistors and Identification Systems
- IX. Small Appliance Repair
- X. Available Sources of the Earth's Energy
- XI. Exploring Occupations

0.			
I.			
II.			
III.			
IV.			
V.			
VI.			
VII.			
VIII.			
IX.			
X.			
XI.			

Rating

(Place this sheet in the front of your notebook as a title page).

School _____

Instructor _____

Name: _____

Date: _____

Period: _____

INFORMATIONAL HANDOUT
STUDENT EVALUATION SYSTEM

Students are graded as follows each quarter:

CITIZENSHIP: _____

The citizenship grade is determined by attitude, cooperation, work habits, clean-up, oral participation, and attendance.

This grade may be lowered as follows:

1. Unexcused absences.
2. Unexcused tardies.
3. Improper attitude or behavior.
4. Shop rule violations.

LABORATORY AND HOMEWORK: _____

The laboratory/homework grade is based on the quality and quantity of the work completed at the end of each quarter.

This grade may be lowered as follows:

1. Quantity and quality below ability.
2. Inconsistent work or progress.
3. Required laboratory experiments, projects, or homework not completed.
4. Failure to observe safety regulations.

TESTS: _____

This grade is determined by averaging quizzes, tests, and final examinations

NOTEBOOK: _____

Notebooks will be collected and graded periodically. Notes will be neat, clear, and in proper sequence. They will contain all materials and assignments completed by students, and also those handed out by the instructor.

FINAL GRADE: _____

The final grade is determined by a collection of grades in the following areas:

1. Laboratory and homework.
2. Citizenship/behavior.
3. Tests
4. Notebook

SCORE:

GRADE:

Name: _____

Date: _____

ANSWER SHEET

Period: _____

EXAM _____

TF
A B C D

1.				
2.				
3.				
4.				
5.				
6.				
7.				
8.				
9.				
10.				
11.				
12.				
13.				
14.				
15.				
16.				
17.				
18.				
19.				
20.				
21.				
22.				
23.				
24.				
25.				

TF
A B C D

26.				
27.				
28.				
29.				
30.				
31.				
32.				
33.				
34.				
35.				
36.				
37.				
38.				
39.				
40.				
41.				
42.				
43.				
44.				
45.				
46.				
47.				
48.				
49.				
50.				

TF
A B C D

51.				
52.				
53.				
54.				
55.				
56.				
57.				
58.				
59.				
60.				
61.				
62.				
63.				
64.				
65.				
66.				
67.				
68.				
69.				
70.				
71.				
72.				
73.				
74.				
75.				

TF
A B C D

76.				
77.				
78.				
79.				
80.				
81.				
82.				
83.				
84.				
85.				
86.				
87.				
88.				
89.				
90.				
91.				
92.				
93.				
94.				
95.				
96.				
97.				
98.				
99.				
100.				

*Show work for problems on back of answer sheet.

ELECTRICITY / ELECTRONICS

CURRICULUM GUIDE INSTRUCTIONAL MODULE

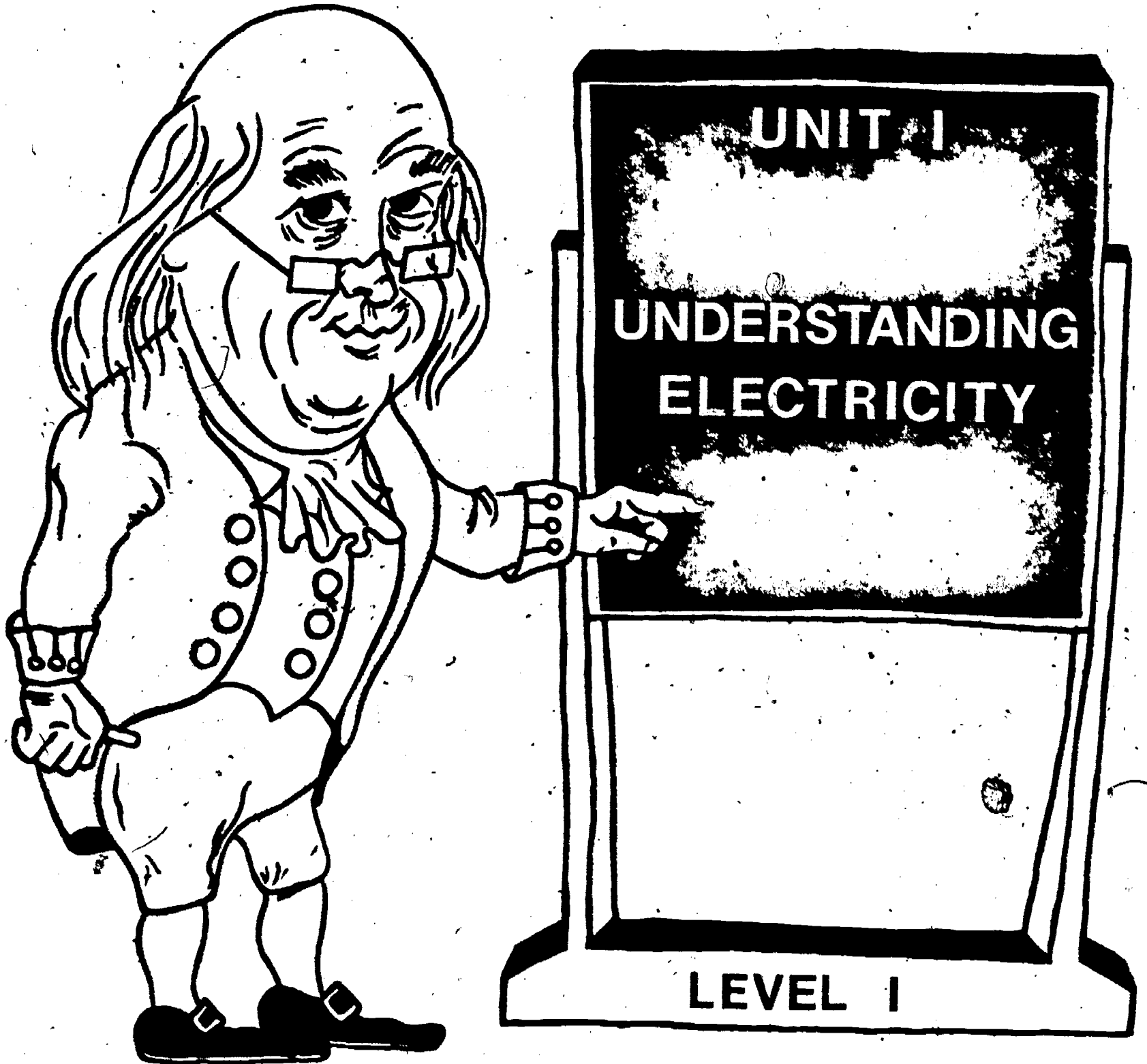

STATE OF CALIFORNIA
DEPARTMENT OF EDUCATION

NAME _____
DATE STARTED _____
DATE COMPLETED _____

BY
R. E. LILLO
N. S. SOFFIOTTO

ELECTRICITY / ELECTRONICS

CURRICULUM GUIDE INSTRUCTIONAL MODULE

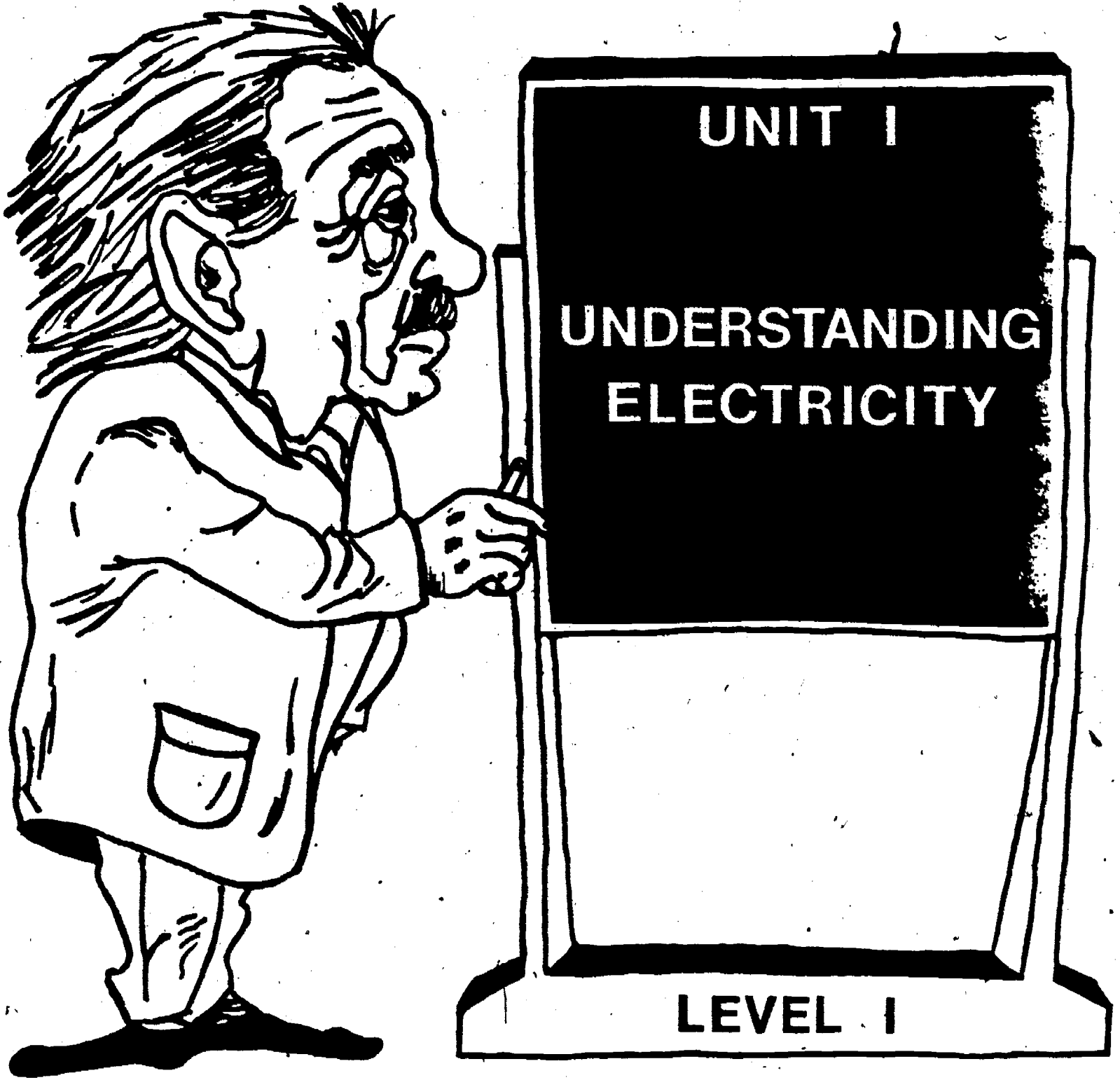

STATE OF CALIFORNIA
DEPARTMENT OF EDUCATION

NAME _____

DATE STARTED _____

DATE COMPLETED _____

BY

R. E. LILLO

N. S. SOFFIOTTO

Title of Unit: Understanding Electricity

Time Allocation: Several Days (Units 0 and 1 = 1 week)

Unit Goal:

To communicate and develop those competencies which will permit students to evaluate the basic characteristics of electricity and to comprehend the dramatic role that electricity plays in our technical society.

Unit Objectives:

The student will be able to:

1. describe in general terms, what is electricity and identify several major applications.
2. define the terms static and/or dynamic electricity, and indicate an appropriate example of each type.
3. explain and/or justify the need for mastering fundamental theories related to the Electricity/Electronics field, and verify the importance of this field to modern society.

Evaluation:

The student will demonstrate his/her competence in terms of these measurable objectives based upon individual instructors acceptable performance criteria, which utilizes a combination of oral, or written testing procedures.

Instructor References:

Basic Electricity. Marcus and Marcus, Prentice-Hall, Inc., 1974.
Chapters: 1 and 2.

Basic Electricity Training Manual. Ted Pipe, Howard W. Sams Inc., 1976.
Chapter: 1.

Introduction to Electricity and Electronics. Loper and Ahr, Delmar 1973.
Chapter: 1.

Overview:

The primary purpose of this unit is to provide an introduction or initial exposure into the Electricity/Electronics area of instruction. The central theme, however, is to provoke student awareness of the nature, characteristics, magnitude, and application of electricity.

The unit lesson should concentrate on first describing that electricity is still in many ways a mystery, although, society has put it to a variety of uses.

Next, a technical presentation explaining the specific principles of both static and dynamic electricity.

Unit 1 should conclude with a review of the importance of electricity and the reasons for its expanding influence and vast market of job opportunities.

This unit will not contain a formal examination as will other modules, because of the length and nature of the subject matter presented.

Suggested Presentation Hints/Methodology:

Follow the instructional module unit outline as a basic skeleton for curriculum presentation, however, note the following:

1. An important aspect of this lesson would be to stress that static electricity is largely a nuisance, a disturber, and a potentially dangerous foe in some instances. A frank discussion about lightning, its cause, and how one can avoid harm should be helpful to the student in terms of personal safety.
2. Some students are hesitant to admit that they are confused or that a concept is not clear to them. The student should be aware that in this class there is no penalty for admitting that they are technically bewildered and in need of further explanation.
3. When explaining the basic difference between static and dynamic electricity try to equate static to electrical charges "at rest" while describing dynamic electricity in relationship to electrical charges in motion to accomplish a specific purpose.
4. It is highly important as they begin their studies in this field that they realize that technical reading requires a slower pace due to the illustrations, schematics, and other graphics that must be digested. Recommend to students that when they read, they concentrate on comprehension rather than reading speed.

Supplemental Activities and Demonstrations:

1. This is a sure fire attention grabber if materials are available. Obtain a static machine or Tesla coil and operate it in a manner to dramatically show the affects of static electricity. Check with the science area at your school for possible support materials.
2. Suspend a charged balloon from a stand, then bring a rubber rod that has been rubbed with cat's fur or flannel near the balloon. Observe the reaction and discuss with your class. Repeat this demonstration utilizing a glass rod rubbed with silk!!
3. With the class, itemize all the uses of electricity that they can think of and then list them on the chalkboard. From this list discuss the significance of this subject field to their daily life and the world around them.

Instructional Module Contents:

1. Unit Outline (overhead)
2. Technical Glossary
3. Worksheet - (vocabulary) Word Search
4. Quest Activities
5. Unit Module Answer Keys

I. Understanding Electricity

A. Why Study Electricity

1. Importance
2. Applications
3. Job opportunities

B. What is Electricity

1. Kinds
 - a. Static
 - b. Dynamic
 1. Electron flow
 2. Direct current
 3. Alternating current

Name: _____

Date: _____

Period: _____

TECHNICAL GLOSSARY

- ALTERNATING CURRENT:** A flow of electrons moving first in one direction through a circuit, stopping, then flowing in the opposite direction. Alternating current can be thought of as a back and forth movement of electrons. Abbrev. AC
- DIRECT CURRENT:** A flow of electrons moving in one direction through a circuit - from negative to positive. Abbrev. DC
- DYNAMIC ELECTRICITY:** A usable, flow or movement of electrical charges. Dynamic electricity provides a continuous flow of electrons which can be used to do work.
- ELECTRIC CHARGE:** A collection of positive or negative particles on an object. A material having many negative particles collected on it is said to have a negative charge. While many positive particles provide a positive charge.
- ELECTRICITY:** A form of energy, (generated by friction, induction, or chemical reaction) which is based upon the movement of free electrons.
- ELECTRON FLOW:** The orderly movement of electrons through a wire, electrical device or circuit.
- ELECTRONICS:** The study of electrical action, and especially the study and development of devices and circuits that use and control electricity.
- ELEKTRON:** The Greek word for amber (a brownish-yellow fossil resin) which later evolved into the words "electrics" and "electricity".
- STATIC ELECTRICITY:** A collection of electrical charges at rest. Static charges are basically an unusable source of electricity, yet can be very dangerous in the form of lightning.

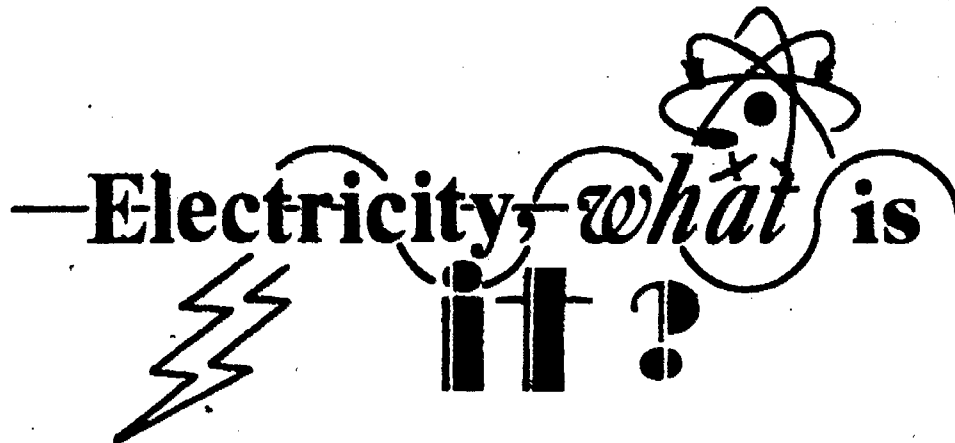

SCORE: _____
 GRADE: _____

Name: _____

Date: _____

Period: _____

WORKSHEET

VOCABULARY - WORD SEARCH

Locate the electrical terms in the puzzle below, and record your findings in the spaces provided. The first letter of each term is given to you. Circle the words as you find them. Words may be forward, backward, vertical, horizontal, or diagonal but must be in a straight line.

A B C D E F G H I D Y N A M I C J K L A E N O P
 Q S U W Z A O C B I E G F H S I R J Q K L P M O
 T R T V Y A L T E R N A T I N G C U R R E N T C
 U A D C M Z D V E E B J A G E O S E W X C O K N
 Y V B B X E A G H C I O W K R U P N Y L T J V E
 T A E X Z E L E C T R O N F L O W C Z S R E L G
 I R W X W Y H J I C M H E R L S H E I D I E X A
 C T B P P G K F K U T A I I O E F H U A C V W T
 I C Q T O H B I J R A L N C V V O E V T C H E I
 R S N U S B O L N R H D I T E P E S R G H S I V
 T R T O I P Q M C E T T V I H G T O O F A A Y E
 C M S C T B Q R T N A M A O S H N T O O R O O M
 E E D K I A V P S T O P H N A I E R U K G N Q J
 L F H J V C W S P W E D T C H U C Y P E L Z Q
 E I G L E O N A O P L L H S B A D K C J Z R X T

1. Amber
2. A
3. D
4. D
5. E
6. E

7. E
8. E
9. F
10. N
11. P
12. S

SCORE :
GRADE :

Name: _____

Date: _____

Period: _____

WORKSHEET

QUEST ACTIVITY

"UNIT 1"

FAMOUS PERSON:

My name is Benjamin Franklin and I am a great American. Please complete this fact sheet about my life. (Hint: an encyclopedia would be a good place to start.)



Date Born:

Date Died:

Birth-Place:

Public Servant Jobs:

Inventions and Experiments

Wow, I was great!!!

ANSWER KEY
UNIT I

A. WORD SEARCH

1. amber
2. alternating current
3. dynamic
4. direct current
5. electron flow
6. electricity
7. electronics
8. electric charge
9. friction
10. negative
11. positive
12. static

B. QUEST ACTIVITY

Date born: January 17, 1706

Date died: April 17, 1790

Birth place: Boston Mass.

Public Servant Jobs: Civic leader

Deputy postmaster, Diplomat

Inventions and Experiments:

Invented lightning rods

Invented bifocal lenses

Invented Franklin stove

Experimented with static electricity

ELECTRICITY / ELECTRONICS

CURRICULUM GUIDE INSTRUCTIONAL MODULE

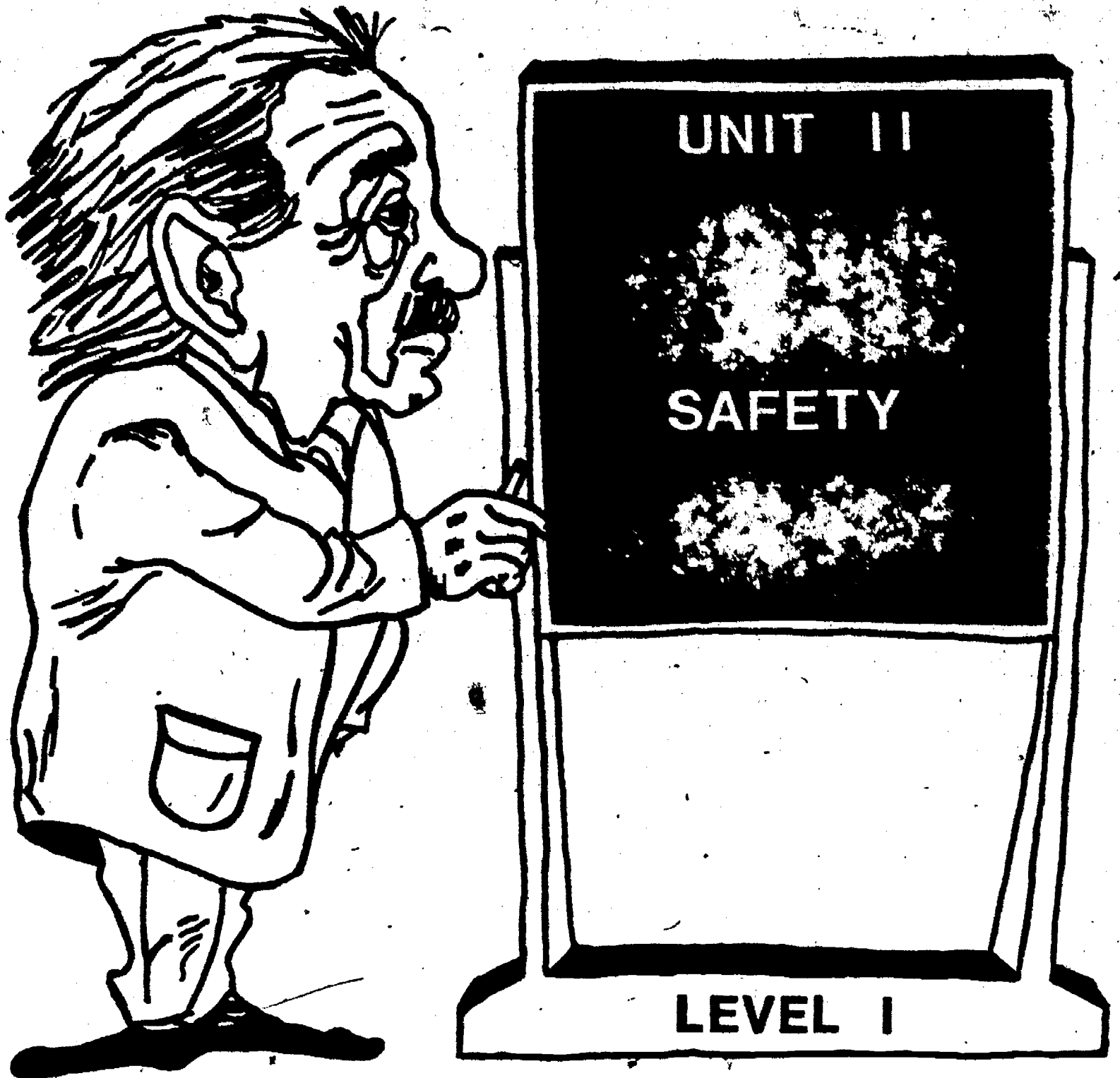

STATE OF CALIFORNIA
DEPARTMENT OF EDUCATION

NAME _____

DATE STARTED _____

DATE COMPLETED _____

BY
R. E. LILLO
N. S. SOFFIOTTO

STATE ELECTRICITY/ELECTRONICS CURRICULUM GUIDE
INSTRUCTOR'S GUIDE TO ACCOMPANY LEVEL I UNIT #2

Title of Unit: Safety

Time Allocation: 1 week

Unit Goal:

To inform and instill student competence in safe guarding themselves and to apply this safety attitude to their daily life, whether in the classroom, on the job, or at home.

Unit Objectives:

The student will be able to:

1. identify the three classes or categories of fires, and indicate the proper method of extinguishing each.
2. distinguish between common, safe laboratory practices and, hazardous conditions, and pass a safety test with 100% accuracy, based on the information discussed.
3. explain and apply the proper safety and first aid procedures when dealing with an electrical hazard or a serious shock.

Evaluation:

The student will demonstrate his/her competence in terms of these measurable objectives based upon individual instructors acceptable performance criteria which utilizes a combination of written or oral testing procedures.

Instructor References:

Basic Electricity: Theory and Practice. Milton Kaufman and J.A. Wilson, McGraw-Hill Book Co., 1973. Appendix A.

Industrial Education Safety Guide. Published by the State of California 1978.

Making Safety Work. National Safety Council, McGraw-Hill Book Co., 1976.

Overview:

The unit should be introduced as a necessary, yet meaningful resource for all activities. In order to place "safety" in its proper perspective within the students' mind, stress that safety instruction should begin early in childhood and extend continuously throughout life! The idea that accidents or electrical shock are unaboidable in this kind of class must be discouraged.

The central safety theme of this unit is promoted by the discussion of rules which have been established to assist students in remembering the fundamentals of preventing accidents.

The next topic of emphasis deals with the nature of electrical shock and the first aid procedures to employ if necessary.

This unit concludes with a brief description of fire prevention and fire classifications. The student will also learn about proper extinguishing techniques to be used, dictated by the type of fire encountered.

Suggested Presentation Hints/Methodology:

Follow the instructional module unit outline as a basic skeleton for curriculum presentation, however, note the following.

1. This unit is often used as the most opportune time to introduce both school fire drills or civil defense drills. Try to impress students, during these kinds of activities, with the idea that disaster preparation is the only thing that really saves lives.
2. In the objectives of this unit it is stated that a safety examination must be passed with 100% accuracy, however, with some students this may be virtually impossible. Allow these few the opportunity to retake the test after a study session, but do not advertise this make up test at the beginning of the safety lesson. Sometimes certain disadvantaged students have a very difficult time to comprehend the vast amount of written material handed out, hence they score lower than other students on the test. A buddy study system will assist them greatly in achieving a successful score.
3. When describing dangerous current levels and their affect on the human body, remember that electrical terms and units of measurement may not be familiar to some students at this time, thus much of the impact will be lost if this is not considered and modified.

Supplemental Activities and Demonstrations:

1. Obtain and show a good safety film from regular film sources, local industries, National Safety Council, or any other company and/or institution which offers such a service.
2. When explaining the classification of fires, demonstrate the actual procedures necessary to activate the fire extinguisher. A blast from a chemical extinguisher while explaining operating techniques can stimulate a class instantaneously.
3. Invite a medical guest speaker to deliver a simple first aid presentation to the class. Prior to the class lesson explain to the guest specific areas of concentration that will help the overall safety program.

Instructional Module Contents:

1. Unit Outline (overhead)
2. Pre-Post Test (keyed)
3. Technical Glossary
4. Worksheet (vocabulary) - Word Scramble Puzzle
5. Quest Activities
6. Informational Handout (Shop Conduct and Procedure Rules)
7. Informational Handout (Classification of Fires and Extinguishing Techniques)
8. Informational Handout (Laboratory Safety Procedures)
9. Informational Handout (Electrical Shock)
10. Unit Module Answer Keys

II: Safety

- A. Safe Use of Hand Tools
- B. Safe Use of Power Tools
- C. First Aid
- D. Fire Safety
- E. Safety Test

UNIT EXAM

ELECTRICAL SAFETY

IMPORTANT-

Indicate your responses on the answer sheet only. Fill in the box corresponding to the correct answer to each question. There is only one correct answer for each question.

1. "Horseplay", running, and throwing of objects are dangerous practices in the shop and are forbidden:
(A) when the teacher is looking, (B) only when students are working, (C) at all times, (D) occasionally.
2. When using machines or hand tools:
(A) give the job all your attention, (B) stand up straight, (C) watch your classmates, (D) watch the clock.
3. The floor, aisles, and passageways should be kept clear of stock, tools, and materials. Objects on the floor:
(A) may be left there if the operator of the machine is in a hurry, (B) may cause someone to slip or trip into a moving machine, (C) may be ignored, (D) are unsightly.
4. Students must not talk to or distract a person operating a machine because:
(A) the operator is likely to be injured, (B) conversation slows down the flow of work, (C) the operator is likely to make a mistake, (D) conversation is annoying to the operator.
5. Report to the teacher any:
(A) damaged tools and equipment, (B) missing guards, (C) equipment not working properly, (D) all of the above.
6. Never operate shop equipment when the teacher is:
(A) out of the shop, (B) in the shop, (C) both A and B, (D) none of the above.
7. Most tools are designed for a specific use or purpose. If they are used incorrectly, the result may be:
(A) damage to the student's project, (B) breakage of tools, (C) injury to the students, (D) damage to the bench tops.

8. Long hair is dangerous around shop equipment. If it is long enough to get caught in the machine, it must be:
(A) tied up and back, (B) burned off, (C) pulled out, (D) none of the above.
9. Loose clothing must be securely fastened or removed and long loose sleeves rolled up above the elbows:
(A) before operating any machine, (B) after operating any machine, (C) during the operation of a machine, (D) only when you are assisting the teacher.
10. All accidents and injuries, no matter how slight must be:
(A) ignored, (B) reported to the principal's secretary immediately, (C) reported to your teacher immediately, (D) reported to the shop foreman immediately.
11. Caution other students if you see a violation of shop:
(A) traffic rules, (B) good manners, (C) safety rules, (D) none of the above.
12. Only the operator and _____ are permitted within the working area around a machine.
(A) one other student, (B) the teacher, (C) a helper, (D) all of the above.
13. Gasoline, paints, kerosene, and other materials that will burn or produce fumes should be used:
(A) with another student, (B) in a well ventilated area, (C) at a workbench, (D) in an enclosed area.
14. Students are to operate only those machines or pieces of equipment for which they have received:
(A) instructions to operate, (B) permission to operate, (C) both A and B, (D) none of the above.
15. When touching electrical switches, plugs, or receptacles be sure your hands are dry because:
(A) a switch will not operate properly if your hands are wet, (B) a plug will easily slip from your fingers if your hands are wet, (C) if your hands are wet, you may receive a severe shock and serious burns, (D) none of the above.

16. Acid or chemicals on the hands or face should be immediately washed away with plenty of:
(A) water, (B) glycerine, (C) olive oil, (D) vaseline.
17. If you notice any breakage or damage to tools, instruments, or machinery, you should:
(A) repair the damage yourself, (B) be careful when using such equipment, (C) say nothing because you might get the blame, (D) none of the above.
18. Screws, nuts, and other nondigestible materials are never to be placed in your:
(A) hand, (B) pocket, (C) mouth, (D) all of the above.
19. If you are in doubt about the use of any tool or machine, or about any shop procedures:
(A) ask an advanced student for help, (B) proceed cautiously, (C) always ask your teacher, (D) none of the above.
20. Always sweep scraps from your workbench or table with a brush or whisk broom rather than your hand because:
(A) sharp or jagged particles may injure your hand, (B) less dust is stirred up, (C) this is the easiest way to clean up, (D) it will cause less work for the janitor.
21. Eye protection is used to:
(A) improve your vision, (B) prevent eyestrain, (C) prevent flying particles or corrosive substances from entering your eyes, (D) none of the above.
22. When tools are carried in the hands, keep the cutting edge or sharp points:
(A) directed toward the floor, (B) directed away from the body, (C) directed over the head, (D) directed toward the body to protect others.
23. NEVER direct compressed air:
(A) toward the floor, (B) toward the teacher, (C) toward another student, (D) all of the above.
24. Extension and power cords should always be checked and kept in good repair because:
(A) breaks and tears in the cord are unsightly, (B) breaks and tears in the cord can cause serious shocks or burns, (C) sparks may cause wood to burn, (D) a short may cause the machines to burn up.

25. Carbon dioxide (CO²) fire extinguishers may be used to put out what types of fires?
(A) electrical fires only, (B) wood fires only, (C) oil fires only, (D) any kind of fire.
26. Water should never be used to put out what kind of fires?
(A) wood fires, (B) electrical and oil fires, (C) paper fires, (D) none of the above.
27. The proper procedure to fight a fire with a fire extinguisher is to:
(A) point the nozzle at the top of the flame, (B) point the nozzle at the middle of the flame, (C) cover the area around the fire and keep it from spreading, (D) point the nozzle at the source of the fire because that is where the fire is located.
28. In case of fire in the shop you should first:
(A) run out of the shop, (B) throw water on it, (C) sound the alarm, (D) none of the above.
29. Lifting any object that is too heavy for you:
(A) is all right if you do it slowly, (B) can be done if you know the right way to lift, (C) should never be done, because it may cause strain or rupture, (D) is a good way to show off your strength.
30. Before the power is turned on, the teacher must check:
(A) the hand tools, (B) the classroom, (C) all special setups, (D) none of the above.
31. The teacher MUST approve:
(A) all "horseplay", (B) all projects, (C) all fighting in the shop, (D) none of the above.
32. Deliberately shorting an electric circuit:
(A) is permissible if the voltage is low, (B) may damage the wires, (C) is an easy method to test whether the circuit is closed or open, (D) may cause an explosion or do bodily harm.
33. Cutting two or more "hot" wires with pliers:
(A) is safe practice if the handles of the pliers are insulated, (B) is permissible if the wires are 18 gage, (C) may be done safely if you are standing on a wooden floor, (D) none of the above.

34. Shop clean up is the responsibility of:
(A) the custodian, (B) all the students, (C) the teacher, (D) the principal.
35. When a machine makes an unusual sound, it should be:
(A) oiled immediately, (B) ignored, (C) reported to the teacher immediately, (D) adjusted.
36. Check a soldering iron for heat with:
(A) your face, (B) your hand, (C) a piece of solder, (D) your feet.
37. To remove excess solder from a soldering iron tip:
(A) wipe with a cloth, (B) flip it off, (C) wash it off, (D) use cleaning fluid.
38. When changing components in an electrical circuit:
(A) leave the plug in, (B) pull the plug out, (C) turn the circuit on its side, (D) turn off the power switch.
39. Make sure that the hand tools you are going to use are:
(A) sharp, (B) the proper tool for the job, (C) in good condition, (D) all of the above.
40. If a tool becomes defective while you are using it you should:
(A) hide it so that no one will know, (B) report the condition of the tool to the instructor, (C) place it back on the tool panel and not say anything (D) repair the tool yourself.
41. Be sure your hands are as free as possible of _____ before using hand tools.
(A) dirt, (B) grease, (C) oil, (D) all of the above.
42. Repairs are to be made on shop equipment only with:
(A) the power on, (B) the machine running, (C) the teacher's permission, (D) none of the above.
43. Spilled oil or grease is dangerous. Always:
(A) clean it up, (B) leave it, (C) pour water on it, (D) none of the above.

44. The motion involved in striking or cutting must be done in a direction:
(A) towards you, (B) away from you, (C) towards other students,
(D) all of the above.
45. A project is still dangerous even after its power switch is turned off because:
(A) it may still be plugged in, (B) some of the components may be hot,
(C) the capacitors can store a charge which can shock you,
(D) all of the above.
46. Never use a file:
(A) without a handle, (B) as a pry bar, (C) as a hammer, (D) all of the above.
47. Pass tools to classmates:
(A) with handles first, (B) with the points first, (C) by throwing them,
(D) none of the above.
48. Before starting a machine, you must:
(A) check all adjustments, (B) make sure all guards work, (C) remove all tools/rags,
(D) all of the above.
49. Before leaving a machine, you must make sure:
(A) the guards are off, (B) the power is off, (C) the machine has come to a complete stop,
(D) both B and C.
50. I did well on this test.
(A) True, (B) False, (C) OK, (D) I blew it.

SAFETY

Name: _____

Date: _____

Period: _____

TECHNICAL GLOSSARY

- ACCIDENT:** An unplanned or unexpected occurrence usually resulting in injury. Most common shop accidents can be prevented by observing safety rules, working carefully, and using common sense.
- ARTIFICIAL RESPIRATION:** A life saving procedure used to revive a person who has stopped breathing. Artificial respiration may be required as a result of electrical shock, drowning, strangling, etc.
- CARDIAC ARREST:** A loss of heartbeat caused by electrical shock, or high blood pressure. Closed cardiac massage is the recommended first aid procedure.
- ELECTRIC SHOCK:** The flow of an electric current through the body. Shock can cause such physical effects as muscle twitching or paralysis, burns, interruption of breathing, unconsciousness, ventricular fibrillation, cardiac arrest, or death.
- FIRE:** A combustion process characterized by heat, flame, and light. There are three general classes of fire: Class A fires involve wood, paper, rubbish, and fabrics; Class B fires involve oil, grease, gasoline, paints, and solvents; Class C fires involve insulation and other combustible materials in electrical and electronic equipment.
- FIRE EXTINGUISHER:** A portable, selfcontained device holding a liquid, or chemical which can be sprayed on a fire to extinguish it.
- FIRST AID:** Emergency treatment for injury, accidents, or sudden illness generally administered before regular medical care is available.
- FLAMMABLE:** A designation for types of materials which are easily ignited or set on fire. Other designations may be used to identify these materials, such as; combustible or inflammable.
- GROUNDING:** A safety precaution which calls for placing the metal housing or case of a device at ground potential to prevent possible operator shock. Most commonly, a third wire is added to the power cord. This wire is connected between the case and earth ground allowing an alternate path for current flow. Thus, if the metal housing of a device becomes electrically "hot", current will flow through the grounding wire to the earth, instead of through the operators body to earth.

Name: _____

Date: _____

Period: _____

- HAND TOOLS:** This term refers to a wide variety of tools which require physical manipulation or primarily the use of your arms and hand muscles for their operation and use. Examples of typical hand tools would be; screwdrivers, wrenches, soldering irons, pliers, etc..
- HAZARD:** The presence of a dangerous or potentially dangerous situation.
- HORSEPLAY:** The undesired, potentially hazardous, activity of clowning or playing in the shop or laboratory.
- INJURY:** Physical harm or damage to ones body.
- LIVE CIRCUIT:** An electrical circuit which is energized, (power applied switch on) and capable of producing current flow.
- MACHINE TOOLS:** Generally, power assisted tools utilized for "heavy" jobs which require work beyond that supplied by hand tools. Examples of machine tools; drill press, grinders, sheet metal shears, box and pan break, etc..
- SAFETY GLASSES:** Protective eye glasses with shatter proof lenses and side shields. Safety glasses should be worn at all times when necessary while working in the shop. They provide invaluable protection by preventing foreign materials (pieces of wire, chips, broken glass, chemicals etc.) from entering or coming in contact with the eyes. Goggles and face shields can be utilized to provide additional eye protection while working in extremely hazardous areas.
- SAFETY PRECAUTION:** An action taken, followed or observed, to avoid a possible hazard or dangerous situation.
- SAFETY RULES:** A specific list of rules designed to identify common accident causing situations and hazards. By observing the safety rules many accidents will be avoided or prevented.
- VENTRICULAR FIBRILLATION:** A type of heart failure, caused by electric shock, in which the heart muscle no longer beats in a regular fashion but rather quivers erratically. If this condition is not corrected rapidly, death will result.



SCORE :
GRADE :

Name : _____

Date : _____

Period : _____

WORKSHEET

VOCABULARY - WORD SCRAMBLE PUZZLE

Unscramble the letters below to uncover the electronic terms.

EXAMPLE:

A. ETSAYF

A. SAFETY

1. EFRI

1. _____

2. AAZHDR

2. _____

3. IUYJRN

3. _____

4. CANTIDEC

4. _____

5. LABELMAFM

5. _____

6. SOREHAYLP

6. _____

7. GGRNNDIUO

7. _____

8. FISTR DAI

8. _____

9. ADHN OLTO

9. _____

10. FTSYE A LUSER

10. _____

11. VILE IRCCUIT

11. _____

12. ATYESF SSSLEAG

12. _____

13. MANEIH C STLO

13. _____

14. TEELCCRI KOSCH

14. _____

SCORE :
GRADE :

Name : _____
Date : _____
Period : _____

WORKSHEET
QUEST ACTIVITY
"UNIT 2"

Connect the dots below to decode the safety poster/message

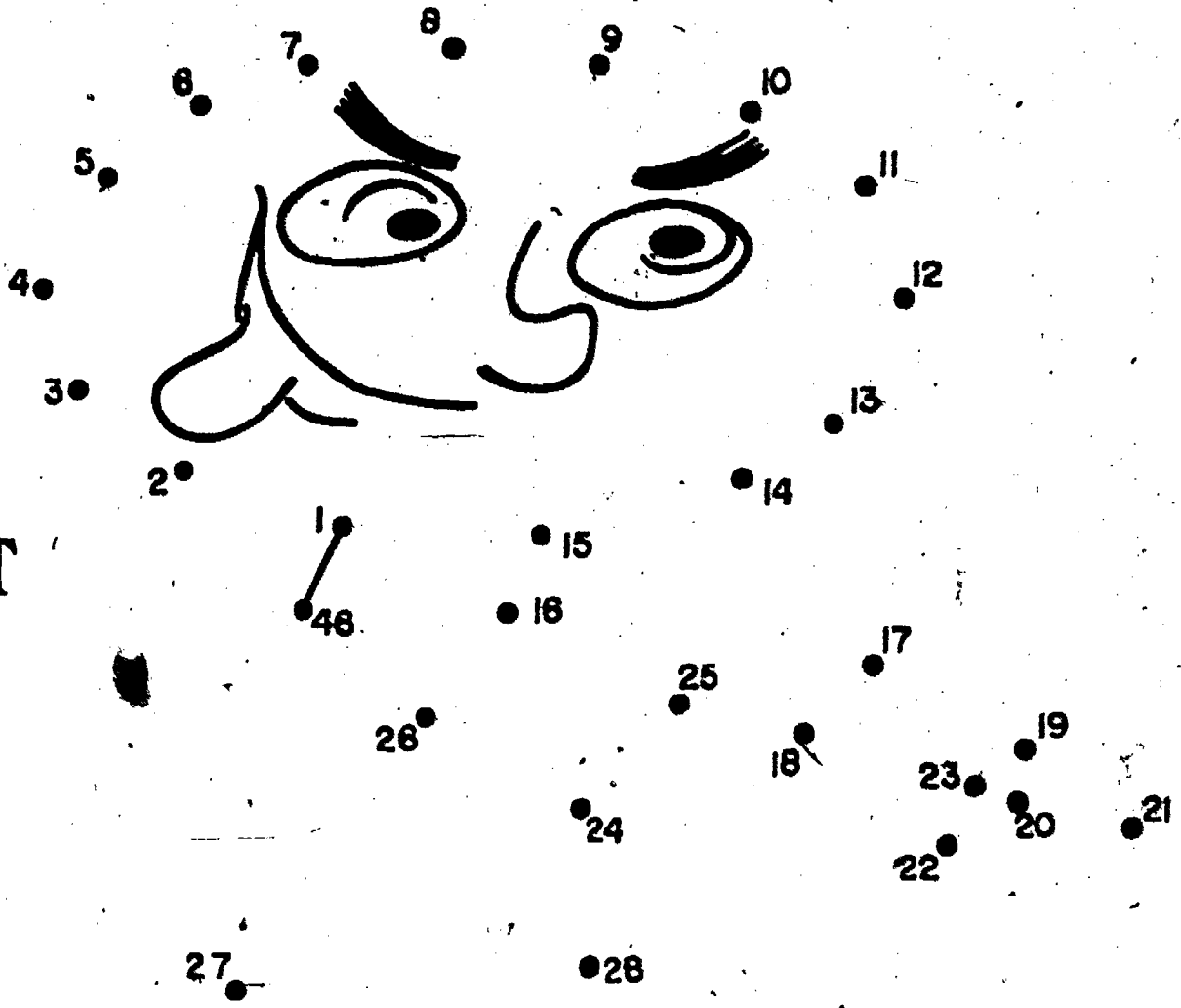

**SAFETY
FIRST**

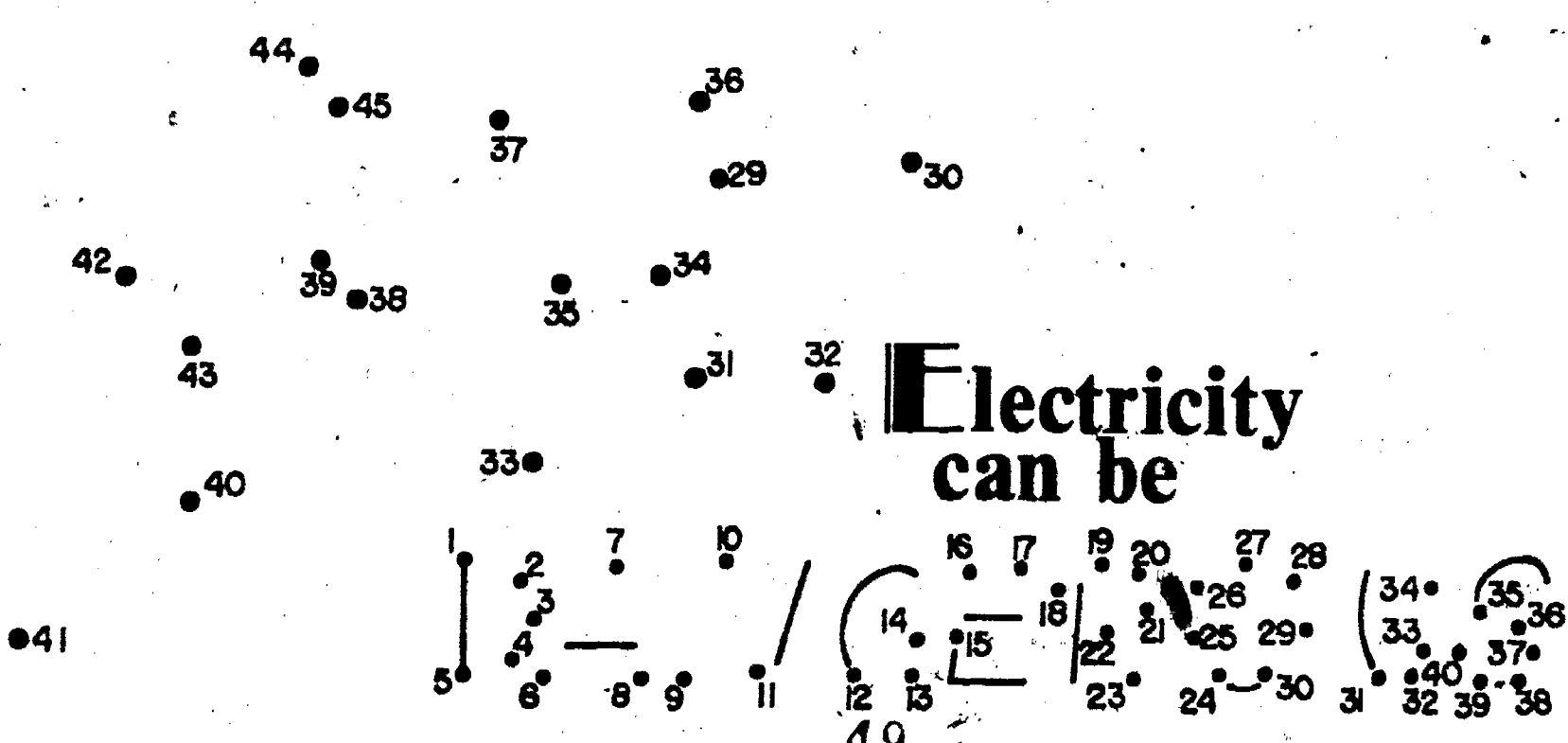

**Electricity
can be**

SAFETY

Name: _____

Date: _____

Period: _____

INFORMATIONAL HANDOUT

SHOP CONDUCT AND PROCEDURE RULES

1. Students must be on time daily and each student must be in his/her assigned seat before the tardy bell rings.
2. You are required to have a notebook specifically for this subject at your desk each day. It will be collected and graded during the year.
3. You must also supply yourself with the necessary materials for classroom notes - paper and a writing tool.
4. All handouts and notes will be kept neatly in your notebook, not scattered in your locker.
5. Seats (and lab. station) will be assigned. Do not change your seat without consulting your teacher.
6. Absolutely no horseplay in the shop. Many painful accidents occur by the careless and thoughtless antics of the so-called "clown." Walk in the shop at all times. Loud talk and unnecessary noise will not be tolerated.
7. No eating, drinking, or gum chewing is allowed in the shop or classroom.
8. Keep your desk (lab. station) and adjacent floor area clean.
9. Pencils should be sharpened before class. All trash (scratch paper etc.) shall be kept at your desk and thrown away after class only.
10. Throwing anything in the classroom is absolutely forbidden.
11. Turn in all assignments on time. Late assignments will be down graded.
12. If you finish your work before others, use the extra time constructively. Do not disturb your fellow students.
13. Poor attendance will hurt your grade, because it is difficult to make up missed work.
14. It is the students responsibility to make up any tests or missed work.
15. Feel free to ask questions anytime on subject matter which you do not understand.
16. If you must leave the room during class, clear it through the instructor first.

Name: _____

Date: _____

Period: _____

17. Work safely and encourage other students to do the same by setting a good example each day.
18. Use only the machines and tools for which you have satisfactorily passed safety tests.
19. Report any injuries or damage to yourself or equipment to the teacher.
20. Malicious damage to equipment and parts will not be tolerated. You will be required to pay for any damage caused in this manner.
21. Do not remove any project, or material, from the shop without the instructor's approval.
22. When the time for clean-up comes, cooperate with the foreman and do your fair share to keep the shop clean and attractive.
23. Students must return to their seats prior to class dismissal at the end of the period. Class will be dismissed only after the shop is clean, all tools are accounted for, and all students are quiet and in their assigned seats.

SHOP CONDUCT AND PROCEDURE RULES

The shop conduct and procedure rules have been read and explained to me. I agree to abide by these rules, and if I have any questions I will ask the instructor.

Students signature: _____

Period: _____

Date: _____

Instructors initial: _____

SAFETY

Name: _____

Date: _____

Period: _____

INFORMATIONAL HANDOUT

CLASSIFICATION OF FIRES AND EXTINGUISHING TECHNIQUES

There are three classification categories for fire. Each type of fire requires special extinguishing techniques. Use the chart below to distinguish the extinguishing techniques.

Class "A"

Fires involving combustible material such as wood, paper or cloth: to extinguish, cool and quench with pump type extinguishers containing water, or soda-acid. CO₂ (carbon dioxide) extinguishers may also be used.

Class "B"

Fires involving flammable liquids such as gasoline, kerosene, greases, thinners, and finishes: smother the burning fuel. Foam and CO₂ type extinguishers may be used.

Class "C"

Fires involving electrical equipment; use a nonconducting type extinguisher such as CO₂ or dry powder, and if possible disconnect the source of electrical energy.

NOTE: Always point the fire extinguisher nozzle at the source of the fire and not at the top of the flame.

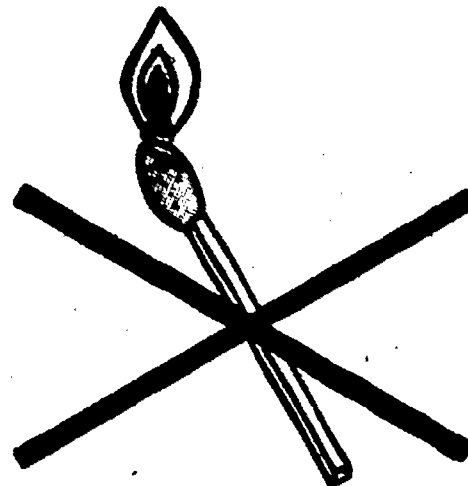
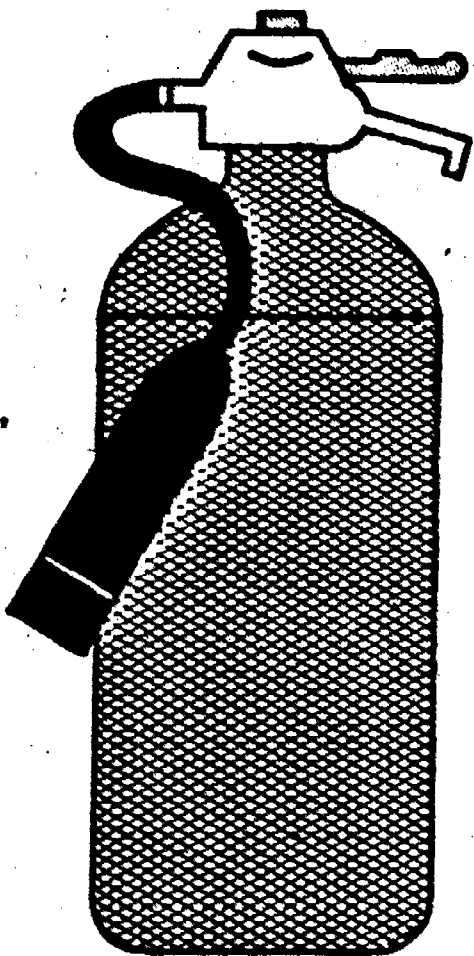

SAFETY

Name: _____

Date: _____

Period: _____

INFORMATIONAL HANDOUT

LABORATORY SAFETY PROCEDURES.

INTRODUCTION:

People working in industry know the importance of safe working habits. Safety training programs are sponsored by unions, management, public agencies, and insurance companies. Despite these good efforts, accidents annually cause lost job time, painful injuries, and needless deaths.

Good safety habits are learned daily. As you begin your laboratory work in electricity, resolve now to learn and practice safe working habits in the laboratory. The choice of your future safety and future laboratory work habits is up to you. Form safe habits now.



Name: _____

Date: _____

Period: _____

GENERAL SAFETY PROCEDURES:

Safe Attitudes. Laboratories are working areas for adults. Tricks, games, and horseplay should be left in the school yard.

Safe Environment. Work areas must have proper power, ventilation, and light. Aisles should be open and clear. Storage areas are to be kept clean and secured. The use of temporary extension cords, fans, heaters, gas or water connections is discouraged. Maintain a neat and orderly work area.

First Aid Procedures. Even with good safety practices someone may be injured. Your instructor and/or the school nurse are trained in first aid procedures, but there are several general rules which you should follow.

Don't panic! Determine if there is any immediate danger to the injured person. Never move an unconscious person without cause. Lay such a person flat. Keep the person warm to prevent shock. Never try to force liquids on an unconscious person. If the victim is breathing normally, keep the person still and comfortable until medical aid arrives.

Severe electrical shock or other types of accidents may interrupt breathing. A procedure such as artificial respiration can be used to stimulate the breathing process. Check for a swallowed tongue before application of artificial respiration. This procedure should be administered by a trained person if possible, and continued until medical help arrives. The two common methods of artificial respiration are mouth-to-mouth and the Schaeffer method.

All injuries should be reported to the instructor. Even minor cuts can become infected, and the best first aid supplies, nurses, and doctors cannot help an unreported injury.

NOTES

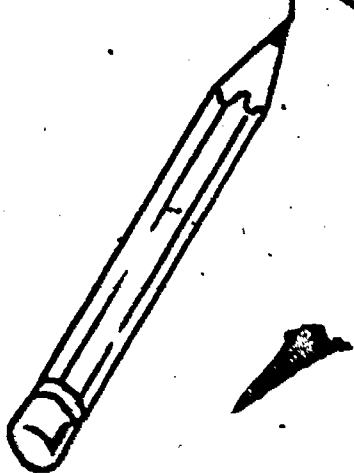

Name: _____

Date: _____

Period: _____

GENERAL SAFETY RULES:



Shop Behavior, and Safety Practices

1. Clowning, scuffling, pushing, running, and throwing objects are dangerous practices in any shop and are forbidden at all times.
2. Obey all warning signs--they are posted for your protection.
3. Caution any student you see violating a safety rule.
4. When using machines or hand tools, give the job at hand all of your attention.
5. Work at a speed consistent with safety. "Foolish hurry," such as rushing to complete a procedure, is dangerous.
6. Cooperate with your classmates in the shop cleanup program.
7. Machines must not be operated while instructor is out of the room.
8. If equipment is not working properly, shut it off and tell the instructor at once.
9. Report to the teacher all breakage or damage to tools, machinery, or equipment.
10. A student who sees a dangerous situation must report it at once to the teacher.



Eye Protection

11. Eye protection must be worn when working in an area where hazardous conditions exist.
12. Face shields or goggles shall be utilized where extra protection is required, such as while grinding or working with caustic substances.
13. Eye glasses must not be used in place of goggles or face shields.
14. When compressed air is used for cleaning, wear eye protection. Take care to direct chips, shavings, and dust away from other students.
NEVER ALLOW THE STREAM OF AIR TO COME IN CONTACT WITH YOUR BODY.

Name: _____

Date: _____

Period: _____



Clothing

15. Wear safe clothing when working in a shop. Fasten or remove loose clothing before you operate any machine. Roll long sleeves above the elbows. Apron fastenings should be such that they will break if the apron becomes entangled in a machine.
16. Long, loose locks of hair can easily be caught in revolving machinery and ripped out causing serious scalp laceration. Have your hair cut short, tied back, or tightly covered.
17. Wearing gloves is forbidden when you are working with power driven machinery in the lab.
18. Remove jewelry--bracelets, rings, chains, and other accessories that are hazardous in shop work.
19. Sharp, pointed tools or materials are not to be carried in clothing. Hold sharp pointed edges down.
20. Always wear protective clothing when working with chemicals. Rubber gloves should be worn when handling chemicals or immersing your hands in chemical solutions.
21. Always wash hands with soap and water after working with materials that might be harmful to the skin.



Housekeeping

22. Keep your work area clean and orderly. Good housekeeping is part of safety.
23. Keep floors, aisles, and passageways clear of materials and equipment.
24. Keep tools in a safe place. Never leave them where they may cause injury. Put them in tool boxes, trays, cases, or on wall panels.
25. Store material neatly and securely and in a place where persons passing will not be injured.
26. If water, grease or oil is spilled on the floor, clean it up immediately to prevent slipping.
27. Extension cords shall always lie flat on the floor in such a way that students will not trip over them.
28. Always use a brush to clean off benches and machines. There may be sharp or jagged particles among the scraps, which could cause serious injury to the hands.

ELECTRICITY / ELECTRONICS

CURRICULUM GUIDE INSTRUCTIONAL MODULE

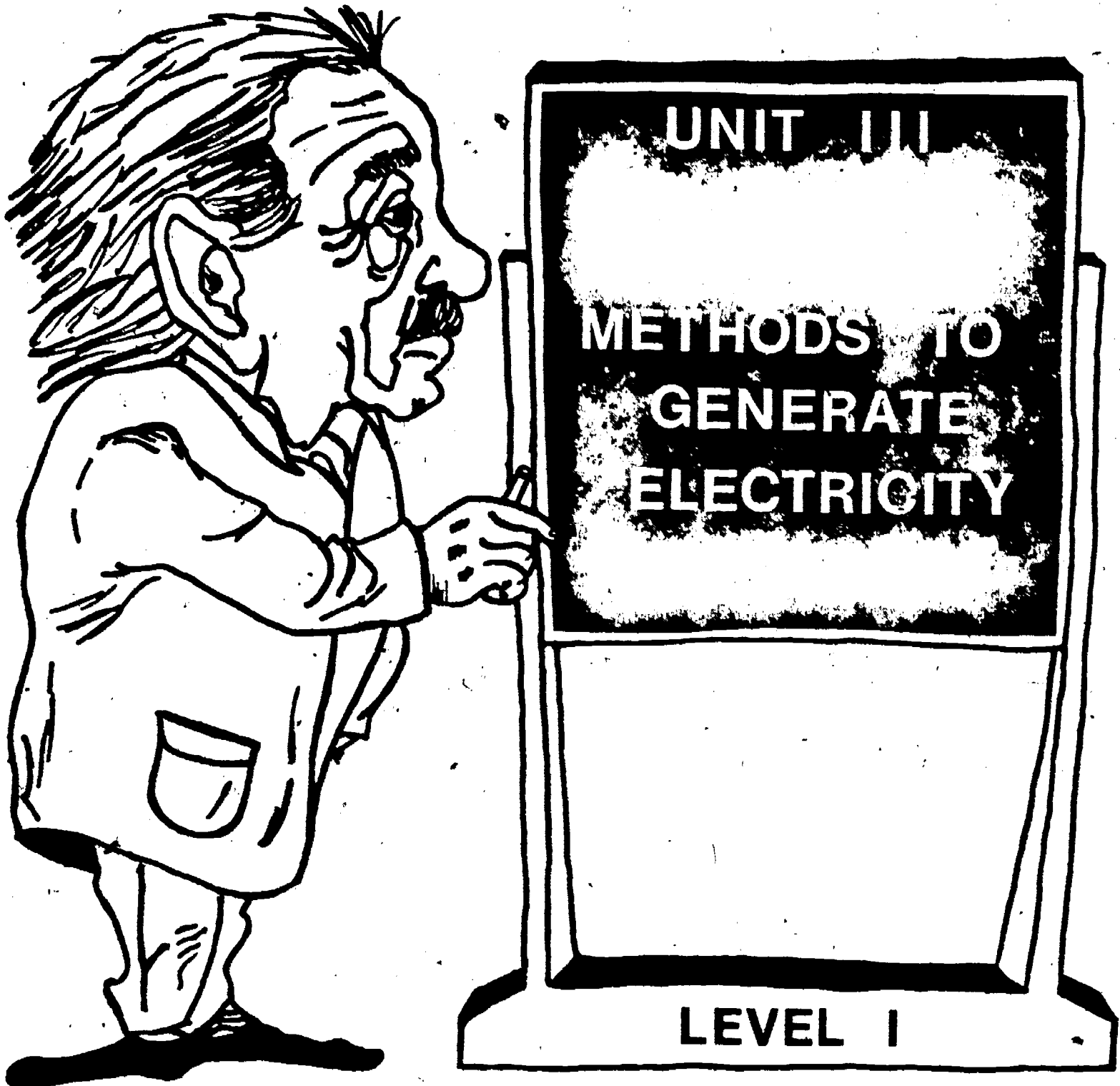

STATE OF CALIFORNIA
DEPARTMENT OF EDUCATION

NAME _____

DATE STARTED _____

DATE COMPLETED _____

BY

R. E. LILLO

N. S. SOFFIOTTO

Title of Unit: Methods to Generate Electricity

Time Allocation: 1 week

Unit Goal:

To disclose those competencies which will introduce the student to a variety of sources and/or methods of producing electricity:

Unit Objectives:

The student will be able to:

1. identify six methods of producing electricity.
2. illustrate by example how each of the sources discussed produces electricity.
3. explain in detail the two kinds of cells that are classified under chemical action.

Evaluation:

The student will demonstrate his/her competence in terms of these measurable objectives based upon individual instructors acceptable performance criteria, which may utilize a combination of written, oral, and laboratory testing procedure.

Instructor References:

Basic Electronics Systems Technology Unit 1. Dugger, Patrick, Suess, and Ziegler, Bruce, 1973. Lessons: 2-6.

Electricity and Electronics. Walter B. Ford and William B. Steinberg, American Technical Society, 1974. Units: 6-9.

Electricity One-Seven. Harry Mileaf, Hayden Book Company, Inc., 1976. Chapter: Electricity 1.

Overview:

Unit 3 focuses on the fact that electricity has become an essential part of our life, therefore it is important to be aware of the sources for creating electrical energy.

The instructor should first examine the sources that are available, then identify those which are small-scale sources and those that are classified as large-scale sources in terms of power produced.

This unit introduces the six basic sources of electricity along with some of the details of application. The actual concept of "how" these sources generate electricity will be considered at a higher level of instruction.

A variety of appropriate exercises and laboratory experiments and/or project should be coordinated with all unit topics when feasible.

Suggested Presentation Hints/Methodology:

Follow the instructional module unit outline as a basic skeleton for curriculum presentation, however, note the following:

1. Try not to leave the impression that the sources presented in this unit are the only sources; they are just the most common ones. Explain further that many other sources have potential, yet are still in the experimental stage in terms of development.
2. Most of the methods of producing electricity can be explored in greater depth during laboratory activities in which the student physically examines and/or performs a variety of experimentation.
3. When discussing heat, light, or pressure methods of producing electricity, under small-scale production, it is important to emphasize that these methods are primarily utilized in control or sensing types of circuits.
4. Discuss with the class in detail the topic of cells and batteries. Present the primary type cells as being basically non-rechargeable, while the secondary type is rechargeable. Stress that the output pressure (voltage) is greater in the secondary cell.
5. Introduce new career choices to your class which may exist in the future in special energy areas like solar, geothermal, wind power, and nuclear fusion, however, note that Unit 10 of this level will deal with this subject in greater detail.

Supplemental Activities and Demonstrations:

1. Producing electricity through heat action can be demonstrated by using a pair of wires (iron and nichrome) and a large galvanometer. Twist the loose ends of the wires together and heat the junction with a match.
2. Producing electricity through pressure action can be demonstrated with a record player pickup. Apply pressure to the needle and then measure the voltage across the cartridge.
3. Producing electricity through light action can be demonstrated with a measurement of the output of a solar cell. The output will increase as the light striking its face increases.
4. Many vendors sell an inexpensive dry cell kit which is both fun and a real learning activity - try it.

Instructional Module Contents:

1. Unit Outline (overhead)
2. Pre-Post Test (keyed)
3. Technical Glossary
4. Worksheet (vocabulary) - Spelling Puzzle
5. Quest Activities
6. Informational Handout (Six Methods Used to Produce Electricity)
7. Unit Module Answer Keys

III. Methods to Generate Electricity

A. Friction

B. Pressure

C. Heat

D. Light

E. Chemical

1. Cells and batteries

a. Primary cells

1. Simple "lemon" cell

2. Carbon-zinc

3. Other types

b. Secondary cells

1. Lead acid cell

2. Other types

F. Magnetic

1. Electromagnetic induction

2. Simple DC generator

G. Project Construction

LI-U3

UNIT EXAM

METHODS TO GENERATE ELECTRICITY

IMPORTANT-

Indicate your responses on the answer sheet only. Fill in the box corresponding to the correct answer to each question - there is only one correct answer for each question.

1. Static electricity is produced by heat. (T-F)
2. A charged rod will attract a neutral material. (T-F)
3. Two types of static charges are positive and negative. (T-F)
4. Most primary cells are rechargeable. (T-F)
5. The common "D" size dry cell uses carbon and tin for its metal plates or electrodes. (T-F)
6. A battery can change chemical reactions into electrical energy. (T-F)
7. Light shining on a crystal will produce a small amount of electricity (T-F)
8. Moving a coil of wire through a magnetic field will produce electricity. (T-F)
9. A thermocouple is an example of a piezoelectric device. (T-F)
10. A DC generator contains a coil of wire (armature), magnetic field (field winding),- and a commutator. (T-F)
11. A charged rubber rod will attract:
(A) a charged glass rod, (B) a positively charged material, (C) a neutral material, (D) all of the above.

12. The liquid in a wet cell is called the:
(A) acid juice, (B) electrolyte, (C) chemical composition, (D) electrode.
13. Piezoelectricity is electricity produced by:
(A) heat, (B) chemical reactions, (C) pressure, (D) magnetism.
14. A generator requires a coil of wire, motion, and _____ in order to produce electricity.
(A) light, (B) heat, (C) friction, (D) magnetism.
15. Which of the following is an example of a photoelectric device?
(A) solar cell, (B) thermocouple, (C) battery, (D) Rochelle salt crystal.

Name: _____

Date: _____

Period: _____

TECHNICAL GLOSSARY

- ACID:** A strong chemical substance with corrosive properties. Vinegar, is an example of a weak acid, other common acids are citric acid and sulfuric acid.
- BATTERY:** Two or more cells connected together. A battery is an important source of DC electrical energy because it is self-contained, and portable.
- CELL:** A single voltaic unit, which is made by combining two dissimilar metals and an acid solution or electrolyte.
- CHEMICAL ELECTRICITY:** A source of DC electricity, which is produced by chemical reactions. A cell and a battery are examples of chemical electrical devices.
- COIL:** A number of turns of insulated wire, usually wrapped in circular form. A coil of wire is a necessary part of a generator.
- GENERATOR:** A device used to produce electricity, by moving a coil of wire through a magnetic field; or by keeping the coil stationary, and moving the magnetic field.
- PHOTOELECTRICITY:** A source of DC electricity, which is produced by light energy. Photoelectrical devices are of three types - photovoltaic, photoconductive, and photoemissive. Photovoltaic devices produce electricity directly from light.
- PIEZOELECTRICITY:** A source of electricity which is produced when pressure is applied to a certain crystal material such as quartz, Rochell salts, or barium titanate.
- PRIMARY CELL:** A type of voltaic cell, which will produce electricity as soon as the chemicals are combined, and generally cannot be recharged.
- SECONDARY CELL:** A cell which requires charging before it will produce electricity, and can be recharged many times.
- STATIC ELECTRICITY:** A collection of electrical charges (both positive, and negative) at rest on the surface of an object. Static charges are produced by friction.
- THERMOCOUPLE:** A device consisting of two different metals joined at a junction. When the junction is heated, a small amount of DC electricity is produced.

SCORE :
GRADE :

Name: _____

Date: _____

Period: _____

WORKSHEET

VOCABULARY - SPELLING PUZZLE

Copy the correctly spelled word in the box to the right as indicated in the example below.

- | | |
|--|---|
| A. (example) (exhample) (xample) | A. <input type="text" value="example"/> |
| 1. (coyle) (koil) (coil) | 1. <input type="text"/> |
| 2. (cel1) (sell) (ceel) | 2. <input type="text"/> |
| 3. (statik) (static) (statick) | 3. <input type="text"/> |
| 4. (primury) (primeary) (primary) | 4. <input type="text"/> |
| 5. (battary) (battery) (batery) | 5. <input type="text"/> |
| 6. (acid) (asid) (asaid) | 6. <input type="text"/> |
| 7. (kemical) (chemikal) (chemical) | 7. <input type="text"/> |
| 8. (generater) (jenerator) (generator) | 8. <input type="text"/> |
| 9. (secondary) (secandary) (secondairy) | 9. <input type="text"/> |
| 10. (alectricity) (electricity) (elektricity) | 10. <input type="text"/> |
| 11. (thermaolcouple) (thermecouple) (thermocouple) | 11. <input type="text"/> |
| 12. (photoelectricity) (fotoelectricity)
(photoalectricity) | 12. <input type="text"/> |

SCORE:
GRADE:

Name: _____

Date: _____

Period: _____

WORKSHEET

QUEST ACTIVITY

"UNIT 3"

Use your testbook, or other resource to locate the information required in the problems below.

1. Draw an accurate sketch of a zinc-carbon cell. Label the major parts of the cell.

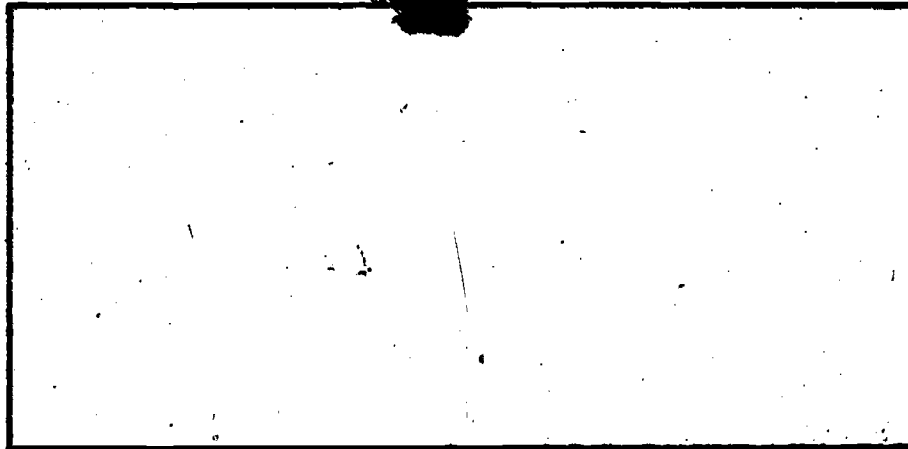

ZINC-CARBON CELL

2. Is the zinc-carbon cell a primary or secondary cell? (Circle one)
3. Draw a sketch of a basic lead-acid battery. Label the major parts of the battery.

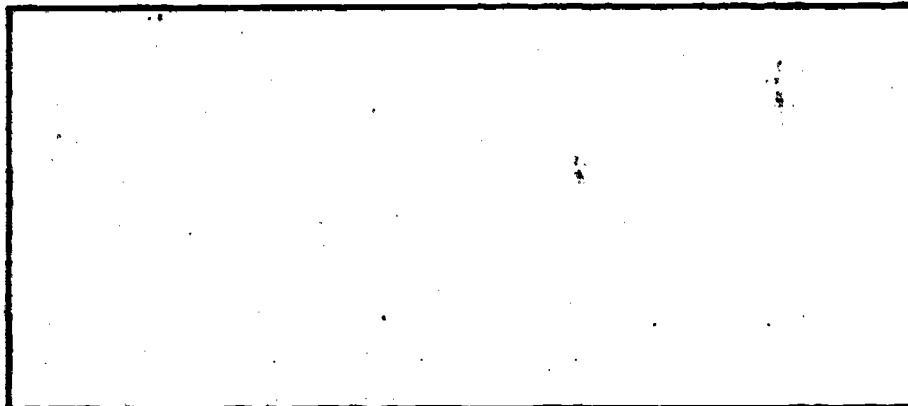

LEAD-ACID BATTERY

4. Is the lead-acid battery a primary or secondary battery? (Circle one)
5. What advantage does a secondary cell have over a primary cell?

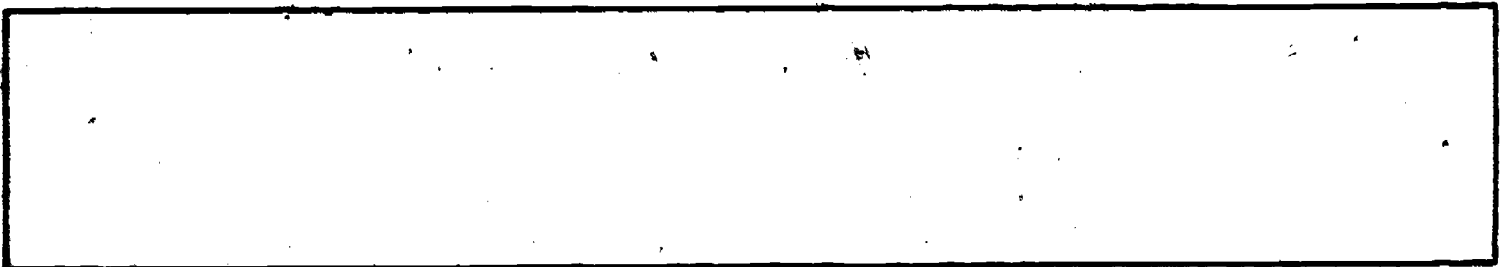

Name: _____

Date: _____

Period: _____

INFORMATIONAL HANDOUT

SIX METHODS USED TO PRODUCE ELECTRICITY

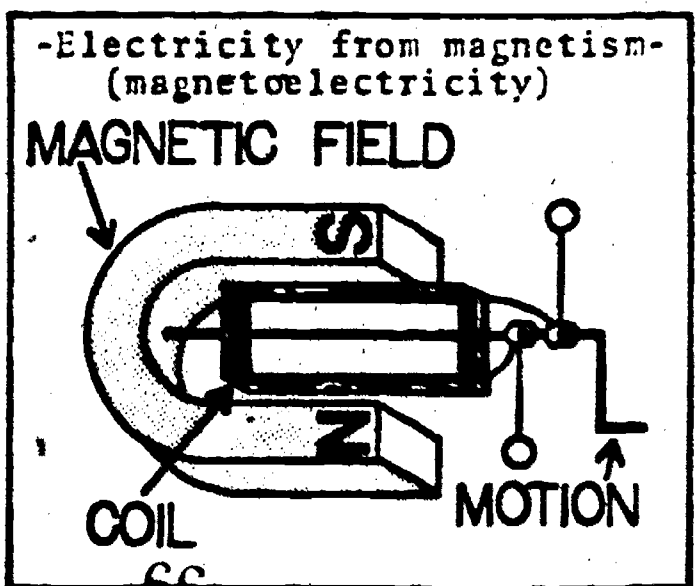
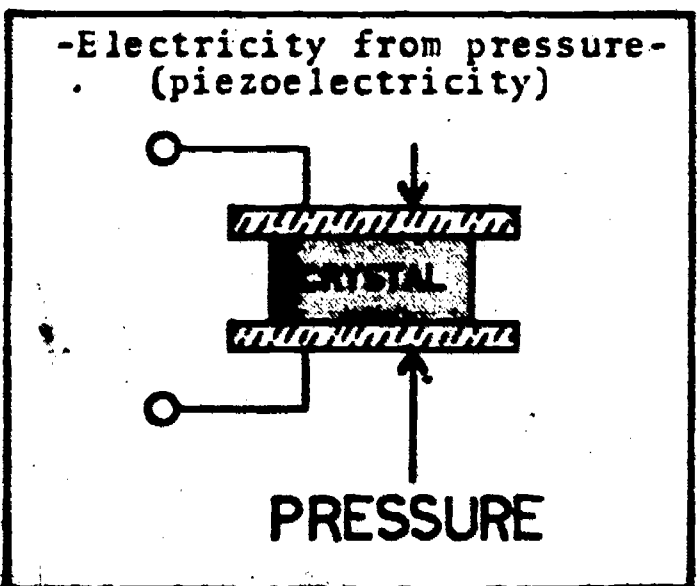
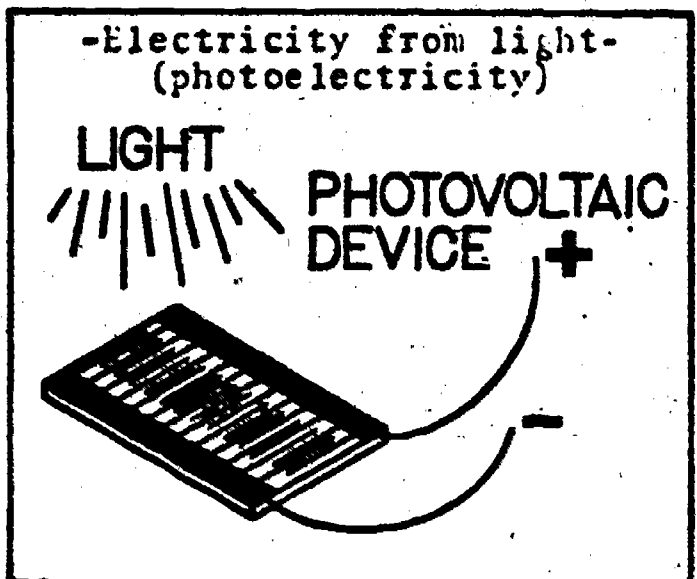
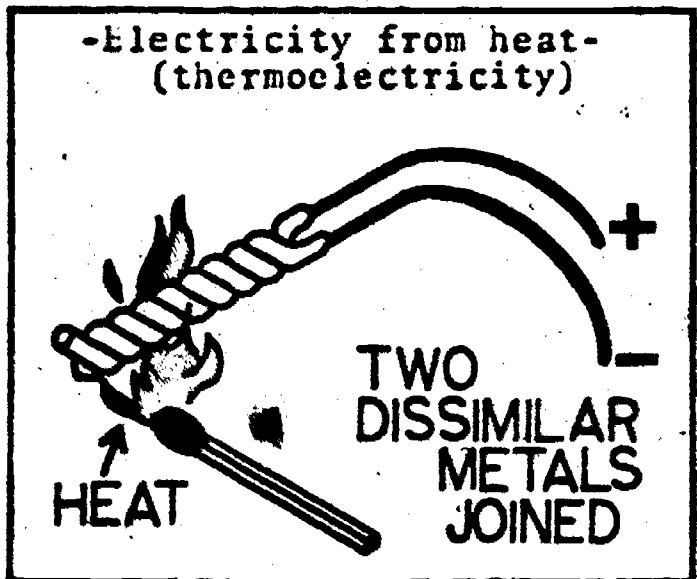
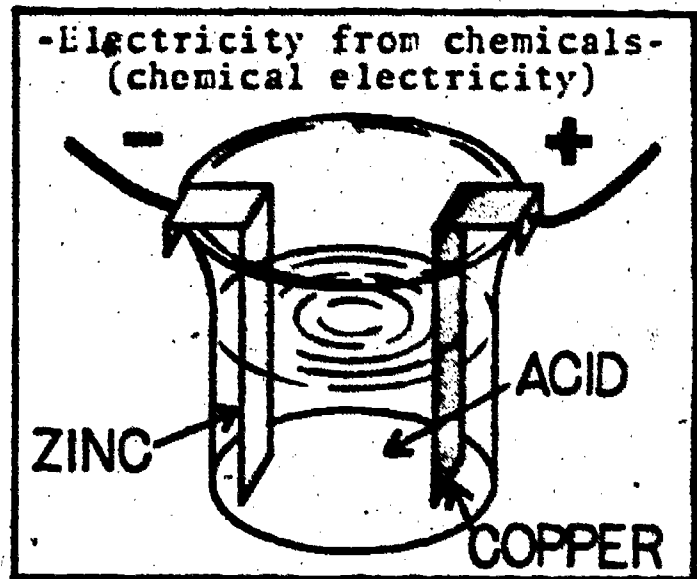
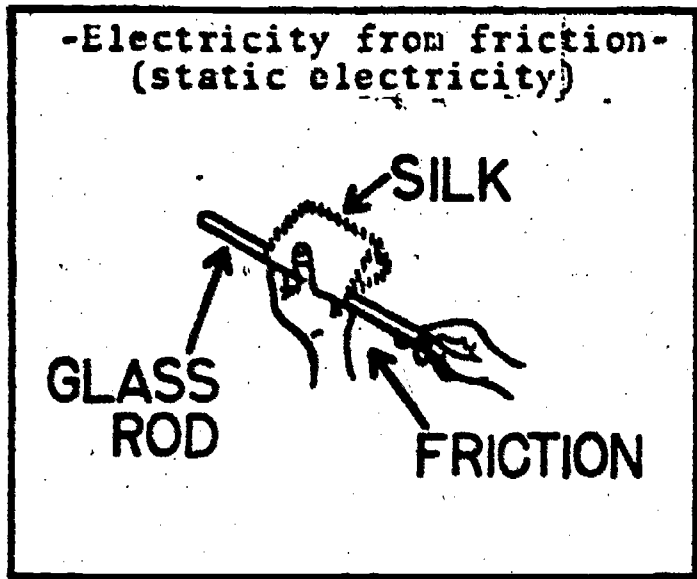

SCORE: _____
 GRADE: _____

Name: _____

Date: _____

Period: _____

ANSWER SHEET

EXAM LI-U3

	T	F	A	B	C	D
1.						
2.						
3.						
4.						
5.						
6.						
7.						
8.						
9.						
10.						
11.						
12.						
13.						
14.						
15.						
16.						
17.						
18.						
19.						
20.						
21.						
22.						
23.						
24.						
25.						

	T	F	A	B	C	D
26.						
27.						
28.						
29.						
30.						
31.						
32.						
33.						
34.						
35.						
36.						
37.						
38.						
39.						
40.						
41.						
42.						
43.						
44.						
45.						
46.						
47.						
48.						
49.						
50.						

	T	F	A	B	C	D
51.						
52.						
53.						
54.						
55.						
56.						
57.						
58.						
59.						
60.						
61.						
62.						
63.						
64.						
65.						
66.						
67.						
68.						
69.						
70.						
71.						
72.						
73.						
74.						
75.						

	T	F	A	B	C	D
76.						
77.						
78.						
79.						
80.						
81.						
82.						
83.						
84.						
85.						
86.						
87.						
88.						
89.						
90.						
91.						
92.						
93.						
94.						
95.						
96.						
97.						
98.						
99.						
100.						

*Show work for problems on back of answer sheet.

ANSWER KEY
UNIT 3

A. SPELLING PUZZLE

1. coil
2. cell
3. static
4. primary
5. battery
6. acid
7. chemical
8. generator
9. secondary
10. electricity
11. thermocouple
12. photoelectricity

B. QUEST ACTIVITY

1. (subjective evaluation)
2. primary
3. (subjective evaluation)
4. secondary
5. (subjective evaluation)

ELECTRICITY / ELECTRONICS

CURRICULUM GUIDE INSTRUCTIONAL MODULE

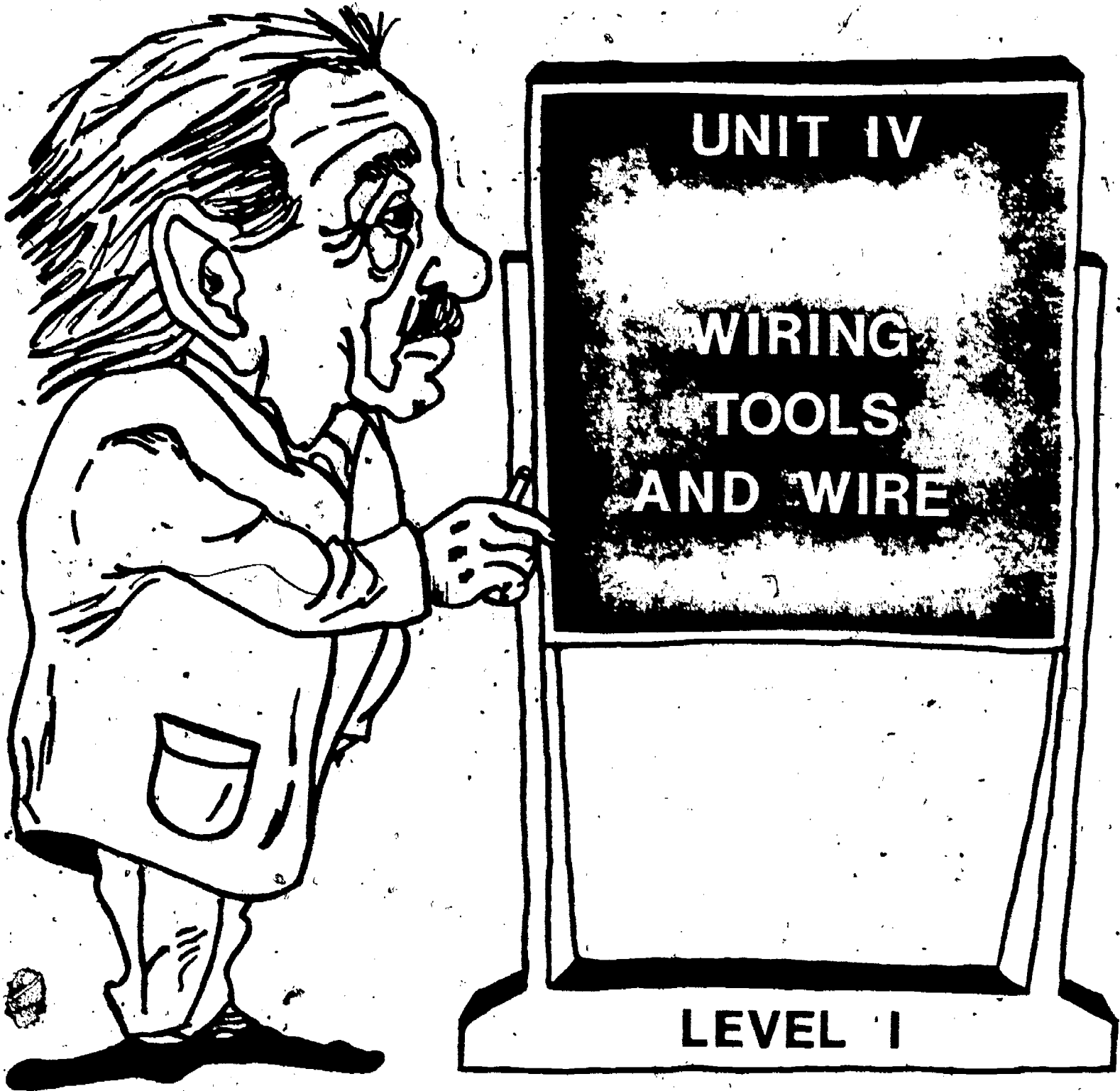

STATE OF CALIFORNIA
DEPARTMENT OF EDUCATION

NAME _____
DATE STARTED _____
DATE COMPLETED _____

BY
R. E. LILLO
N. S. SOFFIOTTO

STATE ELECTRICITY/ELECTRONICS CURRICULUM GUIDE
INSTRUCTOR'S GUIDE TO ACCOMPANY LEVEL I UNIT #4

Title of Unit: Wiring Tools and Wiring

Time Allocation: 1 week

Unit Goal:

To establish basic technical assembly and electrical skills by conveying those competencies relevant to successful usage of tools and wiring techniques.

Unit Objectives:

The student will be able to:

1. describe the function, list safety precautions, and illustrate the correct use of each essential wiring tool presented in this unit.
2. demonstrate the proper method of preparing wire for electrical utilization and explain several standard methods to terminate wire.
3. explain the purpose of wire and insulation, and indicate the reasons for the different types of wires.

Evaluation:

The student will demonstrate his/her competence in terms of these measurable objectives based upon individual instructors acceptable performance criteria, which utilizes a combination of written, oral, and laboratory testing procedures.

Instructor References:

Electronics Assembly and Fabrication Methods. S.R. Duarte and R.L. Duarte, McGraw-Hill Book Co., 1973. Chapters: 1, 5, 6, 7, 8, 9, and 10.

Electronic Techniques. R.S. Villanucci, A.W. Avtgis, and W.F. Megow, Prentice-Hall, Inc., 1974. Chapters: 3-16.

Technical Electricity and Electronics. Peter Buban and Marshall L. Schmitt McGraw-Hill Book Co., 1977. Units: 27-31.

Overview:

Unit 4 will allow the student to develop competencies that will act as a foundation for future mechanical and electrical assembly tasks.

The unit should also be introduced as a valuable resource in project construction. The idea of constructing a project should be stressed as a necessary "hands on" experience in order to facilitate working with devices and processes.

The central theme is to describe a variety of tools and basic electrical skills for the students to become familiar with and develop, however, craftsmanship is also a quality that must be emphasized by the instructor as an on going process that should permeate all levels of activities.

Most major topics in this unit can be presented through laboratory demonstrations, and projects. A student project can really assist in evaluating student understanding and it will further motivate the students in their studies.

Suggested Presentation Hints/Methodology:

Follow the instructional module unit outline as a basic skeleton for curriculum presentation, however, note the following:

1. When illustrating basic hand tools and describing their function, an overhead projection can be easily adapted as a means to show tool outline or shape. In addition, physically tracing tools with color pencils can assist disadvantaged students in learning the basic differences in size, shape, etc.
2. Hopefully, in this unit a variety of simple exercises on wire identification, techniques of wire stripping, methods of wire termination or wire size determination can really help introduce students to many basic assembly techniques.
3. Whatever unit project or lab activities are utilized, it is vital at this age to have activity organization, adequate materials, and good supervision of the class.
4. At this educational level it is also wise when instructing students in tools and wiring techniques to utilize higher ability students to assist in demonstrating a procedure or helping a slower student.

Supplemental Activities and Demonstrations:

1. The vocabulary list presented in this unit is long. Spend a good deal of time describing each term and if possible demonstrate each tool listed and emphasize safety precautions when appropriate.
2. Wire stripping stranded wire is taken for granted by many instructors, however, the correct technique is sometimes difficult for students to acquire. When demonstrating this skill make an effort to explain what happens electrically and mechanically when strands are broken during the stripping process.
3. Remember that safety must be stressed especially in this unit. Try to emphasize to students for example, that when changing an AC plug extreme care must be observed to secure wires in their proper location to avoid a hazardous situation

Instructional Module Contents:

1. Unit Outline (overhead)
2. Pre-Post Test (keyed)
3. Technical Glossary
4. Worksheet (vocabulary) - Tool and Material Identification
5. Quest Activities
6. Informational Handout (Tools and Equipment I May Need)
7. Informational Handout (Wire: Purpose and Use)
8. Informational Handout (Wire Termination Methods)
9. Unit Module Answer Keys

IV. Wiring Tools and Wire

A. Essential Wiring Tools and Usage

1. Long nose pliers
2. Diagonal cutting pliers
3. Wire strippers
4. Other varieties

B. Wires and Cables

1. Wire as a conductor
2. Insulation--purpose and types
3. Kinds of wire
4. Cables and cords
5. Wire size
6. Wire termination methods
7. Wiring plugs.

LI-U4'

UNIT EXAM**IMPORTANT-**

Indicate your responses on the answer sheet only. Fill in the box corresponding to the correct answer to each question - there is only one correct answer for each question.

1. Wire/strippers are used to remove the insulation from wires. (T-F)
2. A stranded wire is less flexible than a solid wire of the same gauge. (T-F)
3. Soldering irons are available in many shapes, sizes, and wattage ratings. For general project work, a 25-35 watt iron is appropriate. (T-F)
4. A conductor provides a path through which electricity can easily flow. (T-F)
5. Plastic is a common conductor used on wires. (T-F)
6. A 24 gauge wire has a larger diameter than a No. 12 American Wire Gauge wire. (T-F)
7. When fastening a wire to a screw terminal, the wire should be wound around the screw in a clockwise direction. (T-F)
8. An insulator offers a difficult path for the flow of electricity. (T-F)
9. Connectors are generally used for a one-time, permanent contact between wires and cables. (T-F)
10. Diagonal-cutting pliers are designed for stripping wires. (T-F)

11. A chassis punch is commonly used to punch round holes in sheetmetal.
(T-F)
12. Long-nose pliers are designed primarily for holding and bending small-gauge wires. (T-F)
13. A Phillips head screw can be driven by either a standard blade screwdriver, or a Phillips screwdriver. (T-F)
14. The proper strain relief knot to use when connecting a plug to an electrical cord is the _____ knot.
(A) Square, (B) Undertakers, (C) Granny, (D) Underwriters.
15. The best conductor for most electrical work:
(A) copper, (B) aluminum, (C) silver, (D) tin.

Name: _____

Date: _____

Period: 7

TECHNICAL GLOSSARY

- ADJUSTABLE WRENCH:** An open-end style wrench with adjustable jaw size. This type of wrench is made with one stationary jaw, and an adjustable jaw, operated by a thumb screw. This allows one wrench to be used on many different nuts or bolt sizes.
- CABLE:** A group of insulated wires held together by an outer covering.
- CENTER PUNCH:** A metal punch with a sharp point. The center punch is used to mark the location of a hole that is to be drilled, preventing drill "wandering."
- CHASSIS PUNCH:** A sheetmetal punch designed for punching round holes in a range of sizes from 1/2" to 3". The punch halves are drawn together with a machine screw.
- CONDUCTOR:** A material through which electricity will easily flow. Wire is a conductor or conducting material.
- CONNECTOR:** A device at the end of a wire or cable used to connect the wires to or disconnect the wires from the equipment.
- DIAGONAL-CUTTING PLIERS:** Pliers used for cutting soft metal wire. Two popular terms used for identifying these pliers are diagonals and dykes.
- FILE:** A tool used mainly to smooth the edges of sheetmetal, and to do small amounts of cutting, shaping, and fitting of metal parts.
- GAUGE:** A standard method for sizing wires. Gauge sizes are given as numbers, such as 24 gauge or 24g. The lower the number, the larger the diameter of the wire.
- HEAT SINK:** A small tool used to draw heat away from an electrical part or connection during the soldering process.
- HEX WRENCH:** A six sided wrench used for removing Allen head set screws or bolts.
- INSULATION:** A material which does not allow electricity to flow through it. Insulation is placed around a wire, connection, or joint to prevent a short circuit or an accidental shock.
- JACK:** A plug-in device or receptacle which accepts a matching plug to complete a connection.

Name: _____

Date: _____

Period: _____

**LONG-NOSE
PLIERS:**

Pliers used primarily for handling small objects and for bending and shaping wires. Most long nose pliers also have a cutting jaw for cutting small gauge wires.

LUG:

A terminal or device which is designed for easily attaching wires or electrical parts. Most lugs require that the wire be wrapped on and soldered.

NUT DRIVER:

A tool designed to rapidly install or remove nuts. The tool resembles a socket wrench attached to a screwdriver handle.

PLUG:

The male half of a connector which is plugged into a matching jack or socket.

**PORTABLE
ELECTRIC DRILL:**

A hand-held power tool used for drilling holes in various materials. The tool uses a chuck to hold the drill bit and generally has a trigger style switch as a control.

REAMER:

A tapered tool used to slightly enlarged holes drilled in sheetmetal.

SCALE:

A tool marked off in divisions and used for measuring length or distance. A one foot ruler is a type of scale.

SCREWDRIVER:

A tool which allows you to produce a twisting motion to tighten or loosen screws. The two common tip types are slotted or standard and Phillips-head.

SCREW TERMINAL:

A type of connector which uses a screw to hold or connect a wire in place. Screw terminals are often found on the back of speakers, on AC plugs, etc.

**SHEETMETAL
NIBBLER:**

A special cutting tool used to nibble away small bits of sheetmetal. A nibbler can be used to cut irregular shaped holes in sheetmetal.

**SLIP JOINT
PLIERS:**

A common type of plier designed for holding or gripping work. The slip joint permits the jaws to be opened wider.

SOLDER:

A mixture of tin and lead, which is melted into an electrical connection to form a bond.

SOLDER AID:

A tool used to bend wires for easy connection to terminals or lugs. Solder aids may also contain a brush or pointed probe for clearing terminals of solder.

SOLDERING IRON:

A tool used to provide the heat required when making a solder connection.

Name: _____

Date: _____

Period: _____

SOLDERLESS TERMINAL:

Also called a solderless connector or crimp connector, these devices do not require soldering, rather, the wire is inserted into a lug, and the lug is squeezed with a special tool, to make the electrical connection.

SOLDER REMOVER:

A device used to remove molten solder from a wire or connection. Most desoldering tools draw the molten solder from the connection with a vacuum or suction force.

SOLID WIRE:

A type of wire that consists of only one solid conductor, usually covered by insulation.

SPLICE:

A method for connecting two or more wires together. Example: Tap splice, Rat-tail splice, or Western Union splice.

STRANDED WIRE:

A type of wire which consists of many strands of fine wire twisted together. The twisted conductors are then covered with an insulating material. Stranded wire is more flexible than solid wire of the same gauge.

STRIPPING:

The process of removing the insulating material (plastic, cloth, enamel) from a wire or conductor.

TERMINATION:

The ending of a wire or wire connection.

TIN SNIPS:

A scissors like tool used for cutting sheetmetal.

UNDERWRITERS KNOT:

A special strain relief knot used on electrical cords. If the cord is accidentally pulled, the knot will absorb the force, rather than the electrical connection.

WISE:

A tool used to securely hold work pieces while drilling, cutting, soldering, etc.. The most common style vise is called a bench vise, although many specialty vises are available for electronics work.

WIRE NUT:

A type of insulated solderless connector used for making Rat-tail joints. To use a wire nut, thread it onto a pair of bare conductors which are held parallel to each other. The conductor will twist and be held together firmly.

WIRE STRIPPERS:

A common tool used to remove the insulation from a conductor or wire.

SCORE:

GRADE:

Name: _____

Date: _____

Period: _____

WORKSHEET

VOCABULARY - TOOL AND MATERIAL IDENTIFICATION

Identify the items pictured below: Use complete names:

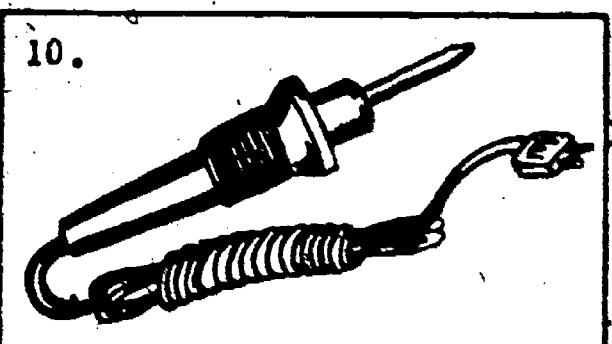
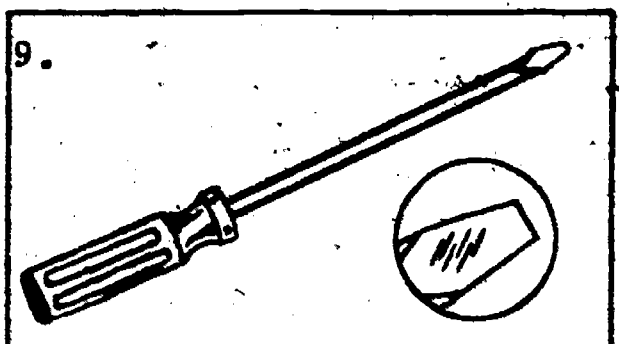
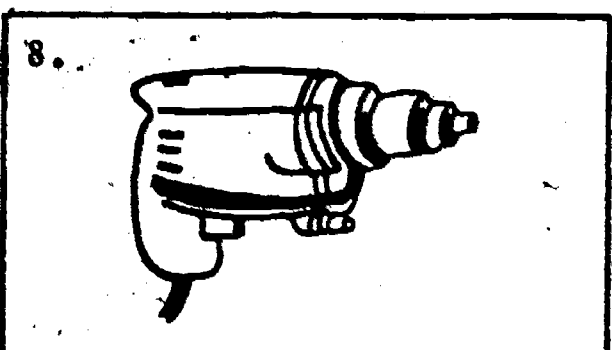
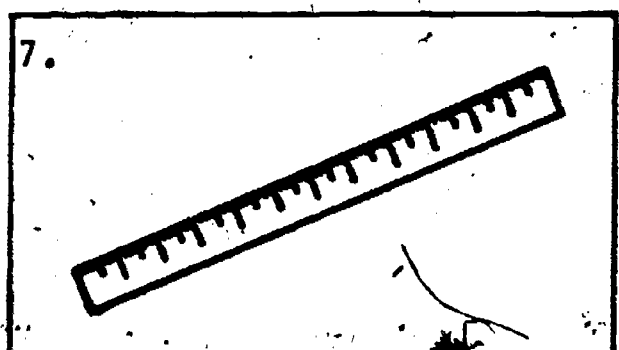
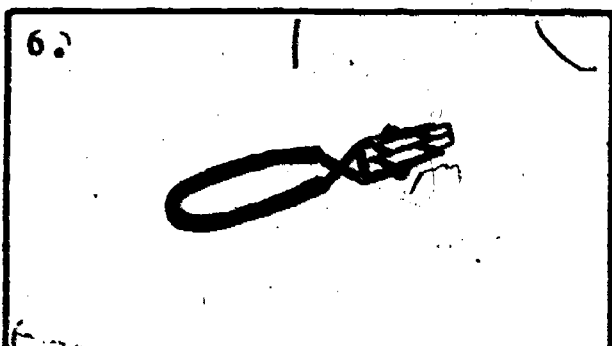
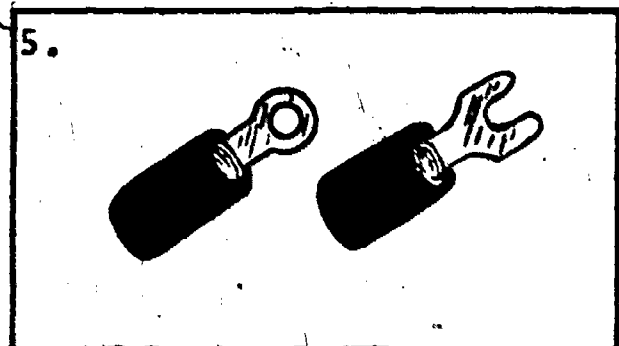
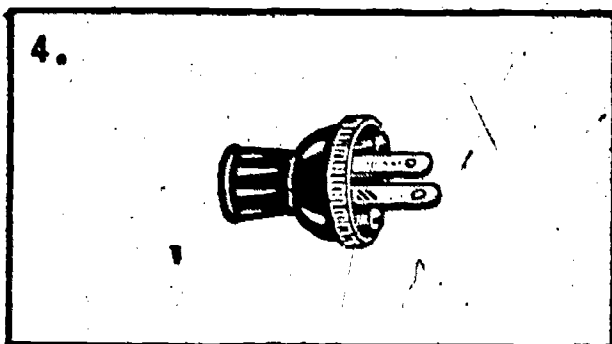
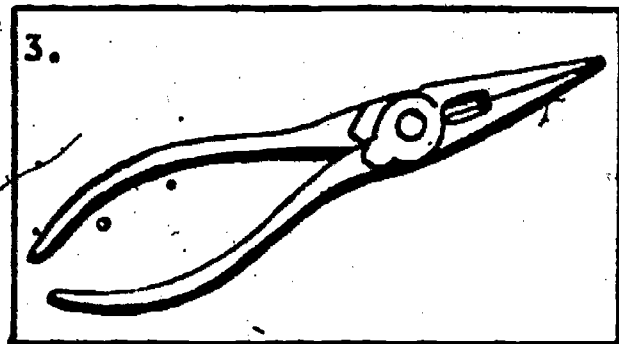
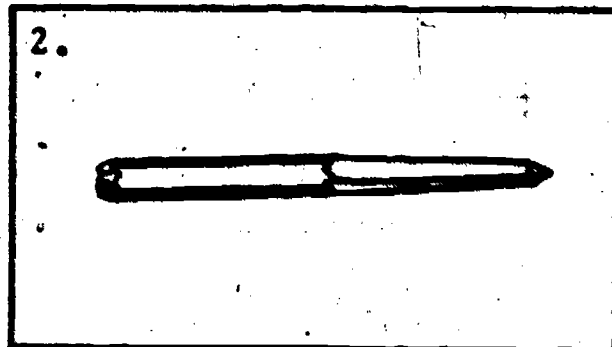
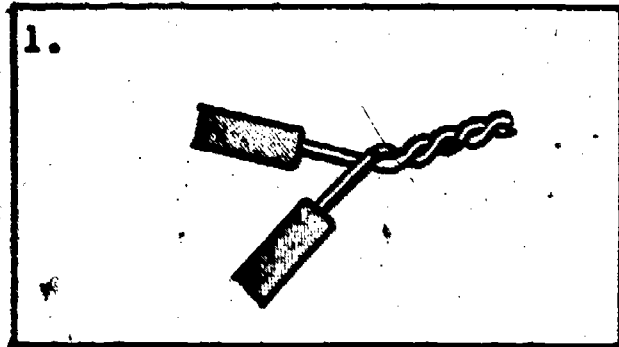

1.

2.

3.

4.

5.

6.

7.

8.

9.

10.

Name: _____

Date: _____

Period: _____

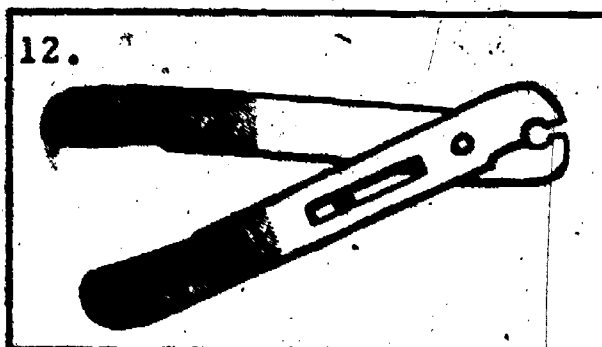
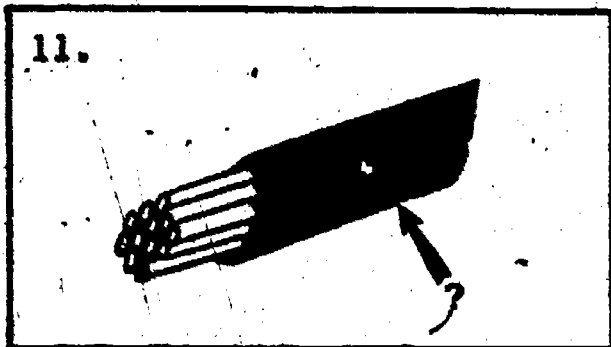

11.

12.

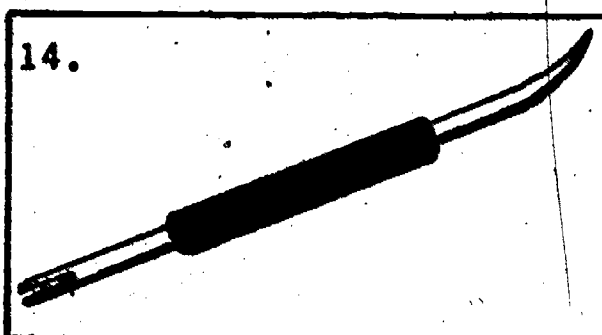
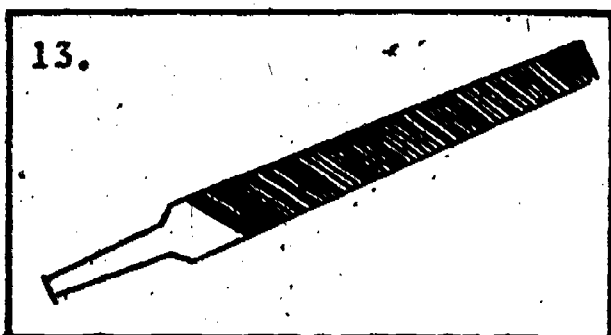

13.

14.

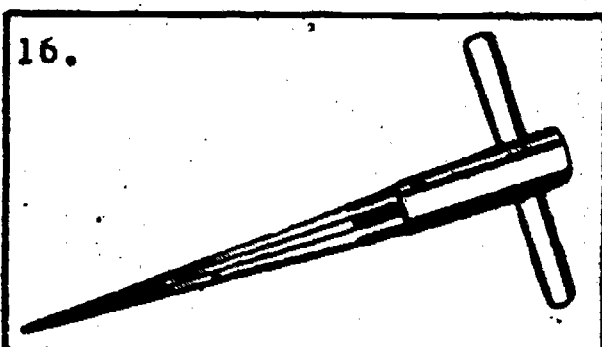
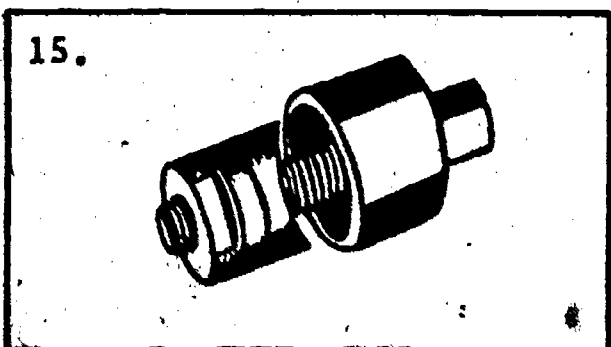

15.

16.

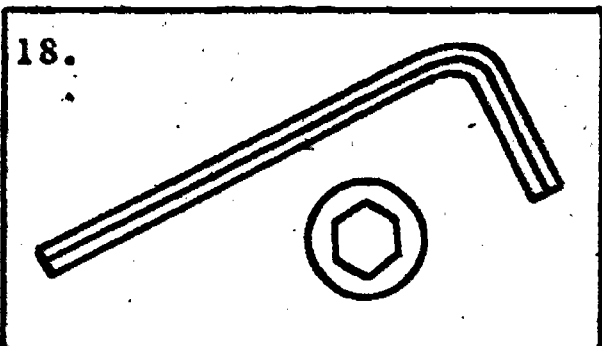
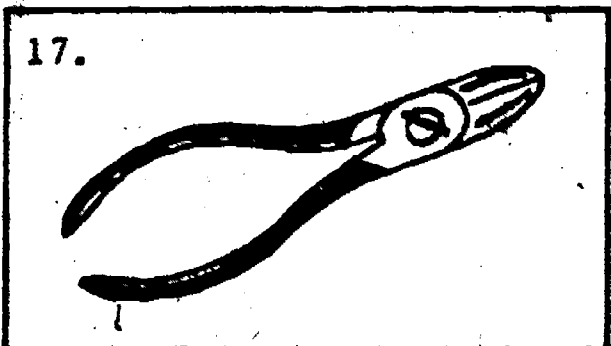

17.

18.

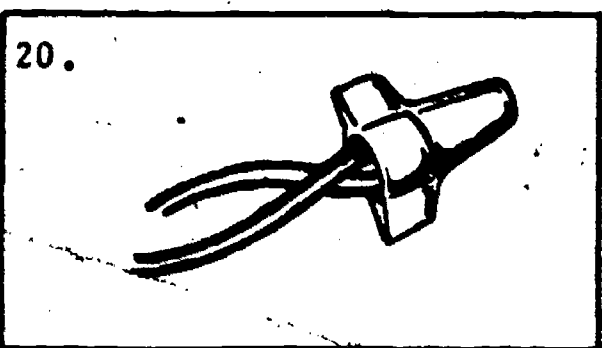
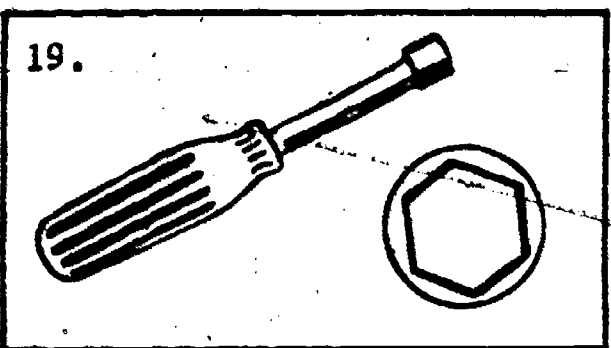

19.

20.

Name: _____

Date: _____

Period: _____

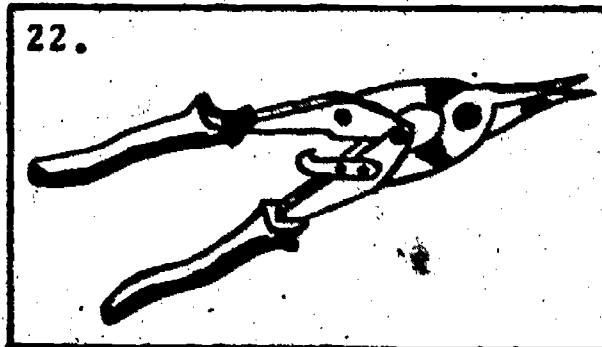
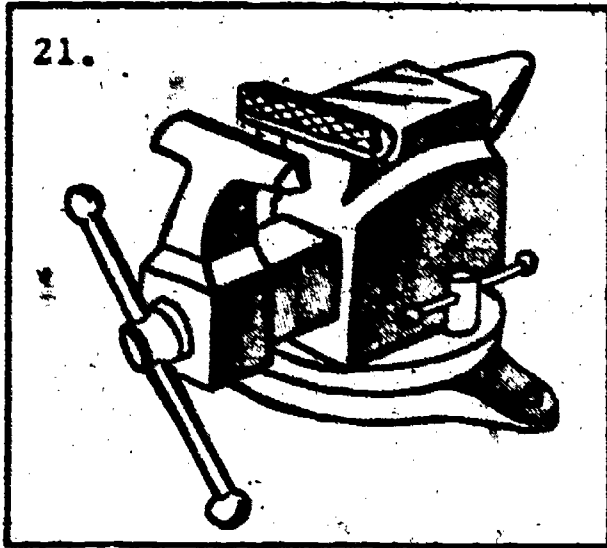

21.

22.

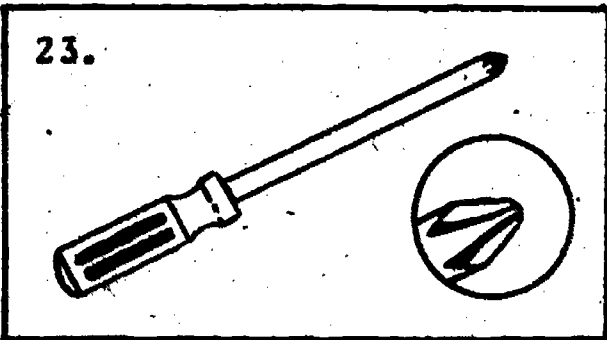

23.

24.

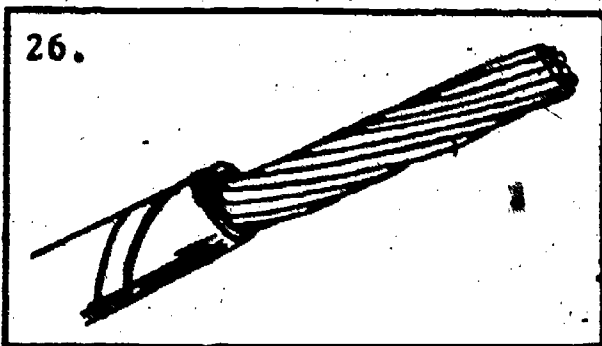
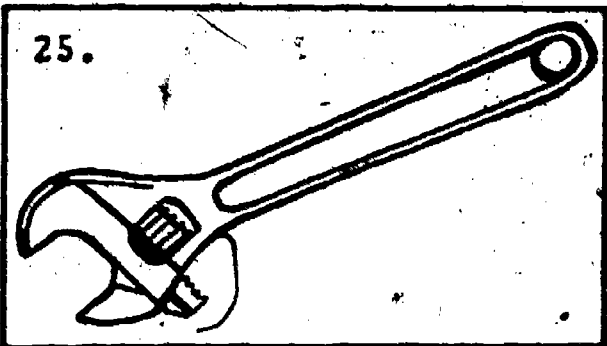

25.

26.

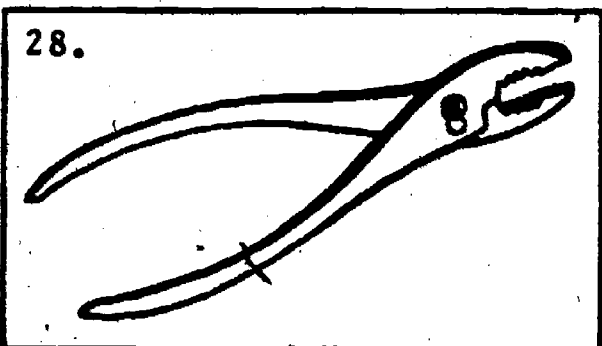
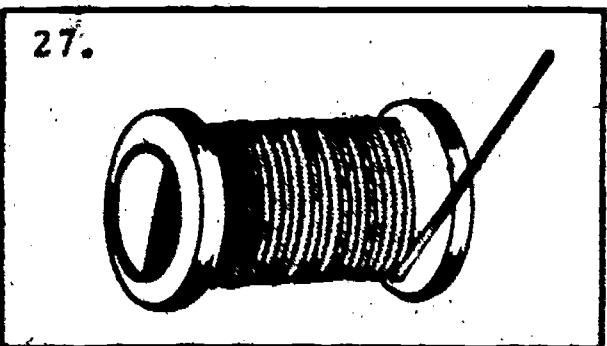

27.

28.

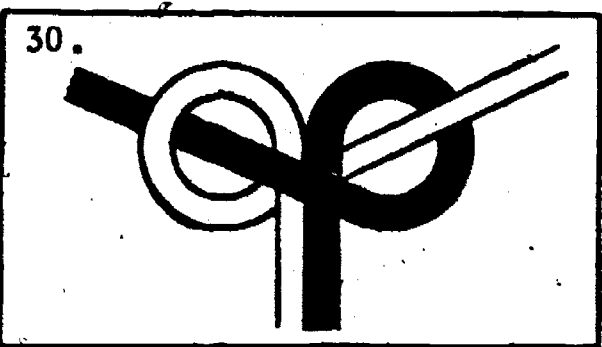
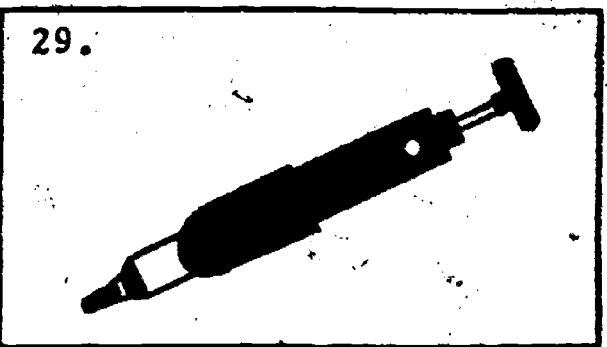

29.

30.

SCORE:

GRADE:

Name: _____

Date: _____

Period: _____

WORKSHEET

QUEST ACTIVITY

"UNIT 4"

GETTING ACQUAINTED WITH HAND TOOLS USED IN ELECTRONICS:

In this exercise you will draw a sketch of a number of basic electrical hand tools, write a simple statement about the tool's use, and list any safety precautions to observe when using the tool. To help in your work, if available, borrow the tool you are drawing from the tool cabinet and have it at your desk to handle and look at.

EXAMPLE:

A. Ball Peen Hammer

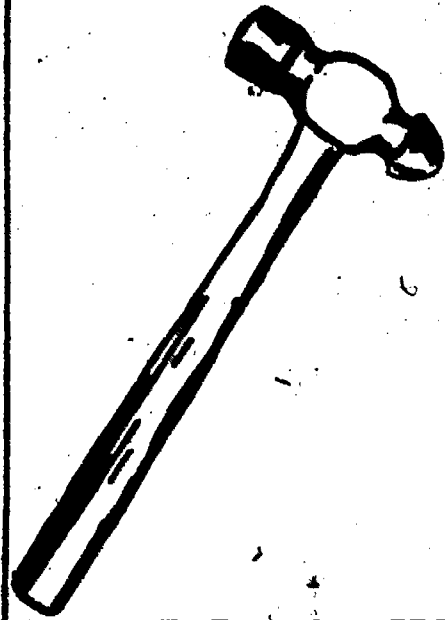

USE:

1. Hitting, striking, or forming metal.
2. Setting rivets

SAFETY:

1. Never hit two hammers together
2. Make sure handle is on tightly.
3. Do not put hammers on the edge of the table.
4. When hammering, hit away from other people.
5. Keep fingers away from the hitting area.

1. Standard Screw-Driver

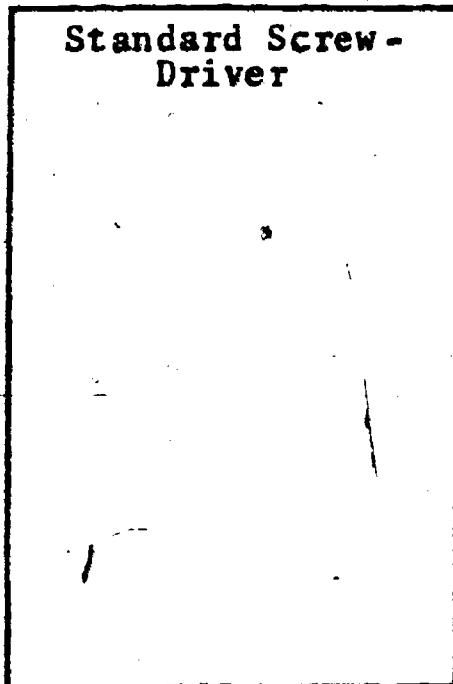

USE:

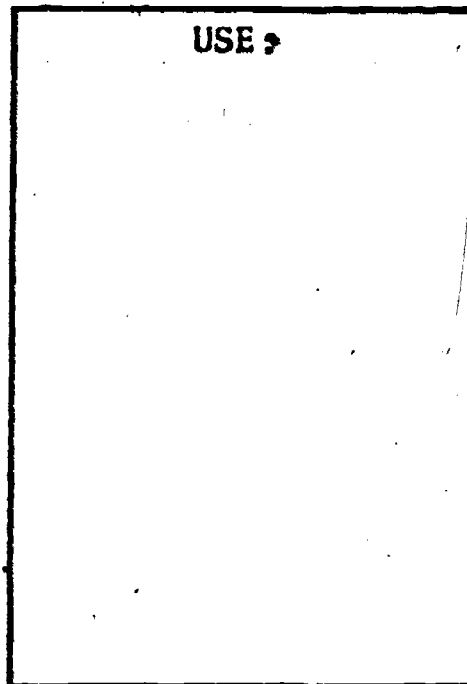

SAFETY:

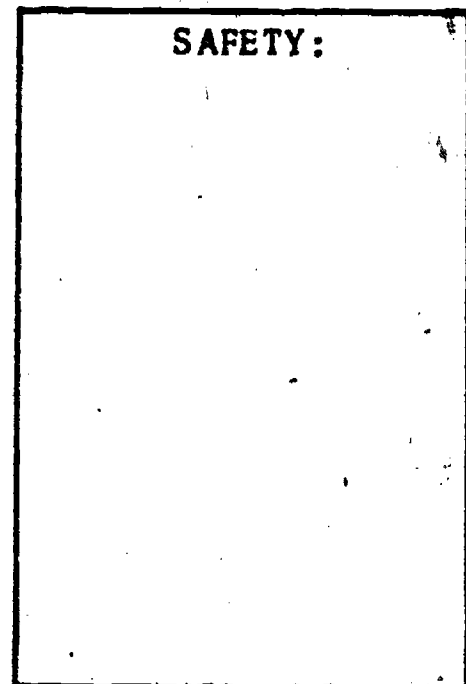

Name: _____

Date: _____

Period: _____

2. **Wire Stripper**

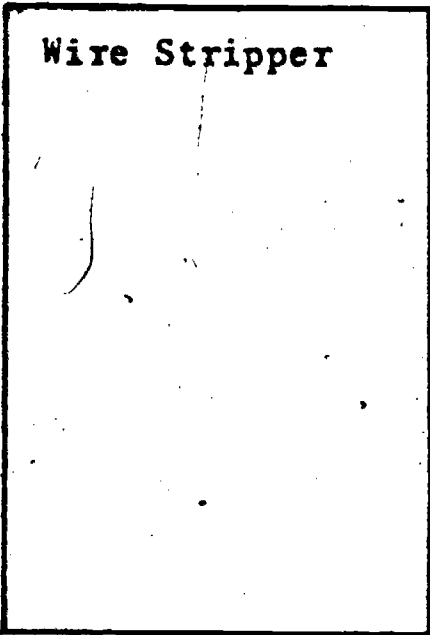

USE:

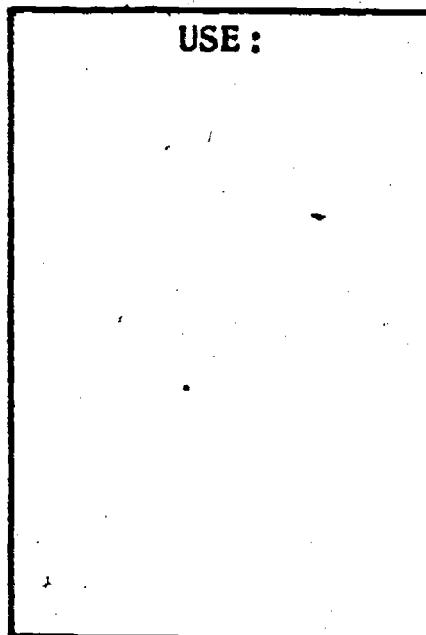

SAFETY:

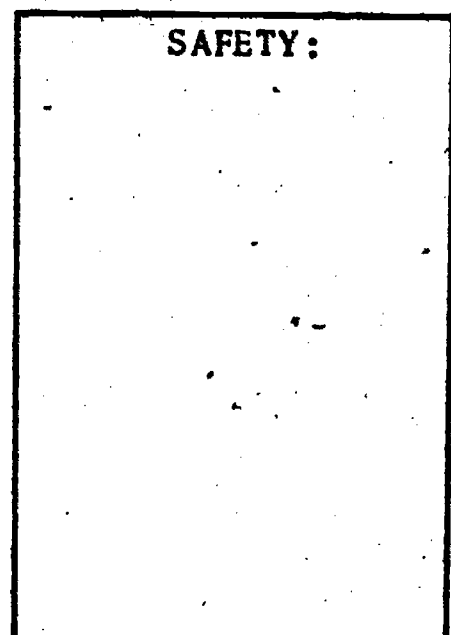

3. **Diagonal Cutting Pliers**

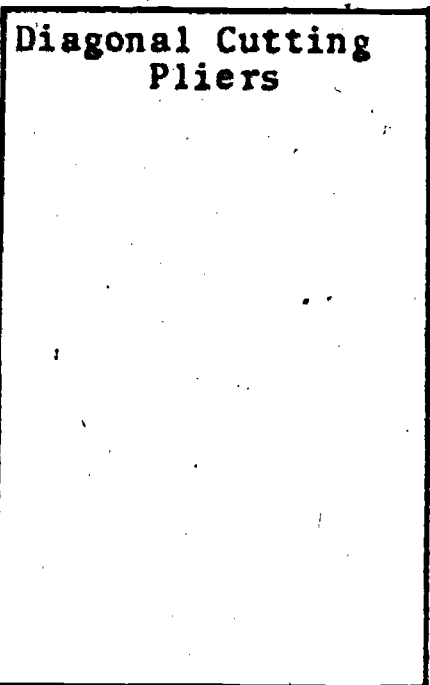

USE:

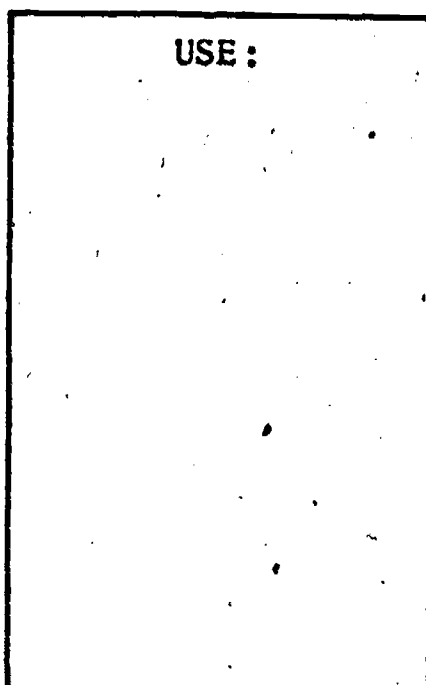

SAFETY:

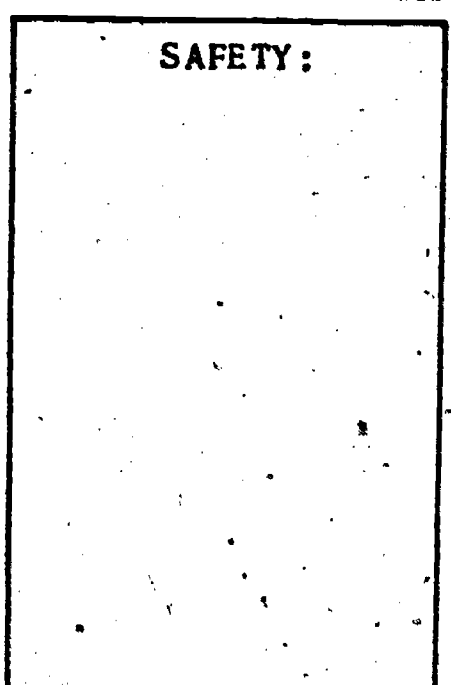

4. **Long Nose Pliers**

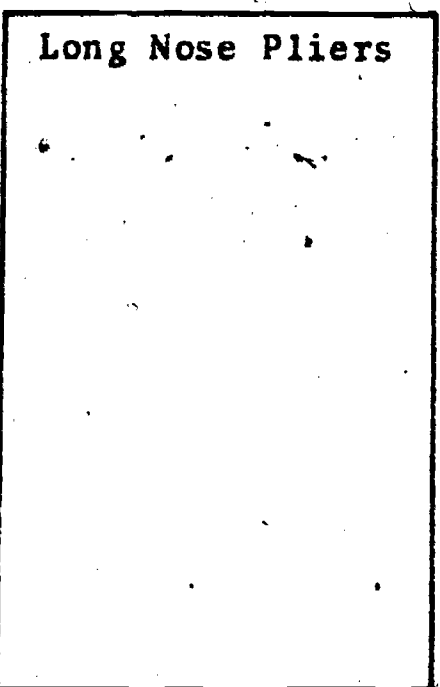

USE:

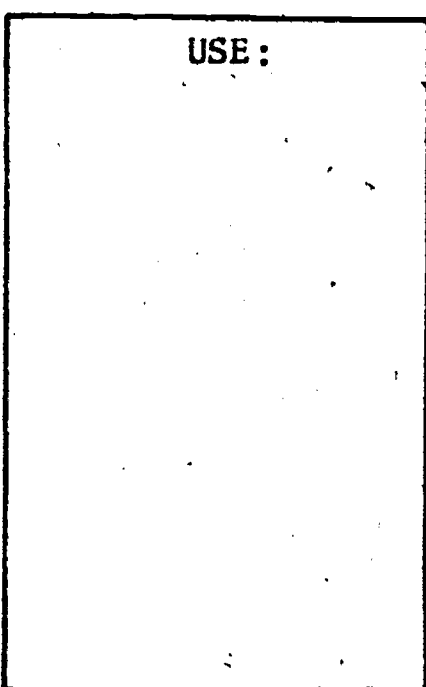

SAFETY:

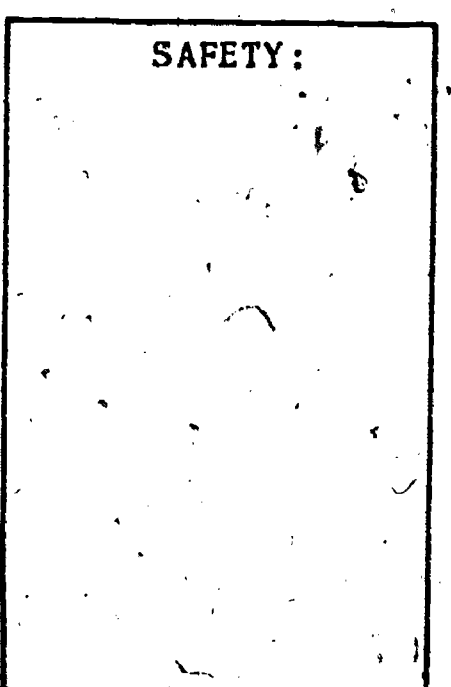

INFORMATIONAL HANDOUT

TOOLS AND EQUIPMENT I MAY NEED

The following tools, and materials are considered as "basic equipment" for building or repairing of electrical projects.

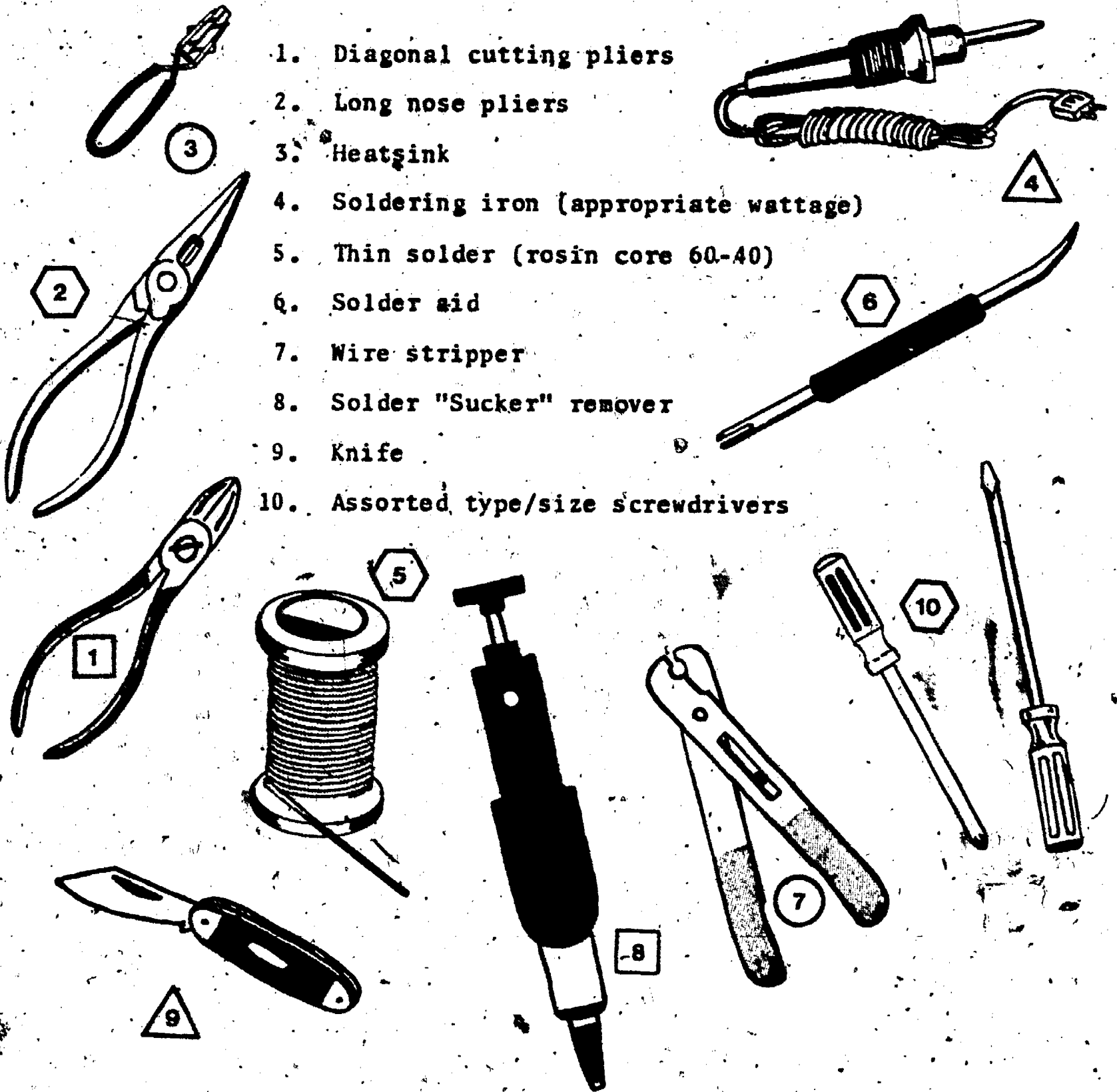

1. Diagonal cutting pliers
2. Long nose pliers
3. Heat sink
4. Soldering iron (appropriate wattage)
5. Thin solder (rosin core 60-40)
6. Solder aid
7. Wire stripper
8. Solder "Sucker" remover
9. Knife
10. Assorted type/size screwdrivers

Name: _____

Date: _____

Period: _____

The following items may be needed and should be available in your school laboratory:

- A. Portable Electric Drill and Bits
- B. Chassis Punch Set
- C. Slip Joint Pliers
- D. Hex Wrenches
- E. Assorted Miniature Files
- F. Nut Driver Set
- G. Scale or Ruler
- H. Vise
- I. Center Punch
- J. Tin Snips
- K. Reamer
- L. Sheetmetal Nibbler
- M. Adjustable Wrench

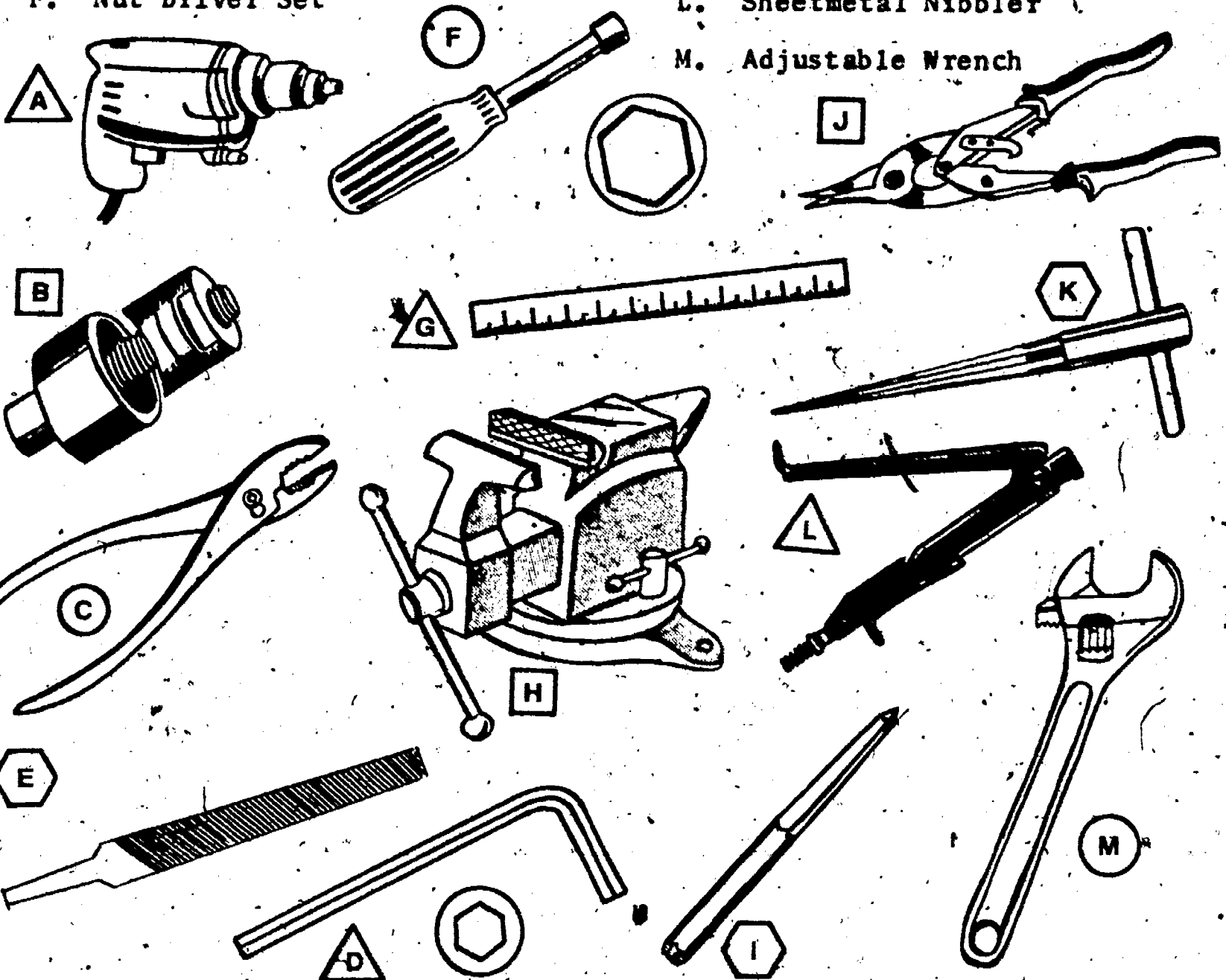

Remember, selecting the proper tools--using them wisely, often makes the difference between a rough, rancid, rookie job and a slick, super, professional one. Each tool works in its own special way so always select tools to fit the construction task.

Name: _____

Date: _____

Period: _____

INFORMATIONAL HANDOUT

WIRE: PURPOSE AND USE

PURPOSE -

insulation  wire

Wire is an important part of all electrical circuits and you should review some of the main factors to be considered when selecting or using wire.

A conductor (wire) provides the path or highway for the movement of electrons, and many times wire is covered with insulation to keep the electricity safely within the wire.

CONDUCTOR + INSULATOR = WIRE

CONDUCTOR - INSULATOR = BARE WIRE

Types of Wire -



Solid wire is usually made from one thick copper thread. It is easy to handle and to solder, yet, when a lot of movement is necessary this kind of wire should not be used. You can buy this wire in a variety of outside colors and sizes. Components like resistors, capacitors, inductors, and transformers have solid wires (leads) extending from the body of the device so that the component may be connected securely to the circuit.



USAGE EXAMPLE: Solid wire is used to complete electrical circuits in the walls of homes, schools and industries.

Stranded wire is made from a bunch or group of copper threads that have been twisted together to appear like one wire. When flexibility or movement is important this is the type of wire to use. Remember that you must really be careful when stripping this kind of wire or some of the strands will be broken. Stranded wire is generally tinned with solder before being connected to a circuit point.

USAGE EXAMPLE: Stranded wire is used in cables, appliances, and extension cords.

WIRE INSULATION -

PROTECTION

Most wires are covered by some kind of insulating material to prevent short circuits and dangerous accidents! Look at the various types of coverings used with each kind of wire on the following page.

Name: _____

Date: _____

Period: _____

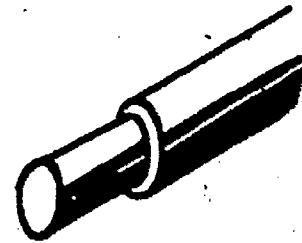
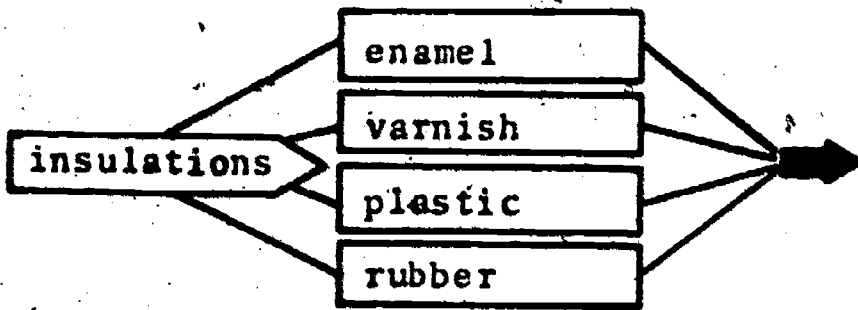

SOLID WIRE

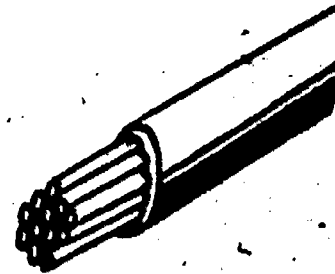
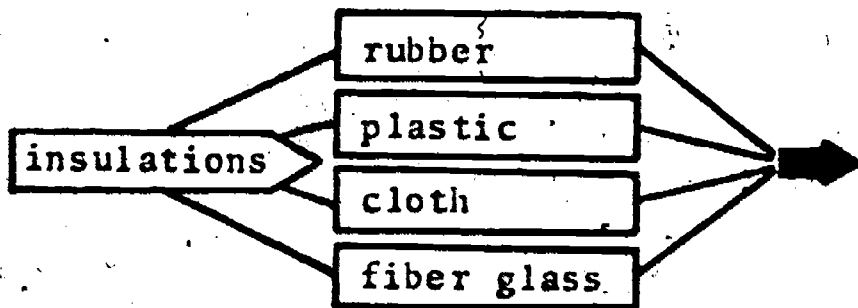

STRANDED WIRE

WIRE SIZES -



The American Wire Gauge (AWG) number is a system of describing by number, the size or electrical capacity of the wire. The larger the wire number, the smaller the diameter of the wire. Of course, it is important to select the proper size of wire for the job at hand.

NOTE: A wire gauge is a device that can be used to determine the size of wire.

SIZE EXAMPLE: A #20 wire can carry less electricity than a #10 wire because the #20 is physically smaller in size, hence less current can travel through this wire.

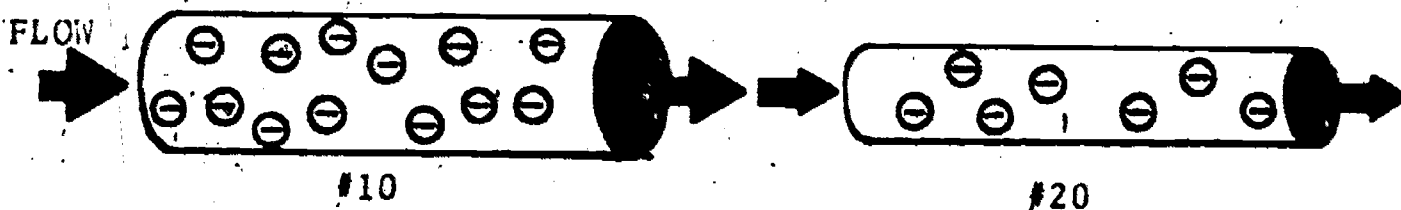

WIRE IN GENERAL

Most wire is now made from copper because it is such a good conductor of electricity and can be purchased at a fair price. Silver is rated as a better conductor, however, it is far more expensive which means increased cost, thus, it is seldom used by manufacturers.

COPPER

ALUMINUM

GOLD

Name: _____

Date: _____

Period: _____

INFORMATIONAL HANDOUT

WIRE TERMINATION METHODS

WIRE TERMINATION METHODS:

After routing a wire to a location in a project, how do you finally end or secure the wire connection? There are several approved methods, some of which are pictured below.

- ① Attach the wire directly to a pin or terminal LUG

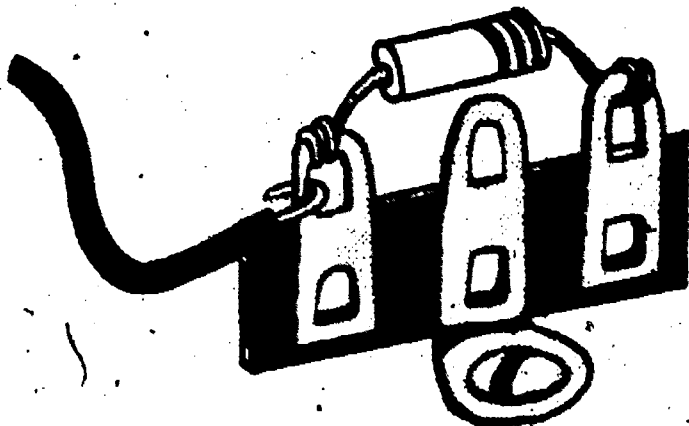

- ② Use a SPLICE to connect one wire to another. Splices are generally soldered and then insulated with black electrical tape.

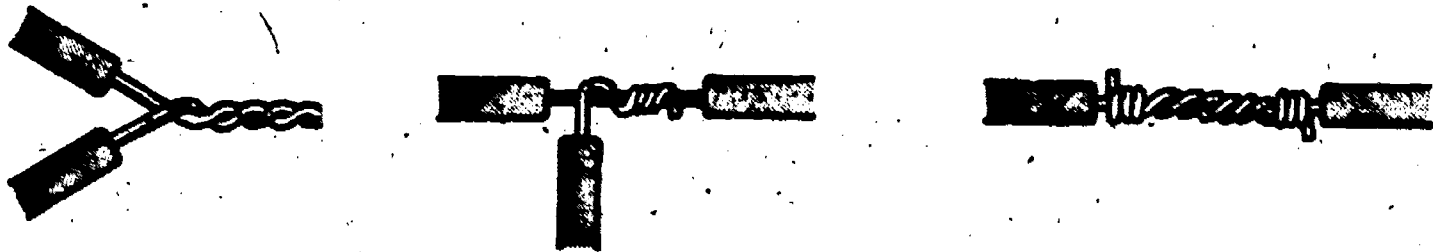

- ③ A WIRE NUT can be used to mechanically hold wires together. Soldering is not required.



Name: _____

Date: _____

Period: _____

- ④ Various types of **CRIMP OR SOLDERLESS TERMINALS** are available for connecting wires together, or attaching a cap or lug to the wire end.

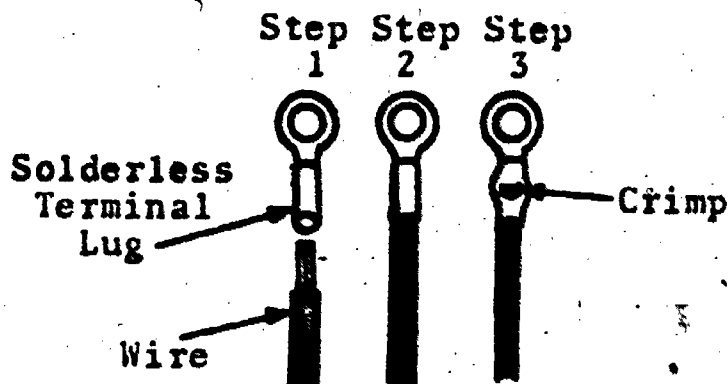

- ⑤ **SCREW TERMINALS** provide another method for securing a wire. Usually the wire is tinned, formed into a loop or hook, and placed under the head of the screw. The screw is tightened down completing the connection.

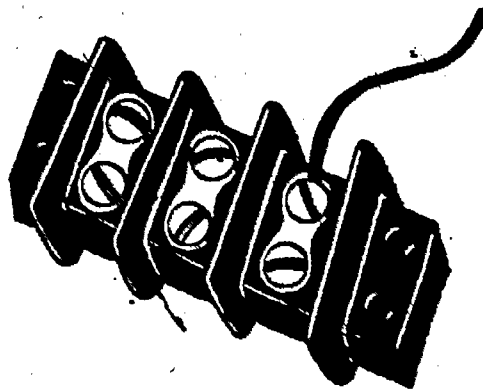

- ⑥ Many times, wires are attached to a **PLUG OR JACK CONNECTOR**. These devices allow the wire connection to be plugged together (joined) or pulled apart (disconnected).



↑
PLUG



↑
JACK

SCORE:
GRADE:

Name: _____
Date: _____
Period: _____

ANSWER SHEET

EXAM LI-U4

	T	F	A	B	C	D
1.						
2.						
3.						
4.						
5.						
6.						
7.						
8.						
9.						
10.						
11.						
12.						
13.						
14.						
15.						
16.						
17.						
18.						
19.						
20.						
21.						
22.						
23.						
24.						
25.						

	T	F	A	B	C	D
26.						
27.						
28.						
29.						
30.						
31.						
32.						
33.						
34.						
35.						
36.						
37.						
38.						
39.						
40.						
41.						
42.						
43.						
44.						
45.						
46.						
47.						
48.						
49.						
50.						

	T	F	A	B	C	D
51.						
52.						
53.						
54.						
55.						
56.						
57.						
58.						
59.						
60.						
61.						
62.						
63.						
64.						
65.						
66.						
67.						
68.						
69.						
70.						
71.						
72.						
73.						
74.						
75.						

	T	F	A	B	C	D
76.						
77.						
78.						
79.						
80.						
81.						
82.						
83.						
84.						
85.						
86.						
87.						
88.						
89.						
90.						
91.						
92.						
93.						
94.						
95.						
96.						
97.						
98.						
99.						
100.						

*Show work for problems on back of answer sheet.



A. TOOL AND MATERIAL
IDENTIFICATION

1. Rat-tail splice
2. center punch
3. long nose pliers
4. AC plug
5. solderless connector
6. heat sink
7. scale
8. portable electric drill
9. standard blade screwdriver
10. soldering iron
11. insulation
12. wire stripper
13. file
14. solder aid
15. chassis punch
16. reamer
17. diagonal cutting pliers
18. Allen wrench
19. nut driver
20. wire nut
21. bench vise
22. aviation shears
23. Phillips screwdriver
24. screw terminal (barrier strip)
25. adjustable wrench
26. stranded wire
27. solder
28. slip joint pliers
29. solder remover
30. Underwriters knot

B. QUEST ACTIVITY

(subjective evaluation)

ELECTRICITY / ELECTRONICS

CURRICULUM GUIDE INSTRUCTIONAL MODULE

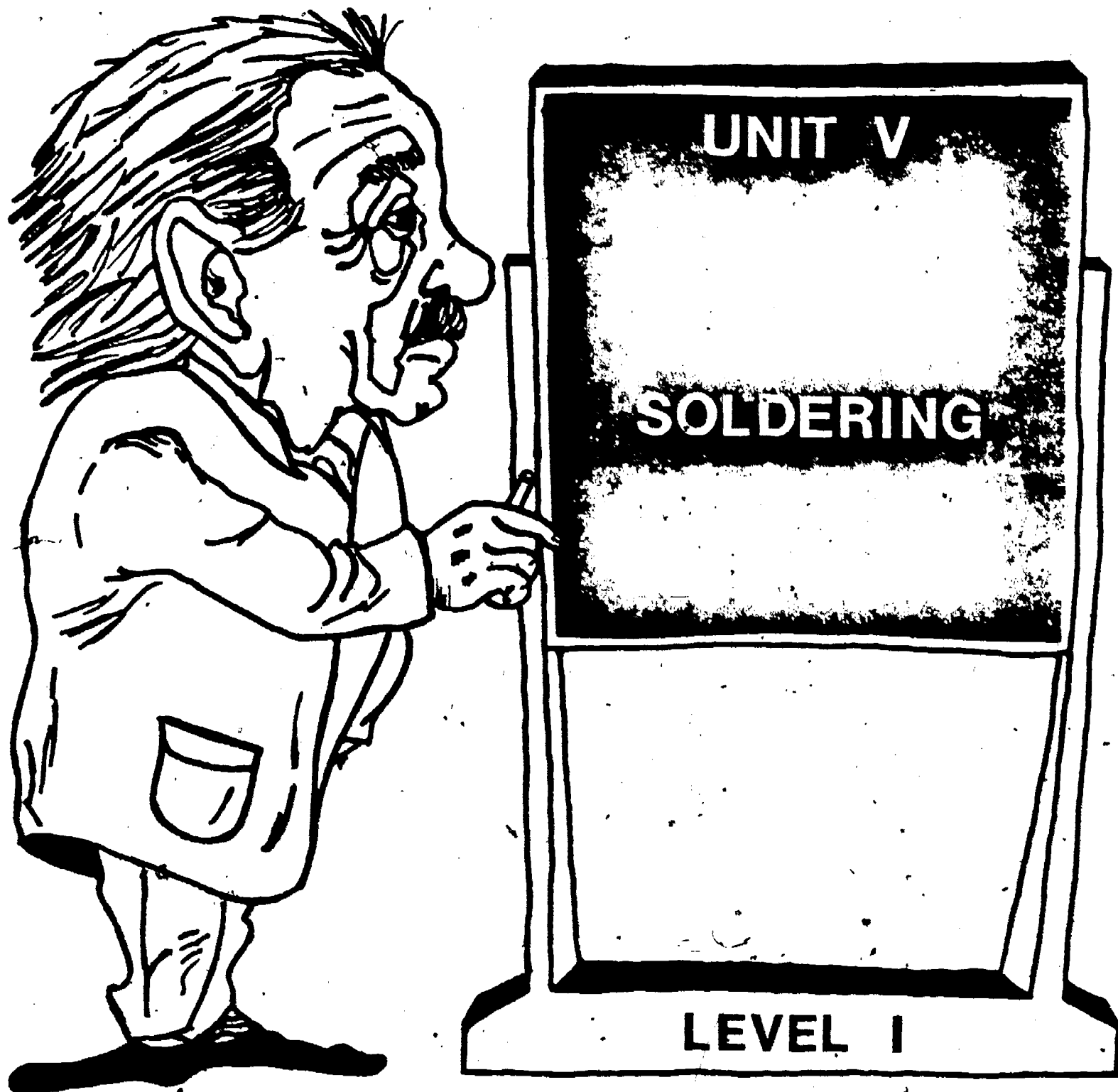

STATE OF CALIFORNIA
DEPARTMENT OF EDUCATION

NAME _____
DATE STARTED _____
DATE COMPLETED _____

BY
R. E. LILLO
N. S. SOFFIOTTO

STATE ELECTRICITY/ELECTRONICS CURRICULUM GUIDE
INSTRUCTOR'S GUIDE TO ACCOMPANY LEVEL I UNIT #5

Title of Unit: Soldering

Time Allocation: 2 week

Unit Goal:

To instill student confidence and competence in operating soldering devices, including knowledge related to the soldering process, wire preparation, solder, and soldering materials.

Unit Objectives:

The student will be able to:

1. describe the function, list safety precautions, and illustrate the correct use of each soldering device presented in this unit.
2. identify and demonstrate proper soldering techniques and methods of preparing wires for soldering.
3. explain the purpose of the following processes: soldering, tinning, mechanical connections and desoldering.

Evaluation:

The student will demonstrate his/her competence in terms of these measurable objectives based upon individual instructors acceptable performance criteria, which may utilize a combination of written, oral, and laboratory testing procedures.

Instructor References:

Electronics Assembly and Fabrication Methods. S.R. Duarte and R.C. Duarte, McGraw-Hill Book Co., 1973. Chapters: 1, and 5-10.

Electronic Techniques. R.S. Villanucci, A.W. Avtgis, and W.F. Megow, Prentice-Hall, Inc., 1974. Chapters: 3-16.

Understanding Electricity and Electronics. Peter Buban and Marshall E. Schmitt, McGraw-Hill Book Co., 1975. Units: 24-28.

Overview:

Like Unit 4 this unit will also allow the student to physically develop skills and/or competencies that will form a foundation for future mechanical and electrical assembly tasks.

Unit 5 is a fun kind of activity unit because it focuses on an aspect of training that is stimulating and fascinating to students.

Technical justification for the soldering process in electrical work along with the fundamental soldering definitions and basic techniques should be the initial topics for the presentation.

Next, safety must be (again emphasized as an on going process when working with tools and material.

The other major topics in this unit can be presented through laboratory demonstrations and activities. Remember, student expertise can be further enhanced by creating activities which are predicated on those competencies depicted in the unit outline.

Suggested Presentation Hints/Methodology:

Follow the instructional module unit outline as a basic skeleton for curriculum presentation, however, note the following:

1. It is recommended that from the outset the use of safety glasses be a mandatory procedure during the soldering process. A method for sanitizing and cleaning should be available in the shop and utilized when appropriate, or on a regular basis.
2. To save wear and tear on table tops or shop benches it is beneficial to invest in some small circular boards or the equivalent and use them when students are soldering or doing any construction work. This will protect the workbenches and leave the shop environment in a more positive condition. Accidents, burns, and scratches over the year can really destroy the furniture. It is also smart to make or purchase holders for the soldering irons to help reduce damage caused by a misplaced "hot" iron.
3. Check the cords on soldering irons frequently for burns and exposed conductors. It is common practice that students will inadvertently burn their own iron's cord and create a potentially dangerous situation. When purchasing a new soldering iron check to see if the cord can be replaced without physically having to splice the replacement line cord to the old cord.
4. One way to control solder is to hand it out in 6 inch pre-cut lengths. This should help reduce the overall consumption of this very expensive material.

Supplemental Activities and Demonstrations:

1. Many soldering demonstration charts are available free, so check around and pick several up. Mount these charts strategically around the classroom for student use.
2. When instructing or demonstrating desoldering techniques it is usually easy to procure old printed circuit boards which are loaded with components. Have students remove parts in an effort to develop their proficiency.
3. If available, demonstrate the use of other kinds of soldering devices. Do not overlook aids, solder suckers, heat sinks, and other support materials.
4. If student soldering exercises are the activity of the day be sure to walk around and examine student work and the general order in which it is being accomplished.

Instructional Module Contents:

1. Unit Outline (overhead)
2. Pre-Post Test (keyed)
3. Technical Glossary
4. Worksheet (vocabulary) - Word Decoding
5. Quest Activities
6. Informational Handout (A Four Step Guide to Soldering)
7. Informational Handout (Electrical Connections)
8. Unit Module Answer Keys

V. Soldering

A. Function--the Solder Bond

B. Solder and Solder Flux

C. Soldering Devices and Aids

D. Wire Preparation for Soldering

E. Soldering Wires to Lugs, Terminals,
and Other Wire

F. Project Construction

LI-US

UNIT EXAM

SOLDERING

IMPORTANT-

Indicate your responses on the answer sheet only. Fill in the box corresponding to the correct answer to each question - there is only one correct answer for each question.

1. The type of solder used in electronic project construction is called 60/40 rosin core solder. (T-F)
2. A dull-colored, rough solder joint is acceptable as long as enough solder is used. (T-F)
3. A wire being soldered to a lug is usually first loosely fastened to the lug to hold it in place. (T-F)
4. Do not move or handle a newly soldered wire until the solder has completely hardened. (T-F)
5. The job of removing solder from a connection is done with a desoldering tool. (T-F)
6. Solder is a mixture of tin and flux. (T-F)
7. The process of coating a wire, terminal, or soldering iron tip with a thin layer of solder is called _____.
8. Solder used for electronic work usually contains one or more cores of _____ flux, which helps to clean the connection.
9. Joining together (twisting) two or more wires to form a permanent connection is called a _____.
10. When soldering parts which are easily damaged by heat, a tool called a _____ should be used.

Name: _____

Date: _____

Period: _____

TECHNICAL GLOSSARY

- CONDUCTOR JOINT:** A method for connecting or attaching two or more wires together. A satisfactory conductor joint must be 1) mechanically secure - wires tightly twisted together, 2) electrically secure - the connection must freely pass electricity, and 3) covered with an approved insulation.
- DESOLDERING TOOL:** A device used to remove molten solder from a wire or connection. Most desoldering tools draw the molten solder from the connection with a vacuum or suction force.
- ELECTRICAL TAPE:** A black vinyl insulating tape used to cover exposed conductor joints.
- FLUX:** A chemical used when preparing wires to be soldered. Flux helps remove dirt and oxides which aids in making a good solder joint. For electrical work use only rosin flux, which is available as a paste, or as a core in the solder itself.
- MECHANICAL CONNECTION:** The process of attaching wires to terminals, or another wire, by twisting or bending them so that the connection remains snug even though it is not soldered.
- SOLDER:** A mixture of tin and lead which is melted into an electrical connection to increase electrical contact, improve mechanical strength and to protect against oxidation. Solder used for electrical work is known as 60/40 rosin core. That is: 60% tin and 40% lead with a core of rosin.
- SOLDER JOINT:** The process of cleaning, heating, and properly applying solder to a connection, splice, or joint.
- SOLDERING IRON:** A tool, with a heated tip, used to heat a connection for soldering. The style of iron used for general electronic work is called a "pencil" iron and has a rating between 25 and 40 watts.
- SPLICE:** A method for connecting two or more wires together. Example. Tap splice, Rat-tail splice, or Western Union splice.
- TINNING:** The process of cleaning and coating with solder. Tinning is usually thought of as the job of preparing the heated tip of a soldering iron, but wires, terminals, and part leads are often tinned before making an electrical connection.

SCORE: _____
 GRADE: _____

Name: _____

Date: _____

Period: _____

WORKSHEET

VOCABULARY - WORD DECODING

The words below have little meaning until they are decoded. Each letter actually stands for another letter in the alphabet. Your task is to break the code and decode each word. The example will get you started. The code will be the same throughout the worksheet.

EXAMPLE:

A. H Q G U A X O
 P R O J E C T

A.

1. P H S V X A
 - - - - -

1.

2. P G S W A Q
 - - - - -

2.

3. O V F F V F C
 - - - - -

3.

4. Q G P V F
 - - - - -

4.

5. P G S W A Q U G V F O
 - - - - -

5.

6. X G F W I X O G Q U G V F O
 - - - - -

6.

7. A S A X O Q V X Z S O Z H A
 - - - - -

7.

8. P G S W A Q V F C V Q G F
 - - - - -

8.

9. W A P G S W A Q V F C O G G S
 - - - - -

9.

10. E A X D Z F V X Z S X G F F A X O V G F
 - - - - -

10.

SCORE:

GRADE:

Name: _____

Date: _____

Period: _____

WORKSHEET

QUEST ACTIVITY

"UNIT 5"

In this activity, you will be able to try your hand at making three basic electrical splices - the rat-tail splice, tap splice, and Western Union splice. Obtain the materials listed below, and use your informational handout as a guide to complete a sample of each type of splice. Mount your completed splice in the areas provided, and turn in the assignment for grading.

MATERIALS REQUIRED:

- Safety glasses
- Soldering iron
- Solder 60/40
- 6 pieces of #14-18 gauge insulated wire 5" long
- Required hand tools

① RAT-TAIL SPLICE

1. Obtain safety glasses.
2. Plug in iron and tin tip as directed.
3. Obtain 2 pieces of solid wire about 5 inches long.
4. Remove about 1 inch insulation from one end of each wire.
5. With the right hand, twist these ends tightly around each other as demonstrated.
6. Finish the splice by cutting off the ends with the lineman's pliers.
7. Solder exposed twisted wire to a shiny finish.
8. Seek instructor's approval and then attach to sheet.

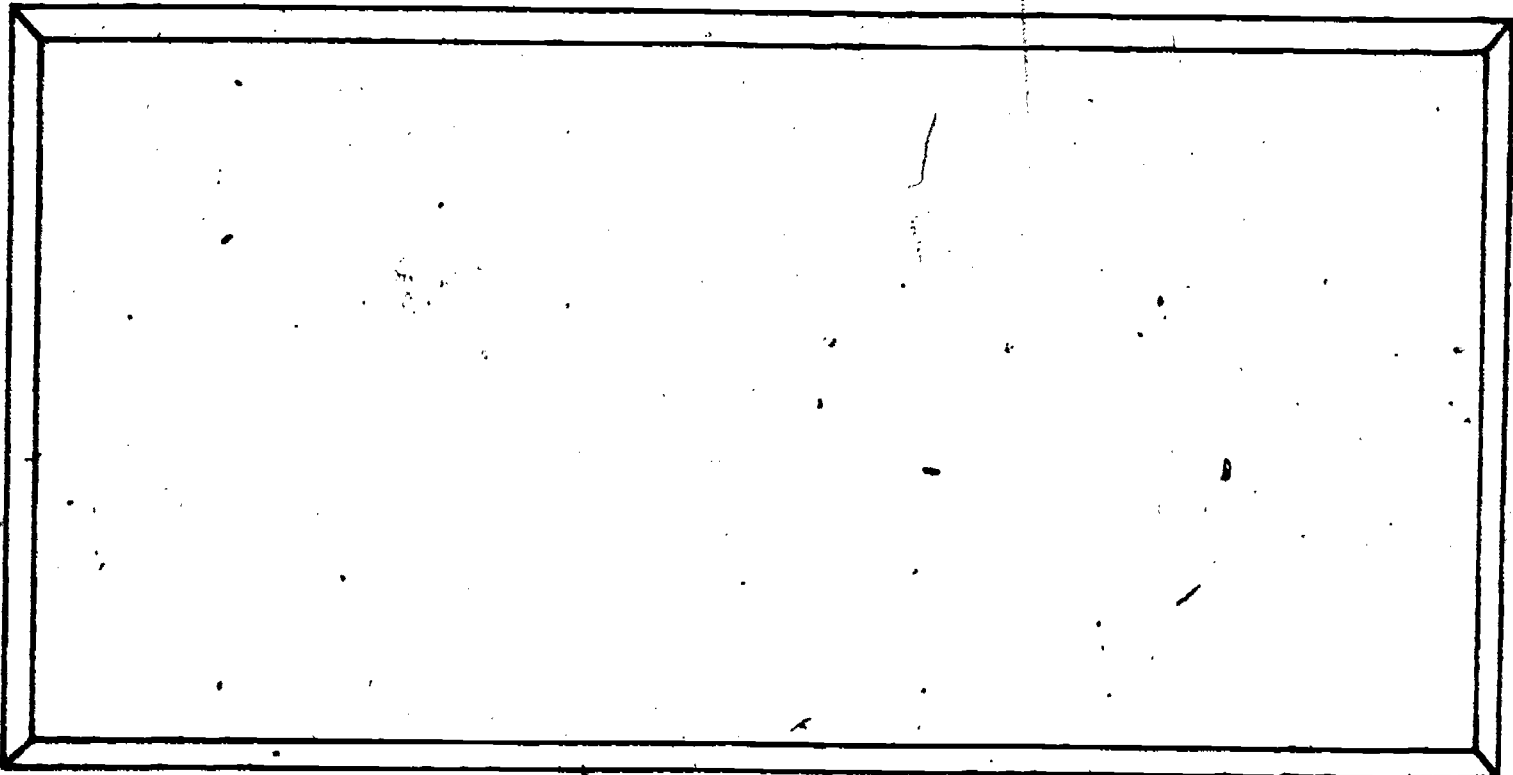

RAT-TAIL SPLICE

Name: _____

Date: _____

Period: _____

② TAP-SPLICE

1. Obtain safety glasses.
2. Plug in iron and tin tip as directed.
3. Obtain two pieces of solid wire about 5" long.
4. Remove about 3" of insulated covering from the end of the tap wire.
5. Remove about 1" of insulation from the middle of the main wire where the branch splice is to be attached.
6. Wrap the tap wire around the main as directed by instructor
7. Make two long turns and four short turns with tap wire.
8. Cut off the extra wire, and solder. Seek instructor's approval and attach to this lab.

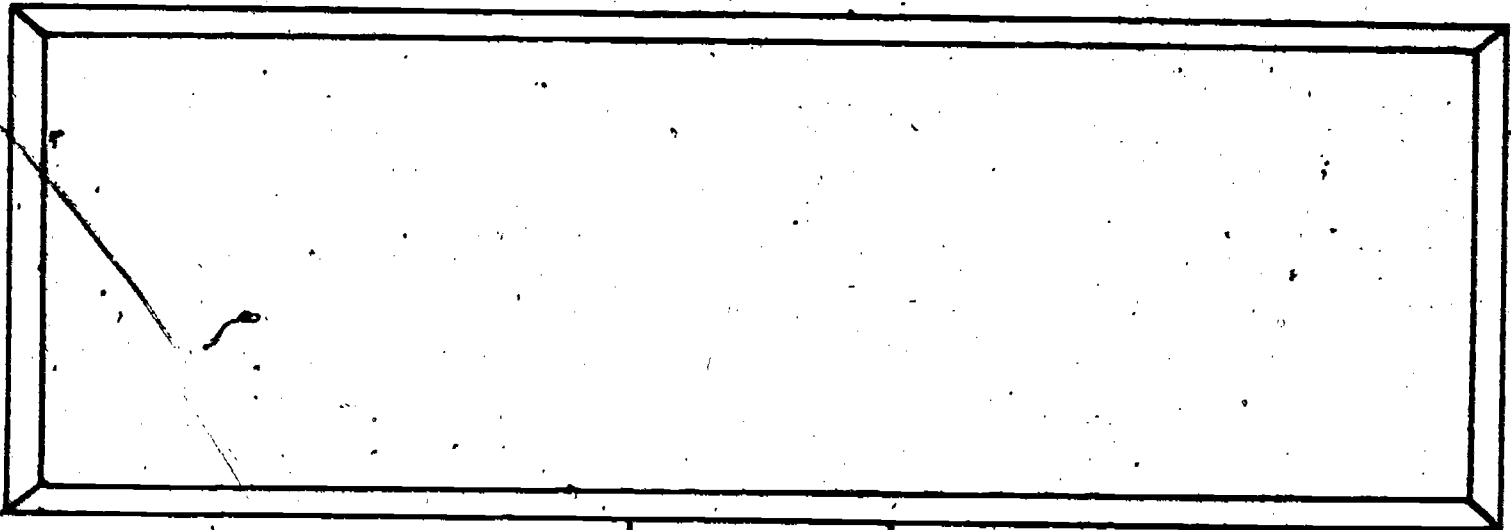

TAP-SPLICE

③ WESTERN UNION SPLICE

1. Obtain safety glasses.
2. Plug in iron and tin tip as directed.
3. Obtain 2 pieces of solid wire about 5" long.
4. Remove 2" of insulation on each wire.
5. Cross the wires at their middle then twist the ends in opposite directions 3 to 4 times.
6. Twist each end sharply, at right angles to the run on the splice, and wind 3 full turns.
7. Cut off the excess ends and solder.
8. Seek instructor's approval and attach to this lab.

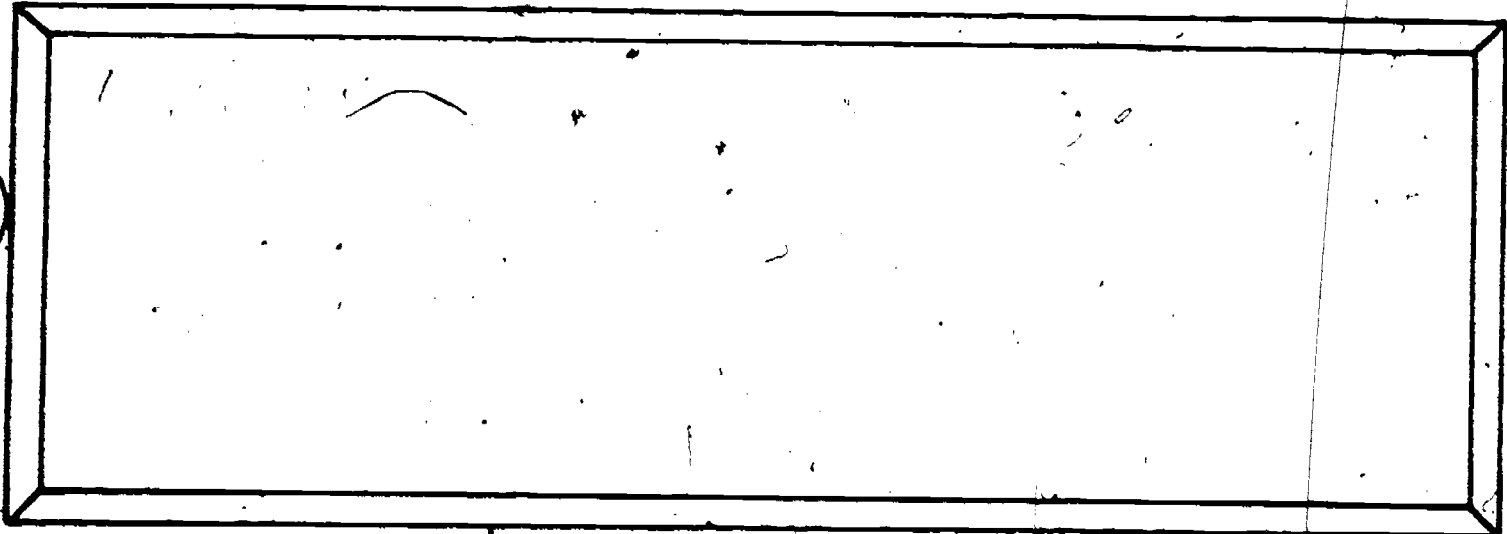

WESTERN UNION SPLICE

Name: _____
 Date: _____
 Period: _____

INFORMATIONAL HANDOUT

A 4 STEP GUIDE TO SOLDERING

INTRODUCTION: What is soldering?

In all Electricity/Electronics work, high quality soldering connections are important. Soldering allows the joining together, both mechanically and electrically, of metal objects (wires, component leads, etc.) using a material called solder and a heating device called a soldering-iron.

SKILL

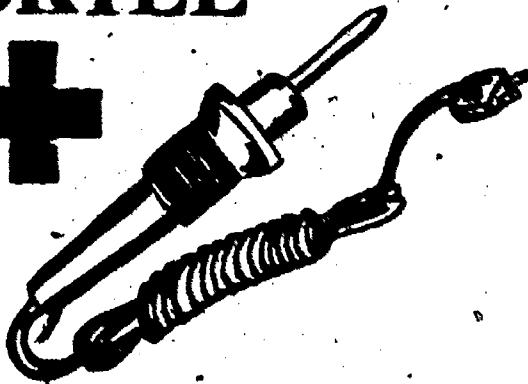

Soldering Iron



Solder

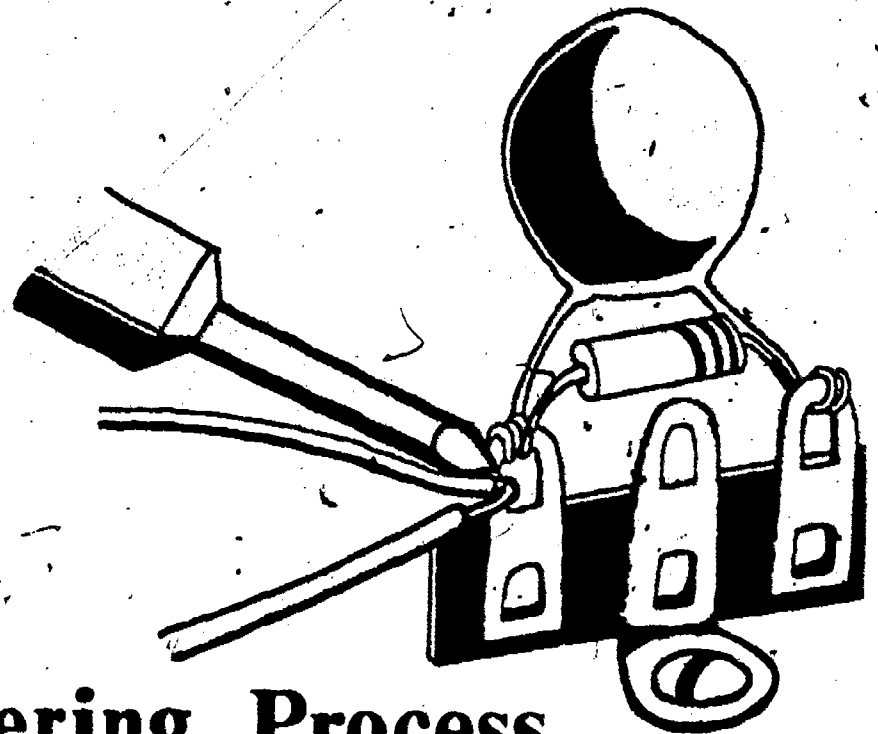
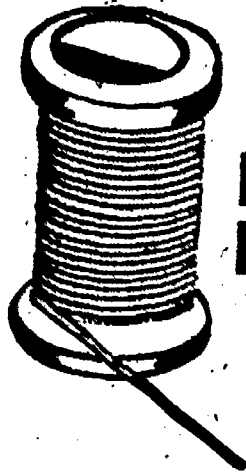

Soldering Process

Many times soldering is required to make sure that an electrical connection will last for a long time. Proper soldering will also

● Prevent corrosion

● Add strength

Name: _____

Date: _____

Period: _____

(SOLDERING ERROR)

(REMEDY)

- Not enough solder used → Apply more solder
- Too much solder used → Remove excess and reflow
- Improper heat application (cold solder joint) → Reheat and remove solder, then reflow

Desoldering Process:

Sometime you will have to remove soldered wires or parts from a project or mounting lugs or terminals, to do this the components must first be desoldered. Desoldering is basically the reverse of the soldering process. Study the list below of the steps that you should follow each time you desolder.

Obtain tools and materials
Plug iron in and clean tip
Tin the tip
Keep tip damp with sponge
Grasp wire or lead
Apply heat
Apply pressure / use solder removing tool
Remove part
Visual check/clean-up

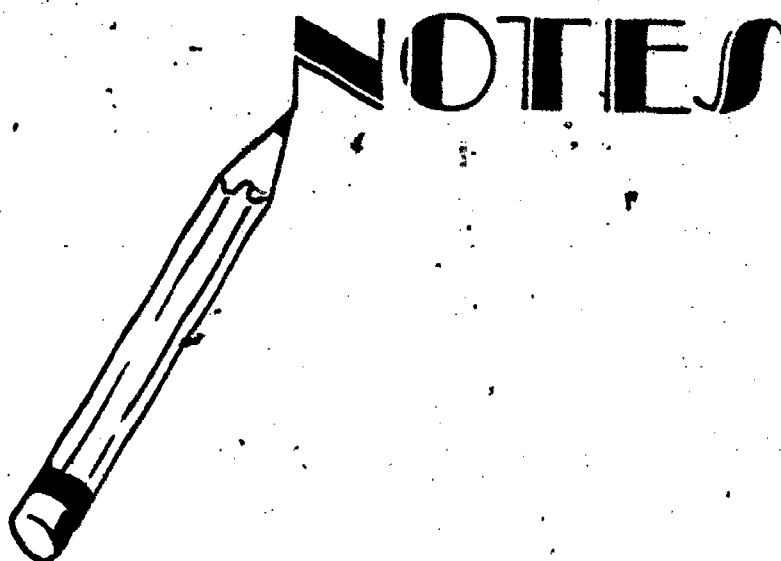

SAFETY

When "resting" a soldering iron always use a soldering iron holder or stand.

Always hold a soldering iron by its handle and when reaching for it be alert and never accidentally grab the "hot" tip.

Do not splash hot solder around by shaking the iron when soldering or desoldering.

Name: _____

Date: _____

Period: _____

① Selecting Soldering Tools and Materials:

Always use the correct tools and materials to complete the task; and remember, proper use of tools and materials will increase your skill and the quality of your work. Check the following list when preparing to solder.

- | | |
|--------------------------|--|
| <input type="checkbox"/> | Safety glasses |
| <input type="checkbox"/> | Proper wattage (heat) soldering iron and tip |
| <input type="checkbox"/> | Rosin core solder - 60/40 |
| <input type="checkbox"/> | Solder aid |
| <input type="checkbox"/> | Solder remover tool/braid |
| <input type="checkbox"/> | Damp sponge |
| <input type="checkbox"/> | Misc. hand tools |
| <input type="checkbox"/> | Vise |

② Soldering Procedures:

Correct soldering requires the learning of a skill, and the best way to learn a skill is to practice. Study the list below of the steps that you should follow each time it is necessary to solder.

Obtain tools and materials
Plug iron in and clean tip
Tin the tip
Prepare parts to be soldered
Make mechanical connection
Protect heat sensitive parts
Apply solder
Don't move parts
Visual check/>>

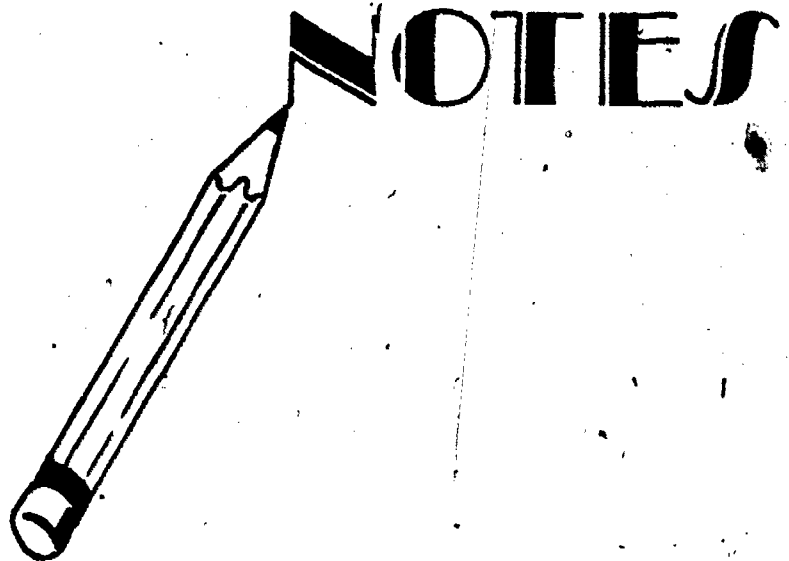

③ Inspection:

Check your work immediately after the solder hardens to avoid making a poor soldering connection. Poor connections are generally caused by "three" specific problems. However, you can fix each of these problems by applying the remedies on the next page.

Name: _____

Date: _____

Period: _____

INFORMATIONAL HANDOUT

ELECTRICAL CONNECTIONS



Electrical connections and electrical circuits must be reliable. Therefore, the individual who is wiring and soldering must be skillful. These sheets will help you master some basic wiring techniques, but remember it takes a great deal of practice to learn a skill, so lets get started!

Note, splices are hand-formed wire connections. The three most commonly used splices are the; Rat-Tail, Tap or Tee, and the Western Union.

3

Common Splices

Rat-Tail:

This splice is generally used where two or more wires are to be joined together. The Rat-Tail joint is commonly used in an electrical junction box, like the ones in your home. This splice should be soldered and taped, or a solderless connector (wire nut) used, before the box cover is replaced. Note, if wire sizes below AWG 14 are used the splice can no longer be formed by hand. Use pliers for twisting and be careful not to damage the wires. Follow the examples below when making this splice.

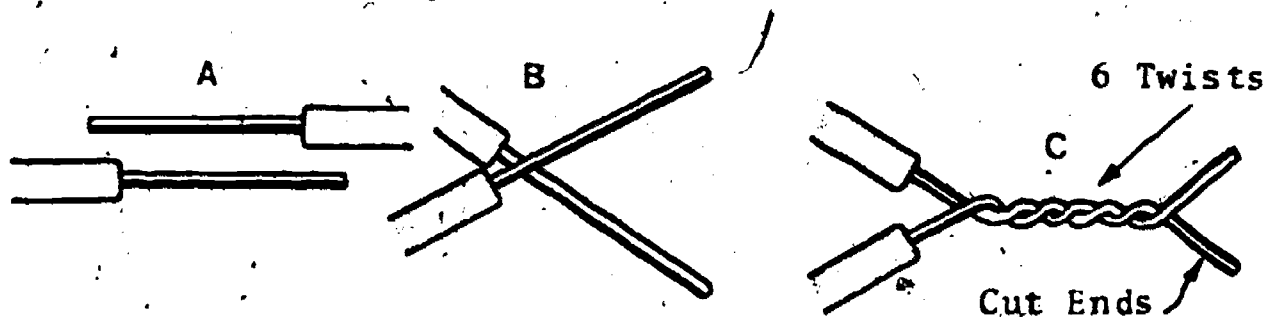

Tap or Tee:

.....then solder and tape.

This splice is also used in home electrical wiring circuits. The Tap splice is used when you want to connect a branch conductor to a main wire or conductor. The advantage of this splice is that the main wire is not

Name: _____

Date: _____

Period: _____

cut, just stripped where the branch wire is joined. This splice should be soldered and taped. Follow the examples given when making this splice.

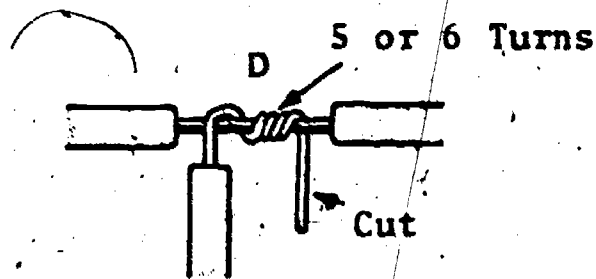
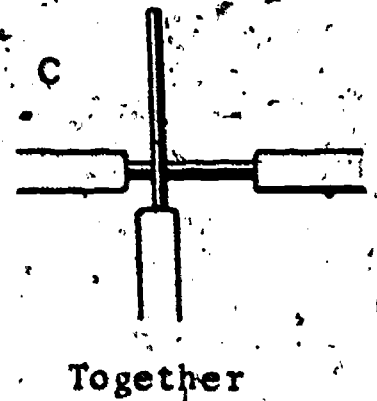
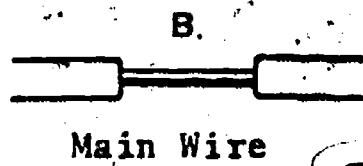
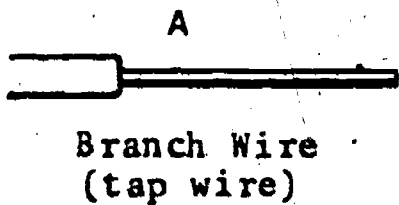

.....then solder and tape.

Western Union:

This splice is the strongest of the three connections shown here, and the most interesting one to make. It is used for splicing a broken/cut wire in a long wire or to extend a wire a few more feet if it is short. This splice should be soldered and taped when completed. This splice has an interesting piece of history attached to its name. When the Western Union Telegraph Company had problems with breaks in telegraphic wires their workers would use this splice to repair the wire. Follow the examples given when making this splice.

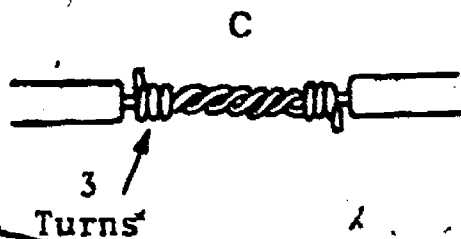
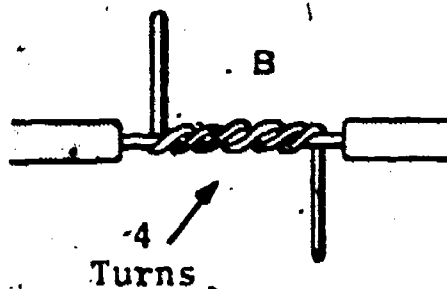
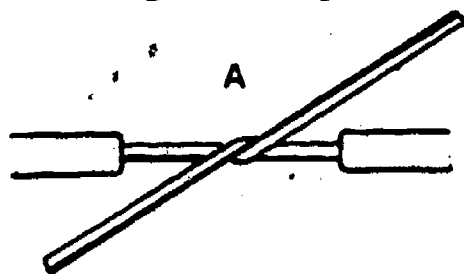

.....then solder and tape.

SCORE:
GRADE:

Name: _____
Date: _____
Period: _____

ANSWER SHEET

EXAM LI-U5

	T	F	A	B	C	D
1.	■					
2.		■				
3.		■				
4.	■					
5.	■					
6.		■				
7.			tin	ning		
8.			rosin			
9.			joint			
10.			heat	sink		
11.						
12.						
13.						
14.						
15.						
16.						
17.						
18.						
19.						
20.						
21.						
22.						
23.						
24.						
25.						

	T	F	A	B	C	D
26.						
27.						
28.						
29.						
30.						
31.						
32.						
33.						
34.						
35.						
36.						
37.						
38.						
39.						
40.						
41.						
42.						
43.						
44.						
45.						
46.						
47.						
48.						
49.						
50.						

	T	F	A	B	C	D
51.						
52.						
53.						
54.						
55.						
56.						
57.						
58.						
59.						
60.						
61.						
62.						
63.						
64.						
65.						
66.						
67.						
68.						
69.						
70.						
71.						
72.						
73.						
74.						
75.						

	T	F	A	B	C	D
76.						
77.						
78.						
79.						
80.						
81.						
82.						
83.						
84.						
85.						
86.						
87.						
88.						
89.						
90.						
91.						
92.						
93.						
94.						
95.						
96.						
97.						
98.						
99.						
100.						

*Show work for problems on back of answer sheet.



A. WORD DECODING

1. splice
2. solder
3. tinning
4. rosin
5. solder joint
6. conductor joint
7. electrical tape
8. soldering iron
9. desoldering tool
10. mechanical connection

B. QUEST ACTIVITY

(subjective evaluation)

ELECTRICITY / ELECTRONICS

CURRICULUM GUIDE INSTRUCTIONAL MODULE

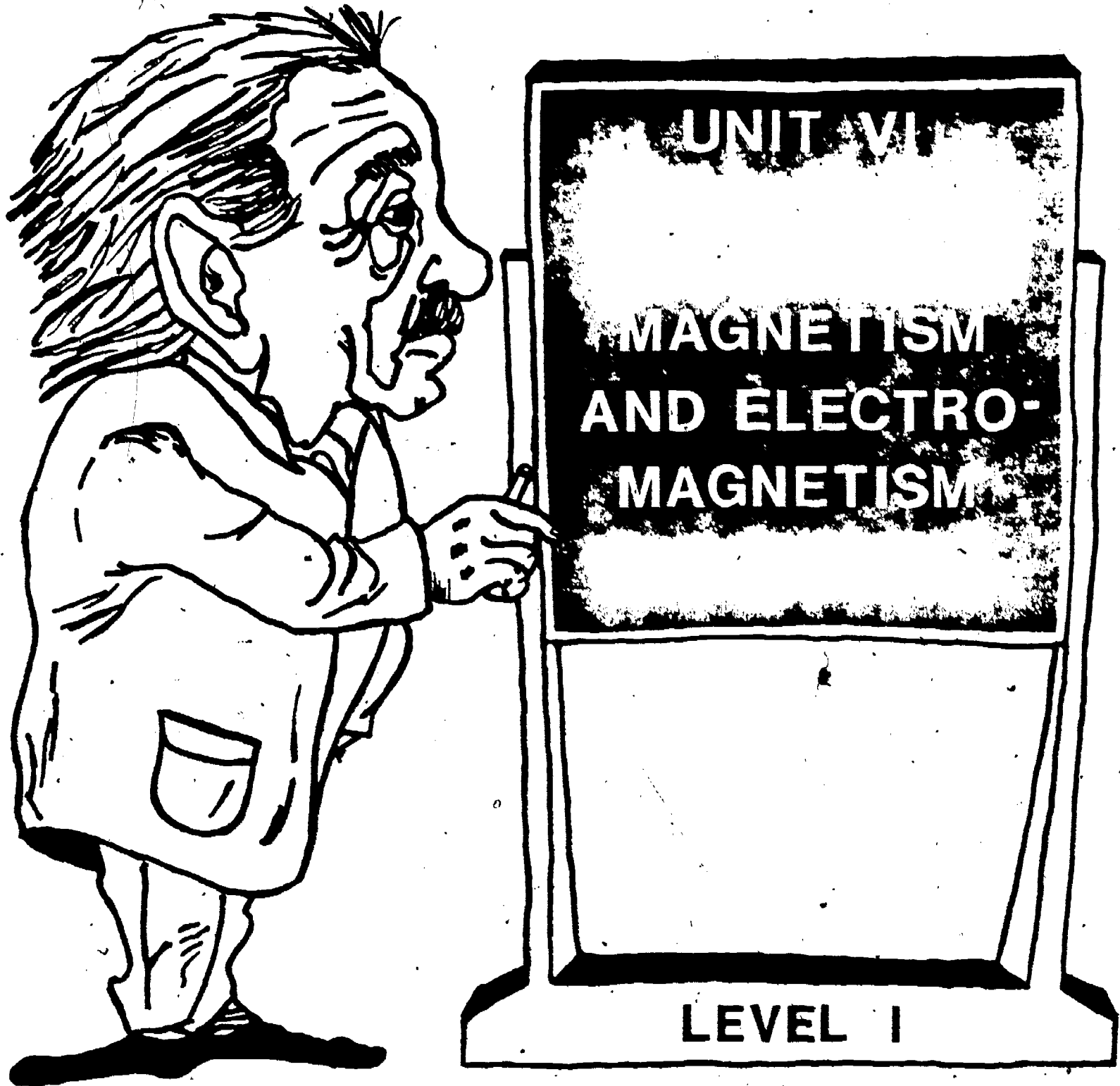

STATE OF CALIFORNIA
DEPARTMENT OF EDUCATION

NAME _____
DATE STARTED _____
DATE COMPLETED _____

BY
R. E. LILLO
N. S. SOFFIOTTO

Title of Unit: Magnetism and Electromagnetism

Time Allocation: 1 week

Unit Goal:

To broaden and impart student competence in terms of comprehending the basic effects, application, and influence that both magnetism and electromagnetism have on their daily living and lifestyles.

Unit Objectives:

The student will be able to:

1. write or recite an explanation describing the characteristics of the phenomenon referred to as magnetism and/or electromagnetism
2. identify and list several common devices or appliances that use the principle of magnetism or electromagnetism in their operation.
3. explain the basic laws of magnetism related to the poles of a magnet, and describe the three fundamental categories for classifying magnets.

Evaluation:

The student will demonstrate his/her competence in terms of these measurable objectives based upon individual instructors acceptable performance criteria, which may utilize a combination of written, oral, and laboratory testing procedures.

Instructor References:

Electricity and Electronics. Howard Gerrish and William Dugger, Goodheart-Willcox Co., 1978. Chapter: 4.

Industrial Arts Electricity. Clifford Lush and Glenn Engle, Chas. A Bennett Co., 1971. Chapter: 2 and 4.

Introduction to Electricity. Kurt Harding Schick, McGraw-Hill Ryerson Limited, 1975. Chapter: 2 and 9.

Overview:

Most students can identify some of the basic properties of magnets through their own personal experiences, hence the subject matter is not foreign and quite easy to introduce.

Stress that this topic has tremendous impact on the lives of each of us, and then trace the historical background of this topic prior to the technical presentation on types of magnets.

The next topic of emphasis should be the basic laws of magnetic attraction and repulsion, and while instructing in this area a discussion in reference to the Earth's magnetism would be appropriate.

Then Oersted's discovery is ideally suited as a point of origin for a discussion on electromagnetism.

Unit 6 should conclude with an emphasis on the uses or applications of both magnetism and electromagnetism in consumer products and in the generation of electricity.

Suggested Presentation Hints/Methodology:

Follow the instructional module unit outline as a basic skeleton for curriculum presentation, however, note the following:

1. When demonstrating magnetic lines or flux with a magnet and iron filings be careful not to use an excessively strong magnet. Too intense of a magnet will not perform adequately because it forces the filings into groups rather than a uniform pattern.
2. Try and create with the students an atmosphere of importance about the concept of electromagnetism so that they realize that this topic is one of the most vital to the modern electrical era. Stress that Oersted's discovery has made possible countless devices from electromagnets to motors.
3. Before a lecture presentation use this activity to generate some enthusiasm. Obtain a small, working, black and white TV and tune it for a local channel. Bring a strong electromagnet close to the front of the C.R.T. and let the class watch the picture distort. Discuss the implication of what has been observed.
4. If a school budget is available and financially sound, try and order a simple assemble-disassemble type kit which will illustrate to students some of the fundamentals of magnetism/ - electromagnetism.

Supplemental Activities and Demonstrations:

1. A natural for this unit would be to have students build a simple electric motor kit. This kind of motor is generally designed for beginning kit-builders and sold complete with a manual that includes information regarding the How and Why of its operation.
2. When demonstrating magnetic principles place a magnet or magnets on the stage plate of an overhead projector and then cover with a clear plastic sheet. Using a shaker, sprinkle some iron filings on top of the sheet, and discuss the pattern created. This can also provide an opportune time to discuss magnetic polarity and the basic law of magnetism.

Instructional Module Contents:

1. Unit Outline (overhead)
2. Pre-Post Test (keyed)
3. Technical Glossary
4. Worksheet (vocabulary) - Know Your Definitions
5. Quest Activities
6. Informational Handout (Classification of Magnets)
7. Informational Handout (Basic Law of Magnetism)
8. Unit Module Answer Keys

VI. Magnetism and Electromagnetism

A. Magnetic principles

B. Types of magnets

C. Electromagnets

D. Transformers

E. Project Construction

Name: _____

Date: _____

Period: _____

TECHNICAL GLOSSARY

- ATTRACT:** The action of drawing or pulling toward an object. For example; a magnet will attract a piece of soft iron.
- BASIC LAW OF MAGNETISM:** A law that explains the interaction of magnetic fields. The law states: Like poles repel and unlike poles attract.
- COMPASS:** A device which uses the earth's magnetic field, and a pivoted magnetic needle which will always point in a north direction.
- ELECTROMAGNET:** A coil of insulated wire wrapped around a soft iron core which becomes magnetic when electricity is forced through it. The strength of the electromagnet depends upon the amount of electricity flowing through the coil, the number of turns of wire in the coil, and the type of core used. If the electricity flowing through the wire is turned off, the magnetic field stops.
- FLUX LINES:** The lines of magnetic force which form around a magnet.
- KEEPER:** A piece of soft iron placed across the poles of a magnet to "hold" the magnetic field within the magnet, and to prevent demagnetizing.
- MAGNET:** A piece of iron, or a special material, which has an invisible force of attraction to materials such as iron, nickel, or cobalt.
- MAGNETIC FIELD:** The space around a magnet which is controlled by the magnet.
- MAGNETIC POLE:** The part of a magnet where the lines of force are the strongest. In every magnet there is one north-seeking pole (N-pole), and one south-seeking pole (S-pole).
- MAGNETISM:** The invisible force, produced by a magnet, that allows it to attract magnetic materials, and to attract or repel other magnets or magnetic fields.
- NATURAL MAGNET:** A material, such as "lodestone" or "magnetite," which in its natural state acts as a magnet.
- PERMANENT MAGNET:** A man-made magnet which when magnetized will keep its magnetism. Steel or alnico are examples of material which can be made into permanent magnets.
- REPEL:** The action of pushing away or forcing back of an object. A north pole of a magnet will repel the north pole of a second magnet.
- TEMPORARY MAGNET:** A man-made magnet that loses its magnetism soon after the magnetizing force is removed. Magnetized soft iron is an example of a temporary magnet.

LI-U6

UNIT EXAM

MAGNETS AND ELECTROMAGNETISM

IMPORTANT-

Indicate your responses on the answer sheet only. Fill in the box corresponding to the correct answer to each question - there is only one correct answer for each question.

1. A magnet will attract both iron and steel. (T-F)
2. A permanent magnet cannot be destroyed or weakened. (T-F)
3. As two magnets are moved apart, their force of attraction increases. (T-F)
4. Lodestone is a type of natural magnet. (T-F)
5. An electromagnet must have electricity flowing through it to produce a strong magnetic field. (T-F)
6. Around each magnet is:
(A) a negative charge, (B) current, (C) a voltage, (D) a magnetic field.
7. A magnet which keeps its magnetism for only a short time is:
(A) a permanent magnet, (B) made of soft iron, (C) a temporary magnet, (D) both B and C.
8. The basic law of magnetism says:
(A) unlike poles repel, (B) like poles repel, (C) two south poles attract, (D) like poles attract.
9. Which of the following operates by magnetism or magnetic force?
(A) electric motor, (B) electric buzzer, (C) electric bell, (D) all of the above.
10. Which pole of a magnet has the most magnetic strength?
(A) N-pole, (B) S-pole, (C) both poles have equal strength, (D) will vary from one magnet to the next.

SCORE :

GRADE :

Name: _____

Date: _____

Period: _____

WORKSHEET

VOCABULARY - KNOW YOUR DEFINITIONS

MATCHING

Match the words below with the statement having a similar meaning.

- 1. Lodestone
- 2. Compass
- 3. Repel
- 4. Attract
- 5. Magnetic Field
- 6. Temporary Magnet
- 7. Basic Law of Magnetism
- 8. Keeper
- 9. Magnetic Pole
- 10. Electromagnet
- 11. Permanent Magnet
- 12. Flux Lines

- A. A suspended magnetic needle which points north.
- B. The space around a magnet which contains the flux lines.
- C. Two N-Poles brought close together.
- D. Electromagnet or soft iron.
- E. A natural magnet.
- F. Unlike poles attract, like poles repel.
- G. One N-Pole and one S-Pole brought close together.
- H. A coil of wire, wound around an iron core which has electricity flowing through it.
- I. A piece of soft iron placed across the poles of a magnet.
- J. The invisible lines of magnetic force around a magnet.
- K. The part of a magnet having the strongest magnetic force.
- L. A man-made magnet which will keep its magnetism for many years.

- 1.
- 2.
- 3.
- 4.
- 5.
- 6.
- 7.
- 8.
- 9.
- 10.
- 11.
- 12.

EXTRA CHALLENGE:

Draw a sketch of the magnetic field which surrounds the bar magnet below.

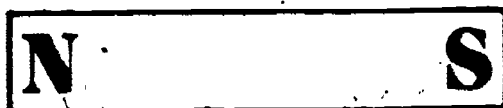

SCORE:
GRADE:

Name: _____
Date: _____
Period: _____

WORKSHEET
QUEST ACTIVITY
"UNIT 6"

Using the clues below, identify this outstanding individual. Your school library or just an Encyclopedia will help you solve the mystery.

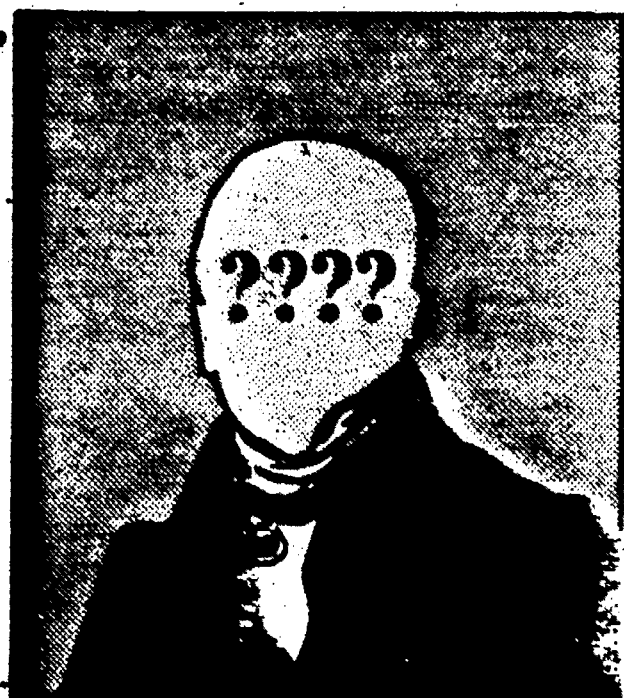

Fill in the names of the books used to solve this "Quest Activity":

1. _____
2. _____
3. _____

WHO AM I...

- Awarded the Copley Medal
- Born in 1777
- Physicist/Chemist
- Believed magnetism and electricity similar
- Helped establish the Royal Polytechnic Institute
- Discoverer of Electromagnetism
- Teacher
- Educated at University of Copenhagen, Denmark
- Discovered Aluminum
- Died in 1851

MY NAME IS...

Name: _____

Date: _____

Period: _____

INFORMATIONAL HANDOUT

CLASSIFICATION OF MAGNETS

Any magnet can be classified as either natural, temporary, or permanent. Carefully study the descriptions below.

NATURAL

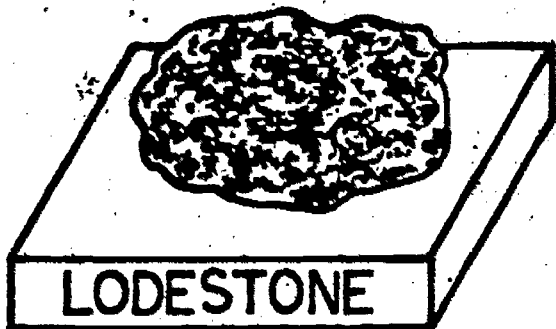

A natural magnet needs no special treatment by people to make it magnetic. Lodestone (or magnetite) is a natural magnet found on the earth. Especially large quantities can be found in the United States, however, these magnets are very weak and really serve little purpose in the modern world.

STEEL ALLOY MAGNET

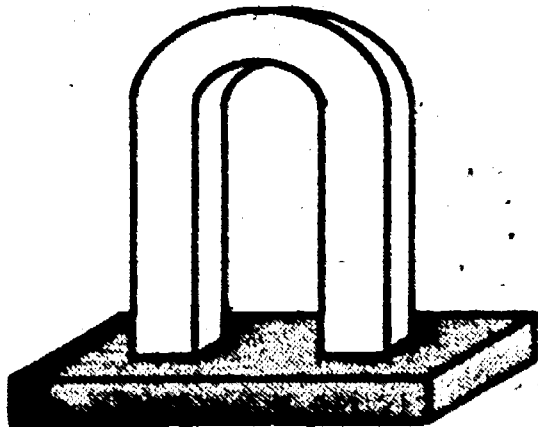

PERMANENT

A permanent magnet or man made magnet, keeps its magnetism for a long time. This type of magnet is produced from magnetic materials and can be made in many different shapes and sizes. They are used frequently in electrical appliances, hardware items, and compasses.

Name: _____

Date: _____

Period: _____

ELECTROMAGNET.

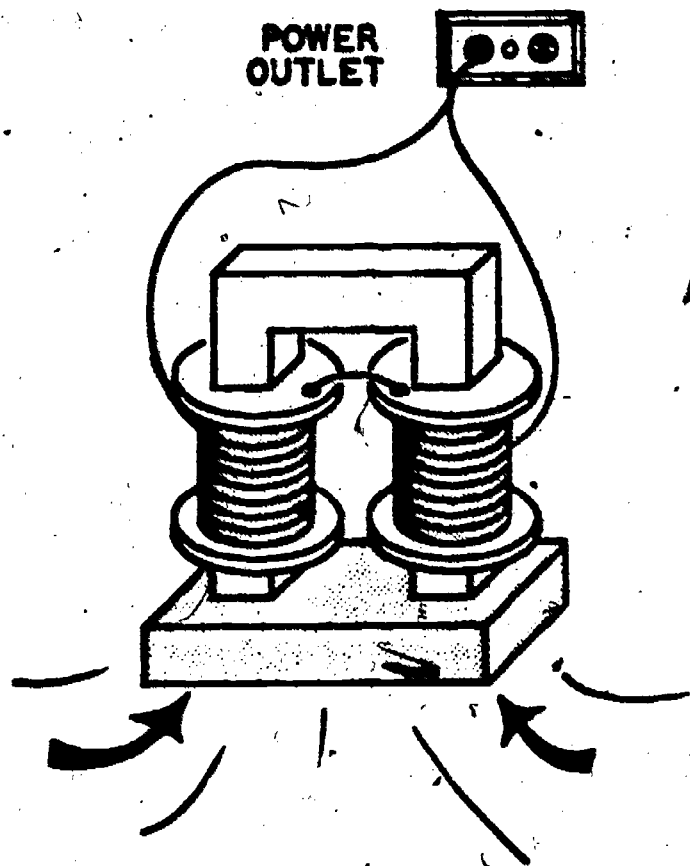

OR →

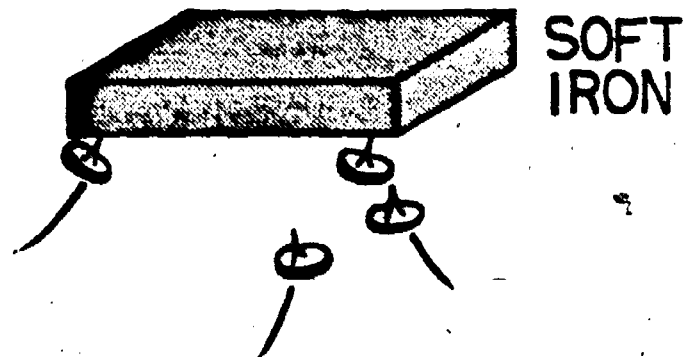

TEMPORARY

Temporary magnets are generally of two types, those made of material that do not keep their magnetism long (soft iron), and those which operate with the help of electricity (electromagnets). Electromagnets operate only when electricity is applied, when the electricity is removed they do not keep their magnetism.

Name: _____

Date: _____

Period: _____

INFORMATIONAL HANDOUT

BASIC LAW OF MAGNETISM

As you probably know from common experience, when two magnets are brought close to each other they will either pull together (attract), or push apart (repel). The action of the two magnets will depend upon the position of the magnetic poles. The basic law of magnetism explains the magnetic reaction in this way:

LIKE POLES REPEL

(N-POLE AND N-POLE REPEL AS WELL AS S-POLE AND S-POLE)

UNLIKE POLES ATTRACT

(N-POLE AND S-POLE ATTRACT)

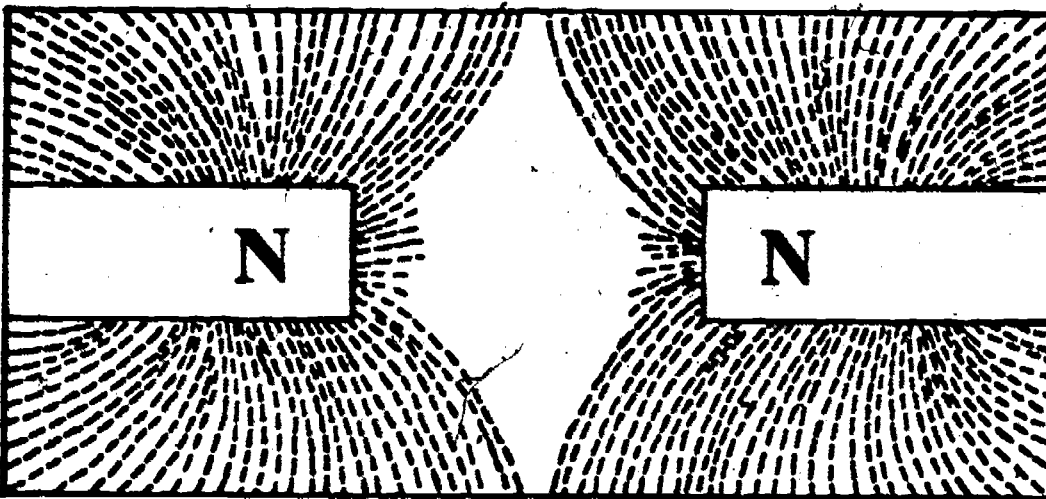

Magnetic Repulsion

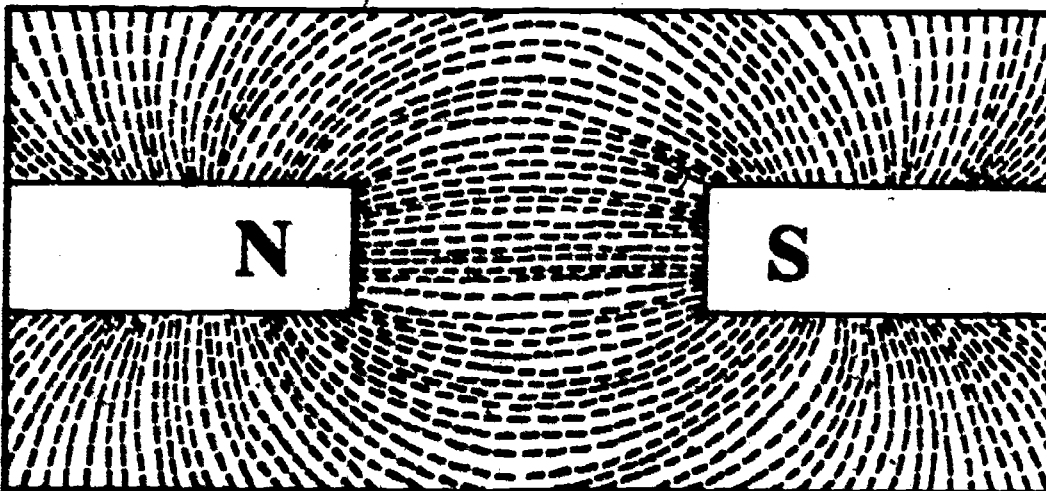

Magnetic Attraction

SCORE:
GRADE:

Name: _____

Date: _____

Period: _____

ANSWER SHEET

EXAM LI-U6

T F
A B C D

1.				
2.				
3.				
4.				
5.				
6.				
7.				
8.				
9.				
10.				
11.				
12.				
13.				
14.				
15.				
16.				
17.				
18.				
19.				
20.				
21.				
22.				
23.				
24.				
25.				

T F
A B C D

26.				
27.				
28.				
29.				
30.				
31.				
32.				
33.				
34.				
35.				
36.				
37.				
38.				
39.				
40.				
41.				
42.				
43.				
44.				
45.				
46.				
47.				
48.				
49.				
50.				

T F
A B C D

51.				
52.				
53.				
54.				
55.				
56.				
57.				
58.				
59.				
60.				
61.				
62.				
63.				
64.				
65.				
66.				
67.				
68.				
69.				
70.				
71.				
72.				
73.				
74.				
75.				

T F
A B C D

76.				
77.				
78.				
79.				
80.				
81.				
82.				
83.				
84.				
85.				
86.				
87.				
88.				
89.				
90.				
91.				
92.				
93.				
94.				
95.				
96.				
97.				
98.				
99.				
100.				

*Show work for problems on back of answer sheet.

ANSWER KEY
UNIT 6

A. KNOW YOUR DEFINITIONS

1. E
2. A
3. C
4. G
5. B
6. D
7. F
8. I
9. K
10. H
11. L
12. J

Extra challenge - (subjective
evaluation)

B. QUEST ACTIVITY

Hans Christian Oersted

ELECTRICITY / ELECTRONICS

CURRICULUM GUIDE INSTRUCTIONAL MODULE

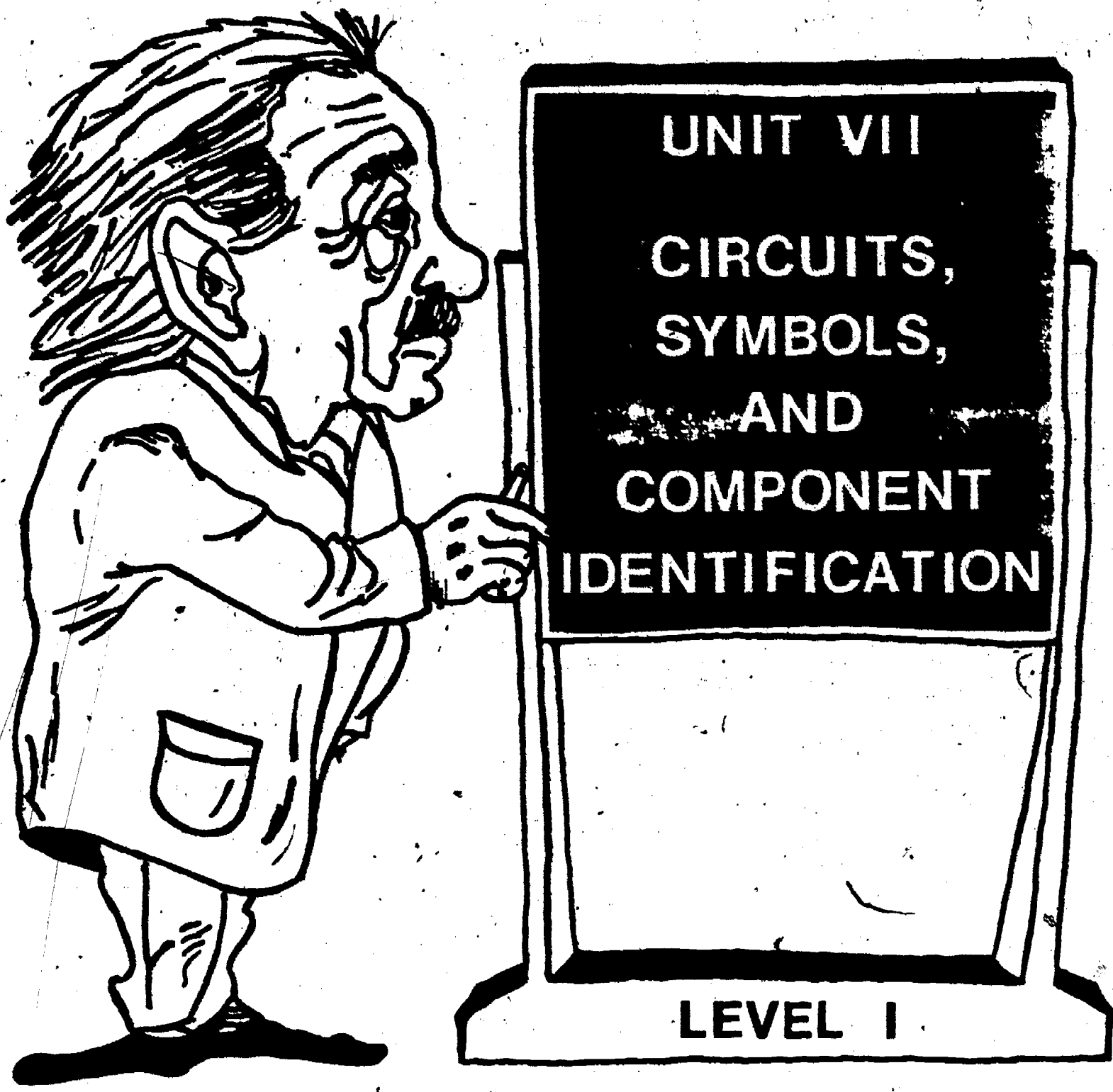

STATE OF CALIFORNIA
DEPARTMENT OF EDUCATION

NAME _____
DATE STARTED _____
DATE COMPLETED _____

BY
R. E. LILLO
N. S. SOFFIOTTO

STATE ELECTRICITY/ELECTRONICS CURRICULUM GUIDE
INSTRUCTOR'S GUIDE TO ACCOMPANY LEVEL I UNIT #7

Title of Unit: Circuits, Symbols, and Component Identification

Time Allocation: 3 weeks

Unit Goal:

To investigate and transmit those competencies related to identifying fundamental electrical components, quantities, and their units of measurement, and to attain student competence in understanding the basic requirements of an electrical circuit.

Unit Objectives:

The student will be able to:

1. identify and draw the schematic symbols of the following common components: resistor, inductor, capacitor, switch, speaker, xenon flashtube, neon lamp, transformer, diode, battery and indicator lamp.
2. differentiate and identify the basic circuit parts of an electrical circuit, and demonstrate the ability to connect components either in a series or parallel configuration.
3. identify and explain the three common types of electrical quantities and their corresponding units of measurements.

Evaluation:

The student will demonstrate his/her competence in terms of these measurable objectives based upon individual instructors acceptable performance criteria, which may utilize a combination of written, oral, and laboratory testing procedures.

Instructor References:

Electronics Assembly and Fabrication Methods. S.R. Duarte and R.L. Duarte, McGraw-Hill Book Co., 1973. Chapters: 2 and 4.

Introduction to Electricity. Kurt H. Schick, McGraw-Hill Ryerson Limited, 1975. Chapters: 3, 7, and 21.

Understanding Electricity and Electronics. Peter Buban and Marshall L. Schmitt, McGraw-Hill Book Co., 1975. Units: 2, 3, and 10.

Overview:

Several basic competencies are introduced in this unit, and these competencies can serve as a solid foundation for succeeding technical units throughout this level as well as future levels if they are acquired.

The unit should be presented carefully in terms of content. First, stress that symbols are utilized in schematic drawings as a means to explain where parts are electrically located. Second, instruction on component identification, with specific emphasis on those common components encountered in typical beginning type projects or kits.

Next, it is necessary to identify basic electrical terms and to emphasize that these quantities operate as a team when performing within a circuit. Once the definitions and functions have been firmly established it is relatively easy to associate letter symbols or units of measurement with the proper quantity.

Finally the requirements for a complete circuit may be evaluated.

Suggested Presentation Hints/Methodology:

Follow the instructional module unit outline as a basic skeleton for curriculum presentation, however, note the following:

1. Be mindful when explaining circuit operation and terminology that very often first exposure to technical expressions can be misunderstood for example "current flow", "potential difference", and "voltage". Spend a significant amount of time with these kinds of terms in order to facilitate your students basic comprehension.
2. Present basic DC circuits by showing students that electrical parts or components comprise a system only when they are wired together to perform a desired result or function. This system can consist of a simple or complex circuit which has at its foundation a supply, control, conductor and load.
3. Do not be afraid to use the art of repetition as a means to drill or impress students with specific units of measurement or letter symbols. Use the blackboard also as an effective vehicle by listing a variety of terms and/or units, then let the students match up the correct pairs.
4. Investigate with the class a variety of components that they might typically encounter when building a simple project. Use an overhead projector and place a component on top of the stage plate and examine its size and shape, then, discuss the general purpose, special properties, value determination/codes, and symbol.

Supplemental Activities and Demonstrations:

1. Class can physically examine a box containing basic parts such as switches, wires, lamps, cells, batteries, bells etc., and categorize their functions on the blackboard in terms of circuit use; supply, control, conductor, or load.
2. Instructor can assemble several simple circuits to dramatize circuit operation, and by utilizing duplicate load devices can easily manipulate configuration into a series, parallel, or combination circuit. Circuit failures can be introduced along with troubleshooting and repair techniques if desired.
3. Many short story booklets on Electricity/Electronics are available from major companies. A letter written on school letterhead indicating a need for a classroom set will usually bring results and thus supplement basic reading materials and technical knowledge.

Instructional Module Contents:

1. Unit Outline (overhead)
2. Pre-Post Test (keyed)
3. Technical Glossary
4. Worksheet (vocabulary) - Cryptics
5. Worksheet - Electrical Symbols and Terms
6. Quest Activities
7. Informational Handout (The Electrical Team)
8. Informational Handout (Basic Electronic Components Used In Project Construction With Schematic Symbol and Letter Designation)
9. Informational Handout (Requirements for, and Types of Electrical Circuits)
10. Unit Module Answer Keys

VII. Circuits, Symbols, and Component Identification

A. Schematic Symbols

1. Purpose

2. Common circuit symbols

B. Component Identification

C. Electrical Terms and Vocabulary

D. Basic Units of Measurement

E. DC Circuits

1. Requirement for a complete electric circuit

2. Series circuits

3. Parallel circuits

4. Combination circuits

F. Project Construction

LI-U7

UNIT EXAM

CIRCUITS; SYMBOLS, AND COMPONENT IDENTIFICATION

IMPORTANT:

Indicate your responses on the answer sheet only. Fill in the box corresponding to the correct answer to each question - there is only one correct answer for each question.

1. The letter abbreviation for voltage is V. (T-F)
2. On a schematic diagram, the components are shown as schematic symbols. (T-F)
3. A supply provides the electricity for circuit operation. (T-F)
4. Electrons always flow from negative to positive in an electrical circuit.
5. Motors, lamps, bells, and heaters can be used as loads in electrical circuits. (T-F)
6. The orderly flow of electrons through a circuit is known as:
(A) current, (B) electromotive force, (C) resistance, (D) power.
7. A circuit which contains more than one path for current flow is known as a(n):
(A) parallel circuit, (B) series circuit, (C) abnormal circuit,
(D) normal circuit.
8. The letter abbreviation for voltage is the:
(A) V, (B) VOL, (C) E, (D) B.
9. The letter abbreviation for current is:
(A) C, (B) I, (C) A, (D) E.
10. " Ω " is the electrical symbol for the:
(A) volt, (B) ampere, (C) resistor, (D) ohm.

11. To qualify as a complete electrical circuit, a supply, conductor, a load and a _____ are required.

12. _____ is the opposition to the flow of electricity, through a circuit.

13. Voltage is measured in the basic unit _____.

14. The ampere is the basic unit of measurement for _____.

15. The ohm is the basic unit of measurement for _____.

Identify the schematic symbols drawn below.

16.  _____

17.  _____

18.  _____

19.  _____

20.  _____

21.  _____

22.  _____

23.  _____

Identify the abbreviations or letter designations listed below.

24. LP: _____

28. V: _____

25. C: _____

29. S: _____

26. R: _____

30. A: _____

27. B: _____

Name: _____

Date: _____

TECHNICAL GLOSSARY

Period: _____

- AMPERE:** The basic unit of measurement for current. Abbrev. A.
- COMBINATION CIRCUIT:** A circuit consisting of one or more series and parallel paths. Combination circuits are often called series-parallel circuits.
- COMPLETE CIRCUIT:** An electrical circuit which contains at least a; supply, load, control, and conductor. All complete electrical circuits must contain these 4 basic parts.
- COMPONENT:** An electronic part.
- CONDUCTOR:** The part of an electric circuit which forms the path through which electricity will flow. Copper wire is an example of a conductor.
- CONTROL:** The part of a complete circuit which turns on, turns off, or routes (directs) electricity through a circuit. A switch is an example of a control.
- CURRENT:** The orderly flow of electrons through a circuit. Current is measured in the basic unit amperes or amps. Letter symbol: I.
- LETTER IDENTIFICATION:** A letter used to identify a particular type of electronic component. Example: The letter identification for a capacitor is C.
- LOAD:** The device which a circuit is designed to operate. Common circuit loads are motors, lamps, speakers, heating elements, etc.
- OHM:** The basic unit of measurement for resistance. Letter symbol: Ω
- PARALLEL CIRCUIT:** A circuit which contains two or more paths for current flow, sometimes referred to as a shunt or branch circuit.
- RESISTANCE:** The opposition that a component or circuit offers to the flow of electricity. Resistance is measured in the basic unit ohms. Letter symbol: R
- SCHEMATIC SYMBOL:** A sketch used to identify an electronic component and often referred to as a graphic symbol.
- SERIES CIRCUIT:** A circuit which allows only one path for current flow. Components connected in series are joined in a line, one after the other.
- SUPPLY:** The device which provides, or supplies, the electricity needed for circuit operation. Some examples of supply devices are batteries, generators, and solar cells. The supply is often referred to as the source.

Name: _____

Date: _____

Period: _____

VOLT:

The basic unit of measurement for voltage. Abbrev. V.

VOLTAGE:

The electrical force or pressure which causes electrons to move through a circuit. Other terms for voltage are electromotive force and potential difference. Voltage is measured in the basic unit volts. Abbrev. E.

FLASHLIGHT

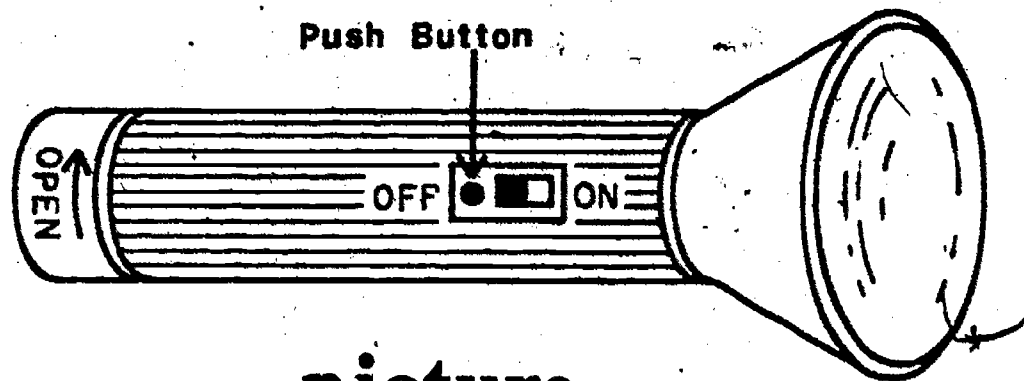

picture

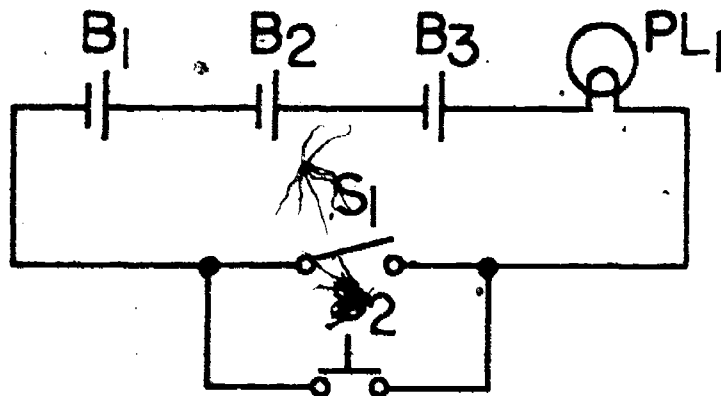

schematic

SCORE:
GRADE:

Name: _____

Date: _____

Period: _____

WORKSHEET

VOCABULARY - CRYPTICS

Decode the cryptic messages below to identify the electronic term.

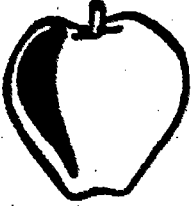

EXAMPLE:

A. **X** +  - **C** +  - Ap

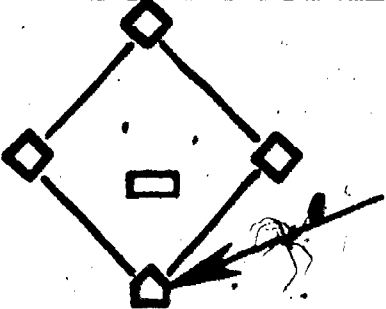
A. EXAMPLE

1.  = **h** = plate



1.

2. **C** +  - **N** + 

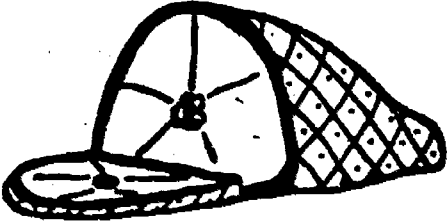
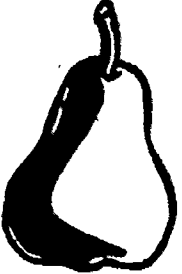
2.

3.  - **h** + 

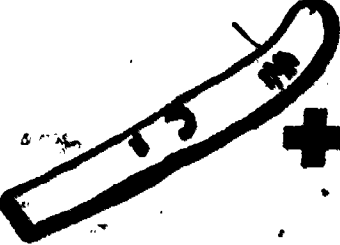
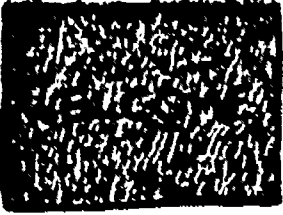
3.

4.  +  +  - ket

4.

SCORE:
GRADE:

Name: _____
Date: _____
Period: _____







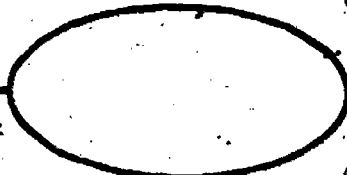
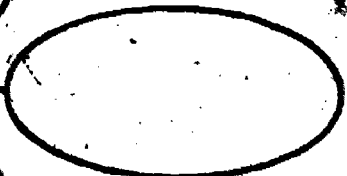
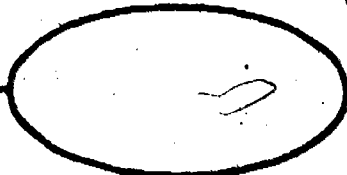
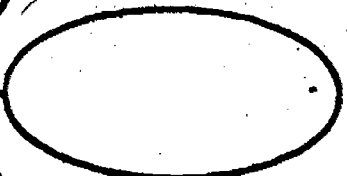
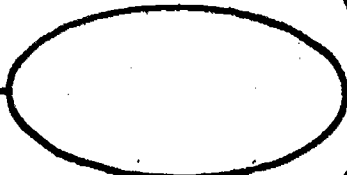
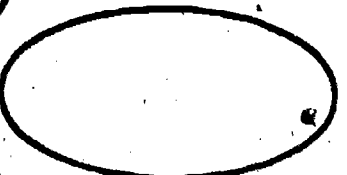
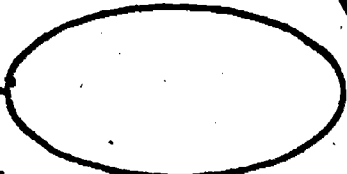

WORKSHEET

ELECTRICAL SYMBOLS AND TERMS

A. Draw in the correct schematic symbol for the following electronic components.

1. Battery: _____ 
2. Carbon composition resistor: _____ 
3. Disc capacitor: _____ 
4. Transformer: _____ 
5. Silicon controlled rectifier: _____ 
6. Incandescent lamp: _____ 
7. Single pole single throw slide switch: _____ 
8. Neon lamp: _____ 

B. Identify the following graphic symbols:

9.  _____
10.  _____
11.  _____
12.  _____
13.  _____
14.  _____
15.  _____
16.  _____

Name: _____

Date: _____

Period: _____

C. Give the letter designation or abbreviation for the following.

- 17. current: _____
- 18. ohm: _____
- 19. capacitor: _____
- 20. battery: _____
- 21. switch: _____
- 22. light emitting diode: _____
- 23. resistor: _____

D. Identify the following letter designations or abbreviations.

- 24. L: _____
- 25. V: _____
- 26. Q: _____
- 27. D: _____
- 28. A: _____
- 29. E: _____
- 30. S: _____









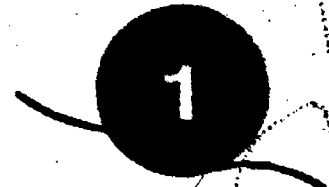

SCORE: _____
 GRADE: _____

Name: _____
 Date: _____
 Period: _____

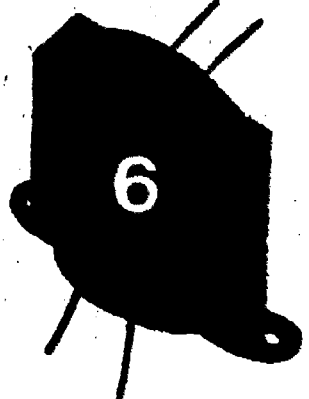
WORKSHEET
 QUEST ACTIVITY

"UNIT 7"

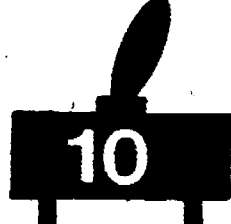
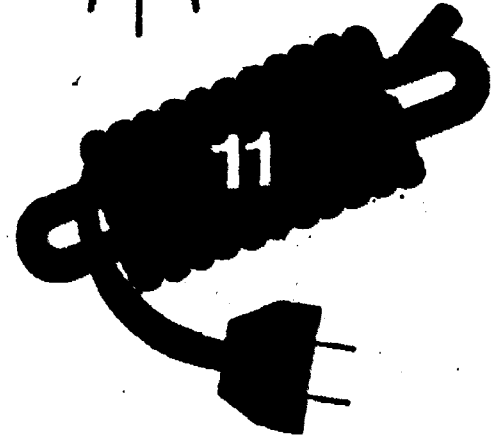
Identify the component drawings shown below.

1.		1.	<input type="text"/>
2.		2.	<input type="text"/>
3.		3.	<input type="text"/>
4.		4.	<input type="text"/>
5.		5.	<input type="text"/>
6.		6.	<input type="text"/>
7.		7.	<input type="text"/>
8.		8.	<input type="text"/>
9.		9.	<input type="text"/>
10.		10.	<input type="text"/>
11.		11.	<input type="text"/>
12.		12.	<input type="text"/>

Name: _____

Date: _____

Period: _____

INFORMATIONAL HANDOUT

THE ELECTRICAL TEAM

Voltage...E

Current...I

Resistance...R

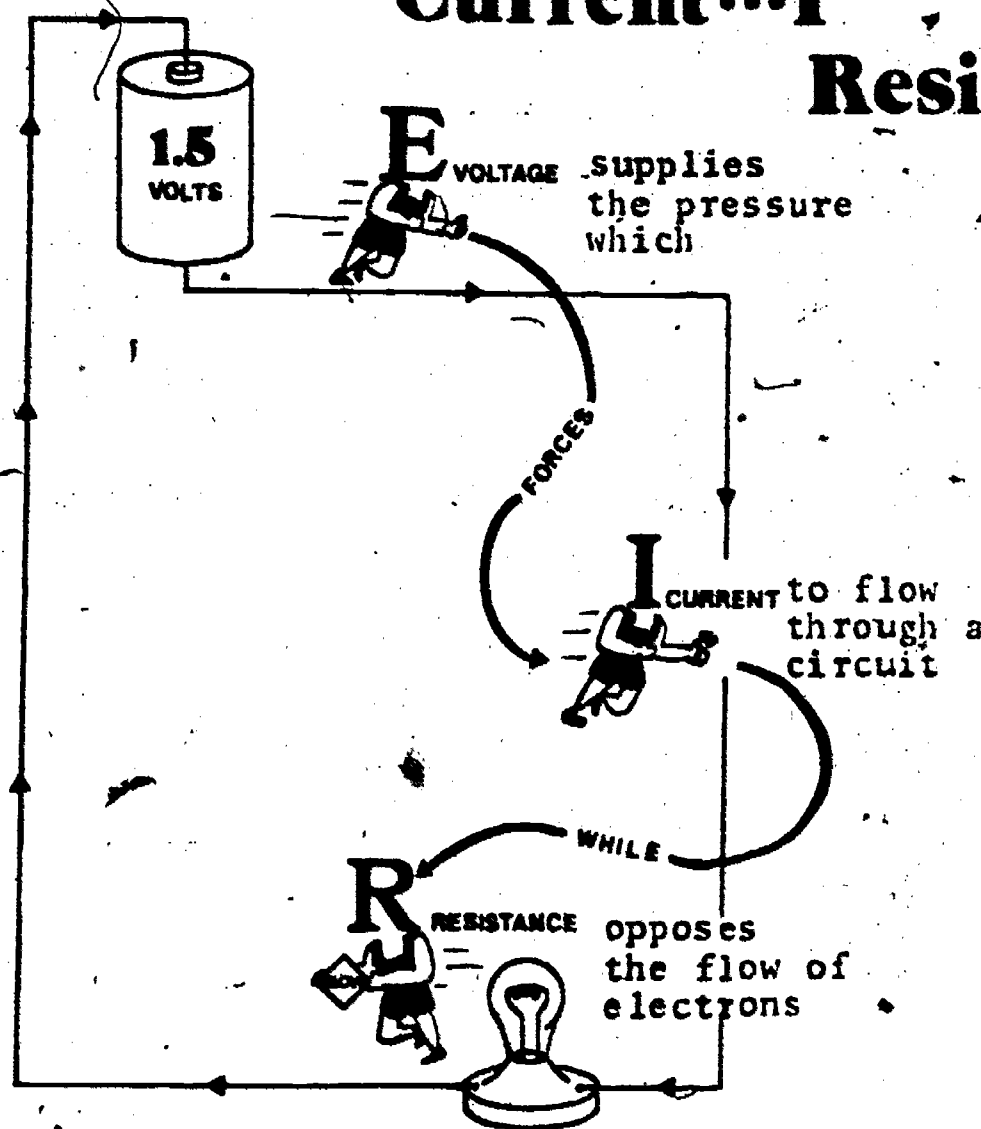

Units of Measurement

Voltage is measured in the basic unit

Current is measured in the basic unit

Resistance is measured in the basic unit

volts (V)
amperes (A)
ohms (Ω)











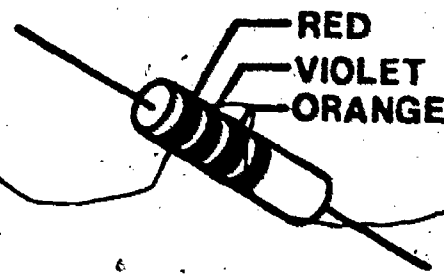

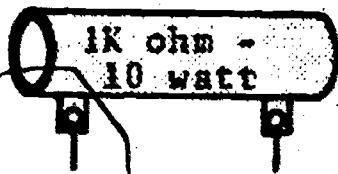
Name: _____

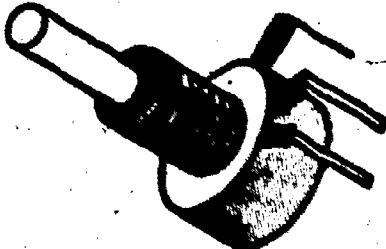
Date: _____

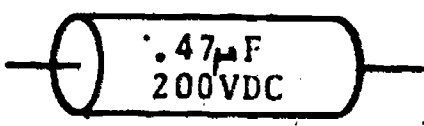
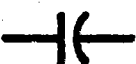
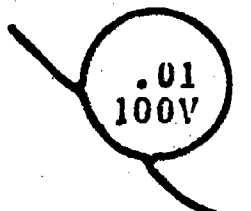
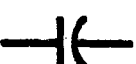
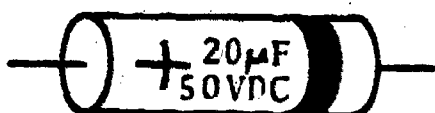
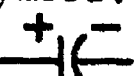
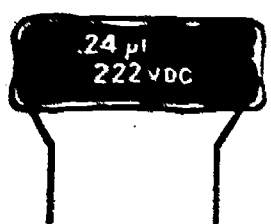
Period: _____

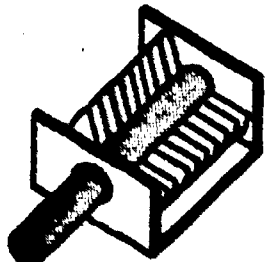
INFORMATIONAL HANDOUT

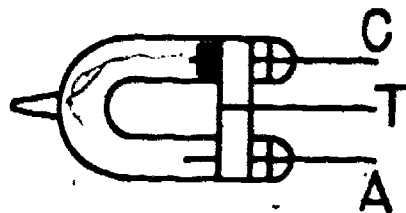











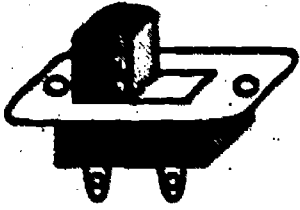

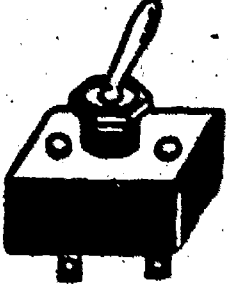
**BASIC ELECTRONIC COMPONENTS USED IN PROJECT CONSTRUCTION
WITH SCHEMATIC SYMBOL AND LETTER DESIGNATION**

 <p>CARBON COMPOSITION RESISTOR</p> <p>Symbol:  Letter Designation: R</p>	 <p>POWER RESISTOR</p> <p>Symbol:  Letter Designation: R</p>	 <p>POTENTIOMETER</p> <p>Symbol:  Letter Designation: R</p>
 <p>TUBULAR CAPACITOR</p> <p>Symbol:  Letter Designation: C</p>	 <p>CERAMIC OR DISC CAPACITOR</p> <p>Symbol:  Letter Designation: C</p>	 <p>ELECTROLYTIC CAPACITOR</p> <p>Symbol:  Letter Designation: C</p>
 <p>MYLAR CAPACITOR</p> <p>Symbol:  Letter Designation: C</p>	 <p>VARIABLE CAPACITOR</p> <p>Symbol:  Letter Designation: C</p>	 <p>XENON FLASHTUBE</p> <p>Symbol:  Letter Designation: LP</p>

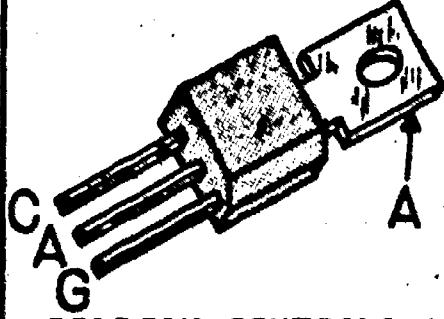

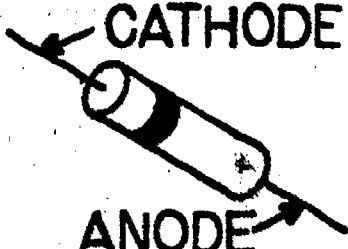

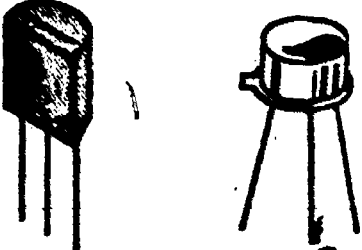

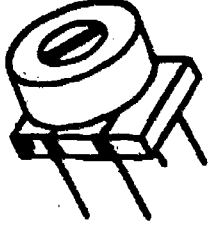
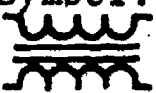
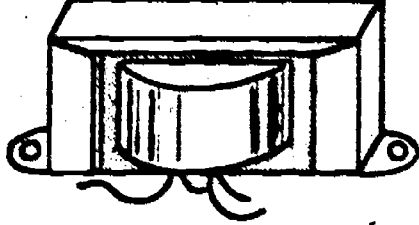
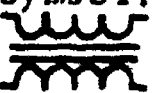



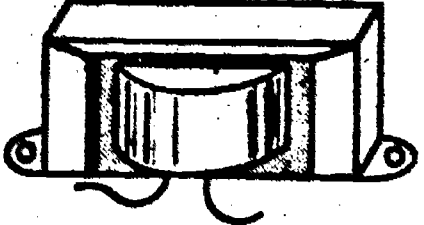

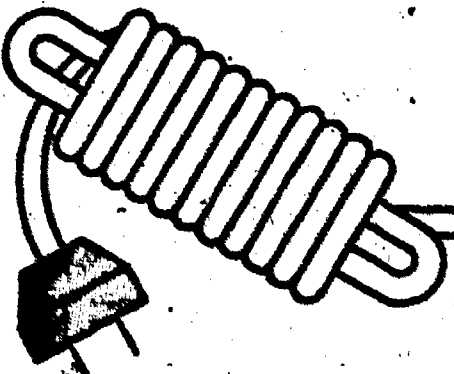
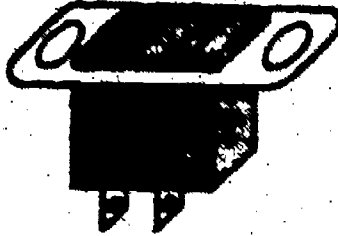
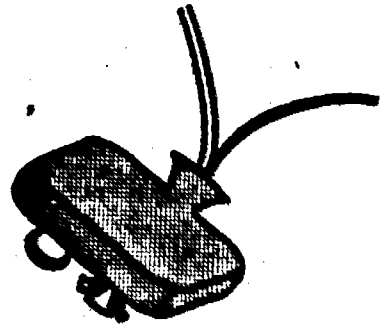
Name: _____

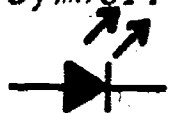
Date: _____

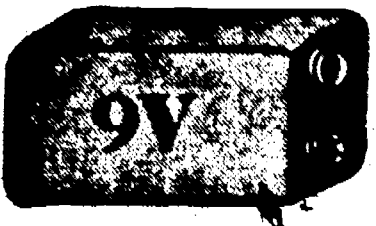
Period: _____

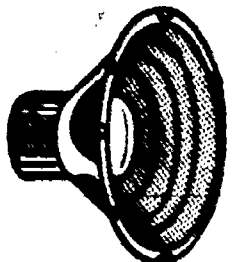
 <p><u>NEON LAMP</u></p> <p>Symbol:  Letter Designation: LP</p>	 <p><u>SPST SLIDE SWITCH</u></p> <p>Symbol:  Letter Designation: S</p>	 <p><u>DPST TOGGLE SWITCH</u></p> <p>Symbol:  Letter Designation: S</p>
 <p><u>N.O. PUSH-BUTTON SWITCH</u></p> <p>Symbol:  Letter Designation: S</p>	 <p><u>SILICON CONTROLLED RECTIFIER</u></p> <p>Symbol:  Letter Designation: SCR</p>	 <p><u>SEMICONDUCTOR DIODE</u></p> <p>Symbol:  Letter Designation: D</p>
 <p><u>TRANSISTOR</u></p> <p>Symbol:  Letter Designation: Q</p>	 <p><u>TRIGGER TRANSFORMER</u></p> <p>Symbol:  Letter Designation: T</p>	 <p><u>TRANSFORMER</u></p> <p>Symbol:  Letter Designation: T</p>

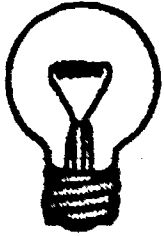
Name: _____
 Date: _____
 Period: _____

 <p><u>INDUCTOR (COIL)</u></p> <p>Symbol:  Letter Designation: L</p>	 <p><u>AC LINE CORD</u></p>	 <p><u>ELECTRICAL CUTLET</u></p>
 <p><u>BATTERY CONNECTOR</u></p>	 <p><u>LIGHT EMITTING DIODE</u></p> <p>Symbol:  Letter Designation: D</p>	 <p><u>INDUCTOR (COIL)</u> air core</p> <p>Symbol:  Letter Designation: L</p>
 <p><u>BATTERY</u></p> <p>Symbol:  Letter Designation: B</p>	 <p><u>SPEAKER</u></p> <p>Symbol:  Letter Designation: SPKR</p>	 <p><u>INCANDESCENT LAMP</u></p> <p>Symbol:  Letter Designation: LP</p>

Name: _____

Date: _____

Period: _____

INFORMATIONAL HANDOUT

REQUIREMENTS FOR, AND TYPES OF ELECTRICAL CIRCUITS

In order to make a working or complete electrical circuit you must have four basic things present in your circuit.

- 1) The **supply** provides the electrical energy to the circuit.

A  is an example of a supply.

- 2) The **control** is used to turn the circuit on or off.

A  is an example of a control.

- 3) The **conductor** forms the pathway for the electricity to flow through.

Copper  is the most common conductor used in electronic projects.

- 4) The **load** is the device that the circuit will operate.

A  is an example of a load.

Electric circuits can be built in three basic forms.

- 1) In a **series circuit**, the parts are connected one after the other. In this type of circuit electricity can move in only one path.

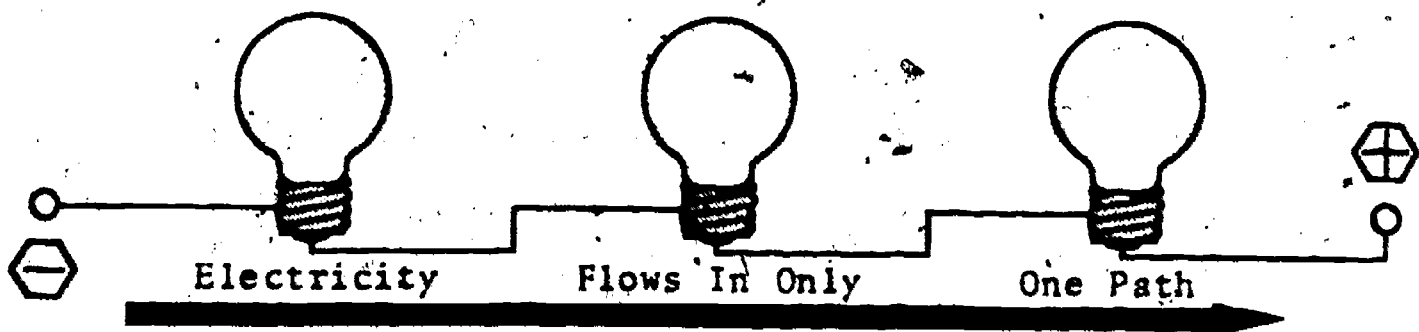

Name: _____

Date: _____

Period: _____

- 2) A **parallel circuit**, or branch circuit allows the electricity to "split up" and take different paths through the circuit.

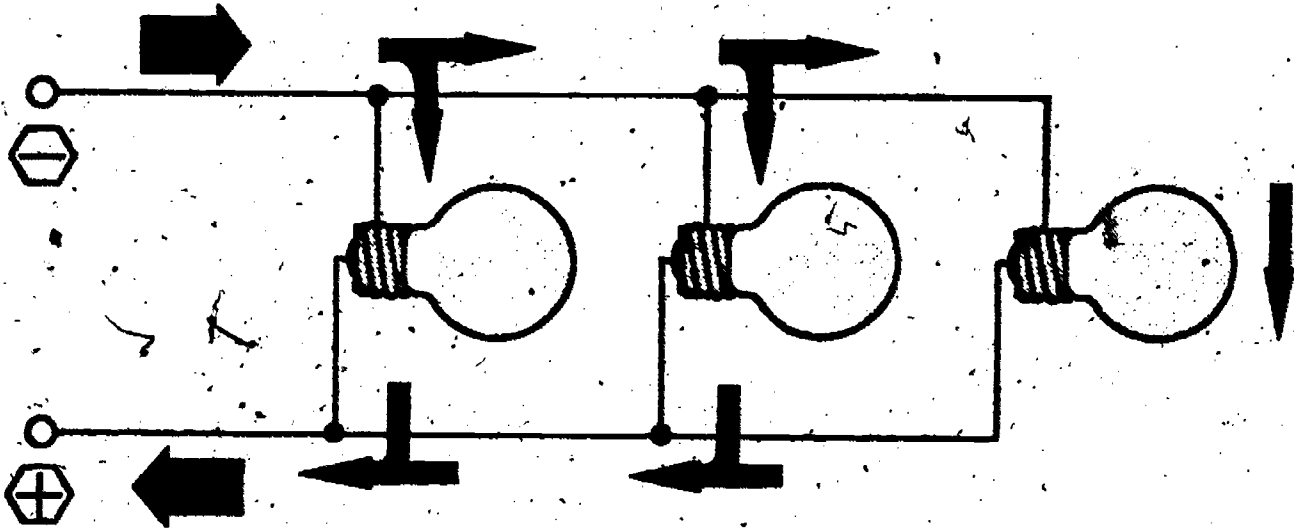

- 3) A **combination circuit** has at least one series and one parallel circuit contained within it.

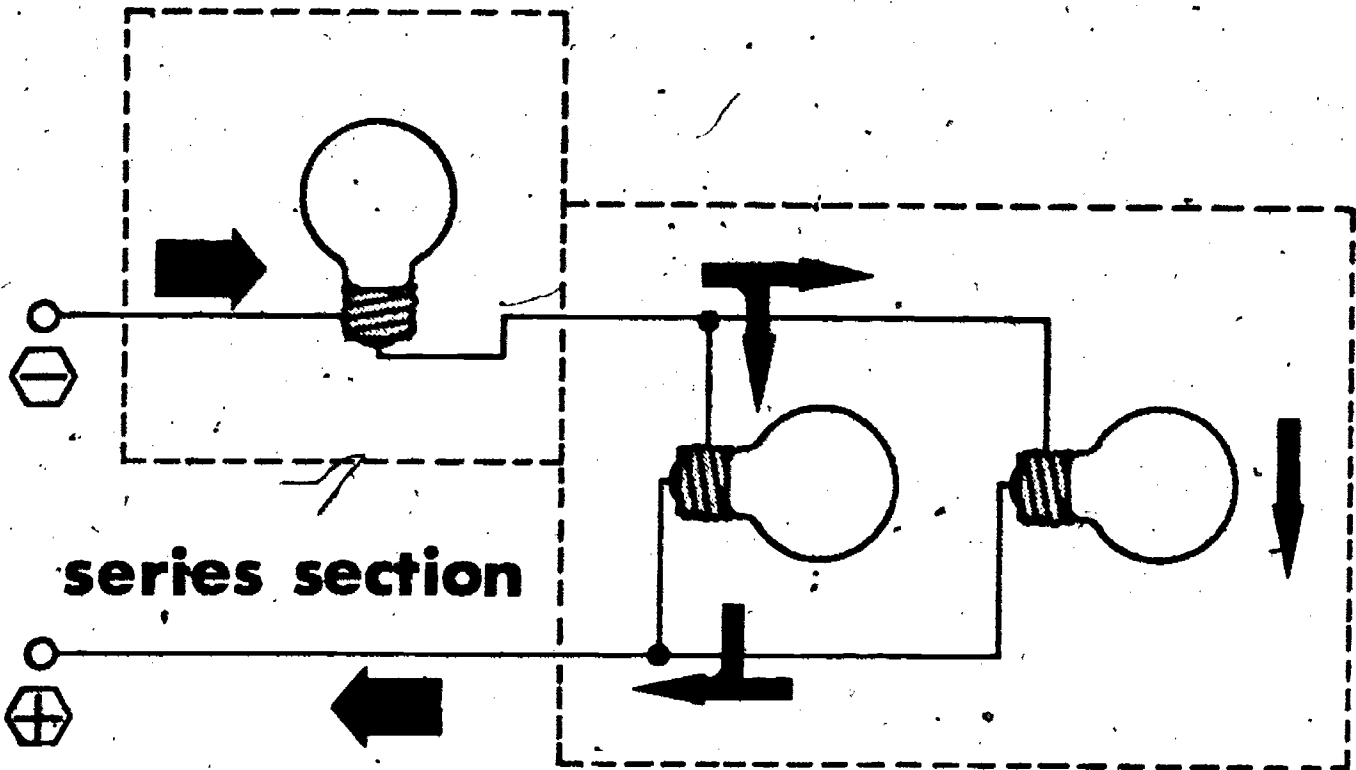

series section

parallel section

SCORE: _____
 GRADE: _____

Name: _____

Date: _____

ANSWER SHEET

Period: _____

EXAM LI-U7

	T	F	A	B	C	D
1.						
2.						
3.						
4.						
5.						
6.						
7.						
8.						
9.						
10.						
11.						
12.						
13.						
14.						
15.						
16.						
17.						
18.						
19.						
20.						
21.						
22.						
23.						
24.						
25.						

	T	F	A	B	C	D
26.						
27.						
28.						
29.						
30.						
31.						
32.						
33.						
34.						
35.						
36.						
37.						
38.						
39.						
40.						
41.						
42.						
43.						
44.						
45.						
46.						
47.						
48.						
49.						
50.						

	T	F	A	B	C	D
51.						
52.						
53.						
54.						
55.						
56.						
57.						
58.						
59.						
60.						
61.						
62.						
63.						
64.						
65.						
66.						
67.						
68.						
69.						
70.						
71.						
72.						
73.						
74.						
75.						

	T	F	A	B	C	D
76.						
77.						
78.						
79.						
80.						
81.						
82.						
83.						
84.						
85.						
86.						
87.						
88.						
89.						
90.						
91.						
92.						
93.						
94.						
95.						
96.						
97.						
98.						
99.						
100.						

*Show work for problems on back of answer sheet.

ANSWER KEY
UNIT 7

A. CRYPTICS

1. ohm
2. current
3. ampere
4. schematic

B. ELECTRICAL SYMBOLS AND TERMS



9. diode
10. capacitor (electrolytic)
11. transistor (NPN)
12. N.O. Push Button Switch
13. variable resistor (POT)
14. fixed inductor
15. speaker
16. light emitting diode
17. I
18. Ω
19. C
20. B
21. S
22. D
23. R
24. inductor
25. volt
26. transistor
27. diode/LED
28. ampere
29. voltage
30. switch

C. QUEST ACTIVITY

1. disc. capacitor
2. fixed resistor
3. incandescent lamp
4. silicon controlled rectifier
5. slide switch
6. transformer
7. capacitor
8. variable resistor (POT)
9. transistor
10. toggle switch
11. line cord
12. Push Button Switch

ELECTRICITY / ELECTRONICS

CURRICULUM GUIDE INSTRUCTIONAL MODULE

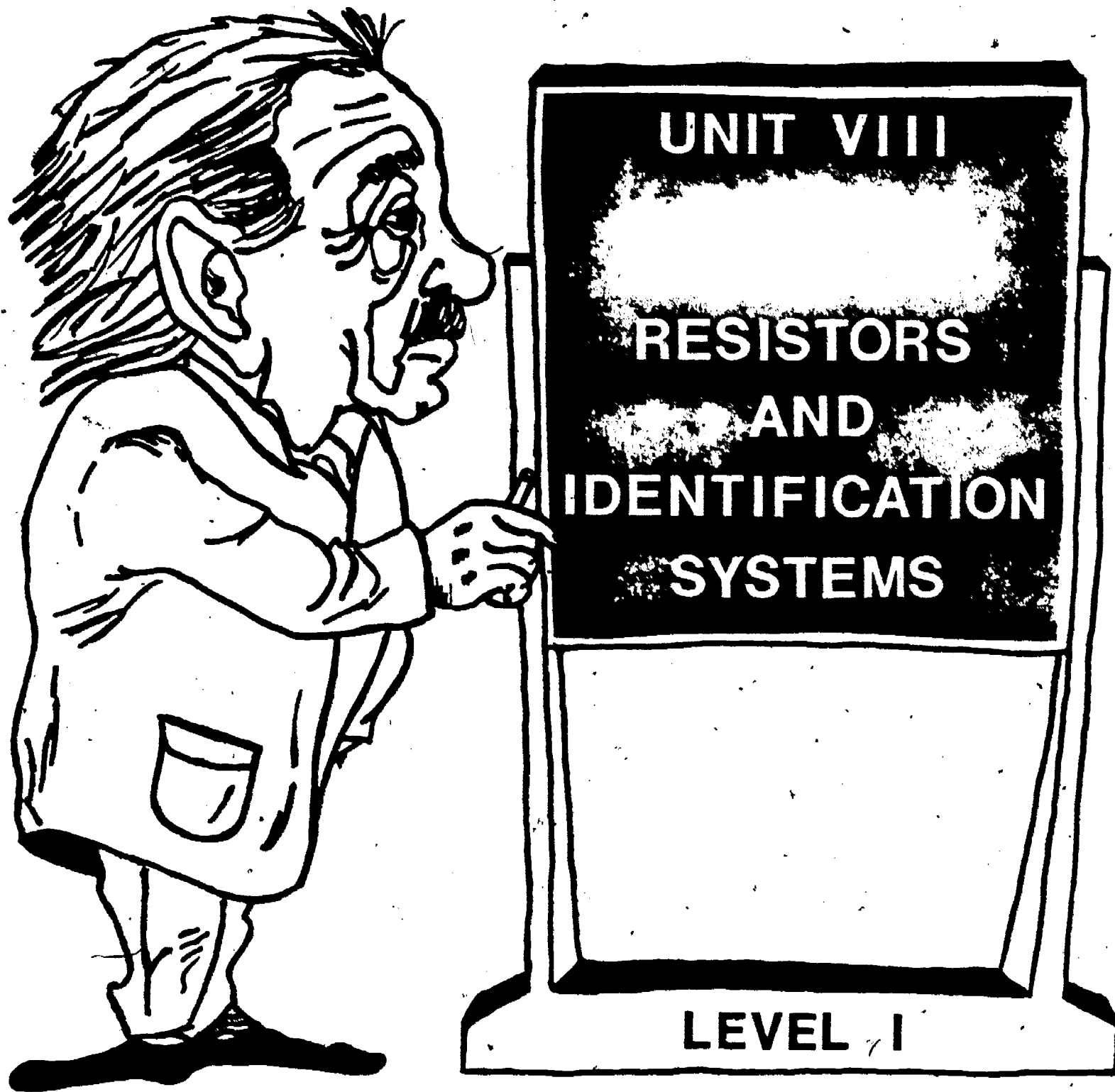

STATE OF CALIFORNIA
DEPARTMENT OF EDUCATION

NAME _____
DATE STARTED _____
DATE COMPLETED _____

BY
R. E. LILLO
N. S. SOFFIOTTO

STATE ELECTRICITY/ELECTRONICS CURRICULUM GUIDE
INSTRUCTOR'S GUIDE TO ACCOMPANY LEVEL I UNIT #8

Title of Unit: Resistors and Identification Systems

Time Allocation: 1 week

Unit Goal:

To develop those student competencies which will enable students to grasp the basic theory and application of resistance, and to familiarize students with the symbols and coding systems that are employed in reference to resistors.

Unit Objectives:

The student will be able to:

1. define the term, symbol, and unit of measurement for resistance.
2. name two common types of resistors and the two coding systems utilized for indicating ohmic values.
3. identify the color coded value of a typical resistor, including the tolerance percentage and mathematically computing the usable tolerance range.

Evaluation:

The student will demonstrate his/her competence in terms of these measurable objectives based upon individual instructors acceptable performance criteria, which may utilize a combination of written, oral, and laboratory testing procedures.

Instructor References:

Electricity One-Seven. Harry Mileaf, Hayden Book Company, Inc., 1976.
Chapter: Electricity Two.

Electronic and Electrical Fundamentals Volume I. Published by G.T.I.
Education Products, Inc., 1976. Chapter: 4.

Individual Learning Program In DC Electronics. Heathkit Continuing
Education, Heath Company, 1976. Unit: 3.

Overview:

Unit 8 has at its main purpose the expansion of the student's technical competencies so that they will include the means to identify color coded resistors.

First, resistance should be defined as the opposition to current flow, and the instructor should indicate also that all materials contain this quality. The thought that resistance might be a desired factor should be explored as well as the traditionally negative aspect of circuit resistance.

The next topic should express the idea that resistors were developed to provide high resistivity in a small package. Types of resistors along with coding systems, and the concepts of resistor value accuracy (tolerance) should be explored in a variety of exercises.

Note, that some related mathematical skills may have to be reviewed to support tolerance computations.

Suggested Presentation Hints/Methodology:

Follow the instructional module unit outline as a basic skeleton for curriculum presentation, however, note the following:

1. Students must be made aware of the fact that resistors are commercially available at electronics stores/dealers in certain sizes only. Indicate that other values are special order devices which will be very expensive to obtain.
2. In this unit the concept or phrase types of resistors will refer to the resistor's internal composition (carbon, wire wound, or film) while the phrase resistor variety is alluding to the physical style (fixed, adjustable, or variable). When presenting this topic display samples of the components that are available in the shop to help students become more familiar with their physical properties.
3. Prior to the class presentation on color code ask students to memorize the complete color code system. Select students individually to recite the colors and the number value.
4. The concept of resistor tolerance and the method of solving specific tolerance ranges are difficult for beginning students to comprehend. Walking the student through some simple problems will improve their understanding and confidence. A review of basic mathematical skills such as percentage determination and decimals can especially assist slower students and is recommended.

Supplemental Activities and Demonstrations:

1. Make a demonstration display that includes a sample of resistor of various types, color code markings, and physical styles. Cement the parts on a board and label.
2. An informative visual aid can be quickly made by using an old cardboard container that has a cylinder shape. Insert a long welding rod through the container and plug the ends. This will act as the body of the resistor with pigtails, now paint the body with one solid color and add various color bands with colored tape.
3. Using a flat piece of cardboard, in the shape of a carbon composition resistor, construct a resistor "mock up" with four see through pockets on one end. Insert different colored paper in each pocket to simulate a coded resistor, then hold the display up so that the class can view and discuss.

Instructional Module Contents:

1. Unit Outline (overhead)
2. Pre-Post Test (keyed)
3. Technical Glossary
4. Worksheet (vocabulary) - Know Your Definitions
5. Worksheet - Resistor Color Coding and Decoding
6. Quest Activity
7. Informational Handout (The Resistor Color Code)
8. Unit Module Answer Keys

VIII. Resistors and Identification Systems

A. Resistors

1. Types

2. Symbols

3. Color code system

4. Related math computations

B. Project Construction

LI-U8

UNIT EXAM

RESISTORS AND IDENTIFICATION SYSTEMS

IMPORTANT-

Indicate your responses on the answer sheet only. Fill in the box corresponding to the correct answer to each question - there is only one correct answer for each question.

1. Carbon composition resistors have their resistance value clearly printed on the body of the device. For example: "1000 Ω +10%" (T-F)
2. The symbol for a fixed value resistor is:  (T-F)
3. Wirewound resistors are made by wrapping special resistance wire around a ceramic core. (T-F)
4. Orange represents the number "4" in the resistance color code. (T-F)
5. If a 100 ohm resistor has a tolerance of 10%, its actual value can be between 90 and 110 ohms. (T-F)

Complete the color code chart below for questions 6 through 14, by filling in the missing number or color.

	COLOR	VALUE
	black	0
6.	brown	?
7.	?	2
8.	orange	?
9.	?	4
10.	green	?
11.	blue	?
12.	?	7
13.	?	8
14.	white	?

For questions 15 through 17 find the ohmic values of the color coded resistors below.

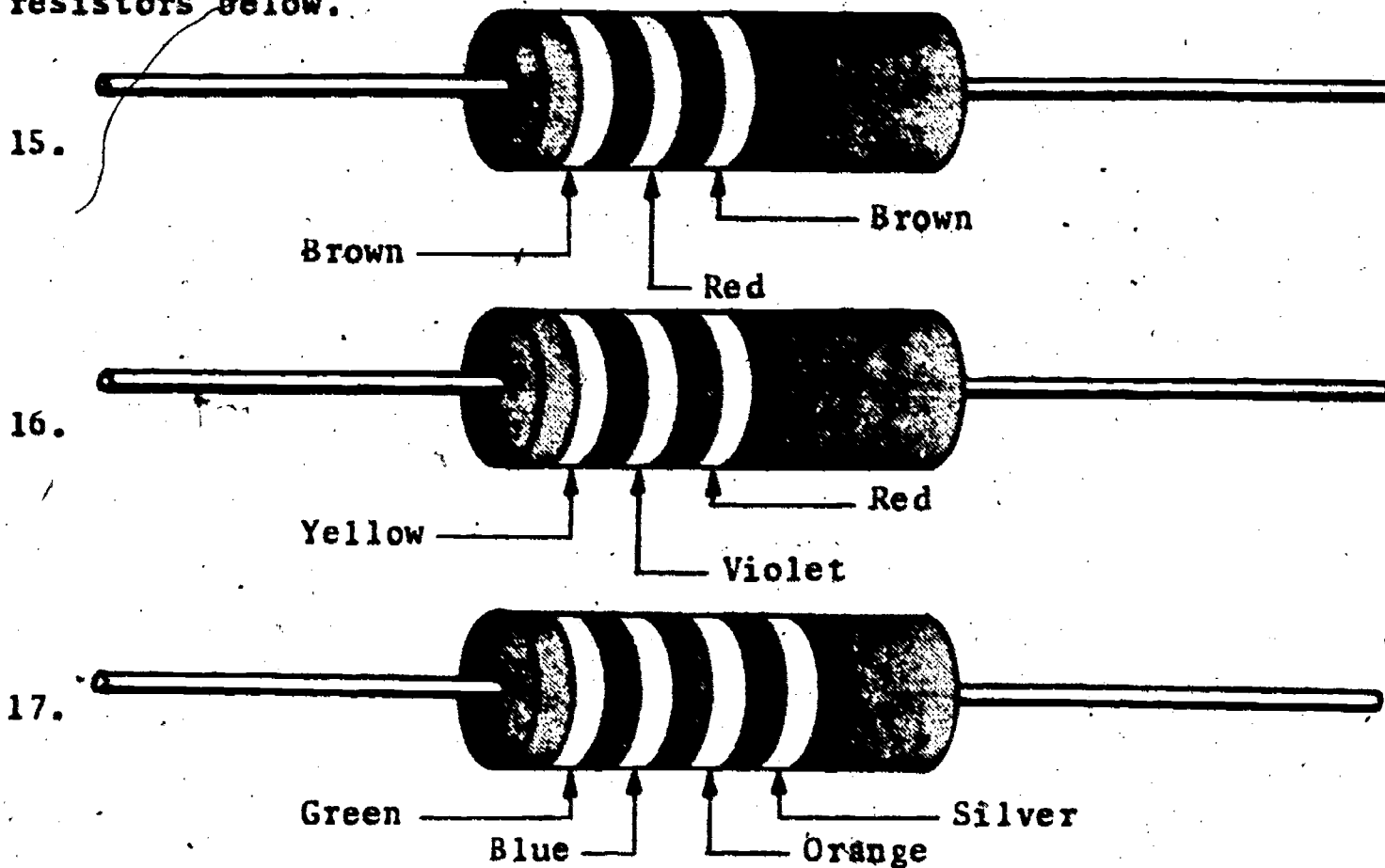

For questions 18 through 20 color code the following resistor value:

$2700\ \Omega \pm 20\%$

18. First color band _____
19. Second color band _____
20. Third color band _____

Name: _____

Date: _____

Period: _____

TECHNICAL GLOSSARY

CARBON COMPOSITION RESISTOR:

The most common type of resistor used in electronic devices. It contains carbon as the resistance material, and uses color bands to indicate its ohmic value.

COLOR CODE:

The resistor color code uses a system of three or four color bands, painted around the resistor, to give the "ohmic value" of the resistor. Each color in the code represents a number or percentage value.

FIXED VALUE RESISTOR:

A resistor which has only one resistance value. Fixed resistors can be either carbon composition, wirewound, or film type.

OHMIC VALUE:

The ohm rating or value of a resistor.

POTENTIOMETER:

A type of variable resistor consisting of resistance material and a movable arm. A terminal is attached to each end of the resistance material and to the movable arm. The resistance can be set by adjusting the movable arm.

POT

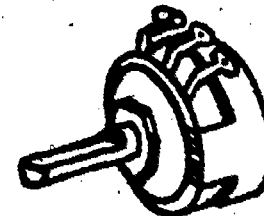

RESISTOR:

An electrical component used to oppose the flow of electricity through a circuit. Resistor values are measured in the basic unit ohms. Symbol:  Letter symbol: R.

TOLERANCE:

The amount by which the actual value of a resistor may vary from its marked value and still be considered good. Tolerances are usually expressed as a percentage. For example, the value of a 1000 Ω resistor with a 10% tolerance can vary between 900 Ω and 1100 Ω .

WATTAGE RATING:

A measurement of the amount of power that a resistor can safely handle. Generally, the larger in size the resistor is the more power it can handle. Excessive power will cause a resistor to overheat and burn-up.

R =

Resistance

in

SCORE: _____
GRADE: _____

Name: _____

Date: _____

Period: _____

WORKSHEET

VOCABULARY - KNOW YOUR DEFINITIONS

Develop a short definition, using your own words, for the following terms. A sketch should be included with your definition when appropriate.

1. COLOR CODE:

Blank box for definition and sketch of COLOR CODE.

2. POTENTIOMETER:

Blank box for definition and sketch of POTENTIOMETER.

3. RESISTOR:

Blank box for definition and sketch of RESISTOR.

4. OHMIC VALUE:

Blank box for definition and sketch of OHMIC VALUE.

5. CARBON COMPOSITION RESISTOR:

Blank box for definition and sketch of CARBON COMPOSITION RESISTOR.

SCORE: _____
 GRADE: _____

Name: _____

Date: _____

Period: _____

WORKSHEET

RESISTOR COLOR CODING AND DECODING

Determine the resistance value of the following color coded resistors.

EXAMPLE:

First Band
 yellow
4

Second Band
 violet
7

Third Band
 brown
0

Fourth Band
 silver
+10%

A. 470Ω +10%

	<u>First Band</u>	<u>Second Band</u>	<u>Third Band</u>	<u>Fourth Band</u>	
1.	Brown	Red	Brown	None	1.
2.	Yellow	Violet	Orange	Silver	2.
3.	Orange	White	Red	Gold	3.
4.	Blue	Gray	Black	None	4.
5.	Green	Blue	Yellow	Gold	5.
6.	Brown	Black	Red	Silver	6.
7.	Gray	Red	Orange	Silver	7.
8.	Brown	Gray	Green	None	8.

Name: _____

Date: _____

Period: _____

Complete the color coding of the following resistors by using the system shown below. This system can be used when converting a "number value" into a color code equal.

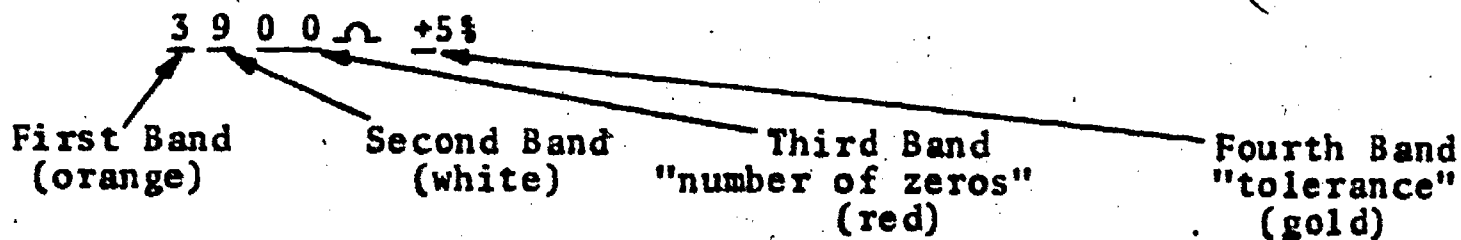

EXAMPLE:

B. 120 Ω +10%

1st Band
Brown

2nd Band

3rd Band
Brown

4th Band
Silver

B:

RED

9. 3300 Ω +5%

Orange

Orange

Gold

9.

10. 47 Ω +20%

Violet

Black

None

10.

11. 680 Ω +10%

Blue

Brown

Silver

11.

12. 56000 Ω +10%

Blue

Orange

Silver

12.

13. 120000 Ω +5%

Brown

Red

Gold

13.

14. 2500 Ω +20%

Red

(A) _____

(B) _____

None

14A.

14B.

EXTRA CHALLENGE: Try this one:

15. 820 Ω +5%

(A) _____

(B) _____

(C) _____

(D) _____

15A.

15B.

15C.

15D.

SCORE :
GRADE :

Name: _____
Date: _____
Period: _____

WORKSHEET
QUEST ACTIVITY
"UNIT 8"

In this activity you will be color coding resistors for an assigned value and computing their tolerance ranges. Cut out the puppets on the attached sheet and use them as the color bands for the blank resistors drawn below. Use colored pencils to shade in each puppet.

EXAMPLE:

A. Color code a $180\Omega \pm 10\%$ resistor and determine its tolerance range.

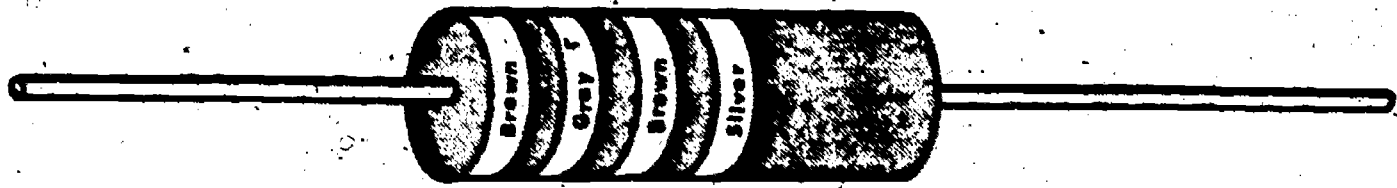

Tolerance range: From 198Ω to 162Ω

percentage	upper limit	lower limit
$\begin{array}{r} 180 \\ \times .10 \\ \hline 000 \\ 180 \\ \hline 18.00 \end{array}$	$\begin{array}{r} 180 \\ + 18 \\ \hline 198 \end{array}$	$\begin{array}{r} 180 \\ - 18 \\ \hline 162 \end{array}$

1. Color code a $100\Omega \pm 20\%$ resistor and determine its tolerance range.

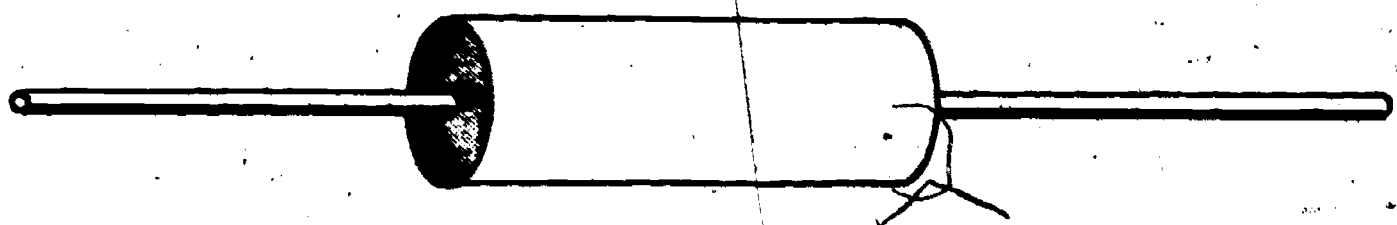

Tolerance range: From _____ to _____

percentage	upper limit	lower limit

Name: _____

Date: _____

Period: _____

2. Color code a $2000\Omega \pm 10\%$ resistor and determine its tolerance range.



Tolerance range: From _____ to _____

Show work:		
<u>percentage</u>	<u>upper limit</u>	<u>lower limit</u>

3. Color code a $15000\Omega \pm 10\%$ resistor and determine its tolerance range.

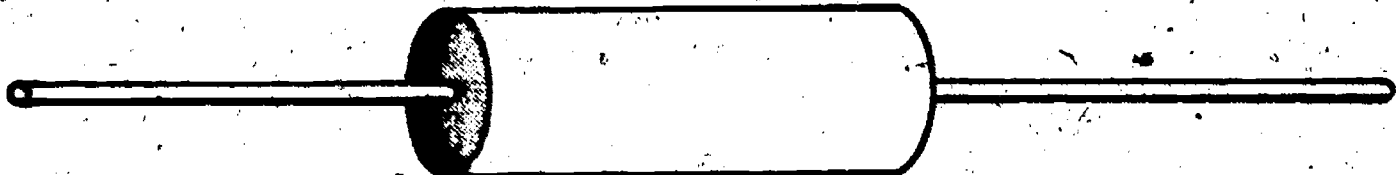

Tolerance range: From _____ to _____

Show work:		
<u>percentage</u>	<u>upper limit</u>	<u>lower limit</u>

4. Color code a $560\Omega \pm 5\%$ resistor and determine its tolerance range.

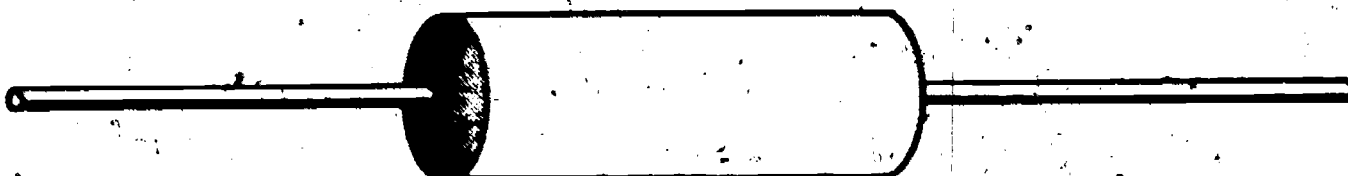

Tolerance range: From _____ to _____

Show work:		
<u>percentage</u>	<u>upper limit</u>	<u>lower limit</u>

SPECIAL QUEST:

5. Have your teacher assign you an individual resistance value. Color code that resistor and compute its tolerance range.

Resistance value: _____



Show work:

Tolerance range: From _____ to _____

<u>percentage</u>	<u>upper limit</u>	<u>lower limit</u>
-------------------	--------------------	--------------------

CUT

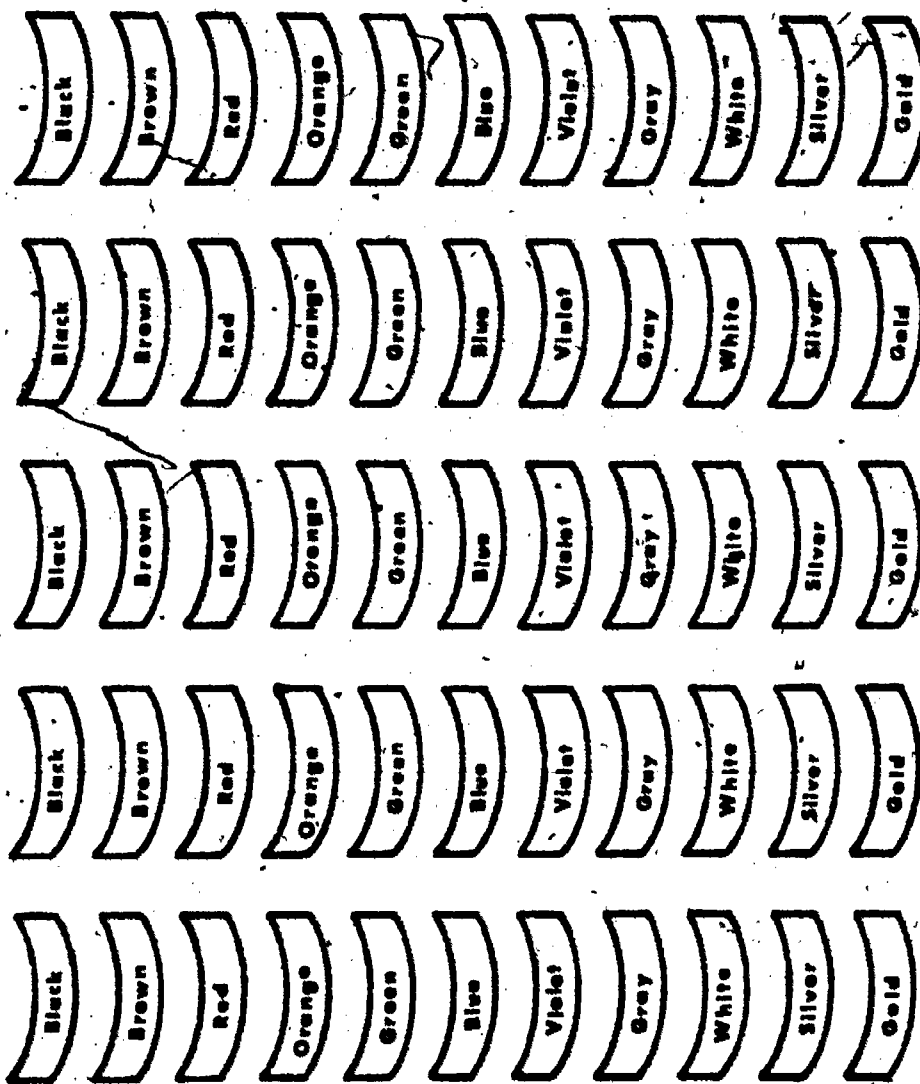

Name: _____

Date: _____

Period: _____

INFORMATIONAL HANDOUT

THE RESISTOR COLOR CODE

Carbon composition resistors use a system of three or four color bands painted on the body of the resistor to give its ohmic value. Each color represents a number or percentage value. Here's how the system works.

Color Code Chart:

	First Color Band	Second Color Band	Third Color Band	Fourth Color Band
Color Code	First Digit	Second Digit	Number of Zeros to Add	Tolerance
0 Black		0	0	No color 20% Silver 10% Gold 5%
1 Brown	1	1	1	
2 Red	2	2	2	
3 Orange	3	3	3	
4 Yellow	4	4	4	
5 Green	5	5	5	
6 Blue	6	6	6	
7 Violet	7	7	7	
8 Gray	8	8		
9 White	9	9		
- Gold	-	-	+ 10	
- Silver	-	-	+ 100	

Locating The Color Bands

Start from
this side

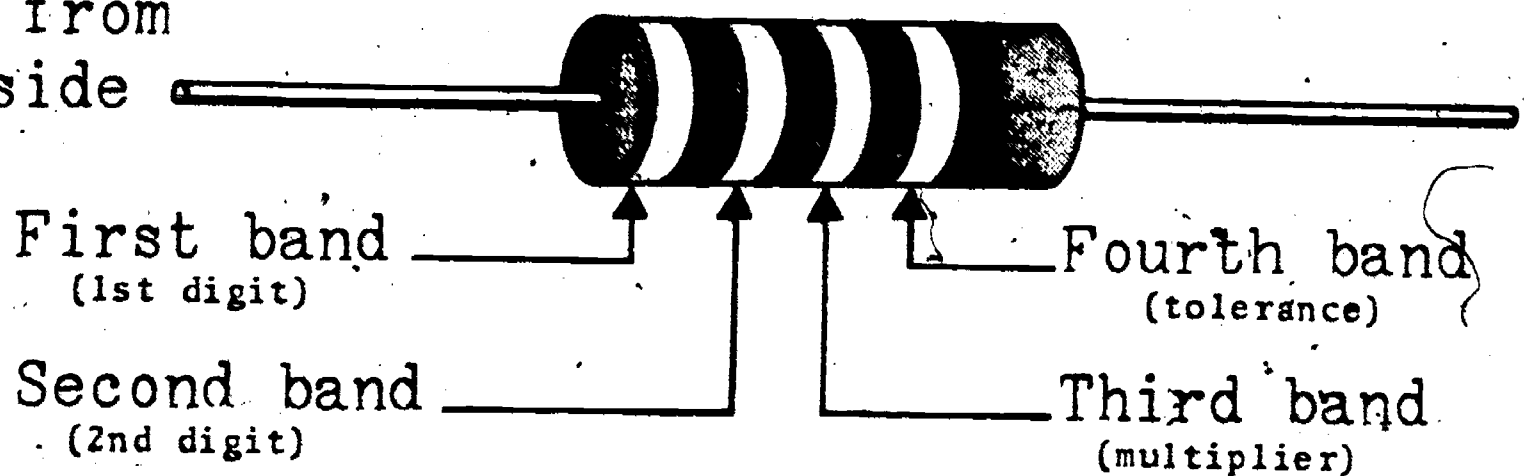

Name: _____

Date: _____

Period: _____

Using The Color Code:

Even though it looks a little difficult, using the color code system is actually pretty easy once you have the hang of it. These are the points to remember!!!

- 1. The first color band represents the first digit.
- 2. The second color band represents the second digit.
- 3. The third color band basically tells how many zeros are added to the first two digits.
- 4. The fourth color band indicates the + tolerance.

EXAMPLE:

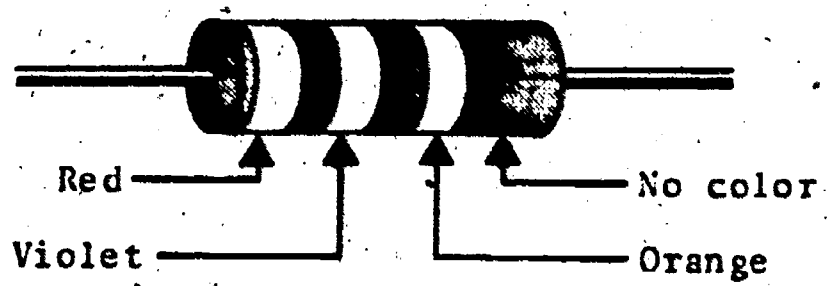

Red = 2
Violet = 7
Orange = (3)000
No color = +20%
Total Value 27000 Ω +20%

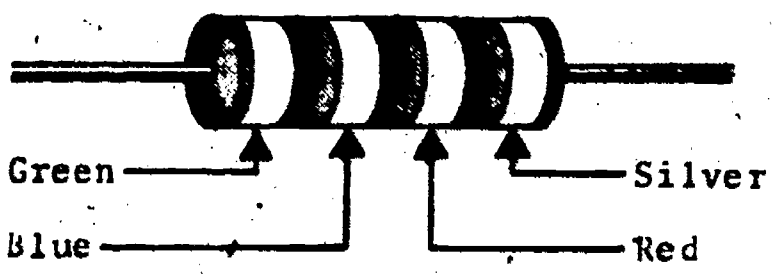

Green = 5
Blue = 6
Red = (2)00
Silver = +10%
Total Value 5600 Ω +10%

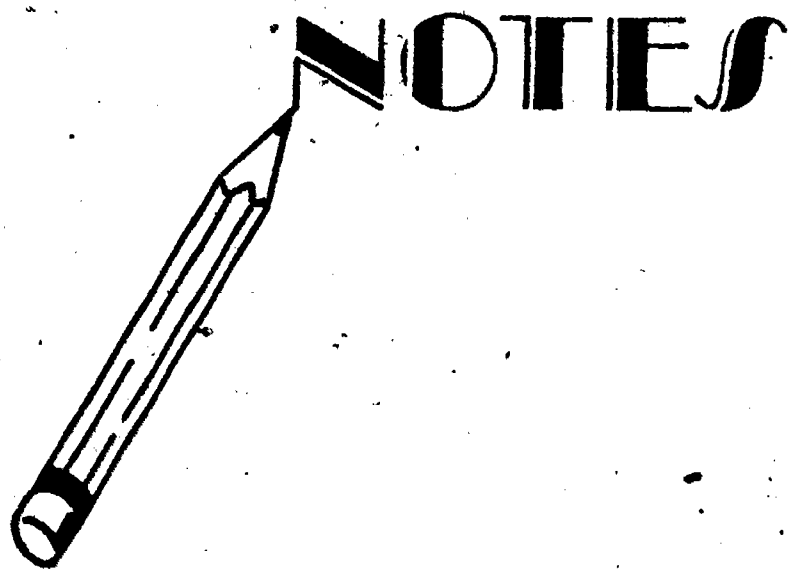

SCORE:

GRADE:

Name: _____

Date: _____

ANSWER SHEET

Period: _____

EXAM LI-U8

TF
A B C D

TF
A B C D

TF
A B C D

TF
A B C D

1.				
2.				
3.				
4.				
5.				
6.	1			
7.	red			
8.	3			
9.	yellow			
10.	5			
11.	6			
12.	violet			
13.	grey			
14.	9			
15.	120n			
16.	4700n			
17.	56000n +10%			
18.	red			
19.	violet			
20.	red			
21.				
22.				
23.				
24.				
25.				

26.				
27.				
28.				
29.				
30.				
31.				
32.				
33.				
34.				
35.				
36.				
37.				
38.				
39.				
40.				
41.				
42.				
43.				
44.				
45.				
46.				
47.				
48.				
49.				
50.				

51.				
52.				
53.				
54.				
55.				
56.				
57.				
58.				
59.				
60.				
61.				
62.				
63.				
64.				
65.				
66.				
67.				
68.				
69.				
70.				
71.				
72.				
73.				
74.				
75.				

76.				
77.				
78.				
79.				
80.				
81.				
82.				
83.				
84.				
85.				
86.				
87.				
88.				
89.				
90.				
91.				
92.				
93.				
94.				
95.				
96.				
97.				
98.				
99.				
100.				

*Show work for problems on back of answer sheet.

ANSWER KEY
UNIT 8

A. KNOW YOUR DEFINITIONS

1. (subjective answer)
2. (subjective answer)
3. (subjective answer)
4. (subjective answer)
5. (subjective answer)

B. RESISTOR COLOR CODING AND
DECODING

1. $120\Omega +20\%$
 2. $47000\Omega +10\%$
 3. $3900\Omega +5\%$
 4. $68\Omega +20\%$
 5. $56000\Omega +5\%$
 6. $1000\Omega +10\%$
 7. $8200\Omega +20\%$
 8. $180000\Omega +20\%$
 9. red
 10. yellow
 11. gray
 12. green
 13. yellow
 - 14A. green
 - 14B. red
- Extra challenge
- 15A. gray
 - 15B. red
 - 15C. brown
 - 15D. gold

C. QUEST ACTIVITY

1. brown, black, brown
 $80\Omega - 120\Omega$
2. red, brown, red, silver
 $1800\Omega - 2200\Omega$
3. brown, green, orange, silver
 $13500\Omega - 16500\Omega$
4. green, blue, brown, gold
 $532\Omega - 588\Omega$
5. (subjective answer)

ELECTRICITY / ELECTRONICS

CURRICULUM GUIDE INSTRUCTIONAL MODULE

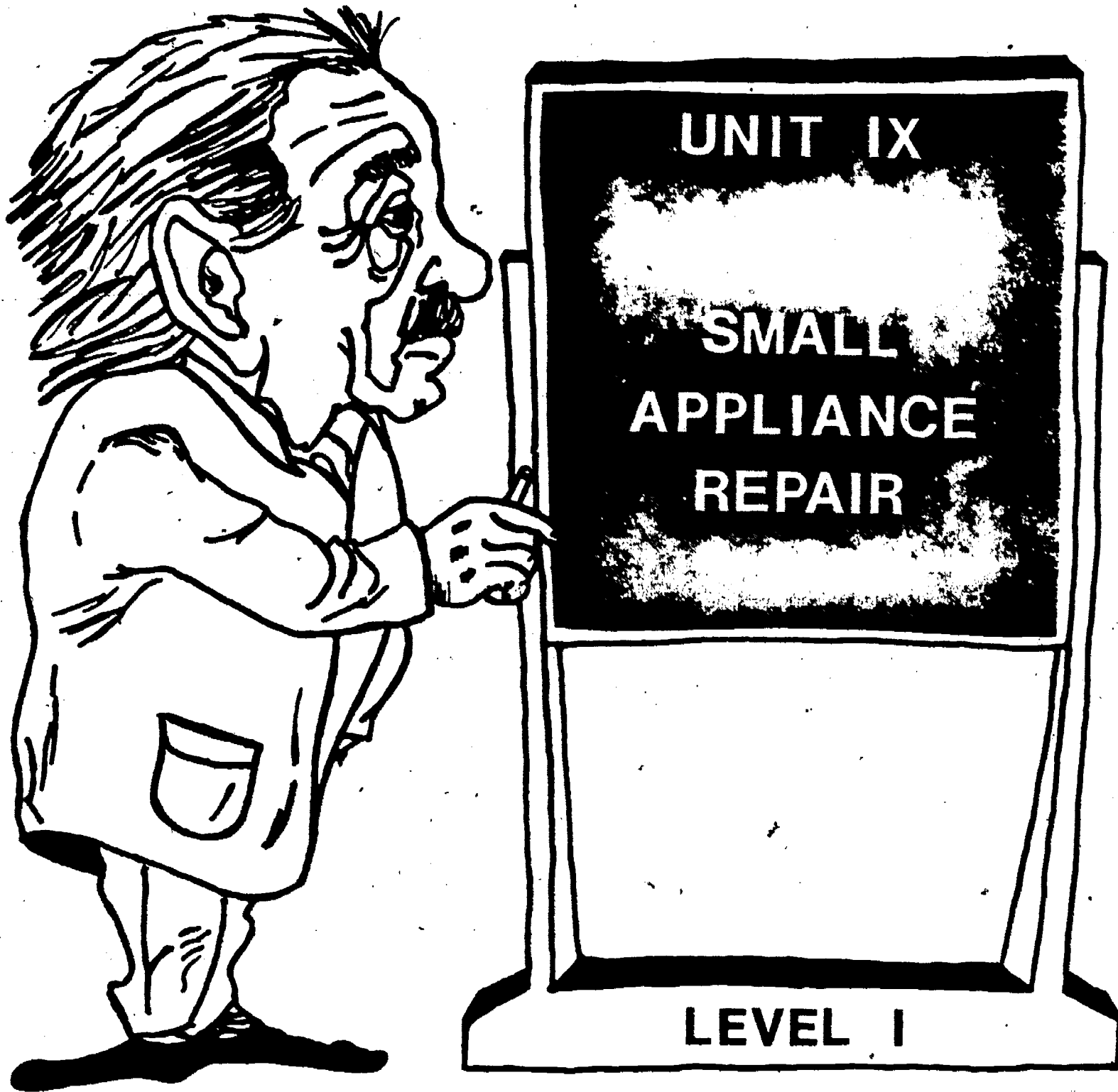

STATE OF CALIFORNIA
DEPARTMENT OF EDUCATION

NAME _____

DATE STARTED _____

DATE COMPLETED _____

BY
R. E. LILLO
N. S. SOFFIOTTO

STATE ELECTRICITY/ELECTRONICS CURRICULUM GUIDE
INSTRUCTOR'S GUIDE TO ACCOMPANY LEVEL I UNIT #9

Title of Unit: Small Appliance Repair

Time Allocation: 5 weeks

Unit Goal:

To achieve student competence in evaluating simple appliance construction and operation, and to develop in students a technical familiarity with several kinds of appliance defects and typical method of repair.

Unit Objectives:

The student will be able to:

1. identify and differentiate between kinds or categories of appliances in terms of basic parts incorporated in the device.
2. perform basic inspection, testing, and troubleshooting procedures in order to locate and remedy simple defects when repairing a malfunctioning appliance.
3. demonstrate the proper method for replacing a line cord, AC plug, and switch while observing all safety procedures that apply.

Evaluation:

The student will demonstrate his/her competence in terms of these measurable objectives based upon individual instructors acceptable performance criteria, which may utilize a combination of written, oral, and laboratory testing procedures.

Instructor References:

How to Repair Small Appliances Volume 1. Jack Darr, Howard W. Sams, Inc., 1972. All.

How to Repair Small Appliances Volume 2. Jack Darr, Howard W. Sams, Inc., 1972. All.

Industrial Electricity. Rex Miller, Chas. A Bennett Col, 1978. Chapter: 15.

Overview:

This unit was designed into Level I for a variety of reasons. First, to serve as a skill review for material previously taught. Next, to motivate students technically and to impart confidence and know-how for simple appliance servicing. Finally, to provide flexibility as a calendar adjustment unit (5 weeks) to facilitate related project planning and fabrication.

The main theme of this unit is appliance servicing, however, review fundamental concepts prior to the presentation of new materials.

Next, emphasize necessary repair tools and materials including the introduction of measuring instruments and circuit testers.

Then present basic appliance construction and operation, highlight the vocabulary words given in this unit when practical. Demonstrate the common kinds of appliance failures that they should be able to recognize and repair, but always stress safety as a vital aspect of the repair process. A variety of appropriate exercises and laboratory experiments and/or projects should be coordinated with all unit topics when feasible.

Suggested Presentation Hints/Methodology:

Follow the instructional module unit outline as a basic skeleton for curriculum presentation, however, note the following:

1. Whenever possible, diagrams (schematics and pictorials) should be used on the blackboard to clarify the operation or construction of an appliance being discussed. These diagrams need not be elaborate, but they should be drawn neatly, with the significant parts clearly labeled.
2. Stress that appliance repair people agree that broken or worn line cords, malfunctioning AC plugs, switches, and defective heating Elements and thermostats, are the most common appliance troubles. Other problems with a fairly high rate of incidents are associated with small electric motors because the consumer fails to lubricate bearings or clean mechanical parts.
3. A project for the student to build is definitely mandatory in this unit. For example, a neon test lamp may be constructed utilizing "assembly line" type techniques. Break the shop into three major work stations; mechanical assembly, electrical assembly, and inspection/testing. Allow the students to perform only those skills associated with that work station, however, rotate students if you desire to expose them to other competencies.
4. When instructing students in "assembly line" project construction or other fabrication techniques utilize pre-completed models or samples to assist students in achieving the best results.

Supplemental Activities and Demonstrations:

1. The vocabulary list presented in this unit is long and cumbersome. Spend a good deal of time describing each term and if possible demonstrate each component or part listed and emphasize safety precautions when appropriate.
2. Demonstrate the use of various chemical products which are very useful for cleaning contacts, cementing parts, insulating wiring etc. Warn students not to use acetates and acrylates since these materials are flammable around hot appliance parts.
3. A big problem in appliance servicing is the procurement of replacement parts especially in rural communities, so explain to students that once the bad part has been located use the telephone in an attempt to locate a supplier that stocks the desired item.

Instructional Module Contents:

1. Unit Outline (overhead)
2. Pre-Post Test (keyed)
3. Technical Glossary
4. Worksheet (vocabulary) - Spelling Puzzle
5. Worksheet - Appliance Classification
6. Quest Activities
7. Quest Activities
8. Informational Handout (Attaching and Replacing Electrical Plugs)
9. Informational Handout (Basic Appliance Components)
10. Informational Handout (A Guide to Repairing Small Appliances)
11. Unit Module Answer Keys

IX. Small Appliance Repair

A. Circuit Requirements and Repair

Instruments

1. Review of electrical fundamentals
2. Measuring instruments for testing electric circuits
 - a. The voltmeter
 - b. Neon test lamp
 - c. The ohmmeter (continuity)

B. Appliance Construction and Operation

1. Basic circuit components for specific household appliances

a. Heating elements and thermostats

b. Small motors

c. Timers

d. Lamps or indicating devices

2. Common failures

a. Line

b. Plugs

c. Attachments

d. Other

1. Testing techniques and diagnosing

C. Appliance Servicing As a Business

LI-U9

UNIT EXAM

SMALL APPLIANCE REPAIR

IMPORTANT-

Indicate your responses on the answer sheet only. Fill in the box corresponding to the correct answer to each question - there is only one correct answer for each question.

1. A continuity test checks for a complete path from one point in a circuit to another. (T-F)
2. All line cords contain only two conductors. (T-F)
3. A neon test lamp can be used to check for voltage above 55 volts. (T-F)
4. An open circuit has a break or gap in the current path. (T-F)
5. Resistance values can be measured by a continuity tester. (T-F)
6. A short circuit to the case of an appliance can cause a dangerous shock hazard. (T-F)
7. Troubleshooting is the process of finding and repairing circuit problems. (T-F)
8. An underover knot is used as a strain relief when attaching a cord to a plug. (T-F)
9. A voltmeter is used to measure circuit voltages. (T-F)
10. Zip cord has a small zipper between the conductors to make it easy to separate the wires. (T-F)

11. Almost all small appliances use either an electric motor or a heating element in their operation. (T-F)
12. Tools must be used properly and only for the job which they are designed. (T-F)
13. For an electric appliance to operate, current must be able to flow from the source, through the circuit and load, and back to the source. (T-F)
14. When removing insulation from a wire, putting a small cut or dent in the wire, or cutting off one or two small wire strands is OK. (T-F)
15. Acid core solder is the recommended type of solder for appliance repair. (T-F)
16. After repairing an appliance always check to be sure wires are not shorting against the metal case. (T-F)
17. A thermostat is used to control the speed of an electric motor. (T-F)
18. When attaching a line cord to a screw terminal, wrap the wire around the screw in a clockwise direction. (T-F)
19. The major problems with appliance motors are dirt, and worn brushes-commutator. (T-F)
20. Over oiling a motor will not cause any problems, and in fact might help the motor to last longer. (T-F)
21. When actual pictures are used to represent electrical parts in an appliance diagram this diagram is called a:
(A) schematic, (B) picture puzzle, (C) blueprint, (D) pictorial.

22. By far the most common service job on appliances is replacement of the:
(A) line cord, (B) motor, (C) wiring, (D) heating element
23. An electrical iron contains two major parts - the heating element and a:
(A) motor, (B) bulb reflector, (C) gear, (D) thermostat.
24. Power cords on appliances often cause trouble by opening or shorting at the:
(A) switch, (B) plug, (C) base, (D) terminals.
25. Nichrome wire is generally used in appliances for:
(A) hook-up wire, (B) heater wire, (C) zip cord, (D) appliance adapters.

Name: _____

Date: _____

Period: _____

TECHNICAL GLOSSARY

- APPLIANCE:** An electrical device used to make household jobs or chores easier. Appliances fall into many groups such as kitchen appliances, (blender, electric knives, etc.) health and beauty aids (hair dryer, shaver, etc.) house and garden appliances (fan, electric hedge shears, etc.) and luxury items.
- APPLIANCE CONNECTORS:** A specially shaped heavy duty plug connected to the appliance end of the line cord, and used to unplug the cord from the appliance. Appliance connectors are used on waffle irons, coffee makers, etc. These plugs often break, and need to be repaired or replaced.
- CONTINUITY:** A complete electrical path through a circuit, from the source, through the load, and back to the source.
- CONTINUITY TEST:** The process of checking a circuit, or parts of a circuit, for a complete, unbroken electrical path.
- HEATER CORD:** A heavy-duty two conductor cord made to be used on appliances that require large amounts of electricity. Many times heater cords have cloth/asbestos insulation.
- HEATING ELEMENT:** A special electrical conductor or wire which becomes hot when electricity is forced through it. Heating elements are found on many home appliances.
- LAMP:** A basic device used to produce light from electrical energy. Lamps use a special socket, sometimes containing a switch, to connect the bulb with the source. Often the lamp socket will require repair or replacement.
- LINE CORD:** A two conductor stranded wire cord usually having an AC plug connected to one end. A line cord is required to carry the electricity from the wall outlet to the appliance.
- MOTOR:** A device used to change electrical energy into a turning or spinning force. Motors are found in many appliances.
- NEON TEST LAMP:** A common troubleshooting tester used to check for the presence of electricity at certain points in a circuit. The neon test lamp is a simple inexpensive, and useful device to have when testing for voltages above 55V.
- OHMMETER:** An electrical test instrument used to measure resistance. The ohmmeter can also be used to test for continuity.
- OPEN CIRCUIT:** A circuit which has a break or gap in the electrical path. The "break" will stop the circuit from working.

Name: _____

Date: _____

Period: _____

- PLUG:** Found at one end of a line cord, for example, a plug allows you to easily connect or disconnect a cord or wire from an outlet, receptical or jack.
- SHORT CIRCUIT:** An accidental connection sometimes caused by loose wires or damaged insulation which causes high current flow, possible circuit damage, and shock hazard.
- STRAIN RELIEF:** A device used to grip the line cord and to keep pressure off of the internal electrical connections in case the cord is pulled or yanked.
- SWITCH:** A basic electrical device used to control or direct electricity through a circuit. Most commonly, switches are used to turn a device on or off.
- THERMOSTAT:** A device which automatically controls the amount of heat produced by a heating element. Thermostats are found in ovens, toasters, coffee pots, heaters, and many other appliances.
- TIMER:** A device which can be set to control the length of time an appliance will operate. Timers are found on oven/stoves, blenders etc.
- TROUBLESHOOTING:** Finding and repairing malfunctions, opens, shorts, or other problems within a circuit.
- VOLTMETER:** A meter used to measure voltage.
- ZIP CORD:** A stranded two-conductor line cord covered with plastic insulation and having a groove down the center to allow easy separation of the two conductors.

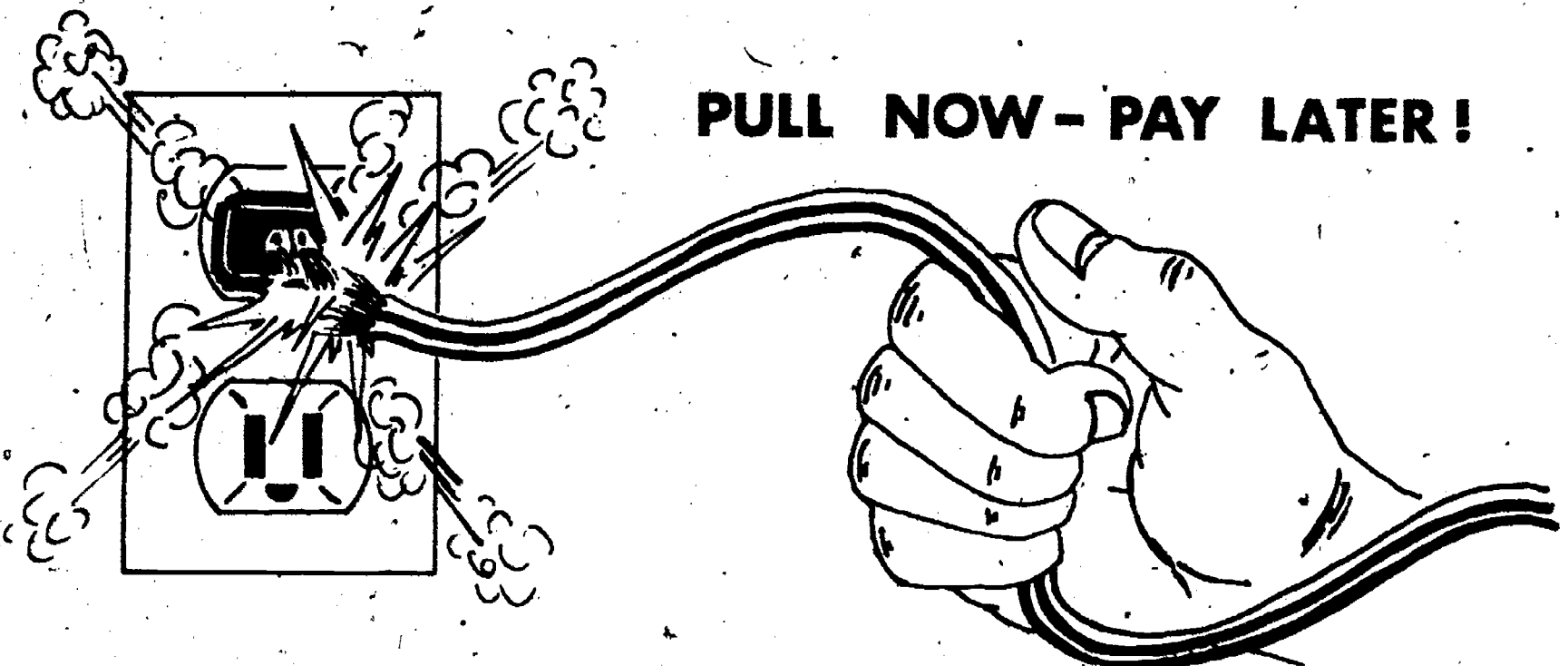

SCORE:
GRADE:

Name: _____

Date: _____

Period: _____

WORKSHEET

VOCABULARY - SPELLING PUZZLE

Copy the correctly spelled word in the box to the right as indicated in the example below.

- | | |
|--|--|
| A. (sampil) (sample) (sampil) | A. <input type="text" value="sample"/> |
| 1. (moter) (motor) (moeter) | 1. <input type="text"/> |
| 2. (swetch) (swtch) (switch) | 2. <input type="text"/> |
| 3. (timer) (tymer) (timor) | 3. <input type="text"/> |
| 4. (heeter) (heater) (heator) | 4. <input type="text"/> |
| 5. (kneeon) (neon) (nion) | 5. <input type="text"/> |
| 6. (apliance) (applience) (appliance) | 6. <input type="text"/> |
| 7. (ohmmeter) (ohmeater) (ohmmeater) | 7. <input type="text"/> |
| 8. (shoret) (shorte) (short) | 8. <input type="text"/> |
| 9. (thermalstat) (thermostat) (thermastat) | 9. <input type="text"/> |
| 10. (continuity) (contenuety) (contineuity) | 10. <input type="text"/> |
| 11. (vaultmeter) (votemeter) (voltmeter) | 11. <input type="text"/> |
| 12. (element) (elament) (elemint) | 12. <input type="text"/> |
| 13. (trubleshootin) (throubilshoting)
(troubleshooting) | 13. <input type="text"/> |
| 14. (circuit) (circut) (sircut) | 14. <input type="text"/> |
| 15. (connektor) (connector) (connekter) | 15. <input type="text"/> |

SCORE :

GRADE :

Name : _____

Date : _____

Period : _____

WORKSHEET

APPLIANCE CLASSIFICATION

In this worksheet you will identify, and group a number of common appliances into two major categories - appliances using heating elements, and appliances using motors. You will also list the names of at least 5 appliances which use a thermostat. To complete the first part of the worksheet, cut out the puppets, on page two, and glue them in the proper area below.

APPLIANCES THAT USE HEATING ELEMENTS:

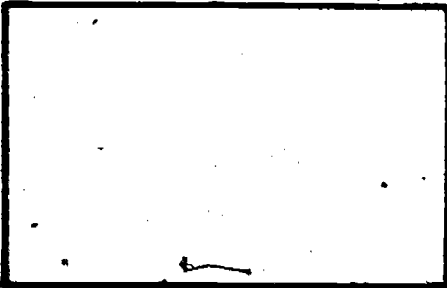
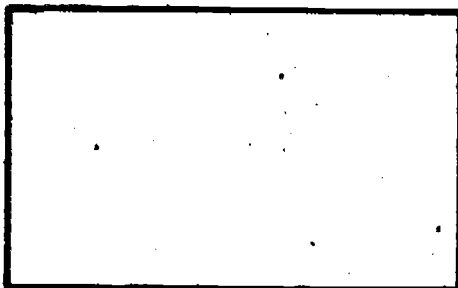
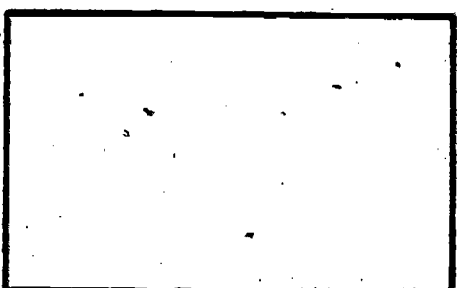
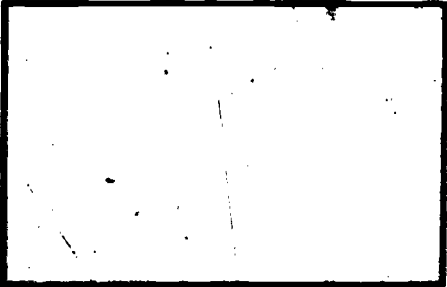
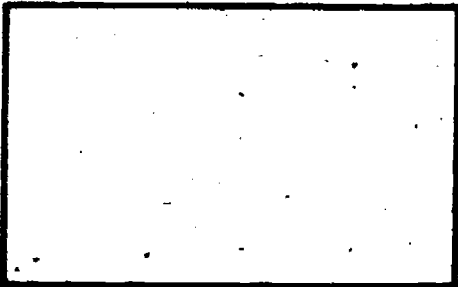
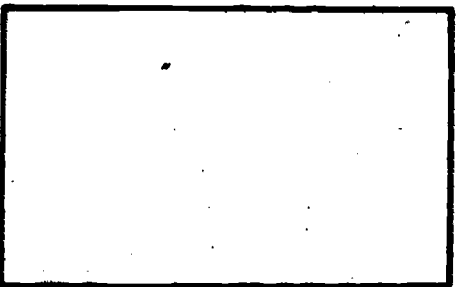
1. 	2. 	3. 
4. 	5. 	6. 

APPLIANCES THAT USE MOTORS:

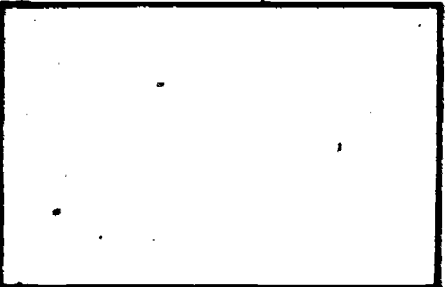
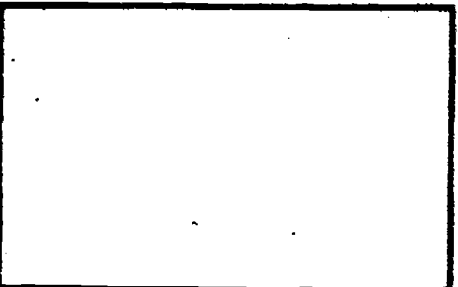
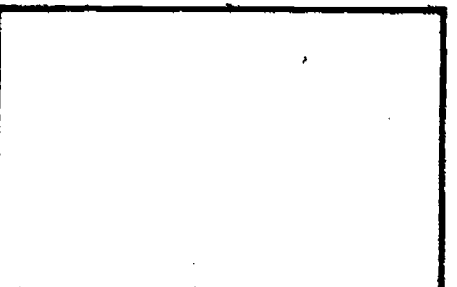
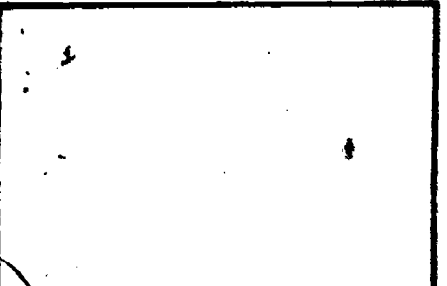
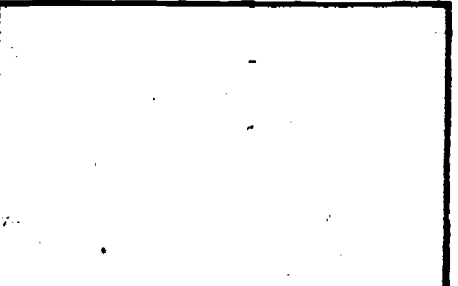
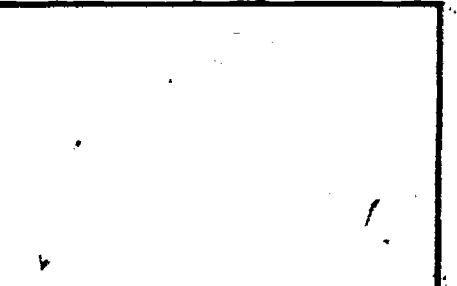
7. 	8. 	9. 
10. 	11. 	12. 

Name: _____

Date: _____

Period: _____

For questions 13-17, name five appliances found in your home that use a thermostat.

13.

14.

15.

16.

17.

For questions 18-20, name three appliances that use a timer.

18.

19.

20.

NOTES

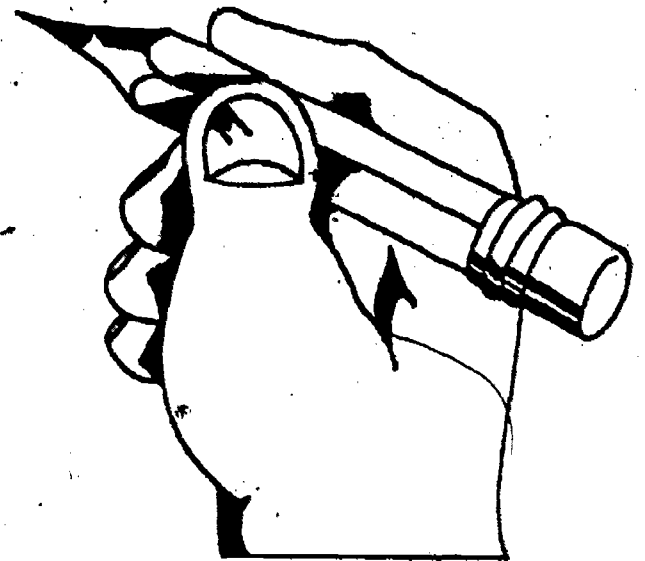

Name: _____

Date: _____

Period: _____

PUPPETS

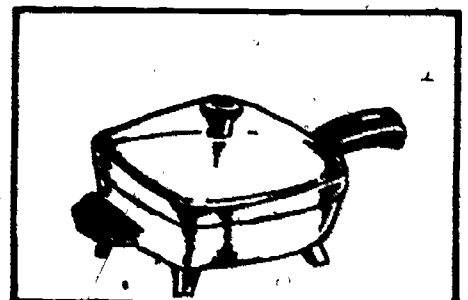
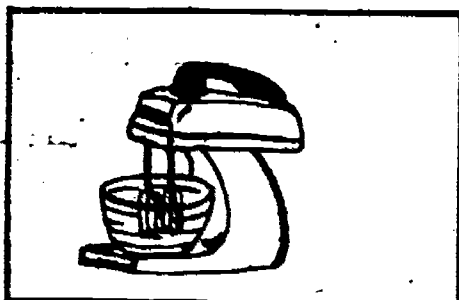
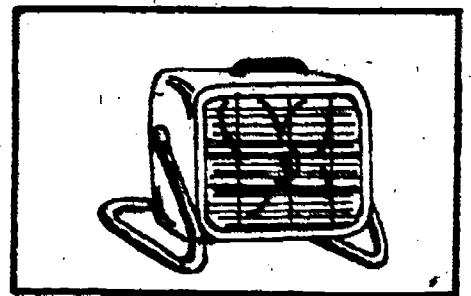
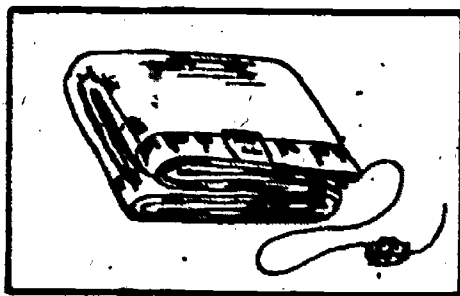
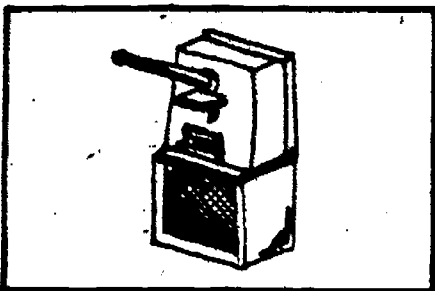
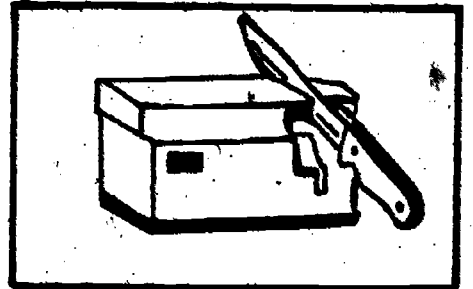
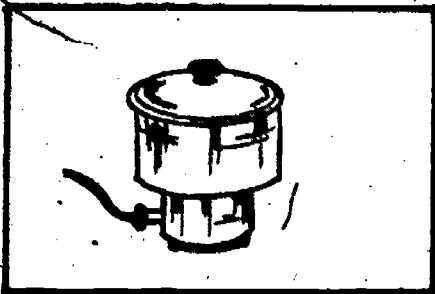
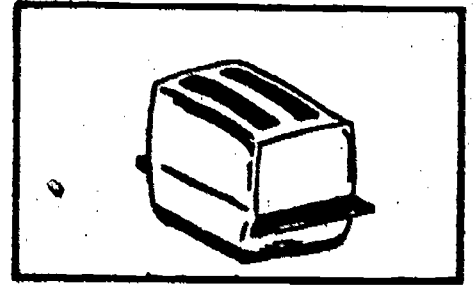

SCORE:

GRADE:

Name: _____

Date: _____

Period: _____

WORKSHEET

QUEST ACTIVITY

"UNIT 9"

From time to time you may have to check or test for electrical power (120VAC) in an appliance, circuit, or electrical outlet. On the following pages construction hints are given to build such a handy test instrument that may be used in a variety of situations. This neon lamp tester can be used to test voltages from 65 volts to 240 volts AC or DC.

NEON TESTER

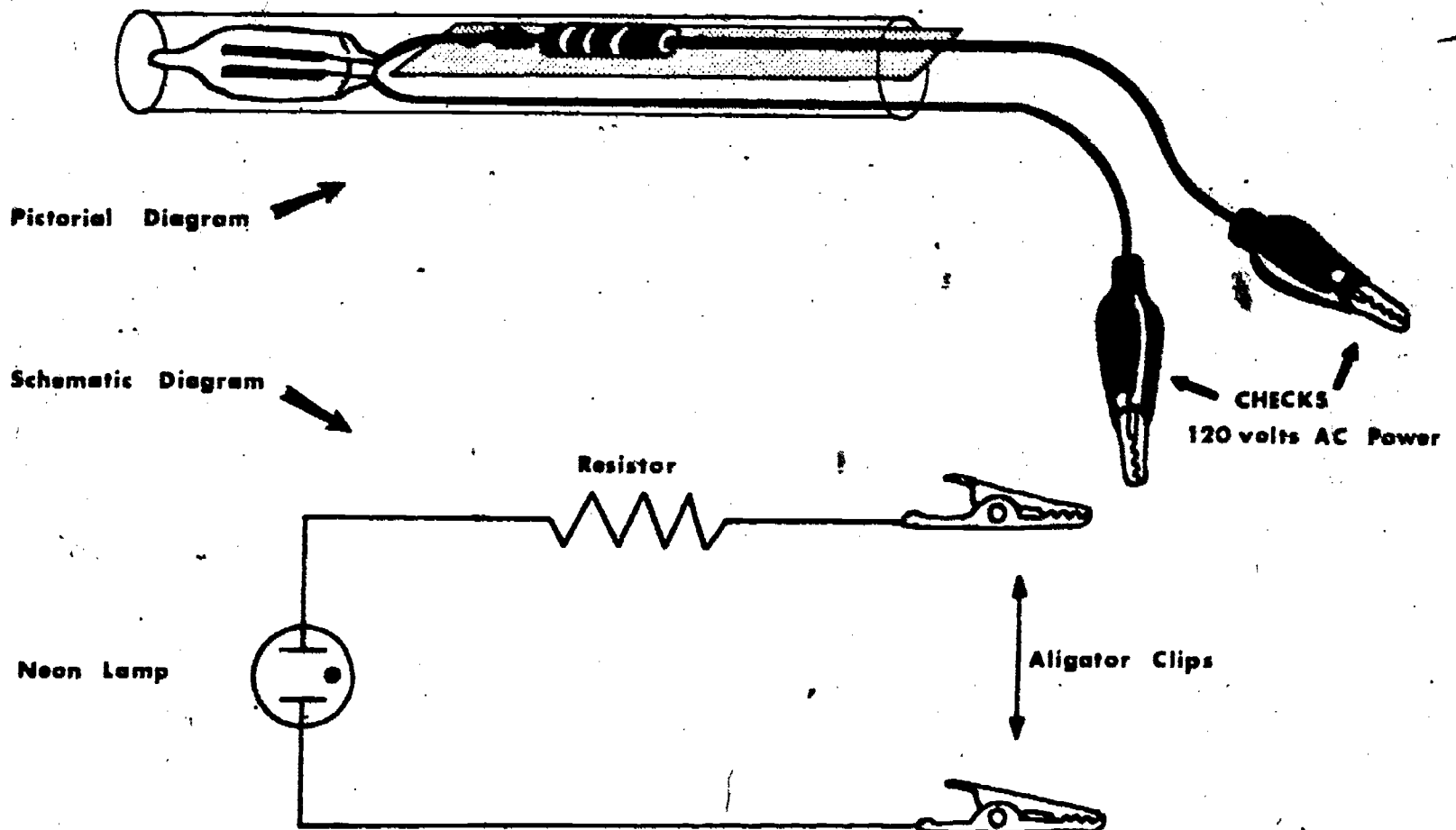

The following components or parts will be necessary to construct this tester - so check with your teacher for any additional directions!

Name: _____

Date: _____

Period: _____

Project Parts List

Check off and identify each part that you have, then place them carefully into a locking plastic bag.

- 1 - NE-2 Neon lamp
- 1 - Resistor 220,000 ohms, 1/2 watt (red, red, yellow)
- 2 - Miniature alligator clips
- 2 - Molded miniature alligator type insulators
- Hook-up wire, stranded 20 gauge (insulated)
- Clear type heat shrinkable tubing (1/4" I.D.)
- Cardboard separator

Soldering Review

For this project to work properly, you must not only connect the circuit right, but also make good solder connections. It is suggested that you review all soldering rules, processes, and actually practice soldering before starting this project!!

Basic Construction

Steps:

1. Use both diagrams on the first page to help you layout the circuit connections.
2. Obtain the neon lamp and attach to one lead, one end of the resistor. Wrap or twist the leads together.....carefully.
3. Now, strip away about 1/2" of insulation from all four ends of the hook-up wire. (2 pieces of wire 6 inches long each) Watch out for broken strands of wire.
4. Attach to the free lead of the neon lamp one end of the Hook-up wire. The other piece of hook-up wire attaches to the free end of the resistor.

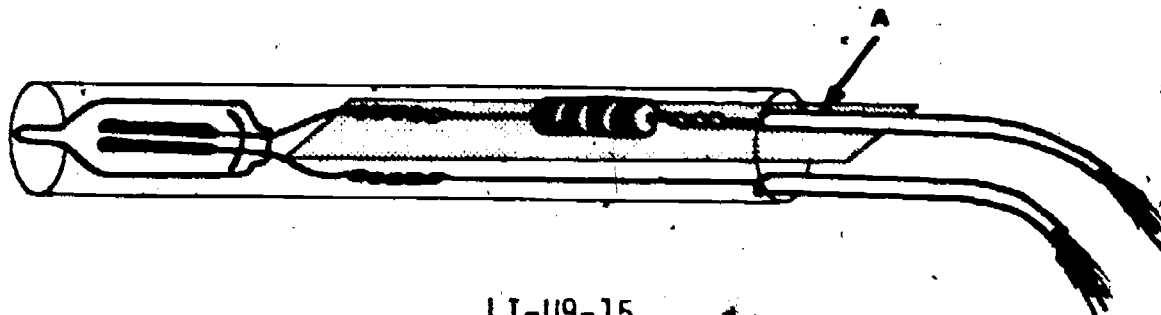

Name: _____

Date: _____

Period: _____

5. Properly solder the connections made in steps 2 and 4 using rosin core solder. Remember too much heat will burn your component
6. Insert a piece of clear tubing about 3" long over the resistor, and connections. Leave about 1/4 inch of tubing past the top of the lamp for protection.
7. Next take a strip of cardboard (index card) about 2 1/2" long and 1/4" wide and place it between the leads of the neon lamp. This will add strength and keep all bare wires apart.
8. Make a knot at point "A". (Look at drawing)
9. Shrink the tubing so, that it fits tightly around the main parts of the tester. (See instructor)
10. Connect the alligator clips to the ends of the hook-up wire. Don't forget to slip the insulators on before soldering the leads to the alligators, and be sure the wires are cut to equal length.

Double check all of your work. Caution: When using this tester, touch only the insulated parts of the clips!!!

Conclusion

You have now finished your own Electrical Tester. Check it by testing circuits or devices in the shop as directed by your instructor.

Lamp Readings

Light Pink - 120V

Bright Pink - 240V

One side of lamp glowing = DC
Both sides glowing = AC
No glow = 0-50 Volts

SCORE:
GRADE:

Name: _____
Date: _____
Period: _____

WORKSHEET
QUEST ACTIVITY
"UNIT 9"

1. Obtain the following materials:
 - A. AC plug with screw terminals
 - B. A length of line cord
 - C. Piece of solder
 - D. Appropriate hand tools

Using your handout as a guide, attach the cord to the plug applying the proper techniques. Do an accurate and complete job. Have your instructor check your work!

For instructors use:

1. Underwriters knot _____
2. Wires properly stripped and tinned _____
3. Attachment to terminals, insulation location. _____

2. Explain the difference between an insulator, and a conductor.

3. What advantage does stranded wire have over solid wire?

4. Draw a sketch showing how an Underwriters knot is made.

Attach your completed plug sample to this worksheet, answer the questions above and turn in for grading.



Name: _____

Date: _____

Period: _____

INFORMATIONAL HANDOUT

ATTACHING AND REPLACING ELECTRICAL PLUGS

WHAT YOU WILL NEED:

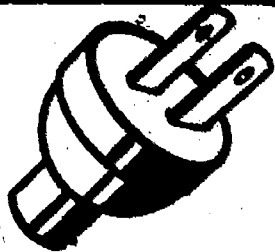

AC plug (available at most hardware stores and super-markets). Purchase the type which uses screw terminals to attach the wires, and has a U.L. approved label.

Screwdriver



Knife or wire stripper



WHAT TO DO:

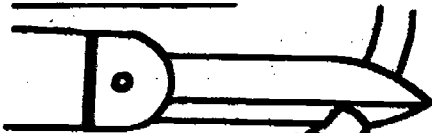

(If you are attaching a plug to a new cord, start with step 2.)

1. Cut the cord off above the damaged section
2. Push the cord through the plug.

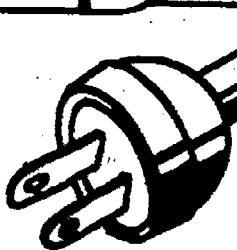

If using a round cord:

3. Remove about 1 1/2" of the outer insulating layer and separate the two inner wires.

If you are using a flat style cord, separate the two wires by carefully cutting along the center divider for a distance of 1 1/2".

4. Tie an Underwriter's knot as shown. This knot acts as a strain relief in case the cord is yanked or pulled.

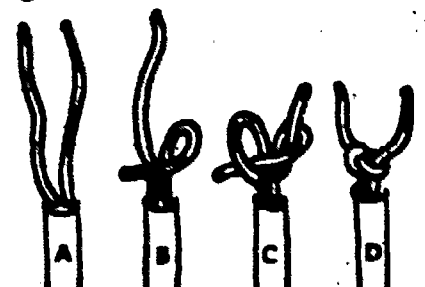
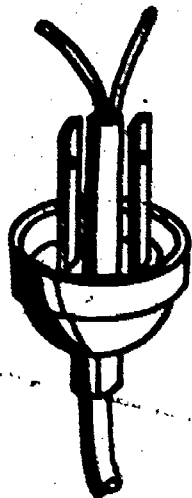
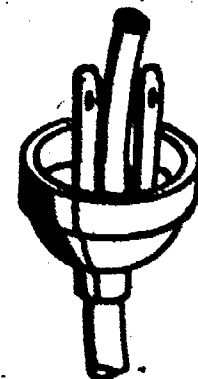

Name: _____

Date: _____

Period: _____

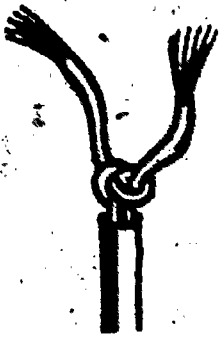

5. Remove 1/2 inch of the insulation from the end of the wires. DO NOT CUT ANY OF THE SMALL WIRES.

6. Twist the small strands of wire together in a clockwise direction. Tin the wires with a small amount of solder; this will prevent them from separating.

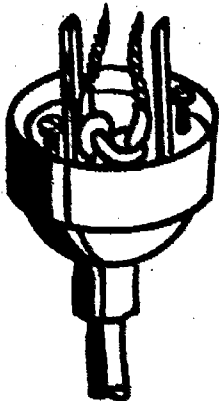

7. Pull the cord and knot down firmly into the plug.

8. Pull one wire around each terminal to the screw.



9. Wrap or hook the wire around the screw in a clockwise direction.



10. Tighten down the screws. The insulation should come up to the screw head, but not be pinched under it.

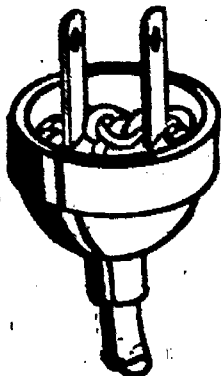
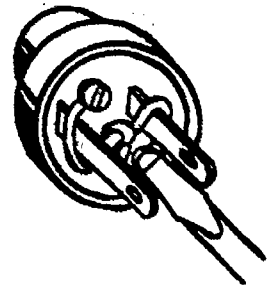

11. Replace the insulating cover back over the plug.

Name: _____

Date: _____

Period: _____

INFORMATIONAL HANDOUT

BASIC APPLIANCE COMPONENTS

Most of the small appliances used in the home contain relatively simple electrical circuits and components. Basically, these appliances contain nothing more than a combination of either heating elements, thermostats, small motors, timers, and of course a line cord and switch. For example, an electric iron is nothing more than a line cord, a heating element, a thermostat and a switch. A mixer is just an electric motor connected to a small gear box which turns two beaters. Let's examine some of these basic appliance components.

HEATING ELEMENTS:

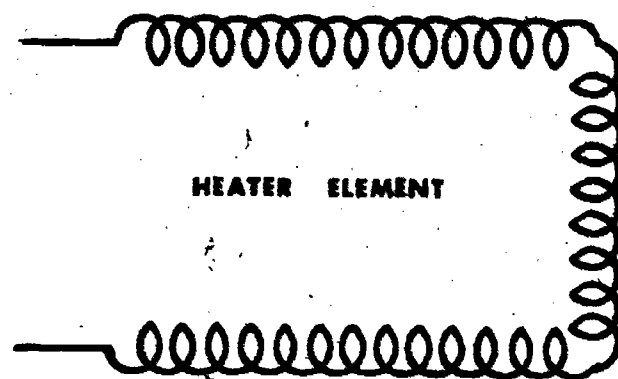
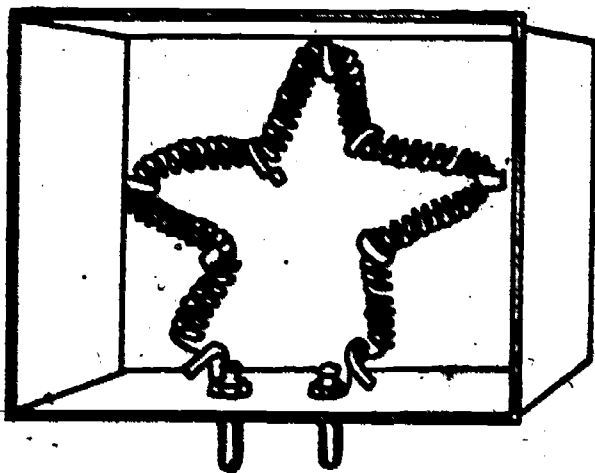

A heating element is designed to become hot when electricity is forced through it. You will find heating elements in various shapes, such as coiled springs, flat ribbons, and straight wires. The newest type of heating element is a quartz rod, which looks like glass, but will produce heat when current flows through it. Many times heating elements are sealed in metal or ceramic, making them sturdier and water proof.

THERMOSTATS:

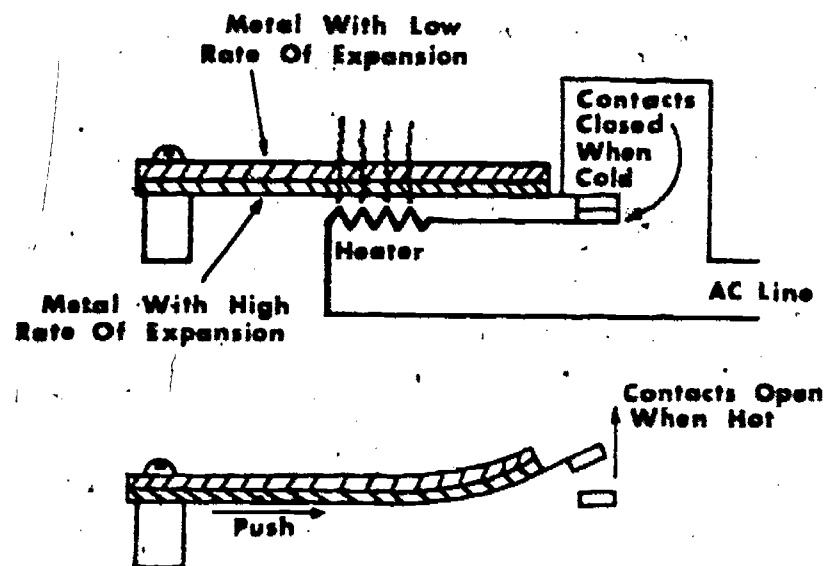
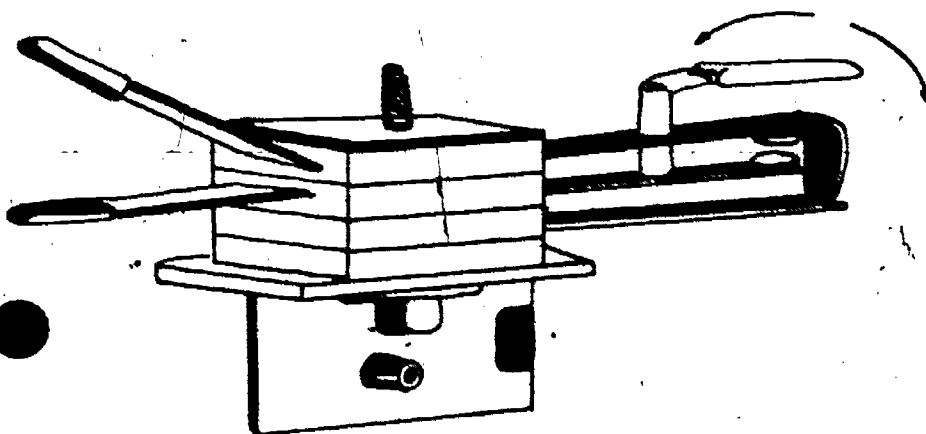

Name: _____

Date: _____

Period: _____

A thermostat is used to control the amount of heat produced by a heating element. For example, when the temperature within an oven reaches a set point, the thermostat will open, turning off the heating element. When the oven cools, the thermostat will close, turning the heating element back on.

MOTORS:

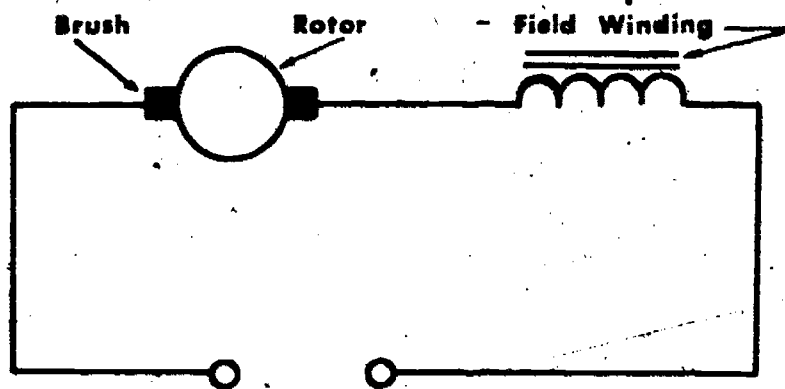
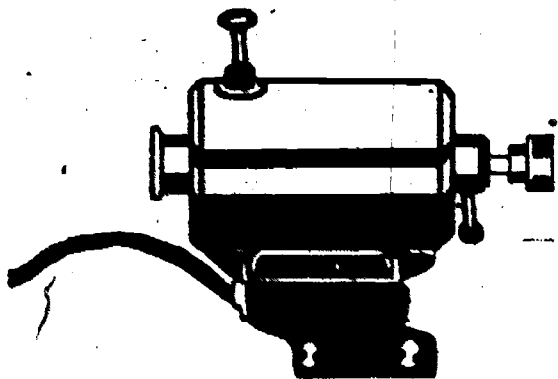

Motors are used to change electrical energy into a rotating or spinning force. This force called torque can be used to operate appliances and equipment.

TIMERS:

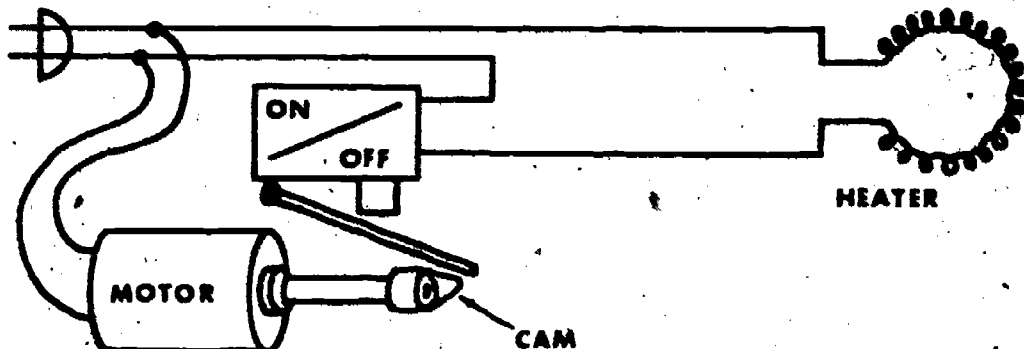
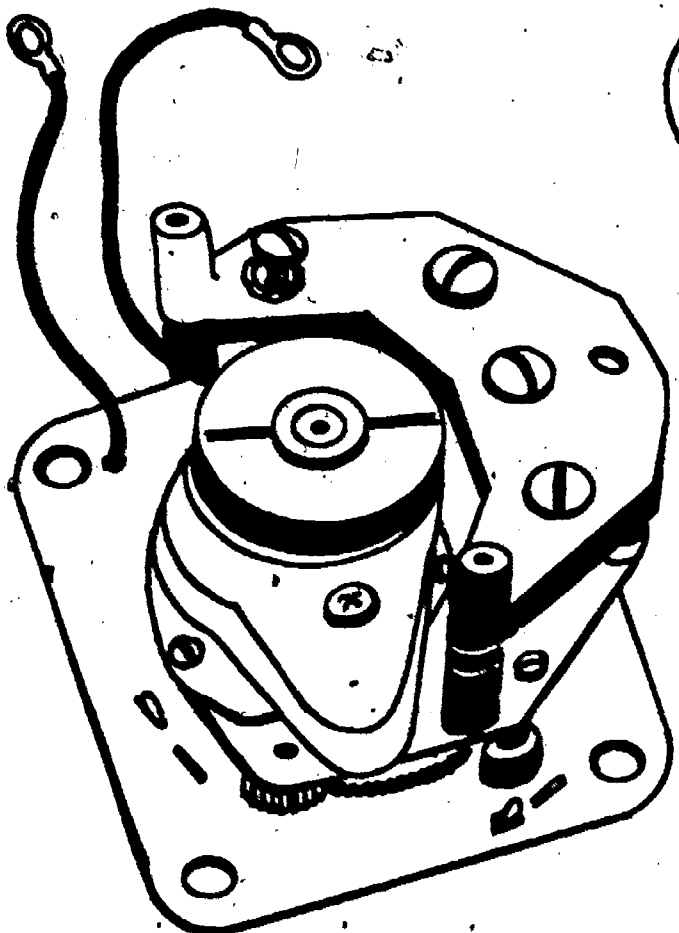

Timers are basically a small electric motor with a gear or cam arrangement used to operate an on/off switch. By setting the timer, you can control the length of time an appliance will operate. The timer will then "automatically" turn the device off.

LINE CORDS AND PLUGS:

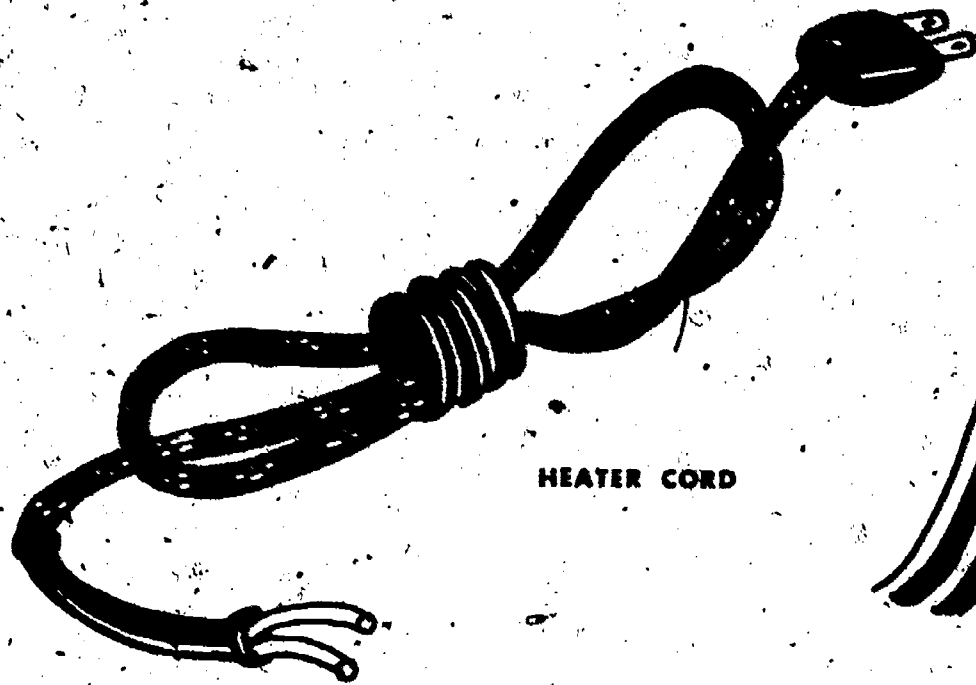

HEATER CORD

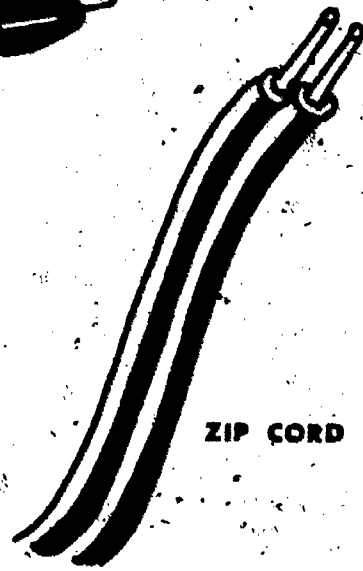

ZIP CORD

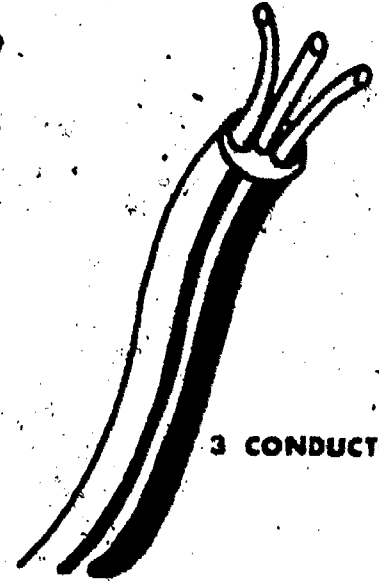

3 CONDUCTOR CORD

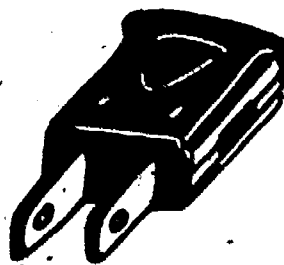
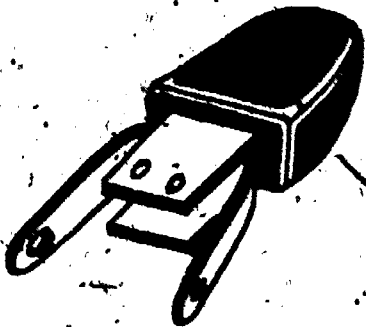
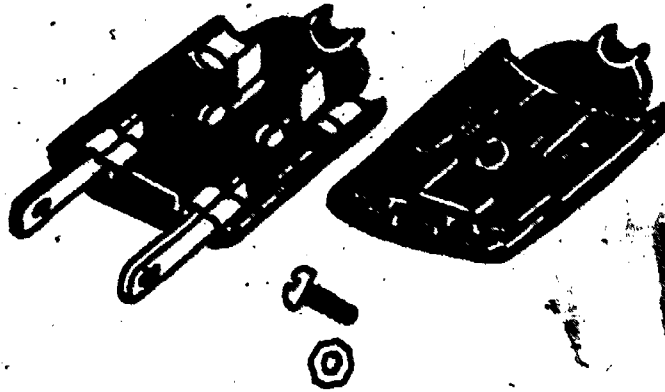
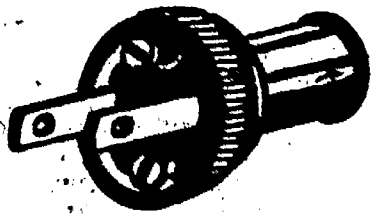

The line cord and plug offer a simple way of getting the electricity from the outlet to the appliance.

Name: _____

Date: _____

Period: _____

INFORMATIONAL HANDOUT

A GUIDE TO REPAIRING SMALL APPLIANCES

The modern family owns a large number of appliances and work saving devices. With proper care these devices will last many years, but sometimes these appliances are accidentally dropped, or mysteriously stop working. What can you do with a broken appliance? Well, you have a few choices: 1) buy a new one, 2) take the appliance to a factory-authorized service agency for repair, or 3) mail the appliance back to the manufacturer. Each of these choices can be rather expensive. But, if you are mechanically handy, and follow a few simple steps you can probably repair many of the common problems or faults yourself.

TESTING TECHNIQUES:

When starting to repair any electrical item you should attack the problem in a "logical" manner. For our purpose, these steps are fairly simple;

1. Find out if there is any electrical power reaching the unit.
2. Find out just which part is not working, such as the motor, heating element, thermostat, switch, etc.
3. Fix or replace the bad part.

SAFETY

The electricity used in your home to power most appliances is 117 volts of alternating current which can cause you serious injury or even death if you are careless. Following the rules below can help you avoid accidents.

1. Never work on an appliance that is plugged in. You can make certain tests with the device plugged in, but when changing parts, making connections, or disconnecting wires, be sure to unplug the line cord.
2. Never touch a bare wire or bare connection if the appliance is plugged in - you could get a shock.
3. Be sure there are no shorts between the AC wiring and the metal case of the device. Use a neon test lamp when checking for shorts.
4. When taking an appliance apart, check very carefully how the wires are connected together. Make a sketch if necessary.

Name: _____

Date: _____

Period: _____

LINE CORDS, PLUGS AND ATTACHMENTS:

Probably the most common appliance repair job is replacing the line cord. Movement, aging, and pulling causes the wire to break, or the insulation to crack or wear. Learn to keep an eye on the condition of the cords on all of your appliances. Broken insulation on a cord can cause fire, shock, etc.

①

IF THE APPLIANCE DOES NOT WORK,

be sure the plug fits tightly into the outlet and of course be sure the outlet is working. Next check to see if the line cord has a broken wire inside the insulation near the plug. To do this, turn on the appliance, hold the plug in one hand and carefully bend the cord back and forth. If the appliance suddenly starts to work, you've found the problem.

REPAIR: Cut off the cord about 6 inches from the plug and install a new plug.

②

If the cord/plug seems to be OK, but the appliance is still not working, unplug the device and carefully open the case so that you can get to the ends of the cord. If possible, take off all other wires that are connected to the cord. Be sure the line cord wires are not touching each other or any part of the appliance. Plug in the cord and use a neon test lamp connected to the ends of the wire to make certain you're getting power.

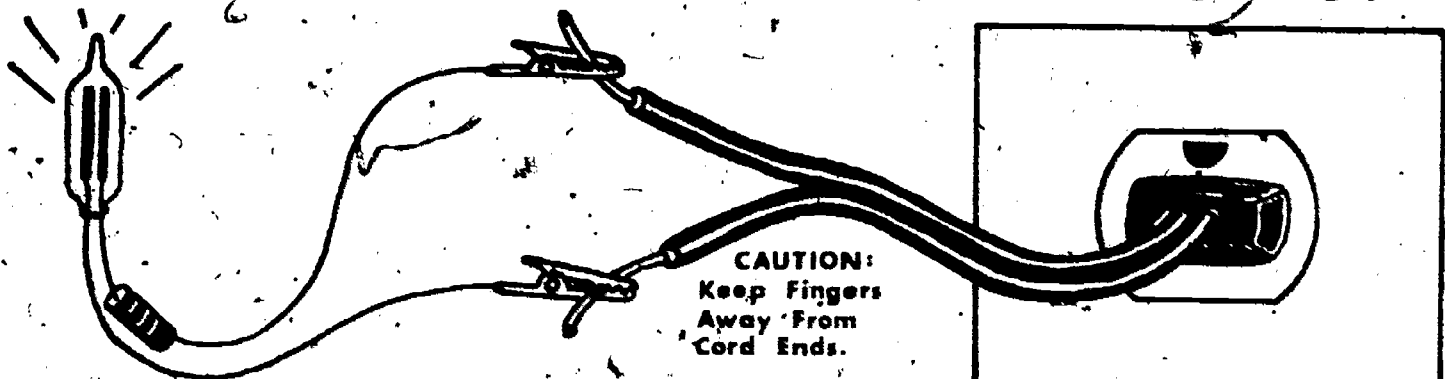

If the lamp lights, you are getting power from the outlet through the line cord to the appliance: If the lamp does not light then you have a bad cord.

REPAIR: Install a new line cord.

SWITCH CLEANING AND REPLACEMENT:

A faulty or bad switch is another common cause of appliance trouble. As a switch is used, its contacts get dirty or burned from arcing. Sooner or later, the contacts will not close properly and the appliance will not turn on. Often a switch is intermittent (works only sometimes) and in this case can usually be repaired by using a special spray cleaner.

Name: _____

Date: _____

Period: _____

If you need to replace a switch and you want an exact duplicate, you will have to purchase it from a dealer who repairs that particular brand of appliance. Take along the make and model number of the appliance, and part numbers that might be on the switch or, just bring along the old switch. Sketch the switch, and the wires connecting to it, so that you can replace the wires correctly on the new switch.

IF YOU THINK THE SWITCH IS BAD,

you can test it in a couple of ways. The simplest way is to use a continuity tester or ohmmeter. Unplug the appliance and open the case so that you can reach the terminals on the switch. Connect the tester across the switch terminals and turn the switch on. If the continuity tester lights, or the ohmmeter indicates "0" ohms, the switch is OK.

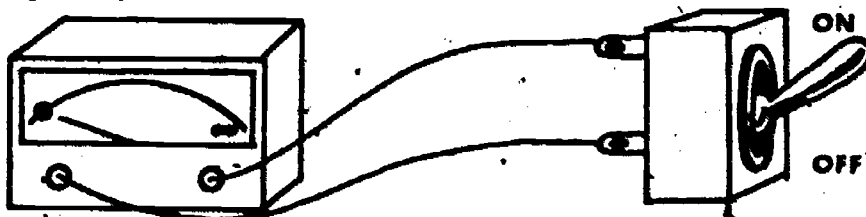

NOTE:

Remove All Power

But, if the continuity tester remains off, or the ohmmeter points to " ∞ ", the switch is bad.

REPAIR: Install a new switch.

You can also check a switch using a neon test lamp as shown below.

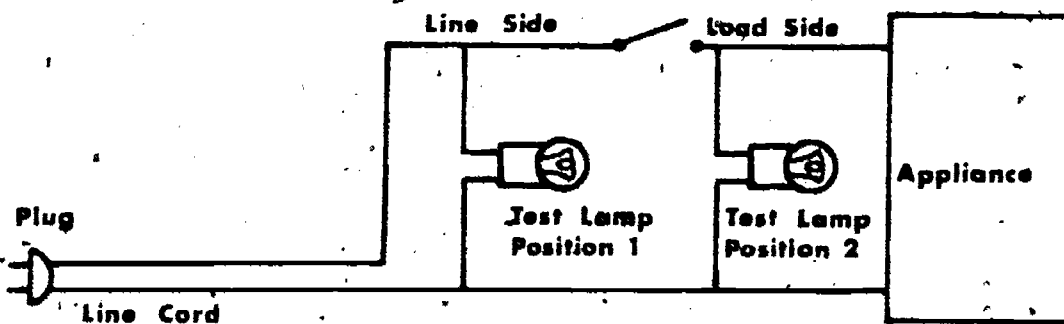

If the lamp in position 1 lights, this tells you that the line cord and plug are OK and bringing power to the circuit. Now move the lamp to position 2 and close the switch. If the lamp lights, the switch is OK, but if the lamp fails to light, the switch is bad.

MOTOR CLEANING AND MAINTENANCE:

Next to heating elements, small electric motors are the most common devices found in home appliances. There are two basic types of motors used in today's appliances: 1) synchronous motors such as those used in clocks or phonographs, and 2) brush-commutator type motors found in most other appliances such as mixers, sewing machines, blenders, can openers, etc.

Name: _____

Date: _____

Period: _____

SYNCHRONOUS MOTORS —

seldom give any electrical problems. Their biggest problem will be lack of lubrication and a build up of dirt. A cleaning and oiling usually solves these problems.

BRUSH TYPE MOTORS —

have two common problems: They won't run fast enough, or they will not run at all. The first problem can be caused by a lack of lubrication or a build up of dirt in the frame of the motor. Cleaning and oiling will solve these problems. The second problem can be caused by worn brushes and/or commutator, or broken wires within the motor itself. Usually a broken wire or winding cannot be repaired and a new motor must be purchased. But, if your problem is with the brushes/commutator - brushes can be replaced and the commutator cleaned to get the motor working again.

CLEANING

①

a motor is a fairly simple job, but try not to get carried away. Carefully take the motor apart, noting where bolts are located and how the case is fitted together. Clean out only the most important places such as the area between the armature and frame, the bearings and armature shafts, the brushes and commutator and especially the ventilation holes. A vacuum cleaner can be used to blow out the dirt gathered in the motor frame and housing. An old toothbrush is also a helpful tool to use when cleaning a motor. It is best to just gently scrape away as much dirt as you can and let the rest go. You may have to use a special cleaning solvent or solution to remove dirt or corrosion from the bearings and shafts.

②

OIL the motor after cleaning. More damage can be caused by over oiling a motor than by under oiling. If a motor is over oiled, dirt tends to stick to the extra oil, and then work its way into the bearings causing wear, or extra oil can also splash on to ventilation screens or holes, gathering dirt, and cutting off the air flow causing the motor to overheat.

Most appliance motors use a sleeve type bearing surrounded by a felt wick, with a small oiling hole drilled into the frame. To oil this type of motor apply a few drops of light oil through the oiling hole on to the felt. The oil on the felt will then work its way through the bearings to lubricate the motor shaft.

These basic hints will help you repair many appliance problems. Remember always work safely and carefully, and don't get in over your head.

SCORE:
GRADE:

Name: _____

Date: _____

Period: _____

ANSWER SHEET

EXAM LI-U9

	T	F	A	B	C	D
1.	■					
2.		■				
3.	■					
4.	■					
5.		■				
6.	■					
7.	■					
8.		■				
9.	■					
10.		■				
11.	■					
12.	■					
13.		■				
14.		■				
15.		■				
16.	■					
17.		■				
18.	■					
19.	■					
20.		■				
21.					■	
22.	■					
23.					■	
24.		■				
25.		■				

	T	F	A	B	C	D
26.						
27.						
28.						
29.						
30.						
31.						
32.						
33.						
34.						
35.						
36.						
37.						
38.						
39.						
40.						
41.						
42.						
43.						
44.						
45.						
46.						
47.						
48.						
49.						
50.						

	T	F	A	B	C	D
51.						
52.						
53.						
54.						
55.						
56.						
57.						
58.						
59.						
60.						
61.						
62.						
63.						
64.						
65.						
66.						
67.						
68.						
69.						
70.						
71.						
72.						
73.						
74.						
75.						

	T	F	A	B	C	D
76.						
77.						
78.						
79.						
80.						
81.						
82.						
83.						
84.						
85.						
86.						
87.						
88.						
89.						
90.						
91.						
92.						
93.						
94.						
95.						
96.						
97.						
98.						
99.						
100.						

*Show work for problems on back of answer sheet.



ANSWER KEY
UNIT 9

A. SPELLING PUZZLE

1. motor
2. switch
3. timer
4. heater
5. neon
6. appliance
7. ohmmeter
8. short
9. thermostat
10. continuity
11. voltmeter
12. element
13. troubleshooting
14. circuit
15. connector

B. APPLIANCE CLASSIFICATION

(subjective evaluation)

C. QUEST ACTIVITY

(subjective evaluation)

D. QUEST ACTIVITY

(subjective evaluation)

ELECTRICITY / ELECTRONICS

CURRICULUM GUIDE INSTRUCTIONAL MODULE

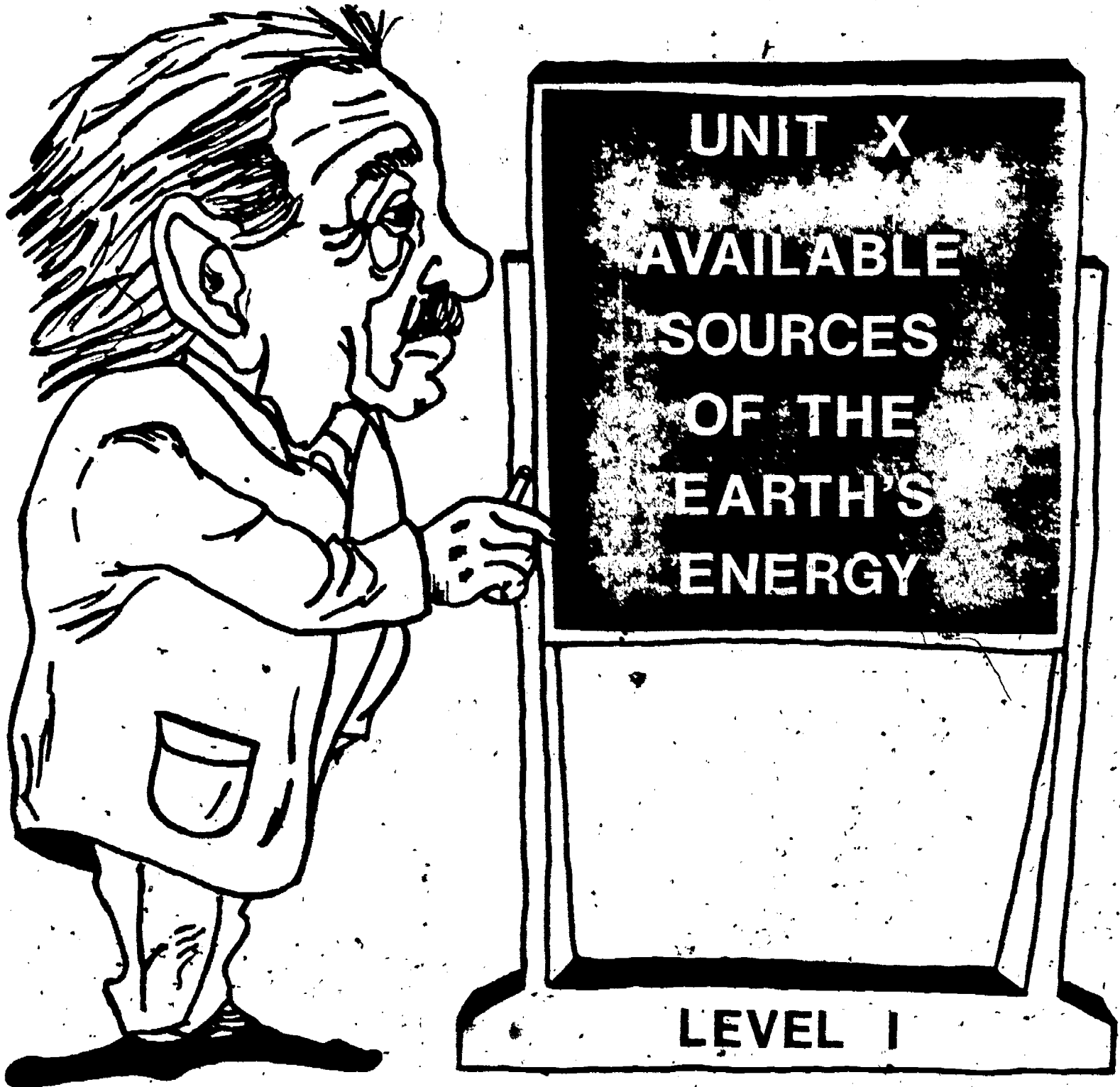

STATE OF CALIFORNIA
DEPARTMENT OF EDUCATION

NAME _____

DATE STARTED _____

DATE COMPLETED _____

BY
R. E. LILLO
N. S. SOFFIOTTO

STATE ELECTRICITY/ELECTRONICS CURRICULUM GUIDE
INSTRUCTOR'S GUIDE TO ACCOMPANY LEVEL I UNIT #10

Title of Unit: Available Sources of the Earth's Energy

Time Allocation: 1 week

Unit Goal:

To impart basic knowledge and competencies related to the methods of producing or generating large amounts of electricity, and to assess which methods are presently more commercially feasible.

Unit Objectives:

The student will be able to:

1. identify the four major sources of the Earth's energy (geothermal, fossil fuels, nuclear, and water), and briefly describe their methods of producing power.
2. state several alternative methods for the generation of electricity which are currently being explored.
3. summarize and discuss the need for conservation in the use or consumption of electrical energy.

Evaluation:

The student will demonstrate his/her competence in terms of these measurable objectives based upon individual instructors acceptable performance criteria, which utilizes a combination of written, oral, and laboratory testing procedures.

Instructor References:

Electricity and Electronics Basic. William B. Steinberg and Walter B. Ford, American Technical Society, 1972. Unit: 16.

Energy Primer. Richard Merrill and Thomas Gage, Dell Publishing Co., 1978.
All.

Industrial Electricity. Rex Miller, Chas. A. Bennett Co., 1978. Chapter:
2.

Overview:

Unit 10 like part of Unit 3 focuses on the fact that electricity has become an essential part of our life, therefore it is important to be aware of the specific methods for producing electrical power in large quantities.

The instructor should first examine the four major or primary sources of the Earth's energy. The examination of these sources, of course, is of a very general nature, but should include the future availability of power plant fuels and the basic history of plant development.

Next, explain that present demand for power may soon be greater than the supply, and to help offset this condition alternative resources and power plants are being considered, along with general conservation of existing supplies.

Finally, awareness that the new sources will take time to be fully developed and implemented should be brought out through a class discussion.

Suggested Presentation Hints/Methodology:

Follow the instructional module unit outline as a basic skeleton for curriculum presentation, however, note the following:

1. Try not to leave the impression that the major methods of producing energy presented in this unit are the only methods; they are just the most common ones. Explain further that other methods have potential, yet, are still in the experimental stage in terms of development.
2. When discussing nuclear power plants present some information related to potential health hazards from radioactive by products. Indicate that strontium, cesium, plutonium and tritium can pose some real problems to human beings.
3. Although energy demand growth has been slowed recently by higher prices and conservation, total energy consumption is still expected to increase about 50% by 1990 - discuss the implication of this one statistic.
4. Note: Fission - involves the splitting of the nucleus of atoms such as uranium. Fusion - involves joining the nuclei of two light atoms such as deuterium and tritium. Remember to explain that in both cases the nuclear reaction produces energy!
5. Introduce new career choices to your class which may exist in the future in such special energy areas as solar, geothermal, wind, and nuclear power.

Supplemental Activities and Demonstrations:

1. Write or telephone your local gas and electric company for information related to the generation of power. Many companies produce free materials that can be distributed to students that will really enhance their knowledge about plant operation and purpose.
2. Mickey Mouse and Goofy Explore Energy is a book in comic form which does an outstanding job in relating current energy information to students. For information about this comic book, write to:

Public Affairs Department
Exxon, U.S.A.
P.O. Box 2180
Houston, Texas 77001

Instructional Module Contents:

1. Unit Outline (overhead)
2. Pre-Post Test Keyed
3. Technical Glossary
4. Worksheet (vocabulary) - Scrambled Word Puzzle
5. Quest Activities
6. Informational Handout (Sources of Energy)
7. Unit Module Answer Keys

X. Available Sources of the Earth's Energy

A. Geothermal

B. Fossil Fuels

1. Natural gas

2. Crude oil

3. Coal

C. Nuclear

D. Water

E. Other

1. Tidal

2. Wind

3. Solar

4. Methane and bio-gas

5. Muscle power

F. Project Construction

LI-U10

UNIT EXAM

AVAILABLE SOURCES OF THE EARTH'S ENERGY

IMPORTANT-

Indicate your responses on the answer sheet only. Fill in the box corresponding to the correct answer to each question - there is only one correct answer for each question.

1. Of the many sources of energy available, fossil fuel is the most widely used. (T-F)
2. Fortunately, the earth has a large supply of usable energy so we need not conserve. (T-F)
3. Most power plants use steam from heated water to turn a turbine-generator. (T-F)
4. Geothermal energy comes from the constant wave and tidal action of the ocean. (T-F)
5. Solar energy supplies both heat and light which can be put to work making electricity or heating liquids. (T-F)

MATCHING

Record the letter of the answer which best matches the numbered term.

- | | |
|---------------------|--|
| 6. Fossil fuel | E. The force produced by the wave action of the ocean. |
| 7. Geothermal power | F. The heat produced by atomic fission. |
| 8. Hydro power | G. Coal, petroleum, natural gas. |
| 9. Tidal power | H. Saving or limiting the use of a resource. |
| 10. Solar power | I. Geysers or natural steam. |
| 11. Conservation | J. Windmills or wind generators. |
| 12. Nuclear power | K. Energy provided by running or falling water. |
| | L. Heat and light provided by the sun. |

Name: _____

Date: _____

Period: _____

TECHNICAL GLOSSARY

- BIO-GAS** An interesting source of energy which has become more popular as an inexpensive fuel. Bio-gas or methane is formed when garbage or natural wastes deteriorate and breakdown. This gas can be trapped and used as a substitute for natural gas.
- COAL:** A hard black fossil fuel, made mostly of carbon, which can be burned to produce heat. Coal has the disadvantage that it gives off a sooty or black smoke when burned.
- CONSERVATION:** The process of saving or limiting the use of a resource, such as fossil fuels, electrical energy, etc.
- CRUDE OIL:** Often called petroleum, this material is a dark, thick and slippery liquid type fossil fuel. Crude oil is refined to produce more usable fuels such as heating oil, diesel fuel, gasoline, etc.
- FOSSIL FUEL:** Fuels such as coal, crude oil, natural gas, and refined petroleum products (gasoline, diesel oil, and fuel oil) which are burned in order to produce heat.
- GEOHERMAL ENERGY:** A source of energy produced when water seeps into the ground, is heated by the Earth's hot magma core, and then rises to the surface as steam. Geysers, steam vents, and fumaroles are examples of geothermal activity.
- MUSCLE POWER:** The oldest form of power, in which human muscles or an animals muscles are used to do work.
- NATURAL GAS:** A type of fossil fuel which is in the form of a vapor or gas. Natural gas is usually found along with petroleum or crude oil. The gas cannot be seen, but it does have an odor. When burned, it makes a clean, hot fire.
- NUCLEAR ENERGY:** A modern source of energy which uses the atomic principles of fission (the breaking of the atom) to produce tremendous amounts of heat. Nuclear energy is safe if handled properly. Just one pound of nuclear fuel (uranium) has as much energy as 3,000 tons of coal.
- SOLAR ENERGY:** The clean, nonpolluting energy available from the sun or the sunbeam. Modern developments in solar energy have lead to more efficient solar collectors and heating units.
- TIDAL POWER:** The energy available from the constant tide or wave action of the ocean.

Name: _____

Date: _____

Period: _____

WATER POWER:

The energy provided by running or falling water. Water power is also referred to as hydro energy.

WIND POWER:

Using the force of the wind to supply power for such jobs as turning a windmill or turbine.

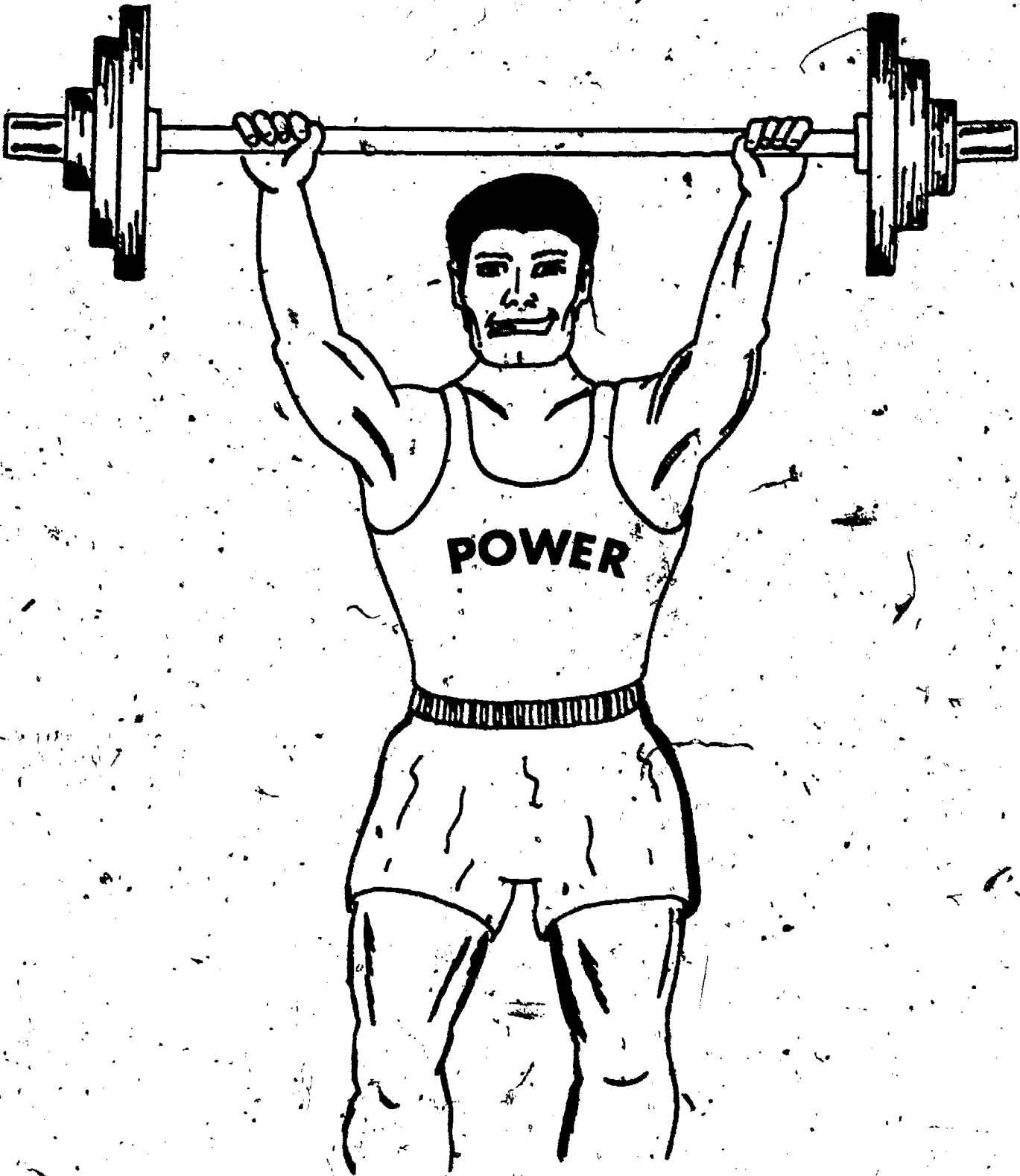

SCORE:
GRADE:

Name: _____

Date: _____

Period: _____

WORKSHEET

VOCABULARY - SCRAMBLED WORD PUZZLE

Unscramble the letters below to uncover the electronic terms.

EXAMPLE:

A. GERYEN

A. ENERGY

1. AOLC

1.

2. SOSLIF EFLU

2.

3. DUREC ILO

3.

4. AOLRS NEEGRY

4.

5. IADLT EORPW

5.

6. TAANLUR AGS

6.

7. NOSE RATVONCI

7.

8. THEMGOREAL GNEEYR

8.

9. RATWE WOPER

9.

10. CLEARNU ERGENY

10.

11. CLUESM ERPOW

11.

12. LOPTREEMU

12.

SCORE :

GRADE :

Name : _____

Date : _____

Period : _____

WORKSHEET

QUEST ACTIVITY

"UNIT 10"

To generate and distribute the electricity used in our homes and businesses, power companys must follow a process that has a number of steps. Below you will find a set of boxes arranged in order or sequence from start to end. Your task will be to arrange the puppets, found on page two, in proper order to show steps used in making electricity. You can use colored pencils to shade in the puppets and to make your work look sharp.

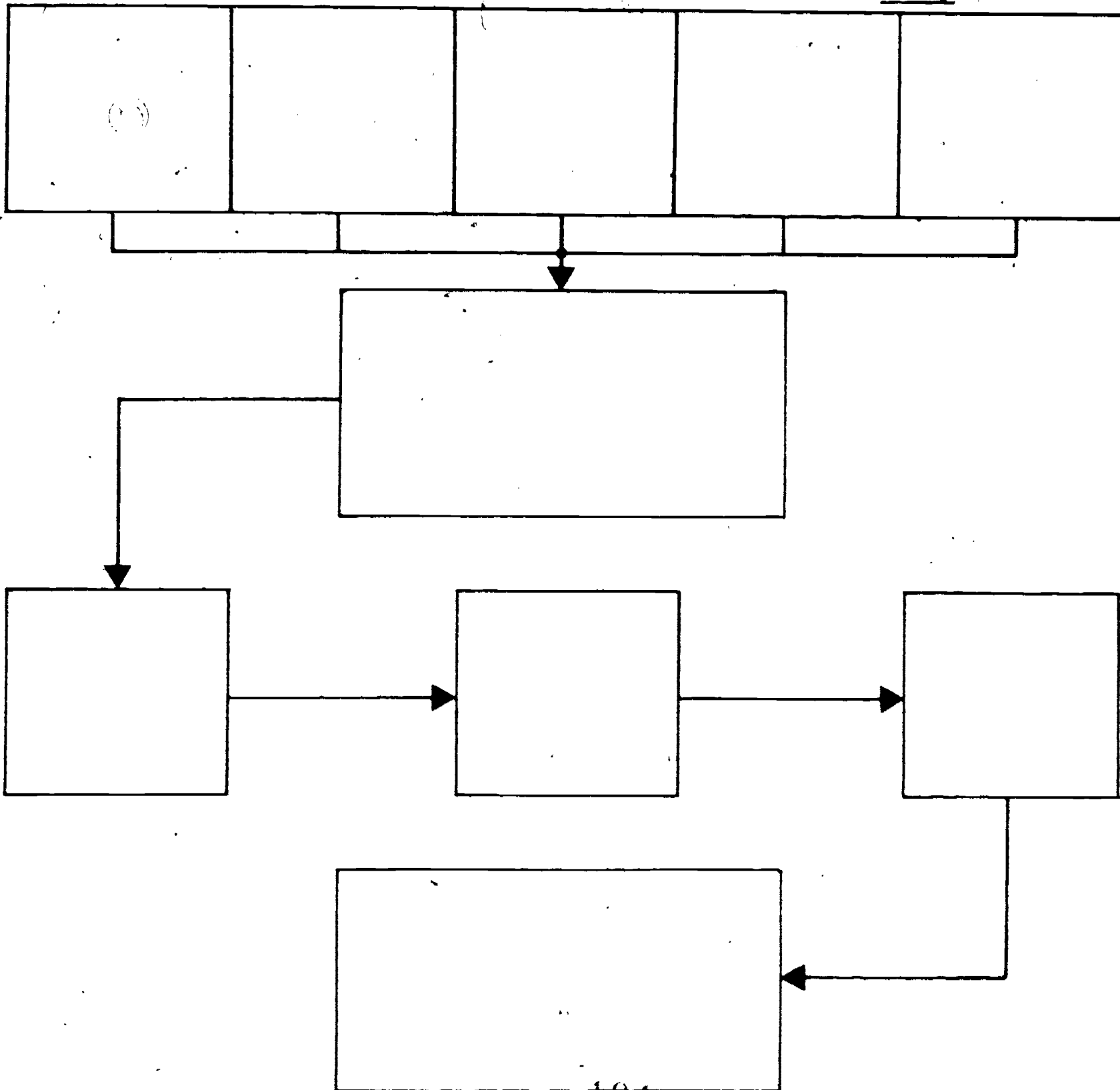

Name: _____

Date: _____

Period: _____

PUPPETS

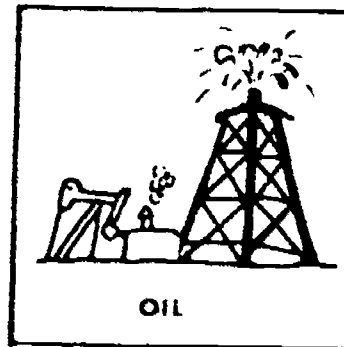
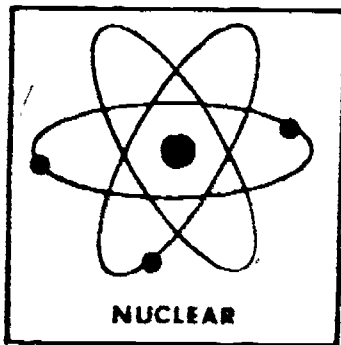
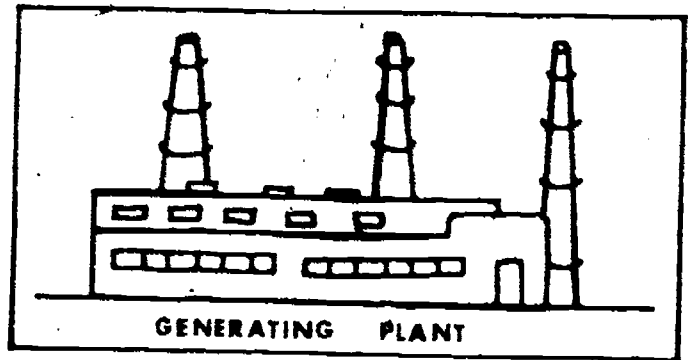
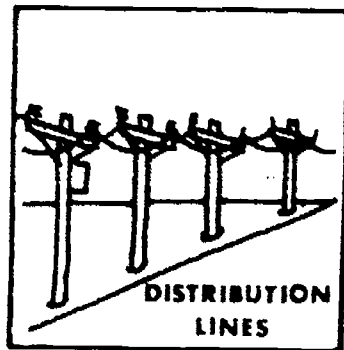
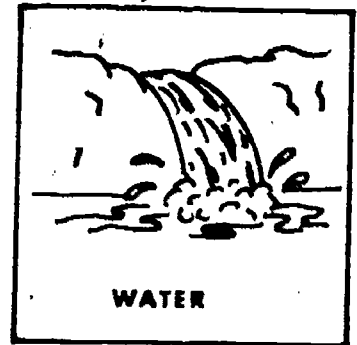
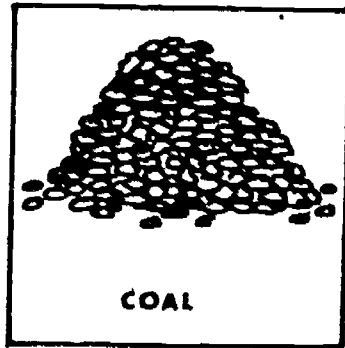
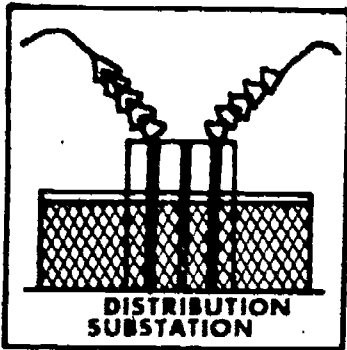
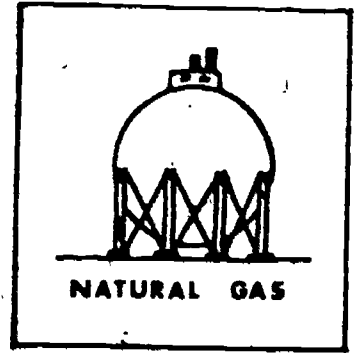
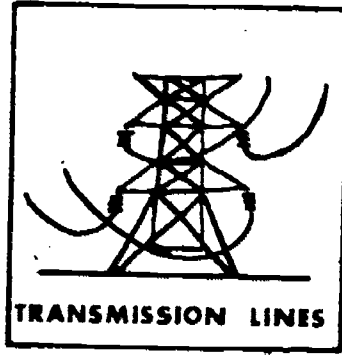
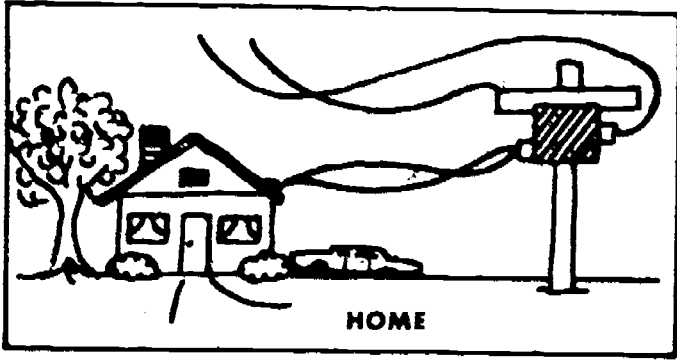

Name: _____

Date: _____

Period: _____

INFORMATIONAL HANDOUT
SOURCES OF ENERGY

GEO THERMAL

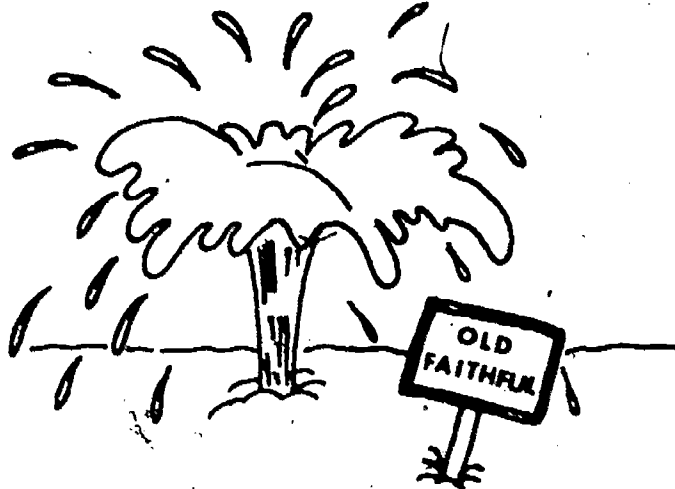

The energy available from geysers or natural steam vents can be harnessed to do work such as turning a turbine. California has the worlds largest geothermal generating plant, which uses 200 wells that bring up natural steam from as far as 10,000 feet below the earths surface to turn 12 turbine generators.

FOSSIL FUELS

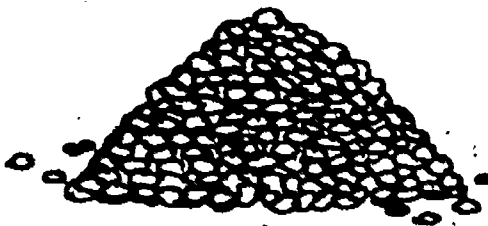

COAL

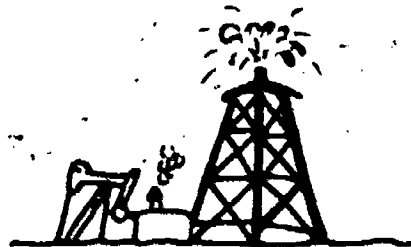

CRUDE OIL

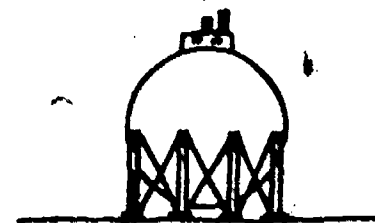

NATURAL GAS

The burning of fossil fuels to release energy is today the largest single source of natural energy. Fossil fuels are formed from decayed remains of ancient animals and plants. These remains have been squeezed and formed by the earth's pressures for many thousands of years to form coal, crude oil, and natural gas. These materials must be mined and carefully removed from the earth. Fossil fuels are then burned to release heat which is used to heat water and make steam. The steam is then used to turn a turbine - generator.

NUCLEAR

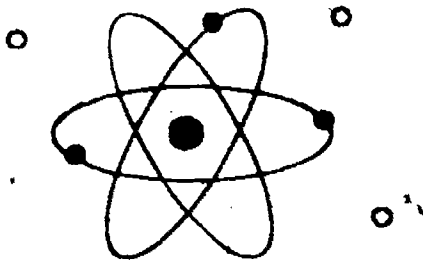

Atomic reactors, which can release the vast amounts of energy trapped within the small atom, can be used as a relatively safe form of energy. As atoms are split in a process called fission, high heats are generated. This heat is used to heat water and produce steam. The steam is then used to turn a turbine - generator.

WATER - HYDRO



The force produced by falling or running water can be harnessed and used to turn a turbine. Water power or hydro energy is an old source of natural power; water wheels were commonly used to operate

Name: _____

Date: _____

Period: _____

TIDAL



factories and machinery. Several states, especially California, count heavily on water power to generate electricity.

The constant wave and tide action of the ocean is being studied as a future source of energy. Special wave action generators have been designed to produce electricity using tidal power.

WIND

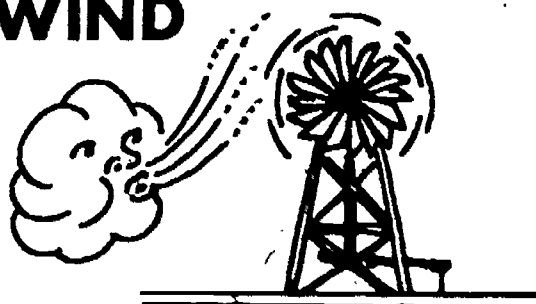

Wind energy may some day become an important and practical source of energy. Today wind energy can be used to turn blades such as on a windmill.

SOLAR

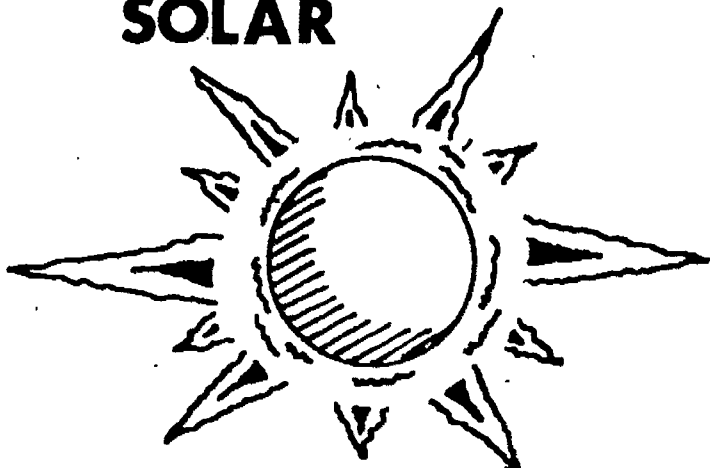

The light and heat produced by the sun can be used in several ways to provide energy. One system which is becoming very popular is solar heating, where sun rays are gathered and used to heat water for home and pool heating. The sun's light energy can be focused on solar cells to produce electricity. By some forecasts, in the year 2020 solar energy will make an important contribution to our energy supply.

MUSCLE

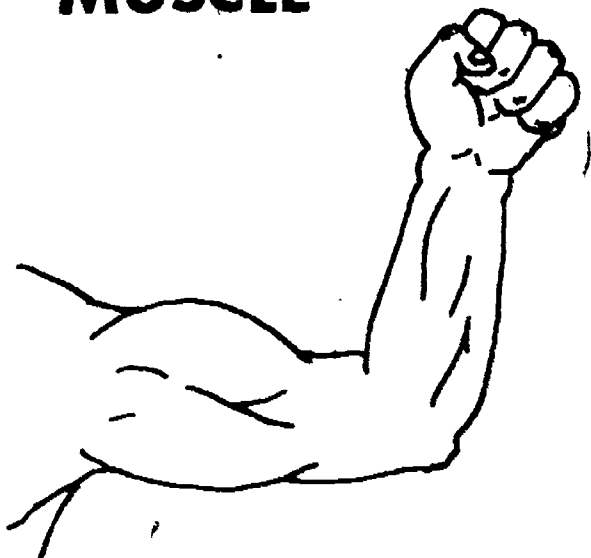

The oldest form of energy where human or animal muscles are used to do work. The ancient civilizations used muscle power exclusively to accomplish such fantastic things as the pyramids of Egypt, the Acropolis in Greece, and the Colosseum of Rome.

SCORE: _____
 GRADE: _____

Name: _____

Date: _____

Period: _____

ANSWER SHEET

EXAM LI-U10

	T	F	A	B	C	D
1.						
2.						
3.						
4.						
5.						
6.	G					
7.	I					
8.	K					
9.	E					
10.	L					
11.	H					
12.	F					
13.						
14.						
15.						
16.						
17.						
18.						
19.						
20.						
21.						
22.						
23.						
24.						
25.						

	T	F	A	B	C	D
26.						
27.						
28.						
29.						
30.						
31.						
32.						
33.						
34.						
35.						
36.						
37.						
38.						
39.						
40.						
41.						
42.						
43.						
44.						
45.						
46.						
47.						
48.						
49.						
50.						

	T	F	A	B	C	D
51.						
52.						
53.						
54.						
55.						
56.						
57.						
58.						
59.						
60.						
61.						
62.						
63.						
64.						
65.						
66.						
67.						
68.						
69.						
70.						
71.						
72.						
73.						
74.						
75.						

	T	F	A	B	C	D
76.						
77.						
78.						
79.						
80.						
81.						
82.						
83.						
84.						
85.						
86.						
87.						
88.						
89.						
90.						
91.						
92.						
93.						
94.						
95.						
96.						
97.						
98.						
99.						
100.						

*Show work for problems on back of answer sheet.

ANSWER KEY
UNIT 10

A. SCRAMBLED WORD PUZZLE

1. coal
2. fossil fuel
3. crude oil
4. solar energy
5. tidal power
6. natural gas
7. conservation
8. geothermal energy
9. water power
10. nuclear energy
11. muscle power
12. petroleum

B. QUEST ACTIVITY

(subjective evaluation)

ELECTRICITY / ELECTRONICS

CURRICULUM GUIDE INSTRUCTIONAL MODULE

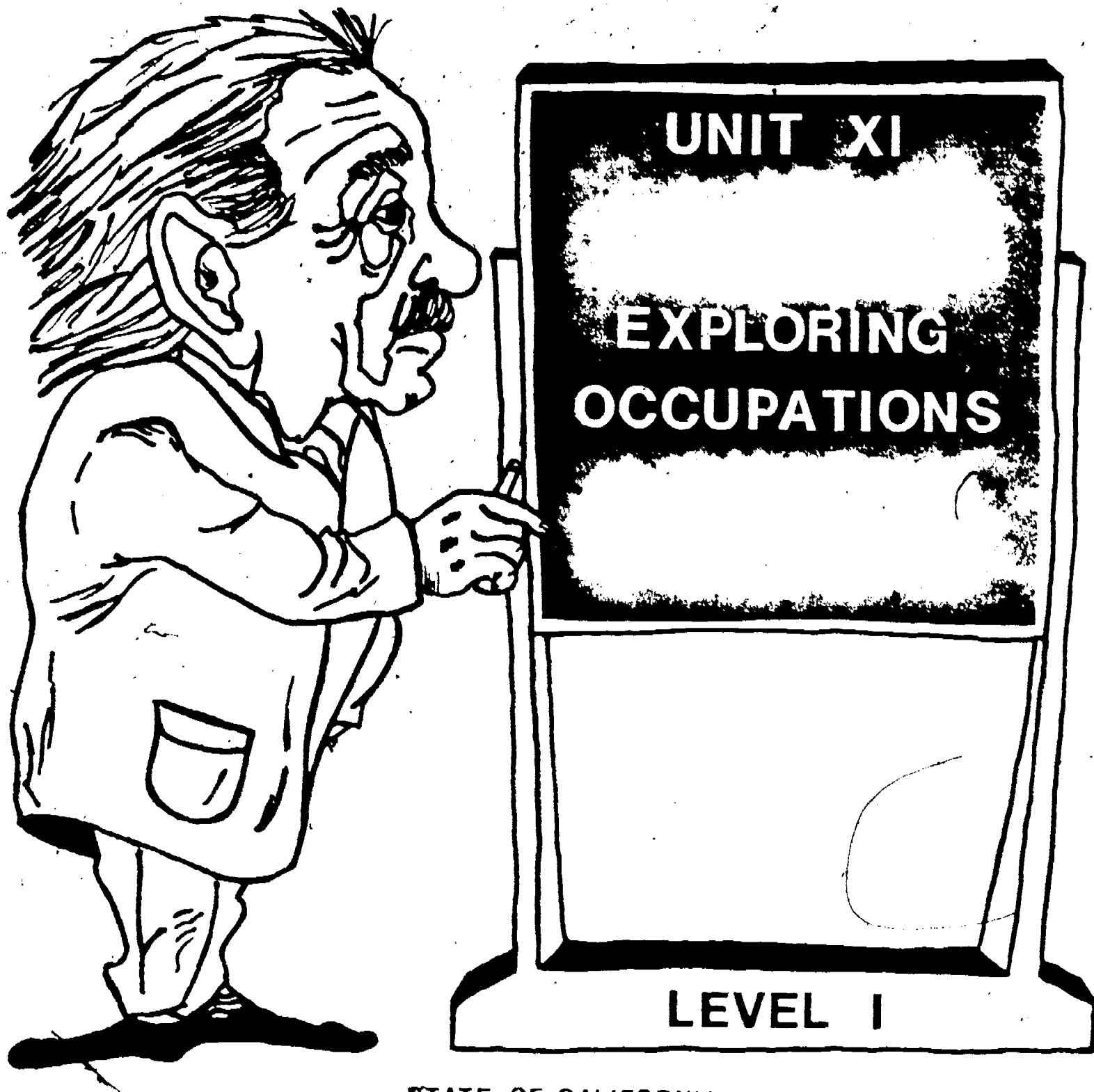

STATE OF CALIFORNIA
DEPARTMENT OF EDUCATION

NAME _____
DATE STARTED _____
DATE COMPLETED _____

BY
R. E. LILLO
N. S. SOFFIOTTO

STATE ELECTRICITY/ELECTRONICS CURRICULUM GUIDE
INSTRUCTOR'S GUIDE TO ACCOMPANY LEVEL I UNIT #11

Title of Unit: Exploring Occupations

Time Allocation: 1 week

Unit Goal:

To inform students in general terms of the world of work, reasons for working, kinds of occupations available, and the process of occupational explorations through career awareness.

Unit Objectives:

The student will be able to:

1. describe what the phrase world of work means and be able to identify their own role in the overall labor picture.
2. explain the necessity for individuals working in this society, and the reasons why, when making occupational decisions, individuals should match their abilities, interests, and attitudes to a corresponding career selection.
3. indicate an awareness of the major types of occupational areas that are available for exploration selection.

Evaluation:

The student will demonstrate his/her competence in terms of these measurable objectives based upon individual instructors acceptable performance criteria, which utilizes a combination of oral, or written testing procedures.

Instructor References:

Industrial Education Electricity/Electronics Curriculum Guide: Grade Levels 7-14. Robert E. Lillo and Nick S. Soffiotto, State of California. 1977. All.

Occupational Outlook Handbook. U.S. Department of Labor, U.S. Government Printing Office, 1977. All.

Your Career in the World of Work. M. Berlye, H.W. Sams, 1975. Chapters:1-13

Overview:

Remember, Unit 11 includes the important instructional topic of guidance which can really support and promote the reasons why students should continue their studies in this specific industrial subject area.

This unit can be introduced with a broad look or overview of the world of work and then the necessity of work. Focus on such reasons for work as economic needs, self-worth, social contact, lifestyle desired, etc.

The idea that they should know their abilities, interests, and attitudes in order to select a possible occupational area that might be satisfying should be a main theme presented, along with what constitutes an occupation.

Next, assist students in becoming aware of the major categories for occupations. Utilize the Occupational Outlook Handbook as a primary source of specific definitions as well as the unit technical glossary.

This unit should conclude with an overview on the present occupational forecast for technical occupations

Suggested Presentation Hints/Methodology:

Follow the instruction module unit outline as a basic skeleton for curriculum presentation, however, note the following:

1. This unit was included also as a means to supplement the school guidance program, hence, draw upon any available resources for knowledge related to current films, tapes, or any other audio visual materials that may coordinate with this unit of instruction.
2. Do not forget to dramatize the sheer value of work in a person's life. Emphasize that most people work for economic, social, and psychological reasons. Remember to explain reasons to students in a manner that is conducive to their understanding at this level.
3. Consult the latest edition of the Occupational Outlook Handbook and the Dictionary of Occupational Titles to keep abreast of current information about career/occupational fields. For more information of this nature contact the U.S. Government Printing Office, Washington 25, D.C.
4. Try and stress the idea that some educational preparation or training is necessary to fulfill the qualifications for entering any occupation.

Supplemental Activities and Demonstrations:

1. If the school has a career center, borrow the Occupational Outlook Handbook and have it available as a valuable resource item. Check with the local Bureau of Labor to obtain additional career opportunity bulletins and occupational reprints.
2. Have students informally evaluate their present school subjects and activities. Make a table with several columns labeled subject, grade, enjoyment, and reason for rating. Discuss those subjects or activities that they feel can also contribute to future "Marketable skills," or preparation for entering an occupation.
3. Point out that women play an important part in the world of work. Indicate that they work in all occupational areas and that in many companies they outnumber men.

Instructional Module Contents:

1. Unit Outline (overhead)
2. Pre-Post Test (keyed)
3. Technical Glossary
4. Worksheet (vocabulary) - Occupational Areas and Job Titles
5. Worksheet - Self-Awareness
6. Quest Activities
7. Informational Handout (Occupational Overview)
8. Unit Module Answer Keys

XI. Exploring Occupations

A. The World of Work--a Broad Picture

1. Importance of work
2. Why work?
3. What is an occupation?
4. Types of occupations
 - a. Industrial production occupations
 - b. Office occupations
 - c. Service occupations
 - d. Education occupations
 - e. Sales occupations
 - f. Construction occupations
 - g. Transportation occupations
 - h. Scientific and technical occupations
 - i. Mechanics and repairers

j. Health occupations

k. Art, design, and
communications occupations

B. Exploration Activity

LI-U11

UNIT EXAM

EXPLORING OCCUPATIONS

IMPORTANT-

Indicate your responses on the answer sheet only. Fill in the box corresponding to the correct answer to each question - there is only one answer for each question.

1. An important aspect of researching careers and indicating possible choices is to first know and understand yourself. (T-F)
2. The way an individual responds or feels about their career has great importance on their overall satisfaction with life. (T-F)
3. Women are generally unsuccessful in professional occupations because of the mental ability required. (T-F)
4. Researching careers is the process of carefully studying information about many different occupations. (T-F)
5. Choosing a career occupation is generally easy and requires very little thought. (T-F)
6. Personal abilities are of little importance in selecting a career. (T-F)
7. A desire to be clean and neat in appearance should have nothing to do with a career choice. (T-F)
8. Finding a career occupation is generally mostly a matter of blind luck. (T-F)
9. All jobs require about the same training and preparation. (T-F)
10. The main reason for work is to earn enough money to go on an expensive vacation. (T-F)

11. The importance of work is the same for all people. (T-F)
12. The world of work means all occupations that employ people to make goods or give services. (T-F)
13. In the United States the main Labor Force is made up of criminals who work in a road gang on projects. (T-F)
14. Having an interest in a career is all that is necessary to be successful in it. (T-F)
15. It is sometimes a good idea to have several possible occupational choices. (T-F)

Name: _____

Date: _____

Period: _____

TECHNICAL GLOSSARY

ART, DESIGN AND COMMUNICATION OCCUPATIONS:

Jobs in this field require creative and communication talents. Major areas include jobs in the performing arts - actors, dancers, musicians, singers; the design occupations - architects, industrial designers; and communication occupations - newspaper reporters, technical writers, and radio-TV announcers.

CONSTRUCTION OCCUPATIONS:

Workers in construction occupations build, repair, and modernize homes and buildings. They also work on other structures such as highways, airports, etc. Some sample occupations are carpenter, bricklayer, cement mason plasterer, floor covering installer, plumber, etc.

EDUCATION OCCUPATIONS:

Occupations involved in teaching or helping other people to learn. Teachers and librarians fall into this group.

HEALTH OCCUPATIONS:

Jobs dealing with the curing of illnesses and injuries. Health jobs include professions such as doctors, dentists, nurses, therapists, medical test technicians, medical practitioners, etc.

INDUSTRIAL PRODUCTION OCCUPATIONS:

These workers perform skilled and semi-skilled jobs involved in the production or building of products. These jobs are usually found in factories, and involve such things as assembly, inspecting, fabrication, finishing, welding, etc.

MECHANICS AND REPAIRERS:

These occupations involve jobs aimed at keeping our automobiles, airplanes, household appliances, and other machinery and equipment in repair and operating properly. Automobile repairers, appliance repairers, and business machine repairers are some of the many jobs that fall into this category.

OCCUPATION:

The job or type of work that you choose to do in order to earn a living.

OFFICE OCCUPATIONS:

Office workers perform a wide range of tasks that are needed to keep businesses and other organizations running on a day to day basis. Clerical workers do jobs such as typing, filing, alphabetizing, billing, and operating office machines. Other office jobs include bookkeeping, cashiers, clerks, receptionists, stock clerks, etc.

SALES OCCUPATIONS:

Occupations dealing with the selling of merchandise. Sales people can sell products for manufacturers, service firms, wholesalers or retailers. Sample jobs would include automobile salesperson, gasoline station attendant, insurance agent, model, real estate sales person, stock broker, etc.

Name: _____

Date: _____

Period: _____

**SCIENTIFIC AND
TECHNICAL
OCCUPATIONS:**

These jobs involve the research and development of new and useful ideas and products. Engineers, for example design, develop and test new equipment or materials. Scientists explore and seek new knowledge of nature and the physical world through experimentation and study. Technicians work hand in hand with scientist and engineers, helping them put their ideas into actual products or physical form. Technicians also help test, inspect and repair products. Other jobs in this area are drafters, surveyors, radio-TV technicians, etc.

**SERVICE
OCCUPATIONS:**

People working in service occupations perform a wide variety of tasks which assist or aid the public in making their lives more comfortable, safe, and enjoyable. The major categories of service occupations are cleaning services - custodians, housekeepers, pest control, etc. Food service occupations - bartenders, cooks and chefs, waiters and waitresses etc. Personal service occupations - barbers, cosmetologists, funeral directors, etc. Protective service occupations- FBI agents, firefighters, guards, police officers, inspectors, etc. Social service occupations - clergy, school counselors, career planning counselors, recreation worker, social worker, etc. and others such as - mail carrier, telephone operators, etc.

**TRANSPORTATION,
COMMUNICATION,
AND PUBLIC
UTILITY
OCCUPATIONS:**

This large occupational area is involved with the transportation of goods and people by air, rail, water and highway; the operation of communication systems such as telephones, radio, television and telegraph; and the running of the public utilities which supply the nation with electricity, gas, and sanitation services. Sample occupations in these fields are; airline pilots, truck drivers, powerplant workers, power line installers and repairers, dock workers, announcers, telephone workers, etc.

world OF WORK

SCORE :

GRADE :

Name : _____

Date : _____

WORKSHEET

Period: _____

VOCABULARY - OCCUPATIONAL AREAS AND JOB TITLES

Below is a list of the major occupational areas found within the world of work. Your task is to identify and list the names of five jobs found in each occupational area.

A. INDUSTRIAL PRODUCTION OCCUPATIONS:

- JOB: 1. 2.
3. 4.
5.

B. OFFICE OCCUPATIONS:

- JOB: 1. 2.
3. 4.
5.

C. SERVICE OCCUPATIONS:

- JOB: 1. 2.
3. 4.
5.

D. EDUCATION OCCUPATIONS:

- JOB: 1. 2.
3. 4.
5.

E. SALES OCCUPATIONS:

- JOB: 1. 2.
3. 4.
5.

Name: _____

Date: _____

Period: _____

F. CONSTRUCTION OCCUPATIONS:

- JOB: 1. 2.
3. 4.
5.

G. TRANSPORTATION, COMMUNICATION, AND PUBLIC UTILITY OCCUPATIONS:

- JOB: 1. 2.
3. 4.
5.

H. SCIENTIFIC AND TECHNICAL OCCUPATIONS:

- JOB: 1. 2.
3. 4.
5.

I. MECHANICS AND REPAIRERS OCCUPATIONS:

- JOB: 1. 2.
3. 4.
5.

J. HEALTH OCCUPATIONS:

- JOB: 1. 2.
3. 4.
5.

K. ART, DESIGN AND COMMUNICATION OCCUPATIONS:

- JOB: 1. 2.
3. 4.
5.

SCORE:
GRADE:

Name: _____

Date: _____

Period: _____

WORKSHEET

SELF - AWARENESS

Each person has different likes, dislikes, abilities, and interests that are important to know when making a possible career choice. To do this then you must be "aware" of the person you are, so write down in the spaces below some of the interests and abilities that you have.

INTERESTS **MY** **ABILITIES**

SCORE: _____
GRADE: _____

Name: _____

Date: _____

Period: _____

WORKSHEET

QUEST ACTIVITY

"UNIT 11"

Answer the following questions in sentence form and please explain yourself in detail in the space provided.

1. **WORLD OF WORK:**

(What is it?)

2. **LABOR FORCE:**

(What is it?)

3. **WHY DO PEOPLE WORK?**

(Reasons:)

Name: _____

Date: _____

Period: _____

INFORMATIONAL HANDOUT

OCCUPATIONAL OVERVIEW

WORLD OF WORK (occupations):

During the week millions of people leave their homes to go to work. Where they work (occupations) varies greatly, some people work as engineers, storekeepers, bankers, technicians, doctors, truckers, teachers, etc., but whatever they do is important! Each person has a useful part in contributing to the goods and services people want and need.

LABOR FORCE: All people working on jobs in the U.S.A.

Around 1985-1990 there will be almost 110 million people in the labor force.

$$\begin{array}{r} 107.9 \\ + 2.1 \\ \hline = 110 \end{array} \begin{array}{l} \text{million - Civilian Force} \\ \text{million - Armed Force} \\ \text{million - Total Force} \end{array}$$

Note: $\frac{1}{2}$ of the labor force will be professionals and technical workers who will need to have some kind of training beyond high school!

There are more than 20,000 different occupations in the United States, so no matter what your interests or abilities may be there are a lot of different jobs to choose from.

Check out those occupations that you think may be satisfying and rewarding.

REMEMBER: The best way to prepare for a satisfying and rewarding job is to get all the education you can in a field or subject that really interests you.

School gives you a chance to explore and an opportunity to prepare for your future -

DON'T WASTE IT!

SCORE:
GRADE:

Name: _____

Date: _____

Period: _____

ANSWER SHEET

EXAM LI-U11

	T	F	A	B	C	D
1.						
2.						
3.						
4.						
5.						
6.						
7.						
8.						
9.						
10.						
11.						
12.						
13.						
14.						
15.						
16.						
17.						
18.						
19.						
20.						
21.						
22.						
23.						
24.						
25.						

	T	F	A	B	C	D
26.						
27.						
28.						
29.						
30.						
31.						
32.						
33.						
34.						
35.						
36.						
37.						
38.						
39.						
40.						
41.						
42.						
43.						
44.						
45.						
46.						
47.						
48.						
49.						
50.						

	T	F	A	B	C	D
51.						
52.						
53.						
54.						
55.						
56.						
57.						
58.						
59.						
60.						
61.						
62.						
63.						
64.						
65.						
66.						
67.						
68.						
69.						
70.						
71.						
72.						
73.						
74.						
75.						

	T	F	A	B	C	D
76.						
77.						
78.						
79.						
80.						
81.						
82.						
83.						
84.						
85.						
86.						
87.						
88.						
89.						
90.						
91.						
92.						
93.						
94.						
95.						
96.						
97.						
98.						
99.						
100.						

*Show work for problems on back of answer sheet.

ANSWER KEY
UNIT 11

A. OCCUPATIONAL AREAS AND
JOB TITLES

(subjective evaluation)

B. SELF-AWARENESS

(subjective evaluation)

C. QUEST ACTIVITY

(subjective evaluation)