

DOCUMENT RESUME

ED 181 887

IB 007 913

AUTHOR Bunderson, C. Victor; And Others
TITLE A Study of Authoring Alternatives for Training-Oriented Videodiscs.
INSTITUTION WICAT, Inc., Orem, Utah.
SPONS AGENCY Navy Personnel Research and Development Center, San Diego, Calif.
REPORT NO NPRDC-TR-79-33
PUB DATE Sep 79
CONTRACT N-66001-78-C-0036-WJC
NOTE 80p.

EDRS PRICE MF01/PC04 Plus Postage.
DESCRIPTORS Delivery Systems; *Educational Problems; Instructional Media; Media Research; Media Selection; Media Technology; *Production Techniques; *Videodisc Recordings

IDENTIFIERS *Instructional Development; Navy

ABSTRACT

This study examined eight areas that are related to the problems of authoring and producing training-oriented videodiscs: the delivery system itself; media selection during instructional systems development; instructional strategies; author mock-up and simulation prior to mastering; mastering; mastering and replication; composition of videodisc authoring teams; and evaluation alternatives. Information and data were gathered through the study and documentation of two ongoing videodisc projects; visits made to industrial training sites and production laboratories and studios in the United States and Europe; discussions held with representatives from military and civilian organizations; a technical literature search; and participation in recent conferences related to videodisc technology. It was concluded that optical videodisc technology and the authoring technologies associated with it are still in a state of flux and can be expected to be changing and evolving during the next five years. The Navy is advised not to plan to deploy videodiscs widely in the immediate future, but to continue to track the rapidly developing knowledge in the videodisc field. (Author/CMV)

 * Reproductions supplied by EDRS are the best that can be made *
 * from the original document. *

NPRDC TR 79-33

U S DEPARTMENT OF HEALTH,
EDUCATION & WELFARE
NATIONAL INSTITUTE OF
EDUCATION

THIS DOCUMENT HAS BEEN REPRO-
DUCED EXACTLY AS RECEIVED FROM
THE PERSON OR ORGANIZATION ORIGIN-
ATING IT. POINTS OF VIEW OR OPINIONS
STATED DO NOT NECESSARILY REPRESENT
OFFICIAL NATIONAL INSTITUTE OF
EDUCATION POSITION OR POLICY

September 1979

**A STUDY OF AUTHORIZING ALTERNATIVES
FOR TRAINING-ORIENTED VIDEODISCS**

C. Victor Bunderson
Stanley Jarvis
Robert W. Mendenhall

WICAT, Inc.
Orem, Utah 84057

Reviewed by
John D. Ford, Jr.

Approved by
James J. Regan
Technical Director

Navy Personnel Research and Development Center
San Diego, California 92152

ED181887

ED007913

REPORT DOCUMENTATION PAGE		READ INSTRUCTIONS BEFORE COMPLETING FORM
1. REPORT NUMBER NPRDC TR 79-33	2. GOVT ACCESSION NO.	3. RECIPIENT'S CATALOG NUMBER
4. TITLE (and Subtitle) A STUDY OF AUTHORIZING ALTERNATIVES FOR TRAINING-ORIENTED VIDEODISCS	5. TYPE OF REPORT & PERIOD COVERED Final Report	
	6. PERFORMING ORG. REPORT NUMBER	
7. AUTHOR(s) C. Victor Bunderson Stan Jarvis Robert W. Mendenhall	8. CONTRACT OR GRANT NUMBER(s) N-66001-78-C-0036 WJC	
9. PERFORMING ORGANIZATION NAME AND ADDRESS WICAT, Incorporated Orem, Utah 84057	10. PROGRAM ELEMENT, PROJECT, TASK AREA & WORK UNIT NUMBERS 63720N 20108.PN30A	
11. CONTROLLING OFFICE NAME AND ADDRESS Navy Personnel Research and Development Center San Diego, California 91252	12. REPORT DATE September 1979	
	13. NUMBER OF PAGES 81	
14. MONITORING AGENCY NAME & ADDRESS (if different from Controlling Office)	15. SECURITY CLASS. (of this report) UNCLASSIFIED	
	15a. DECLASSIFICATION/DOWNGRADING SCHEDULE	
16. DISTRIBUTION STATEMENT (of this Report) Approved for public release; distribution unlimited.		
17. DISTRIBUTION STATEMENT (of the abstract entered in Block 20, if different from Report)		
18. SUPPLEMENTARY NOTES Videodisc technology Instructional systems design (ISD) Media selection Authoring Instructional media		
19. KEY WORDS (Continue on reverse side if necessary and identify by block number)		
20. ABSTRACT (Continue on reverse side if necessary and identify by block number) Videodisc technology shows great promise for use in a variety of training and information dissemination activities within the Navy. Little is known about the problems and procedures associated with the authoring of training-oriented videodiscs, however. This study addresses eight areas that are related to the problems of authoring. These include the delivery system itself (i.e., the various capabilities of players and associated		

computer devices), media selection during instructional systems development, instructional strategies, author mock-up and simulation prior to premastering, premastering, mastering and replication, composition of videodisc authoring teams, and evaluation alternatives.

It was concluded that optical videodisc technology and the authoring technologies associated with it are still in a state of flux and are expected to be changing and evolving during the next 5 years. Thus, the Navy should not plan to deploy videodiscs widely in the immediate future. Rather, the Naval Education and Training Command and its supporting agencies should track the development of knowledge in the videodisc field, which is expected to unfold rapidly in the next 2 years.

FOREWORD

This research and development was performed in response to Navy Decision Coordinating Paper, Education and Training Development (NDCP-Z0108.PN) under subproject Z0108.PN30A, Adaptive Experimental Approach to Instructional Design, and the sponsorship of the Director of Naval Education and Training (OP-102). The objective of the subproject is to develop an empirically-based instructional design support system to aid developers in deciding on instructional alternatives based on costs/benefits and specific resource limitations. This effort, which is concerned with identification of problems and procedures associated with the authoring of training-oriented videodiscs and with the costs and capabilities required to produce them, is one of the first studies of authoring technology. Although data for this report were gathered some time ago, its conclusions and recommendations are still valid. Some of the problems discussed, however, particularly those related to author mock-up and simulation prior to premastering and premastering itself, have been further investigated and recommended solutions documented. References to these documentations have been included as appropriate.

This report described the characteristics of various models of videodisc players. This does not imply government endorsement of these models or any other videodisc player.

Results of this research and development are intended for use by the Chief of Naval Education and Training, the Chief of Naval Technical Training, and the Chief of Naval Education and Training Support. Results will also be of interest to the Naval Publication and Printing Service, and the Navy Technical Information Presentation Program.

Dr. Wallace H. Wulfeck II served as the technical monitor.

DONALD F. PARKER
Commanding Officer

SUMMARY

Problem

Optical videodisc technology, which integrates the features of several different media in one simple and potentially low-cost delivery system, holds great promise for providing cost-effective interactive instruction in both civilian and military training settings. It is also affected by all the problems inherent in these various media. In a recent study, the following eight areas were identified as related to the authoring and production of videodiscs: the delivery system itself, media selection during instructional systems development, instructional strategies, author mock-up and simulation prior to premastering, premastering, mastering and replication, composition of videodisc authoring team, and evaluation alternatives. As used in this report, premastering refers to the production of one single master videotape.

Purpose

The purpose of this study was to study the eight areas listed above to identify problems inherent in each, to discuss existing alternatives and their costs, and to recommend ways for obtaining needed knowledge or exploiting immediate opportunities.

Approach

Information was obtained through the following methods:

1. Studies of two videodisc projects currently underway.
2. Visits to industrial laboratories and facilities.
3. Discussions with representatives from civilian and military organizations.
4. Attendance and participation in conferences on videodiscs.
5. Survey of technical literature on videodisc technology.

Results

1. Four primary delivery systems were defined: a manually-controlled "consumer" model, a microprocessor-controlled player, a computer-controlled player with two display screens (CAI and TV), and a computer-controlled player with a single display.

2. The media selection procedure in the current Interservice Procedures for Instructional Development (IPISD) was found to be unnecessarily complex. An alternate procedure, which narrowed the possible media to a few alternatives before conducting an analysis at the behavioral objectives level, was recommended.

3. Four classes of instructional strategies were discussed, ranging from direct copy of audiovisual media to strategies involving computer-assisted instruction.

4. An author mock-up system for the preproduction of videodisc still frames and motion sequences was proposed that uses relatively straightforward and relatively inexpensive existing equipment.

5. New studio equipment in new configurations may be required to solve problems in premastering from either film or videotape.

6. The problems of mastering and replication were discussed. Contrasts were made between the injection-molding process of MCA, the embossing process of Thompson-CSF, and the photopolymerization process of Philips. It appears that the Navy should have its own mastering and replication facility or facilities.

7. The composition of the videodisc authoring team was discussed in relation to existing personnel classifications the Navy uses in training development centers. The special roles these personnel must perform and the communication that must occur between them were discussed, especially in relation to integration testing of preproduction materials on an author mock-up facility.

8. Several evaluation alternatives were discussed, including technical and experimental assessment of features, conventions, and strategies on the videodisc; studies of how the videodisc might be implemented in real settings; and field evaluations.

Conclusions

Optical videodisc technology and the authoring technologies associated with it are still in a state of flux and are expected to be changing and evolving during the next 5 years. Despite this flux, optical videodiscs are extremely promising as new media delivery system alternatives for the Navy.

Recommendations

1. The Navy should not plan to deploy videodiscs widely in the immediate future. Rather, the Naval Education and Training Command and its supporting agencies should track the development of knowledge in the videodisc field, which is expected to unfold rapidly in the next 2 years.

2. The Navy should examine results of studies on videodiscs funded by both industry and government to determine whether (a) the economic analyses favor the videodisc, and (b) Navy settings exist that could make cost-effective use of the videodisc in the near future. If so, cost studies and plans through the 1980s may begin.

3. The Navy should conduct a variety of R&D studies involving the development and mastering of a series of videodisc strategies on promising delivery system alternatives. These videodiscs should then be subjected to extensive technical assessment and experimentation so that the Navy may be able to influence the strategies and conventions for videodisc design, and to prepare individuals to exploit the videodisc when the technology is sufficiently stable and the direction the Navy should take is sufficiently clear. These studies would provide a base of experience and trained manpower to enable the Navy to make optimum use of this new technology.

4. The Navy should encourage pilot projects using videodisc hardware technologies in a variety of promising settings. This would influence manufacturers to develop hardware and software that would better meet the Navy's requirements, and build a base of experience and trained manpower within the Navy.

CONTENTS

	Page
INTRODUCTION	1
Problem	1
Objectives and Limitations	1
Background	2
APPROACH	3
Level of Presentation	3
Methodology	3
RESULTS AND DISCUSSION	5
Delivery Systems	5
Manually-controlled Videodisc Player	5
Microprocessor-controlled Videodisc Player	8
Computer-controlled Videodisc Player with CAI and TV Screens	9
Computer-controlled Videodisc Player with One Display Screen	10
Direct Read After Write (DRAW) TM Systems	11
Other Alternatives	13
Costs of Delivery System Alternatives 1, 2, and 3	14
Media Selection During Instructional Systems Development	16
IPISD Procedure	16
SDC Procedure	16
Summary	18
Instructional Strategies	18
Direct Transfer of Conventional Audiovisual Media onto Videodiscs	18
Programmed Instruction or Rule-Example-Practice Strategies	21
Moderate Branching Strategy	22
Computer-assisted Instructional Strategies for Videodiscs	23
Author Mock-up and Simulation Prior to Premastering	25
Magnetic Videodiscs	26
TICCIT as an Author Mock-up System	27
A Configuration of Familiar Low-Cost Components	28
Premastering	30
Premastering from Film	30
Premastering from Videotape	34
Problems with Current Premastering Processes	34
Premastering Alternative	43
Mastering and Replication	43
Mastering	43
Replication	44
Composition of Videodisc Authoring Team	47
Evaluation	49
Technical and Experimental Assessments of Videodisc Features	49
Implementation Studies	50
Field Studies	50

	Page
CONCLUSIONS	53
RECOMMENDATIONS	55
REFERENCES	57
APPENDIX A--THE MCGRAW-HILL VIDEODISC PROJECT	A-0
APPENDIX B--VIDEODISC DEMONSTRATION PROGRAM FOR THE MCA PLAYER	B-0
DISTRIBUTION LIST	

LIST OF TABLES

	Page
1. Retail Costs of Components of Three Videodisc Delivery System Alternatives	14
2. Characteristics of Several Media Forms	19
3. Common CAI Strategies	24
4. Rough Cost Estimates for Replication of Videodiscs Based on Assumptions About One-time Set-up Costs and Per-Disc Recurring Costs	47

LIST OF FIGURES

	Page
1. Control functions of the Philips/Magnavox player	6
2. Prototype Optical Disc Data Recorder (DRAW) ^(TM)	12
3. Keyboard of the MCA player	23
4. Proposed author mock-up configuration	29
5. Component devices and signal paths in premastering	31
6. Film transport system for flying spot scanner	32
7. Area of NTSC format requiring SMPTE code	33
8. Typical television signal (simplified)	35
9. The 3:2 pulldown method	36
10. Still frames on a videodisc being refreshed from 0° and 180° positions	37
11. Manuscript page format	39
12. Aspect ratio diagram for video graphics	40
13. Protective coating on the Philips/MCA videodiscs	45
14. Videodisc authoring team flow of activities	49

INTRODUCTION

Problem

Optical videodisc technology, which integrates the features of several different media in one simple and potentially low-cost delivery system, holds great promise for providing cost-effective, interactive instruction in both civilian and military training settings. Heuston (1977), in a report to the National Institute of Education, pointed out that widespread use of the videodisc is inevitable because it combines the greatest strengths of the printing press, audiovisual technology, and interactive computer-assisted instruction (CAI).

Although the videodisc manufacturers have repeatedly delayed the widespread introduction of their products into the national market, it appears that one or more kinds of players will be seriously marketed in the near future. Yet the lead time for developing excellent videodisc training programs for use on these delivery systems is considerable.

As indicated above, videodiscs are promising because they combine the power of several different technologies. They also present a greater set of problems, since the authoring, mastering, and mastering of materials for such a complex and rich medium combines the problems of these technologies. For example, expensive television production studios use technical conventions that have been optimized for the production and display of motion sequences. Editing and production equipment has not been satisfactory in the past nor has it been interfaced extensively with computer equipment. Computer equipment itself is evolving very rapidly. Photographic technology is well developed but the production of still frames containing the rich combination of text, graphics, special symbols, and photographs is expensive. Photographic methods are poorly tailored for some of the problems that arise in videodisc authoring.

In a previous study conducted by WICAT, the following eight areas were identified as being related to the authoring and production of videodiscs:

1. The delivery system itself.
2. Media selection during instructional systems development.
3. Instructional strategies.
4. Author mock-up and simulation prior to mastering.
5. Mastering.
6. Mastering and replication.
7. Composition of videodisc authoring team.
8. Evaluation.

Objectives and Limitations

The objective of this study was to study the eight areas listed above as having implications to the videodisc authoring process. For each area, the inherent problems were identified, existing alternatives and their costs discussed, and recommendations made for obtaining needed knowledge or for exploiting immediate opportunities.

This study was limited in the following ways:

1. Only optical videodisc technology was considered. Mechanical technologies that do not permit freeze frame, random access, and other essential capabilities provided by optical videodiscs were not included since they do not combine the capabilities of other

instructional technologies, but merely provide an alternate method for distributing audiovisual sequences.

2. Costs for the development of existing media that go into videodiscs were not considered since they are not affected by videodisc availability. Thus, the study does not address the costs and alternatives for producing motion picture sequences or audio tracks, or for producing job analysis, task analysis, or manuscripts that might be implemented on a variety of media.

3. Authoring issues that apply to other media as well as the videodisc were not considered.

Background

In the past few years, a considerable number of authors have described the potential impact of the videodisc:

1. Zvaneveld (1974) described videodisc technology from the point of view of audiovisual producers and users.

2. Bennion and Schneider (1975) described the potential of interactive videodisc systems for education, and analyzed the costs of preparing and delivering instruction via the videodisc medium.

3. Kenney (1976) described special-purpose applications of the optical videodisc system.

4. Heustron (1977) detailed the promise and inevitability of videodiscs in education.

5. Cavanagh (1977) noted the educational and institutional features of the optical videodisc system.

6. Mathieu (1977) noted the impact of the videodisc on information retrieval.

7. Poe (1976) assessed all competing videodisc systems for the Navy Information Presentation Program.

Despite this fanfare, however, little attention has been paid to the authoring problems that must be resolved before the promised potential of videodiscs can be achieved. Perhaps the first serious and thorough analysis of some of the problems was Bennion's "Guide to Authoring for Videodiscs" (1976), which he based on his experience in authoring for the TICCIT system, a major CAI system developed under the sponsorship of the National Science Foundation. The TICCIT system combined, on the same color television terminal, still frames similar to those that could be displayed by videodisc, motion sequences from video cassettes loaded centrally on the TICCIT computer, and CAI interactions generated by a NOVA 800 minicomputer.

WICAT, Incorporated made the first attempt to extend the interaction capabilities pioneered on the TICCIT project in May 1977, when it began development of a manually interactive videodisc for McGraw Hill, Inc. This videodisc, which concerns biology and is entitled "The Development of Living Things," is described in Appendix A. A variety of other efforts addressing videodisc authoring problems have been undertaken, including those conducted by Hughes Aircraft; Control Data in cooperation with the University of Illinois; and Data Design, Incorporated.

APPROACH

Level of Presentation

This report assumes an audience of instructional developers--instructional psychologists, educational specialists, media specialists, authors, and managers. Thus, since little background in television, film technology, optics, or computers can be assumed, technical information on technologies and their special interaction in videodisc authoring is introductory and tutorial in nature.

Methodology

Several methods were used to obtain the needed information.

1. Two ongoing videodisc projects being conducted in WICAT's Learning Design Laboratories were studied and documented. The first of these, the McGraw-Hill biology videodisc (see Appendix A), carried one instructional strategy through the entire process of authoring, premastering, mastering, and replication. The second, an MCA project, described in Appendix B, went through the authoring stage.
2. Visits were made to industrial training sites, laboratories of both videodisc and television production companies, commercial production studios, and other related groups. Visits included those to facilities in both the United States and Europe.
3. Discussions were held with representatives from both military and civilian organizations.
4. WICAT personnel participated in recent conferences related to the videodisc. These conferences included (a) the National Science Foundation symposium on intelligent videodisc systems held at Watsonville, California in December 1977, (b) the National Institute of Education conferences held in January 1978 and in March 1978, and (c) the Institute for Graphic Communication conference held at Carmel, California in July 1978.
5. Technical literature on videodisc technology was surveyed.

RESULTS AND DISCUSSION

Delivery Systems

There are four primary delivery system alternatives. They are the manually-controlled videodisc player (consumer model), the microprocessor-controlled videodisc player, the computer-controlled videodisc player with two display screens, and the computer-controlled videodisc player with one display screen. These alternatives, as well as other possible delivery systems, will be discussed in detail in this section. Also, the estimated costs of the first three alternatives listed will be discussed.

Manually-controlled Videodisc Player

The manually-controlled videodisc player (consumer model) is the system that will be most widely available. Magnavox, a subsidiary of North American Philips, began limited marketing of an optical videodisc player in the United States late last year. Sony has demonstrated a player with equivalent capabilities, but its marketing plans are uncertain.

The Magnavox player, which will play two-sided, 30-minute discs, is depicted in Figure 1.

Using the control keys as "learning commands," many meaningful sequences can be entered by the student engaged in his own learning tactics. For example, the sequence

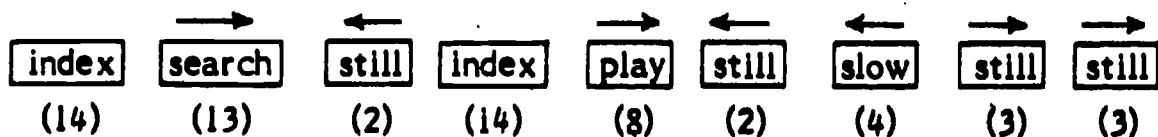

means: "Activate the index number and search for a chosen index number further on in the disc. When the exact frame is located, turn off the index number. Play in normal motion until you desire close scrutiny of a single frame out of the motion sequence, then freeze motion and go back in slow motion until you see the particular picture, then look at it frame-by-frame."

It can be seen, by perusing the key functions listed in Figure 1, that the manual videodisc player is a significant step beyond any of the traditional audiovisual media. In contrast to film projectors, it allows the user rapid random access (manual); that is, by using the index key to search for the designated index number.

An integrated circuit inside the player reads codes that have been replicated in certain lines of the mastered videodisc, such as a picture number for indexing. The integrated circuit in the Philips/Magnavox player reads a 24-bit digital code and generates a character display at the upper left-hand corner of the screen. This display is a five-digit number when the player is in stop or play mode. When the player is in search mode, however, the last two digits are not readable since the player is searching rapidly at up to 400 frames per 1/30th of a second. It is quite remarkable how the laser on a mechanically moving carrier can remain focused on a single 360-degree track during the 1/30th of a second required to display one frame and then flick quickly several hundred frames ahead to pick up another frame. During these brief intervals, the player is able to read the 24-bit code and generate the picture number.

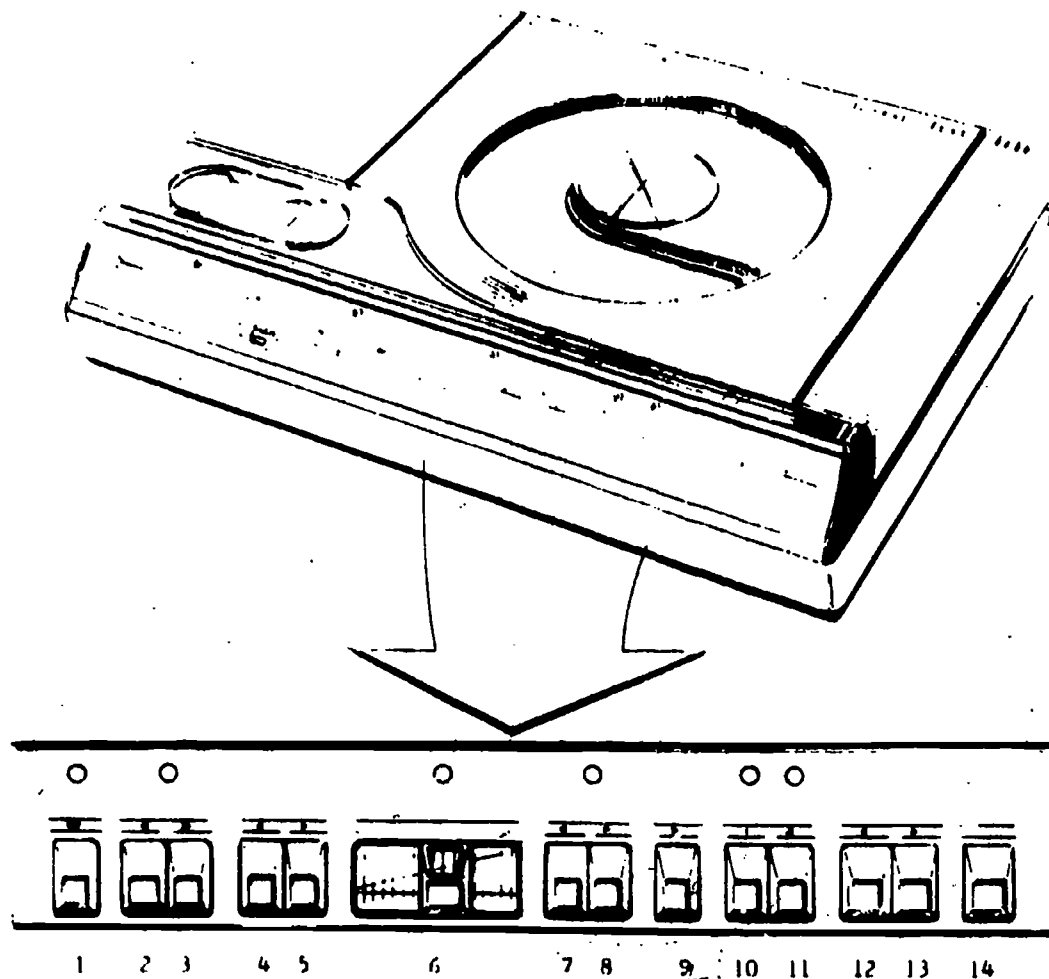

<u>Key No.</u>	<u>Function</u>	<u>Key No.</u>	<u>Function</u>
1.	POWER ON - POWER OFF	8.	NORMAL Speed Forward
2.	STILL FRAME & single frame Reverse	9.	FAST FORWARD (Three Times Normal)
3.	STILL FRAME & single frame Forward	10.	SOUND - Audio Track No. 1
4.	SLOW MOTION - Reverse	11.	SOUND - Audio Track No. 2
5.	SLOW MOTION - Forward	12.	SEARCH - Fast Speed Reverse
6.	SLOW MOTION Slide - Normal to four seconds per frame	13.	SEARCH - Fast Speed Forward
7.	NORMAL Speed Reverse	14.	INDEX (Chapter and Picture Number Display)

Figure 1. Control functions of the Philips/Magnavox player.

In addition to the picture number, the author may, during the premastering process, insert a code on the tape that is later translated into a "chapter stop" on the mastered disc. Different segments may be labeled "chapters" and numbered sequentially up to a maximum of 79. During the mastering process, the codes are changed to sequential chapter numbers. Like picture numbers, they are presented in the upper left-hand corner of the screen. A chapter number may be accessed by depressing the index key a second time. The picture number will then disappear and the one- or two-digit chapter number

will appear. Thus, if the student is in Chapter 1 and wishes to go to Chapter 2, he can cause the chapter number to appear by depressing the index key twice. With the chapter number displayed for Chapter 1, he can search forward until he comes to Chapter 2. When the player reads the code indicating that it is in Chapter 2, it will cause an interrupt to occur and stop the searching procedure. Whatever mode the player was in when the student activated the search will be reinitiated. Thus, if he initiated his search on a stop frame, the player will stop at that new chapter number. If he was in play mode, the player will revert to 30 frames per second play with audio. If he wishes to go on to Chapter 3, he will merely reinitiate the search by pressing the search key again and holding it down until the next chapter stop interrupts searching at Chapter 3.

The chapter function is useful for locating sections generally using the very fast search mode. It could be even more valuable if it were frame accurate. Unfortunately, as the player searches in its rapid search mode, it can leap as far as 400 frames per 30th of a second. Thus, the chapter stop code must be inserted on 400 different frames. The first one that is encountered causes the chapter stop to occur. Since this is within a time interval of 13-1/3 seconds, the chapter stop does not locate the beginning of specific chapters accurately, but is useful for general localization.

In addition to reading the picture number and a potential chapter stop, the player may encounter a code that designates an automatic stop (which is of greater value for enabling access to predesignated frames). At this point, the still frame mode will immediately be activated and the laser will read the same 360-degree frame every 30th of a second, giving the appearance of a single page or frozen motion frame. Generally, a page bearing an automatic stop would carry orientation information and occur at the end of a motion sequence prior to other still pages designed to be viewed separately. Sometimes, however, an author may wish to skip through several still pages before stopping. This gives an additional degree of learner control, since the student could then either go backward or forward a page at a time, depending upon his own knowledge and interest.¹

The Sony videodisc player closely resembles the Magnavox player, in that it will play a two-sided 30-minute disc and will have most of the features described for the Magnavox player. The Sony documentation, however, does not mention the very important automatic stop feature (Naruse & Ohkoshi, 1978). In addition to the 30-minute disc, the Sony player has a dual-speed system that enables it to operate at either 1800 rpm or 900 rpm. At the slower speed, it is able to achieve 60 minutes per side on the same size disc. Two frames are produced per revolution at 900 rpm. (Philips obtains the 1-hour format by varying the player speed between 600 and 1800 rpm. While this is workable for motion sequences, it virtually precludes the use of still frame instructional sequences on the longer format.) On the Sony 900 rpm system, a "pseudo still frame" can be achieved. In a single revolution, the player will pick up and refresh the screen alternately with two sequential frames. If both of these are identical, it is reported that this produces an acceptable still frame, albeit with the greater amount of jitter that four, rather than two fields, would produce. Sony has not announced plans to market their videodisc player. It is apparently waiting until agreements have been made on standards.

¹The consumer model videodisc developed by WICAT Learning Design Laboratories for McGraw-Hill, Inc. uses the automatic stop feature extensively in its design (see Appendix A).

The consumer model videodisc has a number of advantages. First, it will be mass distributed for the consumer market and thus must have a low price tag. The manufacturers have talked in the order of \$500 to \$600, which seems appropriate for the establishment of a large market. The actual prices will not be known until the players are on the market.

Second, the consumer model videodisc player combines the educational potentials of the book and audiovisual media, with additional interactive flexibility provided by the interesting and powerful keyboard. It is not straightforward, however, to obtain the advantages of programmed instruction or any other instructional book. "Orientation strategies" must be implemented to allow the student the rapid manual random access that he has in the book, and the features of good programmed instruction must be provided.

A simple example may illustrate the need for a careful definition of orientation features. Dictionaries have over the centuries, included various standardized features to enable the user to obtain information. For example, bold-type keywords are found at the upper left-hand side of the left page, the lower right-hand corner of the right page, and at the left side of each page. Also, the words appear in alphabetical order. Dictionary users have been taught the cognitive operations of searching for keywords mentally and then locating the keywords by means of the alphabetically-ordered pages. They get feedback by looking at the page displayed. In books other than dictionaries, the page number is often used to locate a particular point referred to in the table of contents or index. This feedback directs the user to continue searching until the keywords sought have been located. The educational videodisc field, as a whole, would do well to adopt similar fixed features so that users can develop habits for successfully finding and using information. These features should be similar from disc to disc so users will be able to transfer their learning strategies from one disc to another.

Microprocessor-controlled Videodisc Player

Microprocessor-controlled players have been developed by Thompson-CSF, a French company, and MCA Disco Vision. MCA, which uses the F-8 microprocessor, has delivered about 30 pilot machines so far, and plans to market a production version of the player in the United States about June 1979. Thompson-CSF has begun pilot marketing and plans to make a limited production run of several hundred players available in late Spring, 1979. The microprocessors in these players can be programmed for limited branching, or they can be interfaced to larger computers. This allows control of access to particular frames, plus the activation of certain modes (e.g., play, stop motion).

Both Thompson-CSF and MCA hope to market to industrial and educational users at a price that is competitive with videotape systems but not with the consumer model videodisc player. Their projected price is in the neighborhood of between \$2000 and \$2500. They recognize that complicated and powerful videotape recorder/player systems sell for around \$1600, but they feel that the microprocessor-controlled videodisc players provide sufficiently attractive features to compete at the somewhat higher price.

There are important differences between Thompson-CSF and MCA as to microprocessor control languages, the optical properties, and the disc replication. The memory on the Thompson-CSF microprocessor player is, at present, more limited than that on the MCA player, which has 1000 bytes of storage and can contain a fairly complex branching program. Neither memory can do any answer processing, scoring, or conditional branching based on saved data. Thompson-CSF assumes that computer-assisted instruction (CAI) will be plugged in the back of its player and activated on some more powerful computer.

Thus, it has not invested heavily in storage or processing capabilities inside the player. The MCA player also permits external control; however, MCA assumes that the users will be able to program more complex branching sequences and store them in the 1000-byte memory. WICAT, in developing a videodisc demonstration program for the MCA player, investigated its programming capabilities. The results of this investigation are discussed below and in Appendix B.

Optically, the MCA player, as well as the Magnavox manually-controlled player, differs from the Thompson-CSF player by using a reflective rather than a transmissive disc. Both Philips and MCA put an aluminum "mirror" backing on the surface containing the laser pits. This is covered with a protective coating and then glued back-to-back with another similar playing surface. When the laser strikes the mirrored surface, it is reflected back. The diffraction pattern contains the information necessary to produce a frequency-modulated television signal.

The Thompson disc has no mirrored surface. Rather, the laser is read directly through the disc. Because of this feature, it is able to track information on either side of the videodisc. Thus, it can reportedly play both sides without turning the disc over.

Computer-controlled Videodisc Player with CAI and TV Screens

Both the Thompson-CSF and the MCA player can be controlled with an external computer having its own display screen, in addition to a TV set. Since Philips offers remote hand units for control of their TV sets, it is likely that they will eventually offer remote hand units for videodisc players as well. A computer could easily be interfaced to such a hand unit.

The concept of this delivery system alternative is to use a CAI system with its own display screen to control a videodisc with its own TV monitor. This has the disadvantage of the expense of two displays, but it has the advantage of having the instructional power of two separate displays. For example, full color pictures may be displayed on the TV display; and a series of questions about those pictures, on the CAI display. Text may be generated on the CAI display directing the student to go through a motion sequence or series of still frames on the TV display. A high level of orientation information can be provided by keeping track of the student's scores and accomplishments and presenting this information on the computer display. Thus, the two displays provide a great deal of flexibility to the instructional designer. Another advantage of two displays is that many of the personal computers, such as the Commodore Pet and the Radio Shack TRS-80, have their own black-and-white monitor as a relatively inexpensive built-in feature.

It is important to distinguish two levels of capability in connecting a videodisc player to a computer. These two levels depend upon whether the computer has a one-way or two-way connection to the player. In the one-way connection, the computer sends commands to the videodisc player over a remote or hard-wired link, as though it were "pushing the keys." This provides the same capabilities as if a person were pushing the keys (see Figure 1), and the ability to send a frame number to the player, which would have built-in servos to search rapidly to that frame number.

In the two-way connection, the computer could read information from the correct video track during any 1/30th of a second interval. This information includes the current picture number, computer programs stored on the disc, or digitized audio.

A variety of instructional strategies can be implemented with a two-screen system, depending upon the level of communication available (one- or two-way). Color, motion,

and audio would be controlled by the computer and presented on the TV monitor; and practice problems, scoring, and computer interactions, on the computer monitor.

An example of this type of delivery system has been developed by Control Data Corporation and the University of Illinois. The CAI screen is a PLATO terminal. Jacks in the back of the PLATO terminal enable PLATO to control a Thompson-CSF player, providing random access to any frame and activating the appropriate player mode. (An MCA player has also been interfaced to PLATO.) As usual, CAI displays can be presented on the PLATO terminal. This presentation is powerful and eye-catching as one might expect, combining the graphics and interactive capabilities of PLATO with still frame, motion, and audio of the Thompson-CSF or MCA players. The projected costs of MCA and Thompson players are competitive with the PLATO random-access audio unit, so the combination may be attractive to PLATO users.

Another example is the System 110 from Data-Design Laboratories. This self-contained instructional unit incorporates a Sony Betamax videotape player, a microprocessor, a keyboard, a minifloppy disc, a color TV monitor, and a simple printer. It has also been interfaced to a Thompson-CSF player.

It may be expected that, when the Magnavox player reaches the market in volumes, firms small and large will be buying them and interfacing them with their mini- and microcomputer products. Whether Magnavox will provide an easy computer interface as a standard feature has not been announced.

Computer-controlled Videodisc Player with One Display Screen

By providing the computer with a character generator that delivers a composite video signal to the back of a TV monitor, the characters and graphics generated by the computer can be combined with the images generated by the videodisc. The interface required is a bit complicated, however, for the character generator must be able to take an external sync pulse from the videodisc player. Character generators that accept an external sync are available. To this, one needs to add a videomixer, of which inexpensive varieties are available, so that the output of the computer's character generator can be mixed with the signals coming from the videodisc. The TV receiver is ignorant of all of these complexities. It simply receives a video signal and displays the result.

This fourth delivery system has some advantages not found in the third type. In particular, it is possible to use images generated from the videodisc and overlay on them characters, arrows, and other graphics generated by the computer. Since the computer display can be dynamically responsive to the student's inputs, a pointing function using characters generated by the computer can move about on a still frame generated by the videodisc to great instructional effect.

Another advantage is that changes can be made in the magnetic computer memory but not in the videodisc. Material on a videodisc that might otherwise become obsolete (e.g., with engineering change orders) could be easily corrected if black-on-white characters could be overlaid from the computer onto a videodisc page. This would "strike out" the incorrect portion of the display and reference a correction. The ability to overlay characters on the videodisc display has great implications for orientation strategies (keeping the student oriented in the midst of thousands of frames and program steps) as well as to presentation strategies. One of the most powerful features of TICCIT was the ability to color "map" boxes red, yellow, or green, depending on the status of the students' scores in their practice problems or lesson tests. The students found this feature to be

extremely valuable and sought after "advisor" information that told them how they were doing. The computer's ability to keep scores and translate these into visual symbols that can be displayed to the student on contents pages or advisor summary pages is indeed a powerful instructional feature. It must be pointed out, however, that the separation of orientation scores onto a separate display, as in Alternative 3, may not detract significantly from its power in orienting and guiding the student, and may indeed have the added advantage of simultaneous availability of orientation and presentation information.

Because of the requirement for the externally synched character generator and video mixer, this delivery system must be regarded as currently nonstandard, although in all likelihood standard systems of the sort described will probably be on the market within the next 2 years. Because of the provision for easy connection to a computer provided by the MCA and Thompson-CSF players, Alternative 3 systems can be considered to be available as soon as the MCA and Thompson players may be purchased, but Alternative 4 systems will not be available initially. Personal computers like the Apple II, which use standard color TV displays, will provide a natural impetus for Alternative 4 systems.

Direct Read After Write (DRAW)TM Systems

Prototype versions of Direct Read After Write (DRAW)TM discs have been demonstrated in the laboratories of North American Philips. The DRAWTM has been conceived as a digital storage system.

It is capable of holding on each of two sides 10^{10} bits of information. In the disc described by Kenney, Lou, Wagner, Zernilee, McFarlane, Milch, and Chem (1978), a laser burns holes in a thin tellurium film that forms one boundary of a small air pocket (a tiny "clean room") at the center of a glass or plastic "air sandwich"TM disc. Figure 2 illustrates the prototype Philips Direct Read After Write information system recorder.

The laser burns pits in the tellurium and any vapors are trapped in the "air sandwich." Digital data are first encoded with a triple-error correcting convolutional code, followed by Miller modulation that feeds an optical modulator and controls the burning of pits. Immediately following the laser that burns the holes, a weaker laser reads the pits, reverses the process of modulation and encoding, and checks to see if the data have been written in an accurate fashion. If not, a code can be burned instructing the reading mechanism to ignore the inaccurate information. The information in question can be rewritten by the laser on the next section of the disc. In this manner, a DRAWTM system connected directly to a computer may store an enormous quantity of information on a disc either in one pass or as an ongoing recording operation.

It is valuable to make a few comparisons between DRAWTM systems and existing storage media for computers. The IBM 2314 compatible disc system, which has been an industry standard for many years, holds 25 million bytes of information. The 10^{10} bit capacity of the DRAWTM, on the other hand, contains 1.25 times 10^9 bytes, the equivalent of 50 of the IBM 2314 magnetic discs. The first version of the TICCIT system, a major CAI system, typically had, on-line, 6 of the 2314 style disc drives containing 150 million bytes of storage. This storage was sufficient to contain a data base consisting of 2½ hours of digitized audio, from 1½ to 2 semesters of freshman English, and from 2 to 4 semesters of freshman and remedial mathematics at the junior college level. In addition, one disc was totally dedicated to graphics, including line drawings, cartoons, and

mathematical functions that were displayed to the students along with the textual information displays. It can be seen that one air sandwichTM disc has the storage capacity to hold over eight data bases equivalent to TICCIT's.

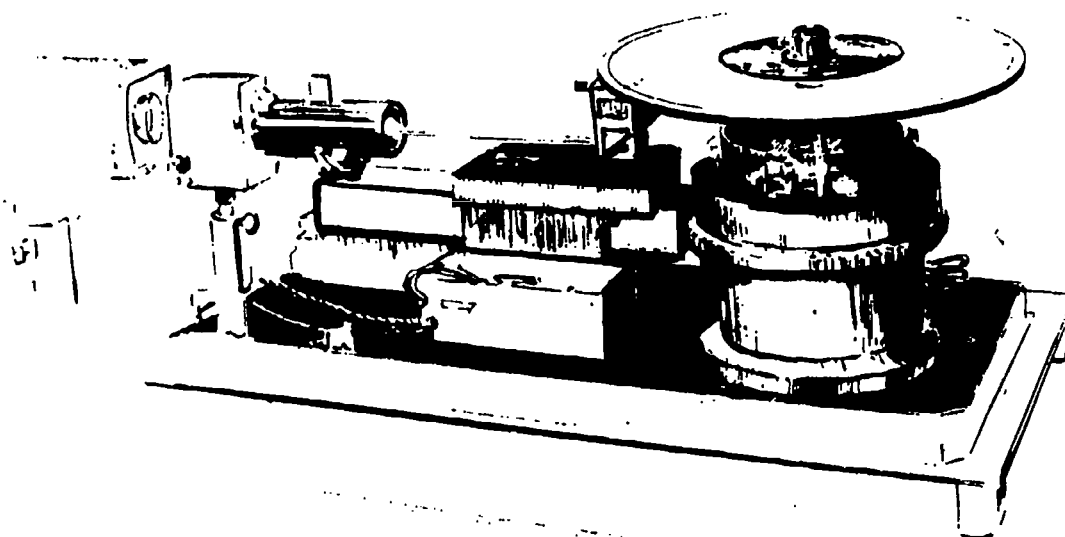

Figure 2. Prototype Optical Disc Data Recorder (DRAW)^(TM).

Much of the current effort with DRAWTM discs is directed toward data storage. Harris Computer Company has received a contract from NASA to develop this concept for such purposes.

One use for DRAWTM systems would be in the data recording function of a central administrative computer at a naval training center, responsible for a particular course of instruction and its export throughout the field. As data are accumulated on the students and their performance in a particular course or courses, they could be recorded by a DRAWTM system. As new data came in to replace the old, the new data would merely be recorded in the next available space and an indexing array in the computer updated to tell which data were current. When the disc was filled, the most recent updated information could be transferred to a new disc and the process repeated. Such a process would not

only greatly cut the cost of disc storage, but would also provide a perfect backup system since a tellurium disc is never "erased." The information is always there as backup for research or for archival purposes.

As an alternative delivery system, the DRAWTM disc would be similar to an Alternative 4 display in that there would be one display screen. While the use of the DRAWTM to generate complete gray scale and color images is conceivable, it has not been shown to be practical. It is possible that motion pictures or still pictures could, with some engineering changes, be mastered on DRAWTM systems. The result could be played back immediately. It would have good resolution but a lower signal-to-noise ratio. Such a device might have important practical use for an author mock-up and editing facility, or a studio premastering facility. RCA is working on a studio system using new proprietary materials and approaches that can be read directly after writing (Lurie, 1978).

Industry representatives told WICAT in late 1977 that DRAWTM systems, like the one operating in prototype form in the laboratories of North American Philips, would be marketed in about 2 years.

Other Alternatives

Work is underway in a variety of laboratories to encode digital signals on the television lines of the frequency modulated audiovisual disc. It is obviously possible to do this since Philips has been successful in encoding a 24-bit digital signal on certain lines of their consumer model videodisc. This 24-bit code is used to generate the picture number and the chapter stop signal. MCA uses a 40-bit code for generating the picture number. Chapter and automatic stops are not available on the MCA player; they would be very useful, however, as they would save considerable time and coding. At present, a program must be written and entered to specify a stop. Engineers at MCA are optimistic that the encoding scheme they use to insert the 40-bit code for picture numbers can be used to store computer programs. Such programs could then be dumped into the 1000 byte memory of their F-8 microprocessor. As this has not been observed in any replicated discs being demonstrated by MCA, caution would indicate that instructional developers should not count on replicating computer programs on discs until after the technical problems of drop-outs in digital codes have been completely solved. The authors have observed unreliable reading of picture numbers on two early copies of the same motion sequence, played on the same MCA player. The two replicates were not identical in the way certain 40-bit codes were read. The solution to these problems could require changes in both the mastering of the discs themselves and in the circuits inside the players that read the digital codes. Thus, the solutions to these problems decidedly are not trivial.

Much has been written about the possibility of storing audio in a digital fashion on a single frame or a small number of single frames ahead of the freeze frame so that several seconds of audio could be played during a freeze frame. This would make the packing capacity of a videodisc for slide tape and similar presentations enormous. Otherwise, the still frames would have to be replicated for as many seconds as the audio track runs.

There are a variety of different technologies that have been proposed for storing digitized or otherwise compressed audio on a small number of still frames and then generating them over a period of several seconds (typically 10 to 20) while the still frame is being refreshed. While engineers are optimistic that they will be able to solve these problems in the near future, the solutions have not been demonstrated on replicated videodiscs.

A great deal of capital is being invested in PCM audio, another application of optical discs for the storage of high fidelity audio. A number of Japanese, European, and American companies are all involved in R&D for PCM audio. The Japanese are meeting to establish standards. Technical successes in this area may cross over into the videodisc area to provide solutions to the encoding problems.

Costs of Delivery System Alternatives 1, 2, and 3²

The costs for the first three of the alternatives discussed above were estimated from data obtained from industry sources and are summarized in Table 1. As shown, the Philips/Magnavox consumer model player is expected to cost \$500-\$600, or "the price of a good TV receiver." Industry spokesmen have not indicated that the price will decline during the first 2 years of marketing.

Table 1
Retail Costs of Components of Three
Videodisc Delivery System Alternatives

	1979	1980
1. Magnavox Consumer model player	\$500-\$600	\$500-\$600
2. MCA Industrial/education player	\$2000-\$2500	\$2000-\$2500
3. Thompson-CSF Industrial/education player	\$4500-\$5000	\$2000-\$2500
4. Personal computer with diskette	\$1500-\$7500	\$1000-\$5000
5. Black and white TV receiver for any of the above	\$150	\$150
6. Color TV receiver for any of the above	\$350	\$350

The MCA industrial/education player may be introduced at \$2000-\$2500 per player. These prices were announced at the IGC conference held July 23-25, 1978 in Carmel, California. So far, however, MCA has placed about 30 players at \$20,000 each (prototype versions).

Thompson-CSF has been fairly explicit in their price announcements, whether accurately or not is not known. Prototype Thompson-CSF players can now be purchased for \$17,000. In 1979, several hundred will be available at prices ranging from \$4500 to \$5000. In 1980, if all has gone well in their marketing, they project a price in the range of \$2000 to \$2500 to compete both with the MCA player's probable target price and with fairly sophisticated videotape playback equipment.

²Manufacturer costs reflect those quoted in late 1978. Up-to-date costs may be obtained from the manufacturers.

Alternative 3 posits a videodisc player like the MCA or Thompson player, interfaced to a personal computer having its own monitor (probably black and white). A number of personal computers are now on the market in the range of \$1500 to \$5500 containing floppy diskette drive units. Both the Radio Shack TRS-80 and the Commodore Pet can be purchased with 16K or core memory, a built-in BASIC operating system in ROM, and a floppy diskette for less than \$1500 in single quantities. At the higher end, the sophisticated TERAK computer system, having a bit mapped graphics display (with many of the dynamic properties of the PLATO display, but with about 1/4th the resolution in terms of the total number of picture elements) can be obtained through a quantity discount for \$5500, or single unit price of \$7500. This includes one floppy disc drive, 28K of core, and the flexible bit mapped graphics and text display. The TERAK display permits the author to specify different character fonts as well as plotting point graphics, as on PLATO. Because of competition and rapid technological evolution in the field of personal computers, it should be possible to get such systems by 1981 in the price range of \$1000 to \$5000, depending upon the features desired. If the large manufacturers, like Texas Instruments, General Instruments, Intel, and others, move strongly into the personal computer market, one may expect personal computers with diskette units to be available closer to the \$1000 price than to the \$5000 price.

All of the videodisc players require television receivers or monitors. Lines 5 and 6 of Table 1 list the retail prices for black-and-white and color TV receivers of sufficient quality for the purposes described above. All of the prices in Table 1 are single unit retail prices. Discounts due to larger purchases could be available to the government. Personal computers with audiotape for program storage were not included in Table 1 because the recording and playback of CAI programs using audio tapes has, in WICAT's experience, been too unreliable and time-consuming for the kind of usage needed by DoD. Diskettes seem to be a better solution. When data can be read from videodiscs, most floppy diskettes could be replaced.

Costs of Alternative 4 configurations cannot be predicted with accuracy at the time of this report. It would be beneficial to DoD if Magnavox, Sony, or some new companies are successful in establishing a mass market for the \$600 players. It is then conceivable that these players or their equivalents could be ruggedized and receive a jack in the back plus certain control logic to make them easy to interface to computers of the user's choice.

Given a mass market for the basic components, the amount of electronics that needs to be added to provide interface to another computer may not prove to be very expensive. The price of industrial/education players is likely to be set more by the videotape competition and the projected small size of the industrial/education market than by the cost of the components that go into augmented players. An alternative desirable for education and training would be that the consumer-oriented manufacturers would find a market for videodisc players with built-in interface to personal computers for the home market, thus driving the price of the systems suitable for Alternatives 3 and 4 down even further.

In summary, by 1980, it can be seen that Alternative 1 systems should be selling in the order of \$550 per player, Alternative 2 systems in the order of \$2000 to \$2500, and Alternative 3 systems could be assembled in the \$2000 to \$5000 range, depending on the features desired. This could be done with off-the-shelf equipment available from more than one manufacturer. Other alternatives are in a state of flux and their costs and configurations cannot be estimated at this time.

Media Selection During Instructional Systems Development

Two alternative procedures for media selection during instructional systems development (ISD) have been selected. Both will consider any or all of the alternative videodisc training delivery systems considered above. The first is a modification of the Interservice Procedures for Instructional Systems Development (IPISD) (CNET, 1975); and the second, a modification of the media selection procedures that have been prepared for the Army Research Institute by the Systems Development Corporation (SDC) (Hoyt, Bennik, & Butler, 1977). The primary difference between these two procedures is that the IPISD procedure is an "objectives out" procedure, while the SDC procedure limits media possibilities to a smaller subset first.

IPISD Procedure

In this procedure, one starts with the training objectives, classifies them into 11 categories, and develops a set of learning guidelines. These learning guidelines have implications for what is to be displayed, what responses the students are to make, and the various settings in which the displays and responses are to be given and made. For each of the 11 categories of learning objectives, there is a decision matrix such that one can evaluate the stimulus, response, and learning setting conditions for a given lesson (consisting of a set of objectives with learning guidelines), and then go through the decision matrix and choose applicable media. This process should result in a small set of acceptable media. One of these is selected on the basis of administrative factors, primarily cost. This procedure takes, for each discrete lesson, the possible universe of all media and, through a logical process of elimination, boils down to the one best medium for a given application. The practical usefulness of this procedure is limited, since, in some locations, constraints exist as to the kind of and time to be allotted to various media. For example, policy may require that 70 percent of the media be print and 30 percent, "other"; or trainees may be required to spend 85 percent of their time reading printed materials and 5 to 10 percent using slide-tape materials. Because of such limitations, the careful objectives-oriented IPISD method is not very useful for media selection per se, but it is helpful in designing instruction within specified media.

Although developers can save time when they know they are constrained to certain types of media, such constraints do pose problems. For example, when they feel that manipulative media such as simulators or actual equipment are required, they may not try to teach objectives requiring such media, but, rather, refer to a "B school" or to on-the-job training. Further, a restriction on audiovisual media may encourage developers to limit the objectives to those that can be taught with the media typically developed at a center.

SDC Procedure

The system selection procedure proposed by SDC provides for an initial prescreening of media based both on the constraints of the real situation and on the overall instructional logic of the entire system. The procedure includes four stages, where decisions may be made for selecting, configuring, and managing the assignment of training and evaluation delivery systems. These stages are:

1. State delivery system requirements and preliminary candidates.
2. Select major delivery systems mix for training program.
3. Configure delivery systems for specific performance modules and lessons.
4. Assign alternatives during implementation.

In the first stage, the major goal is to state requirements, including constraints and performance expectations, that lead to preliminary decisions of candidate media systems. Some examples of requirements statements given in Bennik et al. (1978) appear below:

All delivery systems must be available or readily exportable to field units with no special impacts upon operational equipment.

Training delivery systems and SQT/ARTEP (Skills Qualification Test/Army Training and Evaluation Program) delivery systems must be compatible and realistic for combat performance requirements.

The training program and delivery systems used must reduce the overall life cycle costs of the proponent school training program.

Training approaches and devices shall be designed for a combined pictorial-verbal intelligibility and comprehension level of grade school.

Training approaches and devices shall be compatible with ITDT Milspecs and the DA Technical Documentation and Training Acquisition Handbook. (pp.4-8)

Bennik et al. further state:

Such statements serve as constraints or specifications within which initial delivery system categories are selected. For example, exportable audiovisual and print, as well as system-embedded hardware or software simulation techniques, may be candidates for the requirements stated above. Assessment of supporting technology for the candidate delivery systems against constraints and requirements may reveal a need for further development--as with a major training device.

The goal of the second stage is to select the major delivery system mix for the entire training program. This is a further sensible limitation since a single training program will always have a coordinated set of media. Unlike the IPISD, which leaves the whole universe of possible media available for analysis, this approach has not yet narrowed it down to the individual lesson or module level.

To specify this overall media mix, Bennik et al. provide a "Training Techniques Selection Matrix," which lists, as column stubs, a variety of display presentation parameters for visual, auditory, and tactile displays. These parameters are not unlike the display and response categories provided in the IPISD procedure, but are more detailed. They also provide a set of response parameters and a set of strategy parameters, including some categories similar to the learning settings in IPISD, plus others dealing with feedback, pacing, and sequencing. The row stubs of the selection matrix consist of a list of actual training media, such as overhead transparencies, audio tapes, filmstrips, teaching machines, models, mock-ups, CMI, and CAI. Course design teams may use the matrix to specify the probable media mix for an entire course to fit within the constraints and requirements generated in the first stage.

The third stage of the SDC decision process, where individual modules and lessons are specified, is similar to that specified in the IPISD. Although the procedure is less analytical and more pragmatic than the IPISD procedures, the outcome is similar. Finally, in the fourth stage, the training delivery system is followed into the field and data are collected on the usefulness of the various alternatives that exist within the total media mix.

Table 2 is a modified version of the selection matrix used in the SDC decision process. The training task characteristics are those used by Bennik et al. and the media delivery forms, those used by the Navy IPD center plus the first three videodisc delivery system alternatives. As might be expected, the three videodisc alternatives, which combined the capabilities of print, audiovisual media, and, in some cases, CAI, are generally very applicable. Although the rows in Table 2 may not represent the best set of task characteristics against which to compare videodiscs and other media, the general applicability of videodisc alternatives does raise the possibility of simplifying complex media selection procedures. If videodisc training delivery systems can be deployed within the next 10 years, the present differences among lesser media may cease to be important. Videodiscs are at the top of a "media hierarchy" since they subsume the capabilities of lesser media. When developing lessons for delivery over videodisc/computer delivery systems, if desired, it is possible to spin-off slide-tape presentations, videotapes, motion pictures, print presentations, programmed textual presentations, etc. from the same basic source material used to generate the videodisc, especially if it can be developed in a digital form. During an intermediate time when varieties of media are used, these alternate form productions from the basic video development effort could be made available in the alternate media forms. Later, when videodisc/CAI systems are more widely available, the need for down translation into lesser media would presumably decrease.

Summary

The SDC procedure appears to be more cost effective than the IPISD procedure, primarily because it involves a prior limitation of the media to be considered. Thus, a smaller set is available for consideration before the detailed analysis takes place at the individual objective level. By contrast, the IPISD procedure keeps all media as possible alternatives until an objective-by-objective analysis has been completed.

Instructional Strategies

The four kinds of instructional strategies that can be used with videodisc technology are listed below:

1. Direct transfer of conventional audiovisual media onto videodiscs.
2. Programmed instructional sequences, including rule-example-practice formats.
3. Moderate branching strategies for reference and for branching programmed instruction.
4. Varieties of interactive computer-assisted instructional (CAI) strategies mixed with videodisc displays.

Strategies 1 and 2 are applicable to manually-controlled consumer model videodisc players; Strategy 3, to microprocessor-controlled players; and Strategy 4, to computer-controlled players. Computer-managed instruction is not considered as an instructional strategy but, rather, as a management strategy applicable to prescribing work on videodisc or any medium.

Direct Transfer of Conventional Audiovisual Media onto Videodiscs

The first strategy employs the capabilities of audiovisual media, as well as the kinds of instructional strategies that are used with videotape, slide tape presentations, film

Table 2
 Characteristics of Several Media Forms

Training Task Characteristics	Media Delivery Form					
	Printed Text	Sound Filmstrip	Video Recording/ Playback	Consumer Videodisc Player	Branching Videodisc Player	CAI Videodisc
Display Presentation Parameters						
<u>Visual</u>						
Alphanumerics	1	1	1	1	1	1
Special symbols	1	1	1	1	1	1
2-D situational	1	1	1	1	1	1
3-D representation	1	1	1	1	1	1
Static	1	1	1	1	1	1
Dynamic	--	--	1	1	1	1
Point or vector motion	1	1	1	1	1	1
Rate pattern motion	--	1	1	1	1	1
Rate/distance changes	1	1	1	1	1	1
Object/ground contact	1	1	1	1	1	1
Color cue	1	1	1	1	1	1
<u>Auditory</u>						
Signal cue	--	1	1	1	1	1
Tone discrimination	--	1	1	1	1	1
Speech comprehension	--	1	1	1	1	1
<u>Tactile</u>						
Size/shape cues	--	--	--	--	--	--
Positional cues	--	--	--	--	--	--
Response Parameters						
<u>Performance</u>						
Indication	1	--	2	2	1	1
Manipulation	--	--	2	2	2	2
Read/interpret	--	--	2	1	1	1
Listen/interpret	--	--	2	1	1	1
Voice composition	--	--	--	--	--	--
Situation evaluation	1	--	--	1	1	1
Decide action	1	--	--	1	1	1
<u>Verbal Symbolic</u>						
Choice selection	1	2	2	1	1	1
Specific recall						
Written	1	--	--	1	1	1
Pictorial	1	--	--	1	1	1
Oral	1	--	--	1	1	1

Table 2 (Continued)

Training Task Characteristics	Media Delivery Form					
	Printed Text	Sound Filmstrip	Video Recording/ Playback	Consumer Videodisc Player	Branching Videodisc Player	CAI Videodisc
Strategy Parameters						
Feedback						
Informative	1	1	1	1	1	1
Evaluative	1	2	2	1	1	1
Corrective	1	--	2	1	1	1
Frequency						
Immediate	1	3	2	1	1	1
Delayed	--	--	3	2	2	1
Interaction						
Pacing						
Learner paced	1	1	Y	1	1	1
Program paced	--	1	--	--	1	1
Sequencing						
Linear	1	1	1	1	1	1
Response branching	1	Z	Y	W	1	1
History branching	--	Z	--	--	2	1
Repetitive practice	1	Z	--	1	1	1
Learner controlled	1	1	Y	1	1	1
Console mode						
Independent	1	--	1	1	1	1
Netted	--	--	--	--	2	2
Support Mode						
Instructor facilitator	--	--	1	1	1	1
Instructional monitor	--	--	1	1	1	1
Simulation team	--	--	--	--	X	1
Equipment operator	--	--	--	?	?	?
Trainee stand-alone	1	1	1	1	1	1

Legend:

- = Not suitable
- 1 = Suitable
- 2 = Suitable with special modifications or devices.
- 3 = Suitable only under instructor control for individuals or groups (no response inherent in medium).
- W = Manual branching to any location is convenient.
- X = Contains integrated response control of presentation.
- Y = Presentation can be controlled by separate response system.
- Z = Presentation not controlled by response.

strips, and motion pictures. The student does have more flexibility because of the powerful interactive controls on even the consumer model videodisc. That is, it would be easier for him to retrace his steps, go through something in slow motion, or survey ahead at three times normal rate to get an overview.

These kinds of learner control strategies using the keyboard of the manual player are promising and should be studied, especially since the costs of transferring conventional audiovisual media to videodisc players are less than the costs of developing media specifically for videodiscs. Depending on the number of copies that must be made, it may prove to be more cost effective to replicate and distribute videodiscs than to replicate conventional audiovisual media. (A comparison of costs of conventional audiovisual media against projected costs of the videodisc is beyond the scope of this contract. Contract No. DAAG 39-78-C-0096, which has been let through the Army's Communicative Technology Office, Training Support Center, Ft. Eustis, VA, however, will involve such a cost analysis.)

A major factor in the potential cost effectiveness of the videodisc as a medium for distribution of conventional audiovisual materials is the extent to which the encoding of the audio on one or more single videodisc frames will be accomplished technically and marketed. It would be a waste of videodisc still frames to duplicate a visual frame every 30th of a second as long as an audio message was being played on the audio track. A 20-second message would require that a single still frame be duplicated 600 times. On the other hand, if 20 seconds of audio could be placed on two still frames that could be dumped into a buffer memory at a very rapid rate and played out at a normal audio rate, while a third still frame was displayed continuously in freeze frame mode on the videodisc player, then the space requirement would be reduced by a factor of 200. This would make it possible on a single videodisc to store a large library of slide, tape, or film strip presentations including some short motion sequences. Thus, the slide tape requirements for an entire large course could be stored on one videodisc. Other videodiscs might be needed for extensive television or motion picture sequences that might accompany the same course. There might also be enough room on a videodisc to store a large number of pages of technical information, such as are now distributed via print media. Portions of technical handbooks or the entire handbook could be stored on the 108,000 frames available on the two sides of the 30-minute videodisc.

Since the cost implications of the first alternate videodisc strategy may be substantial, considerable work should be done not only to establish clearly the cost of the videodisc alternatives, but also the cost of the established media against which the new medium must be compared.

Programmed Instruction or Rule-Example-Practice Strategies

Commercial audiovisual media may or may not require the student to stop and answer questions in his notebook and then advance to another frame. This is done more commonly in print media. The Navy has for many years trained authors in the principles of programmed instruction that have grown out of the work of B. F. Skinner and those who have followed the trail he blazed. In more recent years, an advanced instructional strategy built around "content components," including rules, examples, practice items, feedback messages, and helps, has been increasingly employed by Navy authors. An author training course developed under funding from the Defense Advanced Research Projects Agency (DARPA) is now available for use at IPD Centers and other Navy authoring sites (Freedman, Bresee, Hermans, & O'Neal, 1978).

The advantages of the videodisc for presenting programmed instruction are that the student sees only one page at a time. This page need not have the answer on it. The

student can write his answer on a worksheet and then is required to advance to the next frame. This method can, of course, be used with slide tape presentations that can also be manually controlled by the student.

Unlike the Skinnerian model, which is better for simple forms of verbal learning than for higher levels of cognitive learning, the rule-example-practice model is optimized for teaching concept learning and rule-using behaviors. It does this in a framework of learner control, using a unique format that enables learners to access the rules, examples, practice items, etc. easily.

There is no need to elaborate on the implementation of conventional programmed instruction strategies on a videodisc. The procedure would be to break the programmed book into frames of 500 characters or less, creating a series of videodisc still frames that carry the text, graphics, questions, and reinforcement frames in a linear order. The rule-example-practice strategy, however, is much richer than this. This strategy was initially implemented on an interactive CAI system, the TICCIT system, under a philosophy of learner control, which allowed the student to orient himself by jumping from lesson to lesson or from segment to segment within the lesson. In this way he could survey to get an overview of the content of the various lessons. Once he began his learning tactics, he was able to select his own sequence of rules, examples, and practice problems, and even to vary the difficulty level of both rules and practice problems. While it would be possible for a student to go through a rule-example-practice sequence in a linear fashion, even the manual videodisc can be structured so as to give the student a large measure of the learner control enjoyed on the TICCIT system. An attempt was made to accomplish this in the McGraw-Hill videodisc project, mentioned previously. The learning strategy employed on this first application of the rule-example-practice strategy to a videodisc is discussed in Appendix A.

Moderate Branching Strategy

The MCA videodisc player and, to a lesser extent, the Thompson-CSF player provide the opportunity for implementing a branching instructional strategy resembling Crowder's (1960) work in programmed instruction. This work has flowered on such devices as the Mark II Auto-Tutor, and other branching teaching machines, which, except for the error counter in the Mark II Auto-Tutor, resemble the branching videodisc players. Neither the early machines nor the current branching videodisc players permit the keeping of records, the processing of constructed responses, or the generation of dynamic displays. Branching depends on which (of several) button is depressed in response to a multiple-choice question. A branching strategy is illustrated in Appendix B, which describes the videodisc project conducted by WICAT Learning Design Laboratories for MCA.

Figure 3 illustrates the keyboard on the MCA player. The keys on the top of this keyboard permit the same functions found on the manual videodisc player. Thus, the student may work in a manual mode in a nearly identical fashion to the Philips/Magnavox player. When the student presses "RUN," however, he enters a programmed mode and the microprocessor program takes over until the student aborts the programmed mode and reverts to the manual mode. In the programmed mode, the machine may be programmed to search to a given frame, during which time the screen may be blanked, or to play to a given frame and stop. A stop frame may include a multiple-choice question, answered by depressing one of the digits zero through nine in the lower part of the keyboard. Following recognition of one of these digits, the program can direct the player to branch to a motion segment and play it, or to go into any of the variable motion modes, such as slow motion or fast motion.

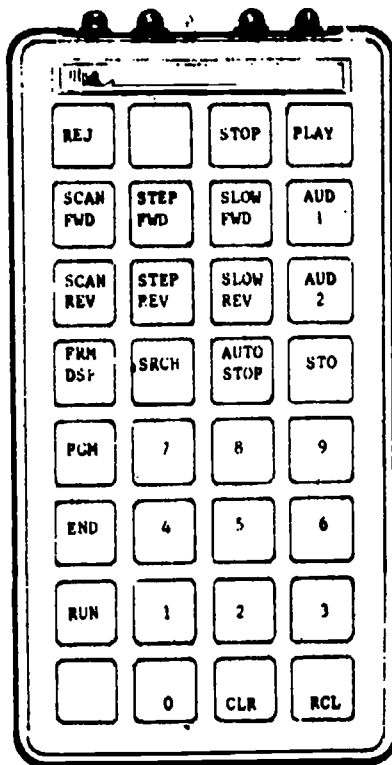

Figure 3. Keyboard of the MCA player.

In addition to strategies like Crowder's, or modifications of it, it is possible to give the student the rule-example-practice branching capabilities of TICCIT, but without the analysis of constructed responses. The branching player can also serve a reference function. In the example illustrated in Appendix B, the student is able to look up references from a manual describing the operation of the Ford Granada. The combination of branching instruction and reference material through hierarchical menu or index structures may prove to be valuable.

Computer-assisted Instructional Strategies for Videodiscs

The third and fourth alternate videodisc delivery systems employ programmable computer-assisted instructional (CAI) systems that generate textual and graphic displays. This opens a whole new range of strategies because the more sophisticated personal computers, even those using only the standard BASIC language available on ROM chips, can be programmed to perform a wide variety of CAI strategies. Table 3 provides a list of these strategies. Item 5--equipment-embedded interaction--uses tactical computers embedded within military equipment. This mode is promising since instructional programs can be displayed on the same display and response devices that the learner must use while operating the equipment in the field. The most widely used strategies in Table 3--drill and tutorial--are discussed below.

Table 3

Common CAI Strategies.

Strategy	Type of Objective
1. Generated Drill or Practice Sets	Usually memory level
2. Tutorial	Concepts, rules
3. Learner Controlled Rule-Example-Practice	Concepts, rules
4. Simulations or Games	Integration of concepts, rules, problem solving
5. Equipment-embedded interaction	Integration of concepts and rules

Drill and Practice. Those drill and practice algorithms that have been in most widespread use are based on some kind of random generation of item contents. For problems involving numbers, the item contents can be generated randomly from bounded sets. Different kinds of exercises have different bounds on the numbers. There can be a "base frame," which contains text outlining the general structure of the problem. Random numbers are then generated into these base frames. Correct and anticipated incorrect answers can be calculated from the randomly generated numbers, as can "help" sequences.

It is also possible to provide files of item contents that can be plugged into base frames sequentially, at random, or according to some algorithm. The construction of base frames and item contents was used extensively in the TICCIT project, a major CAI project, and led to savings in the generation of sets of practice problems. Random generation of items is used in the most popular drill and practice mathematics programs and in many other CAI or computer-based practice systems.

The production of sequences of drill items or practice items using random generation (or generation from files into base frames) has some cost implications for authoring in the Navy. The cost-effectiveness of this approach over approaches requiring the manual composition of each item seems promising.

Tutorial Strategies. Almost all of the early CAI "authoring languages" were built around a basic structure that made tutorial programming easy. A tutorial program may be described as an intrinsic program (a Crowder-like branching program) with constructed responses. Thus, it is a combination of two early programmed instruction modes. Skinner insisted on linear programs with constructed response and felt that the use of multiple choices, which permitted branching, was disadvantageous, as the student would learn the distractors. Crowder felt that a branching program provided better for individual differences than did a linear program. Tutorial CAI makes this distinction irrelevant since answer-judging functions allow the student to type in short constructed responses, and any kind of branching can accompany various alternatives, whether constructed or multiple-choice, right or wrong. Moreover, the branching possible in a Crowder intrinsic program was only one level deep; that is, it was based on the response to the last multiple-choice question. CAI systems, on the other hand, are able to record response history over many trials within the same and previous sessions. Thus, the criteria for

branching can be much more sophisticated. Tutorial programs proved to be costly to develop and hard to maintain. A major reason for this is the heavy use of conditional branches. Computer science has, for several years, emphasized structured programming, which eliminates the use of "Go-To" statements. "Go-To" statements in computer programming are the equivalent of branching in tutorial CAI. In both, they tend to "spaghetti coding," which, as its name implies, is convoluted, hard to follow (by the author or by another programmer), and hard to maintain.

Other Strategies. Simulations, games, and equipment-embedded CAI have considerable promise for Navy training. Low-cost, low fidelity simulations can replace time spent in high-cost simulators or in real equipment. The videodisc can make such low-cost simulations more realistic. Connection of a videodisc/microcomputer system to actual equipment may also have considerable promise for realistic, on-the-job training.

Author Mock-up and Simulation Prior to Premastering

In the premastering step, the material prepared in the manuscript or story board form by the authoring teams must be committed to a final form, either on a film or videotape master. If film is used, further processing is necessary to create a final premastered videotape. All still frames and all motion sequences must be on the videotape in the proper order, as well as codes to indicate to the mastering facility which picture numbers to apply to each frame, where to put chapter interrupts, and where to put automatic stops for the manual disc. Only the picture number codes are necessary for the computer-controlled discs.

Since the steps of going to a final film or tape master and then to a final glass master and thence to replicates are expensive, they should not have to be repeated. Therefore, an author mock-up or simulation capability is needed so that components (still frames and motion sequences) can be reviewed and tested prior to committing the material to premastering and mastering. This capability should consider several criteria:

1. It should permit the mock-up and demonstration of all display features implicit in the videodisc. Since these features combine the capabilities of print, audiovisual media, and interactive computers, it must be possible to mock-up both motion sequences and still frames of any imaginable kind (e.g., text, graphics, photographs, special symbols, special color backgrounds, color cueing) and to simulate the interplay between motion sequences and still frames. For computer model videodiscs, it must also be possible to mock-up the computer-generated frames and the interactions that occur as a result of student responses.

2. It must be easy to edit and change the still frames and the starting and stopping points of motion sequences and to reorder the still frames and motion sequences. It must also be easy to edit and change the computer programs during the pilot tests and reviews that the authors will undertake among themselves and with test students.

3. In developing this capability, consideration must be given to the trade-off between using equipment that is currently available to Department of Defense groups and is familiar, versus using equipment that is state-of-the-art. Initially, the author mock-up functions should use equipment that is available and familiar to the extent possible. When new equipment is introduced, however, it should be state-of-the-art, particularly because of the low-cost, highly flexible equipment that can be expected within a few years.

4. To avoid the necessity for authors to come to an expensive television studio, where their time must be tightly scheduled, there are many demands on the equipment,

and security and maintenance factors make it difficult to bring in informal groups of test students, the equipment should be portable enough to install in any convenient location where training development occurs.

5. Finally, the equipment should be relatively inexpensive.

These five criteria were used to evaluate the following three alternate hardware configurations for author mock-up and simulation:

1. Magnetic videodisc and videotape units with inputs from camera and computer-generated displays, plus a separate CAI computer to mock-up the computer-generated portions.

2. The TICCIT system or modifications of it.

3. A simple configuration made up primarily of available equipment but with certain additions and interfaces.

These alternatives are described below.

Magnetic Videodiscs

Because of the desirability of having the flexibility inherent in the use of single color slides in video format (525 line NTSC standard), the possibility of obtaining a magnetic disc and attaching it and videoplayers to a main-frame computer was investigated. Although this idea is appealing, it is extremely costly in terms of hardware, engineering (especially interfacing), and software development. The least expensive "slo-mo" disc we were able to locate costs about \$45,000. (Most TV studios purchase units costing in excess of \$80,000.) One lower-cost option is the ARVIN-ECHO VDR-1R Video Discassette Recorder, which is less flexible than a "slo-mo" disc. This device, which is used to store up to 200 frame tracks on each side of a "floppy cassette," costs \$10,000.

The magnetic "slo-mo" disc could receive inputs from a computer-controlled character generator. It would also have to be attached to a camera that could input color slides (or any form of still frame an author and artist could imagine). It would also require a magnetic videotape facility of some sort to mock-up the motion sequences, and a computer to mock-up the computer-generated frames and interactions.

It may be tempting for those at a military training development site to utilize an in-house main-frame computer, already justified on the base, for the mock-up of the computer portions. A main-frame computer is defined as a large centralized computer, primarily justified for some other purpose, which might drive some CAI language with good editing features. Use of such a computer, assuming that it has a good software base, can speed up software development. On the other hand, however, software development (e.g., interface software and research data acquisition software) may be heavily constrained by what is happening on the system as a whole, and the protections that the operators and systems people place on any new development on their service computer. It may also prove difficult to interface various devices to this main-frame computer. The cost of leasing time on a main-frame computer may be very low if one has special connections with a particular computer center, but are typically very high if time must be paid for.

Small, stand-alone computers seem more flexible for authoring groups. Also, courseware developers are more likely to use conventional slide and video editing equipment that is available on their bases rather than to invest in expensive magnetic "slo-mo" discs and in the main-frame computers to tie these together with videotape players.

For the ordinary instructional development site in the Navy, the slo-mo disc seems to fall short on the criteria of portability and cost. The slo-mo disc would probably have to be maintained in a television studio, along with other expensive equipment. The cost is high, even with the portable ARVIN-ECHO, which costs around \$10,000. These costs do not compare favorably with the use of a simple random-access slide projector.

Concerning the trade-off between available and familiar equipment and state-of-the-art, magnetic discs may become more cost-effective in the future. Their use is recommended where available in a studio premastering facility, but not for author mock-up.

TICCIT as an Author Mock-up System

During 1976-77, TICCIT, because of its color display and videotape capabilities, was considered an ideal simulator for authoring interactive videodiscs. In May 1977, however, when WICAT attempted to use TICCIT as a simulator in developing an educational videodisc for McGraw-Hill, it was found to be unsatisfactory for several reasons:

1. TICCIT does not have random access, easily edited videotape. Although TICCIT does have videotape cartridges that can be loaded by an operator when a teletype signals that a tape is desired, it is not possible to provide random access to any piece of videotape, to switch cassettes without operator intervention, or to start and stop cassettes. There are a variety of devices on the market that provide random access to video segments.
2. The TICCIT display is too different from a regular TV display:
 - a. It has 43 columns, 14 rows (fixed).
 - b. It has one background color (gray).
 - c. Line 17 is not available (preprogrammed).
 - d. It cannot combine text with a photograph.
 - e. The display is driven at over 10 megahertz instead of the standard 3.5 megahertz delivered by the videodisc. (This led to incorrect thinking that color highlighting could be used on a videodisc-driven standard TV set.)
3. Although the TICCIT data entry system was originally considered to be extremely flexible for the easy composition and editing of CAI sequences, it was soon found that its built-in constraints created some severe difficulties. There is a need for a language that will permit the programming of a wide variety of strategies, and easier control and editing of graphics.
4. The TICCIT configuration is not readily portable. It requires hard discs and at least one rack of equipment.

5. Finally, it is rather expensive.

A Configuration of Familiar Low-Cost Components³

Alternative 3 is a trade-off between using available and familiar low-cost equipment and trying to stay state-of-the-art. It assumes a small microprocessor-based system, or "programmer's workbench," for use in generating the CAI sequences. Such systems are now available for from \$5,000 to \$11,000. They use floppy discs, a built-in character and graphics display, and a microprocessor. One example is the TERAK. It has a powerful structured language, the PASCAL language, which can serve as the basis for easy implementation of any of a variety of existing CAI authoring languages.

After the TICCIT system proved to be inadequate as a simulator for author mock-up purposes (see above), a hand-operated videotape player was used to mock-up the video sequences; and a carousel projector, to mock-up the still frames. Thus, the videotape sequence could be played, and the slide projector could present the still frames that followed this sequence. This was a natural method since it used equipment that was readily available. The editing of videotapes proved to be tractable, though inconvenient, as we arranged and rearranged the motion sequences after each mock-up session. Similarly, the editing and rearranging of single frames is easy when they are on color slides, which were taken from materials typeset with a whole variety of type fonts. Studies on the number of characters that could reasonably be presented, the kerning, the type of line graphics that would be appropriate, and the use of photography overlaid with text were performed. Personnel in courseware development operations at Navy training bases would find it as easy to use improved versions of this system.

A natural improvement would be to use a single output screen, into which would feed the video sources: a random access videotape player, a video camera that would "read in" slides, and the computer display. All three video inputs can be fed directly to an inexpensive video mixer/switcher and then to a color TV display. This configuration is presented in Figure 4. Note that the authors can test portions of the program by typing as a student would do on the keyset. A display would appear on the CRT screen to tell the operator what to do. Looking at the 3-bay monitor, he could access and switch to a slide, a video sequence, the CRT, or a mixture of two of the three. Existing authoring centers could use variations of the equipment in Figure 4, but would need the camera, a slide projector source, a video tape source and a CAI source.

Additional equipment, which is not pictured in Figure 4 in order to simplify the drawing, includes a Dynair Modulator (model TX 2B "Mini-mod") and a sync generator (Telemation model T5G-175). The modulator enables a regular TV set to be used, instead of an expensive monitor. The sync generator pulses both the CRT output and the camera, so that CAI data can be overlaid on the camera output from a color slide.

³The Army Research Institute (ARI) is sponsoring a 3-year study of instructional systems development procedures for the videodisc. The first annual report (Vols. I, II, and III) from the effort recently has been submitted to ARI. Volume II of that report (Bunderson & Campbell, 1979) provides considerable detail about videodisc authoring and production systems. Although the author mock-up described in this section and illustrated in Figure 4 still meets the criteria stated and is a usable concept, it appears to be unnecessarily complex. Rather than using the full capability of the integrated system, it appears that initial practices will be to use various system components for mock-up, review, etc. Although the recommendations to include a small, stand-alone "programmer's workbench" with CAI software for computer programming and low-cost conventional equipment, such as a random access videotape player and slide projector (see Figure 4), still stand, authors should be allowed to work with these separately in a manner that is convenient for them.

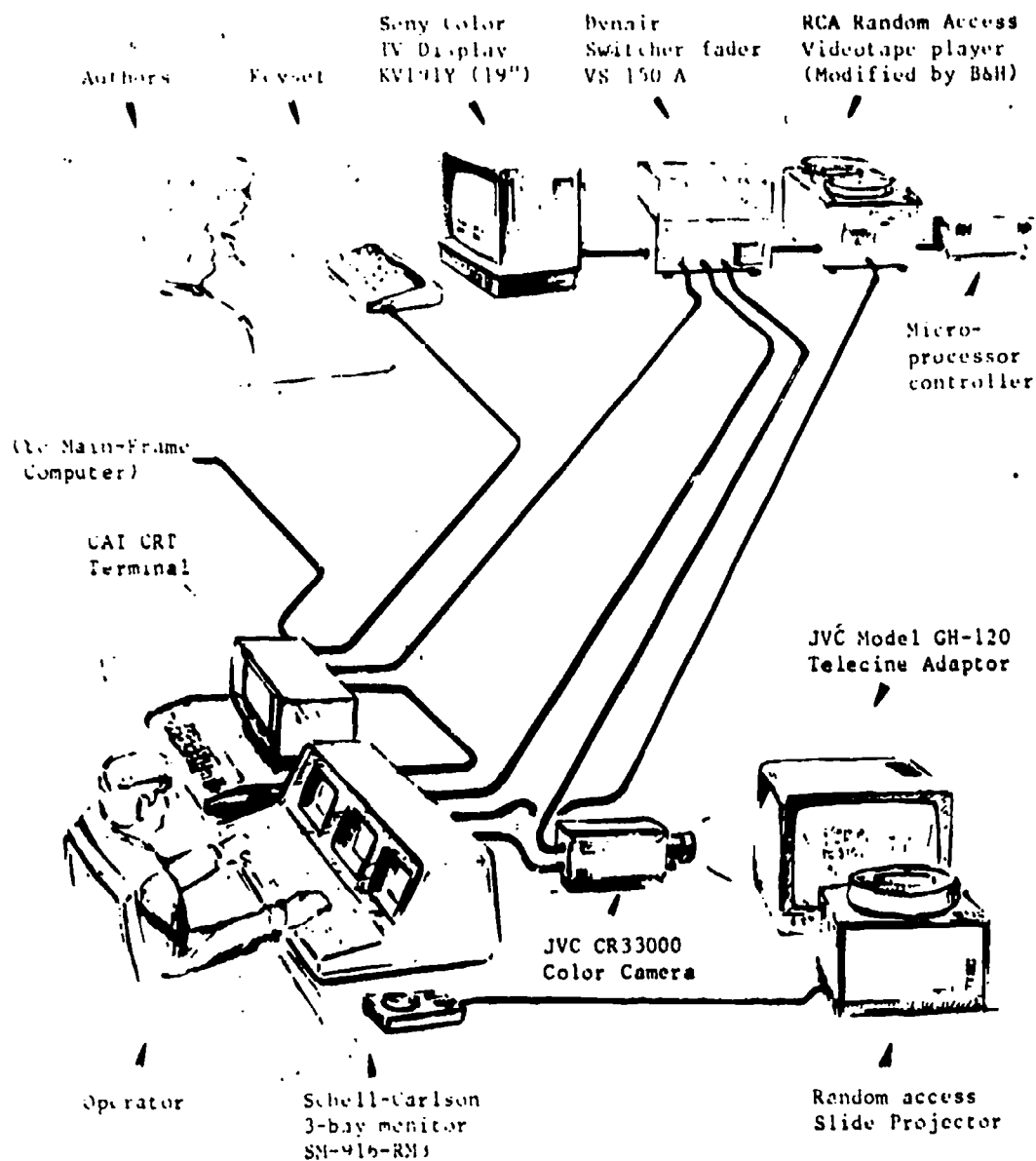

Figure 4. Proposed author mock-up configuration.

The configuration in Figure 4 is highly flexible for testing the three different types of courseware: motion sequences, still frames, and computer-generated displays, including overlay on video frames. All of these components can be reviewed and edited while still in an easily changed form, prior to final production. It is also modular enough to remain "state-of-the-art" as more flexible random access devices based on tape, less expensive cameras, and smaller computer systems are being introduced in the market.

The author mock-up configuration depicted in Figure 4 meets all of the criteria stated at the beginning of this section. It allows all display features to be mocked-up

readily and to be changed and edited readily. It uses equipment that is available and familiar, yet its modularity allows newer state-of-the-art pieces to be moved in as rapidly as possible. It is portable. Also, its cost is within a range acceptable by serious authoring groups, many of whom may already have several of the component parts or their equivalents.

Premastering

The term premastering has no precise definition. The activities of authors in looking at the component slides and motion sequences in a mock-up facility occurs prior to mastering and so could be called premastering. Similarly, the editing activities of the authors in producing the slides and motion sequences in a final form could be considered premastering.

In this report, the term "premastering" refers to the production of one single master videotape, having all lead-in information; motion sequences; still frames; codes for picture numbers, chapter stops, and automatic stops; and lead-out sequences. In cases where a master film is used to produce the master tape, the process of putting the color slides on 16 or 35mm strips of film by means of an optical printer is part of premastering. One complete master film may be prepared, either by running all of the motion sequences through the same optical printer as the slides, or by taking each sequence of slides run through the optical printer and using an AB or ABC edit process to produce one final continuous film master with no splices. Splices are unacceptable because the frames on either side of the splice will be out of focus as they go through the flying spot scanner for conversion to tape.

In contrast to premastering, the mastering procedure uses the videotape resulting from the premastering process as the primary source for producing a master disc, from which stampers can be made for replication. The replication process consists of taking the stampers made from the glass master disc and using them with pressing equipment (or with other equipment discussed below) to produce the replicates.

Two premastering processes were observed during the course of this study. The first, which is used by Magnavox-Philips, requires that a film master be produced so that (1) the freeze frame features of the player will have a minimum amount of jitter, and (2) cue patches to generate the digital codes can be inserted on the edge of the film between the sprocket holes and read by the premastering equipment. The second procedure, which is used by MCA, does not require film but can accept it. A method is provided for encoding signals on a videotape, rather than using cue patches on film. These two processes are described below.

Premastering from Film

This procedure was developed by N. V. Philips, and is available at the Cine Centrum Studios in Hilversum, Holland. It involves a flying spot scanner having the capabilities of the Rank Cintel Mark III; that is, the scanner must be:

1. Able to read cue patches, small elliptically shaped, metal foil dots about 2mm across the major axis and 1.5 across the minor axis, which are placed on the edge of the film to indicate chapter codes or automatic stops.
2. Synchronized with a high quality audio unit on which a separate full-coat audio track for the film is playing in synchronization with the film.

3. Able to activate the "cue code inserter," a special device designed by Philips that inserts pulses on certain lines of the television signal. These pulses can later be read by the mastering equipment, transformed into a 24-bit code, and inserted on certain lines of the mastered videodisc.

A block diagram of the various pieces of equipment that perform these and other functions is provided in Figure 5. Box number 1 in Figure 5 is the studio sync generator, which sends out sync pulses to all of the other pieces of equipment in the system, in addition to generating the subcarrier signal of 3.5 MHz.

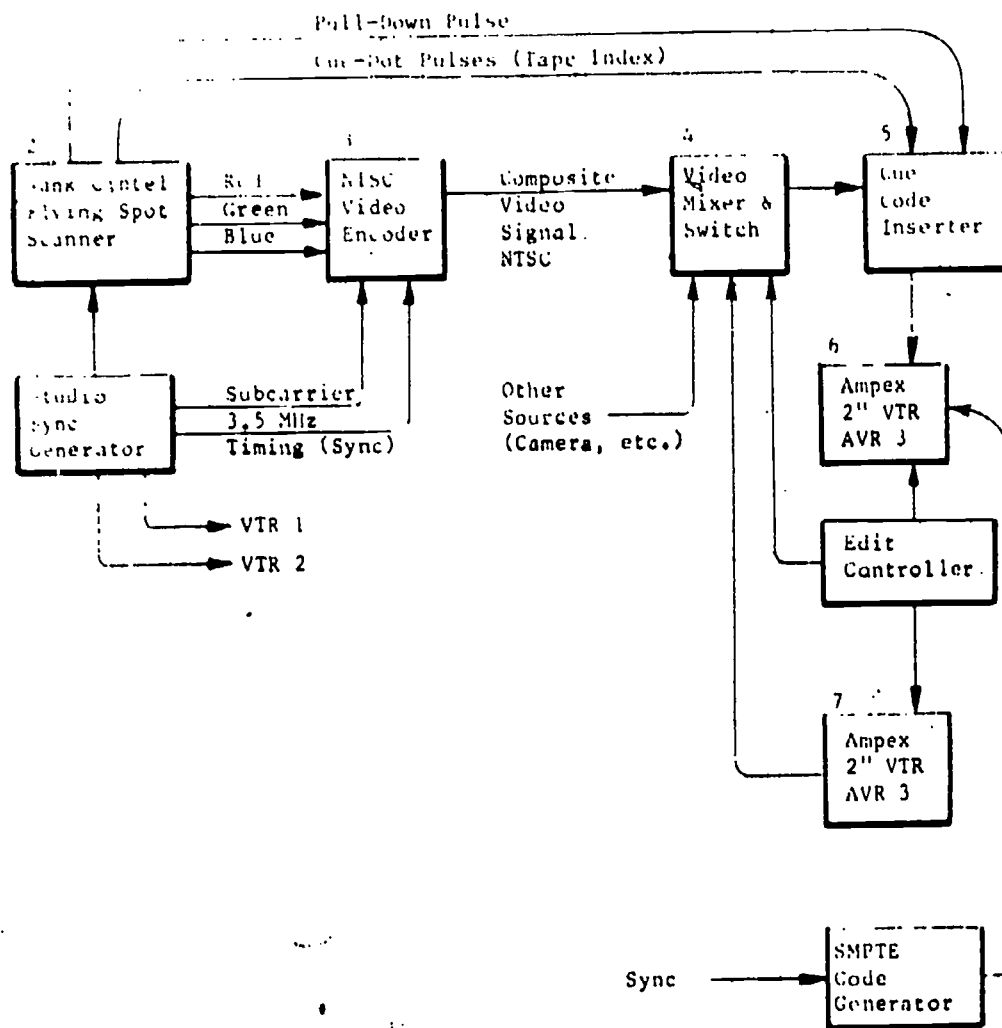

Figure 5. Component devices and signal paths in premastering.

Box number 2 is a flying spot scanner. The film transport system for this scanner is illustrated in Figure 6. As shown, the 16 or 35mm film is loaded onto large reels and passed by the vision gate, where a scanning beam scans each frame 525 times and transfers it to two sequential television signals, called field 1 and field 2. Field 1 traces

out the odd-numbered lines of the 525-line NTSC television standard; and field 2, the even-numbered lines (see page 36). Note the capstan and the 16mm and 35mm optical readers. These readers are used to read the cue patches that are placed on the edge of the film, between the sprocket holes. On 16mm film, a chapter code is indicated by a single cue patch placed 27 frames prior to the frame on which the 400 chapter codes are to start; and an automatic stop, by placing cue patches on two adjacent frames that are, respectively, 26 and 27 film frames prior to the exact film frame on which the automatic stop was to be encoded. On 35mm film, two cue patches must be placed on frames that are 23 and 24 frames ahead of the target frame for each automatic stop.

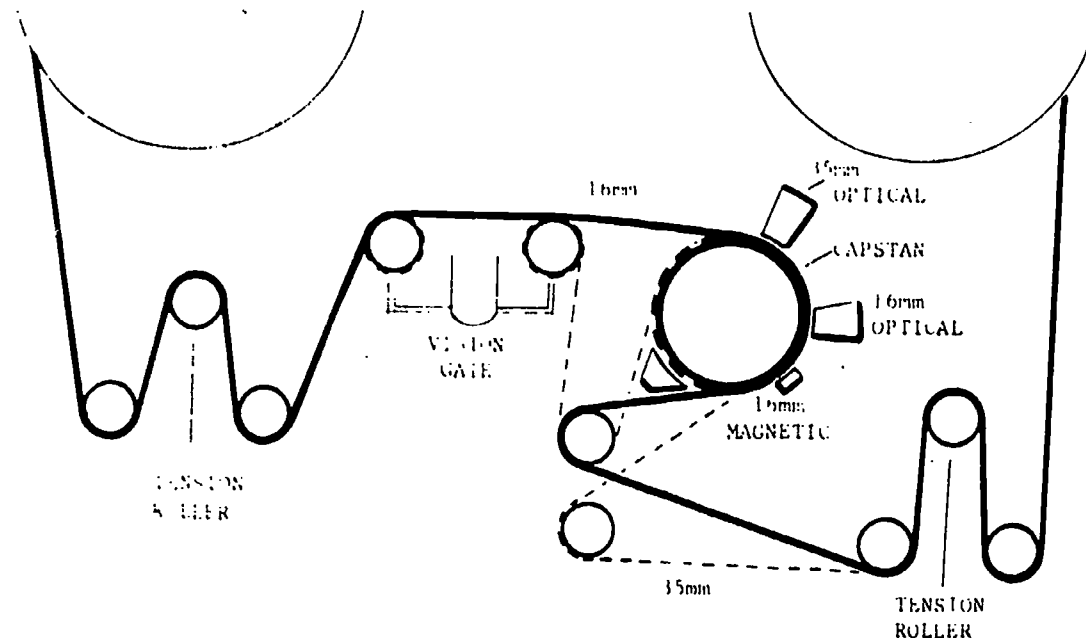

Figure 6. Film transport system for flying spot scanner.

Returning to Figure 5, note that the pull-down pulse and cue-patch pulse (either chapter or automatic stop) signals lead from the flying spot scanner--Box 2--to the cue code inserter--Box 5. The cue code inserter inserts redundant pulses of white level luminance into black lines of the TV signal (Lines 15, 16, 276, and 277). These lines are used to encode the pull-down pulse, automatic stops, and chapter stops. Since there is room to insert as many as five different pulses, two others can be added should future development of videodisc features make them desirable.

Box 3 is the NTSC video encoder, which takes the output red, green, and blue signals from the flying spot scanner, generates luminance signals, and adds subcarrier modulated by color difference signals. The result is the composite video signal, which passes through the video mixer and switch--Box 4. At this point, video can be mixed in from other sources, such as a camera or a tape player. The signal is now complete except for a SMPTE (Society for Motion Picture and Television Engineers) code and the codes that will be inserted by the cue code inserter, prior to being stored on the Ampex 2-inch quad AVR-3 videotape recorder.

The SMPTE code is expressed in hours, minutes, seconds, and frames. Thus, the code 1/10/55/29 refers to the 29th frame of the 55th second of the 10th minute of the 1st hour of a videotape. Quality editing equipment uses SMPTE codes to locate and edit at particular TV frames.

An SMPTE code is placed on each video frame, including lead-in and lead-out frames, and is important in synchronizing the mastering equipment during the mastering step. As shown in Figure 7, it must be generated at least 90 seconds prior to the beginning of the active videodisc program. The picture numbering starts after the 600 lead-in frames, and can continue for a maximum of 30 minutes, 0 seconds, and 0 frames, followed by 600 lead-out frames. All frames in this entire 30 minute, 90 second area must have an SMPTE code properly entered on the tape.

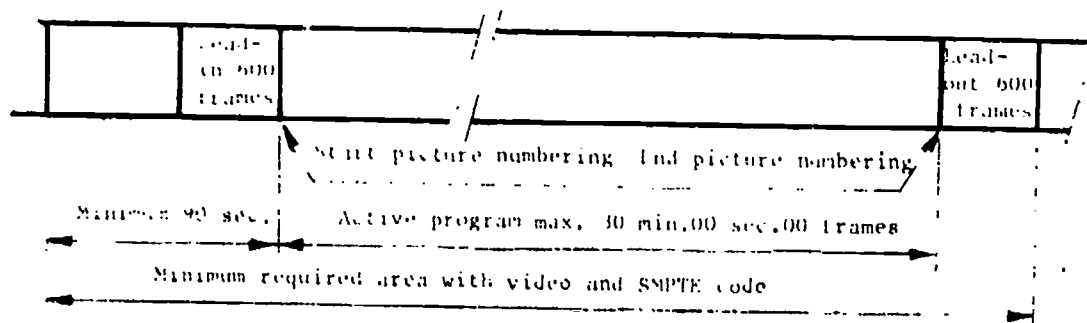

Figure 7. Area of NTSC format requiring SMPTE code.

Boxes 6 and 7 in Figure 5 refer to two 2-inch quad videotape players that are used for later editing. Although the Cine Centrum Studios do not have the second Ampex AVR-3 as indicated by box 7, such a system would be used to edit still frames into one tape off the other at a particular SMPTE code. It is possible to locate a particular frame on the Ampex AVR-3, although observations showed that it is extremely difficult and requires a highly skilled technician. Assuming that a second Ampex, indicated by box 7, has on it a series of still frames representing the one to be edited, then the edit controller could be set at a particular SMPTE code. Then, when that code was reached, the frame from the second Ampex (box 7) could be inserted into the proper field of the Ampex illustrated in box 6. The cue code inserter could be set in a continuous mode so that, during this process, it could continuously be generating a pull-down pulse and either a chapter stop or an automatic stop. Theoretically, then, this would be edited into the right SMPTE code. In practice, this is only useful for editing frames into motion sequences since the Ampex equipment unfortunately edits into field 2. If field 1 already had a pull-down pulse in it, then, after editing a single frame, the following video frame would have its first field overlaid.

At the Cine Centrum Studios, only one AVR-3 is available, but editing can be accomplished using a frame generated continuously by the flying spot scanner instead of from a second videotape player. The film is stopped over the vision gate and generated 30 times per second during the time the single AVR-3 is playing toward the designated SMPTE code. When that code is reached, the single frame is copied onto the videotape (unfortunately, starting in field 2). This process of single frame edit does not work for frames having an automatic stop, but it does work for correcting known errors in chapter codes, which are typically inserted in motion sequences.

Studio equipment is now available that permits field accurate edits; thus, the single frame editing problems observed in Holland were simply a part of the early learning process.

A more fundamental problem with this procedure is the inability to check codes once they have been inserted. Once the codes are read through the flying spot scanner, there is no reliable method of checking to make sure that they have been encoded only on the proper frame and not on other frames, and that all have been included. During the June session in Hilversum, it was observed that the chapter codes had not been properly inserted, but it was not possible to tell whether the 63 automatic stops had been properly inserted. Two days later, however, the 2-inch tape was run through the mastering procedure that includes an accounting device that counts the number of automatic stops on a tape, and results showed that there were too many automatic stops. This is undoubtedly a temporary problem. Because of the vagaries of positioning cue patches and reading them by flying spot scanner equipment, however, it seems highly desirable to have a better checking procedure that would print out the codes and identify the frames on which they had been inserted. It would also be desirable to have time in the studio to make last minute corrections when codes have been read inaccurately, due to either machine or human error in applying the cue patches.

There are several possible ways to provide such a checking facility, but one does not currently exist.

Premastering from Videotape

Rather than solely using the flying spot scanner, the MCA procedure provides a variety of inputs into the final premastered tape. Then high frequency bursts are encoded in the audio track of the final tape, which can be read by the mastering equipment and converted to chapter stops or automatic stops. Since we have not actually followed a disc through the premastering process at MCA, we are unable to speak with as much assurance regarding the details of this procedure. The accuracy with which the proper codes could be located on the master tape is doubtful. It is also doubtful that, once located and inserted, these codes could be checked. MCA does not have a strong incentive to worry about this problem since the MCA player does not use automatic stops or chapter stop features, and interactive discs like the McGraw-Hill disc are not on the MCA production schedule. The computer in the MCA player can be programmed to stop at any position or branch to any position, so it has been assumed that there is no need for chapter or automatic stops. As discussed above, however, the consumer model disc with the learner control rule-example-practice strategy appears to be one of the more cost-effective alternatives for the Navy's use. Therefore, it is important that these problems be solved for all hardware manufacturers.

The strength of the tape mastering approach is that the codes can be inserted at the last possible moment. The weakness is in locating where to insert the codes and in checking the codes once inserted.

Problems with Current Premastering Processes

Because of a number of problems, all of which result from the novel features of the videodisc, neither the film or the videotape premastering process meets all the requirements of accurate and cost-effective premastering of videotape instructional materials. These problems fall under five categories, which are discussed in the following paragraphs.

1. The problem of placing still frames onto tape.
2. The problem of "jitter."
3. The special problems of preparing still frames by photographic methods.
4. The color problems in using film.
5. The general problem of encoding digital information on analog discs.

Placing Still Frames Onto Tape and Mixing Them with Motion Sequences. The circumstances that cause the most problems arise from the fact that videodisc technology never envisioned the requirement for editing still frames into motion sequences with single frame accuracy. Although TV studios claim to be capable of editing still frames onto tape, the process is often performed manually and inaccurately and is extremely expensive in terms of studio time. In the past, the TV industry had no important reason for facing the problem of editing large numbers of still frames and accurately inserting into them special digital codes. At present, moderately priced frame-accurate editing equipment that can be adapted to meet this requirement is available.

To understand the nature of this problem, it is first necessary to understand the nature of a television signal, which is illustrated in Figure 8. Note the position of the sync pulses, which serve the function of synchronizing any of various input sources on both sending and receiving ends. As shown, the high frequency information, which contains the black-and-white as well as the color TV information, occurs in two sequential signals called field 1 and field 2. As indicated previously, field 1 traces out the odd-numbered lines of the 525-line NTSC TV standard; and field 2, the even-numbered lines. Each line contains information that allows the receiver to vary the brightness and color of the individual picture elements traced out by the beam as it scans from left to right across the face of the TV picture tube. These synchronized two-field signals occur about every 30th of a second (the actual number is 29.97 to avoid 60 Hz beats) in the NTSC standard used in the United States. In Europe, either the PAL or the SECAM standard is used, which generates 625 lines per frame with 50 instead of 60 fields per second.

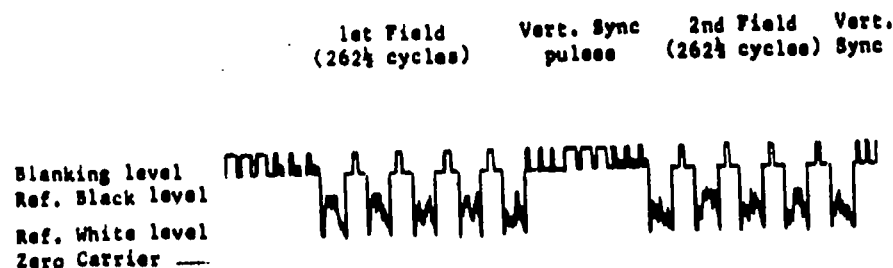

Figure 8. Typical television signal (simplified).

This nearly 60 Hz, two-field signal, representing a single frame, is what generates the major problems in premastering. These can be traced to the following facts:

1. If the pictured object is moving rapidly, fields 1 and 2 will show discernibly different images. Thus, refreshing field 1 and field 2 repeatedly, as in videodisc freeze

frame, will cause "jitter" as the two half-frames cycle back and forth in different positions.

2. Manufacturers of most available videotape editing equipment long ago adopted the standard of editing into the second field. Thus, if one had previously inserted a still frame page in field 1 and field 2 positions and then tried to edit a new one on top of it, the new one would be inserted in field 2 of that frame and field 1 of the next frame.

3. Once a single frame has been edited into a tape, there is no easy way to check whether it is accurate or whether it has interfered with the frames on either side of it. Since tape can be displayed clearly only in the 30 frames per second motion mode, such necessary checking is difficult.

4. Motion picture film is taken at 24 frames per second. Therefore, a method must be used for converting the 24 frames to 30 frames per second and two fields per frame.

It is possible to go from 24 frames per second to 30 in the film premastering process by inserting a duplicate of the two fields for every fourth frame. In 1 second, this would add the six frames necessary to bring the 24 frames per second up to 30 frames. The existing audio track could be read over these 30 frames onto the videotape with no problems. Since the duplication of every fourth frame would cause jumpiness in the motion, however, it would be better to use a "3:2 pulldown" by means of a Rank Cintel Mark III flying spot scanner. (Note: The term "pulldown" comes from the drive mechanism on a film transport that pulls each frame down into position to be projected.) Figure 9, which illustrates how the 3:2 pulldown works, shows that the flying spot scanner can be programmed to read three frames instead of two out of a single film picture: Film picture 1 is scanned for three fields; film picture 2, for two fields; film picture 3, for three fields; and so on. In this way, 60 fields per second, the number required for NTSC, can be obtained.

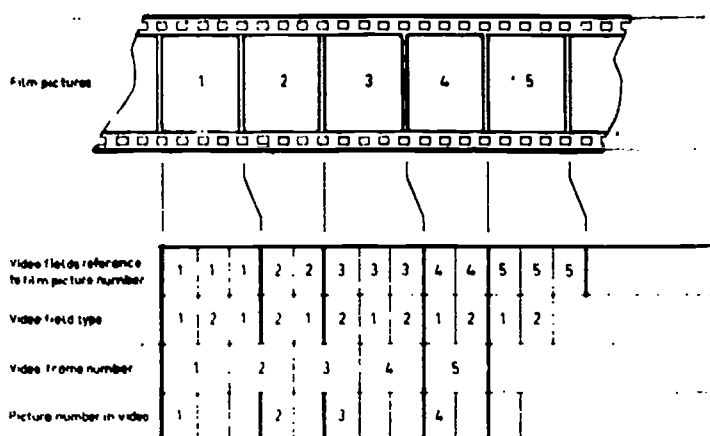

Figure 9. The 3:2 pulldown method.

Unfortunately, the video frame numbers, listed on the next to the bottom row on Figure 9, now do not correspond to discrete images. Although video frame 1 would accurately display film picture 1, video frame 2 would show the even-numbered lines of film picture 1 and, interlaced with them, the lines of film picture 2. This combination is like a "fade" during a motion sequence; assuming two still frames, however, each having

different text and graphics on them, it would be a "double exposure" to the viewer. The videodisc mastering and premastering process must therefore provide the ability to encode a "pulldown pulse" that can be mastered onto the disc that, in turn, tells the videodisc player whether to start its refresh cycle in field 1 or field 2. The videodisc player must have the ability to read this code and repeat a frame, starting at either the 0° or the 180° position on the videodisc. This situation is illustrated in Figure 10. Figure 10a shows a still frame being refreshed from the 0° position. Field 1 is encoded in the right half of the spiral; and field 2, in the left half. Figure 10b shows a frame being refreshed from the 180° position. In this case, field 2 is refreshed first followed by field 1.

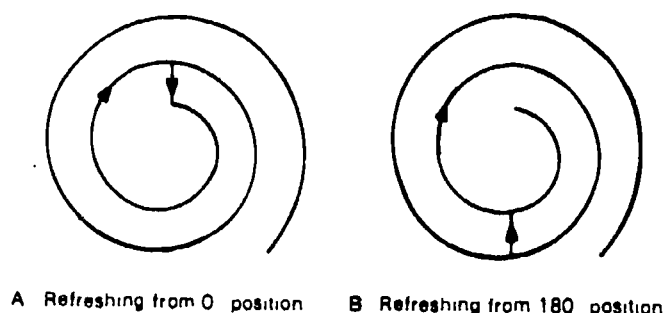

Figure 10. Still frames on a videodisc being refreshed from 0° and 180° positions.

The ability of videodisc players to refresh two fields starting from either the 0 or the 180° position gives them some of the other special playing modes. If the player makes a reverse jump after every half revolution, reverse motion at normal speed is obtained. If the player makes a forward jump every half revolution, the three times normal speed feature (fast forward) effect is produced. Slow motion is produced by refreshing a single still frame from either 0 or 180° according to the pulldown code, either two times each (providing one-half normal speed), three times each (providing one-third normal speed), four times each, and so on. The maximum slow motion setting allows each frame to be refreshed 120 times before advancing to the next frame in the reverse or forward direction, thus providing the same effect as a 4-second setting on a carousel slide projector. It is of vital importance, therefore, when going from film, to provide a pulldown pulse and transfer it to a code on the mastered disc so that the still frames will appear properly, as on the original film. It can also be seen what difficulties will arise unless tape editing is perfectly synchronized with this pulldown pulse.

Varieties of "Jitter". There are two kinds of jitter. One is the video jitter described above, which results from differences in the image generated by field 1 and field 2 of the two-field video frame. The other is caused by the Rank Flying Spot Scanner's inaccurate tracking of a moving film.

In general, all discs mastered from videotapes will suffer badly from the first kind of video jitter whenever the images are moving. Thus, if one wishes to view a ballet a still frame at a time or in slow motion, one will notice a blur as field 1 and field 2 alternate every $1/60$ th of a second between the two distinctly different images taken $1/60$ th of a second apart. If, on the other hand, the ballet were originally taken on film, this extreme video jitter will not be observable but motion smear will be present, depending upon the film exposure times. Video jitter, however, may not necessarily be bad in all cases. For

example, in observing the ballet, one is able to judge the speed of the movement at any point in time by looking at the amount of distance covered by the two images generated by field 1 and field 2. The wider the distance covered in the jittering image, the faster the arm or leg or other object is moving. Thus, one will see a small amount of jitter at the beginning of a leap, a large amount as the body reaches its maximum velocity, and almost no jitter at the top of the trajectory before the body begins falling again. This information regarding velocity is inherent in video jitter and is converted to image smear when 24-frame film is used. Thus, the author of a videodisc would have to determine whether video jitter would be advantageous or disadvantageous before choosing to master from film or tape. He also has another alternative; that is, to use a sophisticated digital process developed at Image Transform Incorporated of North Hollywood, California, which stores the previous frame and then compares--point by point--and assembles the new still frame which resolves the discrepancies between field 1 and field 2. This makes it possible to produce a motion picture film from a videotape.

The second kind of jitter is caused by the difficulty the flying spot scanner has in jumping back to the proper position after scanning the first field in order to scan the second field (or the third in the case of the 3:2 pulldown). (A related problem of flicker occurs when the two fields vary in brightness.) One must respect the incredible sophistication of the scanner in being able to scan out 263 odd-numbered lines and then jump back to a position midway between line 1 and line 3 to start the scanning of the even-numbered lines, particularly since the film has moved forward during the previous 1/60th of a second.

The result is sometimes a discrepancy between the positioning of field 1 and field 2, which causes a bit of jitter in the entire picture. Flying spot scanners that do not use moving film do not have this problem.

One way to resolve this problem completely is to read each frame while it is stopped. Although the procedure of stopping each still frame so that the flying spot scanner would be completely accurate would be extremely costly in studio time, it would produce the highest quality.

The Rank Corporation has another solution to the problem of scanner jitter. It is an option for the Mark III Flying Spot Telecine called Digiscan, which was developed in response to the scanner jitter and flicker problems described. Basically, any differences in video shading or scan geometry between the positions where the beam begins to read another field will lead to brightness flicker or positional jitter respectively. Consequently, the operator must carefully preset adjustments for each film gauge in order to achieve the highest quality video images.

The Digiscan add-on eliminates this interlace flicker and jitter without the need for precise adjustments. In addition, any residual or shading geometry errors will not be converted to brightness flicker or jitter. If there is any dirt in the optical system, it will be shown in a constant position, and thus, will produce a much less objectional disturbance.

Preparing Still Frames by Photographic Methods. After manuscripts are prepared by using special display guides, the material can be typeset and then photographed. The manuscript page format is illustrated in Figure 11. The manuscript display guide uses 10 lines of a maximum of 40 characters, a blank line, and the bottom line for special orientation codes. Graphics can overlap into the extra spaces provided around the 40-character space so long as the elements of the graphics are not too critical.

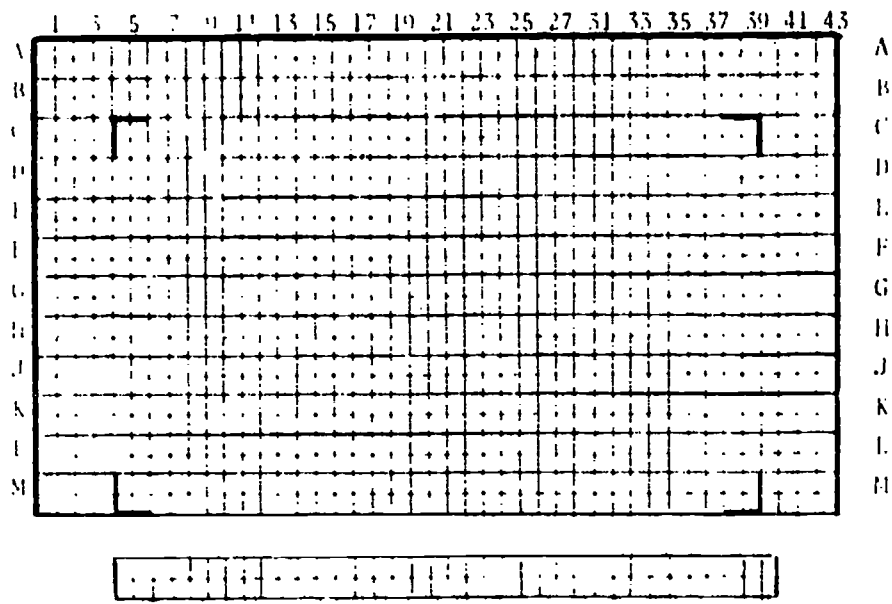

Figure 11. Manuscript page format.

The manuscript pages are typeset with the following typing conventions:

1. Body copy--helvetica medium 24/31, maximum line length 40 picas.
2. Titling--helvetica 36 bold or 24 bold.
3. Labelling--helvetica 24 bold, 24 medium, or 18 bold.
4. Bottom line--helvetica medium 18 point all caps.

When typesetting is completed, the artist pastes it up on individual sheets of chromocoat and adds any drawing required. The paste-up must correspond to an aspect ratio and image area illustrated in Figure 12. The layouts are then reviewed before being sent to the photographer.

Using the chromocoat layouts, the photographer shoots high contrast negatives (Kodaliths). For special strategies, as implemented in the McGraw-Hill disc, the colored backgrounds with color bars for orientation are shot separately. A color bar orients the learner to his position in blocks of still frames (gray or green positions on the bar) or motion sequences (red positions). This is a process requiring careful coordination between an instructional technician completely familiar with the manuscripts and the photographer. The instructional technician works with the manuscript to choose the proper color background and to establish the color bar with the arrows pointing to the proper position on the bar for any particular frame. When this is completed, the correct background and color bar must be matched to the correct Kodalith and the two must be put together to be burned through onto a final slide. This collating takes a great deal of time. If there are one or more color slides to be added into an example frame with a black background, these must also be shot onto 35mm slides and matched with the correct Kodalith and background so that they too can be burned through onto a final slide. It is possible to burn

through two to five images onto a single slide; however, the registration is not exact as it is aligned by eye and shot in by lining it up by this visual method. The slides produced by this method must be reviewed, and many must be redone. When they are redone, it is very difficult to get the background and other colors the same because of the differences in film lighting and processing. Slides that are not done at the same time may not have the same color balance. It does not seem possible to stabilize color throughout a complete sequence using a film process, especially since the slides go through a variety of revisions.

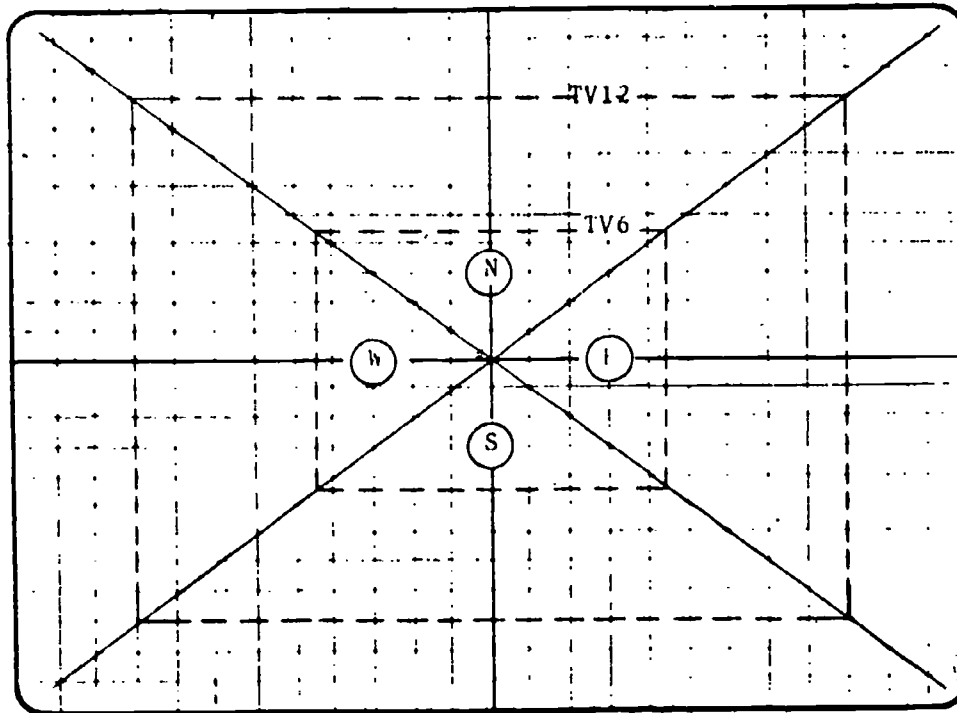

Figure 12. Aspect ratio diagram for video graphics.

Revisions are necessary not only for instructional and proofreading reasons but also for the following technical reasons:

1. It is very difficult and time consuming to collate all backgrounds and color bars properly and get them properly aligned. Errors occur.
2. In reviewing the slides, splotchy backgrounds may occur due to dust on the slide mount or on the camera. Also, the text, the position of the bar code, and the position of the additional pictures burned through may be crooked. These defects may not be noticed when the paste-up is reviewed, and only show up on the finished slide.
3. Color highlighting may smear onto the wrong words. Because of experience gained on TICCAT, WICAT used a color highlighting procedure to highlight key words in still frames. This was done by printing with a small paint brush in a color dye across the Kodalith. Since it is a high contrast negative, the paint that gets on the black portion is not a problem. A clean sweep across the letters will then allow them to be colored properly. Spilled dye on either the line above or below, however, causes problems that appear on slide review. The highlighting errors can be erased on the Kodaliths but another photographic step and burn through is required.

The storage and retrieval of Kodalith backgrounds and color bars for each lesson, or of Kodaliths to be used and reused during these revision cycles, is an important but routine task. It should be automated in some fashion.

An alternate method of still frame production uses an animation table approach. The text is prepared on a transparent sheet and indexed into position over a sheet with the appropriate colored background. If more than one color is used on the text, each additional color type will require a separate sheet. The color bar for the lesson is overlaid on a separate sheet. The final overlay would position the index pointer on the color bar. This system results in fewer retakes being required. The alignments can all be verified prior to film exposure, and text or other components can be easily and quickly revised. Each frame must be shot with the same number of transparent overlays, however, in order to maintain color consistency.

Once the slides are finally produced, reviewed, and revised, they are taken to the optical printer to be put on either 16mm or 35mm film. For the McGraw-Hill videodisc, 16mm film was used since this was the source film for the motion sequences. The process for doing this is to set the slides in order for the operator of the optical printer who shoots 15 frames of black, the sequence of still frames, and 15 more frames of black for each sequence of still frames. The final product from the optical printer is a 16 or 35mm strip of film incorporating sequences of still frames, each with 30 frames of black separating them. These sequences can then be used in an ABC edit process, which requires work prints from motion sequences that are cut exactly to the frames desired in the final edition.

In this process, motion sequences are needed on both A and B rolls and still frames, on a C roll. It is necessary to use two rolls for the motion sequences because they are sometimes separated by only two to six still frames. Thus, the splice terminating the motion sequence would be only one to three frames away from an image. The splice needs to be at least six frames away in the black area of the still frame leader and trailer because it causes a slight lifting off from the film, which puts neighboring frames out of focus when the final print is prepared. Since the students can still frame on the motion sequence frames, this problem must be avoided. In general, if the shortest still frame sequence is 12 frames long, then an AB edit would be feasible with the motion sequences on the A roll and the still frames on the B roll. Otherwise an ABC edit is prescribed.

Once the still frame sequences are edited into the motion sequences, the audio track, which is on a separate full-coat audio film or films, can be edited. The audio track must be cut to match the motion sequences exactly, with the exact number of still frames--with no audio inserted in between these sequences.

There are some problems in attempting to put together audio tracks from a series of pieces of existing film. The narration will not flow exactly right. Music will terminate and begin abruptly in strange ways. In general, it is advisable to renarrate the entire series of motion sequences so the disc will have a uniform feel to it and to overlay appropriate music in a smooth and continuous manner.

Color Problems in Using Film. An advisory committee in Europe has set acceptable quality standards for going from film to television. Levels A, B, C, D, and E have been identified:

1. "A" level means television production beginning with excellent 35mm film.
2. "B" level uses a copy of a 35mm film.

3. "C" level uses a 16mm reversal employing a special television emulsion with a xenon base. It is the last level considered as meeting quality standards for TV by the advisory committee.

4. "D" level uses a negative-positive 16mm film, which is distributed by publishers to schools because it is easy and relatively inexpensive to copy. Although many copies can be provided cheaply for schools, this level of film does not yield good results when transferred to video. It has color noise problems because the film grain becomes visible. Several shots of the same colored area shows flashing "color noise" because of the grain of the film.

5. "E" level uses super eight film, which is considered to be well below acceptable quality standards for television.

The problems with "D" level 16mm film, in addition to the problem of color noise, is one of color balance. 16mm films from different sources have wide variation in color quality. A common problem is for one film sequence to appear quite green compared to another. The solution is to perform color balancing before ABC edit on each separate motion sequence and each sequence of still frames. Each still frame is so randomly unbalanced in color that, for all practical purposes, they can be considered as one color.

Special color balancing equipment such as that found at the Cine Centrum Studios in Hilversum, Holland can be used. Each scene is placed on a special equipment produced by Hazeltine, which allows the operator to match the scene with a standard. A code is generated for each of the three primary colors for each scene. These can be punched into a color printer. The paper tape controls the filters so that, in printing a complete copy, the scene will be corrected to the standard. This color balancing process would correct the color variations between scenes, but not the color noise and poor resolution generated by the older 16mm film.

Encoding Digital Information on Analog Discs. In the discussion of the problem of placing still frames onto tape, the necessity for accurately encoding pulldown pulses, chapter codes, and automatic stop codes was reviewed. The major problem encountered was the lack of a checking facility to assure that the codes had been accurately inserted on the master tape. This problem is equally acute whether a film or tape mastering procedure is used. It is not so much a check of the accuracy of the equipment; this will probably evolve to a rather accurate and stable system. The problem is that the authoring team may have made errors in placing the cue patches on the film or in locating the tape frames into which the pulses are inserted. Thus, there must be a way to identify the exact position to insert codes on either film or tape, and of checking that the codes have been accurately inserted by the cue coder inserter or similar device onto the final tape master. Looking at a replicated videodisc and finding that the codes were inaccurately placed is too late.

The specific problem of encoding these digital codes for picture number, chapter stops, and automatic stops does not give one great confidence about an early solution to the problem of encoding digital information on analog discs since these special codes are highly redundant digital codes. At a conference held in September 1977, a Philips engineer reported that it would be possible to encode 340 bits per line on a consumer model videodisc for future retrieval by computer systems. If 500 lines per frame are available for such encoding, this is a hefty 21,250 bits per frame. MCA engineers may have been more conservative, saying that they will encode 1000 bytes per frame, since this is all that the memory of their microprocessor will hold. No matter how many bytes are eventually encoded on a single frame, however, methods must be found for correctly

inserting the digital information on the right frame, checking to see that it has been so inserted, and for reading the information accurately. A great deal of effort is going to be required before digital information can be properly inserted and replicated on videodiscs. Assuming that it is properly replicated, there appears to be no problem in reading it: The players seem to be able to read the picture numbers that are encoded by a 24-bit scheme on Philips discs and by a 40-bit scheme on MCA discs.

Premastering Alternative⁴

The problems of film and tape premastering discussed above indicate the need for a different hardware solution than is now available. WICAT's investigation into this issue so far indicates that a computer controlled editor-compositor seems to be the best solution. One is available from Telemation, Inc. in Salt Lake City, Utah, with variable character fonts, spacing, color backgrounds, and other features, for a price of \$44,300. This device would permit the production of all of the still frames discussed in this paper, which were produced at such great expense by the photographic process. It includes a magnetic disc that stores digital code defining each still frame produced. The disc is removed and inserted into the character generator at a TV production studio, where the still frames are produced one by one from the output of the character generator. Background images over which this text is to be laid can be derived using a slide chain, a videotape, or a color TV camera pointed directly at the appropriate objective. In this way, each of the frames can be edited in order, along with other scenes constituting the motion sequences. Using an off-line 3/4" editor, the frames can be checked one by one to make sure that the pictures are correct. This solution for production is an expensive one but not excessively so. In fact, in a studio that uses helical-scan tape recorders with SMPTE edit controllers, it is the most economical method of producing videodisc still frames.

The completed videotape would have to be interfaced with a device like the Philips cue code inserter, which would insert codes in the proper lines of the TV signal. Using an off-line editor again, the frames can be checked to be sure that the codes have been inserted properly.

Mastering and Replication

In a report prepared for the Navy, Poe (1976) did a fairly thorough analysis of mastering and replication for the reflective discs of Philips and MCA, the transmissive discs of Thompson-CSF and Zenith (who has since then abandoned their videodisc effort). He also reported on RCA and Iometrics Corporation efforts.

Mastering

MCA, Philips, and Thompson-CSF all use similar mastering processes. They all use a polished plate glass master, a photo-resist, exposure by a laser beam, and then careful developing. Differences will be expected with the electronics dealing with cue code transformation and insertion, and procedures and codes for lead-in, lead-out, and quality control.

The biggest differences between these three companies comes in replication.

⁴See Bunderson and Campbell, 1979 (Volume I) for detailed prescriptions for how military authors using this alternative should proceed. Also, Mendenhall (1979) provides information on premastering alternatives from the perspective of university users.

Replication

In this step, the glass master disc is used as a template to produce nickel stampers by a galvanic process. Since the photo-resist has conductive material in it (e.g., silver ions), it can be used as the cathode in an electrolysis bath. The electrolyte contains nickel ions. The glass master is left in this bath long enough for a layer of nickel to be deposited on the surface. After the master is taken from the electrolytic bath, a heavy aluminum backing is glued onto it and then the original glass master is stripped off. Since this process does not leave any particles on the nickel stamper, cleaning is not necessary. It does deform the original master relief burned into the photo-resist compound, however, so that it cannot be used to make a second stamper. Additional stampers are made from the first stamper. It is the use of the nickel stampers to produce replicates where differences between companies occur.

Embossing. Thompson-CSF uses an embossing technique, in which the nickel master is referred to as the "father." If required, the father can be used to make up to 16 reverse images called "mothers," which in turn, can be used to make up to 16 "daughters" with the same relief as the father. Thompson-CSF reports having stamped out as many as 1000 replicates from a daughter. The relief is transferred from the stamper to a plastic sheet under pressure by a thermoforming cycle that involves heating and cooling. In this cycle, both sides of the disc are embossed. The disc is stamped out from the sheet of plastic and a hole is punched in its center. It is important that precautions be taken to avoid any faults in the embossing, especially from such factors as dust and other impurities. While this process now takes a couple of minutes per disc, Thompson-CSF thinks it can be reduced to three discs per minute.

Injection Molding. The injection molding technique used by MCA is quite similar to that used by Thompson-CSF. Some problems have been encountered by MCA in producing a large quantity of replicated discs. Many stampers must be produced because of the difficulty of obtaining a good stamper, a problem shared to some extent by all manufacturers. This is not surprising when one considers the extremely minute and close packed nature of laser produced pits. Once a good stamper is obtained, however, four to five thousand replicates can be produced.

Photo Polymerization (2P) Process. Philips Laboratories in Eindhoven has developed a promising replication process. It is called the 2P Process, which stands for photo polymerization. Philips does not wish to release the details of this process at this time, but it can be said generally that the process is similar to that of MCA or Thompson-CSF in the production of the nickel stamper. Once the disc is made, the process is about the same as the MCA process in the mirroring of the information-bearing surface, and in the creation of one two-sided disc from two single-sided discs.

The differences occur in the creation of the replicated relief as a reversal copy from the nickel stamper. No high pressures or temperatures are used. A clear liquid compound is poured over the face-up stamper, smoothed under a protective layer of plastic, and polymerized with ultraviolet light (photo polymerization). Once hardened, the disc is removed from the stamper and given a mirrored surface and a second side.

Comparisons Between Methods. The greatest difference between replicated discs is between the Thompson-CSF transmissive disc and the Philips or MCA reflective discs. The Thompson-CSF disc does not have a mirrored surface, nor a protective coating over the disc. The result is a disc that is very thin and flexible. According to Thompson-CSF, one advantage of this flexible disc is that it can be rolled up and mailed or stapled into magazines for a throw-away videodisc record, similar to phonograph records that are

distributed through magazines. Another advantage of the Thompson process is that it is a one-step process that uses much less material than reflective discs. Both sides of the disc are embossed from one thin plastic sheet in one stamping operation. There is no further handling of the disc to provide a mirrored surface or protective coatings as the Philips/MCA discs. There is also little danger of warping. If, for example, the disc were propped at a 45° angle, with nothing supporting it in the middle, the Thompson disc would obviously sag but then spring back into the proper position when placed in the player. Centrifugal force and the air foil effect cause the disc to curve slightly, which produces a rigid surface that can be read by the laser. Both sides can be read by changing focus, without turning the disc over. A rigid disc might warp under the circumstances noted above, making them unusable.

Because of the one-step embossing process, the replication equipment is less expensive for producing the Thompson-CSF disc. Both Philips and MCA must complete several additional steps to provide a reflective surface, protect and smooth it with another thin layer of plastic, and glue two sides together in proper registration. The advantages of the transmissive disc were thoroughly documented Poe (1976). On the other hand, there appears to be potentially serious problems inherent in the thin transmissive disc. The unprotected surface of the disc is extremely vulnerable to scratching, wear, and the accumulation of dust and dirt. The 1.1 millimeter plastic shield over the pits in the Philips/MCA disc acts as a protective surface so that fingerprints, small scratches, small pieces of dust, etc., are out of focus (see Figure 13). Bogels (1977) performed calculations showing why from .4 to 1 millimeter of protective shielding is necessary.

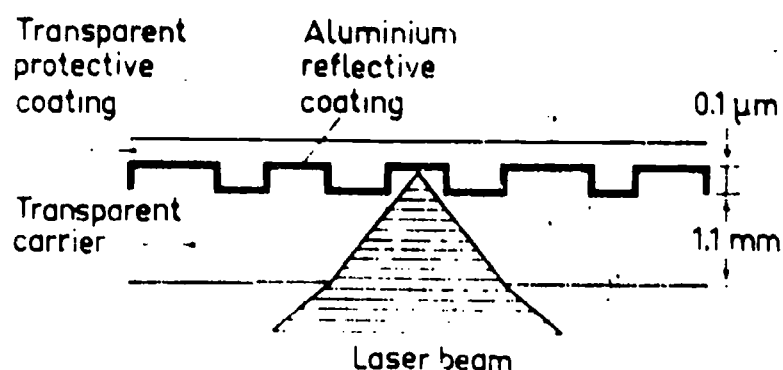

Figure 13. Protective coating on the Philips/MCA videodiscs.

In examining replicated discs and working with them on Philips players, WICAT found that the Philips and MCA discs were not completely invulnerable to fingerprints and dust. It is possible for a heavy oily fingerprint or a large enough piece of dirt or dust adhering to the surface of the disc to cause dropout disturbance in the picture. Anything large enough and opaque to light would prevent the light from reflecting through to get a signal back. When this happens, however, it is very easy to take the rigid disc from the videodisc player and wipe it off with a soft cloth, restoring it to its original image quality. Such does not appear to be the case with the Thompson-CSF disc. Greasy dirt or scratches would cause a permanent disruption of the disc, although it is claimed that cotton swabs and alcohol can be used to remove fingerprints. Thus, the transmissive disc is carefully shielded in a caddy similar to that used to house floppy discs. A person's hands must never touch the disc. With Thompson-CSF discs, it has been difficult to keep the quality of the disc from degrading rapidly over a period of months. A major problem

is that small disturbances, such as moving the hand close to the slot in which the disc is spinning, will cause aerodynamic disturbances that cause the spinning disc to contact the mechanism within the player, producing irreparable damage.

This study is certainly not definitive on the extent to which the Thompson-CSF replication process will prove satisfactory in use. Although the process has the advantages of being inexpensive and being able to read either side without turning the disc over, its vulnerability to irreparable damage seems great. Calculations in Bogel's (1977) paper demonstrate this analytically. Interviews with users of Thompson discs increase the suspicion that the protective carrying caddy may not be sufficient to preserve the image quality over repeated uses.

Both Philips and MCA have considered plans to market thin flexible discs, presumably with a very thin protective coating. These will be reflective, however, and not transmissive. Thus, they will still require the aluminizing step and also the application of a protective coating.

It is difficult to predict which replication process--injection, molding, embossing, or 2P--will prove superior over the long run. Injection molding and embossing are more or less mature technologies because of their long history in the audio record reproduction field. This may put them at a long-term disadvantage compared to the 2P Process, since this is a rather new technology and thus has a much steeper learning curve ahead of it. Further, since the 2P Process is nondestructive in terms of damage to the nickel stamper, it appears that thousands of copies can be made from the same stamper when the process is properly automated. A dark horse in optical mastering and replication is photographic methods. Poe (1976) gave high marks to the Iometrics photographic disc, primarily because of lower costs for mastering and replication, and the prospects for local mastering and replication by the Navy. Iometrics went out of business, and the engineering staff was acquired by Atlantic Richfield. Dr. James Russell of Battelle Northwest Laboratories has an alternate approach that uses low-cost photographic mastering and replication. The big feature is that all signals, TV, audio, and computer programs, are digitized. All circuitry is digital (Russell, 1976).

Costs. The technologies of mastering and replication have important implications to the Navy in their future use of videodiscs. Since much of the information that would be put on videodiscs by the Navy would be classified, the Navy would have to have internal mastering and replication facilities. Most of the Navy's videodisc applications would not involve high volume replication. Few instructional applications would require more than 5,000 discs and most would require considerably less. The great economies of scale in videodisc replication come when the number of replicates exceeds 10,000.

Table 4 is a summary of rough estimates for videodisc replication costs. It should be realized that these figures are all extremely tentative since the videodisc companies are still uncertain as to actual costs. The figures in Table 4 do, however, indicate that whether the mastering cost is \$2,500 or \$1,500, the large quantity production such as envisioned by the consumer market will make the cost of the videodisc extremely attractive. For Navy applications, where between 500 and 5,000 copies will typically be required, the price may or may not be comparable to similar media depending upon how much is packed on each videodisc.

Table 4

Rough Cost Estimates for Replication of Videodiscs
Based on Assumptions About One-time Set-up
Costs and Per-Disc Recurring Costs

Item	Number of Replications					
	10	100	500	1,000	5,000	10,000
Per copy costs						
Philips or MCA \$2500 one-time costs x 2 \$.75 per copy x 2 sides	501.50	51.50	11.50	6.50	2.50	2.00
Thompson-CSF \$1500 one-time costs x 2 \$.30 per copy \$.70 per copy (caddy)	301.00	31.00	7.00	4.00	1.60	1.30

Some rough estimates for low-volume "nonconsumer" discs produced by the 2P Process are available. For very low volume runs, the replicates would cost \$100 each; for quantities of 100, \$70 each; and for quantities of 1,000, \$25 each.

Companies were asked to provide rough estimates of costs for obtaining mastering and replication facilities. In response, Thompson-CSF indicated that a starter facility could be obtained for \$250,000 and a larger scale mastering and replication facility for \$600,000. It is not clear whether or not this includes packaging the replicated discs in protective caddies. MCA estimates it would require at least \$1.5 million to set up a mastering and replication facility. This would include a flying spot scanner and other premastering equipment. It is not an easy matter to obtain such high technology items, to install them, and to bring the facility up to speed in terms of trained personnel and smooth high volume operation. The Navy would have to assume not only the expense of equipment acquisition, but also the time and expense of training and start-up operations over a 2-year period.

Composition of Videodisc Authoring Team

The materials discussed in the previous sections are all related to and dependent on the skills and competencies needed in a videodisc authoring team. Such a team could be composed of either Navy or contracting personnel.

In this regard, it should be noted that ARPA tasked Courseware, Inc. in 1976 to conduct a study of authoring in the Navy and, from that study, to develop an author training course and an author management system. During the course of this study, a survey was made at a number of Navy training development sites (i.e., Service School Commands (SSCs), Naval Training Centers (NTCs), Naval Education and Training Program Development or Support Centers (NAVEDTRAPRODEVCCEN/NAVEDTRASUPPCEN) to obtain information about Navy development personnel and their skill levels. Results indicated that development personnel included subject matter experts (SMEs), educational

specialists, educational technologists, field engineering representatives, writers, members of task analysis groups, editors, print and graphics specialists, and hardware specialists skilled in the development of training devices and simulators (Bunderson, 1977). As to the actual writing of materials (questions and answers), interview results showed that such work was performed by teams of writers--former instructors who are SMEs (SSC, San Diego), SMEs supported by educational specialist advisors and graphics/media detachments (NTC, Great Lakes), SMEs and educational specialists (SSC, Orlando), field engineering representatives (NAVEDTRAPRODEVEN, Pensacola), and educational technologists and specialists (NAVEDTRASUPPCEN, San Diego).

Based on this information and information obtained from the IDP centers, generalizations can be drawn about how these personnel might work together on videodisc projects. Ideally, for videodisc production, there should be close coordination between the artists, media specialists, and writers who work together to complete the prescriptions laid out in lesson specification packages (LSPs). The educational specialists must receive training in videodisc-oriented instructional strategies and in ways to write LSPs that are suitable for videodiscs. The rule-example-practice strategy used in the McGraw-Hill videodisc should readily fit into the Navy procedure to the extent that the ARPA-sponsored training course (Freedman et al., 1978) is used. This training course gives authors the ability to develop rule-example-practice materials. Geographical separation of artists, media specialists, and writers would be disadvantageous to the IDP during author mock-up and simulation, since many review cycles are necessary.

Although the kinds of personnel available in the Navy can certainly learn the technical and instructional procedures required to develop a variety of videodisc-oriented instructional materials, organization and coordination, author mock-up equipment, and training are needed. An outside contractor has the advantage of being able to create the precise number of billets required for a videodisc project and the exact job descriptions without referring to existing government classifications and ratings. Since a contractor can bring in trainees rapidly and fire them rapidly when necessary, it is easier to specify a videodisc team that should meet the various requirements reported in this study. The team should be able to communicate clearly around the author mock-up equipment and other facilities seen as important in assuring cost-effective videodisc production.

Figure 14 illustrates the personnel involved and their interactions in a videodisc authoring team. In the first step, which is certainly not unique to videodisc production, the educational specialist or instructional psychologist writes the LSP. He may wish to consult with a videodisc-trained specialist and also with the author/technologist who will manage the lesson through its production. In the second step, the LSP goes to the author/technologist who will, with a senior SME and perhaps with other authors, divide existing motion footage into the initial film clips and prepare to author the still frame manuscripts. One result of this effort may be the specification for the shooting of new motion footage. The products--motion clips, new script, still frame manuscripts, and story boards for new motion--go to preproduction specialists, including typesetters, photographers, graphic designers, and possibly script writers. These persons work together to produce a mock-up that can be viewed on the author mock-up facility by a review team consisting of the SME, the educational specialist, the manager who must see it all through, and the media specialist who worked with the educational specialist during the production of the lesson specification package. Iterations are accomplished with the author mock-up facility to assure that the material is in a proper form. At some point, test students are brought in to view the mock-up. After a minimum number of such iterations, the lesson is released for the premastering step.

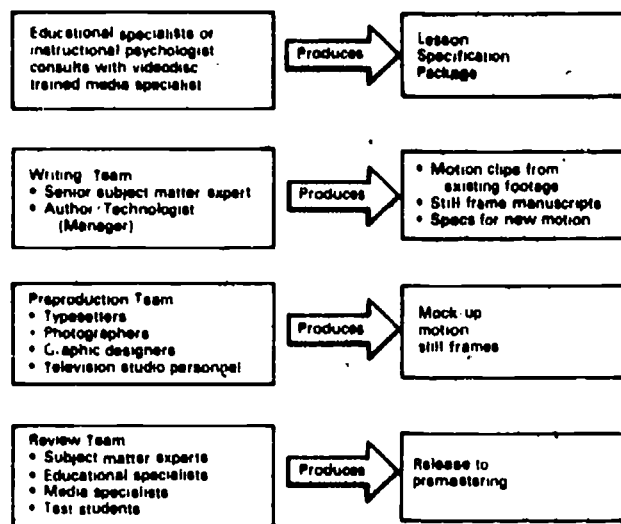

Figure 14. Videodisc authoring team flow of activities.

In summary, of the two alternatives, the training of in-house personnel and the hiring of outside videodisc authoring teams, it is clear that, in the long run, the internal Navy teams must be trained. In the short run, it may be desirable for contractors to develop a number of test discs for the Navy and document the process thoroughly, testing equipment for author mock-up and premastering during the production process. Training materials need to be developed so that the best team organization and skills can be transferred to the educational specialists, writers, and media specialists within the Navy.

Evaluation

During the course of this study, the following three levels of evaluation for videodisc products were identified:

1. Technical and experimental assessment of videodisc features.
2. Implementation studies.
3. Field evaluation and comparison studies.

Technical and Experimental Assessments of Videodisc Features

Technical and experimental assessments should be made of the following:

1. Standards and conventions, component pages, and keyboard features used in a variety of videodisc instructional strategies.
2. Legibility and affect of word spacing, type font, number of words and graphics on the screen, etc. (by ratings and interviews of students).
3. Discriminability and affect associated with different colors.

4. Understandability of various symbols used to communicate via the man-machine conventions adopted for the various videodisc products (by ratings, observations, cognitive items, and interviews).

5. Understandability of different presentation conventions such as the discussion, rule, example, and practice pages in the McGraw-Hill videodisc strategy.

6. Orientation conventions such as the contents and comments pages, indexes, and color bars.

7. Understandability and extent of use of the various keys on the consumer model and computer model videodisc players.

8. Understandability of learning strategies and extent of use of different components in learning strategies such as survey, review, and variations in learning tactics on all of the different model videodisc delivery systems.

These strategy studies can be based in cognitive theory if good tracking procedures are instituted so that the student's use of different videodisc options can be tracked and recorded by computer for later analysis. The opportunity exists to learn a great deal about learning itself since the videodisc instructional medium is so rich. With some of the strategies described above, especially the learner control strategies, good prospects exist for making progress in understanding some of the cognitive aspects of self-paced individualized interactive learning.

In the course of these technical assessment and experimental studies, the instructional effectiveness of the videodisc should be examined. The teaching effectiveness, as measured by cognitive and affective items and by "approach" toward learning with the videodisc, should be investigated. Also, the time consumed on each lesson should be measured.

Another aspect of a technical assessment study deals with the cost of design and development. The projected mature costs when R&D has been completed should be estimated and compared with the production of alternate media to accomplish the same or similar purposes. The cost elements should include the various steps including the manuscript, mock-up, premastering, mastering, replication, evaluation, and revision.

Implementation Studies

The implementation of new technologies like the interactive videodisc into Navy school and field settings has, in the past, proved to be fraught with many hazards. Projects such as TICCIT have clearly shown the importance of the role of the instructor and other humans in an individualized system. Habits and traditions, which also play a major role in the success of the implementation, must be built systematically since they greatly effect learner achievement, particularly in completion rates. Settings that need to be studied include (1) videodisc players installed in the schools for use with groups, (2) a videodisc player surrounded by a small group of students, and (3) a single learner working with a single videodisc delivery system. The support personnel in each of these situations should be studied since they may decisively determine the program's success.

Field Studies

Although, an implementation study could be conducted in a field setting, particular controls would have to be imposed to assure that hypotheses are properly tested. This

would not be easy to accomplish with the field studies envisioned here. Mastered videodiscs should be sent out to the field to test the various implementation models studied under more controlled conditions. Although it would be desirable if base-line data could be collected on the relative success of videodisc and the existing media in teaching the same topics out in the field and at the schools, it would be difficult to perform an evaluation that is a "horse race" between a videodisc and some conventional medium it purports to replace. A videodisc program is such a totally different product, in terms of both the number and the level of the objectives, that a true comparison with an original training program is impossible. It is better to conduct the assessment studies and implementation studies described above, since these produce more scientific information. The field studies, however, are "proof of the pudding" and can provide summative evaluation data not available from the other studies, as well as pragmatic information regarding the constraints and difficulties of implementing videodiscs in the field. Further, the results of such field studies can lead to the refinement of deployment plans for introducing the videodisc in the proper manner throughout the Navy.

CONCLUSIONS

The major conclusion of this study is that, despite some 8 years of development in a variety of industrial laboratories, optical videodisc technology is still in a state of flux and is developing very rapidly. Many changes may be expected over the next 5 years. The positive aspect of this conclusion is that optical recording technology, including frequency modulated videodiscs and direct-read-after-write digital discs, appear to be an extremely promising technology. Since this technology is high on its learning curve, its capabilities may be expected to increase rapidly while its costs decrease. In player design, solid state lasers can be expected to replace the more expensive helium-neon lasers now being used in the production model players. As for production equipment (including authoring, premastering, and mastering/replication equipment), good progress on solutions to problems that now exist in dealing with these important tasks can be expected.

Of fundamental importance is the fact that the videodisc is such a promising technology. Optical encoding of video and digital information provides enormous storage capacity and low-cost replication in quantity. As a training medium, it combines the attributes of the book, motion pictures or television, and interactive computers. Thus, the educational and training power of this medium is greater than any previous instructional medium. In addition, since the technology is evolving rapidly, the costs for achieving the promised increases in effectiveness can become very competitive.

Many aspects of the technology need to "settle down" and numerous problems need to be solved before the Navy can exploit fully the advantages of this technology. First, a stable set of delivery system alternatives needs to emerge. It seems safe to develop applications for the consumer model videodisc, since this model combines the powers of the book and the movie and can be exploited in Navy training in the immediate future. Also, the consumer model videodisc will be the least expensive and complicated. It is not clear, however, whether the consumer model videodisc players available 1 or 2 years from now will have the same capabilities as those described in this report. The force of competition may introduce microcomputers into consumer-oriented videodisc players having varieties of capabilities, so that, at low cost, they may be amplified considerably to include branching capabilities now found in the MCA and Thompson-CSF players and, more importantly, capabilities found in inexpensive personal computers now available and coming on the market in the next few years. There is likely to be a range of industrial/education players, including the MCA and Thompson-CSF players, and these two are likely to evolve. It is not clear how many alternate delivery system configurations will emerge, or whether two-screen systems with the computer screen having a range of computer graphics capabilities, or one-screen configurations will predominate.

Second, equipment available for author mock-up and premastering needs to evolve and become somewhat standardized. Production centers need to be established using this equipment, both commercially and within the Navy, so that videodiscs can be produced rapidly and without exorbitant cost. A major problem is the availability of mastering and replication facilities. These facilities, which are high technology items and quite expensive, take many months to establish in a smoothly operating fashion. At some point, the Navy will probably need to acquire one or more mastering and replication facilities or share it with other government agencies. Navy users need to be assured that, when they have produced a premaster, they will be able to get it mastered and replicated without inordinate delays and uncertainties.

Third, instructional systems development procedures need to evolve to take advantage of the capabilities of the videodisc. Those sections of the IPISD model dealing with media selection need to be altered substantially to consider the videodisc as an alternate training delivery system. The organization of teams for conducting various activities of ISD should fit in with the existing personnel patterns within the Navy; however, new skills must be learned by videodisc authoring teams, including the use of equipment for author mock-up. ISD procedures must evolve to take advantage of technological aids, including those used during the creation and editing of manuscripts, the mock-up phase, and the premastering phase of videodisc production.

Finally, conventions and strategies for orientation, presentation, and other matters need to be defined and standardized. There is a need for formalization and standardization of indexing features, contents pages, orientation symbols such as color bars and color backgrounds, and other graphics to be defined and standardized so that students can learn to transfer strategies from one disc to another, and so authors can set up efficient production procedures. As a guide toward the definition of strategies and conventions, a variety of technical assessment and experimental studies should be conducted with mastered videodiscs to determine which sets of conventions and strategies will be more powerful and useful.

RECOMMENDATIONS

Because of the continued state of flux in videodisc technology, the Navy should not yet plan for its widespread employment. Rather, the Navy Education and Training Command and its supporting agencies should track the development of knowledge in the field, which is expected to unfold rapidly in the next 2 years, under both industry and government-funded studies. Results of these studies should be examined carefully to determine:

1. Whether results of any economic analyses performed favor the videodisc.
2. Which manufacturers are successfully marketing their products and becoming dominant in the field.
3. Which manufacturers appear to be willing to provide the Navy with timely and reasonably priced mastering and replication during the initial years, and to work with the Navy to set up cost-effective mastering and replication facilities to handle volume Navy work.
4. Which videodisc systems can best be applied to meet Navy training needs. Special attention should be paid to two-dimensional computer-based simulators using the rich display resources of the videodisc.

Further, the Navy should consider a variety of R&D studies dealing with the videodisc. Examples are listed below.

1. The Navy should conduct or sponsor studies aimed at identifying Navy training situations (e.g., in "A" or "B" schools, aboard ship, or at other locations) that could make cost-effective use of videodisc systems. These situations should be identified as soon as possible because of the lead time and work necessary to prepare materials and train personnel.
2. The Navy should conduct studies aimed at developing and mastering a series of videodisc strategies using promising hardware alternatives. These alternatives should be subjected to extensive technical assessment and experimentation so that the Navy may be able to influence the strategies and conventions for videodisc design.
3. The Navy should encourage pilot projects using videodisc hardware technologies in a variety of promising settings. This will help manufacturers understand Navy needs and requirements better and thus influence the development of their hardware and authoring software. It would also help build a base of experience and trained manpower within the Navy.

REFERENCES

- Bennik, F. D. et al. Determining TEC media alternatives for field artillery individual-collective training in the FY78-83 period (ARI TR 78-A-3). Alexandria, VA: Army Research Institute, February 1978.
- Bennion, J. L., & Schneider, E. W. Interactive videodisc systems. Journal of the SMPTE, December 1975, Volume 84, Number 12.
- Bennion, J. L. Guide to authoring videodiscs. New York: WICAT Inc, 1977. (First published for limited distribution by Bennion personally in 1976).
- Bogels, P. W. System coding parameters, mechanics, and electromechanics of the reflective videodisc player. Journal of the SMPTE, Vol. 86, February 1977.
- Bunderson, C. V. The ARPA prescriptive authoring systems project: Analysis of needs and goals for author training and production management systems (Tech. Rep. #1). Arlington, VA: Defense Advanced Research Projects Agency, 1977.
- Bunderson, C. V., & Campbell, J. O. Videodisc training delivery systems and videodisc authoring/production systems (Vols. I & II). Alexandria, VA: Army Research Institute for the Behavioral and Social Sciences, June/July 1979.
- Cavanagh, R. T. Educational/institutional features of the optical videodisc systems. Journal of the Society of Motion Picture and Television Engineers, April 1977, Vol. 86, No. 4.
- CNET. Interservice procedure for instructional systems development (NAVEDTRA 106A), 1975.
- Crowder, N. A. Automatic tutoring by intrinsic programming. In Teaching mechanics and programmed learning, P. A. Lumsdaire & R. Glaser (Eds.). Washington, D. C.: Department of Audio-Visual Instruction, NEA, 1960.
- Freedman, Hermans, & O'Neal. Author training course user manual. Arlington, VA: Defense Advanced Research Projects Agency, January 1978.
- Heuston, D. H. The promise and inevitability of the videodisc in education. New York: WICAT, Inc., 1977.
- Hoyt, W. G., Bennik, F. D., & Butler, A. D. The effectiveness of alternative media in conjunction with TEC for improving performance in MOS related tasks (ARI Tech. Rep. 77-A20). Alexandria, VA: U. S. Army Research Institute for the Behavioral and Social Sciences, 1977.
- Kenney, G. C. Special purpose applications of the Philips-MCA videodisc system. Briarcliff Manor, NY: Philips Laboratories, 1976.
- Kenney, G., Lou, D., Wagner, J., Zernilee, F., McFarlane, R., Milch, A., & Chem, A. Development of an optical disc recorder. Arlington, VA: Defense Advanced Research Projects Agency, January 1978. (NTIS No. AD-A050 784)
- Lurie, M. Optical videodisc systems for television broadcasting. Paper presented at Institute for Graphics Communication Conference on Videodiscs, Carmel, CA, July 24, 1978.

- Mathieu, M. A random access system adapted for the optical videodisc: Its impact on information retrieval. Journal of the SMPTE, February 1977, Vol. 86.
- Mendenhall, R. Authoring system alternatives for educational uses of videodisc systems. Washington, DC: National Institute of Education, 1979.
- Naruse, Y., & Ohkoshi, A. A new optical videodisc system with one hour playing time. Tokyo, Japan: SONY, June 1978.
- Poe, S. E. Photographic videodisc technology assessment report. Washington, D. C.: Navy Photographic Center, October 1976.
- Russell, J. T., & Walker, R. A. Optical digital recording. Optical Engineering, January-February 1976, 15, 20-23.
- Shayton, R. L. From lantern-slide to stereograph to videocassette. Chronical of Higher Education, January 23, 1978, p. 40.
- Zvaneveld, E. H. A. E. An audiovisual producer/user's view of videodisc technology. Journal of the SMPTE, July 1974, 83, 584-593.

APPENDIX A
THE MCGRAW-HILL VIDEODISC PROJECT

57

A-0

THE MCGRAW-HILL VIDEODISC PROJECT

The videodisc on biology developed by WICAT, Incorporated for McGraw-Hill is designed for use on the Philips/Magnavox consumer videodisc player. This player allows for flexible manual branching without the use of a computer through a set of keys on the front of the player. With these keys, the user can randomly access individual frames by branching backward or forward very quickly to the desired frame. The player also uses the automatic stop feature, which allows the disc to play through a certain number of frames and stop automatically on a given frame that has been previously marked with an automatic stop.

The videodisc includes (1) an introduction, (2) three units of instruction, for a total of nine 15 to 30 minute instructional lessons, and (3) a glossary. It has a total of 29 minutes of motion sequence, plus 600 still frames, which is equivalent to 20 seconds of motion. An index will be printed on the videodisc dust jacket listing each lesson by frame number.

The disc is organized with a carefully designed man-machine language to allow the student to know where he is on the disc at any given time and to give him flexibility in moving around to different parts of the lessons. This is considered an essential feature of the videodisc design, since, with 54,000 individual frames, it would be easy for the student to feel lost in the middle of the disc. The man-machine language uses the following kinds of pages to orient the student: Content pages, comment pages, instructional pages, and discussion pages.

Content pages reflect the table of contents or index, showing the units in the course or the lessons in a unit. They serve the same function as the table of contents in a book, allowing the student to see how the parts relate to the whole. Since the authored content pages do not reference frame numbers, which are unknown until after the mastering is completed, an index is placed on the dust cover of the disc. The content pages show how a part of a lesson or unit relates to the entire unit or to the entire course, thus helping the student to maintain perspective on where he is in his learning. They have a blue background, thus making them easily identifiable.

Comment pages describe what the student has just seen or is about to see and notes its significance and its relation to what students have already learned. They also initiate suggestions about strategies. For example, a comment page may say "Go back and review a motion sequence," or "Step forward and review an example and then return to the comment page." Like the contents pages, they have a blue background.

There are four types of instructional pages--rule, example, practice, and answer.

1. The rule pages have a red-orange background to make them stand out from all the other pages. Thus, the student, if he desires, can page quickly through the videodisc by hitting still forward or still backward very rapidly and stopping at the orange pages to look at just the rules. It should be noted that the rule pages are written so as to identify as simply as possible the central concept or rule to be learned during a particular lesson. Some lessons involve only one rule and others, several. In any case, each rule is clearly identified and stated as a simple concept.

2. The purpose of the example pages is to illustrate the rules. The example page often requires photographs that are burned through on a window within the frame and surrounded by text. They are presented on pages with a black background since any other color would dilute the color of the photograph.

3. Rules and examples are followed by practice items to test the student's knowledge of the rules. These items, which may be true-false, multiple-choice, or open-ended questions, are presented on pages with a green background.

4. Following each practice page is an answer page, which has a gray background.

The four instructional components are separated by the automatic stop, to allow the student to move freely in a way that is instructionally beneficial to him. Thus, motion sequences both begin and end with automatic stops so that the student can shoot through still frames to start a motion sequence, and stop the motion sequence on the first still frame following it. Automatic stops are also used at the beginning of instructional sequences containing rules and examples, and at the beginning of practice sequences containing practice items and their answers. Thus, the student has the choice within a lesson to look at just the motion sequence, the instructional sequence, the practice sequence, or more than one of these sequences in any order desired. This is important from an instructional point of view in allowing the student to choose his own learning strategy.

The discussion pages were added to promote synthesis of rules. They are on a gray background and are used to tie together all of the student's learning. Thus, a particular rule with its accompanying examples and practice items is learned as a discrete unit but tied together by discussion pages to the previous and following rules, with their accompanying examples and practice items. Thus, even though the instruction is broken down into discrete rules for easy learning, the discussion pages give the student an overall view of the lesson material, enabling him to tie his learning together in a relevant fashion.

Two additional orientation features are provided on each page.

1. In the lower left-hand corner, there are numbers and/or letters to indicate where the student is within the disc. Thus, the sequence 1.2.A would indicate that the student is in unit 1, lesson 2, part A. This sequence is then followed by a listing of the type of pages within that unit; for example, 1.2 Comment, 1.2A Rule, 1.3B Practice, etc.

2. In the lower right-hand corner, a color bar is provided to show the student the content of the lesson and to track his progress through the lesson. The color bar uses three distinct colors--red for motion sequences, gray for discussion sequences, and green for practice sequences. Each sequence is divided by a white vertical line that represents an automatic stop, allowing the student to move quickly through any sequence to the following or the previous sequences. A cursor on this bar shows the student how far he has progressed into the lesson.

APPENDIX B
VIDEODISC DEMONSTRATION PROGRAM
FOR THE MCA PLAYER

VIDEODISC DEMONSTRATION PROGRAM FOR THE MCA PLAYER

This appendix describes branching strategies for both reference and tutorial instruction. The purpose of this program was to demonstrate the videodisc's capabilities for industrial sales and training using the programmed branching capability of the MCA player. The program was based on the Ford Motor Company's videotape for the 1978 Granada.

The completed program is a combination of the motion sequences from the Granada videotape and specially-authored still frames that highlight the following features of the Granada: (1) exterior style features, (2) interior style features, (3) optional equipment, (4) passenger comfort (sound insulation and suspension system), and (5) engine and transmission. The sequence in which the motion sequences and still frames is presented is controlled by the videodisc player's microprocessor.

The documentation that was delivered with the completed program included the following:

1. The Granada videotape originally produced by Ford, which is viewed intact as one user option.

2. Transcriptions of the portions of the videotape script that correspond to each of the five highlighted features listed above.

3. A flow chart showing how the motion sequences and still frames are programmed. It lists specific frames and segments, with arrows showing how the user can move from one frame to another. It begins with the first index frame; that is, the moment when the user is confronted with his first choice. Other preceding frames let the user enter comfortably to that point. Certain characteristic features of the flowchart are illustrated on pages B-5 through B-10. The total flowchart was not reproduced here since it occupies 13 pages, many of which are filled with repeated patterns.

4. Descriptions of the various elements in the flow chart, including the following:

- a. Index frames--Frames used to identify the user's option at various points in the program, and to tell him what to do to make his choices known to the machine.

- b. Discussion frames--Frames that present the basic material to the user. They may contain a photograph or other material. For example, M1 (page B-5) gives the user basic information on the Granada's exterior style.

- c. Extra detail frames--Optional frames providing extra detail on a highlighted area indicated on the flow chart by off-page connectors. For example, if the user wanted extra detail on the Granada's exterior style, he would turn to the page indicated and look for an off-page indicator with the same letter.

- d. Question frames--Frames that give the user practice questions during the instructional sequence. See page B-9, which includes question frames on insulation materials.

- e. Feedback frames--Frames to let the user know whether he answered the practice questions correctly or incorrectly. Again, see page B-9, which includes frames

for response alternatives (three incorrect, one correct) to insulation materials practice questions.

f. Graphics file--A list of the photographs and drawings used on the discussion frames, giving the source of each. The graphic notes on the discussion frames refer by number to the graphics listed in the graphics file.

Turning to the flow chart, we see how the program may be used for different purposes. There are two basic sequences for customers. They may see the entire Granada movie from start to finish (Index 1), or they may see it segment-by-segment, interspersing their viewing by reviewing all or some of the still frame highlights (Index 2). In the second sequence, they may, if desired, review "extra detail" frames. There are also two basic sequences for salesmen. They may undertake a step-by-step study program (Index 4) or they may look up individual topics in a reference section (see page B-10).

The customer "movie and highlights" sequence and the salesman "reference" sequence both cover all highlighted features. In illustrating the principal videodisc features for instruction (Index 4), however, the sequence was limited to only one topic--"sound insulation," within the major topic "passenger comfort." Including all features would have expanded the program dramatically since it would have necessitated the addition of memory aids, practice items, feedback frames, and so on.

The movement from one program element to another is shown on the flow chart by arrows. All movements require the user to push a button(s), with the exception of the return to an index frame following the presentation of the movie or one of its segments, which is automatic. Further information is provided below.

1. Sequential forward and backward movement. Most of the movement through the program is from one frame to another, either backward or forward, in a simple sequence. Although backward movement could be eliminated to simplify the program, it was learned, from experience on TICCIT, that users get frustrated when they want to go back to something they just viewed, and discover there's no simple way to do it.

This backward and forward movement is represented on the flow chart by the simple two-headed arrows (e.g., between D2 and D3 on page B-6). Forward is down; backward is up. These movements can be programmed using the SCAN REV binary choice branching instruction. The machine finds the still frame to be presented, and waits (based on the SCAN REV instruction for the student to input a number. If the student presses 1, he moves to the next frame in the sequence (down the flow chart). If he presses 0 (or any other number except 1), he moves back to the previous frame (up the flow chart).

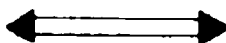
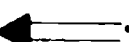
On the discussion frames, this backward-forward choice is presented to the user with this arrow: 0  1. Most of the index frames, however, have only half of the arrow: 0 . The reason is because there is no standard forward sequence from most index frames; there are only optional-sequence choices in a forward direction. There is standard forward movement (and therefore a two-headed arrow) on the index frames for the reference section so the user can move from one index page to another looking for his topic. Backward movement from all index frames is the same as on discussion frames.

2. Choosing optional sequences. At some points in the program, the user is given a choice of two or more optional sequences. Generally, such choices are presented to the user on an index page. For example, from Index 6 (page B-7), the user may choose to view

movie segment 4 (M4), or a passenger comfort sequence beginning with frame D37. The choices from a given index page branch to the right on the flow chart from the vertical line that descends directly below the "I" of the word "Index" in the index frame label as in this example:

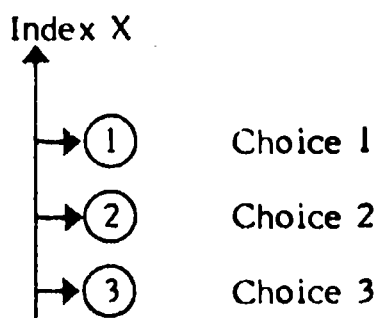

By observing this convention in reading the flow chart, one can avoid confusion about which choices belong to which index frame.

On other occasions, the user may choose an optional sequence from a discussion frame. For example, if the user is on frame D38, he can either continue with the standard sequence by pushing 1, thus moving to frame D56 or move to frame D39 for a more detailed explanation of the sound insulation system by selecting 2. The optional-sequence choice from a discussion frame is represented to the user by this three-headed arrow:

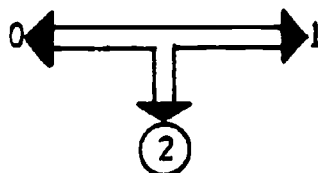

(Detail)

The 0 and the 1 represent the standard forward-backward choices, and 2 is a temporary designation that represents the added choice of dropping down for a more detailed explanation or, in the instructional sequence, for a memory aid. In either case, the user passes through the optional sequence, and returns again to the standard sequence simply by continuing his frame-by-frame forward movement.

As mentioned above, the circled numbers are a temporary author's designation. They do not represent the actual numbers that the user will push; they simply represent the fact that there are different choices. What the student will actually push is determined by the MCA programmers, and then added to the index and discussion frames in the appropriate places. Each of the circled numbers on the flow chart has a corresponding circled number on the designated index or discussion frame that shows where the specific number-to-be-pushed must be placed. The optional-sequence choices could be executed at this time by entering a three-digit number, followed by the RUN command. (Since the machine is waiting for an input based on the SCAN REV instruction, it may be necessary for the user to push CLEAR before entering the number.)

3. No backward-movement option. There are some cases in which the backward-movement choice will not return the user to the frame he just saw. This happens whenever the user exits from an optional sequence. For example, if the user executes a backward movement from frame D56 (page B-7), he will return to frame D38, even though he may have chosen the optional "extra detail" sequence and arrived at frame D56 from frame D55. Frame D55, or any other frame that ends an optional sequence, can only be approached from a forward direction.

4. Off-page connectors. Although an attempt was made to keep all of the choices from a single index frame on the same page, it was sometimes necessary to write the sequence instructions for the various choices on other pages. In such cases, we refer to the other pages with off-page connectors (▷) such as the one shown at the bottom of page B-9. The user simply turns to the page indicated and looks for an off-page connector with the same letter. The sequence begins on the new page at that point.

Additional considerations in the preparation of the final executable program are described below:

1. Simplification. A fairly comprehensive program with up to 10-choice branching was prepared. A simpler program could be prepared if desired simply by eliminating any of the optional choices on any index page, or the third choice on any of the discussion frames that offer a choice in addition to the standard forward-backward movement. It is also possible to eliminate the backward movement choice. As mentioned before, however, it has been found that users find the forward-only strategy to be quite frustrating.

2. Color coding. Different background colors on the different kinds of frames were recommended.

Customer sequence: Movie segments and highlights

Index frames: Blue
Frames in standard sequence: Gray
Optional detail frames: Rust

Instructional sequence

Index frames: Blue
Discussion frames: Gray
Question frames: Green
Feedback frames: Gray

Reference section

Index frames: Blue
Discussion frames: Gray

3. Type faces. The following type faces were recommended:

Body copy

Helvetica med. 24/31, upper and lower case.
Line 40 pica max.
12 lines max.

Bottom line code

Helvetica med. 18 pts., all caps

Titles

Helvetica bold, 36 pt.
Helvetica bold, 24 pt.
Helvetica bold, 18 pt., all caps

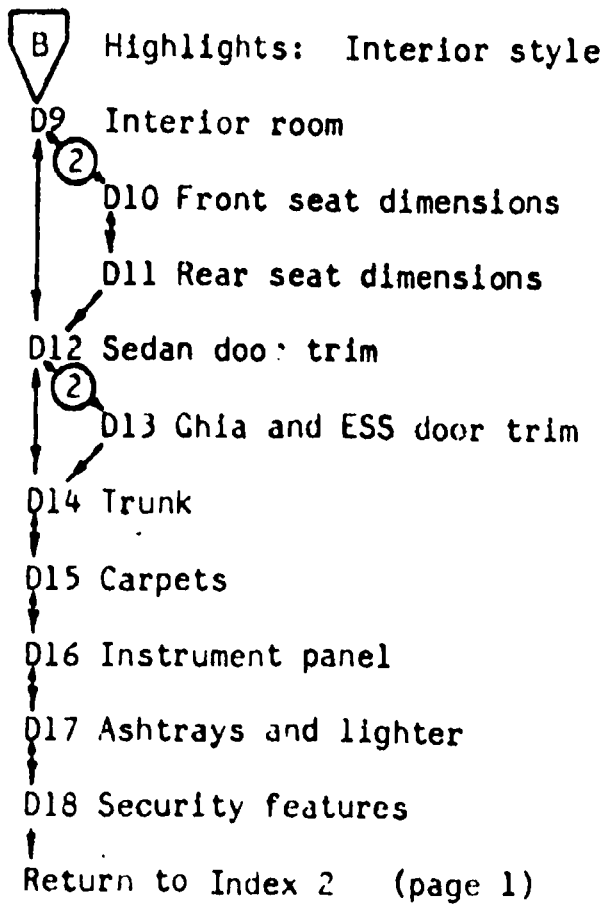
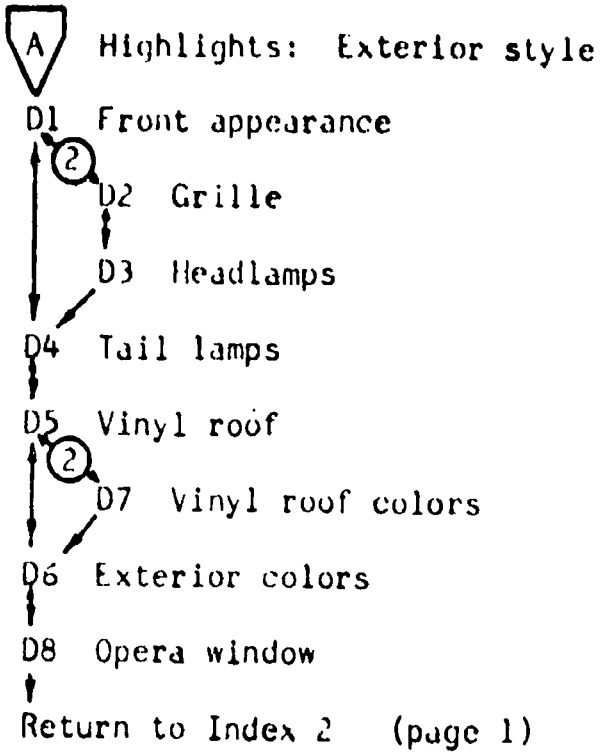

F Instructional sequence: Passenger comfort

- D73 Passenger comfort overview
- D74 Learning goals: Sound insulation
- D75 Learning goals: Suspension system
- D76 How to use the information learned

Index 5 (Instructional options)

① Index 6 (Customer information review, movie & highlights)

① M4, Passenger comfort
Return to Index 6 (this page, above)

② D37 Passenger comfort
D38 Sound insulation
② D39 to D55 (Insulation detail)
D56 Front suspension
② D57 to D60 (Front suspension detail)
D61 Rear suspension
② D62 to D68 (Rear suspension detail)
Return to Index 6 (this page, above)

② H p. 5

③ I p. 5

④ D173 No instruction

⑤ D173 No instruction

⑥ D173 No instruction

⑦ D173 No instruction

H Sound insulation instruction

Index 7 (Option: Locations or materials)

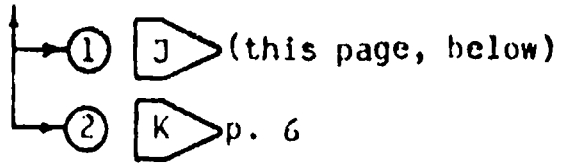

I Sound insulation practice

Index 8 (Option: Locations or materials)

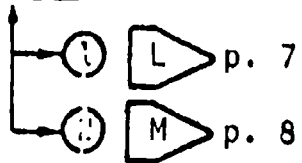

J Insulation locations instruction

D77 Five general locations

2 D83 Memory aid

D78 Engine area locations

2 D84 Memory aid

D79 Front passenger compartment locations

2 D85 Memory aid

D80 Rear passenger compartment locations

2 D86 Memory aid

D81 Luggage compartment locations

D82 Roof area locations

Return to Index 7 (this page, above)

M

Insulation materials practice

Q7

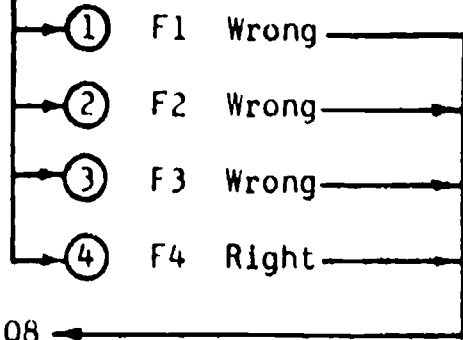

Q8

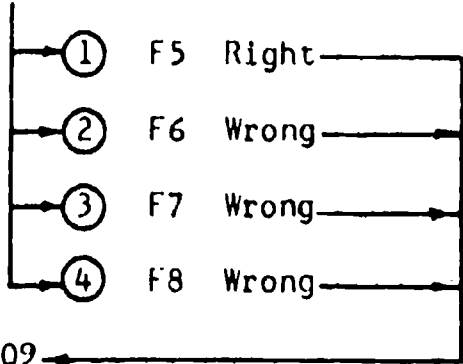

Q9

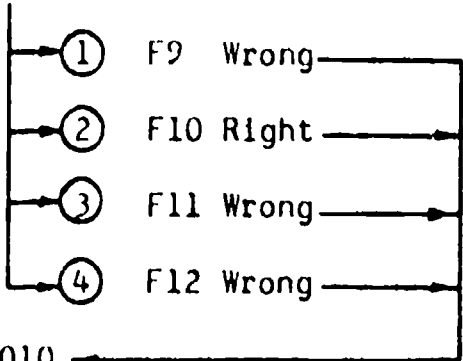

Q10

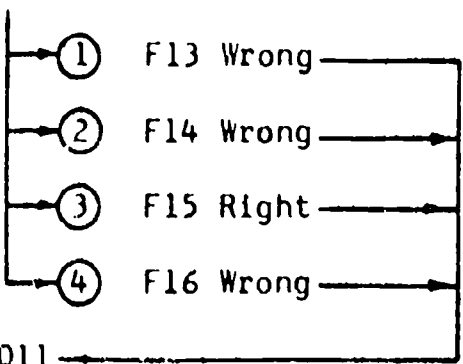

Q11

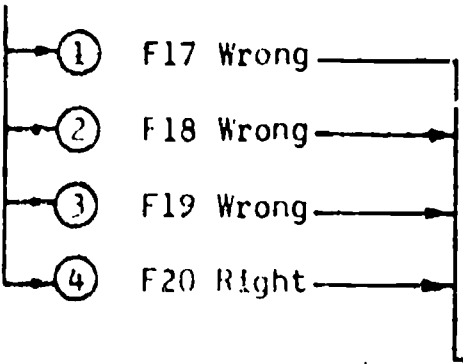

N p. 9

G Reference

Index 9

- ① D109 Air conditioner
- ② D110 Carpeting
- ③ D111 Exterior colors
- ④ D112 Vinyl roof colors
- ⑤ M4 Passenger comfort

Index 10

- ① D113 Digital clock
- ② D114 Front seat dimensions
- ③ D115 Rear seat dimensions
- ④ D116 Standard engine
- ⑤ D117 Optional engine
- ⑥ M1 Exterior style
- ⑦ D118 through D120 Front appearance

Index 11

- ① D119 Grille
- ② D120 Headlamps
- ③ D121 Ignition system
- ④ D122 Instrument panel
- ⑤ M2 Interior style
- ⑥ D123 Opera window
- ⑦ M3 Optional equipment
- ⑧ D124 AM radio

Q p. 13

FLOW CHART

