

DOCUMENT RESUME

ED 178 326

SE 029 209

TITLE Water Management and Sediment Control for Urbanizing Areas.

INSTITUTION Soil Conservation Service (DOA), Columbus, Ohio.

PUB DATE Jun 78

NOTE 235p.; Contains occasional marginal legibility in Tables, Charts, and Figures; Pages 23-24 removed due to oversize

AVAILABLE FROM Superintendent of Documents, U.S. Government Printing Office, Washington, D.C. 20402 (no price quoted)

EDRS PRICE MF01/PC10 Plus Postage.

DESCRIPTORS Agriculture; Development; Environment; Environmental Education; *Environmental Influences; Forestry; *Land Use; Management; Natural Resources; *Soil Conservation; *Urban Environment; *Water Resources

IDENTIFIERS *Erosion; *Sediments

ABSTRACT

This handbook, developed for use by the Soil Conservation Service and property owners, land developers, local government agencies, and consulting firms, is designed to provide information on water management and minimizing erosion on land undergoing development in urban areas. The standards and specifications listed in this handbook are to provide criteria for the design, installation, and maintenance of water management and sediment control practices. Recommendations in the handbook apply to urbanizing lands where housing, industrial, institutional, recreational, and highway developments are occurring or are being planned. Due to wide variations in climate, topography, geology, soils, and plant requirements, these recommendations are somewhat generalized. The document is divided into four chapters: (1) Resource Planning in Urbanizing Areas; (2) Standards and Specifications; (3) Methods for Determining Soil Loss; and (4) Installation and Maintenance Needs. An appendix of related design charts and tables concludes this publication. (FT)

 * Reproductions supplied by EDRS are the best that can be made *
 * from the original document. *

WATER MANAGEMENT AND SEDIMENT CONTROL FOR URBANIZING AREAS

U.S. DEPARTMENT OF HEALTH
EDUCATION & WELFARE
NATIONAL INSTITUTE OF
EDUCATION

THIS DOCUMENT HAS BEEN REPRODUCED EXACTLY AS RECEIVED FROM THE PERSON OR ORGANIZATION ORIGINATING IT. POINTS OF VIEW OR OPINIONS STATED DO NOT NECESSARILY REPRESENT OFFICIAL NATIONAL INSTITUTE OF EDUCATION POSITION OR POLICY.



ED178326

UNITED STATES DEPARTMENT OF AGRICULTURE
SOIL CONSERVATION SERVICE
COLUMBUS, OHIO

029 209
ERIC
Full text provided by ERIC

TABLE OF CONTENTS

	Page
General	1-4
Resource Planning in Urbanizing Areas	5-10
Standards & Specifications	
Critical Area Planting (Temporary Seedings)	11-14
Critical Area Planting (Permanent Seeding, Grasses & Legumes)	15-20
Critical Area Planting (Using Ground Covers, Vines, Shrubs & Trees)	21-24
Diversion (Temporary and Permanent)	25-33
Drainage Interceptor	34-37
Grade Stabilization Structure (Temporary Chute or Flume)	38-41
Grade Stabilization Structure (Temporary Pipe Drop)	42-45
Grassed Waterway or Outlet	46-48
Heavy Use Area Protection	49-51
Land Grading	52-54
Mulching	55-56
Temporary Sediment Basin	57-65
Sodding	66-68
Top Soiling	69-71
Windbreaks	72-76
Method for Determining Soil Loss	77-90
Installation and Maintenance Aids	
Guidelines for Selecting & Protecting Trees During Development	91-94
Repair of Small Wounds on Trees	95
Instructions for Installing Mulch Netting in Waterways	96-98
Land Grading Urban Areas	99-102

Appendix

(Appendix B-1) Parabolic Diversion Design Chart	103-115
(Appendix B-2) Diversion Design Table C & D Retardance	116-119
(Appendix B-3) Waterway Design	120-153
(Appendix B-4) Stone Center Waterway	154-156
(Appendix B-5) Pipe and Earth Spillway Design	157-169
(Appendix B-6) Drain Charts	170-174
(Appendix B-7) Pipe Flow Charts	175-179

GENERAL

Purpose

The purpose of this handbook is to provide information on water management and minimizing erosion and sediment on land undergoing development in urbanizing areas. The handbook pertains to soil, water and plant conservation and their relationships in upgrading the quality of the environment. The handbook has been prepared by the Soil Conservation Service (SCS) in working with Soil and Water Conservation Districts (hereafter referred to as Districts). This material may be used by property owners, land developers, local government agencies, consulting firms and others who share this interest.

The standards and specifications listed in this handbook are to provide criteria for the design, installation, and maintenance of water management and sediment control practices. Those responsible for design of these practices should evaluate the conditions existing on a particular site and determine if the minimum criteria contained in these standards are adequate or if more stringent criteria should be used.

Scope and Authority

The recommendations in the handbook apply to urbanizing lands where housing, industrial, institutional, recreational and highway developments are occurring or are being planned for those uses.

Recommendations are somewhat generalized due to wide variations in climate, topography, geology, soils and plant requirements. Feasible ways to handle water management and to minimize erosion and sediment in the State are varied and complex.

The SCS working through Districts, has broad authority to help people solve problems on soil, water and related resources. There may be times, however, when these problems or related conditions may need to be referred to outside groups for consultive or corrective measures. Any technical assistance given by SCS personnel must conform with established policies and procedures.

Kinds of assistance usually given to Districts in urban areas by SCS fall into three broad phases:

1. Assisting local groups or communities in the development of comprehensive or specific resource plans.
2. Installing soil, water, and plant conservation measures before or during construction.
3. Preparing maintenance programs for treatment measures.

Working relationships in urban areas of a District may be augmented by updating the memorandum of understanding between the District Supervisors and the SCS. The District may also enter into a memorandum of understanding with local planning commissions or other authorized agencies covering technical assistance in erosion and sediment control.

WATER MANAGEMENT AND SEDIMENT PROBLEMS ASSOCIATED WITH URBAN DEVELOPMENTS

The urbanizing process is such that many people may be adversely affected from small areas of land undergoing development. Unplanned water disposal and uncontrolled erosion and sediment from these areas may cause considerable economic damage to individuals and society in general. Stream pollution and damages to public facilities and private homes are among many examples.

Problems associated with urban developments include:

1. A large increase of areas exposed to soil erosion and runoff.
2. Increased volumes of runoff, soil movement, sediment, and peak flows caused by:
 - a. Removal of natural plant cover.
 - b. An increase of impervious surface areas due to construction of streets, buildings, sidewalks, and parking areas.
 - c. Changes in drainage areas caused by grading operations, diversions and streets.
 - d. Changes in volume and duration of water concentrations caused by altering steepness, distance, and surface roughness.

- e. Reduction of water intake of soils from compaction by construction equipment. Compacted soils often reduce moisture infiltration rates from 1/16 to 1/20 of the original rate.
 - f. Prolonged exposure of unprotected sites and service areas to adverse weather conditions.
3. Altering groundwater regime that may adversely affect drainage systems, slope stability, survival of existing vegetation and establishment of new plants.
 4. Creation of new south and west land exposure that may hinder plant growth.
 5. Exposing subsurface materials that are too rocky, too acid, or otherwise unfavorable for establishing plants.
 6. Encroachment on the floodplains by the construction of new buildings, land fills and other obstructions in the floodway.
 7. Poor scheduling of construction and development activities.

The criteria found in this handbook is minimum and in some instances may not meet local requirements. Those responsible for design of these practices should evaluate the conditions existing on a particular site and determine if the minimum criteria contained in these standards are adequate and meet local requirements or if more stringent criteria should be used.

**RESOURCE PLANNING
IN
URBANIZING AREAS**

RESOURCE PLANNING IN URBANIZING AREAS

Broad Resource Planning

Effective solutions to urban water management and sediment problems begin with planning. Broad resource plans can guide and control urban growth preventing wasteful and haphazard developments.

Districts and the SCS can give technical resource data and information that will serve as a basis for decision making by local authorities to fulfill the objectives established by broad plans. These objectives may include reserving best agricultural areas for cropland; maintaining an economic agricultural base; protecting historical, scenic and natural beauty areas; providing for open spaces and parks; developing attractive residential, institutional and industrial areas; and using floodplains and other problem areas for recreation and conservation uses.

Development of Plans

As more specific plans, such as subdivision plans, are developed for smaller increments of the broad region, SCS can furnish more detailed information and interpretations. This information will help determine the suitability of the site for the kind of development to be made. It will also help in planning and treating these lands to greatly reduce erosion and sediment problems during construction.

Certain basic data need to be assembled before adequate technical information and interpretations can be provided for a subdivision or other type of specific plan. These data consist primarily of:

Geography of the Area

Conditions of proposed project areas need to be examined early in the planning stages. These conditions include location, accessibility, present land use, size of proposed tract, topography, drainage pattern, geology, hydrology, soils, vegetation and climate. Such information is obtained from on-site examinations and existing technical reports, maps, records and other documented material usually available from local sources.

Study of Soils in the Area

Soils information, interpretations and data are basic to any urban development. These studies provide an understanding of the capabilities and general limitations of the site.

They point out the feasibility of planned land uses, economic considerations and conservation requirements of the site.

Principles for Effective Water Management and Sediment Control

Based upon data and information described above, planning assistance during the development of the plan may include the following phases:

Water management and sediment control provisions should be incorporated in the planning stage for most effective application in the construction stage of development.

Practical combinations of the following soil and water conservation practices will provide effective water management and sediment control when skillfully planned and applied.

1. The development plan should be fitted to the topography and soils so as to create the least erosion potential, and preserve natural beauty by planning water disposal, road layout, and open spaces before development.
2. Areas with severe unalterable limitations such as flood plains, steep areas, and unstable soils should be delineated for appropriate open space uses.
3. Develop a construction sequence that will keep disturbed areas small and bare for the shortest time possible.
4. Temporary vegetation and/or mulching should be used to protect critical areas exposed during development.
5. Temporary and permanent measures, such as debris basins, diversions, terraces, waterways, and subsurface drainage should be planned, installed, and maintained as appropriate to control runoff, provide drainage and reduce sedimentation to downstream areas during and after development.
6. Design to keep storm water runoff velocities low.
7. Protect disturbed areas from storm water runoff.
8. Use temporary bridges and culverts where there will be a constant fording of streams.
9. Design the final grade of cut and fill slopes flat enough so that they can be vegetated and easily maintained.

10. When feasible allow high quality trees to remain, and protect from damage during construction.
11. Sprinkle or apply dust suppressors. Keep dust down to tolerable limits on construction sites and haul roads.
12. Protect streams from chemicals, fuel, lubricants, and other pollutants.
13. Avoid disposal of fill in flood plains or drainage ways unless adequate means are developed to safely discharge normal flood flows.
14. Locate storage and shop yards where erosion and sediment hazards are slight. Where this is not possible, apply necessary paving and erosion control practices.
15. The permanent vegetation, including use of sod, and structures should be installed and maintained as soon as practical in the development.

Special Considerations for Surface and Subsurface Water Disposal

Generally urban development disturbs normal drainage patterns and increases the volume of runoff. These changes in the natural water disposal regime may or may not create areas of inadequate drainage or unstable and eroding water courses, however, the water disposal system for each developing area needs to be carefully evaluated. It must be emphasized that even though the area within the development has an adequate water disposal system, severe problems can be created downstream when the natural watercourses are overloaded thereby creating flooding, and/or become unstable and erosive due to the change in volume and velocity of flow.

It is extremely difficult to collect surface runoff from a development, carry it in a container, such as a storm sewer or concrete lines channel, and discharge the flow back into a natural watercourse without causing severe erosion problems. Natural watercourses that were non-erosive in "pre-development" conditions, become highly erosive when exposed to high energy from storm sewer discharges. Once a natural watercourse becomes unstable, structural corrective measures are generally required in order to re-establish channel stability. These corrective measures are extremely expensive and often beyond the financial capabilities of the responsible owners or municipalities.

Subsurface drainage may be a useful tool in developing areas for the removal of free water beneath the surface of the ground and lowering the water table of the soil. This type of drainage is applicable to saturated soil conditions where it is physically and economically feasible to use underdrains to remove free water from the root zone of the desired type of vegetation. The characteristics of the soil and the topographic characteristics of a site considered for draining, need to be carefully evaluated in order to design a successful system. The capacity, location, spacing, and depths of the system may be determined using procedures contained in the Ohio Drainage Guide and the SCS Engineering Field Manual for Conservation Practices.

Subsurface drainage systems are very susceptible to being clogged with roots of trees and shrubs, and for this reason, subsurface drainage should only be used in open areas. Systems involving several parcels of land should only be installed where the drains are accessible for inspection and maintenance, and where the use of the land over the drains can be controlled.

Subsurface drains should never be used for collecting and removing polluted water from home sewage systems or from basement drains. Curtain drains should be designed using criteria and guidelines established by the County Sanitarian.

Predicting Soil Losses

Planners can estimate soil losses from construction sites by using the Universal Soil Loss Equation.

Predictions of soil losses in areas to be developed is directly related to resource planning. The predictions will influence the degree of planning and treatment required for proper control of erosion and sediment. Predicted soil losses may also create an awareness among developers, local government agencies and others of the urgent need to install conservation measures concurrent with construction.

(Refer to Pages 77 thru 89 for instructions and examples on how the Universal Soil Loss Equation is used for this purpose).

Erosion and Sediment Control Ordinances

Local ordinances dealing with erosion and sediment control enhance and implement resource planning and development in areas that are to be urbanized. The SCS does not, in any way, participate in the enactment or enforcement of ordinances. This is strictly the responsibility of local government agencies and officials. At the request of the local districts, the SCS may furnish any available technical information or data that may be useful to authorized local government agencies.

Ordinances for control of erosion and sediment in urban developments usually contain several of the following provisions:

1. Developers must furnish local authorities with preliminary subdivision plans and extension of previous plans for approval. These plans must include erosion and sediment control measures.
2. Permits are required for any degree of grading and removal of earth on any property to be developed. Grading needs to be in harmony with the general purpose and intent of zoning regulations and conservation programs of the area.
3. Disturbed areas must be covered with vegetation or mulch as soon as initial grading is completed. Controlled storm drainage systems must supplement vegetative cover. These control measures need to be applied within a prescribed time limit.
4. Design standards governing layout and construction of subdivisions, storm drainage plans, utilities, sewage disposal systems and slope limits must be approved. Treatment measures and design criteria for controlling runoff, erosion and sediment are also required.
5. Posting of a performance bond by contractors to help insure the installation of soil erosion control measures and protection of other resources.

**STANDARDS
AND
SPECIFICATIONS**

STANDARD AND SPECIFICATIONS
FOR
CRITICAL AREA PLANTING
(Temporary Seedings)

STANDARD

Definition

Stabilizing silt producing areas by establishing short-term vegetative cover.

Purpose

To stabilize the area and reduce damages from sediment and runoff to downstream areas.

Criteria

Seeding should be applied the same day that operations are completed that produce the disturbed areas. On areas such as rough grading where additional work is not scheduled for a period of three (3) weeks or longer, the area should be seeded immediately. In areas where unanticipated delays are encountered, the areas should be seeded as soon as the delay is recognized.

All constructed slopes and cuts should be seeded as each vertical interval of no more than ten (10) feet is completed.

The plant species should be selected on the basis of quick germination and growth.

Fertilizer, lime, seedbed preparation, seed coverage, mulch, and irrigation should be used as necessary to promote quick plant growth.

SPECIFICATIONS

I. Site Preparation

- A. Grade as needed and feasible to permit use of conventional equipment for seedbed preparation, seeding, mulch application and anchoring.
- B. Install needed erosion control practices such as diversions, temporary waterways for diversion outlets, and desilting basins. (See Standard and Specifications for above practices in this Handbook).

II. Seedbed Preparation

- A. Lime (In lieu of a soil test) on acid soil and subsoil - 100 pounds per 1000 square feet or 2 tons per acre of agricultural ground limestone or equivalent. For best results make a soil test.
- B. Fertilizer (In lieu of a soil test). Apply 12-15 pounds per 1000 square feet or 500-600 pounds per acre of 10-10-10 or 12-12-12 analysis. For best results make a soil test.
- C. Work lime and fertilizer into the soil with a disk harrow, springtooth harrow, or other suitable field equipment to a depth of 2 inches. On sloping land the final operation should be on the contour.

III. Seeding

- A. Select a species or mixture from Table 1.
- B. Apply seed uniformly with a cyclone seeder, drill, cultipacker seeder, or hydroseeder (slurry may include seed and fertilizer) preferably on a firm, moist seedbed. Cover to a depth of 1/4 to 1/2 inch.
- C. Where feasible, except when a cultipacker type seeder is used, the seedbed should be firmed following seeding operations with a cultipacker, roller, or light drag. On sloping land seeding operations should be on the contour wherever possible.

IV. Mulching

- A. Mulch should be applied to protect soil and provide a better environment for plant growth.

1. Mulch materials should be unweathered small grain straw (preferably wheat) and should be applied immediately after seeding at the rate of 2 tons per acre or 100 pounds (2-3 bales) per 1000 square feet.
2. Spread mulch uniformly by hand or mechanically so that the soil surface is covered.
3. Mulch anchoring methods.
 - a. Mulch anchoring tool - Use a mulch anchoring wool with a series of flat, notched discs that punch and anchor the mulch material into the soil.
 - b. Asphalt Mulch Tie-Down
 - (1) Liquid asphalt - rapid curing (R.C. 70, 250, or 800) or medium curing (M.C. 250 or 800). Apply 0.04 gallons per square yard or 200 gallons per acre. Liquid asphalt, since it is cut back with a kerosene-like product, can be applied during freezing weather.
 - (2) Emulsified asphalt - rapid setting (R.S. 1 or 2) medium setting (M.S. 2) or slow setting (S.S. 1). Apply 0.03 gallons per square yard or 160 gallons per acre. Emulsified asphalt contains approximately 50% water, therefore, it cannot be applied during freezing weather.
 - c. Mulch Nettings - staple light-weight paper, jute, cotton or plastic nettings to the soil surface according to manufacturer's recommendations. Use in areas of water concentration to hold mulch in place.

V. Irrigation

If soil moisture is deficient, supply new seedings with adequate water for plant growth until they are firmly established. This is especially true when seedings are made late in planting season, in abnormally dry or hot seasons, or on adverse sites.

TABLE I
Temporary Seedings and Seeding Dates

Kind of Seed ^{1/}	Seeding Dates ^{2/}	Per 1000 Sq.Ft.	Per Acre
Oats	March 1 - June 15	3 pounds	4 bushel
Oats and Sudangrass	June 16 - Aug. 15	2 pounds 2 pounds	2 bushel 2 bushel
Rye or Wheat	Aug. 16 - Nov. 1	3 pounds	2 bushel

After November 1 use Mulch only.

^{1/} Other seed species may be substituted for the above, check with the local SCS office for recommendations.

^{2/} These seeding dates are ideal. With the use of mulch and irrigation, seedings could be made any time from March to September.

STANDARD AND SPECIFICATIONS
FOR
CRITICAL AREA PLANTING
(Permanent Seeding, Grasses & Legumes)

STANDARD

Definition

Stabilizing silt-producing areas by establishing long-term stands of vegetations.

Purpose

To stabilize the area and reduce damages from sediment and runoff to downstream areas.

Conditions Where Practice Applies

Graded and cleared areas subject to erosion where a permanent, long-lived vegetative cover is needed, on areas where final grading on steep slopes has been completed, and on diversions, grassed waterways, and desilting basins. (See Standard and Specifications for above practices in this Handbook).

SPECIFICATIONS

Vegetation cannot be expected to provide an erosion control cover and prevent soil slippage on a soil that is not stable due to its structure, water movement or excessive slope.

Minimum soil conditions needed for the establishment and maintenance of a long-lived vegetative cover:

- A. Enough fine-grained materials (over 25% silt and clay) to provide the capacity to hold at least a moderate amount of available moisture.

Excessively porous sands which have moisture supplies consistently too low for growth of plants cannot be maintained in good cover regardless of other soil factors.

- B. Sufficient pore space to permit adequate root penetration.
- C. No concentrations of toxic elements.

I. Site Preparation

- A. Stockpile topsoil to apply to sites that are otherwise unsuited for establishing vegetation.
- B. Grade as needed and feasible to permit the use of conventional equipment for seedbed preparation, seeding, mulch application and anchoring, and maintenance. After grading operation spread topsoil where needed.
- C. Install needed erosion control practices such as diversions, grassed waterways for diversion outlets, and desilting basins. (See Standards and Specifications for above practices in this Handbook).

II. Seedbed Preparation

- A. Lime (In lieu of a soil test) on acid soil and subsoil - 100 pounds per 1000 square feet or 2 tons per acre of agricultural ground limestone or equivalent. For best results make a soil test.
- B. Fertilizer (In lieu of a soil test) Apply 25 pounds per 1000 square feet or 1000 pounds per acre of 10-10-10 or 12-12-12 analysis. For best results make a soil test.
- C. Work lime and fertilizer into the soil with a disk harrow, springtooth harrow, or other suitable field equipment to a depth of 3 inches. On sloping land the final operation should be on the contour.

III. Seeding

- A. Select a species or mixture from Table 1.
- B. Apply seed uniformly with a cyclone seeder, drill, culti-packer seeder, or hydro-seeder (slurry may include seed and fertilizer) on a firm, moist seedbed. Cover to a depth of 1/4 to 1/2 inch.

- C. Where feasible, except when a cultipacker type seeder is used, the seedbed should be firmed following seeding operations with a cultipacker, roller, or light drag. On sloping land, seeding operations should be on the contour where feasible.

IV. Mulching

- A. Mulch materials should be unweathered small grain straw (Preferably wheat) and should be applied immediately after seeding at the rate of 2 tons per acre or 100 pounds (2-3 bales) per 1000 square feet.

B. Mulch Anchoring Methods

1. Mulch anchoring tool - Use a mulch anchoring tool with a series of flat, notched disc that punch and anchor the mulch material into the soil.
2. Asphalt Mulch Tie-down
 - a. Liquid asphalt. - rapid curing (R.C. 70, 250, or 800) or medium curing (M.C. 250, 800). Apply 0.04 gallons per square yard or 200 gallons per acre. Liquid asphalt, since it is cut back with a kerosene-like product, can be applied during freezing weather.
 - b. Emulsified asphalt - rapid setting (R.S. 1 or 2) medium setting (M.S. 2) or slow setting (S.S. 1). Apply 0.03 gallons per square yard or 160 gallons per acre. Emulsified asphalt contains approximately 50% water, therefore it cannot be applied during freezing weather.
3. Mulch Nettings - Staple lightweight paper, jute, cotton or plastic nettings to the soil surface according to manufacturer's recommendations. Use in areas of water concentration to hold mulch in place.

V. Maintenance

Maintenance is a vital factor in maintaining an adequate vegetative erosion control cover. See Table 2.

- A. Irrigation - If soil moisture is deficient, supply new seedlings with adequate water for plant growth until they are firmly established. This is especially true when seedlings are made late in the planting season, in abnormally dry and hot seasons, or on adverse sites.

B. Repairs - Inspect all seeded areas for failures and make necessary repairs, replacements, reseeding, and re-mulching within the planting season, if possible.

1. If stand is inadequate, overseed, fertilize, using half of rates originally applied, and mulch.

2. If stand is over 60% damaged, reestablish following original lime, fertilizer, seedbed preparation, seeding recommendations, and mulching recommendations.

TABLE 1

Kind of Seed ^{1/}	Seeding Dates ^{2/}	Per 1000 Sq. Ft.	Per Acre
I. Permanent Seeding			
A. Creeping Red Fescue and Domestic Ryegrass and Kentucky Bluegrass	Mar-May, Aug-Sep	1/2 Pound	20 Pounds
		1/4 Pound	10 Pounds
		1/4 Pound	10 Pounds
B. Tall Fescue	Mar-May, Aug-Sep	1 Pound	40 Pounds
C. Creeping Red Fescue and Tall Fescue	Mar-May, Aug-Sep	1/2 Pound	20 Pounds
		1/2 Pound	20 Pounds
II. Special Area Seedings			
A. Steep Banks or Cuts			
1. Tall Fescue	Mar-May, Aug-Sep	1 Pound	40 Pounds
2. Crownvetch and Tall Fescue	March-May	1/4 Pound	10 Pounds
		1/2 Pound	20 Pounds
B. Waterways and Road Ditches			
1. Tall Fescue	May-May, Aug-Sep	1 Pound	40 Pounds

^{1/} Other seed species may be substituted for these mixtures. Check with local SCS office for recommendations.

^{2/} These seeding dates are ideal. With the use of mulch and irrigation, seedings could be made any time throughout the growing season.

TABLE II

Maintenance Fertilization and Mowing for Permanent Seeding

Mixture	Formula	Fertilizer Rate		Time	Mowing
		Lbs/Ac	Lbs/1000 Sq. Ft.		
I. A. Creeping Red Fescue Domestic Ryegrass Kentucky Bluegrass	10-10-10	500	12	Fall. Yearly or as needed	Not closer than 3"
I. B. Tall Fescue	10-10-10	500	12	Fall. Yearly or as needed	Not closer than 4"
I. C. Creeping Red Fescue	10-10-10	500	12	Fall. Yearly or as needed	Not closer than 4"
II. A. 2 Crownvetch	0-20-20	400	10	Spring. Yearly following establish- ment and every 4-7 years there- after	Do not mow.
II. A. 1, II. B. 1. Tall Fescue	10-10-10	500	12	Fall. Yearly or as needed	Not closer than 4"



STANDARD AND SPECIFICATIONS
FOR
CRITICAL AREA PLANTING

(Using Ground Covers, Vines, Shrubs, and Trees)

STANDARD

Definition

Planting permanent vegetation such as ground covers, vines, shrubs, and trees on critical areas.

Purpose

To stabilize the area; reduce damages from sediment and runoff to downstream areas; to enhance natural beauty.

Conditions Where Practice Applies

Graded or cleared areas subject to erosion, where a permanent long-lived vegetative cover other than turf is desired.

SPECIFICATIONS

Listed are some plants known to be suitable for soil erosion control and possessing aesthetic value. This list is neither inclusive or exclusive. The list includes plants which establish easily on difficult sites, as well as plants that will require some site improvement before they grow satisfactorily.

These plants cannot be expected to provide an erosion control cover and prevent soil slippage on a soil that is not stable due to its structure, water movement, or excessive slope.

Ground covers are not necessarily low-maintenance plants, although some of them are. In general, they are more difficult to establish than turf. Plants included in this list respond favorably to careful treatment during the period of establishment.

I. Planting Time:

A. Early spring. This allows for the maximum root and top development to check soil erosion and allow the plant to become established before winter.

II. Soil Preparation:

A. For short slopes, small areas, and mass plantings of close spacing apply a commercial granular fertilizer, such as 5-10-10, and organic supplement, such as composted cow manure, peat, or well-rotted sawdust, and work into the soil prior to planting. Fertilizer rate - 30-50 pounds per 1000 square feet. The organic material needed will depend upon the soil and plant being used. Plants such as pachysandra require a high rate of organic material, about a 2-inch layer worked into the root zone. Depending on the type and steepness of slope, the depth of soil preparation will vary from 4 to 6 inches.

B. For steep slopes and large area plantings, working up the entire planting area would be impractical and would probably induce erosion. Center hole planting, a hole dug for each plant, would be more desirable. If the soil on the slope is poorly suited to the species being planted, incorporate organic material into the planting hole. Whether organic material is needed or not, fertilize each plant at the rate of one ounce per plant of a complete fertilizer such as 10-10-10. Mix fertilizer with soil below the roots of the plants, or place slow release pellet or packet in bottom of planting hole.

C. Another alternative is to add to the planting hole a sandy loam soil mixed with peat, composted cow manure, or well-rotted sawdust at a rate of 1:1 or 2:1.

D. The entire planted slope should be covered with a protective mulch, such as straw, wood chips, or wood pulp fiber, to conserve moisture and control soil erosion. Weeds should be controlled.

E. Where erosion hazard is very high, jute matting or fiber glass matting stapled to the slope will provide excellent soil erosion control.

III. Establishment:

A. Some Watering, weeding, remulching, and fertilizing may be required of a new planting during the period of establishment. Cultivation is not recommended. This will encourage soil erosion and cause root injury. Competing weeds should be controlled.

B. If a controlled release fertilizer was used at the time of planting, additional fertilizing will not be necessary for several years. Otherwise, fertilize plantings the spring of the second growing season and thereafter as needed, using 2 to 3 pounds per 100 square feet of a granulated commercial fertilizer such as 5-10-10.

PAGES 23-24 "CRITICAL AREA STABILIZATION (WITH TRAILING
PLANTS, VINES, SHRUBS AND TREES)" REMOVED DUE TO
OVERSIZE.

STANDARDS AND SPECIFICATIONS
FOR
DIVERSION
(Temporary and Permanent)

Definition

An earth channel with supporting ridge on the lower side constructed across the slope.

Scope

This standard covers the installation of diversions on construction sites and urban developments.

It includes temporary diversions, interceptors and diversion dikes as well as permanent diversions and level spreaders. Temporary diversions usually have a life expectancy of one year or less and the failure hazard is low.

Purpose

The purpose of this practice is to divert water from areas where it is in excess to sites where it can be used or disposed of safely.

Conditions Where Practice Applies

This practice applies to sites where runoff from higher lying areas is damaging (1) low lying areas, (2) cut or fill slopes or steeply sloping land, (3) critical sediment source areas in construction sites, (4) buildings and residences, and (5) active gullies or other erodible areas.

Diversions must have stable outlets. The site, slopes and soils must be such that the diversion can be maintained throughout its planned life.

Diversions are not applicable below high sediment producing areas unless land treatment practices or structural measures, designed to prevent damaging accumulations of sediment in the channels, are installed with or before the diversions.

Design Criteria

Location

Diversion locations shall be determined by considering outlet conditions, topography, land use, development layout, soil type and length of slope.

Avoid locations in or immediately below unstable or highly erosive soils unless special treatment or stabilization measures are previously applied.

Capacity

Runoff will be computed by the method outlined in Chapter 2, SCS Engineering Field Manual for Conservation Practices or by other acceptable methods. Runoff computations will be based upon the most severe soil and cover conditions that will exist in the area above the diversion during the planned life of the structure.

The minimum design 24-hour storm frequencies and freeboard will comply with Table 1. In all cases, the design storm frequency should be chosen to provide protection which is compatible with hazard or damage that would occur if the diversion should overtop.

Table 1 - Design Frequencies and Freeboard

DIVERSION TYPE	TYPICAL AREA OF PROTECTION	DESIGN FREQUENCY	FREEBOARD REQUIRED
Temporary	Construction Areas (roads, pipelines, etc.)	2 years	0.0
	Building Sites	5 years	0.0
Permanent	Land Areas, Play Fields, Recreation Areas, etc.	25 years	0.3 ft.
	Homes, Schools, Industrial Buildings, etc.	50 years	0.5 ft.

Design Velocity

Diversions should be designed so that the design velocities are as high as will be safe for the planned type of protective vegetation and the expected maintenance. Maximum permissible velocities are dependent upon (1) the erosion resistance of the soil in which the diversion is constructed and (2) the quality of the vegetation established and maintained in the diversion channel.

The maximum allowable velocities for diversions are listed in Table 2.

Table 2 - Permissible Velocities

Soil Texture	Allowable Velocity (V) in Ft./Sec.			
	Bare Channel	Condition of Vegetation		
		Poor	Fair	Good
Sand, silt, sandy loam, silt loam	1.5	1.5	2.0	3.0
Silty clay loam, sandy clay loam	2.0	3.0	4.0	5.0
Clay	2.5	3.0	5.0	6.0

Cross Section

The channel may be parabolic, V-shaped, or trapezoidal. The diversion shall be designed to have stable side slopes. The ridge height shall include a minimum settlement factor of 10 percent. The ridge shall have a minimum top width of 4 feet at the design water elevation. The minimum cross section shall meet the specified dimensions. The top of the constructed ridge shall not be lower at any point than the design water elevation plus the specified overfill for settlement.

Grade

Channel grade for diversions may be uniform or variable. The permissible velocity for the soil type and vegetative cover will determine the maximum grade. Level diversions with blocked ends may be used when adequate pipe outlets are provided.

Channel Dimensions

Channel dimensions will be determined using the appropriate retardance factor, or by Manning's formula using a suitable "n" value. Retardance factors will be determined using Table 3.

Table 3 - Vegetal Retardance Factors

Stand	Average length of vegetation	Degree of retardance	Stand	Average length of vegetation	Degree of retardance
Good	Longer than 24'	A	Fair	Longer than 24"	B
	11 to 24"	B		11 to 24"	C
	6 to 10"	C		6 to 10"	D
	2 to 6"	D		2 to 6"	D
	Less than 2"	E		Less than 2"	E

Parabolic channel sizes may be selected using charts in APPENDIX B-1, and trapezoidal channel sizes may be selected using APPENDIX B-2.

Outlets

Diversions are to have adequate outlets which will convey run-off without causing erosion. The following types of outlets are acceptable.

1. Natural or constructed vegetated outlets capable of safely carrying the design discharge. The outlet should be established and well vegetated prior to construction of the diversion.
2. Properly designed and constructed grade stabilization structures or storm sewers.

Level Spreader

A level lip spreader shall be used at diversion outlets discharging onto areas already stabilized by vegetation. Spreaders shall be excavated at least 6 inches deep into undisturbed soil. The bottom of the excavation and the downstream lip or edge shall be level. Minimum spreader lengths shall be based on the peak rate of flow from a 10-year frequency storm as indicated on the attached design standard for level spreaders.

Diversion Dikes and Interceptors

Diversion dikes for the temporary protection of cut or fill slopes or graded rights-of-way shall be installed in accordance with the attached design standards. Diverted runoff must be discharged onto a stabilized area or through a temporary slope protection structure. (See attached design standard.)

Protection Against Sediment

1. Temporary diversions - none required.
2. Permanent diversions - as a minimum, a filter strip of close growing grass shall be maintained above the channel. The width of the filter, measured from the center of the channel, shall be one-half the channel width plus 15 feet.

The diversion ridge and channel are to be seeded to grass to prevent erosion.

Small eroded areas and sediment producing channels draining into the diversion are to be shaped and seeded prior to or during the construction of the diversion.

June 1978

CONSTRUCTION SPECIFICATION

DIVERSION

All dead furrows, ditches or other depressions to be crossed shall be filled before construction begins or as part of construction, and the earthfill used to fill the depressions will be compacted using the treads of the construction equipment. All old terraces, fence rows, or other obstructions that will interfere with the successful operation of the diversion will be removed.

The base for the diversion ridge is to be prepared so that a good bond is obtained between the original ground and the placed fill. Vegetation is to be removed and the base thoroughly disked prior to placement of fill.

The earth materials used in constructing the earthfill portions of the diversions shall be obtained from the diversion channel or other approved sources.

The earthfill materials used to construct diversions shall be compacted by routing the construction equipment over the fill in such a manner that the entire surface of the fill will be traversed by not less than one tread track of the equipment.

When an excess of earth material results from cutting the channel cross-section and grade, it shall be deposited adjacent to the supporting ridge unless otherwise directed.

The completed diversion shall conform to the cross-section and grade shown on the design.

Fertilizing, seeding, and mulching shall conform to the recommendations in the applicable vegetative standard and specification.

If there is no sediment protection provided on temporary diversions, it should be anticipated that periodic cleanout may be required.

Construction operations shall be carried out in such a manner that erosion and air and water pollution will be minimized. State and local laws concerning pollution abatement shall be complied with.

DIVERSION DIKE ABOVE STEEP SLOPES

FOR USE ON DRAINAGE AREAS OF 5 ACRES OR LESS. LARGER AREAS REQUIRE A DIVERSION DESIGN.

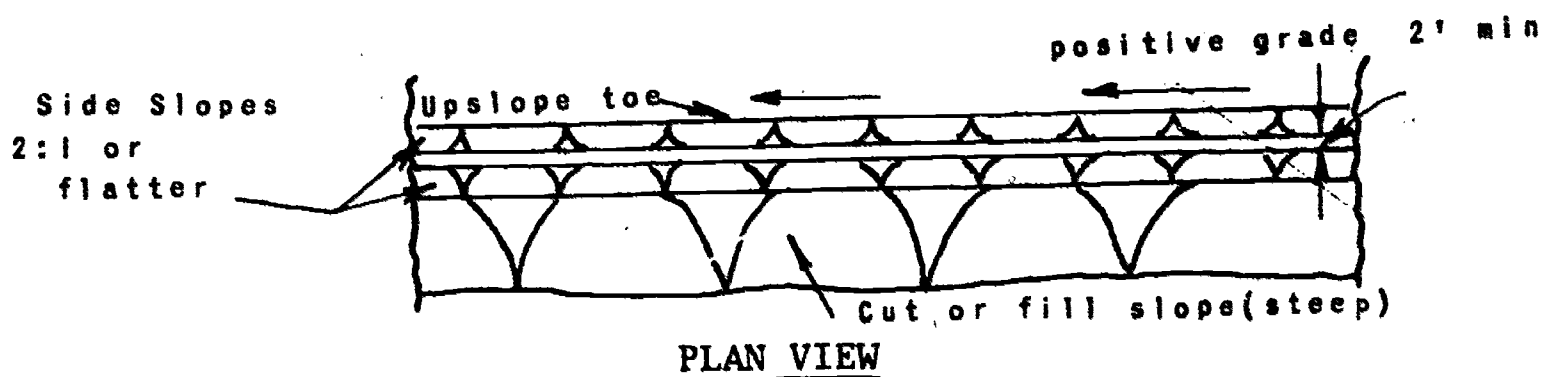
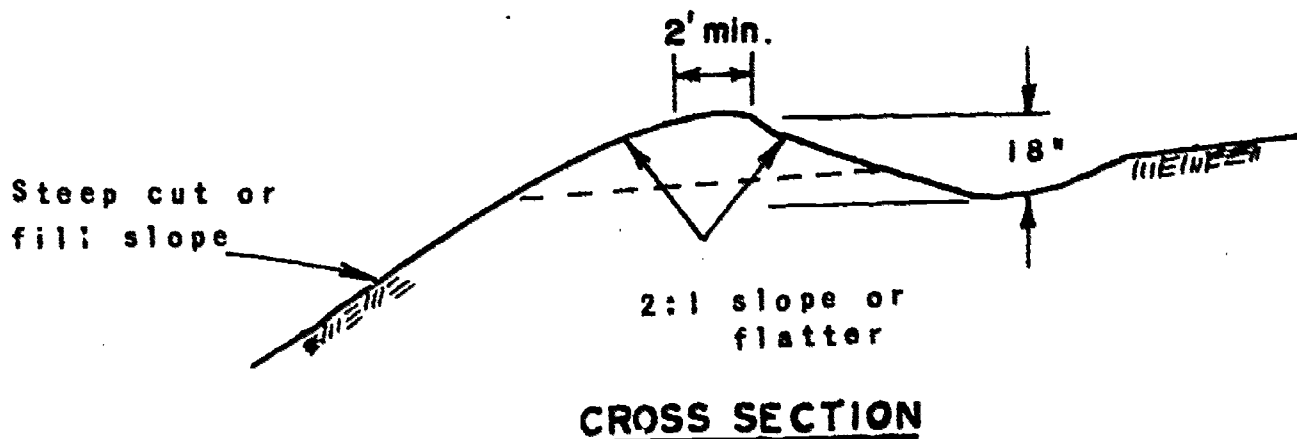

DESIGN CRITERIA

Top width - 2 ft. min.

Height (compacted fill) - 18 in. unless otherwise noted on the plans. (height measured from the upslope toe to top of the dike)

Side slopes - 2:1 or flatter.

Grade - dependent upon topography, but must have positive drainage to the outlet; may require vegetative or mechanical stabilization where grades are excessive.

GENERAL NOTES:

1. All diversions must have positive grade draining to a stabilized outlet.
2. Diverted runoff will outlet onto a stabilized undisturbed area, a prepared level spreader, or into a slope protection structure.
3. Periodic inspection and required maintenance must be provided.

**TEMPORARY INTERCEPTOR DIVERSION
FOR GRADED RIGHT-OF-WAY**

**FOR USE ON DRAINAGE AREAS OF 5 ACRES OR LESS. LARGER AREAS
REQUIRE A DIVERSION DESIGN.**

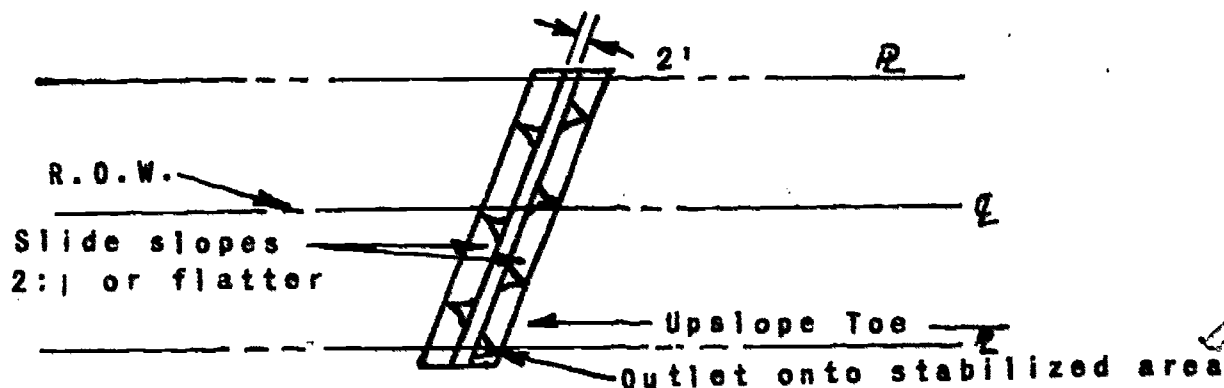
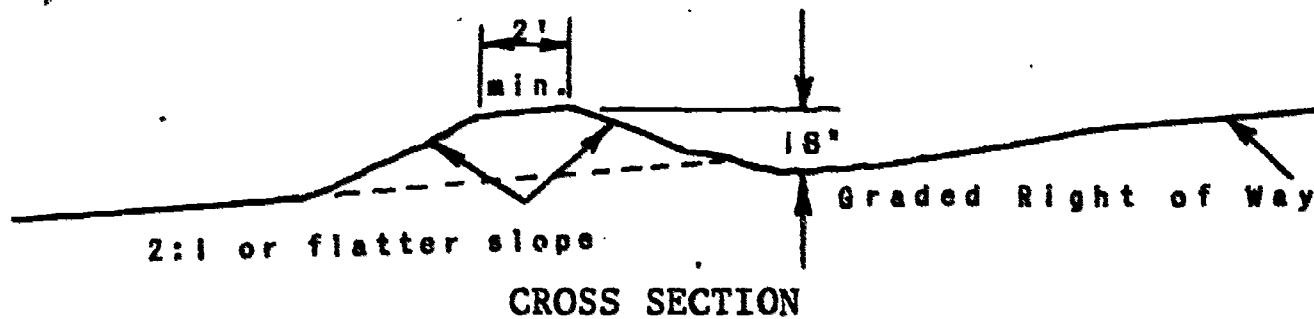

DESIGN CRITERIA

Top width - 2 ft. min.

Height - 18 in. unless otherwise noted on the plans (measured from the slope toe of the ridge).

Side slopes - 2:1 or flatter (flat enough to allow construction traffic to cross if desired).

Grade - 0.5% to 1.0%

Spacing - 200 to 300 ft. between diversions. (The steeper the slope the closer the spacing should be.)

GENERAL NOTES:

1. Top width may be wider and side slopes may be flatter, if desired.
2. Field location should be adjusted as needed to provide a stabilized safe outlet.
3. Diverted runoff shall outlet onto an undisturbed stabilized area, a prepared level spreader, or into a slope protection structure.
4. Periodic inspection and required maintenance must be provided.

LEVEL SPREADER

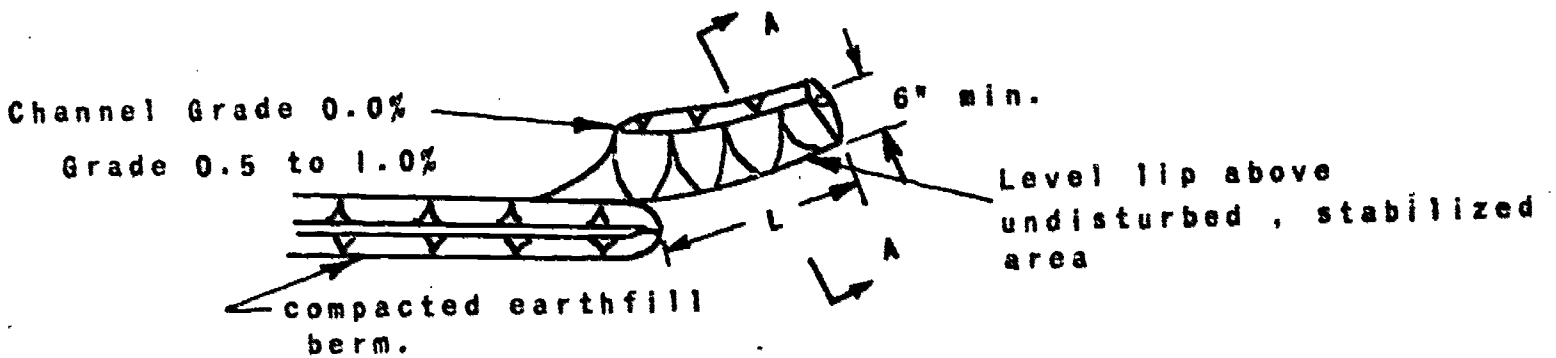
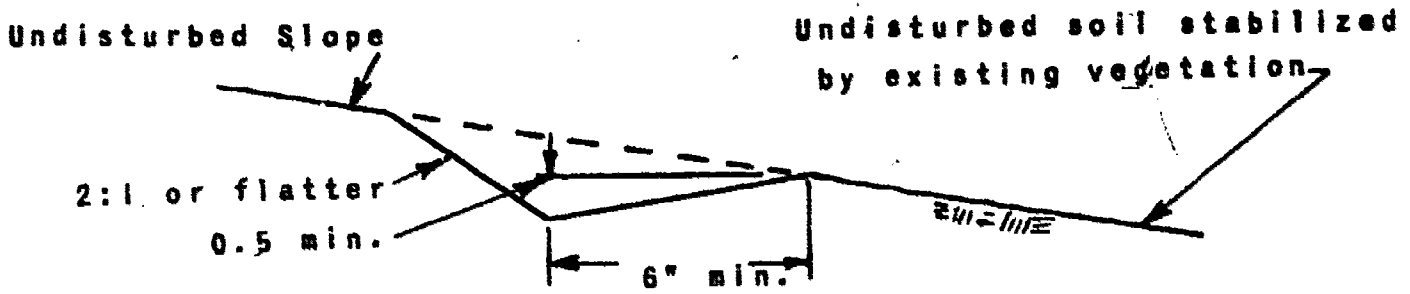

PLAN VIEW

DESIGN CRITERIA

Spreader length will be determined by estimating Q₁₀ (10 year storm frequency) flow and selecting the appropriate length from Table.

Designed Q ₁₀ (cfs)	Minimum Length ("L" in Feet)
up to 10	15
11 to 20	20
21 to 30	26
31 to 40	36
41 to 50	44

GENERAL NOTES:

1. Construct level lip on zero percent grade to insure uniform spreading of storm runoff (converting channel flow to sheet flow).
2. Level spreaders must be constructed on undisturbed soil (not on fill).
3. Entrance to spreader must be graded in a manner to insure that runoff enters directly onto the zero percent graded channel.
4. Storm runoff converted to sheet flow must outlet onto areas already stabilized by existing vegetation.
5. Periodic inspection and maintenance must be provided to insure intended purpose is accomplished.

STANDARDS AND SPECIFICATIONS
FOR
DRAINAGE-INTERCEPTOR

Definition

A conduit, such as tile, pipe, or tubing or channel installed across the slope which collects and conveys seepage water.

Purpose

Interceptor ditches or drains located across the flow of ground water or seepage are installed primarily for intercepting sub-surface flow moving down a slope. While this type of drainage intercepts and diverts both surface and subsurface flows, the removal of surface water is generally referred to as diversion drainage and the removal of subsurface water is referred to as interceptor drainage.

Conditions Where Practice Applies

Interceptor drains are used to intercept ground water or seepage from adjoining highlands. Most ground water for which drainage is required derives from recent rainfall that accumulates on or within the upper ground surface and, after replenishing the soil to water holding capacity, moves downward through the soil to the water table or a barrier above the water table. Here it accumulates and moves laterally toward an outlet. This water accumulation in the subsurface often causes slips and slides in the area where it reaches the surfaces.

Ditches may be used where drains are not feasible. They are used in shallow hardpan soils where the depth of the soil does not permit installation of tile or tubing. Ditches must be deep enough to tap and provide an outlet for ground water found in shallow, permeable strata or water bearing sand.

An outlet for the drainage system shall be available. The outlet shall be adequate for the quantity of water to be disposed of without causing erosion damage.

Design Criteria

The design and installation shall be based on adequate surveys and investigations.

Required Capacity of Drains

The required capacity shall be determined from the following table when actual on-site values are not known.

INTERCEPTOR DRAIN INFLOW RATES

Soil Texture	Inflow Rate Per 1000 Feet of Line in CFS ^{1/}			
	Land Slope %			
	0-2	2-5	5-12	over 12
Coarse sand and gravel	1.00	1.10	1.20	1.30
Sand	0.50	0.55	0.60	0.65
Sandy loam	0.25	0.28	0.30	0.33
Silt loam	0.10	0.11	0.12	0.13
Clay and clay loam	0.20	0.22	0.24	0.26

^{1/} Discharge of flowing springs or direct entry of surface flow through a surface inlet or filter must be added to the values in the chart. Such flow should be measured or estimated.

Size of Drain

The size of the drain may be determined by using the appropriate table in APPENDIX B-6 or the size may be computed by applying Manning's formula based on one of the following assumptions:

1. Hydraulic grade line parallel to the bottom grade of the drain with the drain flowing full at design flow.
2. The drain flowing part full where a steep grade or other condition requires excess capacity.
3. Drain flowing under pressure with hydraulic grade line set by site conditions on a grade which differs from that of the drain. This procedure shall be used only where surface water inlets or nearness of the drain to outlets with fixed water elevations permit satisfactory estimates of hydraulic pressure and flow under design conditions.

The minimum size shall be 4 inches.

Depth and Location

The depth and location of the drain shall be based on site conditions including soils, soil borings, topography, groundwater conditions, and outlets.

The minimum depth of cover shall be 24 inches.

Envelopes and Filters

All interceptor drains shall be provided with a 3-inch sand and gravel envelope to provide bedding for the drain and to improve the permeability in the zone around the drain. Envelope material shall consist of sand gravel material, all of which will pass a 1½ inch sieve, 90 to 100 percent shall pass the ¾ inch sieve and not more than 10 percent shall pass the No. 60 sieve.

When site conditions require a filter to prevent sediment accumulation in the conduit it shall consist of fiberglass filter material that completely encases the drain. It shall be manufactured from borosilicate type glass and the manufacturer shall certify that it is suitable for underground use. The fibers shall be of variable size, with some larger fibers intertwined in the mat in a random manner.

CONSTRUCTION SPECIFICATION

DRAINAGE-INTERCEPTOR

Inspection and Handling of Materials

Materials for drains shall be inspected before installation. Clay and concrete shall be protected from freezing and thawing prior to installation. Bituminized fiber and plastic pipe and tubing shall be protected from hazards causing deformation or warping. All materials shall be satisfactory for intended use and shall meet applicable specifications and standards.

Placement

All drains, both flexible as plastic tubing and non-flexible as clay and concrete tile shall be laid to line and grade and completely surrounded with a minimum of 3 inches of envelope material. A filter where required shall cover all open joints and perforations.

The gap between the drain joints shall not exceed:

Muck	1/8" to 3/8"
Clay soils	1/8" to 1/4"
Loamy soils	1/8"
Sandy soils	1/16" (use filter)

The upper end of the drain shall be capped with concrete or other durable material.

Earth backfill material shall be placed in the trench in such a manner that displacement of the drain will not occur.

STANDARDS AND SPECIFICATIONS
FOR
GRADE STABILIZATION STRUCTURE
(Temporary Chute or Flume)

Definition

A temporary channel of bituminous concrete, Portland cement concrete, or comparable material to conduct surface runoff from the top of a slope to the bottom of the slope.

Purpose

The purpose of this practice is to convey storm runoff safely down cut and fill slopes to minimize erosion.

Conditions Where Practice Applies

Chutes or flumes are to be used where concentrated water will cause excessive erosion on cut and fill slopes. The structures can be left in place until adequate vegetation and the permanent drainage system has been installed.

Design Criteria

The temporary chutes or flumes are divided into two size groups as follows:

Size Group A

1. The height of the dike at the entrance (H) equals 1.5 feet.
2. The depth of flow down the chute (d) equals 8 inches.
3. The length of the inlet and outlet sections (L) equals 5 feet.

Size Group B

1. The height of the dike at the entrance (H) equals 2 feet.
2. The depth of flow down the chute (d) equals 10 inches.
3. The length of the inlet and outlet sections (L) equals 6 feet.

Each size group has various bottom widths and allowable drainage areas as shown in the following tabulation:

Size ^{1/}	Bottom Width, b, ft.	Maximum Drainage Area acres	Size ^{1/}	Bottom Width, b, ft.	Maximum Drainage Area acres
A-2	2	5	B-4	4	14
A-4	4	8	B-6	6	20
A-6	6	11	B-8	8	25
A-8	8	14	B-10	10	31
A-10	10	18	B-12	12	36

^{1/} The size is designated with a letter and a number, such as A-6 which means a chute or flume in Size Group A with a 6 foot bottom.

If a minimum of 75% of the drainage area will have a good grass or woodland cover throughout the life of the structure, the drainage areas listed above may be increased by 50%. If a minimum of 75% of the drainage area will have a good mulch cover throughout the life of the structure, the drainage area listed above may be increased by 25%.

For dimensions, grades, and construction details, see attached design standard. Detail designs are required for drainage areas larger than those indicated above.

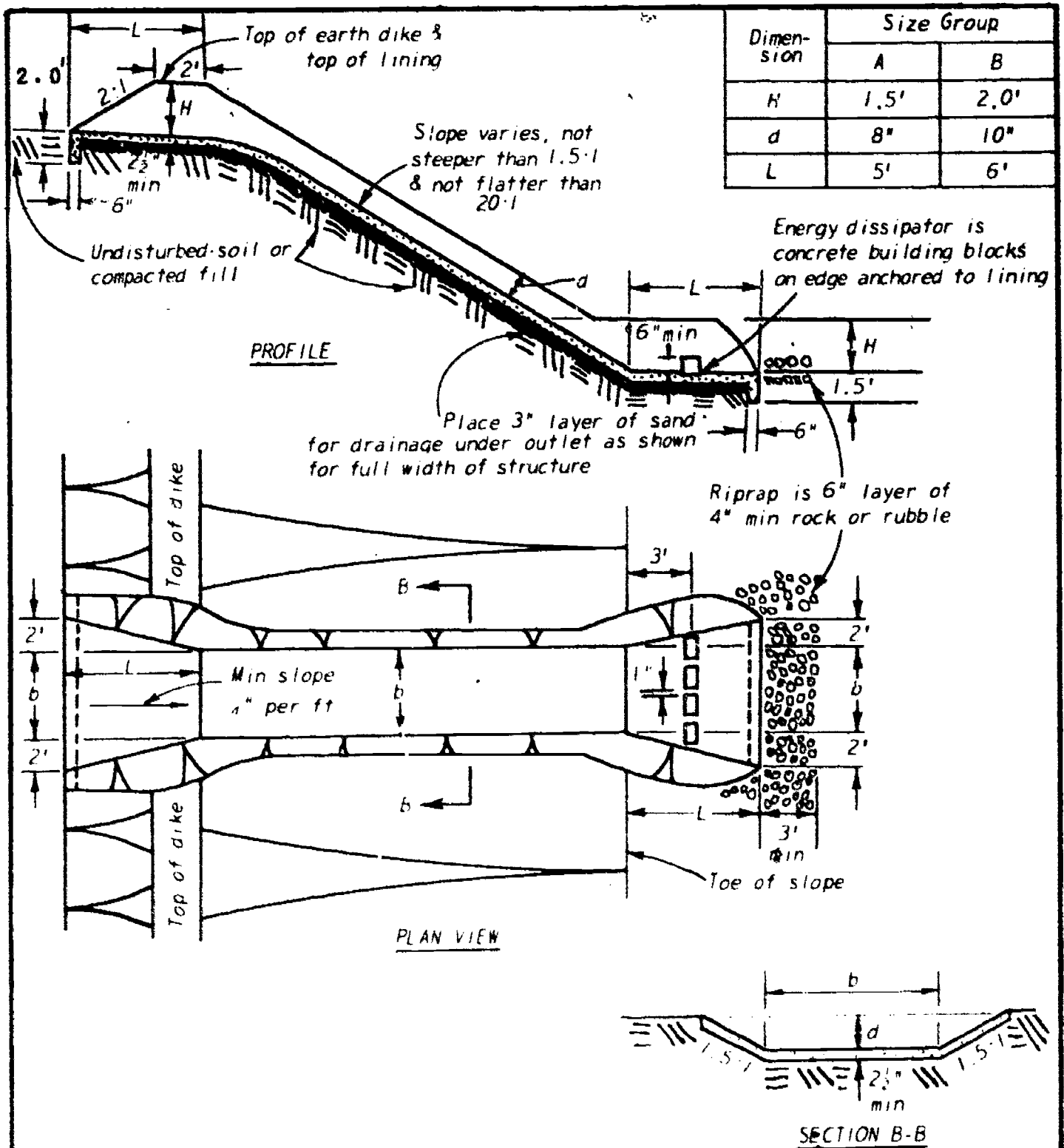

Dimension	Size Group	
	A	B
H	1.5'	2.0'
d	8"	10"
L	5'	6'

Notes:

1. Lining shall be Portland Cement concrete, bituminous concrete or comparable material.
2. Some type of energy dissipator, such as the one shown above, must be used to prevent erosion at the outlet.
3. The size is designated with a letter and a number, such as A-6, which means Size Group A with a 6 ft. bottom width (b). For structure dimensions, see table in upper right hand corner.

U. S. DEPARTMENT OF AGRICULTURE SOIL CONSERVATION SERVICE	GRADE STABILIZATION STRUCTURE (Temporary)	
--	---	--



CONSTRUCTION SPECIFICATION

GRADE STABILIZATION STRUCTURE (Temporary Chute or Flume)

1. The structure shall be placed on undisturbed soil or well compacted fill.
2. The cut or fill slope shall not be steeper than 1 vertical to 1.5 horizontal (1.5:1) and should not be flatter than 20:1.
3. The top of the earth dikes shall not be lower at any point than the top of the lining at the entrance of the structure.
4. The lining should be placed beginning at the lower end and proceeding up the slope to the upper end. The lining shall be well compacted and free of voids. The lining surface shall be reasonably smooth.
5. The entrance floor at the upper end of the structure shall have a slope toward the outlet of 1/4 to 1/2 inch per foot.
6. Concrete shall have a minimum cement content of 6 bags per cubic yard and a maximum water content of 6 gallons per bag of cement.
7. Adequate vegetative protection and drainage works shall be installed within the expected life of the structure which is considered to be about 18 months. The structure shall be removed after serving its useful life and the site is properly graded and seeded.

STANDARDS AND SPECIFICATIONS
FOR
GRADE STABILIZATION STRUCTURE
(Temporary Pipe Drop)

Definition

A temporary pipe installed down a bank slope to safely conduct runoff water from the top to the bottom of the bank slope. (See attached design standard.)

Purpose

The purpose of this practice is to convey storm runoff safely down cut or fill slopes to minimize erosion.

Condition Where Practice Applies

Pipe drops are to be used to stabilize cut or fill banks where water concentrations would cause erosion. Site conditions are such that vegetative measures can be installed and the temporary structure removed within 18 months after installation.

Design Criteria

Capacity

The design capacity for temporary pipes shall be as required to pass the peak runoff expected from a 24-hour, 2-year frequency storm. Runoff will be computed by the method outlined in Chapter 2, SCS Engineering Field Manual for Conservation Practices, or by other acceptable methods. Runoff computation will be based upon the most severe soil and cover conditions that will exist in the area draining into the pipe drop during the planned life of the structure.

Pipe capacities may be determined from the chapter in APPENDIX B-7.

Inlet

A hood inlet type entrance shall be used (APPENDIX B-7). The pipe drop inlet shall be protected by riprap or concrete.

Outlet

Outlet protection shall be provided by riprap or other means.

June 1978

Pipe Size

The pipe diameter shall be determined from design charts in APPENDIX B-7. The pipe shall have sufficient flow area based on head discharge relationships to carry the design capacity.

Dike

Pipe drops should be used in conjunction with and as an outlet for diversion dikes. The dike height above the pipe inlet invert shall be adequate to contain a water elevation sufficient to cause full pipe flow plus an allowance of at least 1.0 feet for freeboard. A water depth of 1.8 times the pipe diameter above the pipe inlet invert is required to assure full pipe flow.

GRADE STABILIZATION STRUCTURE
(TEMPORARY)

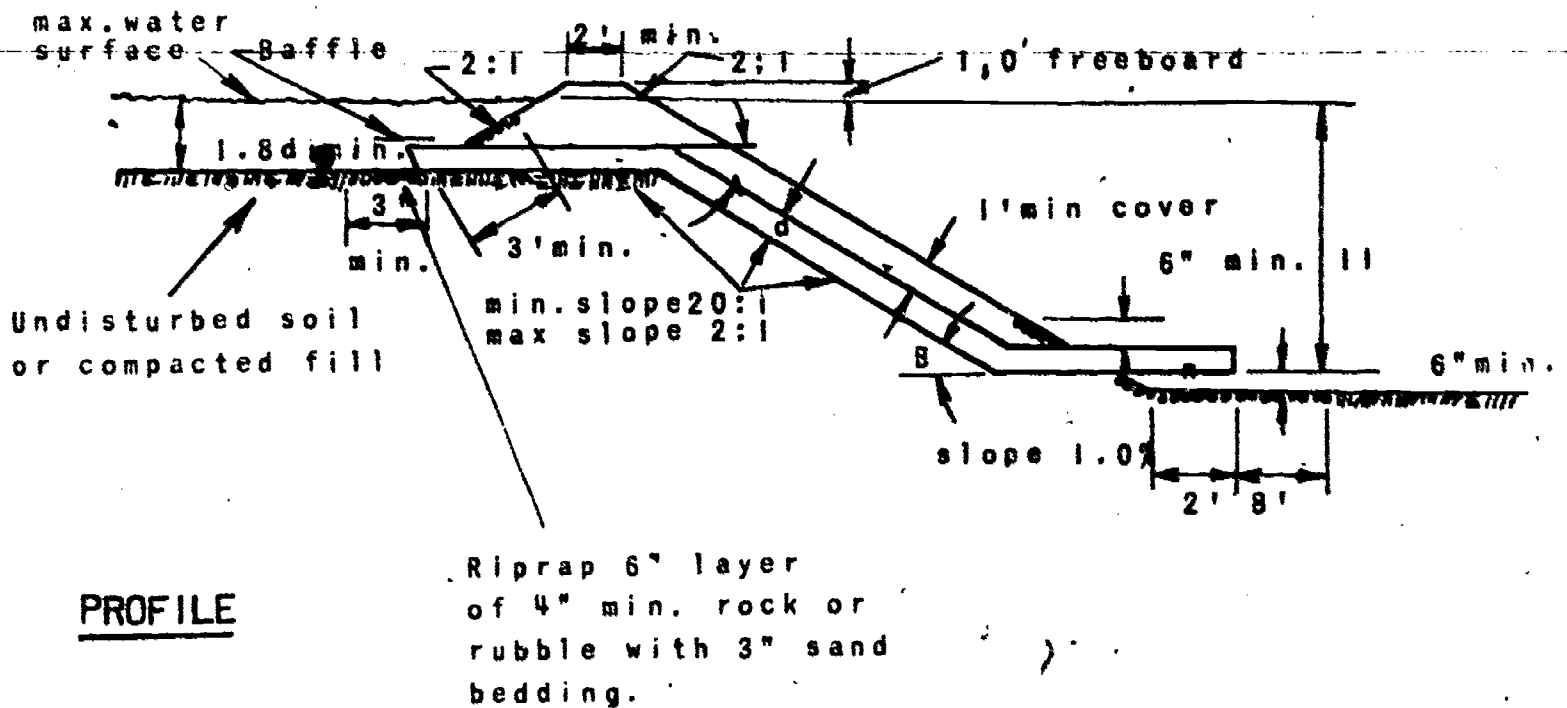

No Scale

Notes:

1. If an emergency spillway is used, its crest shall be at least 1.8d above the intert of the hooded inlet and at least 0.5' freeboard shall be provided above its maximum flow depth.
2. Bend A is optional to ease installation.
3. The baffle shall be similar to that illustrated in APPENDIX B-7.
4. See APPENDIX B-7 for capacity data on both CMP and smooth metal pipe.
5. A reinforced concrete slab may be substituted for the riprap at the pipe inlet. The slab shall be at least 6" thick with a minimum of one grid of #3 re-bars at 6" spacing. The slab shall be bedded with at least 3" of clean sand.

CONSTRUCTION SPECIFICATION
GRADE STABILIZATION STRUCTURE
(Temporary Pipe Drop)

1. The structure shall be placed in undisturbed soil or well compacted fill.
2. The cut or fill slope shall not be steeper than 1 vertical to 1.5 horizontal (1.5:1) and should not be flatter than 20:1.
3. The pipe shall be embedded in the embankment to a depth that will insure stability.
4. Protective measures of concrete or riprap shall be installed at the inlet and outlet as needed to protect against erosion.
5. The pipe shall be of smooth or corrugated metal of the required strength and durability.
6. Backfill shall be placed in layers and tamped to insure adequate compaction.
7. Adequate vegetative protection and drainage works shall be installed within the expected life of a temporary structure which is considered to be about 18 months. The structure shall be removed after serving its useful life and the site is properly graded and seeded.

STANDARDS AND SPECIFICATIONS
FOR
GRASSED WATERWAY OR OUTLET

Definition

A natural or constructed waterway or outlet shaped or graded and established in suitable vegetation as needed for safe disposal of runoff water.

Purpose

To provide for the disposal of excess surface water from construction sites and urban areas without causing erosion.

Condition Where Practice Applies

This practice applies to sites where added capacity or vegetative protection or both are required to control erosion resulting from concentrated runoff.

Supplemental measures may be required with this practice. These may include such things as (1) grade control structures, (2) subsurface drainage to permit growing suitable vegetation and to eliminate wet spots that may be a nuisance, (3) a paved channel bottom or buried storm drain to handle frequently occurring storm runoff, base flow, or snowmelt.

Design Criteria

Capacity

The minimum capacity shall be that required to convey the peak runoff expected from a 24-hour, 10-year frequency storm. Runoff will be computed by the method outlined in Chapter 2, SCS Engineering Field Manual for Conservation Practices, or by other acceptable methods. Runoff computation will be based upon the most severe soil and cover conditions that will exist in the area draining into the waterway during the planned life of the structure.

Velocity

The design velocity is to be based upon soil, duration of flow, and type and quality of vegetation. Design velocities will be determined using charts in APPENDIX B-3, except that velocities exceeding 5 feet per second shall be used only where good cover and proper maintenance can be attained.

Channel Dimensions

Channel dimensions will be determined using the appropriate retardance factor, or by Manning's formula using a suitable "n" value. Parabolic channel sizes may be selected using charts in APPENDIX B-3. On steep areas where stone centered waterways are required, the channel sizes may be selected using APPENDIX B-4.

Cross Section

The cross section may be parabolic, vee-shaped, or trapezoidal.

Width

The bottom width of trapezoidal waterways or outlets are not to exceed 50 feet unless multiple or divided waterways are used, or other means provided to control meander of low flow.

Depth

The minimum depth of waterway receiving water from diversions or tributary channels is to be that required to keep the design water surface in the waterway or outlet at or below the design water surface elevation in the diversion or other tributary channel at their junction. To provide for loss in channel capacity due to vegetal matter accumulation, sedimentation, and normal seed-bed preparation, the channel depth and width should be increased proportionally to maintain the hydraulic properties of the waterway. In parabolic channels this may be accomplished by adding 0.3 foot to the depth and 2 feet to the top width of the channel. This is not required on waterways located in natural watercourses.

Where a paved bottom is used in combination with vegetated side slopes, the paved section is to be designed to handle the base flow, snowmelt or runoff from a one-year frequency storm whichever is greater. The flow depth of the paved section shall be a minimum of 0.5 foot.

Drainage

In areas with high water table or seepage problems, subsurface drainage or stone centers will be provided. A minimum drainage coefficient of 3/8 inch in twenty-four (24) hours is to be used for subsurface drainage design. An open joint storm drain may be used to serve the same purpose and also handle storm runoff, base flow or snowmelt. The storm drain should be designed to handle base flow, snowmelt, or the runoff from at least a one-year frequency storm, whichever is greater.

CONSTRUCTION SPECIFICATION

GRASSED WATERWAY OR OUTLET

All trees, brush, stumps and other objectionable material shall be removed and disposed of in a manner so that they will not interfere with construction or the proper functioning of the waterway or outlet.

The waterway or outlet shall be constructed to the dimensions specified on the design, and the cross section shall be free from bank projections or other irregularities.

All ditches or other depressions below the designed grade will be backfilled with fill material that is free from brush, roots, sod or other perishable material, and rocks in excess of 6 inches in diameter. Backfill will be placed in approximately uniform horizontal layers of not more than 9 inches in thickness and each layer will be compacted using the treads or tracks of the construction equipment.

All excavated material not needed in the construction of the waterway or outlet shall be spread or disposed of so it will not interfere with the flow of water into the waterway.

When specified on the design, topsoil from the construction area will be preserved by stockpiling. After the waterway has been constructed to proper grades and cross section with proper allowance for topsoil, the topsoil will be uniformly spread over the area to a minimum depth of four (4) inches.

Waterways or outlets shall be protected against erosion by vegetative means as soon after construction as practical and before diversions or other channels are outletted into them. Consideration should be given to sodding channels to provide erosion protection immediately after construction.

Seeding, fertilizing, mulching, and sodding shall be performed according to Critical Area Planting Specifications.

STANDARD AND SPECIFICATIONS
FOR
HEAVY USE AREA PROTECTION

Definitions

Protecting heavily used areas by establishing vegetative cover, by surfacing with suitable materials, or by installing needed structures. (Does not include Critical Area Planting or Recreation Area Improvement.)

Purpose

This practice is used to stabilize urban, recreation, or essential facility areas subjected to sustained heavy use by people, animals or vehicles.

Conditions Where Practice Applies

On urban and recreation or other areas subjected to sustained heavy use that require special treatment to protect the area from erosion or other environmental deterioration.

Design Criteria

Drainage and Erosion Control

Provision shall be made for surface and subsurface drainage as needed, and for disposal of runoff without erosion.

Base Course

All areas to be paved shall have a 6-inch base course of gravel, crushed stone, or other suitable material.

Areas subject to automotive traffic shall be designed for a wheel load of at least 4,000-pounds.

Surface Treatment

Asphalt - The thickness of the asphalt course, the kind and size of aggregate, type of proportioning of bituminous materials and the mixing and placing of these materials shall be in accord with good highway practice for the expected loading.

Concrete - The quality and thickness of concrete and the spacing and size of reinforcing steel shall be appropriate for the expected loading and in accord with sound engineering practice.

Gravel - Minimum thickness for gravel surface shall be 2 inches.

Other - Where other surfacing materials are used, such as cinders, tanbark, sawdust, etc., the minimum thickness shall be 2 inches.

Structures

All structures shall be designed in accordance with appropriate Soil Conservation Service standards and specifications.

Sprays and Artificial Mulches

Sprays of asphalt, oil, plastic, manufactured mulches and similar materials will be installed in accordance with the manufacturers recommendations.

Vegetative Measures

Liming, fertilizing, seeding and sodding will be in accord with the Vegetative Standards appropriate to the area.

Safety

Necessary safety features, considering the intended use and site topography, will be included in the plan.

Plans and Specifications

Plans and Specifications for Heavy Use Area Protection shall be in keeping with this standard and shall describe the requirements for application of the practice to achieve its intended purpose.

Special attention will be given to saving and maintaining key trees and other vegetation that has scenic value, provides shade, reduces erosion and runoff, provides den and food for wildlife or that adds to the aesthetics of the area. Measures and construction methods that enhance fish and wildlife values shall be incorporated as needed and practical.

Special features to control erosion during construction will be incorporated as required.

June 1978

All required smoothing, grading, or leveling shall be completed prior to the start of surfacing operations. The subgrade shall be compacted as necessary to attain a firm foundation for the surfacing material.

Bituminous surfacing shall be in accordance with Section 400 of the ODH Construction and Material Specifications.

Construction Operations shall be carried out in such a manner that erosion and air and water pollution will be kept to a minimum.

STANDARDS AND SPECIFICATIONS
FOR
LAND GRADING

Definition

Reshaping the ground surface by grading to planned grades which are determined by engineering survey and layout.

Purpose

The practice is for one or more of the following: Provide more suitable sites for buildings, facilities and other land uses; improve surface drainage; and control erosion.

Conditions Where Practice Applies

The practice is applicable where grading to planned elevations is practical.

Planning Criteria

The grading plan and installation shall be based upon adequate surveys and investigations. The plan is to show the location, slope, cut, fill, and finish elevation of the surfaces to be graded and the auxiliary practices for safe disposal of runoff water, slope stabilization, erosion control and drainage such as waterways, lined ditches, diversions, grade stabilization structures, retaining walls, and surface and subsurface drains.

The development and establishment of the plan shall include the following:

1. The cut face of the earth excavation which is to be vegetated shall not be steeper than 2 horizontal to 1 vertical. Cut slopes of areas not to be vegetated shall be at the safe angle of repose for the materials encountered.
2. The permanent exposed faces of fills shall be no steeper than 2 horizontal to 1 vertical.
3. Provisions are to be made to safely conduct surface water to storm drains or suitable natural water courses and to prevent surface runoff from damaging cut faces and fill slopes.

June 1978

4. Subsurface drainage is to be provided (1) in areas having high water table, or (2) to intercept seepage that would affect slope stability, building foundations or create undesirable wetness.
5. Excavations shall not be made so close to property lines as to endanger adjoining property without supporting and protecting such property from erosion, sliding, settling or cracking.
6. No fill is to be placed where it will slide, or wash upon the premises of another, or so placed adjacent to the bank of a channel as to create bank failure or reduce the natural capacity of the stream.
7. Fills are to consist of material from cut areas, borrow pits, or other approved sources.

CONSTRUCTION SPECIFICATION

LAND GRADING

Timber, logs, brush, rubbish, and vegetable matter which will interfere with the grading operation or affect the planned stability of fill areas shall be removed and disposed of according to the plan.

Topsoil is to be stripped and stockpiled in amounts necessary to completely finish grading of all exposed areas requiring topsoil for the establishment of vegetation.

Fill material is to be free of brush, rubbish, rocks, logs, and stumps in amounts that will be detrimental to constructing stable fills.

Cut slopes which are to be topsoiled will be scarified to a minimum depth of 3 inches prior to placement of topsoil.

Unless otherwise regulated by stricter controls of local building codes, all fills intended to support buildings, structures, sewers and conduits are to be compacted to a minimum of 90 percent of standard proctor with proper moisture control. Compaction of other fills will be as required to reduce slipping, erosion or excess saturation.

Frozen materials or soft, mucky or easily compressible materials are not to be incorporated in fills intended to support buildings, parking lots, roads, structures, sewers or conduits.

Maximum thickness of layers of fills to be compacted are not to exceed 8 inches.

All areas are to be rough graded to within 0.2 foot of the planned elevation after allowance has been made for thickness of topsoil, paving or other installations.

All disturbed areas shall be left with a neat and finished appearance.

Seeding, fertilizing, mulching, and sodding shall be in accordance with applicable standards.

STANDARD AND SPECIFICATIONS
FOR
MULCHING

STANDARD

Definition

Stabilizing silt-producing areas by applying plant residues or other suitable materials, not produced on the site, to the surface of the soil.

Purpose

To reduce runoff and erosion

Conditions Where Practice Applies

Graded or cleared areas which are subject to erosion for six months or less; where seedings may not have a suitable growing season to produce an erosion retardant cover, but which can be stabilized with mulch cover.

SPECIFICATIONS

I. Site Preparation

- A. Grade as needed and feasible to permit use of conventional equipment for applying and anchoring mulch.
- B. Install needed erosion control practices such as diversions, temporary waterways for diversion outlets, and desilting basins.

II. Mulching

- A. Mulching materials should be unweathered small grain straw (Preferably wheat) and should be applied at the rate of 2 tons per acre or 100 pounds (2-3 bales) per 1000 square feet.

- B. Spread mulch uniformly by hand or mechanically so the soil is surface covered.
- C. Mulch Anchoring should be accomplished immediately after placement to minimize loss by wind and water.
- D. Mulch Anchoring Methods.
 1. Mulch anchoring tool - Use a mulch anchoring tool with a series of flat, notched discs that punch and anchor the mulch material into the soil.
 2. Asphalt mulch tie-down
 - a. Liquid asphalt - Rapid curing (R.C. 70, 250, or 800) or medium curing (M.C. 250 or 800). Apply 0.04 gallons per square yard or 200 gallons per acre. Liquid asphalt, since it is cut back with a kerosene like product, can be applied during freezing weather.
 - b. Emulsified asphalt - Rapid setting (R.S. 1 or 2), medium setting (M.S. 2) or slow setting (S.S. 1). Apply 0.03 gallons per square yard or 160 gallons per acre. Emulsified asphalt contains approximately 50% water, therefore it cannot be applied during freezing weather.
 3. Mulch Nettings - Staple lightweight paper, jute, cotton, or plastic nettings to the soil surface according to manufacturers recommendations. Use in areas of water concentration to hold mulch in place.

STANDARD AND SPECIFICATION
FOR
TEMPORARY SEDIMENT BASIN

Definition

A temporary barrier or dam constructed across a watercourse or at other suitable locations to retain sediment and other waterborne debris.

Scope

This standard establishes minimum acceptable quality for the design and construction of temporary sediment basins formed by an embankment, excavation, or a combination of embankment and excavation. This standard is limited to sites where:

- (1) Failure of the structure would not result in loss of life; damage to homes; commercial, or industrial buildings; damage to highways or railroads, or interruption of use or service of private utilities.
- (2) The height of dam is 25 feet or less, as measured from the natural stream bed at centerline of dam to the top of dam.
- (3) The total volume of storage is 150 acre-feet or less.
- (4) The drainage area is 100 acres or less.
- (5) The basin will be removed within a three-year period after construction.

Purpose

Temporary sediment basins are used as a means of trapping and storing sediment from eroding areas in order to protect downstream areas from damage resulting from sedimentation and waterborne debris.

Conditions Where Practice Applies

Temporary sediment basins apply where physical site conditions or other restrictions preclude the installation of erosion control measures to adequately control erosion and sedimentation. It may be used downslope from construction operations which expose areas to erosion. Temporary sediment basins will be removed after the exposed areas are adequately protected against erosion by vegetative or mechanical means.

Compliance with Laws and Regulations

Unless otherwise excepted under Section 1521.06 of The Ohio Revised Code, all dams with a height of ten (10) feet or greater require a construction permit prior to the start of construction. Construction permits are obtained from The Division of Water, Ohio Department of Natural Resources. (The height of dam is measured from the natural streambed at the centerline of dam to the spillway level. If two spillways are used, measure from lowest spillway).

Design and construction shall comply with all local laws, ordinances, rules and regulations.

Design Criteria for Temporary Sediment BasinsSediment Volume

The minimum capacity of the sediment basin to the elevation of the crest of the pipe spillway shall be 200 cubic yards (0.125 acre-feet) for each acre within the drainage area that will be disturbed by construction during the designed life of the sediment basin. If other areas within the drainage area are actively eroding, additional sediment capacity must be added (Volume will be determined based on site conditions).

Sediment basins will be cleaned out to their designed capacity when sediment retained in the basins has reduced its capacity to 60 percent of the designed volume.

Basin dimensions necessary to determine the designed sediment volume shall be clearly shown on the plans to facilitate plan review, construction, operation and maintenance.

Shape of Basin

The basin configuration shall be such that the effective flow length through the basin is at least two times the average width of the basin. Baffles will be used when necessary to prevent short circuiting.

Classes of Sediment Basins

TABLE 1

Class	Maximum Drainage Area (Acres)	Maximum Height * of Embankment (ft.)	Pipe Spillway Required	Emergency Spillway	Design Storm Frequency
1	20	5	Yes	No	10 Yrs.
2	20	25	Yes	Yes	10 Yrs.
3	100	25	Yes	Yes	25 Yrs.

*Height is measured from the low point of original ground at the centerline of dam to the top of the dam.

Pipe Spillway Design

Runoff shall be computed by the method outlined in Chapter 2, Engineering Field Manual for Conservation Practices, SCS, or by other acceptable methods. Runoff computations shall be based upon soil cover conditions of the contributing drainage area during the design life of the structure.

For Class 1 Dams, the capacity of the pipe spillway will be sufficient to pass the runoff of a 10-year frequency 24-hour duration storm. For Class 2 and Class 3 Dams the capacity of the pipe spillway will be sufficient to pass the runoff of a 2-year frequency 24-hour duration storm. In all cases the minimum diameter of the conduit shall be eight inches. Pipes may be designed by using: (1) Peak runoff of the design storm or (2) Flood-routing design storm using the procedure in Appendix B-5.4, or other acceptable methods.

- a. Crest Elevation - The crest elevation of the riser or hood inlet shall be at the elevation of the designed sediment volume.
- b. Riser - Non perforated risers shall be completely watertight except for the inlet opening at the top. Manufactured stubs or knockout plugs for dewatering the basin may be used. The riser shall have a cross-sectional area of at least 1.3 times that of the pipe barrel. Risers may be located in the sediment pool or in the upstream slope of the embankment.

Perforated risers are not recommended because of their adverse effect on the trap efficiency of the basin. However, if it is necessary to use a perforated riser, the pipe will be perforated with 1 1/2 inch diameter holes spaced eight inches vertically and 10 to 12 inches horizontally.

- c. Antivortex Device - an antivortex device shall be installed at and firmly attached to the top of the riser. The antivortex device should be a vertical steel plate and installed parallel with the pipe barrel; minimum length = riser diameter + 12"; minimum height = pipe barrel diameter or 12", whichever is greater.

For hooded inlets an antivortex device shall be installed in accordance with details in Appendix B-5.12.

- d. Trash Rack - Trash racks are recommended for all principal spillways, however, they are required when the basin is located in a wooded drainage area or subject to floating debris, or where the riser will create a safety problem.
- e. Riser Base - The riser shall have a watertight base and shall have sufficient weight to prevent flotation of the riser.

The minimum factor of safety against flotation shall be 1.1. Where concrete is used for the riser base, the following formula may be used in calculating the required volume of concrete:

$$V = 0.62HD^2 - \frac{HW_R}{87.6}$$

Where: H = Height Riser (ft)
 D = Diameter Riser (ft)
 W_R = Weight Riser (lb/ft)
 V = Volume of Concrete (ft³)

- f. Anti-Seep Collars - Anti-seep collars will be installed around the pipe barrel for all installations where the height of earth fill over the top of pipe is five feet or greater. The combination of the number of collars and the collar projections must increase the length of the line of seepage by at least 15 percent.

Select the desired number of collars
and solve for the minimum projection:

$$V = 0.075 L/N$$

-or-

Select the collar projection and solve
for the minimum number of collars.

$$N = 0.075 L/V$$

Where: V = Collar projection in feet
N = Number of collars
L = Length of pipe within embankment

Where more than one collar is used, they shall
be spaced approximately 25 feet apart.

- g. Outlet Projection - The pipe barrel shall outlet at approximately the lowest elevation of the valley cross section at the downstream toe of the dam. Protection using rock riprap, paving or other acceptable materials will be used to convey pipe discharge to a stable watercourse in an erosion free manner.

Emergency Spillway

For Class 1 sediment basins, the embankment will be used as an emergency spillway and the downstream slope shall be 5:1 or flatter. Also, the downstream slope must be immediately protected with vegetation, rock riprap or other acceptable materials.

Emergency spillways shall be constructed for all Class 2 and 3 sediment basins. The spillway cross section shall be trapezoidal with a minimum bottom width of 8 feet and steepest sideslopes of 2:1.

- (1) Crest Elevation - the crest of the emergency spillway will be set at the elevation required to pass the 2-year frequency 24-hour duration storm through the pipe spillway. In no case shall the difference in elevation between the crests of the pipe spillway and the emergency spillway be less than 1.0 foot.
- (2) Capacity - The minimum capacity of the emergency spillway shall be that required to pass the peak

rate of runoff from the design storm (See Table 1), minus the capacity of the pipe spillway. Emergency spillway dimensions can be determined using charts in Appendix B-5.8 through 11.

- (3) Velocities - The maximum allowable velocity of flow in the exit section of vegetated emergency spillways shall be six feet per second. For spillways with erosion protection other than vegetation, velocities shall be in the safe range for the type of protection used.

Freeboard

For Class 2 and 3 basins the freeboard is the difference in elevation between the flow elevation (H_p) of the emergency spillway and the top of the settled embankment. For Class 1 basins the freeboard is the difference in elevation between the stage required to pass the design storm through the pipe spillway and the top of the settled embankment. In all cases the minimum freeboard shall be 1.0 foot.

Embankment (Earthfill)

For Class 1 basins, the minimum top width shall be 10 feet; the upstream slope shall be no steeper than 2:1 and the downstream slope shall be no steeper than 5:1.

For Class 2 and 3 basins, the minimum top width shall be 10 feet, and the side slopes shall be no steeper than 2 1/2:1.

An allowance for settlement of at least 10 percent will be added to the design height of the embankment.

Vegetative Protection

Vegetation will be established upon completion of construction of the embankment, emergency spillway and other areas disturbed by construction.

Safety

Where sediment basins are accessible to the public, they shall be fenced and posted. All additional health and safety measures required by local ordinances will be installed.

CONSTRUCTION SPECIFICATION

TEMPORARY SEDIMENT BASIN

Embankment Basins

The foundation area shall be cleared of all trees, stumps, roots, brush boulders, sod, and debris. All channel banks and sharp breaks shall be sloped to no steeper than 1:1. All topsoil containing excessive amounts of organic matter shall be removed. The surface of the foundation area will be thoroughly scarified before placement of the embankment material.

The cutoff trench shall be excavated to the lines and grades shown on the plans or as changed during construction because of site conditions, and shall be backfilled with suitable material in the same manner as specified for earth embankment. The trench shall be kept free of standing water during backfill operations.

Existing stream channels crossing the foundation area shall be sloped no steeper than 1:1 and deepened and widened as necessary to remove all stones, gravel, sand, roots, and other objectionable material and to accommodate compacting equipment. Such channels shall then be backfilled with suitable material as specified for earth embankment.

The pipe conduit barrel shall be placed on a firm foundation to the lines and grades shown on the plans. Selected backfill material shall be placed around the conduit in layers and each layer shall be compacted to at least the same density as the adjacent embankment. All compaction within two (2) feet of the pipe spillway will be accomplished with hand operated tamping equipment.

The completed spillway excavation shall conform to the lines, grades, bottom width, and side slopes shown on the plans as nearly as skillful operation of the excavation equipment will permit.

All borrow areas outside the pool area shall be graded and left in such a manner that water will not be ponded.

The material placed in the fill shall be free of all sod, roots, frozen soil, stones over six inches in diameter, and other objectionable material. The placing and spreading of the fill material shall be started at the lowest point of the foundation and the fill shall be brought up in approximately 6-inch horizontal layers or of such thickness that the required compaction can be obtained with the equipment used. Construction equipment shall be operated over the area of each layer in a way that will result in the required compaction. Special equipment shall be used when the required compaction be obtained without it.

The distribution and gradation of materials throughout the fill shall be such that there will be no lenses, pockets, streaks, or layers of material differing substantially in texture or gradation from the surrounding material. Where it is necessary to use materials of varying texture and gradation, the more impervious material shall be placed in the upstream and center-portions of the fill.

The moisture content of fill material shall be such that the required degree of compaction can be obtained with the equipment used.

Fill shall not be placed on frozen, slick or saturated soil.

The topsoil material saved in the site preparation shall be placed as a top dressing on the surface of the emergency spillways, embankments, and borrow areas. It shall be evenly spread to a thickness as specified on the plans.

A protective cover of vegetation shall be established on all exposed surfaces of the embankment, spillway, and borrow areas to the extent practical under prevailing soil and climatic conditions.

Seedbed preparation, seeding, fertilizing, and mulching shall comply with the local SCS Technical Guide.

Excavated Basins

The completed excavation shall conform to the lines, grades and elevation shown on the plans as nearly as can be achieved by skillful operation of the excavating equipment.

The material excavated from the basin shall be placed in one of the following ways so that its weight will not endanger the stability of the side slopes and where it will not be washed back into the basin by rainfall:

1. Uniformly spread to a height not exceeding three feet with the top graded to a continuous slope away from the basins.
2. Uniformly placed or shaped reasonably well with side slopes assuming the natural angle of repose for the excavated material behind a berm width equal to the depth of the basin, but not less than 12 feet.

3. When excavated materials are used to construct a low embankment, the embankment shall have a minimum top width of 10 feet, and the steepest side slopes shall be 2 to 1 upstream and 5 to 1 downstream. All sod and other unstable or deleterious material will be removed from under the embankment, prior to placement of excavated material:

Final Disposal

In the case of temporary structures when the intended purpose has been accomplished and the drainage area properly stabilized, the embankment and resulting silt deposits are to be leveled or otherwise disposed of in accordance with the plan.

STANDARD AND SPECIFICATIONS
FOR
SODDING

STANDARD

Definition

Stabilizing silt-producing areas with grass sod.

Purpose

To stabilize the area, to reduce damages from sediment and runoff to downstream areas.

Conditions Where Practice Applies

Graded areas subject to erosion and water concentration where an immediate vegetative cover is desired and feasible.

SPECIFICATIONS

I. Site Preparation

- A. Stockpile topsoil to apply to sites that are otherwise unsuited for establishing vegetation.
- B. Grade as needed and feasible to permit the use of conventional equipment for sodbed preparation. After grading operation spread topsoil where needed.

II. Sodbed Preparation

- A. Lime (In lieu of a soil test) on acid soil and subsoil apply 100 pounds per 1000 square feet or 2 tons per acre of agricultural ground limestone or equivalent. For best results make a soil test.
- B. Fertilizer (In lieu of a soil test). Apply 25 pounds per 1000 square feet or 1000 pounds per acre of 10-10-10 or 12-12-12 analysis. For best results make a soil test.

- C. Work lime and fertilizer into the soil with a disk harrow, springtooth harrow, or other suitable field equipment to a depth of 3 inches.
- D. Prior to sodding, the soil surface should be cleared of all trash, debris, and stones larger than 1 1/2 inches in diameter, and of all roots, brush, wire, and other objects that would interfere with the placing of the sod.
- E. After the lime and fertilizer has been applied and just prior to the laying of the sod, the soil in the area to be sodded should be loosed to a depth of one inch. The soil should be thoroughly dampened immediately after the sod is laid if it is not already in a moist condition.

III. Cutting and Handling of Sod

- A. The sod should consist of strips of live, vigorously growing grass such as bluegrass or tall fescue. The sod should be free of noxious and secondary noxious weeds and should be obtained from good, solid, thick growing stands. The sod should be cut and transferred to the job in as large continuous pieces as will hold together and are practical to handle.

The sod should be cut with smooth clean edges and square ends to facilitate laying and fitting. The sod should be cut to a uniform thickness of not less than two inches measured from the crown of the plants to the bottom of the sod strips for all grasses except bluegrass. Bluegrass sod should be cut to a uniform thickness of not less than one and one-half inch.

The sod should be mowed to a height of not less than two inches nor more than four inches prior to cutting.

The sod should be kept moist and covered during hauling and preparation for placement on the sodbed.

IV. Placing the Sod

- A. No sod should be placed when the temperature is below 32°F. No frozen sod should be placed nor should any sod be placed on frozen soil. When sod is placed between the periods of June 1 and October 1, and between the periods December 1 and March 1, it should be covered immediately with a uniform layer of straw mulch approximately one-half inch thick or so the green sod is barely visible through the mulch.

Sod should be carefully placed and pressed together so it will be continuous without any voids between the pieces. Joints between the ends of strips should be staggered. The edge of the sod at the outer edges of all gutters shall be sufficiently deep so that the surface water will flow over and onto the top of the sod.

On gutter and channel sodding the sod should be carefully placed in rows or strips at right angles to the centerline of the channel (i.e. at right angles to the direction of flow). On steep graded channels each strip of sod should be staked with at least two stakes not more than eighteen inches apart. The stakes should be wood and should be approximately 1/2 X 3/4" X 12". They should be driven flush with the top of the sod and with the flat side against the slope.

On slopes three to one, or steeper, and where drainage into a sod gutter or channel is one half acre or larger, two inch poultry netting should be staked in place on the surface of the sod. The netting and sod should be staked with at least two stakes not more than eighteen inches apart.

The stakes should be wood and should be approximately 1/2" X 3/4" X 24". They should be driven with the flat side against the slope and on an angle toward the slope. The netting should be stapled on the side of each stake within two inches of the top of the stake. The stake should then be driven flush with the top of the sod.

The sod should be tamped or rolled after placing and then watered. Watering should consist of a thorough soaking of the sod and of the sodbed to a depth of at least four inches. The sod should be maintained in a moist condition by watering for a period of thirty days.

Any areas disturbed so as to destroy present seedlings along the edge of the sodbed should be reseeded and mulched as specified in the permanent Seeding Standards and Specifications.

STANDARD AND SPECIFICATIONS
FOR
TOP SOILING

STANDARD

Definition

Obtaining topsoil from other places and spreading it over the area to be stabilized.

Purpose

To provide a suitable soil medium for vegetation growth on areas where other measures will not produce or maintain a stand of desirable vegetation.

Conditions Where Practice Applies

This practice applies to sites where:

1. The texture of the exposed subsoil or present material is clay, silty clay, sand or loamy sand which is not suitable to produce adequate vegetative growth.
2. The soil material is so shallow that the rooting zone is not deep enough to support plants and furnish continuing supplies of moisture and plant food.
3. The soil to be vegetated contains material toxic to plant growth. (Coal blossom, aluminum, iron, extreme acidity, etc.)

SPECIFICATIONS

SECTION I - SUBSOIL PREPARATION (Where topsoil is to be added)

Note: This specification applies only if additional topsoil will be deposited over existing soil.

- A. General: The areas to which these specifications apply and on which topsoil is to be spread shall be indicated on the drawings or as otherwise specified.

- B. Grading: Grades on the areas to be topsoiled which have been previously established in conformance with the drawings shall be maintained.
- C. Liming: Where the subsoil is highly acid, Agricultural Ground Limestone, or its equivalent, shall be spread at the rate of 100 pounds per 1000 square feet. Liming material shall contain calcium and/or magnesium equal to not less than 90% calcium carbonate equivalent, and the material shall be sufficiently fine so that 95% will pass through a U. S. Standard No. 8 sieve and at least 40% shall pass through a U. S. Standard No. 100 sieve. Lime shall be distributed uniformly over the designated areas and worked into the soil with the use of a disk harrow, springtooth harrow, or other suitable field equipment.
- D. Tilling: After the areas to be topsoiled have been brought to grade, and immediately prior to dumping and spreading the topsoil, the subgrade shall be loosened by disking or by scarifying to a depth of at least 2 inches to permit bonding of the topsoil to the subsoil.

SECTION II - TOPSOIL MATERIAL AND APPLICATION

Note: Topsoil on the existing site may often be used but it should meet the same standards as set forth in these specifications.

- A. Materials - Topsoil shall be a sandy loam, clay loam, loam, silt loam, sandy clay loam, or other soil approved by the contracting representative. It shall not be a mixture of subsoil and contain no slag, cinders, stones, lumps of soil, sticks, roots, trash or other extraneous material larger than 1 1/2 inches in diameter. Topsoil must also be free of plants or plant parts of quackgrass, Johnsongrass, nutsedge, poison ivy, Canada thistle, or others as specified. All topsoil shall be tested by a recognized laboratory for pH and soluble salts. A pH of 4.5 to 7.5 is required. Soluble salts shall not be higher than 500 parts per million.

No sod shall be placed on soil which has been treated with soil sterilants until sufficient time has elapsed to permit dissipation of toxic materials.

- B. Grading: The topsoil shall be uniformly distributed on the designated areas and it shall be a minimum depth of 3 inches after firming. Spreading shall be performed in such a manner that sodding can proceed with a minimum of additional soil preparation and tillage. Any irregularities in the surface resulting from topsoiling or other operations shall be corrected in order to prevent the formation of depressions or water pockets. Topsoil shall not be placed while in a frozen or muddy condition, or when the subgrade is excessively wet, or in a condition that may otherwise be detrimental to proper grading or proposed sodding.
- C. Clean Up: After the topsoil has been spread and the final grades approved, it shall be cleaned of all grade stakes, surface trash, and other objects that would hinder maintenance of sodded and seeded areas. Paved areas over which hauling operations are conducted shall be kept clean, and any soil which may be brought upon the surfacing shall be promptly removed. The wheels of all vehicles shall be kept clean to avoid tracking soil on the surfacing of roads, walks, or other paved areas.

STANDARDS AND SPECIFICATIONS
FOR
WINDBREAKS

STANDARD

Definition

A narrow belt of trees or shrubs established adjacent to homes, buildings, streets, or in recreation areas.

Purpose

To protect soil resources, control snow deposition, reduce wind velocity near buildings, screens, and provides wildlife food and cover.

Conditions Where Practice Applies

To the windward of and a serviceable distance from:

- a. Homes and commercial buildings.
- b. Streets.
- c. Recreation Areas.

SPECIFICATIONS

A. Design the Windbreak

1. Number of tree rows needed: 3 is minimum without a shrub row; with 1 shrub row, 2 tree rows is required.
2. Directional orientation.
 - a. Minimum: One-leg, straight-line, perpendicular to prevailing wind.
 - b. Preferable: Two-leg, L-shaped (as viewed from above).

Note: West and southwest winds are prevalent over most of Ohio; west and northwest winter winds are considered most severe for northwest area of Ohio.

3. Distance between windbreak and near edge of protective zone:
 - a. Not closer than: 75 feet.
 - b. Optimum: 100-150 feet.
4. Spacing between rows:
 - a. Not closer than: 10 feet
 - b. Optimum: 16 feet.
5. Spacing in-the-row:
 - a. Trees, narrow crowned: 5-6 feet apart.
 - b. Trees, normal crowns: 10-12 feet apart.
 - c. Shrubs: 2-6 feet apart.
6. Arrangement in-the-rows:
 - a. Stagger seedlings with relation to seedlings in adjacent row.
7. Length of windbreak:
 - a. Minimum: 150 feet, each leg.
 - b. Optimum: Extend each leg 50-100 feet beyond last point needing protection.
8. Tree Species:

Tolerance to Drainage and Acidity

	<u>Poorly to Somewhat Poorly Drained Sites</u>	<u>Moderately Well to Well Drained Sites</u>	<u>pH^{1/} Range</u>
a. Arborvitae (<u>Thuja occidentalis</u>)	Yes	Yes	Medium acid to mildly alkaline
b. Eastern redcedar (<u>Juniperus virginiana</u>)	Limited	Yes	Medium acid to mildly alkaline
c. Austrian pine (<u>Pinus nigra</u>)	Yes	Yes	Slightly acid to mildly alkaline

Tolerance to Drainage and Acidity

	<u>Poorly to Somewhat Poorly Drained Sites</u>	<u>Moderately Well to Well Drained Sites</u>	<u>1/ pH Range</u>
d. Scotch pine (<u>Pinus sylvestris</u>)	No	Yes	Strongly acid to neutral
e. White pine * (<u>Pinus strobus</u>)	Yes	Yes	Medium acid to mildly alkaline
f. Norway spruce (<u>Picea abies</u>)	Yes	Yes	Strongly acid to neutral

*Best suited for leeward side

1/ Extremely acid	Below 4.5	Slightly acid	6.1 - 6.5
Very strongly acid	4.5 - 5.0	Neutral	6.6 - 7.3
Strongly acid	5.1 - 5.5	Mildly alkaline	7.4 - 7.8
Medium acid	5.6 - 6.0		

9. Shrub Species:

	<u>Soil 1/ Drainage Tolerance</u>	<u>Effective 2/ Fruiting Season</u>	<u>Seasons 2/ Most Attractive</u>
a. Autumn Olive (<u>Elaeagnus umbellata</u>)	MW to WD	F	Sp, F
b. Amur privet (<u>Ligustrum amurense</u>)	WD	F	Sp
c. Tatarian honeysuckle (<u>Lonicera tatarica</u>)	MW to WD	S	Sp, F
d. Rugosa rose (<u>Rosa rugosa</u>)	WD	S	S
e. Medium purple willow (<u>Salix purpurea</u>)	VPD-MW	-	S
f. Common lilac (<u>Syringia vulgaris</u>)	MD-WD	-	Sp

	<u>1/</u> Soil Drainage Tolerance	<u>2/</u> Effective Fruiting Season	<u>2/</u> Seasons Most Attractive
g. Wayfaring tree (<u>Viburnum lantana</u>)	WD	F-W	F
h. Nannyberry (<u>Viburnum lentago</u>)	MW-WD	F-W	F
i. Flowering quince (<u>Chaenomeles japonica</u>)	MW-WD	W	Sp.
j. Silky dogwood (<u>Cornus amomum</u>)	VPD-MW	S	Sp
k. American cranberrybush (<u>Viburnum trilobum</u>)	VPD-MW	W	F
l. Winged spindletree (<u>Euonymus alatus</u>)	WD	F	F
m. Forsythia (<u>Forsythia sp.</u>)	MW-WD	-	Sp

* Use in northcentral and northwestern Ohio only.

1/ VPD - Very poorly drained
SPD - Somewhat poorly drained
WD - Well drained
MW - Moderately well drained

2/ Sp - Spring
S - Summer
F - Fall
W - Winter

B. Order Planting Stock

1. Allow time for site preparation.
2. Order early to insure delivery.

C. Prepare the Site

Eliminate weed, grass, and sod growth prior to planting season.

D. Plant the Windbreak Stock

1. Keep stock cool and roots moist.
2. Open planting hole or slit deep enough and wide enough to accommodate roots.
3. Set main root vertical, slightly deeper than it was in nursery; spread branch roots loosely.
4. Close planting hole or slit, bottom to top, and press soil firmly against roots.

E. Protect and Maintain Windbreak

1. Cultivate or chemical-spray against weeds, grass, and other encroaching plants for at least two growing seasons.
2. Irrigate seedlings, as needed, during first summer.
3. Replace individual "drop-out" stock as needed during early years of windbreak life.
4. In subsequent years, before individual trees become crowded in the row, thin lightly as needed.

**METHOD
FOR
DETERMINING EROSION
LOSSES**

WATER EROSION

EROSION FACTORS AND THEIR CONTROL FOR LAND UNDER DEVELOPMENT IN OHIO

The topography of land being developed in Ohio varies widely from steep to nearly level lands. Although erosion will occur at a faster rate on the steeper slopes significant off-site damage from sediment can be observed on nearly level land that is poorly managed during development. The soil erosion process begins with detachment of soil particles due to the impact of raindrops falling on bare, unprotected soil. Water flowing across the soil surface transports these detached particles downslope. When the velocity of the water slows, the sediment is deposited.

Water erosion is affected by several factors: rainfall intensity and duration, soil erodibility, length and steepness of slope, vegetative cover, soil management practices, and erosion control practices. These factors have been combined by scientists (Wischmeier and Smith, 1965) into a universal soil loss equation, for predicting soil losses from a given soil. The equation is based on years of research and field experience with soil erosion and runoff throughout the eastern U. S., and is being refined and improved in accuracy as more data and experience with its use becomes available. This equation can be used to predict sheet and rill erosion, but is not accurate to predict gully erosion. Because of the extensive local data available for use in the equation, it has general applicability on most upland soils in this region. Briefly, the equation is as follows:

$$A = R \times K \times LS \times C \times P$$

Where: A is the computed soil loss in tons per acre per year, R - the rainfall factor, K - the soil erodibility factor, LS - the slope length ratio factor and the slope gradient ratio factor, C - the cover-management (cropping-management) factor, and P - the erosion control practice factor.

Numerical values for each of the six factors in the equation were determined from research data and vary from one locality to another. Reference tables of these values have been developed to predict soil losses under a given set of conditions, and to select that combination of practices to meet a given soil loss limit.

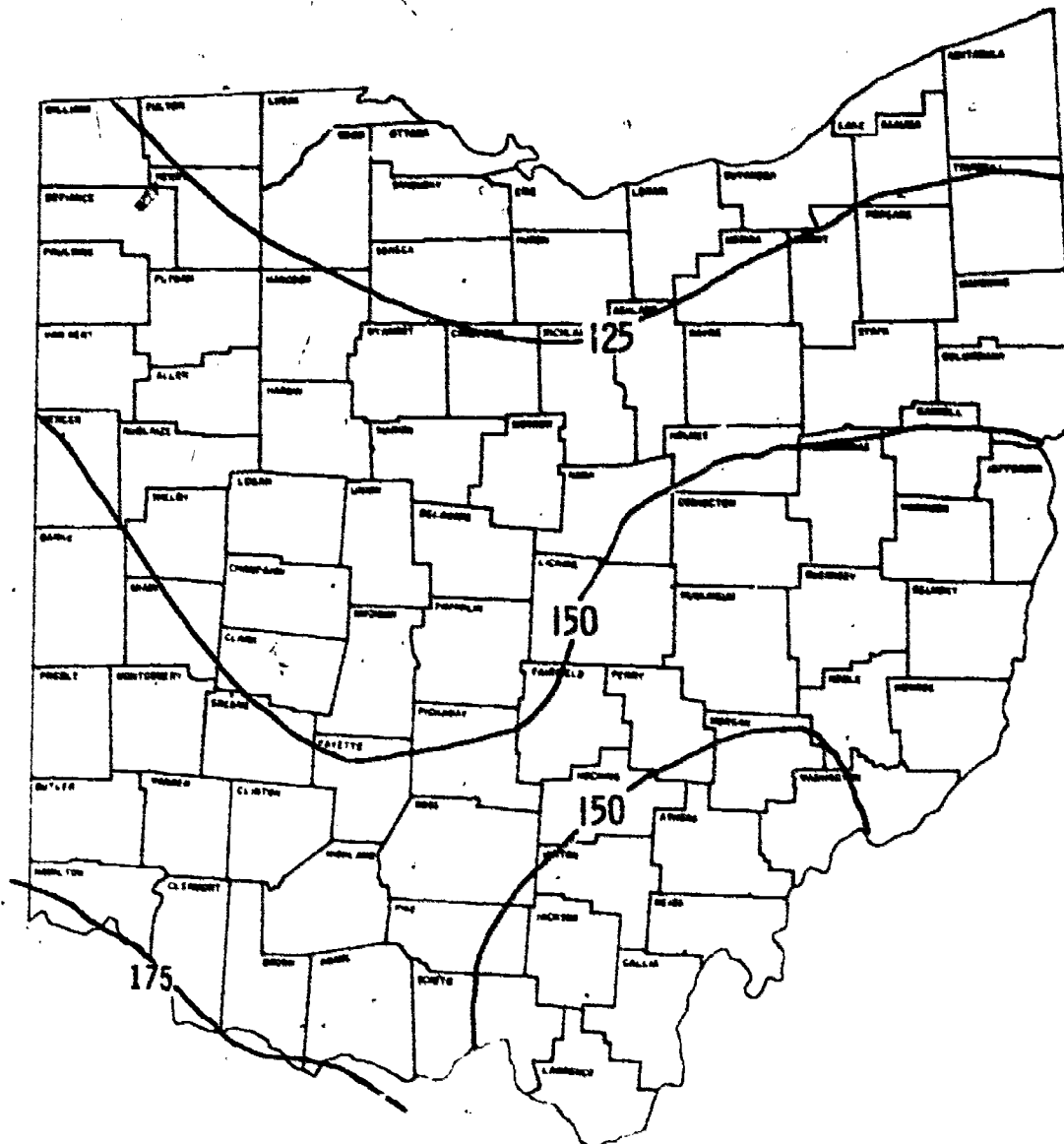

FIGURE 1: Average Annual Values of the Rainfall Factor, R. USDA Agr. Handbook No. 282, 1965

Research in Ohio has helped develop values for the various factors in the soil loss equation for Ohio conditions. This allows use of the equation to help plan proper soil erosion control programs. Some of the information on the soil loss factors in Ohio are as follows:

RAINFALL (R):

The relative erosion potential of rainfall over Ohio varies less than 20 percent as shown in Figure 1. The values shown are a measure of the average annual energy of all rainfall. The R factors range from 175 at Cincinnati to 125 at Toledo. Erosion of bare soil by months is shown in Table 1.

TABLE 1: Percent of Annual Erosion by Months*

Jan	Feb	Mar	Apr	May	June	July	Aug	Sept	Oct	Nov	Dec
2	2	4	6	10	20	20	14	10	6	4	2

*Applicable for bare medium textured Ohio Soil on slopes greater than 2%.

SOIL ERODIBILITY (K):

From direct soil loss measurements on selected soils, the relative erodibility has been determined for most soil types in tons per acre per unit of rainfall erosion potential. The soil erodibility or K value for Ohio soils range from .17 to .49. Obtain K value by determining texture of soil and selecting the proper value from Table 2, and 2A. Table 2 is to be used for undisturbed top soil, Table 2A is to be used for subsoils and Table 2B is to be used for fill slopes.

Table 2 ^{1/}

K Values for Topsoil

Texture of Surface Layer	Estimated K Value
Clay, clay loam, loam, silty clay	.32
Fine sandy loam, loamy very fine sand, sandy loam	.24
Loamy fine sand, loamy sand	.17
Sand	.15
Silt loam, silty clay loam, very fine sandy loam	.37

^{1/} K values for individual soil types are available in the county Soil Conservation Service offices.

Table 2A
K Values for Subsoil

Generalized Soil Category (Texture of Materials)	Estimated K Value of Exposed Subsoil Material:
A. Outwash Soils	
Sand	.17
Loamy Sand	.24
Sandy Loam	.43
Gravel, fine to mod. fine subsoil	.24
Gravel, med. to mod. coarse subsoil	.49
B. Lacustrine Soils	
Silt loam and v. f. sandy loam	.37
Silty clay loam	.28
Clay and silty clay	.28
C. Glacial till	
Loam, fine to mod. fine subsoil	.32
Loam, med. subsoil	.37
Clay loam	.32
Clay and silty clay	.28
D. Loess	.37
E. Residual	
Sandstone	.49
Siltstone, nonchannery	.43
Siltstone, channery	.32
Acid clay shale	.28
Calcareous clay shale or limestone residuum	.24

TABLE 3 SOIL LOSS RATIO (LS) *
(Rev. 3-75)

LENGTH OF SLOPE (L)	PERCENT SLOPE (S)																					
	0.2	0.3	0.4	0.5	1.0	2.0	3.0	4.0	5.0	6.0	8.0	10.0	12.0	14.0	16.0	18.0	20.0	25.0	30.0	40.0	50.0	60.0
20	.05	.05	.06	.06	.08	.12	.18	.21	.24	.30	.44	.61	.81	1.0	1.2	1.6	1.8	2.6	3.5	5.5	8	10
40	.06	.07	.07	.08	.10	.15	.22	.28	.34	.43	.63	.87	1.2	1.4	1.8	2.2	2.6	3.5	5.0	8	11	15
60	.07	.08	.08	.08	.11	.17	.25	.33	.41	.52	.77	1.0	1.4	1.8	2.2	2.6	3.0	4.5	6.0	10	14	18
80	.08	.08	.09	.09	.12	.19	.27	.37	.48	.60	.89	1.2	1.6	2.0	2.6	3.0	3.5	5.5	7	11	16	21
100	.08	.09	.09	.10	.13	.20	.24	.40	.54	.67	.99	1.4	1.8	2.2	2.8	3.5	4.0	6.0	8	13	18	23
110	.08	.09	.10	.10	.13	.21	.30	.42	.56	.71	1.0	1.4	1.8	2.4	3.0	3.5	4.5	6.0	8	13	19	24
120	.09	.09	.10	.10	.14	.21	.30	.43	.59	.74	1.0	1.6	2.0	2.6	3.0	4.0	4.5	6.0	9	14	20	25
130	.09	.09	.10	.11	.14	.22	.31	.44	.61	.77	1.2	1.6	2.0	2.6	3.0	4.0	4.5	7	9	14	20	26
140	.09	.10	.10	.11	.14	.22	.32	.46	.63	.80	1.2	1.7	2.2	2.8	3.5	4.0	5.0	7	9	15	21	27
150	.09	.10	.11	.11	.15	.23	.32	.47	.66	.82	1.2	1.6	2.2	2.8	3.5	4.0	5.0	7	10	15	22	28
160	.09	.10	.11	.11	.15	.23	.33	.48	.68	.85	1.2	1.8	2.2	3.0	3.5	4.5	5.0	7	10	16	23	29
180	.10	.10	.11	.12	.15	.24	.34	.51	.72	.90	1.4	1.8	2.4	3.0	4.0	4.5	5.5	8	11	17	24	31
200	.10	.11	.11	.12	.16	.25	.35	.53	.76	.95	1.4	2.0	2.6	3.0	4.0	5.0	6.0	8	11	18	25	33
300	.11	.12	.13	.14	.18	.28	.40	.62	.93	1.2	1.8	2.4	3.0	4.0	5.0	6.0	7	10	14	22	31	40
400	.12	.13	.14	.15	.20	.31	.44	.70	1.0	1.4	2.0	2.8	3.5	4.5	5.5	7	8	12	16	25	36	46
500	.13	.14	.15	.16	.21	.33	.47	.76	1.2	1.6	2.2	3.0	4.0	5.0	6.0	8	9	13	18	28	40	52
600	.14	.15	.16	.17	.22	.34	.49	.82	1.4	1.8	2.4	3.5	4.5	5.5	7	8	10	14	19	31	44	57
700	.15	.16	.17	.18	.23	.36	.52	.87	1.4	1.8	2.6	3.5	5.0	6.0	8	9	11	16	21	33	47	61
800	.15	.16	.17	.18	.24	.38	.54	.92	1.6	2.0	2.8	4.0	5.0	6.0	8	10	12	17	22	36	50	65
900	.16	.17	.18	.19	.25	.39	.56	.96	1.6	2.0	3.0	4.0	5.5	7	9	10	12	18	24	38	53	69
1000	.16	.18	.19	.20	.26	.40	.57	1.0	1.6	2.2	3.0	4.5	5.5	7	9	11	13	19	25	40	56	73
1100	.17	.18	.19	.20	.27	.41	.59	1.0	1.8	2.2	3.5	4.5	6.0	8	9	11	14	20	26	42	59	77
1200	.17	.18	.20	.21	.27	.42	.61	1.0	1.8	2.4	3.5	4.5	6.0	8	10	12	14	20	28	44	62	80
1300	.18	.19	.20	.21	.28	.43	.62	1.2	2.0	2.4	3.5	5.0	7	8	10	12	15	21	29	46	64	83
1400	.18	.19	.21	.22	.29	.44	.63	1.2	2.0	2.6	3.5	5.0	7	9	11	13	15	22	30	47	67	87
1500	.19	.20	.21	.22	.29	.45	.65	1.2	2.0	2.6	4.0	5.5	7	9	11	13	16	23	31	49	69	90
1600	.19	.20	.21	.23	.30	.46	.66	1.2	2.2	2.6	4.0	5.5	7	9	11	14	16	24	32	51	71	93
1700	.19	.21	.22	.23	.30	.47	.67	1.2	2.2	2.8	4.0	5.5	7	9	12	14	17	24	33	52	73	95
2000	.20	.22	.23	.24	.32	.49	.71	1.4	2.4	3.0	4.5	6.0	8	10	13	15	18	26	36	57	80	104

CONTOUR LIMITS - 2 PERCENT 400 FEET, 8 PERCENT 200 FEET, 10 PERCENT 100 FEET, 14 - 24 PERCENT 60 FEET. THE EFFECTIVENESS OF CONTOURING BEYOND THESE LIMITS IS SPECULATIVE.

WHEN THE LENGTH OF SLOPE EXCEEDS 400 FEET AND (OR) PERCENT OF SLOPE EXCEEDS 24 PERCENT, SOIL LOSS ESTIMATES ARE SPECULATIVE AS THESE VALUES ARE BEYOND THE RANGE OF RESEARCH DATA.

*Where the LS factors do not appear in Section III-A-7, "Soil Loss from Water Erosion (Sheet and Rill)," interpolate between the LS factors in the these tables to determine the soil loss and "C" factor.

SLOPE LENGTH AND STEEPNESS (LS):

Slope (steepness or gradient) and slope length are two important factors that affect erosion. A relative value of 1.0 has been arbitrarily assigned to a 9% slope with a length of 73 feet. The effects of slope steepness and length have been combined into LS values for uniform slopes shown in Table 3. These LS values vary as shown in the table. For example, a 5% slope 100 feet in length has an LS value of .54, while a 14% slope 300 feet in length has an LS value of 4.0.

When a slope steepens or flattens significantly toward the lower end or is composed of a series of convex and concave segments, its overall average gradient and length do not correctly indicate the topographic effect on soil loss. Neither can successive slope segments be evaluated as independent slopes when runoff flows from one segment to the next. For irregular slopes, therefore, values read from Table 3 must be adjusted to account for effects of the gradient changes.

Convex slopes of the same percent and length as concave slopes will have a significantly higher erosion hazard.

If two simplifying assumptions can be accepted, the adjustment can easily be made. The assumptions are that (a) the change in gradient is not sufficient to cause upslope deposition and (b) the irregular slope can be divided into a small number of equal-length segments in such a manner that, for practical purposes, the gradient within each segment can be considered uniform. For most slopes, three segments should be sufficient.

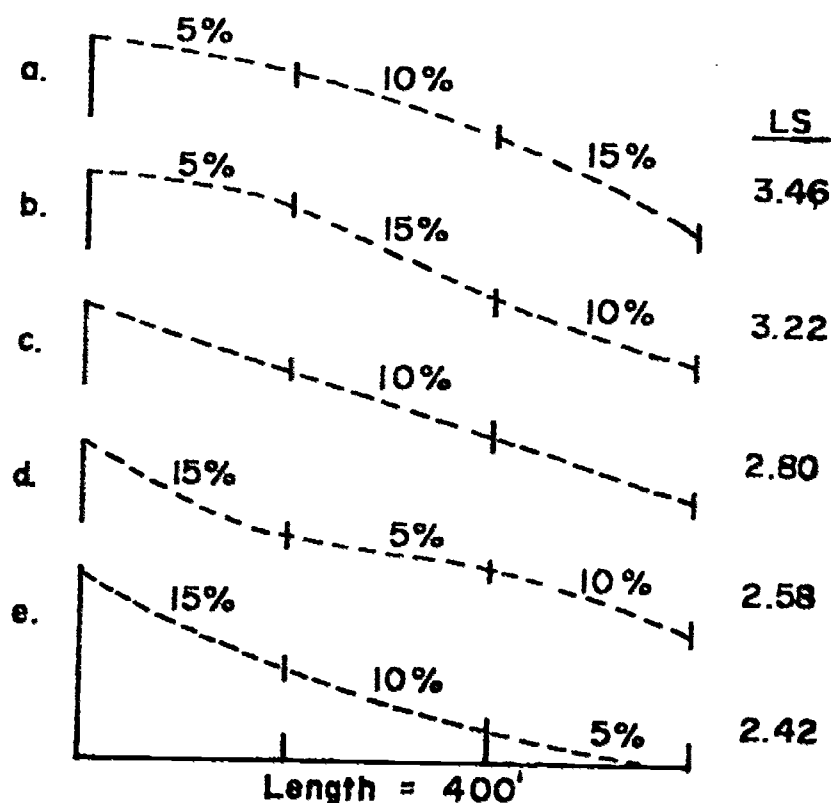

Figure 2. Demonstration of effect of slope shape on LS value.

Table 4. Factors to adjust LS chart values for successive segments of a slope where the slope-length exponent equals 0.5

Segment No. (Top to Bottom)	Number Equal-length Segments into which the Slope is Divided for Evaluation of LS			
	<u>2</u>	<u>3</u>	<u>4</u>	<u>5</u>
1	0.71	0.58	0.50	0.45
2	1.29	1.06	.91	.82
3		1.37	1.18	1.06
4			1.40	1.25
5				1.42

Procedure

Divide the convex, concave, or complex slope into three equal segments (Figure 2) and ascertain the percent slope for each segment. Enter Table 3 with the total slope length, and read the LS value corresponding to the steepness of each of the three slope segments. Multiply the chart value for the upper segment by 0.58, the middle-segment value by 1.06 and the lower-segment value by 1.37 (factors obtained from Table 4). The average of the three products is then a good estimate of the effective LS value for that slope.

If two segments are sufficient, or if more than three are required, substitute the appropriate adjustment factors from Table 4.

Example

Assume a convex slope 400 feet long for which the upper third averages 5 percent slope; the middle third, 10 percent; and the lower third, 15 percent (Figure 2). Enter Table 3 with the 400 foot total slope length and copy the values shown in that line for slopes of 5, 10 and 15 percent: 1.0, 2.8, and 5.0. Multiply the three values by the previously mentioned adjustment factors (Table 4), 0.58, 1.06, and 1.37, respectively, and average the products. In tabular form the computations are as follows:

<u>Segment No.</u>	<u>Slope %</u>	<u>Table 3 Value</u>	<u>Table 4 Factor</u>	<u>Segment LS</u>
1	5	1.0	0.58	.58
2	10	2.8	1.06	2.96
3	15	5.0	1.37	6.85
				—————
Average LS				3.46

For a 400 foot concave slope, assume the percentage reversed (Figure 2)..

<u>Segment No.</u>	<u>Slope %</u>	<u>Table 3 Value</u>	<u>Table 4 Factor</u>	<u>Segment LS</u>
1	15	5.0	.58	2.9
2	10	2.8	1.06	3.0
3	5	1.0	1.37	1.37
				—————
Average LS				2.42

The LS values on Figure 2 show the LS value for slopes with different configurations. Less erosion will take place on a concave slope than on a convex slope. In the above examples, use of the LS value for a 400 foot uniform slope would have under-estimated soil loss by about 30 percent on the convex slope and over-estimated it by about 10 percent on the concave slope. Greater degrees of convexity or concavity would show greater differences.

COVER-MANAGEMENT (C) (CROPPING-MANAGEMENT):

Vegetative cover and its management have an important effect on erosion. This factor is referred to as the "C" factor. There are several variables in these factors that cannot be evaluated independently because of many interactions. These variables include type and height of raised cover, and type and percent of ground cover.

The "C" Factors for grassland are shown in Table 5.

TABLE 5: "C" for Vegetative Cover Conditions¹

Column No.:	Vegetal Canopy		Cover That Contacts the Surface						
	Type and Height of Raised Canopy ²	Canopy Cover ³	Type ⁴	Percent Ground Cover					
				0	20	40	60	80	95-100
		2	3	4	5	6	7	8	9
No appreciable canopy			G	.45	.20	.10	.042	.013	.003
			W	.45	.24	.15	.090	.043	.011
Canopy of tall weeds or short brush (0.5 m fall ht.)	25		G	.36	.17	.09	.038	.012	.003
			W	.36	.20	.13	.082	.041	.011
	50		G	.26	.13	.07	.035	.012	.003
			W	.26	.16	.11	.075	.039	.011
	75		G	.17	.10	.06	.031	.011	.003
			W	.17	.12	.09	.057	.038	.011
Appreciable brush or bushes (2 m fall ht.)	25		G	.40	.18	.09	.040	.013	.003
			W	.40	.22	.14	.085	.042	.011
	50		G	.34	.16	.085	.038	.012	.003
			W	.34	.19	.13	.081	.041	.011
	75		G	.28	.14	.08	.036	.012	.003
			W	.28	.17	.12	.077	.041	.011
Trees but no appreciable low brush (4 m fall ht.)	25		G	.42	.19	.10	.041	.013	.003
			W	.42	.23	.14	.087	.042	.011
	50		G	.39	.18	.09	.040	.012	.003
			W	.39	.21	.14	.085	.042	.011
	75		G	.36	.17	.09	.039	.012	.003
			W	.36	.20	.13	.083	.041	.011

¹ All values shown assume: (1) random distribution of mulch or vegetation, and (2) mulch of appreciable depth where it exists.

² Average fall height of waterdrop: from canopy to soil surface: m = meters.

³ Portion of total-area surface that would be hidden from view by canopy in a vertical projection, (a bird's-eye view).

⁴ G: Cover at surface is grass, grasslike plants, decaying compacted duff, or litter at least 2 inches deep.

W: Cover at surface is mostly broadleaf herbaceous plants (as weeds) with little lateral-root network near the surface, and/or undecayed residue.

A grass with no appreciable canopy and a 95-100 percent ground cover would have a "C" factor of .003. An area with appreciable brush and weeds, 2 meters high and 50 percent canopy and 60 percent ground cover would have a "C" factor of .081.

Table 6

"C" Factors for Annual Cover and Various Quantities of Mulch

Cover or Mulch	"C" Factor
Bare Areas	1.0
1/4 Ton Straw Mulch	.52
1/2 Ton Straw Mulch	.35
3/4 Ton Straw Mulch	.24
1 Ton Straw Mulch	.18
1 1/4 Ton Straw Mulch	.10
2 Ton Straw Mulch	.06
3 Ton Straw Mulch	.03
4 Ton Straw Mulch	.02
Annual Cover	.15

WOODLAND "C" FACTOR

Woodland, well stocked, tree canopy 90% of area, forest litter 90% of area, undergrowth managed, the "C" factor is .001.

Table 7

"C" Factors for Woodland

Stand Condition	Tree Canopy % of ^{1/} Area	Forest Litter % of ^{2/} Area	Undergrowth ^{3/} ^{4/}	Factor
Well Stocked	100-75	100-90	Managed ^{4/}	.001
			Unmanaged	.003 - .011
Medium Stocked	70-40	85-75	Managed	.002 - .004
			Unmanaged	.01 - .04
Poorly Stocked	35-20	70-40	Managed	.003 - .009
			Unmanaged ^{5/}	.02 - .09

^{1/} When tree canopy is less than 20%, the area will be considered as grassland, or cropland for estimating soil loss.

^{2/} Forest litter is assumed to be at least two inches deep over the percent ground surface area covered.

^{3/} Undergrowth is defined as shrubs, weeds, grasses, vines, etc., on the surface area not protected by forest litter. Usually found under canopy openings.

^{4/} Managed - grazing and fires are controlled.

Unmanaged - stands that are overgrazed or subjected to repeated burning.

^{5/} For unmanaged woodland with litter cover of less than 75%, C values should be derived by taking 0.7 of the appropriate values in Table 5. The factor of 0.7 adjusts for the much higher soil organic matter on permanent woodland.

Erosion Control Factors "P".

Normally the "P" factor on urban areas will be a constant of 1.0 except for larger areas where contour planting and/or chiseling are used. This is due to working with bare areas without erosion control practices. All planting and seedbed preparation should be done on the contour. For areas of 5 acres or more the "P" values shown in Table 8 can be used if contour planting or contour chiseling in conjunction with contour planting are used.

Chiseling provides a temporary trap for surface water. To be effective, chiseling must be conducted on the contour immediately after planting. The area should be chiseled to a minimum depth of 12 inches and at an interval of approximately 10 feet. Compaction of the chiseled area must be avoided. Since chiseling is effective for a very short period of time it should be used only when planting is done during the growing season (April 15 - September 15). The "P" values for contour tillage and planting are found in Table 8.

When temporary seeding is to be used rough grading should be considered. Rough grading will provide a temporary trap for water and silt, however, it will not have enough effect to alter the "P" value.

% Slope	Contouring	Contour Chiseling Used in Conjunction w/Contour Planting
2-7	0.5	0.4
7-12	0.6	0.5
12-18	0.8	0.7
18-24	0.9	0.8

EXAMPLES OF THE USE OF SOIL LOSS EQUATION

In order to use the soil loss prediction equation, one must determine soil texture, percent slope, length of slope, cover-management and erosion control practices:

1. Rainfall (R), the R values can be read from Figure 1 by locating the county and taking the nearest R value or by interpolation.
2. Soil Erodibility (K), Table 2 and 2A provides the K values. In order to determine the K value, determine the texture of the soil and select the proper value from Table 2 and 2A.
3. Slope Length, Table 3 gives LS values. The slope length is the distance from the ridge to either (A) the point where the slope decreases to the extent that deposition begins or (b) the point where runoff enters a well-defined channel which may be part of a drainage network or a constructed channel such as a terrace or diversion.
4. Slope Steepness (S), Table 3 gives LS values. The slope steepness is measured from the ridge to the point where either (a) the slope decreases to the extent that deposition begins or (b) the point where runoff enters a well-defined channel which may be part of a drainage network or a constructed channel such as terrace or diversion. To calculate slope steepness, measure the vertical drop per 100 feet of horizontal distance. Slope is expressed as a percentage and is equal to the vertical drop times 100 divided by the horizontal distance.

Example:

Assume slope is uniform

300 ft. at 6%. The soil is a clay loam located in Licking County

$A = R \times K \times LS \times C \times P$

Situation I

Area fallow

$150 \times .32 \times 1.2 \times 1 \times 1 = 57.6 \text{ Tons}$

Situation II

Area seeded - August 1 - No Mulch

Assume 60% Cover by October 1

Refer to Table 1

14% of Annual Soil Loss in August

10% of Annual Soil Loss in September

24% Annual Soil Loss in September and October

24% x 57.6 = 13.8 Tons Soil Loss During September & October

Refer to Table 5

Obtain "C" Value for 60% Ground Cover w/no appreciable canopy = .042

150 x .32 x 1.2 x .042 x 1 = 2.4 Tons

76% x 2.4 = 1.8 Tons of Soil Loss for the Period Oct. 1 to July 31

Total Annual Soil Loss = 13.8 + 1.8 = 15.6 Tons

Situation III

Area seeded and mulched at the rate of 2 T/A of Straw Mulch on Aug. 1

80% Cover can be assumed by October 1

(% Cover can be expected to increase due to Mulch)

Refer to Table 1

24% of Annual Soil Loss occurs in August and September

Refer to Table 6

"C" Value for 2 tons of Straw Mulch is .06

150 x .32 x 1.2 x .06 x 1 = 3.45

24% x 3.45 = .82

Refer to Table 5

"C" Value for 80% Cover w/no appreciable canopy = .013

150 x .32 x 1.2 x .013 x 1 = .75

76% x .75 = .57

Total Annual Soil Loss = .82 + .57 = 1.39 Tons

The Application of Mulch reduces the Annual Soil Loss 14.2 Tons.

**INSTALLATION
AND
MAINTENANCE AIDS**

GUIDELINES FOR SELECTING AND PROTECTING TREES DURING DEVELOPMENT

Saving trees during and after construction has many advantages. These include aesthetic values, beautification, soil erosion control, shade, wildlife enhancement, screening, and breaking the forces of wind.

Builders, contractors, developers, and others planning construction on a wooded area are faced with the problem of what trees to keep and which to remove.

The following are some items that should be considered when selecting trees to remain in an urban area.

Longevity - Long-lived trees are much more valuable than short-lived trees. A short-lived tree must soon be removed, perhaps at considerable cost, and then replaced at more cost. The willows and cottonwoods are rated low partially because of being short-lived.

Cleanliness - Some trees are notoriously dirty; dropping twigs, bark, fruit or plant exudates. A clean tree is easier to maintain and more attractive than a dirty one.

Freedom from Disease and Insects - Disease and insect control costs money and is an inconvenience. A tree that attracts insects may be quite undesirable. An example would be a boxelder with its boxelder bugs.

Hardiness - To be most desirable, a tree must be able to thrive in the climate where used.

Brittleness - Trees with brash wood are often spoiled in appearance as big limbs or tops break out during winds. In addition to being unsightly the breakage may represent a threat to human life and property. It makes the tree more vulnerable to disease and insect attacks. Silver maple is an example of a tree highly subject to breakage.

Weedy Habit - Trees which seed prolifically or sucker profusely from the roots are not desirable in urban areas. Examples of these are Siberian elm and White poplar.

Thorniness - Thorny trees are not generally desirable in urban areas because children may be accidentally injured by the thorns. The thornless varieties are most preferred, when available, such as honeylocust.

Beauty - Handsome bark, good leaf conformation and color, fine autumnal coloration, pleasing form and attractive flowers and fruit are characteristics which make for higher ratings.

Rooting Habits - Some trees have very weak roots and they are easily blown over during high winds. An example is mountain ash.

Information concerning the characteristics of different trees may be obtained by contacting the ODNR, Division of Forestry; the Cooperative Extension Service; or the Soil Conservation Service.

Trees need to be protected from construction equipment, grade changes - either higher or lower - and excavations for utility lines. To protect a tree against mechanical injury, construct a single fence or other barrier around it. Enclose an area at least 10 feet square with the tree in the center. All exposed roots should be inside the barrier to prevent damage from vehicles and construction equipment.

Tree roots need air, water, and minerals to survive. Any changes in grade will affect these important ingredients, and a tree has difficulty in obtaining normal amounts of each. In raising grades, minor fills - 6 inches or less in depth - may not do any harm if soil is fertile and has good tilth. Major grade increases usually require gravel layers and tile drain systems (See Page 168). Tiles are laid on original grade in the form of spokes of a wheel. The "spokes" open into a dry well built around the tree trunk. The dry well acts as the hub of the tile system and holds fill away from the tree trunk. It may be necessary to place a series of bell tiles vertically over the roots and connected to the rim of the wagon-wheel system to allow for additional air and water circulation. The air system will have to be designed for each tree individually, and it will have to fit the contour of the land so water drains away from the tree trunk.

Protecting a tree from a lowered grade is usually less complicated than protecting it from a raised grade. Generally, protection is achieved by terracing the grade. If space is available, the tree may be unharmed by letting it remain on a gently sloping mound. Another way to protect it from a lowered grade is to build a retaining wall between it and the lower grade (See Page 168).

Trees can be protected from underground utility lines. If the route cannot be diverted around the tree, tunneling under it may be necessary (See Page 168). In tunneling, cut as few

USDA, Soil Conservation Service
Columbus, Ohio

roots as possible, cut them clearly, paint cut root ends with a wound dressing like asphalt-base paints, and backfill trench as soon as possible to keep roots from being exposed to air.

There may be occasions when the only way to save a tree is to move it. It is best to move trees when they are dormant. Practically no kind of plant can survive if roots have dried out. Roots must be moist at all times. Trees are moved either by the bare-root method or by the balled and burlapped (B&B) method. Bare-rooted trees may be moved if they are small and dormant, and protected. They should be protected by applying wet material such as peat moss to their roots immediately and kept moist. In the B&B method, balls of earth should enclose most of the root system. Tables listed below give recommended minimum ball diameters and depths of holes for different ball sizes of shrubs and trees.

A more complete discussion of this subject appears in Agricultural Information Bulletin 285, "Protecting Trees Against Damage from Construction Work."

Recommended Minimum Ball Diameter for Different Sizes of Shrubs and Trees			
Shrubs & Small Trees		Larger Trees	
Height of Plant (Ft.)	Diameter of Ball (In.)	Tree Diameter 1 Foot Above Ground (In.)	Diameter of Ball (In.)
1	1.2 - 2	1 1/2 - 1 1/2	18
2	- 3	1 1/2 - 1 3/4	20
3	- 4	1 3/4 - 2	22
4	- 5	2 - 2 1/2	24
5	- 6	2 1/2 - 3	28
6	- 7	3 - 3 1/2	33
7	- 8	3 1/2 - 4	38
8	- 9	4 - 4 1/2	43
9	- 10	4 1/2 - 5	48
10	- 12	5 - 5 1/2	53
12	- 14	5 1/2 - 6	58
14	- 16	6 - 7	65

Recommended Depths to Dig for Different Ball Sizes	
Depth of Ball (Inches)	Diameter of Ball (Inches)
10	8
20	15
30	20
48	30

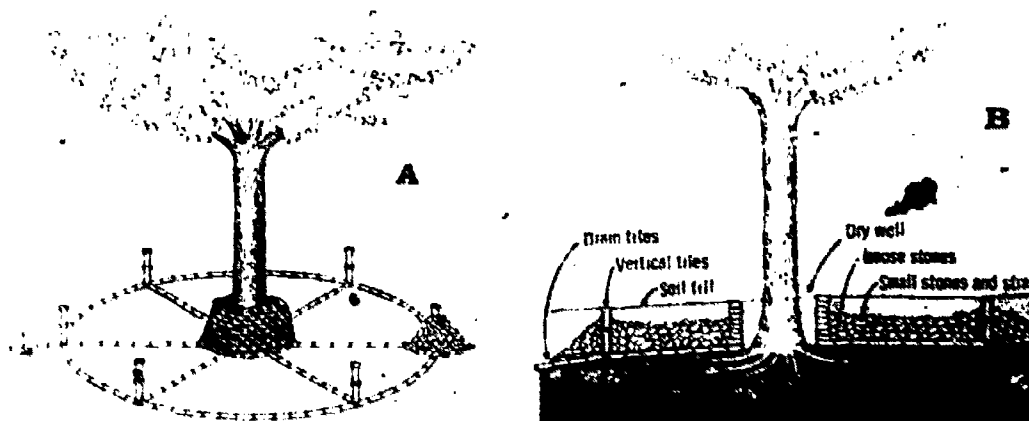

A tile system protects a tree from a raised grade. A, The tile is laid out on the original grade, leading from a dry well around the tree trunk. B, The tile system is covered with small stones to allow air to circulate over the root area.

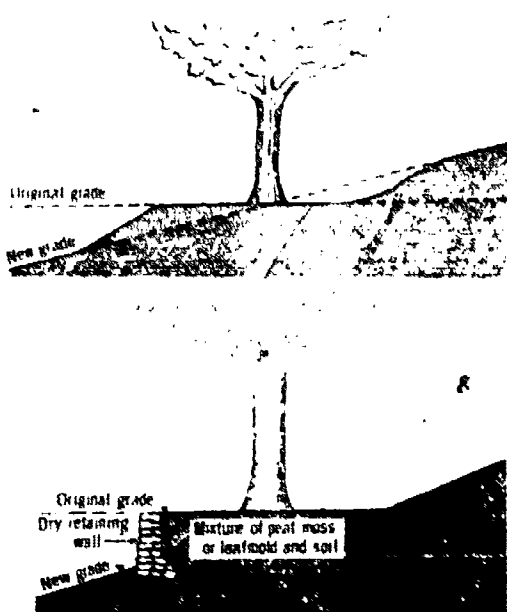

A retaining wall protects a tree from a lowered grade.

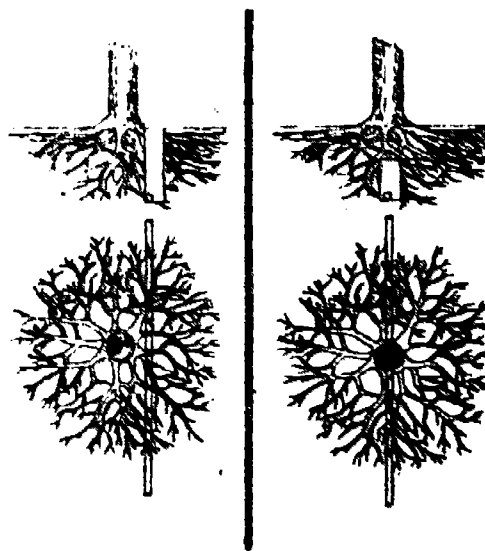

Tunnel beneath root systems. Drawings at left show trenching that would probably kill the tree. Drawings at right show how tunneling under the tree will preserve many of the important, feeder roots.

REPAIR OF SMALL WOUNDS

Small wounds may be made on trees by bulldozers and backhoes during construction. Prompt treatment of damaged areas will avoid costly tree surgery later.

When small wounds occur:

1. Carefully cut away all loose bark back into the undamaged area.
2. Taper cut at top and bottom.
3. Apply a "tree wound" dressing. A light coating of orange shellac before applying the "tree wound" dressing will give an even better protection.

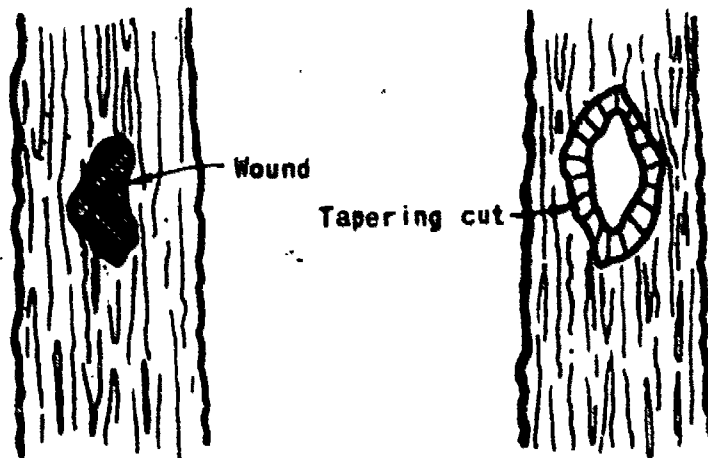

REMOVAL OF LIMBS

During construction it may be necessary to remove tree limbs that have been damaged or limbs that are in the way. Follow the method shown below to preserve valuable trees.

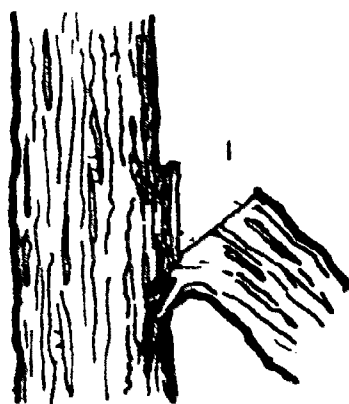

Wrong Method

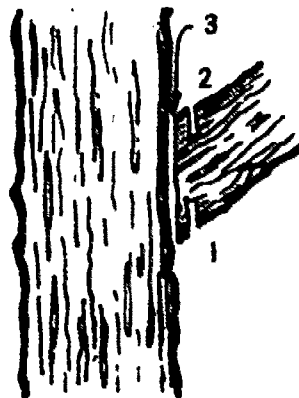

Proper method

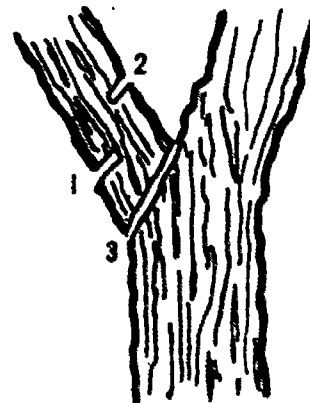

Proper method

The numbered cuts on the two drawings at the right show how to prune the trees without tearing the bark below the pruned limb. Other items to remember are:

1. Never leave the stub of a limb. If left, these rot and cause the trunk of the tree to decay.
2. When a limb is removed, cover the cut with "tree wound" dressing. This material is available at most nurseries or garden supply stores.
3. DO NOT cover the cut with lead or copper based house paints, creosote or roofing tar. These materials crack, peel and are toxic to the tender tree tissues.
4. Major tree surgery, such as topping of large trees, cavity filling, etc. should be done by tree experts with proper equipment.

INSTRUCTIONS FOR INSTALLATION OF MULCH NETTINGS IN WATERWAYS

WHAT IT IS: Mulch netting is made of tightly twisted natural kraft paper yarns, woven with a warp count of one pair of yarns per two inches and a filling count of two per inch. It comes in rolls of 500 lineal yards and 45 inches wide.

WHY USED: Mulch netting is used to hold mulch in place over seeded areas in waterways until the sod is established. It also helps protect the soil from erosion during the critical period of vegetative establishment.

HOW USED: Use in place of sod.

PREPARING A WATERWAY CHANNEL

To prevent meandering, grade center to a parabolic shaped channel to confine low flows to the channel where nettings will be laid.

FERTILIZATION

Lime and fertilize to standard recommendations. Work lime and fertilizer into soil by disking.

SEEDING AND MULCHING

Immediately after lime and fertilizer have been applied prepare seedbed, seed, and mulch according to standard recommendations.

LAYING THE NETTING

Starting at the lower end of the channel, the mulch net shall be laid parallel to the flow of the water and as shown on the drawings.

The mulch net shall be secured in place by use of 0.120" diameter (#8 gauge) wire staples, .6 inch long minimum. Along butt joints and outside edges space staples at 4 foot intervals. In center of netting space staples at 6-foot intervals.

June 1978

Anchor slots shall be used at both upstream and downstream ends of mulch netting. Bury ends in a slit trench, at a minimum of 6 inches deep. Staple to bottom of trench at 6 to 10 inch spacing for added protection. Backfill trench and tamp firmly to conform to channel cross section.

Check slots shall be used whenever rills are likely to form. Such as long slopes where velocity and volume of water may be high, where grade change occurs, or at points of entry of concentrated flow, such as culverts or terraces. At points of entry into the waterway channel of these flows check slots shall be installed on outside edges of the mulch netting.

Check slots shall be installed similar to anchor slots and should extend beyond channel lines to prevent rills that might form outside the channel lining. Spacing of check slots will vary from 25 feet to 100 feet, depending upon erodibility of the soil.

(Do not walk or travel on mulch netting with men or equipment after placement.)

DETAIL FOR STABILIZING WATERWAYS WITH MULCH NETTING

A. Anchor Slots - Bury both ends of the mulch netting in a trench 6 inches or more in depth. Staple to bottom of trench at 6 to 10 inch spacing.

B. Tamp the trench full of soil.

C. Overlap--Bury upper end of lower strip as in 'A' and 'B'. Overlap end of top strip 4 inches and staple.

D. Check Slot --Fold of netting buried in slit trench and tamped, row of staples in bottom of trench.

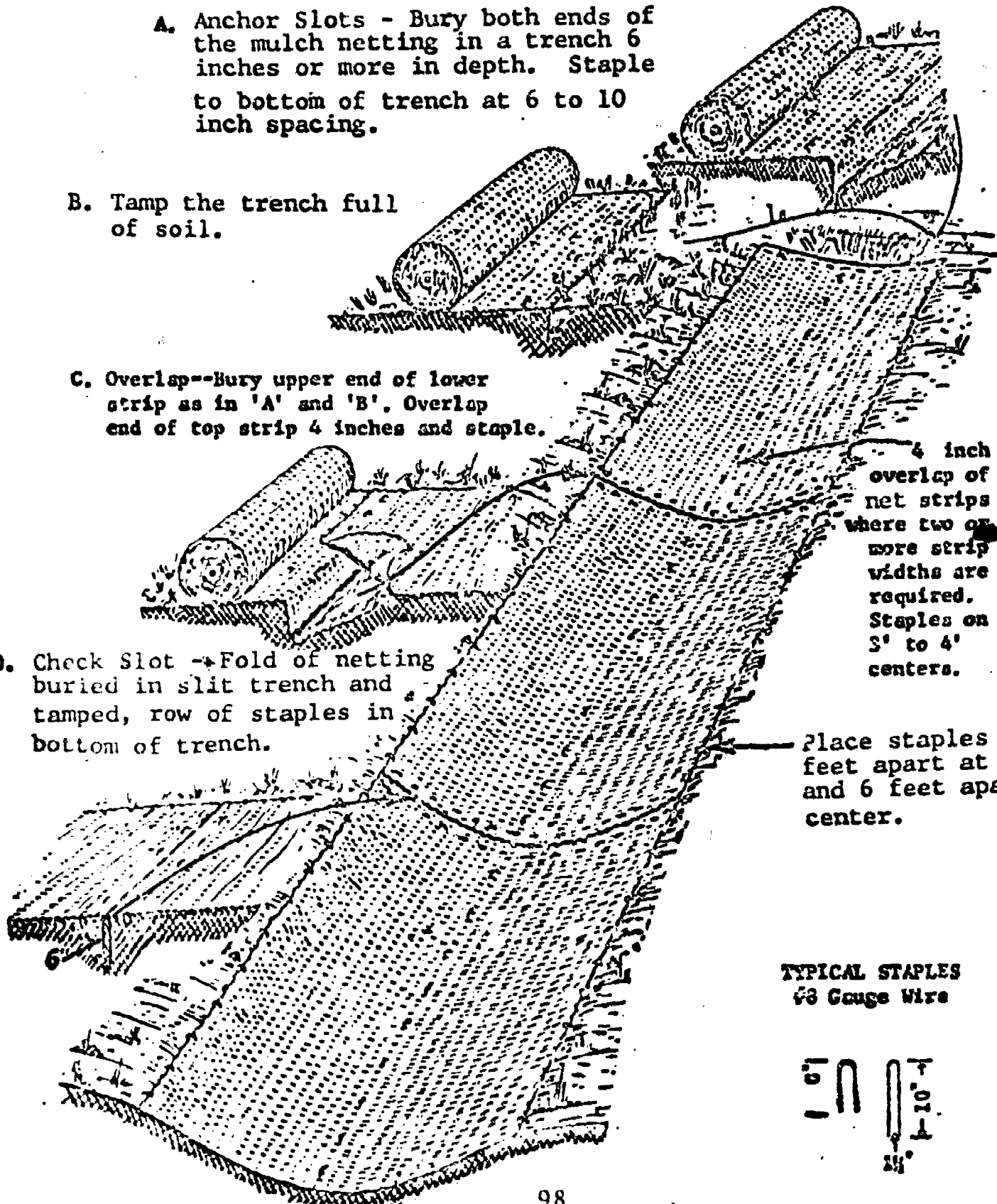

4 inch overlap of net strips where two or more strip widths are required. Staples on 3' to 4' centers.

Place staples 4 feet apart at edge and 6 feet apart in center.

**TYPICAL STAPLES
#8 Gauge Wire**

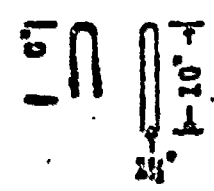

LAND GRADING - URBAN AREAS

June 1978

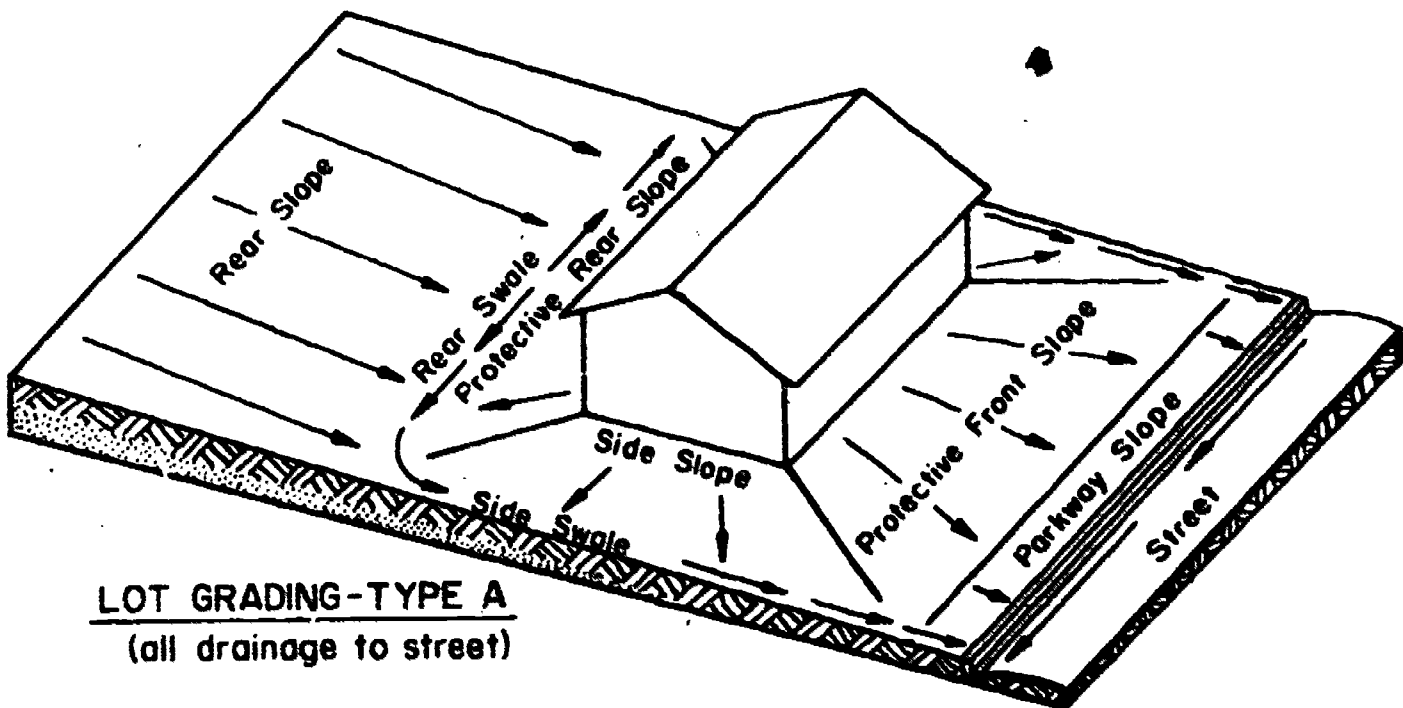
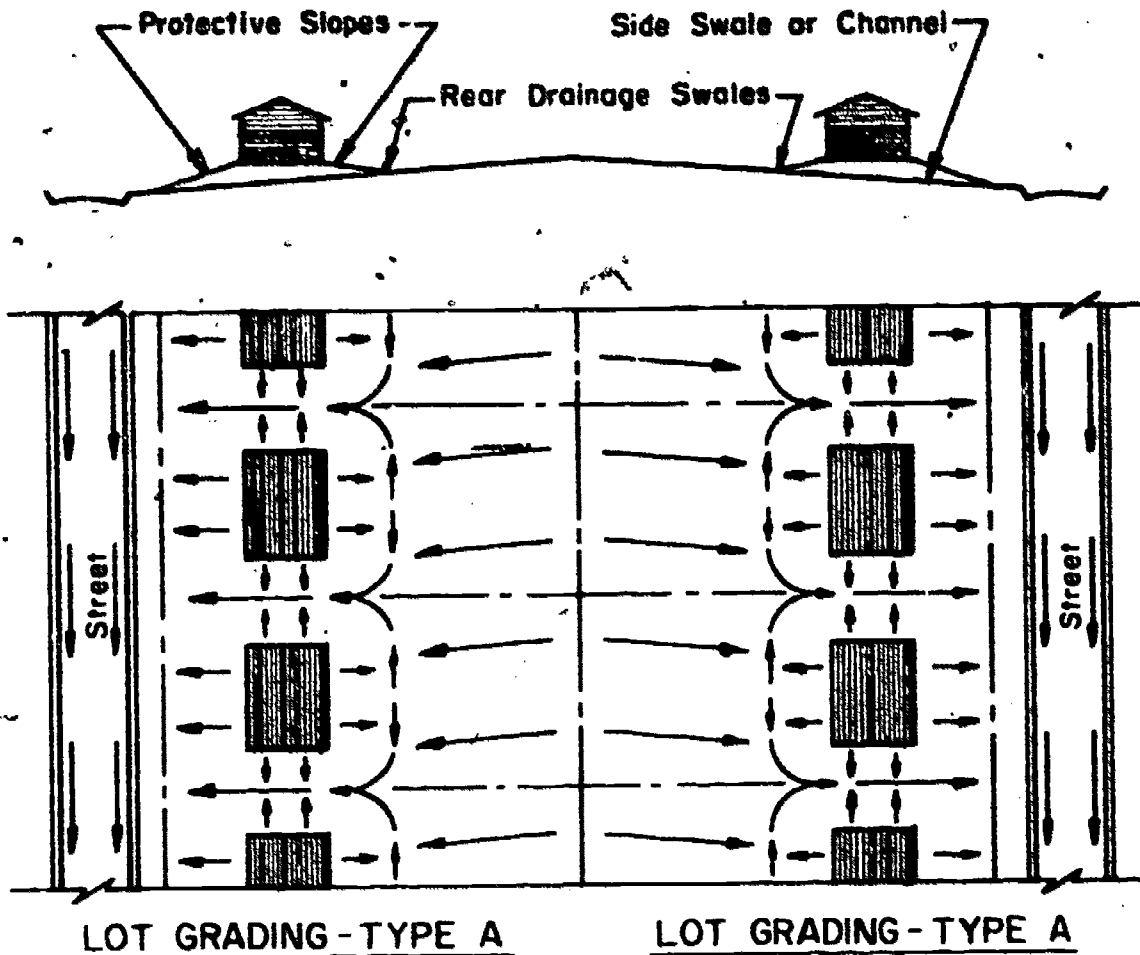

EXAMPLE: BLOCK GRADING TYPE I

Ridge Along Rear Lot Lines

REFERENCE

"Minimum Property Standards for
One and Two Living Units"
HUD-FHA

November 1966

FHA No. 300

US DEPARTMENT OF AGRICULTURE
SOIL CONSERVATION SERVICE

OHIO

LAND GRADING - URBAN AREAS

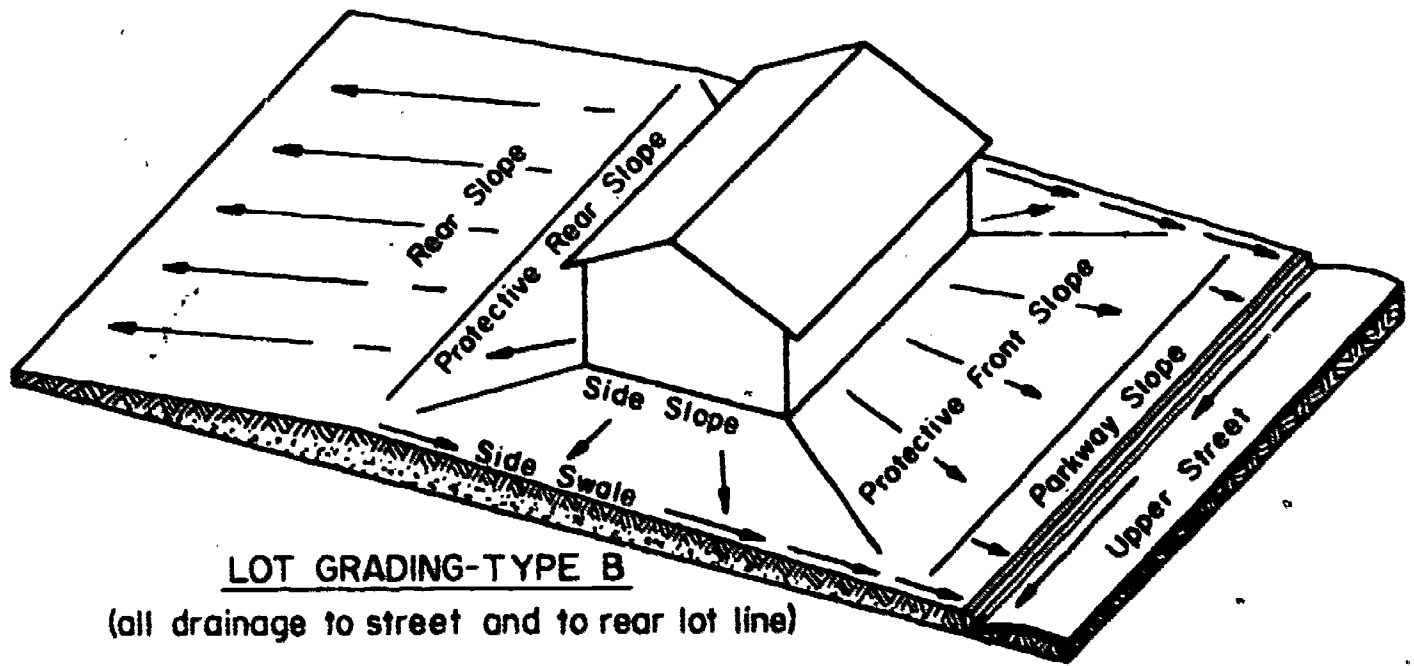
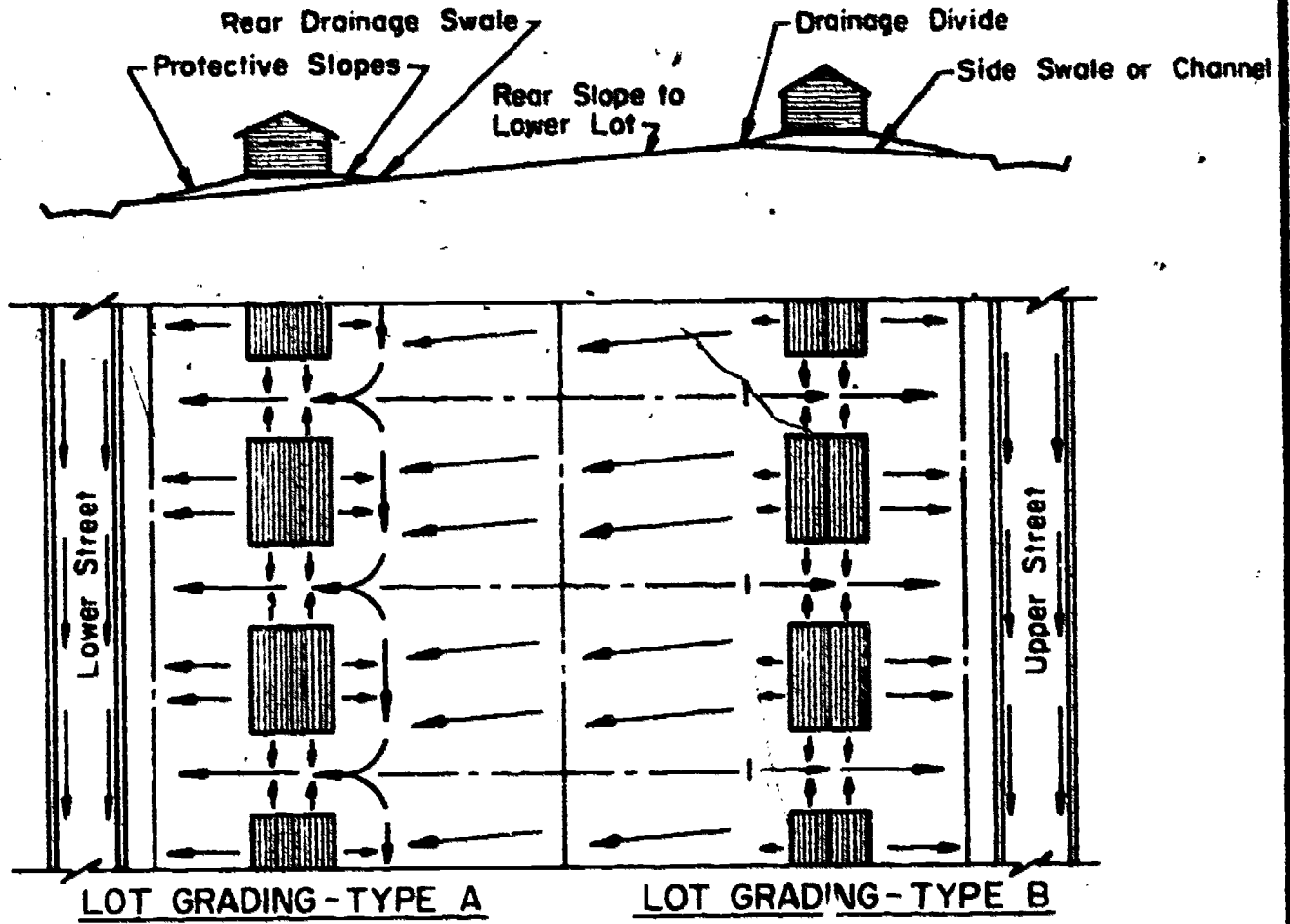

EXAMPLE: BLOCK GRADING TYPE 2 Gentle Cross Slope

<p>REFERENCE "Minimum Property Standards for One and Two Living Units" HUD-FHA November 1966 FHA No. 300</p>	<p>US DEPARTMENT OF AGRICULTURE SOIL CONSERVATION SERVICE OHIO</p>	
---	--	--

LAND GRADING - URBAN AREAS

June 1978

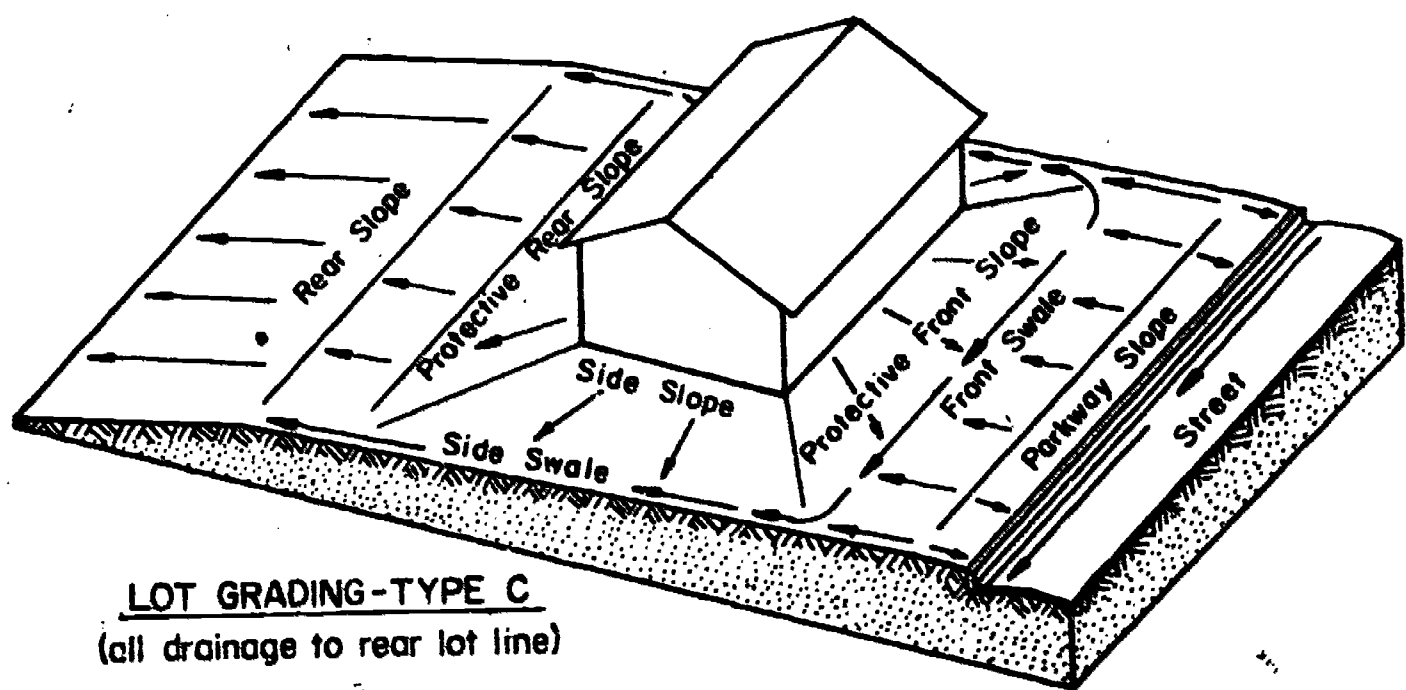
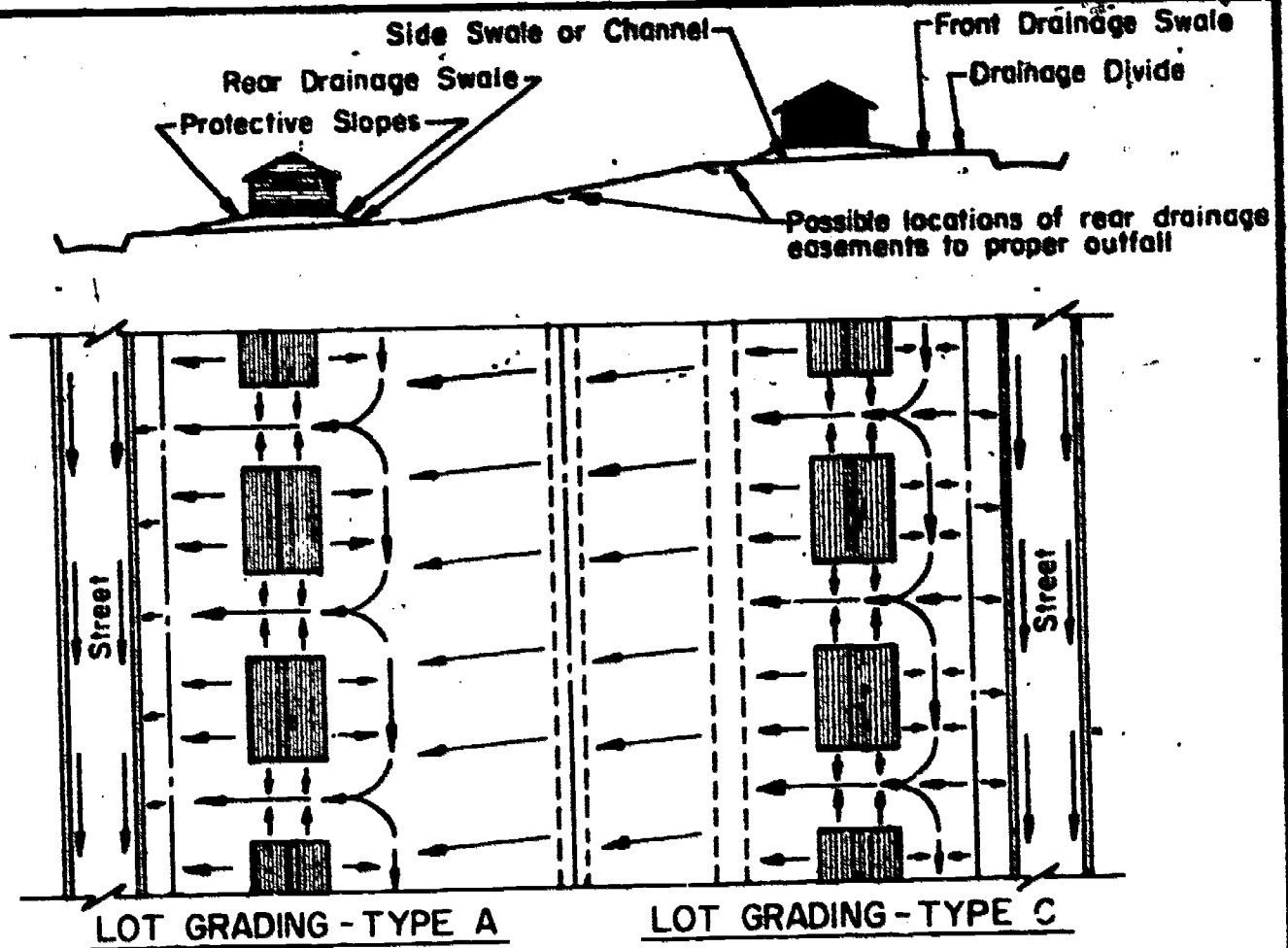

LOT GRADING - TYPE C
(all drainage to rear lot line)

EXAMPLE: BLOCK GRADING TYPE 3 Steep Cross-Slope

REFERENCE
"Minimum Property Standards for
One and Two Living Units"
HUD-FHA
November 1966 FHA No. 300

US DEPARTMENT OF AGRICULTURE
SOIL CONSERVATION SERVICE
OHIO

LAND GRADING - URBAN AREAS

June 1978

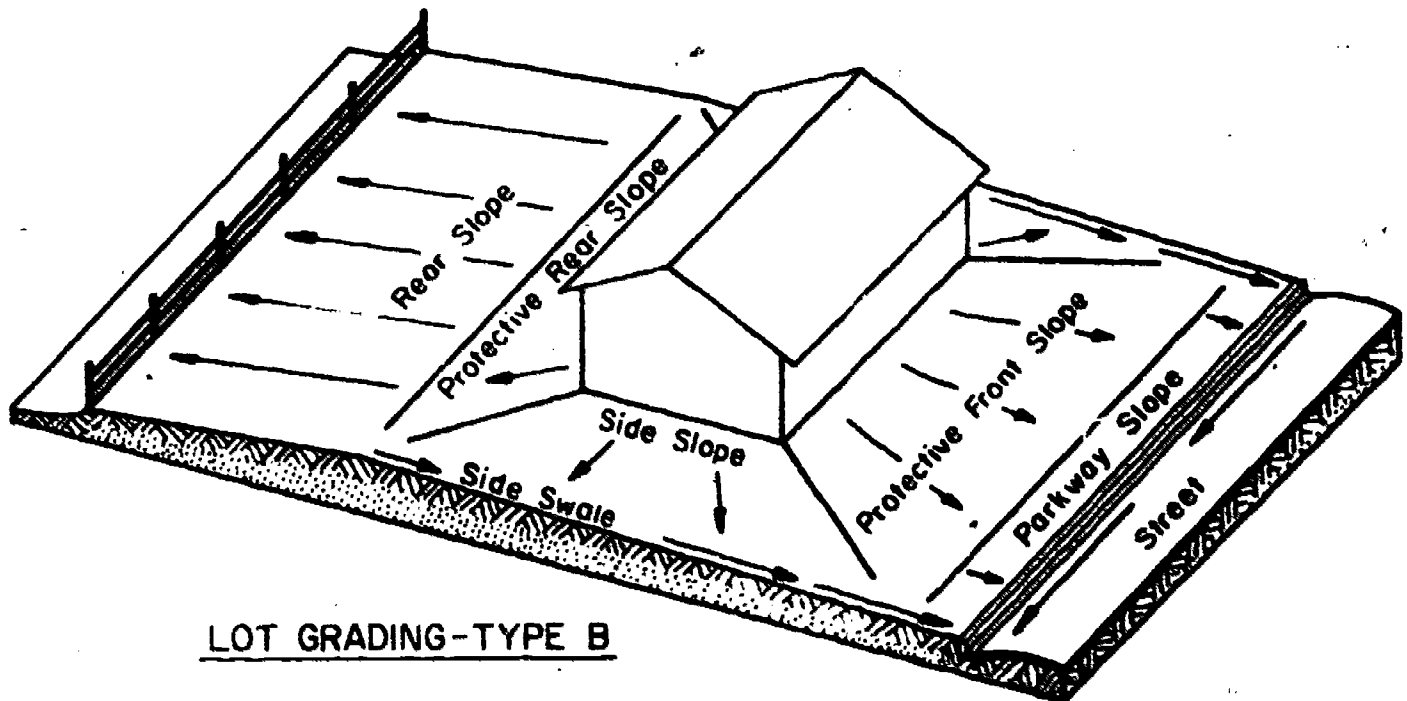
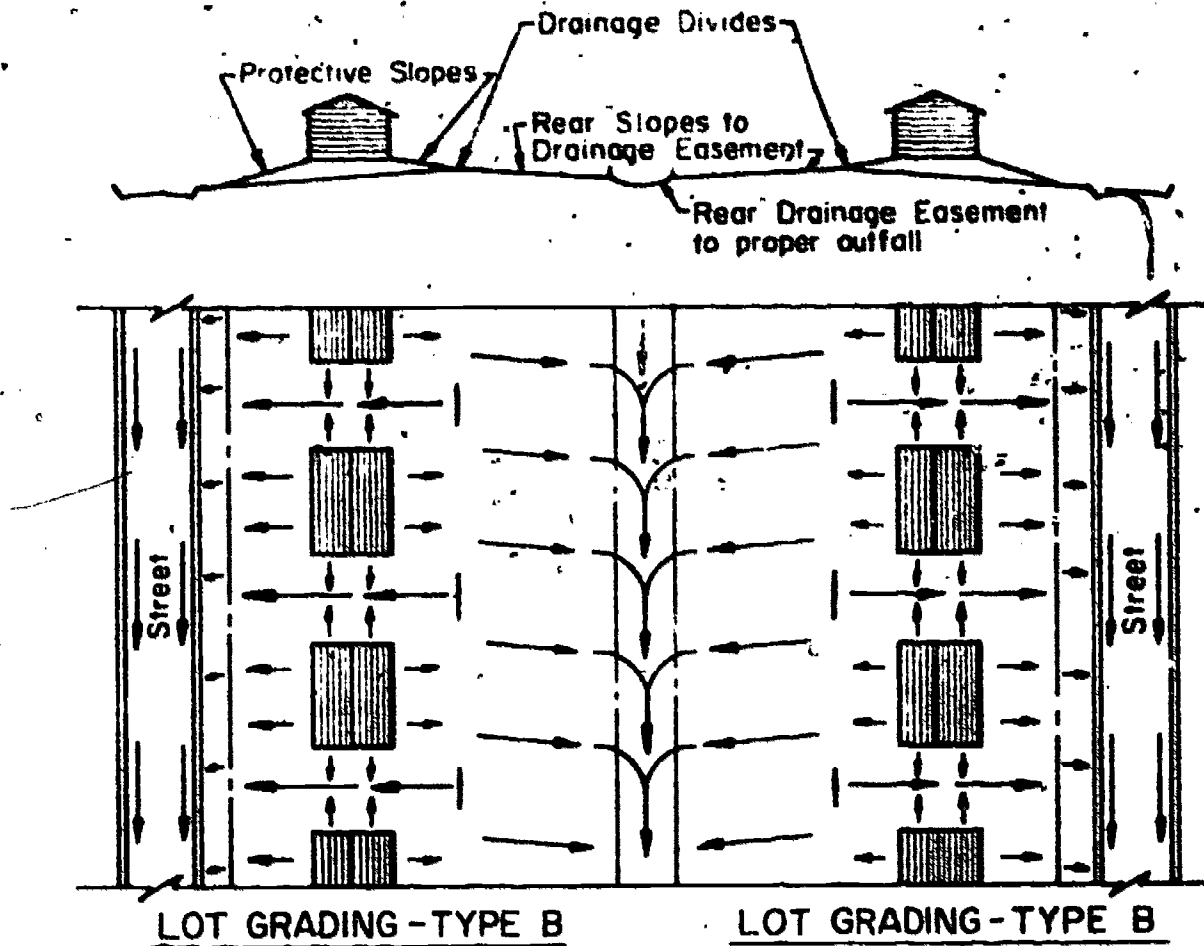

EXAMPLE: BLOCK GRADING TYPE 4

Valley Along Rear Lot Lines

REFERENCE

"Minimum Property Standards for One and Two Living Units"
HUD-FHA

November 1966

FHA No. 300

**US DEPARTMENT OF AGRICULTURE
SOIL CONSERVATION SERVICE**

OHIO

102

106

APPENDIX

V₁ Based on Permissible Velocity of the Soil With Retardance "D"

Grade = 0.25%

Top Width, Depth & V₂ Based on Retardance "B"

Q	V ₁ = 2.0			V ₁ = 2.5			V ₁ = 3.0			V ₁ = 3.5			V ₁ = 4.0			V ₁ = 4.5			V ₁ = 5.0			V ₁ = 5.5			V ₁ = 6.0				
	cfs	T	D	V ₂	T	D	V ₂	T	D	V ₂	T	D	V ₂	T	D	V ₂	T	D	V ₂	T	D	V ₂	T	D	V ₂	T	D	V ₂	
15																													
20																													
25	12	3.8	1.0																										
30	14	3.6	1.1																										
35	17	3.5	1.1																										
40	19	3.5	1.2	13	4.1	1.4																							
45	21	3.4	1.2	14	4.0	1.4																							
50	23	3.4	1.2	16	3.9	1.5																							
55	26	3.4	1.2	17	3.9	1.5																							
60	28	3.4	1.2	19	3.9	1.5																							
65	30	3.4	1.2	20	3.8	1.6																							
70	32	3.4	1.2	22	3.8	1.6	15	4.5	1.8																				
75	34	3.4	1.2	23	3.8	1.6	16	4.4	1.9																				
80	37	3.4	1.2	25	3.8	1.6	17	4.4	1.9																				
90	41	3.4	1.2	28	3.8	1.6	19	4.3	1.9																				
100	46	3.4	1.2	31	3.7	1.6	21	4.3	2.0																				
110	50	3.4	1.2	34	3.7	1.6	23	4.2	2.0																				
120	55	3.4	1.3	37	3.7	1.6	26	4.2	2.0	18	5.0	2.3																	
130	59	3.4	1.3	40	3.7	1.6	28	4.2	2.0	19	4.9	2.4																	
140	64	3.3	1.3	43	3.7	1.7	30	4.2	2.0	21	4.9	2.4																	
150	68	3.3	1.3	46	3.7	1.7	32	4.2	2.0	22	4.8	2.5																	
160	73	3.3	1.3	49	3.7	1.7	34	4.2	2.0	24	4.8	2.5																	
170	77	3.3	1.3	52	3.7	1.7	36	4.2	2.1	25	4.8	2.5	20	5.5	2.8														
180	82	3.3	1.3	55	3.7	1.7	38	4.2	2.1	26	4.7	2.6	21	5.4	2.8														
190	86	3.3	1.3	58	3.7	1.7	40	4.2	2.1	28	4.7	2.6	22	5.4	2.8														
200	91	3.3	1.3	61	3.7	1.7	42	4.2	2.1	29	4.7	2.6	23	5.3	2.9														
220				67	3.7	1.7	46	4.2	2.1	32	4.7	2.6	25	5.3	2.9														
240				73	3.7	1.7	50	4.1	2.1	35	4.7	2.6	27	5.2	3.0														
260				79	3.7	1.7	54	4.1	2.1	38	4.7	2.6	29	5.2	3.0	22	6.0	3.3											
280				85	3.7	1.7	59	4.1	2.1	40	4.6	2.6	31	5.1	3.1	24	5.9	3.4											
300				91	3.7	1.7	63	4.1	2.1	43	4.6	2.7	33	5.1	3.1	26	5.9	3.4											

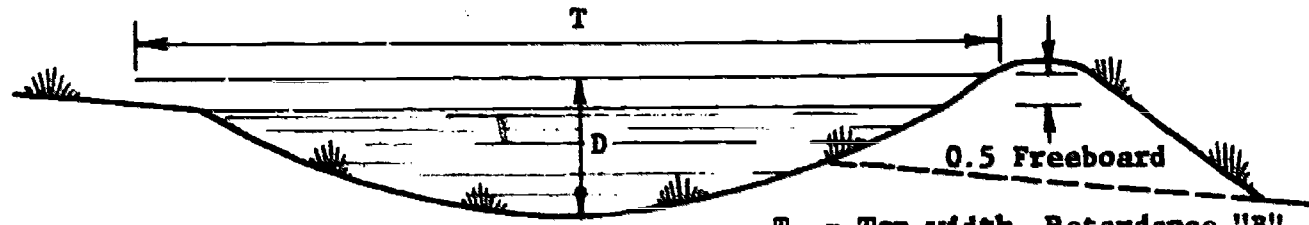

T = Top width, Retardance "B"
 D = Depth, Retardance "B"
 V₂ = Velocity, Retardance "B"
 V₁ = Velocity, Retardance "D"

(Settlement to be added to top of ridge.)

Parabolic diversion design chart (Sheet 1 of 13)

103

June 1978
 Appendix B-1.1

V₁ Based on Permissible Velocity of the Soil With Retardance "D"

Top Width, Depth & V₂ Based on Retardance "B"

Grade = 0.5%

Q cfs	V ₁ = 2.0			V ₁ = 2.5			V ₁ = 3.0			V ₁ = 3.5			V ₁ = 4.0			V ₁ = 4.5			V ₁ = 5.0			V ₁ = 5.5			V ₁ = 6.0					
	T	D	V ₂	T	D	V ₂	T	D	V ₂	T	D	V ₂	T	D	V ₂	T	D	V ₂	T	D	V ₂	T	D	V ₂	T	D	V ₂	T	D	V ₂
15	12	2.8	1.0																											
20	15	2.7	1.0																											
25	18	2.7	1.1	12	3.1	1.4																								
30	22	2.6	1.1	14	3.0	1.4	10	3.4	1.6																					
35	25	2.6	1.1	16	3.0	1.5	12	3.3	1.7																					
40	29	2.6	1.1	18	2.9	1.5	13	3.2	1.8																					
45	33	2.6	1.1	20	2.9	1.5	15	3.2	1.8																					
50	36	2.6	1.1	22	2.9	1.5	17	3.1	1.9	12	3.7	2.1																		
55	40	2.6	1.1	24	2.9	1.6	18	3.1	1.9	13	3.6	2.2																		
60	43	2.6	1.1	27	2.9	1.6	20	3.1	1.9	14	3.6	2.2																		
65	47	2.6	1.1	29	2.9	1.6	21	3.1	1.9	15	3.5	2.3																		
70	50	2.6	1.1	31	2.9	1.6	23	3.1	1.9	16	3.5	2.3																		
75	54	2.6	1.1	33	2.9	1.6	25	3.1	1.9	17	3.5	2.3	14	4.0	2.5															
80	58	2.6	1.1	35	2.9	1.6	26	3.1	1.9	18	3.5	2.4	15	3.9	2.6															
90	65	2.6	1.1	40	2.9	1.6	29	3.1	2.0	21	3.5	2.4	16	3.9	2.6															
100	72	2.6	1.1	44	2.8	1.6	32	3.1	2.0	23	3.4	2.4	18	3.8	2.7	14	4.3	3.0												
110	79	2.6	1.1	48	2.8	1.6	36	3.1	2.0	25	3.4	2.4	20	3.8	2.8	16	4.2	3.1												
120	86	2.6	1.1	52	2.8	1.6	39	3.1	2.0	27	3.4	2.5	21	3.7	2.8	17	4.1	3.1												
130	93	2.6	1.1	57	2.8	1.6	42	3.1	2.0	30	3.4	2.5	23	3.7	2.8	18	4.1	3.2												
140				61	2.8	1.6	45	3.1	2.0	32	3.4	2.5	25	3.7	2.8	19	4.1	3.2												
150				65	2.8	1.6	48	3.1	2.0	34	3.4	2.5	26	3.7	2.9	21	4.1	3.2	17	4.6	3.5									
160				70	2.8	1.6	52	3.0	2.0	36	3.4	2.5	28	3.7	2.9	22	4.0	3.3	18	4.5	3.6									
170				74	2.8	1.6	55	3.0	2.0	39	3.4	2.5	30	3.7	2.9	24	4.0	3.3	19	4.5	3.6									
180				78	2.8	1.6	58	3.0	2.0	41	3.4	2.5	31	3.7	2.9	25	4.0	3.3	20	4.5	3.7									
190				83	2.8	1.6	61	3.0	2.0	43	3.4	2.5	33	3.7	2.9	26	4.0	3.3	21	4.5	3.7									
200				87	2.8	1.6	64	3.0	2.0	45	3.4	2.5	35	3.7	2.9	27	4.0	3.3	22	4.4	3.8	18	5.0	4.0						
220				95	2.8	1.6	71	3.0	2.0	50	3.4	2.5	38	3.7	2.9	30	4.0	3.4	24	4.4	3.8	19	4.9	4.1						
240							77	3.0	2.0	54	3.4	2.5	42	3.7	2.9	33	4.0	3.4	26	4.4	3.8	21	4.9	4.1						
260							83	3.0	2.0	59	3.4	2.5	45	3.7	3.0	36	4.0	3.4	28	4.3	3.9	23	4.8	4.2						
280							90	3.0	2.0	63	3.4	2.5	48	3.7	3.0	38	4.0	3.4	30	4.3	3.9	24	4.8	4.2	20	5.4	4.5			
300							96	3.0	2.0	68	3.4	2.5	52	3.6	3.0	41	4.0	3.4	32	4.3	3.9	26	4.8	4.3	21	5.3	4.6			

T = Top width, Retardance "B"
 D = Depth, Retardance "B"
 V₂ = Velocity, Retardance "B"
 V₁ = Velocity, Retardance "D"

(Settlement to be added to top of ridge.)

Parabolic diversion design chart (Sheet 2 of 13)



V_1 Based on Permissible Velocity of the Soil With Retardance "D"

Top Width, Depth & V_2 Based on Retardance "B"

Grade = 0.75%

Q	$V_1 = 2.0$			$V_1 = 2.5$			$V_1 = 3.0$			$V_1 = 3.5$			$V_1 = 4.0$			$V_1 = 4.5$			$V_1 = 5.0$			$V_1 = 5.5$			$V_1 = 6.0$		
	cfs	T	D	V_2	T	D	V_2	T	D	V_2	T	D	V_2	T	D	V_2	T	D	V_2	T	D	V_2	T	D	V_2		
15	16	2.3	0.9	10	2.7	1.2																					
20	21	2.3	0.9	12	2.6	1.4																					
25	26	2.2	1.0	14	2.5	1.4	11	2.8	1.7																		
30	31	2.2	1.0	17	2.5	1.4	12	2.8	1.8	10	3.1	1.9															
35	36	2.2	1.0	20	2.5	1.5	14	2.7	1.8	11	3.0	2.1															
40	41	2.2	1.0	23	2.5	1.5	16	2.7	1.8	13	2.9	2.1															
45	46	2.2	1.0	26	2.5	1.5	18	2.7	1.9	14	2.9	2.2															
50	51	2.2	1.0	28	2.5	1.5	20	2.7	1.9	16	2.9	2.2	12	3.3	2.5												
55	56	2.2	1.0	31	2.5	1.5	22	2.7	1.9	17	2.9	2.2	13	3.3	2.5												
60	61	2.2	1.0	34	2.5	1.5	24	2.7	1.9	19	2.9	2.2	14	3.2	2.6												
65	66	2.2	1.0	37	2.5	1.5	26	2.6	1.9	20	2.8	2.3	15	3.2	2.6	12	3.5	2.8									
70	71	2.2	1.0	39	2.5	1.5	28	2.6	1.9	22	2.8	2.3	16	3.2	2.7	13	3.5	2.9									
75	76	2.2	1.0	42	2.5	1.5	30	2.6	1.9	23	2.8	2.3	17	3.2	2.7	14	3.5	2.9									
80	81	2.2	1.0	45	2.5	1.5	32	2.6	1.9	25	2.8	2.3	18	3.2	2.7	15	3.4	3.0									
90	91	2.2	1.0	50	2.5	1.5	36	2.6	1.9	28	2.8	2.3	20	3.1	2.8	16	3.4	3.1	13	3.8	3.3						
100				56	2.5	1.5	40	2.6	1.9	31	2.8	2.3	22	3.1	2.8	18	3.4	3.1	15	3.7	3.4						
110				61	2.5	1.5	44	2.6	1.9	34	2.8	2.3	25	3.1	2.8	20	3.3	3.2	16	3.7	3.5						
120				67	2.5	1.5	48	2.6	2.0	37	2.8	2.3	27	3.1	2.8	22	3.3	3.2	18	3.6	3.5	14	4.0	3.8			
130				72	2.5	1.5	52	2.6	2.0	40	2.8	2.3	29	3.1	2.9	23	3.3	3.2	19	3.6	3.6	16	4.0	3.8			
140				78	2.5	1.5	56	2.6	2.0	43	2.8	2.3	31	3.1	2.9	25	3.3	3.2	20	3.6	3.6	17	4.0	3.9			
150				83	2.5	1.6	60	2.6	2.0	46	2.8	2.3	33	3.1	2.9	27	3.3	3.2	22	3.6	3.7	18	3.9	4.0			
160				89	2.5	1.6	64	2.6	2.0	49	2.8	2.3	35	3.1	2.9	29	3.3	3.3	23	3.6	3.7	19	3.9	4.0	15	4.3	4.4
170				94	2.5	1.6	68	2.6	2.0	52	2.8	2.3	38	3.1	2.9	31	3.3	3.3	24	3.5	3.7	20	3.9	4.1	16	4.3	4.4
180							72	2.6	2.0	55	2.8	2.3	40	3.1	2.9	32	3.3	3.3	26	3.5	3.7	21	3.8	4.1	17	4.2	4.5
190							76	2.6	2.0	58	2.8	2.3	42	3.1	2.9	34	3.3	3.3	27	3.5	3.7	22	3.8	4.1	18	4.2	4.5
200							80	2.6	2.0	61	2.8	2.3	44	3.1	2.9	36	3.3	3.3	29	3.5	3.7	23	3.8	4.2	19	4.2	4.5
220							87	2.6	2.0	68	2.8	2.3	48	3.1	2.9	39	3.3	3.3	32	3.5	3.7	26	3.8	4.2	21	4.2	4.6
240							95	2.6	2.0	74	2.8	2.4	53	3.1	2.9	43	3.3	3.3	34	3.5	3.8	28	3.8	4.2	23	4.1	4.6
260										80	2.8	2.4	57	3.1	2.9	46	3.3	3.3	37	3.5	3.8	30	3.8	4.2	25	4.1	4.7
280										86	2.8	2.4	62	3.1	2.9	50	3.3	3.3	40	3.5	3.8	32	3.8	4.3	26	4.1	4.7
300										92	2.8	2.4	66	3.1	2.9	53	3.3	3.3	43	3.5	3.8	35	3.8	4.3	28	4.1	4.7

T = Top width, Retardance "B"
 D = Depth, Retardance "B"
 V_2 = Velocity, Retardance "B"
 V_1 = Velocity, Retardance "D"

(Settlement to be added to top of ridge.)

Parabolic diversion design chart (Sheet 3 of 13)

105

June 1978
 Appendix B-1.3

V₁ Based on Permissible Velocity of the Soil With Retardance "D"

Grade = 1.0%

Top Width, Depth & V₂ Based on Retardance "B"

Q	V ₁ = 2.0			V ₁ = 2.5			V ₁ = 3.0			V ₁ = 3.5			V ₁ = 4.0			V ₁ = 4.5			V ₁ = 5.0			V ₁ = 5.5			V ₁ = 6.0					
	cts	T	D	V ₂	T	D	V ₂	T	D	V ₂	T	D	V ₂	T	D	V ₂	T	D	V ₂	T	D	V ₂	T	D	V ₂	T	D	V ₂		
15	18	2.1	0.9	11	2.3	1.2																								
20	24	2.0	0.9	15	2.2	1.3	10	2.5	1.7																					
25	30	2.0	0.9	19	2.2	1.3	12	2.5	1.7	10	2.7	1.9																		
30	36	2.0	0.9	22	2.2	1.4	15	2.4	1.8	12	2.6	2.0																		
35	42	2.0	0.9	26	2.2	1.4	17	2.4	1.8	14	2.6	2.1	10	2.9	2.4															
40	48	2.0	1.0	29	2.2	1.4	19	2.4	1.8	15	2.5	2.1	12	2.8	2.5															
45	54	2.0	1.0	33	2.2	1.4	22	2.4	1.8	17	2.5	2.1	13	2.8	2.5															
50	59	2.0	1.0	37	2.2	1.4	24	2.4	1.9	19	2.5	2.2	14	2.8	2.5	11	3.1	2.9												
55	65	2.0	1.0	40	2.2	1.4	26	2.4	1.9	21	2.5	2.2	16	2.8	2.6	12	3.1	2.9												
60	71	2.0	1.0	44	2.2	1.4	29	2.4	1.9	23	2.5	2.2	17	2.7	2.6	13	3.0	3.0												
65	77	2.0	1.0	47	2.2	1.4	31	2.4	1.9	25	2.5	2.2	18	2.7	2.6	14	3.0	3.0	11	3.4	3.2									
70	83	2.0	1.0	51	2.2	1.4	33	2.4	1.9	26	2.5	2.2	20	2.7	2.6	15	3.0	3.0	12	3.3	3.3									
75	88	2.0	1.0	54	2.2	1.4	36	2.4	1.9	28	2.5	2.2	21	2.7	2.7	16	3.0	3.1	13	3.3	3.4									
80	94	2.0	1.0	58	2.2	1.4	38	2.4	1.9	30	2.5	2.2	23	2.7	2.7	17	3.0	3.1	14	3.2	3.4									
90				65	2.2	1.4	43	2.4	1.9	34	2.5	2.2	25	2.7	2.7	19	3.0	3.1	16	3.2	3.5	13	3.5	3.8						
100				72	2.2	1.4	47	2.4	1.9	38	2.5	2.2	28	2.7	2.7	21	3.0	3.1	17	3.2	3.6	14	3.4	3.9						
110				79	2.2	1.4	52	2.4	1.9	41	2.5	2.3	31	2.7	2.7	23	2.9	3.2	19	3.2	3.6	16	3.4	3.9	13	3.7	4.1			
120				86	2.2	1.4	57	2.4	1.9	45	2.5	2.3	34	2.7	2.7	25	2.9	3.2	21	3.2	3.6	17	3.4	4.0	15	3.7	4.2			
130				94	2.2	1.4	61	2.4	1.9	49	2.5	2.3	36	2.7	2.7	27	2.9	3.2	22	3.1	3.6	18	3.4	4.0	16	3.6	4.3			
140							66	2.4	1.9	52	2.5	2.3	39	2.7	2.7	29	2.9	3.2	23	3.1	3.6	20	3.4	4.1	17	3.6	4.3			
150							71	2.4	1.9	56	2.5	2.3	42	2.7	2.7	31	2.9	3.2	26	3.1	3.7	21	3.4	4.1	18	3.6	4.4			
160							75	2.4	1.9	60	2.5	2.3	45	2.7	2.7	33	2.9	3.2	27	3.1	3.7	22	3.4	4.1	19	3.6	4.4			
170							80	2.4	1.9	63	2.5	2.3	47	2.7	2.7	35	2.9	3.3	29	3.1	3.7	24	3.4	4.1	20	3.6	4.5			
180							84	2.4	1.9	67	2.5	2.3	50	2.7	2.7	38	2.9	3.3	31	3.1	3.7	25	3.3	4.1	21	3.5	4.5			
190							89	2.4	1.9	71	2.5	2.3	53	2.7	2.7	40	2.9	3.3	32	3.1	3.7	26	3.3	4.2	22	3.5	4.5			
200							94	2.4	1.9	74	2.5	2.3	55	2.7	2.7	42	2.9	3.3	34	3.1	3.7	28	3.3	4.2	24	3.5	4.6			
220										92	2.5	2.3	61	2.7	2.7	46	2.9	3.3	37	3.1	3.7	30	3.3	4.2	26	3.5	4.6			
240										89	2.5	2.3	66	2.7	2.8	50	2.9	3.3	41	3.1	3.7	33	3.3	4.2	28	3.5	4.6			
260										96	2.5	2.3	72	2.7	2.8	54	2.9	3.3	44	3.1	3.8	36	3.3	4.2	30	3.5	4.7			
280													77	2.7	2.8	58	2.9	3.3	47	3.1	3.8	38	3.3	4.2	33	3.5	4.7			
300													83	2.7	2.8	62	2.9	3.3	50	3.1	3.8	41	3.3	4.2	35	3.5	4.7			

T = Top width, Retardance "B"
 D = Depth, Retardance "B"
 V₂ = Velocity, Retardance "B"
 V₁ = Velocity, Retardance "D"

(Settlement to be added to top of ridge.)

Parabolic diversion design chart (Sheet 4 of 13)

June 1978
 Appendix B-1.4

901

114

115

V_1 Based on Permissible Velocity of the Soil With Retardance "D"

Top Width, Depth & V_2 Based on Retardance "B"

Grade = 1.5%

Q	$V_1 = 2.0$			$V_1 = 2.5$			$V_1 = 3.0$			$V_1 = 3.5$			$V_1 = 4.0$			$V_1 = 4.5$			$V_1 = 5.0$			$V_1 = 5.5$			$V_1 = 6.0$					
cfs	T	D	V_2	T	D	V_2	T	D	V_2	T	D	V_2	T	D	V_2	T	D	V_2	T	D	V_2	T	D	V_2	T	D	V_2	T	D	V_2
15	24	1.8	0.9	15	1.9	1.2	10	2.2	1.5																					
20	32	1.8	0.9	20	1.9	1.2	14	2.1	1.6																					
25	39	1.8	0.9	25	1.9	1.2	17	2.1	1.6	11	2.3	2.1																		
30	47	1.8	0.9	31	1.9	1.2	20	2.1	1.6	13	2.3	2.2	11	2.4	2.4															
35	55	1.8	0.9	36	1.9	1.2	23	2.1	1.7	16	2.2	2.2	13	2.4	2.5	10	2.6	2.7												
40	63	1.8	0.9	41	1.9	1.2	27	2.1	1.7	18	2.2	2.2	14	2.3	2.6	12	2.5	2.8												
45	70	1.8	0.9	46	1.9	1.2	30	2.1	1.7	20	2.2	2.2	16	2.3	2.6	13	2.5	2.8	10	2.8	3.2									
50	78	1.8	0.9	51	1.9	1.2	33	2.1	1.7	22	2.2	2.2	18	2.3	2.6	15	2.5	2.9	11	2.8	3.3									
55	86	1.8	0.9	55	1.9	1.2	36	2.1	1.7	24	2.2	2.3	20	2.3	2.6	16	2.5	2.9	12	2.7	3.4	10	3.0	3.5						
60	93	1.8	0.9	60	1.9	1.2	40	2.0	1.7	26	2.2	2.3	21	2.3	2.6	17	2.5	2.9	13	2.7	3.4	11	3.0	3.6						
65				65	1.9	1.2	43	2.0	1.7	29	2.2	2.3	23	2.3	2.6	19	2.5	3.0	14	2.7	3.4	12	2.9	3.7						
70				70	1.9	1.2	46	2.0	1.7	31	2.2	2.3	25	2.3	2.6	20	2.5	3.0	15	2.7	3.4	13	2.9	3.8	11	3.1	4.0			
75				75	1.9	1.2	49	2.0	1.7	33	2.2	2.3	26	2.3	2.7	22	2.5	3.0	16	2.7	3.5	14	2.9	3.8	12	3.1	4.0			
80				80	1.9	1.2	52	2.0	1.7	35	2.2	2.3	28	2.3	2.7	23	2.5	3.0	18	2.7	3.5	15	2.9	3.8	13	3.1	4.2			
90				90	1.9	1.2	59	2.0	1.7	39	2.2	2.3	32	2.3	2.7	26	2.5	3.0	20	2.7	3.5	16	2.8	3.9	14	3.0	4.2			
100							65	2.0	1.7	44	2.2	2.3	35	2.3	2.7	29	2.4	3.0	22	2.7	3.5	18	2.8	4.0	15	3.0	4.3			
110							72	2.0	1.7	48	2.2	2.3	39	2.3	2.7	31	2.4	3.0	24	2.7	3.5	20	2.8	4.0	17	3.0	4.4			
120							78	2.0	1.7	52	2.2	2.3	42	2.3	2.7	34	2.4	3.0	26	2.6	3.6	22	2.8	4.0	18	3.0	4.4			
130							85	2.0	1.7	57	2.2	2.3	45	2.3	2.7	37	2.4	3.0	28	2.6	3.6	23	2.8	4.0	19	3.0	4.4			
140							91	2.0	1.7	61	2.2	2.3	49	2.3	2.7	40	2.4	3.1	30	2.6	3.6	25	2.8	4.0	21	3.0	4.5			
150							97	2.0	1.7	65	2.2	2.3	52	2.3	2.7	43	2.4	3.1	32	2.6	3.6	27	2.8	4.0	22	2.9	4.5			
160										69	2.2	2.3	56	2.3	2.7	45	2.4	3.1	34	2.6	3.6	29	2.8	4.1	24	2.9	4.5			
170										74	2.2	2.3	59	2.3	2.7	48	2.4	3.1	37	2.6	3.6	30	2.8	4.1	25	2.9	4.5			
180	T	= Top width, Retardance "B"									78	2.2	2.3	63	2.3	2.7	51	2.4	3.1	39	2.6	3.6	32	2.8	4.1	27	2.9	4.6		
190	D	= Depth, Retardance "B"									82	2.2	2.3	66	2.3	2.7	54	2.4	3.1	41	2.6	3.7	34	2.8	4.1	28	2.9	4.6		
200	V_2	= Velocity, Retardance "B"									86	2.2	2.3	69	2.3	2.7	56	2.4	3.1	43	2.6	3.7	36	2.8	4.1	30	2.9	4.6		
220	V_1	= Velocity, Retardance "D"									95	2.2	2.3	76	2.3	2.7	62	2.4	3.1	47	2.6	3.7	39	2.8	4.1	33	2.9	4.6		
240													83	2.3	2.7	68	2.4	3.1	51	2.6	3.7	43	2.8	4.1	35	2.9	4.6			
260		(Settlement to be added to top of ridge.)									90	2.3	2.7	73	2.4	3.1	55	2.6	3.7	46	2.8	4.1	38	2.9	4.6					
280										97	2.3	2.7	79	2.4	3.1	60	2.6	3.7	50	2.8	4.1	41	2.9	4.6						
300													84	2.4	3.1	64	2.6	3.7	53	2.8	4.1	44	2.9	4.7						

Parabolic diversion design chart (Sheet 5 of 13)

107

June 1978
Appendix B-1.5

V₁ Based on Permissible Velocity of the Soil With Retardance "D"

Top Width, Depth & V₂ Based on Retardance "B"

Grade = 2.0%

Q	V ₁ = 2.0			V ₁ = 2.5			V ₁ = 3.0			V ₁ = 3.5			V ₁ = 4.0			V ₁ = 4.5			V ₁ = 5.0			V ₁ = 5.5			V ₁ = 6.0					
cfs	T	D	V ₂	T	D	V ₂	T	D	V ₂	T	D	V ₂	T	D	V ₂	T	D	V ₂	T	D	V ₂	T	D	V ₂	T	D	V ₂	T	D	V ₂
15	30	1.6	0.8	18	1.8	1.2	13	1.9	1.4	9	2.1	1.8																		
20	39	1.6	0.8	24	1.8	1.2	17	1.9	1.5	12	2.0	1.9																		
25	49	1.6	0.8	30	1.7	1.2	21	1.9	1.5	15	2.0	2.0	11	2.2	2.4															
30	59	1.6	0.8	35	1.7	1.2	25	1.9	1.5	18	2.0	2.0	13	2.1	2.5	10	2.3	2.8												
35	68	1.6	0.8	41	1.7	1.2	29	1.9	1.5	21	2.0	2.0	15	2.1	2.5	12	2.2	2.9	10	2.4	3.0									
40	78	1.6	0.8	47	1.7	1.2	34	1.9	1.5	23	2.0	2.0	17	2.1	2.5	14	2.2	2.9	11	2.4	3.2									
45	88	1.6	0.8	53	1.7	1.2	38	1.9	1.5	26	2.0	2.0	19	2.1	2.5	15	2.2	2.9	13	2.4	3.2	10	2.6	3.5						
50	97	1.6	0.8	59	1.7	1.2	42	1.9	1.6	29	2.0	2.0	21	2.1	2.6	17	2.2	2.9	14	2.4	3.2	11	2.5	3.6						
55				64	1.7	1.2	46	1.8	1.6	32	2.0	2.0	23	2.1	2.6	19	2.2	2.9	15	2.4	3.3	12	2.5	3.7	10	2.7	4.0			
60				70	1.7	1.2	50	1.8	1.6	35	2.0	2.0	25	2.1	2.6	20	2.2	3.0	17	2.4	3.3	13	2.5	3.7	11	2.7	4.0			
65				76	1.7	1.2	54	1.8	1.6	38	2.0	2.0	27	2.1	2.6	22	2.2	3.0	18	2.3	3.4	15	2.5	3.7	12	2.7	4.1			
70				81	1.7	1.2	58	1.8	1.6	41	2.0	2.1	29	2.1	2.6	24	2.2	3.0	19	2.3	3.4	16	2.5	3.8	13	2.7	4.1			
75				87	1.7	1.2	62	1.8	1.6	43	2.0	2.1	31	2.1	2.6	25	2.2	3.0	21	2.3	3.4	17	2.5	3.8	14	2.7	4.1			
80				93	1.7	1.2	68	1.8	1.6	46	2.0	2.1	33	2.1	2.6	27	2.2	3.0	22	2.3	3.4	18	2.5	3.8	15	2.6	4.2			
90							74	1.8	1.6	52	2.0	2.1	37	2.1	2.6	30	2.2	3.0	25	2.3	3.4	20	2.5	3.8	17	2.6	4.2			
100							83	1.8	1.6	58	2.0	2.1	41	2.1	2.6	34	2.2	3.0	27	2.3	3.4	22	2.5	3.9	18	2.6	4.2			
110							91	1.8	1.6	63	2.0	2.1	45	2.1	2.6	37	2.2	3.0	30	2.3	3.4	24	2.5	3.9	20	2.6	4.2			
120							99	1.8	1.6	69	2.0	2.1	49	2.1	2.6	40	2.2	3.0	33	2.3	3.4	26	2.4	3.9	22	2.6	4.3			
130										75	2.0	2.1	53	2.1	2.6	44	2.2	3.0	35	2.3	3.4	29	2.4	3.9	24	2.6	4.3			
140										80	2.0	2.1	57	2.1	2.6	47	2.2	3.0	38	2.3	3.5	31	2.4	3.9	26	2.6	4.4			
150										86	2.0	2.1	61	2.1	2.7	50	2.2	3.0	41	2.3	3.5	33	2.4	3.9	27	2.6	4.4			
160										91	2.0	2.1	65	2.1	2.7	53	2.2	3.0	43	2.3	3.5	35	2.4	3.9	29	2.6	4.4			
170										97	2.0	2.1	69	2.1	2.7	57	2.2	3.1	46	2.3	3.5	37	2.4	4.0	31	2.6	4.4			
180													73	2.1	2.7	60	2.2	3.1	49	2.3	3.5	39	2.4	4.0	33	2.6	4.4			
190													77	2.1	2.7	63	2.2	3.1	51	2.3	3.5	41	2.4	4.0	34	2.6	4.5			
200													81	2.1	2.7	66	2.2	3.1	54	2.3	3.5	44	2.4	4.0	36	2.6	4.5			
220													89	2.1	2.7	73	2.2	3.1	59	2.3	3.5	48	2.4	4.0	40	2.6	4.5			
240													97	2.1	2.7	79	2.2	3.1	65	2.3	3.5	52	2.4	4.0	43	2.6	4.5			
260																86	2.2	3.1	70	2.3	3.5	56	2.4	4.0	47	2.6	4.5			
280																92	2.2	3.1	75	2.3	3.5	61	2.4	4.0	50	2.6	4.5			
300																99	2.2	3.1	81	2.3	3.5	65	2.4	4.0	54	2.6	4.5			

T = Top width, Retardance "B"
 D = Depth, Retardance "B"
 V₂ = Velocity, Retardance "B"
 V₁ = Velocity, Retardance "D"
 (Settlement to be added to top of ridge.)

Parabolic diversion design chart (Sheet 6 of 13)

108

June 1978
 Appendix B-1.6



V_1 Based on Permissible Velocity of the Soil With Retardance "D"

Top Width, Depth & V_2 Based on Retardance "C"

Grade = 0.25%

Q	$V_1 = 2.0$			$V_1 = 2.5$			$V_1 = 3.0$			$V_1 = 3.5$			$V_1 = 4.0$			$V_1 = 4.5$			$V_1 = 5.0$			$V_1 = 5.5$			$V_1 = 6.0$		
cfs	T	D	V_2	T	D	V_2	T	D	V_2	T	D	V_2	T	D	V_2	T	D	V_2	T	D	V_2	T	D	V_2	T	D	V_2
15																											
20																											
25	11	2.9	1.6																								
30	13	2.8	1.7																								
35	15	2.8	1.7																								
40	17	2.8	1.8	11	3.2	2.1																					
45	19	2.7	1.8	13	3.1	2.2																					
50	21	2.7	1.8	14	3.1	2.2																					
55	23	2.7	1.8	15	3.1	2.3																					
60	25	2.7	1.8	17	3.0	2.3																					
65	27	2.7	1.8	18	3.0	2.3																					
70	29	2.7	1.9	19	3.0	2.3	14	3.6	2.7																		
75	31	2.7	1.9	21	3.0	2.3	15	3.5	2.8																		
80	33	2.7	1.9	22	3.0	2.4	16	3.5	2.8																		
90	37	2.7	1.9	25	3.0	2.4	17	3.5	2.8																		
100	41	2.7	1.9	28	3.0	2.4	19	3.5	2.9																		
110	45	2.7	1.9	30	3.0	2.4	21	3.4	2.9																		
120	49	2.7	1.9	33	3.0	2.4	23	3.4	2.9	16	4.1	3.3															
130	53	2.7	1.9	36	3.0	2.4	25	3.4	2.9	18	4.1	3.3															
140	57	2.7	1.9	38	3.0	2.4	27	3.4	2.9	19	4.0	3.4															
150	61	2.7	1.9	41	3.0	2.4	29	3.4	2.9	20	4.0	3.4															
160	65	2.7	1.9	44	3.0	2.4	30	3.4	3.0	21	4.0	3.4															
170	69	2.7	1.9	46	3.0	2.4	32	3.4	3.0	23	4.0	3.4	18	4.5	3.8												
180	73	2.7	1.9	49	3.0	2.4	34	3.4	3.0	24	4.0	3.5	19	4.5	3.8												
190	77	2.7	1.9	52	3.0	2.4	36	3.4	3.0	25	4.0	3.5	20	4.5	3.9												
200	81	2.7	1.9	55	3.0	2.4	38	3.4	3.0	27	3.9	3.5	21	4.4	3.9												
220	89	2.7	1.9	60	3.0	2.4	42	3.4	3.0	29	3.9	3.5	23	4.4	3.9												
240	97	2.7	1.9	65	3.0	2.5	45	3.4	3.0	32	3.9	3.6	25	4.4	4.0												
260				71	3.0	2.5	49	3.4	3.0	34	3.9	3.6	27	4.4	4.0	21	5.1	4.3									
280				76	3.0	2.5	53	3.4	3.0	37	3.9	3.6	29	4.4	4.0	22	5.1	4.3									
300				82	3.0	2.5	57	3.4	3.0	40	3.9	3.6	31	4.3	4.1	24	5.0	4.4									

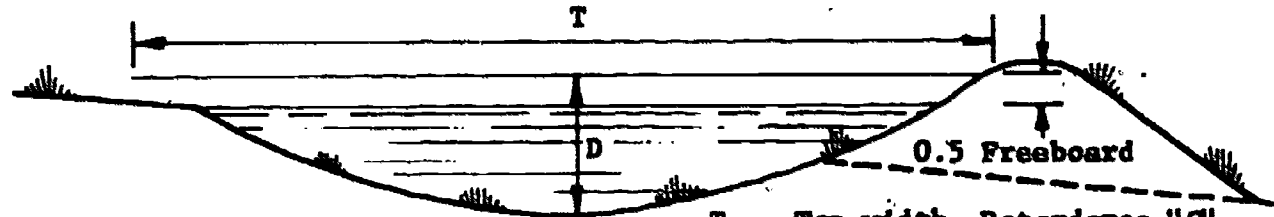

T = Top width, Retardance "C"
 D = Depth, Retardance "C"
 V_2 = Velocity, Retardance "C"
 V_1 = Velocity, Retardance "D"

(Settlement to be added to top of ridge.)

Parabolic diversion design chart (Sheet 7 of 13)

109

120

121

June 1978
 Appendix B-1.7

V₁ Based on Permissible Velocity of the Soil With Retardance "D"

Top Width, Depth & V₂ Based on Retardance "C"

Grade = 0.5%

Q	V ₁ = 2.0			V ₁ = 2.5			V ₁ = 3.0			V ₁ = 3.5			V ₁ = 4.0			V ₁ = 4.5			V ₁ = 5.0			V ₁ = 5.5			V ₁ = 6.0			
	cfs	T	D	V ₂	T	D	V ₂	T	D	V ₂	T	D	V ₂	T	D	V ₂	T	D	V ₂	T	D	V ₂	T	D	V ₂	T	D	V ₂
15	10	2.1	1.6																									
20	13	2.1	1.7																									
25	16	2.1	1.7	10	2.4	2.1																						
30	20	2.1	1.7	12	2.4	2.2	9	2.7	2.5																			
35	23	2.1	1.7	14	2.4	2.3	11	2.6	2.6																			
40	26	2.1	1.7	16	2.3	2.3	12	2.6	2.7																			
45	29	2.0	1.7	18	2.3	2.3	13	2.5	2.8																			
50	32	2.0	1.7	20	2.3	2.4	15	2.5	2.8	11	2.9	3.2																
55	35	2.0	1.7	22	2.3	2.4	16	2.5	2.8	12	2.9	3.3																
60	39	2.0	1.7	24	2.3	2.4	18	2.5	2.8	13	2.9	3.3																
65	42	2.0	1.8	26	2.3	2.4	19	2.5	2.9	14	2.9	3.3																
70	45	2.0	1.8	28	2.3	2.4	21	2.5	2.9	15	2.8	3.4																
75	48	2.0	1.8	30	2.3	2.4	22	2.5	2.9	16	2.8	3.4	12	3.2	3.7													
80	51	2.0	1.8	32	2.3	2.4	23	2.5	2.9	17	2.8	3.4	13	3.2	3.8													
90	57	2.0	1.8	35	2.3	2.4	26	2.5	2.9	19	2.8	3.4	15	3.2	3.8													
100	64	2.0	1.8	39	2.3	2.4	29	2.5	2.9	21	2.8	3.5	16	3.1	3.9	13	3.5	4.1										
110	70	2.0	1.8	43	2.3	2.4	32	2.5	2.9	23	2.8	3.5	18	3.1	3.9	14	3.5	4.2										
120	76	2.0	1.8	47	2.3	2.4	35	2.5	2.9	25	2.8	3.5	19	3.1	3.9	15	3.4	4.3										
130	83	2.0	1.8	51	2.3	2.4	38	2.5	2.9	27	2.8	3.5	21	3.1	4.0	17	3.4	4.4										
140	89	2.0	1.8	55	2.3	2.4	41	2.5	2.9	29	2.8	3.5	22	3.1	4.0	18	3.4	4.3										
150	95	2.0	1.8	59	2.3	2.4	44	2.5	2.9	31	2.8	3.5	24	3.1	4.0	19	3.4	4.4	15	3.8	4.8							
160				62	2.3	2.4	46	2.5	2.9	33	2.8	3.5	25	3.1	4.0	20	3.4	4.4	16	3.8	4.8							
170				66	2.3	2.4	49	2.5	2.9	35	2.8	3.6	27	3.1	4.0	22	3.4	4.4	17	3.8	4.9							
180				70	2.3	2.4	52	2.5	2.9	37	2.8	3.6	29	3.1	4.0	23	3.4	4.5	18	3.8	4.9							
190				74	2.3	2.4	55	2.5	2.9	39	2.8	3.6	30	3.1	4.0	24	3.4	4.5	19	3.8	5.0							
200				78	2.3	2.4	58	2.5	2.9	41	2.8	3.6	32	3.1	4.0	25	3.4	4.5	20	3.8	5.0	16	4.2	5.2				
220				86	2.3	2.4	64	2.5	2.9	45	2.8	3.6	35	3.1	4.0	28	3.4	4.5	22	3.7	5.0	18	4.2	5.3				
240				93	2.3	2.4	69	2.5	2.9	49	2.8	3.6	38	3.0	4.1	30	3.4	4.5	24	3.7	5.0	20	4.2	5.4				
260							75	2.5	2.9	53	2.8	3.6	41	3.0	4.1	33	3.4	4.5	26	3.7	5.0	21	4.1	5.4				
280							81	2.5	3.0	57	2.8	3.6	44	3.0	4.1	35	3.3	4.6	28	3.7	5.0	23	4.1	5.5	19	4.6	5.8	
300							87	2.5	3.0	61	2.8	3.6	47	3.0	4.1	38	3.3	4.6	30	3.6	5.0	24	4.1	5.5	20	4.6	5.8	

T = Top Width, Retardance "C"
D = Depth, Retardance "C"
V₂ = Velocity, Retardance "C"
V₁ = Velocity, Retardance "D"

(Settlement to be added to top of ridge.)

Parabolic diversion design chart (Sheet 8 of 13)

June 1978
Appendix B-1.8



V₁ Based on Permissible Velocity of the Soil With Retardance "D"

Grade = 0.75%

Top Width, Depth & V₂ Based on Retardance "C"

Q	V ₁ = 2.0			V ₁ = 2.5			V ₁ = 3.0			V ₁ = 3.5			V ₁ = 4.0			V ₁ = 4.5			V ₁ = 5.0			V ₁ = 5.5			V ₁ = 6.0			
	cfs	T	D	V ₂	T	D	V ₂	T	D	V ₂	T	D	V ₂	T	D	V ₂	T	D	V ₂	T	D	V ₂	T	D	V ₂	T	D	V ₂
15	14	1.8	1.5																									
20	18	1.8	1.5	10	2.0	2.2																						
25	23	1.8	1.5	13	2.0	2.2																						
30	27	1.8	1.5	15	2.0	2.2	11	2.2	2.7																			
35	32	1.8	1.5	18	2.0	2.3	13	2.2	2.7	10	2.4	3.1																
40	37	1.8	1.5	20	2.0	2.3	15	2.2	2.8	11	2.4	3.2																
45	41	1.8	1.6	23	2.0	2.3	17	2.2	2.8	13	2.3	3.2																
50	45	1.8	1.6	25	2.0	2.3	18	2.1	2.9	14	2.3	3.3	10	2.7	3.7													
55	50	1.8	1.6	28	2.0	2.3	20	2.1	2.9	16	2.3	3.3	11	2.6	3.8													
60	54	1.8	1.6	30	2.0	2.3	22	2.1	2.9	17	2.3	3.3	12	2.6	3.8													
65	59	1.8	1.6	33	2.0	2.3	24	2.1	2.9	18	2.3	3.3	13	2.6	3.8	11	2.9	4.1										
70	63	1.8	1.6	35	2.0	2.3	25	2.1	2.9	20	2.3	3.3	14	2.6	3.9	12	2.9	4.2										
75	68	1.8	1.6	38	2.0	2.3	27	2.1	2.9	21	2.3	3.3	15	2.6	3.9	13	2.8	4.2										
80	72	1.8	1.6	40	2.0	2.3	29	2.1	2.9	23	2.3	3.3	16	2.6	3.9	14	2.8	4.3										
90	81	1.8	1.6	45	2.0	2.3	33	2.1	2.9	25	2.3	3.4	18	2.6	4.0	15	2.8	4.4	12	3.1	4.6							
100	90	1.8	1.6	50	2.0	2.3	36	2.1	2.9	28	2.3	3.4	20	2.6	4.0	17	2.8	4.4	13	3.1	4.8							
110	99	1.8	1.6	55	2.0	2.3	40	2.1	2.9	31	2.3	3.4	22	2.5	4.0	18	2.8	4.5	15	3.1	4.8							
120				60	2.0	2.3	43	2.1	2.9	34	2.3	3.4	24	2.5	4.0	20	2.8	4.5	16	3.0	4.8	13	3.4	5.2				
130				65	2.0	2.4	47	2.1	2.9	36	2.3	3.4	26	2.5	4.0	21	2.7	4.5	17	3.0	4.9	14	3.3	5.3				
140				70	2.0	2.4	50	2.1	2.9	39	2.3	3.4	28	2.5	4.1	23	2.7	4.5	19	3.0	4.9	15	3.3	5.3				
150				75	2.0	2.4	54	2.1	2.9	42	2.3	3.4	30	2.5	4.1	25	2.7	4.5	20	3.0	4.9	16	3.3	5.3				
160				80	2.0	2.4	58	2.1	2.9	45	2.3	3.4	32	2.5	4.1	26	2.7	4.5	21	3.0	4.9	17	3.3	5.4	14	3.6	5.8	
170				85	2.0	2.4	61	2.1	2.9	47	2.3	3.4	34	2.5	4.1	28	2.7	4.5	22	3.0	5.0	18	3.3	5.4	15	3.6	5.8	
180				89	2.0	2.4	65	2.1	2.9	50	2.3	3.4	36	2.5	4.1	29	2.7	4.5	24	3.0	5.0	19	3.3	5.5	16	3.6	5.9	
190				94	2.0	2.4	68	2.1	2.9	53	2.3	3.4	38	2.5	4.1	31	2.7	4.6	25	3.0	5.0	21	3.3	5.5	17	3.6	5.9	
200				99	2.0	2.4	72	2.1	3.0	55	2.3	3.4	40	2.5	4.1	33	2.7	4.6	26	3.0	5.0	22	3.2	5.5	18	3.6	5.9	
220							79	2.1	3.0	61	2.3	3.4	44	2.5	4.1	36	2.7	4.6	29	3.0	5.0	24	3.2	5.5	19	3.6	5.9	
240							86	2.1	3.0	66	2.3	3.4	48	2.5	4.1	39	2.7	4.6	32	3.0	5.0	26	3.2	5.5	21	3.6	6.0	
260							93	2.1	3.0	72	2.3	3.4	52	2.5	4.1	42	2.7	4.6	34	3.0	5.0	28	3.2	5.5	23	3.6	6.0	
280										77	2.3	3.4	56	2.5	4.1	45	2.7	4.6	37	3.0	5.0	30	3.2	5.5	24	3.5	6.0	
300										83	2.3	3.5	60	2.5	4.1	49	2.7	4.6	39	3.0	5.0	32	3.2	5.5	26	3.5	6.0	

T = Top Width, Retardance "C"
D = Depth, Retardance "C"
V₂ = Velocity, Retardance "C"
V₁ = Velocity, Retardance "D"

(Settlement to be added to top of ridge)

111

June 1978
Appendix B-1.9

Parabolic diversion design chart (Sheet 9 of 13)



V₁ Based on Permissible Velocity of the Soil With Retardance "D"

Top Width, Depth & V₂ Based on Retardance "C"

Grade = 1.0%

Q cfs	V ₁ = 2.0			V ₁ = 2.5			V ₁ = 3.0			V ₁ = 3.5			V ₁ = 4.0			V ₁ = 4.5			V ₁ = 5.0			V ₁ = 5.5			V ₁ = 6.0				
	T	D	V ₂	T	D	V ₂	T	D	V ₂	T	D	V ₂	T	D	V ₂	T	D	V ₂	T	D	V ₂	T	D	V ₂	T	D	V ₂	T	D
15	16	1.6	1.5	10	1.8	2.0																							
20	22	1.6	1.5	13	1.8	2.1																							
25	27	1.6	1.5	17	1.8	2.1	11	2.0	2.6																				
30	32	1.6	1.5	20	1.8	2.1	13	2.0	2.7	11	2.1	3.0																	
35	37	1.6	1.5	23	1.8	2.2	15	2.0	2.8	12	2.1	3.1																	
40	43	1.6	1.5	26	1.8	2.2	17	1.9	2.8	14	2.1	3.1	10	2.3	3.7														
45	48	1.6	1.5	29	1.8	2.2	19	1.9	2.8	16	2.1	3.2	12	2.3	3.7														
50	53	1.6	1.5	33	1.8	2.2	22	1.9	2.8	17	2.1	3.2	13	2.3	3.7	10	2.5	4.2											
55	58	1.6	1.5	36	1.8	2.2	24	1.9	2.8	19	2.0	3.3	14	2.3	3.8	11	2.5	4.3											
60	64	1.6	1.5	39	1.8	2.2	26	1.9	2.8	21	2.0	3.3	15	2.2	3.8	12	2.5	4.3											
65	69	1.6	1.5	42	1.8	2.2	28	1.9	2.8	22	2.0	3.3	17	2.2	3.8	13	2.5	4.3	10	2.7	4.7								
70	74	1.6	1.5	45	1.8	2.2	30	1.9	2.8	24	2.0	3.3	18	2.2	3.9	14	2.5	4.4	11	2.7	4.7								
75	79	1.6	1.5	49	1.8	2.2	32	1.9	2.9	26	2.0	3.3	19	2.2	3.9	15	2.5	4.5	12	2.7	4.7								
80	84	1.6	1.5	52	1.8	2.2	34	1.9	2.9	27	2.0	3.3	20	2.2	3.9	16	2.5	4.5	13	2.7	4.9								
90	95	1.6	1.5	58	1.8	2.2	38	1.9	2.9	31	2.0	3.3	23	2.2	3.9	17	2.4	4.5	14	2.7	4.9	12	2.9	5.2					
100				65	1.8	2.2	43	1.9	2.9	34	2.0	3.3	25	2.2	3.9	19	2.4	4.5	16	2.7	4.9	13	2.9	5.3					
110				71	1.8	2.2	47	1.9	2.9	37	2.0	3.3	28	2.2	3.9	21	2.4	4.5	17	2.6	5.0	14	2.9	5.3	12	3.1	5.7		
120				77	1.8	2.2	51	1.9	2.9	41	2.0	3.3	30	2.2	4.0	23	2.4	4.5	19	2.6	5.0	16	2.9	5.4	13	3.1	5.7		
130				84	1.8	2.2	55	1.9	2.9	44	2.0	3.3	33	2.2	4.0	25	2.4	4.5	20	2.6	5.0	17	2.9	5.4	14	3.1	5.8		
140				90	1.8	2.2	59	1.9	2.9	47	2.0	3.3	35	2.2	4.0	27	2.4	4.5	22	2.6	5.0	18	2.8	5.5	15	3.1	5.8		
150				96	1.8	2.2	64	1.9	2.9	51	2.0	3.3	38	2.2	4.0	29	2.4	4.5	23	2.6	5.0	19	2.8	5.5	17	3.1	5.8		
160							68	1.9	2.9	54	2.0	3.3	40	2.2	4.0	30	2.4	4.5	25	2.6	5.0	20	2.8	5.5	18	3.0	6.0		
170							72	1.9	2.9	57	2.0	3.3	43	2.2	4.0	32	2.4	4.5	26	2.5	5.0	22	2.8	5.5	19	3.0	6.0		
180							76	1.9	2.9	61	2.0	3.4	45	2.2	4.0	34	2.4	4.5	28	2.6	5.0	23	2.8	5.5	20	3.0	6.0		
190							80	1.9	2.9	64	2.0	3.4	48	2.2	4.0	36	2.4	4.5	29	2.6	5.0	24	2.8	5.5	21	3.0	6.0		
200							84	1.9	2.9	67	2.0	3.4	50	2.2	4.0	38	2.4	4.5	31	2.6	5.0	25	2.8	5.5	22	3.0	6.0		
220							93	1.9	2.9	74	2.0	3.4	55	2.2	4.0	42	2.4	4.5	34	2.6	5.0	28	2.8	5.5	24	3.0	6.0		
240										81	2.0	3.4	60	2.2	4.0	45	2.4	4.5	37	2.6	5.0	30	2.8	5.5	26	3.0	6.0		
260										87	2.0	3.4	65	2.2	4.0	49	2.4	4.5	40	2.6	5.0	33	2.8	5.5	28	3.0	6.0		
280										94	2.0	3.4	70	2.2	4.0	53	2.4	4.5	43	2.6	5.0	36	2.8	5.5	30	3.0	6.0		
300													75	2.2	4.0	57	2.4	4.5	46	2.5	5.0	38	2.8	5.5	32	3.0	6.0		

T = Top Width, Retardance "C"
D = Depth, Retardance "C"
V₂ = Velocity, Retardance "C"
V₁ = Velocity, Retardance "D"

(Settlement to be added to top of ridge.)

112

Parabolic diversion design chart (Sheet 10 of 13)

V₁ Based on Permissible Velocity of the Soil With Retardance "D"

Top Width, Depth & V₂ Based on Retardance "C"

Grade = 1.5%

Q	V ₁ = 2.0			V ₁ = 2.5			V ₁ = 3.0			V ₁ = 3.5			V ₁ = 4.0			V ₁ = 4.5			V ₁ = 5.0			V ₁ = 5.5			V ₁ = 6.0			
	cfs	T	D	V ₂	T	D	V ₂	T	D	V ₂	T	D	V ₂	T	D	V ₂	T	D	V ₂	T	D	V ₂	T	D	V ₂	T	D	V ₂
15	21	1.4	1.4	14	1.6	1.9																						
20	28	1.4	1.4	18	1.5	1.9	12	1.7	2.5																			
25	35	1.4	1.4	23	1.5	1.9	15	1.7	2.6	10	1.9	3.2																
30	42	1.4	1.4	27	1.5	1.9	18	1.7	2.6	12	1.8	3.2	10	2.0	3.6													
35	49	1.4	1.4	32	1.5	2.0	21	1.6	2.6	14	1.8	3.3	11	1.9	3.7	10	2.1	4.1										
40	56	1.4	1.4	36	1.5	2.0	24	1.6	2.6	16	1.8	3.3	13	1.9	3.7	11	2.1	4.2										
45	63	1.4	1.4	41	1.5	2.0	27	1.6	2.6	18	1.8	3.4	15	1.9	3.8	12	2.0	4.3										
50	70	1.4	1.4	45	1.5	2.0	30	1.6	2.7	20	1.8	3.4	16	1.9	3.9	13	2.0	4.3	10	2.3	4.8							
55	76	1.4	1.5	50	1.5	2.0	33	1.6	2.7	22	1.8	3.4	18	1.9	3.9	14	2.0	4.3	11	2.3	4.9							
60	83	1.4	1.5	54	1.5	2.0	35	1.6	2.7	24	1.8	3.4	19	1.9	3.9	16	2.0	4.4	12	2.3	4.9	10	2.4	5.2				
65	90	1.4	1.5	58	1.5	2.0	38	1.6	2.7	26	1.8	3.4	21	1.9	3.9	17	2.0	4.4	13	2.2	5.0	11	2.4	5.3				
70	97	1.4	1.5	63	1.5	2.0	41	1.6	2.7	28	1.8	3.4	22	1.9	3.9	18	2.0	4.4	14	2.2	5.0	12	2.4	5.4	10	2.6	5.6	
75				67	1.5	2.0	44	1.6	2.7	30	1.8	3.4	24	1.9	3.9	19	2.0	4.4	15	2.2	5.0	12	2.4	5.4	11	2.6	5.6	
80				72	1.5	2.0	47	1.6	2.7	32	1.8	3.4	26	1.9	3.9	21	2.0	4.4	16	2.2	5.0	13	2.4	5.4	12	2.5	5.8	
90				80	1.5	2.0	53	1.6	2.7	36	1.8	3.5	29	1.9	3.9	23	2.0	4.4	18	2.2	5.0	15	2.4	5.4	13	2.5	5.9	
100				89	1.5	2.0	59	1.6	2.7	39	1.8	3.5	32	1.9	3.9	26	2.0	4.5	20	2.2	5.0	17	2.4	5.4	14	2.5	6.0	
110				98	1.5	2.0	64	1.6	2.7	43	1.8	3.5	35	1.9	3.9	28	2.0	4.5	22	2.2	5.0	18	2.3	5.5	15	2.5	6.0	
120							70	1.6	2.7	47	1.8	3.5	38	1.9	4.0	31	2.0	4.5	24	2.2	5.0	20	2.3	5.5	17	2.5	6.0	
130							76	1.6	2.7	51	1.8	3.5	41	1.9	4.0	33	2.0	4.5	26	2.2	5.0	21	2.3	5.5	18	2.5	6.0	
140							82	1.6	2.7	55	1.8	3.5	44	1.9	4.0	36	2.0	4.5	27	2.2	5.0	23	2.3	5.5	19	2.5	6.0	
150							87	1.6	2.7	59	1.8	3.5	47	1.9	4.0	39	2.0	4.5	29	2.2	5.0	25	2.3	5.5	21	2.5	6.0	
160							93	1.6	2.7	63	1.8	3.5	51	1.9	4.0	41	2.0	4.5	31	2.2	5.0	26	2.3	5.5	22	2.5	6.0	
170							99	1.6	2.7	67	1.8	3.5	54	1.9	4.0	44	2.0	4.5	33	2.2	5.0	28	2.3	5.5	23	2.5	6.0	
180										70	1.8	3.5	57	1.9	4.0	46	2.0	4.5	35	2.2	5.0	29	2.3	5.5	25	2.5	6.0	
190										74	1.8	3.5	60	1.9	4.0	49	2.0	4.5	37	2.2	5.0	31	2.3	5.5	26	2.5	6.0	
200										78	1.8	3.5	63	1.9	4.0	51	2.0	4.5	39	2.2	5.0	33	2.3	5.5	27	2.5	6.0	
220										86	1.8	3.5	69	1.9	4.0	56	2.0	4.5	43	2.2	5.0	36	2.3	5.5	30	2.5	6.0	
240										93	1.8	3.5	75	1.9	4.0	61	2.0	4.5	47	2.2	5.0	39	2.3	5.5	33	2.5	6.0	
260													82	1.9	4.0	66	2.0	4.5	51	2.2	5.0	42	2.3	5.5	35	2.5	6.0	
280													88	1.9	4.0	71	2.0	4.5	54	2.2	5.0	46	2.3	5.5	38	2.5	6.0	
300													94	1.9	4.0	76	2.0	4.5	58	2.2	5.0	49	2.3	5.5	41	2.5	6.0	

T = Top width, Retardance "C"
 D = Depth, Retardance "C"
 V₂ = Velocity, Retardance "C"
 V₁ = Velocity, Retardance "D"
 (Settlement to be added to top of ridge.)

Parabolic diversion design chart (Sheet 11 of 13)

113

June 1978
 Appendix B-1.11



V₁ Based on Permissible Velocity of the Soil With Retardance "D"

Top Width, Depth & V₂ Based on Retardance "C"

Grade = 2.0%

Q	V ₁ = 2.0			V ₁ = 2.5			V ₁ = 3.0			V ₁ = 3.5			V ₁ = 4.0			V ₁ = 4.5			V ₁ = 5.0			V ₁ = 5.5			V ₁ = 6.0			
	cfs	T	D	V ₂	T	D	V ₂	T	D	V ₂	T	D	V ₂	T	D	V ₂	T	D	V ₂	T	D	V ₂	T	D	V ₂	T	D	V ₂
15	27	1.3	1.3	16	1.4	1.9	11	1.5	2.4																			
20	35	1.3	1.3	21	1.4	1.9	15	1.5	2.4	11	1.6	3.0																
25	44	1.3	1.3	27	1.4	1.9	19	1.5	2.4	13	1.6	3.0	10	1.8	3.7													
30	53	1.3	1.3	32	1.4	1.9	23	1.5	2.5	16	1.6	3.0	11	1.7	3.7	10	1.8	4.2										
35	61	1.3	1.3	37	1.4	1.9	26	1.5	2.5	19	1.6	3.1	13	1.7	3.8	11	1.8	4.2										
40	70	1.3	1.3	42	1.4	1.9	30	1.5	2.5	21	1.6	3.1	15	1.7	3.8	12	1.8	4.3	10	2.0	4.7							
45	78	1.3	1.4	48	1.4	1.9	34	1.5	2.5	24	1.6	3.1	17	1.7	3.8	14	1.8	4.3	11	1.9	4.8							
50	87	1.3	1.4	53	1.4	1.9	38	1.5	2.5	26	1.6	3.1	19	1.7	3.8	15	1.8	4.3	13	1.9	4.8	10	2.1	5.3				
55	95	1.3	1.4	58	1.4	1.9	41	1.5	2.5	29	1.6	3.1	21	1.7	3.8	17	1.8	4.3	14	1.9	4.9	11	2.1	5.3				
60				63	1.4	1.9	45	1.5	2.5	32	1.6	3.1	23	1.7	3.9	18	1.8	4.4	15	1.9	4.9	12	2.1	5.3	10	2.2	5.7	
65				68	1.4	1.9	49	1.5	2.5	34	1.6	3.1	24	1.7	3.9	20	1.8	4.4	16	1.9	4.9	13	2.1	5.4	11	2.2	5.7	
70				73	1.4	1.9	52	1.5	2.5	37	1.6	3.1	26	1.7	3.9	22	1.8	4.4	18	1.9	4.9	14	2.1	5.4	12	2.2	5.8	
75				78	1.4	1.9	56	1.5	2.5	39	1.6	3.1	28	1.7	3.9	23	1.8	4.4	19	1.9	4.9	15	2.1	5.4	13	2.2	5.9	
80				83	1.4	2.0	60	1.5	2.5	42	1.6	3.1	30	1.7	3.9	24	1.8	4.4	20	1.9	4.9	16	2.1	5.4	14	2.2	5.9	
90				94	1.4	2.0	67	1.5	2.5	47	1.6	3.2	34	1.7	3.9	28	1.8	4.4	22	1.9	4.9	18	2.1	5.5	15	2.2	5.9	
100							74	1.5	2.5	52	1.6	3.2	37	1.7	3.9	31	1.8	4.4	25	1.9	5.0	20	2.1	5.5	17	2.2	6.0	
110							81	1.5	2.5	57	1.6	3.2	41	1.7	3.9	34	1.8	4.4	27	1.9	5.0	22	2.0	5.5	19	2.2	6.0	
120							89	1.5	2.5	62	1.6	3.2	45	1.7	3.9	37	1.8	4.4	30	1.9	5.0	24	2.0	5.5	20	2.2	6.0	
130							96	1.5	2.5	67	1.6	3.2	48	1.7	3.9	40	1.8	4.5	32	1.9	5.0	26	2.0	5.5	22	2.2	6.0	
140										73	1.6	3.2	52	1.7	4.0	42	1.8	4.5	35	1.9	5.0	28	2.0	5.5	23	2.2	6.0	
150										78	1.6	3.2	56	1.7	4.0	46	1.8	4.5	37	1.9	5.0	30	2.0	5.5	25	2.2	6.0	
160										83	1.6	3.2	59	1.7	4.0	48	1.8	4.5	39	1.9	5.0	32	2.0	5.5	27	2.2	6.0	
170										88	1.6	3.2	63	1.7	4.0	51	1.8	4.5	42	1.9	5.0	34	2.0	5.5	28	2.2	6.0	
180										93	1.6	3.2	67	1.7	4.0	54	1.8	4.5	44	1.9	5.0	36	2.0	5.5	30	2.2	6.0	
190										98	1.6	3.2	70	1.7	4.0	57	1.8	4.5	47	1.9	5.0	38	2.0	5.5	32	2.2	6.0	
200													74	1.7	4.0	60	1.8	4.5	49	1.9	5.0	40	2.0	5.5	33	2.2	6.0	
220													81	1.7	4.0	66	1.8	4.5	54	1.9	5.0	44	2.0	5.5	37	2.2	6.0	
240													88	1.7	4.0	72	1.8	4.5	59	1.9	5.0	48	2.0	5.5	40	2.2	6.0	
260													96	1.7	4.0	78	1.8	4.5	64	1.9	5.0	51	2.0	5.5	43	2.2	6.0	
280																84	1.8	4.5	69	1.9	5.0	55	2.0	5.5	46	2.2	6.0	
300																90	1.8	4.5	73	1.9	5.0	59	2.0	5.5	50	2.2	6.0	

T = Top width, Retardance "C"
 D = Depth, Retardance "C"
 V₂ = Velocity, Retardance "C"
 V₁ = Velocity, Retardance "D"
 (Settlement to be added to top of ridge.)

Parabolic diversion design chart (Sheet 12 of 13)

PARABOLIC DIVERSION DESIGN, WITHOUT FREEBOARD

RETARDANCE - D
GRADE, % - 0.25 to 2.0

Velocity, Depth and Top Width Based on Retardance "D"

Q	Grade 0.25%			Grade 0.50%			Grade 0.75%			Grade 1.0%			Grade 1.25%			Grade 1.50%			Grade 2.0%		
	V	D	Q	V	D	Q	V	D	Q	V	D	Q	V	D	Q	V	D	Q	V	D	Q
5				8			10	5		11	6		13	7		14	7	5	15	9	5
10	11			17	9		20	10	7	23	12	8	25	14	8	27	15	10	31	17	11
15	18	9		25	13	8	30	16	10	34	19	12	38	21	13	41	23	15	46	26	16
20	24	12		34	18	10	40	22	14	46	25	16	50	28	18	54	30	20	61	34	22
25	30	15		42	23	13	50	27	17	57	31	20	63	35	22	68	38	24		43	27
30	36	18	10	51	27	16	60	33	20	69	37	24		42	27		45	29		52	33
35	43	21	12	59	32	18	71	38	24		44	28		49	31		53	34		60	38
40	49	24	14	68	36	21	81	44	27		50	32		56	35		61	39		69	44
45	55	27	15	76	41	24	91	49	31		56	36		63	40		68	44			49
50	61	30	17	85	45	26	101	54	34		62	40		70	44			49			55
55	67	33	19	93	50	29	111	60	37		68	43			49			54			60
60	73	36	20	101	54	32		65	41		75	47			53			59			66
65	79	39	22	110	59	34		71	44			51			58			64			71
70	85	42	24		63	37		76	48			55			62			68			
75	91	45	26		68	39		82	51			59			67			73			
80	97	48	27		72	42		87	54			63			71						
90		55	31		81	47		98	61			71									
100		61	34		90	53		109	68												
110		67	38		99	58			75												
120		73	41	108	63				82												
130		79	44		68				89												
140		85	48		74				95												
150		91	51		79																
160		97	55		84																
170			58		89																
180			62		95																
190			65																		
200			68																		

Top widths (T) and depths (D) shown are for the hydraulic section. Freeboard and allowance for settlement are to be added as necessary.

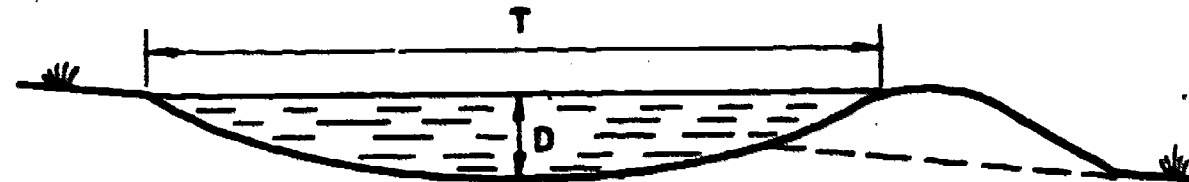

June 1978
Appendix B-1.13

PARABOLIC DIVERSION CHART

U. S. DEPARTMENT OF AGRICULTURE
SOIL CONSERVATION SERVICE

Grade	Triangular				6' bottom width				8' bottom width				10' bottom width				12' bottom width																								
	0.2		0.3		0.4		0.5		0.2		0.3		0.4		0.5		0.2		0.3		0.4		0.5																		
Cfs	d	A	d	A	d	A	d	A	d	A	d	A	d	A	d	A	d	A	d	A	d	A	d	A																	
10	1.9	11	1.8	10	1.7	9	1.6	8	1.3	12	1.1	10	1.0	9	0.9	8	1.2	13	1.1	11	1.0	10	0.9	9	1.1	14	1.0	12	0.9	11	0.8	10	1.0	14	0.9	12	0.8	11	0.7	10	
20	2.2	15	2.1	13	1.9	11	1.8	10	1.5	16	1.4	14	1.2	12	1.1	10	1.4	17	1.3	16	1.2	14	1.1	12	1.3	19	1.2	18	1.1	16	1.0	15	1.1	17	1.0	15	0.9	13			
30	2.5	19	2.3	16	2.2	15	2.0	12	1.8	21	1.6	17	1.5	16	1.3	13	1.7	22	1.5	19	1.4	17	1.2	14	1.5	22	1.4	20	1.2	16	1.1	15	1.0	21	1.0	19	1.2	19	1.1	17	
40	2.8	20	2.5	19	2.3	16	2.2	15	2.0	24	1.8	21	1.7	19	1.5	16	1.9	24	1.7	22	1.6	20	1.4	17	1.7	26	1.5	22	1.4	20	1.2	18	1.0	27	1.5	25	1.3	21	1.2	19	
50	3.0	27	2.9	24	2.7	22	2.5	19	2.3	30	2.1	26	1.9	22	1.7	19	2.1	30	1.9	26	1.8	24	1.6	21	1.7	32	1.8	28	1.7	26	1.5	22	1.3	31	1.6	27	1.5	25	1.3	21	
60		3.1	29	2.9	26	2.7	22	2.5	34	2.3	30	2.1	26	1.9	22	1.9	32	2.4	37	2.2	32	2.0	28	1.8	24	2.3	39	2.1	34	1.9	30	1.7	28	2.1	33	1.9	34	1.8	31	1.6	27
100			3.1	29	2.9	25	2.6	20	2.5	34	2.3	30	2.1	26	1.9	22	2.0	41	2.4	37	2.2	32	2.0	28	1.8	41	2.2	37	2.1	34	1.9	30	2.3	44	2.1	39	1.9	34	1.7	29	
120				3.0	27	3.0	45	2.8	40	2.5	34	2.3	30	2.1	26	1.9	40	2.5	39	2.3	34	2.1	30	1.9	40	2.4	41	2.2	37	2.0	32	2.5	50	2.3	44	2.1	39	1.9	34		
140					2.9	43	2.6	38	2.4	32	2.2	28	1.9	22	1.7	19	2.2	48	2.7	44	2.5	38	2.3	34	2.1	40	2.5	44	2.3	39	2.1	34	2.0	52	2.4	46	2.2	41	2.0	36	
160						3.0	45	2.8	40	2.6	36	2.4	32	2.1	26	1.9	51	2.9	48	2.7	44	2.5	39	2.3	34	2.7	49	2.5	44	2.3	39	2.7	54	2.5	50	2.3	44	2.1	38		
180																	2.6	41	3.0	57	2.8	51	2.6	46			2.4	41	2.8	57	2.6	52	2.4	45	2.2	41	2.0	36			
200																												2.5	44	2.9	60	2.7	54	2.5	50	2.3	44	2.1	38		
220																																									

NOTE: For diversions built on slopes under 2% the available cross-sectional area above normal ground will allow a reduction in design depth as follows:

For land slopes of 1% or less reduce depth of flow (taken from Design Table) 20%.

For land slopes of 1% to 2% reduce depth of flow (taken from Design Table) 15%.

For land slopes greater than 2% use depth of flow taken from Design Table.

For Example: A diversion 6 feet wide with a 2.5 foot depth of flow is required to remove 120 c.f.s. on a 0.4% grade. If this is built on a 1% slope the depth may be reduced 20% thus obtaining a flow depth of 2.0 feet. The required cross-sectional area of the channel plus that above normal ground line will be 34 square feet corresponding to the 2.5 foot depth. The overall height of diversion will be 2.0 feet plus 0.5 foot freeboard or 2.5 feet, instead of the original 3.0 feet.

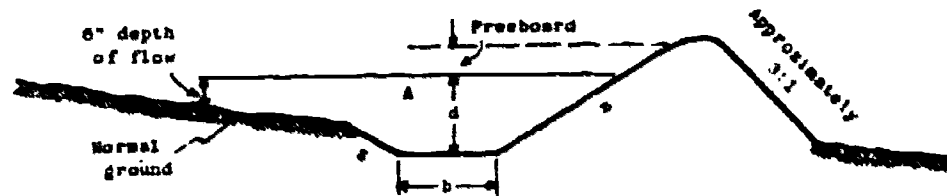

- d = depth of flow, feet
- b = bottom width of channel, feet
- A = channel capacity, sq. ft., including area below 0.5' freeboard and excluding any area less than 0.5' depth of flow
- s = side slope of channel (horizontal to vertical)

IMPORTANT: To all designed depths of flow add freeboard required by State Standards and Specifications to obtain overall height of terrace above bottom of channel. For final check on cross-sectional area subtract required freeboard from settled height of diversion and provide for cross-sectional area shown in table.

Diversion design table - "D" Retardance (V and Trapezoidal Section)
(Sheet 1 of 4)

3/27/53 ← L-8910-1

Grade	Triangular				6' bottom width				8' bottom width				10' bottom width				12' bottom width			
	0.2	0.3	0.4	0.5	0.2	0.3	0.4	0.5	0.2	0.3	0.4	0.5	0.2	0.3	0.4	0.5	0.2	0.3	0.4	0.5
10	1.4 13	1.7 12	1.6 11	1.5 10	1.2 13	1.1 11	1.0 10	0.9 9	1.1 14	1.0 13	0.9 11	0.8 10	1.1 16	1.0 15	0.9 12	0.8 11	1.0 15	0.9 14	0.8 13	0.7 12
20	2.1 19	2.0 16	1.8 13	1.7 12	1.5 18	1.4 16	1.2 13	1.1 11	1.4 19	1.3 17	1.2 15	1.1 14	1.3 20	1.2 18	1.0 14	0.9 12	1.2 20	1.1 18	1.0 16	0.9 14
30	2.4 23	2.2 19	2.1 18	1.9 14	1.9 24	1.6 20	1.5 13	1.3 15	1.7 25	1.6 21	1.4 19	1.3 15	1.5 24	1.4 23	1.2 18	1.1 16	1.3 22	1.2 20	1.2 20	1.1 18
40	2.5 25	2.4 23	2.2 19	2.1 18	1.9 25	1.8 24	1.6 20	1.5 18	1.8 27	1.7 25	1.5 21	1.4 19	1.6 26	1.5 24	1.3 20	1.2 18	1.6 29	1.5 27	1.3 22	1.2 20
60	2.6 31	2.6 27	2.5 25	2.3 21	2.2 33	2.0 29	1.9 26	1.7 23	2.0 32	1.9 30	1.7 25	1.6 23	1.9 33	1.8 31	1.6 26	1.5 24	1.7 32	1.6 29	1.4 25	1.3 22
80	3.1 38	2.9 34	2.7 29	2.5 25	2.4 37	2.2 33	2.1 30	1.9 26	2.3 40	2.1 34	2.0 32	1.9 27	2.2 41	2.1 38	1.8 31	1.6 26	2.0 40	1.9 37	1.7 32	1.6 30
100		3.1 38	2.9 34	2.7 29	2.7 45	2.5 40	2.3 35	2.1 30	2.3 45	2.3 40	2.1 34	1.9 30	2.3 44	2.1 39	2.0 35	1.8 31	2.2 45	2.0 40	1.9 37	1.7 32
120				2.8 31	2.9 51	2.7 45	2.4 37	2.2 33	2.7 51	2.6 45	2.4 40	2.1 34	2.5 50	2.3 44	2.2 41	2.0 36	2.4 52	2.2 46	2.0 40	1.8 35
140					3.0 54	2.8 48	2.6 43	2.4 37	2.8 54	2.6 48	2.5 45	2.3 40	2.6 53	2.4 47	2.3 44	2.1 39	2.5 55	2.3 49	2.2 45	2.0 40
160					3.1 57	2.9 51	2.7 48	2.6 43	3.0 60	2.8 54	2.6 49	2.4 42	2.6 59	2.4 53	2.3 52	2.1 44	2.7 62	2.5 55	2.3 49	2.1 43
180												2.5 48	2.9 63	2.7 56	2.6 55	2.4 47	2.8 65	2.6 58	2.4 52	2.2 46
200																2.2 52	2.9 68	2.7 62	2.5 58	2.3 49
220																	3.0 72	2.8 65	2.6 59	2.4 52

117

Grade	Triangular				6' bottom width				8' bottom width				10' bottom width				12' bottom width			
	0.2	0.3	0.4	0.5	0.2	0.3	0.4	0.5	0.2	0.3	0.4	0.5	0.2	0.3	0.4	0.5	0.2	0.3	0.4	0.5
10	1.6 15	1.5 14	1.4 13	1.3 11	1.2 16	1.1 14	1.0 13	0.9 10	1.1 16	1.0 14	0.9 13	0.8 11	1.1 17	1.0 15	0.9 13	0.8 12	1.0 17	0.9 15	0.8 14	0.7 12
20	1.9 23	1.8 19	1.6 15	1.5 14	1.5 23	1.4 20	1.2 16	1.1 14	1.4 23	1.3 21	1.1 16	1.0 14	1.3 21	1.2 20	1.1 19	1.0 16	1.3 25	1.2 23	1.0 17	0.9 15
30	2.1 27	2.0 24	1.8 19	1.7 17	1.7 28	1.5 23	1.4 20	1.2 16	1.6 28	1.5 26	1.3 21	1.2 18	1.4 26	1.3 23	1.2 20	1.1 18	1.4 32	1.3 27	1.1 20	1.0 18
40	2.3 32	2.2 29	2.0 24	1.8 19	1.8 30	1.7 28	1.5 23	1.4 20	1.7 31	1.6 29	1.4 23	1.3 21	1.5 29	1.4 26	1.3 23	1.2 20	1.5 33	1.4 30	1.3 27	1.2 22
60	2.5 38	2.3 32	2.2 28	2.0 24	2.0 36	1.9 33	1.7 28	1.6 25	1.9 37	1.8 34	1.6 28	1.5 26	1.8 38	1.7 34	1.5 29	1.4 26	1.8 36	1.6 34	1.5 32	1.4 29
80	2.7 44	2.5 38	2.4 35	2.2 29	2.2 42	2.1 39	1.9 33	1.8 30	2.1 43	2.0 40	1.8 34	1.7 31	2.0 44	1.9 41	1.7 34	1.6 31	1.8 41	1.7 37	1.6 34	1.5 32
100	2.9 51	2.7 44	2.6 41	2.4 35	2.4 49	2.2 44	2.1 39	1.9 33	2.3 50	2.1 43	2.0 40	1.8 34	2.2 51	2.1 44	1.9 41	1.7 34	2.1 51	1.9 45	1.8 41	1.6 34
120	3.2 58	2.9 47	2.7 44	2.5 39	2.6 56	2.4 42	2.3 46	2.1 39	2.5 58	2.3 50	2.2 47	2.0 43	2.3 55	2.2 44	1.9 41	1.7 34	2.2 55	2.0 48	1.9 45	1.7 37
140					2.7 61	2.6 56	2.4 49	2.3 46	2.6 61	2.5 58	2.3 55	2.2 47	2.5 63	2.3 55	2.2 51	2.0 44	2.4 64	2.2 53	2.1 51	1.9 45
160					2.9 68	2.8 64	2.6 56	2.5 53	2.8 67	2.6 61	2.5 58	2.3 50	2.7 71	2.5 63	2.4 59	2.2 51	2.6 70	2.4 64	2.3 59	2.1 51
180									2.9 71	2.7 64	2.6 61	2.4 54	2.8 75	2.6 67	2.5 63	2.3 55	2.7 78	2.5 68	2.4 65	2.2 55
200									3.0 78	2.8 67	2.6 61	2.4 54	2.9 79	2.7 77	2.6 67	2.4 59	2.8 81	2.6 78	2.5 68	2.3 58
220												2.5 58				2.4 59	2.9 85	2.7 78	2.5 69	2.3 59
240																2.5 63				2.4 64
260																				2.5 68

Diversion design table - "D" Retardance (V and Trapezoidal Section) (Sheet 2 of 4)

6-1-8618-2

(Based on Handbook of Channel Design, SCS-TT-61)

4:1 Side Slopes
"C" Retardance

Grade	Triangular				6' bottom				8' bottom				10' bottom				12' bottom			
	0.2	0.3	0.4	0.5	0.2	0.3	0.4	0.5	0.2	0.3	0.4	0.5	0.2	0.3	0.4	0.5	0.2	0.3	0.4	0.5
0	d A	d A	d A	d A	d A	d A	d A	d A	d A	d A	d A	d A	d A	d A	d A	d A	d A	d A	d A	d A
30	2.3 19	2.3 16	2.1 13	1.9 11	1.9 22	1.7 19	1.5 16	1.4 14	1.7 22	1.5 19	1.4 17	1.3 15	1.6 20	1.4 20	1.3 19	1.2 18				
30		2.3 19	2.3 16	2.2 15	2.0 24	1.8 21	1.7 19	1.5 16	1.9 26	1.7 23	1.5 19	1.4 17	1.7 26	1.5 22	1.4 20	1.3 18	1.6 27	1.4 23	1.3 21	1.2 19
40			2.3 19	2.4 17	2.2 20	2.0 24	1.9 22	1.7 19	2.0 28	1.8 24	1.6 21	1.5 19	1.9 30	1.7 26	1.6 22	1.4 20	1.6 31	1.5 27	1.4 25	1.4 23
50				2.0 19	2.3 30	2.1 26	2.0 24	1.8 21	2.2 32	2.0 28	1.8 24	1.7 21	2.0 32	1.8 28	1.7 24	1.5 22	1.9 33	1.7 29	1.6 27	1.5 25
60					2.3 34	2.3 30	2.1 26	1.9 22	2.3 34	2.1 30	1.9 26	1.8 24	2.3 37	2.0 32	1.8 28	1.6 24	2.0 36	1.8 31	1.7 29	1.6 27
80						2.3 34	2.3 30	2.1 26	2.3 37	2.1 33	1.9 29	1.8 26	2.4 41	2.1 37	1.9 33	1.7 29	2.0 41	1.8 36	1.7 34	1.7 30
100							2.3 34	2.3 30	2.4 41	2.2 36	2.1 33	1.9 29		2.4 41	2.2 37	2.0 33	2.1 40	1.9 36	1.8 34	1.8 31
120								2.3 34							2.3 39	2.1 34		2.1 40	2.0 38	2.0 36
140																2.3 39				2.1 39
160																				2.3 41
180																				2.3 41
200																				2.3 49
220																				2.6 51

4:1 Side Slopes
"C" Retardance

Grade	Triangular				6' bottom width				8' bottom width				10' bottom width				12' bottom width			
	0.2	0.3	0.4	0.5	0.2	0.3	0.4	0.5	0.2	0.3	0.4	0.5	0.2	0.3	0.4	0.5	0.2	0.3	0.4	0.5
0	d A	d A	d A	d A	d A	d A	d A	d A	d A	d A	d A	d A	d A	d A	d A	d A	d A	d A	d A	d A
30	2.3 23	2.4 23	2.3 21	2.1 18	2.0 28	1.8 24	1.7 20	1.5 18	1.8 27	1.7 25	1.5 21	1.4 19	1.8 31	1.6 26	1.4 22	1.3 20	1.7 32	1.6 29	1.4 25	1.2 20
40		2.3 25	2.4 23	2.2 19	2.1 30	1.9 26	1.7 22	1.6 20	2.0 32	1.8 27	1.6 23	1.5 21	1.9 33	1.7 29	1.5 24	1.4 22	1.8 33	1.7 32	1.5 27	1.3 22
50			2.3 25	2.4 23	2.3 35	2.1 30	1.9 26	1.7 22	2.1 34	1.9 30	1.7 25	1.6 23	2.0 36	1.8 31	1.6 26	1.5 24	1.9 37	1.8 35	1.6 29	1.4 25
60				2.3 25	2.4 37	2.3 33	2.0 28	1.9 26	2.3 40	2.1 34	1.9 30	1.7 25	2.1 39	1.9 34	1.7 29	1.6 25	2.0 40	1.9 37	1.7 32	1.5 27
80						2.4 37	2.2 33	2.0 28	2.4 45	2.3 40	2.1 34	1.9 30	2.3 44	2.1 39	1.9 34	1.8 31	2.2 45	2.0 40	1.8 35	1.7 32
100							2.4 40	2.2 33		2.4 45	2.3 40	2.0 32	2.4 50	2.3 44	2.1 39	1.9 34	2.3 49	2.1 43	2.0 40	1.8 35
120								2.4 40							2.4 47	2.2 39		2.4 49	2.2 45	2.0 40
140																2.4 47				2.1 43
160																				2.4 49
180																				2.4 52
200																				2.4 52
220																				2.6 55

Diversion design table - "C" Retardance (V and Trapezoidal Section)
(Sheet 3 of 4)

10-28-55

4-L-1012E-1

118

138



June 1978
Appendix B-2.3

139

(Based on Handbook of Channel Design, SCS-TP-81)

• 6:1 Side Slopes
"C" Retardance

Grade	Triangular				6' bottom width				8' bottom width				10' bottom width				12' bottom width				
	0.2	0.3	0.4	0.5	0.2	0.3	0.4	0.5	0.2	0.3	0.4	0.5	0.2	0.3	0.4	0.5	0.2	0.3	0.4	0.5	
5	4 A	4 A	4 A	4 A	4 A	4 A	4 A	4 A	4 A	4 A	4 A	4 A	4 A	4 A	4 A	4 A	4 A	4 A	4 A	4 A	4 A
20	2.2 29	2.1 26	1.9 22	1.8 19	1.8 30	1.7 28	1.6 25	1.4 20	1.7 31	1.6 28	1.5 25	1.3 21	1.6 31	1.5 29	1.4 26	1.2 20	1.5 32	1.4 29	1.3 27	1.2 23	
30	2.4 35	2.2 29	2.1 26	1.9 22	2.0 36	1.9 33	1.7 28	1.5 23	1.8 34	1.7 31	1.6 28	1.4 23	1.6 38	1.7 34	1.5 29	1.3 23	1.7 37	1.6 34	1.4 28	1.3 27	
40	2.5 38	2.3 32	2.2 29	2.0 24	2.1 39	2.0 36	1.8 30	1.6 25	2.0 40	1.9 37	1.7 31	1.5 26	1.9 41	1.8 38	1.6 31	1.4 26	1.8 41	1.7 37	1.5 32	1.3 27	
50		2.5 38	2.3 32	2.1 26	2.2 42	2.1 39	1.9 33	1.7 28	2.1 43	2.0 40	1.8 34	1.6 28	2.0 44	1.9 41	1.7 34	1.5 29	1.9 45	1.8 41	1.6 34	1.4 29	
60			2.4 35	2.2 29	2.3 46	2.2 42	2.0 36	1.8 30	2.2 47	2.1 43	1.9 37	1.7 31	2.1 47	2.0 44	1.8 38	1.6 31	2.0 48	1.9 45	1.8 41	1.6 34	
80			2.5 38	2.3 32	2.5 53	2.3 46	2.1 39	1.9 33	2.4 54	2.2 47	2.0 40	1.8 34	2.3 55	2.1 47	1.9 41	1.7 34	2.2 56	2.1 52	1.9 45	1.7 37	
100				2.5 38		2.5 53	2.3 46	2.1 39	2.5 58	2.4 54	2.2 47	2.0 40	2.4 59	2.3 55	2.1 47	1.9 41	2.3 59	2.2 55	2.0 49	1.8 41	
120							2.4 49	2.2 42		2.5 58	2.3 50	2.1 43	2.5 63	2.4 59	2.2 51	2.0 44	2.4 64	2.3 59	2.1 52	1.9 45	
140							2.5 53	2.3 46			2.4 54	2.2 47		2.5 63	2.3 55	2.1 47	2.5 68	2.4 64	2.2 55	2.0 49	
160								2.4 49		2.5 58	2.3 50			2.4 59	2.2 51		2.5 68	2.3 59	2.1 52		
180								2.5 53			2.4 54			2.5 63	2.3 55				2.4 64	2.2 55	
200										2.5 58					2.4 59				2.5 68	2.2 55	
220															2.5 53					2.3 49	

4-1-10122-2

Diversion design table - "C" Retardance (V and Trapezoidal Section) (Sheet 4 of 4).



WATERWAY DESIGN AIDS

The following example demonstrates how to use the exhibit to design a parabolic channel.

Problem: Determine the safe velocity and dimensions for stability and capacity for a waterway with parabolic cross section.

<u>Given:</u>	Runoff	Q = 55 c.f.s.
	Grade	= 5 percent
	Vegetative Cover	Kentucky Bluegrass
	Soil	Easily eroded
	Condition of Vegetation	
	Good stand--Mowed (3" - 4")	= "D" curve retardance (from Page B-3.2)
	Good stand--Headed (6" - 12")	= "C" curve retardance (from Page B-3.2)
	Permissible Velocity V_1	= 4.0 f.p.s. (from Page B-3.3)

Horizontally opposite 55 c.f.s. in B-3.31 (5 percent slope) in the columns headed $V_1 = 4.0$ f.p.s., find $T = 32.6$ feet, $D = 0.75$ foot and $V_2 = 3.33$ f.p.s. Therefore a waterway with parabolic cross section, a top width of 32.6 feet, and a depth of 0.75 foot will carry 55 c.f.s. at a maximum velocity of 4 feet per second when the vegetative lining is short (3" to 4" in height) and 3.33 feet per second when vegetative lining is tall (6" to 12"). This complies with the requirements for safe velocity when vegetation is short ("D" retardance) and capacity when vegetation is tall ("C" retardance).

WATERWAY DESIGN

Retardance	Cover	Stand	Condition and Height
A	Reed canarygrass Tall fescue Smooth bromegrass	Excellent Excellent Excellent	Tall (Average 36") Tall (Average 36") Tall (Average 36")
B	Tall fescue Smooth bromegrass Red fescue Kentucky bluegrass Redtop	Good Good Good Good Good	Average (20" tall) Average (20" tall) Uncut (Average 16" tall) Uncut (Average 16" tall) Average (22" tall)
C	Kentucky bluegrass Red fescue	Good Good	Headed (6 to 12") Headed (6 to 12")
D	Red fescue	Good	Cut to 2.5"

Classification of vegetal cover in waterways and channels as to degree of retardance.

USDA, Soil Conservation Service
Columbus, Ohio

WATERWAY DESIGN

Cover	Slope range ^{2/} (percent)	Permissible Velocity ^{1/}	
		Erosion re- sistant soils (ft. per sec.)	Easily eroded soils (ft. per sec.)
Kentucky bluegrass Tall fescue	0-5	7	5
	5-10	6	4
	over 10	5	3
Grass mixtures	<u>2/</u> 0-5	5	4
	5-10	4	3
Redtop Red fescue	<u>3/</u> 0-5	3.5	2.5

- 1/ Use velocities exceeding 5 feet per second only where good cover and proper maintenance can be obtained.
- 2/ Do not use on slopes steeper than 10 percent except for vegetated side slopes in combination with a stone, concrete, or highly resistant vegetative center section.
- 3/ Do not use on slopes steeper than 5 percent except for vegetated side slopes in combination with a stone, concrete, or highly resistant vegetative center section.

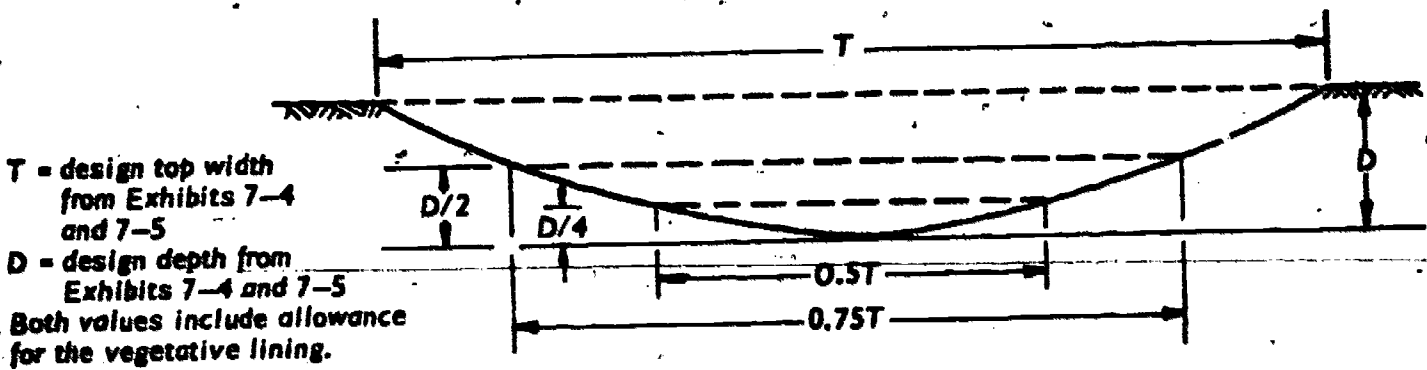

T = design top width from Exhibits 7-4 and 7-5
 D = design depth from Exhibits 7-4 and 7-5
 Both values include allowance for the vegetative lining.

PARABOLIC CROSS SECTION

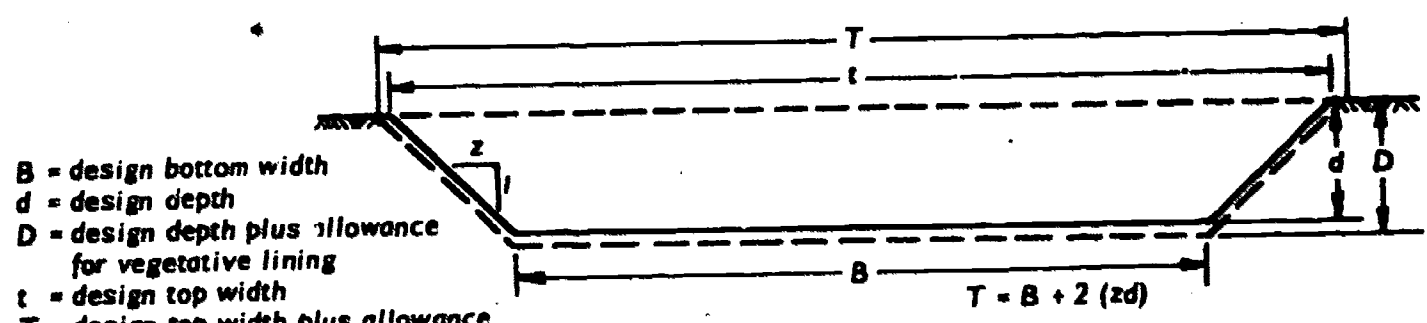

B = design bottom width
 d = design depth
 D = design depth plus allowance for vegetative lining
 t = design top width
 T = design top width plus allowance for vegetative lining
 z = side slope ratio

TRAPEZOIDAL CROSS SECTION

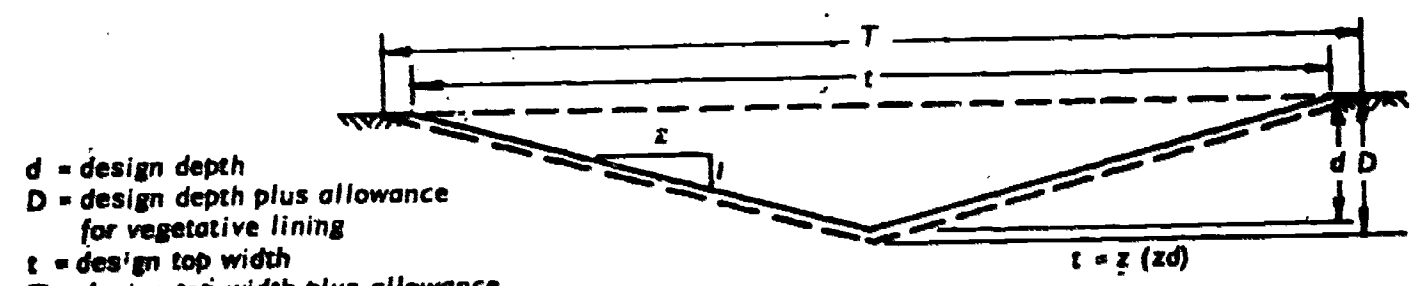

d = design depth
 D = design depth plus allowance for vegetative lining
 t = design top width
 T = design top width plus allowance for vegetative lining
 z = side slope ratio

TRIANGULAR CROSS SECTION

TYPICAL WATERWAY CROSS SECTIONS



PARABOLIC WATERWAY DESIGN, WITHOUT FREEBOARD

RETARDANCE - D & B
GRADE, % - 0.25 to 2.0

V	Grade, 0.25%			Grade, 0.50%			Grade, 0.75%			Grade, 1.0%			Grade, 1.25%			Grade, 1.50%			Grade, 2.0%		
	0.5	1.0	1.5	0.5	1.0	1.5	0.5	1.0	1.5	0.5	1.0	1.5	0.5	1.0	1.5	0.5	1.0	1.5	0.5	1.0	1.5
D	1.5	2.1	2.5	1.0	1.6	1.8	0.8	1.4	1.6	0.7	1.2	1.4	0.7	1.1	1.3	0.6	1.0	1.2	0.5	0.8	1.1
Q	Top Width																				
5	22			27	11		32	14	7	34	15	8	36	17	9	39	19	10	43	20	12
10	43	15		55	23	12	63	27	14	68	31	17	73	34	19	77	36	20	85	40	23
15	65	24	12	82	34	18	95	41	22	102	46	25	109	50	28	115	54	31	128	60	35
20	87	32	16	110	46	24		54	29		61	33		67	37		71	41		79	47
25	108	41	21		57	30		68	36		77	41		84	47		89	51		99	58
30		49	25		69	36		82	43		92	50		101	56		107	61			70
35		57	29		80	41		95	50	107	58			66				72			82
40		65	33		92	47	109	57			66			75				82			93
45		73	37	103	53			64			75			84				92			105
50		81	42		59			72			83			94				102			
55		90	46		65			79			91			103							
60		98	50		71			86		100											
65	106	58			77			93													
70		63			83			100													
75		67			89																
80		75			95																
90		83			107																
100		92																			
110		100																			

V, permissible velocity of soil with vegetative retardance "D"
Depth and top width are for cross section with retardance "B"

Q, in cfs
V, in fps
D, depth in ft.
Top Width, in ft

June 1978
Appendix B-3.5

U. S. DEPARTMENT OF AGRICULTURE
SOIL CONSERVATION SERVICE
UNIT

124



PARABOLIC WATERWAY DESIGN, WITHOUT FREEBOARD.

RETARDANCE - D & C
GRADE, % - 0.25 to 2.0

V	Grade, 0.25%			Grade, 0.50%			Grade, 0.75%			Grade, 1.0%			Grade, 1.25%			Grade, 1.50%			Grade, 2.0%		
	0.5	1.0	1.5	0.5	1.0	1.5	0.5	1.0	1.5	0.5	1.0	1.5	0.5	1.0	1.5	0.5	1.0	1.5	0.5	1.0	1.5
D	1.3	1.5	1.8	1.0	1.1	1.3	0.8	1.0	1.1	0.7	0.9	1.0	0.6	0.8	0.9	0.6	0.8	0.8	0.5	0.7	0.8
Q	Top Width																				
5	20			26	9		30	12	6	33	13	7	35	15	8	37	16		41	18	10
10	40	13		53	19	10	61	23	12	65	27	14	70	30	16	74	32	17	82	36	20
15	60	20	10	79	29	15	91	35	18	98	40	21	105	44	24	111	48	26	123	54	29
20	81	27	14	106	39	20	121	47	24		53	28		59	32		63	34		72	39
25	101	34	17		48	25		58	30		66	35		74	39		79	43		90	49
30		41	21		58	30		70	36		80	42		89	47		95	52		108	59
35		48	25		68	35		82	42		93	49	103	55		111	60				69
40		55	28		77	40		93	49	106	56			63			69				79
45		62	32		87	45	105	55			63			71			77				88
50		69	35		97	50		61			70			79			86				98
55		75	39	106	55			67			77			87			95				108
60		82	43		60			73			84			95		103					
65		89	46		65			79			91			102							
70		96	50		71			85			98										
75		103	53		76			91			105										
80			57		81			97													
90			64		91			109													
100			71		101																
110			78																		
120			85																		
130			93																		
140			100																		

V, permissible velocity of soil with vegetative retardance "D"
Depth and top width are for cross section with retardance "C"

Q, in cfs
V, in fps
D, depth in ft.
Top Width, in ft.

June 1978
Appendix B-3.6

U. S. DEPARTMENT OF AGRICULTURE
SOIL CONSERVATION SERVICE



V₁ for RETARDANCE "D". Top Width (T), Depth (D) and V₂ for RETARDANCE "T".

Grade 0.25 Percent

Q cfs	V ₁ = 2.0			V ₁ = 2.5			V ₁ = 3.0			V ₁ = 3.5			V ₁ = 4.0			V ₁ = 4.5			V ₁ = 5.0			V ₁ = 5.5			V ₁ = 6.0			
	T	D	V ₂	T	D	V ₂	T	D	V ₂	T	D	V ₂	T	D	V ₂	T	D	V ₂	T	D	V ₂	T	D	V ₂	T	D	V ₂	
15																												
20																												
25	11.3	3.27	1.00																									
30	13.2	3.09	1.09																									
35	15.2	3.01	1.13																									
40	17.3	2.99	1.15	12.1	3.61	1.36																						
45	19.3	2.94	1.18	13.4	3.49	1.42																						
50	21.4	2.93	1.18	14.7	3.41	1.48																						
55	23.5	2.92	1.19	16.1	3.38	1.50																						
60	25.5	2.89	1.21	17.5	3.35	1.52																						
65	27.6	2.89	1.21	18.8	3.30	1.56																						
70	29.7	2.89	1.21	20.2	3.28	1.57	14.4	3.98	1.61																			
75	31.7	2.87	1.23	21.6	3.27	1.58	15.3	3.91	1.66																			
80	33.8	2.87	1.23	23.0	3.26	1.58	16.3	3.90	1.67																			
90	38.0	2.87	1.23	25.8	3.25	1.60	18.1	3.80	1.94																			
100	42.1	2.85	1.24	28.6	3.23	1.61	20.0	3.76	1.98																			
110	46.3	2.83	1.24	31.4	3.22	1.62	21.9	3.73	2.01																			
120	50.4	2.84	1.25	34.1	3.20	1.64	23.9	3.73	2.00	17.0	4.47	2.34																
130	54.6	2.85	1.24	36.9	3.19	1.64	25.8	3.70	2.02	18.3	4.42	2.39																
140	58.7	2.84	1.25	39.7	3.19	1.65	27.7	3.68	2.04	19.6	4.37	2.43																
150	62.9	2.85	1.25	42.5	3.19	1.65	29.6	3.67	2.06	20.9	4.35	2.47																
160	67.0	2.84	1.25	45.3	3.18	1.65	31.6	3.68	2.05	22.2	4.30	2.50																
170	71.1	2.84	1.26	48.1	3.18	1.65	33.5	3.66	2.07	23.5	4.27	2.53	18.5	4.93	2.76													
180	75.3	2.84	1.25	50.9	3.18	1.66	35.4	3.65	2.08	24.8	4.24	2.55	19.5	4.90	2.80													
190	79.4	2.84	1.26	53.7	3.18	1.66	37.4	3.64	2.07	26.1	4.22	2.57	20.5	4.87	2.84													
200	83.5	2.84	1.26	56.5	3.18	1.66	39.3	3.65	2.08	27.5	4.23	2.56	21.5	4.83	2.87													
220	91.8	2.84	1.26	62.1	3.18	1.66	43.2	3.65	2.08	30.1	4.19	2.60	23.5	4.77	2.92													
240	100.0	2.83	1.26	67.6	3.17	1.67	47.0	3.63	2.10	32.7	4.15	2.64	25.5	4.72	2.97													
260	108.3	2.84	1.26	73.2	3.17	1.67	50.9	3.63	2.10	35.4	4.15	2.64	27.5	4.68	3.01	21.4	5.50	3.29										
280	116.6	2.84	1.26	78.8	3.17	1.67	54.8	3.63	2.10	38.1	4.14	2.64	29.5	4.64	3.03	22.9	5.44	3.35										
300	124.8	2.84	1.26	84.4	3.17	1.67	58.6	3.62	2.11	40.8	4.14	2.65	31.5	4.61	3.08	24.5	5.42	3.37										

Parabolic waterway design
(retardance "D" and "T")

June 1978
Appendix B-3.7



V₁ for RETARDANCE "D". Top Width (T), Depth (D) and V₂ for RETARDANCE "B".

Grade 0.50 Percent

Q cfs	V ₁ = 2.0			V ₁ = 2.5			V ₁ = 3.0			V ₁ = 3.5			V ₁ = 4.0			V ₁ = 4.5			V ₁ = 5.0			V ₁ = 5.5			V ₁ = 6.0			
	T	D	V ₂	T	D	V ₂	T	D	V ₂	T	D	V ₂	T	D	V ₂	T	D	V ₂	T	D	V ₂	T	D	V ₂	T	D	V ₂	
15	10.2	2.28	0.95																									
20	13.3	2.18	1.02																									
25	16.5	2.15	1.05																									
30	19.7	2.12	1.08	10.5	2.60	1.35																						
35	22.8	2.09	1.09	12.4	2.51	1.42	9.5	2.91	1.60																			
40	26.0	2.08	1.09	14.3	2.45	1.48	10.9	2.81	1.69																			
45	29.2	2.08	1.10	16.3	2.44	1.49	12.3	2.74	1.70																			
50	32.4	2.08	1.10	18.2	2.41	1.52	13.7	2.69	1.81																			
55	35.6	2.08	1.11	20.2	2.40	1.53	15.1	2.64	1.86	11.1	3.22	2.07																
60	38.8	2.08	1.11	22.1	2.38	1.55	16.6	2.64	1.88	12.0	3.11	2.18																
				24.1	2.38	1.55	18.0	2.61	1.90	13.0	3.07	2.23																
65	42.0	2.08	1.11	26.0	2.36	1.57	19.5	2.61	1.89	14.0	3.03	2.27																
70	45.2	2.08	1.11	28.0	2.36	1.57	20.9	2.59	1.92	15.0	3.01	2.31																
75	48.4	2.08	1.11	29.9	2.35	1.59	22.4	2.59	1.92	16.0	2.98	2.34	12.7	3.48	2.52													
80	51.6	2.08	1.11	31.9	2.36	1.58	23.8	2.58	1.94	17.0	2.96	2.36	13.4	3.41	2.60													
90	57.9	2.07	1.12	33.8	2.35	1.59	26.7	2.56	1.96	19.1	2.95	2.37	15.0	3.37	2.64													
100	64.3	2.07	1.11	39.7	2.34	1.60	29.6	2.55	1.97	21.1	2.92	2.42	16.5	3.31	2.72	13.3	3.77	2.96										
110	70.7	2.08	1.11	43.6	2.34	1.61	32.6	2.56	1.96	23.2	2.92	2.42	18.1	3.29	2.75	14.5	3.70	3.03										
120	77.6	2.07	1.12	47.5	2.33	1.61	35.5	2.56	1.97	25.2	2.89	2.45	19.6	3.24	2.81	15.7	3.64	3.12										
130	83.4	2.08	1.12	51.5	2.34	1.61	38.4	2.55	1.98	27.3	2.90	2.45	21.2	3.23	2.82	16.9	3.60	3.18										
140	89.7	2.08	1.12	55.4	2.34	1.61	41.3	2.55	1.98	29.3	2.88	2.47	22.8	3.22	2.84	18.1	3.56	3.23										
150	96.0	2.08	1.12	59.3	2.34	1.61	44.2	2.55	1.99	31.4	2.88	2.47	24.3	3.19	2.88	19.4	3.56	3.23	15.5	4.09	3.52							
160	102.3	2.08	1.12	63.2	2.34	1.61	47.1	2.54	1.99	33.5	2.89	2.47	25.9	3.19	2.88	20.6	3.53	3.27	16.4	4.02	3.60							
170	108.6	2.08	1.12	67.1	2.34	1.62	50.0	2.54	1.99	35.5	2.87	2.48	27.5	3.19	2.89	21.9	3.54	3.27	17.4	4.01	3.62							
180	114.9	2.08	1.12	70.9	2.33	1.62	52.9	2.54	1.99	37.6	2.88	2.48	29.1	3.19	2.89	23.1	3.51	3.30	18.3	3.98	3.69							
190	121.2	2.08	1.12	74.8	2.33	1.62	55.8	2.54	2.00	39.6	2.87	2.49	30.6	3.16	2.92	24.3	3.49	3.34	19.3	3.96	3.70							
200	127.4	2.08	1.13	78.7	2.33	1.62	58.7	2.54	2.00	41.7	2.87	2.49	32.2	3.16	2.93	25.6	3.50	3.33	20.2	3.91	3.77	16.8	4.48	3.96				
220	140.0	2.08	1.13	86.5	2.33	1.62	64.5	2.54	2.00	45.8	2.87	2.50	35.4	3.16	2.93	28.1	3.49	3.35	22.1	3.87	3.83	18.3	4.39	4.08				
240	152.6	2.08	1.13	94.3	2.33	1.63	70.3	2.54	2.01	49.9	2.86	2.51	38.6	3.16	2.93	30.6	3.48	3.36	24.1	3.87	3.84	19.9	4.36	4.12				
260	165.2	2.08	1.13	102.1	2.33	1.63	76.1	2.54	2.01	54.0	2.86	2.51	41.7	3.15	2.93	33.1	3.47	3.38	26.0	3.84	3.88	21.5	4.34	4.15				
280	177.7	2.08	1.13	109.8	2.33	1.63	81.9	2.54	2.01	58.2	2.87	2.50	44.9	3.15	2.93	35.6	3.46	3.39	28.0	3.84	3.88	23.0	4.32	4.24	19.0	4.88	4.50	
300	190.3	2.08	1.13	117.6	2.33	1.63	87.7	2.54	2.01	62.3	2.86	2.51	48.0	3.14	2.97	38.1	3.45	3.40	29.9	3.82	3.92	24.6	4.27	4.26	20.2	4.80	4.61	

Parabolic waterway design
(Retardance "D" and "B")

V₁ for RETARDANCE "D". Top Width (T), Depth (D) and V₂ for RETARDANCE "B".

Grade 0.75 Percent

Q cfs	V ₁ = 2.0			V ₁ = 2.5			V ₁ = 3.0			V ₁ = 3.5			V ₁ = 4.0			V ₁ = 4.5			V ₁ = 5.0			V ₁ = 5.5			V ₁ = 6.0			
	T	D	V ₂	T	D	V ₂	T	D	V ₂	T	D	V ₂	T	D	V ₂	T	D	V ₂	T	D	V ₂	T	D	V ₂	T	D	V ₂	
15	13.7	1.76	0.92	8.0	2.22	1.24																						
20	18.2	1.75	0.93	10.4	2.10	1.35																						
25	22.6	1.73	0.95	12.8	2.03	1.42	9.5	2.33	1.65																			
30	27.1	1.73	0.95	15.3	2.02	1.44	11.2	2.25	1.76	8.9	2.56	1.94																
35	31.5	1.72	0.96	17.8	2.01	1.45	13.0	2.23	1.79	10.2	2.47	2.05																
40	36.0	1.72	0.96	20.2	1.98	1.48	14.8	2.21	1.81	11.6	2.44	2.09																
45	40.4	1.71	0.96	22.7	1.98	1.49	16.5	2.17	1.86	12.9	2.39	2.16																
50	44.9	1.72	0.96	25.2	1.98	1.49	18.3	2.16	1.87	14.3	2.38	2.18	10.6	2.82	2.47													
55	49.3	1.72	0.96	27.6	1.96	1.51	20.1	2.16	1.88	15.7	2.37	2.19	11.6	2.80	2.51													
60	53.7	1.72	0.97	30.1	1.96	1.51	21.9	2.16	1.89	17.1	2.36	2.20	12.5	2.73	2.61													
65	58.1	1.72	0.97	32.5	1.95	1.52	23.6	2.14	1.92	18.4	2.33	2.25	13.5	2.71	2.63	11.2	3.06	2.83										
70	62.5	1.72	0.97	35.0	1.96	1.52	25.4	2.14	1.92	19.8	2.33	2.25	14.4	2.66	2.71	12.0	3.01	2.87										
75	66.9	1.72	0.97	37.4	1.95	1.53	27.2	2.14	1.92	21.2	2.33	2.26	15.4	2.65	2.73	12.8	2.99	2.91										
80	71.2	1.71	0.97	39.9	1.95	1.53	29.0	2.14	1.92	22.5	2.31	2.29	16.4	2.63	2.74	13.5	2.92	3.01										
90	80.0	1.71	0.97	44.8	1.95	1.53	32.5	2.12	1.94	25.3	2.31	2.29	18.4	2.63	2.76	15.1	2.89	3.07	12.4	3.26	3.30							
100	88.8	1.72	0.98	49.7	1.95	1.54	36.1	2.13	1.94	28.1	2.31	2.29	20.4	2.62	2.78	16.7	2.86	3.11	13.7	3.22	3.36							
110	97.6	1.72	0.98	54.7	1.95	1.53	39.7	2.13	1.94	30.8	2.30	2.31	22.4	2.61	2.79	18.3	2.84	3.15	14.9	3.15	3.48							
120	106.3	1.72	0.98	59.6	1.95	1.54	43.2	2.12	1.95	33.6	2.30	2.31	24.4	2.61	2.81	19.9	2.82	3.18	16.2	3.13	3.52	13.4	3.49	3.81				
130	115.0	1.72	0.98	64.5	1.95	1.54	46.8	2.12	1.95	36.4	2.30	2.31	26.3	2.58	2.85	21.5	2.81	3.20	17.5	3.11	3.55	14.5	3.49	3.82				
140	123.7	1.72	0.98	69.4	1.95	1.54	50.3	2.12	1.96	39.1	2.29	2.33	28.3	2.58	2.85	23.1	2.80	3.22	18.7	3.07	3.63	15.5	3.44	3.91				
150	132.4	1.72	0.98	74.2	1.95	1.55	53.9	2.12	1.95	41.9	2.30	2.32	30.3	2.58	2.86	24.7	2.79	3.24	20.0	3.06	3.65	16.5	3.39	3.98	14.4	3.77	4.37	
160	141.1	1.72	0.98	79.1	1.95	1.55	57.4	2.12	1.96	44.6	2.29	2.33	32.3	2.58	2.86	26.3	2.78	3.26	21.3	3.05	3.67	17.6	3.39	3.98	15.3	3.77	4.38	
170	149.7	1.72	0.98	84.0	1.95	1.55	60.9	2.12	1.97	47.4	2.30	2.33	34.3	2.58	2.86	28.0	2.80	3.24	22.6	3.04	3.68	18.6	3.36	4.05	16.1	3.73	4.46	
180	158.3	1.72	0.98	88.8	1.95	1.55	64.5	2.12	1.96	50.1	2.29	2.34	36.3	2.58	2.86	29.6	2.79	3.25	23.9	3.04	3.69	19.6	3.33	4.11	17.0	3.73	4.46	
190	166.9	1.72	0.98	93.7	1.95	1.55	68.0	2.12	1.97	52.8	2.29	2.34	38.3	2.58	2.86	31.2	2.78	3.26	25.2	3.03	3.70	20.7	3.33	4.10	17.0	3.73	4.46	
200	175.5	1.72	0.99	98.5	1.95	1.55	71.5	2.12	1.97	55.6	2.29	2.34	40.2	2.57	2.89	32.8	2.78	3.27	26.5	3.03	3.71	21.7	3.31	4.15	17.8	3.70	4.52	
220	192.8	1.72	0.99	108.3	1.95	1.55	78.6	2.12	1.97	61.1	2.29	2.34	44.2	2.57	2.89	36.0	2.77	3.29	29.1	3.02	3.73	23.8	3.29	4.18	19.5	3.67	4.58	
240	210.1	1.72	0.99	118.0	1.95	1.56	85.6	2.12	1.98	66.6	2.29	2.35	48.2	2.57	2.89	39.2	2.76	3.31	31.7	3.01	3.75	25.9	3.28	4.22	21.8	3.64	4.63	
260	227.3	1.72	0.99	127.7	1.95	1.56	92.7	2.12	1.98	72.1	2.29	2.35	52.2	2.57	2.89	42.5	2.77	3.30	34.3	3.01	3.76	28.0	3.26	4.24	22.9	3.62	4.67	
280	244.5	1.72	0.99	137.4	1.95	1.56	99.7	2.12	1.98	77.6	2.29	2.35	56.2	2.57	2.89	45.7	2.76	3.31	36.4	3.00	3.77	30.1	3.25	4.26	24.7	3.63	4.68	
300	261.7	1.72	0.99	147.1	1.95	1.56	106.8	2.12	1.98	83.0	2.29	2.36	60.1	2.57	2.90	48.9	2.76	3.32	39.5	3.00	3.78	32.2	3.25	4.28	26.4	3.62	4.68	

Parabolic waterway design
(Retardance "D" and "B")

4-28-81 1-68

128

June 1978
Appendix B-3.9

V_1 for RETARDANCE "D", Top Width (T), Depth (D) and V_2 for RETARDANCE "B".

Grade 1.0 Percent

Q cfs	$V_1 = 2.0$			$V_1 = 2.5$			$V_1 = 3.0$			$V_1 = 3.5$			$V_1 = 4.0$			$V_1 = 4.5$			$V_1 = 5.0$			$V_1 = 5.5$			$V_1 = 6.0$		
	T	D	V_2	T	D	V_2	T	D	V_2	T	D	V_2	T	D	V_2	T	D	V_2	T	D	V_2	T	D	V_2	T	D	V_2
15	15.7	1.55	0.91	9.9	1.80	1.24																					
20	20.9	1.54	0.92	13.0	1.74	1.31																					
25	26.0	1.53	0.93	16.2	1.73	1.32	8.8	2.04	1.65																		
30	31.1	1.52	0.94	19.3	1.70	1.35	10.9	1.99	1.70	8.9	2.21	1.87															
35	36.2	1.52	0.94	22.5	1.70	1.36	12.9	1.94	1.78	10.5	2.14	1.98															
40	41.3	1.52	0.95	25.7	1.70	1.36	15.0	1.93	1.86	12.1	2.08	2.06	9.2	2.37	2.37												
45	46.4	1.52	0.95	28.8	1.69	1.37	17.1	1.92	1.81	13.7	2.04	2.12	10.4	2.32	2.45												
50	51.5	1.52	0.95	32.0	1.70	1.37	19.2	1.91	1.82	15.4	2.04	2.12	11.7	2.32	2.46												
55	56.5	1.51	0.95	35.1	1.69	1.38	21.2	1.89	1.83	17.0	2.02	2.16	12.9	2.28	2.52	9.9	2.61	2.66									
60	61.6	1.52	0.95	38.3	1.69	1.37	23.3	1.89	1.86	18.7	2.02	2.16	14.1	2.25	2.57	10.8	2.57	2.93									
							25.4	1.89	1.86	20.3	2.00	2.19	15.3	2.23	2.61	11.7	2.54	3.00									
65	66.6	1.52	0.96	41.4	1.69	1.38	27.5	1.89	1.86	22.0	2.01	2.19	16.6	2.24	2.60	12.7	2.55	2.98	10.6	2.88	3.16						
70	71.6	1.51	0.96	44.6	1.70	1.38	29.5	1.88	1.88	23.6	1.99	2.21	17.8	2.22	2.63	13.6	2.52	3.03	11.3	2.82	3.26						
75	76.6	1.51	0.96	47.7	1.69	1.38	31.6	1.88	1.88	25.3	2.00	2.21	19.0	2.21	2.66	14.3	2.50	3.06	12.0	2.77	3.35						
80	81.6	1.52	0.96	50.8	1.69	1.38	33.7	1.88	1.88	26.9	1.99	2.22	20.3	2.22	2.64	15.4	2.48	3.11	12.7	2.73	3.43						
90	91.7	1.52	0.96	57.1	1.69	1.39	37.8	1.88	1.89	30.2	1.98	2.24	22.8	2.21	2.65	17.3	2.47	3.13	14.2	2.69	3.45	11.8	2.99	3.78			
100	101.7	1.52	0.96	63.4	1.69	1.39	42.0	1.88	1.89	33.5	1.98	2.24	25.2	2.19	2.69	19.2	2.47	3.14	15.7	2.67	3.55	13.0	2.94	3.88			
110	111.7	1.52	0.97	69.6	1.69	1.39	46.1	1.87	1.90	36.8	1.98	2.25	27.7	2.19	2.70	21.9	2.44	3.20	17.3	2.68	3.53	14.3	2.94	3.88	12.4	3.23	4.07
120	121.7	1.52	0.97	75.8	1.69	1.39	50.2	1.87	1.90	40.1	1.98	2.26	30.2	2.19	2.70	22.9	2.44	3.20	18.8	2.66	3.57	15.5	2.91	3.96	13.4	3.17	4.19
130	131.6	1.51	0.97	82.1	1.69	1.39	54.4	1.87	1.90	43.6	1.97	2.26	32.7	2.19	2.70	24.8	2.44	3.20	20.3	2.64	3.61	16.7	2.88	4.03	14.4	3.12	4.30
140	141.5	1.51	0.97	88.3	1.69	1.39	58.5	1.87	1.90	46.7	1.97	2.26	35.2	2.19	2.70	26.6	2.42	3.24	21.8	2.63	3.64	17.9	2.85	4.08	15.5	3.12	4.31
150	151.4	1.52	0.97	94.5	1.69	1.40	62.6	1.87	1.91	50.0	1.98	2.26	37.6	2.18	2.72	28.5	2.42	3.23	23.3	2.62	3.66	19.2	2.86	4.07	16.5	3.08	4.39
160	161.3	1.52	0.97	100.7	1.69	1.40	66.7	1.87	1.91	53.3	1.98	2.26	40.1	2.18	2.72	30.4	2.43	3.23	24.8	2.61	3.68	20.4	2.84	4.11	17.6	3.08	4.39
170	171.1	1.52	0.97	106.8	1.69	1.40	70.8	1.87	1.91	56.5	1.97	2.28	42.6	2.19	2.72	32.2	2.41	3.26	26.3	2.60	3.70	21.7	2.85	4.10	18.6	3.05	4.46
180	180.9	1.52	0.98	113.0	1.69	1.40	74.9	1.87	1.91	59.8	1.97	2.27	45.0	2.18	2.73	34.1	2.42	3.25	27.9	2.61	3.68	22.9	2.83	4.14	19.6	3.02	4.52
190	190.6	1.52	0.98	119.1	1.69	1.40	79.0	1.87	1.91	63.1	1.98	2.27	47.5	2.18	2.73	35.9	2.41	3.27	29.4	2.61	3.69	24.1	2.81	4.17	20.7	3.03	4.51
200	200.4	1.52	0.98	125.3	1.69	1.40	83.0	1.87	1.92	66.3	1.97	2.28	49.9	2.18	2.74	37.8	2.41	3.27	30.9	2.60	3.71	25.4	2.82	4.15	21.7	3.00	4.57
220	220.1	1.52	0.98	137.6	1.69	1.41	91.2	1.87	1.92	72.9	1.97	2.28	54.9	2.18	2.74	41.5	2.41	3.28	33.9	2.59	3.73	27.9	2.82	4.17	23.8	2.99	4.61
240	239.8	1.52	0.98	150.0	1.69	1.41	99.4	1.87	1.93	79.5	1.98	2.28	59.8	2.18	2.75	45.3	2.41	3.28	37.0	2.60	3.72	30.4	2.81	4.18	25.9	2.97	4.64
260	259.4	1.52	0.98	162.3	1.69	1.41	107.6	1.87	1.93	86.0	1.97	2.28	64.8	2.18	2.74	49.0	2.41	3.29	40.0	2.59	3.75	32.9	2.81	4.20	28.0	2.96	4.67
280	279.0	1.52	0.98	174.6	1.70	1.41	115.8	1.87	1.93	92.5	1.97	2.29	69.7	2.18	2.75	52.7	2.40	3.30	43.0	2.58	3.76	35.3	2.79	4.24	30.2	2.97	4.65
300	298.5	1.52	0.98	186.9	1.70	1.41	123.9	1.87	1.93	99.1	1.98	2.29	74.6	2.18	2.75	56.4	2.40	3.30	46.1	2.59	3.75	37.8	2.79	4.24	32.3	2.97	4.67

Parabolic waterway design
(Retardance "D" and "B")

June 1978
Appendix B-3.10

V_1 for RETARDANCE "D", Top Width (T), Depth (D) and V_2 for RETARDANCE "B"

Grade 1.25 Percent

Q cfs	$V_1 = 2.0$			$V_1 = 2.5$			$V_1 = 3.0$			$V_1 = 3.5$			$V_1 = 4.0$			$V_1 = 4.5$			$V_1 = 5.0$			$V_1 = 5.5$			$V_1 = 6.0$		
	T	D	V_2	T	D	V_2	T	D	V_2	T	D	V_2	T	D	V_2	T	D	V_2	T	D	V_2	T	D	V_2	T	D	V_2
15	18.1	1.40	0.88	11.5	1.59	1.21	7.7	1.85	1.55																		
20	24.0	1.38	0.89	15.2	1.56	1.23	10.1	1.79	1.64	7.7	2.03	1.89															
25	30.0	1.38	0.89	19.0	1.56	1.25	12.5	1.75	1.69	9.5	1.97	1.97	7.8	2.19	2.16												
30	35.9	1.38	0.90	22.7	1.55	1.27	14.9	1.73	1.73	11.2	1.90	2.09	9.2	2.11	2.28												
35	41.8	1.38	0.90	26.4	1.54	1.28	17.3	1.71	1.75	13.0	1.88	2.12	10.5	2.02	2.44	8.3	2.36	2.64									
40	47.7	1.38	0.90	30.1	1.54	1.28	19.7	1.70	1.77	14.8	1.87	2.15	12.0	2.02	2.44	9.4	2.32	2.72									
45	53.6	1.38	0.90	33.9	1.54	1.28	22.1	1.69	1.78	16.6	1.86	2.17	13.4	1.99	2.80	10.5	2.28	2.78									
50	59.4	1.38	0.91	37.6	1.54	1.28	24.5	1.69	1.79	18.4	1.85	2.18	14.9	1.99	2.50	11.5	2.22	2.90	9.4	2.49	3.16						
55	65.3	1.38	0.91	41.3	1.54	1.28	26.9	1.69	1.80	20.2	1.84	2.19	16.3	1.97	2.54	12.6	2.20	2.94	10.3	2.47	3.20						
60	71.1	1.38	0.91	44.9	1.53	1.29	29.3	1.68	1.81	22.0	1.84	2.20	17.7	1.96	2.57	13.7	2.19	2.97	11.2	2.45	3.23						
65	76.9	1.38	0.91	48.6	1.54	1.29	31.7	1.68	1.81	23.7	1.82	2.24	19.2	1.97	2.56	14.8	2.18	2.99	12.0	2.40	3.34	9.8	2.76	3.55			
70	82.7	1.38	0.91	52.3	1.54	1.29	34.1	1.68	1.81	25.5	1.82	2.24	20.6	1.95	2.58	15.9	2.17	3.01	12.9	2.39	3.36	10.5	2.74	3.61			
75	88.4	1.38	0.91	55.9	1.53	1.30	36.5	1.68	1.82	27.3	1.82	2.24	22.1	1.96	2.57	17.0	2.16	3.03	13.8	2.39	3.38	11.1	2.67	3.76			
80	94.2	1.38	0.91	59.6	1.54	1.30	38.9	1.68	1.82	29.1	1.82	2.24	23.5	1.95	2.59	18.1	2.16	3.05	14.7	2.38	3.39	11.8	2.65	3.80	10.3	2.92	3.94
90	105.8	1.38	0.91	66.9	1.53	1.30	43.7	1.68	1.82	32.7	1.82	2.25	26.4	1.95	2.60	20.3	2.14	3.07	16.4	2.34	3.48	13.2	2.62	3.87	11.4	2.83	4.14
100	117.3	1.38	0.92	74.3	1.54	1.30	48.5	1.68	1.83	36.3	1.82	2.25	29.3	1.95	2.61	22.5	2.14	3.10	18.2	2.34	3.49	14.6	2.59	3.92	12.4	2.80	4.21
110	128.9	1.38	0.92	81.6	1.54	1.31	53.3	1.68	1.83	39.8	1.81	2.27	32.2	1.95	2.61	24.7	2.13	3.11	20.0	2.34	3.50	16.0	2.58	3.97	13.8	2.77	4.27
120	140.4	1.38	0.92	88.9	1.54	1.31	58.1	1.68	1.83	43.4	1.81	2.27	35.0	1.94	2.64	26.9	2.12	3.13	21.7	2.31	3.56	17.4	2.56	4.00	15.0	2.75	4.32
130	151.8	1.38	0.92	96.1	1.53	1.31	62.9	1.68	1.83	47.0	1.82	2.27	37.9	1.94	2.64	29.1	2.12	3.14	23.5	2.31	3.56	18.8	2.55	4.04	16.2	2.74	4.38
140	163.2	1.38	0.92	103.4	1.54	1.31	67.6	1.68	1.84	50.5	1.81	2.28	40.8	1.94	2.64	31.3	2.12	3.14	25.3	2.31	3.56	20.2	2.54	4.06	17.4	2.72	4.39
150	174.6	1.38	0.92	110.6	1.53	1.31	72.4	1.68	1.83	54.1	1.81	2.28	43.7	1.94	2.64	33.5	2.12	3.15	27.0	2.30	3.60	21.6	2.53	4.08	18.6	2.71	4.42
160	186.0	1.38	0.92	117.8	1.53	1.32	77.1	1.68	1.84	57.6	1.81	2.29	46.5	1.93	2.65	35.7	2.12	3.16	28.8	2.30	3.60	22.9	2.50	4.16	19.8	2.70	4.45
170	197.3	1.39	0.92	125.0	1.54	1.32	81.9	1.68	1.84	61.2	1.81	2.28	49.4	1.94	2.65	37.9	2.12	3.16	30.6	2.30	3.59	24.3	2.50	4.17	21.0	2.69	4.47
180	208.5	1.38	0.93	132.2	1.54	1.32	86.6	1.68	1.84	64.7	1.81	2.29	52.2	1.93	2.66	40.1	2.12	3.16	32.3	2.29	3.62	25.7	2.49	4.18	22.2	2.69	4.49
190	219.8	1.39	0.93	139.3	1.54	1.32	91.3	1.68	1.84	68.2	1.81	2.29	55.1	1.94	2.65	42.8	2.12	3.16	34.1	2.30	3.62	27.1	2.49	4.19	23.4	2.68	4.51
200	231.0	1.39	0.93	146.5	1.54	1.32	96.0	1.68	1.84	71.8	1.82	2.29	57.9	1.93	2.66	44.5	2.12	3.17	35.8	2.29	3.64	28.5	2.49	4.20	24.6	2.68	4.52
220	253.7	1.39	0.93	160.9	1.54	1.32	105.5	1.68	1.84	78.9	1.82	2.29	63.7	1.94	2.66	48.9	2.12	3.17	39.4	2.29	3.63	31.3	2.48	4.22	27.0	2.67	4.55
240	276.3	1.39	0.93	175.3	1.54	1.33	115.0	1.69	1.84	85.9	1.81	2.30	69.4	1.94	2.66	53.3	2.11	3.18	42.9	2.29	3.65	34.1	2.48	4.23	29.4	2.66	4.57
260	298.9	1.39	0.93	189.7	1.54	1.33	124.4	1.68	1.85	93.0	1.81	2.30	75.1	1.93	2.67	57.6	2.11	3.19	46.5	2.29	3.64	36.9	2.48	4.24	31.8	2.65	4.59
280	321.3	1.39	0.93	204.0	1.54	1.33	133.9	1.69	1.85	100.1	1.82	2.30	80.8	1.93	2.67	62.0	2.11	3.19	50.0	2.29	3.65	39.7	2.47	4.25	34.2	2.65	4.61
300	343.7	1.39	0.93	218.2	1.54	1.33	143.3	1.69	1.85	107.1	1.81	2.30	86.5	1.94	2.67	66.4	2.11	3.19	53.5	2.28	3.66	42.5	2.47	4.26	36.8	2.65	4.62

Parabolic waterway design
(Retardance "D" and "B")

130

158

June 1978
Appendix B-3.1



V₁ for RETARDANCE "D". Top Width (T), Depth (D) and V₂ for RETARDANCE "T".

Grade 1.50 Percent

Q cfs	V ₁ = 2.0			V ₁ = 2.5			V ₁ = 3.0			V ₁ = 3.5			V ₁ = 4.0			V ₁ = 4.5			V ₁ = 5.0			V ₁ = 5.5			V ₁ = 6.0		
	T	D	V ₂	T	D	V ₂	T	D	V ₂	T	D	V ₂	T	D	V ₂	T	D	V ₂	T	D	V ₂	T	D	V ₂	T	D	V ₂
15	20.1	1.29	0.84	13.2	1.43	1.17	8.9	1.63	1.31																		
20	26.8	1.29	0.89	17.5	1.42	1.19	11.7	1.60	1.38																		
25	33.4	1.28	0.86	21.8	1.41	1.21	14.3	1.57	1.63																		
30	40.0	1.28	0.87	26.2	1.42	1.20	17.4	1.57	1.63	11.8	1.73	2.13	9.6	1.90	2.43	8.0	2.13	2.60									
35	46.5	1.28	0.87	30.5	1.41	1.21	20.3	1.56	1.63	13.7	1.74	2.18	11.1	1.86	2.50	9.2	2.06	2.72									
40	53.1	1.28	0.87	34.8	1.41	1.21	23.0	1.55	1.63	15.6	1.73	2.20	12.6	1.84	2.56	10.4	2.02	2.82	8.2	2.39	3.03						
45	59.6	1.28	0.88	39.0	1.40	1.22	25.9	1.53	1.63	17.5	1.72	2.22	14.2	1.83	2.55	11.7	2.02	2.82	9.1	2.31	3.16						
50	66.1	1.28	0.88	43.3	1.41	1.22	28.7	1.53	1.63	19.4	1.71	2.24	15.7	1.83	2.58	12.9	1.99	2.89	10.0	2.26	3.27						
55	72.6	1.28	0.88	47.6	1.41	1.22	31.5	1.53	1.66	21.3	1.71	2.25	17.2	1.82	2.61	14.2	1.99	2.89	10.9	2.22	3.36	9.3	2.47	3.54			
60	79.0	1.28	0.88	51.8	1.41	1.22	34.3	1.54	1.66	23.2	1.70	2.25	18.8	1.82	2.60	15.4	1.9	2.94	11.9	2.22	3.36	10.1	2.45	3.59			
65	85.5	1.28	0.88	56.0	1.40	1.23	37.1	1.54	1.69	25.1	1.70	2.26	20.3	1.82	2.62	16.6	1.93	2.98	12.8	2.19	3.43	10.8	2.39	3.73			
70	91.9	1.28	0.88	60.3	1.41	1.22	39.9	1.54	1.69	27.0	1.70	2.26	21.8	1.81	2.64	17.9	1.96	2.96	13.8	2.20	3.43	11.6	2.38	3.76	9.8	2.62	4.03
75	98.2	1.28	0.89	64.5	1.41	1.23	42.7	1.54	1.69	28.9	1.70	2.27	23.3	1.80	2.66	19.1	1.93	3.00	14.7	2.18	3.48	12.4	2.37	3.79	10.5	2.62	4.04
80	104.6	1.28	0.89	68.7	1.41	1.23	45.5	1.54	1.70	30.8	1.70	2.27	24.9	1.81	2.64	20.4	1.93	2.98	15.7	2.18	3.46	13.2	2.36	3.81	11.1	2.58	4.13
90	117.5	1.28	0.89	77.1	1.41	1.23	51.1	1.54	1.70	34.6	1.70	2.28	27.9	1.80	2.67	22.9	1.93	3.00	17.6	2.17	3.50	14.7	2.31	3.93	12.4	2.54	4.24
100	130.3	1.28	0.89	83.6	1.41	1.23	56.7	1.54	1.70	38.3	1.69	2.30	31.0	1.80	2.66	25.4	1.96	3.02	19.5	2.16	3.53	16.3	2.30	3.96	13.7	2.51	4.32
110	143.0	1.28	0.89	94.0	1.41	1.24	62.3	1.54	1.71	42.1	1.69	2.30	34.0	1.79	2.68	27.9	1.94	3.03	21.4	2.15	3.56	17.9	2.30	3.98	15.0	2.49	4.38
120	155.8	1.28	0.89	102.4	1.41	1.24	67.9	1.54	1.71	45.9	1.69	2.30	37.1	1.80	2.68	30.4	1.94	3.03	23.3	2.14	3.57	19.5	2.29	3.99	16.3	2.47	4.43
130	168.4	1.28	0.90	110.7	1.41	1.24	73.4	1.54	1.71	49.7	1.69	2.30	40.1	1.79	2.69	32.9	1.94	3.04	25.2	2.14	3.59	21.1	2.29	4.01	17.6	2.45	4.48
140	181.0	1.28	0.90	119.1	1.41	1.24	79.0	1.54	1.71	53.4	1.69	2.31	43.2	1.80	2.68	35.3	1.93	3.07	27.1	2.14	3.60	22.7	2.29	4.02	18.9	2.44	4.51
150	193.6	1.28	0.90	127.4	1.41	1.24	84.5	1.54	1.72	57.2	1.69	2.31	46.2	1.79	2.70	37.8	1.93	3.07	29.0	2.13	3.61	24.2	2.27	4.07	20.2	2.43	4.54
160	206.2	1.28	0.90	135.7	1.41	1.24	90.0	1.54	1.72	60.9	1.69	2.32	49.3	1.80	2.69	40.3	1.93	3.07	30.9	2.13	3.62	25.8	2.27	4.08	21.6	2.43	4.51
170	218.8	1.28	0.90	144.0	1.41	1.24	95.6	1.54	1.72	64.7	1.69	2.31	52.3	1.80	2.69	42.8	1.93	3.07	32.8	2.13	3.63	27.4	2.27	4.08	22.9	2.44	4.53
180	231.1	1.28	0.90	152.2	1.41	1.25	101.0	1.54	1.72	68.4	1.69	2.32	55.3	1.80	2.70	45.3	1.93	3.07	34.7	2.13	3.63	29.0	2.27	4.08	24.2	2.43	4.56
190	243.3	1.28	0.90	160.4	1.41	1.25	106.5	1.54	1.72	72.1	1.69	2.32	58.3	1.80	2.71	47.7	1.92	3.08	36.5	2.12	3.66	30.6	2.27	4.08	25.5	2.42	4.58
200	255.8	1.28	0.91	168.6	1.41	1.25	112.0	1.54	1.72	75.9	1.69	2.32	61.3	1.79	2.71	50.2	1.93	3.08	38.4	2.12	3.66	32.1	2.26	4.12	26.8	2.42	4.60
220	280.9	1.28	0.91	183.2	1.41	1.25	123.0	1.54	1.73	83.4	1.69	2.32	67.4	1.80	2.71	55.2	1.93	3.08	42.2	2.12	3.67	35.3	2.26	4.12	29.5	2.42	4.58
240	305.8	1.28	0.91	201.7	1.41	1.25	134.1	1.54	1.73	90.9	1.69	2.32	73.5	1.80	2.71	60.1	1.92	3.09	46.0	2.12	3.67	38.5	2.26	4.12	32.1	2.41	4.62
260	330.7	1.28	0.91	219.2	1.41	1.26	145.1	1.54	1.73	98.3	1.69	2.33	79.5	1.80	2.72	65.1	1.93	3.09	49.8	2.12	3.68	41.7	2.26	4.12	34.7	2.41	4.64
280	355.5	1.28	0.91	234.7	1.41	1.26	156.0	1.54	1.73	105.8	1.69	2.33	85.3	1.79	2.72	70.0	1.93	3.10	53.6	2.12	3.68	44.8	2.25	4.14	37.4	2.41	4.63
300	380.2	1.28	0.91	251.1	1.41	1.26	167.0	1.54	1.73	113.2	1.69	2.33	91.6	1.80	2.72	74.9	1.92	3.11	57.4	2.12	3.68	46.9	2.25	4.14	39.0	2.41	4.65

Parabolic waterway design
(Retardance "D" and "T")

V₁ for RETARDANCE "D", Top Width (T), Depth (D) and V₂ for RETARDANCE "B"

Grade 1.75 Percent

Q cfs	V ₁ = 2.0			V ₁ = 2.5			V ₁ = 3.0			V ₁ = 3.5			V ₁ = 4.0			V ₁ = 4.5			V ₁ = 5.0			V ₁ = 5.5			V ₁ = 6.0		
	T	D	V ₂	T	D	V ₂	T	D	V ₂	T	D	V ₂	T	D	V ₂	T	D	V ₂	T	D	V ₂	T	D	V ₂	T	D	V ₂
15	21.8	1.21	0.84	14.2	1.33	1.17	10.0	1.30	1.48	6.9	1.74	1.84															
20	29.0	1.20	0.83	18.9	1.33	1.18	13.2	1.46	1.51	9.0	1.66	1.98	7.6	1.83	2.12												
25	36.2	1.20	0.83	23.9	1.32	1.20	16.4	1.43	1.56	11.2	1.64	2.01	9.3	1.75	2.27	7.6	1.93	2.51									
30	43.4	1.21	0.83	28.2	1.32	1.20	19.6	1.44	1.58	13.3	1.60	2.08	11.1	1.72	2.32	9.0	1.88	2.62									
35	50.5	1.20	0.85	32.8	1.31	1.21	22.8	1.43	1.59	15.3	1.60	2.09	12.8	1.68	2.40	10.4	1.84	2.70	8.2	2.11	2.98						
40	57.6	1.20	0.85	37.4	1.31	1.21	26.0	1.43	1.60	17.6	1.58	2.13	14.6	1.68	2.42	11.8	1.81	2.77	9.3	2.08	3.06						
45	64.6	1.20	0.86	42.0	1.31	1.21	29.2	1.43	1.61	19.8	1.58	2.13	16.4	1.68	2.43	13.2	1.79	2.82	10.3	2.01	3.21	8.6	2.26	3.41			
50	71.6	1.20	0.86	46.6	1.31	1.21	32.4	1.43	1.61	21.9	1.57	2.16	18.2	1.67	2.44	14.7	1.80	2.80	11.4	2.00	3.25	9.9	2.24	3.48			
55	78.6	1.20	0.86	51.2	1.31	1.22	35.6	1.43	1.61	24.1	1.58	2.15	19.9	1.66	2.48	16.1	1.79	2.83	12.9	1.99	3.28	10.3	2.17	3.64	8.6	2.51	3.77
60	85.6	1.20	0.87	55.8	1.31	1.22	38.8	1.43	1.61	26.2	1.57	2.17	21.7	1.66	2.48	17.5	1.78	2.86	13.6	1.98	3.31	11.2	2.16	3.67	9.2	2.41	4.00
65	92.6	1.20	0.87	60.3	1.31	1.22	41.9	1.42	1.62	28.4	1.57	2.16	23.5	1.66	2.48	18.9	1.77	2.88	14.7	1.97	3.33	12.1	2.15	3.70	9.9	2.38	4.08
70	99.5	1.20	0.87	64.9	1.32	1.22	45.1	1.42	1.62	30.5	1.57	2.18	25.2	1.63	2.50	20.3	1.76	2.90	15.8	1.96	3.35	13.0	2.14	3.73	10.6	2.35	4.15
75	106.4	1.20	0.87	69.4	1.31	1.22	48.2	1.42	1.63	32.7	1.57	2.17	27.0	1.63	2.50	21.8	1.78	2.88	16.9	1.96	3.36	13.9	2.13	3.75	11.4	2.37	4.11
80	113.3	1.20	0.87	73.9	1.31	1.22	51.4	1.43	1.62	34.8	1.57	2.18	28.8	1.66	2.50	23.2	1.77	2.90	17.9	1.94	3.43	14.8	2.13	3.77	12.1	2.35	4.17
90	127.2	1.20	0.87	83.0	1.31	1.23	57.7	1.42	1.63	39.1	1.57	2.18	32.3	1.65	2.52	26.0	1.76	2.93	20.1	1.93	3.45	16.6	2.12	3.81	13.9	2.31	4.28
100	141.0	1.20	0.87	92.1	1.32	1.23	64.0	1.42	1.64	43.4	1.57	2.18	35.8	1.64	2.53	28.9	1.76	2.92	22.3	1.93	3.46	18.4	2.11	3.83	14.9	2.28	4.37
110	154.9	1.21	0.87	101.2	1.32	1.23	70.4	1.43	1.63	47.7	1.57	2.19	39.4	1.63	2.52	31.7	1.76	2.94	24.5	1.92	3.47	20.1	2.08	3.91	16.4	2.29	4.36
120	168.6	1.20	0.88	110.2	1.32	1.23	76.6	1.42	1.64	51.9	1.57	2.20	42.9	1.64	2.53	34.6	1.76	2.93	26.7	1.92	3.48	21.9	2.08	3.93	17.8	2.26	4.43
130	182.3	1.21	0.88	119.2	1.32	1.23	82.9	1.42	1.64	56.2	1.57	2.20	46.4	1.64	2.54	37.4	1.76	2.93	28.9	1.92	3.49	23.7	2.07	3.93	19.2	2.25	4.48
140	196.0	1.21	0.88	128.1	1.32	1.23	89.2	1.43	1.64	60.4	1.57	2.21	49.9	1.64	2.55	40.2	1.75	2.96	31.1	1.92	3.49	25.5	2.07	3.96	20.7	2.25	4.47
150	209.6	1.21	0.88	137.1	1.32	1.23	95.4	1.42	1.64	64.7	1.57	2.20	53.4	1.64	2.55	43.1	1.76	2.95	33.3	1.92	3.49			3.95	22.1	2.24	4.51
160	223.1	1.21	0.88	146.0	1.32	1.24	101.6	1.42	1.65	68.9	1.57	2.21	56.9	1.64	2.55	45.9	1.76	2.96	35.4	1.91	3.52			3.98	23.6	2.25	4.49
170	236.6	1.21	0.88	154.9	1.32	1.24	107.9	1.43	1.64	73.1	1.57	2.21	60.4	1.64	2.55	48.7	1.76	2.96	37.6	1.91	3.52	30.5	2.07	3.93	25.0	2.24	4.53
180	250.0	1.21	0.89	163.7	1.32	1.24	114.0	1.43	1.65	77.4	1.57	2.21	63.9	1.64	2.55	51.5	1.75	2.97	39.8	1.92	3.52	32.6	2.06	3.99	26.4	2.23	4.56
190	263.4	1.21	0.89	172.6	1.32	1.24	120.2	1.43	1.65	81.6	1.57	2.21	67.4	1.64	2.55	54.3	1.75	2.97	42.0	1.92	3.52	34.4	2.06	3.99	27.9	2.23	4.56
200	276.7	1.21	0.89	181.4	1.32	1.24	126.4	1.43	1.65	85.7	1.57	2.22	70.8	1.64	2.56	57.1	1.75	2.98	44.1	1.91	3.54	36.2	2.06	3.99	29.3	2.23	4.57
220	303.8	1.21	0.89	199.2	1.32	1.24	138.8	1.43	1.65	94.2	1.57	2.22	77.8	1.64	2.57	62.8	1.76	2.97	48.5	1.91	3.53	39.8	2.07	3.97	32.2	2.22	4.58
240	330.8	1.21	0.89	217.0	1.32	1.24	151.2	1.43	1.66	102.7	1.57	2.22	84.8	1.64	2.57	68.4	1.75	2.98	52.9	1.92	3.53	43.3	2.06	4.02	35.1	2.22	4.58
260	357.7	1.21	0.89	234.7	1.32	1.25	163.6	1.43	1.64	111.1	1.57	2.22	91.8	1.64	2.57	74.1	1.76	2.98	57.2	1.91	3.54	46.9	2.06	4.01	38.0	2.22	4.59
280	384.5	1.21	0.89	252.3	1.32	1.25	176.0	1.43	1.66	119.5	1.57	2.23	98.7	1.64	2.58	79.7	1.76	2.98	61.6	1.92	3.54	50.5	2.06	4.01	40.9	2.22	4.59
300	411.2	1.21	0.90	269.9	1.32	1.25	188.3	1.43	1.66	127.9	1.57	2.23	105.7	1.64	2.57	85.3	1.76	2.99	65.9	1.91	3.55	54.0	2.06	4.03	43.7	2.21	4.62

Parabolic waterway design
(Retardance "D" and "B")

June 1978
Appendix B-3.13

V₁ for RETARDANCE "D". Top Width (T), Depth (D) and V₂ for RETARDANCE "B".

Grade 2.0 Percent

Q cfs	V ₁ = 2.0			V ₁ = 2.5			V ₁ = 3.0			V ₁ = 3.5			V ₁ = 4.0			V ₁ = 4.5			V ₁ = 5.0			V ₁ = 5.5			V ₁ = 6.0		
	T	D	V ₂	T	D	V ₂	T	D	V ₂	T	D	V ₂	T	D	V ₂	T	D	V ₂	T	D	V ₂	T	D	V ₂	T	D	V ₂
15	24.7	1.14	0.79	15.0	1.25	1.18	11.0	1.40	1.43	7.8	1.56	1.81															
20	32.8	1.14	0.79	20.0	1.25	1.18	14.5	1.37	1.49	10.3	1.53	1.88	7.5	1.71	2.29	6.3	1.91	2.44									
25	41.0	1.14	0.79	24.9	1.24	1.20	18.1	1.37	1.50	12.7	1.48	1.96	9.3	1.68	2.36	7.7	1.82	2.62									
30	49.0	1.14	0.80	29.8	1.24	1.20	21.6	1.35	1.52	15.2	1.48	1.98	11.0	1.63	2.47	9.1	1.77	2.76	7.6	1.97	2.95						
35	57.1	1.14	0.80	34.7	1.24	1.21	25.1	1.35	1.54	17.7	1.47	1.99	12.8	1.62	2.50	10.5	1.73	2.86	8.8	1.94	3.03						
40	65.1	1.14	0.80	39.6	1.24	1.21	28.7	1.35	1.53	20.2	1.47	2.00	14.6	1.62	2.51	12.0	1.73	2.86	9.9	1.88	3.18	8.2	2.13	3.38			
45	73.1	1.14	0.80	44.5	1.24	1.21	32.2	1.35	1.54	22.6	1.46	2.03	16.4	1.61	2.52	13.5	1.73	2.86	11.1	1.87	3.21	9.1	2.08	3.52			
50	81.0	1.14	0.81	49.3	1.24	1.22	35.7	1.35	1.55	25.1	1.46	2.03	18.1	1.59	2.57	14.9	1.71	2.92	12.3	1.86	3.24	10.0	2.03	3.64	8.6	2.29	3.76
55	88.9	1.14	0.81	54.2	1.24	1.21	39.2	1.34	1.55	27.6	1.46	2.03	19.9	1.60	2.57	16.4	1.71	2.91	13.5	1.85	3.26	11.0	2.03	3.65	9.3	2.21	3.96
60	96.8	1.14	0.81	59.0	1.24	1.22	42.7	1.34	1.55	30.0	1.45	2.03	21.7	1.60	2.57	17.8	1.69	2.95	14.7	1.85	3.28	11.9	2.00	3.74	10.1	2.19	4.01
65	104.6	1.14	0.81	63.8	1.24	1.22	46.2	1.35	1.55	32.5	1.46	2.04	23.4	1.58	2.60	19.3	1.70	2.94	15.8	1.82	3.36	12.9	2.00	3.73	10.9	2.18	4.06
70	112.4	1.14	0.81	68.6	1.24	1.22	49.7	1.35	1.56	34.9	1.45	2.05	25.2	1.59	2.60	20.7	1.69	2.98	17.0	1.82	3.36	13.8	1.98	3.81	11.7	2.16	4.10
75	120.2	1.14	0.81	73.4	1.24	1.22	53.1	1.34	1.56	37.3	1.45	2.06	27.0	1.59	2.60	22.2	1.69	2.96	18.2	1.82	3.37	14.8	1.98	3.79	12.5	2.15	4.14
80	127.9	1.14	0.82	78.1	1.24	1.23	56.6	1.35	1.56	39.8	1.45	2.06	28.7	1.58	2.62	23.6	1.69	2.99	19.4	1.82	3.37	15.8	1.99	3.78	13.3	2.14	4.17
90	143.6	1.14	0.82	87.8	1.24	1.23	63.5	1.34	1.57	44.7	1.45	2.06	32.3	1.59	2.61	26.5	1.68	3.00	21.8	1.82	3.38	17.7	1.97	3.83	14.9	2.12	4.22
100	159.2	1.14	0.82	97.4	1.24	1.23	70.5	1.34	1.57	49.6	1.45	2.07	35.8	1.58	2.63	29.4	1.68	3.01	24.1	1.80	3.43	19.6	1.96	3.87	16.5	2.11	4.26
110	174.8	1.14	0.82	106.9	1.24	1.23	77.4	1.34	1.57	54.5	1.45	2.07	39.3	1.58	2.64	32.3	1.68	3.02	26.5	1.80	3.43	21.5	1.95	3.90	18.1	2.10	4.30
120	190.3	1.14	0.82	116.5	1.24	1.23	84.3	1.34	1.58	59.4	1.45	2.07	42.8	1.58	2.65	35.2	1.68	3.02	28.9	1.80	3.43	23.4	1.94	3.92	19.7	2.09	4.33
130	205.7	1.14	0.82	126.0	1.24	1.23	91.2	1.34	1.58	64.2	1.45	2.08	46.4	1.58	2.64	38.1	1.68	3.03	31.3	1.80	3.43	25.4	1.95	3.90	21.3	2.09	4.35
140	221.0	1.14	0.82	135.4	1.24	1.24	98.0	1.34	1.58	69.1	1.45	2.08	49.9	1.58	2.64	41.0	1.68	3.03	33.6	1.80	3.46	27.3	1.95	3.92	22.9	2.08	4.37
150	236.3	1.14	0.83	144.9	1.25	1.24	104.9	1.34	1.58	73.9	1.45	2.08	53.4	1.58	2.65	43.9	1.68	3.03	36.0	1.80	3.45	29.2	1.95	3.93	24.5	2.08	4.38
160	251.5	1.14	0.83	154.3	1.25	1.24	111.7	1.34	1.59	78.7	1.45	2.09	56.9	1.58	2.65	46.7	1.67	3.05	38.3	1.79	3.47	31.1	1.94	3.94	26.1	2.08	4.40
170	266.6	1.14	0.83	163.7	1.25	1.24	118.5	1.34	1.59	83.6	1.45	2.08	60.3	1.58	2.66	49.6	1.68	3.05	40.7	1.80	3.46	33.0	1.94	3.95	27.7	2.07	4.41
180	281.7	1.14	0.83	173.0	1.25	1.24	125.2	1.34	1.59	88.4	1.45	2.09	63.8	1.58	2.66	52.5	1.68	3.04	43.0	1.79	3.48	34.9	1.94	3.96	29.3	2.07	4.41
190	296.7	1.14	0.83	182.3	1.25	1.24	132.0	1.34	1.59	93.2	1.45	2.09	67.3	1.58	2.66	55.3	1.68	3.06	45.4	1.80	3.47	36.8	1.94	3.97	30.8	2.06	4.46
200	311.7	1.14	0.83	191.6	1.25	1.24	138.7	1.34	1.60	97.9	1.45	2.10	70.7	1.58	2.67	58.2	1.68	3.05	47.7	1.79	3.49	38.7	1.94	3.97	32.4	2.06	4.47
220	342.1	1.14	0.83	210.4	1.25	1.25	152.4	1.35	1.60	107.6	1.45	2.10	77.7	1.58	2.67	63.9	1.68	3.06	52.5	1.80	3.47	42.5	1.93	3.99	35.6	2.06	4.48
240	372.4	1.14	0.84	229.2	1.25	1.25	165.9	1.34	1.60	117.2	1.45	2.10	84.7	1.58	2.67	69.7	1.68	3.06	57.2	1.80	3.48	46.4	1.94	3.97	38.8	2.06	4.49
260	402.5	1.14	0.84	247.9	1.25	1.25	179.5	1.34	1.60	126.8	1.45	2.10	91.7	1.58	2.67	75.4	1.68	3.07	61.9	1.80	3.49	50.2	1.94	3.99	42.0	2.06	4.49
280	432.6	1.14	0.84	266.5	1.25	1.25	193.0	1.34	1.61	136.4	1.45	2.10	98.6	1.58	2.68	81.1	1.68	3.07	66.6	1.80	3.49	54.0	1.94	3.99	45.2	2.06	4.49
300	462.5	1.14	0.84	285.1	1.25	1.25	206.5	1.35	1.61	146.0	1.46	2.10	105.5	1.58	2.69	86.8	1.68	3.07	71.2	1.79	3.51	57.8	1.94	4.00	48.4	2.06	4.50

Parabolic waterway design
(Retardance "D" and "B")

V_1 for RETARDANCE "D". Top Width (T), Depth (D) and V_2 for RETARDANCE "B".

Grade 3.0 Percent

Q cfs	$V_1 = 2.0$			$V_1 = 2.5$			$V_1 = 3.0$			$V_1 = 3.5$			$V_1 = 4.0$			$V_1 = 4.5$			$V_1 = 5.0$			$V_1 = 5.5$			$V_1 = 6.0$			
	T	D	V_2	T	D	V_2	T	D	V_2	T	D	V_2	T	D	V_2	T	D	V_2	T	D	V_2	T	D	V_2	T	D	V_2	
15	28.1	0.98	0.80	19.2	1.05	1.20	13.4	1.15	1.44	10.3	1.24	1.74	7.6	1.37	2.12	5.8	1.56	2.44										
20	37.4	0.98	0.80	25.6	1.05	1.10	17.8	1.14	1.46	13.7	1.23	1.76	10.0	1.33	2.22	7.6	1.50	2.59	6.8	1.58	2.74							
25	46.7	0.99	0.80	31.9	1.05	1.11	22.2	1.14	1.47	17.0	1.21	1.80	12.5	1.33	2.23	9.4	1.46	2.69	8.4	1.54	2.85	6.9	1.68	3.18				
30	55.9	0.99	0.81	38.2	1.05	1.11	26.6	1.14	1.47	20.3	1.20	1.82	14.9	1.31	2.27	11.2	1.44	2.73	9.9	1.48	3.02	8.2	1.64	3.28	6.7	1.88	3.50	
35	65.0	0.99	0.81	44.4	1.04	1.12	31.0	1.14	1.47	23.7	1.21	1.81	17.3	1.30	2.30	13.0	1.43	2.80	11.5	1.47	3.07	9.5	1.62	3.36	7.7	1.82	3.68	
40	74.1	0.99	0.81	50.6	1.04	1.12	35.3	1.14	1.48	27.0	1.20	1.83	19.7	1.29	2.33	16.8	1.42	2.83	13.1	1.46	3.10	10.8	1.60	3.42	8.7	1.78	3.82	
45	83.2	0.99	0.81	56.8	1.04	1.13	39.7	1.14	1.48	30.3	1.20	1.84	22.1	1.29	2.34	18.6	1.41	2.85	14.7	1.45	3.12	12.1	1.59	3.46	9.7	1.75	3.92	
50	92.2	0.99	0.81	63.0	1.04	1.13	44.0	1.14	1.48	33.6	1.20	1.84	24.6	1.30	2.32	18.4	1.40	2.87	16.3	1.45	3.14	13.4	1.58	3.50	10.7	1.72	4.01	
55	101.1	0.99	0.82	69.1	1.04	1.13	48.3	1.14	1.49	36.9	1.20	1.84	27.0	1.30	2.34	20.2	1.40	2.88	17.9	1.45	3.15	14.7	1.57	3.53	11.7	1.70	4.09	
60	110.1	0.99	0.82	75.3	1.05	1.13	52.6	1.14	1.49	40.2	1.20	1.85	29.4	1.29	2.34	22.0	1.40	2.89	19.5	1.45	3.16	16.0	1.57	3.55	12.7	1.69	4.15	
65	118.9	0.99	0.82	81.4	1.05	1.13	56.9	1.14	1.49	43.4	1.20	1.86	31.8	1.29	2.35	23.8	1.40	2.90	21.1	1.45	3.16	17.3	1.57	3.56	13.8	1.70	4.11	
70	127.8	0.99	0.82	87.4	1.04	1.14	61.1	1.14	1.50	46.7	1.20	1.86	34.2	1.29	2.35	25.6	1.40	2.90	22.7	1.45	3.17	18.5	1.55	3.63	14.8	1.69	4.16	
75	136.4	0.99	0.82	93.5	1.05	1.14	65.4	1.14	1.50	49.9	1.20	1.87	36.6	1.29	2.35	27.4	1.40	2.91	24.2	1.44	3.21	19.8	1.55	3.64	15.8	1.68	4.20	
80	145.3	0.99	0.83	99.5	1.05	1.14	69.6	1.14	1.50	53.1	1.20	1.87	38.9	1.29	2.37	29.2	1.40	2.91	25.8	1.44	3.21	21.1	1.55	3.64	16.9	1.69	4.16	
90	163.1	0.99	0.83	111.7	1.05	1.14	78.2	1.14	1.50	59.7	1.20	1.87	43.7	1.29	2.38	32.7	1.39	2.94	29.0	1.44	3.21	23.7	1.54	3.66	18.9	1.67	4.23	
100	180.8	0.99	0.83	123.8	1.05	1.15	86.7	1.14	1.51	66.2	1.20	1.88	48.5	1.29	2.38	36.3	1.39	2.95	32.2	1.44	3.21	26.3	1.54	3.67	21.0	1.67	4.23	
110	198.3	0.99	0.83	135.9	1.05	1.15	95.2	1.14	1.51	72.7	1.20	1.88	53.3	1.29	2.38	37.9	1.39	2.95	35.4	1.44	3.21	28.9	1.54	3.67	23.1	1.68	4.22	
120	215.8	0.99	0.83	148.0	1.05	1.15	103.7	1.14	1.51	79.2	1.20	1.88	58.1	1.29	2.38	43.5	1.39	2.95	38.3	1.43	3.23	31.5	1.54	3.68	25.1	1.67	4.27	
130	233.3	0.99	0.83	160.0	1.05	1.15	112.1	1.14	1.51	85.7	1.20	1.88	62.8	1.29	2.39	47.0	1.39	2.96	41.7	1.44	3.23	34.1	1.54	3.68	27.2	1.67	4.26	
140	250.6	0.99	0.84	171.9	1.05	1.15	120.5	1.14	1.52	92.1	1.20	1.89	67.6	1.29	2.38	50.6	1.39	2.96	44.8	1.43	3.24	36.7	1.54	3.68	29.3	1.67	4.25	
150	267.8	0.99	0.84	183.8	1.05	1.16	128.9	1.14	1.52	98.5	1.20	1.89	72.3	1.29	2.39	54.1	1.39	2.97	48.0	1.44	3.24	39.3	1.55	3.68	31.3	1.67	4.28	
160	285.0	0.99	0.84	195.7	1.05	1.16	137.2	1.14	1.52	104.9	1.20	1.89	77.0	1.29	2.39	57.7	1.39	2.96	51.1	1.44	3.25	41.8	1.54	3.70	33.4	1.67	4.27	
170	302.0	0.99	0.84	207.5	1.05	1.16	145.5	1.14	1.52	111.3	1.20	1.89	81.7	1.29	2.40	61.2	1.39	2.97	54.3	1.44	3.24	44.4	1.54	3.70	35.4	1.67	4.29	
180	319.0	0.99	0.84	219.2	1.05	1.16	153.8	1.14	1.53	117.7	1.20	1.89	86.4	1.29	2.40	64.7	1.39	2.98	57.4	1.44	3.25	47.0	1.55	3.69	37.5	1.67	4.28	
190	335.9	0.99	0.85	231.0	1.05	1.16	162.1	1.14	1.53	124.0	1.20	1.90	91.1	1.30	2.40	68.2	1.39	2.98	60.5	1.44	3.25	49.5	1.54	3.71	39.5	1.67	4.30	
200	352.7	0.99	0.85	242.6	1.05	1.16	170.3	1.14	1.53	130.3	1.20	1.90	95.7	1.29	2.40	71.7	1.39	2.99	63.6	1.44	3.26	52.1	1.55	3.70	41.6	1.67	4.28	
220	387.1	0.99	0.85	266.3	1.05	1.17	187.0	1.14	1.53	143.1	1.20	1.90	105.1	1.29	2.41	78.8	1.39	2.99	69.9	1.44	3.26	57.2	1.54	3.71	45.7	1.67	4.29	
240	421.2	0.99	0.85	289.9	1.05	1.17	203.6	1.14	1.53	155.9	1.20	1.90	114.5	1.29	2.41	85.9	1.39	2.99	76.2	1.44	3.26	62.3	1.54	3.72	49.8	1.67	4.30	
260	455.2	0.99	0.85	313.4	1.05	1.17	220.2	1.14	1.54	168.6	1.20	1.91	123.9	1.30	2.41	92.9	1.39	2.99	82.4	1.44	3.27	67.5	1.55	3.72	53.9	1.67	4.31	
280	489.7	0.99	0.85	336.9	1.05	1.17	236.7	1.14	1.54	181.3	1.20	1.91	133.3	1.30	2.41	99.9	1.39	3.00	88.6	1.44	3.27	72.6	1.55	3.72	58.0	1.67	4.31	
300	522.6	0.99	0.86	360.2	1.05	1.17	253.2	1.15	1.54	193.9	1.20	1.91	142.6	1.30	2.42	107.9	1.39	3.00	94.9	1.44	3.27	77.7	1.55	3.73	62.0	1.67	4.33	

Parabolic waterway design
(Retardance "D" and "B")

134

V₁ for RETARDANCE "D". Top Width (T), Depth (D) and V₂ for RETARDANCE "B".

Grade 6.0 Percent

Q cfs	V ₁ = 2.0			V ₁ = 2.5			V ₁ = 3.0			V ₁ = 3.5			V ₁ = 4.0			V ₁ = 4.5			V ₁ = 5.0			V ₁ = 5.5			V ₁ = 6.0			
	T	D	V ₂	T	D	V ₂	T	D	V ₂	T	D	V ₂	T	D	V ₂	T	D	V ₂	T	D	V ₂	T	D	V ₂	T	D	V ₂	
15	33.1	0.87	0.77	23.6	0.93	1.01	16.3	1.00	1.36	12.1	1.08	1.69	9.2	1.15	2.08	7.4	1.27	2.34	5.7	1.43	2.69							
20	44.0	0.87	0.77	31.4	0.93	1.01	21.7	1.00	1.37	16.1	1.08	1.70	12.3	1.16	2.08	9.7	1.23	2.48	7.4	1.35	2.94	6.4	1.47	3.12				
25	54.9	0.87	0.77	39.1	0.93	1.02	27.1	1.00	1.37	20.1	1.08	1.71	13.3	1.15	2.11	12.1	1.22	2.50	9.2	1.33	3.01	7.9	1.43	3.26	6.5	1.36	3.62	
30	65.7	0.87	0.78	46.8	0.93	1.02	32.4	0.99	1.38	24.0	1.07	1.73	18.3	1.14	2.13	14.4	1.20	2.57	11.0	1.32	3.05	9.3	1.38	3.46	7.7	1.32	3.78	
35	76.4	0.87	0.78	54.5	0.93	1.02	37.7	0.99	1.39	27.9	1.07	1.74	21.3	1.14	2.14	16.8	1.20	2.57	12.7	1.30	3.14	10.9	1.39	3.42	8.9	1.49	3.90	
40	87.1	0.87	0.78	62.1	0.93	1.03	43.0	0.99	1.39	31.9	1.07	1.74	24.3	1.14	2.15	19.2	1.21	2.56	14.5	1.30	3.15	12.4	1.38	3.47	10.2	1.30	3.87	
45	97.7	0.87	0.78	69.7	0.93	1.03	48.3	0.99	1.39	35.8	1.07	1.74	27.2	1.13	2.17	21.5	1.20	2.59	16.3	1.30	3.16	13.9	1.37	3.51	11.4	1.48	3.95	
50	108.3	0.87	0.78	77.3	0.93	1.03	53.5	0.99	1.40	39.7	1.07	1.75	30.2	1.13	2.17	23.9	1.20	2.58	18.1	1.30	3.16	15.4	1.36	3.54	12.6	1.46	4.01	
55	118.8	0.87	0.78	84.7	0.93	1.04	58.7	0.99	1.40	43.6	1.07	1.75	33.2	1.13	2.17	26.2	1.20	2.60	19.8	1.29	3.21	16.9	1.36	3.56	13.8	1.45	4.06	
60	129.2	0.87	0.79	92.2	0.93	1.04	63.9	0.99	1.40	47.4	1.07	1.76	36.1	1.13	2.18	28.5	1.19	2.62	21.6	1.29	3.20	18.4	1.36	3.57	15.1	1.46	4.02	
65	139.6	0.87	0.79	99.6	0.93	1.04	69.1	0.99	1.41	51.3	1.07	1.76	39.0	1.13	2.19	30.9	1.20	2.61	23.4	1.29	3.19	19.9	1.35	3.58	16.3	1.46	4.06	
70	149.9	0.88	0.79	107.0	0.93	1.04	74.2	0.99	1.41	55.1	1.07	1.77	42.0	1.13	2.19	33.2	1.20	2.62	25.1	1.28	3.23	21.4	1.35	3.59	17.5	1.45	4.09	
75	160.2	0.88	0.79	114.3	0.93	1.05	79.3	0.99	1.42	58.9	1.07	1.77	44.9	1.13	2.19	35.5	1.20	2.62	26.9	1.29	3.22	22.9	1.35	3.60	18.7	1.45	4.12	
80	170.4	0.88	0.79	121.6	0.93	1.05	84.4	0.99	1.42	62.7	1.07	1.77	47.8	1.13	2.20	37.8	1.20	2.63	28.6	1.28	3.24	24.4	1.35	3.60	20.0	1.46	4.08	
90	191.1	0.88	0.80	136.5	0.93	1.05	94.8	0.99	1.42	70.4	1.07	1.78	53.7	1.13	2.20	42.4	1.19	2.65	32.1	1.28	3.26	27.4	1.35	3.62	22.4	1.45	4.13	
100	211.8	0.88	0.80	151.2	0.93	1.05	105.1	0.99	1.42	78.1	1.07	1.78	59.6	1.13	2.20	47.1	1.20	2.64	35.7	1.29	3.24	30.4	1.35	3.63	24.9	1.45	4.12	
110	232.3	0.88	0.80	165.9	0.93	1.06	115.3	0.99	1.43	85.8	1.07	1.78	65.4	1.13	2.21	51.7	1.19	2.65	39.2	1.29	3.25	33.4	1.35	3.63	27.3	1.44	4.16	
120	252.7	0.88	0.80	180.5	0.93	1.06	125.5	0.99	1.43	93.4	1.07	1.78	71.2	1.13	2.22	56.3	1.19	2.66	42.7	1.28	3.26	36.3	1.34	3.66	29.8	1.45	4.14	
130	273.0	0.88	0.80	195.1	0.93	1.06	135.6	0.99	1.43	101.0	1.07	1.79	77.0	1.13	2.22	60.9	1.19	2.66	46.2	1.29	3.26	39.3	1.34	3.66	32.2	1.44	4.16	
140	293.2	0.88	0.80	209.5	0.93	1.06	145.7	0.99	1.44	108.5	1.07	1.79	82.8	1.13	2.22	65.5	1.20	2.66	49.6	1.28	3.28	42.3	1.35	3.66	34.6	1.44	4.18	
150	313.3	0.88	0.81	223.9	0.93	1.07	155.6	0.99	1.44	116.0	1.07	1.80	88.6	1.13	2.22	70.1	1.20	2.66	53.1	1.28	3.28	45.3	1.35	3.66	37.1	1.45	4.17	
160	333.2	0.88	0.81	238.2	0.93	1.07	165.8	1.00	1.44	123.5	1.07	1.80	94.3	1.13	2.23	74.6	1.20	2.67	56.6	1.28	3.28	48.2	1.35	3.67	39.5	1.44	4.18	
170	353.1	0.88	0.81	252.4	0.93	1.07	175.8	1.00	1.44	131.0	1.07	1.80	100.0	1.13	2.23	79.2	1.20	2.67	60.0	1.28	3.29	51.2	1.35	3.67	41.9	1.44	4.19	
180	372.8	0.88	0.81	266.5	0.93	1.07	185.7	1.00	1.45	138.4	1.07	1.80	105.7	1.13	2.24	83.7	1.20	2.68	63.5	1.28	3.29	54.1	1.35	3.68	44.3	1.44	4.20	
190	392.4	0.88	0.81	280.6	0.93	1.08	195.6	1.00	1.45	145.8	1.07	1.81	111.4	1.13	2.24	88.2	1.20	2.68	66.9	1.28	3.30	57.0	1.34	3.69	46.7	1.44	4.21	
200	411.9	0.88	0.82	294.6	0.93	1.08	205.4	1.00	1.45	153.2	1.07	1.81	117.1	1.14	2.24	92.7	1.20	2.68	70.3	1.28	3.30	60.0	1.35	3.68	49.1	1.44	4.21	
220	451.9	0.88	0.82	313.2	0.93	1.08	225.4	1.00	1.46	168.2	1.07	1.81	128.6	1.14	2.24	101.9	1.20	2.68	77.2	1.28	3.31	65.9	1.35	3.69	54.0	1.44	4.21	
240	491.6	0.88	0.82	331.6	0.93	1.09	245.3	1.00	1.46	183.2	1.07	1.81	140.0	1.14	2.25	110.9	1.20	2.69	84.1	1.28	3.32	71.8	1.35	3.70	58.8	1.44	4.22	
260	531.0	0.88	0.82	349.9	0.93	1.09	265.2	1.00	1.46	198.0	1.07	1.82	151.5	1.14	2.25	120.0	1.20	2.69	91.0	1.28	3.32	77.7	1.35	3.70	63.7	1.44	4.21	
280	570.3	0.88	0.82	368.0	0.93	1.09	284.9	1.00	1.47	212.9	1.08	1.82	162.8	1.14	2.25	129.0	1.20	2.70	97.9	1.28	3.32	83.5	1.35	3.71	68.5	1.44	4.22	
300	609.3	0.88	0.83	386.0	0.93	1.09	304.6	1.00	1.47	227.6	1.08	1.83	174.2	1.14	2.25	138.1	1.20	2.69	104.8	1.29	3.32	89.4	1.35	3.71	73.3	1.44	4.23	

Parabolic waterway design
(Retardance "D" and "B")



V₁ for RETARDANCE "D". Top Width (T), Depth (D) and V₂ for RETARDANCE "B".

Grade 5.0 Percent

Q cfs	V ₁ = 2.0			V ₁ = 2.5			V ₁ = 3.0			V ₁ = 3.5			V ₁ = 4.0			V ₁ = 4.5			V ₁ = 5.0			V ₁ = 5.5			V ₁ = 6.0		
	T	D	V ₂	T	D	V ₂	T	D	V ₂	T	D	V ₂	T	D	V ₂	T	D	V ₂	T	D	V ₂	T	D	V ₂	T	D	V ₂
15	34.8	0.80	0.79	25.2	0.86	1.02	17.7	0.92	1.36	14.3	0.96	1.61	10.6	1.04	2.00	8.4	1.12	2.34	6.7	1.23	2.67	5.4	1.36	3.00	6.1	1.40	3.44
20	46.3	0.80	0.79	33.5	0.86	1.02	23.5	0.92	1.37	19.0	0.96	1.62	14.1	1.04	2.02	11.1	1.10	2.41	8.8	1.19	2.81	7.0	1.28	3.29	7.5	1.35	3.64
25	57.7	0.80	0.80	41.7	0.86	1.03	29.3	0.92	1.38	23.7	0.96	1.63	17.5	1.03	2.06	13.8	1.09	2.46	10.9	1.17	2.90	8.7	1.26	3.37	8.9	1.32	3.78
30	69.0	0.80	0.80	49.9	0.86	1.04	35.0	0.91	1.39	28.3	0.95	1.65	21.0	1.03	2.06	16.6	1.10	2.44	13.0	1.15	2.96	10.4	1.25	3.41	10.3	1.30	3.87
35	80.3	0.80	0.80	58.1	0.86	1.04	40.8	0.91	1.39	33.0	0.95	1.65	24.4	1.02	2.08	19.3	1.09	2.46	15.2	1.18	2.94	12.1	1.24	3.45	11.8	1.30	3.85
40	91.5	0.81	0.80	66.2	0.86	1.06	46.5	0.91	1.40	37.6	0.95	1.66	27.8	1.02	2.09	22.0	1.09	2.47	17.3	1.15	2.97	13.8	1.24	3.47	13.2	1.29	3.91
45	102.6	0.81	0.81	74.2	0.86	1.05	52.2	0.91	1.40	42.2	0.95	1.66	31.3	1.03	2.08	24.7	1.09	2.48	19.4	1.15	2.99	15.4	1.22	3.55	14.7	1.30	3.88
50	113.7	0.81	0.81	82.3	0.86	1.05	57.9	0.92	1.40	46.8	0.95	1.66	34.7	1.03	2.08	27.3	1.08	2.51	21.5	1.15	3.01	17.1	1.22	3.55	16.1	1.29	3.93
55	124.7	0.81	0.81	90.2	0.86	1.05	63.5	0.91	1.41	51.4	0.96	1.66	38.0	1.02	2.11	30.0	1.08	2.51	23.7	1.15	2.98	18.8	1.22	3.55	18.1	1.29	3.93
60	135.7	0.81	0.81	98.2	0.86	1.05	69.1	0.91	1.41	56.0	0.96	1.66	41.4	1.02	2.11	32.7	1.08	2.51	25.8	1.15	3.00	20.5	1.22	3.55	17.5	1.28	3.97
65	146.5	0.81	0.81	106.1	0.86	1.05	74.7	0.92	1.41	60.5	0.96	1.67	44.8	1.02	2.10	35.3	1.08	2.53	27.9	1.15	3.00	22.1	1.22	3.59	18.9	1.28	4.00
70	157.3	0.81	0.82	113.9	0.86	1.06	80.2	0.91	1.42	65.0	0.96	1.67	48.1	1.02	2.11	38.0	1.08	2.53	30.0	1.15	3.01	23.8	1.22	3.58	20.4	1.29	3.96
75	168.1	0.81	0.82	121.7	0.86	1.06	85.8	0.92	1.42	69.5	0.96	1.67	51.4	1.02	2.12	40.6	1.08	2.54	32.0	1.15	3.04	25.4	1.21	3.62	21.8	1.28	3.98
80	178.8	0.81	0.82	129.4	0.86	1.06	91.3	0.92	1.42	74.0	0.96	1.67	54.8	1.02	2.12	43.3	1.09	2.53	34.1	1.15	3.04	27.1	1.22	3.61	23.2	1.28	4.00
90	200.5	0.81	0.82	143.2	0.86	1.07	102.4	0.92	1.43	83.0	0.96	1.68	61.5	1.02	2.12	48.6	1.08	2.54	38.3	1.15	3.05	30.4	1.21	3.63	26.1	1.28	4.00
100	222.2	0.81	0.82	160.9	0.86	1.07	113.5	0.92	1.43	92.1	0.96	1.68	68.2	1.02	2.13	53.9	1.08	2.54	42.5	1.15	3.05	33.8	1.22	3.61	28.9	1.28	4.03
110	243.7	0.81	0.82	176.5	0.86	1.07	124.6	0.92	1.43	101.0	0.96	1.69	74.8	1.02	2.14	59.2	1.09	2.55	46.7	1.15	3.05	37.1	1.22	3.63	31.8	1.28	4.02
120	265.0	0.81	0.83	192.0	0.86	1.07	135.6	0.92	1.43	110.0	0.96	1.69	81.4	1.02	2.15	64.4	1.08	2.56	50.8	1.15	3.07	40.4	1.21	3.64	34.6	1.28	4.04
130	286.3	0.81	0.83	207.5	0.86	1.08	146.6	0.92	1.43	118.9	0.96	1.69	88.1	1.02	2.16	69.7	1.09	2.56	55.0	1.15	3.06	43.7	1.21	3.65	37.5	1.28	4.03
140	307.4	0.81	0.83	222.8	0.86	1.08	157.5	0.92	1.44	127.8	0.96	1.69	96.6	1.02	2.15	74.9	1.08	2.57	59.1	1.15	3.07	47.0	1.21	3.65	40.3	1.28	4.04
150	328.4	0.81	0.83	238.1	0.87	1.08	168.3	0.92	1.44	136.6	0.96	1.70	101.2	1.02	2.15	80.1	1.08	2.57	63.2	1.15	3.08	50.2	1.21	3.67	43.1	1.28	4.05
160	349.3	0.81	0.83	253.2	0.86	1.08	179.1	0.92	1.44	145.4	0.96	1.70	107.7	1.02	2.16	85.3	1.09	2.57	67.3	1.15	3.09	53.5	1.21	3.67	45.9	1.28	4.06
170	370.0	0.81	0.84	268.3	0.87	1.09	189.9	0.92	1.45	154.1	0.96	1.70	114.2	1.02	2.16	90.4	1.08	2.58	71.4	1.15	3.09	56.8	1.21	3.67	48.7	1.28	4.07
180	390.7	0.82	0.84	283.3	0.87	1.09	200.6	0.92	1.45	162.9	0.96	1.70	120.7	1.02	2.17	95.6	1.09	2.58	75.5	1.15	3.09	60.0	1.21	3.69	51.5	1.28	4.07
190	411.2	0.82	0.84	298.2	0.87	1.09	211.2	0.92	1.45	171.5	0.96	1.71	127.1	1.02	2.17	100.7	1.08	2.59	79.6	1.15	3.09	63.3	1.21	3.68	54.3	1.28	4.07
200	431.6	0.82	0.84	313.0	0.87	1.09	221.8	0.92	1.46	180.2	0.96	1.71	133.5	1.02	2.18	105.8	1.09	2.59	83.6	1.15	3.10	66.5	1.21	3.69	57.1	1.28	4.08
220	473.3	0.82	0.84	343.4	0.87	1.10	243.4	0.92	1.46	197.8	0.97	1.71	146.6	1.02	2.18	116.2	1.09	2.60	91.9	1.15	3.10	73.1	1.22	3.69	62.7	1.28	4.09
240	514.8	0.82	0.84	373.6	0.87	1.10	264.9	0.92	1.46	215.3	0.97	1.72	159.6	1.02	2.18	126.5	1.09	2.60	100.1	1.15	3.10	79.6	1.21	3.70	68.3	1.28	4.09
260	556.1	0.82	0.85	403.6	0.87	1.10	286.3	0.92	1.46	232.7	0.97	1.72	172.6	1.03	2.19	136.8	1.09	2.61	108.2	1.15	3.11	86.1	1.21	3.71	73.9	1.28	4.10
280	597.1	0.82	0.85	433.5	0.87	1.10	307.6	0.92	1.47	250.1	0.97	1.72	185.5	1.03	2.19	147.1	1.09	2.61	116.4	1.15	3.11	92.6	1.21	3.71	79.5	1.28	4.10
300	638.0	0.82	0.85	463.1	0.87	1.11	328.7	0.92	1.47	267.4	0.97	1.73	198.4	1.03	2.19	157.3	1.09	2.61	124.5	1.15	3.12	99.1	1.22	3.71	85.1	1.28	4.10

Parabolic waterway design
(Retardance "D" and "B")

V₁ for RETARDANCE "D", Top Width (T), Depth (D) and V₂ for RETARDANCE "B".

Grade 6.0 Percent

Q cfs	V ₁ = 2.0			V ₁ = 2.5			V ₁ = 3.0			V ₁ = 3.5			V ₁ = 4.0			V ₁ = 4.5			V ₁ = 5.0			V ₁ = 5.5			V ₁ = 6.0		
	T	D	V ₂	T	D	V ₂	T	D	V ₂	T	D	V ₂	T	D	V ₂	T	D	V ₂	T	D	V ₂	T	D	V ₂	T	D	V ₂
15	40.5	0.72	0.76	26.9	0.81	1.02	19.6	0.83	1.34	14.8	0.90	1.66	11.7	0.96	1.97	9.4	1.02	2.31	7.6	1.09	2.67	6.1	1.18	3.05	5.0	1.32	3.33
20	59.9	0.72	0.76	35.7	0.81	1.03	26.1	0.85	1.34	19.6	0.89	1.69	15.6	0.96	1.97	12.5	1.01	2.33	10.1	1.08	2.71	8.0	1.14	3.23	6.5	1.24	3.63
25	67.1	0.72	0.76	44.9	0.81	1.03	32.5	0.85	1.35	24.5	0.90	1.69	19.4	0.95	2.00	15.5	1.00	2.39	12.5	1.06	2.80	10.0	1.14	3.24	8.1	1.23	3.69
30	80.3	0.72	0.76	53.2	0.80	1.04	38.9	0.85	1.35	29.3	0.89	1.70	23.3	0.96	1.99	18.6	1.00	2.39	15.0	1.06	2.80	11.9	1.12	3.32	9.6	1.20	3.84
35	93.4	0.72	0.76	61.9	0.81	1.04	45.3	0.85	1.35	34.1	0.89	1.70	27.1	0.96	2.00	21.6	0.99	2.42	17.4	1.05	2.84	13.9	1.13	3.31	11.2	1.20	3.84
40	106.4	0.73	0.77	70.6	0.81	1.04	51.6	0.85	1.36	38.9	0.89	1.71	30.9	0.95	2.01	24.7	1.00	2.41	19.9	1.05	2.83	15.8	1.12	3.36	12.7	1.19	3.93
45	119.3	0.73	0.77	79.2	0.81	1.04	57.9	0.85	1.36	43.7	0.90	1.71	34.6	0.95	2.03	27.7	1.00	2.42	22.3	1.05	2.86	17.7	1.11	3.40	14.3	1.19	3.92
50	132.1	0.73	0.77	87.7	0.81	1.05	64.1	0.84	1.37	48.4	0.89	1.71	38.4	0.95	2.03	30.7	0.99	2.43	24.7	1.05	2.87	19.7	1.12	3.39	15.8	1.18	3.98
55	144.9	0.73	0.77	96.2	0.81	1.05	70.4	0.85	1.37	53.1	0.89	1.72	42.2	0.95	2.03	33.7	0.99	2.44	27.1	1.04	2.89	21.6	1.11	3.40	17.4	1.18	3.96
60	157.5	0.73	0.77	104.6	0.81	1.05	76.5	0.84	1.38	57.8	0.89	1.72	45.9	0.95	2.04	36.7	1.00	2.44	29.6	1.03	2.87	23.5	1.11	3.42	18.9	1.18	4.01
65	170.1	0.73	0.78	113.0	0.81	1.06	82.7	0.85	1.38	62.5	0.90	1.72	49.6	0.95	2.04	39.7	1.00	2.44	32.0	1.03	2.88	25.4	1.11	3.43	20.5	1.18	3.98
70	182.6	0.73	0.78	121.3	0.81	1.06	88.8	0.85	1.38	67.2	0.90	1.72	53.3	0.95	2.05	42.7	1.00	2.44	34.4	1.03	2.88	27.4	1.11	3.41	22.0	1.18	4.01
75	195.1	0.73	0.78	129.6	0.81	1.06	94.9	0.85	1.39	71.8	0.90	1.73	57.0	0.95	2.05	45.6	1.00	2.46	36.7	1.04	2.91	29.3	1.11	3.42	23.6	1.18	3.99
80	207.4	0.73	0.78	137.8	0.81	1.06	100.9	0.85	1.39	76.4	0.90	1.73	60.6	0.95	2.06	48.6	1.00	2.45	39.1	1.05	2.91	31.2	1.11	3.42	25.1	1.18	4.02
90	232.6	0.73	0.78	154.5	1.81	1.07	113.2	0.85	1.40	85.8	0.90	1.73	68.1	0.95	2.06	54.6	1.00	2.45	43.9	1.05	2.92	33.0	1.11	3.44	28.2	1.18	4.02
100	257.7	0.73	0.78	171.2	0.81	1.07	125.5	0.85	1.40	95.1	0.90	1.74	75.5	0.95	2.06	60.5	1.00	2.46	48.7	1.05	2.92	36.8	1.11	3.46	31.3	1.18	4.03
110	282.6	0.74	0.78	187.8	0.81	1.07	137.7	0.85	1.40	104.4	0.90	1.74	82.8	0.95	2.07	66.4	1.00	2.47	53.5	1.05	2.92	42.6	1.11	3.47	34.4	1.18	4.03
120	307.3	0.74	0.79	204.2	0.81	1.08	149.8	0.85	1.40	113.6	0.90	1.74	90.2	0.95	2.07	72.3	1.00	2.47	58.3	1.05	2.92	46.4	1.11	3.47	37.4	1.18	4.06
130	331.9	0.74	0.79	220.6	0.81	1.08	161.9	0.85	1.41	122.8	0.90	1.75	97.5	0.95	2.08	78.2	1.00	2.48	63.0	1.05	2.93	50.2	1.11	3.48	40.5	1.18	4.05
140	356.3	0.74	0.79	236.8	0.81	1.08	173.9	0.85	1.41	131.9	0.90	1.75	104.7	0.95	2.09	84.0	1.00	2.48	67.7	1.05	2.94	54.0	1.11	3.48	43.3	1.18	4.07
150	380.5	0.74	0.79	253.0	0.81	1.09	185.8	0.85	1.41	141.0	0.90	1.75	112.0	0.96	2.09	89.9	1.00	2.48	72.5	1.05	2.93	57.8	1.11	3.48	46.8	1.18	4.06
160	404.6	0.74	0.79	269.0	0.81	1.09	197.7	0.85	1.42	150.1	0.90	1.76	119.2	0.96	2.09	95.7	1.00	2.49	77.2	1.05	2.94	61.5	1.11	3.49	49.6	1.18	4.08
170	428.6	0.74	0.79	285.0	0.81	1.09	209.5	0.85	1.42	159.1	0.90	1.76	126.4	0.96	2.09	101.5	1.00	2.49	81.8	1.05	2.95	65.3	1.11	3.49	52.7	1.18	4.07
180	452.4	0.74	0.79	300.8	0.81	1.09	221.3	0.85	1.42	168.1	0.90	1.76	133.5	0.96	2.10	107.2	1.00	2.50	86.5	1.05	2.95	69.0	1.11	3.49	55.7	1.18	4.08
190	476.1	0.74	0.80	316.6	0.81	1.10	233.0	0.85	1.42	177.0	0.90	1.77	140.6	0.96	2.10	113.0	1.00	2.50	91.1	1.05	2.96	72.7	1.11	3.50	58.7	1.18	4.08
200	499.6	0.74	0.80	332.3	0.81	1.10	244.6	0.85	1.43	185.9	0.90	1.77	147.7	0.96	2.11	118.7	1.00	2.50	95.8	1.05	2.96	76.4	1.11	3.51	61.7	1.18	4.09
220	547.7	0.74	0.80	364.5	0.81	1.10	268.4	0.85	1.43	204.1	0.91	1.77	162.1	0.96	2.11	130.3	1.00	2.51	105.2	1.05	2.96	83.9	1.11	3.51	67.8	1.18	4.09
240	595.6	0.74	0.80	396.5	0.81	1.11	292.1	0.85	1.43	222.1	0.91	1.78	176.5	0.96	2.11	141.9	1.00	2.51	114.5	1.05	2.97	91.4	1.11	3.52	73.8	1.18	4.11
260	643.2	0.74	0.80	428.3	0.81	1.11	315.7	0.85	1.43	240.1	0.91	1.78	190.7	0.96	2.12	153.4	1.00	2.52	123.9	1.05	2.97	98.9	1.11	3.52	79.9	1.18	4.10
280	690.5	0.75	0.81	459.9	0.81	1.11	339.1	0.85	1.44	258.0	0.91	1.78	205.0	0.96	2.12	164.9	1.00	2.52	133.2	1.05	2.97	106.3	1.11	3.53	85.9	1.18	4.11
300	737.5	0.75	0.81	491.4	0.81	1.11	362.4	0.85	1.44	275.8	0.91	1.78	219.1	0.96	2.13	176.3	1.00	2.52	142.4	1.05	2.98	113.7	1.11	3.53	91.9	1.18	4.12

Parabolic waterway design
(Retardance "D" and "B")

V_1 for RETARDANCE "D". Top Width (T), Depth (D) and V_2 for RETARDANCE "B".

Grade 8.0 Percent

Q cfs	$V_1 = 2.0$			$V_1 = 2.5$			$V_1 = 3.0$			$V_1 = 3.5$			$V_1 = 4.0$			$V_1 = 4.5$			$V_1 = 5.0$			$V_1 = 5.5$			$V_1 = 6.0$		
	T	D	V_2	T	D	V_2	T	D	V_2	T	D	V_2	T	D	V_2	T	D	V_2	T	D	V_2	T	D	V_2	T	D	V_2
15	43.1	0.64	0.80	31.6	0.71	0.98	22.2	0.76	1.31	18.0	0.79	1.56	13.7	0.84	1.92	11.0	0.89	2.26	9.2	0.93	2.54	7.4	0.99	3.00	6.2	1.09	3.26
20	57.3	0.64	0.80	42.0	0.71	0.99	29.5	0.76	1.32	24.0	0.79	1.56	18.2	0.84	1.94	14.7	0.89	2.25	12.2	0.93	2.59	9.8	0.98	3.08	8.1	1.04	3.49
25	71.4	0.65	0.80	52.3	0.71	0.99	36.7	0.76	1.33	29.9	0.79	1.57	22.7	0.84	1.95	18.3	0.89	2.28	15.2	0.93	2.62	12.2	0.97	3.12	10.1	1.06	3.53
30	85.4	0.65	0.80	62.6	0.71	0.99	43.9	0.76	1.33	35.8	0.79	1.57	27.2	0.84	1.95	21.9	0.89	2.29	18.1	0.92	2.67	14.6	0.97	3.15	12.1	1.03	3.55
35	99.3	0.65	0.80	72.8	0.72	0.99	51.1	0.76	1.34	41.6	0.79	1.58	31.7	0.84	1.95	25.5	0.89	2.30	21.1	0.92	2.67	17.0	0.96	3.16	14.0	1.02	3.64
40	113.1	0.65	0.81	82.9	0.72	1.00	58.2	0.76	1.34	47.4	0.79	1.59	36.1	0.84	1.96	29.0	0.88	2.32	24.1	0.92	2.67	19.4	0.96	3.17	16.0	1.02	3.63
45	126.8	0.65	0.81	93.0	0.72	1.00	65.3	0.76	1.34	53.2	0.79	1.59	40.5	0.84	1.97	32.6	0.88	2.32	27.0	0.92	2.69	21.8	0.97	3.17	18.0	1.02	3.62
50	140.4	0.65	0.81	102.9	0.72	1.01	72.3	0.76	1.35	59.0	0.79	1.59	44.9	0.84	1.97	36.1	0.88	2.33	30.0	0.92	2.68	24.2	0.97	3.17	19.9	1.02	3.67
55	153.9	0.65	0.81	112.8	0.72	1.01	79.3	0.76	1.35	64.7	0.79	1.60	49.3	0.84	1.97	39.6	0.88	2.34	32.9	0.92	2.70	26.3	0.96	3.20	21.9	1.02	3.65
60	167.3	0.65	0.81	122.7	0.72	1.01	86.2	0.76	1.36	70.4	0.79	1.60	53.7	0.84	1.97	43.1	0.88	2.34	35.8	0.92	2.70	28.9	0.97	3.19	23.8	1.02	3.69
65	180.6	0.65	0.82	132.4	0.72	1.01	93.1	0.76	1.36	76.0	0.79	1.61	58.0	0.84	1.98	46.6	0.88	2.35	38.7	0.92	2.71	31.3	0.97	3.18	25.7	1.01	3.71
70	193.9	0.65	0.82	142.2	0.72	1.01	100.0	0.76	1.37	81.7	0.79	1.61	62.3	0.84	1.98	50.1	0.88	2.35	41.6	0.92	2.71	33.6	0.97	3.20	27.7	1.02	3.69
75	207.0	0.65	0.82	151.8	0.72	1.02	106.8	0.76	1.37	87.2	0.79	1.62	66.6	0.84	1.99	53.5	0.88	2.36	44.5	0.92	2.72	35.9	0.96	3.27	29.6	1.02	3.71
80	220.1	0.66	0.82	161.4	0.72	1.02	113.6	0.76	1.37	92.8	0.79	1.62	70.9	0.84	1.99	56.9	0.88	2.37	47.3	0.92	2.73	38.2	0.96	3.23	31.3	1.01	3.72
90	246.8	0.66	0.82	180.9	0.72	1.02	127.4	0.76	1.38	104.1	0.79	1.62	79.5	0.84	2.00	63.9	0.88	2.37	53.1	0.92	2.74	42.9	0.96	3.23	35.4	1.02	3.72
100	273.3	0.66	0.82	200.3	0.72	1.03	141.1	0.76	1.38	115.4	0.79	1.62	88.1	0.84	2.00	70.8	0.88	2.38	58.9	0.92	2.74	47.6	0.97	3.24	39.2	1.01	3.75
110	299.6	0.66	0.83	219.6	0.72	1.03	154.8	0.76	1.38	126.5	0.79	1.63	96.7	0.84	2.01	77.7	0.88	2.38	64.7	0.92	2.74	52.3	0.97	3.25	43.1	1.02	3.74
120	325.7	0.66	0.83	238.8	0.72	1.03	168.4	0.76	1.39	137.7	0.79	1.63	105.3	0.84	2.01	84.6	0.88	2.39	70.4	0.92	2.75	56.9	0.97	3.25	46.9	1.01	3.75
130	351.7	0.66	0.83	257.9	0.72	1.04	181.9	0.76	1.39	148.7	0.79	1.64	113.8	0.84	2.01	91.4	0.88	2.40	76.1	0.92	2.75	61.6	0.97	3.26	50.7	1.01	3.76
140	377.5	0.66	0.83	276.8	0.72	1.04	195.3	0.76	1.39	159.7	0.79	1.64	122.2	0.84	2.02	98.2	0.88	2.40	81.8	0.92	2.76	66.2	0.97	3.25	54.5	1.01	3.77
150	403.1	0.66	0.83	295.6	0.72	1.05	208.6	0.76	1.40	170.7	0.80	1.64	130.6	0.84	2.02	105.0	0.88	2.40	87.4	0.92	2.77	70.8	0.97	3.25	58.3	1.01	3.78
160	428.5	0.66	0.83	314.2	0.72	1.04	221.9	0.76	1.40	181.5	0.79	1.65	139.0	0.85	2.02	111.7	0.88	2.41	93.1	0.92	2.77	75.3	0.97	3.27	62.1	1.01	3.78
170	453.8	0.66	0.84	332.8	0.72	1.05	235.1	0.76	1.40	192.4	0.80	1.65	147.3	0.85	2.03	118.4	0.88	2.42	98.7	0.92	2.77	79.9	0.97	3.27	65.9	1.02	3.78
180	478.9	0.66	0.84	351.2	0.72	1.05	248.2	0.76	1.41	203.1	0.80	1.65	155.6	0.85	2.03	125.1	0.88	2.42	104.3	0.93	2.78	84.4	0.97	3.28	69.6	1.02	3.79
190	503.9	0.66	0.84	369.5	0.72	1.05	261.2	0.77	1.41	213.8	0.80	1.66	163.9	0.85	2.03	131.8	0.89	2.42	109.8	0.92	2.79	89.0	0.97	3.27	73.4	1.02	3.79
200	528.5	0.67	0.84	387.7	0.73	1.05	274.1	0.77	1.42	224.4	0.80	1.66	172.1	0.85	2.04	138.4	0.89	2.43	115.3	0.92	2.79	93.5	0.97	3.28	77.1	1.02	3.80
220	579.5	0.67	0.84	425.1	0.73	1.06	300.7	0.77	1.42	246.2	0.80	1.66	188.8	0.85	2.04	151.8	0.88	2.44	126.6	0.93	2.80	102.6	0.97	3.29	84.7	1.02	3.80
240	630.1	0.67	0.84	462.2	0.73	1.06	327.0	0.77	1.42	267.9	0.80	1.67	205.5	0.85	2.05	165.2	0.89	2.44	137.8	0.93	2.80	111.8	0.97	3.29	92.2	1.02	3.81
260	680.4	0.67	0.85	499.1	0.73	1.06	353.3	0.77	1.42	289.4	0.80	1.67	222.1	0.85	2.05	178.6	0.89	2.45	149.0	0.93	2.80	120.8	0.97	3.30	99.7	1.02	3.82
280	730.4	0.67	0.85	535.6	0.73	1.07	379.3	0.77	1.42	310.8	0.80	1.68	238.6	0.85	2.05	191.9	0.89	2.45	160.1	0.93	2.81	129.9	0.97	3.30	107.2	1.02	3.82
300	780.0	0.67	0.85	572.1	0.73	1.07	405.2	0.77	1.42	332.1	0.80	1.68	255.0	0.85	2.06	205.1	0.89	2.46	171.2	0.93	2.81	138.9	0.97	3.31	114.7	1.02	3.82

Parabolic waterway design
(Retardance "D" and "B")

V₁ for RETARDANCE "D". Top Width (T), Depth (D) and V₂ for RETARDANCE "R".

Grade 10.0 Percent

Q cfs	V ₁ = 2.0			V ₁ = 2.5			V ₁ = 3.0			V ₁ = 3.5			V ₁ = 4.0			V ₁ = 4.5			V ₁ = 5.0			V ₁ = 5.5			V ₁ = 6.0		
	T	D	V ₂	T	D	V ₂	T	D	V ₂	T	D	V ₂	T	D	V ₂	T	D	V ₂	T	D	V ₂	T	D	V ₂	T	D	V ₂
15	51.4	0.56	0.77	38.3	0.63	0.92	27.2	0.69	1.18	19.6	0.73	1.56	15.7	0.76	1.86	12.6	0.81	2.18	10.6	0.85	2.45	8.7	0.90	2.83	7.2	0.94	3.26
20	68.2	0.55	0.78	50.9	0.63	0.92	36.2	0.69	1.18	26.1	0.73	1.56	20.9	0.76	1.87	16.8	0.81	2.18	14.0	0.84	2.53	11.5	0.88	2.91	9.5	0.92	3.39
25	85.0	0.56	0.78	63.4	0.63	0.92	45.1	0.69	1.19	32.5	0.73	1.57	26.1	0.76	1.87	20.9	0.80	2.20	17.5	0.84	2.52	14.3	0.87	2.96	11.9	0.92	3.37
30	101.6	0.56	0.78	75.8	0.63	0.92	53.9	0.69	1.20	38.8	0.72	1.58	31.2	0.76	1.88	25.0	0.80	2.22	20.9	0.83	2.55	17.1	0.87	2.98	14.2	0.91	3.43
35	118.1	0.56	0.78	88.1	0.63	0.93	62.7	0.69	1.20	45.2	0.73	1.58	36.3	0.76	1.88	29.1	0.80	2.22	24.3	0.83	2.57	19.9	0.87	3.00	16.5	0.91	3.46
40	134.6	0.56	0.79	100.3	0.64	0.93	71.3	0.69	1.21	51.5	0.73	1.59	41.3	0.76	1.90	33.2	0.80	2.22	27.7	0.83	2.58	22.7	0.87	3.00	18.9	0.91	3.48
45	150.7	0.56	0.79	112.5	0.64	0.93	80.0	0.69	1.21	57.7	0.72	1.60	46.4	0.76	1.90	37.2	0.80	2.24	31.1	0.83	2.58	25.5	0.87	3.01	21.2	0.91	3.48
50	166.8	0.56	0.79	124.5	0.64	0.93	88.5	0.69	1.21	63.9	0.72	1.60	51.3	0.76	1.91	41.3	0.80	2.23	34.5	0.83	2.58	28.3	0.87	3.01	23.5	0.91	3.48
55	182.8	0.56	0.79	136.4	0.64	0.93	97.1	0.69	1.21	70.1	0.73	1.60	56.3	0.76	1.92	45.3	0.80	2.24	37.8	0.83	2.60	31.1	0.87	3.00	25.8	0.91	3.47
60	198.6	0.56	0.79	148.2	0.64	0.94	105.5	0.69	1.22	76.2	0.72	1.61	61.2	0.76	1.92	49.3	0.80	2.25	41.1	0.83	2.61	33.8	0.87	3.02	28.1	0.91	3.47
65	214.3	0.57	0.79	160.0	0.64	0.94	113.9	0.69	1.22	82.3	0.73	1.62	66.2	0.76	1.92	53.2	0.80	2.26	44.4	0.83	2.62	36.5	0.87	3.04	30.3	0.91	3.51
70	229.9	0.57	0.79	171.6	0.64	0.94	122.2	0.69	1.23	88.4	0.73	1.62	71.0	0.76	1.93	57.2	0.80	2.26	47.7	0.83	2.63	39.3	0.87	3.03	32.6	0.91	3.50
75	245.4	0.57	0.80	183.2	0.64	0.94	130.5	0.69	1.23	94.4	0.73	1.62	75.9	0.76	1.94	61.1	0.80	2.27	51.0	0.83	2.63	42.0	0.87	3.04	34.9	0.91	3.50
80	260.7	0.57	0.80	194.6	0.64	0.95	138.6	0.69	1.24	100.3	0.73	1.63	80.7	0.76	1.94	65.0	0.80	2.27	54.3	0.83	2.63	44.7	0.87	3.04	37.1	0.91	3.52
90	292.1	0.57	0.80	218.1	0.64	0.95	155.4	0.69	1.24	112.5	0.73	1.64	90.5	0.76	1.95	73.0	0.81	2.27	60.9	0.83	2.64	50.1	0.87	3.06	41.7	0.91	3.52
100	323.3	0.57	0.80	241.5	0.64	0.95	172.1	0.69	1.24	124.6	0.73	1.64	100.3	0.76	1.95	80.9	0.81	2.28	67.5	0.83	2.65	55.6	0.87	3.06	46.2	0.91	3.53
110	354.3	0.57	0.80	264.6	0.64	0.95	188.6	0.69	1.25	136.7	0.73	1.64	110.0	0.76	1.96	88.7	0.81	2.29	74.1	0.83	2.65	61.0	0.87	3.07	50.7	0.91	3.54
120	385.0	0.57	0.80	287.6	0.64	0.96	205.0	0.69	1.25	148.7	0.73	1.65	119.6	0.76	1.97	96.5	0.81	2.29	80.6	0.83	2.66	66.4	0.87	3.08	55.2	0.91	3.55
130	415.5	0.57	0.81	310.3	0.65	0.96	222.3	0.69	1.26	160.6	0.73	1.65	129.3	0.76	1.97	104.3	0.81	2.30	87.1	0.83	2.67	71.8	0.87	3.08	59.7	0.91	3.55
140	445.7	0.57	0.81	333.0	0.65	0.96	237.5	0.69	1.26	172.5	0.73	1.65	138.8	0.76	1.97	112.1	0.81	2.30	93.5	0.83	2.68	77.1	0.87	3.09	64.2	0.91	3.55
150	475.7	0.58	0.81	355.4	0.65	0.97	253.6	0.69	1.26	184.2	0.73	1.66	148.4	0.76	1.97	119.8	0.81	2.30	100.0	0.83	2.68	82.5	0.88	3.09	68.6	0.91	3.57
160	505.5	0.58	0.81	377.7	0.65	0.97	269.5	0.69	1.27	195.9	0.73	1.66	157.8	0.76	1.98	127.4	0.81	2.31	106.4	0.83	2.69	87.8	0.88	3.10	73.0	0.91	3.58
170	535.0	0.58	0.81	399.7	0.65	0.97	285.3	0.69	1.27	207.6	0.73	1.66	167.2	0.76	1.98	135.0	0.81	2.32	112.8	0.83	2.69	93.0	0.87	3.11	77.5	0.91	3.57
180	564.3	0.58	0.81	421.7	0.65	0.97	301.0	0.70	1.28	219.1	0.73	1.67	176.6	0.76	1.99	142.6	0.81	2.32	119.1	0.83	2.70	98.3	0.88	3.11	81.8	0.91	3.59
190	593.4	0.58	0.82	443.4	0.65	0.98	316.6	0.70	1.28	230.6	0.73	1.67	185.9	0.76	1.99	150.1	0.81	2.33	125.4	0.83	2.71	103.5	0.88	3.12	86.2	0.91	3.59
200	622.2	0.58	0.82	465.0	0.65	0.98	332.1	0.70	1.28	242.1	0.73	1.68	195.2	0.76	1.99	157.6	0.81	2.33	131.7	0.83	2.71	108.7	0.88	3.13	90.6	0.92	3.59
220	681.9	0.58	0.82	509.6	0.65	0.98	364.1	0.70	1.29	265.5	0.73	1.68	214.1	0.76	2.00	173.0	0.81	2.33	144.6	0.83	2.71	119.3	0.88	3.13	99.4	0.91	3.60
240	741.1	0.58	0.82	553.8	0.65	0.99	395.9	0.70	1.29	288.8	0.73	1.68	233.0	0.76	2.00	188.2	0.81	2.34	157.4	0.84	2.72	129.9	0.88	3.13	108.3	0.92	3.60
260	799.9	0.58	0.82	597.7	0.65	0.99	427.6	0.70	1.29	312.0	0.73	1.69	251.7	0.77	2.01	203.4	0.81	2.34	170.1	0.84	2.72	140.4	0.88	3.14	117.0	0.92	3.61
280	858.2	0.58	0.83	641.3	0.65	0.99	458.7	0.70	1.30	335.0	0.73	1.69	270.4	0.77	2.01	218.3	0.81	2.35	182.7	0.84	2.73	150.9	0.88	3.15	125.8	0.92	3.62
300	916.0	0.59	0.83	684.6	0.65	0.99	489.8	0.70	1.30	357.9	0.73	1.69	289.0	0.77	2.01	233.5	0.81	2.35	195.4	0.84	2.73	161.3	0.88	3.15	134.5	0.92	3.62

Parabolic waterway design
(Retardance "D" and "R")

V_1 for RETARDANCE "D". Top Width (T), Depth (D) and V_2 for RETARDANCE "C".

Grade 0.25 Percent

Q cfs	$V_1 = 2.0$			$V_1 = 2.5$			$V_1 = 3.0$			$V_1 = 3.5$			$V_1 = 4.0$			$V_1 = 4.5$			$V_1 = 5.0$			$V_1 = 5.5$			$V_1 = 6.0$			
	T	D	V_2	T	D	V_2	T	D	V_2	T	D	V_2	T	D	V_2	T	D	V_2	T	D	V_2	T	D	V_2	T	D	V_2	
15																												
20																												
25	9.6	2.36	1.63																									
30	11.4	2.31	1.68																									
35	13.2	2.27	1.73																									
40	15.0	2.25	1.76	10.4	2.67	2.13																						
45	16.8	2.23	1.78	11.6	2.62	2.19																						
50	18.6	2.21	1.80	12.8	2.59	2.24																						
55	20.4	2.20	1.82	14.0	2.56	2.28																						
60	22.2	2.19	1.83	15.2	2.53	2.31																						
65	24.0	2.18	1.84	16.3	2.54	2.30																						
70	25.8	2.18	1.85	17.7	2.52	2.33	12.6	3.05	2.70																			
75	27.6	2.17	1.86	18.9	2.51	2.35	13.4	3.00	2.76																			
80	29.4	2.17	1.87	20.1	2.50	2.37	14.5	3.01	2.76																			
90	33.1	2.17	1.86	22.6	2.49	2.38	16.0	2.97	2.81																			
100	36.7	2.17	1.87	25.1	2.49	2.38	17.7	2.95	2.85																			
110	40.3	2.16	1.88	27.5	2.47	2.41	19.4	2.93	2.88																			
120	43.9	2.16	1.89	30.0	2.47	2.41	21.1	2.91	2.91	15.2	3.58	3.28																
130	47.6	2.16	1.88	32.5	2.48	2.41	22.8	2.89	2.93	16.4	3.55	3.32																
140	51.2	2.16	1.88	34.9	2.46	2.43	24.6	2.91	2.91	17.6	3.53	3.35																
150	54.8	2.16	1.89	37.4	2.47	2.42	26.3	2.90	2.93	18.8	3.51	3.39																
160	58.4	2.16	1.89	39.9	2.47	2.42	28.0	2.89	2.95	20.0	3.49	3.41																
170	62.0	2.16	1.89	42.3	2.46	2.43	29.7	2.88	2.96	21.2	3.47	3.44	16.7	4.03	3.75													
180	65.6	2.16	1.90	44.8	2.47	2.43	31.4	2.87	2.97	22.4	3.46	3.46	17.6	4.00	3.81													
190	69.2	2.16	1.90	47.2	2.46	2.44	33.1	2.87	2.98	23.6	3.45	3.48	18.5	3.97	3.85													
200	72.8	2.16	1.90	49.7	2.46	2.44	34.9	2.88	2.97	24.8	3.44	3.49	19.4	3.94	3.90													
220	80.0	2.16	1.90	54.6	2.46	2.44	38.3	2.87	2.99	27.2	3.42	3.53	21.3	3.92	3.92													
240	87.3	2.16	1.90	59.5	2.46	2.45	41.7	2.86	3.00	29.6	3.40	3.55	23.1	3.88	3.99													
260	94.5	2.16	1.90	64.5	2.46	2.44	45.2	2.86	3.00	32.1	3.41	3.54	25.0	3.87	4.01	19.5	4.57	4.34										
280	101.7	2.16	1.90	69.4	2.46	2.45	48.6	2.85	3.01	34.5	3.40	3.56	26.9	3.86	4.02	21.0	4.57	4.34										
300	108.9	2.16	1.90	74.3	2.46	2.45	52.1	2.86	3.00	36.9	3.39	3.58	28.7	3.83	4.07	22.4	4.53	4.40										

Parabolic waterway design
(Retardance "D" and "C")

140

178

V₁ for RETARDANCE "D". Top Width (T), Depth (D) and V₂ for RETARDANCE "C".

Grade 0.50 Percent

Q cfs	V ₁ = 2.0			V ₁ = 2.5			V ₁ = 3.0			V ₁ = 3.5			V ₁ = 4.0			V ₁ = 4.5			V ₁ = 5.0			V ₁ = 5.5			V ₁ = 6.0			
	T	D	V ₂	T	D	V ₂	T	D	V ₂	T	D	V ₂	T	D	V ₂	T	D	V ₂	T	D	V ₂	T	D	V ₂	T	D	V ₂	
15	8.6	1.63	1.58																									
20	11.3	1.59	1.66																									
25	14.1	1.57	1.67	9.0	1.91	2.14																						
30	16.9	1.56	1.68	10.7	1.87	2.21	8.2	2.18	2.48																			
35	19.6	1.55	1.71	12.4	1.85	2.26	9.4	2.10	2.62																			
40	22.4	1.53	1.71	14.1	1.83	2.30	10.7	2.08	2.66																			
45	25.1	1.54	1.73	15.8	1.82	2.33	11.9	2.03	2.76																			
50	27.9	1.54	1.73	17.5	1.80	2.35	13.2	2.02	2.78	9.6	2.42	3.19																
55	30.7	1.54	1.72	19.2	1.80	2.37	14.5	2.02	2.79	10.5	2.39	3.25																
60	33.4	1.54	1.74	20.9	1.79	2.38	15.8	2.01	2.80	11.4	2.37	3.30																
65	36.1	1.53	1.75	22.7	1.80	2.38	17.0	1.99	2.86	12.3	2.35	3.34																
70	38.9	1.54	1.74	24.4	1.80	2.37	18.3	1.99	2.86	13.2	2.33	3.38																
75	41.6	1.54	1.75	26.1	1.79	2.38	19.6	1.99	2.86	14.1	2.32	3.41	11.2	2.71	3.66													
80	44.3	1.53	1.75	27.8	1.79	2.39	20.9	1.99	2.86	15.0	2.31	3.43	11.8	2.69	3.80													
90	49.6	1.53	1.75	31.2	1.78	2.41	23.5	1.99	2.87	16.9	2.31	3.42	13.3	2.65	3.78													
100	55.3	1.53	1.75	34.6	1.78	2.42	26.0	1.97	2.90	18.7	2.29	3.47	16.7	2.63	3.85	11.9	3.02	4.13										
110	60.8	1.54	1.75	38.1	1.78	2.41	28.6	1.97	2.90	20.5	2.28	3.50	16.1	2.60	3.90	13.0	2.98	4.22										
120	66.3	1.54	1.75	41.5	1.78	2.42	31.2	1.98	2.90	22.4	2.29	3.49	17.5	2.58	3.94	14.1	2.94	4.30										
130	71.7	1.53	1.76	44.9	1.78	2.42	33.7	1.97	2.92	24.2	2.28	3.51	18.9	2.57	3.98	15.2	2.91	4.36										
140	77.2	1.54	1.76	48.3	1.78	2.43	36.3	1.97	2.92	26.0	2.27	3.54	20.4	2.58	3.95	16.4	2.93	4.34										
150	82.6	1.54	1.76	51.7	1.78	2.43	38.9	1.97	2.91	27.9	2.28	3.52	21.8	2.57	3.98	17.5	2.90	4.39	14.0	3.34	4.77							
160	88.0	1.53	1.76	55.1	1.78	2.44	41.4	1.97	2.93	29.7	2.27	3.54	23.2	2.56	4.01	18.6	2.88	4.44	14.9	3.33	4.80							
170	93.4	1.53	1.77	58.5	1.78	2.44	44.0	1.97	2.92	31.5	2.26	3.55	24.6	2.55	4.03	19.8	2.89	4.41	15.7	3.27	4.92							
180	98.8	1.53	1.77	61.9	1.78	2.44	46.5	1.96	2.94	33.3	2.26	3.57	26.1	2.56	4.01	20.9	2.88	4.45	16.6	3.26	4.94							
190	104.2	1.54	1.77	65.3	1.78	2.44	49.1	1.97	2.93	35.2	2.27	3.55	27.5	2.56	4.03	22.0	2.86	4.49	17.5	3.26	4.96							
200	109.6	1.54	1.77	68.7	1.78	2.44	51.6	1.96	2.94	37.0	2.26	3.56	28.9	2.55	4.04	23.1	2.85	4.52	18.4	3.25	4.98	15.3	3.72	5.23				
220	120.5	1.54	1.77	75.5	1.78	2.44	56.8	1.97	2.93	40.7	2.26	3.56	31.8	2.55	4.04	25.4	2.85	4.53	20.2	3.24	5.01	16.7	3.66	5.36				
240	131.3	1.54	1.77	82.3	1.78	2.45	61.9	1.97	2.94	44.3	2.26	3.58	34.6	2.54	4.07	27.7	2.85	4.53	22.0	3.23	5.04	18.2	3.63	5.38				
260	142.1	1.54	1.77	89.1	1.78	2.45	67.0	1.97	2.94	48.0	2.26	3.58	37.5	2.55	4.06	30.0	2.85	4.54	23.8	3.22	5.06	19.7	3.64	5.39				
280	152.9	1.54	1.78	95.9	1.78	2.45	72.1	1.97	2.95	51.6	2.25	3.59	40.3	2.54	4.08	32.2	2.83	4.58	25.6	3.21	5.08	21.1	3.61	5.48	17.5	4.14	5.75	
300	163.7	1.54	1.78	102.6	1.78	2.46	77.2	1.97	2.95	55.3	2.26	3.59	43.2	2.54	4.08	34.5	2.83	4.58	27.3	3.18	5.15	22.6	3.60	5.49	18.7	4.12	5.80	

Parabolic waterway design
(Retardance "D" and "C")

V_1 for RETARDANCE "D". Top Width (T), Depth (D) and V_2 for RETARDANCE "C".

Grade 0.75 Percent

Q cfs	$V_1 = 2.0$			$V_1 = 2.5$			$V_1 = 3.0$			$V_1 = 3.5$			$V_1 = 4.0$			$V_1 = 4.5$			$V_1 = 5.0$			$V_1 = 5.5$			$V_1 = 6.0$		
	T	D	V_2	T	D	V_2	T	D	V_2	T	D	V_2	T	D	V_2	T	D	V_2	T	D	V_2	T	D	V_2	T	D	V_2
15	11.7	1.29	1.47	6.8	1.61	2.02																					
20	15.5	1.27	1.51	8.9	1.54	2.15																					
25	19.3	1.26	1.52	11.0	1.50	2.23	8.2	1.74	2.58																		
30	23.1	1.25	1.54	13.2	1.50	2.26	9.7	1.69	2.70	7.7	1.92	2.99															
35	27.0	1.26	1.53	15.3	1.48	2.29	11.3	1.68	2.72	8.9	1.88	3.08															
40	30.8	1.26	1.53	17.5	1.49	2.28	12.8	1.65	2.80	10.1	1.86	3.16															
45	34.5	1.25	1.55	19.6	1.47	2.31	14.4	1.65	2.80	11.3	1.84	3.21															
50	38.3	1.25	1.55	21.8	1.48	2.30	15.9	1.63	2.85	12.5	1.82	3.26	9.3	2.18	3.65												
55	42.1	1.25	1.55	24.0	1.48	2.29	17.5	1.64	2.85	13.7	1.81	3.30	10.1	2.12	3.80												
60	45.9	1.25	1.55	26.1	1.48	2.31	19.1	1.64	2.84	15.0	1.82	3.26	11.0	2.12	3.82												
65	49.6	1.25	1.56	28.2	1.47	2.33	20.6	1.63	2.88	16.2	1.81	3.29	11.9	2.11	3.84	9.9	2.38	4.08									
70	53.4	1.25	1.56	30.4	1.48	2.32	22.2	1.63	2.87	17.4	1.80	3.31	12.8	2.11	3.85	10.6	2.35	4.15									
75	57.1	1.25	1.56	32.5	1.47	2.33	23.7	1.62	2.90	18.6	1.80	3.34	13.6	2.07	3.95	11.3	2.33	4.22									
80	60.9	1.25	1.56	34.7	1.48	2.32	25.3	1.63	2.89	19.8	1.79	3.35	14.5	2.07	3.95	12.0	2.31	4.28									
90	68.4	1.25	1.56	38.9	1.47	2.34	28.4	1.62	2.91	22.2	1.78	3.39	16.3	2.07	3.97	13.4	2.28	4.38	11.1	2.62	4.59						
100	75.9	1.25	1.56	43.2	1.47	2.34	31.5	1.62	2.92	24.7	1.79	3.37	18.1	2.07	3.98	14.9	2.28	4.37	12.2	2.56	4.75						
110	82.4	1.25	1.57	47.5	1.47	2.34	34.7	1.63	2.90	27.1	1.78	3.40	19.8	2.04	4.04	16.3	2.26	4.45	13.4	2.55	4.78						
120	90.8	1.25	1.57	51.8	1.47	2.34	37.8	1.62	2.91	29.6	1.79	3.38	21.6	2.05	4.04	17.8	2.26	4.43	14.6	2.54	4.80	12.1	2.85	5.16			
130	98.3	1.25	1.57	56.0	1.47	2.35	40.9	1.62	2.92	32.0	1.78	3.40	23.4	2.05	4.04	19.2	2.24	4.49	15.7	2.51	4.91	13.0	2.81	5.29			
140	105.7	1.25	1.57	60.3	1.47	2.35	44.0	1.62	2.92	34.4	1.78	3.41	25.1	2.03	4.09	20.7	2.25	4.48	16.9	2.51	4.92	14.0	2.81	5.29			
150	112.1	1.25	1.58	64.5	1.47	2.36	47.1	1.62	2.93	36.8	1.77	3.43	26.9	2.04	4.08	22.1	2.23	4.52	18.1	2.50	4.92	15.0	2.81	5.30			
160	120.5	1.25	1.58	68.8	1.47	2.35	50.2	1.62	2.93	39.3	1.78	3.41	28.7	2.04	4.07	23.6	2.24	4.50	19.3	2.50	4.93	15.9	2.77	5.40	13.1	3.13	5.80
170	127.9	1.25	1.58	73.0	1.47	2.36	53.3	1.62	2.93	41.7	1.78	3.42	30.4	2.03	4.11	25.0	2.23	4.54	20.4	2.48	5.00	16.9	2.78	5.39	13.9	3.12	5.83
180	135.2	1.25	1.58	77.2	1.47	2.36	56.4	1.62	2.93	44.1	1.78	3.43	32.2	2.03	4.10	26.5	2.24	4.52	21.6	2.48	5.00	17.8	2.75	5.48	14.7	3.11	5.85
190	142.6	1.25	1.58	81.5	1.47	2.36	59.5	1.62	2.93	46.5	1.77	3.43	34.0	2.04	4.09	27.9	2.23	4.56	22.8	2.48	5.00	18.8	2.75	5.46	15.5	3.11	5.87
200	149.9	1.25	1.58	85.7	1.47	2.36	62.5	1.62	2.95	48.9	1.77	3.44	35.7	2.03	4.12	29.4	2.23	4.54	24.0	2.49	4.99	19.7	2.73	5.54	16.3	3.10	5.88
220	164.7	1.25	1.58	94.2	1.47	2.36	68.7	1.62	2.95	53.8	1.78	3.43	39.3	2.03	4.11	32.3	2.23	4.55	26.3	2.47	5.05	21.7	2.74	5.52	17.9	3.09	5.92
240	179.4	1.25	1.59	102.6	1.47	2.37	74.9	1.62	2.95	58.6	1.77	3.44	42.8	2.03	4.12	35.2	2.23	4.56	28.7	2.47	5.04	23.6	2.72	5.57	19.4	3.05	6.04
260	194.1	1.25	1.59	111.1	1.47	2.37	81.1	1.62	2.95	63.5	1.78	3.44	46.3	2.02	4.14	38.1	2.23	4.57	31.0	2.46	5.09	25.5	2.71	5.61	21.0	3.05	6.05
280	208.8	1.25	1.59	119.5	1.47	2.37	87.3	1.62	2.95	68.3	1.77	3.44	49.9	2.03	4.12	41.0	2.22	4.58	33.4	2.46	5.08	27.4	2.70	5.65	22.6	3.04	6.07
300	223.5	1.26	1.59	127.9	1.47	2.37	93.4	1.62	2.96	73.1	1.77	3.45	53.4	2.03	4.13	43.9	2.22	4.58	35.8	2.47	5.07	29.4	2.71	5.62	24.2	3.04	6.08

Parabolic waterway design
(Retardance "D" and "C")

June 1978
Appendix B-3.25

V₁ for RETARDANCE "D". Top Width (T), Depth (D) and V₂ for RETARDANCE "C".

Grade 1.0 Percent

Q cfs	V ₁ = 2.0			V ₁ = 2.5			V ₁ = 3.0			V ₁ = 3.5			V ₁ = 4.0			V ₁ = 4.5			V ₁ = 5.0			V ₁ = 5.5			V ₁ = 6.0		
	T	D	V ₂	T	D	V ₂	T	D	V ₂	T	D	V ₂	T	D	V ₂	T	D	V ₂	T	D	V ₂	T	D	V ₂	T	D	V ₂
15	13.4	1.13	1.47	8.4	1.30	2.03																					
20	17.8	1.12	1.49	11.1	1.27	2.10	7.6	1.52	2.55																		
25	22.2	1.11	1.50	13.9	1.27	2.09	9.4	1.49	2.64	7.6	1.62	2.99															
30	26.6	1.11	1.50	16.6	1.26	2.13	11.2	1.46	2.71	9.1	1.61	3.03															
35	30.9	1.11	1.52	19.3	1.25	2.15	13.0	1.45	2.75	10.5	1.57	3.14	8.0	1.80	3.59												
40	35.3	1.11	1.52	22.1	1.26	2.13	14.8	1.44	2.79	12.0	1.57	3.14	9.1	1.78	3.65												
45	39.7	1.11	1.52	24.8	1.25	2.15	16.7	1.45	2.76	13.4	1.55	3.21	10.2	1.76	3.70												
50	44.0	1.11	1.52	27.5	1.25	2.16	18.5	1.44	2.79	14.9	1.55	3.21	11.3	1.75	3.74	8.7	2.02	4.20									
54	48.3	1.11	1.53	30.2	1.25	2.16	20.3	1.43	2.80	16.3	1.54	3.26	12.4	1.75	3.76	9.5	1.99	4.30									
60	52.7	1.11	1.52	32.9	1.25	2.17	22.1	1.43	2.82	17.8	1.54	3.25	13.5	1.74	3.78	10.4	2.01	4.26									
65	57.0	1.11	1.53	35.6	1.25	2.17	23.9	1.43	2.83	19.2	1.53	3.29	14.6	1.73	3.81	11.2	1.98	4.33	9.3	2.22	4.66						
70	61.3	1.11	1.53	38.3	1.25	2.17	25.7	1.43	2.84	20.7	1.53	3.27	15.6	1.71	3.90	12.0	1.96	4.40	10.0	2.21	4.69						
75	65.6	1.11	1.53	41.0	1.25	2.18	27.5	1.42	2.85	22.1	1.53	3.31	16.7	1.71	3.90	12.8	1.95	4.46	10.7	2.21	4.71						
80	69.8	1.11	1.54	43.7	1.25	2.18	29.3	1.42	2.85	23.6	1.53	3.29	17.8	1.71	3.91	13.7	1.96	4.42	11.3	2.16	4.85						
90	78.5	1.11	1.54	49.1	1.25	2.18	32.9	1.42	2.87	26.5	1.53	3.31	20.0	1.70	3.93	15.3	1.93	4.52	12.7	2.16	4.87	10.6	2.42	5.20			
100	87.1	1.11	1.54	54.5	1.25	2.18	36.6	1.43	2.85	29.4	1.52	3.32	22.2	1.70	3.94	16.3	1.93	4.52	14.1	2.15	4.89	11.7	2.39	5.31			
110	95.6	1.11	1.54	59.9	1.25	2.18	40.2	1.42	2.86	32.3	1.52	3.33	24.4	1.70	3.94	18.3	1.93	4.52	15.4	2.12	5.00	12.9	2.60	5.28	11.1	2.59	5.67
120	104.2	1.11	1.54	65.2	1.25	2.19	43.8	1.42	2.87	35.2	1.52	3.33	26.6	1.70	3.95	20.5	1.92	4.59	16.8	2.12	5.00	14.0	2.37	5.36	12.1	2.59	5.69
130	112.7	1.11	1.55	70.6	1.25	2.19	47.4	1.42	2.87	38.1	1.52	3.34	28.8	1.70	3.95	22.0	1.92	4.58	18.2	2.13	5.00	15.1	2.35	5.44	13.0	2.55	5.83
140	121.2	1.11	1.55	76.0	1.25	2.19	51.0	1.42	2.87	41.0	1.52	3.34	30.9	1.69	3.99	23.7	1.92	4.57	19.6	2.13	5.00	16.2	2.34	5.50	14.0	2.55	5.83
150	129.7	1.11	1.55	81.3	1.25	2.19	54.6	1.42	2.87	43.9	1.52	3.34	33.1	1.69	3.99	25.3	1.91	4.62	20.9	2.11	5.07	17.4	2.35	5.46	15.0	2.55	5.84
160	138.1	1.11	1.55	86.6	1.25	2.20	58.2	1.42	2.88	46.8	1.52	3.34	35.3	1.69	3.99	27.0	1.91	4.61	22.3	2.11	5.06	18.5	2.33	5.51	15.9	2.52	5.95
170	146.6	1.11	1.55	91.9	1.25	2.20	61.7	1.42	2.89	49.7	1.52	3.34	37.5	1.69	3.99	28.7	1.92	4.60	23.7	2.11	5.05	19.6	2.32	5.56	16.9	2.52	5.94
180	155.0	1.11	1.55	97.2	1.25	2.20	65.3	1.42	2.89	52.5	1.52	3.36	39.6	1.69	4.01	30.3	1.91	4.63	25.0	2.10	5.10	20.7	2.31	5.60	17.9	2.52	5.93
190	163.4	1.11	1.55	102.5	1.25	2.20	68.9	1.42	2.89	55.4	1.52	3.36	41.8	1.69	4.01	32.0	1.91	4.62	26.4	2.10	5.09	21.9	2.32	5.56	18.8	2.50	6.02
200	171.7	1.11	1.56	107.8	1.25	2.20	72.4	1.42	2.90	58.3	1.52	3.35	44.0	1.69	4.00	33.6	1.91	4.65	27.8	2.11	5.08	23.0	2.32	5.59	19.8	2.50	6.01
220	188.7	1.11	1.56	118.4	1.25	2.21	79.6	1.42	2.89	64.0	1.52	3.37	48.4	1.70	4.00	37.0	1.91	4.63	30.5	2.10	5.12	25.3	2.32	5.59	21.7	2.48	6.08
240	205.5	1.11	1.56	129.0	1.25	2.21	86.7	1.42	2.90	69.8	1.52	3.37	52.7	1.69	4.01	40.3	1.91	4.63	33.3	2.10	5.11	27.5	2.30	5.65	23.6	2.47	6.13
260	222.4	1.11	1.56	139.6	1.25	2.21	93.9	1.42	2.90	75.5	1.52	3.38	57.1	1.69	4.01	43.6	1.91	4.66	36.0	2.10	5.14	29.8	2.30	5.64	25.6	2.48	6.11
280	239.1	1.11	1.56	150.2	1.25	2.22	101.0	1.42	2.91	81.3	1.52	3.37	61.4	1.69	4.02	46.9	1.90	4.68	38.8	2.10	5.12	32.1	2.31	5.63	27.5	2.47	6.15
300	255.9	1.11	1.56	160.8	1.25	2.22	108.1	1.42	2.91	87.0	1.52	3.38	65.7	1.69	4.03	50.3	1.91	4.66	41.5	2.10	5.14	34.3	2.30	5.68	29.5	2.48	6.12

Parabolic waterway design
(Retardance "D" and "C")

June 1978
Appendix B-3.24

V₁ for RETARDANCE "D". Top Width (T), Depth (D) and V₂ for RETARDANCE "C".

Grade 1.25 Percent

Q cfs	V ₁ = 2.0			V ₁ = 2.5			V ₁ = 3.0			V ₁ = 3.5			V ₁ = 4.0			V ₁ = 4.5			V ₁ = 5.0			V ₁ = 5.5			V ₁ = 6.0		
	T	D	V ₂	T	D	V ₂	T	D	V ₂	T	D	V ₂	T	D	V ₂	T	D	V ₂	T	D	V ₂	T	D	V ₂	T	D	V ₂
15	15.3	1.00	1.45	9.8	1.15	1.95	6.6	1.37	2.44																		
20	20.4	1.00	1.45	12.9	1.12	2.04	8.7	1.33	2.55	6.6	1.49	2.98															
25	25.4	0.99	1.47	16.1	1.12	2.05	10.8	1.31	2.61	8.2	1.47	3.06	6.7	1.62	3.38												
30	30.5	1.00	1.46	19.3	1.12	2.06	12.9	1.30	2.66	9.7	1.43	3.20	7.9	1.56	3.58												
35	35.5	0.99	1.47	22.5	1.12	2.06	15.0	1.29	2.68	11.3	1.42	3.22	9.2	1.55	3.62	7.2	1.78	4.02									
40	40.5	0.99	1.47	25.7	1.12	2.06	17.1	1.28	2.70	12.9	1.42	3.26	10.5	1.55	3.66	8.2	1.77	4.07									
45	45.5	0.99	1.48	28.8	1.11	2.08	19.2	1.28	2.72	14.4	1.40	3.31	11.7	1.52	3.75	9.1	1.72	4.25									
50	50.4	0.99	1.49	32.0	1.12	2.08	21.3	1.28	2.73	16.0	1.40	3.31	13.0	1.52	3.75	10.1	1.71	4.27	8.3	1.95	4.57						
55	55.4	0.99	1.48	35.1	1.11	2.09	23.4	1.28	2.74	17.6	1.40	3.31	14.3	1.52	3.75	11.1	1.71	4.29	9.1	1.93	4.63						
60	60.3	0.99	1.49	38.3	1.12	2.09	25.5	1.28	2.74	19.1	1.39	3.36	15.6	1.52	3.75	12.1	1.71	4.30	9.9	1.92	4.67						
65	65.2	0.99	1.49	41.4	1.11	2.10	27.6	1.28	2.74	20.7	1.39	3.35	16.8	1.51	3.81	13.0	1.68	4.41	10.6	1.88	4.84	8.7	2.18	5.06			
70	70.1	0.99	1.50	44.6	1.12	2.09	29.7	1.28	2.75	22.3	1.39	3.35	18.1	1.51	3.80	14.0	1.68	4.41	11.4	1.87	4.86	9.3	2.15	5.18			
75	75.0	0.99	1.50	47.7	1.12	2.09	31.8	1.28	2.75	23.8	1.39	3.38	19.4	1.51	3.80	15.0	1.68	4.40	12.2	1.87	4.88	9.9	2.12	5.28			
80	79.9	0.99	1.50	50.8	1.12	2.10	33.9	1.27	2.77	25.4	1.39	3.37	20.6	1.50	3.84	16.0	1.69	4.40	13.0	1.87	4.89	10.5	2.10	5.37	9.2	2.33	5.51
90	89.7	0.99	1.50	54.1	1.12	2.10	38.0	1.27	2.77	28.5	1.38	3.39	23.2	1.51	3.83	17.9	1.67	4.48	14.6	1.86	4.92	11.8	2.09	5.40	10.3	2.31	5.60
100	99.6	0.99	1.50	63.3	1.11	2.11	42.2	1.27	2.77	31.7	1.39	3.38	25.7	1.50	3.86	19.9	1.67	4.47	16.2	1.85	4.94	13.1	2.09	5.42	11.4	2.29	5.68
110	109.4	0.99	1.50	69.6	1.12	2.11	46.4	1.27	2.77	34.8	1.39	3.39	28.3	1.50	3.85	21.9	1.67	4.46	17.8	1.85	4.96	14.4	2.09	5.43	12.4	2.24	5.88
120	119.1	0.99	1.51	75.8	1.12	2.11	50.5	1.27	2.78	37.9	1.38	3.41	30.8	1.50	3.87	23.8	1.66	4.51	19.3	1.83	5.05	15.6	2.06	5.55	13.5	2.23	5.91
130	128.9	1.00	1.51	82.0	1.12	2.11	54.7	1.27	2.78	41.1	1.39	3.39	33.3	1.49	3.89	25.8	1.67	4.50	20.9	1.83	5.05	16.9	2.06	5.55	14.6	2.22	5.95
140	138.6	1.00	1.51	88.2	1.12	2.12	58.8	1.27	2.79	44.2	1.39	3.40	35.9	1.50	3.87	27.8	1.67	4.48	22.5	1.83	5.06	18.2	2.06	5.55	15.7	2.22	5.97
150	148.2	1.00	1.51	94.4	1.12	2.12	63.0	1.27	2.78	47.3	1.39	3.41	38.4	1.50	3.88	29.7	1.66	4.52	24.1	1.83	5.06	19.4	2.04	5.63	16.8	2.21	6.00
160	157.9	1.00	1.51	100.6	1.12	2.12	67.1	1.27	2.79	50.4	1.39	3.41	40.9	1.50	3.89	31.7	1.67	4.51	25.7	1.83	5.06	20.7	2.05	5.62	17.9	2.21	6.01
170	167.5	1.00	1.51	106.7	1.12	2.12	71.2	1.27	2.79	53.5	1.39	3.41	43.4	1.49	3.90	33.6	1.66	4.53	27.3	1.83	5.06	22.0	2.05	5.62	19.0	2.21	6.03
180	177.1	1.00	1.51	112.9	1.12	2.12	75.3	1.27	2.80	56.6	1.39	3.42	46.0	1.50	3.88	35.6	1.67	4.52	28.9	1.84	5.05	23.3	2.05	5.61	20.1	2.21	6.04
190	186.6	1.00	1.52	119.0	1.12	2.12	79.4	1.27	2.80	59.7	1.39	3.42	48.5	1.50	3.89	37.5	1.66	4.54	30.4	1.83	5.10	24.5	2.04	5.67	21.2	2.20	6.05
200	196.1	1.00	1.52	125.1	1.12	2.13	83.5	1.27	2.80	62.8	1.39	3.42	51.0	1.50	3.90	39.5	1.67	4.52	32.0	1.83	5.09	25.8	2.04	5.66	22.3	2.20	6.06
220	215.4	1.00	1.52	137.4	1.12	2.13	91.8	1.27	2.80	69.0	1.39	3.42	56.0	1.50	3.91	43.4	1.67	4.53	35.2	1.83	5.09	28.3	2.03	5.70	24.5	2.20	6.08
240	234.7	1.00	1.52	149.8	1.12	2.13	100.0	1.27	2.81	75.2	1.39	3.42	61.0	1.50	3.90	47.3	1.67	4.54	38.4	1.83	5.09	30.9	2.04	5.68	26.7	2.20	6.10
260	253.8	1.00	1.52	162.0	1.12	2.13	108.2	1.27	2.81	81.4	1.39	3.42	65.0	1.50	3.91	51.2	1.66	4.55	41.5	1.83	5.12	33.4	2.03	5.72	28.8	2.18	6.18
280	273.0	1.00	1.52	174.3	1.12	2.13	116.4	1.27	2.81	87.6	1.39	3.42	69.0	1.50	3.92	55.1	1.67	4.55	44.7	1.83	5.11	36.0	2.03	5.70	31.0	2.18	6.18
300	292.0	1.00	1.53	186.5	1.12	2.14	124.6	1.27	2.82	93.7	1.39	3.42	73.0	1.50	3.91	59.0	1.67	4.55	47.8	1.82	5.13	38.5	2.03	5.73	33.2	2.18	6.19

Parabolic waterway design
(Retardance "D" and "C")

June 1978
Appendix B-3.25

V_1 for RETARDANCE "D". Top Width (T), Depth (D) and V_2 for RETARDANCE "C".

Grade 1.50 Percent

Q cfs	$V_1 = 2.0$			$V_1 = 2.5$			$V_1 = 3.0$			$V_1 = 3.5$			$V_1 = 4.0$			$V_1 = 4.5$			$V_1 = 5.0$			$V_1 = 5.5$			$V_1 = 6.0$		
	T	D	V_2	T	D	V_2	T	D	V_2	T	D	V_2	T	D	V_2	T	D	V_2	T	D	V_2	T	D	V_2	T	D	V_2
15	17.0	0.92	1.42	11.3	1.05	1.86	7.6	1.20	2.41																		
20	22.7	0.92	1.41	14.9	1.03	1.93	10.0	1.17	2.53	7.0	1.40	3.01	5.7	1.52	3.39												
25	28.3	0.92	1.42	18.6	1.03	1.94	12.4	1.15	2.59	8.6	1.35	3.19	7.0	1.46	3.60												
30	33.9	0.92	1.43	22.3	1.03	1.96	14.9	1.15	2.59	10.3	1.34	3.22	8.4	1.46	3.62	6.9	1.59	4.03									
35	39.5	0.92	1.43	26.0	1.03	1.95	17.3	1.14	2.62	11.9	1.31	3.32	9.7	1.43	3.74	8.0	1.56	4.13									
40	45.0	0.92	1.44	29.7	1.03	1.94	19.8	1.15	2.61	13.6	1.31	3.32	11.1	1.43	3.73	9.1	1.55	4.20	7.1	1.79	4.64						
45	50.5	0.92	1.44	33.3	1.02	1.96	22.2	1.14	2.63	15.2	1.30	3.39	12.4	1.41	3.81	10.2	1.54	4.25	8.0	1.79	4.63						
50	56.1	0.92	1.44	37.0	1.03	1.95	26.6	1.14	2.65	16.9	1.30	3.38	13.7	1.39	3.88	11.3	1.53	4.29	8.8	1.75	4.78						
55	61.5	0.92	1.45	40.6	1.02	1.96	27.1	1.14	2.64	18.6	1.30	3.37	15.1	1.40	3.86	12.4	1.52	4.32	9.6	1.73	4.91	8.2	1.93	5.14			
60	67.0	0.92	1.45	44.2	1.02	1.97	29.5	1.14	2.65	20.2	1.29	3.41	16.4	1.39	3.91	13.5	1.52	4.35	10.5	1.73	4.88	8.9	1.91	5.23			
65	72.5	0.92	1.45	47.8	1.02	1.98	31.9	1.14	2.66	21.9	1.30	3.40	17.8	1.40	3.88	14.6	1.51	4.37	11.3	1.71	4.97	9.6	1.89	5.30			
70	77.9	0.92	1.45	51.4	1.02	1.98	34.3	1.14	2.66	23.5	1.29	3.43	19.1	1.39	3.92	15.7	1.51	4.39	12.2	1.72	4.94	10.3	1.88	5.36	8.8	2.12	5.55
75	83.3	0.92	1.46	55.0	1.02	1.98	36.7	1.14	2.67	25.2	1.29	3.42	20.5	1.40	3.89	16.8	1.51	4.40	13.0	1.70	5.02	11.0	1.87	5.41	9.4	2.10	5.61
80	88.7	0.92	1.46	58.6	1.02	1.98	39.1	1.14	2.67	26.8	1.29	3.44	21.8	1.39	3.93	17.9	1.50	4.41	13.9	1.71	4.98	11.7	1.86	5.46	9.9	2.05	5.63
90	99.6	0.92	1.46	65.8	1.02	1.99	44.0	1.14	2.66	30.1	1.29	3.46	24.5	1.39	3.93	20.1	1.50	4.43	15.6	1.71	5.02	13.2	1.87	5.42	11.1	2.04	5.90
100	110.5	0.92	1.46	73.0	1.02	1.99	48.8	1.14	2.67	33.4	1.29	3.47	27.2	1.39	3.94	22.3	1.50	4.45	17.3	1.70	5.05	14.6	1.85	5.50	12.3	2.03	5.95
110	121.4	0.92	1.46	80.2	1.02	1.99	53.6	1.14	2.68	36.7	1.28	3.47	29.9	1.39	3.94	24.5	1.50	4.46	19.0	1.70	5.07	16.0	1.84	5.56	13.5	2.02	6.00
120	132.2	0.92	1.46	87.3	1.02	2.00	58.4	1.14	2.68	40.0	1.28	3.48	32.6	1.39	3.95	26.7	1.49	4.47	20.7	1.69	5.09	17.5	1.85	5.52	14.7	2.01	6.03
130	142.9	0.92	1.47	94.5	1.02	2.00	63.2	1.14	2.68	43.3	1.29	3.48	35.3	1.39	3.94	28.9	1.49	4.48	22.4	1.69	5.10	18.9	1.84	5.57	15.9	2.00	6.06
140	153.6	0.92	1.47	101.6	1.02	2.00	68.0	1.14	2.69	46.6	1.29	3.48	37.9	1.38	3.97	31.1	1.49	4.48	24.0	1.68	5.18	20.3	1.83	5.61	17.1	2.00	6.08
150	164.3	0.92	1.47	108.7	1.03	2.00	72.8	1.14	2.68	49.9	1.29	3.48	40.6	1.39	3.97	33.3	1.49	4.49	25.7	1.68	5.18	21.7	1.82	5.64	18.3	2.00	6.10
160	175.0	0.92	1.47	115.7	1.02	2.01	77.6	1.14	2.68	53.2	1.29	3.48	43.3	1.39	3.97	35.5	1.50	4.49	27.4	1.68	5.19	23.2	1.83	5.60	19.5	1.99	6.12
170	185.6	0.92	1.48	122.8	1.03	2.01	82.3	1.14	2.69	56.4	1.29	3.49	45.9	1.38	3.99	37.7	1.50	4.49	29.1	1.68	5.19	24.6	1.83	5.65	20.7	1.99	6.13
180	196.2	0.92	1.48	129.8	1.02	2.01	87.1	1.14	2.69	59.7	1.29	3.49	48.6	1.39	3.98	39.8	1.49	4.52	30.8	1.68	5.19	26.0	1.82	5.66	21.9	1.99	6.14
190	206.7	0.92	1.48	136.8	1.03	2.02	91.8	1.14	2.69	62.9	1.29	3.50	51.3	1.39	3.97	42.0	1.49	4.52	32.5	1.68	5.18	27.4	1.82	5.68	23.1	1.99	6.15
200	217.2	0.92	1.48	143.8	1.03	2.02	96.5	1.14	2.70	66.2	1.29	3.49	53.9	1.39	3.99	44.2	1.49	4.51	34.2	1.68	5.18	28.9	1.83	5.64	24.3	1.99	6.16
220	238.5	0.92	1.48	157.9	1.03	2.02	106.0	1.14	2.70	72.7	1.29	3.50	59.3	1.39	3.98	48.6	1.50	4.51	37.6	1.68	5.19	31.7	1.82	5.68	26.7	1.99	6.18
240	259.7	0.92	1.49	172.0	1.03	2.02	115.6	1.15	2.70	79.3	1.29	3.50	64.6	1.39	3.99	53.0	1.50	4.51	40.9	1.67	5.23	34.6	1.82	5.67	29.1	1.98	6.19
260	280.9	0.92	1.49	186.1	1.03	2.03	125.0	1.15	2.71	85.8	1.29	3.51	69.9	1.39	3.99	57.3	1.49	4.53	44.3	1.68	5.22	37.4	1.82	5.70	31.5	1.98	6.20
280	302.0	0.92	1.49	200.1	1.03	2.03	134.5	1.15	2.71	92.3	1.29	3.51	75.2	1.39	4.00	61.7	1.50	4.53	47.7	1.68	5.22	40.3	1.82	5.69	33.9	1.98	6.21
300	323.0	0.93	1.49	214.1	1.03	2.03	143.9	1.15	2.71	98.8	1.29	3.51	80.5	1.39	4.00	66.0	1.49	4.54	51.1	1.68	5.21	43.1	1.82	5.71	36.3	1.98	6.21

Parabolic waterway design
(Retardance "D" and "C")

V₁ for RETARDANCE "D". Top Width (T), Depth (D) and V₂ for RETARDANCE "C".

Grade 1.75 Percent

Q cfs	V ₁ = 2.0			V ₁ = 2.5			V ₁ = 3.0			V ₁ = 3.5			V ₁ = 4.0			V ₁ = 4.5			V ₁ = 5.0			V ₁ = 5.5			V ₁ = 6.0		
	T	D	V ₂	T	D	V ₂	T	D	V ₂	T	D	V ₂	T	D	V ₂	T	D	V ₂	T	D	V ₂	T	D	V ₂	T	D	V ₂
15	18.5	0.87	1.38	12.1	0.97	1.89	8.5	1.08	2.40	5.9	1.28	2.92															
20	24.5	0.86	1.41	16.1	0.96	1.91	11.3	1.07	2.43	7.8	1.25	3.03	6.5	1.34	3.38												
25	30.6	0.86	1.41	20.1	0.96	1.91	14.1	1.07	2.45	9.7	1.23	3.09	8.1	1.33	3.43	5.6	1.46	3.81									
30	36.7	0.86	1.40	24.1	0.96	1.92	16.8	1.06	2.50	11.6	1.22	3.13	9.6	1.29	3.57	7.8	1.41	4.01									
35	42.7	0.86	1.41	28.1	0.96	1.92	19.6	1.06	2.50	13.4	1.20	3.23	11.2	1.29	3.58	9.1	1.41	4.02	7.1	1.59	4.57						
40	48.7	0.86	1.42	32.0	0.96	1.93	22.4	1.06	2.50	15.3	1.20	3.26	12.7	1.27	3.67	10.3	1.38	4.15	8.1	1.58	4.61						
45	54.7	0.86	1.42	36.0	0.96	1.93	25.1	1.05	2.53	17.2	1.20	3.24	14.3	1.28	3.66	11.6	1.39	4.16	9.1	1.57	4.64	7.5	1.73	5.12			
50	60.7	0.86	1.42	39.9	0.96	1.94	27.9	1.06	2.52	19.1	1.20	3.25	15.8	1.26	3.72	12.8	1.37	4.22	10.0	1.54	4.80	8.3	1.71	5.20			
55	66.6	0.86	1.42	43.8	0.96	1.94	30.6	1.05	2.53	21.0	1.20	3.25	17.4	1.27	3.70	14.1	1.37	4.21	11.0	1.54	4.80	9.1	1.70	5.25	7.5	1.91	5.65
60	72.5	0.86	1.43	47.7	0.96	1.95	33.3	1.05	2.55	22.8	1.19	3.29	18.9	1.26	3.75	15.4	1.38	4.19	12.0	1.54	4.81	9.9	1.69	5.30	8.2	1.92	5.63
65	78.4	0.86	1.43	51.6	0.96	1.95	36.1	1.06	2.54	24.7	1.19	3.28	20.5	1.26	3.73	16.6	1.37	4.25	12.9	1.52	4.92	10.7	1.68	5.34	8.8	1.88	5.79
70	84.3	0.86	1.43	55.5	0.96	1.95	38.8	1.05	2.54	26.6	1.19	3.28	22.0	1.26	3.76	17.9	1.37	4.23	13.9	1.52	4.91	11.5	1.68	5.38	9.5	1.89	5.76
75	90.2	0.86	1.43	59.4	0.96	1.95	41.5	1.05	2.55	28.5	1.20	3.27	23.6	1.26	3.74	19.1	1.36	4.28	14.9	1.52	4.90	12.3	1.67	5.40	10.1	1.87	5.89
80	96.0	0.86	1.43	63.2	0.96	1.96	44.2	1.05	2.56	30.3	1.19	3.30	25.1	1.26	3.77	20.4	1.37	4.25	15.9	1.53	4.89	13.1	1.67	5.43	10.8	1.88	5.85
85	101.8	0.86	1.44	67.0	0.96	1.96	46.9	1.05	2.56	32.1	1.19	3.29	26.2	1.26	3.78	22.9	1.37	4.28	17.8	1.51	4.96	14.7	1.66	5.47	12.1	1.86	5.93
90	107.8	0.86	1.44	71.0	0.96	1.96	49.7	1.05	2.55	34.1	1.19	3.29	28.2	1.26	3.78	24.9	1.37	4.28	19.8	1.52	4.94	16.3	1.65	5.51	13.4	1.85	5.99
100	119.5	0.86	1.44	78.8	0.96	1.96	55.1	1.05	2.56	37.8	1.19	3.31	31.3	1.26	3.79	25.4	1.36	4.30	19.8	1.52	4.94	16.3	1.65	5.51	13.4	1.85	5.99
110	131.2	0.86	1.44	86.5	0.96	1.97	60.5	1.05	2.57	41.5	1.19	3.32	34.4	1.26	3.79	27.9	1.36	4.31	21.7	1.51	4.99	17.9	1.65	5.53	14.7	1.84	6.05
120	142.9	0.86	1.44	94.2	0.96	1.97	65.9	1.05	2.58	45.3	1.19	3.31	37.5	1.26	3.79	30.4	1.36	4.32	23.7	1.51	4.97	19.5	1.65	5.55	16.0	1.83	6.09
130	154.5	0.86	1.45	101.9	0.96	1.97	71.3	1.05	2.58	49.0	1.19	3.31	40.6	1.26	3.79	32.9	1.36	4.33	25.6	1.51	5.01	21.1	1.65	5.57	17.3	1.82	6.12
140	167.1	0.87	1.45	109.6	0.96	1.97	76.7	1.05	2.58	52.7	1.19	3.32	43.7	1.26	3.79	35.4	1.36	4.33	27.6	1.51	4.99	22.7	1.64	5.58	18.6	1.82	6.15
150	17.6	0.87	1.45	117.2	0.96	1.98	82.1	1.05	2.58	56.4	1.19	3.32	46.8	1.26	3.79	37.9	1.36	4.33	29.5	1.51	5.02	24.3	1.64	5.59	19.9	1.82	6.17
160	189.1	0.87	1.45	124.8	0.96	1.98	87.5	1.06	2.58	60.1	1.19	3.33	49.8	1.26	3.81	40.4	1.36	4.33	31.4	1.50	5.04	25.9	1.64	5.60	21.3	1.83	6.10
170	200.5	0.87	1.45	132.4	0.96	1.98	92.8	1.05	2.58	63.7	1.19	3.34	52.9	1.26	3.80	42.9	1.36	4.33	33.4	1.51	5.02	27.5	1.64	5.60	22.6	1.83	6.13
180	211.7	0.87	1.46	140.0	0.96	1.98	98.1	1.05	2.59	67.4	1.19	3.34	55.9	1.26	3.82	45.4	1.36	4.33	35.3	1.51	5.04	29.1	1.64	5.61	23.9	1.83	6.14
190	223.0	0.87	1.46	147.5	0.96	1.99	103.4	1.05	2.59	71.1	1.19	3.34	59.0	1.26	3.81	47.8	1.36	4.36	37.2	1.50	5.06	30.7	1.64	5.61	25.2	1.82	6.16
200	234.6	0.87	1.46	155.1	0.97	1.99	108.7	1.06	2.60	74.7	1.19	3.35	62.0	1.26	3.82	50.3	1.36	4.35	39.2	1.51	5.03	32.3	1.64	5.61	26.5	1.82	6.17
220	257.6	0.87	1.46	170.3	0.96	1.99	119.4	1.06	2.60	82.1	1.19	3.35	68.1	1.26	3.83	55.3	1.36	4.35	43.1	1.51	5.03	35.5	1.64	5.62	29.1	1.82	6.20
240	280.4	0.87	1.47	185.5	0.97	1.99	130.1	1.06	2.60	89.5	1.19	3.35	74.3	1.26	3.82	60.3	1.36	4.33	46.9	1.51	5.06	38.7	1.64	5.62	31.7	1.81	6.22
260	303.2	0.87	1.47	200.6	0.97	2.00	140.8	1.06	2.60	96.9	1.19	3.35	80.4	1.26	3.82	65.2	1.36	4.37	50.8	1.51	5.06	41.9	1.64	5.63	34.3	1.81	6.24
280	326.0	0.87	1.47	215.7	0.97	2.00	151.4	1.06	2.61	104.2	1.19	3.36	86.5	1.26	3.83	70.2	1.36	4.36	54.7	1.51	5.05	45.1	1.64	5.63	36.9	1.81	6.25
300	348.6	0.87	1.47	230.8	0.97	2.00	162.0	1.06	2.61	111.5	1.19	3.36	92.5	1.26	3.84	75.1	1.36	4.37	58.5	1.51	5.07	48.3	1.65	5.63	39.5	1.81	6.26

Parabolic waterway design
(Retardance "D" and "C")

June 1978
Appendix B-3.27

146

190



191

V_1 for RETARDANCE "D". Top Width (T), Depth (D) and V_2 for RETARDANCE "C".

Grade 2.0 Percent

Q cfs	$V_1 = 2.0$			$V_1 = 2.5$			$V_1 = 3.0$			$V_1 = 3.5$			$V_1 = 4.0$			$V_1 = 4.5$			$V_1 = 5.0$			$V_1 = 5.5$			$V_1 = 6.0$		
	T	D	V_2	T	D	V_2	T	D	V_2	T	D	V_2	T	D	V_2	T	D	V_2	T	D	V_2	T	D	V_2	T	D	V_2
15	20.8	0.81	1.32	12.8	0.91	1.90	9.3	1.00	2.37	6.7	1.15	2.85															
20	27.6	0.80	1.33	17.1	0.91	1.89	12.3	0.99	2.43	8.8	1.12	3.00															
25	34.5	0.81	1.33	21.3	0.91	1.91	15.4	0.99	2.43	11.0	1.11	3.01															
30	41.3	0.81	1.34	25.5	0.91	1.92	18.4	0.98	2.46	13.2	1.11	3.02															
35	48.0	0.80	1.35	29.7	0.91	1.93	21.5	0.99	2.44	15.3	1.10	3.08															
40	54.8	0.80	1.34	33.9	0.91	1.93	24.5	0.98	2.46	17.5	1.10	3.07															
45	61.5	0.80	1.35	38.1	0.91	1.93	27.5	0.98	2.47	19.6	1.10	3.11															
50	68.2	0.80	1.35	42.3	0.91	1.93	30.5	0.98	2.48	21.8	1.10	3.09															
55	74.9	0.81	1.35	46.4	0.91	1.94	33.5	0.98	2.48	23.9	1.09	3.12															
60	81.5	0.81	1.36	50.6	0.91	1.93	36.5	0.98	2.49	26.1	1.10	3.10															
65	88.1	0.81	1.36	54.7	0.91	1.94	39.5	0.98	2.49	28.2	1.10	3.12															
70	94.7	0.81	1.36	58.8	0.91	1.94	42.5	0.98	2.49	30.3	1.09	3.14															
75	101.2	0.81	1.36	62.9	0.91	1.94	45.5	0.99	2.49	32.4	1.09	3.15															
80	107.8	0.81	1.36	67.0	0.91	1.95	48.4	0.98	2.50	34.6	1.10	3.13															
90	121.0	0.81	1.37	75.2	0.91	1.95	54.4	0.98	2.50	38.8	1.09	3.15															
100	134.2	0.81	1.37	83.4	0.91	1.96	60.4	0.99	2.50	43.1	1.10	3.15															
110	147.3	0.81	1.37	91.6	0.91	1.96	66.3	0.98	2.51	47.4	1.10	3.15															
120	160.4	0.81	1.38	99.8	0.91	1.96	72.2	0.98	2.51	51.6	1.10	3.16															
130	173.3	0.81	1.38	107.9	0.91	1.96	78.1	0.98	2.51	55.8	1.09	3.17															
140	186.3	0.81	1.38	116.0	0.91	1.97	84.0	0.99	2.52	60.1	1.10	3.16															
150	199.2	0.81	1.38	124.1	0.91	1.97	89.9	0.99	2.52	64.3	1.10	3.16															
160	212.0	0.81	1.38	132.1	0.91	1.97	95.7	0.99	2.52	68.5	1.10	3.17															
170	224.8	0.81	1.39	140.2	0.91	1.97	101.6	0.99	2.52	72.7	1.10	3.17															
180	237.5	0.81	1.39	148.2	0.91	1.98	107.4	0.99	2.53	76.8	1.10	3.18															
190	250.2	0.81	1.39	156.1	0.91	1.98	113.2	0.99	2.53	81.0	1.10	3.18															
200	262.8	0.81	1.39	164.1	0.91	1.98	119.0	0.99	2.53	85.2	1.10	3.18															
220	288.5	0.81	1.40	180.2	0.91	1.99	130.7	0.99	2.54	93.6	1.10	3.18															
240	314.1	0.81	1.40	196.2	0.91	1.99	142.4	0.99	2.54	102.0	1.10	3.19															
260	339.5	0.81	1.40	212.2	0.91	1.99	154.0	0.99	2.54	110.3	1.10	3.20															
280	364.9	0.81	1.40	228.2	0.92	1.99	165.6	0.99	2.55	118.7	1.10	3.19															
300	390.2	0.81	1.40	244.1	0.92	2.00	177.2	0.99	2.55	127.0	1.10	3.20															

Parabolic waterway design
(Retardance "D" and "C")

V₁ for RETARDANCE "D". Top Width (T), Depth (D) and V₂ for RETARDANCE "C".

Grade 3.0 Percent

Q cfs	V ₁ = 2.0			V ₁ = 2.5			V ₁ = 3.0			V ₁ = 3.5			V ₁ = 4.0			V ₁ = 4.5			V ₁ = 5.0			V ₁ = 5.5			V ₁ = 6.0			
	T	D	V ₂	T	D	V ₂	T	D	V ₂	T	D	V ₂	T	D	V ₂	T	D	V ₂	T	D	V ₂	T	D	V ₂	T	D	V ₂	
15	23.6	0.69	1.35	16.3	0.76	1.80	11.4	0.83	2.33	8.8	0.90	2.77	6.5	1.01	3.37	5.0	1.16	3.78										
20	31.4	0.69	1.34	21.7	0.76	1.81	15.2	0.83	2.34	11.7	0.90	2.81	8.6	0.99	3.48	6.6	1.13	3.94										
25	39.2	0.69	1.36	27.0	0.75	1.83	19.0	0.83	2.33	14.6	0.90	2.83	10.8	0.99	3.44	8.1	1.09	4.18	7.3	1.16	4.33	6.0	1.27	4.80				
30	46.9	0.69	1.37	32.4	0.75	1.82	22.7	0.83	2.36	17.4	0.88	2.89	12.9	0.98	3.49	9.7	1.08	4.22	8.7	1.15	4.44	7.1	1.24	5.03	5.8	1.41	5.37	
35	54.6	0.69	1.37	37.7	0.75	1.83	26.4	0.83	2.38	20.3	0.89	2.88	15.0	0.98	3.53	11.3	1.08	4.25	10.1	1.13	4.51	8.3	1.24	5.02	6.7	1.38	5.55	
40	62.2	0.69	1.37	43.0	0.75	1.83	30.2	0.83	2.37	23.2	0.89	2.88	17.1	0.98	3.55	12.9	1.08	4.26	11.3	1.13	4.57	9.4	1.22	5.17	7.6	1.36	5.70	
45	69.9	0.70	1.37	48.3	0.75	1.83	33.9	0.83	2.37	26.0	0.88	2.90	19.2	0.97	3.57	14.5	1.08	4.27	12.9	1.12	4.61	10.6	1.22	5.14	8.5	1.34	5.81	
50	77.4	0.69	1.38	53.5	0.75	1.84	37.6	0.83	2.38	28.9	0.89	2.89	21.3	0.97	3.58	16.0	1.06	4.36	14.3	1.12	4.63	11.7	1.21	5.24	9.4	1.33	5.90	
55	85.0	0.70	1.38	58.7	0.75	1.85	41.2	0.83	2.40	31.7	0.89	2.91	23.4	0.97	3.58	17.6	1.06	4.35	15.7	1.11	4.66	12.9	1.21	5.20	10.4	1.35	5.80	
60	92.5	0.70	1.38	64.0	0.75	1.84	44.9	0.83	2.40	34.5	0.88	2.97	25.5	0.97	3.59	19.2	1.07	4.35	17.1	1.11	4.67	14.0	1.20	5.28	11.3	1.34	5.87	
65	99.9	0.69	1.39	69.1	0.75	1.85	48.6	0.83	2.39	37.3	0.88	2.93	27.6	0.97	3.59	20.8	1.07	4.34	18.5	1.11	4.69	15.2	1.21	5.24	12.2	1.33	5.93	
70	107.3	0.69	1.39	74.3	0.75	1.86	52.2	0.83	2.40	40.1	0.88	2.93	29.7	0.98	3.59	22.3	1.06	4.39	19.9	1.11	4.69	16.3	1.20	5.20	13.1	1.32	5.98	
75	114.7	0.70	1.39	79.4	0.75	1.86	55.8	0.83	2.41	42.9	0.88	2.94	31.8	0.98	3.59	23.9	1.06	4.38	21.3	1.11	4.70	17.5	1.21	5.26	14.0	1.32	6.02	
80	122.1	0.70	1.40	84.5	0.75	1.87	59.4	0.83	2.42	45.7	0.88	2.94	33.9	0.98	3.58	25.5	1.07	4.36	22.7	1.11	4.70	18.6	1.20	5.31	15.0	1.33	5.94	
90	137.0	0.70	1.40	94.9	0.75	1.87	66.7	0.83	2.42	51.4	0.89	2.93	38.0	0.97	3.61	28.6	1.06	4.40	25.5	1.11	4.72	20.9	1.20	5.33	16.8	1.32	6.01	
100	151.8	0.70	1.40	105.2	0.75	1.87	74.0	0.83	2.42	57.0	0.89	2.94	42.2	0.98	3.61	31.7	1.06	4.42	26.3	1.11	4.73	23.2	1.20	5.36	18.6	1.31	6.08	
110	166.6	0.70	1.41	115.3	0.75	1.87	81.3	0.83	2.42	62.6	0.89	2.95	46.4	0.98	3.61	34.9	1.06	4.40	31.0	1.10	4.78	25.5	1.20	5.34	20.5	1.32	6.04	
120	181.3	0.70	1.41	125.7	0.75	1.88	88.5	0.83	2.43	68.2	0.89	2.95	50.5	0.98	3.62	38.0	1.06	4.42	33.8	1.11	4.78	27.7	1.19	5.40	22.3	1.32	6.08	
130	195.9	0.70	1.41	135.9	0.76	1.88	95.7	0.83	2.43	73.7	0.89	2.96	54.6	0.98	3.63	41.1	1.06	4.43	36.6	1.11	4.77	30.0	1.19	5.40	24.2	1.32	6.04	
140	210.5	0.70	1.41	146.1	0.76	1.88	102.8	0.83	2.44	79.3	0.89	2.96	58.8	0.98	3.62	44.2	1.06	4.44	39.4	1.11	4.77	32.3	1.20	5.39	26.0	1.32	6.08	
150	225.0	0.70	1.42	156.2	0.76	1.89	110.0	0.83	2.44	84.8	0.89	2.96	62.9	0.98	3.63	47.3	1.06	4.44	42.1	1.11	4.80	34.6	1.20	5.38	27.8	1.31	6.11	
160	239.4	0.70	1.42	166.2	0.76	1.89	117.1	0.83	2.45	90.3	0.89	2.97	67.0	0.98	3.63	50.4	1.06	4.45	44.9	1.11	4.79	36.8	1.19	5.42	29.6	1.31	6.13	
170	253.7	0.70	1.42	176.2	0.76	1.90	124.2	0.83	2.45	95.8	0.89	2.97	71.1	0.98	3.64	53.5	1.06	4.45	47.7	1.11	4.78	39.1	1.20	5.41	31.5	1.32	6.09	
180	268.0	0.70	1.43	186.2	0.76	1.90	131.2	0.83	2.46	101.3	0.89	2.97	75.2	0.98	3.64	56.6	1.06	4.45	50.4	1.11	4.80	41.3	1.19	5.44	33.3	1.32	6.11	
190	282.2	0.70	1.43	196.1	0.76	1.90	138.3	0.83	2.46	106.7	0.89	2.98	79.2	0.98	3.65	59.7	1.07	4.45	53.1	1.11	4.81	43.6	1.20	5.42	35.1	1.32	6.12	
200	296.3	0.70	1.43	206.0	0.76	1.90	145.3	0.83	2.46	112.2	0.89	2.98	83.3	0.98	3.65	62.7	1.06	4.47	55.9	1.11	4.80	45.8	1.19	5.45	36.9	1.32	6.14	
220	325.1	0.70	1.44	226.1	0.76	1.91	159.5	0.83	2.47	123.2	0.89	2.98	91.5	0.98	3.65	68.9	1.06	4.47	61.4	1.11	4.81	50.4	1.20	5.43	40.6	1.32	6.12	
240	353.8	0.70	1.44	246.2	0.76	1.91	173.7	0.83	2.47	134.2	0.89	2.99	99.7	0.98	3.65	75.1	1.07	4.47	66.9	1.11	4.81	54.9	1.20	5.44	44.2	1.32	6.15	
260	382.4	0.70	1.44	266.1	0.76	1.92	187.8	0.83	2.48	145.1	0.89	2.99	107.8	0.98	3.67	81.3	1.07	4.47	72.4	1.11	4.82	59.4	1.20	5.45	47.8	1.31	6.17	
280	410.8	0.70	1.45	286.0	0.76	1.92	201.9	0.83	2.48	156.0	0.89	3.00	116.0	0.98	3.66	87.4	1.07	4.48	77.9	1.11	4.82	63.9	1.20	5.46	51.5	1.32	6.15	
300	439.0	0.70	1.45	305.8	0.76	1.92	215.9	0.83	2.49	166.9	0.89	3.00	124.1	0.98	3.67	93.6	1.07	4.47	83.3	1.11	4.83	68.4	1.20	5.46	55.1	1.32	6.17	

Parabolic waterway design
(Retardance "D" and "C")

148

194

195

V₁ for RETARDANCE "D". Top Width (T), Depth (D) and V₂ for RETARDANCE "C".

Grade 4.0 Percent

Q cfs	V ₁ = 2.0			V ₁ = 2.5			V ₁ = 3.0			V ₁ = 3.5			V ₁ = 4.0			V ₁ = 4.5			V ₁ = 5.0			V ₁ = 5.5			V ₁ = 6.0			
	T	D	V ₂	T	D	V ₂	T	D	V ₂	T	D	V ₂	T	D	V ₂	T	D	V ₂	T	D	V ₂	T	D	V ₂	T	D	V ₂	
15	27.9	0.62	1.29	19.9	0.66	1.68	13.9	0.73	2.20	10.3	0.79	2.73	7.9	0.85	3.28	6.3	0.92	3.78	4.9	1.06	4.21							
20	37.1	0.62	1.29	26.5	0.66	1.69	18.5	0.72	2.21	13.7	0.78	2.76	10.5	0.84	3.33	8.4	0.92	3.81	6.4	1.01	4.52	5.5	1.09	4.88				
25	46.2	0.62	1.30	33.0	0.66	1.70	23.0	0.72	2.24	17.1	0.78	2.77	13.1	0.84	3.35	10.5	0.92	3.82	8.0	1.01	4.55	6.8	1.06	5.09	5.7	1.20	5.34	
30	55.3	0.62	1.30	39.5	0.66	1.70	27.6	0.72	2.23	20.4	0.77	2.82	15.7	0.84	3.36	12.5	0.91	3.9	9.5	0.99	4.71	8.2	1.07	5.03	6.7	1.15	5.71	
35	64.3	0.62	1.31	46.0	0.66	1.71	32.1	0.72	2.25	23.8	0.78	2.81	18.3	0.84	3.37	14.6	0.91	3.90	11.1	0.99	4.70	9.5	1.06	5.15	7.8	1.15	5.77	
40	73.3	0.62	1.31	52.4	0.66	1.71	36.6	0.72	2.25	27.1	0.77	2.83	20.8	0.83	3.42	16.6	0.90	3.96	12.7	1.00	4.68	10.8	1.04	5.24	8.9	1.14	5.81	
45	82.2	0.62	1.32	58.8	0.66	1.72	41.1	0.72	2.26	30.4	0.77	2.85	23.4	0.84	3.41	18.7	0.91	3.94	14.2	0.98	4.77	12.2	1.05	5.17	10.0	1.14	5.83	
50	91.1	0.62	1.32	65.2	0.66	1.72	45.6	0.72	2.26	33.7	0.77	2.86	26.0	0.84	3.40	20.7	0.90	3.97	15.8	0.99	4.74	13.5	1.05	5.24	11.1	1.14	5.85	
55	99.9	0.62	1.32	71.5	0.66	1.73	50.1	0.72	2.26	37.0	0.77	2.86	28.5	0.84	3.43	22.8	0.91	3.95	17.0	0.98	4.80	14.8	1.04	5.28	12.2	1.14	5.87	
60	108.7	0.62	1.32	77.8	0.66	1.73	54.5	0.72	2.26	40.3	0.77	2.87	31.0	0.83	3.45	24.8	0.90	3.97	18.9	0.99	4.77	16.1	1.04	5.32	13.3	1.14	5.88	
65	117.4	0.62	1.33	84.1	0.66	1.73	58.9	0.72	2.27	43.6	0.77	2.87	33.6	0.84	3.43	26.8	0.90	3.99	20.4	0.98	4.81	17.5	1.05	5.26	14.3	1.12	6.00	
70	126.1	0.62	1.33	90.3	0.66	1.74	63.3	0.72	2.27	46.9	0.77	2.86	36.1	0.84	3.44	28.8	0.90	4.01	21.9	0.98	4.85	18.8	1.04	5.29	15.4	1.12	6.00	
75	134.7	0.62	1.33	96.5	0.66	1.74	67.7	0.72	2.28	50.1	0.77	2.88	38.6	0.84	3.45	30.9	0.91	3.98	23.5	0.98	4.82	20.1	1.04	5.31	16.5	1.12	5.99	
80	143.3	0.62	1.34	102.7	0.66	1.74	72.1	0.72	2.28	53.3	0.77	2.89	41.1	0.84	3.46	32.9	0.91	3.99	25.0	0.98	4.84	21.4	1.04	5.33	17.6	1.13	5.98	
90	160.8	0.62	1.34	115.2	0.66	1.75	80.9	0.72	2.28	59.9	0.77	2.89	46.2	0.84	3.46	36.9	0.90	4.01	28.1	0.98	4.85	24.0	1.04	5.38	19.7	1.12	6.07	
100	178.2	0.62	1.34	127.7	0.66	1.75	89.7	0.72	2.29	66.4	0.77	2.90	51.2	0.84	3.47	41.0	0.91	4.00	31.2	0.98	4.85	26.7	1.04	5.35	21.9	1.12	6.05	
110	195.4	0.62	1.35	140.1	0.66	1.76	98.5	0.72	2.29	72.9	0.77	2.90	56.2	0.84	3.48	45.0	0.90	4.02	34.3	0.98	4.85	29.3	1.04	5.37	24.1	1.12	6.03	
120	212.6	0.62	1.35	152.5	0.66	1.76	107.2	0.72	2.30	79.4	0.77	2.90	61.2	0.84	3.49	49.0	0.90	4.03	37.3	0.98	4.88	31.9	1.04	5.40	26.2	1.12	6.09	
130	229.6	0.62	1.35	164.8	0.66	1.76	115.9	0.72	2.30	85.9	0.77	2.91	66.2	0.84	3.49	53.0	0.90	4.03	40.4	0.98	4.87	34.6	1.04	5.36	28.4	1.12	6.07	
140	246.6	0.62	1.36	177.0	0.66	1.77	124.5	0.72	2.30	92.3	0.77	2.91	71.2	0.84	3.49	57.0	0.90	4.04	43.4	0.98	4.90	37.2	1.04	5.38	30.5	1.12	6.10	
150	263.5	0.62	1.36	189.1	0.66	1.77	133.2	0.73	2.30	98.7	0.77	2.92	76.2	0.84	3.49	61.0	0.91	4.04	46.5	0.98	4.88	39.8	1.04	5.39	32.7	1.12	6.08	
160	280.3	0.62	1.36	201.2	0.66	1.78	141.7	0.73	2.31	105.1	0.77	2.92	81.1	0.84	3.50	65.0	0.91	4.04	49.5	0.98	4.90	42.4	1.04	5.40	34.8	1.12	6.11	
170	296.9	0.62	1.37	213.3	0.67	1.78	150.3	0.73	2.31	111.5	0.78	2.92	86.0	0.84	3.51	68.9	0.91	4.05	52.5	0.98	4.91	45.0	1.04	5.40	36.9	1.12	6.13	
180	313.5	0.62	1.37	225.3	0.67	1.78	158.8	0.73	2.32	117.8	0.78	2.93	90.9	0.84	3.52	72.9	0.91	4.05	55.6	0.98	4.90	47.6	1.04	5.40	39.1	1.12	6.11	
190	330.0	0.62	1.37	237.2	0.67	1.79	167.3	0.73	2.32	124.2	0.78	2.93	95.8	0.84	3.52	76.8	0.91	4.06	58.6	0.98	4.90	50.2	1.04	5.40	41.2	1.12	6.12	
200	346.4	0.62	1.37	249.1	0.67	1.79	175.7	0.73	2.32	130.5	0.78	2.93	100.7	0.84	3.52	80.7	0.91	4.07	61.6	0.98	4.91	52.7	1.04	5.43	43.3	1.12	6.14	
220	380.0	0.62	1.38	273.3	0.67	1.79	192.9	0.73	2.33	143.3	0.78	2.93	110.6	0.84	3.53	88.7	0.91	4.07	67.6	0.98	4.93	57.9	1.04	5.44	47.6	1.12	6.14	
240	413.3	0.62	1.38	297.4	0.67	1.80	209.9	0.73	2.33	156.0	0.78	2.94	120.4	0.84	3.53	96.6	0.91	4.07	73.7	0.98	4.93	63.1	1.04	5.44	51.9	1.12	6.14	
260	446.5	0.62	1.39	321.4	0.67	1.80	227.0	0.73	2.33	168.7	0.78	2.94	130.2	0.84	3.54	104.5	0.91	4.08	79.7	0.98	4.94	68.3	1.04	5.44	56.2	1.12	6.13	
280	479.5	0.62	1.39	345.3	0.67	1.80	243.9	0.73	2.34	181.3	0.78	2.95	140.0	0.84	3.54	112.3	0.91	4.09	85.8	0.99	4.93	73.5	1.04	5.44	60.4	1.12	6.15	
300	512.3	0.62	1.39	369.0	0.67	1.81	260.8	0.73	2.34	193.9	0.78	2.95	149.8	0.84	3.55	120.2	0.91	4.09	91.8	0.99	4.94	78.6	1.04	5.46	64.7	1.12	6.14	

Parabolic waterway design
(Retardance "D" and "C")

149

V₁ for RETARDANCE "D". Top Width (T), Depth (D) and V₂ for RETARDANCE

Grade 5.0 Percent

Q CFS	V ₁ = 2.0			V ₁ = 2.5			V ₁ = 3.0			V ₁ = 3.5			V ₁ = 4.0			V ₁ = 5.0			V ₁ = 5.5			V ₁ = 6.0					
	T	D	V ₂	T	D	V ₂	T	D	V ₂	T	D	V ₂	T	D	V ₂	T	D	V ₂	T	D	V ₂	T	D	V ₂			
15	29.3	0.57	1.33	21.1	0.60	1.74	15.0	0.66	2.23	12.2	0.70	2.58	9.0	0.75	3.25	7.2	0.83	3.70	5.8	0.93	4.09	4.6	0.99	4.81	5.3	1.06	5.21
20	39.0	0.57	1.33	28.1	0.61	1.74	19.9	0.66	2.26	16.2	0.70	2.52	12.0	0.75	3.26	9.5	0.81	3.84	7.6	0.89	4.35	6.1	0.97	4.95	6.5	1.02	5.56
25	48.6	0.57	1.34	35.1	0.61	1.73	24.8	0.66	2.28	20.3	0.70	2.59	15.0	0.75	3.27	11.9	0.81	3.82	9.5	0.89	4.37	7.6	0.96	5.03	6.5	1.02	5.56
30	58.1	0.57	1.34	42.0	0.61	1.74	29.7	0.66	2.28	24.3	0.70	2.61	18.0	0.76	3.26	14.2	0.80	3.89	11.3	0.87	4.49	9.1	0.96	5.08	7.8	1.01	5.59
35	67.6	0.57	1.35	48.8	0.61	1.75	34.6	0.66	2.28	28.2	0.70	2.64	20.9	0.75	3.30	16.6	0.81	3.86	13.2	0.88	4.47	10.5	0.94	5.26	9.1	1.01	5.60
40	77.0	0.57	1.35	55.7	0.61	1.75	39.5	0.66	2.28	32.2	0.70	2.64	23.9	0.75	3.29	18.9	0.80	3.90	15.1	0.88	4.46	12.0	0.94	5.26	10.3	0.99	5.77
45	86.4	0.57	1.35	62.5	0.61	1.75	44.3	0.66	2.29	36.1	0.70	2.65	26.8	0.75	3.31	21.3	0.81	3.87	16.9	0.87	4.52	13.5	0.94	5.25	11.6	1.00	5.75
50	95.7	0.57	1.36	69.2	0.61	1.76	49.1	0.66	2.30	40.1	0.70	2.64	29.7	0.75	3.32	23.6	0.81	3.89	18.8	0.88	4.50	15.0	0.94	5.25	12.9	1.00	5.73
55	105.0	0.57	1.36	75.9	0.61	1.77	53.9	0.66	2.30	44.0	0.70	2.65	32.6	0.75	3.33	25.9	0.81	3.90	20.6	0.87	4.54	16.5	0.94	5.24	14.1	0.99	5.84
60	114.2	0.57	1.36	82.6	0.61	1.77	58.7	0.66	2.30	47.9	0.70	2.66	35.5	0.75	3.34	28.2	0.81	3.92	22.4	0.87	4.57	17.9	0.93	5.32	15.4	0.99	5.81
65	123.4	0.57	1.36	89.3	0.61	1.77	63.4	0.66	2.31	51.8	0.70	2.66	38.4	0.75	3.34	30.5	0.81	3.92	24.3	0.87	4.54	19.4	0.94	5.30	16.7	1.00	5.78
70	132.4	0.57	1.37	95.9	0.61	1.77	68.2	0.66	2.31	55.5	0.70	2.67	41.3	0.75	3.34	32.8	0.81	3.93	26.1	0.87	4.56	20.8	0.93	5.36	17.9	0.99	5.85
75	141.5	0.57	1.37	102.4	0.61	1.78	72.9	0.66	2.31	59.4	0.70	2.68	44.1	0.75	3.36	35.1	0.81	3.93	27.9	0.87	4.58	22.3	0.93	5.34	19.2	1.00	5.82
80	150.5	0.57	1.37	109.0	0.61	1.78	77.5	0.66	2.32	63.3	0.70	2.68	47.0	0.75	3.36	37.4	0.81	3.92	29.7	0.87	4.60	23.8	0.94	5.32	20.4	0.99	5.88
90	168.8	0.57	1.38	122.3	0.61	1.79	87.0	0.66	2.33	71.0	0.70	2.69	52.8	0.75	3.38	42.0	0.81	3.93	33.4	0.87	4.59	26.7	0.94	5.35	22.9	0.99	5.91
100	187.0	0.57	1.38	135.5	0.61	1.79	96.5	0.66	2.33	78.7	0.70	2.70	58.5	0.75	3.37	46.5	0.81	3.96	37.0	0.87	4.62	29.6	0.93	5.38	25.5	0.99	5.86
110	205.1	0.57	1.38	148.7	0.61	1.79	105.9	0.66	2.33	86.4	0.70	2.70	64.3	0.75	3.37	51.1	0.81	3.96	40.7	0.87	4.61	32.5	0.93	5.39	28.0	0.99	5.88
120	223.1	0.57	1.39	161.8	0.61	1.80	115.3	0.66	2.33	94.1	0.70	2.70	70.0	0.75	3.38	55.7	0.81	3.96	44.3	0.87	4.62	35.4	0.93	5.41	30.5	0.99	5.89
130	240.9	0.57	1.39	174.8	0.61	1.80	124.6	0.66	2.34	101.7	0.70	2.71	75.7	0.76	3.38	60.2	0.81	3.97	47.9	0.87	4.64	38.3	0.93	5.41	33.0	0.99	5.90
140	258.7	0.57	1.40	187.7	0.61	1.81	133.9	0.66	2.34	109.3	0.70	2.71	81.3	0.75	3.39	64.7	0.81	3.98	51.5	0.87	4.64	41.2	0.93	5.42	35.5	0.99	5.91
150	276.4	0.58	1.40	200.6	0.61	1.81	143.1	0.66	2.35	116.8	0.70	2.72	87.0	0.76	3.39	69.3	0.81	3.97	55.1	0.87	4.65	44.1	0.93	5.42	37.9	0.99	5.96
160	293.9	0.58	1.40	213.4	0.61	1.81	152.3	0.66	2.35	124.3	0.70	2.72	92.6	0.76	3.40	73.7	0.81	3.99	58.7	0.87	4.65	47.0	0.94	5.42	40.4	0.99	5.95
170	311.4	0.58	1.40	226.1	0.61	1.82	161.5	0.66	2.35	131.8	0.70	2.73	98.2	0.76	3.41	78.2	0.81	3.99	62.3	0.87	4.65	49.9	0.94	5.41	42.9	0.99	5.95
180	328.7	0.58	1.41	238.8	0.61	1.82	170.6	0.66	2.36	139.2	0.70	2.73	103.8	0.76	3.41	82.7	0.81	3.99	65.9	0.87	4.65	52.7	0.93	5.44	45.4	0.99	5.94
190	346.0	0.58	1.41	251.4	0.61	1.83	179.7	0.67	2.36	146.6	0.70	2.74	109.4	0.76	3.41	87.1	0.81	4.00	69.4	0.87	4.67	55.6	0.94	5.43	47.8	0.99	5.97
200	363.1	0.58	1.42	263.9	0.61	1.83	188.7	0.67	2.37	154.0	0.70	2.74	114.9	0.76	3.42	91.6	0.81	4.00	73.0	0.87	4.66	58.4	0.94	5.43	50.3	0.99	5.96
220	398.3	0.58	1.42	289.6	0.62	1.83	207.1	0.67	2.37	169.0	0.70	2.75	126.1	0.76	3.43	100.6	0.81	4.00	80.1	0.87	4.68	64.2	0.94	5.45	55.2	0.99	5.99
240	433.2	0.58	1.42	315.0	0.62	1.84	225.4	0.67	2.37	184.0	0.70	2.75	137.4	0.76	3.43	109.5	0.81	4.01	87.3	0.87	4.68	69.9	0.94	5.46	60.2	0.99	5.98
260	467.9	0.58	1.43	340.4	0.62	1.84	243.7	0.67	2.38	198.9	0.70	2.76	148.5	0.76	3.44	118.5	0.81	4.01	94.4	0.87	4.69	73.6	0.94	5.47	65.1	0.99	5.99
280	502.5	0.58	1.43	365.6	0.62	1.84	261.8	0.67	2.38	213.7	0.70	2.76	159.7	0.76	3.44	127.4	0.81	4.02	101.5	0.87	4.70	81.4	0.94	5.48	70.0	0.99	6.01
300	536.7	0.58	1.43	390.7	0.62	1.85	279.9	0.67	2.38	228.5	0.71	2.77	170.7	0.76	3.45	136.2	0.81	4.03	108.6	0.87	4.70	87.0	0.94	5.48	74.9	0.99	6.01

Parabolic waterway design
(Retardance "D" and "C")

V₁ for RETARDANCE "D". Top Width (T), Depth (D) and V₂ for RETARDANCE "C".

Grade 6.0 Percent

Q cfs	V ₁ = 2.0			V ₁ = 2.5			V ₁ = 3.0			V ₁ = 3.5			V ₁ = 4.0			V ₁ = 4.5			V ₁ = 5.0			V ₁ = 5.5			V ₁ = 6.0		
	T	D	V ₂	T	D	V ₂	T	D	V ₂	T	D	V ₂	T	D	V ₂	T	D	V ₂	T	D	V ₂	T	D	V ₂	T	D	V ₂
15	34.6	0.53	1.22	22.6	0.57	1.72	16.6	0.61	2.20	12.6	0.65	2.68	10.0	0.70	3.15	8.1	0.76	3.59	6.6	0.82	4.05	5.3	0.90	4.61	4.3	0.98	5.19
20	46.0	0.53	1.22	30.0	0.57	1.73	22.1	0.61	2.20	16.8	0.66	2.68	13.2	0.69	3.25	10.7	0.74	3.71	8.7	0.80	4.22	7.0	0.88	4.79	5.7	0.96	5.36
25	57.2	0.52	1.23	37.4	0.57	1.74	27.6	0.61	2.20	21.0	0.66	2.68	16.5	0.69	3.25	13.3	0.73	3.78	10.8	0.79	4.32	8.7	0.86	4.90	7.0	0.92	5.69
30	68.5	0.53	1.23	44.7	0.57	1.75	33.0	0.61	2.22	25.1	0.66	2.70	19.8	0.69	3.24	16.0	0.74	3.75	13.0	0.80	4.29	10.4	0.86	4.97	8.4	0.92	5.71
35	79.6	0.53	1.24	52.0	0.57	1.76	38.4	0.61	2.22	29.2	0.65	2.71	23.0	0.69	3.28	18.6	0.74	3.78	15.1	0.79	4.34	12.1	0.85	5.01	9.8	0.92	5.72
40	90.6	0.52	1.24	59.3	0.57	1.76	43.8	0.61	2.22	33.3	0.65	2.72	26.3	0.69	3.26	21.2	0.74	3.80	17.2	0.79	4.37	13.8	0.85	5.04	11.2	0.92	5.72
45	101.6	0.53	1.25	66.5	0.57	1.76	49.1	0.61	2.24	37.4	0.66	2.72	29.5	0.69	3.28	23.8	0.73	3.81	19.4	0.79	4.33	15.5	0.85	5.05	12.5	0.91	5.85
50	112.5	0.53	1.25	73.6	0.57	1.77	54.4	0.61	2.24	41.5	0.66	2.72	32.7	0.69	3.29	26.4	0.74	3.82	21.5	0.79	4.35	17.2	0.85	5.06	13.9	0.91	5.83
55	123.3	0.53	1.25	80.8	0.57	1.77	59.7	0.61	2.25	45.5	0.66	2.73	35.9	0.69	3.29	29.0	0.74	3.82	23.6	0.79	4.37	18.8	0.84	5.15	15.3	0.92	5.82
60	134.1	0.53	1.26	87.8	0.57	1.78	65.0	0.61	2.25	49.5	0.66	2.74	39.1	0.69	3.30	31.6	0.74	3.82	25.7	0.79	4.38	20.5	0.84	5.14	16.6	0.91	5.90
65	144.7	0.53	1.26	94.9	0.57	1.78	70.2	0.61	2.26	53.5	0.66	2.75	42.2	0.69	3.32	34.1	0.73	3.85	27.8	0.79	4.36	22.2	0.85	5.14	18.0	0.91	5.87
70	155.3	0.53	1.27	101.9	0.57	1.79	75.4	0.61	2.26	57.5	0.66	2.75	45.4	0.69	3.31	36.7	0.74	3.86	29.9	0.79	4.39	23.9	0.85	5.13	19.3	0.91	5.94
75	165.8	0.53	1.27	108.8	0.57	1.80	80.6	0.61	2.26	61.5	0.66	2.75	48.5	0.69	3.33	39.2	0.73	3.86	31.9	0.79	4.43	25.5	0.84	5.18	20.7	0.91	5.91
80	176.3	0.53	1.27	115.7	0.57	1.80	85.8	0.61	2.27	65.4	0.66	2.76	51.7	0.69	3.32	41.8	0.74	3.85	34.0	0.79	4.42	27.2	0.85	5.16	22.0	0.91	5.96
90	197.6	0.53	1.28	129.8	0.57	1.80	96.2	0.61	2.28	73.4	0.66	2.77	58.0	0.69	3.33	46.9	0.74	3.87	38.2	0.79	4.43	30.5	0.84	5.20	24.8	0.91	5.91
100	218.8	0.53	1.28	143.8	0.57	1.81	106.6	0.61	2.28	81.4	0.66	2.77	64.3	0.69	3.34	52.0	0.74	3.88	42.4	0.79	4.42	33.9	0.85	5.18	27.5	0.91	5.93
110	239.9	0.53	1.28	157.7	0.57	1.81	117.0	0.61	2.28	89.3	0.66	2.78	70.6	0.69	3.35	57.1	0.74	3.88	46.5	0.79	4.45	37.1	0.84	5.20	30.2	0.91	5.95
120	260.8	0.53	1.29	171.5	0.57	1.82	127.3	0.61	2.29	97.2	0.66	2.79	76.9	0.69	3.35	62.2	0.74	3.89	50.7	0.79	4.44	40.5	0.84	5.22	32.9	0.91	5.96
130	281.5	0.53	1.29	185.3	0.57	1.82	137.6	0.61	2.29	105.1	0.66	2.79	83.1	0.69	3.36	67.2	0.74	3.90	54.8	0.79	4.46	43.8	0.84	5.23	35.6	0.91	5.96
140	302.1	0.53	1.30	199.0	0.57	1.83	147.8	0.61	2.30	112.9	0.66	2.80	89.3	0.69	3.36	72.3	0.74	3.90	58.9	0.79	4.46	47.1	0.84	5.24	38.3	0.91	5.97
150	322.6	0.53	1.30	212.6	0.57	1.83	157.9	0.61	2.30	120.7	0.66	2.80	95.5	0.69	3.37	77.3	0.74	3.91	63.0	0.79	4.47	50.4	0.84	5.24	40.9	0.91	6.01
160	342.9	0.53	1.30	226.1	0.57	1.84	168.0	0.61	2.31	128.5	0.66	2.80	101.7	0.69	3.37	82.3	0.74	3.91	67.1	0.79	4.47	53.7	0.85	5.24	43.6	0.91	6.00
170	363.1	0.53	1.31	239.6	0.57	1.84	178.0	0.61	2.32	136.2	0.66	2.81	107.8	0.69	3.37	87.3	0.74	3.91	71.2	0.79	4.47	56.9	0.84	5.27	46.3	0.91	5.99
180	383.1	0.53	1.31	253.0	0.57	1.84	188.0	0.61	2.32	143.9	0.66	2.81	113.9	0.69	3.38	92.2	0.74	3.93	75.2	0.79	4.49	60.2	0.85	5.26	48.9	0.91	6.02
190	403.0	0.53	1.32	266.3	0.57	1.85	197.9	0.61	2.33	151.5	0.66	2.82	120.0	0.70	3.38	97.1	0.74	3.94	79.3	0.79	4.49	63.4	0.84	5.28	51.6	0.91	6.01
200	422.7	0.53	1.32	279.5	0.57	1.85	207.8	0.61	2.33	159.1	0.66	2.82	126.1	0.70	3.39	102.1	0.74	3.93	83.3	0.79	4.50	66.7	0.85	5.27	54.2	0.91	6.03
220	463.4	0.53	1.32	306.6	0.57	1.86	228.0	0.61	2.33	174.6	0.66	2.83	138.4	0.70	3.39	112.0	0.74	3.95	91.5	0.79	4.50	73.2	0.85	5.29	59.6	0.91	6.02
240	503.8	0.53	1.33	333.6	0.57	1.86	248.1	0.61	2.34	190.1	0.66	2.83	150.7	0.70	3.40	122.0	0.74	3.95	99.7	0.80	4.50	79.8	0.85	5.28	64.9	0.91	6.04
260	543.8	0.53	1.33	360.4	0.57	1.86	268.1	0.61	2.34	205.6	0.66	2.84	162.9	0.70	3.40	131.9	0.74	3.96	107.8	0.80	4.51	86.3	0.85	5.29	70.2	0.91	6.05
280	583.6	0.53	1.34	387.0	0.57	1.87	287.9	0.61	2.35	220.7	0.66	2.85	175.1	0.70	3.41	141.8	0.74	3.96	115.9	0.80	4.51	92.8	0.85	5.30	75.5	0.91	6.05
300	623.2	0.53	1.34	413.5	0.58	1.87	307.7	0.61	2.36	235.9	0.66	2.85	187.2	0.70	3.41	151.6	0.74	3.97	123.9	0.80	4.53	99.3	0.85	5.30	80.8	0.91	6.06

Parabolic waterway design
(Retardance "D" and "C")

June 1978
Appendix B-3.32

V_1 for RETARDANCE "D", Top Width (T), Depth (D) and V_2 for RETARDANCE "C".

Grade 5.0 Percent

C ft/s	$V_1 = 2.0$			$V_1 = 2.5$			$V_1 = 3.0$			$V_1 = 3.5$			$V_1 = 4.0$			$V_1 = 4.5$			$V_1 = 5.0$			$V_1 = 5.5$			$V_1 = 6.0$		
	T	D	V_2	T	D	V_2	T	D	V_2	T	D	V_2	T	D	V_2	T	D	V_2	T	D	V_2	T	D	V_2	T	D	V_2
15	37.0	0.47	1.26	26.6	0.51	1.65	18.7	0.54	2.19	15.3	0.57	2.54	11.7	0.61	3.08	9.4	0.65	3.61	7.9	0.70	3.99	6.4	0.74	4.62	5.3	0.80	5.18
20	49.2	0.47	1.26	35.3	0.50	1.66	24.9	0.54	2.19	20.4	0.57	2.54	15.6	0.61	3.08	12.5	0.65	3.65	10.4	0.68	4.17	8.5	0.74	4.70	7.1	0.80	5.16
25	61.2	0.47	1.27	44.0	0.50	1.67	31.0	0.54	2.21	25.4	0.57	2.56	19.4	0.61	3.12	15.6	0.65	3.67	13.0	0.68	4.17	10.6	0.73	4.75	8.8	0.79	5.32
30	73.2	0.47	1.28	52.8	0.50	1.67	37.2	0.54	2.19	30.4	0.57	2.57	23.3	0.61	3.10	18.7	0.65	3.67	15.4	0.68	4.17	12.7	0.73	4.77	10.5	0.78	5.41
35	85.1	0.47	1.28	61.2	0.50	1.68	43.2	0.54	2.21	35.3	0.57	2.59	27.1	0.61	3.12	21.7	0.64	3.72	18.1	0.68	4.23	14.8	0.73	4.78	12.2	0.77	5.48
40	96.9	0.47	1.28	69.7	0.50	1.68	49.3	0.54	2.21	40.3	0.57	2.59	30.9	0.61	3.13	24.8	0.64	3.71	20.7	0.68	4.20	16.9	0.73	4.78	13.9	0.77	5.53
45	108.6	0.47	1.29	78.1	0.51	1.68	55.3	0.54	2.22	45.2	0.57	2.60	34.6	0.61	3.16	27.8	0.64	3.73	23.2	0.68	4.24	19.0	0.73	4.78	15.7	0.78	5.45
50	120.2	0.48	1.29	86.5	0.50	1.69	61.2	0.54	2.23	50.0	0.57	2.62	38.4	0.61	3.15	30.9	0.65	3.71	25.8	0.68	4.21	21.0	0.73	4.84	17.4	0.78	5.48
55	131.8	0.48	1.30	94.9	0.51	1.70	67.1	0.54	2.24	54.9	0.57	2.62	42.1	0.61	3.17	33.9	0.65	3.73	28.3	0.68	4.23	23.1	0.73	4.83	19.1	0.78	5.50
60	143.2	0.48	1.30	103.1	0.51	1.70	73.0	0.54	2.24	59.7	0.57	2.62	45.9	0.61	3.16	36.9	0.65	3.73	30.8	0.68	4.24	25.1	0.73	4.87	20.8	0.78	5.51
65	154.6	0.48	1.30	111.4	0.51	1.71	78.9	0.54	2.24	64.5	0.57	2.63	49.6	0.61	3.16	39.9	0.65	3.74	33.3	0.68	4.25	27.2	0.73	4.85	22.5	0.78	5.52
70	165.9	0.48	1.31	119.5	0.51	1.71	84.7	0.54	2.25	69.3	0.57	2.63	53.2	0.61	3.19	42.8	0.64	3.76	35.8	0.68	4.26	29.2	0.73	4.88	24.1	0.77	5.59
75	177.1	0.48	1.31	127.6	0.51	1.72	90.5	0.54	2.25	74.1	0.57	2.63	56.9	0.61	3.19	45.8	0.65	3.78	38.2	0.68	4.29	31.2	0.73	4.90	25.8	0.77	5.59
80	188.2	0.48	1.32	135.6	0.51	1.72	96.2	0.54	2.26	78.8	0.57	2.64	60.5	0.61	3.20	48.7	0.64	3.78	40.7	0.68	4.29	33.3	0.73	4.87	27.5	0.77	5.58
90	210.9	0.48	1.32	152.1	0.51	1.73	108.0	0.54	2.26	88.4	0.57	2.65	67.9	0.61	3.21	54.7	0.65	3.78	45.7	0.68	4.29	37.4	0.73	4.88	30.9	0.77	5.59
100	233.5	0.48	1.32	168.4	0.51	1.73	119.6	0.55	2.27	98.0	0.57	2.65	75.3	0.61	3.21	60.7	0.65	3.78	50.6	0.68	4.32	41.4	0.73	4.92	34.2	0.77	5.64
110	255.9	0.48	1.33	184.6	0.51	1.74	131.2	0.55	2.28	107.5	0.57	2.66	82.6	0.61	3.22	66.6	0.65	3.79	55.6	0.68	4.32	45.5	0.73	4.91	37.6	0.77	5.63
120	278.1	0.48	1.33	200.7	0.51	1.74	142.7	0.55	2.28	116.9	0.57	2.67	89.9	0.61	3.22	72.5	0.65	3.79	60.5	0.68	4.33	49.5	0.73	4.93	40.9	0.77	5.66
130	300.2	0.48	1.34	216.6	0.51	1.75	154.1	0.55	2.29	126.4	0.57	2.67	97.1	0.61	3.24	78.3	0.65	3.81	65.4	0.68	4.34	53.6	0.73	4.92	44.3	0.77	5.64
140	322.1	0.48	1.34	232.5	0.51	1.76	165.5	0.55	2.29	135.7	0.57	2.67	104.4	0.62	3.23	84.2	0.65	3.81	70.3	0.68	4.34	57.6	0.73	4.93	47.6	0.77	5.66
150	343.9	0.48	1.34	248.3	0.51	1.76	176.8	0.55	2.30	145.0	0.57	2.68	111.5	0.61	3.25	90.0	0.65	3.82	75.2	0.68	4.35	61.6	0.73	4.94	50.9	0.77	5.67
160	365.5	0.48	1.35	264.0	0.51	1.76	188.1	0.55	2.30	154.3	0.57	2.68	118.7	0.62	3.25	95.8	0.65	3.82	80.0	0.68	4.36	65.6	0.73	4.94	54.2	0.77	5.68
170	386.9	0.48	1.35	279.6	0.51	1.77	199.3	0.55	2.31	163.5	0.57	2.69	125.8	0.62	3.26	101.6	0.65	3.82	84.8	0.68	4.37	69.5	0.73	4.97	57.5	0.77	5.69
180	408.2	0.48	1.36	295.1	0.51	1.77	210.6	0.55	2.31	172.7	0.57	2.69	132.8	0.62	3.27	107.3	0.65	3.84	89.7	0.68	4.38	73.5	0.73	4.98	60.8	0.77	5.69
190	429.3	0.48	1.36	310.5	0.51	1.78	221.4	0.55	2.32	181.8	0.57	2.70	139.9	0.62	3.27	113.0	0.65	3.84	94.4	0.68	4.38	77.4	0.73	4.98	64.0	0.77	5.71
200	450.2	0.48	1.36	325.7	0.51	1.78	232.4	0.55	2.32	190.8	0.57	2.71	146.9	0.62	3.28	118.7	0.65	3.85	99.2	0.68	4.39	81.4	0.73	4.97	67.3	0.77	5.71
220	493.4	0.48	1.37	357.1	0.51	1.79	254.9	0.55	2.33	209.4	0.58	2.71	161.1	0.62	3.29	130.3	0.65	3.85	108.9	0.68	4.39	89.3	0.73	4.99	75.9	0.77	5.72
240	536.2	0.48	1.37	388.3	0.51	1.79	277.3	0.55	2.34	227.8	0.58	2.71	173.4	0.62	3.29	141.8	0.65	3.86	118.6	0.68	4.40	97.3	0.74	4.99	80.5	0.77	5.72
260	578.8	0.48	1.38	419.3	0.51	1.80	299.5	0.55	2.34	246.2	0.58	2.72	189.5	0.62	3.30	153.3	0.65	3.87	128.2	0.68	4.40	105.2	0.74	5.00	87.0	0.77	5.74
280	621.1	0.48	1.38	450.1	0.51	1.80	321.6	0.55	2.35	264.4	0.58	2.72	203.6	0.62	3.31	164.8	0.65	3.87	137.8	0.68	4.41	113.1	0.74	5.00	93.5	0.77	5.75
300	663.1	0.48	1.39	480.7	0.51	1.81	343.6	0.55	2.35	282.6	0.58	2.73	217.6	0.62	3.31	176.1	0.65	3.88	147.4	0.68	4.41	120.9	0.74	5.02	100.1	0.78	5.75

Parabolic waterway design
(Retardance "B" and "C")

152

205

205

V_1 for RETARDANCE "D". Top Width (T), Depth (D) and V_2 for RETARDANCE "C".

Grade 10.0 Percent

Q cfs	$V_1 = 2.0$			$V_1 = 2.5$			$V_1 = 3.0$			$V_1 = 3.5$			$V_1 = 4.0$			$V_1 = 4.5$			$V_1 = 5.0$			$V_1 = 5.5$			$V_1 = 6.0$		
	T	D	V_2	T	D	V_2	T	D	V_2	T	D	V_2	T	D	V_2	T	D	V_2	T	D	V_2	T	D	V_2	T	D	V_2
15	45.2	0.43	1.14	32.5	0.45	1.50	22.9	0.49	1.98	16.6	0.52	2.56	13.4	0.55	2.99	10.7	0.58	3.55	9.0	0.61	3.99	7.4	0.65	4.57	6.2	0.70	5.08
20	60.1	0.43	1.14	43.2	0.45	1.50	30.4	0.49	2.00	22.1	0.52	2.56	17.8	0.55	3.02	14.3	0.59	3.52	12.0	0.61	4.00	9.9	0.65	4.55	8.3	0.70	5.06
25	74.8	0.43	1.15	53.8	0.45	1.51	37.9	0.49	2.00	27.5	0.52	2.59	22.3	0.55	2.99	17.8	0.58	3.56	14.9	0.61	4.08	12.3	0.65	4.63	10.3	0.69	5.18
30	89.3	0.43	1.15	64.2	0.45	1.52	45.3	0.49	2.01	33.0	0.52	2.58	26.6	0.55	3.03	21.3	0.58	3.58	17.9	0.61	4.05	14.7	0.64	4.68	12.4	0.70	5.13
35	103.7	0.43	1.16	74.6	0.45	1.53	52.6	0.48	2.03	38.3	0.52	2.60	31.0	0.55	3.02	24.8	0.58	3.59	20.8	0.61	4.09	17.2	0.65	4.63	14.4	0.69	5.19
40	118.0	0.43	1.16	85.0	0.46	1.53	59.9	0.48	2.04	43.7	0.52	2.60	35.3	0.55	3.04	28.3	0.58	3.59	23.8	0.61	4.06	19.6	0.65	4.66	16.4	0.69	5.24
45	132.2	0.43	1.17	95.2	0.45	1.53	67.2	0.49	2.04	49.0	0.52	2.61	39.6	0.55	3.05	31.7	0.58	3.62	26.7	0.61	4.08	22.0	0.65	4.68	18.4	0.69	5.27
50	146.3	0.43	1.17	105.3	0.45	1.54	74.4	0.49	2.04	54.3	0.52	2.61	43.9	0.55	3.05	35.2	0.58	3.61	29.6	0.61	4.09	24.4	0.65	4.68	20.4	0.69	5.28
55	160.2	0.43	1.17	115.4	0.46	1.55	81.5	0.49	2.06	59.5	0.52	2.63	48.2	0.55	3.05	38.6	0.58	3.62	32.4	0.61	4.13	26.7	0.64	4.74	22.4	0.69	5.29
60	174.0	0.43	1.18	125.3	0.46	1.55	88.6	0.49	2.06	64.7	0.52	2.63	52.4	0.55	3.07	42.0	0.58	3.63	35.3	0.61	4.12	29.1	0.65	4.73	24.4	0.69	5.30
65	187.6	0.43	1.18	135.2	0.46	1.56	95.6	0.49	2.07	69.9	0.52	2.64	56.6	0.55	3.08	45.4	0.58	3.64	38.2	0.61	4.12	31.5	0.65	4.72	26.4	0.69	5.30
70	201.2	0.43	1.19	145.0	0.46	1.57	102.6	0.49	2.08	75.1	0.52	2.64	60.8	0.55	3.08	48.7	0.58	3.66	41.0	0.61	4.14	33.8	0.65	4.75	28.4	0.69	5.29
75	214.6	0.43	1.19	154.7	0.46	1.57	109.6	0.49	2.08	80.2	0.52	2.65	65.0	0.55	3.08	52.1	0.58	3.66	43.8	0.61	4.15	36.2	0.65	4.74	30.3	0.69	5.34
80	227.9	0.43	1.20	164.3	0.46	1.58	116.4	0.49	2.09	85.3	0.52	2.65	69.1	0.55	3.09	55.4	0.58	3.67	46.6	0.61	4.16	38.5	0.65	4.76	32.3	0.69	5.33
90	255.2	0.43	1.20	184.1	0.46	1.58	130.5	0.49	2.10	95.6	0.52	2.67	77.5	0.55	3.11	62.1	0.58	3.69	52.3	0.61	4.17	43.2	0.65	4.78	36.3	0.69	5.33
100	282.4	0.43	1.20	203.7	0.46	1.59	144.5	0.49	2.10	105.9	0.52	2.67	85.9	0.56	3.11	68.8	0.58	3.70	58.0	0.61	4.18	47.9	0.65	4.78	40.2	0.69	5.36
110	309.2	0.43	1.21	223.2	0.46	1.60	158.4	0.49	2.11	116.2	0.52	2.68	94.3	0.56	3.11	75.5	0.58	3.71	63.7	0.61	4.18	52.6	0.65	4.79	44.2	0.69	5.34
120	335.9	0.43	1.21	242.4	0.46	1.60	172.2	0.49	2.12	126.4	0.52	2.68	102.5	0.56	3.12	82.2	0.58	3.71	69.3	0.61	4.19	57.3	0.65	4.79	48.1	0.69	5.36
130	362.3	0.43	1.22	261.6	0.46	1.61	185.9	0.49	2.12	136.5	0.52	2.69	110.8	0.56	3.13	88.8	0.58	3.72	74.9	0.61	4.20	61.9	0.65	4.81	52.0	0.69	5.37
140	388.4	0.44	1.22	280.5	0.46	1.61	199.5	0.49	2.13	146.5	0.52	2.70	119.0	0.56	3.13	95.4	0.58	3.73	80.5	0.61	4.20	66.5	0.65	4.82	55.9	0.69	5.38
150	414.4	0.44	1.23	299.3	0.46	1.62	213.0	0.49	2.13	156.5	0.52	2.71	127.1	0.56	3.14	101.9	0.58	3.74	86.0	0.61	4.22	71.1	0.65	4.83	59.7	0.69	5.41
160	440.1	0.44	1.23	318.1	0.46	1.62	226.5	0.49	2.14	166.4	0.53	2.71	135.2	0.56	3.15	108.4	0.58	3.75	91.6	0.62	4.21	75.7	0.65	4.83	63.6	0.69	5.41
170	465.5	0.44	1.24	336.7	0.46	1.63	239.8	0.49	2.14	176.3	0.53	2.72	143.3	0.56	3.15	114.9	0.58	3.76	97.1	0.62	4.22	80.3	0.65	4.83	67.4	0.69	5.42
180	490.8	0.44	1.24	355.1	0.46	1.63	253.1	0.49	2.15	186.1	0.53	2.73	151.3	0.56	3.16	121.3	0.58	3.77	102.5	0.62	4.24	84.9	0.65	4.83	71.3	0.69	5.42
190	515.7	0.44	1.25	373.5	0.46	1.64	266.3	0.49	2.15	195.9	0.53	2.73	159.3	0.56	3.17	127.7	0.58	3.78	108.0	0.62	4.24	89.4	0.65	4.84	75.1	0.69	5.43
200	540.5	0.44	1.25	391.6	0.46	1.64	279.4	0.49	2.16	205.6	0.53	2.74	167.2	0.56	3.17	134.1	0.58	3.79	113.4	0.62	4.25	93.9	0.65	4.85	78.9	0.69	5.43
220	592.0	0.44	1.26	429.2	0.46	1.65	306.3	0.49	2.17	225.4	0.53	2.75	183.5	0.56	3.18	147.1	0.58	3.80	124.4	0.62	4.26	103.1	0.65	4.85	86.6	0.69	5.45
240	643.0	0.44	1.26	466.4	0.46	1.65	333.1	0.49	2.17	245.2	0.53	2.75	199.6	0.56	3.19	160.0	0.58	3.81	135.4	0.62	4.27	112.2	0.65	4.87	94.3	0.69	5.45
260	693.6	0.44	1.27	503.4	0.46	1.66	359.6	0.49	2.18	264.8	0.53	2.76	215.6	0.56	3.19	172.9	0.58	3.82	146.4	0.62	4.27	121.3	0.65	4.87	101.9	0.69	5.47
280	743.7	0.44	1.27	540.0	0.46	1.66	386.0	0.49	2.18	284.4	0.53	2.77	231.6	0.56	3.20	185.8	0.59	3.82	157.3	0.62	4.28	130.4	0.65	4.88	109.6	0.69	5.47
300	793.4	0.44	1.28	576.4	0.46	1.67	412.3	0.49	2.19	303.8	0.53	2.77	247.5	0.56	3.21	198.6	0.59	3.83	168.1	0.62	4.29	139.4	0.65	4.89	117.2	0.69	5.48

Parabolic waterway design
(Retardance "D" and "C")



STONE CENTER WATERWAY

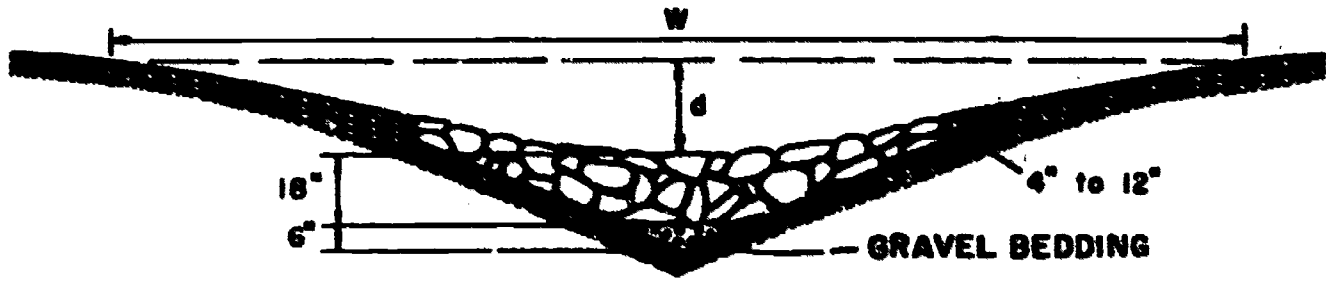

Waterway with stone center drain
V section shaped by motor patrol

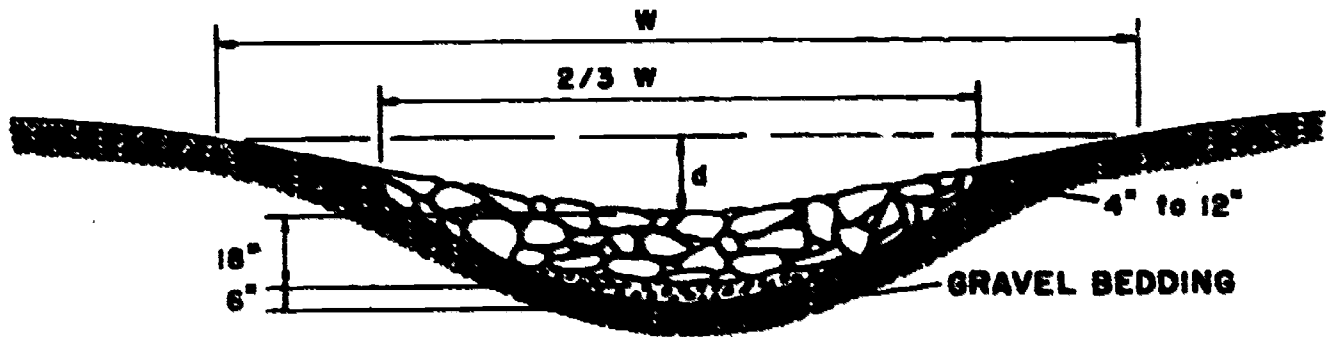

Waterway with stone center drain
Rounded section shaped by bulldozer

Waterway with stone center

PARABOLIC STONE CENTER WATERWAY

RETARDANCE - C
GRADE, %- 6, 8, 10, 12, 15

Velocity, Top Width and Depth Based on Retardance "C"

V	Grade 6 Percent		Grade 8 Percent		Grade 10 Percent		Grade 12 Percent		Grade 15 Percent	
	8.0	10	8.0	10.0	8.0	10.0	8.0	10.0	8.0	10.0
D	1.3	1.6	1.1	1.3	1.0	1.2	0.9	1.1	0.8	0.9
Q	Top Widths									
20							5		5	
25					5		6		6	4
30			5		6		7		7	5
35			6		7		8	5	8	6
40	6		7		8	5	9	6	10	7
45	7		8		9	6	10	6	11	7
50	7		9	6	10	7	11	7	12	8
55	8		9	6	11	7	12	8	13	9
60	9		10	7	12	8	13	8	14	9
65	9		11	7	12	9	14	9	16	11
70	10	7	12	8	13	9	15	10	17	11
75	11	7	13	9	14	10	16	10	18	12
80	12	8	14	9	15	10	18	11	19	13
90	13	9	15	10	17	12	20	13	21	15
100	14	10	17	11	19	13	22	14	24	16
110	16	11	19	13	21	14	24	15	26	18
120	17	11	21	14	23	16	26	17	29	20
130	19	12	22	15	25	17	29	18	31	21
140	20	13	24	16	27	18	31	19	33	23
150	22	14	26	17	29	20	33	21	36	24
160	23	15	27	18	31	21	35	22	38	26
170	25	16	29	19	33	22	37	24	40	28
180	26	17	31	20	34	23	39	25	43	29
190	27	18	32	22	36	25	42	26	45	31
200	29	19	34	23	38	26	44	28	47	33
220	32	21	38	25	42	29	48	31	52	38
240	35	23	41	27	46	31	53	33	57	39
260	38	25	44	30	50	34	57	36	62	42
280	40	27	48	32	54	36	61	39	67	45
300	43	29	51	34	57	39	66	42	71	49

155

June 1978
Appendix B-4.2

U. S. DEPARTMENT OF AGRICULTURE
SOIL CONSERVATION SERVICE

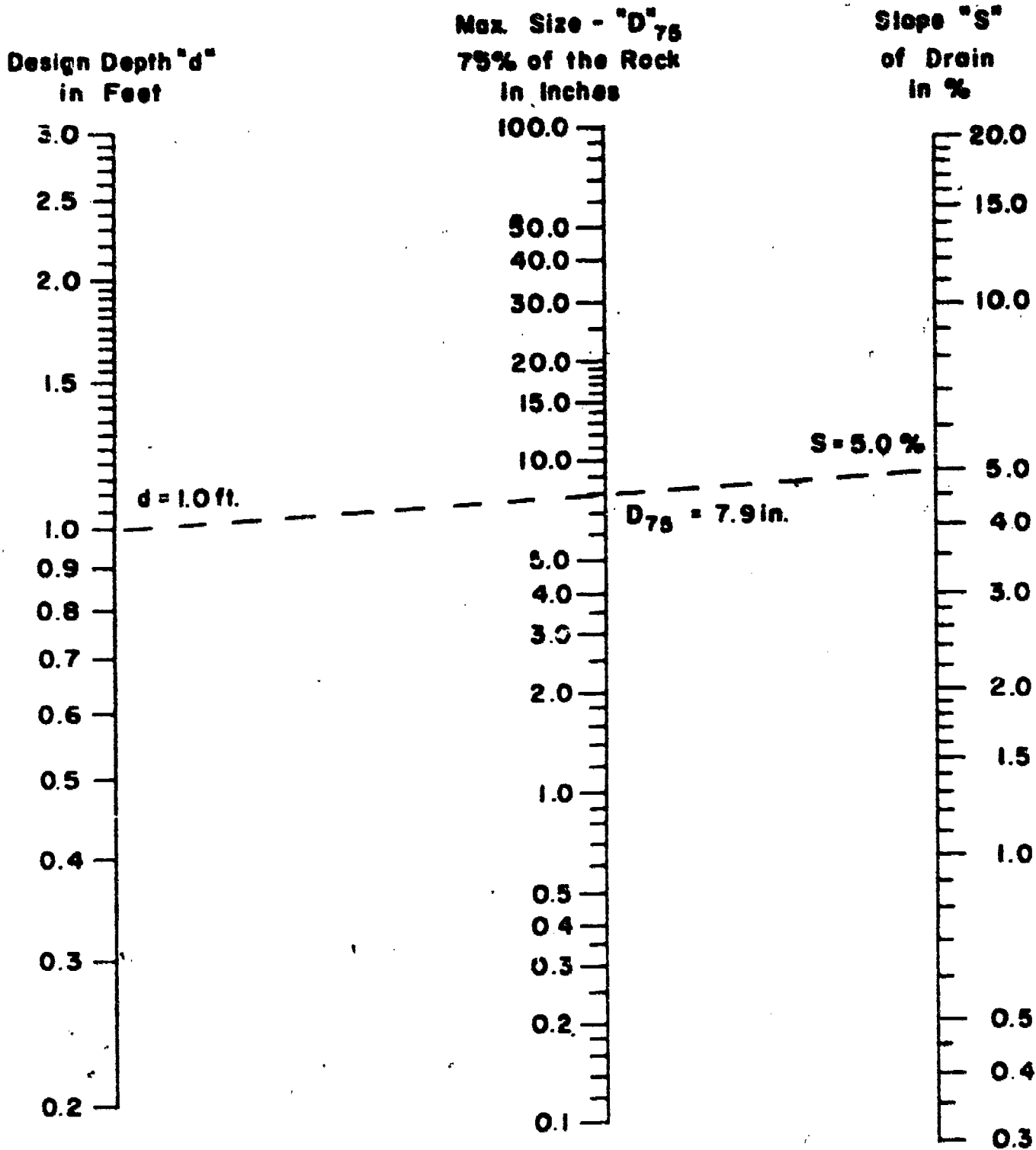

EXAMPLE: "d" = 1.0 Feet "S" = 5 %

Place straight edge at "d" value in Design Depth column and at "S" value in Slope column. Read rock size in middle column 7.9 inches. Say 8 inches.

FOR DESIGN:

25 % of the rock by volume should be in sizes of: 8 inches or slightly larger. The remaining 75 % or less should be of well graded material, smaller than 8 inches, including sufficient sands and gravels to fill the voids between the larger rock.

Determination of rock size for stone center waterway

TEMPORARY SEDIMENT BASIN DESIGN DATA SHEET

Computed by _____ Date _____
Checked by _____ Date _____

Project _____

Basin Number _____; Location _____

Total Drainage Area _____ Acres; Disturbed Area _____ Acres

SEDIMENT STORAGE DESIGN

1. Disturbed Area _____ (Ac) x 200 (cy/Ac) = _____ Sed. vol. allocated for Dist. Area (cy)
2. Allocated Sediment Volume for other actively Eroding Areas in Dr. Area _____ (cy)
3. Allocated Sed. Vol. for Disturbed Area _____ (cy) + Other _____ (cy) = Design Sed. Vol. _____ (cy)
4. Elevation in Sediment Pool when clean out is required _____; Distance below riser crest _____ ft.

PIPE SPILLWAY DESIGN

5. Design Frq. _____ (yr). Design Duration 24 (hr); Inflow (Qi) _____ cfs (Peak)
6. Vol. Runoff (Vr) _____ Ac.ft. = Vol. Runoff _____ inches X Dr. Area _____ Acres ÷ 12
7. Vol. Storage (Vs) _____ Ac.ft. = Surface Area _____ Ac. X Storage Height (Hs) _____ ft.
8. Vs/Vr = _____ / _____ = _____
9. Qo/Qi = _____ (From Appendix B-5.4)
10. Qo _____ cfs = Qo/Qi X Qi _____ cfs
11. Head-on Pipe _____ ft. = Hs _____ ft. + (Crest El. Riser _____ - El. Pipe Outlet _____)
12. Pipe Barrel: Diam. _____ inches (From Appendix B-5.5&6); Type Material _____
13. Riser Size: Diam. _____ inches (Min. Area of Riser = 1.3 X Area Barrel)

EMERGENCY SPILLWAY DESIGN

14. Design Freq. _____ Yr; Design Duration 24 hr.; Runoff Vol. _____ inches, Peak Inflow _____ cfs
15. Design Discharge _____ cfs = Peak Inflow _____ cfs - Pipe Discharge _____ cfs
16. Bottom Width _____ ft; Hp _____ ft; Length Level Sect. 20 ft.
Min. Length Exit Section (X) _____ ft; Velocity (V) _____ FPS (Appendix B-5.8 thru 5.11)

DESIGN ELEVATIONS

17. Riser Crest _____; Centerline Pipe Spillway Outlet _____
Em. Spl Crest _____; Design High Water _____
Settled Top of Dam _____; Constructed Top of Dam _____

CUTOFF COLLAR DATA

18. No. Collars _____; Projection _____ ft.; Spacing _____ ft.

ANTI VORTEX DEVICE DATA

19. Height _____ ft.; Length _____ ft.

INSTRUCTIONS FOR USE OF TEMPORARY SEDIMENT BASIN
DESIGN DATA SHEET

1. The minimum required sediment volume from the disturbed area is 200 cubic yards per acre or 0.125 acre feet per acre.
2. Any actively eroding areas outside the disturbed area but within the drainage area must be evaluated with regard to sediment yield. This will be accomplished by estimates or special studies. In most stable watersheds this volume will be zero.
3. The design sediment volume is obtained by adding the sediment volumes calculated in steps 1 and 2.
4. The basin must be cleaned out when sediment reduces the design volume to 60% capacity. This elevation and other vertical distance below the crest of the riser will depend on the geometry of the site.
5. The design frequency is 10 year for Class 1 Basins and 2 year for Class 2 & 3 Basins. It is recommended that the runoff volume and peak inflow be determined using the SCS, Engineering Field Manual for Conservation Practices.
6. Convert runoff volume from watershed inches to acre feet.
7. Select a vertical interval between the riser crest and emergency spillway crest; then calculate the volume of flood storage V_s by multiplying this value by the surface area of the sediment pool (Riser Crest).
8. Calculate the percentage of the total runoff that will be temporarily stored below the crest of the emergency spillway. This will be used in Step 9.
9. From Appendix B-5.4 find the required pipe outflow to peak inflow ratio. This procedure is approximate, but it is satisfactory for structure proportioning when the pipe spillway primes at or below the crest of the emergency spillway.
10. Using values obtained in Steps 5 & 9, calculate the minimum required pipe discharge.
11. Determine the head on the pipe which is the vertical interval between the centerline of the pipe outlet and the crest of the emergency spillway. (Free outlet condition assumed).
12. Using Appendix B-5.5 or 5.6 determine the minimum size of the pipe barrel. If this size pipe is not satisfactory, change H_s and repeat steps 7 thru 12.
13. Determine riser size. In order to assure that the pipe will prime the cross-sectional area of the riser must be at least 1.3 that of the pipe barrel. The riser must also be adequate to prime the pipe at or below the crest elevation of the emergency spillway (Refer to Appendix B-5.7). This step is deleted when a hooded inlet is used.
14. Use only for Class 2 & 3 basins. For drainage areas 20 acres or less use 10-yr. frequency, and for drainage areas greater than 20 acres and less than 100 acres use 25-year frequency. Use same references for determining runoff and peak inflow as were used in Step 5.
15. Determine emergency spillway design capacity by subtracting pipe spillway flow from the peak inflow rate.
16. Proportion emergency spillway using Appendix B-5.8 thru 5.11.
17. Record design elevations. The design high water elevation is equal to the elevation of the emergency spillway crest elevation plus H_p . The settled top of dam shall be at least 1 foot (freeboard) above the design high water elevation. Add a 10% minimum allowance for settlement to determine the constructed top of the dam.
18. Determine number, spacing and projection of cutoff collars using procedure on page III K-5.
19. The minimum length of the antivortex plate shall be the diameter of the riser plus 1 foot, and the minimum height pipe barrel diameter. When hooded inlet is used refer to Appendix B-5.12.

SEDIMENT BASIN COMPONENTS

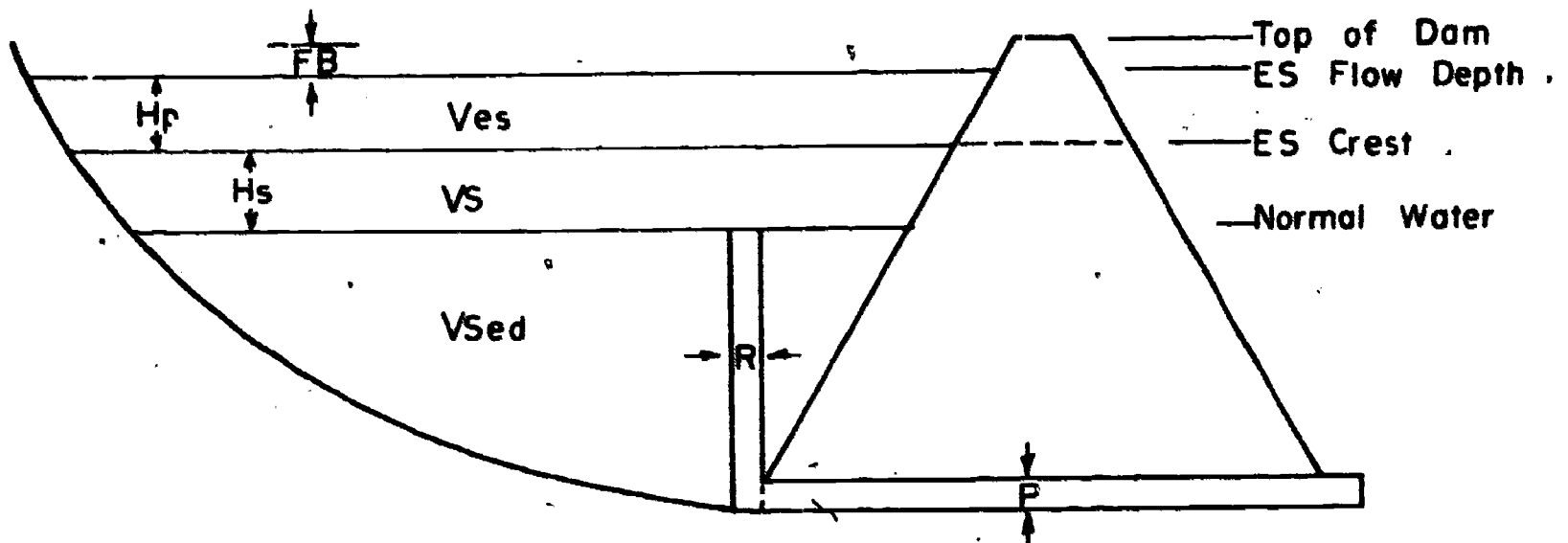

Profile Thru Dam

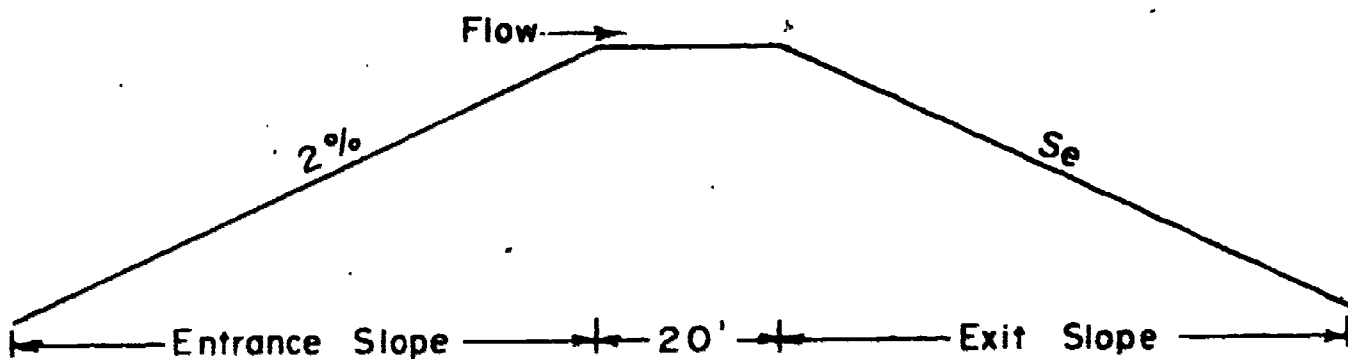

Profile Thru Emergency Spillway

Legend

- $V_{sed.}$ = Design volume of sediment (ac.ft.)
- V_s = Volume of flood storage below crest of emergency spillway (ac.ft.)
- V_{es} = Volume of flood storage above crest of emergency spillway (ac.ft.)
- H_p = Difference in elevation between the crest of emergency spillway and the design water surface in the reservoir (ft.)
- H_s = Difference in elevation between the pipe spillway inlet and the crest of the emergency spillway.
- FB = Freeboard (ft.)
- P = Pipe conduit diameter (in.)
- R = Riser diameter (in.)
- BW = Bottom width emergency spillway (ft.)
- Se = Exit slope of emergency spillway (percent)

PIPE SPILLWAY DISCHARGE ALLOWING
FOR TEMPORARY STORAGE

Vs/Vr	$\frac{Q_0}{Q_1}$									
	0.00	.01	.02	.03	.04	.05	.06	.07	.08	.09
0.0	1.00	0.99	0.98	0.96	0.95	0.94	0.92	0.91	0.90	0.88
0.1	0.87	0.85	0.84	0.82	0.81	0.79	0.78	0.76	0.74	0.73
0.2	0.72	0.70	0.68	0.67	0.65	0.64	0.62	0.61	0.60	0.58
0.3	0.57	0.55	0.54	0.52	0.51	0.50	0.49	0.47	0.46	0.45
0.4	0.44	0.43	0.42	0.41	0.40	0.39	0.38	0.37	0.36	0.35
0.5	0.34	0.33	0.32	0.31	0.30	0.29	0.28	0.27	0.27	0.26
0.6	0.25	0.24	0.23	0.23	0.22	0.21	0.20	0.20	0.19	0.18
0.7	0.18	0.17	0.16	0.15	0.15	0.14	0.14	0.13	0.12	0.12
0.8	0.11	0.11	0.10	0.09	0.09	0.08	0.08	0.07	0.07	0.06
0.9	0.05	0.05	0.04	0.04	0.03	0.03	0.02	0.02	0.01	0.01

Basic equation: $\frac{V_s}{V_r} = 1 - 2\left(\frac{Q_0}{Q_1}\right) + 1.8\left(\frac{Q_0}{Q_1}\right)^2 - 0.8\left(\frac{Q_0}{Q_1}\right)^3$

Where: V_s = Volume of temporary storage, Ac-Ft.
 V_r = Volume of runoff, Ac-Ft.
 Q_0 = Required principal spillway discharge, cfs
 Q_1 = Peak flow from design storm, cfs

EXAMPLE:

Given: $V_s = 8.0$ Ac-Ft.
 $V_r = 12.0$ Ac-Ft.
 $Q_1 = 75$ c.f.s.

Find: Q_0

Solution: $\frac{V_s}{V_r} = \frac{8.0}{12.0} = 0.67$

$\frac{Q_0}{Q_1} = 0.20$ (from table)

$Q_0 = 0.20 \times Q_1$
 $= 0.20 \times 75 = \underline{15.0}$ c.f.s.

NOTE: This procedure is approximate but gives reliable values where pipe spillway primes at or below the crest of the emergency spillway.

PIPE FLOW CHART (Full flow assumed)

For Corrugated Metal Pipe Inlet $K_e + K_b = 1.0$ and 70 feet of Corrugated Metal Pipe Conduit $n = 0.025$. Note correction factors for other pipe lengths.

Di. H	12"	15"	18"	21"	24"	30"	36"	42"
2	2.84	4.92	7.73	11.30	15.60	26.60	40.77	58.12
3	3.48	6.03	9.47	13.84	19.10	32.58	49.93	71.19
4	4.02	6.96	10.94	15.98	22.06	37.62	57.66	82.20
5	4.49	7.78	12.23	17.87	24.66	42.06	64.46	91.90
6	4.92	8.52	13.40	19.57	27.01	46.07	70.60	100.65
7	5.32	9.21	14.47	21.14	29.19	49.77	76.28	108.75
8	5.68	9.84	15.47	22.60	31.19	53.19	81.53	116.23
9	6.03	10.44	16.41	23.97	33.09	56.43	86.49	123.30
10	6.36	11.00	17.30	25.26	34.88	59.48	91.16	129.96
11	6.67	11.54	18.14	26.50	36.59	62.39	95.63	136.33
12	6.96	12.05	18.95	27.68	38.21	65.16	99.87	142.37
13	7.25	12.55	19.72	28.81	39.77	67.83	103.96	148.21
14	7.52	13.02	20.47	29.90	41.27	70.39	107.88	153.80
15	7.78	13.48	21.19	30.95	42.72	72.85	111.66	159.18
16	8.04	13.92	21.88	31.96	44.12	75.24	115.32	164.40
17	8.29	14.35	22.55	32.94	45.48	77.55	118.87	169.46
18	8.53	14.77	23.21	33.90	46.80	79.81	122.33	174.39
19	8.76	15.17	23.84	34.83	48.08	81.99	125.67	179.15
20	8.99	15.56	24.46	35.73	49.33	84.12	128.93	183.80
21	9.21	15.95	25.07	36.62	50.55	86.21	132.13	188.36
22	9.43	16.32	25.65	37.47	51.73	88.22	135.21	192.76
23	9.64	16.69	26.23	38.32	52.90	90.21	138.27	197.12
24	9.85	17.05	26.80	39.14	54.04	92.15	141.24	201.35
25	10.05	17.40	27.35	39.95	55.15	94.05	144.15	205.50
L	Correction Factors For Other Pipe Lengths							
40	1.23	1.22	1.20	1.19	1.16	1.14	1.13	1.11
50	1.14	1.13	1.12	1.11	1.10	1.09	1.08	1.07
60	1.07	1.06	1.06	1.05	1.05	1.04	1.04	1.03
70	1.00	1.00	1.00	1.00	1.00	1.00	1.00	1.00
80	0.95	0.95	0.95	0.96	0.96	0.96	0.97	0.97
90	0.90	0.91	0.91	0.92	0.92	0.93	0.94	0.94
100	0.86	0.87	0.88	0.89	0.89	0.90	0.91	0.92

Pipe flow chart for corrugated metal pipe drop inlet spillway

PIPE FLOW CHART (Full Pipe flow assumed)

For R/C Drop Inlet, $K_e + K_b = 0.65$ with 70 feet of R/C conduit, $n = .013$. Note correction factors for other pipe lengths.

Dia. H	12"	15"	18"	21"	24"	30"	36"	42"
2	4.54	8.01	11.74	16.60	22.44	36.74	54.65	76.02
3	5.56	9.81	14.39	20.33	27.49	45.00	66.94	93.11
4	6.42	11.33	16.61	23.48	31.74	51.96	77.30	107.52
5	7.18	12.66	18.57	26.25	35.49	58.09	86.42	120.21
6	7.87	13.86	20.34	28.75	38.87	63.63	94.65	131.66
7	8.50	14.98	21.98	31.06	41.99	68.74	102.27	142.25
8	9.08	16.01	23.49	33.20	44.88	73.47	109.30	152.03
9	9.64	17.00	24.92	35.22	47.61	77.94	115.95	161.28
10	10.16	17.91	26.26	37.12	50.18	82.15	122.21	169.99
11	10.65	18.78	27.55	38.94	52.64	86.18	128.20	178.32
12	11.13	19.62	28.77	40.67	54.97	89.99	133.88	186.22
13	11.58	20.42	29.95	42.33	57.23	93.68	139.37	193.86
14	12.01	21.18	31.07	43.93	59.37	97.19	144.59	201.12
15	12.44	21.93	32.17	45.47	61.46	100.62	149.69	208.21
16	12.85	22.65	33.22	46.96	63.48	103.92	154.60	215.04
17	13.24	23.35	34.24	48.40	65.43	107.12	159.35	221.65
18	13.63	24.03	35.24	49.81	67.34	110.23	163.99	228.10
19	14.00	24.68	36.21	51.17	69.18	113.25	168.48	234.34
20	14.36	25.32	37.14	52.50	70.97	116.18	172.84	240.41
21	14.72	25.95	38.07	53.80	72.73	119.07	177.13	246.38
22	15.06	26.56	38.96	55.06	74.43	121.85	181.27	252.13
23	15.40	27.16	39.84	56.31	76.11	124.60	185.36	257.83
24	15.73	27.74	40.69	57.51	77.75	127.28	189.35	263.37
25	16.06	28.32	41.53	58.70	79.35	129.90	193.25	268.80
L	Correction Factors For Other Pipe Lengths							
40	1.15	1.13	1.11	1.09	1.08	1.06	1.06	1.05
50	1.09	1.08	1.07	1.06	1.05	1.04	1.04	1.03
60	1.04	1.04	1.04	1.03	1.03	1.02	1.02	1.02
70	1.00	1.00	1.00	1.00	1.00	1.00	1.00	1.00
80	0.96	0.96	0.97	0.97	0.98	0.98	0.98	0.99
90	0.93	0.94	0.94	0.95	0.95	0.96	0.97	0.97
100	0.90	0.91	0.92	0.93	0.93	0.95	0.95	0.96

Pipe flow chart for concrete pipe drop inlet spillway

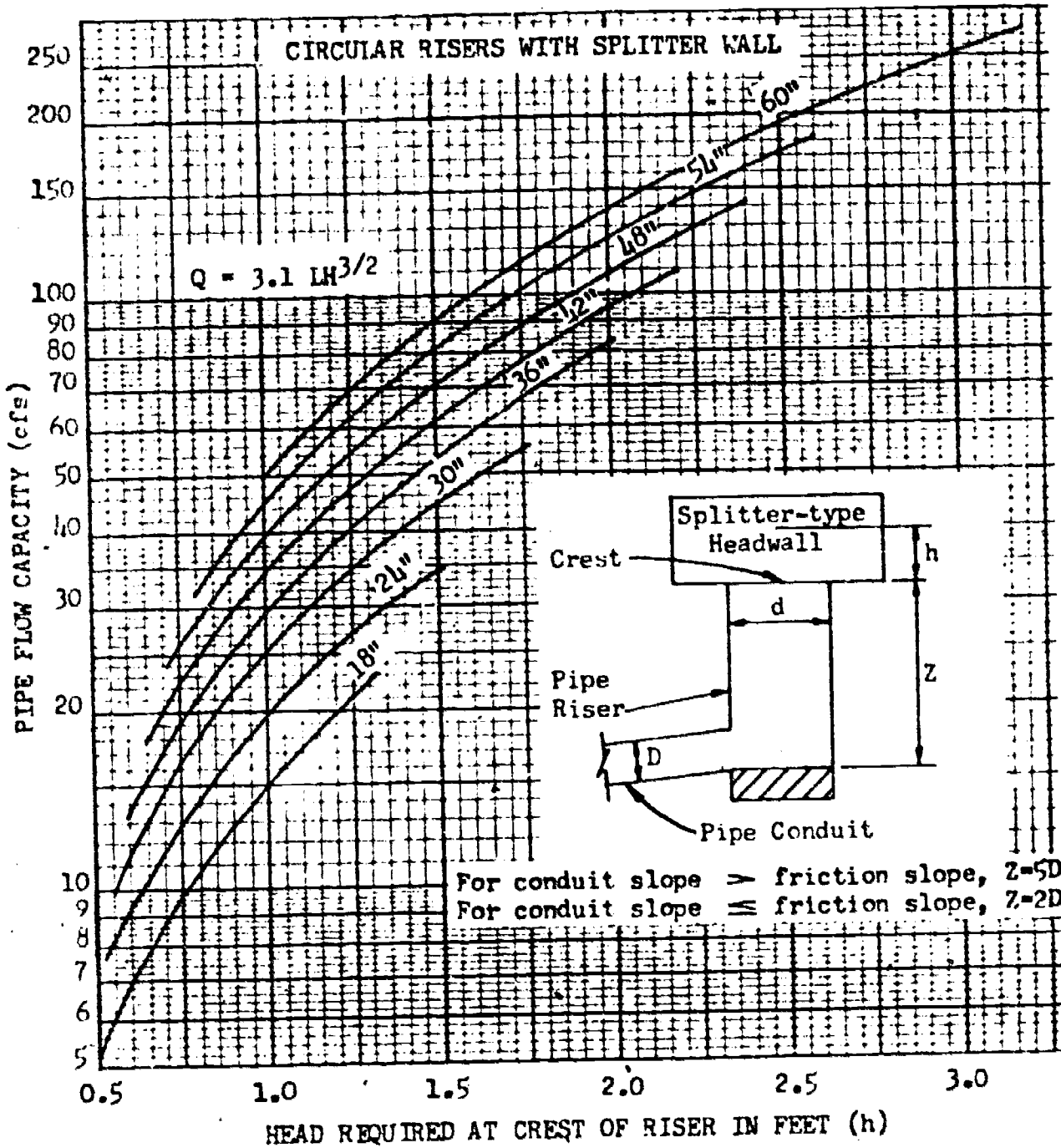

Pipe Drop Inlet Spillway Design:

For a given Q and H, refer to B-5.2 or B-5.3 for conduit size. Then determine the riser diameter (d) from the Inlet Proportions table.

Next, refer to the above curves, using the conduit capacity and riser diameter and find the head (h) required above the crest of the riser. The height of the riser should not be less than $5D - h$, except as noted in the above sketch.

Example - Given: CMP; Q = 20 cfs; H = 14 ft.; L = 70 ft. From Figure 6-25 find conduit size (D) = 18 inches. From Inlet Proportions table, riser size = 24 inches. Head (h) required for Q = 20 and d = 30 is 1.0 foot.

Chart for determining inlet proportions and required head over inlet

DESIGN DATA FOR EARTH SPILLWAYS

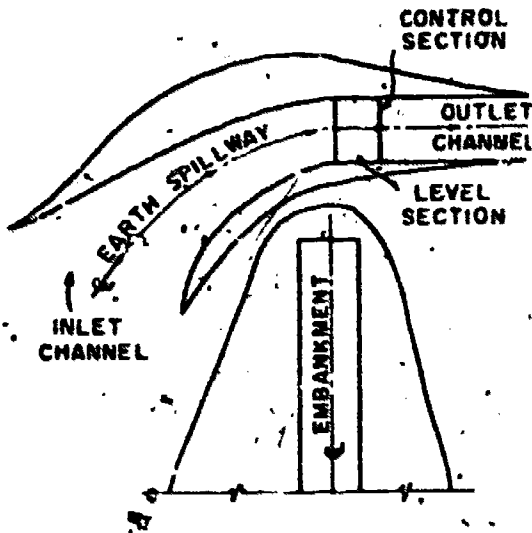

PLAN OF EARTH SPILLWAY

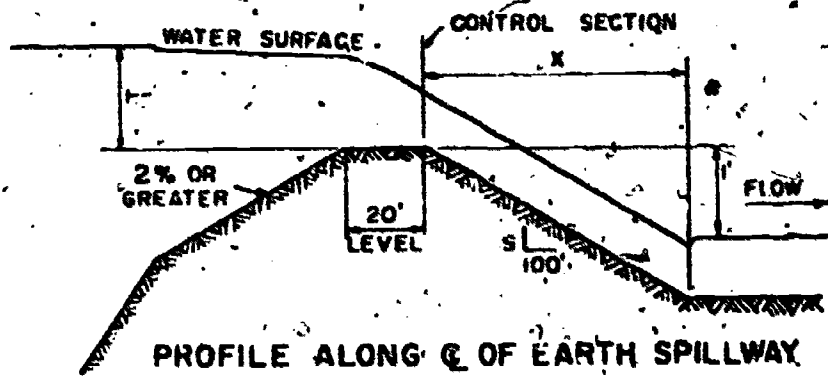

PROFILE ALONG C OF EARTH SPILLWAY

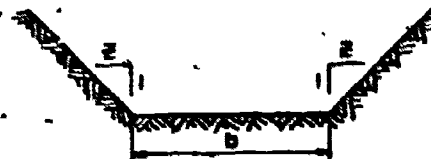

CROSS SECTION OF EARTH SPILLWAY AT CONTROL SECTION

LEGEND

- n Manning's Coefficient of Roughness
- H_p Difference in Elevation between Crest of Earth Spillway at the Control Section and Water Surface in Reservoir, in Feet
- b Bottom Width of Earth Spillway at the Control Section, in Feet
- Q Total Discharge, in cfs
- V Velocity, in Feet Per Second, that will exist in Channel below Control Section, at Design Q, if Constructed to Slope (S) that is shown
- S Flattest Slope (S), in %, allowable for Channel below Control Section
- X Minimum Length of Channel below Control Section, in Feet
- Z Side Slope Ratio

INDEX

SIDE SLOPE RATIO (Z)	COVER	COEFFICIENT OF ROUGHNESS	SHEET
4:1	VEGETATED	n = 0.040	2
3:1	VEGETATED	n = 0.040	3
2:1	VEGETATED	n = 0.040	4

NOTE: DATA TO RIGHT OF HEAVY VERTICAL LINES ON DRAWINGS SHOULD BE USED WITH CAUTION, AS THE RESULTING SECTIONS WILL BE EITHER POORLY PROPORTIONED OR HAVE VELOCITIES IN EXCESS OF 6 FT. / SEC.

REFERENCE

ENGINEERING HANDBOOK 9CS
SECTION 8, HYDRAULICS
HANDBOOK OF HYDRAULICS BY KING
FOURTH EDITION

U. S. DEPARTMENT OF AGRICULTURE
SOIL CONSERVATION SERVICE

164

SHEET 1 OF 4

June 1978

Appendix B-5.9

DESIGN DATA FOR EARTH SPILLWAYS

SIDE SLOPE 4:1

VEGETATED n=0.040

STAGE (FOOT) IN FEET	SPILLWAY VARIABLES	BOTTOM WIDTH (b) IN FEET																
		8	10	12	14	16	18	20	22	24	26	28	30	32	34	36	38	40
05	Q	7	8	9	10	12	14	16	18	19	21	23	25	27	28	29	30	32
	V	26	26	26	26	27	27	27	27	27	27	27	27	27	27	27	27	27
	S	40	40	39	39	39	39	39	39	39	39	39	39	39	39	39	39	39
	K	32	33	33	33	33	33	33	33	33	33	33	33	33	33	33	33	33
06	Q	9	11	12	14	17	19	21	23	25	28	30	32	34	36	38	40	41
	V	29	29	29	29	29	29	30	30	30	30	30	30	30	30	30	30	30
	S	37	37	37	37	37	37	37	37	37	37	37	37	37	37	37	37	37
	K	36	36	36	36	36	37	37	37	37	37	37	37	37	37	37	37	37
07	Q	11	14	16	19	21	24	26	29	31	34	37	39	43	44	47	50	52
	V	32	32	32	32	32	32	33	33	33	33	33	33	33	33	33	33	33
	S	35	35	35	35	35	35	35	35	35	35	35	35	35	35	35	35	35
	K	40	40	40	40	41	41	41	41	41	41	41	41	41	41	41	41	41
08	Q	14	17	20	23	26	30	32	35	38	42	45	48	52	54	57	61	64
	V	34	35	35	35	35	35	35	35	35	36	36	36	36	36	36	36	36
	S	33	33	33	32	32	32	32	32	32	32	32	32	32	32	32	32	32
	K	44	44	44	44	45	45	45	45	45	45	45	45	45	45	45	45	45
09	Q	19	22	25	27	32	36	40	45	49	51	55	59	64	68	71	75	79
	V	37	37	37	37	37	37	37	37	38	38	38	38	38	38	38	38	38
	S	31	31	31	31	31	31	31	31	31	31	31	31	31	31	31	31	31
	K	48	48	48	48	48	49	49	49	49	49	49	49	49	49	49	49	49
10	Q	22	27	31	35	39	45	48	53	57	61	65	70	75	80	85	89	93
	V	39	39	39	39	39	40	40	40	40	40	40	40	40	40	40	40	40
	S	30	30	30	30	30	30	30	30	30	30	30	30	30	30	30	30	30
	K	52	52	52	52	53	53	53	53	53	53	53	53	53	53	53	53	53
11	Q	27	32	36	41	47	52	57	60	66	71	76	81	87	92	97	103	108
	V	40	41	41	41	41	42	42	42	42	42	42	42	42	42	42	42	42
	S	30	29	29	29	29	29	29	29	29	28	28	28	28	28	28	28	28
	K	55	55	56	56	57	57	57	57	57	57	57	57	57	57	57	57	57
12	Q	34	38	43	50	57	61	67	72	78	84	90	96	102	109	115	120	126
	V	42	43	43	43	43	43	44	44	44	44	44	44	44	44	44	44	44
	S	29	28	28	28	28	28	28	28	28	28	28	28	28	28	28	28	28
	K	60	60	60	60	60	60	60	60	61	61	61	61	61	61	61	61	61
13	Q	38	45	50	57	64	73	81	89	91	98	106	110	117	124	131	139	145
	V	44	44	44	45	45	45	46	46	46	46	46	46	46	46	46	46	46
	S	28	28	28	27	27	27	27	27	27	27	27	27	27	27	27	27	27
	K	63	64	64	64	65	65	65	65	65	65	65	65	65	65	65	65	65
14	Q	43	51	58	66	75	81	89	95	102	109	117	125	133	140	147	156	163
	V	45	46	47	47	47	47	47	47	47	47	47	47	47	47	47	47	47
	S	27	27	27	27	27	27	27	26	26	26	26	26	26	26	26	26	26
	K	67	67	67	68	69	69	69	69	69	69	69	69	69	69	69	69	69
15	Q	50	58	67	74	84	93	100	110	118	125	134	143	152	160	170	175	183
	V	47	48	48	48	48	49	49	49	49	49	49	50	50	50	50	50	50
	S	27	27	26	26	26	26	26	26	26	26	26	26	26	26	26	26	26
	K	72	72	72	72	72	72	72	72	72	72	72	72	72	72	72	72	72
16	Q	57	71	75	83	92	100	113	121	131	141	149	159	168	179	187	195	205
	V	49	49	50	50	50	50	50	51	51	51	51	51	51	51	52	52	52
	S	26	26	26	26	26	26	26	25	25	25	25	25	25	25	25	25	25
	K	76	76	76	76	76	76	76	76	76	76	76	76	76	76	76	76	76
17	Q	63	75	85	95	106	115	124	133	144	153	164	175	183	196	204	215	225
	V	50	51	51	51	52	52	52	52	52	52	52	52	52	52	52	52	52
	S	25	25	25	25	25	25	25	25	25	25	25	25	25	25	25	25	25
	K	80	80	80	80	80	80	81	81	81	81	81	81	81	81	81	81	81
18	Q	71	88	95	106	118	129	137	149	160	171	183	194	204	215	226	239	247
	V	51	52	52	53	53	53	53	54	54	54	54	54	54	54	54	54	54
	S	25	25	25	25	25	25	25	25	24	24	24	24	24	24	24	24	24
	K	84	84	84	84	84	84	84	84	84	84	84	84	84	85	85	85	85
19	Q	80	92	104	114	128	141	152	163	176	184	200	213	223	236	248	262	271
	V	53	53	54	54	54	55	55	55	55	56	56	56	56	56	56	56	56
	S	25	25	25	25	24	24	24	24	24	24	24	24	24	24	24	24	24
	K	87	87	88	88	88	88	88	88	88	88	88	88	88	88	88	89	89
20	Q	89	102	113	127	140	153	167	180	191	205	217	230	243	259	269	285	297
	V	54	55	55	55	56	56	56	56	57	57	57	57	57	57	58	58	58
	S	25	24	24	24	24	24	24	24	24	24	24	24	24	24	24	24	24
	K	92	92	92	92	92	92	92	92	92	93	93	93	93	93	93	93	93
21	Q	96	112	125	140	154	168	186	199	207	223	238	253	268	280	296	311	325
	V	55	56	56	57	57	57	58	58	58	58	59	59	59	59	59	59	59
	S	24	24	24	24	24	24	24	24	23	23	23	23	23	23	23	23	23
	K	95	95	95	95	95	95	95	95	96	96	96	96	97	97	98	98	98
22	Q	105	122	137	153	168	183	198	216	229	244	261	274	287	303	319	335	352
	V	56	57	57	58	59	59	59	59	60	60	60	60	60	60	61	61	61
	S	24	24	24	24	24	24	24	24	24	23	23	23	23	23	23	23	23
	K	99	99	99	100	100	101	101	101	101	101	101	101	101	101	102	102	102
23	Q	119	134	149	166	183	200	215	232	247	266	282	297	312	330	343	361	378
	V	57	58	59	59	60	60	60	60	61	61	61	61	61	62	62	62	62
	S	24	24	24	24	24	24	24	24	24	24	24	24	24	24	24	24	24
	K	104	105	105	105	105	105	106	106	106	106	106	106	106	106	106	106	106
24	Q	129	146	162	179	198	217	232	252	266	284	302	319	338	357	371	385	404
	V	59	60	60	61	61	62	62	62	62	62	62	63	63	63	63	63	63
	S	23	23	23	23	23	23	23	22	22	22	22	22	22	22	22	22	22
	K	108	109	109	109	109	109	109	110	110	110	110	110	110	111	111	111	111

REFERENCE

U. S. DEPARTMENT OF AGRICULTURE
SOIL CONSERVATION SERVICE



Appendix B-5.10
DESIGN DATA FOR EARTH SPILLWAYS

SIDE SLOPE 3:1
VEGETATED n=0.040

STAGE (ft) IN FEET	SPILLWAY VARIABLES	BOTTOM WIDTH (ft) IN FEET																		
		8	10	12	14	16	18	20	22	24	26	28	30	32	34	36	38	40		
05	Q	7	8	9	10	12	14	16	18	20	22	24	26	28	30	32	34	36	38	40
	V	27	27	27	27	27	27	27	27	27	27	27	27	27	27	27	27	27	27	27
	S	34	39	39	39	39	39	39	39	39	39	39	39	39	39	39	39	39	39	39
06	Q	8	11	12	14	16	19	20	22	24	26	28	30	32	34	36	38	40		
	V	29	29	30	30	30	30	30	30	30	30	30	30	30	30	30	30	30	30	30
	S	37	37	37	37	37	37	37	37	37	37	37	37	37	37	37	37	37	37	37
07	Q	11	14	16	19	21	24	26	29	31	33	36	38	41	43	45	48	49		
	V	32	32	32	32	32	32	32	32	32	32	32	32	32	32	32	32	32	32	32
	S	35	35	35	35	35	35	35	35	35	35	35	35	35	35	35	35	35	35	35
08	Q	14	17	20	23	26	30	32	35	38	42	45	47	50	52	55	58	60		
	V	35	35	35	36	36	36	36	36	36	36	36	36	36	36	36	36	36	36	36
	S	33	33	33	33	32	32	32	32	32	32	32	32	32	32	32	32	32	32	32
09	Q	19	23	25	28	32	36	40	43	47	51	55	59	63	66	68	73	76		
	V	37	37	38	38	38	38	38	38	38	38	38	38	38	38	38	38	38	38	38
	S	31	31	31	31	31	31	31	31	31	31	31	31	31	31	31	31	31	31	31
10	Q	20	27	30	35	38	43	48	52	56	61	64	69	74	79	82	86	90		
	V	39	40	40	40	40	40	40	40	40	40	40	40	40	40	40	40	40	40	40
	S	30	30	30	30	30	30	30	30	30	30	30	30	30	30	30	30	30	30	30
11	Q	25	31	34	40	45	48	54	60	65	70	74	79	84	90	95	100	105		
	V	41	41	42	42	42	42	42	42	42	42	42	42	42	42	42	42	42	42	42
	S	29	29	29	29	29	29	29	29	29	29	29	29	29	29	29	29	29	29	29
12	Q	30	37	42	47	52	59	65	71	76	82	88	92	99	105	110	116	122		
	V	43	43	44	44	44	44	44	44	44	44	44	44	44	44	44	44	44	44	44
	S	29	29	28	28	28	28	28	28	28	28	28	28	28	28	28	28	28	28	28
13	Q	35	42	48	55	62	68	75	82	89	95	101	109	116	122	127	134	140		
	V	45	45	46	46	46	46	46	46	46	46	46	46	46	46	46	46	46	46	46
	S	28	28	28	27	27	27	27	27	27	27	27	27	27	27	27	27	27	27	27
14	Q	41	48	56	64	70	78	86	93	100	108	114	121	130	138	146	152	159		
	V	47	47	47	48	48	48	48	48	48	48	48	48	48	48	48	48	48	48	48
	S	27	27	27	27	27	27	26	26	26	26	26	26	26	26	26	26	26	26	26
15	Q	46	54	63	71	82	88	96	106	113	121	128	136	144	154	164	173	180		
	V	48	49	49	49	49	49	50	50	50	50	50	50	50	50	50	50	50	50	50
	S	27	27	26	26	26	26	26	26	26	26	26	26	26	26	26	26	26	26	26
16	Q	52	60	70	81	90	100	110	118	129	137	145	155	162	172	182	192	201		
	V	49	50	51	51	51	51	51	51	51	51	51	51	51	51	51	51	51	51	51
	S	26	26	26	26	26	25	25	25	25	25	25	25	25	25	25	25	25	25	25
17	Q	58	68	78	90	100	110	121	132	141	149	160	168	179	190	201	212	222		
	V	50	52	52	53	53	53	53	53	53	53	53	53	53	53	53	53	53	53	53
	S	25	25	25	25	25	25	25	25	25	25	25	25	25	25	25	25	25	25	25
18	Q	65	76	88	100	110	122	133	145	155	166	175	188	196	208	220	232	243		
	V	52	53	54	54	54	54	54	54	54	54	54	54	54	54	54	54	54	54	54
	S	25	25	25	25	25	25	25	25	24	24	24	24	24	24	24	24	24	24	24
19	Q	72	84	98	110	124	134	148	160	172	182	192	204	218	232	240	253	266		
	V	54	54	55	56	56	56	56	56	56	56	56	56	56	56	56	56	56	56	56
	S	25	25	25	24	24	24	24	24	24	24	24	24	24	24	24	24	24	24	24
20	Q	79	94	107	120	133	148	160	172	186	197	212	224	236	252	265	276	288		
	V	55	56	56	57	57	57	57	57	57	57	57	57	57	57	57	57	57	57	57
	S	25	24	24	24	24	24	24	24	23	23	23	23	23	23	23	23	23	23	23
21	Q	88	102	118	132	146	160	176	190	202	217	229	241	255	271	286	300	315		
	V	56	57	58	58	58	58	58	58	58	58	58	58	58	58	58	58	58	58	58
	S	24	24	24	24	24	23	23	23	23	23	23	23	23	23	23	23	23	23	23
22	Q	95	112	128	143	158	176	192	204	220	234	246	263	280	297	313	328	340		
	V	57	58	59	59	59	59	59	59	59	59	59	59	59	59	59	59	59	59	59
	S	24	24	24	23	23	23	23	23	23	23	23	23	23	23	23	23	23	23	23
23	Q	104	120	138	155	172	190	205	222	236	251	266	284	299	319	336	354	367		
	V	58	59	60	61	61	61	61	61	61	61	61	61	61	61	61	61	61	61	61
	S	24	24	23	23	23	23	23	23	22	22	22	22	22	22	22	22	22	22	22
24	Q	114	132	150	168	185	205	222	237	252	269	288	309	321	340	359	378	392		
	V	60	60	61	62	62	63	63	63	63	63	63	63	63	63	63	63	63	63	63
	S	23	23	23	23	23	22	22	22	22	22	22	22	22	22	22	22	22	22	22

REFERENCE

U. S. DEPARTMENT OF AGRICULTURE
 SOIL CONSERVATION SERVICE



DESIGN DATA FOR EARTH SPILLWAYS

SIDE SLOPE 2:1
VEGETATED n=0.040

STAGE (NO) - IN FEET	SPILLWAY VARIABLES	BOTTOM WIDTH (B) IN FEET																
		8	10	12	14	16	18	20	22	24	26	28	30	32	34	36	38	40
05	Q	6	7	8	10	11	13	14	15	17	18	20	21	22	24	25	27	28
	V	27	27	27	27	27	27	27	27	27	27	27	27	27	27	27	27	27
	S	39	39	39	39	39	39	39	39	39	39	39	39	39	39	39	39	39
	X	32	33	33	33	33	33	33	33	33	33	33	33	33	33	33	33	33
06	Q	8	10	12	14	16	18	20	22	24	26	28	30	32	34	36	38	40
	V	30	30	30	30	30	30	30	30	30	30	30	30	30	30	30	30	30
	S	37	37	37	37	37	37	37	37	37	37	37	37	37	37	37	37	37
	X	38	38	38	38	38	38	38	38	38	38	38	38	38	38	38	38	38
07	Q	11	13	15	18	20	23	25	28	30	33	35	38	41	43	46	48	50
	V	32	32	33	33	33	33	33	33	33	33	33	33	33	33	33	33	33
	S	39	39	39	39	39	39	39	39	39	39	39	39	39	39	39	39	39
	X	39	40	40	40	41	41	41	41	41	41	41	41	41	41	41	41	41
08	Q	13	16	19	23	26	29	32	35	38	42	45	48	51	54	57	60	63
	V	33	33	33	33	33	33	33	33	33	33	33	33	33	33	33	33	33
	S	33	33	33	33	33	33	33	33	33	33	33	33	33	33	33	33	33
	X	44	44	44	44	45	45	45	45	45	45	45	45	45	45	45	45	45
09	Q	17	20	24	28	32	35	39	43	47	51	53	58	61	64	68	71	75
	V	37	38	38	38	38	38	38	38	38	38	38	38	38	38	38	38	38
	S	32	31	31	31	31	31	31	31	31	31	31	31	31	31	31	31	31
	X	47	47	48	48	48	48	48	48	48	48	48	49	49	49	49	49	49
10	Q	20	24	29	33	38	42	47	51	56	61	63	68	72	77	81	86	90
	V	40	40	40	40	40	40	40	40	40	40	40	40	40	40	40	40	40
	S	31	30	30	30	30	30	30	30	30	30	30	30	30	30	30	30	30
	X	51	51	51	51	52	52	52	52	52	52	52	52	52	52	52	52	52
11	Q	23	28	34	39	44	49	54	60	65	70	74	79	84	89	94	99	104
	V	42	42	42	43	43	43	43	43	43	43	43	43	43	43	43	43	43
	S	29	29	29	29	29	29	29	29	29	29	29	29	29	29	29	29	29
	X	55	55	55	55	55	55	55	56	56	56	56	56	56	56	56	56	56
12	Q	28	33	40	45	51	58	64	69	76	80	86	92	98	104	110	116	122
	V	44	44	44	44	44	44	44	44	44	44	44	44	44	44	44	44	44
	S	29	29	28	28	28	28	28	28	28	28	28	28	28	28	28	28	28
	X	58	58	59	59	59	59	59	59	60	60	60	60	60	60	60	60	60
13	Q	32	38	46	53	58	65	73	80	86	91	99	106	112	119	125	133	140
	V	45	46	46	46	46	46	46	47	47	47	47	47	47	47	47	47	47
	S	28	28	28	27	27	27	27	27	27	27	27	27	27	27	27	27	27
	X	62	62	62	63	63	63	63	63	63	63	63	63	64	64	64	64	64
14	Q	37	44	51	59	66	74	82	90	96	103	111	119	127	134	142	150	158
	V	47	48	48	48	48	48	48	48	48	49	49	49	49	49	49	49	49
	S	28	27	27	27	27	27	27	27	26	26	26	26	26	26	26	26	26
	X	65	66	66	66	66	67	67	67	67	67	67	67	68	68	68	68	69
15	Q	41	50	58	66	75	85	92	101	108	116	125	133	142	150	160	169	178
	V	48	49	49	50	50	50	50	50	50	50	50	50	50	50	50	50	50
	S	27	27	26	26	26	26	26	26	26	26	26	26	26	26	26	26	26
	X	69	69	70	70	71	71	71	71	71	71	71	71	72	72	72	72	72
16	Q	46	56	65	75	84	94	104	112	122	132	142	149	158	168	178	187	197
	V	50	51	51	51	51	52	52	52	52	52	52	52	52	52	52	52	52
	S	26	26	26	26	26	26	26	26	26	26	26	26	26	26	26	26	26
	X	72	74	74	75	75	76	76	76	76	76	76	76	76	76	76	76	76
17	Q	52	62	72	83	94	105	115	126	135	145	156	167	175	187	196	206	217
	V	52	52	52	53	53	53	53	54	54	54	54	54	54	54	54	54	54
	S	26	26	26	26	26	26	26	26	26	26	26	26	26	26	26	26	26
	X	78	78	79	80	80	80	80	80	80	80	80	80	80	80	80	80	80
18	Q	58	69	81	93	104	116	127	138	150	160	171	182	194	204	214	226	233
	V	53	54	54	55	55	55	55	55	55	55	55	55	56	56	56	56	56
	S	25	25	25	25	24	24	24	24	24	24	24	24	24	24	24	24	24
	X	80	82	83	84	84	84	84	84	84	84	84	84	84	84	84	84	84
19	Q	64	76	88	102	114	127	140	152	164	175	188	201	213	225	235	248	260
	V	55	55	55	56	56	56	57	57	57	57	57	57	57	57	57	57	57
	S	25	25	25	24	24	24	24	24	24	24	24	24	24	24	24	24	24
	X	84	85	86	87	88	88	88	88	88	88	88	88	88	88	88	88	88
20	Q	71	83	97	111	125	139	153	164	178	193	204	218	232	245	256	269	283
	V	56	57	57	57	58	58	58	58	58	58	58	58	59	59	59	59	59
	S	25	24	24	24	24	24	24	24	24	24	24	24	24	24	24	24	24
	X	88	90	91	91	91	92	92	92	92	92	92	92	92	92	92	92	92
21	Q	77	91	107	122	135	149	162	177	192	207	220	234	250	267	276	291	302
	V	57	58	59	59	59	59	59	60	60	60	60	60	60	60	60	60	60
	S	24	24	24	24	24	24	24	24	24	24	24	24	24	24	24	24	24
	X	92	93	93	93	93	93	93	93	93	93	93	93	93	93	93	93	93
22	Q	84	100	116	131	146	163	177	194	210	224	238	253	269	284	301	314	330
	V	59	59	60	60	60	61	61	61	61	61	61	61	61	61	61	61	61
	S	24	24	24	23	23	23	23	23	23	23	23	23	23	23	23	23	23
	X	96	98	99	99	99	99	99	99	100	100	100	100	100	100	100	100	100
23	Q	90	108	124	140	158	175	193	208	226	243	258	275	292	306	323	341	353
	V	60	61	61	61	62	62	62	62	63	63	63	63	63	63	63	63	63
	S	24	24	23	23	23	23	23	23	23	22	22	22	22	22	22	22	22
	X	100	102	102	103	103	103	104	104	104	105	105	105	105	105	105	105	105
24	Q	99	116	136	152	170	189	206	224	244	260	275	294	312	327	344	364	378
	V	61	62	62	63	63	63	64	64	64	64	64	64	64	64	64	64	64
	S	23	23	23	23	23	22	22	22	22	22	22	22	22	22	22	22	22
	X	105	105	106	107	107	108	108	108	109	109	109	109	109	109	109	109	109

REFERENCE

U. S. DEPARTMENT OF AGRICULTURE
SOIL CONSERVATION SERVICE



HOOD INLET-CORRUGATED METAL PIPE 8" TO 12" DIAMETER DETAILS FOR INLET AND BAFFLE

TABLE OF QUANTITIES & MATERIAL LIST FOR ANTI-VORTEX PLATE

Pipe Dia. Inches	Plate Gage	Plate Size Inches	1 1/2" x 1 1/2" x 1/4" Angle Braces (One Right and One Left) Inches					Req'd. No.	1 1/2" x 1 1/2" x 1/4" Angle Support Feet and Inches		Req'd. No.	3/8" x 1 1/2" Machine Bolt with nut and washer No. Required
			a	b	c	d	e					
8	14	12x12	-	-	-	-	-	0	-	0	1	4
10	14	15x15	-	-	-	-	-	0	-	3	1	4
12	14	18x18	8	3 1/4	7	5	5 1/2	2	1	6	1	12

Metal Baffle Support and Angle braces shall be of the same material and have the same coating as the pipe to which it is attached. Metal Baffle may be made of corrugated or smooth sheet metal and shaped circular, square or as shown. Sharp corners shall be removed.

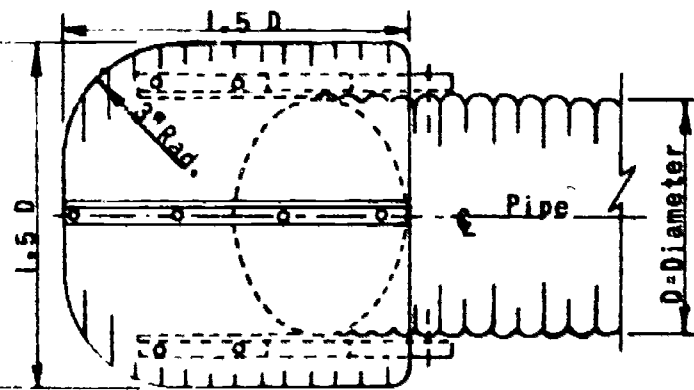

PLAN

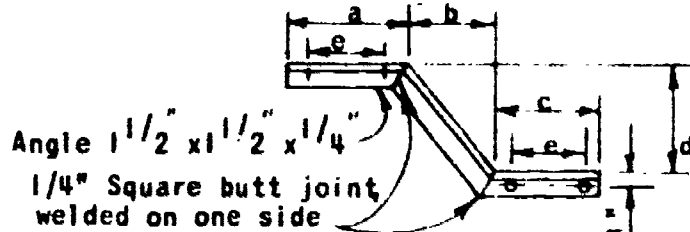

ANGLE BRACE DETAIL

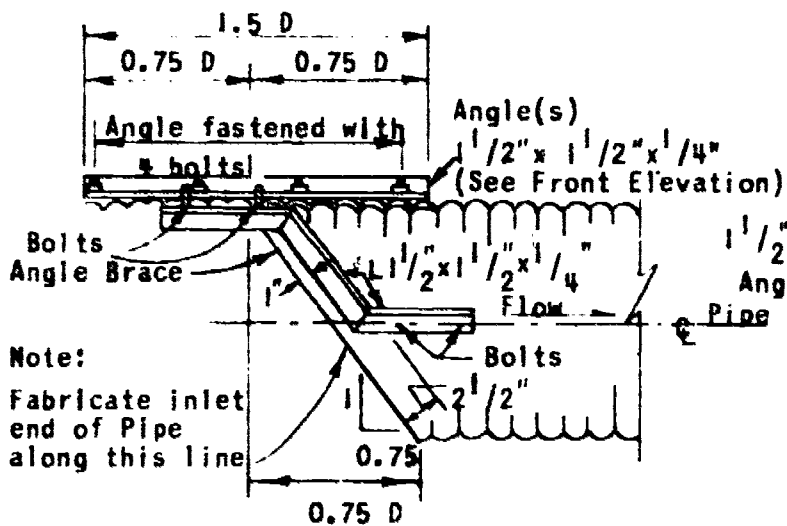

SIDE ELEVATION

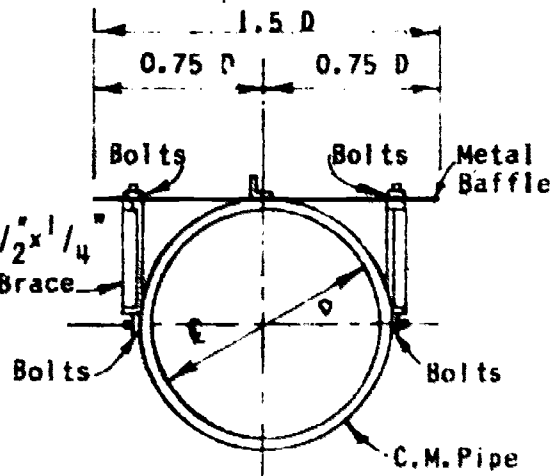

FRONT ELEVATION

Notes:

- Bolts shall be 3/8" x 1 1/2" with nut and split washers.
- Holes for bolts shall be drilled 7/16" diameter.
- Nuts, bolts and washers shall be galvanized or stainless steel.
- All cuts shall be saw or shear cuts.
- Holes in the angle brace shall be spaced and located to match corrugations in pipe and baffle.
- All galvanizing damaged by cutting, drilling or welding shall be repaired by painting with two (2) coats of zinc dust- zinc oxide primer.

(Owner)

(Location)

Sheet ____ of ____

WELDED STEEL PIPE-HOODED INLET DETAILS FOR INLET BAFFLE AND ANTI-SEEP COLLAR

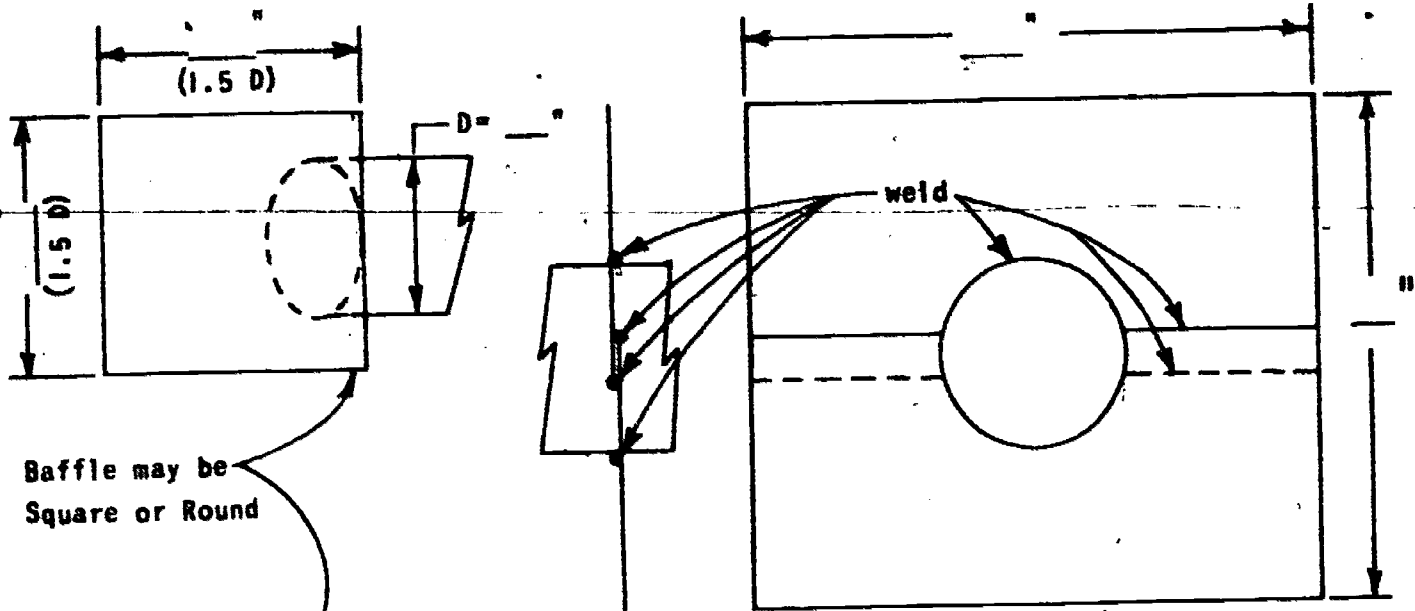

Baffle may be
Square or Round

ANTI-SEEP COLLAR

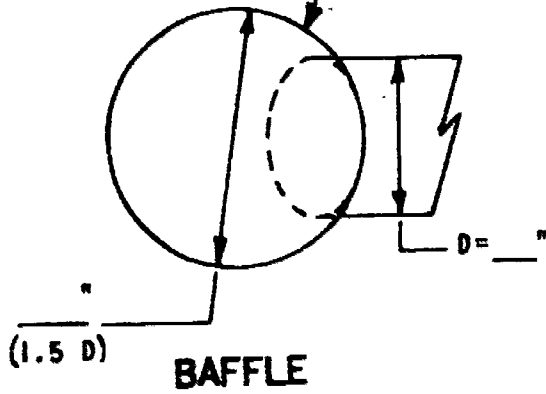

BAFFLE

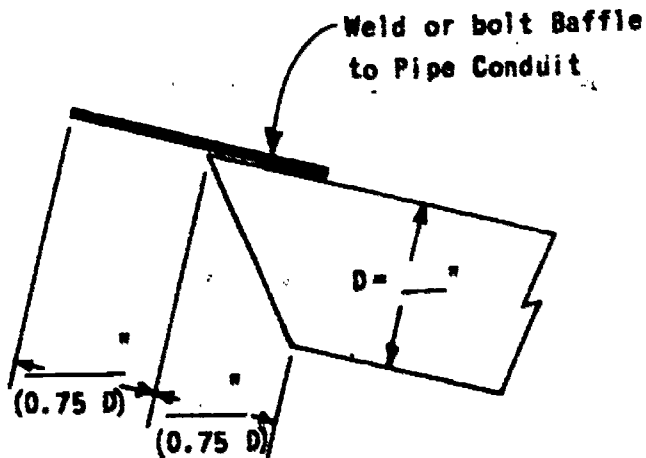

Weld or bolt Baffle
to Pipe Conduit

INLET SECTION

Note: All welds shall be watertight.
All pipe and steel plates shall
have minimum thickness of _____.

(Owner)

(Location)
Sheet _____ of _____

DRAIN CHART - CLAY, CONCRETE TILE AND BITUMINIZED FIBER PIPE

170

USE THIS SCALE FOR SINGLE LINES OF RANDOM OR INTERCEPTOR DRAINS AND MAINS

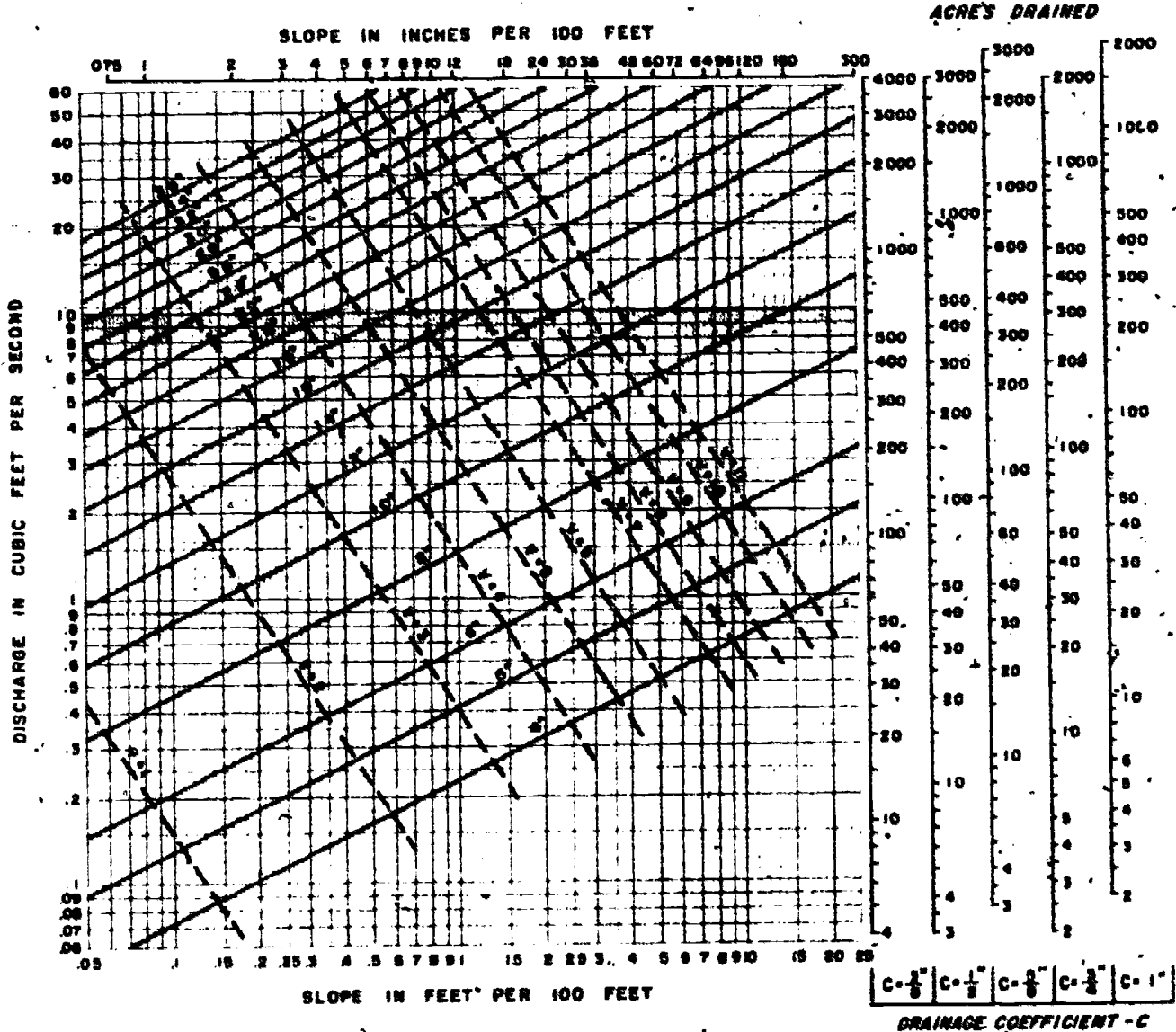

USE THESE SCALES ON PATTERN OR SYSTEMATIC DRAINAGE

REFERENCE
 DISCHARGE BASED ON:
 $V = 1.488 R^{2/3} S^{1/2}$
 PIPE FLOWING FULL, MANNING N = 0.011

U. S. DEPARTMENT OF AGRICULTURE
 SOIL CONSERVATION SERVICE

June 1978
 Appendix B-6.1

DRAIN CHART - CORRUGATED PLASTIC DRAIN TUBING

171

USE THIS SCALE FOR SINGLE LINES OF RANDOM OR INTERCEPTOR DRAINS AND MAINS

DISCHARGE IN CUBIC FEET PER SECOND

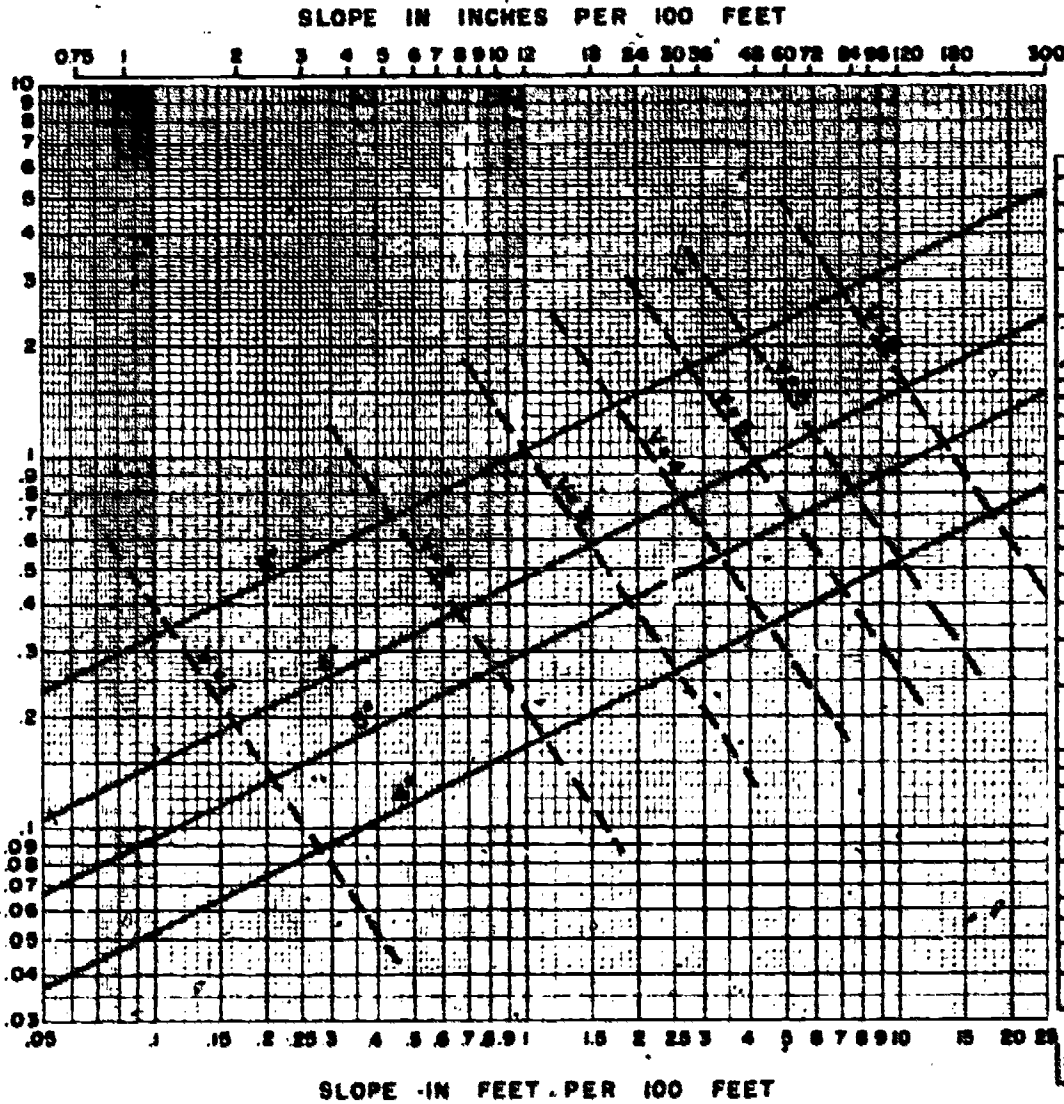

ACRES DRAINED

USE THESE SCALES ON PATTERN OR SYSTEMATIC DRAINAGE

$C = \frac{1}{8}$ | $C = \frac{1}{4}$ | $C = \frac{1}{2}$ | $C = \frac{3}{4}$ | $C = 1$

DRAINAGE COEFFICIENT - C

Exhibit 14-11.2

REFERENCE

DISCHARGE BASED ON:
 $V = 0.588 R^{2/3} S^{1/2}$
 PIPE FLOWING FULL, MANNING N = 0.015

U. S. DEPARTMENT OF AGRICULTURE
 SOIL CONSERVATION SERVICE

June 1978
 Appendix B-6.2

DRAIN CAPACITY CHART - CORRUGATED METAL PIPE

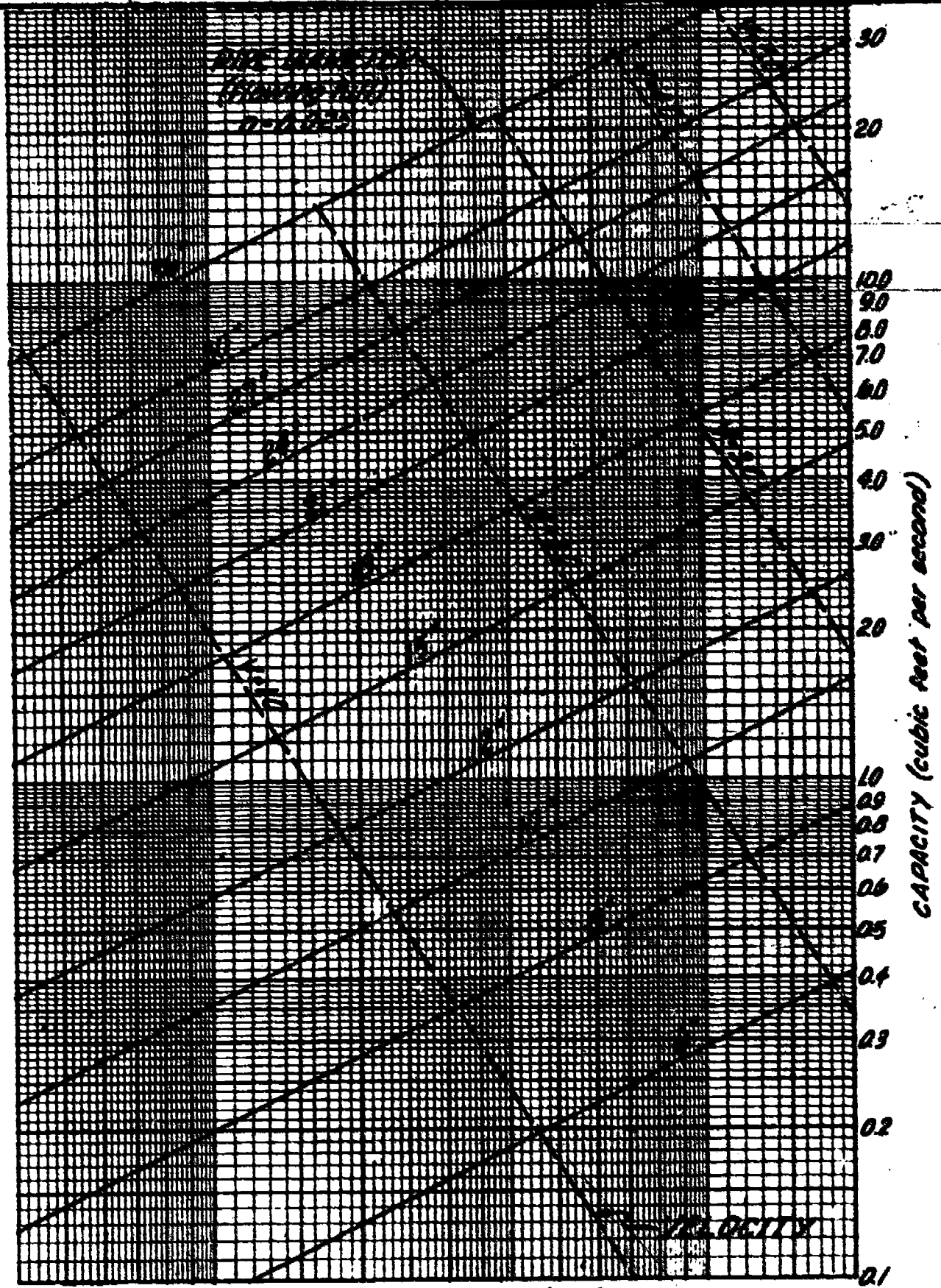

0.0004 0.0005 0.0006 0.0007 0.0008 0.0009 0.0010 0.002 0.003 0.004 0.005 0.006 0.007 0.008 0.009 0.010

HYDRAULIC GRADIENT (feet per foot)

30 20 10 9 8 7 6 5 4 3 2 1

0.1 0.2 0.3 0.4 0.5 0.6 0.7 0.8 0.9 1 2 3 4 5 6 7 8 9 10 20 30

PIPE DIAMETER (inches)

VELOCITY

Exhibit 14-11.3

REFERENCE

DISCHARGE BASED ON
 $V = 88 R^{2/3} S^{1/2}$
PIPE FLOWING FULL, MANNING N=0.028

U. S. DEPARTMENT OF AGRICULTURE
SOIL CONSERVATION SERVICE

227



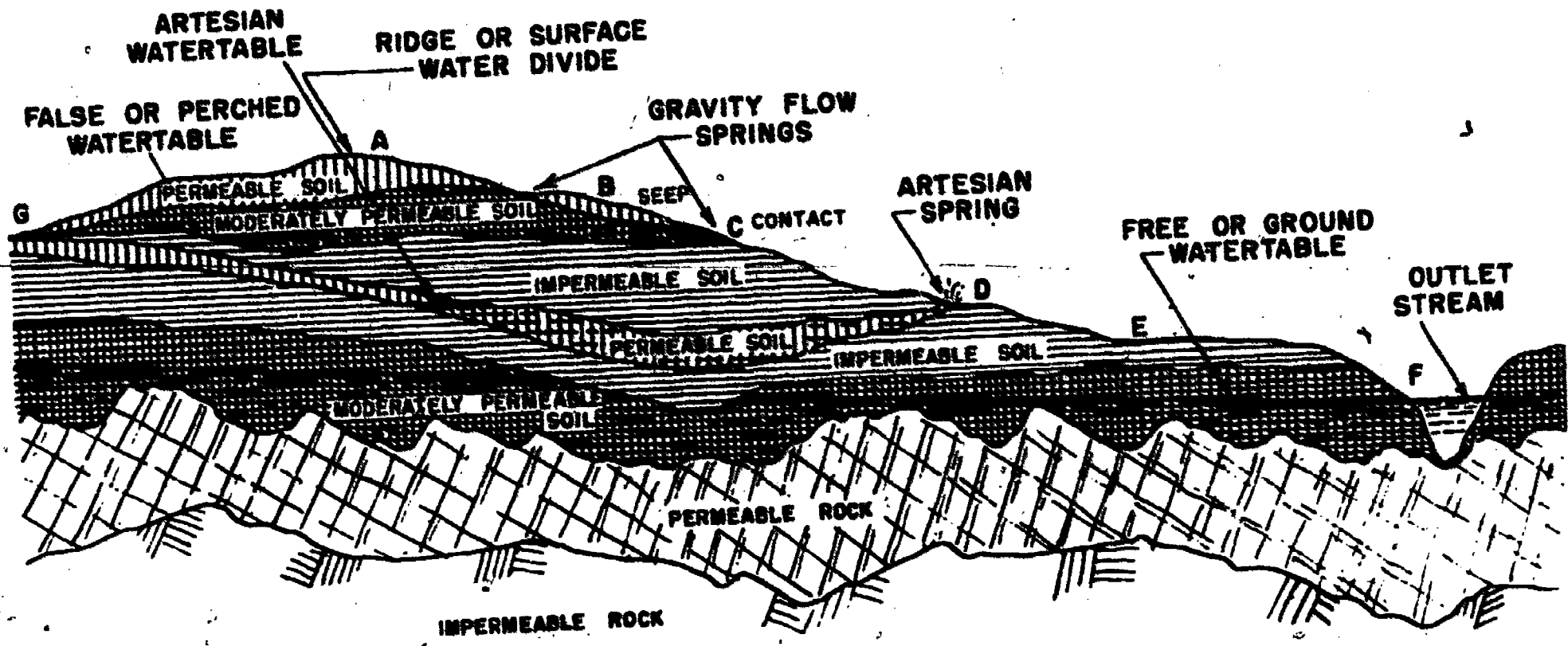

173

Ground water movement

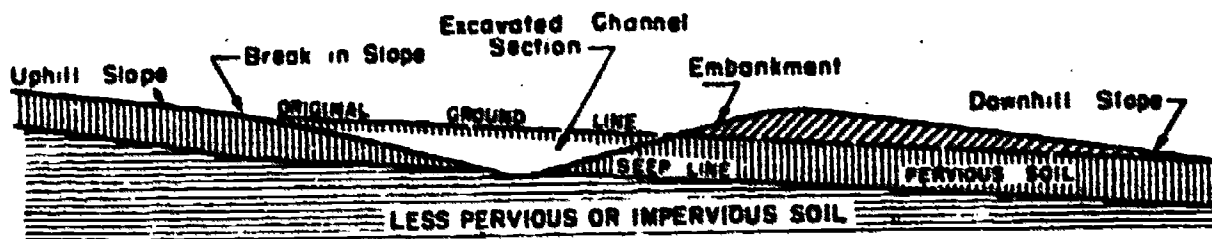

A. - CROSS SECTION SHOWING DITCH AS SURFACE WATER DIVERSION AND SUB-SURFACE INTERCEPTOR ON SLOPE

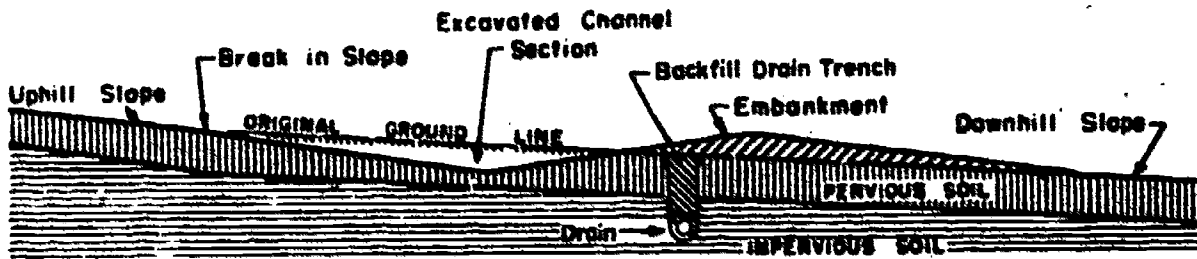

B. - CROSS SECTION SHOWING DITCH AS SURFACE WATER DIVERSION WITH DRAIN AS SUB-SURFACE INTERCEPTOR

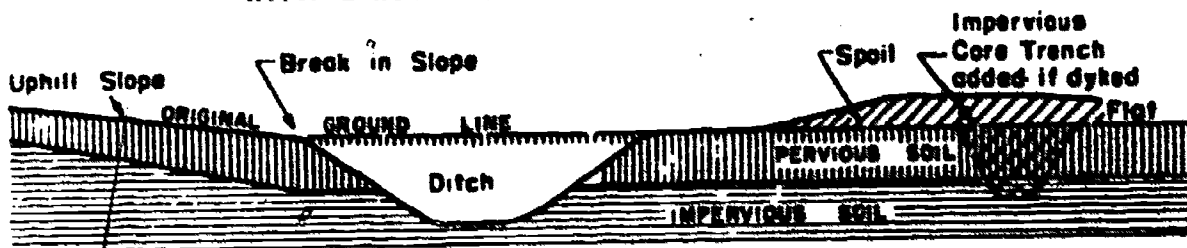

C. - CROSS SECTION SHOWING DITCH AS SURFACE WATER DIVERSION AND SUB-SURFACE INTERCEPTOR FOR FLAT LAND

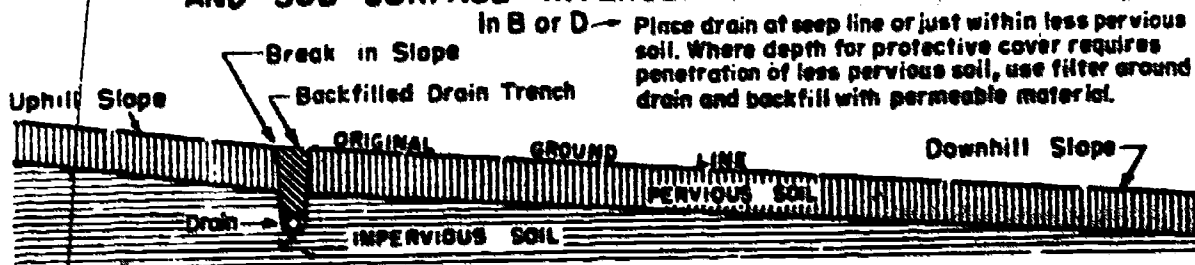

D. - CROSS SECTION SHOWING DRAIN AS SUB-SURFACE INTERCEPTOR

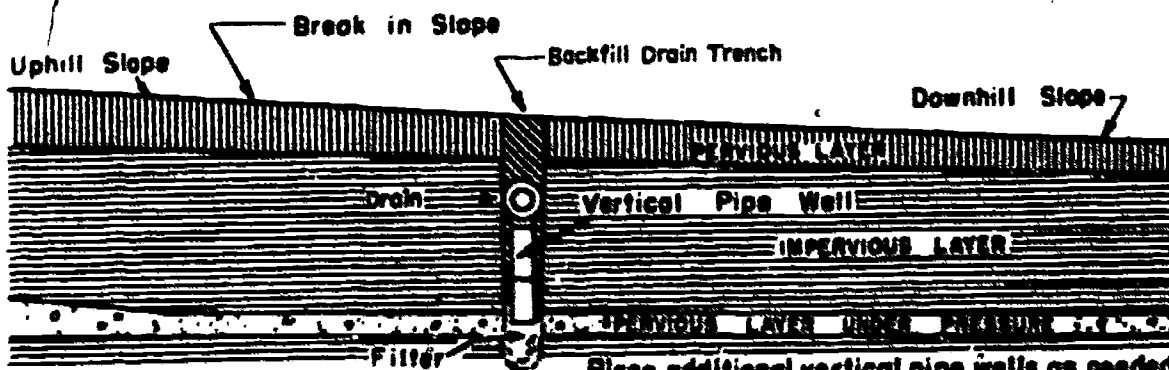

E. - CROSS SECTION SHOWING RELIEF WELL AND INTERCEPTOR DRAIN

Typical interceptor installations

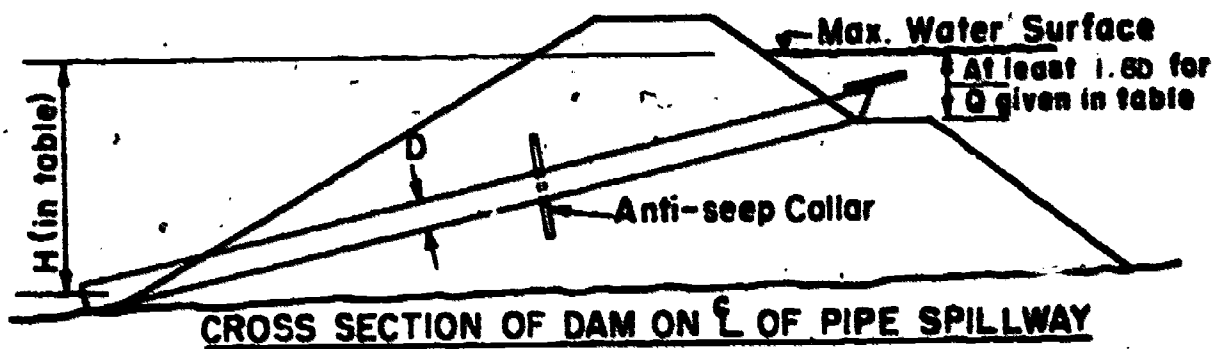

CAPACITY TABLE OF HOODED INLET IN C.F.S. FOR VARYING HEADS						
Head H	8" DIAMETER PIPE For Pipe Lengths of:			12" DIAMETER PIPE For Pipe Lengths of:		
	50'	70'	90'	50'	70'	90'
5	1.8	1.6	1.4	5.0	4.4	4.0
6	2.0	1.7	1.5	5.5	4.8	4.4
7	2.1	1.9	1.7	6.0	5.2	4.7
8	2.3	2.0	1.8	6.3	5.6	5.0
9	2.4	2.1	1.9	6.7	5.9	5.4
10	2.6	2.2	2.0	7.1	6.2	5.6
11	2.7	2.3	2.1	7.4	6.5	5.9
12	2.8	2.4	2.2	7.8	6.8	6.2
13	2.9	2.5	2.3	8.1	7.1	6.4
14	3.0	2.6	2.3	8.4	7.4	6.7
15	3.1	2.7	2.4	8.7	7.6	6.9
16	3.2	2.8	2.5	9.0	7.9	7.1
17	3.3	2.9	2.6	9.2	8.1	7.3
18	3.4	3.0	2.7	9.5	8.4	7.6
19	3.5	3.0	2.7	9.8	8.6	7.8
20	3.6	3.1	3.0	10.0	8.8	8.0

Capacity chart for 8- and 12-inch C.M.
pipe hood inlet spillway

The use of some type of device to prevent vortex formation is necessary for developing maximum capacity shown in the previously mentioned figures.

PIPE FLOW CHART (Full flow assumed)

For Hooded Inlet $K_e = 1.08$ and 70 feet of Corrugated Metal Pipe Conduit, $n = 0.025$.
Note corrections for other pipe-lengths.

Dia. H	12"	15"	18"	21"	24"	30"	36"	42"
2	2.79	4.89	7.72	11.16	15.48	26.31	40.28	57.42
3	3.41	5.99	9.46	13.67	18.97	32.32	49.34	70.34
4	3.94	6.92	10.92	15.78	21.90	37.32	56.98	81.22
5	4.40	7.74	12.21	17.64	24.48	41.72	63.70	90.80
6	4.82	8.47	13.37	19.32	26.82	45.70	69.77	99.45
7	5.21	9.16	14.45	20.88	28.97	49.37	75.38	107.45
8	5.57	9.78	15.44	22.31	30.97	52.77	80.57	114.85
9	5.91	10.38	16.38	23.61	32.85	55.98	85.47	121.83
10	6.23	10.94	17.26	24.95	34.62	59.00	90.09	128.41
11	6.53	11.48	18.11	26.17	36.32	61.90	94.50	134.70
12	6.82	11.99	18.91	27.33	37.93	64.64	98.69	140.67
13	7.10	12.48	19.69	28.45	39.49	67.29	102.73	146.44
14	7.37	12.95	20.43	29.52	40.97	69.83	106.61	151.96
15	7.63	13.40	21.15	30.56	42.41	72.27	110.34	157.28
16	7.88	13.84	21.84	31.56	43.80	74.64	113.96	162.44
17	8.12	14.27	22.51	32.53	45.15	76.94	117.46	167.44
18	8.36	14.68	23.17	33.48	46.46	79.17	120.88	172.31
19	8.59	15.08	23.80	34.32	47.73	81.34	124.19	177.02
20	8.81	15.47	24.42	35.28	48.97	83.45	127.41	181.61
21	9.03	15.86	25.02	36.16	50.18	85.52	130.57	186.12
22	9.24	16.23	25.61	37.00	51.36	87.52	133.62	190.46
23	9.45	16.59	26.19	37.84	52.52	89.49	136.64	194.77
24	9.65	16.95	26.69	38.65	53.64	91.42	139.57	198.95
25	9.85	17.30	27.30	39.45	54.75	93.30	142.45	203.05
L	Correction Factors For Other Lengths							
40	1.23	1.21	1.19	1.18	1.16	1.13	1.12	1.10
50	1.14	1.13	1.12	1.11	1.10	1.09	1.08	1.07
60	1.06	1.06	1.05	1.05	1.04	1.04	1.04	1.03
70	1.00	1.00	1.00	1.00	1.00	1.00	1.00	1.00
80	0.95	0.95	0.95	0.96	0.96	0.96	0.97	0.97
90	0.90	0.91	0.91	0.92	0.92	0.93	0.94	0.94
100	0.86	0.87	0.88	0.89	0.89	0.90	0.91	0.92

Pipe flow chart for corrugated metal pipe hood inlet spillway

PIPE FLOW CHART (Full flow assumed)

For Hooded Inlet $K_e = 1.08$ and 70 feet of smooth pipe conduit, $n = 0.010$. Note corrections for other lengths.

Dia. H	10"	12"	14"	15"	18"	21"
2	3.20	4.85	6.85	7.99	11.92	16.64
3	3.92	5.94	8.38	9.79	14.60	20.39
4	4.53	6.85	9.68	11.31	16.86	23.54
5	5.06	7.66	10.82	12.64	18.85	26.32
6	5.54	8.39	11.86	13.84	20.64	28.83
7	5.99	9.07	12.81	14.96	22.30	31.15
8	6.40	9.69	13.69	15.99	23.84	33.29
9	6.79	10.28	14.52	16.96	25.29	35.31
10	7.16	10.84	15.31	17.87	26.65	37.22
11	7.51	11.36	16.05	18.74	27.95	39.03
12	7.83	11.87	16.77	19.58	29.20	40.77
13	8.16	12.36	17.46	20.41	30.39	42.45
14	8.47	12.82	18.11	21.15	31.54	44.05
15	8.77	13.27	18.75	21.89	32.64	45.59
16	9.06	13.71	19.36	22.61	33.72	47.08
17	9.33	14.13	19.96	23.31	34.75	48.53
18	9.61	14.54	20.54	23.99	35.76	49.94
19	9.87	14.94	21.10	24.64	36.74	51.31
20	10.12	15.33	21.65	25.28	37.69	52.64
21	10.38	15.71	22.19	25.91	38.63	53.95
22	10.62	16.07	22.70	26.51	39.53	55.21
23	10.86	16.44	23.24	27.11	40.42	56.45
24	11.09	16.79	23.72	27.69	41.29	57.67
25	11.32	17.14	24.21	28.26	42.14	58.86
L	Correction Factors for Other Lengths					
40	1.11	1.09	1.08	1.08	1.06	1.05
50	1.07	1.06	1.05	1.05	1.04	1.03
60	1.03	1.03	1.02	1.02	1.02	1.02
70	1.00	1.00	1.00	1.00	1.00	1.00
80	0.97	0.97	0.98	0.98	0.98	0.98
90	0.95	0.95	0.96	0.96	0.96	0.97
100	0.93	0.93	0.94	0.94	0.95	0.96

Metal Baffle shall have the same coating as the pipe to which it is attached. Where Metal Baffle is fabricated of more than one piece of metal, the separate pieces shall be securely fastened to each other. Sharp corners shall be removed. Metal Baffle may be made of corrugated or smooth sheet metal. End shaped circular, square or as shown.

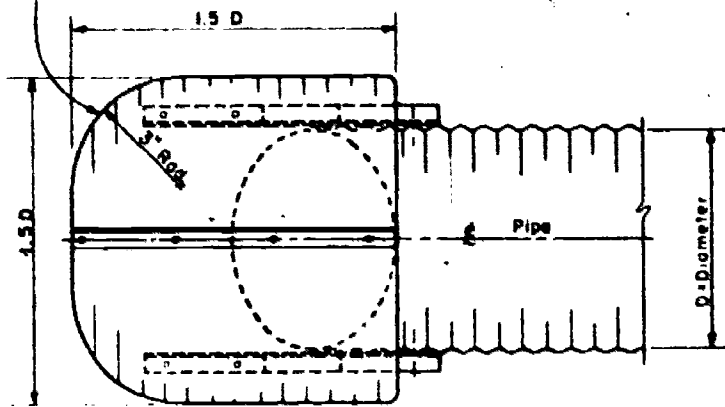

PLAN

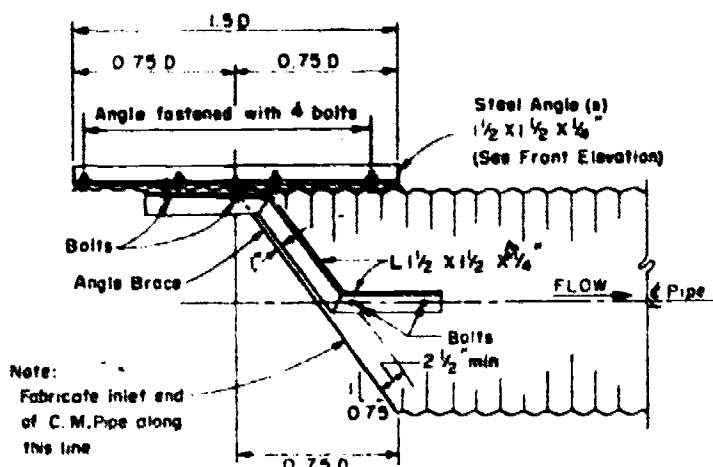

SIDE ELEVATION

GAGE OF METAL BAFFLE AND DIMENSIONS OF ANGLE BRACE						
Diam of Pipe D	Gage of Baffle	Angle Brace Dimensions in inches when used				
		a	b	c	d	e
6"	16					
8"	16					
10"	16					
12"	16	8	3 1/2	9	5	5 1/2
15"	16	9	4 1/2	9	6 1/2	5 1/2

Note: Angle Brace is optional

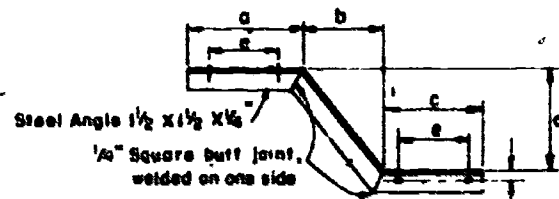

ANGLE BRACE DETAIL

(1 left and 1 right required for each baffle)

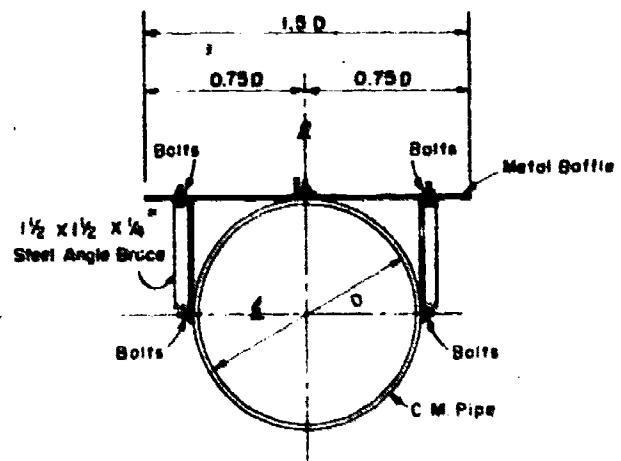

FRONT ELEVATION

Notes

- All bolts shall be 3/8" x 1/2" with nut and split washers
- All holes for bolts shall be drilled 7/8" diameter.
- All nuts, bolts and washers shall be galvanized, cadmium plated, or stainless steel
- All cuts shall be saw or shear cuts
- Holes in the angle brace shall be spaced and located to match corrugations in pipe and baffle
- Steel angles shall be galvanized.
- All galvanizing damaged by cutting, drilling or welding shall be repaired by painting with two (2) coats of zinc dust-zinc oxide primer.

Details of a typical hood inlet and baffle for 6- to 15-inch diameter corrugated metal pipe

Under full pipe flow conditions, high velocities exist near the pipe entrance, which generally causes a scour hole in the embankment face unless protected by paving or riprap. It is, therefore, desirable to provide protection to prevent the formation of a scour hole under the inlet. Paving is better than riprap in that it prevents the growth of vegetation near the inlet.

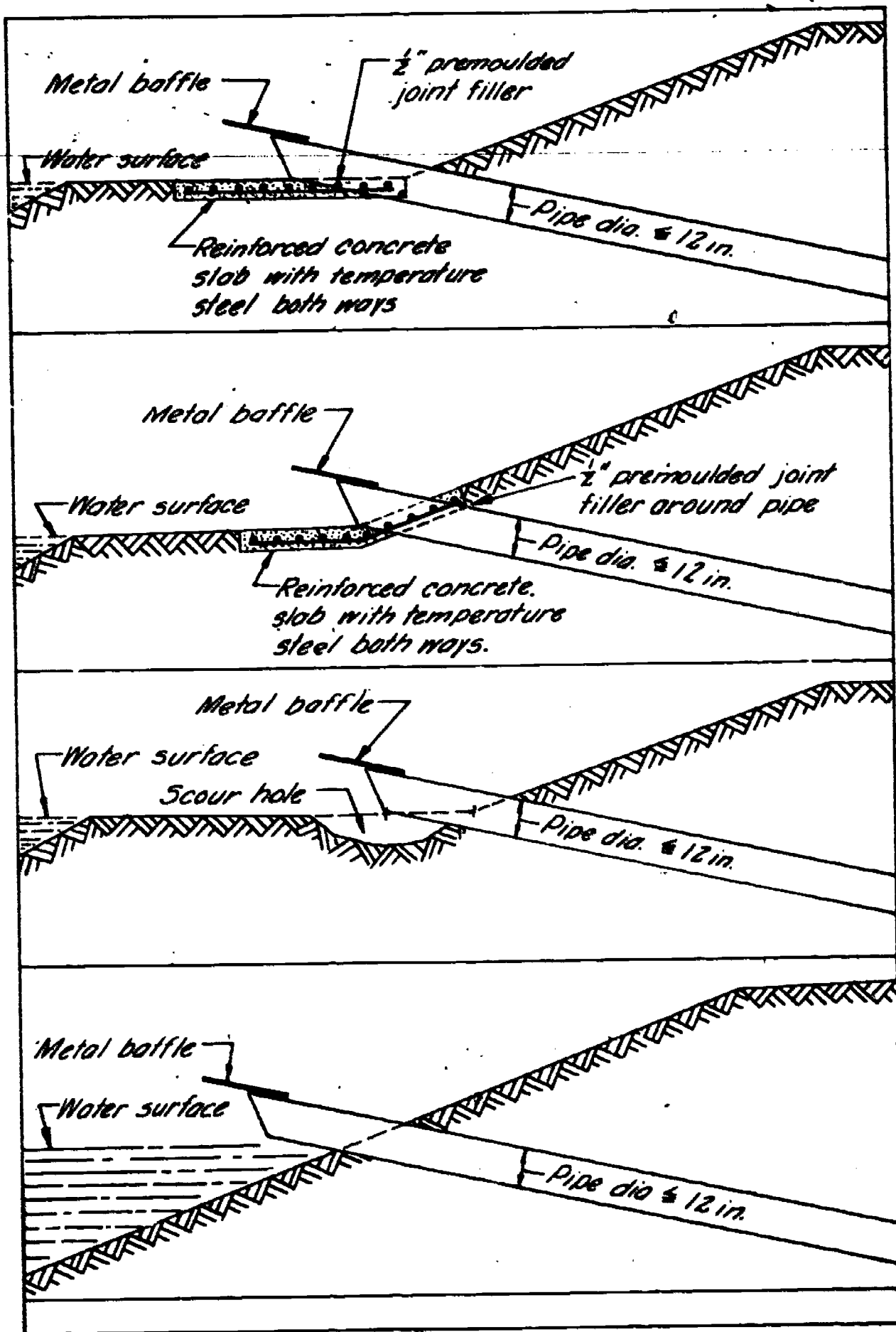

Typical layouts of inlets for 12-inch or less hood inlet spillways