

DOCUMENT RESUME

ED 143 532

SE 023 011

AUTHOR Chinn, William G.; And Others  
 TITLE Mathematics for the Elementary School, Book 1 (Part-  
 1). Student Text. Special Edition (Revised).  
 INSTITUTION Stanford Univ., Calif. School Mathematics Study  
 Group.  
 SPONS AGENCY National Science Foundation, Washington, D.C.  
 PUB DATE 66  
 NOTE 138p.; For related documents, see SE 023 012-014

EDRS PRICE MF-\$0.83 HC-\$7.35 Plus Postage.  
 DESCRIPTORS \*Arithmetic; Disadvantaged Youth; Elementary  
 Education; \*Elementary School Mathematics; Grade 1;  
 \*Instructional Materials; Mathematics; Mathematics  
 Education;. \*Number Concepts; Set Theory;  
 \*Textbooks  
 IDENTIFIERS \*School Mathematics Study Group

ABSTRACT

This textbook is based on the SMSG kindergarten and first grade materials as a framework. This special edition is designed to meet the needs of disadvantaged children. Chapters in the book include: (1) Sets and Numbers; (2) Numerals and the Number Line; (3) Sets of Ten; and (4) Introduction to Addition and Subtraction. The student text contains a variety of activities and exercises with limited directions. Detailed instructions for the teacher and background materials are included in the Teacher's Commentary.  
 (RH)

\*\*\*\*\*  
 \* Documents acquired by ERIC include many informal unpublished \*  
 \* materials not available from other sources. ERIC makes every effort \*  
 \* to obtain the best copy available. Nevertheless, items of marginal \*  
 \* reproducibility are often encountered and this affects the quality \*  
 \* of the microfiche and hardcopy reproductions ERIC makes available \*  
 \* via the ERIC Document Reproduction Service (EDRS). EDRS is not \*  
 \* responsible for the quality of the original document. Reproductions \*  
 \* supplied by EDRS are the best that can be made from the original. \*  
 \*\*\*\*\*

U.S. DEPARTMENT OF HEALTH,  
EDUCATION & WELFARE  
NATIONAL INSTITUTE OF  
EDUCATION

THIS DOCUMENT HAS BEEN REPRODUCED EXACTLY AS RECEIVED FROM THE PERSON OR ORGANIZATION ORIGINATING IT. POINTS OF VIEW OR OPINIONS STATED DO NOT NECESSARILY REPRESENT OFFICIAL NATIONAL INSTITUTE OF EDUCATION POSITION OR POLICY.

PERMISSION TO REPRODUCE THIS  
MATERIAL HAS BEEN GRANTED BY

SMSC

TO THE EDUCATIONAL RESOURCES  
INFORMATION CENTER (ERIC) AND  
THE ERIC SYSTEM CONTRACTORS

# MATHEMATICS FOR THE ELEMENTARY SCHOOL

## BOOK 1 (Part 1)

### *Student Text*

SPECIAL EDITION (Revised)

The following is a list of all those who participated in the preparation of this volume:

William G. Chinn, San Francisco Unified School District, San Francisco, California  
M. E. Dunkley, SMSG, Stanford University  
Mary O. Folsom, University of Miami, Florida  
E. Glenadine Gibb, State College of Iowa  
Lenore John, University of Chicago Laboratory School, Chicago, Illinois  
Gloria Leiderman, SMSG, Stanford University  
Emma M. Lewis, District of Columbia Public Schools, Washington, D. C.  
Susan H. Talbot, Gunn High School, Palo Alto, California  
J. Fred Weaver, Boston University  
Margaret F. Willerding, San Diego State College

© 1965 and 1966 by The Board of Trustees of the Leland Stanford Junior University  
All rights reserved  
Printed in the United States of America

*Permission to make verbatim use of material in this book must be secured from the Director of SMSG. Such permission will be granted except in unusual circumstances. Publications incorporating SMSG materials must include both an acknowledgment of the SMSG copyright (Yale University or Stanford University, as the case may be) and a disclaimer of SMSG endorsement. Exclusive license will not be granted save in exceptional circumstances, and then only by specific action of the Advisory Board of SMSG.*

*Financial support for the School Mathematics Study Group has been provided by the National Science Foundation.*

Teachers' Commentary  
TABLE OF CONTENTS

Chapter 1.	SETS AND NUMBERS	
1 - 1.	Set and member .....	1 - 6
1 - 2.	The Empty Set .....	7 - 9
1 - 3.	Pairing and Equivalence .....	10 - 21
1 - 4.	Comparison of Sets (More Than) .....	22 - 33
1 - 5.	Comparison of Sets (Fewer Than) .....	34 - 39
1 - 6.	Review .....	40 - 41
1 - 7.	Numbers and Equivalence .....	42 - 45
1 - 8.	Number Perception, Without Counting ...	
1 - 9.	Comparison of Numbers .....	46 - 47
Chapter 2.	NUMERALS AND THE NUMBER LINE	
2 - 1.	Arranging Sets in Succession .....	48 - 72
2 - 2.	The Numerals 0 through 9 .....	73 - 107
2 - 3.	The Number Line .....	108 - 111
Chapter 3.	SETS OF TEN	
3 - 1.	Sets of Ten .....	112 - 113
3 - 2.	Naming Multiples of Ten .....	
3 - 3.	Application: Money .....	114 - 115
3 - 4.	Problem Solving with Sets of Ten .....	
Chapter 4.	INTRODUCTION TO ADDITION AND SUBTRACTION	
4 - 1.	Joining .....	
4 - 2.	Joining Sets and Counting .....	
4 - 3.	Joining Sets and Adding Numbers .....	116 - 125
4 - 4.	Subsets .....	126 - 127
4 - 5.	Removing Sets and the Remaining Set .....	
4 - 6.	Removing Sets and Subtracting Numbers ..	128 - 132

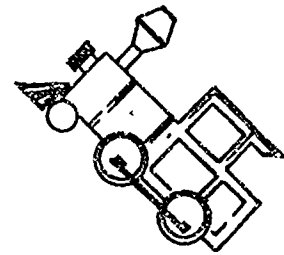
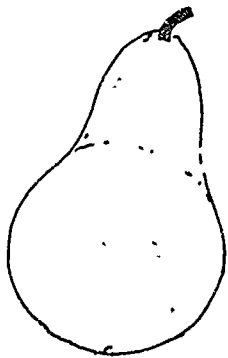
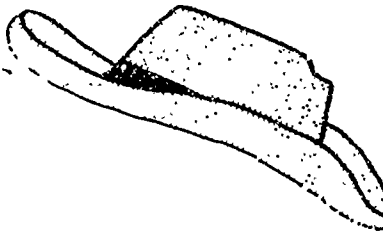
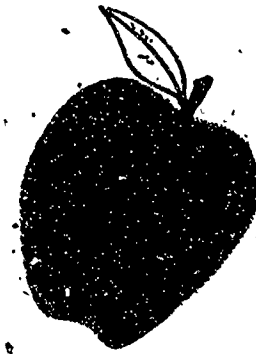
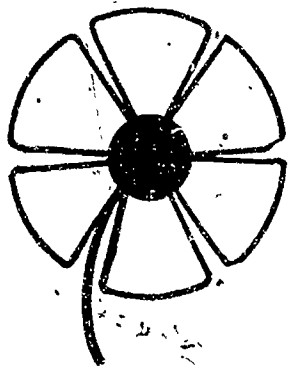

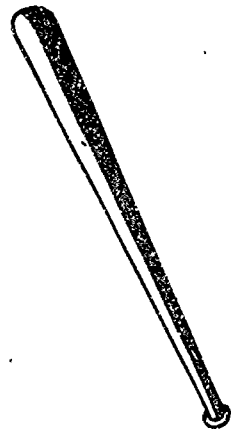
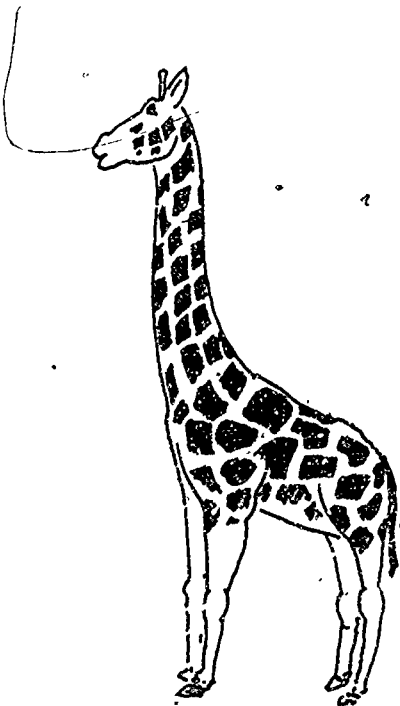
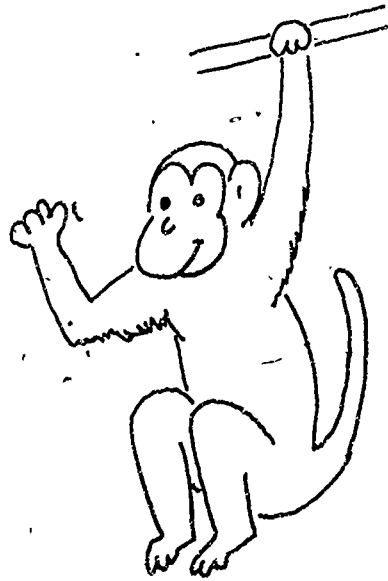
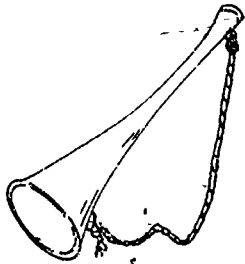
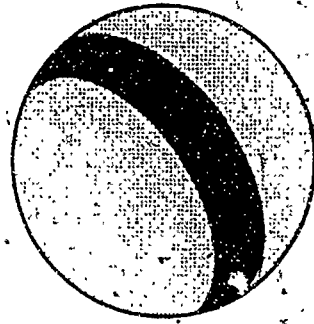

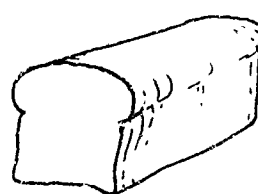
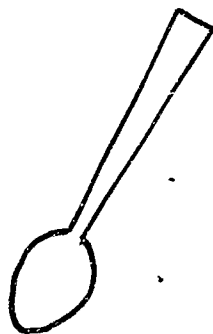
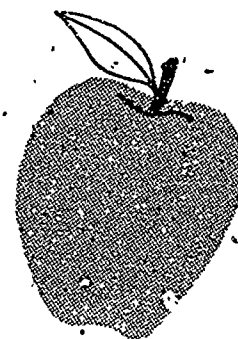
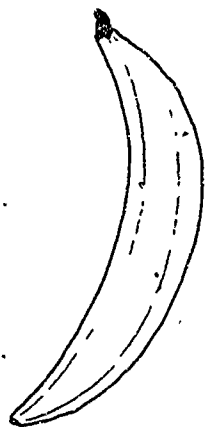

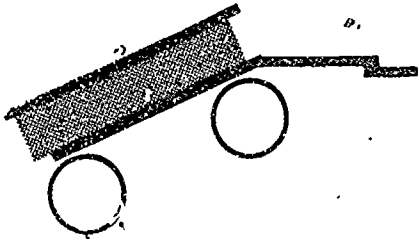
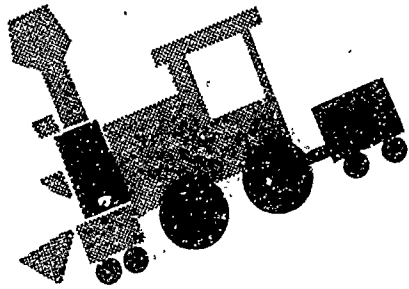
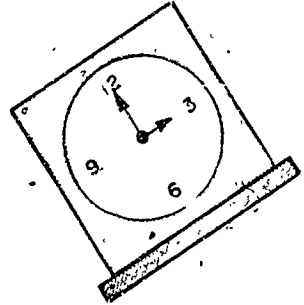
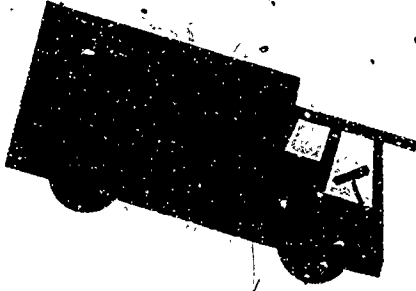
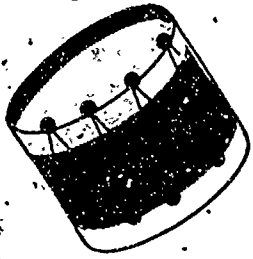



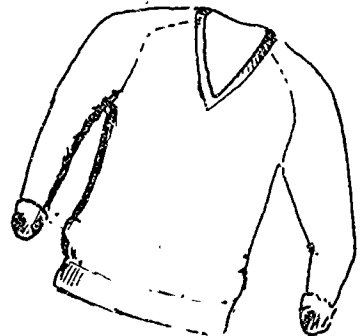
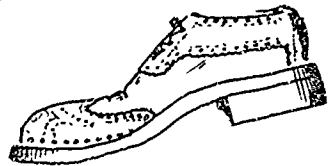
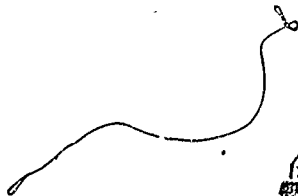
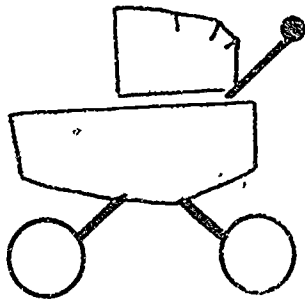
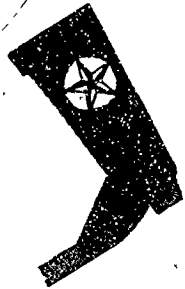
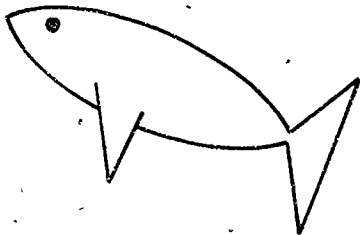
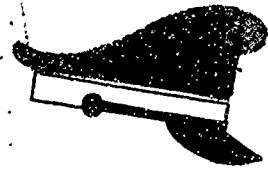
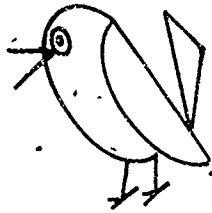

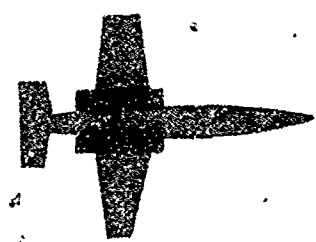
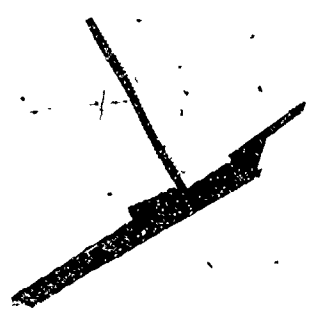
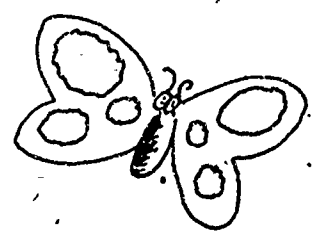
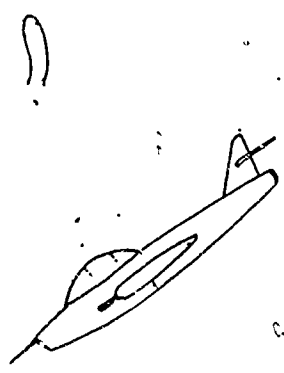

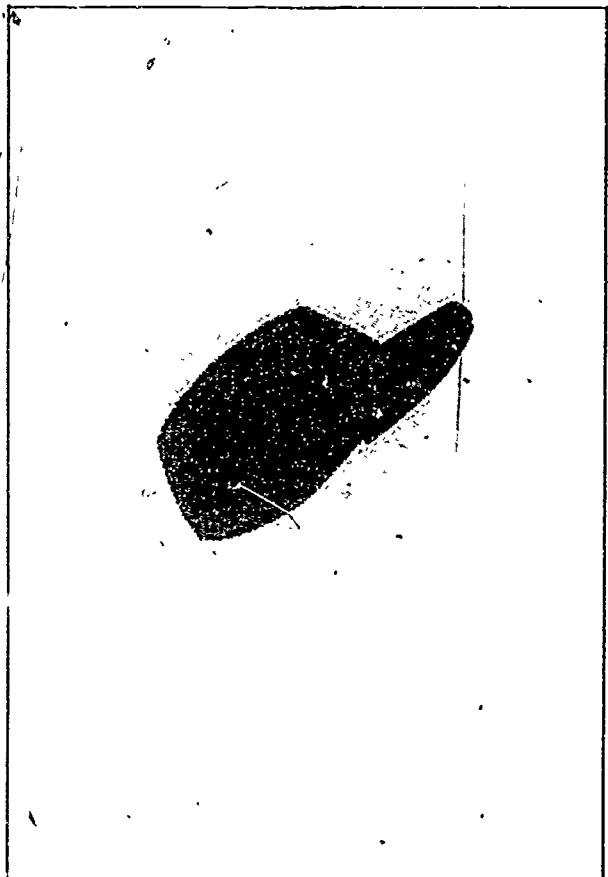
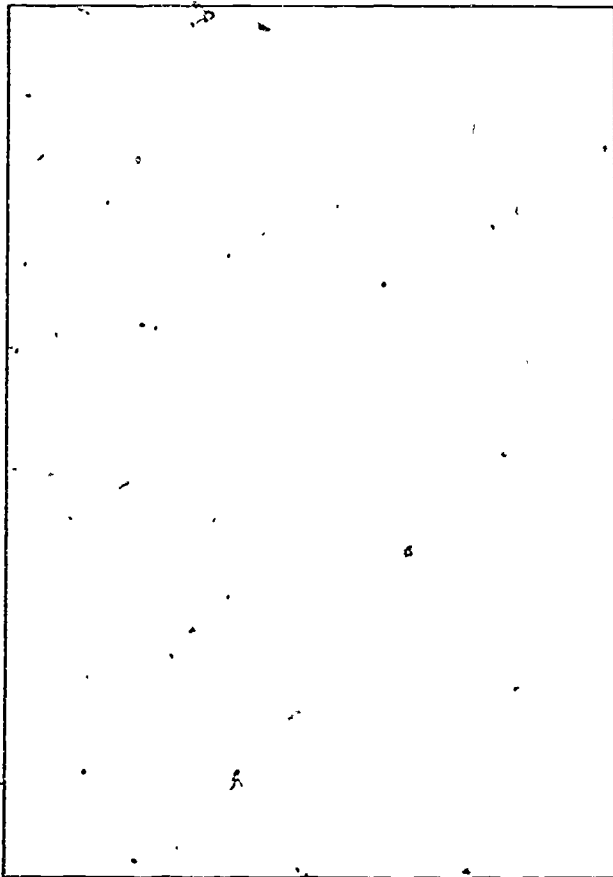
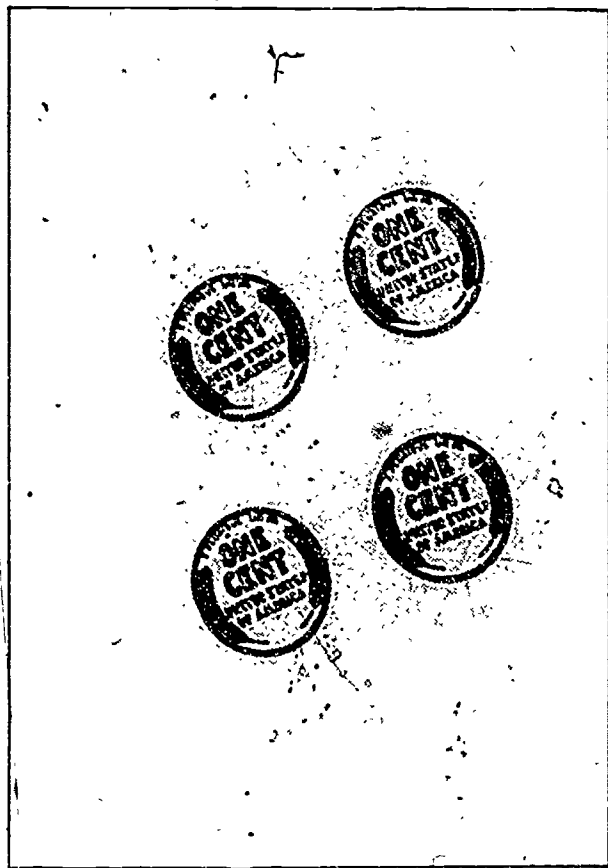
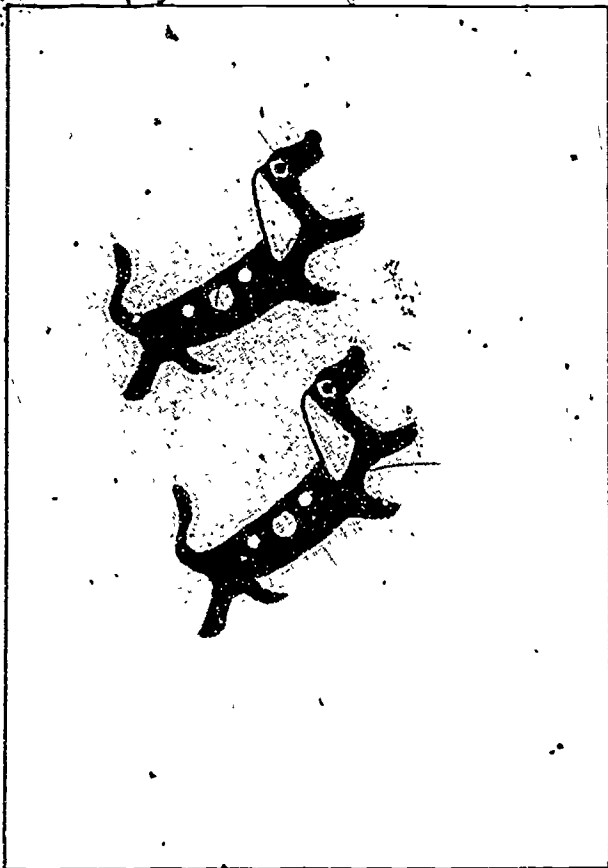

The empty set

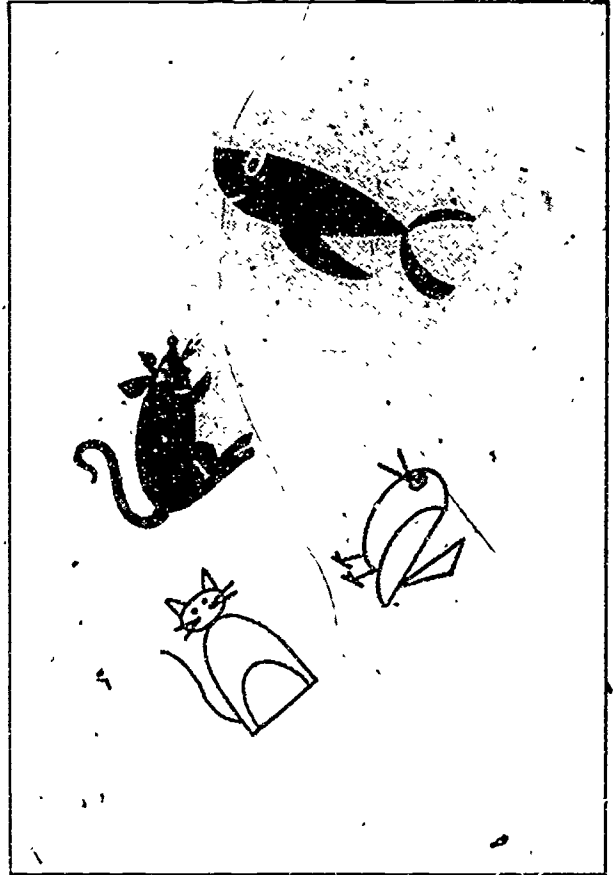
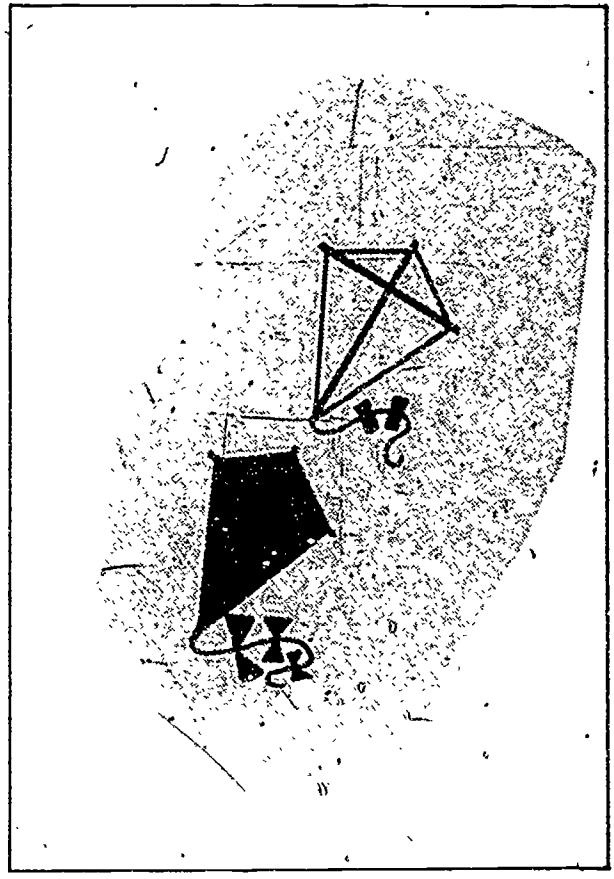

The empty set

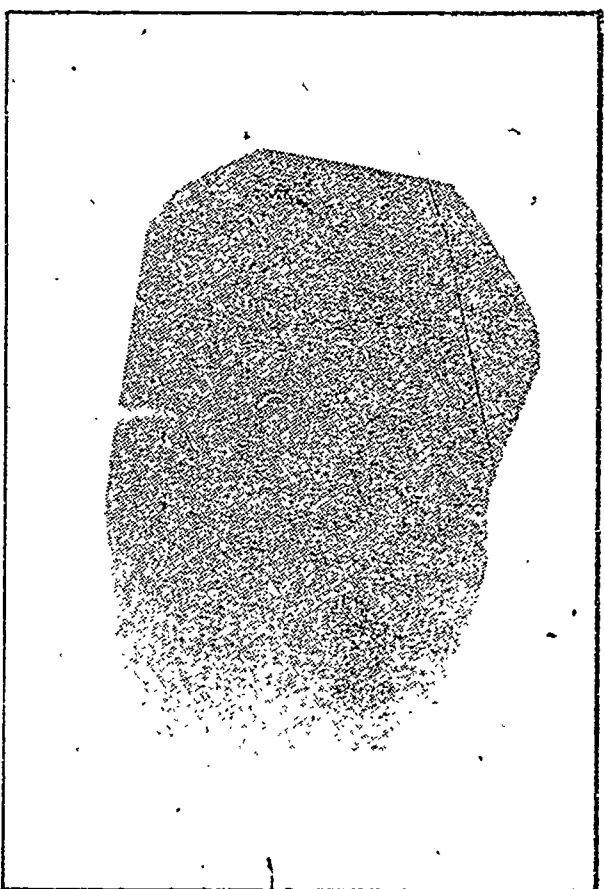
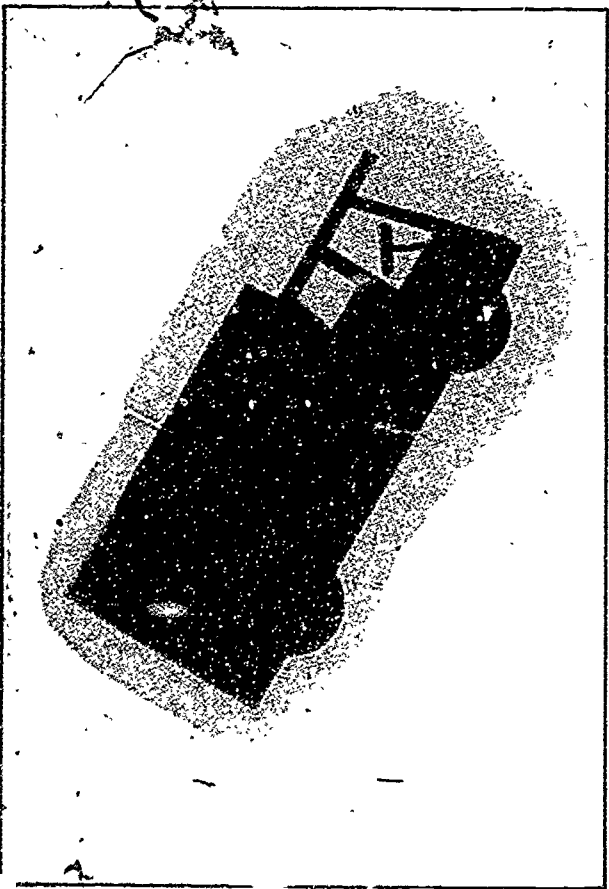
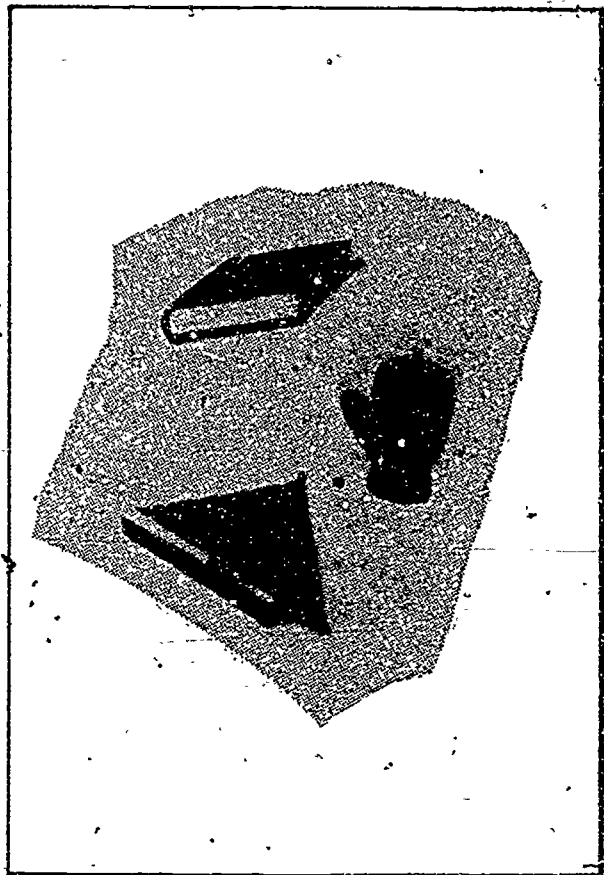

Are the sets equivalent?

1

Yes      No

Yes      No

Are the sets equivalent?

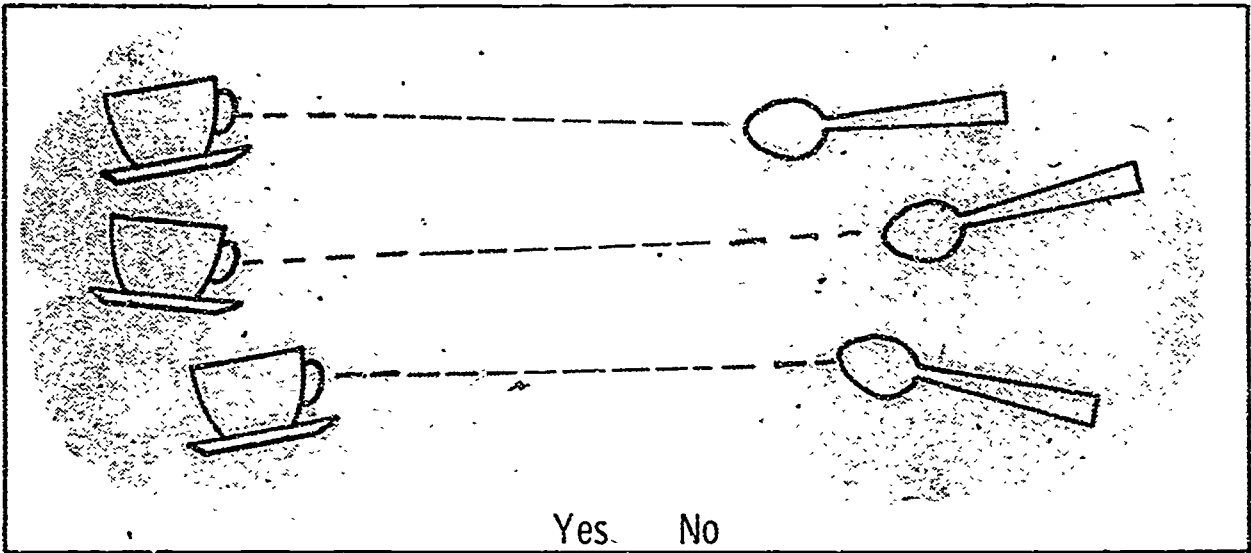

Yes No

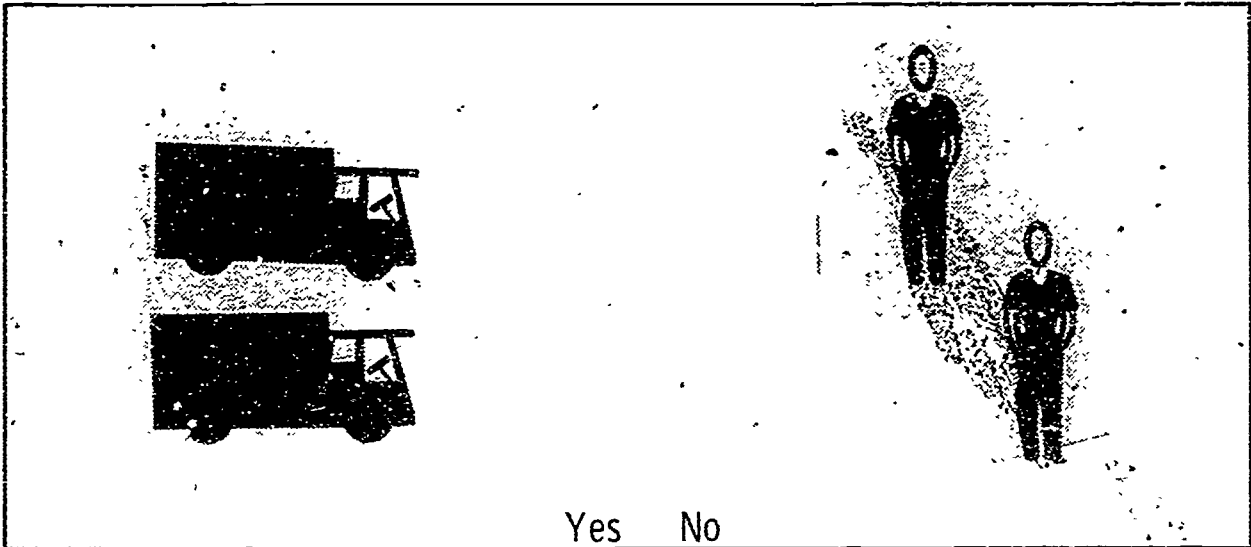

Yes No

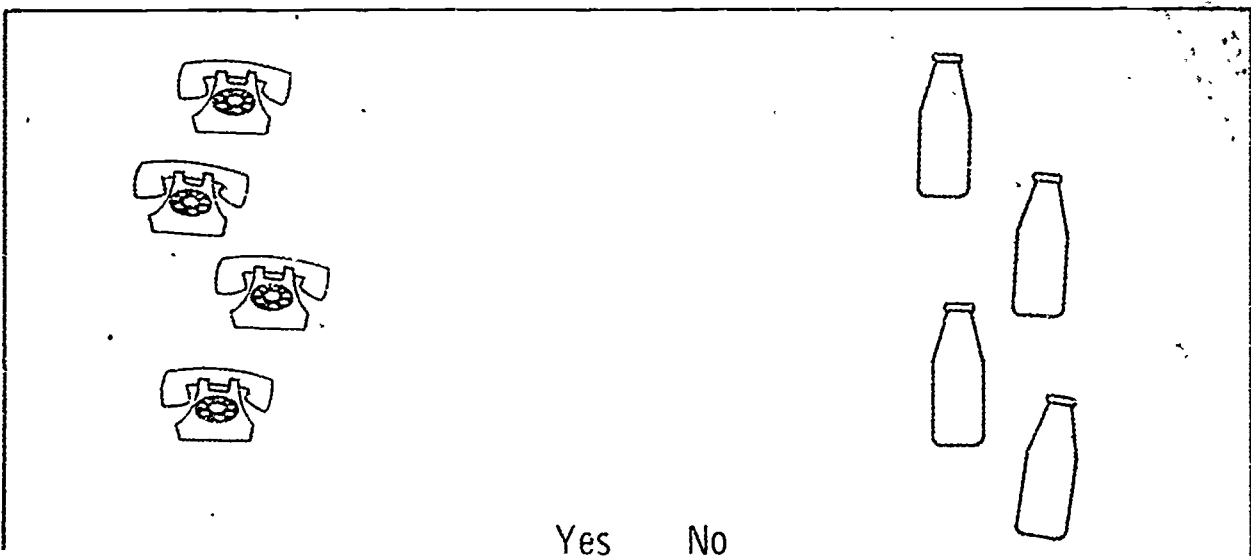

Yes No

Are the sets equivalent?

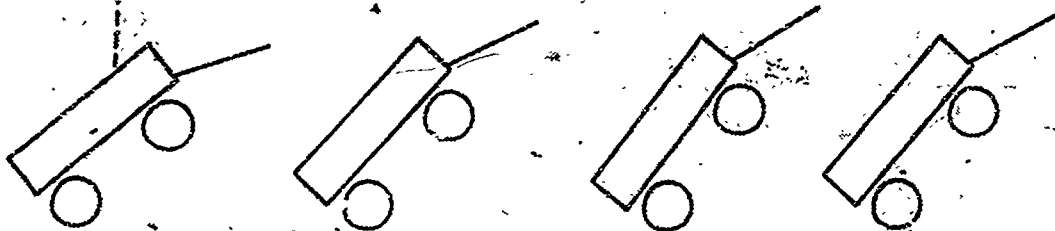
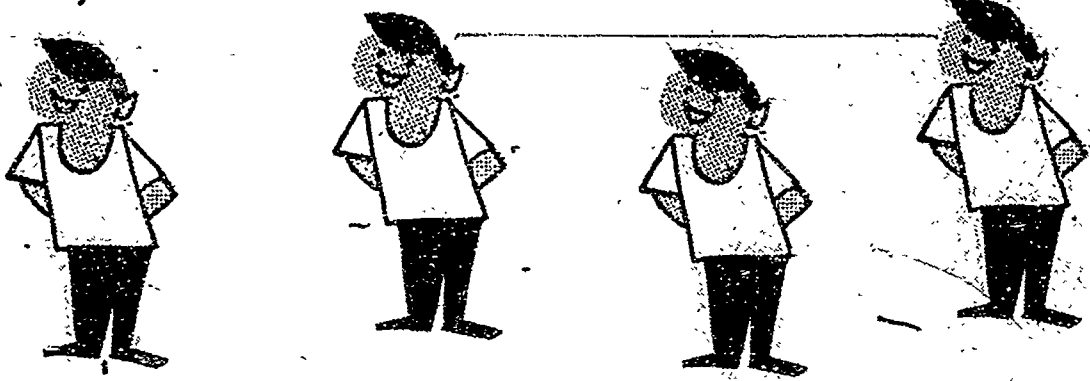

Yes No



Yes No

16



Are the sets equivalent?

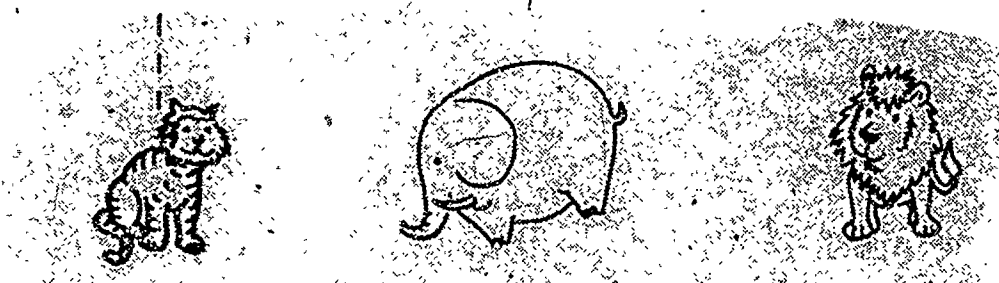
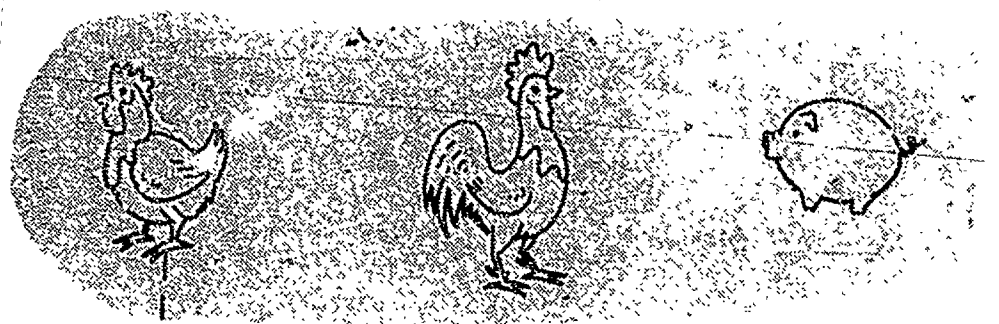

Yes No

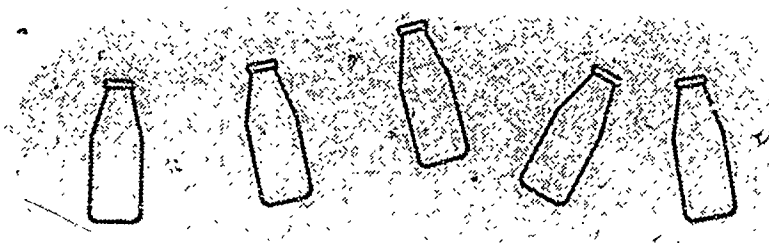

Yes No

Are the sets equivalent?

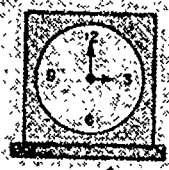

Yes      No

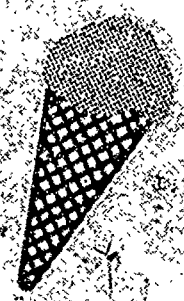

Yes      No

Are the sets equivalent?

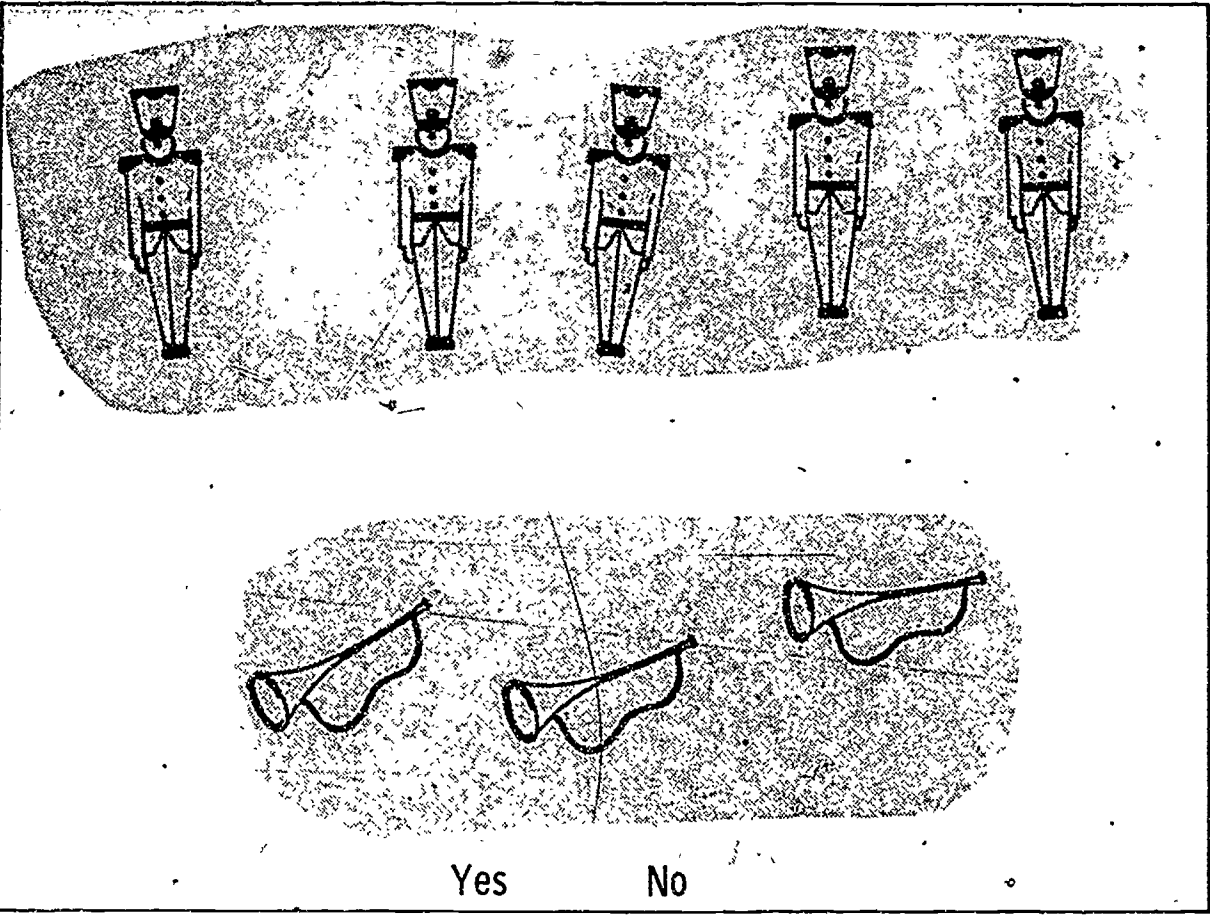

The first set contains five identical nutcracker figures. The second set contains three identical glasses. Below the glasses are the labels "Yes" and "No".

Yes      No

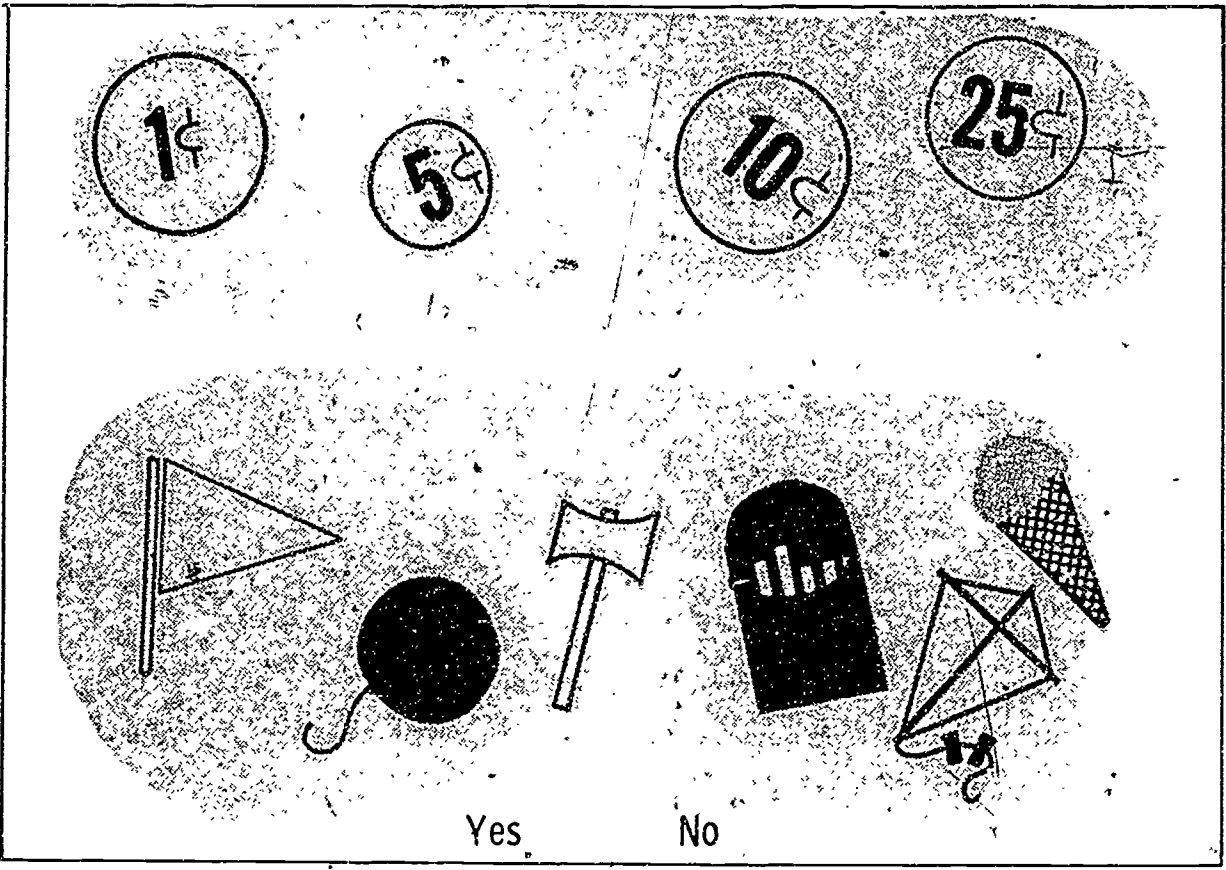

The first set contains four coins: one 1-cent coin, one 5-cent coin, one 10-cent coin, and one 25-cent coin. The second set contains a triangle, a ball, an axe, a door, a kite, and an ice cream cone. Below the second set are the labels "Yes" and "No".

Yes      No

Are the sets equivalent?

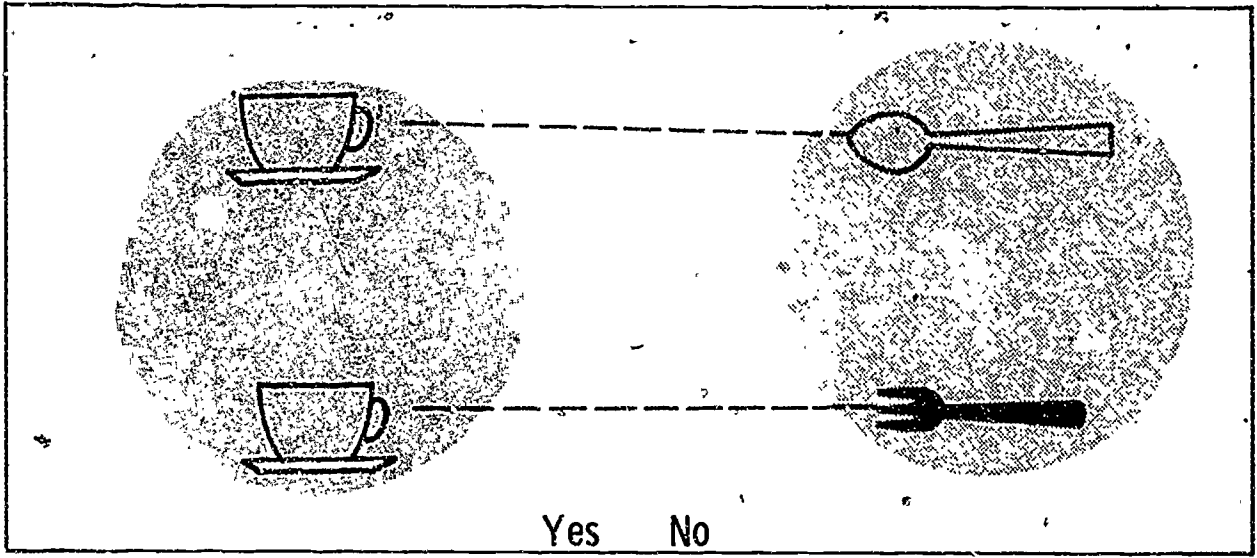

Yes No

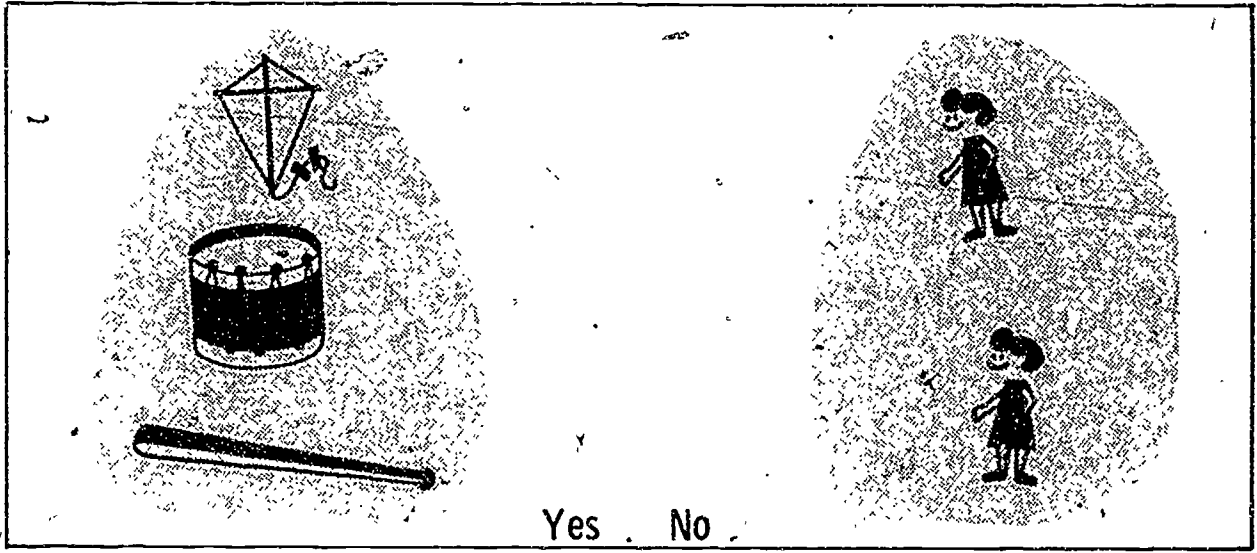

Yes No

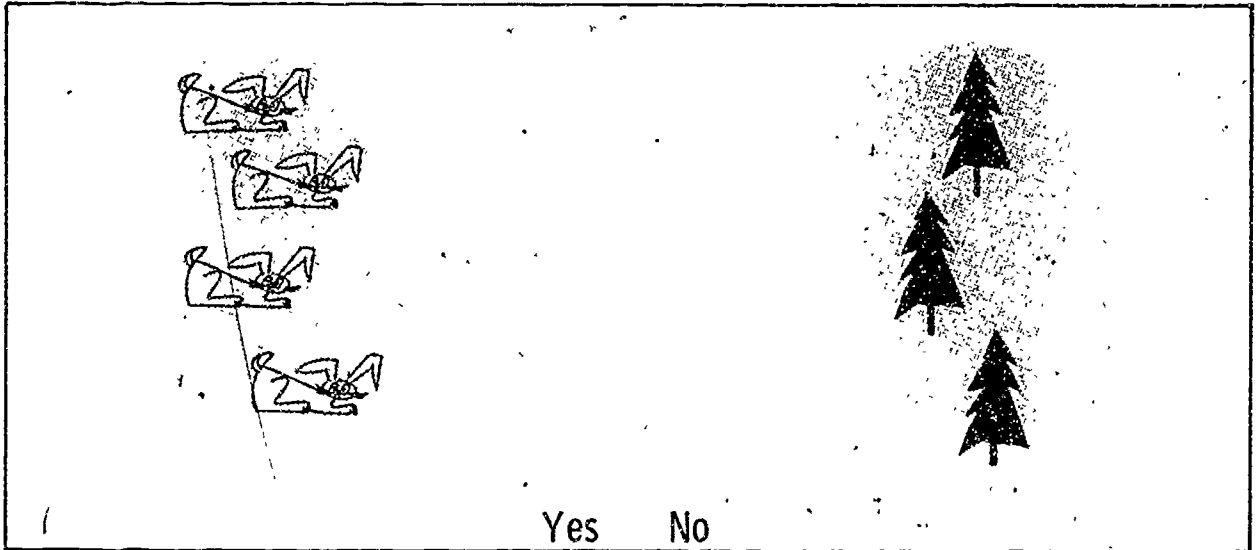

Yes No

Are the sets equivalent?

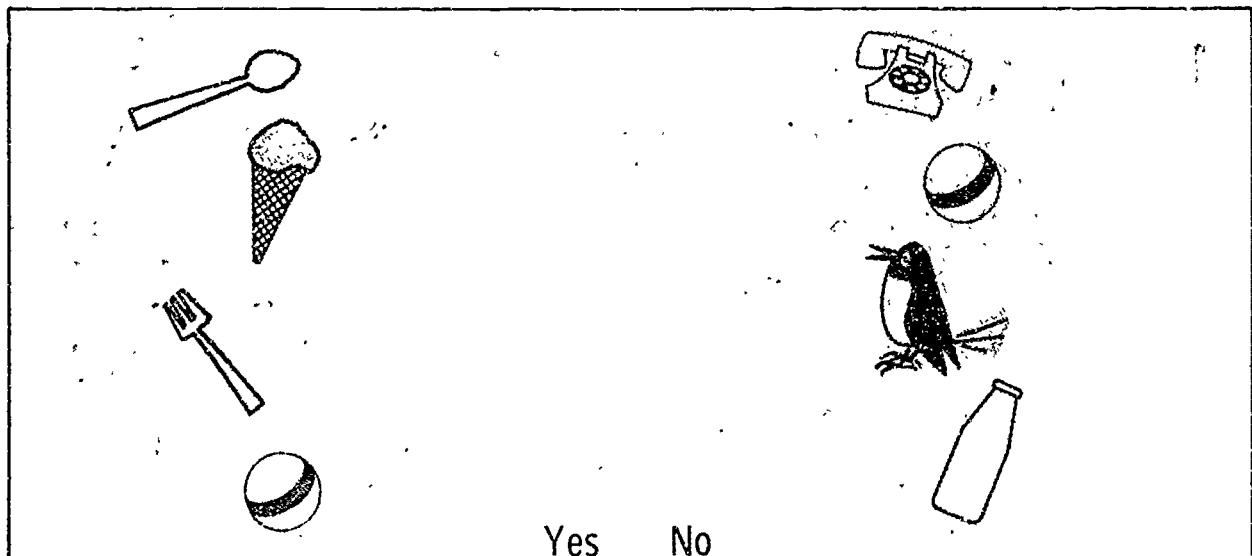
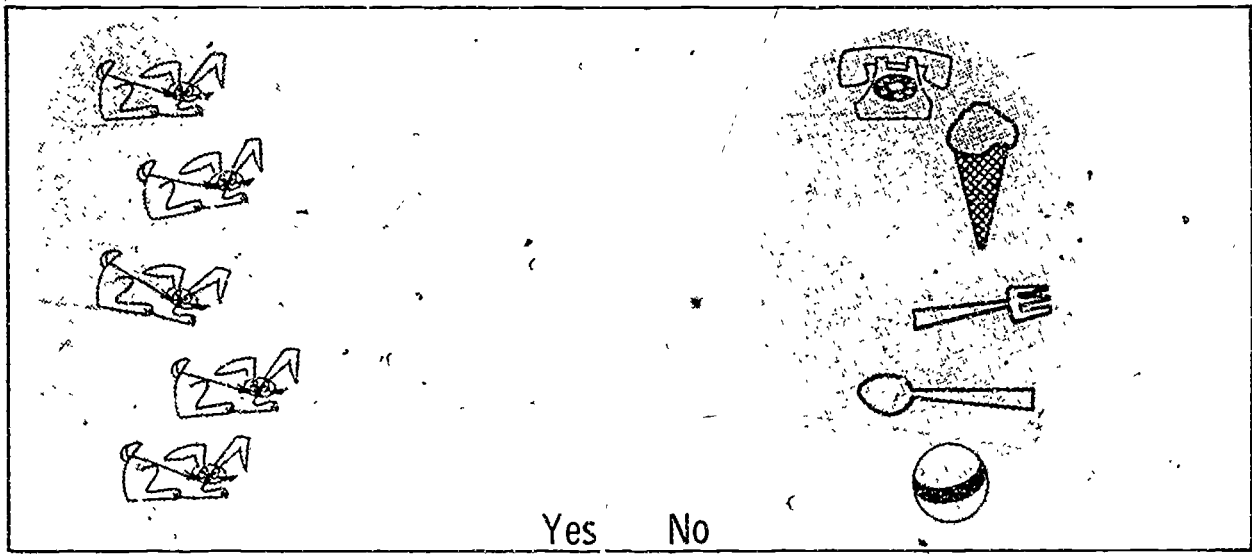
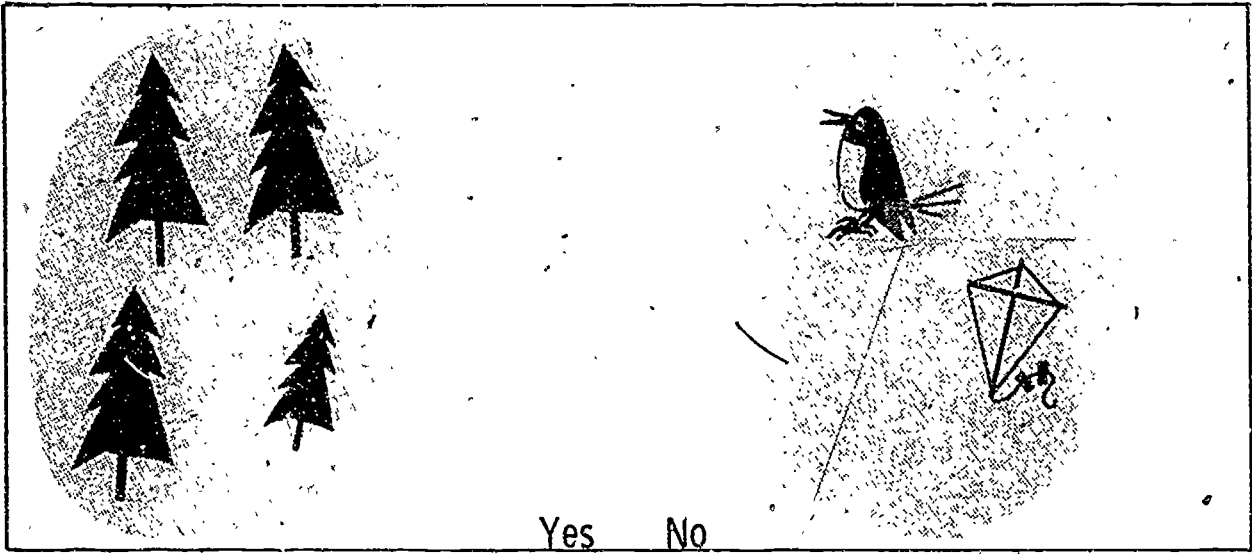

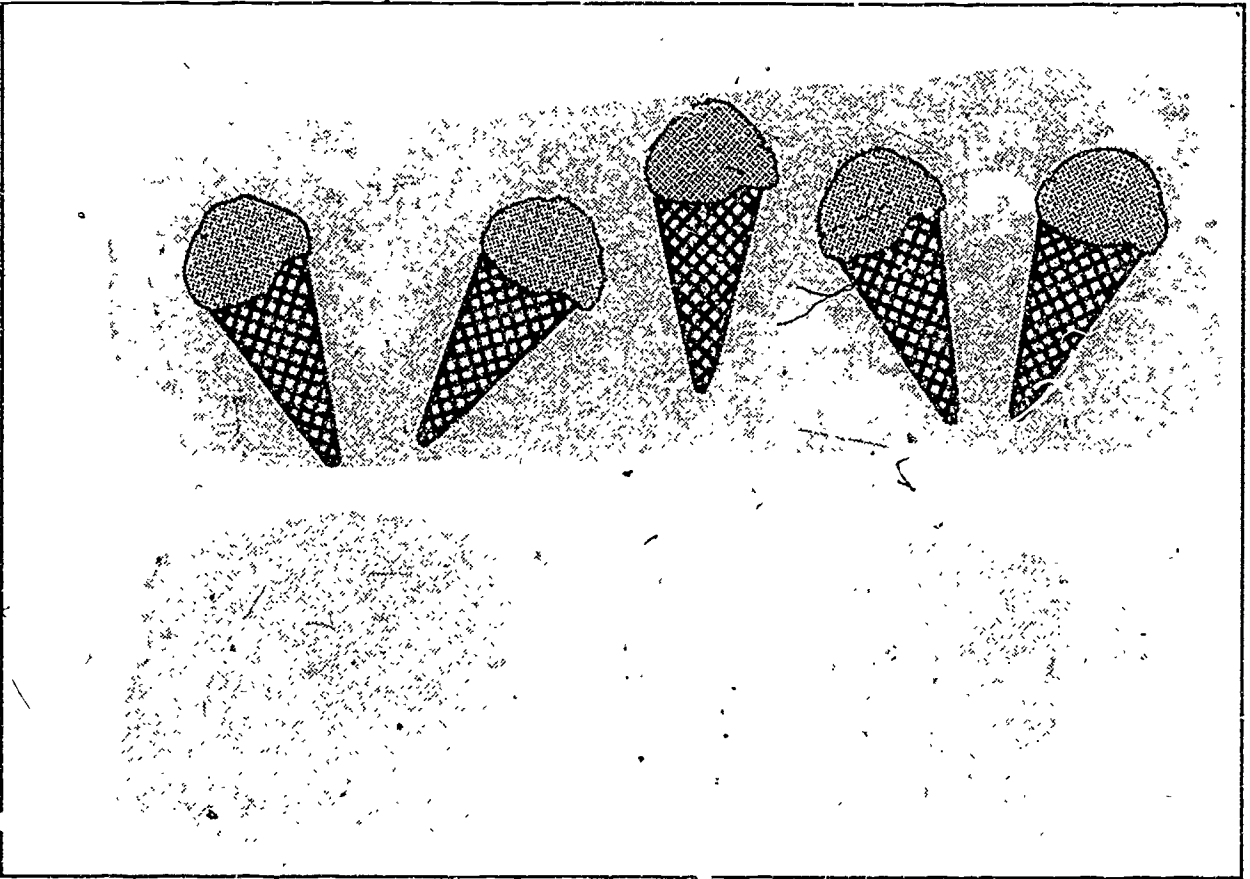
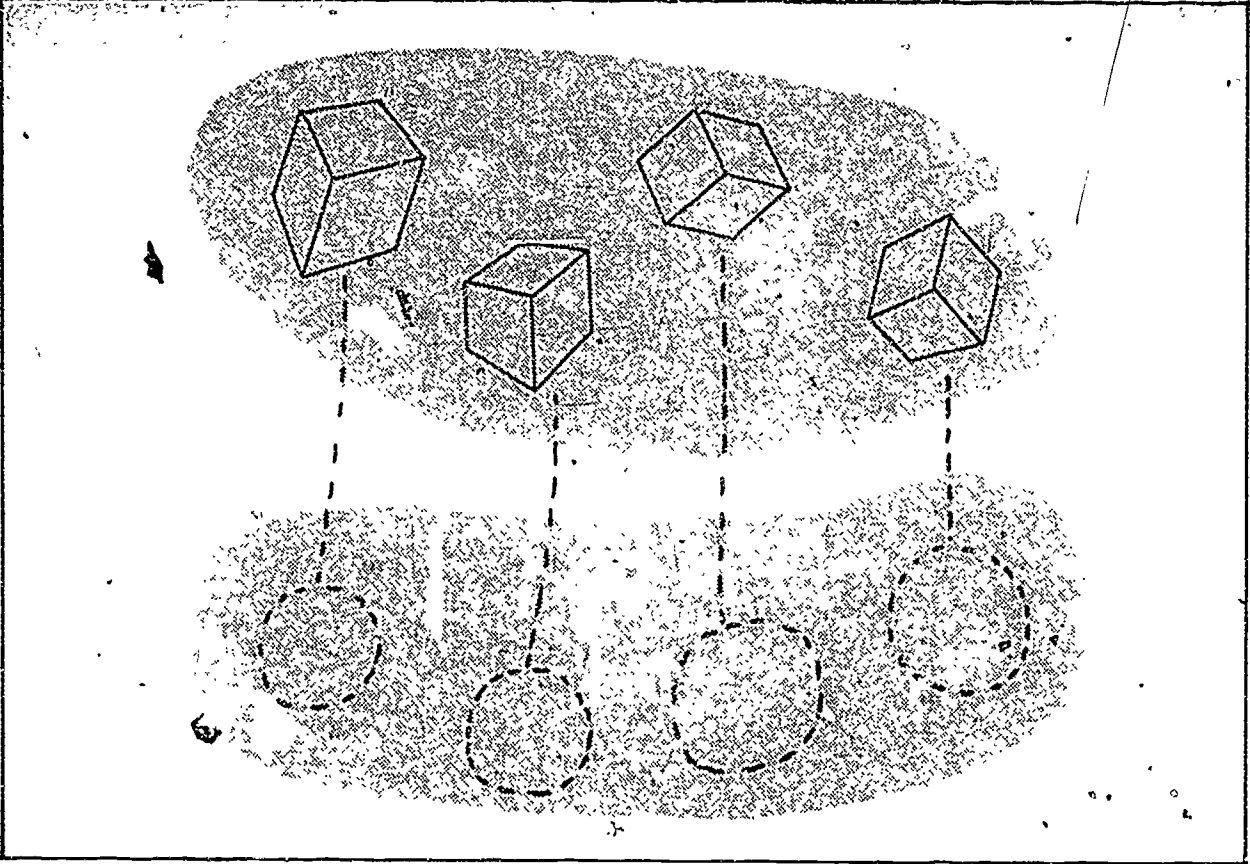

Show equivalent sets

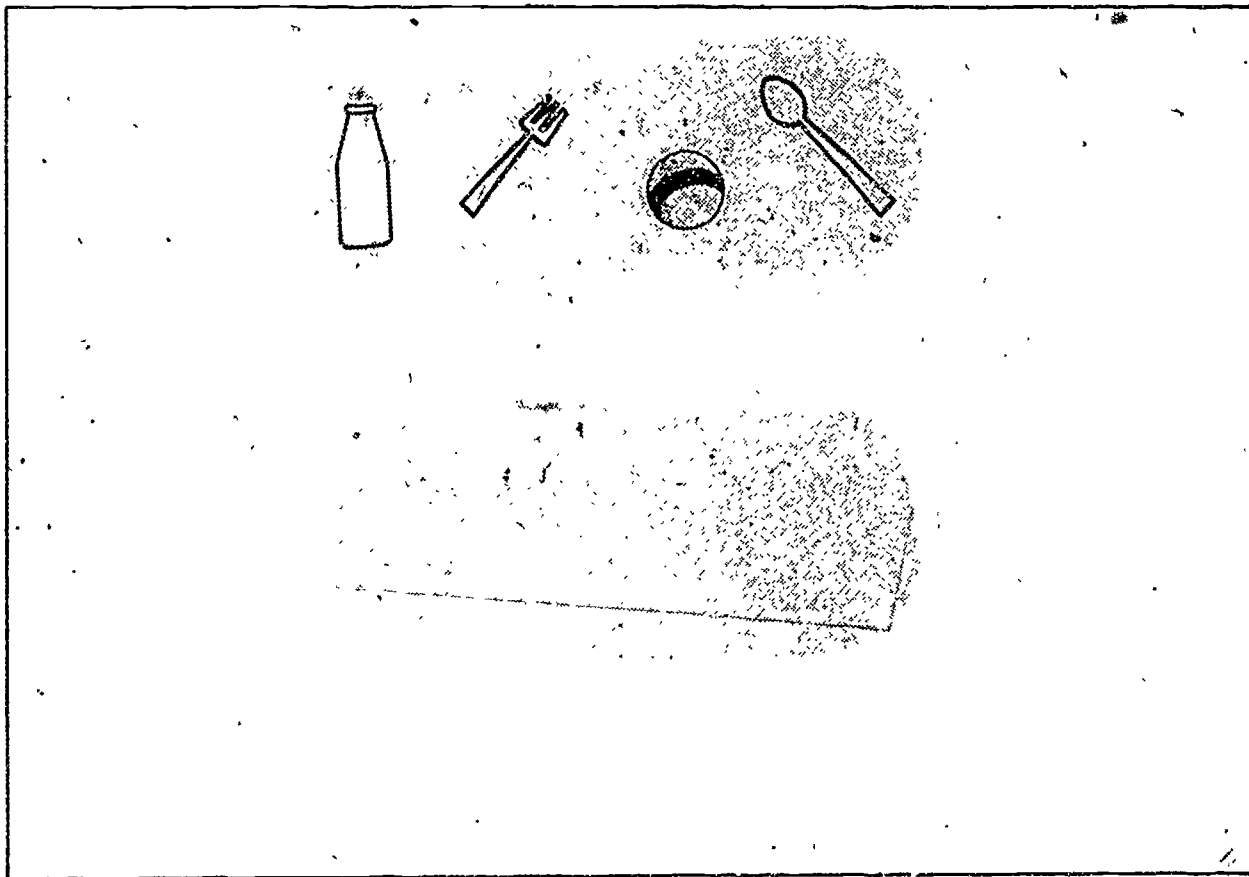
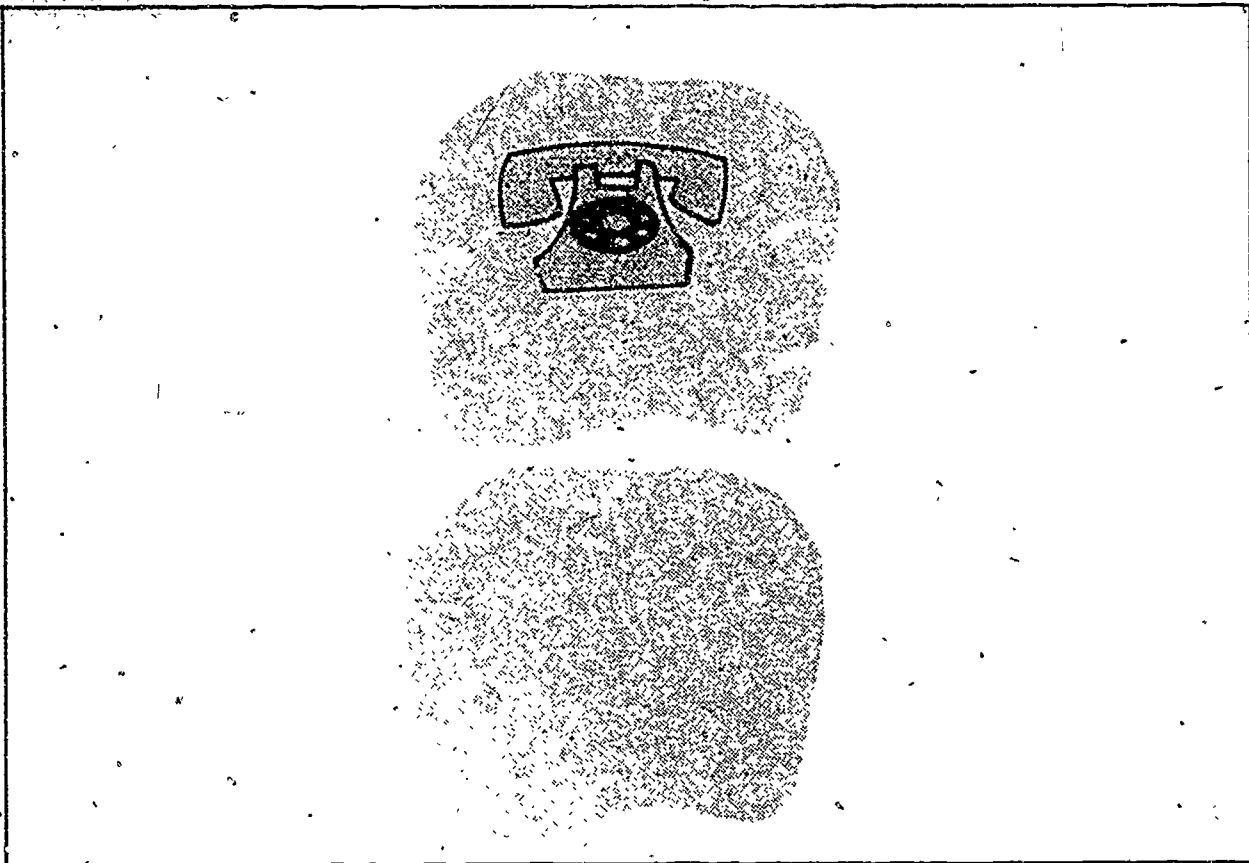

Show equivalent sets

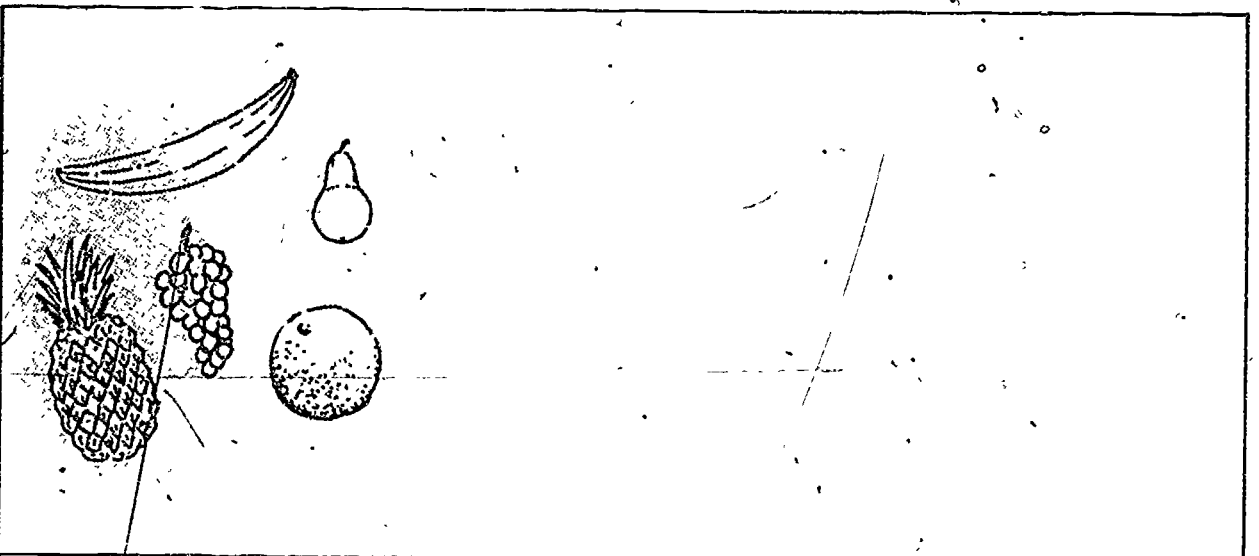
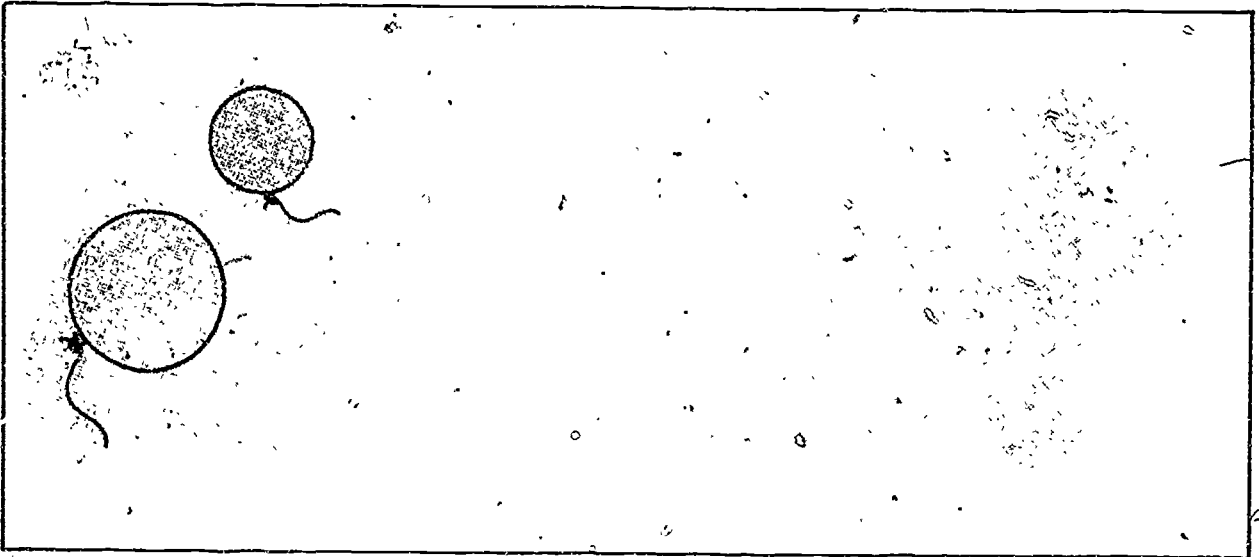
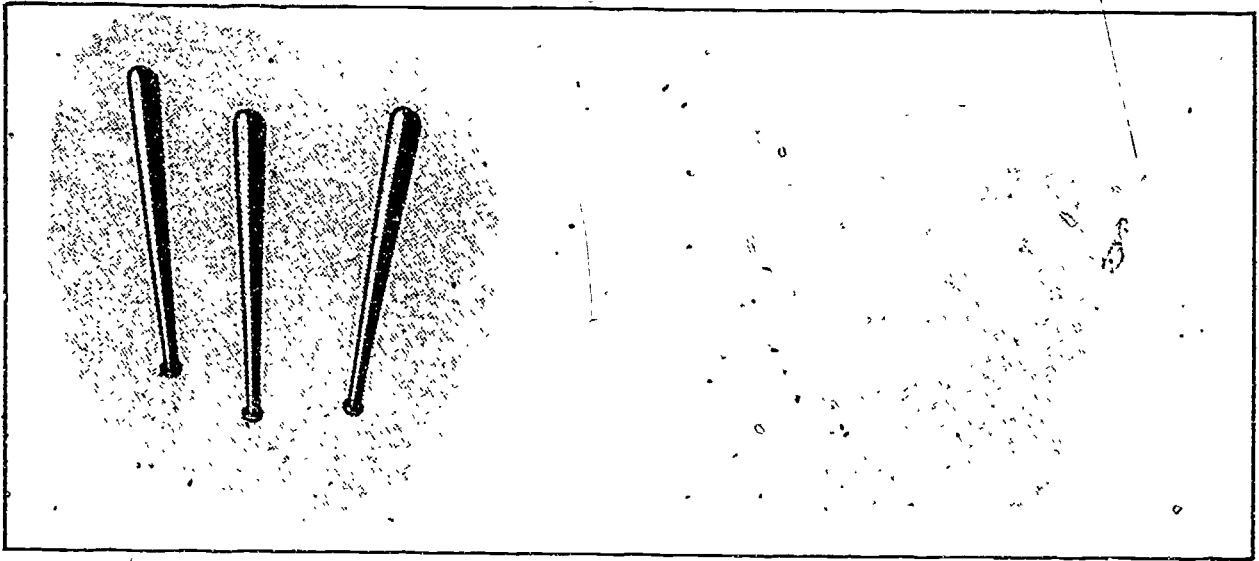



Show equivalent sets

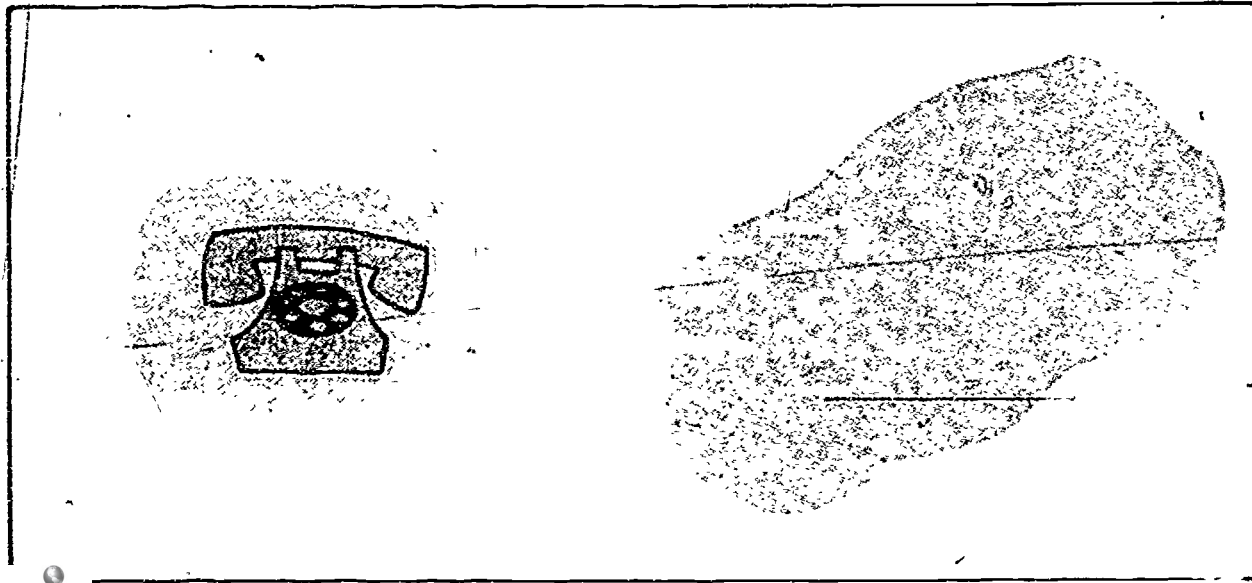
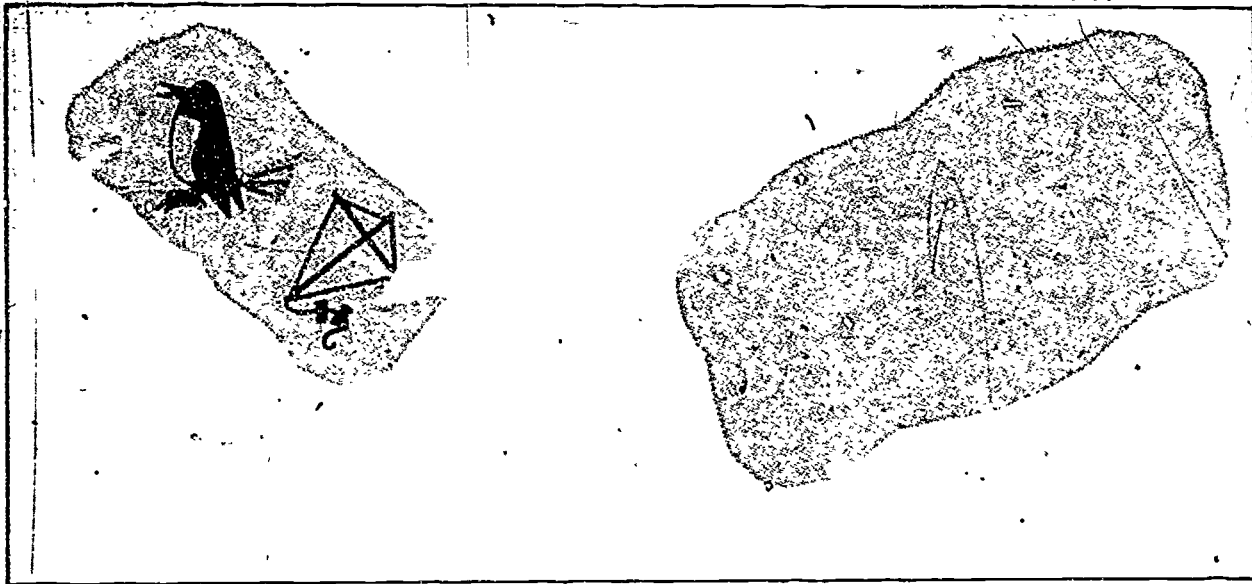
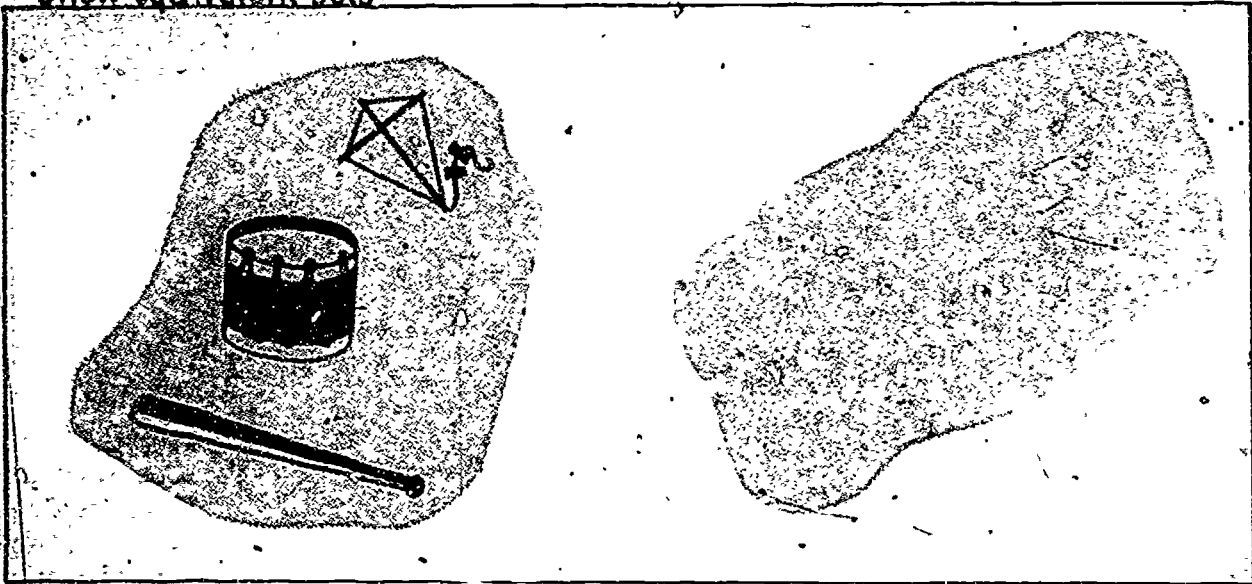

Which set has more members? Mark it

Top set: 4 cubes

Bottom set: 2 cubes

Mark: ~~—~~

Mark: —

Top set: 3 items (teardrop, grapes, round object)

Bottom set: 2 items (cat, spider)

Mark: —

Mark: —

Which set has more members? Mark it



\_\_\_\_\_



\_\_\_\_\_



\_\_\_\_\_



\_\_\_\_\_

Which set has more members? Mark it

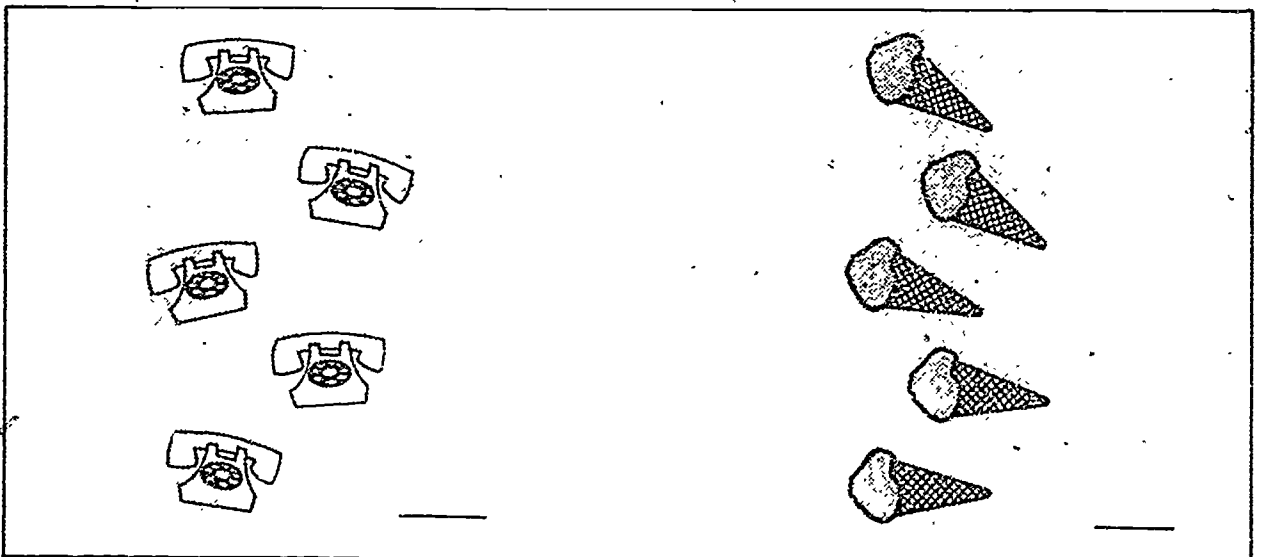
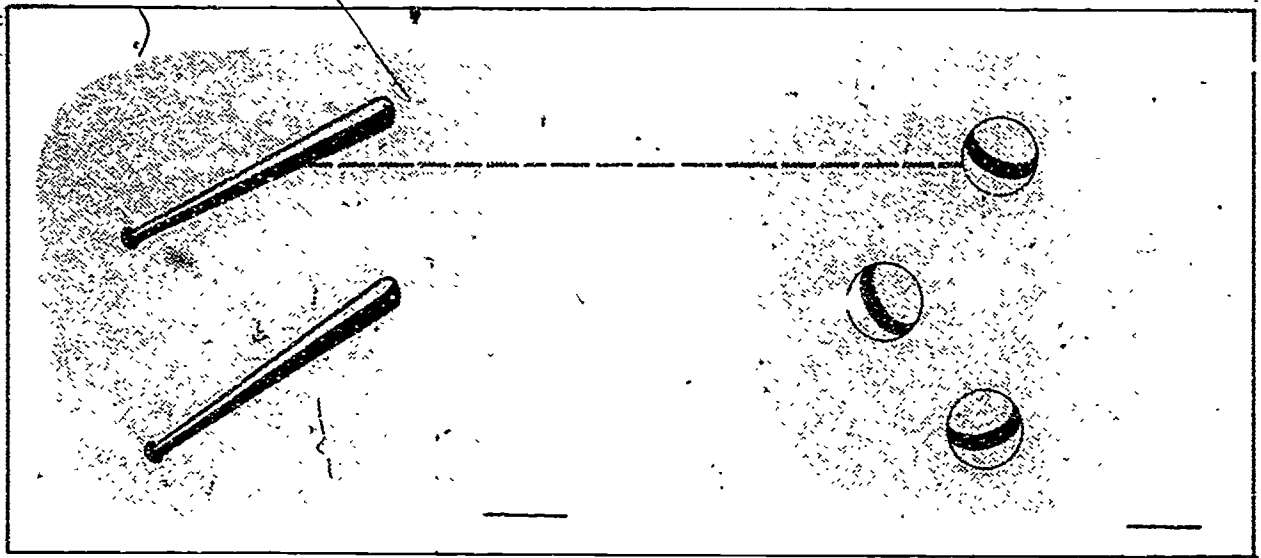

Which set has more members? Mark it

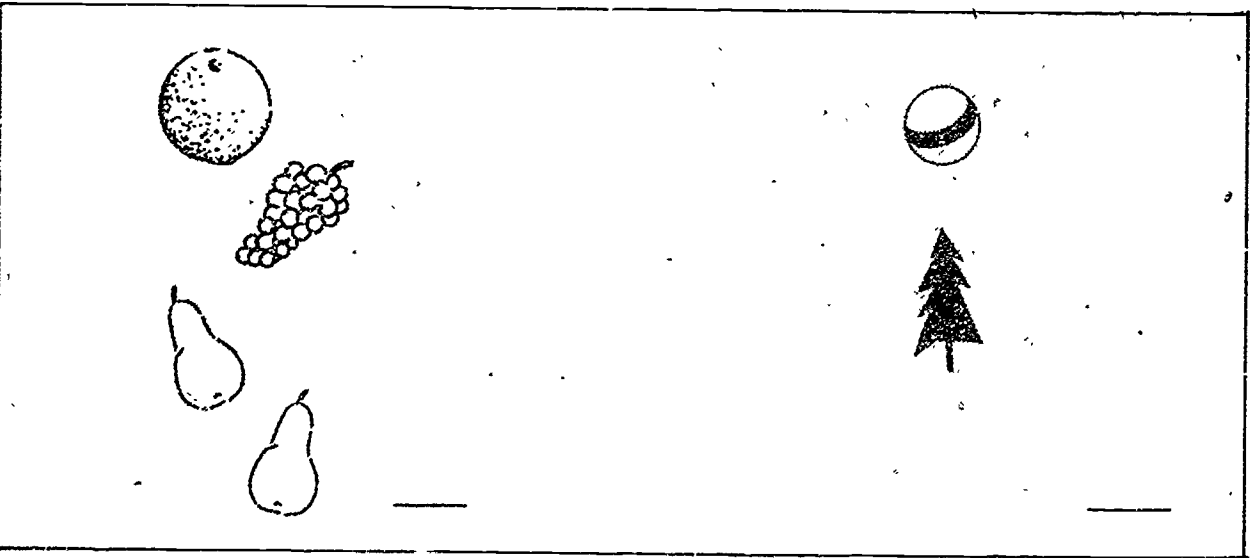
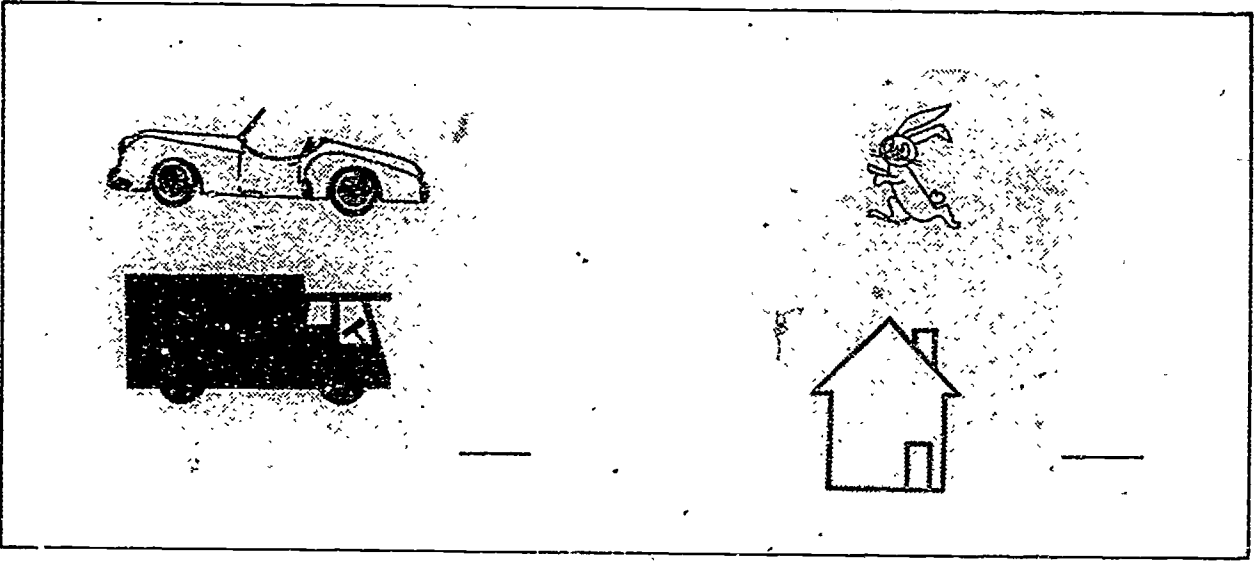
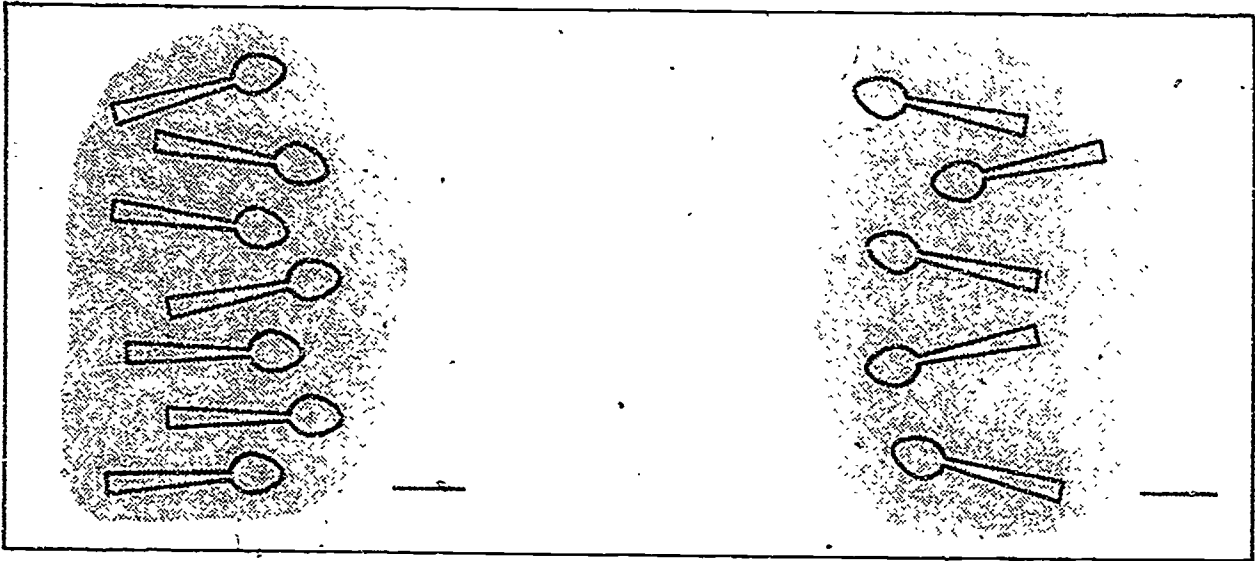

Which set has more members? Mark it.

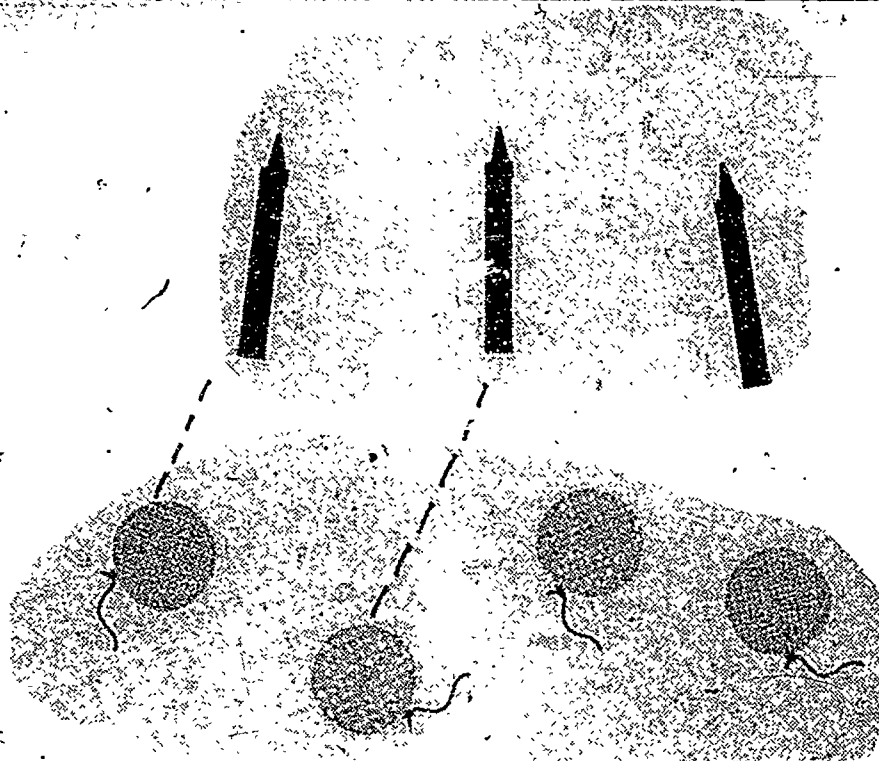

A collection of three pencils is shown in the upper portion of the box, and a collection of four marbles is shown in the lower portion. Dashed lines separate the two groups. To the right of the pencils is a horizontal line, and to the right of the marbles is an 'X' symbol.



A single large black oval is shown in the upper portion of the box, and a single small white oval is shown in the lower portion. To the right of the large oval is a horizontal line, and to the right of the small oval is another horizontal line.

Which set has more members? Mark it



\_\_\_\_\_



\_\_\_\_\_



\_\_\_\_\_



\_\_\_\_\_

Show an equivalent set

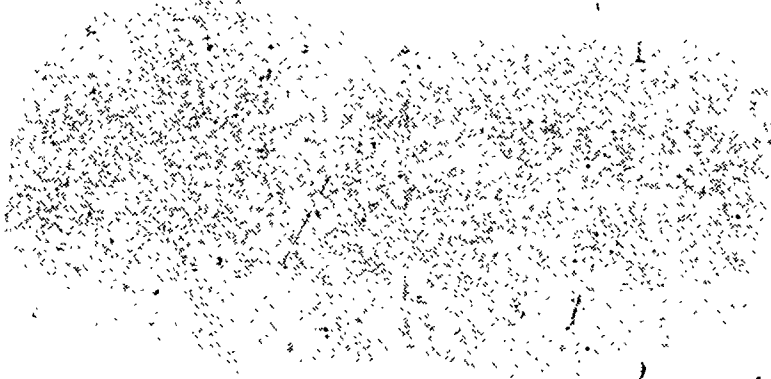
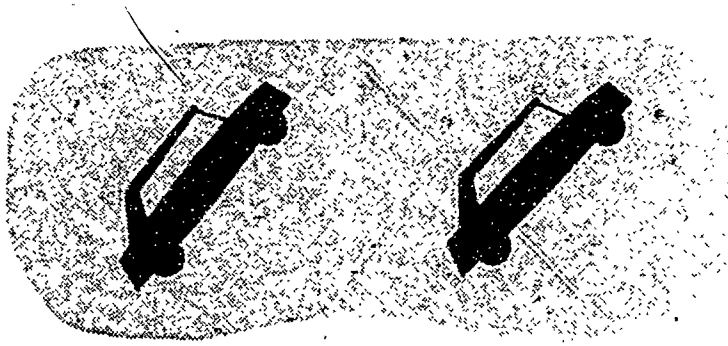



Show an equivalent set.

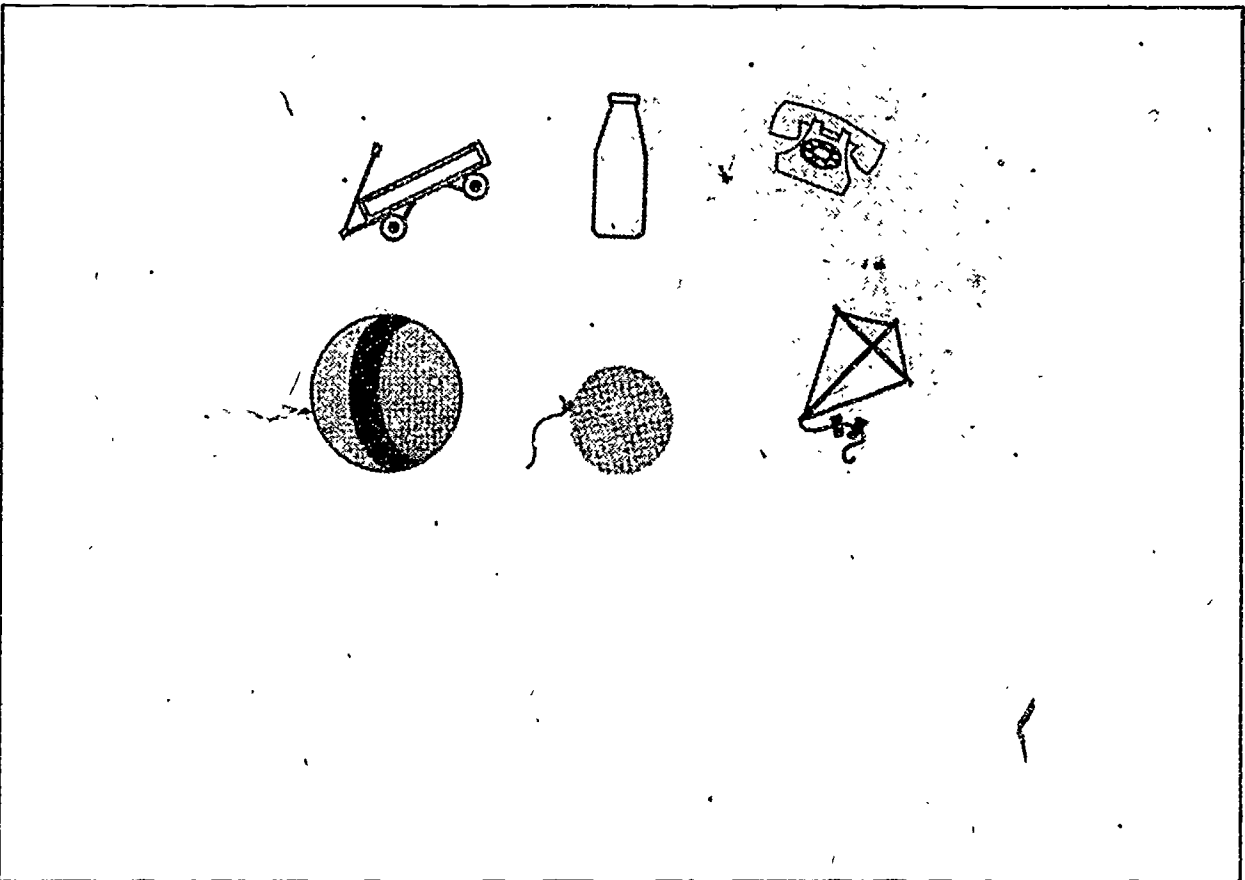
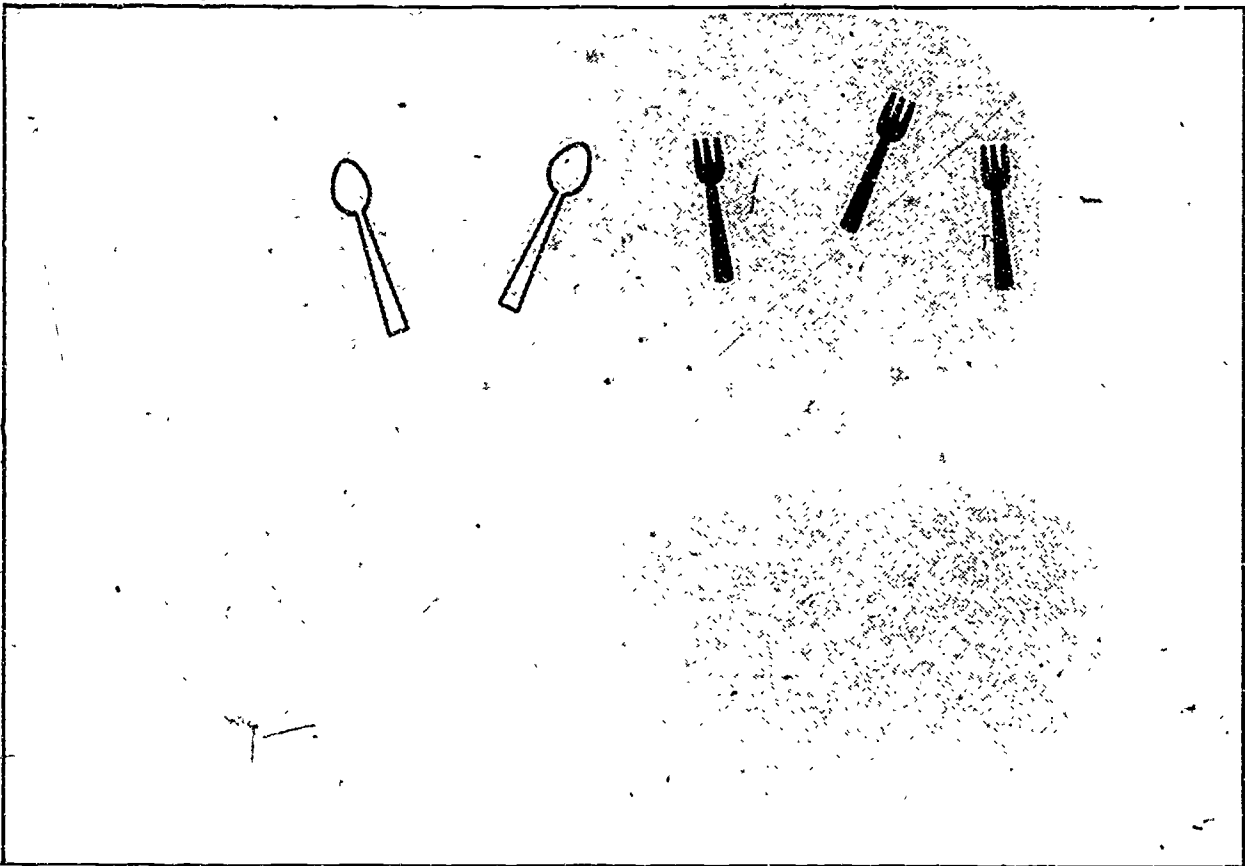

Show a set with more members

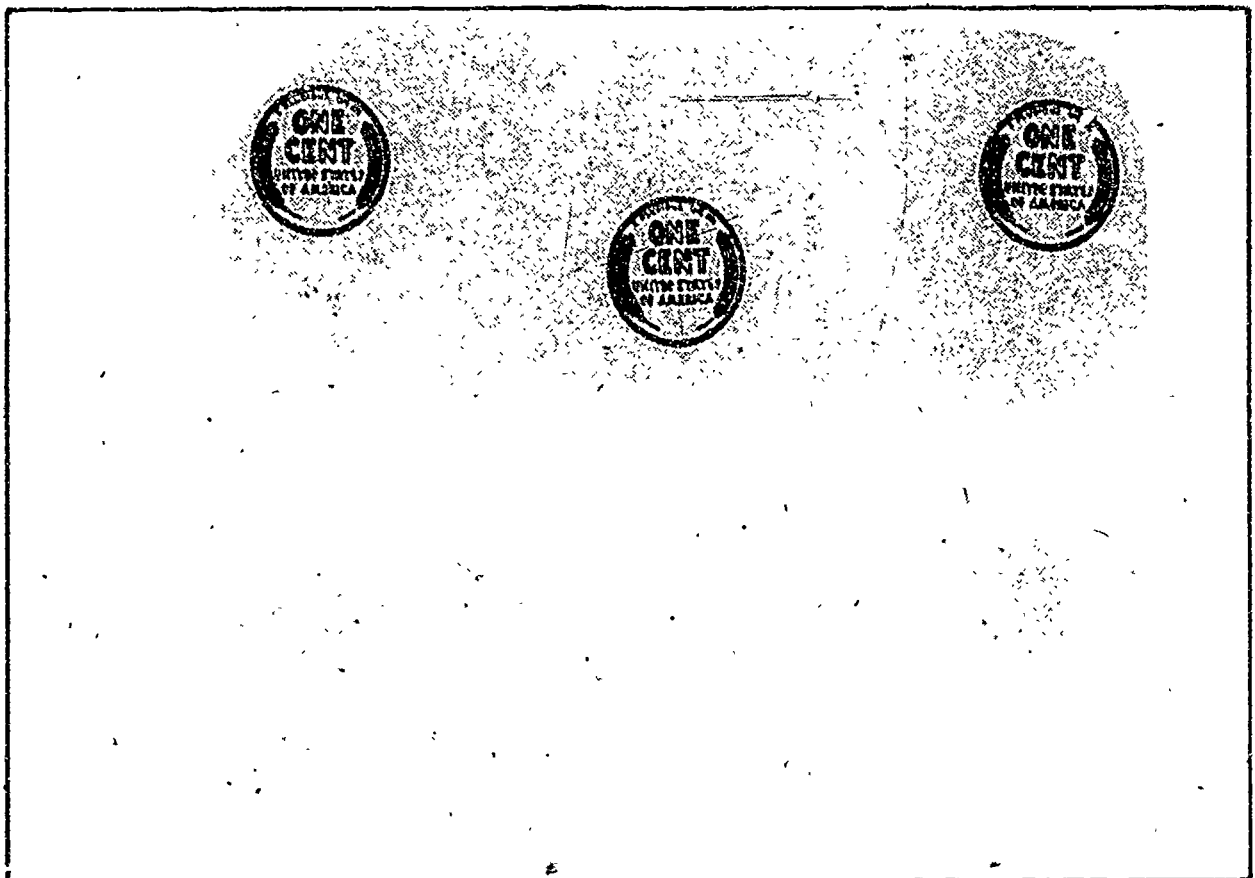
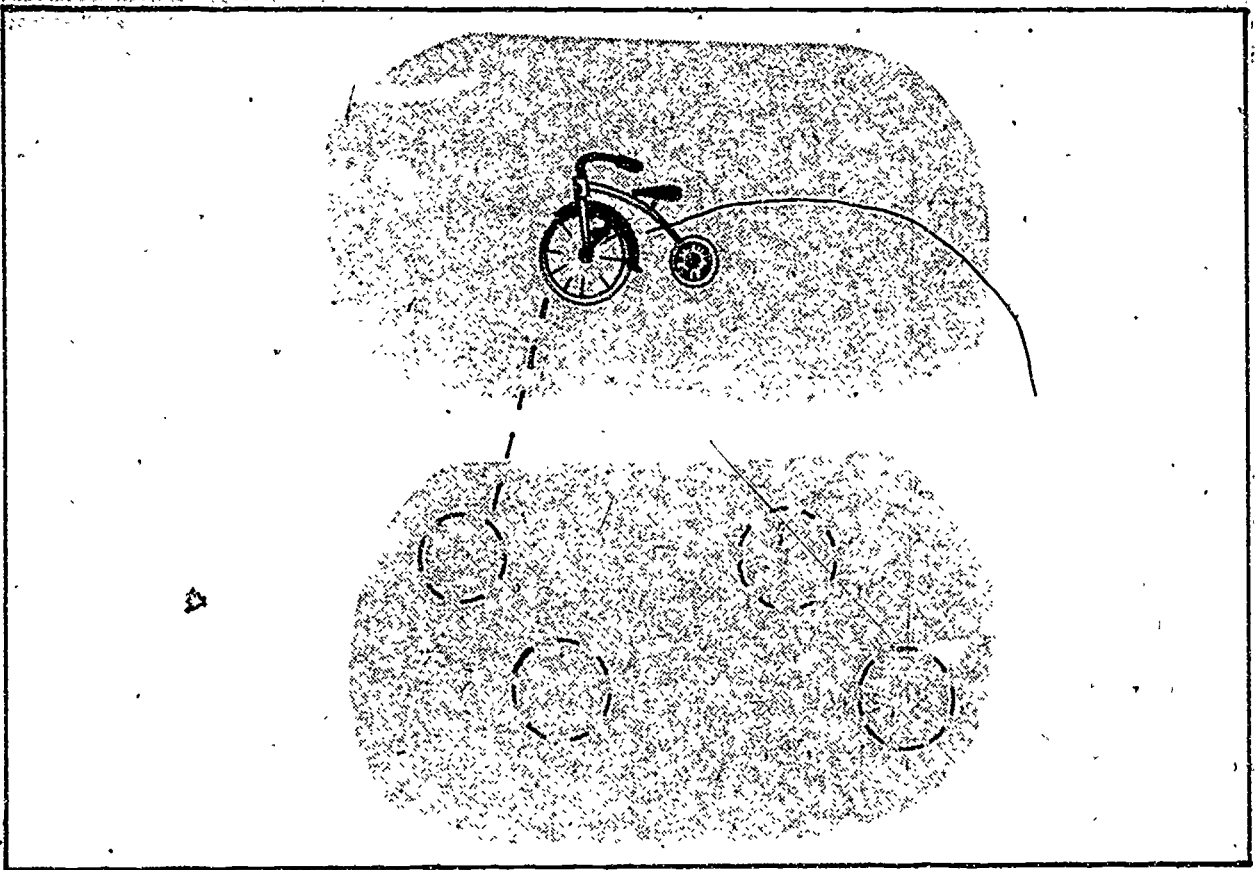

Show a set with more members

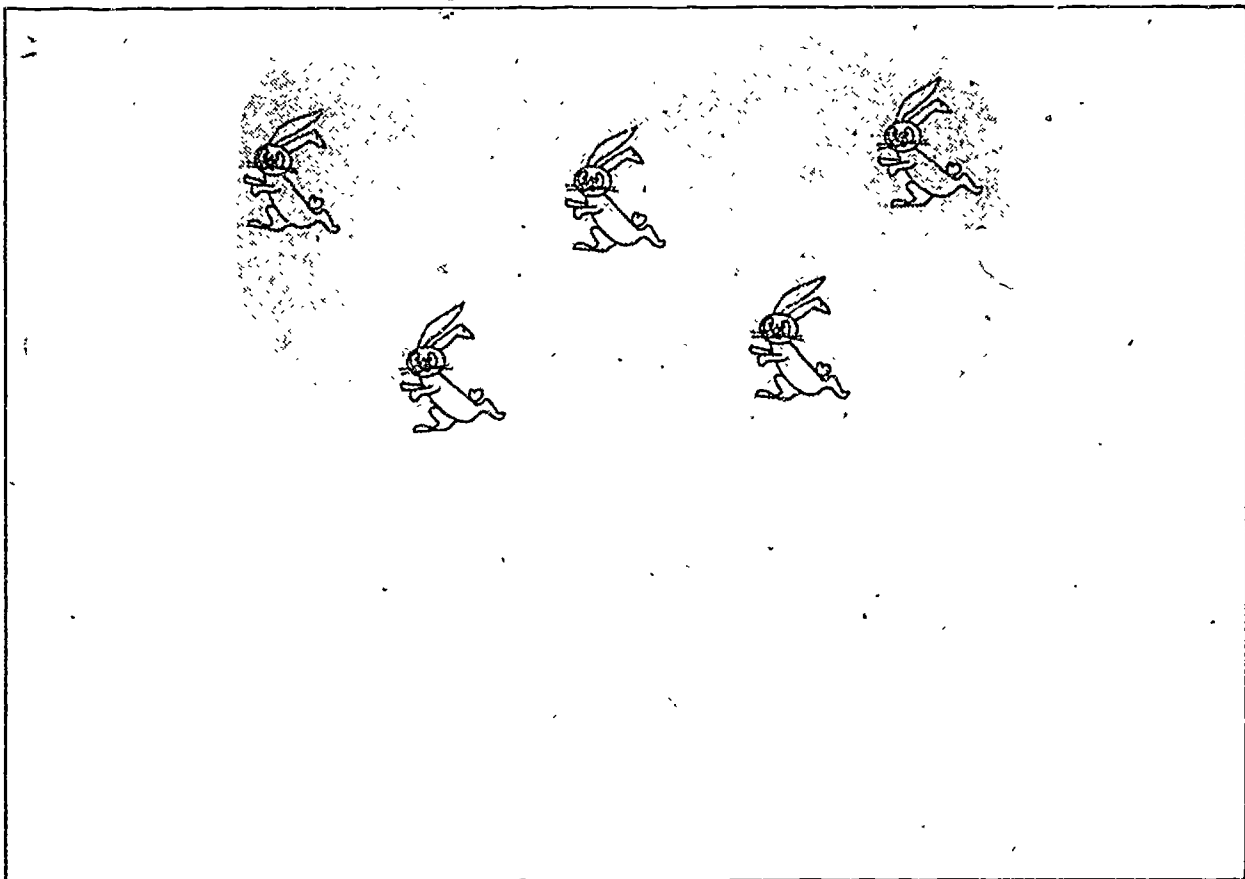
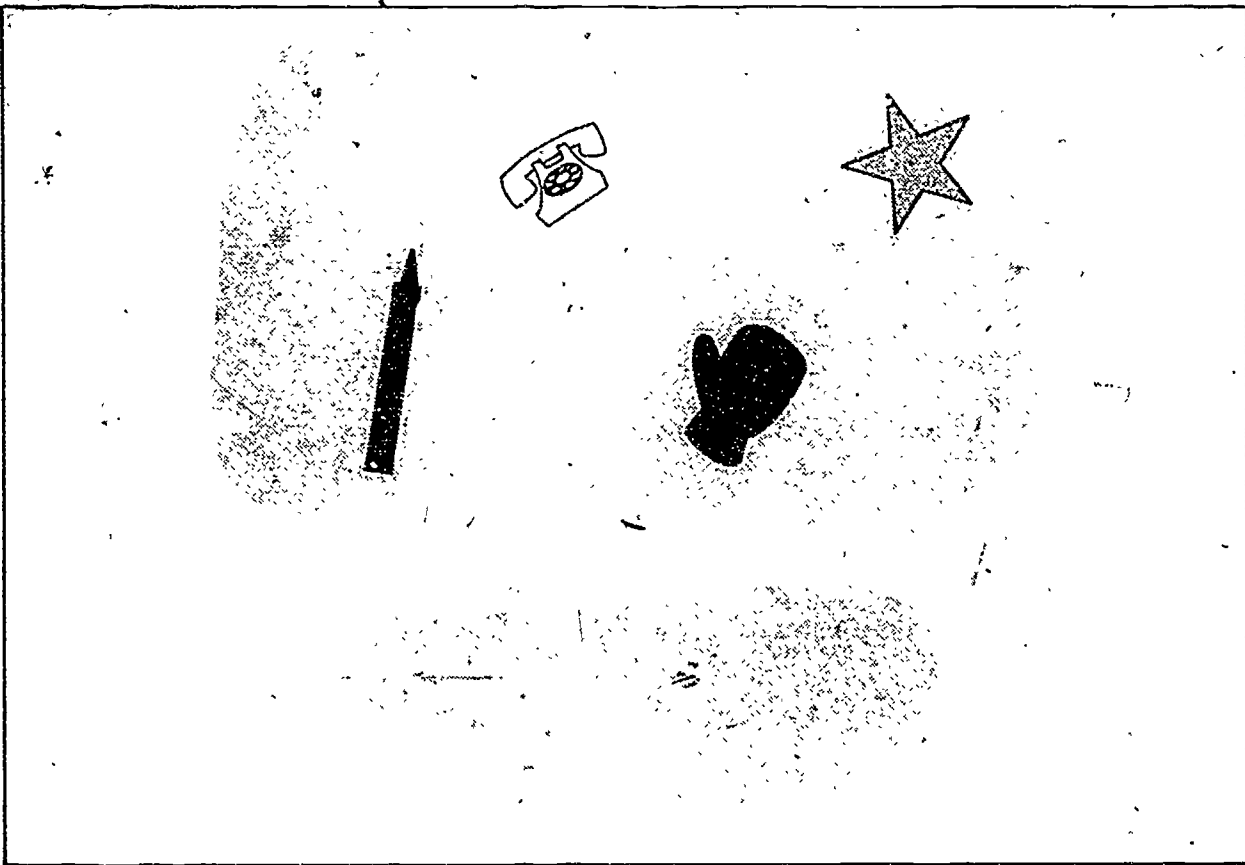

Show a set with more members

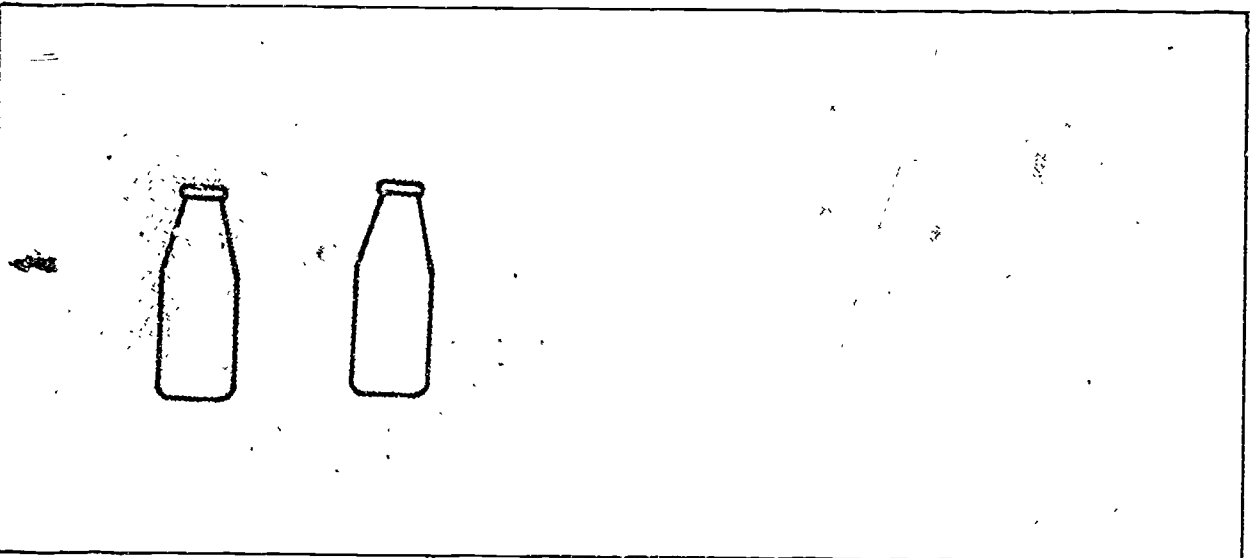
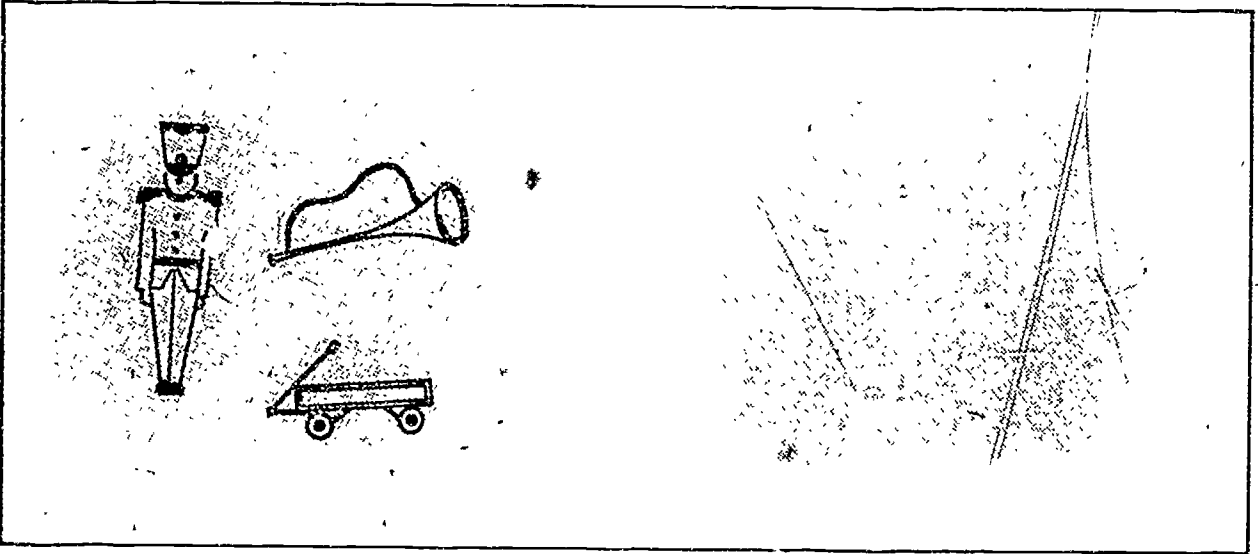
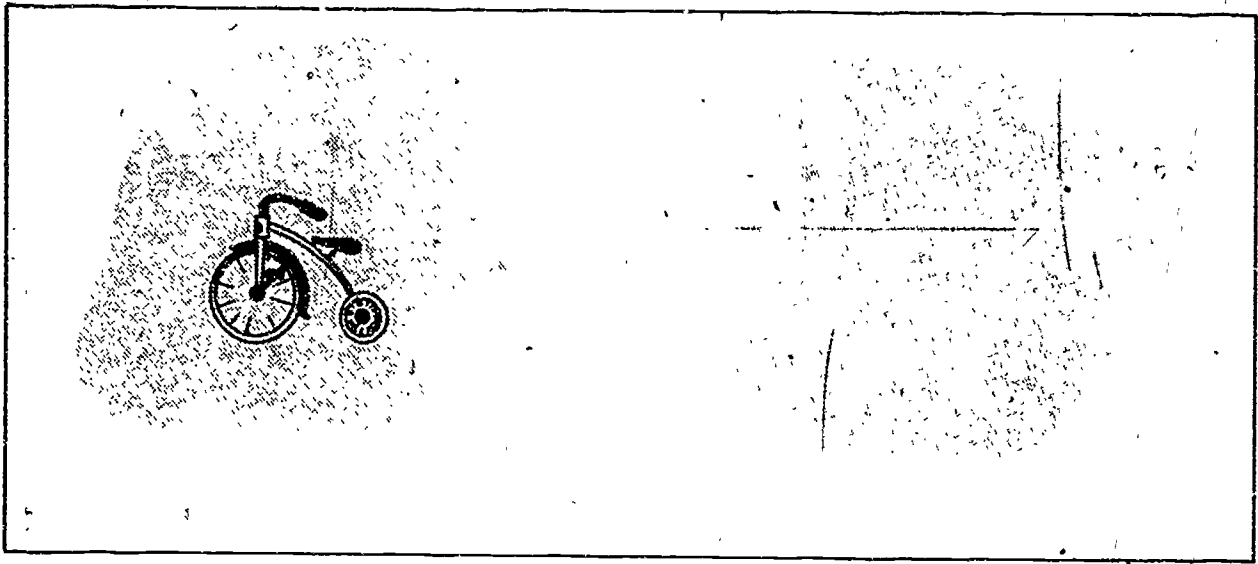

Show an equivalent set

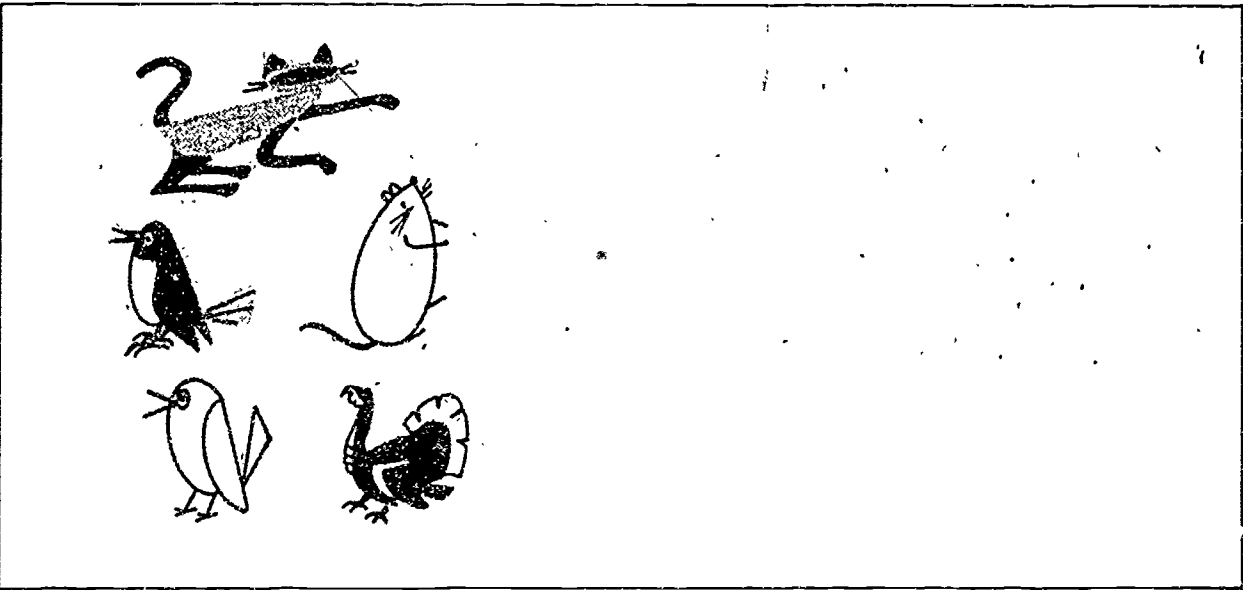
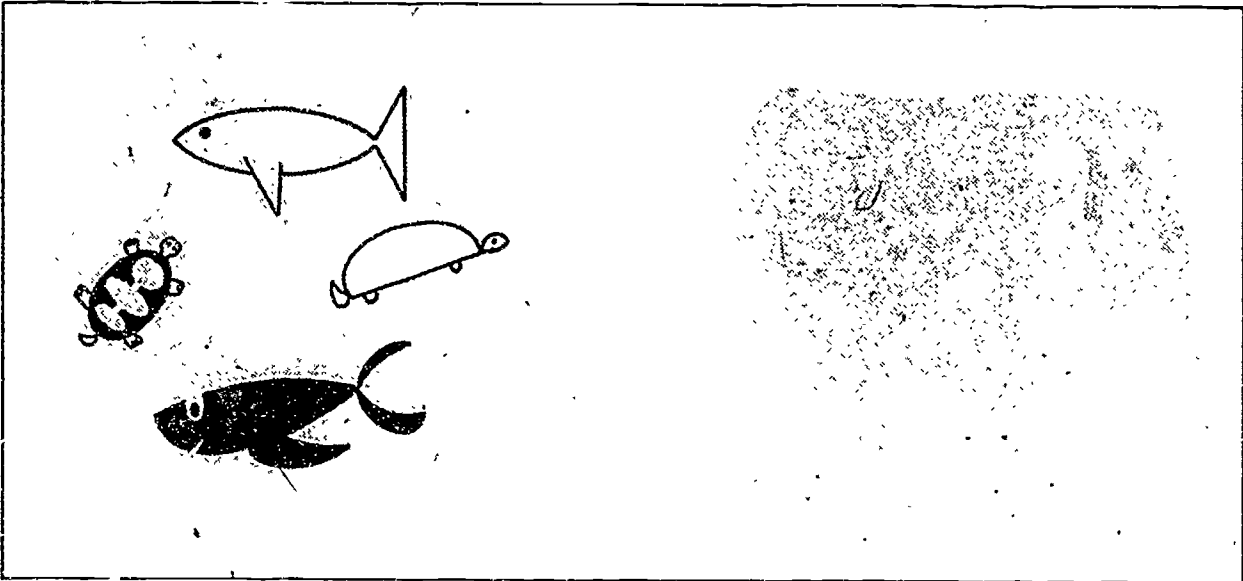
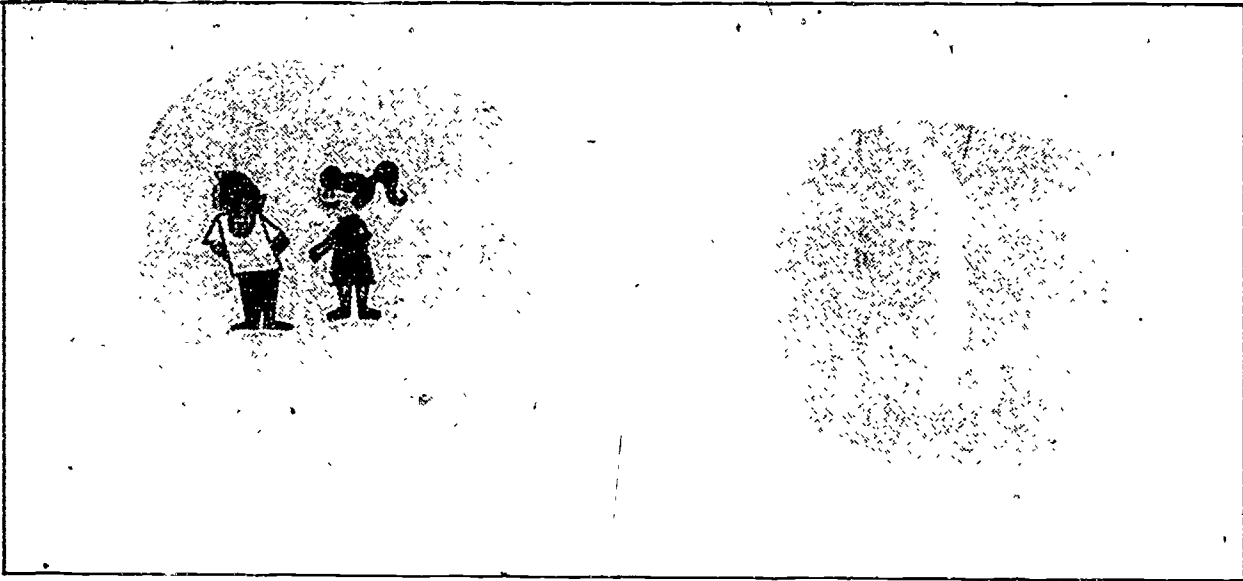

Which set has fewer members? Mark it

Two sets of items are shown for comparison. The left set contains three identical circular candles, each with the words "LITTLE LIGHTS" written on it. The right set contains two identical turkeys. Below each set is a horizontal line for marking the answer.

Two sets of items are shown for comparison. The left set contains one cartoon rabbit. The right set contains two identical chickens. Below each set is a horizontal line for marking the answer.

Two sets of items are shown for comparison. The left set contains four children, consisting of two boys and two girls. The right set contains three identical candles. Below each set is a horizontal line for marking the answer.

Which set has fewer members? Mark it

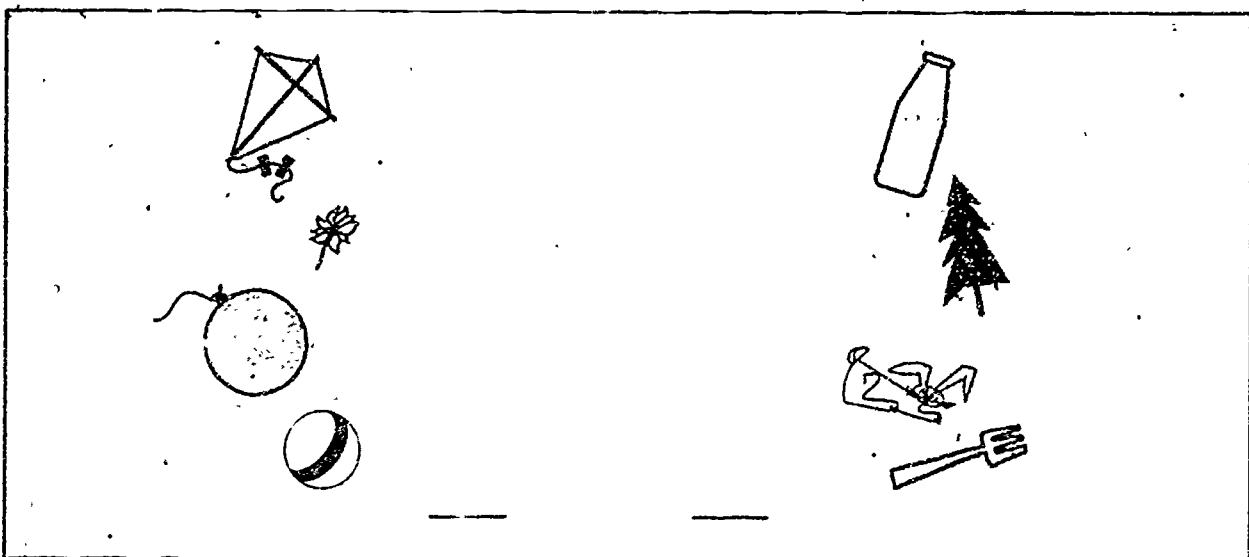
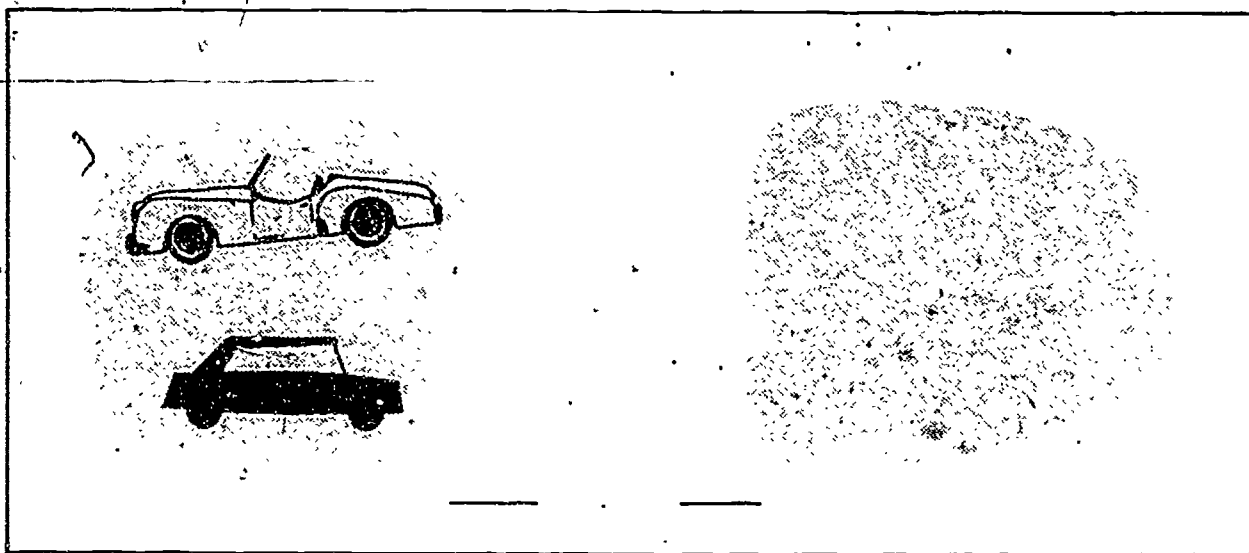
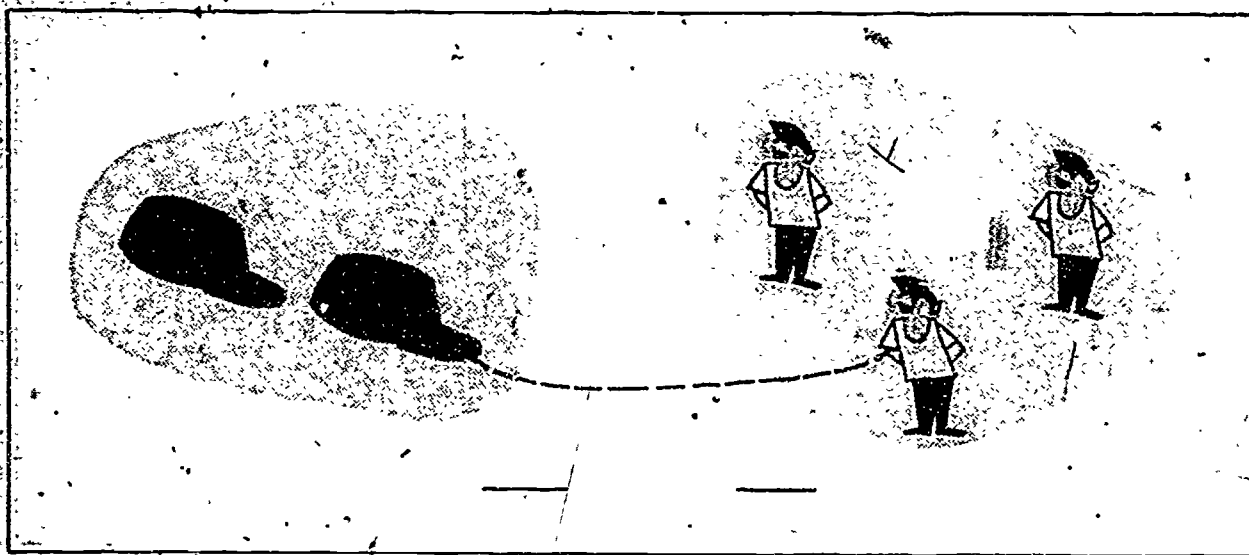

Which set has fewer members? Mark it

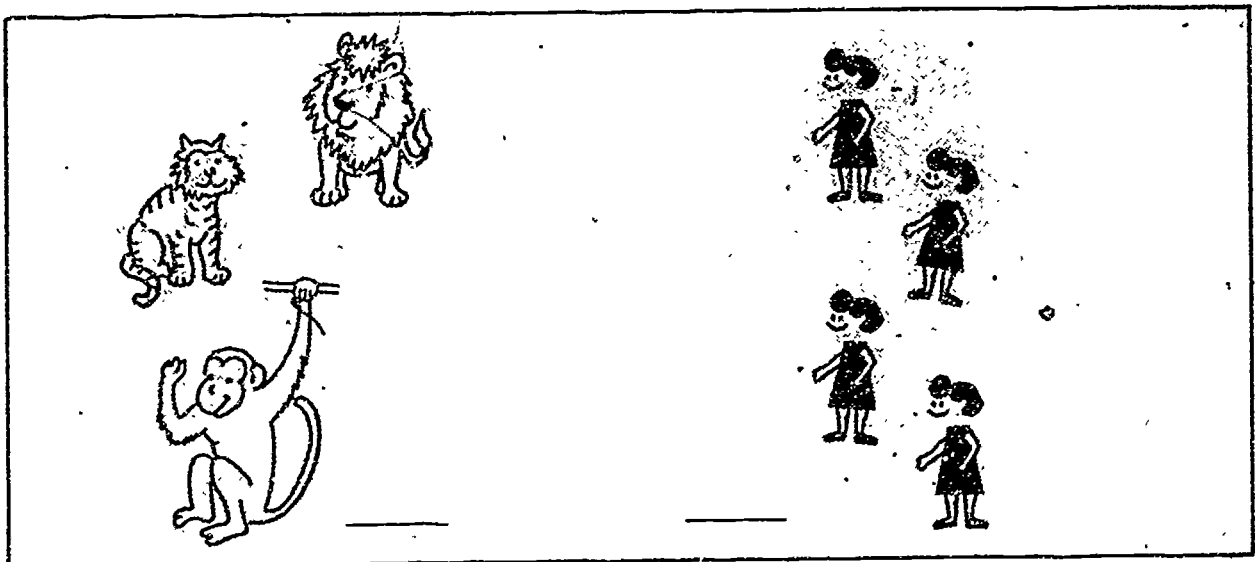
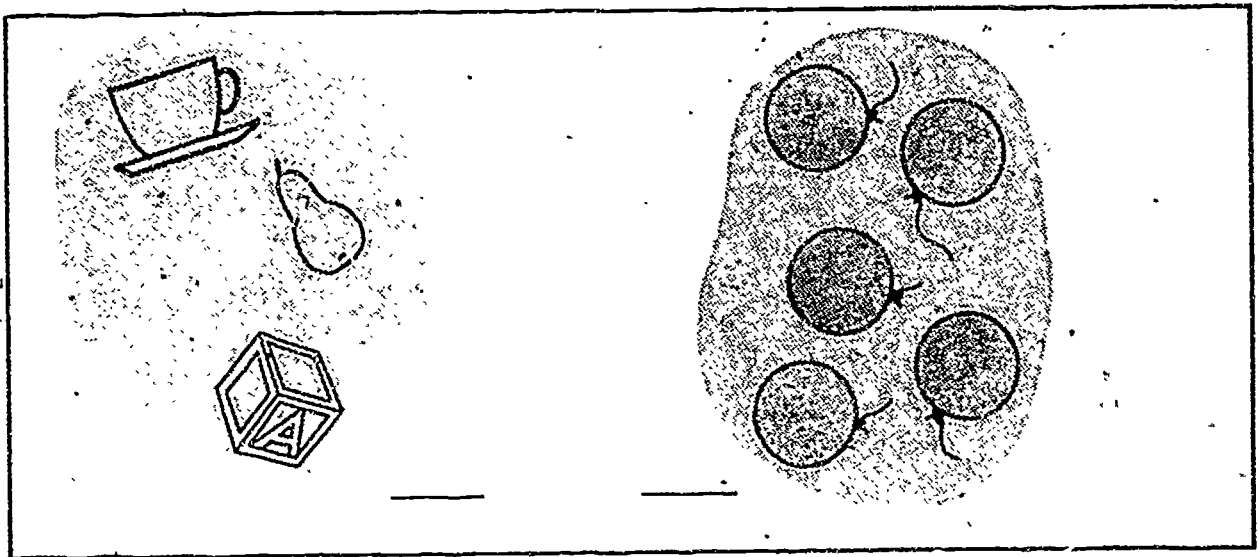
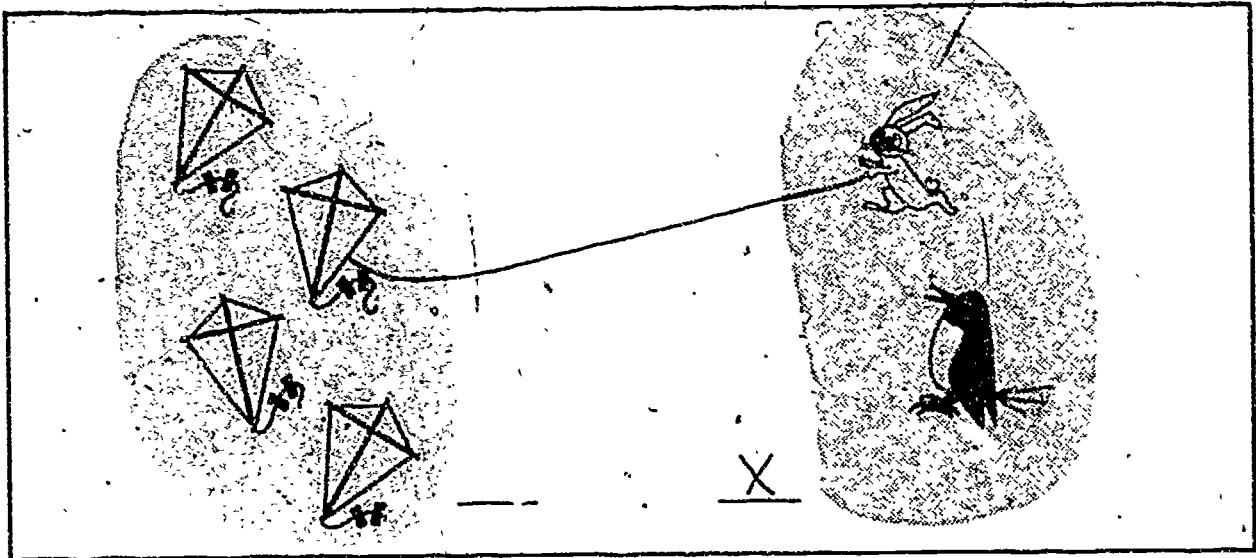



Which set has fewer members? Mark it

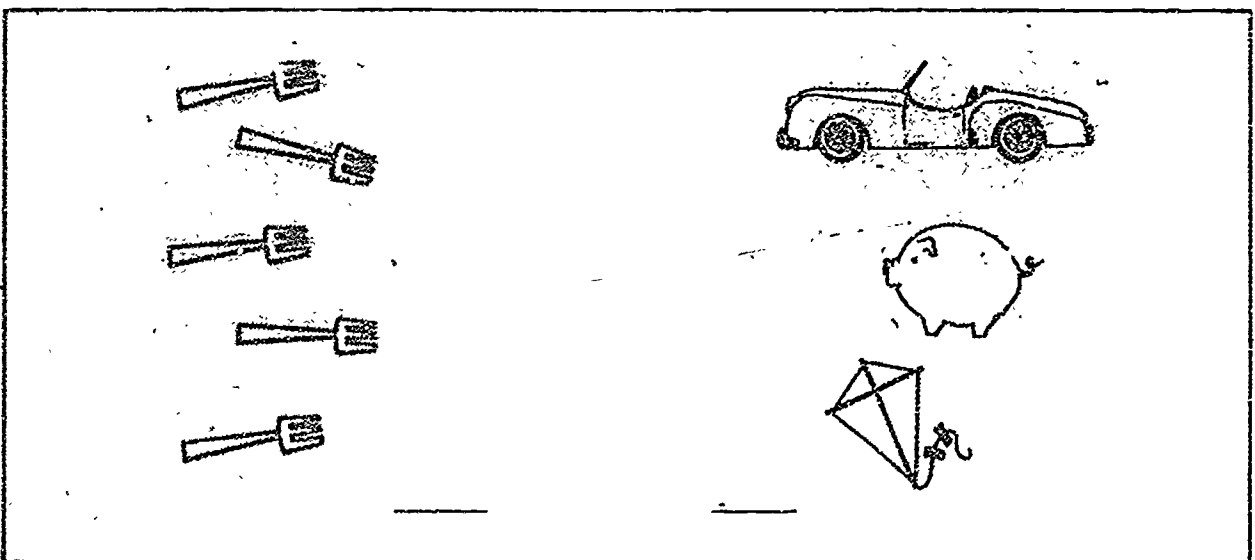
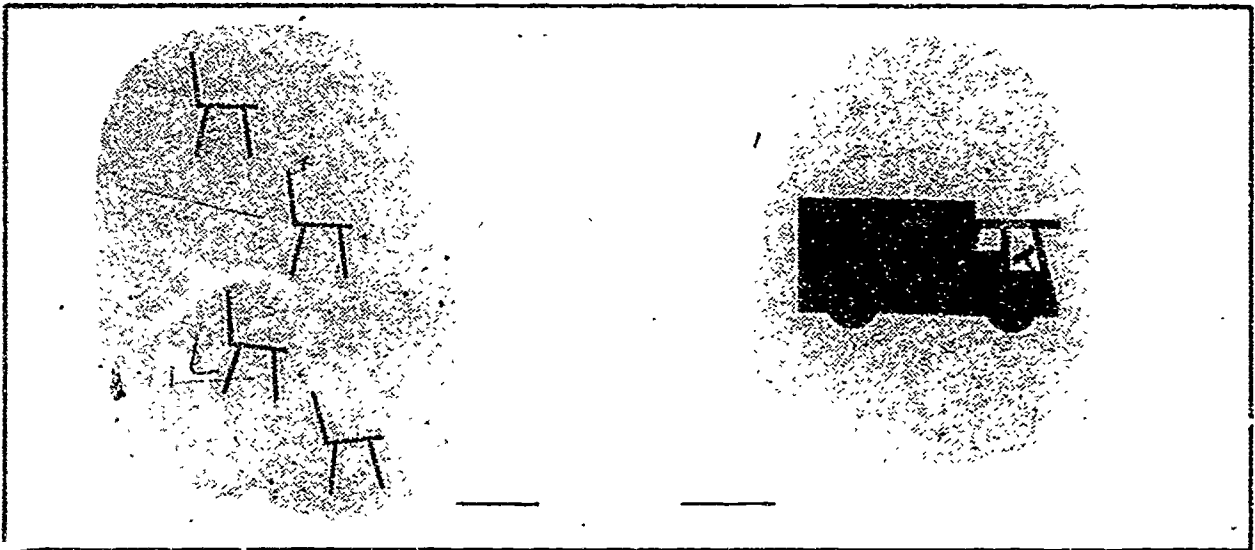
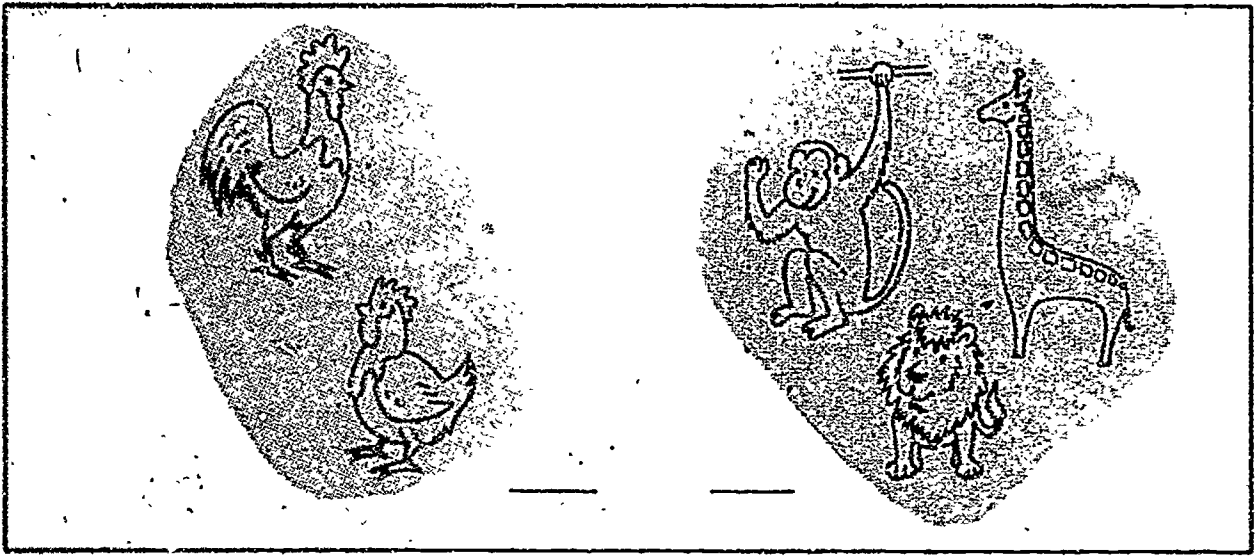

Show a set with fewer members

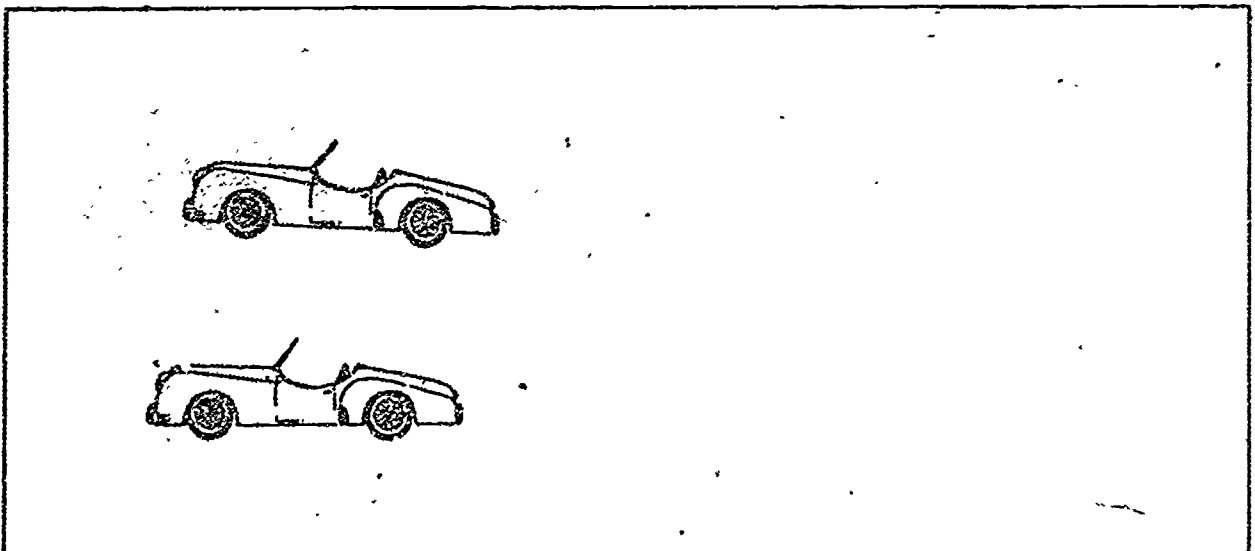
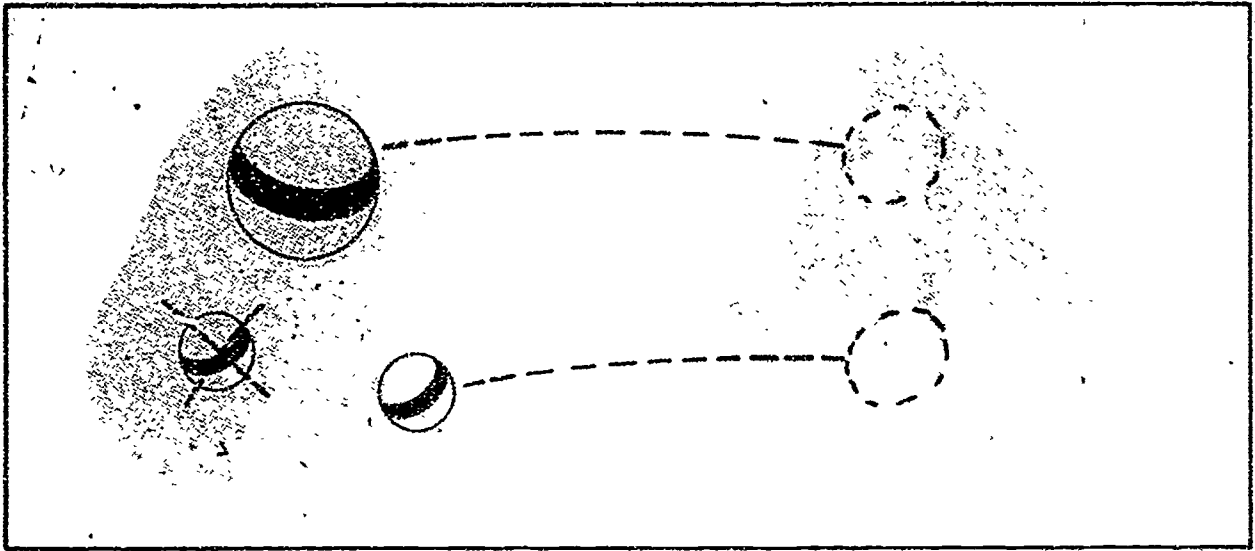

Show a set with fewer members

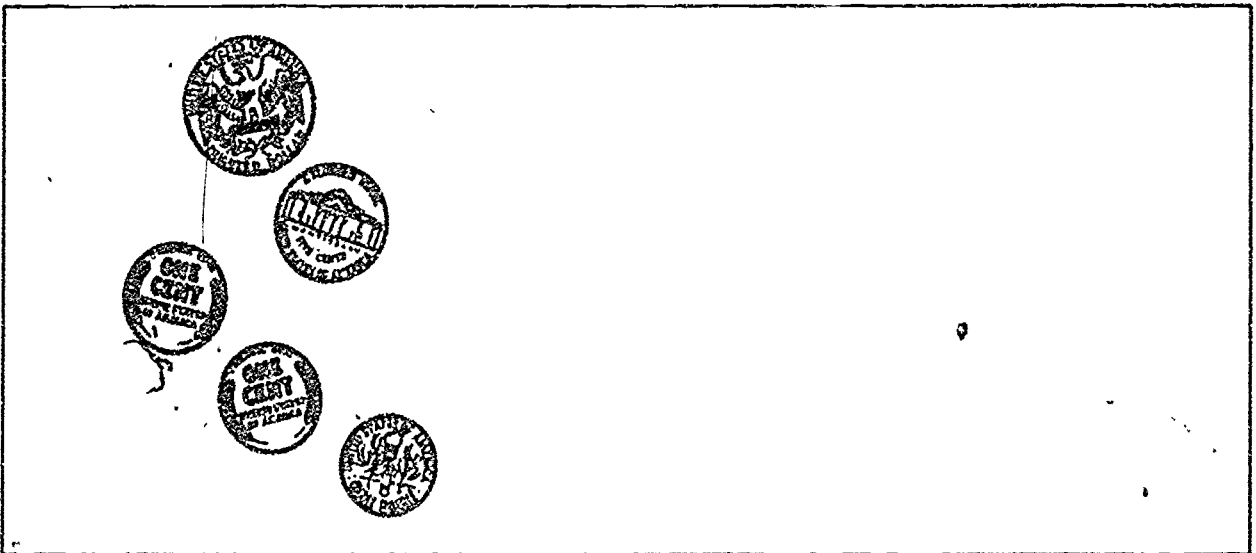
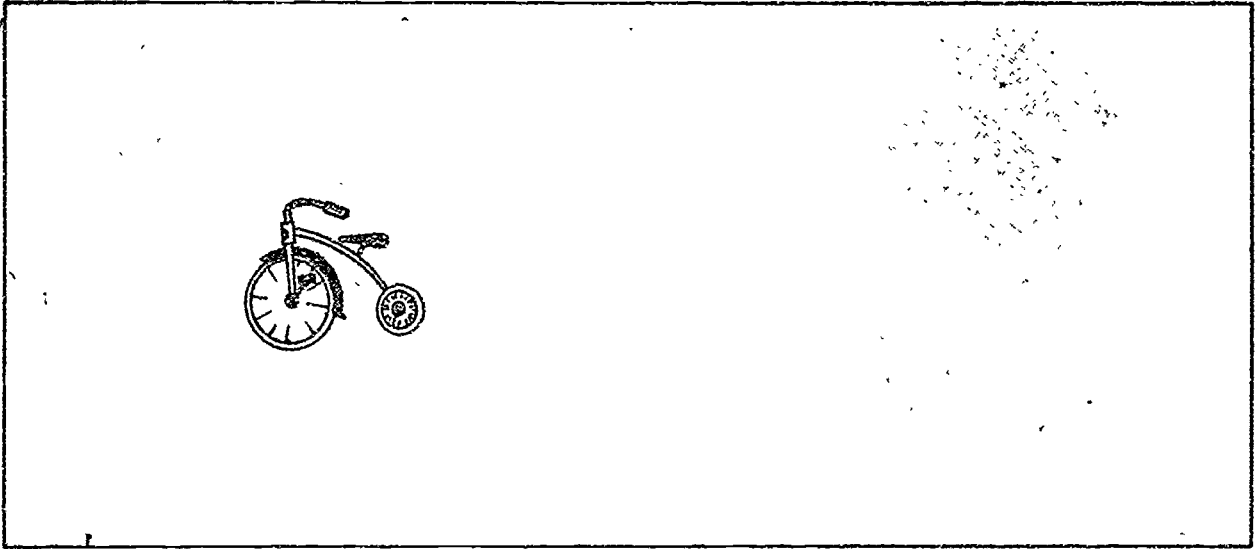
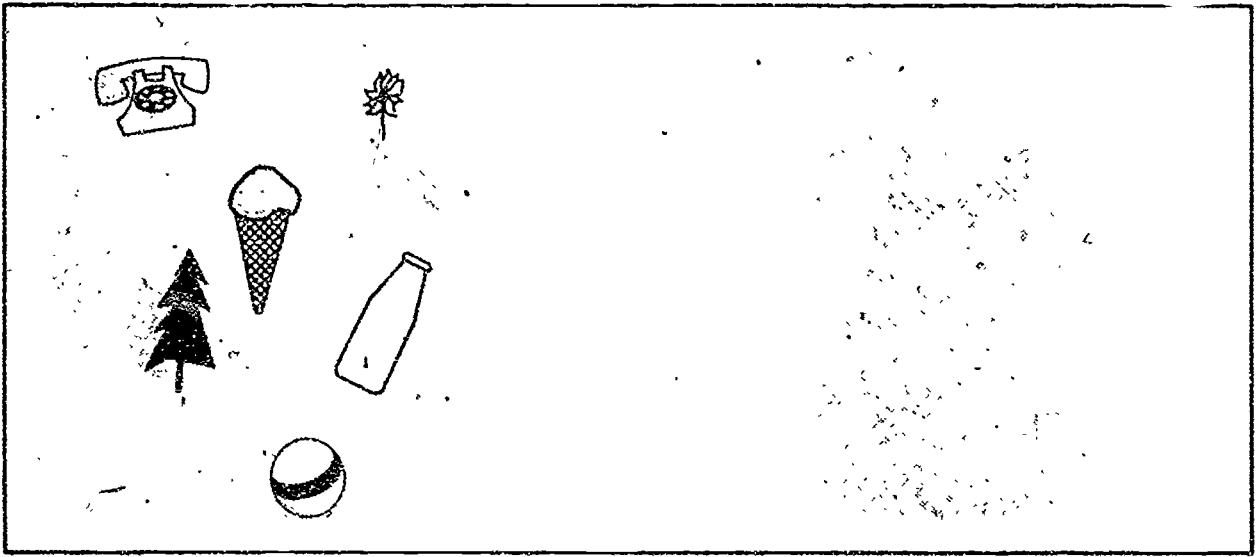

Compare these sets

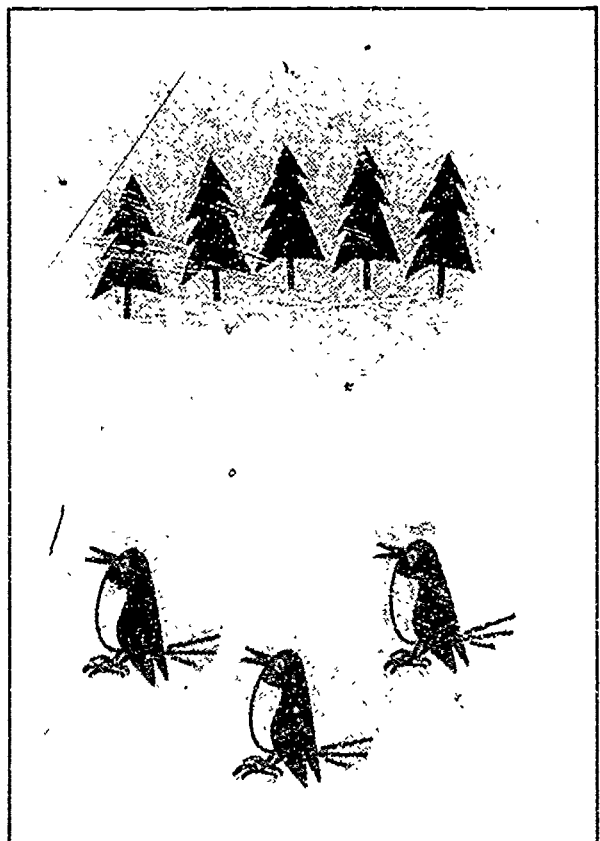
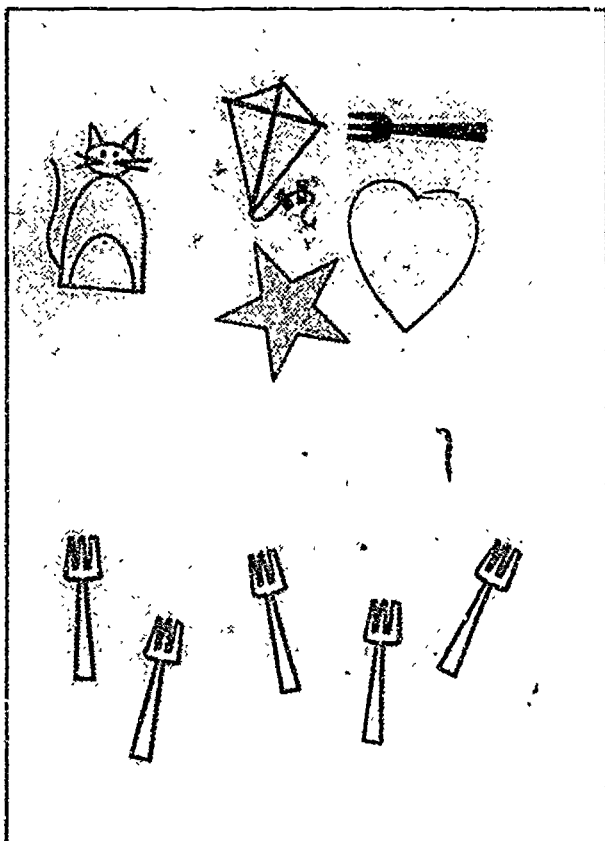
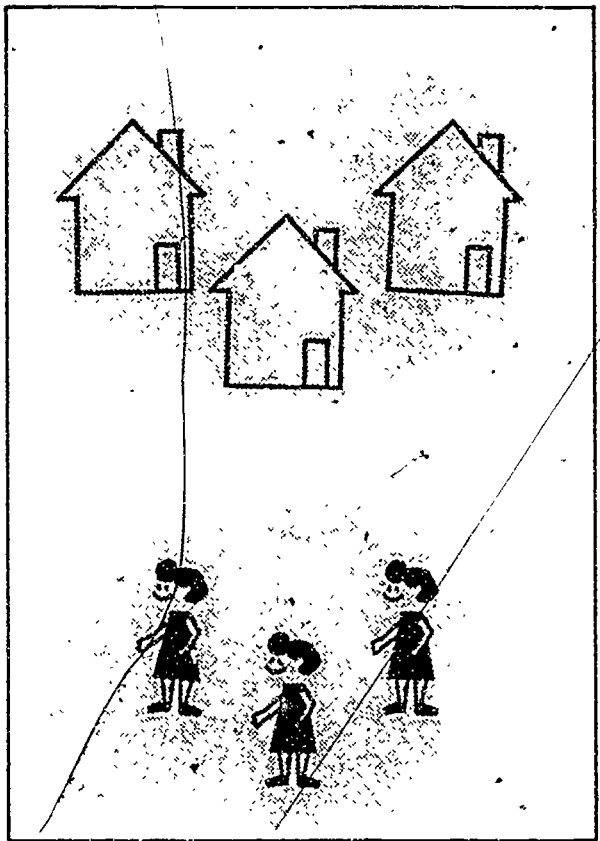
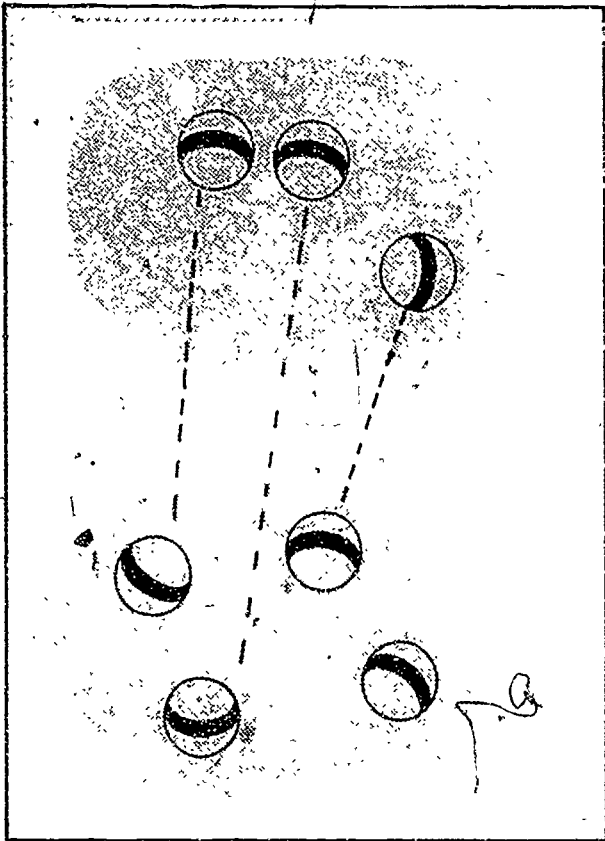

Compare these sets

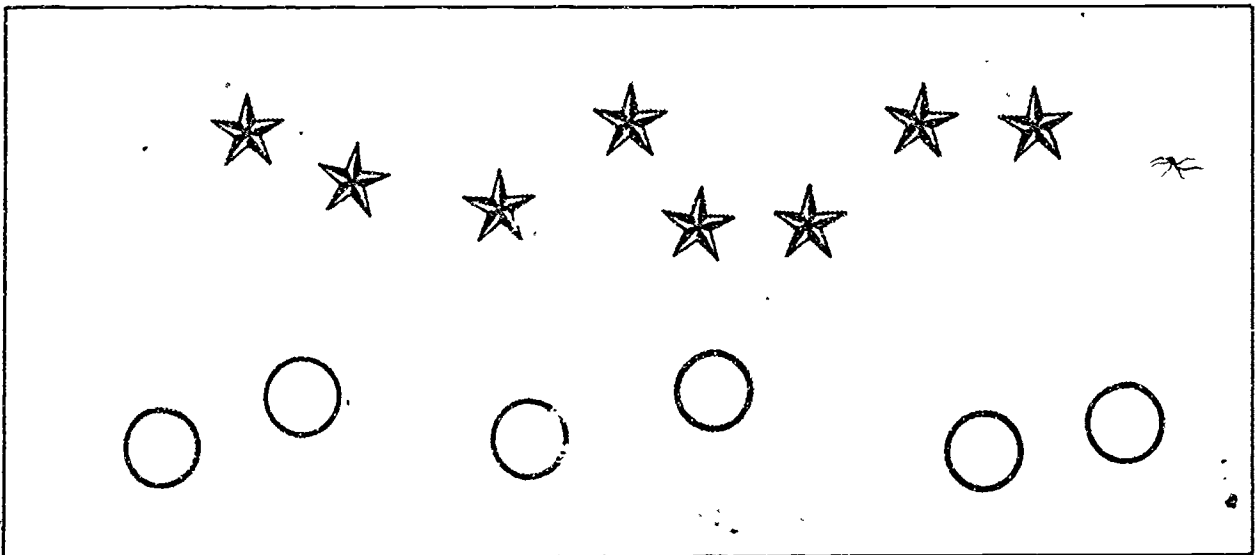
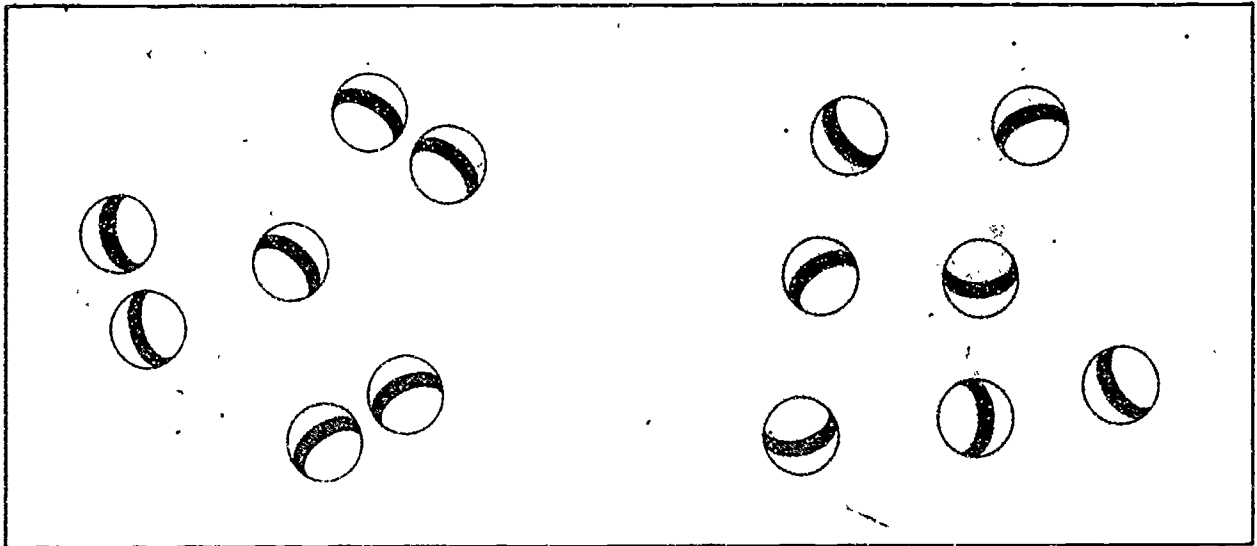
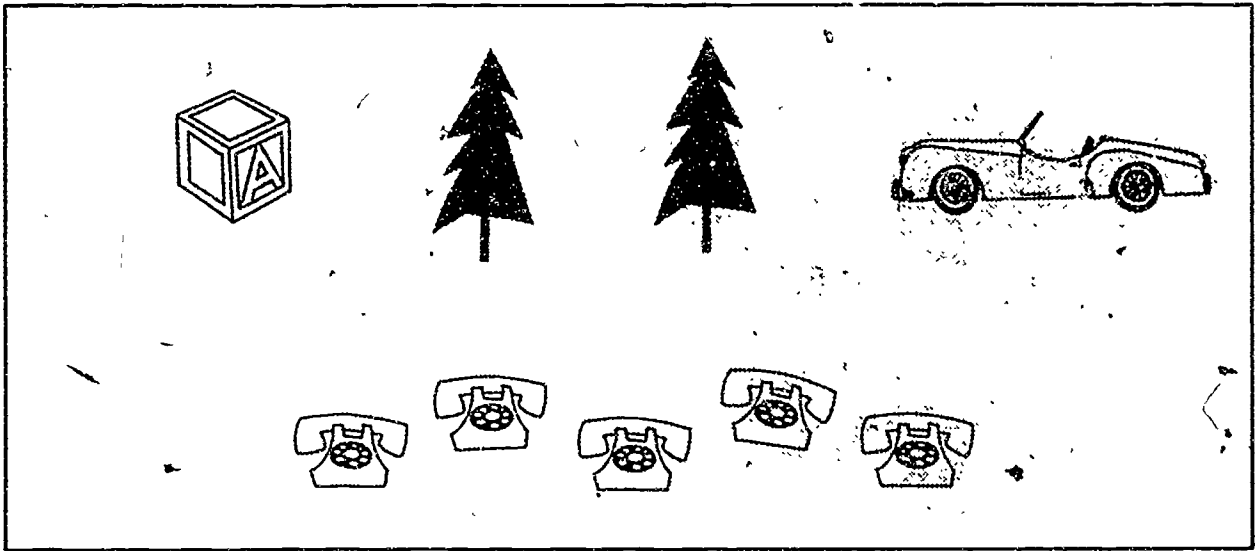

Same number of members

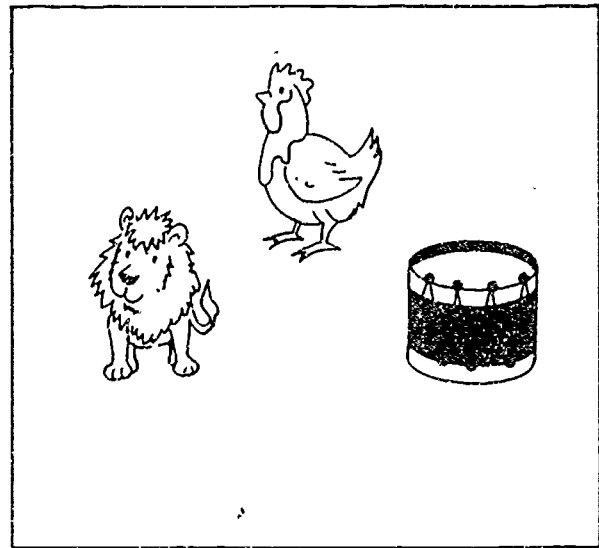
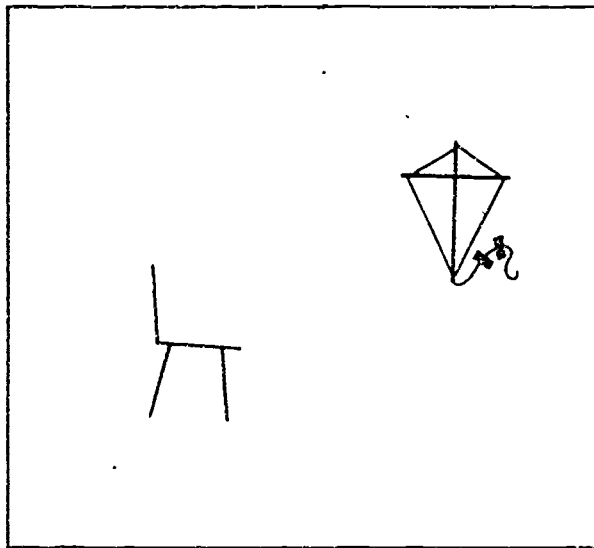
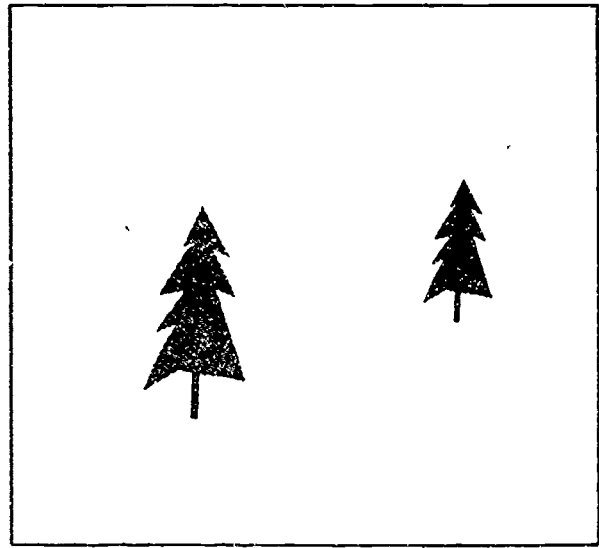
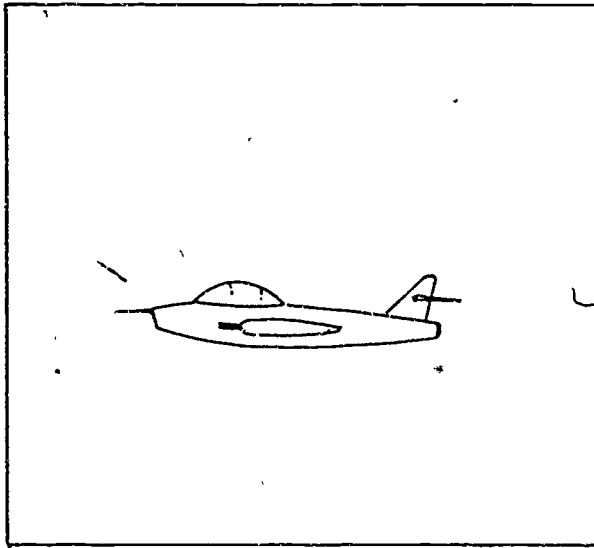
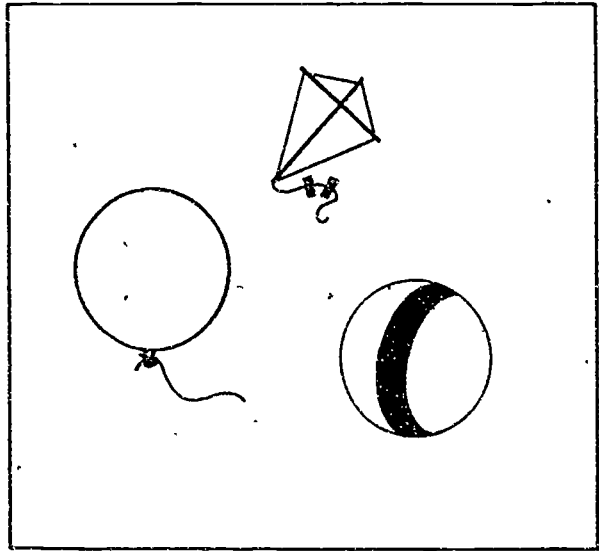
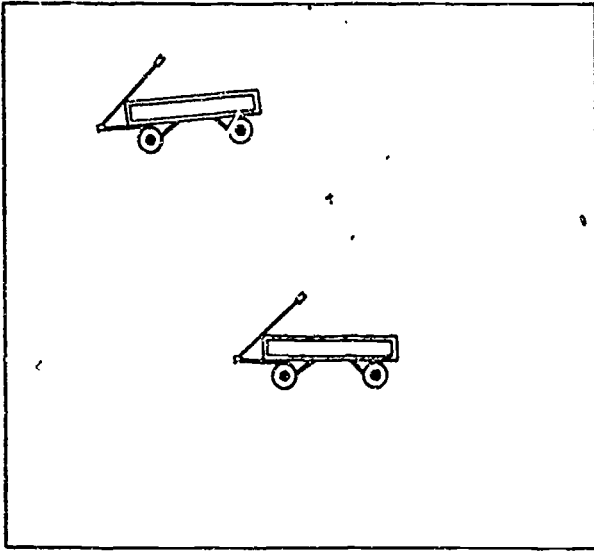

Same number of members

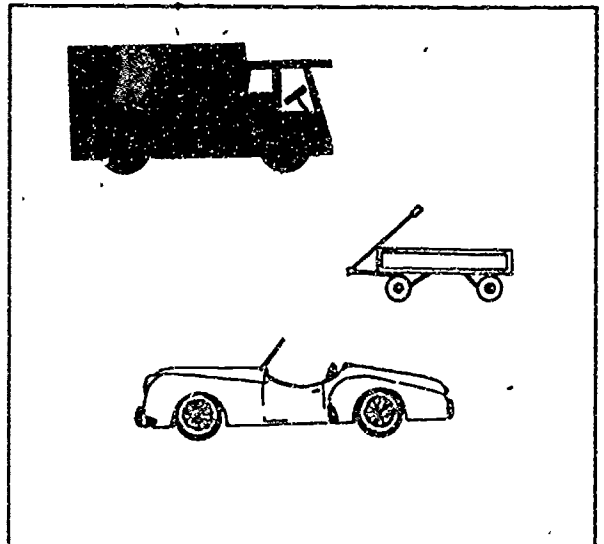
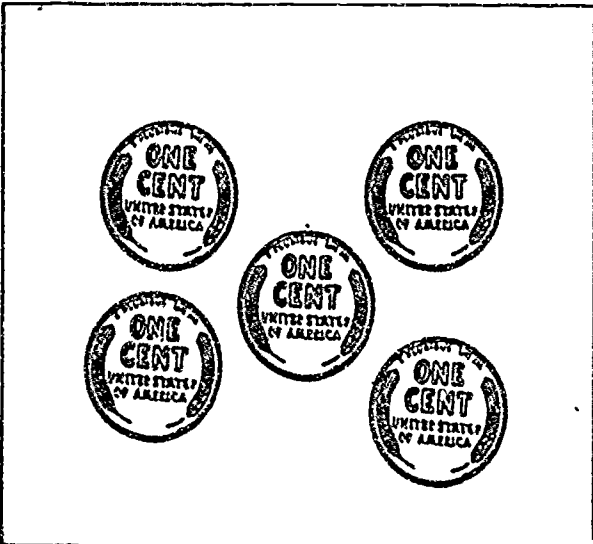
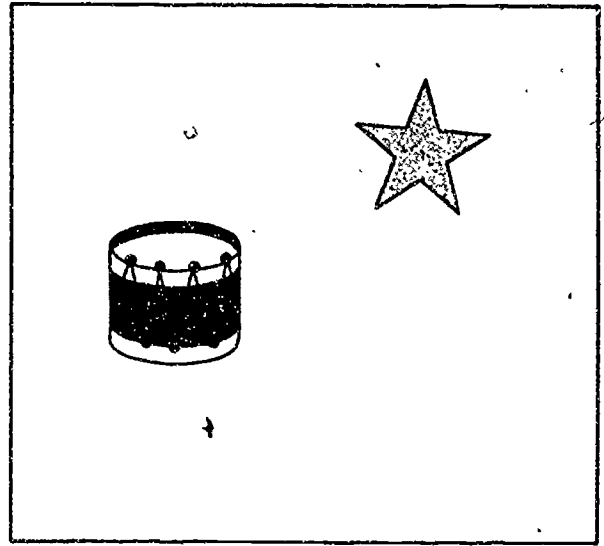
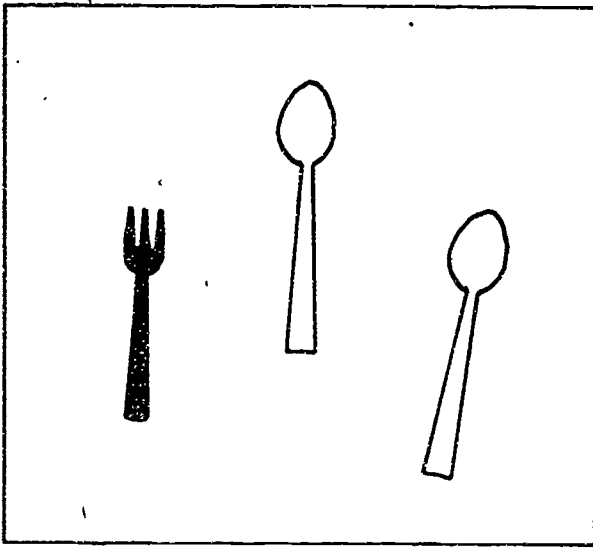
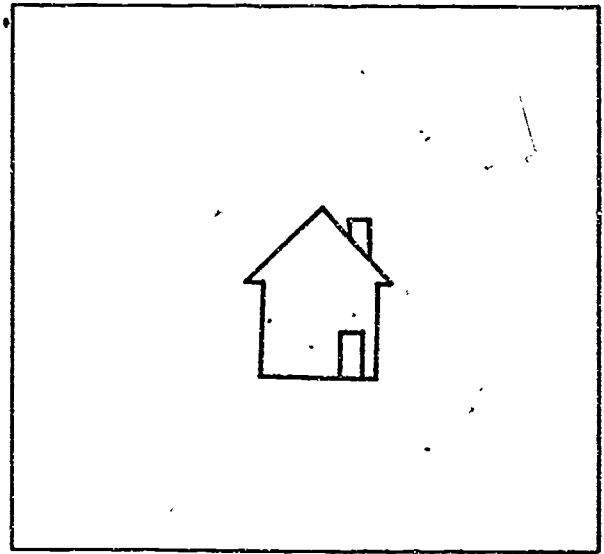
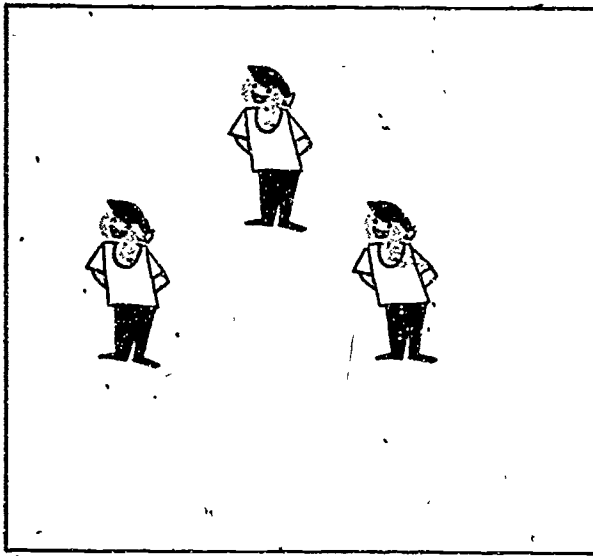

Same number of members

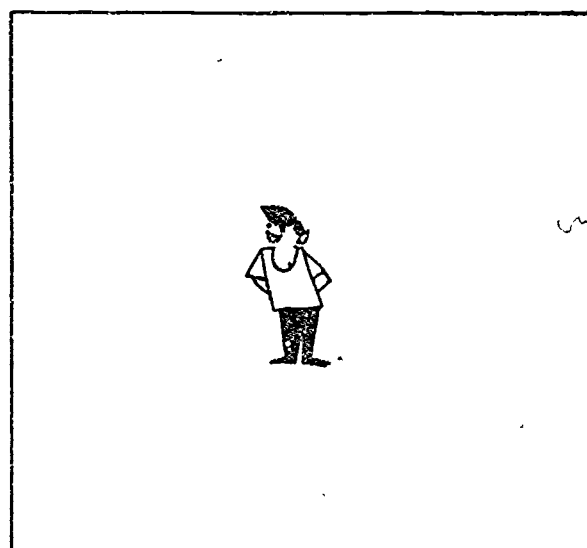
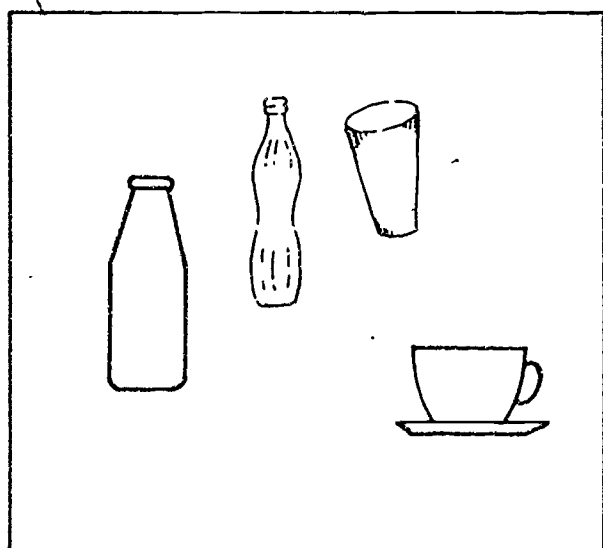
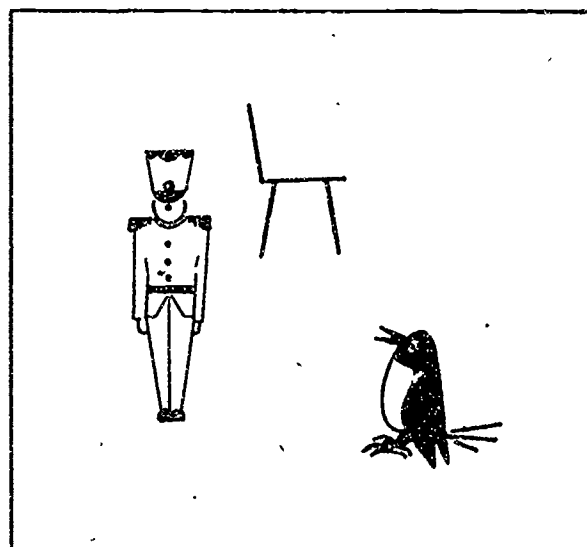
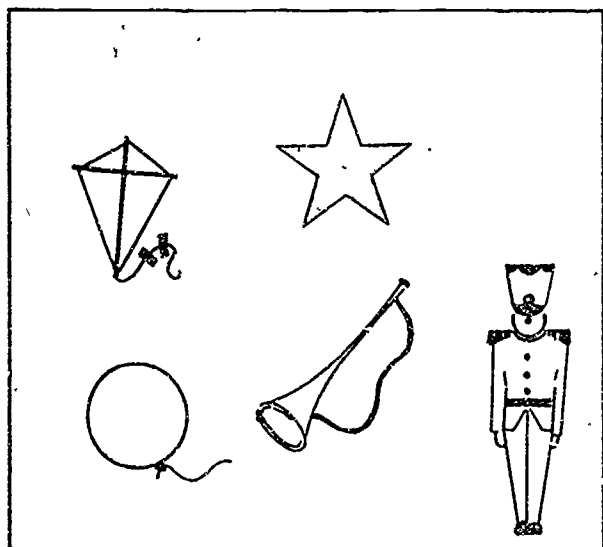
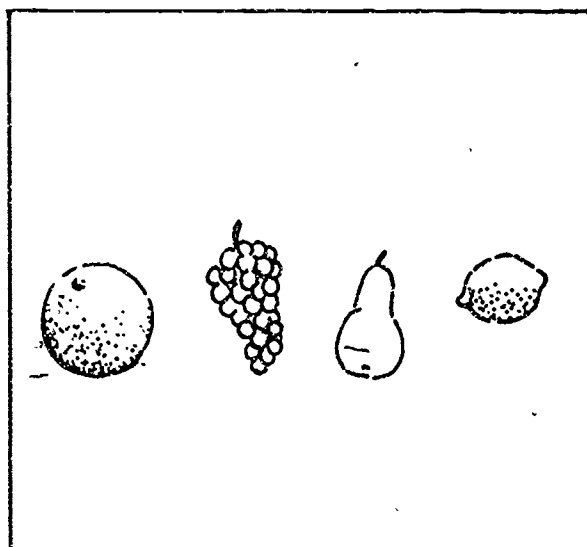
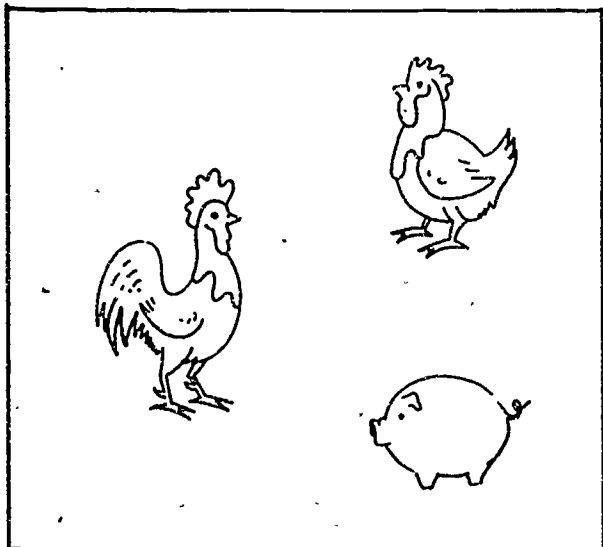



Same number of members

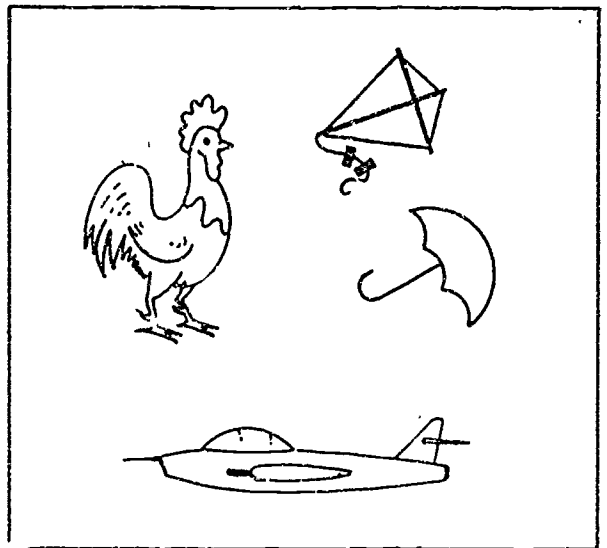
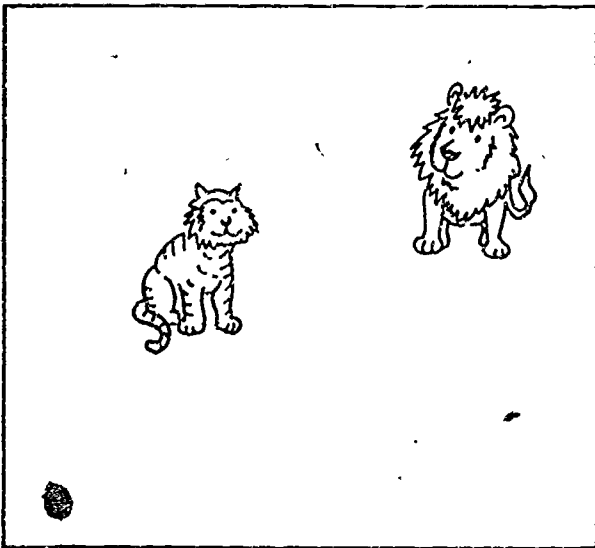
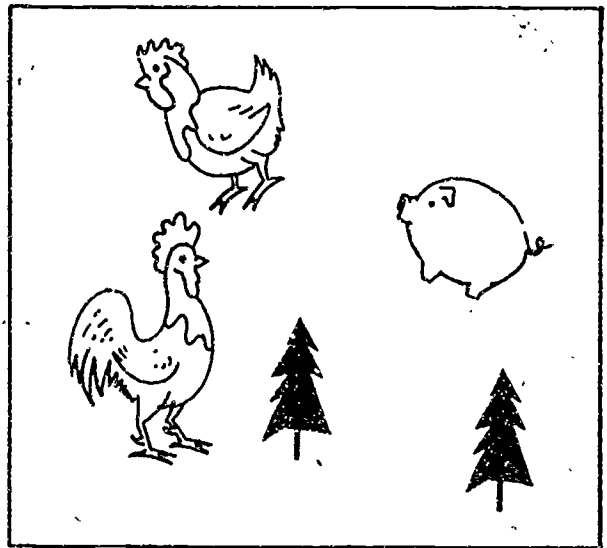
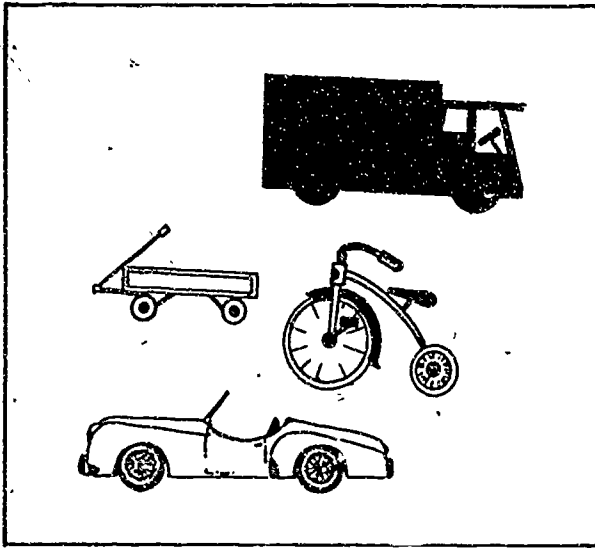
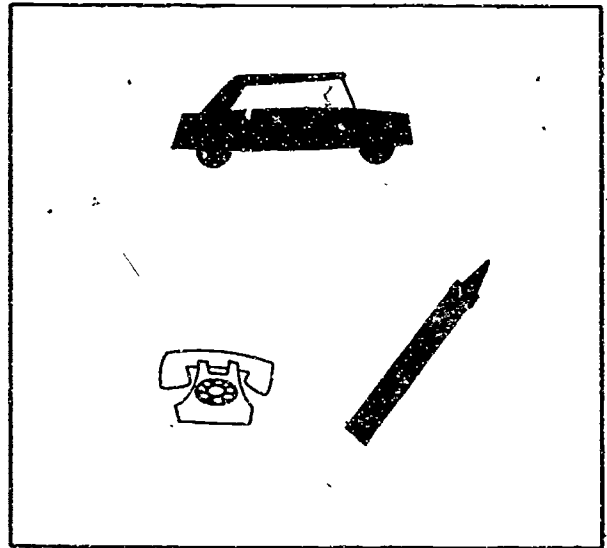
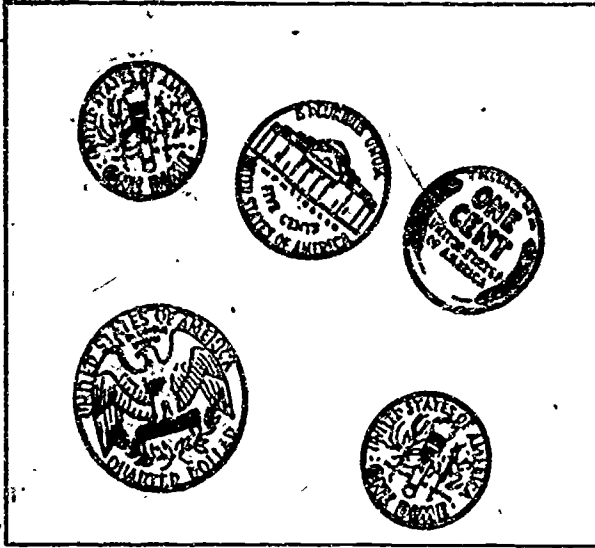

Greater than - less than

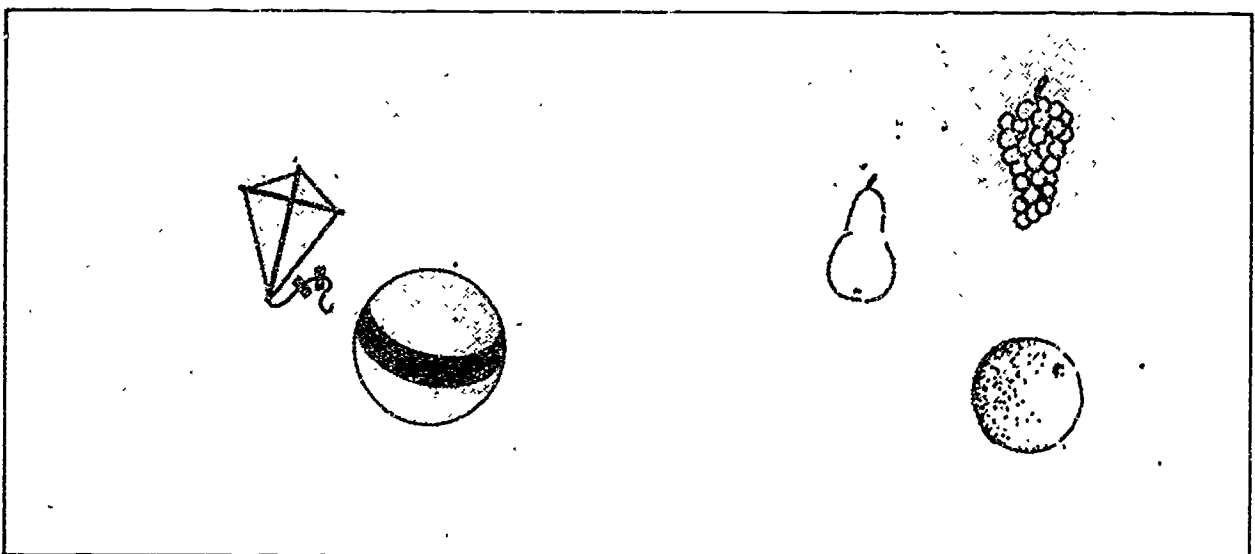
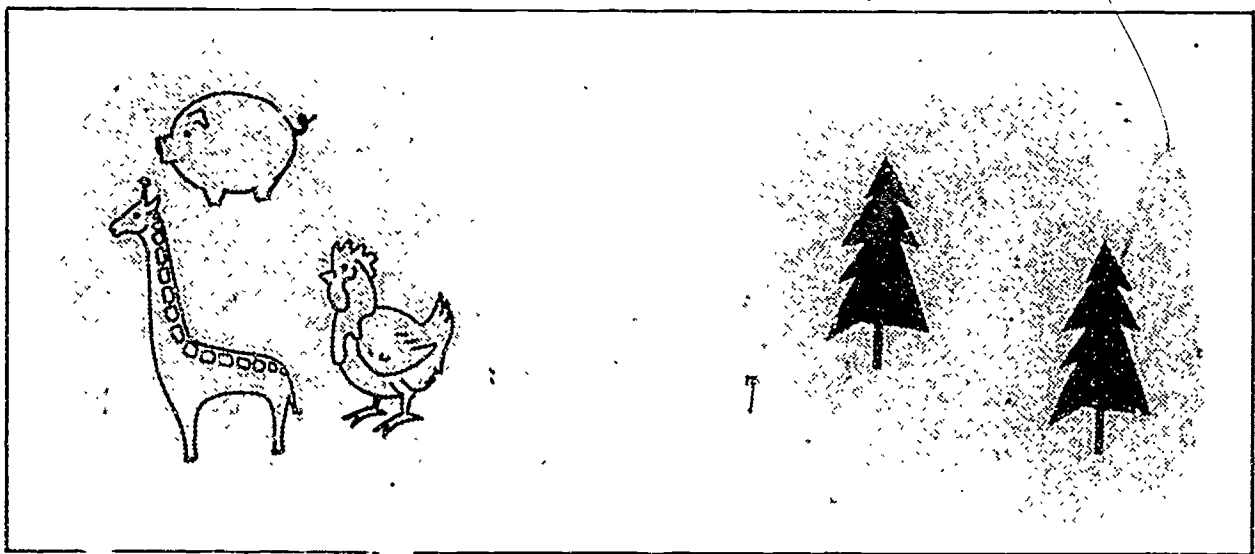
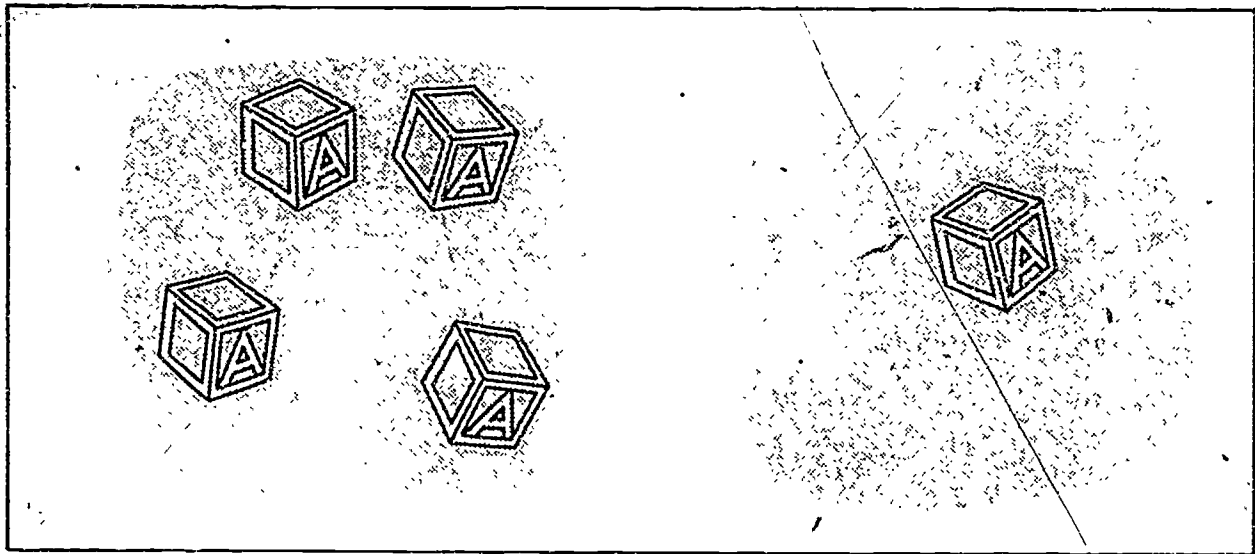

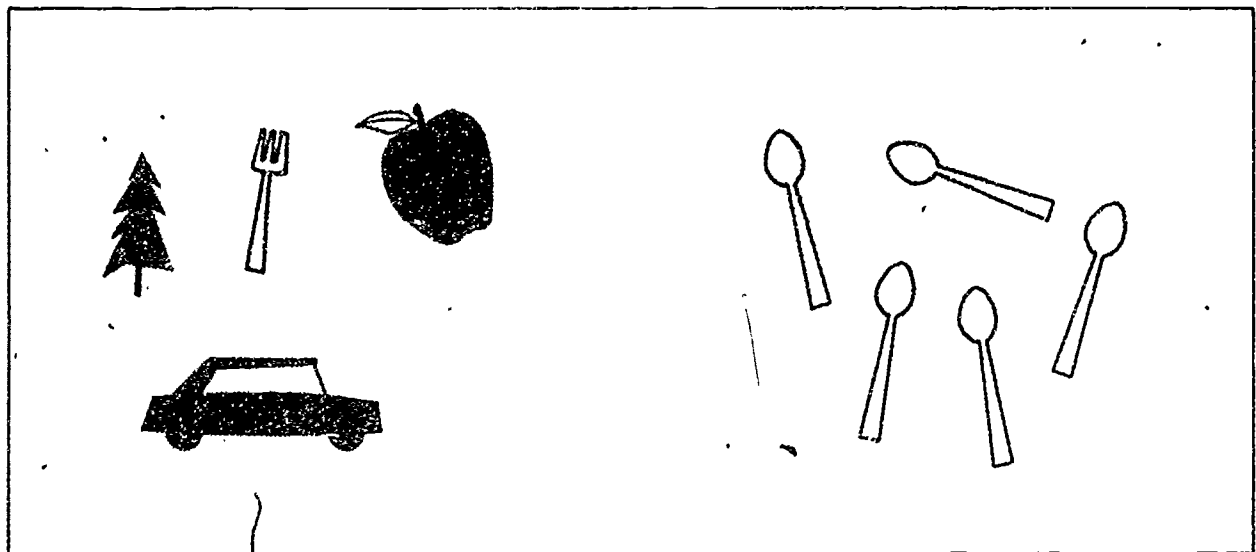
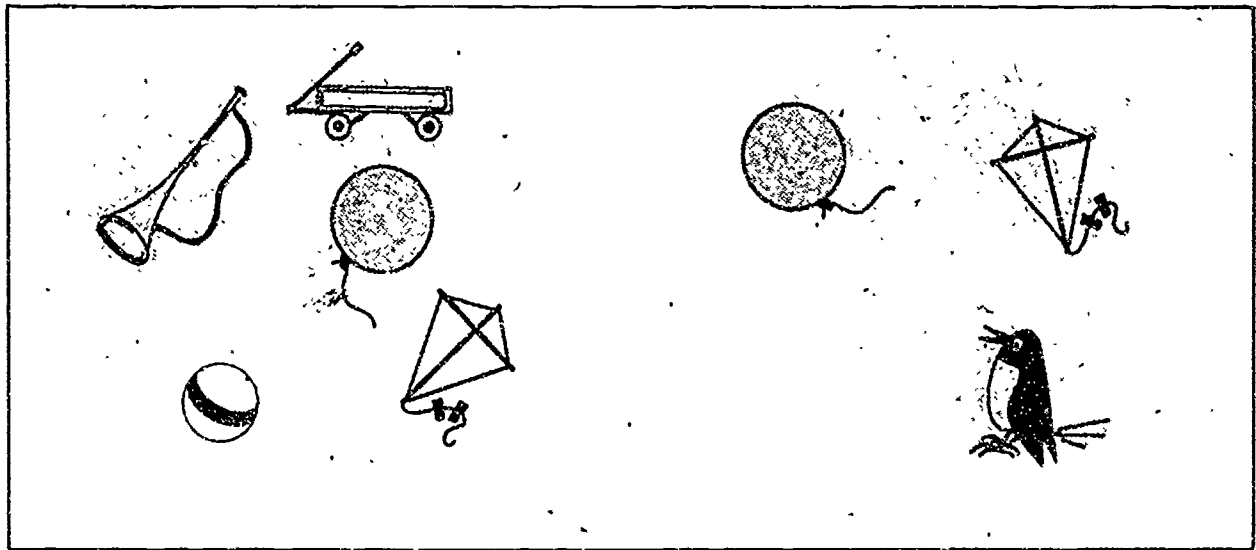
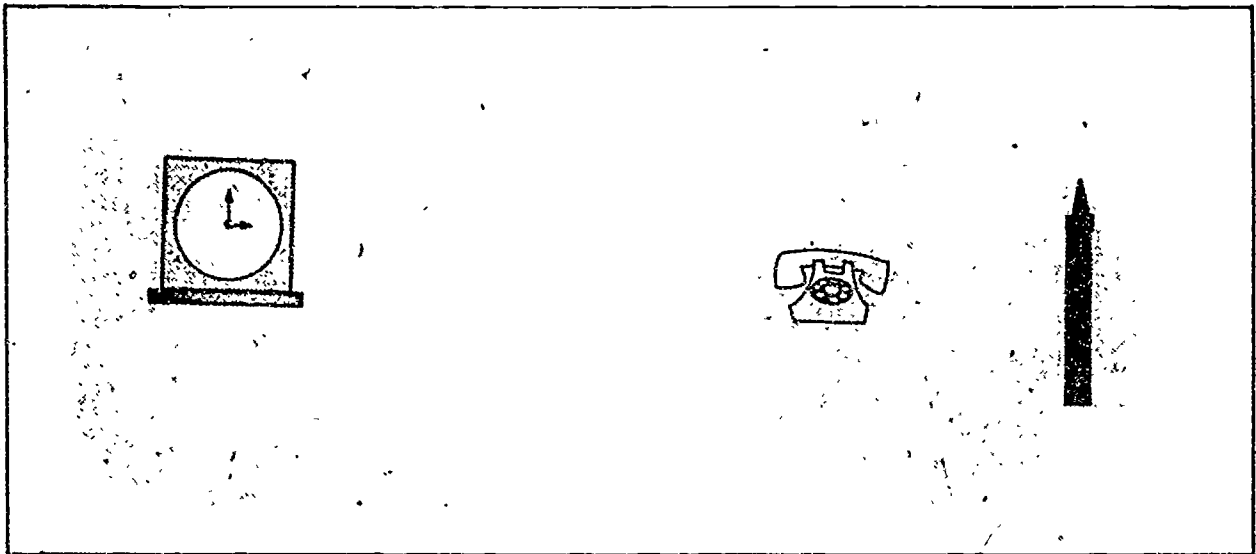

Greater than - less than

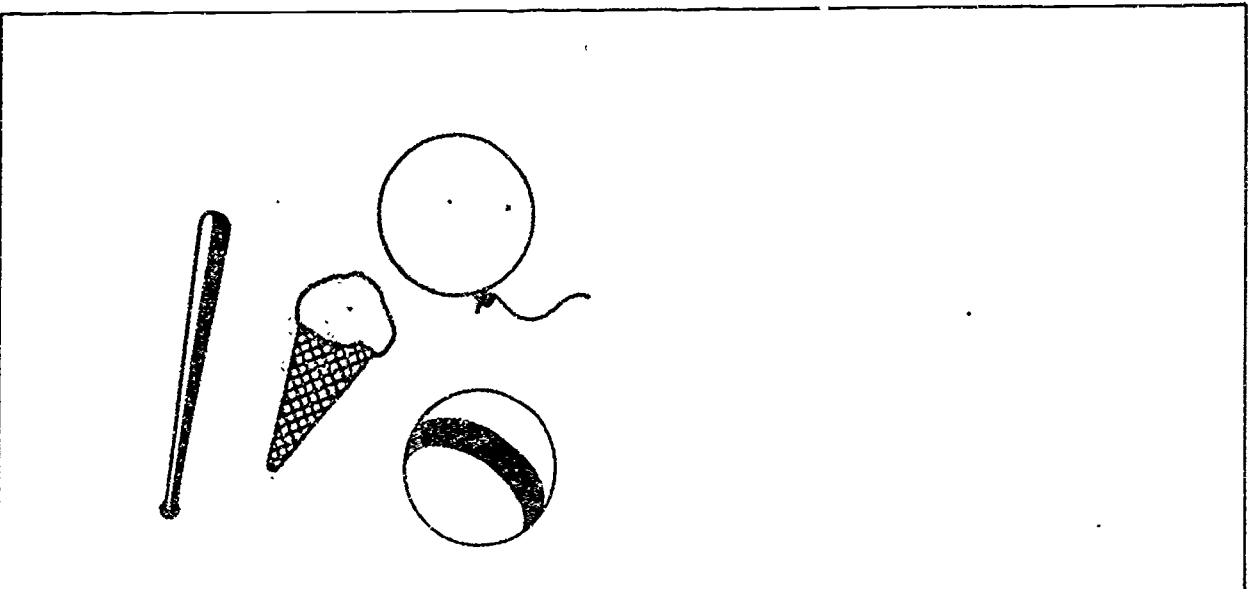
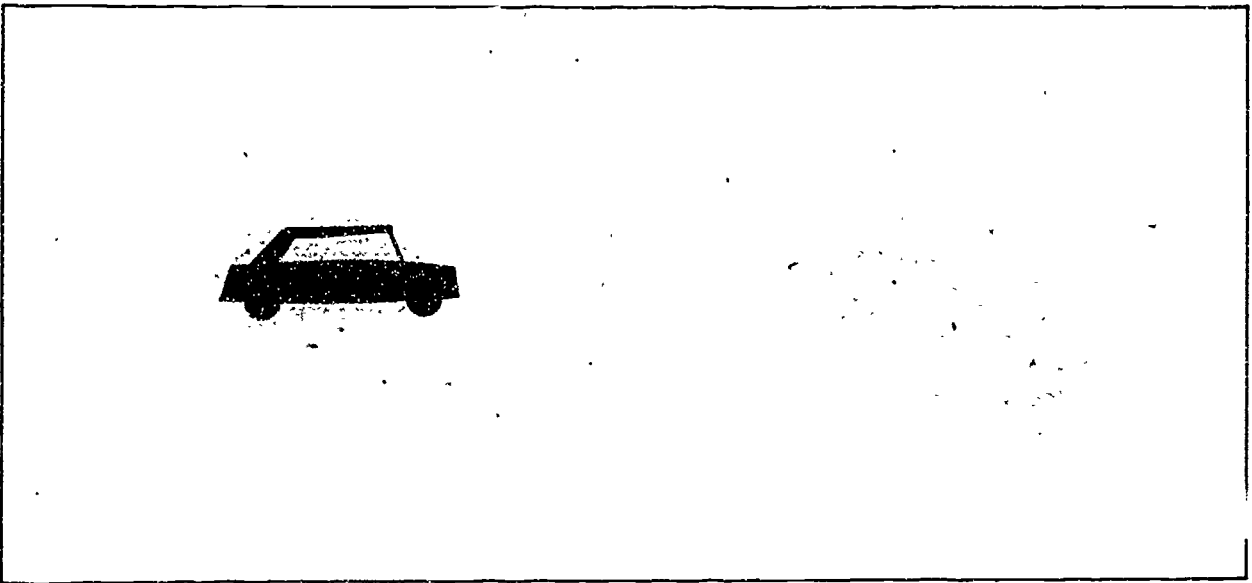
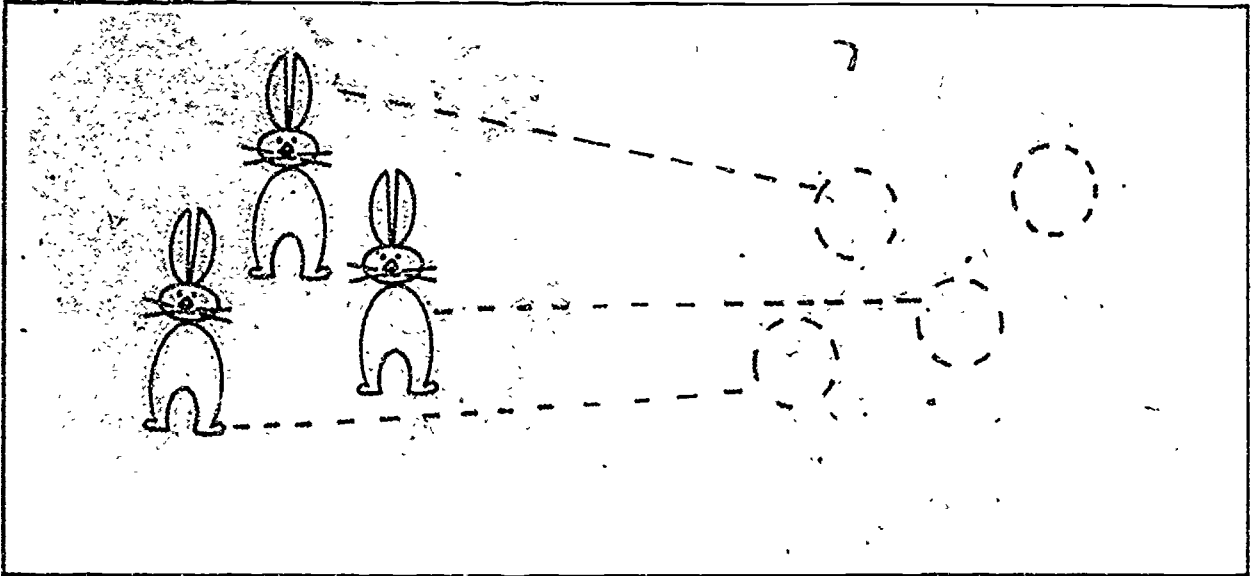

Sets with one more member



Sets with one more member

	
---	---

	
---	--

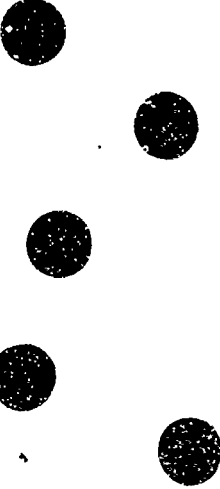
	
--	--

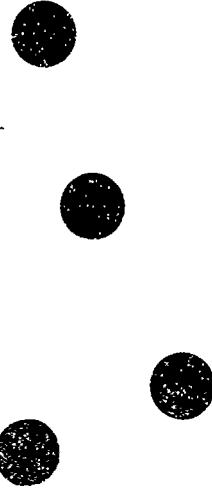
	
---	--

--	--

	
--	--

Sets with one more member

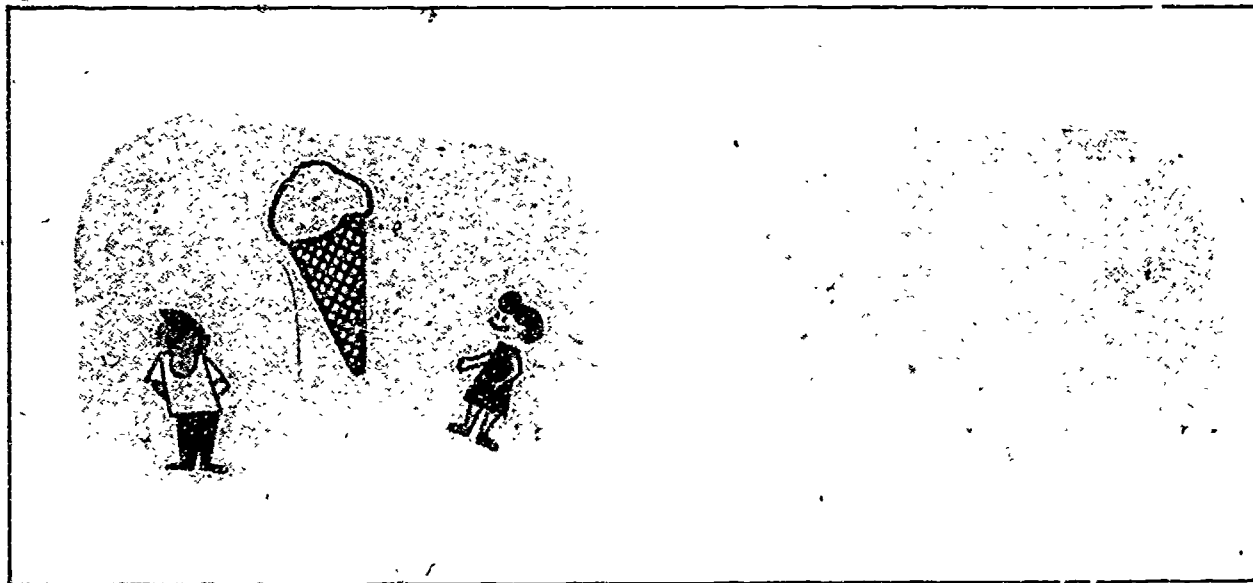
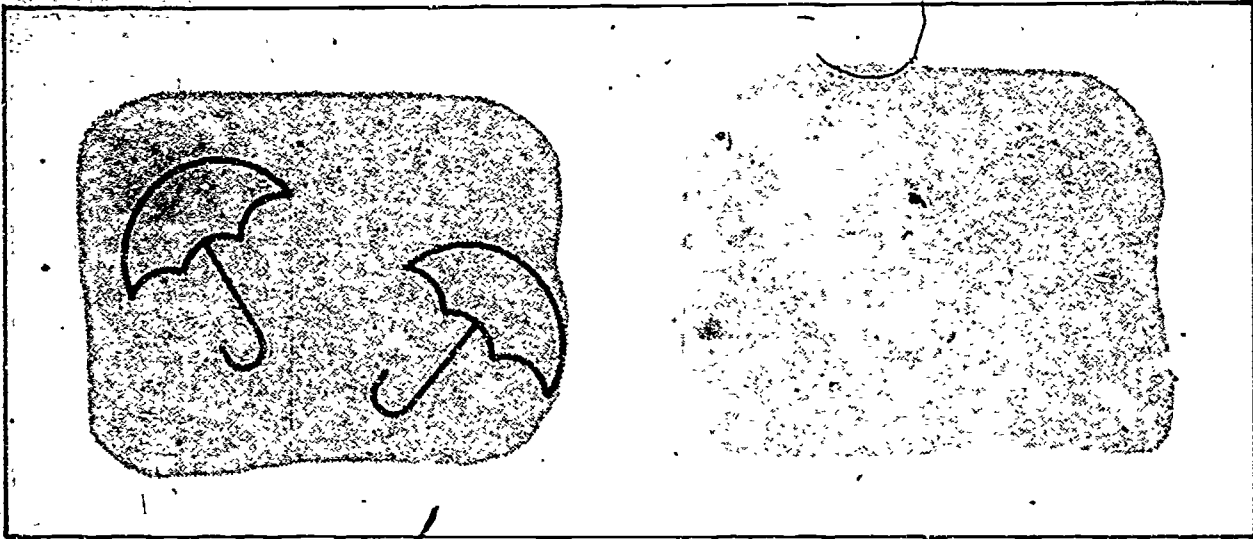

Sets with one more member

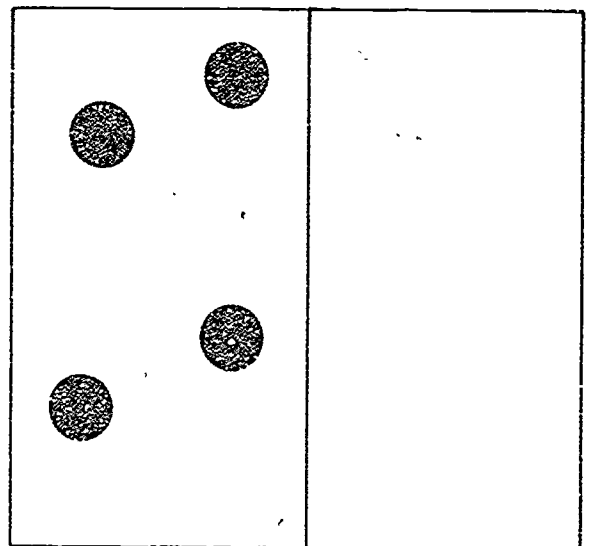
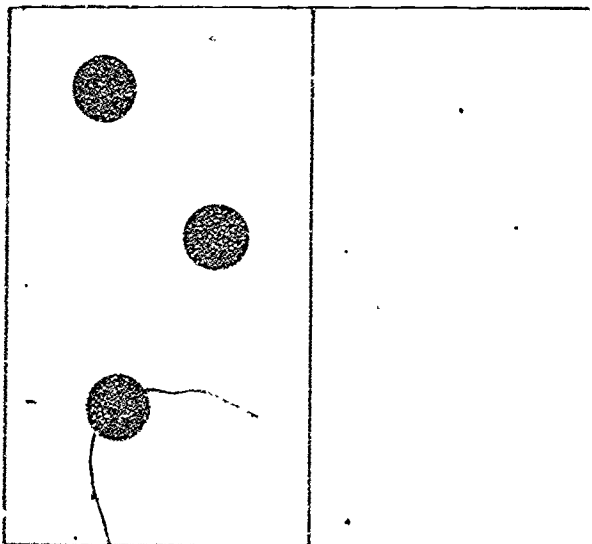
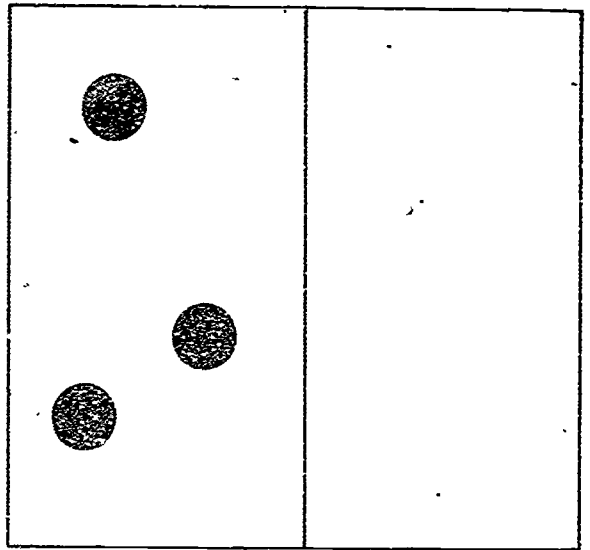
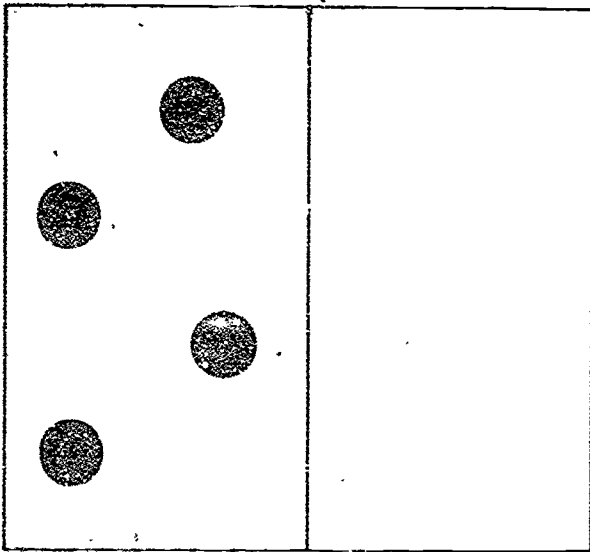
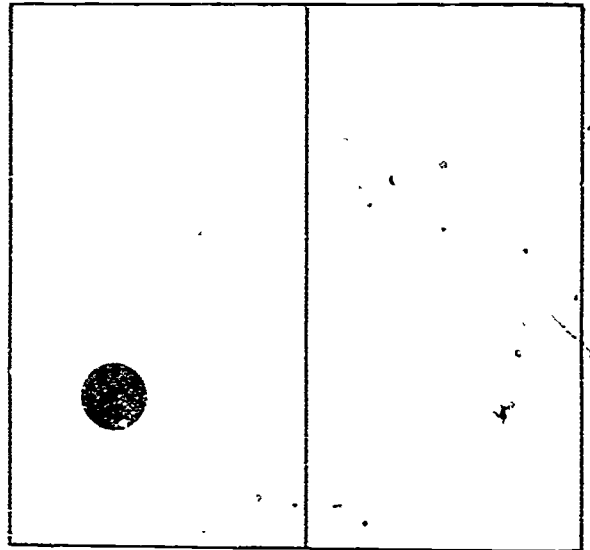
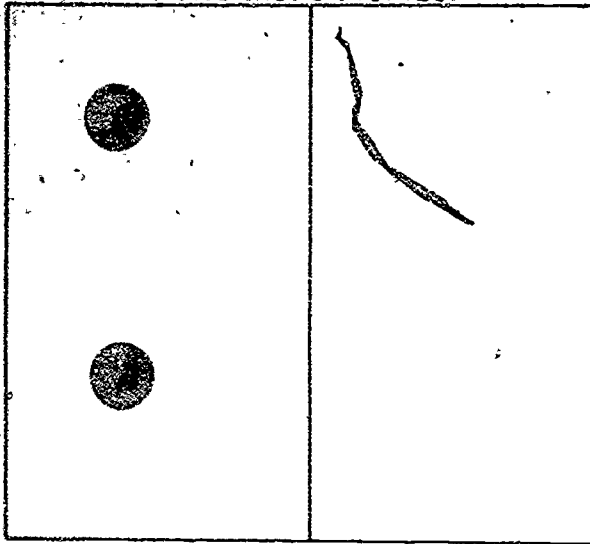

### Sets with one less member

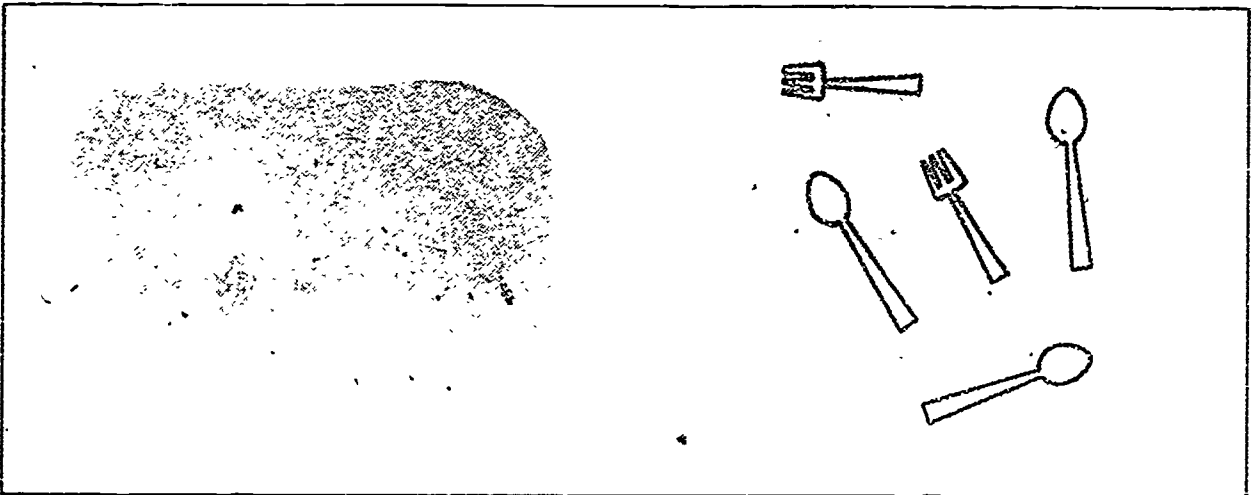
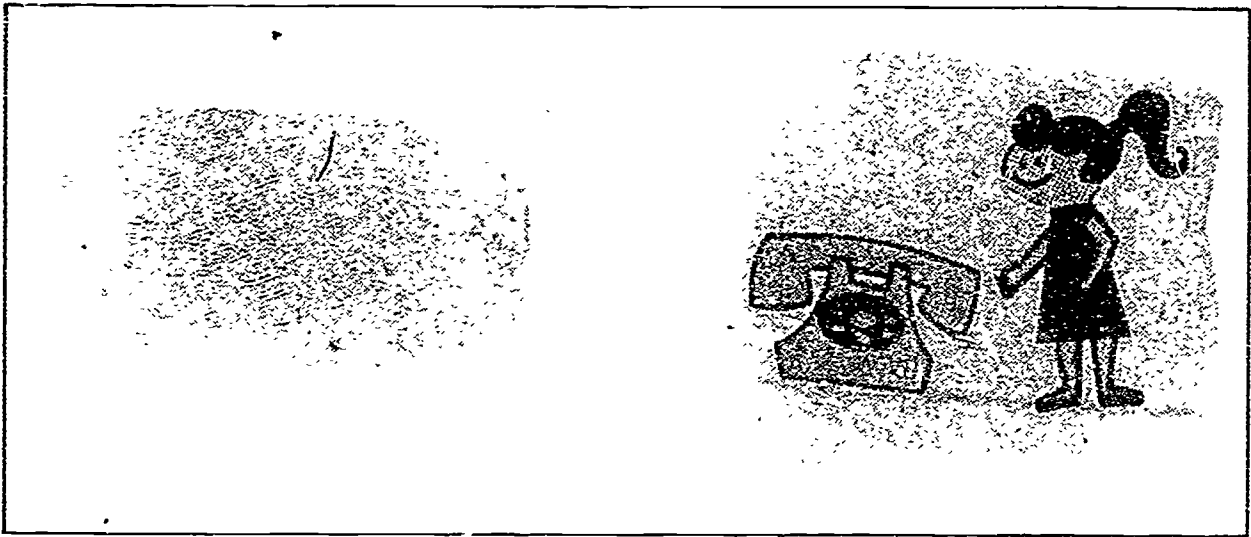
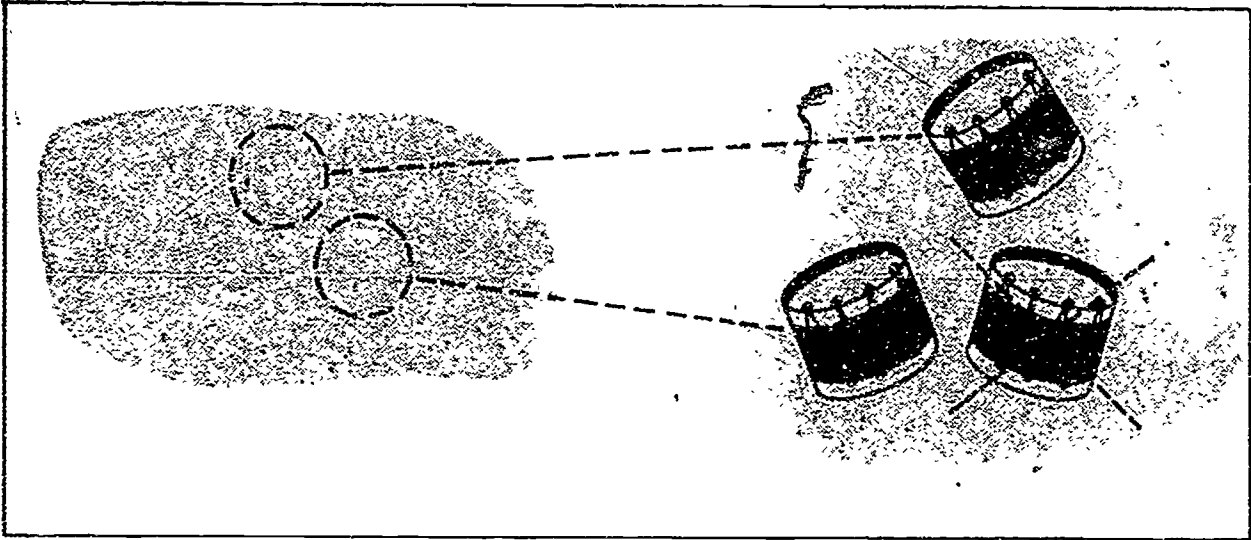



Sets with one less member

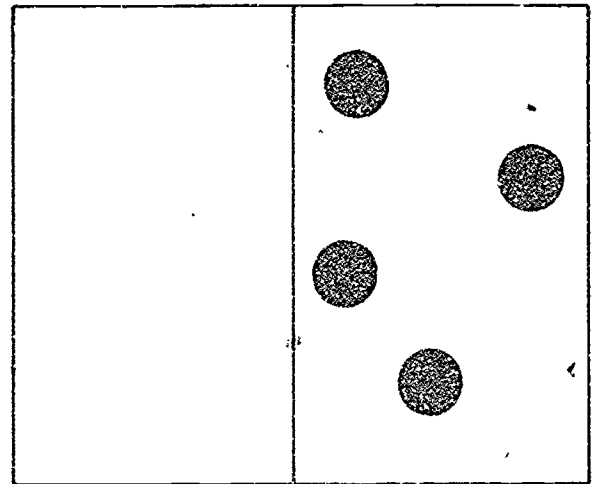
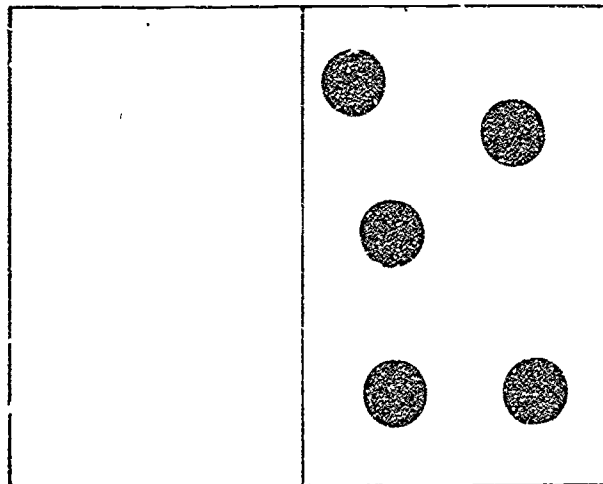
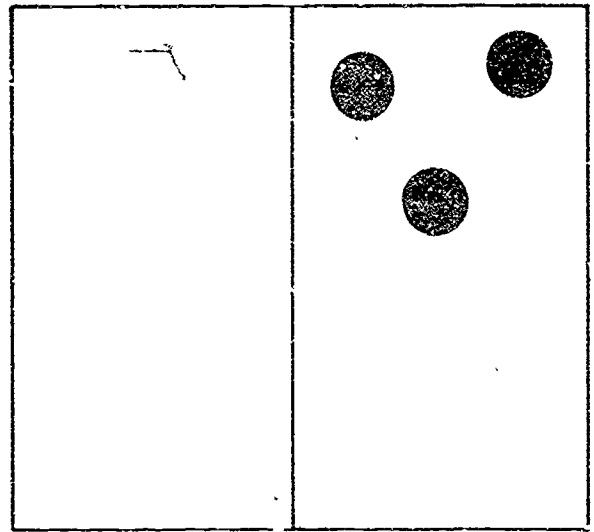
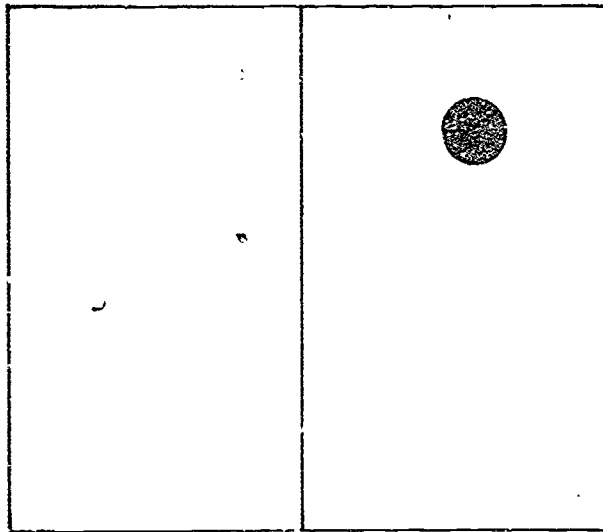
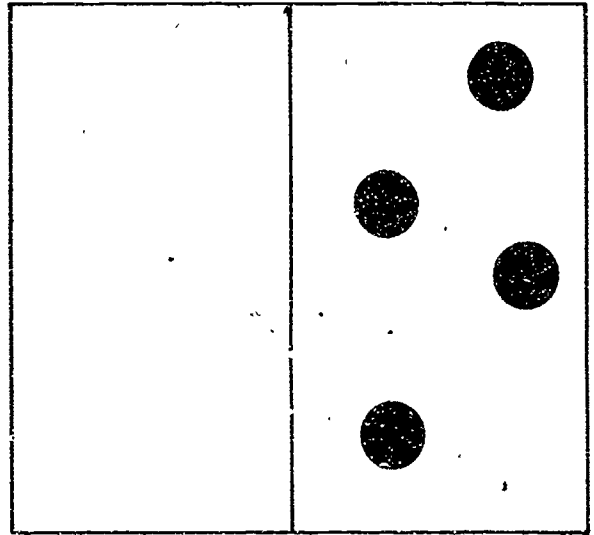
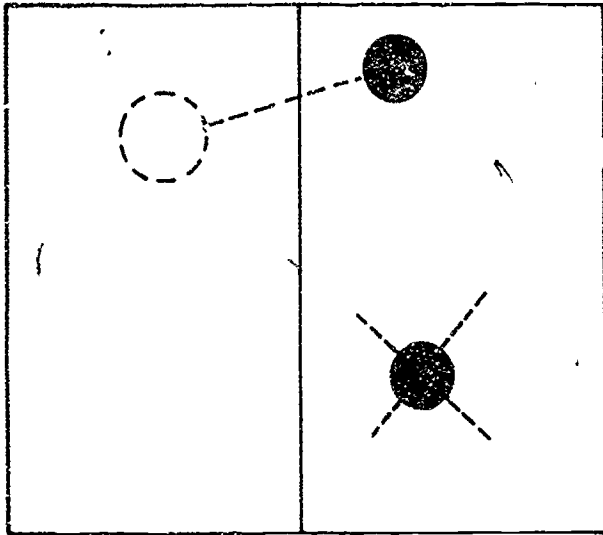

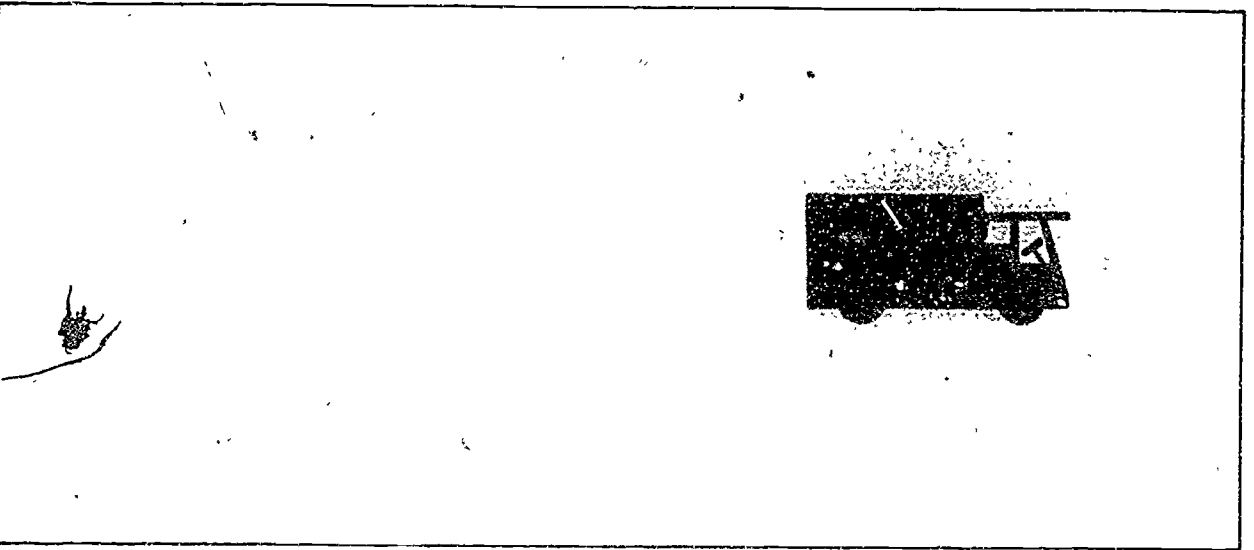
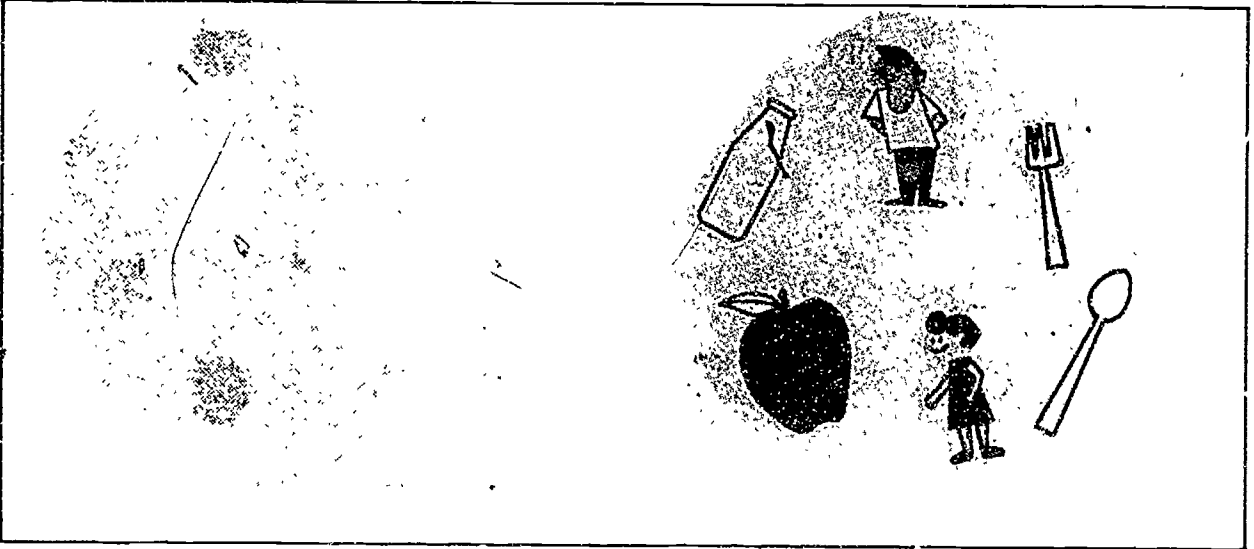
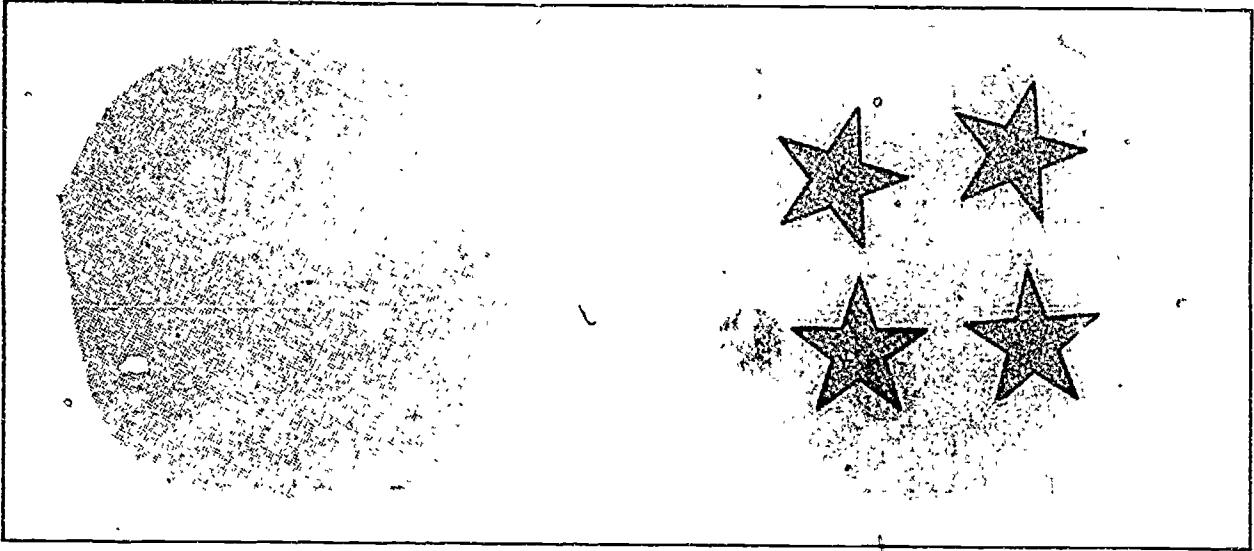

Sets with one less member

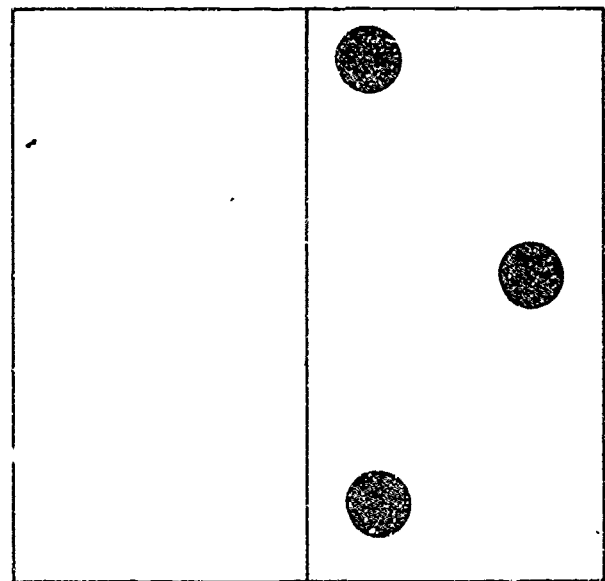
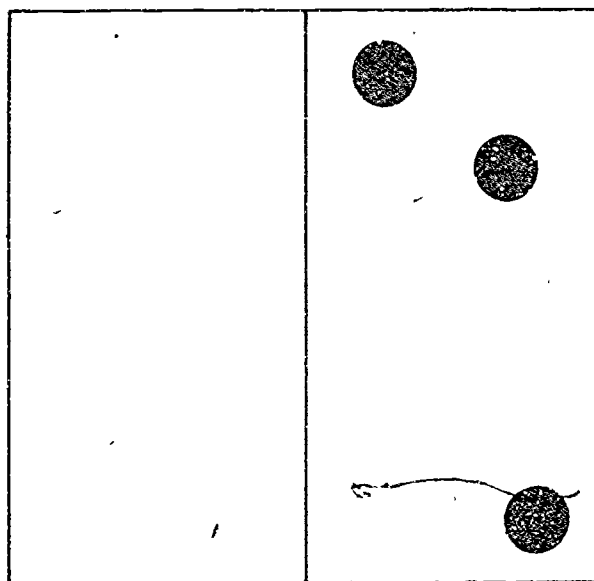
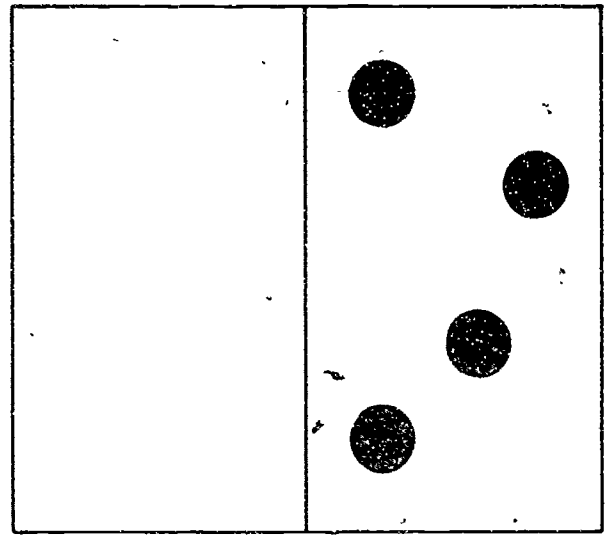
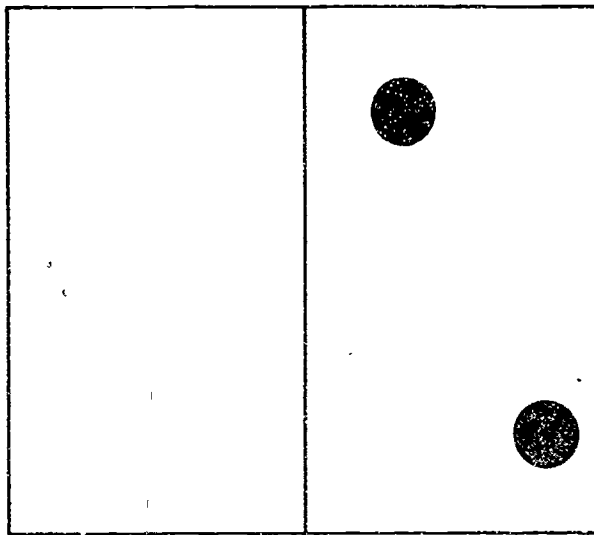
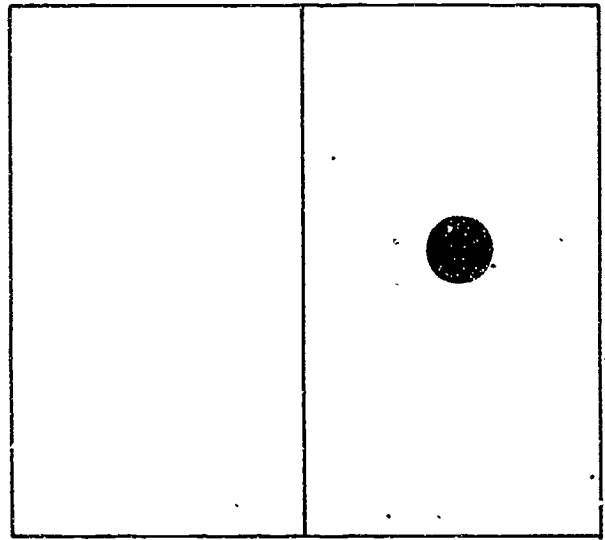
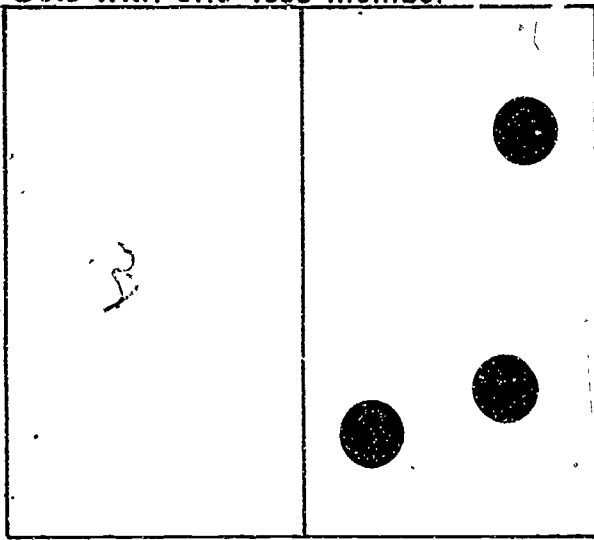

Sets with one less member

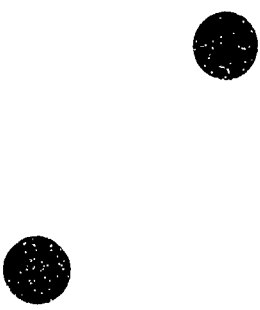

Order of sets

		
---	---	---

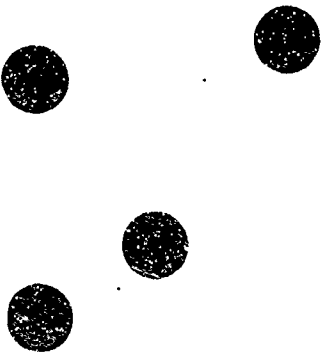
		
--	--	--

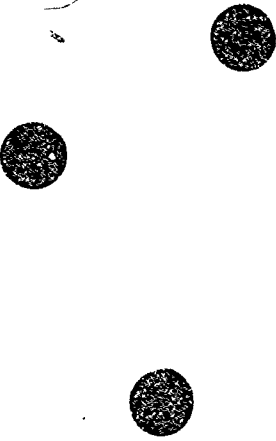
		
--	---	--

Order of sets

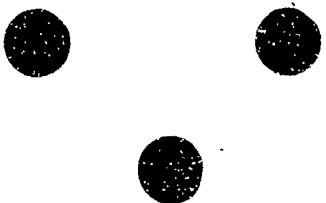
		
--	---	--

		
--	---	--

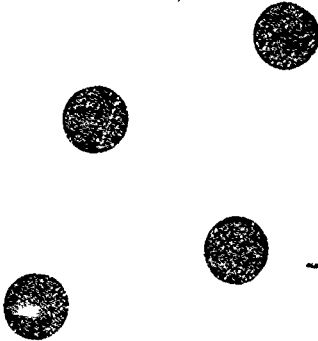
		
--	---	--

Which sets have six members?

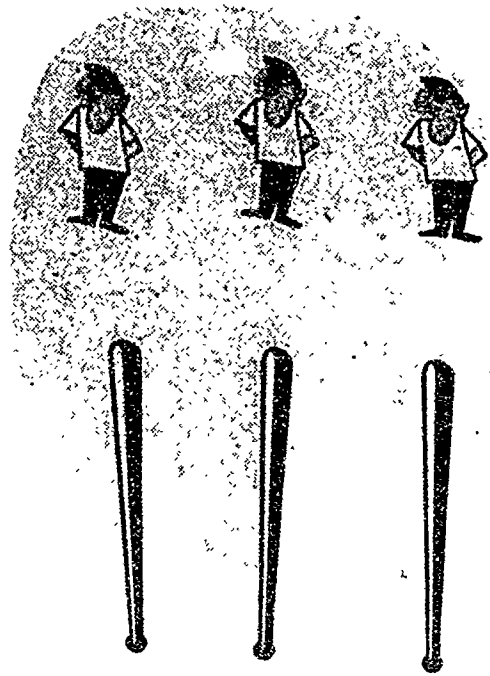
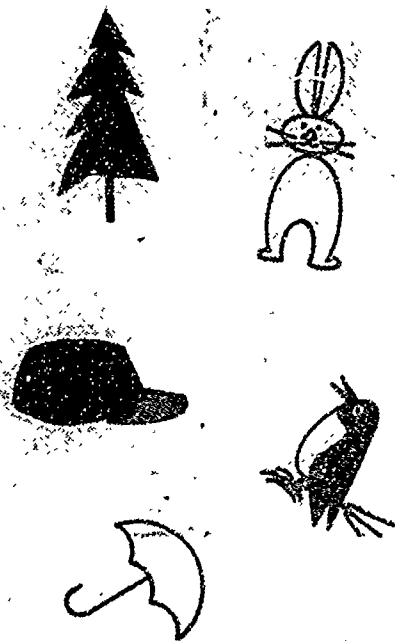
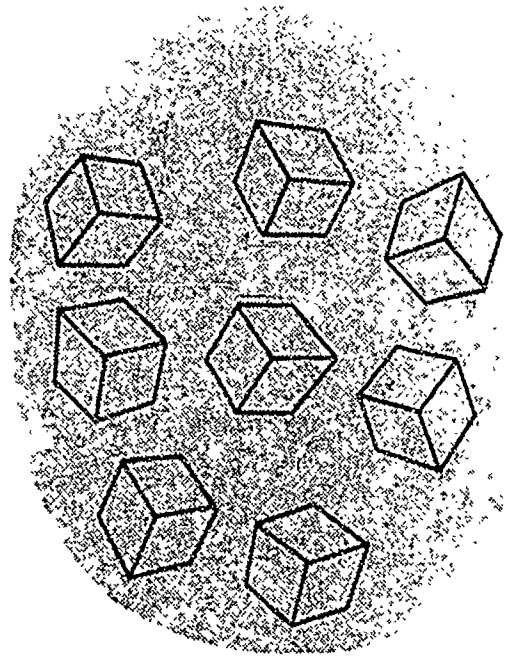
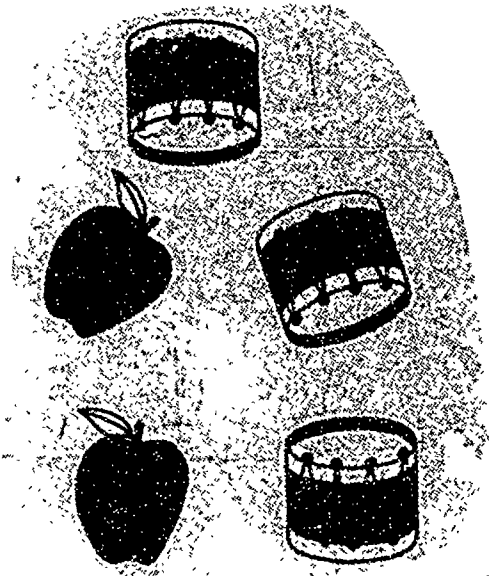

Which sets have six members?

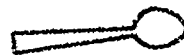
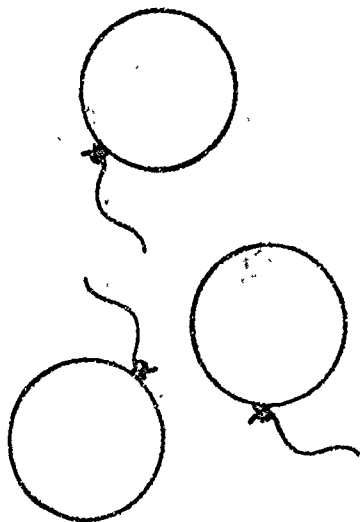
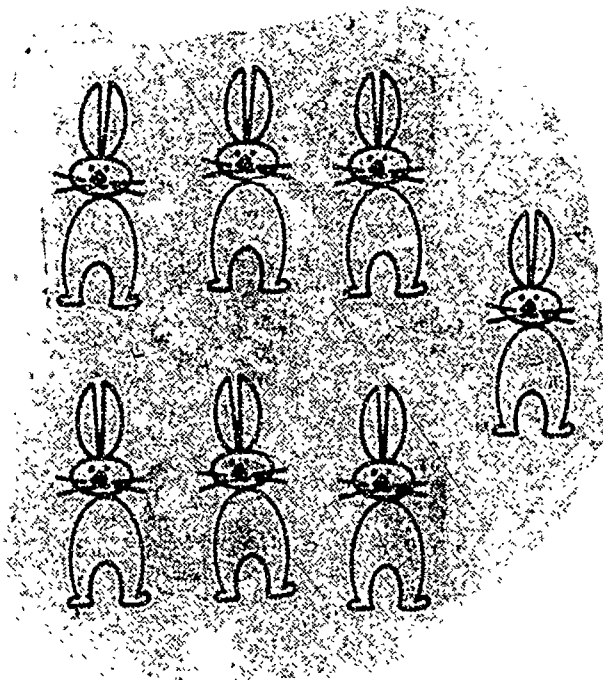
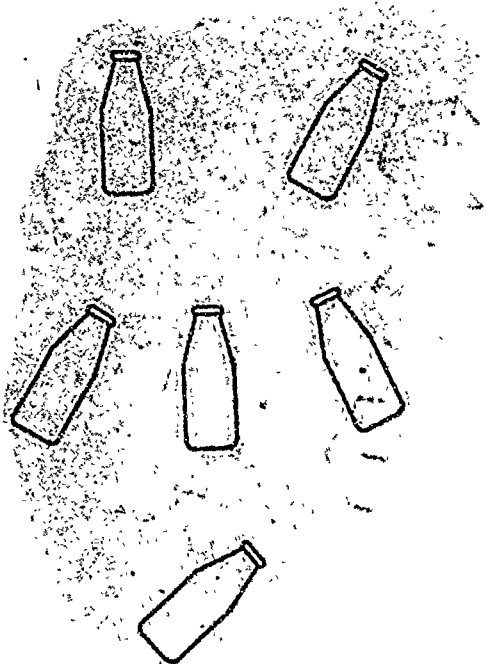

Which sets have seven members?

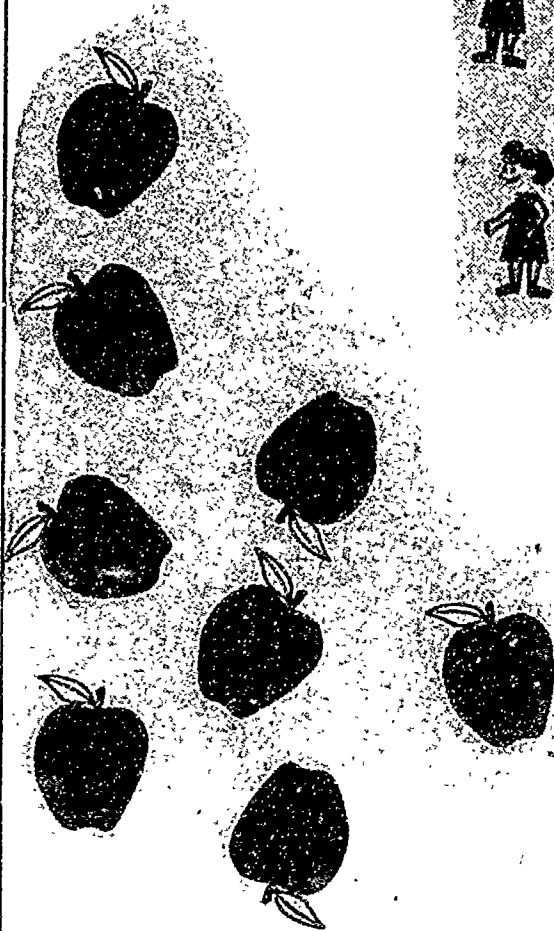
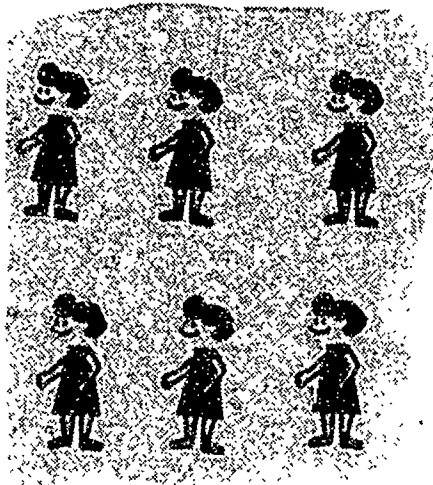
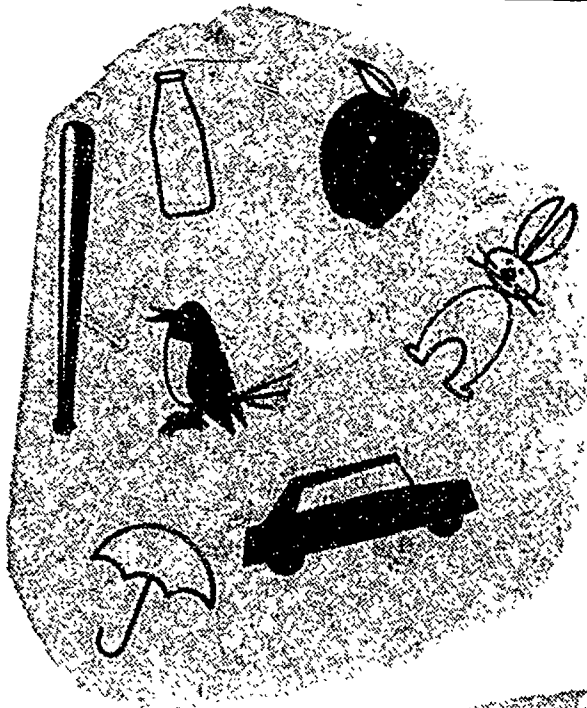



Which sets have seven members?

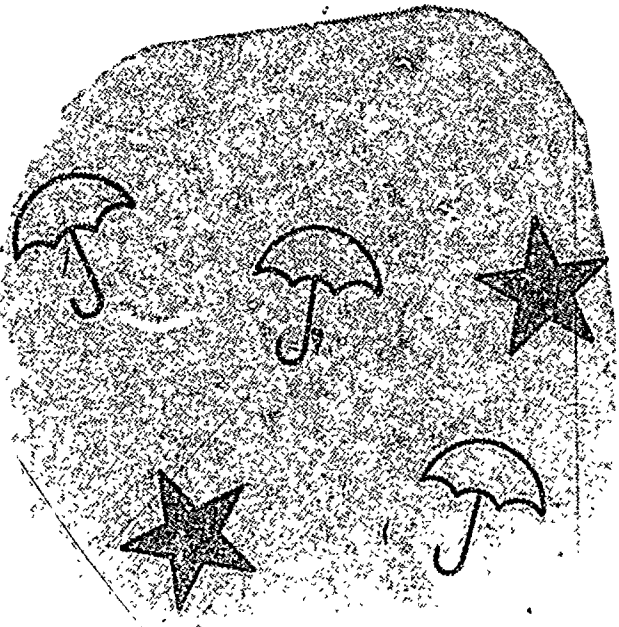
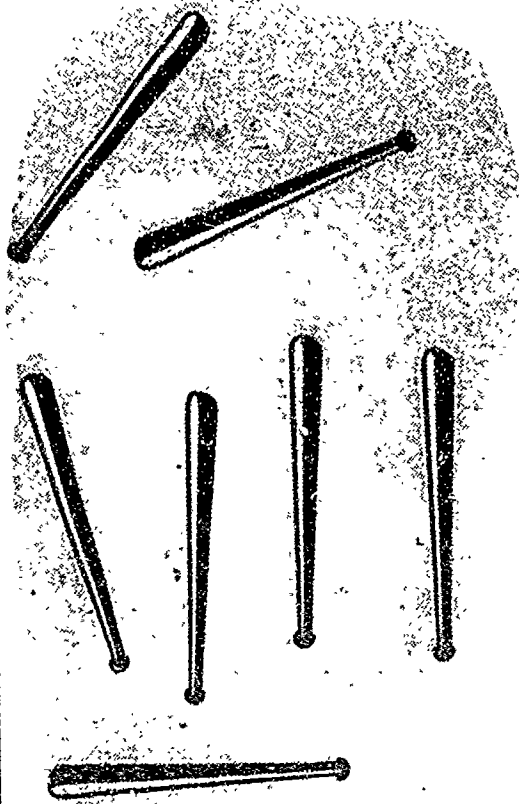
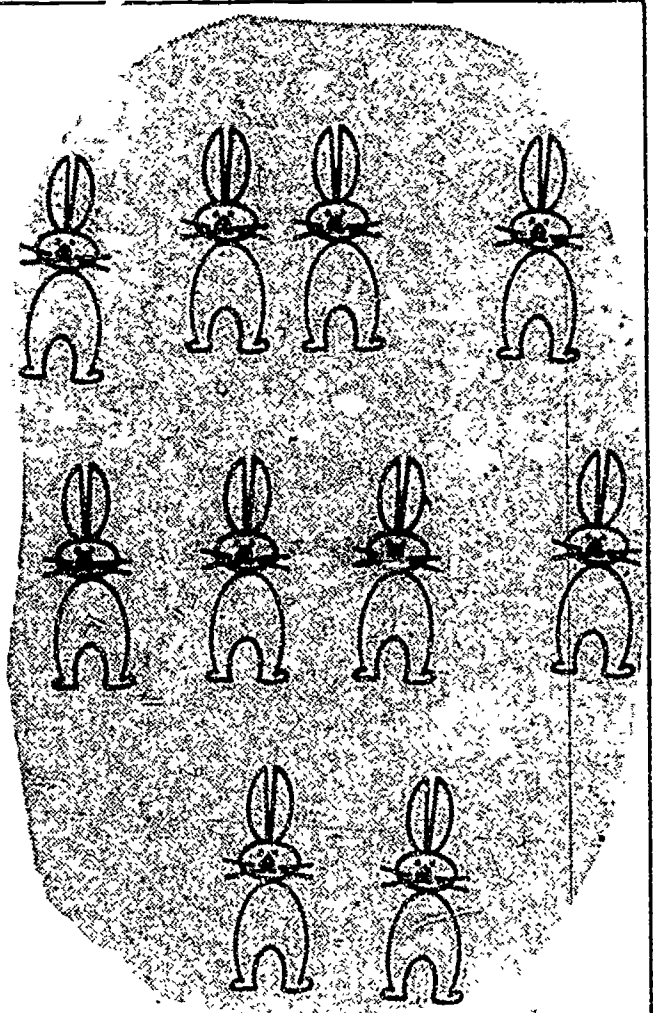

Which sets have eight members?

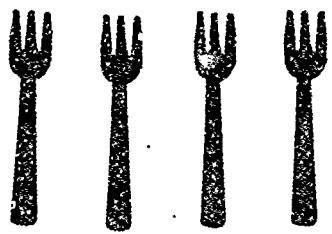
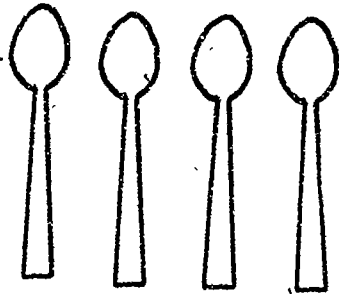
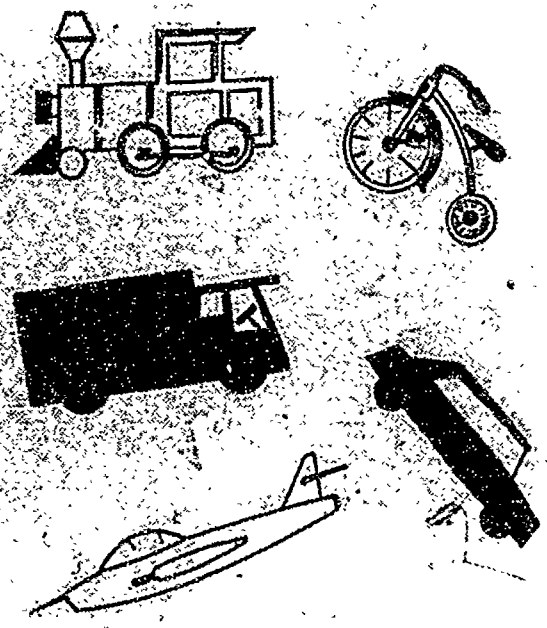
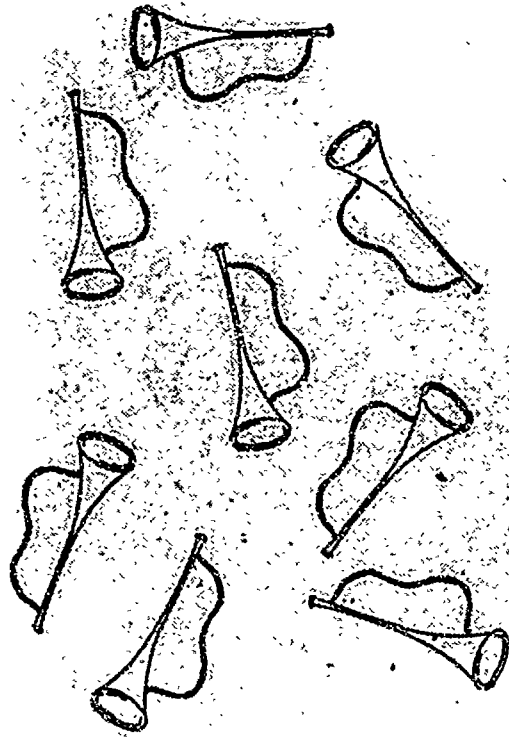
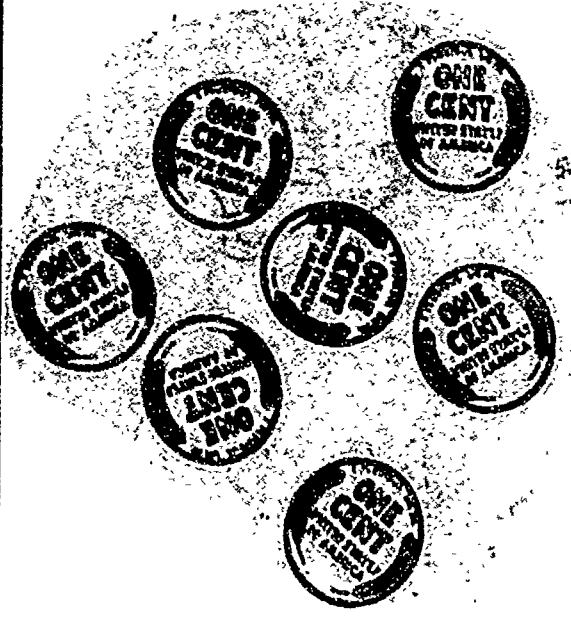

Which sets have eight members?

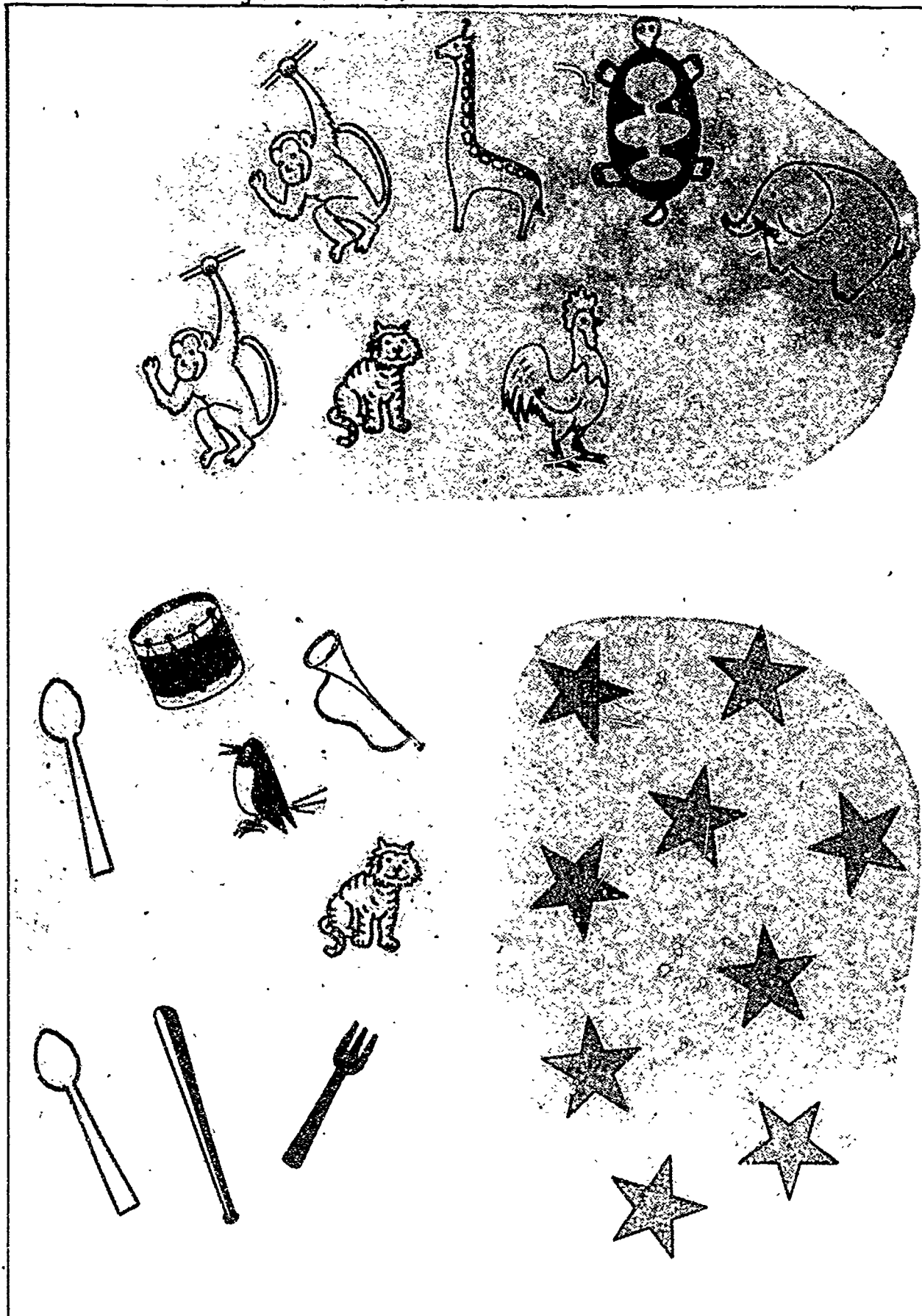

Which sets have nine members?

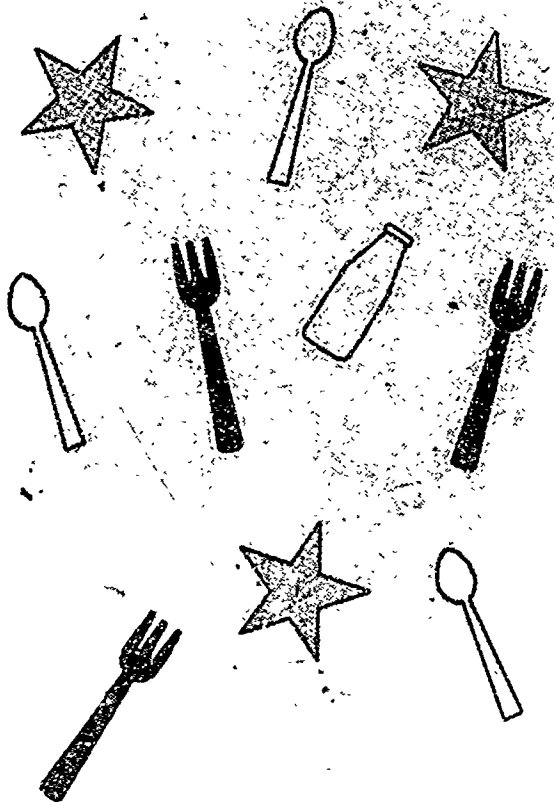
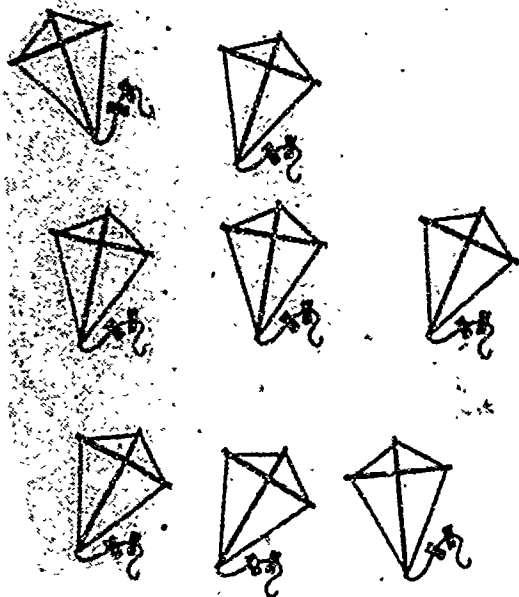
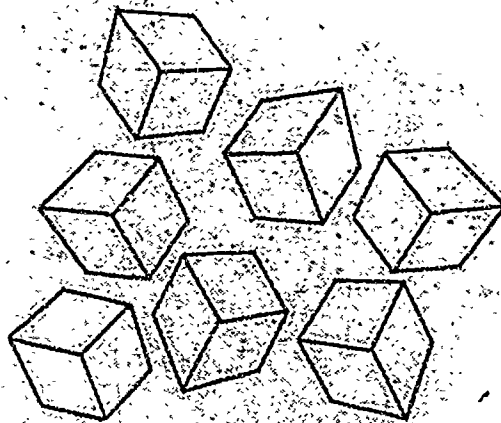
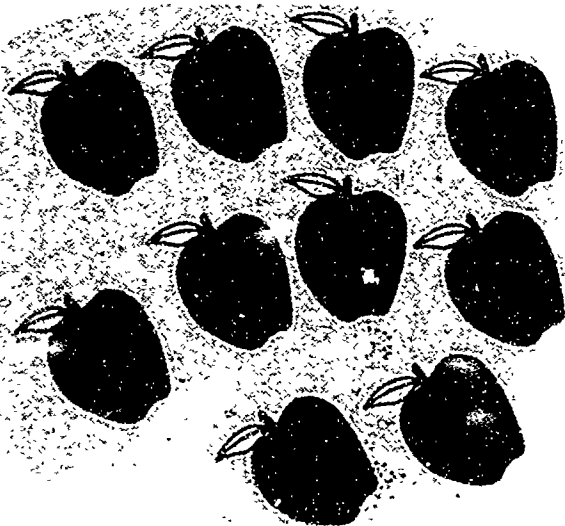

Which sets have nine members?

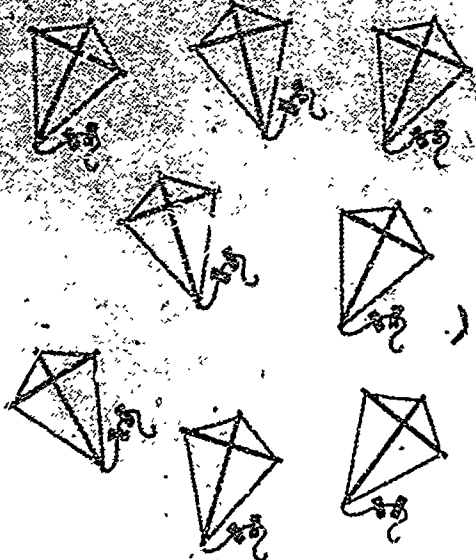
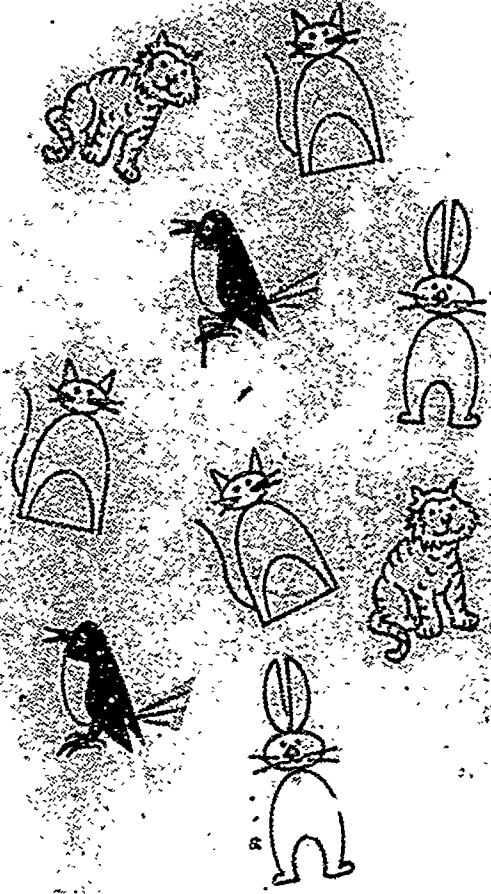
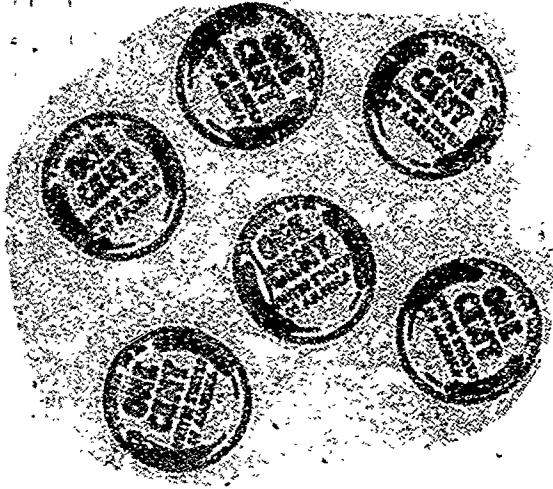

Which sets have ten members?

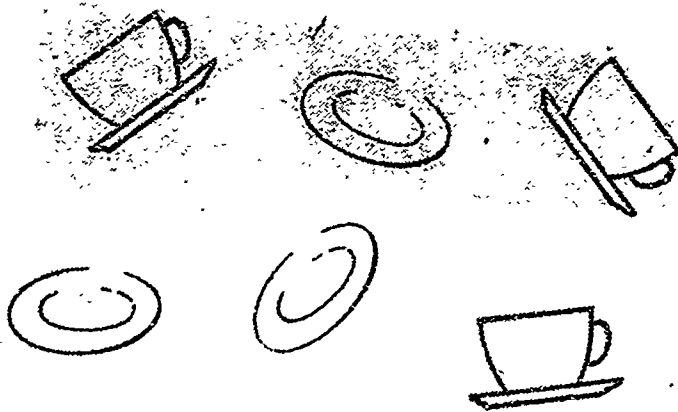
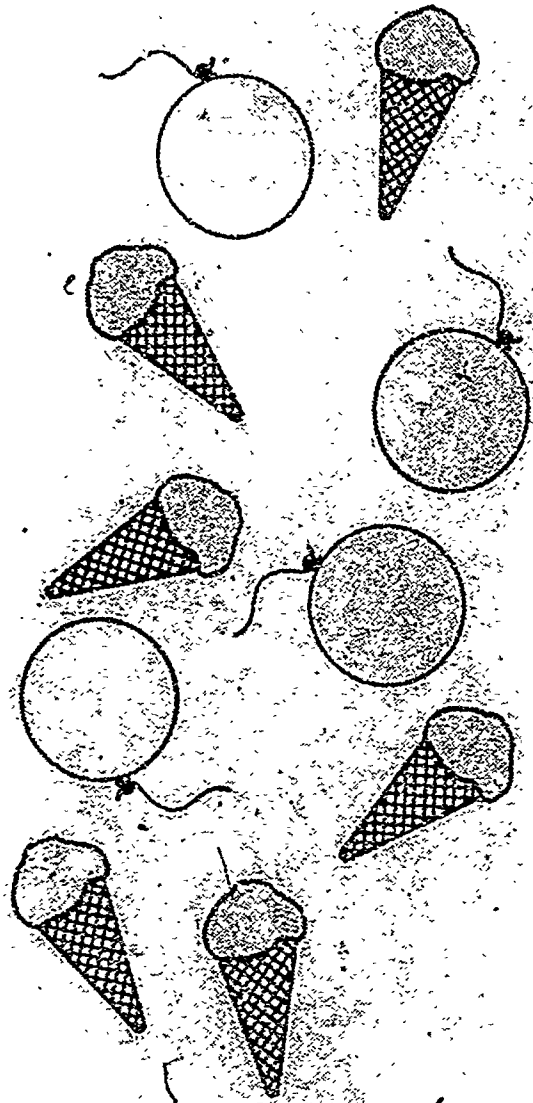

Which sets have ten members?

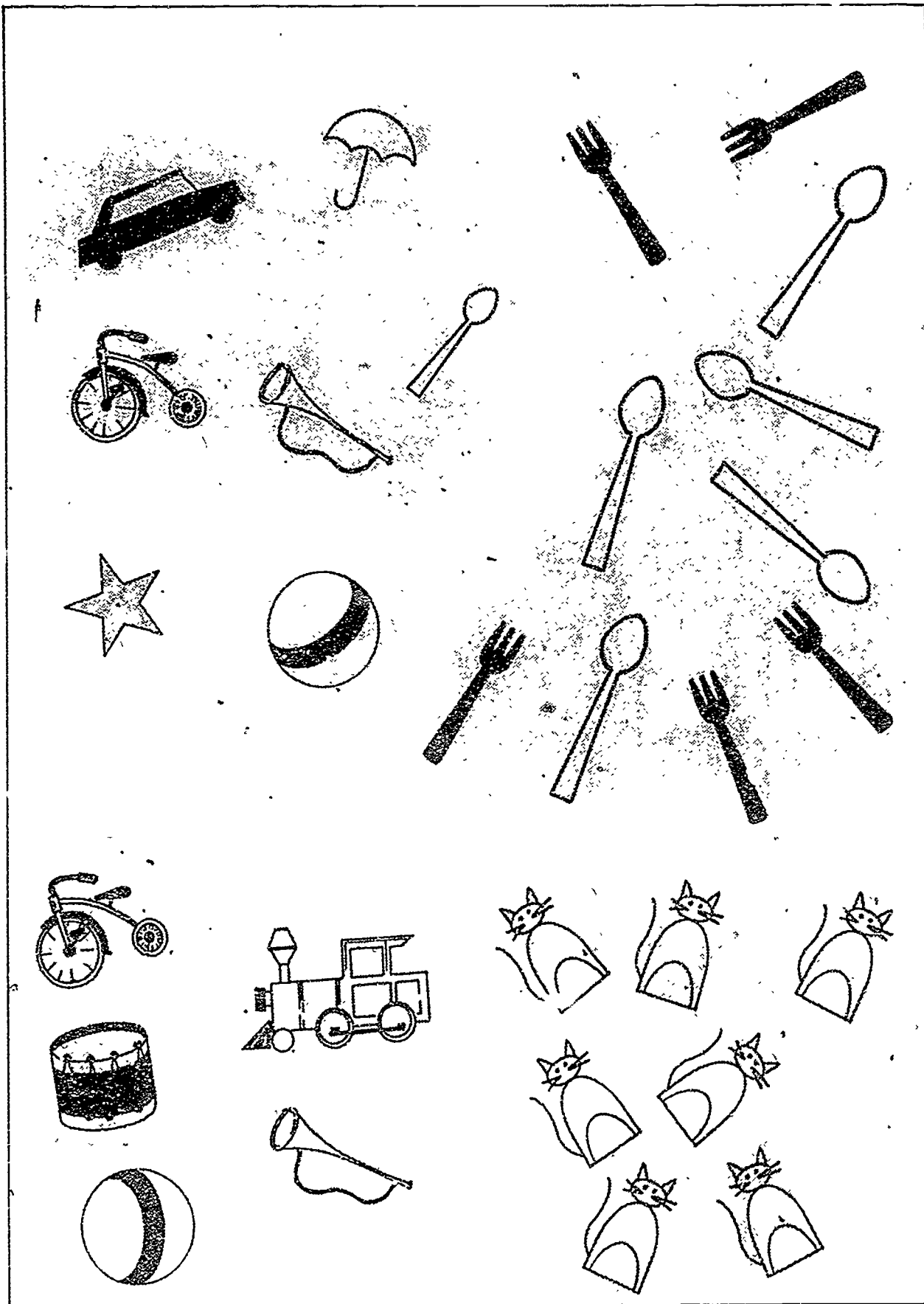

Sets with one more member

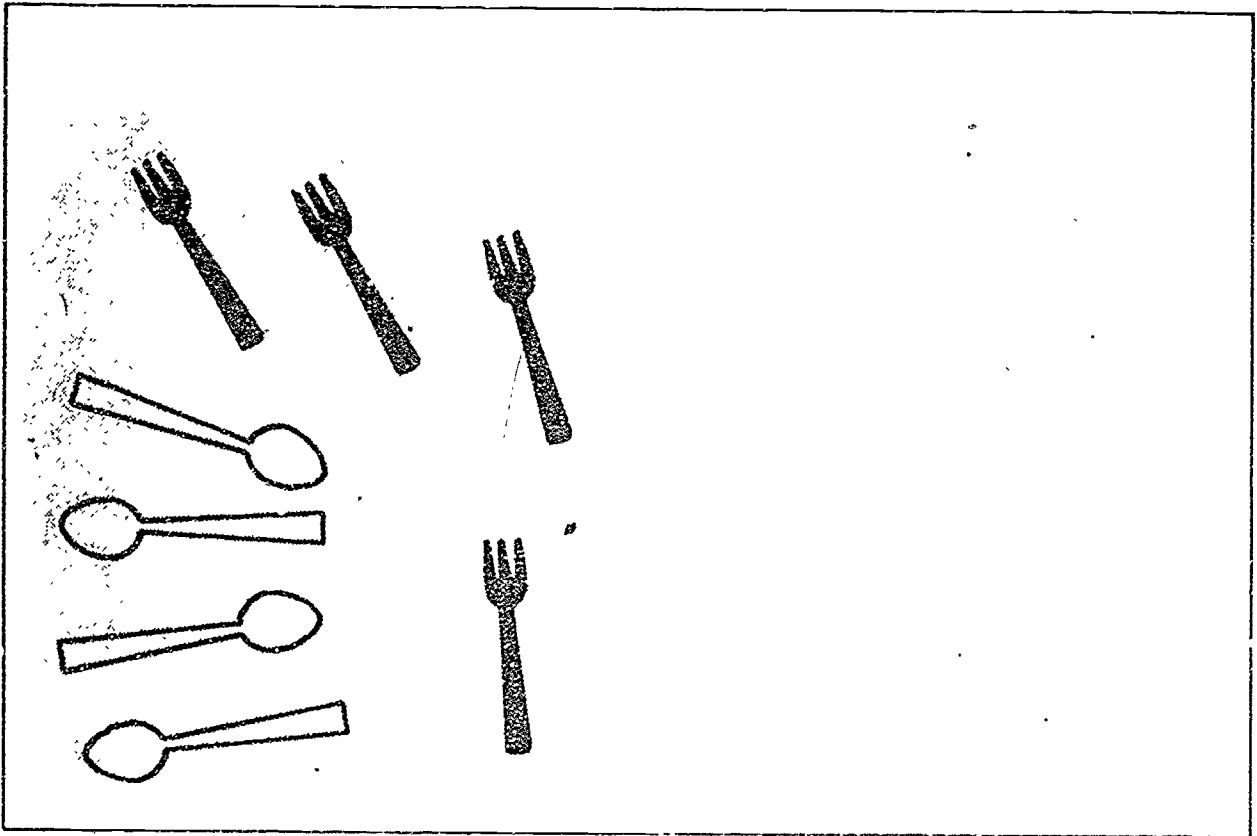
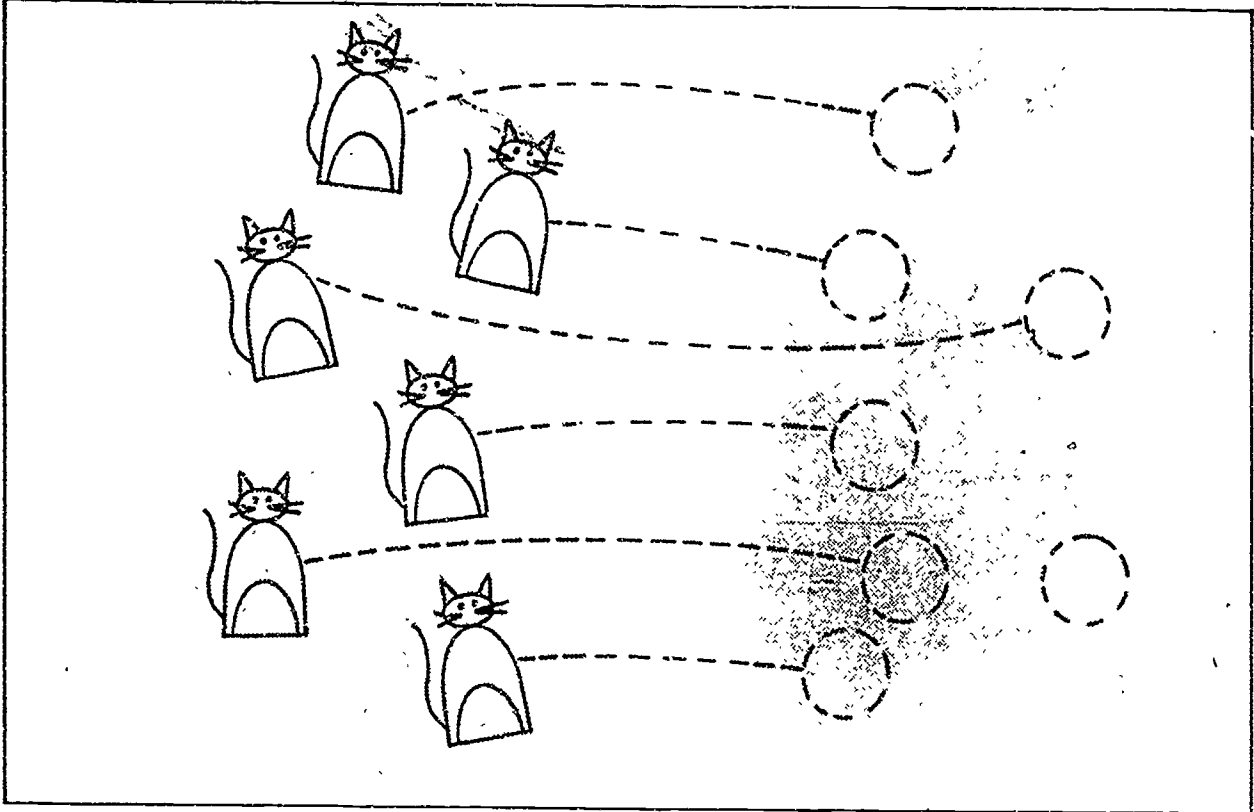



Sets with one more member

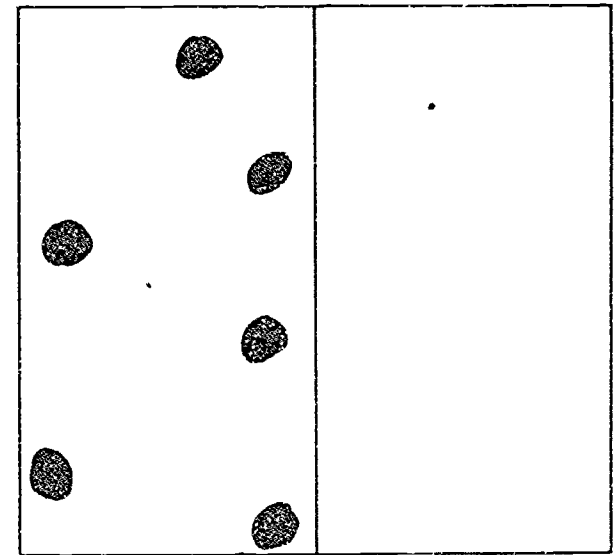
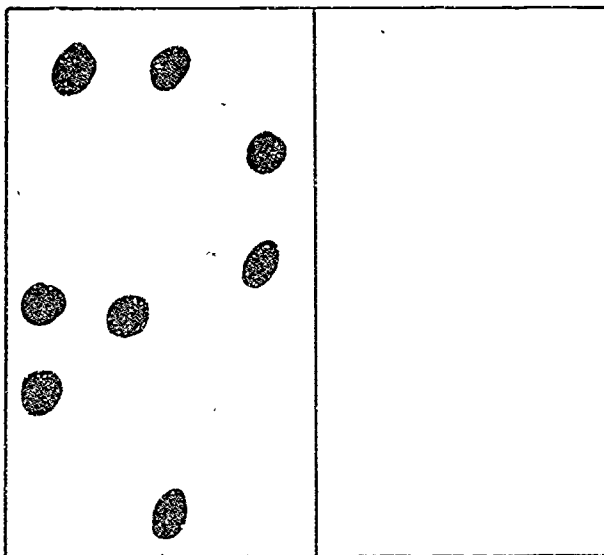
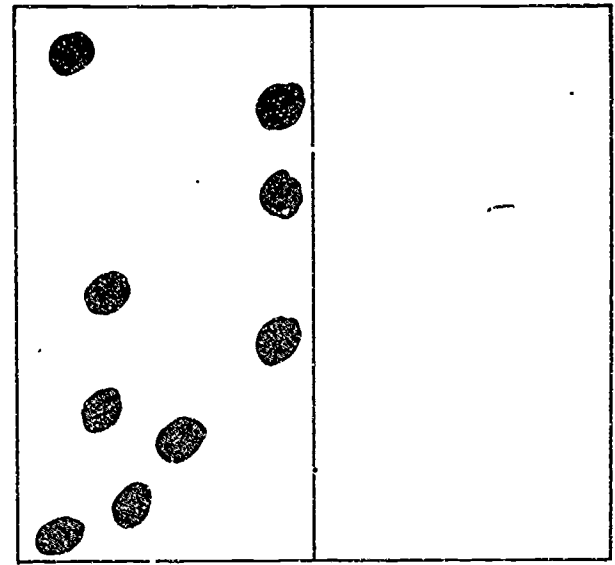
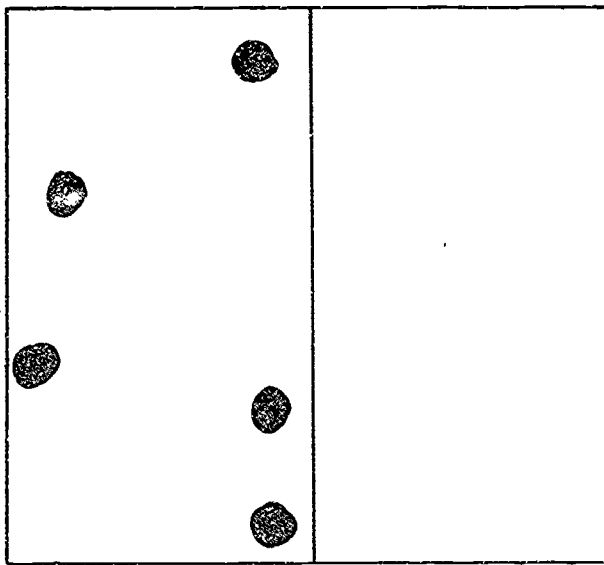
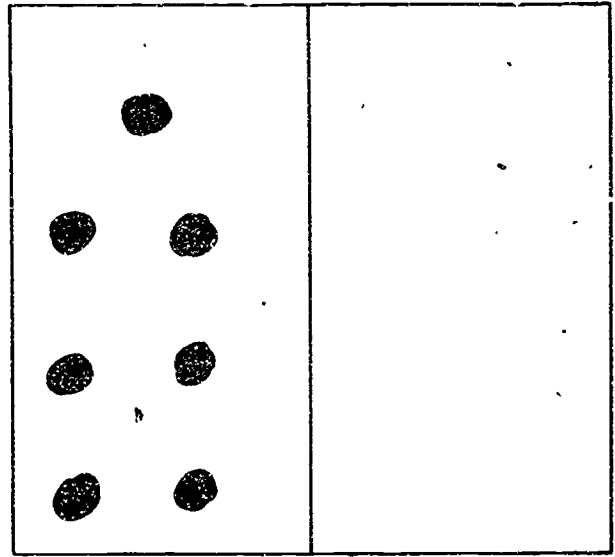
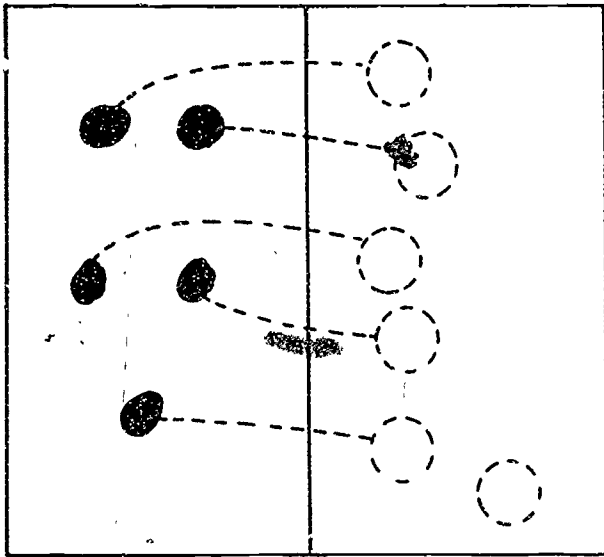

# Sets with one less member

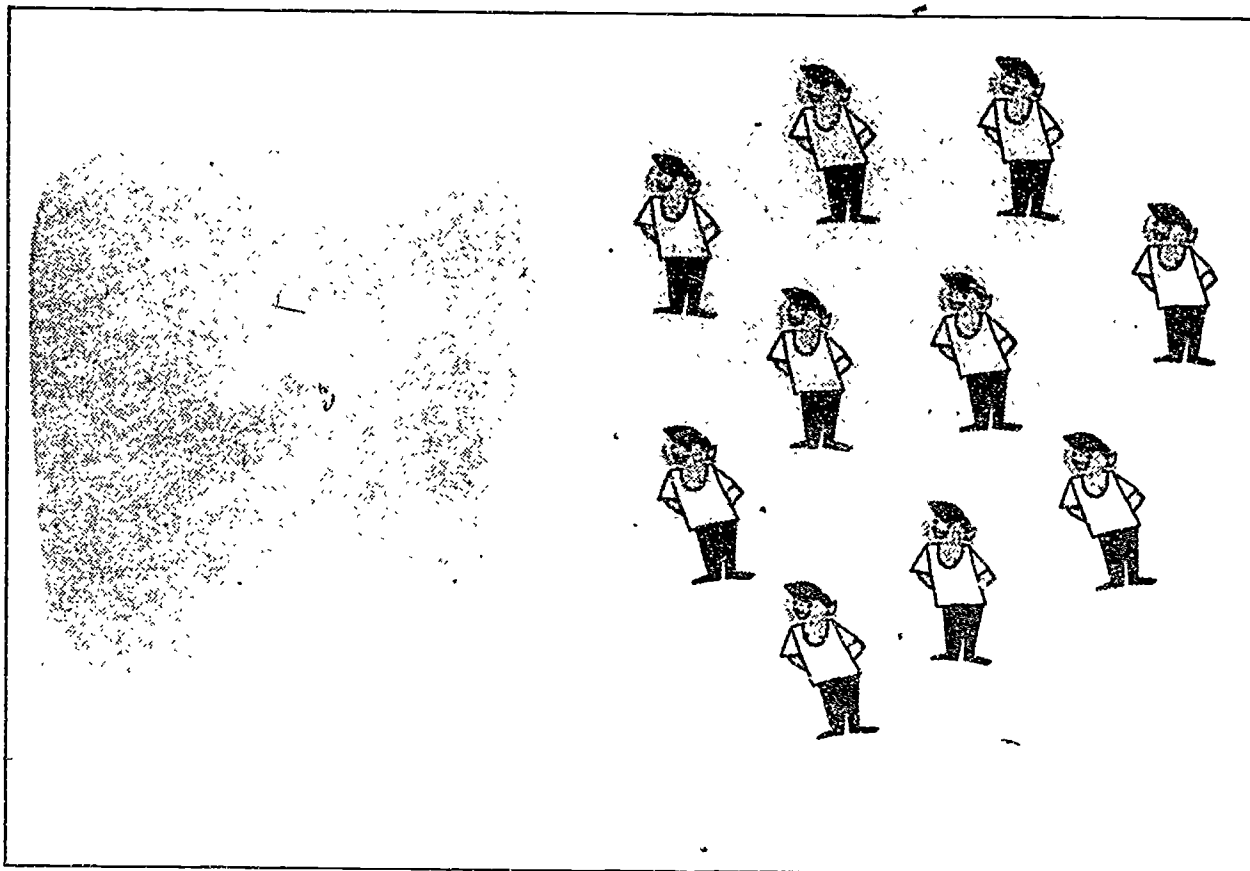
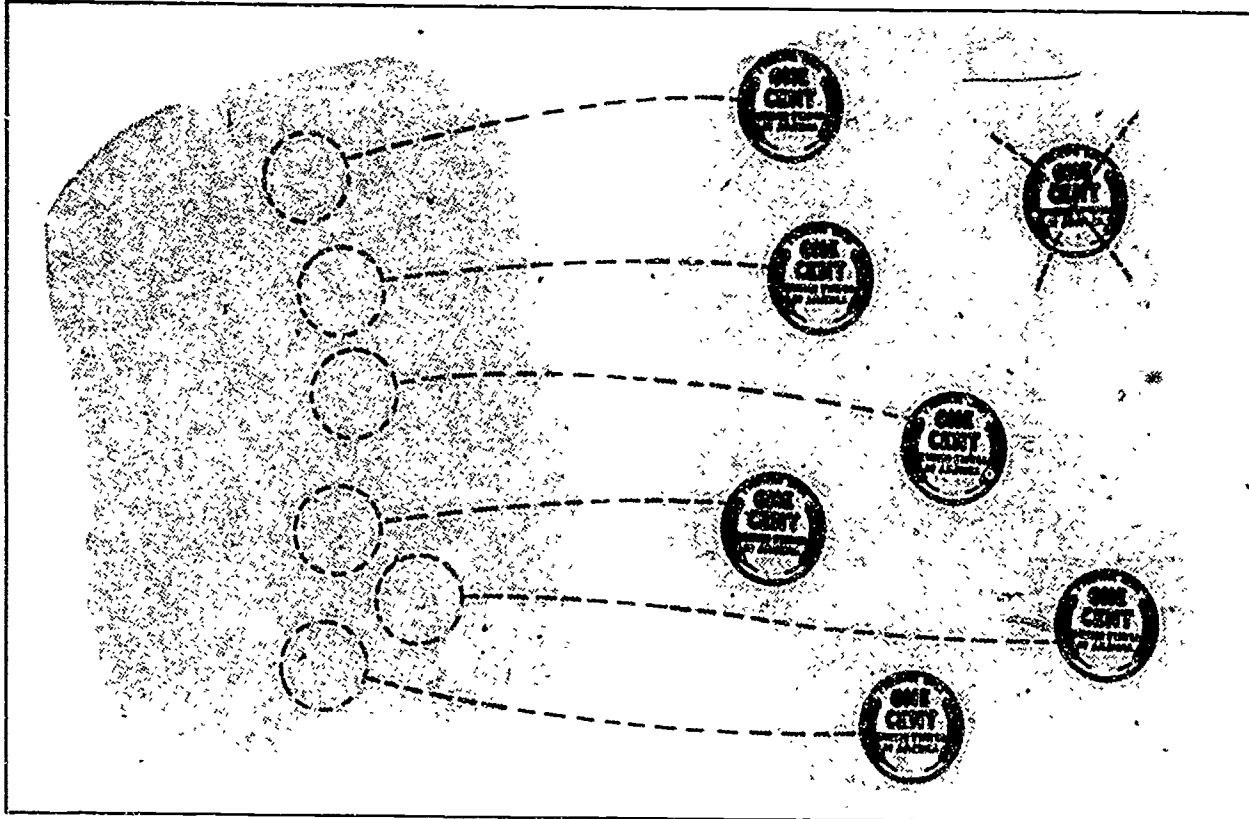

Sets with one less member

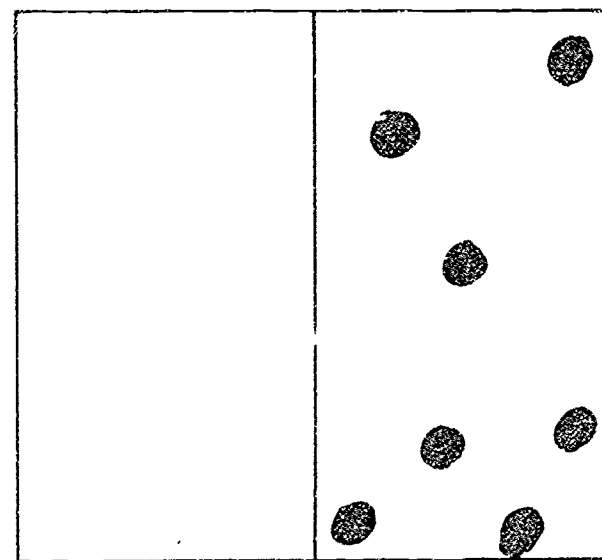
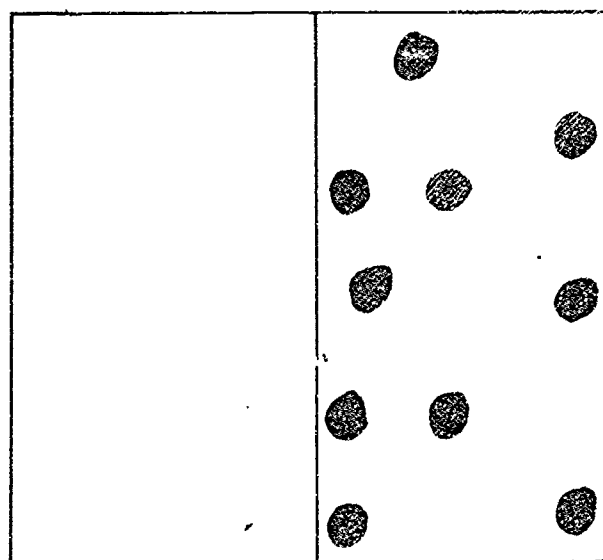
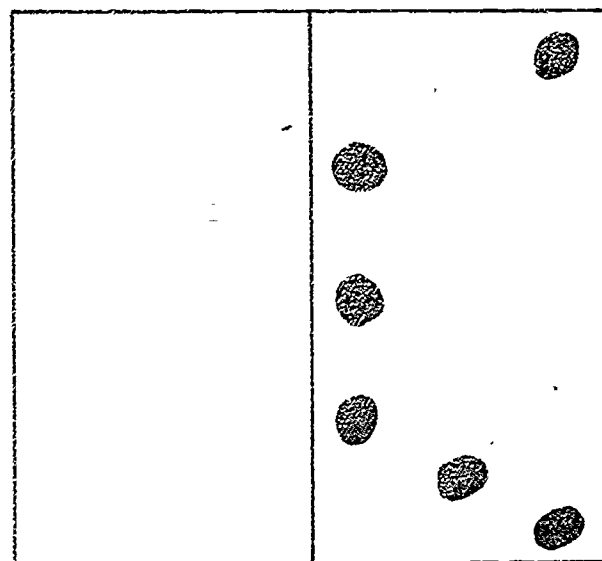
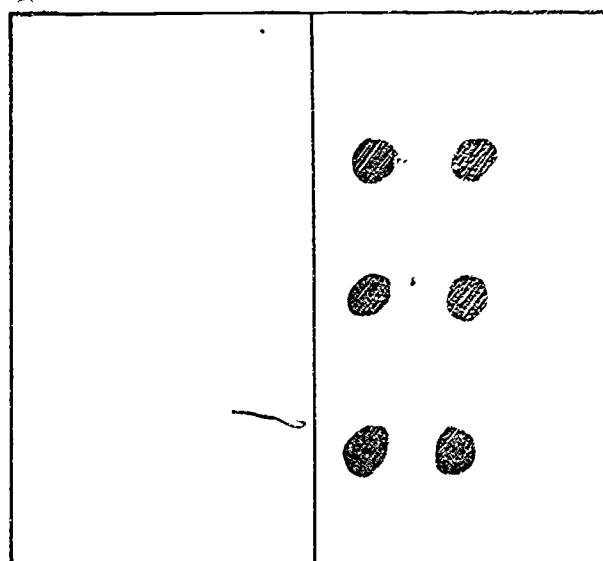
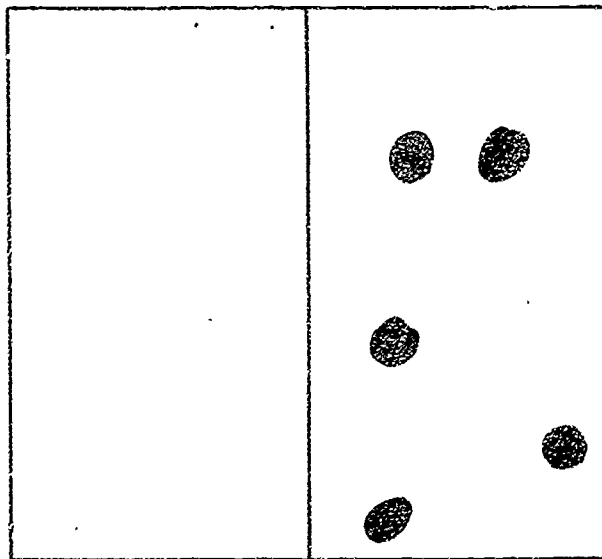
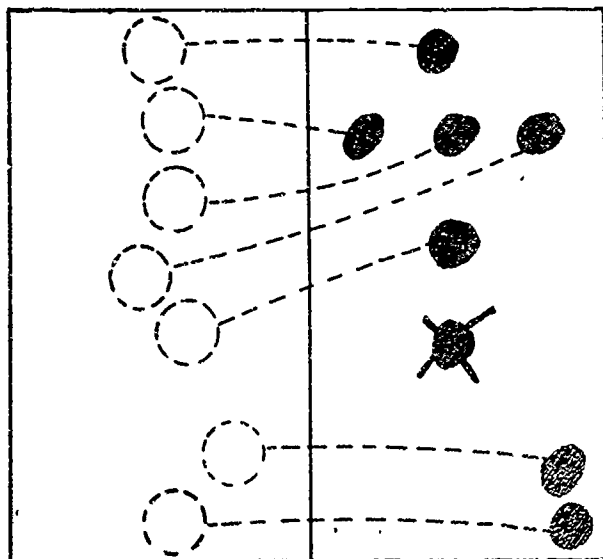

# Order of Sets

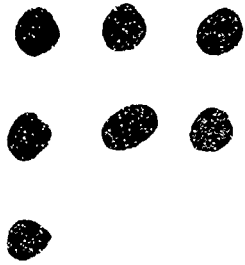
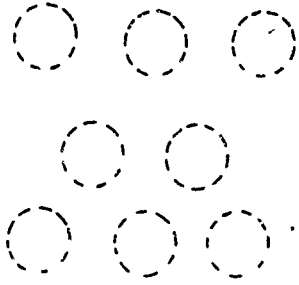
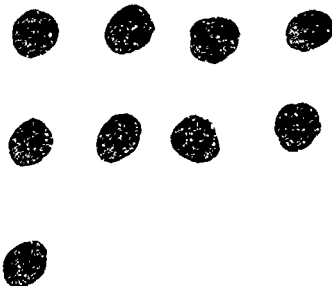
		
---	---	--

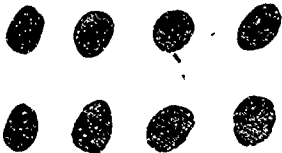
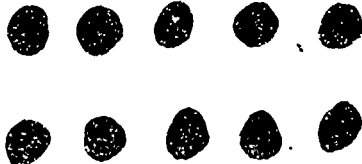
		
---	--	--

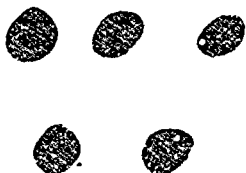
		
---	--	--

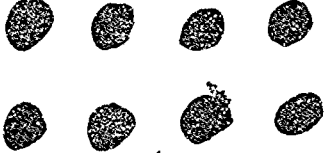
		
---	--	--

Which sets go with 0 ?

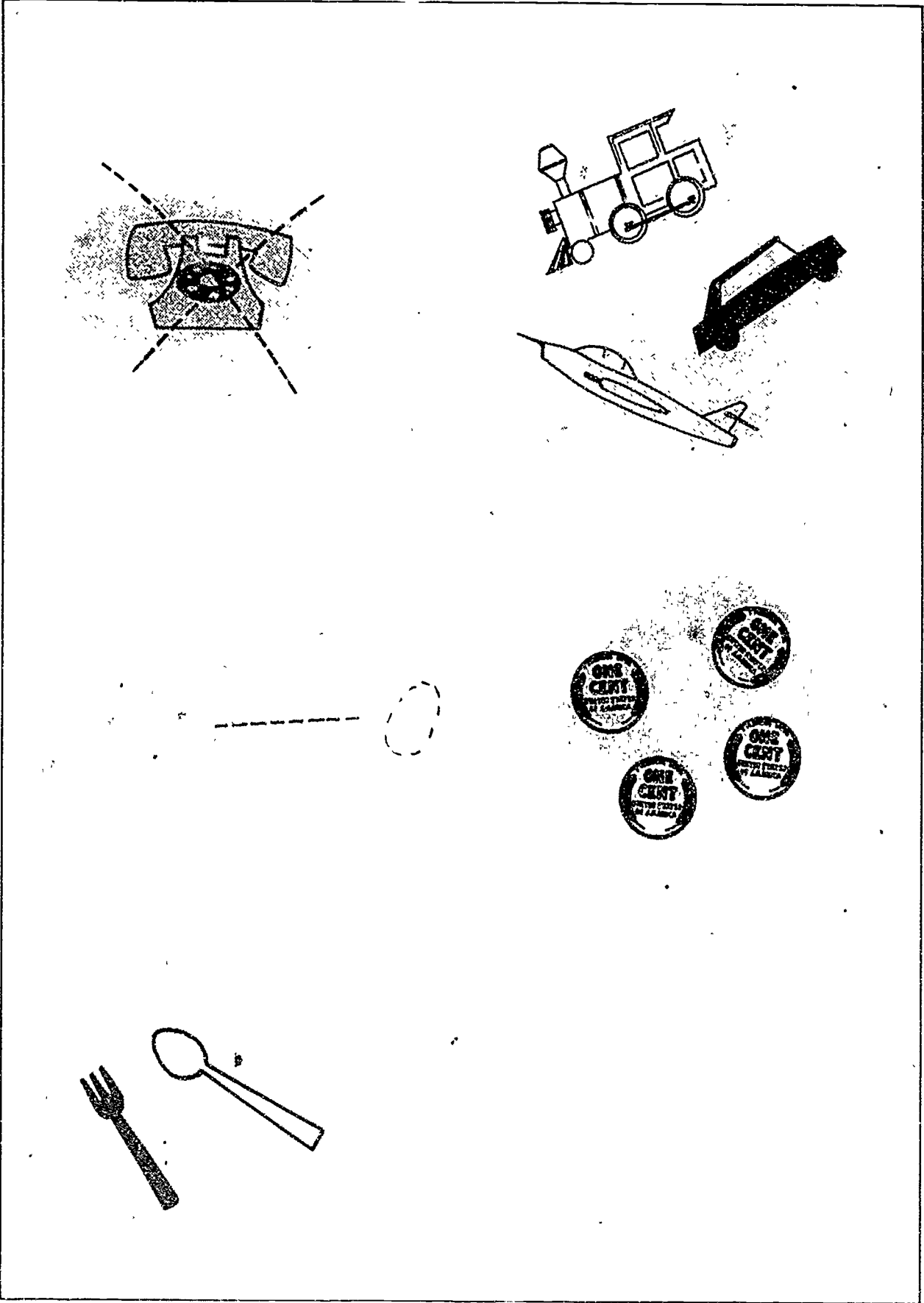

Which sets go with 1 ?

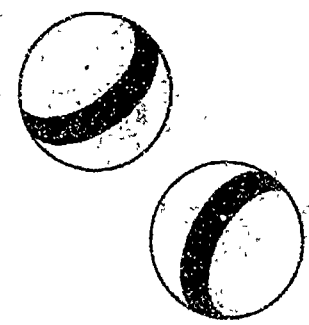
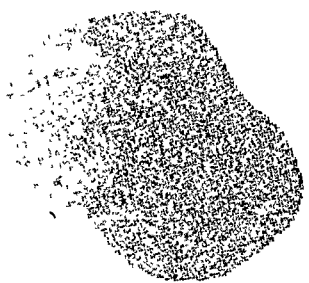
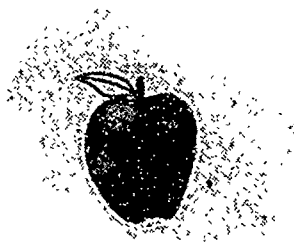

1

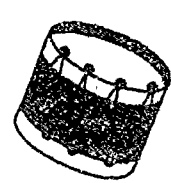
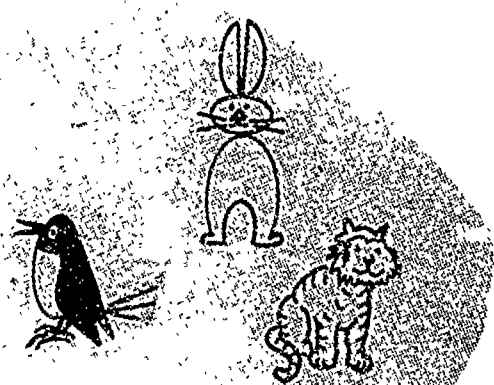

Which sets go with 2 ?

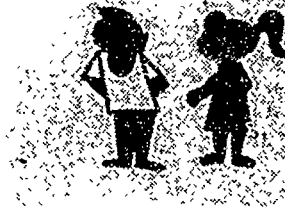
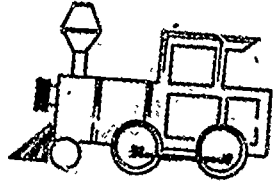

2

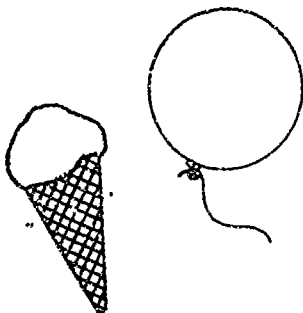
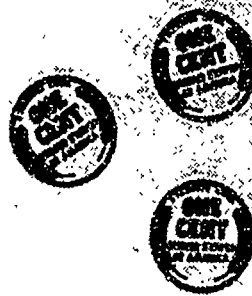

Pair each set with its number name

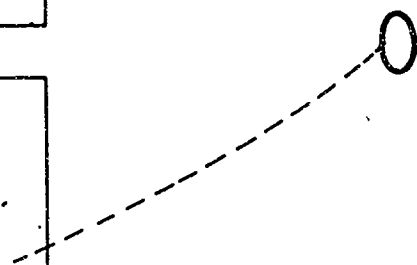
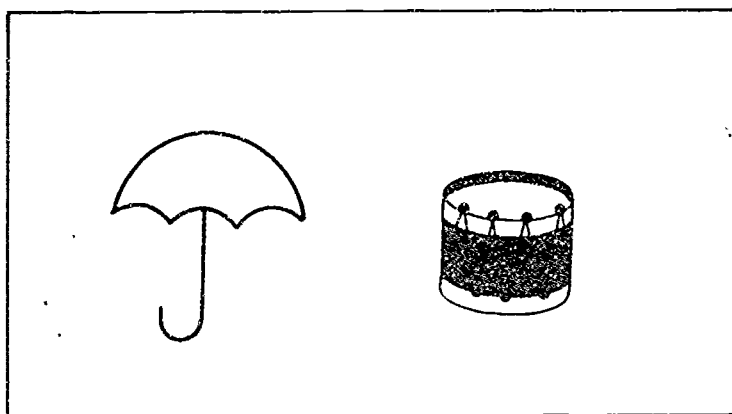
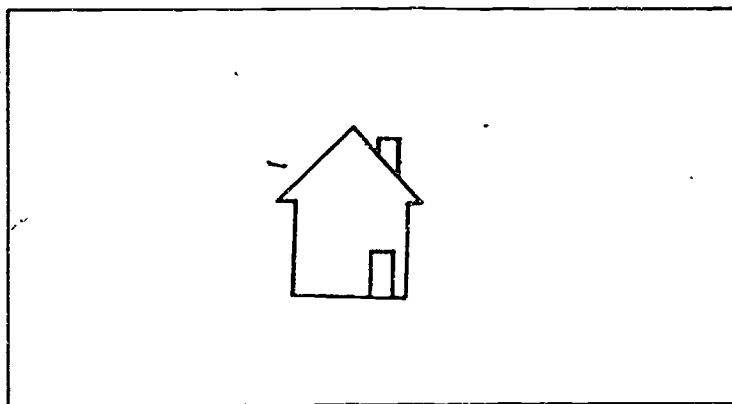
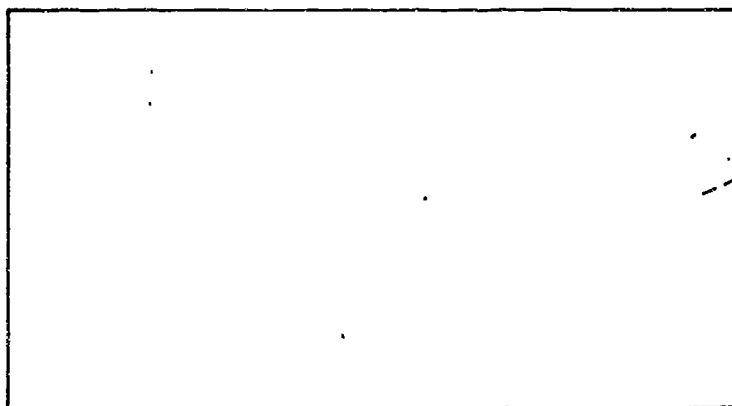
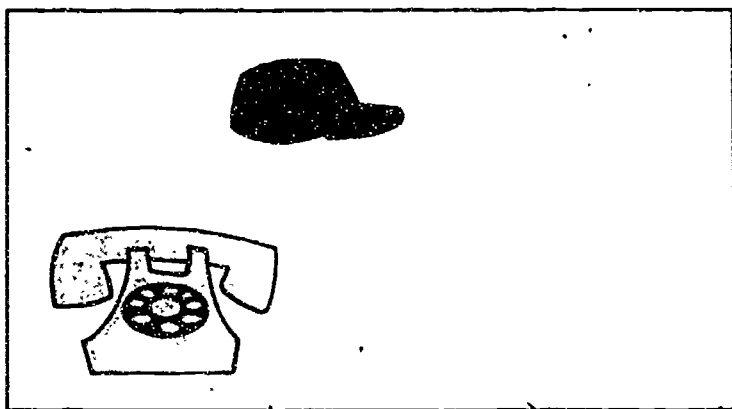

1

2



Which sets go with 3 ?

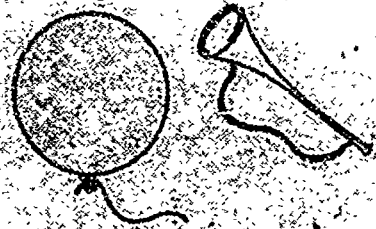

3

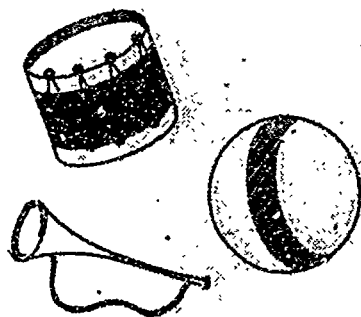
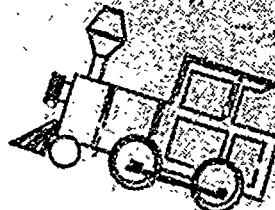

Pair each set with its number name

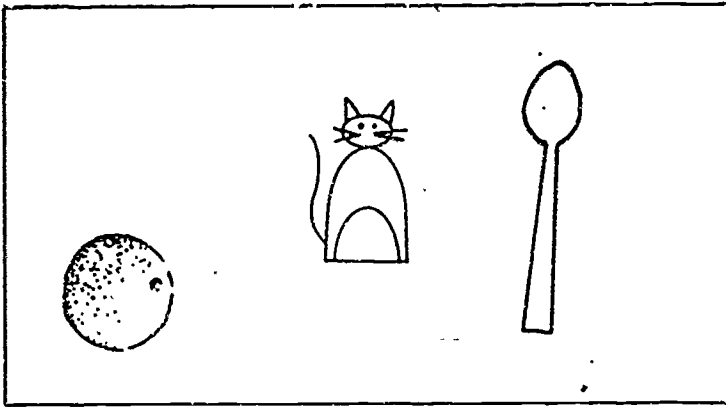

0

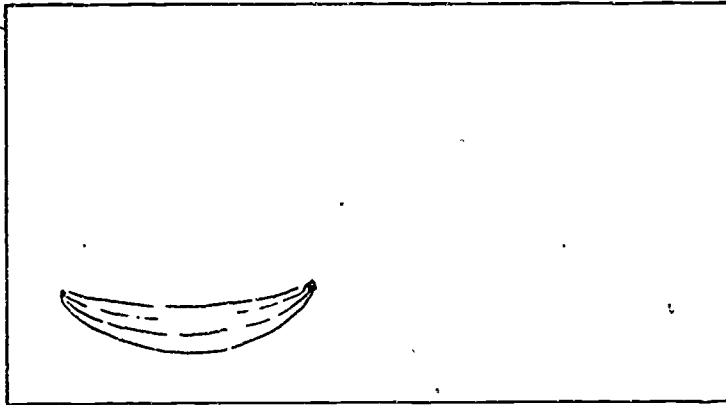

1

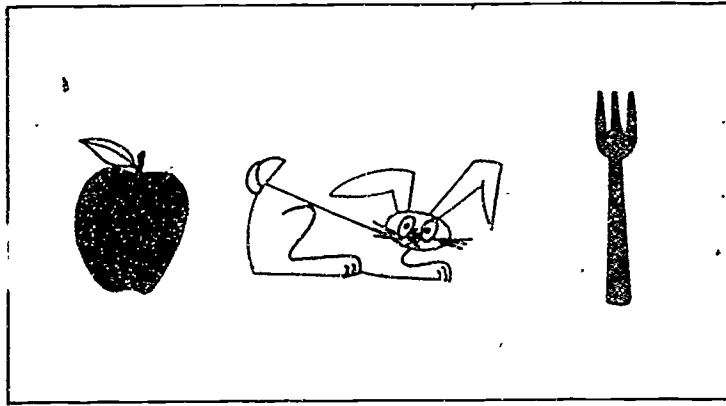

2

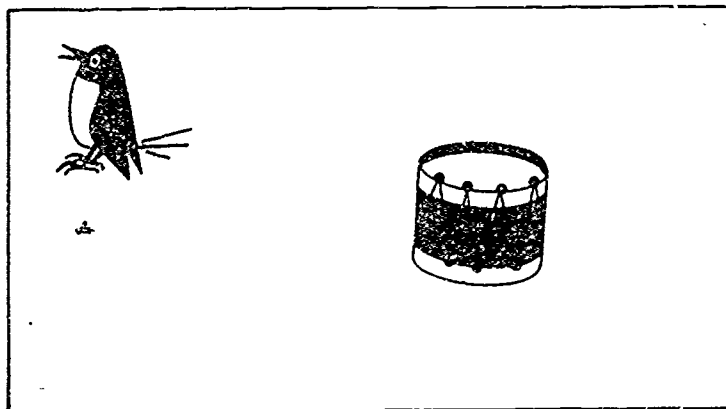

3

Which sets go with 4?

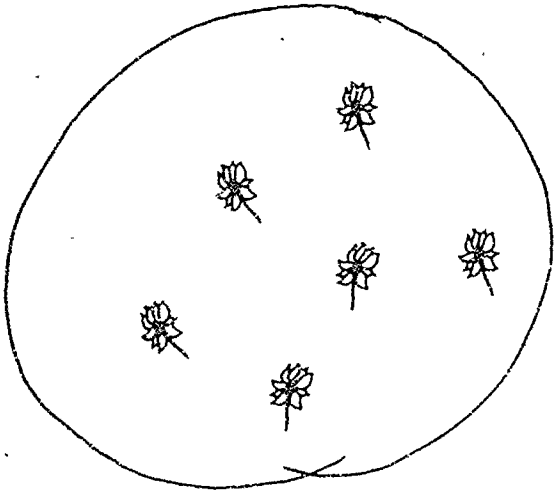
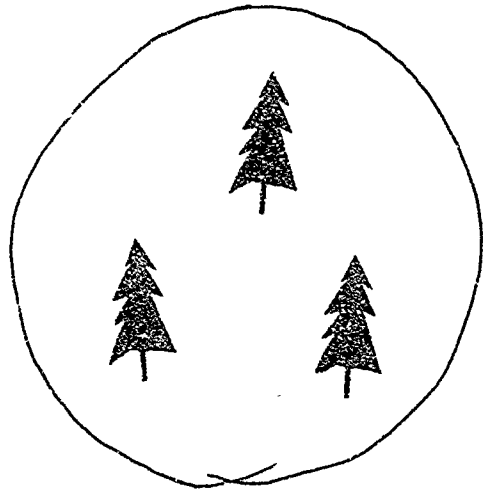
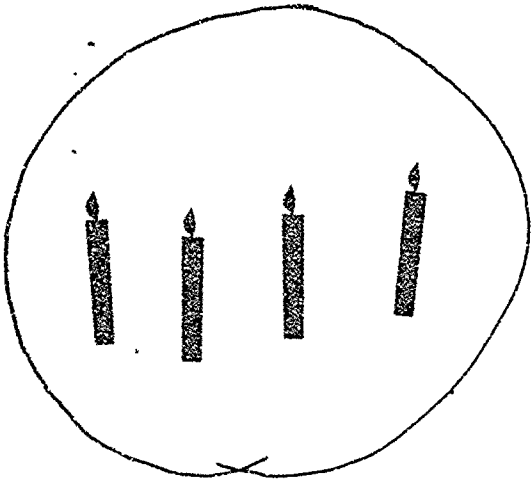

4

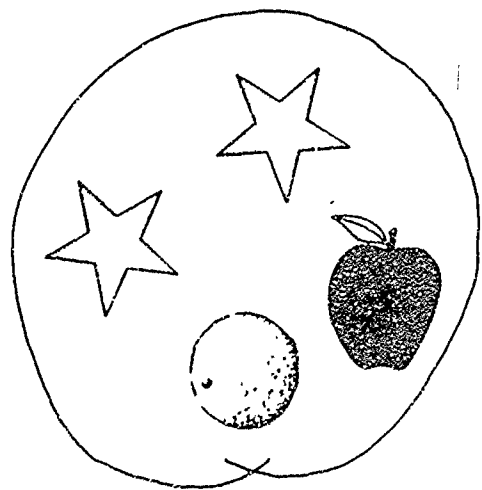
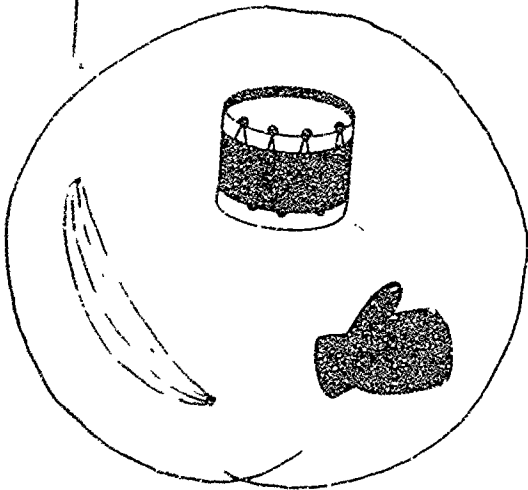
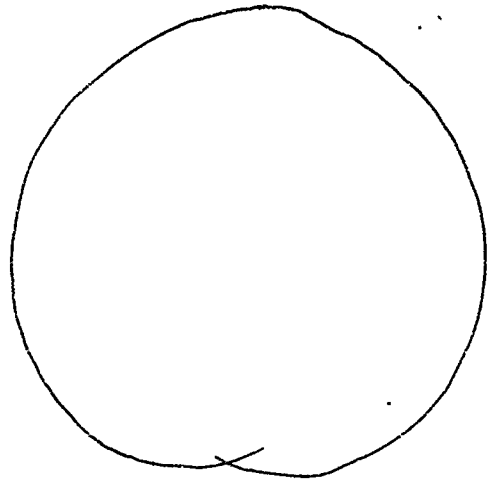

Which sets go with which numbers?

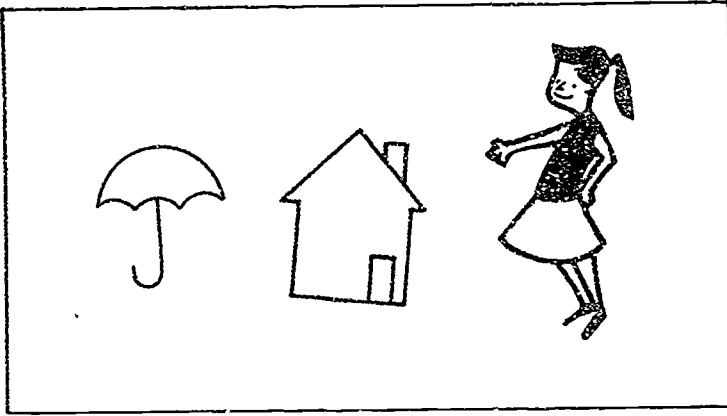

1

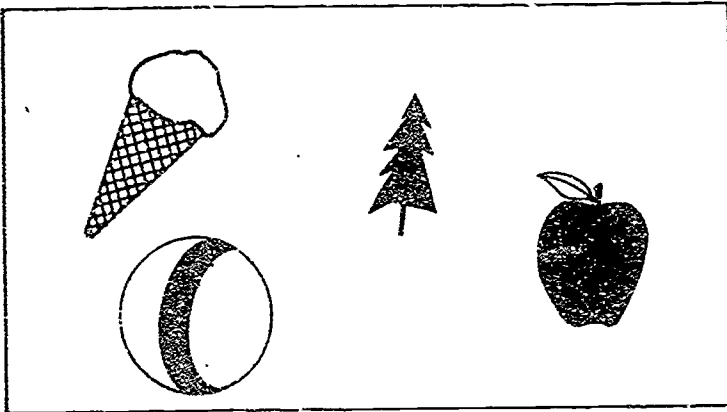

2

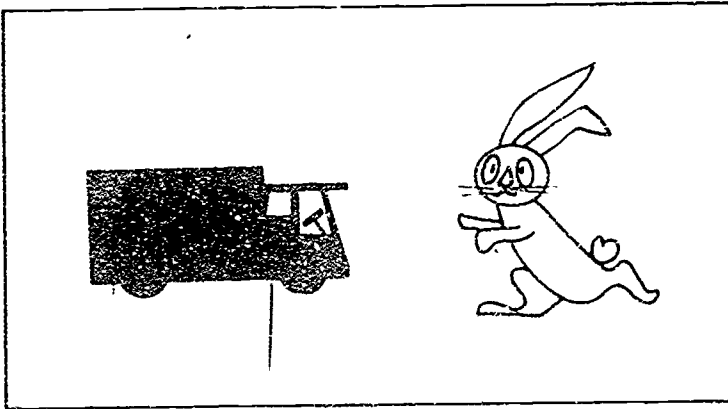

3

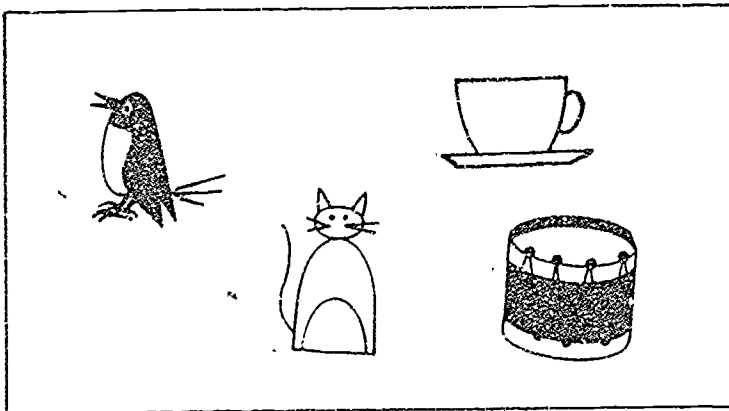

4

Which sets go with 5?

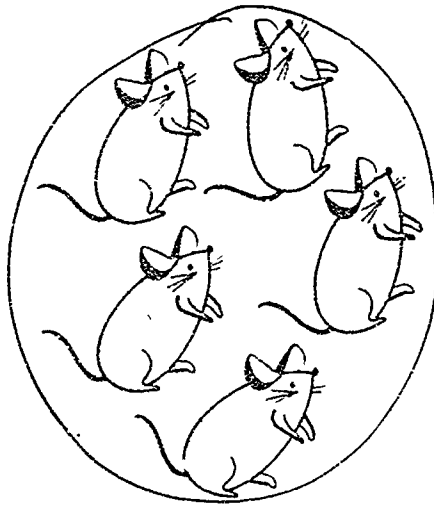
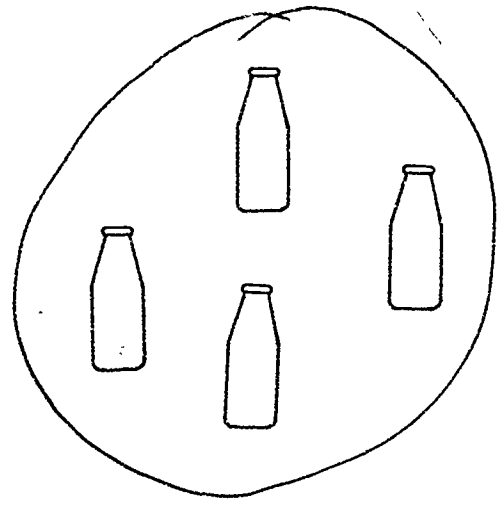
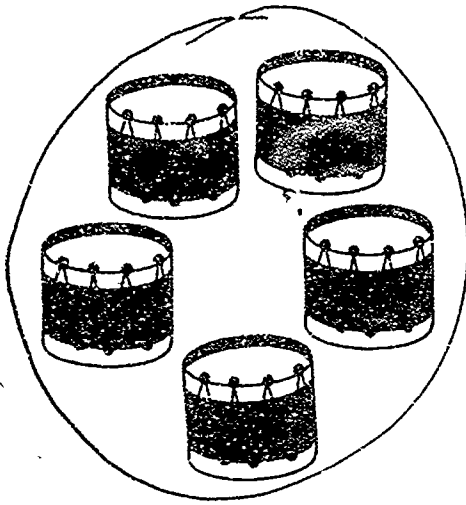

5

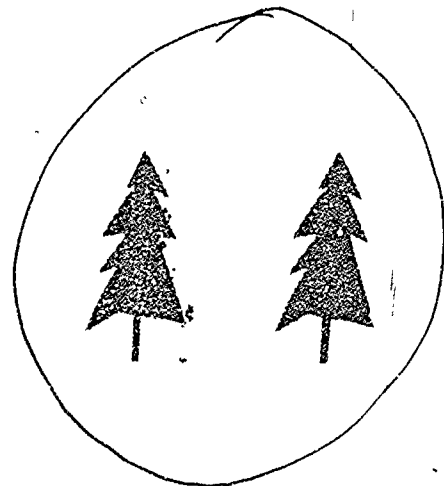
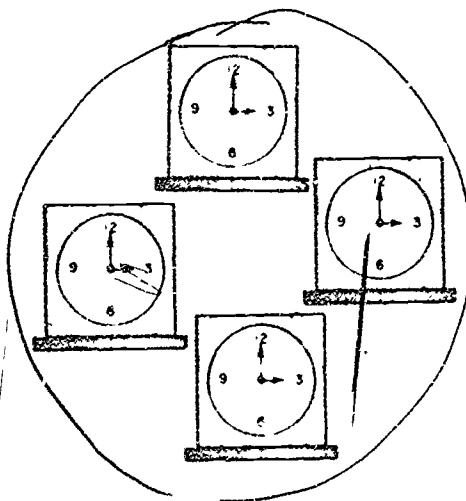
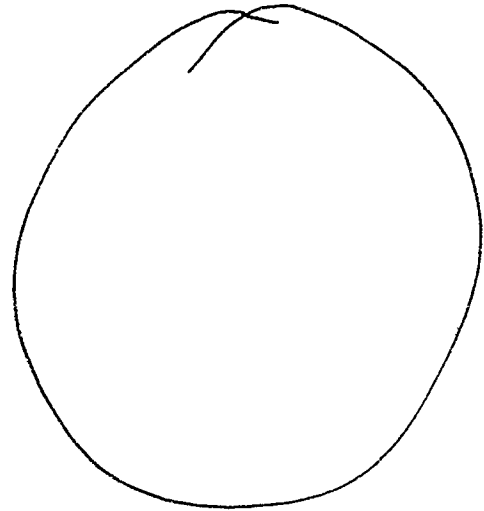

Pair each set with its number name

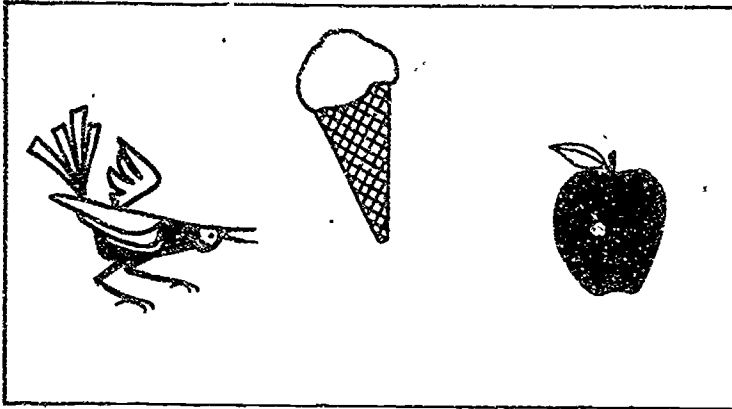

2

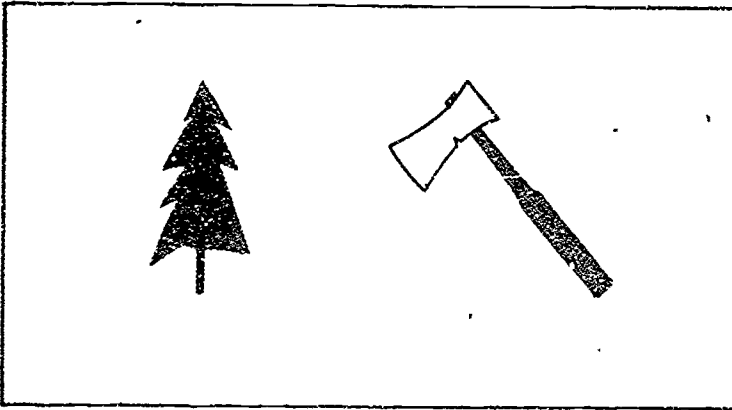

3

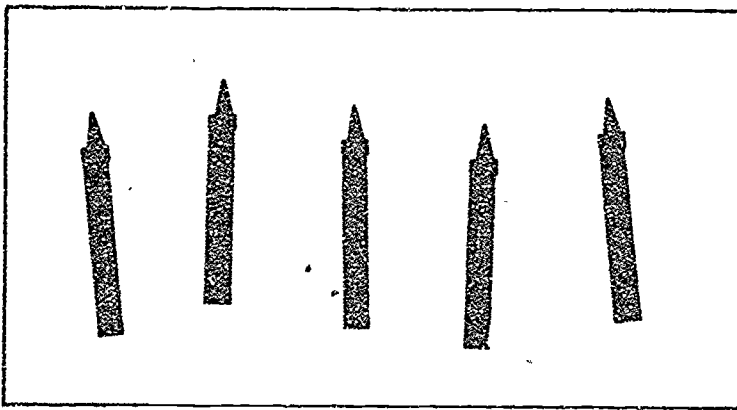



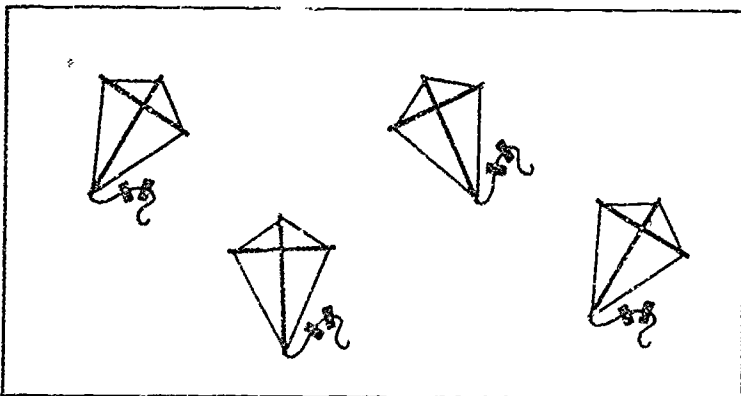



4

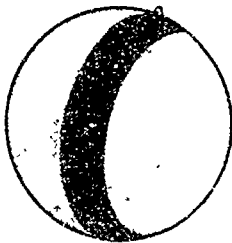

5

Ring the correct numeral

		2
		4
		0

			5
			3
			4

			3
			1
			0

Ring the correct numeral

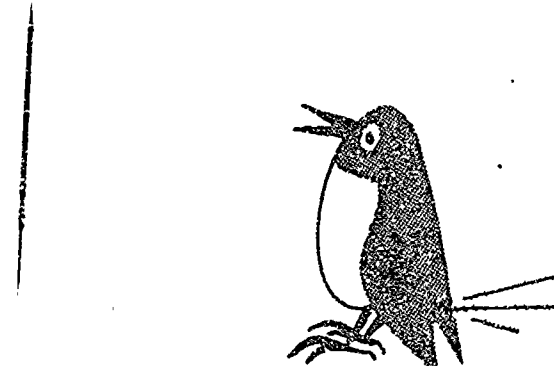

	4 3 5
--	-------------

	1 2 3
---	-------------

	2 1 4
---	-------------

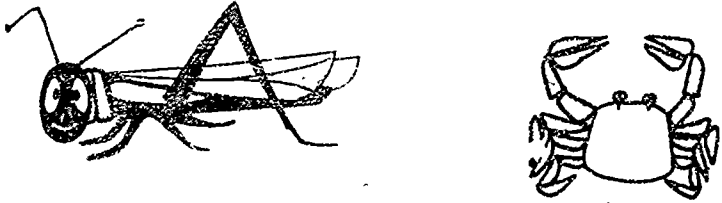

Ring the correct numeral!

	3
	4
	5

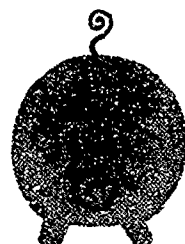
	0
	1
	3

	2
	1
	0

Which numbers are greater?

3	<del>2</del>	5	4
---	--------------	---	---

4	0	5	1
---	---	---	---

1	2	4	0
---	---	---	---

5	4	0	1
---	---	---	---

0	3	5	2
---	---	---	---

2	0	4	1
---	---	---	---

Which numbers are greater?

2	3	0	4
---	---	---	---

0	5	3	1
---	---	---	---

5	0	2	3
---	---	---	---

3	1	5	4
---	---	---	---

1	2	0	3
---	---	---	---

4	0	5	2
---	---	---	---

Which numbers are less?

3	2	<del>5</del>	<del>4</del>
---	---	--------------	--------------

4	0	5	1
---	---	---	---

1	2	4	0
---	---	---	---

5	4	0	1
---	---	---	---

0	3	5	2
---	---	---	---

2	0	4	1
---	---	---	---

Which numbers are less?

2	1	<del>4</del>	0
---	---	--------------	---

4	2	5	3
---	---	---	---

1	3	0	5
---	---	---	---

5	2	1	3
---	---	---	---

0	4	2	1
---	---	---	---

3	5	0	2
---	---	---	---

How many in each set?

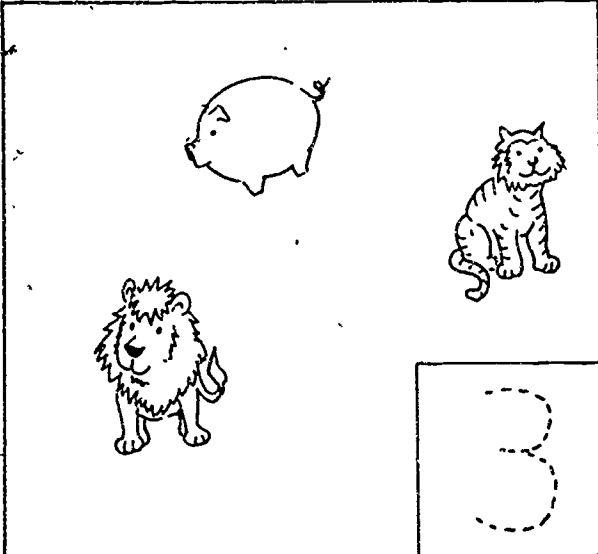

A rectangular box containing three line drawings: a pig at the top, a lion at the bottom left, and a tiger at the bottom right. Below the box is a smaller rectangular box containing a dashed outline of the number 3.

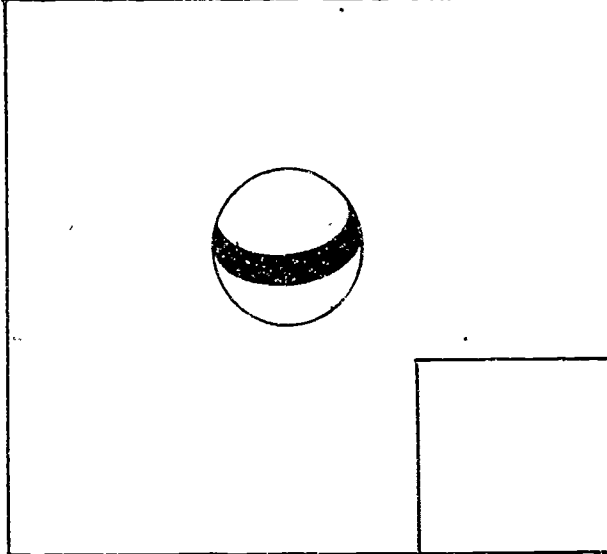

A rectangular box containing one beach ball with a dark band around its middle. Below the box is an empty rectangular box for the answer.

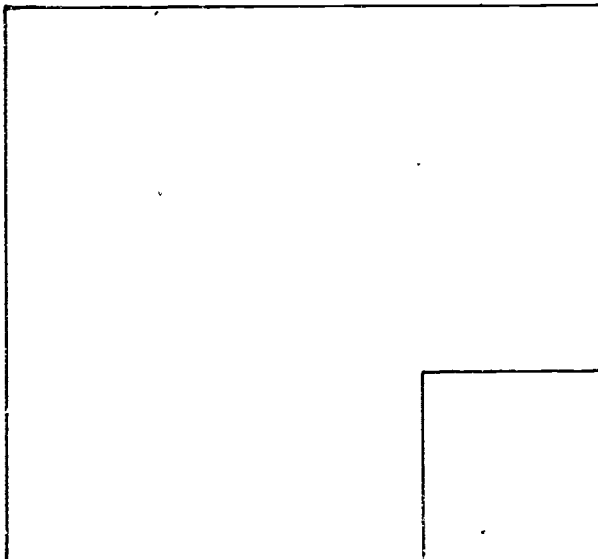

An empty rectangular box with a smaller empty rectangular box below it for the answer.

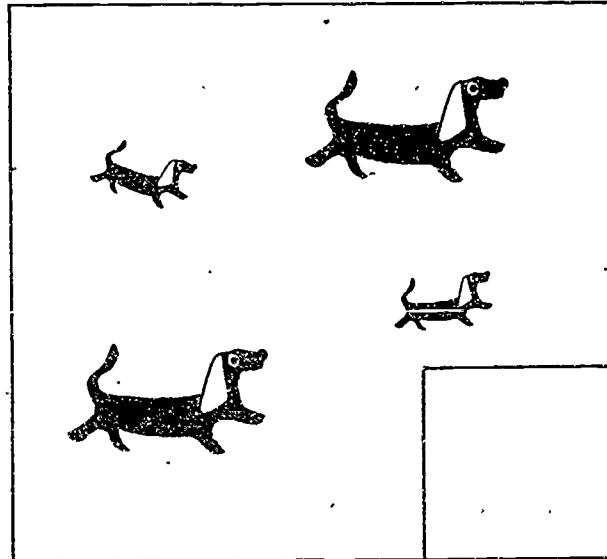

A rectangular box containing four line drawings of dogs in various poses. Below the box is an empty rectangular box for the answer.

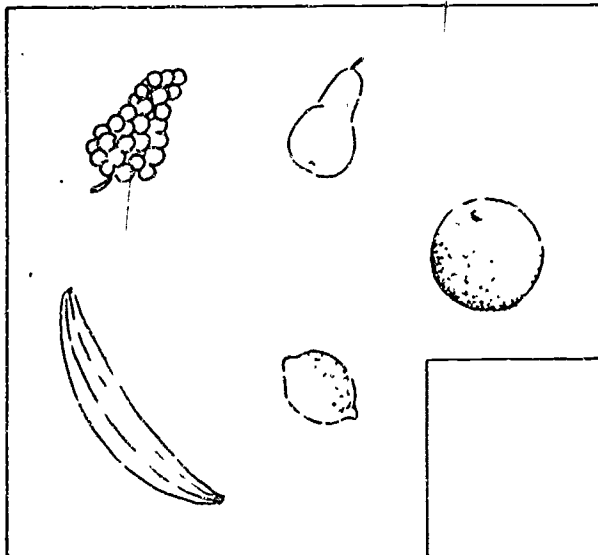

A rectangular box containing five line drawings of fruits: a bunch of grapes at the top left, a pear at the top right, an orange at the middle right, a banana at the bottom left, and a lemon at the bottom right. Below the box is an empty rectangular box for the answer.

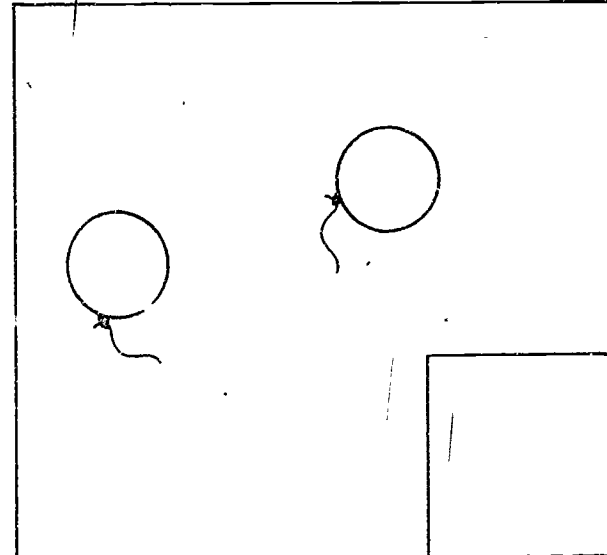

A rectangular box containing two line drawings of balloons. Below the box is an empty rectangular box for the answer.

How many in each set?

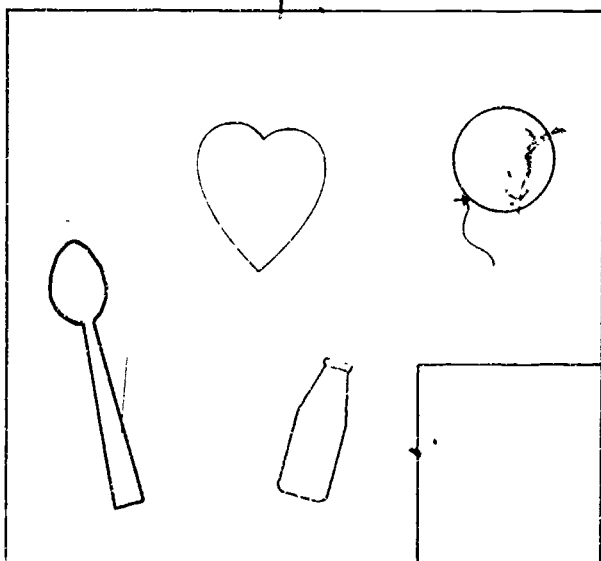
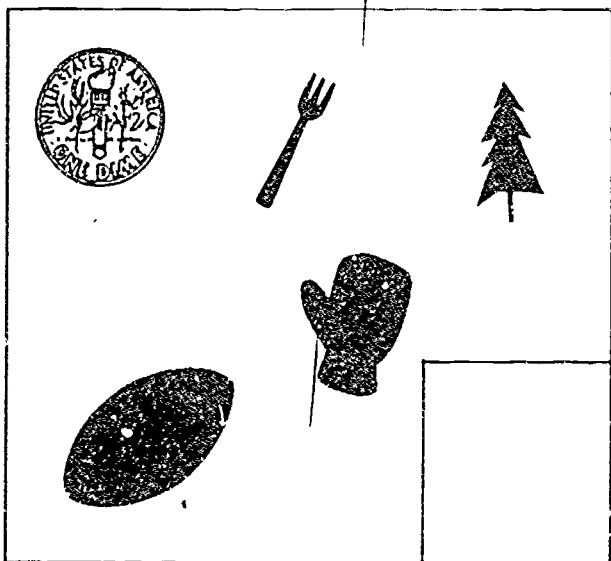
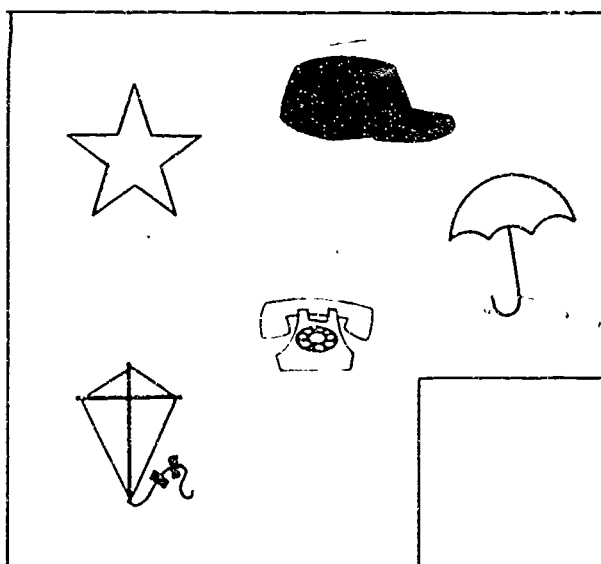
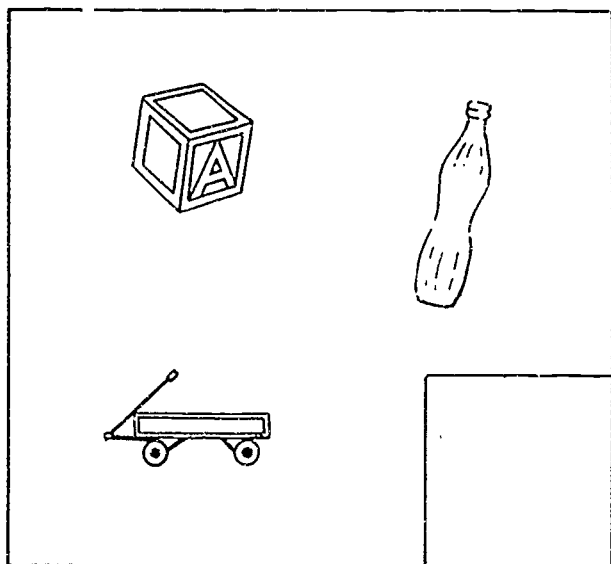
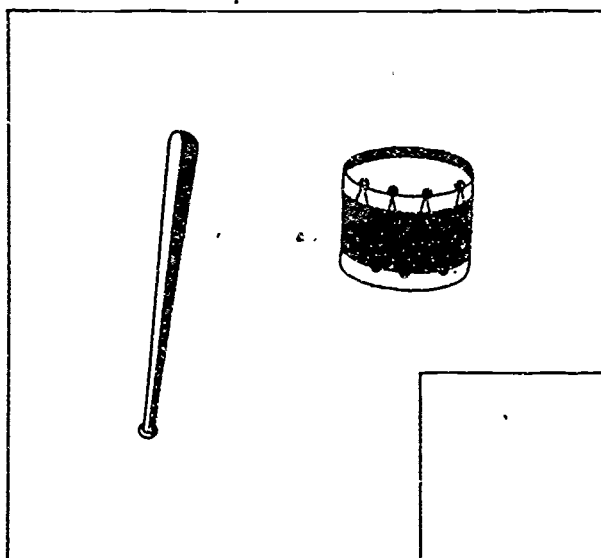
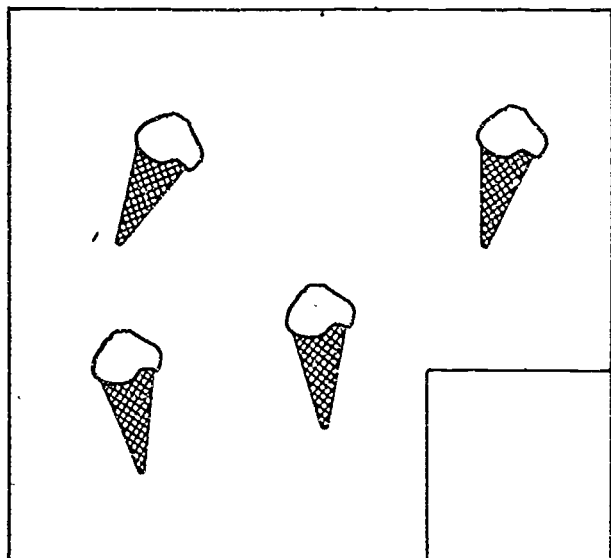

Which sets go with 6?

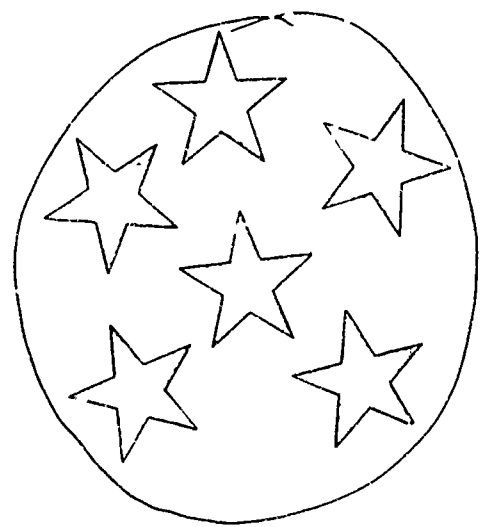
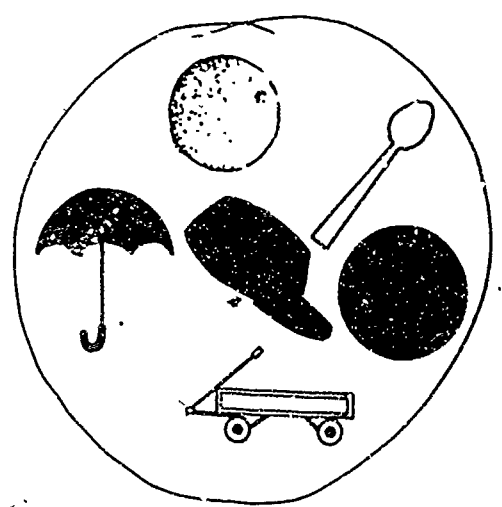
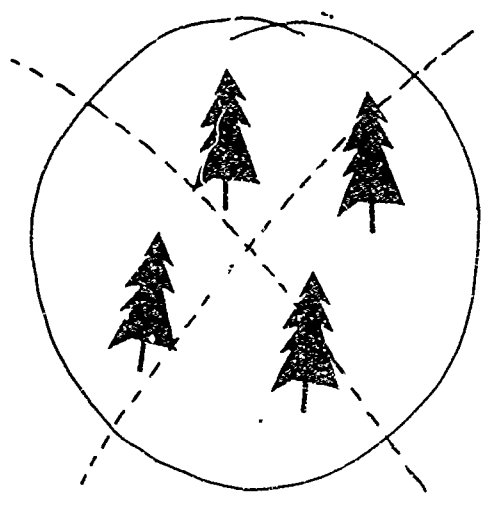

6

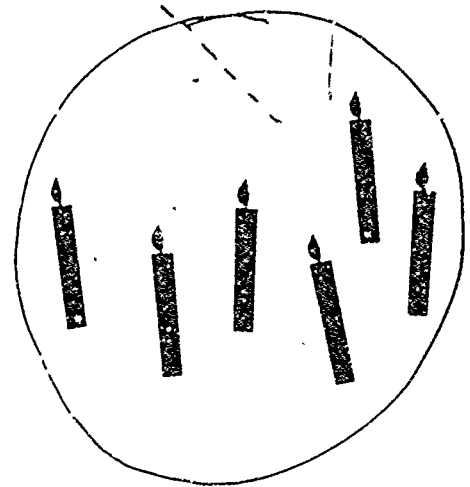
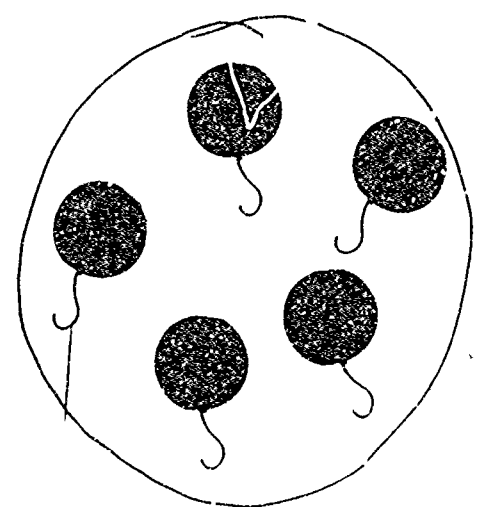
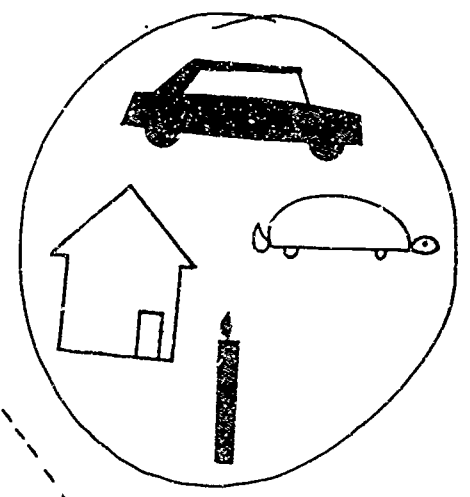



Set and member

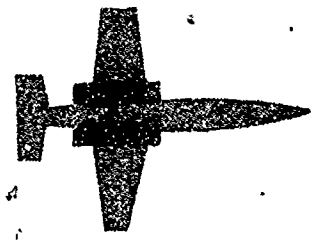
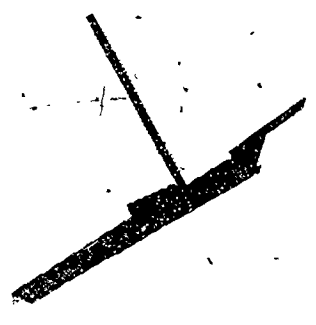
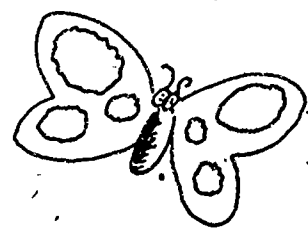
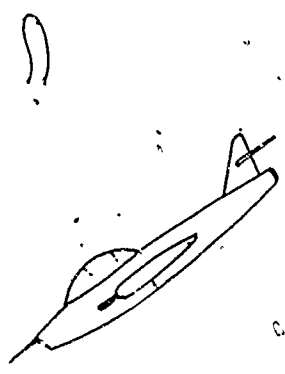



28 25

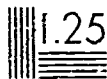

12.

Which sets go with which numbers?

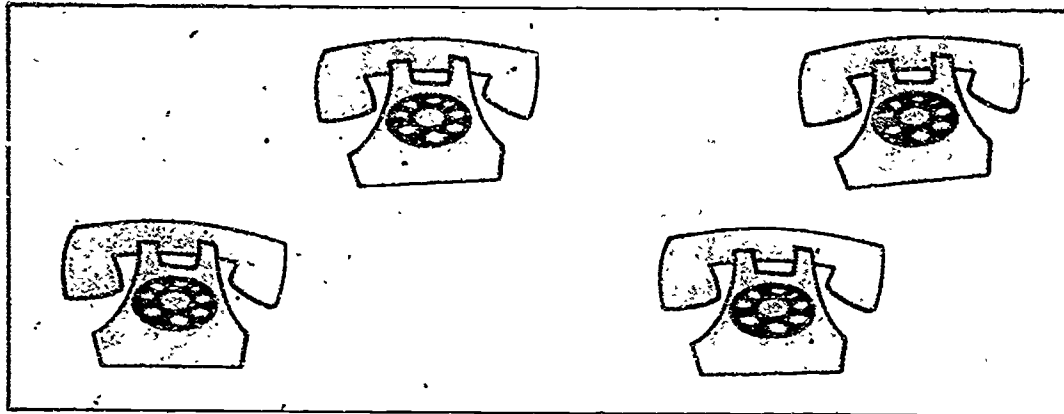

2

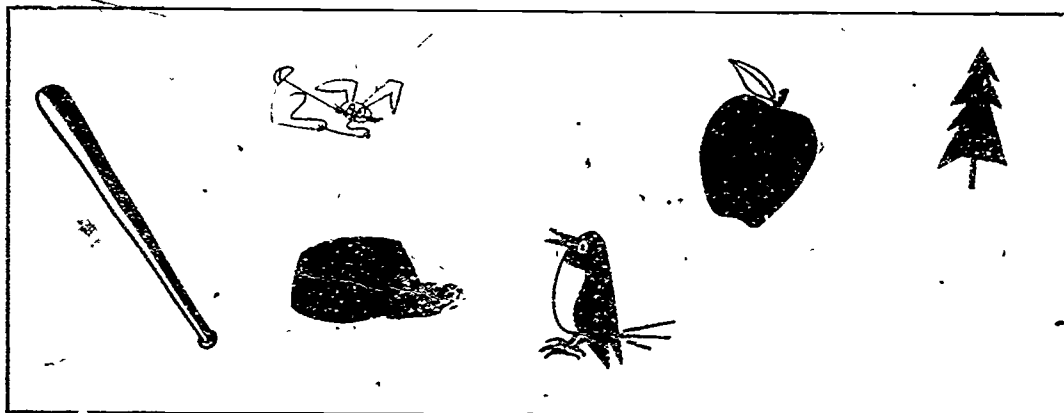

3

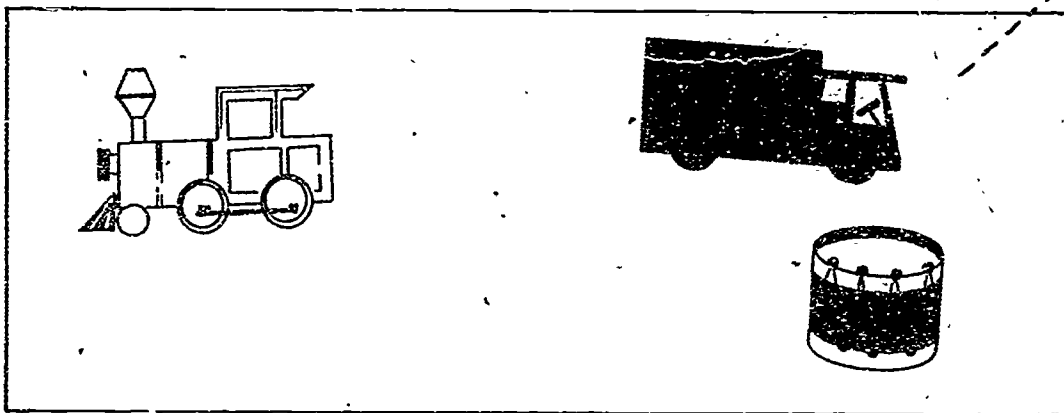

4

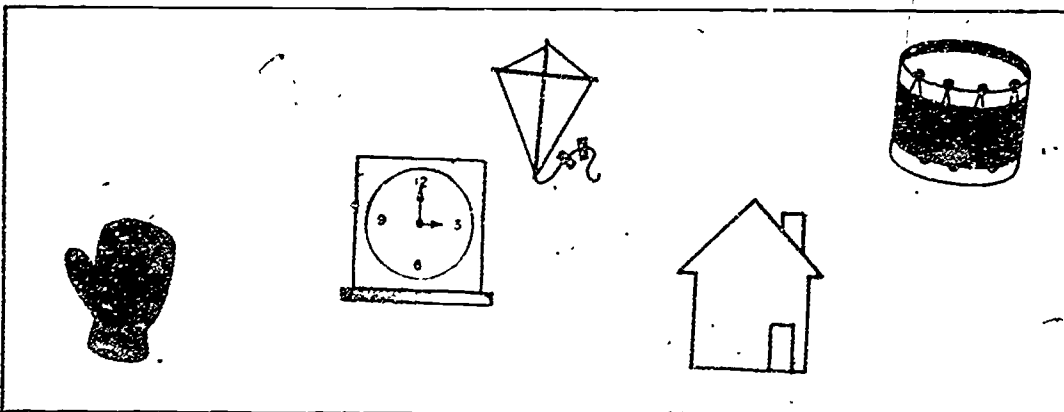

5

6

Which sets go with 7?

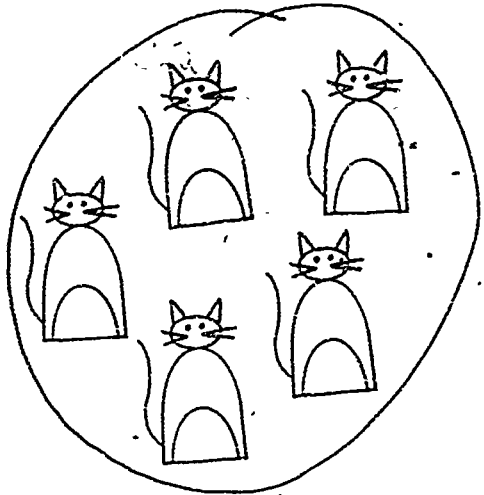
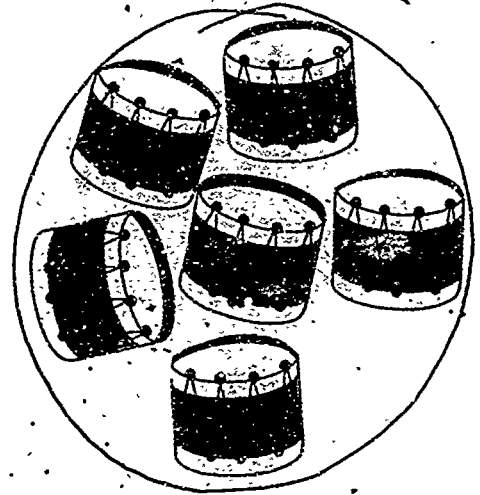
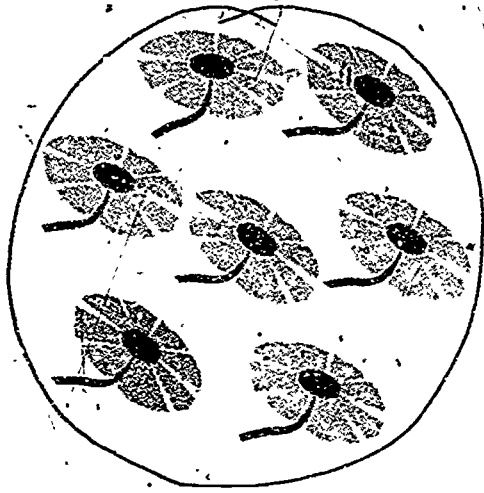

7

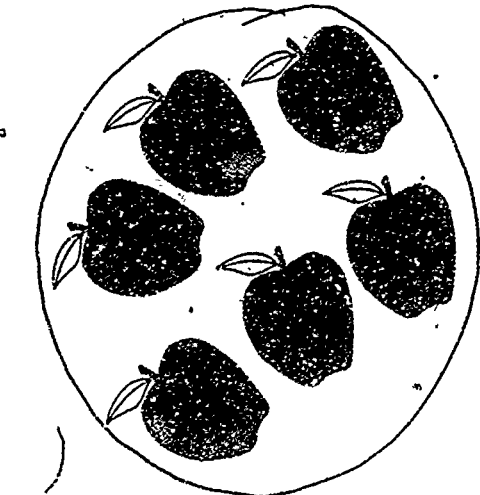
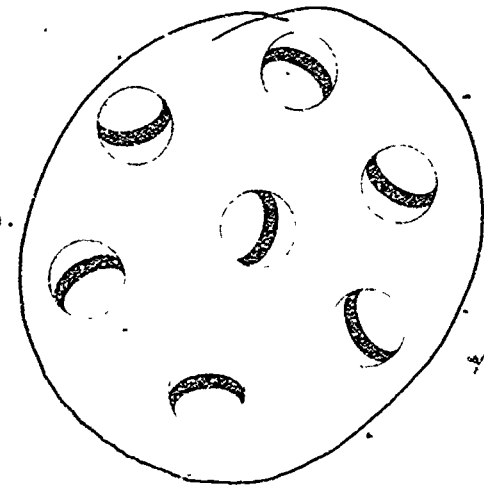
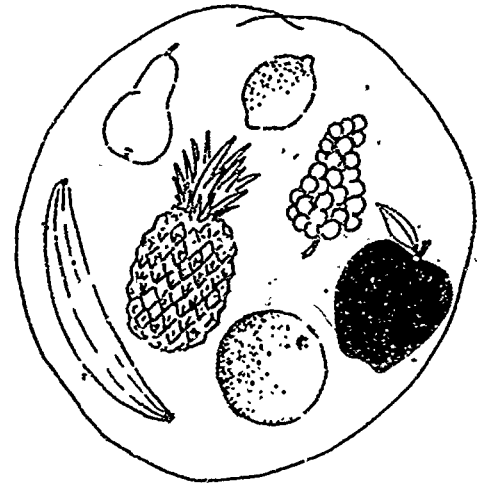

Which sets go with which numbers?

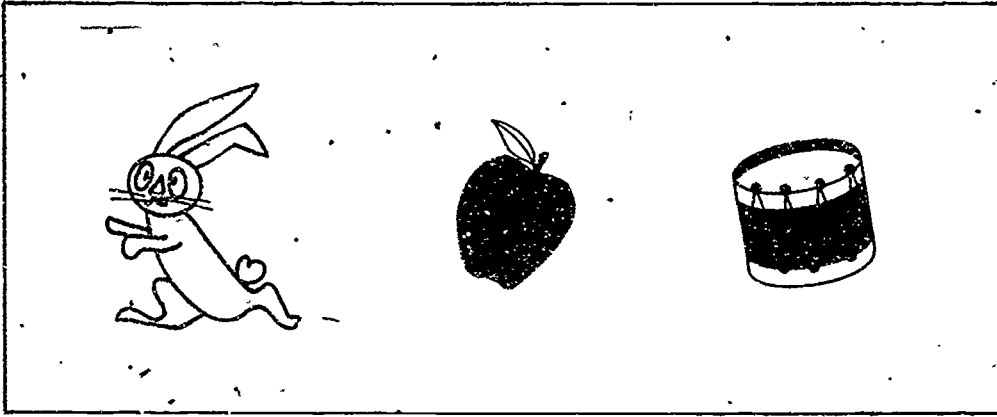

3

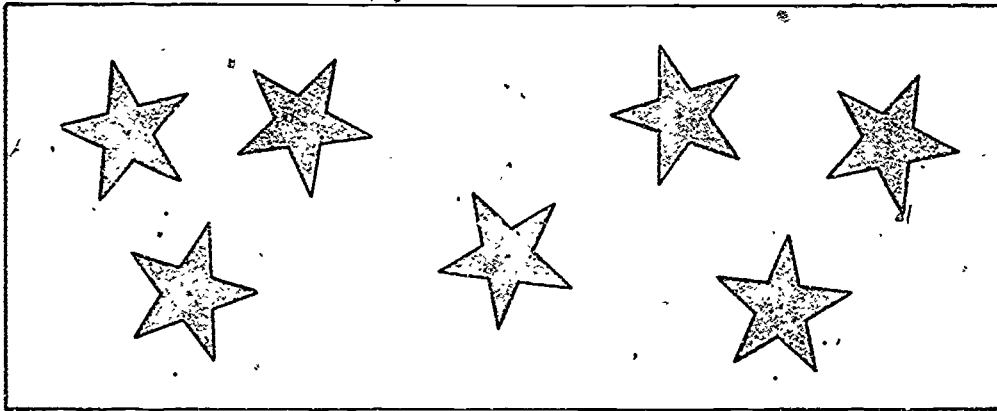

4

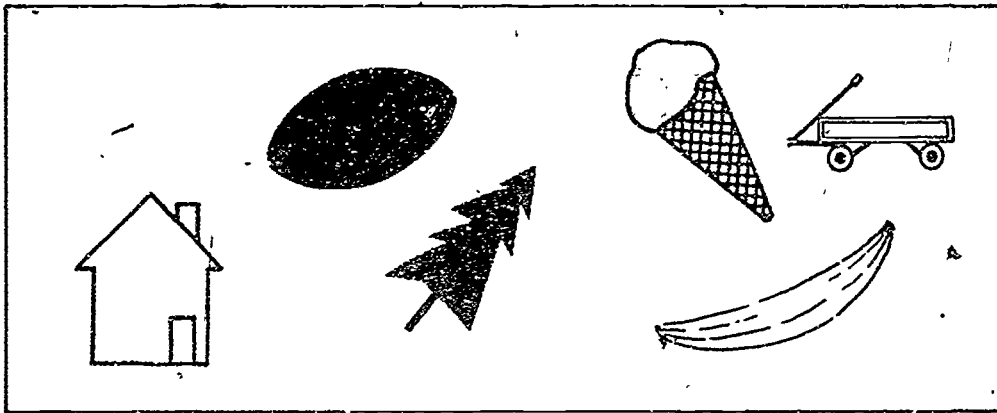

5

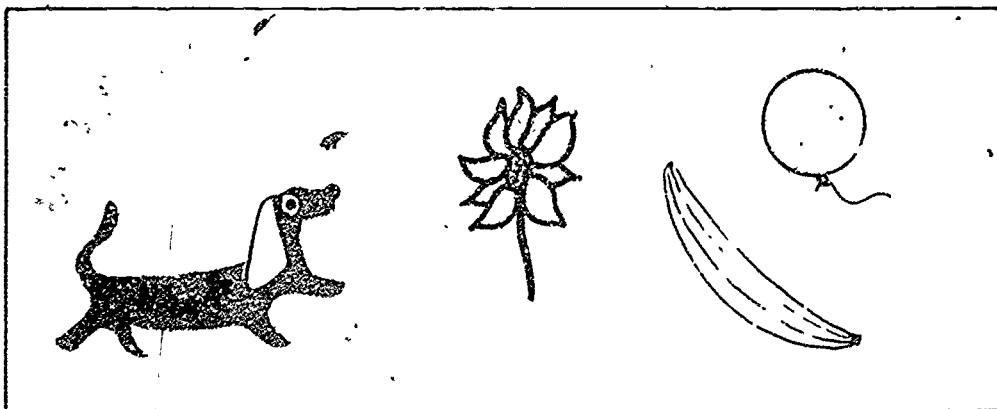

6

7

Which sets go with 8?

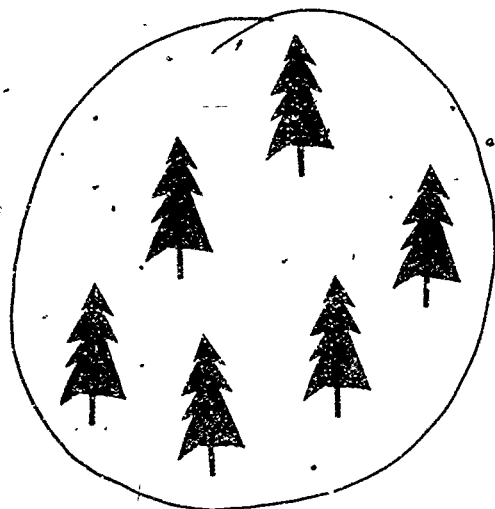
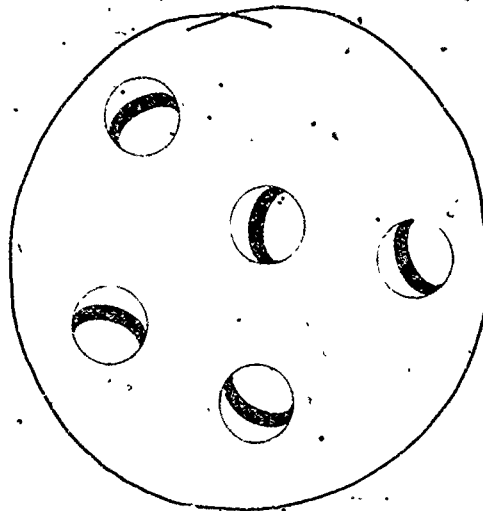
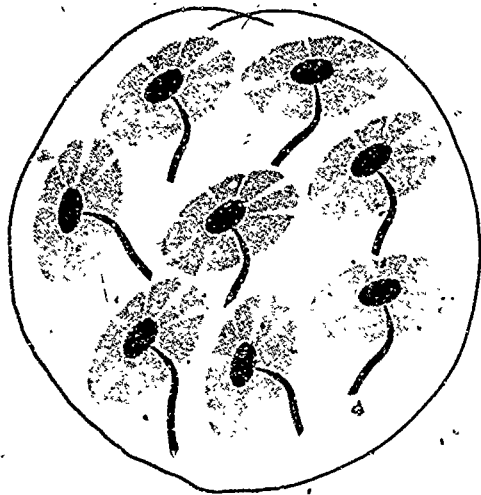

8

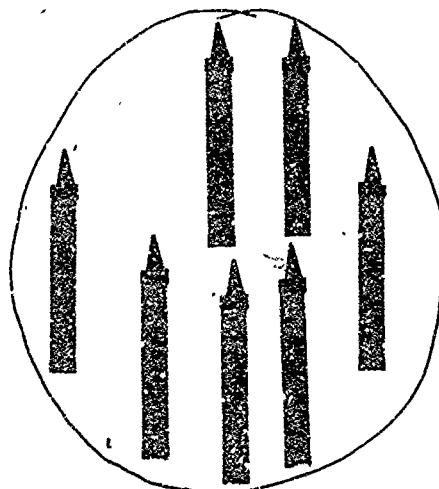
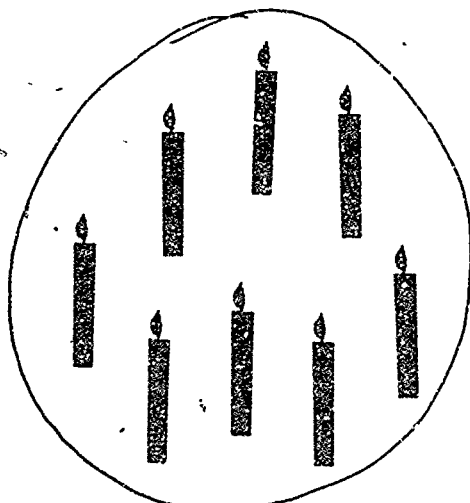
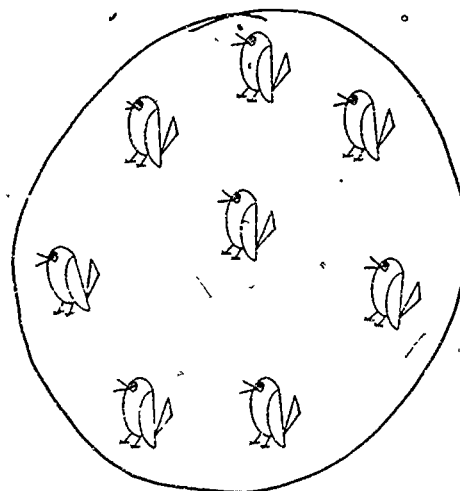

Which sets go with which numbers?

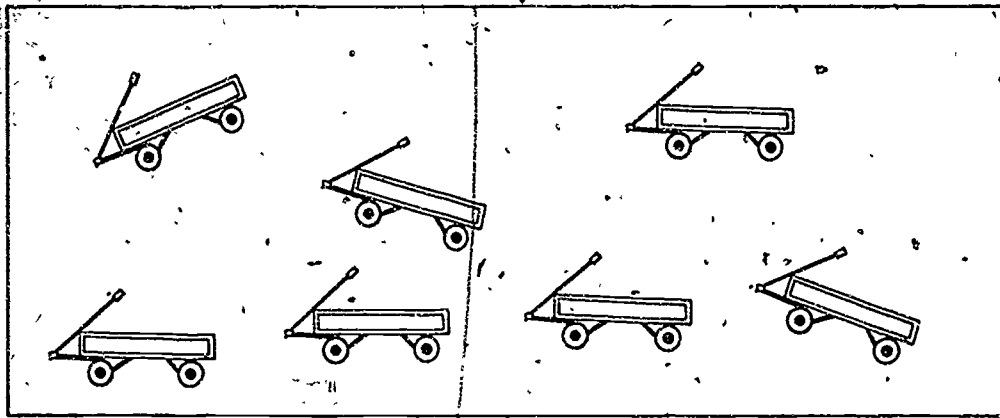

4

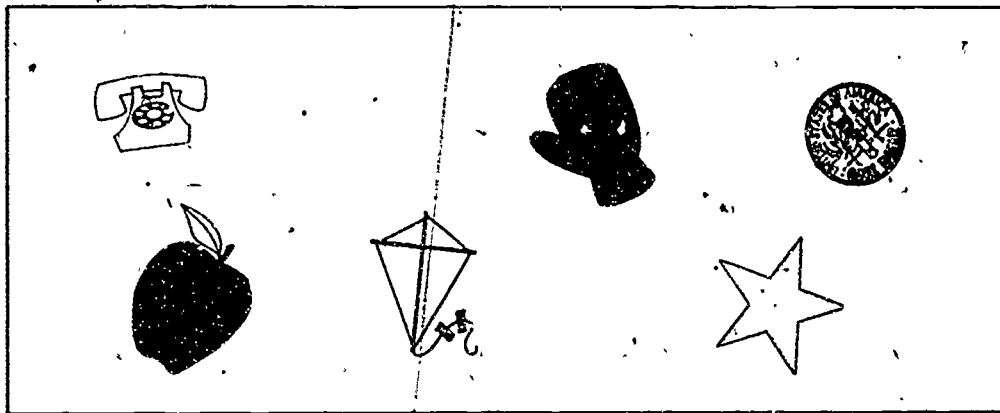

5

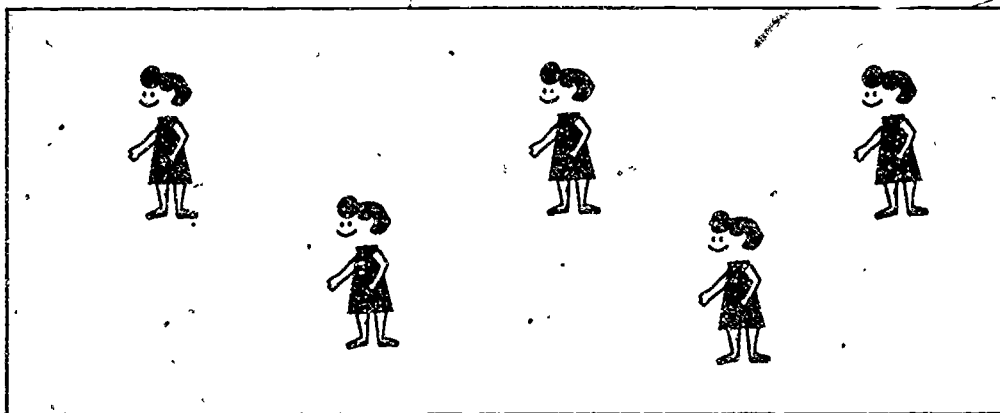

6

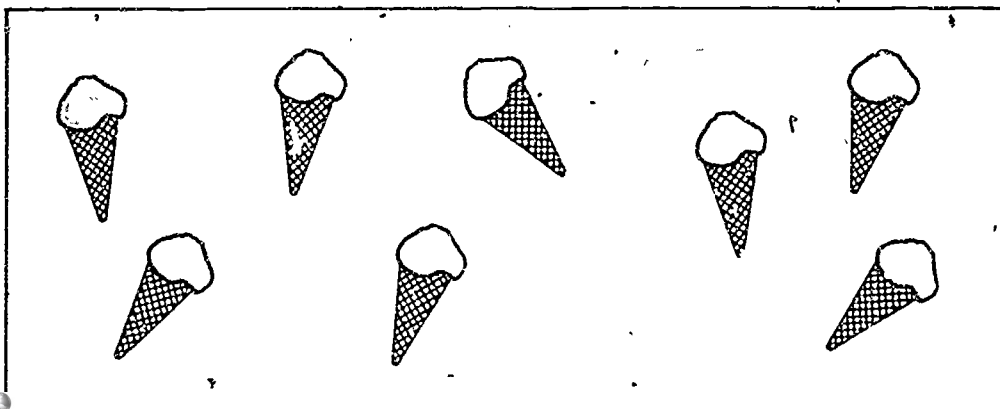

7

8



Which sets go with 9?

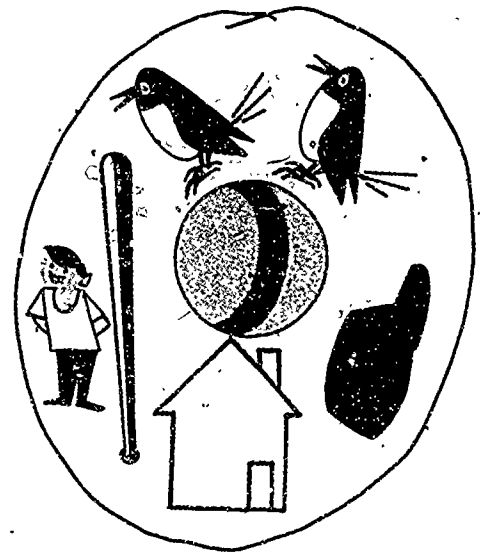
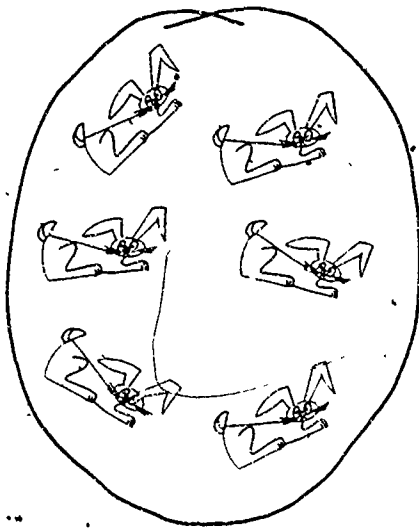
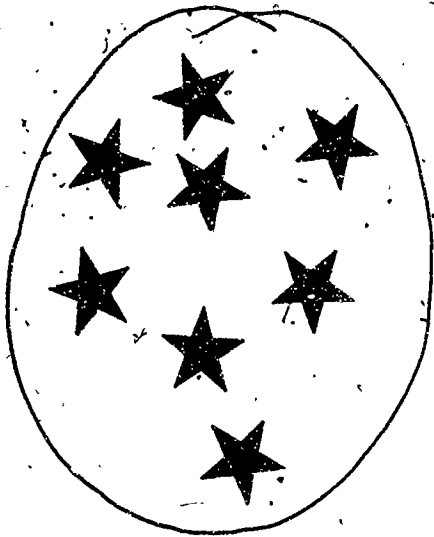

9

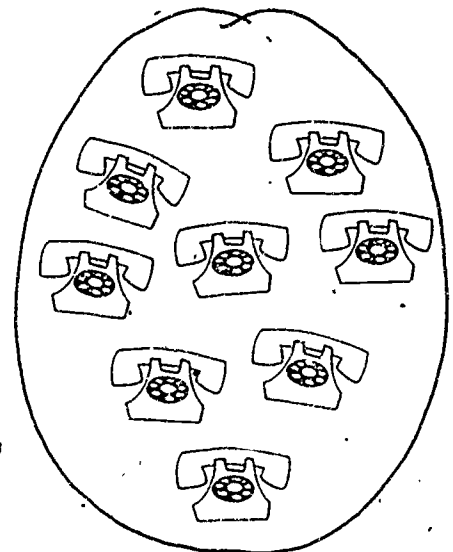

Which sets go with which numbers?

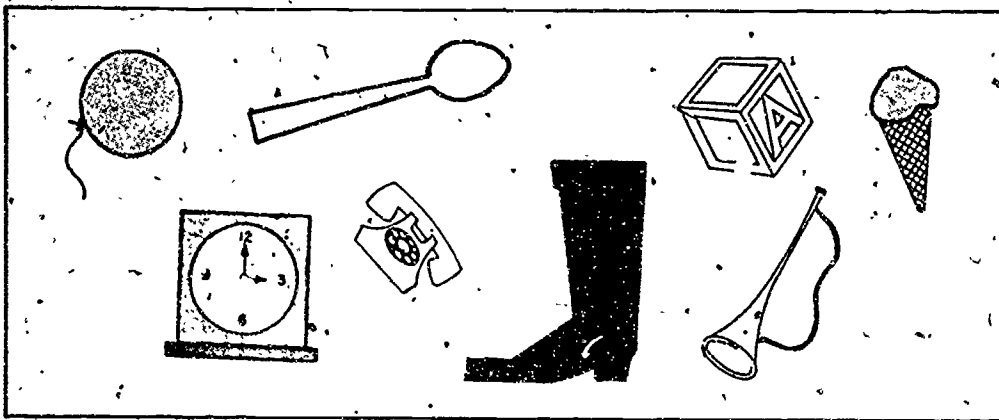

5

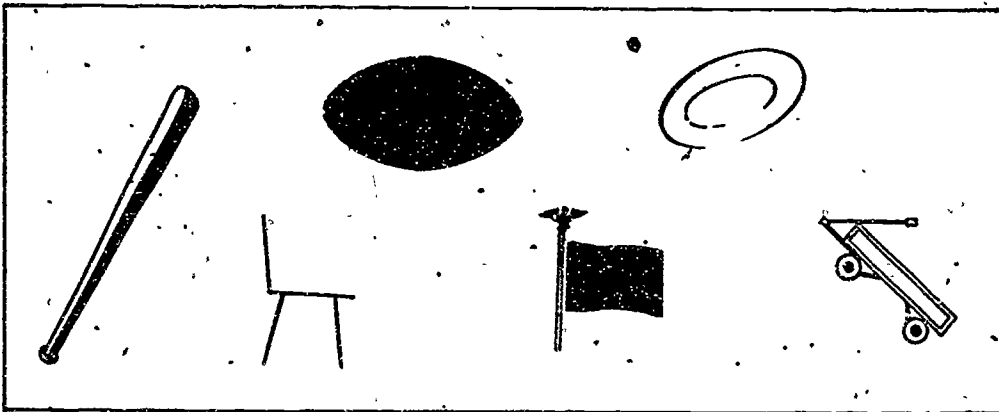

6

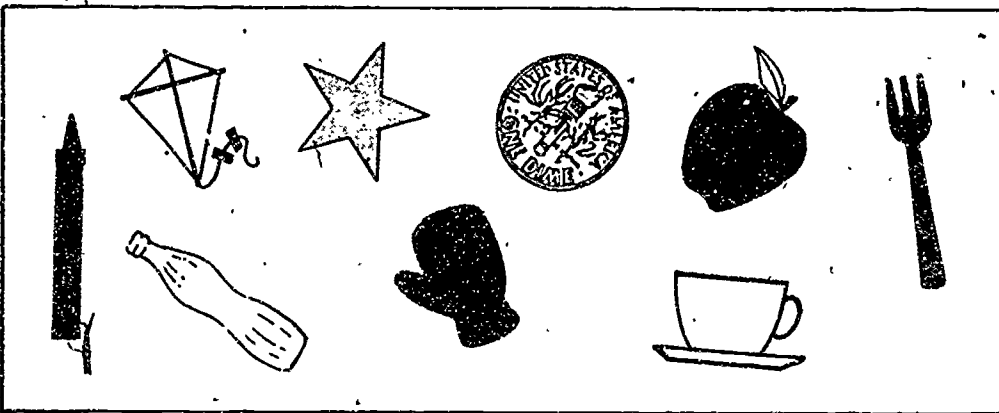

7

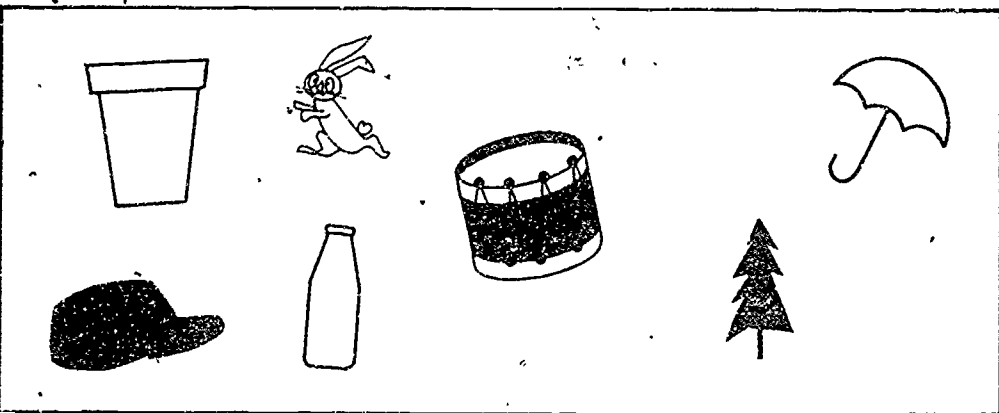

8

9

Ring the correct numeral

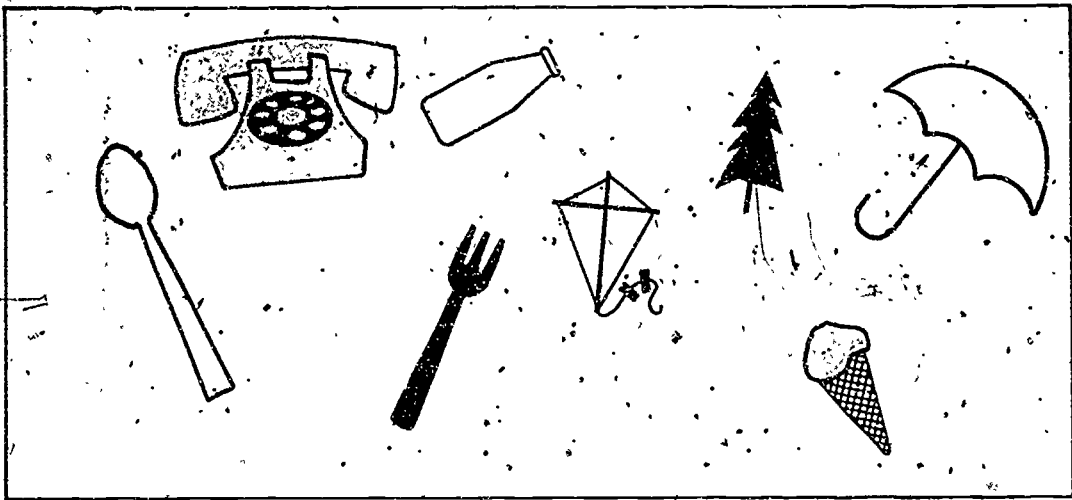
	6 7 8
--	-------------

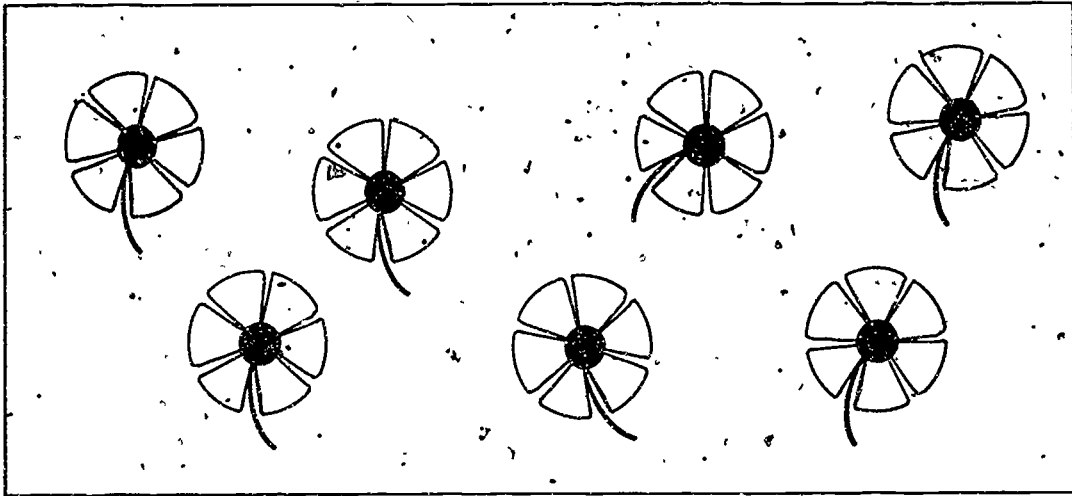
	6 7 8
---	-------------

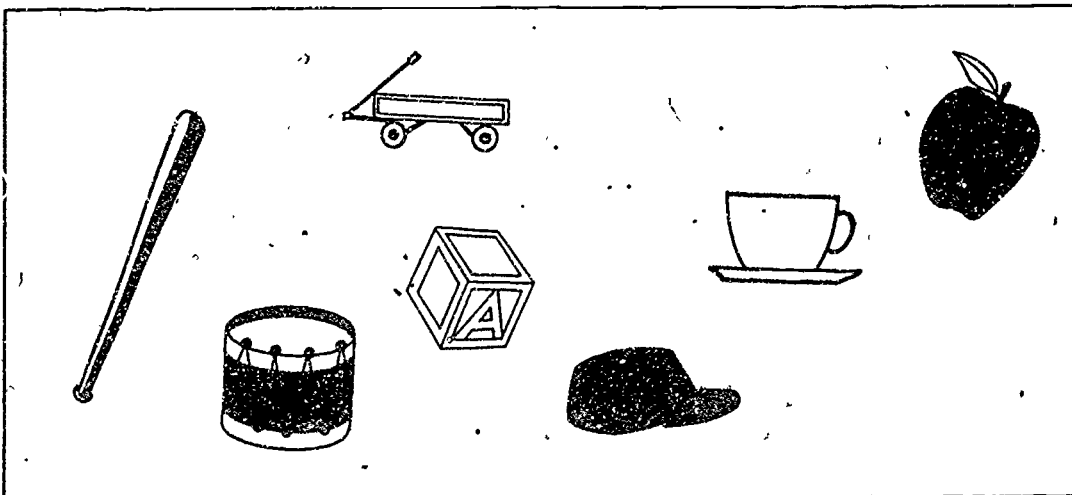
	6 7 8
--	-------------

Ring the correct numeral

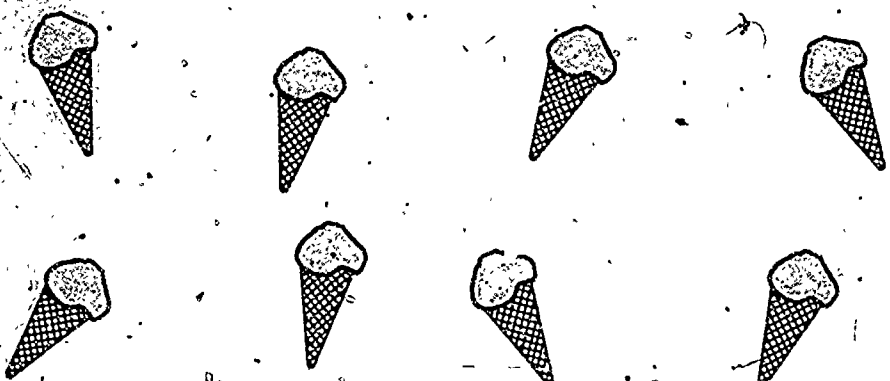
	6 7 8
--	-------------

	7 8 9
---	-------------

	6 7 8
--	-------------

Ring the correct numeral

	2 7 4
--	-------------

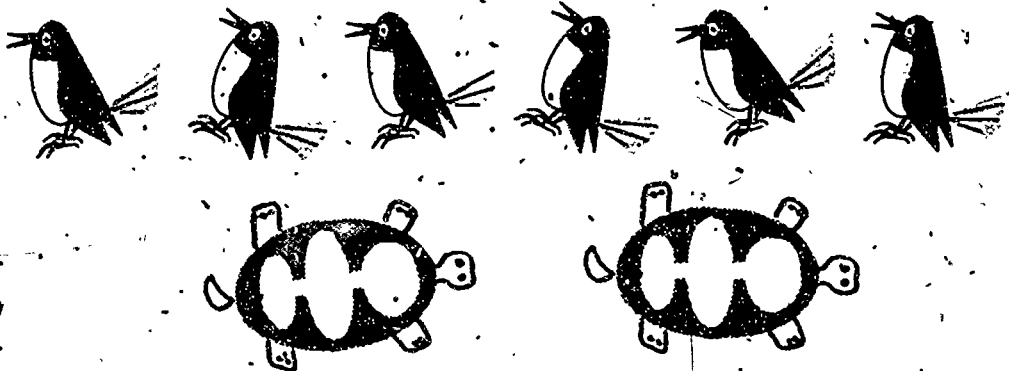
	8 6 4
--	-------------

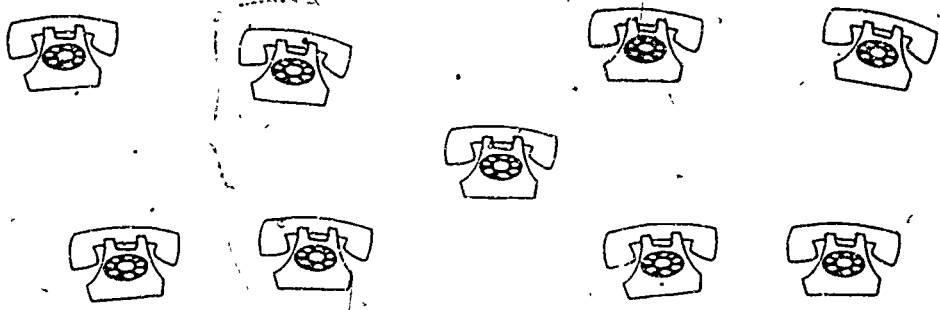
	3 9 0
--	-------------

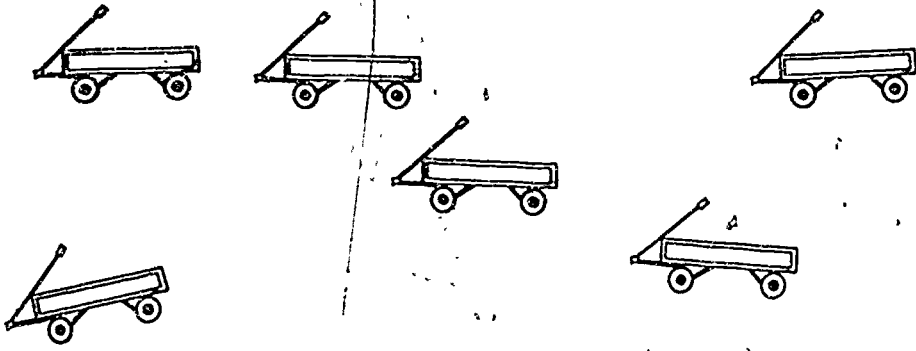
	5 6 1
--	-------------

How many members in each set?

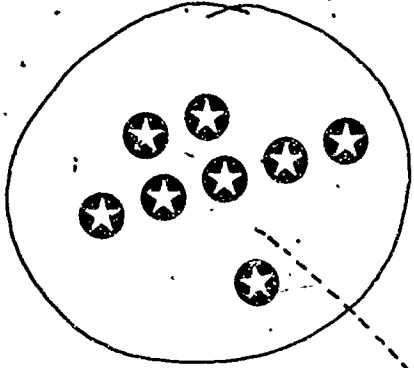
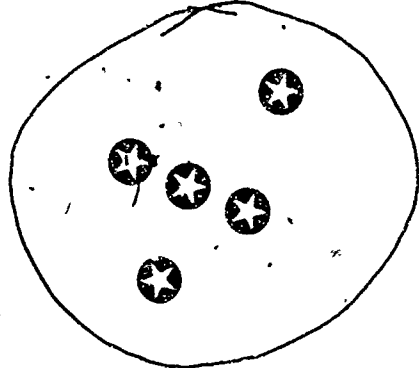
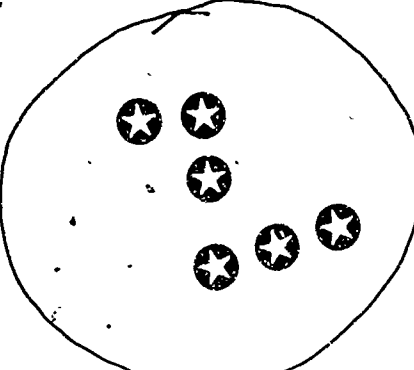
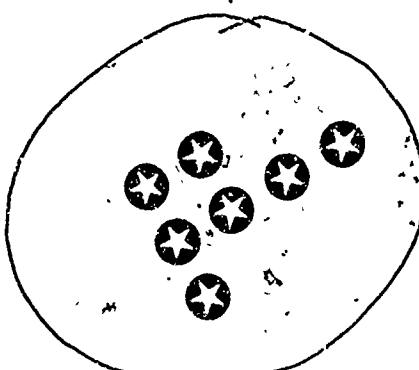
	5	
	6	
	7	
	8	
	9	

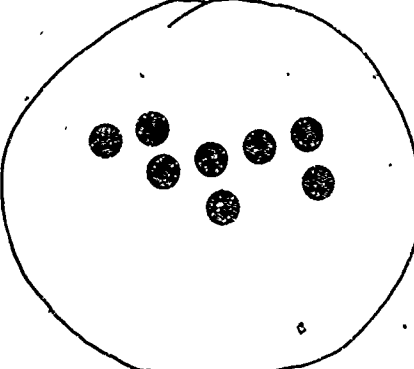
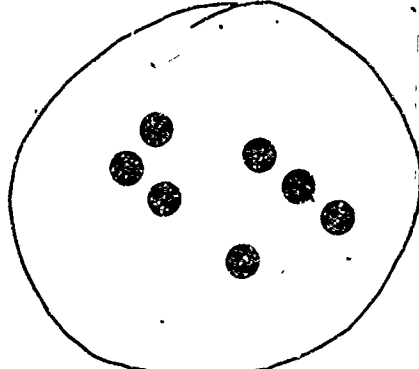
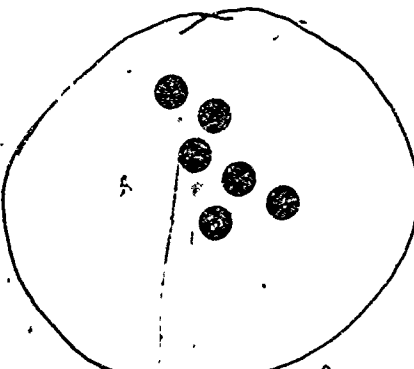
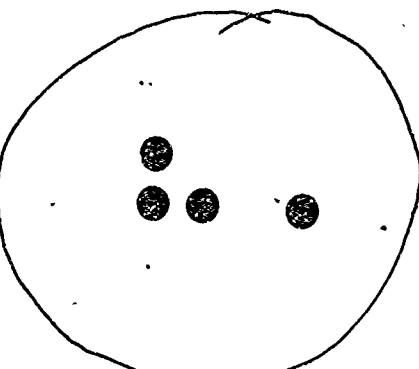
	4	
	6	
	7	
	8	
	9	

How many members in each set?

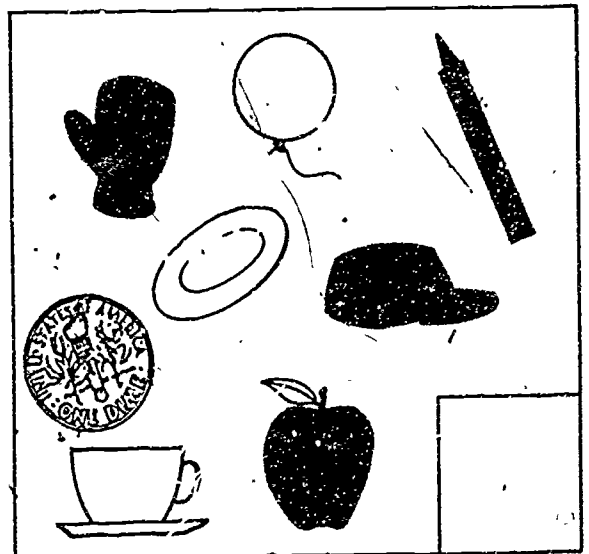
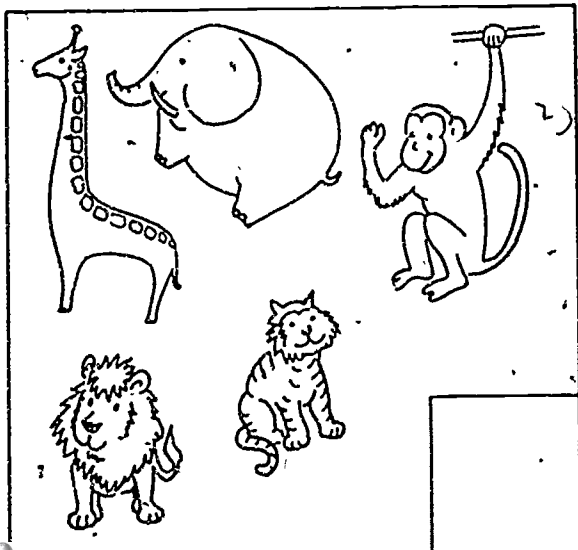
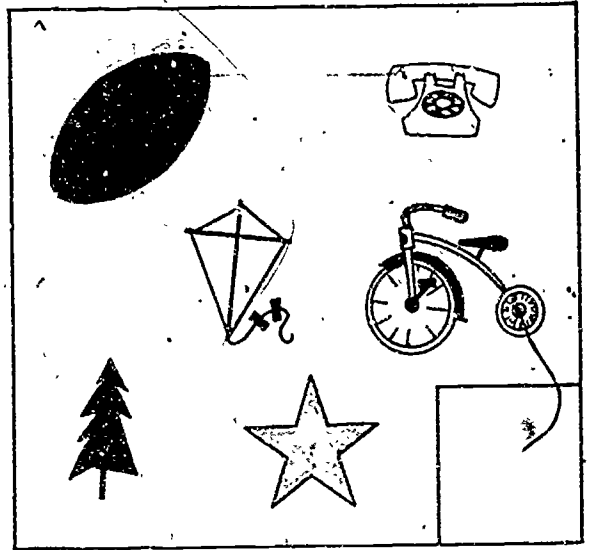
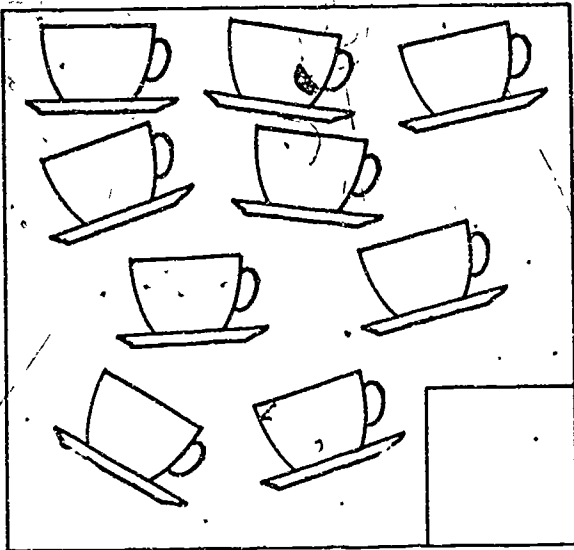
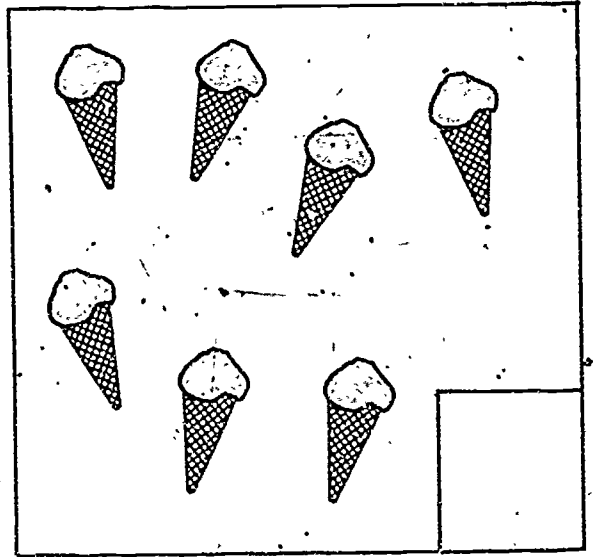
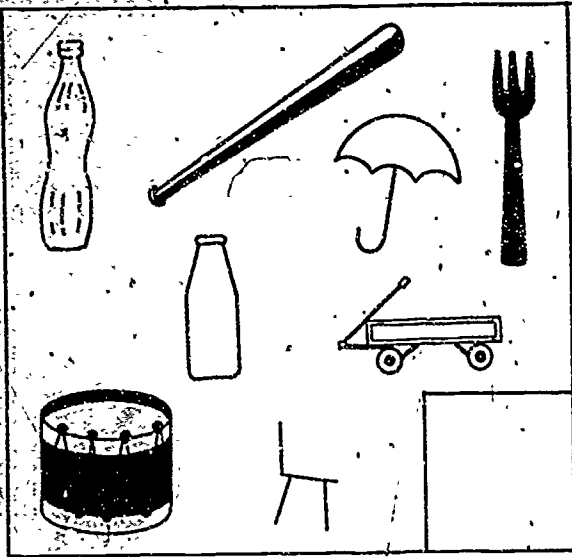

How many members in each set?

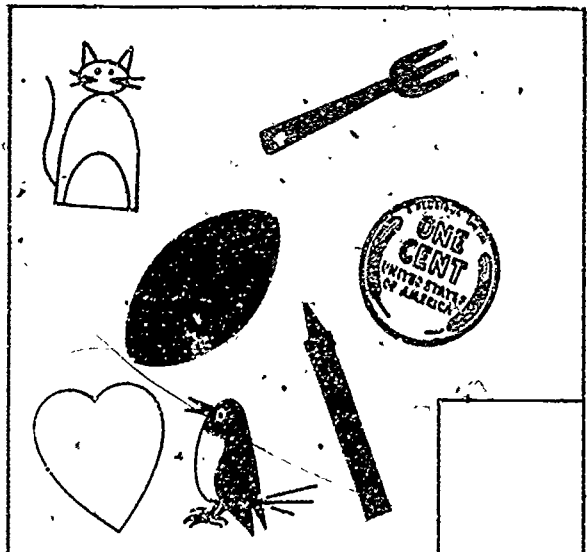
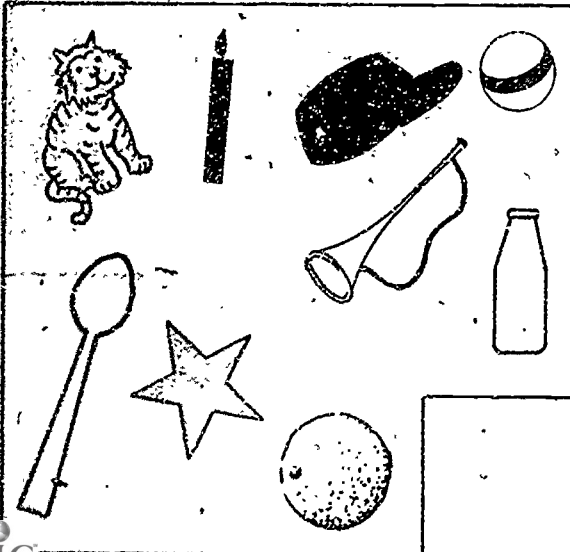
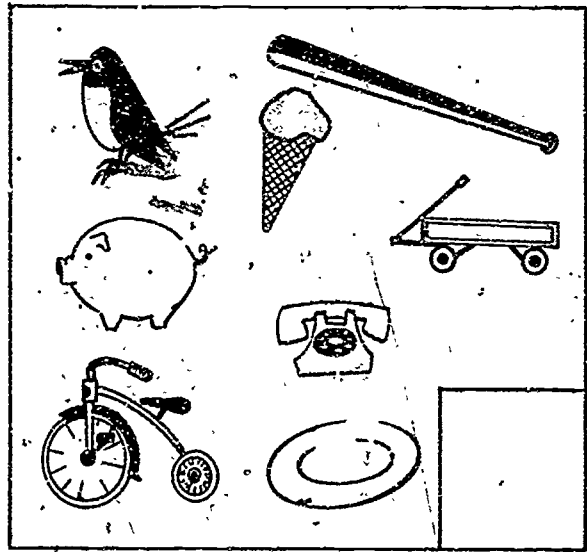
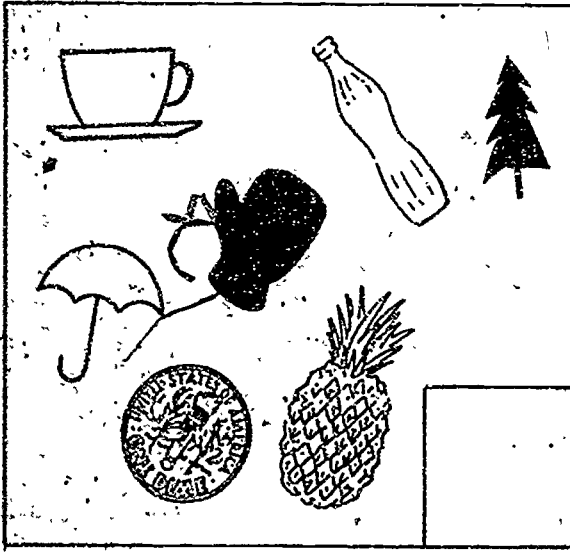
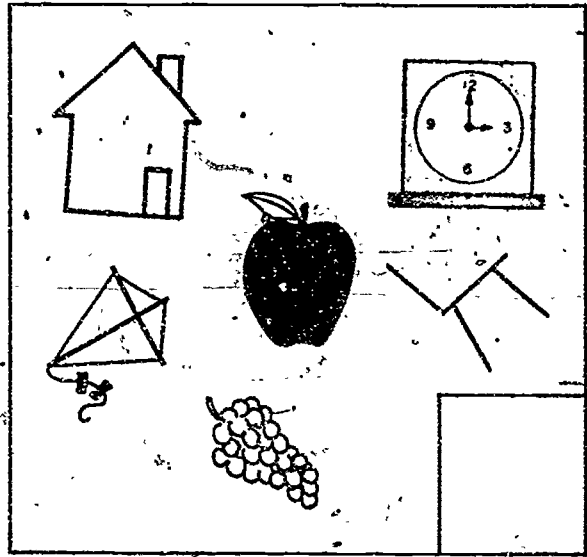
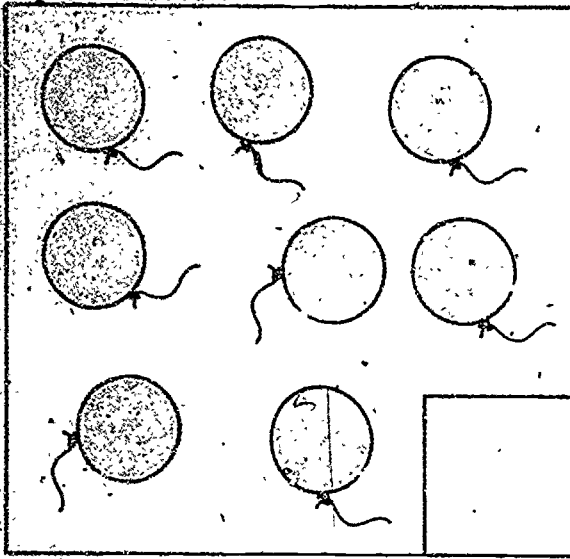



Which number is greater?

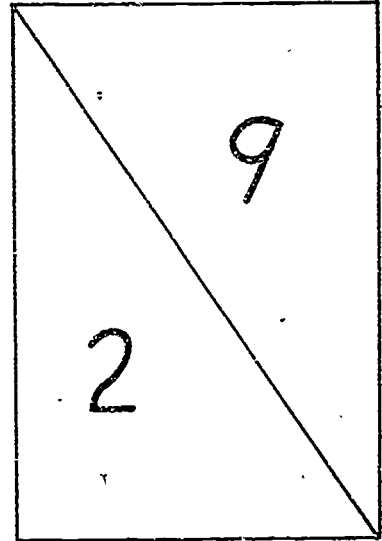
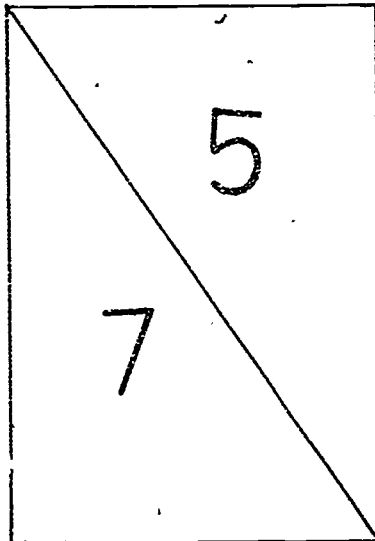
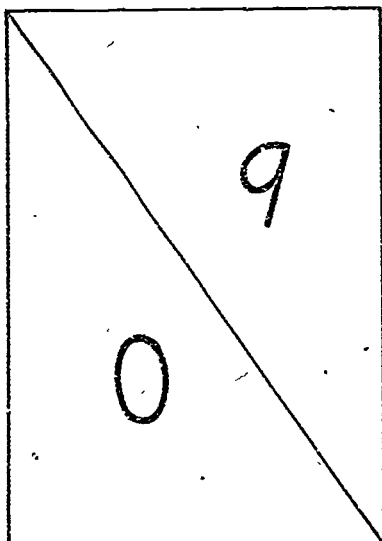
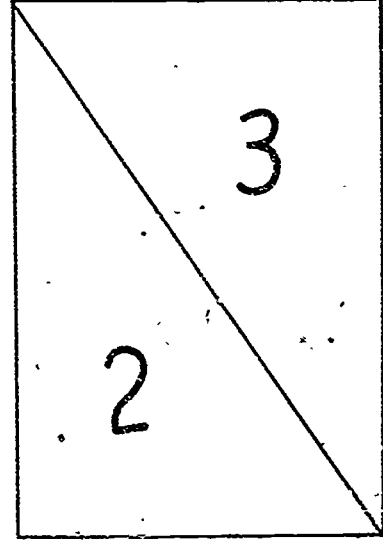
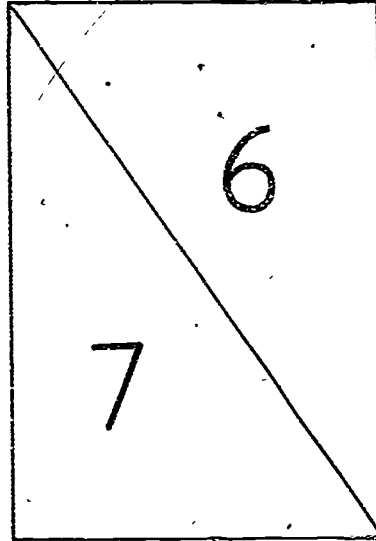
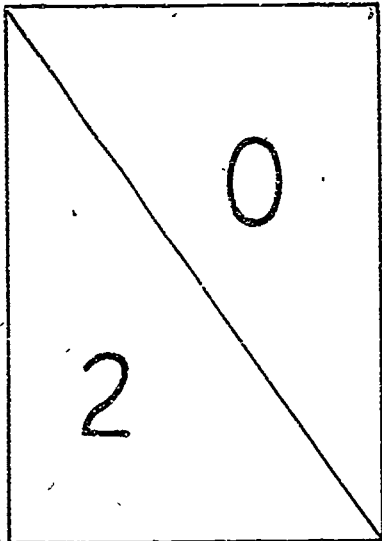
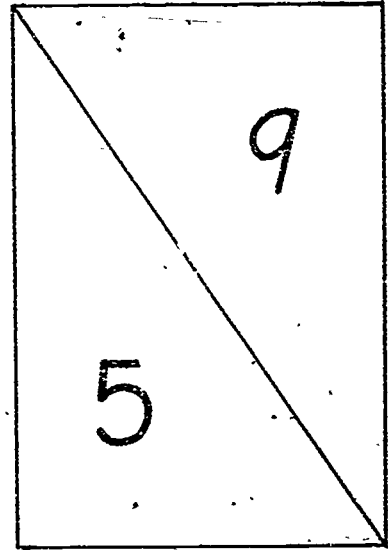
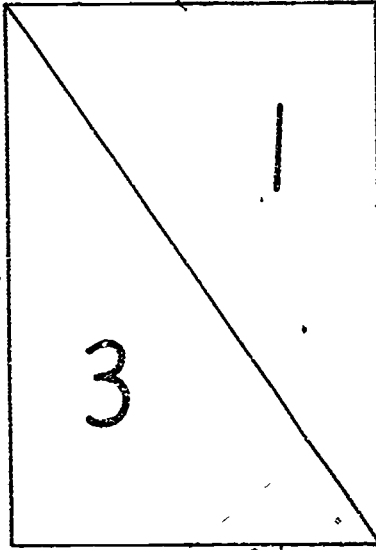
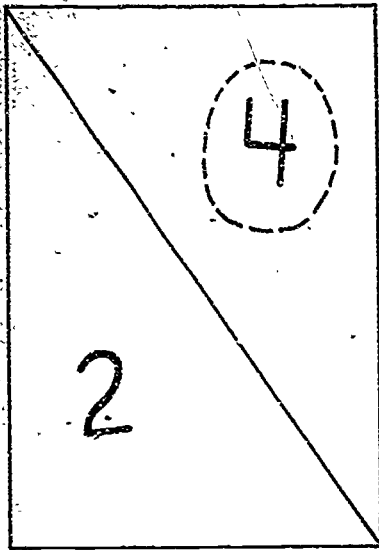

Which number is less?

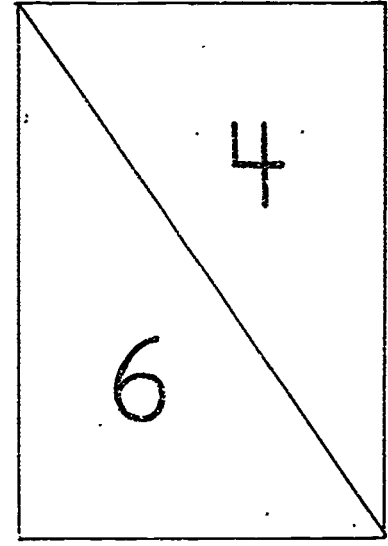
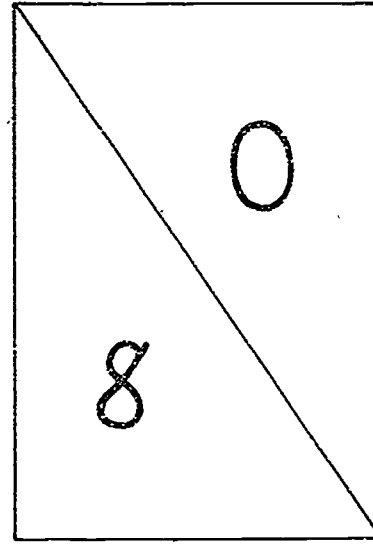
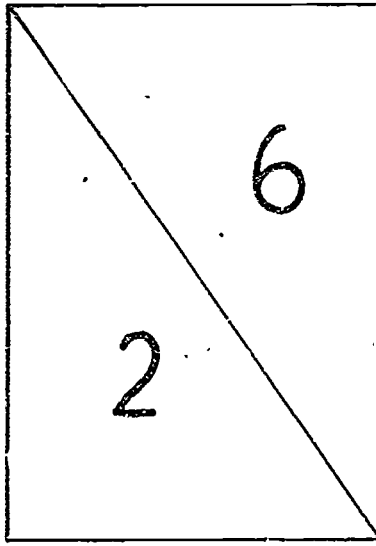
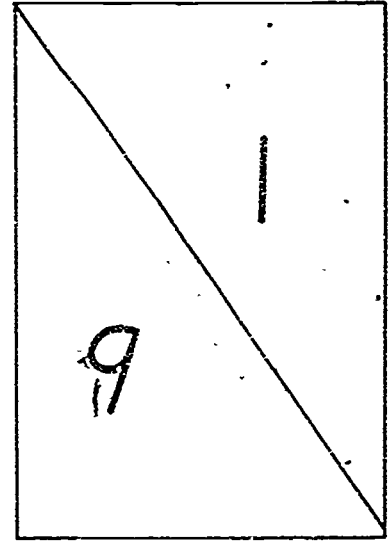
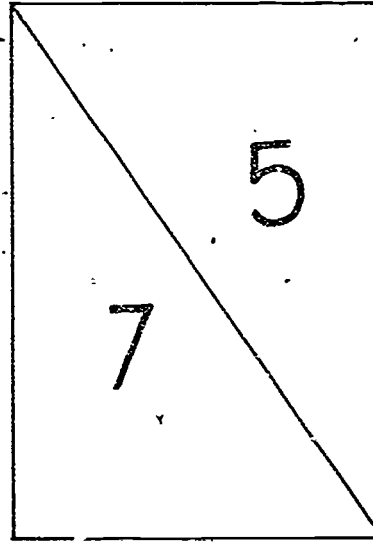
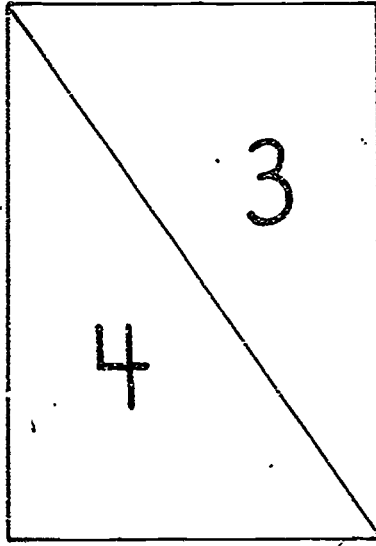
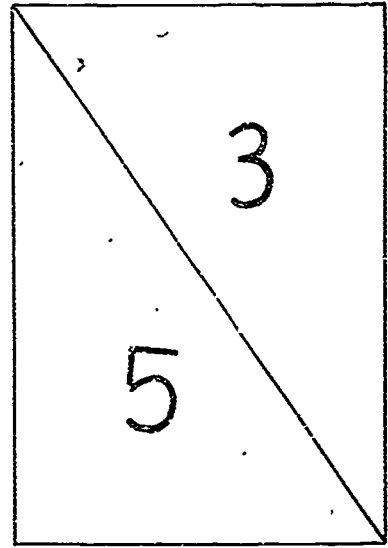
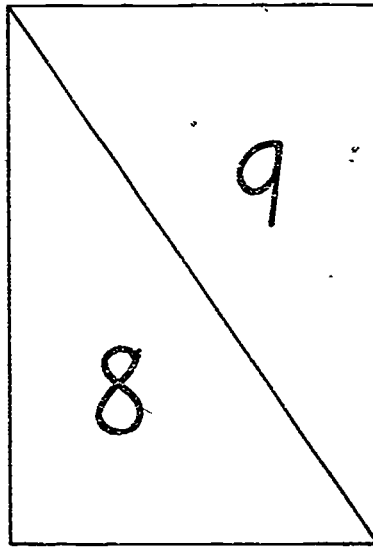
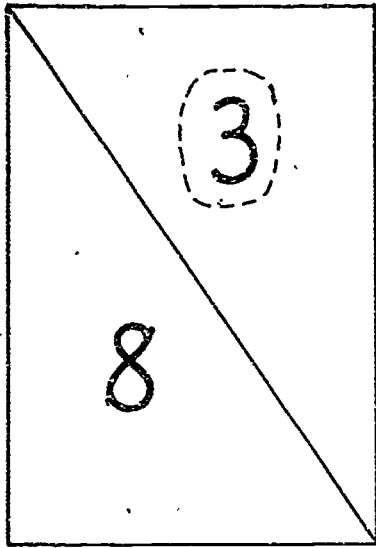

Where do the numerals belong?

0

1

9

8

5

0

2

4

3

7

1

6

108

Name the points.

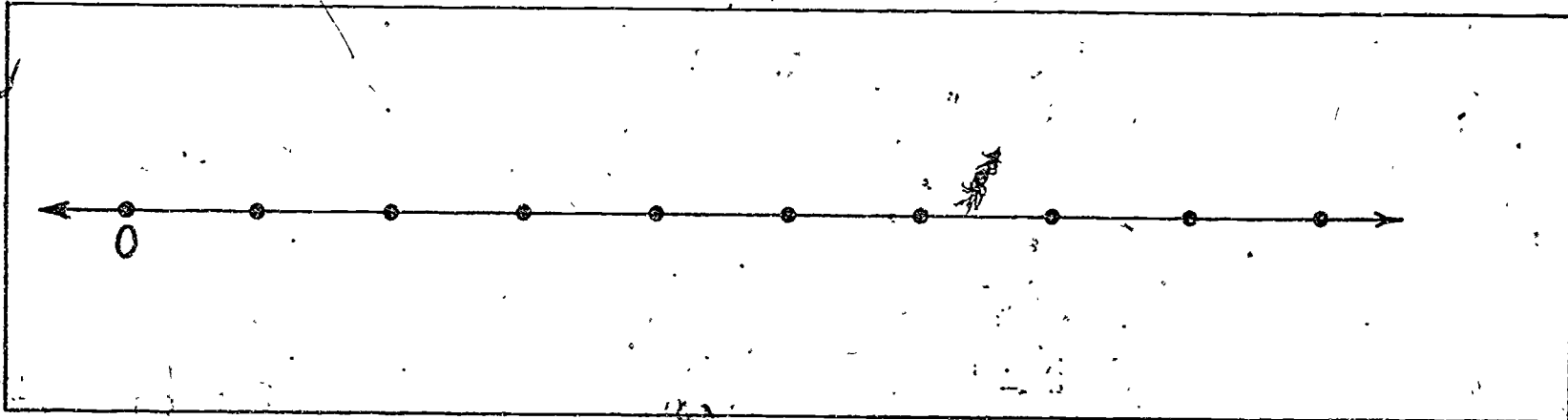
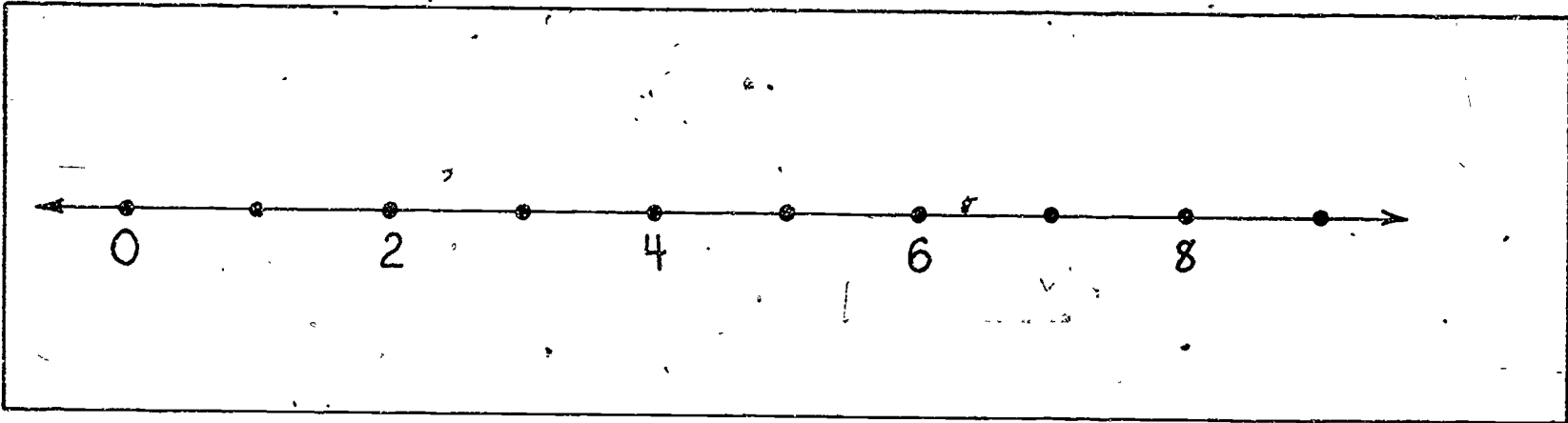

109

2-3

Use the number line

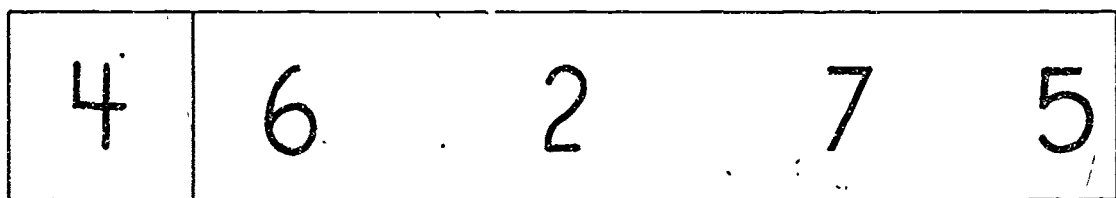
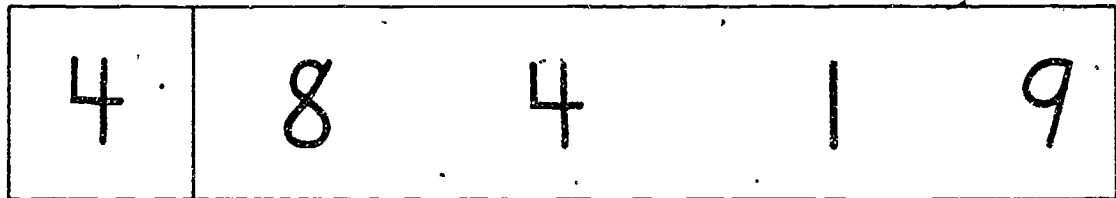
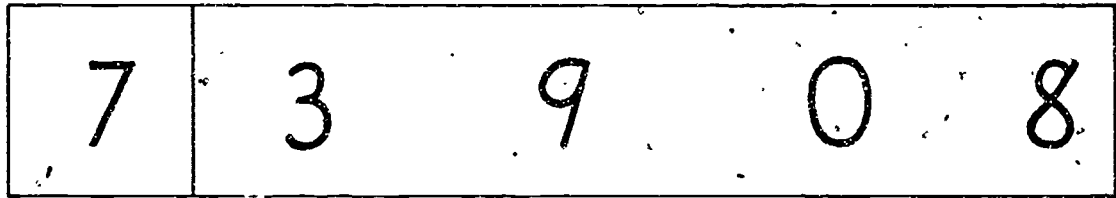
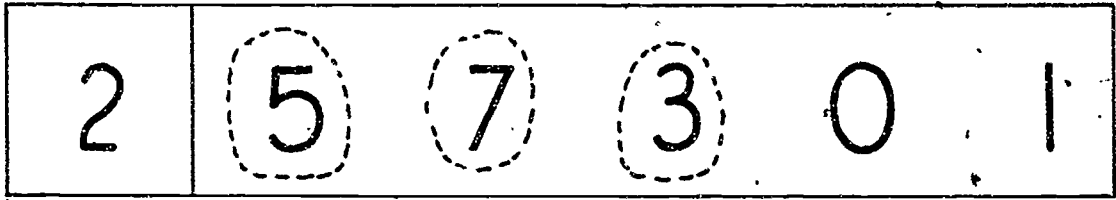
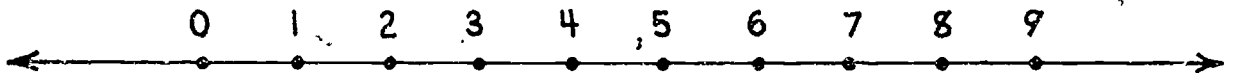

Use the number line

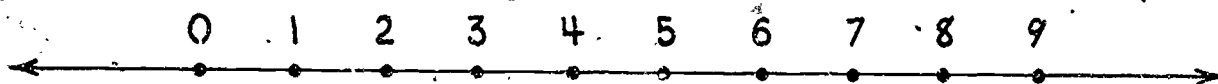

7	4	8	2	5
---	---	---	---	---

4	3	6	0	9
---	---	---	---	---

1	9	6	2	0
---	---	---	---	---

9	3	7	6	8
---	---	---	---	---

How many tens?

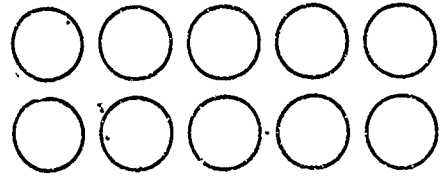
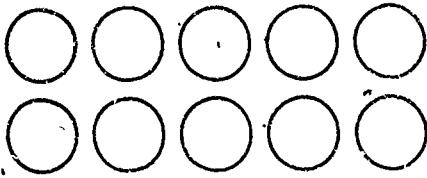

\_\_\_\_\_ Tens

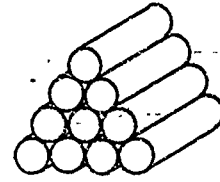
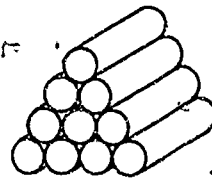
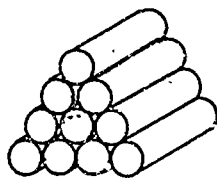
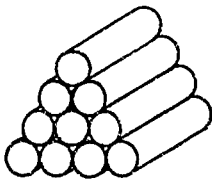

\_\_\_\_\_ Tens

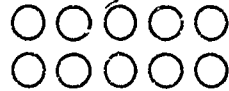
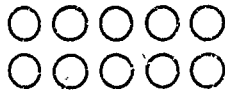

\_\_\_\_\_ Tens

How many tens?

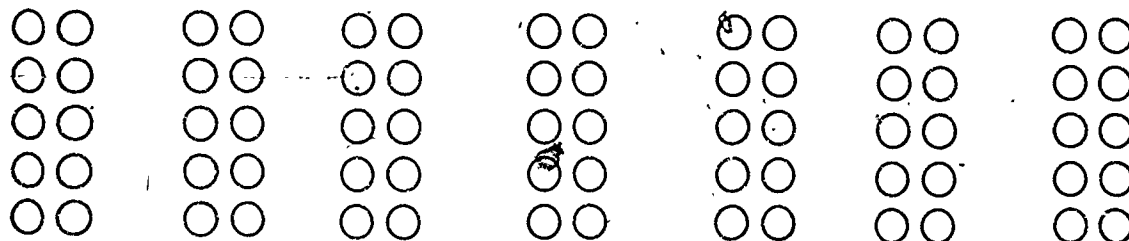

\_\_\_\_\_ Tens

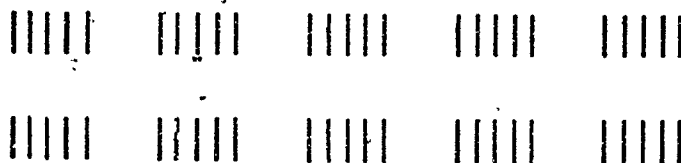

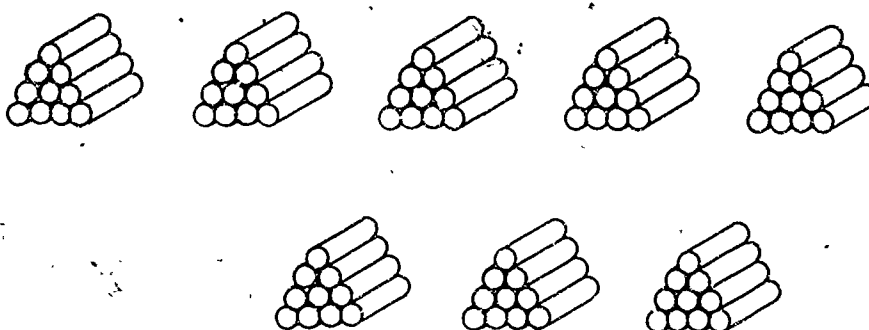

\_\_\_\_\_ Tens





\_\_\_\_\_ Tens



Dimes and cents





























	
<p>One cent</p>	<p>One dime Ten cents</p>











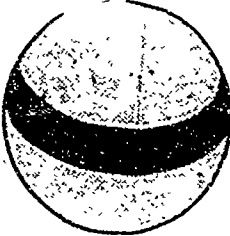









































Mark enough pennies to buy each toy.

	
	
	

Dimes and cents  
Mark enough pennies to buy each toy

	      
	      
	     
	     

How many?

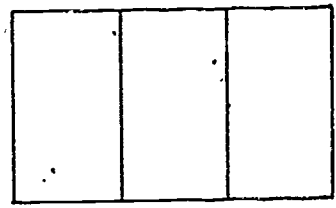
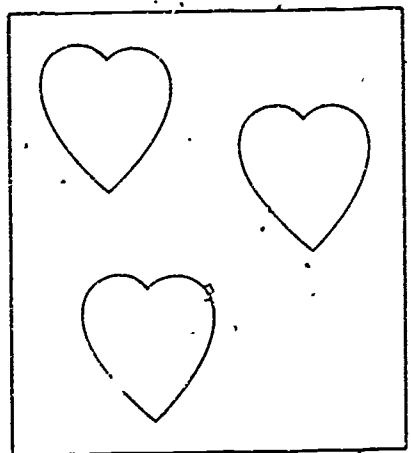
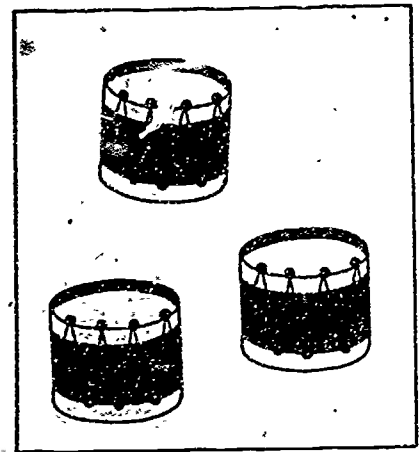
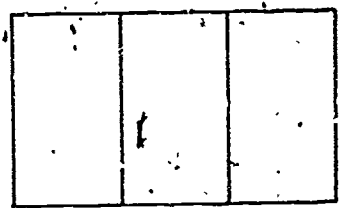
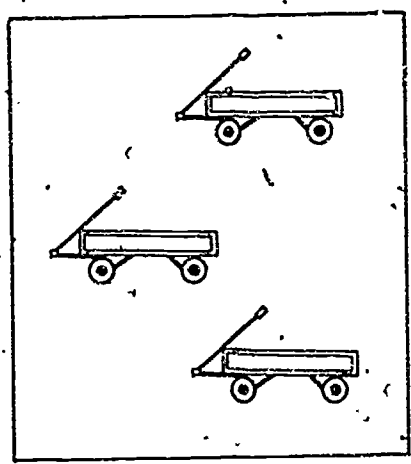
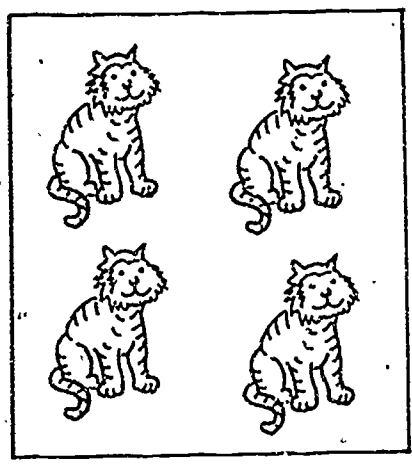
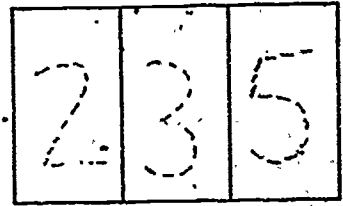
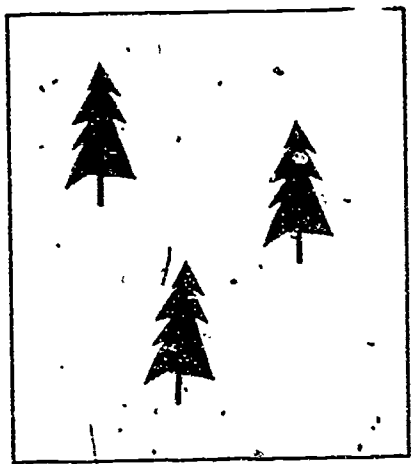
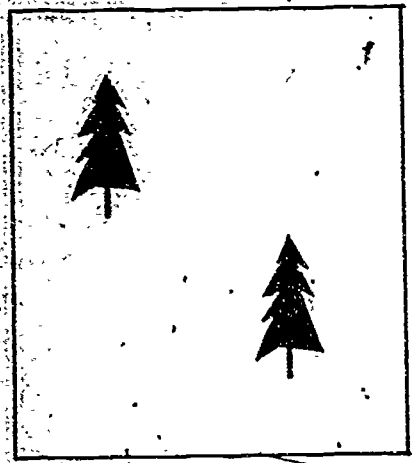

How many?

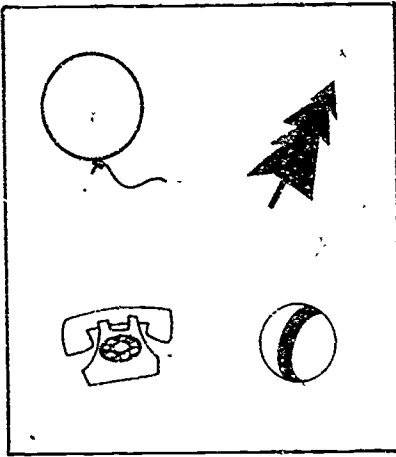
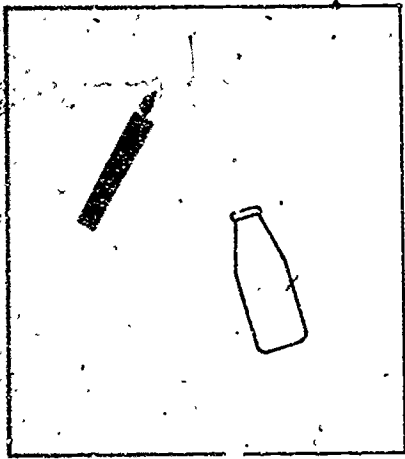

--	--	--

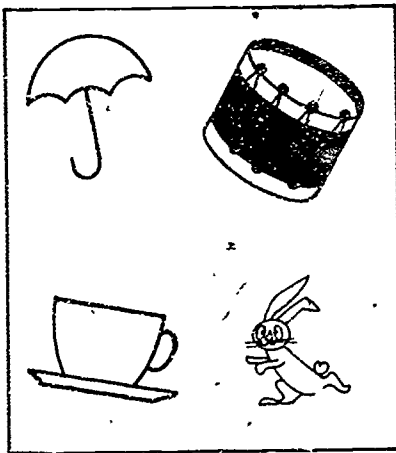
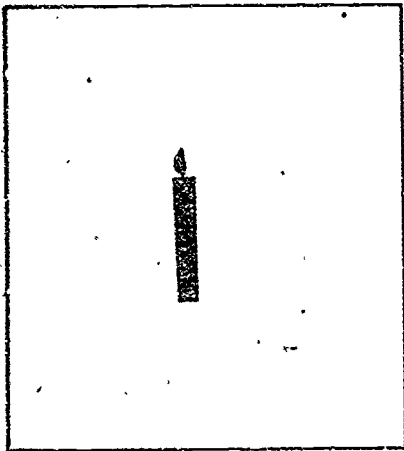

--	--	--

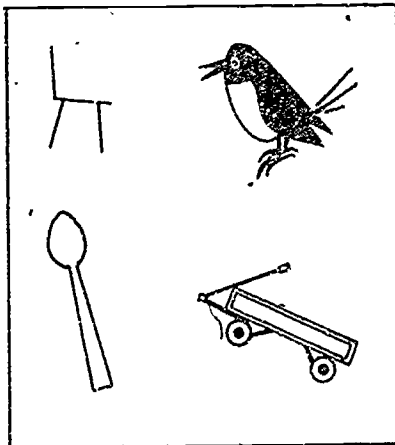
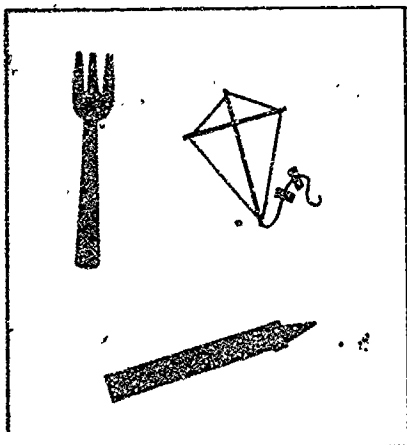

--	--	--

How many? Write the equation

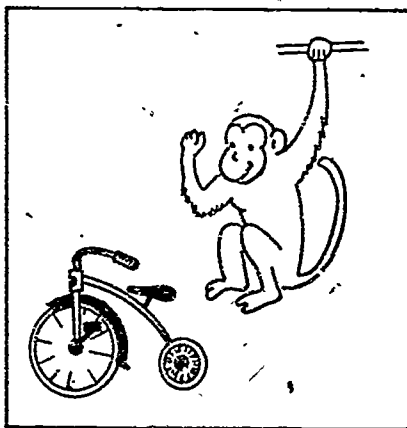
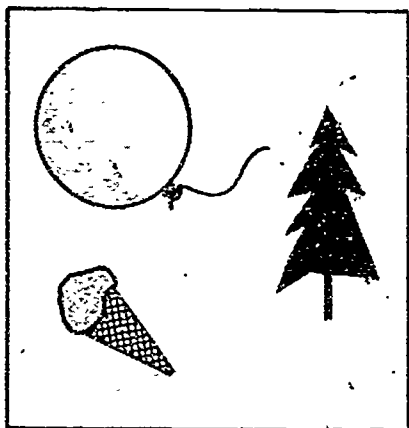

$$\underline{\hspace{2cm}} + \underline{\hspace{2cm}} = \underline{\hspace{2cm}}$$

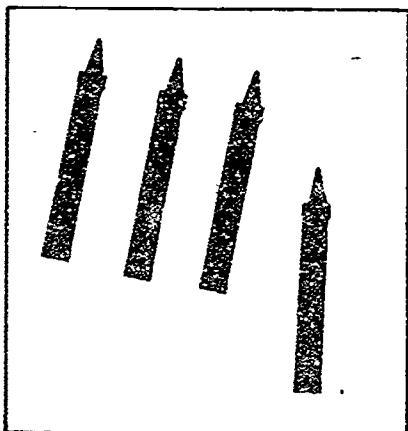

$$\underline{\hspace{2cm}} + \underline{\hspace{2cm}} = \underline{\hspace{2cm}}$$

How many? Write the equation

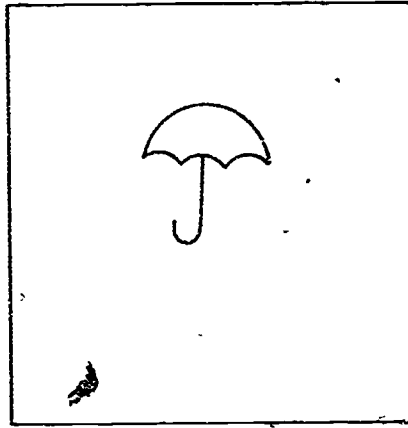
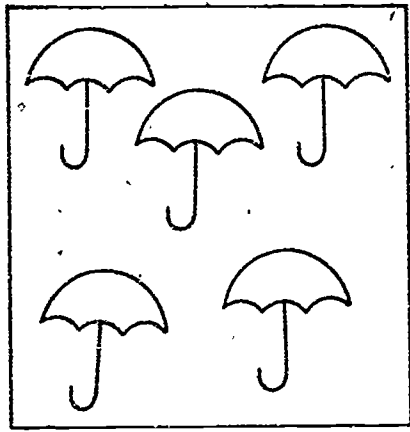

$$\underline{\quad} + \underline{\quad} = \underline{\quad}$$

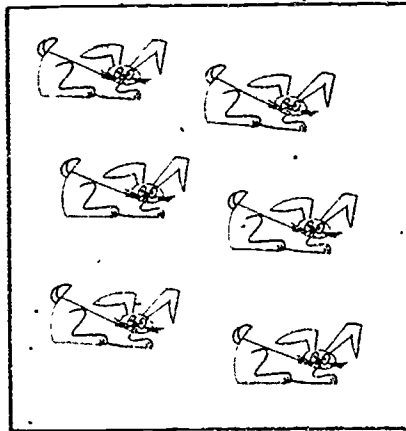
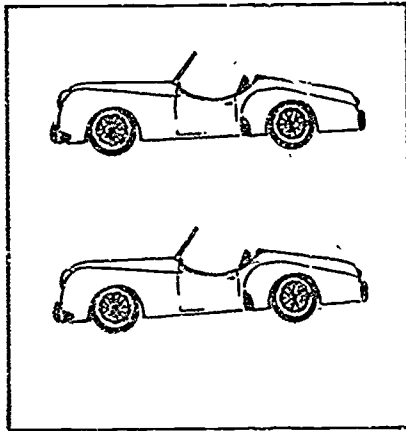

$$\underline{\quad} + \underline{\quad} = \underline{\quad}$$

## Equations

$4 + 1 = \square$

$2 + 3 = \square$

$3 + 0 = \square$

$0 + 6 = \square$

$2 + 2 = \square$

$1 + 3 = \square$

$1 + 5 = \square$

$2 + 4 = \square$

# Equations

$0 + 1 = \square$

$5 + 1 = \square$

$1 + 1 = \square$

$6 + 1 = \square$

$2 + 1 = \square$

$7 + 1 = \square$

$3 + 1 = \square$

$8 + 1 = \square$

$4 + 1 = \square$



# Equations

$2 + 0 = \square$

$2 + 4 = \square$

$2 + 1 = \square$

$2 + 5 = \square$

$2 + 2 = \square$

$2 + 6 = \square$

$2 + 3 = \square$

$2 + 7 = \square$

# Equations

$3 + 0 = \square$

$3 + 1 = \square$

$3 + 2 = \square$

$3 + 3 = \square$

$3 + 4 = \square$

$3 + 5 = \square$

$3 + 6 = \square$

# Equations

$2 + 1 = \square$

$1 + 2 = \square$

$3 + 1 = \square$

$1 + 3 = \square$

$2 + 3 = \square$

$3 + 2 = \square$

$4 + 1 = \square$

$1 + 4 = \square$

$2 + 4 = \square$

$4 + 2 = \square$

# Equations

$$4 + 3 = \square$$

$$2 + 5 = \square$$

$$5 + 0 = \square$$

$$5 + 1 = \square$$

$$2 + 6 = \square$$

$3 + 4 = \square$

$5 + 2 = \square$

$0 + 5 = \square$

$1 + 5 = \square$

$6 + 2 = \square$

A set and some of its subsets

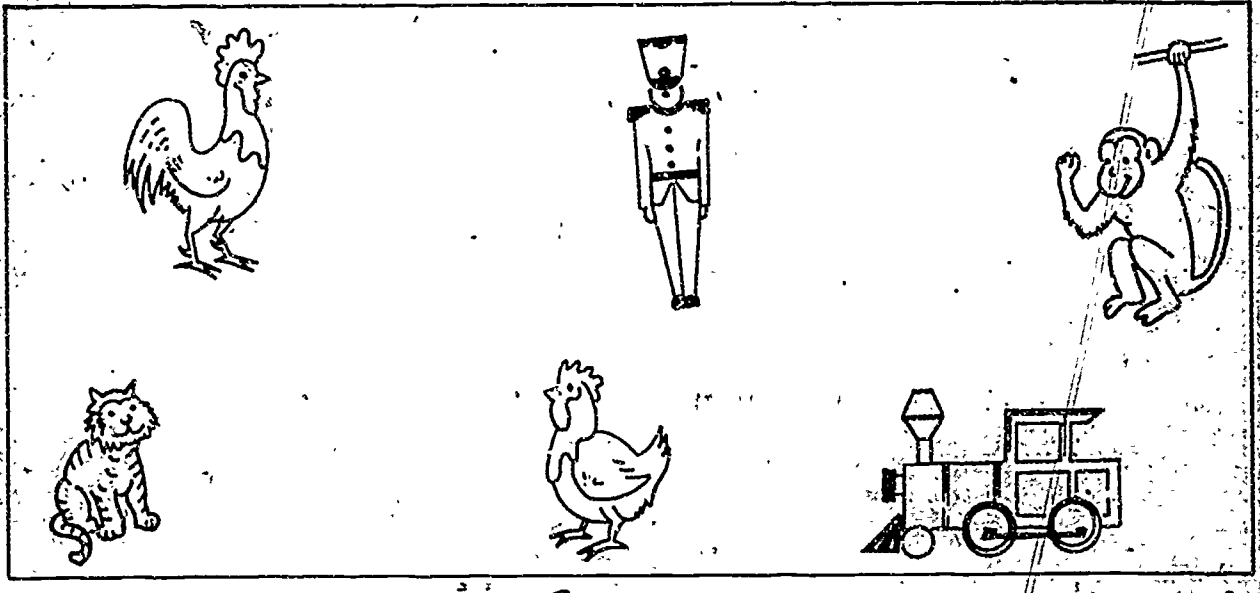

A.

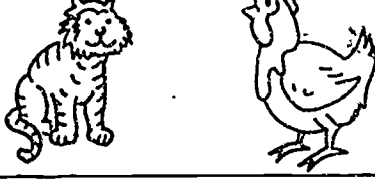

B.

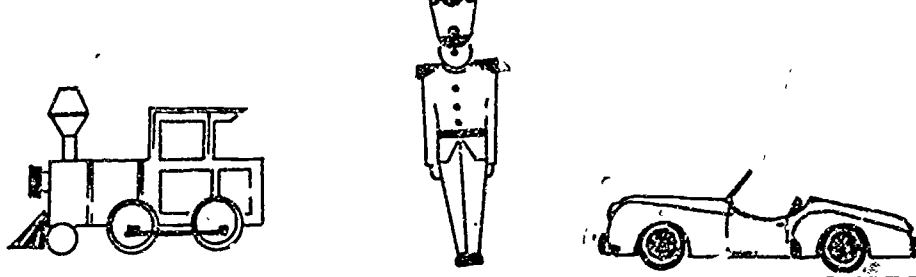

C.



D.



A set and some of its subsets

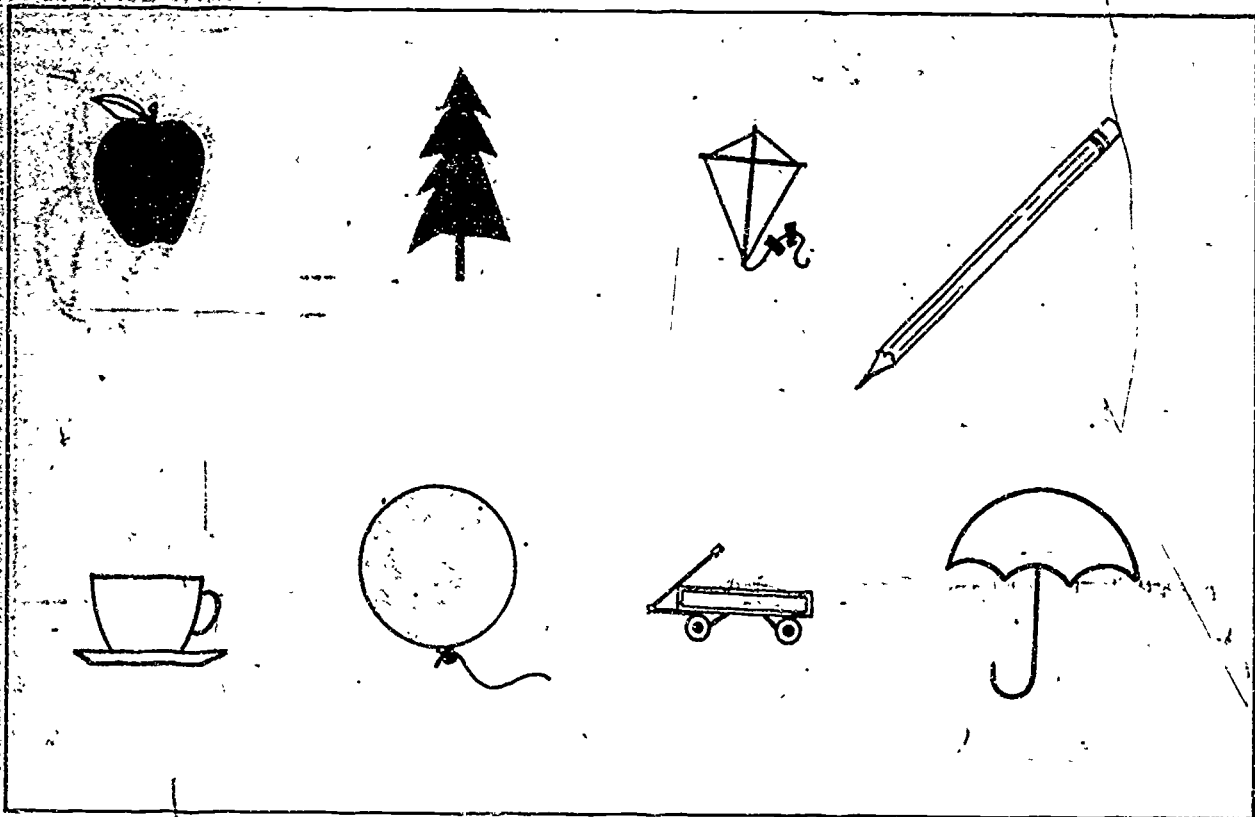

A.



B.



C.

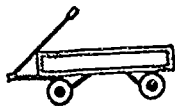

D.



E.

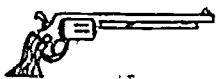

F.



Remove a subset











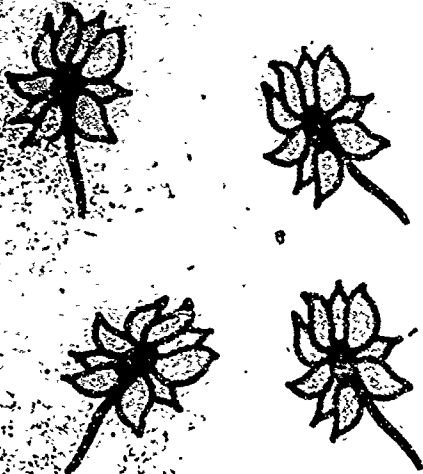

Removing subsets

		
	1	

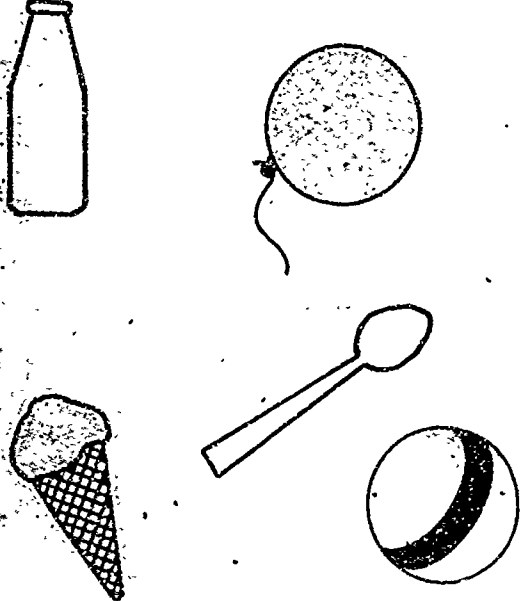
		
	2	

		
	4	

		
	0	

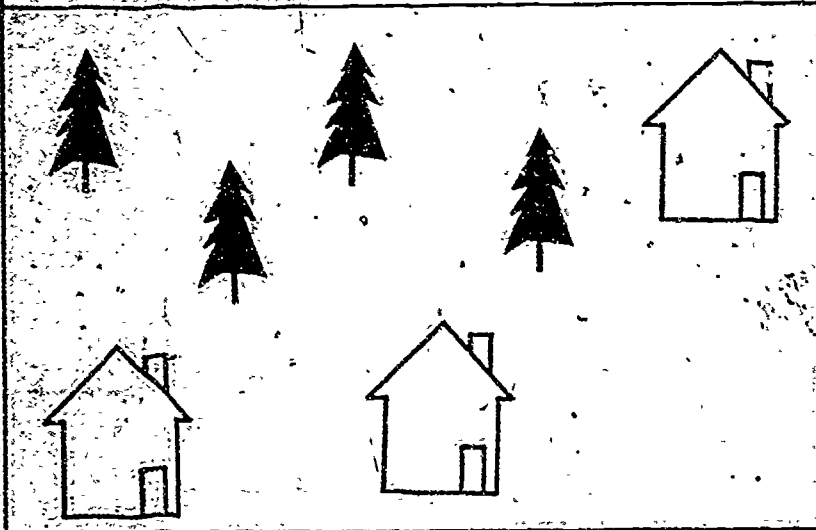

	4	
--	---	--

	-	4	=	
--	---	---	---	--

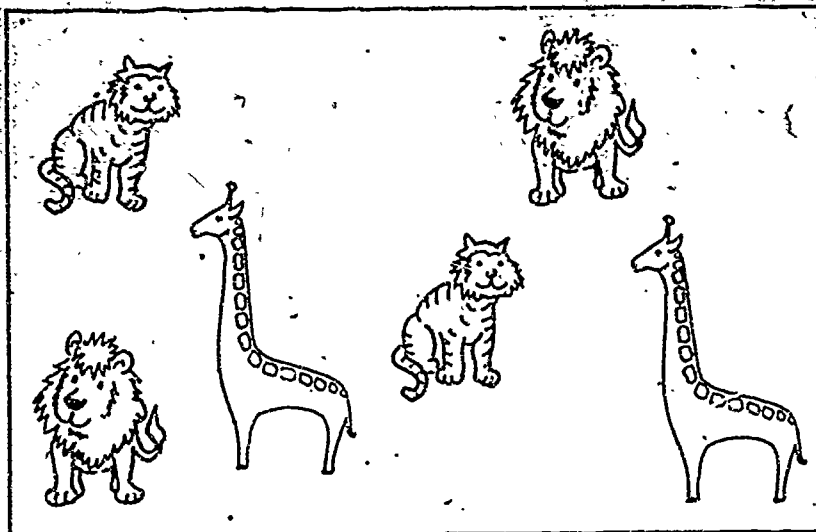

	2	
--	---	--

	-	2	=	
--	---	---	---	--

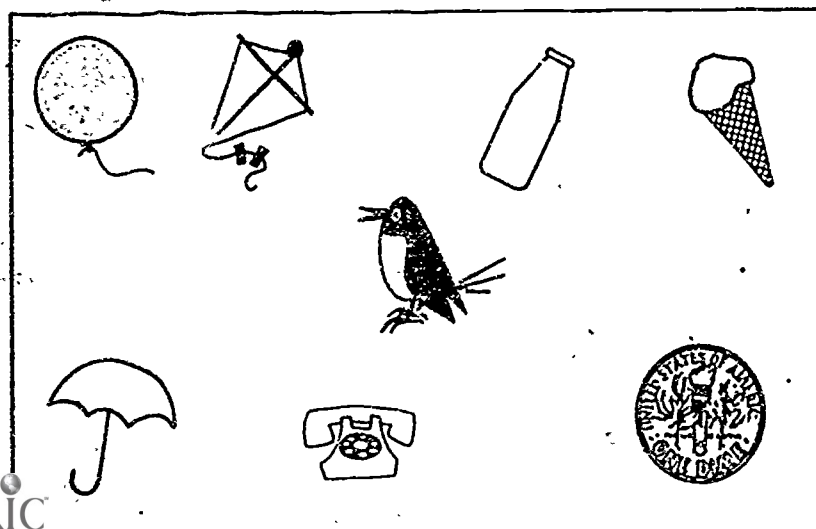

	4	
--	---	--

	-	4	=	
--	---	---	---	--

Remove a subset

Equation

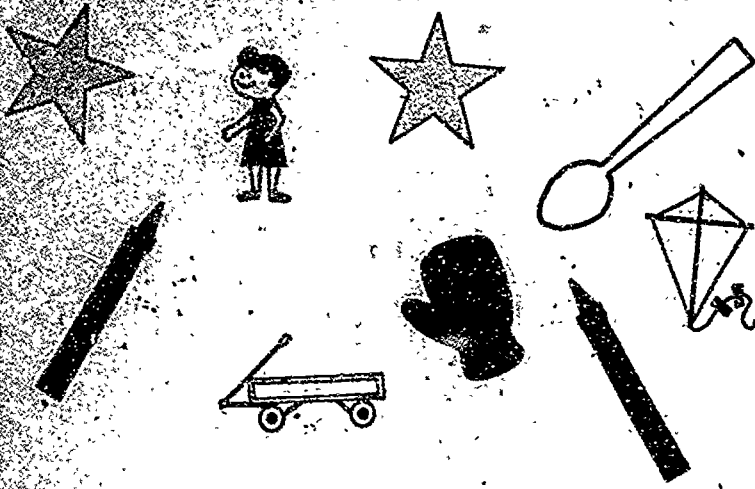

	5	
--	---	--

	-		=	
--	---	--	---	--

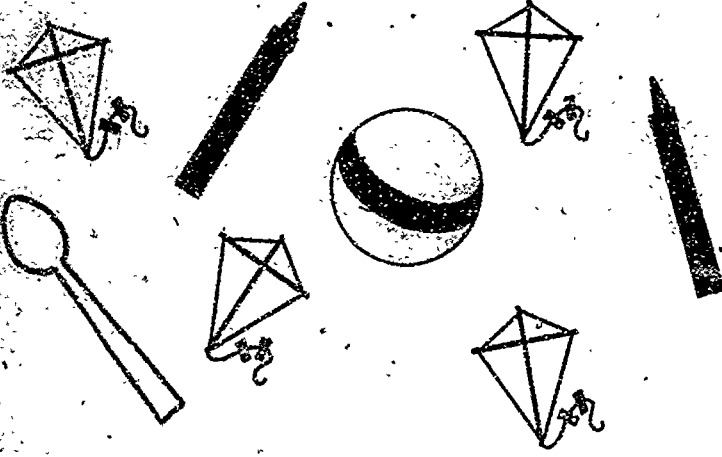

	1	
--	---	--

	-		=	
--	---	--	---	--

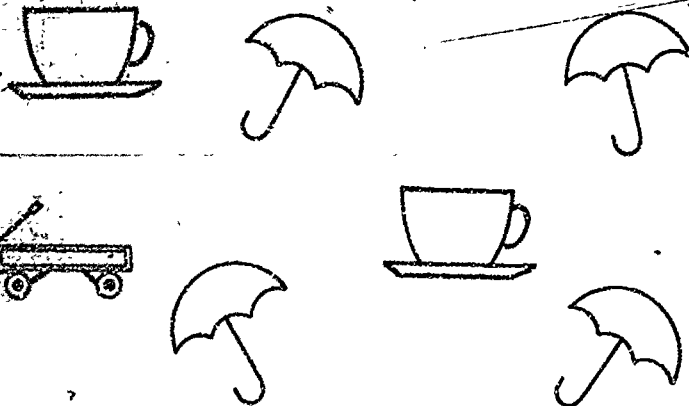

	6	
--	---	--

	-		=	
--	---	--	---	--

Write the equations

$5 - 1 = \square$

$3 - 2 = \square$

$1 - 1 = \square$

$4 - 2 = \square$

$3 - 1 = \square$

$2 - 1 = \square$

$4 - 3 = \square$

$5 - 2 = \square$

$6 - 2 = \square$

$7 - 5 = \square$