

DOCUMENT RESUME

ED 140 064

CE 011 442

AUTHOR Kessman, William A.
 TITLE Food Services. Reading and Language Activities.
 INSTITUTION Rutgers, The State Univ., New Brunswick, N.J.
 Curriculum Lab.
 SPONS AGENCY New Jersey State Dept. of Education, Trenton. Div. of
 Vocational Education.
 PUB DATE Apr 77
 NOTE 99p.
 AVAILABLE FROM New Jersey Vocational-Technical Curriculum
 Laboratory, Building 4103, Kilmer Campus, Rutgers
 University, New Brunswick, New Jersey 08903 (\$2.00
 plus postage)

EDRS PRICE MF-\$0.83 HC-\$4.67 Plus Postage.
 DESCRIPTORS *Career Exploration; *Food Service; Instructional
 Materials; Language Development; *Language Skills;
 *Learning Activities; Reading Development; Reading
 Materials; *Reading Skills; Secondary Education;
 Special Education; Vocabulary Development; Vocational
 Education

ABSTRACT

Written primarily for special needs students in the exploratory phase of a vocational program in food services, this activity book employs basic content material of the food service trade to serve as a vehicle for developing reading and language skills. Each lesson follows a similar format. The lesson is introduced by an illustration and a list of key words found in the reading selection which follows. Each reading selection is followed by short answer questions (getting the main idea, getting the meaning from the context), true-false questions, sentences to complete, vocabulary-spelling exercises, and a word puzzle. The titles of the lessons are A New School; A New Shop; What to Wear; Clean Hands, Please; Setting the Table; What to Use; Dishes and Glassware: How to Hold; What Is Flatware?; How a Table Is Set; Kitchen Work; Kinds of Foods; Large Kitchen Equipment; and Small Kitchen Equipment. (The last two lessons include a number of illustrations.) (LMS)

 * Documents acquired by ERIC include many informal unpublished *
 * materials not available from other sources. ERIC makes every effort *
 * to obtain the best copy available. Nevertheless, items of marginal *
 * reproducibility are often encountered and this affects the quality *
 * of the microfiche and hardcopy reproductions ERIC makes available *
 * via the ERIC Document Reproduction Service (EDRS). EDRS is not *
 * responsible for the quality of the original document. Reproductions *
 * supplied by EDRS are the best that can be made from the original. *

State of New Jersey
Department of Education
Division of Vocational Education

ED140064

FOOD SERVICES READING AND LANGUAGE ACTIVITIES

U S DEPARTMENT OF HEALTH,
EDUCATION & WELFARE
NATIONAL INSTITUTE OF
EDUCATION
THIS DOCUMENT HAS BEEN REPRO-
DUCED EXACTLY AS RECEIVED FROM
THE PERSON OR ORGANIZATION ORIGIN-
ATING IT. POINTS OF VIEW OR OPINIONS
STATED DO NOT NECESSARILY REPRESENT
OFFICIAL NATIONAL INSTITUTE OF
EDUCATION POSITION OR POLICY

William A. Kessman, Instructor

Neal B. Perkins, Superintendent
Bergen County Vocational School
Paramus, New Jersey

Vocational-Technical
Curriculum Laboratory
Rutgers - The State University
Building 4103 - Kilmer Campus
New Brunswick, New Jersey

April 1977

ERIC
Full Text Provided by ERIC
011 442

NEW JERSEY DEPARTMENT OF EDUCATION

FRED G. BURKE, COMMISSIONER

RALPH H. LATAILLE, DEPUTY COMMISSIONER

DIVISION OF VOCATIONAL EDUCATION

WILLIAM WENZEL, ASSISTANT COMMISSIONER

JOHN E. RADVANY, DEPUTY ASSISTANT COMMISSIONER

HAROLD R. SELTZER, DEPUTY ASSISTANT COMMISSIONER (Acting)

JOSEPH F. KELLY, DIRECTOR

BUREAU OF OCCUPATIONAL AND CAREER RESEARCH DEVELOPMENT

FREDERICK L. CAPPELLO, DIRECTOR

VOCATIONAL CURRICULUM AND MEDIA DEVELOPMENT

RUTGERS – THE STATE UNIVERSITY

PHILIP L. EDGECOMB, DIRECTOR (Acting)

NEW JERSEY VOCATIONAL-TECHNICAL

CURRICULUM LABORATORY

RUTGERS – THE STATE UNIVERSITY

BUILDING 4103 – KILMER CAMPUS

NEW BRUNSWICK, NEW JERSEY

ACKNOWLEDGMENTS

The author wishes to acknowledge his indebtedness to the following for their cooperation in furnishing information, illustrations, and photographs:

Barbara K. Furneisen, Instructor
Marie H. Katzenbach School for the Deaf
West Trenton, New Jersey

Hobart Manufacturing Company

TO THE TEACHER

This **Food Service—Reading and Language Activity Book** has been written primarily for special needs students in the exploratory phase of a vocational program in food services. The book employs basic content material of the food service trade and serves as a vehicle for developing reading and language skills.

Generally, the lessons follow an orderly sequence. However, it is not imperative that they be presented in the order given. It is suggested that an appropriate lesson choice should complement and reinforce the actual shop activity on a given day. For example, if a student is learning how to set a table, the reading lesson relating to that job skill would be the one of choice. The intention here is to refine the basic skills of reading comprehension, vocabulary building, spelling, word usage, and word recognition while relating these skills to some of the information an exploratory student in a food service program must know.

TABLE OF CONTENTS

	Page
Acknowledgments	i
To the Teacher	ii
A New School	1
A New Shop	9
What To Wear	16
Clean Hands, Please	21
Setting the Table: What To Use	28
Dishes and Glassware: How To Hold	36
What Is Flatware?	43
How a Table Is Set	52
Kitchen Work	61
Kinds of Foods	66
Large Kitchen Equipment	74
Small Kitchen Equipment	82

A NEW SCHOOL



Key Words

cafeteria

food services

nervous

permanently

schedule

several

vocational

It was Jim Nelson's first day at the new Best County Vocational School. Jim felt nervous. He sat down with the other new students in homeroom 113. Jim had not been doing very well in school for the past several years. He had failed both English and Math. He had gone to many other schools. None of them met his needs. B.C.V.S. was the first vocational school he had ever been to. Jim hoped that this new school would help him more than the others had. Two of his friends from his old school had already spent one year at B.C.V.S. They told Jim it was the best school they had ever been to.

Mr. Parker, the homeroom teacher, began to read the names of the students in the room. Jim called, "Here!" when he heard his name read. After this Mr. Parker passed out the schedule cards to the students. All the new students would spend one week in each of the school's shops. This would help the students decide which shop was the best for them. After seven to eight weeks they would be placed in one of the shops permanently.

Jim had done some work in the cafeteria at his old school. He had washed dishes, cleaned tables, and stacked supplies. He hoped to get food services as his permanent shop.

Soon the bell rang. The students passed to their first period class. The students in homeroom 113 left their seats and walked out of the classroom.

* * * * *

I. Getting the Main Idea

Directions: Below are three sentences. One of them tells the main idea of what you just read. Put an X next to that sentence.

1. _____ Jim became a food services student.
2. _____ Jim spent his first day at the Best County Vocational School.
3. _____ Jim wanted to quit school.

II. Getting the Meaning from the Context

Directions: Read each sentence carefully. Pay close attention to the dark word. There are three meanings after each sentence. Put an X next to the best meaning for the dark word.

1. Jim Nelson was going to a vocational school to learn a trade.
 - _____ a. having to do with a holiday
 - _____ b. having to do with a job
 - _____ c. having to do with a vacation

2. Jim felt **nervous** and shaky the first day of school.
- _____ a. very much at ease
_____ b. sure of himself
_____ c. not at ease and not sure of himself
3. He went to **several** different schools before.
- _____ a. more than three
_____ b. old
_____ c. new
4. Jim read his **schedule** card to find out what his period class was.
- _____ a. a listing of telephone numbers
_____ b. a listing of students' names
_____ c. a listing of classes with room numbers
5. He hoped to be placed in the shop class **permanently**.
- _____ a. not changing
_____ b. for two weeks
_____ c. for one month
6. He had cleaned the tables in the **cafeteria** at his old school.
- _____ a. a room where movies are shown
_____ b. a room where food is served and eaten
_____ c. a room where basketball is played

7. In the food services shop Jim would make salads, wash dishes, and clean tables.

- _____ a. eating food
- _____ b. all the work that has to do with making and serving food
- _____ c. housework

III. True or False

Directions: Tell whether the following statements are true or false. Label either T or F.

- _____ 1. Jim Nelson was nervous on his first day at B.C.V.S.
- _____ 2. Jim had gone to several other vocational schools before.
- _____ 3. Jim had done well in the other schools he had been to.
- _____ 4. The other schools Jim had gone to really seemed to help him a lot.
- _____ 5. Mr. Parker passed out schedule cards to the students.
- _____ 6. The new students would spend two weeks in each shop.

- _____ 7. Jim wanted to take building maintenance as his permanent shop.
- _____ 8. Mr. Parker was Jim's homeroom teacher.
- _____ 9. Jim had done some work in the cafeteria at his old school.
- _____ 10. Jim had two friends that liked B.C.V.S.

IV. Sentences to Complete

Directions: Below are some sentences. Some words have been left out. Fill in each blank with the correct word from the list.

Word List

cafeteria	schedule
food services	several
nervous	vocational
permanently	

1. Jim Nelson felt _____ as he took a seat in homeroom 113.
2. He had not been doing very well in school for the past _____ years.
3. This was the first _____ school Jim had ever gone to.

4. He hoped to be placed in the _____
_____ shop.
5. Jim had done some work in his old school's
_____.
6. Mr. Parker passed out the _____
cards to his students.
7. The new students would be placed in one of the shops
_____ after 7 or 8
weeks.

V. Vocabulary--Spelling

Directions: Fill in the missing letters in the following words from the story.

1. s _____ e d _____ l _____
2. c _____ f _____ t _____ r _____ a
3. _____ e _____ v _____ s
4. vo _____ a _____ _____ a l
5. s _____ v _____ r _____
6. p _____ m _____ n _____ ly
7. f _____ d s _____ v _____ s

VI. Word-Find Puzzle

Directions: Find the following words in this puzzle. Draw a circle around each word. They may be going across, down, or on a slant. The first word has been found for you.

Words To Find in Puzzle

cafeteria	schedule
food services	several
nervous	vocational
permanently	

P O N D Z H D F T V R C
O E E I T J T O S O O E
G I R L E R A C T C E U
M B V M S P H N A A R L
S E O B A E V F Q T H Y
R P U X D N E A U I N E
N L S U L T E L J O W S
X G L A E S G N N N V K
P E U R C A C O T A Y E
O N I S E V E R A L P L
N A B K Y C M O H T Y A
F O O D S E R V I C E S
I V X B J D F B A U X T

FOR EXTRA CREDIT: Find other words in the puzzle. Circle them and add them to the list above.

A NEW SHOP



Key Words

cafeteria
dining room
kitchen
prepare
serve
trained

Jim Nelson tried out all the shops at Best County Vocational School. He was placed in the Food Services shop permanently. His teacher's name was Mr. Davis. Jim was very happy to be in Mr. Davis's shop class. He had hoped to be trained as a food service worker. There were seven other students in Jim's shop class. Some were boys and some were girls.

Mr. Davis told the students why a food service worker has an important job. "Everyone needs to eat. Someone needs to make the food and serve the food. This is the work of the food service worker," he said.

"To make food ready for people to eat is to prepare food," Mr. Davis explained. "You will help to prepare food. You will put food on dishes. The room where food is prepared is the kitchen."

Jim listened quietly to Mr. Davis as he went on.

"To put food on the table for someone to eat is to serve food," he said. "You will serve food to people when they are ready to eat. The place where food is served and eaten is called the cafeteria or dining room."

Jim remembered working in the cafeteria at his old school. He liked the work he did there.

Mr. Davis told his students, "The food service worker also sets tables. This must be done neatly. Be sure everything is on the tables."

Jim set the table at home once in a while. He wasn't always sure where everything went. He was glad to learn how to do this.

"When everyone is done eating, the food service worker takes the dirty dishes off the tables," Mr. Davis went on. "Then the tables must be washed and dried."

Mr. Davis explained to his students that it was important to do these things well. The students would practice them again and again.

* * * * *

I. Getting the Main Idea

Directions: Below are three sentences. One of them tells the main idea of what you just read. Put an X next to that sentence.

- _____ 1. Jim Nelson learned what work a food service worker must do.
- _____ 2. Jim Nelson learned how to serve food.
- _____ 3. Mr. Davis showed his students how to wash dishes.

II. Getting the Meaning from the Context

Directions: Read each sentence carefully. Pay close attention to the dark word. There are three meanings after each sentence. Put an X next to the best meaning for the dark word.

1. Jim wanted to be trained as a food service worker.
- _____ a. punished
- _____ b. walked
- _____ c. taught skills for a job
2. A food service worker must prepare food for people.
- _____ a. make ready
- _____ b. clean up
- _____ c. throw out

3. Mr. Davis made lunch in the kitchen.
- _____ a. a small box where food is kept
 - _____ b. a place where food is bought
 - _____ c. a room where food is cooked and put on dishes
4. The students set the tables in the dining room.
- _____ a. a place where food is served and eaten
 - _____ b. a place where food is prepared
 - _____ c. a place where food is kept
5. Jim Nelson learned how to serve food to people.
- _____ a. cook
 - _____ b. bake
 - _____ c. put food on the table for someone to eat

III. True or False

Directions: Tell whether the following statements are true or false. Label each either T or F.

- _____ 1. Jim Nelson was placed in the Food Services shop permanently.
- _____ 2. Jim was not very happy to be in Mr. Davis's class.
- _____ 3. Jim did not want to be trained as a food service worker.
- _____ 4. Mr. Davis told his students why a food service worker is important.
- _____ 5. To prepare food means to get it ready for people to eat.
- _____ 6. A food service student learns how to serve food.

- _____ 7. The dining room is where food is cooked.
- _____ 8. A food service worker does not set tables.
- _____ 9. Jim set the table at home once in a while.
- _____ 10. A food service worker takes dirty dishes off tables.

IV. Sentences to Complete

Directions: Below are some sentences. Some words have been left out. Fill in each blank with the correct word from the list.

Word List

cafeteria	prepare
dining room	serve
kitchen	trained

- 1. To make food ready to eat is to _____ food.
- 2. The _____ and _____ are two places where food is eaten.
- 3. The place where food is prepared is called the _____.
- 4. Jim Nelson wanted to be _____ as a food service worker.
- 5. _____ means to put food on the table for someone to eat.

V. Find the Missing Letters

Directions: Below are the words you have been learning, but some of the letters are missing. You are to print the letters in the empty spaces.

1. t r _____ e d

2. k _____ t _____ e n

3. s _____ v _____

4. p _____ p _____ r _____

5. d _____ n _____ r _____ m

6. c _____ e t _____ i a

VI. Word-Find Puzzle

Directions: Find the following words hidden in the puzzle. Draw a circle around each. They may be going across, down or on a slant.

Words to Find in Puzzle

trained

kitchen

serve

cafeteria

prepare

dining room

J M E S N I R D T D E F
R P D N Q U Z I P Z E Y
M O P T R A I N E D L K
R N R Y A V M I R E F A
E L E D I S B N C D O U
H P P O N T E G N I Z P
E C A F E T E R I A K S
S A R C O N K O V M S H
O T E A D I E O L E N K
A U B L T R I M T L T N
A C O C U W S S P T I A
S B H B M P E T O S I R
T E R Y L A D P C A H C
N F W X E F R S J B U P

FOR EXTRA CREDIT: Find other words in the puzzle. Circle them and add them to the list above.

WHAT TO WEAR

KEY WORDS: apron hairnet uniform

Mr. Davis, the Food Services teacher, told his students how they should dress for shop.

"All food service workers must be very clean and neat," he said. "Before you begin working, you must put on a clean uniform. The boys should wear a white shirt and white pants. The girls should wear a white dress. A uniform is worn only at work. It must always be clean and neat."

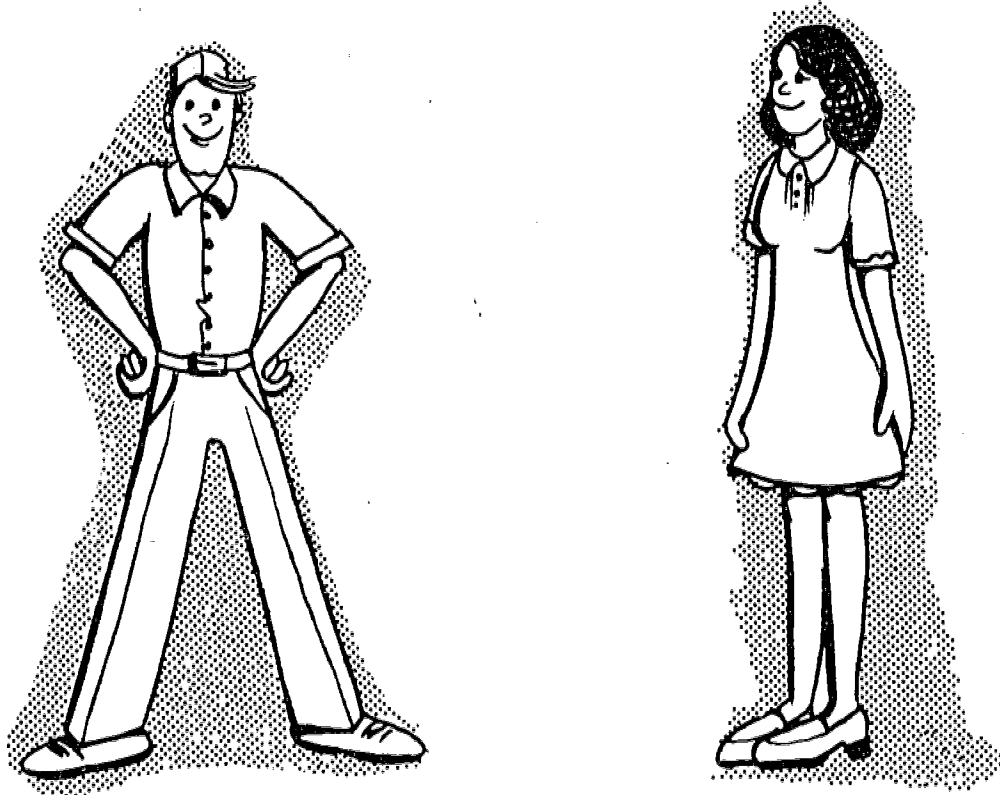

Jim and the other shop students listened as Mr. Davis continued.

"Another item you must wear is a hairnet or hat. A hairnet is worn over your hair. It keeps hair from falling in the food."

"You must also wear a clean apron over your uniform," said Mr. Davis. "An apron helps keep your uniform clean. If your apron gets dirty, you should put on a clean one."



* * * * *

I. Getting the Main Idea

Directions: Below are three sentences. One of them tells the main idea of what you just read. Put an X next to that sentence.

1. _____ Mr. Davis told his students how to wear an apron.
2. _____ Mr. Davis told his students how to comb their hair.
3. _____ Mr. Davis told his students how a food service worker should dress.

II. Getting the Meaning from the Context

Directions: Read each sentence carefully. Pay close attention to the dark word. There are three meanings after each sentence. Put an X next to the best meaning for the dark word.

1. The food service worker wears a clean, white uniform on the job.

_____ a. certain clothes worn only at work
_____ b. a type of pan
_____ c. handkerchief

2. You should always wear a hairnet when you prepare food.

_____ a. a net used for making tuna fish
_____ b. a raincoat
_____ c. a net worn over your hair to keep it in place

3. An apron keeps the food service worker's clothes clean.

_____ a. a brush used in the kitchen
_____ b. something worn over the front of your clothes to keep them clean
_____ c. a type of whisk broom

III. Sentences to Complete

Directions: Below are some sentences. Some words have been left out. Fill in each blank with the correct word from the list.

Word List

apron

hairnet

uniform

1. She wears a _____ to keep her hair out of the food.
2. The clothing you wear only at work is called a _____.
3. An _____ helps to keep your clothing clean.

IV. Find the Missing Letters

Directions: Fill in the missing letters in the following words from the story.

1. _____ p _____ n
2. h _____ n _____ t
3. _____ i f _____ m

V. **Word—Find Puzzle**

Directions: Find the following words in the puzzle. Draw a circle around each. They may be going across, down, or on a slant.

Words To Find In Puzzle

apron

hairnet

uniform

I	E	T	O	F	N	W	R	M	E
O	A	R	S	L	E	L	E	U	P
E	C	C	D	U	N	T	N	D	R
H	T	G	I	W	E	I	T	S	N
L	A	R	N	R	F	Z	A	L	B
Y	S	I	K	O	Z	J	P	T	Z
N	J	U	R	A	H	S	R	B	O
R	A	M	E	N	T	F	O	M	A
T	O	S	P	O	E	V	N	N	I
U	L	K	M	B	S	T	I	T	C

FOR EXTRA CREDIT: Find other words in the puzzle. Circle them and add them to the list above.

CLEAN HANDS, PLEASE

KEY WORDS: paper towel rinse sink

"Food Service workers must have clean hands," Mr. Davis told his students. "They touch food as they work. Other people eat this food. You, too, must have clean hands. Before you start working, you should wash your hands like this."

Mr. Davis went to the sink. Jim Nelson and the other food service students watched.

"First, wet your hands like this," he said.
"Use very hot water."

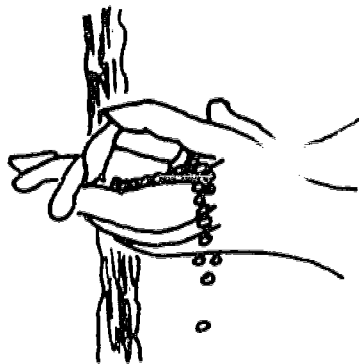
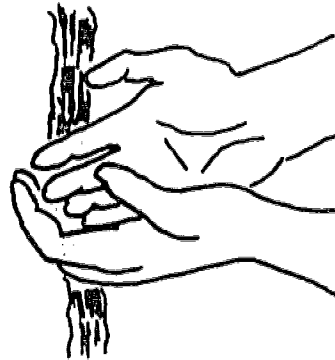

"Second, rub soap on your hands. Be sure to get soap under your fingernails and between your fingers."

“Third, make sure you use running water. Do not fill the sink with water. Use a brush to clean dirt spots that do not come off.”

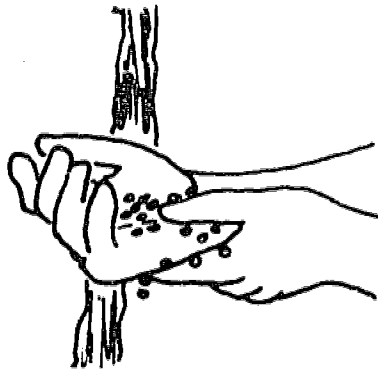
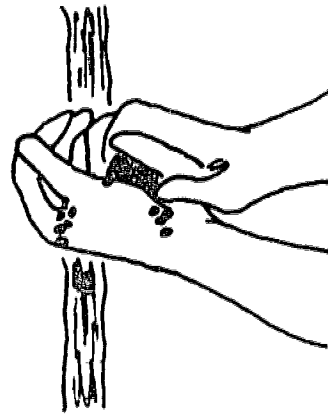

“Fourth, rub your hands together, back and forth and around and around,” Mr. Davis showed his students. “Wash all the way up to your elbows.”

“Put your fingers together and rub back and forth. Then rinse your hands well under the running water.”

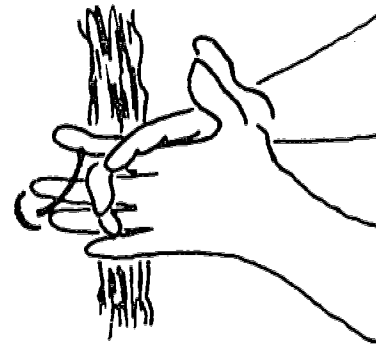

“Lastly, dry your hands well with a paper towel.”

Jim Nelson and the other students then washed their hands.
They were now ready to start work.

* * * * *

I. Getting the Main Idea

Directions: Below are three sentences. One of them tells the main idea of what you just read. Put an X next to that sentence.

1. _____ Jim Nelson learned the best way to cut his fingernails.
2. _____ Mr. Davis showed Jim and the other students how to wash their hands.
3. _____ The students learned how to make a lunch.

II. Getting the Meaning from the Context

Directions: Read each sentence carefully. Pay close attention to the dark word(s). There are three meanings after each sentence. Put an X next to the best meaning for the dark word(s).

1. He washed his hands in the sink.
_____ a. shop
_____ b. a basin that has running water and a drain
_____ c. a dishpan
2. Mr. Davis had to then rinse the soap off his hands.
_____ a. scrub
_____ b. scrape
_____ c. wash off with water

3. He dried his hands with a paper towel.
- _____ a. a piece of special paper used for drying
- _____ b. newspaper
- _____ c. dish rag

III. Find the Right Order

Directions: Below are listed all the steps that the students followed in washing their hands. They are all mixed up. Put them in the right order by writing the letter on the blank line next to the correct step no. The first one has been done to get you started.

- | | Step No. |
|--|----------------------|
| A. Rub soap on hands. | |
| B. Dry hands with a paper towel. | 1. <u> D </u> |
| C. Use a brush to clean dirt spots that do not come off. | 2. <u> </u> |
| | 3. <u> </u> |
| D. Wet hands with very hot water. | 4. <u> </u> |
| E. Rinse hands well under running water. | 5. <u> </u> |
| F. Rub hands together, back and forth and around and around. | 6. <u> </u> |

IV. True or False

Directions: Tell whether the following statements are true or false. Label either T or F.

- _____ 1. Use cold water to wash your hands.
- _____ 2. You should put soap under your fingernails when washing your hands.
- _____ 3. The sink should be filled with water.
- _____ 4. You should wash all the way up to your elbows.
- _____ 5. The food service students washed their hands before starting work.
- _____ 6. Use a cloth to clean dirt spots that are hard to get off.
- _____ 7. Rinse your hands with soap and water.
- _____ 8. Dry your hands with a paper towel.
- _____ 9. A food service worker must have clean hands.
- _____ 10. Use running water to rinse your hands.

V. Find the Missing Letters

Directions: Fill in the missing letters in the following words from the story.

1. _____ a _____ _____ r t _____ _____ el

2. _____ in _____ e

3. _____ in _____

VI. **Word--Find Puzzle**

Directions: Find the following words in the puzzle. Draw a circle around each. They may be going across, down, or on a slant.

Words to Find in Puzzle

paper towel

rinse

sink

R I W S C A U D L M S L
G T P O E G L I S N T E
C L N A O D S O I F E A
A C E G P I J H N F D B
K M O Q U E Z S K P N L
D C I N R P R Y A O T I
S O E A Y I P T G R P A
F N R A N L S I O N G I
J I E S R P E Y L W N M
C F E R A E B I O T E A
R C T H G V C I N K O L

FOR EXTRA CREDIT: Find other words in the puzzle. Circle them and add them to the list above.

SETTING THE TABLE: WHAT TO USE

KEY WORDS:	dishes	mealtime	saucer
	glassware	platter	

One of the first jobs that Jim Nelson learned was how to set a table. First, though, he had to learn the names of the dishes and glassware used. Mr. Davis showed Jim and the other students the different kinds of dishes.

"When we speak of dishes, we mean all the plates, cups, bowls, and platters used at the table," said Mr. Davis. "The dishes are kept in the kitchen. They must be brought to the dining room at mealtime. Let's look at the dishes we will use."

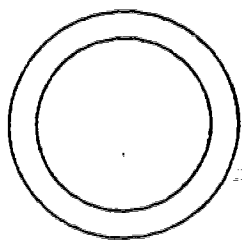

Dinner Plate

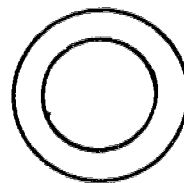

Bread and Butter Plate

or

Salad Plate



Saucer



Dessert Dish

or

Vegetable Dish



Sherbet Dish



Cup

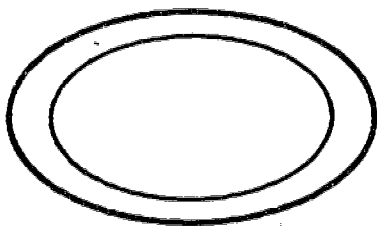

Platter

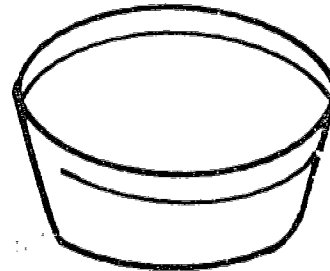

Bowl

"We also need **glassware** to set the table," explained Mr. Davis. "Glassware is all the glasses used at the table. We use two sizes of glasses. A large glass is used for milk or water. A small glass is used for juice. Glassware is kept in the kitchen. It is brought into the dining room when we set the table."

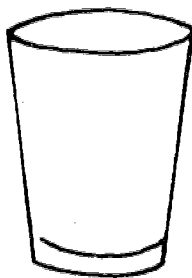

Milk or Water Glass



Juice Glass

I. **Getting the Main Idea**

Directions: Below are three sentences. One of them tells the main idea of what you just read. Put an X next to that sentence.

_____ 1. Jim Nelson and the other shop students learned the names of dishes and glassware used to set the table.

_____ 2. Mr. Davis explained how to make a salad.

_____ 3. Mr. Davis told his students how to wash glassware.

II. **What Is Its Name?**

Directions: Dishes and glassware used to set the table are shown on the next page. Write the name of each on the lines given, using the word list.

Word List

bread and butter plate	dinner plate
platter	sherbet dish
cup	juice glass
saucer	dish or vegetable dish
bowl	milk or water glass

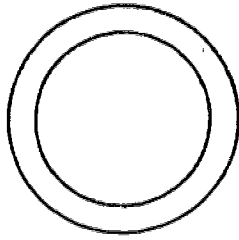

1. _____

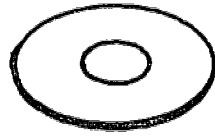

2. _____



3. _____

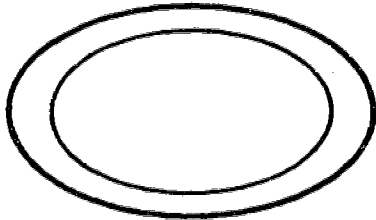

4. _____

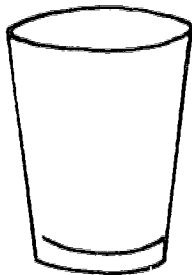

5. _____

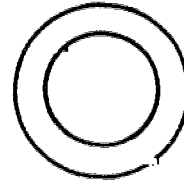

6. _____



7. _____



8. _____

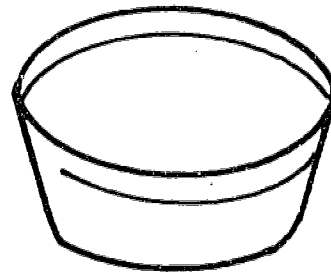

9. _____



10. _____

III. True or False

Directions: Tell whether the following statements are true or false. Label either T or F.

- _____1. A dessert dish is also used for vegetables.
- _____2. A bread and butter plate is placed under a cup.
- _____3. Glassware means all the glasses we use at the table.
- _____4. A platter is a large plate used for serving food.
- _____5. A salad plate is the same as a bread and butter plate.
- _____6. A saucer is usually placed under a cup.
- _____7. A large glass is usually used for juice.
- _____8. A small glass is used for milk or water.
- _____9. Dishes and glassware are kept in the kitchen.
- _____10. One of the first jobs Jim learned was setting a table.

IV. Sentences to Complete

Directions: Below are some sentences. Some words have been left out. Fill in each blank with the correct word from the list.

Word List

dishes

glassware

mealtime

platter

saucer

1. A _____ is a large plate used for serving food.
2. A table is set at _____.
3. A _____ is placed under a cup.
4. All the glasses used at the table are called _____.
5. _____ are all the plates, cups, bowls, and platters used at the table.

V. Find the Missing Letters

Directions: Fill in the missing letters in the following words from the story.

1. m _____ l _____ i _____ e

2. d i _____ s

3. _____ a t _____ r

4. g l _____ w a _____

5. s _____ c e _____

VI. **Word-Find Puzzle**

Directions: Find the following words in this puzzle. Draw a circle around each word. They may be going across, down, or on a slant.

Words to Find in Puzzle

dishes glassware mealtime platter saucer
dessert bowl cup plate

J A D I T C L Y P N E G
O T P J L E A T T C N L
B C H L P L C J A V H A
O D I S A U C E R W P S
W H T R P T L P L L V S
L J D I U C E B A Q U W
T T I F J P R T Y U I A
D E S S E R T D H A E R
N B H E M E A L T I M E
A D E B R R C N O A R N
T M S R Z H L T A A S A

FOR EXTRA CREDIT: Find other words in the puzzle. Circle them and add them to the list above.

DISHES AND GLASSWARE: HOW TO HOLD

KEY WORDS:	correctly
	surfaces
	handles
	edges
	sanitary

After learning the names of the different kinds of dishes and glassware, Jim learned how to hold them **correctly**. Mr. Davis explained to his students certain rules for doing this.

"Plates and platters are held by the sides," he said. "You should never put your thumb or fingers on the surfaces."

Mr. Davis picked up a plate correctly to show his students.

"You should pick up cups by the **handles**," he told his students. "Never put your fingers inside the cup. This is not **sanitary**."

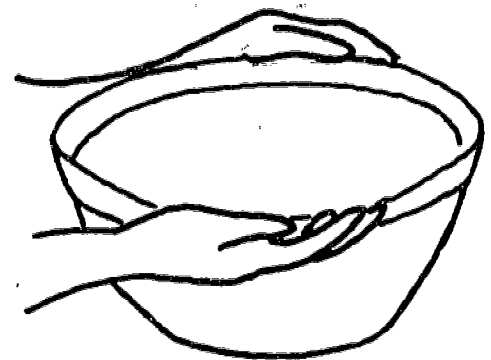

"Bowls should be held by the sides. It is important to keep your fingers out of the bowl."

"You should carry glassware by the bottom," Mr. Davis said. "Never stack glasses. Never hold glasses by the top edges. This is not sanitary. Someone will put the top edge in his mouth to drink from the glass."

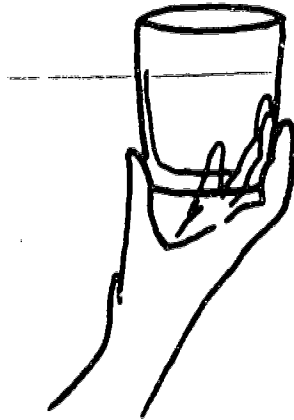

Jim Nelson could see why it was important to hold dishes and glassware correctly. By following the rules that Mr. Davis explained, dishes and glassware could be kept clean.

* * * * *

I. Getting the Main Idea

Directions: Below are three sentences. One of them tells the main idea of what you just read. Put an X next to that sentence.

- _____ 1. Mr. Davis showed his students how to stack glassware.
- _____ 2. Mr. Davis explained rules for holding dishes and glassware.
- _____ 3. Mr. Davis showed his students how to wash dishes and glassware.

II. Getting the Meaning from the Context

Directions: Read each sentence carefully. Pay close attention to the dark word. There are three meanings after each sentence. Put an X next to the best meaning for the dark word.

1. Jim held the platter **correctly**.
- _____ a. the right way
- _____ b. upside down
- _____ c. the wrong way
2. Do not put your fingers on the eating **surface** of the plate.
- _____ a. the rim
- _____ b. the handle
- _____ c. the flat side of the plate where the food is placed

3. He held the cups by the handles.
- _____ a. the parts that stick out so something can be held
 - _____ b. the sides
 - _____ c. the insides
4. You should not put your fingers on the top edge of a glass.
- _____ a. side
 - _____ b. the top rim
 - _____ c. corner
5. It is not sanitary to put your fingers inside the bowl.
- _____ a. proper
 - _____ b. nice
 - _____ c. clean and germ free

III. True or False

Directions: Tell whether the following statements are true or false. Label either T or F.

- _____1. You should put your fingers on the surfaces of plates.
- _____2. Mr. Davis showed his students how to hold dishes and glassware correctly.
- _____3. Glassware should be held by the bottom.

4. Bowls should be held by the insides.
5. Glasses should always be stacked.
6. Hold cups by the handles.
7. It is not sanitary to put your fingers inside a cup.
8. Jim knew it was not important to follow the rules Mr. Davis explained.

IV. Sentences to Complete

Directions: Below are some sentences. Some words have been left out. Fill in each blank with the correct word from the list.

Word List

correctly sanitary
edges surfaces
handles

1. Jim Nelson held the cups by the _____.
2. Do not put your fingers on the top _____
of the glasses.
3. He knew not to put his fingers on the eating
_____ of the plates.

4. It isn't _____ to
put your fingers inside the cup.

5. Jim held dishes and glassware _____.

V. Find the Missing Letters

Directions: Fill in the missing letters in the following words from the story.

1. e _____ g _____ s

2. h _____ _____ le _____

3. _____ a n _____ t _____ r _____

4. _____ o r _____ e _____ t _____

5. s _____ f _____ e s

VI. **Word-Find Puzzle**

Directions: Find the following words in this puzzle. Draw a circle around each word. They may be going across, down, or on a slant.

Words to Find in Puzzle

correctly edges handles sanitary surfaces

L C A F N E O V G U P I
S E I T I V I T C A H U
E C N S A N E T N A I R
N A O U M S S E N K B A
R M S R W A K D F D R S
J F K F R H L H J E A C
G F R A M E N T C N W M
W R P C S G C B I B A K
E D G E S O C T C U P A
T A L S N O A D L E V L
O I M N P R O R T Y E P
G A B R Y D M E J O E O

FOR EXTRA CREDIT: Find other words in the puzzle. Circle them and add them to the list.

WHAT IS FLATWARE?

KEY WORDS:	dessert fork	serving spoon
	dinner fork	silverware
	flatware	soup spoon
	knife	tablespoon
	ladle	teaspoon
	salad fork	tines

“Another item used to set a table is **flatware**,” said Mr. Davis. “Flatware is sometimes called **silverware** or **silver**. It is another name for all knives, forks, and spoons used on the table.”

Jim Nelson and the other shop students looked at each piece of flatware that Mr. Davis showed them.

Look at them yourself below:



knife



dinner fork



teaspoon



tablespoon or serving spoon

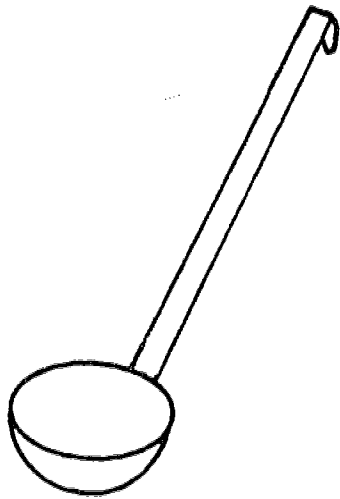

ladle



salad fork or dessert fork



soup spoon

"The dinner fork is used to eat the main part of a meal," explained Mr. Davis. "It has longer tines than the salad or dessert fork. The tines are the prongs that we stick into the food to pick it up from the plate.



"Another piece of flatware is called a ladle," Mr. Davis continued. "It is used to serve soup. A ladle is usually used in the kitchen. It is not placed on the table with the other pieces of flatware."

"Now that we know the names of the flatware pieces, we are now ready to set the table."

* * * * *

I. **Getting the Main Idea**

Directions: Below are three sentences. One of them tells the main idea of what you just read. Put an X next to that statement.

1. _____ Jim Nelson learned the names of the different pieces of flatware.
2. _____ Jim Nelson learned how to set a table correctly.
3. _____ Jim Nelson learned how to serve soup.

II. **What Is Its Name?**

Directions: Below are pictured different pieces of flatware. Write the names of each on the lines given using the word list.

Word List

dessert or salad fork dinner fork knife
ladle soup spoon tablespoon or serving spoon
teaspoon







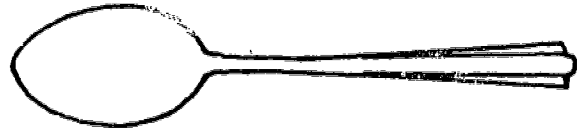

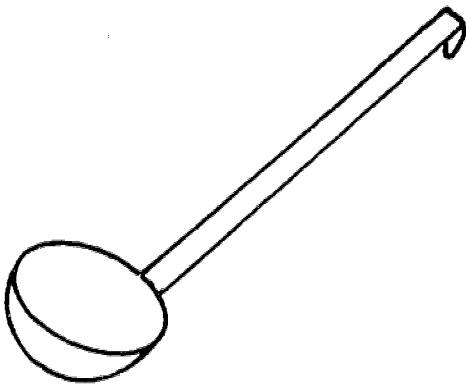





III. True or False

Directions: Tell whether the following statements are true or false. Label either T or F.

- _____ 1. A ladle is used to serve soup.
- _____ 2. A soup spoon is used for eating salad.
- _____ 3. Another name for flatware is silverware.
- _____ 4. A tablespoon is sometimes called a serving spoon.
- _____ 5. A teaspoon is larger than a tablespoon.
- _____ 6. A dinner fork is used to eat the main meal.
- _____ 7. A dessert fork can also be used to eat salad.
- _____ 8. A salad fork is larger than a dessert fork.

IV. Sentences to Complete

Directions: Look at the sentences below. Some words have been left out. Fill in each blank with the correct word(s) from the list.

Word List

dinner fork ladle
flatware soup spoon
knife tablespoon
teaspoon

1. A spoon which is smaller than a tablespoon is a _____.
2. We use a _____
to eat soup.
3. A serving spoon is also called a _____.
4. A _____ is used for cutting food.
5. We use a _____
for eating the main meal.
6. A _____ is used
for serving soup.
7. _____ is
a name for all the knives, forks, and spoons used on the table.

V. Find the Missing Letters

Directions: Fill in the missing letters in the following words from the story.

1. _____ a _____ l _____
2. k _____ i _____ e
3. _____ a _____ l _____ s _____ o _____ n
4. d _____ n _____ e _____ _____ o r _____
5. s _____ l _____ _____ f _____ _____ k
6. _____ l _____ t _____ a _____ e
7. t _____ n _____ s
8. s _____ _____ p _____ _____ o o n
9. t _____ _____ s _____ o _____ n
10. s _____ l _____ e _____ w _____ _____ _____

VI. **Word-Find Puzzle**

Directions: Find the following words in this puzzle. Draw a circle around each word. They may be going across, down, or on a slant.

Words to Find in Puzzle

dessert fork	serving spoon
dinner fork	silverware
flatware	soup spoon
knife	tablespoon
ladle	teaspoon
salad fork	tines

S A L A D F O R K D R I C O T L
D E S S E R T F O R K F T A A Y
A T R U B S X R J N P Z Z U B N
F E S V C L K H O X V D K T L K
L A N D I N N E R F O R K C E V
A S O T I N E S L O Y T A G S O
T P C F H E G R S C O U L E P E
W O E D E C C S O U P S P O O N
A O I C N Y L O P E I D A N O F
R N L A D L E X J O X B Y T N K
E J D Q U I N V E E O N D Q U P
S I L V E R W A R E W N Y I N E
A C N U T A P A L P L E A T E C
S U E T C I D W N O V T A N D T

FOR EXTRA CREDIT: Find other words in the puzzle. Circle them and add them to the list above.

HOW A TABLE IS SET

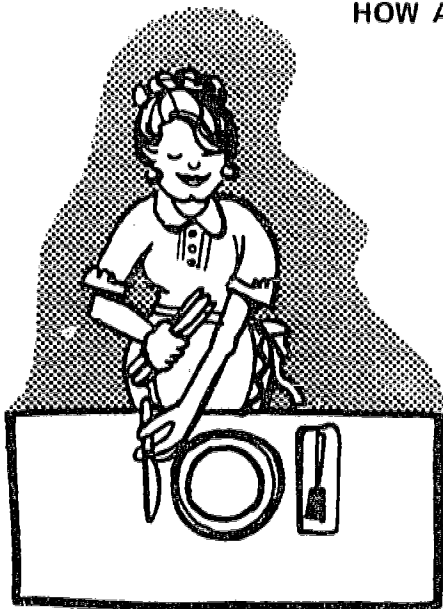

KEY WORDS

blade
bowl
inch
napkin
toward

Jim and the other Food Service students knew about dishes, glassware, and flatware. Now they were ready to learn how to set a table.

Mr. Davis showed his students how it was done.

"Each place setting should look the same for one meal," he said, "and each must be neat. The dinner plate is placed one inch from the edge of the table."

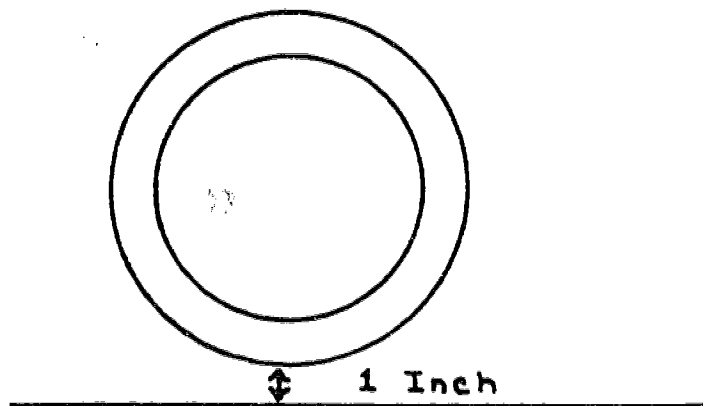

58

52

“The knife is placed to the right of the dinner plate,” he continued. “The sharp edge of the knife’s blade is placed toward the plate. You should always lay the knife one inch from the table’s edge.”

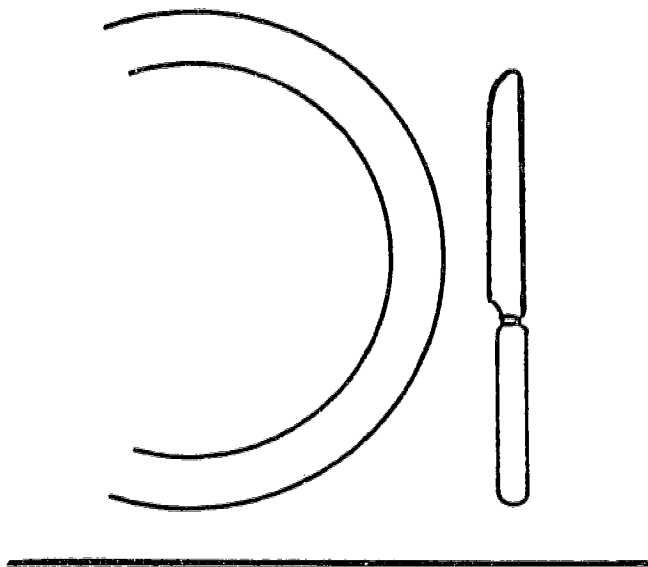

“The teaspoon is placed to the right of the knife. It should be one inch from the edge of the table.”

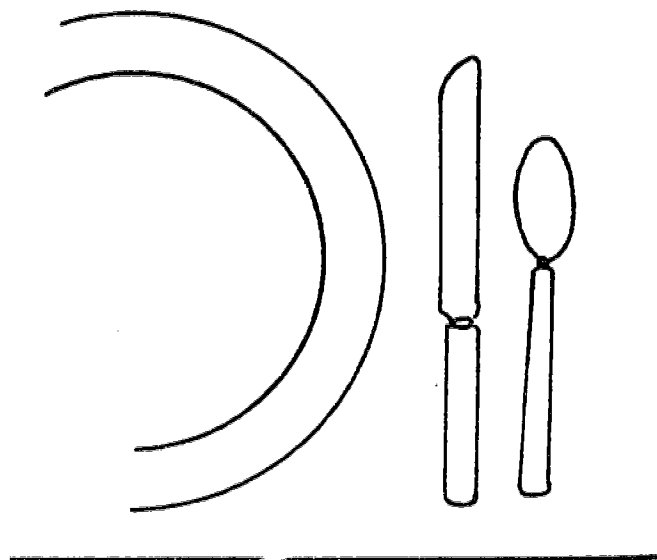

“The fork is put to the left of the dinner plate. It should be one inch from the edge of the table. Make sure the tines of the fork are turned up.”

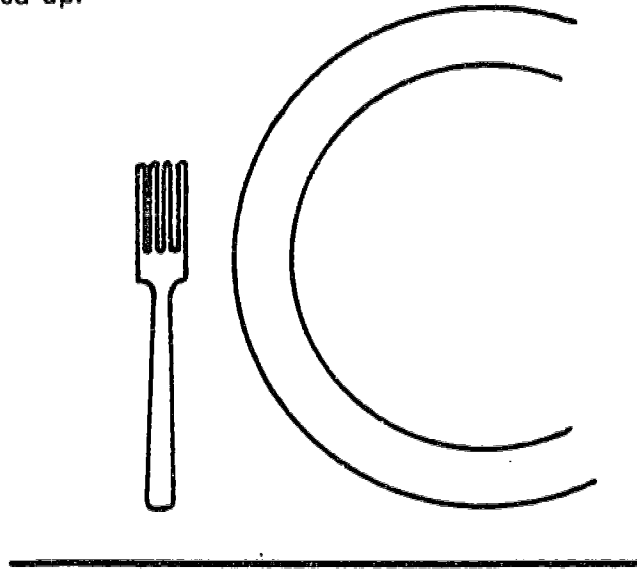

“The napkin is placed to the left of the fork. The open corner of the napkin should be placed at the lower right, about one inch from the table’s edge.”

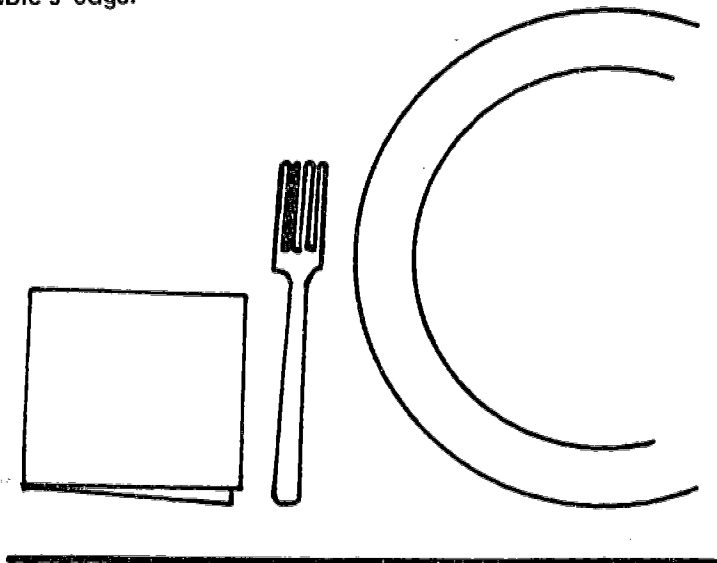

"The water or milk glass goes at the top of the knife. There should be a one inch space between the tip of the knife and the glass."

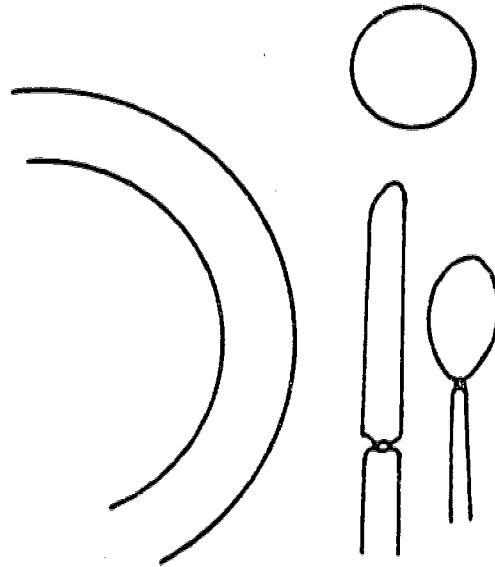

"The cup and saucer is put to the right of the teaspoon. The cup should be even with the bowl of the spoon. The handle of the cup should be turned a little toward the bottom edge of the table."

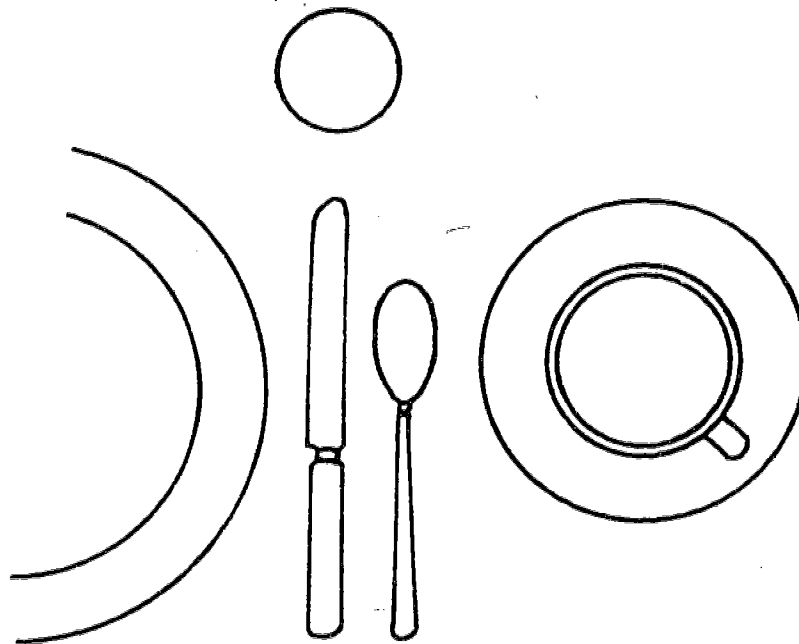

After Mr. Davis showed his students how to set a table, they practiced doing it themselves.

I. **Getting the Main Idea**

Directions: Below are three sentences. One of them tells the main idea of what you just read. Put an X next to that sentence.

 1. Jim Nelson and the other Food Service students learned how to use a knife.

 2. Mr. Davis explained how to fold a napkin.

 3. Jim Nelson and his classmates learned how to set a table correctly.

II. **Word Meaning Matching**

Directions: Using the glossary below, match the words in column A with those that go with them in column B. Write the correct letter from column B on the lines in column A.

Glossary

blade – the part of a knife that cuts the food

bowl – the round part of a spoon that holds the food

inch – a unit of length

napkin – a piece of cloth or paper you use to keep your mouth clean while eating

toward – near or facing something

Column A

Column B

- | | |
|-----------------|-------------------|
| _____ 1. inch | a. spoon |
| _____ 2. blade | b. facing |
| _____ 3. napkin | c. cloth or paper |
| _____ 4. bowl | d. ruler |
| _____ 5. toward | e. knife |

III. True or False

Directions: Tell whether the following statements are true or false. Label each either T or F.

- _____ 1. Each place setting should look the same.
- _____ 2. The knife is placed to the left of the dinner plate.
- _____ 3. The dinner plate should be placed one inch from the edge of the table.
- _____ 4. The water or milk glass goes at the top of the knife.
- _____ 5. The napkin is placed to the right of the fork.
- _____ 6. The teaspoon is placed to the right of the knife.
- _____ 7. The cup and saucer goes to the right of the fork.
- _____ 8. The fork is placed to the right of the dinner plate.

9. The blade of the knife should be placed toward the spoon.

10. All of the flatware in a place setting should be one inch away from the table's edge.

IV. Sentences to Complete

Directions: Below are some sentences. Some words have been left out. Fill in each blank with the correct word(s) from the list.

Word List

blade inch toward
bowl napkin

1. The _____ of the teaspoon is the round part which holds the food.
2. The _____ goes to the left of the fork.
3. The _____ of the knife is placed _____ the plate.
4. The plate should be placed about one _____ from the edge of the table.

V. Find the Missing Letters

Directions: Fill in the missing letters in the following words from the story.

1. _____ a _____ k _____ n

2. t _____ w _____ r _____

3. b _____ _____ l

4. _____ l _____ _____ e

5. i _____ c _____

VI. **Word-Find Puzzle**

Directions: Find the following words in this puzzle. Draw a circle around each word. They may be going across, down, or on a slant.

Words to Find in Puzzle

blade napkin toward
bowl inch

B M A K E R E R A S B E P U
Z L Z L E O C C U O P A T I
O N A C A K E J W U N L Y O
L H O D S T B L R O C K T O
N K G S E L A N T A R O T U
N D N A P K I N F A R R O E
F O O D S M N E A T U P W E
W V R A T E C F I S H I A O
H E A D E E H P U B L S R W
I R O G C T H E R R I D D N
S E N I O R V I C E P R E S
J A M Z E O M C P T B A R K
W L I M E S M N A S K A L I

FOR EXTRA CREDIT: Find other words in the puzzle. Add them to the list.

KITCHEN WORK

KEY WORDS: cook
portion
tools

"The kitchen is where we prepare the food," Mr. Davis told his class. "It is here that food is made ready for people to eat."

"The food service worker helps the cook prepare the food. The **cook** is the person in the kitchen who prepares the meats, vegetables, and other foods. The food service worker puts food on dishes. To put food on dishes for serving in the dining room is to **portion** food."



"There are many different kinds of foods," continued Mr. Davis. "Each food is portioned in a certain way. You will learn what tools and dishes we use to portion food."

I. **Getting the Main Idea**

Directions: Below are three sentences. One of them tells the main idea of what you just read. Put an X next to that sentence.

 1. Mr. Davis told his students what work is done in the kitchen.

 2. Mr. Davis named all the tools used for portioning.

 3. Jim Nelson learned how to cook a portion of food.

II. **Getting the Meaning from the Context**

Directions: Read each sentence carefully. Pay close attention to the dark word. There are three meanings after each sentence. Put an X next to the best meaning for the dark word.

1. Jim Nelson would help the **cook** prepare food in the kitchen.

 a. an oven

 b. the person who prepares all meats, vegetables, and other foods

 c. a person who waits on tables

2. He would learn how to portion different kinds of food.

_____ a. to divide food into parts and put them on dishes.

_____ b. to wrap

_____ c. to bake

3. Jim would learn what tools to use to prepare food.

_____ a. skills

_____ b. temperature

_____ c. things you use to do a certain job

III. True or False

Directions: Tell whether the following statements are true or false. Label either T or F.

_____ 1. Food is served in the kitchen.

_____ 2. A cook is a kitchen tool.

_____ 3. Food service workers help cooks prepare food.

_____ 4. Food service workers portion food.

_____ 5. Food is prepared in the kitchen.

_____ 6. Tools are not used to portion food.

IV. Sentences to Complete

Directions: Below are some sentences. Some words have been left out. Fill in each blank with the correct word from the list.

Word List

cook

portion

tools

1. We use all kinds of _____ in the kitchen.
2. One of the jobs of a food service worker is to _____ food.
3. A food service worker helps the _____ prepare food.

V. Fill in the Missing Letters

Directions: Fill in the missing letters in the following words from the story.

1. _____ o _____ k
2. t _____ l _____
3. p _____ t _____ n

VI. Crossword Puzzle

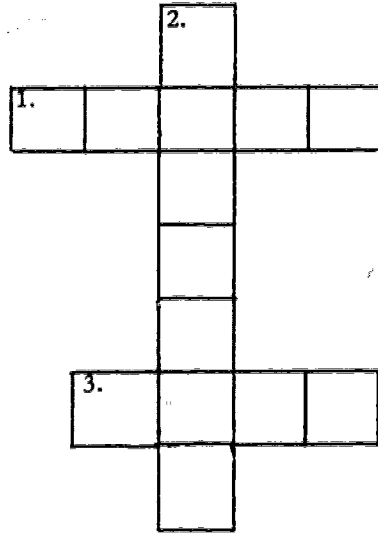

ACROSS

DOWN

- | | |
|---|--|
| 1. things used to do
a certain job | 2. to divide into parts
and put into dishes |
| 3. the person who prepares
food in the kitchen | |

KINDS OF FOODS

KEY WORDS:	beverages	poultry
	cereal	refrigerator
	fish	salads
	freezer	sandwiches
	fruit	starches
	heat	temperature
	meat	vegetables

"In food services we work with two kinds of food," said Mr. Davis to his students. "One is hot food. The other is cold food."

"The food service worker helps the cook prepare hot food. The food service worker portions hot food and then serves it to people."

"Some examples of hot food are:"

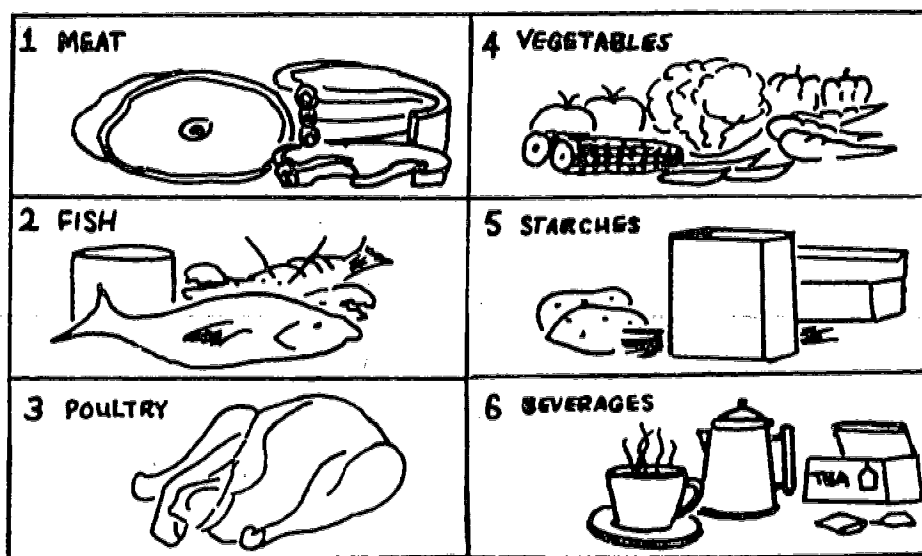

"Hot foods must be kept in places where they will stay warm," continued Mr. Davis. "They should be served hot."

"Cold foods are prepared by either the cook or the food service worker. Cold foods do not need to be heated. Some cold foods need to be put in a refrigerator or freezer to keep them fresh. Other cold foods can be kept at room temperature."

"Some examples of cold food are:"

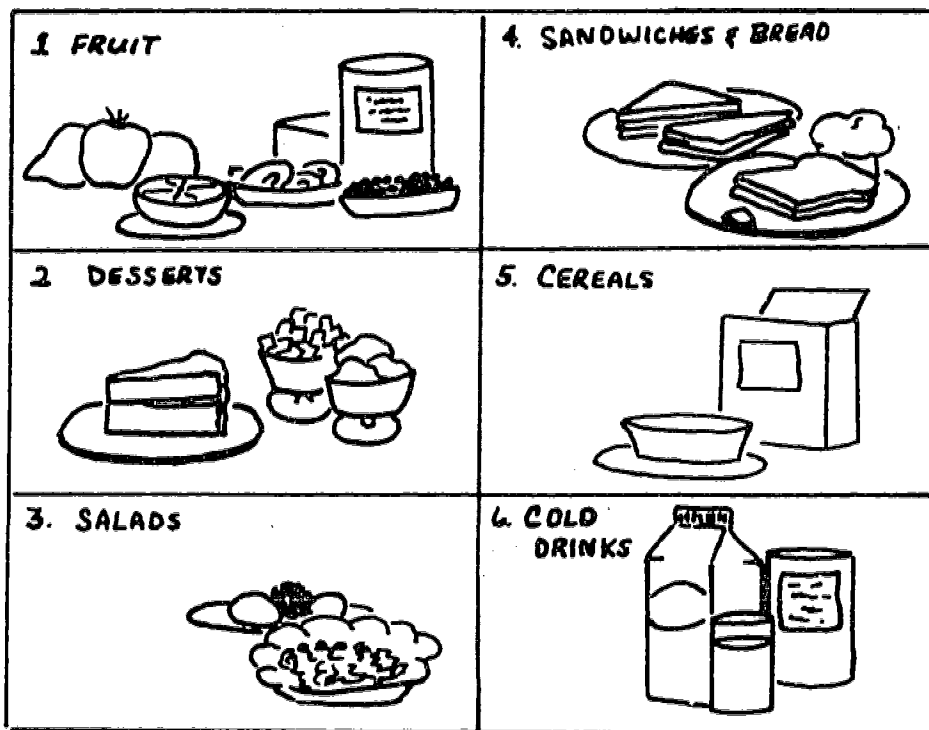

* * * * *

I. Getting the Main Idea

Directions: Below are three sentences. One of them tells the main idea of what you just read. Put an X next to that sentence.

 1. Jim Nelson learned how to freeze foods.

 2. Jim Nelson helped the cook prepare a meal.

 3. Mr. Davis talked about hot and cold foods.

II. Word Meaning Matching

Directions: Read the glossary below. Use it to match the words in column A with those that go with them in column B. Write the correct letter from column B on the blank lines in column A.

Glossary

beverage – something to drink like milk, coffee, or tea

cereal – a food made from grains like corn flakes, oatmeal, or shredded wheat

freezer – a box that keeps food so cold that the food becomes hard

poultry – foods like chicken, turkey or duck

refrigerator – a box that keeps cold foods cold

starches – foods like potatoes or rice

temperature – how hot or cold something is

Column A

Column B

_____ 1. freezer

a. chicken

_____ 2. temperature

b. coffee

_____ 3. starches

c. ice cubes

_____ 4. beverage

d. hot or cold

_____ 5. cereal

e. keeps food cold

_____ 6. poultry

f. rice

_____ 7. refrigerator

g. bran flakes

III. True or False

Directions: Tell whether the following statements are true or false. Label either T or F.

1. Hot foods are kept in the refrigerator.
2. The food service worker helps the cook prepare hot food.
3. Some cold foods can be kept at room temperature.
4. Cold foods always need to be heated.
5. A salad is a hot food.
6. Potatoes and noodles are starches.
7. Milk is a beverage.
8. Ice cream is kept in a freezer.
9. Cold foods are prepared only by the cook.
10. The food service worker portions hot food and serves it to people.

IV. Spelling Stairway

Directions: Fill in the missing letters in the boxes below to complete the words going across. The words you need are listed below.

Word List

- freezer beverages fruit
- salads temperature fish
- refrigerator starches vegetables

F			H								
F				T							
S					S						
F						R					
S							S				
B								S			
V									S		
T										E	
R											R

V. Sentences to Complete

Directions: Below are some sentences. Some words have been left out. Fill in each blank with the correct word(s) from the list.

Word List

beverages

freezer

poultry

refrigerator

starches

temperature

1. Cold foods are kept fresh by putting them in either a _____ or a _____.
2. Coffee, tea, and milk are _____.
3. Some cold foods can be kept at room _____.
4. Chicken and turkey are two kinds of _____.
5. Mashed potatoes and rice are two kinds of _____.

VI. Word-Find Puzzle

Directions: Find the following words in the puzzle. Draw a circle around each. They may be going across, down or on a slant.

Words to Find in Puzzle

beverages
cereal
fish
freezer
fruit
heat
meat

poultry
refrigerator
salads
sandwiches
starches
temperature
vegetables

A F R E E Z E R C C E N B S T
U A M T I N S I D I O E U A S
A B S E O L U T E L V W I N S
E S A L A D S U N E E C O D M
M O C N D T E V R I G H C W E
C O P E Y W R A I G E H T I D
U R E F R I G E R A T O R C N
D E I R M E I N T Y A O U H R
C S A L S O A U F S B N E E S
H W E H O L D L R T L H E S E
T E M P E R A T U R E C O N S
R U T H S T O B I E S T N C O
T A T U P O U L T R Y I A E W
S T A R C H E S E R A T S K Z

LARGE KITCHEN EQUIPMENT

KEY WORDS:	coleslaw
	equipment
	food chopper
	food slicer

"When we work in the kitchen we need to use special machines and tools," Mr. Davis told his students. "Equipment is the machines and tools we use to do different jobs."

"Some of the larger pieces of equipment make our work easier to do. The food slicer is used to cut meat, cheese, and other foods into slices. These slices can be used for making sandwiches. The food slicer has a very sharp, round blade. This does the cutting. It can make thin slices or thick ones."

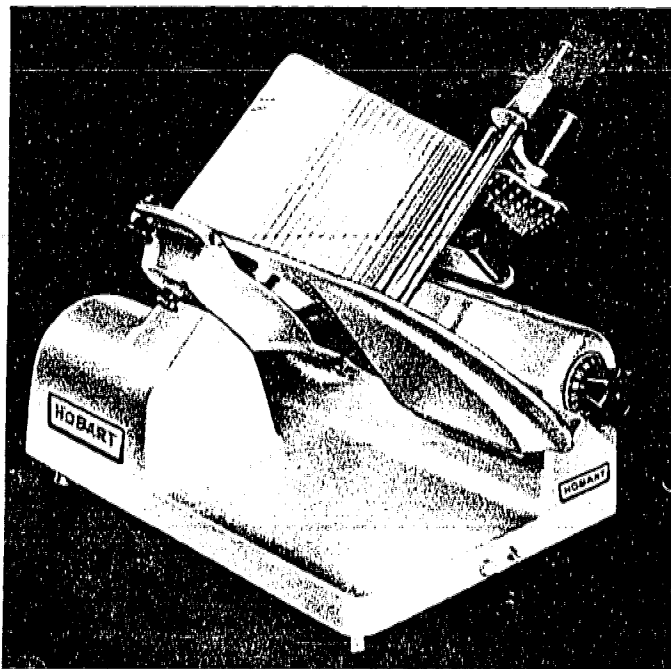

Courtesy of Hobart Mfg. Co.

"Another large machine is the mixer," continued Mr. Davis. "The mixer is used for mixing, beating, and whipping food. We use the mixer to make whipped cream. The mixer has three parts: mixing bowls, beaters, and the machine."

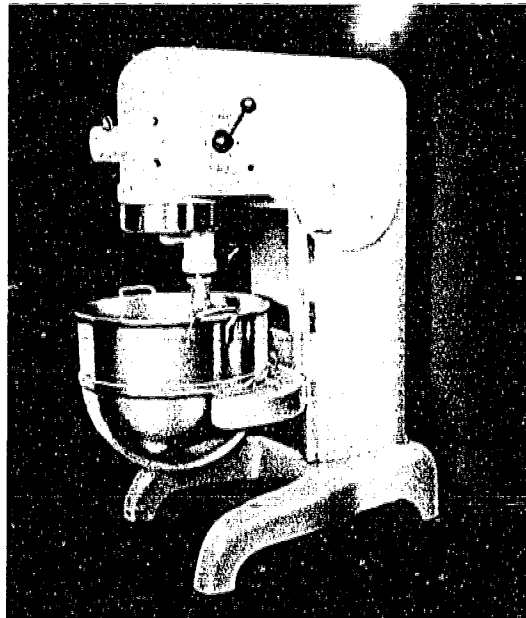

"When we need to cut food into small pieces, we use a food chopper," said Mr. Davis. "The food chopper is used to prepare coleslaw and fillings for sandwiches. The food chopper has three parts: a bowl, very sharp knives, and the machine."

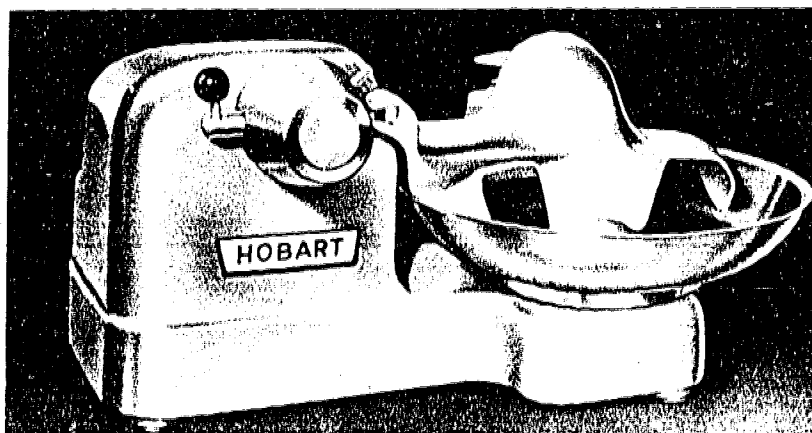

Jim Nelson and the other Food Service students would learn how to use these machines correctly. They would also learn how to clean them.

I. Getting the Main Idea

Directions: Below are three sentences. One of them tells the main idea of what you just read. Put an X next to that sentence.

- _____ 1. Jim Nelson learned how to prepare whipped cream.
- _____ 2. Mr. Davis talked to his students about three pieces of large equipment.
- _____ 3. Jim and the other shop students cleaned machines.

II. What Is Its Name?

Directions: Below are pictured some pieces of equipment found in the kitchen. Write the name of each on the lines given.

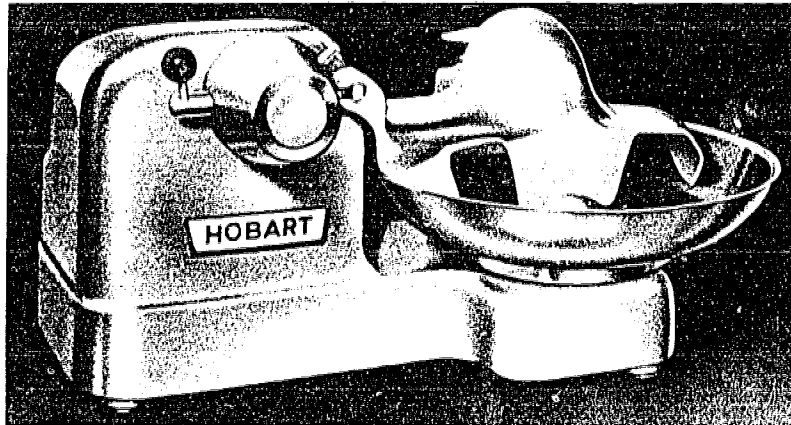

1. _____

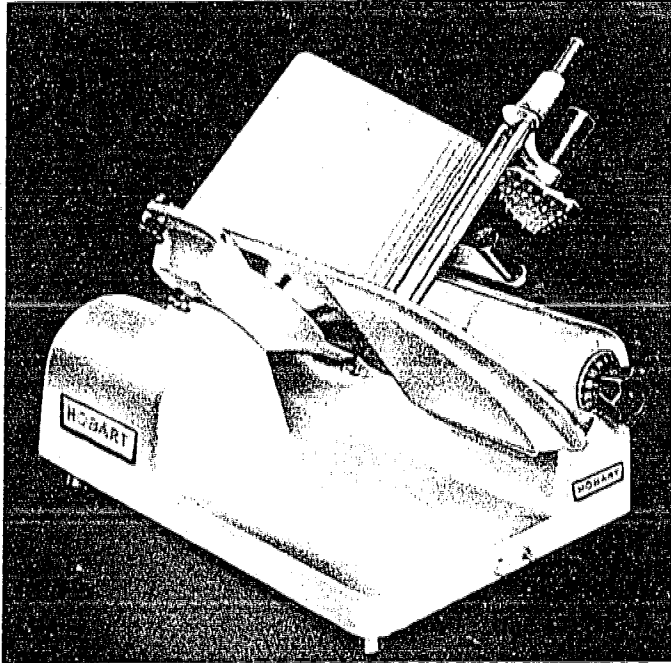

2. _____

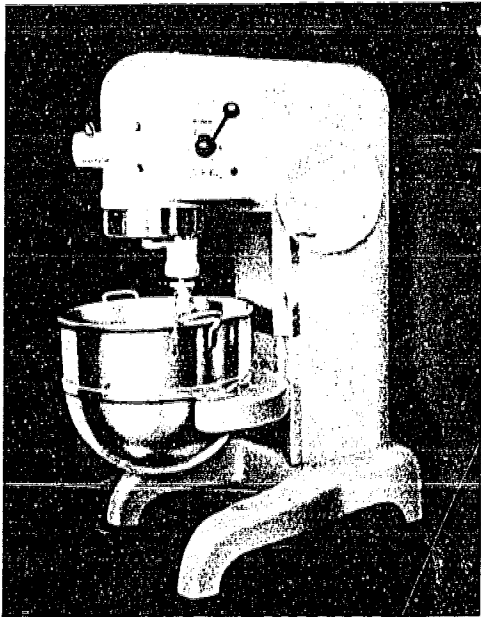

3. _____

III. Sentences to Complete

Directions: Here are some sentences. Some words have been left out. Fill in each blank with the correct word from the list.

Word List

coleslaw equipment food chopper
food slicer mixer

1. Tools and machines used in the kitchen are called _____.
2. We use a _____ to make whipped cream.
3. When we make _____ we use a _____.
4. A _____ slices meat and cheese for sandwiches.

IV. True or False

Directions: Tell whether the following statements are true or false. Label either T or F.

- _____ 1. Large equipment makes kitchen work harder.
- _____ 2. The mixer has a very sharp, round blade.
- _____ 3. We use a mixer for making ice cream.

- _____ 4. A food chopper comes in handy for making coleslaw.
- _____ 5. The food chopper has very sharp knives.
- _____ 6. We can use a food slicer to cut cheese into slices.
- _____ 7. The food chopper has two beaters.
- _____ 8. The food slicer can only make thick slices.

V. Find the Missing Letters

Directions: Fill in the missing letters in the following words from the story.

1. _____ i _____ r.
2. f _____ d _____ op _____ e _____
3. e _____ i _____ m _____
4. c _____ s _____ aw
5. _____ o _____ d _____ i _____ er

VI. Word-Find Puzzle

Directions: Find the following words in the puzzle. Draw a circle around each. They may be going across, down, or on a slant.

Words to Find in Puzzle

coleslaw

equipment

food chopper

food slicer

mixer

W N E F L R A E D U R D O
A B C A C E T A M T U N C
N F O O D S L I C E R C A
T O V I L I X S A J E T I
C O R E W E O C I D E N C
T D A L R I S N S U T E R
W C I L A S A L A S M I L
S H A N I I S S A E D T C
T O A N B I H M E W E S L
K P N E D W I S H O U J I
Q P O U K Y N O W Y O U W
U E Q U I P M E N T A N T
I R T O A E S I T E M K M
T W O R D S T O F I N D I

FOR EXTRA CREDIT: Find other words in the puzzle. Add them to the list above.

SMALL KITCHEN EQUIPMENT

"Most of the equipment we use in the kitchen are small tools," explained Mr. Davis. "Some tools hang above the cook's table. Others are in the drawers of the cook's table."

Mr. Davis showed his students some of the tools that were often used in the shop.

"We will learn what each tool is used for and how to use it. For now I want you to learn just the name of each tool."

The tools that Mr. Davis showed his students are pictured below:

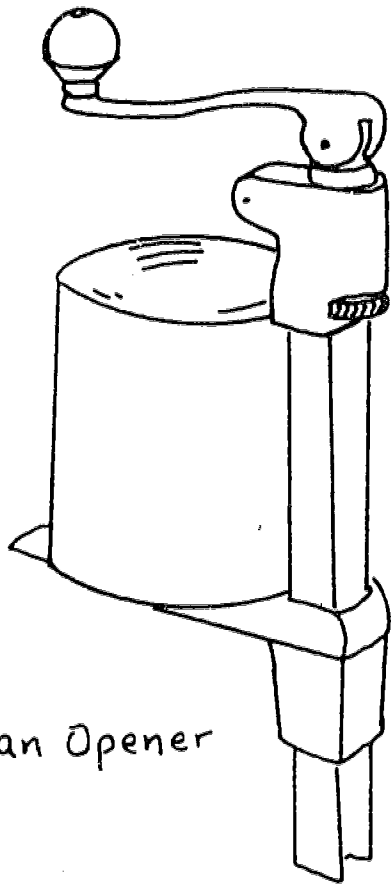

Can Opener

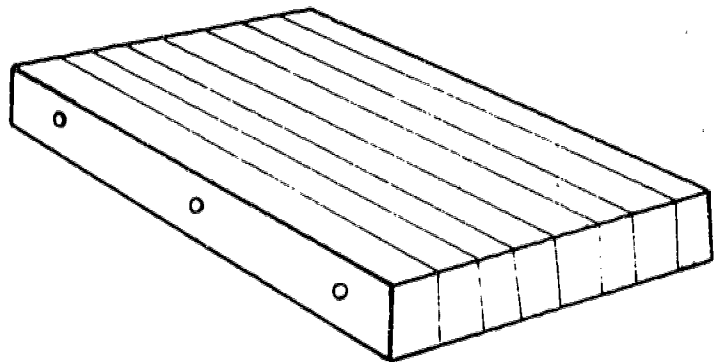

Cutting Board

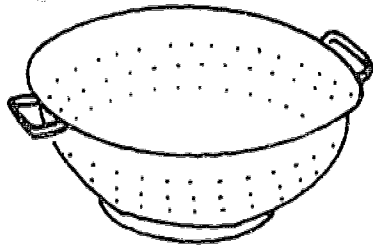

Colander

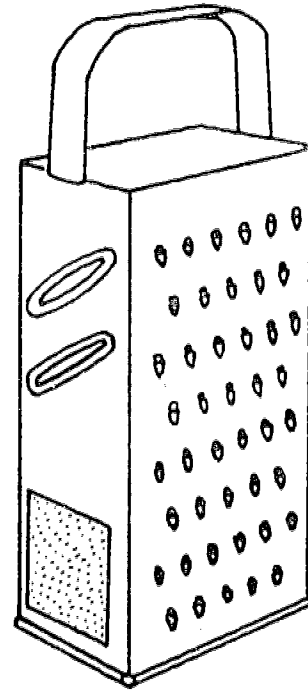

Grater

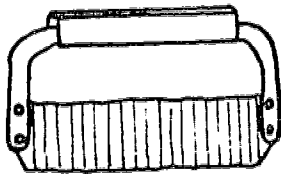

Garnisher

Knives



Paring



Slicer



Utility



Measuring Cups

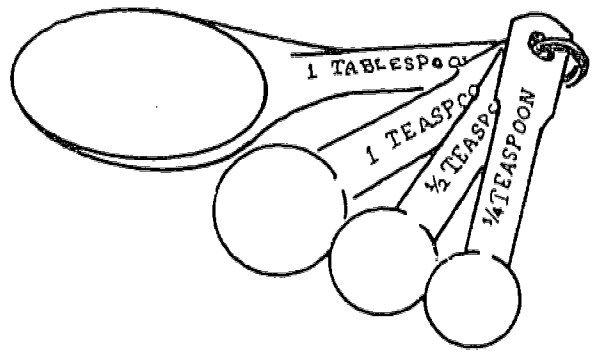

Measuring Spoons

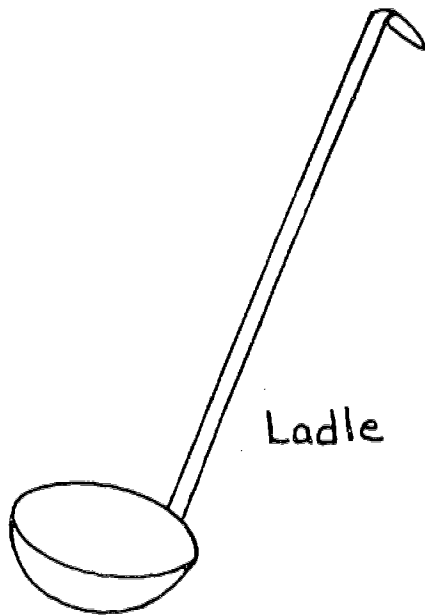

Ladle

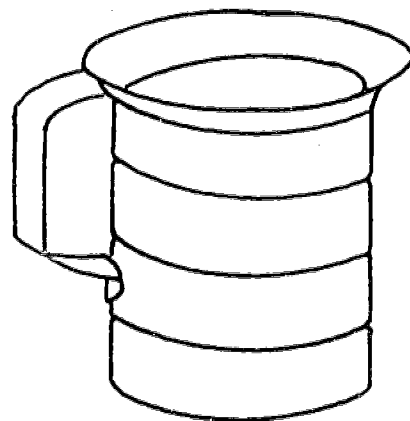

Measure



Peeler

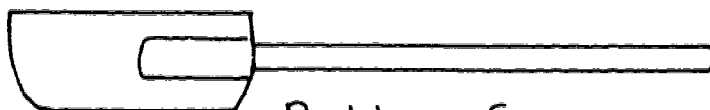

Rubber Scraper

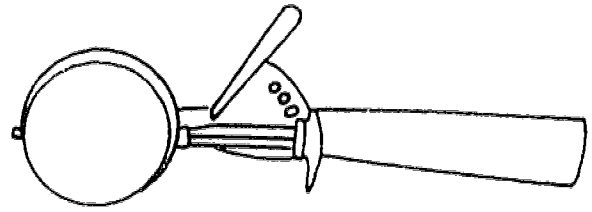

Scoop



Skimmer



Spatula

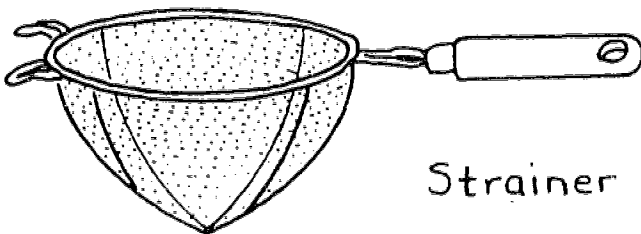

Strainer

Spoons

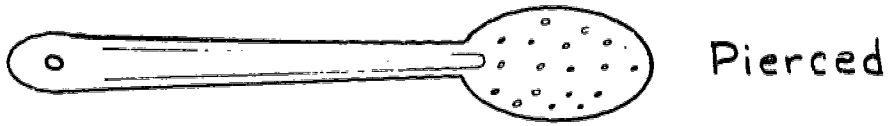

Pierced

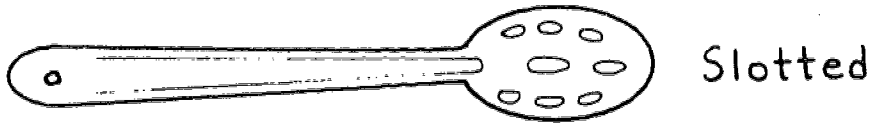

Slotted

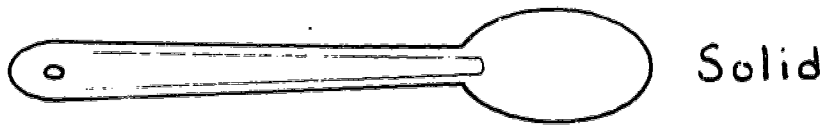

Solid

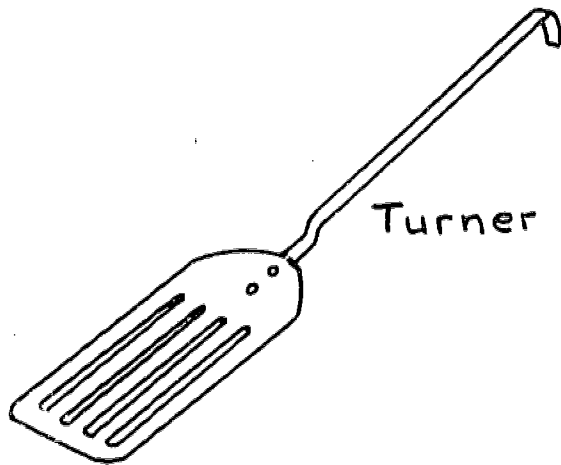

Turner

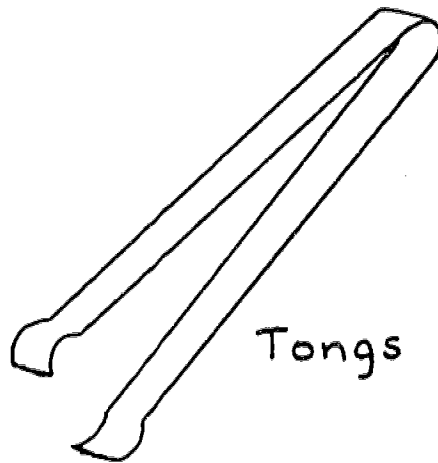

Tongs



Vegetable Brush

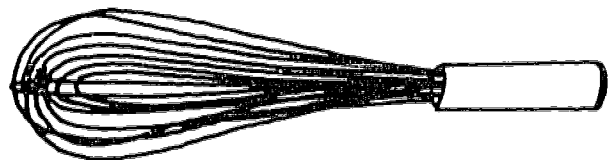

Wire Whip

I. Getting the Main Idea

Directions: Below are three sentences. One of them tells the main idea of what you just read. Put an X next to that sentence.

1. Mr. Davis kept kitchen tools in a drawer.
2. Mr. Davis went over the names of small kitchen equipment.
3. The students learned how to use some of the kitchen equipment.

II. Spelling Drill

Directions: Listed below are some of the words from the story. Write each word twice on the lines given.

1. colander _____

2. grater _____

3. knives _____

4. ladle _____

5. measure _____

6. peeler _____

7. scoop _____

8. skimmer _____

9. spatula _____

10. strainer _____

11. turner _____

12. tongs _____

III. Crossword Puzzle

Directions: Identify each picture. Write the correct name in the boxes given in the puzzle. The pictures are on the next few pages.

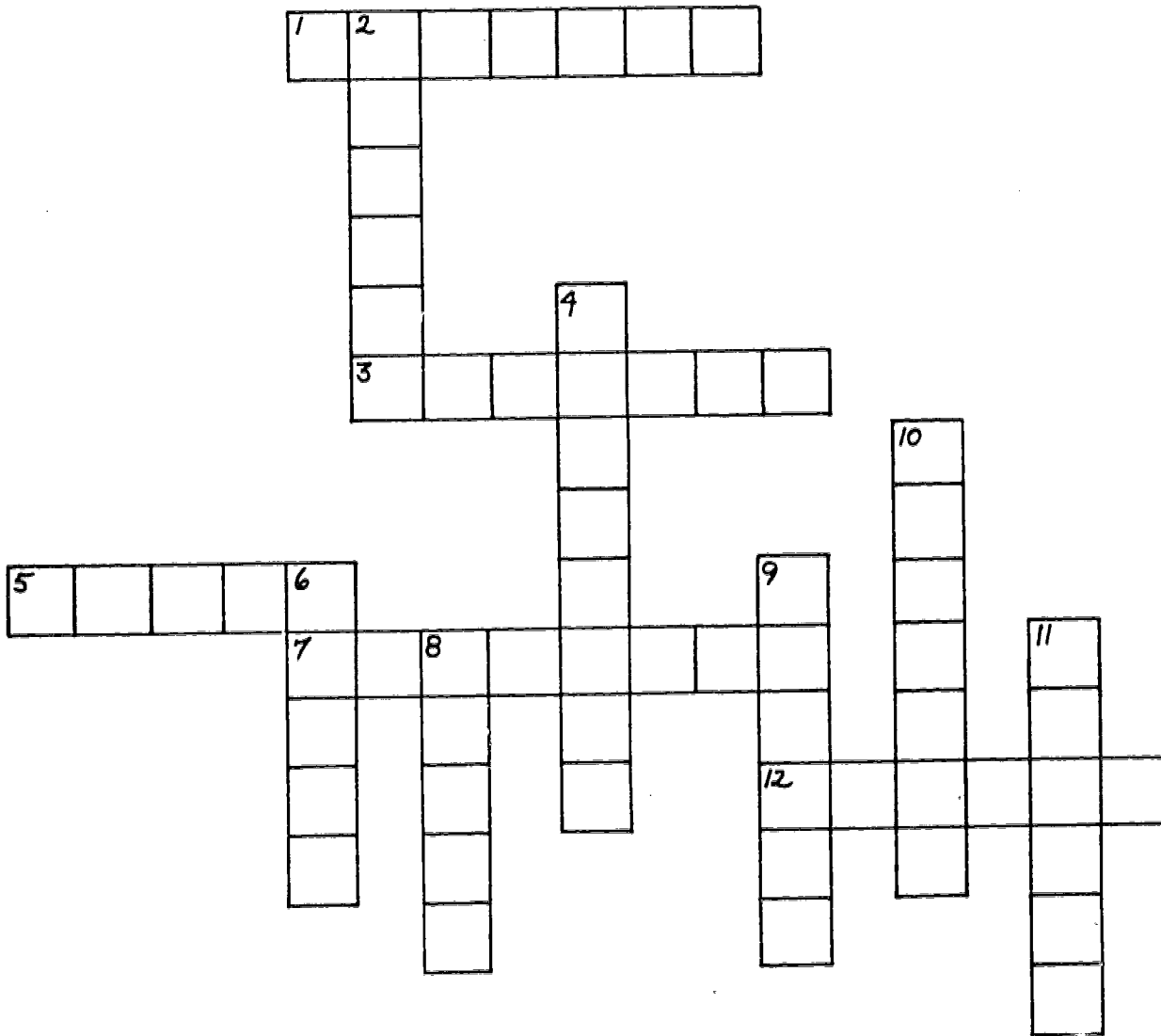

ACROSS

1.

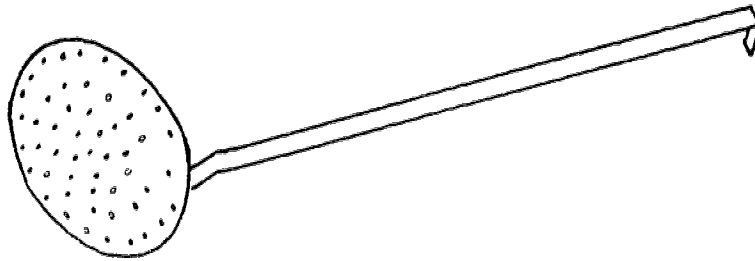

3.



5.

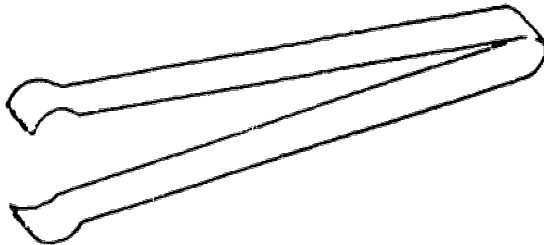

7.

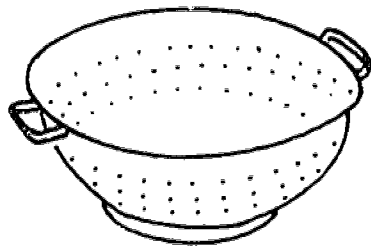

12.

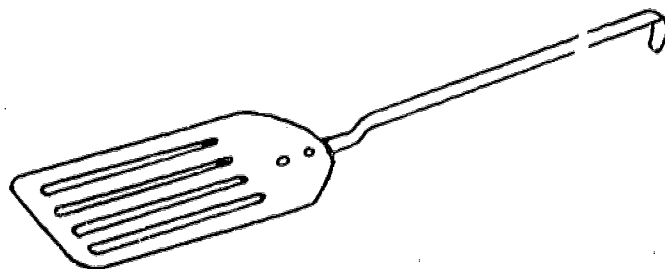

DOWN

2.

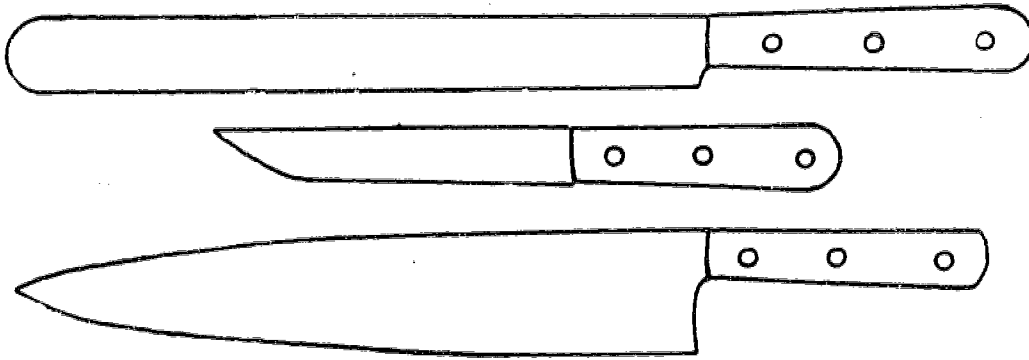

4.

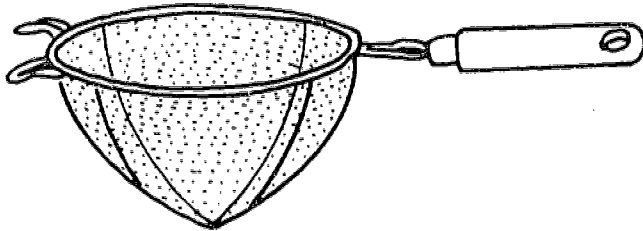

6.

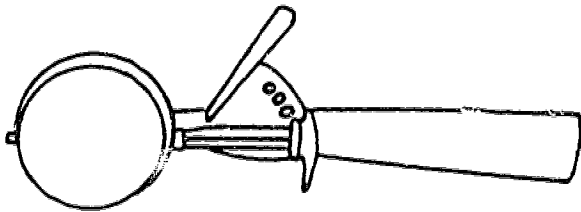

8.

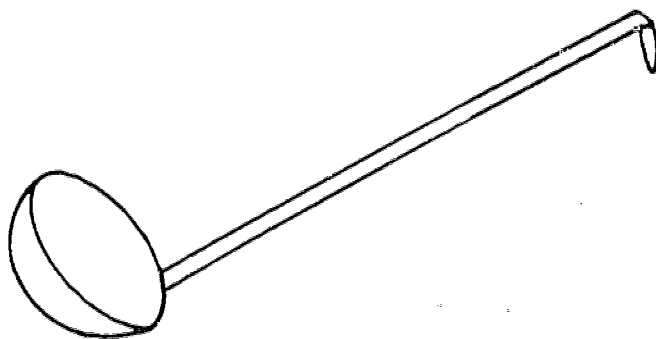

97

91

DOWN

9.

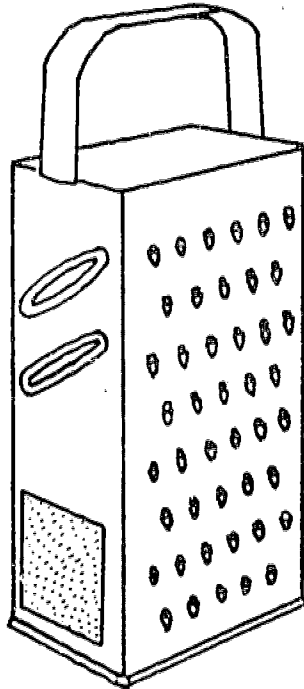

10.

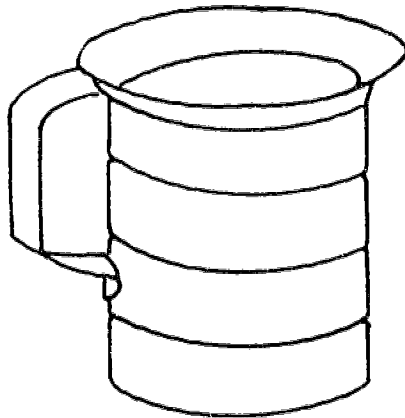

11.



IV. Find the Missing Letters

Directions: Fill in the missing letters in the following words that we have been learning.

1. c _____ tt _____ _____ _____ o _____ rd

2. w _____ r _____ w _____ i _____

3. t _____ _____ _____ s

4. c _____ n _____ p _____ n _____ _____

5. g _____ r _____ i _____ _____ er

6. p _____ _____ l _____ _____

7. _____ _____ at _____ la

8. l _____ _____ le

9. m _____ _____ s _____ r _____

10. _____ _____ r _____ i _____ er