

DOCUMENT RESUME

ED 136 062

CE 010 380

AUTHOR Ekisman, Kenneth E., Comp.; Gerberich, Charles F., Comp.

TITLE Plumbing. Trade and Industrial Education Course of Study.

INSTITUTION Pennsylvania State Univ., University Park. Coll. of Education.

SPONS AGENCY Pennsylvania State Dept. of Education, Harrisburg. Bureau of Vocational Education.

PUB DATE 76

NOTE 473p.; For related documents see CE 010 380-382 and CE 007 942-944

EDRS PRICE MF-\$0.83 HC-\$24.77 Plus Postage.

DESCRIPTORS Curriculum; Instructional Materials; *Job Skills; *Learning Activities; *Plumbing; Post Secondary Education; Secondary Education; Task Performance; *Trade and Industrial Education; Vocational Education

ABSTRACT

Intended to be used as a teaching and learning guide, the basic course of study presented in these materials is designed to provide the essentials of the plumbing trade, insuring that students who successfully complete the course will have sufficient competencies for initial employment and ample orientation for growth and development. The course of study is designed as a 3-year curriculum involving approximately 1,500 hours of class and laboratory instruction. The material has been arranged in major divisions of the trade: (1) Pipes and Fittings, (2) Valves, (3) Cold Water Supply, (4) Hot Water Supply, (5) Drainage Systems, and (6) Fixtures. Most of the course material consists of job sheets, which indicate to the student what to do in performing various jobs assigned, and skill competency sheets, which supplement job sheets and indicate to the student how to perform the manipulative handling of tools and materials that make up the doing part of the occupation. They are simply written and highly illustrated. A cumulative reuse of the skill competencies continues throughout the entire job sheet collection. The job sheets are arranged in an order that gradually exposes the skill competencies to insure the introduction of each operation or skill competency in a controlled manner. Included for use by the teacher are general course objectives, suggested teaching methods and vehicles of instruction, and a list of items to be developed by the local teacher. Sample information sheets, sample assignment sheets, and a bibliography are included. (HD)

Documents acquired by ERIC include many informal unpublished materials not available from other sources. ERIC makes every effort to obtain the best copy available. Nevertheless, items of marginal reproducibility are often encountered and this affects the quality of the microfiche and hardcopy reproductions ERIC makes available via the ERIC Document Reproduction Service (EDRS). ERIC is not responsible for the quality of the original document. Reproductions supplied by EDRS are the best that can be made from the original.

ED 136062

TRADE AND INDUSTRIAL EDUCATION

COURSE OF STUDY

FOR

PLUMBING

COMPILED BY

Kenneth E. Erisman
Franklin County Area Vocational Technical School

Charles F. Gerberich
Lebanon County Area Vocational Technical School

IN COOPERATION WITH

Division of Occupational and Vocational Studies
College of Education
The Pennsylvania State University

AND

Department of Education
Bureau of Vocational Education
Harrisburg, Pennsylvania

1976

U S DEPARTMENT OF HEALTH,
EDUCATION & WELFARE
NATIONAL INSTITUTE OF
EDUCATION
THIS DOCUMENT HAS BEEN REPRO-
DUCED EXACTLY AS RECEIVED FROM
THE PERSON OR ORGANIZATION ORIGIN-
ATING IT. POINTS OF VIEW OR OPINIONS
STATED DO NOT NECESSARILY REPRESENT
OFFICIAL NATIONAL INSTITUTE OF
EDUCATION POSITION OR POLICY

C10 380

Commonwealth of Pennsylvania
Milton J. Shapp, Governor

Department of Education
John C. Pittenger, Secretary

Office of Basic Education
Frank S. Manchester, Commissioner
Harry K. Gerlach, Deputy Commissioner

Bureau of Vocational Education
John W. Struck, Director

Vocational Program Development Division
T. Dean Witmer, Chief

Trade and Industrial Education
Robert Jacoby, Senior Program Specialist

Pennsylvania Department of Education
Box 911
Harrisburg, PA 17126

TABLE OF CONTENTS

PREFACE	i
COURSE PHILOSOPHY	1
GENERAL COURSE OBJECTIVES	2
PLAN OF INSTRUCTIONAL PRACTICES	3
BIBLIOGRAPHY	5
COURSE OUTLINE	
. Occupational Description and Major Divisions	7
. Skill Competency Development Jobs	8
. Skill Competencies and Information Lessons	15
WRITTEN INSTRUCTIONAL AIDS	
. Introduction	27
. Job Sheets	29
. Operation Sheets	439
. Information Sheets (Sample)	651
. Assignment Sheets (Sample)	653

PREFACE

In recent years, we have planned and constructed the finest of vocational education facilities and have placed fine equipment in these facilities. Equal attention must be directed to provide the teacher with the basic tools for instruction to assist in providing quality instruction.

This basic course of study is intended to be used as a teaching and learning guide. The information provides the essentials of the occupation, insuring that the students who successfully complete the course will have sufficient competencies for initial employment and ample orientation for growth and advancement. The teacher who uses this course may find it necessary to modify and supplement the material to meet the needs of specific students and the local industrial community.

This material has been prepared by a committee of teachers under the general direction of the staff of the Division of Occupational and Vocational Studies at The Pennsylvania State University in cooperation with the Trade and Industrial Education staff of the Bureau of Vocational Education of the Department of Education.



Robert Jacoby
Senior Program Specialist
Trade and Industrial Education
Bureau of Vocational Education

1976



Frederick G. Welch
Associate Professor, Project Director
Division of Occupational and Vocational
Studies
The Pennsylvania State University

COURSE PHILOSOPHY

Educational Philosophy of Plumbing

The old saying, "the plumber protects the health of the nation" is more true today than ever before. Plumbing is the center of modern sanitation and is considered by many authorities to be one of the most scientific of all building trades.

Vocational education in the plumbing and pipefitting industry is essential to the community and the nation. It helps instill in all students the need for good sanitary facilities, venting systems, and public and private water supply systems.

The primary function of this plumbing course is to provide training in the development of salable skills and those understandings and attitudes that make the worker an intelligent and productive participant in economic life.

GENERAL COURSE OBJECTIVES

<u>Objectives</u>	<u>Activities to Achieve Objectives</u>
1. To understand the importance of plumbing to the health and welfare of the nation.	<ol style="list-style-type: none">1. Discussions on plumbing codes.2. Visit sanitary disposal plants.3. Visit plumbing jobs that are being constructed and ones that are completed.4. Present to students literature and audio-visuals pertaining to sanitation.
2. To develop good work habits, attitudes, and appreciate good workmanship.	<ol style="list-style-type: none">1. Have students plan their own work, "lay out their own jobs".2. Set up standards for each work job.3. Arrange for field trips to various stages of job construction.4. Give praise where it is due.
3. To develop an understanding of the interrelationship of employers and employees.	<ol style="list-style-type: none">1. Arrange for talks by men in management and organized labor.2. Assign reading in different trade magazines.3. Provide a suggestion box.4. Have shop talks dealing with employee/employer relations.
4. To develop ability to work cooperatively with fellow employees.	<ol style="list-style-type: none">1. Set up jobs/projects for group participation.2. Encourage students to seek one another's help.3. Provide a student planning committee.
5. To develop occupational safety habits and understanding.	<ol style="list-style-type: none">1. Demonstrate safe work habits.2. Establish a set of safety rules to follow.3. Display safety posters.4. Utilize audio-visuals on safety.
6. To stimulate the development of leadership.	<ol style="list-style-type: none">1. Provide for students to plan their own jobs and projects.2. Provide a plan for students to appraise their own work.
7. To develop skills and understandings of the operation of machines and hand tools, as well as the skills of the processes of the occupation.	<ol style="list-style-type: none">1. Demonstrations by instructor.2. Series of individual projects.3. Group projects.

PLAN OF INSTRUCTIONAL PRACTICE

The effectiveness of instruction depends on the careful organization and control of the routine details concerning the management of the pupil, equipment, teaching methods and the physical laboratory arrangement. The teacher must determine the best management practices and formulate a very definite statement of the basic standards to be followed in teaching the course to bring about the attainment of the learning goals.

Length of Course

The course of study is designed as a three-year curriculum involving approximately 1500 hours of class and laboratory instruction, primarily for beginning students who are interested in securing employment in the occupation. Where job entry is the goal, the entire course of study would be appropriate. In adult programs, it may be found that a single thrust is the student's goal, therefore, the course content may be restricted to a single major division.

Use of This Course of Study

The material has been arranged in major divisions of the trade. In most cases, the material contained in the first division must be learned before progressing to the next division. The nature of some trade areas permit entry into random divisions after the introductory basic material is covered. Some divisions of the occupation can be taught separately.

The content of this course material consists of job sheets (yellow) and skill competency sheets (white). The skill competency sheets are simply written and highly illustrated. These sheets outline the manipulative handling of tools and materials that make up the doing part of the occupation. The sequence of the skill competency sheets (SC) is based on the organization of the job sheets. Notice that job number one incorporates the basic skill competencies and job number two includes additional skill competencies. This cumulative reuse of the skill competencies continues throughout the entire job sheet collection. After a number of jobs have insured that the student has been sufficiently exposed to a skill competency, no further reference to that skill competency is made.

The job sheets are arranged in an order that gradually exposes the skill competencies. The purpose of the job sheet is to insure the introduction of each operation or skill competency in a controlled manner. Look at this group of jobs as a framework that can be added to, by you, to meet local needs. You may decide to design new or different jobs that will be inserted between or replace any of the suggested jobs. In time you will be able to custom design a course of study for your own needs. There will be little or no need to vary the skill competency sheets.

Teaching Methods

The following procedures are offered as the most productive in achieving the desired results in this course.

1. Demonstrations — Operations and Procedures will be demonstrated while the students observe. The purpose is to show how things are done correctly and safely.
2. Class Discussion — A method of teaching in which the students and the teacher take part, directed and controlled by the teacher to a predetermined objective. Technical and related information common to a class or group of students will be presented in this manner. Evaluation of the material presented in this manner should be done by objective testing.
3. Laboratory Talks — Short, informal talks by the instructor during laboratory activities to convey information pertinent to the activity in progress. Not scheduled and not timed, this activity should occur at any appropriate time and for periods of varying duration.
4. Observation and Input — This teacher activity should take place at all times when students are performing psychomotor skills. The purpose is to reinforce a previously given demonstration, class discussion, or laboratory talk, or to update the students' skills by further demonstration and/or further disclosures of technical and related information.
5. Individual Reports — Student assigned certain sections or chapters from trade journals, manuals, periodicals, etc., which present related trade information.
6. Individual and Group Projects — Student involvement in planning, problem solving, skill development, and evaluation through hands-on experience.

Vehicles of Instruction

The application phase of this course will consist of work assignments kept as close to industrial conditions as a shop situation permits. Job, operation and information sheets will be provided, so that students of different levels of skill and ability can understand them. The students will be encouraged to progress as rapidly as possible, and achieve the standard set for the course. Special attention will be given to the unique student, offering special assistance so that slow as well as fast students may progress at their own rate of speed.

Items for Development by Local Teacher

The following items are peculiar to the local school situation and need to be developed by each local instructor.

- . Standards of attainment required of students
- . Pupil work evaluation and grading
- . Shop controls and regulations
- . Pupil personnel organization
- . Method of tool control
- . Records and forms

BIBLIOGRAPHY

1. Almond, Sr., Joseph P., Plumber's Handbook, Library of Congress, Cat. Card No. 70-182461.
2. Audel (Howard Sams), Plumbers and Pipefitters Library (three volumes).
3. Babbitt, Harold E., Plumbing, McGraw-Hill.
4. Daniels, George, Home Guide to Plumbing and Heating and Air Conditioning, Harper & Row.
5. Blueprint Reading and Sketching with Instructor's Guide, Delmar Publishers.
6. Mathematics - Plumbers and Pipefitters with Teacher's Key, Delmar Publishers.
7. Related Information - Plumbing I and Answer Book, Delmar Publishers.
8. Related Information - Plumbing II and Answer Book, Delmar Publishers.
9. Damske, Richard, Plumbing, Grosset & Dunlap.
10. Lindsey, Forrest R., Pipefitters Handbook, Industrial Press, Inc.
11. Manas, Vincent T., National Plumbing Code Handbook, McGraw-Hill.
12. Manas, Vincent T., National Plumbing Code Illustrated, Manas Publications.
13. Mathais and Smith, How to Design and Install Plumbing, American Technical Society.
14. O'Brien, Thomas J., Plumbers Reference Manual, Library of Congress, Cat. Card No. 67-30517,
15. Sosnin, H.A., The Theory and Technique of Soldering and Brazing of Piping Systems, Library of Congress, Cat. Card No. 72-181079.

COURSE OUTLINE

Instructional Title: Plumbing

Code: 17.1007

OCCUPATION DESCRIPTION

Specialized classroom and shop learning experience concerned with layout, assembly, installing, altering and repairing piping systems and related fixtures and fitting in structures by use of pipe cutting, bending and threading tools; welding, soldering and brazing equipment; other hand tools and equipment. Basic operations such as making soil pipe joints, soldering, threading, installing plastic and glass pipe, welding and brazing are included. The student also learns to repair faucets, pumps, damaged pipes, gas fittings and heater pipes.

MAJOR DIVISIONS OF THE OCCUPATION

- I. Pipes and Fittings
 - A. Cast Iron Pipe
 - B. Bituminized Fiber Pipe
 - C. Terra-Cotta
 - D. Glass Pipe
 - E. Lead Pipe
 - F. Iron and Steel Pipe
 - G. Brass Pipe
 - H. Copper Tubing
 - K. Plastic Pipe
- II. Valves
- III. Cold Water Supply
- IV. Hot Water Supply
- V. Drainage Systems
- VI. Fixtures

Skill Competency Development Jobs

The following is a list of suggested jobs, assigned by the teacher, to provide experiences for the student to assist him in developing competencies of the plumbing trade. These are Job Titles only. The numbers correspond with the identifying numbers on the job sheets that follow.

UNIT I. PIPES AND FITTINGS

A. Cast Iron Pipe

- J-1A-1 Measure and Cut Cast-Iron Soil Pipe
- J-1A-2 Check Cast-Iron Soil Pipe
- J-1A-3 Set Up and Light Lead Torch
- J-1A-4 Yarn, Pack and Align Vertical Cast-Iron Soil Pipe Joint
- J-1A-5 Pour and Calk Vertical Cast-Iron Soil Joint
- J-1A-6 Make a 2" Lead and Oakum (Vertical) Joint
- J-1A-7 Make a 4" Lead and Oakum (Horizontal) Joint
- J-1A-8 Make a 2" Lead and Oakum (Horizontal) Joint
- J-1A-9 Make a 4" Lead and Oakum (Wye & 1/8 Bend) Combination Joint
- J-1A-10 Make a 4" X 2" Lead and Oakum (Wye & 1/8 Bend) Joint
- J-1A-11 Remove 4" Lead and Oakum 1/8 Bend
- J-1A-12 Remove 2" Lead and Oakum 1/8 Bend
- J-1A-13 Install Cast-Iron Soil Pipe Sewer Line
- J-1A-14 Install Sission Joint
- J-1A-15 Install Kaffer Joint
- J-1A-16 Install a 4" Cast Iron Soil Compression Gasket Line
- J-1A-17 Install a 4" Cast Iron Soil No-Hub Coupling Line
- J-1A-18 Drill Cast-Iron Soil Pipe
- J-1A-19 Tap Cast-Iron Soil Pipe

B. Bituminized Fiber Pipe

- J-1B-1 Measure and Cut Bituminous-Fiber Pipe

- J-1B-2 Bevel Bituminous-Fiber Pipe Ends
- J-1B-3 Install Bituminous Fiber Sewer Line
- J-1B-4 Join Bituminized Fiber Pipe to Cast-Iron Pipe

C. Terra Cotta

- J-1C-1 Measure and Cut Terra Cotta Pipe
- J-1C-2 Cemented Terra-Cotta Pipe Joint
- J-1C-3 Install Terra-Cotta Sewer Line (Cemented)
- J-1C-4 Bituminous Terra-Cotta Joint
- J-1C-5 Install Terra-Cotta Sewer Line (Bituminous)
- J-1C-6 Join Cast-Iron to Terra-Cotta

D. Glass Pipe

- J-1D-1 Measure and Cut Glass Pipe
- J-1D-2 Make a 1½" - 2" E to C Glass Pipe Joint
- J-1D-3 Make a 1½" - 2" C to C Glass Pipe Joint
- J-1D-4 Join Glass Pipe to Cast-Iron Hub

E. Lead Pipe

- J-1E-1 Measure and Cut Sheet Lead
- J-1E-2 Tin a Soldering Iron
- J-1E-3 Solder Flat and Vertical Seams
- J-1E-4 Construct a Lead Drain Pan
- J-1E-5 Measure, Cut and Prepare Lead Pipe
- J-1E-6 Wipe a Horizontal Lead Joint
- J-1E-7 Wipe a Vertical Lead Joint
- J-1E-8 Tin a Brass Ferrule
- J-1E-9 Join Lead Pipe to Cast Iron Pipe

F. Iron and Steel Pipe

- J-1F-1 Measure and Cut Steel Pipe
- J-1F-2 Ream and Thread Steel Pipe
- J-1F-3 Make a ½" Steel Pipe E to C Joint
- J-1F-4 Make a ¾" Steel Pipe C to C Joint
- J-1F-5 Make a 1" Steel Pipe C to C Joint
- J-1F-6 Make a ½" Steel Pipe Nipple Set
- J-1F-7 Make a ¾" Steel Pipe Nipple Set
- J-1F-8 Make a 1¼" Steel Pipe C to C Joint
- J-1F-9 Make a 1½" Steel Pipe E to C Joint
- J-1F-10 Make a 2" Steel Pipe C to C Joint
- J-1F-11 Make a 3" - 4" E to C Steel Pipe Joint
- J-1F-12 Make a 3" - 4" C to C Steel Pipe Joint
- J-1F-13 Construct a Steel Pipe Plumbing Square
- J-1F-14 Set Up Oxy-Acetylene Torch
- J-1F-15 Cut Steel Plate with Oxy-Acetylene Torch
- J-1F-16 Gas Weld Steel Strips
- J-1F-17 Cut Steel Pipe with Oxy-Acetylene Torch
- J-1F-18 Gas Weld Steel Pipe
- J-1F-19 Make up a 1½" Steel Pipe E to C Gas Welded Joint
- J-1F-20 Make up a 1½" Steel Pipe C to C Gas Welded Joint
- J-1F-21 Arc Weld Steel Plate
- J-1F-22 Arc Weld Steel Pipe
- J-1F-23 Braze Galvanized Steel Pipe

G. Brass Pipe

- J-1G-1 Make a ½" Brass Pipe Nipple Set
- J-1G-2 Make a ¾" Brass Pipe E to C Measurement

J-1G-3 Make a 3/4" Brass Pipe C to C Measurement

J-1G-4 Make a Combination Silver Brazed Joint

H. Copper Tubing

J-1H-1 Measure, Cut and Ream Copper Tube

J-1H-2 Anneal Copper Tubing

J-1H-3 Make a 1/2" Soldered Joint

J-1H-4 Make a 3/4" Soldered Joint

J-1H-5 Make a 1/2" Flared Joint

J-1H-6 Make a 3/4" Flared Joint

J-1H-7 Make a 1/2" Swedged Joint

J-1H-8 Make a 3/4" Swedged Joint

J-1H-9 Make a 3/4" Offset Joint

J-1H-10 Make a 1 1/2" Soldered Joint

J-1H-11 Make a Combination Silver Soldered Joint

K. Plastic Pipe

J-1K-1 Make a 1/2" - 3/4" Insert Joint

J-1K-2 Make a 1/2" - 3/4" Cemented Joint

J-1K-3 Make a 1 1/2" ABS-DWV Offset Stack

J-1K-4 Make a 3/4" - 1" Flared Joint

UNIT II. VALVES

J-2-1 Disassemble and Assemble Gate and Globe Valves

J-2-2 Disassemble and Assemble Check Valves

J-2-3 Disassemble and Assemble a Common Compression Faucet

J-2-4 Disassemble and Assemble a Single Lever Valve Faucet

J-2-5 Disassemble and Assemble a Ball Faucet

- J-2-6 Disassemble and Reassemble a Cartridge Faucet
- J-2-7 Disassemble and Reassemble a Flush Valve
- J-2-8 Disassemble and Assemble a Tank Flush Valve
- J-2-9 Disassemble and Assemble a Tank Ball Cock
- J-2-10 Tighten and Position Gate, Globe or Check Valves
- J-2-11 Dress (Reface) a Valve Seat

UNIT III COLD WATER SUPPLY

- Install Water Service
- J-3-2 Install a Water Meter
- J-3-3 Rough-in and Install a Cold Water Supply
- J-3-4 Install Air Chambers
- J-3-5 Install Lawn Faucets
- J-3-6 Repair Leak in Iron Pipe (Temporarily)
- J-3-7 Repair Leak in Copper Tubing
- J-3-8 Repair a Leak in Plastic Pipe
- J-3-9 Repair Leaks in an Existing System

UNIT IV. HOT WATER SUPPLY

- J-4-1 Rough-in and Install a Hot Water Supply
- J-4-2 Install a Hot Water Coil
- J-4-3 Install an Electric Water Heater
- J-4-4 Install a Heating Element
- J-4-5 Install Gas Water Heater (Water Piping)
- J-4-6 Install Gas Water Heater (Vent Piping)
- J-4-7 Install Gas Water Heater (Gas Piping)
- J-4-8 Install Relief Valves

UNIT V. DRAINAGE SYSTEMS

- J-5-1 Lay Out and Determine Drains and Soil Stack Locations
- J-5-2 Cut Openings for Drain and Soil Stacks
- J-5-3 Install House Trap and Fresh Air Vent
- J-5-4 Install Soil Stack
- J-5-5 Install a Vent Through the Roof
- J-5-6 Install Roof Flashing
- J-5-7 Install Branch House Drains
- J-5-8 Install Test Plugs and Test Drainage System
- J-5-9 Install Cellar Drains and Sump
- J-5-10 Open a Clogged Commode with Closet Auger
- J-5-11 Open a Clogged Commode with Toilet Plunger
- J-5-12 Open a Clogged Sewer with Sewer Rod
- J-5-13 Open a Clogged Drain with Electric Snake
- J-5-14 Clear a Clogged Drain with Sewer Ram

UNIT VI. FIXTURES

- J-6-1 Temporarily Set a Built-In Bathtub
- J-6-2 Fasten Wall Support, Fixture Backing and Cut Drain Opening
- J-6-3 Install Bath Waste and Overflow
- J-6-4 Set and Cover Bathtub
- J-6-5 Rough-in Bath and Shower Fixture
- J-6-6 Install Combination Lavatory Fixture
- J-6-7 Install Bracket and Hang Lavatory
- J-6-8 Connect Lavatory Supplies
- J-6-9 Connect Lavatory Trap
- J-6-10 Install Closet Bowl
- J-6-11 Install Closet Tank

- J-6-12 Connect Closet Supply
- J-6-13 Install Wall Brackets, Drain Outlet and Hang Urinal
- J-6-14 Install Urinal Flush Valve
- J-6-15 Install Sink Faucet with Spray
- J-6-16 Install Sink Basket Strainers
- J-6-17 Install Counter-top Sink
- J-6-18 Connect Water Supply to Sink Faucet
- J-6-19 Install Continuous Waste and Sink Trap
- J-6-20 Install Garbage Disposal

SKILL COMPETENCIES AND INFORMATION LESSONS

The left hand column lists the tasks of the occupation which form the skill competencies required of the student. These competencies should be demonstrated by the teacher and practiced by the student.

The information lessons outline the general technical information and knowledge needed to perform the skill competencies. These items represent the common information taught on a group instruction basis. Additional information will emerge to be taught on an individual student basis as pupils work on the skill competencies.

The numbers preceding each title correspond to the identifying numbers of the operation sheets and the information sheets. The information lessons relate to the particular major unit of instruction but do not necessarily relate to corresponding skill competency numbers.

UNIT I. PIPES AND FITTINGS

SKILL COMPETENCIES/OPERATIONS The student will be able to:	INFORMATION LESSONS
<u>A. Cast Iron Pipe</u>	<u>A. Cast Iron Pipe</u>
SC-1A-1 Marking with a Pencil, Soap Stone, Chalk or Scribe	IL-1A-1 Cast Iron Soil Pipe
SC-1A-2 Cut Cast Iron Soil Pipe with Hammer and Chisel	IL-1A-2 Soil Pipe Bends
SC-1A-3 Ring Soil Pipe	IL-1A-3 Y-Branched
SC-1A-4 Lighting a Torch	IL-1A-4 Soil Tee
SC-1A-5 Setting Up and Lighting the Lead Torch	IL-1A-5 Soil Offsets
SC-1A-6 Yarn and Pack Vertical Oakum Joints	IL-1A-6 Combination Soil Fittings
SC-1A-7 Aligning Pipe	IL-1A-7 Soil Pipe Traps
SC-1A-8 Pouring Lead	IL-1A-8 Types and Uses of Pipe Hangers
SC-1A-9 Calking a Lead Joint	IL-1A-9 Hanger Fastenings
SC-1A-10 Yarning, Pouring and Calking Horizontal Lead and Oakum Joints	IL-1A-10 Joining Soil Pipe and Fittings
SC-1A-11 Picking a Cast-Iron Soil Joint	IL-1A-11 Drainage Traps
	IL-1A-12 Floor and Area Drains
	IL-1A-13 Roof Flashings
	IL-1A-14 Closet Bends

SKILL COMPETENCIES/OPERATIONS The student will be able to:		INFORMATION LESSONS	
SC-1A-12	Cutting Cast-Iron Soil Pipe with Soil Pipe Cutter	IL-1A-15	Miscellaneous Soil Pipe Fittings
SC-1A-13	Insert and Lubricate Gasket	IL-1A-16	Back Water Valves
SC-1A-14	Join Soil Pipe Compression Gasket System	IL-1A-17	Increasesers and Reducers
SC-1A-15	Join Soil Pipe - No Hub System	IL-1A-18	Insertable Joints
SC-1A-16	Marking Metal with a Prick or Center Punch	IL-1A-19	Care and Safe Use of Lead Torch
SC-1A-17	Drilling Holes with Electric Hand Drill	IL-1A-20	Care and Safe Use of Electric Drills
SC-1A-18	Threading Holes with a Tap		
SC-1A-19	Adjusting and Using Adjustable Wrench		

B. Bituminized Fiber Pipe

SC-1B-1	Cutting to a Line with a Cross Cut Saw	IL-1B-1	Types and Sizes of Bituminized Fiber Pipe
SC-1B-2	Trimming Pipe with Beveling Tool	IL-1B-2	Uses of Bituminized Fiber Pipe
SC-1B-3	Prepare Sewer Trench	IL-1B-3	Care and Use of Transit Levels
SC-1B-4	Join Bituminized Fiber Pipe	IL-1B-4	Various Soil Conditions
SC-1B-5	Pour Bituminous Compound	IL-1B-5	Shoring Trenches
SC-1B-6	Backfill Trench		

B. Bituminized Fiber Pipe

C. Terra-Cotta

SC-1C-1	Cut Terra-Cotta with Hammer and Chisel	IL-1C-1	Types and Uses of Terra-Cotta Pipe and Fittings
SC-1C-2	Preparing Cement Mixture	IL-1C-2	Types of Joints
SC-1C-3	Join Terra-Cotta Pipe (Cement Joint)	IL-1C-3	Composition and Manufacture of Field Tile
		IL-1C-4	Sizing Exterior Sewer Piping

C. Terra-Cotta

SKILL COMPETENCIES/OPERATIONS
The student will be able to:

INFORMATION LESSONS

<u>D. Glass Pipe</u>		<u>D. Glass Pipe</u>	
SC-1D-1	Cut Glass Pipe	IL-1D-1	Types and Sizes of Glass Pipe and Fittings
SC-1D-2	Assemble Speed Read End	IL-1D-2	Care and Uses of Glass Fitting and Pipe
SC-1D-3	Join Beaded Ends with Coupling	IL-1D-3	Comparison Properties of Acid Waste Drain Lines
		IL-1D-4	Temperature and Deflection Factors
		IL-1D-5	Pressure Factors
<u>E. Lead Pipe</u>		<u>E. Lead Pipe</u>	
SC-1E-1	Marking Along a Straight Edge	IL-1E-1	Weight and Melting Point of Lead
SC-1E-2	Making a Straight Cut with Straight, Combination or Bulldog Snips	IL-1E-2	Sizes and Uses of Sheet Lead
SC-1E-3	Light and Adjust Soldering Furnace	IL-1E-3	Types and Sizes of Bending Springs
SC-1E-4	Shaping and Smoothing Surfaces with a File	IL-1E-4	Types and Uses of Roof Flashings
SC-1E-5	Using Sal Ammoniac Bricks	IL-1E-5	Types and Sizes of Lead Shower Pans
SC-1E-6	Bevel Edge of Seam and Tallow	IL-1E-6	Types and Sizes of Soldering Coppers
SC-1E-7	Sprinkle with Rosin and Tack Solder Seam	IL-1E-7	Uses of Shave Hooks and Lead Dresser
SC-1E-8	Indent and Bend Using Flat Dresser	IL-1E-8	Uses of Expanding Pliers
SC-1E-9	Laying Out Curves and Arcs with a Divider	IL-1E-9	Use of Plumber's Soil
SC-1E-10	Making an Inside Curved Cut with Hand Shears	IL-1E-10	Types and Uses of Wiping Cloths
SC-1E-11	Cutting Tubing or Pipe with a Hack Saw	IL-1E-11	Composition of Wiping Cloths
		IL-1E-12	Use of Holding Clamps

SKILL COMPETENCIES/OPERATIONS
The student will be able to:

INFORMATION LESSONS

SC-1E Lead Pipe with a

SC-1E-13 Soil, Flare and Bevel
Lead Pipe Ends

SC-1E-14 Gaging Lines with a
Rule and Pencil

SC-1E-15 Using the Wiping Cloth

SC-1E-16 Tinning Brass Fittings

F. Iron and Steel Pipe

F. Iron and Steel Pipe

SC-1F-1 Cut Steel Pipe with a Pipe
Cutters

IL-1F-1 Long Pipe

SC-1F-2 Reaming Rigid Conduit or
Pipe with a Pipe Reamer

IL-1F-2 American Standard Pipe
Thread

SC-1F-3 Threading Pipe Using Pipe
Dies

IL-1F-3 Pipe Threading Principle

SC-1F-4 Make Up Fittings

IL-1F-4 Pipe Measurements

SC-1F-5 Operate a Portable Power
Machine

IL-1F-5 Fitting Allowance

SC-1F-6 Thread Steel Pipe with
Adjustable Receding Die

IL-1F-6 Making Up Fittings

SC-1F-7 Threading Pipe with
Universal Die

IL-1F-7 Pipe Nipples

SC-1F-8 Cutting Large Pipe with
Power Hack Saw

IL-1F-8 Fitting Angles

SC-1F-9 Transporting Acetylene and
Oxygen Cylinders

IL-1F-9 Malleable Elbows

SC-1F-10 Setting Up Gas Welding
Equipment

IL-1F-10 Fitting Specifications

SC-1F-11 Opening and Closing the
Oxy-Acetylene Equipment
for Welding

IL-1F-11 Bushings and Reducing Couplings

SC-1F-12 Attaching and Lighting a
Cutting Torch

IL-1F-12 Unions

IL-1F-13 Union Elbows

IL-1F-14 Flange Unions

IL-1F-15 Drainage Elbows

IL-1F-16 Drainage Tees

IL-1F-17 Drainage Y-Branches

SKILL COMPETENCIES/OPERATIONS The student will be able to:		INFORMATION LESSONS	
SC-1F-12A	Flamecutting with a Hand Torch	IL-1F-18	Shop Safety Rules and Regulations
SC-1F-13	Lighting and Adjusting the Torch and Flame	IL-1F-19	Types and Sizes of Pipe Cutting-Threading Equipment
SC-1F-14	Cleaning Cutting or Welding Tips with a Tip Cleaner	IL-1F-20	Safety for Oxy-Acetylene Welding and Cutting
SC-1F-15	Piercing Holes with a Cutting Torch	IL-1F-21	Types and Sizes of Welding and Cutting Tips
SC-1F-16	Joining Metal by Fusion Welding with Filler Rod	IL-1F-22	Proper Care of Torches and Tips
SC-1F-17	Strike an Arc and Run a Bead	IL-1F-23	Proper Care of Regulators
SC-1F-18	Running a Braze Bead	IL-1F-24	Proper Care of Oxy-Acetylene Hoses
		IL-1F-25	Care and Use of Personal Equipment: a. Helmet d. Apron & Cape b. Safety e. Goggles Glasses f. Beanie c. Gloves
	<u>G. Brass Pipe</u>		<u>G. Brass Pipe</u>
SC-1G-1	Using the Strap Wrench	IL-1G-1	Types and Sizes of Brass Pipe and Fittings
		IL-1G-2	Use of Brass Pipe
		IL-1G-3	Types and Uses of Strap Wrenches
		IL-1G-4	Composition of Brass Pipe and Fittings
	<u>H. Copper Tubing</u>		<u>H. Copper Tubing</u>
SC-1H-1	Cut and Ream Copper Tubing	IL-1H-1	Types of Copper Tubing
SC-1H-2	Set Up and Light Prestolite Torch	IL-1H-2	Copper Tubing Fittings
		IL-1H-3	Copper Tubing Joints
		IL-1H-4	Types of Solder

SKILL COMPETENCIES/OPERATIONS The student will be able to:		INFORMATION LESSONS	
SC-1H-3	Sweat Copper Tubing	IL-1H-5	Types and Sizes of Torches
SC-1H-4	Flare Copper Tubing	IL-1H-6	Types and Sizes of Tubing Benders
SC-1H-5	Swedge Copper Tubing	IL-1H-7	Types and Sizes of Tubing Cutters
SC-1H-6	Bend Copper Tubing	IL-1H-8	Types and Uses of Abrasive Cloths
<u>K. Plastic Pipe</u>		<u>K. Plastic Pipe</u>	
SC-1K-1	Cut and Ream Plastic Pipe	IL-1K-1	Types and Sizes of Plastic Pipe and Fitting
SC-1K-2	Join Flexible Plastic Tubing	IL-1K-2	Care of Plastic Pipe and Fittings
SC-1K-3	Assemble Plastic Pipe/ Fittings with Solvent	IL-1K-3	Types of Solvents
SC-1K-4	Flare Plastic Pipe		

UNIT II. VALVES

SKILL COMPETENCIES/OPERATIONS The student will be able to:		INFORMATION LESSONS	
SC-2-1	Using Smooth Jawed Wrenches	IL-2-1	Types and Sizes of Check Valves
SC-2-2	Tighten and Loosen Fasteners with a Box End Wrench	IL-2-2	Uses of Check Valves
SC-2-2A	Tightening and Loosening Fasteners with an Open End Wrench	IL-2-3	Types, Uses and Sizes of Globe Valves
SC-2-3	Removing Pins With a Needle Nose Pliers	IL-2-4	Types, Uses and Sizes of Gate Valves
SC-2-4	Tightening and Loosening Screws with Flat Screwdriver	IL-2-5	Types and Uses of Reducing Valves
SC-2-5	Tightening and Loosening Fasteners with Allen Wrenches.		
SC-2-6	Holding and Tightening with a Rib Lock Plier		

UNIT III. COLD WATER SUPPLY

SKILL COMPETENCIES/OPERATIONS The student will be able to:		INFORMATION LESSONS	
SC-3-1	Cutting a Hole in a Masonry Wall with a Star Chisel	IL-3-1	Types and Sizes of Water Softeners
SC-3-2	Installing and Tightening a Union	IL-3-2	Methods of House Piping
SC-3-3	Drilling Holes with an Electric Drill	IL-3-3	Methods of Estimating Pressure Gages
SC-3-4	Installing and Tightening Dresser Couplings	IL-3-4	Pipe Drawings and System Designs
		IL-3-5	Frost Protection
		IL-3-6	Water Sources
		IL-3-7	Water Pollution
		IL-3-8	Water Pressure
		IL-3-9	Water Hammer
		IL-3-10	Curb and Corporation Cocks

UNIT IV. HOT WATER SUPPLY

SKILL COMPETENCIES/OPERATIONS The student will be able to:		INFORMATION LESSONS	
SC-4-1	Using a Socket Wrench with a Ratchet	IL-4-1	Principles of Circulation
SC-4-2	Testing with Soap	IL-4-2	Vertical Hot Water Tanks
SC-4-3	Lighting Gas Appliances	IL-4-3	Horizontal Hot Water Tanks
		IL-4-4	Furnace Coils
		IL-4-5	Tank Heaters
		IL-4-6	Gas Tank Heater
		IL-4-7	The British Thermal Unit and the Expansion of Water
		IL-4-8	Conduction--Convection--Radiation
		IL-4-9	Automatic Storage Gas Water Heater
		IL-4-10	Thermostats
		IL-4-11	Lever, Spring-Type, and Diaphragm Relief Valves
		IL-4-12	Electric Water Heaters
		IL-4-13	Summer-Winter Hook-Up
		IL-4-14	Indirect Heater--Steam Boiler
		IL-4-15	Solar Heaters

UNIT V. DRAINAGE SYSTEMS

SKILL COMPETENCIES/OPERATIONS The student will be able to:		INFORMATION LESSONS	
SC-5-1	Using the Plumb Bob	IL-5-1	Public and Private Sewers
SC-5-2	Pulling Nails with the Claw Hammer	IL-5-2	Sewer Connections
SC-5-3	Cutting Curves with a Compass Saw	IL-5-3	House Sewer
SC-5-4	Chiseling Across Grain	IL-5-4	Joints on Vitrified Clay Pipe
SC-5-5	Driving Nails with a Claw Hammer	IL-5-5	Obtaining Grades of Pipes within a Level
SC-5-6	Using the Level for Leveling	IL-5-6	Main House Trap
		IL-5-7	Fresh Air Inlets
		IL-5-8	Excavating Trenches
		IL-5-9	The House Drain
		IL-5-10	Angles of Branches
		IL-5-11	Cleanouts
		IL-5-12	Testing Drainage Systems
		IL-5-13	Clearing Fixtures
		IL-5-14	Clearing Stoppage in Drains
		IL-5-15	Floor and Area Drains
		IL-5-16	Fixture Units
		IL-5-17	Soil Stacks and Stack Inlet Fittings
		IL-5-18	Waste and Vent Stacks
		IL-5-19	Loss of Trap Seals
		IL-5-20	Continuous Vent and Wet Vent
		IL-5-21	Loop and Circuit Vents
		IL-5-22	Cross Connections
		IL-5-23	Fixture and Grease Traps
		IL-5-24	Garage Sand Traps

SKILL COMPETENCIES/OPERATIONS
The student will be able to:

INFORMATION LESSONS

- IL-5-25 Rain Leaders
- IL-5-26 Sumps and Cellar Drainers
- IL-5-27 Blow-off Tanks
- IL-5-28 So-Vent Drainage System
- IL-5-29 Electric Sewer Augers
- IL-5-30 Water Rams

UNIT VI. FIXTURES

SKILL COMPETENCIES/OPERATIONS The student will be able to:		INFORMATION LESSONS	
SC-6-1	Cutting Wire with Side Cutters or Diagonals	IL-6-1	Trap and Faucet Connections
SC-6-2	Marking a Line with a Combination Square	IL-6-2	Connected Waste and Overflow
SC-6-3	Cutting to a Line with a Cross Cut Saw	IL-6-3	Patent Overflow
SC-6-4	Cutting Thin Material with a Knife	IL-6-4	Duplex Strainer
SC-6-5	Using the Basin Wrench	IL-6-5	Fixture Supports
SC-6-6	Using the Sink Strainer Wrench	IL-6-6	Types-Uses of Bathtubs
SC-6-7	Using a Sabre Saw	IL-6-7	Types-Uses of Lavatories
		IL-6-8	Types-Uses of Water Closet
		IL-6-9	Types-Uses of Kitchen Sink
		IL-6-10	Garbage Disposers

WRITTEN INSTRUCTIONAL AIDS

Introduction

Instruction sheets are aids used in developing the most effective and efficient teaching/learning situation that is possible. Four types of sheets are generally used including job sheets, operation sheets, information sheets and assignment sheets.

JOB SHEETS indicate to the student what to do in performing the various jobs assigned by the instructor. The jobs that will be used as vehicles of instruction in the course are listed in the COURSE OUTLINE section.

The job involves a sequential performance of operations by the learner to "tryout" and develop the skill competencies (operations) of the occupation resulting in a product or service. It is the vehicle of instruction or the media by which the student practices and develops a series of skill competencies (operations).

OPERATION SHEETS supplement the job sheets and indicate to the student how to perform the many skill competency operations necessary to complete the assigned jobs. The operations that will be taught in the course are listed in the COURSE OUTLINE section under skill competencies/operations. The operation sheets should be numbered to correspond with the Skill Competencies listed in the course outline.

Operations are the subdivision in the breakdown of a job. Each operation represents a process, way of doing or how to perform the particular skill competency or operation.

INFORMATION SHEETS supplement the job sheets and provide the student with information necessary for completing the assigned jobs with highest possible degree of understanding. The information units that will be stressed in the course are listed in the course outline under information lessons. The information sheets included in this section should be numbered to correspond with the Information Lessons listed in the course outline.

ASSIGNMENT SHEETS supplement the job sheets and provide the student with mental activities necessary to learn the "knowing" that accompanies the "doing" of a trade. The student is assigned related studies or technical information to be "sought out" on an individual basis through the use of problems or "exercises." The Assignment Sheets should be numbered to correspond with the information lessons listed.

JOB: Measure and Cut Cast-Iron
Soil Pipe

JOB SHEET
IDENTIFICATION CODE

UNIT I: Pipes and Fittings

JOB NUMBER: J-1A-1

COURSE: Plumbing

MATERIAL: 5' Double Hub Cast-Iron Soil Pipe

TOOLS: 6' Folding Rule
Soapstone, Chalk, or Pencil
1-1½ lb. Ball Peen Hammer
½" - 1" Cold Chisel
Leather Wrap-Around

SAFETY PRECAUTIONS:

1. Safety glasses or goggles, and gloves should be worn when cutting cast-iron soil pipe.
2. Watch out for mushroomed chisel head.

COMPETENCE - PROCEDURE/STEPS The student will be able to:	TEACHING/LEARNING ACTIVITIES
1. Lay pipe to be measured and cut on ground.	
2. Measure and mark pipe where cut is to be made.	. SC-1A-1
3. Hold chisel at right angle to the pipe and strike chisel with the hammer.	. SC-1A-2
4. Continue striking chisel around pipe until pipe separates.	. SC-1A-2
5. Check job for accuracy of measurement and straightness of cut.	

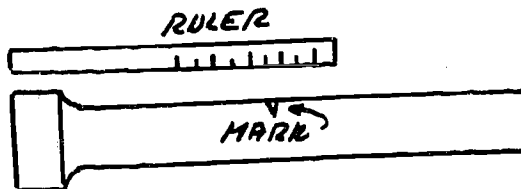

METHOD OF EVALUATION:

1. Proper procedure
2. Accuracy of measurement
3. Appearance of cut
4. Care and use of hammer and chisel

JOB: Check Cast-Iron Soil Pipe

JOB SHEET
IDENTIFICATION CODE

UNIT I: Pipes and Fittings

JOB NUMBER: J-1A-2

COURSE: Plumbing

MATERIAL: 2-3 Assorted Soil Pipe Fittings (1 cracked)
2-3 Cut-off Pieces Soil Pipe (1 cracked)

TOOLS: 12-16 oz. Ball Peen Hammer

SAFETY PRECAUTIONS:

1. Safety glasses or goggles must be worn when working with cast-iron soil pipe.

COMPETENCE - PROCEDURE/STEPS	TEACHING/LEARNING ACTIVITIES
------------------------------	------------------------------

The student will be able to:

NOTE: Cast-iron soil pipe is subject to cracking and must be checked regularly.

- | | |
|--|-----------|
| 1. Select one of the soil pipe fittings from the pile of assorted fittings and "ring" the fitting. | . SC-1A-3 |
| 2. Continue Step 1 until all soil pipe fittings are "rung". | |
| 3. Select one of the cut-off pieces of soil pipe from the pile and "ring" the pipe. | . SC-1A-3 |
| 4. Continue Step 3 until all soil pipe cut-offs are "rung". | |

NOTE: Cast-iron pipe cut in the preceding job (J-1A-1) should also be checked at this time.

METHOD OF EVALUATION:

1. Proper procedure
2. Project judgment
3. Safe use of hammer

JOB: Set Up and Light Lead Torch

JOB SHEET
IDENTIFICATION CODE

UNIT I: Pipes and Fittings

JOB NUMBER: J-1A-3

COURSE: Plumbing

MATERIAL: Lead

EQUIPMENT: Lead Torch
Lead Pot

TOOLS: Ladle
Propane Torch
Flint Striker

SAFETY PRECAUTIONS:

1. Safety glasses or goggles must be worn when working with cast-iron soil pipe.
2. Extreme care must be exercised when lighting the torch and when lead is melted.

COMPETENCE - PROCEDURE/STEPS The student will be able to:	TEACHING/LEARNING ACTIVITIES
1. Assemble and set lead torch at a safe location.	. SC-1A-5
2. Light propane torch.	. SC-1A-4
3. Turn on gas slightly and light torch.	. SC-1A-5
4. Place lead pot on the torch and turn on more gas.	NOTE: Never put an empty lead pot on the torch.
5. After lead has melted to proper temperature, turn down the gas.	. SC-1A-5

METHOD OF EVALUATION:

1. Proper procedure
2. Safe use of propane torch
3. Proper heating and removal of slag

JOB: Yarn, Pack and Align Vertical Cast-Iron
Soil Pipe Joint

JOB SHEET
IDENTIFICATION CODE

UNIT I: Pipes and Fittings

JOB NUMBER: J-1A-4

COURSE: Plumbing

MATERIAL: 2 pieces, 4" Soil Pipe
Oakum

TOOLS: 16 oz. Ball Peen Hammer
Yarning Irons
Packing Iron
Plumb-Bob

SAFETY PRECAUTIONS:

1. Safety glasses or goggles must be worn when working with cast-iron soil pipe.
2. Gloves should be worn until beginner feels confident striking irons.

COMPETENCE - PROCEDURE/STEPS The student will be able to:	TEACHING/LEARNING ACTIVITIES
1. "Ring" both pieces of soil pipe.	. SC-1A-3
2. Insert spigot end of pipe into hub.	
3. Yarn oakum into joint.	. SC-1A-6
4. Pack oakum with packing iron.	NOTE: Use only dry oakum.
5. Align pipe.	. SC-1A-7
6. Pack if necessary.	

METHOD OF EVALUATION:

1. Proper procedure
2. Appearance of finished job
3. Proper and safe use of yarning and packing irons

JOB: Pour and Calk Vertical Cast-Iron
Soil Joint

JOB SHEET
IDENTIFICATION CODE

UNIT I: Pipes and Fittings

JOB NUMBER: J-1A-5

COURSE: Plumbing

MATERIAL: 2 pieces, 4" Soil Pipe (Yarned and packed in previous job)
Lead

EQUIPMENT: Lead Pot and Furnace

TOOLS: Pouring Ladle
Calking Irons
15 oz. Ball Peen Hammer

SAFETY PRECAUTIONS:

1. Safety glasses or goggles must be worn when working with cast-iron soil pipe.
2. Keep face back from hot lead.
3. Check calking irons for "mushrooming".

COMPETENCE - PROCEDURE/STEPS The student will be able to:	TEACHING/LEARNING ACTIVITIES
1. Heat and melt lead.	. SC-1A-5
2. Pre-heat pouring ladle.	. SC-1A-8
3. Pour lead.	. SC-1A-8
4. Calk lead joint.	. SC-1A-9

METHOD OF EVALUATION:

1. Proper procedure
2. Appearance of finished job
3. Safety practices followed when heating and pouring lead
4. Proper and safe use of calking irons

JOB: Make a 2" Lead and Oakum (Vertical)
Joint

JOB SHEET
IDENTIFICATION CODE

UNIT I: Pipes and Fittings

JOB NUMBER: J-1A-6

COURSE: Plumbing

DRAWING NO: D-1A-6

MATERIAL: (2) Lengths of 2" Soil Pipe
Oakum
Lead

EQUIPMENT: Lead Pot and Furnace
Safety Glasses

TOOLS: Ball Penn Hammer Chisel
 Yarning Iron Ladle
 Packing Iron Calking Irons
 Plumb-bob

SAFETY PRECAUTIONS:

1. Wear safety glasses at all times.
2. Check tools for "mushrooming".
3. Use only dry oakum.
4. Keep face back from hot lead.

COMPETENCE - PROCEDURE/STEPS The student will be able to:	TEACHING/LEARNING ACTIVITIES
1. Ring both pieces of soil pipe.	. SC-1A-3
2. Place spigot end into hub.	
3. Pack and drive oakum joint.	. SC-1A-6
4. Check pipe for alignment.	. SC-1A-7
5. Heat and melt lead.	. SC-1A-5
6. Pour lead.	. SC-1A-8
7. Calk lead joint.	. SC-1A-9

METHOD OF EVALUATION:

1. Accuracy of measurement
2. Appearance of finished job
3. Cleanliness of tools and work area
4. Time:

LEAD AND OAKUM JOINT

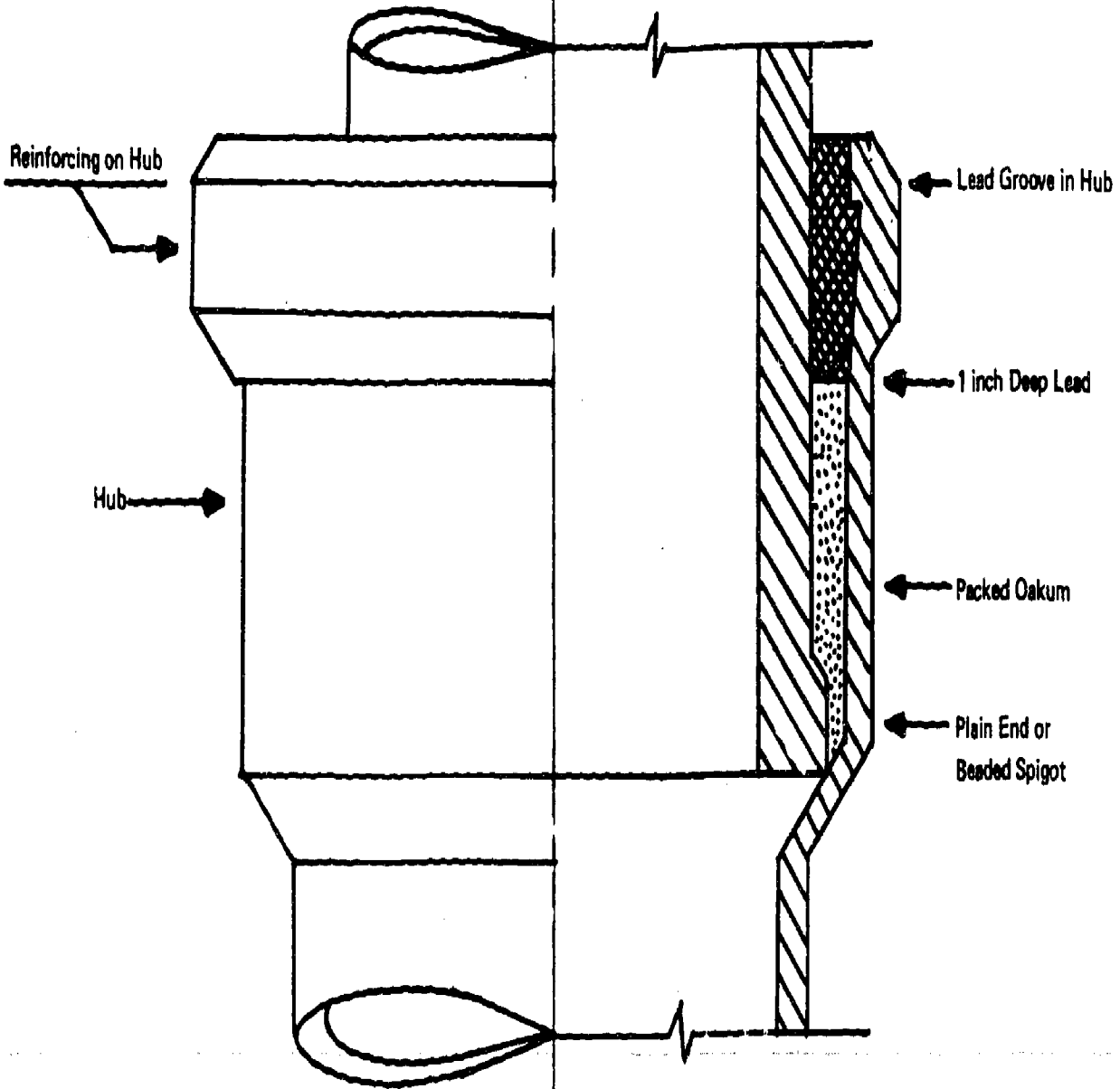

TWO INCH VERTICAL LEAD AND OAKUM JOINT

DRAWING NUMBER

D-7A-6

JOB: Make a 4" Lead and Oakum (Horizontal)
Joint

JOB SHEET
IDENTIFICATION CODE

UNIT I: Pipes and Fittings

JOB NUMBER: J-1A-7

COURSE: Plumbing

MATERIAL: (2) Lengths of 4" X H Soil Pipe
Oakum
Lead

EQUIPMENT: Lead Pot and Furnace
Safety Glasses

TOOLS: Ball Peen Hammer (16 oz.) Packing Iron
Yarning Irons Calking Irons
Plumb-bob Ladle
Chisel Lead Runner

SAFETY PRECAUTIONS:

1. Wear safety glasses at all times.
2. Check tools for "mushrooming".
3. Use only dry oakum.
4. Keep face back from hot lead.

COMPETENCE - PROCEDURE/STEPS The student will be able to:	TEACHING/LEARNING ACTIVITIES
1. Ring both pieces of soil pipe.	. SC-1A-3
2. Place spigot end into hub.	
3. Pack and drive oakum joint.	. SC-1A-10
4. Check pipe for alignment.	. SC-1A-7
5. Heat and melt lead.	. SC-1A-5
6. Pour lead.	. SC-1A-10
7. Calk lead joint.	. SC-1A-10

METHOD OF EVALUATION:

1. Accuracy of measurement
2. Appearance of finished job
3. Cleanliness of tools and work area
4. Time:

40

JOB: Make a 2" Lead and Oakum (Horizontal) Joint

JOB SHEET
IDENTIFICATION CODE

UNIT I: Pipes and Fittings

JOB NUMBER: J-1A-8

COURSE: Plumbing

MATERIAL: (2) Lengths of 2" X H Soil Pipe
Oakum
Lead

EQUIPMENT: Lead Pot and Furnace
Safety Glasses

TOOLS: Ball Peen Hammer (12 oz.) Calking Irons
Yarning Iron Chisel
Packing Iron Lead Runner
Plumb-bob Ladle

SAFETY PRECAUTIONS:

1. Wear safety glasses at all times.
2. Check tools for "mushrooming".
3. Use only dry oakum.
4. Keep face back from hot lead.

COMPETENCE - PROCEDURE/STEPS The student will be able to:	TEACHING/LEARNING ACTIVITIES
1. Ring both pieces of soil pipe.	. SC-1A-3
2. Place spigot end into hub.	
3. Pack and drive oakum joint.	. SC-1A-10
4. Check pipe for alignment.	. SC-1A-7
5. Heat and melt lead.	. SC-1A-5
6. Pour lead.	. SC-1A-10
7. Calk lead joint.	. SC-1A-10

METHOD OF EVALUATION:

1. Accuracy of measurement
2. Appearance of finished job
3. Cleanliness of tools and work area
4. Time: **41**

JOB: Make a 4" Lead and Oakum (Wye & 1/8 Bend) Combination Joint

JOB SHEET
IDENTIFICATION CODE

UNIT I: Pipes and Fittings

JOB NUMBER: J-1A-9

COURSE: Plumbing

MATERIAL: 4" x H Wye Oakum
4" x H 1/8 Bend Lead

EQUIPMENT: Lead Pot and Furnace
Safety Glasses

TOOLS: Yarning Irons Ladle Calking Irons
Packing Irons Chisel Plumb-bob
Ball Peen Hammer (16 oz.)

SAFETY PRECAUTIONS:

1. Wear safety glasses at all times.
2. Check tools for "mushrooming".
3. Use only dry oakum.
4. Keep face back from hot lead.

COMPETENCE - PROCEDURE/STEPS The student will be able to:	TEACHING/LEARNING ACTIVITIES
1. Ring both fittings.	. SC-1A-3
2. Place 1/8 bend into wye. Check the drawing.	
3. Pack and drive oakum joint.	. SC-1A-6
4. Check pipe for alignment.	. SC-1A-7
5. Heat and melt lead.	. SC-1A-5
6. Pour lead.	. SC-1A-8
7. Calk lead joint.	. SC-1A-9

METHOD OF EVALUATION:

1. Accuracy of measurement
2. Appearance of finished job
3. Cleanliness of tools and work area
4. Time:

JOB: Make a 4" x 2" Lead and Oakum
(Wye & 1/8 Bend) Joint

JOB SHEET
IDENTIFICATION CODE

UNIT I: Pipes and Fittings

JOB NUMBER: J-1A-10

COURSE: Plumbing

MATERIAL: 4" x 2" X H Wye
2" X H 1/8 Bend

EQUIPMENT: Lead Pot and Furnace
Safety Glasses

TOOLS: Ladle Packing Irons Calking Irons
Chisel Yarning Irons Ball Peen Hammer
Plumb-bob

SAFETY PRECAUTIONS:

1. Wear safety glasses at all times.
2. Check tools for "mushrooming".
3. Use only dry oakum.
4. Keep face back from hot lead.

COMPETENCE - PROCEDURE/STEPS The student will be able to:	TEACHING/LEARNING ACTIVITIES
1. Ring both fittings.	. SC-1A-3
2. Place 1/8 bend into wye. Check the drawing.	
3. Pack and drive oakum joint.	. SC-1A-6
4. Check pipe for alignment.	. SC-1A-7
5. Heat and melt lead.	. SC-1A-5
6. Pour lead.	. SC-1A-8
7. Calk lead joint.	. SC-1A-9

METHOD OF EVALUATION:

1. Accuracy of measurement
2. Appearance of finished job
3. Cleanliness of tools and work area
4. Time:

JOB: Remove 4" Lead and Oakum 1/8 Bend

JOB SHEET
IDENTIFICATION CODE

UNIT I: Pipes and Fittings

JOB NUMBER: J-1A-11

COURSE: Plumbing

MATERIAL: 4" Lead and Oakum Joint

EQUIPMENT: Safety Glasses

TOOLS: Ball Peen Hammer (12 oz.)
Picking Irons

SAFETY PRECAUTIONS:

1. Wear safety glasses.
2. Check pick to see that tool head is not "mushroomed".

COMPETENCE - PROCEDURE/STEPS The student will be able to:	TEACHING/LEARNING ACTIVITIES
1. Ring hub to check if hub is cracked.	. SC-1A-3
2. Start to pick joint and make a v-shaped pocket until you reach the bottom of the lead.	. SC-1A-11
3. Continue to pick until you have removed half the circumference of lead.	
4. Try to move joint in an up and down position with pipe laying horizontal.	
5. When remaining lead protrudes, pry lead from joint and take apart.	
6. Finally, ring hub to see that hub is still solid.	

METHOD OF EVALUATION:

1. Accuracy of measurement
2. Appearance of finished job
3. Cleanliness of tools and work area

JOB: Remove 2" Lead and Oakum 1/8 Bend

JOB SHEET
IDENTIFICATION CODE

UNIT I: Pipes and Fittings

JOB NUMBER: J-1A-12

COURSE: Plumbing

MATERIAL: 2" Lead and Oakum Joint

EQUIPMENT: Safety Glasses

TOOLS: Ball Peen Hammer (12 oz.)
Picking Irons

SAFETY PRECAUTIONS:

1. Wear safety glasses.
2. Check pick to see that tool head is not "mushroomed".

COMPETENCE - PROCEDURE/STEPS The student will be able to:	TEACHING/LEARNING ACTIVITIES
1. Ring hub to check if hub is cracked.	. SC-1A-3
2. Start to pick joint and make a v-shaped pocket until you reach the bottom of the lead.	. SC-1A-11
3. Continue to pick until you have removed half the circumference of lead.	
4. Try to move joint in an up and down position with pipe laying horizontal.	
5. When remaining lead protrudes, pry lead from joint and take apart.	
6. Finally, ring hub to see that hub is still solid.	

METHOD OF EVALUATION:

1. Accuracy of measurement
2. Appearance of finished job
3. Cleanliness of tools and work area

JOB: Install Cast-Iron Soil Pipe
Sewer Line

JOB SHEET
IDENTIFICATION CODE

UNIT I: Pipes and Fittings

JOB NUMBER: J-1A-13

COURSE: Plumbing

DRAWING NO: D-1A-13

MATERIAL: 4" Cast-Iron Soil Pipe 4" Cast-Iron Soil Ywe
4" Cast-Iron 1/8 Bend 4" Cast-Iron Soil Trap

EQUIPMENT: Lead Pot and Torch
Soil Pipe Cutters

TOOLS: 16 oz. Ball Peen Hammer Lead Ladle Plumb-Bob
Yarning Irons Joint Runner 2' Level
Packing Irons Flat Chisel 6' Folding Rule
Calking Irons

SAFETY PRECAUTIONS:

1. Safety glasses or goggles must be worn when working with cast-iron soil pipe.
2. Care must be taken when moving assembled soil joints.

COMPETENCE - PROCEDURE/STEPS The student will be able to:	TEACHING/LEARNING ACTIVITIES
1. Lay out job.	. D-1A-13
2. Ring soil pipe.	. SC-1A-3
3. Yarn, pack and align joint.	. SC-1A-6, SC-1A-7
4. Heat and melt lead.	. SC-1A-5
5. Pour and calk joint.	. SC-1A-8, SC-1A-9
6. Lay assembly on trench.	
7. Measure for next section of pipe.	. D-1A-13, SC-1A-1
8. Continue steps 2 through 5.	
9. Lay assembly in trench and align with previously laid pipe.	
10. Join assemblies together - steps 2 through 5 (horizontal).	

COMPETENCE - PROCEDURE/STEPS

TEACHING/LEARNING ACTIVITIES

11. Repeat steps 2 through 10 until sewer line is completed.

METHOD OF EVALAUTION:

1. Proper procedure
2. Accuracy of layout and measurement
3. Appearance/neatness of finished job
4. Safety practices followed during job
5. Cleanliness of tools and work area

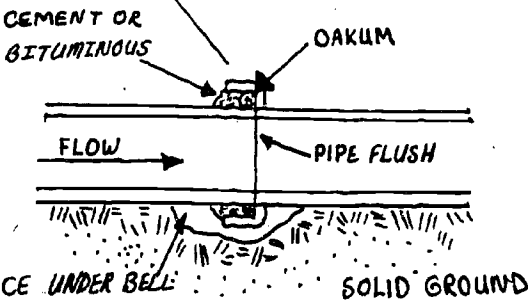
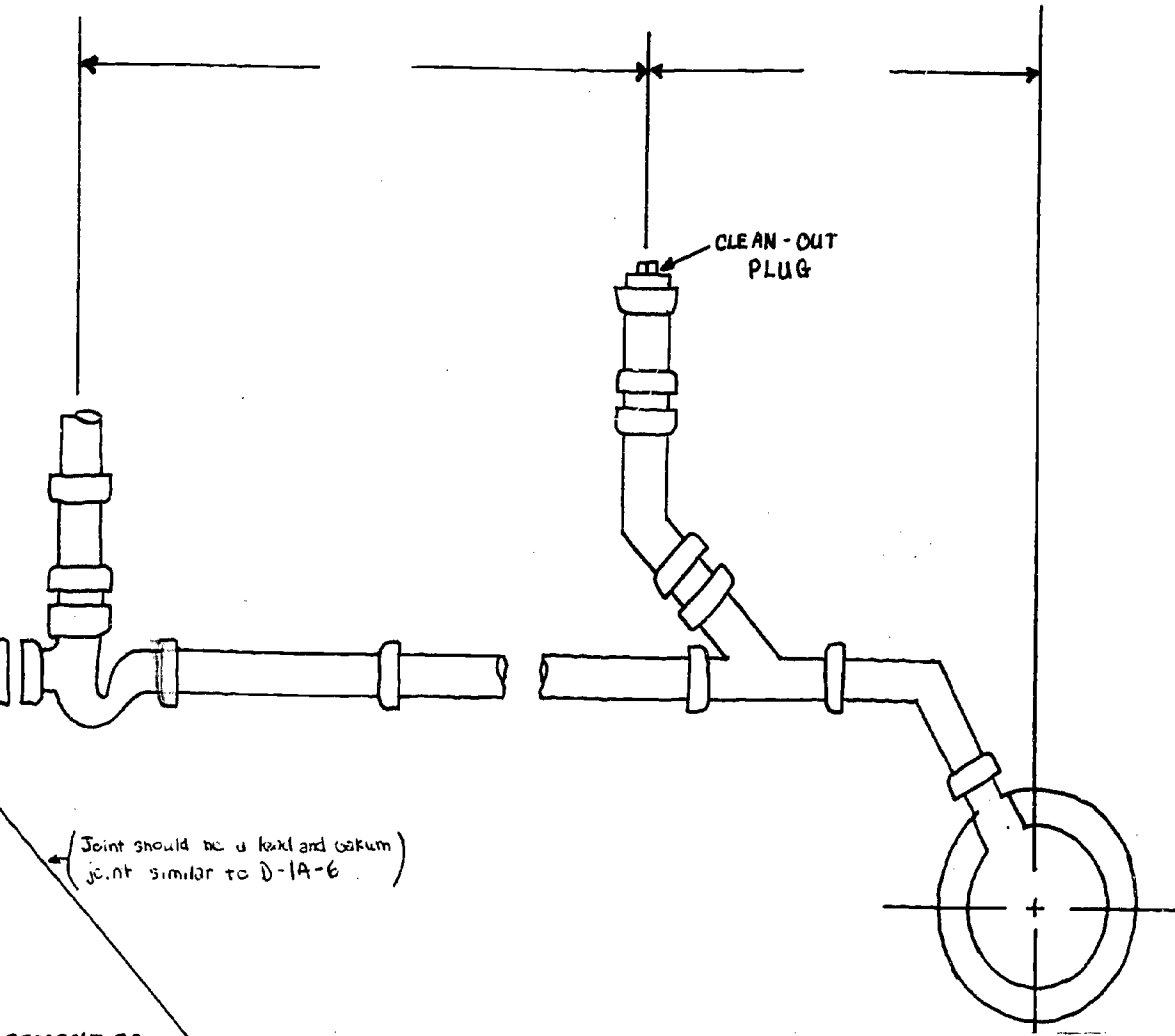

LEAD AND OAKUM CAST IRON SOIL PIPE JOINTS		49
		DRAWING NUMBER D-1A-13

JOB: Install Sission Joint

JOB SHEET
IDENTIFICATION CODE

UNIT I: Pipes and Fittings

JOB NUMBER: J-1A-14

COURSE: Plumbing

MATERIAL: 4" Sission Insertable Joint

EQUIPMENT: Lead Pot and Furnace
Safety Glasses

TOOLS: Ball Peen Hammer Yarning Irons
 Packing Irons Plumb-line
 Calking Irons Chisel
 Soil Pipe Cutter

SAFETY PRECAUTIONS:

1. Wear safety glasses at all times.
2. Check tools for "mushrooming".
3. Use only dry oakum.
4. Keep face back from hot lead.

COMPETENCE - PROCEDURE/STEPS The student will be able to:	TEACHING/LEARNING ACTIVITIES
1. Mark soil pipe for cutting.	. SC-1A-1
2. Cut cast iron soil pipe.	. SC-1A-12
3. Pick lead joint.	
4. Insert sission joint.	
5. Pack and drive oakum joint.	. SC-1A-6
6. Heat and melt lead.	. SC-1A-5
7. Pour lead.	. SC-1A-8
8. Calk lead joint.	. SC-1A-9

METHOD OF EVALUATION:

1. Accuracy of measurement
2. Appearance of finished job
3. Cleanliness of tools and work area
4. Time:

JOB: Install Kaffer Joint

JOB SHEET
IDENTIFICATION CODE

UNIT I: Pipes and Fittings

JOB NUMBER: J-1A-15

COURSE: Plumbing

MATERIAL: 4" Kaffer Tee
Soil Stack already in place

EQUIPMENT: Lead Pot and Furnace
Safety Glasses

TOOLS: Ball Peen Hammer Yarning Irons
 Packing Irons Plumb-bob
 Calking Irons Chisel
 Soil Pipe Cutter

SAFETY PRECAUTIONS:

1. Wear safety glasses at all times.
2. Check tools for "mushrooming".
3. Use only dry oakum.
4. Keep face back from hot lead.

COMPETENCE - PROCEDURE/STEPS The student will be able to:	TEACHING/LEARNING ACTIVITIES
1. Mark soil pipe for cuttings.	. SC-1A-1
2. Cut cast iron soil pipe.	. SC-1A-12
3. Pick lead joint.	. SC-1A-11
4. Remove bell and slide it on the pipe above the fitting.	
5. Insert kaffer tee.	
6. Pack and drive oakum joint.	. SC-1A-6
7. Check pipe for alignment.	. SC-1A-7
8. Heat and melt lead.	. SC-1A-5
9. Pour lead.	. SC-1A-8
10. Calk lead joint.	. SC-1A-9

METHOD OF EVALUATION:

1. Accuracy of measurement
2. Appearance of finished job
3. Cleanliness of tools and work area
4. Time:

51

JOB: Install a 4" Cast Iron Soil
Compression Gasket Line

JOB SHEET
IDENTIFICATION CODE

UNIT I: Pipes and Fittings

JOB NUMBER: J-1A-16

COURSE: Plumbing

MATERIAL: 4" Soil Pipe Neoprene Gaskets
 4" Fittings Lubricant

TOOLS: Pulling Tool
 Lead Mallet
 Pry-bar

COMPETENCE - PROCEDURE/STEPS The student will be able to:	TEACHING/LEARNING ACTIVITIES
1. Check blueprint for complete job.	
2. Lubricate gaskets.	. SC-1A-13
3. Insert neoprene gaskets.	. SC-1A-13
4. Join soil pipe and fittings.	. SC-1A-14
5. Plug and test line.	
6. Show instructor results.	

METHOD OF EVALUATION:

1. Accuracy of measurement
2. Appearance of finished job
3. Cleanliness of tools and work area
4. Time:

JOB: Install a 4" Cast Iron Soil
No-Hub Coupling Line

JOB SHEET
IDENTIFICATION CODE

UNIT I: Pipes and Fittings

JOB NUMBER: J-1A-17

COURSE: Plumbing

MATERIAL: No-Hub Coupling
No-Hub Pipe and Fittings

TOOLS: Stainless Steel Retaining Clamp Torque Wrench

SAFETY PRECAUTIONS:

Do not tighten clamp with fingers.

<u>COMPETENCE - PROCEDURE/STEPS</u> The student will be able to:	<u>TEACHING/LEARNING ACTIVITIES</u>
1. Insert fitting or pipe into neoprene gasket.	. SC-1A-15
2. Fit stainless steel clamp over gasket.	. SC-1A-15
3. Check pipe for alignment.	. SC-1A-7
4. Tighten with torque wrench.	. SC-1A-15
5. Test and show instructor.	

METHOD OF EVALUATION:

1. Appearance of measurement
2. Appearance of finished job
3. Cleanliness of tools and work area
4. Time:

JOB: Drill Cast-Iron Soil Pipe

JOB SHEET
IDENTIFICATION CODE

UNIT I: Pipes and Fittings

JOB NUMBER: J-1A-18

COURSE: Plumbing

MATERIAL: (1) Piece 4" Cast-Iron Soil Pipe

EQUIPMENT: Pipe Vise
1/2" Electric Drill

TOOLS: 16 oz. Ball Peen Hammer 6' Folding Rule
Center Punch 1-3/4" Hole Saw

SAFETY PRECAUTIONS:

1. Safety glasses must be worn when working with cast-iron soil pipe.
2. Extreme care must be exercised when operating the electric drill.

COMPETENCE - PROCEDURE/STEPS The student will be able to:	TEACHING/LEARNING ACTIVITIES
1. Place soil pipe in the vise.	
2. Mark soil pipe with center punch.	. SC-1A-16
3. Tighten hole saw in drill chuck.	. SC-1A-17
4. Start drill, applying light pressure to start the point of the pilot bit in soil pipe.	. SC-1A-17 NOTE: No cutting oil will be used with drilling cast-iron soil pipe.
5. Apply pressure on drill forcing pilot bit and hole saw to cut through the soil pipe.	. SC-1A-17 NOTE: The most critical time is the pilot bit breaking through the soil pipe. Too much pressure at this time will cause the hole saw to dig-in, break or pull out of the mandrel.
6. Remove hole saw from drill chuck.	

192

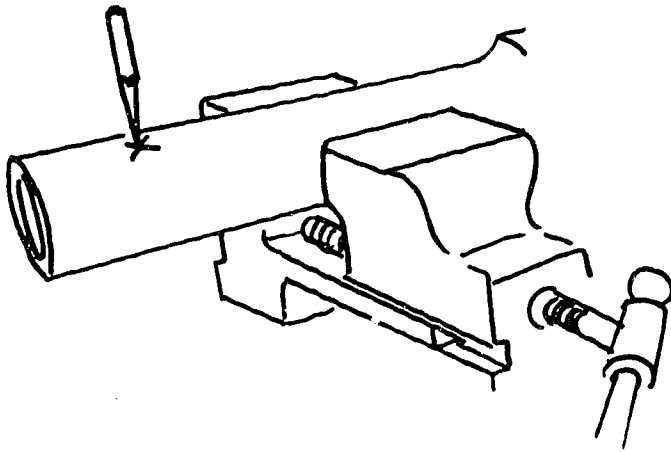

495

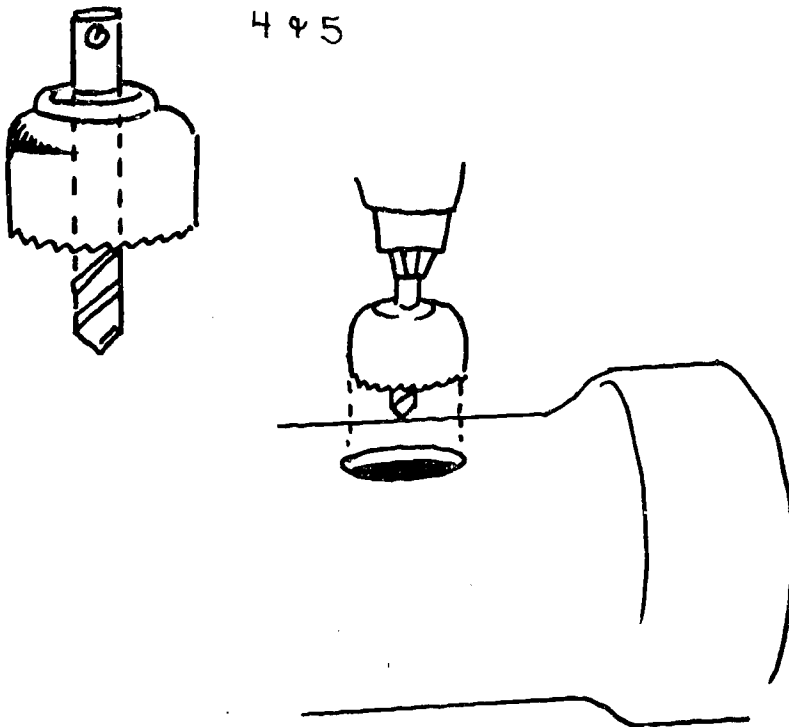

METHOD OF EVALUATION

1. Proper procedure
2. Proper and safe use of power drill
3. Appearance of hole

55

JOB: Tap Cast-Iron Soil Pipe

JOB SHEET
IDENTIFICATION CODE

UNIT I: Pipes and Fittings

JOB NUMBER: J-1A-19

COURSE: Plumbing

MATERIAL: (1) Piece 4" Soil Pipe (previously drilled)

EQUIPMENT: Pipe Vise

TOOLS: 1½" Pipe Tap
12" Adjustable Wrench

SAFETY PRECAUTIONS:

1. Safety glasses or goggles must be worn when working with cast-iron soil pipe.
2. Care must be exercised when tapping - do not force tap!
3. Do not check internal thread with your fingers.

COMPETENCE-PROCEDURE/STEPS The student will be able to:	TEACHING/LEARNING ACTIVITIES
1. Hold tap in left hand and place the end of the tap in the hole.	. SC-1A-18
2. Adjust wrench to fit square tap head.	. SC-1A-19
3. Position tap squarely in hole and apply steady downward pressure while turning with the wrench.	. SC-1A-18 NOTE: After two or three turns, check for squareness.
4. Continue turning tap into hold until internal thread is completed.	NOTE: It is good practice to back-off the tap 1/2 turn after each one or two forward turns.
5. Check threads with an 1½" pipe nipple.	

METHOD OF EVALUATION:

1. Proper procedure
2. Proper and safe use of the pipe tap
3. Appearance of finished threads

JOB: Measure and Cut Bituminous-Fiber Pipe

JOB SHEET
IDENTIFICATION CODE

UNIT I: Pipes and Fittings

JOB NUMBER: J-1B-1

COURSE: Plumbing

MATERIAL: (1) 8' Section 4" Orangeburg Pipe

EQUIPMENT: Pipe Vise

TOOLS: 6' Folding Rule Hand Saw (Carpenters)
Soapstone, Chalk, or Pencil

SAFETY PRECAUTIONS:

1. Safety glasses or goggles must be worn.
2. Extreme care must be exercised when starting cut.

COMPETENCE - PROCEDURE/STEPS The student will be able to:	TEACHING/LEARNING ACTIVITIES
1. Measure pipe to desired length.	. SC-1A-1
2. Place pipe in vise with mark protruding in front of vise.	NOTE: Tightening vise too tight might crack the pipe.
3. Cut pipe at mark.	. SC-1B-1
4. Check pipe cut for squareness - trim if necessary.	. SC-1B-1

METHOD OF EVALUATION:

1. Proper procedure
2. Proper and safe use of saw
3. Appearance (squareness) of finished cut

JOB: Bevel Bituminous-Fiber Pipe Ends

JOB SHEET
IDENTIFICATION CODE

UNIT I: Pipes and Fittings

JOB NUMBER: J-1B-2

COURSE: Plumbing

MATERIAL: (1) Section 4" Orangeburg Pipe Without Tapered End

EQUIPMENT: Pipe Vise
Bituminous-Fiber Pipe Bevel Tool Guide and Cutter

TOOLS: 6' Folding Rule

SAFETY PRECAUTIONS:

1. Safety glasses or goggles must be worn.
2. Care must be exercised when forcing cutter onto pipe.

COMPETENCE - PROCEDURE/STEPS The student will be able to:	TEACHING/LEARNING ACTIVITIES
1. Place pipe in vise with approximately 6" protruding in front of vise.	
2. Insert tool guide into pipe and tighten.	. SC-1B-2
3. Insert cutter over guide and cut taper.	. SC-1B-2
4. Remove cutter and guide.	. SC-1B-2
5. Inspect taper with a coupling.	

METHOD OF EVALUATION:

1. Proper procedure
2. Proper and safe use of bevel tool
3. Appearance and fit of finished taper

JOB: Install Bituminous Fiber
Sewer Line

JOB SHEET
IDENTIFICATION CODE

UNIT I: Pipes and Fittings

JOB NUMBER: J-1B-3

COURSE: Plumbing

DRAWING NO: D-1B-3

MATERIAL: 4" Orangeburg Ywe 4" Orangeburg 45° Ell
4" Orangeburg Trap (2-4) 10' Lengths of 4" Orangeburg

EQUIPMENT: Orangeburg Field Lathe or Beveling Machine

TOOLS: Shovel (Dirt) Digging Iron Ball Peen Hammer
2' Level Hand Saw (Carpenters) (1½ lb.)

SAFETY PRECAUTIONS:

1. Wear goggles when cutting and tapering orangeburg.
2. Exercise extreme care and caution when excavating, grading and backfilling trenches.
3. Orangeburg pipe must be handled with care - Do not drop on end or lay over rocks.

COMPETENCE - PROCEDURE/STEPS The student will be able to:	TEACHING/LEARNING ACTIVITIES
1. Prepare trench for installation of pipes.	. SC-1B-3
2. Place coupling or fitting over one end of the pipe and drive firmly into place.	. SC-1B-4
3. Lay pipe in trench and check grade.	
4. Measure for next section of pipe.	. SC-1A-1
5. Cut orangeburg to measurement.	. SC-1B-1
6. Bevel cut end.	. SC-1B-2
7. Place fitting over end of pipe and drive firmly into place.	. SC-1B-4
8. Lay section in trench and align with previously laid pipe.	
9. Join the two sections - driving them firmly together.	. SC-1B-4

COMPETENCE - PROCEDURE/STEPS	TEACHING/LEARNING ACTIVITIES
10. Complete steps 2 through 9 until sewer line is completed.	
11. Test and backfill sewer lateral.	. SC-1B-6

NOTE: Avoid rocks thrown or shoveled against pipe.

METHOD OF EVALUATION:

1. Accuracy of measurement and lay-out
2. Appearance/neatness of finished job
3. Cleanliness of tools and work areas

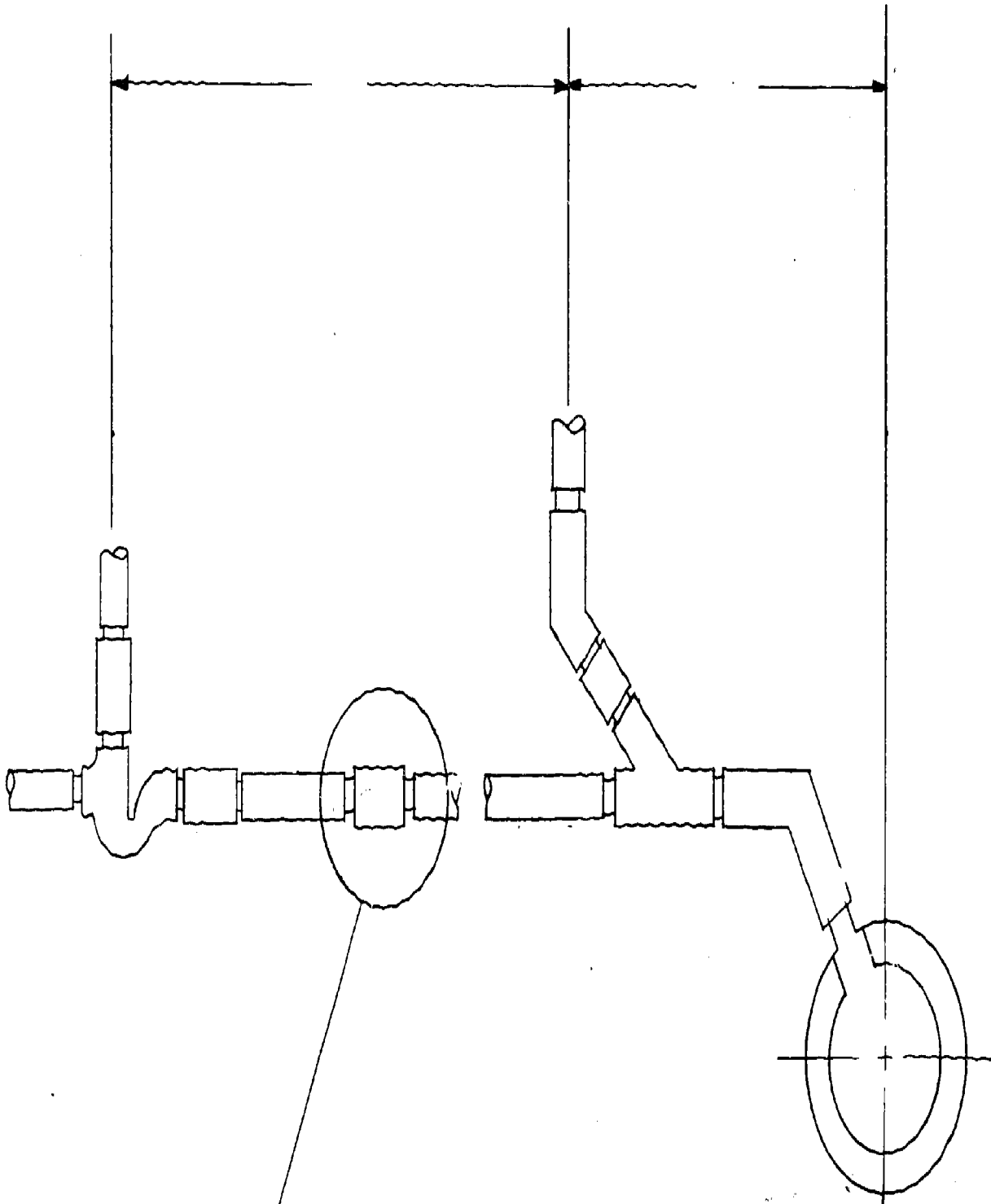

DETAIL

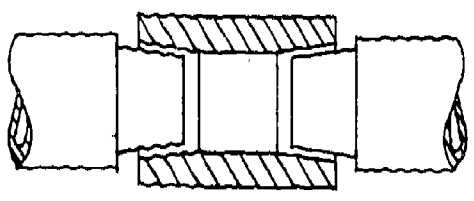

BITUMINIZED PIPE JOINTS

62

DRAWING NUMBER:
D-1B-3

JOB: Join Bituminized Fiber Pipe to
Cast-Iron Pipe

JOB SHEET
IDENTIFICATION CODE

UNIT: Pipes and Fittings

JOB NUMBER: J-1B-4

COURSE: Plumbing

DRAWING NO: D-1B-4

MATERIAL: (2-3) Bituminized to Cast-Iron Adapters
Bituminized Compound and Oakum
(1-2) Sections of 4" Cast-Iron Pipe
4" Cast-Iron Clean-out Plug

EQUIPMENT: Cast-Iron Pot and Furnace

TOOLS: Yarning Irons Ball Peen Hammer Joint Runner
Packing Irons Joint Ladle

SAFETY PRECAUTIONS:

1. Only dry oakum should be used.
2. Exercise extreme care and caution when working with or around hot molten materials.
3. Gloves should be worn when pouring molten bituminous compound.

COMPETENCE - PROCEDURE/STEPS The student will be able to:	TEACHING/LEARNING ACTIVITIES
1. Check blueprint for location of adapters.	
2. Place adapter over the end of the pipe and drive firmly into place.	. SC-1B-4
3. Insert clean-out plug into adapter and make-up bituminous joint.	. SC-1B-5
4. Repeat step two (2).	. SC-1B-4
5. Insert section of 4" cast-iron into adapter and make-up bituminous joint.	. SC-1B-5
6. Test and check for leaks.	

METHOD OF EVALUATION:

1. Appearance/neatness of finished job
2. Cleanliness of tools and work areas
3. Safety practices observed when working with hot molten material

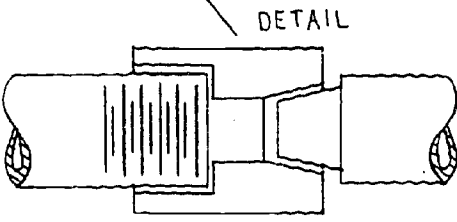
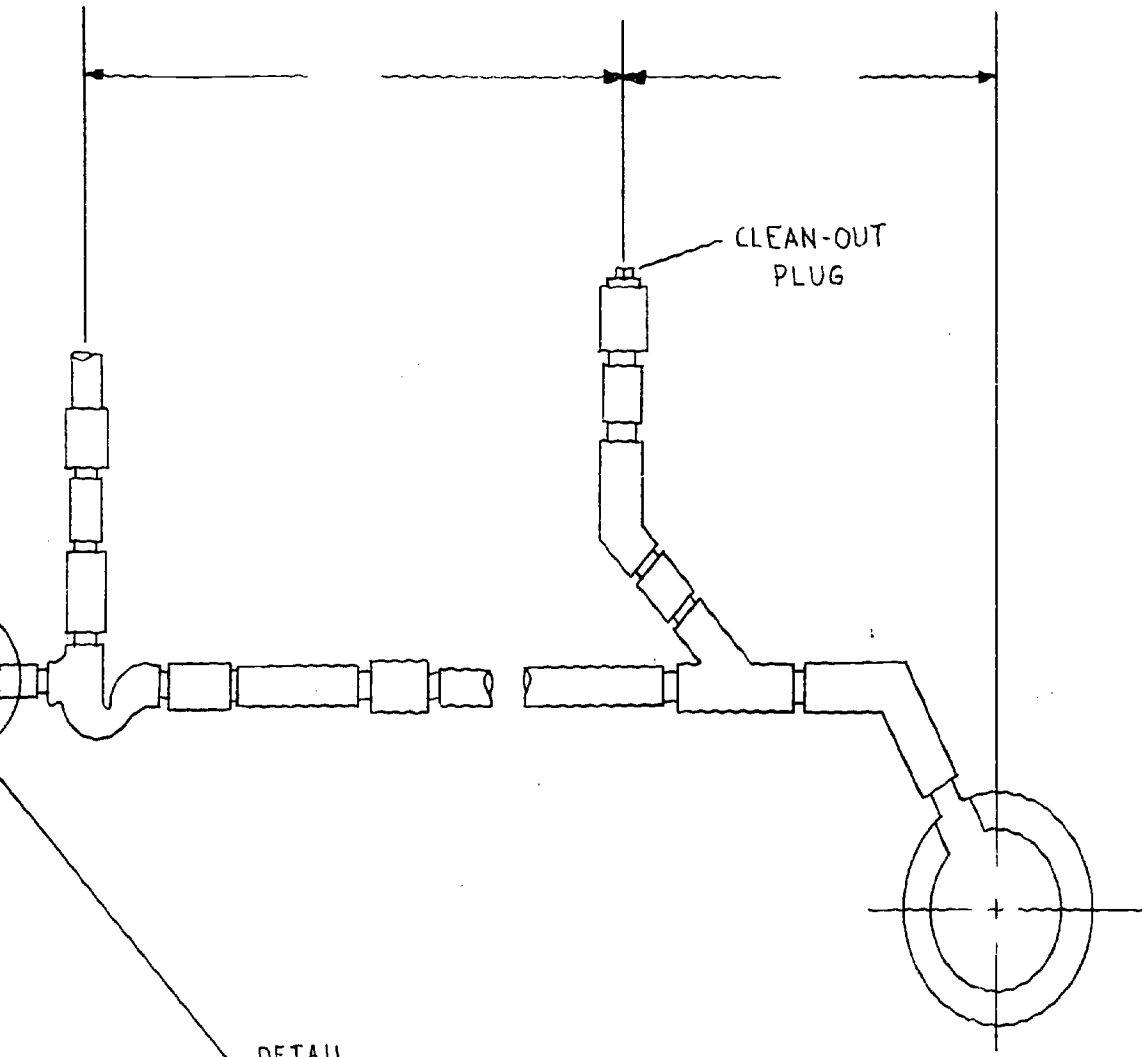

BITUMINIZED TO CAST-IRON JOINTS		65
DRAWING NUMBER:		D-1B-4

JOB: Measure and Cut Terra-Cotta Pipe

JOB SHEET
IDENTIFICATION CODE

UNIT I: Pipes and Fittings

JOB NUMBER: J-1C-1

COURSE: Plumbing

MATERIAL: (1) Section 4" Terra-Cotta Pipe

TOOLS: 6' Folding Rule
Soapstone, Chalk, or Pencil
Leather Wrap Around
12 or 16 oz. Ball Peen Hammer
½" Flat Chisel

SAFETY PRECAUTIONS:

1. Safety glasses or goggles must be worn.
2. Care must be taken when handling and working with clay pipe.

COMPETENCE - PROCEDURE/STEPS The student will be able to:	TEACHING/LEARNING ACTIVITIES
1. Lay pipe on soft solid ground.	
2. Measure pipe and mark length.	. SC-1A-1
3. Place chisel on mark striking the chisel with quick <u>light</u> blows.	. SC-1C-1
4. Continue Step 3 until pipe separates.	. SC-1C-1
5. Check cut for squareness - chipping with a hammer and chisel might be necessary.	

METHOD OF EVALUATION:

1. Proper procedure
2. Proper and safe use of hammer and cold chisel
3. Appearance of finished cut

JOB: Cemented Terra-Cotta Pipe Joint

JOB SHEET
IDENTIFICATION CODE

UNIT I: Pipes and Fittings

JOB NUMBER: J-1C-2

COURSE: Plumbing

MATERIAL: (2-3) Sections 4" Terra-Cotta Pipe
Portland Cement and Sand
Oakum

TOOLS: Yarning Irons Pointed Cement Trowel
Packing Irons Bucket

SAFETY PRECAUTIONS:

1. Safety glasses or goggles must be worn.
2. Care must be exercised when handling and working with clay pipe.

COMPETENCE - PROCEDURE/STEPS The student will be able to:	TEACHING/LEARNING ACTIVITIES
1. Insert spigot end of pipe into hub end of pipe.	NOTE: Wipe bell and spigot clean and dry to assure tight bond of cement.
2. Yarn and pack oakum into joint.	. SC-1A-6
3. Mix proper cement-sand with water.	. SC-1C-2
4. Pack cement into joint and smooth with the trowel.	. SC-1C-3
5. Wipe off excess cement from joint.	NOTE: Do not bump or move joint until cement is set.
6. Clean tools and bucket.	

METHOD OF EVALUATION:

1. Proper procedure
2. Appearance of finished joint
3. Cleanliness of tools and work area

JOB: Install Terra-Cotta Sewer
Line (Cemented)

JOB SHEET
IDENTIFICATION CODE

UNIT I: Pipes and Fittings

JOB NUMBER: J-1C-3

COURSE: Plumbing

DRAWING NO: D-1C-3

MATERIAL: 4" Terra-Cotta Ywe
4" Terra-Cotta Trap Cement and Oakum (10) 4' Lengths of 4" Terra-Cotta
4" Terra-Cotta 45° Curve

TOOLS: Digging Iron Shovel (Dirt) Pointed Cement Trowel
Yarning Irons 2' Level Chisel (½" Cold)
Packing Irons Ball Peen Hammer Bucket (2½ or 5 gal.)

SAFETY PRECAUTIONS:

1. Goggles must be worn when cutting terra-cotta pipe.
2. Exercise extreme care and caution when excavating, grading and backfilling trenches.
3. Terra-cotta must be handled with extreme care - Do not drop or lay over rocks.

COMPETENCE - PROCEDURE/STEPS The student will be able to:	TEACHING/LEARNING ACTIVITIES
1. Lay out and prepare trench.	. SC-1B-3
2. Lay lengths of terra-cotta in trench to first fitting.	
3. Check grade and measure for next section of pipe.	. SC-1A-1
4. Cut terra-cotta to measurement.	. SC-1C-1
5. Lay cut piece and other lengths of terra-cotta in trench to next fitting.	
6. Repeat step three (3).	
7. Repeat step four (4).	
8. Pack each joint with oakum.	. SC-1A-6
9. Mix cement-sand.	. SC-1C-2

COMPETENCE - PROCEDURE/STEPS	TEACHING/LEARNING ACTIVITIES
10. Cement each joint.	. SC-1C-3
11. Test and backfill sewer lateral.	. SC-1B-6

NOTE: Do not throw or shovel rocks against pipe.

METHOD OF EVALUATION:

1. Accuracy of measurement and layout
2. Appearance/neatness of finished job
3. Cleanliness of tools and work areas

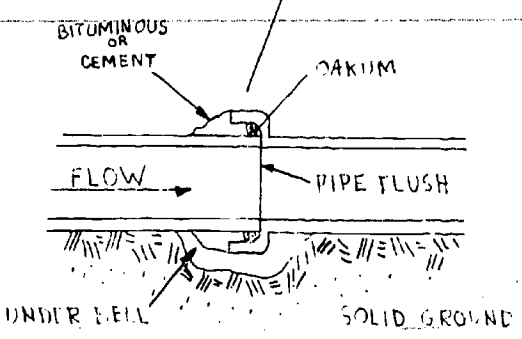
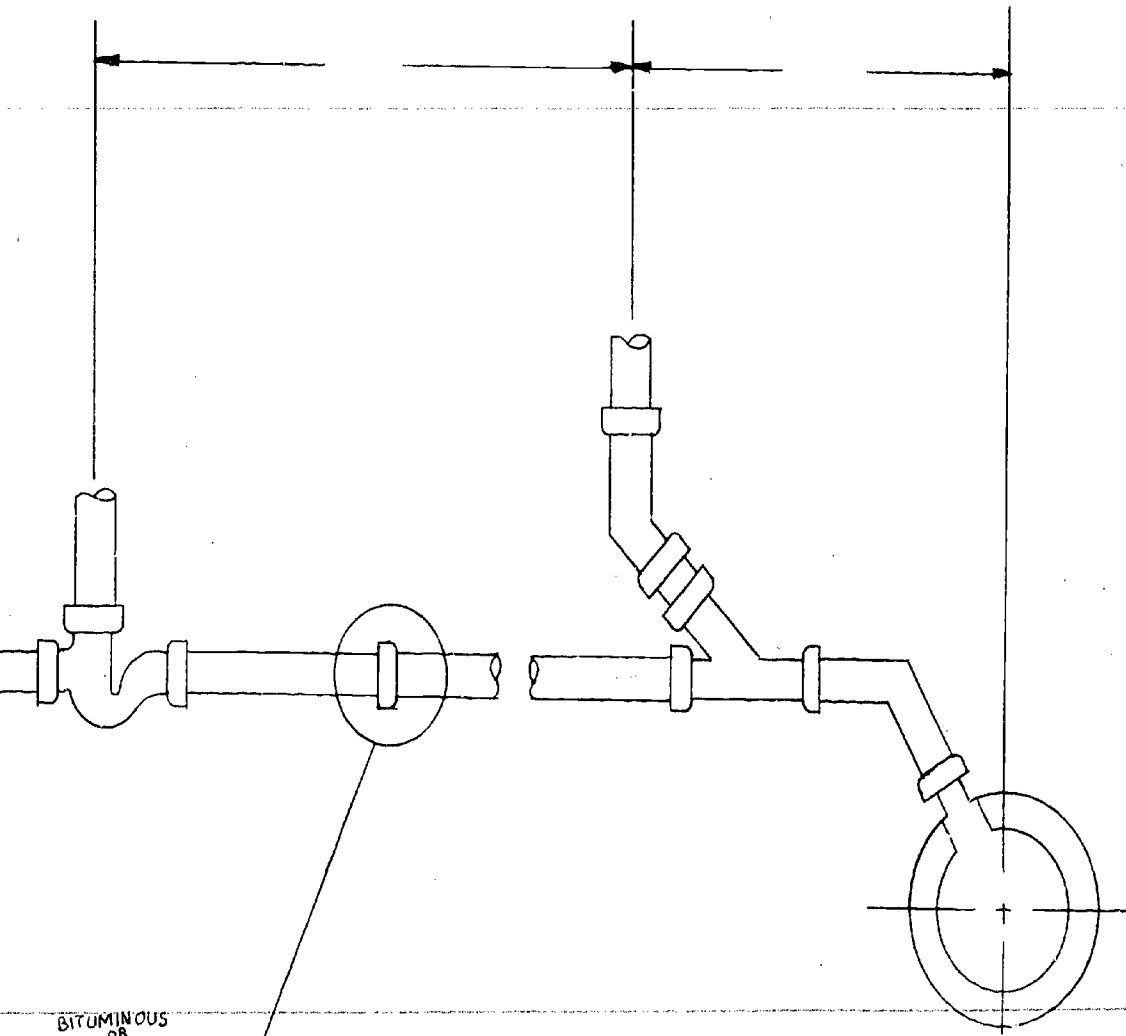

TERRA-COTTA PIPE JOINTS		71
		DRAWING NUMBER D-1C-3

JOB: Bituminous Terra-Cotta Joint

JOB SHEET
IDENTIFICATION CODE

UNIT I: Pipes and Fittings

JOB NUMBER: J-1C-4

COURSE: Plumbing

MATERIAL: (2-3) Sections Terra-Cotta Pipe
Oakum
Bituminous Compound

EQUIPMENT: Lead Pot and Torch

TOOLS: Yarning Irons
Packing Irons
Lead Ladle

SAFETY PRECAUTIONS:

1. Safety glasses or goggles must be worn.
2. Extreme care must be exercised when working with molten bituminous compound.
3. Keep face clear from hot bituminous compound.

COMPETENCE - PROCEDURE/STEPS The student will be able to:	TEACHING/LEARNING ACTIVITIES
1. Insert spigot end of pipe into hub end of pipe.	NOTE: Wipe bell and spigot clean and dry to assure tight bond of bituminous compound.
2. Yarn and pack oakum into joint.	. SC-1A-6
3. Heat and melt bituminous compound.	. SC-1A-5
4. Clamp joint runner tightly against bell keeping the "gate" or opening slightly to the right or left of center.	. SC-1A-10
5. Pour the joint with compound.	. SC-1B-5
6. Let set and pick off excess compound.	

METHOD OF EVALUATION:

1. Proper procedure
2. Proper and safe use of lead torch
3. Appearance of finished joint
4. Cleanliness of tools and work area

COMPETENCE - PROCEDURE/STEPS	TEACHING/LEARNING ACTIVITIES
10. Clamp joint runner against bell and pour each joint.	. SC-1B-5
11. Test and backfill sewer lateral.	. SC-1B-6

NOTE: Do not throw or shovel rocks against pipe.

METHOD OF EVALUATION:

1. Accuracy of measurement and layout
2. Appearance/neatness of finished job
3. Cleanliness of tools and work areas
4. Safety practices observed when working with hot materials

JOB: Join Cast-Iron to Terra-Cotta

JOB SHEET
IDENTIFICATION CODE

UNIT I: Pipes and Fittings

JOB NUMBER: J-1C-6

COURSE: Plumbing

DRAWING NO: D-1C-6

MATERIAL: 4" Cast-Iron Clean-out Plug
(1-2) Sections of 4" Cast-Iron Pipe
Cement or Bituminous Compound and Oakum

EQUIPMENT: Cast-Iron Pot and Furnace

TOOLS: Yarning Irons Joint Runner Bucket (2½ or 5 gal.)
Packing Irons Ladle Pointed Cement Trowel

SAFETY PRECAUTIONS:

1. Exercise extreme care and caution when with or around hot molten materials.
2. Gloves should be worn when pouring hot material.

COMPETENCE - PROCEDURE/STEPS	TEACHING/LEARNING ACTIVITIES
The student will be able to:	
1. Check blueprint for location of change in piping.	. D-1C-6
2. Insert clean-out plug into bell of terra-cotta and make-up a cemented or bituminous joint.	
3. Insert section of cast-iron pipe into terra-cotta bell and make-up a cemented or bituminous joint.	
4. Test and check for leaks.	

METHOD OF EVALUATION:

1. Appearance/neatness of finished job
2. Cleanliness of tools and work areas
3. Safety practices observed while working with hot molten bituminous material

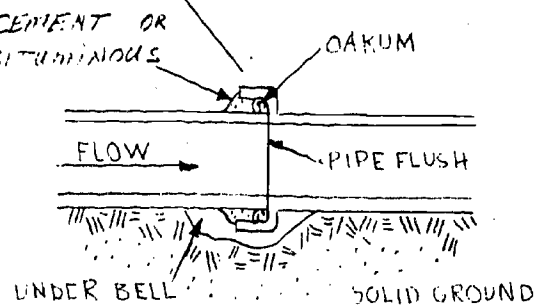
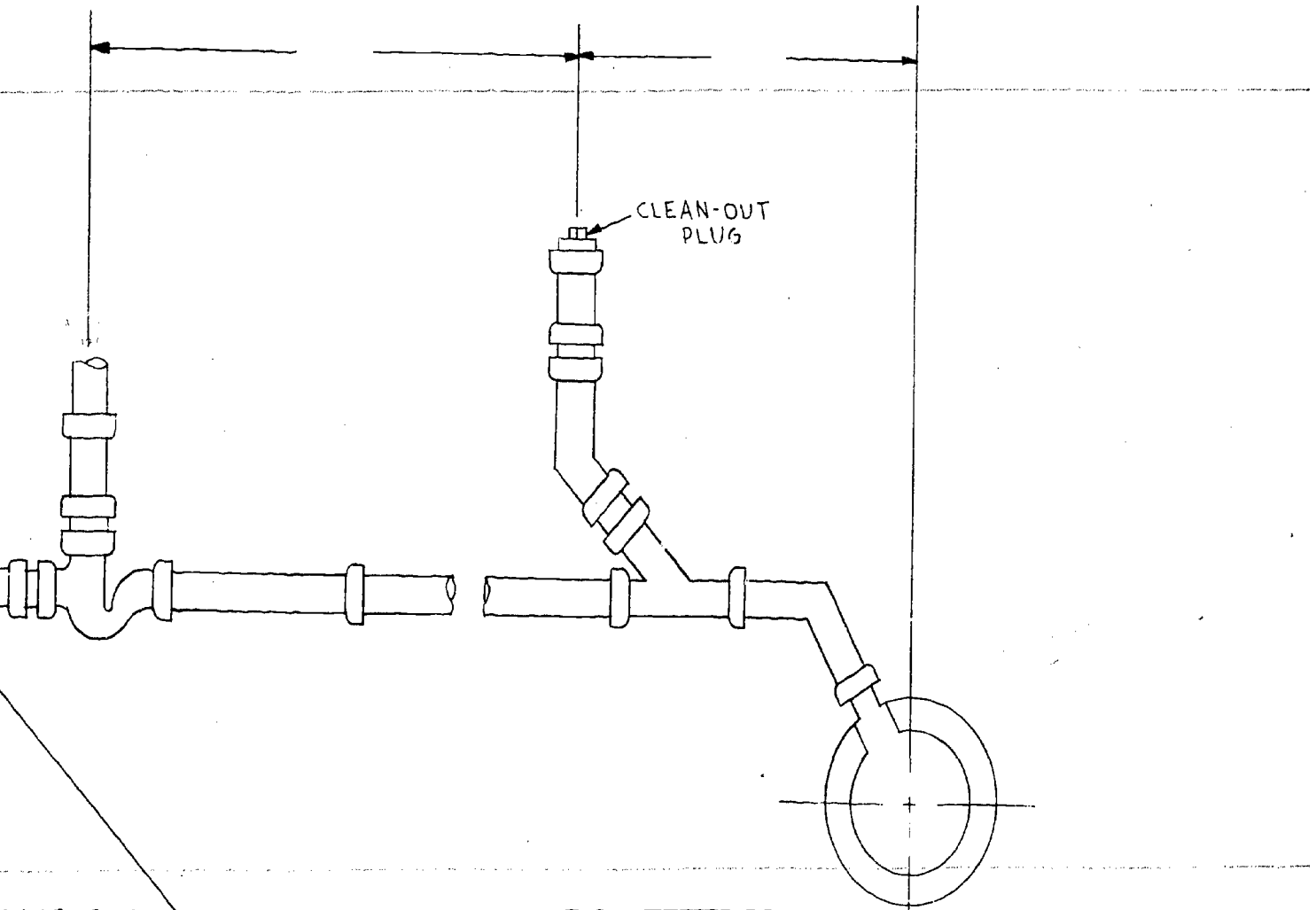

TERRA COTTA TO CAST-IRON PIPE JOINTS		
SCALE:	APPROVED BY:	DRAWN BY: <i>Gary Leese</i>
DATE:		REVISED
TERRA-COTTA TO CAST-IRON PIPE JOINTS		77
		DRAWING NUMBER D-1C-6

JOB: Measure and Cut Glass Pipe

JOB SHEET
IDENTIFICATION CODE

UNIT I: Pipes and Fittings

JOB NUMBER: J-1D-1

COURSE: Plumbing

MATERIAL: (1) Section 1½" or 2" Glass Pipe

TOOLS: 6' Folding Rule Pipe Scorer
Grease Pencil Heater with Assorted Heads

SAFETY PRECAUTIONS:

1. Safety glasses or goggles must be worn.
2. Extreme care must be exercised when handling and working with glass pipe.

COMPETENCE - PROCEDURE/STEPS The student will be able to:	TEACHING/LEARNING ACTIVITIES
1. Measure and mark pipe.	. SC-1A-1
2. Drop a drop of scoring catalyst on scorer cutter wheel.	. SC-1D-1
3. Score pipe.	. SC-1D-1
4. Lay pipe on flat surface and insert heater into pipe.	. SC-1D-1
5. Turn on heater separating pipe.	. SC-1D-1

METHOD OF EVALUATION:

1. Proper procedure
2. Proper and safe use of scorer and heater
3. Appearance of finished cut

JOB: Make a 1½" - 2" E to C
Glass Pipe Joint

JOB SHEET
IDENTIFICATION CODE

UNIT I: Pipes and Fittings

JOB NUMBER: J-1D-2

COURSE: Plumbing

DRAWING NO: D-1D-2

MATERIAL: 12", 18", 24" Stock Lengths 90° Elbow
2 Speed Couplings Glass Pipe

EQUIPMENT: Speed-bead Electric Heating Element with Accessories

TOOLS: 6' Extension Rule Grease Pencil Pliers
Scoring Catalyst Pipe Scorer

SAFETY PRECAUTIONS:

1. Handle glass pipe carefully during installation.
2. Use care when handling tools around glass pipe.
3. Glass pipe must be installed in a manner to be free of strain.

COMPETENCE - PROCEDURE/STEPS The student will be able to:	TEACHING/LEARNING ACTIVITIES
1. Check blueprint.	
2. Measure pipe.	. SC-1A-1
3. Mark and score pipe.	. SC-1D-1
4. Select proper head and insert heater in pipe.	. SC-1D-1
5. Assemble speed-bead.	. SC-1D-2
6. Bond end.	. SC-1D-2
7. Allow to cool.	
8. Apply coupling.	
9. Repeat until finished with assembly.	

METHOD OF EVALUATION:

1. Accuracy of measurement
2. Appearance of finished job
3. Cleanliness of tools and work area
4. Time:

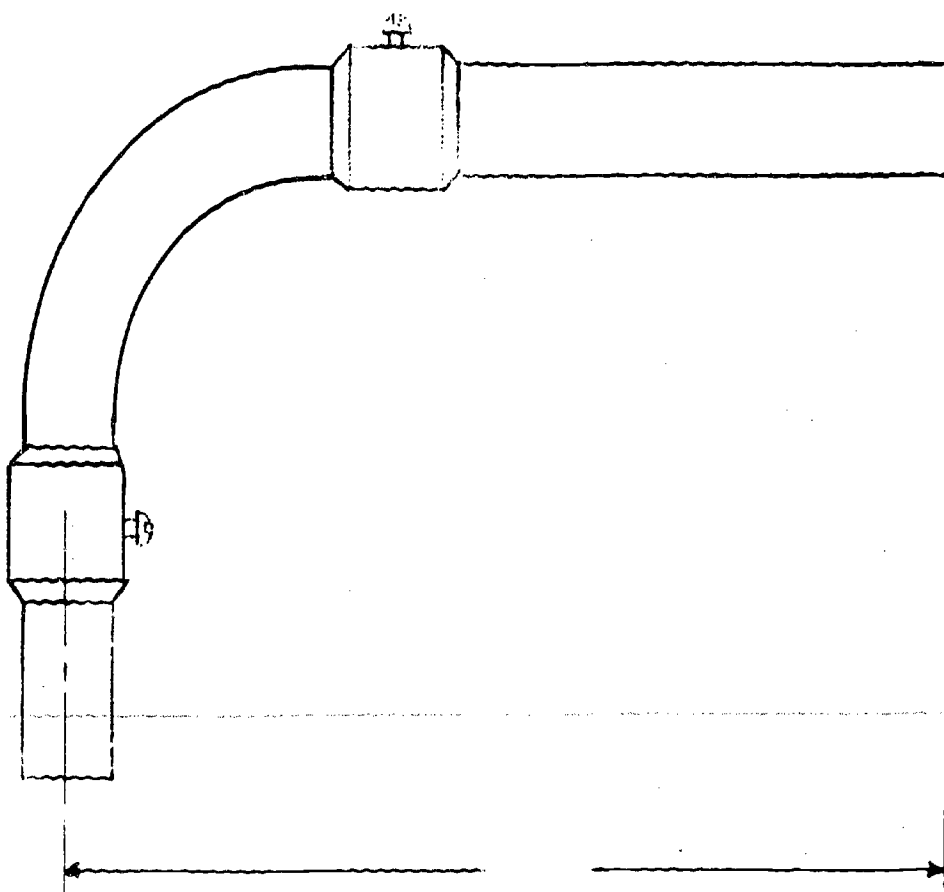

E TO C GLASS PIPE JOINT

DRAWING NUMBER

D-1D-2

JOB: Make a 1½" - 2" C to C
Glass Pipe Joint

JOB SHEET
IDENTIFICATION CODE

UNIT I: Pipes and Fittings

JOB NUMBER: J-1D-3

DRAWING NO: D-1D-3

COURSE: Plumbing

MATERIAL: (2) 90° Elbows 12", 18", 24" Stock Lengths
4 Speed Couplings 1½" or 2" Glass Pipe

EQUIPMENT: Speed-bead Electric Heating Element with Accessories

TOOLS: Pliers Grease Pencil Scoring Catalyst
6' Extension Rule Pipe Scorer

SAFETY PRECAUTIONS:

1. Handle glass pipe carefully during installation.
2. Use care when handling tools around glass pipe.
3. Glass pipe must be installed in a manner to be free of strain.

COMPETENCE - PROCEDURE/STEPS The student will be able to:	TEACHING/LEARNING ACTIVITIES
1. Check blueprint.	
2. Measure pipe.	. SC-1A-1
3. Mark and score pipe.	. SC-1D-1
4. Select proper head and insert heater in pipe.	. SC-1D-1
5. Assemble speed-bead.	. SC-1D-2
6. Bond end.	. SC-1D-2
7. Allow to cool.	
8. Apply coupling.	. SC-1D-3
9. Repeat until finished with assembly.	

METHOD OF EVALUATION:

1. Accuracy of measurement
2. Appearance of finished job
3. Cleanliness of tools and work area
4. Time:

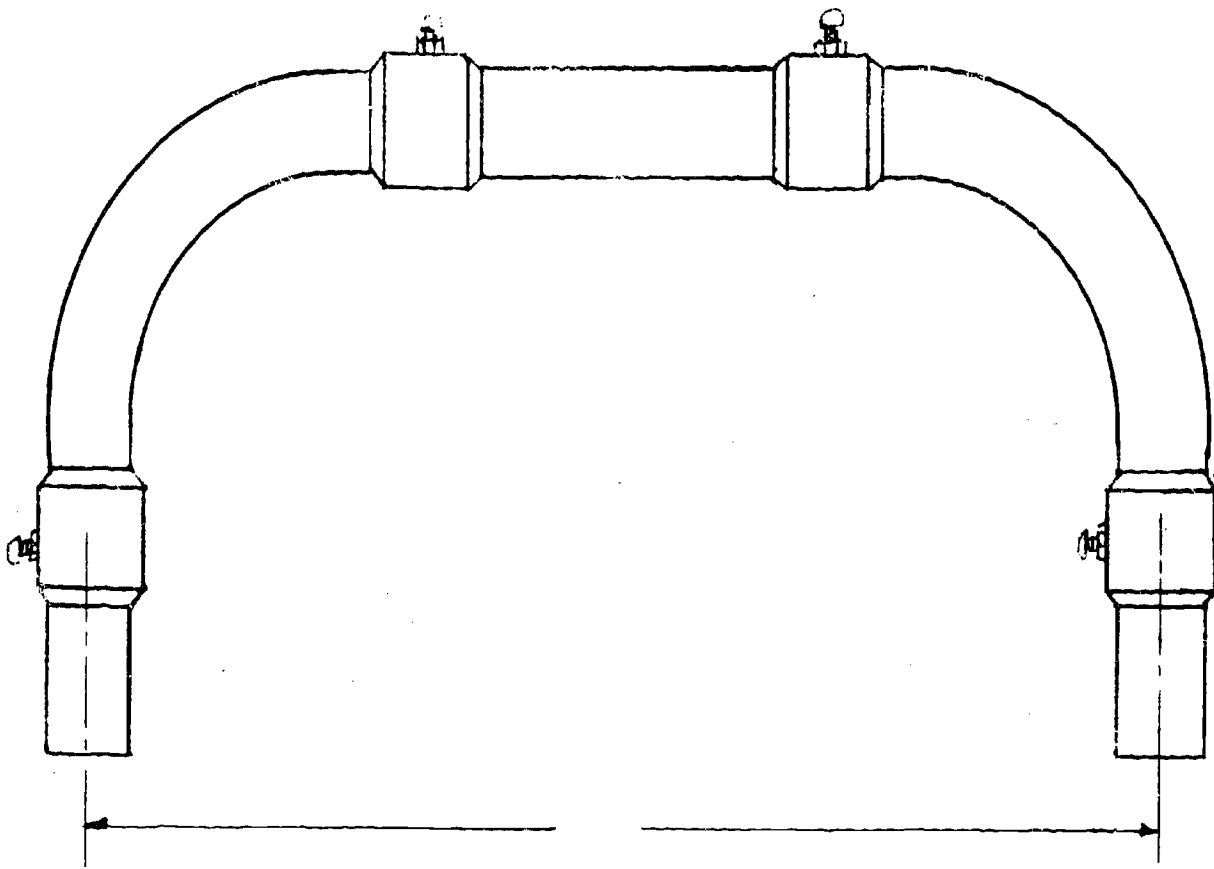

C TO C GLASS PIPE JOINT

DRAWING NUMBER

D-1D-3

JOB: Join a Glass Pipe to Cast-Iron Hub

JOB SHEET
IDENTIFICATION CODE

UNIT I: Pipes and Fittings

JOB NUMBER: J-1D-4

COURSE: Plumbing

DRAWING NO: D-1D-4

MATERIAL: 12", 18"-2" Glass Pipe
(1') 2" Cast-Iron Pipe with Hub

Asbestos Rope
Lead

EQUIPMENT: Lead Pot and Furnace
Propane Hand Torch

TOOLS: 6' Extension Rule Yarning Irons
Ball Peen Hammer Calking Irons

SAFETY PRECAUTIONS:

1. Wear goggles when dipping and pouring lead.
2. Use dry asbestos rope.
3. Keep face back when dipping and pouring lead.

<u>COMPETENCE - PROCEDURE/STEPS</u> The student will be able to:	<u>TEACHING/LEARNING ACTIVITIES</u>
1. Check blueprint.	
2. Place a layer of asbestos rope in lower hub.	. SC-1A-6
3. Insert glass pipe in hub.	
4. Yarn asbestos rope to desired depth.	. SC-1A-6
5. Check alignment.	. SC-1A-7
6. Heat and melt lead.	. SC-1A-5
7. Preheat glass.	
8. Pour lead.	. SC-1A-8
9. Calk lead joint.	. SC-1A-9

METHOD OF EVALUATION:

1. Appearance of finished job
2. Cleanliness of tools and work area
3. Time:

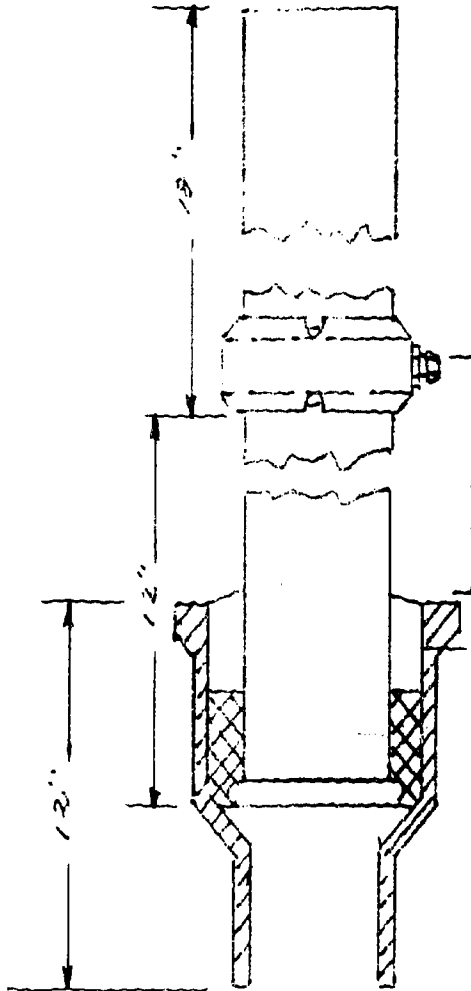

GLASS PIPE TO CAST-IRON HUB

DRAWING NUMBER

D-10-4

JOB: Measure and Cut Sheet Lead

JOB SHEET
IDENTIFICATION CODE

UNIT I: Pipes and Fittings

JOB NUMBER: J-1E-1

COURSE: Plumbing

TOOLS: 6' Folding Rule
Straight Edge

Scribe or Pencil
Straight or Combination Shears

SAFETY PRECAUTIONS:

1. Safety/glasses or goggles must be worn.
2. Be extra careful of the point on the scribe and shear blades.

<u>COMPETENCE - PROCEDURE/STEPS</u> The student will be able to:	<u>TEACHING/LEARNING ACTIVITIES</u>
1. Measure and mark to size on sheet lead.	. SC-1A-1
2. Scribe lines for cutting.	. SC-1E-1
3. Cut six strips 10" long.	. SC-1E-2
4. Check strips for straightness.	

METHOD OF EVALUATION:

1. Proper procedure
2. Measurement and layout
3. Appearance (straightness) of cuts

JOB: Tin a Soldering Iron
 UNIT I: Pipes and Fittings
 COURSE: Plumbing
 MATERIAL: Block - Sal Ammoniac
 50-50 Solder
 EQUIPMENT: Bench Soldering Furnace
 TOOLS: Soldering Iron
 Flat File (Smooth - cut)

JOB SHEET
IDENTIFICATION CODE

JOB NUMBER: J-1E-2

SAFETY PRECAUTIONS:

1. Safety glasses must be worn.
2. Extreme care must be taken when lighting the soldering furnace.
3. Care must be exercised when handling the hot iron.

COMPETENCE - PROCEDURE/STEPS The student will be able to:	TEACHING/LEARNING ACTIVITIES
1. Select proper iron for work to be done.	
2. Light soldering furnace.	. SC-1E-3
3. Heat soldering iron to a working heat.	NOTE: Proper heat may be determined by holding the heated iron about 6" from the face, noting the heat it gives off.
4. File one or two surfaces of the point until clean and bright.	. SC-1E-4
5. Make a depression in the sal ammoniac block with the hot iron and melt a few drops of solder into it.	. SC-1E-5
6. Repeat steps 3 through 5 on the remaining surfaces of the point.	NOTE: Tinning should be done immediately after filing so the bright surfaces will not oxidize. . SC-1E-4, SC-1E-5

METHOD OF EVALUATION:

1. Proper procedure
2. Safe use and handling of soldering iron
3. Appearance of tinned iron

JOB: Solder Flat and Vertical Seams
 UNIT I: Pipes and Fittings
 COURSE: Plumbing
 MATERIAL: (6) 1" X 10" Strips - 4 lb. Sheet Lead
 50-50 Solder
 TOOLS: Soldering Iron
 Shave Hook

JOB SHEET
IDENTIFICATION CODE

JOB NUMBER: J-1E-3

Powdered Rosin
 Candle Tallow

SAFETY PRECAUTIONS:

1. Safety glasses or goggles must be worn.
2. Care must be exercised when soldering -- sheet lead and solder will liquify within 200°.

COMPETENCE - PROCEDURE/STEPS The student will be able to:	TEACHING/LEARNING ACTIVITIES
--	------------------------------

- | | |
|---|--|
| 1. Flatten sheet lead strips. | |
| 2. True edges with coarse file. | . SC-1E-3 |
| 3. Bevel edges with shave hook. | . SC-1E-6 |
| 4. Apply tallow over shaved parts. | . SC-1E-6 |
| 5. Light and adjust soldering furnace. | . SC-1E-3 |
| 6. Heat soldering iron. | NOTE: If necessary tin soldering iron. |
| 7. Place edges firmly together and sprinkle powdered rosin along the joint. | . SC-1E-7 |
| 8. Tack solder sheet lead strips. (4" to 6" apart) | . SC-1E-7 |
| 9. Solder seam. | |

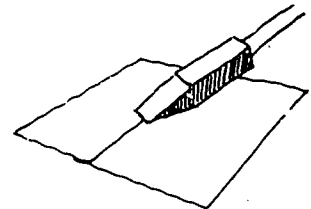
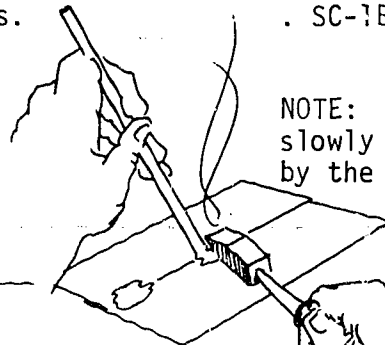

METHOD OF EVALUATION:

1. Proper procedure
2. Safe use and handling of shave hook and soldering iron
3. Appearance of finished joint

90

-117-

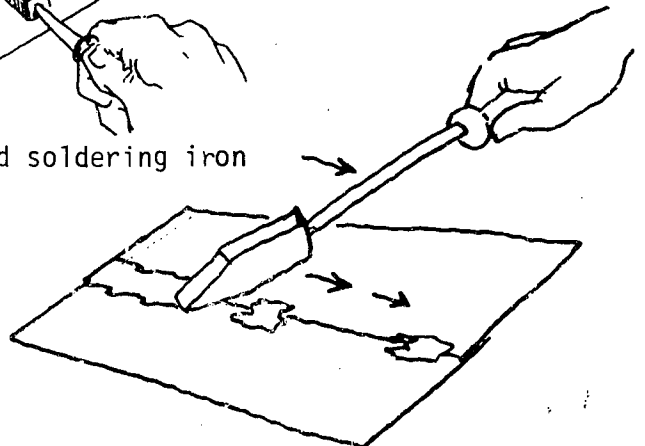

JOB: Construct a Lead Drain Pan
 UNIT I: Pipes and Fittings
 COURSE: Plumbing
 MATERIAL: 14" Square - 4 lb. Sheet Lead
 Powdered Rosin
 Candle Tallow
 50-50 solder

JOB SHEET
IDENTIFICATION CODE

JOB NUMBER: J-1E-4

EQUIPMENT: Soldering Furnace

TOOLS: Flat Dresser Scribe
 Soldering Iron Straight or Combination Shears
 Dividers Aviation Snips
 Straightedge

SAFETY PRECAUTIONS:

1. Safety glasses or goggles must be worn.
2. Care must be taken not to puncture sheet lead.
3. Care must be exercised when handling hot soldering iron and lighting furnace.

COMPETENCE - PROCEDURE/STEPS The student will be able to:	TEACHING/LEARNING ACTIVITIES
1. Cut out sheet to construct pan.	. SC-1E-2
2. Lay out and scribe inside pan measurement.	. SC-1A-1
3. Make a slight indentation along scribed lines (inside pan) to facilitate bending.	. SC-1E-8
4. Form and smooth out the upstands.	. SC-1E-8
5. Flatten the pig-eared corners against the upstands.	. SC-1E-8
6. Complete corner by trimming off and cleaning lead, and soldering.	. SC-1E-2, SC-1E-7

NOTE: At each corner almost perfectly shaped pig ears should remain.



COMPETENCE - PROCEDURE/STEPS	TEACHING/LEARNING ACTIVITIES
------------------------------	------------------------------

- | | |
|---|------------|
| 7. Mark drain opening in bottom of pan. | . SC-1E-9 |
| 8. Cut hole in bottom of pan. | . SC-1E-10 |
| 9. Check finished job for accuracy. | |

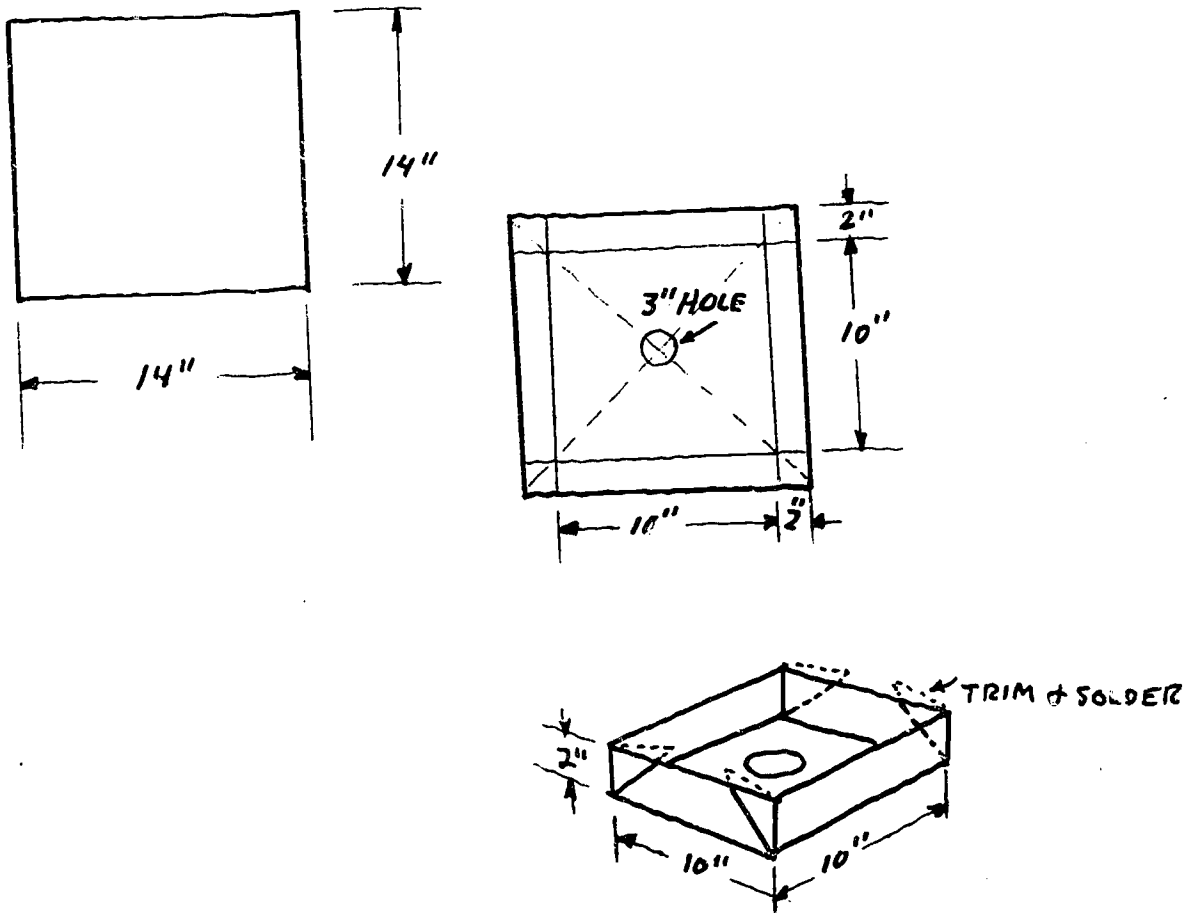

METHOD OF EVALUATION:

1. Proper procedure
2. Accuracy of measurement
3. Appearance of final job
4. Cleanliness of tools and work area

JOB: Measure, Cut and Prepare Lead Pipe

JOB SHEET
IDENTIFICATION CODE

UNIT I: Pipes and Fittings

JOB NUMBER: J-1E-5

COURSE: Plumbing

MATERIAL: 2' - 1 1/2" Lead Pipe
Plumbers Soil
Tallow (Candle)

TOOLS: 6' Folding Rule Knife
Pencil Turn-Pin
Hack Saw Shave Hook
Flat File

SAFETY PRECAUTIONS:

1. Safety glasses or goggles must be worn.
2. Exercise care when using hack saw and knife.
3. Care must be taken not to dent, kink, smash, etc. lead pipe.

COMPETENCE - PROCEDURE/STEPS The student will be able to:	TEACHING/LEARNING ACTIVITIES
1. Measure pipe to length.	. SC-1A-1
2. Cut pipe at mark with hack saw.	. SC-1E-11
3. Square ends with file.	. SC-1E-4
4. Ream ends with knife.	. SC-1E-12
5. Apply plumber soil.	. SC-1E-13
6. Flare end to be joined.	. SC-1E-13
7. Bevel end to be joined.	. SC-1E-13
8. Mark flared and beveled ends for scraping.	. SC-1E-14
9. Scrape clean with shave hook.	. SC-1E-6
10. Apply tallow to clean ends.	. SC-1E-6
11. Fit and brace joint.	

METHOD OF EVALUATION:

1. Proper procedure
2. Safe and proper use of hack saw, knife and shave hook
3. Appearance of final preparation
4. Cleanliness of tools and work area

JOB: Wipe a Horizontal Lead Joint

JOB SHEET
IDENTIFICATION CODE

UNIT I: Pipes and Fittings

JOB NUMBER: J-1E-6

COURSE: Plumbing

MATERIAL: Prepared Lead Pipe (J-1E-5)
Wiping Solder

EQUIPMENT: Lead Pot and Furnace

TOOLS: Ladle
Wiping Cloth
Propane Torch
Flint Striker

SAFETY PRECAUTIONS:

1. Safety glasses or goggles must be worn.
2. Care must be exercised when lighting torch and working with molten solder.
3. Special care must be taken to avoid having solder too hot, or it will melt the lead pipe.

COMPETENCE - PROCEDURE/STEPS The student will be able to:	TEACHING/LEARNING ACTIVITIES
1. Check prepared joint.	. J-1E-5
2. Heat and melt wiping solder.	. SC-1A-5
3. Test wiping solder for proper heat.	
4. Pour and wipe joint.	. SC-1E-15
	NOTE: For a beginner it is well to go through all the motions of pouring and wiping the joint first without using any solder, until coordination is perfected.
5. Check and finish joint.	. SC-1E-15

METHOD OF EVALUATION:

1. Proper procedure
2. Safe practices followed when working with molten wiping solder
3. Appearance of finished joint

JOB: Wipe a Vertical Lead Joint

JOB SHEET
IDENTIFICATION CODE

UNIT I: Pipes and Fittings

JOB NUMBER: J-1E-7

COURSE: Plumbing

MATERIAL: Prepared Lead Pipe (J-1E-5)
Wiping Solder

EQUIPMENT: Lead Pot and Furnace

TOOLS: Ladle
Wiping Cloth
Propane Torch
Flint Striker

SAFETY PRECAUTIONS:

1. Safety glasses or goggles must be worn.
2. Care must be exercised when lighting torch and working with molten solder.
3. Special care must be taken to avoid having solder too hot, or it will melt the lead pipe.

COMPETENCE - PROCEDURE/STEPS The student will be able to:	TEACHING/LEARNING ACTIVITIES
1. Prepare and fit joint.	. J-1E-5
2. Heat and melt wiping solder.	. SC-1A-5
3. Test solder for proper heat.	
4. Pour and wipe joint.	. SC-1E-15
	NOTE: For a beginner it is well to go through all the motions of pouring and wiping the joint first without using any solder, until coordination is perfected.
5. Check and finish joint.	. SC-1E-15

METHOD OF EVALUATION:

1. Proper procedure
2. Safe practices followed when working molten wiping solder
3. Appearance of finished joint

JOB: Tin a Brass Ferrule

JOB SHEET
IDENTIFICATION CODE

UNIT I: Pipes and Fittings

JOB NUMBER: J-1E-8

COURSE: Plumbing

MATERIAL: Brass Ferrule
50 - 50 Solder
Plumbers Soil
Rosin (Powdered)

EQUIPMENT: Soldering Furnace

TOOLS: 6' Folding Rule Soldering Iron
Pencil
Flat File

SAFETY PRECAUTIONS:

1. Safety glasses or goggles must be worn.
2. Brass is a good conductor of heat--ferrule will become hot when tinning.
3. Care must be exercised when lighting furnace and handling the soldering iron.

COMPETENCE - PROCEDURE/STEPS The student will be able to:	TEACHING/LEARNING ACTIVITIES
1. Measure and mark 1 1/2" from end of ferrule (rough measurement).	. SC-1E-14
2. File the fitting to rough mark.	. SC-1E-4
3. Measure and mark for tinning.	. SC-1E-14
4. Soil from line back a reasonable distance.	. SC-1E-13
5. Sprinkle with powdered rosin.	. SC-1E-7
6. Tin brass ferrule.	. SC-1E-16

METHOD OF EVALUATION:

1. Proper procedure
2. Safe and proper use of the soldering iron
3. Appearance of finished job

JOB: Join Lead Pipe to Cast Iron Pipe

JOB SHEET
IDENTIFICATION CODE

UNIT I: Pipes and Fittings

JOB NUMBER: J-1E-9

COURSE: Plumbing

MATERIAL: Tallow Brass Ferrule
Soil Wiping Cloth
Piece of 4" Lead

EQUIPMENT: Furnace

TOOLS: Rasp Shaving Hook Ball Peen Hammer
Ladle Lead Pot Calking Irons
Lead Wiping Solder Lead Runner
Flat Dresser Yarning Iron

SAFETY PRECAUTIONS:

1. Safety glasses or goggles must be worn.
2. Remove all rings when wiping joints.
3. Check wiping solder for correct temperature.
4. Exercise extreme caution when working with hot molten solder.

COMPETENCE - PROCEDURE/STEPS The student will be able to:	TEACHING/LEARNING ACTIVITIES
1. Tin brass ferrule.	. J-1E-8
2. Slip lead 3/4" inside brass ferrule.	
3. Mark line with dividers.	. SC-1E-14
4. Clean and soil.	. SC-1E-13
5. Wipe horizontal lead joint.	. J-1E-6
6. Pack ferrule into cast iron pipe.	. SC-1A-6
7. Check pipe for alignment.	. SC-1A-7
8. Heat and melt lead.	. SC-1A-5
9. Pour lead.	. SC-1A-8
10. Calk lead joint.	. SC-1A-9

METHOD OF EVALUATION:

1. Accuracy of measurement
2. Appearance of finished job
3. Cleanliness of tools and work area
4. Time:

JOB: Measure and Cut Steel Pipe

JOB SHEET
IDENTIFICATION CODE

UNIT I: Pipes and Fittings

JOB NUMBER: J-1F-1

COURSE: Plumbing

MATERIAL: 2'-10' Steel Pipe

EQUIPMENT: Pipe Vise

TOOLS: 6' Folding Rule
Pencil
Pipe Cutters

SAFETY PRECAUTIONS:

1. Safety glasses must be worn.
2. Turn and hold pipe cutters square with pipe.
3. Be careful of piece being cut off.

COMPETENCE - PROCEDURE/STEPS The student will be able to:	TEACHING/LEARNING ACTIVITIES
1. Place pipe in vise.	
2. Measure desired length.	. SC-1A-1
3. Mark at length.	. SC-1A-1
4. Set cutter on pipe at mark.	. SC-1F-1
5. Cut pipe.	. SC-1F-1

METHOD OF EVALUATION:

1. Proper procedure
2. Safe and proper use of pipe cutters
3. Accuracy of measurement

JOB: Ream and Thread Steel Pipe

JOB SHEET
IDENTIFICATION CODE

UNIT I: Pipes and Fittings

JOB NUMBER: J-1F-2

COURSE: Plumbing

MATERIAL: 2'-10' Steel Pipe
Cutting Oil

EQUIPMENT: Pipe Vise
Oiler

TOOLS: 6' Folding Rule
Pencil
Pipe Cutters
Pipe Reamer
Stock and Die (Pipe)

SAFETY PRECAUTIONS:

1. Safety glasses or goggles must be worn.
2. Avoid oily tool handles.
3. Do not check reamed or threaded ends with fingers.

COMPETENCE - PROCEDURE/STEPS The student will be able to:	TEACHING/LEARNING ACTIVITIES
1. Place pipe in vise.	. SC-1A-1
2. Measure and mark pipe.	. SC-1F-1
3. Cut steel pipe.	. SC-1F-2
4. Ream steel pipe.	. SC-1F-3
5. Thread steel pipe.	. SC-1F-3
6. Inspect finished threads.	

METHOD OF EVALUATION:

1. Proper procedure
2. Safe and proper use of pipe reamer and threader
3. Cleanliness of tools and work area

JOB: Make a ½" Steel Pipe
E to C Joint

JOB SHEET
IDENTIFICATION CODE

UNIT I: Pipes and Fittings
Iron and Steel Pipes

JOB NUMBER: J-1F-3

COURSE: Plumbing

DRAWING NO: D-1F-3

MATERIAL: Cutting Oil 15½" - ½" Black Pipe without Threads
Pipe Joint Compound Black Mall Elbow

EQUIPMENT: Power Vise

TOOLS: Pipe Cutter
Pipe Reamer 14" Pipe Wrench
Stock and Die 6' Extension Rule

SAFETY PRECAUTIONS:

1. Use good tools.
2. Tighten pipe properly in vise.
3. Provide a clean work place.
4. Avoid oily tool handles.
5. Do not work with oily hands or gloves.

COMPETENCE - PROCEDURE/STEPS The student will be able to:	TEACHING/LEARNING ACTIVITIES
1. Check blueprint.	. D-1F-3
2. Place pipe in vise.	
3. Ream end of pipe.	. SC-1F-2
4. Thread pipe.	. SC-1F-3
5. Use pipe joint compound on male thread only.	. SC-1F-4
6. Make up elbow.	. SC-1F-4
7. Remove pipe from vise.	
8. Measure from center of elbow.	
9. Mark pipe.	
10. Replace pipe in vise with unthreaded end extending far enough to allow space for die and stock and room cut thread.	

COMPETENCE - PROCEDURE/STEPS	TEACHING/LEARNING ACTIVITIES
11. Cut pipe at mark.	. SC-1F-1
12. Ream pipe.	. SC-1F-2
13. Thread pipe.	. SC-1F-3
14. Remove from vise or power vise and check work.	

METHOD OF EVALUATION:

1. Accuracy of measurement
2. Appearance of finished job
3. Cleanliness of tools and work area
4. Time:

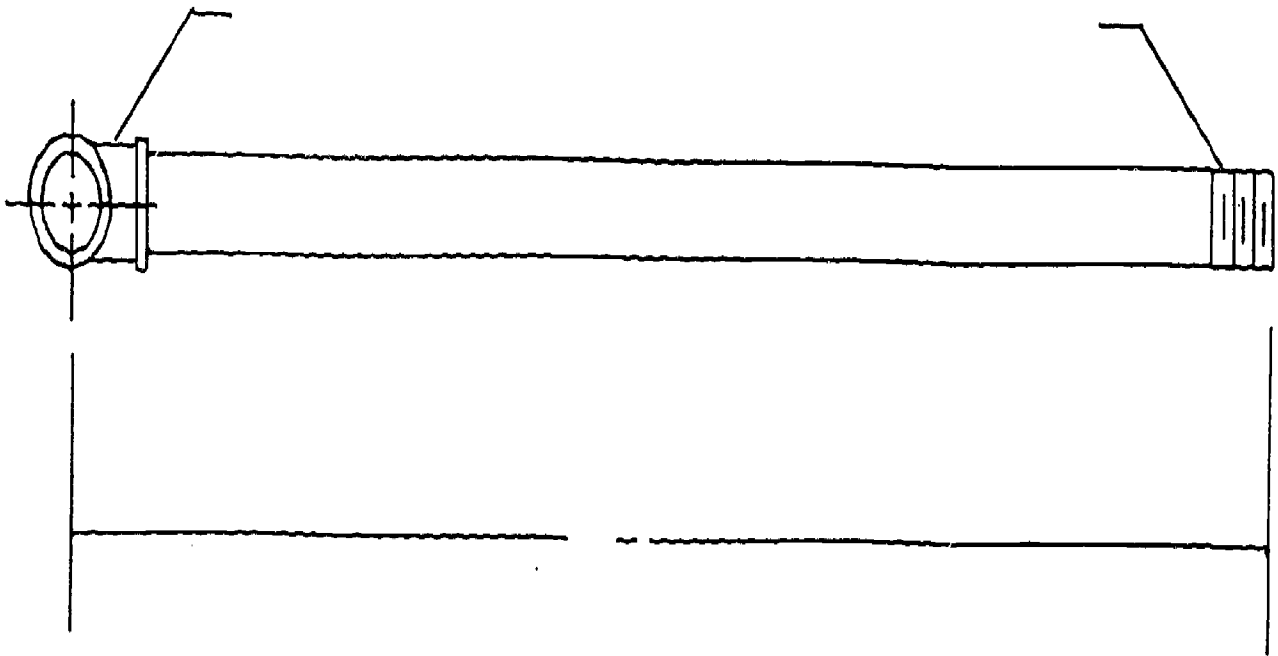

STEEL PIPE E TO C JOINT

DRAWING NUMBER

D-1F-3

-137-

JOB: Make a 3/4" Steel Pipe
C to C Joint

JOB SHEET
IDENTIFICATION CODE

UNIT I: Pipes and Fittings

JOB NUMBER: J-1F-4

COURSE: Plumbing

DRAWING NO: D-1F-4

MATERIAL: Cutting Oil
Pipe Joint Compound

16" - 3/4" Black Pipe without Threads
2-3/4" Black Mall Elbow

EQUIPMENT: Pipe Vise

TOOLS: Stock and Die
Pipe Cutter
Pipe Reamer

14" Pipe Wrench
6' Extension Rule

SAFETY PRECAUTIONS:

1. Use good, clean tools.
2. Tighten pipe properly in vise.
3. Provide a good, clean work area.
4. Avoid oily tool handles.
5. Do not work with oily hands or gloves.

COMPETENCE - PROCEDURE/STEPS The student will be able to:	TEACHING/LEARNING ACTIVITIES
1. Check blueprints	. D-1F-4
2. Place pipe in vise.	
3. Ream end of pipe.	. SC-1F-2
4. Thread pipe.	. SC-1F-3
5. Use pipe joint compound on male thread.	. SC-1F-4
6. Make a 90° elbow.	. SC-1F-4
7. Remove pipe from vise.	
8. Measure from the center of elbow and check fitting allowance.	. SC-1A-1
9. Mark pipe.	. SC-1A-1
10. Place pipe in vise.	

COMPETENCE - PROCEDURE/STEPS	TEACHING/LEARNING ACTIVITIES
11. Cut pipe at mark.	. SC-1F-1
12. Ream pipe.	. SC-1F-2
13. Thread pipe.	. SC-1F-3
14. Use pipe joint compound on male thread.	. SC-1F-4
15. Make a 90° elbow.	. SC-1F-4
16. Remove pipe from vise and check work.	

METHOD OF EVALUATION:

1. Accuracy of measurement
2. Appearance of finished job
3. Cleanliness of tools and work area
4. Time:

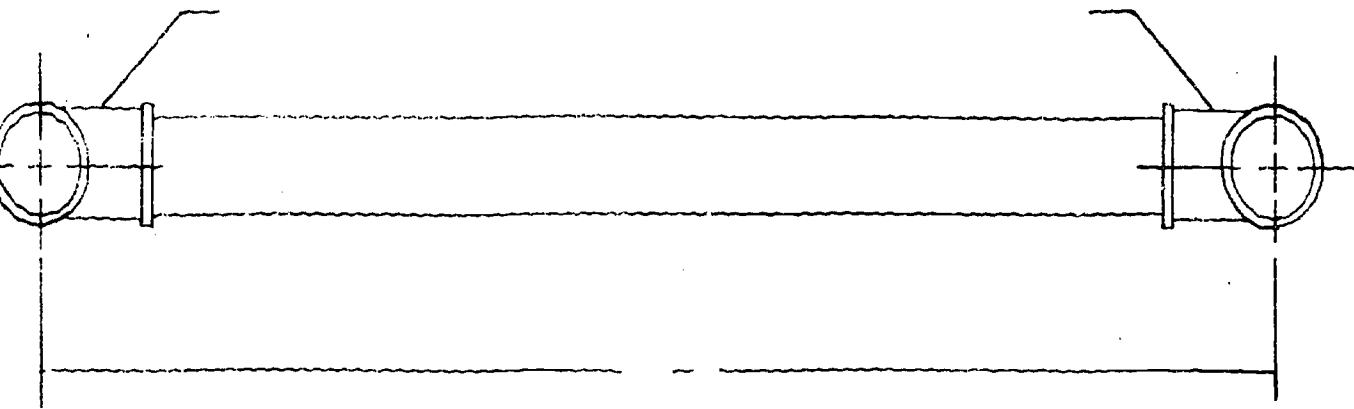

STEEL PIPE C TO C JOINT

DRAWING NUMBER

D-1F-4

107

JOB: Make a 1" Steel Pipe Offset Joint
 UNIT I: Pipes and Fittings
 COURSE: Plumbing
 MATERIAL: 14½" - 1" Black Pipe without Threads
 2-1" Black 45° Ells
 EQUIPMENT: Pipe Vise
 TOOLS: Pipe Cutter 14" Pipe Wrench
 Pipe Reamer 6' Extension Rule
 Stock and Die

JOB SHEET
IDENTIFICATION CODE

JOB NUMBER: J-1F-5

DRAWING NO: D-1F-5

Cutting Oil
 Pipe Joint Compound

SAFETY PRECAUTIONS:

1. Use good, clean tools.
2. Tighten pipe properly in vise.
3. Provide a good, clean work area.
4. Avoid oily tool handles.
5. Do not work with oily hands or gloves.

COMPETENCE - PROCEDURE/STEPS The student will be able to:	TEACHING/LEARNING ACTIVITIES
1. Check blueprints.	
2. Place pipe in vise.	
3. Ream end of pipe.	. SC-1F-2
4. Thread pipe.	. SC-1F-3
5. Use pipe joint compound on male thread.	. SC-1F-4
6. Make a 45° elbow.	. SC-1F-4
7. Remove pipe from vise.	
8. Measure from the center of 45° elbow and check fitting allowance.	. SC-1A-1
9. Mark pipe.	. SC-1A-1
10. Place pipe in vise.	
11. Cut pipe at mark.	

COMPETENCE - PROCEDURE/STEPS**TEACHING/LEARNING ACTIVITIES**

12. Ream pipe.
13. Thread pipe.
14. Use pipe joint compound on the thread.
15. Make a 45° elbow.
16. Remove pipe from vise and check work.

METHOD OF EVALUATION:

1. Accuracy of measurement
2. Appearance of finished job
3. Cleanliness of tools and work area
4. Time:

109

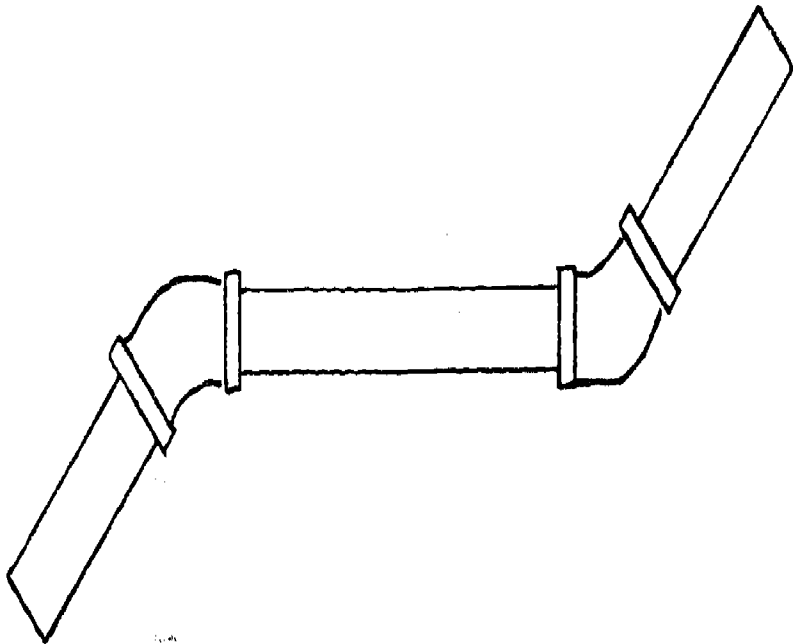

STEEL PIPE OFFSET JOINT

DRAWING NUMBER

D-1F-5

JOB: Make a 1/2" Steel Pipe Nipple Set

JOB SHEET
IDENTIFICATION CODE

UNIT I: Pipes and Fittings

JOB NUMBER: J-1F-6

COURSE: Plumbing

MATERIAL: Cutting Oil
32 1/2" of 1/2" Gal. Pipe without Threads

EQUIPMENT: Power Vise

TOOLS: Pipe Cutter
Pipe Reamer
Die
Nipple Chuck
10" Pipe Wrench
6' Extension Rule
Exposed Ratchet Drop Head Threader

SAFETY PRECAUTIONS:

1. Use tools in good condition.
2. Tighten pipe properly in vise.
3. Provide a good, clean work place.
4. Avoid oily tool handles.
5. Do not work with oily hands or gloves.

COMPETENCE - PROCEDURE/STEPS The student will be able to:	TEACHING/LEARNING ACTIVITIES
1. Place pipe in power vise.	. SC-1F-5
2. Ream pipe.	. SC-1F-2
3. Thread pipe.	. SC-1F-3
4. Measure pipe.	. SC-1A-1
5. Cut pipe.	. SC-1F-1
6. Ream and thread other end of nipple.	NOTE: NEVER use your fingers to check pipe. YOUR EYES can do the job.
7. Repeat each step for each nipple until you have completed a set of nipples.	NOTE: A good check of threads is to use a fitting of the same size and see if fitting will start on starting threads.

METHOD OF EVALUATION:

1. Accuracy of measurement
2. Appearance of finished job
3. Cleanliness of tools and work area

JOB: Make a 3/4" Steel Pipe Nipple Set

JOB SHEET
IDENTIFICATION CODE

UNIT I: Pipes and Fittings

JOB NUMBER: J-1F-7

COURSE: Plumbing

MATERIAL: Cutting Oil
32½" of 3/4" Gal. Pipe without Threads

EQUIPMENT: Power Vise

TOOLS: 3/4" Die 6' Extension Rule
Pipe Cutter Nipple Chuck
Pipe Reamer Exposed Ratchet Drop Head Threader
Pipe Wrench

SAFETY PRECAUTIONS:

1. Use good, clean tools.
2. Tighten pipe properly in vise.
3. Provide a clean work place.
4. Avoid oily tool handles.
5. Don't work with oily hands or gloves.

COMPETENCE - PROCEDURE/STEPS The student will be able to:	TEACHING/LEARNING ACTIVITIES
1. Place pipe in power vise.	. SC-1F-5
2. Ream pipe.	. SC-1F-2
3. Thread pipe.	. SC-1F-3
4. Measure pipe.	. SC-1A-1
5. Cut pipe.	. SC-1F-1
6. Ream and thread other end of nipple.	NOTE: NEVER use your fingers to check the pipe. YOUR EYES can do the job.
7. Repeat each step for each nipple until you have completed a set of nipples.	NOTE: A good check of threads is to use a fitting of the same size and see if fitting will start on starting threads.

METHOD OF EVALUATION:

1. Accuracy of measurement
2. Appearance of finished job
3. Cleanliness of tools and work area

JOB: Make a 1¼" Steel Pipe
C to C Joint

JOB SHEET
IDENTIFICATION CODE

UNIT I: Pipes and Fittings

JOB NUMBER: J-1F-8

COURSE: Plumbing

DRAWING NO: D-1F-8

EQUIPMENT: Pipe Vise

TOOLS: Adjustable Receding Die
Pipe Cutter
Pipe Reamer

18" Pipe Wrench
6' Extension Pole
Pencil-crayon or soapstone

SAFETY PRECAUTIONS:

1. Use good, clean tools.
2. Tighten pipe properly in vise.
3. Provide a good, clean work area.
4. Avoid oily tool handles.
5. Do not work with oily hands or gloves.

COMPETENCE - PROCEDURE/STEPS The student will be able to:	TEACHING/LEARNING ACTIVITIES
1. Check blueprints.	
2. Place pipe in vise.	
3. Ream end of pipe.	. SC-1F-2
4. Thread pipe.	. SC-1F-6
5. Use pipe joint compound on male thread.	. SC-1F-4
6. Make a 90° elbow.	. SC-1F-4
7. Remove pipe from vise.	
8. Measure from the center of elbow and check fitting allowance.	
9. Mark pipe.	. SC-1A-1
10. Place pipe in vise.	
11. Cut pipe at mark.	. SC-1F-1
12. Ream pipe.	. SC-1F-2

COMPETENCE - PROCEDURE/STEPS	TEACHING/LEARNING ACTIVITIES
13. Thread pipe.	. SC-1F-6
14. Use pipe joint compound on male thread.	. SC-1F-4
15. Make a 90° elbow.	. SC-1F-4
16. Remove pipe from vise and check work.	

METHOD OF EVALUATION:

1. Accuracy of measurement
2. Appearance of finished job
3. Cleanliness of tools and work area
4. Time:

115

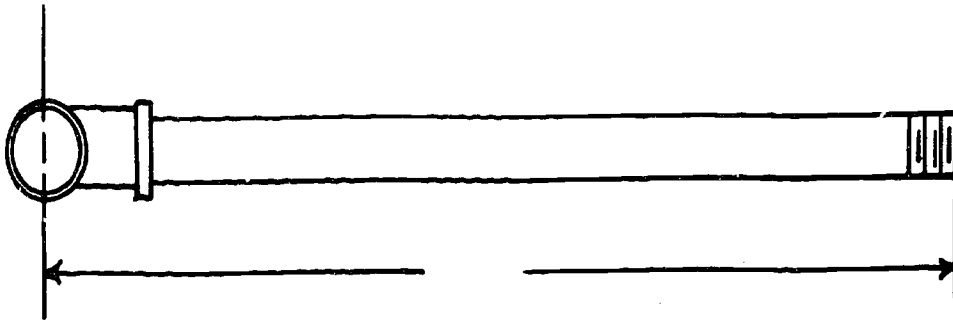

STEEL PIPE C TO C JOINT

DRAWING NUMBER

D-1F-8

JOB: Make a 1½" Steel Pipe
E to C Joint

JOB SHEET
IDENTIFICATION CODE

UNIT I: End Fittings

JOB NUMBER: J-1F-9

COURSE: Plumbing

DRAWING NO: D-1F-9

EQUIPMENT: Pipe Vise

TOOLS: Adjustable Receding Die
Pipe Cutter
Pipe Reamer

18" Pipe Wrench
6' Extension Rule
Pencil-crayon or Soapstone

SAFETY PRECAUTIONS:

1. Use good, clean tools.
2. Tighten pipe properly in vise.
3. Provide a good, clean work area.
4. Avoid oily tool handles.
5. Do not work with oily hands or gloves.

COMPETENCE - PROCEDURE/STEPS
The student will be able to:

TEACHING/LEARNING ACTIVITIES

1. Check blueprint.
2. Place pipe in vise.
3. Ream end of pipe.
4. Thread pipe.
5. Use pipe joint compound on male thread only.
6. Make an elbow.
7. Remove pipe from vise.
8. Measure from center of elbow.
9. Mark pipe.
10. Replace pipe in vise with unthreaded end extending far enough to allow space for die and stock and room cut thread.
11. Cut pipe at mark.
12. Ream pipe.

COMPETENCE - PROCEDURE/STEPS

TEACHING/LEARNING ACTIVITIES

13. Thread pipe.
14. Remove from vise or power vise and check work.

METHOD OF EVALUATION:

1. Accuracy of measurement
2. Appearance of finished job
3. Cleanliness of tools and work area
4. Time:

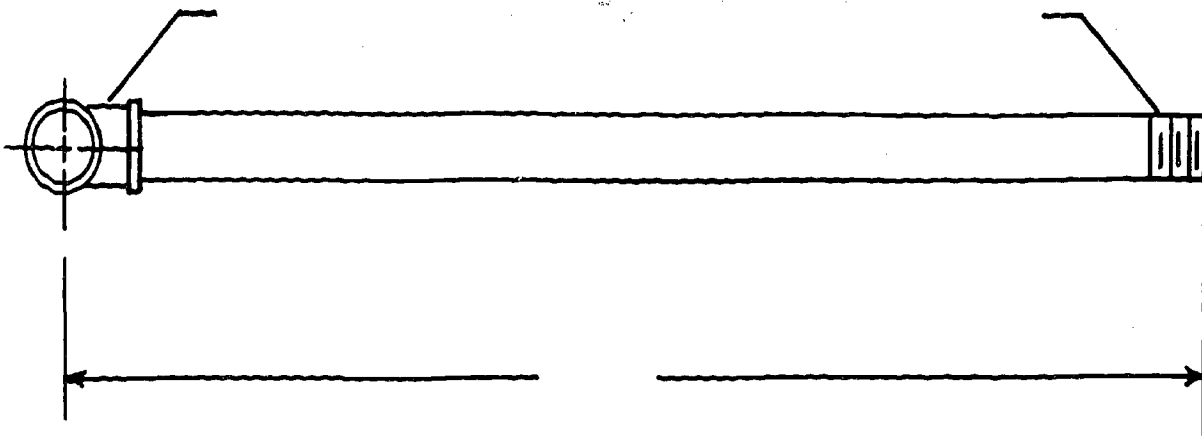

STEEL PIPE E TO C JOINT

DRAWING NUMBER

D-1F-9

JOB: Make a 2" Steel Pipe
C to C Joint

JOB SHEET
IDENTIFICATION CODE

UNIT I: Pipes and Fittings

JOB NUMBER: J-1F-10

COURSE: Plumbing

DRAWING NO: D-1F-10

EQUIPMENT: Power Vice

TOOLS: Adjustable Receding Die 24" Pipe Wrench
Pipe Cutter 6' Extension Rule
Pipe Reamer Pencil-crayon or Soapstone

SAFETY PRECAUTIONS:

1. Use good, clean tools.
2. Tighten pipe properly in vise.
3. Provide a good, clean work area.
4. Avoid oily tool handles.
5. Do not work with oily hands or gloves.

COMPETENCE - PROCEDURE/STEPS The student will be able to:	TEACHING/LEARNING ACTIVITIES
--	------------------------------

1. Check blueprints.
2. Place pipe in power vise.
3. Ream end of pipe.
4. Thread pipe.
5. Use pipe joint compound on male thread.
6. Make a 90° elbow.
7. Remove pipe from power vise.
8. Measure from the center of elbow and check fitting allowance.
9. Mark pipe.
10. Place pipe in power vise.
11. Cut pipe at mark.
12. Ream pipe.
13. Thread pipe.

COMPETENCE - PROCEDURE/STEPS

TEACHING/LEARNING ACTIVITIES

14. Use pipe joint compound on male thread.
15. Make a 90° elbow.
16. Remove pipe from power vise and check work.

METHOD OF EVALUATION:

1. Accuracy of measurement
 2. Appearance of finished job
 3. Cleanliness of tools and work area
 4. Time:
-

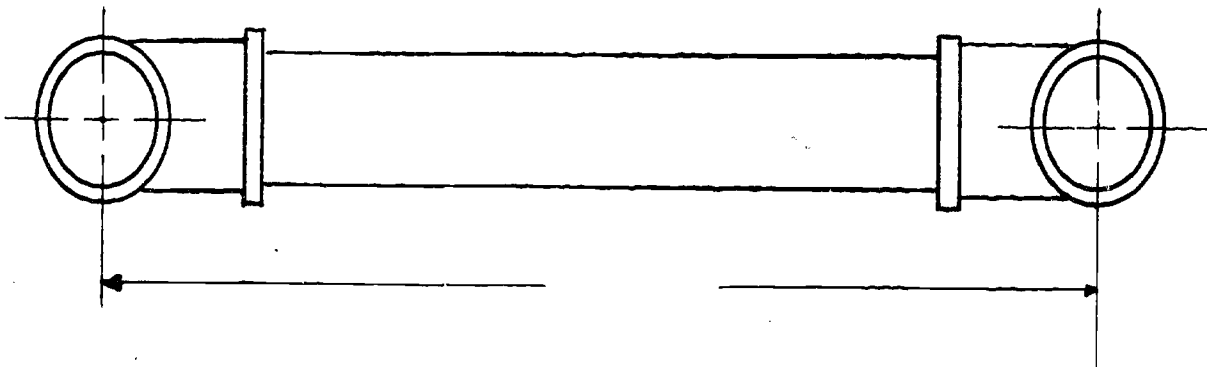

STEEL PIPE C TO C JOINT

DRAWING NUMBER

D-1F-10

JOB: Make a 3"-4" E to C Steel Pipe Joint

JOB SHEET
IDENTIFICATION CODE

UNIT I: Pipes and Fittings

JOB NUMBER: J-1F-11

COURSE: Plumbing

DRAWING NO: D-1F-11

EQUIPMENT: Power Vise
Power Hack Saw
Oiler

TOOLS: Universal Die
Pipe Reamer
36" Pipe Wrench

6' Extension Rule
Pencil-Crayon or Soapstone

SAFETY PRECAUTIONS:

1. Use good, clean tools.
2. Tighten pipe properly in vise.
3. Provide a good, clean work area.
4. Avoid oily tool handles.
5. Do not work with oily hands or gloves.

COMPETENCE - PROCEDURE/STEPS The student will be able to:	TEACHING/LEARNING ACTIVITIES
1. Check blueprint.	
2. Place pipe in vise.	
3. Ream end of pipe.	. SC-1F-2
4. Thread pipe.	. SC-1F-7
5. Use pipe joint compound on male thread only.	
6. Make an elbow.	. SC-1F-4
7. Remove pipe from vise.	
8. Measure from center of elbow and mark pipe.	. SC-1A-1
9. Cut pipe at mark.	
10. Replace pipe in vise with unthreaded end extending far enough to allow space for universal die and room to cut thread.	. SC-1F-8
11. Ream pipe.	. SC-1F-2

COMPETENCE - PROCEDURE/STEPS	TEACHING/LEARNING ACTIVITIES
12. Thread pipe.	. SC-1F-7
13. Remove from vise and check work.	

METHOD OF EVALUATION:

1. Accuracy of measurement
 2. Appearance of finished job
 3. Cleanliness of tools and work area
 4. Time:
-

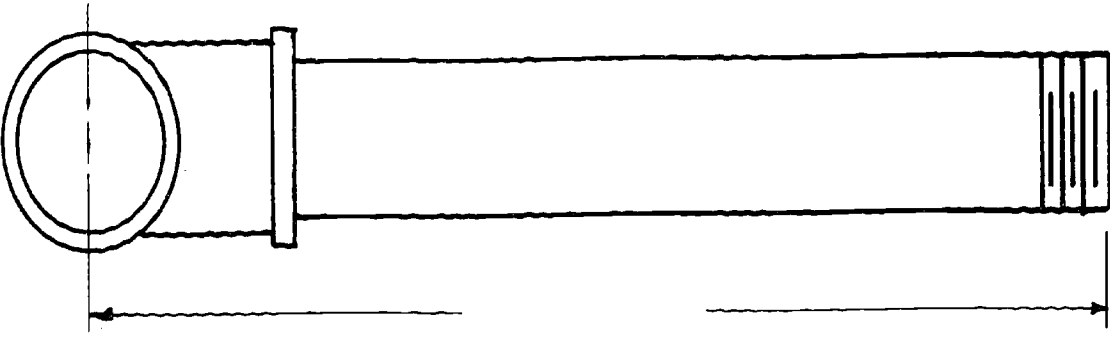

E TO C STEEL PIPE JOINT

DRAWING NUMBER

D-1F-11

JOB: Make a 3" - 4" C to C Steel Pipe Joint

JOB SHEET
IDENTIFICATION CODE

UNIT I: Pipes and Fittings

JOB NUMBER: J-1F-12

COURSE: Plumbing

DRAWING NO: D-1F-12

EQUIPMENT: Power Vise
Power Hack Saw
Oiler

TOOLS: Universal Die
Pipe Cutter
Pipe Reamer

36" Pipe Wrench
6' Extension Rule
Pencil-Crayon or Soapstone

SAFETY PRECAUTIONS:

1. Use good, clean tools.
2. Tighten pipe properly in vise.
3. Provide a good, clean work area.
4. Avoid oily tool handles.
5. Do not work with oily hands or gloves.

COMPETENCE - PROCEDURE/STEPS The student will be able to:	TEACHING/LEARNING ACTIVITIES
1. Check blueprints.	
2. Place pipe in vise.	
3. Ream end of pipe.	. SC-1F-2
4. Thread pipe.	. SC-1F-7
5. Use pipe joint compound on male thread.	
6. Make a 90° elbow.	. SC-1F-4
7. Remove from power vise.	
8. Measure from the center of elbow, check fitting allowance and mark pipe.	. SC-1A-1
9. Place pipe in vise.	
10. Cut pipe at mark.	. SC-1F-1
11. Ream pipe.	. SC-1F-2
12. Thread pipe.	. SC-1F-7
13. Use pipe joint compound on male thread.	

COMPETENCE - PROCEDURE/STEPS	TEACHING/LEARNING ACTIVITIES
14. Make a 90° elbow.	. SC-1F-4
15. Remove from vise and check work.	

METHOD OF EVALUATION:

1. Accuracy of measurement
2. Appearance of finished job
3. Cleanliness of tools and work area
4. Time

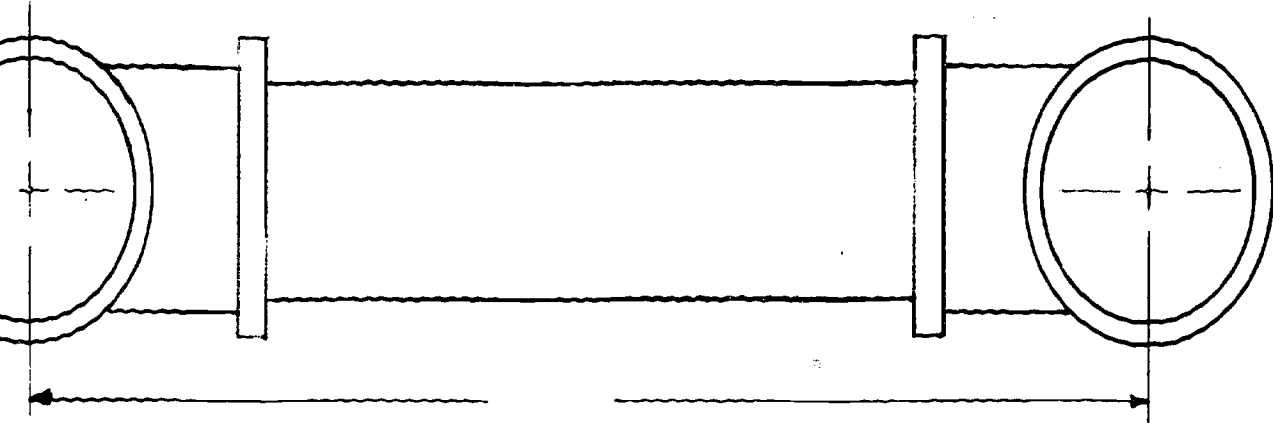

C TO C STEEL PIPE JOINT

DRAWING NUMBER

D-1F-12

JOB: Construct a Steel Pipe Plumbing Square

JOB SHEET
IDENTIFICATION CODE

UNIT: Pipes and Fittings

JOB NUMBER: J-1F-13

COURSE: Plumbing

MATERIAL: 8' Steel Pipe
4 - 90° Elbows
1 Union
Pipe Dope
Cutting Oil

EQUIPMENT: Power Vise
Oiler

TOOLS: Stock and Die
Pipe Cutter
Pipe Reamer

Pipe Wrenches
6' Folding Rule
Pencil

SAFETY PRECAUTIONS:

1. Use good, clean tools.
2. Tighten pipe properly in vise.
3. Provide a good, clean work area.
4. Avoid oily tool handles.
5. Do not work with oily hands or gloves.

COMPETENCE - PROCEDURE/STEPS The student will be able to:	TEACHING/LEARNING ACTIVITIES
1. Check blueprint.	
2. Place pipe in vise.	
3. Ream and thread pipe.	. SC-1F-2 thru SC-1F-4
4. Screw in fitting.	
5. Measure and cut pipe.	. SC-1A-1, SC-1F-1
6. Repeat steps 2 through 6 until plumbing square is complete.	

METHOD OF EVALUATION:

1. Proper procedure
2. Accuracy of measurement
3. Appearance of finished job
4. Cleanliness of tools and work area
5. Time:

134

-171-

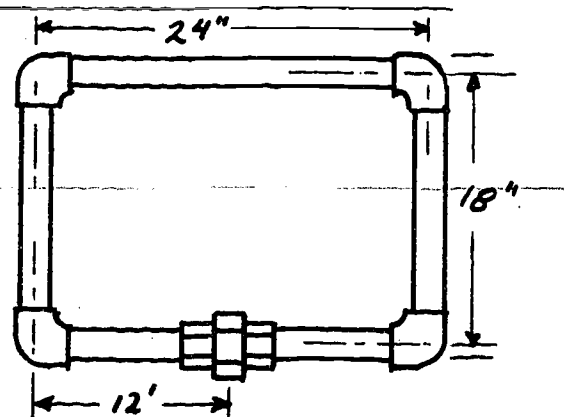

JOB: Set Up Oxy-Acetylene Torch
 UNIT I: Pipes and Fittings
 COURSE: Plumbing
 MATERIAL: Soapy Water
 EQUIPMENT: Oxy-Acetylene Cylinders
 Oxy-Acetylene Outfit
 Oxy-Acetylene Cart
 TOOLS: Tank Wrench
 Brush

JOB SHEET
 IDENTIFICATION CODE

JOB NUMBER: J-1F-14

SAFETY PRECAUTIONS:

1. Never move cylinders without valve protection caps.
2. Never open cylinder valve without checking to make sure regulator adjusting screw is free.

COMPETENCE - PROCEDURE/STEPS The student will be able to:	TEACHING/LEARNING ACTIVITIES
1. Move cylinders to cart and chain in place.	. SC-1F-9
2. Remove cylinder caps.	
3. Attach regulators.	. SC-1F-10
4. Attach hoses.	. SC-1F-10
5. Attach tip.	. SC-1F-10
6. Open oxygen cylinder valve.	. SC-1F-11
7. Open acetylene cylinder valve.	. SC-1F-11
8. Adjust oxygen regulator to working pressure.	. SC-1F-11
9. Check oxygen connections with soapy water.	
10. Adjust acetylene regulator to working pressure.	
11. Check acetylene connections with soapy water.	

METHOD OF EVALUATION:

1. Proper procedure
2. Safety practices

135

JOB: Cut Steel Plate with Oxy-Acetylene Torch

JOB SHEET
IDENTIFICATION CODE

UNIT I: Pipes and Fitting

JOB NUMBER: J-1F-15

COURSE: Plumbing

MATERIALS: 12" X 12" X 1/4" Mild Steel Plate

EQUIPMENT: Oxy-Acetylene Torch

TOOLS: Striker
Tank Wrench
Gloves
Welding Goggles

6' Folding Rule
Soapstone

SAFETY PRECAUTIONS:

1. Wear protective clothing.
2. Wear properly tinted welding goggles.
3. Clear area of combustible items.

COMPETENCE - PROCEDURE/STEPS The student will be able to:	TEACHING/LEARNING ACTIVITIES
1. Lay out and mark metal to be cut with soapstone.	. SC-1A-1
2. Lay metal to be cut on gas welding bench.	
3. Light and adjust cutting torch.	. SC-1F-12
4. Flame cut with torch.	. SC-1F-12A
5. Remove slag.	

METHOD OF EVALUATION:

1. Proper procedure
2. Safety practices
3. Appearance of cut

JOB: Gas Weld Steel Strips
UNIT I: Pipes and Fittings
COURSE: Plumbing
MATERIAL: Steel Strips (J-1F-15)
Filler Rod
EQUIPMENT: Oxy-Acetylene Outfit
TOOLS: Tank Wrench
Striker
Goggles
Gloves

JOB SHEET
IDENTIFICATION CODE

JOB NUMBER: J-1F-16

SAFETY PRECAUTIONS:

1. Wear protective clothing.
2. Wear properly tinted welding goggles.
3. Clear area of combustible items.

COMPETENCE - PROCEDURE/STEPS The student will be able to:	TEACHING/LEARNING ACTIVITIES
1. Lay metal on welding bench in the butt welding position (flat).	
2. Light and adjust torch.	. SC-1F-13
3. Tack strips approximately every 4".	
4. Fusion weld strips using filler rod.	. SC-1F-16
5. Clean joint.	

METHOD OF EVALUATION:

1. Proper procedure
2. Safe practices
3. Bead appearance
4. Penetration of weld

137

JOB: Cut Steel Pipe with Oxy-Acetylene Torch

JOB SHEET
IDENTIFICATION CODE

UNIT I: Pipes and Fittings

JOB NUMBER: J-1F-17

COURSE: Plumbing

MATERIAL: 2 to 8 pieces, 1 1/4" - 2" Scrap Pipe

EQUIPMENT: Oxy-Acetylene Outfit

TOOLS: Striker
Tank Wrench
Gloves
Welding Goggles
6' Folding Rule
Soapstone

SAFETY PRECAUTIONS:

1. Wear protective clothing.
2. Wear properly tinted welding goggles.
3. Clear area of combustible items.

COMPETENCE - PROCEDURE/STEPS The student will be able to:	TEACHING/LEARNING ACTIVITIES
1. Measure and mark pipe with soapstone.	. SC-1A-1
2. Lay pipe to be cut on welding bench.	
3. Light and adjust torch.	. SC-1F-12
4. Pierce hole on line to be cut.	. SC-1F-15
5. Flame cut around pipe.	. SC-1F-12A
6. Remove slag.	

METHOD OF EVALUATION:

1. Proper procedure
2. Safety practices
3. Appearance of cut

138

JOB: Gas Weld Steel Pipe
 UNIT I: Pipes and Fittings
 COURSE: Plumbing
 MATERIAL: 2 to 8 pieces, 1 1/4" - 2" Steel Pipe
 Filler Rod
 EQUIPMENT: Oxy-Acetylene Outfit
 TOOLS: Tank Wrench
 Striker
 Goggles
 Gloves

JOB SHEET
IDENTIFICATION CODE
 JOB NUMBER: J-1F-18

SAFETY PRECAUTIONS:

1. Wear protective clothing.
2. Wear properly tinted welding goggles.
3. Clear area of combustible items.

COMPETENCE - PROCEDURE/STEPS The student will be able to:	TEACHING/LEARNING ACTIVITIES
1. Lay pipe to be welded on welding bench in the butt position.	
2. Light and adjust torch.	. SC-1F-13
3. Tack pipe as shown.	
4. Fusion weld pipe using filler rod.	. SC-1F-16
5. Clean joint.	

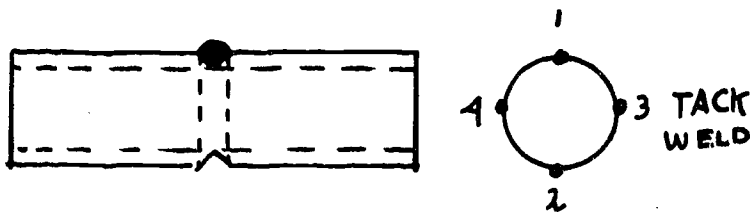

METHOD OF EVALUATION:

1. Proper procedure
2. Safe practices
3. Appearance of bead
4. Penetration of weld

JOB: Make Up a 1-1/2" Steel E to C
Gas Welded Joint

JOB SHEET
IDENTIFICATION CODE

UNIT I: Pipes and Fittings

JOB NUMBER: J-1F-19

COURSE: Plumbing

MATERIAL: 8" - 12" 1-1/2" Steel Pipe
1 - 1-1/2" 90° Weld Elbow
Filler Rod

EQUIPMENT: Oxy-Acetylene Outfit

TOOLS: 6' Folding Rule
Soapstone
Tank Wrench
Striker
Goggles

SAFETY PRECAUTIONS:

1. Wear protective clothing.
2. Wear properly tinted welding goggles.
3. Clear area of combustible items.

COMPETENCE - PROCEDURE/STEPS The student will be able to:	TEACHING/LEARNING ACTIVITIES
1. Lay pipe and fitting on weld bench.	
2. Light and adjust torch.	. SC-1F-13
3. Tack pipe and fitting.	
4. Fusion weld pipe using filler rod.	. SC-1F-16
5. Clean joint.	
6. Measure and mark pipe.	. SC-1A-1
7. Light and adjust torch.	. SC-1F-12
8. Flame cut to length.	. SC-1F-12A

METHOD OF EVALUATION:

1. Proper procedure
2. Safe practices
3. Appearance of bead
4. Penetration of weld
5. Accuracy of measurement

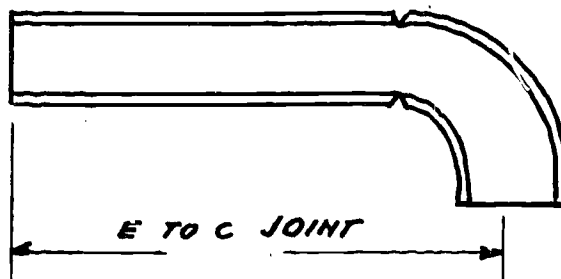

JOB: Make Up a 1 1/2" Steel C to C Gas
Welded Joint

JOB SHEET
IDENTIFICATION CODE

UNIT I: Pipes and Fittings

JOB NUMBER: J-1F-20

COURSE: Plumbing

MATERIAL: 8" - 12" 1 1/2" Steel Pipe
2 - 1 1/2" 90° Weld Elbows

EQUIPMENT: Oxy-Acetylene Outfit

TOOLS: 6' Folding Rule
Soapstone
Tank Wrench
Striker
Goggles

SAFETY PRECAUTIONS:

1. Wear protective clothing.
2. Wear properly tinted welding goggles.
3. Clear area of combustible items.

COMPETENCE - PROCEDURE/STEPS The student will be able to:	TEACHING/LEARNING ACTIVITIES
1. Lay pipe and fitting on weld bench.	
2. Light and adjust torch.	. SC-1F-13
3. Tack pipe to fitting.	
4. Fusion weld using filler rod.	. SC-1F-16
5. Measure and mark pipe.	. SC-1A-1
6. Light and adjust torch.	. SC-1F-12
7. Flame cut to length	. SC-1F-12A
8. Light and adjust torch.	. SC-1F-13
9. Tack pipe to fitting.	
10. Fusion weld using filler rod.	. SC-1F-16
11. Clean joint.	

METHOD OF EVALUATION:

1. Proper procedure
2. Safe practices
3. Appearance of bead
4. Penetration of weld
5. Accuracy of measurement

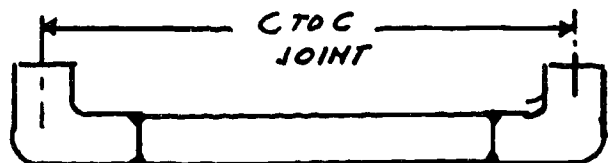

141

-185-

JOB: Arc Weld Steel Plate
UNIT I: Pipes and Fittings
COURSE: Plumbing
MATERIAL: 12" X 2" X 1/4" Steel Strips
EQUIPMENT: AC-DC Arc Welder
Welding Helmet
TOOLS: Chipping Hammer
Gloves

JOB SHEET
IDENTIFICATION CODE

JOB NUMBER: J-1F-21

SAFETY PRECAUTIONS:

1. Wear protective clothing.
2. Make sure proper lense is in helmet.
3. Weld in protected area only.

COMPETENCE - PROCEDURE/STEPS	TEACHING/LEARNING ACTIVITIES
------------------------------	------------------------------

- | | |
|--|---------|
| 1. Lay steel strips on welding table in butt position (flat) | |
| 2. Tack strip at each end and center. | J-1F-17 |
| 3. Arc weld joint. | J-1F-17 |
| 4. Chip slag. | |

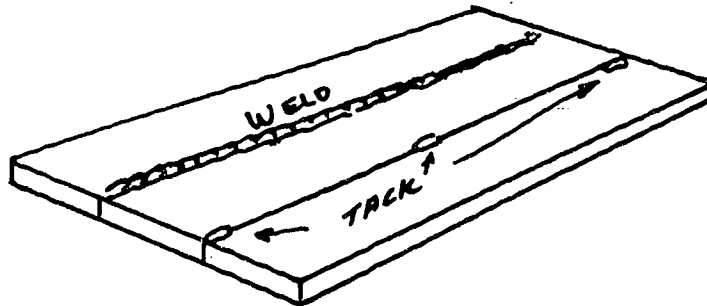

METHOD OF EVALUATION:

1. Proper welding procedures
2. Safe practices
3. Appearance of bead
4. Penetration

142

-187-

JOB: Arc Weld Steel Pipe
 UNIT I: Pipes and Fittings
 COURSE: Plumbing
 MATERIAL: Scrap 1 1/4" - 2" Steel Pipe
 EQUIPMENT: AC-DC Welder
 TOOLS: Chipping Hammer
 Welding Helmet
 Gloves

JOB SHEET
IDENTIFICATION CODE
 JOB NUMBER: J-1F-22

SAFETY PRECAUTIONS:

1. Wear protective clothing.
2. Make sure proper lense is in helmet.
3. Weld in protected area only.

COMPETENCE — PROCEDURE/STEPS The student will be able to:	TEACHING/LEARNING ACTIVITIES
1. Lay steel pipe on welding table in butt position.	
2. Tack pipe.	
3. Arc weld joint.	. SC-1F-17
4. Chip slag.	. SC-1F-17

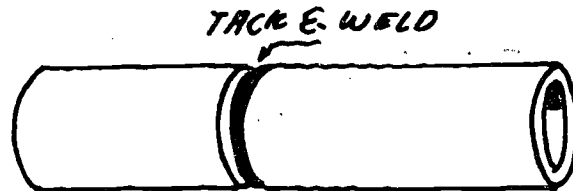

METHOD OF EVALUATION:

1. Proper welding procedures
2. Safe practices
3. Appearance of bead
4. Penetration

143

JOB: Braze Galvanized Steel Pipe

JOB SHEET
IDENTIFICATION CODE

UNIT I: Pipes and Fittings

JOB NUMBER: J-1F-23

COURSE: Plumbing

MATERIAL: Scrap Galvanized Pipe
Bronze Filler Rod

EQUIPMENT: Oxy-Acetylene Outfit

TOOLS: Tank Wrench
Striker
Goggles
Gloves

SAFETY PRECAUTIONS:

1. wear protective clothing.
2. wear properly tinted welding goggles.
3. Clear area of combustible items.

COMPETENCE - PROCEDURE/STEPS	TEACHING/LEARNING ACTIVITIES
The student will be able to:	
1. Lay scrap pipe to be brazed on welding table.	
2. Light and adjust torch.	. SC-1F-13
3. Tack pipe.	
4. Braze galvanized pipe using bronze filler rod.	. SC-1F-18

METHOD OF EVALUATION:

1. Proper procedure
2. Safe practices
3. Appearance of bead
4. Penetration of weld

JOB: Make a 1/2" Brass Pipe Nipple Set

JOB SHEET
IDENTIFICATION CODE

UNIT I: Pipes and Fittings

JOB NUMBER: J-1G-1

COURSE: Plumbing

MATERIAL: (4') 1/2" Brass Pipe

EQUIPMENT: Power Vise and Threader
Nipple Chuck

TOOLS: 6' Extension Rule

SAFETY PRECAUTIONS:

1. Use good clean dies.
2. Care must be exercised when tightening brass pipe in the vise.
3. Keep dies clean of pipe thread chips.

COMPETENCE - PROCEDURE/STEPS The student will be able to:	TEACHING/LEARNING ACTIVITIES
1. Secure pipe in power vise.	. SC-1F-5
2. Ream pipe.	. SC-1F-2
3. Thread pipe.	. SC-1F-3
4. Measure nipple.	. SC-1A-1
5. Cut and ream pipe.	
6. Thread pipe.	
7. Repeat each step until nipple set is complete.	
8. Check nipples.	NOTE: Check nipple threads by using a fitting of the same size (1/2"), seeing that the fitting will screw on the starting threads.

METHOD OF EVALUATION:

1. Accuracy of nipple measurements
2. Appearance of finished job
3. Cleanliness of tools and work area
4. Time:

JOB: Make a 3/4" Brass Pipe
E to C Measurement

JOB SHEET
IDENTIFICATION CODE

UNIT I: Pipes and Fittings

JOB NUMBER: J-1G-2

COURSE: Plumbing

DRAWING NO: D-1G-2

MATERIAL: (1'-2') 3/4" Brass Pipe Pipe Joint Compound
(1) 3/4" Brass 90° Elbow Cutting Oil

EQUIPMENT: Power Vise
Oiler

TOOLS: 6' Folding Rule Strap Wrench
Pencil or Crayon Stock & Die
Pipe Cutter Pipe Reamer

SAFETY PRECAUTIONS:

1. Use good clean dies.
2. Care must be exercised when tightening brass pipe in the vise.
3. Keep tool handles clean of oil.
4. Keep dies clean of pipe thread chips.

COMPETENCE - PROCEDURE/STEPS The student will be able to:	TEACHING/LEARNING ACTIVITIES
1. Check blueprint.	. D-1G-2
2. Secure pipe in vise.	
3. Ream pipe.	. SC-1F-2
4. Thread pipe.	. SC-1F-3
5. Apply pipe joint compound on male thread and attach a 90° elbow.	. SC-1F-4 . SC-1G-2
6. Measure from center of elbow, check fitting allowance, and mark pipe.	. SC-1A-1
7. Secure pipe in vise.	
8. Cut and ream pipe.	. SC-1F-1 . SC-1F-2
9. Thread pipe.	. SC-1F-3
10. Check work and measurements.	

METHOD OF EVALUATION:

1. Accuracy of measurement
2. Appearance of finished job
3. Cleanliness of tools and work area
4. Time:

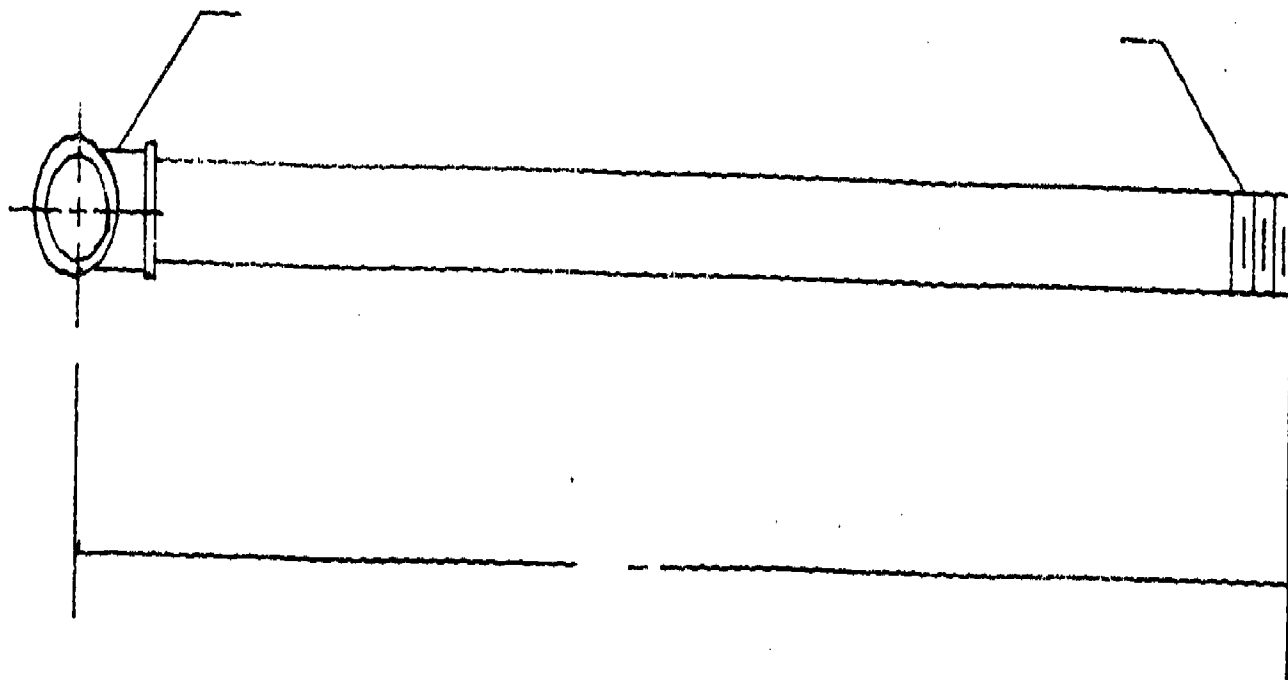

E TO C BRASS PIPE JOINT

DRAWING NUMBER

D-16-2

-197-

JOB: Make a 3/4" Brass Pipe
C to C Measurement

JOB SHEET
IDENTIFICATION CODE

UNIT I: Pipes and Fittings

JOB NUMBER: J-1G-3

COURSE: Plumbing

DRAWING NO: D-1G-3

MATERIAL: (12") 3/4" Brass Pipe
(2) 3/4" Brass 90° Elbows
1 Can Pipe Joint Compound

EQUIPMENT: Vise
Mechanical Oiler

TOOLS: 6' Extension Rule
Pipe Cutter
Strap Wrench
1/2" Drop-head Stock and Die
Pipe Reamer

SAFETY PRECAUTIONS:

1. Use good clean dies.
2. Care must be exercised when tightening brass pipe in the vise.
3. Keep tool handles clean of oil.
4. Keep dies clean of pipe thread chips.

<u>COMPETENCE - PROCEDURE/STEPS</u> The student will be able to:	<u>TEACHING/LEARNING ACTIVITIES</u>
1. Check blueprint.	. D-1G-3
2. Secure pipe in vise.	
3. Ream pipe.	. SC-1F-2
4. Thread pipe.	. SC-1F-3
5. Apply pipe joint compound on male thread and attach a 90° elbow.	. SC-1F-4 . SC-1G-2
6. Measure from center of elbow, check fitting allowance, and mark pipe.	. SC-1A-1
7. Secure pipe in vise.	
8. Cut and ream pipe.	. SC-1F-1 . SC-1F-2
9. Thread pipe.	. SC-1F-3

COMPETENCE - PROCEDURE/STEPS	TEACHING/LEARNING ACTIVITIES
10. Apply pipe joint compound on male thread and attach a 90° elbow.	. SC-1F-4 . SC-1G-2
11. Check work and measurements.	

METHOD OF EVALUATION:

1. Accuracy of measurement
2. Appearance of finished job
3. Cleanliness of tools and work area
4. Time:



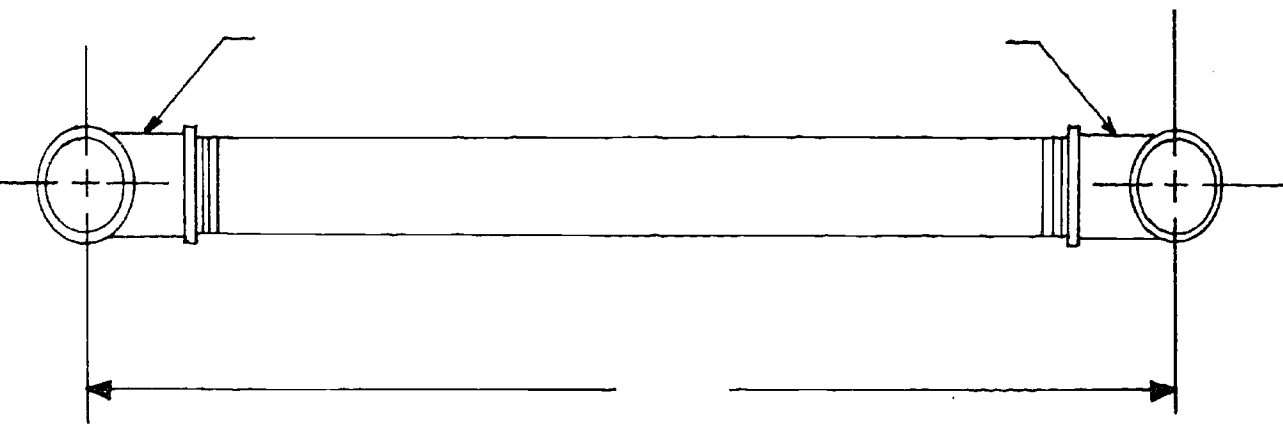

C TO C BRASS PIPE JOINT

D-1G-3

JOB: Make a Combination Silver
Braze Joint

JOB SHEET
IDENTIFICATION CODE

UNIT I: Pipes and Fittings

JOB NUMBER: J-1G-4

COURSE: Plumbing

DRAWING NO: D-1G-4

MATERIAL: Emery Cloth
Silver Brazing Flux
Silver Brazing Alloy

(18") 1/2" or 3/4" Brass Pipe
(2) 1/2" or 3/4" Brass 90°
Threadless or Silbraze Elbows

EQUIPMENT: Oxy-acetylene Torch
Pipe Vise
Safety Goggles

TOOLS: 6' Extension Rule
Pipe Cutters
Pipe Reamers
Flint Striker
#3 Welding Tip
Pliers (Water Pump)
Ball Peen Hammer

SAFETY PRECAUTIONS:

1. Use adequate ventilation.
2. Avoid overheating and hot spots.
3. Wear shaded safety goggles.
4. Observe all safety precautions when lighting and using the torch.

COMPETENCE - PROCEDURE/STEPS The student will be able to:	TEACHING/LEARNING ACTIVITIES
1. Check blueprint.	. D-1G-4
2. Measure brass pipe.	. SC-1A-1
3. Cut brass pipe.	. SC-1F-1
4. Ream brass pipe.	. SC-1F-2
5. Assemble and check measurements.	
6. Set up and light torch.	. SC-1F-10 thru 13
7. Silver braze assembled pipe and fittings.	. SC-1G-1
8. Check joints and shut off torch.	
9. Remove flux residue and clean assembled pipe and fittings.	

METHOD OF EVALUATION:

1. Accuracy of measurement
2. Appearance/neatness of finished job
3. Time:

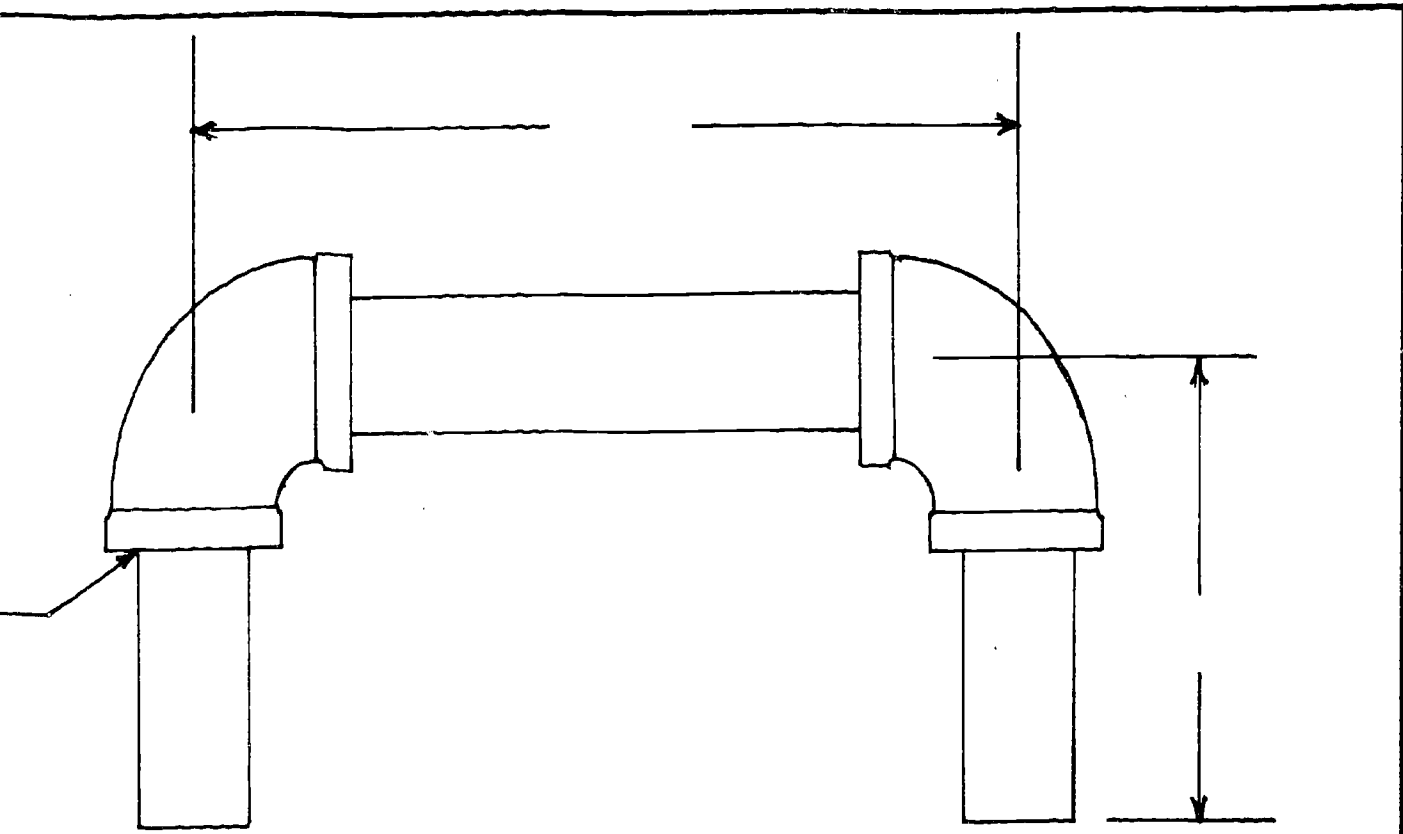

COMBINATION SILVER BRAZED JOINT

D-1G-4

JOB: Measure, Cut and Ream
Copper Tube

UNIT I: Pipe and Fittings

COURSE: Plumbing

MATERIAL: (2'-4') ½" Hard Copper Tube

TOOLS: 6' Folding Rule
Pencil or Crayon
Copper Tubing Cutters

JOB SHEET
IDENTIFICATION CODE

JOB NUMBER: J-1H-1

SAFETY PRECAUTIONS:

1. Safety glasses or goggles must be worn.
2. Hold tubing cutter square to tubing.
3. Do not use fingers to check for burrs.

COMPETENCE - PROCEDURE/STEPS The student will be able to:	TEACHING/LEARNING ACTIVITIES
1. Measure desired length and mark with pencil or crayon.	. SC-1A-1
2. Place tubing cutter on tube with cutting wheel centered on mark.	. SC-1H-1
3. Cut tube.	. SC-1H-1
4. Ream tube.	. SC-1H-1
5. Check measurement and cut.	

METHOD OF EVALUATION:

1. Proper procedure
2. Accuracy of measurement
3. Safe and proper use of tubing cutters

JOB: Anneal Copper Tubing

JOB SHEET
IDENTIFICATION CODE

UNIT I: Pipes and Fittings

JOB NUMBER: J-1H-2

COURSE: Plumbing

MATERIAL: (2'-4') 1/2" Hard Tubing

EQUIPMENT: Pipe Vise
Presto-lite Torch

TOOLS: 6' Folding Rule Pencil or Crayon
 Flint Stiker 1/2" Bending Spring

SAFETY PRECAUTIONS:

1. Safety glasses or goggles must be worn.
2. Heat will be conducted through tubing far beyond where heated.
3. Exercise care when operating the torch and working around hot tubing.

<u>COMPETENCE - PROCEDURE/STEPS</u> The student will be able to:	<u>TEACHING/LEARNING ACTIVITIES</u>
1. Measure and mark area to be annealed.	. SC-1A-1
2. Place tubing in vise.	
3. Set up and light presto-lite torch.	. SC-1H-2
4. Heat tubing until proper colors are established.	. IL-1H-5
5. Allow tubing to cool.	
6. Check tubing for proper annealing by bending tube between marks.	. SC-1H-6

METHOD OF EVALUATION:

1. Proper procedure
2. Safe and proper use of presto-lite torch
3. Appearance of finished job

JOB: Make a ½" Soldered Joint

JOB SHEET
IDENTIFICATION CODE

UNIT I: Pipes and Fittings

JOB NUMBER: J-1H-3

COURSE: Plumbing

DRAWING NO: D-1H-3

MATERIAL: (18") ½" Copper Tubing
(4) ½" Copper 90° Elbows
Emery Cloth and/or Steel Wool

Soldering Flux
50/50 Wire Solder

EQUIPMENT: Presto-lite Torch

TOOLS: Flint Striker
6' Extension Rule
Ball Peen Hammer

Copper Tubing Cutters
Pliers (Water Pump)

SAFETY PRECAUTIONS:

1. Never use fingers to check for burrs - handle tubing carefully.
2. Place presto-lite torch in a safe secure position and observe all safety precautions when lighting and using the torch.
3. You are using extreme heat - be cautious of yourself and your co-workers.

COMPETENCE - PROCEDURE/STEPS The student will be able to:	TEACHING/LEARNING ACTIVITIES
1. Check blueprint.	. D-1H-3
2. Measure copper tubing.	. SC-1A-1
3. Cut and ream copper tubing.	. SC-1H-1
4. Clean and flux tubing and fittings.	. SC-1H-3
5. Assemble and check measurements.	
6. Set-up and light presto-lite torch.	. SC-1H-2
7. Solder assembled tubing and fittings.	. SC-1H-3
8. Check work and properly shut off torch.	

METHOD OF EVALUATION:

1. Accuracy of measurement
2. Appearance/neatness of finished job
3. Time:

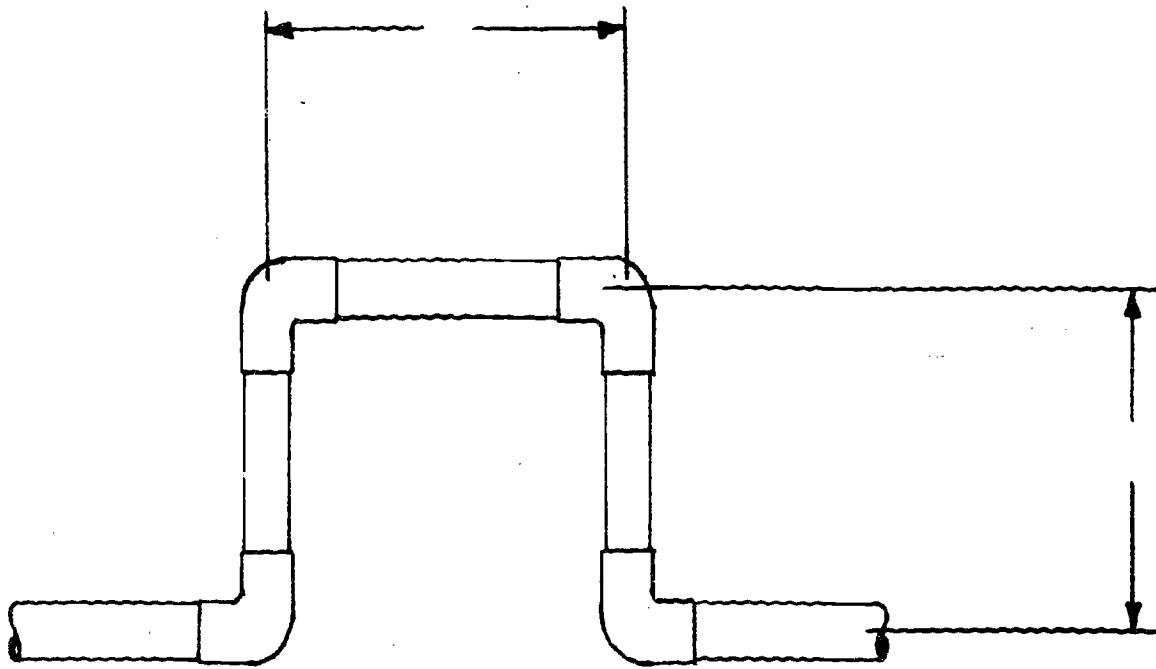

1/2" SOLDERED COPPER TUBING JOINT

D-1H-3

160

JOB: Make a 3/4" Soldered Joint

JOB SHEET
IDENTIFICATION CODE

UNIT I: Pipes and Fittings

JOB NUMBER: J-1H-4

COURSE: Plumbing

DRAWING NO: D-1H-4

MATERIAL: (18") 3/4" Copper Tubing
(2) 3/4" Copper 90° Elbows
Emery Cloth and/or Steel Wool

Flux
50/50 Wire Solder
(2) 3/4" Copper Tees

EQUIPMENT: Presto-lite Torch

TOOLS: 6' Extension Rule
Flint Striker
Ball Peen Hammer

Copper Tubing Cutter
Pliers (Water Pump)

SAFETY PRECAUTIONS:

1. Never use fingers to check for burrs - handle tubing carefully.
2. Place presto-lite torch in a safe secure position and observe all safety precautions when lighting and using the torch.
3. You are using extreme heat - be cautious of yourself and your co-workers.

<u>COMPETENCE - PROCEDURE/STEPS</u> <u>The student will be able to:</u>	<u>TEACHING/LEARNING ACTIVITIES</u>
1. Check blueprint.	. D-1H-4
2. Measure copper tubing.	. SC-1A-1
3. Cut and ream copper tubing.	. SC-1H-1
4. Clean and flux tubing and fittings.	. SC-1H-4
5. Assemble and check measurements.	
6. Set-up and light presto-lite torch.	. SC-1H-2
7. Solder assembled tubing and fittings.	. SC-1H-4
8. Check work and properly shut off torch.	

METHOD OF EVALUATION:

1. Accuracy of measurement
2. Appearance/neatness of finished job
3. Time:

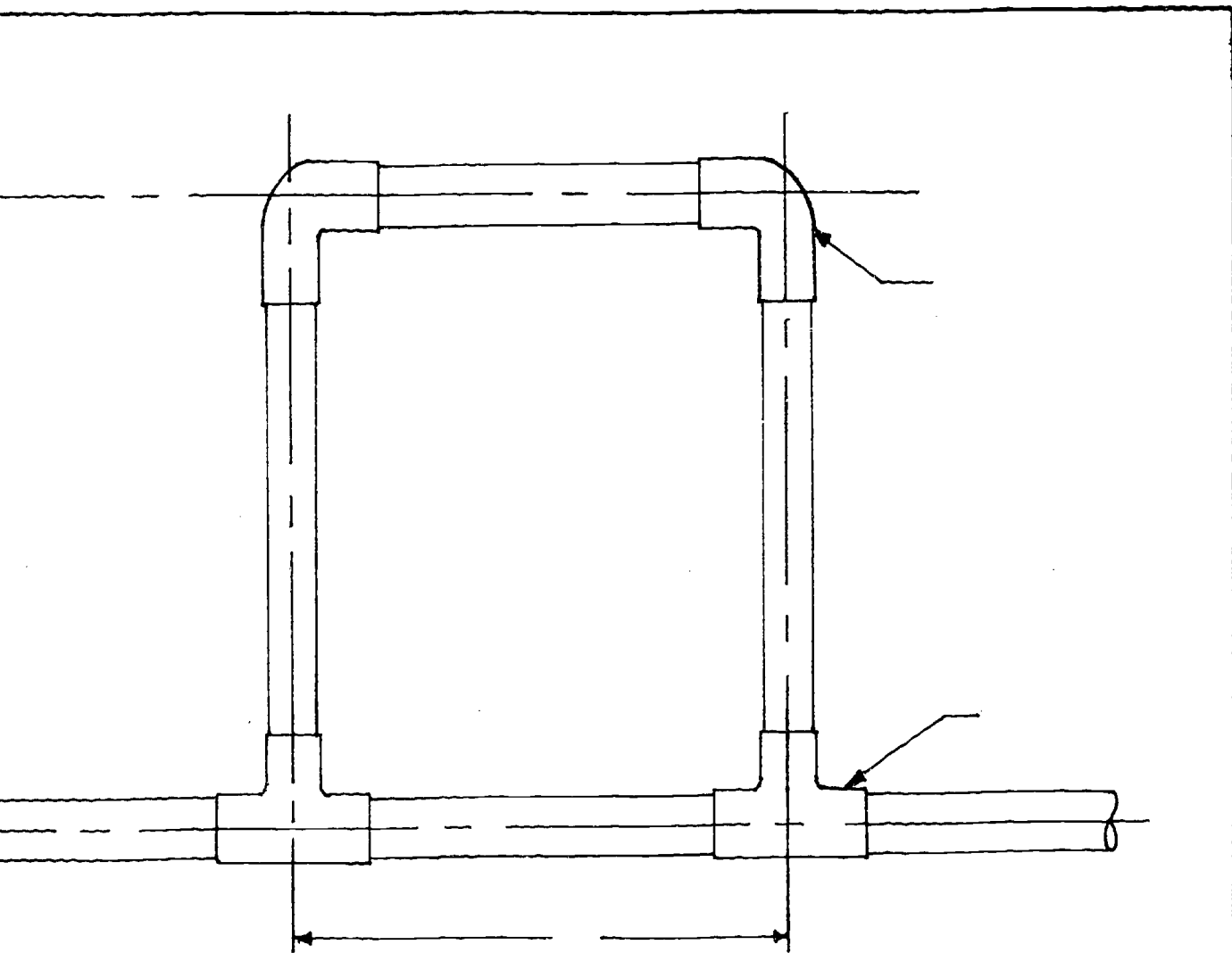

3/4" SOLDERED COPPER TUBING JOINT

D-1H-4

63

JOB: Make a 1/2" Flared Joint

JOB SHEET
IDENTIFICATION CODE

UNIT I: Pipes and Fittings

JOB NUMBER: J-1H-5

COURSE: Plumbing

DRAWING NO: D-1H-5

MATERIAL: (2') 1/2" Soft Copper Tubing
1 Can of Pipe Joint Compound
5/8" O.D. Flared X 1/2" M.I.P. Adapter

1/2" Gas Cock
5/8" O.D. Flared Coupling

TOOLS: 6' Extension Rule
Copper Tubing Cutters

Copper Flaring Tool
(2) 12" Crescent or Hex Wrench

SAFETY PRECAUTIONS:

1. Never use fingers to check for burrs - handle tubing carefully.
2. Do not drop or force the flaring tool.
3. You will be working with soft tubing - watch for kinks and dents from handling and cutting.

COMPETENCE - PROCEDURE/STEPS The student will be able to:	TEACHING/LEARNING ACTIVITIES
1. Check blueprint.	. D-1H-5
2. Measure copper tubing	. SC-1A-1
3. Cut and ream copper tubing.	. SC-1H-1
4. Select proper flaring tool.	. SC-1H-4
5. Flare copper tubing.	. SC-1H-4
6. Slide flare nut over flared end and tighten onto flare fitting.	. SC-1A-19
7. Assemble as per blueprint.	. D-1H-5
8. Check work and measurements.	

METHOD OF EVALUATION:

1. Accuracy of measurement
2. Appearance/neatness of finished job
3. Time:

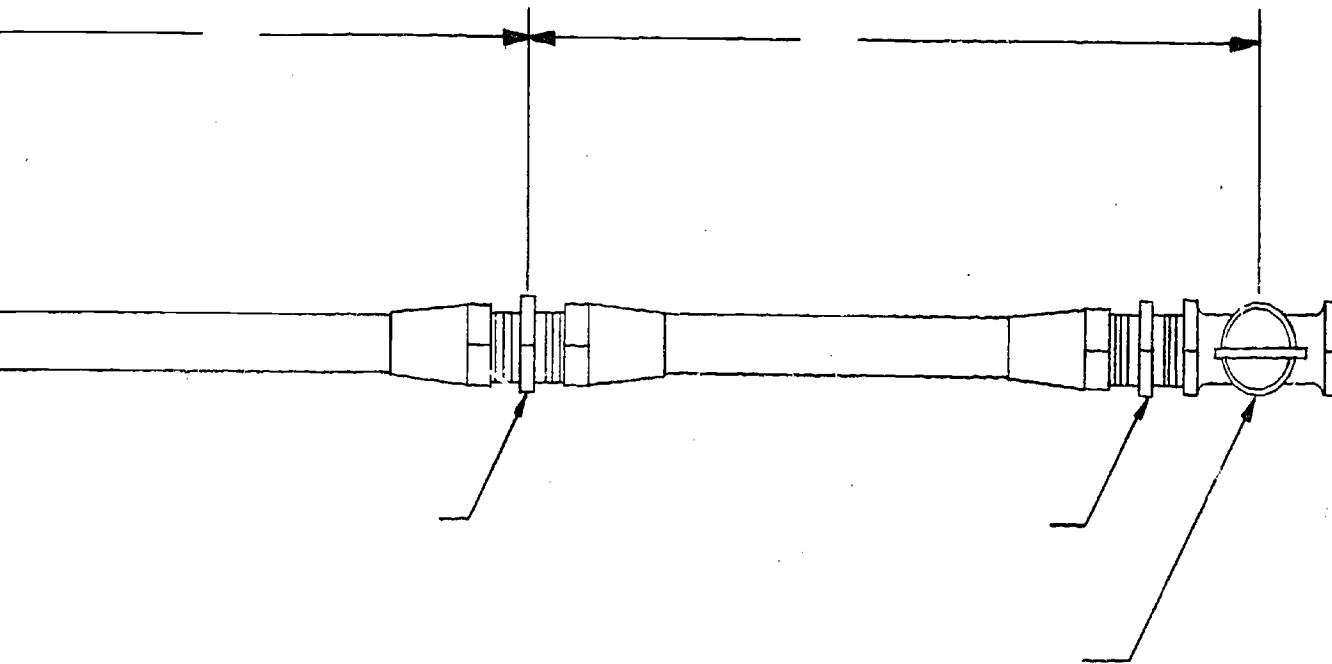

1/2" FLARED COPPER TUBING	
	D-1H-5 166

JOB: Make a 3/4" Flared Joint

JOB SHEET
IDENTIFICATION CODE

~~UNIT I: Pipes and Fittings~~

JOB NUMBER: J-1H-6

COURSE: Plumbing

DRAWING NO: D-1H-6

MATERIAL: 3/4" Curb Stop
3/4" Gate Valve
(3') 3/4" Soft Copper Tubing

1 Can - Pipe Joint Compound
(3) 7/8" O.D. Flared X 3/4"
M.I.P. Adapter

TOOLS: 6' Extension Rule
Copper Tubing Cutters

(2) 12" Crescent or Hex Wrenches
Copper Flaring Tool

SAFETY PRECAUTIONS:

1. Never use fingers to check for burrs - handle tubing carefully.
2. Do not drop or force the flaring tool.
3. You will be working with soft tubing - watch for kinks and dents from handling and cutting.

COMPETENCE - PROCEDURE/STEPS The student will be able to:	TEACHING/LEARNING ACTIVITIES
1. Check blueprint.	. D-1H-6
2. Measure copper tubing.	. SC-1A-1
3. Cut and ream copper tubing.	. SC-1H-1
4. Select proper flaring tool.	. SC-1H-4
5. Flare copper tubing.	. SC-1H-4
6. Slide flare nut over flared end and tighten onto flare fitting.	. SC-1A-19
7. Assemble as per blueprint.	. D-1H-6
8. Check work and measurements.	

METHOD OF EVALUATION:

1. Accuracy of measurement
2. Appearance/neatness of finished job
3. Time:

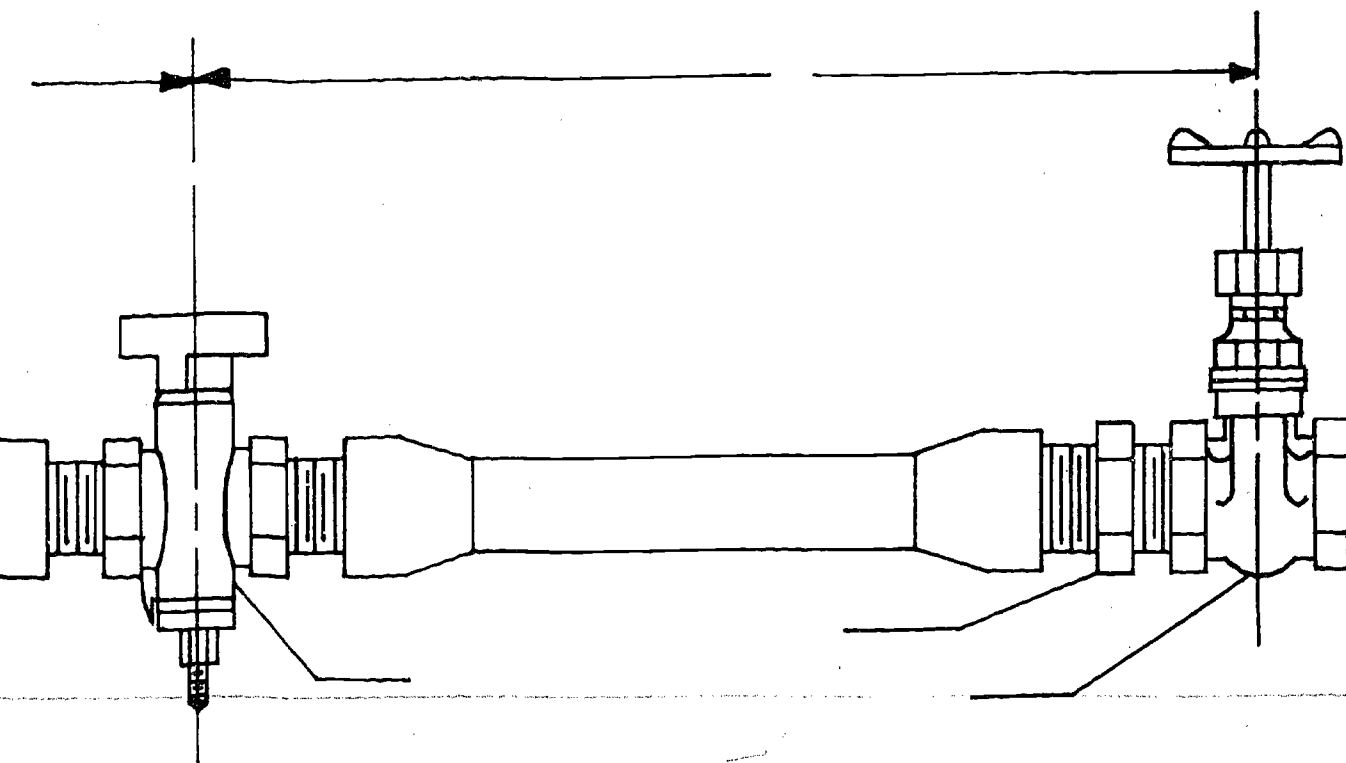

3/4" FLARED COPPER TUBING

DRAWING NUMBER

D-7H-6

JOB: Make a 1/2" Swedged Joint

JOB SHEET
IDENTIFICATION CODE

UNIT I: Pipes and Fittings

JOB NUMBER: J-1H-7

COURSE: Plumbing

DRAWING NO: D-1H-7

MATERIAL: Emery Cloth (16") 1/2" Copper Tubing
Steel Wool 1/2" Copper X 1/2" M.I.P. Adapter
Soldering Flux 1/2" Copper X 1/2" F.M.I.P. Adapter
50/50 Wire Solder 1/2" I.P. Drain Cock

EQUIPMENT: Presto-lite Torch

TOOLS: 6' Extension Rule Flint Striker
12 oz. Ball Peen Hammer Pliers (Water Pump)
Swedging Tool (2) 12" Crescent or Hex Wrenches
Copper Tubing Cutters Safety Glasses or Goggles

SAFETY PRECAUTIONS:

1. Never use fingers to check for burrs.
2. Wear safety glasses while swedging and soldering.
3. Place presto-lite torch in a safe secure position and observe all safety precautions when lighting and using the torch.

COMPETENCE - PROCEDURE/STEPS The student will be able to:	TEACHING/LEARNING ACTIVITIES
1. Check blueprint.	. D-1H-7
2. Measure copper tubing.	. SC-1A-1
3. Cut and ream copper tubing.	. SC-1H-1
4. Swedge copper tubing.	. SC-1H-5
5. Clean and flux tubing and fittings.	. SC-1H-3
6. Assemble and check measurements.	
7. Set up and light presto-lite torch.	. SC-1H-2
8. Solder assembled tubing and fittings.	. SC-1H-3
9. Apply pipe joint compound to drain cock and tighten into female adapter.	. SC-1F-4

COMPETENCE - PROCEDURE/STEPS	TEACHING/LEARNING ACTIVITIES
10. Apply pipe joint compound to male adapter and tighten into test valve.	. SC-1F-4
11. Pressure test and check work.	

METHOD OF EVALUATION:

1. Accuracy or measurement
2. Appearance/neatness of finished job
3. Time:

171

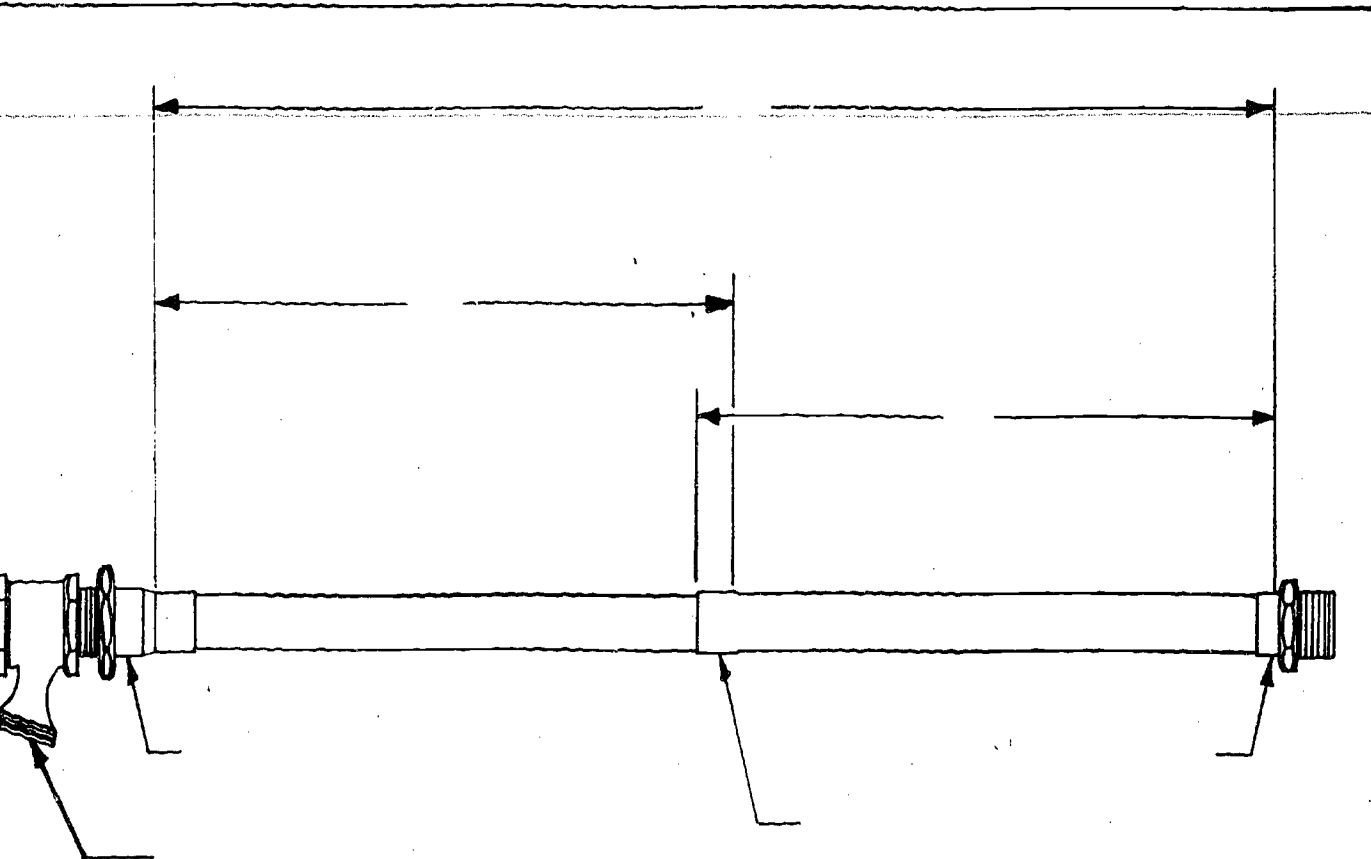

1/2" SWEDGED COPPER TUBING JOINT

D-1H-7

173

2

JOB: Make a 3/4" Swedged Joint

JOB SHEET
IDENTIFICATION CODE

UNIT I: Pipes and Fittings

JOB NUMBER: J-1H-8

COURSE: Plumbing

DRAWING NO: D-1H-8

MATERIAL: Emery Cloth
Steel Wool
Soldering Flux
50/50 Wire Solder

(18") 3/4" Copper Tubing
3/4" Copper X 1/2" M.I.P. Adapter
3/4" Copper X 1/2" F.M.I.P. Adapter
1/2" I.P. Drain Cock

EQUIPMENT: Presto-lite Torch

TOOLS: 6' Extension Rule
12 oz. Ball Peen Hammer
Swedging Tool
Copper Tubing Cutters

Pliers (Water Pump)
(2) 12" Crescent or Hex Wrenches
Safety Glasses or Goggles
Flint Striker

SAFETY PRECAUTIONS:

1. Never use fingers to check for burrs.
2. Wear safety glasses while swedging and soldering.
3. Place presto-lite torch in a safe secure position and observe all safety precautions when lighting and using the torch.

COMPETENCE - PROCEDURE/STEPS The student will be able to:	TEACHING/LEARNING ACTIVITIES
1. Check blueprint.	. D-1H-8
2. Measure copper tubing.	. SC-1A-1
3. Cut and ream copper tubing.	. SC-1H-1
4. Swedge copper tubing.	. SC-1H-5
5. Clean and flux tubing and fittings.	. SC-1H-3
6. Assemble and check measurements.	
7. Set up and light presto-lite torch.	. SC-1H-2
8. Solder assembled tubing and fittings.	. SC-1H-3
9. Apply pipe joint compound to drain cock and tighten into female adapter.	. SC-1F-4

COMPETENCE - PROCEDURE/STEPS	TEACHING/LEARNING ACTIVITIES
10. Apply pipe joint compound to male adapter and tighten into test valve.	. SC-1F-4
11. Pressure test and check work.	

METHOD OF EVALUATION:

1. Accuracy of measurement
2. Appearance/neatness of finished job
3. Time:

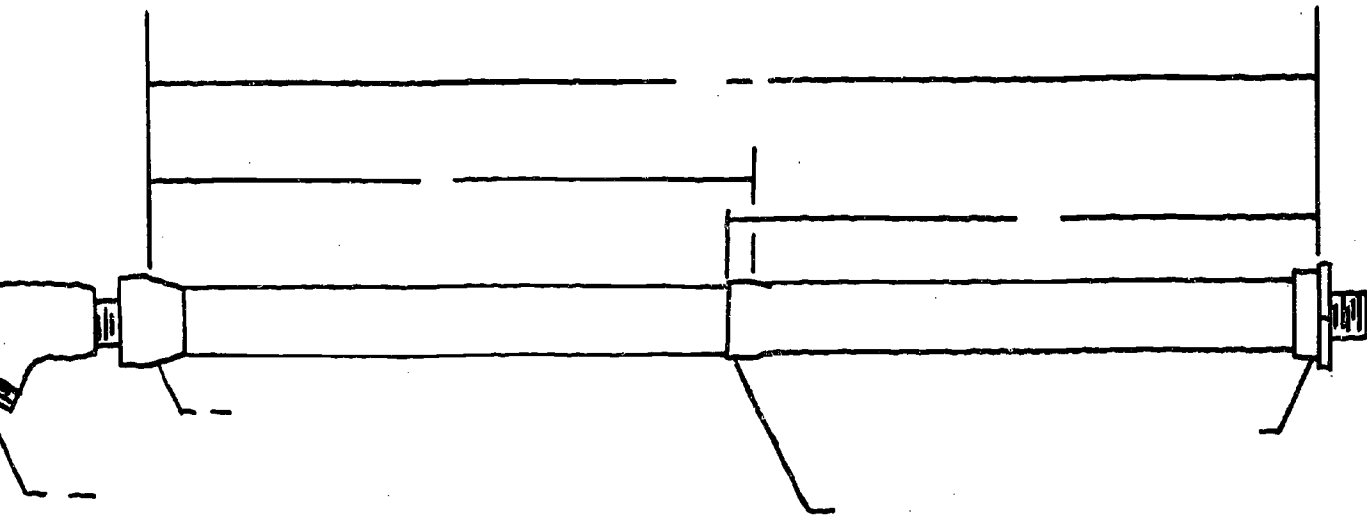

3/4" SWEDGED COPPER TUBING JOINT

DRAWING NUMBER

D-TH-8

177

JOB: Make a 3/4" Offset Joint

JOB SHEET
IDENTIFICATION CODE

UNIT I: Pipes and Fittings

JOB NUMBER: J-1H-9

COURSE: Plumbing

DRAWING NO: D-1H-9

MATERIAL: 3/4" Copper Union
Soldering Flux
50/50 Wire Solder

(2') 3/4" Soft Copper Tubing
Emery Cloth and/or Steel Wool

EQUIPMENT: Presto-lite Torch

TOOLS: 6' Extension Rule
3/4" Bending Spring
Copper Tubing Cutter

12" Adjustable Wrench
Flint Striker
Pliers (Water Pump)

SAFETY PRECAUTIONS:

1. Never use fingers to check for burrs - handle tubing carefully.
2. Be careful not to strain the bending spring.
3. You will be working with soft copper tubing - be careful of kinks and dents from cutting and bending tubing.

COMPETENCE - PROCEDURE/STEPS The student will be able to:	TEACHING/LEARNING ACTIVITIES
1. Check blueprint.	. D-1H-9
2. Measure copper tubing.	. SC-1A-1
3. Bend copper tubing.	. SC-1H-6
4. Measure copper tubing.	. SC-1A-1
5. Cut and ream copper tubing.	. SC-1H-1
6. Clean and flux tubing and fittings.	. SC-1H-3
7. Assemble and check measurements.	
8. Set up and light presto-lite torch.	. SC-1H-2
9. Solder assembled tubing and fittings.	. SC-1H-3
10. Check work and measurements.	

METHOD OF EVALUATION:

1. Accuracy of measurement
2. Appearance/neatness of finished job
3. Time:

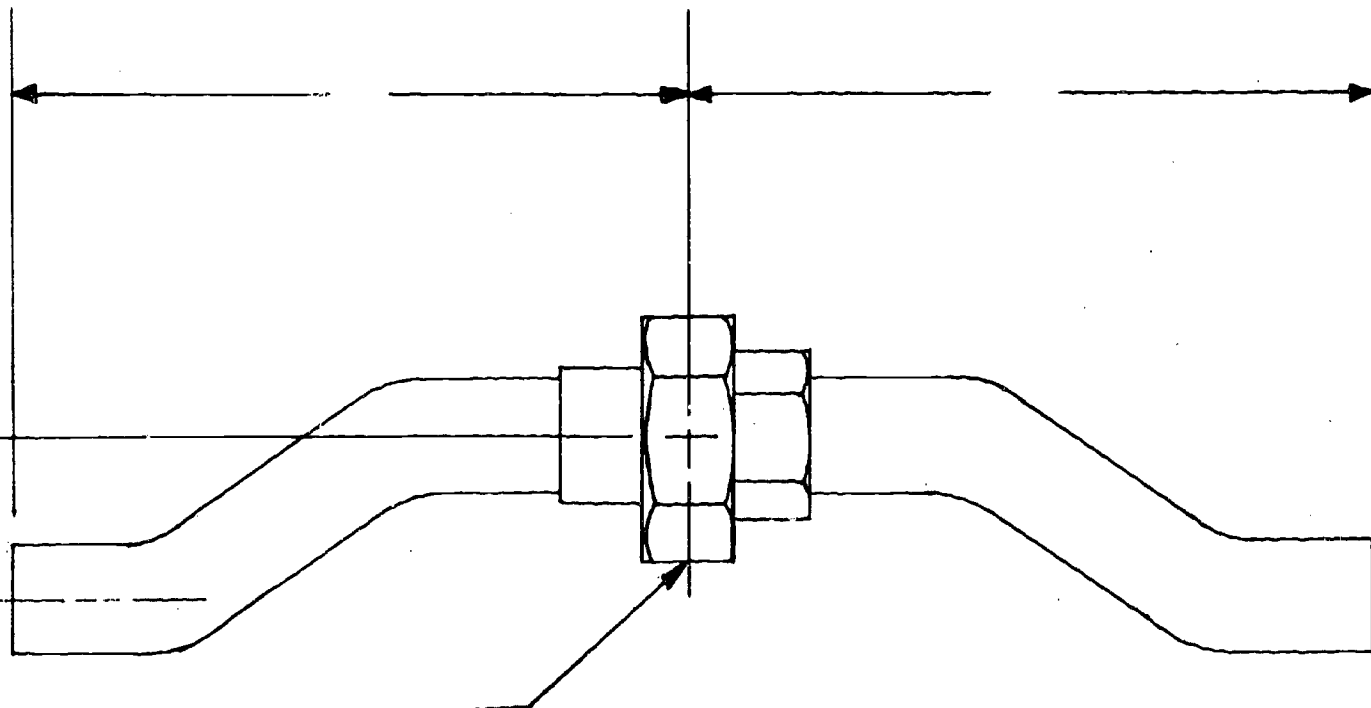

3/4" OFFSET COPPER TUBING JOINT

9

D-1H-9

180

JOB: Make a 1½" Soldered Joint

JOB SHEET
IDENTIFICATION CODE

UNIT I: Pipes and Fittings

JOB NUMBER: J-1H-10

COURSE: Plumbing

DRAWING NO: D-1H-10

MATERIAL: (14") 1½" Copper Tubing
(2) 1½" Copper 90° Elbows
Emery Cloth and/or Steel Wool

Soldering Flux
50/50 Wire Solder

EQUIPMENT: Presto-lite Torch

TOOLS: 6' Extension Rule
Flint Striker
Ball Peen Hammer

Copper Tubing Cutters
Pliers (Water Pump)

SAFETY PRECAUTIONS:

1. Never use fingers to check for burrs - handled tubing carefully
2. Place presto-lite torch in a safe secure position and observe all safety precautions when lighting and using the torch.
3. You are using extreme heat - be cautious of yourself and your co-workers.

COMPETENCE - PROCEDURE/STEPS The student will be able to:	TEACHING/LEARNING ACTIVITIES
1. Check blueprint.	. D-1H-10
2. Measure copper tubing.	. SC-1A-1
3. Cut and ream copper tubing.	. SC-1H-1
4. Clean and flux tubing and fittings.	. SC-1H-3
5. Assemble and check measurements.	
6. Set up and light presto-lite torch.	. SC-1H-2
7. Solder assembled tubing and fittings.	. SC-1H-3
8. Check work and properly shut off torch.	

METHOD OF EVALUATION:

1. Accuracy of measurement
2. Appearance/neatness of finished job
3. Time:

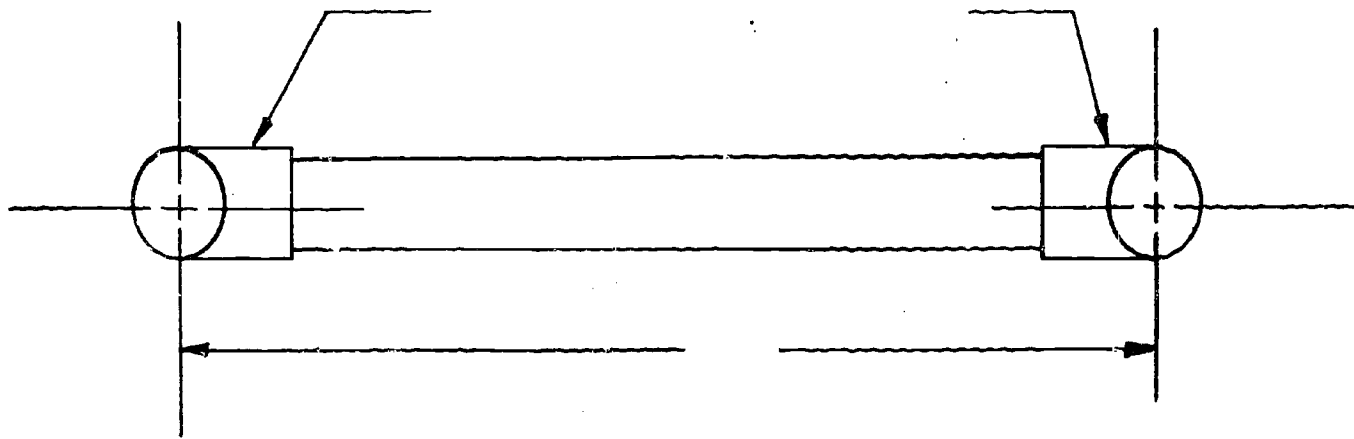

1 1/2" SOLDERED COPPER TUBING JOINT

DRAWING NUMBER

D-TH-10

JOB: Make a Combination Silver Soldered Joint

JOB SHEET
IDENTIFICATION CODE

UNIT I: Pipes and Fittings

JOB NUMBER: J-1H-11

COURSE: Plumbing

DRAWING NO: D-1H-11

MATERIAL: (18") 3/4" Copper Tubing
(2) 3/4" Copper 90° Elbows
Silver Soldering Flux

Silver Solder
Emery Cloth

EQUIPMENT: Presto-lite or Turbo Torch
Safety Goggles

TOOLS: 6' Extension Kule
Copper Tubing Cutters
Flint Striker

Pliers (Water Pump)
Ball Peen Hammer

SAFETY PRECAUTIONS:

1. Use adequate ventilation.
2. Avoid overheating and hot spots.
3. Wear shaded safety goggles.
4. Observe all safety precautions when lighting and using the torch.

COMPETENCE - PROCEDURE/STEPS The student will be able to:	TEACHING/LEARNING ACTIVITIES
1. Check blueprints.	. D-1H-1i
2. Measure copper tubing.	. SC-1A-1
3. Cut and ream tubing.	. SC-1H-1
4. Clean and flux tubing and fittings.	. SC-1H-3
5. Assemble and check measurements.	
6. Set up and light torch.	. SC-1H-2
7. Silver solder assembled tubing and fittings.	. SC-1H-3
8. Check joints and shut off torch.	
9. Remove flux residue and clean assemble tubing and fittings.	

METHOD OF EVALUATION:

1. Accuracy of measurement
2. Appearance/neatness of finished job
3. Time:

184

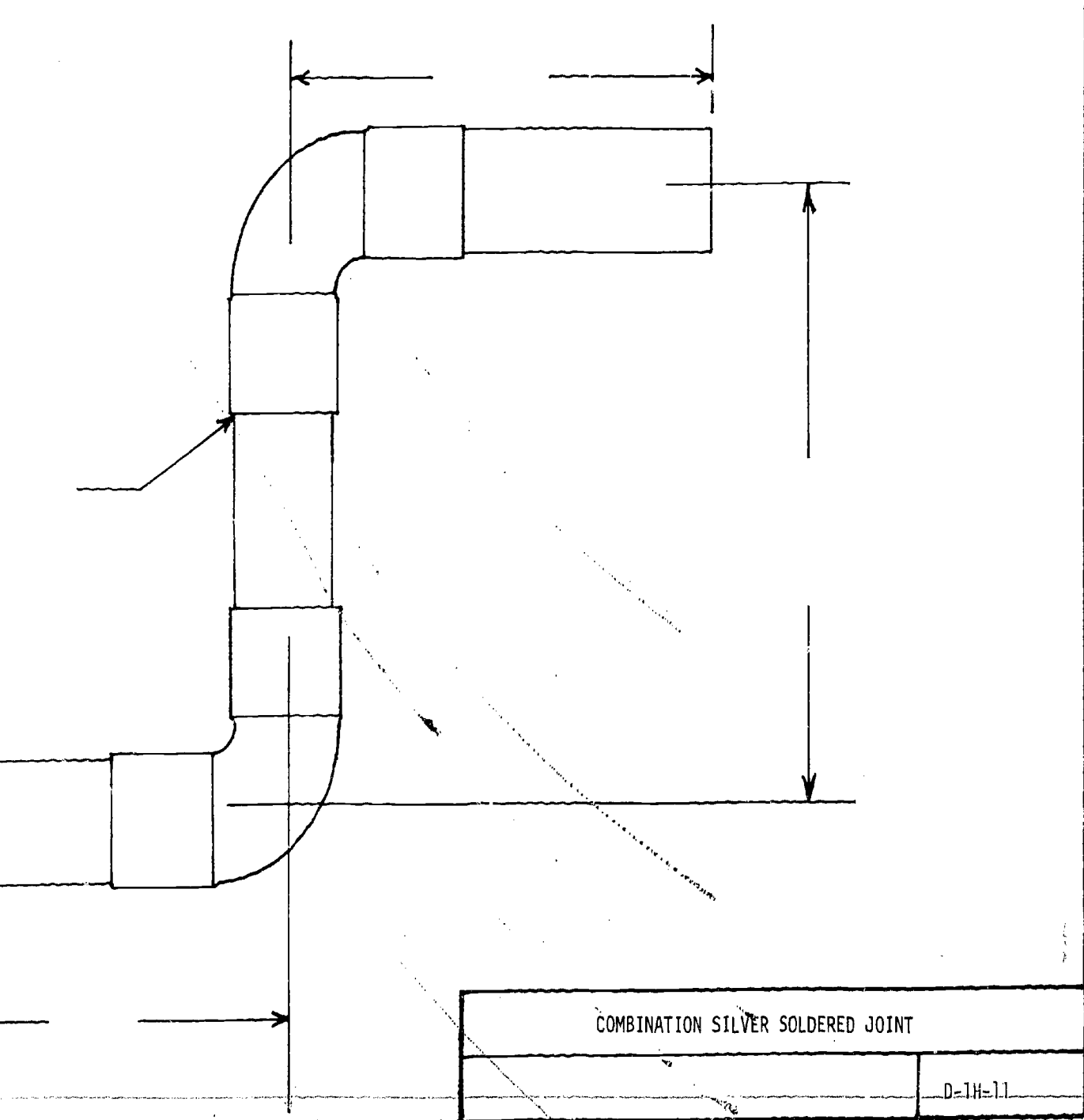

JOB: Make a 1/2" - 3/4" Insert Joint

JOB SHEET
IDENTIFICATION CODE

UNIT I: Pipes and Fittings

JOB NUMBER: J-1K-1

COURSE: Plumbing

DRAWING NO: D-1K-1

MATERIAL: (5') 1/2" - 3/4" Flexible Plastic
(3) 1/2" - 3/4" Insert Tees
(3) 1/2" - 3/4" Insert 90° Ells
1/2" or 3/4" Insert X FM Adapter
1/2" or 3/4" Drain Cock
(16) 1/2" - 3/4" Stainless Steel Clamps

TOOLS: 10" Hex Wrench Hacksaw (w/10" Blade)
10" Strap Wrench Screwdriver
Pocket Knife 6' Extension Rule

SAFETY PRECAUTIONS:

1. Use proper tools.
2. Use strap wrench rather than standard pipe wrench.
3. Use only petroleum jelly (e.g., Vaseline) or Teflon tape on male or female threads.

COMPETENCE - PROCEDURE/STEPS The student will be able to:	TEACHING/LEARNING ACTIVITIES
1. Check blueprint for layout.	. D-1K-1
2. Measure plastic pipe.	. SC-1A-1
3. Cut and ream plastic pipe.	. SC-1K-1
4. Align pipe and fitting and force pipe and fitting together.	. SC-1K-2
5. Tighten clamps.	. SC-1K-2
6. Assemble as per blueprint.	. D-1K-1
7. Check joints for tightness.	
8. Test and check for leaks.	

METHOD OF EVALUATION:

1. Accuracy of measurements
2. Appearance of finished job
3. Cleanliness of tools and work areas
4. Time:

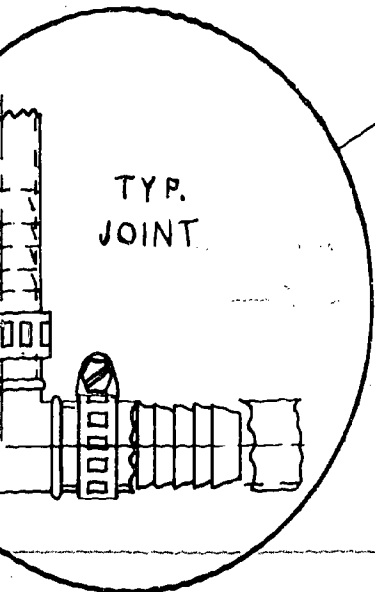
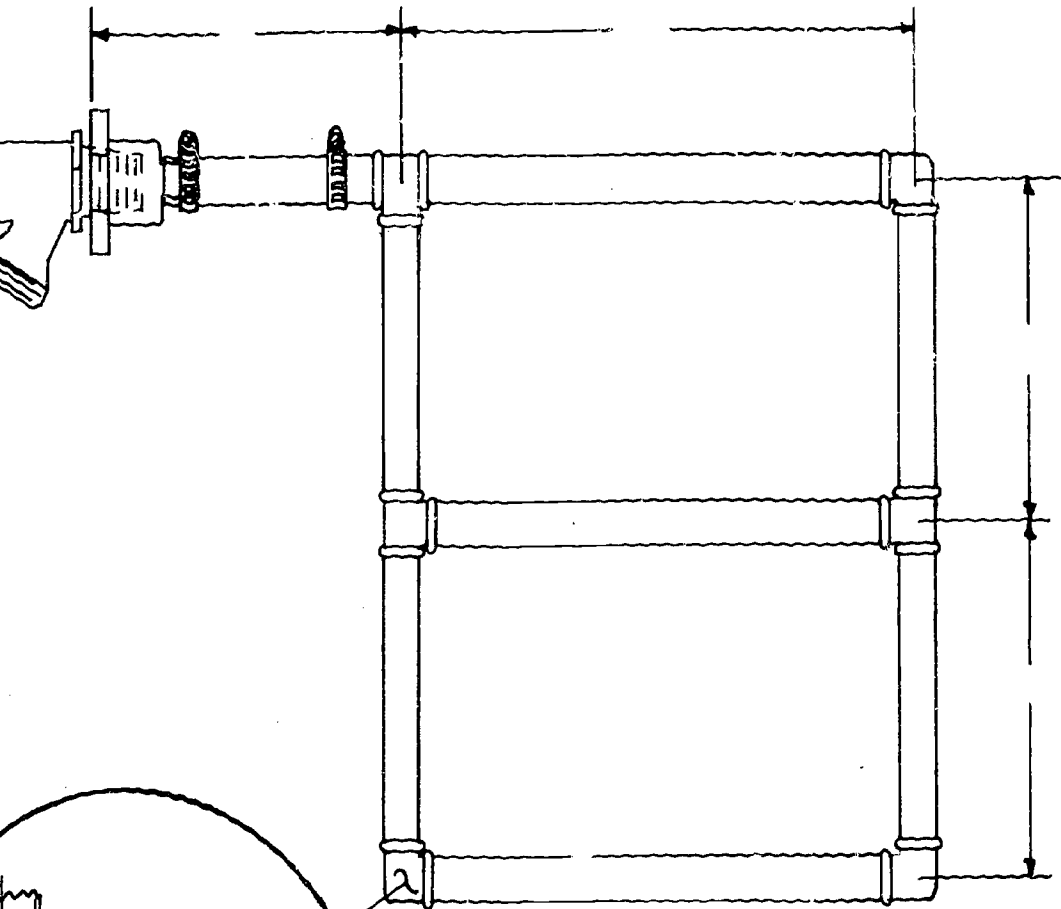

1/2" - 3/4" INSERT JOINT

DRAWING No.
D-1K-1 189

JOB: Make a 1/2" - 3/4" Cemented Joint

JOB SHEET
IDENTIFICATION CODE

JNIT I: Pipes and Fittings

JOB NUMBER: J-1K-2

COURSE: Plumbing

DRAWING NO: D-1K-2

MATERIAL: Solvent Cement (CPVC)
Liquid Cleaner (CPVC)
1/2" - 3/4" CPVC Ywe
1/2" - 3/4" Drain Cock
1/2" - 3/4" CPVC 45° E11

(5') 1/2" - 3/4" CPVC Pipe
(3) 1/2" - 3/4" CPVC 90° E11s
(4) 1/2" - 3/4" CPVC Tees
1/2" - 3/4" CPVC FM Adapter

TOOLS: 10" Hex Wrench
Hacksaw (w/10" Blade)
Acid Brush

Pipe Cutters (w/Plastic Cutter Wheel)
Pocket Knife
6' Extension Rule

SAFETY PRECAUTIONS:

1. Use proper tools.
2. Use only petroleum jelly (e.g., Vaseline) or Teflon tape on male or female threads.
3. Avoid prolonged breathing of cleaner and solvent fumes.

COMPETENCE - PROCEDURE/STEPS The student will be able to:	TEACHING/LEARNING ACTIVITIES
1. Check blueprint for layout.	. D-1K-2
2. Measure plastic pipe.	. SC-1A-1
3. Cut and ream plastic pipe.	. SC-1K-1
4. Clean plastic pipe.	
5. Apply solvent to fittings and pipe.	. SC-1K-3
6. Remove excess solvent cement from exterior of joint.	. SC-1K-3
7. Assemble as per blueprint.	. D-1K-2
8. Test and check for leaks.	

METHOD OF EVALUATION:

1. Accuracy of measurements
2. Appearance of finished job
3. Cleanliness of tools and work areas
4. Time:

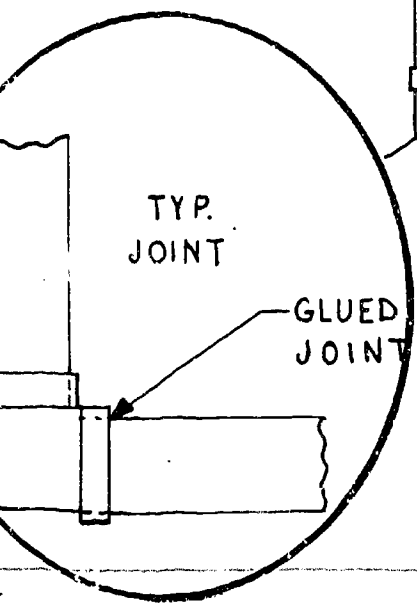
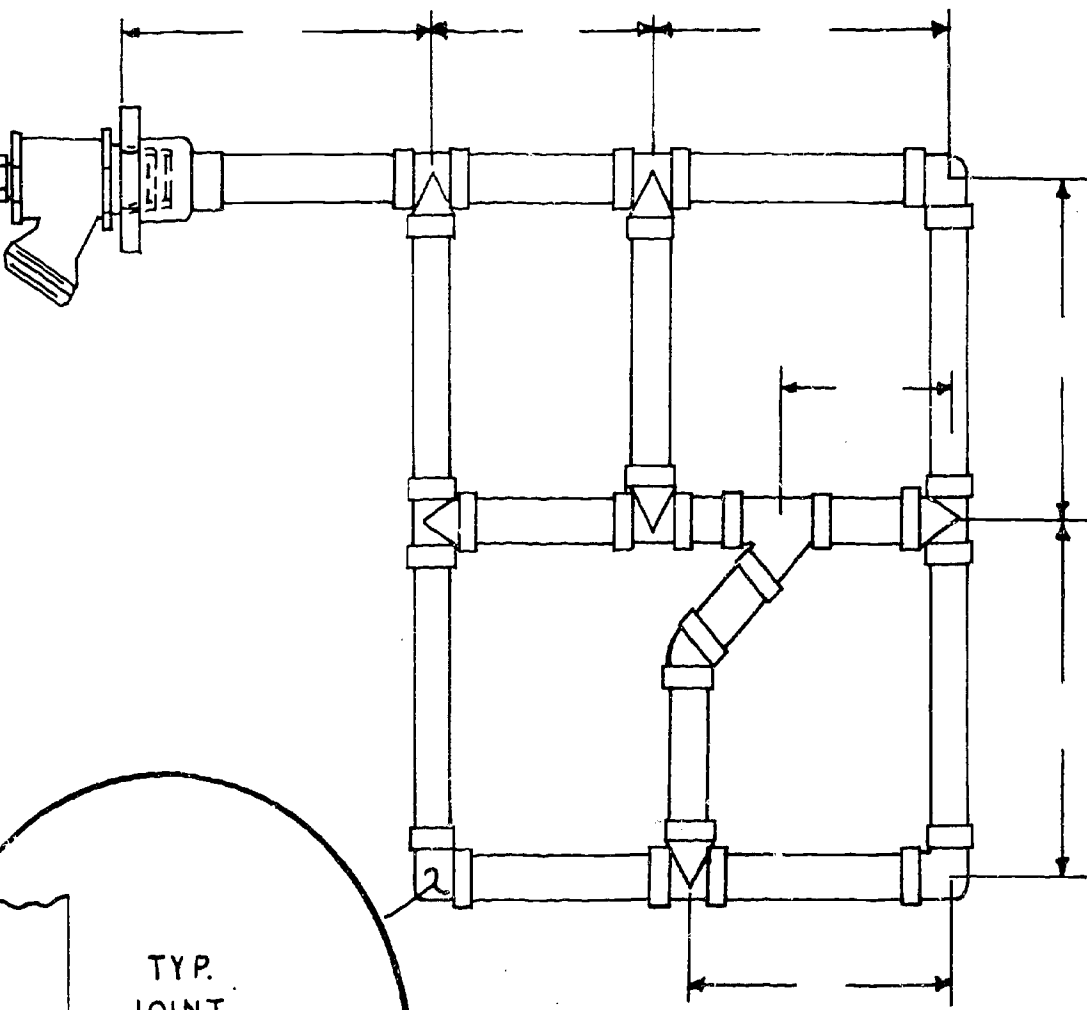

1/2" - 3/4" CEMENTED JOINT

DRAWING NUMBER
D-1K-2 192

JOB: Make a 1½" ABS-DWV Offset Stack

JOB SHEET
IDENTIFICATION CODE

UNIT I: Pipes and Fittings

JOB NUMBER: J-1K-3

COURSE: Plumbing

DRAWING NO: D-1K-3

MATERIAL: 1½" ABS - DWV Ywe
1½" ABS - DWV 45° E11
1½" ABS - DWV 90° E11
Solvent Cement (ABS)

1½" x 1¼" ABS - DWV Fitting Trap Adapter
(2) 1½" ABS - DWV Sanitary Tees
(10') 1½" ABS - DWV Plastic Pipe

TOOLS: Pocket Knife
Acid Brush

Hacksaw
Pipe Cutters (w/Plastic Cutter Wheel)

SAFETY PRECAUTIONS:

1. Use proper tools.
2. Avoid prolonged breathing of solvent fumes.
3. Clean off excess cement - use proper amount only.

COMPETENCE - PROCEDURE/STEPS The student will be able to:	TEACHING/LEARNING ACTIVITIES
1. Check blueprint for layout.	. D-1K-3
2. Measure plastic pipe.	. SC-1A-1
3. Cut and ream plastic pipe.	. SC-1K-1
4. Dry-fit, roll or align, and scribe.	
5. Apply solvent to fittings and pipe.	. SC-1K-3
6. Remove excess solvent from exterior of joint.	. SC-1K-3
7. Assemble as per blueprint.	. D-1K-3
8. Test and check for leaks.	

METHOD OF EVALUATION:

1. Accuracy of measurements
2. Appearance of finished job
3. Cleanliness of tools and work areas
4. Time:

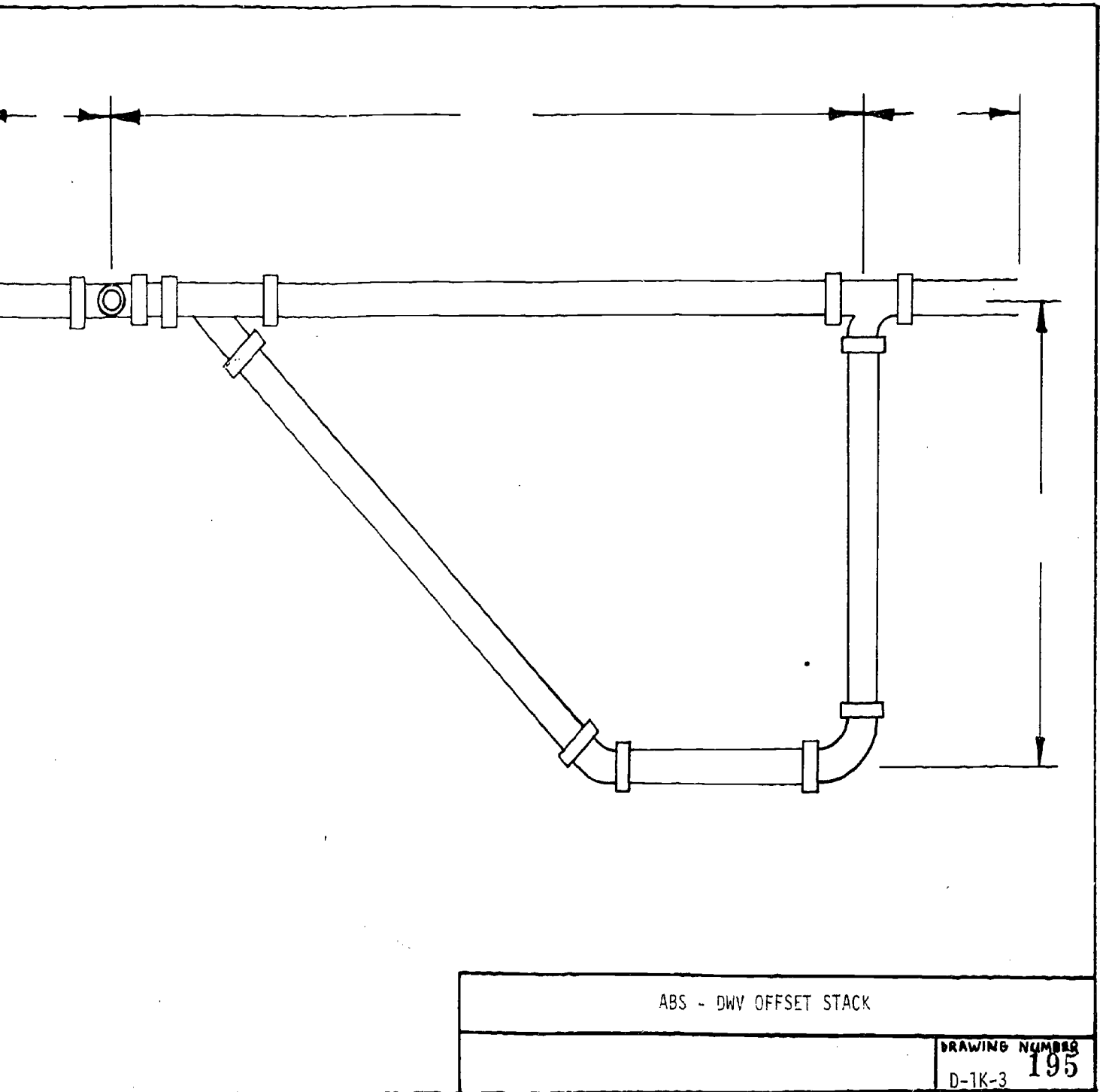

JOB: Make a 3/4" - 1" Flared Joint

JOB SHEET
IDENTIFICATION CODE

UNIT I: Pipes and Fittings

JOB NUMBER: J-1K-4

COURSE: Plumbing

DRAWING NO: D-1K-4

MATERIAL: 3/4" Curb Stop (3) 7/8" OD or (1) 1/8" OD Flared X
3/4" Gate Valve 3/4" MIP Adapters
Pipe Joint Compound (3'-5') 3/4" - 1" Flexible Plastic Pipe

TOOLS: Pocket Knife Zip-Flare Tool (3/4" or 1")
6' Extension Rule (2) 12" Hex or Crescent Wrenches
Hacksaw (10" - 24" Blade)

SAFETY PRECAUTIONS:

1. Use proper tools.
2. Do not drop or force flaring tool.
3. Care must be taken not to kink or smash plastic pipe.

COMPETENCE - PROCEDURE/STEPS The student will be able to:	TEACHING/LEARNING ACTIVITIES
1. Check blueprint.	. D-1K-4
2. Measure plastic pipe.	. SC-1A-1
3. Cut and ream plastic pipe.	. SC-1K-1
4. Select proper flaring tool.	. SC-1K-4
5. Flare plastic pipe.	. SC-1K-4
6. Slide nut over flared end and tighten onto flared fitting.	. SC-1A-19
7. Assemble as per blueprint.	. D-1K-4
8. Check work and measurements.	
9. Test and check for leaks.	

METHOD OF EVALUATION:

1. Accuracy of measurement
2. Appearance of finished job
3. Cleanliness of tools and work areas
4. Time:

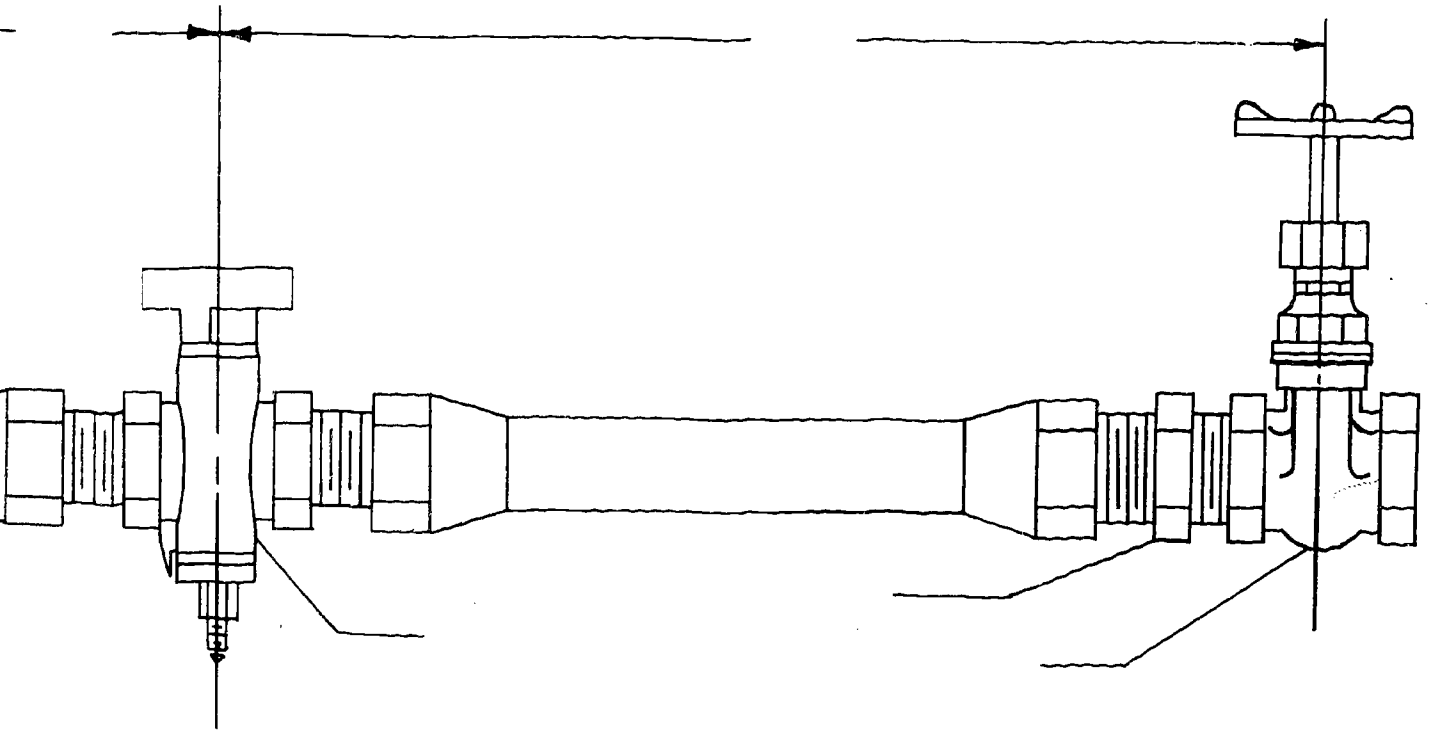

FLARED PLASTIC PIPE JOINT

DRAWING NUMBER

D-1K-4

JOB: Disassemble and Assemble Gate and
Globe Valves

JOB SHEET
IDENTIFICATION CODE

UNIT II: Valves

JOB NUMBER: J-2-1

COURSE: Plumbing

MATERIAL: 3/4" to 1 1/4" Gate Valve
3/4" to 1 1/4" Globe Valve

TOOLS: Screwdriver
Adjustable Wrench - Spud, Hex or Monkey Wrench

SAFETY PRECAUTIONS:

Use proper tools, pipe wrenches are for pipe only!

COMPETENCE - PROCEDURE/STEPS The student will be able to:	TEACHING/LEARNING ACTIVITIES
1. Unscrew packing nut with an adjustable wrench.	NOTE: Always raise valve stem before removing or tightening valve bonnet. SC-2-1
2. Remove the packing gland.	
3. Remove the packing.	
4. Raise the valve stem and remove the bonnet.	
5. Remove the valve stem from the body.	
6. Remove the gate or disc from the stem.	
7. Check gate, disc, and valve seat.	
8. Reassemble valve, (reverse steps 1 thru 6).	

NOTE: Use valve grease when reassembling valves.

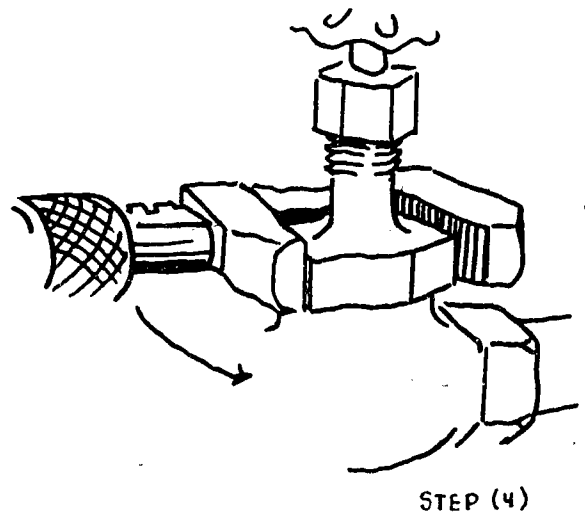
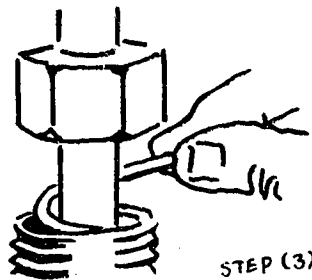
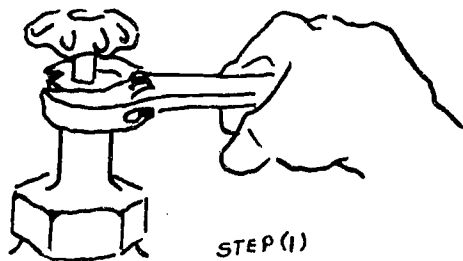

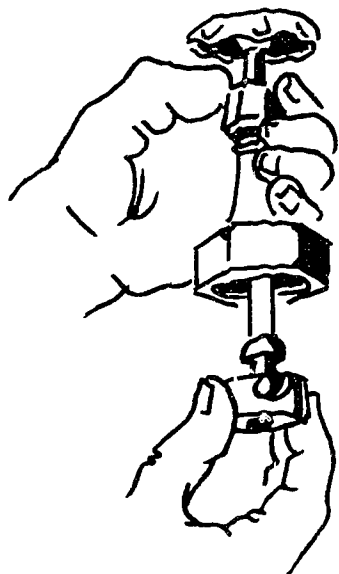

STEP (6)

METHOD OF EVALUATION:

1. Proper procedure
2. Assembled correctly

200

JOB: Disassemble and Assemble Check Valves

JOB SHEET
IDENTIFICATION CODE

UNIT II: Valves

JOB NUMBER: J-2-2

COURSE: Plumbing

MATERIAL: 3/4" to 1 1/4" Check Valve

TOOLS: Adjustable, Spud, Hex or Monkey Wrench
Box or Open End Wrench
Needle Nose Pliers

SAFETY PRECAUTIONS:

Use proper tools - pipe wrenches are for pipe only!

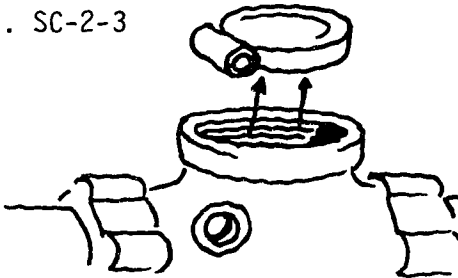
COMPETENCE - PROCEDURE/STEPS The student will be able to:	TEACHING/LEARNING ACTIVITIES
1. Remove the valve cap using a smooth jawed wrench.	. SC-2-1
2. Remove the hanger pin plugs using a box or open end wrench.	. SC-2-2, SC-2-2A
3. Remove the hanger pin with needle nose pliers.	. SC-2-3
4. Remove the valve disc.	
5. Remove the access opening plug with a box or open-end wrench.	
6. Check the valve seat.	
7. Reassemble the valve (reverse steps 1 thru 5).	NOTE: Use valve grease when reassembling valves.

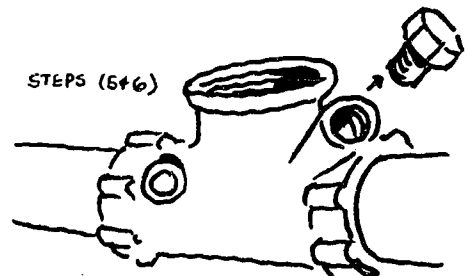
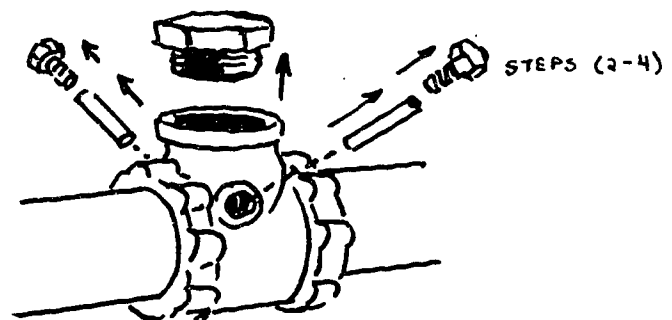
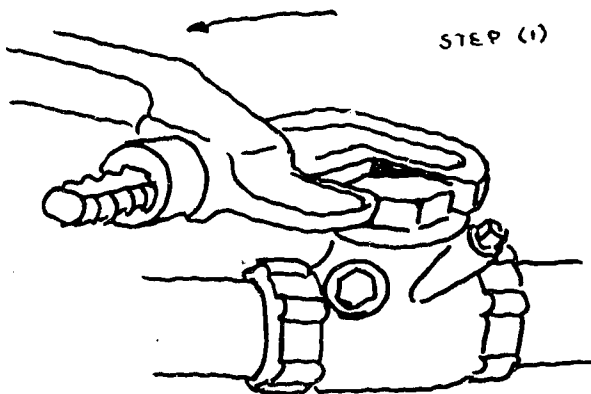

201

METHOD OF EVALUATION:

1. Proper procedure
2. Assembled correctly

JOB: Disassemble and Assemble a Common Compression Faucet

JOB SHEET
IDENTIFICATION CODE

UNIT II: Valves

JOB NUMBER: J-2-3

COURSE: Plumbing

DRAWING NO: D-2-3

MATERIAL: Single or Double Compression Faucet

TOOLS: Screwdriver
Adjustable, Spud, Hex or Monkey Wrench

SAFETY PRECAUTIONS:

1. Use proper tools - pliers will mark chrome surfaces.
2. Care must be exercised when removing bibb screw.

COMPETENCE - PROCEDURE/STEPS The student will be able to:	TEACHING/LEARNING ACTIVITIES
--	------------------------------

1. Remove the handle screw and handle.

. SC-2-4

2. Unscrew the packing nut.

3. Remove the packing.

4. Turn the valve stem out of the body.

5. Remove the brass bibb screw.

6. Remove the washer.

7. Remove the valve seat.

8. Check the washer and seat.

9. Reassemble the valve, (reverse steps 1 thru 7).

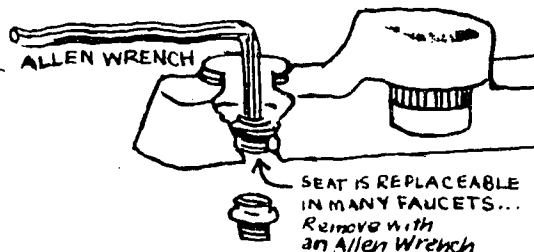
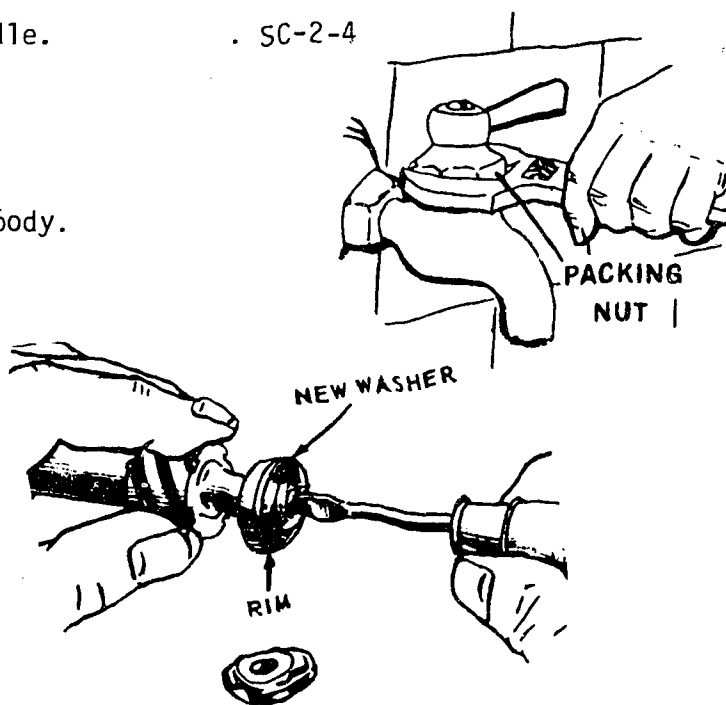

METHOD OF EVALUATION:

1. Proper procedure
2. Assemble correctly

-269-

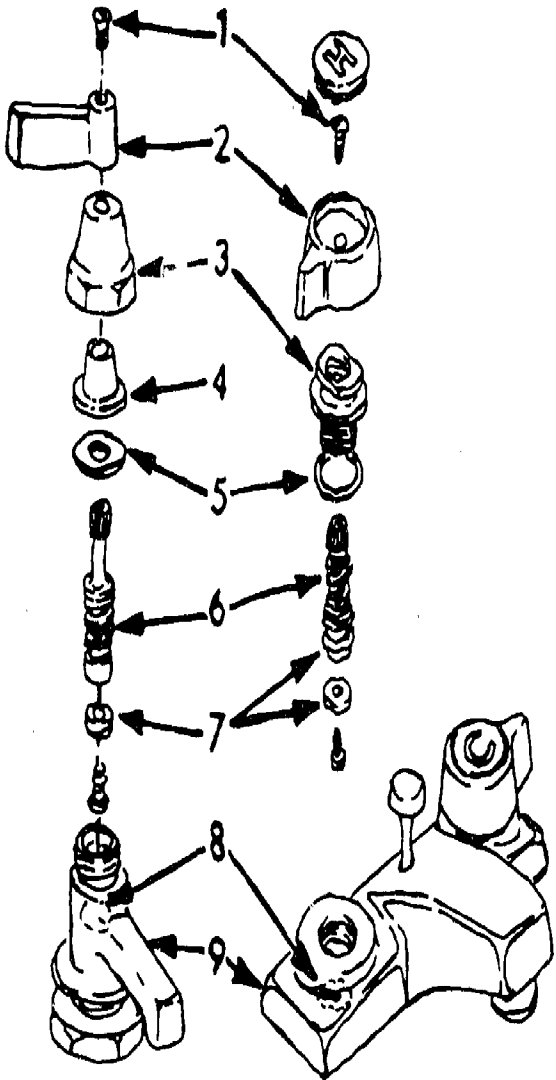

- 1. Handle Screw
- 2. Handle
- 3. Packing Nut
- 4. Packing Material
- 5. Washer
- 6. Stem
- 7. Washers
- 8. Valve Seat
- 9. Valve Body

COMMON COMPRESSION FAUCET

DRAWING NUMBER

D-2-3 205

JOB: Disassemble and Assemble a Single
Lever Valve Faucet

JOB SHEET
IDENTIFICATION CODE

UNIT II: Valves

JOB NUMBER: J-2-4

COURSE: Plumbing

DRAWING NO: D-2-4

MATERIAL: Single Lever Valve Faucet

TOOLS: Channel Lock Pliers
Needle Nose Pliers
Allen Wrenches
Box or Open End Wrenches

SAFETY PRECAUTIONS:

1. Use heat resistant valve grease when reassembling faucet.

COMPETENCE - PROCEDURE/STEPS The student will be able to:	TEACHING/LEARNING ACTIVITIES
1. Remove the swing spout connecting ring or nut with channel lock pliers. (2)	. SC-2-6
2. Lift out the swing spout. (1)	NOTE: Protect surface of chrome connecting ring before using pliers.
3. Lift off the faucet body cover. (4)	
4. Remove the valve plug and gasket. (5 & 6)	. SC-2-2
5. Lift out the strainer and valve stem. (8)	. SC-2-3
6. Remove the valve seat. (9)	. SC-2-5
7. Check the valve seat, stem, and strainer.	
8. Reassemble the faucet (reverse steps 1 thru 6).	NOTE: Use valve grease when reassembling faucet.

METHOD OF EVALUATION:

1. Proper procedure
2. Assembled correctly

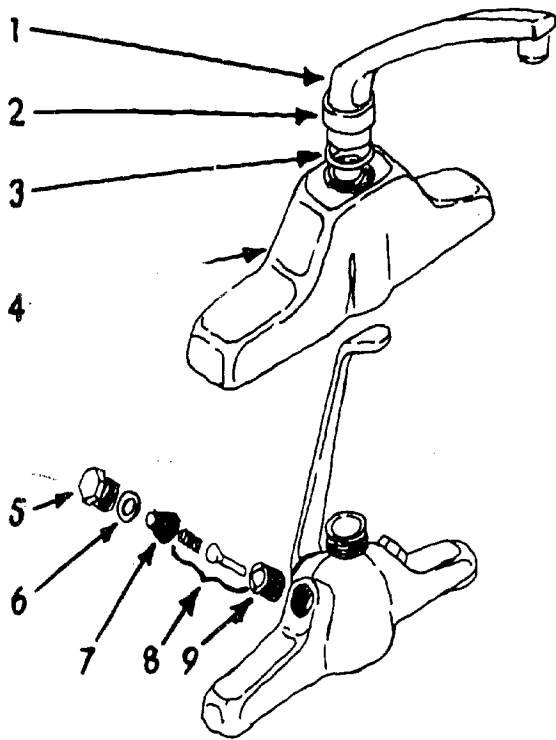

1. Swing Spout
2. Swing Spout Connecting Nut
3. Swing Spout Connecting Ring
4. Faucet Body Cover

5. Valve Plug
6. Valve Gasket
7. Valve Strainer
8. Valve Stem
9. Valve Seat

SINGLE LEVER VALVE FAUCET

DRAWING NUMBER

D-2-4 208

JOB: Disassemble and Assemble a Ball Faucet
 UNIT II: Valves
 COURSE: Plumbing
 MATERIAL: Single Lever Ball Faucet
 TOOLS: Channel Lock Pliers
 Allen Wrench

JOB SHEET
 IDENTIFICATION CODE
 JOB NUMBER: J-2-5

COMPETENCE - PROCEDURE/STEPS The student will be able to:	TEACHING/LEARNING ACTIVITIES
--	------------------------------

1. Loosen the handle set screw. (5)
2. Lift off the handle. (4)
3. Remove the faucet cap. (1)
4. Lift out the cam assembly and ball. (2 & 3)
5. Remove the seat assembly.
6. Lift up (pull off) the spout. (5)
7. Remove the "O" rings. (6)
8. Check the cam assembly, ball, seat assemblies, and O rings.
9. Reassemble the faucet (reverse steps 1 thru 7).

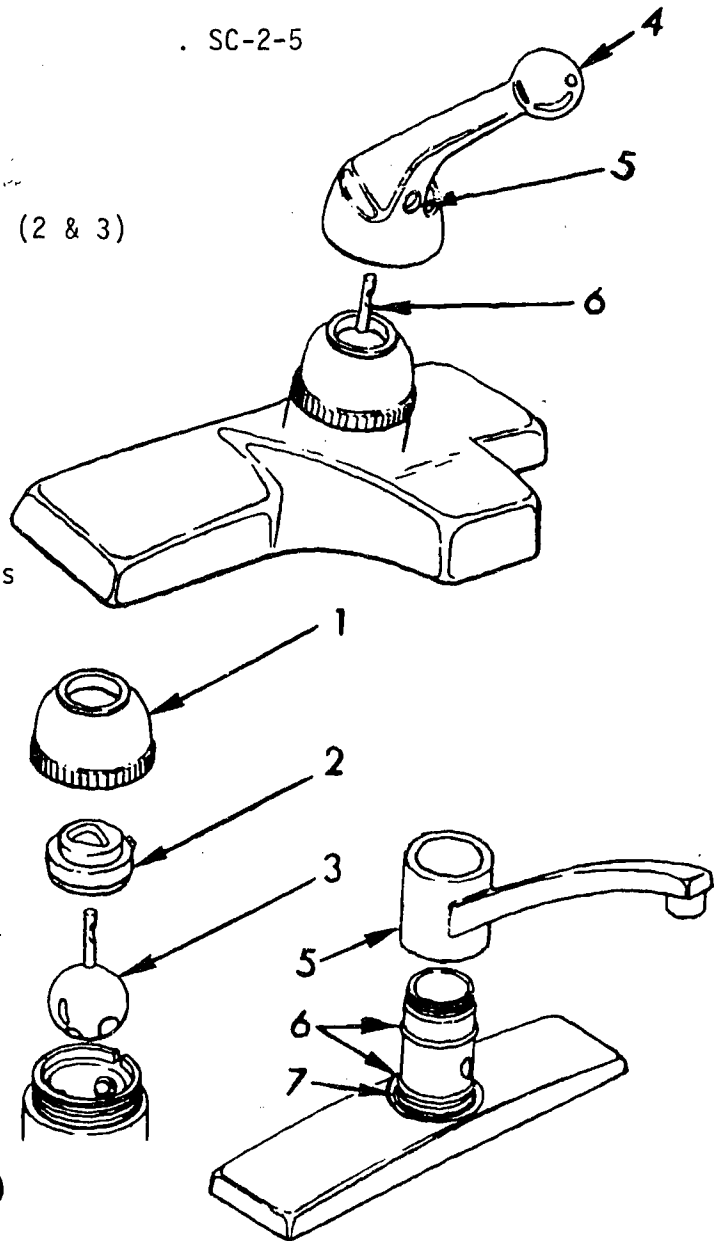

METHOD OF EVALUATION:

1. Proper procedure
2. Assembled correctly

JOB: Disassemble and Reassemble a Cartridge
Faucet

JOB SHEET
IDENTIFICATION CODE

UNIT II: Valves

JOB NUMBER: J-2-6

COURSE: Plumbing

DRAWING NO: D-2-6

MATERIAL: Single Lever Cartridge Faucet

TOOLS: Screwdriver

COMPETENCE - PROCEDURE/STEPS The student will be able to:	TEACHING/LEARNING ACTIVITIES
1. Remove the "snap-in" cap at the handle (1).	
2. Remove the handle screw (2).	. SC-2-4
3. Lift off the handle (3).	
4. Lift off the clip retaining ring and grooved sleeve (4).	
5. Remove the retaining clip (6).	
6. Pull out the cartridge assembly (5).	NOTE: There are times when the cartridge assembly must be pulled out with pliers.
7. Check the cartridge assembly	
8. Reassemble the faucet (reverse steps 1 thru 6).	NOTE: Use valve grease when reassembling faucet.

METHOD OF EVALUATION:

1. Proper procedure
2. Assembled correctly

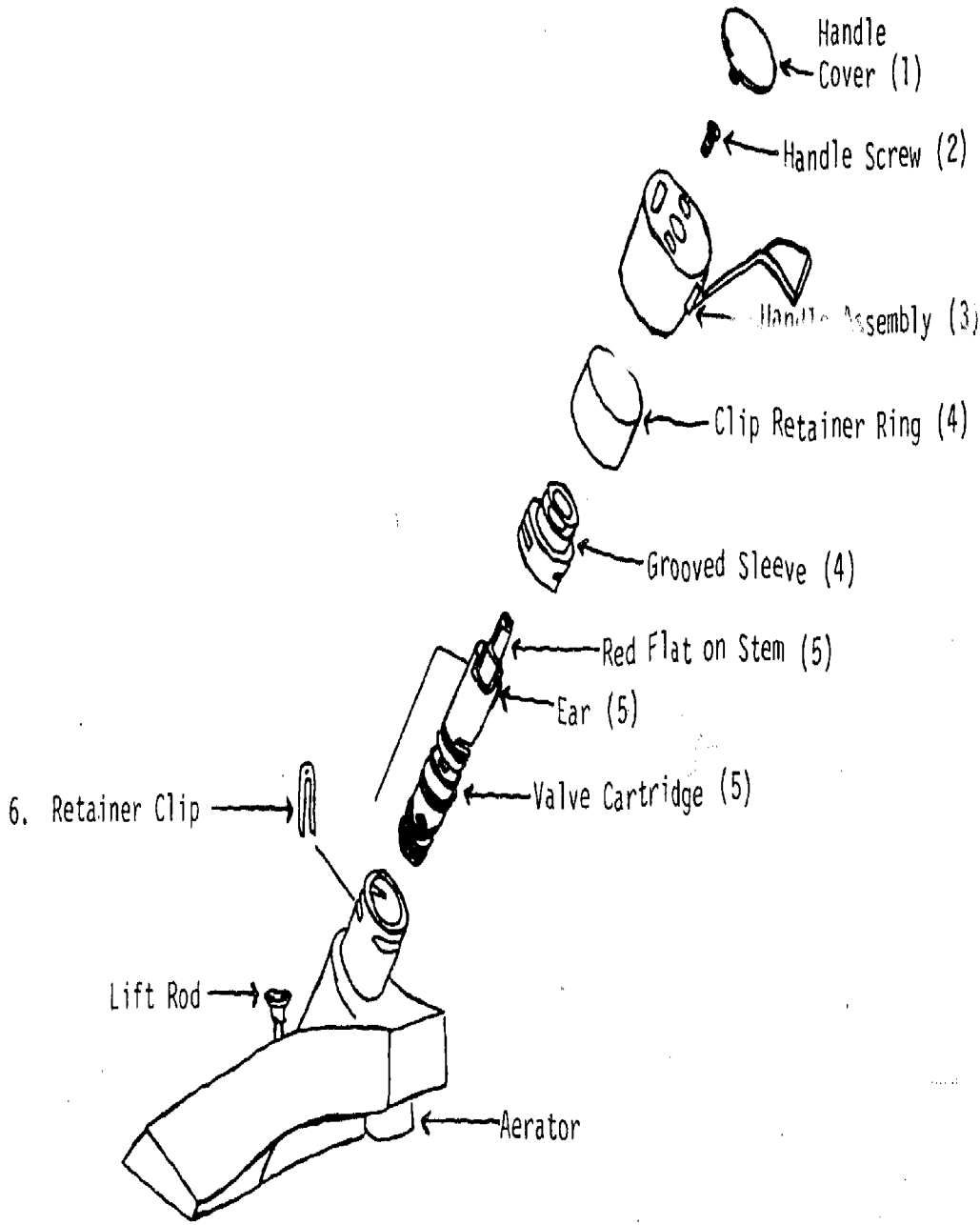

BALL FAUCET

DRAWING NUMBER

D-2-6

JOB: Disassemble and Reassemble a
Flush Valve

JOB SHEET
IDENTIFICATION CODE

UNIT II: Valves

JOB NUMBER: J-2-7

COURSE: Plumbing

DRAWING NO: D-2-7

MATERIAL: 1 - Closet or Urinal Flush Valve

TOOLS: Smooth Jawed Wrench (Hex, Spud, Monkey, Adjustable)

SAFETY PRECAUTIONS:

1. Be protective of chrome finishes.
2. Use flat jawed wrench to protect chrome finish.

COMPETENCE - PROCEDURE/STEPS The student will be able to:	TEACHING/LEARNING ACTIVITIES
<ol style="list-style-type: none">1. Unscrew outside cover (14) turning counterclockwise.2. Lift off inside cover (15).3. Lift relief stem (16) out of diaphragm (18).4. Lift diaphragm assembly (18) out of valve (9).5. Hold top seat assembly (17) and unscrew valve guide (20).6. Remove silencer ring (19).7. Unscrew handle bonnet nut (1) from stem assembly guide adapter (7).8. Ease handle stem assembly (3, 4, 5, 6) out of valve (9) and adapter guide (7).9. Remove packing (6), sleeve (5), and spring (4) from handle stem (3).10. Unscrew stem assembly guide adapter (7) from valve body (9) and remove "O" ring (8).11. Check parts and reassemble valve, reversing steps 1 through 10.	

METHOD OF EVALUATION:

1. Proper procedure
2. Proper assembly of valve
3. Proper use of smooth jawed wrench

1. Handle Bonnet Nut
2. Handle
3. Stem Assembly
4. Handle Spring
5. Sleeve
6. Packing
7. Adapter
8. "O" Ring
9. Valve Body
10. Set Screw
11. "O" Ring
12. Coupling Nut
13. Nipple

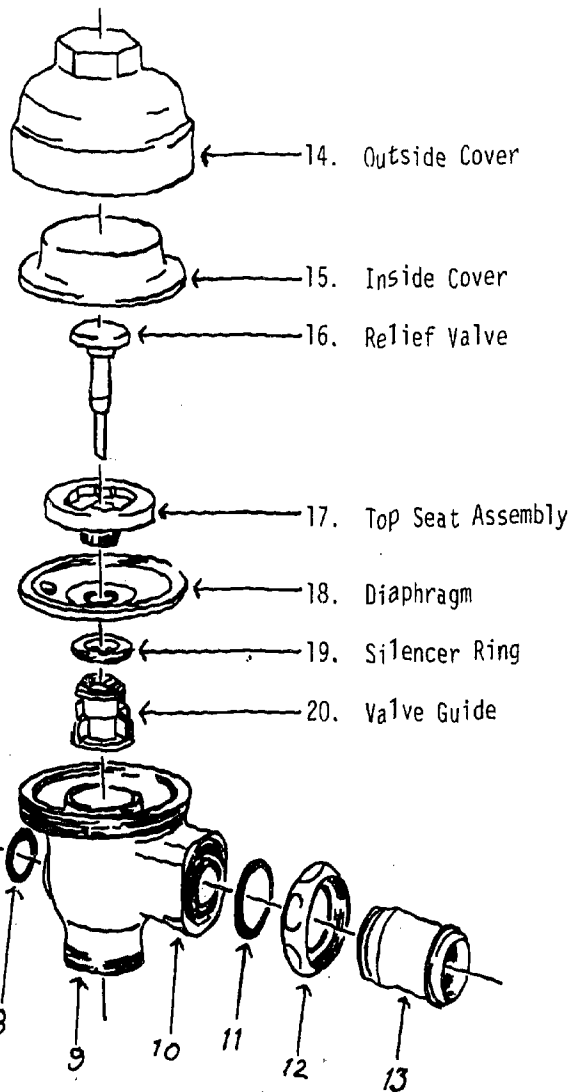

FLUSH VALVE

DRAWING NUMBER

D-2-7

JOB: Disassemble and Assemble a Tank
Flush Valve

UNIT II: Valves

COURSE: Plumbing

MATERIAL: Closet Tank Flush Valve

TOOLS: Combination Pliers

JOB SHEET
IDENTIFICATION CODE

JOB NUMBER: J-2-8

DRAWING NO: D-2-8

COMPETENCE - PROCEDURE/STEPS The student will be able to:	TEACHING/LEARNING ACTIVITIES
--	------------------------------

1. Remove the tank lid. (1)
2. Unscrew the lower lift rod from the flush ball. (5)
3. Remove the lower lift rod. (7)
4. Remove the flush ball. (8)
5. Remove the upper lift rod. (4)
6. Remove the rod guide. (6)
7. Check the lift rods, flush ball, rod guide and flush valve seat.
8. Reassemble the flush valve (reverse steps 1 thru 5).

NOTE: Use valve grease when reassembling valve.

METHOD OF EVALUATION:

1. Proper procedure
2. Assembled correctly

-287-

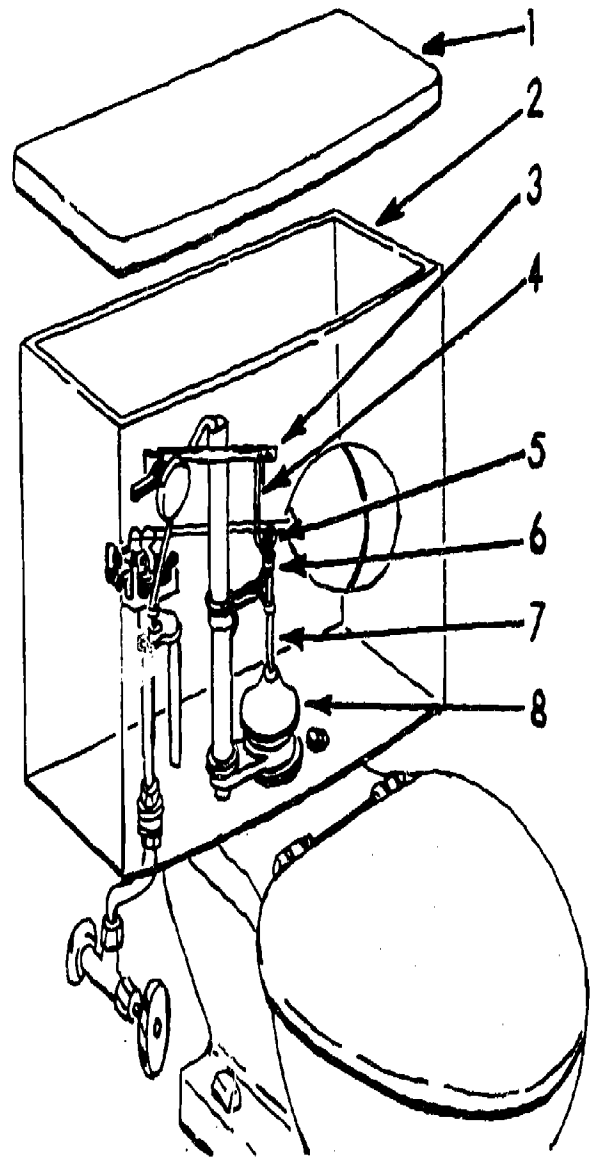
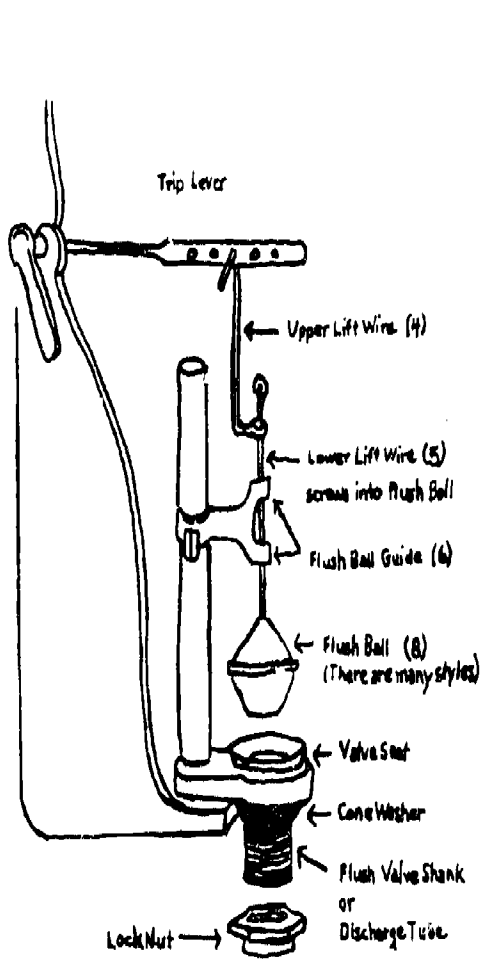

TANK FLUSH VALVE

DRAWING NUMBER

D-2-8218

JOB: Disassemble and Assemble a Tank Ball
Cock

JOB SHEET
IDENTIFICATION CODE

UNIT II: Valves

JOB NUMBER: J-2-9

COURSE: Plumbing

MATERIAL: Closet Tank Ball Cock

TOOLS: Combination Pliers

COMPETENCE - PROCEDURE/STEPS The student will be able to:	TEACHING/LEARNING ACTIVITIES
<ol style="list-style-type: none">1. Unscrew and remove the float ball. (3)2. Unscrew and remove the float rod. (2)3. Loosen and remove the thumb screws (6).4. Remove the linkage arm and lift up the inlet valve plunger assembly.5. Check the plunger assembly and valve seat.6. Reassemble the ball cock assembly (reverse steps 1 thru 4).	<p>NOTE: There are times when thumb screws must be loosened with pliers.</p> <p>NOTE: Use valve grease when reassembling ball cock.</p>

METHOD OF EVALUATION:

1. Proper procedure
2. Assembled correctly

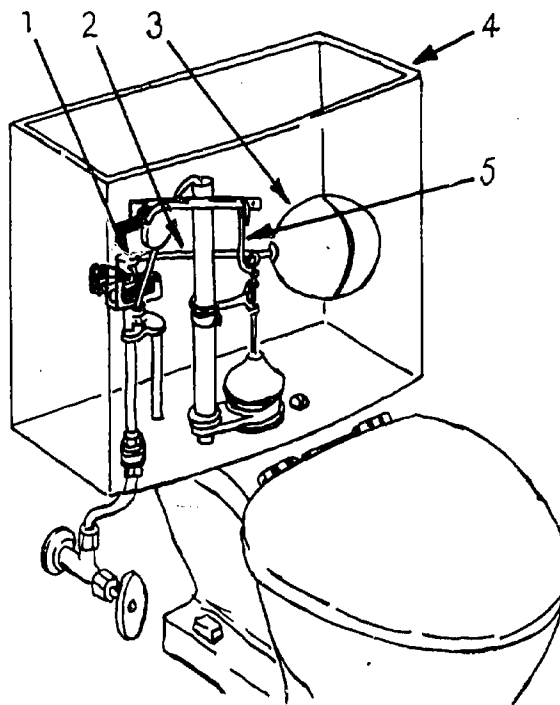
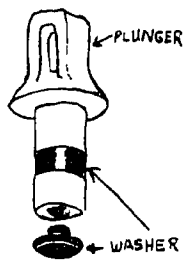
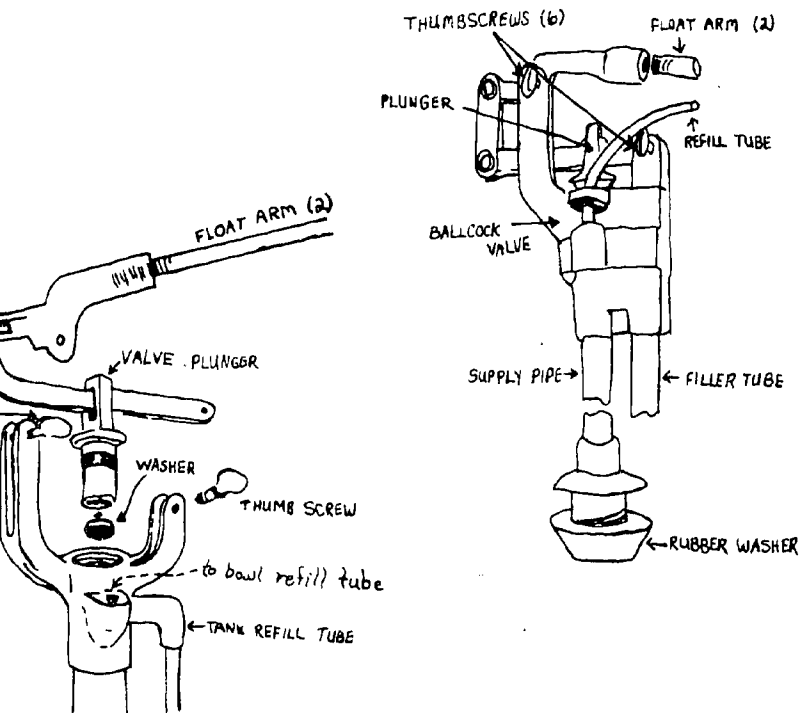

TANK BALL COCK

DRAWING NUMBER
D-2-9 **221**

JOB: Tighten and Position Gate, Globe or
Check Valves

JOB SHEET
IDENTIFICATION CODE

UNIT II: Valves

JOB NUMBER: J-2-10



COURSE: Plumbing

MATERIAL: 3/4" to 1 1/4" Valve
Pipe Joint Compound

TOOLS: Pipe Wrench
Adjustable, Spud, Hex or Monkey Wrench

SAFETY PRECAUTIONS:

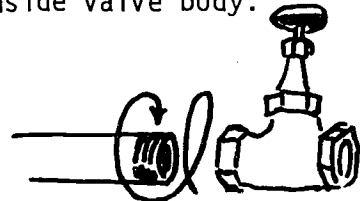
Keep valve in closed position during installation.

COMPETENCE - PROCEDURE/STEPS The student will be able to:	TEACHING/LEARNING ACTIVITIES
1. Apply pipe dope on the pipe.	NOTE: Pipe dope should be applied to the pipe end only, not inside valve body.
2. Hand tighten the valve in the pipe.	
3. Place pipe wrench on pipe near valve and flat jawed wrench on valve end nearest pipe.	NOTE: Never use unnecessary force with a wrench.
4. Tighten the valve on the pipe.	
5. Position the valve with the stem up in a vertical position.	
6. Check the flow direction and open the valve.	

METHOD OF EVALUATION:

1. Proper procedure
2. Appearance of finished job
3. Position of tightened valve

JOB: Dress (Reface) a Valve Seat
 UNIT II: Valves
 COURSE: Plumbing
 MATERIAL: Common Compression Faucet
 TOOLS: Bibb Seat Dresser

JOB SHEET
 IDENTIFICATION CODE

JOB NUMBER: J-2-11

DRAWING NO: D-2-11

SAFETY PRECAUTIONS:

1. The bibb seat is a precision tool; keep it cleaned and oiled at all times.
2. Do not use your fingers to check the ground seat; brass chips and slivers are sharp.

COMPETENCE - PROCEDURE/STEPS The student will be able to:	TEACHING/LEARNING ACTIVITIES
<ol style="list-style-type: none"> 1. Remove the packing nut, and stem from the faucet. 2. Select the proper dresser cutter. (F) 3. Insert the seat-dressing tool in the valve body. 4. Fasten the dresser cone onto the bonnet threads of the valve body. (D-E) 5. Loosen the lock key. Turn the handle down until the cutter meets the bibb seat. Tighten the lock key and turn the handle 4 to 5 turns. (C-A) 6. Repeat step 5 until bibb seat is ground smooth. 7. Flush out all brass chips and slivers. 8. Insert the faucet stem and tighten the packing nut. 	<div style="text-align: center;">  </div> <p>NOTE: Handle must turn free before changing cutter.</p> <p>NOTE: Check the handle position.</p>

METHOD OF EVALUATION:

1. Proper procedure
2. Safe and proper use of dressing tool
3. Appearance of dressed bibb seat



374

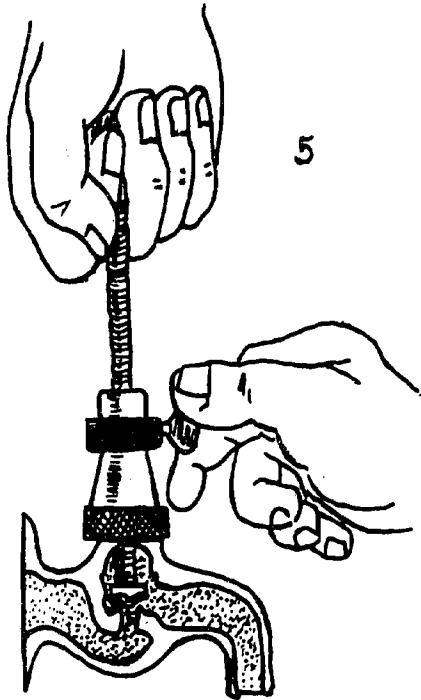

5

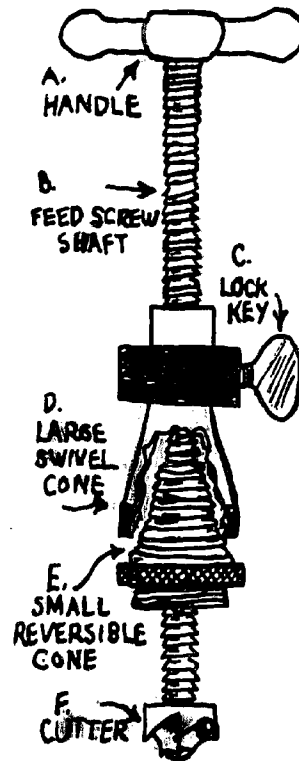

VALVE SEAT	
	DRAWING NUMBER
	D-2-11

JOB: Install Water Service

JOB SHEET
IDENTIFICATION CODE

UNIT III: Cold Water Supply

JOB NUMBER: J-3-1

COURSE: Plumbing

MATERIAL: 3/4" Type "K" Copper Tube
3/4" Flare Fittings
3/4" Curb Stop
3/4" Gate Valve

EQUIPMENT: Flaring Tool

TOOLS: Tubing Cutters Bending Spring Hammer
50' Steel Tape 14" Pipe Wrench 12" Adjustable Wrench
1" Star Drill

SAFETY PRECAUTIONS:

1. Care must be taken not to kink or smash tubing.
2. Care must be exercised when working in trenches.
3. Water service piping must be installed below frost level to prevent freezing.

COMPETENCE - PROCEDURE/STEPS The student will be able to:	TEACHING/LEARNING ACTIVITIES
1. Layout the water lines and stop locations.	
2. Prepare the trench.	
3. Unroll the proper length of tubing from the roll.	
4. Extend the pipe through the basement wall and make proper bends to the meter stop location.	. SC-3-1
5. Cut and ream both ends of the copper tubing.	
6. Flare both ends of the copper tubing.	
7. Connect the tubing to the curb stop.	. SC-2
8. Connect the opposite end of the tubing to the meter stop.	
9. Shut the meter stop. Open the curb stop and check for leaks.	
10. Flush the line.	
11. Backfill the trench.	

METHOD OF EVALUATION:

1. Appearance of finished job
2. Accuracy of measurements and layout

JOB: Install a Water Meter

JOB SHEET
IDENTIFICATION CODE

UNIT III: Cold Water Supply

JOB NUMBER: J-3-2

COURSE: Plumbing

MATERIAL: Water Meter 3/4" Gate Valve
Pipe Joint Compound 3/4" Male Copper Adapter

TOOLS: Pipe Wrenches (12" - 14")
Hex Wrench (12")
Adjustable Wrench (12")

SAFETY PRECAUTIONS:

1. Care must be exercised when tightening meter unions.
2. Adjust wrenches properly--pull don't push.

COMPETENCE - PROCEDURES/STEPS The student will be able to:	TEACHING/LEARNING ACTIVITIES
1. Tighten the meter spud into the meter stop.	
2. Align and tighten the union on the inside of the meter (curb side).	. SC-3-2
3. Tighten the meter spud into the 3/4" gate valve.	
4. Tighten the 3/4" copper male adapter into the opposite end of the gate valve.	
5. Align the assembly and tighten the union to the outside of the meter (house side).	
6. Close the house side meter valve. Open the curb side meter valve.	
7. Test and check for leaks.	

METHOD OF EVALUATION:

1. Appearance of finished job
2. Cleanliness of tools and work area
3. Time:

JOB: Rough-in and Install a Cold Water Supply

JOB SHEET
IDENTIFICATION CODE

UNIT III: Cold Water Supply

JOB NUMBER: J-3-3

COURSE: Plumbing

MATERIAL: 50-50 Solder Steel Wool or Emery Cloth
Solder Flux 1/2" Copper Hangers (Clips)
1/2" Copper Tubing 1/2" Copper Stop and Waste Valves
1/2 " Copper Fittings

EQUIPMENT: Presto-lite Torch
Electric Drill

TOOLS: Hammer Swedging Tool 6' Extension Rule
Flint Striker 3/4" Wood Bit Pliers (water pump)
Tubing Cutter

SAFETY PRECAUTIONS:

1. Handle tubing carefully-never use fingers to check for burrs.
2. Place presto-lite torch in a safe secure position and observe all safety rules when lighting and using the torch.
3. You will be using extreme heat, be careful of the surroundings and your co-workers.

COMPETENCE - PROCEDURE/STEPS The student will be able to:	TEACHING/LEARNING ACTIVITIES
1. Lay out the cold water lines for rough-in.	
2. Drill the required holes.	. SC-3-3
3. Cut and ream the tubing.	
4. Clean the proper fittings and tube.	
5. Swedge the copper tubing where couplings are necessary.	
6. Bend the offsets where necessary.	
7. Position and align the tubing and fittings.	
8. Secure the tubing with proper hangers.	
9. Set-up and light the torch.	
10. Solder all the tubing connections.	
11. Continue lines until cold water supply is completed.	
12. Turn on the water supply and test for leaks.	

T3. If necessary, repair soldered leaks.

METHOD OF EVALUATION:

1. Accuracy of layout **230**
2. Appearance of finished job
3. Time:

JOB: Install Air Chambers

JOB SHEET
IDENTIFICATION CODE

UNIT III: Cold Water Supply

JOB NUMBER: J-3-4

COURSE: Plumbing

DRAWING NO: D-3-4

MATERIAL: Solder Flux
50-50 Solder
1/2" or 3/4" Tubing
1/2" or 3/4" Tee
1/2" or 3/4" Air Chamber
1/2" or 3/4" Female Adapter
Steelwool or Emery Cloth

EQUIPMENT: Presto-lite Torch

TOOLS: Flint Striker
Tubing Cutter
6' Extension Rule
Pliers (water pump)

SAFETY PRECAUTIONS:

1. Handle tubing carefully-never use fingers to check for burrs.
2. Place presto-lite torch in a safe secure position and observe all safety rules when lighting and using the torch.
3. You will be using extreme heat, be careful of the surroundings and your co-workers.

COMPETENCE - PROCEDURE/STEPS The student will be able to:	TEACHING/LEARNING ACTIVITIES
1. Lay out and determine the chamber location.	
2. Shut off the water supply and measure for fitting.	
3. Cut, ream, clean, and flux the copper tubing.	
4. Clean, flux, align and install the tee.	
5. Clean and flux the female adapter and install if in the tee branch.	
6. Set up and light the presto-lite torch.	
7. Solder the assembly.	
8. Install an air chamber.	
9. Turn on the water supply and check for leaks.	
10. If necessary, repair soldered leaks.	

METHOD OF EVALUATION:

1. Appearance of finished job
2. Cleanliness of tools and work area

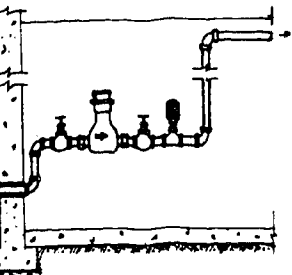

WATER METER SERVICE

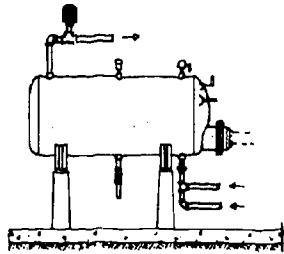

HOT WATER GENERATION EQUIPMENT

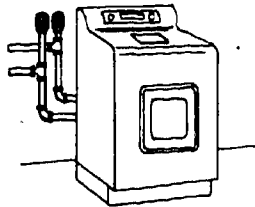

HOME LAUNDRY MACHINES

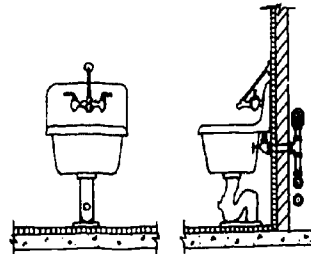

QUICK ACTING VALVES

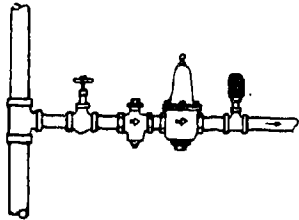

PRESSURE REDUCING EQUIPMENT

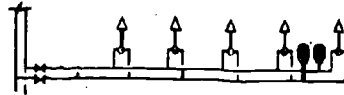

GROUP SHOWERS

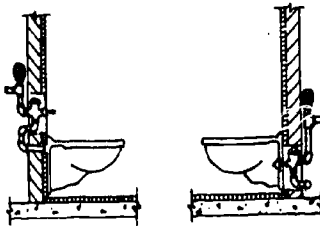
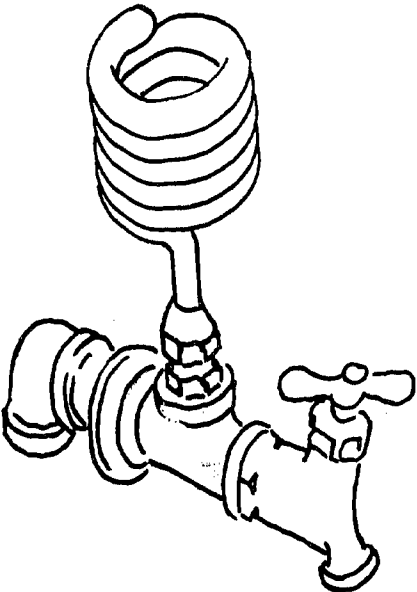
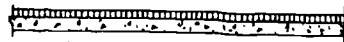

QUICK ACTING VALVES

AIR CHAMBERS	
	DRAWING NUMBER D-3-4 233

JOB: Install Lawn Faucets

JOB SHEET
IDENTIFICATION CODE

UNIT III: Cold Water Supply

JOB NUMBER: J-3-5

COURSE: Plumbing

MATERIAL: 50-50 Solder
Solder Flux
1/2" or 3/4" F.M. Adapter (2) Anti-freeze Lawn Faucets
Steelwool or emery cloth 1/2" or 3/4" Copper Tubing

EQUIPMENT: Presto-lite Torch

TOOLS: Tubing Cutter Hammer 6' Extension Rule
1" Star Drill Flint Striker Pliers (water pump)

SAFETY PRECAUTIONS:

1. Handle tubing carefully--never use fingers to check for burrs.
2. Place presto-lite torch in a safe secure position and observe all safety rules when lighting and using the torch.
3. You will be using extreme heat, be careful of the surroundings and your co-workers.

COMPETENCE - PROCEDURE/STEPS	TEACHING/LEARNING ACTIVITIES
The student will be able to:	
1. Lay out and determine faucet location.	
2. Cut a hole through the wall.	. SC-3-1, SC-3-3
3. Screw the faucet into the F.M. adapter.	
4. Clean and flux the adapter.	
5. Measure, cut, and ream the tubing.	
6. Assemble to the water line.	
7. Set up and light the torch.	
8. Solder the assembly.	
9. Turn on the water and test for leaks.	NOTE: Make sure antifreeze faucet is in the open position when soldering.
10. Repair leaks.	

METHOD OF EVALUATION:

1. Appearance of finished job
2. All leaks repaired
3. Cleanliness of tools and work area



JOB: Repair Leak in Iron Pipe (Temporarily)

JOB SHEET
IDENTIFICATION CODE

UNIT III: Cold Water Supply

JOB NUMBER: J-3-6

COURSE: Plumbing

MATERIAL: Rubber Gasket Material
Pipe Joint Compound

TOOLS: Screwdriver

SAFETY PRECAUTIONS:

Care must be taken when using flat blade screwdriver
so it will not slip.

COMPETENCE - PROCEDURE/STEPS The student will be able to:	TEACHING/LEARNING ACTIVITIES
--	------------------------------

1. Locate the leak.
2. Shut off the water.
3. Place a rubber patch on the leak with pipe joint compound.
4. Put a pipe clamp in place.
5. Tighten the pipe clamp.
6. Turn on the water supply and check the patch.

NOTE: The pipe should be replaced as soon as possible.

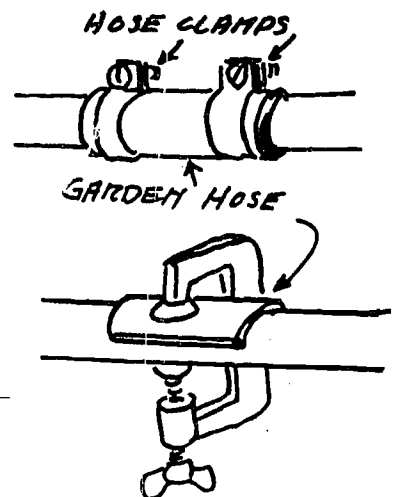
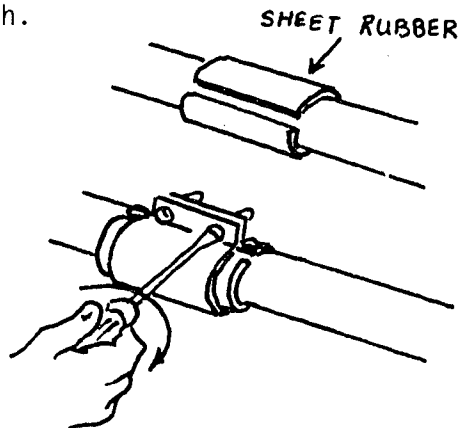

METHOD OF EVALUATION:

1. Following of procedures
2. Cleanliness of work area
3. Time:

235

JOB: Repair Leak in Copper Tubing

JOB SHEET
IDENTIFICATION CODE

UNIT III: Cold Water Supply

JOB NUMBER: J-3-7

COURSE: Plumbing

MATERIAL: Short Section of Copper Tube Flux
Steel Wool Solder

EQUIPMENT: Presto-lite Torch

TOOLS: Copper Cutter
Flint Striker

SAFETY PRECAUTIONS:

1. Exercise care when lighting and operating torch.
2. Water in lines will build up to steam very quickly, be careful.

COMPETENCE - PROCEDURE/STEPS	TEACHING/LEARNING ACTIVITIES
------------------------------	------------------------------

- | | |
|---|--|
| 1. Locate the leak. | |
| 2. Turn off the water. | |
| 3. Remove that portion of the copper tubing that is leaking. | |
| 4. Swedge the copper to replace the copper tubing that was removed. | |
| 5. Solder the new tubing in place. | |
| 6. Turn on the water and check for leaks. | |

METHOD OF EVALUATION:

1. Following of procedures
2. Care and use of equipment
3. Time:

236

-313-

JOB: Repair a Leak in Plastic Pipe

JOB SHEET
IDENTIFICATION CODE

UNIT III: Cold Water Supply

JOB NUMBER: J-3-8

COURSE: Plumbing

MATERIAL: Short Section of Plastic Pipe
2-3 Plastic Pipe Couplings

TOOLS: Hack Saw
Plastic Joint Solvent

SAFETY PRECAUTIONS:

Keep lid on plastic joint solvent when not in use.

COMPETENCE - PROCEDURE/STEPS The student will be able to:	TEACHING/LEARNING ACTIVITIES
--	------------------------------

1. Locate the leak.
2. Turn off the water supply
3. Cut the plastic about 4 inches from the fitting on all sides of the fitting.
4. Cement the coupling on the cut plastic lines.
5. Measure to the new fitting and cut short pieces of plastic.
6. Cement the short pieces in the new fitting.
7. Cement the short pieces in the new coupling.
8. Turn on the water supply and check for leaks.

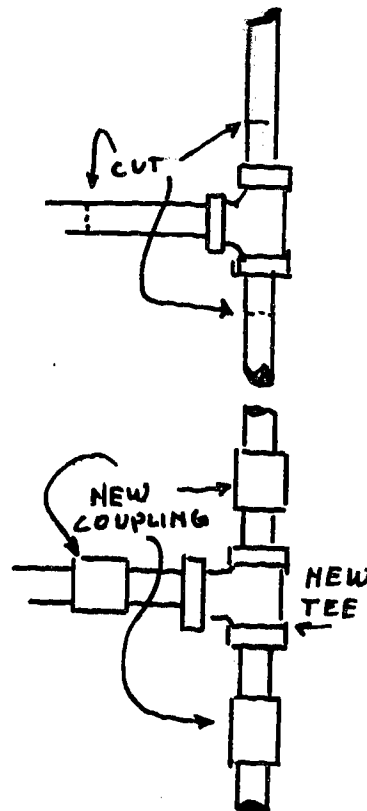

NOTE: Allow plastic solvent to dry for 30 minutes before you test it.

METHOD OF EVALUATION:

1. Accuracy of fit
2. Tightness of joint
3. Time:

237

JOB: Repair Leaks in an Existing System

JOB SHEET
IDENTIFICATION CODE

UNIT III: Cold Water Supply

JOB NUMBER: J-3-9

COURSE: Plumbing

MATERIAL: Pipe Joint Compound
1/2" or 3/4" Galvanized Unions
or Dresser Unions

1/2" or 3/4" Galvanized Fittings
1/2" or 3/4" Galvanized Pipe
Nipples

EQUIPMENT: Ratchet Stock Threader

TOOLS: Hack Saw Pipe Cutters
Pipe Reamers Pipe Wrenches 6' Extension Rule

COMPETENCE - PROCEDURE/STEPS The student will be able to:	TEACHING/LEARNING ACTIVITIES
1. Locate and determine the leak.	
2. Shut off the water supply.	
3. Measure, cut, and ream the pipe.	
4. Thread the steel pipe.	
5. Tighten the half union onto the pipe or slide the dresser coupling nuts and washer over the pipe.	. SC-3-4
6. Tighten the nipple into the fitting.	
7. Tighten the half union onto the nipple or slide the dresser coupling nut and washer over pipe.	. SC-3-4
8. Tighten the union.	. SC-3-4
9. Turn on the water.	
10. Test and check for leaks.	

METHOD OF EVALUATION:

1. Appearance of finished job
2. Cleanliness of tools and work area

JOB: Rough-in and Install a Hot Water Supply JOB SHEET
IDENTIFICATION CODE

UNIT IV: Hot Water Supply JOB NUMBER: J-4-1

COURSE: Plumbing

MATERIAL: 50-50 Solder
Solder Flux
1/2" Copper Tubing
1/2" Copper Fittings
1/2" Copper Hangers (Clips)
1/2" Copper Stop and Waste Valves
Steelwool or Emery Cloth

EQUIPMENT: Presto-lite Torch
Electric Drill

TOOLS: Hammer
Flint Striker
Tubing Cutter
Swedging Tool
3/4" Wood Bit
6' Extension Rule
Pliers (Water Pump)

SAFETY PRECAUTIONS:

1. Handle tubing carefully--never use fingers to check for burrs.
2. Place presto-lite torch in a safe secure position and observe all safety rules when lighting and using the torch.
3. You will be using extreme heat--be careful of the surroundings and your co-workers.

COMPETENCE - PROCEDURE/STEPS The student will be able to:	TEACHING/LEARNING ACTIVITIES
1. Lay out the hot water lines for rough-in.	
2. Drill the required holes.	. SC-3-3
3. Cut and ream the tubing.	
4. Clean the proper fittings and the tubing.	
5. Swedge the copper tubing where couplings are necessary.	
6. Bend offsets where necessary.	
7. Position and align the tubing and fittings.	
8. Secure the tubing with proper hangers.	
9. Set up and light the torch.	
10. Solder all the tubing connections.	
11. Continue the lines until the hot water supply is completed.	

COMPETENCE - PROCEDURE/STEPS	TEACHING/LEARNING ACTIVITIES
12. Turn on the water supply and test for leaks.	
13. Repair the leaks.	

METHOD OF EVALUATION:

1. Accuracy of rough-in measurements
2. Appearance of finished job
3. Cleanliness of tools and work areas

JOB: Install a Hot Water Coil

JOB SHEET
IDENTIFICATION CODE

UNIT IV: Hot Water Supply

JOB NUMBER: J-4-2

COURSE: Plumbing

MATERIAL: Hot Water Coil With Gasket
1/2" or 3/4" Copper Fittings 1/2" Boiler Drain Cocks
1/2" or 3/4" Copper Tubing 50-50 Solder
1/2" or 3/4" Stop and Waste Pipe Joint Compound
Steelwool or Emery Cloth Solder Flux

EQUIPMENT: Presto-lite Torch

TOOLS: Hammer
Flint Striker 6' Extension Rule 12" Adjustable Wrench
Tubing Cutter Swedging Tool 1 Set Combination Open
3/4" Wood Bit Pliers (Water Pump) End-Box End Wrenches

SAFETY PRECAUTIONS:

1. Handle tubing carefully--never use fingers to check for burrs.
2. Place presto-lite torch in a safe secure position and observe all safety rules when lighting and using the torch.
3. You will be using extreme heat, be careful of the surroundings and your co-workers.

COMPETENCE - PROCEDURE/STEPS The student will be able to:	TEACHING/LEARNING ACTIVITIES
1. Drain the hot water boiler.	NOTE: Disconnect burner switch.
2. Remove the old coil or cover plate.	. SC-2-2
3. Clean the gasket and oil studs or bolts.	
4. Insert and tighten the coil.	
5. Insert and tighten the male adapters.	
6. Measure, position, assemble, and align tubing, fittings and valves.	
7. Set up and light the torch.	
8. Solder all the tubing connections.	
9. Insert and tighten the boiler drain cocks.	
10. Install the proper aquastat.	
11. Open the cold water inlet valve and check for leaks.	
12. Repair any leaks.	

COMPETENCE - PROCEDURE/STEPS
The student will be able to:

TEACHING/LEARNING ACTIVITIES

METHOD OF EVALUATION:

1. Appearance of finished job
2. Cleanliness of tools and work area

242

-322-

JOB: Install an Electric Water Heater

JOB SHEET
IDENTIFICATION CODE

UNIT IV: Hot Water Supply

JOB NUMBER: J-4-3

COURSE: Plumbing

DRAWING NO: D-4-3

MATERIAL: Solder Flux
50-50 Solder
1/2" or 3/4" Copper Tubing
1/2" or 3/4" Copper Fitting
Pipe Joint Compound
Electric Water Heater
1/2" or 3/4" Copper Stop and Waste
Steelwool or Emery Cloth.
Temperature-Pressure Relief Valve

EQUIPMENT: Presto-lite Torch

TOOLS: Hammer
Flint Striker
Tubing Cutter
Swedging Tool
6' Extension Rule
Pliers (Water Pump)
14" Pipe Wrench
3/4" Wood Bit
12" Adjustable Wrench
1 Set Combination Open
End-Box End Wrenches

SAFETY PRECAUTIONS:

1. Handle tubing carefully--never use fingers to check for burrs.
2. Place presto-lite torch in a safe secure position and observe all safety rules when lighting and using the torch.
3. You will be using extreme heat, be careful of the surroundings and your co-workers.

COMPETENCE - PROCEDURE/STEPS The student will be able to:	TEACHING/LEARNING ACTIVITIES
1. Unpack and position the water heater.	NOTE: Heater should be equally close to kitchen and bathroom when possible.
2. Solder a short piece of tubing into the inlet and outlet adapters.	
3. Tighten the inlet and outlet adapters into the water heater inlet and outlet ports.	
4. Position, measure, assemble, and align tubing, fittings, valves and tee for the relief valve if no outlet is provided.	
5. Set-up and light the torch.	
6. Solder the assembled tubing and connections.	
7. Insert and tighten the relief valve in the provided outlet.	
8. Complete the cold water connection.	

COMPETENCE - PROCEDURE/STEPS	TEACHING/LEARNING ACTIVITIES
9. Complete the hot water connection.	
10. Turn on the cold water supply. Fill the water heater and check it for leaks.	

METHOD OF EVALUATION:

1. Appearance of finished job
2. Cleanliness of tools and work area

JOB: Install a Heating Element
 UNIT IV: Hot Water Supply
 COURSE: Plumbing
 MATERIAL: Heating Element (Immersion type)
 TOOLS: Screwdrivers
 Socket Wrenches
 Wire Brush

JOB SHEET
IDENTIFICATION CODE

JOB NUMBER: J-4-4

SAFETY PRECAUTIONS:

1. Make double sure electricity to the water heater is off.
2. The water heater tank and element will be hot.

COMPETENCE - PROCEDURE/STEPS The student will be able to:	TEACHING/LEARNING ACTIVITIES
1. Shut off the electric current to the water heater.	
2. Shut off the water supply.	
3. Drain the water below the element to be replaced.	
4. Disconnect the wires to the element.	
5. Remove the element bolts.	
6. Pull the element.	
7. Clean off the old gasket, rust, corrosion, etc.	
8. Insert the new element and tighten it.	
9. Connect the wires to the element.	
10. Turn on the water supply filling the heater.	
11. Check for leaks.	
12. Turn on the electric current.	

METHOD OF EVALUATION:

1. Appearance of finished job
2. Cleanliness of tools and work area

JOB: Install Gas Water Heater (Water Piping)

JOB SHEET
IDENTIFICATION CODE

UNIT IV: Hot Water Supply

JOB NUMBER: J-4-5

COURSE: Plumbing

DRAWING NO: D-4-5

MATERIAL: Temperature-Pressure Relief Valve
1/2" or 3/4" Stop and Waste Valves
Steelwool or Emery Cloth
1/2" or 3/4" Copper Tubing
1/2" or 3/4" Copper Fittings

50-50 Solder
Solder Flux
Gas Water Heater

EQUIPMENT: Presto-lite Torch

1/4" Electric Drill

TOOLS: Hammer
Flint Striker
Tubing Cutter
14" Pipe Wrench

6' Extension Rule
Swedging Tool
3/4" Wood Bit
Pliers (Water Pump)

12" Adjustable Wrench
1 Set Combination
Open End-Box End
Wrenches

SAFETY PRECAUTIONS:

1. Handle tubing carefully--never use fingers to check for burrs
2. Place presto-lite torch in a safe secure position and observe all safety rules when lighting and using the torch
3. You will be using extreme heat. Be careful of the surroundings and your co-workers

COMPETENCE - PROCEDURE/STEPS The student will be able to:	TEACHING/LEARNING ACTIVITIES
1. Unpack and position the water heater.	NOTE: The heater should be equally close to kitchen and bathroom when possible.
2. Solder a short piece of tubing into the inlet and outlet adapters.	
3. Tighten the inlet and outlet adapters into the water heater inlet and outlet ports.	
4. Position, measure, assemble, and align tubing, fittings, valves and tee for the relief valve if no outlet is provided.	
5. Set up and light the torch.	
6. Solder the assembled tubing and connections.	
7. Insert and tighten the relief valve in the provided outlet.	
8. Turn on the cold water supply. Fill the water heater and check for leaks.	

METHOD OF EVALUATION:

1. Appearance of finished job
2. Cleanliness of tools and work area

JOB: Install Gas Water Heater Vent Piping

JOB SHEET
IDENTIFICATION CODE

UNIT IV: Hot Water Supply

JOB NUMBER: J-4-6

COURSE: Plumbing

MATERIAL: 3" Conductor Pipe Metal Screws
 3" Conductor Ells

EQUIPMENT: 1/4" Electric Drill

TOOLS: Hack Saw Star Drill
 Tin Snips Ball Peen Hammer
 Screwdriver

SAFETY PRECAUTIONS:

1. Exercise care when cutting thin conductor pipe.
2. Safety glasses or goggles must be worn.

COMPETENCE - PROCEDURE/STEPS The students will be able to:	TEACHING/LEARNING ACTIVITIES
1. Lay out vent piping and select a place at outside wall or chimney for venting.	
2. Cut a hole in the wall or chimney.	NOTE: There are times when a basement window pane is replaced with a metal sleeve to facilitate outside venting.
3. Install a vent hood on the water heater.	
4. Run conductor pipe to the outside or chimney.	NOTE: Venting should have a light uphill grade toward the point of termination.
5. Secure the pipe with metal screws and hangers.	
6. Seal the holes around the pipe to the outside or chimney.	

METHOD OF EVALUATION:

1. Proper procedure
2. Appearance of vent line
3. Cleanliness of tools and work area

JOB: Install Gas Water Heater Gas Piping

JOB SHEET
IDENTIFICATION CODE

UNIT IV: Hot Water Supply

JOB NUMBER: J-4-7

COURSE: Plumbing

MATERIAL: 1/2" Black Pipe 1/2" Gas Cock
 1/2" Black Mall Fittings 1/2" Black Nipple Assortment

EQUIPMENT: Pipe Vise Pipe Joint Compound
 1/2" Drop Head Die Liquid Soap Detergent

TOOLS: Pipe Cutters
 Pipe Reamer
 Pipe Wrenches

SAFETY PRECAUTIONS:

1. Make double sure gas is shut off when making connections.
2. Open flame, spark, etc. must be eliminated during the installation and testing of the gas line.

COMPETENCE - PROCEDURE/STEPS The students will be able to:	TEACHING/LEARNING ACTIVITIES
1. Layout gas piping and select the location of the line "tie-in."	
2. Turn off the main gas valve.	
3. Cut the main at the tie-in location and insert the tee branch.	
4. Install the gas cock to the tree branch.	
5. Connect tee, nipples, union, and drip leg at the water heater gas valve.	
6. Run the gas line from the main to the water heater.	
7. Turn on the gas main and soap test for leaks.	. SC-4-2
8. Light all pilots to existing appliances and water heater.	. SC-4-3
9. Check water heater flame.	

METHOD OF EVALUATION:

1. Proper procedure
2. Appearance of gas lines
3. Cleanliness of tools and work area

JOB: Install Relief Valves

JOB SHEET
IDENTIFICATION CODE

UNIT IV: Valves

JOB NUMBER: J-4-8

COURSE: Plumbing

MATERIAL: Relief Valve

EQUIPMENT: Power Machine

TOOLS: Pipe Cutter
Pipe Reamer

Pipe Wrench
Spud Wrench

Stock and Die
6' Extension Rule

SAFETY PRECAUTIONS:

1. Use the proper tools.
2. Tighten the valve properly.
3. Do not plug outlet at anytime.

COMPETENCE - PROCEDURE/STEPS	TEACHING/LEARNING ACTIVITIES
------------------------------	------------------------------

1. Select the proper location for the relief valve.

2. Turn off water to boiler.

. SC-4-3

3. Drain heating system to boiler below height where safety valve is to be installed.

4. Cut the line and install the tee for the relief valve.

5. Properly tighten and position the valve on the pipe.

6. Turn on water and check for leaks.

METHOD OF EVALUATION:

1. Accuracy of measurement
2. Appearance of finished job
3. Cleanliness of tools and work area

JOB: Lay Out and Determine Drains
and Soil Stack Locations

JOB SHEET
IDENTIFICATION CODE

UNIT V: Drainage Systems

JOB NUMBER: J-5-1

COURSE Plumbing

MATERIAL: Drawing or Rough-in Booklet

TOOLS: 6' Folding Rule
Pencil, Crayon, etc.
Plumb Bob

COMPETENCE - PROCEDURE/STEPS	TEACHING/LEARNING ACTIVITIES
The student will be able to:	
1. Check blueprint or building and measure for layout of walls and partitions.	
2. Check blueprint and measure for building drain location.	
3. Check blueprint and measure for fixture locations.	
4. Mark the centers of all holes to be cut or drilled for the first floor openings.	
5. Use plumb bob and mark stack center line for the second floor stack opening.	. SC-5-1
6. Mark center of all holes to be cut or drilled for second floor openings.	
7. Use plumb bob and mark the vent center line for the roof opening.	
8. Double check all locations and openings laid out.	

METHOD OF EVALUATION:

1. Proper procedure
2. Accuracy of hole locations and measurements

JOB: Cut Openings for Drain and
Soil Stacks

JOB SHEET
IDENTIFICATION CODE

UNIT V: Drainage Systems

JOB NUMBER: J-5-2

COURSE: Plumbing

EQUIPMENT: 1/2" Electric Drill

TOOLS: Wood Bits (Assorted Sizes)
Compass Saw
Saw (Carpenters)
Wood Chisel

SAFETY PRECAUTIONS:

Electric drills should be properly grounded.

COMPETENCE - PROCEDURE/STEPS The student will be able to:	TEACHING/LEARNING ACTIVITIES
1. Check all center marks for openings.	
2. Check area before drilling holes through floors and partitions for wires, nails, etc.	. SC-5-2
3. Drill holes where applicable with proper size drill bit.	
4. Drill hole at soil stack location to facilitate compass saw blade.	
5. Cut out stack opening with compass saw.	. SC-5-3
6. Drill hole at closet flange location to facilitate compass saw blade.	
7. Cut out flange opening with compass saw.	NOTE: If any openings contact wood studs or joists, some chiseling may be required.
8. Double-check all openings.	. SC-5-4

METHOD OF EVALUATION:

1. Proper procedure
2. Safe and proper use of electric drill
3. Appearance of cut openings

JOB: Install House Trap and Fresh Air Vent

JOB SHEET
IDENTIFICATION CODE

UNIT V: Drainage Systems

JOB NUMBER: J-5-3

COURSE: Plumbing

MATERIAL: 4" Cast-Iron Soil Pipe 4" 1/4 Bend
4" House Trap 4" Return Bend
4" Clean Out 4" Tee

EQUIPMENT: Lead Furnace and Pot
Oakum and lead

TOOLS: 6' Folding Rule Calking Tools Joint Runner
Yarning Tools Ball Peen Hammer Smooth Jawed Wrench
Parking Tools Pouring Ladle

SAFETY PRECAUTIONS:

1. Set Lead Furnace at a clear safe location.
2. Avoid moisture at joints and on oakum.
3. Wear face shield when melting and pouring lead.

COMPETENCE - PROCEDURE/STEPS The student will be able to:	TEACHING/LEARNING ACTIVITIES
1. Place the house trap inside the basement wall into the sewer line.	
2. Make the proper lead joint.	
3. Install a clean out plug in the vent outlet of the house trap.	
4. Apply pipe joint compound in the plug screw threads and tighten it into the plug.	
5. Place a sanitary tee into the house trap and make the proper joint.	
6. Run a vent line to the outside of the house making the proper joints.	

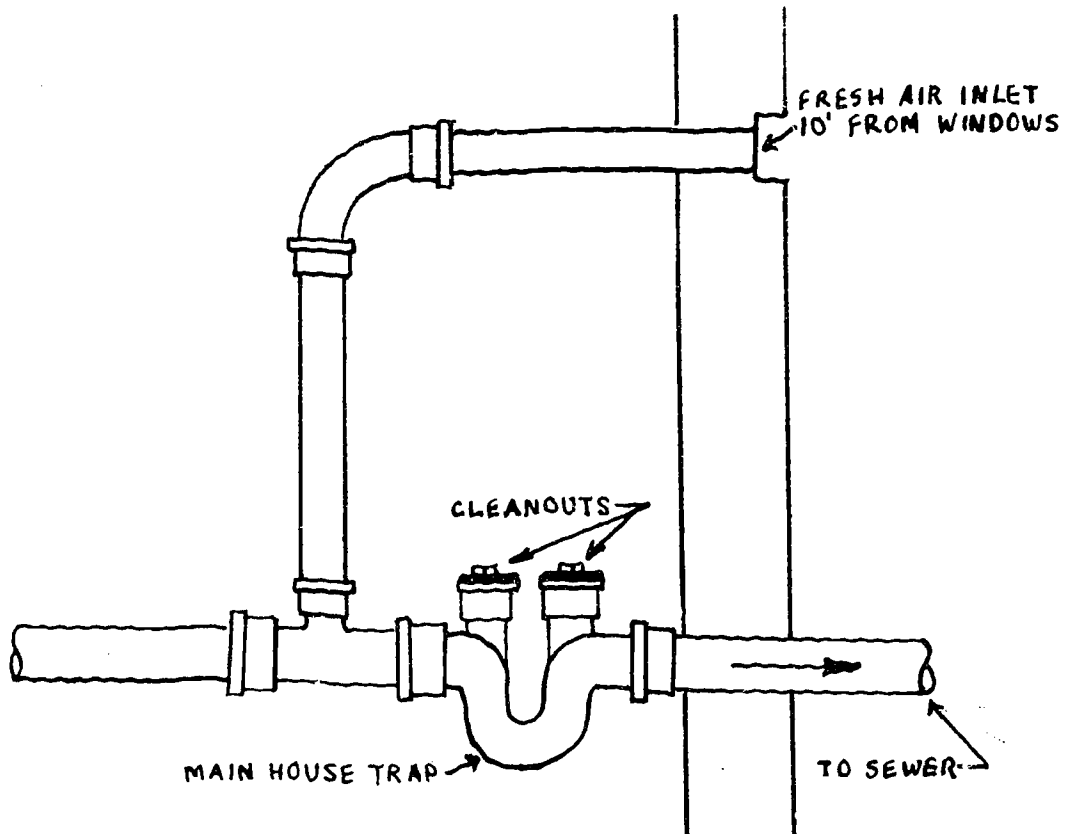

METHOD OF EVALUATION:

1. Proper procedure
2. Appearance of finished job
3. Safe and proper use of lead furnace

JOB: Install Soil Stack

JOB SHEET
IDENTIFICATION CODE

UNIT V: Drainage Systems

JOB NUMBER: J-5-4

COURSE: Plumbing

MATERIAL: 4" Soil Pipe
4" Soil Fittings
Lead and Oakum

EQUIPMENT: Furnace
Lead Pot

TOOLS: Ladle Yarning Iron Ball Peen Hammer (16 oz.)
Chisel Packing Iron Calking Irons

SAFETY PRECAUTIONS:

1. Wear safety glasses at all times.
2. Check tools for "mushrooming".
3. Use only dry oakum.
4. Keep face back from hot lead.

COMPETENCE - PROCEDURE/STEPS	TEACHING/LEARNING ACTIVITIES
<hr/>	
The student will be able to:	
<hr/>	
1. Put combination wye and 1/8" bend into length of soil pipe.	
2. Make lead and oakum joint.	
3. Fasten pipe into position.	
4. Make connection into sewer line.	
5. Make lead and oakum joint.	
6. Extend soil pipe under roof rafter.	
7. Install increase, it should extend at least 12" above the roof.	

METHOD OF EVALUATION:

1. Accuracy of measurement
2. Appearance of finished job
3. Cleanliness of tools and the work area

JOB: Install a Vent Through the Roof

JOB SHEET
IDENTIFICATION CODE

UNIT V: Drainage Systems

JOB NUMBER: J-5-5

COURSE: Plumbing

MATERIAL: 4" Soil Pipe
4" Soil Fittings
Lead and Oakum

EQUIPMENT: Furnace
Lead Pot

TOOLS: Ladle Yarning Iron Calking Irons
Chisel Packing Iron Ball Peen Hammer (16 oz.)

SAFETY PRECAUTIONS:

1. Wear safety glasses at all times.
2. Check tools for "mushrooming".
3. Use only dry oakum.
4. Keep face back from hot lead.

COMPETENCE - PROCEDURE/STEPS The student will be able to:	TEACHING/LEARNING ACTIVITIES
1. Cut a hole of proper size thru roof.	. IL-1C-13
2. Insert vent pipe thru hole in roof and let protrude approximately 2'.	. IL-5-20
3. Make a lead and oakum joint.	
4. Water proof flashing with roof mastic.	

METHOD OF EVALUATION:

1. Accuracy of measurement
2. Appearance of finished job
3. Cleanliness of tools and work area

JOB: Install Roof Flashing

JOB SHEET
IDENTIFICATION CODE

UNIT V: Drainage Systems

JOB NUMBER: J-5-6

COURSE: Plumbing

MATERIAL: Lead Roof Flashing
Roof Mastic

TOOLS: Ball Peen Hammer

SAFETY PRECAUTIONS:

1. Exercise extreme care and caution while working on the roof.
2. Nail flashing under the roofing material only.

COMPETENCE - PROCEDURE/STEPS	TEACHING/LEARNING ACTIVITIES
------------------------------	------------------------------

- | | |
|--|----------|
| 1. Place flashing over the vent pipe. | |
| 2. Slip the flashing under the roofing material with the lower part over the roofing material. | |
| 3. Nail the flashing to the roof. | . SC-5-5 |
| 4. Turn down the lead flashing inside of vent pipe and calk it tight. | |
| 5. Water proof the flashing with roof mastic. | |

METHOD OF EVALUATION

1. Proper procedure
2. Tight water proof seal
3. Appearance of finished job

258

JOB: Install Branch House Drains

JOB SHEET
IDENTIFICATION CODE

UNIT V: Drainage Systems

JOB NUMBER: J-5-7

COURSE: Plumbing

MATERIAL: Pipe (Galvanized, Copper, Plastic)
Pipe Fittings (Drainage)

TOOLS: Type of Branch Material Dictates Necessary Tools

SAFETY PRECAUTIONS:

Wear safety glasses or goggles.

COMPETENCE - PROCEDURE/STEPS	TEACHING/LEARNING ACTIVITIES
The student will be able to:	
1. Make the connection of the branch drain into the branch stack fittings.	NOTE: Type of branch material dictates joint material.
2. Run branch lines to the fixture rough-in.	
3. Make proper pipe joints.	
4. Repeat steps 1 thru 3 until all branch lines are roughed-in.	
5. Test and check for leaks.	

METHOD OF EVALUATION:

1. Proper procedure
2. Accuracy of measurements
3. Finished job appearance

JOB: Install Test Plugs and Test
Drainage System

JOB SHEET
IDENTIFICATION CODE

UNIT V: Drainage Systems

JOB NUMBER: J-5-8

COURSE: Plumbing

MATERIAL: Test Plugs Pipe Joint Compound
Water Hose Pipe Caps (coincide with type of branch materia

TOOLS: Pump if Necessary
Rib Joint Pliers

SAFETY PRECAUTIONS:

1. Do not tighten wing nuts by tapping with a hammer, etc.
2. Exercise care when removing test plugs.

COMPETENCE - PROCEDURE/STEPS The student will be able to:	TEACHING/LEARNING ACTIVITIES
--	------------------------------

1. Close all the branch openings.
2. Close all the floor and drain openings.
3. Remove the brass plug from the test tee.
4. Insert the test plug into the test tee.
5. Tighten the test plug wing nut.
6. Attach a water hose to the water faucet and to the test plug.
7. Turn on water and fill the system to the roof.
8. Check all joints, pipe, and fittings for leaks and defects.
9. Repair any leaks.

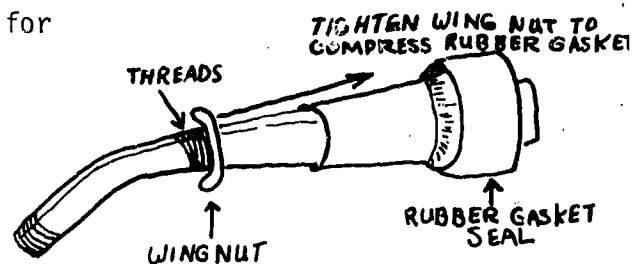

METHOD OF EVALUATION:

1. Proper procedure
2. Number of leaks
3. Number of missed openings

JOB: Install Cellar Drains and Sump

JOB SHEET
IDENTIFICATION CODE

UNIT V: Drainage Systems

JOB NUMBER: J-5-9

COURSE: Plumbing

MATERIAL: Soil and Trap or
Bell Trap
Pipe (determine type used)

Pipe Fittings (determine type used)
Joint Material (determine type used)

EQUIPMENT: Sump Pump

TOOLS: Shovel Wrenches Joint Tools (determined by type of pipe)

SAFETY PRECAUTIONS:

1. Wear safety glasses.
2. Do not stand in water while checking or plugging in the pump.

COMPETENCE - PROCEDURE/STEPS

The student will be able to:

TEACHING/LEARNING ACTIVITIES

1. Check and determine the locations of drains.
2. Position and level the traps. . SC-5-6
3. Run drain lines from the sump pit to the traps.
4. Determine the pump discharge.
5. Install a 4' to 7' line into the pump base.
6. Set the pump in a pit.
7. Install a union on discharge line.
8. Install a check valve on the discharge line.
9. Run a discharge line to the drain opening branch.
10. Run and test the pump.

METHOD OF EVALUATION:

1. Proper procedure
2. Accuracy of measurement
3. Appearance of finished job

261

JOB: Open a Clogged Commode with Closet Auger

JGB SHEET
IDENTIFICATION CODE

UNIT V: Drainage Systems

JOB NUMBER: J-5-10

COURSE: Plumbing

TOOLS: Closet Auger

SAFETY PRECAUTIONS:

Wash hands and auger thoroughly when completing job.

COMPETENCE - PROCEDURE/STEPS

The student will be able to:

TEACHING/LEARNING ACTIVITIES

1. Withdraw the auger handle.
2. Push the auger into the trap until you feel the obstruction.
3. Turn the handle clockwise slowly and at the same time pushing the auger through the trap.
4. Pull the handle back and remove the obstruction when possible.
5. Push the auger in again until it moves freely.
6. Flush the toilet and check its operation.
7. Wash closet auger with hot water.

NOTE: Use toilet paper when checking flushing operation.

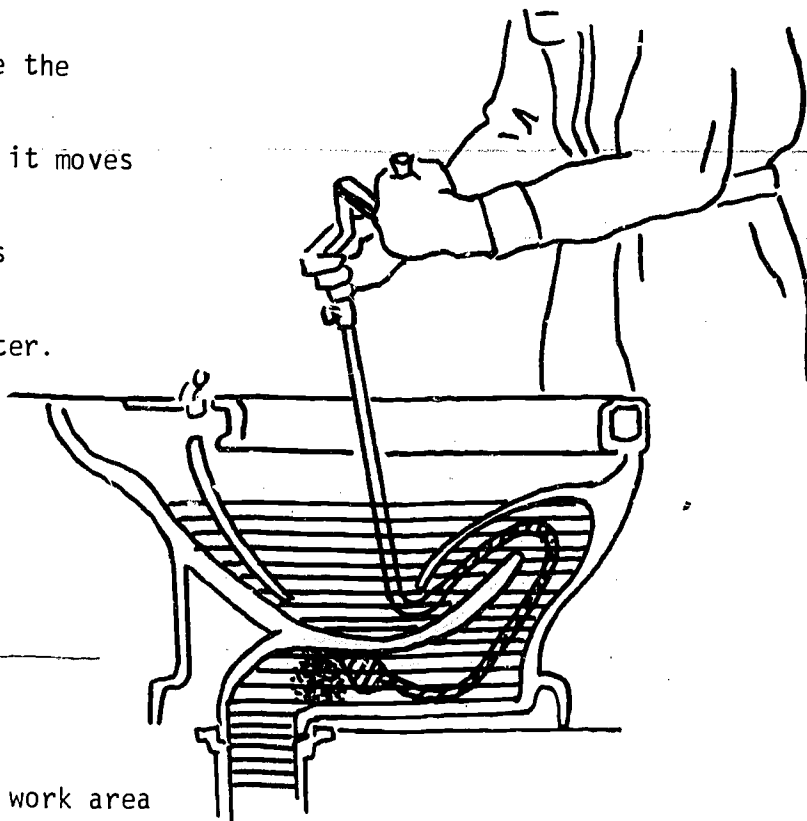

METHOD OF EVALUATION:

1. Proper procedure
2. Cleanliness of tools and work area

JOB: Open Clogged Commode with Toilet Plunger

JOB SHEET
IDENTIFICATION CODE

UNIT V: Drainage Systems

JOB NUMBER: J-5-11

COURSE: Plumbing

TOOLS: Closet Plunger (Plumber's Friend)

SAFETY PRECAUTIONS:

Wash hands and plunger thoroughly when completing job.

COMPETENCE - PROCEDURE/STEPS
The student will be able to:

TEACHING/LEARNING ACTIVITIES

1. Place the plunger in the closet.
2. Using two hands, press plunger downward.
3. Release plunger by pulling it up.
4. Repeat pushing-pulling action until clogged mass is forced down the sewer.
5. Flush toilet and check its operation.
6. Wash closet plunger with hot water.

NOTE: Use toilet paper when checking operation of commode.

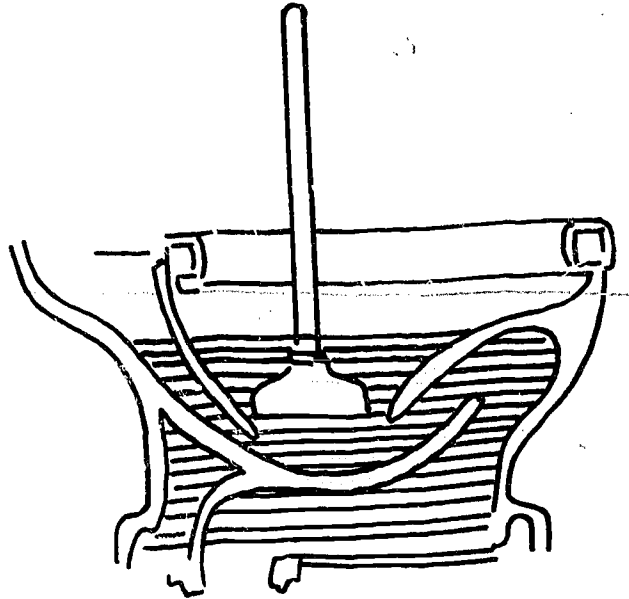

METHOD OF EVALUATION:

1. Proper procedure
2. Cleanliness of tools and work area

JOB: Open Clogged Sewer with Sewer Rod

JOB SHEET
IDENTIFICATION CODE

UNIT V: Drainage Systems

JOB NUMBER: J-5-12

COURSE: Plumbing

MATERIAL: Pipe Joint Compound

TOOLS: Sewer Rod
Smooth Jawed Wrench

SAFETY PRECAUTIONS:

1. Wash hands and sewer rod thoroughly when job is completed.
2. Be careful when removing clean out plug, clogged lines are usually under pressure.

COMPETENCE - PROCEDURE/STEPS
The student will be able to:

TEACHING/LEARNING ACTIVITIES

1. Remove the sewer clean out plug.
2. Insert coil wire head into the sewer pipe at the clean out.
3. Force the coil into sewer until obstruction is met.
4. Work the coil forward and backward forcing the obstruction down the line or breaking it up.
5. After line seems clear of obstruction, use water hose and flush out the line.
6. Reinstall the clean out plug.
7. Flush the commode and check the other house drains.
8. Wash the sewer rod with hot water.

NOTE: Remove carefully and place a bucket below the clean out if possible.

NOTE: Bends in sewer pipe will also feel like an obstruction.

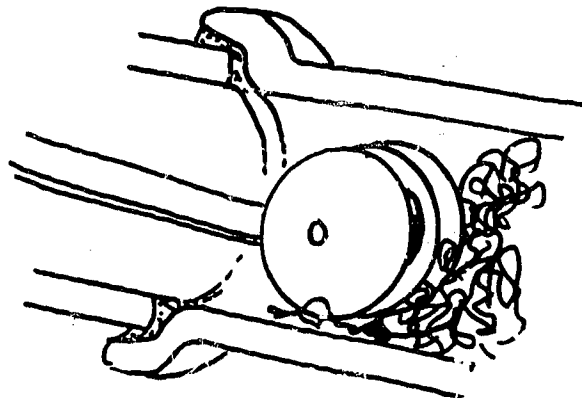
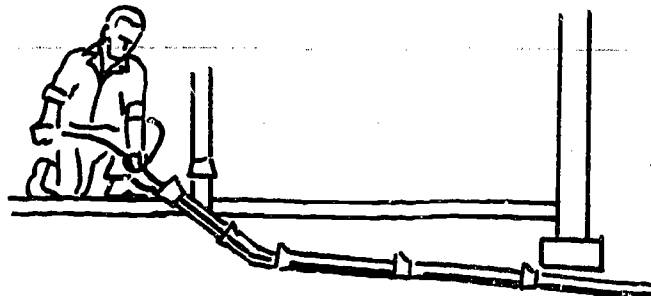

METHOD OF EVALUATION:

1. Proper procedure
2. Cleanliness of tools and work area

JOB: Open Clogged Drain with Electric Snake

JOB SHEET
IDENTIFICATION CODE

UNIT V: Drainage Systems

JOB NUMBER: J-5-13

COURSE: Plumbing

EQUIPMENT: Electric Sewer Auger

SAFETY PRECAUTIONS:

Wash hands and sewer auger thoroughly when job is completed.

COMPETENCE - PROCEDURE/STEPS	TEACHING/LEARNING ACTIVITIES
The student will be able to:	
<ol style="list-style-type: none">1. Remove the trap or fixture of the clogged drain.2. Loosen chuck. Remove approximately 12" of cable from container and insert it in the line to be cleared.3. Tighten chuck. With switch in forward, pull trigger slowly to avoid quick torque build-up.4. Push cable gently into line. Forcing can cause the cable to kink.5. Repeat instruction 1, 2 and 3-- inserting about 12" of additional cable to line.6. If the motor pulls hard and stalls, put it in reverse and back off before proceeding. When possible, keep water running through the pipeline to flush out debris.7. After the line seems clear, reconnect the trap or fixture and flush the line thoroughly.8. Wash the sewer cable with hot water.	NOTE: Always wash your hands after working on any clogage.

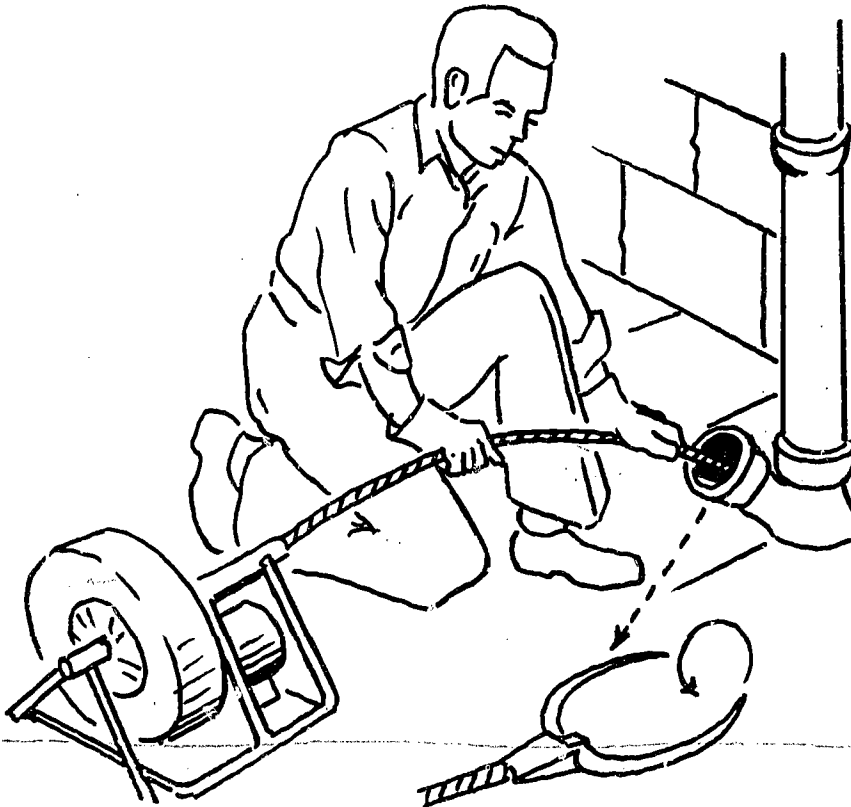

METHOD OF EVALUATION:

1. Check the proper procedure
2. Safe and proper use of the electric auger
3. Cleanliness of tools and work area.

JOB: Clear a Clogged Drain With
Sewer Ram

JOB SHEET
IDENTIFICATION CODE

UNIT V: Drainage Systems

JOB NUMBER: J-5-14

COURSE: Plumbing

EQUIPMENT: Sewer Ram

SAFETY PRECAUTIONS:

Wash ram parts and hands thoroughly when job is completed

COMPETENCE - PROCEDURE/STEPS

The student will be able to:

TEACHING/LEARNING ACTIVITIES

1. Check for overflow or opposite sink strainer and close the opening with an old rag.
2. Cover the drain hole completely with proper size rubber cone or plug.
3. Pump up the ram to approximately 80-100 lbs.
4. Using two hands, force the ram downward against the drain opening.
5. Snap ram trigger releasing pressure.
6. Repeat steps 3-5 if necessary.
7. Fill the fixture with water and flush the drain.
8. Wash the ram parts with hot water.

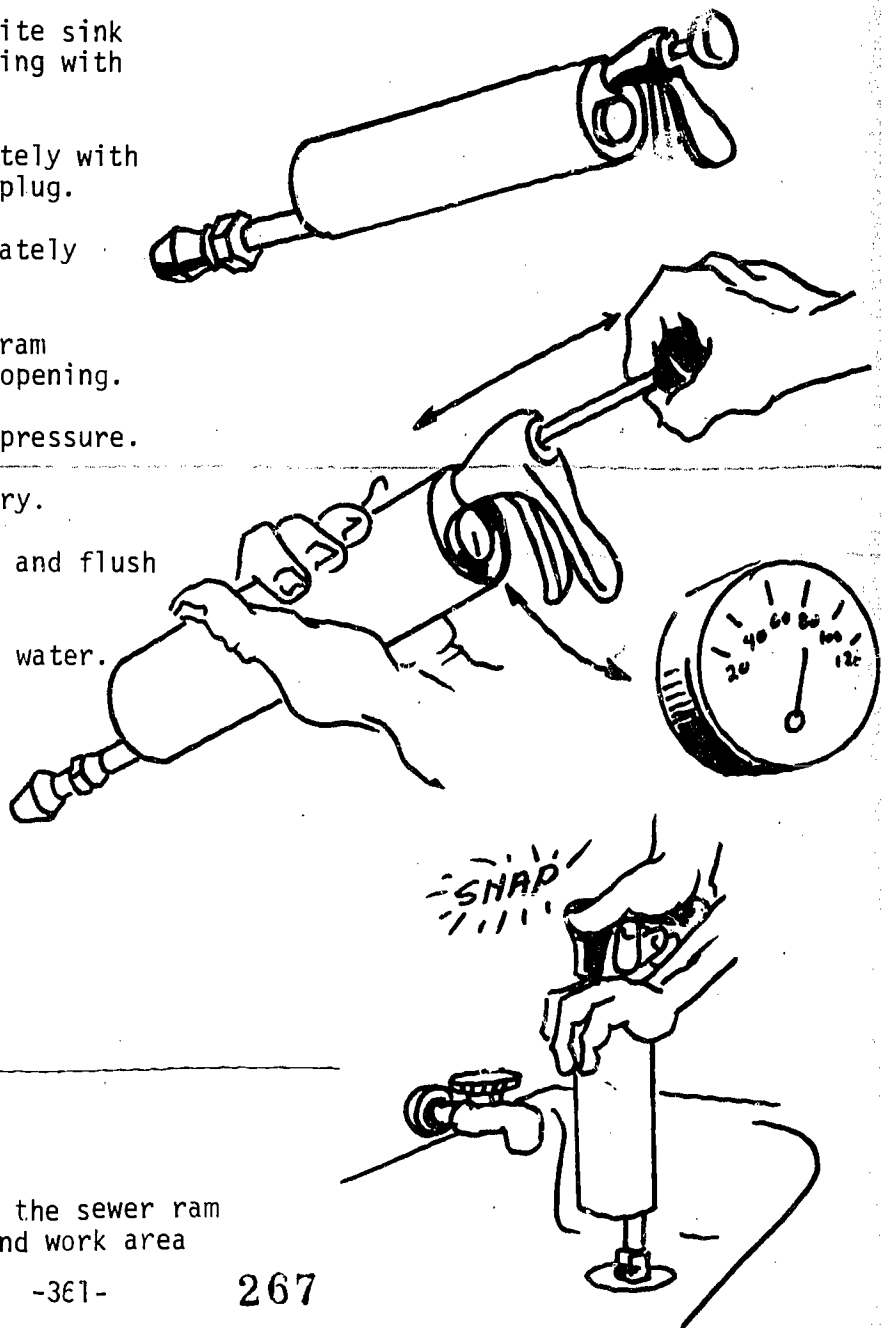

METHOD OF EVALUATION:

1. Proper procedure
2. Safe and proper use of the sewer ram
3. Cleanliness of tools and work area

JOB: Temporarily Set a Built-In Bathtub

JOB SHEET
IDENTIFICATION CODE

UNIT VI: Fixtures

JOB NUMBER: J-6-1

COURSE: Plumbing

DRAWING NO: D-6-1

MATERIAL: 5' Recessed Bathtub

TOOLS: Six Foot Folding Rule Claw Hammer
 Marking Pencil Cutting Pliers
 Two Foot Level

SAFETY PRECAUTIONS:

Safety glasses, goggles or face shield must be worn when cutting the binding around tub crate.

COMPETENCE - PROCEDURE/STEPS The student will be able to:	TEACHING/LEARNING ACTIVITIES
1. Cut the wire or band binding around the tub crate and remove the crate from the tub.	. SC-6-1
2. Clean the recessed area and the immediate area in front of the recess free from dirt and debris.	
3. Place a piece of cardboard in front of the recessed area and lay the tub on its' apron side on the cardboard.	NOTE: A bathtub is a heavy fixture and should not be handled alone.
4. Tilt the tub and temporarily set it in the recessed area with the tub setting on the apron edge and the back rim resting against the wall studs.	
5. Lay the level on the end rim and move the back rim up or down to level. Lay the level on the other end rim and also on the back rim and level them.	NOTE: Sometimes the rough floor must be notched out or shims used to level the tub on all three rims.
6. Hold the point of the pencil level and mark each stud along the top edge of the back rim. Mark the drain opening on the floor under the tub. Measure the desired height for the bath-and-shower fixture above the end rim of the tub and mark the studs.	

7. Lift the back rim of the tub away from the studs, tilting the tub so it sits on its' apron side.

METHOD OF EVALUATION:

1. Proper procedure
2. Care and safe handling of the tub
3. Accuracy of measurement and use of level

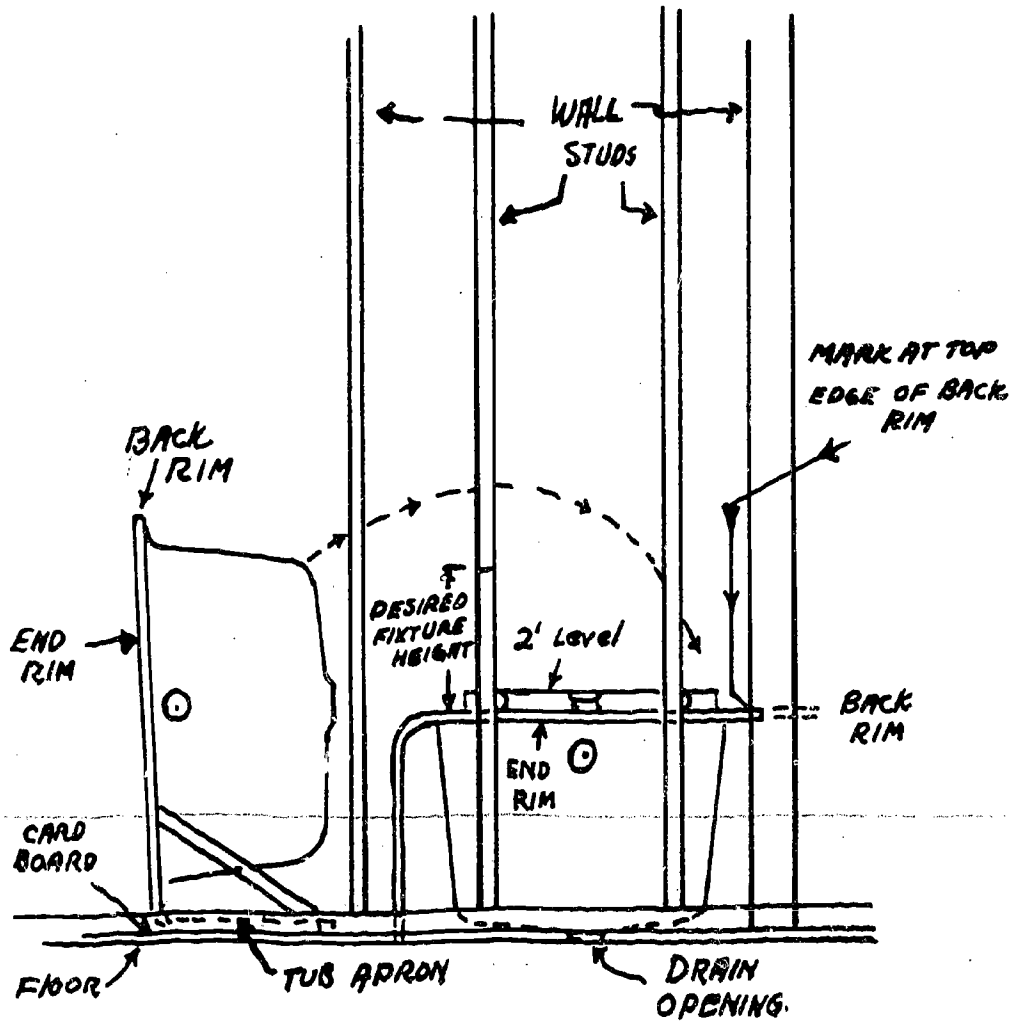

BUILT-IN BATH TUB

DRAWING NUMBER

D-6-1

JOB: Fasten Wall Support, Fixture
Backing and Cut Drain Opening

JOB SHEET
IDENTIFICATION CODE

UNIT VI: Fixtures

JOB NUMBER: J-6-2

COURSE: Plumbing

DRAWING NO: D-6-2

EQUIPMENT: Electric Drill

TOOLS: Six Foot Folding Rule Two Foot Level Carpenters Saw
Marking Pencil Wood Bits Comb. Square
Claw Hammer Compass Saw

SAFETY PRECAUTIONS:

Care must be exercised at all times when working around or near the bathtub, because of its' enameled surface. Dropped tools, carrying tools in pockets, using the tub as a saw horse or stepping stool, etc., are all common practices that must be avoided when working around the bathtub.

COMPETENCE - PROCEDURE/STEPS	TEACHING/LEARNING ACTIVITIES
The student will be able to:	
1. Measure the thickness of the back rim of the tub, and each mark on the wall studs, must be lowered to the same distance.	. SC-6-2
2. Measure the length of the recessed area and cut a 2 X 4 about 1/2" smaller than the measurement.	. SC-6-3
3. Hold the 2 X 4 against the wall studs with the top of the 2 X 4 on the bottom marks, and nail the 2 X 4 secure to each stud.	. SC-5-5
4. Mark off and cut out the drain opening.	. SC-5-3
5. Measure the distance between the wall studs at the desired fixture height. Cut a 3/4" X 12" board to this measurement and nail flush with the <u>face</u> of the wall studs, center on previous marks.	. SC-6-2, SC-6-3
6. Measure the distance between the same studs 6' 6" above the floor. Cut a 2 X 4 to this measurement and nail flush with the <u>back</u> of the wall studs, center with the <u>6' 6"</u> marks. 272	. SC-6-2, SC-6-3

METHOD OF EVALUATION:

1. Proper procedure
2. Accuracy of measurements and cuts
3. Cleanliness of work area

273

END VIEW

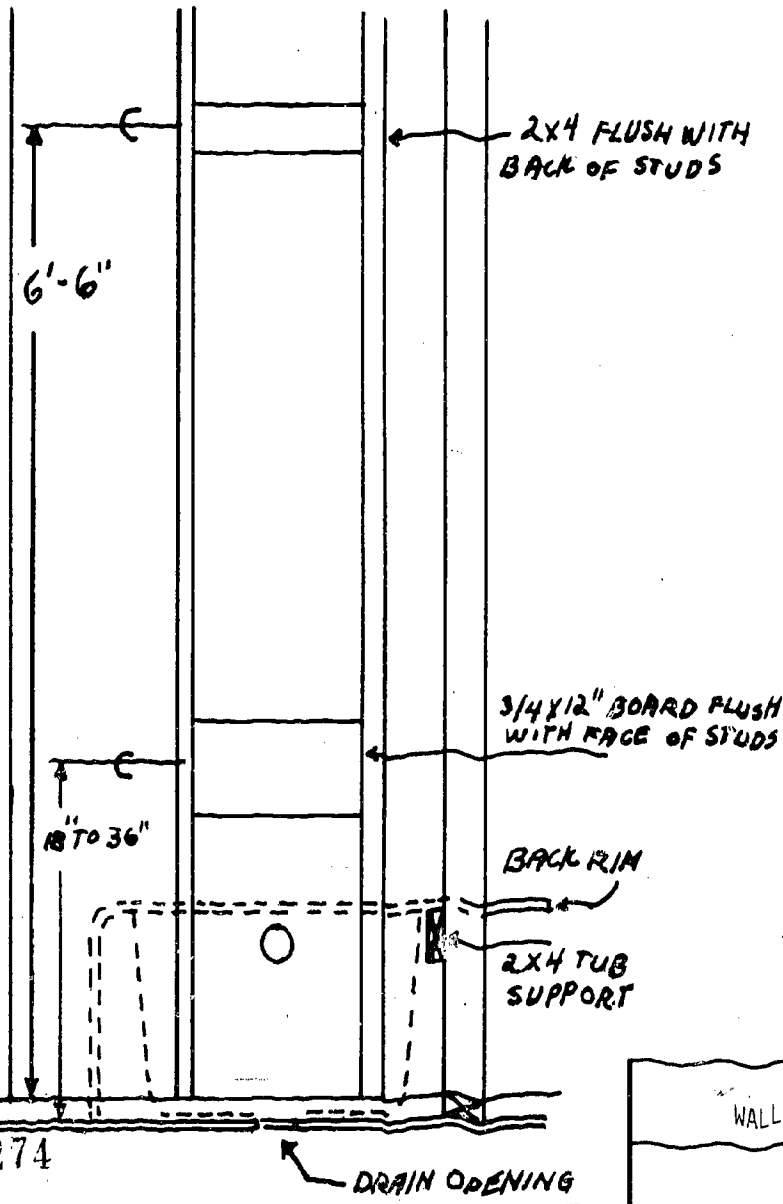

TOP VIEW

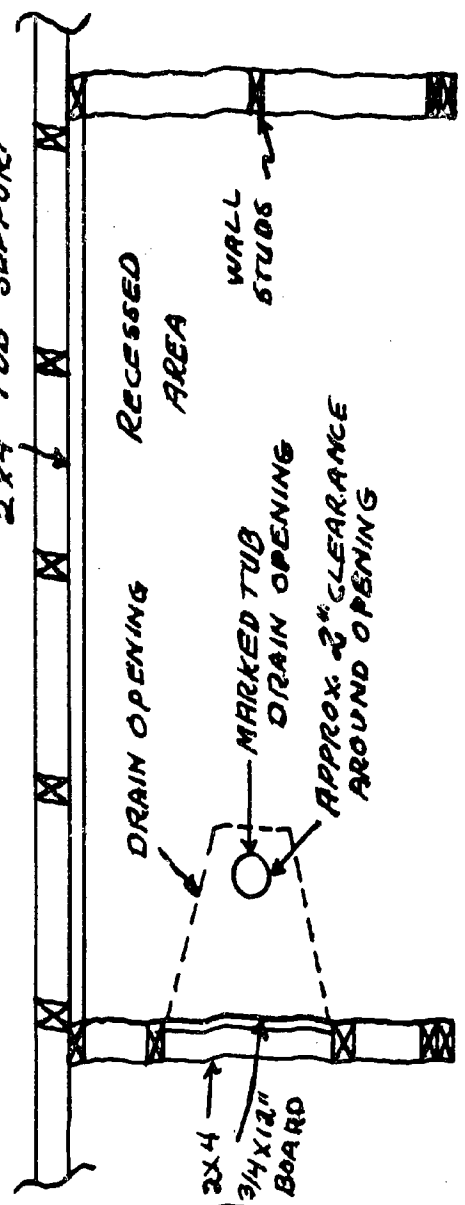

WALL SUPPORT, FIXTURE BACKING WITH DRAIN OPENING

DRAWING NUMBER
D-6-2 275

JOB: Install Bath Waste and Overflow

JOB SHEET
IDENTIFICATION CODE

UNIT VI: Fixtures

COURSE: Plumbing

JOB NUMBER: J-6-3

MATERIAL: Bath Waste and Overflow
Putty
Pipe Joint Compound

DRAWING NO: D-6-3

TOOLS: Screwdriver.
Hex or Spud Wrench
Rib Joint Pliers

SAFETY PRECAUTIONS:

Care must be exercised at all times when working around enameled surfaces.

COMPETENCE - PROCEDURE/STEPS

The student will be able to:

TEACHING/LEARNING ACTIVITIES

1. Remove the perforated strainer or chrome stopper from the drain outlet of spud and apply a small amount of putty to the underside of the outlet spud flange.
2. Insert the drain spud through the tub drain opening from the inside; place the drain spud washer over the drain spud and screw on the face of the drain outlet elbow.
3. Tighten drain spud, using rib joint pliers, until it is secure.
4. Place a slip joint nut and one slip joint washer on the drain outlet, tube, and one slip joint nut and one slip joint washer on the overflow riser tube. Place the overflow riser tube into the long end of the waste tee and hand tighten.
5. Place the overflow washer on the face of the overflow elbow and push the complete assembly, (tee, riser tube, and elbow), onto the drain outlet tube and hand tighten.

NOTE: When drain spud is secure, the drain tube from the drain outlet elbow should point directly toward the fixture end of the tub.

276

6. Line up the overflow elbow with the tubs' overflow opening and insert plunger or drain linkage through the tub overflow opening into the overflow elbow and feed down through the overflow tube until the chrome handle and overflow plate line up with the overflow opening on the tub and the overflow elbow. Secure the chrome overflow plate in place by screwing the two oval head screws through the chrome plate into the overflow elbow and tighten.
7. Using the hex or spud wrench, tighten the two slip joint nuts so the drain tube and overflow riser tube are sealed to the waste tee.
8. Apply a small amount of pipe dope on the fine threads of the tailpiece and screw the tailpiece into the bottom of the waste tee.
9. After the tub is placed in position, the perforated strainer or chrome stopper should be replaced on the drain outlet spud.

NOTE: Plunger assembly or drain linkage may need to be adjusted for the drain to work properly.

NOTE: Since the threads on the tailpiece are fine threads--hand tightening only is required.

NOTE: Adjustment of the plunger assembly or drain linkage should also be rechecked at this time.

METHOD OF EVALUATION:

1. Proper procedure
2. Proper linkage adjustment
3. Appearance of finished job

277

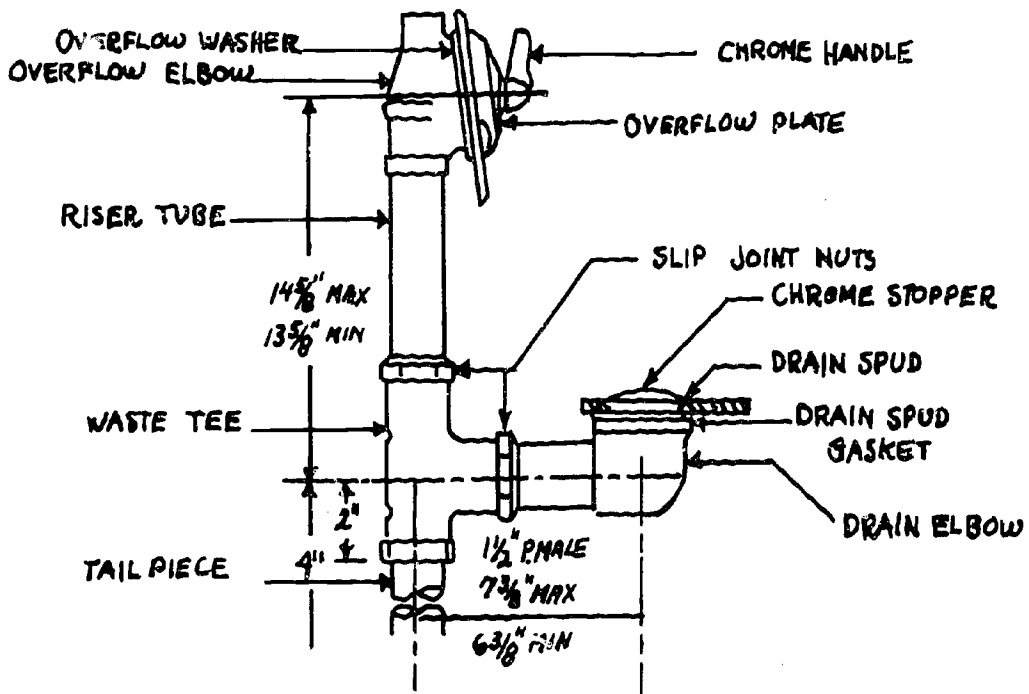

BATH WASTE AND OVERFLOW

DRAWING NUMBER

D-6-3 279

JOB: Set and Cover Bathtub
UNIT VI: Fixtures
COURSE: Plumbing
MATERIAL: Tub Cover or Newspaper

JOB SHEET
IDENTIFICATION CODE

JOB NUMBER: J-6-4
DRAWING NO: D-6-4

TOOLS: Two Foot Level
2" Tub Tape or Wheat Paste

SAFETY PRECAUTIONS:

If the tub cover must be cut to fit the tub size, be careful not to use the enameled surface of the tub as a backing when cutting the cardboard or plastic.

COMPETENCE - PROCEDURE/STEPS	TEACHING/LEARNING ACTIVITIES
------------------------------	------------------------------

1. Hold the back rim of the tub and tilt the tub from its' apron and set it in place with the back rim resting on the 2 X 4 support and the front on the apron edge of the tub.
2. Recheck the tub for level and make sure the tub is setting solid.
3. Place the part of the tub cover which fits in tub in position and step into the tub.
4. Using the tub tape, tape along the three rims of the tub keeping the edge of the tape approximately 1" from the studs.
5. Tape the inside cover to the tub so approximately 1/2 of the tape width is on the cover and 1/2 on the previously installed tape--Step 4.

NOTE: Tub covers are standardized to fit either 14" or 16" tubs and therefore at times must be cut to fit the tub.

. SC-6-4

6. Place the front part of the tub cover in position and tape it fast to the tub.

COMPETENCE - PROCEDURE/STEPS

TEACHING/LEARNING ACTIVITIES

METHOD OF EVALUATION:

Proper procedure
Appearance of finished job

281

-376-

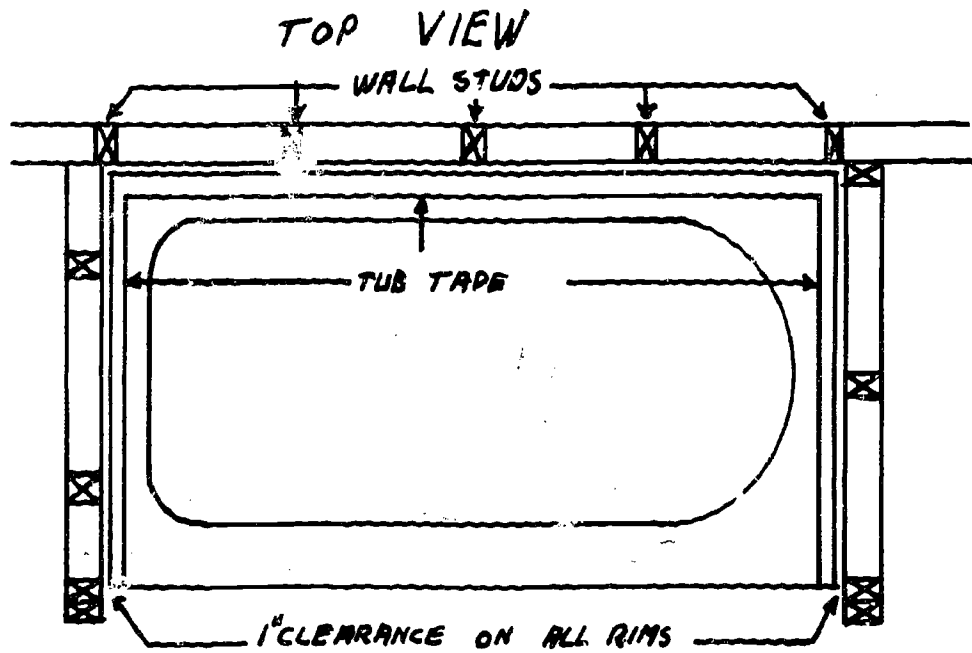

BATHTUB	
	DRAWING NUMBER D-6-4

JOB: Rough-in Bath and Shower Fixture

JOB SHEET
IDENTIFICATION CODE

UNIT VI: Fixtures

JOB NUMBER: J-6-5

COURSE: Plumbing

DRAWING NO: D-6-5

MATERIAL: Bath and Shower Fitting
1/2 Copper Tube and Fitting Steelwood
Pipe Joint Compound Flux and Solder

EQUIPMENT: Prestolite or Propane Torch

TOOLS: Six Foot Folding Rule Screwdriver
Marking Pencil Brace and Bit
Two Foot Level Plumb-bob
Adjustable Wrench Copper Cutters
Pipe Wrench Striker
Claw Hammer Combination Pliers

SAFETY PRECAUTIONS:

Even though the tub is covered during this operation, be careful when drilling the holes for the bath and shower fixture, and do not drop your screwdriver when fastening the shower drop ell.

COMPETENCE - PROCEDURE/STEPS The student will be able to:	TEACHING/LEARNING ACTIVITIES
1. Hold a level at the desired height of the fixture and mark a horizontal line across the backing board; plumb the center of the overflow outlet and mark a vertical line on center, intersecting the horizontal line.	
2. Measure 4" on either side of the center line and mark a vertical line intersecting the horizontal line.	
3. Drill two (2)--1 1/4" holes at each of the intersecting points 4" from center.	NOTE: Depending on the type of bath and shower fixture, all three intersecting lines may have to be drilled.
4. Measure 4" above the bathtub rim and mark a horizontal line across the fixture backing board. Plumb down from the previous marked center line, (step 2), and mark a vertical line intersecting the horizontal line 4" above the tub rim and drill a 1 1/4" hole at the intersecting lines.	



5. Cut two (2) length of 1/2" copper tube, 12" longer than the height of the fixture from the floor, and solder them into the fixture inlets.
6. Insert the fixture into the previously drilled holes on the backing board, and measure the distance from the fixtures' tub outlet to the center of the tub spouts' location.
7. Cut a length of 1/2" copper tube or brass pipe to measurement, and solder or screw it into the fixtures' tub outlet.
8. Hold a level across the 2 X 4 shower backing and mark a horizontal line at the desired height of the shower arm; plumb down to the center of the bath and shower fixture and mark a vertical line intersecting the horizontal line.
9. Measure the distance from the fixtures' shower outlet to the center of the shower arms location; cut a length of 1/2" copper tube using a drop ell for center measurement.
10. Solder the drop ell onto one end of the length of tube; insert the other end into the fixtures shower outlet and solder.
11. Fasten the bath and shower fixture to the support backing and screw the drop ell fast to the 2 X 4 support backing; insert 1/2" risers into the tub spout ell and into the shower arms' drop ell.

CAUTION: Be careful not to burn the backing board.

METHOD OF EVALUATION:

1. Proper procedure
2. Appearance of finished rough-in
3. Safe and proper use of torch

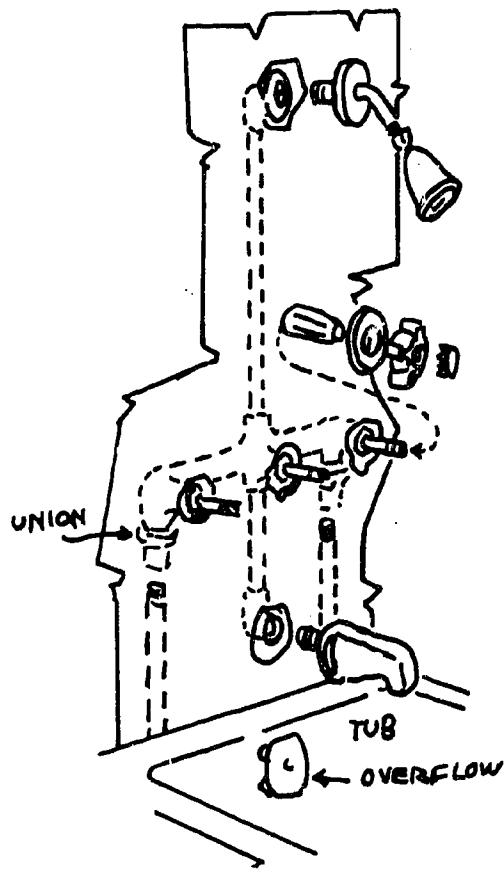

BATH AND SHOWER FIXTURE

DRAWING NUMBER

D-6-5 287

JOB: Install Combination Lavatory Fixture

JOB SHEET
IDENTIFICATION CODE

UNIT VI: Fixtures

JOB NUMBER: J-6-6

COURSE: Plumbing

DRAWING NO: D-6-6

MATERIAL: Combination Lavatory Fitting
Putty
Pipe Joint Compound

EQUIPMENT: Lavatory

TOOLS: Basin Wrench
Rib Joint Pliers
Smooth Jawed Wrench

SAFETY PRECAUTIONS:

1. Handle china or enameled lavatory with care.
2. Be protective of chrome finishes.

COMPETENCE - PROCEDURE/STEPS The student will be able to:	TEACHING/LEARNING ACTIVITIES
1. Apply putty to combination lavatory fixture.	
2. Put in place and tighten lock nuts with basin lug wrench.	. SC-6-5
3. Wipe excess putty away from fixture.	
4. Apply putty to pop-up waste.	
5. Put in place with rubber and metal washer under lavatory.	
6. Tighten lock nut with spud wrench.	
7. Wipe excess putty from pop-up.	
8. Apply a small amount of pipe dope on the fine threads of the tail piece and screw tail piece into lavatory waste.	
9. Fasten lift rod from pop-up to handle.	

METHOD OF EVALUATION:

1. Following of procedures
2. Proper care and use of tools
3. Cleanliness of work area

288

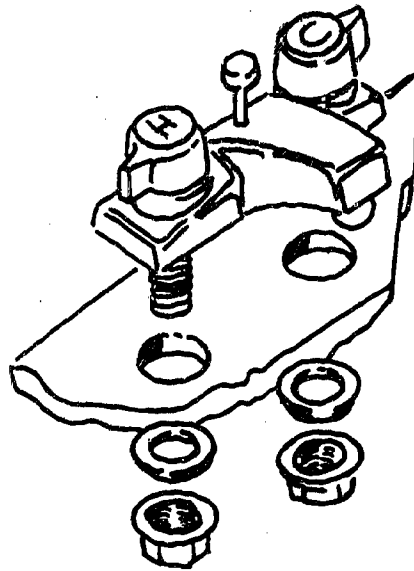
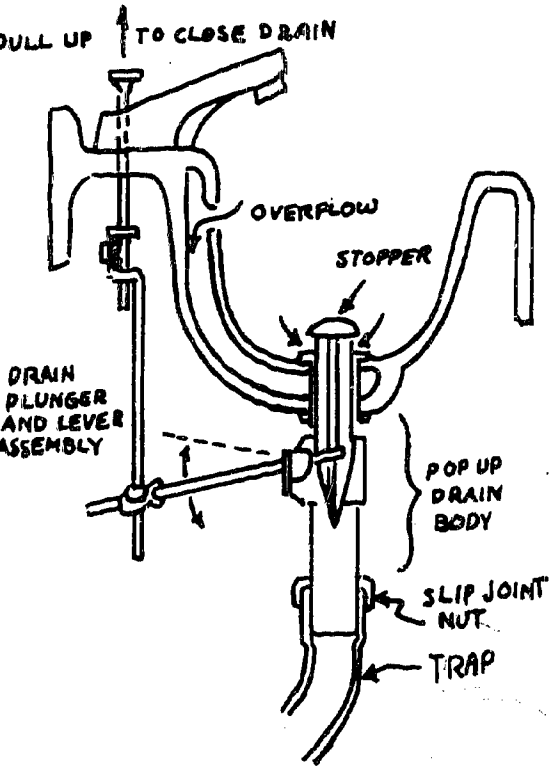

COMBINATION LAVATORY FIXTURE

DRAWING NUMBER
290
D-6-6

289

JOB: Install Bracket and Hand Lavatory

JOB SHEET
IDENTIFICATION CODE

UNIT VI: Fixtures

JOB NUMBER: J-6-7

COURSE: Plumbing

DRAWING NO: D-6-7

MATERIAL: Wood Screws
Lavatory Bracket

EQUIPMENT: Wall Hung Lavatory
1/4" Electric Drill

TOOLS: Hammer
2' Level
6' Folding Rule
Marking Pencil
Center Punch
1 1/4 Masonry Bit

SAFETY PRECAUTIONS:

1. Handle china or enameled lavatory with care.
2. If hanging lavatory on ceramic tile be careful not to crack tile when center punching.

COMPETENCE - PROCEDURE/STEPS The student will be able to:	TEACHING/LEARNING ACTIVITIES
1. Select location and mark for center of lavatory.	NOTE: Backing board should have been installed during rough-in.
2. Uncrate lavatory and hanger bracket.	. SC-6-1
3. Hold hanger bracket against lavatory and measure distance for proper mounting.	NOTE: Lavatory should hang so that front rim is 31" off finished floor.
4. Measure up wall and mark when lavatory bracket will be installed.	
5. Level across center mark (step 1) and mark off all bracket holes.	. SC-5-6
6. Center punch all cross marks.	
7. Drill through wall material until backing board is met.	
8. Fasten bracket to finished wall with proper size wood screws.	
9. Check bracket for level and hang lavatory on bracket.	
10. Check lavatory for level.	

METHOD OF EVALUATION:

1. Proper procedure
2. Accuracy of measurements
3. Cleanliness of tools and work area

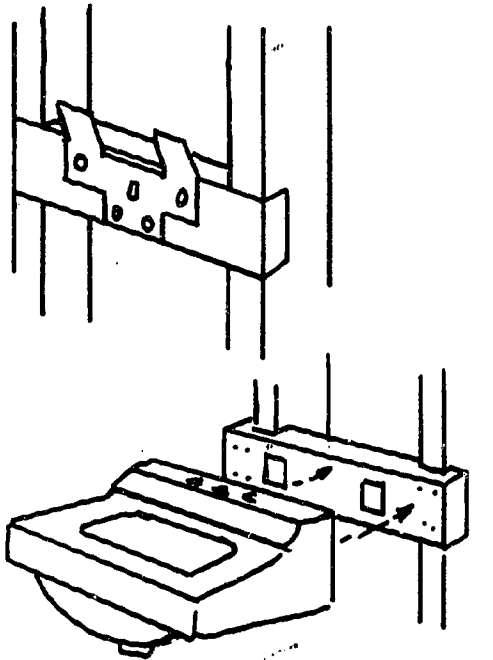
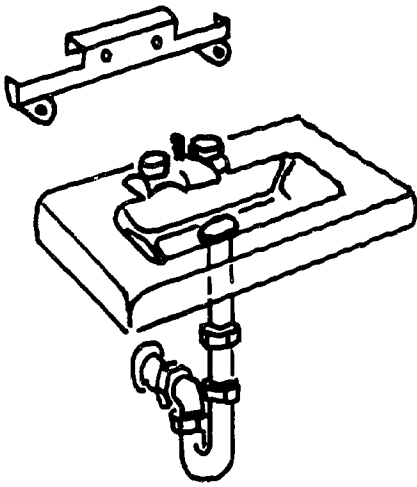

BRACKET AND HANG LAVATORY

DRAWING NUMBER

D-6-7 294

METHOD OF EVALUATION:

1. Following of procedures
2. Proper care and use of tools
3. Cleanliness of work area
4. Time:

296

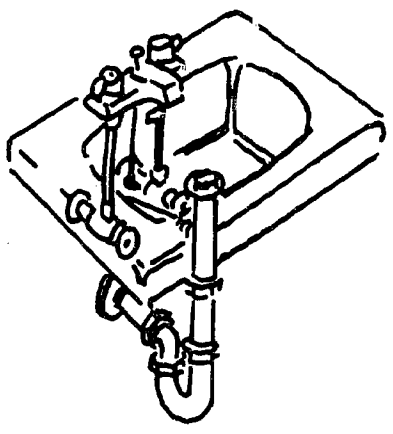
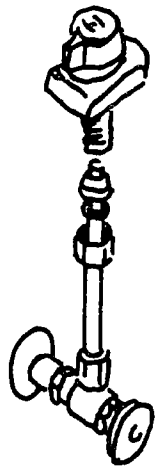
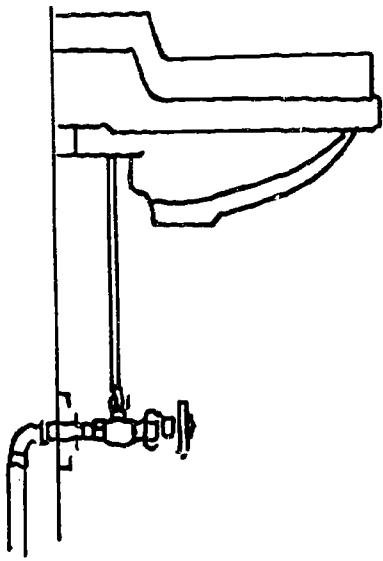

97

LAVATORY SUPPLIES	
	DRAWING NUMBER D-6-8 298

JOB: Connect Lavatory Trap
UNIT VI: Fixtures
COURSE: Plumbing
MATERIAL: 1 1/4" Chrome P or S Trap

JOB SHEET
IDENTIFICATION CODE

JOB NUMBER: J-6-9

DRAWING NO: D-6-9

TOOLS: Smooth Jawed Wrench
Copper Cutters Marking Pencil

SAFETY PRECAUTIONS:

1. Be protective of chrome surfaces.
2. Do not tighten friction nut too tight.

COMPETENCE - PROCEDURE/STEPS	TEACHING/LEARNING ACTIVITIES
The student will be able to:	
<ol style="list-style-type: none">1. Put friction nut and rubber washer on tail piece.2. Insert enlarged end of trap on tail piece and hand tighten friction nut.3. Put friction nut and washer on outlet part of trap.4. Insert outlet part of trap into drainage connection with friction nut and washer.5. Connect union end that has ground joint and tighten with spud wrench.6. Complete tightening of friction nuts and test for leaks.	CAUTION: Make sure that rubber washers are not twisted when put in place.

METHOD OF EVALUATION:

1. Following of procedures
2. Care and use of tools
3. Cleanliness of work area

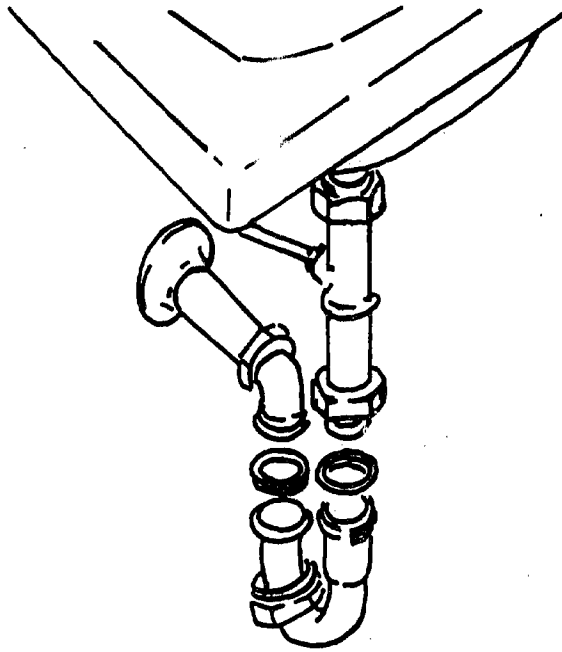

LAVATORY TRAP

DRAWING NUMBER

D-6-9

301

METHOD OF EVALUATION:

1. Proper procedure
2. Appearance of finished job
3. Cleanliness of work area

303

-400-

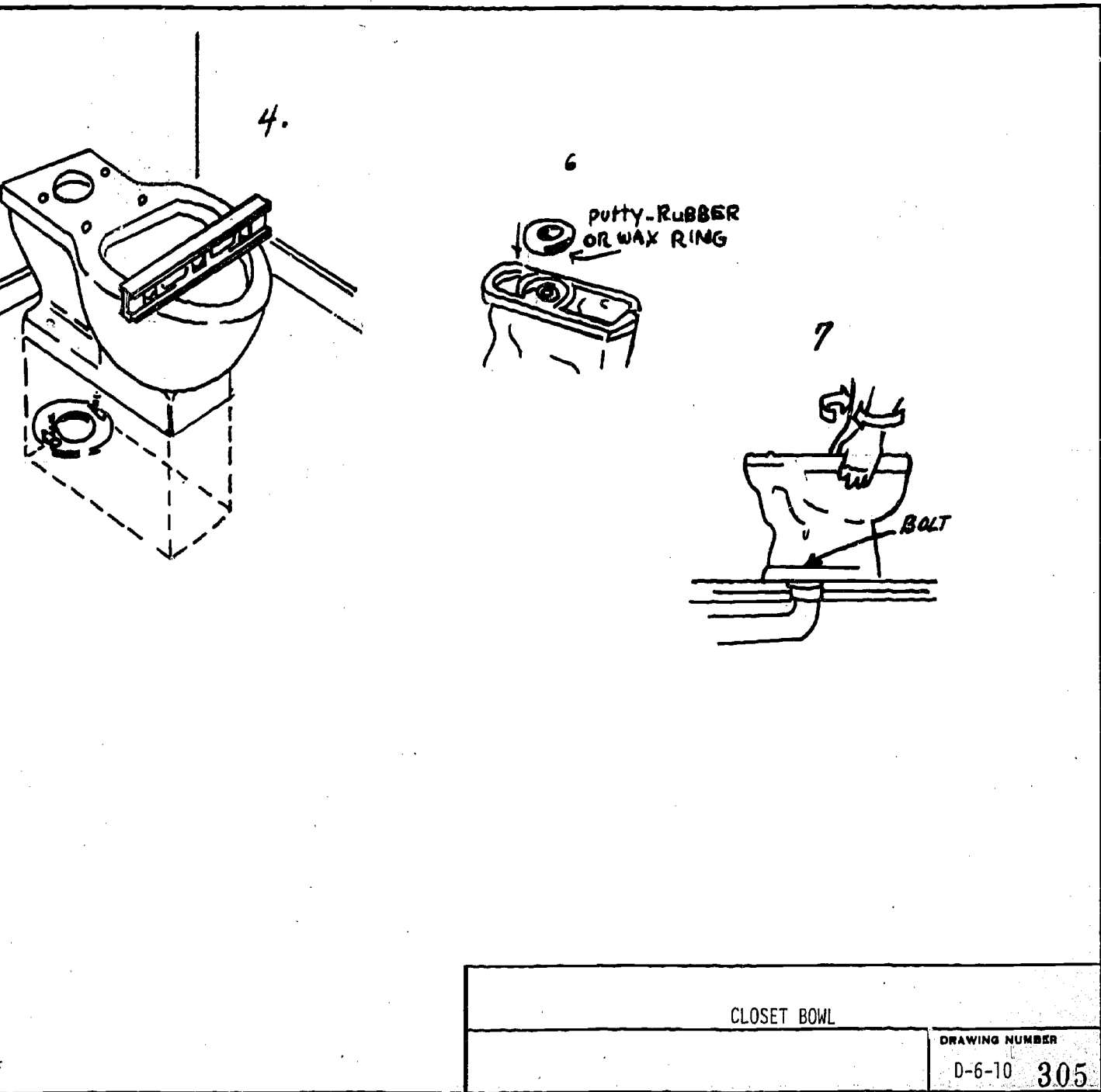

JOB: Install Closet Tank
UNIT VI: Fixtures
COURSE: Plumbing
MATERIAL: Closet Tank

JOB SHEET
IDENTIFICATION CODE

JOB NUMBER: J-6-11
DRAWING NO: D-6-11

TOOLS: Open or Box End Wrench
2' Level
6' Rule

SAFETY PRECAUTIONS:

1. Care must be exercised when working around china surfaces-- closets are known to crack and chip very easily.
2. When setting fixtures, you will be working in finished surroundings; tiled walls, finished floors, etc.; be careful of scuff marks, dropped tools, tramped in dirt, etc.

COMPETENCE - PROCEDURE/STEPS The student will be able to:	TEACHING/LEARNING ACTIVITIES
1. Remove tank and lid from carton.	NOTE: Place lid at a safe location while setting closet tank.
2. Open plastic envelope and place large doughnut shaped washer on tank outlet.	
3. Place tank on closet bowl ledge, lining up tank outlet with closet bowl inlet and tank bolt holes with closet bowl bolt holes.	
4. Place rubber washer in tank bolts and insert bolts down through tank and bowl.	
5. Position brass washer on each bolt and draw up nuts finger tight.	
6. Set level on tank and alternate tightening the bolts snug.	NOTE: Tank should also set equal distance (parallel) from wall surface. NOTE: Do not overtighten tank bolts.

METHOD OF EVALUATION:

1. Proper procedure
2. Appearance of finished job
3. Cleanliness of work area

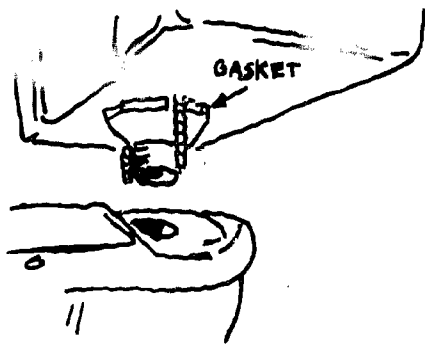

CLOSET TANK

DRAWING NUMBER

D-6-11

309

JOB: Connect Closet Supply
UNIT VI: Fixtures
COURSE: Plumbing
MATERIAL: Closet Supply with Angle Valve
3/8" Chrome Nipple
Pipe Joint Compound

JOB SHEET
IDENTIFICATION CODE

JOB NUMBER: J-6-12

DRAWING NO: D-6-12

TOOLS: 6' Rule
Marking Pencil
Adjustable Wrench
Copper Cutters
Rib Joint Pliers

SAFETY PRECAUTIONS:

1. Be protective of chrome finishes.
2. Do not over-tighten compression fitting.

COMPETENCE - PROCEDURE/STEPS The student will be able to:	TEACHING/LEARNING ACTIVITIES
1. Place a small amount of pipe joint compound on nipple.	
2. Tighten 3/8" chrome nipple into outlet in wall.	
3. Tighten 3/8" chrome angle valve on nipple.	
4. Measure flexible supply pipe and cut to proper size.	
5. Slip top coupling on supply pipe toward ground joint.	
6. Slip bottom coupling and brass ring on bottom of supply pipe.	
7. Slip supply pipe into valve.	
8. Tighten top coupling to closet supply.	
9. Tighten bottom coupling.	
10. Turn on water, test, and adjust ball cock.	
11. Place closet tank lid on top of closet tank.	

METHOD OF EVALUATION:

1. Following of procedures.
2. Cleanliness of work area.
3. Care and use of tools.

311

-409-

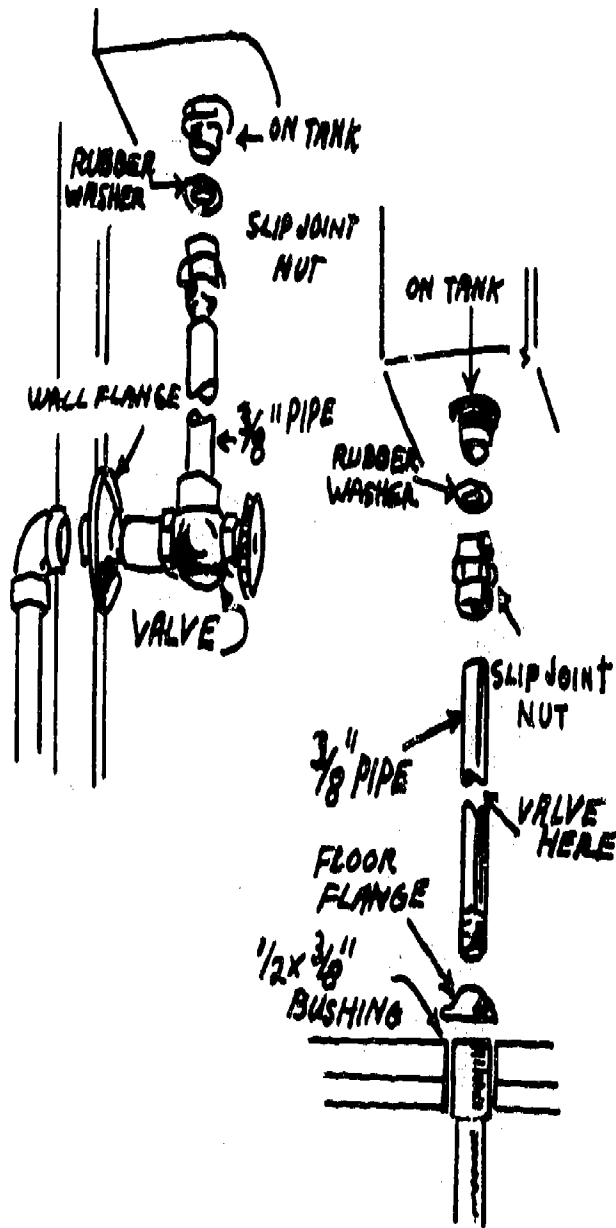

312

CLOSET SUPPLY

DRAWING NUMBER

D-6-12 313

JOB: Install Wall Brackets, Drain Outlet,
and Hang Urinal

JOB SHEET
IDENTIFICATION CODE

UNIT VI: Fixtures

JOB NUMBER: J-6-13

COURSE: Plumbing

DRAWING NO: D-6-13

MATERIAL: Wall Hung Urinal
Pipe Joint Compound

Wood Screws
2" Nipple Assortment

EQUIPMENT: 1/4" Electrical Drill

TOOLS: 6' Rule Center Punch Screwdriver
Marking Pencil 1/4" Masonry Bit Open or Box End Wrench
2' Level 18" Pipe Wrench Claw Hammer

SAFETY PRECAUTIONS:

1. Handle china or enameled urinal with care.
2. If hanging urinal on ceramic tile be careful not to crack tile when center punching.

COMPETENCE - PROCEDURE/STEPS

The student will be able to:

TEACHING/LEARNING ACTIVITIES

1. Clean dirt and debris from around and adjacent to the urinals' location, and uncrate and inspect the urinal.
2. Check drain outlet and measure for outlet nipple.
3. Apply pipe dope on male thread of nipple and tighten outlet connection to drain.
4. Insert outlet bolts through the outlet connection ears and set outlet gasket against outlet connection.
5. Plumb up from outlet connection. (center) for centerline of urinal and mark near bracket height.
6. Measure up from outlet connector. (center) for bracket height, mark and level across to right and left of plumbed centerline.
7. Measure to right and left of center for bracket installation and mark off bracket holes.

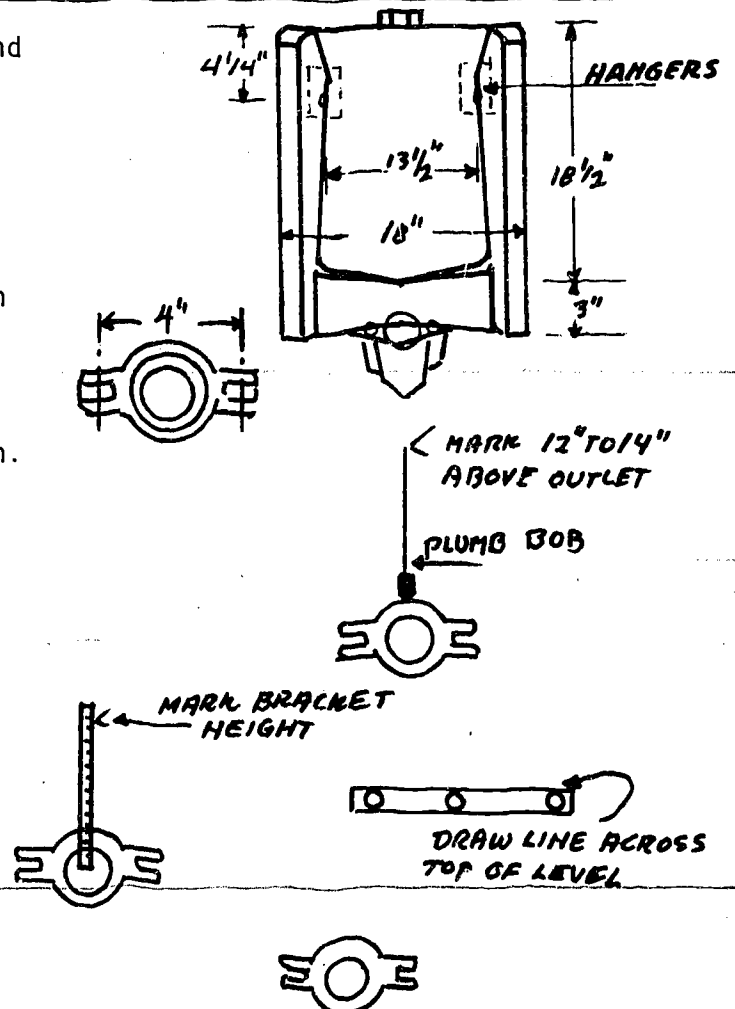

COMPETENCE - PROCEDURES/STEPS	TEACHING/LEARNING ACTIVITIES
8. Center punch marked holes and drill through wall surface until backing board is met.	
9. Fasten brackets to finished wall with proper size wood screws.	
10. Check brackets for level, check outlet gasket at outlet connection, and hang urinal.	
11. Tighten drain outlet belts.	NOTE: Do not overtighten drain outlet bolts.
12. Recheck urinal for level.	

METHOD OF EVALUATION:

1. Proper procedure
2. Accuracy of measurements
3. Appearance of finished job (level)

JOB: Install Urinal Flush Valve
UNIT VI: Fixtures
COURSE: Plumbing
MATERIAL: 3/4" Chrome Nipple Assortment
Pipe Joint Compound
Urinal Flush Valve

JOB SHEET
IDENTIFICATION CODE

JOB NUMBER: J-6-14

DRAWING NO: D-6-14

TOOLS: 6' Rule
Marking Pencil
Hex or Spud Wrench
Copper Cutters

SAFETY PRECAUTIONS:

Care must be exercised when working around china surfaces--
urinals are known to crack and chip very easily. BE CAREFUL!
Be protective of chrome finishes.

COMPETENCE - PROCEDURE/STEPS The student will be able to:	TEACHING/LEARNING ACTIVITIES
1. Turn off water supply and remove rough-in nipple.	
2. Mount the flush valve on the urinal (hand tighten only), and insert the flush valve control stop into the flush valve.	
3. Measure the distance for the desired control stop nipple, insert through the chrome flange and apply pipe dope to male threads.	
4. Screw the nipple and control stop into the roughed-in ell or adapter.	NOTE: Pipe wrenches or pliers are not to be used on chrome surfaces.
5. Tighten the flush valve slip joint nuts from the control stop and to the urinal inlet spud.	
6. Turn on water and test the urinal and flush valve for leaks and proper adjustment.	

METHOD OF EVALUATION:

1. Proper procedure
2. Accuracy of measurement
3. Appearance of finished job

316

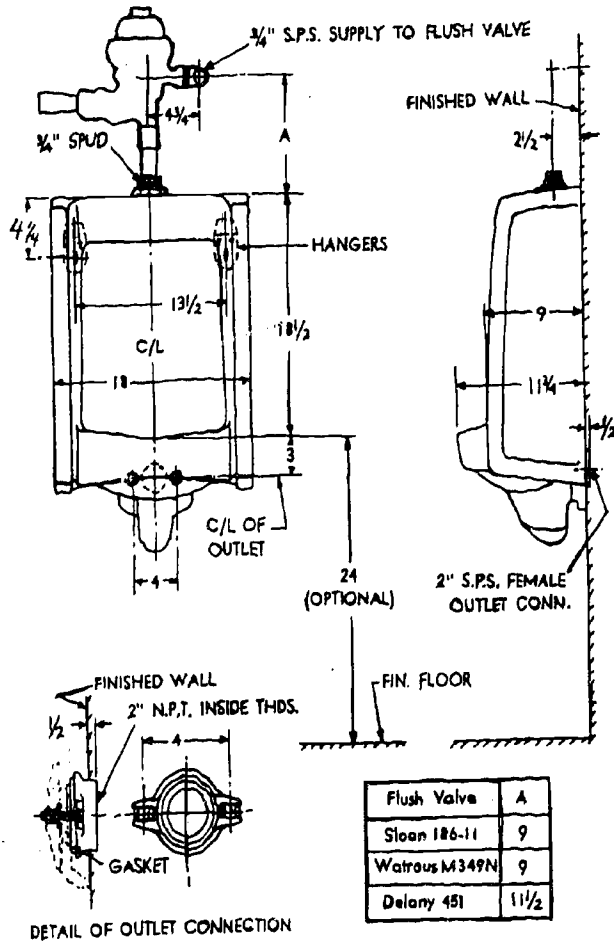

URINAL FLUSH

DRAWING NUMBER

D-6-14 318

JOB: Install Sink Faucet with Spray

JOB SHEET
IDENTIFICATION CODE

UNIT VI: Fixtures

JOB NUMBER: J-6-15

COURSE: Plumbing

DRAWING NO: D-6-15

MATERIAL: Sink
Sink Faucet with Spray
Putty
Pipe Joint Compound

TOOLS: Rib Joint Pliers
Basin Wrench

SAFETY PRECAUTIONS:

Be protective of chrome finishes.

COMPETENCE - PROCEDURE/STEPS The student will be able to:	TEACHING/LEARNING ACTIVITIES
1. Clean away all material from holes.	
2. Place putty on the underside of faucet. Press in place with fingers.	
3. Insert into position.	
4. Place rubber washers and lock nuts on underside of faucet.	
5. Center faucet before tightening.	
6. Tighten in place with basin lug wrench.	. SC-6-5
7. Place putty on spray holder, insert, and place rubber washer and lock nut on under- side of holder.	
8. Tighten in place with basin lug wrench.	
9. Insert spray through holder and screw into center outlet of faucet.	NOTE: When installing faucet without spray, close fourth (4th) hole with cock hole cover.

METHOD OF EVALUATION:

1. Following of procedures.
2. Proper care and use of tools.
3. Cleanliness of tools and work areas.

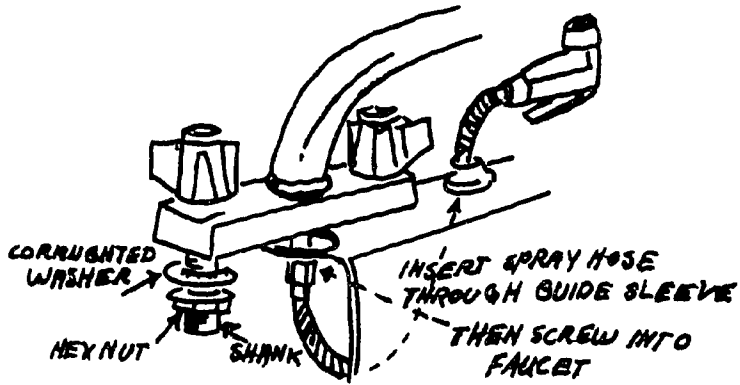

SINK FAUCET WITH SPRAY

DRAWING NUMBER

D-6-15 321

JOB: Install Sink Basket Strainers

JOB SHEET
IDENTIFICATION CODE

UNIT VI: Fixtures

COURSE: Plumbing

JOB NUMBER: J-6-16

MATERIAL: 2 - Basket Strainer
Putty

DRAWING NO: D-6-16

TOOLS: Rib Joint Pliers
Sink Strainer Wrench

COMPETENCE - PROCEDURE/STEPS	TEACHING/LEARNING ACTIVITIES
The student will be able to:	
1. Apply a ring of putty under flange of strainer.	
2. Place strainer into 4" hole sink.	
3. Place rubber and metal gasket over the strainer on the outside of the sink.	
4. Tighten lock nut drawing gasket and strainer against sink.	. SC-6-6
5. Place the tail piece washer between strainer bottom and tail piece, and tighten tail piece coupling nut to strainer threads.	
6. Repeat steps thru 5 for 2nd strainer.	
7. Clean excess putty from around sink and strainer.	

METHOD OF EVALUATION:

1. Proper procedure
2. Care and use of tools
3. Appearance of finished job



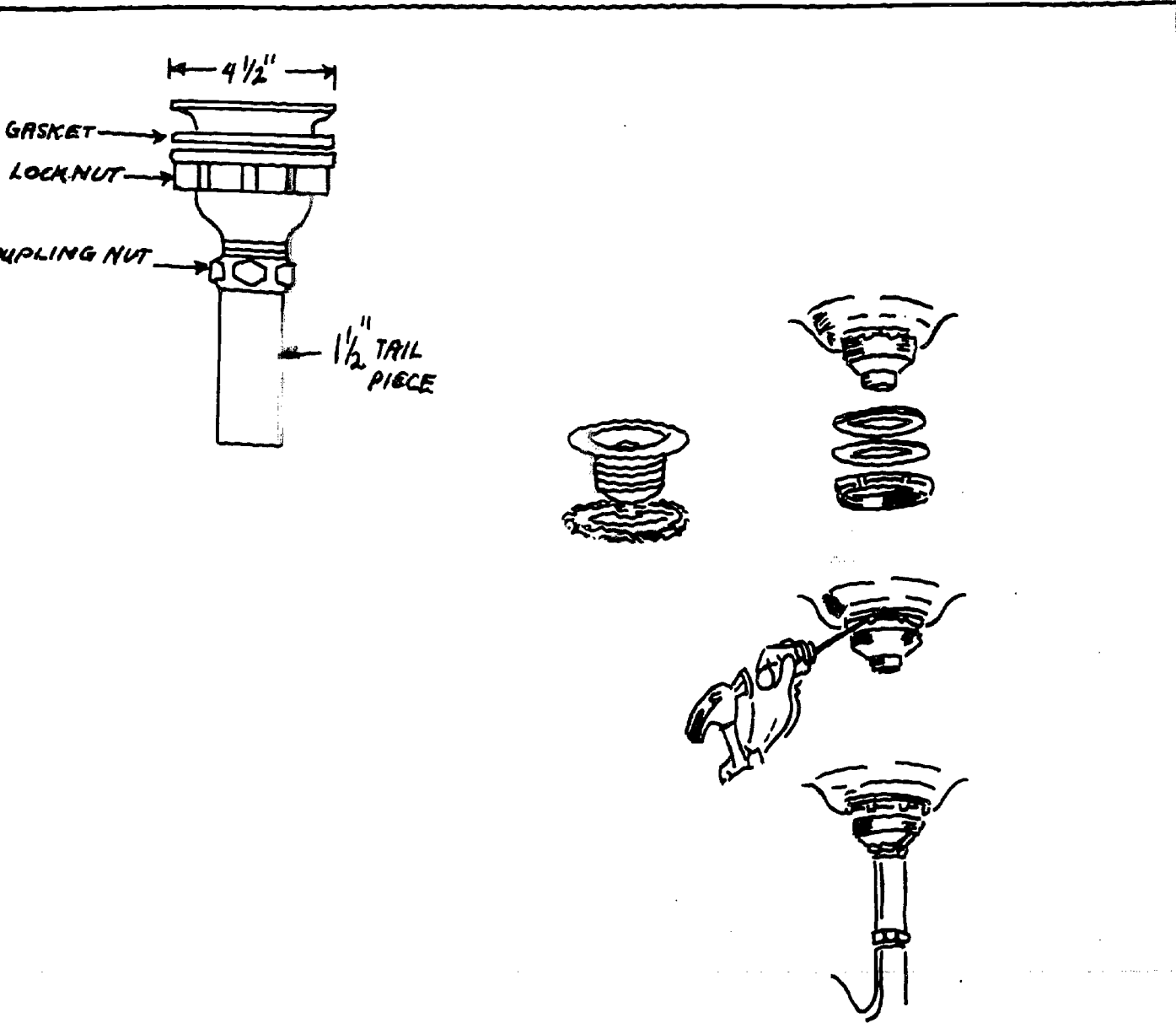

SINK BASKET STRAINERS

DRAWING NUMBER
D-6-16 324

JOB: Install Counter-top Sink

JOB SHEET
IDENTIFICATION CODE

UNIT VI: Fixtures

JOB NUMBER: J-6-17

COURSE: Plumbing

DRAWING NO: D-6-17

MATERIAL: Counter-top Sink
"Hudee" Sink Ring
Putty

EQUIPMENT: Sabre Saw Marking Pencil
 Electric Drill 3/4" Wood Bit
 6' Rule Sabre Saw Blades (fine wood)

SAFETY PRECAUTIONS:

1. Cast-iron enameled sinks are heavy and must be handled by two men. Again we have enameled surfaces and are working around finished walls, floors, cabinets, etc.
2. Place blade thru starting hole before starting saw.

COMPETENCE - PROCEDURE/STEPS The student will be able to:	TEACHING/LEARNING ACTIVITIES
1. Lay the "Hudee" ring on the counter-top at the desired location, center and mark the counter-top along the outside edge.	NOTE: Location of the sink depends largely on the cabinet construction and the kitchen layout.
2. Remark the counter-top, 5/16" inside the previous mark from step one (1).	
3. Bore a 3/4" hole through the counter-top at any location along the <u>inside</u> line-on the <u>inside</u> of the line.	
4. Using the 3/4" hole as a starting location, cut out the inside marked area of the counter-top.	NOTE: Check "Hudee" ring for proper fit. . SC-6-7
5. Lower the sink through the hole in the counter-top leaving it rest on the cabinet floor.	
6. Apply a layer of putty to the under-sides of the "Hudee" ring, and set the ring in the counter-top.	
7. Raise the sink up to the "Hudee" ring; insert and tighten sink ring clamps.	
8. Clean excess putty from around sink and "Hudee" ring.	

METHOD OF EVALUATION:

1. Accuracy of measurement.
 2. Appearance of finished job.
 3. Cleanliness of tools and work area.
-

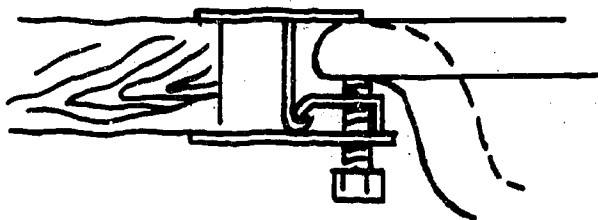
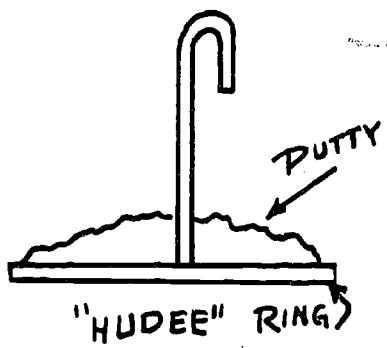

COUNTER-TOP SINK

DRAWING NUMBER

D-6-17 328

JOB: Connect Water Supply to Sink Faucet

JOB SHEET
IDENTIFICATION CODE

UNIT VI: Fixtures

JOB NUMBER: J-6-18

COURSE: Plumbing

DRAWING NO: D-6-18

MATERIAL: 1/2" Copper Tubing
1/2" Copper Fittings
1 Roll 50/50 Solder

Emery Cloth
Soldering Paste
1/4" Tailpieces

EQUIPMENT: Presto-lite Torch

TOOLS: Tubing Cutter
Swedging Tool
Hammer
Basin Wrench
Copper Bending Tool

Channel-Lock Pliers
Striker
6 Foot Folding Rule
Copper Flaring Tool

SAFETY PRECAUTIONS:

Care must be exercised when lighting the torch and soldering under sink.

COMPETENCE - PROCEDURE/STEPS	TEACHING/LEARNING ACTIVITIES
<hr/>	
1. Measure distance from rough-in shut-off valve to faucet inlet. (Use shortest but nearest route.)	
2. Cut and ream tubing.	
3. Bend offsets as required.	
4. Clean fittings and copper.	
5. Place flared tailpieces on faucet inlets.	
6. Swedge one end of copper offset.	
7. Insert faucet coupling nut.	
8. Place swedged joint in position at roughed-in water supply.	
9. Seal joints. (Solder copper, tighten threaded.)	

10. Turn on water supply and test for leaks.

METHOD OF EVALUATION:

1. Proper procedure
2. Appearance of finished lines
3. Cleanliness of work area
4. Safe and proper use of torch

330

-430-

-431-

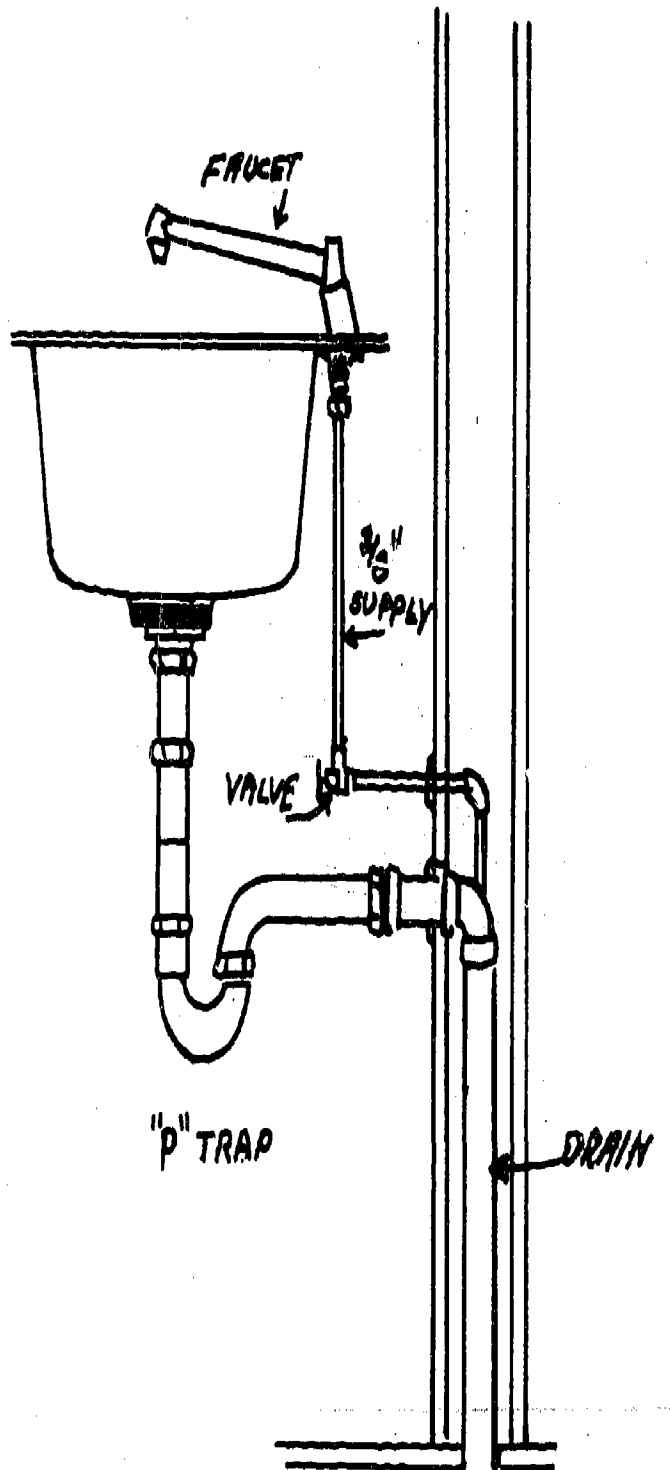

SINK FAUCET

DRAWING NUMBER

D-6-18 332

JOB: Install Continuous Waste and Sink Trap

JOB SHEET
IDENTIFICATION CODE

UNIT VI: Fixtures

JOB NUMBER: J-6-19

COURSE: Plumbing

DRAWING NO: D-6-19

MATERIAL: 1 1/2" Continuous Waste (End or Center Outlet)
1 1/2" Chrome P or S Trap

TOOLS: Hex or Spud Wrench

SAFETY PRECAUTIONS:

Be protective of chrome finishes.

COMPETENCE - PROCEDURE/STEPS	TEACHING/LEARNING ACTIVITIES
The student will be able to:	
<ol style="list-style-type: none">1. Attach tail piece into tee and fasten friction nut to sink strainer.2. Attach sink ell with tail piece to sink strainer with friction nut.3. Fit over piece into tee. If waste must be cut use large tubing cutter.4. Tighten all friction nuts.5. Put friction nut and rubber washer on tail piece.6. Insert enlarged end of trap on tail piece and hand tighten friction nut.7. Put friction nut and washer on outlet of trap.8. Insert outlet part of trap into drainage connection with friction nut and washer.9. Connect union end that has ground joint and tighten with spud wrench.10. Complete tightening of friction nuts and test for leaks.	CAUTION: Be sure rubber washers are not twisted when put in place.

METHOD OF EVALUATION:

1. Following of procedures
2. Care and use of tools
3. Appearance of finished job

333

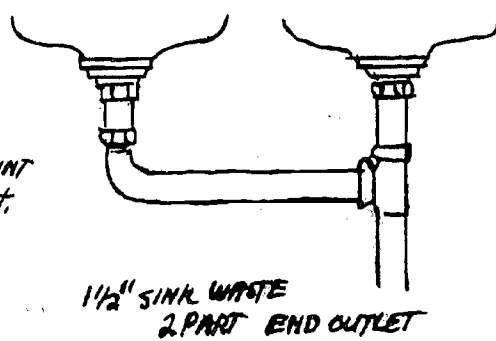
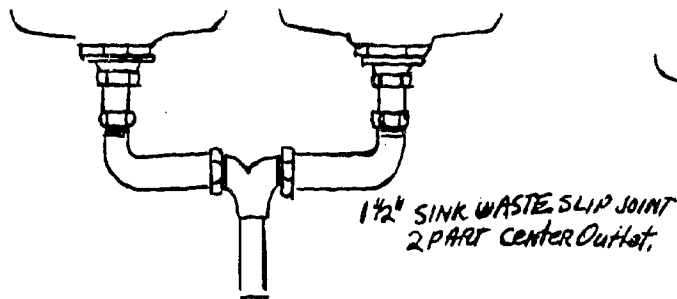
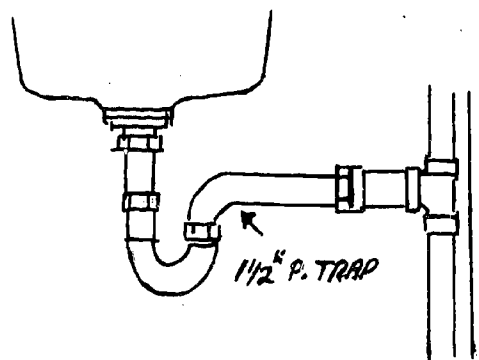
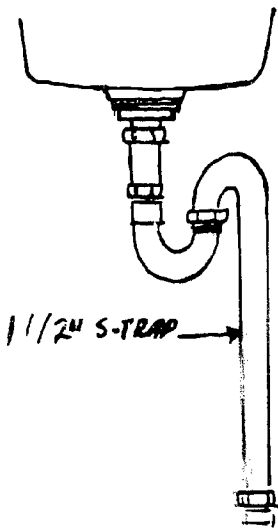

CONTINUOUS WASTE AND SINK TRAP	
	DRAWING NUMBER D-6-19 335

JOB: Install Garbage Disposal

JOB SHEET
IDENTIFICATION CODE

UNIT VI: Fixtures

JOB NUMBER: J-6-20

COURSE: Plumbing

DRAWING NO: D-6-20

MATERIAL: Putty
Garbage Disposal

1 1/2" Sink Tray

TOOLS: Screwdriver
Spud Wrench

Pliers
Pipe Wrench

SAFETY PRECAUTIONS:

1. Use proper tools.
2. Check inside the disposer grinding chamber and remove any foreign material if present.

COMPETENCE - PROCEDURE/STEPS
The student will be able to:

TEACHING/LEARNING ACTIVITIES

1. Prepare the sink for installation by removing the present trap, strainer and drain line.
2. Apply liberal amount of putty around sink sleeve.
3. From underneath sink, place fibre sleeve gasket over sink sleeve.
4. Follow fibre gasket with back up ring.
5. Slip on the mounting ring containing the three screws.
6. Slide all these parts above the groove in sleeve and insert steel snap ring.
7. Tighten the three mounting screws.
8. Raise disposer to sink mounting assembly and attach.
9. Attach the discharge tube to disposer.
10. Use the slip nut on the trap for connection to discharge tube.
11. Tighten all connections and test.

METHOD OF EVALUATION:

1. Accuracy of measurement
2. Appearance of finished job
3. Cleanliness of tools and work area

COMPETENCY: Marking with a Pencil, Soap Stone, Chalk or Scribe

COURSE: Plumbing

UNIT I: Pipes and Fittings

OBJECTIVE: To be able to mark a surface for lay out of lines to work to

COMPETENCE - PROCEDURE/STEPS
The student will be able to:

TEACHING/LEARNING ACTIVITIES

NOTE: This kind of marking requires accuracy, the marks are used in many trade areas.

1. Hold the ruler, tape, or scale firmly in place with the left hand.

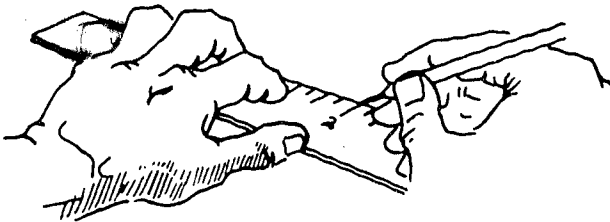

2. Place the point of the pencil or other marking device at the desired location on the surface to be marked.
3. Strike a small mark diagonally to the right.

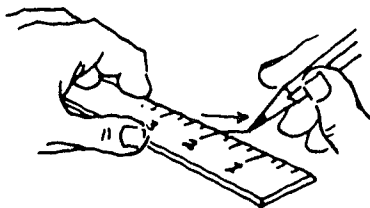

4. Return the pencil to the original starting point and strike a line diagonally to the left. The resulting point on the V mark is the desired location.

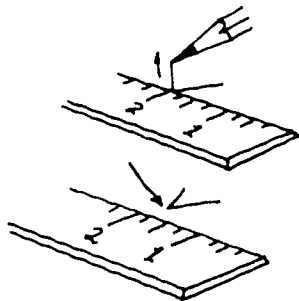

337

METHOD OF EVALUATION:

1. Proper procedure
2. Accuracy of measurement

COMPETENCY: Cut Cast Iron Soil Pipe with Hammer and Chisel

COURSE: Plumbing

UNIT I: Pipes and Fittings

OBJECTIVE: To accurately and neatly cut cast iron pipe into different lengths

COMPETENCE - PROCEDURE/STEPS	TEACHING/LEARNING ACTIVITIES
------------------------------	------------------------------

The student will be able to:

1. Measure and mark the pipe at proper length.
2. Lay the pipe to be cut on a 2" X 4" as indicated--to have a sharp edge support below the cutting point.
3. The pipe is now ready to be cut. Check to make sure your chisel is not "mush-roomed" and is not too sharp.
4. Hold the chisel at a right angle to the pipe surface.
5. Cut a groove around the pipe, using the hammer to strike the chisel.
6. Continue cutting this groove deeper and deeper in continuous movement around the pipe until the pipe breaks off.
7. Check pipe for accuracy and squareness of cut.

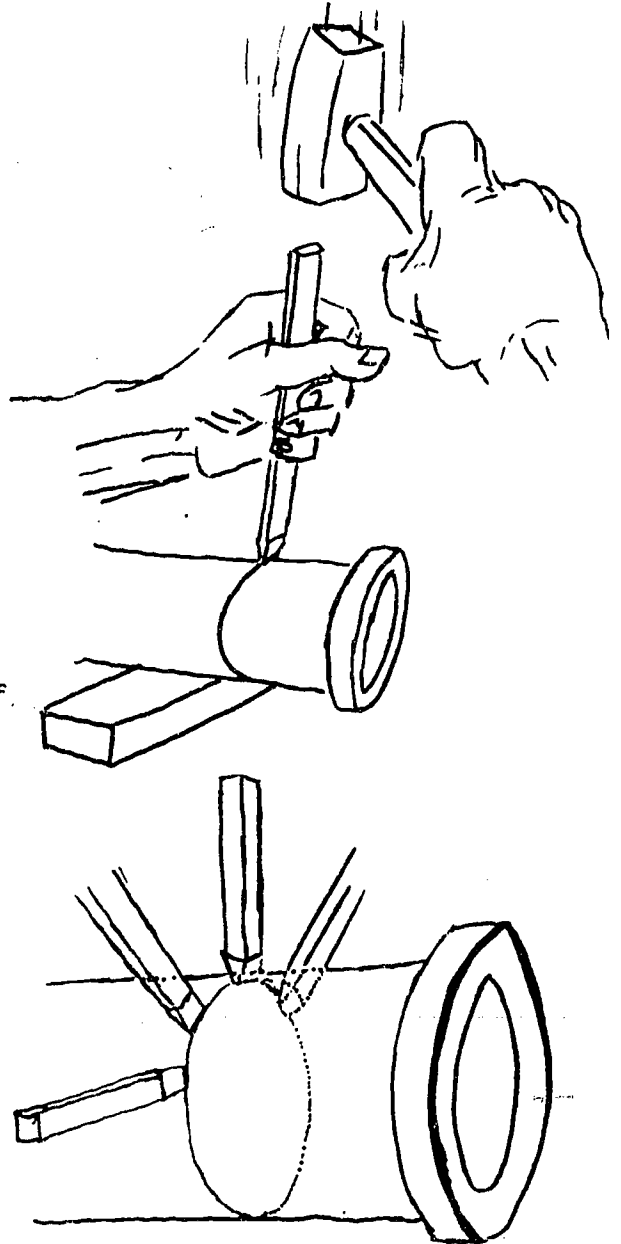

METHOD OF EVALUATION:

1. Proper procedure
2. Appearance of cut
3. Care and use of hammer and chisel
4. Time:

COMPETENCY: Ring Soil Pipe

COURSE: Plumbing

UNIT I: Pipes and Fittings

OBJECTIVE: To check soil pipes and fittings to make sure they are solid

COMPETENCE - PROCEDURE/STEPS The student will be able to:	TEACHING/LEARNING ACTIVITIES
--	------------------------------

1. Soil pipes and fittings must be "rung" before installation.
2. Using a light ball peen hammer strike the pipe or fitting to be checked about 1" from the end and listen to the "ring".
3. Check the opposite end of soil pipe or fitting as in procedure step 2.
4. See notes #1 and 2.

NOTE: If "ring" is clear you may proceed with installation.

NOTE: If "ring" is dull cut another fitting.

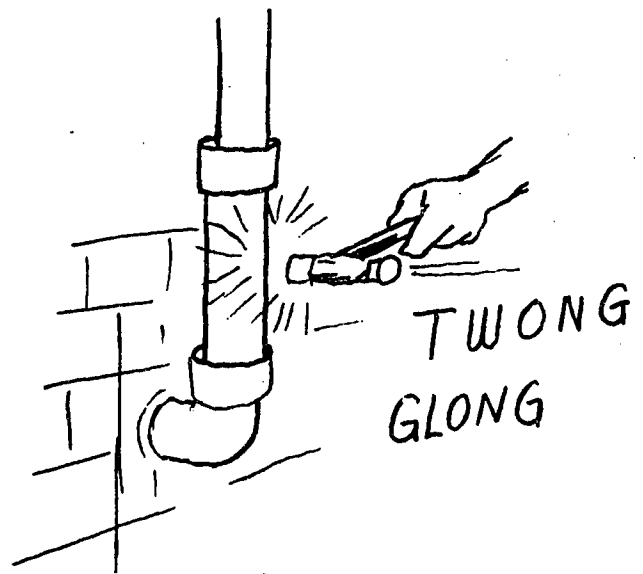

METHOD OF EVALUATION:

1. Proper procedure
2. Accuracy in determining cracked pipe or fitting
3. Proper handling of soil pipe

COMPETENCY: Lighting a Torch

COURSE: Plumbing

UNIT I: Pipes and Fittings

OBJECTIVE: To properly light a propane torch in a safe and efficient manner

COMPETENCE - PROCEDURE/STEPS
The student will be able to:

TEACHING/LEARNING ACTIVITIES

1. Put the head on the torch. Turn the head clockwise until it is hand tight.

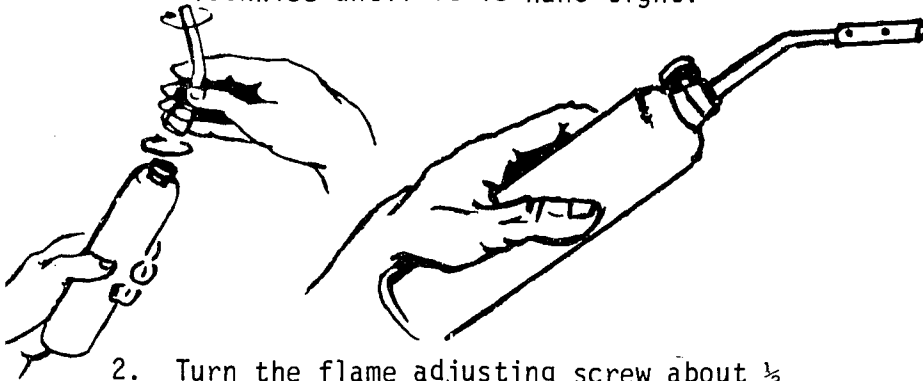

2. Turn the flame adjusting screw about $\frac{1}{2}$ turn counterclockwise.

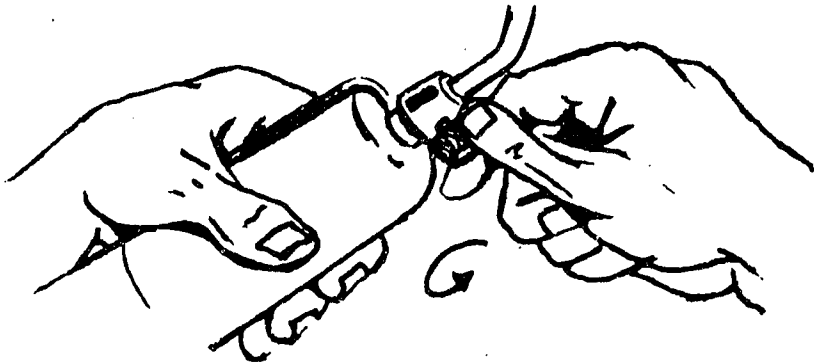

3. Light a match and hold it about $\frac{1}{4}$ " from the head of the torch.

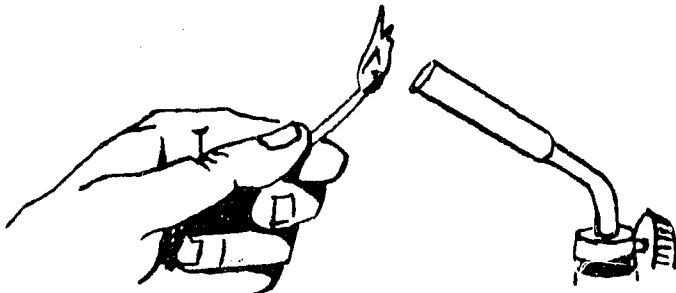

CAUTION: DO NOT get your finger directly in front of the torch tip when you are lighting it or after it is lit.

341

4. After the torch is lit, turn the flame adjusting screw in either direction until the flame you want is reached.

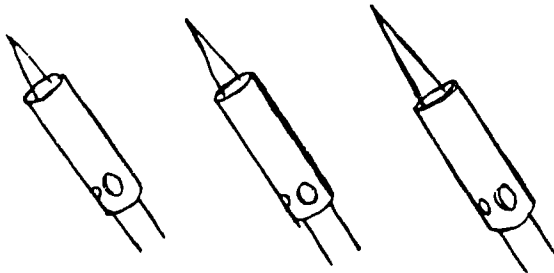

5. To turn the torch off, turn the flame adjusting screw clockwise until it is tight. (The flame will keep burning for about 5 seconds.)

CAUTION: The neck of the torch remains hot for a while after the torch is turned off so be careful not to touch it.

METHOD OF EVALUATION:

1. Proper procedure
2. Flame appearance
3. Care and use of torch

COMPETENCY: Setting Up and Lighting the Lead Torch

COURSE: Plumbing

UNIT I: Pipes and Fittings

OBJECTIVE: To be able to properly heat and test lead for pouring.

COMPETENCE - PROCEDURE/STEPS
The student will be able to:

TEACHING/LEARNING ACTIVITIES

1. Set tank at a safe level location.
2. Attach burner base to tank, thread until tight.
3. Turn on gas slightly, and light lead torch.
4. Set lead pot on burner base and turn on more gas.
5. When lead has melted, check for heat by dipping ladle in molten lead. (See Note)
6. If lead is hot enough, turn down gas slightly to maintain proper temperature.

NOTE: Lead should not harden on ladle, should be fluid.

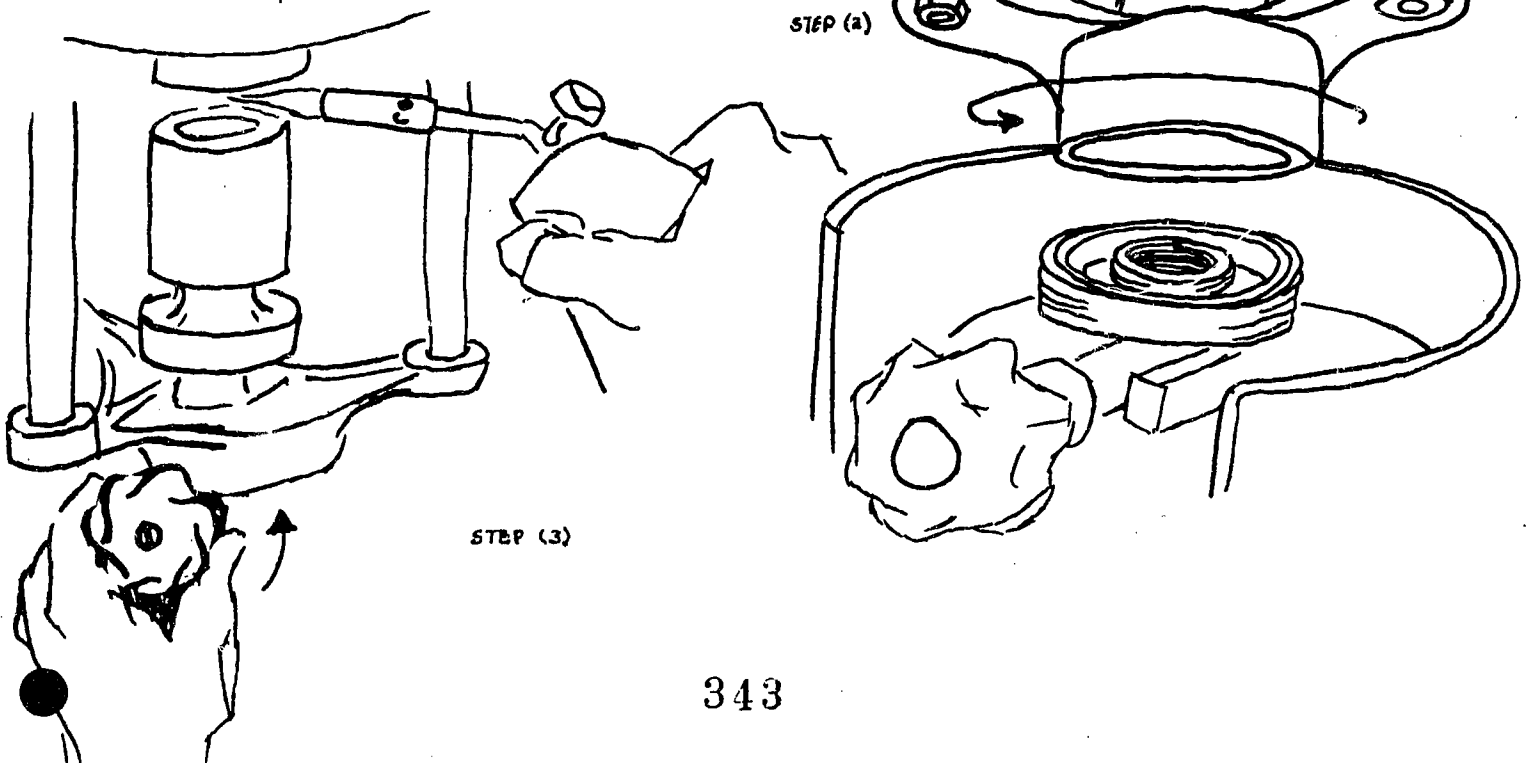

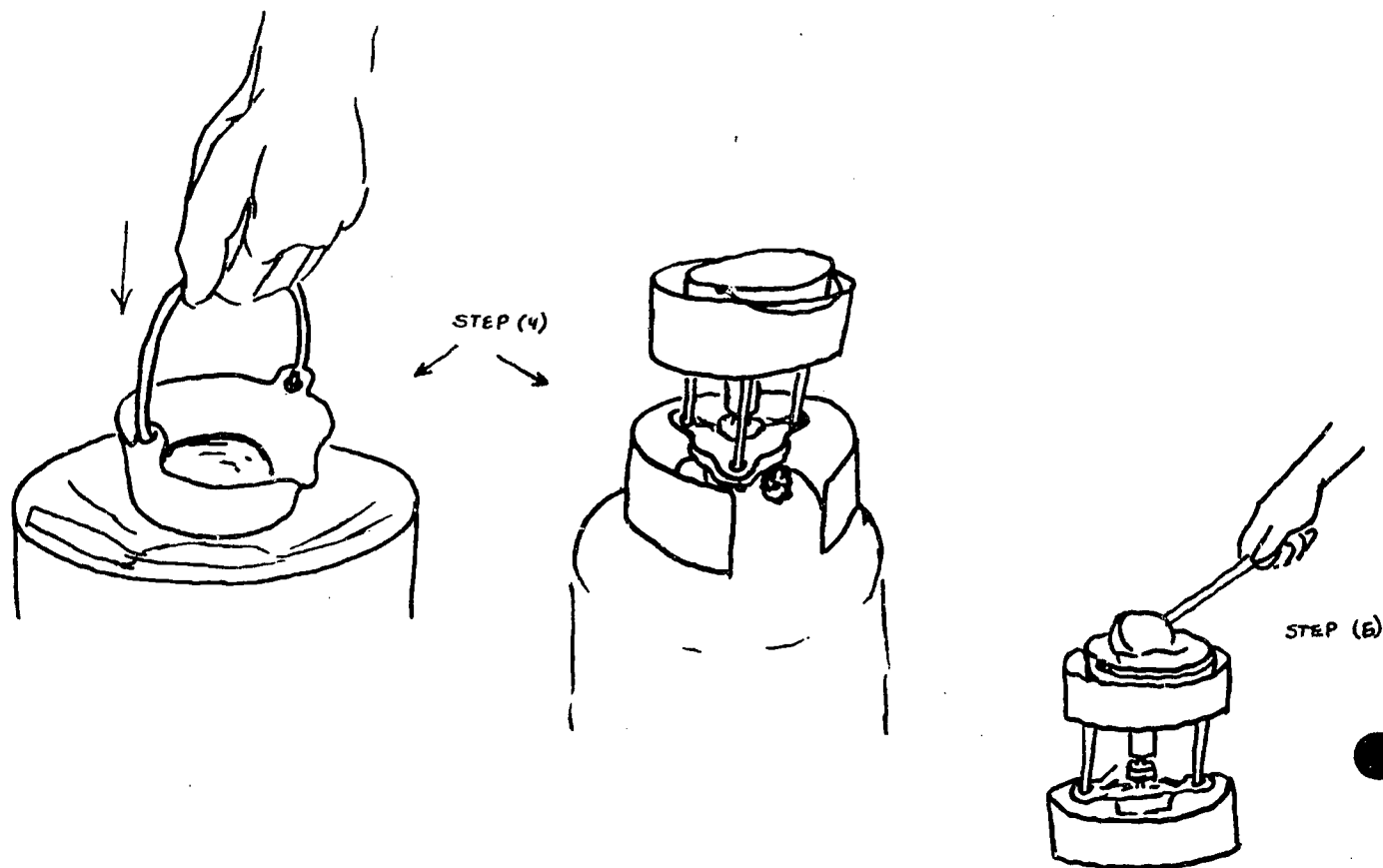

METHOD OF EVALUATION:

1. Proper procedure
2. Proper heating and testing temperature
3. Safe handling of lead and ladle

COMPETENCY: Yarn and Pack Vertical Oakum Joints

COURSE: Plumbing

UNIT I: Pipes and Fittings

OBJECTIVE: To yarn and pack a vertical oakum joint

COMPETENCE - PROCEDURE/STEPS The student will be able to:	TEACHING/LEARNING ACTIVITIES
--	------------------------------

1. Examine the mating portions.
2. Stand up and align the two pieces.
3. Take a piece of oakum and separate the strands.
4. Pack each strand with yarning iron.
5. Several strands are needed to fill the void.
6. After each strand, drive oakum with packing iron, leaving a 3/4" deep void to receive hot lead.
7. The packing iron may be marked and used to check the 3/4" deep void for the lead.

NOTE: See that they fit snugly.

NOTE: The space between the bell and pipe is called the void.

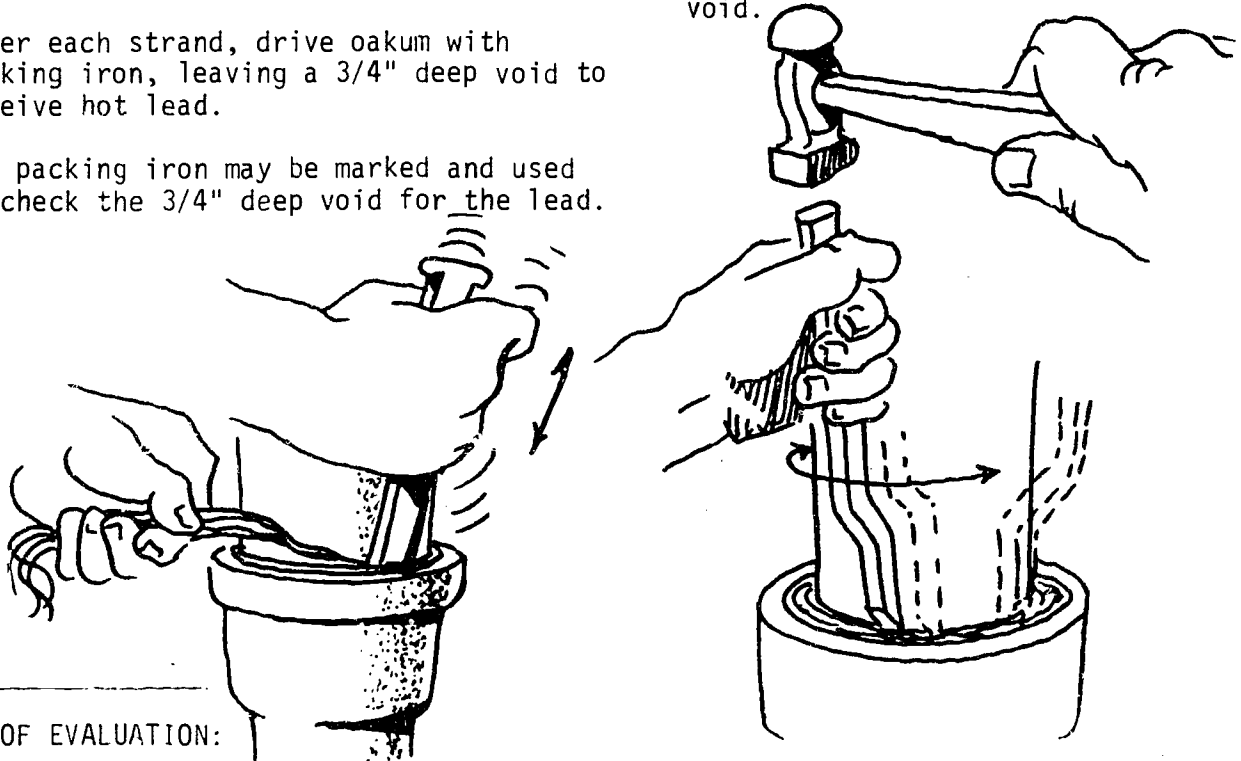

METHOD OF EVALUATION:

1. Following of proper procedures.
2. Proper yarning and packing of joint.
3. Time:

COMPETENCY: Aligning Pipe

COURSE: Plumbing

UNIT I: Pipes and Fittings

OBJECTIVE: To properly align, so as to have a uniform appearance

COMPETENCE - PROCEDURE/STEPS The student will be able to:	TEACHING/LEARNING ACTIVITIES
--	------------------------------

1. When two pieces of soil pipe are joined together make sure seams are in line. (Fig. A)
2. For beginners: Use plumb-bob to check line. A journeyman will have the ability to use his eye to sight the proper alignment.
3. If out of alignment hold top bell at A and tap at B. (Fig B)
4. After checking front elevation then check side elevation for true alignment.

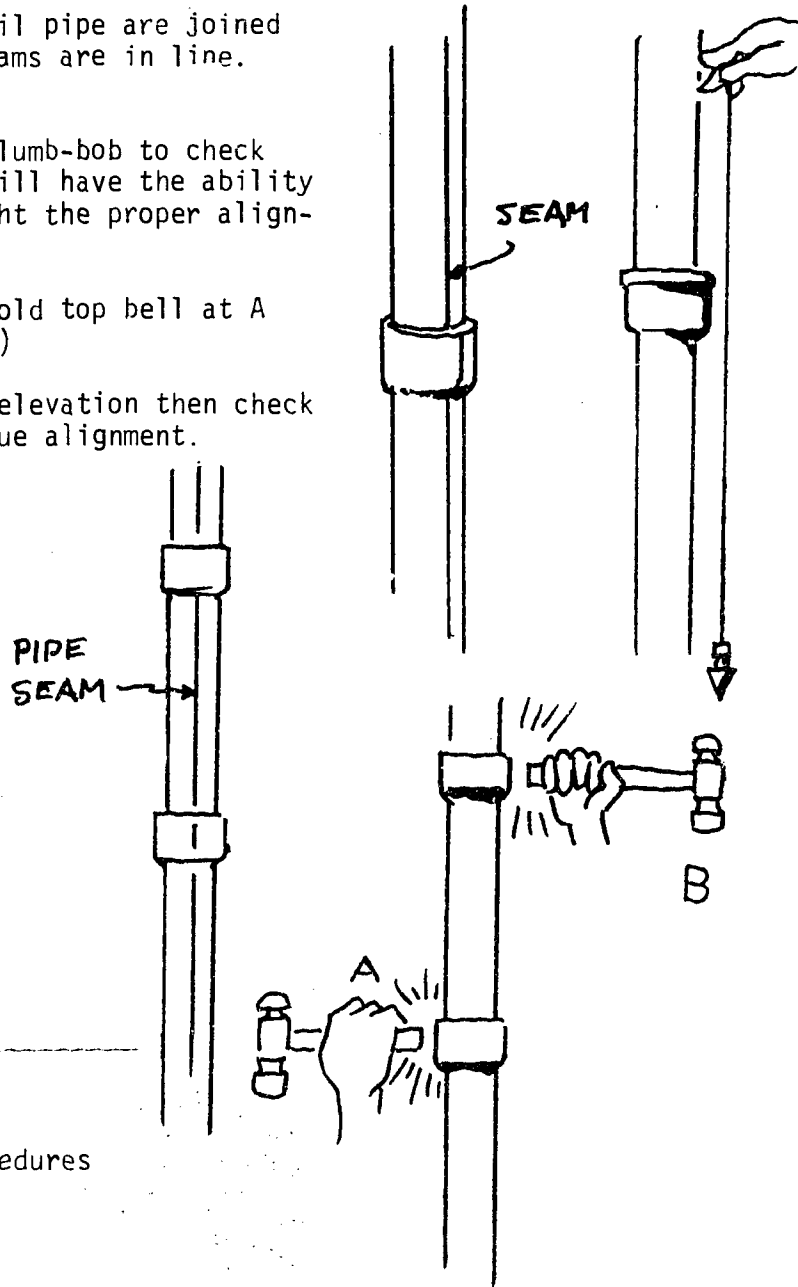

METHOD OF EVALUATION:

1. Following of procedures
2. Proper alignment

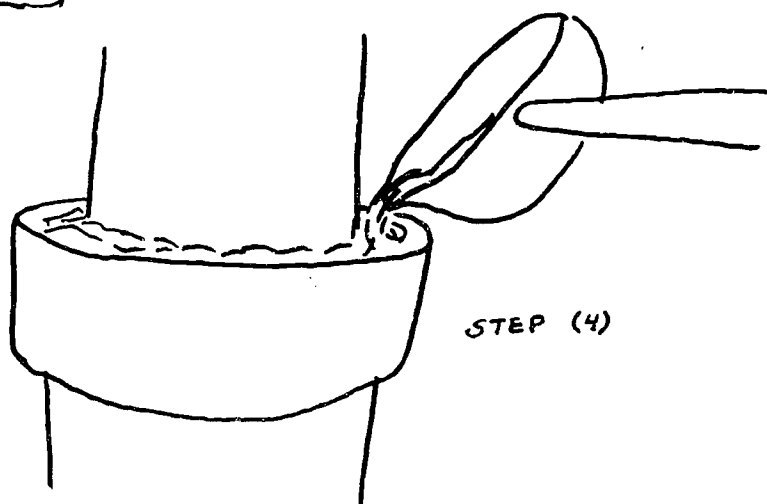
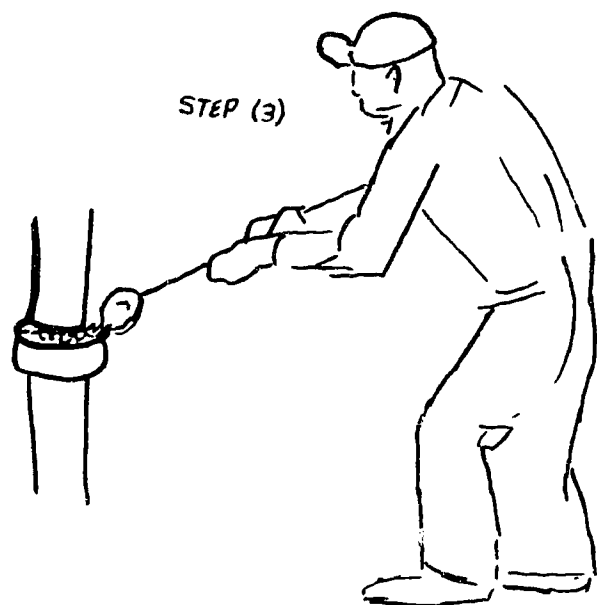

METHOD OF EVALUATION:

1. Following of proper procedure
2. Proper lead temperature
3. Joint appearance

COMPETENCY: Calking a Lead Joint

COURSE: Plumbing

UNIT I: Pipes and Fittings

OBJECTIVE: To properly calk a joint leaving a neat and aligned appearance

COMPETENCE - PROCEDURE/STEPS	TEACHING/LEARNING ACTIVITIES
------------------------------	------------------------------

1. After the lead hardens, tap the lead using a light ball peen hammer and calking irons.
2. Tap the outside calking iron against the lead gently with the hammer.
3. While tapping, slowly move the iron around the outside of the joint.
4. Repeat step 2 using an inside calking iron.
5. Repeat step 3 moving around the inside of the joint.
6. Using a wide iron, smooth and clean-up the joint.

NOTE: On rough pours, excess lead must be removed using a chisel.

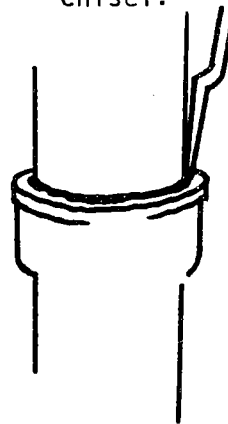

METHOD OF EVALUATION:

1. Proper procedure
2. Appearance and neatness of calking
3. Safe and proper use of calking irons

OPERATION SHEET
SC-1A-10

COMPETENCY: Yarning, Pouring, and Calking Horizontal
Lead and Oakum Joints

COURSE: Plumbing

UNIT I: Pipes and Fitting

OBJECTIVE: To be able to yarn, pack, pour, and calk horizontal
lead joints.

COMPETENCE - PROCEDURE/STEPS	TEACHING/LEARNING ACTIVITIES
The student will be able to:	
1. Lay pipe on floor or ground fitting them snugly.	
2. Yarn and pack the joint starting with the bottom of the void first.	NOTE: The space between the bell and the pipe is called the void.
3. Continue <u>step 2</u> leaving a 3/4" - 1" deep void for lead.	
4. Slide the joint runner under and around the joint.	
5. Pull the joint runner snug and apply the clamp.	NOTE: Keep the opening or "gate" slightly off center so the lead will flow around in one direction, so trapped gases may escape.
6. Pour joint.	
7. After joint has cooled, remove runner.	
8. Remove excess lead with flat chisel.	
9. Calk outside of joint.	
10. Calk inside of joint.	

METHOD OF EVALUATION:

1. Proper procedure
2. Completeness of pour
3. Appearance of finished joint

COMPETENCY: Picking a Cast-Iron Soil Joint

COURSE: Plumbing

UNIT I: Pipes and Fittings

OBJECTIVE: To be able to remove lead from a finished lead and oakum joint using picking irons.

COMPETENCE - PROCEDURE/STEPS The student will be able to:	TEACHING/LEARNING ACTIVITIES
--	------------------------------

1. Tap the straight picking iron into the lead using a ball peen hammer forming a V-shaped pocket.
2. Continue step 1 until you reach the bottom of the lead.
3. Using the curved picking iron continue to pick until you remove at least half of the circumference.
4. Pry remaining lead from joint and take joint apart.
5. Ring hub after joint is picked free from lead.

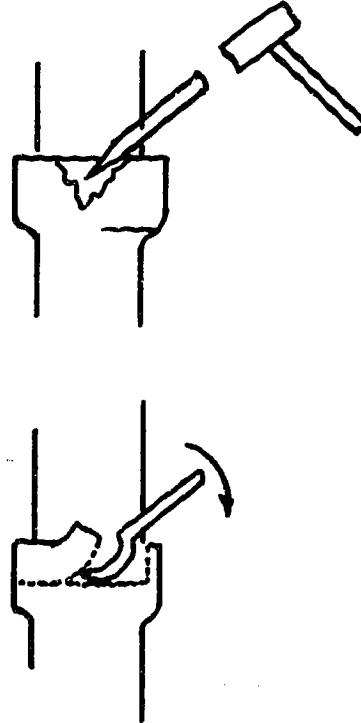

METHOD OF EVALUATION:

1. Proper procedure
2. Proper and safe use of picking irons

COMPETENCY: Cutting Cast-Iron Soil Pipe with Soil Pipe Cutter

COURSE: Plumbing

UNIT I: Pipes and Fittings

OBJECTIVE: To be able to make an even-true cut in cast-iron soil pipe using a soil pipe cutters.

COMPETENCE - PROCEDURE/STEPS The student will be able to:	TEACHING/LEARNING ACTIVITIES
--	------------------------------

1. Mark soil pipe to be cut.
2. Position chain around soil pipe at mark.
3. Hook cutter pin on chain into cutter as shown.
4. Align center of chain on mark made on soil pipe and check for squareness of chain on pipe.
5. Turn adjusting screw to allow cutter handles to open.
6. With left foot on flat end of lower handle, apply pressure on upper handle until pipe separates.
7. Check for clean even cut.

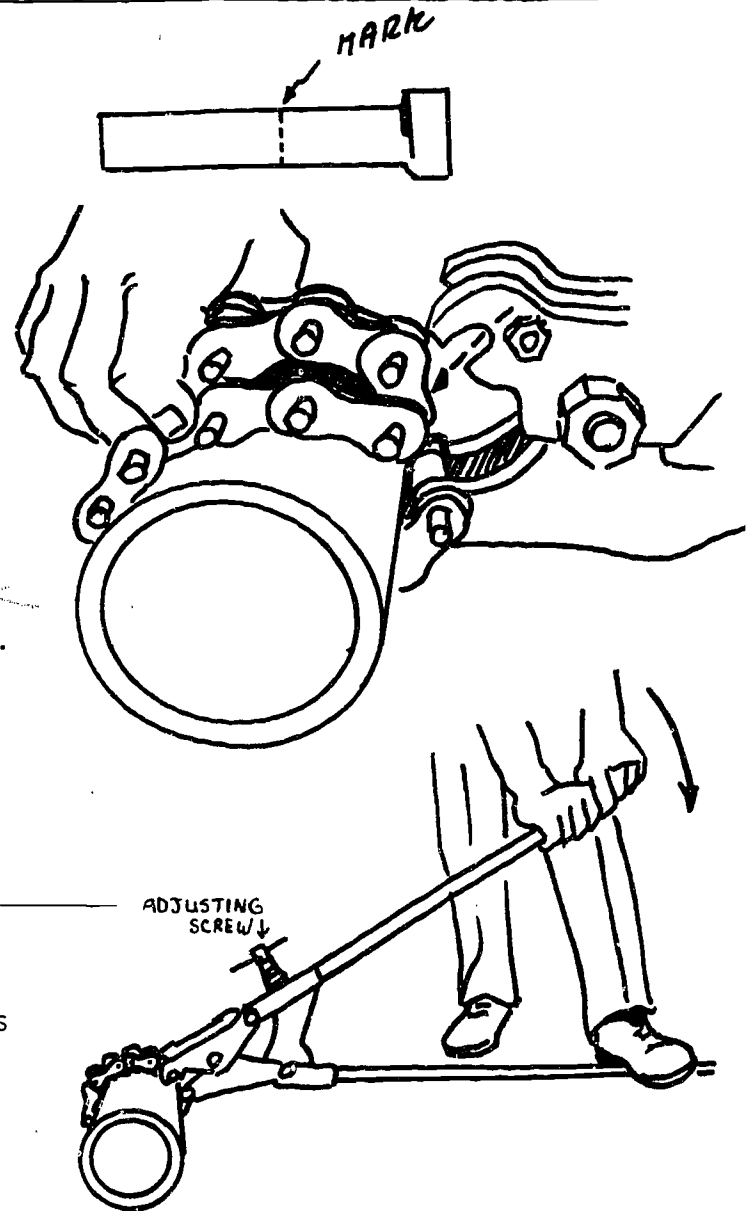

METHOD OF EVALUATION:

1. Following of proper procedures
2. Appearance of finished cut
3. Time:
4. Care and use of cutter

COMPETENCY: Insert and Lubricate Gasket

COURSE: Plumbing

UNIT I: Pipes and Fittings

OBJECTIVE: To be able to properly insert neoprene gaskets into hub and lubricate.

COMPETENCE - PROCEDURE/STEPS The student will be able to:	TEACHING/LEARNING ACTIVITIES
--	------------------------------

1. Squeeze gasket together with both hands double folding gasket.
2. Insert squeezed or double folded gasket into soil pipe hub.
3. Withdraw hands from gasket. As hands are withdrawn gasket unfolds or "snaps" into place.
4. Coat inner surface of gasket liberally with lubricate.
5. Coat outside of spigot end of soil pipe liberally with lubricate.

NOTE: Gasket may also be inserted by holding hands on the outside circumference of the gasket and pressing thumbs down and in, as though to turn gasket inside out.

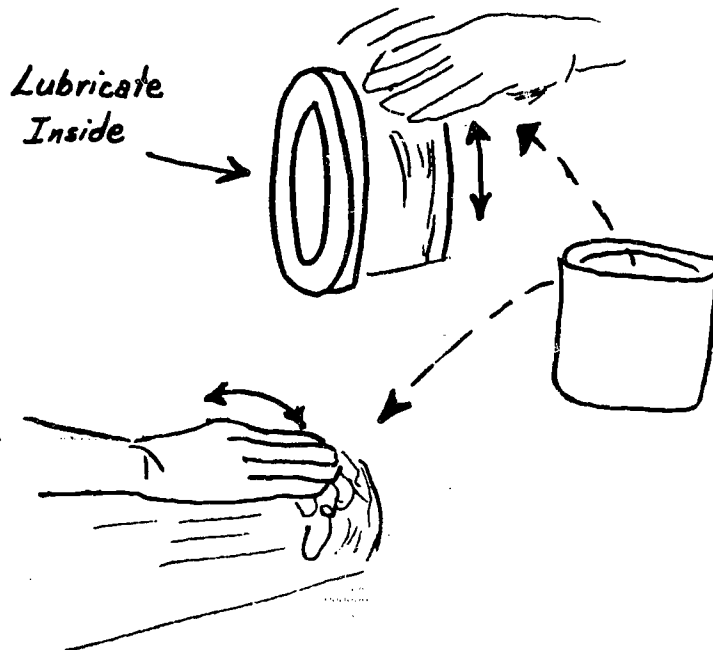

353

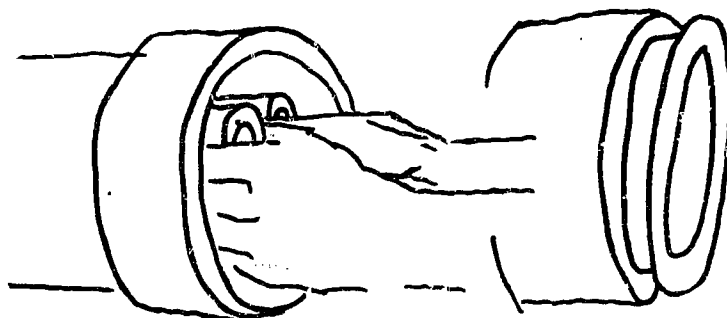
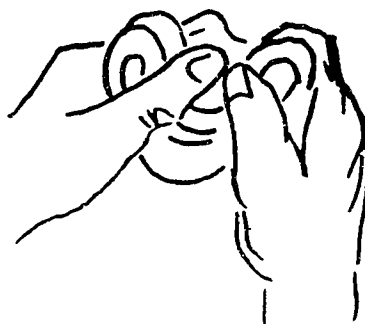
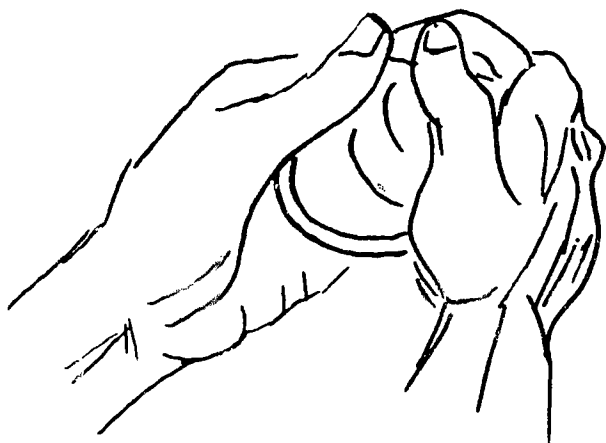

METHOD OF EVALUATION:

1. Following of proper procedure
2. Appearance of inserted basket

COMPETENCY: Join Soil Pipe Compression Gasket System

COURSE: Plumbing UNIT I: Pipes and Fittings

OBJECTIVE: To properly join a compression gasket soil pipe joint

COMPETENCE - PROCEDURE/STEPS	TEACHING/LEARNING ACTIVITIES
------------------------------	------------------------------

1. Lubricate pipe and gasket.
2. Lock chain wrench around spigot to provide for pulling tool as shown.

NOTE: Soil pipe can also be joined with a pry-bar when using the compression gasket system.

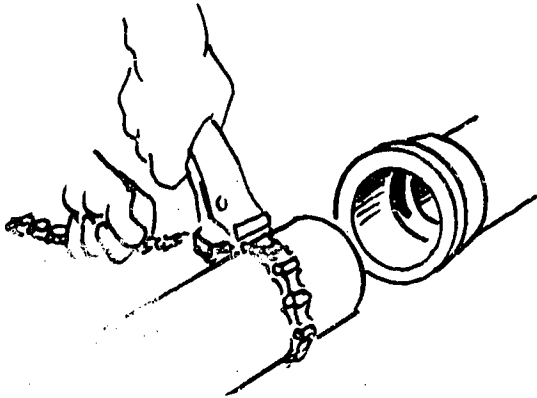

3. Match pipes and place pulling tool with one yoke behind bell, the other behind chain.

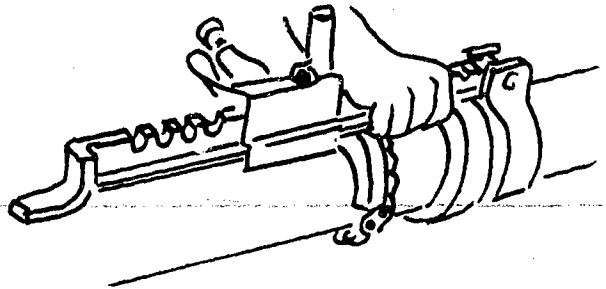

4. Operate pulling tool handle to pull spigot into hub.

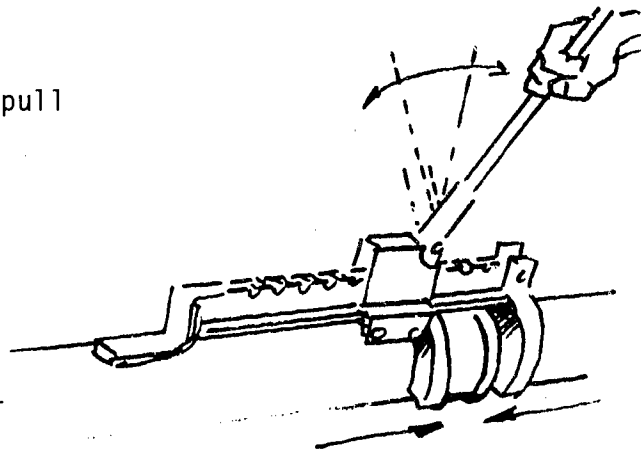

5. Remove tool and chain wrench.

METHOD OF EVALUATION:

1. Proper procedure
2. Tightness of joint
3. Time:

355

COMPETENCY: Join Soil Pipe - No Hub System

COURSE: Plumbing

UNIT I: Pipes and Fittings

OBJECTIVE: To be able to properly join soil pipe using the no-hub system

COMPETENCE - PROCEDURE/STEPS The student will be able to:	TEACHING/LEARNING ACTIVITIES
<ol style="list-style-type: none"> 1. Place gasket on one end at pipe or fittings to be joined. 2. Place stainless steel shield and band clamps on end of other pipe or fitting. 3. Insert pipe or fitting into gasket and butt against integrally-molded cushion. 4. Slide stainless steel shield and band clamps over gasket. 5. Alternately tighten screws with torque wrench. 	

METHOD OF EVALUATION:

1. Proper procedure
2. Appearance of joint
3. Time
4. Care and use of tools

COMPETENCY: Marking Metal with a Prick or Center Punch

COURSE: Plumbing

UNIT I: Pipes and Fittings

OBJECTIVE: To properly mark a metal object allowing for accurate drilling of holes

COMPETENCE - PROCEDURE/STEPS
The student will be able to:

TEACHING/LEARNING ACTIVITIES

1. Hold the punch in one hand and place the point right on the spot to be marked.

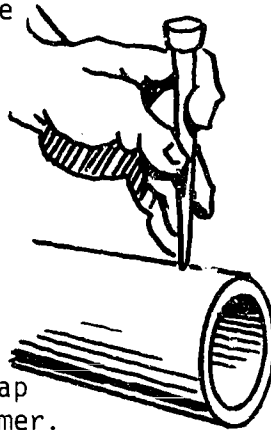

2. Hold the punch straight up and tap the top of it lightly with a hammer.

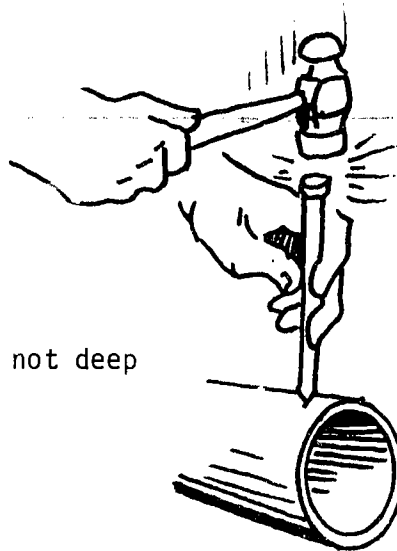

3. Tap it again if the mark is not deep enough.

METHOD OF EVALUATION:

1. Following of proper procedure
2. Depth of mark

357

COMPETENCY: Drilling Holes with Electric Hand Drill

COURSE: ~~Plumbing~~ UNIT I: ~~Pipes and Fittings~~

OBJECTIVE: To learn the safe and proper methods used when drilling with the electric hand drill

COMPETENCE - PROCEDURE/STEPS
The student will be able to:

TEACHING/LEARNING ACTIVITIES

1. Place drill bit on punch mark.
2. Squeeze the trigger and apply firm pressure to drill.
3. Apply oil occasionally.
4. Continue drilling to desired depth.

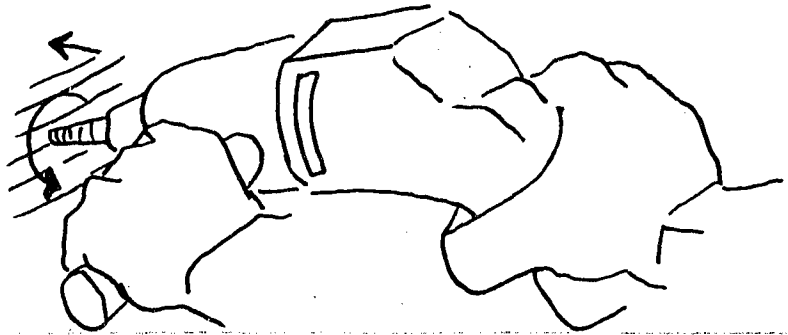

METHOD OF EVALUATION:

1. Following of proper procedures
2. Neat, accurate holes

COMPETENCY: Threading Holes with a Tap

COURSE: Plumbing

UNIT I: Pipes and Fittings

OBJECTIVE: To be able to properly start and tap internal threads

COMPETENCE - PROCEDURE/STEPS
The student will be able to:

TEACHING/LEARNING ACTIVITIES

1. Place the tap in the tap handle.

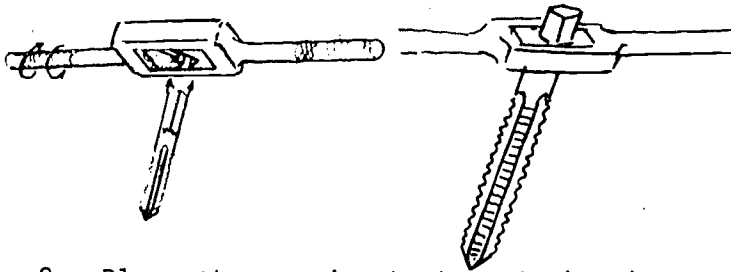

2. Place the tap in the hole to be threaded.
3. Turn the handle clockwise about 2 turns.

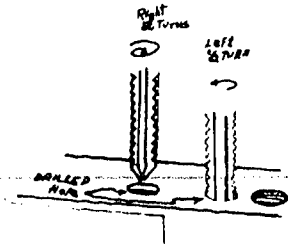

4. Turn handle back when it binds.
5. Continue turning and backing until desired depth is reached

NOTE: Use oil while cutting threads.

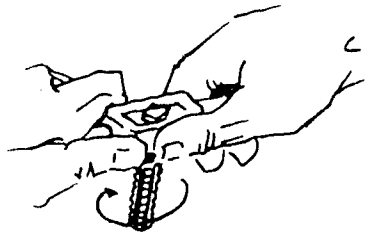

METHOD OF EVALUATION:

1. Proper procedure
2. Appearance of threads
3. Care and use of tools

COMPETENCY: Adjusting and Using Adjustable Wrench

COURSE: Plumbing

UNIT I: Pipes and Fittings

OBJECTIVE: To adjust and use the wrench in an efficient manner

Page 1 of 1 page

COMPETENCE - PROCEDURE/STEPS
The student will be able to:

TEACHING/LEARNING ACTIVITIES

1. Hold adjustable wrench in your hand with thumb on the knurled worm gear.

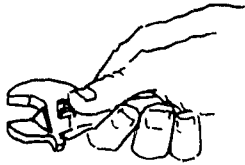

2. Roll the gear with your thumb to open or close the jaw of the wrench.

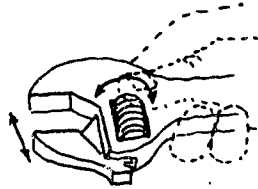

3. Open wrench jaw large enough to fit over the bolt, nut or stud. Close jaw on bolt head until it is tight.

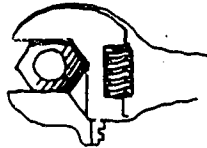

4. Turn nut or bolt to tighten or loosen.

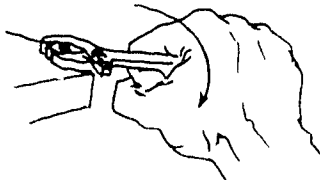

METHOD OF EVALUATION:

1. Proper technique
2. Safe and proper use of wrench

OPERATION SHEET
SC-1B-1

COMPETENCY: Cutting to a Line with a Cross Cut Saw

COURSE: Plumbing

UNIT I: Pipes and Fittings

OBJECTIVE: To properly cut bituminous pipe in a safe and efficient manner

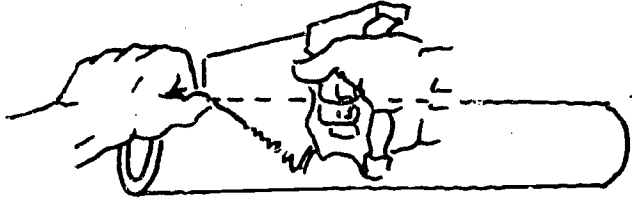
COMPETENCE - PROCEDURE/STEPS The student will be able to:	TEACHING/LEARNING ACTIVITIES
<ol style="list-style-type: none">1. Hold the saw with your thumb and index finger along the handle.2. Hold the pipe with the end of your thumb-nail acting as a guide for the saw. Start the cut by putting the cutting edge of the saw on the waste side of the pipe and right beside the line. Pull the saw toward you to start the cut.	<p>CAUTION: Be sure the work is well supported or clamped.</p> <p>CAUTION: Saw teeth are sharp and will cut fingers as well as pipe. The saw may jump when you start the cut, so begin slowly.</p>
	
<ol style="list-style-type: none">3. Keep the side of the saw square with the face of the pipe and the whole length of the saw in line with your forearm. Take short, light strokes to begin. Then gradually increase the strokes to the full length of the saw.4. When you are sawing, watch the line and not the saw. The line should be left on the pipe when you are done. The saw may be brought back to line by twisting the heel of the saw a little in the direction the kerf needs to move.	



5. Final strokes should be taken slowly and the waste material should be grasped with your left hand to prevent splitting.

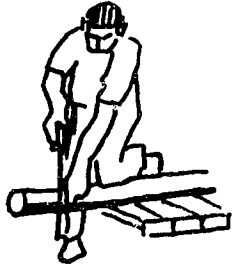

METHOD OF EVALUATION:

1. Proper procedure
2. Appearance of cut
3. Accuracy of cut
4. Time:

302

COMPETENCY: Trimming Pipe with Beveling Tool

COURSE: Plumbing

UNIT I: Pipes and Fittings

OBJECTIVE: To be able to properly taper bituminous pipe ends for proper joining of the pipe and fittings

COMPETENCE - PROCEDURE/STEPS	TEACHING/LEARNING ACTIVITIES
------------------------------	------------------------------

1. Place pipe to be beveled into vise.
2. Insert beveling tool guide into pipe.
3. Turn handle clockwise expanding tool guide until firm.
4. Insert tool cutter over guide.
5. Push cutter into pipe and turn cutter clockwise until standard depth is met.
6. Remove tool cutter from guide.
7. Remove tool guide from pipe.

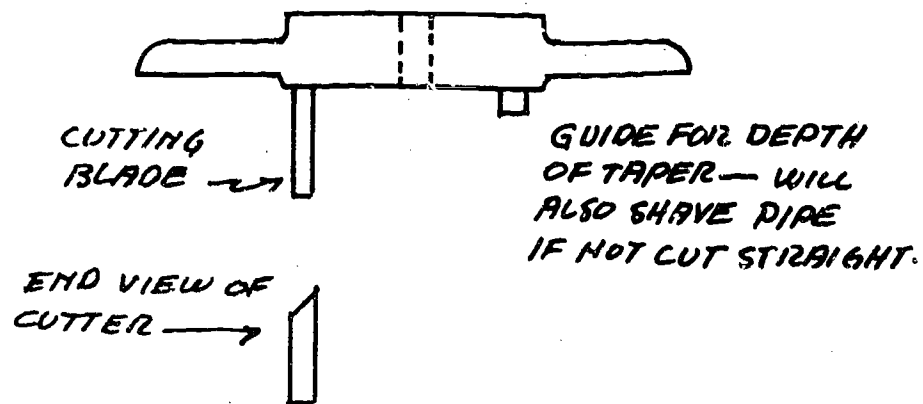
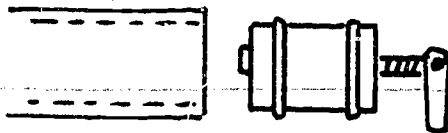

METHOD OF EVALUATION:

1. Proper procedure
2. Appearance of bevel
3. Time:

363

COMPETENCY: Prepare Sewer Trench

COURSE: Plumbing

UNIT I: Pipes and Fittings

OBJECTIVE: To be able to properly prepare and grade sewer trench suitable for laying pipe

COMPETENCE - PROCEDURE/STEPS The student will be able to:	TEACHING/LEARNING ACTIVITIES
--	------------------------------

1. Chip or loosen the soil using a pick or digging iron.
2. Scoop up loose soil with a shovel and remove from trench.
3. Repeat steps 1 and 2 until proper grade is reached.
4. Smooth off trench bottom and dig bell holes.

NOTE: Bell hole measurement varies with length and type of pipe to be laid.

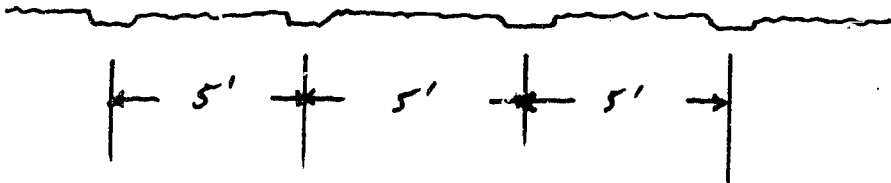

METHOD OF EVALUATION:

1. Proper procedure
2. Accuracy of bell hole placement
3. Accuracy of grade





364

COMPETENCY: Join Bituminized Fiber Pipe

COURSE: Plumbing

UNIT I: Pipes and Fittings

OBJECTIVE: To properly join bituminized fiber pipe for proper installation

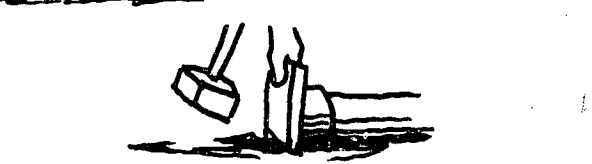
COMPETENCE - PROCEDURE/STEPS The student will be able to:	TEACHING/LEARNING ACTIVITIES
1. Check tapered end of pipe and fitting for foreign matter.	
2. Place clean coupling on tapered end of pipe.	
3. Insert second length of pipe into coupling.	
4. Place coupling on end of second length of pipe.	
5. Hold hardwood block firmly against last coupling and drive couplings together with two or three smart blows of hammer.	
6. Repeat this operation throughout job.	

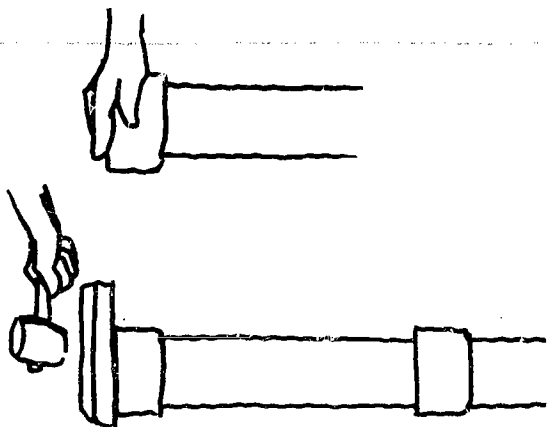

NOTE: Pipe compounds or lubricants are not needed to join two lengths of bituminized fiber pipe; it is recommended that you use them only when joining Bermico to pipes of other materials.

METHOD OF EVALUATION:

1. Following of procedures
2. Care and use of tools
3. Appearance of finished joint

OPERATION SHEET
SC-1B-5

COMPETENCY: Pour Bituminous Compound

COURSE: Plumbing

UNIT I: Pipes and Fittings

OBJECTIVE: To be able to properly pour hot-molten bituminized compound
in a safe efficient manner.

COMPETENCE - PROCEDURE/STEPS The student will be able to:	TEACHING/LEARNING ACTIVITIES
1. Check for protruding strands of oakum.	
2. Wrap joint runner around pipe at joint.	
3. Clamp joint runner against bell.	NOTE: Keep the "gate" or opening slightly off center so the compound will flow around pipe in one direction.
4. Heat and melt bituminous compound.	
5. Preheat lead ladle.	
6. Stand as far away as possible and pour the joint with the compound.	NOTE: Bituminous compound should be as fluid as possible.
7. Remove the joint runner when compound has cooled.	

METHOD OF EVALUATION:

1. Proper procedure
2. Joint appearance

366

COMPETENCY: Backfill Trench

COURSE: Plumbing

UNIT I: Pipes and Fittings

OBJECTIVE: To properly backfill a trench without disturbing or injuring previously laid pipe

COMPETENCE - PROCEDURE/STEPS The student will be able to:	TEACHING/LEARNING ACTIVITIES
--	------------------------------

1. Visually check trench, pipe, and material to be backfilled.
2. Backfill trench around pipe using clean dirt, gravel, or crushed stone.
3. Tramp backfill material into place so that there are no voids around the pipe.
4. Backfill approximately 6" to 12" above pipe using same material as in step #2.
5. Tramp backfill material into place.
6. Final layers of backfill is usually completed with existing material.

NOTE: The first layer of material shall extend to a level not more than slightly above the horizontal diameter of the pipe.

NOTE: Place material under the haunches of the pipe and tramp firmly.

NOTE: The second layer shall be carried to a level when compacted to from six to twelve inches above the top of the pipe.

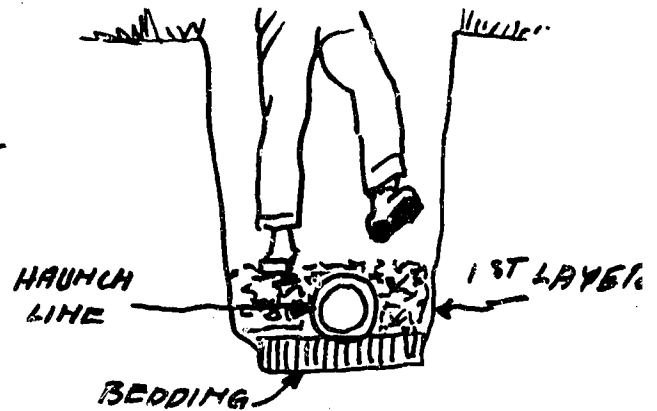
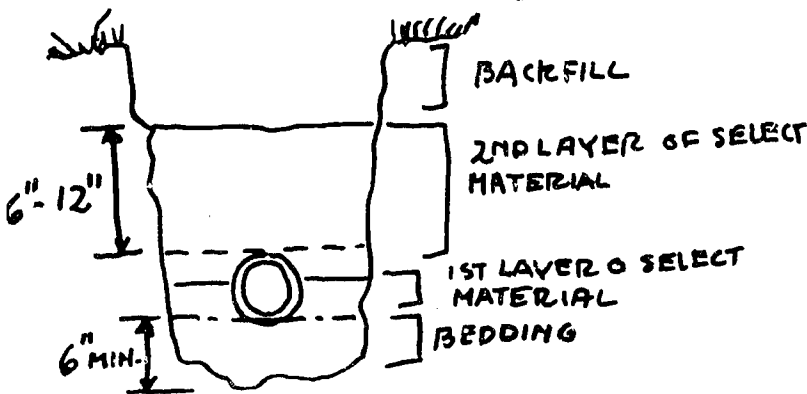

METHOD OF EVALUATION:

1. Following of procedures
2. Time:

COMPETENCY: Cut Terra-Cotta with Hammer and Chisel

COURSE: Plumbing

UNIT 1: Pipes and Fittings

OBJECTIVE: To accurately cut terra-cotta pipe with hand tools

COMPETENCE - PROCEDURE/STEPS	TEACHING/LEARNING ACTIVITIES
------------------------------	------------------------------

1. Lay terra-cotta on soft ground. Check to make sure your chisel is not "mushroomed" and is sharp.
2. The chisel should be held at right angles to the pipe surface.
3. Cut a groove around the pipe, by chipping through glaze with hammer and chisel.
4. Continue cutting this groove deeper and deeper in continuing movement around the pipe.
5. Complete cut and check pipe.

NOTE: Terra-cotta can also be cut with a soil pipe cutter.

METHOD OF EVALUATION:

1. Following of procedures
2. Care and proper use of tools

OPERATION SHEET
SC-1C-2

COMPETENCY: Preparing Cement Mixture

COURSE: Plumbing

UNIT I: Pipes and Fittings

OBJECTIVE: To be able to properly mix sand and cement suitable for terra-cotta pipe joints

COMPETENCE - PROCEDURE/STEPS The student will be able to:	TEACHING/LEARNING ACTIVITIES
--	------------------------------

1. Determine the amount of cement needed.
2. Pour cement (1/2 of amount of mixture desired) into bucket or wheelbarrow.
3. Pour sand (1/2 of amount of mixture desired) into bucket or wheelbarrow.
4. Using a hoe or large trowel dry mix cement and sand.
5. Add estimated amount of water needed to mixture.
6. Mix sand, cement and water until proper mixture is formed.

METHOD OF EVALUATION:

1. Proper procedure
2. Consistency of mixture

COMPETENCY: Join Terra-Cotta Pipe (Cement Joint)

COURSE: Plumbing

UNIT I: Pipes and Fittings

OBJECTIVE: To be able to join Terra-Cotta pipe for drain lines

COMPETENCE - PROCEDURE/STEPS The student will be able to:	TEACHING/LEARNING ACTIVITIES
--	------------------------------

1. Align and pack joint with oakum.
2. Using prepared cement mixture, pack cement into void of joint.
3. After cement is packed into joint, put more cement on joint with a pointing trowel and "bank" the cement.
4. Wipe off any excess cement from pipe.

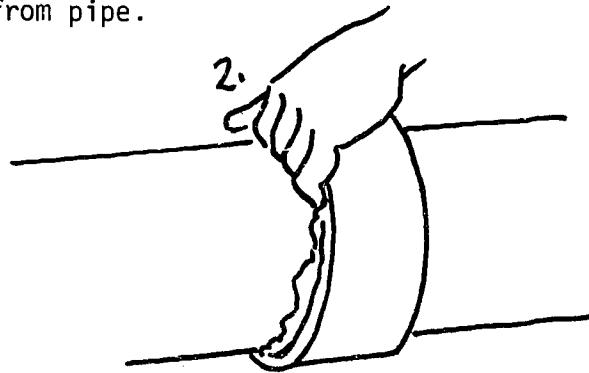
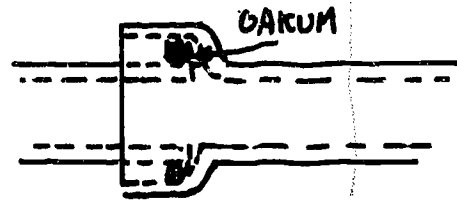

METHOD OF EVALUATION:

1. Proper procedure
2. Joint appearance
3. Time:

370

COMPETENCY: Cut Glass Pipe

COURSE: Plumbing

UNIT I: Pipes and Fittings

OBJECTIVE: To properly cut glass pipe to odd lengths

COMPETENCE - PROCEDURE/STEPS The student will be able to:	TEACHING/LEARNING ACTIVITIES
--	------------------------------

1. Mark pipe with a grease pencil at the required length.
2. Place a drop of scoring catalyst on the cutter wheel.
3. Place the pipe in the scorer and push the ratchet shaft in until the cutter wheel touches the grease pencil mark. Continue to push in until the black V-block will draw away from the pipe.

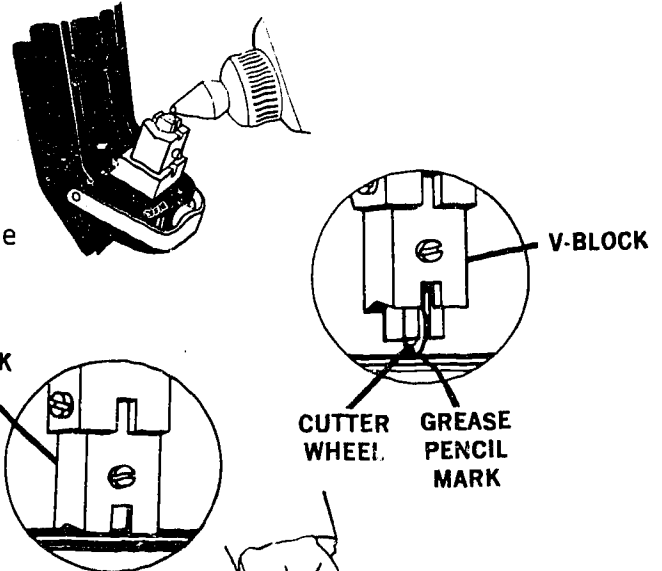

4. Turn the knurled knob clockwise, advancing the V-block until it seats against the pipe. Then turn a quarter turn more.
5. Revolve the pipe scorer around the pipe once. Check to make sure that the score goes completely around the pipe.
6. Draw the black V-block away from the pipe by turning the knurled knob counter-clockwise until it stops. Hold the pipe and scorer with one hand, and with the other hand depress the quick release and pull the ratchet shaft back from the pipe.

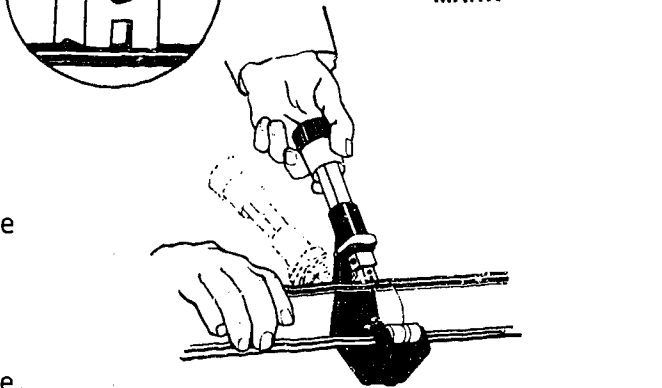

7. Select the proper size heater head and add extenders, if necessary, for length. Then attach the heater cord.

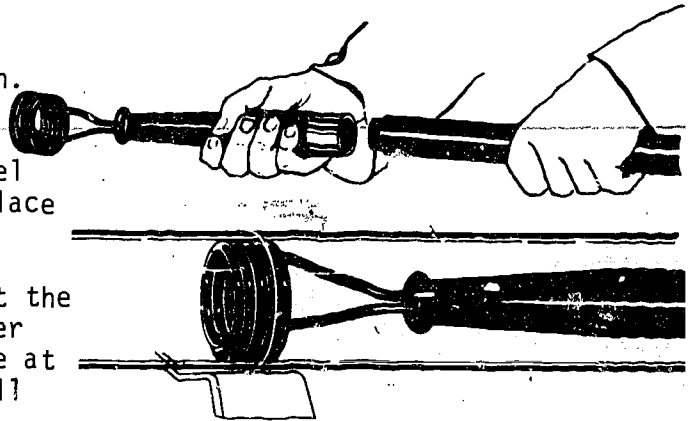

8. Lay the pipe on a flat surface so barrel of pipe is continually supported, or place the pipe in the V-supports with one V-support under the score. Turn on the heater and insert into the pipe so that the heater head is beneath the score. After several seconds, the pipe will separate at the score. If it does not separate pull the lengths apart, without bending.

METHOD OF EVALUATION:

1. Following of procedures
2. Care and use of cutter
3. Time:

372

-496-

COMPETENCY: Assemble Speed - Bead End

COURSE: Plumbing

UNIT I: Pipes and Fittings

OBJECTIVE: To properly assemble a speed - bead for joining installation

COMPETENCE -- PROCEDURE/STEPS	TEACHING/LEARNING ACTIVITIES
-------------------------------	------------------------------

1. When you are ready to assemble, snap the disc from the Speed - Bead end.
2. Lay the Speed - Bead end on a flat surface, with the TFE bead down and insert the pipe completely into the Speed - Bead end. Make sure the pipe end is snug against the inside of the TFE bead.
3. Using pliers, first squeeze one ear on the stainless-steel band, then the other ear, to contract the band tightly around the pipe.
4. Place the pipe on V-supports.
5. To bond the Speed - Bead end on the pipe, turn on the heater and insert in the pipe so the heater head is roughly centered under the stainless steel band. Let the heater remain in the pipe for about 60 to 80 seconds.
6. Remove the heater head from the pipe.
7. Check to see that the Speed - Bead end is properly bonded to the pipe by looking for a slight brownish discoloration of the white bonding sleeve beneath the stainless steel band. If discoloration appears, the bond is a good one. If no discoloration appears, replace the heater head in the pipe and heat for a few more seconds, then check for a slight brownish discoloration.

NOTE: The pipe end must be cool to the touch before inserting into the Speed - Bead end.

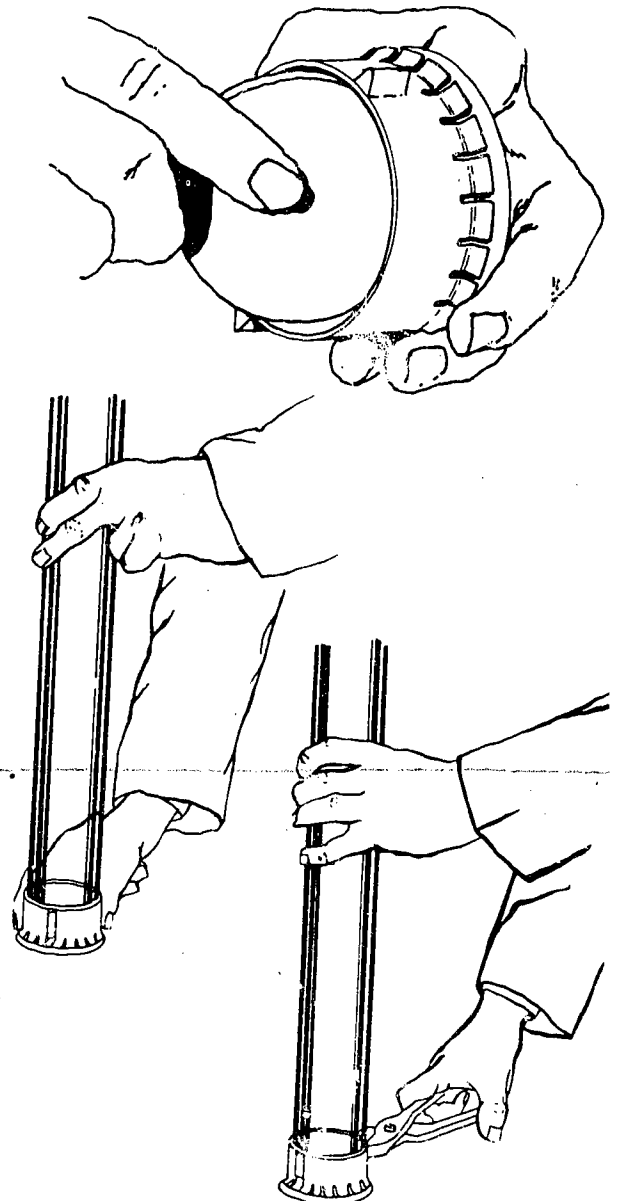

8. Allow the pipe to cool for 2 or 3 minutes before stabbing into the coupling.

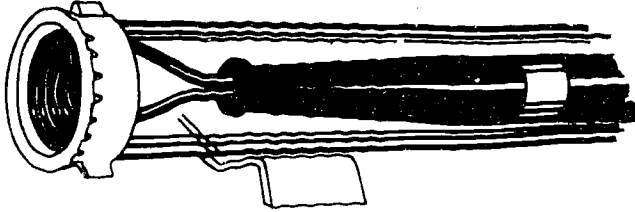

METHOD OF EVALUATION:

1. Following of procedures
2. Care and proper use of equipment

374

COMPETENCY: Join Beaded Ends with Coupling

COURSE: Plumbing

UNIT I: Pipes and Fittings

OBJECTIVE: To properly join glass pipe for installation

COMPETENCE - PROCEDURE/STEPS
The student will be able to:

TEACHING/LEARNING ACTIVITIES

1. Insert a beaded pipe end into the coupling. This is easily done by resting the coupling on a flat work surface or by holding it in the palm of your hand.
2. Insert a second beaded pipe end into the opposite side of the coupling.
3. Use 12-inch pump pliers to squeeze the coupling tight around the joint. You may water test the system immediately after installation.
4. To open a coupling, use a screwdriver to pry the upper portion of the locking mechanism up and away from the lower portion. The coupling can be re-used.

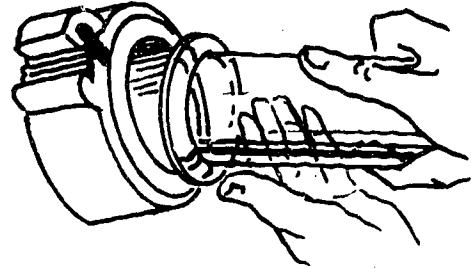

NOTE: The key to successful installation is firm pressure on the pliers to engage as many interlocking teeth as possible without applying excessive strain on the tool or installer. Because of normal manufacturing tolerances in couplings and pipe, some variations in the number of teeth closed may be expected from joint to joint. So long as firm pressure is applied in closing the coupling, leak free performance is assured.

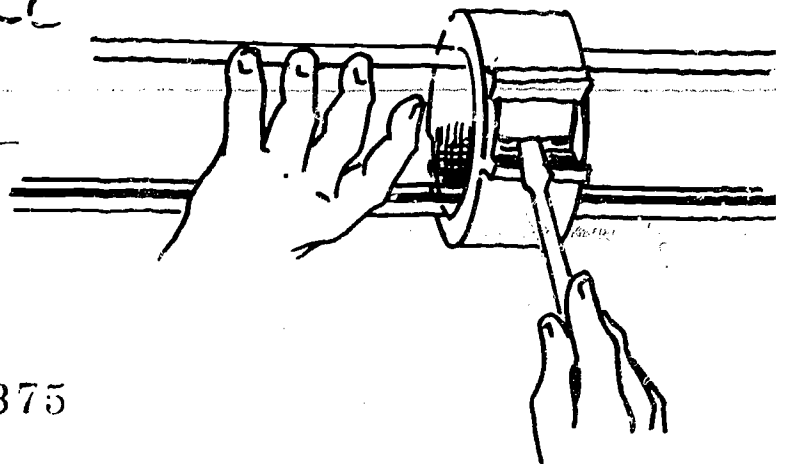
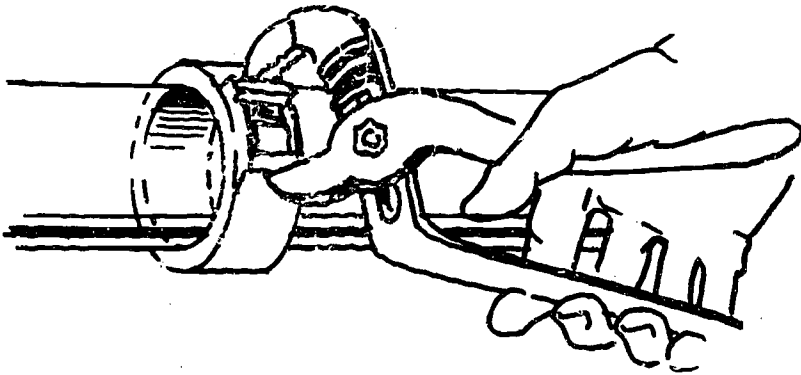

METHOD OF EVALUATION:

1. Following of procedures.
2. Care and use of tools.
3. Time:

375

COMPETENCY: Marking along a Straight Edge

COURSE: Plumbing

UNIT I: Pipes and Fittings

OBJECTIVE: To properly mark a straight line on a flat object using a straight edge

COMPETENCE - PROCEDURE/STEPS	TEACHING/LEARNING ACTIVITIES
------------------------------	------------------------------

The student will be able to:

1. Hold straight edge in desired position with thumb and fingers.

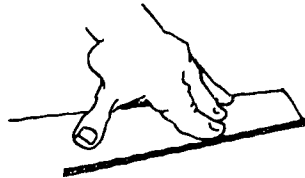

2. Place pencil at edge of straight edge.

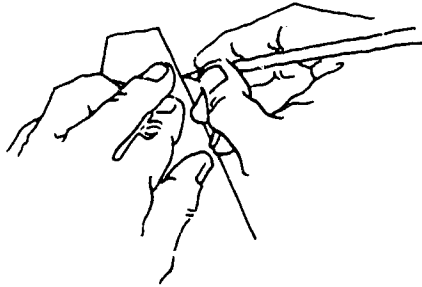

3. Pull pencil toward yourself while firmly holding down straight edge.

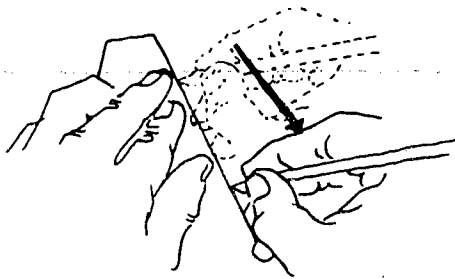

METHOD OF EVALUATION:

1. Proper procedure
2. Line straightness

376

COMPETENCY: Making a Straight Cut With Straight, Combination or Bulldog Snips

COURSE: Plumbing

UNIT I: Pipes and Fittings

OBJECTIVE: To be able to properly cut out a flat sheet on line and straight

COMPETENCE - PROCEDURE/STEPS

The student will be able to:

TEACHING/LEARNING ACTIVITIES

1. Grasp the snips with one hand and the shorter side of the sheet lead in the other.



2. Open the blades wide and start the cut at the edge of the sheet.



3. Hold the blades of the snips at a right angle to the sheet and cut. Keep from getting jagged edges by closing the blades just short of the full length.

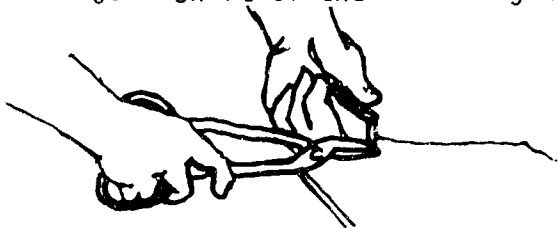

4. Start the next cut at the end of the one before.

5. Finish the cut. Keep the snips on the line by changing the angle of the cut if necessary.

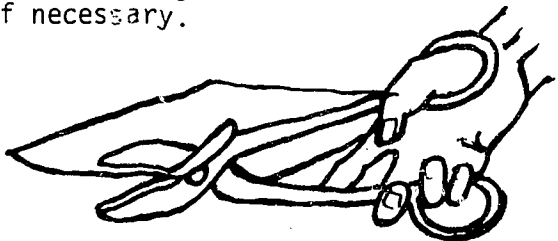

METHOD OF EVALUATION:

1. Proper procedure
2. Smoothness of edge on cut
3. Straightness of cut

COMPETENCY: Light and Adjust Soldering Furnace

COURSE: Plumbing

UNIT I: Pipes and Fittings

OBJECTIVE: To be able to light and adjust the soldering furnace in a safe and efficient manner.

COMPETENCE - PROCEDURE/STEPS	TEACHING/LEARNING ACTIVITIES
------------------------------	------------------------------

The student will be able to:

1. Check to make sure main gas valve and furnace gas valves were turned off previously.
2. Light propane torch.
3. Open main gas valve.
4. Slightly open furnace gas valve.
5. Standing to the side of furnace, light furnace burner using lit propane torch.
6. Adjust furnace gas valve to desired setting.
7. Open other furnace valve if needed, lighting other burner.

. SC-1A-4

NOTE: In some situations main gas valve might not be at an accessible location.

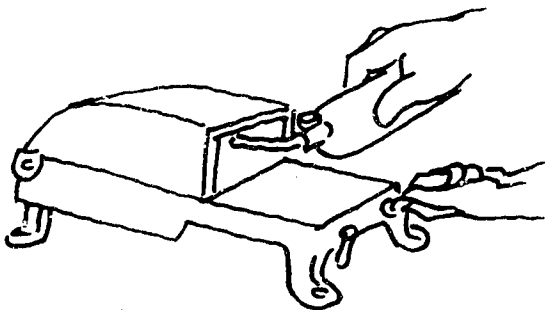
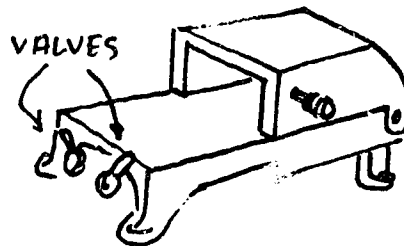

METHOD OF EVALUATION:

1. Proper procedure
2. Flame adjustment
3. Safe practices

COMPETENCY: Shaping and Smoothing Surfaces with a File

COURSE: Plumbing

UNIT I: Pipes and Fittings

OBJECTIVE: To properly use the file while shaping or smoothing surfaces

COMPETENCE - PROCEDURE/STEPS	TEACHING/LEARNING ACTIVITIES
------------------------------	------------------------------

The student will be able to:

1. Hold the handle of the file in one hand with your index finger stretched out on top the file. Hold the point of the file with the thumb and first two fingers of your other hand.

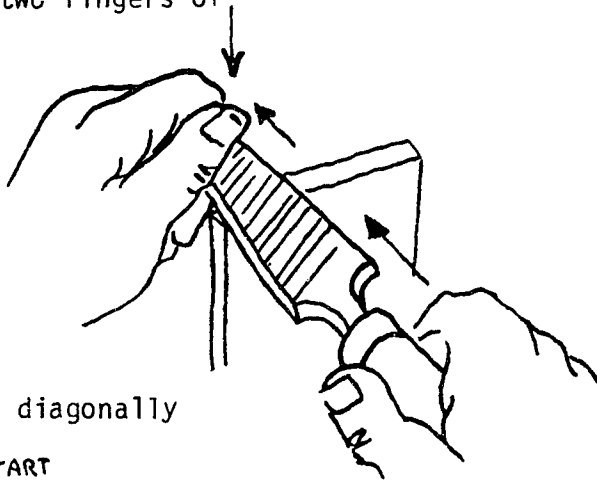

2. File with forward strokes diagonally across the work.

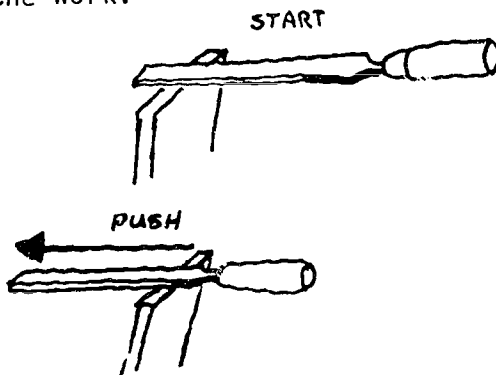

3. Lift the file and move it back to make the next stroke. Don't drag the file back across the work.

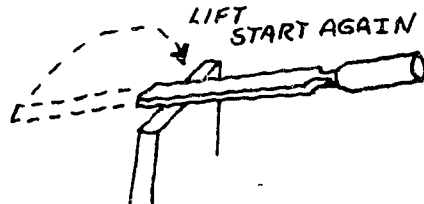

METHOD OF EVALUATION:

1. Proper procedure

379

COMPETENCY: Using Sal Ammoniac Bricks

COURSE: Plumbing

Unit I: Pipes and Fittings

OBJECTIVE: to be able to properly use the Sal Ammoniac Brick for soldering and tinning the iron.

COMPETENCE - PROCEDURE/STEPS The student will be able to:	TEACHING/LEARNING ACTIVITIES
--	------------------------------

1. Heat the soldering iron

NOTE: Place the entire iron in the furnace.

2. Make a depression in the sal ammoniac brick by forcing the hot iron into it.

NOTE: Fumes from sal ammoniac brick are toxic.

3. Heat the bar solder and drop a few drops of solder into the depression from step 2.

4. Place the soldering iron in the depression and rub the iron in the solder on the brick.

NOTE: A slight pulling felt on the iron as it is rubbed over the brick, indicates correct heat of the iron.

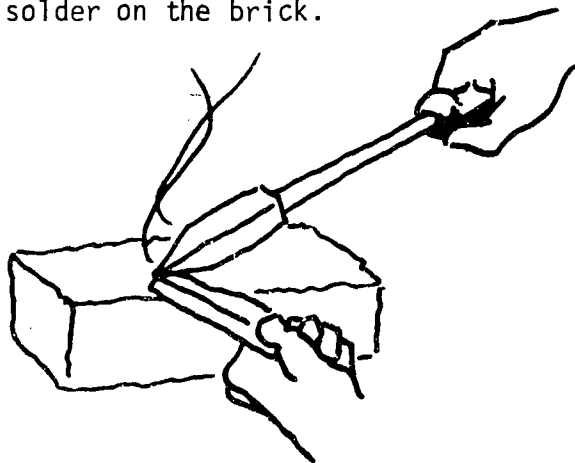

METHOD OF EVALUATION:

1. Proper procedure
2. Appearance of tinned iron
3. Appearance of Sal-Ammoniac Brick

COMPETENCY: Bevel Edge of Seam and Tallow

COURSE: Plumbing

UNIT I: Pipes and Fittings

OBJECTIVE: To be able to properly bevel sheet lead and apply tallow for protection of seam.

COMPETENCE - PROCEDURE/STEPS The student will be able to:	TEACHING/LEARNING ACTIVITIES
--	------------------------------

1. Lay sheet lead on work bench with approximately 1/2" protruding from bench.
2. Hold share hook in left or right hand and pull toward body while applying pressure shaving lead.
3. Continue step 2 until an angle of 45° or more is reached.
4. After shaving, immediately apply tallow by rubbing tallow over all shaved parts.

NOTE: Wrap a piece of cloth around the index finger of the hand holding shave and use this finger as a guide when drawing share hook along the edge.

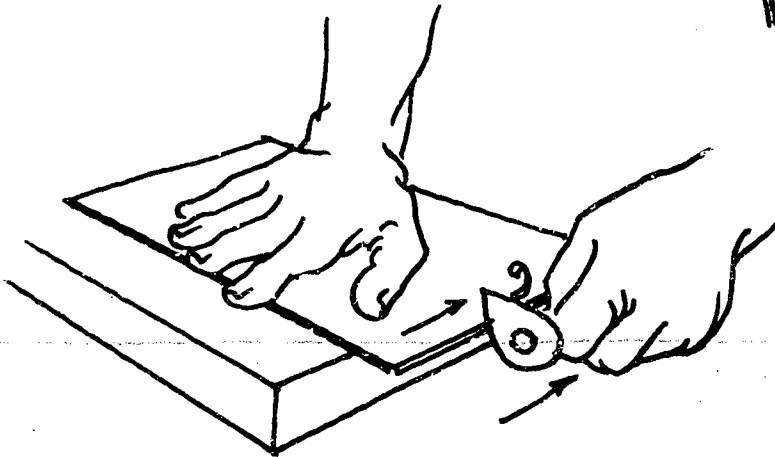
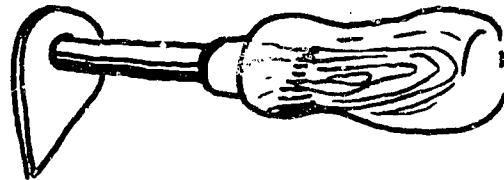

METHOD OF EVALUATION:

1. Proper procedure
2. Appearance of bevel

COMPETENCY: Sprinkle with Rosin and Tack
Solder Seam
COURSE: Plumbing

UNIT I: Pipes and Fittings

OBJECTIVE: To be able to properly prepare and solder flat beveled butt seam.

COMPETENCE - PROCEDURE/STEPS The student will be able to:	TEACHING/LEARNING ACTIVITIES
--	------------------------------

1. Lay sheet lead to be joined flat on soldering bench.
2. Butt edges firmly together.
3. Sprinkle powdered rosin along seam to be joined.
4. Tack edges at intervals of 4" to 6" apart.
5. Place the iron against the seam and feed 50 - 50 solder slowly allowing melted solder to fill the groove.
6. Draw the iron along the groove of the seam while applying solder until joint is complete.

NOTE: A drop of solder at each tack is sufficient.

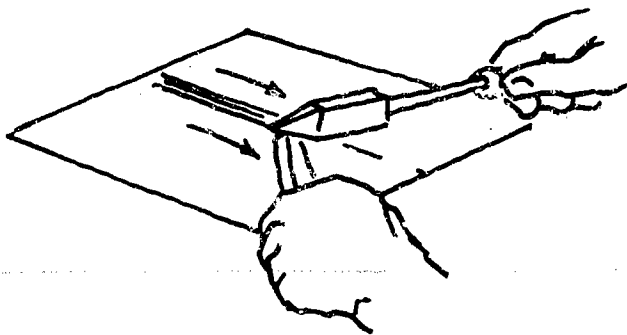

METHOD OF EVALUATION:

1. Proper procedure
2. Joint appearance
3. Safe and proper use of soldering iron

COMPETENCY: Indent and Bend Using Flat Dresser

COURSE: Plumbing

UNIT I: Pipes and Fittings

OBJECTIVE: To be able to properly bend and form sides or "upstands" when making sheet lead pan.

COMPETENCE - PROCEDURE/STEPS The student will be able to:	TEACHING/LEARNING ACTIVITIES
--	------------------------------

1. Lay sheet of lead on a smooth, clean work bench.
2. Hold the flat dresser on edge and top with wooden mallet making a slight indentation in the lead.
3. Continue step 2 until all bend lines are indented.
4. Using a 2 X 4 about the same length as bend, line up the 2 X 4 along indentation.
5. With one hand holding 2 X 4 pull up lead sides or "upstand" to form side.

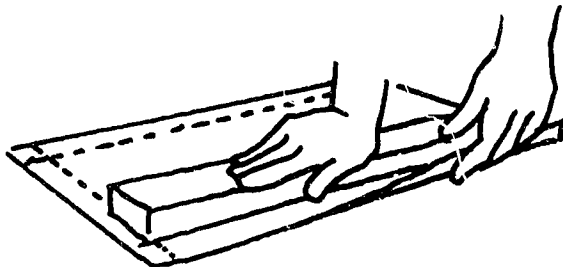
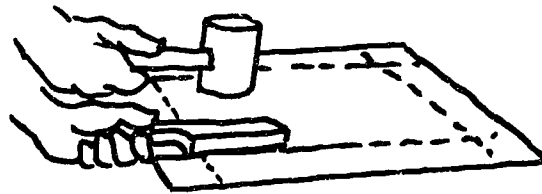

METHOD OF EVALUATION:

1. Proper procedure
2. Tool usage
3. Appearance of bends

COMPETENCY: Laying Out Curves and Arcs with a Divider

COURSE: Plumbing

UNIT I: Pipes and Fittings

OBJECTIVE: To layout and properly mark round openings using the dividers

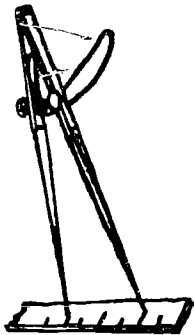
COMPETENCE - PROCEDURE/STEPS The student will be able to:	TEACHING/LEARNING ACTIVITIES
<ol style="list-style-type: none">1. Set the dividers. Hold them in one hand and place the point of one leg on the 1" mark of the rule. Adjust the other leg of the dividers until it rests on the mark equal to the radius you need plus 1".	
	
<ol style="list-style-type: none">2. To mark the arc or circle, hold the dividers or compass between your fingers and thumb.3. Place the point of one leg on the center mark. Press on it hard enough to hold the point in place.4. Swing the other leg clockwise, and push down on it to scribe or mark the arc or circle.	<p>NOTE: Follow the same procedure when using the compass.</p>

METHOD OF EVALUATION:

1. Proper procedure
2. Depth and visibility of scribe

COMPETENCY: Making an Inside Curved Cut with Hand Shears

COURSE: Plumbing

UNIT I: Pipes and Fittings

OBJECTIVE: To be able to properly cut out an inside circle using the hand shears

COMPETENCE - PROCEDURE/STEPS
The student will be able to:

TEACHING/LEARNING ACTIVITIES

1. Insert one blade of the shears in the starting slit.

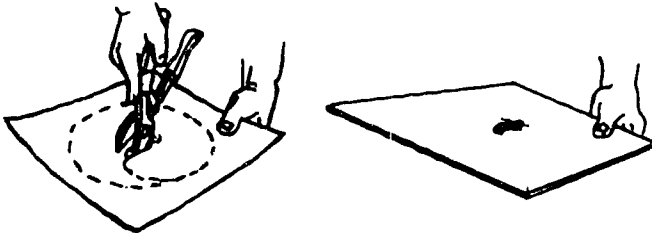

2. Start the cut by squeezing the shears. Relax your hand and they will open automatically.
3. Keep the blades of the shears vertical and cut an arc to the scribed circle.

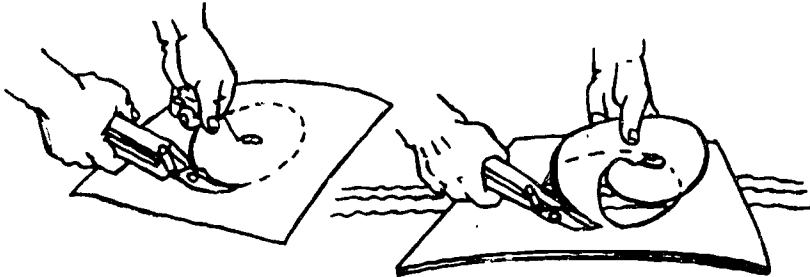

4. Work the shears with one hand and at the same time turn the metal with the other hand. Cut until the circle is complete.

METHOD OF EVALUATION:

1. Proper procedure
2. Appearance of cut

COMPETENCY: Cutting Tubing or Pipe with a Hack Saw

COURSE: Plumbing

UNIT I: Pipes and Fittings

OBJECTIVE: To properly cut pipe or tubing using a hack saw

COMPETENCE - PROCEDURE/STEPS
The student will be able to:

TEACHING/LEARNING ACTIVITIES

1. Place the hack saw along the line you want to cut.

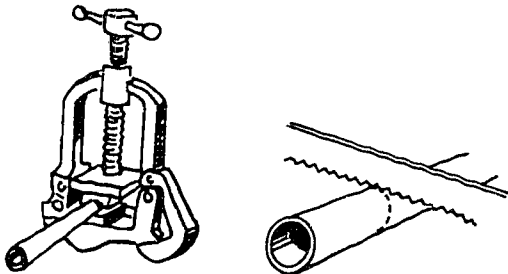

2. Push downward on the saw and pull it back toward you.

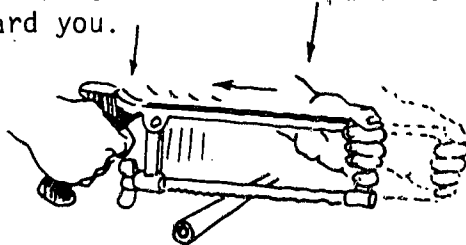

3. Repeat steps 1 and 2 until a groove is cut in the pipe or tubing.

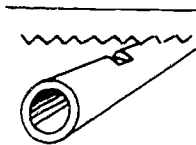

4. Place the blade as shown. Push downward on it and push the saw forward.

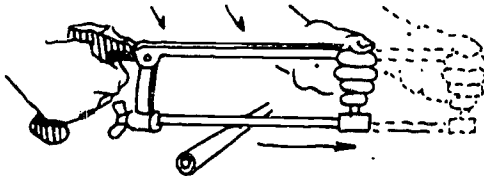

5. Let up on the downward pressure and pull the blade back.

6. Repeat steps 4 and 5 until the pipe or tubing is almost cut through.
7. Hold the material to be cut off with your left hand.

NOTE: Make sure you hold the material straight.

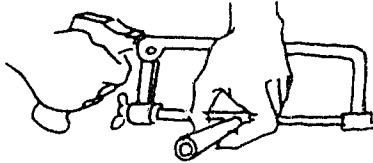

8. Keep making short strokes until the material is cut off completely.

METHOD OF EVALUATION:

1. Proper procedure
2. Appearance of cut

COMPETENCY: Ream Lead Pipe with a Knife

COURSE: Plumbing

UNIT I: Pipes and Fittings

OBJECTIVE: To ream-out lead pipe using a knife

COMPETENCE - PROCEDURE/STEPS
The student will be able to:

TEACHING/LEARNING ACTIVITIES

1. Hold lead pipe in left hand.

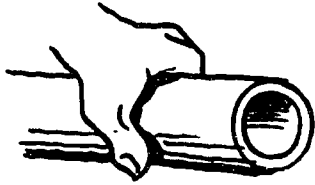

2. Hold knife in right hand as shown.



3. Ream with a squeezing action using thumb and fingers for pressure.

CAUTION: The knife blade is close to your holding hand.

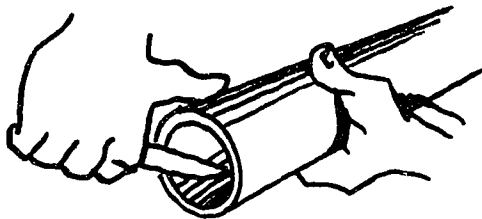

METHOD OF EVALUATION:

1. Proper procedure
2. Appearance of inside of pipe

COMPETENCY: Soil, Flare and Bevel Lead Pipe Ends

COURSE: Plumbing

UNIT I: Pipes and Fittings

OBJECTIVE: To be able to properly soil, flare and bevel pipe ends preparing for soldering or wiping joints.

COMPETENCE - PROCEDURE/STEPS The student will be able to:	TEACHING/LEARNING ACTIVITIES
--	------------------------------

1. Clean surface of pipe about 4" from pipe ends using grit or emery cloth.
2. Dust or wipe off cleaned surfaces.
3. Brush on plumbers soil to the cleaned pipe ends using large acid brush.
4. Ream out pipe ends to be joined with a knife.
5. Flare one end by tapping a turn-pin with a wood mallet into the pipe spreading the end.
6. Bevel other pipe end to be joined with the flat file.
7. Check ends for proper fit.

NOTE: Some plumbers prefer soiling after flaring and fitting the joint.

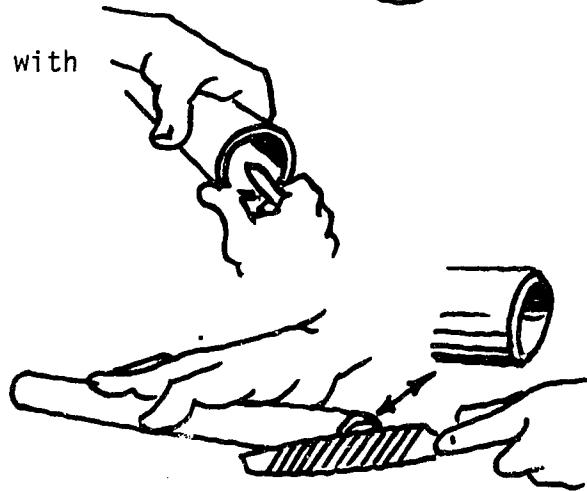
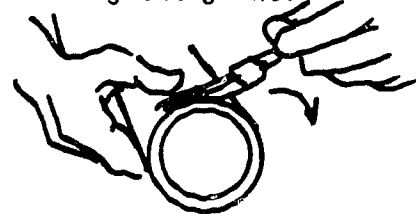

METHOD OF EVALUATION:

1. Proper procedure
2. Appearance of bevel



COMPETENCY: Gaging Lines with a Rule and Pencil

COURSE: Plumbing

UNIT I: Pipes and Fittings

OBJECTIVE: To gage and mark around pipe ends

COMPETENCE - PROCEDURE/STEPS
The student will be able to:

TEACHING/LEARNING ACTIVITIES

1. Hold your thumbnail on the edge of the rule at the graduation you need.



2. Hold the pencil almost straight up in your other hand.

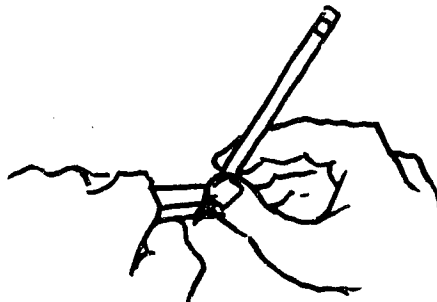

3. Use your thumbnail as a guide and pull the rule and pencil around the pipe marking as you go.

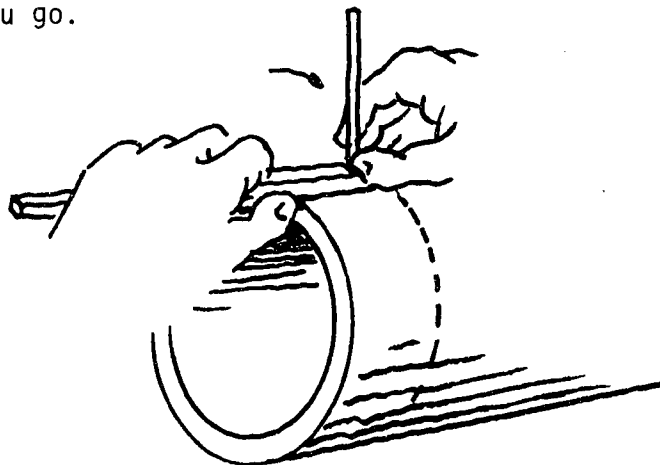

METHOD OF EVALUATION:

1. Proper procedure
2. Accuracy of mark
3. Visibility of mark

390

COMPETENCY: Using the Wiping Cloth

COURSE: Plumbing

UNIT I: Pipes and Fittings

OBJECTIVE: To be able to properly handle and use the plumbers wiping cloth

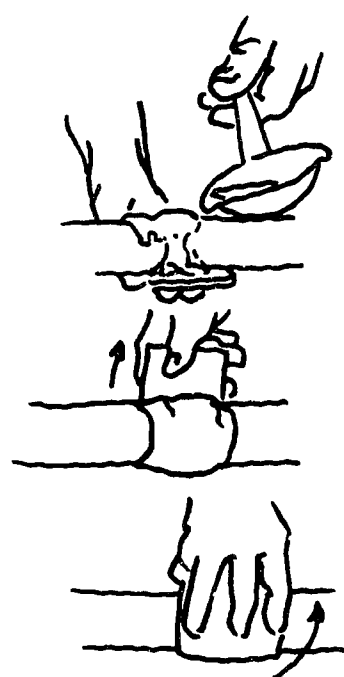
COMPETENCE - PROCEDURE/STEPS The student will be able to:	TEACHING/LEARNING ACTIVITIES
<ol style="list-style-type: none">1. Work tallow into 3 or 4 layers of the wiping cloth on both sides.2. Hold wiping cloth about 1" below pipe and pour solder slowly over cleaned portion of pipe.3. Catch the solder with the wiping cloth after it runs around pipe.4. Press caught solder against the bottom of the pipe building up heat.5. Continue steps 2 thru 4 until pipe is hot enough to hold solder.6. Remove excess solder from soiled portions of pipe with wiping cloth.7. Reach under the joint as far as possible and draw wiping cloth up and around the pipe side.8. Reverse sides and repeat step 7.9. Complete joint by forming in as few strokes as possible.	<p data-bbox="990 541 1380 640">NOTE: The surfaces of wiping cloths become dry when in use.</p> 

METHOD OF EVALUATION:

1. Proper procedure
2. Appearance of joint
3. Safe procedures followed during operation

COMPETENCY: Tinning Brass Fittings

COURSE: Plumbing

UNIT I: Pipes and Fittings

OBJECTIVE: To be able to properly tin brass fitting preparing for
wiped lead joint.

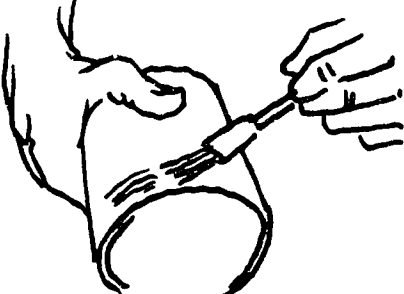
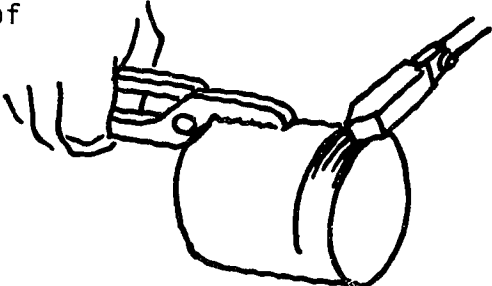
COMPETENCE - PROCEDURE/STEPS The student will be able to:	TEACHING/LEARNING ACTIVITIES
<ol style="list-style-type: none">1. File and clean fitting approximately 1 1/2" from end to be tinned.2. Soil fitting approximately 1 1/4" beyond cleaned portion of fitting.3. Sprinkle powdered rosin on cleaned portion at fitting.4. Using 50-50 solder and a well tinned soldering iron, tin the outside of the fitting.5. Repeat step 4, tinning the inside of the fitting.	 <p data-bbox="992 867 1458 957">NOTE: A thin coating of solder is better than a thick coat.</p> 

METHOD OF EVALUATION:

1. Proper procedure
2. Appearance of tinning
3. Safe and proper use of soldering iron

COMPETENCY: Cut Steel Pipe with a Pipe Cutters

COURSE: Plumbing

UNIT I: Pipes and Fittings

OBJECTIVE: To properly cut steel pipe with a hand cutters

COMPETENCE - PROCEDURE/STEPS	TEACHING/LEARNING ACTIVITIES
------------------------------	------------------------------

The student will be able to:

1. Place black steel pipe in vise.
2. Place cutter on pipe--on mark-- cutter opening up.
3. The pipe to be cut fits between the two rollers and cutting wheel and should be tightened against the pipe for the initial rotating of cutter.
4. The handle on the screw is then tightened $\frac{1}{4}$ turn by turning clockwise and the cutter is rotated counter clockwise around the entire pipe.
5. After each rotation handle is tightened $\frac{1}{4}$ turn clockwise to cut the groove deeper. Cutting oil should be used.
6. The sharp cutting wheel will cut a groove in the outside surface of the pipe, and the groove is made deeper by a continual turning of the handle--until the pipe is cut through.
7. Make sure you have some method of catching the piece that is being cut off.

CAUTION: Do not tighten the handle too tight as it will crack or dull the cutter wheel.

CAUTION: On short cut-offs, watch your upper arm so it is not cut on the pipe while rotating the cutter.

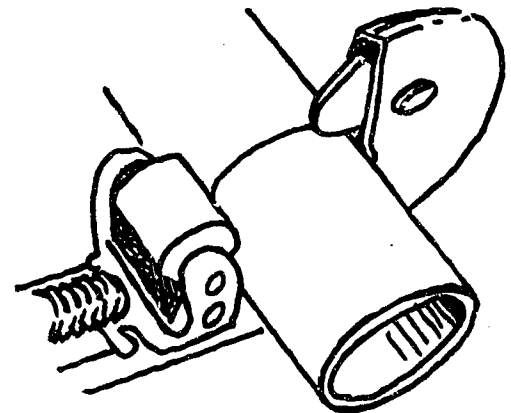

METHOD OF EVALUATION:

1. Accuracy of measurement
2. Proper fitting allowance
3. Correct calculating procedure

COMPETENCY: Reaming Rigid Conduit or Pipe With a Pipe Reamer

COURSE: Plumbing

UNIT I: Pipes and Fittings

OBJECTIVE: To ream a pipe to reduce the friction and resistance that may otherwise cause trouble after the plumbing is in operation

COMPETENCE - PROCEDURE/STEPS	TEACHING/LEARNING ACTIVITIES
------------------------------	------------------------------

The student will be able to:

1. Hold the reamer as shown.
2. Place the reamer in the end of the conduit and push in on it with your left hand.
3. Push down on the handle of the reamer with your right hand.

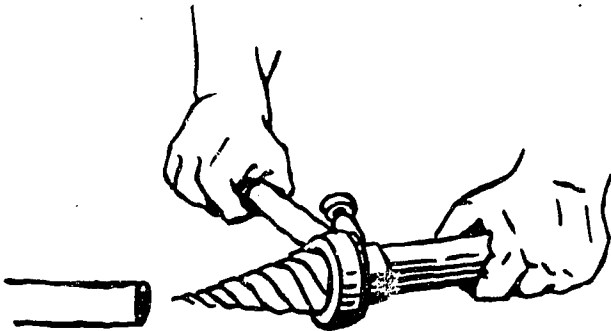

4. Ratchet the handle up and down until the burrs are removed from the conduit.

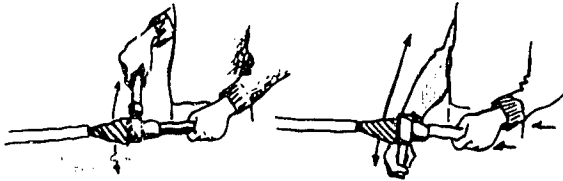

5. Keep rotating the reamer while you remove it so you don't leave a burr caused by the reamer.

METHOD OF EVALUATION:

1. Correct procedure
 2. Smoothness of pipe edge
 3. Depth of ream
- 394

COMPETENCY: Threading Pipe Using Pipe Dies

COURSE: Plumbing

UNIT I: Pipes and Fittings

OBJECTIVE: To thread steel pipe with the use of stocks and dies

COMPETENCE - PROCEDURE	TEACHING/LEARNING ACTIVITIES
------------------------	------------------------------

1. Put the pipe to be threaded in a hinged pipe vise with the end sticking out about 6".
2. Put the right size die into the die holder, and set the die for clockwise cutting.

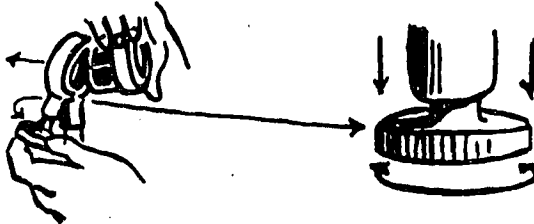

3. Hold the die holder in your right hand and slip guide the end of the die over the end of the pipe.

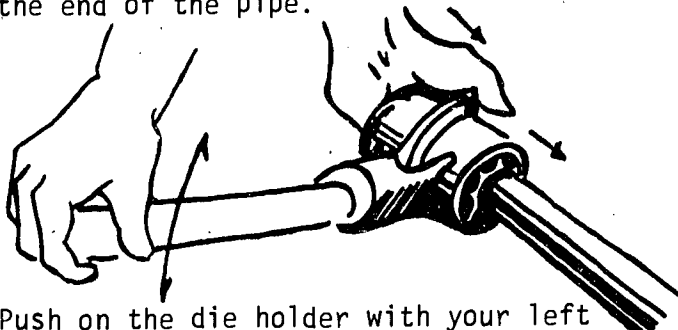

4. Push on the die holder with your left hand, and turn it clockwise until the die starts cutting thread.
5. Apply cutting oil to the threading area on every rotation.

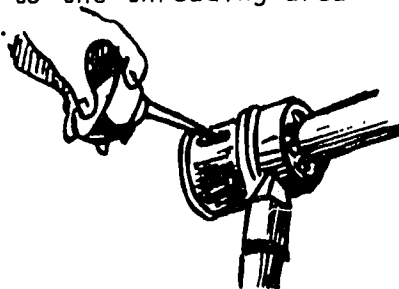

6. Ratchet the die holder in the arc shown.

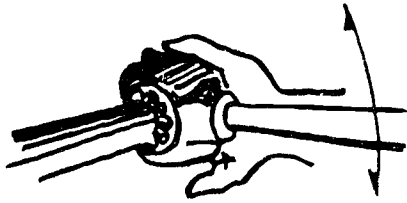

7. Cut threads until one thread comes through the die.
8. Re-set the die rotation with your left hand and back the die off.
9. With the wipe cloth, wipe off the excess cutting oil as shown.

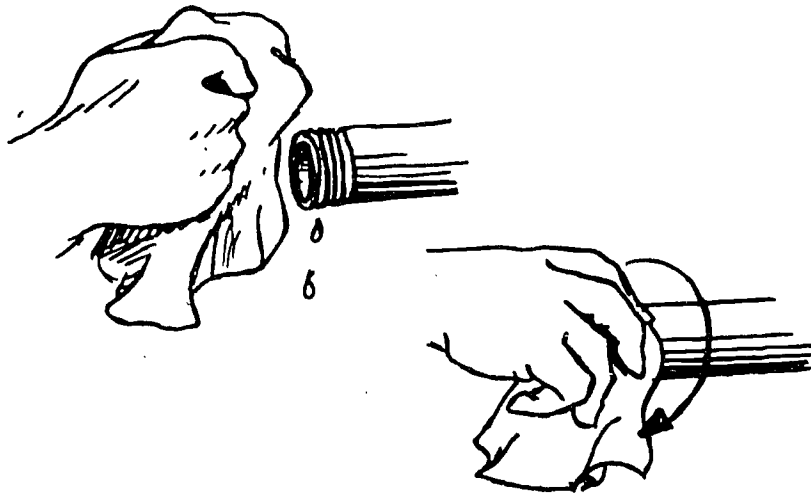

METHOD OF EVALUATION:

1. Accuracy of measurement
2. Proper fitting allowance
3. Correct calculating procedure

COMPETENCY: Make up Fittings

COURSE: Plumbing

UNIT I: Pipes and Fittings

OBJECTIVE: To make up a fitting without using excessive strength therefore stretching and twisting it out of shape

COMPETENCE - PROCEDURE/STEPS The student will be able to:	TEACHING/LEARNING ACTIVITIES
--	------------------------------

1. Place the pipe in the pipe vise.
2. Examine the threads.
3. Apply a small amount of pipe dope on the male thread.
4. Screw the fitting on clockwise by hand until tight.
5. Place a wrench on the bead of the fitting.
6. Turn about one or possibly two more turns, no more.

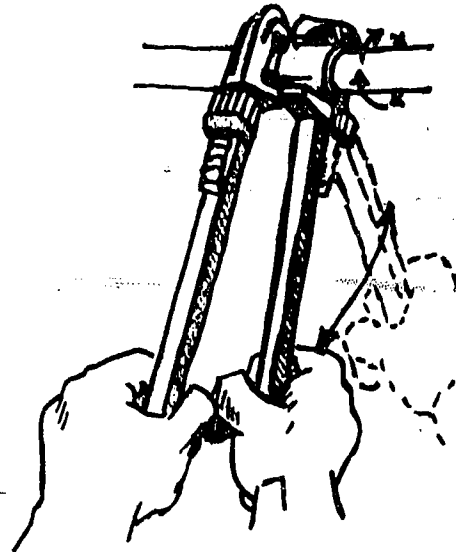
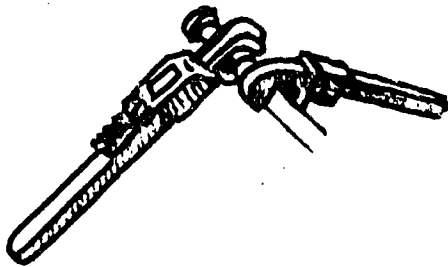
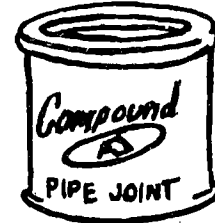
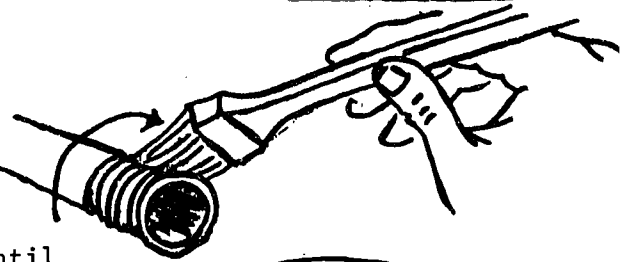

METHOD OF EVALUATION:

1. Following of proper procedures
2. Appearance of finished job
3. Cleanliness of tools and work area

COMPETENCY: Operate a Portable Power Machine

COURSE: Plumbing

UNIT I: Pipes and Fittings

OBJECTIVE: To know how to properly operate a portable power machine

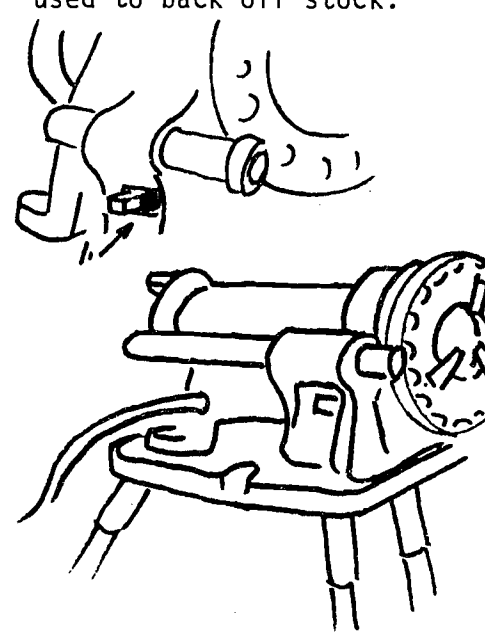
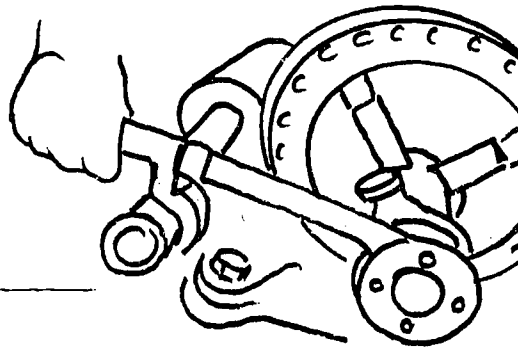
COMPETENCE - PROCEDURE/STEPS The student will be able to:	TEACHING/LEARNING ACTIVITIES
<ol style="list-style-type: none">1. Check to make sure that you know which is forward and reverse.2. Turning outer ring.3. Place steel pipe in chuck and lock.4. Cut pipe to size. (Forward) Hold cutter with bar.5. Ream pipe forward.6. Place stock in position before starting machine forward.7. Use cutting oil while threading.8. Stop machine change stock to remove position. Turn on power machine to reverse and remove stock.9. Wipe excess oil off pipe and check threads.	<p data-bbox="974 546 1429 630">NOTE: Reverse will only be used to back off stock.</p>  

METHOD OF EVALUATION:

1. Following of procedures
2. Proper use of dies
3. Accuracy of length of thread



COMPETENCY: Thread Steel Pipe, Adjustable Receding

COURSE: Plumbing

UNIT I: Pipes and Fittings

OBJECTIVE: To cut 1", 1¼", 1½", and 2" pipe threads using the same stock having 11½ threads per inch

COMPETENCE - PROCEDURE/STEPS The student will be able to:	TEACHING/LEARNING ACTIVITIES
--	------------------------------

1. Place pipe in vise with proper length protruding.
2. Adjust die and guide for proper pipe size by rotating die collar.
3. Center the die on the pipe.
4. Tighten the thumb screw on guide.
5. Apply cutting oil freely when threading.
6. Ratchet the stock to standard mark.
7. Change lever to back off stock.
8. Loosen thumb screw on guide and remove stock.
9. Remove cutting from threaded pipe.
10. Wipe excess oil off and check threads.

. IL-1A-2, IL-1A-3

DO NOT TOUCH THREADS with fingers. Make a visual inspection.

NOTE: Cuttings left in pipe will injure valve seat or washer.

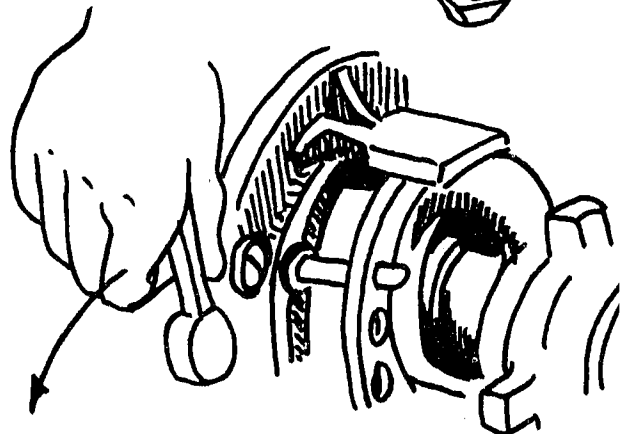
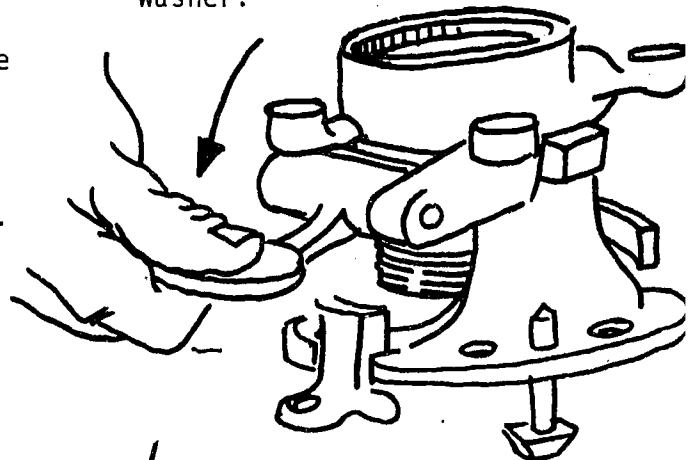
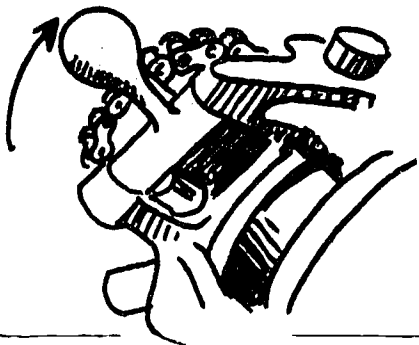

METHOD OF EVALUATION:

1. Following of procedures
2. Proper use of dies
3. Accuracy of length of thread

COMPETENCY: Threading Pipe with Universal Die

COURSE: Plumbing

UNIT I: Pipes and Fittings

OBJECTIVE: To be able to properly set up and cut threads on large pipe
(3" - 4")

COMPETENCE - PROCEDURE/STEPS The student will be able to:	TEACHING/LEARNING ACTIVITIES
<ol style="list-style-type: none"> 1. Place pipe vise and power vise about 6' apart, facing each other. 2. Place pipe in pipe vise. 3. Set universal die to size of pipe being threaded. 4. Place die over pipe, center, and tighten. 5. Place drive end of drive shaft into power vise and place head of drive shaft over drive stud and tighten set screw. 6. Turn on power vise, oil and cut threads on pipe until standard threads are cut. 7. Reverse step 6. 	

METHOD OF EVALUATION:

1. Proper procedure
2. Appearance of thread
3. Care of die

400

OPERATION SHEET
SC-1F-8

COMPETENCY: Cutting Large Pipe with Power Hack Saw

COURSE: Plumbing

UNIT I: Pipes and Fittings

OBJECTIVE: To be able to cut pipe square and even using a power hack or hand saw

COMPETENCE - PROCEDURE/STEPS The student will be able to:	TEACHING/LEARNING ACTIVITIES
1. Place pipe through saw frame clamp and support opposite end if necessary.	
2. Eye-sight mark on pipe with saw blade and tighten clamp.	
3. Lower saw so blade is approximately 1/4" to 1/2" from pipe and check with mark on pipe to be cut.	NOTE: Realign mark to saw blade if necessary and retighten clamp.
4. Start the saw and lower blade slowly to pipe to start cut.	
5. Continue sawing until pipe is cut in two.	NOTE: Be careful of protruding pipe falling after cut.

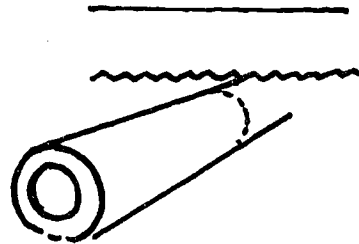
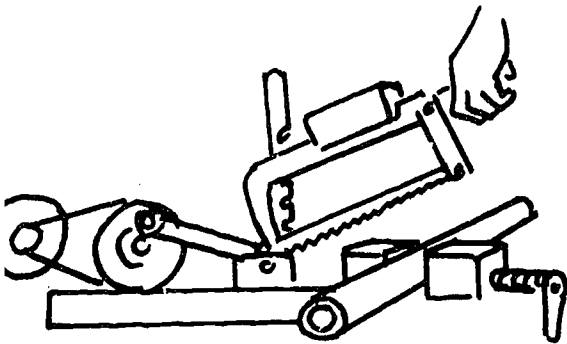

METHOD OF EVALUATION:

1. Proper procedure
2. Appearance of cut

OPERATION SHEET
SC-1F-9

COMPETENCY: Transporting Acetylene and Oxygen Cylinders

COURSE: Plumbing

UNIT I: Pipes and Fittings

OBJECTIVE: To move acetylene and oxygen cylinders safely

COMPETENCE - PROCEDURE/STEPS
The student will be able to:

TEACHING/LEARNING ACTIVITIES

1. Move the cylinder by holding the valve protection cap in your left hand and tilting the cylinder toward the left. Roll the cylinder with your right hand.

NOTE: Tanks should be stored upright.

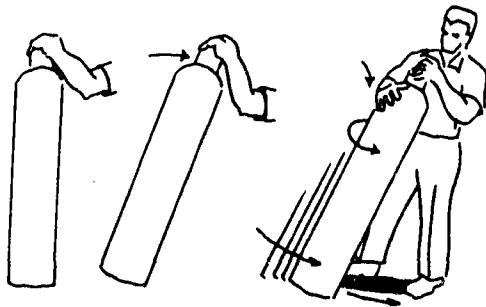

2. Rock the cylinder onto the cart and strap or chain it so that it will not upset.
3. Tilt the cart back and push or pull it where you want it.

NOTE: Move cylinders on an approved cart.

CAUTION: Never move an oxygen cylinder without the valve protection cap in place.

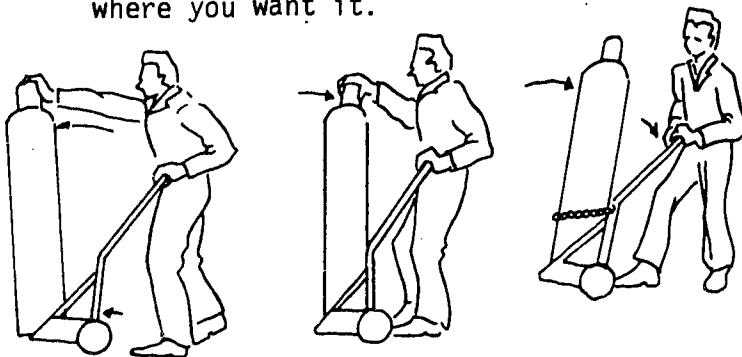

NOTE: Keep the cylinder away from grease, oil, and open flame.

METHOD OF EVALUATION:

1. Proper procedure
2. Safe procedure

COMPETENCY: Setting Up Gas Welding Equipment

COURSE: Plumbing

UNIT I: Pipes and Fittings

OBJECTIVE: To set up an oxy-acetylene torch outfit in a safe and sufficient manner

COMPETENCE - PROCEDURE/STEPS The student will be able to:	TEACHING/LEARNING ACTIVITIES
--	------------------------------

1. Crack open and quickly close the cylinder valves before you connect the regulators.

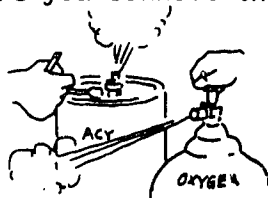

CAUTION: Never open both tanks at the same time.

2. Attach the regulators to the cylinder nozzles.

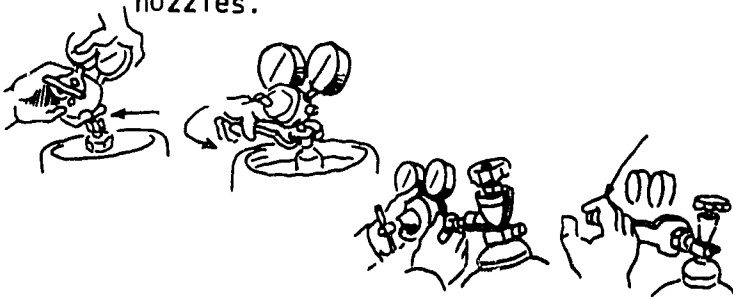

NOTE: The oxygen is right-hand threaded and the acetylene is left-hand threaded.

3. Attach the hoses to the regulators.



4. Attach the hoses to the torch.

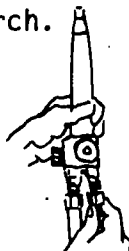

5. Attach the proper tip and mixing head.



6. Back on the regulator screws on ' units and 's turn freely.



NOTE: Be sure both needle valves on the torch are turned off -- clockwise.

NOTE: All oxy-acetylene gages should read no pressure.

7. Open the oxygen cylinder valve all the way.



8. Open the acetylene cylinder $\frac{1}{4}$ to $\frac{1}{2}$ turn counterclockwise.

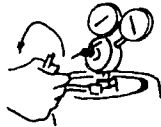

9. Turn the acetylene regulator screw in to adjust the acetylene working pressure.



10. Check the acetylene system with soapy water.



11. Turn the regulator screw on the oxygen in to adjust the working pressure.



12. Check the oxygen system with soapy water.



METHOD OF EVALUATION:

1. Safe and proper procedures
2. Leakage
3. Proper regulator screw adjustment

COMPETENCY: Opening and Closing Oxy-Acetylene Equipment for Welding

COURSE: Plumbing

UNIT I: Pipes and Fittings

OBJECTIVE: To open and close the oxy-acetylene equipment in a safe and sufficient manner

COMPETENCE - PROCEDURE/STEPS
The student will be able to:

TEACHING/LEARNING ACTIVITIES

1. Slowly open the acetylene cylinder $\frac{1}{4}$ to $\frac{1}{2}$ turn.

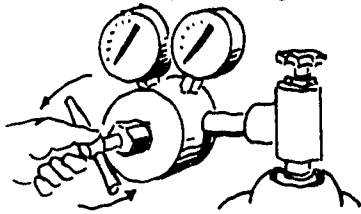

CAUTION: Make sure the regulator adjusting screws are turned out (counter clockwise) until they are free of pressure and that the torch valves are closed.

2. Slowly open the oxygen cylinder valve all the way.

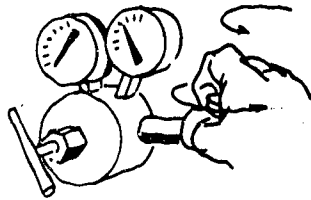

3. Turn the regulator adjusting screws to the proper working pressure on low pressure gages.

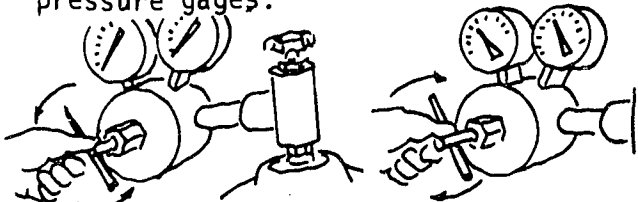

4. Purge the acetylene line by opening the acetylene line and then closing it again quickly.
5. Purge the oxygen line by opening the oxygen line and then closing it again quickly.

6. Close the cylinder valves.

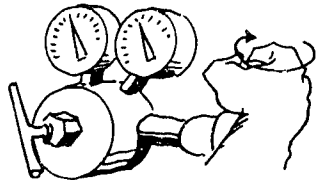

7. Open the torch valves and drain the hose.

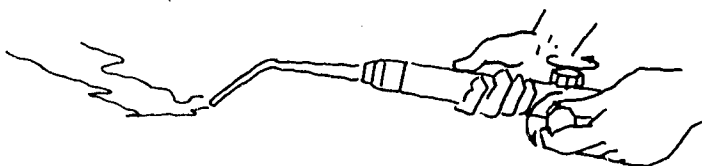

8. Unscrew the regulator pressure keys.

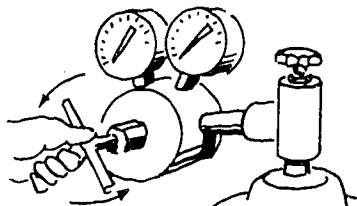

9. Close the torch valve.

METHOD OF EVALUATION:

1. Safe and proper procedure
2. Proper flame adjustment

COMPETENCY: Attaching and Lighting a Cutting Torch

COURSE: Plumbing

UNIT I: Pipes and Fittings

OBJECTIVE: To attach and light the cutting torch in a safe and sufficient manner

COMPETENCE - PROCEDURE/STEPS	TEACHING/LEARNING ACTIVITIES
------------------------------	------------------------------

The student will be able to:

1. Hold the torch in your right hand and the cutting attachment in your left hand.
2. Seat the cutting attachment and line the top up with the acetylene needle valve.

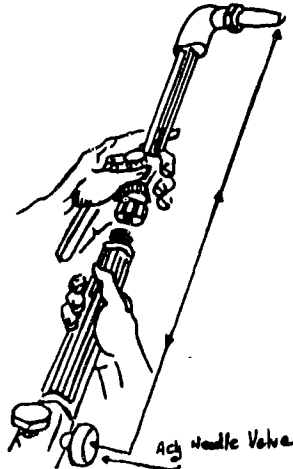

3. Tighten the cutting attachment nut to the torch body hand tight.

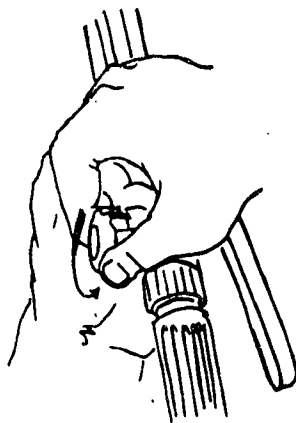

4. Turn the oxygen needle valve on the torch handle completely open.

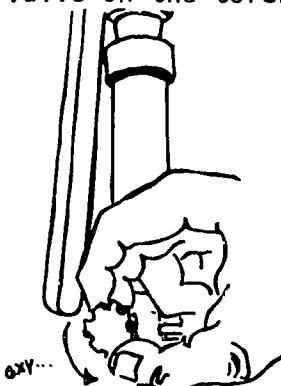

5. Open the acetylene needle valve on the torch handle one turn and light the torch.

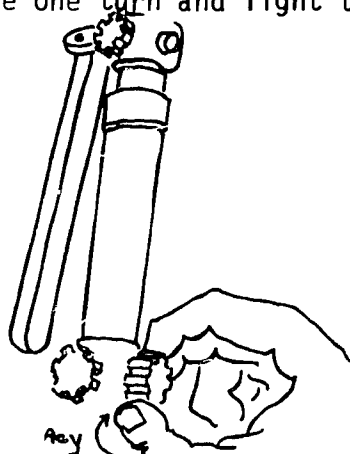

6. Adjust the acetylene to between smoke and blow off.
7. Open the needle valve on the cutting attachment and adjust to neutral flame.

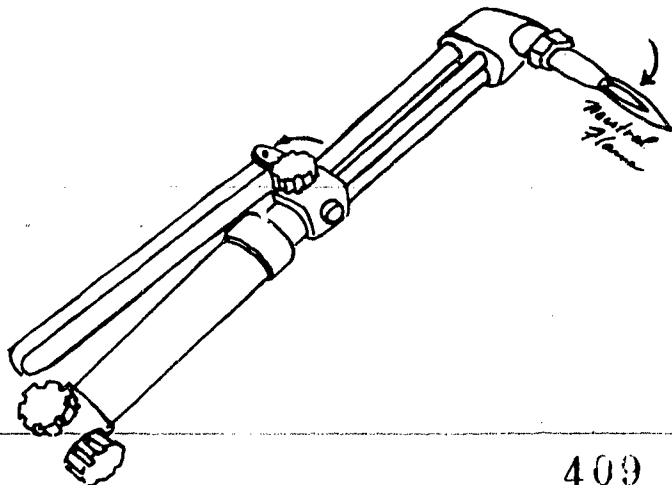

8. Press the cutting lever fully and re-adjust the flame to neutral if necessary.

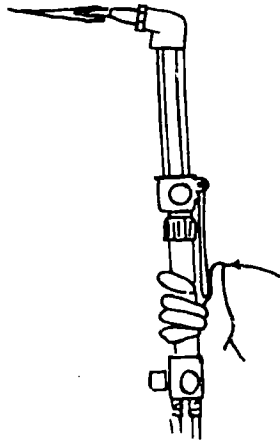

METHOD OF EVALUATION:

1. Safe and proper procedure
2. Proper kerf appearance

COMPETENCY: Flamecutting with a Hand Torch

COURSE: Plumbing

UNIT I: Pipes and Fittings

OBJECTIVE: To use the torch to flame cut steel

COMPETENCE - PROCEDURE/STEPS The student will be able to:	TEACHING/LEARNING ACTIVITIES
--	------------------------------

1. Place the metal to be cut so there is room for spark shower clearance under it.
2. With the torch adjusted to neutral flame, hold the torch handle firmly with your right hand.
3. Hold the torch tip vertical to the metal.
4. Hold the inner cone 1/16" above the surface to be cut.

NOTE: Start the cut at the edge of the plate when you can.

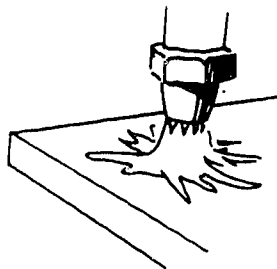

5. Keep the torch in this position until the metal turns bright red.

6. Slowly press the oxygen cutting lever and move the torch along the cutting line.

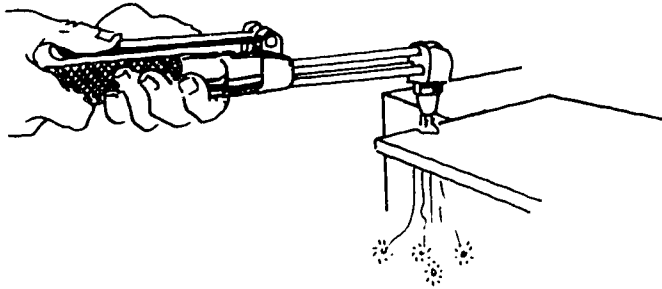

METHOD OF EVALUATION:

1. Proper torch adjustment
2. Proper cutting procedure
3. Tools properly cared for and cleaned

COMPETENCE: Lighting and Adjusting the Torch and Flame

COURSE: Plumbing

UNIT I: Pipes and Fittings

OBJECTIVE: To light and adjust the oxy-acetylene torch and flame for safe and sufficient operation

COMPETENCE - PROCEDURE/STEPS
The student will be able to:

TEACHING/LEARNING ACTIVITIES

1. Hold the torch in your right hand and the striker in your left hand.

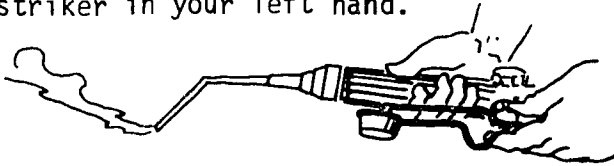

2. With your left hand, open the acetylene torch valve 1/4 turn.

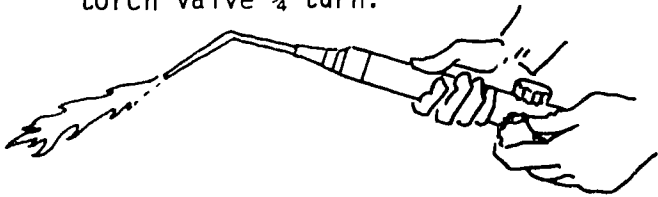

3. Light the torch with the striker.



4. Adjust the acetylene flame with the torch valve until the flame is between smoke and blow off.

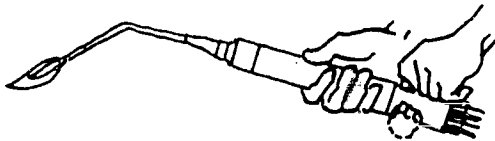

COMPETENCE - PROCEDURE/STEPS

TEACHING/LEARNING ACTIVITIES

5. Open the oxygen valve and adjust it to the proper flame.

NOTE: Neutralizing, oxidizing, and carburizing flames are different.

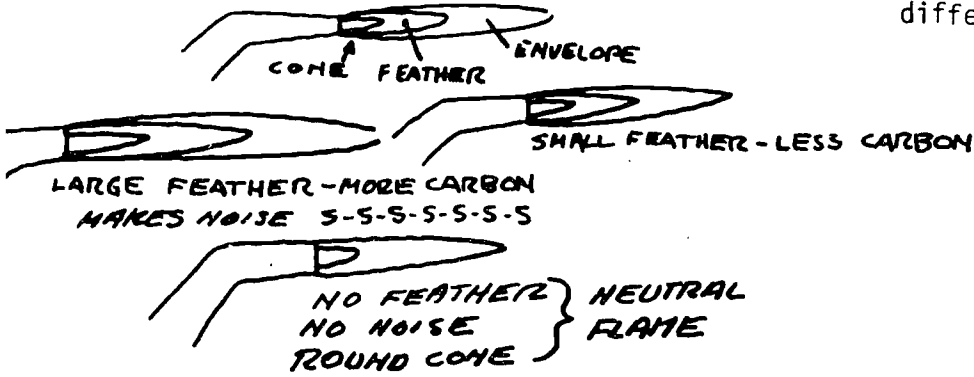

6. Shut the torch off by first closing the acetylene torch valve.
7. Close the oxygen valve.

METHOD OF EVALUATION:

1. Safe and proper procedure
2. Flame adjustment

COMPETENCY: Cleaning Cutting or Welding Tips with a Tip Cleaner

COURSE: Plumbing

UNIT I: Pipes and Fittings

OBJECTIVE: To properly clean and maintain cutting and welding tips for safe and sufficient operation

COMPETENCE - PROCEDURE/STEPS
The student will be able to:

TEACHING/LEARNING ACTIVITIES

1. File the tip edges and face to remove all particles of slag and to bring the tip back to shape.

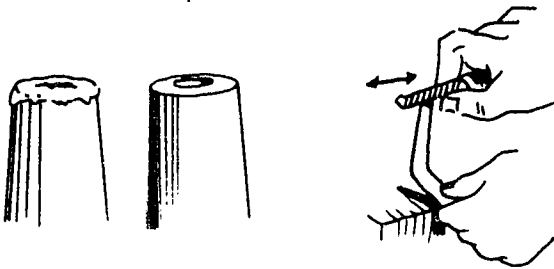

2. Hold the selected cleaner firmly and clean the opening with an up and down motion.

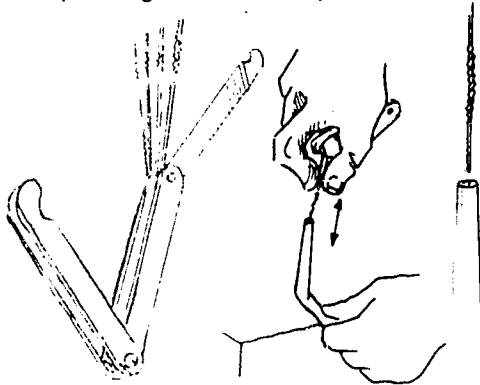

NOTE: Never ram, twist or turn the cleaner. For a proper tip core the cleaner must float freely.

METHOD OF EVALUATION:

1. Proper procedure
2. Tip appearance

COMPETENCY: Piercing Holes with a Cutting Torch

COURSE: Plumbing

UNIT I: Pipes and Fittings

OBJECTIVE: To properly pierce a hole with the torch for cutting operations

COMPETENCE - PROCEDURE/STEPS The student will be able to:	TEACHING/LEARNING ACTIVITIES
--	------------------------------

1. Hold the tip about $\frac{1}{4}$ " above the work surface.

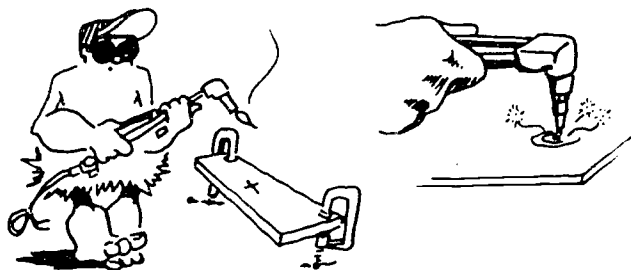

2. Start to raise the tip ($\frac{1}{2}$ " to 1" above the work). At the same time, slowly press the cutting oxygen lever all the way.

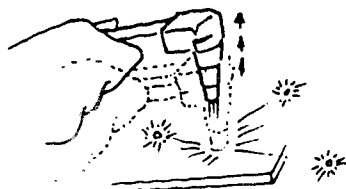

3. Hold the tip steady until a hole is pierced in the metal.
4. Lower the tip to normal height and make sure it is square with the work. Rotate the tip to make the hole as large as you want it to be.

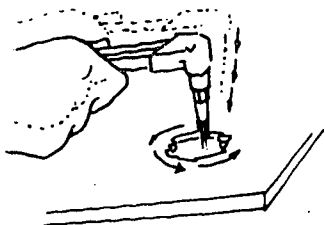

METHOD OF EVALUATION:

1. Safe and proper procedure
2. Hole appearance

COMPETENCY: Joining Metal by Fusion Welding with Filler Rod

COURSE: Plumbing

UNIT I: Pipes and Fittings

OBJECTIVE: To join metal by adding filler rod to puddle

COMPETENCE - PROCEDURE/STEPS The student will be able to:	TEACHING/LEARNING ACTIVITIES
--	------------------------------

1. Put the metal on a bench covered with firebricks.
2. Hold the torch at a 45° angle, and, beginning at the right side of the plate, melt the two pieces of metal together--tack weld.

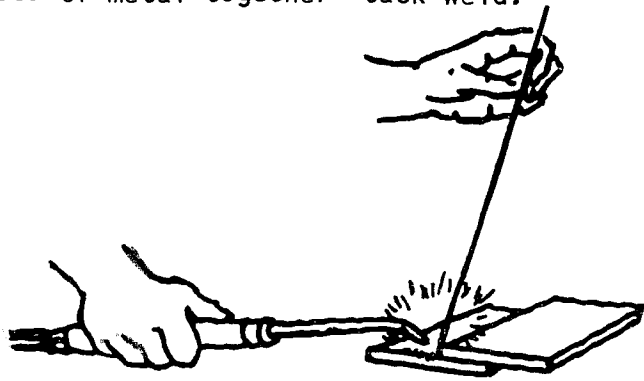

3. Holding the torch at a 45° angle from the direction of travel, melt the edges of the left side--tack weld.

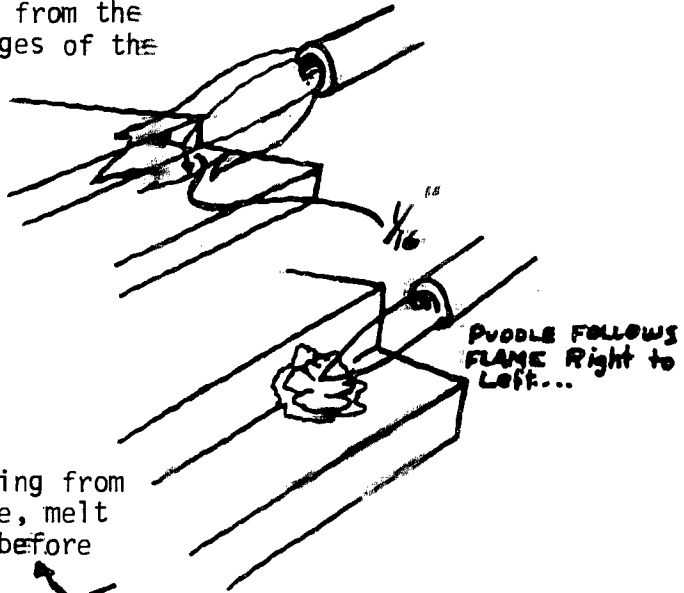

4. Holding the torch at 45°, traveling from right to left, forehand technique, melt the base metal to form a puddle before you add the filler rod.

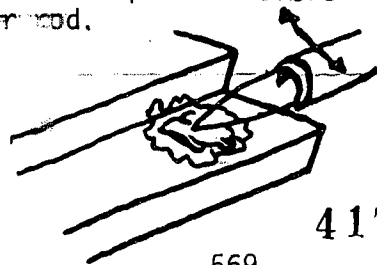

COMPETENCE - PROCEDURE/STEPS

TEACHING/LEARNING ACTIVITIES

5. Place the filler rod in the leading edge of the puddle at a 45° angle, 1/16" from the zone of the flame.

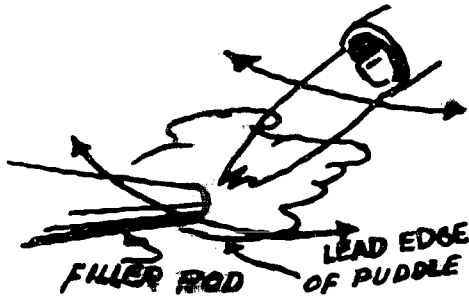

6. Moving the puddle right to left, add enough filler to keep the right bead size.

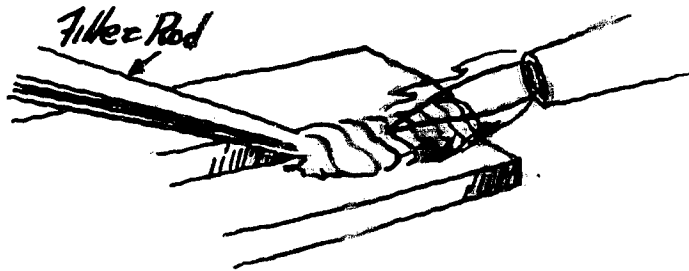

METHOD OF EVALUATION:

1. Safe and proper procedure
2. Bead appearance

COMPETENCY: Strike an Arc and Run a Bead

COURSE: Plumbing

UNIT I: Pipes and Fittings

OBJECTIVE: To run smooth, even, properly formed beads with electric welder

COMPETENCE - PROCEDURE/STEPS The student will be able to:	TEACHING/LEARNING ACTIVITIES
--	------------------------------

1. Establish the arc on the plane according to method shown:

NOTE: Listen for the arc sound (frying sound)

Tap - Scratch

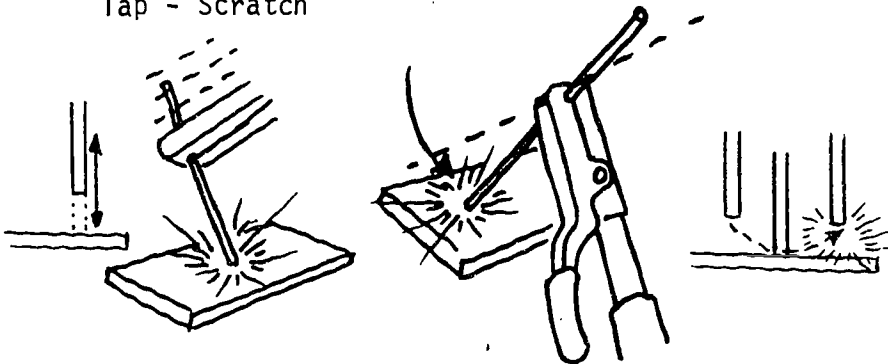

2. Maintain the arc length and begin to move electrode from left to right.

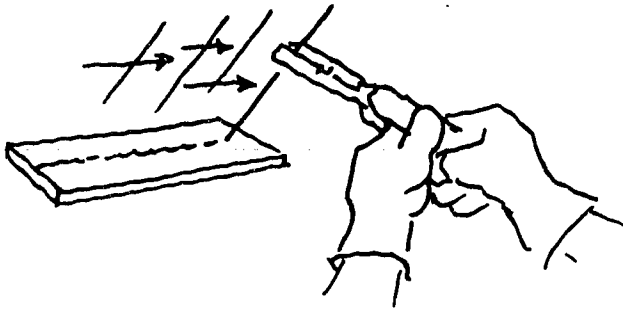

3. As you progress along the plane continually lower rod into puddle as it is consumed.

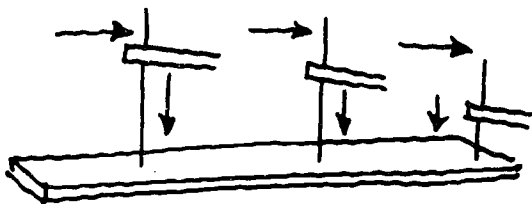

4. Lift rod to stop weld, (break the arc).

5. To re-start strike arc ahead of puddle (about 1"), maintain long arc to develop heat needed. Move back into puddle and continue on with weld.

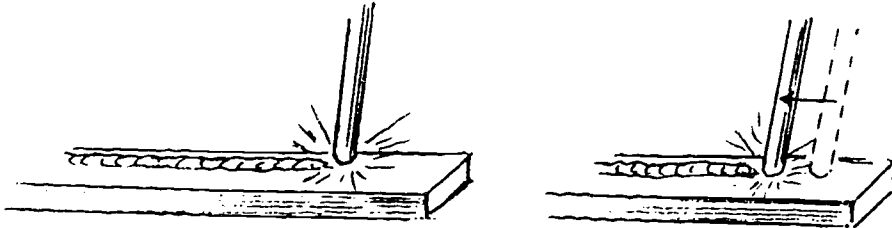

6. When weld is completed reverse direction of weld slightly to fill crater - or lift rod slowly allowing crater to fill.

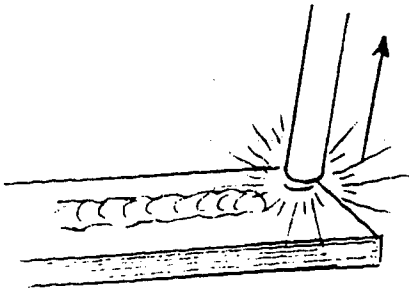

METHOD OF EVALUATION:

1. Proper procedure
2. Appearance
3. Safe practices

COMPETENCY: Running a Braze Bead

COURSE: Plumbing

UNIT I: Pipes and Fittings

OBJECTIVE: To join metal by hard soldering with brass rod

COMPETENCE - PROCEDURE/STEPS	TEACHING/LEARNING ACTIVITIES
------------------------------	------------------------------

The student will be able to:

1. Place the metal on a bench covered with fire bricks.
2. Heat the end of the brazing rod and dip it into flux.
3. Hold the torch at a 45° angle and pre-heat the base metal to dull red on the right edge of the plate.
4. Touch the rod to the heated portion and let it melt and react with the base metal--tack weld.
5. Repeat step 4 on the left edge to finish tacking the plate.
6. Hold the torch at a 45° angle and reheat the right edge of the plate to dull red. Weave the rod and flame in a steady motion until entire joint is brazed.

NOTE: Skip this step if you are using a flux coated rod.

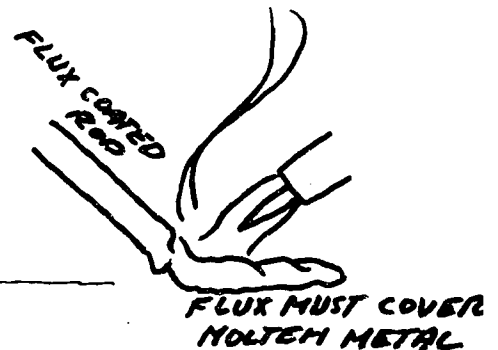
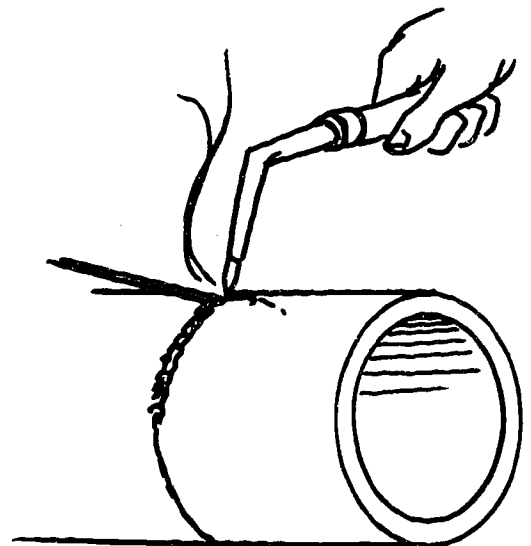

METHOD OF EVALUATION:

1. Safe and proper procedure
2. Bead appearance

OPERATION SHEET
SC-1G-1

COMPETENCY: Using the Strap Wrench

COURSE: Plumbing

UNIT I: Pipes and Fittings

OBJECTIVE: To be able to properly care for and use the strap wrench

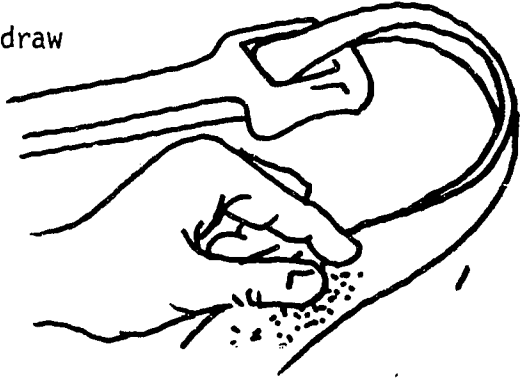
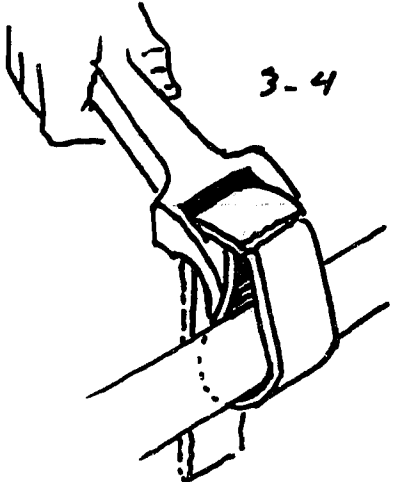
COMPETENCE - PROCEDURE/STEPS The student will be able to:	TEACHING/LEARNING ACTIVITIES
<ol style="list-style-type: none">1. Apply powdered rosin to strap of wrench insuring maximum gripping action.2. Wrap strap around pipe to be turned or held.3. Insert strap through wrench head and draw snug.4. Push on wrench handle squeezing strap against pipe.5. Turn or hold pipe as desired.	<p>NOTE: If strap becomes oily, clean it by dousing it in a pail of solvent and scrubbing.</p> 
 <p>3-4</p>	

METHOD OF EVALUATION:

1. Proper procedures
2. Tightness of wrench to job

OPERATION SHEET
SC-1H-1

COMPETENCY: Cut and Ream Copper Tubing

COURSE: Plumbing

UNIT I: Pipes and Fittings

OBJECTIVE: To make neat cuts of copper tubing with properly reamed edges

COMPETENCE - PROCEDURE/STEPS The student will be able to:	TEACHING/LEARNING ACTIVITIES
1. Measure and mark tubing to be cut.	. SC-1A-1
2. Open tubing cutter as required to fit over tubing.	
3. Place cutter over tubing with cutter wheel on mark made from measuring. (Fig. 1)	
4. Close tubing cutter on tubing and rotate cutter completely around tubing.	NOTE: Avoid turning handle too hard and applying too much pressure on the tubing.
5. Continue to rotate cutter on tubing and after each rotation tighten handle about $\frac{1}{4}$ turn to increase the pressure on the cutting wheel.	
6. Continue step 5 until tubing separates.	
7. Insert reamer blade into newly cut end of tubing. (Fig. 2)	
8. Apply slight pressure while turning reamer in a clockwise direction.	
9. Continue step 8 until all burrs are removed.	NOTE: Never use fingers to check if burrs are removed.

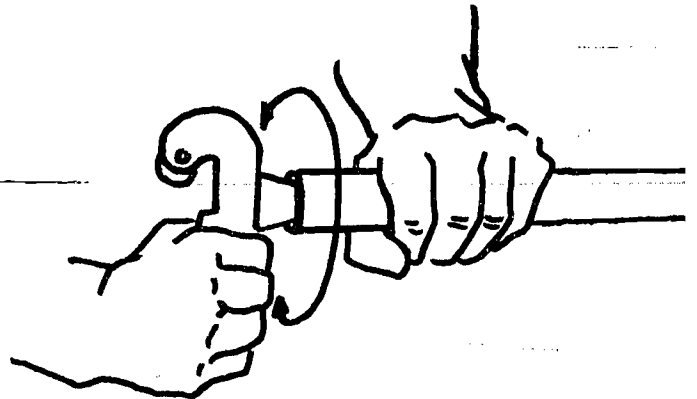
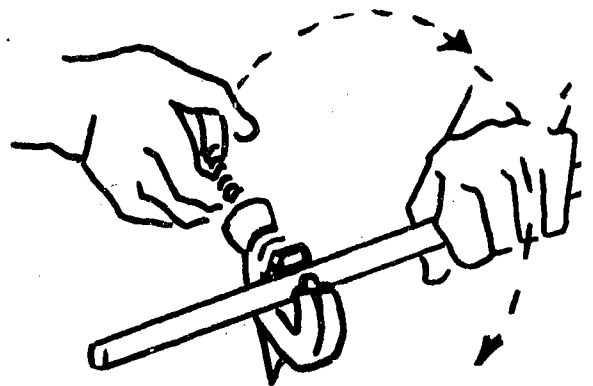

METHOD OF EVALUATION:

1. Proper procedures
2. Care and use of tubing cutters
3. Appearance of cut and reamed end

COMPETENCY: Set Up and Light Prestolite Torch

COURSE: Plumbing

UNIT I: Pipes and Fittings

OBJECTIVE: To set up and operate a Prestolite torch in a safe sufficient manner

COMPETENCE - PROCEDURE/STEPS The student will be able to:	TEACHING/LEARNING ACTIVITIES
--	------------------------------

TO CONNECT THE OUTFIT

1. Attach regulator to tank. Tighten nut with wrench.

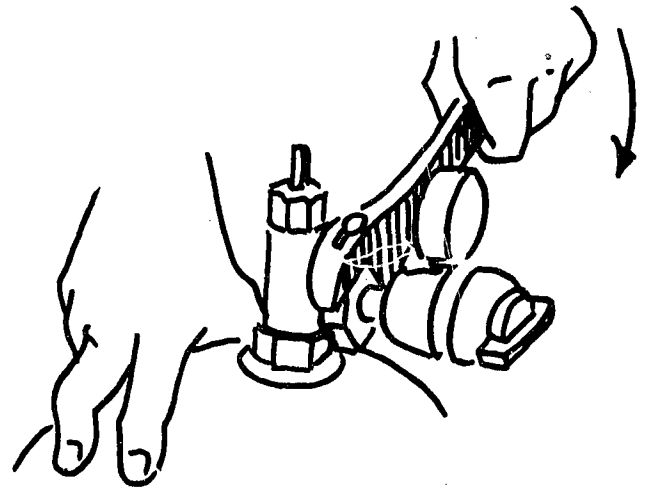
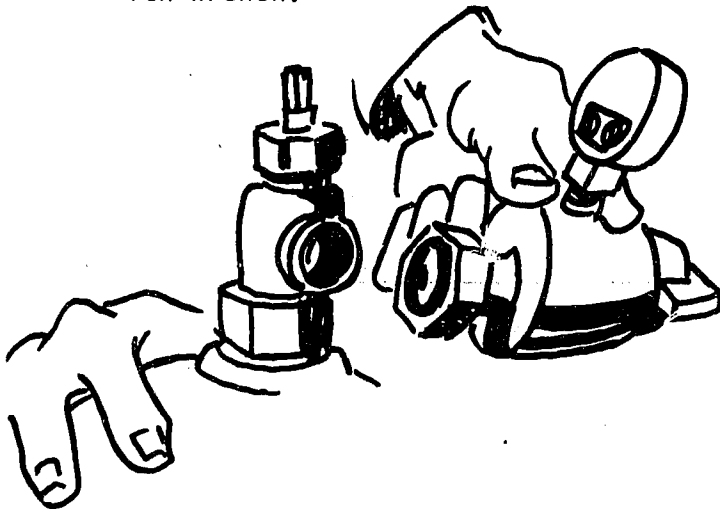

2. Attach hose assembly to regulator and handle. Tighten nuts with wrench.

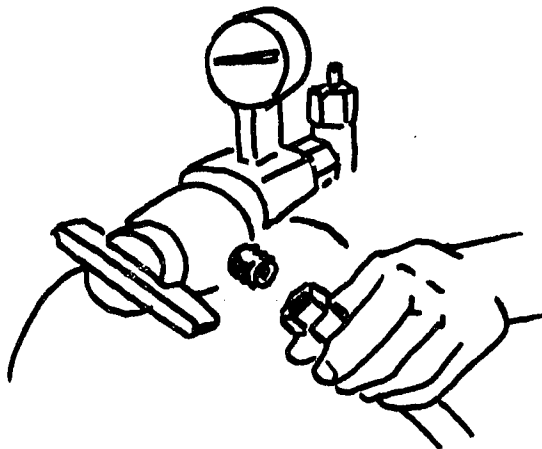

3. Attach stem to handle. Tighten the connection nut with your fingers.

TO LIGHT THE TORCH

1. Make sure both the main valve and pilot valve on the torch handle are closed. Open the tank valve one turn.
2. Set the pressure-adjusting screw for the approximate pressure desired.
3. Open the torch handle shutoff valve. Light the flame, using a friction lighter. Then readjust the regulator pressure-adjusting screw to get the desired flame size.

NOTE: Always use a Prestolite tank key - not pliers - and leave the key on the valve.

TO SHUT OFF THE TORCH

1. First close the tank valve. Then close the shutoff valve on the torch handle.

NOTE: The shutoff valve on the torch handle may be used to shut off the torch for short intervals, up to half an hour.

METHOD OF EVALUATION:

1. Following of proper procedures
2. Care and use of the torch

COMPETENCY: Sweat Copper Tubing

COURSE: Plumbing

UNIT I: Pipes and Fittings

OBJECTIVE: To join copper tubing by using solder and its accessories

COMPETENCE - PROCEDURE/STEPS The student will be able to:	TEACHING/LEARNING ACTIVITIES
--	------------------------------

1. Clean copper tubing and fittings using emery cloth, steel wool, or other suitable cleaner.
2. Apply a thin coating of flux to the cleaned areas.

NOTE: Avoid using your fingers to apply flux.

3. Fit tubing and fitting together by inserting the tubing into the female fitting.
4. Apply the flame of the torch to the fitting section.

5. Bend over end of solder wire about as long as the size of the fitting... $\frac{1}{2}$ " solder for $\frac{1}{2}$ " fitting, etc.

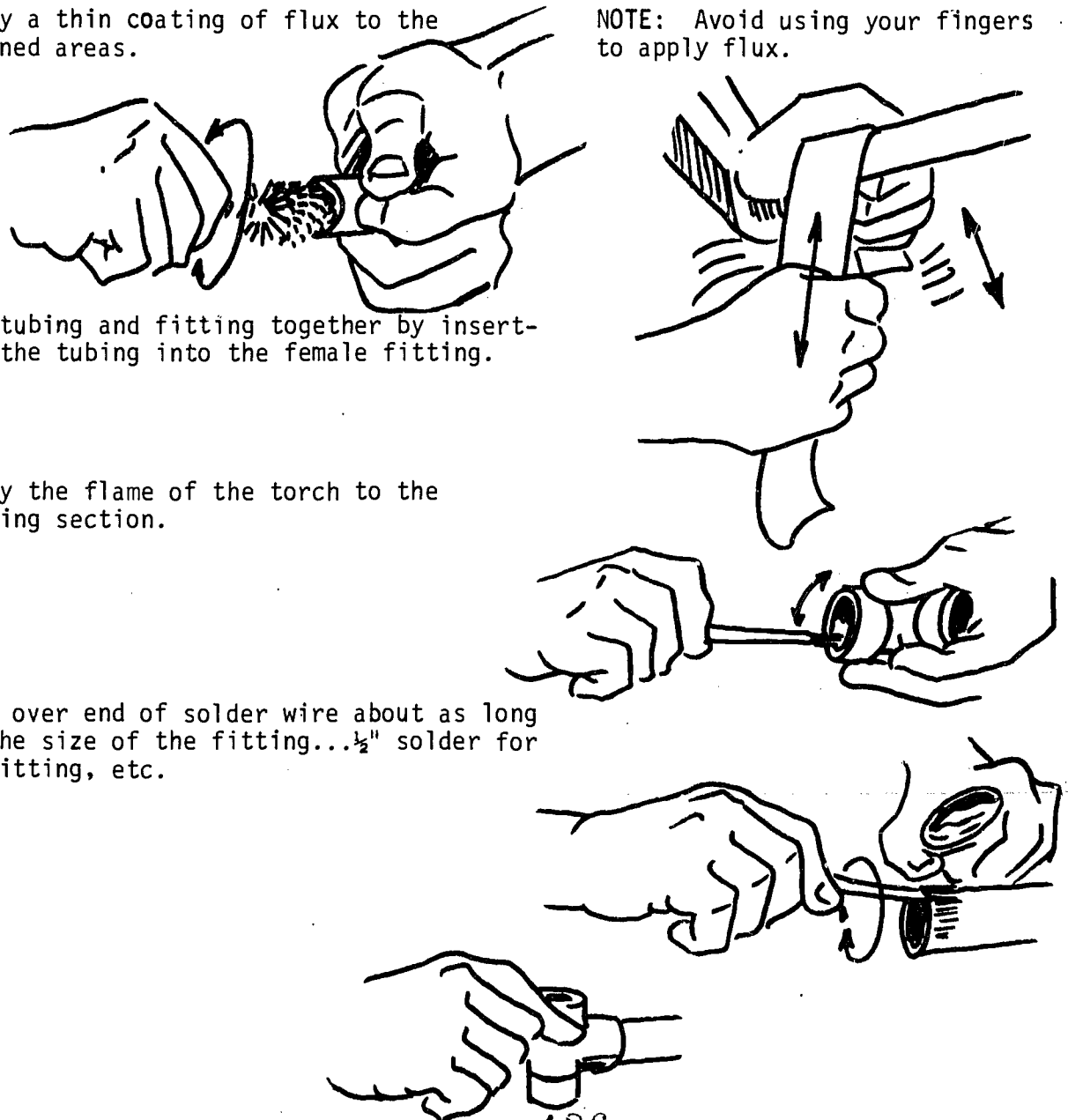

6. Apply 50/50 solder to the heated joint. . IL-1B-4

7. When the solder is drawn into the joint by the natural force of capillary attraction, remove the heat.

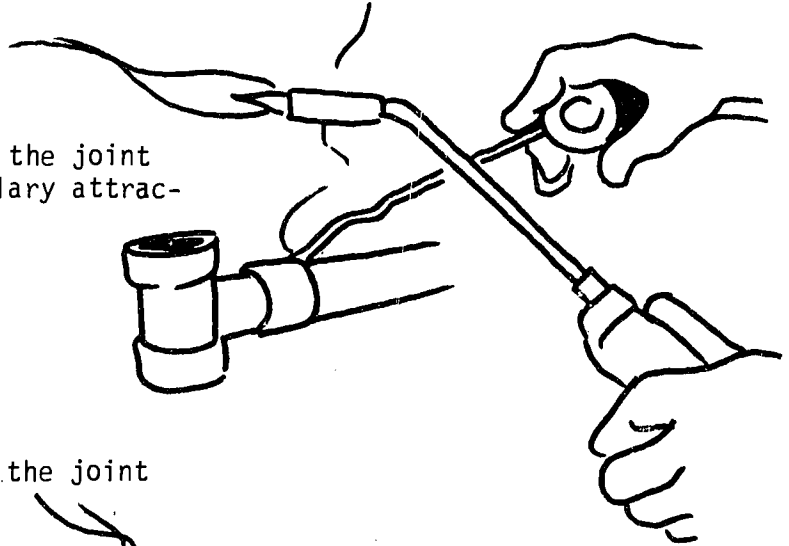

8. Remove any excess solder from the joint while it is still plastic.

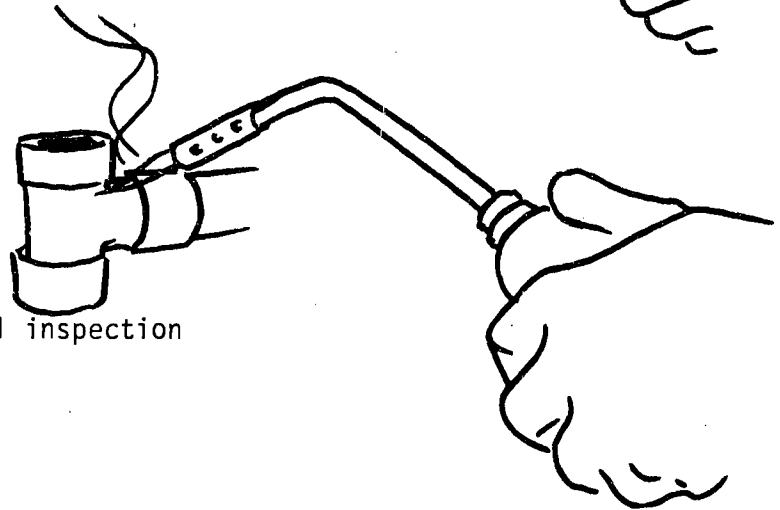

9. Allow to cool and make visual inspection for accuracy.

METHOD OF EVALUATION:





1. Proper procedures
2. Appearance of finished coat
3. Care and safe use of torch

COMPETENCY: Flare Copper Tubing

COURSE: Plumbing

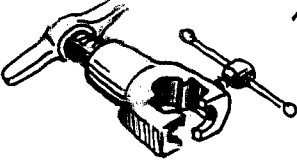
UNIT I: Pipes and Fittings

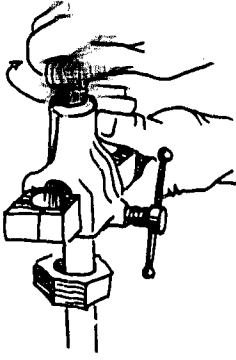
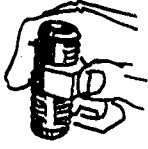
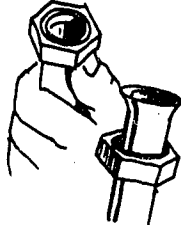
OBJECTIVE: To flare copper tubing and properly make this type of joint

COMPETENCE - PROCEDURE/STEPS The student will be able to:	TEACHING/LEARNING ACTIVITIES
1. Cut and ream tubing to be flared.	
2. Slip the flare nut over the end of the tubing that is to be flared.	NOTE: Be sure the threads are toward the end to be flared.
3. Open the flaring tool block and place the tubing through the block to the desired length.	
4. Clamp the tubing in the flaring tool block so the end of the tube is slightly above the face of the block (approximately 1/16" to 3/16").	
5. Place the yoke of the flaring tool on the block so the beveled end of the compressor cone is centered over the tubing end.	
6. Turn the yoke handle compressing screw down, forming the flare between the countersink chamber in the flaring block and the beveled compressor cone.	
7. Remove the yoke and flaring block.	
8. Slide the connection nut over the flare just made to make sure it clears and fits snug.	
9. Tighten the flared nut onto the fitting.	

METHOD OF EVALUATION:

1. Proper procedure
2. Appearance of finished flare
3. Care and use of flaring tool

COMPETENCY: Swedge Copper Tubing

COURSE: Plumbing

UNIT I: Pipes and Fittings

OBJECTIVE: To properly swedge 1/2" and 3/4" copper tubing

COMPETENCE - PROCEDURE/STEPS The student will be able to:	TEACHING/LEARNING ACTIVITIES
--	------------------------------

1. Cut and ream a piece of 1/2" or 3/4" soft tubing approximately 6" long.
2. Insert one end of the tubing in the proper slot of a flaring tool block with the end extended through the block approximately 1".
3. Tighten the flaring tool block wing nuts and fasten the block in a vice.
4. Insert the swedging tool in the open end of the extended tubing.
5. Drive the swedging tool into the tubing using a hammer, until the tubing is expanded to the proper depth.
6. Tap the swedging tool lightly while exerting a pulling force to remove it from the finished joint.

NOTE: Remove flaring tool yoke and handle.

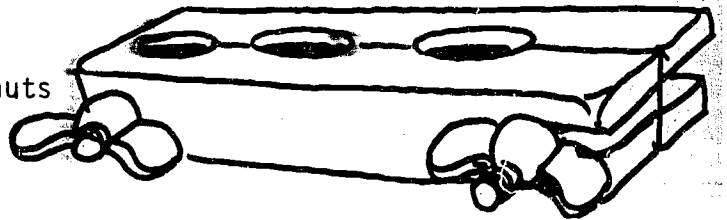

NOTE: A drop or two of oil should be applied to the tapered end of the swedging tool.

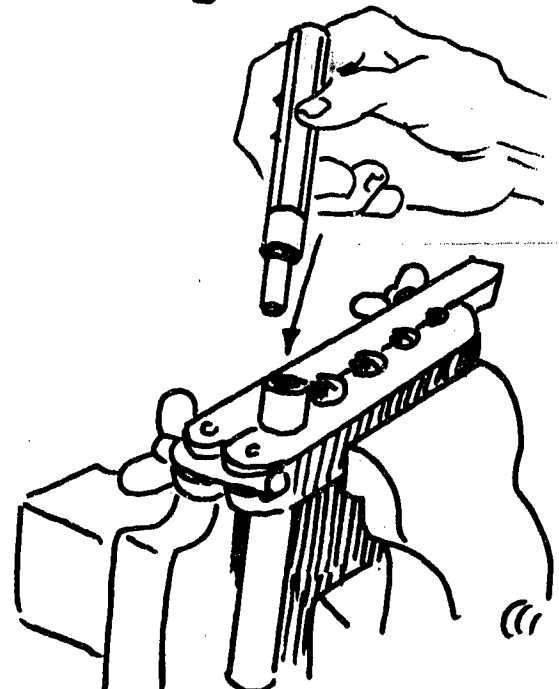
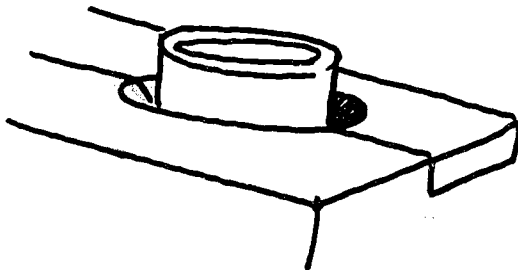
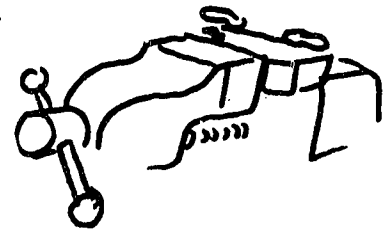

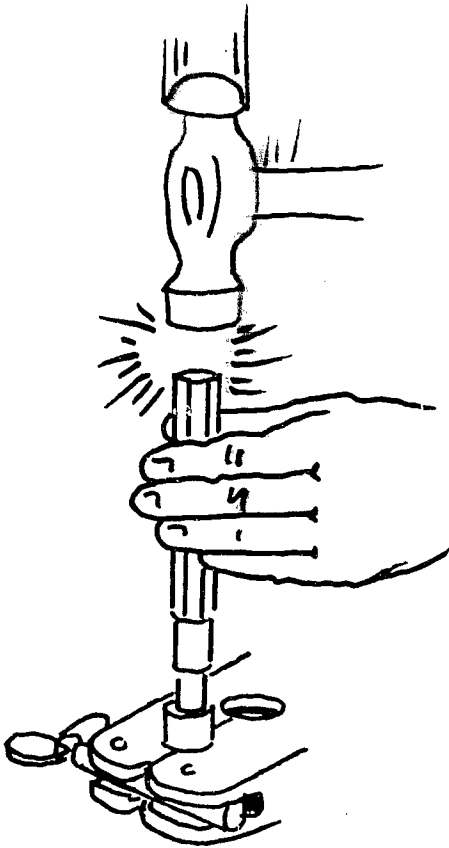

METHOD OF EVALUATION:

1. Proper procedure
2. Appearance of finished swedge
3. Care and use of swedging tool

430

COMPETENCY. Bend Copper Tubing

COURSE: Plumbing

UNIT I: Pipes and Fittings

OBJECTIVE: To properly bend copper tubing using a bending spring

COMPETENCE - PROCEDURE/STEPS
The student will be able to:

TEACHING/LEARNING ACTIVITIES

1. Slide bending spring over tubing to the proper position. Be sure spring is located properly.
2. Hold one end of the bending spring firmly in one hand, and pull the opposite end toward your body to the approximate angle desired.
3. Remove the spring with a turn-pulling motion.
4. Check angle for accuracy using an adjustable square.
5. Repeat steps 4, 5 and 6 in compliance with the offset layout desired.

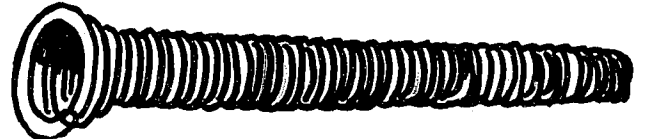

NOTE: Since the bending spring is not a precision tool, experience and judgement will greatly help in acquiring accuracy.

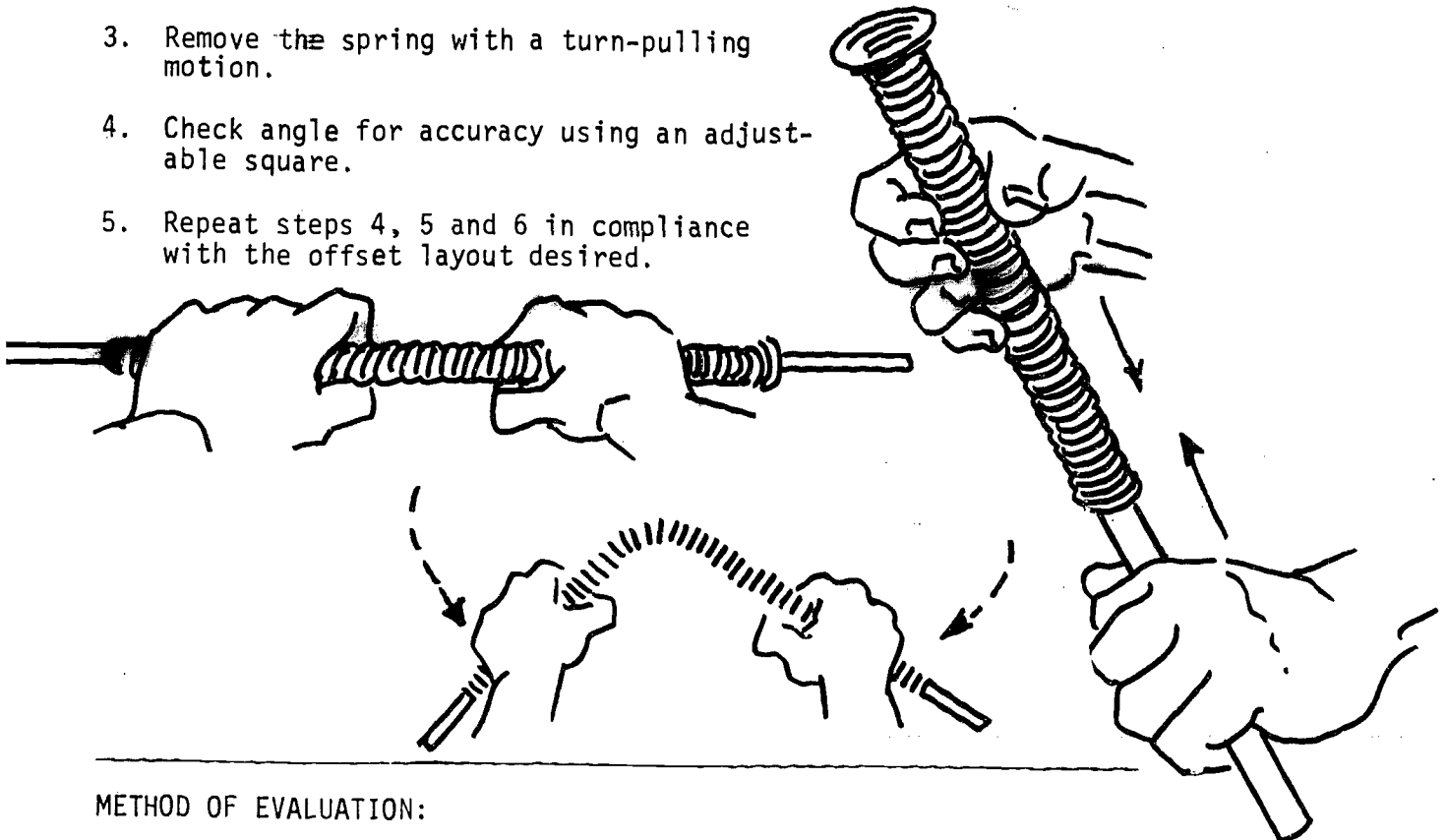

METHOD OF EVALUATION:

1. Proper procedures
2. Appearance of finish offset
3. Accuracy of measurement

COMPETENCY: Cut and Ream Plastic Pipe

COURSE: Plumbing

UNIT I: Pipes and Fittings

OBJECTIVE: To cut plastic pipe square and remove all burrs in a skillful manner

COMPETENCE - PROCEDURE/STEPS The student will be able to:	TEACHING/LEARNING ACTIVITIES
--	------------------------------

1. Slide plastic pipe through miter box, centering measured mark with the saw guide.
2. Cut plastic pipe using a finetooth saw.
3. Using a pocket knife or tubing cutter reamer, remove all burrs.
4. Check dry fit.

NOTE: Plastic pipe may also be cut with a tubing cutter designed for plastic.

NOTE: If a tubing cutter was used to cut the plastic pipe, burrs will occur both on the inside and outside of the pipe.

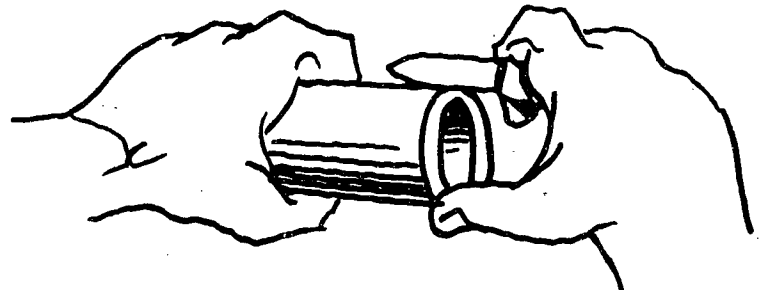
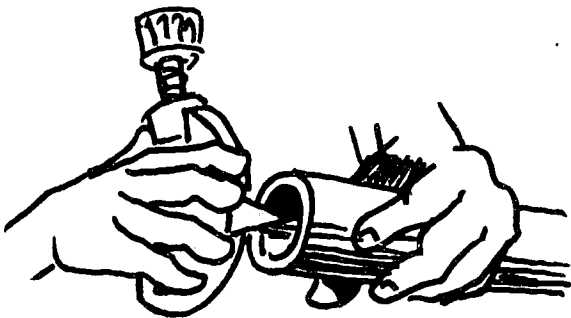
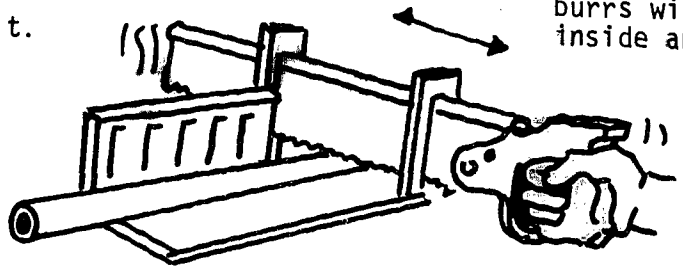

METHOD OF EVALUATION:

1. Proper procedures
2. Care and use of pipe and tools
3. Appearance of finished pipe

COMPETENCY: Join Flexible Plastic Tubing

COURSE: Plumbing

UNIT I: Pipes and Fittings

OBJECTIVE: To join flexible plastic using inert fittings and stainless steel clamps

COMPETENCE - PROCEDURE/STEPS

The student will be able to:

TEACHING/LEARNING ACTIVITIES

1. Slide a clamp over each of the two cut ends of the plastic pipe.

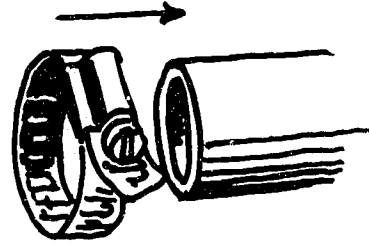

2. Insert desired fitting onto the plastic pipe using a twisting, pushing motion.

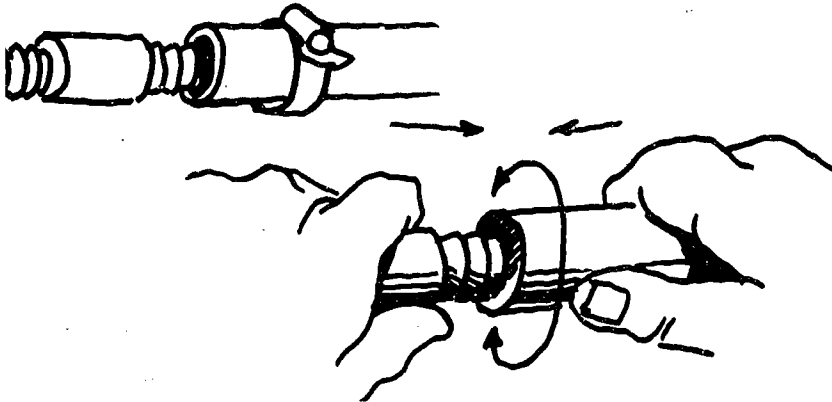

NOTE: Petroleum jelly such as Vaseline may be used on the insert fitting.

3. Slide the stainless steel clamps into position, approximately $\frac{1}{2}$ " from cut end and 1" between clamps.

4. Tighten the clamps using a screwdriver.

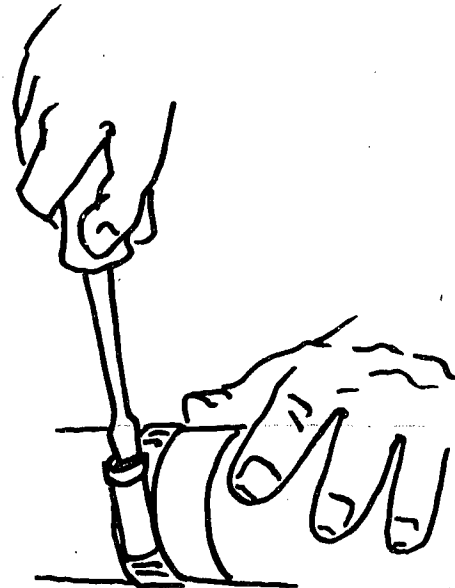
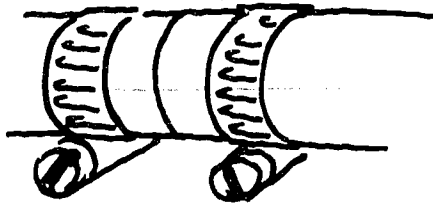

METHOD OF EVALUATION:

1. Proper procedures
2. Proper use of bladed tools (Knife, screwdriver)
3. Appearance of finished job

COMPETENCY: Assemble Plastic Pipe/Fittings with Solvent

COURSE: Plumbing

UNIT I: Pipes and Fittings

OBJECTIVE: To properly assemble plastic pipe and fitting with solvent, making a leakproof joint

COMPETENCE - PROCEDURE/STEPS
The student will be able to:

TEACHING/LEARNING ACTIVITIES

1. Check dry fit.

. SC-1E-1

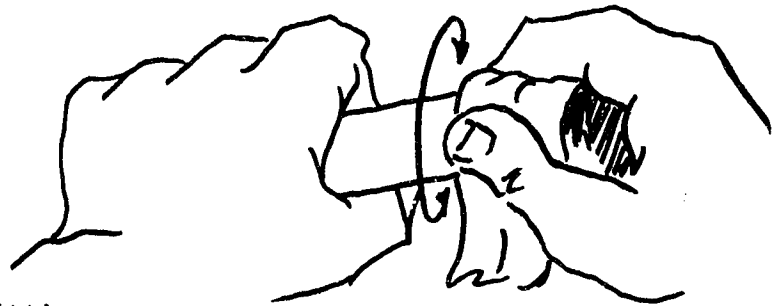
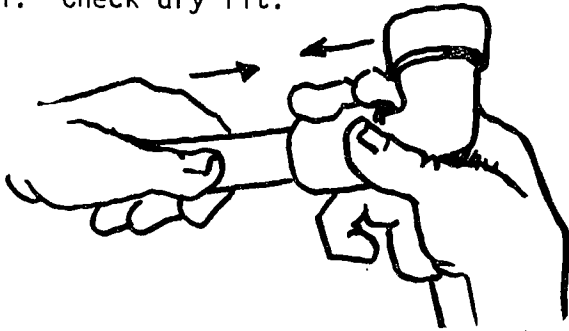

2. Remove gloss by wiping pipe and fittings with a cleaner or fine sand paper.

3. Apply solvent on the outside of the pipe and on the inside of the fitting.

NOTE: Work quickly while applying cement.

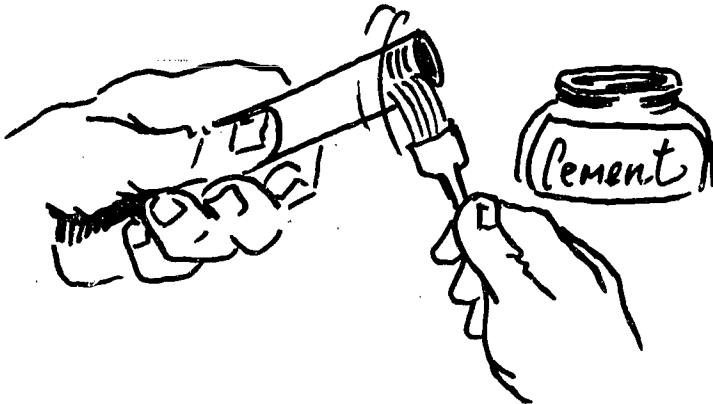

4. Assemble immediately--rotate and bottom pipe in fitting socket while both surfaces are still wet.
5. Hold in position for about one minute and wipe off excess cement.

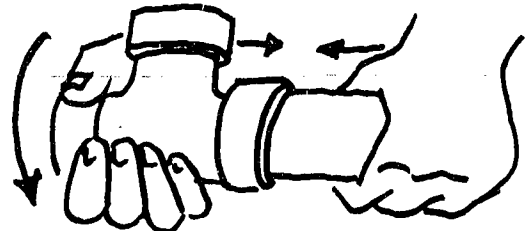

COMPETENCE - PROCEDURE/STEPS

TEACHING/LEARNING ACTIVITIES

6. Allow to set before handling or applying pressure.

. IL-1E-3

NOTE: Set period will depend on:
a. type of cement.
b. size of pipe.
c. air tightness.

METHOD OF EVALUATION:

1. Proper procedures
2. Cleanliness of work area
3. Appearance of finished joint

435

COMPETENCY: Flare Plastic Pipe

COURSE: Plumbing

UNIT I: Pipes and Fittings

OBJECTIVE: To make a cold flare with flexible plastic pipe

COMPETENCE - PROCEDURE/STEPS The student will be able to:	TEACHING/LEARNING ACTIVITIES
1. Slip flare nut over tubing.	. SC-1E-1
2. Insert pilot plug of flaring tool into plastic pipe.	
3. Apply clamping pliers.	
4. Crank the flaring tool 5 to 6 revolutions.	. IL-1E-2
5. Check for perfect flare.	NOTE: Heat generated by friction during flaring kills memory characteristics of the plastic and assures permanent shape of the flare and tight connections.
6. Remove the clamping pliers and flaring tool.	
7. Fit the flared pipe against the fitting and slide the flare nut over the flare on the fitting.	NOTE: The flare should ripple over each thread as the flare nut is tightened.
8. Wrench tighten the joint.	

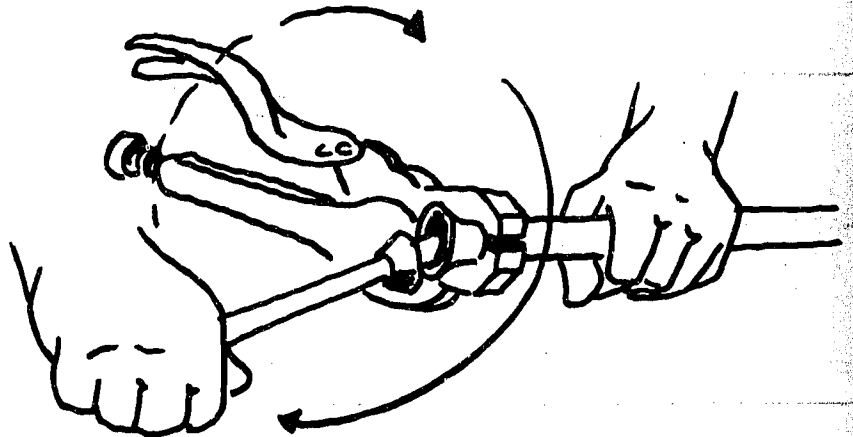

METHOD OF EVALUATION:

1. Following of procedures
2. Appearance of flare
3. Tightness of finished joint

COMPETENCY: Using Smooth Jawed Wrenches

COURSE: Plumbing

UNIT II: Valves

OBJECTIVE: To use smooth-jawed wrenches--monkey, spud, hex, etc.; in a proper and safe manner

COMPETENCE - PROCEDURE/STEPS The student will be able to:	TEACHING/LEARNING ACTIVITIES
<ol style="list-style-type: none">1. Hold adjustable wrench in your hand with thumb on the knurled worm gear.2. Roll the gear with your thumb to open or close the jaw of the wrench.3. Open wrench jaw large enough to fit over the bolt, nut or stud. Close jaw on bolt head until it is tight.4. Turn nut or bolt to tighten or loosen.	<p>NOTE: When using smooth jawed wrenches apply force in the direction of the movable jaw.</p>

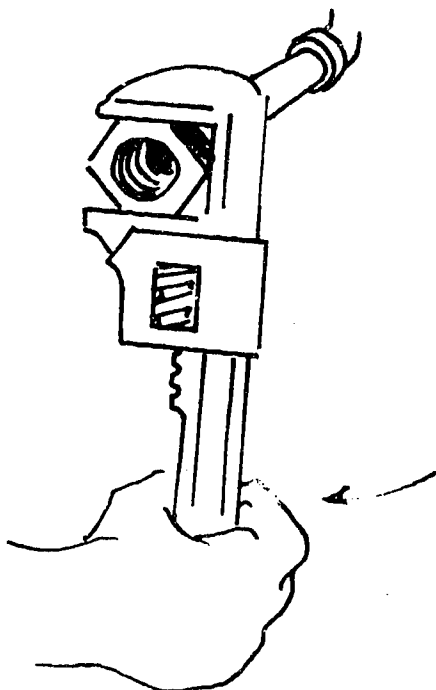
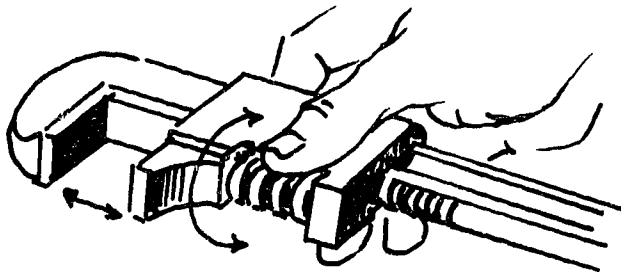

METHOD OF EVALUATION:

1. Proper technique

437

COMPETENCY: Tighten and Loosen Fasteners with a Box End Wrench

COURSE: Plumbing

UNIT II: Valves

OBJECTIVE: To be able to effectively use the box end wrench

COMPETENCE - PROCEDURE/STEPS
The student will be able to:

TEACHING/LEARNING ACTIVITIES



NOTE: The box end wrench is designed to prevent slippage and to work in difficult areas.

1. Place the proper size box end wrench over the fastener.

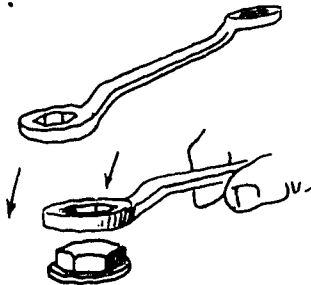

2. Pull the wrench handle to tighten or loosen the bolt, nut or stud.

NOTE: Tightening is usually clockwise, loosening is usually counterclockwise.

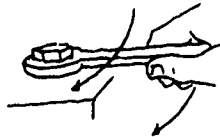

3. Position yourself so that you are always pulling rather than pushing.
4. Final tightening or original loosening may require two hands.

METHOD OF EVALUATION:

Proper technique

COMPETENCY: Tightening and Loosening Fasteners with an Open End Wrench

COURSE: Plumbing

UNIT II: Valves

OBJECTIVE: To be able to safely and effectively use the open end wrench

COMPETENCE - PROCEDURE/STEPS
The student will be able to:

TEACHING/LEARNING ACTIVITIES

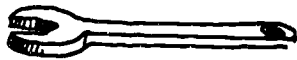

1. Place the open end wrench over the fastener. Be sure of a good fit.



2. Pull the wrench handle to tighten or loosen the fastener.

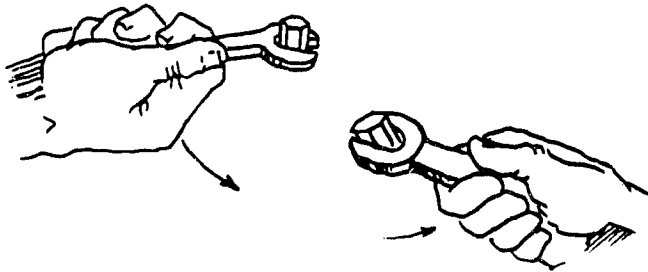

3. Position yourself so that you are always pulling instead of pushing.

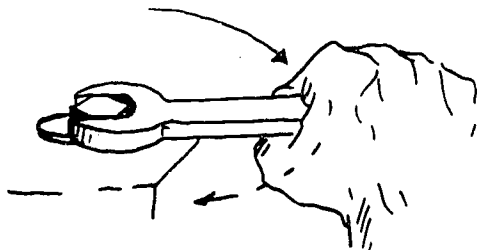

4. Final tightening or original loosening may require the use of two hands.

NOTE: The open end wrench is designed to slip straight onto the fastener.

NOTE: Tightening is usually clockwise, loosening is usually counterclockwise.

METHOD OF EVALUATION:

Proper technique

439

COMPETENCY: Removing Pins With a Needle Nose Pliers

COURSE: Plumbing

UNIT II: Valves

OBJECTIVE: To use the needle nose pliers in a safe and efficient manner

COMPETENCE - PROCEDURE/STEPS
The student will be able to:

TEACHING/LEARNING ACTIVITIES

1. Hold plier in hand as shown.

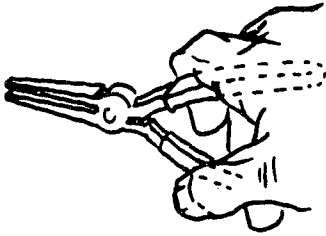

2. Use little finger to open plier.



3. Grasp work with tip of plier.

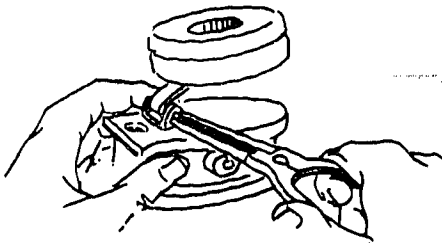

CAUTION: Do not apply excessive pressure. This plier is more for holding than force.

4. Pull pin from seat

METHOD OF EVALUATION:

1. Proper technique
2. Proper tool selection

440

COMPETENCY: Tightening and Loosening Screws with Flat Screwdriver

COURSE: Plumbing

UNIT II: Valves

OBJECTIVE: To use a screwdriver safely and efficiently

COMPETENCE - PROCEDURE/STEPS	TEACHING/LEARNING ACTIVITIES
The student will be able to:	

1. Place blade into screw slot as shown.

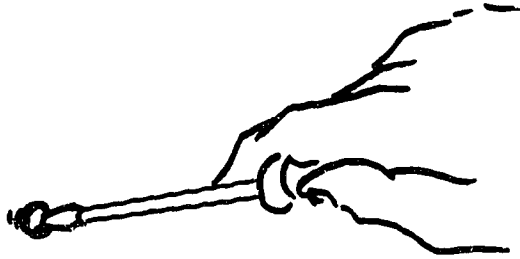

2. Use thumb and forefinger of left hand to keep blade centered.

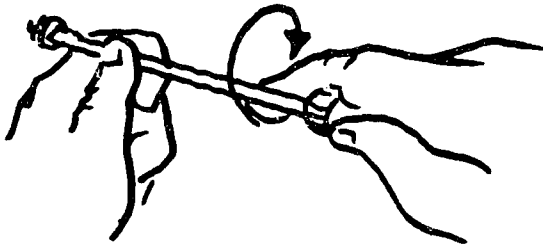

3. With handle of screwdriver in palm of right hand, securing with thumb and forefinger twist screwdriver to the right.

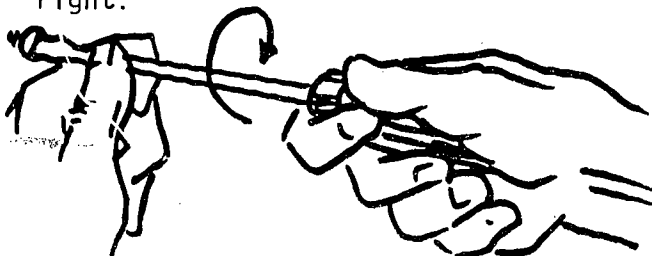

4. Relax right hand, twist wrist counter-clockwise. Repeat step 3.
5. Continue steps 3 and 4 until screw snugs down.
6. Reverse steps 3 and 4 to loosen.

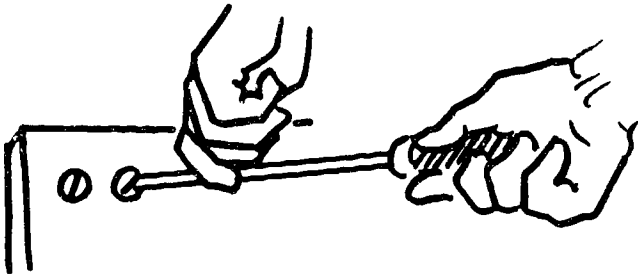

METHOD OF EVALUATION:

1. Proper technique
2. Proper tool selection

COMPETENCY: Tighten and Loosen Fasteners with Allen Wrenches

COURSE: Plumbing

UNIT II: Valves

OBJECTIVE: To use allen wrenches in a safe, efficient manner

COMPETENCE - PROCEDURE/STEPS

The student will be able to:

TEACHING/LEARNING ACTIVITIES

1. Insert proper wrench into hex hole in fastener. (If the fit is sloppy, use a larger size.)

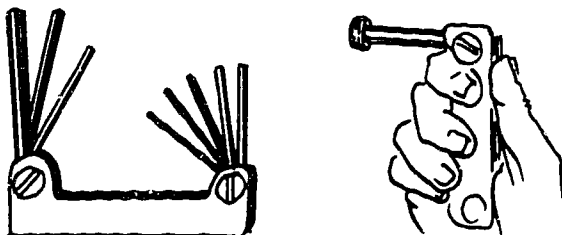

2. Turn fastener clockwise or counter-clockwise to tighten or remove.

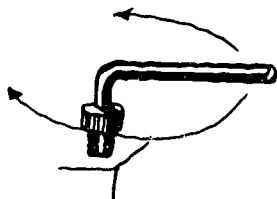

3. Insert the short end for more leverage. Insert the long end for hard to reach places.

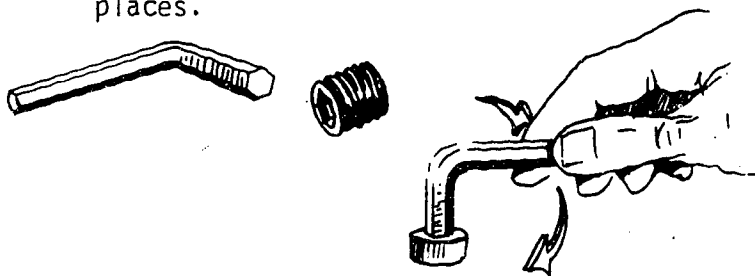

METHOD OF EVALUATION:

1. Proper procedure
2. Proper tool selection

COMPETENCY: Holding and Tightening with a Rib Lock Plier

COURSE: Plumbing

UNIT II: Valves

OBJECTIVE: To use the rib lock pliers in a safe and efficient manner

COMPETENCE - PROCEDURE/STEPS	TEACHING/LEARNING ACTIVITIES
------------------------------	------------------------------

The student will be able to:

1. Open jaws fully; slide jaws to proper rib.
2. Close jaws and squeeze to hold item.
3. Maintain pressure while turning or holding.
4. Release pressure to move to a new location.

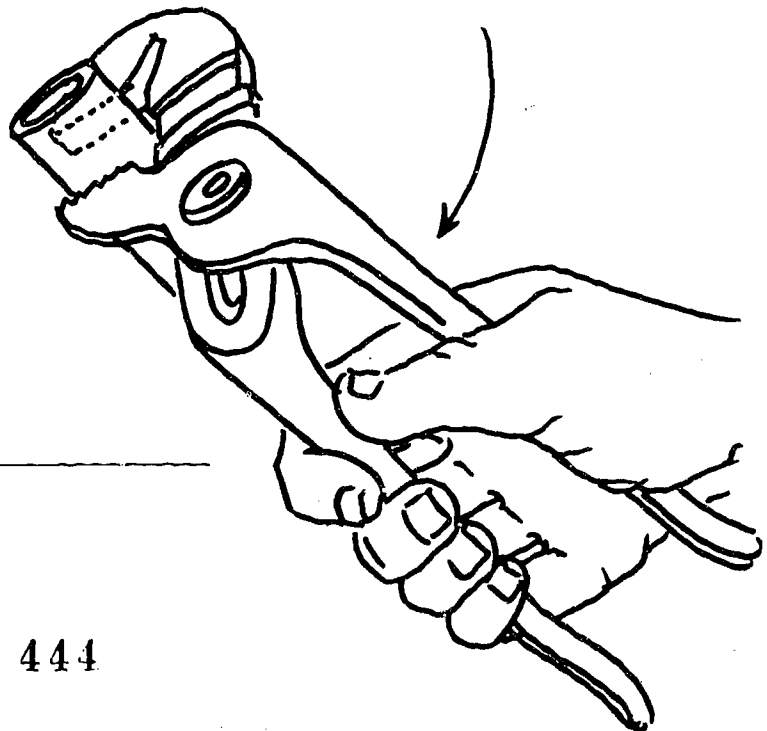
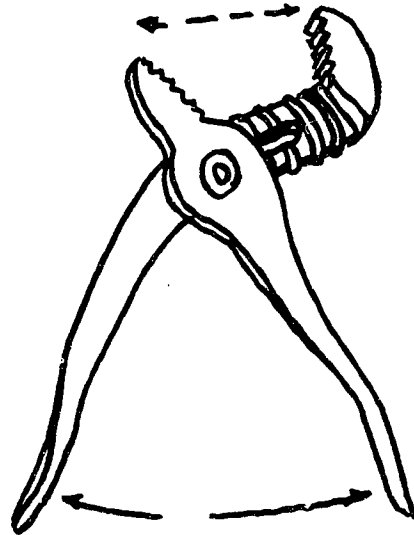

METHOD OF EVALUATION:

1. Proper use of tool
2. Care of tool

COMPETENCY: Cutting a Hole in a Masonry Wall with a Star Chisel

COURSE: Plumbing

UNIT III: Cold Water Supply

OBJECTIVE: To be able to cut holes through masonry walls using a star drill

COMPETENCE - PROCEDURE/STEPS
The student will be able to:

TEACHING/LEARNING ACTIVITIES

1. Hold point of chisel on location with left hand (firmly).



2. Strike end of chisel with a heavy hammer.

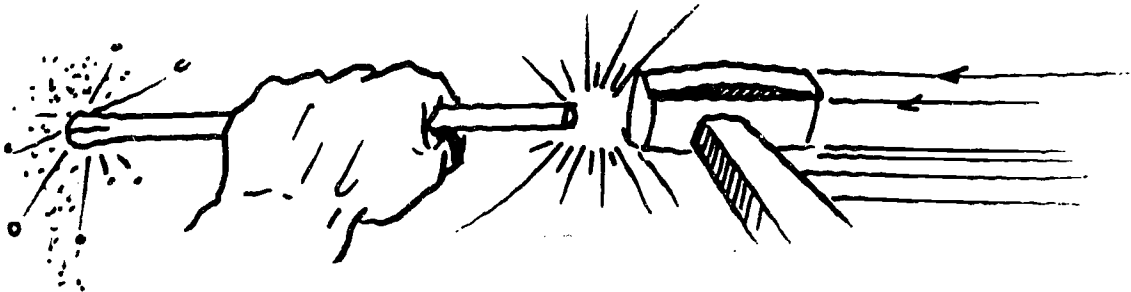

3. Rotate chisel 1 1/4 turn, strike again.

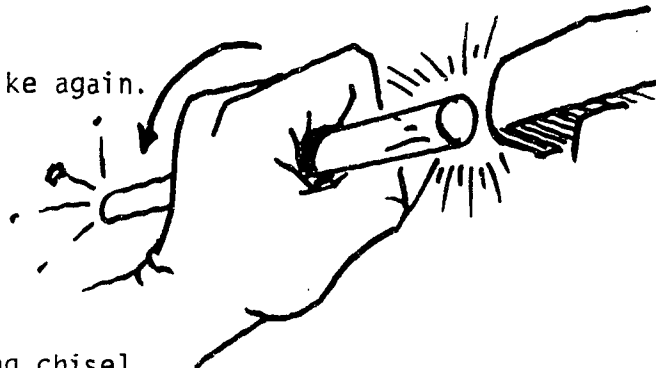

4. Continue hammering and rotating chisel until desired depth is reached.

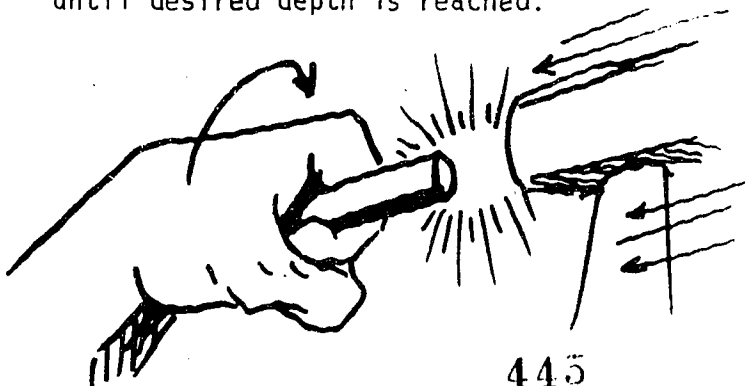

METHOD OF EVALUATION:

1. Proper procedure
2. Appearance of hole

COMPETENCY: Installing and Tightening a Union

COURSE: Plumbing

UNIT III: Cold Water Supply

OBJECTIVE: To install and tighten unions properly and efficiently

COMPETENCE - PROCEDURE/STEPS

The student will be able to:

TEACHING/LEARNING ACTIVITIES

1. Apply pipe joint compound on the pipe threads. (1)
2. Hand tighten the half union nut (2) on the pipe (1).
3. Using two wrenches, tighten the nut (2) onto the pipe (1).
4. Place the large union connecting nut (5) over other pipe. (6)
5. Apply the pipe joint compound on the pipe threads. (4)
6. Hand tighten the half union nut (3) on the pipe. (4)
7. Using two wrenches, tighten the nut (3) and the pipe (4).
8. Position pipes together and hand tighten the connection nut (5) onto the half union nut. (2)
9. Using two wrenches tighten the nut (5) onto the nut. (2)

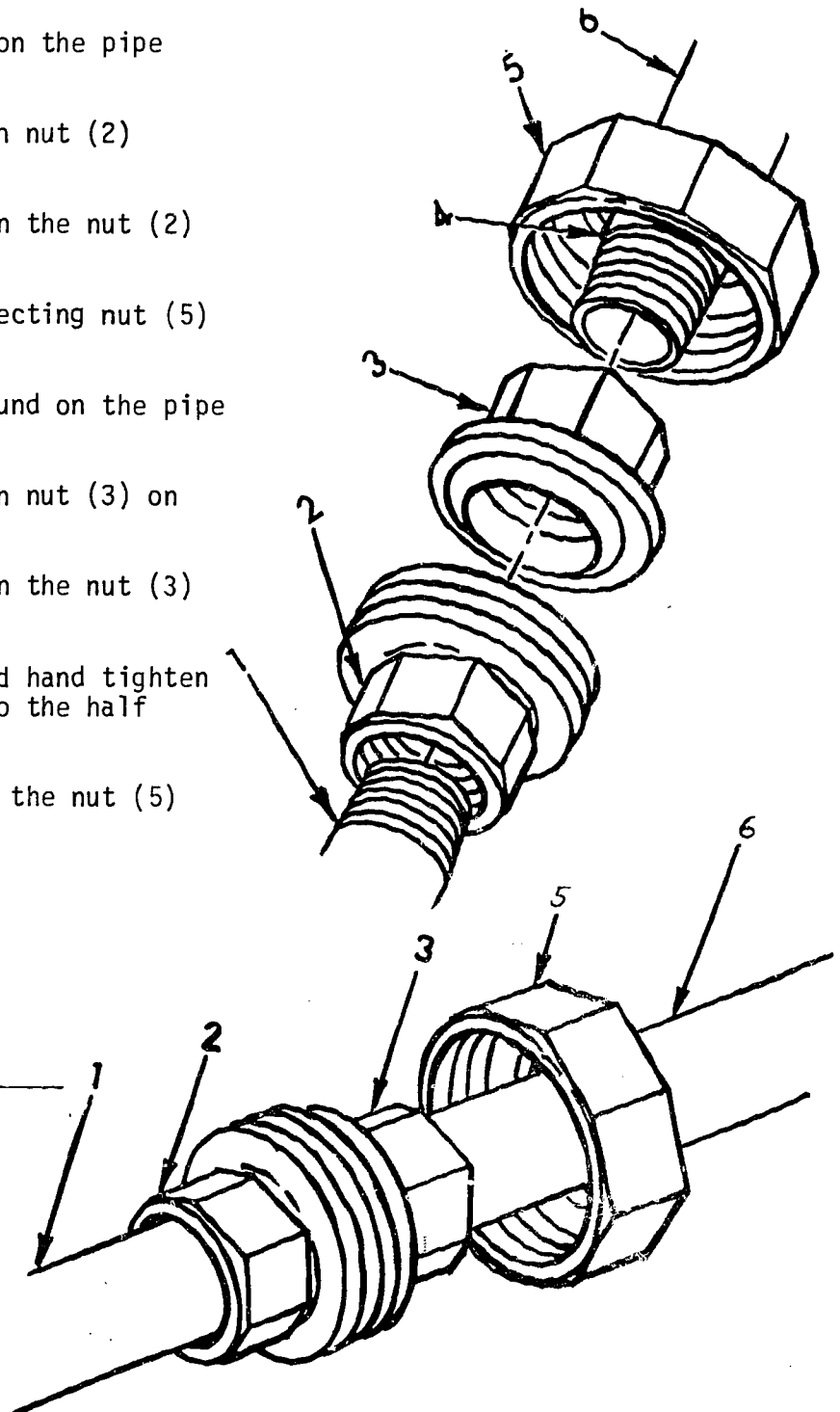

METHOD OF EVALUATION:

1. Proper assembly
2. Tightness of joint
3. Leakproof

COMPETENCY: Drilling Holes with an Electric Drill

COURSE: Plumbing

UNIT III: Cold Water Supply

OBJECTIVE: To drill good clean holes applying the proper amount of pressure

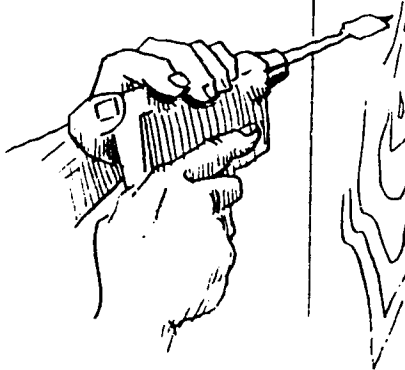
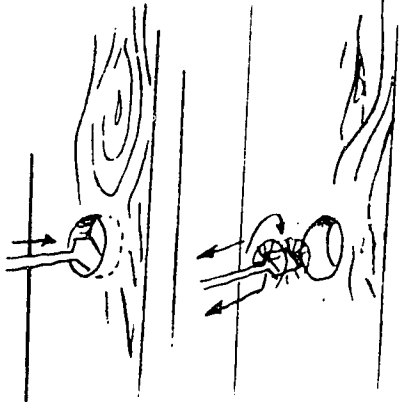
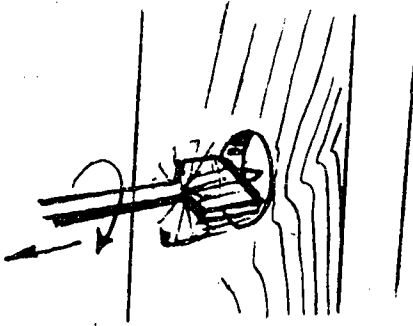
COMPETENCE - PROCEDURE/STEPS	TEACHING/LEARNING ACTIVITIES
The student will be able to:	
1. Center the bit on the stud and apply pressure on the drill. Keep the bit perpendicular to the stud and keep a good tight grip on the drill motor with both hands.	
2. Squeeze the trigger and keep pushing gently. Too little pressure will make the drill bit cut too slowly. Too much pressure will make the motor stall. Continue pushing until the bit is all the way through the stud.	
3. Keep the drill motor running and perpendicular to the stud. Keep a good tight grip on the motor. Use both hands and pull the motor back toward you. This makes the bit easy to take out of the hole and it cleans out the wood chips in the hole.	

METHOD OF EVALUATION:

1. Proper procedure
2. Appearance of hole

447

COMPETENCY: Installing and Tightening Dresser Couplings

COURSE: Plumbing

UNIT III: Cold Water Supply

OBJECTIVE: To be able to install and tighten dresser couplings properly and efficiently

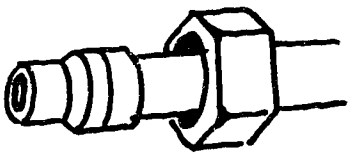
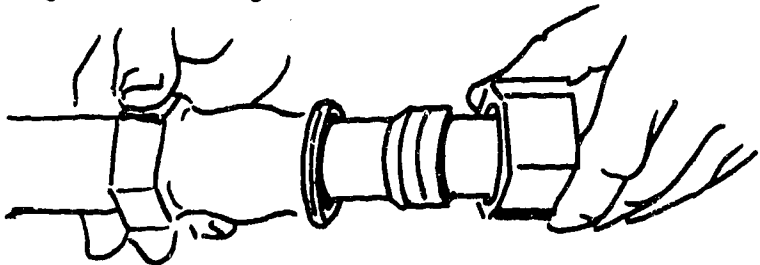
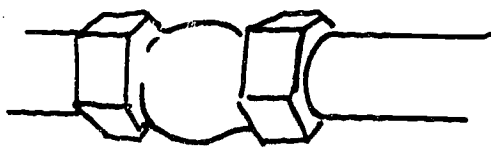
COMPETENCE - PROCEDURE/STEPS The student will be able to:	TEACHING/LEARNING ACTIVITIES
<ol style="list-style-type: none"> 1. Clean pipe end with a rag or fine wire brush. 2. Slide friction nut and washers onto the pipe. 3. Slide dresser coupling over pipe. 4. Slide friction washers and nuts against dresser coupling and hand tighten. 5. Clean the second pipe end with a rag or fine wire brush. 6. Slide friction nut and washers on the pipe. 7. Insert pipe into dresser coupling (butt other pipe). 8. Slide friction nuts and washers against dresser coupling and hand tighten. 	 <p>NOTE: One-half the length of the dresser coupling is slid over the pipe.</p>
 	

METHOD OF EVALUATION:

- | | |
|-----------------------|-----|
| 1. Proper assembly | 448 |
| 2. Tightness of joint | |
| 3. Leakproof | |

COMPETENCY: Using a Socket Wrench With a Ratchet

COURSE: Plumbing

UNIT IV: Hot Water Supply

OBJECTIVE: To use the socket and ratchet effectively and safely

COMPETENCE - PROCEDURE/STEPS The student will be able to:	TEACHING/LEARNING ACTIVITIES
--	------------------------------

1. Snap the socket onto the ratchet end.

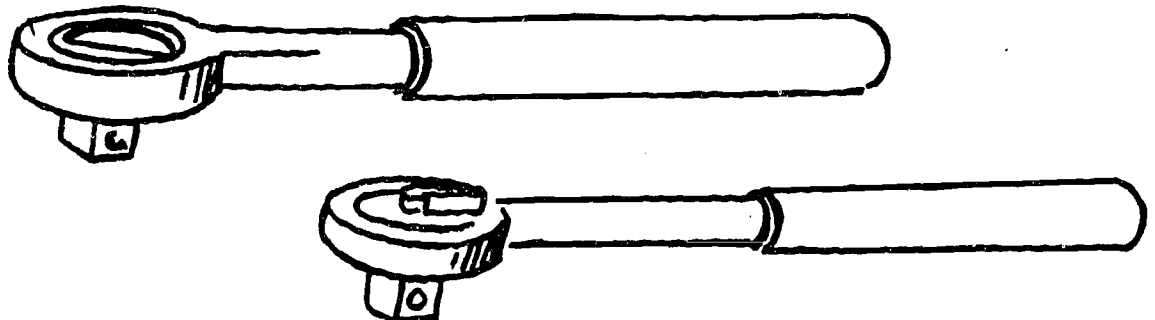

2. Place the socket over the hex nut or bolt.

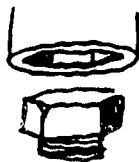

3. Hold the socket in place with your left hand.

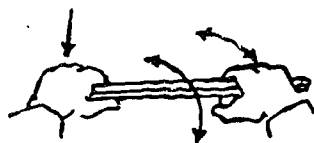

4. Turn the ratchet reversing knob to tighten the bolt.
5. Tighten the bolt.
6. To remove a bolt, turn the ratchet reversing knob the other way.
7. Loosen the bolt.

METHOD OF EVALUATION:

Proper technique

449

OPERATION SHEET

SC-4-2

COMPETENCY: Testing With Soap

COURSE: Plumbing

UNIT IV: Hot Water Supply

OBJECTIVE: To test flammable (gas, oil, etc.) lines safely and efficiently

COMPETENCE - PROCEDURE/STEPS The student will be able to:	TEACHING/LEARNING ACTIVITIES
--	------------------------------

1. Mix proper soap and water forming a liquid substance and place it in small container.
2. Using a 1/2" - 1" acid brush, apply the liquid to the first pipe joint at the main "tie-in" branch fitting.
3. See that the liquid is on the pipe joint the whole way around the joint.
4. Check for leaks by watching the liquid soap for air bubbles.
5. Repeat steps 2 through 4 at each joint from the gas line to the water heater.
6. Repair or replace any leaking joint or fittings.

NOTE: Liquid detergent can be used instead of soap mixture.

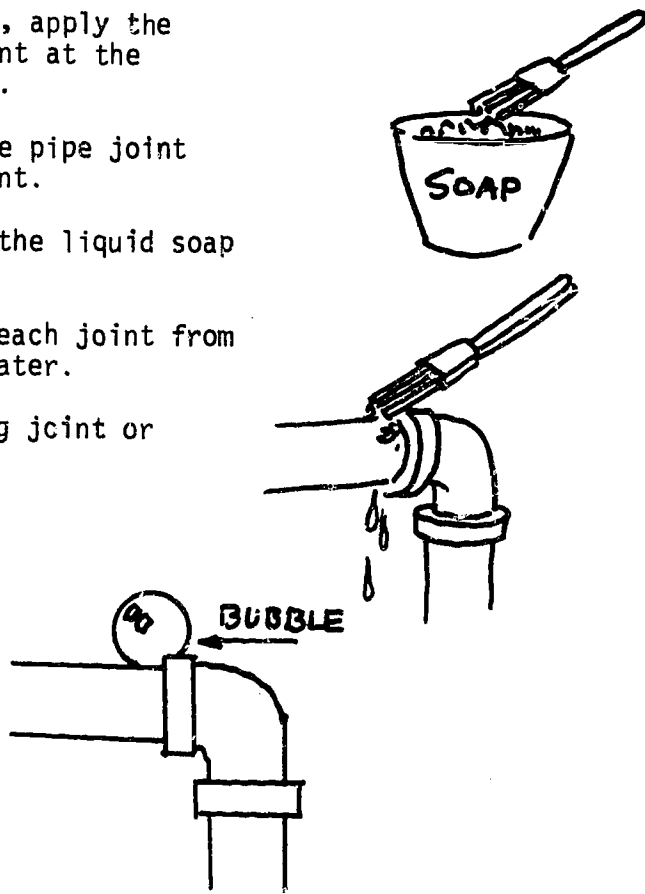

METHOD OF EVALUATION:

1. Proper procedure
2. Proper visual sighting of leaks

COMPETENCY: Lighting Gas Appliances

COURSE: Plumbing

UNIT IV: Hot Water Supply

OBJECTIVE: To light gas pilots and burners in a safe, sufficient manner

COMPETENCE - PROCEDURE/STEPS	TEACHING/LEARNING ACTIVITIES
The student will be able to:	
<ol style="list-style-type: none">1. Light a taper.2. Turn the control to the pilot.3. Depress the button.4. Release the button and check to see if the pilot is lit. Repeat if necessary.5. Turn the control to "ON" position and check the flame for the proper color, greenish inner cone.6. If the burner light goes out, open the doors and windows, wait five (5) minutes and repeat.	CAUTION: Make sure gas has been off at least five (5) minutes before starting to light a gas water heater.

METHOD OF EVALUATION:

1. Proper procedure
2. Flame adjustment

COMPETENCY: Using the Plumb Bob

COURSE: Plumbing

UNIT V: Drainage Systems

OBJECTIVE: To accurately level in a vertical position

COMPETENCE - PROCEDURE/STEPS
The student will be able to:

TEACHING/LEARNING ACTIVITIES

1. Hold or suspend the line attached to the plumb bob at the point or against the object being plumbed.
2. When plumb bob is motionless (hand steady no wind blowing) place a point or small x exactly below the point of the plumb bob.

NOTE: The plumb bob is used to set things, such as wall frames, plumb. It is used to plumb points down from above or up from below, and it is used to check things that are in place to see if they are plumb.

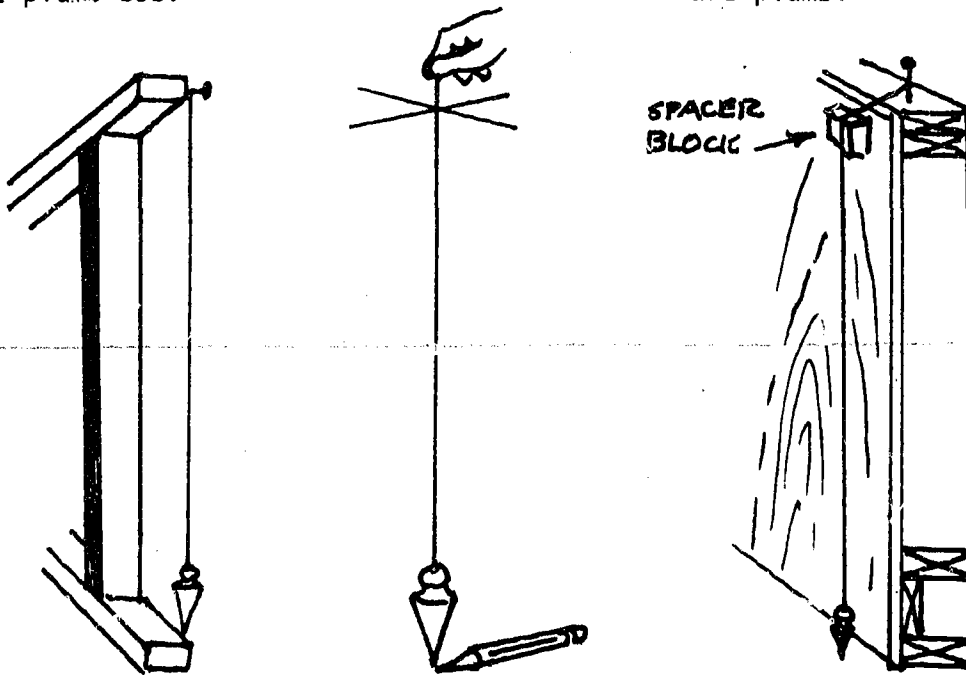

METHOD OF EVALUATION:

1. Proper technique
2. Proper alignment

COMPETENCY: Pulling Nails with the Claw Hammer

COURSE: Plumbing UNIT V: Drainage Systems

OBJECTIVE: To properly pull nails with the claw hammer

COMPETENCE - PROCEDURE/STEPS
The student will be able to:

TEACHING/LEARNING ACTIVITIES

1. Set the claw of the hammer firmly under the head of the nail.

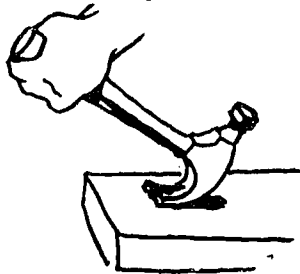

2. Pull the hammer handle until it is almost straight up.

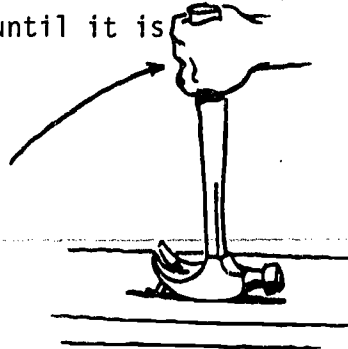

3. Tip the hammer handle forward so you can put a block of scrap wood under the head of the hammer.

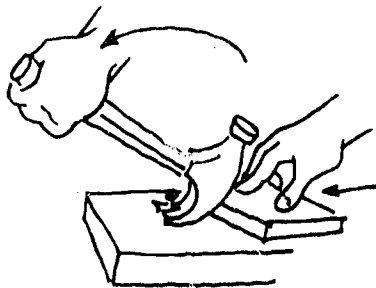

4. Draw the nail again until the nail is free or until the handle is again straight up.

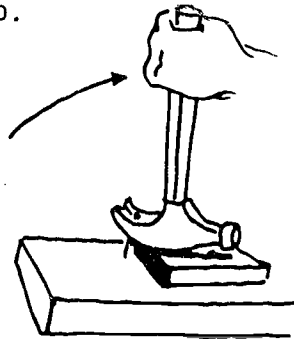

5. If the nail is not out, add a second block of wood and repeat step 4.

METHOD OF EVALUATION:

1. Safe and proper procedure

COMPETENCY: Cutting Curves with a Compass Saw

COURSE: Plumbing

UNIT V: Drainage Systems

OBJECTIVE: To properly and accurately cut curves with the compass saw without buckling or breaking the saw blade

COMPETENCE - PROCEDURE/STEPS
The student will be able to:

TEACHING/LEARNING ACTIVITIES

1. Hold the saw as you do other hand saws-- with your index finger extended along the handle.

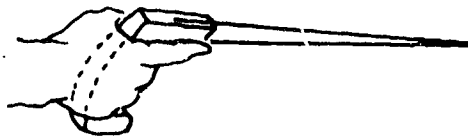

2. Hold the saw blade perpendicular to the work.

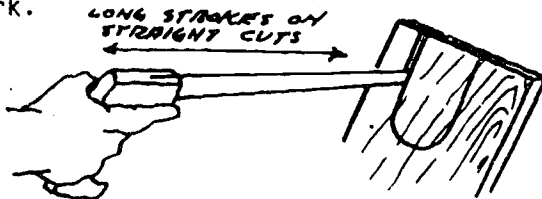

3. Saw with short, choppy strokes.
4. To follow a curved line, twist the blade slightly in the direction of the curve.

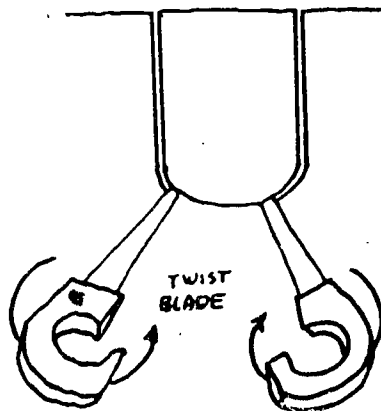

NOTE: Don't force the saw. Forcing could make it buckle or break.

NOTE: For small curves, use only the tip of the blade.

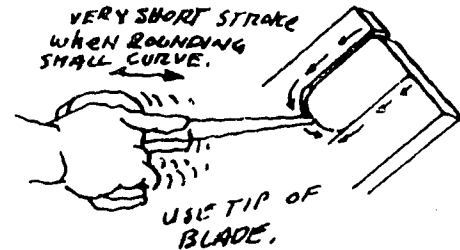

NOTE: To make an inside cut, drill a hole big enough for the saw blade to pass through in the area to be cut out. Use the hole as a starting point to cut out the rest of the pattern.

METHOD OF EVALUATION:

1. Proper technique
2. Appearance of cut

COMPETENCY: Chiseling Across Grain

COURSE: Plumbing

UNIT V: Drainage Systems

OBJECTIVE: To gain skill, using the chisel to make crosswise cuts taking care not to splinter the stock

COMPETENCE - PROCEDURE/STEPS
The student will be able to:

TEACHING/LEARNING ACTIVITIES

1. Hold the cutting edge of the chisel a little above the horizontal guide line with the bevel side up.
2. Lower the chisel handle a little so that you will make an upward cut between the shoulder cut.

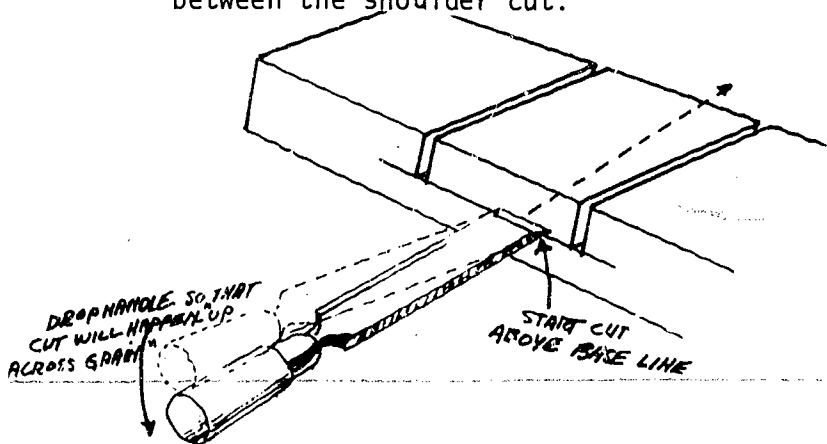

3. Strike the handle of the chisel a light blow with the mallet. Remove the stock.

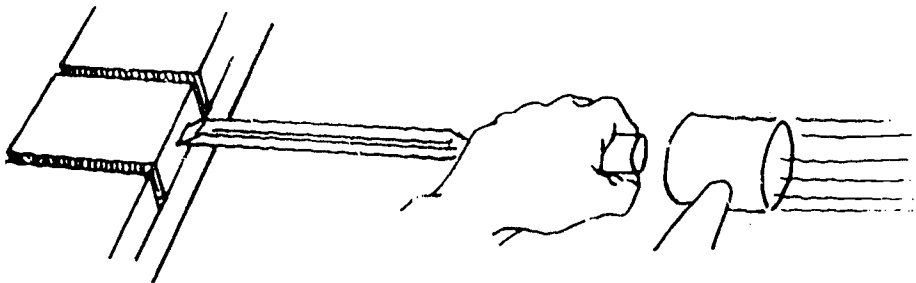

4. Make the same cut from the other side.

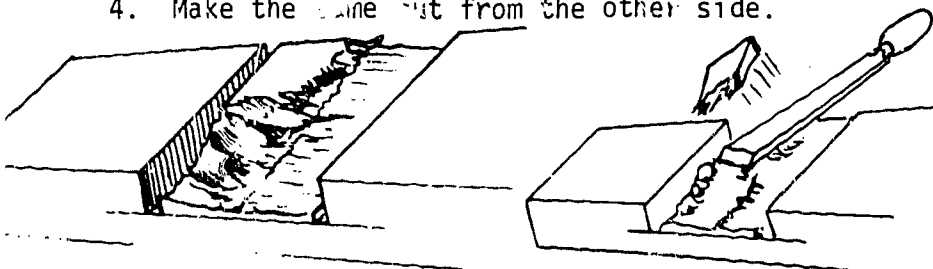

- To make the final paring cut, place the cutting edge of the chisel on the horizontal line with the bevel face up. Hold the blade of the chisel in your left hand and the handle in your right.

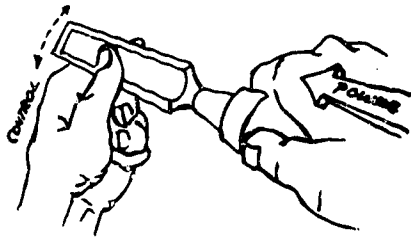

- Push on the handle with steady, even pressure with your right hand. Guide the chisel with your left hand. Press your forefinger and thumb together on the chisel.

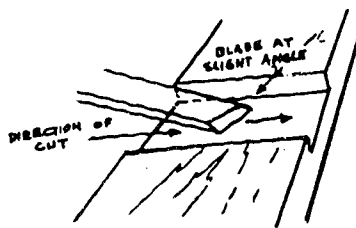

- Hold the chisel at a slight angle to the direction of the cut. (A shearing cut will be made.)

NOTE: To keep the stock from splintering, cut from each side toward the center. Take out the center stock last.

METHOD OF EVALUATION:

- Proper procedure
- Appearance of cut

453

COMPETENCY: Driving Nails with a Claw Hammer

COURSE: Plumbing

UNIT V: Drainage Systems

OBJECTIVE: To properly drive nails with the claw hammer taking care not to miss and damage the wood

COMPETENCE - PROCEDURE/STEPS

The student will be able to:

TEACHING/LEARNING ACTIVITIES

1. Hold the hammer with your fingers underneath and your thumb alongside or on top of the handle. Except for light blows, the handle is held close to the end.



2. Hold the nail between the fingers and thumb of your other hand. Use the rest of the hand to help position the nail.

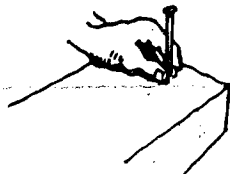

3. Rest the face of the hammer on the head of the nail. Raise the hammer slightly and give the nail a light tap. This starts the nail and will help to set the aim of the nail.



4. Line the hammer up so that the nail is struck squarely so you don't bend the nail or mar the wood.



5. Drive the nail until the head is almost level with the surface of the wood.



6. Finish driving the nail with light blows so you don't damage the surface of the wood.

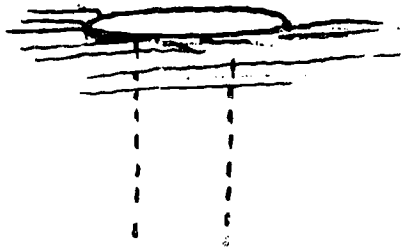

METHOD OF EVALUATION:

1. Proper technique
2. Appearance of driven nail
3. Straightness of nail and blows

COMPETENCY: Using the Level for Leveling

COURSE: Plumbing

UNIT V: Drainage Systems

OBJECTIVE: To properly use the level to obtain accurate and precise readings

COMPETENCE - PROCEDURE/STEPS The student will be able to:	TEACHING/LEARNING ACTIVITIES
--	------------------------------

1. Locate point from which you wish to level.
2. Place the end of the level on the point you have established. Hold the one end of the level on that point.

NOTE: Use only the best and most accurate level. Inaccurate tools are frequent causes of inaccurate work.

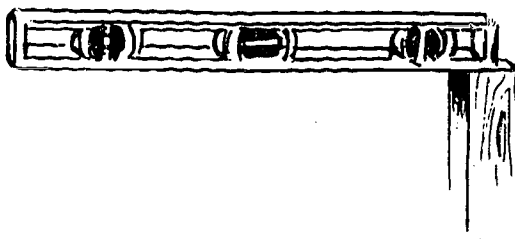

3. Raise or lower the opposite end until the bubble is exactly at level reading.

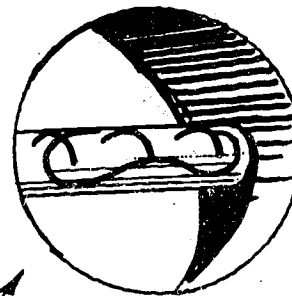
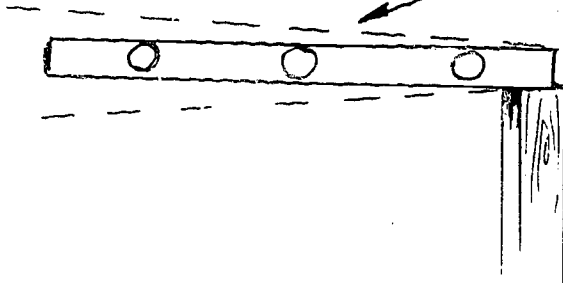

NOTE: Some levels have two lines of which the bubble should be centered as shown. Some have one line at which the bubble should be centered as shown.

CAUTION: Do not drop or jar this instrument, it could cause it to become inaccurate.

NOTE: Always use as large a leveling tool as possible. Your reading will always be more accurate.

METHOD OF EVALUATION:

1. Proper procedure
2. Levelness of object

COMPETENCY: Cutting Wire with Side Cutters or Diagonals

COURSE: Plumbing

UNIT VI: Fixtures

OBJECTIVE: To safely cut wire and bending with the side cutting pliers

COMPETENCE - PROCEDURE/STEPS
The student will be able to:

TEACHING/LEARNING ACTIVITIES

1. Hold the side cutters in your right hand.

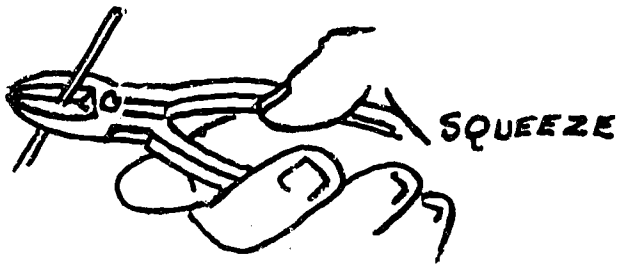
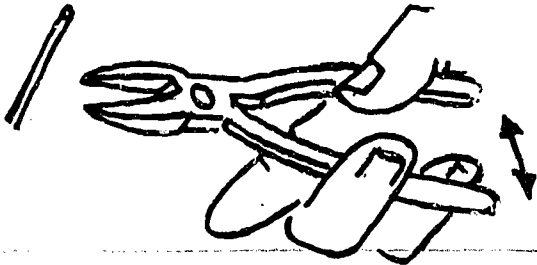
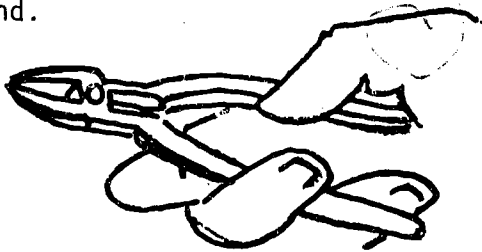

METHOD OF EVALUATION:

Proper procedure

COMPETENCY: Marking a Line with a Combination Square

COURSE: Plumbing

UNIT VI: Fixtures

OBJECTIVE: To mark studs and boards squarely for cutting

COMPETENCE - PROCEDURE/STEPS

The student will be able to:

TEACHING/LEARNING ACTIVITIES

1. Place the head of the square against the edge of the stock.



2. Slide the square along the edge of the stock until the edge of the blade is aligned with the mark to be squared.
3. Mark a line along the edge of the blade with a sharp pencil.

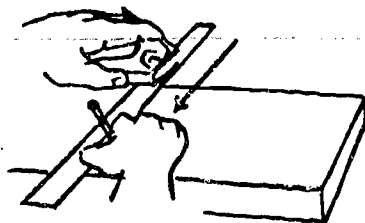

METHOD OF EVALUATION:

1. Accuracy of measurement
2. Correct use of tools

COMPETENCY: Cutting to a Line with a Cross Cut Saw

COURSE: Plumbing

UNIT VI: Fixtures

OBJECTIVE: To cut a backing or trim board square for installation

COMPETENCE - PROCEDURE/STEPS
The student will be able to:

TEACHING/LEARNING ACTIVITIES

1. Hold the saw with your thumb and index finger along the handle.



CAUTION: BE SURE the work is well supported or clamped.

2. Hold the stock with the end of your thumb-nail acting as a guide for the saw. Start the cut by putting the cutting edge of the saw on the waste side of the stock and right beside the line. Pull the saw toward you to start the cut.

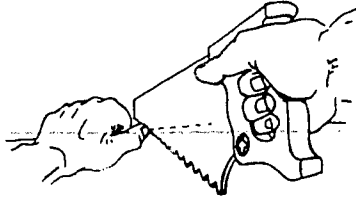

CAUTION: Saw teeth are sharp and will cut fingers as well as wood. The saw may jump when you start the cut, so begin slowly.

3. Keep the side of the saw square with the face of the board and the whole length of the saw in line with your forearm. Take short, light strokes to begin. Then gradually increase the strokes to the full length of the saw.

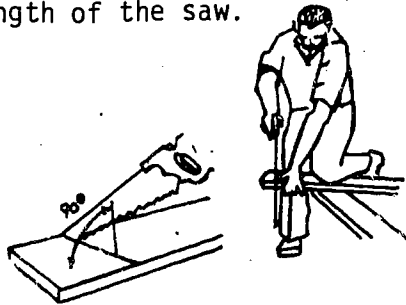

4. When you are sawing, watch the line and not the saw. The line should be left on the stock when you are done. The saw may be brought back to line by twisting the heel of the saw a little in the direction the kerf needs to move.

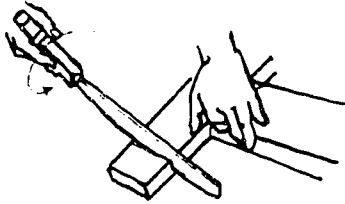

5. Final strokes should be taken slowly and the waste material should be grasped with your left hand to prevent splinting.

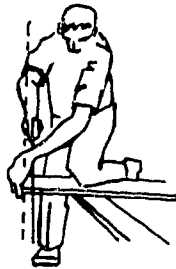

METHOD OF EVALUATION:

1. Proper procedure
2. Accuracy of cut
3. Time:

465

COMPETENCY: Cut Thin Material with a Knife

COURSE: Plumbing

UNIT VI: Fixtures

OBJECTIVE: To thin material straight and safe using a pocket knife

COMPETENCE - PROCEDURE/STEPS	TEACHING/LEARNING ACTIVITIES
------------------------------	------------------------------

The student will be able to:

1. Place material on a flat surface (may require a hard or soft surface).
2. Hold material in place with left hand.

3. Pull blade toward yourself while applying enough pressure to cut through.

NOTE: Curves can be cut by steering blade like a rudder.

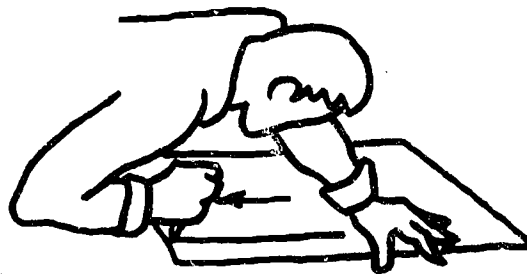
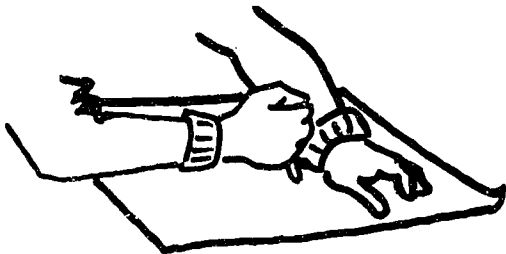

METHOD OF EVALUATION:

1. Safe and proper procedure

COMPETENCY: Using the Basin Wrench

COURSE: Plumbing

UNIT VI: Fixtures

OBJECTIVE: To be able to properly tighten sink and lavatory connections at hard-to-reach places

COMPETENCE - PROCEDURE/STEPS	TEACHING/LEARNING ACTIVITIES
------------------------------	------------------------------

The student will be able to:

1. Set jaw end of wrench for position desired (tightening or loosening).
2. Place fixed jaw against faucet lock nut or supply nut.
3. Using finger, press adjustable jaw around pipe or nut and apply slight pressure on wrench handle.
4. Grasp handle with right hand and wrench shank with left hand apply pressure to tighten nut.
5. Loosen grip and repeat steps 2 through 3 until tight.
6. To remove wrench loosen grip and back off slightly.

NOTE: This slight pressure will assure position of jaws.

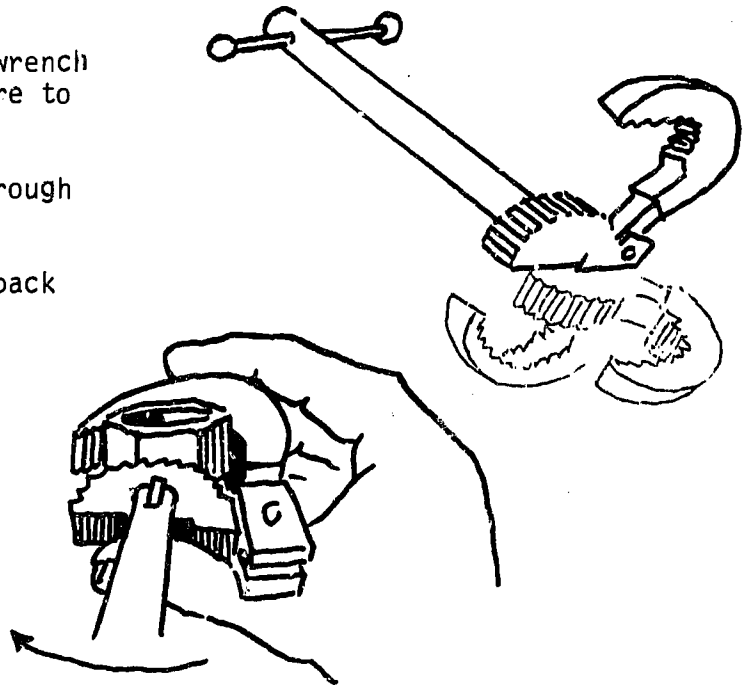

METHOD OF EVALUATION:

1. Proper procedure
2. Care and safe use of wrench

COMPETENCY: Using the Sink Strainer Wrench

COURSE: Plumbing

UNIT VI: Fixtures

OBJECTIVE: To be able to properly use the sink strainer wrench while tightening up or removing sink strainers

COMPETENCE - PROCEDURE/STEPS The student will be able to:	TEACHING/LEARNING ACTIVITIES
--	------------------------------

1. Check bottom of strainer to determine side of strainer wrench to be used.
2. After rubber and metal gasket and nut are hand tightened on strainer, slide strainer wrench up tight against strainer bottom.
3. Hand tighten strainer wrench nut onto strainer bottom.
4. Hold strainer wrench handle with one hand while tightening or loosening strainer nut with the other.
5. Loosen strainer wrench nut and drop or move wrench from strainer.

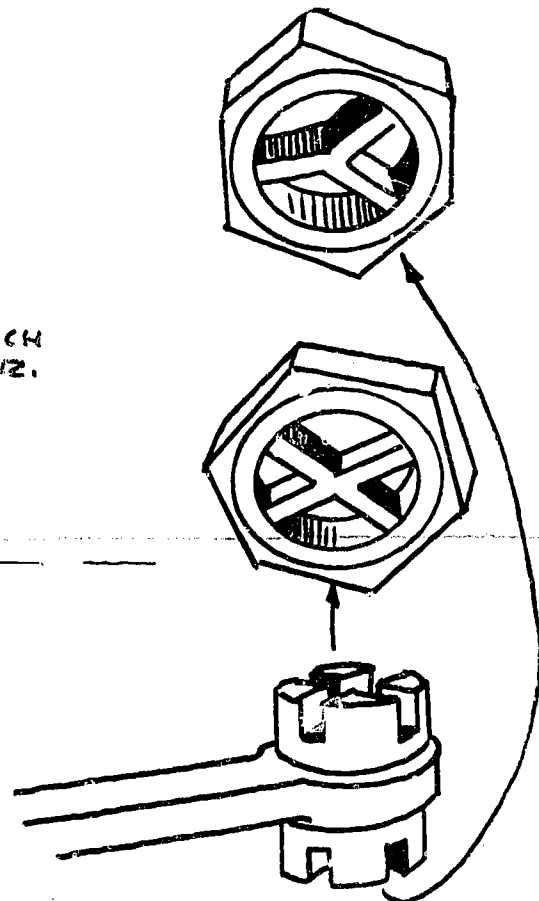
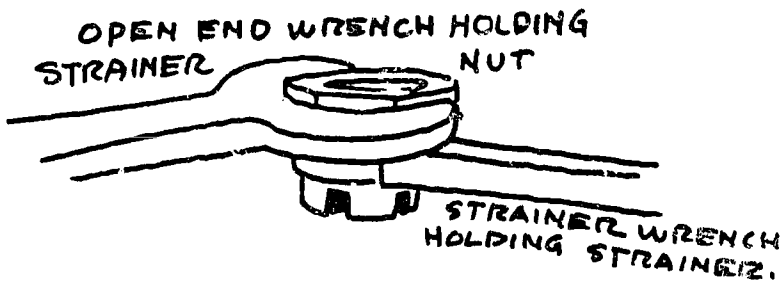

METHOD OF EVALUATION:

1. Proper procedure
2. Care and safe use of wrenches

COMPETENCY: Using a Sabre Saw

COURSE: Plumbing

UNIT VI: Fixtures

OBJECTIVE: To use the sabre saw in a safe and efficient manner

COMPETENCE - PROCEDURE/STEPS The student will be able to:	TEACHING/LEARNING ACTIVITIES
--	------------------------------

1. Insert saw blade into pre holes.

NOTE: Blade should be quite ridged and have approximately 24 to 32 teeth per inch.

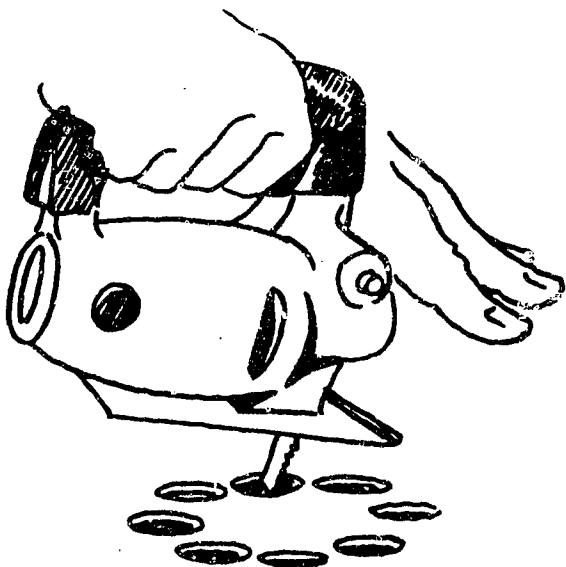

2. Hold the saw base firmly against the deck.
3. Start the saw and guide the blade on line where you wish to cut.



4. Continue cutting until entire hole is cut through.

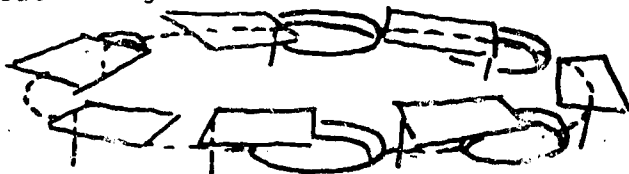

COMPETENCE - PROCEDURE/STEPS

TEACHING/LEARNING ACTIVITIES

8. Shut off saw before removing from cut.

CAUTION: Be sure you are wearing your safety glasses.

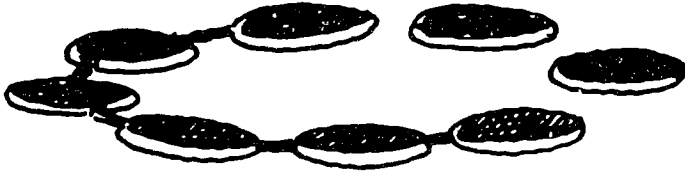

METHOD OF EVALUATION:

1. Proper procedure
2. Appearance of cut

470

TITLE: Shop Safety Rules and Regulations

COURSE: Plumbing

UNIT I: Pipes and Fittings

Safety means more than merely being careful. The plumber is dependent largely upon the careful and conscientious adherence to safety rules by the workmen who may have preceded him on the job. It is the duty of every workman to consider not only his own personal safety at the time of doing a piece of work, but also any possible effect that the work may have on the safety of those who work near him.

One of the most valuable skills you can acquire in your shop, or anywhere else, is the formulation of a positive safety attitude. The following rules and regulations for safety as applied to the plumbing and pipe fitting shop have been established for three good reasons:

1. To protect you and your co-workers from bodily harm.
 2. To minimize damage to the facilities, machinery, and tools which you must work with.
 3. To provide you with the experience in safety concepts as they apply not only to plumbing and pipe fitting work but to all vocational fields.
1. ALWAYS WEAR SUITABLE CLOTHES. A plumber's clothes should fit snugly. Anything that can snag or get in the way, such as neckties, loose patch pockets, watches, rings, or gloves, should not be worn. One may, however, wear suitable gloves or hand pads when handling heavy, rough, or hot materials and chemicals.
 2. ALWAYS WEAR PROTECTIVE GOGGLES. When the danger from flying particles does not necessarily need goggles, wear a face shield. There are several types of goggles; be sure to select the type needed for protection while performing a particular job.
 3. A GOOD WORKER IS ALSO A GOOD HOUSEKEEPER. The area around a job must be kept clean and orderly as possible. Never leave tools or materials lying around or overhead. Keep fire-protection equipment and safety devices easily accessible.
 4. ~~THERE IS NO PLACE FOR PRACTICAL JOKING AND HORSEPLAY ON THE JOB.~~ Conducting yourself in a proper manner does not include scuffling, pushing, wrestling, giving the "hotfoot," or tripping. A workman should have a wholesome attitude toward safety.
 5. Lift by crouching as close to the load as possible keeping your back muscles locked so that the back is held rigid and with your leg muscles in tension ready to do the work.

6. When nearing a corner or doorway with a long piece of pipe, the worker should raise the front end of the pipe high enough so that it will be above the height of a man. This is done to avoid striking the head of an unseen person who may be approaching.
7. POWER TOOLS AND MACHINES:
 - A. Never remove guards from machines, keep guards in place and in working order.
 - B. Use goggles while working on a machine that grinds, cleans, drills or cuts.
 - C. Disconnect tools - when not in use, before servicing, when changing accessories such as blades, bits, cutters, etc.
 - D. Do not touch a machine that is being operated by another student. Do not disturb the operator of a running machine.
 - E. Secure work, use clamps or a vise to hold work. It's safer then holding it in your hand and it frees your hands to operate tools.
8. HAND TOOLS:
 - A. Chisels, punches, and similar tools often burr over the top after continual pounding. These are called "Mushroomed" heads - grind off all mushroom heads whenever they start to form.
 - B. When using a wrench, always pull--never push. This gives you more control and leverage and will avoid skinned knuckles if the wrench slips.
 - C. Never use a hard hammer on machined, tempered, or hardened surfaces.
 - D. Always use a file with a handle. Using a file without one will eventually mean a skinned hand or other wounds.
 - E. Never carry tools in your pocket. Should you fall, sharp ends might be driven into your body and even more commonly, you might gouge another worker.
9. AIR HOSES AND MECHANICAL OILERS:
 - A. Never point air guns or mechanical oilers at another student.
 - B. Never use an air hose for dusting off clothing or hair.
 - C. Clean spilled oil from the floor immediately.
 - D. Use goggles when using an air hose.
10. Report all accidents to the instructor immediately regardless of nature or severity. Report unsafe equipment, tools and machinery to the instructor at once. Whenever you are in doubt about the correct safety procedure, ask the instructor. All safety rules will receive 100% enforcement in our shop. It is better to have a few rules which are always enforced than have a large number that are seldom or never enforced.

ASSIGNMENT SHEET NO. 5-9

TITLE: Stoppage of Fixtures, Drains and Sewers

COURSE: Plumbing

PURPOSE: To develop the ability to locate stoppage and leaks often found in drains and sewers.

INTRODUCTION: A great part of the plumber's time is spent locating stoppages and leaks often found in many older drain systems and plumbing. The contents of this lesson is important; the information provided can save you much time on the job.

TEXT/REFERENCE: PLUMBING, pp. 472-476
Babbitt

- QUESTIONS:
1. Name two methods of gaining access to sewer pipes.
 2. List 12 maintenance problems that a plumber is often called on to fix.
 3. What plumbing tool is common and usually used in clearing a stopped lavatory?
 4. Draw and label five sewer-cleaning tools and give one use of each.
 5. Name three trees that have root systems that often cause stoppage in sewer systems.
 6. Name two methods of removing tree roots.
 7. The placing of _____ in pipe joints is a patented method of combating tree roots.
 8. What is the simplest method of finding buried sewer pipe?
 9. How are concealing breaks in pipes located?
 10. What are the three most common methods of locating leaks in buried water pipes?