

DOCUMENT RESUME

ED 115 468

SE 018 843

TITLE Radiological Defense. Textbook.
 INSTITUTION Defense Civil Preparedness Agency (DOD), Washington, D.C.
 REPORT NO SM-11.22-2
 PUB DATE Jun 74
 NOTE 201p.; For Training Purposes Only

EDRS PRICE MF-\$0.76 HC-\$10.78 Plus Postage
 DESCRIPTORS *Educational Programs; *Emergency Programs; *Instructional Materials; *National Defense; Radiation; *Radiation Effects; Safety; Science Education; Textbooks
 IDENTIFIERS Department of Defense; DOD

ABSTRACT

This textbook has been prepared under the direction of the Defense Civil Preparedness Agency (DCPA) Staff College for use as a student reference manual in radiological defense (RADEF) courses. It provides much of the basic technical information necessary for a proper understanding of radiological defense and summarizes RADEF planning and expected operations. This textbook is not intended to provide RADEF operational procedures or direction for the development of RADEF plans and organizations. Such guidance will be found in other DCPA publications. Among the chapters are: (1) an Introduction; (2) Basic Concepts of Nuclear Science; (3) Effects of Nuclear Weapons; (4) Nuclear Radiation Measurements; and (5) Radiological Monitoring Operations and Techniques. (LS)

 * Documents acquired by ERIC include many informal unpublished *
 * materials not available from other sources. ERIC makes every effort *
 * to obtain the best copy available. Nevertheless, items of marginal *
 * reproducibility are often encountered and this affects the quality *
 * of the microfiche and hardcopy reproductions ERIC makes available *
 * via the ERIC Document Reproduction Service (EDRS). EDRS is not *
 * responsible for the quality of the original document. Reproductions *
 * supplied by EDRS are the best that can be made from the original. *

THIS DOCUMENT HAS BEEN REPRO-
DUCE EXACTLY AS RECEIVED FROM
THE PERSON OR ORGANIZATION ORIGIN-
ATING IT. POINTS OF VIEW OR OPINIONS
STATED DO NOT NECESSARILY REPRESENT
OFFICIAL NATIONAL INSTITUTE OF
EDUCATION POSITION OR POLICY

SCOPE OF INTEREST NOTICE

The ERIC Facility has assigned
this document for processing
to:

SE CE

In our judgement, this document
is also of interest to the clearing-
houses noted to the right. Index-
ing should reflect their special
points of view.

ED# 115 468

RADIOLOGICAL

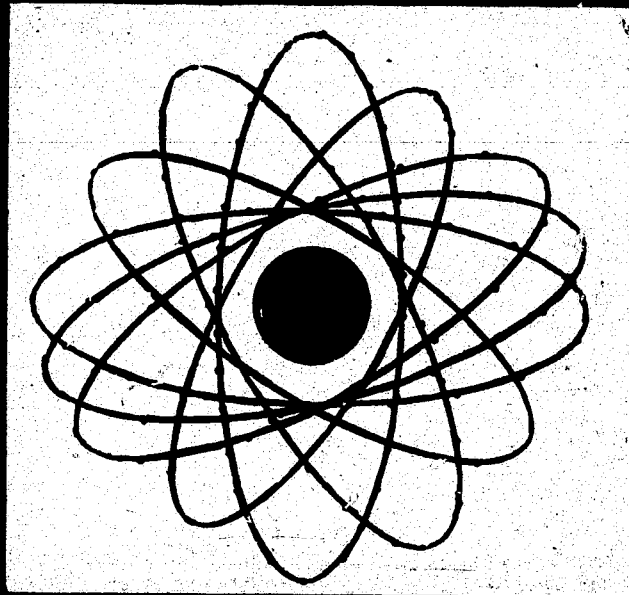

TEXTBOOK

SE 018 843

2

DEFENSE CIVIL PREPAREDNESS AGENCY

DEPARTMENT OF DEFENSE



FOR TRAINING PURPOSES ONLY

RADIOLOGICAL DEFENSE

TEXTBOOK

DEFENSE CIVIL PREPAREDNESS AGENCY • DEPARTMENT OF DEFENSE

(Supersedes SM-11.22-2 dated JUNE 1968)

FOREWORD

This textbook has been prepared under the direction of the Defense Civil Preparedness Agency (DCPA) Staff College for use as a student reference manual in radiological defense courses. It provides much of the basic technical information necessary for a proper understanding of radiological defense and summarizes RADEF planning and expected operations.

This textbook is not intended to provide RADEF operational procedures or direction for the development of RADEF plans and organizations. Such guidance will be found in other DCPA publications.

TABLE OF CONTENTS

Chapter		Page
1	INTRODUCTION TO RADIOLOGICAL DEFENSE ----- Discusses the nature of the radiological threat and the measures being taken to counteract that threat.	1
2	BASIC CONCEPTS OF NUCLEAR SCIENCE ----- Discusses those factors in nuclear radiation physics which RADEF personnel should understand in order to carry out their responsibilities in the most effective manner.	5
3	EFFECTS OF NUCLEAR WEAPONS ----- Describes how nuclear weapons differ in both degree and kind from conventional explosive weapons, and what the effects of a nuclear explosion are, both in sequence and nature.	25
4	NUCLEAR RADIATION MEASUREMENT ----- To deal with the radiological effects of nuclear explosions it is vital to be able to detect and to measure harmful levels or rates of radiation. This chapter describes the principles by which we are able to do this.	55
5	RADIOLOGICAL EQUIPMENT ----- Describes those radiological detection and measurement instruments constructed on the principles set forth in Chapter 4 which are available to the radiological defense program.	69
6	RADIOACTIVE FALLOUT ----- One of the principal effects of nuclear weapons is the production of radioactive material which comes back to earth in the form of fallout. This chapter tells how fallout is formed, how it is distributed, how it is a hazard, and how its movement can be predicted.	81
7	EFFECTS OF NUCLEAR RADIATION EXPOSURE ----- This chapter tells what happens to the human body when subjected to radiation at various levels, and why these biological effects occur.	97
8	EXPOSURE AND EXPOSURE RATE CALCULATIONS ----- A central concept in dealing with nuclear radiation is the decrease in radiation levels of radioactive fission products with the passage of time. This chapter tells how this decrease or decay may be calculated under various conditions and by various methods.	117
9	RADIOLOGICAL MONITORING TECHNIQUES AND OPERATIONS ----- Describes the objectives of radiological monitoring and how those objectives are achieved.	135
10	PROTECTION FROM RADIATION ----- There are various kinds of radiation emitted from fallout. This chapter explains what they are, how they differ, and by what means we may protect ourselves from them.	142
11	RADIOLOGICAL DECONTAMINATION ----- Describes the general nature of radiological decontamination and the principles and phases of decontamination operations.	153
12	RADEF OPERATIONS ----- Describes the role of RADEF at each level of operations.	164

Chapter		Page
13	RADEF PLANNING ----- We all accept the need to look before we leap, but why is planning with its cost in money and manhours really of such crucial importance? This chapter provides some answers to that question.	168
14	"PAPER PLANNING" OR REAL RADEF ----- A plan can be just words or it can be a blueprint for action. The difference lies in the availability of certain skills and knowledge necessary to translate the plan into effective action. This chapter discusses what these are.	179
	GLOSSARY -----	185

INTRODUCTION TO RADIOLOGICAL DEFENSE

A strong civil preparedness program is vital to this nation's security. Today, every citizen and officials at every level of government should be concerned with preparing for disasters of all kinds. This book is primarily concerned with one such potential disaster; that of a nuclear attack on this country.

This chapter will show why civil preparedness is vital to our security by stating the nature of the threat we face and the role that an effective preparedness posture can play in our national response to that threat. It will also define what we mean by "radiological defense" and will indicate how such defense is organized. Another objective of this chapter, and perhaps the most important one, is to explain how effective radiological defense requires trained and dedicated personnel. We cannot develop a radiological defense capability unless we can count on all of our citizens to learn something of the nature of nuclear radiation and to gain an understanding of the measures that can be taken to defend against its effects should this nation ever face nuclear attack.

THE NATURE OF THE THREAT

1.1 Any assumptions about a possible nuclear attack upon the United States are dangerous since we can never be sure about a potential enemy's objectives or even specific capabilities. Studies made by the Department of Defense and others for exercise purposes use attack patterns that represent current estimates of weapon size and total yield that could be delivered on this country in an all out nuclear attack.

1.2 Specific attack patterns assume hundreds of nuclear weapons with many millions of tons of TNT equivalent are

dropped on a mixture of military, industrial and population targets as both surface and air bursts. The results vary, of course, but the unmistakable fact remains that millions of Americans would be killed outright in any such attack by the direct effects of blast and fire. The locations at which weapons were detonated would suffer unprecedented physical damage and the fallout radiation from surface weapons would affect hundreds of square miles in a downwind direction from those bursts. Additional millions of casualties would be caused depending on the amount of fallout protection available in the affected areas. In one simulated attack in which 800 nuclear weapons of 3,500 megatons were assumed, there would be about 97 million people killed either outright or who died subsequently from the direct effects or from fallout. Another 30 million would have been injured but would survive while the remaining 67 million out of a total population of 194 million would not be affected.

1.3 Three things are worth noting about this threat. They are:

First, there is no equivalent in human experience for the destructiveness of multi-megaton hydrogen weapons. It is worth remembering that all the bombing raids on Germany in World War II . . . by all the allied forces . . . together totalled but *one* megaton.

Second, not only are the weapons in a new dimension of destruction, but the delivery systems are now in a new dimension of effectiveness. Unless an anti-missile missile is developed that can not only hit an enemy missile, but hit it almost immediately after it leaves the launching pad, and further, can discriminate between missile and decoy, the advantage in

modern strategic missile warfare seems certain to remain with the attacker. This factor, coupled with the enormous destructiveness of modern weapons, places a premium on surprise.

Third, this hypothetical attack would produce casualties to more than half of our population under the conditions then prevailing. If the conditions were changed to the extent of providing an effective civil preparedness program, the casualties would be reduced to a major degree.

NOTE

Our system of ethics is based upon the belief that each individual life is precious. This belief underlies all our American institutions. It is, in fact, the basic way we differ from systems embracing totalitarianism, where the individual is the servant of the State, rather than our system where governments derive "... their just powers from the consent of the governed ..." This central fact, which motivates the government in working for civil preparedness, should not be obscured by statistics dealing with millions of casualties. "Megadeath" like "genocide" are words that spring from systems of government alien to our way of life and our system of right and wrong. Unfortunately, the grim facts of the missile age force us to consider these terms, so hostile to our belief in the supreme value of the individual.

THE ROLE OF CIVIL PREPAREDNESS AND RADIOLOGICAL DEFENSE

1.4 The national defensive posture of a nation incorporates, among other things, the concept of "Active" and "Passive" offensive and/or defensive capabilities. "Active" offensive and defensive capabilities include items such as a nation's military forces and arms, both conventional and nuclear, as well as any other capability which represents an "Active" resource for implementing and maintaining an offensive or defensive posture. ICBM's, bombers, naval ships, etc., represent obvious examples of an "Active" capability. "Passive" capabilities, however, are those items lacking the visibility of a military force, but which may contribute significantly to a nation's defensive capability.

Civil preparedness is a prime example of a "Passive" capability.

1.5 The Strategic Arms Limitation Talks (SALT) were designed to effect a balance of power among the two primary nuclear powers—the United States and the Soviet Union. The SALT negotiations would basically effect this balance by placing limitations or curbs upon the "Active" offensive and defensive capabilities of a nation. It then becomes apparent that, assuming the effectiveness of the SALT negotiations, a nation with a strong "Passive" defensive capability occupies a position of strength. Herein lies the importance of civil preparedness and radiological defense.

1.6 Since the civil preparedness program is a vital element of a meaningful "Passive" defensive posture, it is extremely important that it be an effective element with trained personnel ready to provide an immediate response in a crisis situation. Thus, in terms of the recognizable nuclear threat, radiological defense occupies a very realistic and substantial role within the United States civil preparedness program and within the total defensive posture of the nation.

RADIOLOGICAL DEFENSE

1.7 In evaluating the results of a hypothetical nuclear attack upon the United States, several means of protection must be utilized. Assuming that a crisis period or period of marked increased international tension will probably precede an actual attack, crisis evacuation procedures can remove segments of the population away from probable high risk areas. Additionally, to the extent that it is available, protection against blast and other direct effects should be taken by utilizing available shelters. Equally important, however, is the need in all defensive plans for protection against nuclear fallout. Radiological defense maximizes this type of protection.

1.8 Thus, radiological defense is an extremely important element of civil preparedness. Radiological defense is defined as:

**The Organized Effort Through
Detection, Warning, and
Preventive and Remedial Measures
To Minimize the Effect of
Nuclear Radiation
on People and Resources.**

GENERAL RADIOLOGICAL DEFENSE REQUIREMENTS

1.9 Following are the requirements of a sound radiological and civil preparedness program:

(a) A system of shelters, equipped and provisioned to protect our population from the fallout effects of a nuclear attack.

(b) Organization and planning of emergency actions necessary to restore a functioning society.

THE IMPORTANCE OF SHELTERS

1.10 Shelters—both individual and community—are “keys” for survival. This is because shelter plays a dual role in an effective radiological defense program; first, as a shield protecting individuals; and second, as a shield protecting the persons who, by possessing special knowledge, skills, and habits of organization, can combine to assure the continuing of a functioning, democratic society. Thus, a shelter is not only a passive shield; it is also an active element in the system of countermeasures that would have to be taken to assure the survival of the nation after an attack.

As radiation levels decline, people can leave their shelters to perform needed tasks of recovery. But when can they leave their shelters? This and other questions, such as determining what the radiation levels are within the shelter, can be satisfactorily answered in one way only: through accurate measurement or monitoring.

MONITORING AND THE MONITORING SYSTEM

1.11 To assure adequate measurement of radiation levels to support postattack radiological defense operations, the nation

needs a large number of fallout monitoring stations. Some of these stations may be located within community shelters, since such shelters form strong points of survival and bases of ultimate recovery operations. Those community shelters that provide for extended geographic and communications coverage are particularly suited for serving in the additional capacity of monitoring stations.

1.12 Whether in separate monitoring stations or carrying out monitoring procedures from community shelters, the primary job of the monitor will be to supply information on radiation levels, information basic to survival and recovery operations. In carrying out their duties, the monitors should receive technical direction and supervision from their organizational Radiological Defense Officer.

RADIOLOGICAL DEFENSE ORGANIZATION

1.13 As stated in Public Law 85-606, it is the intent of Congress, in providing funds for radiological defense, that the responsibility for such defense be “vested jointly in the Federal Government and the several States and their political subdivisions.” The division of responsibilities among governments, which is a central feature of our Federal system, is fully reflected in the organization of radiological defense. The DCPA recommended program describes in some detail the responsibility of each element and level of government, and the organization established to give effect to these levels of responsibility.

1.14 In order to make the radiological defense program a success, there is need for radiological monitoring stations at Federal, State, and local facilities throughout the nation. This means that there is a need for money to pay for the instruments and equipment required; there is need for management to assure that these stations operate effectively and in one coordinated system. But there is even more need for trained men and women who can operate the equipment, do the other specific jobs needed, and provide

leadership in radiological defense matters on the local level. An essential part of such local leadership is the training of RADEF personnel.

1.15 DCPA training courses are designed to produce a core of competent radiological defense personnel including those who will go back to their communities and train others. For without trained people, the best laid plans become little more than complicated dreams. Trained

men and women breathe life into plans. This is the reason behind the organization of DCPA courses. The courses offer the training. If that offering is taken—to the fullest potential—then all the effort, and planning, and hopes of those deeply concerned with protecting our society, from the President on down, will be realized. For on men and women like ourselves, in the last analysis, will lie the success of the radiological defense program.

BASIC CONCEPTS OF NUCLEAR SCIENCE

We will begin by ending the mystery. Since the aim of this book is to help you in your work of radiological defense, it is essential that you understand what you are defending against—nuclear radiation.

This, then, is the primary objective of this chapter:

Understanding Nuclear Radiation

There are many kinds of radiation, some of which, such as long and short radio waves, infrared (or heat) radiation, visible-light, and ultraviolet radiation are familiar to all of us. However, nuclear radiation, the noiseless, odorless, unseen, unfelt something that can be so deadly seems, as Winston Churchill said of Russia, "a riddle wrapped in mystery inside an enigma".

Fortunately, this need not be so. A few concentrated hours of study will quickly make radiation understandable.

However, if our job were how to stop air contamination from automobile exhausts, we would not get too far by confining ourselves to the nature of the exhaust alone. It would be necessary to study the fuel, the way the auto engine burned the fuel, as well as many other things. Only then could we understand, and possibly cope with, the factors in the exhaust fumes that were harmful.

The same need exists with nuclear radiation. If we are to understand it, we must see the whole picture; we must know the *why* as well as the *what* of nuclear radiation.

Therefore, to help us understand nuclear radiation, the major objective of this chapter, we must also have some grasp of:

WHAT is meant by "matter" and "energy"

WHAT are the kinds of nuclear radiation

WHAT is the language of nuclear physics, the terms, signs and symbols used to describe the world of the atom and radiation

WHAT is the structure of the atom

WHAT is the nature of its parts

HOW do these parts behave

HOW is nuclear radiation measured

TWO FUNDAMENTALS AND A BOMBSHELL

2.1 There are two physical laws that we must understand before we talk about the atom.

2.2 The first of these is known as the **LAW OF CONSERVATION OF MATTER**. According to this law, the total mass of the material universe remains always the same, regardless of all the rearrangements of its component parts. This was first demonstrated by the brilliant French physicist Antoine Lavoisier, whose genius was cut short by the French Revolution. Lavoisier burned a candle of known weight until it disappeared. He then weighed the oxygen used by the burning candle, the wax that remained and the foul gas (carbon dioxide) and water vapor formed by the burning candle. He found that the weight of the candle that disappeared and the weight of the oxygen that combined with it equalled the weight of the carbon dioxide and water vapor. This is one demonstration of the **LAW OF CONSERVATION OF MATTER**.

2.3 The second law of conventional physics is known as the **LAW OF CONSERVATION OF ENERGY**. This law

states that one form of energy can be converted to another form, but the total amount of energy in the universe neither increases nor decreases.

2.4 Until 1905, matter or mass and energy were looked at as separate entities, as indeed they appear to be.

2.5 Then, a young mathematician and physicist working in the Swiss Patent Office produced a bombshell. The young man was Albert Einstein. He said, in what is probably the most important mathematical equation in history, that *E equals mc²*, or, in plain English, that there is an exact equivalence between mass and energy. Mass can be converted to energy and, even more strangely, energy can sometimes be converted to mass.

2.6 According to Einstein, it is not mass or energy as a separate entity, but rather the total mass-energy of the universe that remains constant. In his equation $E = mc^2$ *E* stands for energy, in ergs, generated by any reaction; *m* is for "mass" in grams, lost in any reaction; and *c* is the speed of light, equivalent to 3×10^{10} cm per second (186,000 miles per second).

NOTE

As you read through this and other chapters you may meet words and

terms new or unclear to you, such as "ergs". All of these words are included in the GLOSSARY found at the end of the text.

POWER IMPLICATIONS

2.7 Although no one has succeeded through nuclear fission in converting to energy more than a small fraction of any mass, the advantages of nuclear fission over chemical power (such as combustion) are enormous. (See Figure 2.7 for some examples). For instance, in the fissioning of uranium, as in the bomb dropped over Hiroshima, only a minute part of the total mass of radioactive substance is changed to energy—but this release of energy is gigantic. The Hiroshima blast was equivalent to 20,000 tons of TNT. This was produced by the fission of 2.2 pounds of uranium (since only a minute part of the total actually underwent fission, the uranium contained in the bomb was considerably more than 2.2 pounds). Why so little mass can produce so much energy is precisely what was explained in Einstein's $E = mc^2$ formula.

NATURE OF MATTER

2.8 About the year 1900 a chemist, if asked to explain the material world in

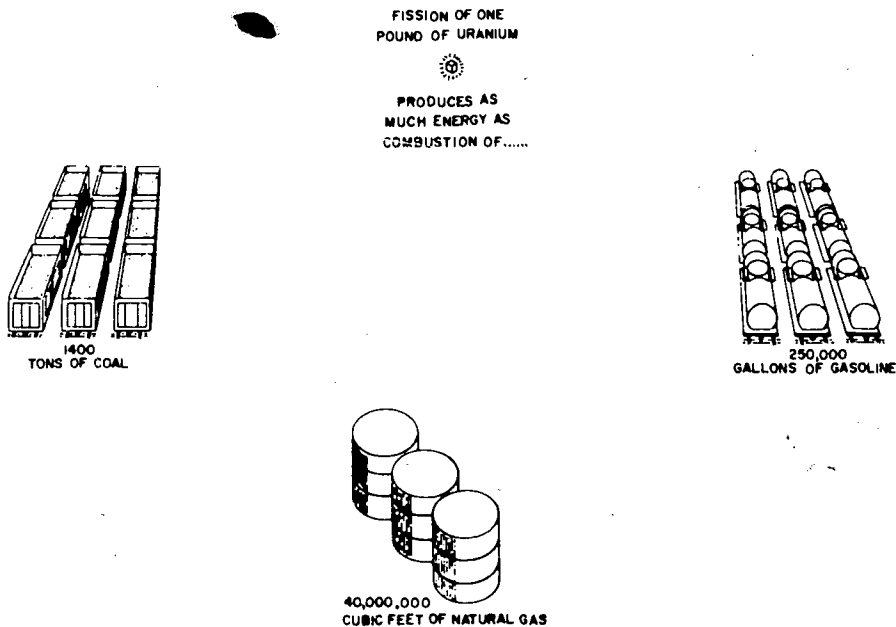

FIGURE 2.7.—Nuclear energy as compared with chemical energy.

FIGURE 2.7.—Nuclear energy as compared with chemical energy.

non-technical language, would have spoken somewhat as follows, stressing certain facts that are *still valid* and are *still fundamental* to an understanding of more recent discoveries.

2.9 The chemist would speak of **ELEMENTS**, of the **ATOM**, of **MIXTURES** and **COMPOUNDS**, of **ATOMIC WEIGHT** and the **PERIODIC TABLE**. Let us take these one at a time.

2.10 *Elements*.—All material is made up of one or more elements. These are substances that cannot be broken down into other and simpler substances by any chemical means. Our 1900 vintage chemist did not know it, but you will see later, that it is possible to cause both decomposition and production of certain elements by means of nuclear reactions. There are now over 100 known basic materials or elements such as iron, mercury, hydrogen, etc., that have been discovered and classified. Some have never been found in a natural environment, but are manmade.

2.11 Iron, mercury, and hydrogen—existing at normal temperatures as a solid, a liquid, and a gas respectively—are typical elements. By heating, a solid element can be changed to a liquid and even to a gas. Conversely, by cooling, a gaseous element can be changed to a liquid and even to a solid.

2.12 *The Atom*.—The smallest portion of any element that shares the general characteristics of that element is called an **ATOM**, which is a Greek word meaning **INDIVISIBLE PARTICLE**.

2.13 *Mixtures*.—Elements may be mixed without necessarily undergoing any chemical change. For example, if finely powdered iron and sulfur are stirred and shaken together, the result is a mixture. Even if it were possible to grind this mixture to atom-size particles, the iron atoms and the sulfur atoms would remain distinct from each other.

2.14 *Compounds*.—Under certain conditions, however, two or more elements can be brought together in such a way that they unite chemically to form a compound. The resulting substance may differ widely from any of its component elements. For

example, drinking water is formed by the chemical union of two gases, hydrogen and oxygen; edible table salt is *compounded* from a deadly gas, chlorine, and a poisonous metal, sodium.

2.15 Whenever a compound is produced, two or more atoms of the combining elements join chemically to form the **MOLECULE** that is typical of the compound. The molecule is the smallest unit that shares the distinguishing characteristic of a compound.

2.16 *Atomic Weight*.—Hydrogen is the lightest element. Experiments have demonstrated that the oxygen atom is almost exactly 16 times as heavy as the hydrogen atom. Chemists express this truth by saying that oxygen has an **ATOMIC WEIGHT** of 16. Through many experiments, the atomic weights of the remaining elements have been found.

2.17 *The Periodic Table*.—Figure 2.17 is a standard table of the elements. The atomic number of each element appears above its chemical symbol. The vertical columns represent family groups. All members—from the lightest to heaviest—of a family behave like one another in forming (or refusing to form) chemical compounds with other families.

2.18 While still essentially correct, this circa 1900 chemist's view of matter needs to be supplemented (but not entirely replaced) by an analysis of the atom. In 1900, only a few advanced scientists had become convinced that the atom is *divisible* after all. This was a new idea, since the atom is very small, having an overall diameter of about 10^{-8} centimeters.

THE ATOM AND ITS BUILDING BLOCKS

2.19 Small as it is, the atom proved to be composed of yet smaller particles. In fact, as shown in Figure 2.19a, it proved to be mostly empty space, with the actual matter contained in a central mass. The new knowledge of the nature of the atom has added many terms to those known to our 1900 vintage chemist. Let us take a few of these terms and relate them to some diagrams of the atom. The terms most useful are **NUCLEUS**, **ELEC-**

THE PERIODIC TABLE OF THE ELEMENTS

Period 1	1 H											2 He						
Period 2	3 Li	4 Be											9 F	10 Ne				
Period 3	11 Na	12 Mg											17 Cl	18 Ar				
Period 4	19 K	20 Ca	21 Sc	22 Ti	23 V	24 Cr	25 Mn	26 Fe	27 Co	28 Ni	29 Cu	30 Zn	31 Ga	32 Ge	33 As	34 Se	35 Br	36 Kr
Period 5	37 Rb	38 Sr	39 Y	40 Zr	41 Nb	42 Mo	43 (Tc)	44 Ru	45 Rh	46 Pd	47 Ag	48 Cd	49 In	50 Sn	51 Sb	52 Te	53 I	54 Xe
Period 6	55 Cs	56 Ba	57-71 Lanthanides	72 Hf	73 Ta	74 W	75 Re	76 Os	77 Ir	78 Pt	79 Au	80 Hg	81 Tl	82 Pb	83 Bi	84 Po	85 At	86 Rn
Period 7	87 Fr	88 Ra	89-10 Actinides	104 (-)														

Lanthanide Series	57 La	58 Ce	59 Pr	60 Nd	61 (Pm)	62 Sm	63 Eu	64 Gd	65 Tb	66 Dy	67 Ho	68 Er	69 Tm	70 Yb	71 Lu
Actinide Series	89 Ac	90 Th	91 Pa	92 U	93 (Np)	94 (Pu)	95 (Am)	96 (Cm)	97 (Bk)	98 (Cf)	99 (Es)	100 (Fm)	101 (Md)	102 (-)	103 (Lw)

Figure 2.17

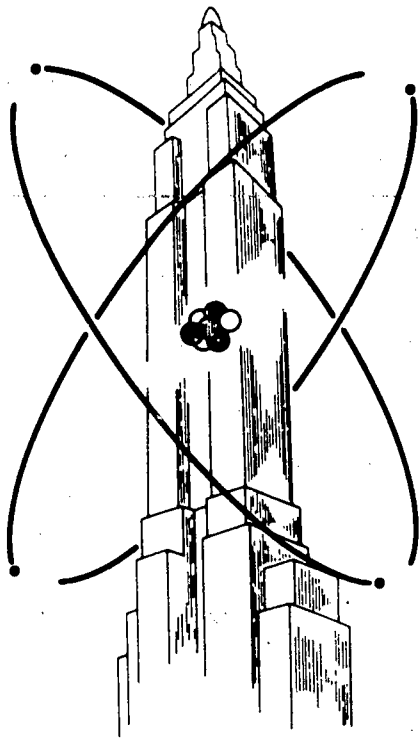

FIGURE 2.19a.—If an atom were the size of the Empire State Building, its nucleus would be as large as a pea and the electrons would revolve around the nucleus at a distance of several hundred feet. (Understanding that there is so much unoccupied space within the atom is important to an understanding of the interaction of radiation with matter.)

TRONS, PROTONS and NEUTRONS, the latter three comprising the basic atomic building blocks as shown in detail in Figure 2.19b.

2.20 The NUCLEUS is the heavy, dense core of the atom, containing practically all of its weight. As we have seen, this nucleus is surrounded at quite some

UNIT	SYMBOLS	WEIGHT OR RELATIVE MASS IN ATOMIC MASS UNITS *	RELATIVE ELECTRICAL CHARGE
PROTON	p OR e^+	1.007593 amu	+1
NEUTRON	n OR e^0	1.00898 amu	0
ELECTRON	e OR e^- OR $-e^0$ OR -	0.000549 amu	-1

* AN ATOMIC MASS UNIT (amu) IS EQUAL TO 1.6×10^{-24} GRAMS OR ONE BILLIONTH OF A BILLIONTH OF A MILLIONTH OF A GRAM

FIGURE 2.19b.—Atomic building blocks.

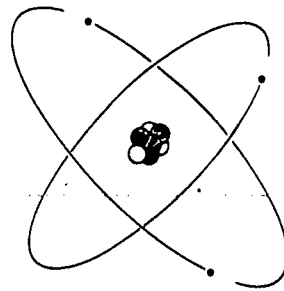

- ELECTRON (Negative Charge)
- PROTON (Positive Charge)
- NEUTRON (No Charge)

FIGURE 2.21.—Elementary particles that make up an atom.

distance by ELECTRONS which whirl around the nucleus at tremendous speeds. Electrons are very small and have practically no weight.

2.21 If we examine the structure of the nucleus in greater detail, we see that it consists of little individual balls of matter that are about the same size in all atoms. Some of these little balls of matter have a *positive electrical charge*. These are called PROTONS. Others, called NEUTRONS, have *no electrical charge* and are said to be electrically neutral. Both a proton and a neutron are much larger and heavier than an electron (see Figure 2.21).

2.22 For each positively charged PROTON in the nucleus, there is a negatively charged electron in orbit around the nucleus. The number of protons in the nu-

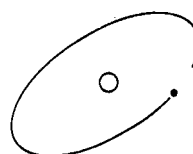

1. HYDROGEN

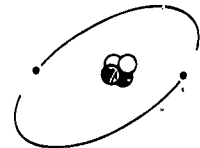

2. HELIUM

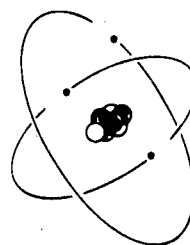

3. LITHIUM

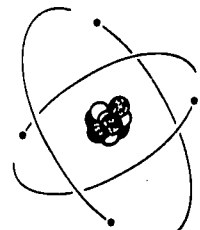

4. BERYLLIUM

FIGURE 2.22.—Comparing the atoms of the first four elements.

nucleus, therefore, determines the number of electrons which are in orbit around the nucleus. *The number of protons also determines the nature of the element.* For example, the single positive charge on the hydrogen nucleus balances the negative charge on the electron. Thus, in its normal or UNEXCITED state, the hydrogen atom as a whole is electrically neutral. The next element heavier than hydrogen is helium, and it has two electrons that move in a single orbit. Two positive charges in the helium nucleus counterbalance the negative effect of the two electrons. Lithium, the next heavier element, has three electrons. Only two of these travel in the comparatively small area near the nucleus, the third has a much larger orbit. The lithium nucleus, therefore, has three positive charges. See Figure 2.22 for examples.

2.23 If time and space permitted, the atoms of all the elements could be examined one by one. For present purposes, however, the oxygen atom (Figure 2.23) will be an adequate example.

2.24 The oxygen atom has eight protons, and therefore eight positive charges in its nucleus. To balance these eight positive charges, eight electrons are required. The first two electrons are in the inner orbit, as is normal in any atom above hydrogen. Three outer orbits, contain the other three pairs of electrons, as shown in

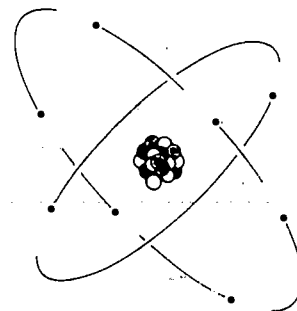

• ELECTRON (Negative Charge)
 ○ PROTON (Positive Charge)
 ● NEUTRON (No Charge)

FIGURE 2.23.—The oxygen atom.

the drawing. One way to think of the six outer electrons, all revolving and spinning, is as if they were tracing a hollow shell like an ultra-light tennis ball. Scientists customarily speak of electrons as being located in SHELLS, classified as K, L, M, N, O, P, A, and sub-shells, in accordance with their energy level, which is proportional to a distance from the nucleus.

2.25 Continuing with our detailed look at the oxygen atom, we see that in addition to the eight protons and the two shells with a total of eight electrons, there are also eight uncharged particles or neutrons.

2.26 With the single exception of hydrogen in its simplest form, all atomic nuclei contain neutrons as well as protons. The lighter elements tend to have approxi-

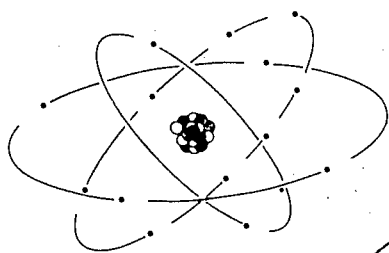

AN ATOM

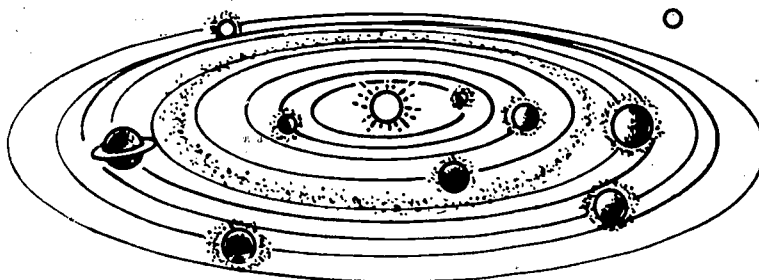

THE SOLAR SYSTEM

FIGURE 2.24.—Another way of viewing the atom is as a minute solar system. Instead of the sun at the center, there is the nucleus; instead of the planets in orbit, there are the electrons.

mately equal quotas of neutrons and protons; *the heavier elements have more neutrons than protons*. This fact, to be explained in greater detail later, is important to an understanding of radiation.

ISOTOPES

2.27 The number of neutrons in the nucleus may range from zero to almost 150. In certain elements it is found that different atoms of the same element have the same number of protons but vary in the number of neutrons. To the chemist, this is of little concern because the chemist works with the orbital electrons, and since all of these atoms have the same number of protons, they will have the same number of electrons in orbit. Since they have a different number of neutrons in the nucleus, however, the various atoms of the same element will not all weigh the same.

MASS.—A measure of the quantity of matter

WEIGHT.—A measure of the force with which matter is attracted to the earth

2.28 To the nuclear physicist and physical chemist, these are different forms of the same chemical element differing only in the number of neutrons in the nucleus. Many of the isotopes are stable. Some of the isotopes are unstable, *and therefore radioactive*.

2.29 Figure 2.29 shows various isotopes of the element hydrogen. The heavier isotopes make up a very small fraction of one percent of the total amount of hydrogen found in nature. Ordinary water consists of molecules each of which is made up of two atoms of hydrogen and one atom of oxygen. If water contains hydrogen which is *not the normal isotope* of hydrogen (one proton) but the deuterium isotope (one proton and one neutron) it will look like regular water, taste like regular water, and, from the chemical point of view, it will be water. However, from a nuclear point of view, this is **HEAVY WATER** because it is made with the heavier isotope of hydrogen.

2.30 The third form of hydrogen called

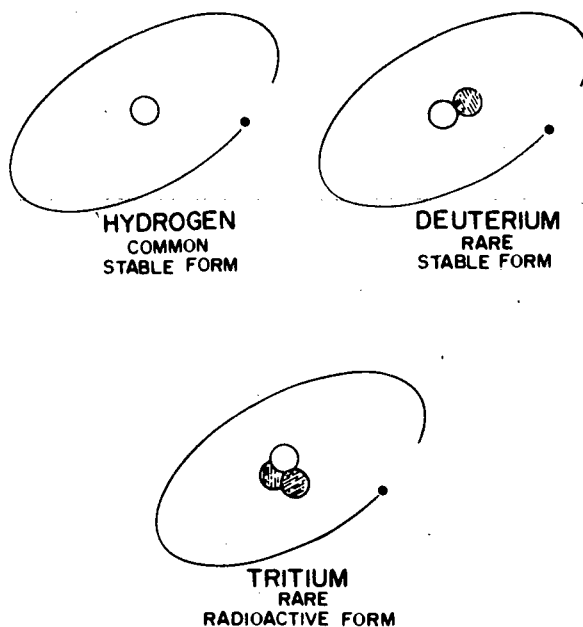

FIGURE 2.29.—Isotopes of the element hydrogen.

tritium contains one proton and two neutrons in its nucleus. The addition of the second neutron to the nucleus produces an unbalance in the proton to neutron ratio thereby causing an unstable or *excited* condition due to the excess energy. This excess energy is emitted in the form of *radiation*. Tritium is the only isotope of hydrogen that is radioactive.

2.31 Only three isotopes of the element hydrogen exist. Attempts to produce a fourth isotope fail because the nucleus of a tritium atom will not capture an additional neutron.

2.32 Figure 2.32 shows two different isotopes of uranium. One is called uranium 238. Its nucleus contains 92 protons and 146 neutrons which combined total 238 particles. The other, uranium 235, contains 92 protons and 143 neutrons which total 235 particles. Both of these will react chemically in exactly the same way. Therefore, to the chemist they are the same. The important difference to the nuclear physicist is the fact that, although both are radioactive, the U^{235} will sustain a chain reaction whereas the U^{238} will not.

2.33 As previously stated, the first element, hydrogen, has only three isotopes in its family. The number of isotopes for each of the other elements varies considerably

with, for example, as many as 25 isotopes for the fiftieth element, tin.

2.34 Altogether there are over 1,200 isotopes, the majority of which are radioactive. Most elements have two or more isotopes. While the number of neutrons in the nucleus does not materially affect chemical behavior, the neutron to proton (n:p) ratio of the nucleus does affect the atom in other ways.

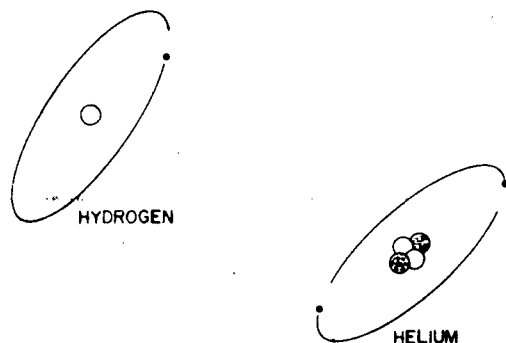

FIGURE 2.39a.—Atoms of the element hydrogen and the element helium.

We are close to our main objective—
—understanding nuclear radiation!!!

2.35 Before the discovery of the neutron, scientists identified any element by a one-letter or two-letter symbol representing its chemical name—H for hydrogen, Cl for chlorine, Na for sodium (whose latinized technical name is natrium, hence the Na), and so on. The nuclear physicist accepts these time-honored letter symbols; but when speaking in general terms, he refers to any of them as SYMBOL X.

2.36 To make precise reference to a given atom, the nuclear physicist (1) precedes symbol X with a numerical *subscript* called SYMBOL Z and (2) follows symbol X with a number (often, but not always, written as a *superscript*) called SYMBOL A. His identification of an atom, then, takes the form ${}_Z\text{X}^A$ or sometimes when Z is clearly understood, simply X^A or XA. For example, U235 and U238.

2.37 *SYMBOL Z*.—The subscript Z is called the *ATOMIC NUMBER*; it tells how many protons the nucleus contains (and simultaneously, of course how many planetary electrons the atom has in its normal state). For hydrogen Z is 1; for oxygen it is 8; for uranium it is 92.

2.38 *SYMBOL A*.—The final identifying symbol is an *ATOMIC MASS NUMBER* representing the sum of the protons and the neutrons.

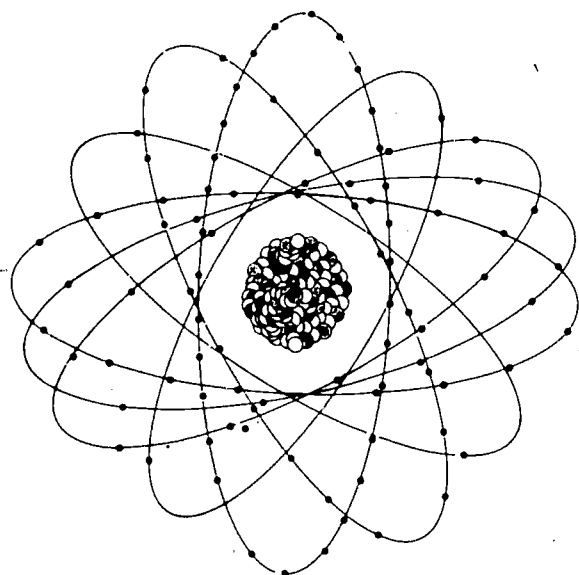

URANIUM²³⁵
RADIOACTIVE

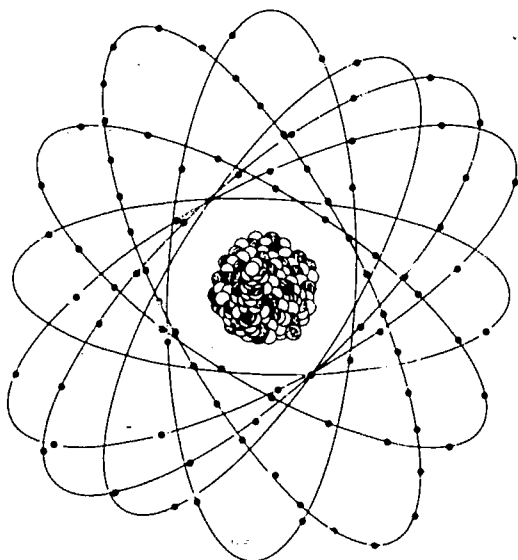

URANIUM²³⁶
RADIOACTIVE

FIGURE 2.32.—Isotopes of the element uranium.

SUBSTANCE SYMBOL	PRO-TONS (Z)	ATOMIC MASS NUMBER (A)	NEU-TRONS (A-Z)	ELEC-TRONS (=Z)
HYDROGEN ${}_1\text{H}^1$	1	1	0	1
DEUTERIUM ${}_1\text{H}^2$ OR ${}_1\text{D}^2$	1	2	1	1
TRITIUM ${}_1\text{H}^3$ OR ${}_1\text{T}^3$	1	3	2	1
OXYGEN ${}_8\text{O}^{16}$	8	16	8	8
URANIUM ${}_{92}\text{U}^{238}$	92	238	146	92

FIGURE 2.39b.—Symbol meanings.

IMPORTANT

To find the number of *neutrons* in any fully identified atom, subtract Z from A.

2.39 Let us see a few examples of the uses of these symbols. In Figure 2.39a, we see an atom of hydrogen with the subscript 1 as its atomic number (Z), since hydrogen has only one proton, and superscript 1 as its atomic mass number (A), since the atom contains only the one proton and no neutrons. The Z number for helium is two, since it has two protons in the nucleus. As we have seen, each element has a distinctive atomic number representing the number of protons in the nucleus, and we can determine the number of neutrons in the nucleus by subtracting the atomic number Z from the atomic mass number A. As examples, the nucleus of ${}_{92}\text{U}^{238}$ contains 146 neutrons and the nucleus of ${}_{27}\text{C}^{59}$ contains 32 neutrons. Since normal atoms are electrically neutral, each atom will have the same number of electrons as there are protons in the nucleus, i.e., the Z number will equal the number of protons in the nucleus or the number of electrons in orbit about the nucleus. The subscript Z number is sometimes disregarded because the atom is identified by chemical symbol. Thus He^4 or ${}_2\text{He}^4$ both have the same meaning. Figure 2.39b shows how symbols are interpreted.

2.40 The ratio of neutrons to protons within the nucleus of the atom largely determines the stability of the atom. The

protons being positively charged tend to repel each other. The repulsive force is counteracted, however, by a nuclear attractive force called *Binding Energy*. Very little is known of this energy. However, it is known that for elements which have relatively low atomic weights, nuclear stability occurs when the number of protons and neutrons are nearly equal. Heavier elements, those with higher Z numbers, require a higher neutron to proton (n:p) ratio for stability. Whereas those elements in the lower part of the periodic table (Figure 2.17) are stable when the isotope has an n:p ratio of approximately one (approximately the same number of neutrons as protons). The n:p ratio must increase as the Z number increases if the stability of the atom is to be maintained. Beginning with the element bismuth, atomic number 83, when the n:p ratio increases above 1.5:1 there are no stable isotopes. The stable range of n:p ratios for many elements is not critical, i.e., there are several elements with many stable isotopes.

2.41 An *unstable atom*, one with a n:p ratio either too high or too low, will eventually achieve stability by spontaneous emission of energy and/or particles from its nucleus. This process is known as **RADIOACTIVITY**. It may be the natural decay of unstable isotopes which occur in nature or it may be as the result of artificial radioactivity which has been caused by man. In each case the nucleus is in an unstable or excited state, having an *excess of energy which will be radiated allowing the nucleus to achieve a stable or ground state*.

RADIOACTIVITY is the spontaneous disintegration of unstable nuclei with the resulting emission of *nuclear radiation*.

2.42 Radiation is the conveyance of energy through space. Everyone is familiar with the radiation of heat from stoves, light from electric lights and the sun, and the fact that some kind of energy is received by our radio and television sets to make them operate. The radiation of energy from radioactive materials is compa-

ANGSTROM UNIT - A PHYSICAL UNIT OF LENGTH, EQUAL TO 1/10⁸ CENTIMETERS.
 ELECTRON VOLT - THE AMOUNT OF ENERGY ACQUIRED BY AN ELECTRON FALLING THROUGH A POTENTIAL DIFFERENCE OF ONE VOLT.
 ELECTRON VOLTAGE (V) IS RELATED TO THE WAVELENGTH OF RADIATION (λ), IN ANGSTROM UNITS, APPROXIMATELY THUS
 $V = 12420/\lambda$

WAVELENGTH AND FREQUENCY ARE RELATED BY: $c = \lambda \nu$
 $c =$ VELOCITY OF ELECTROMAGNETIC WAVES
 $= 3 \times 10^{10}$ CENTIMETERS PER SECOND
 ν - FREQUENCY = CYCLES/SEC. = VIBRATIONS PER SECOND
 λ = WAVELENGTH IN CENTIMETERS
 VISIBLE SPECTRUM LIMITS
 4,000 ANGSTROMS - 8,000 ANGSTROMS
 7.5×10^{14} CYCLES/SEC. - 3.7×10^{14} CYCLES/SEC.

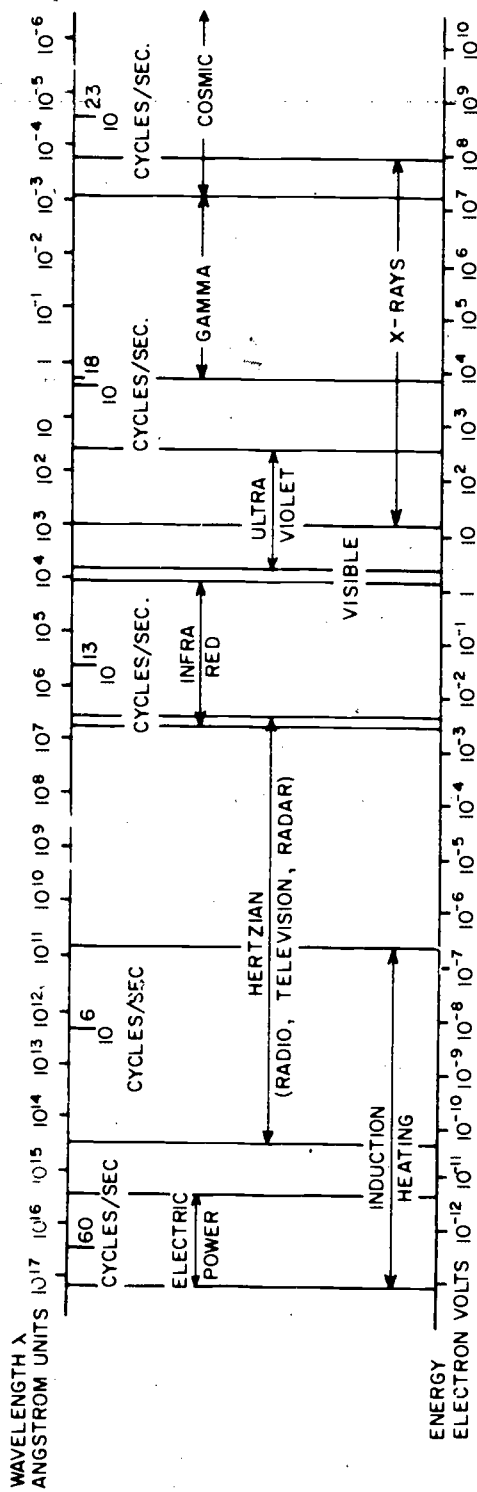

FIGURE 2.42.—Electromagnetic spectrum.

rable to these familiar forms of radiation but, as indicated by Figure 2.42, are generally higher in frequency and, therefore, represent greater energies.

NOTE

Remember, radioactivity is a PROCESS. Nuclear radiation is the PRODUCT of this process.

2.43 Atoms in the unbalanced state described in paragraph 2.41 are said to be **RADIOACTIVE**. They are spontaneously emitting some type of **IONIZING** radiation energy. **IONIZATION** is a process which results in the formation of electrically charged particles (**IONS**) from neutral atoms or molecules.

2.44 For a closer look at ionization, consider Figure 2.44 in which a normal atom is subjected to a bombardment of energy. The energy of this bombardment may knock an electron from its orbit into free space, i.e., it will not be associated with any atom. It is a negatively charged particle in space and is referred to as a **NEGATIVE ION**. The remainder of the atom from which the electron was dislodged is also electrically unbalanced by this event. Having lost one electron with its negative charge, it now has an effective net positive charge of one since it now contains one proton for which there is no counterbalancing electron. The positively charged atom (or atoms) is known as a **POSITIVE ION**.

ION. The two particles, the positive ion (atom or atoms) and the negative ion (dislodged electron) are known as an **ION PAIR**. The process which caused this separation of particles making up the atom and the attendant electrical unbalance is known as **IONIZATION**.

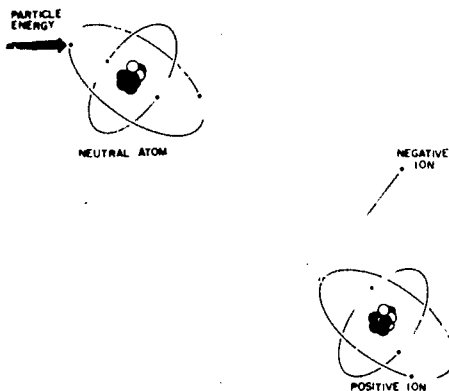

FIGURE 2.44.—Ionization.

2.45 Nuclear radiations are given off by atoms which have more than the normal complement of energy. The physicist says they are **UNSTABLE**. This unstable condition is often caused by too low or too high an n:p ratio as explained earlier. Radioactive atoms literally erupt from time to time emitting energy from the nucleus. These nuclear radiation emissions are classified as **ALPHA PARTICLES**, **BETA PARTICLES** and **GAMMA RAYS**. Each type of radiation will be discussed in more detail in later paragraphs.

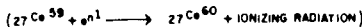
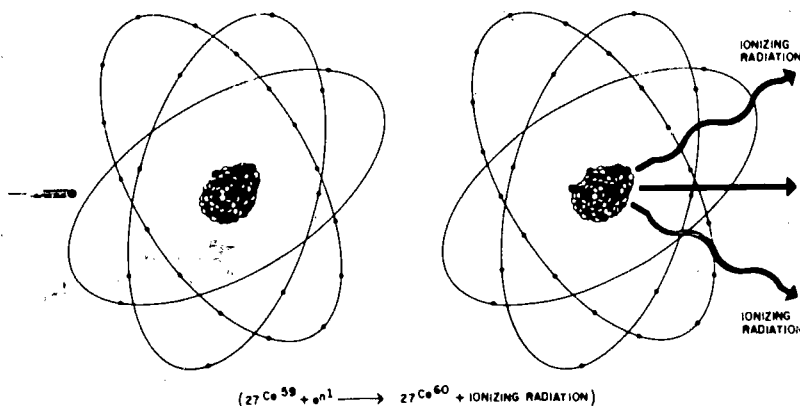

FIGURE 2.47.—The normal atom of Co^{59} bombarded by a neutron. In this case, the atom accepts this neutron in its nucleus; the A number increases by one to Co^{60} and the atom is radioactive.

2.46 Nuclear radiation differs from other forms of radiation in the sense that the nucleus of an unstable atom contains an excess of energy which will be emitted regardless of man's efforts. Use of heat, chemicals or pressure will not stop or alter the rate of nuclear radiation emissions from a radioactive atom. Man can cause or stop other types of radiation such as heat, light, or even other atomic radiations which in many ways compare to nuclear radiation. In the case of heat and light radiations caused by electricity, merely flipping a switch can start or stop these radiations.

2.47. Many nuclear radiations are caused by bombarding atoms with energy, causing them to radiate energy which ceases whenever the bombardment stops. However, if the atoms in the material become radioactive as a result of the bombardment, they will then spontaneously emit ionizing radiation of one or more types until they reach a stable condition. One of the sources of nuclear radiation commonly encountered in radiological defense training is ${}_{27}\text{Co}^{60}$ (Cobalt 60). Figure 2.47 shows how this isotope of Cobalt is developed from ${}_{27}\text{Co}^{59}$.

2.48 Different radioactive elements vary greatly in the frequency with which their atoms erupt. Some radioactive materials in which there are only infrequent emissions or radiations tend to have a very long life while those which are very active, radiating frequently, may have a comparatively short life. The time difference is very great between short and long lived radioactive materials. Some substances may stabilize themselves in a small part of a second, while a radioactive isotope with a long life may change or decay only slightly in thousands or millions of years. The rate of radioactive decay is usually measured in HALF-LIFE, the time required for the radioactivity of a given amount of a particular material to decrease to half its original value.

2.49 The half-life of a radioactive material may range from fractions of a second

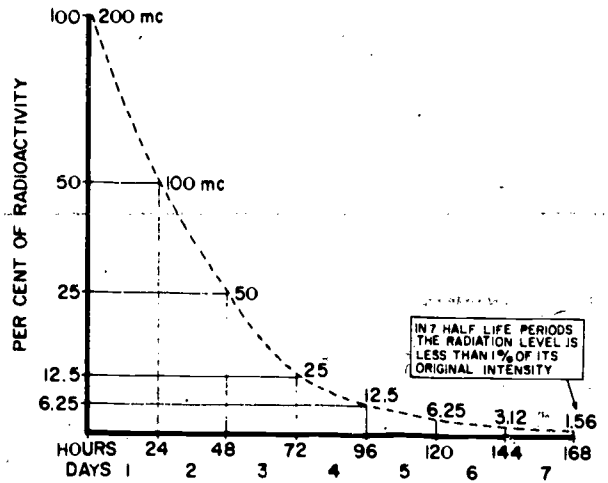

FIGURE 2.49.—Decay curve.

up to millions of years. The following radioactive elements demonstrate this wide range of half-lives: argon 41,109 minutes; iodine 131, 8 days; radium 226, 1,620 years; plutonium 239, 24,000 years. Figure 2.49 depicts a gamma emitting material with a 24-hour half-life. This material when first made radioactive has a quantity of radioactivity of 200 millicuries. In 24 hours the radioactivity would be down to 100 millicuries; in another 24 hours it would be down to 50; in another 24 hours it would be down to 25, etc.

PROTACTINIUM

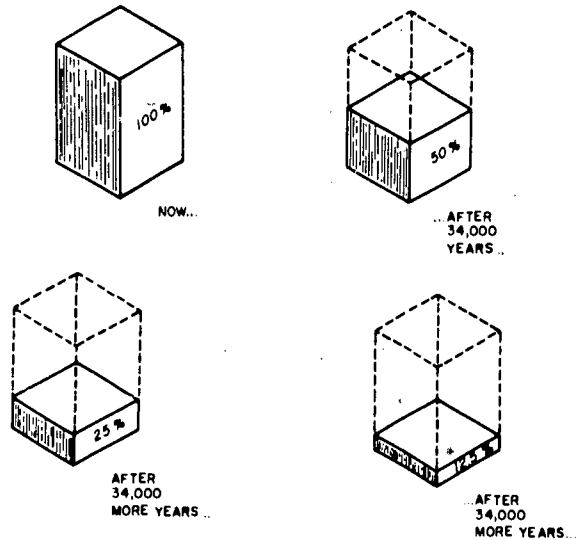

FIGURE 2.50.—Another view of half-life.

2.50 Let us look at another example. Assume that the block shown at the upper left in Figure 2.50 is composed entirely of the radioactive protactinium isotope known as Pa²³¹. The half-life of this particular isotope is 34,000 years. At the end of 34,000 years; therefore, half of the original protactinium atoms will have undergone transmutation to other elements. The rest will still be protactinium. If they were separated from the transmuted atoms, the protactinium atoms would now constitute the second block in Figure 2.50.

2.51 The second block will not decay completely in the second 34,000 year period. Unquestionably, it has only half as many atoms as the original block; but by that very fact it offers only half the original opportunity for atomic reactions to take place. As before, half of the atoms (a quarter of the original protactinium atoms) will remain unchanged at the end of the second half-life.

2.52 During the third half-life, the number of protactinium atoms will again be cut in half—and so on. In general terms, then “x” grams of any radioactive isotope will decay in accordance with the following series:

$$\frac{x}{2} + \frac{x}{4} + \frac{x}{8} + \frac{x}{16} + \frac{x}{32} + \frac{x}{64} + \frac{x}{128} + \frac{x}{256} \dots + \frac{x}{n}$$

2.53 No matter how far this series is extended, its final term, x/n will represent only half of the protactinium atoms that were intact at the beginning of the given half-life. If x/n atoms have been lost during the preceding half-life through decay, an equal number still remain to start the next half-life.

2.54 In other words, the sum of this series approaches x, the original number of atoms, but (in theory at least) never quite reaches it. There is always a fraction, equal to x/n, representing the atoms that are still intact.

2.55 A useful rule of thumb is that the passage of 7 half-lives will reduce the radioactivity to a little less than 1 percent of

its original activity, and in 10 half-lives the activity will be down to less than 0.1 percent. The shorter the half-life, the more highly radioactive the material will be.

2.56 As we will see in more detail in subsequent chapters, half-life has important bearings on safety. It is obvious, first of all, that any isotope with a long half-life is potentially dangerous if it is produced in large amounts. When such an isotope is once formed—whether by nature or in an atomic power plant or during a nuclear explosion—it will contaminate its surroundings for a long time to come.

2.57 For some of the artificially produced radioactive isotopes, the half-life is measured in hours, minutes, or even seconds. These isotopes are extremely active; that is why they decay so fast.

COMMON TYPES OF NUCLEAR RADIATION

2.58 There are three common types of nuclear radiation with which you must become familiar: ALPHA and BETA PARTICLES, and GAMMA RAYS.

2.59 *Alpha Radiations* emitted by radioactive materials are often called alpha radiation or simply alpha. Alpha particles are comparatively large, heavy particles of matter which have been ejected from the nucleus of a radioactive material with very high velocity. The velocity with which these particles leave the nucleus determines the distance (range) that they will travel in any substance. As indicated in Figure 2.59, an alpha particle carries a net positive electrical charge of two and an atomic mass of 4.00277. Thus the alpha particle is equal to the nucleus of a helium atom which contains two protons (with one positive charge each) and two neutrons. However, when we compare the speed of alpha to that of beta and gamma, we find this to be a relatively slow rate as might be expected due to alpha's size and weight. Alpha rays are literally small pieces of matter traveling through space at speeds

of 2,000 to 20,000 miles per second. When a radioactive atom decays by emitting an alpha particle, transmutation of this atom to an atom of lower atomic number (Z) and lower atomic mass number (A) occurs.

RADIATION SYMBOLS	TYPE	ATOMIC MASS UNITS	ELECTRICAL CHARGE	REMARKS
ALPHA α	PARTICLE	4.00277	+2	IDENTICAL TO A HELIUM ATOM STRIPPED OF ITS ELECTRONS
BETA β	PARTICLE	0.000549	-1	IDENTICAL TO A HIGH-SPEED ELECTRON
GAMMA γ	ENERGY	NONE	NONE	ELECTROMAGNETIC WAVE OF ENERGY.

FIGURE 2.59.—Characteristics of nuclear radiation.

2.60 *Beta Particles* are identical to highspeed electrons. They carry a negative electrical charge of one and are extremely light, traveling at speeds nearly equal to the speed of light, 186,000 miles per second. Although the atomic nucleus does not contain free electrons, only protons and neutrons, the electrons which are emitted as beta particles result from the spontaneous conversion of a neutron into a proton and an electron. The neutron which lost or emitted the beta particle has become a proton with a positive charge and thus the atom has been changed. Transmutation has produced an atom with a higher Z number.

2.61 *Gamma Rays* are a type of electromagnetic radiation which travel with the speed of light. As indicated in Figure 2.59, they have no measurable mass or electrical charge. We have become accustomed to the use of X-rays in the medical field. X-rays and gamma rays are similar, but there are two important differences between them. First, as indicated in Figure 2.42, while there is some overlapping, gamma rays are generally of a higher frequency. The basic difference, however, is their source. *Gamma rays originate in the nucleus while X-rays originate in the cloud of electrons about the nucleus.* The emission of an alpha or beta particle from the nucleus of an atom as shown in Figure 2.61, almost invariably leaves the nucleus with an excess of energy (excited state) and will be accompanied by the emission of gamma rays to reach ground or stable condition.

2.62 The neutron is another type of radiation which accompanies certain types of nuclear reactions but is not encountered in natural radioactive decay. As was discussed previously, this type radiation is

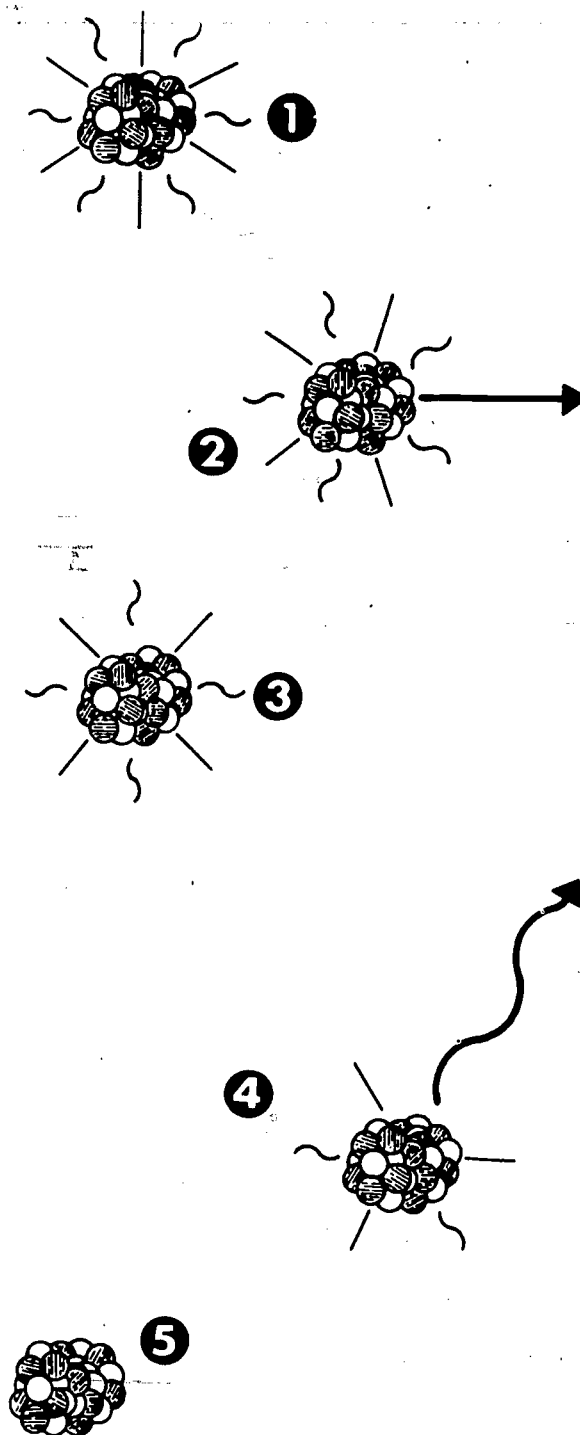

FIGURE 2.61.—Excited to stable nucleus.

able to induce radioactivity in stable isotopes.

RADIOACTIVE DECAY AND DAUGHTER PRODUCTS

2.63 Radioactive decay, often results in "transmutations", i.e., the change of one element into another and the dream of the medieval alchemists. Some radioisotopes decay directly to a stable state in one transmutation. Others decay through a series of transmutations or steps forming different radioactive elements called **DAUGHTER PRODUCTS** before finally reaching a stable state.

2.64 Consider now what happens when a radioactive isotope emits radiation, and follow one atom of uranium through its successive transmutations. Starting with an atom of uranium 238, which has 92 protons and 146 neutrons, follow the transmutations in Figure 2.64.

2.65a Uranium 238 emits an alpha particle. An alpha particle consists of two protons and two neutrons, and therefore is an atomic nucleus in its own right. It is the nucleus of the helium atom. (Helium has a nucleus composed of two protons and two neutrons.) With the alpha particle emitted, there are now 90 protons and 144 neutrons. The nucleus now weighs 234

ELEMENT AND ATOMIC WEIGHT	TYPE OF RADIATION EMITTED	NUMBER OF	
		PROTONS	NEUTRONS
URANIUM-238	ALPHA PARTICLE	92 -2	146 -2
THORIUM-234	BETA PARTICLE	90 +1	144 -1
PROTACTINIUM-234	BETA PARTICLE	91 +1	143 -1
URANIUM-234	ALPHA PARTICLE	92 -2	142 -2
THORIUM-230	ALPHA PARTICLE	90 -2	140 -2
RADIUM-226	ALPHA PARTICLE	88 -2	138 -2
RAOON-222	ALPHA PARTICLE	86 -2	136 -2
POLONIUM-218	ALPHA PARTICLE	84 -2	134 -2
LEAD-214	BETA PARTICLE	82 +1	132 -1
BISMUTH-214	BETA PARTICLE	83 +1	131 -1
POLONIUM-214	ALPHA PARTICLE	84 -2	130 -2
LEAD-210	BETA PARTICLE	82 +1	128 -1
BISMUTH-210	BETA PARTICLE	83 +1	127 -1
POLONIUM-210	ALPHA PARTICLE	84 -2	126 -2
LEAD-206	STABLE ATOM	82	124

FIGURE 2.64.—The decay chain of a uranium atom.

units; and since the number of protons has been changed, *it is no longer uranium but is, in fact, thorium 234.*

2.65b Thorium 234 emits not an alpha particle but a beta particle. Where does the beta particle come from? Remember that a neutron is electrically neutral. We have seen that an electrically neutral state can be reached when positive and negative charges balance one another and that a neutron can act like a proton with an electron tightly tied onto it as shown in Figure 2.65b.

2.65c The negative charge of the electron balances the positive charge of the proton resulting in a neutron. When this negatively charge electron is ejected as a beta particle the remainder is no longer electrically neutral, but now has a positive charge, thus changing a neutron to a proton. In effect, one proton has been gained and one neutron has been lost. Now there are 91 protons and 143 neutrons. The weight is still 234, but since the number of protons has been changed, the nature of the element has been changed, and is now an atom of protactinium 234.

2.65d Protactinium 234 also emits a beta particle so 1 proton is added, and 1 neutron is subtracted, leaving 92 protons and 142 neutrons. Its weight is 234, but the element is, of course, again uranium because it now has 92 protons.

2.65e Uranium 234 emits an alpha particle, 2 neutrons and 2 protons are subtracted, leaving 230 particles in the nucleus. Since the number of protons is back to 90, the element is now thorium 230.

2.65f Thorium 230 emits an alpha particle. Subtract 2 protons and 2 neutrons. It now has a weight of 226, and since it has

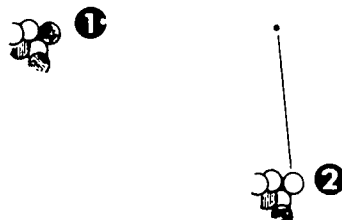

FIGURE 2.65b.—Concept of a neutron changing into a proton by emitting a beta particle.

only 88 protons in the nucleus, it is the element radium.

2.65g Radium emits an alpha particle, so 2 neutrons and 2 protons are lost leaving 86 protons and 136 neutrons. Our element is now radon 222 which is a gas.

2.65h Radon-222 emits an alpha particle, leaving 84 protons and 134 neutrons. Again a different element is formed—polonium 218.

2.65i Polonium emits an alpha particle, which leaves 82 protons and 132 neutrons, and is lead 214.

2.65j Lead 214 emits a beta particle which increases the number of protons by 1 and decreases the number of neutrons by 1, leaving 83 protons and 131 neutrons. This forms bismuth 214.

2.65k Bismuth 214 emits a beta particle which adds 1 proton and subtracts 1 neutron, leaving 84 protons and 130 neutrons. This is polonium 214.

2.65l Polonium 214 emits an alpha particle which takes away 2 neutrons and 2 protons, leaving 82 protons and 128 neutrons for a mass of 210, and the element is lead 210.

2.65m Lead 210 emits a beta particle, leaving 83 protons and 127 neutrons, which now becomes bismuth 210.

2.65n Bismuth 210 emits a beta particle which adds a proton and subtracts a neutron, leaving 84 protons and 126 neutrons. This is polonium 210.

2.65o Polonium 210 emits an alpha, which leaves 82 protons and 124 neutrons. The total weight is 206; the element is lead 206.

2.65p Lead 206 is stable and not radioactive, therefore, this is "the end of the line".

2.66 Well, that's fine, and all very interesting, and accounts for beta and alpha radiation, but what about gamma radiation? Where does that come from? As we saw in paragraph 2.61, gamma radiation originates when the discharge of one of these particles from a nucleus does not take sufficient energy along with it to leave the nucleus in quite a contented state. If the particle leaving the nucleus

does not take with it all of the energy that the atom would like to get rid of in this particular disintegration, it throws off some of the energy in the form of gamma radiation. Therefore gamma radiation can be given off by many radioactive materials in addition to the beta or alpha radiation.

2.67 The foregoing makes it clear why gamma radiation occurs and can therefore be detected from a radium dial wrist watch or from uranium ore by a prospector. Both radium and uranium are pure alpha emitters, but as time passes the decay process goes on and forms daughter products in the radium and uranium. It is from the decay of these various radioactive "daughter products" that the gamma radiation is given off. Pure radium or uranium, freshly prepared, represents only an alpha hazard and could safely be handled with the bare hands as far as external hazard is concerned. (Handling it with the bare hands is not a good idea because of the possibility of introducing some radium into the body by this means and, besides, heavy metals are toxic.) After the passage of time, however, the daughter products start to build up and alpha, beta, and gamma radiation are all being given off from the radium and its associated daughters.

INTERACTION OF RADIATION WITH MATTER

NOTE

The important thing to remember about nuclear radiation is that it is a "shooting out" of particles or bits of energy, some large, some small; some fast, some slow; some weak, some powerful. Since everything contains atoms—including our bones, skin, and organs, of course—these particles strike the atoms with force, the amount depending on the kind of particle, and other factors. Actually, since the atom is, as we have seen, made up of an extremely compact core and shells of electron(s), these electrons bear the brunt of the hammering given out when the atom is struck by particles. As will be seen, the electrons react to this hammering in various ways. This has great significance to the study of

radiation safety and the effects of radiation on the body, as you will discover later.

2.68 Alpha particles lose their energy rapidly and hence have a limited range, only about 6 or 7 centimeters in air, and are completely stopped by a sheet of paper. When the alpha particle is stopped, stabilized, or reaches ground state, it has picked up two electrons which are available in space thus making it a neutral helium atom. The loss of energy by the alpha particle as it traverses space is due to its high specific ionization, i.e., the number of ion pairs produced per centimeter of path. Each ionization event in air requires about 32–36 ELECTRON VOLTS per ion pair produced. The unit electron volt is the amount of energy acquired by a unit charge of electricity when the charge moves through a potential difference of one volt. For example, if an electron should start at a potential of zero volts and be accelerated to a point having a potential of 32 volts, it would acquire an energy equivalent to 32 electron volts. An electron volt is a very small amount of energy. More common terms are thousand electron volts (keV), and million electron volts (MeV).

2.69 The high specific ionization of alpha particles, 20,000–80,000 ion pairs per centimeter of air traversed, is due to several factors. First, alpha is a relatively large particle and has a high positive charge; hence it will not only collide with other matter, but there will be frequent electrostatic interactions with the electrons associated with the atoms through which the particle is passing. These interactions result in a loss of energy by literally knocking an electron from its orbit (ionization), or it may lose energy to the atom by merely displacing electrons from their normal orbits without ejecting them from the atom (excitation). Figure 2.69 shows the difference between an excited atom and a positive ion.

2.70 In addition to being *large* and *positively charged*, the alpha particle is also comparatively *slow*, and by remaining in the vicinity of the atoms in its path, there

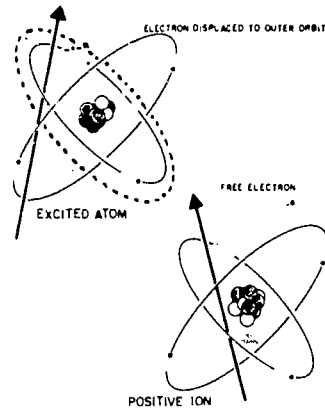

FIGURE 2.69.—Excitation and ionization by an alpha particle.

is a greater probability of ionizing them. With this loss of energy there is a reduction in speed and hence a steadily increasing amount of ionization, at first slowly and then more rapidly, reaching a maximum and then dropping sharply almost to zero. Figure 2.70 is a representative curve for the specific ionization of alpha particles. The range and specific ionization varies somewhat for different radioactive isotopes due to variation in the energy with which the alpha particle is ejected, 4.0 MeV to 10.6 MeV. However, all alpha particles emitted in a specific nuclear reaction have essentially the same energy, and so the same range.

2.71 The beta particle does not lose its energy as rapidly as the alpha particle. This is due to the fact that it is a very *small* particle, has *less* charge than the

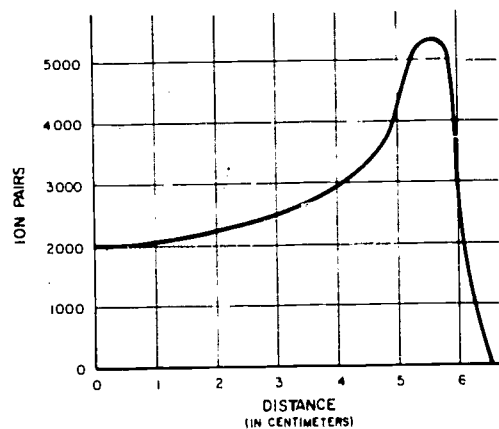

FIGURE 2.70.—Specific ionization of alpha particles.

alpha particle, and is moving at a *higher rate of speed*. An alpha particle, because of its relatively heavy weight, is not easily deflected and tends to travel in a straight path causing a high degree of ionization. A beta particle, being lightweight is easily bounced around in any material. Therefore, its range in terms of distance from the point of origin to the point where it finally associates itself with an atom may vary considerably. The actual distance traveled by the beta particle also varies to a considerable extent but not as much as the measurement from the point of origin to the point where complete loss of excess energy occurs. Unlike alpha, the beta particles emitted by any given nucleus have a range of velocities and only mean or maximum energies can be assigned to primary beta particles. Tables almost invariably show maximum energies.

2.72 The range of velocities for beta particles ranges from about 25 to 99 percent of the speed of light, with corresponding energy variations from 0.025 MeV to 3.15 MeV with a majority of them being in the vicinity of 1 MeV. The range of the beta particle is proportional to its energy. Therefore, a 3 MeV beta particle will travel further than a 1 MeV beta particle.

2.73 Range is only approximately inversely proportional to the density of the absorbing material through which it passes, i.e., the more dense, the higher the Z number, the more effective that material will be in stopping beta particles. However, because of the emission of X-rays when beta particles react with high Z number materials, low Z number materials such as aluminum, glass and plastics are normally used as beta shields.

2.74 The specific ionization of beta particles is approximately 50-500 ion pairs per centimeter in air varying according to the energy of the beta particle and the density of the absorbing material. The range of beta particles in air would be several meters. Thus, compared to the few-centimeter range of alpha in air, beta has a long range.

2.75 Gamma rays do not consist of particles, have no mass, travel at the speed of light and hence do not lose their energy as

RADIATION	RANGE IN AIR	SPEEDS	SPECIFIC IONIZATION
ALPHA	5-7 cm	2,000-20,000 MI/SEC	20,000-80,000 ion pairs/cm
BETA	200-800 cm	25-99% SPEED OF LIGHT	50-500 ion pairs/cm
GAMMA	USE OF HALF-THICKNESS	SPEED OF LIGHT 186,000 MI/SEC	5-8 ion pairs/cm

FIGURE 2.74.—Characteristics of nuclear radiation.

rapidly as either alpha or beta particles. Gamma rays or photons produce no direct ionization by collision as alpha and beta because gamma rays have no mass. They are absorbed or lose their energy by three processes known as the PHOTOELECTRIC EFFECT, the COMPTON EFFECT, and PAIR PRODUCTION.

2.76 Gamma rays are highly penetrating, their effective range depending on their energy. The effect of air on a gamma ray is so small that it is not practical to measure the range of gamma radiation in terms of inches, feet, or meters, but its penetrating power is measured in terms of the amount of material that will be required to reduce the gamma ray to some fraction of its original value.

2.77 As a gamma ray or photon passes through an atom it may transfer all of its energy to an orbital electron ejecting it

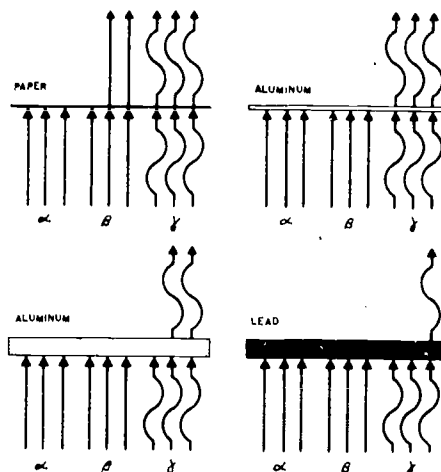

FIGURE 2.76.—Penetration-absorption of nuclear radiation.

from the atom. If the photon carries more energy than necessary to remove the electron from its orbit, this excess energy can be transferred to the electron in the form of kinetic energy. Figure 2.77 shows electrons ejected in this manner. These are referred to as PHOTOELECTRONS, and the process by which this transfer of energy was accomplished is known as the PHOTOELECTRIC EFFECT. Since the orbital electron in this case has completely absorbed the energy of the gamma ray, the photon disappears. The photoelectron will ultimately lose its energy through the formation of ion pairs. The photoelectric effect generally occurs with low energy gamma photons of approximately one-tenth MeV or less.

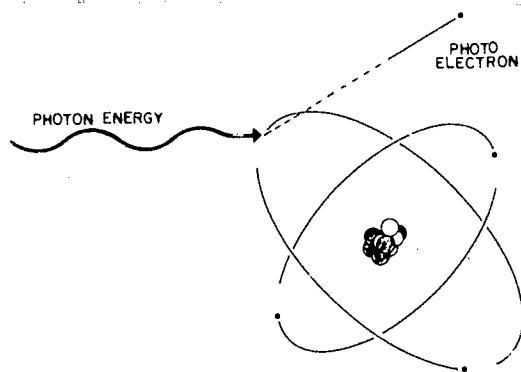

FIGURE 2.77.—Absorption of gamma radiation by the photoelectric effect.

2.78 The COMPTON EFFECT does not completely absorb the energy of the gamma ray. A gamma ray loses a part of its energy to a free or loosely bound orbital electron but will continue as a scattered gamma photon of lower energy. *The energy of this photon will equal the difference in original energy less the amount of energy transferred to the electron.* The gamma photon reacting with an orbital electron acts as though it had mass since it causes the electron to be ejected with high energy and a lower energy photon rebounds at some angle. Both the electron which is ejected at an angle to the path of the original gamma photon and the lower energy gamma photon which is also scattered at an angle may cause further ionization. Figure 2.78 shows the Compton effect. This effect occurs with intermedi-

ate gamma photons of approximately one-tenth to one MeV.

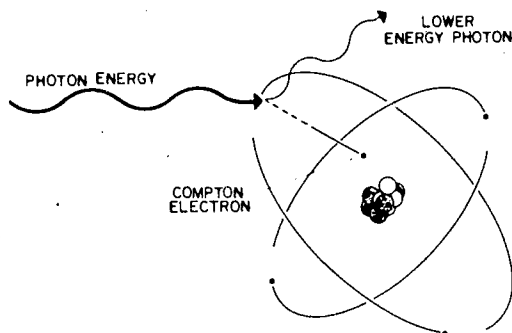

FIGURE 2.78.—Absorption of gamma radiation by the Compton effect.

2.79 PAIR PRODUCTION occurs only with high-energy gamma rays. In this process, as the photon approaches the nucleus of the absorbing atom, it *completely converts itself into a pair of electrons*. One of these is called a NEGATRON but actually is an ordinary electron with a negative charge. The other particle which has exactly the same mass as the negatron (electron) but carries a positive charge rather than a negative charge is known as a POSITRON and is designated by the symbol e^+ . This process requires gamma rays with a minimum energy of 1.02 MeV, and at energy levels above this the possibility of this interaction increases. Figure 2.79 is a diagram of this reaction.

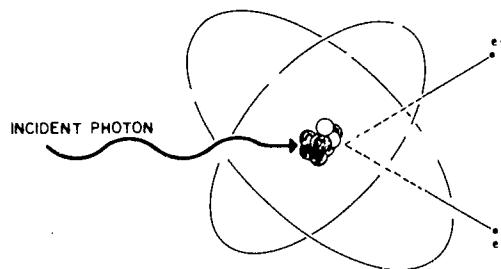

FIGURE 2.79.—Absorption of gamma radiation by pair production.

2.80 Energy in excess of 1.02 MeV is shared by the negatron-positron pair in the form of kinetic energy. The positron usually acquires somewhat more energy than the negatron. *This process is often used as an example of Einstein's mass-energy theory ($E = mc^2$, see paragraph 2.5), since it is an example of the creation of matter (the pair of electrons) out of pure energy (the gamma ray).* It has been found

that the mass of one electron is equal to 0.51 MeV. Since the pair production process involves the conversion of energy to a negatron-positron pair, the energy required must be at least two times the energy equivalent of one electron, 0.51 MeV. Any energy in the photon that is in excess of 1.02 MeV causes the ejected particles to have greater kinetic energy. The negatron is now equal to the beta particle, usually a very energetic beta particle, and will react and be stabilized in the same manner as previously explained. The positron has an extremely short life, which is ended by combining with an electron. However, before this happens it will cause ionization of other atoms. When the positron does join an electron they are annihilated with the production of two gamma photons of 0.51 MeV each, which eventually will be absorbed by Compton or photoelectric effect.

CURIES AND ROENTGENS

To be effective in your radiological defense work, you must get a firm grasp on the ways radiation is measured. "Radiation", like "distance" is a general concept. You would have a weak understanding of distance if you were vague about "foot", "inch", "mile", "kilometer", "light year" and the other ways by which distance is measured. The same is true for radiation.

2.81 The CURIE (Ci) is the unit used to measure the activity of all radioactive substances. It is a measurement of rate of decay or nuclear disintegration that occurs within the radioactive material. The curie initially established the activity (that is, the decay rate) of radium as the standard with which the activity of any other substance was compared.

2.82 By using a formula that takes into account the number of atoms per gram and the value of the half-life in seconds, scientists have determined that the activity of radium is equal to 3.7×10^{10} nuclear disintegrations per gram per second. This value is now the standard unit of comparison. A curie of *any* radioactive isotope,

therefore, is *the amount of that isotope that will produce 3.7×10^{10} nuclear disintegrations per second*. Since the measure is based on number of disintegrations, the weight of the radioisotope will vary from that of radium. A curie of pure Co^{60} would weigh less than 0.9 milligrams, while a curie of U^{238} would require over two metric tons. The curie is a relatively large unit. In training, a millicurie, mCi (one-thousandth curie) and the microcurie, μCi (one-millionth curie) are common units in use. At the opposite extreme, the curie is too small a unit for convenient measurement of the high-order activity produced by a nuclear explosion. For this purpose, the megacurie (one million curies) is used.

2.83 The ROENTGEN (R) by definition measures exposure to gamma and X-rays. It is an expression of the ability of gamma or X-ray radiation to ionize air. One R will produce 2.083×10^9 ion pairs per cubic centimeter of air or 1.61×10^{12} ion pairs per gram of air. (See Par 4.13 for a more complete discussion.)

The curie measures radioactivity.
The roentgen measures X or gamma radiation.

REFERENCES

The Effects of Nuclear Weapons.—Glasstone, Samuel, 1964. Prepared by the U. S. Department of Defense, and published by the U. S. Atomic Energy Commission April 1962; Revised Edition Reprinted February 1964. (For sale by Superintendent of Documents, U. S. Government Printing Office, Washington, D.C. 20402. Price \$3.00, with calculator \$4.00.)

Explaining the Atom.—Hecht, Selig, Explorer Books Edition, Viking Press, Inc., 1964.

Nuclear Radiation Physics.—Lapp, Ralph E. and Andrews, Howard L., Prentice-Hall, Inc., 1972.

Sourcebook on Atomic Energy.—Glasstone, Samuel, D. Van Nostrand Company, Inc., 1967.

Radiological Health Handbook.—Public Health Service, January 1970.

EFFECTS OF NUCLEAR WEAPONS

After our introduction to the language of nuclear physics, we are ready to use some of these terms in arriving at an understanding of a nuclear detonation and a knowledge of what can be expected from a nuclear detonation. This is our primary objective and in reaching it, we will also cover:

- WHAT is a chain reaction
- WHEN does it occur
- HOW is it like a chemical explosion
- HOW is it different
- WHAT is fission and fusion
- HOW a nuclear weapon works
- WHAT are the effects of a nuclear explosion
- WHAT is fallout

FAMILIARITY BREEDS CONTROL

3.1 During World War II many large cities in England, Germany, and Japan were subjected to terrific attacks by high-explosive and incendiary bombs. Before the war, it was fully expected that such attacks would cause great panic among the civilian residents of bombed cities. Observations during the attacks and subsequent detailed studies, however, fail to bear out this expectation. The studies showed that when proper steps were taken for the protection of the civilian population and for the restoration of services after the bombing, there was little, if any, evidence of panic. In fact, when such measures are taken, the studies showed that there was a *definite decline in overt fear reactions as the air bombings continued, even when the raids become heavier and more destructive.*

3.2 The history of nuclear defense may

be said to have started with the explosion of the two bombs over Japan in August, 1945.

These, the first and only nuclear weapons ever used against an enemy, caused unprecedented casualties. Many of these casualties could have been prevented if there had been sufficient warnings to permit clearing the streets, and if the people of Hiroshima and Nagasaki had known what to expect and what to do. For example, only 400 people out of a population of almost a quarter of a million were inside the excellent tunnel shelters at Nagasaki that could well have protected 75,000 people.

3.3 Information accumulated at Alamogordo, Hiroshima, Nagasaki, Bikini, Eniwetok, and Nevada, as well as experience gained from other types of warfare, has contributed to the store of defensive knowledge. From this knowledge, methods of coping with a nuclear weapon attack have been, and are being devised.

NUCLEAR WEAPON DETONATION VS. HIGH EXPLOSIVE DETONATION

3.4 The nuclear bomb was designed as a blast weapon. Therefore, although immensely more powerful, it resembles bombs of the conventional type, insofar as its destructive effect is due mainly to the blast or shock that follows the detonation. However, nuclear detonations *do* differ from conventional detonations in four important respects:

First—a fairly large amount of the energy from a nuclear detonation is emitted as THERMAL RADIATION, generally referred to as LIGHT and HEAT;

Second—the explosion is accompanied by highly-penetrating, harmful but IN-

VISIBLE NUCLEAR RADIATIONS;

Third—the nuclear reaction PRODUCTS, which remain after the detonation, are RADIOACTIVE, emitting radiations capable of producing harmful consequences in living organisms;

Fourth—nuclear explosions can be many thousands (or millions) of times more powerful than the largest conventional detonations.

PRINCIPLES OF A CHEMICAL DETONATION

3.5 Before the discovery of how nuclear energy could be released for destructive purposes, the explosive material in bombs of the type in general use, often referred to as conventional bombs, consisted largely of atoms of the elements carbon, nitrogen, hydrogen, and oxygen, in TNT (trinitrotoluene) or of a related chemical material. These explosive substances are unstable in nature, and are easily broken up into more stable molecules. This process is associated with the liberation of a relatively large amount of energy, mainly as heat. Once the decomposition of a few molecules of TNT is initiated, by means of a suitable detonator, the resulting shock causes still more molecules to decompose. As a result, the overall rate at which TNT molecules break up is very high. This type of behavior is characteristic of many explosions, the process being accompanied by the liberation of a large quantity of energy in a very short period of time within a limited space.

3.6 The products of the decomposition of conventional explosives are mainly nitrogen and oxides of nitrogen, oxides of carbon, water vapor, and solids, notably carbon, which are readily dissipated in the surrounding air. Therefore, the substances remaining after the explosion do no more harm than the poisonous carbon monoxide present in the exhaust gases when automobile and airplane engines are operated in the open air.

3.7 With a conventional explosive the chemical molecules comprising the various atoms are held together by certain forces, sometimes referred to as valence bonds. When the molecules undergo decomposi-

tion, there is a rearrangement of the atoms, and there is a change in the character of the valence bonds. As stated above, a chemical explosive is an unstable compound, and in it the valence forces are relatively weak. In the molecules of the decomposition products, however, the same atoms are bound more strongly. It is a law of physics that the conversion of any system in which the constituents are held together by weak forces into one in which the forces are stronger, must be accompanied by the release of energy. Consequently, the decomposition of an unstable chemical explosive results in the liberation of energy.

PRINCIPLES OF NUCLEAR DETONATIONS

3.8 An atomic or nuclear explosion resembles chemical explosions in the respect that it is due to the *rapid release of a large amount of energy*. But the difference lies in the fact that in the nuclear explosion, the energy results from *rearrangement within the central portion, or nucleus* of the atom, rather than among the atoms themselves as in a chemical explosion. Since the forces existing between the protons and neutrons in the nucleus are much greater than the forces between the atoms in a molecule of chemical explosive material, energy changes, accompanying nuclear rearrangements are very much greater than those associated with chemical reactions.

3.9 The basic requirement for energy release is that the total mass of the interacting species should be greater than that of the resultant product (or products) of the reaction. As we saw in Chapter II, there is a definite equivalence between mass and energy. Thus, when a decrease of mass occurs in a nuclear reaction, there is an accompanying release of a certain amount of energy related to the decrease in mass. In addition to the necessity for the nuclear process to be one in which there is a net decrease in mass, the release of nuclear energy in amounts sufficient to cause an explosion requires that the reaction should be able to *reproduce itself* once it has been started. Two types of nuclear

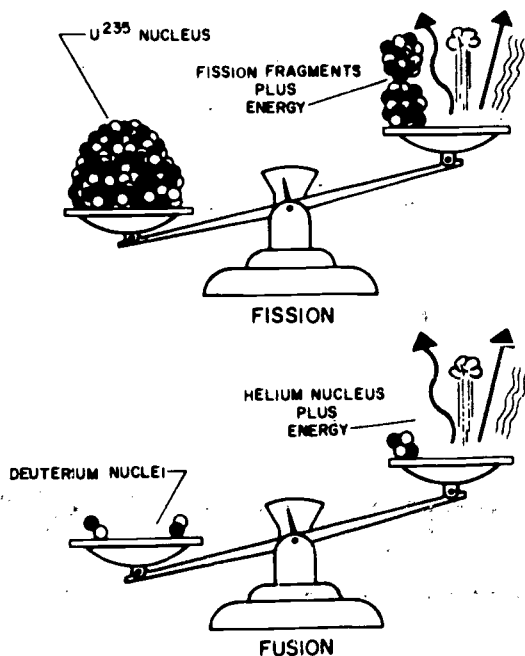

FIGURE 3.9.—Fission and fusion.

interactions which can meet the requirements for the production of large amounts of energy in a short time are FISSION and FUSION. The fission process takes place with some of the heaviest nuclei (high atomic number), whereas the fusion process involves some of the lightest nuclei (low atomic number). (See Figure 3.9.)

NUCLEAR FISSION

3.10 The fissile materials which can presently be used to produce nuclear explosions are the uranium isotopes U^{233} , U^{235} , and the plutonium isotope Pu^{239} . When a neutron enters the nucleus of the appropriate atom, the nucleus splits (fissions) into two daughter nuclei and two to three neutrons (Figure 3.10). For U^{233} , U^{235} , and Pu^{239} , unlike the case for U^{238} , there is no lower limit for the kinetic energy that a neutron must possess to enable it to cause fission on capture by a nucleus of any of these three isotopes. For this reason, these isotopes are called fissile materials, and only these three are of practical significance. In the case of a nonfissile nucleus, the energy of the incident neutron must exceed a certain threshold value to enable it to cause fission or capture. The threshold values for U^{238} and Th^{232} (Thor-

ium 232) are nearly 0.9 MeV and 1.1 MeV respectively. Generally speaking, any heavy nucleus can undergo fission if the excitation energy is large enough, e.g., fission of gold occurs with neutrons of about 100 MeV energy.

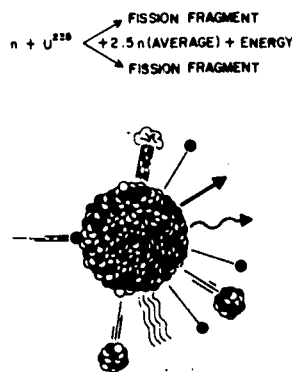

FIGURE 3.10.—Fission of uranium 235 produces neutrons.

FISSION CHAIN REACTION

3.11 In addition to the large amount of energy released in nuclear fission, the second important fact, which has made possible the production of an explosion as a result of fission, is that the process is accompanied by the release of two or more NEUTRONS (Figure 3.10). The neutrons thus liberated in the fission process are able to cause the fission of other uranium or plutonium nuclei. In each case more neutrons are released, which can produce further fission, and so on. Hence, a single neutron could start a self-sustained¹ chain of fissions, the number of nuclei involved increasing at a tremendous rate.

3.12 Actually, not all the neutrons liberated in the fission process are available for causing more fissions. Some of these neutrons escape and others are lost in non-fission reactions. It will be assumed, however, for simplicity, that for each uranium (or plutonium) nucleus undergoing fission, there are two neutrons produced capable of initiating further fission. Suppose a single neutron is captured by a nucleus in a quantity of uranium, so that fission occurs. Two neutrons are then lib-

¹ A self-sustained chain reaction in pure U^{238} or pure Th^{232} or natural uranium is not possible.

erated and these cause two more nuclei to undergo fission. This results in the production of four neutrons available for fission. The fissions increase by geometric progression (1,2,4,8,16,32,64,128,256,512,1024,2048,4096, and so on). By the eighty-first step of this process, we have 2.5×10^{24} fissions—enough to fission a kilogram of refined uranium. The time required for the 81 steps is $\frac{1}{10^8}$ seconds. As you can see, this tremendous activity takes place almost instantaneously, thus producing an explosive reaction.

3.13 The actual loss of mass in the fission of uranium or plutonium is only about one-tenth of a percent of the total. That is, if all the atomic nuclei in one pound of uranium or plutonium undergo fission, the decrease of mass would be roughly five-tenths of a gram or one-sixtieth part of an ounce. Nevertheless, the amount of energy released by the disappearance of this quantity of matter would be about the same as that produced by the explosion of 8,000 tons of TNT.

CRITICAL SIZE OF NUCLEAR FISSION BOMB

3.14 When a piece of fissile material is below a certain size, a few of the atoms are continually undergoing fission, but more neutrons escape through its surface than are produced in fission, and an increasing chain of fissions is not built up. Such a mass is called **SUBCRITICAL**. On the other hand, when a mass (in a given shape) is just great enough to support a sustaining chain reaction, it is called a **CRITICAL** mass. As we can readily see,

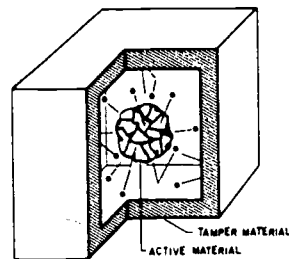

FIGURE 3.14.—Tamper

then, if several pieces of fissile material, totalling more than the critical amount, are suddenly brought together inside a strong container or TAMPER (see Figure 3.14) a nuclear detonation results.

What constitutes a **CRITICAL** mass depends upon a number of factors, including the density of the material (whether solid metal or in porous, spongy form); and also upon the nature of the TAMPER and whether it absorbs neutrons or can reflect them back into the fissile charge.

3.15 Published information suggests that an unconfined sphere of U^{235} metal of about $6\frac{1}{2}$ inches diameter and weighing about 48 kilograms would be a critical amount; this would be reduced to about $4\frac{1}{2}$ inches diameter (16 kg.) for a U^{235} sphere enclosed in a heavy tamper (Figure 3.14). The critical sizes for U^{233} and Pu^{239} have not been disclosed. The increasing mechanical complication of bringing together, rapidly and simultaneously, a number of subcritical pieces of fissile material, sets a practical limit to the power of nuclear fission weapons. Another important consideration is that the size of a purely fission-type bomb is limited because, above a certain critical size, a lump of fissile material is self-destructive.

(BEFORE DETONATION)

(AFTER DETONATION)

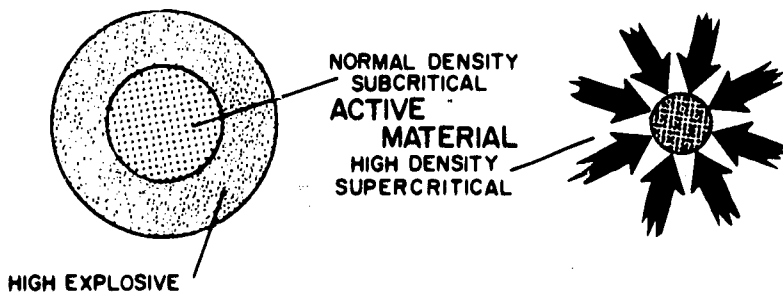

FIGURE 3.16a.—Implosion principle.

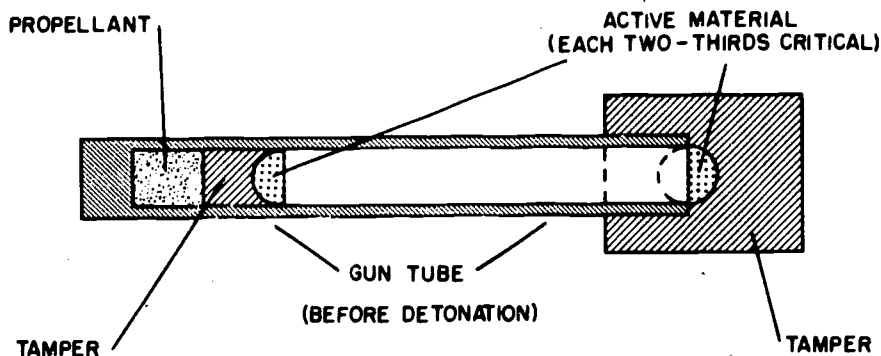

FIGURE 3.16b.—Gun assembly principle.

3.16 As we have seen, subcritical masses or pieces of fissile material, when brought together rapidly can, under proper conditions, cause a chain reaction and subsequent explosion. As a very necessary safety precaution, it is obvious that the masses of fissionable material present in a nuclear bomb must be *kept subcritical* until time for the bomb to be detonated. And when that time arrives, the subcritical masses must form a supercritical mass instantaneously. One way of producing a supercritical mass is by forcing two or more subcritical masses together. Another way is to squeeze a subcritical mass tightly into a new shape and/or a greater density. Such a mass becomes supercritical without the addition of any more substance. This latter method, first used in a crude form in the Nagasaki bomb, is called the implosion principle (Figure 3.16a). In this bomb, a given amount of fissile material, subcritical in the form of a thin spherical shell, became critical when compressed into a solid sphere. This compression was brought about by firing specially fabricated shapes of ordinary high explosive arranged spherically on the outside surface of the hollow sphere. When the explosive is detonated, the mass is compressed, immediately becoming supercritical and the atomic detonation takes place. The other method was used with the Hiroshima bomb. The subcritical masses, enclosed in something like a gun barrel, were impelled against each other by the action of regular chemical explosives (Figure 3.16b).

FISSION AND FUSION . . . AND THERMONUCLEAR WEAPONS

3.17 A fission explosion produces—briefly and in a small space—intensities of light and heat comparable to those in the sun. A fusion explosion does still more: it duplicates a part of the actual process by which the sun and other stars produce their light and heat. This process is not a chemical burning reaction. It is a nuclear fusion reaction in which four nuclei of simple hydrogen become one nucleus of stable helium, with a conversion of mass to radiant energy. Through this process our sun, every second, loses about 4 to 5 million tons of matter, radiated as energy. From experiments made in laboratories with cyclotrons and similar devices, it was concluded that man could partially duplicate the process of the sun, by the fusion of isotopes of hydrogen. This element is known to exist in three isotopic forms in which the nuclei have masses of 1, 2, and 3, respectively. These are generally referred to as hydrogen (H^1), deuterium (H^2 or D^2), and tritium (H^3 or T^3). Several different fusion reactions have been observed among the nuclei of the three hydrogen isotopes, involving either two similar or two different nuclei. In order to make these reactions occur to an appreciable extent, the nuclei must have high energies. One way in which this energy can be supplied is by means of a charged-particle accelerator, such as a cyclotron, as mentioned earlier. Another possibility is to raise the temperature to very high

levels. In these circumstances, the fusion processes are referred to as "thermonuclear reactions".

3.18 Temperatures of the order of a million degrees are necessary in order to make the nuclear fusion reactions take place. The only known way in which such temperature can be obtained on earth is by means of a fission explosion. At temperatures of millions of degrees centigrade, atoms are stripped of most of their surrounding cloud of electrons and the nuclei move at very high speeds experiencing many collisions with one another. Under these circumstances, the nuclei of the rarer hydrogen isotopes deuterium and tritium have enough energy of motion to overcome the repulsive forces between their single positive electrical charges and they are able to fuse together. The energy released in the fusion of these two nuclei is about one-twelfth of that released in the fission of a single U^{235} nucleus; but on an equal weight basis, the fusion energy is about three times as large as the energy of fission of U^{235} . The actual quantity of energy liberated, for a given mass of material, depends on the particular isotope (or isotopes) involved in the nuclear fusion reaction. Four thermonuclear fusion reactions are noted below:

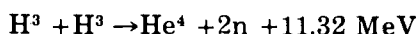
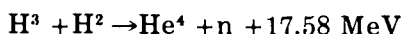
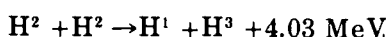
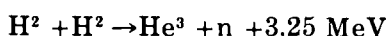

where He is the symbol for helium and n (mass = 1) represents a neutron. The energy liberated in each case is expressed in million-electron-volts (MeV).

3.19 Used alone, deuterium and tritium, as isotopes of the gaseous element hydrogen, have to be liquefied at a very low temperature and maintained there for containment in a thermonuclear device. This is inconvenient although it has been reported that the first American thermonuclear device tested in 1952 was of this

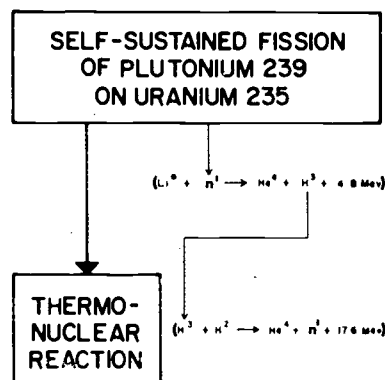

FIGURE 3.19.—Fission-fusion reaction.

type. In later weapons the deuterium is combined chemically with the metal lithium in the form of a white powder. Each neutron (1 mass unit) released by the triggering fission bomb splits a lithium atom (6 mass units) into the non-radioactive gas helium (4 mass units) and tritium (3 mass units), and the latter fuses with the deuterium atoms present in the compound (Figure 3.19). There is no limit, other than the convenience of delivery, to the size of a fusion or thermonuclear weapon, and it is claimed that lithium deuteride is less costly than fissile materials such as U^{235} , U^{238} or Pu^{239} .

3.20 In considering weapon designs, it is possible also to have a fission-fusion-fission type weapon (Figure 3.20). In the process of fusion, a neutron is released at a very high speed and it has enough energy to split the commoner atoms of U^{235} . A thermonuclear weapon can be designed with a core of fissile U^{235} as a fusion initia-

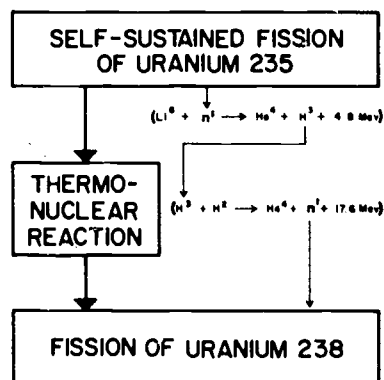

FIGURE 3.20.—Fission-fusion-fission reaction.

tor encased in a heavy container of U^{238} . This U^{238} casing will undergo fission from the high-speed neutrons produced in the hydrogen fusion detonation. Since the casing might be many times heavier than the fissile core of U^{235} , correspondingly larger quantities of fission products would be released as fallout from such a weapon.

3.21 A much more detailed discussion of fission products will be taken up later in this chapter, but it might be mentioned here that all existing types of nuclear weapons release fission products. "Dirty" bombs produce a great deal and "clean" bombs produce little, the dirtiness depending upon the ratio of fission to fusion energy produced by the bomb. The dividing line between "clean" and "dirty" bombs is, thus, a matter of opinion, but the fission-fusion-fission type of weapon mentioned in paragraph 3.20 would be a relatively "dirty" one.

ENERGY YIELD OF A NUCLEAR EXPLOSION

3.22 The power of a nuclear detonation is expressed in terms of the total amount of energy released as compared with the energy liberated by TNT when it explodes. A 1-kiloton nuclear detonation is one which releases energy equivalent to 1,000 tons of TNT which is called the kiloton (KT). The advent of thermonuclear hydrogen bombs made it desirable to use a unit about 1,000 times larger still, and the megaton (MT) unit was adopted. It is equivalent to the energy released by the detonation of 1,000,000 tons of TNT. The bombs detonated over Hiroshima and Nagasaki, and those used in the 1946 test at Bikini, released roughly the same amount of energy as 20,000 tons (or 20 kilotons) of TNT. In recent years, much more powerful weapons, with energy yields high in the megaton range, have been developed.

DISTRIBUTION OF ENERGY

3.23 Although the detonation of chemical explosives, such as TNT, and the detonation of a nuclear weapon both produce

heat or thermal radiation, the proportion as well as the quantity is much higher in the case of the nuclear weapon. The basic reason for this difference is that, weight for weight, the energy produced in a nuclear explosion is millions of times as great as that in a chemical explosion. Consequently, the temperatures reached in the nuclear explosion are much higher than in a chemical explosion—tens of millions of degrees in a nuclear explosion compared with a few thousands in a chemical explosion.

3.24 For a nuclear detonation in the atmosphere below 100,000 feet, about 85 percent of the total energy appears first as intense heat. As shown in Figure 3.24, almost immediately a considerable part of this heat is converted to blast or shock; the remaining thermal energy moves radially outward at the speed of light as heat and visible light. The remaining 15 percent of the energy of the nuclear explosion is released as various nuclear radiations. Of this, 5 percent constitutes the nuclear radiation produced within a minute or so of explosion, whereas the final 10 percent of the bomb energy is in the form of residual radiation emitted over a period of time. The residual radiation includes the **FALLOUT** we will discuss in later chapters.

TYPES AND HEIGHTS OF NUCLEAR DETONATIONS

3.25 As we have seen, an explosion is the release of a large quantity of energy in a short interval of time within a limited

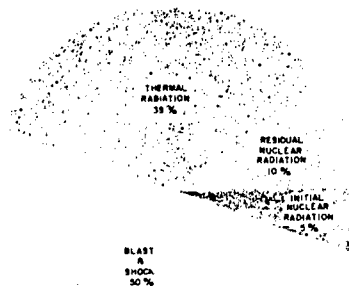

FIGURE 3.24.—Distribution of energy in a typical air burst of a fission weapon in air at an altitude below 10,000 feet.

space. The liberation of this energy is accompanied by a considerable increase in temperature, so that the products of the explosion become extremely hot gases. These gases, at high temperature and pressure, move outward rapidly. In doing so, they push away the surrounding medium—air, earth, or water—with great force, thus causing the destructive (blast or shock) effects of the explosion. The term “blast” is generally used for the effect in air, because it resembles (and is accompanied by) a very strong wind. In water or under the ground, however, the effect is referred to as “shock” because it is like a sudden impact.

3.26 The immediate phenomena associated with a nuclear explosion, as well as the effects of shock and blast, and thermal and nuclear radiation, vary with the location of the point of burst in relation to the surface of the earth. For each weapon of specific power, there is a critical height of burst above which the fireball will not touch the ground and, hence, it will not produce appreciable contamination on the earth's surface. Although many variations and intermediate situations can arise in practice, for descriptive purposes three types of bursts are distinguished. The main types, which will be defined below, are air, surface, and sub-surface burst.

CHARACTERISTICS OF AN AIR BURST

3.27 An air burst (frequently the most efficient means of accomplishing a military objective, and the type used over Japan) is defined as one in which the bomb is exploded in the air, above land or water, at such a height that the fireball (at maximum brilliance) does not touch the surface. The aspects of an air burst will be dependent upon the actual height of the explosion, as well as upon the energy yield of the weapon, but the general phenomena are much the same in all cases.

3.28 In the following discussion, it will be supposed first, that the weapon detonation takes place in the air at a considerable height above the surface. The descriptions given here refer mainly to the phenomena accompanying the explosion of a

1-megaton TNT equivalent nuclear bomb. The important aspects of a nuclear explosion in the air are summarized in Figures 3.28a to 3.28e.

THE FIREBALL

3.29 As already seen, nuclear reactions involving fission and fusion in a nuclear weapon lead to the liberation of a large amount of energy in a very short period of time within a limited space. As a result, the nuclear reaction products, bomb casing, other weapon parts, and surrounding air are raised to extremely high temperatures, approaching those in the center of the sun. Due to the great heat produced by the nuclear explosion, all the materials are converted into the gaseous form. Since the gases, at the instant of explosion, are restricted to the region occupied by the original constituents in the bomb, tremendous pressure will be produced. These pressures are many hundreds of thousands times the atmospheric pressure,² i.e., of the order of millions of pounds per square inch.

3.30 Within a fraction of a second of the detonation of the bomb, the intensely hot gases at extremely high pressure appear as a roughly spherical, highly luminous mass. This is the fireball referred to in paragraph 3.26. A typical fireball accompanying an air burst is shown in Figure 3.28a. Although the brightness decreases with time, after about a millisecond,³ the fireball of a 1-megaton nuclear bomb explosion would appear to an observer 60 miles away to be *many times as bright as the sun at noon*.

3.31 As a general rule, the luminosity of the fireball does not vary greatly with the yield (or power) of the bomb. The surface temperatures attained, upon which the brightness depends, are thus not very different, in spite of differences in the total amounts of energy released.

3.32 Immediately after its formation, the fireball begins to enlarge in size, engulfing cooler surrounding air. The growth

² The normal atmospheric pressure at sea level is 14.7 pounds per square inch (PSI).

³ A millisecond is one-thousandth part of a second.

in size of the fireball is accompanied by a decrease in temperature (and pressure) and, hence, in luminosity. At the same time, the fireball rises, much like a fiery doughnut. As it rises, there are updrafts through the center of the doughnut and downdrafts on the outside.

3.33 Within seven-tenths of a millisecond from the detonation, the fireball from a 1-megaton bomb reaches a radius of

about 220 feet, and this increases to a maximum of about 3,600 feet in 10 seconds. The diameter is then some 7,200 feet and the fireball is rising at the rate of 250 to 350 feet per second. One minute after detonation, the fireball has cooled, due to the emission of heat and entrainment of cool air, to such an extent that it is no longer luminous. It has, by this time, risen roughly 4.5 miles from the point of burst.

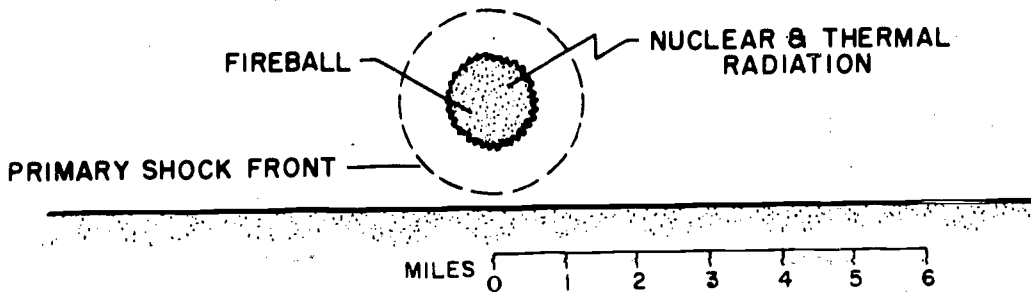

FIGURE 3.28a.—Chronological development of an air burst: 1.8 seconds after 1-megaton detonation.

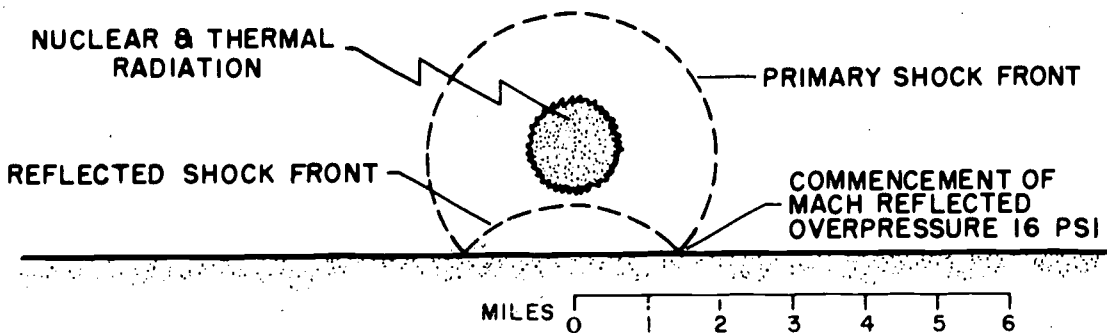

FIGURE 3.28b.—Chronological development of an air burst: 4.6 seconds after 1-megaton detonation.

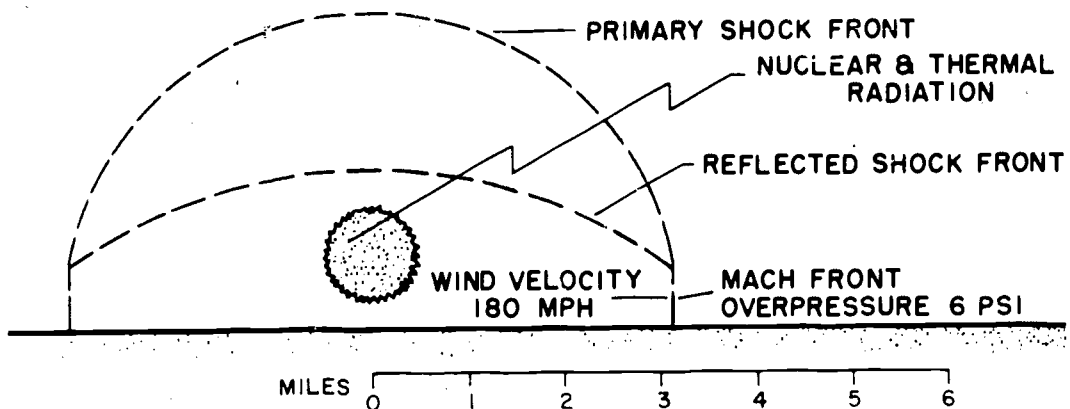

FIGURE 3.28c.—Chronological development of an air burst: 11 seconds after 1-megaton detonation.

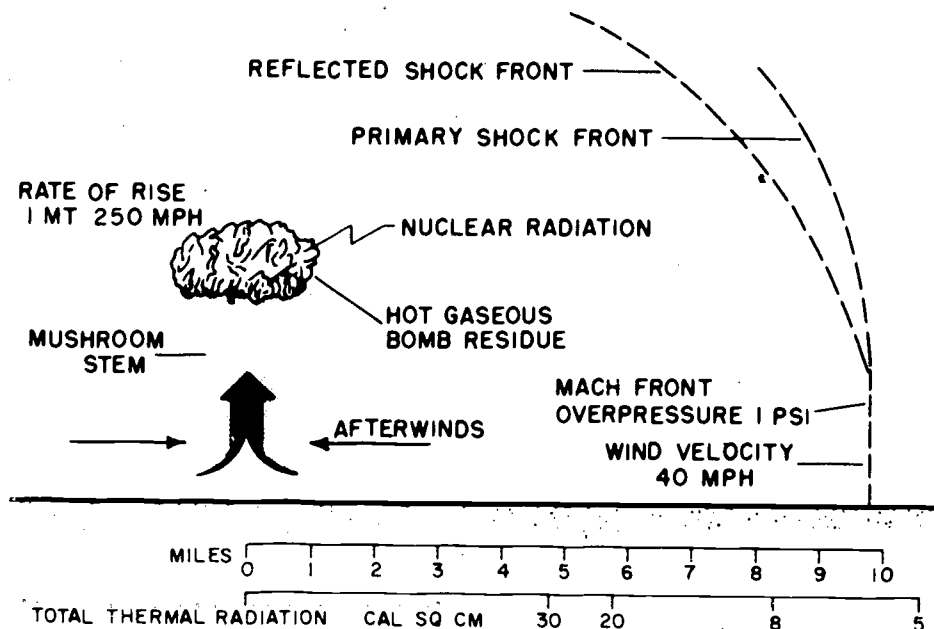

FIGURE 3.28d.—Chronological development of an air burst: 37 seconds after 1-megaton detonation.

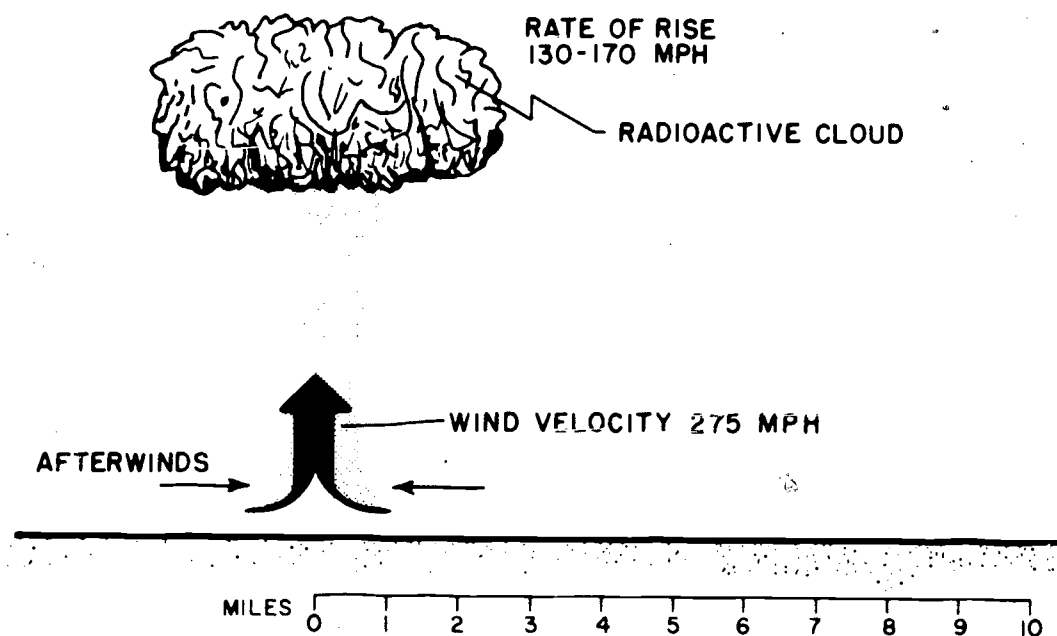

FIGURE 3.28e.—Chronological development of an air burst: 110 seconds after 1-megaton detonation.

THE BLAST WAVE

3.34 At a fraction of a second after the explosion, a destructive high-pressure wave develops in the air around the fireball and moves rapidly away, behaving like a moving wall of highly compressed air. After the lapse of 10 seconds, when the fireball of a 1-megaton nuclear bomb has

attained its maximum size (7,200 feet across), the blast front is some 3 miles further ahead. About a minute after the explosion, when the fireball is no longer visible, the blast wave has traveled approximately 12 miles. It is then moving at about 1,150 feet per second, which is slightly faster than the speed of sound at sea level.

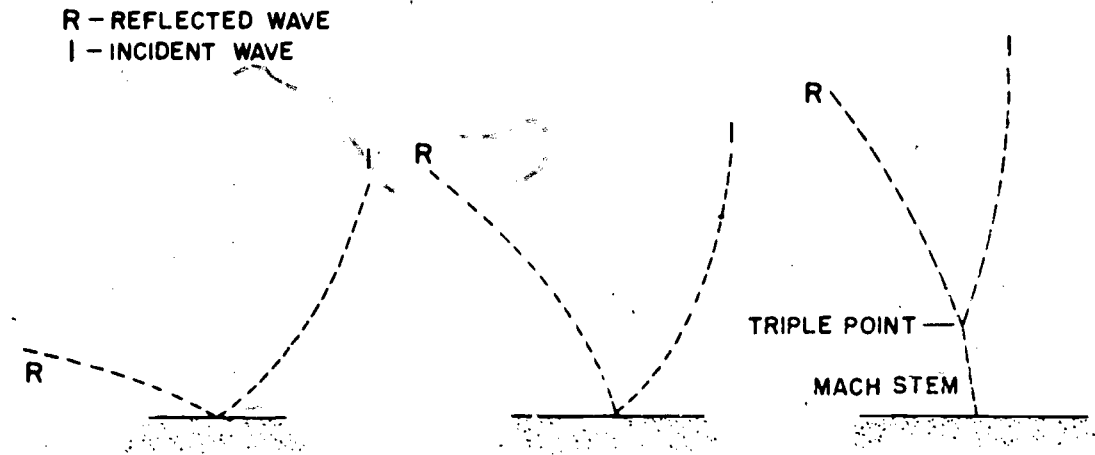

FIGURE 3.35.—Fusion of incident and reflected waves and formation of Mach stem.

THE MACH WAVE

3.35 When the blast wave strikes the surface of the earth, it is reflected in a way similar to a sound wave producing an echo. This reflected blast wave, like the original (or direct) wave, is also capable of causing material damage. At a certain region on the surface, the position of which depends chiefly on the height of the burst above the surface and the energy of the explosion, the direct and reflected blast fronts fuse as shown in Figure 3.35. This fusion phenomenon is called the **MACH EFFECT**. The **OVERPRESSURE**, i.e., the pressure of the blast wave in excess of the normal atmospheric value, at the front of the Mach wave is generally about twice as great as that at the direct shock front. The maximum overpressure value, i.e., at the blast front, is called the *Peak overpressure*.

3.36 For a "typical" air burst of a 1-megaton nuclear weapon, the Mach effect will begin approximately 5 seconds after the explosion, in a rough circle at a radius of 1.3 miles from ground zero. The term "**GROUND ZERO**" refers to the point on the earth's surface immediately below (or above) the point of detonation.

3.37 At first, the height of the Mach front is small (Figure 3.37), but as the blast front continues to move outward, the height increases steadily forming a **MACH STEM**. During this time, however, the overpressure, like that in the original blast wave, decreases correspondingly because of the continuous loss of energy and the ever-increasing area of the advancing front. After the lapse of about 40 seconds, when the Mach front from a 1-megaton nuclear bomb is 10 miles from ground zero, the overpressure will have decreased to

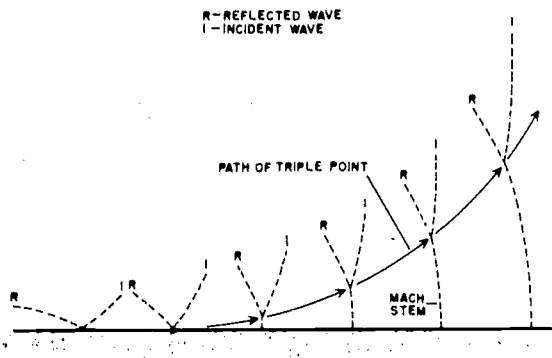

FIGURE 3.37.—Outward motion of the blast wave near the surface in the Mach region.

roughly 1 pound per square inch. Most of the material damage caused by an air burst nuclear bomb is due mainly—directly or indirectly—to the blast (or shock) wave. The majority of structures will suffer some damage from air blast when the overpressure in the blast wave is about one-half pound per square inch or more.

3.38 The distance from ground zero at which the Mach stem commences, and to which an overpressure of one-half pound per square inch will extend, depends on the yield or size of the explosion and on the height of the burst. As the height of the burst for an explosion of given energy is decreased, Mach reflection commences nearer to ground zero, and the overpressure at the surface near ground zero becomes larger. If the bomb is exploded at a greater height, the Mach fusion commences farther away, and the overpressure at the surface is reduced. An actual contact surface burst leads to the highest possible overpressures near ground zero, but no Mach effect occurs, since there is no reflected wave.

3.39 In the nuclear explosions over Hiroshima and Nagasaki during World War II, the height of burst was about 1,850 feet. It was estimated, and has since been confirmed by nuclear test explosions, that a 20-kiloton bomb burst at this height would cause maximum blast damage to structures on the ground for the particular targets concerned. Actually, there is no single optimum height of burst, with regard to blast effects, for any specified explosion energy yield, because the chosen height of burst will be determined by the nature of the target. As a rule, strong (or hard) targets will require low air or surface bursts. For weaker targets, which are destroyed or damaged at relatively low overpressures or dynamic pressures (the dynamic pressure is a function of the wind velocity and air density behind the blast front), the height of burst may be raised in order to increase the area of damage, since the distance at which low overpressure would result would be extended because of the Mach effect.

POSITIVE AND NEGATIVE PHASES

3.40 As the blast wave travels in the air away from its source, the overpressures at the front steadily decrease, and the pressure behind the front falls off in a regular manner. After a short time, when the blast front has traveled a certain distance from the fireball, the pressure behind the front drops below that of the normal atmosphere and a so-called **NEGATIVE PHASE** of the blast wave forms. *In this region the air pressure is below that of the original (or ambient) atmosphere.*

3.41 During the negative overpressure (or suction) phase, a partial vacuum is produced and the air is sucked in, instead of being pushed away, as it is when the overpressure is positive. In the positive (or compression) phase, the wind associated with the blast wave blows away from the explosion, and in the negative phase its direction is reversed.

3.42 This wind is often referred to as a "transient" wind because its velocity decreases rapidly with time. During the positive phase, these winds may have peak velocities of several hundred miles per hour at points near ground zero, and even at more than 6 miles from the explosion of a 1-megaton nuclear explosion, the peak velocity may be greater than 70 miles per hour. It is evident that such strong winds can contribute greatly to the blast damage following an air burst. The peak negative values of overpressure are small compared with the peak positive overpressures. Thus, it is during the compression phase that most of the destructive action of blast from an air burst will be experienced. However, the winds associated with the negative phase can be quite damaging to weakened structures.

3.43 From the practical viewpoint, it is of interest to visualize the changes of overpressure in the blast wave with time at a fixed location. The variation of overpressure with time that would be observed at such a location in the few seconds following the detonation is shown in Figure 3.43a. The corresponding general effects to be expected on a light structure, a tree, and a small animal are indicated at the

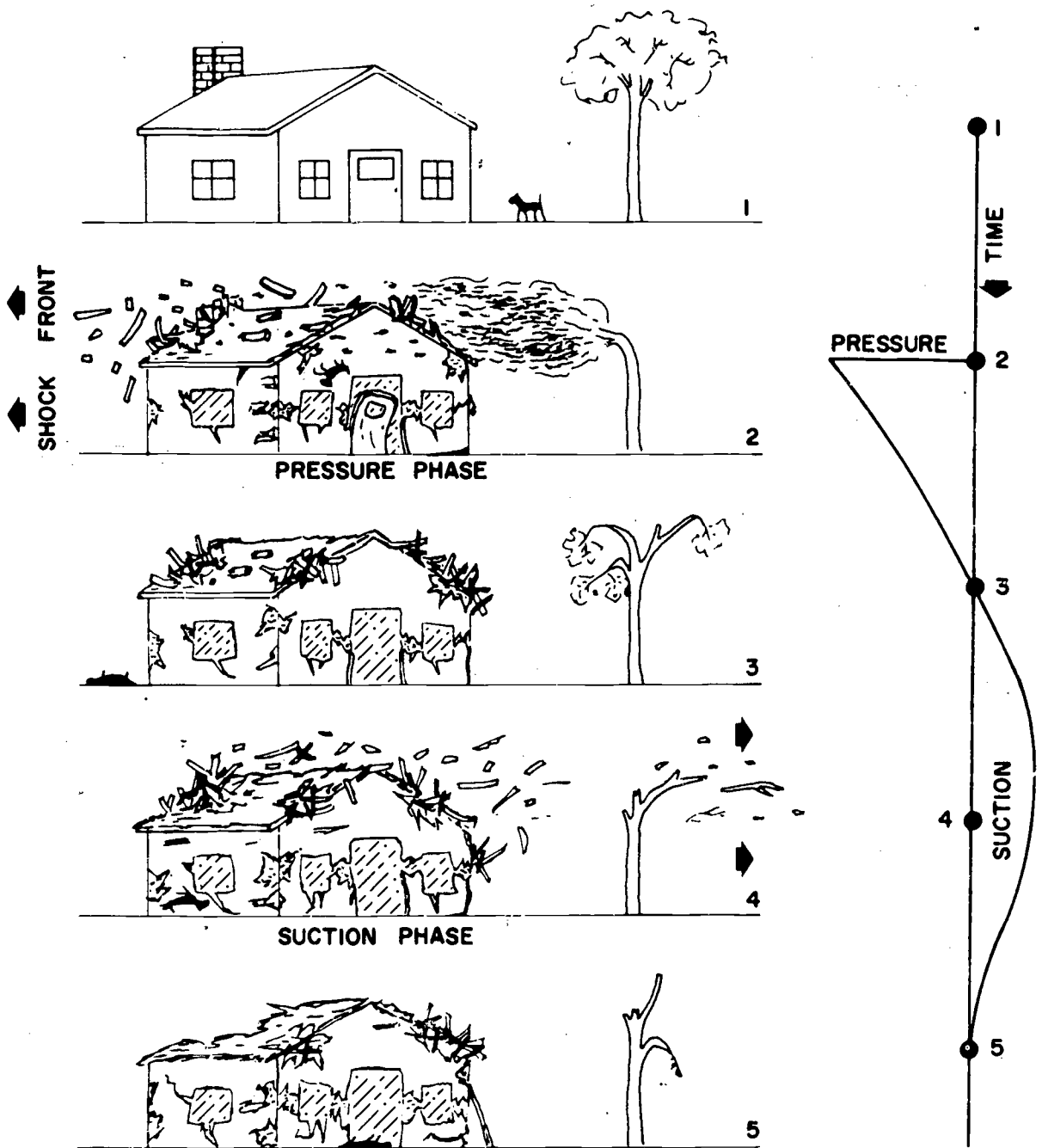

FIGURE 3.43a.—Variation of pressure with time at a fixed location and effect of blast wave passing over a structure.

left of the figure. Additional data is presented in Figures 3.43b and 3.43c.

BLAST CASUALTIES

3.44 There are four different kinds of injuries caused by the blast of an atomic weapon. Victims may be injured in one or

all of these four ways, depending upon many factors, including the degree of protection, closeness to ground zero, size of bomb, height of detonation, etc.

3.45 The four kinds of blast injuries are:

- (1) primary blast injuries, caused by the high pressures of the blast wave;

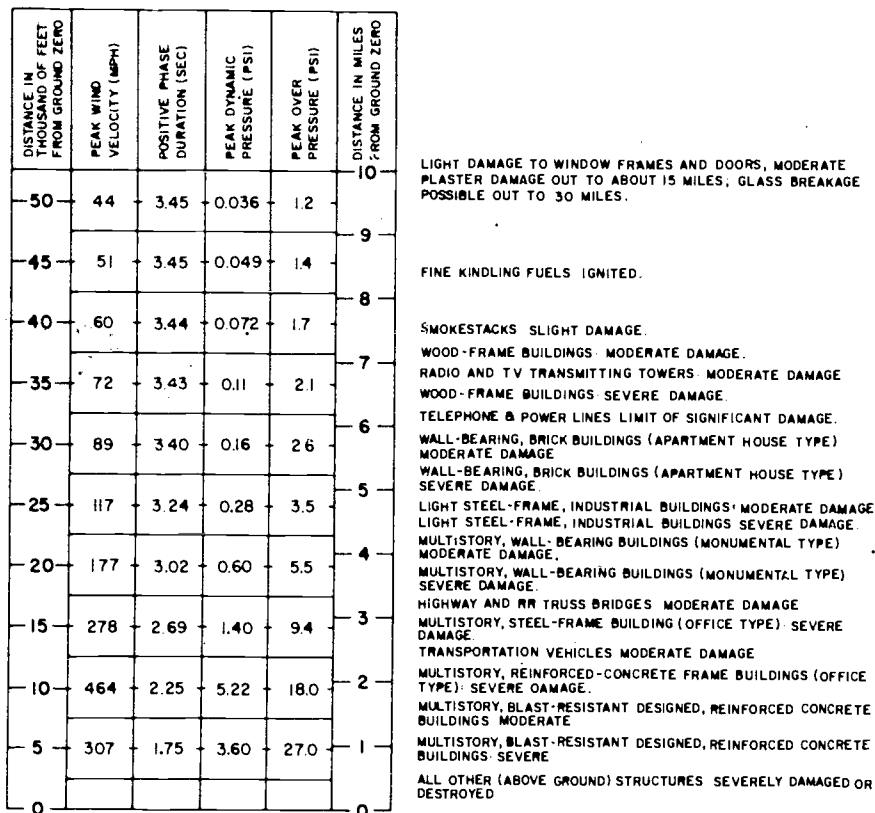

FIGURE 3.43b.—Damage ranges for a 1-MT typical air burst.

(2) those from the impact of missiles thrown about by the force of the blast;

(3) result of being thrown about by the blast; and

(4) miscellaneous injuries, such as exposure to ground shock; dust inhalation; fires caused by the explosion, etc.

3.46 Seventy percent of those who survived the nuclear bombing in Japan suffered from blast injury. Since many of the survivors were also injured in other ways (burns and/or radiation—both to be discussed later) we cannot say that this is the percentage of injuries caused by blast. Nevertheless, blast *was* one of the major causes of injury and, certainly, a major cause of death.

THE BOMB (RADIOACTIVE) CLOUD

3.47 In addition to the transient winds associated with the passage of the blast front, a strong updraft with inflowing winds, called "afterwinds", is produced in the immediate vicinity of the detonation due to the rising fireball. These afterwinds

cause varying amounts of dirt and debris to be sucked up from the earth's surface into the atomic cloud. (Refer to Figure 3.28e.)

3.48 At first, the rising mass of bomb residue carries the particles upward, but after a time, the particles begin to spread out and fall slowly under the influence of wind and gravity. This is FALLOUT.

THERMAL RADIATION

3.49 Immediately after the fireball is formed, it starts to emit thermal radiation. Because of the very high temperatures of the fireball, this radiation consists of visible light rays, invisible ultraviolet rays of shorter wave length, and invisible infrared rays of longer wave length. These rays all travel with the speed of light. Due to certain physical phenomena associated with the absorption of the thermal radiation by the air in front of the fireball, the surface temperature of the fireball undergoes a curious change. The temperature

STRUCTURE TYPE	DAMAGE	EXPLOSION YIELD (Distance in miles)		
		100 KT	1 MT	10 MT
WOOD-FRAME BUILDING, RESIDENTIAL TYPE	MODERATE	3.2	6.6	14
	SEVERE	2.4	5.5	12
WALL-BEARING, MASONRY BUILDING, APARTMENT HOUSE TYPE	MODERATE	2.4	4.7	10
	SEVERE	1.7	3.5	8.7
MULTISTORY, WALL- BEARING BUILDING, MONUMENTAL TYPE	MODERATE	1.6	3.5	7.4
	SEVERE	1.3	2.8	6.1
REINFORCED CONCRETE (NOT EARTHQUAKE RESISTANT) BUILDING, CONCRETE WALL, SMALL WINDOW AREA	MODERATE	1.5	3.4	7.2
	SEVERE	1.1	2.5	5.9

FOR A SURFACE BURST THE RESPECTIVE DISTANCES ARE THREE QUARTERS OF THOSE FOR AN AIR BURST OF THE SAME YIELD.

FIGURE 3.43c.—Maximum ranges from ground zero for structural damage from air bursts.

decreases rapidly for a fraction of a second. Then, the surface temperature increases again for a somewhat longer time, after which it falls continuously. In other words, there are effectively two surface-temperature pulses: the first is of very short duration, whereas the second lasts for a much longer time. This behavior is quite standard with all size weapons, although the duration times of the two pulses increase with the energy yield of the explosion. After about 3 seconds from the detonation of a 20 KT bomb, the fireball, although still very hot, has cooled to such an extent that the thermal radiation is no longer important, whereas amounts of thermal radiation still continue to be emitted from the fireball at 11 seconds after a 1-megaton explosion.

3.50 Corresponding to the two temperature pulses, there are two pulses of emission of thermal radiation from the fireball (Figure 3.50). In the first pulse, which lasts about a tenth of a second for a 1-megaton explosion, the temperatures are mostly very high. As a result, much of the radiation emitted in this pulse is in the ultraviolet region. Moderately large doses of ultraviolet radiation can produce painful blisters, in milder form these effects are familiar as sunburn. However, in most circumstances, the first pulse of thermal radiation is not a significant hazard, with regard to skin burns, for several reasons. In the first place, only about 1 percent of the thermal radiation appears in the initial pulse because of its short duration. Second, the ultraviolet rays are readily

absorbed in the atmosphere, so that the dose delivered at a distance from the explosion may be comparatively small. Further, it appears that the ultraviolet radiation from the first pulse could cause significant effect on the human skin only within ranges where people would be killed outright by the blast and at which other radiation effects are much more serious.

3.51 The situation with regard to the second pulse is, however, quite different. This pulse may last for several seconds and carries about 99 percent of the total thermal radiation energy from the bomb. Since the temperatures are lower than in the first pulse, most of the rays reaching the earth consist of visible and infrared light. It is this radiation which is the main cause of skin burns of various degrees suffered by exposed individuals out to 12 miles or more from the explosion of a 1-megaton bomb, on a fairly clear day. The warmth may be felt at a distance of 75 miles. For air bursts of higher energy yields, the corresponding distances, will, of course, be greater. Generally, thermal radiation is capable of causing skin burns on exposed individuals at such distances from the nuclear explosion that the effects of blast and of the initial nuclear radiation are not significant.

THERMAL RADIATION CASUALTIES

3.52 It is convenient to divide thermal

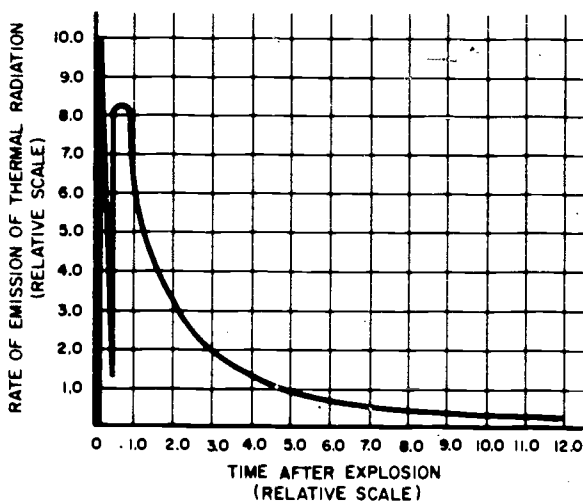

FIGURE 3.50.—Emission of thermal radiation in two pulses.

burns due to a nuclear explosion into two classes, namely (1) primary burns, and (2) secondary burns. As in the case of blast injuries, the terms primary and secondary refer to the manner in which the burns are inflicted. Those in the first class are a direct result of thermal radiation from the bomb, while those in the second group arise indirectly from fires caused by the explosion. From the medical point of view, a burn is a burn, whether received as a flash burn from the initial thermal burst or, at a later time, from the burning environment.

3.53 Experiments in the laboratory and in the field have established criteria for assessing the degree of thermal damage to be expected for doses of thermal radiation delivered to human tissue within specified time limits. Medical diagnosis usually recognizes three grades of thermal injury: first, second and third degree injury in ascending order of severity. A first-degree burn corresponds to a moderate sunburn or erythema. Such damage, while quite painful, is reparable with time and requires no special treatment beyond the relief of pain. The second-degree burn involves the skin thickness down to and including portions of the dermis. A characteristic feature of second-degree burns is the formation of blisters. The second-degree burn is extremely painful but also reparable with time. Infection usually occurs since the protective barrier of the epidermis has been pierced, leaving the tissues open to infective pathogens. Given time and opportunity to combat infection, the majority of second-degree wounds heal without undue aftereffects though permanent pigmentation changes may persist. The third-degree burn involves complete destruction of the whole skin thickness. Except for very small area burns these are *not* reparable with time but require skin grafting in all cases. Infection is invariably present. Paradoxically, the third-degree burn is not as painful as the second-degree burn because the nerve endings have been destroyed; yet third-degree burns to more than 25 percent of the human body area might represent a fatal injury.

3.54 The treatment of severe thermal injury on areas in excess of 25 percent of the whole body represents a grave medical problem even in a modern hospital and under the best of circumstances. For mass burn casualties under field conditions the situation takes on overwhelming proportions. An unwarned urban population caught out of doors during a nuclear attack would suffer almost complete annihilation from blast and thermal energy out to a radius of many miles from ground zero. While it is feasible to avoid the prompt thermal flash by taking cover, it is not so evident how to avoid the secondary effects of the burning environment which develops soon after the burst. It is probable that burns from secondary fires engendered by the bomb would represent a major proportion of the casualties even for a population which had received warning of imminent attack. (From 65–85% of the atom bomb survivors in Japan were burned to some degree.) Figure 3.54 shows the ranges in miles at which people in the open would suffer various degrees of skin burn from surface burst weapons of different power.

THERMAL EFFECTS OF WEAPONS OF DIFFERENT YIELDS

3.55 A 10MT weapon radiates 500 times as much heat as a 20KT bomb. According to the "inverse square" law a 10MT weapon should produce the same amount of heat as the 20KT weapon at a distance

WEAPON POWER	RADI IN MILES					
	20 KT	100 KT	1 MT	2 MT	5 MT	10 MT
FIRST DEGREE BURN	1.5	3.0	8.0	11.0	15.0	21.0
SECOND DEGREE BURN	1.0	2.0	5.5	7.5	11.0	15.0
THIRD DEGREE BURN	0.875	1.5	4.75	6.25	9.5	13.0

FIGURE 3.54.—Range of effects from surface bursts on people exposed in open.

22 times greater (since $\sqrt{500} = 22$ approx.). But the heat from the larger bomb is spread over a much longer period, 20 seconds compared with a 1½ second flash from the 20KT bomb, so that more of the heat is dissipated.

3.56 Nuclear weapons of 10–100KT deliver at least 60 percent of the total thermal radiation from the second radiation pulse in less than 0.5 second. Weapons in the 1–10MT range, while producing more thermal energy over a greater radius from the burst than weapons of 100KT or less, deliver this thermal energy at a much slower rate than the small weapons. Thus, for equal thermal doses incident on tissue, the small weapons are more effective in producing thermal injury because the large weapons require anywhere from 5 to 15 seconds to deliver 60 percent of the thermal dose. For example, it requires 7–9 cal./cm.² to produce second-degree burns from a 10MT weapon. This illustrates a most important factor: *The larger the weapon, the greater the time available for evasive action.* However, evasive tactics must be exercised before 60 percent of the total energy has been delivered. For personnel well indoctrinated in evasive tactics, this could mean the difference between a moderate sunburn and severe thermal injury. Figure 3.56 shows thermal energies required to cause first, second and third-degree burns from different yield weapons.

3.57 Temporary or permanent blindness could be caused by the thermal radiation

EXPLOSIVE YIELD	1 KT	20 KT	100 KT	1 MT	10 MT	20 MT
FIRST DEGREE BURN	2.0	2.5	2.7	3.2	3.7	3.8
SECOND DEGREE BURN	4.1	4.9	5.4	6.2	7.2	7.5
THIRD DEGREE BURN	6.0	7.3	8.1	9.4	10.8	11.4

FIGURE 3.56.—Approximate thermal energies in Cal./cm.² required to cause skin burns in air or surface burst.

tion if a person is looking in the general direction of the fireball at the precise moment of detonation. The lens of the eye focuses heat as well as light rays on the retina of the eye. Thus in addition to temporary or "flash" blindness of a few seconds or minutes duration from the intense light, actual burns of the retina could occur from undue amounts of thermal radiation entering the eye. Neither flash blindness nor retinal damage constitute major hazards during daylight because of natural restriction of the diameter of the pupil which limits the amount of light entering the eye; furthermore the blink reflex, one hundred and fifty thousandths of a second, protects the eye from undue amounts of radiation, except in those cases where the thermal pulse is delivered within extremely short times. This is the case for low-yield weapons and can also be true for high altitude bursts.

3.58 It is an interesting fact that among the survivors in Hiroshima and Nagasaki, eye injuries directly attributable to thermal radiation appeared to be relatively unimportant. There were many cases of temporary blindness, occasionally lasting up to 2 or 3 hours, but more severe eye injuries were not common.

3.59 The eye injury known as keratitis (an inflammation of the cornea) occurred in some instances. The symptoms, including pain caused by light, foreign-body sensation, lachrymation, and redness, lasted for periods ranging from a few hours to several days.

EFFECT OF SMOKE, FOG AND SHIELDING

3.60 In the event of an air burst occurring above a layer of dense cloud, smoke, or fog, an appreciable portion of the thermal radiation will be scattered upward from the top of the layer. This scattered radiation may be regarded as lost, as far as a point on the ground is concerned. In addition, most of the radiation which penetrates the layer will be scattered and very little will reach the given point by direct transmission. These two effects (smoke or fog) will result in a substantial decrease in

the amount of thermal energy reaching a ground target.

3.61 It is important to understand that the decrease in thermal radiation by fog and smoke will be realized only if the burst point is above or, to a lesser extent, within the fog (or similar) layer. If the explosion should occur in moderately clear air beneath a layer of cloud, or fog, some of the radiation which would normally proceed outward into space will be scattered back to earth. As a result, the thermal energy received will actually be greater than for the same atmospheric transmission condition without a cloud or fog cover.

3.62 Unless scattered, thermal radiation from a nuclear explosion, like ordinary light in general, travels in straight lines from its source, the fireball. *Any solid object, opaque material, such as a wall, a hill, or a tree, between a given object and the fireball, will act as a shield and provide protection from thermal radiation.* Transparent materials, on the other hand, such as glass or plastics, allow thermal radiation to pass through, only slightly absorbed.

3.63 In the case of an explosion in the kiloton range, it would be necessary to take evasive action within a small fraction of a second if an appreciable decrease in thermal injury is to be realized. The time appears to be too short for such action to be possible. On the other hand, for explosions in the megaton range, evasive action taken within a second or two of the appearance of the ball of fire could reduce the severity of injury due to thermal radiation in many cases and may even prevent injury in others.

NUCLEAR RADIATION

3.64 It was stated in paragraph 3.4 that one of the unique features of a nuclear explosion is that it is accompanied by the emission of various nuclear radiations. These radiations, which are quite different from thermal radiation, consist of gamma rays, neutrons, beta particles, and a small proportion of alpha particles. Essentially all the neutrons and part of the gamma rays are emitted in the actual fission proc-

ess. That is, these radiations are produced simultaneously with the nuclear explosion, whereas the beta particles and the remainder of the gamma rays are liberated from fission products in the course of their radioactive decay. The alpha particles result from the normal radioactive decay of the uranium or plutonium that has escaped fission in the bomb.

3.65 Because of the nature of the phenomena associated with a nuclear explosion, either in the air or near the surface, it is convenient for practical purposes to consider the nuclear radiation as being divided into two categories; namely, initial and residual.

INITIAL NUCLEAR RADIATION

3.66 The initial nuclear radiation is generally defined as that emitted from the fireball and the atomic cloud within the first minute after the detonation. It includes neutrons and gamma rays given off almost instantaneously, as well as the gamma rays emitted by the radioactive fission products in the rising cloud. It should be noted that, although alpha and beta particles are present in the initial radiation, they have not been considered. This is because they are so easily absorbed that they will not reach more than a few yards, at most, from the atomic cloud.

3.67 The somewhat arbitrary time period of 1 minute for the duration of the initial nuclear radiation was originally based upon the following considerations. As a consequence of absorption by the air, the effective range of the fission gamma rays and those from the fission products from a 20-kiloton explosion is very roughly 2 miles. In other words, gamma rays originating from such a source at an altitude of over 2 miles can be ignored as far as their effect at the earth's surface is concerned. Thus, when the atomic cloud has reached a height of 2 miles, the effects of the initial nuclear radiation are no longer significant. Since it takes roughly a minute for the cloud to rise this distance, the *initial nuclear radiation is defined as that emitted in the first minute after the explosion.*

3.68 The foregoing discussion is based

on the characteristics of a 20-kiloton nuclear bomb. For a bomb of higher energy, the maximum distance over which the gamma rays are effective will be greater than given above. However, at the same time, there is an increase in the rate at which the cloud rises. Similarly for a bomb of lower energy, the effective distance is less, but so is the rate of ascent of the cloud. The period over which the initial nuclear radiation extends may consequently be taken to be approximately the same; namely, 1 minute irrespective of the energy release of the bomb.

3.69 Neutrons produced directly in the thermonuclear reactions mentioned in paragraph 3.18 are of special significance. Some of the neutrons will escape but others will be captured by the various nuclei present in the exploding bomb. These neutrons absorbed by fissionable species may lead to the liberation of more neutrons as well as to the emission of gamma rays, just as described above for an ordinary fission bomb. In addition, the capture of neutrons in non-fission reactions is usually accompanied by gamma rays. It is seen, therefore, that the initial radiation from a bomb in which both fission and fusion (thermonuclear) processes occur, consists essentially of neutrons and gamma rays. The relative proportions of these two radiations may be somewhat different than for a bomb in which all the energy released is due to fission, but for present purposes, this difference may be disregarded. The range of lethal effects from initial nuclear radiation are well within the areas of severe blast and thermal damage.

RESIDUAL NUCLEAR RADIATION

3.70 The radiation which is emitted 1 minute after a nuclear explosion is defined as residual nuclear radiation. This radiation arises mainly from the bomb residue; that is, from the fission products and, to a lesser extent, from the uranium and plutonium which have escaped fission. In addition, the residue will usually contain some radioactive isotopes formed as a result of neutron capture by bomb materials.

Another source of residual nuclear radiation is the activity induced by neutrons captured in various elements present in the earth, in the sea, or in the substances which may be in the explosion environment.

3.71 With surface and, especially, sub-surface explosions, the demarcation between initial and residual nuclear radiation is not as definite. Some of the radiation from the bomb residue will be within the range of the earth's surface at all times so that the initial and residual categories merge continuously into one another. For very deep underground and underwater bursts, the initial gamma rays and neutrons produced in the fission process may be ignored. Essentially the only nuclear radiation of importance is that arising from the bomb residue. It can consequently be treated as consisting exclusively of the residual radiation. In an air and surface burst, however, both initial and residual nuclear radiation must be taken into consideration.

3.72 One additional important consideration of nuclear radiation is that the residual nuclear radiation *can, under some conditions, represent a serious hazard at great distances from a nuclear explosion, well beyond the range of blast, shock, thermal radiation, and initial nuclear radiation.* This phenomenon—**FALLOUT**—will be discussed at length in later chapters.

CHARACTERISTICS OF A SURFACE BURST

3.73 In a surface burst, the ball of fire in its rapid initial growth will touch the surface of the earth. Because of the intense heat, a considerable amount of rock, soil, and other material located in the area will be vaporized and taken into the ball of fire. It has been estimated that if only 5 percent of a 1-megaton bomb's energy is spent in this manner, something like 20,000 tons of vaporized soil material will be added to the normal constituents of the fireball. In addition, the high winds at the earth's surface will cause large amounts of dirt, dust, and other particles to be sucked up as the ball of fire rises (See Figure 3.28e).

3.74 *An important difference between a surface burst and an air burst is that in the surface burst the atomic cloud is much more heavily loaded with debris (and so produces much more **FALLOUT**).* This will consist of particles ranging in size from the very small ones produced by condensation as the fireball cools, to the much larger particles which have been raised by the surface winds. The exact composition of the cloud will, of course, depend on the nature of the terrain and the extent of contact with the fireball.

3.75 For a surface burst associated with a moderate amount of debris, as was the case in several test explosions in which the bombs were detonated near the ground, the rate of rise of the cloud is much the same as given earlier for an air burst. The atomic cloud reaches a height of several miles before spreading out into a mushroom shape.

3.76 The vaporization of dirt and other material when the fireball has touched the earth's surface, and the removal of material by the blast wave and winds accompanying the explosion, result in the formation of a crater. The size of the crater will vary with the height above the surface at which the bomb is exploded and with the character of the soil, as well as the energy of the bomb. It is believed that for a 1-megaton bomb there would be no appreciable crater formation unless detonation occurs at an altitude of 450 feet or less.

3.77 If a nuclear bomb is exploded near the surface of the water, large amounts of water will be vaporized and carried up into the atomic cloud. For example, if it is supposed, as above (paragraph 3.73), that 5 percent of the energy of the 1-megaton bomb is expended in this manner, about 100,000 tons of water will be converted into vapor. At high altitudes this will condense to form water droplets similar to those in an ordinary atmospheric cloud.

AIR BLAST AND GROUND SHOCK

3.78 The overall blast effect due to the air shock from a surface burst will be less than that from an air burst for weapons of equivalent yield. For one thing, part of the

energy of the bomb is used up in vaporizing materials on the surface and in forming a crater. In addition, up to 15 percent of the energy may go into ground shock. The main point, however, is that because the bomb explodes close to the earth's surface, the overpressure near ground zero will be much greater than for an air burst, but it will fall off more rapidly with increasing distance from ground zero.

3.79 As a result, energy will be wasted on targets close to ground zero which could have been destroyed by much lower overpressures. At the same time, the overpressures at some distance away will be too low to cause any considerable damage. In other words, there will be an "over-destruction" of nearby surface targets and an "under-destruction" of those further away. *The energy that has gone to produce ground shock may contribute, however, to the destruction of underground targets protected from the air blast such as missile launching sites.* Figure 3.43c, (and its legend), will provide additional specific information on surface bursts.

THERMAL RADIATION

3.80 The general characteristics of the thermal radiation from a nuclear detonation at the surface will be essentially the same as for an air burst, described previously. As stated earlier, if evasive action can be taken within a second or so, part of the heat radiation may be avoided.

INITIAL NUCLEAR RADIATION

3.81 The initial nuclear radiation from

a surface burst will be similar to that in an air burst. However, if the low level nuclear explosion occurred in a more or less built-up area, the structures through which it passed would serve to reduce, even though they would not completely shield, the gamma radiation. For practical purposes, however, it would be advisable to treat these two types of burst as the same as far as initial nuclear radiation is concerned.

RESIDUAL NUCLEAR RADIATION

3.82 With respect to residual radioactivity, a nuclear explosion at a low level would produce effects somewhat similar to a subsurface burst. That is, a considerable amount of dirt and other debris or water, would be hurled into the air, and upon descending, it might produce a base surge (highly radioactive cloud of dust or vapor) which will be contaminated partly from the condensation on the ground of the nuclear reaction products from the ball of fire, partly from the fallout of heavier pieces, and partly from radioactivity induced by neutrons.

CHARACTERISTICS OF A SUBSURFACE BURST

3.83 When a nuclear bomb is exploded under the ground, a ball of fire is formed consisting of extremely hot gases at high pressures, including vaporized earth and bomb residue. If the detonation occurs at not too great a depth, the fireball may be seen as it breaks through the surface, before it is obscured by clouds of dirt, and dust. As the gases are released, they carry up with them into the air large quantities

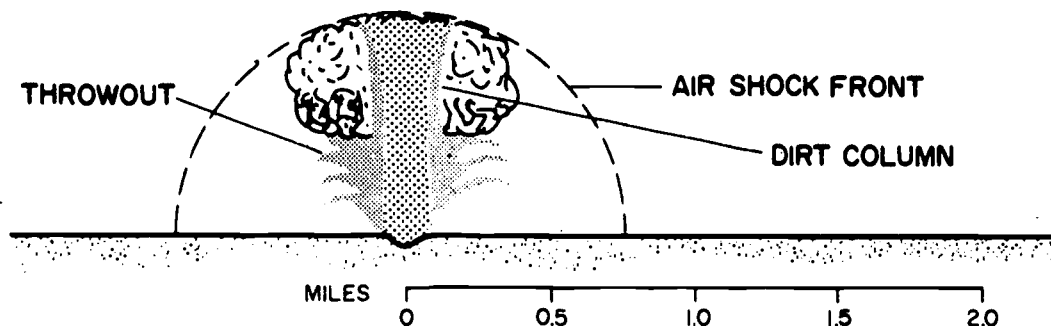

FIGURE 3.83a.—Chronological development of a 100-KT shallow underground burst: 2.0 seconds after detonation.

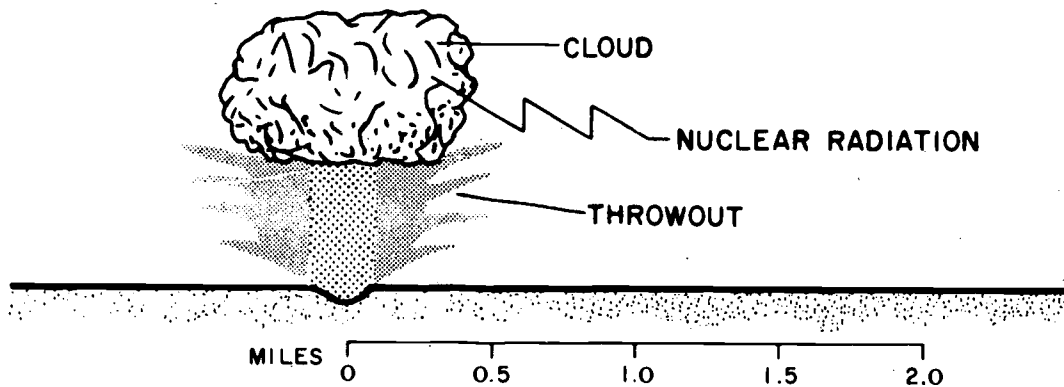

FIGURE 3.83b.—Chronological development of a 100-KT shallow underground burst: 9.0 seconds after detonation.

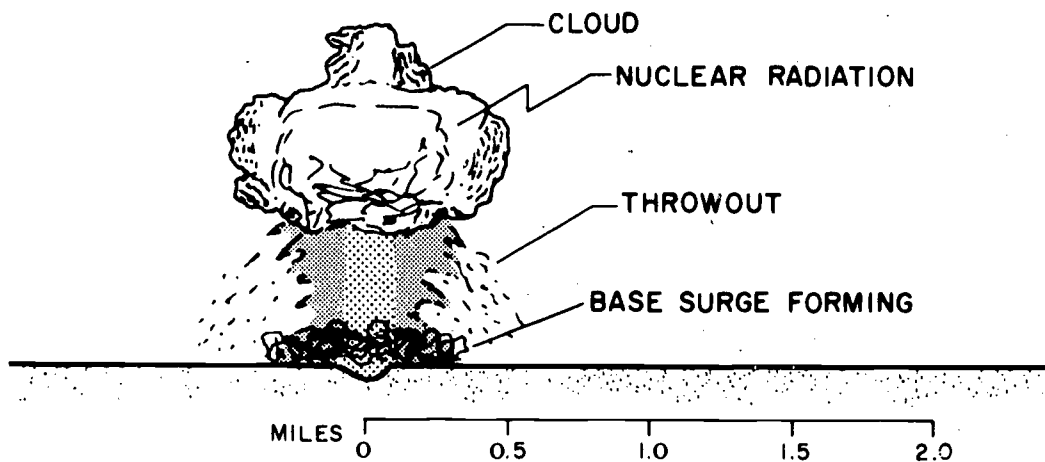

FIGURE 3.83c.—Chronological development of a 100-KT shallow underground burst: 45 seconds after detonation.

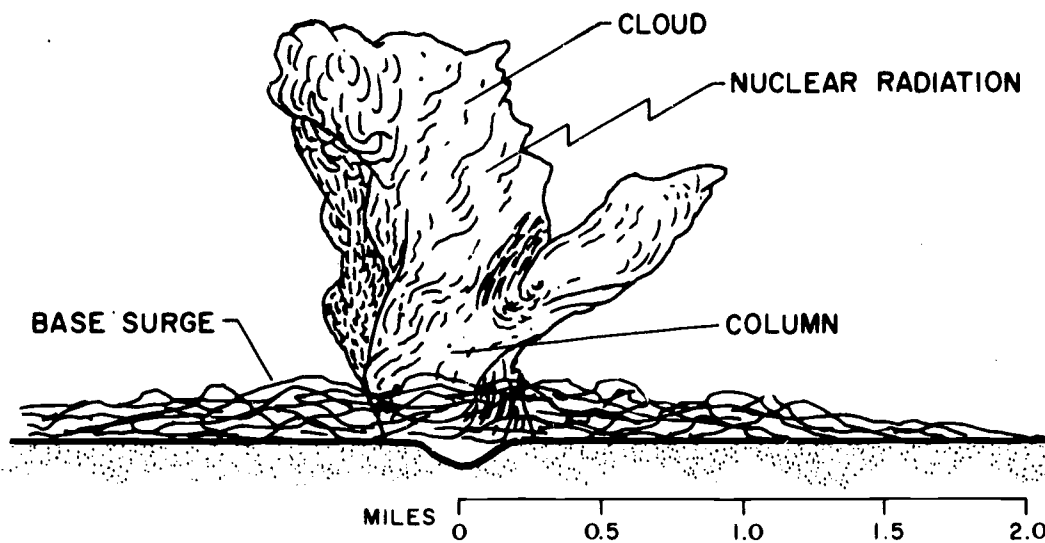

FIGURE 3.83d.—Chronological development of a 100-KT shallow underground burst: 4.5 minutes after detonation.

of earth, rock, and debris in the form of a cylindrical column. The chronological development of some of the phenomena associated with an underground explosion, having an energy yield of 100 kilotons, is represented by Figures 3.83a to 3.83d.

3.84 It is estimated from tests made in Nevada that, if a 1-megaton bomb were dropped from the air and penetrated underground in sandy soil to a depth of 50 feet before exploding, the resulting crater would be about 300 feet deep and nearly 1,400 feet across. This means that approximately 10 million tons of soil and rock would be hurled upward from the earth's surface. The volume of the crater and the mass of material thrown up by the force of the explosion will increase roughly in proportion to the energy of the bomb. As they descend to earth, the finer particles of soil may initiate a base surge as shown in Figure 3.83d.

AIR BLAST AND GROUND SHOCK

3.85 The rapid expansion of the bubble of hot, high-pressure gases formed in the underground burst initiates a shock wave in the earth. Its effects are somewhat similar to those of an earthquake of moderate intensity, except that the disturbance originates fairly near the surface instead of at a great depth. The difference in depth of origin means that the pressures in the underground shock wave caused by a nuclear bomb probably fall off more rapidly with distance than do those due to earthquake waves.

3.86 Part of the energy from an underground nuclear explosion appears as a blast wave in the air. The fraction of the energy imparted to the air in the form of blast depends primarily upon the depth of the burst. The greater the penetration of the bomb before detonation occurs, the smaller is the proportion of the shock energy that escapes into the air.

THERMAL AND NUCLEAR RADIATION

3.87 Essentially all the thermal radiation emitted by the ball of fire while it is still submerged is absorbed by the surrounding earth. When the hot gases reach

the surface and expand, the cooling is so rapid that the temperature drops almost immediately to a point where there is no further appreciable emission of thermal radiation. It follows, therefore, that in an underground nuclear explosion the thermal radiation can be ignored as far as its effects on personnel and as a source of fire are concerned.

3.88 It is probable, to, that most of the neutrons and gamma rays liberated within a short time of the initiation of the explosion will also be absorbed by the earth. But, when the fireball reaches the surface and the gases are expelled, the gamma rays (and beta particles) from the fission products will represent a form of initial nuclear radiation. In addition, the radiation from the fission (and neutron-induced radioactive) products present in the cloud stem, radioactive cloud, and base surge, all three of which are formed within a few seconds of the burst, will contribute to the initial effects.

3.89 However, the fallout from the cloud and the base surge are also responsible for the residual nuclear radiation. For a subsurface burst, it is thus less meaningful to make a sharp distinction between initial and residual radiation, such as is done in the case of an air burst. The initial nuclear radiation merges continuously into those which are produced over a period of time following the nuclear explosion.

HIGH ALTITUDE BURSTS

3.90 For nuclear detonations at heights up to about 100,000 feet the density of air is such that the distribution of the explosion energy remains almost unchanged, approximating that described for an air burst, e.g., about 45 to 55 percent (of the fission energy) appears as blast and shock and 30 to 40 percent is received as thermal radiation.

3.91 At greater altitudes, this distribution begins to change noticeably with increasing height of burst, a smaller proportion of the energy appearing as blast. It is for this reason that the level of 100,000 feet has been chosen for distinguishing

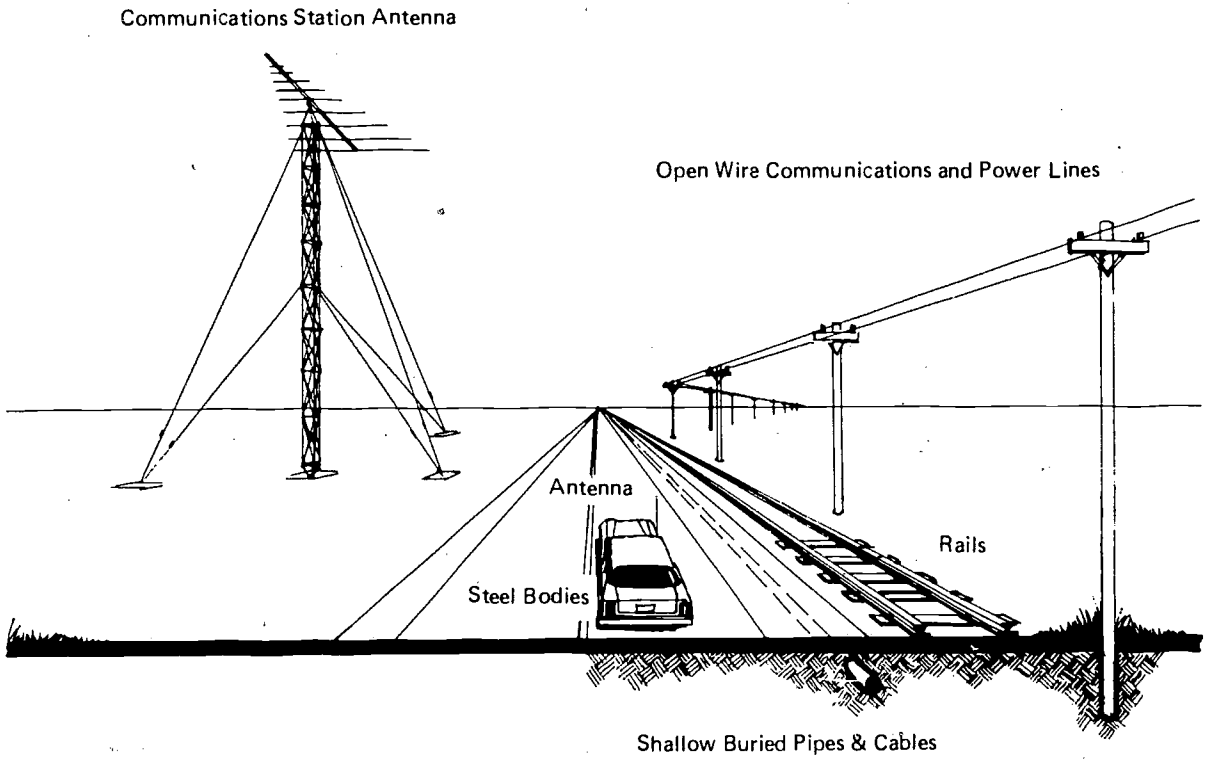
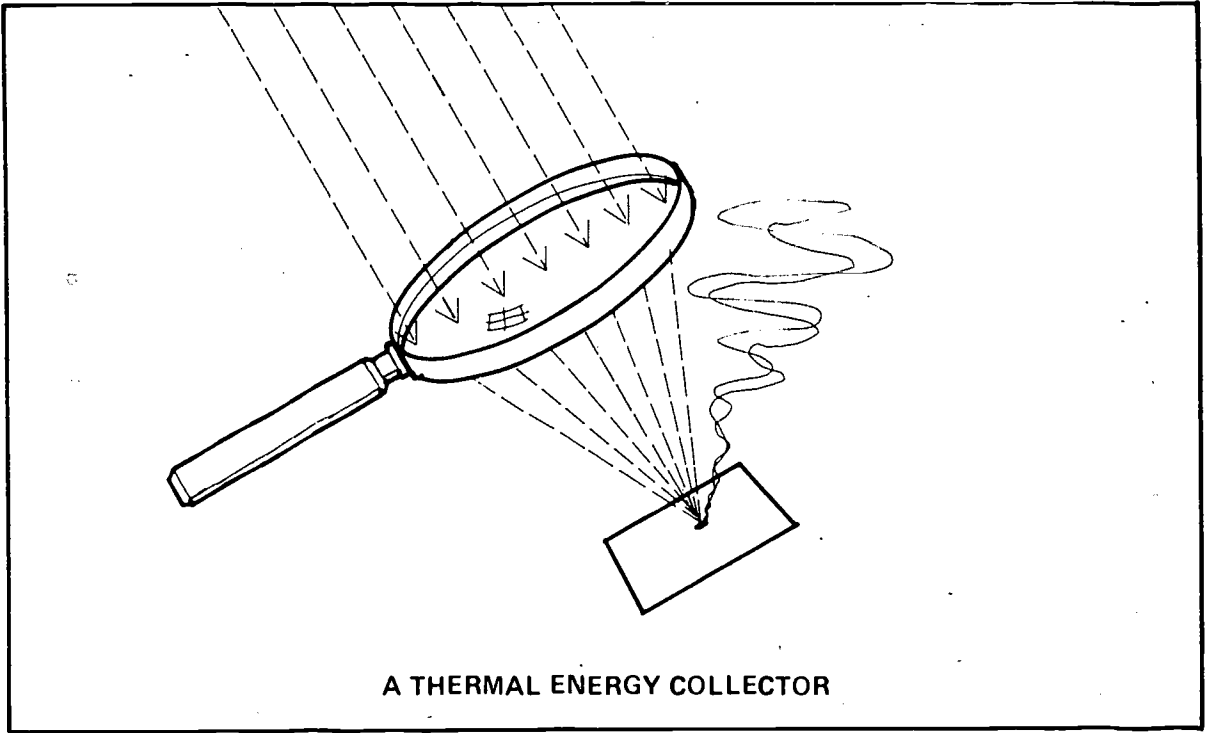

EMP ENERGY COLLECTORS

FIGURE 3.95.—EMP ENERGY COLLECTOR.

between air bursts and high-altitude bursts.

3.92 There is, of course, no sharp change in behavior at this elevation, and so the definition of a high-altitude burst as being at a height above 100,000 feet is somewhat arbitrary. Although there is a progressive decline in the blast energy with increasing height of burst above 100,000 feet, the proportion of the explosion energy received as effective thermal radiation on the ground does not at first change appreciably. This is due to the interaction of the primary thermal radiation with the surrounding air and its subsequent emission in a different spectral region. At still higher altitudes, the effective thermal radiation received on the ground decreases and is, in fact, less than at an equal distance from an air burst of the same total yield.

3.93 One aspect of a high-altitude burst that has received increased attention in recent years is the electromagnetic pulse (EMP). Its implications were first noted during an experimental high-altitude burst over Johnson Island in the Pacific Ocean in 1962 when street light failures and communications disruptions occurred on Oahu, 750 miles away. In an era of intercontinental ballistic missile systems, and defenses against those missiles, the possibility of a high-altitude burst in a nuclear attack becomes very real.

3.94 Put simply, the electromagnetic pulse is that portion of the electromagnetic spectrum (Figure 2.42) in the medium to low frequency range extending roughly from the frequencies used in radar and TV down to those used in electric power. Since most of the energy is radiated in the frequency bands commonly used for radio and TV communications, it is sometimes called "radio-flash." It is differentiated from the thermal radiation "pulse" that produce heat and light and the initial radiation "pulse" of gamma and X-rays.

3.95 There is concern about EMP because the energy in the pulse can be collected and concentrated, much as the sun's rays can be focused to produce a fire,

as shown in the upper portion of Figure 3.95. The lower portion of the diagram shows some common EMP energy collectors. Sufficient energy can be collected by these means to cause damage to attached electrical and electronic equipment.

3.96 In a surface or near-surface burst the relevant EMP energies are generally well within the blast and thermal damage areas close to the point of nuclear detonation and thus cover a relatively small geographical area.

3.97 By contrast, if a nuclear weapon is detonated high above the earth's atmosphere, the X-rays and gamma rays emitted downward from the explosion will be absorbed in a big "pancake" layer of the atmosphere between 12½ and 25 miles above the earth's surface, as shown in Figure 3.97. The gamma energy is converted into lower-frequency electromagnetic energy in this interaction region and propagated downward to the earth's surface as a very brief but powerful electromagnetic pulse. The strength of this pulse on the ground is much the same as in the moderate damage area of a surface burst. However, very large areas, otherwise undamaged, can be affected by the high altitude detonation, as the lateral extent of the "interaction region" is generally limited only by the curvature of the earth.

3.98 The extent of that damage can be seen by considering a typical high-altitude burst over Omaha, Nebraska as shown in Figure 3.98. Within the circle passing through Dallas, Texas the EMP hazard would be the greatest. The outer circle shows that there is potential damage from EMP effects over the whole area of the United States.

3.99 EMP can cause two kinds of damage. First, functional damage that would require replacement of a component or piece of equipment. Examples would be the burnout of a radio receiver "front end" or the blowing of a fuse. Second, operational upset of equipment such as opening of circuit breakers or erasure of a portion of the memory of a computer.

3.100 Experiments have shown that CD radiation detection equipment is not sus-

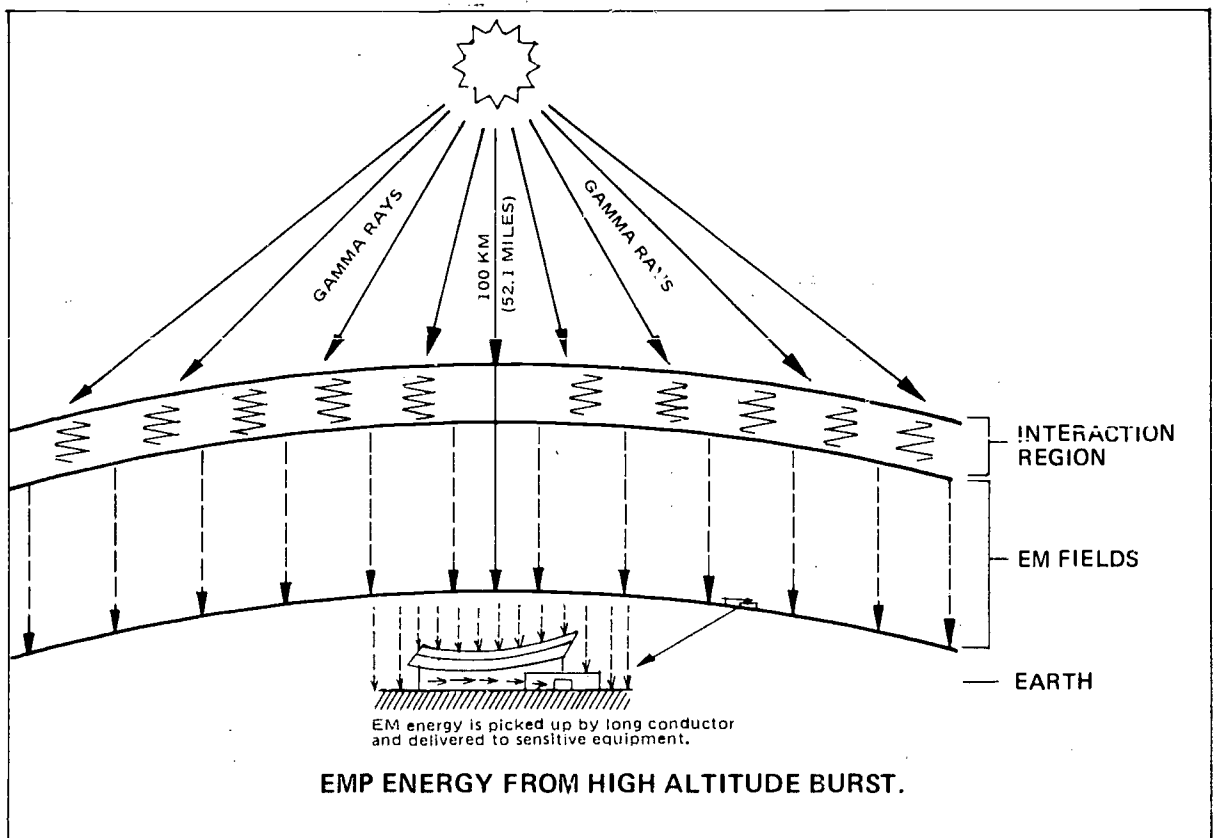
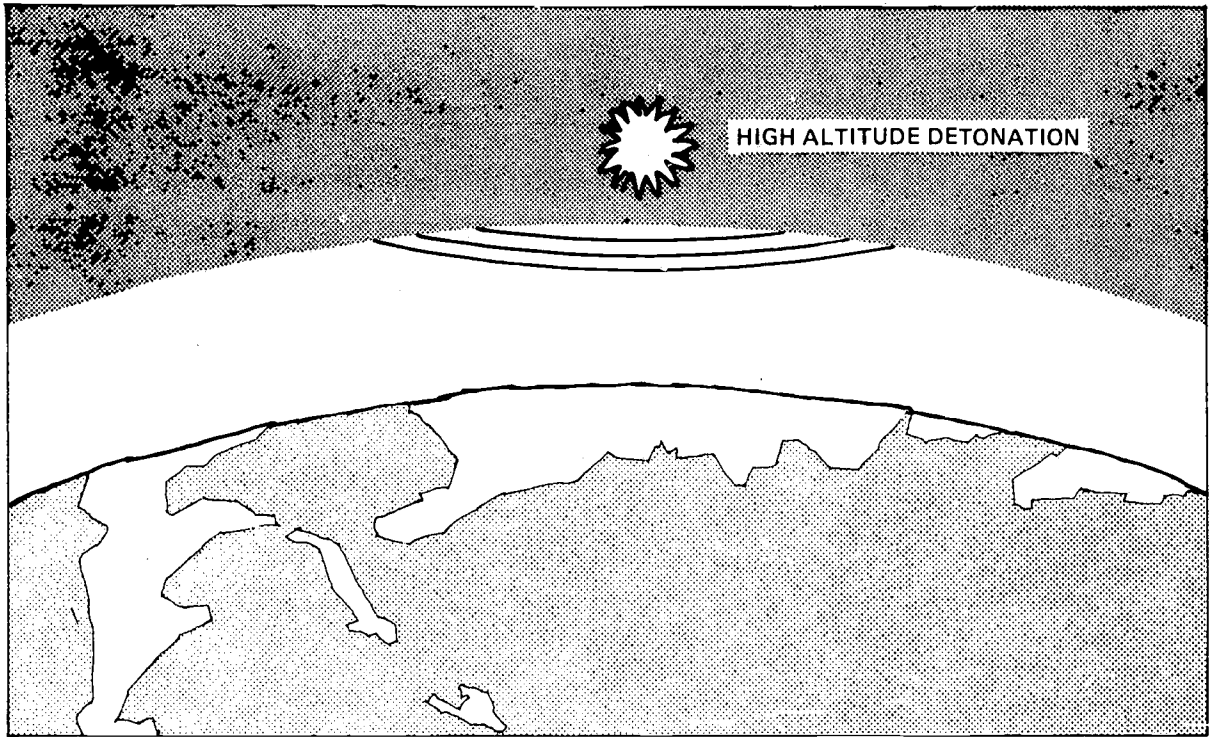

From: *Survive*, November-December 1969

FIGURE 3.97.—EMP energy from high altitude burst.

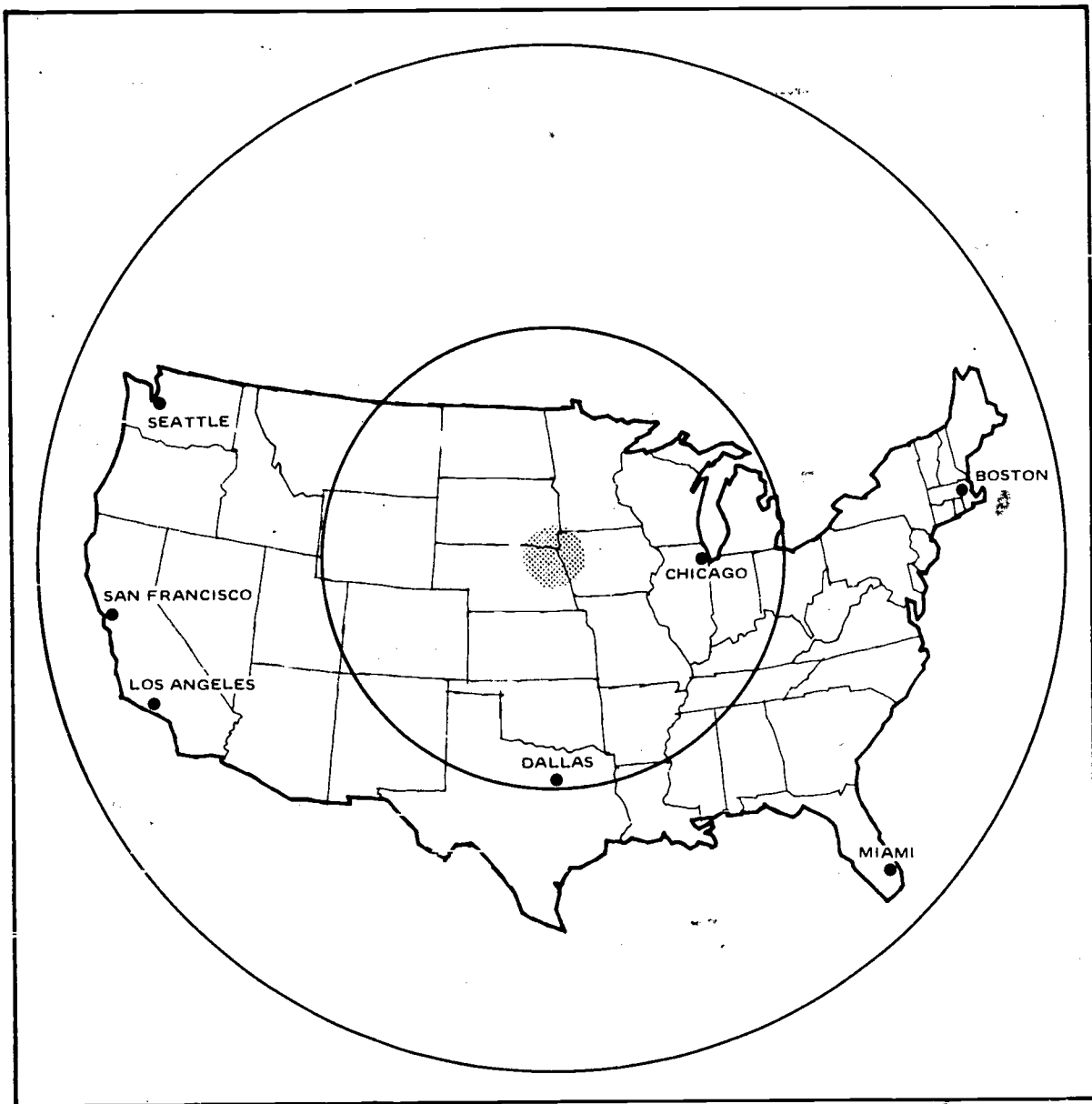

EMP GROUND COVERAGE OF HIGH ALTITUDE BURSTS

Source: Defense Nuclear Agency

FIGURE 3.98.—EMP ground coverage of high altitude bursts

ceptible to direct damage nor are hand held Citizens Band walkie-talkies or FM radio receivers. The vulnerability of individual electrical or electronic equipment can vary greatly. Transistors and micro-wave diodes, for example, are relatively more vulnerable than vacuum tubes or electric motors.

3.101 The EMP threat and protective measures for civil preparedness related systems and equipment are available in technical publications of DCPA. Emergency operating centers, broadcast radio and TV, telephone and electric power systems and public safety radio are some of the areas of concern.

3.102 Listed below are seven anti-EMP actions that could be applicable to local civil preparedness operations.

1. Maintain a supply of spare parts.
2. Shift to emergency power at the earliest possible time.
3. Rely on telephone contact during threat period so long as it remains operational.
4. If radio communication is essential during threat period, use only one system at a time. Disconnect all other systems from antennas, cables, and power.
5. Disconnect radio base stations when not in use from antennas and power line.
6. Plan for mobile-to-mobile backup communications.
7. Design emergency operating plans so that operations will "degrade gracefully" if communications are lost.

SUMMARY OF EFFECTS OF VARIOUS TYPE BURSTS ⁴

3.103 Some general conclusions can be offered in summary of the degree or severity of the particular effects of the various types of nuclear detonations. The various degrees are relative to each other for a given burst type, and are best interpreted in terms of the descriptions given below.

⁴ This summary is reprinted from THE EFFECTS OF NUCLEAR WEAPONS.

HIGH ALTITUDE BURST ⁵

LIGHT: Very intense.

HEAT: Moderate, decreases with increasing burst altitude.

INITIAL NUCLEAR RADIATION: Negligible.

SHOCK: Negligible.

AIR BLAST: Small on the ground, decreasing with increasing burst altitude.

EARLY FALLOUT: None.

SUMMARY: The most significant effect will be flash blindness over a very large area; eye burns will occur in persons looking directly at the explosion. Other effects will be relatively unimportant.

AIR BURST

LIGHT: Fairly intense, but much less than for high-altitude burst.

HEAT: Intense out to considerable distances.

INITIAL NUCLEAR RADIATION: Intense, but generally hazardous out to shorter distance than heat.

SHOCK: Negligible except for very low air bursts.

AIR BLAST: Considerable out to distances similar to heat effects.

EARLY FALLOUT: Negligible.

SUMMARY: Blast will cause considerable structural damage; burns to exposed skin are possible over a large area and eye effects over a still larger area; initial nuclear radiation will be a hazard at closer distances; but the early fallout hazard will be negligible.

GROUND SURFACE BURST

LIGHT: Less than for an air burst, but still appreciable.

HEAT: Less than for an air burst, but significant.

INITIAL NUCLEAR RADIATION: Less than for an air burst.

SHOCK: Will cause damage within about three crater radii, but little beyond.

⁵ As modified by 3.93-3.102.

AIR BLAST: Greater than for an air burst at close-in distances, but considerably less at farther distances.

EARLY FALLOUT: May be considerable (for a high-yield weapon) and extend over a large area.

SUMMARY: Except in the region close to ground zero, where destruction would be virtually complete, the effects of blast, thermal radiation, and initial nuclear radiation will be less extensive than for an air burst; however, early fallout may be a very serious hazard over a large area which is unaffected by blast, etc.

SHALLOW UNDERWATER BURST

LIGHT, HEAT, AND INITIAL NUCLEAR RADIATION: Less than for a ground surface burst, depending on the extent to which the fireball breaks through the surface.

SHOCK: Water shock will extend farther than a water surface burst.

AIR BLAST: Less than for surface burst, depending upon depth of burst.

EARLY FALLOUT: May be considerable, if the depth of burst is not too large, and in addition there may be a highly radioactive base surge.

SUMMARY: Light, heat, and initial nuclear radiation will be less than for a ground surface burst; early fallout can be significant, and at distances not too far from the explosion the base surge will be an important hazard.

WATER SURFACE BURST

LIGHT: Somewhat more intense than for a ground surface burst.

HEAT: Similar to ground surface burst.

INITIAL NUCLEAR RADIATION: Similar to ground surface burst.

SHOCK: Water shock can cause damage to ships and underwater structures to a considerable distance.

AIR BLAST: Similar to ground surface burst.

EARLY FALLOUT: May be considerable.

SUMMARY: The general effects of a water

surface burst are similar to those for a ground surface burst, except that the effect of the shock wave in water will extend farther than ground shock. In addition, water waves can cause damage on a nearby shore by the force of the waves and by inundation.

SHALLOW UNDERGROUND BURST

LIGHT, HEAT, AND INITIAL NUCLEAR RADIATION: Less than for a water surface burst, depending upon how much of the fireball breaks through the surface.

SHOCK: Ground shock will cause damage within about three crater radii, but little beyond.

AIR BLAST: Less than for a surface burst, depending on the depth of burst.

EARLY FALLOUT: May be considerable, if the depth of burst is not too large, and in addition there may be a highly radioactive base surge.

SUMMARY: Light, heat, initial nuclear radiation, and blast effects will be less than for a surface burst; early fallout can be significant, but at distances not too far from the explosion the radioactive base surge will be an important hazard. Water waves can also cause damage, as in the case of a water surface burst.

CONFINED SUBSURFACE BURST

LIGHT, HEAT, AND INITIAL NUCLEAR RADIATION: Negligible or none.

SHOCK: Severe, especially at fairly close distances from the burst point.

AIR BLAST: Negligible or none.

SUMMARY: If the burst does not penetrate the surface, either of the ground or water, the only hazard will be from ground or water shock. No other effects will be significant.

REFERENCES

The Effects of Nuclear Weapons.—Glasstone, Samuel, 1964.

EMP Threat and Protective Measures, DOD/OCD, TR-61, August 1970.

DCPA Attack Environment Manual.

NUCLEAR RADIATION MEASUREMENT

Since we cannot hear, see, smell, taste or feel nuclear radiation from the fallout, we must rely entirely upon instruments in order to DETECT its presence and MEASURE the degree of danger. In this chapter, then, we will look at:

- HOW nuclear radiation may be *detected*
- HOW nuclear radiation may be *measured*
- WHAT instruments exist to do the detecting and the measuring
- HOW do instruments operate
- WHY do we need different types of instruments
- WHAT are the units we use to measure nuclear radiation

INTRODUCTION

4.1 Man is aware of his environment through his senses. He can see, smell, taste, hear and feel. Yet, none of these senses will make him aware of the presence of nuclear radiation. This situation is not really unusual. In fact it is like his inability to respond directly to the waves of ultraviolet light and radar, television, or radio transmission. For example, a man may receive a serious sunburn due to overexposure to the sun's ultraviolet rays, yet his first indication of over-exposure may come several hours later when he feels pain. In this situation he was not aware of the ultraviolet rays during the exposure period; however, in a sense, he did detect the ultraviolet light indirectly since he certainly would be aware of a painful sunburn. Similarly, since man cannot rely on his senses to detect nuclear radiation he must rely on some *secondary* means such as instrumentation.

4.2 At the present time, nuclear radiation detection instruments are widely used in industry and research. X-ray films and Geiger counters are items of everyday conversation. In this chapter we will discuss the principles and theory of operation of many nuclear radiation detection instruments, or radiological instruments as we will refer to them. These instruments are very similar to other types of electronic equipment. *Their main distinguishing characteristic is their ability to respond to nuclear radiation.*

4.3 The term DETECTION is used in this text to include only the indication of the presence of nuclear radiation. The term MEASUREMENT will be reserved for both the detection and quantitative estimation of the amount of nuclear radiation present.

PRINCIPLES OF RADIATION DETECTION

4.4 Radiological instruments detect the interaction of radiation with some type of matter. The different principles of radiation detection are characterized by the nature of the interaction of the radiation with the detecting or sensing element. Several types operate by virtue of the ionization which is produced in them by the passage of charged particles. In other detectors, excitation and sometimes molecular disassociation play important roles.

4.5 During the 1890's, Henri Becquerel found that photographic plates, when placed in proximity to ores or compounds of uranium, were affected in the same manner as if they had been exposed to light. This occurred even when the plates were protected by sufficient covering to assure that the strongest light could not affect them. This date marked the discov-

ery of radioactivity, and today this principle is still used to detect and measure the *product of radioactivity*, NUCLEAR RADIATION.

4.6 The photographic detection technique is relatively simple. As a charged particle passes through a photographic emulsion, it will generally cause changes which will result in a blackening of the emulsion when the film is developed. The photographic emulsion consists of finely divided crystals of a silver halide, usually silver bromide, suspended in gelatin and spread evenly on a glass, cellulose, or paper base. When charged particles strike the emulsion, some sort of ionization not well understood takes place. This local disturbance of the electrons in the crystals of silver bromide creates a latent image which is invisible to the eye when formed, but which can be developed later by chemical action. The chemical developer acts as a reducing agent to deposit metallic silver only at those points in the emulsion where radiation interacted and in proportion to the amount of radiation which acted on the silver salt. The amount of blackening on the film is a function of several factors: the time of exposure, the intensity of the exposure, the sensitivity of the film, and the chemical processes of development. By rigidly controlling these factors, the blackening of the film can be made proportional to the radiation exposure.

4.7 A second method of detecting radiation was again first employed by Becquerel and Rutherford in their early work with radioactive substances. Certain materials will produce small flashes of visible light when struck by alpha, beta, or gamma radiation. These flashes are called scintillations. The mechanism of formation of these scintillations is very complex but essentially it involves the initial formation of higher energy (or excited) electronic states of molecules (or atoms) in certain materials. Some of the absorbed energy which has been derived directly or indirectly from the incident radiation will be emitted in a very short time as photons of visible or ultraviolet light. These light photons are then converted into an electrical current by a photomultiplier tube and

the current is measured. Since the light intensity and the resulting electrical current are proportional to the rate of radiation exposure, the instrument can be calibrated to read radiation exposure rates.

4.8 A third principle for detecting radiation is based on the fact that many substances undergo chemical changes when exposed to radiation. This is particularly true of chemicals in aqueous solutions where the decomposition of the water itself contributes to the reaction. If the extent of the chemical change can be conveniently measured, the reaction can be used for measuring radiation. There are several chemical reactions which may be utilized in this manner. One of the first used was the liberation of acid from a chlorinated hydrocarbon such as chloroform. Chloroform, water, and an indicator dye are sealed into a glass tube. As radiation penetrates the tube, hydrochloric acid is liberated from the chloroform. The liberation of this acid reduces the pH of the solution and causes a distinctive color change in the dissolved indicator. The extent of the color change is an estimate of the radiation exposure of the tube.

4.9 Becquerel's discovery that gases become electrical conductors as a result of exposure to radiation provides us with a fourth means of detecting and measuring radiation. When a high-speed particle or a photon passes through a gas, it may cause the removal of an electron from a neutral atom or molecule causing the formation of an ion pair. This process of ionization in a gas is the basic phenomenon in all **ENCLOSED GAS VOLUME INSTRUMENTS**. The electron produced may have rather high energies and may produce more ionization in the gas until its energy is expended and it is finally captured by an oppositely charged ion. If two oppositely charged collecting electrodes are introduced into the gas filled chamber, the ion pairs will migrate to their respective electrodes. Negative ions will move toward the positively charged electrode and the positive ions toward the negatively charged one. When the ions reach the electrodes, they will be neutralized, resulting in a reduction of the charge on the electrodes. In one type of

instrument this loss in charge is used as a measure of the radiation exposure. In another type, batteries are used to replace the charge on the electrodes resulting in a current flow in the external circuit. Within certain limits, this ionization current will be proportional to the radiation exposure rate.

4.10 In addition to the four principles discussed above, there are several other principles which may be utilized for the detection of radiation, but to date these have not been as widely used.

TYPES OF RADIOLOGICAL INSTRUMENTS

4.11 In the development of radiological instruments, the choice of detector is an important factor. An equally important factor in their design is the type of information required by the user. Normally this information falls into two categories: the measurement of total accumulated exposure to radiation, and the instantaneous rate of exposure. The first is referred to as an **EXPOSURE MEASUREMENT** and the second, as an **EXPOSURE RATE MEASUREMENT**. As an example of a situation in which both types of information are required, consider the following. An area is contaminated with fallout. A person is required to enter the area and not exceed an exposure of 25 roentgens. This situation requires an instrument which will measure the total accumulated radiation exposure during the period of stay in the contaminated area. Instruments designed to provide such measurements are called **DOSIMETERS**. Next, assume that the operation to be performed will require two hours to complete. In order to determine if entry into the area is practical, it is necessary to know the instantaneous rate of exposure to which the person would be exposed in the contaminated area. Instruments designed to measure exposure rate are called **SURVEY METERS**.

4.12 It is important to emphasize that radiological instruments measure exposures and not absorbed or biological doses. Such **EXPOSURE** is a measure of the strength of the radiation field, while the **ABSORBED DOSE** is a measure of the amount

of energy liberated in the absorbing material, and the **BIOLOGICAL DOSE** is a measure of the biological effect of a particular radiation absorbed by an individual. However, it is also important to emphasize that the ultimate objective for measuring an exposure to radiation is to relate that to a certain biological response of the exposed individual.

UNITS OF RADIATION MEASUREMENT

4.13 As discussed in Chapter 2, the roentgen is the unit of radiation exposure. This unit is based on the effect of X or gamma radiations on the air through which they pass. It is defined as that quantity of X or gamma radiation such that the associated corpuscular emission per cubic centimeter of dry atmospheric air at 0° centigrade and 760 mm of mercury produces, in air, ions carrying one electrostatic unit of charge of either sign (2.083×10^9 ion pairs/cc). Since this unit is rather large for measuring peacetime occupational exposures, the milliroentgen, which is equivalent to 1/1000th of a roentgen, is frequently used for measuring small exposures. Since dosimeters measure exposure, they measure in **ROENTGENS** or **MILLIROENTGENS**, while survey meters, which measure exposure rates, measure in **ROENTGENS per hour** or **MILLIROENTGENS per hour**. It is important to note that *the roentgen applies only to the measurement of X or gamma radiation, and does not apply to the measurement of alpha or beta radiation.*

4.14 These units of exposure and exposure rate are related by a time factor analogous to the relationship between total distance traveled and speed. For example, the total distance from Battle Creek, Michigan, to Detroit, Michigan, is approximately 120 miles. A person leaving Battle Creek and averaging 40 miles per hour would require three hours to travel to Detroit. Similarly, if a person entered a radioactive contaminated area where the exposure rate was 40 roentgens per hour and remained for three hours, his total accumulated exposure would be 120 roentgens. This, of course, assumes that the 40

roentgens per hour exposure rate remained constant. Just as it is difficult to maintain a speed of 40 miles per hour, so might it be difficult to maintain a radiation field of 40 roentgens per hour, since radioactive materials decay according to fixed natural laws. This decay will cause the 40 roentgens per hour exposure rate to decrease with time. However, if the radioactive material has a relatively long half-life, the decrease in exposure rate during a three-hour period may be negligible. (With fallout, especially in the early hours after detonation, the decrease in exposure rate will be appreciable during a three-hour period.)

DOSIMETERS

4.15 As indicated above, it is necessary in emergency operations to provide an instrument capable of measuring an individual's total exposure to radiation. It is clear from the definition of the roentgen that the measurement of ionization in air is basic to the determination of radiation exposure. In Civil Preparedness an ionization chamber employing the principle of enclosed gas volume has proved most satisfactory for exposure measurement.

4.16 To understand the operation of do-

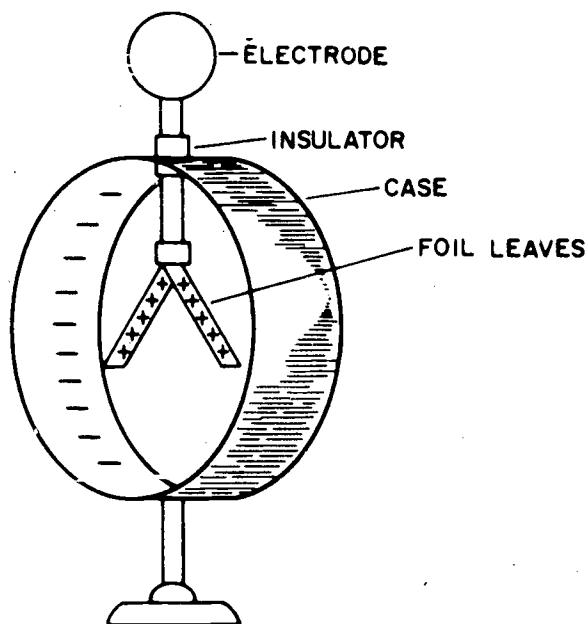

FIGURE 4.16a.—Charged electroscope.

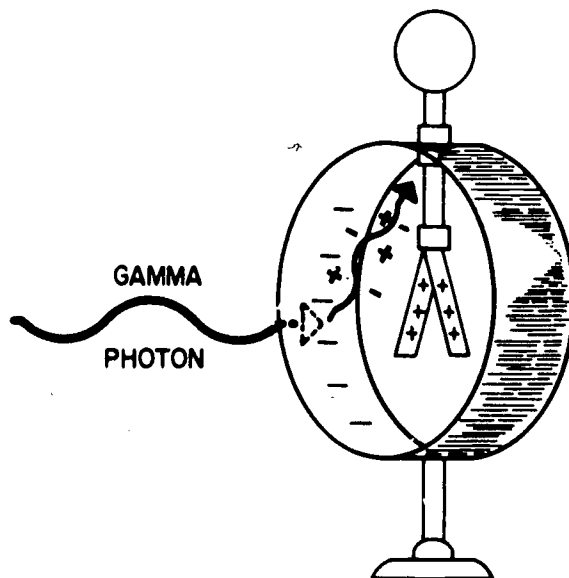

FIGURE 4.16b.—Radiation effect on charged electroscope.

simeters, consider a foil leaf electroscope (Figure 4.16a) consisting of an outside metal shell in which is mounted an externally projecting electrode. An insulator such as amber or sulfur insulates the electrode from the outside case. Two narrow strips of a thin foil are cemented to the enclosed stem of the electrode to form the moving part of the electroscope. Normally, windows in the case serve for viewing the foil leaves. If an electrical charge is applied to the externally projecting electrode, it is transferred through the electrode to the foil leaves. Because of the mutual repulsion of like charges, the leaves will immediately repel each other until the electrical repulsion is just counter-balanced by the gravitational force tending to bring them back together. If the air in the enclosed chamber is ionized by radiation (Figure 4.16b), it becomes an electrical conductor and this permits the charge on the leaves to leak away. Since the electrical charge is reduced, the mutual repulsion of the leaves is reduced and they assume a position closer together. This same principle is basic to the operation of dosimeters. The electrostatic self-indicating dosimeter used in Civil Preparedness is nothing more than a sophisticated electroscope.

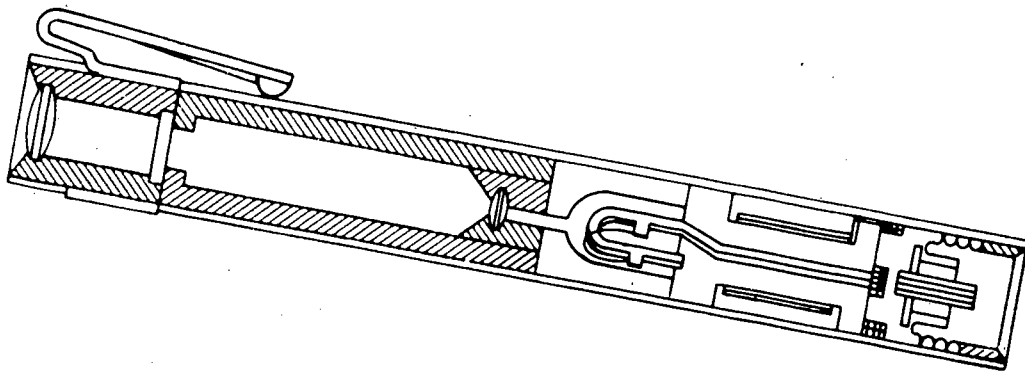

FIGURE 4.17.—Construction principles of an electrostatic self-indicating dosimeter.

4.17 The dosimeter consists of a quartz fiber electrometer suspension mounted inside an ionization chamber (Figure 4.17). The electrometer suspension is supported by means of a highly insulated material inside an electrically conducting cylinder. The enclosed air volume surrounding the electrometer suspension is the ionization chamber or the radiation sensitive component of the instrument. The indicating element is a five micron (1/5000 in.) quartz fiber which is part of the electrometer suspension. The quartz fiber has an electrically conducting coating evaporated on its surface and has the same form factor as the metal frame of the electrometer. In most dosimeters both frame and fiber are in the shape of a horseshoe, the fiber being attached to two offsets on the lower extremities of the frame.

4.18 The dosimeter contains an electrical capacitor in parallel with the electrometer suspension and the chamber wall. The range of the dosimeter is determined by the size of the capacitor, the chamber volume, the sensitivity of the electrometer, the pressure inside the ionization chamber and the optical system. Only pressure and capacitance variation offer a wide selection of ranges. Therefore, the function of the electrical capacitor is to change the range of the dosimeter. However, for a particular dosimeter, the range will be fixed by the selection of the capacitor at the time of its manufacture.

4.19 The charging switch assembly consists of a bellows and a contact rod, which is normally isolated from the electrometer

suspension. Only when the dosimeter is placed on a dosimeter charger and the bellows depressed can contact be made between the rod and electrometer. This arrangement provides a very high electrical resistance, and the hermetic sealing allowed by such construction makes the dosimeter readings essentially independent of humidity and pressure changes.

4.20 Focused on the quartz fiber is a 75 to 125 power microscope which magnifies the image of the quartz fiber so that it is visible. The microscope consists of one objective lens, one eyepiece lens, and contains a scale or reticle at the real image of the quartz fiber. The scale is graduated in roentgens or milliroentgens depending on the range of the instrument.

4.21 In preparation for exposure to radiation, the dosimeter is charged to about 160 to 175 volts to bring the image of the quartz fiber to zero on the scale. (Figure 4.21). In charging the dosimeter, an external source of electrical power is used. The ionization chamber is held at ground potential and the metal frame and fiber of the electrometer assume the other extreme of the voltage difference. The fiber is repelled from the frame since both are at the same potential. The position of the quartz fiber will then vary with the potential difference. This variance is linear for the voltage range covered by the scale. When the instrument reads full scale, the potential difference is not zero but usually some intermediate voltage between 75 and 125 volts.

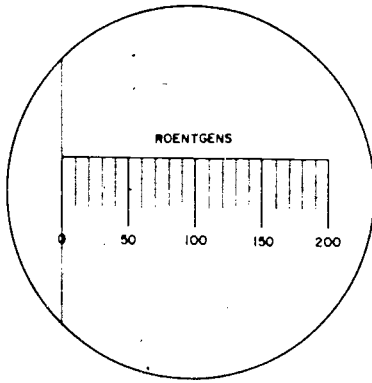

FIGURE 4.21.—Zero dosimeter reading.

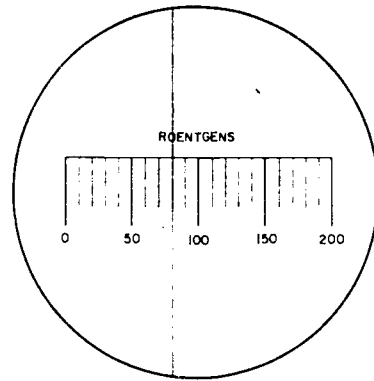

FIGURE 4.22b.—80 R dosimeter reading.

4.22 As the dosimeter is exposed to X or gamma radiation, the photons will interact with the wall of the ionization chamber producing secondary electrons (Figure 4.22a). These electrons enter the sensitive volume of the dosimeter and ionize the air molecules. Under the influence of the electrical field in the chamber, the ion pairs migrate to the electrode of opposite charge and are neutralized. This causes a proportionate discharge of the capacitor system and decreases the potential difference between the electrometer and the chamber wall. The quartz fiber now assumes a new position corresponding to the new potential difference. This is reflected by an up-scale movement of the

hairline image of the quartz fiber (Figure 4.22b).

The movement of the fiber is a function of the total amount of radiation to which the dosimeter is exposed, regardless of the rate of exposure to radiation.

4.23 If the dosimeter reading is zero at the start of a period, the exposure may be read directly from the dosimeter. However, any initial dosimeter reading must be subtracted from the final reading to obtain a correct indication of the total exposure. For example, if a dosimeter reads 10 rem at the start of a period and reads 55 rem at the end, the exposure during the period is 45 rem. Performance characteristics of dosimeters will be discussed in the next chapter.

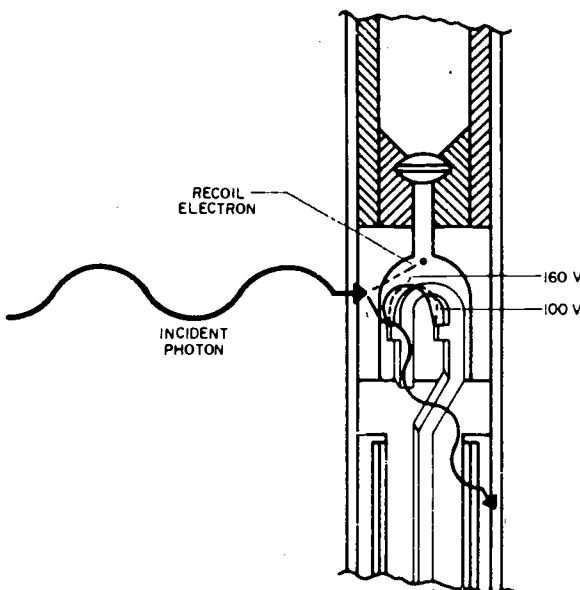

FIGURE 4.22a.—Operation of an electrostatic dosimeter.

DOSIMETER CHARGERS

4.24 The design of dosimeter chargers has progressed to the point that the later models all use transistorized circuits to provide the required charging voltage. Although some of the earliest chargers were not transistorized, probably all future ones will be because of the ease of opera-

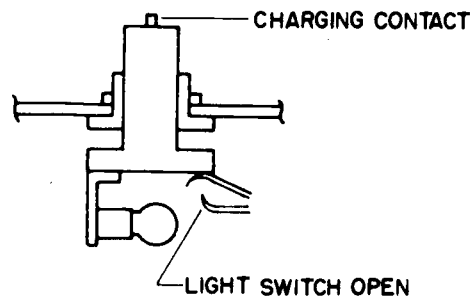

FIGURE 4.25a.—Initial condition.

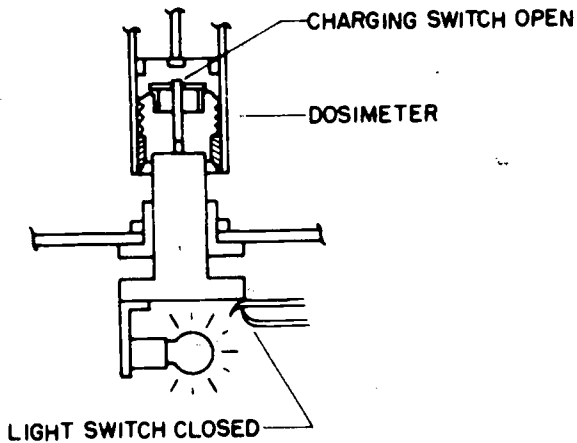

FIGURE 4.25b.—Reading position.

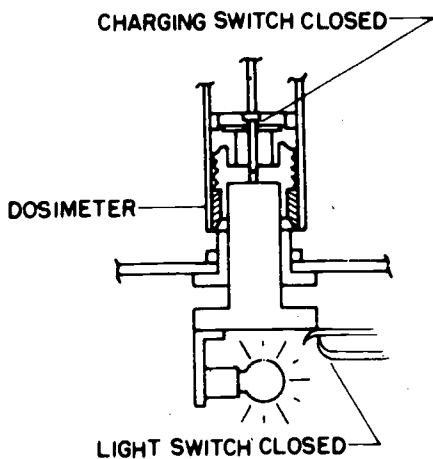

FIGURE 4.25c.—Charging position.

tion of the transistorized models and prolonged battery life.

4.25 In the transistorized chargers, the circuit is powered by a single 1.5 volt battery. The charging contact is shown in its initial condition in Figure 4.25a. When a dosimeter is placed on the charging contact and pressure is applied, the light switch closes and the bulb lights (Figure 4.25b). However, in this position the dosimeter cannot be charged, since the dosimeter charging switch is still open. Additional pressure must be applied to close this switch (Figure 4.25c). A transistor oscillator converts the direct current from a flashlight battery to alternating current so that the transformer can "step up" the battery voltage (1.5 volts) to the voltage required by the dosimeter. The current is

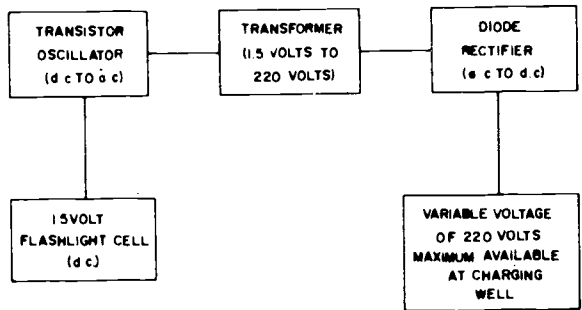

FIGURE 4.25d.—Simplified diagram of a CD V-750 dosimeter charger.

then rectified by a diode and a potential of 220 volts maximum is available at the charging contact. A voltage control is used to adjust the output voltage to the exact value required to bring the dosimeter to zero.

4.26 The mechanics of charging a dosimeter with this type of charger will be discussed in the next chapter.

SURVEY METERS

4.27 Our discussions in paragraph 4.11 established an additional requirement for an instrument which would measure exposure rate for use in survey operations. This instrument should measure the rate of formation of ion pairs rather than the total number that are produced by radiation. To date the enclosed gas volume principle has again proved most satisfactory for Civil Preparedness uses.

4.28 There are two types of Civil Preparedness exposure rate instruments which depend on the principle of electrical collection of ions (enclosed gas volume) for their operation. The characteristics of each depend mainly on the voltage at which the enclosed gas volume is operated. To understand their operation, it is necessary to investigate the behavior of ions in an electrical field. A system for investigating this behavior is illustrated in Figure 4.28. It consists of a chamber filled with air in which are fixed two parallel metal plates to act as electrodes. The electrodes are connected to a battery in such a way that the voltage can be increased steadily from zero to several hundred volts. A me-

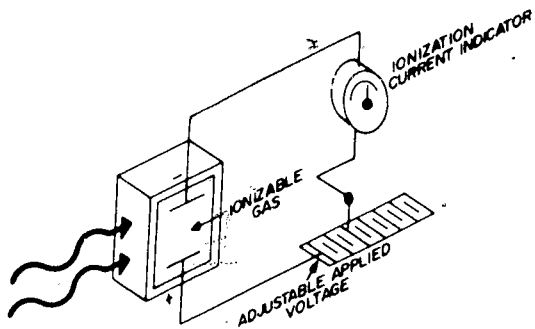

FIGURE 4.28.—Circuit for measuring the behavior of ions in an electrical field.

ter is placed in the circuit to measure the size of the electrical current produced.

4.29 Normally, the air in the ionization chamber will not conduct electricity and no current will flow in the external circuit. If a single ionizing radiation enters the chamber when a small difference of potential is applied to the electrodes, a number of ion pairs will be produced which will move to the oppositely charged electrode. When these charges collect, a current pulse will be measured by the meter in the external circuit. If a constant source of *gamma radiation* is used and the size of the current pulse is plotted against the voltage applied to the electrodes, the

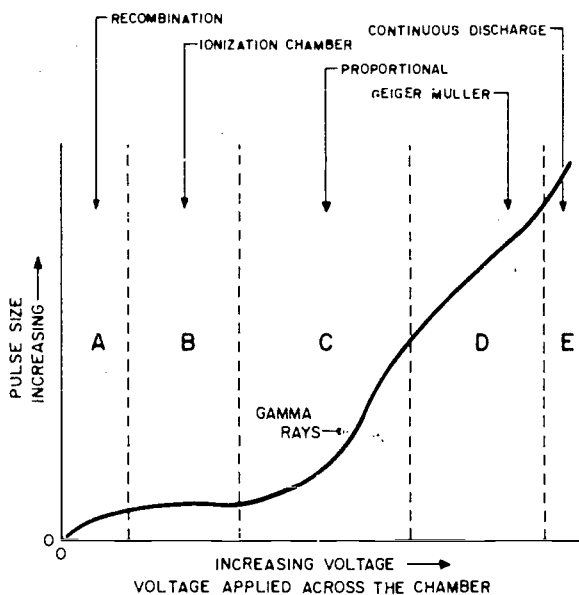

FIGURE 4.29—Pulse size vs. applied voltage for gamma radiation.

curve in Figure 4.29 will result. For convenience, the curve is divided into five regions, A, B, C, D and E.

4.30 When the voltage applied to the electrodes is low, the electrical accelerating force is small. Thus, the ions move rather slowly and have sufficient time to recombine with other ions of opposite sign in the vicinity. The size of the pulse measured will be less than if all of the ion pairs formed succeeded in reaching the electrodes. As the applied voltage is increased, the ions travel faster. Their chances of recombination are lessened and the pulse size increases. Finally, as the applied voltage is increased sufficiently, all of the primary ion pairs will be collected at the electrodes. This voltage is referred to as the saturation voltage. As the electrode voltage increases above this point, no increase in the size of current pulse is immediately experienced since all of the primary ion pairs have been collected. Therefore, the pulse size remains relatively constant throughout region B of the curve in Figure 4.29. The actual voltage range over which the pulse size is constant depends on many factors, which include the gas used in the chamber, the pressure of the gas, and the distance between the electrodes.

4.31 Region B of the curve is referred to as the ionization chamber region, and instruments designed to operate in this region are called ionization chamber instruments. Since batteries are usually used as the source of electrical power in RADEF instruments, this region is well adapted for their use. If the operating voltage for a particular ionization chamber is chosen at the upper end of the plateau, the size of the electrical pulse produced by radiation will not vary appreciably as the electrode voltage decreases with both age and use of the batteries.

4.32 As the applied voltage is increased beyond the ionization chamber region, the size of the pulse is increased. In region C of the curve, the increased electrical field causes the primary ions to gain sufficient kinetic energy to cause secondary ionization of other atoms and molecules in the gas. This secondary ionization leads to an

increase in the size of the pulse, which amounts to an internal amplification of the pulse in the enclosed gas volume. This amplification increases with applied voltage and remains linear until an internal amplification factor of approximately 1,000 is obtained. Region C is the proportional region, and instruments operating in this region are called proportional counters. No Civil Preparedness instruments operate in this range.

4.33 In the proportional region, a large number of secondary ion pairs are produced at only one point within the enclosed gas volume. However, when the applied voltage is increased further, the secondary ionization occurs throughout the enclosed gas volume. Therefore, since the amplification is so great in the Geiger Muller region, the size of the pulse is almost independent of the number of ion pairs produced. Thus, one initial ionizing event occurring within the enclosed gas volume will initiate an ELECTRON AVALANCHE (explained in paragraph 4.46) which will spread quickly throughout the entire tube. Instruments operating in this region will produce one large pulse for each ionizing event to which the tube is subjected. Gas amplification factors of the order of 100 million are common.

4.34 When the operating voltage exceeds the Geiger Muller region, it is so high that once ionization takes place in the gas, there is a continuous discharge of electricity so that it cannot be used for counting purposes. The upper end of the Geiger Muller region is marked by this breakdown voltage.

OPERATION OF ION CHAMBER SURVEY METERS

4.35 The development of ionization chamber survey meters has also progressed to the point that the later models of ionization chamber survey meters and probably future models will use a modification of the simplified schematic circuit drawn in Figure 4.35. The basic components of this circuit are: (1) an ionization chamber, (2) a source of electrical power, and (3) a measuring circuit consisting of

an electrometer tube and an indicating meter.

4.36 The detecting element of the instrument is an hermetically sealed air-equivalent ionization chamber. It consists of a conducting cylindrical container of plastic and steel called the shell and a thin conducting disk, which is located in the center of the shell, called the collector. These are respectively the positive and negative electrodes and are insulated from each other by an extremely high resistance feed-thru insulator. A collecting voltage is applied to these two chamber electrodes.

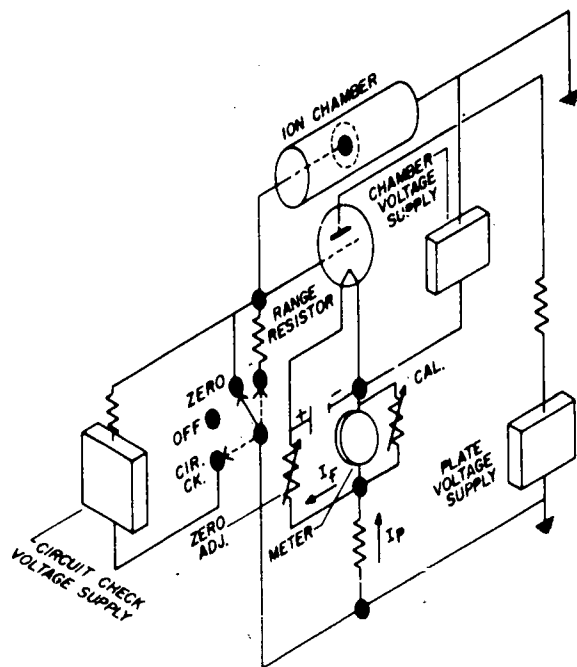

FIGURE 4.35.—Simplified circuit diagram for a Civil Preparedness ion chamber survey meter.

4.37 When the instrument is exposed to radiation, some of the energy of the radiation field is absorbed within the walls of the ionization chamber. As a result, electrons are ejected from the walls into the air contained within the chamber. As these electrons traverse the chamber, they create a considerable amount of ionization in the air. Under the influence of the electric field existing between the chamber electrodes, the ions move to the electrode having the opposite charge; that

is, positive ions move toward the collecting disk and the negative ions toward the shell. The arrival of these ions at the electrodes constitutes a current, the magnitude of which is proportional to the number of ions collected. Since the number of ions created is proportional to the radiation exposure rate, this ionization current is proportional to the exposure rate in the ionization chamber.

4.38 A very small ionization current (approximately 0.00005 microamperes at full scale on the most sensitive range) flows through a "high-meg" resistor and develops a measurable voltage. This voltage is applied to the grid of a vacuum tube called an electrometer tube because it is capable of measuring voltages at extremely small current values. The electrometer tube is connected as a triode. Its three elements are: (1) the filament which, when heated by current from the 1.5 volt battery, emits electrons, (2) the grid, which controls the flow of these electrons according to the voltage applied to it, and (3) the plate, which receives the electrons and passes them to the circuit in the form of a measurable current.

4.39 Measurement of the grid voltage of the electrometer tube is accomplished by metering the change in plate current (I_p) directly. With the selector switch in the zero position, the high-meg range resistor is removed from the grid circuit so that no signal voltage can be developed as a result of any ionization chamber current. The quiescent value of the plate current is then exactly balanced by the bucking current (I_b) so that the resultant current through the meter is zero. The bucking current is adjusted by means of the zero adjust potentiometer.

4.40 When the selector switch is placed in a range position, one of the high-meg range resistors is reinstated into the grid circuit. The ionization current, therefore, produces a positive signal voltage across this resistor, which in turn results in an increase in the plate current. Thus, the resultant current through the meter is no longer zero and the meter measures the increase in plate current. Since this change is proportional to the magnitude of

the radiation field, the meter scale can be calibrated directly in roentgens per hour.

4.41 Prior to use for measuring exposure rates, the static plate current must be cancelled by the reverse filament current to obtain zero meter current (zero reading) at zero radiation levels. Since it will probably be necessary to zero the instrument in a radiation field, a section of the selector switch is used to short out the high-meg resistor and prevent any ionization signal from being sensed by the grid circuit. Thus, when the selector switch (Figure 4.41) is in the zero position, zero radiation conditions are duplicated and the zeroing process can be accomplished even in the presence of a high radiation field.

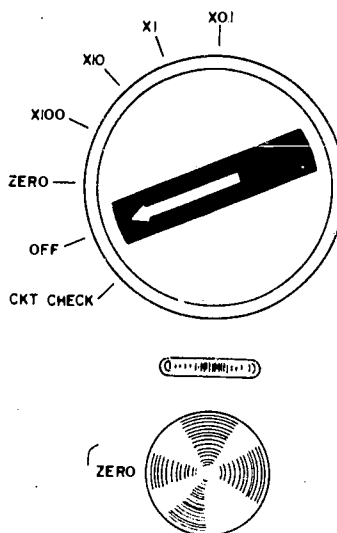

FIGURE 4.41.—Selector switch and zero control.

4.42 The proper functioning of the measuring circuit including the batteries may be checked by turning the selector switch to the circuit check position (Figure 4.41) and observing the meter readings. In this position, a predetermined voltage is impressed on the grid of the electrometer tube to make the meter read approximately full scale. Deterioration of any of the components or batteries in the circuit will change this reading. Therefore, this voltage can be used to check the entire circuit with the exception of the ionization chamber and high-meg resistor.

4.43 All radiological instruments should be calibrated prior to their initial field use and periodically thereafter. This may be done by using a calibrated source of radioactive material. If the instrument does not read properly when placed in a radiation field of known exposure rate, the calibration control can be adjusted to give the desired meter indication corresponding to the known exposure rate.

4.44 Sensitivity of the instrument is changed by switching high-meg resistors. This is accomplished by the selector switch (Figure 4.41). On each range the meter reading must be multiplied by 0.1, 1, 10, and 100 to obtain the measured exposure rate.

OPERATION OF GEIGER COUNTERS

4.45 Geiger counter operation is based on the ionization of gases similar to the operation of ionization chamber survey meters. In the ionization chamber instrument, a very small current is developed, amplified, and then measured on a sensitive meter. The current is smooth in character since the many ionizing events are averaged. Geiger counters differ materially in that the current flow is not smooth but it is delivered in surges or pulses.

4.46 Geiger counters take advantage of the extreme gas amplification that can be obtained when high accelerating voltages are applied to the electrodes within the chamber. As ion pairs are formed in the gas, they will move with increasing velocity toward the electrodes until either recombination or collision with another air molecule occurs. The average distance between successive collisions is referred to as the mean free path. If the mean free path is small and the accelerating voltage relatively high, each ion will gain only a small amount of energy between collisions. As the operating pressure of the Geiger tube is reduced, the mean free path is increased, causing the ions to gain additional energy between collisions. When the kinetic energy of the ions is sufficient, they will cause secondary ionization. These secondary ions will also be accelerated by the electrical field and will pro-

duce further ionization. This cumulative increase in ions is similar to a single rock precipitating an avalanche and is, therefore, often referred to as **ELECTRON AVALANCHE**. This avalanche may produce as many as 100 million other ion pairs for each initial ion pair produced in the chamber. The gas amplification factor of the tube under these conditions would be about 100 million.

4.47 Consider a Geiger tube filled with a gas, frequently argon or neon, to an absolute pressure of ten centimeters of mercury and exposed to a constant radiation intensity. If the number of pulses per second occurring within the tube is plotted against the voltage applied to the electrodes, a characteristic curve similar to Figure 4.47 is produced. This curve differs from the curve in Figure 4.29 in that the number of pulses is plotted against the applied voltage rather than the size of the pulse. Since, under the operating conditions placed on the tube, no gas amplification occurs at low voltages, there is a threshold below which no pulses will be recorded. As the voltage increases and the gas amplification factor increases, the number of pulses increases. At first, only the most ionizing particles would be counted and the weak ones lost. As the voltage increases, however, practically every particle entering the tube will be counted. When this condition occurs, the

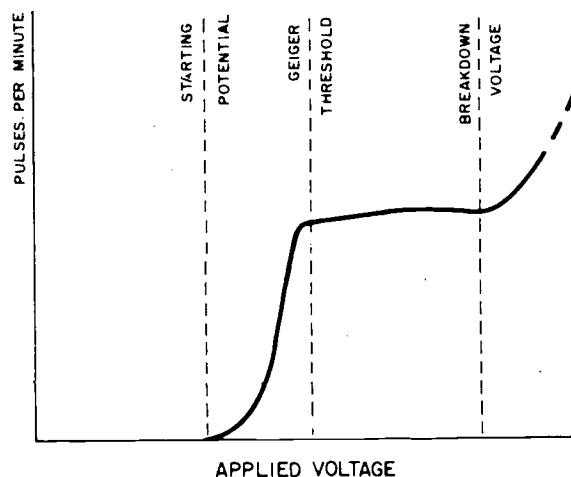

FIGURE 4.47.—Number of pulses vs. applied voltage for a Geiger tube.

curve will flatten out. This is called the Geiger plateau and it is desirable that it be long and flat so that the counting rate does not depend strongly upon the applied voltage. Above the Geiger plateau voltage, the tube goes into a continuous discharge state and is not suited for counting purposes.

4.48 Avalanche formation will take place in the vicinity of the central wire of the Geiger tube, since here the electric field is high and each electron on its way to the central wire acquires sufficient energy for further ionization in each mean free path. Thus, a large number of electrons and positive ions will be formed near the center wire in the first avalanche. The electrons having a small mass and already positioned close to the central wire will move toward it with high velocities and will be completely collected in about one millionth of a second. The heavier positive ions travel more slowly out to the negatively charged cylinder. This causes a positive ion cloud or space charge which reduces the electric field and stops the avalanche formation. In about one ten thousandth of a second, the positive ions or space charge will reach the cylinder wall. As a positive ion approaches very close to the cylinder, it will pull an electron from the cylinder and be converted to a neutral molecule. Generally, the electron will move into one of the upper energy levels of the molecule resulting in an excited molecular state. The electron will move to the ground state and in so doing may produce photons in the ultraviolet region which will have sufficient energy to liberate photoelectrons from the metal cylinder. With high tube voltages, this single photoelectron will start a second avalanche and thus the entire process will be repeated over and over again. This repeated discharge must be stopped and the tube restored to its initial condition if the tube is to be used to measure radiation. The process by which the tube is prevented from repeating the discharge is called quenching.

4.49 Quenching may be accomplished either electronically or by adding a suitable

gas to the Geiger tube. Utilizing a suitable electronic circuit, the operating voltage of the Geiger tube can be momentarily reduced below the voltage required for a self-perpetuating discharge as soon as the avalanche begins. Other Geiger tubes, called self-quenched tubes, utilize a small amount of alcohol or halogen gas to quench the discharge. In this case, both argon and alcohol molecules participate in the avalanche. As the positive ions migrate to the electrode, the argon ions having an ionization potential of 15.7 volts collide with alcohol molecules with an ionization potential of 11.3 volts. This difference in ionization potential causes the charge to be transferred to the alcohol molecules and only these ions reach the electrode. As they approach the electrode, they will pull electrons from the cylinder wall. The energy of the excited states of the alcohol molecules will disassociate other alcohol molecules rather than cause further ionization. The self-perpetuating discharge is prevented in this manner.

4.50 Since some of the quenching gas is disassociated at each discharge, the supply is constantly depleted and the Geiger tube will have a limited useful life of about one billion counts. Halogens, particularly chlorine and bromine, are currently being used as quenching gases in argon-filled counters and have some advantages over the alcohol-quenched tubes. Since the halogen atoms will recombine after the disassociation process, tubes filled with this gas will have essentially an unlimited life. Halogens, however, are extremely reactive gases and great care must be exercised in choosing electrode materials.

4.51 Figure 4.51 illustrates a typical simplified circuit diagram of a Geiger counter. The Geiger tube consists of a thin cylindrical shell which serves as the cathode, a fine wire anode suspended along the longitudinal axis of the shell, and a small amount of a quenching gas. A potential of approximately 900 volts is applied between the two electrodes.

4.52 When radiation penetrates the tube, a gas molecule is ionized. The resulting ion pair is accelerated toward the electrodes by the electric field. Because of the

high accelerating voltages, the creation of additional ions is very rapid, thus producing a discharge (avalanche) in the tube. This discharge results in a pulse in the

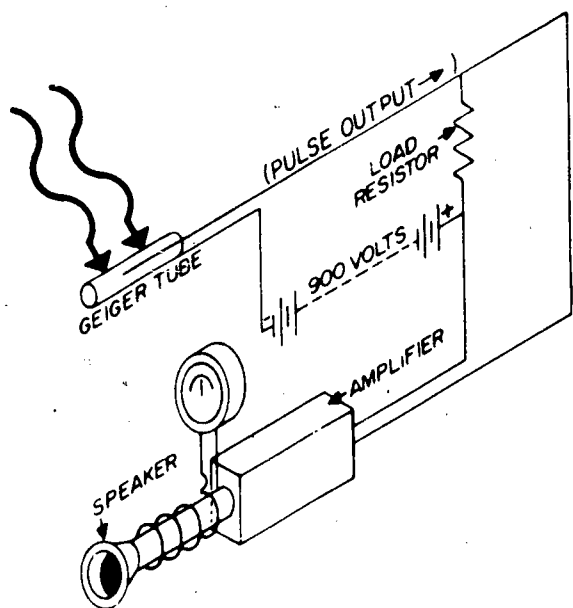

FIGURE 4.51.—Simplified circuit of a Geiger counter.

external circuit. The frequency of such pulses is proportional to the strength of the radiation field. The small amount of halogen gas in the tube serves to stop each discharge and restore the tube to its initial condition.

4.53 The pulse output from the Geiger tube is amplified by conventional electronic means and then measured by a sensitive meter which sums up the radiation effects in the form of a reading in either counts per minute or, in the case of gamma rays, milliroentgens per hour. In addition to the meter indication, most Geiger counters are provided with headphones which detect the pulses from the Geiger tube and produce an audible click.

REFERENCES

Sourcebook on Atomic Energy.—Glasstone, Samuel, D. Van Nostrand, 1967.

Nuclear Radiation Physics.—Lapp, Ralph E. and Andrews, Howard L., Prentice-Hall, Inc., 1972.

RADIOLOGICAL EQUIPMENT

Having covered the theory of radiological instrumentation in the previous chapter, we are ready to move to the practical aspects of detecting and measuring nuclear radiation. This means it is time for a look at the various types of radiological equipment available and the different situations in which each item would be applied. In addition to learning what we have in the way of different pieces of equipment, we will also be shown:

- WHAT the equipment can do
- WHAT it cannot do
- WHEN to use a particular piece of equipment
- HOW to check it, operate it and care for it

RADIOLOGICAL INSTRUMENT REQUIREMENTS

5.1 There is no exact equivalent of combat experience upon which to base the requirements for Civil Preparedness radiological equipment. However, extensive tests of nuclear weapons under known conditions have indicated the kinds and extent of residual radiation that could result from the use of such weapons. The knowledge gained from these and other types of experiments makes it possible to relate radiation conditions to biological effects on man and thus establish equipment requirements.

5.2 Because of the many variables associated with the detonation of a nuclear weapon, it is not possible to predict accurately the radiation levels that will result from fallout. Furthermore, no single instrument meets all of the operational requirements that might result from a nuclear attack. Therefore, a wide capability for radiation measurement is required.

DCPA has developed several instruments that, together, provide this wide monitoring capability. These instruments fall into two distinct classes:

Radiation survey meters for use by monitoring personnel in determining contaminated areas and radiation exposure rates.

Exposure measuring instruments (dosimeters) needed by all Civil Preparedness workers such as fire fighters, first aiders, rescue teams, and radiation monitors who have to perform their emergency duties in contaminated areas.

5.3 **SURVEY METERS** provide the information required for locating contaminated areas and for estimating the degree of the hazard. Since it would not be practical to compute your total radiation exposure from survey meter measurements if the exposure rate varied during the exposure period, **DOSIMETERS** are also needed for recording the total amount of an individual's exposure. Estimates of total exposure and related biological effects can be made on the basis of exposure rate measurements, decay rates, and probable exposure times, but these estimates should be used for planning purposes only. Determination of *actual* exposure times and exposures during emergency operations must be based on both the exposure rate, as read on survey meters, and on the total exposure as indicated by dosimeters.

5.4 Alpha, beta, and gamma radiations may be present in radioactive fallout. Since the hazards from these radiations will be discussed in detail in later chapters, it suffices here to indicate that gamma radiation is an external hazard and, under certain conditions, beta radiation may also be an external hazard. In addition, these three types of radiation may be internal hazards.

5.5 Alpha radiation does *not* present an external hazard, since it will not penetrate beyond the surface layers of the skin. Alpha emitters must get inside the body before they can cause appreciable damage. Because alpha emitters will probably not present a significant hazard relative to the beta and gamma hazard immediately following a nuclear attack and for some time thereafter, and further, because of the difficulty in developing *portable* alpha measuring instruments, DCPA does not provide a standard instrument sensitive to this type of nuclear radiation. During the recovery phase, the determination of the seriousness of the alpha contamination in food and water will probably be accomplished by laboratory-type instruments.

MEASURING BETA AND GAMMA RADIATION

5.6 Since the biological effects of beta and gamma radiation differ, radiological instruments must discriminate between them. Measurement of beta radiation is complicated by the very wide range of energies of these particles. Most beta detection instruments will not respond to extremely low energy beta particles. However, that portion of the beta radiation that *can* be detected *should* be detected, so that its proportion to the total radiation exposure can be determined. This is necessary to estimate possible damage by each type of radiation. It should be noted, however, that the units of measurement used on radiological instruments to show accumulative exposures and exposure rates of gamma radiation are the roentgen and the roentgen per hour and the roentgen is defined in terms of *X or gamma radiation* exposure in air. Therefore, these units do not relate directly to measurements of beta radiation. Consequently, meter indications of beta radiation can be interpreted only in a general way.

5.7 The sensitivity requirement of a radiation instrument depends upon the type of information it is expected to provide. An instrument used to measure the contamination of personnel, food, water, equipment, or living quarters must indicate

very small amounts of radiation above normal background radiation. This type of instrument would therefore have little use in areas of heavy contamination.

5.8 To provide adequate monitoring, portable radiological instruments should be capable of measuring gamma exposure rates as high as 500 R/hr and also indicate when exposure rates exceed this figure. Measurement above this amount is not necessary for portable survey instruments, because a higher level of radiation would be so dangerous as to preclude further surface operations.

5.9 When surface level exposure rates are very high or when rapid monitoring of large areas is required, aerial monitoring may be practical. Survey meters designed for this purpose must be extremely sensitive in order to give correct readings of radiation levels on the ground. Remote reading instruments used to indicate radiation levels outside fallout shelters are also required and should indicate gamma exposure rates up to at least 500 R/hr.

5.10 Within the entire group of radiological instruments developed by DCPA, the capability exists for measurement of ionizing radiation exposure rates ranging from a minimum of natural background radiation to a maximum of 500 R/hr. This wide range of measurement capability is considered adequate for all operational needs.

TYPES OF DCPA RADIOLOGICAL INSTRUMENTS

5.11 Each of the DCPA radiological instruments will be discussed in terms of its uses, significant operating characteristics, important specifications, and the care and maintenance to be accomplished by the instrument operator or monitor.

CD V-700

5.12 The CD V-700 radiation survey meter (Figure 5.12) is a highly sensitive low-range instrument that can measure gamma radiation and discriminate between beta and gamma radiations. DCPA recommends its use primarily in long-term clean-up and decontamination operations.



FIGURE 5.12.—CD V-700, low range beta-gamma survey meter.

5.13 The instrument can also be used in training programs where low radiation exposure rates will be encountered. The detecting element of the CD V-700 is a Geiger tube shielded so that only the gamma exposure rate is measured or beta and gamma can be detected together with the shield open. A headphone for audible indication is supplied with this instrument.

IMPORTANT SPECIFICATIONS OF THE CD V-700

1. RANGE: 0-0.5, 0-5.0, 0-50 milliroentgens per hour.
2. DETECTS: beta and gamma radiation.
3. ACCURACY: $\pm 15\%$ of true exposure rate from cobalt 60 or cesium 137.
4. RESPONSE TIME: 95% of final reading in approximately 8 seconds.
5. TEMPERATURE: instrument shall operate properly from -10°F to $+125^{\circ}\text{F}$.
6. PRESSURE: instrument shall operate properly from sea level to 25,000 feet.
7. JAMMING: exposure rates from 50 milliroentgens per hour to 1 roentgen per hour shall produce off-scale readings.
8. LIGHT SENSITIVITY: direct sunlight shall not affect the operation of the instrument.

9. ELECTROMAGNETIC INTERFERENCE: the instrument shall operate properly in normally encountered electromagnetic fields.
10. OPERATIONAL CHECK SOURCE: a permanently sealed radioactive source shall provide a reading of $2\text{ mR/hr} \pm 0.5\text{ mR/hr}$ when the probe, with beta shield open, is held over it.
11. BATTERY LIFE: 100 hours continuous use (minimum).

OPERATOR USE, CARE AND MAINTENANCE OF THE CD V-700

5.14 *Batteries.*—Whenever the instrument fails to respond to the radioactive source on the side of the instrument, check the batteries. Replace bad batteries in accordance with the instructions in the manual accompanying the instrument.

During extended storage periods the batteries should be removed from the instrument and stored in a cool, dry place.

Battery contacts should be inspected monthly, and any dirt or corrosion present should be removed. Whenever the instrument is not in use, **MAKE CERTAIN IT IS TURNED OFF**; otherwise, the batteries will be depleted and the instrument rendered ineffective.

5.15 *Geiger Tube.*—The Geiger tubes in the later models of the CD V-700 are halogen quenched so that their operating life is unaffected by use and, therefore, rarely require replacement. However, when fresh batteries are installed and the instrument does not work correctly, it may be necessary to replace the Geiger tube. To check for a faulty Geiger tube, replace the suspected tube with a good tube from a properly operating CD V-700.

5.16 *Headphones.*—If the operator chooses to use the headphones with the instrument, they may be screwed into the connector provided at the lower left corner of the instrument cover. In using the headphone, the operator will note that each pulse or count is indicated by a distinctly audible click. When the headphones are not in use, the protective cap on the headphone receptacle should be replaced.

5.17 *Carrying Strap.*—The instrument may be carried in the hand or by a strap over the shoulder. The strap anchors are arranged in such a way that the meter is visible when carried over the right shoulder.

5.18 *Controls.*—There is only one control on this instrument for the operator's use. This control, called the selector switch, includes an off position and three ranges, labeled X 100, X 10, and X 1. On the X 1, the X 10 and X 100 ranges, the meter readings must be multiplied by a factor of 1, 10, and 100, respectively, to obtain the measured exposure rate.

5.19 *Operational Check.*—The selector switch should be turned to the X 10 range. The beta shield on the probe should be rotated to the fully open position and the probe placed as close as possible to the radioactive sample located either on the bottom surface of the case or underneath the manufacturer's name plate (see instrument manual). The open area of the probe must be directly facing the radioactive sample. The meter should be adjusted to read $2 \pm .5$ milliroentgens per hour. No external radiation must be present when making this check. The source should be used to determine the operability of the instrument only. It is not intended to replace the need for calibrating the instrument against a known source.

5.20 *Calibration.*—The instrument should be calibrated periodically to verify that it is measuring correctly.

5.21 *Contamination.*—At all times the operator should attempt to prevent radiological contamination of the instrument, particularly of the probe. In case of contamination, the instrument can be cleaned by a cloth dampened in a mild soap solution.

CD V-715

5.22 The CD V-715 (Figure 5.22) is a high-range gamma survey meter for general postattack operational use. The detecting element of the CD V-715 is an ionization chamber. The instrument is designed for ground survey and for use in fallout shelters. It will be used by a radiol-

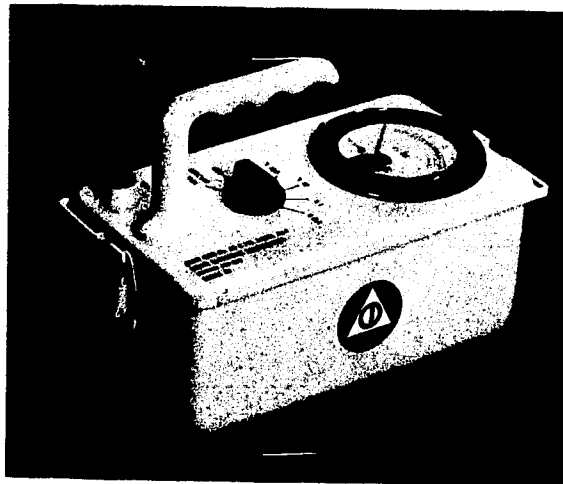

FIGURE 5.22.—CD V-715, high-range gamma survey meter.

ogical monitor for the major portion of survey requirements in the period immediately following a nuclear weapon attack. The CD V-715 has replaced the now obsolete CD V-710 medium-range 0-50 R/hr gamma survey meter.

IMPORTANT SPECIFICATIONS OF THE CD V-715

1. RANGE: 0-0.5, 0-5.0, 0-50, 0-500 roentgens per hour; operate from -20° F. to 110° F.
2. DETECTS: gamma radiation only.
3. ACCURACY: $\pm 20\%$ of true exposure rate from cobalt 60 or cesium 137.
4. SPECTRAL DEPENDENCY: $\pm 15\%$ for gamma radiation energies between 80 keV and 1.2 MeV.
5. RESPONSE TIMES: 95% of final reading in 9 seconds.
6. TEMPERATURE: instrument shall operate properly from -20° F to $+125^{\circ}$ F.
7. PRESSURE: instrument shall operate properly from sea level to 25,000 feet.
8. JAMMING: exposure rates from 500 roentgens per hour to 5,000 roentgens per hour shall produce off-scale readings at the high end.
9. ELECTROMAGNETIC INTERFERENCE: instrument shall operate properly in normally encountered electromagnetic fields.

OPERATOR USE, CARE AND MAINTENANCE OF THE CD V-715

5.23 *Batteries.*—Battery replacement is normally required whenever the instrument can no longer be zeroed or when the meter indicates below the "CIRCUIT CHECK BAND". Batteries should be replaced in accordance with the instruction in the instrument manual. *If the instrument is to be stored for more than a few weeks, the batteries should be removed and stored in a cool dry location.* For instruments in continuous use, batteries should be removed monthly and the battery contacts cleaned of any dirt or corrosion present.

5.24 *Controls.*—Two controls are provided. One control, the selector switch, has seven positions: circuit check, off, zero, X 100, X 10, X 1, and X 0.1 ranges. On the X 0.1, X 1, X 10, and X 100 ranges, the meter readings must be multiplied by a factor of 0.1, 1, 10, and 100 respectively in order to obtain the measured exposure rate. The second control, the zero control, is used to adjust the meter reading to zero during an operational check.

5.25 *Carrying Strap.*—The instrument is equipped with a carrying strap which may be adjusted to any length to suit the operator.

5.26 *Operational Check.*—Turn the selector switch to the zero position, wait a minute or two for the electrometer tube to warm up and adjust the zero control to make the meter read zero. Turn the selector switch to the circuit check position. The meter should read within the red band marked "Circuit Check". As the selector switch is turned through the zero position to the four ranges, recheck the zero setting. Turn the selector switch to the X 100, X 10, X 1, and X 0.1 range. When no radiation is present, the reading should not be more than two scale divisions up scale. If difficulty is encountered with any step in the operational check, refer to the instrument manual for corrective procedure. Many models have internal adjustments which may correct the difficulty. During normal use, the CD V-

715 should be zeroed frequently, at least every half hour.

5.27 *Calibration.*—The CD V-715 should be calibrated periodically to verify the accuracy of its measurements.

5.28 *Contamination.*—The operator should attempt to prevent radiological contamination of the instrument at all times. In case of contamination, the instrument can be cleaned by a cloth dampened in a mild soap solution.

5.29 *Modification (CD V-717).*—Some of the CD V-715's are equipped by the manufacturer with a removable ionization chamber attached to 25 feet of cable. This modification, called the CD V-717, provides a remote reading capability for fallout monitoring stations. The operating characteristics are identical to the CD V-715 except that the removable ionization chamber must be placed outside the shelter in an unshielded area and protected from possible contamination by placing it in a bag or cover of light-weight material. All readings may then be observed from within the fallout monitoring station. After the early periods of heavy fallout and the requirement for a remote reading instrument diminishes, the removable ionization chamber should be checked for contamination with the CD V-700, decontaminated if necessary, and returned to the case. The CD V-717 may then be used for other monitoring operations.

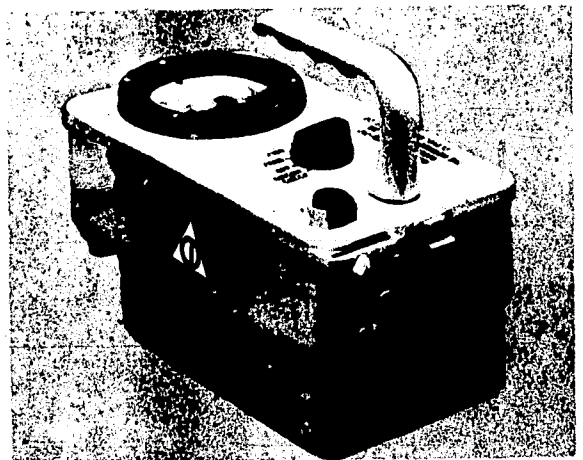

FIGURE 5.29.—CD V-717, Remote Ion Chamber.

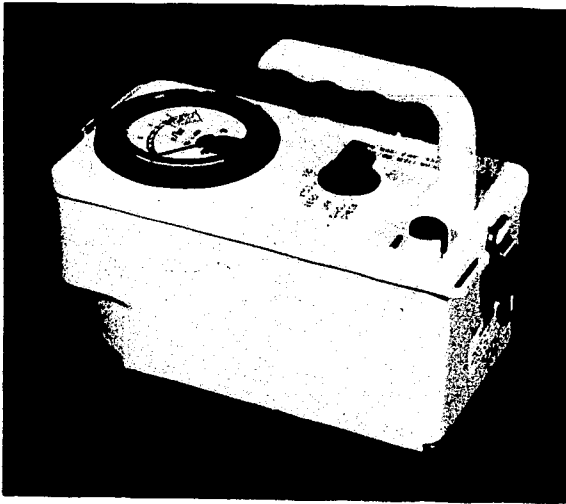

FIGURE 5.30.—CD V-720, beta-gamma survey meter.

CD V-720

5.30 The CD V-720 (Figure 5.30) is a high range (0-500 R/hr) beta-gamma survey meter designed for postattack use by monitors. It will be used in high-level contamination areas where civil preparedness operations are necessary and for making high-level beta radiation determinations. Many of the Federal agencies maintain a sizeable number of these instruments to fulfill their special requirements. The detecting element of the CD V-720 is an ionization chamber, shielded so that gamma radiation only can be measured, or both beta and gamma can be detected with the shield open.

OPERATOR USE, CARE AND MAINTENANCE OF THE CD V-720

5.31 The use, care, and maintenance of the CD V-720 are similar to the use, care, and maintenance of the CD V-715. (Refer to paragraphs 5.23 to 5.28 for details.)

CD DOSIMETERS

5.32 Personnel who must work in contaminated areas require radiation integrating instruments to keep them continuously informed of their exposure. For this purpose DCPA recommends the use of the self-indicating quartz-fiber electrostatic dosimeter (Figure 5.32).

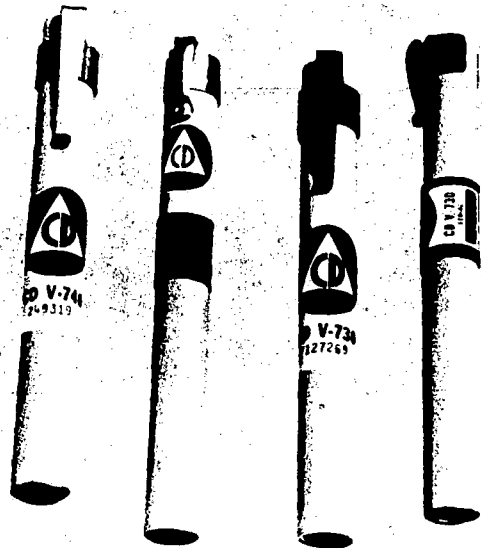

FIGURE 5.32.—CD operational dosimeters.

5.33 DCPA has procured three dosimeters for operational use. These are the CD V-730, with a range of 0-20 roentgens, the CD V-740, with a range of 0-100 roentgens, and the CD V-742, with a range of 0-200 roentgens. The CD V-730 is used when a monitor expects small repeated exposures over a long period of time. The CD V-740 and CD V-742 dosimeters are recommended for use when personnel could be accidentally exposed to large doses of radiation. They should be used when personnel are required to enter fields of high radiation or remain in low radiation fields for long periods during postattack survival and recovery missions. After current stocks of the CD V-730 and CD V-740 are depleted, DCPA will procure and issue the CD V-742 only. For training purposes, the CD V-138 with a range of 0-200 milliroentgens is recommended.

IMPORTANT SPECIFICATIONS OF THE CD DOSIMETERS

1. RANGE: CD V-138 0-200 milliroentgens
 CD V-730 0-20 roentgens
 CD V-740 0-100 roentgens
 CD V-742 0-200 roentgens
2. DETECT: gamma radiation.

3. **ACCURACY:** $\pm 10\%$ of true exposures from cobalt 60 or cesium 137
4. **SPECTRAL DEPENDENCY:** $\pm 20\%$ of true exposure for gamma radiation energies between 50 keV and 2 MeV.
5. **ELECTRICAL LEAKAGE:** CD V-730 and CD V-742. Beginning ten minutes after exposure, leakage shall not exceed 5% of full scale in a four-hour period. Beginning 48 hours after exposure, leakage shall not exceed 2% of full scale in 96 hours.
 CD V-740. Leakage shall not exceed 2% of full scale in 24 hours.
 CD V-138. Beginning 10 minutes after exposure, leakage shall not exceed 5% of full scale in 4 hours. Beginning 48 hours after exposure, leakage shall not exceed 3% of full scale in 48 hours.
6. **GEOTROPISM:** reading shall not vary more than $\pm 4\%$ of full scale when rotated about the horizontal axis.
7. **TEMPERATURE:** instrument shall operate properly from -40°F to $+150^{\circ}\text{F}$.
8. **PRESSURE:** instrument shall operate properly from sea level to 25,000 feet.
9. **SHOCK:** instrument shall operate properly after four drops from a height of four feet onto a hard wood floor.

OPERATOR USE, CARE AND MAINTENANCE OF THE DOSIMETER

5.34 *Maintenance.*—No maintenance should be performed by the user on the self-indicating electrostatic dosimeters.

5.35 *Care.*—When the instruments are received, the operator should check the ability to zero the dosimeter, check its response to radiation, and check its electrical leakage characteristics. When using the dosimeters, the operator should keep the hairline as close to zero as possible and should prevent the dosimeter from becoming contaminated. When not in use, the dosimeters should be charged and stored in a dry place.

5.36 Since most electrostatic dosimeters will require a "soak-in" charge after long-term storage in an uncharged condition, such dosimeters should be charged and the reading observed for a few hours



FIGURE 5.37.—CD V-750, dosimeter charger.

before use. A second charging may be required before the instruments are ready for operation.

CD V-750

5.37 The CD V-750 dosimeter charger is used to read and charge self-indicating electrostatic dosimeters (Figure 5.37). A standard 1.5 volt flashlight cell is used as the source of electrical power.

IMPORTANT SPECIFICATIONS FOR THE CD V-750

1. **LIGHT SOURCE:** instrument must provide illumination for reading and/or charging the dosimeter.
2. **TEMPERATURE:** instrument shall operate properly from -20°F to $+125^{\circ}\text{F}$.
3. **PRESSURE:** instrument shall operate properly from sea level to 25,000 feet.
4. **SHOCK:** instrument shall operate properly after 6 four-foot drops onto a hard wood floor.

OPERATOR USE, CARE AND MAINTENANCE OF THE CD V-750

5.38 *Batteries.*—The 1.5 volt flashlight cell should be replaced when the lamp dims noticeably on actuating the charging switch. Replace bad batteries in accordance with instructions in the instrument manual. **WHENEVER THE INSTRU-**

MENT IS STORED FOR MORE THAN A FEW WEEKS, THE BATTERY SHOULD BE REMOVED TO PREVENT POSSIBLE DAMAGE.

5.39 *Operations.*—To read a dosimeter, remove the dust cap from the charging contact, place the dosimeter on the charging contact, and press lightly to light the lamp. Read the dosimeter and replace the dust cover when finished. The dosimeter may also be read by holding it toward any light source sufficient to illuminate the hairline. To charge a dosimeter follow the procedure printed on the CD V-750.

CD V-457

5.40 The CD V-457 (Figure 5.40) is a Geiger counter which has been especially designed for classroom demonstration use. It operates on a normal 110 volt AC power supply and produces both visible and audible responses to nuclear radiation. The instrument is used in teaching basic nuclear radiation physics and for decontamination demonstrations.



FIGURE 5.40.—CD V-457, classroom demonstration unit.

CD V-778

5.41 The CD V-778 30 millicurie Training Source Set consists of six Cobalt 60

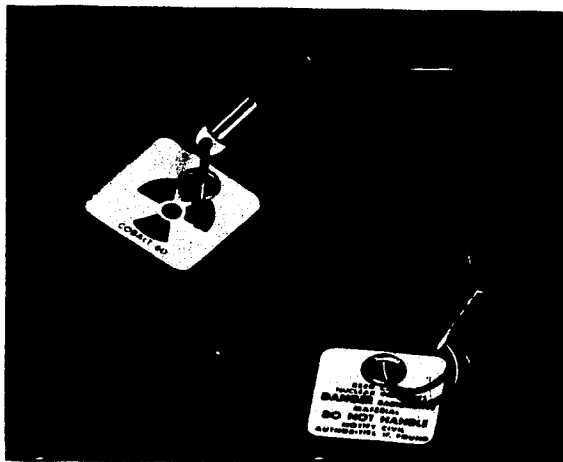

FIGURE 5.41.—Sealed source capsules, open and sealed.

sealed sources (Figure 5.41) and accessory equipment. It should be noted that this Training Source Set has been designed specifically for use in training exercises and is not intended as an accurate calibration source.

5.42 The CD V-778 Training Source Set consists of the following items:

- 6—5.0 mCi Cobalt 60 Sealed Sources totaling 30 mCi, CD V-784
- 1—Lead Container, small (CD V-791)
- 1—Lead Container, medium (CD V-792)
- 2—Locks for Lead Container CD V-792
- 1—Long-Handled Tongs for Handling Sources (CD V-788)
- 8—Radiation Area Signs
- 2—0-200 mR Dosimeters (CD V-138)
- 1—Dosimeter Charger (CD V-750)
- 1—Geiger Counter (CD V-700)

CD V-794

5.43 The CD V-794 (Figure 5.43) is a calibration unit containing a Cesium 137 source of approximately 130 curies. The primary shield is composed of depleted uranium, and is shaped to beam the radiation from the radioactive cesium into a shielded exposure chamber. Interposed in the radiation beam path is an attenuator disk by means of which radiation levels of 0.4, 4, 40, and 400 R/hr are produced in the exposure chamber. Jigs are provided to

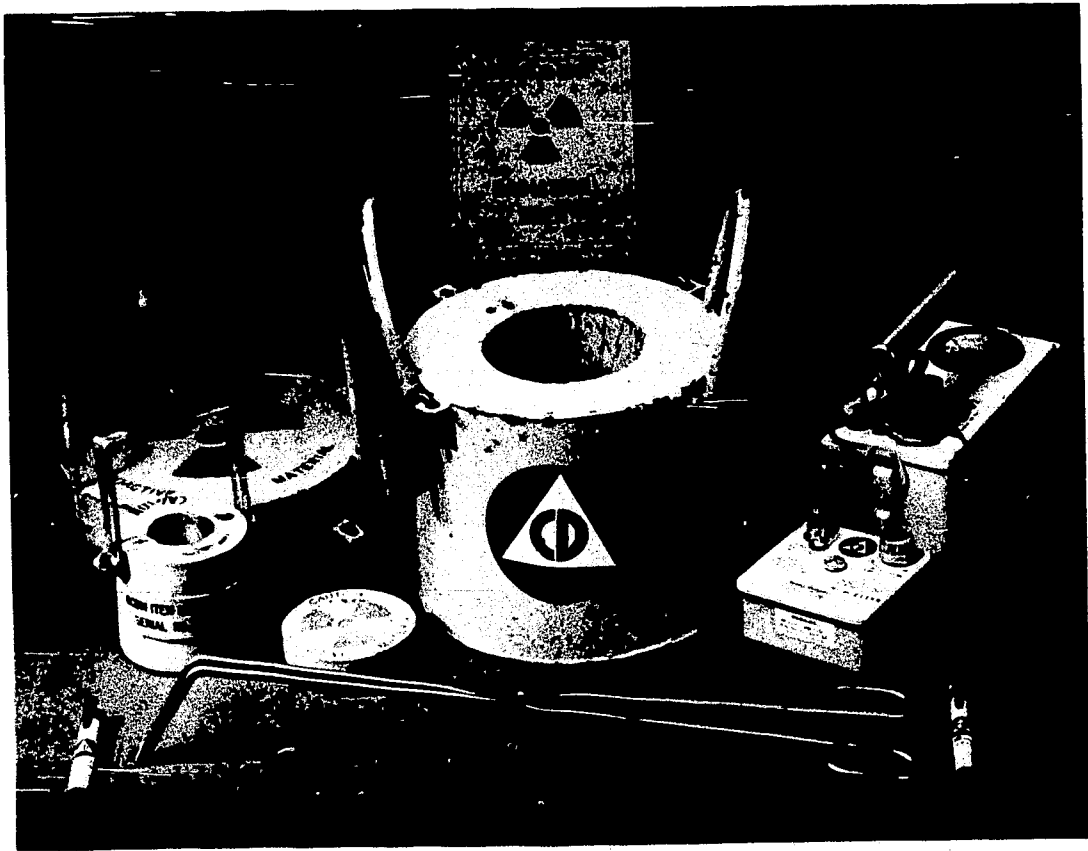

FIGURE 5.42.—CD V-778, Training Source Set.

properly position the instruments during calibration. The range switch and calibrating potentiometers are adjusted through flexible linkages leading outside of the exposure chamber. The unit is designed to provide suitable protection from radiation hazards to the operator.

CD V-757

5.44 The Barrier Shielding Demonstrator Set, CD V-757, is a low range radiation detection instrument coupled to a neon lighted remote readout indicator that is readily visible in large conference rooms or small auditoriums. With the large indicator, a lecturer can show how radiation from a radioactive source is affected by distance and shielding.

A small amount of cesium 137, which gives off gamma rays, is housed in a lead ball mounted in the demonstration platform. A hole in the platform leads to the cesium source, and gamma radiation is

beamed vertically. The aperture is normally closed by a tungsten plug which is

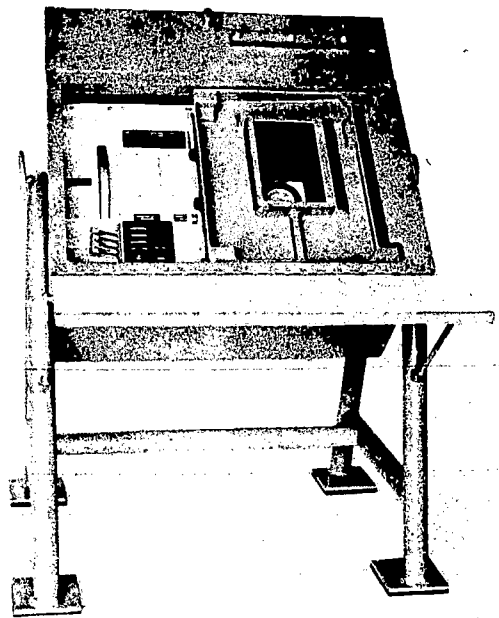

FIGURE 5.43.—CD V-794, calibration unit.

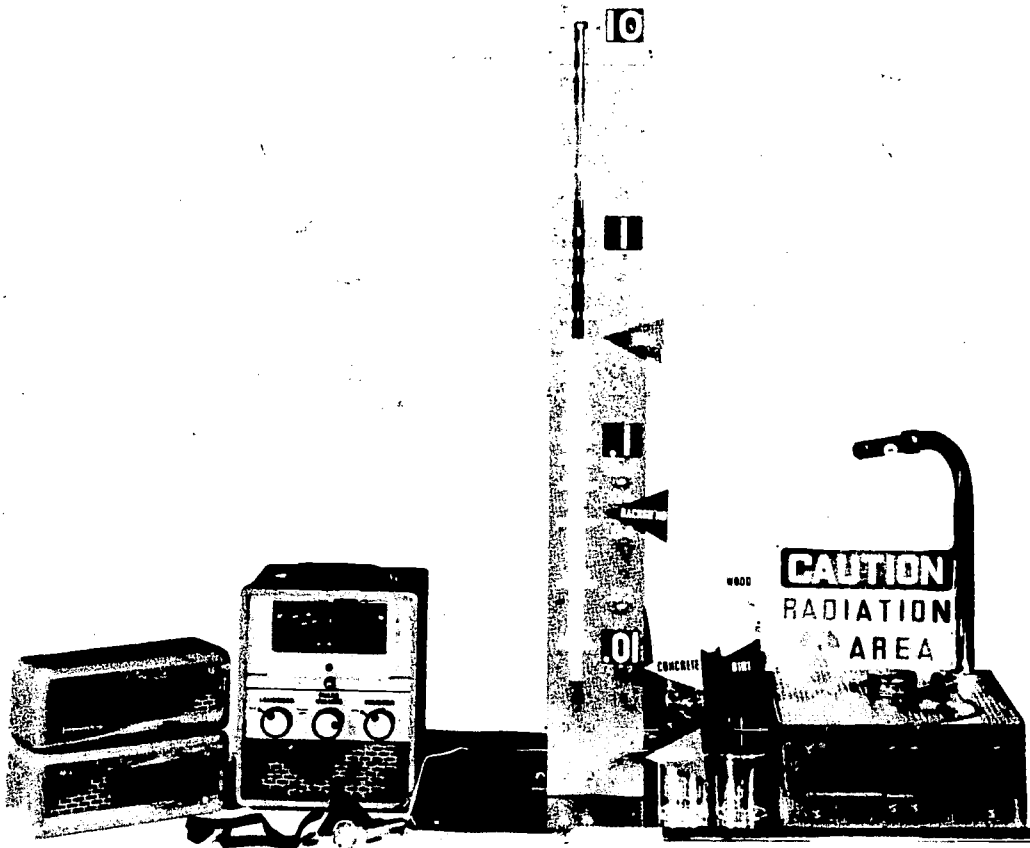

FIGURE 5.44.—CD V-757.

padlocked in position. Mounted directly over the hole is a Geiger Muller tube that is in the radiation beam when the tungsten plug is removed.

By placing a radiation absorbing material over the platform hole, the intensity of the radiation beam is attenuated, resulting in a lower exposure rate readout. Comparison of radiation absorbing materials can readily be made by placing them in the radiation beam.

The relatively simple mathematical relationship that exists for distances from a point source is demonstrated by doubling the distance between the detector and source, and observing the effect upon the radiation level on the large indicator.

CD V-781

5.45 The CD V-781, Aerial Survey Meter (Figure 5.45), is designed for limited

postattack operational use in slow low-flying aircraft. The CD V-781 will be used by specially trained monitors. The four major components of the CD V-781 aerial survey set are: detector unit (three Geiger-Mueller tubes); metering unit with three range dials (0-0.1 R/hr, 0-1.0 R/hr, and 0-10 R/hr); simulator unit with dials corresponding to the metering unit; and a magnetic tape recorder.

IMPORTANT SPECIFICATIONS OF THE CD V-781

1. RANGE: 0-0.1, 0-1.0, and 0-10 roentgens per hour.
2. DETECTS: gamma radiation only.
3. ACCURACY: $\pm 10\%$ of true exposure rate from Cobalt 60 or Cesium 137.
4. CALIBRATION: is performed by the State maintenance shops.

5. TEMPERATURE: the instrument will operate from 20° F. to 110° F.
6. HUMIDITY: to 95%.
7. ALTITUDE: to 20,000 feet; preferably below 1,000 feet.
8. OPERATING TIME: 40 hours on nine flashlight batteries ("D" cells).
9. TRACKING ERROR: between the simulator dials and the metering dials shall not be more than 10%.
10. READING TIME: not less than 15 seconds—preferably 1 minute.
11. SHOCK AND VIBRATION: instrument is designed to withstand normal shock and vibration encountered in small aircraft operation.
12. DETECTOR UNIT: contains three Geiger-Mueller tubes similar to the CD V-700. The detector unit should be carefully handled when installing batteries.
13. WARMUP TIME: 2 minutes.

OPERATIONAL CHECK PROCEDURES

5.46 *Metering Unit.*—Prior to mounting

the *metering unit* into the aircraft, the instrument should be operationally checked with the use of the *simulator unit*. The following procedures should be used:

1. Attach the cable of the *metering unit* to the connector provided on the *simulator unit*.
2. Position the power switch on the *metering unit* to "Battery" power position and allow the instrument a warm-up period of at least 2 minutes.
3. By rotation of the meter-reading control knob on the *simulator unit*, check each of the three meters at half scale.
4. Starting with the metering control knob in the extreme counterclockwise position, slowly rotate the knob clockwise. The tracking error between the meters of the *simulator unit* and corresponding meters on the *metering unit* should be no more than 10% at any simulated exposure rate.

5.47 The audio output may be checked by plugging in the headset to the *metering unit*. The audio output should be from 225

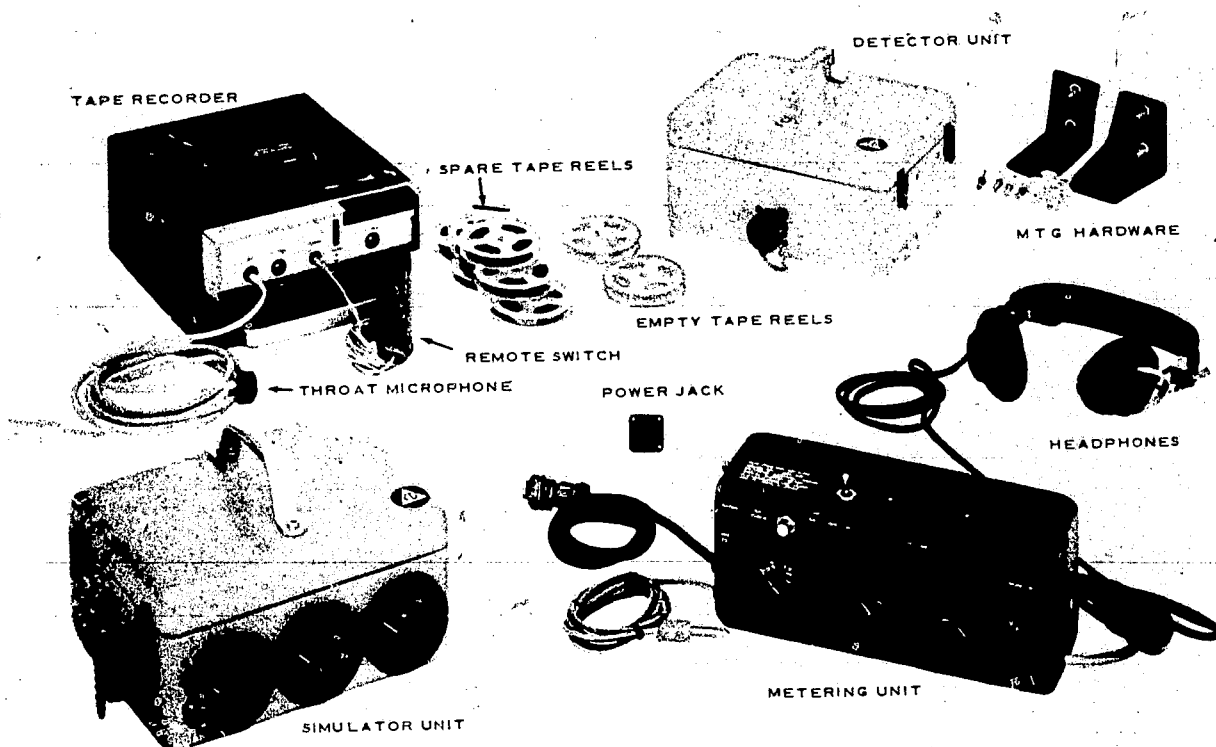

FIGURE 5.45.—Aerial survey meter, CD V-781, model 1

to 275 cycles per second (within one or two notes of middle C) for normal radiation background. The audio output can be operated with the *simulator unit*.

5.48 After installation of the CD V-781 Aerial Survey Meter into the aircraft, the operational check is performed as follows:

1. Instrument Battery Supply
 - a. Observe meters prior to turning on instrument. Meters should indicate zero within one scale division (the instrument has no zero adjustment).
 - b. Position the power switch on the *metering unit* to the "Battery" power switch position and allow the instrument a warmup period of at least 2 minutes.
 - c. Observe the meters after warmup period. Meters should continue to indicate zero within one scale division when only normal background radiation is present. In the event external radiation from fallout prohibits this check, it should be assumed the instrument is operating properly if it indicates radiation levels above normal background.
 - d. Press the "Battery Check" switch. The 0-0.1 R/hr meter should read

at, or slightly above, the battery check point.

2. Aircraft Power Supply

- a. When the aircraft electrical power source is used, position the power switch on the *metering unit* to the "Plane" power position.
- b. Repeat steps c and d above.

THE TAPE RECORDER

5.49 The manufacturer's manual supplied with the recorder indicates precautions to be observed and provides detailed instructions for operation. A monitor expecting to use the recorder should practice using it until he is proficient both on the ground and in flight. The recording and playback of preliminary survey information will provide a check of the recorder's operability. Prior to a mission, the "Battery Voltage Indication" should be observed and batteries replaced, if required.

REFERENCES

Handbook for Radiological Monitors.—FG-E-5.9, April 1963. Instrument manuals accompanying each instrument.

Handbook for Aerial Radiological Monitors.—FG-E-5.9.1, July 1966.

RADIOACTIVE FALLOUT

Now we are ready for a closer look at our enemy—RADIOACTIVE FALLOUT. We have learned how it is produced through a nuclear detonation and we have learned how to measure it when it arrives. This prompts a question:

Must we *wait* until fallout actually arrives before we can decide where it is going and what to do about it?

. . . and the answer is . . .

NO!!!

True enough, we cannot detect nor can we measure fallout *before* it arrives but we definitely *do not have to just sit and wait for it*. Although it may appear that the fallout makes its own rules, its movement is affected by a number of elements, some of which we can measure. This lets us make predictions about the behavior of fallout, to estimate its location. In short, when we take our close look at fallout in this chapter, we will see how RADEF techniques can provide life-saving and morale-supporting warnings of the direction of fallout movement. We will see:

WHY	there is fallout
HOW	fallout is formed
HOW	it is spread
WHAT	influences that spread
WHERE	is fallout most likely to land
WHEN	to expect it

INTRODUCTION

6.1 "Fallout" is one of those words which define themselves. Say the word, and you have grasped its essential meaning; the fallback to earth of radioactive particles produced by the detonation of a nuclear weapon. It is only when we begin

to learn more about fallout that we start to lose sight of this central and simple idea. Words like "clean bomb" and "dirty bomb"; "early fallout" and "worldwide fallout"; "fission products" and "fusion products"; "local fallout" and "late fallout"; "surface burst" and "air burst"; "strontium 90" and "carbon 14" make us wonder if we know what fallout is after all, despite that built in definition. So, let us look at these words and see what they mean.

SOURCES OF RADIOACTIVE MATERIAL

6.2 Let us first consider where the radioactive material in fallout comes from? How many sources are there and are all equally important?

6.3 When uranium or plutonium are fissioned the heavy atoms are split into smaller atoms and a vast amount of energy is released. Millions upon millions of these atomic nuclei are split or fissioned in the explosion of a nuclear weapon. About 200 different isotopes of about 35 elements are produced as fission products. Most of these are radioactive, decaying by emission of beta particles frequently accompanied by gamma radiation. These fission products constitute the largest single source of radioactive material in the fallout.

6.4 What about the radioactivity of the *fusion* products? The different fusion reactions used in fission—fusion type weapons may produce tritium (a radioactive hydrogen isotope) and the neutrons produced in the reaction may cause the formation of radioactive carbon (carbon 14) from the nitrogen in the air. However, the carbon 14 produced is small relative to that normally present in the atmosphere. Only insofar as possible genetic effects might theoretically be incurred over the next sev-

eral thousand years could carbon 14 or tritium be considered possible hazards. Otherwise, fusion products are *neglected* as an important source of radioactive material contributing to the immediate post-attack survival problem.

6.5¹ The uranium and plutonium which may have escaped fission in the nuclear weapon represent a further possible source of residual nuclear radiation. The fissionable isotopes of these elements emit alpha particles and also some gamma rays of low energy. However, because of their very long half-lives, the activity is very small compared with that of the fission products.

6.6 It will be seen later that the alpha particles from uranium and plutonium, or from radioactive sources in general, are completely absorbed in an inch or two of air. This, together with the fact that the particles cannot penetrate ordinary clothing, indicates that uranium and plutonium deposited on the earth do not represent a serious external hazard. Even if they actually come in contact with the body, the alpha particles emitted are unable to penetrate the unbroken skin.

6.7 The last source of radioactive material to be considered is the neutron induced activity. The neutrons liberated in the fission process, but which are not involved in the propagation of the fission chain, are ultimately captured by the weapon materials through which they must pass before they can escape, by nitrogen (especially) and oxygen in the atmosphere, and by various elements present in the earth's surface. As a result of capturing neutrons, substances may become radioactive. They, consequently, emit beta particles, frequently accompanied by gamma radiation, over an extended period of time following the explosion. Such neutron-induced activity, therefore, is part of the residual nuclear radiation.

6.8 The activity induced in the weapon materials is highly variable, since it is greatly dependent upon the design or structural characteristics of the weapon.

Any radioactive isotopes produced by neutron capture in the residues will remain associated with the fission products. In the period from 20 hours to 2 weeks after the burst, depending to some extent upon the weapon materials, such isotopes, as uranium-237 and -239 and neptunium-239 and -240 can contribute up to 40 percent of the total activity of the weapon residues. At other times, their activity is negligible in comparison with that of the fission products.

6.9 An important contribution to the residual nuclear radiation can also arise from the activity induced by neutron capture in certain elements in the earth and in sea water. The extent of this radioactivity is highly variable. The element which probably deserves most attention, as far as environmental neutron-induced activity is concerned, is sodium. Although this is present only to a small extent in average soils, the amount of radioactive sodium-24 formed by neutron capture can be quite appreciable. This isotope has a half-life of 15 hours and emits both beta particles, and more important, gamma rays of relatively high energy.

6.10 How much radioactive material is available for distribution as fallout?

6.11 At 1 minute after a nuclear explosion, when the residual nuclear radiation has been postulated as beginning, the gamma-ray activity of the 2 ounces of *fission products* from a 1-kiloton fission yield explosion is comparable with that of about 30,000 tons of radium in equilibrium with its decay products. It is seen, therefore that for explosions in the megaton-energy range the amount of radioactivity produced is enormous. Even though there is a decrease from the 1-minute value by a factor of over 3,000 by the end of the day, the radiation intensity will still be large.

6.12 It has been calculated that if all the *fission products* from an explosion with a 1-megaton fission yield could be spread uniformly over a smooth area of 10,000 square miles, the radiation exposure rate after 24 hours would be 6 roentgens per hour at a level of 3 feet above the ground. In actual practice, a uniform distribution would be improbable, since a

¹ Paragraphs 6.5 through 6.18 are reprints of selected paragraphs from *The Effects of Nuclear Weapons*.

large proportion of the fission products would be deposited nearer ground zero than at farther distances. Hence, the radiation intensity will greatly exceed the average at points near the explosion center, whereas at much greater distances it will usually be less. The above example does not include any neutron induced activity.

FORMATION OF FALLOUT

6.13 In a surface burst, large quantities of earth or water enter the fireball at an early stage and are fused or vaporized. When sufficient cooling has occurred, the fission products and other radioactive residues become incorporated with the earth particles as a result of the condensation of vaporized fission products into fused particles of earth, etc. A small proportion of the solid particles formed upon further cooling are contaminated, fairly uniformly throughout with radioactive fission products and other weapon residues, but in the majority the contamination is found mainly in a thin shell near the surface. In water droplets, the small fission product particles occur at discrete points within the drops. As the violent disturbance due to the explosion subsides, the contaminated particles and droplets gradually fall back to earth. This effect is referred to as the "fallout". It is the associated radioactivity in the fallout, which decays over a long period of time, that is the main source of residual nuclear radiations.

6.14 The extent and nature of the fallout can range between wide extremes. The actual behavior will be determined by a combination of circumstances associated with the energy yield and design of the weapon, the height of the explosion, the nature of the surface beneath the point of burst, and the meteorological conditions, which we will discuss later. In the case of an *air burst*, for example, occurring at an appreciable distance above the earth's surface, so that no surface materials are sucked into the cloud, negligible fallout is produced. Thus at Hiroshima and Nagasaki, where approximately 20-kiloton devices were exploded 1,850 feet above the

surface, casualties due to fallout were completely absent.

6.15 On the other hand, a nuclear explosion occurring at or *near the earth's surface* can result in severe contamination by the radioactive fallout. In the case of the 15-megaton thermonuclear device tested at Bikini Atoll on March 1, 1954—the BRAVO shot of Operation CASTLE—the ensuing fallout caused substantial contamination over an area of more than 7,000 square miles. The contaminated region was roughly cigar-shaped and extended more than 20 statute miles upwind and over 320 miles downwind. The width in the crosswind direction was variable, the maximum being over 60 miles.

6.16 It should be understood that the fallout is a gradual phenomenon extending over a period of time. In the BRAVO explosion, for example, about 10 hours elapsed before the contaminated particles began to fall at the extremities of the 7,000 square mile area. By that time, the radioactive cloud had thinned out to such an extent that it was no longer visible. This brings up the important fact that fallout can occur even when the cloud cannot be seen. Nevertheless, the area of contamination which presents the most serious hazard generally results from the fallout of visible particles.

6.17 The fallout pattern from particles of visible size will have been established within about 24 hours after the burst. This is referred to as "early fallout" and is also sometimes called "local" or "close-in" fallout. In addition, there is the deposition of very small particles which descend very slowly over large areas of the earth's surface. This is the "delayed fallout," also referred to as "worldwide fallout," to which residues from nuclear explosions of various types—air, high-altitude, surface, and shallow subsurface—may contribute.

6.18 Although the test of March 1, 1954 produced the most extensive local fallout yet recorded, it should be pointed out that the phenomenon was not necessarily characteristic of (nor restricted to) thermonuclear explosions. It is very probable that if the same device had been detonated at an appreciable distance above the Coral Is-

land, so that the large fireball did not touch the surface of the ground, the early fallout would have been of insignificant proportions.

WHAT GOVERNS THE LOCATION OF EARLY FALLOUT—

6.19 There are several factors governing the location of early fallout. These are:

1. Kind of weapon.
2. Yield of the burst.
3. Altitude of the burst.
4. Height and dimension of the cloud.
5. Distribution of radioactive particles within the cloud.
6. Radioactivity associated with various particle sizes.
7. Rate of fall of the particles.
8. Meteorological conditions, including wind structure to the top of the cloud and any type of precipitation.

6.20 These factors are so interrelated that it is almost impossible to isolate the effects of any one factor with precision. However, *it is possible to discuss the general significance of each factor.*

6.21 *Kind of Weapon.*—Since the fusion products do not make a significant contribution of radioactive material to fallout, even when the weapon is a thermonuclear one (i.e., fusion is involved), *only the fission yield of a given weapon is important in determining the total amount of radioactive fallout.* For example, although the total amount of radioactive material produced would be approximately the same in a 1 megaton 50% fission yield weapon and a 2 megaton 25% fission yield weapon, the resulting fallout patterns would probably differ because of the greater height obtained by the 2 megaton cloud.

6.22 *Altitude of the Burst (This is a crucial factor).*—The fraction of the total radioactivity of the bomb residues that appear in the early fallout depends upon the extent that the fireball touches the surface. Thus, the proportion of the available activity contributing to early fallout increases, as the height of burst decreases and more of the fireball comes into contact with the earth.

6.23 *Height and Dimension of the Cloud.*—It is obvious that the physical size of the cloud at the time of stabilization will have an effect on the distribution of early fallout. The height to which the individual particles are carried principally determines how far downwind a given particle size will drift, and the horizontal extent of the cloud affects the width of the area over which fallout will occur.

6.24 The eventual height reached by the nuclear cloud depends upon the energy of the bomb and upon the temperature and density of the surrounding air. The greater the amount of energy liberated the greater will usually be the upward thrust due to buoyancy and so the greater will be the distance the cloud ascends. It is probable, however, that the maximum height obtainable by the nuclear cloud is affected by the height of the tropopause, which is the boundary layer between the relatively stable air of the stratosphere and the more turbulent troposphere. (See Figure 6.24.)

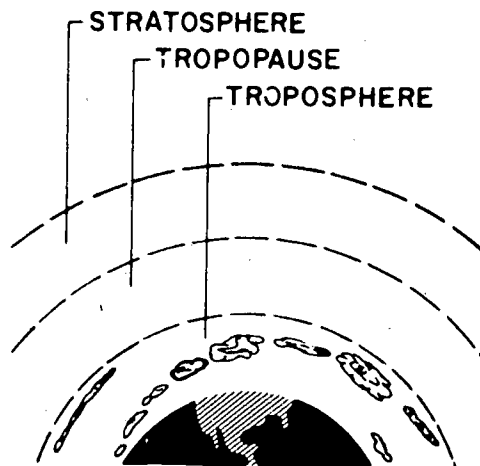

FIGURE 6.24.—The earth's atmosphere.

6.25 The height of the tropopause is usually slightly above 50,000 feet in the tropics and at 30,000 to 40,000 feet in middle latitudes in the summer. In winter, in the middle latitudes, it is somewhat lower on the average than in the summer. For smaller kiloton weapons the height of the tropopause generally limits the height of the nuclear cloud. Even for larger size

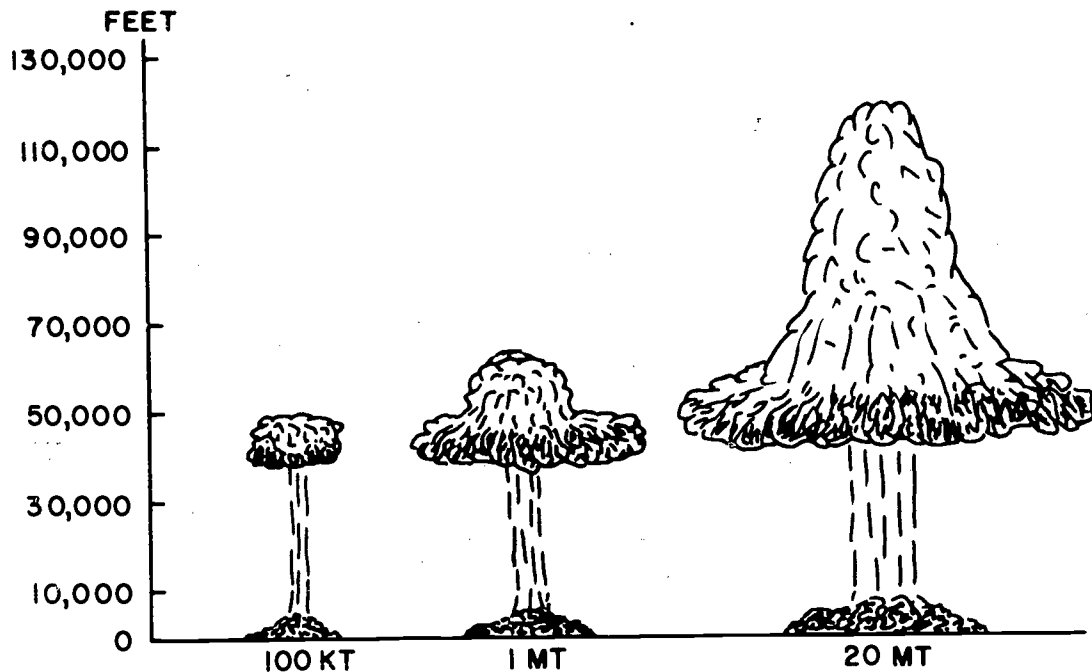

FIGURE 6.25.—Representative nuclear detonation cloud heights.

weapons in the megaton range, the development of the cloud slows down as the cloud builds up into the stratosphere. Thus the lower the tropopause, the less the total height of the cloud. Figure 6.25 illustrates rough estimates of some possible cloud heights under "typical" conditions.

6.26 *Distribution of Radioactivity within the clouds.*—Figure 6.26 summarizes the distribution of radioactivity within the nuclear cloud. You will note that approximately 90% of the total activity is located in the cloud and only 10% or less in the stem section with the bulk of the activity in the base of the cloud. It is further assumed that the bulk of the radioactive material that contributes to early fallout will be at or below about 80,000 feet. Above this altitude the particles will probably be in a finely divided state and will contribute most to worldwide fallout.

6.27 *Amount of Radioactivity Associated with Various Particle Sizes.*—From experimental evidence radioactive particles are known to exist with diameters ranging from .01 to 1,000 microns (A mi-

cron is 1 millionth of a meter). It is quite possible that even smaller particles exist since the lower limit of this range is the limit of the resolving power of the electron microscope. To determine the fallout patterns from a nuclear detonation it is necessary to know the distribution of the total radioactivity among particles of various

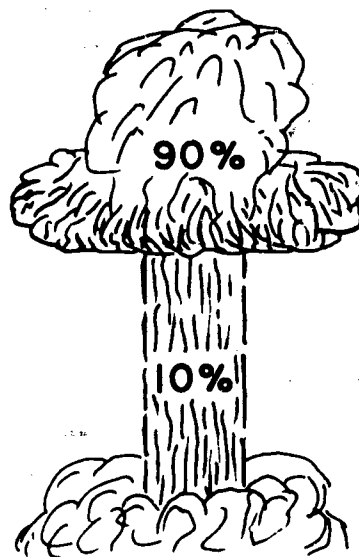

FIGURE 6.26.—Distribution of radioactivity.

sizes. Knowledge in this area is still rather limited because of the difficulty in obtaining large and representative samples of radioactive debris from a nuclear cloud.

6.28 *Rate of Fall of Particles.*—The particles carried up into the atmosphere by a nuclear detonation are acted upon by gravity and carried by the winds. Since

wind directions and speeds usually vary from one level to another, each particle follows a constantly changing course, and changing speed as it falls to earth. The rate of fall depends upon the particle size, shape and weight and the characteristics of the air. The stronger the wind in each layer the further the particles will be car-

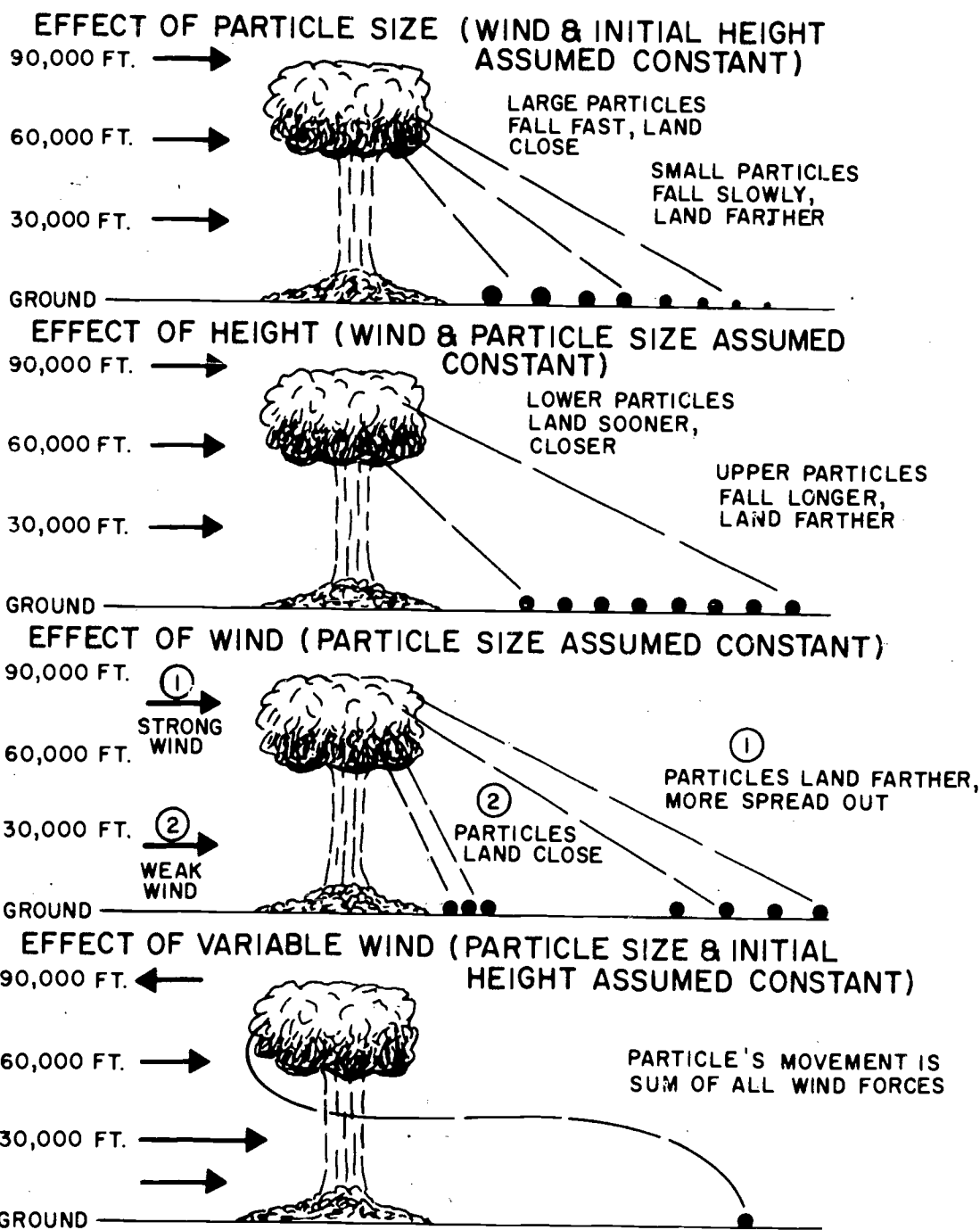

FIGURE 6.28.—Factors affecting distribution of radioactive particles.

ried in that layer. The faster the particle falls, the less influence the wind will have on it and the closer to ground zero it will land. The higher the altitude at which it begins to fall, the longer it will be carried by the wind, and under most conditions—when the winds at different altitudes do not oppose one another—the farther it will travel. (See figure 6.28.)

6.29 *Meteorological Conditions.*—Winds are the principal factor which affect the movement of the nuclear cloud. Even with the same type, yield, and altitude of detonation, different wind conditions will produce different fallout patterns of irregular shape. The speed and vertical shear of the upper air winds will also affect the concentration of radioactive material on the ground. A fallout pattern under conditions of strong winds aloft would differ from that of weak winds in two ways. First, the strong wind would spread the material over a larger area tending to reduce the concentration close to the source. Second, at a given distance the fallout would arrive sooner and would have had less time to decay.

6.30 The United States has a variety of upper air winds. During the winter, spring, and fall seasons the United States winds are primarily the “prevailing westerlies.” By this it is meant that the winds over the United States blow more frequently from the western quarter than from any other quarters of the compass. The westerlies in the middle latitudes become increasingly predominant with increasing height up to about 40,000 feet. At 5,000 feet the winds are from the western quadrant about half the time; while at 30–40,000 feet they are from that quadrant about three-fourths of the time. Above 40,000 feet, the percentage of westerly winds again decreases.

6.31 The predominance of westerly wind direction changes with the seasons. Upper winds blow from the west more often during winter than during summer. The increase in frequency of other directions in the summer is more pronounced in the southeastern portion of the country, where directions become variable at all levels. Along the Pacific Coast, the winds blow less constantly from the west than in

other sections of the country. Southwesterly and northwesterly winds are more common. Above 60,000 feet, easterly winds occur frequently in all seasons and are the rule in summer over most of the United States.

6.32 In describing direction of fallout from the point of detonation (GZ—ground zero), the terms “upwind” and “downwind” are often used. The “downwind” direction is the direction toward which the wind blows, while “upwind” means against the wind. When applied to fallout, the terms upwind and downwind will apply to the resultant or total effect of all the winds through which the particles have fallen. An upwind component results from the very rapid expansion of the cloud in all directions immediately after detonation. The disturbances at the time of the explosion will deposit radioactive material in upwind and crosswind directions for relatively short distances from ground zero.

6.33 Since the direction of fallout is determined by winds up to at least 80,000 feet, and since winds in the upper air frequently are quite different than winds at the surface, *surface wind directions cannot be used as an indication of direction of flow of high atmosphere winds.* It is not at all uncommon to have east, south, or north winds at the surface and westerly winds aloft.

6.34 In considering the possible area of fallout, *wind speed is as important as wind direction.* Depending on particle size, the direction determines the *sector to which they are carried*; and the *speed governs how far they will travel* before coming to the earth. Wind speeds over the United States generally are less in the summer than in winter at all heights and above all sections of the United States. The only exceptions would be during the passage of hurricanes or tornadoes which produce very strong surface winds in the warm seasons. This difference between seasons is greatest in the southeastern portion of the country, where winds become particularly light and variable in the summer. During the winter, upper winds along the Pacific Coast generally have lower speed than in any other section of the United

States. Wind speeds increase with altitude from the surface up to a level between 30,000 and 40,000 feet. Above this level they usually decrease in speed until at 60,000 to 80,000 feet they become relatively light.

6.35 The winds of greatest speed usually occur between 30,000 and 40,000 feet, winds exceeding 50 m.p.h. being the rule all over the country in winter and in the northeast in the summer. In this layer, winds greater than 100 m.p.h. are at times experienced over all areas of the United States, but have been observed most often over the northeast, where they are found about 25% of the time. In this northeastern area, winds of 200 m.p.h. occur frequently, with speeds of 300 m.p.h. observed on rare occasions. The high speed winds usually occur in narrow meandering currents within the broad belt of middle-latitude westerly winds, and are called "jet-streams".

6.36 The strongest winds encountered by a falling particle have the greatest proportional influence on its total movements. The strongest winds are usually at altitudes in the vicinity of 40,000 feet. *These winds would largely determine the general direction and length of the fallout area, although all the winds up to more than twice that height could be effective.*

6.37 Fallout patterns over the United States would probably differ in shape and extent. In the northern half of the country considerably longer patterns would be expected, spreading toward the east because of the strong upper air westerly winds. The passage of low pressure areas would cause shifts from a more northeasterly to a more southeasterly spread of the fallout pattern from one day to another. In the summer, particularly in the southern part of the country, a great variety of patterns might be expected with a broad irregular spreading in all directions in some cases, and elongated streaks in others. It should be remembered also that *in an area where several target cities are situated within a few hundred miles of one another, fallout from more than one detonation might occur at the same place.*

6.38 Variation of the winds by day and night has little effect on factors that determine fallout patterns. Winds a few hundred feet aboveground frequently change from day to night, but those higher up, which have the greatest effect on the fallout pattern, do not follow a daily cycle. Cloudiness or fog alone are not believed to have a marked effect on fallout, although the combination of fallout particles with cloud droplets may result in a faster rate of fall. Some cloud types also have upward and downward air currents. The downward currents might tend to bring some of the radioactive debris down more rapidly than it would otherwise settle.

6.39 In addition to the wind, *precipitation* in a fallout area will affect the radioactive deposition. Rain drops and snow flakes collect a large proportion of the atmospheric impurities in their paths. Particles of radioactive debris are "washed" or "scrubbed" out of the air by precipitation. The result is that contaminated material, which would be spread over a much larger area by the slower dry weather fallout process, is rapidly brought down in local rain or snow areas. It is conceivable that hazardous conditions can occur in rain areas where ordinary fallout estimates might indicate a safe condition. This scrubbing reduces the amount of contamination left in the air to fall out farther downwind.

6.40 Terrain features will also cause a variation in the degree of deposition. Hills, valleys and slopes of a few hundred feet would probably not have a great effect on the fallout radiation levels. However, large mountains or ridges could cause significant variation in deposition by receiving more fallout on the sides facing the surface wind. This is true for both dry weather fallout and "rainout".

WORLDWIDE FALLOUT

6.41 Worldwide fallout by definition is much more widespread than early fallout. Worldwide fallout is that portion of the bomb residues which consists of very fine material that remains suspended in the air for times ranging from days to years.

These fine particles can be carried over large areas by the wind and may ultimately be deposited on parts of the earth remote from the point of burst. It should not be inferred from this term, however, that none of the fine material is deposited in areas near the explosions nor that such material is deposited uniformly over the earth.

6.42 You will recall that early fallout is important only when the nuclear burst occurs at or near the earth's surface so that a large amount of debris is carried up into the nuclear cloud. Contributions to worldwide fallout, however, can come from nuclear explosions of *all types*, except those so far beneath the surface that the ball of fire does not break through and there is no nuclear cloud, or those detonated in outer space. With regard to the mechanism of the worldwide fallout, a distinction must be drawn between the behavior of explosions of low energy yield and those of high energy yield. If the burst occurs in the lower part of the atmosphere the nuclear cloud from a detonation in the kiloton range will not generally rise above the top of the troposphere, consequently, nearly all the fine particles present in the bomb debris from such explosions will remain in the troposphere until they are eventually deposited.

6.43 The fine fallout particles from the troposphere are deposited in a complex way, complex, since various processes in addition to simple gravitational settling are involved. *The most important of these processes appears to be the scavenging effect of rain or other forms of moisture precipitation.* Almost all of the tropospheric fallout will be deposited within two to three months after the detonation so that bomb debris does not remain for very long in the troposphere.

6.44 While the fine debris is suspended in the troposphere the major part of the material is moved by the wind at high altitudes. In general, the wind pattern is such that the debris is carried rapidly in an easterly direction, making a complete circuit of the globe in some 4 to 6 weeks. Diffusion of the cloud to the north and south is relatively slow, with the result

that most of the fine tropospheric fallout is deposited in a short period of weeks in a fairly narrow band and encircling the earth at the latitude of the nuclear detonation.

6.45 For explosions of high energy yield in the megaton range nearly all the bomb debris will pass up through the troposphere and enter the stratosphere. The larger particles will be deposited locally for a surface or sub-surface burst, while the very fine particles from bursts of all types can be assumed to be injected into the stratosphere. Due to their fineness and the absence of clouds and rainfall at such high altitudes, the particles will settle earthward very slowly. Although agreement does not exist as to the mechanism that produces observed differences in worldwide fallout, it is now clear that non-uniform circulation of stratospheric debris between the hemispheres is a characteristic of worldwide fallout. Also no agreement exists as to the residence time for worldwide fallout in the upper atmosphere, but it appears to be somewhere between 1 to 5 years.

6.46 During its long residence in the stratosphere, the bomb residues diffuse slowly but widely, so that they enter the troposphere at many points over the earth's surface. Once in the troposphere, fine material behaves like that which remained initially in that part of the atmosphere, and is brought to earth fairly rapidly by rain or snow.

6.47 An important feature of the stratospheric worldwide fallout is the fact that the radioactive particles are, in effect, stored in the stratosphere with a small fraction continuously dribbling down to the earth's surface. While in stratospheric storage, the debris does not represent a direct radioactive hazard. In fact, during this time most of the activity of the short-lived isotopes decays away and some of the activity of the longer-lived isotopes is appreciably reduced. Thus, stratospheric worldwide fallout is a slow, continuous non-uniform deposition of radioactive material over the entire surface of the earth, the rate of deposition depending on the total amount of bomb debris still present

in the stratosphere, the season of the year and the amount of precipitation.

REPRESENTATION OF EARLY FALLOUT AREAS

6.48 In a somewhat idealized situation, it is to be expected that, except for the very smallest particles which descend over a wide area, the fallout of the larger particles fall to earth forming a kind of elongated (or cigar shaped) pattern of contamination. The shape and dimensions will be determined by the wind velocities and directions at all altitudes between the ground and the nuclear cloud. It should be emphasized that these elongated fallout patterns are idealized, and an actual fallout pattern will not conform to these patterns.

6.49 At a particular time after the detonation of a nuclear weapon, the radiation exposure rate is apt to be highest at ground zero, and will decrease as the distance from ground zero increases. This is because the amount of fallout per unit area is also likely to be less. There is another factor that contributes to this decrease in exposure rate with increasing distances from the explosion. This factor is time. The later times of arrival of the fallout at these greater distances mean that the fission products have *decayed* to some extent while the particles were suspended in the air.

6.50 Some idea of the manner in which a fallout pattern may develop over a large area during the period of several hours following a high-yield nuclear surface burst may be seen in Figure 6.50. For simplicity of representation, the actual complex wind pattern is replaced by an approximately equivalent or effective wind of 15 miles per hour. Figure 6.50 shows a number of contours for certain arbitrary exposure rates that could possibly have been observed on the ground at 1, 6 and 18 hours ($H + 1$; $H + 6$; $H + 18$) respectively after the explosion. It should be understood that the various exposure rates change *gradually* from one contour line to the next. Similarly, the last contour line shown does not represent the limit of

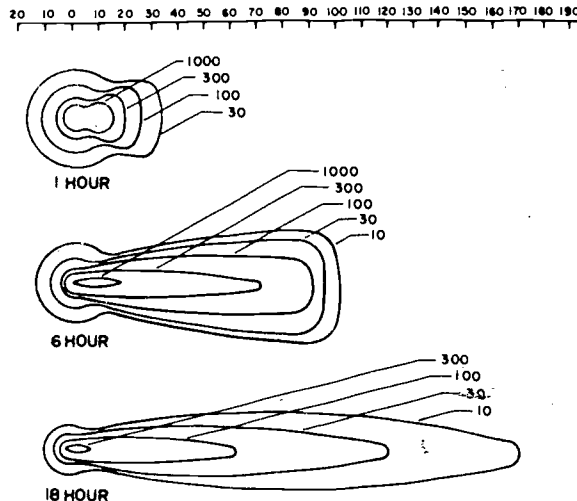

FIGURE 6.50.—Contours from fallout at 1, 6, and 18 hours after a surface burst with a fission yield in the megaton range (15 m.p.h. effective wind). Values given are in roentgens per hour.

contamination since the exposure rate will fall off steadily over a greater distance.

6.51 Consider first, a location 32 miles downwind from ground zero.—At one hour after the detonation the observed exposure rate is seen to be about 30 R/hr; at 6 hours the exposure rate which lies between the contours for 1,000 and 300 R/hr has increased to about 800 R/hr; but at 18 hours it is down to roughly 200 R/hr. The increase in exposure rate from 1 to 6 hours means the fallout was not complete one hour after detonation. The decrease from 6 to 18 hours is then due to the natural decay of the fission products. On the other hand a total radiation exposure received at the given location at one hour after the explosion would be relatively small because the fallout has only just started to arrive. By 6 hours the total exposure could reach over 3,000 R and by 18 hours a total exposure of some 5,000 R could have accumulated. Subsequently, the total exposure would continue to increase but at a slower rate.

6.52 Next, consider a point 100 miles downwind from ground zero.—At one hour after the explosion the exposure rate, as indicated in Figure 6.50, is zero since the fallout will not have reached the specified location. At 6 hours the exposure rate is 10

R/hr and at 18 hours about 50 R/hr. The total (infinite) exposure will not be as great as at locations closer to ground zero because the quantity of fission products reaching the ground decreases at increasing distances from the explosion.

UNCERTAINTIES IN FALLOUT PREDICTIONS

6.53 Idealized fallout patterns are useful for planning purposes, but they are not blueprints of the actual fallout pattern that would occur. There are just too many uncertainties or variables involved in fallout, affecting both distribution of early fallout and rate of decrease of radioactivity, to make precise prediction possible.

6.54 It is difficult to estimate the extent of the induced radioactivity because of differences in type of weapon, the height of burst, and the nature of the soil or other material in which neutron bombardment has caused radioactivity. Furthermore, the existence of unpredictable hot spots will affect local radiation exposure rates, as will the nature of the terrain (buildings, trees, etc., may reduce the average radiation exposure rate above the ground to 70 or 75 percent of the value measured in open, flat terrain); weathering (wind may move surface-deposited fallout from one area to another or rain may wash it into the soil); fractionization (any

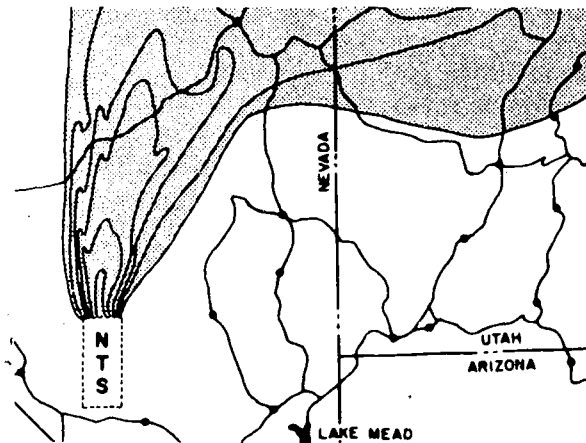

FIGURE 6.54b.—Fallout patterns from nuclear test detonation at the Nevada Test Site.

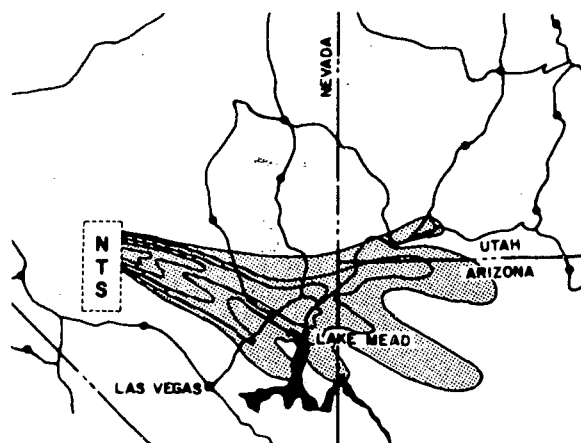

FIGURE 6.54c.—Fallout patterns from nuclear test detonation at the Nevada Test Site.

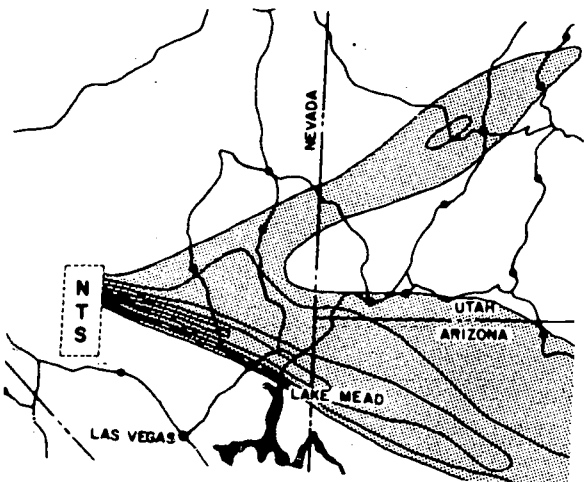

FIGURE 6.54a.—Fallout patterns from nuclear test detonation at the Nevada Test Site.

one of several processes, apart from radioactive decay, that results in change in the composition of the radioactive weapon debris); fission products of differing ages and other factors. These uncertainties or variables mean that the cigar-shaped fallout patterns are *idealized*, not necessarily real. To see how the idealized pattern differs from an actual pattern, refer to Figures 6.54a through 6.54c which show fallout patterns from actual test detonations at the Nevada Test Site. These patterns were developed from monitored readings taken shortly after the test shots.

6.55 So far we have examined the fallout problem in general terms without trying to show the magnitude of the situa-

tion that could exist if the entire nation should be attacked. The map in Figure 6.55a illustrates an assumed *hypothetical* nuclear attack. Each circle represents a 20 megaton surface explosion. There are 50 of these. Each square represents a 10 megaton surface burst. There are 100 of these. Each triangle represents a 5 megaton burst and there are also 100 of these. In this hypothetical attack there are 250 weapons dropped on 144 different targets which include military, industrial and population objectives. The total yield of these 250 weapons is equivalent to 2500 megatons or 2.5 billion tons of TNT!

6.56 Figure 6.55b shows the area that would be affected by fallout and the theoretical levels of radiation one hour after the attack. The fallout areas would be 30 to 50 miles long, depending upon wind speed and in the center of these areas the levels of radiation could be greater than 3,000 R/hr at H + 1.

6.57 Figure 6.55c illustrates the situation 6 hours after attack. Fallout would have spread over about 40% of the national land area. However, the radiation levels would have decayed by approximately a factor of ten. The exposure rates in these areas would range from one R/hr along the border to perhaps 400 R/hr in the center. Figure 6.55d illustrates the areas that would be affected by fallout one day after attack. Approximately 70% of the country's total area would be covered by fallout exposure rates greater than 0.2 R/hr. About 18% of the land area would have a very serious fallout condition.

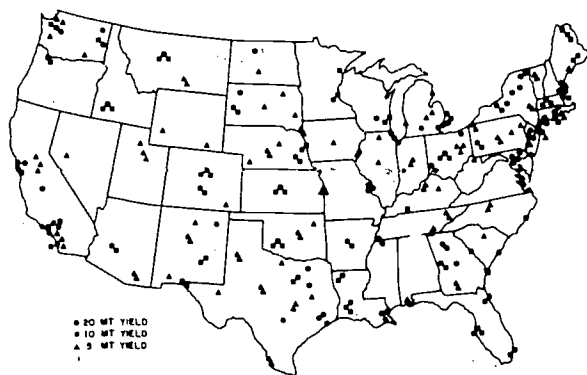

FIGURE 6.55a.—Hypothetical attack pattern.



FIGURE 6.55b.—Hypothetical attack, H + 1 situation. Exposure rates exceed 10 R/hr.

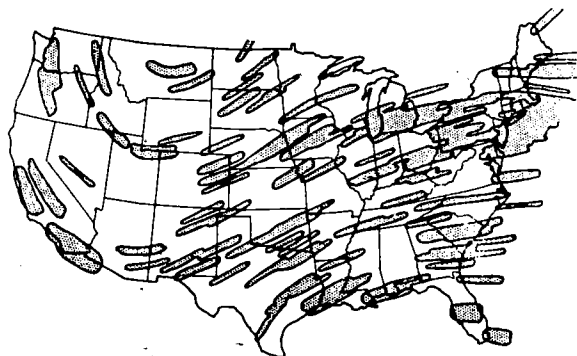

FIGURE 6.55c.—Hypothetical attack, H + 6 situation. Exposure rates exceed 1 R/hr.

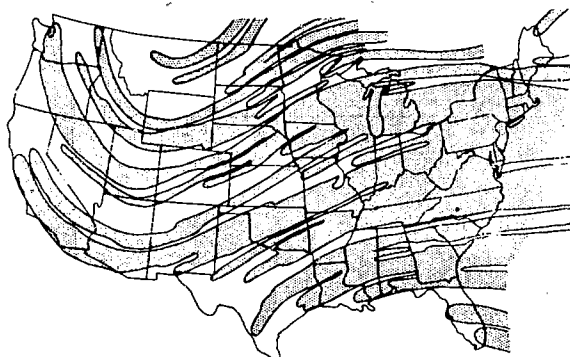

FIGURE 6.55d.—Hypothetical attack, H + 24 situation. Exposure rates exceed .2 R/hr.

6.58 Shortly after the first day radioactive decay would begin to predominate over further deposition of fallout. The boundaries of these fallout areas would gradually shrink.

Figure 6.55e illustrates the situation one week after attack during which time the radioactive areas would have been decreasing in size and the exposure rates decreasing as a result of decay. Only about one-third of the nation's area would be



FIGURE 6.55e.—Hypothetical attack, H +1 week situation. Exposure rates exceed .2 R/hr.



FIGURE 6.55f.—Hypothetical attack, H +2 months situation. Exposure rates exceed .2 R/hr.

covered by fallout exposure rates exceeding 0.2 R/hr. This reduction in exposure rate would continue. Two months after attack, the situation might exist as illustrated in Figure 6.55f. We would find only isolated elongated islands where the levels of radiation would exceed 0.2 R/hr.

6.59 It is emphasized that this training exercise represents just one attack pattern applied to the winds and weather of one day. Had a different attack pattern been selected or the weather for another day, the fallout situation would have developed quite differently.

6.60 To illustrate the effects of different wind patterns on a hypothetical nuclear attack, figure 6.60 shows a fallout projection for a 156 weapon—384 megaton attack using the wind conditions that existed on June 28, 1957.

6.61 Figure 6.61 shows the theoretical fallout from the identical attack pattern—

the same ground zeros and the same weapon yields—but, based on the weather of July 12, 1957. You will note that the axis of fallout deposition of many locations has shifted by more than 120 degrees. On another day the wind could swing in any other direction and turn safe areas on these maps into areas of extreme fallout danger.

FALLOUT FORECASTING

6.62 We have seen that one of the most significant factors affecting the dispersion of fallout was the wind. We also saw that data can be obtained on wind direction and speed at various altitudes. Since a major influence on fallout is one about which considerable data are known, it enables us to predict with some degree of accuracy the probable pattern of fallout dispersion. The requirements of fallout

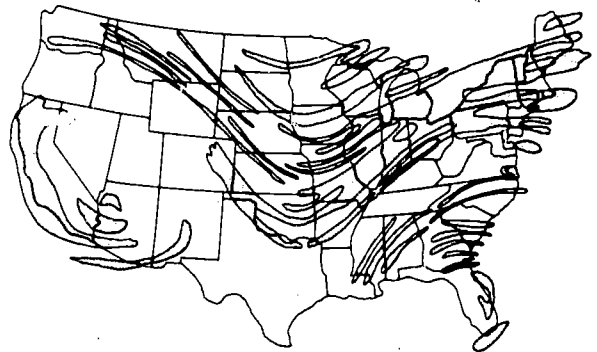

FIGURE 6.60.—Hypothetical attack, fallout pattern for winds of June 28, 1957.

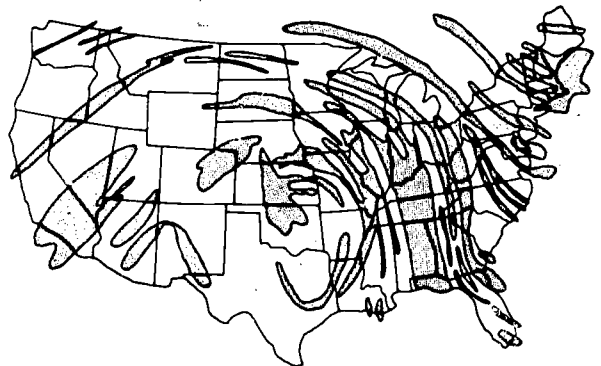

FIGURE 6.61.—Hypothetical attack, fallout pattern for winds of July 12, 1957.

prediction from wind direction and speed are two: accurate data and current data. Both of these conditions are met by the network of rawin observatories established by the United States and Canadian Weather Services.

6.63 The purpose of preparing fallout forecast plots is to provide graphic estimates of areas that are likely to receive fallout and the approximate time of fallout arrival. Figure 6.63 illustrates a fallout forecast plot. The area inside the heavy "U" shaped pattern and the dashed three-hour line represents land which could be covered with fallout within three hours of a nuclear surface detonation upon the city of Roanoke. The dashed one-hour and two-hour lines represent fallout arrival times and provide for forecasting fallout arrival at various places within the forecast plot.

For example, at Lynchburg, fallout would be forecast to arrive about one hour after detonation.

Information provided by the forecasts is limited to areas that may be covered by fallout and the approximate times of fallout arrival within the forecast area. Predicted radiation levels or exposure rates are not included in the forecasts.

6.64 Meteorological data for the construction of fallout forecast plots are available to all levels of government in the form of "DF" messages which are transmitted by teletype over the national weather service network. Data points are shown on Figure 6.64. Arrangements for the receipt of LF messages should be made to support operations in the event of a fallout emergency.

6.65 The Defense Civil Preparedness

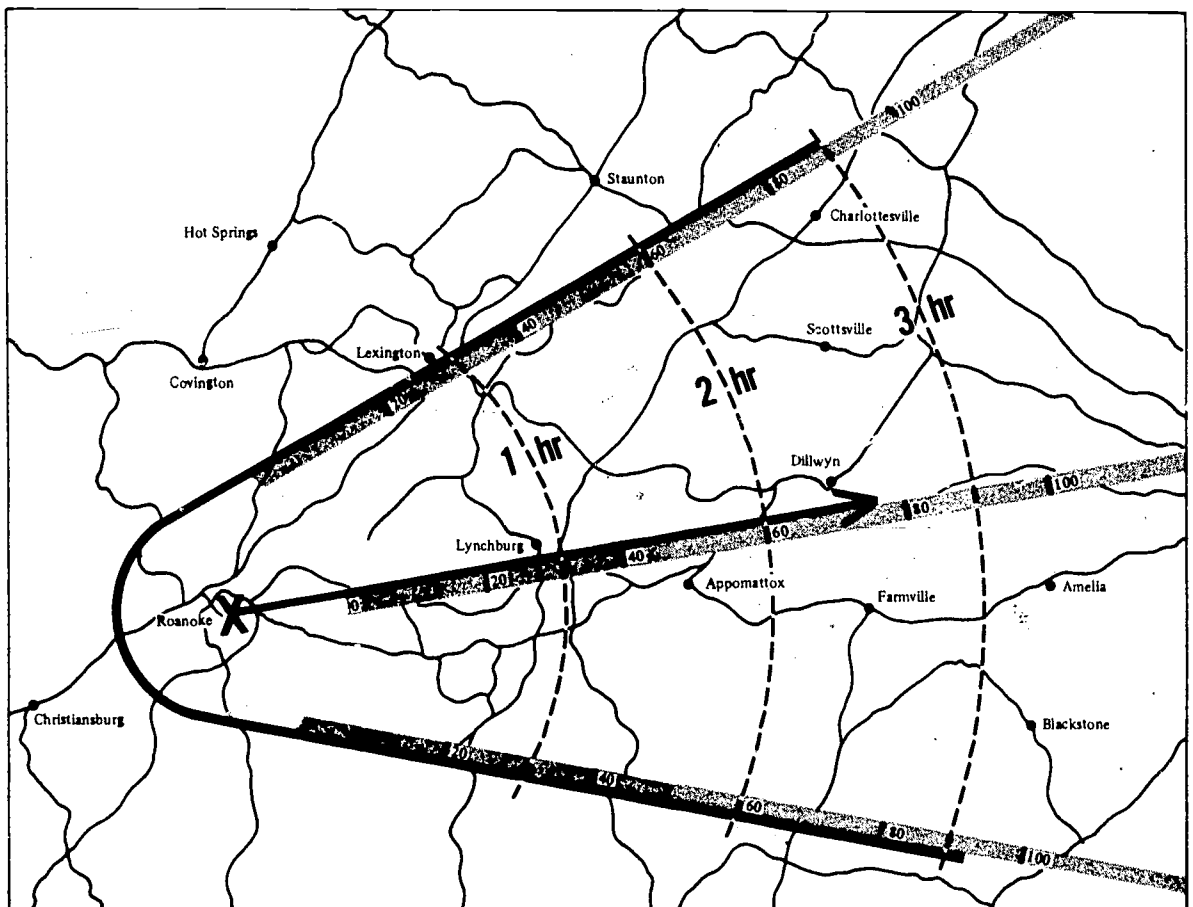

FIGURE 6.63.—A fallout forecast plot.

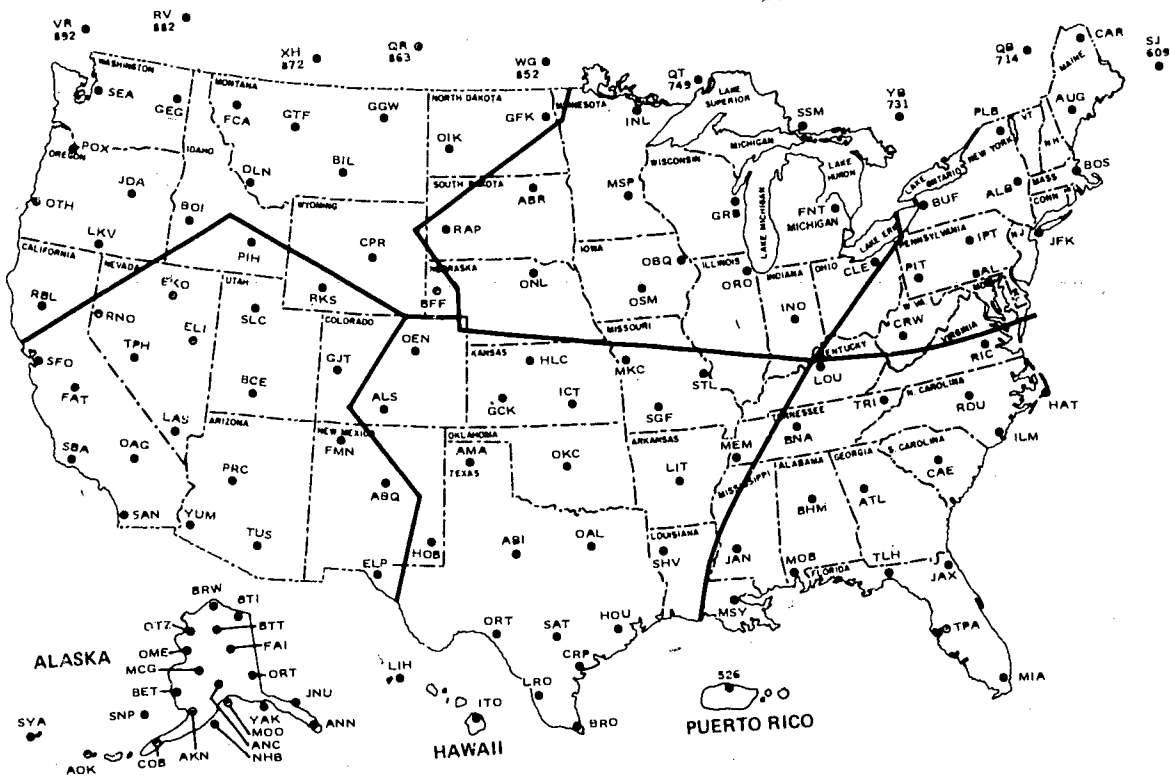

FIGURE 6.64.--DF data points.

Agency has prepared a manual of detailed instructions on the construction and use of fallout forecasts. This manual is entitled "Users Manual—Meteorological Data for Radiological Defense," (FG-E-5.6/1). The manual explains the "DF" message format, gives instructions on preparing fallout forecast areas, and illustrates how to estimate fallout arrival time for operational use. The manual may be obtained through regular civil preparedness channels.

REFERENCES

The Effects of Nuclear Weapons.—Glasstone, Samuel, 1964.

Fallout From Nuclear Tests.—Hearings before the Special Subcommittee on Radiation of the Joint Committee on Atomic Energy, Congress of the United States, May 1959.

Users Manual—Meteorological Data for Radiological Defense.—FG-E-5.6/1, July 1970.

EFFECTS OF NUCLEAR RADIATION EXPOSURE

We have learned that nuclear radiation is a form of energy which has the power to damage living cells or tissue. In this chapter, our objective is to explain:

WHAT are the effects of nuclear radiation

HOW are they produced

We are going to take a look into a human cell and see what happens when it is subjected to nuclear radiation, what kind of damage is produced and the effects of this damage. And there is something else we will learn, too, something that is VITAL in effective RADEF work:

WHAT is the *tolerance* of the human body to nuclear radiation—how *much* can we stand—how *long* can we stand it

INTRODUCTION

7.1 Late one November afternoon in 1895, as the German physicist Wilhelm Roentgen was sending an electric current at high voltage through a vacuum tube, he noticed a weak light that shimmered on a little bench he knew was located nearby. It seemed as if the spark of light inside the tube was being reflected in a mirror. Striking a match, he saw that a screen with some barium salt crystals on the bench was shining with fluorescent brilliance. Later, he held a piece of paper, then a playing card, and then a book between the tube and the screen. He was amazed to see that, even with the book placed in front of the tube, **THE CRYSTALS STILL BECAME FLUORESCENT**. Despite every law of science (as then understood) he had to admit it: **SOMETHING**, some unknown or "X" quantity, was passing right *through* the solid book. He then tried to see if other

materials would stop the "something". Eventually, he tried placing a thin sheet of lead between the tube and the crystals and found that it did stop the passage of that something. Trying further experiments, he picked up a small lead piece and held it up before the tube. He was staggered to see that not only did the round dark shadow of the disk appear on the screen of barium crystals, **BUT THAT HE COULD DISTINGUISH THE OUTLINE OF HIS THUMB AND FINGERS**. Not only that, but within this outline were darker shadows: **THE BONES OF HIS HAND**. These phenomena were so contrary to common sense, that Roentgen worked in secrecy, afraid that he might be discredited for such "unscientific" work. Even his best friends were kept in the dark. When one insisted on knowing what was going on, Roentgen said, "I have discovered something interesting, but I do not know whether or not my observations are correct."

7.2 Finally, after continued experiments including the first X-ray photograph (taken of his wife's hand), Roentgen realized that he must tell the world of his findings. He reported all his experiments, stating that the phenomena were caused by some form of invisible radiant energy. He called this energy "X-rays", the "X" standing for unknown.

7.3 The story broke in the *Vienna Presse* on January 5, 1896, and soon scientists all over the world, including Thomas Edison, were excitedly experimenting with this new kind of ray. The boon to medicine of X-rays, or Roentgen-rays as they were later called, was obvious: examining broken bones and fractures; locating tumors or other abnormalities. For some, X-rays were even a source of amusement, a hobby

or playtoy. In 1896, the following advertisement appeared in the magazine *Scientific American*:

"Portable X-ray apparatus for physicians, professors, photographers and students, complete in handsome case, including coil, condenser, two sets of tubes, battery, etc., for the price of \$15.00 net, delivered in the United States with full guarantee."

7.4 Not understanding the nature of X-rays, those early users of this new form of energy did not treat it with respect. It was even customary to use the hand as a fluoroscopic test object in controlling the quality of the roentgen or X-rays. Soon, those who were exposed to continual large doses of X-rays, patients, doctors, students, scientists alike, began to notice painful effects. One, Dr. Emil H. Grubbe of Chicago, said: "I had developed dermatitis on the back of my left hand which was so acute that I sought medical aid." The "dermatitis" was a radiation burn, and Dr. Grubbe's fingers and hands had been so badly burned by the X-rays that subsequently they were amputated piecemeal as the damaging effects of overexposure spread.

7.5 Since it was noticed that exposure to X-rays caused the hair to fall out, some concluded that X-rays were a good way to remove excess hair. One example, cited by Dr. W. E. Chamberlain of Temple University, shows what could happen:

A doctor in a small town heard that X-rays make hair fall out. His comely little secretary complained of having hairy arms. Apparently unaware of the potentialities for harm, the doctor administered X-rays with his portable radiographic machine. Horrible X-ray burns developed, and in due time the young lady's arms had to be amputated.

7.6 By 1922 it was estimated that 100 radiologists had perished from overexposure to radiation. Continued experiments clearly showed that all living tissue could be destroyed provided it was bombarded with a sufficiently high dosage of radiation.

7.7 A few months after Roentgen discovered X-rays, the French scientist Henri Becquerel found that certain uranium

salts gave off penetrating rays, similar in operation to X-rays. Later, Pierre Curie and his wife, Marie, tried to find the substance responsible for the radiation that Becquerel had observed. It was Marie Curie who termed this activity **RADIOACTIVITY**, to which you were introduced in Chapter 2. After intensive work, the Curies found two new radioactive elements, "polonium" and "radium". From repeated overexposures in her work with radioactive substances, Madam Curie suffered radiation injury and subsequently died from the delayed effects of radium damage. Her daughter, Irene Curie, carried on the mother's work, and she too died from overexposure to radiation.

7.8 What happens when living tissue is bombarded with radiation? Why does it cause so much havoc to the body? These, and other questions will be answered in subsequent paragraphs.

NUCLEAR RADIATION INJURIES

7.9 Each advance in man's power over nature has brought with it an element of danger. X-ray and nuclear radiation is no exception. We adopt a policy of acceptable risk in every facet of our lives. Society must decide what risk it will accept in the use of nuclear radiation. The scientist must clearly set forth the hazards.

The primary biological effect of nuclear radiation on life is in the cell. The normal life process in a cell uses a very small amount of energy with a high degree of self-regulation. When ionizing radiation strikes a cell it disrupts the living process. The specialized parts of a cell, such as the genes, are damaged not only by direct hits but also by the chemical poisons produced by ionization of the cell fluid. Many years ago radiologists noted that the number of cells damaged by a given exposure to radiation is a simple function of the number of living cells present. In other words, the number of cells damaged per unit of dose is constant. The number of cells in which genetic damage occurs is also a function of dose.

7.10 A higher plant or animal such as man consists of many cells. Higher forms

of life are a society of specialized and interdependent cells. Radiation damage to one organ or group of specialized cells can disturb other organs and weaken the whole organism. Man's life functions are carried out within a very narrow range of temperature, air, nutrients, water and radiation. This cooperative action of cells and tissues makes higher forms of life much more vulnerable to radiation than lower forms of life. Furthermore, individuals of the same species react differently to a radiation dose just as people react differently to a cold.

RADIATION UNITS

7.11 The radiation unit is known as the roentgen. By definition, it is applicable only to gamma rays or X-rays and not to other types of ionizing radiation, such as alpha and beta particles and neutrons. Since the roentgen refers to a specific result in air accompanying the passage of an amount of radiation through air, it does not imply any effect which it would produce in a biological system. Because of this, the roentgen is, strictly speaking, a measure of radiation "exposure." The effect on a biological system, however, is expressed in terms of an "absorbed dose." By comparing the actual biological effects of different types of ionizing radiation, it is possible to convert the absorbed dose into a "biologically significant dose" which provides an index of the biological injury that might be expected.

7.12 The absorbed dose of radiation was originally expressed in terms of a unit called the "rep," the name being derived from the initial letters of "roentgen equivalent physical." It was used to denote a dose of about 97 ergs of any nuclear radiation absorbed per gram of body tissue; however, for various reasons this unit has proved to be somewhat unsatisfactory. In order to avoid difficulties arising in the use of the rep, a new unit of radiation absorption, called the "rad," has come into general use. The rad is defined as the absorbed dose of any nuclear radiation which is accompanied by the liberation of 100 ergs of energy per gram of absorbing

material. For soft tissue, the difference between the rep and the rad is small, and numerical values of absorbed dose formerly expressed in reps are essentially unchanged when converted to rads.

7.13 Although all ionizing radiations are capable of producing similar biological effects, the absorbed dose (measured in rads) which will produce a certain effect may vary appreciably from one type of radiation to another. This difference in behavior is expressed by means of the "relative biological effectiveness" (or RBE) of the particular nuclear radiation. The RBE of a given radiation is defined as the ratio of the absorbed dose in rads of gamma radiation (of a specified energy)² to the absorbed dose in rads of the given radiation having the same biological effect.

7.14 The value of the RBE for a particular type of nuclear radiation depends upon several factors, including the dose rate, the energy of the radiation, the kind and degree of the biological damage, and the nature of the organism or tissue under consideration. As far as nuclear weapons are concerned, the important criteria are disabling sickness and death.

7.15 With the concept of the RBE in mind, it is now useful to introduce another unit, known as the "rem," an abbreviation of "roentgen equivalent mammal (or man)." The rad is a convenient unit for expressing energy absorption, but it does not take into account the biological effect of the particular nuclear radiation absorbed. The rem, however, which is defined by: dose in rems = RBE X dose in rads, provides an indication of the extent of biological injury (of a given type) that would result from the absorption of nuclear radiation. Thus, the rem is a dose unit of biological effect, whereas the rad is a unit of absorbed energy dose and the roentgen (for X or gamma rays) is one of exposure.

² Because 1 roentgen exposure gives about 1 rad absorbed dose in tissue for photons of intermediate energies (0.3 to 3 MeV), the absorbed dose for gamma (or X-) rays is often stated, somewhat loosely, in "roentgens." However, for photon energies outside the range from 0.3 to 3 MeV, the exposure in roentgens is no longer simply related to the absorbed dose in rads.

7.16 All radiation capable of producing ionization (or excitation) directly or indirectly, e.g., alpha and beta particles, X-rays, gamma rays, and neutrons, cause radiation injury of the same general type. However, although the effects are qualitatively similar, the various radiations differ in the depth to which they penetrate the body and in the degree of injury corresponding to a specified amount of energy absorption. As seen above, the latter difference is expressed by means of the RBE.

7.17 The RBE for gamma rays is approximately unity. For beta particles, the RBE is also close to unity; this means that for a given amount of energy absorbed in living tissue, beta particles produce about the same extent of injury within the body as do X-rays or gamma rays. The RBE for alpha particles from radioactive sources have been variously reported to be from 10 to 20, but this is believed to be too large in most cases of interest. For nuclear weapon neutrons, the RBE for acute radiation injury is now taken as 1.0, but it is appreciably larger where the formation of opacities of the lens of the eye (cataracts) is concerned. In other words, neutrons are much more effective than gamma rays in causing cataracts.

7.18 In considering the possible effects on the body of gamma radiations from external sources, it is necessary to distinguish between an "acute" (or "one-shot") exposure and a "chronic" (or extended) exposure. In an acute exposure the whole radiation dose is received in a relatively short interval of time. This is the case, for example, in connection with the initial nuclear radiation. It is not possible to define an acute dose precisely, but it may be somewhat arbitrarily taken to be the dose received during a 24-hour period. Although the delayed radiations from early fallout persist for longer times, it is during the first day that the main exposure would be received and so it is regarded as being acute. On the other hand, an individual entering a fallout area after the first day or so and remaining for some time would be considered to have been subjected to a chronic exposure.

7.19 The importance of making a distinction between acute and chronic exposures lies in the fact that, if the dose rate is not too large, the body can achieve partial recovery from some of the consequences of nuclear radiations while still exposed. Thus, apart from certain effects mentioned later, a larger total gamma-radiation dose would be required to produce a certain degree of injury if the dose were spread over a period of several weeks than if the same dose were received within a minute or so.

7.20 All living creatures are always exposed to ionizing radiations from various natural sources, both inside and outside the body. These are chronic exposures continuing for a lifetime. The chief internal source is the radioisotope potassium-40, which is a normal constituent of the element potassium as it exists in nature. Carbon-14 in the body is also radioactive, but it is only a minor source of internal radiation. Some potassium-40, as well as radioactive uranium, thorium, and radium in varying amounts, is also present in soil and rocks. The so-called "cosmic rays," originating in space, are another important source of ionizing radiations in nature. The radiation dose received from these rays increases with altitude up to about 90,000 feet; at 15,000 feet, it is more than five times as great as at sea level. The high radiation levels encountered in the Van Allen belts at much higher altitudes do not contribute to the background radiation on earth.

GENERAL RADIATION EFFECTS

7.21 The effect of nuclear radiations on living organisms depends not only on the total dose, that is, on the amount absorbed, but also on the rate of absorption, i.e., on whether it is acute or chronic, and on the region and extent of the body exposed. A few radiation phenomena, such as genetic effects, apparently depend primarily upon the total dose received and to a lesser extent on the rate of delivery. The injury caused by radiation to the germ cells under certain conditions appears to be cumulative. In the majority of instances, however, the biological effect of a

given total dose of radiation decreases as the rate of exposure decreases. Thus, to cite an extreme case, 1,000 rems in a single dose would be fatal if the whole body were exposed, but it would probably not have any noticeable external effects in the majority of persons if delivered more or less evenly over a period of 30 years.

7.22 The injury caused by a certain dose of radiation will depend upon the extent and part of the body that is exposed. One reason for this is that when the exposure is restricted, the unexposed regions can contribute to the recovery of the injured area. But if the whole body is exposed, many organs are affected and recovery is much more difficult.

7.23 Different portions of the body show different sensitivities to ionizing radiations, and there are variations in degree of sensitivity among individuals. In general, the most radiosensitive parts include the lymphoid tissue, bone marrow, spleen, organs of reproduction, and gastrointestinal tract. Of intermediate sensitivity are the skin, lungs, and liver, whereas muscle, nerves, and adult bones are the least sensitive.

EFFECTS OF ACUTE RADIATION DOSES

7.24 Before the nuclear bombings of Hiroshima and Nagasaki, radiation injury was a rare occurrence and relatively little was known of the phenomena associated with whole-body exposure and radiation injury. In Japan, however, a large number of individuals were exposed to doses of radiation ranging from insignificant quantities to amounts which proved fatal. The effects were often complicated by other injuries and shock, so that the symptoms of radiation sickness could not always be isolated. Because of the great number of patients and the lack of facilities after the explosions, it was impossible to make detailed observations and keep accurate records. Nevertheless, certain important conclusions have been drawn from Japanese experience with regard to the effects of nuclear radiation on the human organism.

7.25 Since 1945, further information on this subject has been gathered from other

sources. These include a few laboratory accidents involving a small number of human beings, whole-body irradiation used in treating various diseases and malignancies, and extrapolation to man of observations on animals. In addition, detailed knowledge has been obtained from a careful study of over 250 persons in the Marshall Islands, who were accidentally exposed to nuclear radiation from fallout following the test explosion on March 1, 1954. The exposed individuals included both Marshallese and a small group of American servicemen. The whole-body radiation doses ranged from relatively small values (14 rems), which produce no obvious symptoms, to amounts (175 rems) which caused marked changes in the blood-forming system.

7.26 No single source of data directly yields the relationship between the physical dose of ionizing radiation and the clinical effect in man. Hence, there is no complete agreement concerning the effect associated with a specific dose or dose range. Attempts in the past have been made to relate particular symptoms to certain narrow ranges of exposure; however, the data are incomplete and associated with many complicating factors that make interpretation difficult. For instance, the observations in Japan were very sketchy until 2 weeks following the exposures, and the people at that time were suffering from malnutrition and preexisting bacterial and parasitic infections. Consequently, their sickness was often erroneously attributed to the effects of ionizing radiation when such was not necessarily the case. The existing conditions may have been aggravated by the radiation, but to what extent it is impossible to estimate in retrospect.

7.27 In attempting to relate the radiation dose to the effect on man, it should be mentioned that reliable information has been obtained for doses up to 200 rems. As the dose increases from 200 to 600 rems the data from exposed humans decrease rapidly and must be supplemented more and more by extrapolations based on animal studies. Nevertheless, the conclusions drawn can be accepted with a reasonable

RANGE	0 TO 100 REMS SUBCLINICAL RANGE	100 TO 1,000 REMS THERAPEUTIC RANGE			OVER 1,000 REMS LETHAL RANGE	
		100 TO 200 REMS	200 TO 600 REMS	600 TO 1,000 REMS	1,000 TO 5,000 REMS	OVER 5,000 REMS
INCIDENCE OF VOMITING	NONE	CLINICAL SURVEILLANCE 100 REMS 5% 200 REMS 50%	THERAPY EFFECTIVE 300 REMS 100%	THERAPY PROMISING 100%	THERAPY PALLIATIVE 100%	
DELAY TIME	-	3 HOURS	2 HOURS	1 HOUR	30 MINUTES	
LEADING ORGAN	NONE	HEMATOPOIETIC TISSUE			GASTROINTESTINAL TRACT	CENTRAL NERVOUS SYSTEM
CHARACTERISTIC SIGNS	NONE	MODERATE LEUKOPENIA	SEVERE LEUKOPENIA; PURPURA; HEMORRHAGE; INFECTION. EPILATION ABOVE 300 REMS		DIARRHEA; FEVER DISTURBANCE OF ELECTROLYTE BALANCE.	CONVULSIONS; TREMOR; ATAXIA; LETHARGY.
CRITICAL PERIOD POST-EXPOSURE	-	-	4 TO 6 WEEKS		5 TO 14 DAYS	1 TO 48 HOURS
THERAPY	REASSURANCE	REASSURANCE; HEMATOLOGIC SURVEILLANCE.	BLOOD TRANSFUSION; ANTIBIOTICS.	CONSIDER BONE MARROW TRANSPLANTATION.	MAINTENANCE OF ELECTROLYTE BALANCE.	SEDATIVES
PROGNOSIS	EXCELLENT	EXCELLENT	GOOD	GUARDED	HOPELESS	
CONVALESCENT PERIOD INCIDENCE OF DEATH	NONE NONE	SEVERAL WEEKS NONE	1 TO 12 MONTHS 80 TO 80% (var.)	LONG 80% TO 100% (var.)	90 TO 100%	
DEATH OCCURS WITHIN	-	-	2 MONTHS		2 WEEKS	2 DAYS
CAUSE OF DEATH	-	-	HEMORRHAGE; INFECTION		CIRCULATORY COLLAPSE	RESPIRATORY FAILURE; BRAIN EDEMA.

PALLIATIVE-AFFORDING RELIEF, BUT NOT A CURE.
HEMATOPOIETIC TISSUE-BLOOD FORMING TISSUE.
LEUKOPENIA-REDUCTION IN NUMBER OF WHITE BLOOD CELLS (leukocytes)

PURPURA-LIVID SPOTS ON THE SKIN OR MUCOUS MEMBRANES
EDEMA-ABNORMAL ACCUMULATION OF FLUIDS IN THE TISSUE

FIGURE 7.28.—Summary of effects from brief nuclear radiation exposure.

degree of confidence. Beyond 600 rems, however, observations on man are so sporadic that the relationship between dose and biological effect must be inferred or conjectured almost entirely from observations made on animals exposed to ionizing radiations.

7.28 With the foregoing facts in mind, Figure 7.28 is presented as the best available summary of the effects of various whole-body dose ranges of ionizing radiation on human beings. Below 100 rems, the response is almost completely subclinical; that is to say, there is no sickness requiring special attention. Changes may, nevertheless, be occurring in the blood, as will be seen later. Between 100 and 1,000 rems is the range in which therapy, i.e., proper medical treatment, will be successful at the lower end and may be successful at the upper end. The earliest symptoms of radiation injury are nausea and vomiting, which may commence within about 1 to 3 hours of exposure, accompanied by discomfort (malaise), loss of appetite, and fatigue. The most significant, although not immediately obvious, effect in the range under consideration, is that on the hematopoietic tissue, i.e., the organs concerned with the formation of blood. An important manifestation of the changes in the functioning of these organs is leukopenia, that is, a decline in the number of leukocytes (white blood cells). Loss of hair (epilation) will be apparent about 2 weeks or so after receipt of a dose exceeding 300 rems.

7.29 Because of the increase in the severity of the radiation injury and the variability in response to treatment in the range from 100 to 1,000 rems, it is convenient to subdivide it into three sub-sections, as shown in Figure 7.28. For whole-body exposures from 100 to 200 rems, hospitalization is generally not required, but above 200 rems admission to a hospital is necessary so that the patient may receive such treatment as may be indicated. Up to 600 rems, there is reasonable confidence in the clinical events and appropriate therapy, but for doses in excess of this amount there is considerable uncertainty and variability in response.

7.30 Beyond 1,000 rems, the prospects

of recovery are so poor that therapy may be restricted largely to palliative measures. It is of interest, however, to subdivide this lethal range into two parts in which the characteristic clinical effects are different. Although the dividing line has been somewhat arbitrarily set at 5,000 rems in Figure 7.28, human data are so limited that this dose level might well have any value from 2,000 to 6,000 rems. In the range from 1,000 to (roughly) 5,000 rems, the pathological changes are most marked in the gastrointestinal tract, whereas in the range above 5,000 rems, it is the central nervous system which exhibits the major injury.

7.31 The superposition of radiation effects upon injuries from other causes may be expected to result in an increase in the number of cases of shock. For example, the combination of sublethal nuclear radiation exposure and moderate thermal burns will produce earlier and more severe shock than would the comparable burns alone. The healing of wounds of all kinds will be retarded because of the susceptibility to secondary infection accompanying radiation injury and for other reasons. In fact, infections, which could normally be dealt with by the body, may prove fatal in such cases.

CHARACTERISTICS OF ACUTE WHOLE-BODY RADIATION INJURY

7.32 Single doses in the range of from 25 to 100 rems over the whole body will produce nothing other than blood changes. These changes do not usually occur below this range and are not produced consistently at doses below 50 rems. Disabling sickness does not occur and exposed individuals should be able to proceed with their usual duties. Thus, for

doses of 25 to 100 rems: no illness

7.33 Exposure of the whole body to a radiation dose in the range of 100 to 200 rems will result in a certain amount of illness but it will rarely be fatal. Doses of this magnitude were common in Hiroshima and Nagasaki, particularly among persons who were at some distance from the nuclear explosion. Of the 267 individu-

als accidentally exposed to fallout in the Marshall Islands following the test explosion of March 1, 1954, a group of 64 received radiation doses in this range. It should be pointed out that the exposure of the Marshallese was not strictly of the acute type, since it extended over a period of some 45 hours. More than half the dose, however, was received within 24 hours and the observed effects were similar to those to be expected from an acute exposure of the same amount. Thus, for

doses of 100 to 200 rems : slight or no illness

7.34 The illness from radiation doses in this range does not present a serious problem in that most patients will suffer little more than discomfort and fatigue and others may have no symptoms at all. There may be some nausea and vomiting on the first day or so following irradiation, but subsequently there is a so-called "latent period," up to 2 weeks or more, during which the patient has no disabling illness and can proceed with his regular occupation. The usual symptoms, such as loss of appetite and malaise, may reappear, but if they do, they are mild. The changes in the character of the blood, which accompany radiation injury, become significant during the latent period and persist for some time. If there are no complications, due to other injuries or to infection, there will be recovery in essentially all cases. In general, the more severe the early stages of the radiation sickness, the longer will be the process of recovery. Adequate care and the use of antibiotics, as may be indicated clinically, can greatly expedite complete recovery of the small proportion of more serious cases.

7.35 For doses between 200 and 1,000 rems the probability of survival is good at the lower end of the range but poor at the upper end. The initial symptoms are similar to those common in radiation injury, namely, nausea, vomiting, diarrhea, loss of appetite, and malaise. The larger the dose, the sooner will these symptoms develop, generally during the initial day of the exposure. After the first day or two the symptoms disappear and there may be a latent period of several days to 2 weeks

during which the patient feels relatively well, although important changes are occurring in the blood. Subsequently, there is a return of symptoms, including fever, diarrhea, and a step-like rise in temperature which may be due to accompanying infection. Thus, for

doses of 200 to 1,000 rems : survival possible

7.36 Commencing about 2 or 3 weeks after exposure, there is a tendency to bleed into various organs, and small hemorrhages under the skin (petechiae) are observed. This tendency may be marked. Particularly common are spontaneous bleeding in the mouth and from the lining of the intestinal tract. There may be blood in the urine due to bleeding in the kidney. The hemorrhagic tendency depends mainly upon depletion of the platelets in the blood, resulting in defects in the blood-clotting mechanism. Loss of hair, which is a prominent consequence of radiation exposure, also starts after about 2 weeks, immediately following the latent period, for doses over 300 rems. (See Figure 7.36.)



FIGURE 7.36.—Epilation due to radiation exposure.

7.37 Susceptibility to infection of wounds, burns, and other lesions, can be a serious complicating factor. This would result to a large degree from loss of the white blood cells, and a marked depression in the body's immunological process. For example, ulceration about the lips may commence after the latent period and spread from the mouth through the entire gastrointestinal tract in the terminal stage of the sickness. The multiplication of bacteria, made possible by the decrease in the white cells of the blood and injury to other immune mechanisms of the body, allows an overwhelming infection to develop.

7.38 Among other effects observed in Japan was a tendency toward spontaneous internal bleeding near the end of the first week. At the same time, swelling and inflammation of the throat was not uncommon. The development of severe radiation illness among the Japanese was accompanied by an increase in the body temperature, which was probably due to secondary infection. Generally there was a step-like rise between the fifth and seventh days, sometimes as early as the third day following exposure, and usually continuing until the day of death.

7.39 In addition to fever, the more serious cases exhibited severe emaciation and delirium, and death occurred within 2 to 8 weeks. Examination after death revealed a decrease in size of and degenerative changes in testes and ovaries. Ulceration of the mucous membrane of the large intestine, which is generally indicative of doses of 1,000 rems or more, was also noted in some cases.

7.40 Those patients in Japan who survived for 3 to 4 months, and did not succumb to tuberculosis, lung disease, or other complications, gradually recovered. There was no evidence of permanent loss of hair, and examination of 824 survivors some 3 to 4 years later showed that their blood composition was not significantly different from that of a control group in a city not subjected to nuclear attack.

7.41 Very large doses of whole-body radiation (approximately 5,000 rems or more) result in prompt changes in the central nervous system. The symptoms are hyper-

excitability, ataxia (lack of muscular coordination), respiratory distress, and intermittent stupor. There is almost immediate incapacitation, and death is certain in a few hours to a week or so after the acute exposure. If the dose is in the range from 1,000 to roughly 5,000 rems, it is the gastrointestinal system which exhibits the earliest severe clinical effects. There is the usual vomiting and nausea followed, in more or less rapid succession, by prostration, diarrhea, anorexia (lack of appetite and dislike for food), and fever. As observed after the nuclear detonations in Japan, the diarrhea was frequent and severe in character, being watery at first and tending to become bloody later; however, this may have been related to preexisting disease. Thus, for

large dose (over 1,000 rems): survival improbable

7.42 The sooner the foregoing symptoms of radiation injury develop the sooner is death likely to result. Although there may be no pain during the first few days, patients experience malaise, accompanied by marked depression and fatigue. At the lower end of the dose range, the early stages of the severe radiation illness are followed by a latent period of 2 or 3 days (or more), during which the patient appears to be free from symptoms, although profound changes are taking place in the body, especially in the blood-forming tissues. This period, when it occurs, is followed by a recurrence of the early symptoms, often accompanied by delirium or coma, terminating in death usually within a few days to 2 weeks.

EFFECTS OF RADIATION ON BLOOD CONSTITUENTS

7.43 Among the biological consequences of exposure of the whole body to a single dose of nuclear radiation, perhaps the most striking and characteristic are the changes which take place in the blood and blood-forming organs. Normally, these changes will occur only for doses greater than 25 rems. Much information on the hematological response of human beings to nuclear radiation was obtained after

the nuclear explosions in Japan and also from observations on victims of laboratory accidents. The situation which developed in the Marshall Islands in March 1954, however, provided the opportunity for a very thorough study of the effects of small and moderately large doses of radiation (up to 175 rems) on the blood of human beings. The descriptions given below, which are in general agreement with the results observed in Japan, are based largely on this study.

7.44 One of the most striking hematological changes associated with radiation injury is in the number of white blood cells. Among these cells are the neutrophils, formed chiefly in the bone marrow, which are concerned with resisting bacterial invasion of the body. The number of neutrophils in the blood increases rapidly during the course of certain types of bacterial infection to combat the invading organisms. Loss of ability to meet the bacterial invasion, whether due to radiation or any other injury, is a very grave matter, and bacteria which are normally held in check by the neutrophils can then multiply rapidly, causing serious consequences. There are several types of white blood cells with different specialized functions, but which have in common the general property of resisting infection or removing toxic products from the body, or both.

7.45 After the body has been exposed to radiation in the sub-lethal range, i.e., about 200 rems or less, the total number of white blood cells may show a transitory increase during the first 2 days or so, and then decrease below normal levels. Subsequently the white count may fluctuate and possibly rise above normal on occasions. During the seventh or eighth weeks, the white cell count becomes stabilized at low levels and a minimum probably occurs at about this time. An upward trend is observed in succeeding weeks but complete recovery may require several months or more.

7.46 The neutrophil count parallels the total white blood cell count, so that the initial increase observed in the latter is apparently due to increased mobilization of neutrophils. Complete return of the

number of neutrophils to normal does not occur for several months.

7.47 In contrast to the behavior of the neutrophils, the number of lymphocytes, produced in parts of the lymphatic tissues of the body, e.g., lymph nodes and spleen, shows a sharp drop soon after exposure to radiation. The lymphocyte count continues to remain considerably below normal for several months and recovery may require many months or even years. However, to judge from the observations made in Japan, the lymphocyte count of exposed individuals 3 or 4 years after exposure was not appreciably different from that of unexposed persons.

7.48 A significant hematological change also occurs in the platelets, a constituent of the blood which plays an important role in blood clotting. Unlike the fluctuating total white count, the number of platelets begins to decrease soon after exposure and falls steadily and reaches a minimum at the end of about a month. The decrease in the number of platelets is followed by partial recovery, but a normal count may not be attained for several months or even years after exposure. It is the decrease in the platelet count which partly explains the appearance of hemorrhage and purpura in radiation injury.

7.49 The red blood cell (erythrocyte) count also undergoes a decrease as a result of radiation exposure and hemorrhage, so that symptoms of anemia, e.g., pallor, become apparent. However, the change in the number of erythrocytes is much less striking than that which occurs in the white blood cells and platelets, especially for radiation doses in the range of 200 to 400 rems. Whereas the response in these cells is rapid, the red cell count shows little or no change for several days. Subsequently, there is a decrease which may continue for 2 or 3 weeks, followed by a gradual increase in individuals who survive.

7.50 As an index of severity of radiation exposure, particularly in the sublethal range, the total white cell or neutrophil counts are of limited usefulness because of the wide fluctuations and the fact that several weeks may elapse before the

maximum depression is observed. The lymphocyte count is of more value in this respect, particularly in the low dose range, since depression occurs within a few hours of exposure. However, a marked decrease in the number of lymphocytes is observed even with low doses and there is relatively little difference with large doses.

7.51 The platelet count, on the other hand, appears to exhibit a regular pattern, with the maximum depression being attained at approximately the same time for various exposures in the sublethal range. Furthermore, in this range, the degree of depression from the normal value is roughly proportional to the estimated whole-body dose. It has been suggested, therefore, that the platelet count might serve as a convenient and relatively simple direct method for determining the severity of radiation injury in the sublethal range. The main disadvantage is that an appreciable decrease in the platelet count is not apparent until some time after the exposure.

LATE EFFECTS OF IONIZING RADIATION

7.52 There are a number of consequences of nuclear radiation which may not appear for some years after exposure. Among them, apart from genetic effects, are the formation of cataracts, non-specific life shortening, leukemia, other forms of malignant disease, and retarded development of children in utero at the time of the exposure. Information concerning these late effects has been obtained from continued studies of various types, including those in Japan made chiefly under the direction of the Atomic Bomb Casualty Commission.³

7.53 The Atomic Bomb Casualty Commission was established in 1947 to provide surveys and studies on the delayed effects of the A-bombs. Over 400 reports had been issued by 1973. A nationwide enumeration was made in Japan at the time of the 1950 national census to identify who was in

Hiroshima and Nagasaki at the time of burst. The major Atomic Bomb Casualty Commission studies relate to the survivors who were alive during the initial survey, about five years after the burst. Therefore, the sample excludes the more severely injured who died prior to 1950. These exposed people have been studied, through both a biennial physical examination and after death by an autopsy program. Because of different latent periods the effects of radiation have developed with the years since 1947. For example, in the 1970's, as leukemia decreases, malignant neoplasms (tumors) are rising rapidly, for those exposed in utero or in childhood. Some of the most significant findings from various studies are extracted here in paragraphs 7.54-7.61 from the 1973 technical report of the Atomic Bomb Casualty Commission's report "Radiation Effects on Atomic Bomb Survivors."

GENETIC EFFECTS

7.54 Significant effects of parental exposure to the A-bomb on stillbirth or infant mortality rates, birth weight of child, or on the frequency of congenital malformations have not been detected. The sex ratio (ratio of male to female babies) was expected to decrease if the mother had been irradiated, and to increase with paternal irradiation. An earlier study suggested such a shift, but additional data failed to confirm this hypothesis. No relationship has been observed between parental exposure and the mortality of children. No significant increase in leukemia incidence has been observed in the offspring of persons exposed to A-bomb radiation. A preliminary study of the offspring of A-bomb survivors showed no evidence of radiation effects on chromosomes. Recent studies show white corpuscle damage after 20 years (see 7.61).

RADIATION INJURIES

7.55 Three major symptoms of acute radiation exposure were observed—loss of hair, bleeding, and mouth lesions. Acute radiation symptoms increased from 5% to 10% among those exposed to total dose of

³ The Atomic Bomb Casualty Commission of the U.S. National Academy of Sciences-National Research Council is sponsored by the Atomic Energy Commission and administered in cooperation with the Japanese National Institute of Health. One of its purposes is to study the long-term effects of exposure to nuclear radiation.

50 rem to 50% to 80% of those with about 300 rem exposure, after which the proportion leveled off.

DELAYED EFFECTS ON GROWTH AND DEVELOPMENT

7.56 Head circumference and height were significantly smaller in children in utero whose mothers were exposed and evidenced major radiation symptoms. Consistently smaller head and chest circumferences, weight, standing and sitting heights at ages 14 to 15 years were found among Nagasaki children whose mothers were exposed to high doses. Height, weight and head circumferences at 17 years of age were significantly smaller in the Hiroshima in utero children whose mothers were exposed. Decreased head circumference was most prominent among those in the first trimester of gestation at time of burst (ATB). Body size was smaller and body maturity advanced in the Hiroshima exposed children. Adult height was significantly less among Hiroshima children 0-5 years of age ATB (at time of burst) exposed to high doses. Dose effect declined with increasing age ATB, but adult weight was less regardless of age ATB. Tissue samples from the exposed population suggest accelerated ageing among those exposed. There was no radiation effect on bone growth among those exposed to radiation in utero ATB.

DELAYED EFFECTS OF DISEASE OCCURRENCE

7.57 The first demonstrated delayed effects of the A-bombs were radiation cataracts in about 2¹/₂% of survivors within 1000 meters from ground zero ATB. Cataracts were the only delayed manifestations of ocular injury from the A-bomb. The latent period for subjective disturbances from cataracts appears to have been about two years. Prevalence of mental retardation was high in those exposed in utero less than 1500 meters from ground zero. Mental retardation was more frequent in those exposed between the 6th and 15th weeks of pregnancy, the period of brain development. For in utero children,

the death rate for all causes, especially among infants, increased with intensity of radiation exposure of the mother. However, no increase in mortality from leukemia and other cancers was observed. No relationship between rheumatoid arthritis and radiation dose has been found. A negative finding does not mean that certain effects will not occur later. Abnormalities of the minute surface blood vessels were found in those under 10 years ATB who were exposed to 100 rem or more. Lip and tongue mucous membranes were more frequently affected than were nail fold and eyelids. These findings suggest that A-bomb exposure affected the entire vascular system. There was no evidence of a relationship between the prevalence of cardiovascular diseases and radiation exposure, or between mortality from cardiovascular diseases and radiation.

NEOPLASMS

7.58 There were minor elevations in mortality from causes other than neoplasms (abnormal growth) but, all in all, there was little evidence of radiation effect on other causes of death, including tuberculosis, stroke, and other diseases of the circulatory system. Lung cancer mortality increased with dose. This increase was particularly significant for those exposed at ages 35 years and over ATB. The occurrence of thyroid cancer was higher in women than in men and showed a significant elevation with the increase in dose. For those less than 20 years ATB, no sex difference for thyroid cancer was evident. Salivary gland tumors increased more than five-fold among survivors exposed to high radiation doses compared with the nonirradiated population. The relative risk of breast cancer was significantly higher among the heavily irradiated women. Women who were young at the time of the bomb are now entering the ages of high risk from breast cancer. No relationship has been found to date between radiation dose and prevalence of cancers of the stomach, gall bladder and bile duct, liver, bone, and skin. Mortality from disease was higher among survivors who received large radiation doses than

among those with small doses or those not in the cities. Excessive mortality was especially high for leukemia, where the radiation effect appeared to be present even among those estimated to have received 10-49 rem. Mortality from cancer apart from leukemia was also elevated in survivors with large radiation doses, but could be demonstrated with reliability only among those with doses exceeding 200 rem.

LEUKEMIA

7.59 Leukemia rates in the high dose groups have declined persistently during the period 1950 to 1970, but have not reached the level experienced by the general population. However, death rates for cancer of other sites have increased sharply in recent years. The latent period for radiation induced cancers other than leukemia appears to be 20 years or more. There was increased leukemia with a dose-response relationship with the peak occurring about six years after exposure. The effect was greatest among those exposed during childhood. The lowest dose category with a high frequency of leukemia was 20-49 rem. This effect at 20-49 rem was found in Hiroshima where neutrons constituted a substantial fraction of the total dose. In Nagasaki, exposure to neutrons was very small and no cases of leukemia occurred among survivors exposed to 5-99 rem.

MALIGNANT NEOPLASMS

7.60 After a latent period of about 15 years, children who received radiation doses of 100 rem or more have begun to develop an excessive number of malignant neoplasms. Now, 25 years after exposure, the accumulated increase is most striking, with no evidence that a peak has been reached. During the next 10 years, these persons will be entering ages when cancer incidence ordinarily begins to increase. Forty cases of anemia were confirmed in A-bomb survivors in a 20-year period, but the increase in risk due to radiation exposure was not significant when compared to the population. The prevalence of thyroid

disease increased with dose among Hiroshima females and among those 0-19 years ATB in Nagasaki. An increase in prevalence of miscellaneous eye diseases after radiation exposure was noted, except among females age 50 or more ATB.

OTHER FINDINGS

7.61 No consistent differences have been found by radiation exposure for pregnancy, birth and stillbirth rates, and zero pregnancies. Studies of cultured lymphocytes (white corpuscles) have demonstrated that radiation induced chromosome changes still persist more than 20 years after exposure. Furthermore, their frequency appears to be proportional to the exposure dose. A high proportion of those in utero whose mothers received a dose of at least 100 rem evidenced complex chromosomal abnormalities as compared to the comparison groups. There has been no manifestation of clinical disease associated with chromosomal abnormalities.

EXTERNAL HAZARD: BETA BURNS

7.62 Injury to the body from external sources of beta particles can arise in two general ways. If the beta-particle emitters, e.g., fission products in the fallout, come into actual contact with the skin and remain for an appreciable time, a form of radiation damage, sometimes referred to as "beta burn," will result. In addition, in an area of extensive early fallout, the whole surface of the body will be exposed to beta particles coming from many directions. It is true that clothing will attenuate this radiation to a considerable extent; nevertheless, the whole body could receive a large dose from beta particles which might be significant.

7.63 Valuable information concerning the development and healing of beta burns has been obtained from observations of the Marshall Islanders who were exposed to fallout in March 1954. Within about 5 hours of the burst, radioactive material commenced to fall on some of the islands. Although the fallout was observed as a white powder, consisting largely of particles of lime (calcium oxide) resulting from

the decomposition of coral (calcium carbonate) by heat, the island inhabitants did not realize its significance. Because the weather was hot and damp, the Marshalese remained outdoors; their bodies were moist and they wore relatively little clothing. As a result, appreciable amounts of fission products fell upon their hair and skin and remained there for a considerable time. Moreover, since the islanders, as a rule, did not wear shoes, their bare feet were continually subjected to contamination from fallout on the ground.

7.64 During the first 24 to 48 hours, a number of individuals in the more highly contaminated groups experienced itching and a burning sensation of the skin. These symptoms were less marked among those who were less contaminated with early fallout. Within a day to two all skin symptoms subsided and disappeared, but after the lapse of about 2 to 3 weeks, epilation and skin lesions were apparent on the areas of the body which had been contaminated by fallout particles. There was apparently no erythema, either in the early stages (primary) or later (secondary), as might have been expected, but this may have been obscured by the natural coloration of the skin.

7.65 The first evidence of skin damage was increased pigmentation, in the form of dark colored patches and raised areas (macules, papules, and raised plaques). These lesions developed on the exposed parts of the body not protected by clothing, and occurred usually in the following order: scalp (with epilation), neck, shoulders, depressions in the forearm, feet, limbs, and trunk. Epilation and lesions of the scalp, neck, and foot were most frequently observed (see Figures 7.65a and 7.65b).

7.66 In addition, a bluish-brown pigmentation of the fingernails was very common among the Marshalese and also among American Negroes. The phenomenon appears to be a radiation response peculiar to the dark-skinned races, since it was not apparent in any of the white Americans who were exposed at the same time. The nail pigmentation occurred in a number of individuals who did not have skin lesions. It is probable that this was



FIGURE 7.65a.—Beta burn on neck shortly after exposure.



FIGURE 7.65b.—Beta burn on feet shortly after exposure.

caused by gamma rays, rather than by beta particles, as the same effect has been observed in dark-skinned patients undergoing X-ray treatment in clinical practice.

7.67 Most of the lesions were superficial without blistering. Microscopic examination at 3 to 6 weeks showed that the damage was most marked in the outer layers of the skin (epidermis), whereas damage to the deeper tissue was much less severe. This is consistent with the short range of beta particles in animal tissue. After formation of dry scab, the lesions healed rapidly leaving a central depigmented area, surrounded by an irregular zone of increased pigmentation. Normal



FIGURE 7.68a.—Beta burn on neck after healing.

pigmentation gradually spread outward in the course of a few weeks.

7.68 Individuals who had been more highly contaminated developed deeper lesions, usually on the feet or neck, accompanied by mild burning, itching and pain. These lesions were wet, weeping, and ulcerated, becoming covered by a hard, dry scab; however, the majority healed readily with the regular treatment generally employed for other skin lesions not connected with radiation. Abnormal pigmentation effects persisted for some time, and in sev-



FIGURE 7.68b.—Beta burn on feet after healing.

eral cases about a year elapsed before the normal (darkish) skin coloration was restored (see Figures 7.68a and 7.68b).

7.69 Regrowth of hair, of the usual color (in contrast to the skin pigmentation) and texture, began about 9 weeks after contamination and was complete in 6 months. By the same time, nail discoloration had grown out in all but a few individuals. Seven years later, there were only 10 cases which continued to show any effects of beta burns, and there was no evidence of malignant changes. Blood studies of platelets and red blood cells indicated levels lower than average at 5 years after exposure; at 7 years after exposure the platelets continued to be slightly depressed. It thus appears that repair of bone marrow injury was not complete at this time. In the 1961 examination of the Marshallese people there was a possible indication of bone growth retardation in children who were babies at the time of the explosion.

INTERNAL HAZARD

7.70 Wherever fallout occurs there is a chance that radioactive material will enter the body through the digestive tract (due to the consumption of food and water contaminated with fission products), through the lungs (by breathing air containing fallout particles), or through wounds or abrasions. It should be noted that even a very small quantity of radioactive material present in the body can produce considerable injury. Radiation exposure of various organs and tissues from internal sources is continuous, subject only to depletion of the quantity of active material in the body as a result of physical (radioactive decay) and biological (elimination) processes. Furthermore, internal sources of alpha emitters, e.g., plutonium, or of beta particles, or soft (low-energy) gamma-ray emitters, can dissipate their entire energy within a small, possibly sensitive, volume of body tissue, thus causing considerable damage.

7.71 The situation just described is sometimes aggravated by the fact that certain chemical elements tend to concen-

trate in specific cells or tissues, some of which are highly sensitive to radiation. The fate of a given radioactive element which has entered the blood stream will depend upon its chemical nature. Radiosotopes of an element which is a normal constituent of the body will follow the same metabolic processes as the naturally occurring, inactive (stable) isotopes of the same element. This is the case, for example, with iodine which tends to concentrate in the thyroid gland.

7.72 An element not usually found in the body, except perhaps in minute traces, will behave like one with similar chemical properties that is normally present. Thus, among the absorbed fission products, strontium and barium, which are similar chemically to calcium, are largely deposited in the calcifying tissue of bone. The radioisotopes of the rare earth elements, e.g., cerium, which constitute a considerable proportion of the fission products, and plutonium, which may be present to some extent in the fallout, are also "bone-seekers." Since they are not chemical analogues of calcium, however, they are deposited to a smaller extent and in other parts of the bone than are strontium and barium. Bone-seekers, are, nevertheless, potentially very hazardous because they can injure the sensitive bone marrow where many blood cells are produced. The damage to the blood-forming tissue thus results in a reduction in the number of blood cells and so affects the entire body adversely.

7.73 The extent to which early fallout contamination can get into the blood stream will depend upon two main factors: (1) the size of the particles, and (2) their solubility in the body fluids. Whether the material is subsequently deposited in some specific tissue or not will be determined by the chemical properties of the elements present, as indicated previously. Elements which do not tend to concentrate in a particular part of the body are eliminated fairly rapidly by natural processes.

7.74 The amount of radioactive material absorbed from early fallout by inhalation appears to be relatively small. The

reason is that the nose can filter out almost all particles over 10 microns (0.001 centimeter) in diameter, and about 95 percent of those exceeding 5 microns (0.0005 centimeter). Most of the particles descending in the fallout during the critical period of highest activity, e.g., within 24 hours of the explosion, will be considerably more than 10 microns in diameter. Consequently, only a small proportion of the early fallout particles present in the air will succeed in reaching the lungs. Furthermore, the optimum size for passage from the alveolar (air) space of the lungs to the blood stream is as small as 1 to 2 microns. The probability of entry into the circulating blood of fission products and other weapon residues present in the early fallout, as a result of inhalation, is thus low. Any very small particles reaching the alveolar spaces may be retained there or they may be removed either by physical means, e.g., by coughing, or by the lymphatic system to lymph nodes in the mediastinal (middle chest) area, where they may accumulate.

7.75 The extent of absorption of fission products and other radioactive materials through the intestine is largely dependent upon the solubility of the particles. In the early fallout, the fission products as well as uranium and plutonium are chiefly present as oxides, many oxides of strontium and barium, however, are soluble, so that these elements enter the blood stream more readily and find their way into the bones.⁴ The element iodine is also chiefly present in a soluble form and so it soon enters the blood and is concentrated in the thyroid gland.

7.76 In addition to the tendency of a particular element to be taken up by a specific organ, the main consideration in determining the hazard from a given radioactive isotope inside the body is the total radiation dose delivered while it is in the body (or specific organ). The most important factors in determining this dose are the mass and half-life of the radioisotope, the nature and energy of the radiations emitted, and the length of time it

⁴ Even under these conditions, only about 10 percent of the strontium or barium is actually absorbed.

stays in the body. This time is dependent upon the "biological half-time" which is the time taken for the amount of a particular element in the body to decrease to half of its initial value due to elimination by natural (biological) processes. Combination of the radioactive half life and biological half-time gives rise to the "effective half-life," defined as the time required for the amount of a specified radioactive isotope in the body to fall to half of its original value as a result of both radioactive decay and natural elimination. In most cases of interest, the effective half-life in the body as a whole is essentially the same as that in the principal tissue (or organ) in which the element tends to concentrate. For some isotopes it is difficult to express the behavior in terms of a single effective half-life because of their complicated metabolic mechanisms in the human body.

7.77 The isotopes representing the greatest potential internal hazard are those with relatively short radioactive half-lives and comparatively long biological half-times. A certain mass of an isotope of short radioactive half-life will emit particles at a greater rate than the same mass of another isotope, possibly of the same element, having longer half-life. Moreover the long biological half-time means that the active material will not be readily eliminated from the body by natural processes. For example, the element iodine has a fairly long biological half-time in many individuals. The actual value varies over a wide range, from a few days in some people to many years in others, but on the average it is about 90 days. Iodine is quickly taken up by the thyroid gland from which it is generally eliminated slowly. The radioisotope iodine-131, a fairly common fission product, has a radioactive half-life of only 8 days. Consequently, if a sufficient quantity of this isotope enters the blood stream it is capable of causing serious damage to the thyroid gland, because it remains there during essentially the whole of its radioactive life.

7.78 At short times after a detonation, other radioisotopes of iodine, e.g., iodine

133 and 135, would contribute materially to the total dose to the thyroid gland. However, their radioactive half-lives are measured in hours, and so they decay to insignificant levels within a few days of their formation. It should be mentioned that, apart from immediate injury, any radioactive material that enters the body, even if it has a short effective half-life, may contribute to damage which does not become apparent for some time.

7.79 In addition to radioidine, the most important potentially hazardous fission products, assuming sufficient amounts get into the body, fall into two groups. The first, and more significant, contains strontium 89, strontium 90, cesium 137, and barium 140, whereas the second consists of a group of rare earth and related elements, particularly cerium 144 and the chemically similar yttrium 91.

7.80 Another potentially hazardous element, which may be present to some extent in the early fallout, is plutonium, in the form of the alpha-particle emitting isotope plutonium 239. This isotope has a long radioactive half-life (24,000 years) as well as a long biological half-time (about 200 years). Consequently, once it is deposited in the body, mainly on certain surfaces of the bone, the amount of plutonium present and its activity decrease at a very slow rate. In spite of their short range in the body, the continued action of alpha particles over a period of years can cause significant injury. In sufficient amounts, radium, which is very similar to plutonium in these respects, is known to cause necrosis and tumors of the bone, and anemia resulting in death.

7.81 Experimental evidence indicates that nearly all, if not all, inhaled plutonium deposits in the lungs where a certain portion, less than 10 percent, remains. Some of this is found in the bronchial lymph nodes. For this reason, the primary hazard from inhaled plutonium is to the lungs and bronchial lymph nodes. It is of interest to note that despite the large amounts of radioactive material which may pass through the kidneys in the process of elimination, these organs ordinarily are not greatly affected. By contrast, ura-

nium causes damage to the kidneys, but as a chemical poison rather than because of its radioactivity.

7.82 Early fallout accompanying the nuclear air bursts over Japan was so insignificant that it was not observed. Consequently, no information was available concerning the potentialities of fission products and other weapon residues as internal sources of radiation. Following the incident in the Marshall Islands in March 1954, however, data of great interest were obtained. Because they were not aware of the significance of the fallout, many of the inhabitants ate contaminated food and drank contaminated water from open containers for periods up to 2 days.

7.83 Internal deposition of fission products resulted mainly from ingestion rather than inhalation for, in addition to the reasons given above, the radioactive particles in the air settled out fairly rapidly, but contaminated food, water, and utensils were used all the time. The belief that ingestion was the chief source of internal contamination was supported by the observations on chickens and pigs made soon after the explosion. The gastrointestinal tract, its contents, and the liver were found to be more highly contaminated than lung tissue.

7.84 From radiochemical analysis of the urine of the Marshallese subjected to the early fallout, it was possible to estimate the body burden, i.e., the amounts deposited in the tissues, of various isotopes. It was found that iodine 131 made the major contribution to the activity at the beginning, but it soon disappeared because of its relatively short radioactive half-life (8 days). Somewhat the same was true for barium 140 (12.8 days half-life), but the activity levels of the strontium isotopes were more persistent. Not only do these isotopes have longer radioactive half-lives, but the biological half-time of the element is also relatively long.

7.85 No elements other than iodine, strontium, barium, and the rare earth group were found to be retained in appreciable amounts in the body. Essentially all other fission product and weapon residue activities were rapidly eliminated, because

of either the short effective half-lives of the radioisotopes, the sparing solubility of the oxides, or the relatively large size of the fallout particles.

7.86 The body burden of radioactive material among the more highly contaminated inhabitants of the Marshall Islands was never very large and it decreased fairly rapidly in the course of 2 or 3 months. The activity of the strontium isotopes fell off somewhat more slowly than that of the other radioisotopes, because of the longer radioactive half-lives and greater retention in the bone. Nevertheless, even strontium could not be regarded as a dangerous source of internal radiation in the cases studied. At 6 months after the explosion, the urine of most individuals contained only barely detectable quantities of radioactive material.

7.87 The most heavily exposed group, some 64 Marshallese inhabitants of Rongelap atoll, received an estimated 175 rem whole-body dose before being evacuated. While internal contamination was of concern in 1954, the consensus of the scientists and medical people was that internal burdens of radionuclides were not likely to produce injury, even in the heavily exposed group. All early symptoms were due to whole-body exposure doses and to skin-deposited fallout particles. Based on analysis of urine samples, it was accepted that the Marshall Island people were fully recovered from their accidental exposure to thermonuclear fallout in 1954.

7.88 In 1963 a thyroid nodule was discovered during routine examination of a 12-year-old-girl, and in the following years additional cases were discovered during the annual medical surveys. By 1969, 15 of the 19 children who had been under 10 years of age at the time of exposure had developed thyroid nodules, and another two had severe atrophy of the thyroid gland. The method of treatment of all 15 nodule cases was either partial or total removal of the thyroid gland.

7.89 No children in the less heavily exposed group, with whole-body doses up to about 70 rem, have developed thyroid nodules to date. Adults in the Rongelap group have developed thyroid nodules, but the

rate of incidence has been less than $\frac{1}{10}$ the rate for children.

7.90 It seems clear that the course* of the thyroid abnormalities was beta irradiation by the radioiodines concentrated in the thyroid gland after ingestion and/or inhalation. It is likely there is more trouble ahead over the years for the Marshall Islanders, both adults who were heavily exposed and those who were children in the 70 rem exposure group. It is thought the latency period for neoplasms is inversely related to dose. This theoretical rule of latency may explain the bunching of thyroid effects from 9 to 14 years after exposure.

7.91 The experience of the Marshallese children illustrates one combination of conditions leading to a serious radioiodine threat in nuclear warfare. The children were exposed, for the first two days, to all of the radiological effects of the fallout field, estimated to be 100 R/hr at 1 hour after detonation. They received whole-body exposure of about 175 rem. The air they breathed, during and after fallout deposition was unfiltered. They ate contaminated food and drank contaminated water.

7.92 Had the exposure at Rongelap been even a factor of three higher, more than half of the exposed people would have died within a month from the whole-body gamma radiation exposure. Studies indicate that in a nuclear attack against the U.S., exposure could be a factor of 30 or higher than at Rongelap in some areas. Fallout shelters having a protection factor of forty would be necessary to limit the shelter period whole-body exposure to 175 rem, i.e., the dose that the people at Rongelap received.

7.93 Protection against the threat of inhaled and ingested iodines could be provided if (1) only filtered air were breathed, and (2) only preattack-stored food and water were consumed for 30-40 days or 4-5 I^{131} half-lives. Since vapor filters are not provided in fallout shelters, any radioiodine in the gaseous state would reach the

shelterees; particles stopped by particle filters could still release their radioiodine into the ventilation system. Although it is not possible to predict, even within order of magnitude, the thyroid doses that could be caused by inhalation of fallout radioiodines, the threat of inhaled radioiodines is real. Fortunately, this threat is likely to affect only small areas of the country and it can be countered safely and inexpensively by the timely administration of stable "blocking" iodine to reduce the thyroid uptake of radioiodines. In general, the uptake of radioiodines by inhalation is believed to be minor compared to that from ingestion.

WHOLE-BODY EXPOSURE

7.94 There is agreement among most authorities that a single whole-body exposure of 200 R will not affect the average adult to the extent that he is incapable of performing his ordinary activities. In fact, whole-body exposures of 200-300 R have been given to many patients with advanced cancer without any manifest harmful effect on their physical condition. Changes in the blood count occurred, as was expected, but these were not sufficient to require medical treatments. The Marshall Islanders who had the largest exposure to fallout, received about 175 R over a period of 36 hours. In this group, which included people of all ages, the only evidence of acute radiation sickness was vomiting on the day fallout occurred (about 10 percent reported this symptom) and changes in the white blood cell count and platelet count several weeks later. There is also general agreement that a single whole-body exposure of 200 R or less should not cause radiation sickness severe enough to require medical care in the majority (9 out of 10) of healthy adults.

7.95 The expected results of various radiation exposures, if received over various periods of time, are shown in the following figure (Figure 7.95). (This figure is tentative; it may be modified as a result of recommendations currently being developed by the National Council of Radiation Protection and Measurements. The numbers, however, are believed to be realistic.)

*Final Report, Inhalation of Radioiodine from Fallout: Hazards and Countermeasures, Defense Civil Preparedness Agency, Washington, D.C. 20301, August 1972, Number 2380.

Roentgen Exposure in Any	1 Week	1 Month	4 Months
Acute Effects			
Medical Care Not Needed	150	200	300
Some Need Medical Care Few if Any Deaths	250	350	500
Most Need Medical Care 50% + Deaths	450	600	*

*Little or no practical consideration.

FIGURE 7.95'.—Radiation Exposure Doses.

7.96 To illustrate use of the figure, most people receiving no more than a total of 150 R during a time interval less than a week (1 hour, 1 day, 3 days, for instance) are not expected to need medical care nor to become ineffective in work performance. Also, people receiving more than 500 R during one month will need medical care, and 50% or more may die.

7.97 This "penalty figure" is intended for use by civil preparedness officials during a war emergency to provide them a simple and straightforward basis for taking into account the radiological elements of the problem. For example, replenishment of a shelter's inadequate water supply might be justified if a small crew could do so, and if each member's total week's exposure could be kept to less than 150 R, or the month's exposure less than 200 R.

7.98 It is known that radiation increases the chances of genetic damage and

other long-term effects. These effects are comparatively minor. In a war emergency, first minimize the number of deaths and second, keep the number of people for whom medical care is needed as small as possible. When circumstances permit, preferred consideration should be given to children and adults still capable of procreation. As conditions permit, emergency measures should be terminated and normal standards reinstated.

REFERENCES

The Effects of Nuclear Weapons.—Glasstone, Samuel, 1964.

DCPA Attack Environment Manual.

Radiation Effects on Atomic Bomb Survivors.—Technical Report 6-73, Atomic Bomb Casualty Commission, 1973.

Final Report-Inhalation of Radioiodine from Fallout: Hazards and Countermeasures.—DCPA, 1972, No. 2380.

¹Taken from DCPA Attack Environment Manual, Chapter 1.

EXPOSURE AND EXPOSURE RATE CALCULATIONS

Up to this point we have learned that the effects of radiation exposure are important and we have seen what the medical consequences are for exposures over different periods of time. We need a means of calculation that will assist us in meeting guidelines established for emergency workers. Tall order? Complicated mathematics? Not at all. At least not at the end of this chapter because by then we will have learned:

- HOW to determine exposure and exposure rates
- HOW to predict future exposure and exposure rates
- WHEN can someone leave shelter and for how long
- WHY prediction and measurement are possible

INTRODUCTION

8.1 In chapter 6 we saw that fallout arrives at particular locations with respect to ground zero at various times after burst, depending on such factors as distance, meteorological conditions, etc.

8.2 It was also shown that radioactive contamination from fallout could deny the use of considerable areas for an appreciable period of time. Thus, even without the material destruction from blast or thermal radiation, many areas, facilities and equipment could not be used or occupied for some time without extreme danger.

8.3 In deciding what protective measures should be taken, including survey monitoring operations in an area contaminated with fallout, it is necessary:

1. To make some estimate of the permissible *time of stay* for a prescribed exposure, or
2. To determine the exposure that would be received in a *certain time period*.
3. To determine an "entry time" for a prescribed exposure and a prescribed stay time.

8.4 If the radiation exposure rate from the fission products produced by a single weapon is known at a certain time in a given location, this knowledge may be used to estimate the exposure rate at any other time at the *same* location assuming that there has been no externally produced change in the fallout (i.e., from additional contamination or by decontamination). In any such calculation, the concept of **RADIOACTIVE DECAY IS VERY IMPORTANT.**

DECAY OF FISSION PRODUCTS

8.5 As we saw in Chapter 2, each radioisotope has a characteristic decay scheme (*half-life*). These range from a few millionths of a second to millions of years. When a number of different radioisotopes are present—in this case the fission products of the bomb (fallout)—no one half-life applies for the composite. For the fission products, the short-lived radioisotopes predominate in the period immediately following the burst. Since their half-lives (decay rates) are so short (rapid), the radiation level falls off quickly after the detonation. And as these short-lived radioisotopes expend themselves through decay, the longer half-life isotopes form an increasing proportion of the fission products and the *rate of decay* of the fission products *decreases*. Because of this pattern of decay, the material deposited on the ground at increasing times after the burst will be *less and less radioactive*.

8.6 In calculating the radiation exposure (or exposure rate) due to fallout from fission products, the gamma rays (because of their long range and penetrating power) are of greater significance than the beta particles, provided of course that the radioactive material is not actually in contact with the skin or inside the body.

8.7 Even though there are different proportions of gamma ray emitters among the radioisotopes in fallout at different periods of time, the fact that there is a pattern of decay does permit the development through estimates or calculations of levels of exposure and exposure rate at certain times after a detonation and, in fact, permits prediction of exposure and exposure rate with a fair degree of accuracy. There are various ways of coming up with these estimates or calculations, some employing a rule of thumb, some employing mathematical formulae, and others employing graphic presentations (nomograms).

NOTE

No computation of exposure or exposure rate should be made until they begin to decrease. You SHOULD NOT CALCULATE EXPOSURE RATES WHILE THEY ARE INCREASING. Further, calculation is no substitute for accurate instrument readings.

THE 7:10 RULE OF THUMB

8.8 After exposure rates have begun to decrease, you can get a rough idea of future rates by using the 7:10 rule. Simply stated, this rule is that for every seven-fold increase in time after detonation, there is a ten-fold decrease in exposure rate. Figure 8.8 demonstrates this rule of thumb.

8.9 Therefore, we see that, through use of this rule of thumb, if a 50 R/hr radiation exposure rate exists at three hours after detonation, by the end of 21 hours it will have decreased to 5 R/hr, and by the end of 147 hours it will have decreased to 0.5 R/hr.

TIME (H)	DECAY	RADIATION INTENSITY
1	—	1000 R/hr
7	1/10	100 R/hr
49	1/100	10 R/hr
343	1/1000	1 R/hr

FIGURE 8.8.—The 7:10 rule of thumb for rate of decay.

STANDARD DECAY— THE EXPOSURE RATE FORMULA

8.10 The following formula is used in calculating exposure rates:

$$R_1 = R T^n$$

8.11 In this equation:

R = rate at a specific time (T)

R_1 = rate one hour after detonation
(H + 1)

T = time (hours) after detonation

n = 1.2 (fallout decay exponent)

NOTE

When n is equal to 1.2 the situation is referred to as standard decay. When n assumes other values nonstandard decay conditions exist.

STANDARD DECAY—AN EXPOSURE RATE PROBLEM

8.12 If the exposure rate at a given location one hour after detonation was 30 R/hr, what would the rate be at this location 12 hours after detonation?

SOLUTION

$$R_1 = 30 \text{ R/hr}$$

$$R = ?$$

$$T = 12 \text{ hours}$$

$$n = 1.2$$

Substitute values in the above formula:

$$R_1 = RT^n$$

$$30 = R(12)^{1.2}$$

$$30 = R (19.74)^*$$

$$R = \frac{30}{19.73} = 1.52 \text{ R/hr}$$

* From Figure 8.14 $(12)^{-1.2} = 19.73$

$$E = \frac{50}{1.2 - 1} (5^{1-1.2} - 15^{1-1.2})$$

$$E = \frac{50}{.2} (5^{-0.2} - 15^{-0.2})$$

$$E = 250 (0.725 - 0.582)**$$

$$E = (250) (0.143)$$

$$E = 36 \text{ R}$$

**From Figure 8.14 $5^{-0.2} = 0.725$ and $15^{-0.2} = 0.582$

STANDARD DECAY—THE EXPOSURE FORMULA

8.13 The following formula is used in calculating exposure.

$$E = \frac{R_1}{n - 1} (T_1^{1-n} - T_2^{1-n})$$

8.14 In this equation:

E = exposure from time T_1 to T_2

R_1 = exposure rate one hour after detonation ($H + 1$)

T_1 = time of entry

T_2 = time of exit

n = 1.2 (fallout decay exponent)

8.15 As an aid in using either formula presented above, Figure 8.14 gives the computed values of $T^{1.2}$ and $T^{-0.2}$ for various selected values of T .

STANDARD DECAY—AN EXPOSURE PROBLEM

8.16 What exposure would a monitoring team receive in a radioactive contaminated area if the team entered the area 5 hours after a nuclear burst and stayed for a period of 10 hours? The exposure rate at $H + 1$ was 50 R/hr.

SOLUTION

$$E = ?$$

$$R_1 = 50 \text{ R/hr}$$

$$T_1 = 5 \text{ hours}$$

$$T_2 = 5 + 10 = 15 \text{ hours}$$

$$n = 1.2$$

Substitute values in the above formula:

$$E = \frac{R_1}{n - 1} (T_1^{1-n} - T_2^{1-n})$$

STANDARD DECAY—EXPOSURE RATE NOMOGRAM

8.17 If, of the factors (1) time after detonation, (2) exposure rate at $H + 1$, and (3) exposure rate at a particular time, we know any two, then the other one can be found by using a nomogram developed specifically for exposure rate calculations. (You will recognize these factors as coming from the formula of paragraph 8.10, namely, $R_1 = RT^n$). The nomogram appears as Figure 8.17 and is based upon the standard fallout decay exponent of 1.2.

8.18 To use the exposure rate nomogram shown in Figure 8.17, connect any two known quantities with a straightedge and read the unknown quantity directly.

STANDARD DECAY—AN EXPOSURE RATE NOMOGRAM PROBLEM

8.19 If the exposure rate in an area is 60 R/hr at $H + 5$, what will be the rate at $H + 10$?

8.20 Solution: With a straightedge, connect 60 R/hr on the "Exposure Rate at $H + T$ " column with 5 hours on the "Time After Burst" column. The rate of 410 R/hr is read on the "Exposure Rate at $H + 1$ " column. Next, connect, with the straightedge, 10 hours on the "Time After Burst" column with 410 R/hr on the "Exposure Rate at $H + 1$ " column and read the answer directly from the "Exposure Rate at $H + T$ " column.

Answer: 26 R/hr.

T = TIME IN HOURS	T ^{1/2}	T ^{-0.2}	T = TIME IN HOURS	T ^{1/2}	T ^{-0.2}	T = TIME IN HOURS	T ^{1/2}	T ^{-0.2}	T = TIME IN HOURS	T ^{1/2}	T ^{-0.2}
0.1	0.0631	1.586	19.0	34.23	0.555	48.0	104.1	0.461			
0.2	0.1450	1.381	20.0	36.41	0.550	49.0	106.7	0.459			
0.3	0.2358	1.273	21.0	38.61	0.544	50.0	109.3	0.457			
0.4	0.3330	1.202	22.0	40.82	0.539	55.0	122.6	0.449			
0.5	0.4352	1.149	23.0	43.06	0.534	60.0	136.1	0.441			
0.6	0.5417	1.110	24.0	45.31	0.530	65.0	149.8	0.434			
0.7	0.6518	1.074	25.0	47.59	0.525	70.0	163.7	0.427			
0.8	0.7651	1.046	26.0	49.89	0.521	72.0	169.4	0.425			
0.9	0.8812	1.021	27.0	52.20	0.518	75.0	177.8	0.422			
1.0	1.000	1.000	28.0	54.52	0.514	80.0	192.2	0.417			
1.5	1.627	0.922	29.0	56.87	0.510	85.0	206.7	0.412			
2.0	2.300	0.871	30.0	59.23	0.506	90.0	211.1	0.407			
2.5	3.003	0.833	31.0	61.61	0.503	95.0	236.2	0.402			
3.0	3.737	0.803	32.0	64.00	0.500	96.0	239.2	0.401			
4.0	5.278	0.758	33.0	66.41	0.497	100.0	251.2	0.398			
5.0	6.899	0.725	34.0	68.83	0.494	120.0	312.6	0.384			
6.0	8.586	0.698	35.0	71.27	0.491	140.0	376.2	0.372			
7.0	10.33	0.678	36.0	73.72	0.488	144.0	389.1	0.370			
8.0	12.13	0.660	37.0	76.18	0.486	160.0	442.5	0.362			
9.0	13.96	0.644	38.0	78.66	0.483	168.0 (1 wk)	468.1	0.360			
10.0	15.85	0.631	39.0	81.15	0.480	180.0	508.5	0.354			
11.0	17.77	0.619	40.0	83.67	0.478	220.0	577.1	0.347			
12.0	19.73	0.608	41.0	86.17	0.476	250.0	754.3	0.332			
13.0	21.71	0.599	42.0	88.70	0.474	300.0	938.7	0.319			
14.0	23.74	0.590	43.0	91.23	0.472	336.0 (2 wk)	1075.0	0.313			
15.0	25.78	0.582	44.0	93.79	0.470	504.0 (3 wk)	1745.0	0.288			
16.0	27.86	0.574	45.0	96.35	0.467	672.0 (4 wk)	2471.0	0.272			
17.0	29.96	0.567	46.0	98.93	0.465	720.0 (1 Mo.)	2611.0	0.268			
18.0	32.09	0.560	47.0	101.5	0.463	1440.0 (2 Mo.)	6166.0	0.234			
						2160.0 (3 Mo.)	10031.0	0.216			

FIGURE 8.14.— $T^{1/2}$ and $T^{-0.2}$ for selected values of T .

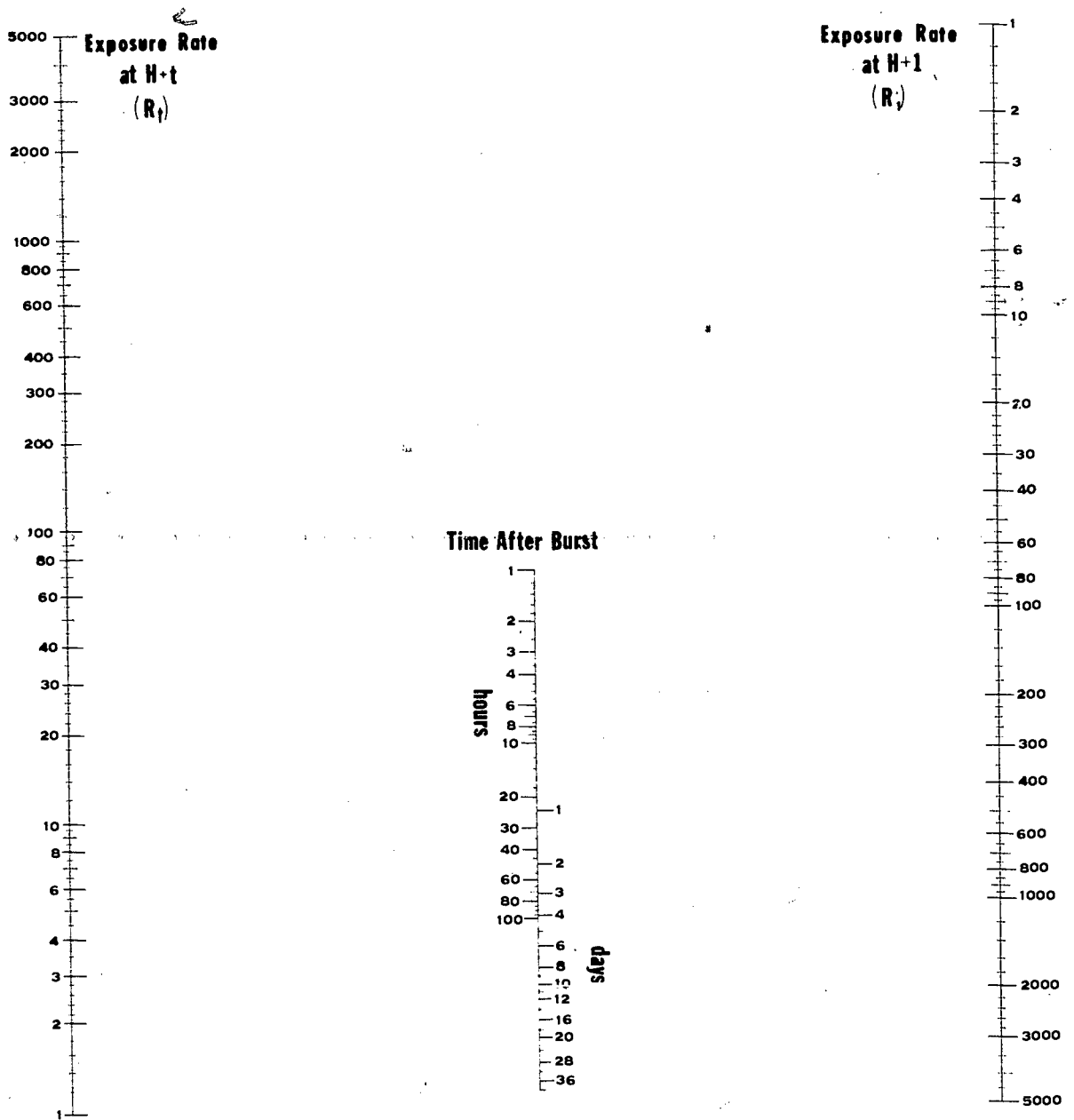

FIGURE 8.17.—Exposure rate nomogram.

STANDARD DECAY—ENTRY TIME—STAY TIME—TOTAL EXPOSURE NOMOGRAM

8.21 Just as it is possible to develop a nomogram for exposure rates and time through the use of the exposure rate formula and standard fallout decay exponent of 1.2, so can we produce a nomogram for the exposure formula.

8.22 This nomogram is found in Figure 8.22.

8.23 To use this nomogram, connect two known quantities with a straightedge and locate the point on the "E/R₁" column where the straightedge crosses it. Connect this point with a third known quantity and read the answer from the appropriate column.

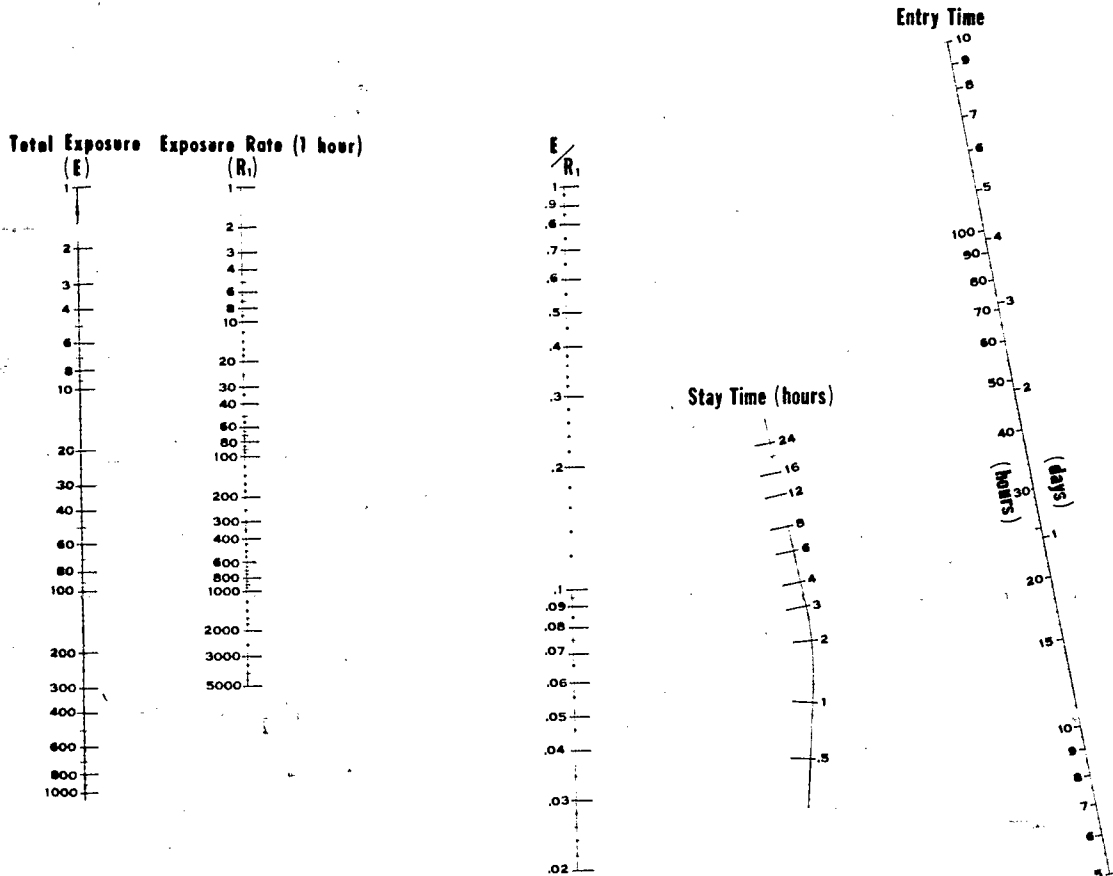

FIGURE 8.22.—Entry time-stay total-exposure nomogram.

STANDARD DECAY—AN ENTRY TIME NOMOGRAM PROBLEM

8.24 The exposure rate in an area at H + 7 is 35 R/hr. The stay time is to be 5 hours and the mission exposure is set at 35 R. What is the earliest possible entry time?

8.25 Solution: Find the exposure rate at H + 1 from the Exposure Rate Nomogram (Figure 8.17). Connect this value on the "Exposure Rate at H + 1" column with 35 R on the "Total Exposure" column and read 0.1 on the "E/R₁" column. Connect 0.1 on the "E/R₁" column with 5 hours on "Stay Time" column and read the answer from the "Entry Time" column.

Answer: H + 24.

STANDARD DECAY—A STAY TIME NOMOGRAM PROBLEM

8.26 Entry into an area with an expo-

sure rate of 100 R/hr at H + 1 will be made at H + 6. What will be the maximum mission stay time, if the exposure is not to exceed 20 R?

8.27 Solution: Connect 20 R in the "Total Exposure" column with 100 R/hr in the "Exposure Rate at H + 1" column and read 0.2 in the "E/R₁" column. Connect 0.2 in the "E/R₁" column with 6 hours in the "Entry Time" column, and read the answer directly from the "Stay Time" column.

Answer: 2.1 hours.

STANDARD DECAY—AN EXPOSURE NOMOGRAM PROBLEM

8.28 Find the total exposure for an individual who must work in an area in which the exposure rate was 300 R/hr at H + 1. Entry will be made at H + 11 and the length of stay will be 4 hours.

8.29 Solution: Connect H +11 on the "Entry Time" column with 4 hours on the "Stay Time" column and read 0.19 from the "E/R," column. Connect 0.19 in the "E/R," column with 300 R/hr on the "Exposure Rate at H +1" column and read the answer from the "Total Exposure" column.

Answer: 60 R.

WHAT METHOD SHOULD MONITORS USE?

8.30 Nomograms, based on theoretical fallout radiation decay characteristics, should be used by monitors when it is necessary for them to make rough estimates of future exposure rates and exposures that might be expected in performing necessary tasks outside the shelter. However, when fallout from several nuclear weapons, detonated more than 24 hours apart is deposited in an area, the decay rate may differ markedly from the assumed decay rate. For this reason, calculations using nomograms should be limited as follows:

- a. The time of detonation must be known with a reasonable degree of accuracy—plus or minus one hour for forecasts made within the first twelve hours, and plus or minus 2-3 hours for later forecasts.
- b. If nuclear detonations occur more than 24 hours apart, predicted rates may be considerably in error. In this case, use the H hour of the latest detonation to compute "Time After Burst".
- c. At the time of calculation, exposure rates must have been decreasing for at least 2-3 hours, and forecasts should be made for periods no farther in the future than the length of time the radiation levels have been observed to decrease.

8.31 Have we covered the subject of exposure and exposure rate calculations? That question prompts another question. What level of the RADEF organization are we talking about? Monitors? In that case, yes, we have covered exposure and

exposure rate calculations. How about the RADEF Officer? Have we taken care of him yet? You'll find *that* answer below.

AN OPEN LETTER TO RADEF OFFICERS

We have arrived at the point where you will have to bear down hard. This is the point at which your own professional-type RADEF knowledge makes its departure from the standard RADEF know-how that will be shared by so many members of your RADEF organization.

The following paragraphs are not impossible but then neither are they easy. If you miss a point, go back and reread it because the basic material is really here. You will probably notice, here and there, some repetition over the preceding paragraphs but it is intended as an aid to better understanding.

We will begin with * * *

A REVIEW OF RADIOACTIVE DECAY

8.32 Each radioactive isotope has a characteristic half-life. These range from a few millionths of a second to millions of years. However, when many radioisotopes contribute to the exposure rate, as in the case of the fission products from a nuclear weapon, no one half-life applies for the composite. With fission products there is a predominance of short-lived radioisotopes in the period immediately following the burst; hence the exposure rate decreases very rapidly. As these short-lived radioisotopes expend themselves, the longer half-life isotopes become dominant and the decay rate of the fission products decreases.

8.33 We know that radioactive decay of the fission products can be estimated using the general equation $R_1 = RT^n$ where R_1 equals the exposure rate at unit time, R equals the exposure rate at any time T measured from the time of burst, and n is the fallout decay exponent. Time may be measured in any units—minutes, hours, days, weeks, etc., provided unit time and T are expressed in the same units.

STANDARD DECAY—A WORD ABOUT THE EXPONENT (1.2)

8.34 Attempts to fit observed decay of

fallout from actual tests with a general equation of the form $R_1 = RT^n$ have required values of n ranging from about 0.9 to 2.2. We have learned that attempts to predict the decay of actual fallout fields on the basis of any given decay law (i.e., assuming some constant value for n) are almost certain to be grossly inaccurate. The value of n will vary with bomb design, the amount and type of neutron-induced activity, fractionation, and in a particular area, with weathering and decontamination.

8.35 For planning purposes, a value of $n = 1.2$ is frequently used and, for planning, this value is quite satisfactory. However, accurate information of exposure rates and rates of decay must depend on repeated monitoring under the same conditions at the same locations.

PLOTTING THE EXPOSURE RATE HISTORY

8.36 Since the fallout at any location may consist of radioactive material from several different weapons detonated at materially different times, it will be impractical to keep track of the individual contributions and ages of each set of fission products comprising the fallout. The most practical method of forecasting exposure rates under these conditions appears to be based upon the technique of plotting observed rates versus time after detonation on log-log paper and extrapolating the plotted curve.

8.37 Plots of this type for two or three representative points across a community will generally be adequate. If the requirement exceeds this, it may be advantageous to compute the value of the fallout decay exponent n and use the general equation $R_1 = RT^n$ to predict future exposure rates in areas where the fission product composition is the same.

8.38 $R_1 = R_x T_x^n$ and $R_1 = R_y T_y^n$ etc. The most useful form of the general equation will probably be $R_x T_x^n = R_y T_y^n$. Application of this formula is discussed in a later paragraph (8.55).

8.39 The procedure for plotting observed exposure rates is as follows. From NUDET (report of time of detonation) re-

ports or simply from observations of the flash, the blast wave, or the cloud of the detonation, the time of burst of most weapons within a radius of 100 to 200 miles will be known. Thus, the RADEF Officer will know the time of formation of most of the fission products in his immediate area and from the current "DF" report he will generally know which specific detonation is causing the major fallout problem in his community.

8.40 The RADEF Officer can then plot or direct the plotting of observed exposure rates against time on log-log paper. Future rates can be estimated by projecting the curve to future times of concern.

8.41 *However, as a practical limit, forecasts of future exposure rates generally should be made for periods no farther in the future than the length of time exposure rates have been observed to decrease.*

8.42 For example, if exposure rate observations have been decreasing for the preceding 12 hours, they will be plotted and, provided the plot for the last few hours approximates a straight line, the curve can be extrapolated (extended) for 12 additional hours to forecast the rates during that time period. Caution must be exercised in extrapolating the curve during periods of fluctuation.

8.43 If, after a period during which the logarithmic decay is approximately a straight line, the rate is observed to materially increase—this indicates the arrival of significant additional fallout. If the exposure rate appears to be equal to or less than the *maximum* exposure rate from earlier fallout, continue the original plot based on the "H hour" of the original fallout.

8.44 However, if considerable time has elapsed since arrival of the first fallout, and the increase in exposure rate equals or exceeds the maximum exposure rate from earlier fallout, plot a new graph using the estimated H hour of the latest fallout as the reference time.

8.45 After the plot indicates an orderly decrease (nearly a straight line log-log plot), extrapolation of the curve can again provide a reasonable basis for estimating

exposure rates for future periods subject to the above-mentioned restriction.

8.46 It should be emphasized that the actual exposure rate may vary considerably from the forecast rate. Thus, operations likely to require high radiation exposures should be carried out on the basis of observed rates, *not* forecast rates. The forecast is simply a guide to aid a local coordinator in planning his forthcoming survival and recovery operations.

8.47 A forecast exposure rate could be considerably in error if additional fallout occurred after the forecast was made or if the rate of decay changed materially from that indicated by the plots on the log-log graph.

8.48 The latest fallout analysis, based upon current exposure rate reports, should be the basis for current operations. Plans for future operations should be based upon the current fallout analysis, modified according to the forecast from a log-log plot.

A PRACTICAL EXAMPLE

8.49 The following exercise presents a hypothetical situation in which we will predict future exposure rates from a series of radiological reports. (The curve which will be used does *not* necessarily represent a fallout decay curve which might be expected in an actual situation.)

8.50 We are given certain data as follows:

Time after burst (Hours)	Exposure rate (R/hr)	Time after burst (Hours)	Exposure rate (R/hr)
1	0	18	380
2	0	20	390
3	1	22	410
4	23	24	415
5	250	26	410
6	270	28	405
7	280	30	400
8	285	36	325
9	285	42	280
10	770	48	240
12	640	54	210
14	540	60	185
16	460		

1. First, we plot the data as indicated by the arrows in Figure 8.50a.
2. Next, we draw a smooth curve through the plotted points as shown in Figure 8.50b.
3. Now, in order to forecast the exposure rate at H + 80 and H + 90, we extend the curve to 90 hours as a *dotted* line. This is shown in Figure 8.50c.
4. Assume that we now receive additional monitored data as follows:

Time after burst (hours)	Exposure rate (R/hr)	Time after burst (hours)	Exposure rate (R/hr)
70	155	100	103
80	131	110	91
90	115	120	83

5. We plot the additional data.
6. Then we draw a smooth curve through these additional points as shown in Figure 8.50d. Notice the comparison between the forecast exposure rates and the actual up-dated plot.

8.51 The fallout decay exponent n may be computed directly from the plotted exposure rate curve since n is numerically equal to the slope of the curve. Further, n is constant only when the plotted line is straight. We can determine n from the graph by dividing the *measured* distance ΔY in inches by the *measured* distance ΔX in inches as indicated in Figure 8.50e.

8.52 Looking at Figure 8.50e, let's determine n at H + 110. We see that ΔY and ΔX are the vertical and horizontal distances, respectively, covered by the curve in the area of our interest. we *measure* these distances in inches, divide ΔY by ΔX , and find that n at H + 110 is equal to 1.1.

8.53 Now, if practical, n can be used to forecast exposure rates as indicated in the following example. (A table of logarithms and a brief explanation of their use is included as Figures 8.53a and 8.53b.)

8.54 Before working out our example, go back and reread paragraph 8.38. You will find it helpful in solving the example.

8.55 Now for the sample problem in

exposure rate forecasting using a computed value of n . The exposure rate at

$H + 4$ days is 108 R/hr; if $n = 1.1$, predict the rate at $H + 8$ days.

$$R_x = 108 \text{ R/hr} \quad R_x T_x^n = R_y T_y^n$$

$$T_x = 4 \text{ days} \quad (108)(4)^{1.1} = (R_y)(8)^{1.1}$$

$$R_y = ? \quad \log 108 + 1.1 \log 4 = \log R_y + 1.1 \log 8$$

$$T_y = 8 \text{ days} \quad (2.0334) + 1.1 (.6021) = \log R_y + 1.1 (.9031)$$

$$n = 1.1 \quad \log R_y = 2.0334 + 0.6623 - 0.9934 = 1.7023$$

Answer: $R_y = 50$ R/hr.

EXPOSURE CALCULATION FROM AN EXPOSURE RATE HISTORY CURVE

8.56 DCPA recommended radiological defense reporting procedures provide for accumulated exposure reports each day from fallout monitoring stations for the first six days following an attack. These reports will be based on dosimeter measurements, which are the simplest means of determining exposures. Dosimeters integrate the exposure over a period of time and account directly for the decrease in exposure rates due to decay.

8.57 However, there may be instances when the RADEF Officer must estimate exposure from a series of exposure rate measurements. The following paragraphs will provide a quick and easy method of estimating such exposures.

8.58 It is relatively simple to forecast exposure rates and, consequently, total exposure of individuals when the fallout decay exponent remains constant over long periods of time. These estimates, however, are normally made only after fallout is complete.

8.59 If we are concerned with estimating the total exposure for the periods (1) of fallout deposition, (2) when the value of the fallout decay exponent is changing rapidly, or (3) when fallout from several detonations contributes to the exposure rate, calculation of these estimates becomes more complex.

8.60 A satisfactory estimate of total exposure can be obtained by plotting exposure rates versus time after detonation and determining total exposures from the graph.

8.61 First, divide the exposure period into small increments. When the slope of the curve is changing rapidly, the increments should be small. When the slope is relatively straight over the exposure period, the increments may be larger. *The increments need not be equal in size.*

8.62 As a general rule, an increment should not exceed one-half of the time from detonation to the beginning of the increment. For example, if the increments begins at $H + 10$, it should not be larger than 5 hours. However, if the slope of the curve changes appreciably during this time, it may be necessary to use even smaller increments. During the initial periods of fallout deposition, the increments should be no larger than 1 hour.

8.63 Now look at Figure 8.63 to see how a sample exposure period is broken into increments.

8.64 Next, we determine the average exposure rate within each increment and multiply this by the elapsed time. This will give us the exposure for each increment and the sum of these exposures will give us the total exposure for the period. The calculations involved are presented below.

Increment	Average exposure rate	Average exposure rate × elapsed time = exposure
A -----	$(100+80) \div 2 = 90$	$90 \times 2 = 180$
B -----	$(80+50) \div 2 = 65$	$65 \times 3 = 195$
C -----	$(50+30) \div 2 = 40$	$40 \times 5 = 200$

Total 575 R

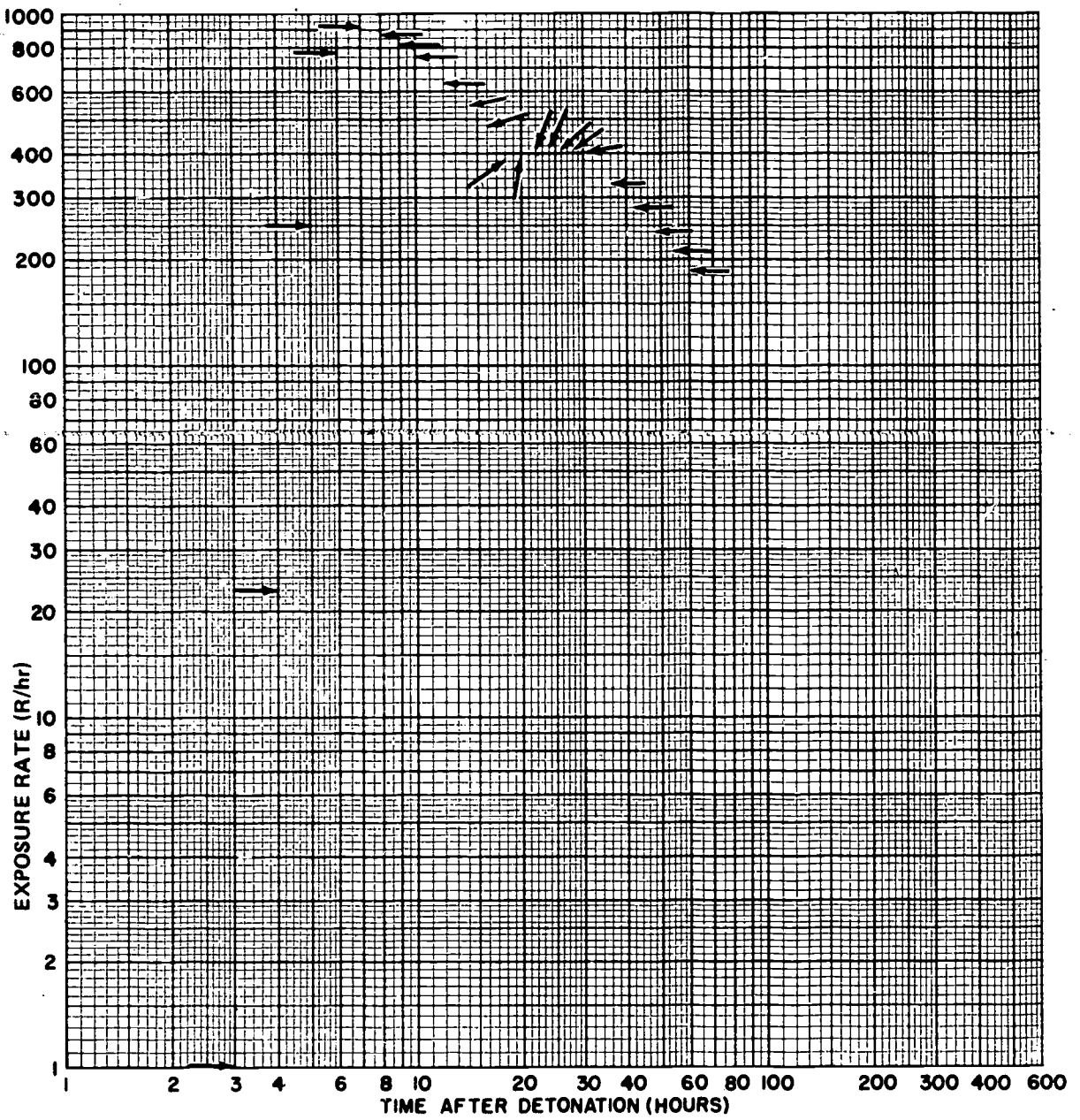

FIGURE 8.50a

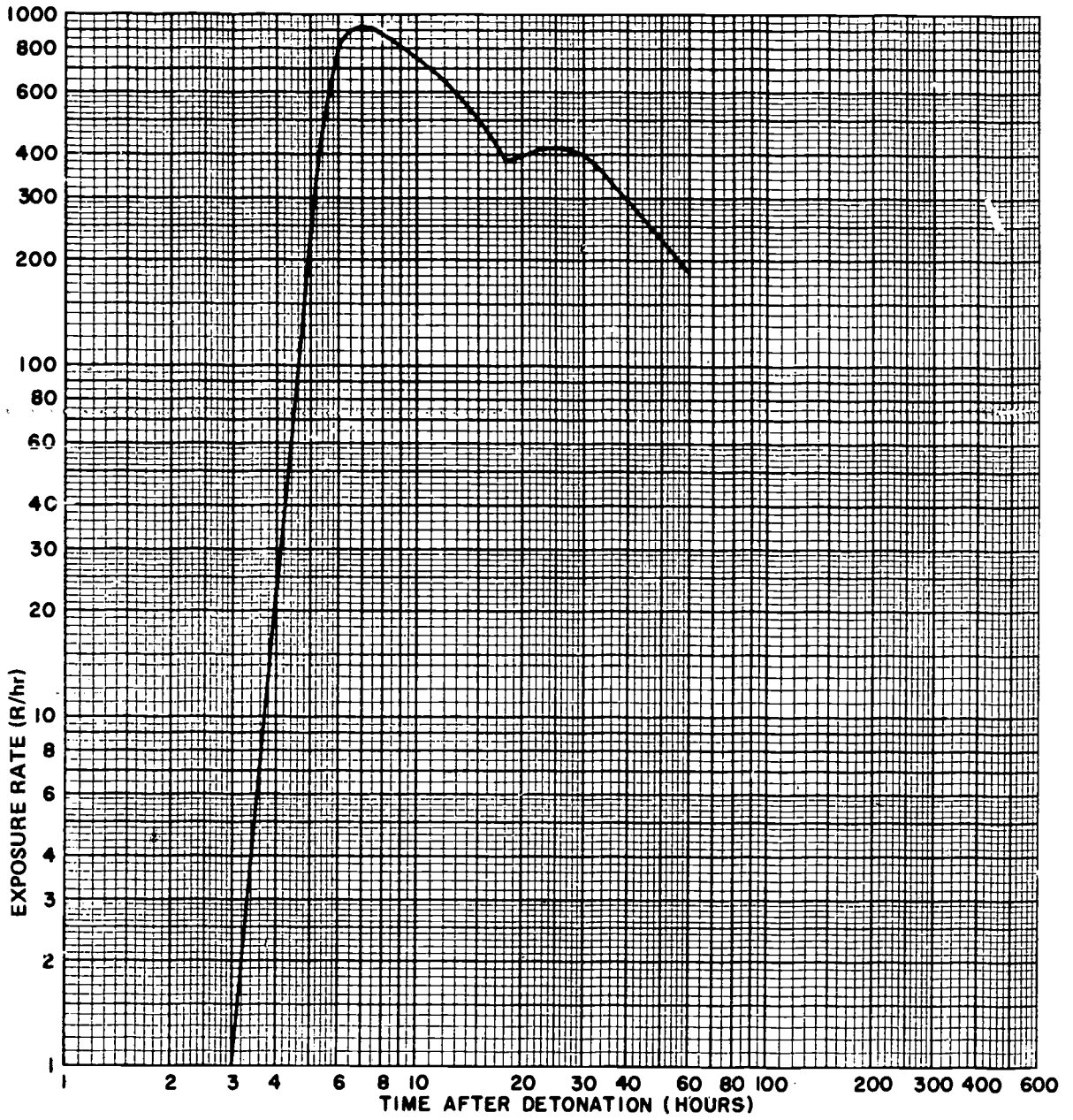

FIGURE 8.50b

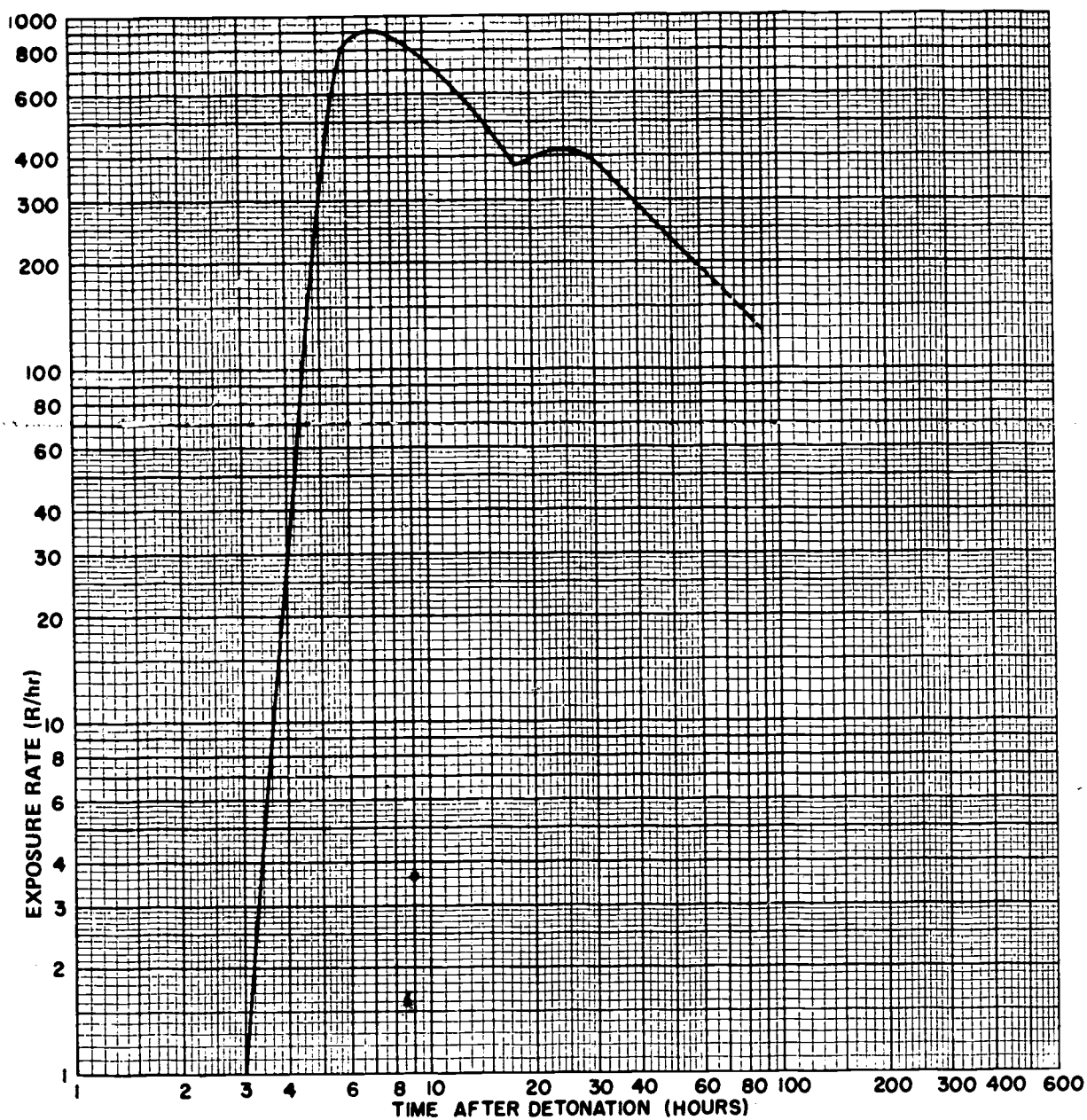

FIGURE 8.50c

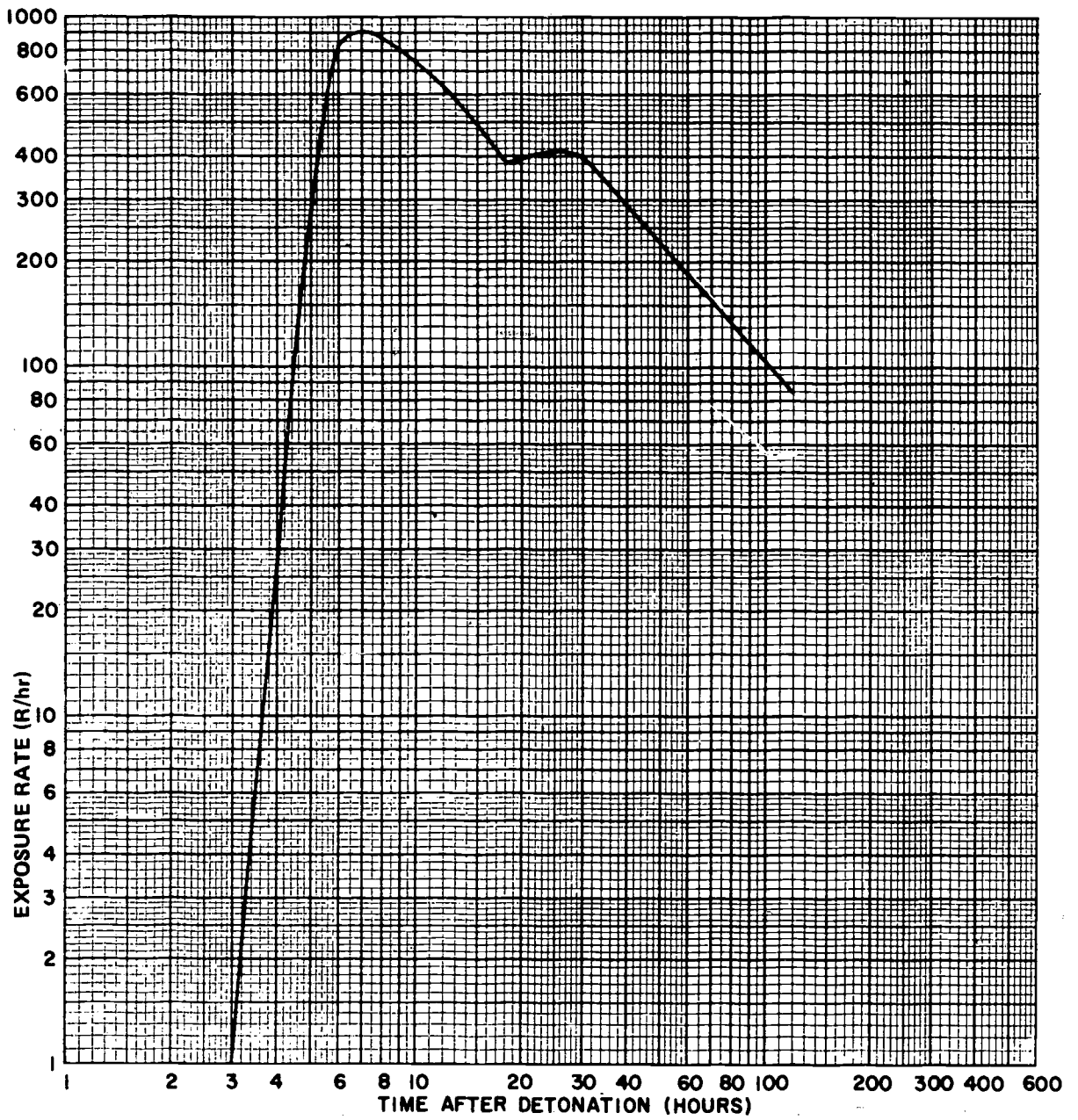

FIGURE 8.50d

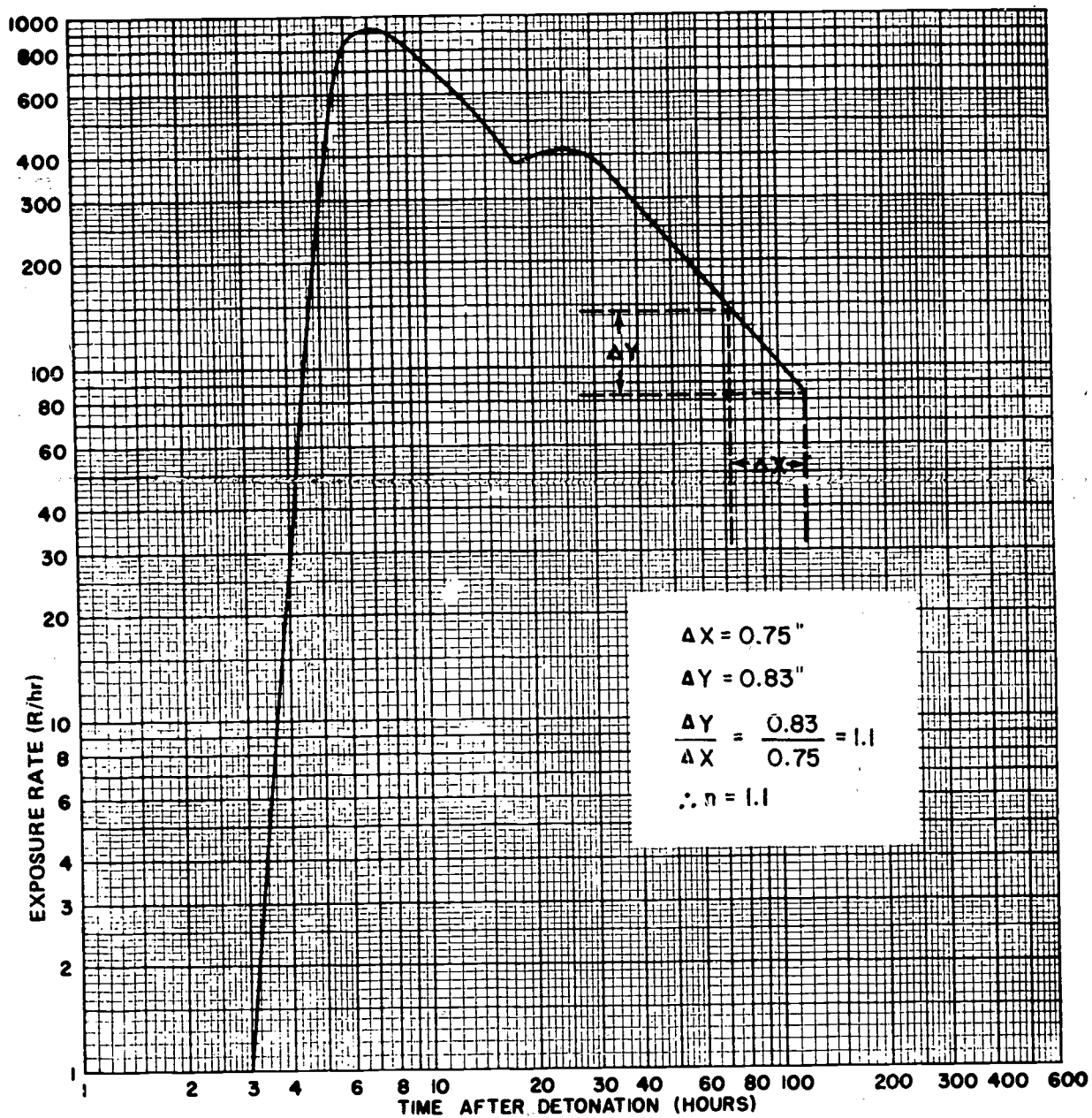

FIGURE 8.50e

10	0000	0043	0086	0128	0170	0212	0253	0294	0334	0374	N	0	1	2	3	4	5	6	7	8	9
11	0414	0453	0492	0531	0569	0607	0645	0682	0719	0755	55	7404	7442	7480	7518	7555	7592	7629	7666	7703	7740
12	0792	0828	0864	0899	0934	0969	1004	1038	1072	1106	56	7482	7520	7557	7594	7631	7668	7705	7742	7779	7816
13	1139	1173	1206	1239	1271	1303	1335	1367	1399	1430	57	7559	7596	7633	7670	7707	7744	7781	7818	7855	7892
14	1461	1492	1523	1553	1584	1614	1644	1673	1703	1732	58	7634	7671	7708	7745	7782	7819	7856	7893	7930	7967
15	1761	1790	1818	1847	1875	1903	1931	1959	1987	2014	59	7709	7746	7783	7820	7857	7894	7931	7968	8005	8042
16	2041	2068	2095	2122	2148	2175	2201	2227	2253	2279	60	7782	7819	7856	7893	7930	7967	8004	8041	8078	8115
17	2304	2330	2355	2380	2405	2430	2455	2480	2504	2529	61	7853	7890	7927	7964	8001	8038	8075	8112	8149	8186
18	2533	2577	2601	2625	2648	2672	2695	2718	2742	2765	62	7924	7961	7998	8035	8072	8109	8146	8183	8220	8257
19	2788	2810	2833	2856	2878	2900	2923	2945	2967	2989	63	7993	8030	8067	8104	8141	8178	8215	8252	8289	8326
20	3010	3032	3054	3075	3096	3118	3139	3160	3181	3201	64	8062	8099	8136	8173	8210	8247	8284	8321	8358	8395
21	3222	3243	3263	3284	3304	3324	3345	3365	3385	3404	65	8129	8166	8203	8240	8277	8314	8351	8388	8425	8462
22	3424	3444	3464	3483	3502	3522	3541	3560	3579	3598	66	8195	8232	8269	8306	8343	8380	8417	8454	8491	8528
23	3617	3636	3655	3674	3692	3711	3729	3747	3766	3784	67	8261	8298	8335	8372	8409	8446	8483	8520	8557	8594
24	3802	3820	3838	3856	3874	3892	3909	3927	3945	3962	68	8325	8362	8399	8436	8473	8510	8547	8584	8621	8658
25	3979	3997	4014	4031	4048	4065	4082	4099	4116	4133	69	8388	8425	8462	8499	8536	8573	8610	8647	8684	8721
26	4150	4166	4183	4200	4216	4232	4249	4265	4281	4298	70	8451	8488	8525	8562	8599	8636	8673	8710	8747	8784
27	4314	4330	4346	4362	4378	4393	4409	4425	4440	4456	71	8513	8550	8587	8624	8661	8698	8735	8772	8809	8846
28	4472	4487	4502	4518	4533	4548	4564	4579	4594	4609	72	8573	8610	8647	8684	8721	8758	8795	8832	8869	8906
29	4624	4639	4654	4669	4683	4698	4713	4728	4742	4757	73	8633	8670	8707	8744	8781	8818	8855	8892	8929	8966
30	4771	4786	4800	4814	4829	4843	4857	4871	4886	4900	74	8692	8729	8766	8803	8840	8877	8914	8951	8988	9025
31	4914	4928	4942	4955	4969	4983	4997	5011	5024	5038	75	8751	8788	8825	8862	8899	8936	8973	9010	9047	9084
32	5051	5065	5079	5092	5105	5119	5132	5145	5159	5172	76	8808	8845	8882	8919	8956	8993	9030	9067	9104	9141
33	5185	5198	5211	5224	5237	5250	5263	5276	5289	5302	77	8865	8902	8939	8976	9013	9050	9087	9124	9161	9198
34	5315	5328	5340	5353	5366	5378	5391	5403	5416	5428	78	8921	8958	8995	9032	9069	9106	9143	9180	9217	9254
35	5441	5453	5465	5478	5490	5502	5514	5527	5539	5551	79	8976	9013	9050	9087	9124	9161	9198	9235	9272	9309
36	5563	5575	5587	5599	5611	5623	5635	5647	5658	5670	80	9031	9068	9105	9142	9179	9216	9253	9290	9327	9364
37	5682	5694	5705	5717	5729	5740	5752	5763	5775	5786	81	9085	9122	9159	9196	9233	9270	9307	9344	9381	9418
38	5798	5809	5821	5832	5843	5855	5866	5877	5888	5899	82	9138	9175	9212	9249	9286	9323	9360	9397	9434	9471
39	5911	5922	5933	5944	5955	5966	5977	5988	5999	6010	83	9191	9228	9265	9302	9339	9376	9413	9450	9487	9524
40	6021	6031	6042	6053	6064	6075	6085	6096	6107	6117	84	9243	9280	9317	9354	9391	9428	9465	9502	9539	9576
41	6128	6138	6149	6160	6170	6180	6191	6201	6212	6222	85	9294	9331	9368	9405	9442	9479	9516	9553	9590	9627
42	6232	6243	6253	6263	6274	6284	6294	6304	6314	6325	86	9345	9382	9419	9456	9493	9530	9567	9604	9641	9678
43	6335	6345	6355	6365	6375	6385	6395	6405	6415	6425	87	9395	9432	9469	9506	9543	9580	9617	9654	9691	9728
44	6435	6444	6454	6464	6474	6484	6493	6503	6513	6522	88	9445	9482	9519	9556	9593	9630	9667	9704	9741	9778
45	6532	6542	6551	6561	6571	6580	6590	6599	6609	6618	89	9494	9531	9568	9605	9642	9679	9716	9753	9790	9827
46	6628	6637	6646	6656	6665	6675	6684	6693	6702	6712	90	9542	9579	9616	9653	9690	9727	9764	9801	9838	9875
47	6721	6730	6739	6749	6758	6767	6776	6785	6794	6803	91	9590	9627	9664	9701	9738	9775	9812	9849	9886	9923
48	6812	6821	6830	6839	6848	6857	6866	6875	6884	6893	92	9638	9675	9712	9749	9786	9823	9860	9897	9934	9971
49	6902	6911	6920	6928	6937	6946	6955	6964	6972	6981	93	9685	9722	9759	9796	9833	9870	9907	9944	9981	10000
50	6990	6998	7007	7016	7024	7033	7042	7050	7059	7067	94	9731	9768	9805	9842	9879	9916	9953	9990	10000	10000
51	7076	7084	7093	7101	7110	7118	7126	7135	7143	7152	95	9777	9814	9851	9888	9925	9962	9999	10000	10000	10000
52	7160	7168	7177	7185	7193	7202	7210	7218	7226	7235	96	9823	9860	9897	9934	9971	10000	10000	10000	10000	10000
53	7243	7251	7259	7267	7275	7284	7292	7300	7308	7316	97	9868	9905	9942	9979	10000	10000	10000	10000	10000	10000
54	7324	7332	7340	7348	7356	7364	7372	7380	7388	7396	98	9912	9949	9986	10000	10000	10000	10000	10000	10000	10000
55	7404	7412	7420	7428	7436	7444	7452	7460	7468	7476	99	9956	9993	10000	10000	10000	10000	10000	10000	10000	10000

FIGURE 8.53a.—Common Logarithms.

This discussion of logarithms will deal only with the so-called "common" logarithms which use a base equal to 10.

First, a definition of a logarithm:

the logarithm of a number N to the base a is the exponent x or the power to which the base must be raised to equal the number N.

In other words:

$\log N$ is the logarithm of N to the base 10

Thus:

if $N = 10^x$, then $x = \log N$

Further:

$\log N = \text{characteristic} + \text{mantissa}$

(For instance, $\log 12.3 = 1 + .0864 = 1.0864$)

The mantissa (or decimal part of the logarithm) is found from the tables of logarithms (Figure 8.53a).

The characteristic is determined in accordance with two rules:

if the number N is greater than 1, the characteristic of its logarithm is one

less than the number of digits to the left of its decimal point . . .

or

if the number N is less than 1, the characteristic of its logarithm is negative; if the first digit which is not zero is found in the kth decimal place, the characteristic is -k.

Now, to use logarithms to multiply two numbers, M and N, find $\log M$ and $\log N$:

if $N = 10^x$, then $x = \log N$

if $M = 10^y$, then $y = \log M$

To multiply M times N:

$x + y = \log M + \log N = \log (M \cdot N)$

When x (the logarithm of N) is added to y (the logarithm of M), the sum is another logarithm, the logarithm of M times N. The antilogarithm of this value of x plus y is M times N. Or:

$\text{antilog}(x + y) = \text{antilog}(\log M + \log N)$
 $= M \text{ times } N$

Antilogs are found by using the tables in reverse, i.e., enter the tables with a log (not a number) in order to find a number (not a log).

FIGURE 8.53b.—Using Common Logarithms.

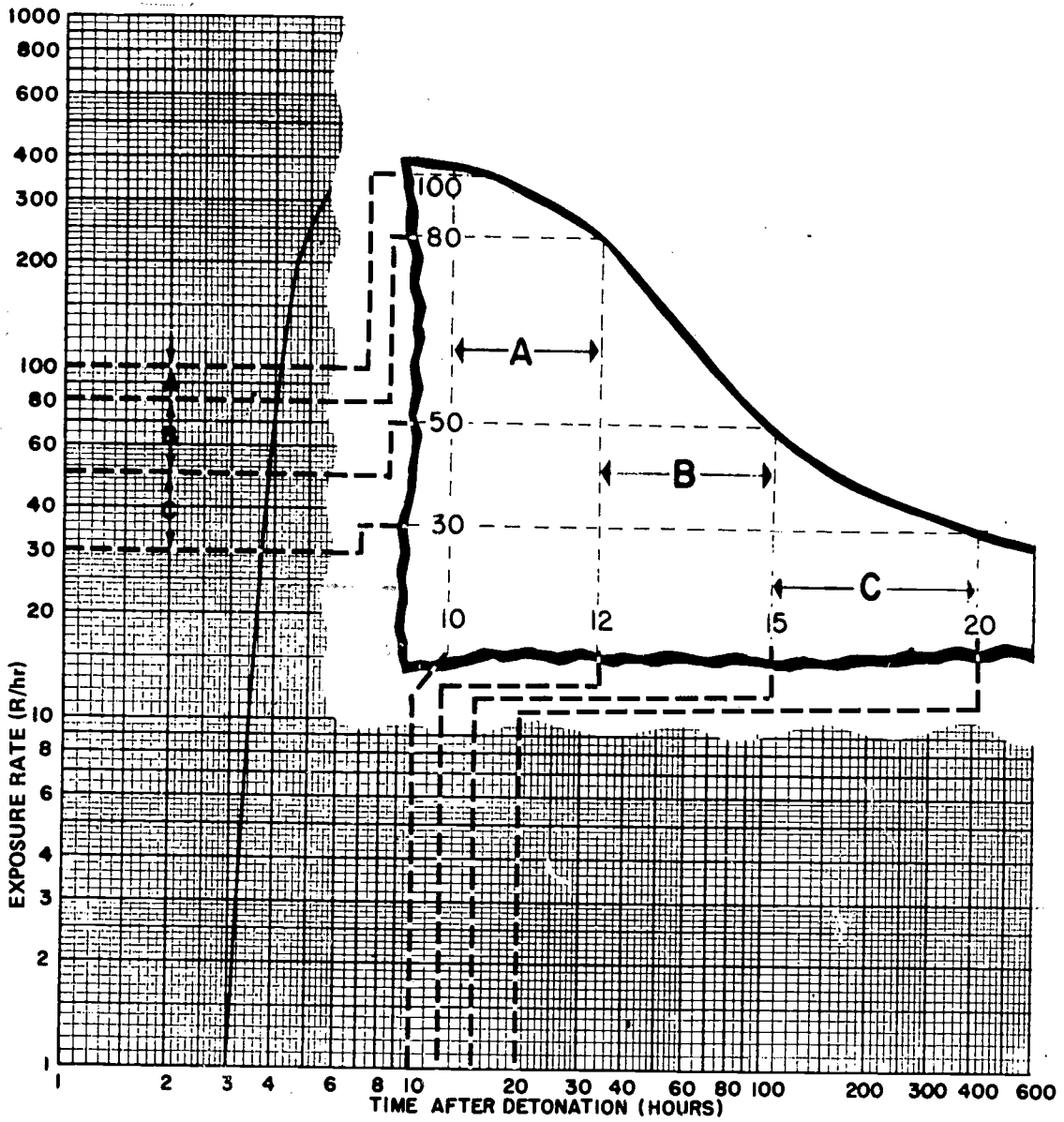

FIGURE 8.63

RADIOLOGICAL MONITORING TECHNIQUES AND OPERATIONS

Consider, for just a moment, what kind of radiological defense could we build if we did not have radiological monitoring? It wouldn't be worth much, would it? Radiological defense is built on facts and radiological monitoring provides those facts for RADEF decisions and actions. Once a nuclear attack is past, this becomes even more true with each passing hour for just as long a time as radiation remains a danger. So if there is a technique in this business of radiological monitoring (and there is, very definitely), let's take a look at it to find out:

HOW to monitor
 WHEN to monitor
 WHAT to monitor
 WHO to monitor
 WHERE to monitor

(. . . as to WHY to monitor, we have learned all the reasons for *that* one quite a few pages back!)

INTRODUCTION

9.1 The data supplied by radiological monitors is the key to RADEF decisions on *what* to do and *how* to do it. And in time of emergency these decisions may be the key to living or dying. Let's take a closer look at this vital activity.

WHAT IS RADIOLOGICAL MONITORING?

9.2 Radiological monitoring is defined as the detection and measurement of radiation emitted by fallout. With the information gained through monitoring we can: (1) determine extent and location of fallout; (2) validate predictions about fallout; and (3) decide on a course of action.

MONITORING TECHNIQUES¹

9.3 The following paragraphs describe the detailed techniques and procedures for conducting each type of radiological monitoring activity. Fallout station monitors are responsible for performing all of the monitoring techniques outlined in this section. Shelter monitors are responsible for performing all of the techniques, except for unsheltered exposure rate measurements and unsheltered exposure measurements.

SHELTER AREA MONITORING

9.4 Exposure rates should be measured inside of a shelter or a fallout monitoring station to determine the best shielded portions of the shelter and its immediate adjoining areas. Procedures for this monitoring are as follows:

1. Use the CD V-715.
2. Check the operability of the instrument.
3. Hold the instrument at belt height (3 feet above the ground).
4. take readings at selected locations throughout the shelter and adjoining areas and record these on a sketch of the area.

UNSHeltered EXPOSURE RATE MEASUREMENTS

9.5 Fallout monitoring stations report unsheltered exposure rate readings. Procedures for observing unsheltered exposure rates are as follows:

1. Use the CD V-715.

¹ Paragraphs 9.3 through 9.30 are based upon the HANDBOOK FOR RADIOLOGICAL MONITORS, FG-E-5.9.

2. Check the operability of the instrument.
3. Take an exposure rate reading at a specific location in the fallout monitoring station. This should be done as soon as the exposure rate reaches or exceeds 0.05 R/hr.
4. Go outside immediately to a pre-planned location in a clear, flat area (preferably unpaved), at least 25 feet away from buildings, and take an outside reading. The outside reading should be taken within three minutes of the reading in step 3 above.
5. Calculate the outside/inside ratio of the fallout monitoring station by dividing the outside exposure rate by the inside exposure rate. The protection may vary from location to location within the station. The outside/inside ratio referred to here is appropriate only for the location where the inside exposure rate measurement is observed.
6. Multiply future inside exposure rate readings by the outside/inside ratio at the selected location to obtain the outside exposure rate. For example: If the inside reading is 0.5 R/hr and the outside reading is 80 R/hr, the ratio can be found by dividing the outside reading by the inside reading. Thus, $80 \div 0.5 =$ an outside/inside ratio of 160. If a later inside reading at the same location in the fallout monitoring station is 4 R/hr, thus outside exposure rate can be calculated by multiplying the ratio by the inside reading. Thus, $160 \times 4 = 640$ R/hr.
7. Recalculate the outside/inside ratio at least once every 24 hours during the first few days postattack, unless the outside exposure rate is estimated to be above 100 R/hr. This is necessary because the energy of gamma radiation is changing, thus changing the outside/inside ratio of the fallout monitoring station.
8. Record and report the exposure rate measurement in accordance with the particular RADEF organization

standard operating procedure. NOTE: It is anticipated that radiation reports from the county level of government upwards would be limited to:

- a. A flash report immediately upon measurement of .5 R/hr and increasing.
 - b. A severe radiation report when the radiation level reaches 50 R/hr and increasing.
 - c. The highest or radiation peak level if above 50 R/hr.
 - d. The time when the decaying exposure rate passes downward and below 50 R/hr.
 - e. The time when the radiation level decays to .5 R/hr.
9. Take all exposure rate measurements outside after the unsheltered exposure rate has decreased to 25 R/hr.
- 9.6 The CD V-717 remote reading instrument may be used for taking outside exposure rate measurements. The CD V-717 is used as described below:
1. Position the instrument at a selected location within the fallout monitoring station.
 2. Place the removable ionization chamber 3 feet above the ground in a reasonably flat area and at least 20 feet from the fallout station. Preferably this should be done prior to fallout arrival. It is desirable to cover the ionization chamber with a light plastic bag or other lightweight material.
 3. Observe outside exposure rates directly.
 4. Record and report exposure rates in accordance with the particular RADEF organization standard operating procedure.

UNSHeltered EXPOSURE MEASUREMENTS

9.7 Fallout monitoring stations report unsheltered exposure readings. Procedures for taking these readings are listed below:

1. Zero a CD V-742.
2. Measure the unsheltered exposure

rate in accordance with paragraph 9.5.

3. Select an inside location where the exposure rate is approximately one-tenth to one-twentieth of the unsheltered exposure rate and position the CD V-742 at this location.
4. Determine the outside/inside ratio for this location in accordance with the procedure explained previously.
5. Read the CD V-742 daily. If the daily exposure at this location could exceed 200 R, estimate the time required for a 150 R exposure on the CD V-742. Record this reading, rezero the dosimeter, and reposition it. To determine the daily unsheltered exposure, multiply the daily exposure at this location by the outside/inside ratio.
6. Record the readings and rezero the instrument.

PERSONNEL EXPOSURE MEASUREMENTS

9.8 The monitor must determine the daily exposure of all shelterees or fallout monitoring station occupants. Procedures for determining daily exposures are as follows:

1. Zero all available CD V-742's.
2. Position the dosimeters so that representative shelter exposures will be measured by the instruments. The monitor must exercise judgment in positioning these instruments. The outside/inside ratio may vary considerably at different locations within the shelter. The instruments should be placed within the areas of greatest occupancy, which may change with time. During the early high radiation period, occupancy will be concentrated in the high protection areas of the shelter. Later, the occupancy of the shelter can be expanded. If representative readings are to be obtained, the dosimeters must follow the location shifts of the occupants.
3. If several dosimeters are positioned in one compartment, read the dosimeters each day and average the total exposures. Recharge dosimeters

RADIATION EXPOSURE RECORD			Date(s) of Exposure(s)	Daily Exposure(s)	Total Exposure to Date
Name <u>JOHN DOE</u>					
Address <u>227 N MOORLAND</u>					
<u>BATTLE CREEK MICH</u>					
Soc. Sec. No. <u>545-24-5535</u>					
Date(s) of Exposure(s)	Daily	Total Exposure to Date			
<u>6/16/42</u>	<u>15"</u>	<u>15"</u>			
<u>6/17/42</u>	<u>5"</u>	<u>20"</u>			
<u>JUNE 9</u>	<u>25"</u>	<u>45"</u>			
<u>6-5-42/12</u>	<u>5"</u>	<u>50"</u>			
DDO FORM _____ DATE _____					

FRONT SIDE

BACK SIDE

FIGURE 9.8.—Radiation exposure record.

which read more than half scale. If some shelters are divided into compartments or rooms that may have different outside/inside ratios, the exposure should be measured or calculated for each compartment.

4. Instruct the shelter occupants to record their individual exposures on their radiation exposure record (Figure 9.8), as approved by the shelter manager. Exposure entries should be made to the nearest roentgen. Continue to read the dosimeters each day. Record the accumulated exposure, if measurable.

9.9 If monitors or other persons are required to go outside, these additional exposures should be measured and recorded.

PERSONNEL MONITORING

9.10 The present DCPA concept is that any amount of contamination remaining on clothing after brushing and shaking as a countermeasure would be insignificant as a health hazard.

FOOD AND WATER MONITORING

9.11 Food and water monitoring criteria and techniques are being reevaluated, and are subject to change. During an early fallout condition, the radiation level is

likely to be above the range of the CD V-700 and, in effect, render it unsuitable for determining whether food and water supplies are acceptable for human consumption.

9.12 Since radiation passing through food does not contaminate it, the only danger would be the actual swallowing of fallout particles that happen to be on or in the food itself (or on the can or package containing the food). Fallout particles should be wiped or washed off. Reaping, threshing, canning and other processing would prevent dangerous quantities of fallout from getting into most processed foods. It is believed that ordinary precautions, normally taken in preparing foods to eat, would keep radiological contamination within acceptable limitations.

9.13 Water systems might be affected by radioactive fallout, but the risk would be small. Water stored in covered containers, or in covered wells would not be contaminated after an attack. Even in uncovered containers, indoors, such as buckets or bathtubs filled with emergency supplies of water, it is highly unlikely that the water would be contaminated by fallout particles. Practically all of the fallout particles that drop into open reservoirs, lakes, and streams would settle to the bottom.

9.14 Do not discard food and water known, or suspected to be contaminated. It should be placed in storage and used when other less contaminated food is not longer available. If only contaminated food or water is available use supplies with the smallest amount of contamination first.

AREA (MOBILE) MONITORING

9.15 Area monitoring is used to locate zones of contamination and determine the exposure rates within these zones. The monitor should be informed by his Radiological Defense Officer concerning routes to be followed, locations where readings are needed, the mission exposure, and the estimated time needed to accomplish the mission.

9.16 First, plan to keep personnel exposures as low as possible:

1. Know the specific accomplishment, extent, and importance of each monitoring mission.
2. Know the allowable exposure for each mission and the expected exposure rates to be encountered.
3. Make allowances for the exposure to be received traveling to and from the monitoring area. Obtain information about the condition of roads, bridges, etc., that might interfere with the mission and lengthen exposure time.

9.17 Next, consider the clothing which will be needed for the mission.

1. Tie pants cuffs over boots or leggings.
2. When dusty conditions prevail, wear a protective mask, gloves, head covering, and sufficient clothing to cover skin areas. If no masks are available, cover the nose and mouth with a handkerchief.

9.18 Very important, of course, is the equipment needed for the mission.

1. Use the CD V-715. If the exposure rates are expected to be below 50 mR/hr—also carry the CD V-700.
2. Wear a CD V-742.
3. Carry contamination signs, if areas are to be marked. This may also require stakes, heavy cord, hammer and nails for posting the signs.
4. Carry a pencil, paper, and a map with monitoring points marked.

3.19 The procedures for area monitoring are as follows:

1. Zero the dosimeter before leaving the shelter and place it in a pocket to protect it from possible contamination.
2. Check the operability of the CD V-715 and CD V-700, if it is to be used.
3. Use vehicles such as autos, trucks, bicycles, or motorcycles when distances are too great to cover quickly on foot. Keep auto and truck cab windows and vents closed when traveling under extremely dusty conditions. The use of a bicycle or motorcycle may be more practical if roadways are blocked.
4. Take readings at about three feet

(belt high) above the ground. If readings are taken from a moving vehicle, the instrument should be positioned on the seat beside the driver. If readings are to be taken outside a vehicle, the monitor should move several feet away from the vehicle to take the reading.

5. Record the exposure rate, the time and location for each reading. If readings are taken within a vehicle, this should be noted in the report.
6. Post markers, if required by the mission. The marker should face away from the restricted area. Write the date, time, and exposure rate on the back of the marker.
7. Read the pocket dosimeter at frequent intervals to determine when return to shelter should begin. Allowances should be made for the exposure to be received during return to the shelter.
8. Remove outer clothing on return to the shelter and visually check all personnel for contamination.
9. Decontaminate, if required.
10. Report results of the survey.
11. Record radiation exposure (see Figure 9.8).

EXPOSURE RATE READINGS FROM DOSIMETERS

9.20 Survey instruments should always be used to measure exposure rates. However, if no operable survey instruments are available, dosimeters can be used to calculate exposure rates by following the steps listed below.

1. Zero a CD V-742.
2. Place the zeroed dosimeter at a selected location.
3. Expose the dosimeter for a measured interval of time, but do not remain in the radiation field while the dosimeter is being exposed. This interval should be sufficient to allow the dosimeter to read at least 10 R. It may take one or two trials before the proper interval can be selected.
4. Read the dosimeter.

5. Divide sixty minutes by the number of minutes the dosimeter was exposed. Multiply this number by the measured exposure. Example: If the exposure is 10 R for a measured interval of five minutes, the rate can be calculated as follows:

$$(60 \div 5) \times 10 = 12 \times 10 = 120 \text{ R/hr.}$$

MONITORING OPERATIONS

9.21 Radiological monitors, whether assigned to community shelters or fallout monitoring stations, perform essentially similar operations. Any departures from the operations described here will be the result of decisions by State and local organizations and must be reflected in their standard operating procedures. If local or State standard operating procedures are not in existence, monitors should follow the procedures outlined in the following paragraphs.

READINESS OPERATIONS

9.22 During peacetime, all assigned monitors should:

1. Participate in refresher training exercises and tests as scheduled to maintain an organized monitoring capability.
2. Prepare a sketch of the monitoring station or shelter and adjoining areas for use during shelter occupancy.
3. Plan a location in the shelter in coordination with the shelter manager to serve as the center of monitoring operations.
4. Make all operational sets available once every two years to the State maintenance shop for recalibration, repairs if necessary, and new batteries.

SHELTER OPERATIONS

9.23 Upon attack or warning of attack, a shelter monitor reports to the shelter manager in his assigned shelter and performs the following CHECK LIST of operations in order:

1. Perform an operational check on all survey meters.

2. Charge dosimeters.
3. Position dosimeters at pre-designated locations in the shelter.
4. Report to the shelter manager on the conditions of the instruments and the positioning of dosimeters.
5. Check to see the doors, windows, or other openings are closed during fallout deposition.
6. Begin outside monitoring to determine the time of fallout arrival. Advise the shelter manager when the rate begins to increase.
7. Insure that all persons who have performed outside missions in contaminated areas, follow the protective actions indicated.
8. Food and water stored in the shelter should be acceptable for consumption. Leave contaminated items outside the shelter or place them in isolated storage near the shelter.
9. Take readings at selected locations throughout the shelter and record the exposure rates on prepared sketches of the area. Particular attention should be given to monitoring any occupied areas close to filters in the ventilating system. Show the time of readings on all sketches.
10. Furnish all sketches to the shelter manager and recommend one of the following courses of action:
 - a. If exposure rates are not uniform, occupy the areas with lowest exposure rates.
 - b. If space prohibits locating all shelterees in the better protected areas, rotate personnel to distribute exposure evenly. Do not rotate personnel unless there is a significant difference in the exposure between the best and the least protected shelter occupants.
11. Repeat the above procedure at least once daily. If there is a rapid change in the exposure rate, repeat at least once every six hours.
12. Inform the shelter manager to notify the appropriate emergency operating center and request guidance if:
 - a. The inside exposure rate reaches or exceeds 10 R/hr at any time during the shelter period.
 - b. The calculated exposure will exceed 75 R within any two days period of shelter.
13. Issue each shelter occupant a Radiation Exposure Record. As approved by the shelter manager, advise each person once daily of their exposure during the previous 24 hours. Follow procedures in paragraph 9.8 to calculate exposure of shelter occupants.
 - 9.24 During the latter part of the shelter period, when there is a less frequent need for in-shelter monitoring, some of the shelter monitors may be required to provide monitoring services in support of other emergency operations. A monitoring capability should always be retained in the shelter until the end of the shelter period.
 - 9.25 At the conclusion of the shelter period, all shelter monitors, except those regularly assigned to emergency services, may expect reassignment.

FALLOUT MONITORING STATION OPERATIONS

9.26 For his own protection and the protection of all members of a fallout monitoring station, the monitor should perform the same shelter operations as described in paragraph 9.23. *In addition*, the fallout station monitor will measure, record, and report unsheltered exposure and exposure rates to the appropriate EOC. Unless otherwise specified by the local standard operating procedure, the monitor will:

1. Make a FLASH REPORT when the outside exposure rate reaches or exceeds 0.5 R/hr.
2. Record and report exposure and exposure rates in accordance with local reporting requirements.

MONITORING IN SUPPORT OF EMERGENCY OPERATIONS

9.27 As soon as radiation levels decrease sufficiently to permit high priority

operations and later, as operational recovery activities including decontamination of vital areas and structures are begun, all fallout station monitors and most community shelter monitors are required to provide radiological monitoring support to these operations. Radiological Defense Officers will direct the systematic monitoring of areas, routes, equipment and facilities to determine the extent of contamination. This information will help the Civil Preparedness organization determine when people may leave shelter, what areas may be occupied, what routes may be used, and what areas and facilities must be decontaminated.

9.28 Many government services personnel, such as fire, police, health, and welfare personnel, will serve as shelter monitors or fallout station monitors during the shelter period. However, as operational recovery activities are begun, they will have primary responsibility in their own fields, with secondary responsibilities in radiological defense. Most services will provide for a radiological monitoring capability for the protection of their operational crews performing emergency activities. The capability is provided until the Radiological Defense Officer determines that it is not required. Services provide this capability from their own ranks, to the extent practical, supported by shelter monitors and fallout station monitors, when required.

9.29 When a service is directed to perform a mission, the emergency operating center furnishes the following information:

1. The time when the service may leave shelter to perform its mission.
2. The allowable exposure for the complete mission; that is, from time of departure until return to shelter.
3. The exposure rate to be expected in the area of the mission.

9.30 The monitor supporting emergency operations will:

1. Read his instruments frequently during each operation and advise the individual in charge of the mission on necessary radiological protective measures and when the crew must leave the area and return to shelter to avoid exceeding the planned mission exposure.
2. Determine the effectiveness of decontamination measures, if supporting decontamination operations.
3. Monitor equipment on return to shelter, or base of operations, to determine if it is contaminated, and if so, direct decontamination of that equipment.
4. Advise the crew on personnel decontamination if necessary.

PROTECTION FROM RADIATION

Different forms of protection from nuclear radiation are available to us. Some of these are all right, some are excellent and some are poor.

We need information on these forms of protection and this chapter will give us that information. We will see:

- HOW time can provide protection
- HOW distance can provide protection
- HOW shielding can provide protection
- WHAT makes a shelter
- WHAT else is necessary

INTRODUCTION

10.1 As we have seen in previous chapters, the residual nuclear radiation from fallout presents a number of difficult and involved problems. This is so not only because the radiations are invisible, and require special instruments for their detection and measurement, but also because of the widespread and long lasting character of the fallout. In the event of a surface burst of a high yield nuclear weapon, the area contaminated by the fallout could be expected to extend well beyond that in which casualties result from blast, thermal radiation, and the initial nuclear radiation. Further, whereas the other effects of a nuclear explosion are over in a few seconds, the residual radiation persists for a considerable time.

10.2 In Chapter 6 we learned that radioactive material released by a nuclear explosion consists of: (1) radioactive particles created by the fissioning of the bomb material, (2) particles made radioactive by neutrons released at the time of explosion,

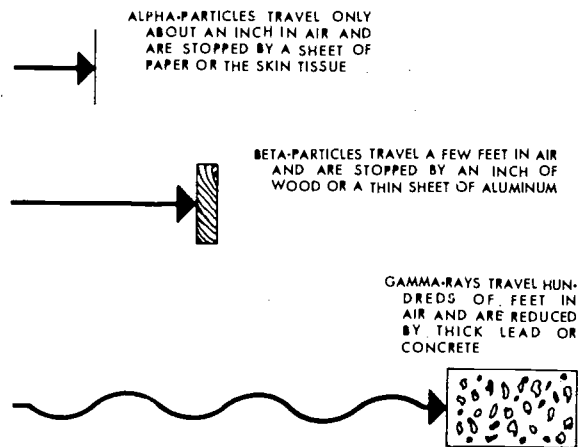

FIGURE 10.2.—Three kinds of nuclear radiation.

(3) the unfissioned material of the bomb itself. The unfissioned material is generally alpha emitting, while the fission products and the neutron-induced radioactive isotopes are beta-gamma emitters. See Figure 10.2 to refresh your memory about the penetrating power of the 3 major kinds of radiation.

PROTECTION FROM EXTERNAL RADIATION

10.3 To protect against external radiation, (basically gamma rays), there are three things you can put between you and the fallout causing the radiation: **TIME, DISTANCE, AND A SHIELD**. Protection is provided by: (1) controlling the length of time of exposure; (2) controlling the distance between the body and the source of radiation; and (3) placing an absorbing material between the body and the source of radiation.

10.4 It is not generally possible to use only one factor of protection. *The factor of time is always involved, that is, time is usually used in combination with distance,*

shielding, or both. For comparison, consider the problem of protecting the eyes from ultraviolet rays when taking a sunbath. Ultraviolet rays may be harmful to the eyes. A certain amount can be tolerated, but beyond this point damage may be caused. The eyes can be protected in three ways. First is to regulate the time spent under the sunlamp. Second is to regulate the distance maintained between the eyes and the sunlamp, Third is to shield the eyes with sunglasses. The denser the glasses, the more ultraviolet rays are filtered out and therefore an individual can be closer to the lamp and stay there a longer period of time without hurting his eyes. In order to understand each of the three factors of protection, it is necessary to discuss them separately.

TIME

10.5 For simplicity, let us disregard the decay of the radioactive materials in fallout and assume that we are in an area where the exposure rate remains constant at 25 R/hr. In one hour, we would be exposed to 25 roentgens of radiation. If we stayed 2 hours, we would be exposed to 50 R. If we stayed 4 hours, our exposure would be 100 R, and for an 8 hour stay we would receive an exposure of 200 R. Thus, time could be used as a protective measure by keeping the period of exposure down to an absolute minimum. For instance, if work must be done in a high radiation area, the work should be carefully planned to minimize the stay time in the contaminated area.

10.6 As discussed in Chapter 8, the decay of radioactive materials will cause the radiation levels from fallout to decrease with time. In the early periods after detonation, the decrease in exposure rates is very rapid. At later times, the decrease is not as rapid because the longer lived fission products make the major contribution to the exposure rate. Knowledge of the general decay pattern of radioactive fallout suggests an additional way in which time is important. All work in contaminated areas should be postponed as long as practicable after the detonation of nu-

clear weapons in order to permit radiation levels to decrease. It should be remembered, however, that it is possible for radiation levels to increase after long periods of decreasing exposure rates, because of the deposition of additional fallout.

DISTANCE

10.7 The effect of distance from a fallout field is sometimes misunderstood. When the distances are large in relation to the size of the radioactive source, the exposure rates decrease by the square of the distance from the source. This "inverse square law" can be an effective protective measure when using the sealed protective sources (sometimes called point sources) in a DCPA Training Source Set. However, in a fallout field, which consists of billions of "point sources" spread over large areas, the inverse square law is of no value to a RADEF Officer in computing the decrease in exposure rates with distance from contaminated areas.

10.8 The fact that exposure rates do decrease with distance from a fallout field will be very important to us, however, when we discuss the protective features of large buildings later in this chapter. Distance is also important to the RADEF Officer when he considers the use of decontamination as a radiological countermeasure. An area called a buffer zone is usually decontaminated around a vital facility to increase the distance of the fallout field from the facility. The function of the buffer zone is to reduce the gamma exposure rate which originates in the surrounding unreclaimed area.

SHIELDING

10.9 You will recall that the damaging effects of gamma rays comes from the fact that the rays strike electrons in the body and knock them out of their orbit, and if this happens to sufficient electrons in the body, radiation injury occurs. If we wish to stop a high proportion of the rays before they get to us, we can place between ourselves and the source of the radiation a material which has a lot of electrons in its

makeup. The more electrons there are in the makeup of the material the more radiation will be stopped.

10.10 Figure 10.10 shows lead and water in a rough comparison of their atomic makeup. Since lead has a lot more electrons in the orbits of each atom than does water, lead makes a better shield than water.

10.11 Figure 10.11 shows the relative efficiency of various shielding materials. These materials are efficient in about the proportions shown on the chart in stopping the same amount of gamma. Various shielding materials are used in various applications, depending upon the purpose to be served. Lead, for instance, is quite compact and is most suitable where space requirements are a factor. On the other hand, water is used where it is necessary to see through the shielding material and to work through it with a long-handled tool to perform necessary operations, such as, in processes in atomic plants where sawing or cutting the radioactive materials is necessary.

10.12 When considering fallout shelters, protection is generally achieved in two ways. One method is to place a barrier between the fallout field and the individ-

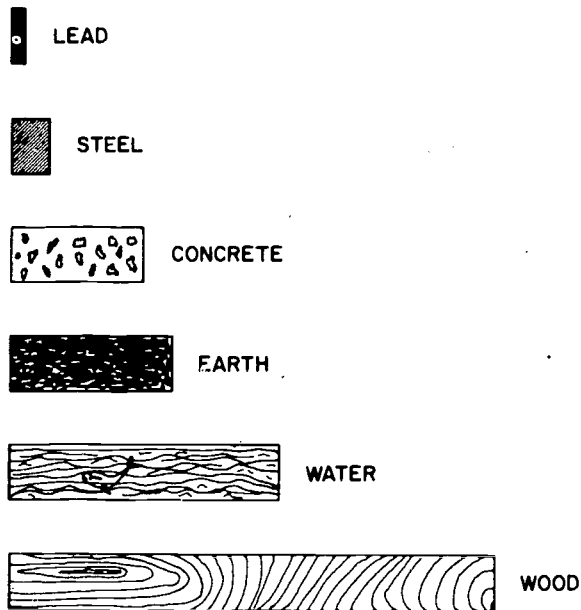

FIGURE 10.11.—Relative efficiency of various shielding materials.

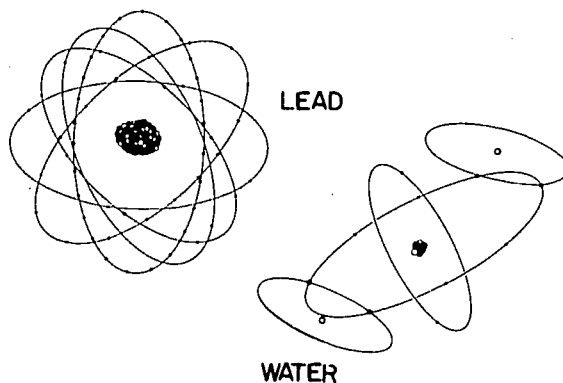

FIGURE 10-10.—Comparison between lead atom and water molecule.

ual. This is termed "barrier shielding." The second method is to increase the distance of the individual from the fallout field contributing to the individual's exposure. This is termed "geometry shielding."

10.13 In most analyses it is necessary to consider the effects of both barrier and geometry shielding. This is termed "combined shielding."

10.14 The heavier the barrier between fallout and the individual, the greater the barrier shielding effect. Examples of barriers in structures are walls, floors, and ceilings.

10.15 Geometry shielding is determined by the extent of the fallout field affecting an individual, and/or his distance from it. Consider an example of geometry shielding.

10.16 If two buildings are of the same height and similar construction, but of different area, the protection from ground contamination would be greater on the first floor in the building with the larger area. On the other hand, if two buildings are of equal area and similar construction, but differ in height, protection from ground contamination would be greater on the upper floor of the higher building.

THE SHELTER PROTECTION FACTOR

10.17 The effects of geometry shielding and barrier shielding are combined into a term very useful for considering the effectiveness of various types of shelters. This combined term is **THE PROTECTION**

FACTOR. One definition is: a calculation of the relative reduction in the amount of radiation that would be received by a person in a protected location, compared to the amount he would receive if he were unprotected in the same location. (See Glossary for the difference between outside/inside ratio and protection factor.)

10.18 If a shelter has a protection factor of 100, an unprotected person at the same location would be exposed to 100 times more radiation than someone inside the shelter.

10.19 Where conditions are favorable, added protection can be had for little extra cost. While licensed public shelters have a minimum of PF 40, a higher degree of protection up to say 1,000 is advantageous. This will frequently be possible in building protection into new structures.

10.20 There are two ways to go about setting up adequate shelters: **COMMUNITY ACTION** and **FAMILY ACTION**. It should be stressed that they are not mutually exclusive. In fact, they supplement each other in a very necessary way. Most people spend the largest part of their time at or near their homes and there are strong sociological advantages to keeping family groups together in a time of crisis and hardship. However, for many people it is not practical to construct home shelters. And, even if one possesses the finest shelter in the world, it will do no good if he is caught away from home at a time of dangerous fallout.

PUBLIC SHELTERS

10.21 Further, experience in Europe in World War II and other human experiences under disaster conditions have pointed to distinct advantages of the public shelter when compared with the family shelter. There are several reasons why group shelters are preferable in many circumstances:

1. A larger than family-size group probably would be better prepared to face a nuclear attack than a single family, particularly if some members should be away from home at the time of attack.

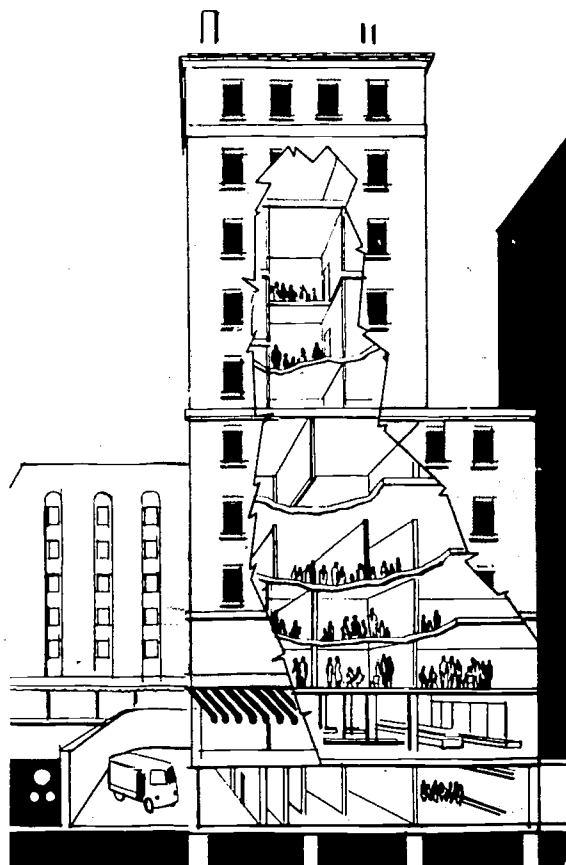

FIGURE 10.22.—Group sheltering in a large building.

2. There would be more opportunity to find first aid and other emergency skills in a group, and the risk of radiation exposure after an attack could be more widely shared.
3. Community shelters would provide shelter for persons away from their homes at the time of an attack.
4. Group shelters could serve as a focus for integrated community recovery activities in a postattack period.
5. Group shelters could serve other community purposes, as well as offer protection from fallout following an attack.

10.22 These are the reasons why the Federal Government has been involved with a number of activities—involving guidance, technical assistance, and money—to encourage the development of public shelters. The overall program, which got underway with the National

Shelter Survey, aims at securing shelters in existing and new structures, marking them, and making them available to the public in an emergency. Where there are not enough public shelters to accommodate all citizens, efforts are being made to provide more. In some cases, such as in large cities, it may not be possible to build individual family fallout shelters. Group shelters such as illustrated in Figure 10.22 may be required to provide adequate protection in such situations.

FAMILY SHELTERS

**A Home Shelter May Save Your Life*

10.23 Even though public fallout shelters usually offer many advantages over home shelters, in many places—especially suburban and rural areas—there are few public shelters. If there is none near you, a home fallout shelter may save your life.

10.24 The basements of some homes are usable as family fallout shelters as they now stand, without any alterations or changes—especially if the house has two or more stories, and its basement is below ground level.

10.25 However, most home basements would need some improvements in order to



FIGURE 10.24.—Home basement.

*Paragraphs 10.23 through 10.57 are from the DCPA publication "In Time of Emergency," H-11, March 1968.

shield their occupants adequately from the radiation given off by fallout particles. Usually, householders can make these improvements themselves, with moderate effort and at low cost. Millions of homes have been surveyed for the Defense Civil Preparedness Agency (DCPA) by the U. S. Census Bureau, and these householders have received information on how much fallout protection their basements would provide, and how to improve this protection.

Shielding Material Is Required

10.26 In setting up any home fallout shelter, the basic aim is to place enough "shielding material" between the people in the shelter and the fallout particles outside.

10.27 Shielding material is any substance that would absorb and deflect the invisible rays given off by fallout particles outside the house, and thus reduce the amount of radiation reaching the occupants of the shelter. The thicker or denser the shielding material is, the more it would protect the shelter occupants.

10.28 Some radiation protection is provided by the existing, standard walls and ceiling of a basement. But if they are not thick or dense enough, other shielding material will have to be added.

10.29 Concrete, bricks, earth and sand are some of the materials that are dense or heavy enough to provide fallout protection. For comparative purposes, 4 inches of concrete would provide the same shielding density as:

—5 to 6 inches of bricks.

—6 inches of sand or gravel.

(May be packed into bags, cartons, boxes, or other containers for easier handling.)

—7 inches of earth.

—8 inches of hollow concrete blocks (6 inches if filled with sand).

—10 inches of water.

—14 inches of books or magazines.

—18 inches of wood.

How to Prepare a Home Shelter

10.30 If there is no public fallout shelter near your home, or if you would prefer

to use a family-type shelter in a time of attack, you should prepare a home fallout shelter. Here is how to do it:

10.31 **A PERMANENT BASEMENT SHELTER.** If your home basement—or one corner of it—is below ground level, your best and easiest action would be to prepare a permanent-type family shelter there. The required shielding material would cost perhaps \$100–\$200, and if you have basic carpentry or masonry skills you probably could do the work yourself in a short time.

10.32 Here are three methods of providing a permanent family shelter in the “best” corner of your home basement—that is, the corner which is most below ground level.

Ceiling Modification Plan A

10.33 If nearly all your basement is below ground level, you can use this plan to build a fallout shelter area in one corner of it, without changing the appearance

of it or interfering with its normal peacetime use.

10.34 However, if 12 inches or more of the basement wall is above ground level, this plan should not be used unless you add the “optional walls” shown in the sketch.

10.35 Overhead protection is obtained by screwing plywood sheets securely to the joists, and then filling the spaces between the joists, with bricks or concrete blocks. An extra beam and a screwjack column may be needed to support the extra weight.

10.36 Building this shelter requires some basic woodworking skills and about \$150–\$200 for materials. It can be set up while the house is being built, or afterward.

Alternate Ceiling Modification Plan B

10.37 This is similar to Plan A except that new extra joists are fitted into part of the basement ceiling to support the added

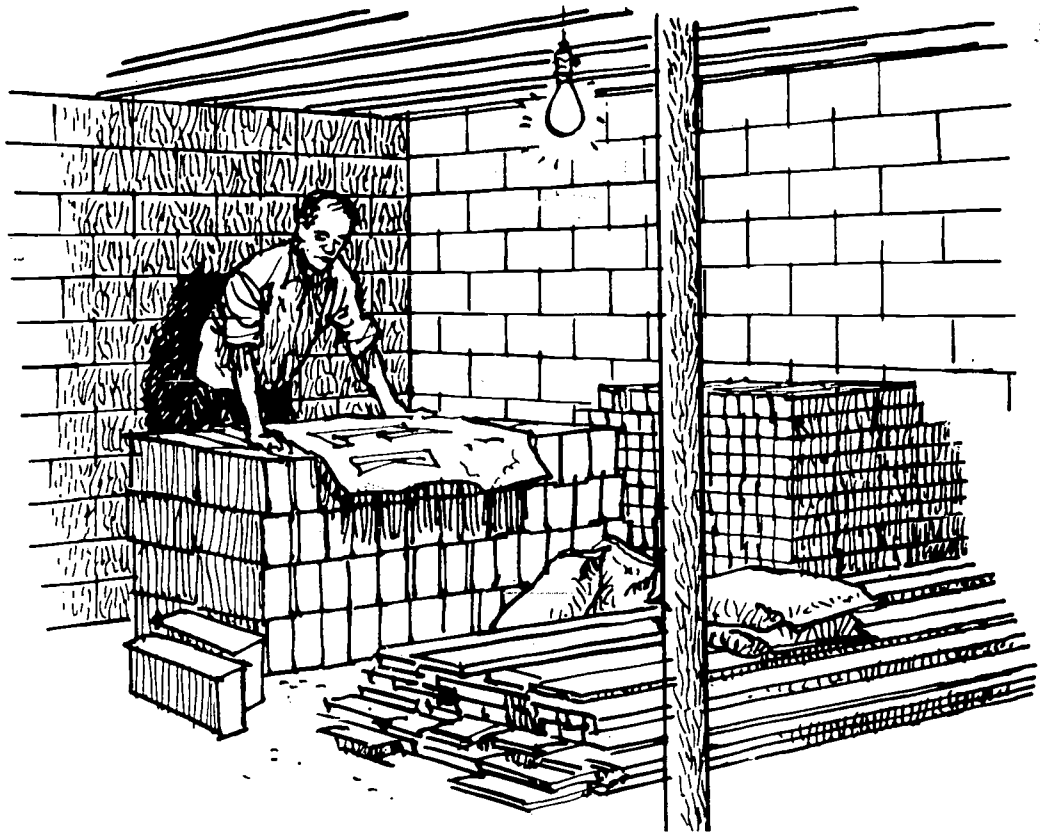

FIGURE 10.31.—Permanent basement shelter.

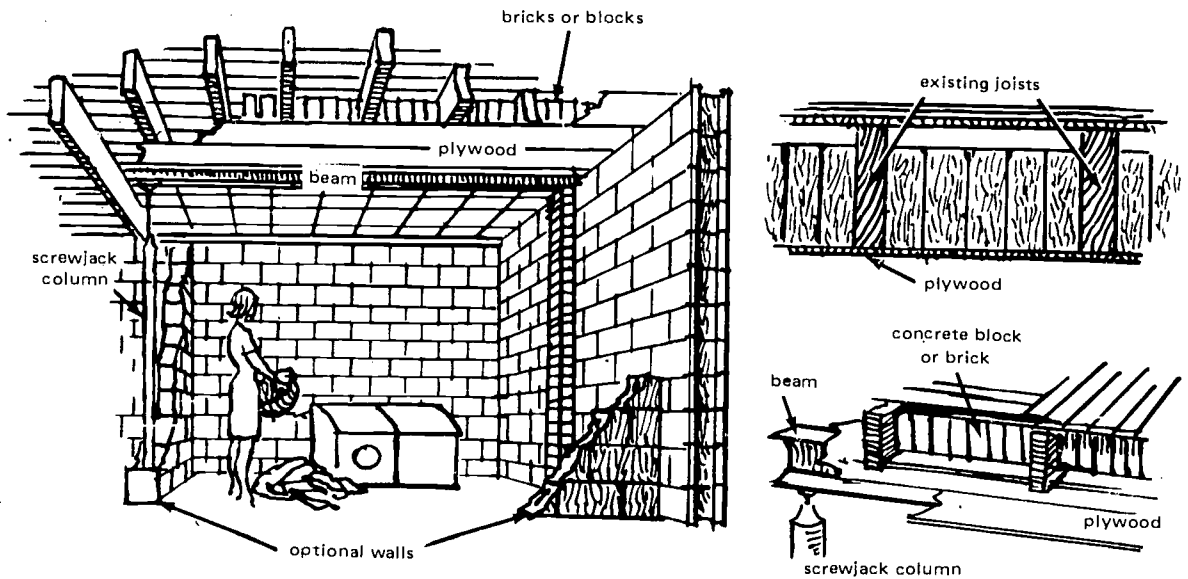

FIGURE 10.33.—Ceiling modification plan A.

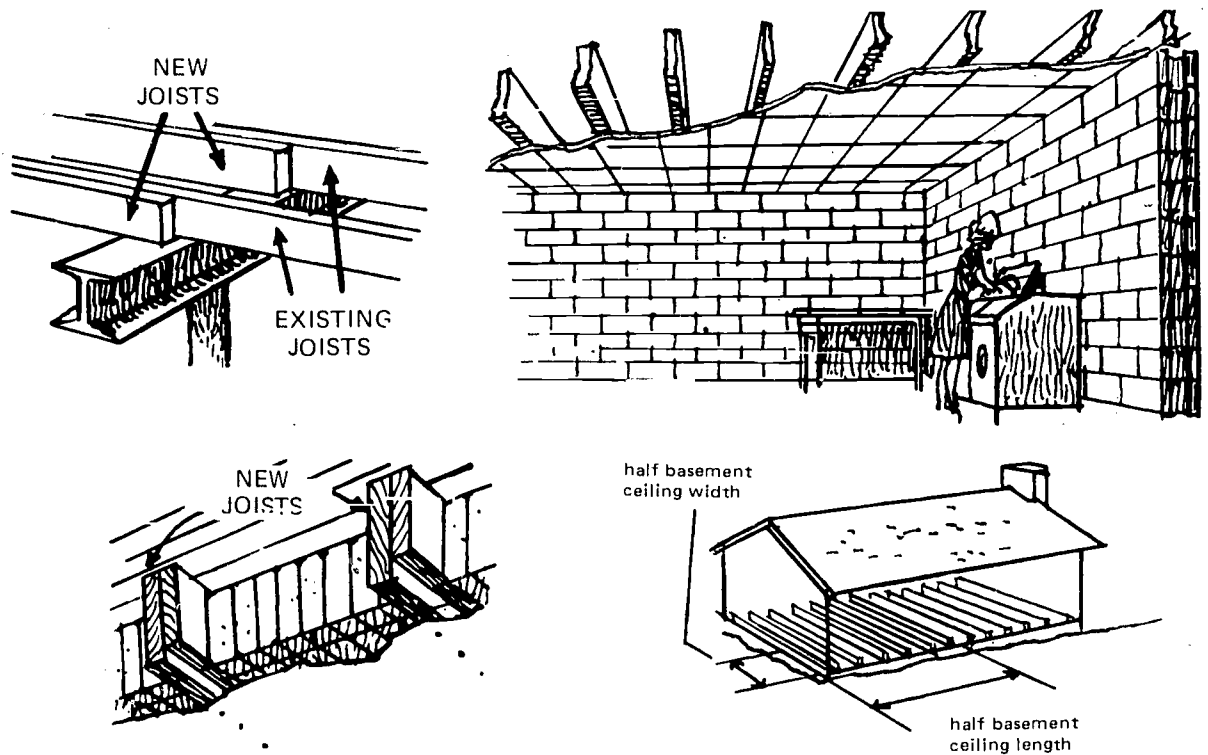

FIGURE 10.37.—Alternate ceiling modification Plan B.

weight of the shielding (instead of using a beam and a screwjack column).

10.38 The new wooden joists are cut to length and notched at the ends, then installed between the existing joists.

10.39 After plywood panels are screwed securely to the joists, bricks or concrete blocks are then packed tightly into the spaces between the joists. The bricks or blocks, as well as the joists themselves,

will reduce the amount of fallout radiation penetrating downward into the basement.

10.40 Approximately one-quarter of the total basement ceiling should be reinforced with extra joists and shielding material.

10.41 Important: This plan (like Plan A) should not be used if 12 inches or more of your basement wall is above ground level, unless you add the "optional walls" inside your basement that are shown in the Plan A sketch.

Permanent Concrete Block or Brick Shelter Plan C

10.42 This shelter will provide excellent protection, and can be constructed easily

at a cost of \$150 in most parts of the country.

10.43 Made of concrete blocks or bricks, the shelter should be located in the corner of your basement that is most below ground level. It can be built low, to serve as a "sitdown" shelter; or by making it higher you can have a shelter in which people can stand erect.

10.44 The shelter ceiling, however, should not be higher than the outside ground level of the basement corner where the shelter is located.

10.45 The higher your basement is above ground level, the thicker you should make the walls and roof of this shelter,

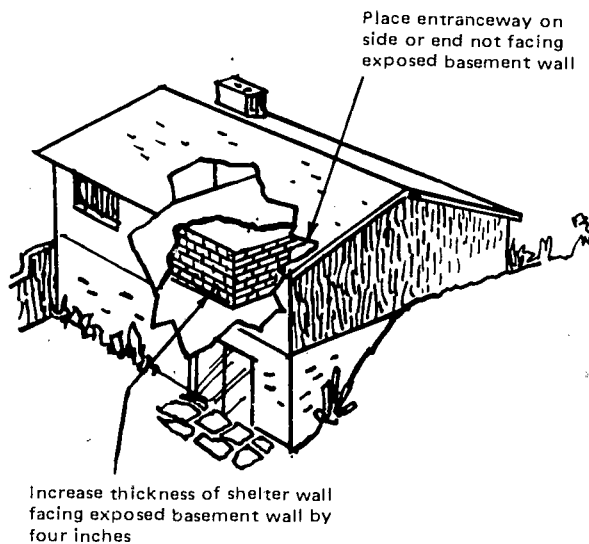
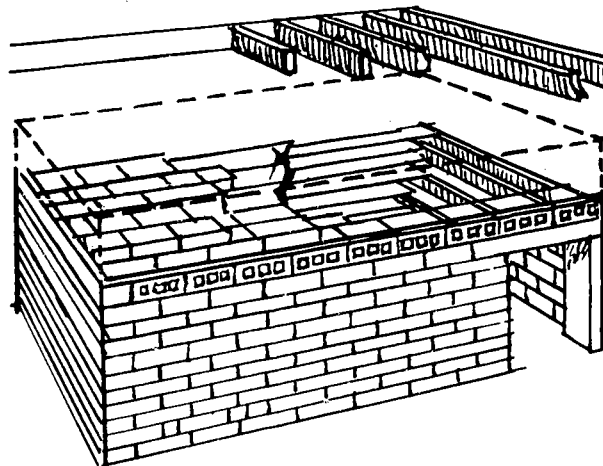

FIGURE 10.42.—Permanent concrete block or brick shelter plan C.

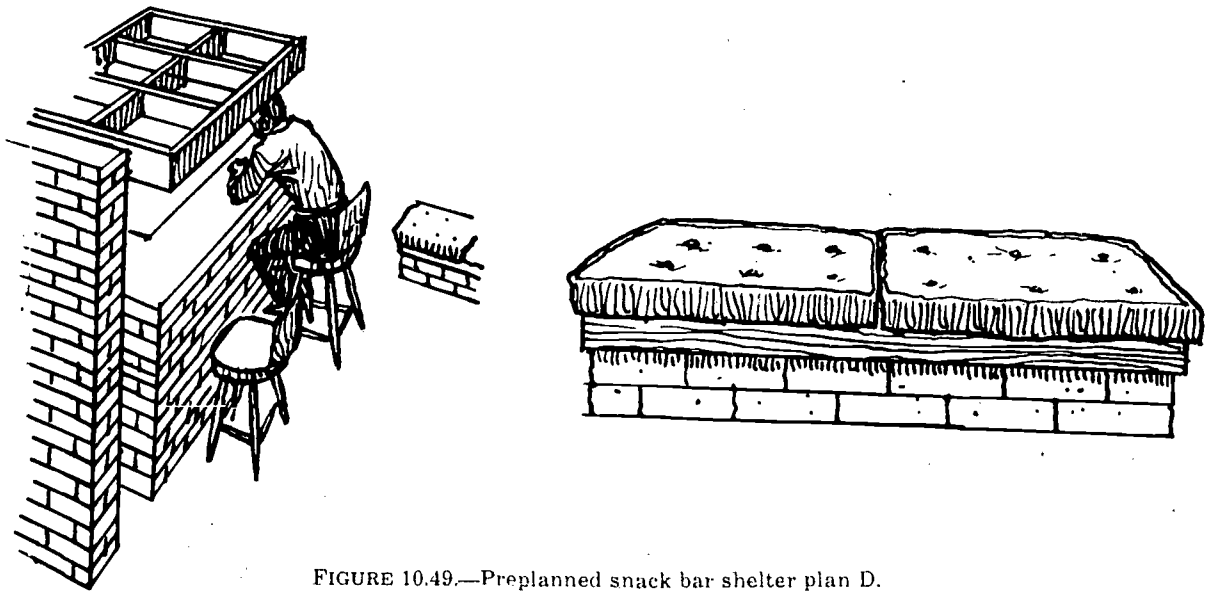

FIGURE 10.49.—Preplanned snack bar shelter plan D.

since your regular basement walls will provide only limited shielding against outside radiation.

10.46 Natural ventilation is provided by the shelter entrance, and by the air vents shown in the shelter wall.

10.47 This shelter can be used as a storage room or for other useful purposes in non-emergency periods.

A Preplanned Basement Shelter

10.48 If your home has a basement but you do not wish to set up a permanent-type basement shelter, the next best thing

would be to arrange to assemble a “pre-planned” home shelter. This simply means gathering together, in advance, the shielding material you would need to make your basement (or one part of it) resistant to fallout radiation. This material could be stored in or around your home, ready for use whenever you decided to set up your basement shelter. Here are two kinds of preplanned basement shelters.

Preplanned Snack Bar Shelter Plan D

10.49 This is a snack bar built of bricks or concrete blocks, set in mortar, in the

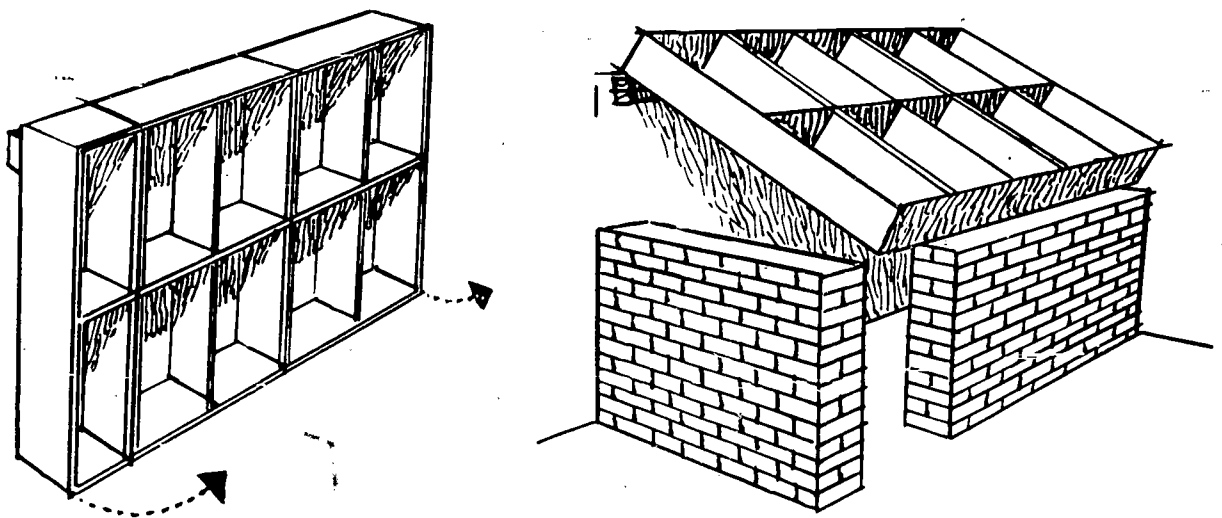

FIGURE 10.51.—Preplanned tilt-up storage unit plan E

"best" corner of your basement (the corner that is most below ground level). It can be converted quickly into a fallout shelter by lowering a strong, hinged "false ceiling" so that it rests on the snack bar.

10.50 When the false ceiling is lowered into place in a time of emergency, the hollow sections of it can be filled with bricks or concrete blocks. These can be stored conveniently nearby, or can be used as room dividers or recreation room furniture (see bench in Figure 10.49).

Preplanned Tilt-Up Storage Unit Plan E

10.51 A tilt-up storage unit in the best corner of your basement is another method of setting up a "preplanned" family fallout shelter.

10.52 The top of the storage unit should be hinged to the wall. In peacetime, the unit can be used as a bookcase, pantry, or storage facility.

10.53 In a time of emergency, the storage unit can be tilted so that the bottom of it rests on a wall of bricks or concrete blocks that you have stored nearby.

10.54 Other bricks or blocks should then be placed in the storage unit's compartments, to provide an overhead shield against fallout radiation.



FIGURE 10.56.—Covering basement windows

10.55 The fallout protection offered by your home basement also can be increased by adding shielding material to the outside, exposed portion of your basement walls, and by covering your basement windows with shielding material.

10.56 You can cover the aboveground portion of the basement walls with earth, sand, bricks, concrete blocks, stones from your patio, or other material.

10.57 You also can use any of these substances to block basement windows and thus prevent outside fallout radiation from entering your basement in that manner.

INDIVIDUAL PROTECTIVE MEASURES

10.58 If the presence of fallout is suspected before an individual can reach shelter, the following actions will help minimize its effects.

1. Cover the head with a hat, or a piece of cloth or newspaper.
2. Keep all outer clothing buttoned or zipped. Adjust clothing to cover as much exposed skin as possible.
3. Brush outer clothing periodically.
4. Continue to destination as rapidly as practicable.

10.59 Assume that all persons arriving at a shelter or a fallout monitoring station after fallout arrival, and all individuals who have performed outside missions are contaminated. All persons should follow the protective measures below:

1. Brush shoes, and shake or brush clothing to remove contamination. This should be done before entering the shelter area.
2. Remove and store all outer clothing in an isolated location.
3. Wash, brush, or wipe thoroughly, contaminated portions of the skin and hair being careful not to injure the skin.

COLLECTIVE PROTECTION

10.60 During fallout deposition, all windows, doors, and nonvital vents in sheltered locations should be closed to control

the contamination entering the shelter. Similar protective measures should be applied to vehicles.

10.61 When radiation levels become measurable inside the shelter, make a survey of all shelter areas to determine the best protected locations. Repeat this procedure periodically. This information is used to limit the exposure of shelter occupants.

TASKS OUTSIDE OF SHELTER

10.62 When personnel leave shelter appropriate protective measures should be taken to prevent the contamination of their bodies. Clothing will not protect personnel from gamma radiation, but will prevent most airborne contamination from depositing on the skin. Most clothing is satisfactory, however, loosely woven clothing should be avoided. Instruct shelter occupants to:

1. Keep time outside of shelter to a minimum when exposure rates are high.
2. Wear adequate clothing and cover as much of the body as practical. Wear boots or rubber galoshes, if available. Tie pants cuffs over them to avoid possible contamination of feet and ankles.
3. Avoid highly contaminated areas whenever possible. Puddles and very dusty areas where contamination is more probable should also be avoided.
4. Under dry and dusty conditions, do not stir up dust unnecessarily. If dusty conditions prevail, a man's handkerchief or a folded piece of closely woven cloth should be worn over the nose and mouth to keep the inhalation of fallout to a minimum.

5. Avoid unnecessary contact with contaminated surfaces such as buildings and shrubbery.

10.63 Individuals using vehicles for outside operations should remain in the vehicle, leaving it only when necessary. To prevent contamination of the interior of the vehicle, all windows and outside vents should be closed when dusty conditions prevail. Vehicles provide only slight protection from gamma radiation but they do provide excellent protection from beta and prevent contamination of the occupants.

FOOD AND WATER

10.64 To the extent practicable, prevent fallout from becoming mixed into food and water. Food and water which is exposed to radiation, but not contaminated, is not harmed and is fit for human consumption. If it is suspected that food containers are contaminated, they should be washed or wiped prior to removal of the contents. Food properly removed from such containers will be safe for consumption.

10.65 Water in covered containers and underground sources will be safe. Before the arrival of fallout, open supplies of water such as cisterns, open wells, or other containers should be covered. Shut off source of supply of potentially contaminated water.

REFERENCES

The Effects of Nuclear Weapons.—Glasstone, Samuel, 1964.

Handbook for Radiological Monitors.—DOD/OCD, FG-E-5.9, April 1963.

In Time of Emergency, OCD H-14, March 1968.

RADIOLOGICAL DECONTAMINATION

Although there are many forms of protection against nuclear radiation, as we learned in the preceding chapter, they are obviously not foolproof. Even if they were 100% effective, there is still the case of *unavoidable* contamination, contamination which could occur during the performance of a critically important mission, contamination which could be deliberately and knowingly accepted. Obviously, then, we need another RADEF tool to take care of contamination. That tool is DECONTAMINATION and this chapter will explain:

HOW to tell if decontamination is necessary

WHAT are the steps in decontamination

HOW does a decon worker protect *himself* from contamination

WHAT should be done to decontaminate an area, a structure, an orange, somebody named Henry, a cat, the power company, a red sportshirt or a farm tractor

INTRODUCTION

11.1 Closely allied with the problem of monitoring, discussed in Chapter 9, is the problem of decontamination. The two are, in fact, closely linked and cooperation and coordination between monitors and decontamination personnel is a basic requirement if wasted effort or unnecessary hazard are to be avoided.

WHAT IS CONTAMINATION?

11.2 As we saw in Chapter 6, the radioactive fallout from a nuclear explosion consists of radioisotopes that have attached themselves to dust particles or

water droplets. *This material behaves physically like any other dirt or moisture. In fact, the phenomena of radioactive contamination is exactly the same as getting "dirty" EXCEPT that very small amounts of "dirt" are required to produce a hazard and that the "dirt" is radioactive.*

WHAT IS DECONTAMINATION?

11.3 The objective of radiological decontamination is to reduce the contamination to an acceptable level with the least possible expenditure of labor and materials, and with radiation exposure to decontamination personnel held to a minimum commensurate with the urgency of the task. Radioactivity cannot be destroyed or neutralized, but in the event of nuclear attack, the fallout radiation hazard could be reduced by removing radioactive particles from a contaminated surface and safely disposing of them, by covering the contaminated surface with shielding material, such as earth, or by isolating a contaminated object and waiting for the radiation from it to decrease through the process of natural radioactive decay.

11.4 This chapter is directed to those persons who are responsible for planning and establishing radiological decontamination operations in States and localities. It contains guidance on the various types of decontamination procedures and the relative effectiveness of each.

DECONTAMINATION OF PERSONNEL AND CLOTHING

11.5 State and local public welfare departments and agencies, as the welfare arms of their respective governments, have primary responsibility for planning and preparing the facilities and develop-

ing capabilities essential to provide emergency welfare at the local level. Voluntary social welfare agencies will assist.

11.6 Decontamination of personnel and clothing of personnel engaged in recovery operations would be the responsibility of the various operational services, such as fire departments, police departments, and decontamination teams. Many persons would be responsible for decontamination of themselves and their families in accordance with instructions of the local government.

PERSONNEL

11.7 It is important that all people, and particularly those directing emergency operations, understand that the total radiation injury from fallout is a composite due to several causes, including contamination of the surrounding areas, contamination of skin areas, and ingestion and inhalation of fallout materials. To keep the total radiation injury low, the effect of each potential source of radiation on the *total radiation exposure* must be kept in mind, and each contributing element should be kept as low as operationally feasible. Normally, ordinary personal cleanliness procedures will suffice for personnel decontamination in the postattack period.

11.8 All persons seeking shelter after fallout starts should brush or shake their outer clothing before entering the shelter area. Ordinary brushing will remove most of the contaminated material from the shoes and clothing, and often may reduce the contamination to, or below a permissible level. It is important to brush or shake from the upwind side. Under rainy conditions, the outer clothing should be removed before entering the shelter area.

Upon entering the shelter area and as soon as practicable, wash, brush, or wipe thoroughly the exposed portions of the body, such as the skin and hair. If sufficient quantities of water are available, persons should bathe, giving particular attention to skin areas that had not been covered by clothing.

THE INJURED

11.9 It is desirable that contamination of medical facilities and personnel be kept at a minimum. Medical personnel, whose skills would be needed for the saving of lives, should be protected from radiation to the extent feasible. Persons entering a medical treatment station or hospital should be monitored, decontaminated if necessary, and tagged to show that he is not contaminated. To do this, a check point could be established at a shielded location at each medical treatment station and hospital. Although decontamination procedures for the injured are the same as those previously described for personnel decontamination (i.e., the removal of outer clothing, and other clothing if necessary, and finally the washing of contaminated body areas, if required) special factors also must be considered. In the face of urgency for decontamination, there will be many casualties who are unable to decontaminate themselves and whose condition will not permit movement. For some cases a medical examination will determine that first aid must take priority over decontamination. Also, it may not be possible to decontaminate some casualties without seriously aggravating their injuries. These will have to be segregated in a controlled area of the treatment facility.

CLOTHING

11.10 Thorough decontamination of clothing can be deferred until after the emergency shelter period when supplies of water and equipment are available. Equipment for decontamination of clothing includes whisk brooms, or similar types of brushes, vacuum cleaners (if available) and laundry equipment. For more effective decontamination of clothing, washer and dryer equipment should be available. Since there is normally little accumulation of "dirt" in a washing machine, virtually all of the decontaminant would be flushed down the drain. The chance of significant residual contamination of the washing machine appears to be quite small. Although there is little serious danger involved in

washing, direct contact with the contamination should be kept to a minimum.

11.11 The procedures for decontamination of clothing should be as follows: First, brush or shake the clothing outdoors; second, vacuum clean; third, wash; and fourth, *if the previous procedures are not effective*, allow natural radioactive decay. Monitoring of the clothing upon completion of each step will indicate the effectiveness of the decontamination procedure and indicate any need for further decontamination. In many cases, depending upon the amount and kind of radioactive contaminant, brushing or simply shaking the clothing to remove the dust particles may reduce the contamination to a negligible amount. If two thorough brushings do not reduce the contamination to an acceptable level, vacuum cleaning should be attempted. Care should be taken in disposing of the contaminated material from the dust bag of the vacuum cleaner. If the clothing is still contaminated after dry methods of decontamination are completed, it should be laundered. Clothing usually can be decontaminated satisfactorily by washing with soap or detergent.

11.12 Any clothing that still remains highly contaminated should then be stored to allow the radioactivity to decay. Storage should be in an isolated location so that the contaminated clothing will not endanger personnel.

DECONTAMINATION OF FOOD, AGRICULTURAL LAND AND WATER

11.13 State and local public agencies, assisted by radiological defense personnel, will be responsible for the decontamination of food and water. Stored foods in warehouses, markets, etc., will be the responsibility of the agency controlling the distribution of the food items. Water supply personnel of the local government or private organizations will be responsible for monitoring, and if required, decontamination of the water supplies they operate. Each person or family not expecting to be protected in a community shelter, is responsible for providing, before attack, sufficient food and water to supply its needs

for at least 2 weeks, since outside assistance may not be available during this period.

FOOD

11.14 The following guidance is provided for individuals and groups who need to use food which may have been contaminated with fallout. Before opening a food package, the package should be wiped or washed if contamination is suspected. Caution should be taken when wiping or washing outer containers to avoid contaminating the food itself. When possible, the package surface should be monitored with a radiation detection instrument before removing the food as a check on the effectiveness of the decontamination procedure.

11.15 Meats and dairy products that are wrapped or are kept within closed showcases or refrigerators should be free from contamination. Fallout on unpackaged meat and other food items could present a difficult salvage problem. Fresh meat could be decontaminated by trimming the outer layers with a sharp knife. The knife should be wiped or washed frequently to prevent contaminating the incised surfaces.

11.16 Fruits and vegetables harvested from fallout zones in the first month post-attack may require decontamination before they can be used for food. Decontaminate fruits and vegetables by washing the exposed parts thoroughly to remove fallout particles, and if necessary, peeling, paring or removing the outer layer in such a way as to avoid contamination of the inner parts. It should be possible to decontaminate adequately fruits, such as apples, peaches, pears, and vegetables, such as carrots, squash, and potatoes, by washing and/or paring. This type of decontamination can be applied to many food items in the home.

11.17 Animals should be put under cover before fallout arrives, and should not be fed contaminated food and water, if uncontaminated food and water are available. If the animals are suspected of being externally contaminated, they should be

washed thoroughly before being processed into food.

11.18 Even when animals have received sufficient radiation to cause later sickness or death, there will be a short period (1 to 10 days following exposure, depending on the amount) when the animals may not show any symptoms of injury or other effects of the radiation. If the animals are needed for food, if they can be slaughtered during this time without undue radiation exposure to the worker, and if no other disease or abnormality would cause unwholesomeness, the meat would be safe for use as food. In the butchering process, care should be taken to avoid contamination of the meat, and to protect personnel. The contaminated parts should be disposed of in a posted location and in such a manner as to present a negligible radiological or sanitation hazard. If any animal shows signs of radiation sickness, it should not be slaughtered for food purposes until it is fully recovered. This may take several weeks or months. Animals, showing signs of radiation sickness (loss of appetite, lack of vitality, watery eyes, staggering or poor balance) should be separated from the herd because they are subject to bacterial infection and may not have the recuperative powers necessary to repel diseases. They could infect other animals of the herd.

AGRICULTURAL LAND

11.19 The uptake of radioactive fallout material would be a relatively long term process, and the migration of fission products through the soil would be relatively slow. Therefore, crops about to be harvested at the time fallout occurs would not have absorbed great amounts of radioactive material from the soil. However, if crops are in the early stages of growth in an intense fallout area, they will absorb radioactive materials through their leaves or roots and become contaminated. Thus, if eaten by livestock or man, it may cause some internal hazard. Before use, the degree of contamination should be evaluated by a qualified person. Foods so contaminated could not be decontaminated easily

because the contaminants would be incorporated into their cellular structure. Do not destroy these contaminated foods.

11.20 Liming of acid soil will reduce the uptake of strontium since the plant system has a preference for calcium over strontium and has some ability to discriminate. The plant's need for calcium leads to the absorption of the similar element strontium. In soils low in exchangeable calcium, more strontium will be taken up by the plant. By liming acid soils, more calcium is made available to the plant and less strontium will be absorbed.

11.21 Another method to limit the uptake of strontium is to grow crops with low calcium content such as potatoes, cereal, apples, tomatoes, peppers, sweet corn, squash, cucumbers, etc., on areas of heavy fallout. Other foods with high calcium content such as lettuce, cabbage, kale, broccoli, spinach, celery, collards, etc., could be grown in areas of relatively light fallout.

WATER

11.22 Following a nuclear attack, water in streams, lakes and uncovered storage reservoirs might be contaminated by radioactive fallout. The control of internal radiation hazards to personnel will be dependent, in large part, upon proper selection and treatment of drinking water.

11.23 If power is not available for pumping, or if fallout activity is too heavy to permit operation of water treatment plants, the water stored in the home may be the only source of supply for several weeks. Emergency sources of potable water can be obtained from hot water tanks, flush tanks, ice cube trays etc. It is advisable to have a 2-weeks emergency water ration (at least 7 gallons per person) in or near shelter areas.

11.24 Emergency water supplies may be available from local industries, particularly beverage and milk bottling plants, or from private supplies, country clubs, and large hotels or motels.

11.25 If contaminated surface water supplies must be used, both conventional and specialized treatment processes may be employed to decontaminate water. The

degree of removal will depend upon the nature of the contaminant (suspended or dissolved) and upon the specific radionuclide content of the fallout.

11.26 Radioactive materials absorbed in precipitates or sludges from water treatment plants must be disposed of in a safe manner. Storage in low areas or pits, or burial in areas where there is little likelihood of contaminating underground supplies, is recommended.

11.27 Several devices for treating relatively small quantities of water under emergency conditions have been tested. Most of them use ion exchange or absorption for removal of radioactive contaminants.

a. Small commercial ion exchange units containing either single or mixed-bed resins, designed to produce softened or demineralized water from tap water, could be used to remove radioactive particles from water. Many of them have an indicator which changes the color of the resins to indicate the depletion of the resins' capacity. Tests of these units have indicated removals of over 97 percent of all radioactive materials.

b. Emergency water treatment units consisting of a column containing several 2-inch layers of sand, gravel, humus, coarse vegetation, and clay have been tested for removal of radioactive materials from water. This type of emergency water treatment unit removed over 90 percent of all dissolved radioactive materials.

c. Tank-type home water softeners are capable of removing up to 99 percent of all radioactive materials, and are especially effective in the removal of the hazardous strontium 90 and cesium 137 contaminants.

DECONTAMINATION OF VEHICLES AND EQUIPMENT

11.28 Decontamination of vehicles and equipment of the various operational services, such as fire departments, police departments, and decontamination teams, will be the responsibility of the various services, aided by radiological defense services. Individuals will be responsible

for decontamination of their own vehicles and equipment in accordance with instructions of local government.

EXTERIOR OF VEHICLES AND EQUIPMENT AND VEHICLE INTERIORS

11.29 The simplest and most obvious method for partial decontamination of vehicles and equipment is by water hosing. Quick car-washing facilities are excellent for more thorough decontamination.

11.30 Special precautions should be used when vehicles and equipment are brought in for maintenance. The malfunctioning part of the vehicle or equipment should be checked for excessive contamination.

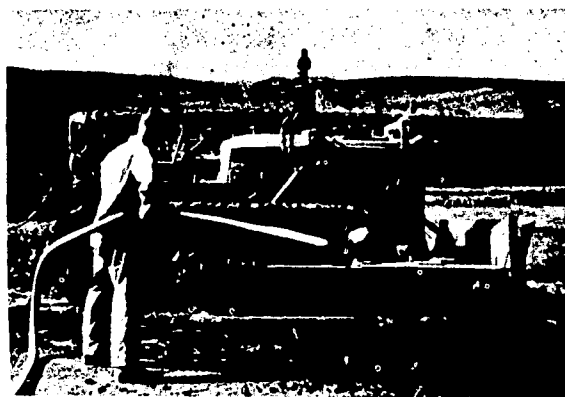

FIGURE 11.31.—Equipment decontamination.

11.31 Hosing should not be used on upholstery or other porous surfaces on the interior of vehicles, as the water would penetrate and carry the contamination deeper into the material.

11.32 The interior of vehicles can be decontaminated by brushing or vacuum cleaning. Procedures for decontaminating interiors of vehicles by vacuum cleaning are similar to those used on the interior of structures.

VEHICLES AND EQUIPMENT USED BY DECONTAMINATION PERSONNEL

11.33 Upon completion of missions in a contaminated area, vehicles and equipment used by decontamination personnel should be monitored, and decontaminated

if necessary. Complete decontamination may not be necessary, but attempts should be made to reduce the hazard to tolerable levels.

11.34 A decontamination station set up at a control point adjacent to the staging area would be the best place for decontaminating vehicles and equipment. A paved area would be desirable so that it could be hosed off after the equipment is decontaminated. Monitoring should follow the application of each decontamination method.

DECONTAMINATION OF VITAL AREAS AND STRUCTURES

11.35 The operational planning aspects of decontamination of vital areas and structures are very complex and require trained decontamination teams from government services, industry, and private and public utilities under the direction of a decontamination specialist. All methods described in this chapter are common techniques with which personnel of the emergency services are generally familiar. Operational details associated with use of the equipment are not discussed. However, operational aspects peculiar to radiological recovery are emphasized. The method of decontamination selected will depend upon the type and extent of contamination, type of surface contaminated, the weather and the availability of personnel, material, and equipment. Each type of surface presents an individual problem and may require a different method of decontamination. The type of equipment and skills required for radiological decontamination are not new. Ordinary equipment now available, such as water hoses, street sweepers, and bulldozers, and the skills normally used in operating the equipment are the basic requirements for radiological decontamination.

PAVED AREAS AND EXTERIOR OF STRUCTURES

11.36 Decontamination of paved areas and the exterior surface of structures requires two principal actions; loosening the fallout material from the surface and re-

moving the material from the surface to a place of disposal. Some decontamination methods for paved areas are street sweeping and motorized flushing. Firehosing may be used for both paved areas and the exterior of structures.

11.37 Street sweeping is termed a dry decontamination method because water is not used. There are many advantages of this method over wet methods. In the absence of adequate water supplies for large scale decontamination procedures, dry street sweeping would be the preferred procedure. Also, during cold weather, wet decontamination procedures may not be practical.

11.38 Most commercial street sweepers have similar operating characteristics. A powered rotary broom is used to dislodge the debris from streets into a conveyor system which transports it to a hopper. Thus, a removal and bulk transport system is inherent in the design. Some sweepers utilize a fine water spray to dampen the surface ahead of the pickup broom to limit dust generation. This use of a spray previous to brushing would reduce the effectiveness of the procedure for decontamination because the combination would tend to produce a slurry which would make complete removal of surface contamination more difficult.

11.39 A variation in equipment of this type is the sweeper in which the broom system is enclosed in a vacuum equipped



FIGURE 11.38.—Commercial street sweeper.

housing. The material picked up by the broom and the dust trapped by the filters are collected in a hopper.

11.40 Normally a single operator is required per street sweeper. However, because fallout material would be concentrated in the hopper, the operator may be subjected to a high radiation exposure. This may make it necessary to rotate personnel for street sweeping operations. The operator should be instructed to keep a close check on his dosimeter, and dump the hopper often at the predesignated disposal area, as precautions to keep his accumulated radiation exposure low.

11.41 In decontaminating paved areas by street sweeping, decontamination factors¹ better than 0.1 can be realized, depending upon the rate of operation and the amount of fallout material.

11.42 The flushing or sweeping action of water is employed in decontaminating paved areas by motorized flushing. Conventional street flushers using two forward nozzles and one side nozzle under a pressure of 55 pounds per square inch (psi) are satisfactory for this purpose. In flushing paved areas, it is important that fallout material be moved towards drainage facilities.

11.43 Decontamination factors of 0.06 to 0.01 can be realized by motorized flushing, depending upon the rate of operation and the type and roughness of the surface.

11.44 The flushing or sweeping action of water also is used in decontaminating paved areas and the exterior of structures by firehosing. Equipment and personnel are commonly available for this method. Employment of the method is dependent upon an adequate postattack water supply. When decontaminating paved areas and structures, it is important that fallout material be swept toward predesignated drainage facilities, and, where possible, downwind from operational personnel.

11.45 Standard fire fighting equipment and trucks equipped with pumping apparatus may be used in this decontamination

method. The most satisfactory operating distance from nozzle to the point of impact of the water stream with open pavements is 15 to 20 feet. On vertical surfaces, the water should be directed to strike the surface at an angle of 30° to 45°. As many as three men per nozzle may be required for firehosing.

11.46 When decontaminating rough and porous surfaces or when fallout material is wet, the use of both firehosing and scrubbing are recommended for effective reduction of the radiation hazard. Initial firehosing should be done rapidly to remove the bulk of fallout material. Hosing followed by scrubbing would remove most of the remaining contamination. Two additional men per hose may be required for the scrubbing operation.

11.47 Decontamination factors between 0.6 and 0.01 can be realized by firehosing tar and gravel roofs with very little slope, and 0.09 to 0.04 in decontaminating composition shingle roofs that slope 1 foot in every 2½ feet. Decontamination factors of 0.06 can be realized in firehosing of pavements.

UNPAVED LAND AREAS

11.48 Decontamination of unpaved land areas can be accomplished by removing the top layer of soil, covering the area with uncontaminated soil, or by turning the contaminated surface into the soil by plowing. The two latter methods employ soil as a shielding material.

11.49 The effectiveness of any of the methods is dependent on the thoroughness with which they are carried out. Spills or misses and failure to overlap adjoining passes should be avoided. Reliance should be placed on radiation detection instruments to find such areas, although in heavily contaminated areas the fallout material may be visible. Large spills or misses should be removed by a second pass of the equipment. Small areas can be decontaminated with the use of shovels, front end loaders, and dump trucks.

11.50 Large scale scraping operations require heavy motorized equipment to scrape off the top layer (several inches) of

¹ For decontamination of vital areas and structures, the term decontamination factor (DF) is used. This represents the decimal fraction remaining after decontamination is accomplished.



FIGURE 11.48.—Turning contaminated soil.

contaminated soil, and carry the soil to suitable predesignated dumping grounds. The contaminated soil should be deposited 100 or more feet beyond the scraped area if possible; if not, at least to the outer edge of the scraped area. Scraping can be done with a motorized scraper, motor grader, or bulldozer. Effectiveness of the procedure depends upon the surface conditions. In decontaminating unpaved areas by scraping, decontamination factors over 0.04 can be realized if all spills and misses are cleaned up.

11.51 The motor grader is designed for grading operations, such as for spreading soil or for light stripping. This grader can be used effectively on any long narrow area where contaminated soil can be dumped along the edge of the cleared area. The blade should be set at an angle sufficient for removing several inches of the contaminated soil. The scraped up earth should be piled along the ground in a windrow parallel to the line of motion. The windrow can be either pushed to the side of the contaminated field and buried by the grader or removed by other pieces of earthmoving equipment.

11.52 The bulldozer can be useful in scraping small contaminated areas, burying material, digging sumps for contaminated drainage, and in back-filling sumps. It would be particularly suitable in rough terrain where it could be used to clear obstructions and as a prime mover to assist in motorized scraping. The contami-

nated soil stripped off by a bulldozer should be deposited at the outer edge of the scraped area, or beyond, if practicable.

11.53 Filling may offer no advantage over scraping, either in effectiveness or speed. Its principal use would be where scraping procedures could not be used, either because of rocky ground or because of permanent obstructions. Filling can be used in combination with other methods to achieve a low decontamination factor. The object of filling is to cover the contaminated area with uncontaminated soil or fill material to provide shielding. For these operations a motorized scraper, bulldozer, mechanical shovel, or dump truck and grader may be used.

11.54 The effectiveness of filling relatively flat surfaces will vary with the depth of fill. A 6-inch fill of earth can reduce the radiological hazard directly above to a decontamination factor of 0.15, and a 12-inch fill can reduce the hazard to a decontamination factor of 0.02.

11.55 Plowing provides earth shielding from radiation by turning the contaminated soil under. It is a rapid means of decontamination, but may not be suitable in areas in which personnel must operate or travel over the plowed surface. The depth of plowing should be from 8 to 10 inches. In decontaminating unpaved land areas by plowing, decontamination factors of 0.2 can be realized if the depth of plowing is from 8 to 10 inches.

11.56 Two or more methods can be applied in succession, achieving a reduction in the radiation field not possible, practical, or economical with one method alone. Any of three combinations of methods—scraping and filling, scraping and plowing, or plowing, leveling and filling—could be effective in unpaved areas. In some cases, any of the three might be more rapid than individual removal of spillage. The equipment used would be the same as in component methods previously discussed.

11.57 Because large earthmoving equipment could not be used in small areas, such as those around a building, other methods of decontamination must be used. If the area is large enough for a

small garden type tractor, or front-end loaders, these can be used for plowing and scraping the soil. Improvised methods of scraping small areas, such as using a jeep to tow a manually operated bucket scoop, could be used. There would remain some areas requiring hand labor with shovels, to dig up or remove the top layer of soil, or sod. Equipment and manpower requirements for loading and hauling the soil to a disposal area should be included in estimate of decontamination "costs". The rates of operation of these methods would vary with the type of terrain and its vegetative cover. The various procedures can result in decontamination factors of 0.15 to 0.1.

INTERIOR OF STRUCTURES

11.58 The two principal methods for decontaminating interiors of structures are vacuum cleaning and scrubbing with soap and water. Vacuum cleaning is useful for the decontamination of furniture, rugs, and floors. Floors, tables, walls, and other surfaces can be decontaminated by scrubbing them with soap and water. Mild detergents can be substituted for soap. Rags, hand brushes (or power-driven rotary brushes, if available), mops, and brooms are suitable for scrubbing.

COLD WEATHER DECONTAMINATION PROCEDURES

11.59 Cold weather decontamination methods will depend upon the weather conditions prior to and after the arrival of fallout. Various problems such as fallout on various depths of snow, on frozen ground or pavement, mixed with snow or freezing rain, and under various depths of snow could occur after a contaminating attack. The presence of snow or ice would complicate the situation since large quantities of these materials would have to be moved along with the fallout material. In addition, snow and ice could cause loss of mobility to men and to equipment. Fallout may be clearly visible as a dark film or layer of soil or powder on or within snow unless it precipitates with the snow.

11.60 The principal cold weather decontamination methods for paved areas, and structures are: (1) Snow loading, (2) sweeping, (3) snow plowing, and (4) firehosing.

11.61 Snow loading is accomplished with a front-end loader and is applicable for snow covers. When fallout is on snow, the front-end loader bucket is used to scoop up the contaminant and top layer of snow, which are forced into the bucket by the forward motion of the vehicle. The snow cover should be observed closely for pieces of contaminated debris which may have penetrated to some depth. The loader carries the contaminated material to a dump truck which removes it to a dumping area. The remaining clean snow is removed by normal snow-removal procedures. Decontamination factors of approximately 0.10 can be realized by this process, depending mainly on the amount of spillage.



FIGURE 11.61.—Front-end loader.

11.62 Pavement sweepers can be used for fallout on dry pavement, traffic-packed snow, or reasonably level frozen soil or ice. Pavement sweepers are more effective than firehosing where there is a drainage problem, or when temperatures are low. Sweepers will not effectively pick up contaminant on wet pavement above the freezing or slush point on ice or packed snow. Decontamination factors are approximately 0.10.

11.63 Snow plowing is applicable for all depths of contaminated snow. When fal-

lout is precipitated with snow, all of the snow must be removed to the dumping area. Blade snowplows, road graders, or bulldozers in echelon, windrow the contaminated snow to one side until the blades are stalled by the snow mass. A snow loader can be used to put the contaminated snow in dump trucks, which move it to the dumping area. Decontamination factors of 0.15 can be realized by this method.

11.64 Firehosing is possible and can be used on paved areas and exteriors of structures slightly below freezing temperatures. Firehosing is not recommended where slush from snow will clog drains. Problems associated with firehosing below 32° F are freezing of the water, thereby sealing the contaminant in ice and causing slippery conditions for the operating personnel. The principle of operation, and equipment used in temperate weather, will be the same under cold weather conditions. The effectiveness of firehosing will depend on surface and standard exposure

rates, and the decontamination factors will vary from 0.5 to 0.1.

11.65 In small areas, such as roofs of buildings, and around buildings, where large snow removal equipment could not be used, other methods of decontamination must be used. With small amounts of dry snow on roofs or paved areas, sweeping the area with brooms is satisfactory. With larger amounts of snow, with the fallout material on top of the snow, or mixed with the snow, shoveling the snow and removing it to an area where large snow removal equipment can be used is practicable. The rates of operation of these methods would vary with the amount of snow to be removed and the type of surface to be decontaminated. The various procedures can result in decontamination factors of 0.15 to 0.1.

11.66 In order to locate needed services and to guide the movement of decontamination equipment through heavy snow covers, colored poles should mark street corners, drains, hydrants and hidden ob-

AGENT	TYPE OF SURFACE	SITUATIONS
STEAM	PAINTED OR OILED, NONPOROUS	ROOMS WHERE CONTAMINATED SPRAY CAN BE CONTROLLED. BUILDINGS.
DETERGENTS	NON-POROUS (METAL, PAINT, PLASTICS, ETC.). INDUSTRIAL FILMS, OILS, & GREASES.	SURFACE COVERED WITH ATMOSPHERIC DUST AND GREASE. FIXED OR MOVABLE ITEMS.
COMPLEXING AGENTS	METAL OR PAINTED.	LARGE, UNWEATHERED SURFACE. SURFACES WHERE CORROSION IS NOT TOLERABLE. AS AN ADJUNCT TO WATER OR STEAM TREATMENT.
* ORGANIC SOLVENTS	PAINTED OR GREASED.	FINAL CLEANING. WHERE COMPLETE IMMERSION DIPPING OPERATIONS ARE POSSIBLE. MOVABLE ITEMS.
* INORGANIC ACID	METAL OR PAINTED, ESPECIALLY THOSE EXHIBITING POROUS DEPOSITS, SUCH AS RUST, MARINE GROWTH.	DIPPING OF MOVABLE ITEMS.
* CAUSTICS	PAINTED.	LARGE, SURFACES. DIPPING OF PAINTED OBJECTS.
ABRASIONS	METAL AND PAINTED	LARGE, WEATHERED SURFACES. FIXED OR MOVABLE ITEMS.
* UNUSUAL HAZARDS ARE ASSOCIATED WITH THESE METHODS, AND SPECIAL PRECAUTIONS OR PROTECTIVE EQUIPMENT AND REQUIRED.		

FIGURE 11.67.—Small scale decontamination methods.

stacles. Open ground areas planned for postattack use should be cleared of rocks, stumps, etc., prior to the arrival of snow.

11.67 Figure 11.67 lists other decontamination methods that may be used on a small scale, for specific areas of high contamination.

REFERENCE

Radiological Defense Planning and Operations Guide.—SM-11.23.2, Revised November 1968.

RADEF OPERATIONS

The man-in-the-street often thinks of modern war as "push button war" with visions of all our forces moving automatically at the pressing of a button on the President's desk. This just isn't so, of course. If there is no such thing as "push button war", how much more so is there no such thing as "push button radiological defense." We may have sensitive machines and instruments to measure nuclear radiation, but these devices must be operated, interpreted and the information acted upon. It is the prime objective of this chapter to explain how and by whom RADEF operations are carried out, and how the responsibilities for such operations vary among different types of RADEF personnel and within the various levels of government.

INTRODUCTION

12.1 To be effective, radiological defense countermeasures require rapid detection, measurement, reporting, plotting, analysis, and evaluation of fallout contamination for use during the early period after attack and trained radiological personnel are needed at all levels of the government—Federal, State, and local, to provide such information and skills.

12.2 The RADEF Officer and other RADEF personnel, in carrying out their responsibilities, act in a "staff" rather than in a "command" capacity. They provide an important part of the technical information upon which Civil Preparedness command decisions will be based.

12.3 It must be stressed that though RADEF personnel serve in a staff capacity at the various levels of government, fallout radiation is a *physical* not a *political* phenomenon. In short, fallout does not recognize city, state, or county bounda-

ries. As a consequence, effective RADEF countermeasures demand cooperation among the various RADEF organizations. This cooperation must be both horizontal and vertical: horizontal among organizations on the same level of government (e.g., different counties or States); vertical among levels (e.g., city and State). Also, cooperation must not wait until an attack—it must be planned for and worked at *now*.

WHO WILL CARRY OUT RADEF OPERATIONS?

12.4 To carry out the various functions of radiological defense, there is need for Radiological Defense Officers, Assistant Radiological Defense Officers, Monitors, Analysts, and Plotters. The following paragraphs define each of these positions and summarize duties and responsibilities. These definitions are necessary at this point to avoid repetition in the later level-by-level description of the operational process.

DEFINITIONS

12.5 *Radiological Defense Officer.*—A person who has been trained to assume the responsibility for policy recommendations for the radiological defense of a State, county, locality, facility, or a relatively large group of organized personnel.

This officer must be conversant with measurement and reporting procedures, capable of evaluating the probable effects of reported radiation on the people and their environment, and capable of recommending appropriate protective measures (such as remedial movement, shelter, and decontamination) to be taken as a result of the evaluation.

12.6 *Assistant Radiological Defense Officer.*—Definition similar to that of the Radiological Defense Officer. Less administrative capability is required, but the capabilities listed above are required. It should be borne in mind that the term "assistant" is an organizational distinction rather than indicative of anything less than 100% possession of all necessary RADEF Officer qualifications.

12.7 *Monitor.*—A person who has been trained to detect, record, and report radiation exposures and exposure rates. He will provide limited field guidance on radiation hazards associated with operations to which he is assigned.

12.8 *Analyst.*—A person who has been trained to prepare monitored radiological data in analyzed form for use in the area served as well as by other levels of government to which reports of such data are sent. He will also evaluate the radiation decay patterns as a basis for estimates of future exposure rates and radiation exposures associated with emergency operations.

12.9 *Plotter.*—A person trained to record incoming data in appropriate tabular form and to plot such data on maps. He will also perform routine computations under direction.

LEVEL-BY-LEVEL RADEF OPERATIONS

12.10 *Fallout monitoring station activities.*—Upon receipt of warning of likely attack, monitors (at least four should be assigned to each station to provide 24-hour continuous monitoring), will be advised of the likelihood of attack. They will then begin to carry out the emergency plan. Upon arrival at the monitoring station, all equipment and procedures should be checked and an operational readiness report made to the emergency operating center (EOC) RADEF Officer, thus verifying that the station is ready to operate. The monitoring station will send the EOC a FLASH REPORT the first time the unsheltered exposure rate equals or exceeds 0.5 R/hr. The station also sends scheduled EXPOSURE RATE REPORTS and EXPOSURE REPORTS, plus SPECIAL RE-

PORTS whenever a declining rate trend is reversed and there is a rapid increase.

NOTE

For the monitoring station, and for all levels, the time before fallout arrives is a time of intense activity. Not a moment should be lost by RADEF personnel between arrival at assigned locations and performance of all prescribed readiness actions.

12.11 *Shelter monitoring activities.*—After checking his equipment, the shelter monitor will make an operational readiness report to the shelter manager (who, in turn, will report that fact to the EOC). The shelter monitors will measure and report to the shelter manager the daily cumulative exposure of shelter occupants. This in-shelter exposure will be reported to the EOC if it exceeds 75 R. Should this be exceeded during the first two days in shelter, or should the exposure rate exceed 10 R/hr, an EMERGENCY REPORT should be sent to the EOC requesting advice. The shelter monitor will also report to the shelter manager as to the daily exposure rate. Should any occupied area of the shelter be receiving a rate of 2 R/hr or more, the monitor will report on the exposure rates within various areas of the shelter so that the manager may move shelter occupants to safer positions in the shelter. The shelter may also be designated as a station in the regular monitoring network, in which instance the operations described in paragraph 12.10 will also be performed.

12.12 *The local emergency operating center.*—Local emergency operating centers first determine that monitoring stations are in a state of operational readiness. Subsequently, the local EOC's will receive reports from these monitoring stations and shelters and will transmit summary-type data to the State EOC. In addition, and as previously agreed upon, this data can be made available to neighboring EOC's. The reports to the State EOC will include flash reports made upon their receipt from any of the monitoring stations within the network of the local EOC. Exposure and exposure rate reports will also be

made in summary form to the State EOC as determined by the State Civil Preparedness Plan. The exposure rate report will include a typical exposure rate if the area within the jurisdiction of the local EOC is small. The local EOC's will also report the accumulated unsheltered exposure at least once each day to the State EOC. It should be noted that the term "local EOC" is used here to designate the operating echelon or echelons between the monitoring station and the State EOC. (A very large city may have local area EOC's sandwiched in between the stations and the local EOC's.) In addition, some States may have county EOC's between the local and State EOC's. These various EOC's may report to a sub-State EOC depending on the State's geography and population.

12.13 *The State Emergency Operating Center.*—This is the command level for each State's Civil Preparedness organization. The State EOC receives reports from local, local area, county and/or sub-State EOC's within the State and will, in turn, send to the appropriate DCPA regional office flash reports summarizing the spread of fallout across the State as well as exposure rate analyses. The State EOC will also send selected flash reports as appropriate to the local EOC to alert them of approaching fallout and exposure rate reports to advise local centers of exposure rates in neighboring communities. Neighboring States, in addition, and Canadian provinces can also be sent flash reports and exposure rate analyses by the State EOC. State EOC's are tied into a national

RADEF system through the DCPA regions to which they report.

12.14 In addition to collecting and reporting data, RADEF Officers at the State (sometimes sub-State) level have the responsibility of providing the data for fallout warning and other fallout advisories issued to the general populace by the Governor or other properly designated civil authority. There are many possible types of advisories which could be issued, depending upon local conditions.

EMERGENCY OPERATING CENTER PERSONNEL

12.15 Communities over 500 population, State and county governments, and certain field installations of Federal agencies require other radiological defense personnel in addition to monitors. These are the RADEF Officers, Assistant RADEF Officers, Plotters, and Analysts located at EOC's. Their functions were summarized in paragraphs 12.5 to 12.9. As a rule, rural areas will need only monitors. The number of Assistant Radiological Defense Officers will depend on community size. Large cities will require several, while small communities may require none.

12.16 A suggested guide to the number of Analysts and Plotters for communities of various sizes is shown in Figure 12.16. A Radiological Defense Officer can "double in brass," filling in for a variety of RADEF personnel where no other individual is available to perform the particular function.

POPULATION	PLOTTERS NEEDED	ANALYSTS NEEDED
Under 2,500	1	1
2,500 to 25,000	1	1
25,000 to 250,000	4	2
Over 250,000	6	3

FIGURE 12.16.—Requirements guide for plotters and analysts.

NOTE

This is a "one-way street," however, because an analyst, for example, CAN NOT perform the functions of a Radiological Defense Officer unless he IS a Radiological Defense Officer.

A REPORTING NETWORK

12.17 The monitoring stations must be

linked into a well organized and extensive reporting system, running up through the sub-State and State organization all the way to the national center. It is vital that the data produced at each level should support the higher levels. Also, data must be consistent between and among reporting levels. No correct conclusions can be drawn from data that employ different units of measurement or time bases.

RADEF PLANNING

In a church in Caracas, Venezuela, a pickpocket, hoping to stir up some excitement during which he could work more easily, shouted "Fire." There was no fire but the congregation stampeded anyway. When the screaming mob finally burst out of the church, many huddled forms were left behind, trampled and broken. Fifty-three of them, including 22 children, would never discover that there was no fire.

After the *Titanic* smashed against an iceberg a Mrs. Dickinson Bishop left \$11,000 in jewelry behind in her stateroom, but asked her husband to dash back to pick up a forgotten muff. Another passenger on the sinking vessel, Major Arthur Peuchen, grabbed three oranges and a good-luck pin, overlooking \$300,000 in securities he had in his cabin. Still another passenger carried into the lifeboat nothing but a musical toy pig.

There are countless cases of persons who in their haste to escape hotel fires, jump from upper story windows located just a few feet from a fire escape.

The cause of this strange and illogical behavior is panic and the cure is planning. The major objective of this chapter is to describe the importance of planning to effective Radiological Defense.

THE EXPERIMENTAL EVIDENCE

13.1 In a series of 42 varying experiments with from 15 to 21 subjects, the psychologist Alexander Mintz clearly showed the wide difference between planned and unplanned behavior in a period of stress. The experimental situation consisted of a large glass bottle with a narrow mouth. Inserted in this bottle were a number of aluminum cones. These cones were attached to strings each of which

was held by one of the participants in the experiment. The idea, of course, was to pull the cones out of the bottle. When conditions such as we might have during a sudden emergency arose and there was "every man for himself", traffic jams occurred. Sometimes but one or two cones were jerked free before the rest were hopelessly snarled.

But, when the participants were given time for prior consultation and planning, *there were no traffic jams*. In one instance all the cones were removed in under 10 seconds.¹

13.2 But what happens when there are no plans? We saw the experimental evidence. Cones get jammed. Strings get twisted. The evidence of real life is just as simply stated: people get killed and injured; property gets destroyed. It is said that casualty statistics are people with the tears wiped off. Let's look behind the statistics and examine a few of the legion of tearful stories.

THEY HAD NO PLANS

13.3 A bustling city of 30,000 was located at the point where two swift streams met. The city was built along the low river banks, surrounded by steep hills. As a result of this situation, the lower part of the city suffered from floods every spring.

13.4 Upstream was a huge dam, originally built to store water for a canal but progress made the canal uneconomical, so it was abandoned and maintenance halted on the dam. Gradually the dam deteriorated. Water seeped out in a hundred places and within a few years the water level had dropped to half. When a small break

¹ Non-Adaptive Group Behavior, Alexander Mintz, Readings in Social Psychology, p. 190-195. Henry Holt & Co. New York, 1952.

occurred, the water level was low and only part of the city was flooded.

13.5 Subsequently, a hunting and fishing club leased the dam and the lake it impounded. The club tried to repair the dam. Their work seemed sound. But into the break had been dumped tree stumps, sand, leaves, straw and other debris. Later on, heavy rains caused many leaks in the dam and floods in the city.

13.6 Finally, there was an even heavier rainfall. After six inches of rain, the water level in the dam rose rapidly. Crews hired by the hunting and fishing club worked to repair the leaks but the rising waters kept eating away at the rotten structure.

13.7 Finally, a civil engineer inspected the dam. He realized it would not hold and tried to get word to the city below. There were no telephones and the storms had downed the telegraph wires. Word did not get through. Meanwhile, the workers watched in horror as the waters began to roar over the top of the dam racing for the city, 12 miles away and 400 feet lower in elevation.

13.8 A half million cubic feet of water rushed through that breach picking up on the way trees, houses, boulders. When it reached the city it was a wall 30 feet high moving at 20 miles an hour. The result: annihilation! The city was destroyed, and 2,000 people lost their lives in an instant of terror.

13.9 But the disaster need never have happened had the warnings of the *dam itself* been heeded during the preceding quarter century. Even if no efforts had been made to remove the cause—the obviously unsound condition of the dam—it seems unbelievable that no one *planned* for a possible serious break, and no one *planned* a warning system.

AND STILL NO PLANS

13.10 But we need not go all the way back to the Johnstown flood to see the effect of lack of planning. The greatest manmade disaster in recent American history is replete with examples of lack of planning, from its beginnings in the hold of a ship in Galveston Bay to its end a few

hours later in a devastated city, ravaged to the tune of 552 dead, 3,000 injured and maimed and over \$50,000,000 in property damage.

13.11 It all began with a few wisps of smoke from the cargo of fertilizer carried on board the SS *Grandcamp*. A crewman investigated, but even after shifting several bags of the fertilizer, he could find nothing. He tried throwing buckets of water in the direction of the smoke. No effect. Next he tried a fire extinguisher. Still no effect. So he called for a fire hose. But the foreman objected. Hosing down the cargo would ruin it. The Captain ordered the hatches battened down and the turning on of the steam jets. Turning on steam to fight fires is standard marine firefighting practice, and has been for years. But *this* fertilizer was ammonium nitrate, which, when heated to about 350 degrees Fahrenheit, becomes a high explosive.

13.12 *Someone* should have known how to deal with this explosive fertilizer. *Someone* should have made plans for putting out a possible fire in or near the nitrate. But no one had. And so, at 12 minutes after 9 on the morning of April 16, 1947, the 10,419-ton *Grandcamp* and all those aboard were blown to bits. The explosion, calculated as equivalent to 250 five-ton blockbusters (1.25 kilotons) going off at once, dropped 300-pound pieces of the *Grandcamp* 3 miles away. Two small planes, flying at about 1,000 feet above the harbor disintegrated from the tremendous concussion. The blast swept across the complex of oil refineries and chemical plants, smashing them flat and setting off other explosions and fires.

13.13 As a result of this explosion and the later and even more violent blast from another ammonium nitrate laden ship, the SS *High Flyer*, chaos reigned in Texas City. Though the citizens of the city worked with courage and initiative to help the injured, for the first few hours their work was uncoordinated.

13.14 *There was no disaster plan.*

13.15 The head of the Texas City disaster organization is quoted as saying: "We

had an organization, but it was designed for hurricane. We weren't prepared for anything like this. In a hurricane, you have some warning and you can get your organization ready. But we had no warning in this, and our organization was scattered all over town. And do you know what happened at our meeting to develop a disaster organization just 3 weeks before the explosion? People pooh-poohed the idea!"²

MORE LACK OF PLANNING

13.16 On September 5, 1934, the SS *Morro Castle* steamed out of Havana harbor. A seagoing hotel, the ship was crammed with passengers heading back to New York after a Caribbean vacation. The ship was equipped with all the latest equipment to detect, confine, and extinguish fires.

13.17 Captain Wilmott was confident in the fire safety of his ship. But 2 days later he was dead of a heart attack and his second in command had scarcely gotten accustomed to being Captain when a deck night watchman reported a fire.

13.18 After investigating, a belated alarm was sounded and the crew tried to put out the fire. The ship was equipped with fire doors which, if shut in time, might have kept the fire from spreading past the point of origin.

13.19 *But no one had been assigned to close the fire doors.*

13.20 This, and other evidence of serious planning deficiencies, caused the Acting Captain and Chief Engineer to be sentenced to prison for incompetence and neglect of duty (they were later cleared by a higher court) and the steamship line was fined \$15,000 for failure to enforce safety regulations and for placing unqualified personnel in charge of the ship. The final cost was 134 dead and \$4,800,000 property loss.

ANOTHER CATASTROPHE

13.21 Or take the case of the former French liner *Normandie*. The lack of plan-

ning is summed up in a straight-from-the-shoulder report of the National Fire Protection Association:

"The fire-spreading conditions aboard this vessel had been allowed to become so bad during the execution of a \$4,000,000 conversion contract that a wayward spark from a cutting tool, inexcusably landing in a kapok life preserver, was sufficient to culminate in the total destruction of an *uninsured* \$53,000,000 ship. Because although the incipient outbreak started in broad daylight under the eyes of 1,750 employees of the contractor—plus another 1,650 Navy, Coast Guard and subcontractor personnel—not one of them had the rudimentary training required to stop the thing—or even the wit to promptly call in somebody with the training. By the time the fire department was summoned, the blaze had advanced so far that a fifth alarm was required, putting to work more apparatus than is owned by cities the size of St. Paul, Minn., or Toledo, Ohio."

A FINAL TRAGEDY

13.22 Finally, there was the Coconut Grove fire.

13.23 The Coconut Grove was many things. It was a fire trap infested with safety violations (for which the owner was later sentenced to prison for from 12 to 15 years). It was the last hour for 450 persons. It was also an example of lack of planning, from the major exit door that opened *inward* (where some 100 bodies were found jammed), to the narrow stairways, to the inflammable decorations, even to the lack of planning in sending the victims to hospitals.

13.24 Boston's City Hospital received 129 fire victims, thus greatly overloading its facilities. Massachusetts General Hospital received only 39 and could have handled many more. Thirty other victims were distributed among 10 other civilian hospitals. Seventy-eight percent were sent to City Hospital simply because that is where accident victims usually were sent.

13.25 No one planned for the disaster

² Quoted in THE FACE OF DISASTER, Donald Robinson, p. 130, Doubleday & Co., New York, 1959.

when masses of people would simultaneously, become the victims of accident.

THEY HAD PLANS

13.26 When an exploding ammunition ship faced South Amboy, N.J., with the same situation as Texas City, the mayor had a disaster plan all set to go. Immediately the rescue operation went into high gear.

13.27 Men knew where they were supposed to go, and they went there. Off-duty police were automatically called in. Road blocks controlled traffic keeping the sightseers out and letting relief supplies in. Liaison was established, per plan, with the State Police and the National Guard.

13.28 The property destruction at South Amboy was nearly as great as at Texas City (\$36,000,000) but the loss of life was far less (31 dead).

PLANNING PAYS OFF

13.29 In what was termed "the most successful exercise . . . ever heard of in the United States", some 200,000 people evacuated low lying areas on the Texas coast to avoid hurricane Carla.

13.30 The success and smooth functioning of this gigantic movement had many reasons. According to the Governor of Texas, "The success of evacuation was the result of careful planning which began 10 years ago in the Governor's office when its Division of Defense and Disaster Relief was set up." A Red Cross official added, ". . . critics said the Government was pouring money down a rathole (for planning). It wasn't—it was this plan we were able to use. The State has a CD plan and made the plan work—that is why we were able to do so much".

13.31 The head of the Texas Department of Public Safety, when asked why the operation had been such a resounding success, answered, "Why? It was done because of preplanning and training". A county judge added, "Let people know the value of preplanning". In Louisiana, the Lake Charles Civil Defense Office stated that, "The biggest lesson of Carla was that

all of the effort put into some 3 or 4 years of intense training and planning paid off. When it was needed, the organization was ready to roll—it was only a matter of calling the staff together and giving them the job."³

EMERGENCY VERSUS CATASTROPHE

13.32 Despite differences in dictionary definitions, often the only real difference between an emergency and a catastrophe is—*prior planning*.

13.33 Perhaps the best concrete example is the damage control system used by all major modern navies. Naval combat ships are not designed from the standpoint of wishful thinking—optimistically hoping that there will be no hits and do damage. Rather, naval vessels are designed with the point of view that the ship that can take the most punishment and still fight on is the ship that will survive and win victory. Hence, naval combat vessels have elaborate, but very practical, damage control systems. These systems include watertight compartments of various sizes, provisions for pumping, for counter-flooding to restore balance, of standby and auxiliary power, intensive training and effective organization of the crew, and many other features. All these are the result of the analysis of thousands of accidents at sea, naval engagements, and just plain hard, logical thinking. Thus, when a ship slides down the ways it is the product of countless plans, not the last of which is planning to keep an *emergency* from turning into a *disaster*.

AN IMPORTANT LESSON

13.34 You might well wonder what the preceding paragraphs have to do with radiological defense planning as such. How does the *Morro Castle*, the *Coconut Grove*, our Navy's damage control systems, or *Johnstown*, Pennsylvania, relate to the problems of planning for civil preparedness; what do the explosive qualities of ammonium nitrate have to do with de-

³ Quotes from Department of Defense, Office of Civil Defense, Hurricane Carla, p. 93, Superintendent of Documents, U.S. Government Printing Office, Washington, D.C.

fense against or recovery from nuclear attack? The answer is both simple and logical.

13.35 The cases which have been documented above all serve as illustrations of a single, vital truth. Namely, planning consists of a two-pronged approach to a potential problem area which can be summarized as:

1. LOGICAL ASSUMPTIONS
2. PRACTICAL ANSWERS

This is no less the case for radiological defense planning than for any other type. The sole purpose of the preceding paragraphs has been to "set the stage" along these lines for our consideration of RADEF planning which will follow.

RADIOLOGICAL DEFENSE PLANNING

13.36 In the previous chapter, we took a level-by-level look at the operations of the RADEF organization from the basic monitoring station on up to the State emergency operating center. We will follow this same procedure in this chapter but, first, some general comments on RADEF planning are in order.

WHERE DOES PLANNING ORIGINATE?

13.37 Though there is obviously a need for careful planning in RADEF, most people are aware that this does not mean these plans can be finalized in Washington and shipped out to the States and local communities to adopt and put into effect. On the contrary, with a country as diverse as the United States, a plan worked out for Chicago or New York will not be the same, indeed *should* not be the same, as a plan devised for a farm community or a seacoast area. An understanding of the wide diversity of the United States is behind the establishment of a Federal system of government by the Founding Fathers. They knew that differing situations required different methods. This is also true in RADEF, for at the various levels of government, state, county and local, some radiological defense functions are similar, some are materially different and the em-

phasis on a given function may appropriately vary from level to level.

PLANNING RESPONSIBILITY RESTS ON GOVERNMENT AT ALL LEVELS

13.38 At the community or urban level, detailed and current radiological intelligence would be essential for warning and directing the protective action to be taken by the local populace as well as for control of radiation exposure to personnel performing locally directed emergency and recovery functions as called for in the complete Civil Preparedness plan.

13.39 At the higher levels of government, there is increasing responsibility for planning, coordinating, and, as necessary, directing protective, remedial and recovery actions and programs beyond the capabilities of the individual communities. In order to perform such RADEF functions within the framework of the overall plan, the State, county or local level needs areawide intelligence which is dependent upon reliable monitoring and reporting.

13.40 Each State has the major responsibility for planning, development and implementation of Civil Preparedness programs, and intrastate administration of Federal assistance for development of emergency operation capabilities at local to State levels.

13.41 Although the State plan need not present complete detail of all purely local radiological defense operations, local capability is a prime requisite for successful statewide operations and must be provided for as a part of the more basic State plan. Having a State plan is, alone, just not enough.

NOTE

Don't forget: The primary responsibility for Civil Preparedness planning, and therefore RADEF, rests with the primary legal authority for whatever government unit is involved.

13.42 Once again, planning is the responsibility of the Coordinator of Civil Preparedness at each level. In large or complex jurisdictions, a special planning group might be established to assist the

director in making the plan. This special group should work with him (or his deputy). The members of such a group generally should be relieved from all, or many, of their other duties to give major time and attention to planning.

NOTE

When authenticated by the proper official, acting within the legal purview of his authority, the Civil Preparedness operational plan bears the full force of law.

13.43 Remember, a *sound* planning cycle is a *continuous* planning cycle. There are excellent reasons for this.

NO PLAN WILL EVER BE COMPLETE OR FINAL

13.44 Many wars have been lost because generals learned their lessons too well and formed their plans too firmly. The lessons they learned were from the *previous* war. They analyzed the tactics, they studied the success and defeats, the advances and retreats. *They* would never make those mistakes. And they never did. They made *new* mistakes because, while learning their lessons, and building plans on the basis of those lessons, the world was changing. New methods were appearing. Thus, the French army in World War I, learning well the lessons of the previous Franco-Prussian War, determined to attack, attack, always attack. Unfortunately, the introduction of machine guns, barbed wire, heavy artillery, and other new weapons gave the advantage to the defense. When the pride of France broke against the German defenses in Alsace-Lorraine, the war then passed into a phase dictated *not* by old plans but by new weapons. Thousands of lives were lost to gain a few yards of soil. Any lessons based on the early phase of World War I would equally have been incorrect during World War II, for the tank, self-propelled artillery, and parachute troops gave the initiative once again to the attack.

13.45 Yesterday's plans often do not fit today's problems, and those who will not lift their eyes from the plans to take a

hard look at reality may be doomed to face disaster.

13.46 Anyone could produce a plan, for example to counter the Texas City disaster *now that it is history*. The real trick would have been to plan for it *before* it happened as was done in South Amboy.

NOTE

Remember, the difference between emergency and catastrophe is planning!

MONITORING STATION PLANNING

13.47 If Mr. Jones, newly appointed RADEF Officer for the town of Anywhere, U.S.A., were to address himself to the question of planning for the monitoring network which he feels is necessary to support his radiological defense effort, the logical starting point might well be taken as the determination, in view of population and geography, of the total number of radiological monitoring stations he will require. This may be logical but it is also wrong! The correct starting point would be a careful perusal of RADEF plans *already in existence* for his city or his country or even his State.

13.48 *Every State has an emergency operations plan already in existence*. Some plans are better than others and, logically, some RADEF annexes to these plans are more complete than others. But, in any event, before Mr. Jones does any planning, he should check to see how much planning has already been done. If he disagrees with the plan, he has just discovered his *real* starting point for building up a RADEF capability for the town of Anywhere, U.S.A.

13.49 But suppose, for the sake of argument, Mr. Jones found a well-conceived RADEF annex to his existing area Civil Preparedness plan, one which spelled out requirements, locations, numbers of monitors and so forth in complete and correct detail. Suppose, further that he inherited a going monitor instruction program, had all the equipment he required and had a long waiting list of people begging him for a chance to be radiological monitors. Give

him his full quota of monitoring stations, all with a protection factor of 100 plus two-way radios as well as telephones. Would it be possible for him to still have a monitoring station problem in the midst of all this plenty?

13.50 The answer, of course, is yes. He would have a very definite problem in spite of all the RADEF assists spelled out above if he could not point to at least one more plus feature, that of a functioning program of instrument maintenance, repair and calibration. His other enviable RADEF assets would not count for much in an emergency if only, say, 20% of his monitoring equipment could be either operated or relied upon.

SHELTER MONITORING PLANNING

13.51 Anywhere, U.S.A., has a sufficient number of public shelters and the most marginal protection factor in any one of them is at least 100. Adequate equipment is available and already in place in each shelter to permit it to perform its self-protecting monitoring function. Mr. Jones was pleased when he learned this, but he was doubly pleased when he also learned that there was no personnel requirement for monitors, every shelter had its full quota. Now, perhaps, he can move to one of his other RADEF problem areas?

13.52 If he does move away from shelter monitoring at this point, he could be making a very big mistake. The availability of a facility, the required equipment and the personnel to operate it are all essential ingredients to a RADEF capability, true enough, but they are not sufficient to guarantee it. A fourth factor is required, an all-important factor, and that is *training*.

13.53 But let's say that Mr. Jones investigates and finds that his local plan calls for a systematic series of field exercises on a regular basis. One exercise series has just concluded and every single monitor passed with flying colors. They demonstrated a firm grasp of reporting requirements. Surely, this would indicate that training is maintained at an adequate level.

13.54 Yes, it does, but only if Mr. Jones wants to ignore the potential need for performing tasks outside shelters. We can be reasonably sure he won't, though, because he recognizes there is more to monitoring than just taking readings and reporting them. We can rest assured that our Mr. Jones will see to it that his plan provides for adequate and continuous dissemination of such important instruction.

EMERGENCY OPERATING CENTER PLANNING

LOCAL AREAS

13.55 By the time he began to review or prepare the portion of the local plan which deals with his own EOC, Mr. Jones had learned quite a few lessons about not leaving anything to chance. He approached this task carefully and thoughtfully, making certain, first of all, that the selected facility was adequate both from the standpoint of sufficient space as well as sufficient space for the display of RADEF data.

13.56 Further, he made sure that there would be provision for an adequate staff of plotters and analysts as well as communication personnel. When he realized that these people had to be trained, provided with forms, pencils, paper, pencil sharpeners, food, water, etc., etc., he began to worry about the size of the job which faced him as RADEF Officer.

13.57 One night he sat bolt upright in bed with the shocked realization that although he had taken care of all of these many items in his EOC planning, he did not know the protection factor of the building which would house the center!

13.58 He had, he realized, just taken the appearance of the building at its face value and assumed that its protection factor would be satisfactory. He recognized the enormity of his mistake immediately and lost no time the next day before asking and learning that the protection factor was more than adequate (much to his relief).

13.59 But he did not recognize his *real* mistake until it was pointed out by his wife when he told her what had happened, or rather, what *could* have happened.

"George," she said, "it's simple. You need an assistant and that's all there is to it!" She was right, of course, because George Jones had made a very human mistake, one which is not confined to the ranks of Radiological Defense Officers either. He had simply failed to notice the point at which he was "spreading himself too thin" and his RADEF plan encompassed more area than one man could handle.

13.60 While in the State capital on a business trip, George Jones dropped in on the State Radiological Defense Officer to renew their acquaintance and in the course of their conversation told him how well Fred Green, the new Assistant RADEF Officer for Anywhere, U.S.A., was working out in the job. He mentioned the series of events which had led to the appointment and was intrigued to hear the expression, "unmanageable span of control," used in reference to his problem.

13.61 It was an exceptionally apt description, he concluded as he drove home that evening, and this set him to thinking in terms of the span of control of his own local RADEF organization. He had discussed "span of control" (although not in such a precise term) sufficiently with Fred Green to assure himself that it did not represent a problem to their organization. As he turned into his driveway, however, he was struck by the sudden thought that this comfortable situation might not be true of the County Emergency Operating Center to which his organization reported. He decided to look into the matter further at his earliest opportunity.

13.62 Three months later, the Anywhere, U.S.A., Emergency Operating Center was duly entered in the State Civil Defense Plan and all other supporting documents. George's suspicion had proved to be correct, something that the County Civil Preparedness Coordinator had been thinking of himself for some time. He had recognized that the analysis load thrown on his own RADEF organization would simply be too large to handle if an emergency should occur during the evening hours, a time when the bulk of the population in the county had redistributed itself

into a series of small suburban communities, each with its own little EOC.

13.63 In explaining his situation to George Jones, he ruefully acknowledged that all initial planning had been based on the concept of a daytime emergency and for many months no one had thought to examine the county RADEF setup in terms of how it would function in the evening hours. He went on to point out that the mistake had been uncovered, interestingly enough, through the reappraisal of apparently inadequate means of alerting certain key operating personnel during the evening hours. This had led, in turn, to the interesting discovery that a surprising number of his volunteers had accepted equivalent assignments in their own home communities, some of which were as far as twenty-eight miles away from the county seat. The County Coordinator acknowledged that all of these people had advised his office of their decision and, further, that his office had complete records of these facts. When his secretary had casually mentioned that they seemed to be in for a rough time if an emergency should ever start in the evening, though, he suddenly realized that his fine daytime RADEF organization would be a desperately overworked group if it ever had to commence functioning during the night.

13.64 As he worked with George Jones on the new plans which called for several of the newer local EOC's to report to the Anywhere, U.S.A., Area Emergency Operating Center rather than to the County EOC, the phrase, "reduce the span of control to manageable proportions," was heard over and over again because it is such an apt expression of the purpose of an area EOC.

13.65 George Jones realized that the work he had done with the County Coordinator would be extremely worthwhile for the county as a whole even though it meant that his own RADEF organization was taking on a substantial added responsibility in receiving, analyzing, summarizing and reporting the additional data which the several local operating centers would be sending in. In view of the changed situation, he knew that his own,

personal span of control and Fred Green's as well had both been stretched past the danger point and something would have to be done about it. He and Fred would have to review their entire tables of organization as well as all their initial planning concepts. Undoubtedly, at least one new assistant would be required, perhaps even two. "One thing is certain," thought George Jones, "if I have to make mistakes in this RADEF work, at least I'm going to make *new* mistakes!"

13.66 The County Coordinator reflected that the new plans growing out of his efforts with George Jones were a big help in more ways than one. Now he had more time to devote to an item which he had never felt was all it should be, specifically, the county's radiological monitoring network. There was a perfectly adequate number and distribution of urban monitoring stations, true enough, but he was not completely satisfied with his setup in rural and mobile monitoring. After all, the problems of a county EOC could be considerably more complex than those of a local EOC in that county-type RADEF problems had to be approached from the standpoint of area as well as population. Although this *could* be true for a local EOC it was *always* true for a county EOC.

13.67 The more he thought about it, the more the County Coordinator was convinced that a county EOC was practically a State EOC on a smaller scale.

13.68 He was certain, for instance, that the State Civil Preparedness organization had an easier time with maps than he did because the Highway Department had complete up-to-the-minute information on every road in the State, all new construction, road conditions, etc., etc. As a matter of fact, the County Division Office of the Highway Department (which was located just down the hall from his own office) was the proud possessor of one of those master maps that the State used in its highway maintenance and construction program. It was a real beauty, showed everything that anyone could possibly want to know about roads in the State. And it was so much better than the maps that he and his mobile monitors were using. . . .

13.69 "Just a minute!" he thought, "Why not use that big camera over in our County Records Section and make copies of their map for ourselves?"

13.70 The more he thought about the idea, the better he liked it. In the first place, there simply *wasn't* any better map available anywhere, either in or out of the State. Second, he ticked off, it will be maintained by an outside organization and every time a major change occurs, a new set of maps can be produced in just a very few minutes. Third, he realized, it would be an invaluable addition to the resources of his operations center. He decided to lose no time in putting his plan into effect.

13.71 When the first copies of the State Highway Department's map were delivered to his office, the County Coordinator lost no time in looking them over. He decided that the quality of reproduction was very good, that the maps would fill his requirement perfectly. Inspecting the maps a little more closely, he noticed that the span of roads which would connect with the new bridge to be built in a neighboring county were just about complete, even though work had not yet begun on the bridge itself. He was reminded of a conversation he'd had with George Jones a few days before in which George had been telling him what a boon the new bridge would be. George, had mentioned that his delivery trucks had a choice whenever they had a stop to make in the next county. They could drive ten miles upriver on a road that was only fair to get to the closest bridge or they could drive eighteen miles downriver on a very good road and make their crossover there. The new bridge couldn't go up too soon, as far as George Jones was concerned.

13.72 A sudden thought hit the County Coordinator.

13.73 He never could think about George Jones very much without also thinking about "span of control" which always led him, in turn, to consider George's area EOC and how well the plan was working out in actual practice. The words, "area EOC" and the fact that he had just been thinking about his mobile

monitoring a few seconds before were the two things that sparked his idea. He looked at the map once more. There it was!

13.74 If George Jones' trucks had to travel either ten or eighteen miles to cross the river, why then so would the mobile monitoring teams sent out by the County Coordinator of the next county!

13.75 "But if the area on our side of the river were to be monitored by our own teams," he mused, "then our neighbors wouldn't have to make those long trips just to get across the river. We're *already* across the river as far as they are concerned. Why couldn't we take this area over and monitor it for them? If we did take over, our crews would be receiving only a fraction of the radiation exposure which their crews would be getting!"

13.76 Little did the County Coordinator, realize that his idea would produce the first sub-state EOC in his state and, further, that his own county EOC would become it! He could see the basic reasoning behind the move, however, once it had been explained to him because, after all, he would be taking over just about half of the area monitoring work of the neighboring county and so might as well take over area RADEF control as well. He had been a little skeptical about the manpower requirements represented by the new responsibility, but was pleasantly surprised to learn that he would be getting a boost from the State EOC in the training of additional monitors because the State center expected to have him take over additional area responsibilities as soon as he was organized to handle them.

13.77 "One lesson I've learned from this," he told George Jones when describing the new RADEF plan to him later on, "is that you never can really forget about that 'span of control' idea that you were the first to point out to me. Even though this latest move had its beginning idea completely outside such a concept, it was still a case of reducing the span of control to manageable proportions, at least so far as the State EOC was concerned."

STATE EMERGENCY OPERATING CENTER PLANNING

13.78 Some weeks later, the State Radiological Defense Officer dropped in on the County Coordinator to see how his new Substate EOC planning was shaping up. He was, of course, particularly interested in any RADEF developments which might be of use to him in his role of RADEF advisor to other EOC's within the State. He didn't really expect to pick up anything so far as his own operation in the State EOC was concerned because, after all, it had been a going concern for at least 2 years and a great deal of time and talent had been devoted to making it so.

13.79 As the County Coordinator was showing him the new setup, he noticed two transparent plastic panels which had been vertically mounted on sturdy pairs of legs. The panels were pushed back in a corner out of the way and were apparently without any use that he could discover. He inquired about them.

13.80 "Oh, that's my own, personal little brain-child," said the County Coordinator, "and I don't mind telling you I'm sort of proud of it, too, even though I don't know anyone who uses a similar system. You see, I was having some real difficulties in the trial runs we had held here insofar as using the information we had plotted and analyzed. There was too much confusion in trying to maintain a current display of the RADEF situation while it was in use by the director and members of his staff.

13.81 "These plastic panels are the answer to the problem," he went on. "Tomorrow morning, a man is coming in to paint the outline of our control area, plus the major features such as roads, the river, and so forth, on each panel. In an actual exercise, the panels will be out in the center of our operating area so that everyone who has to can see them. Our Plotters will use grease pencils and, *writing backwards*, will spot in exposure information on one and exposure rate information on the other. Our Analysts," he continued, "will be in front of the panels and they will also use grease pencils to draw in contours

as well as add any other information which we might need in a graphic form. Of course there are many ways to display the data and this only represents one way."

13.82 "Say, now," exclaimed the State RADEF Officer, "this is really something: As a matter of fact, I think I might even become the first official thief of your idea because it strikes me as a refinement worth introducing into our State EOC! You can appreciate how much I need such a system if you need it to control a *piece* of the *total* area that I have to worry about. It just goes to show that no plan is ever really final and that includes first of all, our own State Plan."

ONE FINAL WORD

13.83 No operations plan, however sound in concept and complete in detail, is of much value if it is untested or untried. The readiness posture of a plan is measured by its ability to be implemented. Therefore, each operational plan should be subjected to one or more tests as a part of the planning cycle. Plan tests should be made as realistic as possible, and each test should be evaluated by qualified observers as well as by the participants. Following the test, an evaluation report should be made. The report and evaluation should be used as the basis for revision and the start of a *new planning cycle*.

"PAPER PLANNING" OR REAL RADEF?

To implement the RADEF plan, of course, a variety of elements is required. It is necessary to have equipment and a facility in which to store and use it, that much certainly is obvious. Further, the equipment and the facility cannot do much by themselves, putting them to use takes people, sometimes a rather large number of people, to say nothing of money. And, finally, these people must have some idea of what they are to do or else the equipment will remain inert and the facility will be without purpose. This is just another way of saying that RADEF personnel need training.

But what should come first, where is the starting point? How can you tell when you have a balanced RADEF team? How do you maintain a RADEF capability once it is established? And so forth.

The objective of this chapter, then, is to put these various essentials of an effective RADEF plan into their proper perspective ... to demonstrate what is necessary to breathe life into a paper plan and turn it into an honest-to-goodness RADEF capability.

INTRODUCTION

14.1 We saw in Chapter 13 that planning can spell the difference between an emergency which is promptly dealt with on a systematic basis and, on the other hand, an utter catastrophe. We saw that planning guides us to the best use of all available resources, and, ultimately, helps save lives. We saw that effective planning requires organized, equipped, trained personnel as an essential ingredient. We began to see that all this requires money.

14.2 Now we are ready to break this planning ingredient down into its essential parts. These are the basic tools of

RADEF planning and an effective RADEF organization. There are four of them.

EQUIPMENT—FACILITIES—PERSONNEL— TRAINING

We will examine these four items in sequence in this chapter. As we do so, it would be well to remember that these requirements do not come from inspirations or visions. They come, instead, as a result of the planning process which is, in turn, a two-step procedure.

14.3 To repeat our summary of these two steps, the first consists of the establishment of some reasonable, sensible, well-thought-out, practical assumptions. The second step is one of meeting these assumptions with reasonable, sensible, well-thought-out, practical answers.

EQUIPMENT

14.4 In considering the question of radiological instruments and equipment, it immediately becomes apparent that one of the first questions to be answered is, "what kind and how much?" as well as, "where can we get it?"

14.5 To answer the last question first, the Defense Civil Preparedness Agency has made radiological equipment available to the States through their duly constituted Civil Preparedness organizations. This is a "through official channels" type of exercise and therefore a detailed presentation of the fifty different channels is obviously outside the scope of this discussion.

14.6 Although a detailed answer to the first question in paragraph 14.4 is even further outside our scope, it is nevertheless possible to demonstrate an important point about RADEF planning in offering a

comment on it. Specifically, the answer should lie in *your own* plan or its RADEF annex and, if it does not, then that plan is drastically in need of additional work!

14.7 The fact that such an answer should be found in an existing plan also highlights another feature of planning. The elements of a plan are interdependent and interrelated if the plan is a good one, and further, if any one of these elements should change or alter in any way, such a change should be the signal for a reappraisal and possible revision of the plan.

14.8 In considering equipment requirements for a particular radiological defense area, it is important to remember that this does not merely mean operational equipment but, in addition, includes training equipment. In this regard, an individual responsible for a DCPA Training Source Set must hold a Byproduct Material User's Certificate from his respective State. And here, incidentally, is further proof of the interaction of ostensibly separate elements in the RADEF plan.

14.9 Not only is the RADEF Officer responsible for obtaining the required operational equipment and making sure that sufficient training equipment is available, he is also responsible for maintenance. To this end, a "chief monitor" should be appointed for each monitoring station. Further, supplementary instruments might be reasonably required and it is up to the RADEF Officer to determine if this is the case as well as to prepare the necessary justification to obtain them.

FACILITIES

14.10 If a RADEF plan is to be capable of execution, there must be a sufficient number of radiological monitoring stations and communications over which they can make their reports. The RADEF Officer is responsible for converting a number on a piece of paper (the local area RADEF plan) into a real monitoring and reporting network.

14.11 Since this monitoring and reporting network will not be worth much without a place to receive such reports, this leads the RADEF Officer next to the facil-

ity for his local EOC. He must also have radiological monitoring for community shelters under close control. While some of these community shelters might presumably be a part of his regular monitoring network in addition to their mission of RADEF protection for the shelter, others will not. But in any event he will be responsible for the adequacy of the facility insofar as it concerns any aspect of RADEF.

14.12 Protection factor is, of course, of paramount importance in determining the suitability of a RADEF facility and this is another area for which the RADEF Officer is *responsibe*. He must assure himself that each facility which has been mapped in as a part of the RADEF operation has a sufficient protection factor. In addition to protection factor, an important feature of such facilities will be their ability to fit into the local communications plan. In other words, each facility which is selected and added to the overall RADEF network must be capable of carrying out its assigned function while simultaneously performing the vital task of self-protection.

14.13 Before leaving the question of facilities, a word on arrangements for emergency food and water for monitoring personnel would be in order.

14.14 Food and water stocks, it could be claimed, are not really a part of the consideration of a facility. It could be argued equally well that food and water are certainly not radiological "equipment". The point is, however, no matter what label is placed upon these two commodities, human beings cannot exist or function very long without either one. Thus it behooves the RADEF Officer to make certain that his facilities have adequate stocks of these items.

PERSONNEL

14.15 One of the largest contributing factors to RADEF personnel requirements is found in the radiological monitoring network.

14.16 Once again, the particular local Civil Preparedness plan or its RADEF annex should provide the explicit answer to this question and, if it does not, the prob-

lem is not one of the monitoring network but rather one of completing the plan first. Although the final answer to this question must remain a local one to be based upon population, industrial distribution, geography and the like, there are, nevertheless, certain criteria which can be used. Federal and State governments periodically issue guidelines on the number of monitoring stations needed in rural and urban areas. This information should be considered only as a starting point in evaluating the RADEF monitoring network requirements because final answers will always depend upon the individualities of the particular local area in question.

NOTE

Do you think in terms of so many men for this job, so many men for that one, or so many men in the EOC, and so forth? If you do, then . . .

STOP RIGHT NOW!

There are millions of intelligent, sincere, capable women in our country. There are undoubtedly thousands in your own RADEF area. Be sure that you remember this in your planning and personnel recruitment activities!!!

14.17 As a general rule, RADEF personnel should be selected primarily from State and local government employees. This will provide all the advantages of working on the basis of an existing organizational framework. For monitors, it is suggested that firemen, State highway patrolmen, highway maintenance personnel, their auxiliaries and their reserves be selected for training. Further, radiation monitoring should be included as a part of the basic training for all new recruits in these services and refresher monitor training should be routinely scheduled for all personnel. To supplement this initial cadre of monitors, high school and college science teachers, selected State, county, and municipal employees in the engineering, sanitation, welfare, and health services could also be selected for monitor training.

14.18 In areas where monitoring stations have been established in industrial plants, hospitals, commercial buildings

and other facilities which have an adequate protection factor, appropriate personnel who are normally employed at these facilities represent another excellent source of monitors.

14.19 In rural and suburban areas where a home shelter may have been designated as a part of the monitoring and reporting system, members of the family who will occupy the shelter should, if possible, be recruited as a part of the RADEF organization.

14.20 Once again, since a large cadre of monitors will be needed, the selection of personnel for training should be fairly broad. Remember that women, as well as men, can perform a very significant role in monitoring, and certainly should not be overlooked in any recruitment effort.

14.21 For decontamination training, selection of key personnel should be primarily among the fire, sanitation, public works and engineering services. However, selection should also be extended to those personnel who operate street sweeping and flushing equipment, road graders, scrapers, and earth moving and demolition equipment. Selection of such key personnel will be from State, county, and municipal employees, but should also be extended to others such as highway construction contractors, since most of the equipment needed for decontamination work will be found in these areas to say nothing of a ready source of personnel trained in its use.

TRAINING

14.22 There are two basic areas of training, the training of monitors and the training of the RADEF staff. The latter is of particular importance for it is imperative that the leadership staff be provided in order to form a seed-bed for providing further training to other personnel.

RADEF OFFICER AND RADIOLOGICAL MONITORING FOR INSTRUCTORS TRAINING

14.23 Local and State jurisdictions have the responsibility for obtaining trained Radiological Defense Officers.

Upon completion of his training, the RADEF Officer provides instruction to the people who have been selected for his RADEF staff and the monitors needed in his community.

14.24 Be sure you don't overlook the resource represented by the capabilities existent in the Armed Forces to supplement monitor training resources.

14.25 As monitors are trained, the RADEF Officer should assign them to a specific monitoring station for operational purposes. Generally, monitors should be assigned to facilities which are near where they normally work or reside. Each monitor will be ordered to report to his designated shelter or monitoring station in an emergency. All monitors should be instructed to find *some* shelter in the event they cannot reach their assigned station. In addition, provision must be made for the families of monitors, both as a morale factor and also by way of avoiding possible confusion during an emergency.

14.26 Upon completion of his training, each monitor will be furnished a **HANDBOOK FOR RADIOLOGICAL MONITORS, FCDG-E-5.9** containing detailed instructions for monitoring and reporting operations as well as special instructions concerning his responsibilities for dealing with routine and emergency radiation conditions. DCPA will provide these manuals for distribution to the monitors.

14.27 Continuing training of monitors to provide for personnel attrition and refresher training of monitors on an annual to 6 months basis should be arranged for by the local RADEF Officer.

14.28 The following paragraphs provide a summary of some important points for persons concerned with establishing RADEF training programs, either for radiological monitors or for the RADEF staff.

TRAINING REQUIREMENTS

14.29 The first step is to find out what we need in the way of training. We must

determine how many monitors we need. To do this it is necessary to analyze the local RADEF plan since training requirements will stem from the assessment contained in the plan. (If no plan is available, one should be developed first.)

RECRUITMENT OF RADEF PERSONNEL

14.30 After we have found how many trained personnel are needed, it will be necessary to recruit the manpower for training. By far the best sources will be full-time municipal, county and State employees. Since they are also one of the best sources for Civil Preparedness personnel other than RADEF, coordination will be necessary to avoid conflicting assignments. Another possible difficulty is that RADEF activities have no exact counterpart in existing governments. In other words, the Civil Preparedness plan which fits the police force into the law and order role or the sanitation department into the decontamination role during an emergency will not find a ready-made governmental activity which fits RADEF activities.

NOTE

It is important, both for motivation and realism in training, that the student have an assignment based on the RADEF plan BEFORE he begins to undergo training.

TRAINING LOCATION

14.31 The courses should be taught in locations convenient for the students—since many will presumably be volunteers, it is doubly important that all impediments to training, such as distant places and inflexible or inconvenient class hours, be removed. If on-the-job training can be arranged with local government authorities, this will materially aid in the rapid training of monitors and others.

TRAINING LOGISTICS

14.32 It is important that training equipment be ordered at the earliest moment after training requirements are determined, and that the necessary user permits needed for handling Training Source Sets be applied for. The Defense Civil Preparedness Agency provides a "Radiological Monitoring Training Package," K-24 which includes an Instructor Guide, and supporting visual aid material. This, too, should be obtained without delay and in sufficient quantity.

TRAINING ASSISTANCE

14.33 It is vital that liaison be established with all agencies, public and private, that can offer assistance in teaching or recruitment. Whatever instructor capabilities already exist on the local level should be appraised and utilized. Find out from the already existing Civil Preparedness organization what is available. Other cities in your area may have a fully functioning organization with a number of qualified instructors. There's no advantage in "going it alone" so, if you can get help from outside your immediate jurisdiction, don't hesitate to take it. After all, fallout will not recognize any boundaries.

TRAINING METHODS

14.34 As we have seen, we are not training just for training's sake nor are we training to increase theoretical or academic knowledge. *We are training for specific jobs.* Hence, the selection of course content material should aim at:

- training to do a *particular job*
- training to instill desirable *habits*
- training to enhance *operational knowledge*

To achieve these ends, course material should stress student participation. Passive lecture methods should be avoided in favor of the active approach featuring demonstration, exercises, laboratory, and question and answer methods. Teaching aids, models, slides, films, vugraphs, flannel boards, and other visual aids should be used when they support learning as an

end in themselves. Incidentally, one of the most important things to do when using such equipment is to *check it out in advance*; be sure it works, and that you know how to use it.

TRAINING EVALUATION

14.35 It is important that there be frequent tests of skills learned in the training courses. Such evaluation should be on proficiency—through demonstration—rather than student reproduction of academic or theoretical knowledge. *Make it realistic* should be the guide to effective training and evaluation of such training.

NOTE

The best things in life may be free, but building and training a RADEF organization is not! At any level of government, there is a requirement of budgeting for RADEF. DON'T FORGET TO PUT RADEF IN THE BUDGET!

A BIRD'S-EYE VIEW OF RADEF

14.36 It's no secret to anyone who has had any contact with radiological defense that, as a subject, it is technical and it is complex. Although a single individual assignment can be presented in a relatively simple, straightforward manner, the sum of all such assignments covers a very wide range of knowledge and presents a rather complicated picture.

14.37 This situation leads us to a single simple question, "Who will tie all these loose ends together?". We have radiological instruments, monitoring stations, shelter radiological requirements, training source sets, data to be plotted, curves to be drawn, reports to be received, reports to be sent, the list is literally endless and yet some sort of knowledgeable coordination must take place between all these facets and elements and bits and pieces.

14.38 For the sake of argument, let's consider what would be necessary if we were to decide to go into a manufacturing business. Let's for example, make it furniture manufacturing. Immediately we realize that we need someone who knows something about building furniture. This

leads us to a conclusion that he should also know something about the wood and other materials which will be required, where to find them and how to use them. He must be aware of the availability and uses of a whole variety of special tools. And he must know a great deal more as well. We are aware of how foolish we would be to hire cabinet makers, salesmen, clerks, and so forth until we were certain we had our man who knew the furniture manufacturing business. This example is so obvious it's almost ridiculous, isn't it?

14.39 But it is not ridiculous when the radiological defense parallel is drawn because it is surprisingly easy to become bogged down in the many technical considerations of RADEF work and, as a result, lose sight of a basic fact. That fact is:

Monitors, facilities, instructors, instruments, communications, decontamination teams, RADEF plans and all the rest of it do *not* constitute a radiological defense capability . . . unless . . .

RADIOLOGICAL DEFENSE OFFICERS

are available to tie the package together into the real countermeasure for survival that RADEF is meant to be.

Just as most other facts can be expressed in corollary terms, this one can be given such expression with equal ease. The corollary is:

Provided that there are sufficient

RADIOLOGICAL DEFENSE OFFICERS

available, a radiological defense capability is in process of building, regardless of inadequacies in any other RADEF area.

14.40 These facts can be expressed on a national scale as well as a purely local one. Our national RADEF capability requires facilities, monitors, instruments and many other elements of survival in the nuclear age . . . and must include a cadre of capable, trained Radiological Defense Officers. With such a group, we can have a national RADEF capability but without it, *never*.

RADEF OFFICERS ARE MADE, NOT BORN!

14.41 There is no such thing as being appointed an expert on any given subject and radiological defense is no different from any other subject in this regard. The only road to becoming a Radiological Defense Officer is study and training.

14.42 But what about Joe Smith who has just received his doctorate in, of all things, nuclear physics? Can't we at least recognize him as a Radiological Defense Officer because of his provable knowledge of atomic structure, fission, radiation, curies and things like that?

14.43 No, we cannot recognize Doctor Joe Smith, nuclear physicist, as a Radiological Defense Officer unless he has been trained as a Radiological Defense Officer.

14.44 The point may seem obvious but it is nevertheless very well taken. Certainly there is nothing wrong with having a RADEF Officer who is also a nuclear physicist, no more so than there is anything wrong with having one who is a science instructor, industrial scientist, or an engineer, but none of these individuals will be a RADEF Officer until he has actually been trained as such.

14.45 Along these general lines, it is a good idea to remember that the DCPA courses which lead up to qualifying as a RADEF Officer have been developed with a view toward providing the technical information which will be required to do the job. The individual is, of course, expected to carry out a certain amount of independent study as well as keep himself up to date on the subject through continuing close contact via the channels of his own Civil Preparedness organization.

IMPORTANT

Our nation needs thousands of capable, trained RADEF Officers . . . Instructors can and will provide the training . . . the individual, however, must provide the capability!

GLOSSARY ¹

A

ABSORBED DOSE: see DOSE.

AFTERWINDS: Wind currents set up in the vicinity of a nuclear explosion directed toward the burst center, resulting from the updraft accompanying the rise of the fireball.

AIR BURST: The explosion of a nuclear weapon at such a height that the expanding fireball does not touch the earth's surface when the luminosity is a maximum (in the second pulse).

ALPHA PARTICLE: A particle emitted spontaneously from the nuclei of some radioactive elements. It is identical with a helium nucleus, having a mass of four units and an electric charge of two positive units. See *Radioactivity*.

AMBIENT: Going or moving around; also enclosing encompassing.

ATOM: The smallest (or ultimate) particle of an element that still retains the characteristics of that element. Every atom consists of a positively charged central nucleus, which carries nearly all the mass of the atom, surrounded by a number of negatively charged electrons, so that the whole system is electrically neutral. See *Element, Electron, Nucleus*.

ATOMIC BOMB (OR WEAPON): A term sometimes applied to a nuclear weapon utilizing fission energy only. See *Fission, Nuclear Weapon*.

ATOMIC CLOUD: See *Radioactive Cloud*.

ATOMIC NUMBER: See *Nucleus*.

ATOMIC WEIGHT: The relative weight of an atom of the given element. As a basis of reference, the atomic weight of the common isotope of carbon (carbon 12) is taken to be exactly 12; the atomic weight of hydrogen (the lightest element) is then 1.008. Hence, the atomic weight of any element is approximately the weight of an atom of that element relative to the weight of a hydrogen atom.

AVALANCHE EFFECT: The multiplicative process in which a single charged particle accelerated by a strong electric field produces additional charged particles through collision with neutral gas molecules. This cumulative increase of ions is also known as Townsend ionization or a Townsend avalanche. Avalanche occurs in the Geiger tube of a CD V-700.

B

BACKGROUND RADIATION: Nuclear (or ionizing) radiations arising from within the body and from the surroundings to which individuals are always exposed. The main sources of the natural background radiation are potassium-40 in the body, potassium-40 and thorium, uranium, and their decay products (including radium) present in rocks, and cosmic rays.

BARRIER SHIELDING: Shielding gained by interposing a physical barrier between a given point and radiation source.

BETA PARTICLE: A charged particle of very small mass emitted spontaneously from the nuclei of certain radioactive elements. Most (if not all) of the direct

¹ When possible, definitions have been reprinted from the glossary of *The Effects of Nuclear Weapons*, February 1964.

fission products emit (negative) beta particles. Physically, the beta particle is identical with an electron moving at high velocity. See *Electron, Fission Products, Radioactivity*.

BINDING ENERGY: The tremendous energy which holds the neutrons and protons of an atomic nucleus together.

BIOLOGICAL DOSE: See *Dose*.

BLAST WAVE: A pulse of air in which the pressure increases sharply at the front, accompanied by winds, propagated continuously from an explosion. See *Shock Wave*.

BODY BURDEN: The amount of radioactive material in the body at a given time.

C

CALIBRATION: Determination of variation in accuracy of radiological instruments. Radioactive sources are used to produce known exposure rates at specified distances. The variation in accuracy of a radiological instrument can be determined by comparing it with these known exposure rates.

CHAIN REACTION: When a fissionable nucleus is split by a neutron it releases energy and one or more neutrons. These in turn split more fissionable-nuclei releasing more energy and neutrons, thus making the process a self-sustaining chain reaction.

CHROMOSOME: One of the particles into which a portion of the cell nucleus splits up prior to cell division: assumed to be determinants of species and of sex.

CLEAN WEAPON: One in which measures have been taken to reduce the amount of residual radioactivity relative to a "normal" weapon of the same energy yield.

COMPTON EFFECT: The scattering of photons (of gamma or X-rays) by the orbital electrons of atoms. In a collision between a (primary) photon and an electron, some of the energy of the photon is transferred to the electron which is gen-

erally ejected from the atom. Another (secondary) photon, with less energy, then moves off in a new direction at an angle to the direction of motion of the primary photon.

CONTAINED UNDERGROUND BURST: An underground detonation at such a depth that none of the radioactive residues escape through the surface of the ground.

CONTAMINATION: The deposit of radioactive material on the surfaces of structures, areas, objects, or personnel, following a nuclear explosion. This material generally consists of fallout in which fission products and other weapon debris have become incorporated with particles of dirt, etc. Contamination can also arise from the radioactivity induced in certain substances by the action of neutrons from a nuclear explosion. See *Decontamination, Fallout, Induced Radioactivity, Weapon Debris*.

CONTAMINATION CONTROL: Action to prevent the spread of fallout and reduce contamination of people, areas, equipment, food and water.

COSMIC RAYS: Very high energy particulate (particles) and electromagnetic (rays) radiations which originate out in space and constantly bombard the earth.

CRITICAL MASS: The minimum mass of a fissionable material that will just maintain a fission chain reaction under precisely specified conditions, such as the nature of the material and its purity, the nature and thickness of the tamper (or neutron reflector), the density (or compression), and the physical shape (or geometry). For an explosion to occur, the system must be supercritical, i.e., the mass of material must exceed the critical mass under the existing conditions. See *Supercritical*.

CURIE (Ci): A unit of radioactivity; it is the quantity of any radioactive species in which 3.700×10^{10} nuclear disintegrations occur per second. The **GAMMA**

CURIE is sometimes defined correspondingly as the quantity of material in which this number of gamma-ray photons are emitted per second.

CYCLOTRON: An apparatus which obtains high-energy electrically charged particles by whirling them at immense speeds in a strong magnetic field; used especially to create artificial radioactivity; an atom smasher.

D

DAUGHTER PRODUCT: The product (different element) formed when a radioactive material decays. Some radioactive elements will form many daughter products during their decay to a stable state.

DECAY (OR RADIOACTIVE DECAY): The decrease in activity of any radioactive material with the passage of time, due to the spontaneous emission from the atomic nuclei of either alpha or beta particles, sometimes accompanied by gamma radiation. See *Half-Life, Radioactivity*.

DECONTAMINATION: The reduction or removal of contaminating radioactive material from a structure, area, object, or person. Decontamination may be accomplished by (1) treating the surface so as to remove or decrease the contamination; (2) letting the material stand so that the radioactivity is decreased as a result of natural decay; and (3) covering the contamination.

DEUTERIUM: An isotope of hydrogen of mass 2 units; it is sometimes referred to as heavy hydrogen. It can be used in thermonuclear fusion reactions for the release of energy. Deuterium is extracted from water which always contains 1 atom of deuterium to about 6,500 atoms of ordinary (light) hydrogen. See *Fusion, Thermonuclear*.

DIRTY WEAPON: One which produces a larger amount of radioactive residues than a "normal" weapon of the same yield.

DOSE¹: A (total or accumulated) quantity of ionizing (or nuclear) radiation. The term dose can be used in the sense of the exposure dose, expressed in roentgens, which is a measure of the total amount of ionization that the quantity of radiation could produce in air. This should be distinguished from the absorbed dose, given in rems or rads, which represent the energy absorbed from the radiation per gram of specified body tissue. Further, the biological dose, in rems, is a measure of the biological effectiveness of the radiation exposure. See *RAD, REM, REP, Roentgen*.

DOSE RATE¹: As a general rule, the amount of ionizing (or nuclear) radiation to which an individual would be exposed or which he would receive per unit of time. It is usually expressed as roentgens, rads, or rems per hour or in multiples or submultiples of these units, such as milliroentgens per hour. The dose rate is commonly used to indicate the level of radioactivity in a contaminated area.

DOSIMETER: An instrument for measuring and registering total accumulated exposure to ionizing radiations.

DRAG LOADING: The force on an object or structure due to the transient winds accompanying the passage of a blast wave. The drag pressure is the product of the dynamic pressure and the drag coefficient which is dependent upon the shape (or geometry) of the structure or object. See *Dynamic Pressure*.

DYNAMIC PRESSURE: The air pressure which results from the mass air flow (or wind) behind the shock front of a blast wave. It is equal to the product of half the density of the air through which the blast wave passes and the square of the particle (or wind) velocity behind the shock front as it impinges on the object or structure.

¹ In this revised text, "exposure" and "exposure rate" have been substituted for "dose" and "dose rate" in those instances where the measurement is explicitly or implied in roentgen units. Dose and dose rate have been retained where the meaning is an absorbed quantity or rate in rad or rem units.

E

EARLY FALLOUT: See *Fallout*.

ELECTROMAGNETIC PULSE (EMP): Energy radiated by a nuclear detonation in the medium-to-low frequency range that may affect or damage electrical or electronic components and equipment.

ELECTROMAGNETIC RADIATION: A traveling wave motion resulting from oscillating magnetic and electric fields. Familiar electromagnetic radiations range from X-rays (and gamma rays) of short wavelength, through the ultraviolet, visible, and infrared regions, to radar and radio waves of relatively long wavelength. All electromagnetic radiations travel in a vacuum with the velocity of light. See *Photon*.

ELECTRON: A particle of very small mass, carrying a unit negative or positive charge. Negative electrons, surrounding the nucleus, are present in all atoms; their number is equal to the number of positive charges (or protons) in the particular nucleus. The term electron, when used alone, commonly refers to these negative electrons. A positive electron is usually called a positron, and a negative electron is sometimes called a negatron. See *Beta Particle*.

ELECTRON VOLT (eV): The energy imparted to an electron when it is moved through a potential difference of 1 volt. It is equivalent to 1.6×10^{-12} erg.

ELEMENT: One of the distinct, basic varieties of matter occurring in nature which, individually or in combination, compose substances of all kinds. Approximately ninety different elements are known to exist in nature and several others, including plutonium, have been obtained as a result of nuclear reactions with these elements.

EMERGENCY OPERATING CENTER (EOC): The protected site from which civil government officials exercise direction and control in an emergency.

ENERGY: Capacity for performing work.

EPIDERMIS: The outer skin.

EPILATION: Loss of hair.

ERG: A unit of energy or work. An erg is the energy required for an electron to ionize about 20 billion molecules of air.

ERYTHEMA: A superficial skin disease characterized by abnormal redness, but without swelling or fever.

EXCITATION: The raising or transferring of an atom from its normal energy level to a higher energy level.

EXPOSURE CONTROL: Procedures taken to keep radiation exposures of individuals or groups from exceeding a recommended level, such as keeping outside missions as short as possible.

EXPOSURE: See *Dose*.

EXPOSURE RATE: See *Dose Rate*.

F

FALLOUT: The process or phenomenon of the fallback to the earth's surface of particles contaminated with radioactive material from the radioactive cloud. The term is also applied in a collective sense to the contaminated particulate matter itself. The early (or local) fallout is defined, somewhat arbitrarily, as those particles which reach the earth within 24 hours after a nuclear explosion. The delayed (or worldwide) fallout consists of the smaller particles which ascend into the upper troposphere and into the stratosphere and are carried by winds to all parts of the earth. The delayed fallout is brought to earth, mainly by rain and snow, over extended periods ranging from months to years.

FALLOUT MONITORING STATION: A designated facility for the collection of radiological data by trained and assigned monitors using instruments stored or assigned to that location. It should have good fallout protection and relatively reliable communications. Examples might be a fire station, police or public works building, public fallout shelter, etc.

FILM BADGE: A small metal or plastic frame, in the form of a badge, worn by personnel, and containing X-ray (or similar photographic) film for estimating the total amount of ionizing (or nuclear) radiation to which an individual has been exposed.

FIREBALL: The luminous sphere of hot gases which form a few millionths of a second after a nuclear explosion as the result of the absorption by the surrounding medium of the thermal X-rays emitted by the extremely hot (several tens of millions degrees) weapon residues. The exterior of the fireball in air is initially sharply defined by the luminous shock front and later by the limits of the hot gases themselves (radiation front).

FIRE STORM: Stationary mass fire, generally in built-up urban areas, generating strong, intrushing winds from all sides; the winds keep the fires from spreading while adding fresh oxygen to increase their intensity.

FISSION: The process whereby the nucleus of a particular heavy element splits into (generally) two nuclei of lighter elements, with the release of substantial amounts of energy. The most important fissionable materials are uranium 235 and plutonium 239.

FISSION FRACTION: The fraction (or percentage) of the total yield of a nuclear weapon which is due to fission. For thermonuclear weapons the average value of the fission fraction is about 50 percent.

FISSION PRODUCTS: A general term for the complex mixture of substances produced as a result of nuclear fission. A distinction should be made between these and the direct fission products or fission fragments which are formed by the actual splitting of the heavy-element nuclei. Something like 80 different fission fragments result from roughly 40 different modes of fission of a given nuclear species, e.g., uranium 235 or plutonium 239. The fission fragments, being radioactive, immediately begin to decay,

forming additional (daughter) products, with the result that the complex mixture of fission products so formed contains about 200 different isotopes of 36 elements.

FLASH BURN: A burn caused by excessive exposure (of bare skin) to thermal radiation. See *Thermal Radiation*.

FRACTIONATION: Any one of several processes, apart from radioactive decay, which results in change in the composition of the radioactive weapon debris. As a result of fractionation, the delayed fallout generally contains relatively more of strontium 90 and cesium 137, which have gaseous precursors, than does the early fallout from a surface burst.

FREE AIR OVERPRESSURE (OR FREE FIELD OVERPRESSURE): The unreflected pressure, in excess of the ambient atmospheric pressure, created in the air by the blast wave from an explosion.

FUSION: The process whereby the nuclei of light elements, especially those of the isotopes of hydrogen, namely, deuterium and tritium, combine to form the nucleus of a heavier element with the release of substantial amounts of energy. See *Thermonuclear*.

G

GAMMA RAYS (OR RADIATIONS): Electromagnetic radiations of high energy originating in atomic nuclei and accompanying many nuclear reactions, e.g., fission, radioactivity, and neutron capture. Physically, gamma rays are identical with X-rays of high energy, the only essential difference being that the X-rays do not originate from atomic nuclei, but are produced in other ways, e.g., by slowing down (fast) electrons of high energy. See *Electromagnetic Radiation, X-Rays*.

GEIGER COUNTER: An electrical device which can be used for detecting and measuring relatively low levels of nuclear radiation.

GENETIC EFFECT: The effect (of nuclear radiation, in particular) of producing changes (mutations) in the hereditary components (genes) in the germ cells present in the reproductive organs (gonads). A mutant gene causes changes in the next generation which may or may not be apparent.

GEOMETRY SHIELDING: Shielding gained by distance from the source of radiation.

GRAM: A unit of mass and weight in the metric system equal to approximately one-thirtieth of an ounce.

GROUND ZERO: The point on the surface of land or water vertically below or above the center of a burst of a nuclear (or atomic) weapon; frequently abbreviated to GZ. For a burst over or under water, the term surface zero should preferably be used.

GUN-TYPE WEAPON: A device in which two or more pieces of fissionable material, each less than a critical mass, are brought together very rapidly so as to form a supercritical mass which can explode as the result of a rapidly expanding fission chain.

H

HALF-LIFE: The time required for the activity of a given radioactive species to decrease to half of its initial value due to radioactive decay. The half-life is a characteristic property of each radioactive species and is independent of its amount or condition. The effective half-life of a given isotope is the time in which the quantity in the body will decrease to half as a result of both radioactive decay and biological elimination.

HALF-VALUE THICKNESS: The thickness of a given material which will absorb half the gamma radiation incident upon it. This thickness depends on the nature of the material—it is roughly inversely proportional to its density—and also on the energy of the gamma rays.

HALOGEN: The family of elements con-

taining fluorine, chlorine, bromine, iodine and astatine.

HEAVY HYDROGEN: See *Deuterium*.

HEAVY WATER: Water containing heavy hydrogen (deuterium) atoms in place of the normal hydrogen atoms.

HIGH-ALTITUDE BURST: This is defined, somewhat arbitrarily, as a detonation at an altitude over 100,000 feet. Above this level the distribution of the energy of the explosion between blast and thermal radiation changes appreciably with increasing altitude due to changes in the fireball phenomena.

HOT SPOT: Region in a contaminated area in which the level of radioactive contamination is somewhat greater than in neighboring regions in the area. See *Contamination*.

HYDROGEN BOMB (OR WEAPON): A term sometimes applied to nuclear weapons in which part of the explosive energy is obtained from nuclear fusion (or thermonuclear) reactions. See *Fusion, Nuclear Weapon, Thermonuclear*.

IMPLOSION WEAPON: A device in which a quantity of fissionable material, less than a critical mass, has its volume suddenly decreased by compression, so that it becomes supercritical and an explosion can take place. The compression is achieved by means of a spherical arrangement of specially fabricated shapes of ordinary high explosive which produce an inwardly directed implosion wave, the fissionable material being at the center of the sphere. See *Supercritical*.

INDUCED RADIOACTIVITY: Radioactivity produced in certain materials as a result of nuclear reactions, particularly the capture of neutrons, which are accompanied by the formation of unstable (radioactive) nuclei. The activity induced by neutrons from a nuclear (or atomic) explosion in materials containing the elements sodium, manganese, silicon, or aluminum may be significant.

INFRARED: Electromagnetic radiations of wavelength between the longest visible red (7,000 Angstroms or 7×10^{-4} millimeter) and about 1 millimeter. See *Electromagnetic Radiation*.

INITIAL NUCLEAR RADIATION: Nuclear radiation (essentially neutrons and gamma rays) emitted from the fireball and the cloud column during the first minute after a nuclear (or atomic) explosion. The time limit of one minute is set, somewhat arbitrarily, as that required for the source of part of the radiations (fission products, etc., in the radioactive cloud) to attain such a height that only insignificant amounts reach the earth's surface. See *Residual Nuclear Radiation*.

INTENSITY: The energy (of any radiation) incident upon (or flowing through) unit area, perpendicular to the radiation beam, in unit time. The intensity of thermal radiation is generally expressed in calories per square centimeter per second falling on a given surface at any specified instant. As applied to nuclear radiation, the term intensity is sometimes used, rather loosely, to express the exposure rate at a given location, e.g. in roentgens (or milliroentgens) per hour.

INTERNAL RADIATION: Nuclear radiation (alpha and beta particles and gamma radiation) resulting from radioactive substances in the body. Important sources are iodine 131 in the thyroid gland, and strontium 90 and plutonium 239 in the bone.

INVERSE SQUARE LAW: The law which states that when radiation (thermal or nuclear) from a point source is emitted uniformly in all directions, the amount received per unit area at any given distance from the source, assuming no absorption, is inversely proportional to the square of that distance.

IONIZATION: The separation of a normally electrically neutral atom or molecule into electrically charged components. The term is also employed to describe the degree or extent to which this

separation occurs. In the sense used in this book, ionization refers especially to the removal of an electron (negative charge) from the atom or molecule, either directly or indirectly, leaving a positively charged ion. The separated electron and ion are referred to as an ion pair. See *Ionizing Radiation*.

ION PAIR: See *Ionization*.

IONIZING RADIATION: Electromagnetic radiation (gamma rays, or X-rays) or particulate radiation (alpha particles, beta particles, neutrons, etc.) capable of producing ions, i.e., electrically charged particles, directly or indirectly, in its passage through matter.

ISOCROME: A line connecting those points on the earth at which fallout from any one weapon is forecast to reach the surface at the same time.

ISOTOPES: Forms of the same element having identical chemical properties but differing in their atomic masses (due to different numbers of neutrons in their respective nuclei) and in their nuclear properties, e.g., radioactivity, fission, etc. For example, hydrogen has three isotopes, with masses of 1 (hydrogen), 2 (deuterium), and 3 (tritium) units, respectively. The first two of these are stable (nonradioactive), but the third (tritium) is a radioactive isotope. Both of the common isotopes of uranium, with masses of 235 and 238 units, respectively, are radioactive, emitting alpha particles, but their half-lives are different. Furthermore, uranium 235 is fissionable by neutrons of all energies, but uranium 238 will undergo fission only with neutrons of high energy. See *Nucleus*.

J

(None)

K

KILO-ELECTRON VOLT (keV): An amount of energy equal to 1,000 electron volts. See *Electron Volt*.

KILOTON ENERGY (KT): The energy of a nuclear (or atomic) explosion which is equivalent to that produced by the ex-

plosion of 1 kiloton (i.e., 1,000 tons) of TNT, i.e., 10^{12} calories of 4.2×10^{19} ergs. See *Megaton Energy, TNT Equivalent*.

L

LD/50 or LD-50 or LD₅₀: Abbreviations for median lethal dose. See *Median Lethal Dose*.

M

MACH EFFECT: See *Mach Stem*.

MACH STEM: The shock front formed by the fusion of the incident and reflected shock fronts from an explosion. The term is generally used with reference to a blast wave, propagated in the air, reflected at the surface of the earth. The Mach stem is nearly perpendicular to the reflecting surface and presents a slightly convex (forward) front. The Mach stem is also called the Mach front.

MALAISE: Uneasiness. Discomfort.

MASS: A measure of the quantity of matter. The material equivalent of energy. Mass and energy are different forms of the same thing.

MASS NUMBER: See *Nucleus*.

MEDIAN LETHAL DOSE: The amount of ionizing (or nuclear) radiation exposure over the whole body which, it is expected, would be fatal to 50 percent of a large group of living creatures or organisms. It is commonly (although not universally) accepted that about 450 roentgens, received over the whole body in the course of a few days or less, is the median lethal dose for human beings.

MEGACURIE: One million curies. See *Curie*.

MEGATON ENERGY (MT): The energy of a nuclear explosion which is equivalent to 1,000,000 tons (or 1,000 kilo-tons) of TNT, i.e., 10^{15} calories or 4.2×10^{22} ergs. See *TNT Equivalent*.

MEV (MeV): Million electron volts, a unit of energy commonly used in nuclear physics. It is equivalent to 1.6×10^{-6} erg. Approximately 200 MeV of energy are produced for every nucleus that undergoes fission. See *Electron Volt*.

MICROCURIE: A one-millionth part of a curie. See *Curie*.

MICRON: A one-millionth part of a meter, i.e., 10^{-6} meter or 10^{-4} centimeter; it is roughly four one-hundred-thousandths (4×10^{-5}) of an inch.

MICROSECOND: A one-millionth part of a second.

MILLICURIE (mCi): A one-thousandth part of a curie.

MILLIREM: A one-thousandth part of a rem.

MILLIROENTGEN (mR): A one-thousandth part of a roentgen.

MILLISECOND: A one-thousandth part of a second.

MITOSIS: The process by which living cells multiply in the body by splitting or fissioning.

MOLECULE: The smallest unit of a chemical compound. For example a molecule of water consists of two hydrogen atoms combined with one atom of oxygen (H_2O), and a molecule of sugar consists of a combination of twelve carbon atoms, twenty-two hydrogen atoms, and eleven oxygen atoms ($C_{12}H_{22}O_{11}$).

MONITOR: An individual trained to measure, record, and report radiation exposure and exposure rates; provide limited field guidance on radiation hazards associated with operations to which he is assigned; and perform operator's maintenance of radiological instruments.

MONITORING: The procedure or operation of locating and measuring radioactive contamination by means of survey instruments which can detect and measure ionizing radiations. The individual performing the operation is called a monitor.

MUTATION: A change in the characteristics of an organism produced by altering the usual hereditary pattern. Radiation can cause mutations in all living things.

N

NEGATIVE PHASE: See *Shock Wave*.

NEUTRON: A neutral particle, i.e., with no electrical charge, of approximately unit mass, present in all atomic nuclei, except those of ordinary (light) hydrogen. Neutrons are required to initiate the fission process, and large numbers of neutrons are produced by both fission and fusion reactions in nuclear explosions.

NUCLEAR FISSION: See *Fission*.

NUCLEAR RADIATION: Particulate and electromagnetic radiation emitted from atomic nuclei in various nuclear processes. The important nuclear radiations, from the weapons standpoint, are alpha and beta particles, gamma rays, and neutrons. All nuclear radiations are ionizing radiations, but the reverse is not true; X-rays, for example, are included among ionizing radiations, but they are not nuclear radiations since they do not originate from atomic nuclei. See *Ionizing Radiation, X-Rays*.

NUCLEAR REACTOR: An apparatus in which nuclear fission is sustained in a regulated self-supporting chain reaction.

NUCLEAR WEAPON (OR BOMB): A general name given to any weapon in which the explosion results from the energy released by reactions involving atomic nuclei, either fission or fusion or both. Thus, the A- (or atomic) bomb and the H- (or hydrogen) bomb are both nuclear weapons. It would be equally true to call them atomic weapons, since it is the energy of atomic nuclei that is involved in each case. However, it has become more-or-less customary, although it is not strictly accurate, to refer to weapons in which all the energy results from fission as A-bombs or atomic bombs. In order to make a distinction, those weapons in which part, at least, of the energy results from thermonuclear (fusion) reactions among the isotopes of hydrogen have been called H-bombs or hydrogen bombs.

NUCLEON: The common name for a constituent particle of a nucleus such as a proton or neutron.

NUCLEUS (OR ATOMIC NUCLEUS): The small, central, positively charged region of an atom which carries essentially all the mass. Except for the nucleus of ordinary (light) hydrogen, which is a single proton, all atomic nuclei contain both protons and neutrons. The number of protons determines the total positive charge, or atomic number; this is the same for all the atomic nuclei of a given chemical element. The total number of neutrons and protons, called the mass number, is closely related to the mass (or weight) of the atom. The nuclei of isotopes of a given element contain the same number of protons, but different numbers of neutrons. They thus have the same atomic number, and so are the same element, but they have different mass numbers (and masses). The nuclear properties, e.g., radioactivity, fission, neutron capture, etc., of an isotope of a given element are determined by both the number of neutrons and the number of protons. See *Atom, Element, Isotope, Neutron, Proton*.

NUDET: Report of nuclear detonation.

o

ORGAN: Organized group of tissue having one or more definite functions to perform in a living body.

OUTSIDE/INSIDE RATIO (OI): The measured ratio of the fallout gamma radiation exposure rate at some point outside a shelter to the exposure rate at some point inside the shelter. For radiological defense purposes, the specific outside point selected should have minimal protection. (See *Protection Factor*.)

OVERPRESSURE: The transient pressure, usually expressed in pounds per square inch, exceeding the ambient pressure, manifested in the shock (or blast) wave from an explosion. The variation of the overpressure with time depends on the energy yield of the explosion, the distance from the point of burst, and the medium in which the weapon is detonated. The peak overpressure is the maximum value of the over-

pressure at a given location and is generally experienced at the instant the shock (or blast) wave reaches that location. See *Shock Wave*.

P

PAIR PRODUCTION: The process whereby a gamma-ray (or X-ray) photon, with energy in excess of 1.02 MeV. in passing near the nucleus of an atom is converted into a positive electron and a negative electron. As a result, the photon ceases to exist. See *Photon*.

PEAK OVERPRESSURE: The maximum overpressure value at the blast front.

PERIODIC TABLE: A chart showing the arrangement of chemical elements in order of increasing atomic number in addition to grouping according to certain chemical similarities.

PERSONNEL EXPOSURE MEASUREMENTS: The measured exposure received by shelter occupants and operations personnel in the field.

PHOTOELECTRIC EFFECT: The process whereby a gamma-ray (or X-ray) photon, with energy somewhat greater than that of the binding energy of an electron in an atom, transfers all its energy to the electron which is consequently removed from the atom. Since it has lost all its energy, the photon ceases to exist. See *Photon*.

PHOTON: A unit or "particle" of electromagnetic radiation, possessing a quantum of energy which is characteristic of the particular radiation. If ν is the frequency of the radiation in cycles per second and λ is the wave length in centimeters, the energy quantum of the photon in ergs is $h\nu$ or hc/λ where h is Planck's constant, 6.62×10^{-27} erg-sec and c is the velocity of light (3.00×10^{10} centimeters per second). For gamma rays, the photon energy is usually expressed in million electron volt (MeV) units, i.e., $1.24 \times 10^{-10}/\lambda$ where λ is in centimeters or $1.24 \times 10^{-2}/\lambda$ if λ is in Angstroms.

PIG: A container (usually lead) used to

transport and store radioactive materials. The thick walls protect the person handling the container from nuclear radiation.

PLUTONIUM: (Chemical symbol Pu.) A manmade transuranium element, atomic number 94. When uranium 238 is bombarded with neutrons in an atomic reactor some of the uranium is converted by nuclear reactions into plutonium, a fissionable material.

POINT SOURCE: A point at which radioactivity is concentrated as opposed to an area over which radioactive material might be spread. The DCPA Training Source Set sealed capsule is an example of a point source.

POSITRON: Positively charged electron.

POSITIVE PHASE: See *Shock Wave*.

PROTECTION FACTOR (PF): The ratio of gamma radiation exposure at a Standard Unprotected Location to exposure at a protected location, such as a fallout shelter. The Standard Unprotected Location is defined as a point 3 feet above an infinite, smooth, ground plane uniformly covered with fallout. Protection factor is a calculated value suitable for planning purposes as an indicator of relative protection. (See Outside/Inside Ratio.)

PROTON: A particle of mass (approximately) unity carrying a unit positive charge; it is identical physically with the nucleus of the ordinary (light) hydrogen atom. All atomic nuclei contain protons. See *Nucleus*.

Q

(None)

R

RAD: A unit of absorbed dose of radiation; it represents the absorption of 100 ergs of nuclear (or ionizing) radiation per gram of the absorbing material or tissue.

RADEF: Radiological Defense.

RADIOACTIVE CLOUD: An all-inclusive term for the mixture of hot gases, smoke, dust, and other particulate matter from the weapon itself and from the environment, which is carried aloft in conjunction with the rising fireball produced by the detonation of a nuclear weapon.

RADIOACTIVITY: The spontaneous disintegration of unstable nuclei with the resulting emission of nuclear radiation.

RADIATION EXPOSURE RECORD: The card issued to individuals for recording their personal radiation exposures.

RADIATION INJURY: The harmful effects caused by ionizing radiation.

RADIOLOGICAL DEFENSE: The organized effort, through warning, detection, and preventive and remedial measures, to minimize the effect of nuclear radiation on people and resources.

RBE (RELATIVE BIOLOGICAL EFFECTIVENESS): The ratio of the number of rads of gamma radiation of a certain energy which will produce a specified biological effect to the number of rads of another radiation required to produce the same effect is the RBE of this latter radiation.

REM: A unit of biological dose of radiation; the name is derived from the initial letters of the term "roentgen equivalent man (or mammal)." See *RAD*.

REMEDIAL MOVEMENT: Movement of people postattack to a less contaminated area or a better protected location.

REP: A unit of absorbed dose of radiation now being replaced by the rad; the name rep is derived from the initial letters of the term "roentgen equivalent physical." Basically, the rep was intended to express the amount of energy absorbed per gram of soft tissue as a result of exposure to 1 roentgen of gamma (or X-) radiation. This is estimated to be about 97 ergs, although the actual value depends on certain experimental data which are not precisely known. The rep

is thus defined, in general, as the dose of any ionizing radiation which results in the absorption of about 97 ergs of energy per gram of soft tissue. For soft tissue, the rep and the rad are essentially the same. See *RAD, Roentgen*.

RESIDUAL NUCLEAR RADIATION: Nuclear radiation, chiefly beta particles and gamma rays, which persists for some time following a nuclear (or atomic) explosion. The radiation is emitted mainly by the fission products and other bomb residues in the fallout, and to some extent by earth and water constituents, and other materials, in which radioactivity has been induced by the capture of neutrons. See *Fallout, Induced Radioactivity, Initial Nuclear Radiation*.

ROENTGEN (R): A unit of exposure to gamma (or X-) radiation. It is defined precisely as the quantity of gamma (or X-) radiation such that the associated corpuscular emission per 0.001293 gram of air produces, in air, ions carrying one electrostatic unit quantity of electricity of either sign. From the accepted value (34 electron volts) for the energy lost by an electron in producing a positive-negative ion pair in air, it is estimated that 1 roentgen of gamma (or X-) radiation, would result in the absorption of about 87 ergs of energy per gram of air.

5

SHELTER: A habitable structure or space stocked with essential provisions and used to protect its occupants from fallout radiation.

SHIELDING: Any material or obstruction which absorbs radiation and thus tends to protect personnel or materials from the effects of a nuclear explosion. A moderately thick layer of any opaque material will provide satisfactory shielding from thermal radiation, but a considerable thickness of material of high density may be needed for nuclear radiation shielding.

SHOCK WAVE: A continuously propagated pressure pulse (or wave) in the

surrounding medium which may be air, water, or earth, initiated by the expansion of the hot gases produced in an explosion. A shock wave in air is generally referred to as a blast wave, because it resembles and is accompanied by strong, but transient, winds. The duration of a shock (or blast) wave is distinguished by two phases. First there is the positive (or compression) phase during which the pressure rises very sharply to a value that is higher than ambient and then decreases rapidly to the ambient pressure. The positive phase for the dynamic pressure is somewhat longer than for overpressure, due to the momentum of the moving air behind the shock front. The duration of the positive phase increases and the maximum (peak) pressure decreases with increasing distance from an explosion of given energy yield. In the second phase, the negative (or suction) phase, the pressure falls below ambient and then returns to the ambient value. The duration of the negative phase is approximately constant throughout the blast wave history and may be several times the duration of the positive phase. Deviations from the ambient pressure during the negative phase are never large and they decrease with increasing distance from the explosion. See *Dynamic Pressure, Overpressure*.

SOMATIC: Of or relating to the body, as opposed to the spirit; physical.

SPECTRUM: An image, visible or invisible, formed by rays of light or other radiant energy, in which parts are arranged according to their refrangibility or wave-length, so that all of the same wave-length fall together while those of different wave-lengths are separated from each other, forming a regular progressive series.

STRATOSPHERE: A relatively stable layer of the atmosphere between the tropopause and a height of about 30 miles in which the temperature changes very little (in polar and temperate zones) or increases (in the tropics) with increasing altitudes. In the stratosphere

clouds of water never form and there is practically no convection. See *Tropopause, Troposphere*.

SUBCRITICAL: The inability of a fissionable material to support a self-sustained chain reaction.

SUBSURFACE BURST: See *Underground Burst, Underwater Burst*.

SUPERCritical: A term used to describe the state of a given fission system when the quantity of fissionable material is greater than the critical mass under the existing conditions. A highly supercritical system is essential for the production of energy at a very rapid rate so that an explosion may occur. See *Critical Mass*.

SURFACE BURST: The explosion of a nuclear (or atomic) weapon at the surface of the land or water or at a height above the surface less than the radius of the fireball at maximum luminosity (in the second thermal pulse). An explosion in which the weapon is detonated actually on the surface (or within $5W^{0.3}$ feet, where W is the explosion yield in kilotons, above or below the surface) is called a contact surface burst or a true surface burst. See *Air Burst*.

SURVEY METER: A portable instrument, such as a Geiger counter or ionization chamber, used to detect nuclear radiation and to measure the exposure rate. See *Monitoring*.

SYNDROME, RADIATION: The complex of symptoms characterizing the disease known as radiation injury, resulting from excessive exposure of the whole (or a large part) of the body to ionizing radiation. The earliest of these symptoms are nausea, vomiting, and diarrhea, which may be followed by loss of hair (epilation), hemorrhage, inflammation of the mouth and throat, and general loss of energy. In severe cases, where the radiation exposure has been relatively large, death may occur within two to four weeks. Those who survive 6 weeks after the receipt of a single exposure of radiation may generally be expected to recover.

T

TAMPER: A strong container.

THERMAL ENERGY: The energy emitted from the fireball as thermal radiation. The total amount of thermal energy received per unit area at a specified distance from a nuclear (or atomic) explosion is generally expressed in terms of calories per square centimeter. See *Thermal Radiation*.

THERMONUCLEAR: An adjective referring to the process (or processes) in which very high temperatures are used to bring about the fusion of light nuclei, such as those of the hydrogen isotopes (deuterium and tritium), with the accompanying liberation of energy. A thermonuclear bomb is a weapon in which part of the explosion energy results from thermonuclear fusion reactions. The high temperatures required are obtained by means of a fission explosion. See *Fusion*.

THERMAL RADIATION: Electromagnetic radiation emitted (in two pulses from an air burst) from the fireball as a consequence of its very high temperature; it consists essentially of ultraviolet, visible, and infrared radiations. In the early stages (first pulse of an air burst), when the temperature of the fireball is extremely high, the ultraviolet radiation predominates; in the second pulse, the temperatures are lower and most of the thermal radiation lies in the visible and infrared regions of the spectrum. From a high-altitude burst, the thermal radiation is emitted in a single short pulse.

TNT EQUIVALENT: A measure of the energy released in the detonation of a nuclear weapon, or in the explosion of a given quantity of fissionable material, expressed in terms of the weight of TNT which would release the same amount of energy when exploded. The TNT equivalent is usually stated in kilotons or megatons. The basis of the TNT equivalence is that the explosion of 1 ton of TNT releases 10^9 calories of energy. See *Kiloton, Megaton, Yield*.

TRANSMUTATION: The changing of one element into another by a nuclear reaction.

TRITIUM: A radioactive isotope of hydrogen, having a mass of 3 units; it is produced in nuclear reactors by the action of neutrons on lithium nuclei.

TROPOPAUSE: The imaginary boundary layer dividing the stratosphere from the lower part of the atmosphere, the troposphere. The tropopause normally occurs at an altitude of about 25,000 to 45,000 feet in polar and temperate zones, and at 55,000 feet in the tropics.

TROPOSPHERE: The region of the atmosphere immediately above the earth's surface and up to the tropopause in which the temperature falls fairly regularly with increasing altitude, clouds form, convection is active, and mixing is continuous and more or less complete.

U

ULTRAVIOLET: Electromagnetic radiation of wave length between the shortest visible violet and soft X-rays.

UNDERGROUND BURST: The explosion of a nuclear weapon with its center more than $5W^{0.3}$ feet, where W is the explosion yield in kilotons, beneath the surface of the ground. See *Contained Underground Burst*.

UNDERWATER BURST: The explosion of a nuclear weapon with its center beneath the surface of the water.

URANIUM: (Chemical symbol U.) The heaviest naturally occurring radioactive element, atomic number 92. The only appreciable source of fissionable material occurring in nature is in uranium ore. This contains about 0.7% of the fissionable isotope U^{235} and 99.3% of the nonfissionable isotope U^{238} .

V

(None)

W

WEIGHT: A measure of the force with which matter is attracted to the earth.

WORLDWIDE FALLOUT: See *Fallout*.

X

X-RAYS: Electromagnetic radiations of high energy having wave lengths shorter than those in the ultraviolet region, i.e., less than 10^{-6} cm or 100 Angstroms. As generally produced by X-ray machines, they are bremsstrahlung resulting from the interaction of electrons of 1 kilo-electron volt or more energy with a metallic target. See *Gamma Rays, Electromagnetic Radiation*.

Y

YIELD (OR ENERGY YIELD): The total effective energy released in a nuclear explosion. It is usually expressed in terms of the equivalent tonnage of TNT required to produce the same energy release in an explosion. The total energy yield is manifested as nuclear radiation, thermal radiation, and shock (and blast) energy, the actual distribution being dependent upon the medium in which the explosion occurs (primarily) and also upon the type of weapon and the time after detonation.

Z

(None)