



DOCUMENT RESUME

ED 107 858

CE 003 962

**AUTHOR** Kemp, Louie E., Comp.  
**TITLE** The Inside Story [Learning Packages for Exploratory Career Education--7th and 8th Grades: Teacher and Student Editions.]  
**INSTITUTION** Mississippi Research Coordinating Unit for Vocational-Technical Education, State College.  
**SPONS AGENCY** Mississippi State Dept. of Education, Jackson. Div. of Vocational and Technical Education.  
**PUB DATE** 72  
**NOTE** 144p.  
**AVAILABLE FROM** Research and Curriculum Unit, Drawer DX, Mississippi State, Mississippi 39762 (\$1.00 each edition, Home Economics Publication Nos. 6001-6008)

**EDRS PRICE** MF-\$0.76 HC-\$6.97 PLUS POSTAGE  
**DESCRIPTORS** \*Career Education; \*Career Exploration; Child Care; Course Content; Course Objectives; Curriculum Guides; Dietitians; \*Instructional Materials; Junior High Schools; Nursing; Resource Materials; \*Resource Units; Secondary Education; Sewing Instruction; \*Teaching Guides

**ABSTRACT**

The four learning packages for exploratory career education are designed for use at the seventh and eighth grade levels. Each unit includes coordinated teacher and student editions. The units are: Culinary Cubs, focusing on occupations in the areas of food management, production, and services, with special reference to dietitians; Mini Nursery, focusing on child care related occupations, with special reference to the tasks and responsibilities of a baby-sitter; Polka Dots, focusing on home and institutional management and supportive services, with special reference to nursing; and Gift Boutique, focusing on clothing and interior decorating occupations, with special references to use of the sewing machine. Step-by-step instructional procedures, pre- and posttests, scripts for tapes, and instruction sheets follow the statement of purpose and objectives and general instructions in each teacher edition. The student editions contain pretests, personal inventories, and lesson plans. Additional resources are suggested. (SA)

\*\*\*\*\*  
 \* Documents acquired by ERIC include many informal unpublished \*  
 \* materials not available from other sources. ERIC makes every effort \*  
 \* to obtain the best copy available. nevertheless, items of marginal \*  
 \* reproducibility are often encountered and this affects the quality \*  
 \* of the microfiche and hardcopy reproductions ERIC makes available \*  
 \* via the ERIC Document Reproduction Service (EDRS). EDRS is not \*  
 \* responsible for the quality of the original document. Reproductions \*  
 \* supplied by EDRS are the best that can be made from the original. \*  
 \*\*\*\*\*

# TEACHER EDITION

## CULINARY CUBS

U S DEPARTMENT OF HEALTH,  
EDUCATION & WELFARE  
NATIONAL INSTITUTE OF  
EDUCATION

THIS DOCUMENT HAS BEEN REPRO-  
DUCED EXACTLY AS RECEIVED FROM  
THE PERSON OR ORGANIZATION ORIGIN-  
ATING IT. POINTS OF VIEW OR OPINIONS  
STATED DO NOT NECESSARILY REPRE-  
SENT OFFICIAL NATIONAL INSTITUTE OF  
EDUCATION POSITION OR POLICY

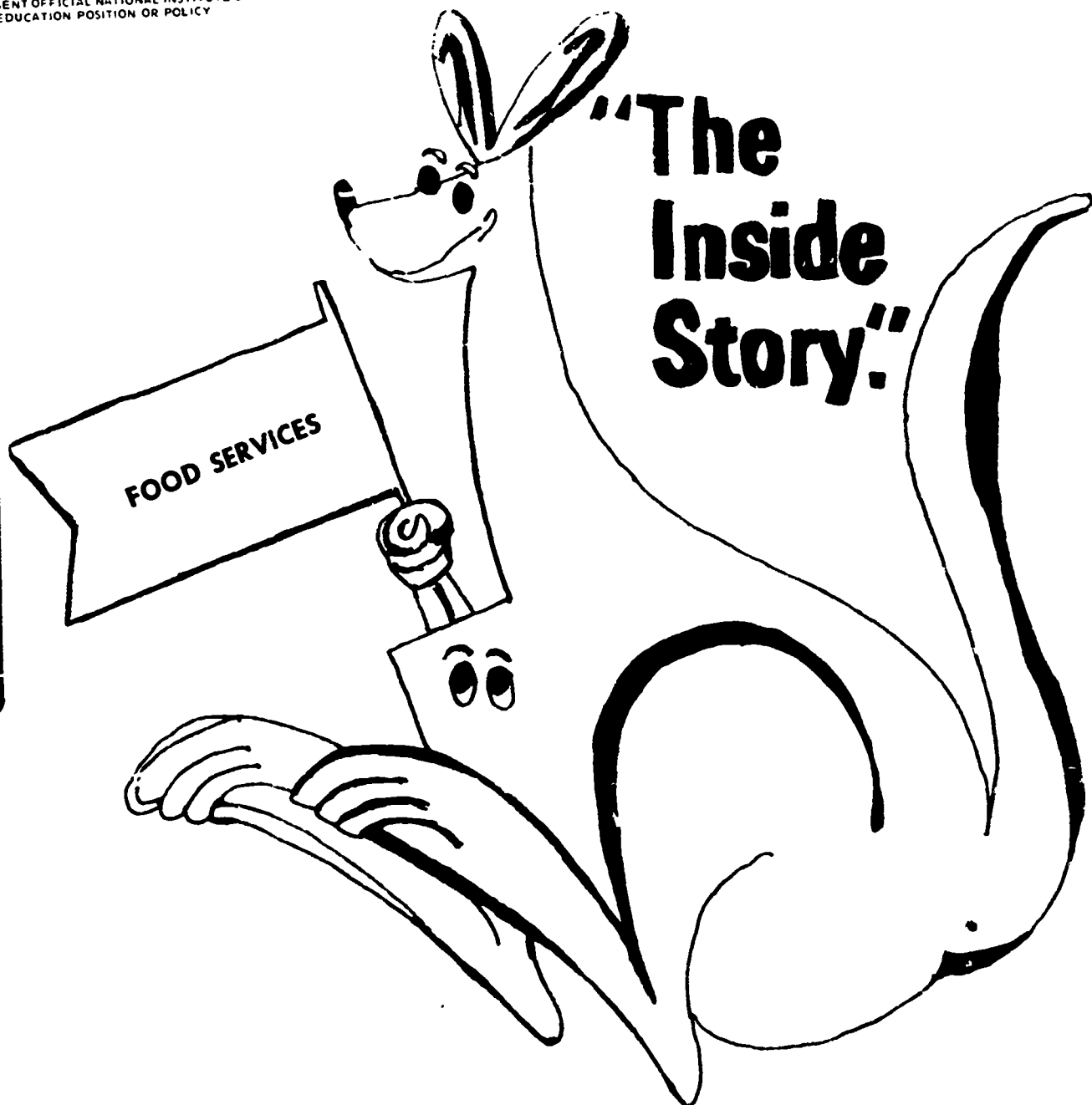

# "The Inside Story."

ED107858

03962

Culinary Cubs

Teacher Section

compiled by

Louie E. Kemp  
Curriculum Coordinator  
Home Economics

Published by

Mississippi State University  
RESEARCH AND CURRICULUM UNIT  
FOR  
VOCATIONAL AND TECHNICAL EDUCATION  
State College, Mississippi

In Cooperation With

Division of Vocational and Technical Education  
State Department of Education  
Jackson, Mississippi

Home Economics Publication Number 6004

1972

Direct inquiries to:

Research and Curriculum Unit  
Drawer DX  
Mississippi State, MS

Mississippi State University does not discriminate on the grounds of race, color, or national origin.

Home Economics Learning Package  
Career Exploration

Identification Page

Title: Culinary Cubs

Subject: Occupations related to nutrition

Performance Level: Exploratory -- 7th and 8th grades

Purpose: This packet is designed to acquaint the student with some of the purposes, activities, and responsibilities involved in occupations related to Food Management, Production and Services. The search for identification of self is an integral part of growing up. To find a satisfying and rewarding role in the world of work requires exploration and decision making.

Producer: Louie E. Kemp  
Drawer DX  
Research and Curriculum Unit  
Mississippi State, MS 39762

Date: 1973

CULINARY CUBS  
TEACHER'S SECTION

I. Statement of Purpose:

A. Generalization:

By exploring the duties, responsibilities, and tasks performed by workers in Food Service occupations, students may begin to identify interests that will lead to future careers in this field.

B. Components:

1. Setting attractive, useful trays
2. Planning simple meals
3. Using kitchen utensils, equipment, and measuring tools in meal preparation
4. Learning to prepare and serve simple meals

II. Instructional Objectives:

- A. The student will set up a tray, by properly preparing and arranging silverware, napkins, serving dishes, and glassware to be served to a patient in a hospital or nursing home.
- B. The student will identify in writing, meals for a hospital patient by selecting foods that are nutritious, appealing, and suitable for the diet recommended for a patient.
- C. The student will identify, with 100% accuracy, kitchen equipment, tools, utensils, and measurements that are needed to prepare a simple breakfast for a hospital or nursing home patient.
- D. The student will prepare and serve a simple breakfast meal to a hospital or nursing home patient. This meal preparation will be limited to two foods, such as milk and cinnamon toast, orange juice and buttered toast, etc.

## INSTRUCTIONS TO THE TEACHER

### I. Instructional Approach:

The student section of this exploratory learning package will use the quasi-discovery approach, which means that there will be factual information given to the students, but there will also be provisions made for students to explore and discover information. By presenting educational materials and suggested learning experiences that are directly related to the instructional objectives and criteria for evaluation, the student will hopefully gain some understanding of the duties, responsibilities and tasks performed by workers in Food Service Occupations.

### II. Identification of the Learner:

This learning package is developed for the average seventh and eighth grade student. It will be used to help students explore careers related to Food Services.

### III. Special Instructions:

#### A. Equipment Needed:

Tape Player

Filmstrip Projector

#### B. Material Needed:

##### Books:

First Foods, Crovan, Marion L., and Atwood, June C. Peoria, Illinois: Chas. A. Bennett Co., Inc., 1971.

Teen Guide to Homemaking, Barclay, Marion S., and Champion, Frances. New York: Webster Division, McGraw-Hill Company, 1967.

##### Tray Supplies:

Trays, baking tins or some objects that will substitute for trays;



serving dishes; silverware; glassware; coffee spoons; napkins; tray card holders; 3" x 4" poster paper.

#### C. Media Needs:

##### Filmstrips:

Feeding the Patient, McGraw-Hill Book Co., Inc., Webster Division, Manchester Rd., Manchester, Missouri 64111.

Headstart on Health, Carnation Co., 5145 Wilshire Blvd., Los Angeles, California 90036.

Headstart on Homemaking, Carnation Co., 5145 Wilshire Blvd., Los Angeles, California 90036.

##### Tape:

For those students who prefer or who will profit from learning by listening, it is suggested that the key reading in each lesson be made available on tape. This will necessitate the taping of the material, Tray-Your Personality is Showing, by the teacher.

#### IV. Instructions for Evaluation:

Two instruments for evaluation are given. The pretest is planned as a learning experience as well as a diagnostic device. The post test is the same as the pretest and should indicate behavioral changes resulting from the use of the learning packages. Copies of the pretest and post test with answer keys are included in the teacher section only. A sample pretest will be found in the student section.

#### V. Suggested Instructional Procedure:

- A. Explain the use and care of the student section of the learning packages to the students. The following explanations to students are suggested:

1. Read the introduction and the instructional objectives.  
This information will identify the occupation that the student will explore, and will explain the extent to which they are expected to explore the occupation.
2. Explain to the students that the pretest will be administered to assess their knowledge of food services occupations. Pass a copy of the pretest to each student. Remind the students that they will not write on the sample pretest in the learning package, and that they will not get a grade on the pretest.
3. Following the pretest, the students will begin Lesson I The component and the objectives explain what they will learn. The instructions direct them to the learning experiences, and explain the number of learning experiences they must successfully complete before attempting Lesson II.
4. Follow the same procedure through the remaining lessons.
5. When they have completed their last lesson and feel that they are ready, they should ask the teacher for a post or final test. A grade should be given on the post test. This will mean that they have completed their exploration of this occupation.
6. If they need equipment, media, or materials, if they do not understand a direction given, or if they need help in any activity they are undertaking, they should ask the teacher for help and she will be glad to assist them.

7. Students will not write their names or anything else on or in the learning packages. These will be used by students in other classes this year and in years to come. All written assignment sheets will be given to them.

B. Show and explain to the students the location and the method of filing the learning packages.

1. Each learning package will be kept in a manila folder. Each folder will have the name of the learning package written on it.
2. The folders containing the learning packages will be kept in a file drawer or a box on a table beside the teacher's desk.
3. When students come to class, they should get a manila folder that contains a learning package in which they are working. This folder will be taken from the file drawer or box. At the end of the period, they will replace the folder and the learning package in the same file drawer or box. They will not take the learning packages out of the classroom.

C. Introduce the subject matter area that the learning package is designed to explore. The following is a suggested approach:

Explain to the students that this learning package will help them find out more about the occupations in Food Services. They may become interested enough in these occupations to want to know the training they must have in order to qualify for these occupations. They may decide

that this is not exactly "their cup of tea," but they may wonder if there is another occupation similar to this that would appeal to them. Build an interest approach that will cause the students to become enthusiastic about the occupation. An attractive bulletin board, a film, or a resource person may be valuable aids.

- D. Identify the equipment, materials, and media that will be needed by the students and point out the locations of these available supplies. Students should ask to use the supplies, and request assistance if needed.
- E. Instruct the students not to write on or in the package. Tests or any other written assignment sheets should be made available to the students upon request. An adequate supply of work sheets should be available when students begin the package.

### Pretest

Instructions: Place a T or F in the blank before the number.

- \_\_\_ 1. The tray cover should be made of plastic.
- \_\_\_ 2. Serving portions of food for patients should be large.
- \_\_\_ 3. Food should be served to patients any time they get hungry.
- \_\_\_ 4. Cooked cereal may be included in a soft diet.
- \_\_\_ 5. Hard candy is good for a patient on a liquid diet.
- \_\_\_ 6. Tender meat is included in most light diets.
- \_\_\_ 7. Food prepared for patients should be appetizing.
- \_\_\_ 8. Cups used to drink from at the table should be used for measuring cups.
- \_\_\_ 9. A one cup measuring cup holds 1<sup>1</sup>/<sub>2</sub> tablespoons.
- \_\_\_ 10. Measuring spoons come in five sizes: 1/4 teaspoon, 3/4 teaspoon, 1 teaspoon and 1 tablespoon.
- \_\_\_ 11. 3t = 1 tablespoon.
- \_\_\_ 12. Flour and milk should be measured the same way.
- \_\_\_ 13. A wool dress will absorb food odors and is out of place in the kitchen.
- \_\_\_ 14. Well written recipes give step-by-step directions.
- \_\_\_ 15. T means tablespoon.
- \_\_\_ 16. Tbsp means tablespoon.
- \_\_\_ 17. A record should be made of the food the patient eats.
- \_\_\_ 18. A tray card should have only a friendly note on it.
- \_\_\_ 19. The breakfast and dinner trays should be set the same way.
- \_\_\_ 20. Plain gelatin desserts are on a liquid diet.

KEY

Post Test  
&  
Pretest

Instructions: Place a T or F in the blank before the number.

- F 1. The tray cover should be made of plastic.
- F 2. Serving portions of food for patients should be large.
- F 3. Food should be served to patients any time they get hungry.
- T 4. Cooked cereal may be included in a soft diet.
- F 5. Hard candy is good for a patient on a liquid diet.
- T 6. Tender meat is included in most light diets.
- T 7. Food prepared for patients should be appetizing.
- F 8. Cups used to drink from at the table should be used for measuring cups.
- F 9. A one cup measuring cup holds 1+ tablespoons.
- F 10. Measuring spoons come in five sizes: 1/4 teaspoon, 1/2 teaspoon, 3/4 teaspoon, 1 teaspoon, and 1 tablespoon.
- T 11. 3t = 1 tablespoon.
- F 12. Flour and milk should be measured the same way.
- T 13. A wool dress will absorb food odors and is out of place in the kitchen.
- T 14. Well written recipes give step-by-step directions.
- T 15. T means tablespoon.
- T 16. Tbsp means tablespoon.
- T 17. A record should be made of the food the patient eats.
- F 18. A tray card should have only a friendly note on it.
- F 19. The breakfast and dinner trays should be set the same way.
- T 20. Plain gelatin desserts are on a liquid diet.

## Script for Tape

### Tray-Your Personality Is Showing

The dietitian is the coach of your Culinary Cubs team. This coach wants to have a winning team, and she needs your help. You play a very important position on the team. You are the one who can make the team click, if you learn to play the game according to the rules set up by "Coach Dietitian."

The dietitian plans the diets for patients, assigns duties to the cubs and supervises the cubs as they perform their duties. One duty that the dietitian assigns to the Culinary Cubs is to arrange trays that will be attractive and appealing. Your ability to make a tray appealing to a patient, may be the part you can play in helping a patient to recover from an illness.

Observe the following rules as you arrange a tray and watch the personality of the tray begin to show.

- (1) The size of the tray should suit the size of the meal to be served.
- (2) The tray cover and the napkin should be of good quality fabric or paper, free from wrinkles and spotlessly clean.
- (3) The silver should be clean and polished. Only necessary pieces should be on the tray.
- (4) Serving dishes and glassware should be attractive, clean, and free from chips.
- (5) Attractive color combinations should be chosen when selecting tray covers, serving dishes and glassware.
- (6) Serve portions of food that should appeal to the patient's appetite.

(7) The tray should be served on time.

(8) Food should be served at proper temperatures.

Items to be used in setting up a tray:

(1) Tray cover

(2) Napkin

(3) Salt, pepper, sugar

(4) Cup, saucer and/or glass

(5) Silverware (may be sacked)

(6) Bread and butter plate (if used)

(7) Cold foods

(8) Tray card

To make the tray more appealing, the food is usually served on the main plate. The dessert, fruit and salad plate, depending on the ones to be used, are added to the tray after the tray has been set up.



STUDENT EDITION  
CULINARY CUBS

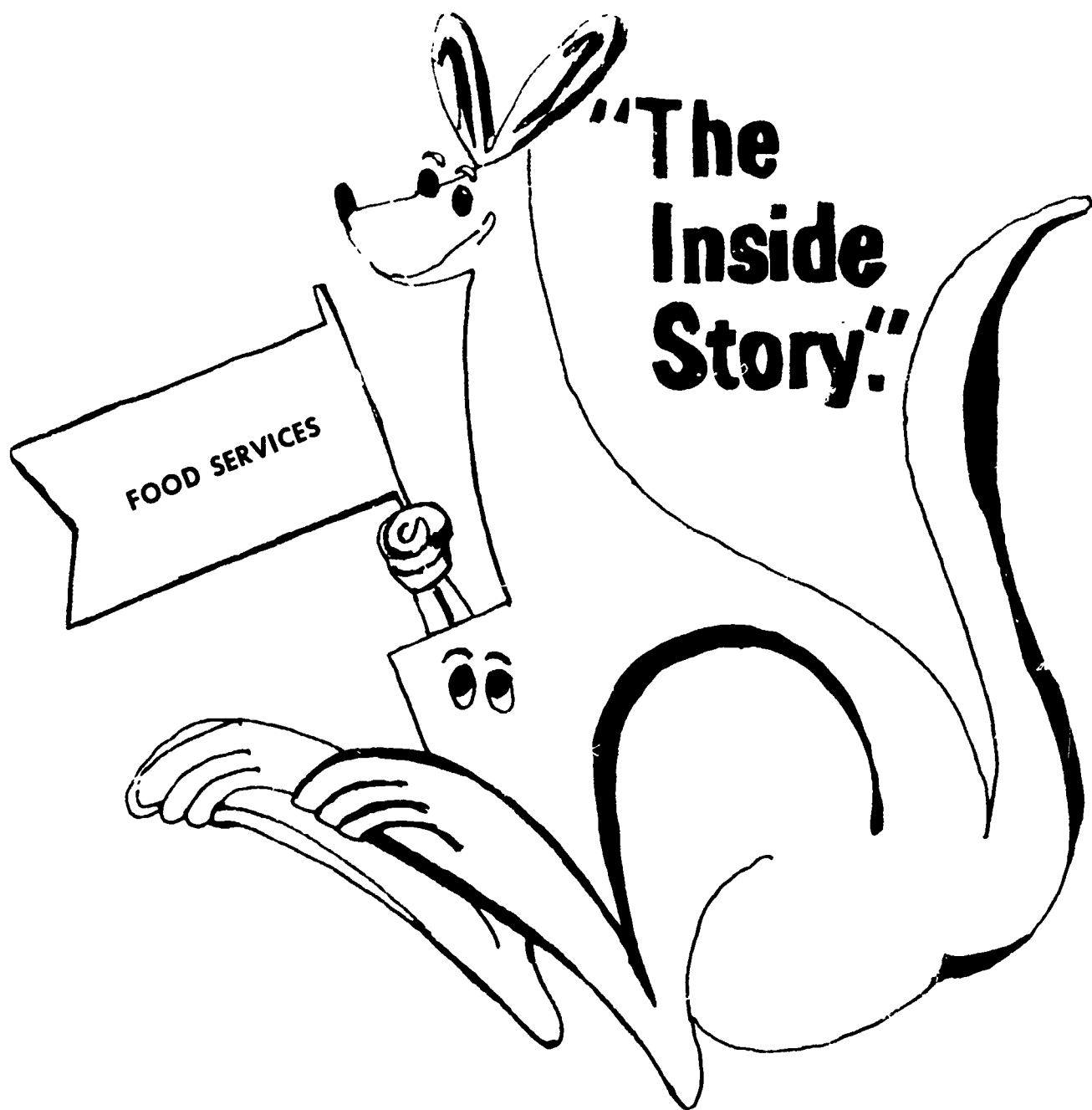

CE003962

Culinary Cubs

Student Section

compiled by

Louie E. Kemp  
Curriculum Coordinator  
Home Economics

Published by

Mississippi State University  
RESEARCH AND CURRICULUM UNIT  
FOR  
VOCATIONAL AND TECHNICAL EDUCATION  
Mississippi State, Mississippi

In Cooperation With

Division of Vocational and Technical Education  
State Department of Education  
Jackson, Mississippi

Home Economics Publication Number 6003

1972



*A complimentary copy of this publication is sent to you by the*

## RESEARCH AND CURRICULUM UNIT

Drawer DX, Mississippi State, Mississippi 39762

The Unit is a cooperative effort between  
The Division of Vocational and Technical Education  
Mississippi Department of Education  
and  
Mississippi State University

*Additional copies are priced at 1.00*  
*Direct inquiries to the above address*



Direct inquiries to:

Research and Curriculum Unit  
Drawer DX  
Mississippi State, MS

Mississippi State University does not discriminate on the grounds of race, color, or national origin.

## Introduction

Today you will begin an adventure. This will be just as interesting and just as much fun as you choose to make it. You will explore a world of helpfulness. You will help others and you will help yourself as a result of this adventure. You will help yourself by finding out whether you are interested in becoming a dietitian. You may discover that you have other food service interests. Let's see what ideas you get about helping other people, as you become familiar with some of the duties and responsibilities of a dietitian.

## Learning Objectives

When you complete this learning package you will have a better understanding of the duties, responsibilities and tasks performed by dietitians and their helpers. You will demonstrate your understanding by successfully accomplishing the following objectives:

- A. Set up a tray, properly prepare and arrange silverware, napkins, serving dishes and glassware for a tray to be served to a patient in a hospital or nursing home.
- B. Identify in writing, meals for a hospital patient by selecting foods that are nutritious, appealing and suitable for the diet recommended for the patient.
- C. Identify kitchen equipment, tools, utensils and measurements, with 100% accuracy, that are needed to prepare a simple breakfast for hospital or nursing home patients.
- D. Prepare and serve a simple meal that is appropriate for a patient on a regular diet.

### Pretest

Instructions: Place a T or F in the blank before the number.

- \_\_\_ 1. The tray cover should be made of plastic.
- \_\_\_ 2. Serving portions of food for patients should be large.
- \_\_\_ 3. Food should be served to patients any time they get hungry.
- \_\_\_ 4. Cooked cereal may be included in a soft diet.
- \_\_\_ 5. Hard candy is good for a patient on a liquid diet.
- \_\_\_ 6. Tender meat is included in most light diets.
- \_\_\_ 7. Food prepared for patients should be appetizing.
- \_\_\_ 8. Cups used to drink from at the table should be used for measuring cups.
- \_\_\_ 9. A one cup measuring cup holds 14 tablespoons.
- \_\_\_ 10. Measuring spoons come in five sizes: 1/4 teaspoon, 1/2 teaspoon, 3/4 teaspoon, 1 teaspoon and 1 tablespoon.
- \_\_\_ 11. 3t = 1 tablespoon.
- \_\_\_ 12. Flour and milk should be measured the same way.
- \_\_\_ 13. A wool dress will absorb food odors and is out of place in the kitchen.
- \_\_\_ 14. Well written recipes give step by step directions.
- \_\_\_ 15. T means tablespoon.
- \_\_\_ 16. Tbsp means tablespoon.
- \_\_\_ 17. A record should be made of the food the patient eats.
- \_\_\_ 18. A tray card should have only a friendly note on it.
- \_\_\_ 19. The breakfast and dinner trays should be set the same way.
- \_\_\_ 20. Plain gelatin desserts are on a liquid diet.

HOW WILL I RATE AS A CULINARY CUB?

	Most of the Time	Sometimes	Not Usually
1. Do I enjoy working with people? I must see people and be with people every day.			
2. Am I <u>really</u> interested in the way other people feel? I must be sincere or the patient may feel worse, not better.			
3. Am I always clean, neat and well-groomed? This shows others that I respect and like myself.			
4. Am I dependable? If I am not on time and if I do not follow instructions, I may make an error that will cause unhappiness and harm.			
5. Do I work well with others? If I am a troublemaker the entire hospital or nursing home will be disturbed.			
6. Can I take instructions without fussing? Instructions are necessary if I learn to perform my tasks; I cannot <u>know</u> everything. Everyone can learn <u>something</u> .			
7. Am I in good health? Good health is very important to everyone. I can work better when I feel my best. To feel my best, I must be in good physical and mental health.			
8. Am I willing to work? If I am willing to work, I will not stop when my task is finished. I will help others who are behind, or I will search for new tasks to help make our team a better team.			

Assignment - Select 1 or 2 of the questions that you checked in the "sometimes" or "not usually" column. Work out a plan for improving yourself in these areas.

## Lesson 1

Component: Setting Attractive, Useful Trays

Objective: As a result of the following experiences you will be able to: Properly set up a tray by determining and arranging silverware, napkins, serving dishes, and glassware that will meet the needs of a patient in a hospital or nursing home

Instructions: You must complete Learning Experience 1 or 2, and Learning Experiences 3, 4, 5, 6, and 7

### Learning Experiences:

1. Read - Tray - Your Personality Is Showing
2. Listen to tape - Tray - Your Personality Is Showing

#### Tray - Your Personality Is Showing

The dietitian is the coach of your Culinary Cubs team. This coach wants to have a winning team, and she needs your help. You play a very important position on the team. You are the ones who can make the team click, if you learn to play the game according to the rules set up by "Coach Dietitian."

The dietitian plans the diets for patients, assigns duties to the cubs and supervises the cubs as they perform their duties. One duty that the dietitian assigns to the Culinary Cubs is to arrange trays that will be attractive and appealing. Your ability to make a tray appealing to a patient, may be the part you can play in helping a patient to recover from an illness.

Observe the following rules as you arrange a tray and watch the personality of the tray begin to show

- (1) The size of the tray should suit the size of the meal to be served.
- (2) The tray cover and the napkin should be of good quality fabric or paper, free from wrinkles and spotlessly clean.

- (3) The silver should be clean and polished. Only necessary pieces should be on the tray.
- (4) Serving dishes and glassware should be attractive, clean, and free from chips.
- (5) Attractive color combinations should be chosen when selecting tray covers, serving dishes and glassware.
- (6) Serve portions of food that should appeal to the patient's appetite.
- (7) The tray should be served on time.
- (8) Food should be served at proper temperatures.

Items to be used in setting up a tray:

- (1) Tray cover
- (2) Napkin
- (3) Salt, pepper, sugar
- (4) Cup, saucer and/or glass
- (5) Silverware (may be sacked)
- (6) Bread and butter plate (if used)
- (7) Cold foods
- (8) Tray card

To make the tray more appealing, the food is usually served on the main plate. The dessert, fruit and salad plate, depending on the ones to be used, are added to the tray after the tray has been set up.

3. Study the diagrams on the next page. Identify and list in writing the serving utensils that are the same on both trays. List in writing the utensils that are different on the two trays.



The diagrams below show typical breakfast and dinner place settings for nursing home or hospital tray service.

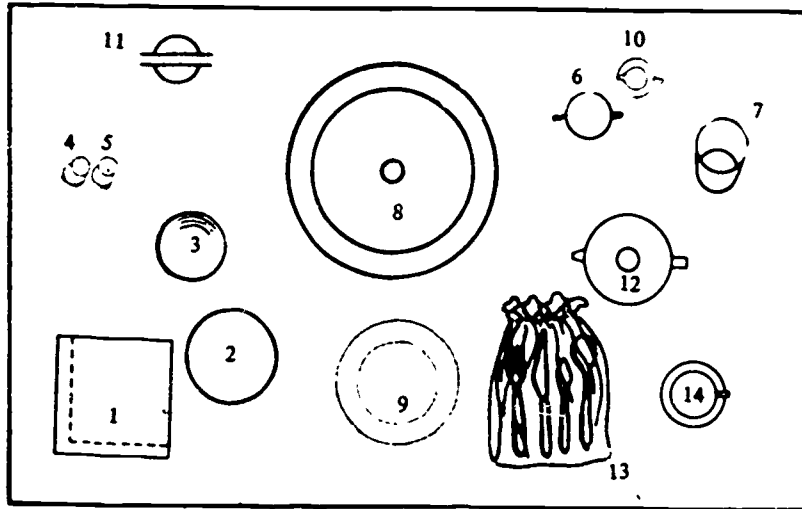

**BREAKFAST**

- |                          |          |                         |                      |
|--------------------------|----------|-------------------------|----------------------|
| 1 Napkin                 | 4 Salt   | 8 Main Plate with Cover | 11 Tray Card Holder  |
| 2 Bread-and-Butter Plate | 5 Pepper | 9 Fruit Plate           | 12 Beverage Pot      |
| 3 Cereal Bowl            | 6 Sugar  | 10 Creamer              | 13 Sacked Silverware |
|                          | 7 Milk   |                         | 14 Cup and Saucer    |

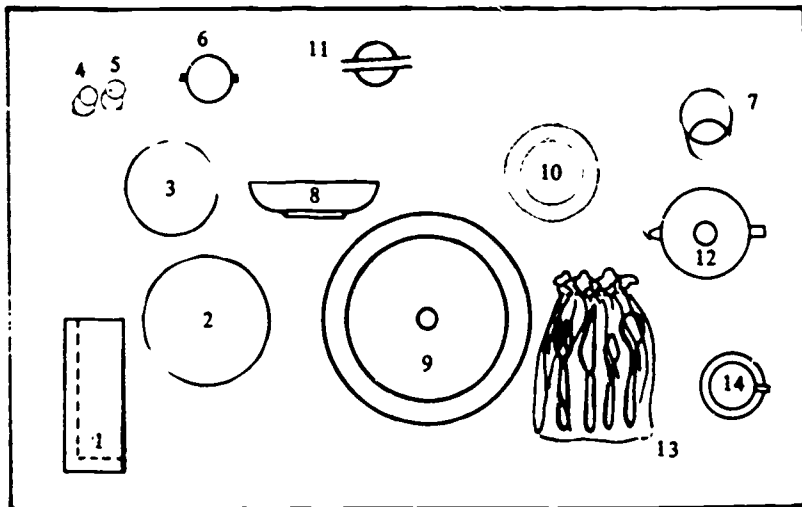

**DINNER**

- |                          |          |                         |                      |
|--------------------------|----------|-------------------------|----------------------|
| 1 Napkin                 | 4 Salt   | 8 Vegetable Dish        | 11 Tray Card Holder  |
| 2 Salad Plate            | 5 Pepper | 9 Main Plate with Cover | 12 Beverage Pot      |
| 3 Bread-and-Butter Plate | 6 Sugar  | 10 Dessert Plate        | 13 Sacked Silverware |
|                          | 7 Milk   |                         | 14 Cup and Saucer    |

4. Read pp. 420-21, Teen Guide to Homemaking. Ask your teacher for instructions before you read the reference. View filmstrip, Feeding the Patient. Ask the teacher for instructions.
5. The tray card should contain the following information:
  - a. Patient's name
  - b. Patient's room number
  - c. Type of diet

Sylvia Boyd is in room 620 and she is on a special diet. Make a card for her tray that will include all of the necessary information. Ask your teacher for the material to work with when making the tray card. Write your name on the back of the card and put the card on the teacher's desk. She will evaluate it and return it to you.

6. Sylvia Boyd, who is seventeen, needs your help. Remember, she is on a special diet. Set up her tray for a typical breakfast. Add anything to the tray that you think will make Sylvia feel better. The teacher has a selection of trays, utensils, and articles from which you may choose to use on your tray. Ask two of your classmates and your teacher to check your tray.
7. Extended learning - Set up a tray that may be appealing to a four-year-old child, Jane Jones, who is a patient in "Children's Hospital." Jane has a broken leg, and is on a regular diet. Do your own thing!

## Lesson II

**Component:** Planning Simple Meals

**Objective:** List in writing, a selection of foods that will make nutritious, appealing and suitable meals for a hospital or nursing home patient.

**Instructions:** Complete Learning Experiences 1 and 2.

**Learning Experiences:**

1. View filmstrip, Head Start on Health, as a group in your cluster. Your teacher will explain to you the type of discussion or other class participation she expects from you following the filmstrip.
2. Choose three meals for a patient on a regular diet by choosing food from the Hospital Menu on the next page. List your chosen food on the chart below. Place each food under the food group to which it belongs. Choose one breakfast, one lunch, and one dinner.

Meal	Milk & Milk Products	Fish, Eggs Meat	Fruit and Vegetables	Breads and Cereals
Breakfast				
Lunch				
Dinner				

Hospital Menu

Regular Diet

Breakfast	Dinner	Supper
Orange juice Apple juice	Baked chicken Roast	Pork chop Baked Ham
Oatmeal Cornflakes	Rice Mashed potatoes	Asparagus Casserole Stuffed celery
Scrambled eggs Soft boiled eggs	Butter beans String beans	Sliced tomatoes Head lettuce
Bacon Ham	Green salad Fruit salad	Biscuit White bread
Toast Sweet roll	Corn bread Rolls	Milk Tea
Hot chocolate Coffee Milk	Peach Cobbler Chocolate cake  Tea Milk	

### Lesson III

Component: Use of kitchen utensils, equipment and measuring tools in meal preparation

Objective: Identify kitchen equipment, tools, utensils, and measurements, with 100% accuracy, that are needed to prepare a simple breakfast for hospital or nursing home patients.

Instructions: Complete Learning Experiences 1, 2, 3, and 4.

Learning Experiences:

1. Copy in your notebook "Measurements to know - You'll use them often," First Foods, p. 20.
2. Demonstrate your understanding of the correct use of these measurements by demonstrating to your group the first eight measurements listed.
3. Identify orally by name each piece of measuring equipment listed in "Measurements to know - You'll use them often."
4. Read pp. 250-256, Teen Guide to Homemaking. Identify kitchen tools listed on pp. 250-251 and utensils listed on p. 252 by finding these items in the cabinet and naming them orally to your group. Replace tools and utensils in cabinets after your identification.

## Lesson IV

Component: Simple Meal Service

Objective: To prepare and serve a simple meal to be served to a patient in a hospital or nursing home.

Instructions: Complete Learning Experiences 1, 2, 3, and 4.

Learning Experiences:

1. View filmstrip, Head Start on Homemaking, as a group in your cluster. Your teacher will explain to you the type of discussion or other class participation she will expect from you following the filmstrip.
2. Read pp. 254-257, Teen Guide to Homemaking. Check with your teacher for an evaluation sheet that will help you decide whether you are ready to prepare a meal.
3. Plan a simple meal for a patient on a regular diet in a hospital or nursing home. Check with your teacher for her approval. Use Part Four of Teen Guide to Homemaking as one reference for recipes. Ask your teacher for other suggestions. Prepare enough food to serve to the individuals in your cluster.
4. Serve the meal you have prepared. Use a tray to serve the meal to a member of your group to evaluate your tray arrangement, food preparation and service.

### ! Post Test

Ask your teacher for your post test. Follow instructions. This post test will help you discover how much you have learned about the duties, responsibilities, and tasks performed by dietitians.

#### Quests:

Would you like to know more about dietitians or other occupations in the area of food management in businesses or institutions? The following suggestions may interest you.

1. Make an appointment with a dietitian in a local hospital or some other institution. Ask for a tour of the kitchen to explore equipment, to talk to employees and to observe activities engaged in by employees.
2. In the library, find information on styles of food service in restaurants. Compare these styles with those used in hospitals.
3. Explore any other areas related to food services that interest you.

TEACHER EDITION

MINI NURSERY

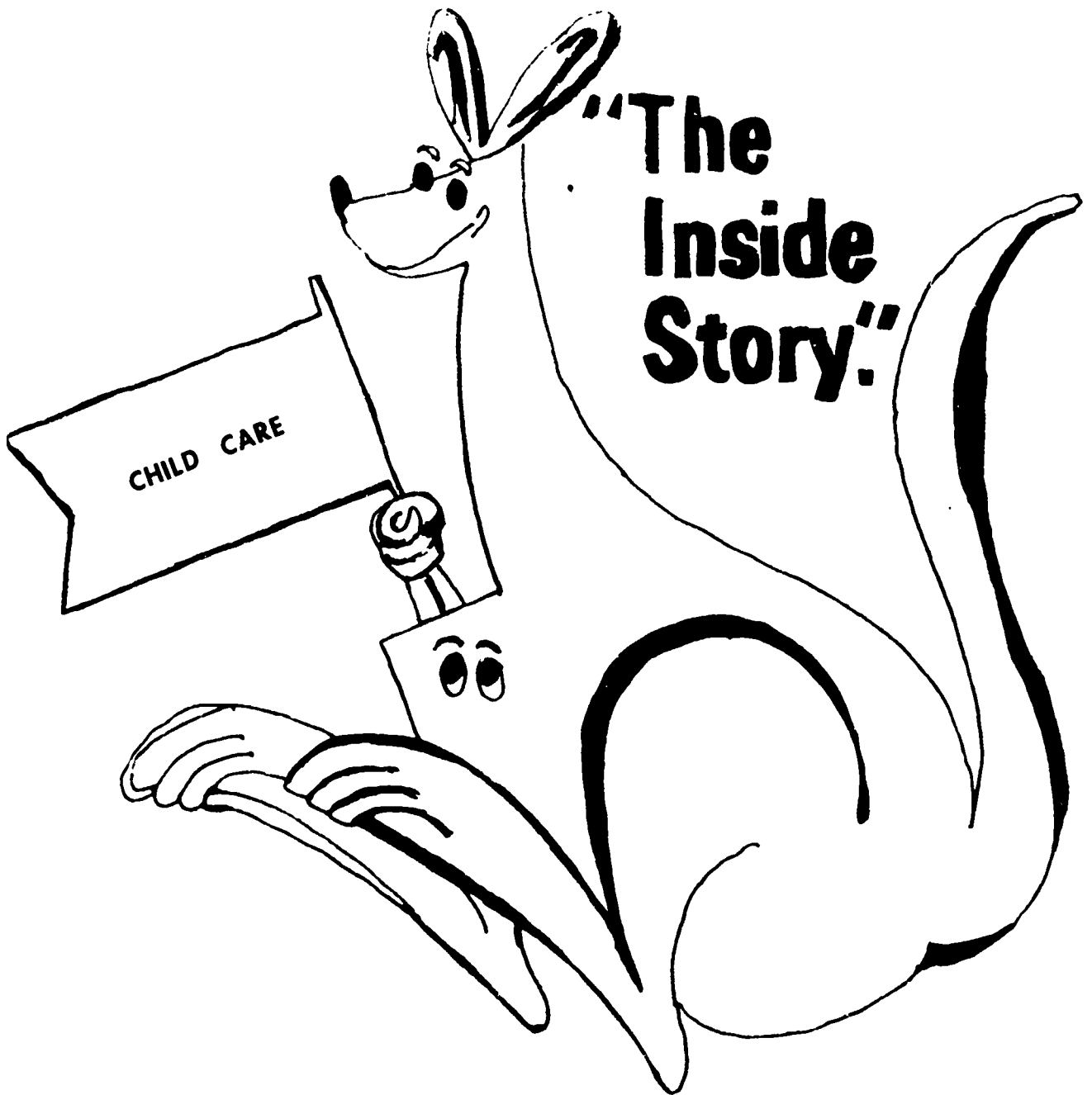

8965003968



**Mini-Nursery  
Teacher Section**

compiled by

**Louie E. Kemp  
Curriculum Coordinator  
Home Economics**

Published by

**Mississippi State University  
RESEARCH AND CURRICULUM UNIT  
FOR  
VOCATIONAL AND TECHNICAL EDUCATION  
Mississippi State, Mississippi**

In Cooperation With

**Division of Vocational and Technical Education  
State Department of Education  
Jackson, Mississippi**

Home Economics Publication Number 6008

1972

Direct inquiries to:

Research and Curriculum Unit  
Drawer DX  
Mississippi State, MS

Mississippi State University does not discriminate on the grounds of race, color, or national origin.

Home Economics Learning Package  
Career Exploration

Identification Page

Title: Mini-Nursery

Subject: Occupations related to child care

Performance Level: Exploratory -- 7th and 8th grades

Purpose: To assist students in exploring the activities and responsibilities involved in child care related occupations. Wiser decisions regarding future careers may be reached through a developmental process.

Producer: Louie E. Kemp  
Drawer DX  
Research and Curriculum Unit  
Mississippi State, MS 39762

Date: 1973

MINI-NURSERY  
TEACHER'S SECTION

I. Statement of Purpose:

A. Generalization:

By exploring the responsibilities, duties and tasks performed by workers in child care occupations, students may begin to identify interests that will lead to future careers in the area of child care.

B. Components:

1. Responsibilities of a baby-sitter
2. The value of play for preschool children
3. Nutritious and appealing snacks for preschool children
4. Schedule of activities while baby-sitting

II. Instructional Objectives:

- A. Students will list in writing and/or orally state the responsibilities that a baby-sitter should assume when caring for children.
- B. Students will identify play equipment, materials and media that will promote learning and afford entertainment for children from one-to-six years-old. They will construct one simple play material, one game, and one story that will be suitable for a preschool child.
- C. Students will plan, prepare and serve a simple nutritious and appealing snack suitable for preschool children.
- D. Students will plan in writing a schedule of activities to be carried out while they are baby-sitting for three hours, with two children who are four and five years of age.

## INSTRUCTIONS TO THE TEACHER

### I. Instructional Approach:

The student section of this experiential learning package will use the quasi-discovery approach, which means that there will be factual information given to the students, but there will also be provisions made for students to explore and discover information. By presenting educational materials and suggested learning activities that are directly related to the instructional objectives and criteria for evaluation, the student will hopefully gain some understanding of the duties, responsibilities and tasks performed by workers in child care occupations.

### II. Identification of the Learner:

This learning package is developed for the average seventh and eighth grade student. It will be used to help students explore careers related to child care.

### III. Special Instructions.

#### A. Equipment Needed:

Film Projector  
Tape Player

Measuring Cups  
Measuring Bowls

Measuring Spoons  
2 Qt. Sauce Pans  
Mixing Spoons

#### B. Materials Needed:

##### Books:

Teen Guide to Homemaking, Barbara Martin S. and Champion, Francis.  
New York: Webster Division, McGraw-Hill Book Company, 1967.

Your Child From One to Six, Social and Rehabilitation Service, U. S.  
Department of Health Education and Welfare, Washington, D. C.: U. S.  
Government Printing Office.

##### Phamplet:

"Sitting" Safely, McInnes, Edna M. Fremont, Michigan: Gerber  
Products Co., 1970.

##### Supplies:

Flour  
Salt

lique starch  
Argo starch

Short Cakes  
Food coloring

Glycerine

C. Instruction Sheet Needed:

1. Preparing to Baby-Sit
2. Do's for Baby-Sitters
3. Don't's for Baby-Sitters
4. Snack Facts
5. Low-Cost and No-Cost Toys and Play Materials and Media
6. Recipes

D. Media Needed:

Filmstrips:

To a Baby-Sitter, Health Film Catalog of the State Board of Health, Film Library, P. O. Box 1700, Jackson, MS 39205.

Tape:

For those students who prefer or who will profit from learning by listening, it is suggested that the key readings in each lesson be made available on tape. This will necessitate the taping of Important Information That A Baby-Sitter Needs, Play Helps Children Learn, and Play Materials, Toys, Music and Stories Help Children In Their Play.

IV. Instructions for Evaluation:

Two instruments for evaluation are given. The pretest is planned as a learning experience as well as a diagnostic device. The post test is the same as the pretest and should indicate behavioral changes resulting from the use of the learning package. Copies of the pretest and post test with answer keys are included in the teacher section only. A sample pretest will be found in the student section.

V. Suggested Instructional Procedure:

- A. Explain the use and care of the student section of the learning package to the students. The following explanations to students are suggested:
  1. Read the introduction and the instructional objectives. This information will identify the occupation that the students will explore,

and will explain the extent to which they are expected to explore it.

2. Explain to the students that the pretest will be administered to help them discover how much they know about child care occupations. Pass a copy of the pretest to each student. Remind the students that they will not write on the sample pretest in the learning package, and that they will not get a grade on the pretest.
  3. Following the pretest, the students will begin Lesson I. The component and the objectives explain what they will learn. The instructions direct them to the learning experiences, and explain the number of learning experiences they must successfully complete before attempting Lesson II.
  4. Follow the same procedure through the remaining lessons.
  5. When they have completed their last lesson and feel that they are ready, they should ask the teacher for a post or final test. A grade should be given on the post test. This will mean that they have completed their exploration of this occupation.
  6. If they need equipment, media, or materials, if they do not understand a direction given, or if they need help in any activity they are undertaking, they should ask the teacher for help and she will be glad to assist them.
  7. Students will not write their names or anything else on or in the learning packages. These will be used by students in other classes this year and in years to come. All written assignment sheets will be given to them.
- B. Show and explain to the students the location and the method of filing the learning packages.

1. Each learning package will be kept in a manila folder. Each folder will have the name of the learning package written on it.
  2. The folders containing the learning packages will be kept in a file drawer or a box on a table beside the teacher's desk.
  3. When students come to class, they should get a manila folder that contains a learning package in which they are working. This folder will be taken from the file drawer or box. At the end of the period, they will replace the folder and the learning package in the same file drawer or box. They will not take the learning package out of the classroom.
- C. Introduce the subject matter area that the learning package is designed to explore. The following is a suggested approach:

Explain to the students that this learning package will help them find out more about the occupations in child care services. They may become interested enough in these occupations to want to know the training they must have in order to qualify for these occupations. They may decide that this is not exactly "their cup of tea," but they may wonder if there is another occupation similar to this that would appeal to them. Build an interest approach that will cause the students to become enthusiastic about the occupation.

An attractive bulletin board, a film, or a resource person may be valuable aids.

- D. Identify the equipment, materials, and media that will be needed by the students, and point out the locations of these available supplies. Students should ask to use the supplies, and request assistance if needed.
- E. Instruct the students not to write on or in the package. Tests or any other written assignment sheet's should be made available to the students upon request. An adequate supply of work sheets should be available when students begin the package.



Key  
Post Test & Pretest

Directions: Place a T or F in the blank before the number.

- T   1. A baby-sitter should interview the parents before sitting with a child.
- T   2. A baby-sitter's parents should know where the baby-sitter will be working.
- F   3. A written list of instructions for the baby-sitter from the parents is not needed.
- T   4. A baby-sitter should learn where the light switches are before the parents leave the house.
- F   5. If a child will not cooperate, the baby-sitter should threaten or frighten him.
- T   6. The salary of a baby-sitter should be settled before the baby-sitter takes the job.
- F   7. The baby-sitter should entertain herself on the telephone while she baby-sits.
- T   8. A baby-sitter should know where the parents can be reached by phone.
- T   9. The telephone number of the family doctor should be left with the baby-sitter.
- F   10. A baby-sitter should have her boyfriend visit her often when she baby-sits.
- F   11. A baby-sitter should not prepare any food for children.
- T   12. If a baby-sitting engagement should have to be broken, the employer should be notified immediately.
- T   13. A baby-sitter should not "tell the family secrets" after she leaves the job.
- T   14. Safety of children should come first with baby-sitters.
- T   15. Snacks may be prepared by baby-sitters, with the permission of the parents of the children.
- F   16. Children should not be allowed to watch television with a baby-sitter.
- T   17. When reading to a group of children, the children should be seated in a semicircle.
- T   18. Skates are play materials to be used in active play.
- T   19. Children learn by playing.
- F   20. Play dough and finger paint must be bought.

## Pretest

Directions: Place a T or F in the blank before the number.

- \_\_\_ 1. A baby-sitter should interview the parents before sitting with a child.
- \_\_\_ 2. A baby-sitter's parents should know where the baby-sitter will be working.
- \_\_\_ 3. A written list of instructions for the baby-sitter from the parents is not needed.
- \_\_\_ 4. A baby-sitter should learn where the light switches are before the parents leave the house.
- \_\_\_ 5. If a child will not cooperate, the baby-sitter should threaten or frighten him.
- \_\_\_ 6. The salary of a baby-sitter should be settled before the baby-sitter takes the job.
- \_\_\_ 7. A baby-sitter should entertain herself on the telephone while she baby-sits.
- \_\_\_ 8. A baby-sitter should know where the parents can be reached by phone.
- \_\_\_ 9. The telephone number of the family doctor should be left with the baby-sitter.
- \_\_\_ 10. A baby-sitter should have her boyfriend visit her often when she baby-sits.
- \_\_\_ 11. A baby-sitter should not prepare any food for children.
- \_\_\_ 12. If a baby-sitting engagement should have to be broken, the employer should be notified immediately.
- \_\_\_ 13. A baby-sitter should not "tell the family secrets" after she leaves the job.
- \_\_\_ 14. Safety of children should come first with baby-sitters.
- \_\_\_ 15. Snacks may be prepared by baby-sitters, with the permission of the parents of the children.
- \_\_\_ 16. Children should not be allowed to watch television with a baby-sitter.
- \_\_\_ 17. When reading to a group of children, the children should be seated in a semicircle.
- \_\_\_ 18. Skates are play materials to be used in active play.
- \_\_\_ 19. Children learn by playing.
- \_\_\_ 20. Play dough and finger paint must be bought.

Instruction Sheet 1

Preparing To Baby-Sit

1. Find out how you will get to the job and how long it will take you to get there.
2. Wear clothes that are comfortable and that will not soil or damage easily.
3. Take a notebook and pencil or pen to jot down important instructions that the parents give you.
4. Take a snack in case you get hungry.
5. Take materials to keep you occupied while the child sleeps. (Homework, books, magazines, sewing, etc.)
6. Decide how much you will charge for your services.
7. Decide whether you will charge for your services from the time you leave your home, or after you arrive on the job.
8. Decide whether you or your employer will pay your transportation.
9. Decide whether your fees will be higher after midnight and on special occasions, such as holidays.

## Instruction Sheet 2

### Do's For Baby-Sitters

Find out:

1. Where the parents may be reached by phone or by an address. (List the telephone numbers.)
2. When the parents plan to return home.
3. Where the first-aid supplies are located.
4. Where a doctor, the police and a neighbor may be reached by phone. (List the numbers.)
5. Where the children's clothes are kept.
6. If and when the children are to be fed.
7. If and how the food is to be prepared.
8. When and how long the children should be allowed to play.
9. What time is bedtime for the children.
10. What messages should be given to telephone callers.
11. Where the blankets and covers are kept.
12. Whether you are permitted to use the television.
13. Whether you may invite a girl friend to sit with you.
14. The ages of the children.
15. Whether you will be expected to do extra work while you care for the children.
16. Whether food will be made available to you.
17. The arrangements that have been made to get you home.

### Instruction Sheet 3

#### Don'ts For Baby-Sitters

1. Don't leave a young child alone. Take him with you if you have to leave the house or answer the phone.
2. Don't go to sleep. (When you go to sleep you are not on the job.)
3. Don't entertain your date while you are baby-sitting. (Remember this is a job, not a social engagement.)
4. Don't snoop around the house. (Opening closet doors, looking in chest and desk drawers, and reading other people's mail is snooping.)
5. Don't talk distastefully about the child, the family or the home to outsiders.
6. Don't open any outside door unless you are sure who is there. (Have them identify themselves by talking to you through the closed door or by going to a closed window so you can see them.)
7. Don't baby-sit when you have a cold or some other communicable disease.
8. Don't baby-sit with a child who has a cold or is ill, except in an emergency to help the family.
9. Don't try to play doctor. If a child has fever, has a bad fall or becomes ill in any way, call the parents, a doctor or a neighbor. It is better to be safe than sorry.

## Instruction Sheet 4

### Snack Facts

Young children need a lift between meals, but they do not need to spoil their appetite for the next meal.

#### Suggested Snack Foods List

1. Apple wedges
2. Peanut butter and crackers
3. Vegetable juices
4. Fruit juices
5. Simple cookies (without icing)
6. Carrot sticks
7. Celery sticks
8. Simple sandwiches
9. Soups (such as tomato, vegetable, and chicken noodle)
10. Cheese sticks
11. Milk
12. Toast

#### Fun Ways To Serve Snacks

1. "Finger" foods:  
Carrot, celery, cheese sticks, crackers, toast, sandwiches.
2. "Wacky" sandwiches  
(Use only one slice of bread)
  - a. Pimento cheese with vegetable face
  - b. Peanut butter with raisin face
  - c. Meat spread with pickle face
  - d. Cookie cutter sandwiches

## Instruction Sheet 5

### Low-cost and No-cost Toys and Play Materials and Media

1. Pictures from old magazines to tell stories about or use to make puzzles
2. Cardboard boxes for making play trains
3. Paper hats from newspapers and grocery bags
4. Play clothes (from Mother's old clothes, heels, hats, bags )
5. Empty boxes and cans for playing store
6. Play dough (ask the teacher for directions )
7. Finger paints (ask the teacher for directions )
8. Storybooks
9. Blocks made from scrap lumber (sandpaper the edges )
10. Macaroni or spools to string
11. Stuffed animals or dolls
12. Aluminum foil and pipe cleaners to make toys
13. Finger or hand puppets

## Instruction Sheet 6

### Recipes

#### Play Dough

1/2 cup flour

1/4 cup salt

1/8 cup water or enough to make a dough that you can handle

Food coloring

Mix together the flour, salt and water. If necessary, add more water, one teaspoonful at a time. Add a few drops of food coloring. Continue mixing by kneading the dough with your hands.

#### Finger Paint

1/2 cup starch

1 and 1/2 cup soap flakes

1 tablespoon glycerine

Food coloring

Small jars with lids

Mix starch with enough water (about 2 tablespoons) to make a smooth paste. Add 1/4 cup of boiling water and cook until it looks glossy (about 1 minute.) Stir constantly. Stir in soap flakes while mixture is warm. Add 1 tablespoon of glycerine. Pour mixture into jars. Add food coloring to each jar. (You may wish to use more than one color.)



## Paste

1 teaspoon flour

2 teaspoons cornstarch

1/4 teaspoon alum

3 ounces water

Mix flour, cornstarch and alum. Slowly add water. Cook over low heat.

Stir constantly. Remove from heat when mixture thickens. Pour into a small jar and cover tightly.

PLAY MATERIALS, TOYS, STORIES AND MUSIC

AID CHILDREN IN THEIR PLAY

It has been decided that play is essential for children. Play materials, toys, stories, music, and games can add to the fun and aid a child in learning, if they are selected wisely. What things would you look for if you were selecting a toy for a preschool child? The following are characteristics of a good toy: attractive in shape and color; sturdy and well-made; constructed to help a child learn shapes, colors, and sounds; safe; easily cleaned; reasonable in cost.

A good story is enjoyed by everyone. Children's stories need to be a bit different from those enjoyed by teenagers. The following are characteristics of a good story: contains familiar places, people or animals; allows a child to use his imagination; does not frighten or upset a child; has lots of action; has a simple theme built around a child.

Play materials should stimulate a child to take part in an activity. An example of a good play material is play dough. When a preschool child feels play dough, he begins to create some object. There are many other good play materials, such as finger paint, paste, pictures and puzzles.

Music that is simple and has a definite rhythm appeals to preschool children. Children usually begin to keep time and sing with music. They like to hear a favorite song or a favorite story repeated many times.

Another great aid to play is a playmate. A playmate offers a chance for social contact, even though young children actually play very little with others. They watch their playmates. They like to know that there are other children close and that they are playing.

Teenagers can also aid in a child's play. The following are ways teenagers can help children in their play.

1. Let them play on their own as much as possible.
2. Find time to help a child when he needs or asks for help.
3. Keep in mind that a child does not play very long with one toy or in one activity.
4. Provide play materials and experiences that are suitable to a child's age, size and capabilities.
5. Encourage a child to be creative in play.
6. Remember to keep a child safe and, if possible, to keep him happy.

PLAY HELPS CHILDREN LEARN

How many children do you know who do not like to play? All normal, healthy children like to play. Some children seem to have a built-in bundle of energy always ready to explode; others are quiet. Children, like adults, are individuals with different likes and dislikes. Since children are individuals with individual differences, a variety of play experiences may be necessary in order to meet their needs.

Play is an activity that is enjoyed by a child. A child really works and learns through play. The difference in work and play is determined by the attitude the child takes when participating in an activity. If a mother is cleaning and dusting and a child gets out his own mop, broom and vacuum cleaner to help, he is playing. If a child is assigned the job of cleaning his room, the play becomes work.

Play is the main business of childhood. Through play a child develops an alert mind that is full of imagination, and a strong body. Play also lays the foundation for a child to develop into a well-adjusted adult. Play is valuable to children for many reasons. The following are examples: play serves as an outlet for energy, jealousy, and fear; it provides exercises that help develop the body; and it promotes good appetites and sound sleep. It also helps to develop many skills that will be useful forever. Play helps children to cooperate, share, get along with others, and conform to certain rules. In other words, play provides opportunities to develop physically, emotionally, socially and morally.

IMPORTANT INFORMATION THAT A BABY-SITTER NEEDS

Baby-sitting is one of the most responsible and one of the most rewarding jobs that anyone can perform. Young people who make the best baby-sitters are ones who have stable personalities and who are able to accept responsibilities. It is a good idea for a baby-sitter to learn, ahead of time, as much as possible about the child or children, the home, what to do in case of emergencies, where supplies are kept and the general routine of the daily schedule of the family. Try to gain an understanding of the way the mother handles the children, and what she expects the baby-sitter to allow them to do. If the children are old enough to understand, it will prove helpful for the parents to give the baby-sitter instructions about duties and responsibilities in the presence of the children.

To prepare to become a good baby-sitter, read books and pamphlets about children of different ages; help with young children at home; observe and do volunteer work in a play school, nursery school or day-care center; take a course in first aid at the local Red Cross Center.

A well-prepared, responsible baby-sitter will always be in demand, but a baby-sitter must realize that parents will not know that their services are available unless the baby-sitter makes it known to them by applying for a job. Learn as much as possible about job application, and job acceptance. Demonstrate an ability to be a responsible, and sincere baby-sitter; also, show a genuine understanding of and fondness for children. Remember the two most important things that a baby-sitter should keep in mind are to keep the children safe and to keep the children happy.

STUDENT EDITION

MINI NURSERY

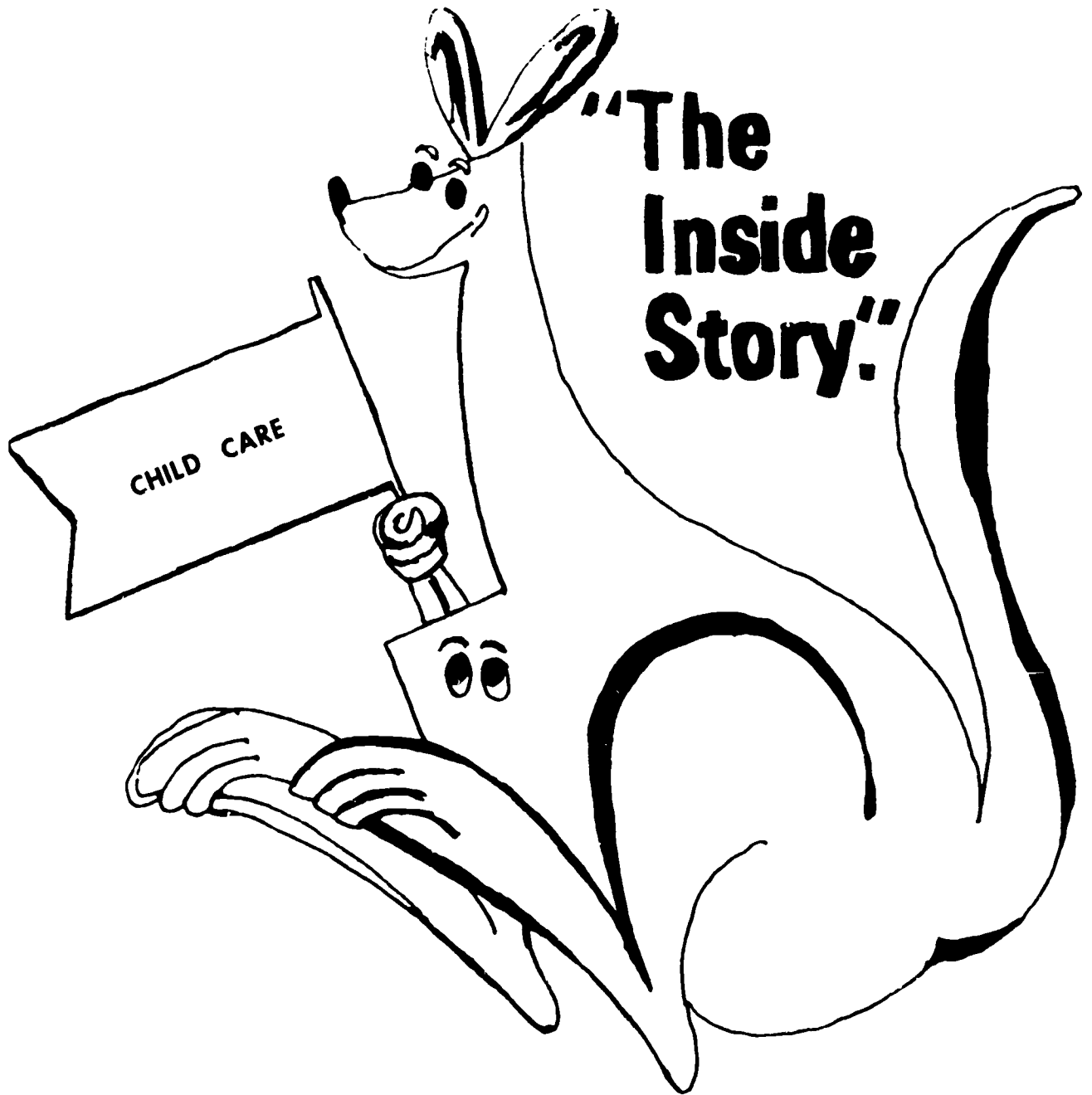

CHILD CARE

"The  
Inside  
Story:"

CE003962

Mini-Nursery  
Student Section

compiled by  
Louie E. Kemp  
Curriculum Coordinator  
Home Economics

Published by  
Mississippi State University  
RESEARCH AND CURRICULUM UNIT  
FOR  
VOCATIONAL AND TECHNICAL EDUCATION  
Mississippi State, Mississippi

In Cooperation With  
Division of Vocational and Technical Education  
State Department of Education  
Jackson, Mississippi

Home Economics Publication Number 6007

1972

Direct inquiries to:

Research and Curriculum Unit  
Drawer 211  
Mississippi State, MS

Mississippi State University does not discriminate on the grounds of race, color, or national origin.



## Introduction

There is a great demand for baby-sitters today. Young people are being called upon to baby-sit, and they are paid for baby-sitting. An efficient baby-sitter who can be trusted will have more job offers than he or she can handle. Teenagers usually find a need for the money they make baby-sitting, and they usually enjoy this type of job.

Have you ever considered being a mother or daddy substitute? You substitute for mother and daddy when you baby-sit. Caring for children can be rewarding in many different ways. Besides the money you will make, you may feel loved, respected and appreciated by the parents and the children. To gain the confidence and love of parents and children and to learn the basic rules of baby-sitting, takes some time, thought, and study. This is one occupation that can be called a private enterprise, because this can be your individual business. Let's learn a few things that can contribute to a successful teenage baby-sitting business.

## Learning Objectives

After you complete this learning package, you will have a better understanding of the duties and responsibilities of individuals who are desirable child care workers. You will demonstrate your understanding by successfully accomplishing the following objectives:

- A. You will list in writing or state orally the responsibilities of a good baby-sitter.
- B. You will identify one play material, one game, and one story that will help a preschool child develop physically, socially, emotionally and morally; and you will explain in writing or orally state the proper way to use the chosen play material, game, and story.
- C. You will plan, prepare and serve a nutritious and appealing snack to a group of preschool children.
- D. You will plan in writing a schedule of activities to be carried out while you are baby-sitting for three hours with two children whose ages are four and five.

## Pretest

Directions: Place a T or F in the blank before the number.

- \_\_\_ 1. A baby-sitter should interview the parents before sitting with a child.
- \_\_\_ 2. A baby-sitter's parents should know where the baby-sitter will be working.
- \_\_\_ 3. A written list of instructions for the baby-sitter from the parents is not needed.
- \_\_\_ 4. A baby-sitter should learn where the light switches are before the parents leave the house.
- \_\_\_ 5. If a child will not cooperate, the baby-sitter should threaten or frighten him.
- \_\_\_ 6. The salary of a baby-sitter should be settled before the baby-sitter takes the job.
- \_\_\_ 7. A baby-sitter should entertain herself on the telephone while she baby-sits.
- \_\_\_ 8. A baby-sitter should know where the parents can be reached by phone.
- \_\_\_ 9. The telephone number of the family doctor should be left with the baby-sitter.
- \_\_\_ 10. A baby-sitter should have her boyfriend visit her often when she baby-sits.
- \_\_\_ 11. A baby-sitter should not prepare any food for children.
- \_\_\_ 12. If a baby-sitting engagement should have to be broken, the employer should be notified immediately.
- \_\_\_ 13. A baby-sitter should not "tell the family secrets" after she leaves the job.
- \_\_\_ 14. Safety of children should come first with baby-sitters.
- \_\_\_ 15. Snacks may be prepared by baby-sitters, with the permission of the parents of the children.
- \_\_\_ 16. Children should not be allowed to watch television with a baby-sitter.
- \_\_\_ 17. When reading to a group of children, the children should be seated in a semicircle.
- \_\_\_ 18. Skates are play materials to be used in active play.
- \_\_\_ 19. Children learn by playing.
- \_\_\_ 20. Play dough and finger paint must be bought.

## PRETEST QUESTIONNAIRE

**DIRECTIONS:** Consider each question carefully and place a check (✓) in the appropriate column. You may check 2 columns.

	Yes	No	Would like to study
1. Do you like children and want to have them around you?			
2. Do you feel at ease with children of different ages?			
3. Do you want to baby-sit?			
4. Should a child be picked up when he cries?			
5. Are children born without fear?			
6. Do you know how much a child should eat?			
7. Do you know how to change a diaper?			
8. Do you know how to dress a baby?			
9. Can you give baby his bottle or baby food?			
10. Do you know which games and stories children like?			
11. Can you tell a story so it is meaningful to children?			
12. Do you know which toys are best for children of different ages?			
13. Do you know what to expect from children of different ages?			
14. Do you know what to do in case of fire or other accidents?			
15. Have you done baby-sitting?			
16. Do you know how to care for a child in a temper tantrum?			
17. Do you know how to direct children's play?			
18. Do you know how to be a good baby-sitter?			
19. Do you know how to select good music for children?			
20. Are some TV programs too exciting for children?			

## Lesson I

The responsibility for taking care of a child or a group of children is a serious matter, but it can be fun. To be a good baby-sitter, one must love children, be patient, understanding and dependable. There are other qualifications that are needed by "sought after" baby-sitters, such as alertness, a knowledge of games and other methods of play, the ability to discipline children, and a knowledge of safety rules for children. Remember, children are the future teenagers and the future adults; so, when you care for children you are in a sense guiding and protecting a future generation. These children will never forget you; you can be a great influence on them. Baby-sitting provides an opportunity for teenagers to earn money for the many extras they want. You may find that you want to learn more about child development and may enjoy a career in some area of child care.

### Component:

Responsibilities of a baby-sitter

### Objectives:

- A. You will identify important information that a baby-sitter needs to know by listing the information in writing or by stating it orally to the teacher.
- B. You will demonstrate your knowledge of the responsibilities of a baby-sitter by role playing an interview with parents who want to employ you as a baby-sitter.

### Instructions:

You will complete Learning Experiences 1 or 2. You will also complete Learning Experiences 3 or 4, and 5 and 6.

### Learning Experiences:

1. Read, Important Information That a Baby-Sitter Needs. Ask the teacher for this material.
2. Listen to a tape, Important Information That a Baby-Sitter Needs. Secure the tape from the teacher.

3. Read page 414, "Reminders for Baby-Sitters" and pages 410 and 411, Teen Guide To Homemaking.
4. Read, Preparing To Baby-Sit, Do's For Baby-Sitters and Don'ts for Baby-Sitters. Secure this reading material from the teacher.
5. View film, To a Baby-Sitter.
6. Role play: The J.-Teen Baby-Sitting Service will have two of its employees interview the parents of two preschool children so that there will be a clear understanding of the responsibilities of the baby-sitter and the parents before the employees accept the baby-sitting job. Remember, this is a business type interview.

## Lesson II

Do you remember your favorite game, toy or story when you were a preschool child? More than likely you can recall one of them; perhaps you were not aware that you learned from a favorite game, toy or story because it was fun, but you did learn. If you remember that children learn through play, you will be more careful when selecting toys, games, records, and storybooks as gifts for them. You should also remember this when you are caring for young children.

### Component:

The value of play for preschool children

### Objective:

You will name one game, one story and one kind of play material that will provide helpful learning experiences for preschool children, and you will list in writing or you will state orally one reason why they are helpful learning experiences.

### Instruction:

You will perform Learning Experiences 1 and 2 or 3 and 4. Complete Learning Experiences 5, 6, and 7.

### Learning Experiences:

1. Read pages 406 - 411, Teen Guide To Homemaking.
2. Read pages 43 - 48, Your Child From One to Six.
3. Listen to tape, Play Helps Children Learn.
4. Listen to tape, Play Materials and Toys and Stories Help Children In Their Play.
5. Read, Low-Cost and No-Cost Toys, Play Materials and Media. Ask the teacher for a copy of this.

6. Prepare a baby-sitter's "Surprise Kit". Make one no-cost or low-cost toy and one play media or material to include in the kit. List in writing, one song, one record, and one story that you will put in the kit. The "Surprise Kit" should be suitable for a preschool child. (A brown paper bag may be used as a no-cost container.)
  
7. List in writing and/or state orally the age of the child for which you prepared the "Surprise Kit." Explain orally to a classmate, why you chose the story or the song you listed in the "Surprise Kit".



## Lesson III

Between-meal snacks have become an important part of the diet of preschool children. Children should have a mid-morning, a mid-afternoon and a before-bed snack. 'Snacks' are usually eaten more quickly and with less fuss by preschoolers than the regular meals. The wrong kind of "snack" can cause mealtime problems and the development of dislike for the nutritious foods.

### Component:

Nutritious and appealing snacks for preschoolers

### Objective:

You will plan, prepare and serve a nutritious and appealing snack to a group of four of your classmates who will pretend to be preschoolers, or to a group of preschool children.

### Instructions:

You will complete Learning Experiences 1, 2, and 3. If you would like, you may complete Learning Experience 4.

### Learning Experiences:

1. Read page 48. "Watch Those Snacks." Teen Guide To Homemaking.
2. Ask the teacher for the instruction sheet, Snack Facts. After reading the sheet, plan and write a menu containing three foods from the foods listed. Sign your name to your menu. Place the menu on the teacher's desk. The teacher will evaluate it and return it to you.
3. You will draw a number from a basket. Those choosing Numbers 1 through 4 will be a group. Those choosing Numbers 5 through 8 will be a group. Follow this method of grouping for the entire class. Each group will prepare a simple snack that will consist of two foods from the foods list. Prepare and serve a snack that will appeal to preschoolers in your group.
4. Read "Sitting" Safely. Discuss new ideas you learned from this reading with a member of your class.

## Lesson IV

When you accept a job of any kind and you get paid for your work, it is a good idea to be prepared for the job, and to be businesslike when you begin the job. The first step toward being businesslike in a baby-sitting job is to find out what time you are to report for duty and to plan activities for the time you will be on duty.

### Component:

Schedule of activities while baby-sitting

### Objective:

You will plan in writing a schedule of activities to be carried out while you are baby-sitting for three hours with two preschool children who are four- and five-years old.

### Instructions:

You will complete Learning Experiences 1, 2, and 3.

### Learning Experiences:

1. Read pages 409 - 414, Teen Guide To Homemaking.
2. List in writing, the things you would do to prepare yourself for a baby-sitting job with a four-and a five-year-old child.
3. List in writing, the activities you plan for the four- and five-year-old children while you are with them for three hours. List the time that you plan to use to carry out each activity.
4. Ask your teacher for final instructions.

## Post Test

Ask your teacher for the post test. This test will help you discover how much you have learned about caring for preschool children and about baby-sitting.

### Quests:

If you want to explore other activities that are related to child care, the following suggestions may interest you.

1. Read pages 397-402, Teen Guide To Homemaking.
2. Observe a local kindergarten, nursery school or day care center.  
Ask for an interview with the teacher to find out what training is necessary to qualify for this type of work.
3. Any other idea you wish to explore.

TEACHER EDITION

POLKA DOTS

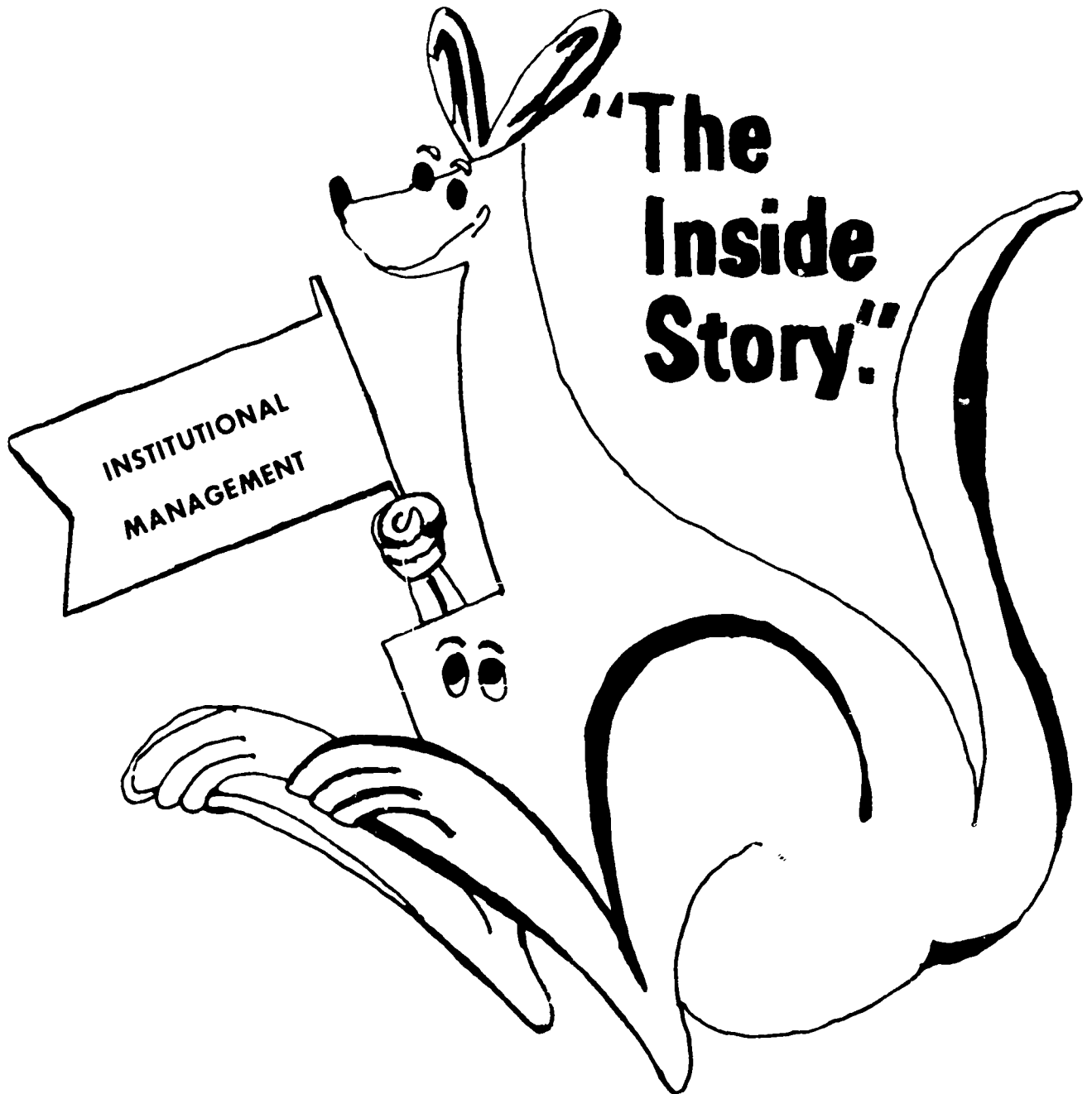

05003962

Polka Dots  
Teacher Section

compiled by  
Louie E. Kemp  
Curriculum Coordinator  
Home Economics

Published by  
Mississippi State University  
RESEARCH AND CURRICULUM UNIT  
FOR  
VOCATIONAL AND TECHNICAL EDUCATION  
Mississippi State, Mississippi

In Cooperation With  
Division of Vocational and Technical Education  
State Department of Education  
Jackson, Mississippi

Home Economics Publication Number 6002

1972

Direct inquiries to:

Research and Curriculum Unit  
Drawer 21  
Mississippi State, MS

Mississippi State University does not discriminate on the grounds of race, color, or national origin.

Home Economics Learning Package  
Career Exploration  
Identification Page

Title: The Polka Dots

Subject: Occupations related to nursing

Performance Level: Exploratory -- 7th and 8th grades

Purpose: To provide challenging exploratory experiences including "hands on" experiences that will aid students in identifying a possible area of interest in occupations related to Home and Institutional Management and Supportive Services.

Producer: Louie E. Kemp  
Drawer DX  
Research & Curriculum Unit  
Mississippi State, MS 39762

Date: 1973

## POLKA DOTS

### TEACHER'S SECTION

#### I. Statement of Purpose

##### A. Generalization:

By exploring the duties, responsibilities and tasks performed by workers in Institutional Management occupations, students may begin to identify interests that will lead to future careers in this field.

##### B. Components

1. Concern for others
2. Function, use and care of thermometers
3. Pulse and respiration count
4. Bed making
5. Improvise nursing care equipment

#### II. Instructional Objectives:

- A. Students will demonstrate their concern for others by arranging flowers for entrance halls and patients' rooms, delivering packages and papers, reading to patients, rolling patients in wheel chairs, and playing games with patients.
- B. Students will identify two kinds of clinical thermometers according to appearance and function. They will also demonstrate the proper procedure for preparing, using, reading and caring for the oral thermometer.
- C. Students will demonstrate their understanding of the equipment and procedure necessary to count pulse and respiration by counting and recording an individual's pulse and respiration.



- D. Students will demonstrate and explain orally the proper procedure for making an empty bed.
- E. Students will identify nursing equipment that can be improvised. Each student will construct one piece of such equipment.

#### INSTRUCTIONS TO THE TEACHER

##### I. Instructional Approach: Quasi-Discovery

The student section of this exploratory learning package will use the quasi-discovery approach which means that there will be factual information given to the students, but there will also be provisions made for students to explore and discover information. By presenting educational materials and suggested learning experiences that are directly related to the instructional objectives and criteria for evaluation, the student will hopefully gain some understanding of the duties, responsibilities and tasks performed by workers in Institutional Management Occupations.

##### II. Identification of Learners:

This learning package is designed for average seventh and eighth grade students for the purpose of exploring and evaluating information and interests regarding Institutional and Home Management and Supportive Services.

##### III. Special Instructions:

###### A. Equipment needed:

Film Projector

Filmstrip Projector

Overhead Projector

###### B. Material needed:

Books:

Teen Guide to Homemaking, Barclay, Marion S., and Champion, Frances. New York: Webster Division, McGraw-Hill Book Company, 1967.

American Red Cross Home Nursing Book, Nursing Services, American Red Cross. New York: Doubleday and Co., Inc., 1963.

Thermometer Kit:

Two clinical thermometers (one oral and one rectal)

One container of wipes (absorbent cotton, paper tissues, or pieces of clean gauze or cloth)

One container of cool, clean water

One bar of soap

One waste container (paper bag)

Games:

Checkers, Rook cards, Bridge cards, and other games of your choice.

C. Media needed:

Films:

The following films may be ordered from: Health Film Catalogue of the State Board of Health, Film Library, P. O. Box 1700, Jackson, MS 39205.

Helping Hands for Julie

Helping Hands

Aides in Daily Living

Patient Is A Person, The

Filmstrips:

The following filmstrips may be ordered from: Health Film Catalogue of the State Board of Health, Film Library, P. O. Box 1700, Jackson, MS 39205.

Simple Nursing Series - Patient's Bed

Care of the Hospital P.d

General Principles of Practical Nursing

Transparency Set:

The following transparency set may be ordered from: Film Library,  
Drawer DX, State College, MS 39762.

Attitude and Manner: Their Influence on Accomplishment

Tape:

For those students who prefer or who will profit from learning by listening, it is suggested that the key reading in each lesson be made available on tape. This will necessitate the taping of Flower Arrangements and Care and Use of the Clinical Thermometer.

IV. Instructions for Evaluations:

Two instruments for evaluation have been included in this package. The pretest is planned as a learning experience as well as a diagnostic device. The post test is the same as the pretest and should indicate the behavioral changes resulting from the use of the learning package. Copies of the pretest, and post test with answer keys are included in the teacher section only. A sample pretest will be found in the student section.

V. Suggested Instructional Procedure:

- A. Explain the use and care of the student section of the learning package to the students. The following explanations to students are suggested:
  1. Read the introduction and the instructional objectives. This information will identify the occupation that the student will

explore, and will explain the extent to which they are expected to explore the occupation.

2. Explain to the students that the pretest will be administered to help them assess their knowledge of occupations related to nursing. Pass a copy of the pretest to each student. Remind the students that they will not write on the sample pretest in the learning package and that they will not get a grade on the pretest.
3. Following the pretest, the students will begin Lesson I. The component and the objectives explain what they will learn. The instructions direct them to the learning experiences, and explain the number of learning experiences they must successfully complete before attempting Lesson II.
4. Follow the same procedure through the remaining lessons.
5. When they have completed their last lesson and feel that they are ready, they should ask the teacher for a post or final test. A grade should be given on the post test. This will mean that they have completed their exploration of the occupation.
6. If they need equipment, media, or materials, if they do not understand a direction given, or if they need help in an activity they are undertaking, they should ask the teacher for help and she will be glad to assist them.
7. Students will not write their names or anything else on or in the learning packages. These will be used by students in other classes this year and in years to come. All written assignment sheets will be given to them.

B. Show and explain to the students the location and the method of filing the learning packages.

1. Each learning package will be kept in a manila folder. Each folder will have the name of the learning package written on it.
2. The folders containing the learning packages will be kept in a file drawer or a box on a table beside the teacher's desk.
3. When students come to class, they should get a manila folder that contains a learning package in which they are working. This folder will be taken from the file drawer or box. At the end of the period, they will replace the folder and the learning package in the same file drawer or box. They will not take the learning package out of the classroom.

C. Introduce the subject matter area that the learning package is designed to explore. The following is a suggested approach:

Explain to the students that this learning package will help them find out more about the occupations in Food Services. They may become interested enough in these occupations to want to know the training they must have in order to qualify for these occupations. They may decide that this is not exactly "their cup of tea," but they may wonder if there is another occupation similar to this that would appeal to them. Build an interest approach that will cause the students to become enthusiastic about the occupation. An attractive bulletin board, a film, or resource person may be valuable aids.

D. Identify the equipment, materials, and the media that will be needed by the students, and point out the locations of these available

supplies. Students should ask to use the supplies, and request assistance if needed.

- E. Instruct the students not to write on or in the package. Tests or any other written assignment sheets should be made available to the students upon request. An adequate supply of work sheets should be available when students begin the packages.

Prizes:

1. TLC means \_\_\_\_\_.
2. Normal temperature is \_\_\_\_\_ °F when taken by mouth.
3. Temperature taken under the arm is \_\_\_\_\_ to \_\_\_\_\_ degree less than when taken by mouth.
4. Always \_\_\_\_\_ the thermometer after taking the temperature.
5. Never put a thermometer in \_\_\_\_\_.
6. The normal pulse rate for the healthy adult is \_\_\_\_\_ beats per minute.
7. When blood pressure is low the pulse rate is \_\_\_\_\_.
8. The patient's hair should be combed and brushed \_\_\_\_\_ a day.
9. Knowing \_\_\_\_\_ to place flowers in the room is just as important as knowing how to arrange them.
10. Flowers help to satisfy the \_\_\_\_\_ and \_\_\_\_\_ needs which may be of great importance to the patient.
11. Flowers that are received at a \_\_\_\_\_ should be placed immediately in cold water.
12. Careless \_\_\_\_\_ is one of the most frequent causes of hospital fires.
13. When an accident occurs to a patient, it should be \_\_\_\_\_.
14. Metal furniture may be cleaned by frequent washing with \_\_\_\_\_ and \_\_\_\_\_.
15. When making an empty bed, allow \_\_\_\_\_ inches of bottom sheet for tucking under the head of the mattress.
16. A rubber or plastic sheet and a \_\_\_\_\_ sheet are sometimes used for protection.
17. A bed table can be improvised by placing the free end of an \_\_\_\_\_ across the bed.
18. A bed table can be made from a \_\_\_\_\_.
19. A shoulder stand can be made from a \_\_\_\_\_.
20. A disposal bag can be made by collecting a \_\_\_\_\_.



KEY

Pretest & Post Test

1. TLC means Tender Loving Care.
2. Normal temperature is 98.6°F when taken by mouth
3. Temperature taken under the arm is 1/2 to 1 degree less than when taken by mouth.
4. Always clean the thermometer after taking the temperature.
5. Never put a thermometer in hot water.
6. The normal pulse rate for the healthy adult is 72-80 beats per minute.
7. When blood pressure is low the pulse rate is slow.
8. The patient's hair should be combed and brushed once a day.
9. Knowing where to place flowers in the room is just as important as knowing how to arrange them.
10. Flowers help to satisfy the love and beauty needs which may be of great importance to the patient.
11. Flowers that are received in a box should be placed immediately in cold water.
12. Careless smoking is one of the most frequent causes of hospital fires.
13. When an accident occurs to a patient, it should be reported.
14. Metal furniture may be cared for by frequent washing with soap and water.
15. When making an empty bed, allow 18 inches of bottom sheet for tucking under the head of the mattress.
16. A rubber or plastic sheet and a draw sheet are sometimes used for protection.
17. A bed table can be improvised by placing the free end of an open ironing board across the bed.
18. A bed table can be made from a cardboard carton.
19. A shoulder shawl can be made from a bath towel.
20. A disposal bag can be made by folding a newspaper.



## Script for Tape

### Care and Use of the Clinical Thermometer

A clinical thermometer is one used to take body temperature. A clinical thermometer is made of glass, and it must be handled with care. When not in use, the thermometer should be kept in a safe, cool place. The bulb end of the thermometer should be kept clean at all times.

There are two kinds of clinical thermometers, oral and rectal. The oral thermometer has a long, slender bulb; and the rectal thermometer has a short, stubby bulb. If only one thermometer can be bought, buy one with a stubby bulb; because it can be used to take the temperature by mouth, rectum or armpit.

You have probably noticed your mother, a nurse or someone else "shake down" a thermometer. Have you ever wondered why they did this? The construction of the thermometer is the reason why it must be shaken down. The glass tube that holds the mercury narrows at the bulb end of the tube to keep the mercury from returning to the bulb; so, the only way to return the mercury to the bulb is to force it back with pressure caused by shaking.

To shake the thermometer down, use a loose wrist movement, as though you were shaking water off the hand. Be sure and shake the thermometer down to 95°F or below before taking the temperature.

The patient should lie or sit down when the temperature is being taken. The thermometer should always be held by the top, or the end opposite the bulb. The bulb of the thermometer should be placed under the tongue and left in the mouth at least three minutes to assure an accurate reading. The thermometer should be read with the bulb pointing to the left of the person holding it. Make sure the light is adequate for reading the thermometer. Locate the clear or silver bubble and streak and turn the thermometer back and forth slowly. The clear or silver streak will stop at or near a degree mark on the thermometer. The temperature that is considered normal for most people is 98.6°F.

The thermometer should be cleaned immediately after it has been read. To clean the thermometer, moisten a wipe (piece of gauze or cloth) and soap it well. Begin at the top and wipe down the thermometer with firm strokes. Moisten another wipe with cool water and rinse the thermometer. Dry the thermometer and put it in its case, bulb end first.

Pictures illustrating the correct way to shake down a thermometer, place a thermometer under the tongue and read and clean a thermometer are shown on page 190, American Red Cross Home Nursing Textbook. Also, on page 187 in American Red Cross Home Nursing Textbook is shown a magnified diagram of the 98.6° mark which is considered average normal temperature.

One important reminder -- record the temperature as soon as you read the thermometer. You might forget and give the wrong report to your mother, a nurse, or a doctor.

Ask your teacher if she has a thermometer that you may examine. She will probably give you some suggestions for activities that will allow you to put into practice some of the things you have learned about the care and use of the thermometer.

Flower Arrangements

Patients in hospitals or at home need love; and they need beautiful, interesting surroundings that will help to cheer them. Flowers can help greatly in meeting these needs. The art of flower arranging is not new. From early paintings and tapestries there is evidence that flowers have an important place in the lives of people everywhere. Nature has provided us with flowers of different colors, textures, sizes and shapes. Many people, without any training, can plunge right in and become a success at arranging flowers; other people may need to study the basic principles or basic rules used in making attractive flower arrangements. The next time you are out for a walk, look around you with a "seeing eye" and attempt to discover the center of an interesting arrangement, such as a beautifully curved pine branch, a dried seed pod, or a pear or peach limb. Materials for an arrangement do not have to be florist-grown or expensive to be attractive.

Flower arranging is such a wonderful way to express yourself. You can do your individual thing by using the basic principles of art and by staying away from "hidebound rules."

There are at least five questions that we need to ask ourselves if we are sincere in wanting to learn to make flower arrangements that will be beautiful enough to be admired by others, and beautiful enough to bring happiness to others. These questions are: (1) What equipment is needed for making flower arrangements? (2) What flower containers are needed to make attractive flower arrangements? (3) What are some rules that should apply to flower arrangements? (4) What accessories should be used in making flower arrangements? (5) Where should flower arrangements be placed?

Let's find some answers to question Number One. What equipment is needed for making flower arrangements? Basic equipment that is needed for most arrangements is: needle point flower holders, modeling or florist clay, meshed chicken wire, fine wire with green covering, transparent tape, pipe cleaners or twistems, sharp knife, wire cutters, or heavy shears. Have you ever seen these pieces of equipment? Your teacher will show you each piece, and she will explain the use of each piece of equipment.

Question Number Two. What flower containers are needed when making flower arrangements? The question may be hard to answer, because there are so many containers that can be used for so many arrangements. You can "do your own thing" when choosing, but remember that off-whites, soft greens and earth colors make good color backgrounds for flowers. You may find an ideal container among dishes or pots and pans. Often bowls, oblong vegetable dishes, trays, or even tea kettles are used as flower containers.

Question Number Three: What are some rules that apply to flower arrangements? This question may be answered simply, or it may be answered by quoting complicated rules. We will choose the simple route. Here are some simple steps to follow. 1. Be individual. 2. Be aware of pleasing color combinations, flowers, containers and surroundings. 3. Establish a focal point or center of interest. 4. Strive for good proportion; generally, flowers or branches should be one and one-half to twice the width of a low container. 5. Strive to attain good balance. Prevent a top-heavy look by keeping larger and darker flowers toward the center and bottom of the arrangement. 6. The flowers and the container should be suitable to each other in color, texture, and size. 7. Use flowers that have different forms and shapes to add interest to an arrangement. One shape may form the line of the arrangement, and the other shape may serve as a filler. These few rules of good design can make the difference between just putting flowers in a vase, and actually making an arrangement. Learn to apply these rules, and you will gain confidence in your ability to arrange flowers.

Question Number Four concerning accessories is often puzzling. Just remember that accessories should improve the attractiveness of the arrangement; so, accessories must be in harmony with the arrangement.

Question Five: Where should flower arrangements be placed? This question reminds us to consider the size, shape, color, and texture of the arrangement, the room in which it will be placed, and the vertical and horizontal space in which the arrangement will be placed.

Look in magazines or books; look at pictures; look at flower arrangements in homes and in florist shops. You may prefer fruit arrangements, or a combination of fruit and flowers. You may choose to try to make a miniature arrangement to use on a tray. Just think of the small bottles, plastic containers, bottle tops, odd shaped rocks, and many other items that you might use as containers. Ask your classmates and your teacher for ideas; then exchange ideas. Don't stop now; try making a flower arrangement! This could be the beginning of something big in your life. You may decide to own your own florist shop some day.

POLKA DOTS WORK WITH

HOSPITAL  
ADMINISTRATORS

REGISTERED  
NURSES

DOCTORS

EXECUTIVE  
HOUSEKEEPERS

LICENSED  
PRACTICAL  
NURSES

MEDICAL  
TECHNICIANS

PERSONNEL  
DIRECTORS

NURSES'  
AIDES

PATIENTS

DIETICIANS

ORDERLIES

FAMILIES  
AND  
FRIENDS

IT'S ALL IN THE WAY YOU LOOK AT IT

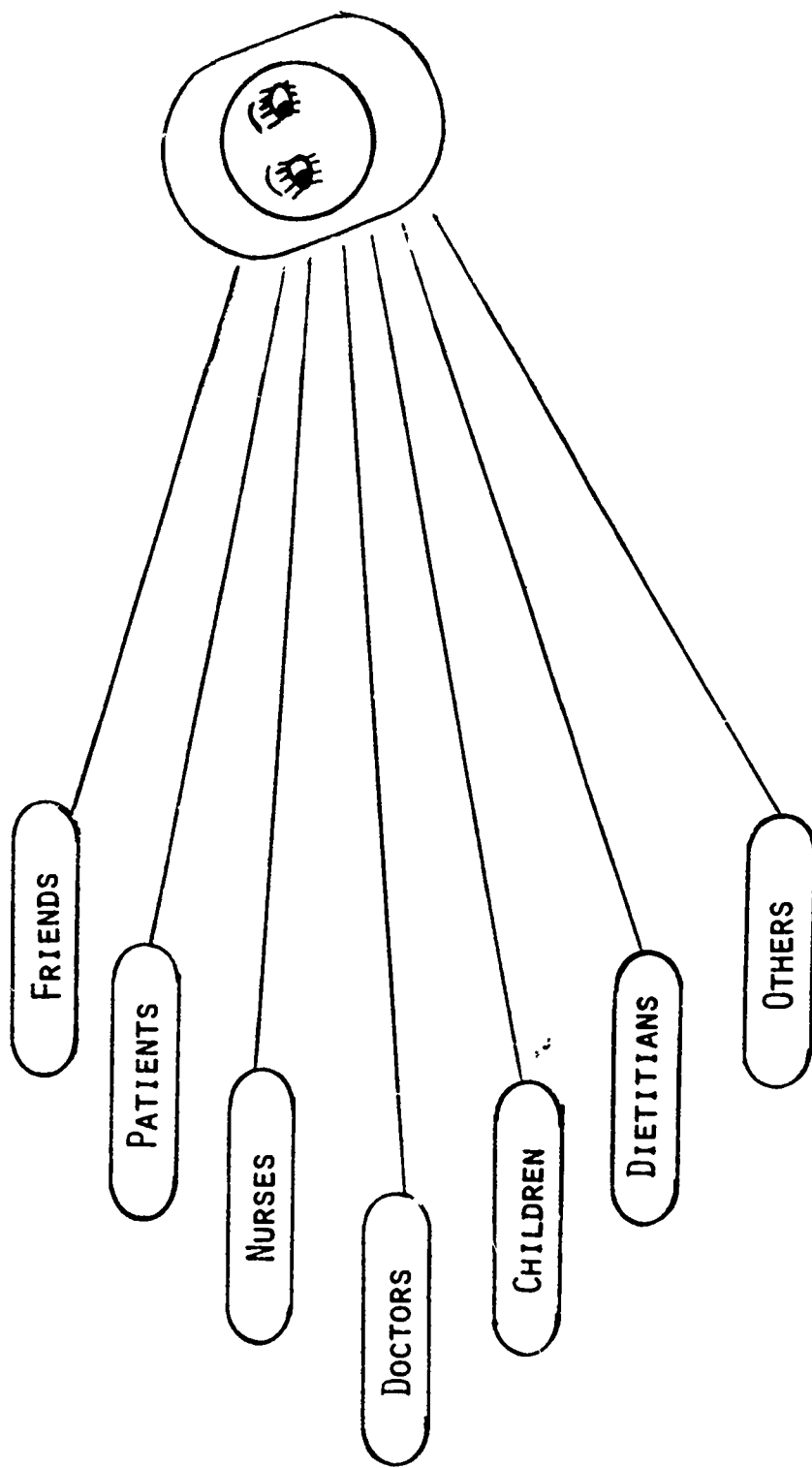

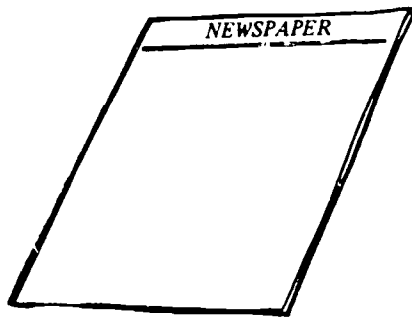

1. A DOUBLE SHEET OF NEWSPAPER,

2. FOLD A DOUBLE SHEET OF NEWSPAPER, HORIZONTALLY INTO HALF; THEN FOLD THE BOTTOM HALF AGAIN AS SHOWN.

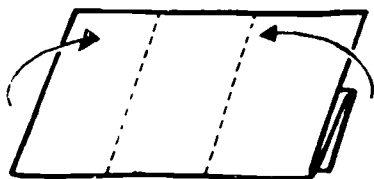
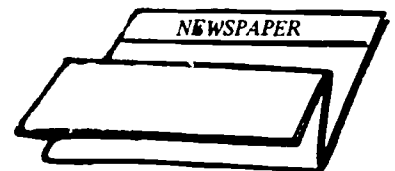

3. FOLD THE NEWSPAPER VERTICALLY INTO THIRDS, AND CREASE.

4. TUCK ONE SIDE OF THE CUFF OF THE PAPER INTO THE OPPOSITE SIDE OF THE CUFF.

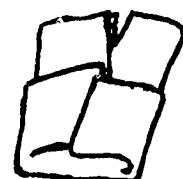

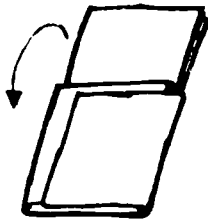

5. FOLD BACK THE FLAP THAT STANDS UP OVER THE TUCKED-IN SIDE OF THE CUFF. (THIS FLAP WILL ACT AS A BRACE WHEN THE BAG IS STANDING AND IT MAY BE USED TO FASTEN THE BAG TO THE BED.)

6. PLACE HANDS INSIDE THE OPENING AND PULL THE SIDES OF THE BAG APART.

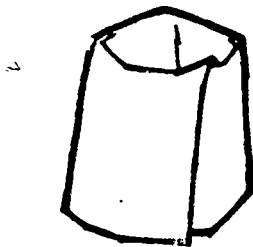

7. OPEN BAG, STANDING WITH THE AID OF THE FLAP.

8. OPEN BAG, FLAP EXTENDED UPWARD, READY TO FASTEN TO A BED.





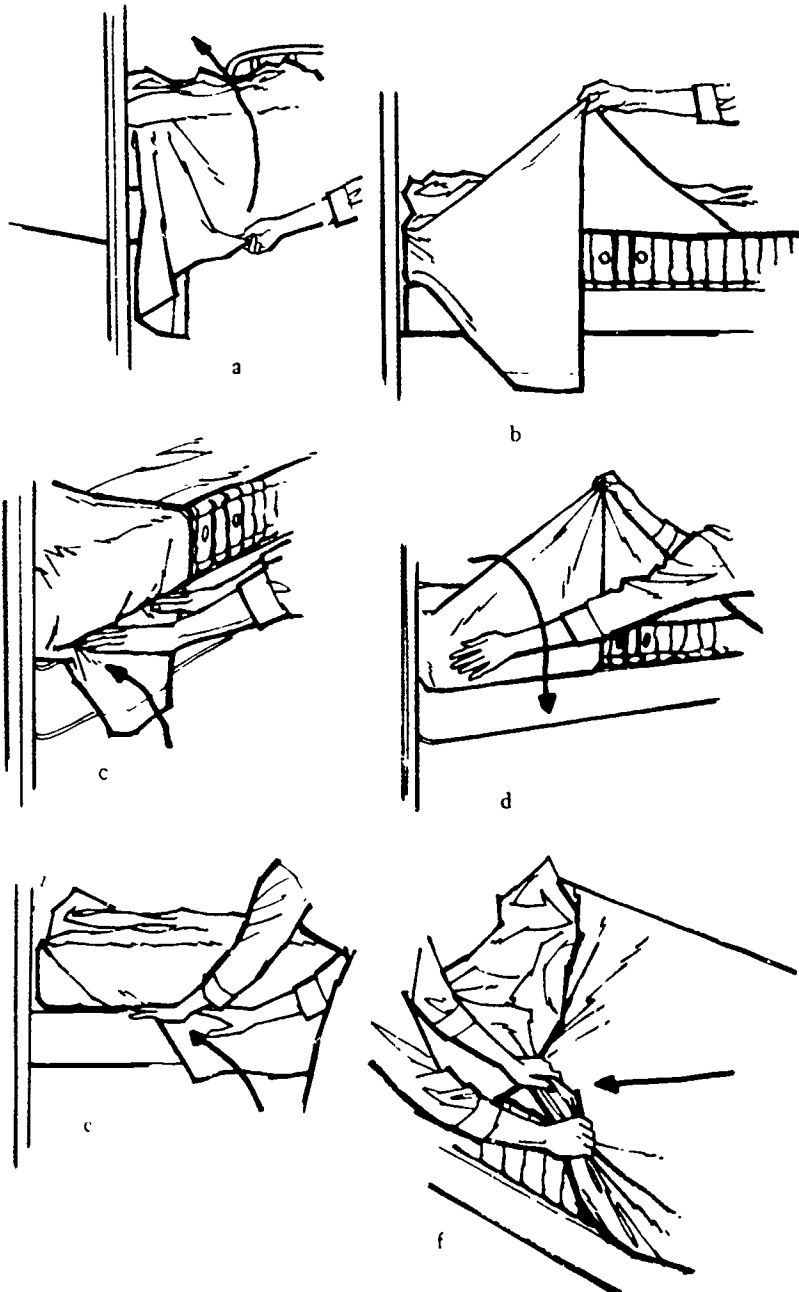

Steps in putting on the bottom sheet

STUDENT EDITION

POLKA DOTS

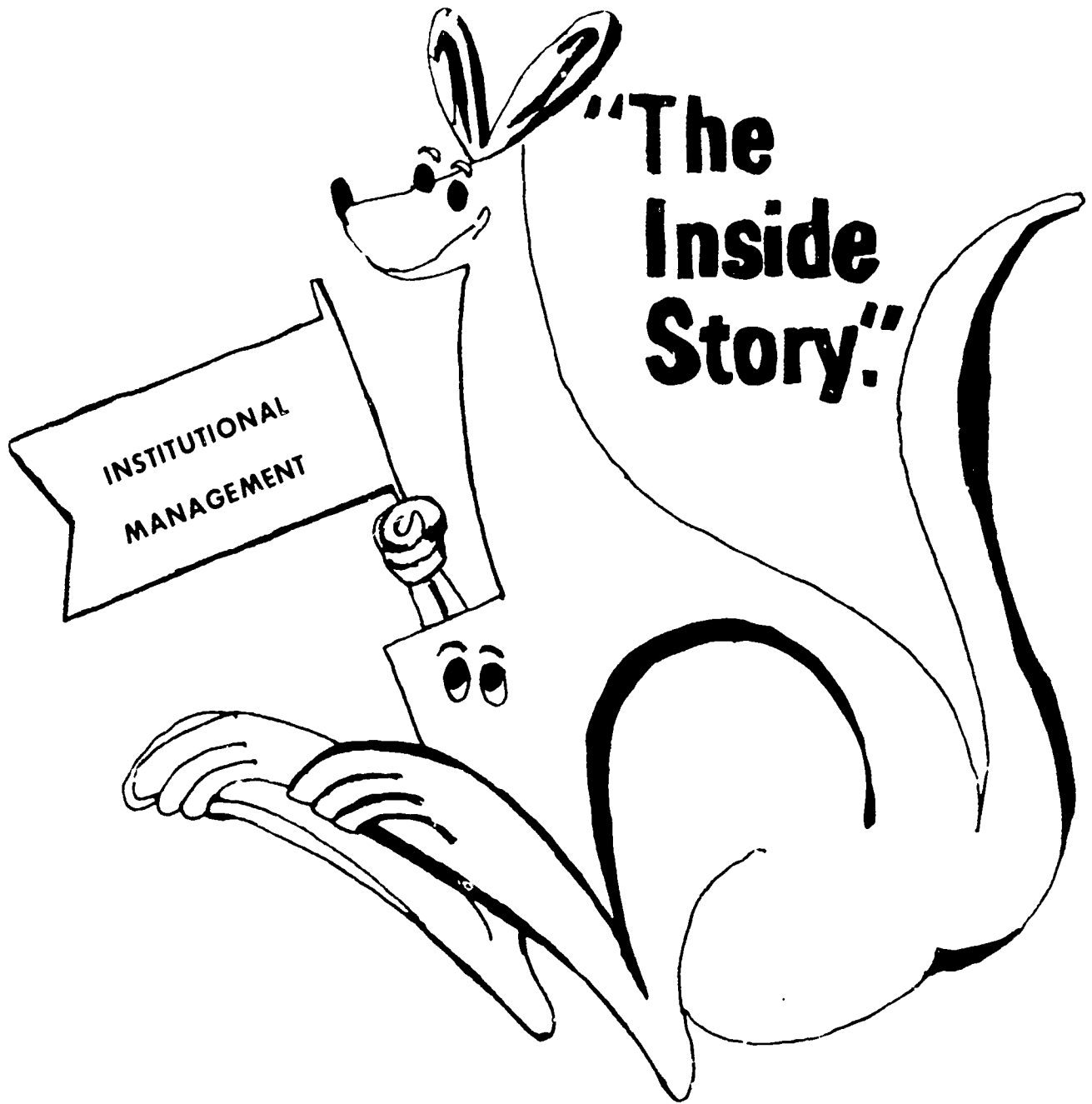

02008762

Polka Dots  
Student Section

compiled by

Louie E. Kemp  
Curriculum Coordinator  
Home Economics

Published by

Mississippi State University  
RESEARCH AND CURRICULUM UNIT  
FOR  
VOCATIONAL AND TECHNICAL EDUCATION  
Mississippi State, Mississippi

In Cooperation With

Division of Vocational and Technical Education  
State Department of Education  
Jackson, Mississippi

Home Economics Publication Number 6001

1972

Direct inquiries to:

Research and Curriculum Unit  
Drawer DX  
Mississippi State, MS

Mississippi State University does not discriminate on the grounds of race, color, or national origin.

What Does TLC Mean

Introduction

The words "TLC" mean "Tender Loving Care". What do they mean to you? TLC stands for "Tender Loving Care". After this is an aid to recovery that cannot be replaced by any other treatment. Can you go to the drugstore and get a prescription filled that will provide TLC? No, but you can fill the prescription if you learn as much as you can about simple nursing techniques and the use of other people. This type of love means unselfishness and sincere consideration for others.

There are many things that you can learn to do to help calm the worried hearts of people who are in the hospital. You learn to bring happiness and comfort to patients. You help the nurse to staff the families of patients, and you may help yourself realize what you will choose some health occupation as a career. (For instance, can be exciting!) Let's explore the entrance skills. The nursing student and maybe a patient's room in "Home Economics section." What can you learn to do? What will the activities in the institution allow you to do?

Make the patient comfortable by taking temperatures and read a thermometer, count pulse rate, take bloods and sputum from patients, make useful gadgets like paper vests, bags, bandages, etc. Help patients in a wheel chair, entertain the patient, help the young to visit hospital rooms, run errands for nurses, etc. etc. etc. and assist volunteer workers at the information desk. (Some of the activities can be fun!)

Learning Objectives

After the completion of the learning package, you will have a better understanding of the purposes, activities, responsibilities, concern for

patients, and close working relationships among members of the hospital staff. You will have demonstrated this by successfully accomplishing the following objectives:

- A. You will demonstrate your concern for others by arranging flowers for entrance halls and patients' rooms, delivering packages and papers, reading to patients, rolling patients in wheel chairs, and playing games with patients.
- B. Given: Two kinds of clinical thermometers. You will identify each according to appearance, and function. You will demonstrate the proper procedure to use when preparing, using, reading and caring for the oral thermometer.
- C. You will demonstrate your understanding of the equipment and procedure to use when counting and recording a person's pulse and respiration.
- D. Given: A doll bed mattress or couch cushion. Demonstrate and explain orally the proper procedure to use when making an empty bed for a patient in the hospital, nursing home or home. List in writing the equipment necessary to make a bed.
- E. Given: Pictures of nursing care equipment. You will identify nursing care equipment that can be improvised. From the following list choose one piece of equipment to make and display: 1. Bed table, 2. Blanket bathrobe, 3. Shoulder shawl, 4. Newspaper waste container, 5. Accessory bag.

### Pretest

1. TLC means \_\_\_\_\_.
2. Normal temperature is \_\_\_\_\_°F when taken by mouth.
3. Temperature taken under the arm is \_\_\_\_\_ to \_\_\_\_\_ degree less than when taken by mouth.
4. Always \_\_\_\_\_ the thermometer after taking the temperature.
5. Never put a thermometer in \_\_\_\_\_.
6. The normal pulse rate for the healthy adult is \_\_\_\_\_ beats per minute.
7. When blood pressure is low the pulse rate is \_\_\_\_\_.
8. The patient's hair should be combed and brushed \_\_\_\_\_ a day.
9. Knowing \_\_\_\_\_ to place flowers in the room is just as important as knowing how to arrange them.
10. Flowers help to satisfy the \_\_\_\_\_ and \_\_\_\_\_ needs which may be of great importance to the patient.
11. Flowers that are received in a \_\_\_\_\_ should be placed immediately in cold water.
12. Careless \_\_\_\_\_ is one of the most frequent causes of hospital fires.
13. When an accident occurs to a patient, it should be \_\_\_\_\_.
14. Metal furniture may be cared for by frequent washing with \_\_\_\_\_ and \_\_\_\_\_.
15. When making an empty bed, allow \_\_\_\_\_ inches of bottom sheet for tucking under the head of the mattress.
16. A rubber or plastic sheet and a \_\_\_\_\_ sheet are sometimes used for protection.
17. A bed table can be improvised by placing the free end of an \_\_\_\_\_ across the bed.
18. A bed table can be made from a \_\_\_\_\_.
19. A shoulder shawl can be made from a \_\_\_\_\_.
20. A disposal bag can be made by folding a \_\_\_\_\_.

## Lesson I

Love and consideration for others can mean happiness and health. You, a teenager, can give happiness and can aid in improving the physical and mental health of patients of all ages in hospitals, and of older patients in nursing homes.

Listen to that "little voice" that lives inside you. That "little voice," your conscience, will talk "happy talk" and will make you feel 10 feet tall when you do nice, helpful things for others. You might even begin to like yourself.

### Component:

Concern for others

### Objectives:

- A. You will demonstrate your concern for others by making a flower arrangement and placing it in a patient's room or in the entrance of a hospital.
- B. You will choose a game that will be a source of entertainment to an elderly patient. You will state in writing, two reasons for selecting this game. You will play this game with a student in your group to prove the wisdom of your selection.

### Instructions:

You must complete Learning Experience 1 or 2. You must complete Learning Experience 3 or 4, after which you must complete Learning Experience 5. Complete Learning Experience 6, if you choose to do so.

### Learning Experiences:

1. Read pp. 223-229, Homes with Character.



2. Listen to tape, Flower Arrangements. The tape is on the teacher's desk; ask her permission to hear it.
3. Given: Flower containers, frogs, floral clay, flowers, and other equipment necessary to make a flower arrangement. Make a flower arrangement. Explain to a classmate or the teacher the procedure you used to construct the flower arrangement. Display the arrangement, and ask for comments from your group.
4. Given: A selection of games. Choose a game that will be enjoyed by an elderly person in a hospital or nursing home. Role play, with the aid of a classmate, the proper way to play the game and explain your reasons for choosing this particular game.
5. Explain in writing how you would be able to help in the following situation. Mrs. Bennett is in the hospital and will be there for at least two weeks. Her husband has come to visit her, and has brought their two-year-old son with him. The policies of the hospital prohibit children under 12 years of age from visiting in hospital rooms. You are helping at the information desk at the hospital. What would you do to help the Bennett family? Place your written explanation on the teacher's desk, or ask the teacher's permission to role play your answer.
6. Ask your teacher for the transparency set. View transparencies. Attitude and Manner: Their Influence on Accomplishment. Discuss each transparency with your group.



## Lesson II

Do you feel "On top of the world" today? This feeling may be telling you that your temperature is normal; your physical condition is great! Have you ever felt "washed-out," "faded," "out of it?" Possibly your temperature was below normal. How can you find out whether your temperature is normal? Why is it important that you know whether you have temperature?

### Component:

The function, use, and care of thermometers

### Objective:

Given: Two clinical thermometers. You will identify each thermometer, demonstrate the proper use, explain the function, and demonstrate the proper care of the oral thermometer.

### Instructions:

You will perform Learning Experience 1 or 2; then you must complete Learning Experiences 3 and 4.

### Learning Experiences:

1. Read pp.186-191, American Red Cross Home Nursing Textbook.
2. Listen to tape, Care and Use of the Clinical Thermometer. Get the tape from the teacher's desk.
3. Ask your teacher for the thermometer kit. Explore the kit. Identify the oral clinical thermometer. Write a description of the appearance of the thermometer. Which shape thermometer can be used for all purposes?
4. Role play. Choose a classmate to be a patient. Demonstrate to your group the proper procedure to go through when taking a

patient's temperature, when reading a thermometer, and when cleaning and storing the thermometer.

5. Write one reason why you think it is important to know how to use a thermometer correctly. Write one thing that a temperature of 102° may indicate. Explain your reason.

### Lesson III

You have probably noticed a pulsing movement at your wrist, at your ankle, and possibly at your temple. Do you ever wonder about this? How many times a minute does this beat occur? Why? Let's explore these questions.

#### Component:

Counting pulse and respiration

#### Objectives:

- A. You will identify the reasons for differences in pulse counts and respiration counts.
- B. You will identify and demonstrate the equipment and the proper procedure to use when counting pulse and respiration.

#### Instructions:

You will complete Learning Experiences 1, 2, and 3. When you complete Experience 3, check with your teacher to see whether you are ready for Lesson IV.

#### Learning Experiences:

1. Read pp. 193-194, "Counting Pulse and Respiration" in American Red Cross Home Nursing Textbook.
2. Discuss, after reading pp. 193-194, the information you learned with a classmate or with your teacher. Write at least a paragraph to explain why the pulse and respiration counts vary with different people. Also, state one condition that the pulse count and the respiration count may indicate.
3. Use one of your group as a patient to demonstrate the proper

way to count pulse and respiration. Ask your teacher to observe and evaluate the demonstration. If your teacher approves this demonstration, you are ready for Lesson IV.

## Lesson IV

Is there anything more uncomfortable than a wrinkled, unmade bed?

An uncomfortable bed can be about as harmful to a patient as the wrong kind of medicine. If you learn to make a bed properly, you will help a patient rest better, and you can help yourself to a good night's rest in your own bed.

### Component:

Making an empty bed

### Objectives:

Given: A doll bed and mattress, a cushion from a couch or a real mattress. You will demonstrate the steps to take when you properly make an empty bed.

### Instructions:

Complete Learning Experiences 1, 2, and 3.

### Learning Experiences:

1. Read pp. 226-229, American Red Cross Nursing Textbook.
2. View transparency, Steps in Putting on the Bottom Sheet. Ask your teacher for the transparency.
3. Demonstrate for the teacher or a classmate, after practicing, the proper way to make an empty bed.

Proceed to Lesson V.

## Lesson V

Tender loving care that means so much to everyone, especially to individuals who are sick, can be given in many ways. Concern for others, personal attention, or even showing that you care by helping to make a patient comfortable can be ways of demonstrating TLC. Improvised equipment for the sick is easy to make, and it is fun to make. This will give you an opportunity to be creative, to do your own thing. You may have an idea that has never been thought of before. Let's go into action and learn to help others.

### Component:

Improvise nursing care equipment

### Objectives:

- A. You will identify nursing care equipment and state in writing reasons why this equipment should or should not be improvised.
- B. You will construct at least one piece of nursing care equipment that you have identified.

### Instructions:

You must complete Learning Experiences 1, 2, and 3.

### Learning Experiences:

1. Read pp. 318-324, American Red Cross Home Nursing Textbook.
2. Read pp. 422-427, Teen Guide to Homemaking.
3. List in writing, materials and directions needed for constructing three different kinds of nursing care equipment that can be improvised.
4. Construct at least one of the pieces of nursing care equipment you listed, after you have discussed your choice with your



teacher. Display your equipment so the class may view it.

5. Ask your teacher for final instructions.

#### Post Test

Ask your teacher for the post test. This test will help you discover how much you have learned about the activities, functions and responsibilities in which hospital workers are involved.

#### Quests

If you want to explore other activities that are a part of daily hospital routine, the following suggestions may interest you.

1. Baby Care - Read pp. 298-311, American Red Cross Home Nursing Book.
2. View film - Nurses' Aides Role in Physical Therapy and Psychological Rehabilitation for the Aged.
3. Any other idea that you want to explore.

TEACHER EDITION

GIFT BOUTIQUE

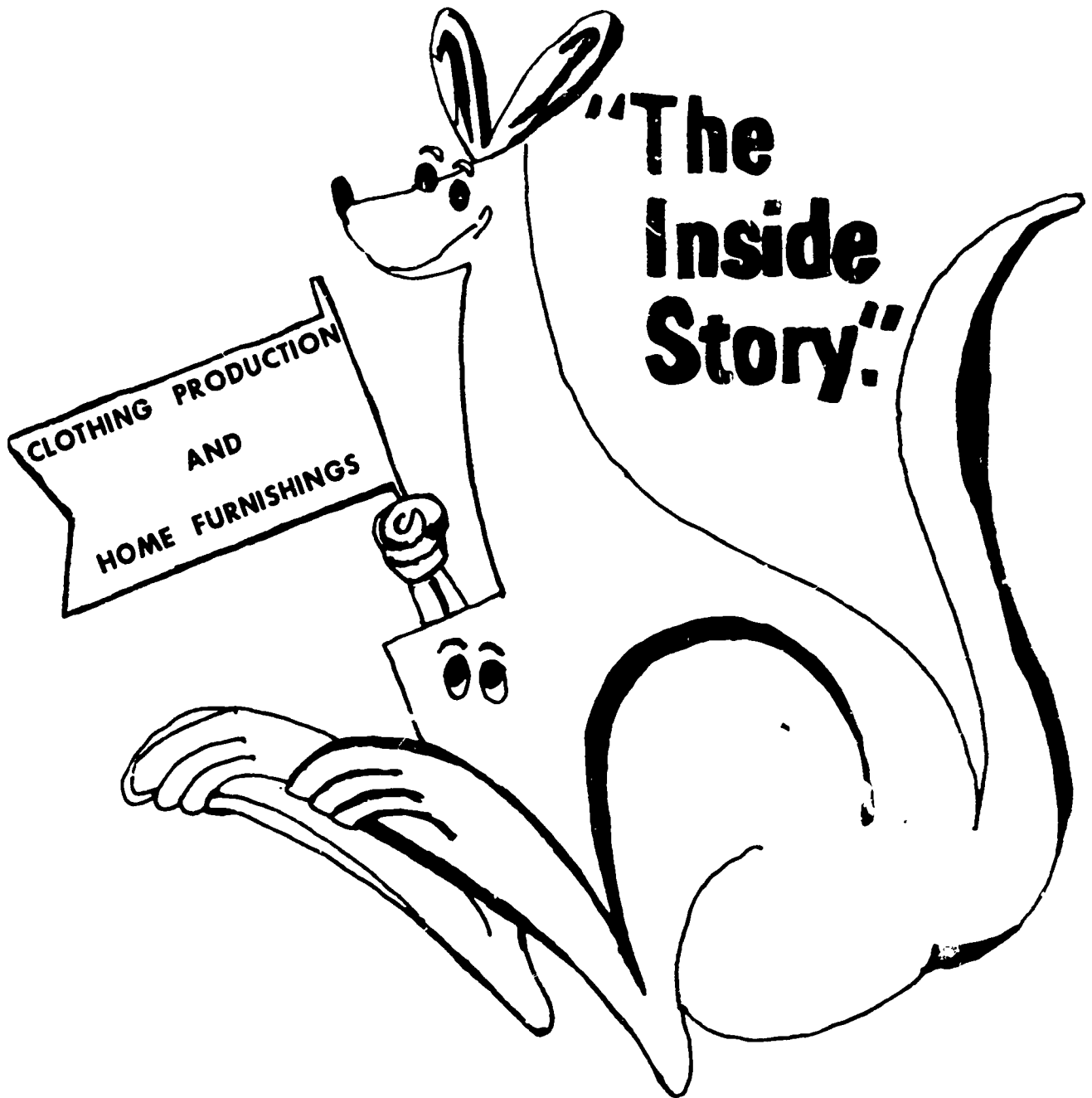

Gift Boutique  
Teacher Section

compiled by  
Louie E. Kemp  
Curriculum Coordinator  
Home Economics

Published by  
Mississippi State University  
RESEARCH AND CURRICULUM UNIT  
FOR  
VOCATIONAL AND TECHNICAL EDUCATION  
Mississippi State, Mississippi

In Cooperation With  
Division of Vocational and Technical Education  
State Department of Education  
Jackson, Mississippi

Home Economics Publication Number 6006

1972

Direct inquiries to:

Research and Curriculum Unit  
Drawer DX  
Mississippi State, MS

Mississippi State University does not discriminate on the grounds of  
race, color, or national origin.

Home Economics Learning Package  
Career Exploration

Identification Page

Title: Gift Boutique

Subject: Clothing Production and Interior Decoration

Performance Level: Exploratory -- 7th and 8th grades

Purpose: To gain some understanding of the duties, responsibilities and tasks performed by workers in the clothing and interior decorating occupations.

Producer: Louie E. Kemp  
Drawer DX  
Research and Curriculum Unit  
Mississippi State, MS 39762

Date: 1973

## GIFT BOUTIQUE

### Teacher Section

#### I. Statement of Purpose:

##### A. Generalization:

Learning to operate a sewing machine is a skill that must be learned in order to successfully construct clothing or to create many items that are used by interior decorators.

##### B. Components:

1. Identification of the parts of a sewing machine
2. Threading the sewing machine and the bobbin
3. Stitching properly on the sewing machine
4. Constructing a simple article

#### II. Instructional Objectives:

- A. The student will identify the parts of the sewing machine by showing and by orally stating the names of the parts of the sewing machine to the teacher.
- B. The student will properly insert a needle in the sewing machine and will practice stitching on the lines of notebook paper.
- C. The student will thread the sewing machine, thread the bobbin, place the bobbin in the bobbin case, thread the bobbin case, and sew a 5/8" seam.
- D. The student will construct a simple article that may be found in a gift or novelty shop.

## INSTRUCTIONS TO THE TEACHER

### I. Instructional Approach:

The student section of this exploratory learning package will use the quasi-discovery approach, which means that there will be factual information given to the students, but there will also be provisions made for students to explore and discover information. By presenting educational materials and suggested learning experiences that are directly related to the instructional objectives and criteria for evaluation, the student will hopefully gain some understanding of the duties, responsibilities and tasks performed by workers in Food Service occupations.

### II. Identification of Learners:

This learning package is designed for average seventh and eighth grade students who are exploring careers related to Home Economics.

### III. Special Instructions:

#### A. Equipment Needed:

Sewing Machines      Overhead Projector      Tape Player      Scissors      Stapler

#### B. Material Needed:

##### Books:

Teen Guide to Homemaking, Barclay, Marion S., and Champion, Frances.

New York: Webster Division, McGraw-Hill Book Company, 1967.

How You Look and Dress, Carson, Byrta. New York: Webster Division,

McGraw-Hill Book Company, 1969.

Steps In Clothing Skills, Dunn, Lucille, Bailey, Anetta, Vansickle, Wanda.

Peoria, Illinois: Chas. A. Bennett Company, Inc., 1970.

101 Things to Make For Fun or Money, Peake, Miriam M. New York,

New York: Scholastic Book Services.

Experiences In Homemaking, Pollard, Belle, Laitem, Helen H., and Miller, Frances S., Rev. Ed. Boston, Mass.: Ginn and Company, 1968.

C. Instruction Sheets Needed:

1. Fringed Napkin or Place Mat
2. Fish Potholder, (including pattern)
3. Christmas Tree Wallhanging (including pattern)
4. Terry Cloth Pillow
5. Clothesline Coat Hanger
6. Wig Rack
7. Belt Coat Hanger
8. Tie-dye Tank Top

D. Media Needed

1. Transparency Masters:

The following transparency masters are included in this package:

- a. Sewing Machine Head
- b. Threading The Sewing Machine

2. Tape:

For those students who prefer or who will profit from learning by listening, it is suggested that the key readings in each lesson be made available on tape. These key readings will include textbook references listed in learning experiences in the student package.

IV. Instructions for Evaluations:

Three instruments for evaluation have been included in this package. They are the pretest, the sewing machine license, and the post



test. The sewing machine license will serve as a self-test, since each student will become aware of his knowledge of the sewing machine, and his skill in the use of the sewing machine. The post test should indicate the extent to which behavioral changes have taken place as a result of participation in learning experiences since the pretest was given.

V. Suggested Instructional Procedure:

A. Explain the use and care of the student section of the learning packages to the students. The following explanations to students are suggested:

1. Read the introduction and the instructional objectives. This information will identify the occupation that the student will explore, and will explain the extent to which they are expected to explore the occupation.
2. Explain to the students that the pretest will be administered to help them assess their knowledge of clothing and home furnishings occupations. Pass a copy of the pretest to each student. Remind the students that they will not write on the sample pretest in the learning package, and that they will not get a grade on the pretest.
3. Following the pretest, the students will begin lesson one. The component and the objectives explain what they will learn. The instructions direct them to the learning experiences, and explain the number of learning experiences they must successfully complete before attempting lesson two.

4. Follow the same procedure through the remaining lessons.
  5. When they have completed their last lesson and feel that they are ready, they should ask the teacher for a post or final test. A grade should be given on the post test. This will mean that they have completed their exploration of this occupation.
  6. If they need equipment, media, or materials; if they do not understand a direction given, or if they need help in any activity they are undertaking, they should ask the teacher for help and she will be glad to assist them.
  7. Students will not write their names or anything else on or in the learning packages. These will be used by students in other classes this year and in years to come. All written assignment sheets will be given to them.
- B. Show and explain to the students the location and the method of filing the learning packages.
1. Each learning package will be kept in a manila folder. Each folder will have the name of the learning package written on it.
  2. The folders containing the learning packages will be kept in a file drawer or a box on a table beside the teacher's desk.
  3. When students come to class, they should get a manila folder that contains a learning package in which they are working. This folder will be taken from the file drawer or box. At the end of the period, they will replace the

folder and the learning package in the same file drawer or box. They will not take the learning package out of the classroom.

- C. Introduce the subject matter area that the learning package is designed to explore. The following is a suggested approach:

Explain to the students that this learning package will help them find out more about the occupations in Food Services. They may become interested enough in these occupations to want to know the training they must have in order to qualify for these occupations. They may decide that this is not exactly "their cup of tea", but they may wonder if there is another occupation similar to this that would appeal to them. Build an interest approach that will cause the students to become enthusiastic about the occupation. An attractive bulletin board, a film, or a resource person may be valuable aids.

- D. Identify the equipment, materials, and media that will be needed by the students, and point out the locations of these available supplies. Students should ask to use the supplies, and request assistance if needed.
- E. Instruct the students not to write on or in the package. Tests or any other written assignment sheets should be made available to the students upon request. An adequate supply of work sheets should be available when students begin the package.

## Instruction Sheet 1

### Fringed Napkin or Place Mat

Equipment Needed: Scissors, pins, sewing machine, bobbin, ruler or tape measure.

Materials Needed: 18" x 18" fabric for 1 napkin, 24" x 18" fabric for 1 place mat, thread.

- Directions:
1. Measure and cut fabric into a square, 18" x 18" (or 24" x 18" for a place mat).
  2. Stitch on the sewing machine 1" from the edge of the fabric with thread the same color or a color that contrasts with the fabric.
  3. Ravel the outer edge of the fabric to the row of stitching. Use a pin to aid you in raveling.

## Instruction Sheet 2

### Fish Potholder

**Equipment Needed:** Scissors, ruler or tape measure, sewing machine, pins.

**Materials Needed:** Felt scraps: black, pink, green, and blue are some suggested colors, but any colors may be used; white sewing thread; 1 white plastic ring; fish potholder pattern.

- Directions:**
1. Lay long fish A on a single piece of felt; pin and cut.
  2. Lay short fish B on a single piece of felt; pin and cut.
  3. Lay fin C on a double piece of felt; pin and cut.
  4. Lay fin D on a double piece of felt; pin and cut.
  5. Lay eye E on a single piece of felt; pin and cut.
  6. Stitch eye in place on fish B.
  7. Stitch curved head line with white thread.
  8. Place fishes A and B together. Pin and stitch  $5/8$ " from edge of fish, beginning stitching at the top tail end of fish B and stitching to the bottom tail end of fish B.
  9. Pin fins in place and stitch across fins  $5/8$ " from the edge of fish B, or follow the stitching line you used to stitch fishes A and B together.
  10. Leave tail end open for inserting pot handle.
  11. Sew ring to the tip of the nose.

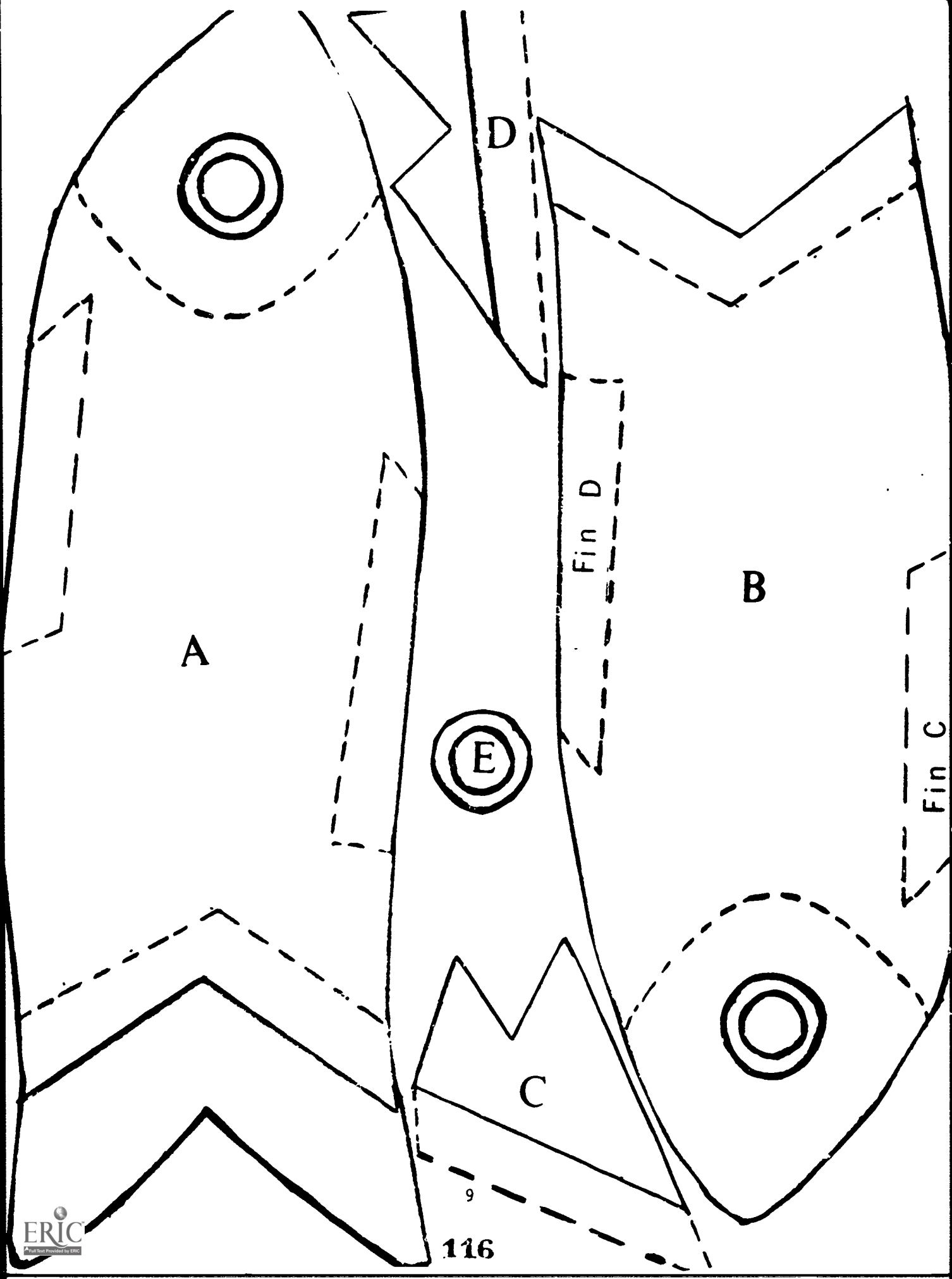

A

D

B

E

Fin D

Fin C

C

9

## Instruction Sheet 3

### Christmas Tree Wall Hanging

**Equipment Needed:** Scissors, ruler or tape measure, pins, stapler, sewing machine.

**Materials Needed:** 1 piece of green or red velvet, felt, or other fabric, 6" x 4"; 1 piece of gold or off-white fabric, 9" x 12"; 15" of gold braid; 24 sequins; 1 piece of green or red felt, velvet, or other fabric, 2½" x 1½"; 5 leaves (cloth or from old artificial stems); 1 piece of cardboard, 8½" x 11½"; 1, 8" cord; 1 spool of thread, Christmas tree pattern, glue.

**Directions:**

1. Lay Christmas tree pattern on fabric; pin and cut.
2. Pin the base of the tree to the tree, allowing a ½" lap. Cut. Remove pattern from fabric.
3. Stitch across the entire base of the tree ¼" from the edge of the fabric; continue stitching up the left side and down the right side of the tree.
4. Pin the gold braid on the back side of the tree, letting any desired amount of braid show on the front side.
5. Pin the tree near the 3 corners of the tree to the 9" x 12" fabric.
6. Stitch over the line of stitching made when the base of the tree was attached.
7. Remove pins.
8. Pin leaves to a 2½" piece of gold braid, and stitch on the sewing machine.
9. Pin and stitch the braid and leaves across the bottom of the tree base.
10. Cover the 8½" x 11½" cardboard with the 9" x 12" fabric.
11. Turn edges to the back and glue, keeping pressure on the glued edges until the glue dries.

12. Staple a cord to the back edges about 3" from the top.
13. Glue the sequins to the front of the tree. Space them as you would lights on a Christmas tree.



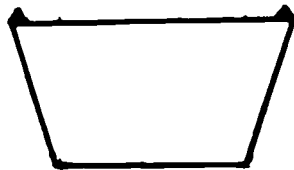
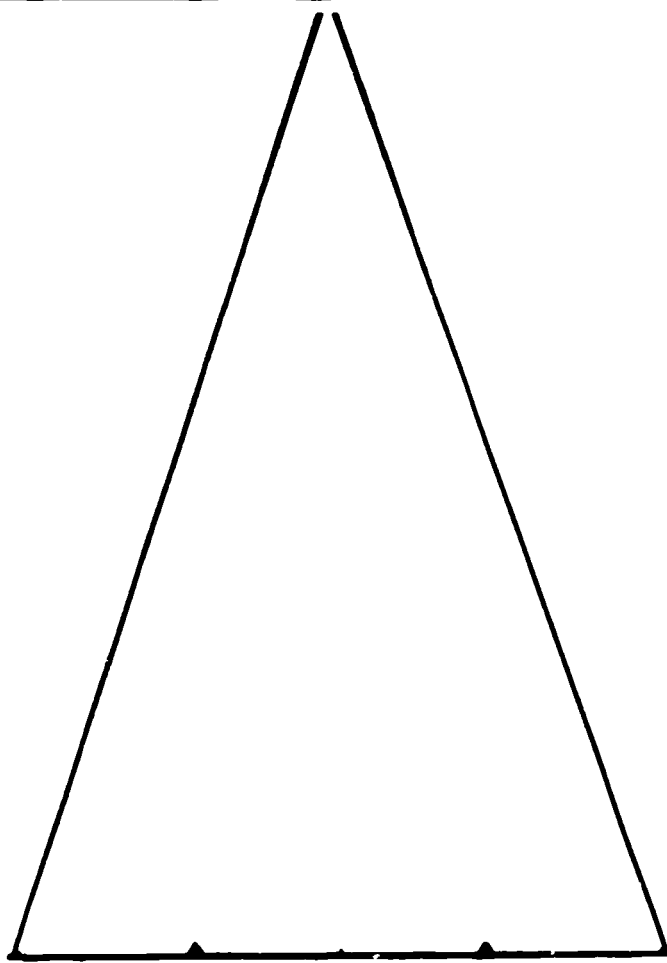

## Instruction Sheet 4

### Terry Cloth Pillow

**Equipment Needed:** Sewing machine, pins.

**Materials Needed:** 2 bath cloths, 12" x 12"; 1 piece of fringe, 48" long; 1 spool of thread; foam rubber or feathers.

- Directions:**
1. Pin edges of bath cloths together on three sides.
  2. Stitch on the sewing machine the three pinned edges  $\frac{1}{4}$ " from the outside edge.
  3. Pin fringe to the three edges that have been stitched and to the top side of the edge that has not been stitched, leaving the one side open for stuffing the pillow.
  4. Stuff the pillow with foam rubber or feathers to a desired fullness.
  5. Stitch the open edges of the pillow together on the sewing machine.

## Instruction Sheet 5

### Clothesline Coat Hanger

**Equipment Needed:** Sewing machine, wire, scissors, ruler or tape measure, pins, coat hanger, clothespins.

**Materials Needed:** Bias tape, fabric, thread.

- Directions:**
1. Stitch together the edges of the 45" double fold bias tape; attach 6 snap clothespins to the tape; space the clothespins 7" apart.
  2. Cut 2 pieces of fabric the size and shape of a wire coat hanger, plus 1/2" seam allowance.
  3. Put right sides of fabric together.
  4. Stitch top, curved seam, leaving 1/2" opening to insert hanger hook.
  5. Turn under 1/2" on bottom opening.
  6. Pin tape at 7 evenly spaced places on the bottom of the fabric on the hanger
  7. Stitch bottom opening closed on the sewing machine. If the stitching does not catch the bias tape, restitch the points of the tape.

## Instruction Sheet 6

### Wig Rack

**Equipment Needed:** Scissors, ruler or tape measure.

**Materials Needed:** Oatmeal box, yarn, ribbon, wallpaper or fabric, glue, paint, crayons or water colors.

**Directions:**

1. Cover a round oatmeal box with wallpaper or fabric.
2. Glue 18 pieces of yarn,  $3\frac{1}{2}$ " long, over the top edge for bangs.
3. Cut nine strands of yarn 18" long, and braid 6" of each end.
4. Tie ends with ribbon and make bows.
5. Glue across top and over bangs.
6. Paint black closed eyes, black round dots for nose, and red lips.

## Instruction Sheet 7

### Belt Coat Hanger

**Equipment Needed:** Sewing machine, wire coat hanger, scissors, ruler or tape measure, pins, eyelets, "S" hooks.

**Materials Needed:** Fabric, thread, felt 16" long, 3" wide.

- Directions:**
1. Cut a piece of felt 16" long and 3" wide; fold in half lengthwise over the bottom of a wire coat hanger. Pin.
  2. Place the coat hanger, with the hook to the left, under the sewing machine. Stitch the length of the coat hanger, 1/2" from the cut edge of the felt.
  3. Fasten five metal eyelets, evenly spaced across the length of the coat hanger, through the double felt.
  4. Place an "S" hook in each eyelet.

## Instruction Sheet 8

### Tie-dye Tank Top

Equipment Needed: 1 - 4 quart boiler  
1 - wooden spoon  
1 - squeeze bottle or eye dropper

Materials Needed: White stretch fabric tank top, rubber bands, three colors of fabric dye, tissues, rubber gloves, liquid soap.

- Directions:
1. Wet tank top in warm water and wring out well. Put on rubber gloves.
  2. Drip dye from squeeze bottle or eye dropper to form stripes. Drip three or five stripes of different colors and widths around the right armhole.
  3. Work dye in with fingers, and blot excess dye with tissues.
  4. Make 1/2" accordian pleats along the stripes in a vertical direction.
  5. Fold the accordian pleats horizontally into a double S shape.
  6. Cover each "hump" of the S tightly with rubber bands.
  7. Wash in cool, soapy water until the water is clear.
  8. Place tank top in a boiler that contains enough hot water to cover the tank top and 1/4 cup of dye (use the color of one of the stripes).
  9. Simmer the tank top for one hour; stir occasionally.
  10. Rinse in cold water until the water is clear. Untie. Re-rinse. Iron while damp.

### Pretest

1. All of the top part of the sewing machine that works to make stitches is called the \_\_\_\_ of the machine.
2. The sewing machine may be started by pushing the \_\_\_\_ lever or the \_\_\_\_ pedal.
3. When sewing on a machine, light should shine over the \_\_\_\_ shoulder.
4. \_\_\_\_ keeps one from tiring easily when sewing on the machine.
5. The \_\_\_\_ holds the spool of thread.
6. The \_\_\_\_ are metal hooks that guide the thread toward the needle.
7. The \_\_\_\_ moves the fabric under the needle.
8. The \_\_\_\_ holds the fabric smooth for stitching.
9. The \_\_\_\_ raises and lowers the presser foot.
10. The lower thread on the sewing machine is wound on a \_\_\_\_.
11. You must bring the \_\_\_\_ thread to the top of the machine before you begin to sew.
12. The \_\_\_\_ changes the size of the stitch.
13. Time is wasted when you thread a sewing machine \_\_\_\_.
14. A \_\_\_\_ is a row of stitching that holds two pieces of fabric together.
15. The handwheel should be turned \_\_\_\_ you to set the needle down when you begin to sew.

KEY

Pretest  
&  
Post Test

1. All of the top part of the sewing machine that works to make stitches is called the head of the machine.
2. The sewing machine may be started by pushing the knee lever or the foot pedal.
3. When sewing on a machine, light should shine over the left shoulder.
4. Good posture keeps one from tiring easily when sewing on the machine.
5. The spool pin holds the spool of thread.
6. The thread guides are metal hooks that guide the thread toward the needle.
7. The feed dog moves the fabric under the needle.
8. The presser foot holds the fabric smooth for stitching.
9. The presser bar lifter raises and lowers the presser foot.
10. The lower thread on the sewing machine is wound on a bobbin.
11. You must bring the bobbin thread to the top of the machine before you begin to sew.
12. The stitch regulator changes the size of the stitch.
13. Time is wasted when you thread a sewing machine incorrectly.
14. A seam is a row of stitching that holds two pieces of fabric together.
15. The handwheel should be turned toward you to set the needle down when you begin to sew.



SEWING MACHINE OPERATOR LICENSE

Name \_\_\_\_\_

Date \_\_\_\_\_

This is to certify that \_\_\_\_\_  
has successfully accomplished the following tasks:

- \_\_\_\_\_ 1. Name and identify the parts of the sewing machine.
- \_\_\_\_\_ 2. Thread the machine properly.
- \_\_\_\_\_ 3. Thread the bobbin properly.
- \_\_\_\_\_ 4. Insert the bobbin in the bobbin case.
- \_\_\_\_\_ 5. Replace the needle properly.
- \_\_\_\_\_ 6. Remove and replace the presser foot properly.
- \_\_\_\_\_ 7. Remove and replace the throat plate properly.
- \_\_\_\_\_ 8. Remove and replace the foot control properly.
- \_\_\_\_\_ 9. Sew a straight seam using the 5/8 inch guide on the bed of the machine as a guide.
- \_\_\_\_\_ 10. Reverse the stitches at the beginning and the end of a seam.
- \_\_\_\_\_ 11. Regulate speed to a smooth, steady rhythm.
- \_\_\_\_\_ 12. Regulate stitch length.
- \_\_\_\_\_ 13. Join bobbin thread with needle thread.
- \_\_\_\_\_ 14. Adjust presser foot pressure.

Signed \_\_\_\_\_

Home Economics Teacher

\_\_\_\_\_ School

To insert needle - The long groove of the needle goes in the direction of the last thread guide.

# Getting to Know Your Machine

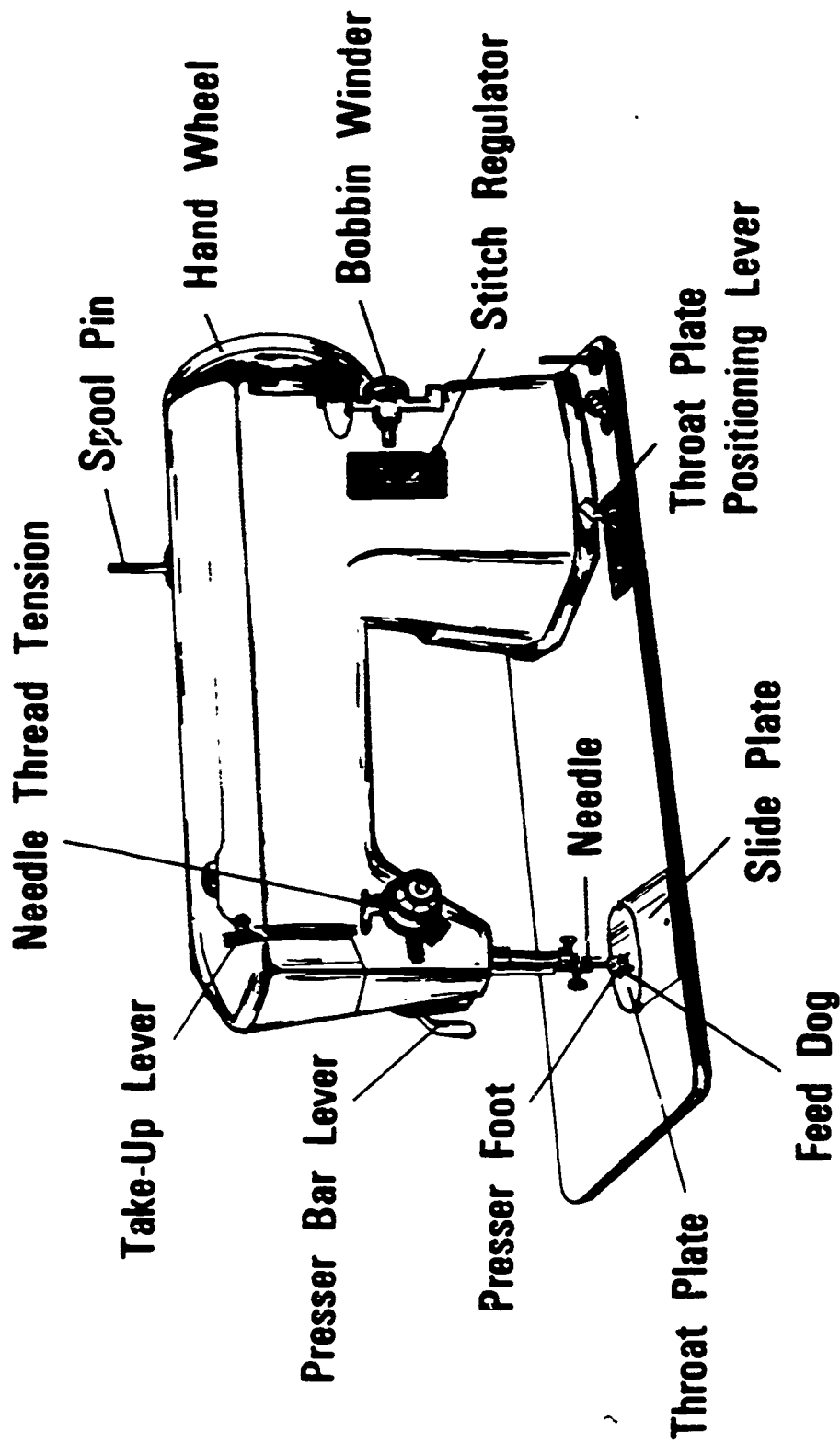

Courtesy of:  
Curriculum and Instructional Materials Center, State Department of Vocational and Technical Education, Stillwater, Oklahoma 74074.

# Getting to Know Your Machine

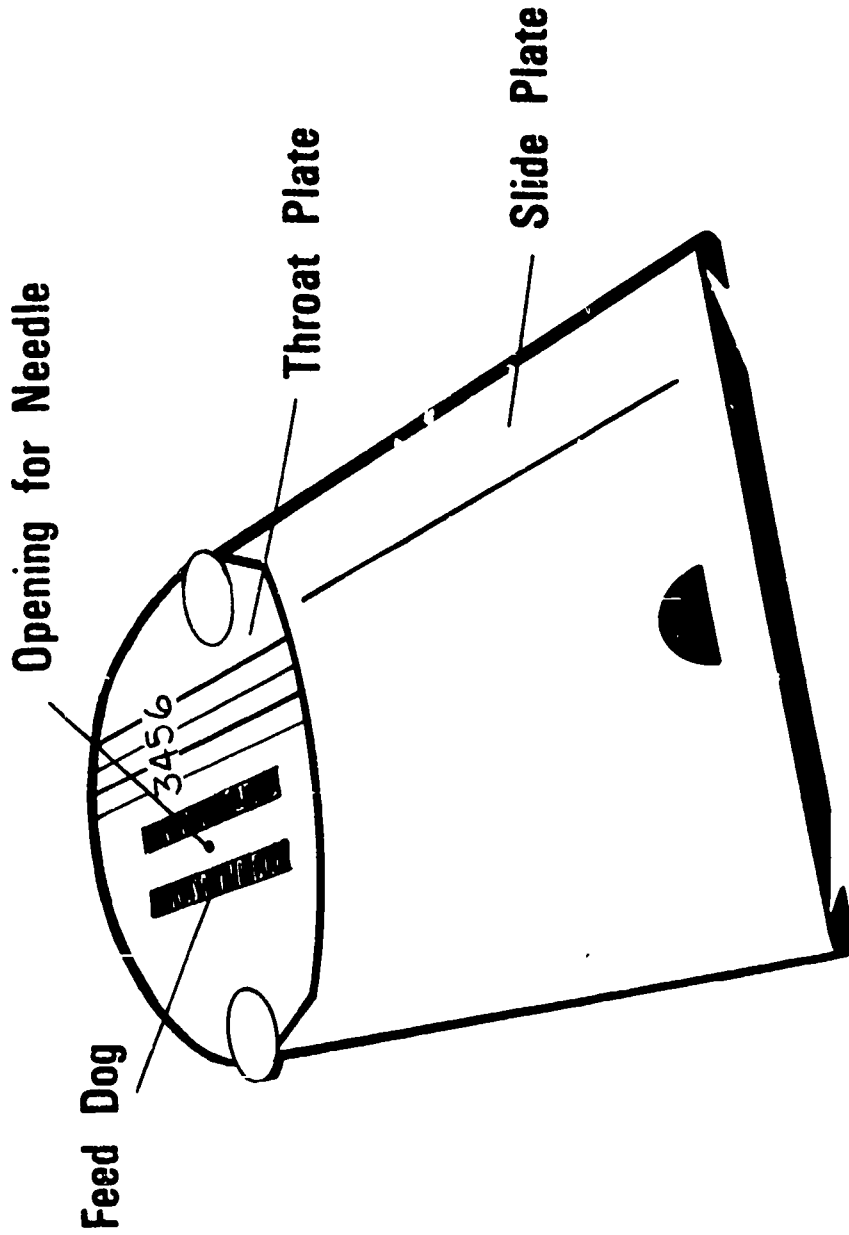

Courtesy of:  
Curriculum and Instructional Materials Center, State Department of Vocational and Technical Education, Stillwater, Oklahoma 74074.

# Getting to Know Your Machine

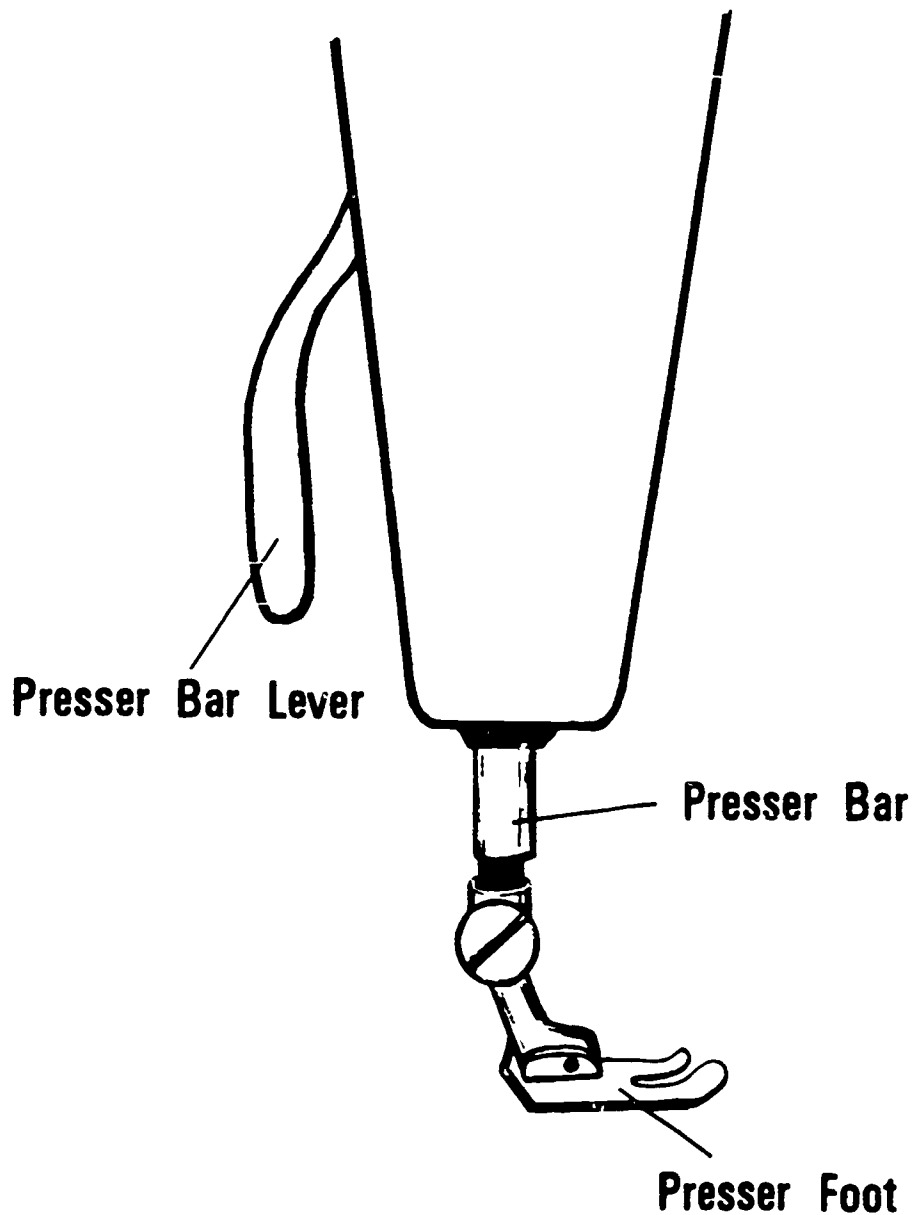

Courtesy of:  
Curriculum and Instructional Materials Center, State Department of Vocational and Technical  
Education, Stillwater, Oklahoma 74074.

# Getting to Know Your Machine

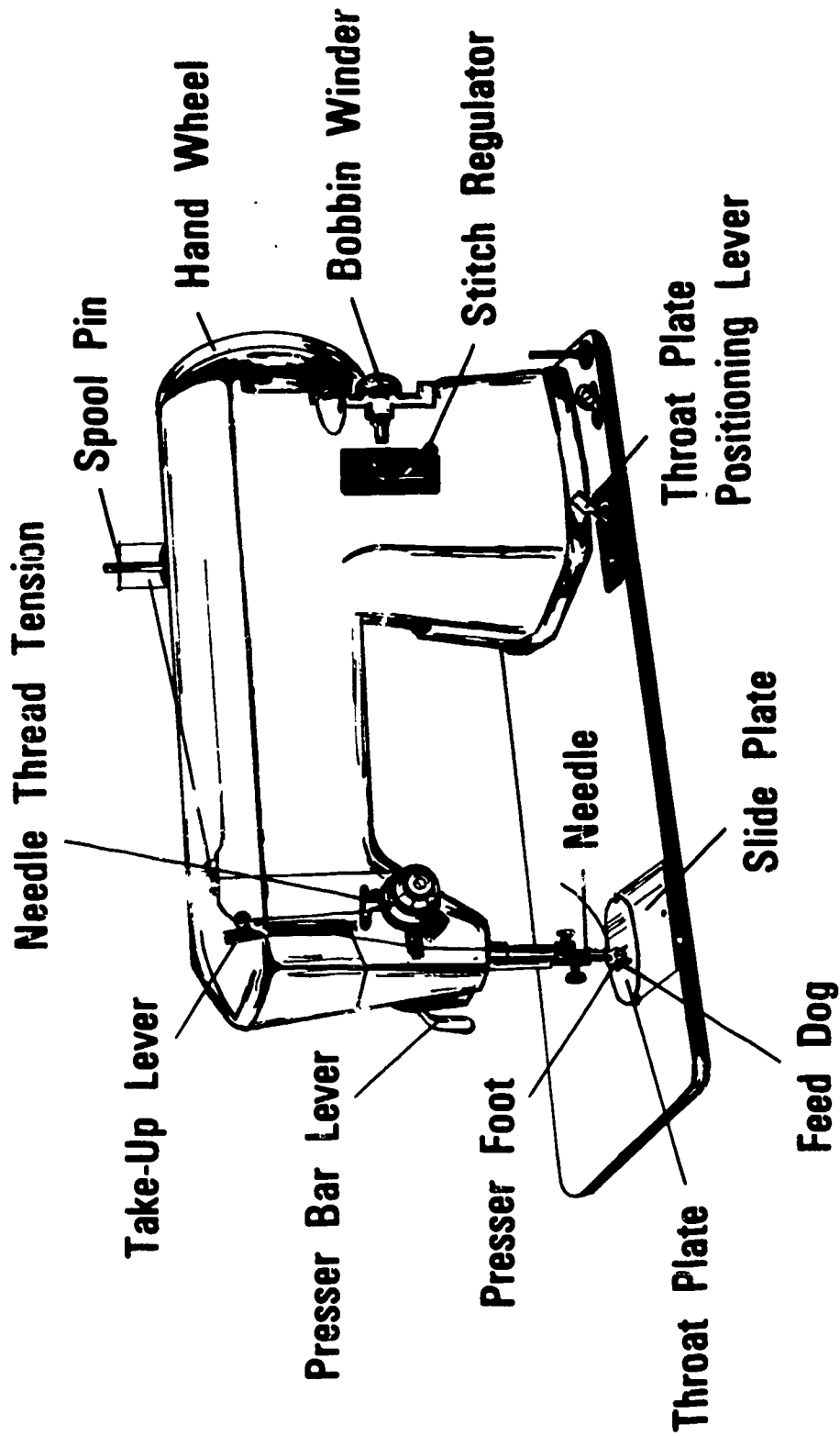

Courtesy of:  
Curriculum and Instructional Materials Center, State Department of Vocational and Technical Education, Stillwater, Oklahoma 74074.

STUDENT EDITION

GIFT BOUTIQUE

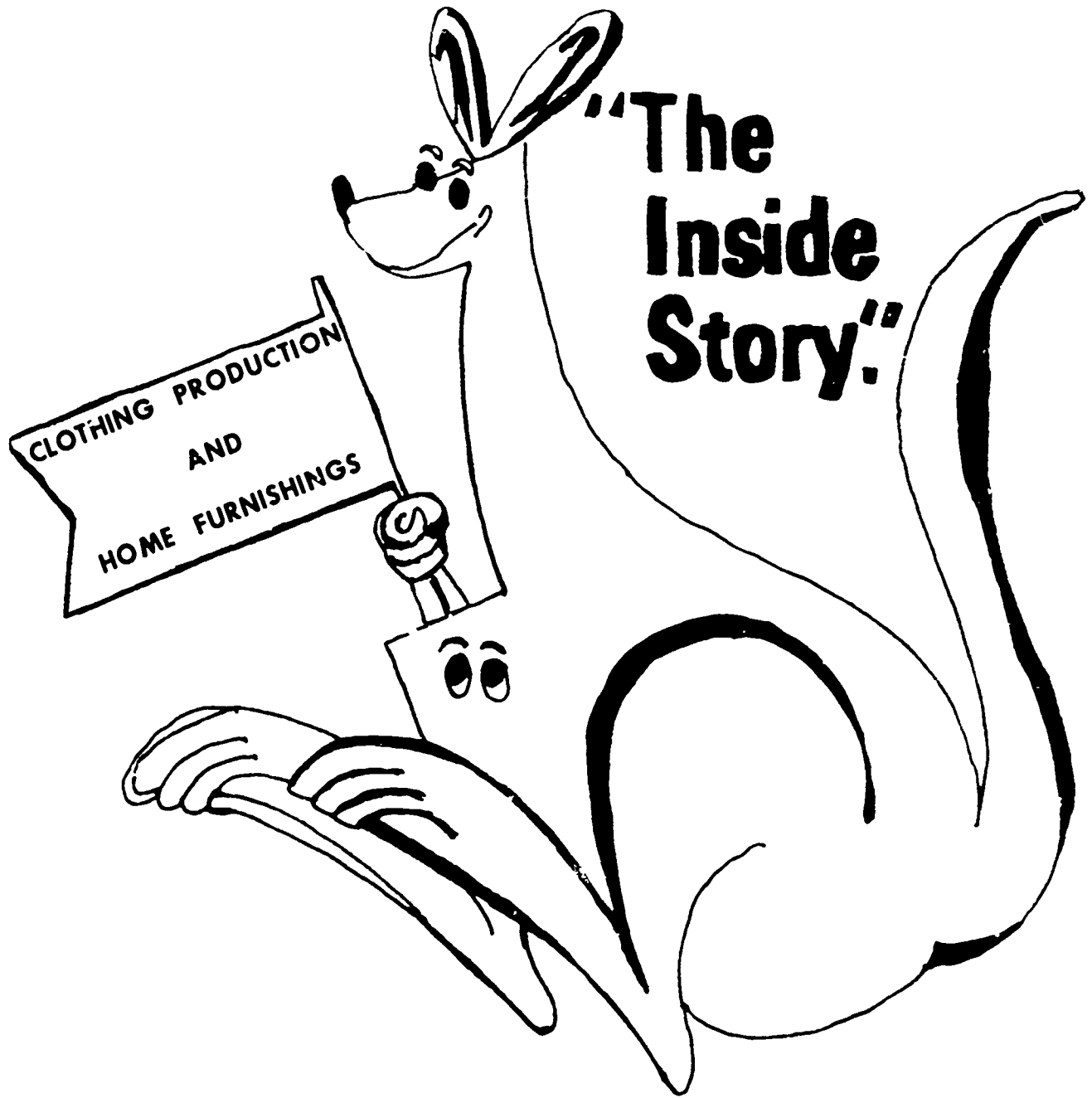

2965003962

Gift Boutique  
Student Section

compiled by  
Louie E. Kemp  
Curriculum Coordinator  
Home Economics

Published by  
Mississippi State University  
RESEARCH AND CURRICULUM UNIT  
FOR  
VOCATIONAL AND TECHNICAL EDUCATION  
Mississippi State, Mississippi

In Cooperation With  
Division of Vocational and Technical Education  
State Department of Education  
Jackson, Mississippi

Home Economics Publication Number 6005

1972

Direct inquires to:

Research and Curriculum Unit  
Drawer DX  
Mississippi State, MS.

Mississippi State University does not discriminate on the grounds of  
race, color, or national origin.



## The Gift Boutique

### Introduction

There comes a time in your life when you want a little privacy. You need to be alone with your thoughts, problems, tears, laughter and any other mood that appears. A little miracle called "planning and organization" can help you attain and enjoy your own special hideaway. Believe it or not,  $1 + 1 + 1 = 3$ . Furniture + Accessories + know-how = your own private corner. There is one other ingredient that is a must if your hideaway is to be complete. The ingredient is you. Your personality will be reflected in your choice of colors, wall hangings, window treatments, and other furnishings that are in your domain. Your personality will also be reflected in the clothes you wear, the gifts you choose or make for friends, and the attitude and manners you display to others.

Understanding and skills are needed if you reflect an image that will be satisfying to you. Sewing is an easy, satisfying way to let your creativity show. About 85% of today's teenagers are learning to sew. When a sewing project enters your world, make it feel welcome by giving it your attention. Learn the skills necessary to do a top job. You may discover a talent that has been dormant until now. But don't stop here - you've only just begun to get a good thing going.

### Learning Objectives

After you complete this learning package you will have a better understanding of the information and of the sewing skills necessary

to construct clothing or room accessories. You may discover an interest in clothing or home furnishings that will lead you to a future career, after you successfully accomplish the following objectives:

- A. You will identify the parts of a sewing machine by locating and by orally stating the names of the parts of the sewing machine to the teacher.
- B. You will properly insert a needle in the sewing machine, and you will stitch, following the lines on notebook paper.
- C. You will thread the sewing machine, thread the bobbin, place the bobbin in the bobbin case, thread the bobbin case, and sew a 5/8" seam.
- D. You will construct a simple article that you might find in a gift or novelty shop.

### Pretest

1. All of the top part of the sewing machine that works to make stitches is called the \_\_\_\_\_ of the machine.
2. The sewing machine may be started by pushing the \_\_\_\_\_ lever or the \_\_\_\_\_ pedal.
3. When sewing on a machine, light should shine over the \_\_\_\_\_ shoulder.
4. \_\_\_\_\_ keeps one from tiring easily when sewing on the machine.
5. The \_\_\_\_\_ holds the spool of thread.
6. The \_\_\_\_\_ are metal hooks that guide the thread toward the needle.
7. The \_\_\_\_\_ moves the fabric under the needle.
8. The \_\_\_\_\_ holds the fabric smooth for stitching.
9. The \_\_\_\_\_ raises and lowers the presser foot.
10. The lower thread on the sewing machine is wound on a \_\_\_\_\_.
11. You must bring the \_\_\_\_\_ thread to the top of the machine before you begin to sew.
12. The \_\_\_\_\_ changes the size of the stitch.
13. Time is wasted when you thread a sewing machine \_\_\_\_\_.
14. A \_\_\_\_\_ is a row of stitching that holds two pieces of fabrics together.
15. The hand-wheel should be turned \_\_\_\_\_ you to set the needle down when you begin to sew.

## Lesson I

Great things are happening in the sewing field. Do a little detective work on your own; you may discover an interest in clothing construction or in home decorating that has been hiding from you. "Do your own thing" is a cliché that can become a truth as you work in "The Gift Boutique," if you employ such helpers as a sewing machine, needles, pins, thread and scissors. Let's learn to stitch correctly and creatively.

### Component:

The sewing machine

### Objectives:

- A. You will identify the parts of a sewing machine by locating and by orally stating to the teacher the names of the machine parts.
- B. You will properly insert a needle in the machine. Without using thread, stitch six lines on notebook paper.

### Instructions:

Complete Learning Experiences 1 and/or 2. Then complete Learning Experiences 3 and 4.

### Learning Experiences:

1. Read pp. 242-248, Steps in Clothing Skills, or read pp. 268-269. Teen Guide to Homemaking. View transparency, Sewing Machine Head.
2. Observe the teacher as she opens the sewing machine, names, locates and explains the uses of the different parts of the sewing machine.

3. Given: A sewing machine. Locate, name and explain the uses of the different parts of the machine.
4. Given: A machine needle. You will properly insert the needle in the machine. Place a sheet of notebook paper in a horizontal position under the presser foot. Set the needle down on a blue line. Read pp. 246-247, Steps in Clothing Skills. "Controlling Your Speed" and "Stitching a Straight Line" are two very important topics on these pages. Stitch a line as straight as possible on six lines of notebook paper. Compare line one with line six. Do you need more practice? If so, continue stitching on the lines of notebook paper.

Sign your name to the practice sheet; lay it on the teacher's desk, and she will evaluate your stitching.

## Lesson II

You have become acquainted with the sewing machine, but there is still more to learn before you actually construct an article on the machine. In order for you to operate the machine correctly, you must learn to thread the sewing machine, thread the bobbin, and learn to regulate sewing speed. After these tasks have been accomplished, you may enjoy creating gifts for others or items for yourself that will bring you happiness and that may even influence your choice of a career.

### Component:

Threading and operating a sewing machine

### Objectives:

- A. After studying pictures of sewing machine heads and bobbins, and after observing demonstrations of threading machines and bobbins, you will thread a machine and bobbin with 100% accuracy.
- B. You will operate a sewing machine at an even, moderate speed by practicing the correct use of the knee and/or foot to operate the controls of the machine.
- C. You will satisfactorily complete the information required to obtain a "Sewing Machine Operator's License" by performing each task for the teacher.

### Instructions:

Complete Learning Experiences 1, 2, 3 and 4.

Learning Experiences:

1. Read pp. 251-256, Steps in Clothing Skills. View transparency, Threading the Sewing Machine.
2. Obtain a manual or a direction sheet that gives you visual directions for threading a machine and bobbin. Thread the machine and bobbin. Ask the teacher to check your work. The teacher will tell you whether you are ready for the next learning experience.
3. Read again pp. 246-247, "Controlling Your Speed," Steps In Clothing Skills. Go to the machine and practice controlling your speed when operating the machine. Ask the teacher to check your progress. The teacher will tell you whether you are ready for the next learning experience.
4. Given: A blank "Sewing Machine Operator's License." Complete the instructions listed on the sheet. The teacher will evaluate you in action as you complete each task. When the teacher signs your license, you are capable of operating a sewing machine in your classroom. Happy sewing!

### Lesson III

You have arrived! This is where the action is, and the time has come for you to participate. Do you feel creative? Certainly you have prepared yourself well. Be sure that you are capable of constructing whatever you choose to construct, and that you will be happy with your production. You can outgrow your task by mastering it, and you may be surprised to find that you want to try a more difficult job. You may develop a real interest in clothing production or in interior decoration.

#### Component:

Using the sewing machine to construct an article

#### Objectives:

- A. You will construct one article by applying, to the best of your ability, the knowledge and skills you acquired when learning to operate a sewing machine.
- B. You will plan and set up a "Gift Boutique." In the "Gift Boutique" you will display the article you have constructed. You will observe the articles constructed by your classmates.

#### Instructions:

Complete Learning Experience 1. From Learning Experience 2, choose one article from A, B, C or D to construct. Complete Learning Experiences 2, 3, 4, 5, 6 and 7.

#### Learning Experiences:

1. Read pp. 158-161. Steps In Clothing Skills. Follow directions for constructing a slipcase for glasses or shades, and scissors or shears case.



2. Request from your teacher, instruction sheets that give directions for constructing the following articles:

- A. Napkins and/or place mats
- B. Christmas tree wall hanging
- C. Fish potholder
- D. Terry cloth pillow

Read the instructions. If you do not understand the instructions, ask the teacher to help you.

3. Select one of the described articles to construct. Ask the teacher for permission to proceed with the construction, after you read p. 233, Steps In Clothing Skills, or pp. 148-149, How You Look and Dress. List in writing, the equipment and materials you will need to construct the article; then read Teen Guide to Homemaking, pp. 108-109.

4. You will find pins on the teacher's desk. Ask her permission to use them to pin your pattern on your fabric. Pin the pattern on the fabric, but do not cut until the teacher checks with you and gives you permission to cut.

5. Follow directions on your instruction sheet. Set up the machine, thread the bobbin and thread the machine. Stitch according to directions. Ask the teacher for help if you do not understand the instructions.

6. Evaluate the article you constructed. Pin your name to the article and place it on the teacher's desk. The teacher will evaluate and return your article to you.

7. Set up a "Gift Boutique." You will display the article you constructed. Invite classmates, teachers and parents to view the article.

Quests:

Do you have a sewing or decorating fever? A sew-a-rama may reduce this fever. The following suggestions may help you to decide whether or not you would like to create another article and, if so, what you would like to create.

1. Tie-dyeing - (Ask the teacher for directions)
2. Terry cloth slippers - Directions may be found on p. 316, Experiences In Homemaking by Pollard, Laiten and Miller
3. Clothesline coat hanger - (Ask the teacher for directions)
4. Oatmeal box wig rack - (Ask the teacher for directions)
5. Belt coat hanger - (Ask the teacher for directions)
6. An article of your choice