

DOCUMENT RESUME

ED 103 334

SO 008 205

AUTHOR Young, Mildred; And Others
TITLE Elementary Art Guide, 1972-1973.
INSTITUTION Greenville County School District, Greenville,
S.C.
PUB DATE 73
NOTE 145p.
EDRS PRICE MF-\$0.76 HC-\$6.97 PLUS POSTAGE
DESCRIPTORS *Aesthetic Education; Art Activities; *Art Education;
Ceramics; Curriculum Guides; Elementary Education;
*Elementary School Curriculum; *Handicrafts;
Instructional Materials; Painting; Puppetry;
Sculpture; Sewing Instruction

ABSTRACT

This guide to teaching art in the elementary grades aims to develop art experiences that stimulate visual awareness, personal expression, self-evaluation, and ease in using art media. The following art experiences are covered with activities classified in order of difficulty: clay, collage, crayon, drawing, masks, mobiles, mosaics, murals, painting, paper, printmaking, puppets, stitchery, three dimensional art, and weaving. Other practical resources include tools and materials necessary for a complete art program, formulas for art media, ways to display art, a guide to basic needlework stitches, and a list of art elements and principles. The manual also introduces the teacher to the characteristics of a well-conducted art class and to ways for motivating and evaluating children's experiences with art. Other educational guides for the teacher include a categorization of developmental stages for art activities and the mechanics of an art lesson. (JH)

ED103334

ELEMENTARY ART GUIDE

1972 - 1973

BEST COPY AVAILABLE

U.S. DEPARTMENT OF HEALTH
EDUCATION & WELFARE
NATIONAL INSTITUTE OF
EDUCATION
THIS DOCUMENT HAS BEEN REPRODUCED EXACTLY AS RECEIVED FROM THE PERSON OR ORGANIZATION ORIGINATING IT. POINTS OF VIEW OR OPINIONS STATED DO NOT NECESSARILY REPRESENT THE OFFICIAL NATIONAL INSTITUTE OF EDUCATION POSITION OR POLICY.

ART

Greenville County School District

BEST COPY AVAILABLE

BOARD OF TRUSTEES

T. G. Chappellear, Chmn.

J. H. Bonds

Dr. Alex A. Chambers

Palmer Covil

T. C. Hooper

Dr. Donald G. Kilgore, Jr.

George W. Morrow

W. D. Workman, III

Melvin K. Younts

SUPT. OF SCHOOLS

Dr. J. Floyd Hall

ASST. SUPT. FOR INSTRUCTION

Gordon L. Smith

THIS ART GUIDE IS THE PROPERTY OF
GREENVILLE COUNTY SCHOOL SYSTEM

ELEMENTARY ART GUIDE

GREENVILLE COUNTY SCHOOL DISTRICT

PREFACE

No curriculum is ever complete. Space is limited. Trends change. Methods change.

This art guide points toward a unified art program. It offers general objectives and responsibilities. Ideas for conducting the art lesson intend to expand the children's experiences. Variation and innovation are encouraged.

While lessons are classified by grade level, work remains to be done toward structuring art experiences in such a way as to avoid repetition from grade to grade and insure new challenges for each competence level. K. through 12.

The material that follows is based on needs expressed in a survey of Greenville's elementary teachers. Major space has been given to those matters receiving most inquiry.

It goes without saying that the contents of this guide represent many hours of unselfish, enthusiastic work on the part of the committees listed below. To them and their tireless efforts go sincere appreciation.

Indebtedness is also acknowledged to many of the nation's leading art educators from whose learning we have distilled useful ideas.

Guide Committee: Mrs. Mildred Young, Chmn.
Miss Susan Barber
Mrs. Gladys Blackmon
Mrs. Dorothy Sullivan
Mrs. Dorothy Zeis
Mrs. Margaret Gilliam, Art Dir.

Review & Critique: Mrs. Annabell Bennett
Mrs. Kay Quinn.

Sponsored & funded by
The Curriculum Council

Contents

TABLE OF CONTENTS

	Page	Page
Preface	1	Art Experiences, continued
Contents	2	Clay
Foreword	3	Collage
Philosophy and Objectives	4	Crayon
Staff Responsibilities	5, 6	Drawing
Principal		Masks
Teachers		Mobiles
Specialist		Mosaics
Consultant		Murals
Art And The Teacher	7	Painting
The Well-Conducted Art Class		Paper
Motivation		Printmaking
Evaluation		Puppets
Appreciation		Stitchery
Correlation		Stitchery Guide
Development Stages	11	3-Dimensional Art
Contests And Competitions	12	Weaving
Art Experiences	13	Formulas
Conducting The Art Lesson	14	Display
Art Elements And Principles	14	Basic Materials
Art Activities	15	Storage And Care Of Materials
		Bibliography
		In Conclusion

00005



"Art experiences are essential to the fullest development of youth at all levels of growth, because they promote the self-realization of the whole individual by integrating the imaginative, creative, intellectual and manual capacities." - Byron W. Hansford, Commission of Education, Colorado State Department of Education, 1964.

This statement serves as a most appropriate introduction to our Elementary Art Guide. We realize that art affects everyone in his daily living. The improvement of our community has its basis in the foundations of the fine arts as well as the social environment. If we are to foster creativity in students, we must place strong emphasis upon art experiences as a continuing and vital part of the total development of the child.

The main purpose of this guide is to offer ideas for realizing a more effective art program in the schools. We encourage teachers and administrators to use it as a professional tool from which they can secure help in improving art instruction. Specific activities and procedures will need to be worked out in the local school to be consistent with community values.

J. F. Hall
Superintendent

Much time and effort have gone into the writing of this Art program. Since it is the first guide available, you will want to study it carefully. An honest effort has been made to acquaint our teachers with concepts, techniques, materials and understanding of art.

Many materials are available in your school through the principal. Others, as you study your guide, may be improvised from items often discarded. It is hoped that if you have questions as you adopt this program for your own, you will contact your principal or the director of art. Both can be of help to you!

Ben Carson
Director, Elementary Education

The purpose of this Elementary Art Guide is to enable every teacher to bring esthetic sensitivity into the life of each pupil.

The art guide is a first of its size for Greenville County and possibly for any school district in S.C. It recognizes the need to put good art into every classroom.

Art learning goes beyond being an activity. It has a responsibility for sensitizing and judgment building, for developing creativity in problem solving. It offers an atmosphere free from fear of failure since what appears to be errors can often be turned into useful innovations. Individual worth is given high priority, while sharing of ideas enhances and enriches each pupil's contribution.

Successfully implementing the art program will require maximum cooperation from the principals in providing necessary materials, and in developing professional interests on the part of the teachers.

Art has always belonged in the curriculum. We believe the Elementary Art Guide will do much to lend emphasis and support to the development of a sound elementary school art program.

Assistant Superintendent for Instruction
Gordon L. Smith

PHILOSOPHY

We believe that:

Educators have a responsibility to foster esthetic creativity as a counter-balance for dehumanizing forces.

Art is a human need.

Art expression is also a pleasing and natural communication for children.

Experience with an expanding range of art media will enhance the child's personal expression and creativity.

Growth in art ability comes through continuous use and training.

The child is directed toward a healthy leisure time pursuit when his artistic perception and skill are cultivated.

Consistent art experiences make discriminating art consumers.

Children become more actively concerned with the beauty and harmony of the environment when their esthetic sensitivities are nurtured.

OBJECTIVES

To provide two hours of weekly art experiences for every elementary pupil in Greenville County School District.

To aid the classroom teacher in the important need for developing individual creativity.

To develop through art experiences the child's abilities toward

- a. visual awareness
- b. personal expression
- c. self evaluation
- d. ease in using art media

To generate from the child's experiences an understanding of the expressions of the fine artist.

To provide for the verbally inarticulate a successful non-verbal communication.

To utilize creative art for the heightening of appeal of other subjects.

To add to the attractiveness of attending school.

To motivate pupils toward constructive, creative use of leisure time.

Eventually to affect the upward progress of our community through the contributions of mature, sensitive, imaginatively constructive human beings.

STAFF RESPONSIBILITIES

Art activity is an integral part of the elementary curriculum. At this time, two hours of each week are designated by the administration for pure (not correlated) art in the Greenville County School District.

PRINCIPAL'S RESPONSIBILITIES

- To have concern for building positive cultural activities to fill the growing leisure needs of youth
- To schedule two hours of art in the curriculum on a regular weekly basis
- To budget, at this time, approximately \$1.25 per child for art materials
- To provide adequate art materials, fairly shared and fully used by every teacher
- To confer with teachers about materials needed
- To facilitate the collection and storage of found materials, useful for art activities
- To provide a prompt means of purchasing special materials such as paper bags, wood scraps, wire screen, spray paint, balloons, etc., from local dealers. Teachers should not have to buy these.
- To dispense with display of copy work, stencils, tracing, color book products, passing as children's art
- To provide adequate display space for children's art in halls, cafeteria, library, foyer, etc.
- To encourage teachers to attend art workshops and to follow through in the classroom
- To encourage field trips, museum visits, and other enriching activities
- To appoint a key teacher to represent community art interests and communicate with other teachers in this regard

To see that communications from the art director reach the teachers, and vice versa

To realize that his own enthusiasm is reflected wherever he shows an interest

TEACHERS' RESPONSIBILITIES

- To provide two hours of art activity a week
- To care seriously about the cultural development of each individual child
- To know the physical, social and intellectual environment of the community
- To encourage a creative climate in the classroom
- To make the classroom esthetically appealing
- To plan and order far enough in advance to assure having adequate materials on hand
- To work for continuity in art growth
- To inform principal of art needs at the proper time
- To work with the art specialist when one is available
- To avoid tracing, patterns, copy work, opaque projections, stereo-typed techniques which are often passed off as art
- To hold a positive view of every child's art efforts
- To make use throughout the school of available space to display children's art
- To cooperate with those community art undertakings approved by the school administration
- To beware of art competitions and other influences exploiting the child
- To grow along with pupils, both creatively and appreciatively

STAFF RESPONSIBILITIES - Cont.

ART SPECIALISTS' RESPONSIBILITIES

- To be responsible to Art Director
- To know and support objectives of the overall program
- To evaluate progress
- To identify needs and report them to director
- To work with teachers and principal to improve the art program
- To assist, not replace, the teacher
- To keep abreast of new trends, projects and materials
- To maintain personal creativity
- To share with the teacher responsibilities for developing the creative potential and personal art expression of every child
- To aid in implementing county-wide displays, exhibitions, etc.

DIRECTOR'S RESPONSIBILITIES

- To coordinate art program
- To provide leadership in professional development and forward planning
- To clear all art related requests from civic, etc.. organizations
- To aid in implementing county-wide displays, exhibitions, etc.
- To conduct or arrange workshops for professional development
- To assist in planning art facilities for new schools
- To correlate collections of art resources; viz films, books, reproductions
- To up-date and evaluate art materials in warehouse
- To stay abreast of current trends, new literature, research and materials
- To interpret art program to administration and to community
- To maintain personal creativity
- To be on call when principal requests help
- To develop and evaluate innovations in art teaching
- To supervise art specialists
- To be responsible to Assistant Superintendent in charge of Instruction.





ART AND THE TEACHER

“For educators not to grasp the vitality, the spirituality and the intellectuality of art as central to an educated man is to ignore the measure by which our civilization will be judged.”

William Schulman

President, Lincoln Center for the Performing Arts

THE NORMAL WELL CONDUCTED ART CLASS

Will be characterized by purposeful moving about

A chatter of voices

Occasional exclamations, laughter

1. The atmosphere will be free:
 - of fear of failure
 - of anxiety
 - of demands for perfection
2. "Permissiveness" (not mayhem) implies:
 - encouragement to think originally
 - classroom order that is flexible -- not abandoned
 - experiment and exploration
 - responsibility on part of each child to be considerate of others
3. Materials and their use will be well organized as the result of pre-planning in the following sequence:
 - Plan materials needed. Obtain them.
 - Plan classroom procedures: viz. distribution, motivation, visual, aids, protecting furniture and clothing, clean-up, storage, display.
 - Set out materials for use. Make them attractive.
 - Discuss time element for project.
 - Motivate discussions related to interests and experiences by demonstrating how to use materials and by considering their proper ties.
 - by asking questions
 - by means of audio-visuals, stories, recalled experiences, imagined events.
 - by challenge to invent and discover.
 - by creating a mood (music, poetry, drama).
4. Work begins.
 - After explaining clean-up, helpers distribute materials.
 - Teacher moves constantly among pupils, remaining aware of whole class.
 - Teacher encourages, re-motivates
 - by conversational approach to draw out ideas
 - by sympathetic inquiry into problem
 - by finding a new way

For pupils who work too rapidly --

they may try again, altering the problem, or some of the materials or colors used

For pupils too slow -- more competent child helps the slow one

The teacher is alert to wasteful activities.

The teacher is alert to entire class even while helping an individual.

The teacher faces the largest part of the group at all times.

5. Follow-through includes orderly clean-up. A small committee takes up tools and materials. Others clean up at their own pace, then sit down. A wastebasket is passed around the room. Spills, etc., are noted by teacher for special attention.

6. Evaluation

Teacher looks for and appreciates diversity of handling

Teacher involves child's opinion

Teacher guides thru leading questions

Something positive is found in every child's work.

7. Displaying

Children are helpful with displaying work. Often, each piece carries a small explanation by the artist: viz. "This is my house and my daddy standing under a tree."

In the room, every piece of work is not placed on view at once. Four or five pieces, changed frequently, suffice. Every child does not display every painting, but each will have a fair share of opportunities.

Whenever this class has access to larger display space in the hall or library, either class-work on a group project, or individual work from every child is used. Choosing from several different projects offers an easier choice for quality. Each child's name is given beside his work.

8. Art activities, for their own worth, consume a minimum of 2 hours per week of a pupil's education.

Additional art may be correlated with other subjects.

Art may be carried on by the whole class, in groups, or individually.

MOTIVATION

Motivation is simply winning a child's interest and enthusiasm to the point of action and sustaining him until he has finished.

While motivation is necessary to all subjects, it finds no more spontaneous reception than in art. It can originate from any of the following.

- walks to appreciate nature
- field trips to the zoo, park, museum, farm, mountains, lake, public building, architectural specimens
- movies, filmstrips, film loops, slides, etc.
- music, rhythms, games
- stories to which the child can relate
- pets, toys
- "dressing-up"
- visits from interesting (and interested) people
- ETV and television
- collections and hobbies
- current events of note
- the child's own experiences

For artistic purposes motivation acquires momentum through appeal to

- | | | |
|---------------|---------------|--------------|
| novelty | discovering | helping |
| curiosity | inventing | imagining |
| exploring | enjoying | manipulating |
| experimenting | communicating | |

EVALUATION

Traditionally, evaluation takes place at the completion of an art project. The purpose is to broaden understanding and perceptiveness, and to appreciate variety in art expression. (This is also a good time to evaluate the teaching).

As much as possible, avoid picking out "the best one." Children will volunteer their preferences. Let them explain why. Lead them by informal questioning to seek other good qualities not observed. (Reference to the section on Design Elements and Principles will help the teacher here).

Ways to present work for evaluation

1. Let each child show his own work and explain it.
2. Put up all the work for viewing and let pupils, grades 3-5-6, tell what they like about various pieces. These should be spontaneous responses not required of every child.
3. If some unique treatment shows up, let child explain how he did it. Even happy accidents are a source of learning.
4. Point out something good on every piece, even if it is only the fact that the pupil spent much effort. Appreciate and encourage him.
5. Display children's work in the room and the school so that they develop a sense of worth about their artistic efforts. This is why commercial art, patterns, and adult art should be minimized. What the teacher displays tells what the teacher values. It also implies what she considers unworthy.
6. Treat children's art with respect when storing and handling it. Careless piles of messy art work demean the child's efforts.
7. When displaying, be sure the child's name is visible. A brief written or typewritten explanation, (his), attached alongside or below the work heightens its appeal to viewers.
8. Never allow the manner of evaluating to stifle a child's enthusiasm for art output. This is how talent gets inhibited. Be super-sensitive on this point. Remember the value in evaluate.

Research is indicating that decisions the child makes while creating are the most important phase of evaluation. Educators suggest that encouraging a child to pause in the early stages of his art activity to review his own objectives is good. Letting the pupil discuss what he plans for his project helps him clarify and enrich his own ideas.

APPRECIATION

The appreciation of art includes, but reaches beyond understanding paintings and sculpture.

The presence or lack of esthetic properties in our television programs, films, furnishings, clothing, environment, etc., is our direct concern. Ability to criticize, select and even design discriminately in these areas becomes more and more needful.

Therefore, children's perceptions need not only to be directed toward the achievements of by-gone masters, but also need to be whetted toward what is inspiring in today's artifacts and surroundings. Nature's assets also deserve greater appreciation.

Field trips, collections, museum visits, finely illustrated texts, dramatic presentations, music, rhythms, direct experiences, can all be controlled to heighten esthetic perception. For personal growth, the teacher needs a chance to enjoy these, too.

The presence of fine art reproductions in the classroom can develop the child's affinity for his cultural heritage, as well as to implant artistic concepts. In purposeful viewings of paintings, etc., the teacher may lead pupils into discussions of the story, mood, costume, action, personal reaction. If there is obvious use of a design element or elements, these may be called to their attention. Line, shapes, color, value, texture, shading, distance or space apply. Do not strain to detect elements not too apparent. This can become confusing.

Resources for art appreciation

Local artists	Special window displays	Beauty spots in classroom
Art exhibits	Experiences with art media	Films and film loops, slides
Architectural landmarks	Cooperative efforts in decoration	Art magazines and books
Landscaping landmarks		Art reproductions

CORRELATION

Because art communicates visually, it has immense value for synthesizing and clarifying learnings in other areas. It strengthens associations and leads to new concepts.

Art is the child's statement about what he has learned and what is significant to him. Usually, if the teacher encourages him to tell about his "artistic" rendering she will gain insights rarely touched by tests.

Don't ask him to write *about* his art work. His art work is his calligraphy.

Using art to interpret cognitive learnings does not mean copying pictures from books. It does not mean using the opaque projector. It does not mean drawing charts and maps. These require faithful duplication. They can be attractive, but they give no clue to the child's mental images.

Encourage the pupil to employ art media for expressing his ideas about his other studies. As a matter of economy, the teacher and pupils may have to reach an agreement about the media used. But the art expression should not be dictated. It should be *his*.

Art projects are grouped in this book under types of media, so that the teacher may become familiar with some of the many possibilities inherent in each material. Ideas can then be provided to spark pupils' imaginations.

For the sake of sharing ideas, pupils may also elect to work in groups. Types of cooperative projects from which to choose include

Banners	Mosaics
Murals	Mobikes
Collages	Book jackets
Composite stitchery panels	Costumes
Comic strip sequences	Illustrations of events
Papier Mache' figures	Model cities, villages
Masks	Dramatizations
Totems	Puppet plays
Posters (original)	Shadow plays
Ceramic modeling	"Environments"

For examples of these and many more, refer to magazines such as *Arts and Activities* and *School Arts*.

DEVELOPMENT STAGES

Developmental stages cannot be arbitrarily isolated. They merge one into the other, at different rates and at different ages.

The following phases do not fall neatly within each grouping, but serve as a progression index. For more complete data, see Lowentfeld. (Bibliog)

K-2 MANIPULATIVE CHARACTERISTICS

scribbles - random to controlled, to "names";
geometric shapes
short attention span
intuitive design and unity
activity centered in large muscles
enjoys handling of manipulative materials
gradual progress from drawing one person to including two

SUGGESTIONS

Materials
paste, magic markers, scissors
wood scraps
glue
Manila paper
big brushes, large paper
big soft crayons
soft clay
finger paint
non-drip tempera
natural objects (shells, plants, etc.)

Guidance

encourage — appreciate
build experiences with animals, people, surroundings
provide activities for bodily movement
tie in pantomime and rhythmical music
discuss where, when, what, how
never disparage child's efforts
share drawings with adults who understand child art
teacher mixes paint

DESIRABLE OUTCOMES

Ability to:
tear paper forms
fold paper
cut paper
paste
use large crayons and paper
use tempera paint
use finger paint
make seasonal projects
model simple clay shapes
learn repeat patterns
work together
enjoy pictures of children and animals
enjoy beauty in nature and common objects

PRIMARY — THROUGH 3RD

select, choose, arrange
perceive color (primary, secondary and intermediate colors)
use decorative design (flat)
use crayon, chalk, tempera, water color
use finger paint, (not expertly)
model in clay
create rhythmic effect
create repeat patterns
create 3-D things from paper, cardboard, found objects
weave simple things - in paper, oil, cloth
work with heavy yarns on cardboard loom
work neatly
draw crude figures

3-4 SCHEMATIC PHASE

geometric forms turn into set figure representations
size indicates importance
earth is a base line
sky is a top line
radial sun is often used
interior-exterior view
sequence of events in one picture
figures perpendicular to tables, walks, etc.
jointed bodies appear
finer muscular control
intuitive design sense still evident

SUGGESTIONS

materials
same tools, plus round brushes #6 - #12
wider color range in tempera, chalk, charcoal, yarns
assorted colors of construction paper
simple 3-D materials
quick-drying glue
activities
use play that dramatizes action such as walking, running, jumping
simple experiences in stitching thru wide mesh
bold simple weaving
box constructions with glue
simple sawing and hammering
drawing and painting
guidance
avoid emphasis on realism
help child to relate to other people, things
always appreciate efforts
teacher does color mixing
build contacts with beautiful things

DESIRABLE OUTCOMES

4th — ability to:
recognize dark and light colors, shades and tints
recognize pleasing color combinations
perceive color and beauty in objects
perceive patterns, proportions, space
express seasonal changes in pictures
apply positive self-criticism
grow in awareness of shapes and forms
improve proportions
represent near and far objects
represent action
control lettering, arranging, marginal spacing
effect realism in modeling

DEVELOPMENTAL STAGES

5-6 PRE-ADOLESCENT PHASE

becomes self-critical
more cautious
sex interests diverge
pictures more complete
backgrounds get more attention
sky meets ground
drawings strive for realism
colors include tints and shades
development of overlap and softened color to represent
depth, light, shade, texture
some understanding of linear perspective

SUGGESTIONS

materials
include smaller brushes
white construction paper, drawing paper, colored tissues
watercolor, colored inks
3-D materials
quick drying glue
yarns, wire
broad range of creative materials

activities
children mix paints
dramatizations, dance, and music for emotional release
viewing films on nature, adventure, other countries
figure drawing, landscape
not too much still life
opportunities to do abstract design

guidance
help the child to feel that success comes
thru trial and error
encourage
recognize his desire to conform
familiarize with neighboring colors (analogous), warm
and cool colors, through use, not memorization
avoid formal teaching of linear perspective
devise opportunities for abstract design

DESIRABLE OUTCOMES

5th
cooperation with group and individual
interest in dress, costume, uniforms
feeling for decorative design
attempt to evaluate own and other's work objectively
desire to construct and draw realistically
originality in design
action and texture in modeling
group pride in room, display bulletin-board
group management of art procedures

6th
greater confidence in art ability
knowledge of color terms primary, secondary, intermediate, warm and cool, tints and shades,
contrast
feelings for balance, proportion, rhythm, alternation,
dominance, unity
use of lettering pens
knowledge of variety of alphabets
fair control of cutting tools
fair ability in poster design
improved manual control
realistic-minded children use more correct proportion,
detail and depth

CONTESTS AND COMPETITIONS

To value the uniqueness and personal quality of every individual art expression is an important goal of art education.

Art contests and competitions counteract this purpose.

Commercial firms and organizations know that parents and teachers are dazzled by offers of prestige and recognition. Not perceiving the vulnerable emotions of children, their glowing promotions build toward a tremendous disappointment for all but one or two.

For the non-winning majority of pupils, high hopes are dashed. They are led to look upon themselves as rejected.

Meanwhile, the winner is misled into a false impression of his talent. After the prizes, publicity and acclaim, he tends to imitate his first success, rather than give his abilities free rein. Failing to win the next contest becomes, for him, an exercise in frustration.

Because children are not emotionally ready for the vagaries of adult judges, or for the blow to their hopeful anticipations, the school administration firmly discourages contests for those of tender years.

ART EXPERIENCES

“The young child, no less than the mature artist states, ‘This is what I know and understand; this is the meaning I find in my life.’”

Ernest Zeigfield

CONDUCTING THE ART LESSON

Discussion proceeds the art activity. It should involve the thinking of the pupils and the expressing of their ideas. Talking to them is not the same thing.

Their sharing of ideas fertilizes new concepts and sparks an urge to give expression to them.

Interest must occasionally be renewed as the young artist meets difficult passage in his work. He can be helped by one or more of the following: questions to clarify his idea

suggestion for a different approach

getting him away from his immediate problem by diverting attention to some other phase.

letting him talk it over with his neighbor

helping him over a technical difficulty. (If you show how, do it on something else, not his work, then remove your work from sight).

moving his seat temporarily to a spot beside a capable and helpful child letting him go see what some of the others are doing

finding out if he understands directions

determining whether he has had previous experiences needed for the project

giving him a chance (not too soon) to start over

finding something good in his work and complimenting it

praising his efforts, and assuring him his way of doing something might invent a new technique or style

encouraging "difference": it may not make sense yet, but given time and faith, it may

If the teacher cannot help a child, and neither can anyone else, let him try a different medium — if he can't do a painting, give him toothpicks and glue and see if he can say anything this way. Let him try clay, torn paper design, etc., or let him go to a quiet spot and review the motivational filmstrips, film loops, slides, or other simple visuals employed.

ART ELEMENTS AND PRINCIPLES

While the teacher does not use a formal approach in teaching design, it is useful to know the elements and principles of design. It will then be possible to recognize and draw attention to their successful use when they appear in children's work. Beauty results from a limited, harmonious choice of elements.

Some projects are purposely devised for developing design consciousness, but undue emphasis is not to be used in evaluation.

Design elements

Line

Kinds of lines — straight, angular, curved, broken, thick, thin, sweeping, shaded, etc.

Effects of lines — vertical — suggests upward or downward movement
horizontal — restfulness
diagonal — energy
circular — fluid motion
jagged — roughness, activity
fine — delicacy
heavy — boldness

Shapes

Large, small: regular, irregular; voluminous, narrow; geometric, free-forms; solid, open

Texture

Tactile appearance — fuzzy, sharp, prickly, rovy, woven, mossy, sandy, rippled, etc.

Color

Neighboring colors, opposite (warm or cool) colors, gradation, mixing, intense or subdued

Value

Varying lightness or darkness of color
Tints and shades

Space

Areas found between and around objects (positive-negative)
Illusion of depth (perspective). Achieved by overlapping, diminishing size, relative position in picture, bright colors in foreground and subdued colors in background.

Design principles

Balance

Affect the use of design elements.
An over all visual sense of stability
The items in the picture are not all on one side.
The shapes balance each other in apparent weight (not form).

Use of dark color is relieved by a little light color and vice versa.
Smooth areas break monotony of highly textured ones.

Positive areas include some negative space.

"The youngsters in our classes are entitled to the most, not the least we can give them."

Frank Wachowiak

"Children are born wanting to experiment with the strange and therefore exciting substances of this world"

Margaret Greenbery

Opposition	Using strong lights and darks Using opposing colors (warm vs cool) Using large versus small Using highly textured versus smooth, etc.
Emphasis	Making something become the center of attention. This can be done by placement, by comparative size, by color impact, by highlighting, by shading for form, by greater attention to details.
Subordination	Assisting emphasis by playing down other parts of composition thru subdued color, diminished size, flattened surface, finer texture, minimum detail, etc.
Repetition	Repeating design elements, to create pattern.
Rhythm	Using repeats to create a harmonious feeling of movement.
Transition	Making a directional effect which leads the eye easily around through the composition.
Variety	Finding and inventing different ways of repeating given design elements to avoid monotony.

ART ACTIVITIES

No art activity described hereafter is offered as a rigid procedure.

Diversity in the way students handle their art efforts is an indication of creative thinking and involvement. Encourage it. There really is no "right way."

Art activities have been classified in order of difficulty.

K - 2 = Kindergarten through second grade

3 - 4 = Third grade through fourth grade

5 - 6 = Fifth grade through sixth grade

Projects listed on lower levels can be useful to higher levels if the pupils are going to explore media and techniques for new possibilities and improved skills.

It is advisable for the teacher to try out a project before giving it to the class. It will refresh the teacher's outlook, and help determine if it suits the pupils' capabilities. Do not feel that having done a project once, it should not be tried again. Look for new and better effects; try for improved skills; apply new interpretations.

No activity should be begun without sufficient materials on hand or without sufficient motivation. (See Motivation). It should also include an evaluation. (See Evaluation).

Copy work, stencils, color books, opaque projectors, do not belong in the art program.

NOTES

CLAY

“The youngsters in our classes are entitled to the most, not the least we can give them.”

Frank Wachowiak
Emphasis Art

CLAY

- General Objectives: To experience control of a malleable substance.
 To work with a material closely derived from the earth.
 To encounter the chemical effect of heat on clay and glazes.
 To discover the numerous creative possibilities of ceramics.

GENERAL INSTRUCTIONS FOR USING CLAY & GLAZES

In teaching clay work to primary children, give them only the barest essentials for handling their material. Avoid telling what the product should look like. For instance, tell them *how* to join, but not *where*.

With intermediate children, broadening the possibilities of what can be done is important, but again, avoid directing the kind, shape and exact decoration of the final product.

It is assumed of course, that the usual procedure of making plans for the projects will already have been made.

Surface for working:

Clay will lift easily from newspaper (unless soaked), also from wood and from plaster.

To work with clay, the minimum tools are:

- popsicle sticks for fashioning
- sponge for moistening
- a board for support
- bowl for water
- plastic bag for keeping moist

Other useful tools are:

- vegetable knife
- rolling pin
- paddle
- brush
- sculpting tool
- burlap

Care must be taken to:

- maintain even texture — no lumps
- have the right consistency of moisture
- avoid air holes
- avoid thin spots
- have no thin projecting edges or points
- join clay parts thoroughly
- dry finished piece thoroughly

No piece of clay work should be over an inch thick. Hollow out thick objects. Do not try to mend dry clay forms. Clay will mend if still *moist* by scoring broken surfaces and applying slip (gooey consistency) to them and then sticking together. Let stand. Wipe off excess.

PREPARATIONS FOR ALL CLAY WORK

These directions will not be repeated with each project. It is understood they are automatically a part of all preparations.

Spread newspaper over table.

Provide small amount of water.

ROLLING A SLAB

To roll slabs of clay evenly, use a rolling pin and two strips of wood, placing the clay between the strips. These keep the rolling pin at an even pressure. Blisters appearing in rolled slabs indicate enclosed air. Prick them and smooth out. Too many of these mean the clay needs reworking.

JOINING CLAY PIECES:

Be sure clay is firm, but not dry.

Score the sides to come in contact.

Wet the scored areas.

Apply a coat of slip (mushy clay).

Let stand for a few moments.

Press together.

Join with wooden tool.

Fill in tool impressions with more clay.

For little folks, scoring, then pressing clay pieces together and working edges into each other will usually do.

No piece to be fired should be over one inch thick.

Sculpture should be hollowed out as much as possible.

OTHER TIPS

Never apply excessive or sudden pressure to clay. Easy does it.

Cracks in clay mean one of two things — too dry or too much pressure. Usually the first.

Too much water on clay forms makes them go limp.

Let clay on clothing dry without touching. It will then brush out easily.

Green ware = dry unfired pieces

Bisque ware = fired without glaze

Glazed ware = fired a second time, decorated with glaze

Bisque-wax = a commercial wax finish to be used on bisque ware. Will not waterproof the piece, but gives beautiful finish. Can be antiqued easily with a second color bisque wax. Available at hobby shop.

DRYING

When piece is finished, leave in plastic covering, but do not cover so securely that air may not seep in. It must dry slowly.

After piece begins to reach leather hardness, lift plastic cover so that it covers object lightly.

When the color of the clay becomes lighter, expose to open air.

Set on a rack if possible to insure even drying.

When clay is no longer cool to the cheek, it is dry.

It is also very brittle and must be handled carefully.

It is now called greenware.

Do not attempt to dry clay over a radiator or heater. Weak places dry faster and pull away from heavier ones causing cracks.

Provide a popsicle stick for reaching difficult places. Give each child a wooden board to work on. Also a plastic bag and string for tightly covering unfinished work.

Place a sponge for every two pupils.

Have wet towels handy for cleaning hands. (Saves many trips to the sink). Keep a fruit knife on hand for cutting out pieces.

Plan using helpers to distribute materials and clean up. Rotate this job.

CONSTRUCTION METHODS

SLAB

Roll a flattened ball of clay with rolling pin. Determine thickness desired. Usually $\frac{1}{4}$ " is minimum. For constructing a small box, use paper pattern and cut clay out with knife. Fold up sides of box, press corners together and reinforce with small pieces of coil.

For larger constructions roll out and cut a base and sides. Score edges of base and slab where they will join. Moisten slightly and press together. Follow immediately with reinforcing coil, which is used to fill seam. Smooth this into base and side. Repeat for each side. Join sides in same way base was joined.

PINCH METHOD

A ball of clay is gradually pressed between the fingers into desired shape. For a hollow object, begin by slowly working thumb into ball and then pressing outward toward fingers, rotating the clay ball as you work.

For animals, lumps are pinched up from the central ball and are fashioned into head, legs, tail, arms, etc.

COIL METHOD

A lump of clay is shaped roughly into a thick roll. Then laying it on a wooden board, or on newspaper it is rolled back and forth under the flattened palm of the hand. Pressure must be kept even, and the clay must be soft, but not sticky. Usually a slab base is cut and coils are built upward from this, laying coils in place in a circular manner.

Whenever a coil gives out, pinch the end into a wedge shape and do the same with the end of the new coil. Overlap them and continue.

The coils must be joined together as you build. There are several ways. One is to press the clay of the upper coil into the lower and vice versa. Another is to roll very thin coils and press them firmly into the grooves between the large coils. The third is to pinch off soft clay and smooth it into the inside until no coils show. The same may be done to the outside.

CARVING

A large block of clay is carved to desired dimensions and shape on the outside, and then hollowed out inside.

ROLLING A COIL

See that clay is of even consistency, that it is not sticky, but very pliable. This is of utmost importance. The minute the clay gets too firm, it flattens from rolling. Keep your hand level, and your pressure even, without extra push at the end of strokes.

Do not try to make coils too long; they tend to break.

Be sure the surface you're working on is smooth.

If you are working on newspaper, keep shifting to a dry spot.

BISQUE — FIRING

Set the kiln-sitter with cone 05.

Greenware can be stacked in the kiln, one piece inside the other if care and judgment are used. Do not let greenware touch sides of kiln.

Raise the temperature slowly.

Leave kiln top slightly raised while on LOW.

Close kiln top on MEDIUM.

Insert plugs on HIGH.

Firing will be completed when lever on kiln sitter drops, cutting off electric current.

Do not open kiln.

Allow kiln to become barely warm before opening.

Using clean gloves, paper, or cloth, lift pieces out.

They are now known as bisque ware.

Do not handle bisque ware with the bare hands. Oily spots cause glaze to crawl.

GLAZING

Dust bisque piece inside and out with dry, clean brush.

A barely damp, wrung-out sponge will remove remaining dust.

Set bisque ware on a piece of cardboard.

Check glaze for a whipping cream thickness.

For pottery you usually do the inside first.

If the neck is too small for painting, pour the glaze into it, rotate the piece, and pour out. The excess is still usable.

To apply glaze with brush, dip into glaze, and flow onto the piece. Never brush thinly, except to reduce little ridges.

Brushing glaze on ceramic ware is usually done in three coats, unless the ware is damp. This sometimes requires four.

Alternate the direction of the strokes, being sure to let each coat get dry. Only one coat on the bottom.

GLAZE — FIRING

Set the kiln sitter with 05 or 06 cones for most glazes.

Place each glazed piece at least one inch away from any other and one inch away from the kiln wall.

Each piece must be set on a stilt.

Firing can go faster with glazes. One hour per heat level should be adequate. Follow the same venting procedures given for bisque.

Never take glazed ware out of the kiln until it is practically cold. The glazes often acquire fine cracks if cooled too fast.

If you find thin places in the glazes, don't give up, you can add more glaze and fire again.

One word of warning. The chemicals of some glazes react unexpectedly on others. You never know what you are going to get, and there will be variations under the most controlled conditions.

Never fire reds or oranges near greens. Reds burn out in many cases if fired over cone 09, and it is safest to fire them separately.

CLAY

PROJECTS MADE FROM COILS

Pot — Begin with a slab base, and attach coil. Build coil on coil, setting each coil slightly out from mid-line of coil below. This increases volume. Reverse by putting coils slightly inside mid-line to decrease the interior. Follow general directions for joining. Many different shapes can be made.

Bowl — (Can be made by above method). For a more decorative effect, get a large mixing bowl and cover smoothly inside with damp newspaper strips. Coils can be begun in bottom and added one over the other for several inches. Then, the pupil may begin making designs with the coils and inserting them in a ring above the last coil. Be sure no open spaces are left. Add a coil or two above the designs and repeat with design band of different width. Continue to rim of bowl. Pinch off soft clay and fill in over the whole interior bit by bit until all small crevices are filled. Let the bowl become firm before removing. Fire. Glaze may be applied to interior only.

Decorations: Coils can be rolled to almost any thickness. Very thin ones, can be used to create cord-like designs on surface.

Finger-thick coils can be laid on surfaces to enrich the textural effect.

Coils sliced into regular-sized pieces can be applied as beading on surfaces.

Large, thick coils (2") can be cut into equal lengths to form salt and peppers, which must be shaped into desired form, cut in half, hollowed out, rejoined and perforated suitably at either end.

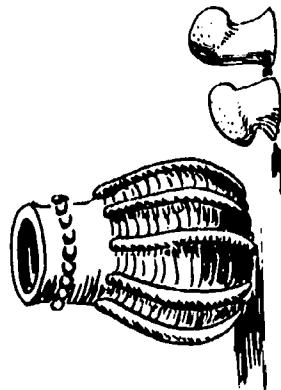
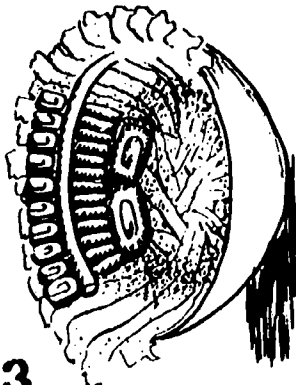
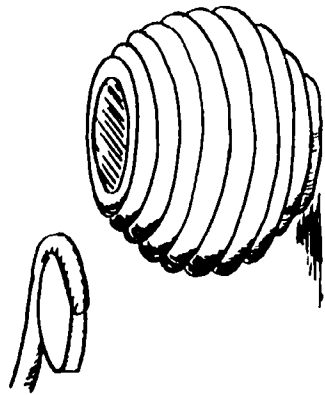

PROJECTS FROM PINCH METHOD

Bowl — Roll clay into ball. Begin pressing thumb into center. Work *gradually* down to 3" approx. from bottom. Apply pressure between thumb inside and fingers outside, rotating and pressing, working the clay gradually thinner. Occasionally jog the bottom lightly on the table to keep it flat. Be careful to avoid thin spots inside created by uneven pressure. Smaller children should not work too thin. When bowl reaches a thickness suitable to its size, adjust shape and trim rim even with knife. Press textures carefully into outer surface.

Planter — Roll clay into a large roll 3" in diameter. Jog to flatten on one side. Press fingers into middle top of roll, and begin forming a groove. Turn piece around and work from other side. When 3/4" from bottom is reached, begin pressing sides between thumb and forefinger. Turn and continue till the clay has the appearance of a hollow log. Smooth inside and use comb to texture lengthwise on outside.

Carved vase — Follow pinch bowl instructions but keep sides fairly thick. Be sure they are even. Use a hairpin or improvised wire loop and scoop out designs on the outside. Cut 2/3 into thickness. Keep the design large and bold. After firing, glaze carving one color and outer surface another. Match color inside to carving.

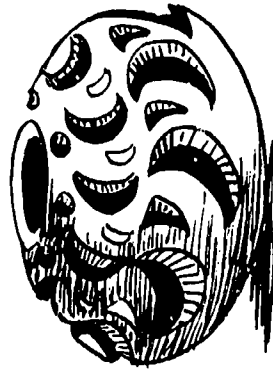
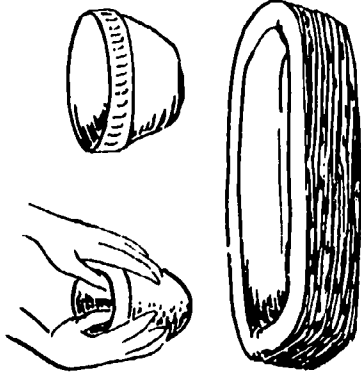

PROJECTS MADE FROM CLAY SLABS

Preplanning

Objectives

To grasp the versatility of flattened clay pieces
To make use of many decorative possibilities.

Materials

In addition to general suggestions add saran wrap, tools for impressing, knives for cutting.

Preparation

See general instructions

PROCEDURE

After rolling out clay, shapes may be cut with the rim of a coffee can or other container, or they may be cut by drawing a paper pattern and tracing it onto the clay. Clay edges should then be smoothed to reduce sharpness. Take found objects such as shells, buttons, tongue depressors, scissor, etc. and try pressing textured effects on scrap clay. Then create textures in design pattern, on the cut-out piece. Fine coils can also be used. Some interesting possibilities for this technique are:

Birds: roll rather thin slab. Cut, decorate and punch two holes for hanging. Birds can later be assembled on a burlap background or as tree ornaments.

Tiles: Roll clay $3/8$ " thick. Cut in squares. Decorate each square with impressed designs, scratch design, built up designs, carved designs. Tiles after firing and glazing can be assembled into a mural. If this is the objective, select a common idea or theme.

Mobiles: Using other shapes follow the directions for birds and assemble into a mobile.

Trivets: $1/4$ " to $3/8$ " thick. Cut desired shape. Create an attractive incised design. Lift cut out pieces. Texture surface of trivet. Allow to stand until the clay does not tend to give readily. (1 hr.) Roll a coil, cut 3 or 4 equal lengths ($1/2$ " approx.) and join to underside of trivet for feet. Place several small wads of clay under middle areas of trivet to hold it level until it hardens.

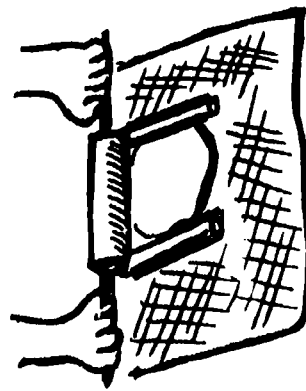

00024

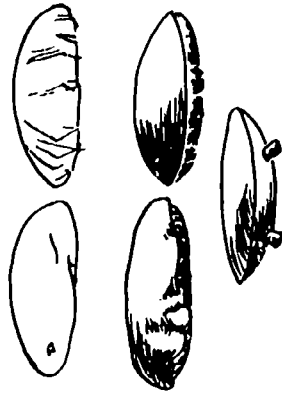
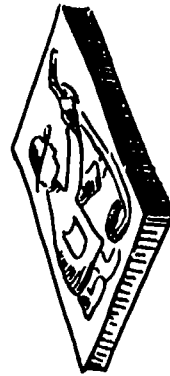

Drape mold (ash tray)

Use a large Idaho potato with even contours or the underside of an acorn squash, well shaped grapefruit or bowl. Cover this with Saran. Lay clay slab over it and press gently to fit contour. Allow to become firm but not hard. Trim edges to even them, remove from form and smooth inside with tongue depressor. Add carved or scratched design. Fasten legs, or carefully flatten bottom so that it will stand.

Variation

Lay rubber bands in a design when rolling slab for tray. Rolling pin will impress rubber bands. Drape and shape this over form. When you remove from the form, pull rubber bands away. After firing to bisque ware, glaze in several colors, fitting to rubber band design. Fire once, glaze into grooves with dark color, wipe away ragged edges of dark glaze and refire.

Cityscape: Each child rolls out a slab of clay and draws a house or building on it. Then cut it out, add textures for roof, bricks, windows, blinds, architectural trim.

Note: Use a hairpin or wire loop to cross hatch $1/8$ " deep on back of each piece. This helps prevent warping. Fire, glaze in variety of colors, refire, and assemble on a long plywood panel stained with brown or tan shoe polish.

Medallions: Circular, oval, triangular, etc. shapes can be cut from thin slabs of clay. Decorate by piercing, impressing and/or adding clay. Be sure to make two holes at top for hanging on chain or cord. Glaze.

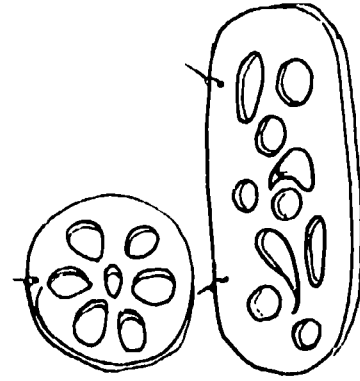
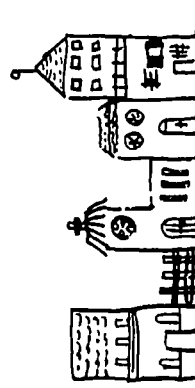

Other projects: planters, vases, plaques

CLAY

CLAY ANIMALS OR PEOPLE

Preplanning

Objectives

- to create figures with action
- to avoid joining most of the appendage

Materials and Preparation

already explained

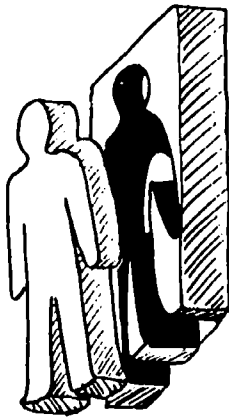
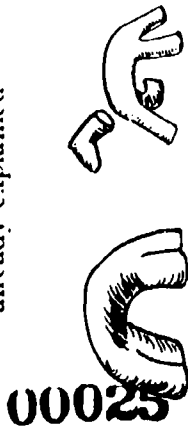

Procedure

Roll a large thick coil. Use knife and split at either end. Bend into u-shape and spread split ends. Stand ends on table. Roll a smaller ball and pinch into general shape of neck and head. Score, moisten and join to one "corner" of the inverted u shape. From this point the pupils' powers of observation and imagination should be left to complete the job. A comment here and there about the appearance of a particular animal will aid the young. Sculptors ask what each animal is "doing" to suggest postures showing action.

Alternate procedure

Form a very thick slab of clay. Flatten sides a bit. Draw animal shape on the clay and then cut it out around outline. The form then needs only to be refined.

Second Alternate Procedure

Use a ball of clay and squeeze appendages from it very much as if milking a cow. These can be shortened later, or compressed, or thinned according to need. Be sure to make them ample at the start. Form legs, head, etc. and adjust to proper relationship with remainder of clay which becomes the body. This method has no joining problems.

Evaluate

Note: Clay tiles make an effective display when assembled and glued to a masonite backing for hanging.

Preplanning

Objectives

To create modeling medium from household materials

To work with a "clay" which requires minimum skills.

Materials

salt, flour food coloring, shellack brush, solox, newspaper

Preparation

Prepare salt and flour mix.

- 2 cups salt
- 3 cups flour
- 1½ cups water

Make a smooth paste with the flour and water. Put the salt over a low flame until it snaps and crackles stirring constantly.

Stir salt into flour-paste.

Knead until smooth. Pack in a covered jar to keep moist. Color may be added after modeling by brushing on, or it can be added to portions during kneading.

Procedure

Spread newspaper. Shape clay with fingers into desired form. Can be dried in slow oven, or air dried. Turn for even drying. Paint. Shellac with white shellac, or spray with clear varnish. Miniature fruits, flowers on wire stems, beads, figurines, candle holders, plaques, puppet heads, animals, contour maps, small buildings, etc. are some of the many articles possible in this medium.

Evaluate

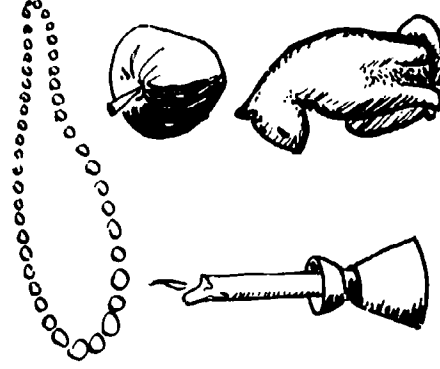

COLLAGE

“Creative expression gives to every child the opportunity to choose the ideas or subject matter for his art that are most meaningful to him.”

**Blanche Jefferson
Asst. Professor of Education
University of Pittsburgh**

COLLAGE

The word collage comes from the French word *coller*, which means to paste. However, the term has expanded to include most 2-d works put together with glued items, and some 3-d pieces if not too much "in the round." Montage, decollage, and assemblages are variations of collage.

General Objectives

To learn to combine overlap, group, discriminate in the choice of shapes, colors, lines, and textures for pleasing composition.

WOOD ASSEMBLAGE K-2, 3-4, 5-6

Preplanning

Objectives

To appreciate wood-grain, weight and shape.
To enjoy possibilities of sculptural form.

Material

Glue; heavy cardboards; celotex; masonite or boards; wood scraps; turnings.

Preparation

Visit a cabinet maker, lumber dealer, or pulp-wood plant and collect scraps. Sometimes pupils can bring scraps. Remove unwieldy pieces and put the remainder into low-cut cardboard cartons from which pupils can help themselves. Have collection complete before starting project.

Motivate

Procedure

Distribute the boards which are to serve as background support. Let pupils select several pieces of wood each. Pupils will then be asked to examine shapes of pieces, try different arrangements with them until satisfied with the most pleasing design, showing variation in color, weight and grain. Have them glue pieces into position. Assemblages can be sanded and shellacked, if they merit it.

Evaluate

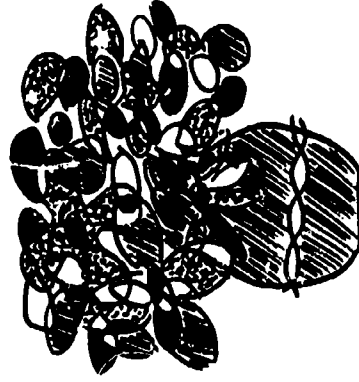

TISSUE COLLAGE 3-4

Preplanning

Objectives

to teach warm and cool colors
to sensitize pupil to transparent overlay

Materials

assorted colored tissue, white glue plus 1-3 H₂O, containers for same, large brushes, sheets of glass or waxed paper, newspaper to cover tables, scissors

Preparation

Set up a still life of objects in a variety of shapes, spread tissues on a nearby table. Put glue in milk cartons, one for each two children. One brush each. Let two or three pupils at a time select one large tissue sheet. Put smaller pieces torn tissue on each table.

Motivate

Procedure

Pupils are encouraged to select a large shape from the still life and cut or tear it from the big sheet. Other and smaller shapes can come from the torn pieces. Encourage them to use small pieces in the open spaces. Overlay large pieces on smaller color bits.

Variation

Caution about tendency of some tissues to bleed. Suggest that pupils do not brush over tissue excessively. Use 3 or 4 layers of tissue. Tear or cut geometric shapes. Vary the sizes. Vary the colors. Arrange shapes on paper, overlapping and forming interesting spaces between the colors. Glue each piece in succession by brushing glue on background, and laying tissue into glue. Brush glue over tissue lightly. Work for an effective over all design.

Evaluate

TEXTURE COLLAGE 3-4

Preplanning

Objectives

To become aware of texture in cloth.
To create with textiles.

Materials

cloth scraps; white glue (1, 3 glue to 2/3 H₂O); cardboard sheet (shirt board); scissors; large brushes

Preparation

Prepare several low boxes of different textured fabric scraps. Have helpers distribute cardboard, glue, scissors and brushes.

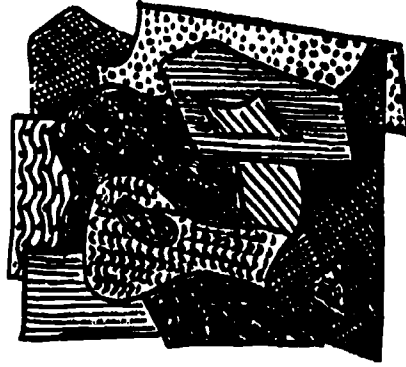

Procedure

Blindfold pupils and let them feel different textures of fabrics. Remove blindfold and let them select pieces for collage. Cut cloth into various shapes and sizes. Arrange cloth shapes into a pleasing design on cardboard. Glue one piece at a time until all are secure. Cover entire cardboard. Overlaps can be effective.

Variation

Yarn, braid, trim, buttons, etc., can be glued over cloth to add variety and texture.

Evaluate

COLLAGE

TISSUE AND CORD 3-4

Preplanning

Objectives

- To create a design with string and tissue
- To grasp the useful resistance of waxpaper to glue
- To enjoy transparency of tissue

Materials

Wax-paper, pencil, newsprint or butcher paper, white glue, string, colored tissue, scissors, paper cups

Preparation

Cut cord lengths. Tear wax paper lengths and pin each to a sheet of newsprint. Dilute white glue and place in paper cups. Have pupil helpers distribute materials.

Motivate

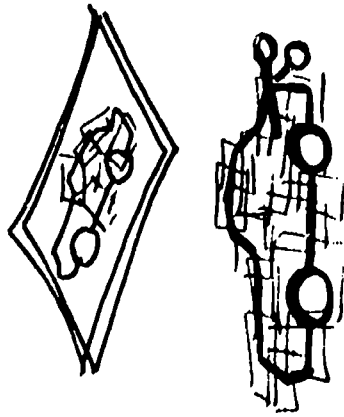

Procedure

Discuss simple shapes pupils can easily cut. Ask about shapes of moon, roof top, television, car; use associated shapes. After distributing materials, have pupils draw shapes on newsprint. Then pull wax sheet over drawing and trace shapes with glue. Lay string over same lines. Then apply colored tissues over the string. In some instances the tissue may be cut in shapes similar to the string designs and laid over them. Brush all tissue with glue. Cover wax sheet completely. Let dry. Then lift off wax paper. Trim edges, frame with construction paper and put against foil background or glass.

Evaluate

RELIEF OR RAISED COLLAGE 5-6

Preplanning

Objectives

- To obtain depth.
- To create 3-dimensional forms.

Materials

Have pupils get own materials from an easily accessible location. scissors, construction paper, paste, masking tape, background cardboard

Preparation

Discuss and show forms commonly found in nature such as leaves, pods, cones, shells. Demonstrate scoring.

Motivate

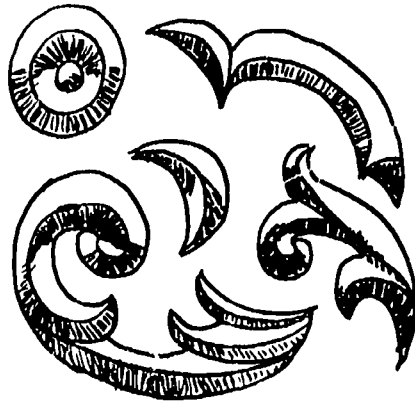

Procedure

For paper shapes, draw outline on construction paper, and cut out. Score the paper where it should be raised by holding down with one hand and using the blunt end of the scissors to form a crease. Bend along scored line to create a raised effect. Attach in a planned arrangement to background by using rolled tape (in loops) on underside. Paste where there is sufficient contact.

Variation

Other depth effects can be made by using egg cartons, small boxes, bottle caps, nutshells, rings cut from towel tubes, macaroni, etc. Finished arrangements can be sprayed white or painted.

Evaluate

COLLAGE MURAL — (SEE MURALS)

BEST COPY AVAILABLE

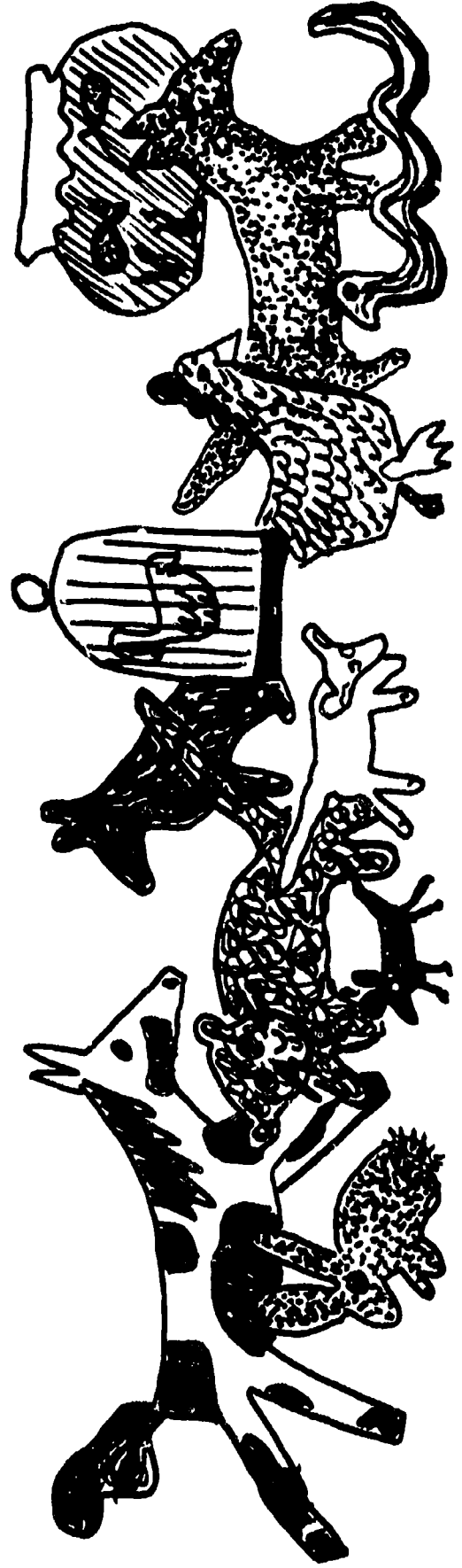

NOTES

CRAYON

“The essential difference in the child’s approach to art and to other subjects is that in speaking, reading, writing and ciphering he must master symbols and systems invented by others. In his art (he) . . . devises and uses his own symbols.”

Lark-Horovitz-Lewis-Luca

*Understanding Children’s Art
for Better Teaching*

00030

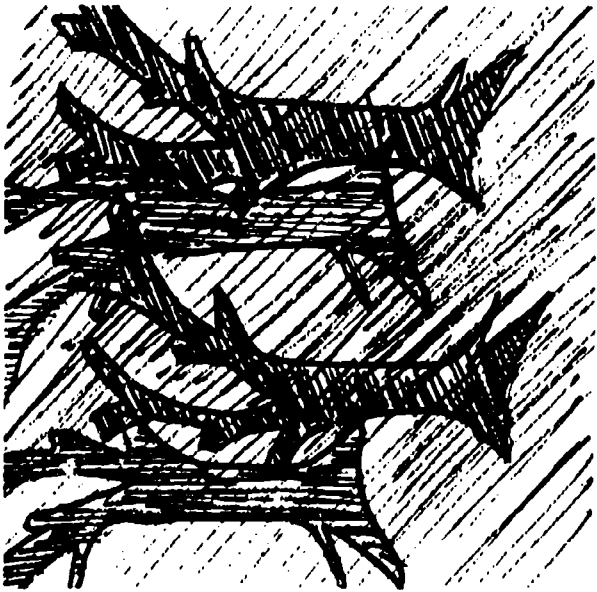

CRAYON

Characteristics:

Dark wax crayons can easily be drawn over lighter areas. Dark colors are opaque.
Lighter colors laid on a dark area appear to mix with it.
Paper: Rough paper surface will not be filled as thickly.
Smooth colors can be rubbed and mixed with fingers or a rag.
Wax crayons are soluble in turpentine, tandothine and benzine.
Heavy waxed areas can be blurred with a brush dipped in turpentine.

RESIST 3-4

Preplanning

Objectives
to combine 2 art media
to learn that resist involves the principles that oil and water do not mix.

Materials

crayons (wax), paper, tempera, brush, or sponge. Optional: large baking pan.

Preparation

Cover work area with newspaper. Each child will need crayons and paper. Have tempera placed in an easily accessible area.

CRAYONS — OBJECTIVES

to experiment with different qualities of crayons
to experiment with color
to learn to combine crayons with other media

STENCILING K-2 3-4

Preplanning

Objectives
to use repeat designs
to overlap for depth

Materials
cardboard (old file folders, crayons, scissors, paper, newsprint, Manila)

Preparation

Each child will need file folder, scissors, crayons and paper.

Procedure

Using light, bright colors, draw textures and solid shapes directly on paper, pressing heavily. When drawing is complete, cover entire paper with a dark color of tempera (white or light color of tempera may also be used). Keep paint fairly thin by adding water. Brush or sponge over paper. Crayon areas will resist paint. Another way of applying paint is to mix thinned solution in a jar. Set a pan large enough to catch drippings and simply pour paint over crayoned sheet. Paint caught in pan can be poured back into jar for continued use. Lay design on newspaper for drying.

Variation

Make drawing on dark paper using light colored oil pastels. Use light tempera as overlay.

Evaluate

Procedure

Sketch a simple object (tree, animal, flower, building, etc.) with crayon on cardboard file folder. Cut out. Child can cut into sheet from edge and tape slash together afterward. This gives a positive and a negative stencil. Use either or both.

Place stencil on a flat surface. Cover with paper. Rub with crayon held on flat side. Move object and rub again. Place a second or third object over the ones already there. Let them overlap. Stagger placement by moving up or down on paper.

Variation

The stencil may be placed on top of the paper and heavily chalked around outline. Turn, using fingers, rub chalk on to paper with strokes perpendicular to edge.

Evaluate

Does the composition have a feeling of depth? Have objects been overlapped, staggered?



CRAYON

CRINOLINE — SANDPAPER 3-4

Preplanning

Objectives
To achieve textured effect of rough surface to experience the process of producing, re-producing by applying heat to crayon.

Materials
for crinoline: crayons (wax) iron, paper (Manila or construction).

for sandpaper: crayons (wax) iron and paper (Manila construction).

Preparation
(Cover work area and ironing area with newspaper. Have iron set on WARM. Each child will need crayons (wax), paper and crinoline or sandpaper.)

Motivate

Procedure

Crinoline: Sketch with crayons directly on crinoline as you would on paper. Color in *all* areas. Keep objects large. Apply crayons heavily. Place face up between 2 sheets of manila or construction paper. Press with warm iron. Remove print. To repeat, color crinoline again.

Sandpaper: Using crayons, draw and color entire sheet heavily. Place between 2 sheets paper. Press over lightly with warm iron. Remove. Sandpaper can be colored and reprinted many times. Touch up occasionally.

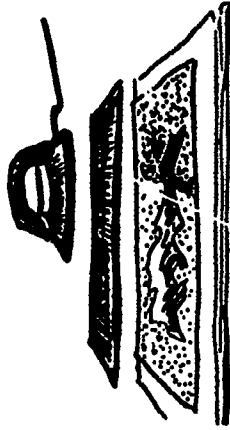

Evaluate

ETCHING 3-4, 5-6

Preplanning

Objectives
to learn in a simplified way how the art of etching is done, to create textures by combining various scratching techniques.

Materials
crayons (wax), paper, scratching tool (sticks, broken pencil, bobbie pin, etc.), (for variation, tempera and liquid detergent).

Preparation
Cover work area with newspaper. Each child will need crayons, paper, and a scratching tool.

Motivate

Procedure

Using light, bright crayons put big patches of colors *all over paper*. (Limit to 3-4 colors). Press heavily. Using black crayon, color over all the bright colors. Color until the bright colors appear faintly through black or are completely covered. With sharp tool, sketch picture directly over black. Scrape away with tool making thin, thick, wavy, etc. lines. Create many textures.

Variation

Cover bright crayon areas with tempera mixed with liquid detergent instead of black crayon. Scratch through tempera. (Tempera consistency: 1 cup tempera to 1 tablespoon detergent.)

Evaluate



CRAYON MURAL — (SEE MURALS)

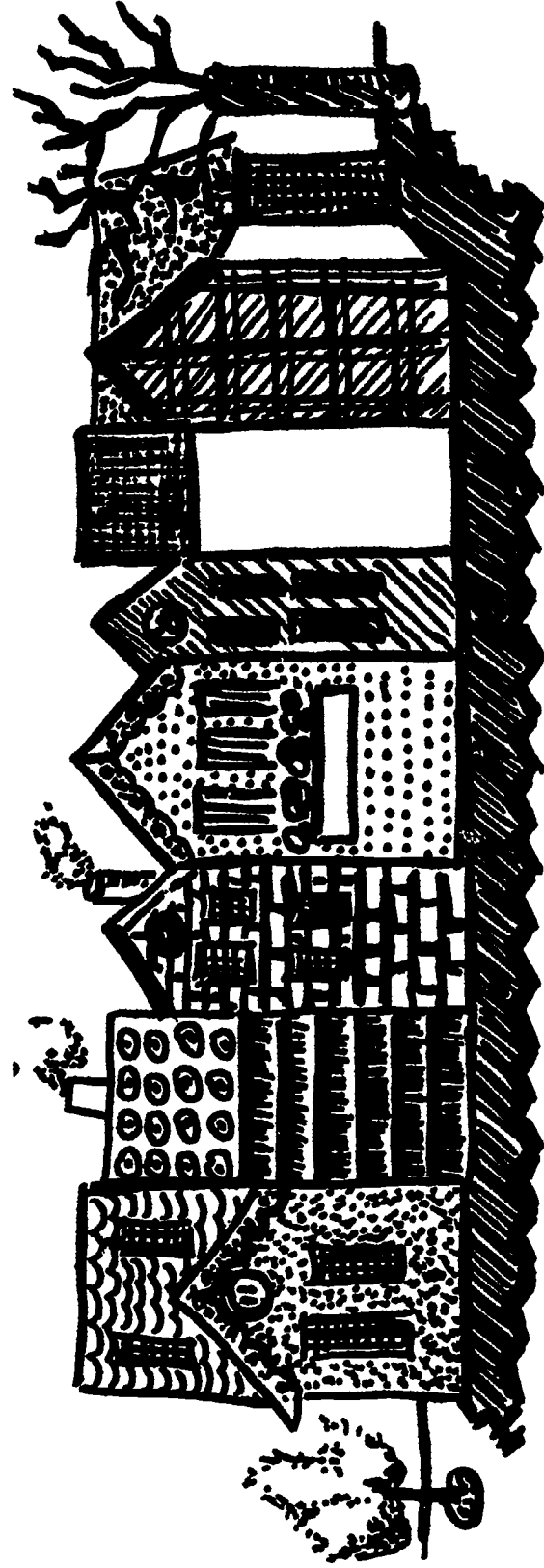

BEST COPY AVAILABLE

CRAYON

ENCAUSTIC (TURPENTINE) 3-4

Preplanning Objectives
To achieve an encaustic (or melted) effect.

Materials
Crayons (wax); paper; turpentine; brush or rag

Preparation
Cover work area with newspaper. Have turpentine placed in paper cups. Distribute brushes or rags for daubing on small areas of turpentine. Each child will need paper, crayons, and turpentine.

Motivate



Procedure
Using wax crayons, draw solid shapes directly on paper. Wet small areas (as you work), or dip finished piece in turpentine. This will cause wax to melt a little and run. Areas of the drawing can be done over or outlined after turpentine dries.

Evaluate

Preplanning Objectives

To apply heat to wax, causing a melted effect.
To apply wax in layers, building one layer on another.

Materials
Crayons (wax); paper; heat (lighted candle, hair dryer or iron).

Preparation
Cover work area with newspaper. (If candle is used, set it in a jar lid and cover newspapers with foil. Each child will need crayons, paper and candle (or access to hair dryer or iron).

Motivate

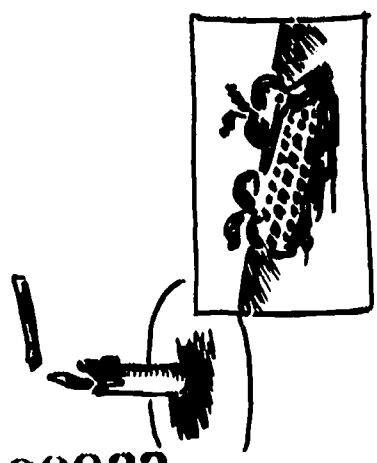

Procedure

Using crayon, stick end into flame of candle just enough to melt. Use on paper immediately while still wet. Thick areas may be built up by applying wax on wax (impasto).
Hair dryer can be used to heat paper from under side, causing crayon areas to melt. In this technique, the paper, not crayon is heated. An electric iron applied to under side will do the same.

Evaluate

TRANSPARENCIES 5-6

Preplanning Objectives

To experience the spontaneous quality of melted crayon.
To combine other media with crayons (string, foil, tissue).

Materials
Crayons (wax), wax paper, grater (or edge of scissors), iron, paper (construction or Manila), string, plastic milk cartons.

Preparation
Cover work area and ironing area with newspapers. Each child will need paper, (wax) crayons, grater, string, bits of foil and tissue.

Motivate

Procedure

Place wax paper or plastic wrap on work surface. Place crayon shavings on the paper. Use shavings sparingly or colors will run together. Arrange string around the various color areas. Bits of foil and colors of tissue can be added.
Place a second piece of wax on top and press gently with WARM iron. Crayons will bond paper together.
Stained glass window effect will be obtained.
String may be glued to edges and hung as mobiles.

Variation

Make a sketch with crayon on paper (construction, fingerpaint, butcher). Place crayon shavings in the picture area of design. Use crayons sparingly. Stay within outlines of sketch. Place newsprint over sheet of shavings. Iron gently—WARM iron. Add more crayons and iron again if needed.

Evaluate



CRAYONS

TEXTURE RUBBINGS 5-6

Preplanning

Objectives
to discover and invent many different textures to learn to use areas of texture in a drawing.

Materials
crayons, paper, found materials, screen wire, corduroy, things with raised or rough surfaces).

Preparation

Each child will need crayons and paper and assorted found materials.

Motivate

Evaluate

Procedure

Using crayon (flat side), lay paper over different surfaces and rub to pick up pattern. Use over one or two surfaces as beginning. With another piece of paper, rub many surfaces. Arrange as a collage. Several colors of crayon may be used. With crayons and paper make a sketch (buildings, farm, home, community), (draw outlines). Fill in outlined area with textures rubbed from different surfaces.

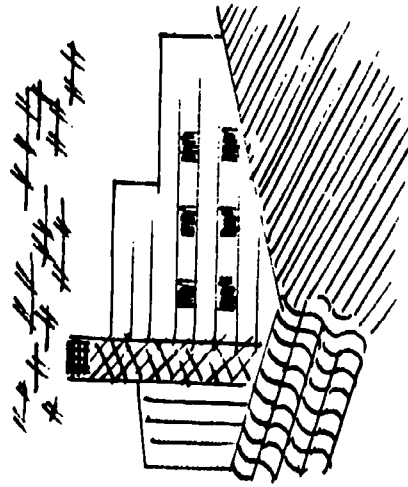

00034

CRAYON BATIK 5-6

Preplanning

Objectives
To learn a simplified method of the ancient technique of batik.

Materials
crayons (wax): white poster paper; black tempera; brush (soft); soft cloth; container of water; newspapers.

Preparation

Each child will need poster paper and crayons. Have black tempera available. Pad sink area with newspapers (for drying).

Motivate

Evaluate

Procedure

Draw in light, bright crayon on white paper. Color heavily but leave 1/8" road ways between shapes. When completed, crumple into tight ball. Wet paper for several minutes. Uncrumple, lay on newspapers and cover drawing with black tempera using a soft brush. Carry to sink and wash lightly under faucet. Return to newspaper for drying. After drying burnish with soft cloth.

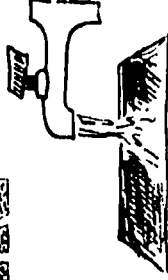

SCRATCHBOARD 5-6

Preplanning

Objectives
to achieve a white on black drawing instead of black on white to experiment with many techniques for achieving texture.

Materials
Freezer paper, newspaper, black crayons, scratching tool (sharp stick, scissors, nail, etc.)

Motivate

Each child will need freezer paper, black crayon, and a scratching tool. Spread newspaper on tables.

Procedure

Working over newspaper, coat freezer paper with broad even strokes of black crayon. Apply thickly. Cover entire freezer paper (or nearly to edge). Use scratching tool to scratch picture or design into black surface. Use many different lines to achieve texture (thick, thin, cross-hatch, criss-cross, zig-zag, broken, etc.)

Evaluate

"The child shapes his art work by what he knows, by his imagination and his world of fantasy, and by his spirited childlike perceptiveness."

Sarita Rainey

NOTES

DRAWING

"Copying presents a moral, esthetic, and educational problem. Morally the child becomes involved in a kind of forgery . . . Copying is an esthetic problem, because children acquire conventional, often obsolete concepts of design and techniques which are difficult to change. Copying is an educational problem because the copyist accepts the solutions of the artist . . . and does not solve the problem for himself."

Victor D'Amico
Educational Director
Museum of Modern Art

DRAWING

K - 2

To the K-2 group, drawing and painting are synonymous. It is a characteristic to use outline, and often corrections (self-imposed) are drawn over first effort with no attempt to erase. As the pupil progresses he will color within his outline and does not yet see that the mass of color alone can represent form. He needs the feeling of control given by the outline.

During this time he draws not from a visual, but from a mental image. His inner vision far surpasses what he is able to draw. If models are used, he will take a look, and draw without referring to them again. Only when the drawings lose their schematic look and the child begins to attempt realism will he respond to the visual data before him.

K - 4

Ways to help children: with figure drawing

Other than providing many opportunities for drawing no direct effort is suggested for this period. There is a natural growth from primitive schema to more sophisticated renderings. The objective is to assist the developmental stages along in an informal unobtrusive manner. The pupil is best helped by broadening his experiences in observation of body parts, clothing, body movement, size relationships, details of dress and facial features. Pantomime, play activities, story telling can be tied in with the drawing period to sensitize perceptions. Shadow play, mirrors, drawing each other, also stimulate awareness of body articulation.

Materials and motivation are all that are needed to stimulate K-4 projects. Therefore, no specific drawing activities are given.

3 - 6

General Objectives

- Line
 - to learn to use the whole arm
 - to discover qualities of lines (thick, thin, wavy, broken, bent, straight, etc.)
- Figure Drawing
 - to learn to observe, show action, represent people in groups.
- Landscapes - Cityscapes
 - to plan grouping and selecting objects and in a composition.
 - to provide experience of on-the-spot sketching.
 - to learn to feel and represent the particular "mood" of an area.
- Animals
 - to observe animals in action, their individual characteristics, and their habits.
 - to record elements which typify the above.
- Still-Life
 - to provide opportunities for children to design by being selective.
 - to depict space by overlapping, and varying sizes of objects.

Children need simple, bold materials for drawing and painting. Big magic markers, large wax crayons, and 1" to 1 1/2" paint brushes with 10" handles are most suitable to their muscular control.

Chalks and charcoal are too dusty for the first years.

This school district carries a thick tempera called Texture-tone especially for the primary pupils. It does not drip or run and therefore offers the child less difficulty in expressing himself.

A word about drawing

When children begin to walk, they are given joyous encouragement and faith that their early stumblings and wobbly gait will improve.

When children begin to draw, the same outlook is needed. The process takes many more years, because finer muscle coordination must develop. Expecting realistic representations of a child is like expecting a two-year-old to do adult figure-skating.

The child can be made happy over his drawing efforts or he can be discouraged to the point of giving up. It is all in the way he is handled.

Drawing to express ideas rather than to show skill allows his ability to develop naturally. About the 6th or 7th year in school he will begin to seek for ways to improve. At this point he is ready for adult assistance with drawing techniques.

DRAWING

EXPERIMENTS WITH LINES 3-4, 5-6

DRAWING APPROACHES

- I Experiments with lines
- II Figure Drawing
- III Animals
- IV Landscape - Cityscape
- V Still-Life

Preplanning

Objectives (see beginning)

Materials
brushes (for young children), newsprint paper, pencils, charcoal, sticks, magic markers, chalk, etc.)

Preparation

Each child will need paper and a variety of tools similar to those above making lines.

Motivate

Procedure

(Each step can be a separate lesson)

A. STRAIGHT LINES

1. Horizontal line—Have children make many kinds of lines (thick, thin, wavy, broken, fuzzy, etc.) Encourage child to use whole arm. Hold up work and discuss the types of lines with class.

2. Vertical lines: Using variety of tools, have children make line *in air first*. Then, when movement becomes bold and large, have him transfer it to the paper. Think of MOVEMENT—not the line. Have class think of lines that grow out of bottom or top of page and “drop”. Show action of climbing-dropping. Show to class.

3. Horizontal or Vertical Lines: Use many different sketching tools. This time emphasize the various tools.

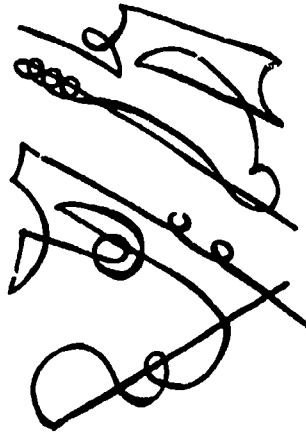

B. CIRCLES AND COMBINATION OF VERTICAL, AND HORIZONTAL. Have children make circular motions in air (use free motion). When they feel confident, have them bring arm down to paper. Use circles of various sizes. Fill paper. Using pages gathered so far (circles and straight lines) have each child combine on one sheet lines which interest him. He may use cross-hatch, scribbling, criss-crossing, etc.

C. CURSIVE LINE

1. Begin with straight line. Then bend it and wind a line around it.
2. Begin with a circle on a new piece of paper. Wind another line through and around it.
3. New paper: Have it covered with a network of lines—as a spider web. *Work slowly*: Have same thing repeated on new paper with eyes closed. Open eyes after few minutes. Fill in some areas with a tone (charcoal, criss-cross or cross hatch lines.)
4. Contours: Have children use lines which follow the rectangular shape of the paper. Let lines wander, pressing close in places, stretching out in others. Add lines until they run out the edges of the paper. Shading can be added between some of the lines.

Figure drawing — ways to help pupils

1. Use model: let each pupil sketch from several angles.
2. Pose model in costume: provide background (sheet, cardboard).
3. Group models in twos or threes.
4. For feel, let each pupil enact the pose.
5. Use poses in a motion sequence (swinging tennis racquet)
6. Vary tools, paper, and drawing method (gesture, scribble, contour)
7. Try cutting or tearing figure from paper
8. If available, use skeleton, or artist's manikin.

FIGURE DRAWING

C. Groups and Crowds of People
Begin with a discussion of crowds. What parts do you actually see? (Heads or feet). Have children use a line to outline the heads and shoulders visible without lifting the pencil, charcoal or crayon. Do the same with legs, pants and hemlines. Details and values can be added. (Sometimes detail is not visible).

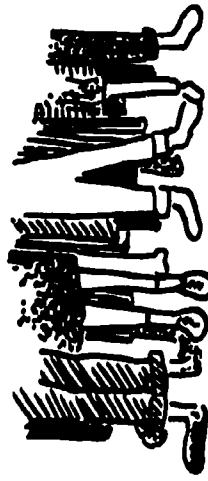
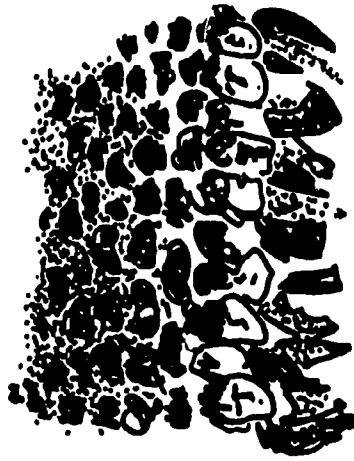
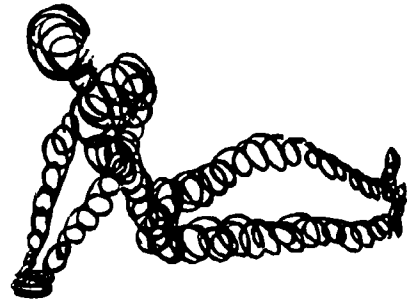

LANDSCAPES — CITYSCAPES

Approaches for outdoor sketching:

- A. Have child begin with sketch of planes and basic shapes, then develop darker values and details.
- B. When view is complicated, suggest finding something of interest in center. Sketch it first and then let rest "grow" around it.

Principles to aid in defining distance

- A. Objects/shapes closer are usually drawn larger.
- B. Objects/shapes farther away are smaller, higher up on page.
- C. Overlapping objects create feeling of depth.

CONTOURS AND GESTURES 5-6

Preplanning Objectives

to experience bending and moving of the figure to limber arm and shoulder movements for sketching

Materials
paper (newsprint, butcher paper, newspaper), sketching tools (variety such as charcoal, crayon, felt markers, pencils)

Preparation
Have children stand, use own dark area. Each child will need paper and a sketching tool.

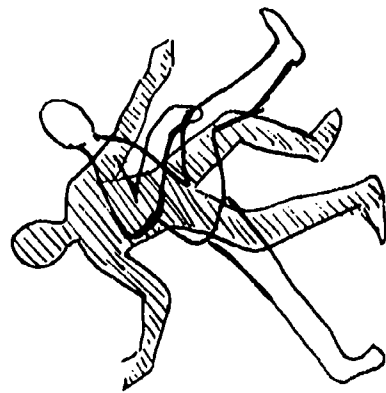

Procedure

(Each step can be a separate lesson)

- A. Contours — Use lines that follow the surface shape (as if you are feeling the edge of the shape.) Let a child run, have others watch. Then sketch in air the movement of the figure. Now draw from memory the action of running.

Now use a model. Pose on table (up high). Pose in running position. Have class draw, concentrating on *main lines of action*. Ignore details. Follow contour shape of figure.

Have class look at model and **NOT PAPER**. Let tool (crayon, charcoal) follow the outline shape. Do not pick up tool. Use one continuous line. Children may "feel" for edges of paper.

Variation

Have model take an action pose (diving, stretching, throwing, etc.) Sketch. Then have model move a little. Sketch. Then move a bit more (until he assumes a standing position from a dive or a stooping position from a stretch.) Drawings can be done over each other, using different colors for each pose. This shows action.

Group Contours

Pose group of 3 to 4. Have class draw overall contour of group first, then go back and put in details, always using continuous lines (instead of short, broken lines).

B. Gestures

Have children pretend that they are "wrapping their model in string." Start with head and wrap (using crayon, or pencil and moving entire arm and shoulder). Make circular movements. Use continuous line, enlarging circles when body enlarges, shrinking circles for limbs. Pose model *in action*. Sketches show action **ONLY**. They do not define (as in contours).

(Continued)

DRAWING

LANDSCAPES — CITYSCAPES 5-6

Preplanning Objectives

to learn to recognize planes and shapes into a picture to learn to see and record particular characteristics of a landscape cityscape.

Materials

paper (newsprint or Manila), sketching tools (pencil, charcoal, felt markers, pen, stick, India ink, crayon.)

Preparation

Sketching trip should be discussed with class. Suggest things to look for (mood or atmosphere, special characteristics, roof lines, dark light, ways of breaking up or using space of sky and foreground.)

Motivate

Procedure

Have student sketch directly on paper after looking and planning. He can shift objects or shapes if needed. He should be reminded to repeat shapes, overlap, group objects, add textures, balance dark and light.

Variation

Make sketch on paper. Add details, paying close attention to design. Repeat shapes and lines. Shade with ink or charcoal.

Evaluate

- B. Select small area of whole still-life and use for composition.
- C. Make light sketch of overall shape, then fill in details.
- D. Select large object as center of interest; draw it in roughly, and place other shapes and sizes in comparative relation to it. (Center of interest does not mean center of the drawing.)

STILL-LIFE — BASIC SHAPES 5-6

Preplanning Objectives

to organize objects into a picture to see basic shapes of objects

Materials

charcoal or crayon, paper (newsprint, Manila), still-life set up (simple forms as cylinders (cans), squares (boxes), rectangles (boxes), sphere (ball)).

Preparation

Each child will need paper and a sketching tool.

Motivate

BEST COPY AVAILABLE

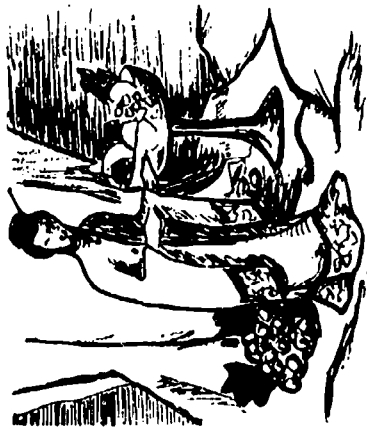
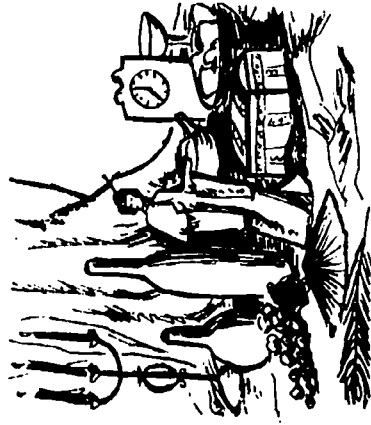

STILL-LIFE 5-6

Suggestions for setting up

- A. Use variety of forms (small, large, tall, short, simple, complex, textured, plain)
- B. Arrange in various places about the room.
- C. Include many objects — child can select few or use all for more complicated design.

Suggestions for beginning

- A. Draw an object in center, then move to next and so on, including just what is needed for a good arrangement.
- or (next column)

Procedure

Sketch is made on paper. Using side of charcoal or crayon, experiment with shading one side heavily (shadow) opposite side lightly (light side). Practice ways of making tones (criss-cross, cross-hatch, scribbles, etc.) If you have access to a flood light, by all means use it. Don't draw everything. Be selective.

Variation

Substitute fruit, vegetables etc. for basic shapes used. Shadow and shade —light can be used the same way.

Evaluate

DRAWING

ANIMALS

Suggestions for helping children with animal compositions

- Draw from live models when possible
- Involve the animal in an activity or typical situation
- Begin with one animal
- Make sketch -- then add detail
- Fill in natural setting around animal (rocks, foliage, flowers). Films and filmstrips can suggest jungle scenery. Also photos of flora in area.

SKETCHING LIVE ANIMALS 5-6

Preplanning

Objectives

to learn to observe and record characteristics of animals to use natural habitat of the animal in the composition

Materials

Sketching tool (pencil, charcoal, crayon, felt marker), paper (newsprint, Manila), desk area of board (if on a field trip)

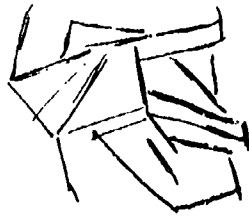

Preparation

Discuss the characteristics of animals to be observed (pets, farm, zoo, circus, foreign in a museum). Talk about natural habitat, what you would expect to see where the animal lives. Each child will need a sketching tool, paper and a board.

Procedure

Have children observe the animal for sometime. Notice surface appearance (color, hair, feet, ears, nose, eyes, etc.). Watch the animal in action and observe how he bends and moves. Then, sketch quickly at first, trying to capture movement. Make several sketches from several angles. Then go back and refine drawing. Fill in area around animal with natural setting of the particular area. Color can be added by crayons or by making notes for painting later.

Variation

Use films and filmstrips for suggestions of natural scenery.

Draw several animals or groups by using suggestions for drawing crowds of people.

Evaluate

Cube

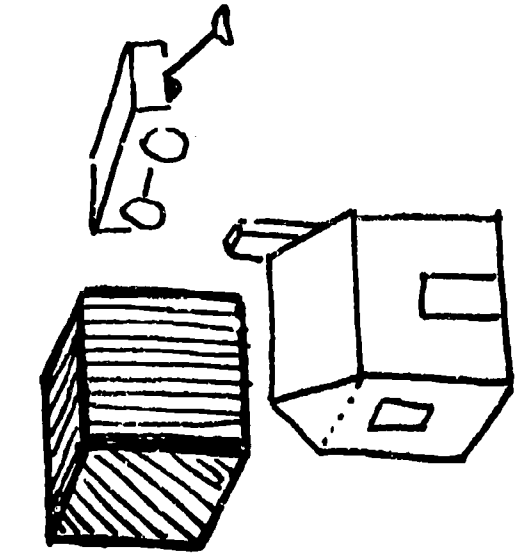

Cone

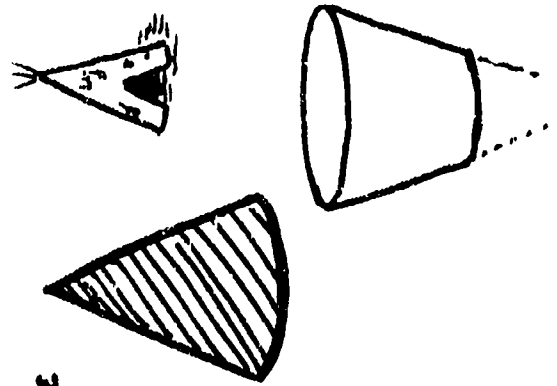

Cezanne has stated that all drawing can be based on the cone, the cube and the sphere.

Sphere

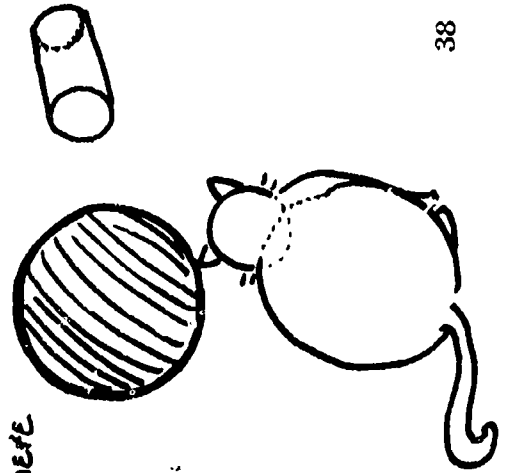

MASKS

"We know too well that knowledge alone does not make people happy. Art for your child, introduced in his early years, may well mean the difference between a happy adjusted individual and one who, in spite of all learning will remain an unbalanced individual who has difficulty in his relationship to his environment."

Viktor Lowenfeld
Your Child and His Art

MASKS

PAPER BAG MASKS K-2

Preplanning Objectives

See general objectives

Materials

Paper bags to slip over heads; construction paper scraps, cloth scraps; found objects; scissors, glue

Preparation

Cut paper and cloth scraps into triangles, crescents, and other odd shapes. Talk about different animals or people that could be made. Discuss what variations in features do to appearance.

Give each pupil a bag and scissors; put other materials out on table.

Motivate

Procedure

Place bag over head. Mark spots for eyes. Decorate to look like chosen character, using scraps and other found materials.

Variation

Bags can be painted with tempera. Tempera can be combined with construction paper, crayons, found materials, etc.

Evaluate

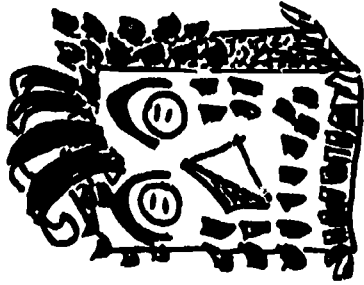

General Objectives: to create expressive individual characters; to work imaginatively with variety of media; to learn the historic significance of masks.

HALF-MASK 3-4

Preplanning

Objectives

Materials

Oak tagboard, hole reinforcements, paint, brushes, scissors

Preparation

Put painting equipment in convenient place to be used as needed.

Spread newspapers on desk.

Helpers pass out oak tag paper, hole reinforcement; scissors

Motivate

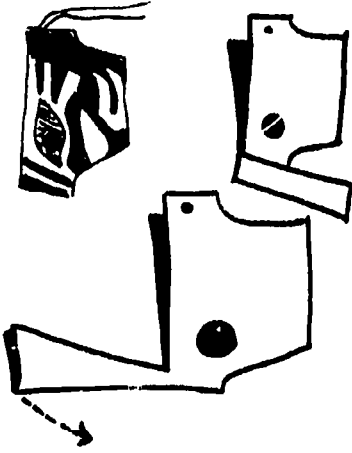

Procedure

Fold paper at center, cut holes for eyes, shape for nostrils and mouth; cut out projection on sides for attaching string. Punch hole (reinforce). Children then experiment cutting various edging patterns. To make nose: fold projection down. Shaped pieces may be glued on to add contours. Paint features in bright colors.

Evaluate

COAT HANGER MASK K-2, 3-4

Preplanning

Objectives

To create a mask with yarn and found materials

Materials

coat hangers
stockings
needles (large)
yarn, cloth scraps,
buttons, trim, beads, jewelry
white glue

Preparation

Each child will need a coat hanger, one stocking, and needle. Have yarn and other assorted materials in a centrally located place.

Motivate

Discuss features of the character (or animal). Self portraits can be done.

Procedure

Shape coat hanger to form mask-like shape. Slip a piece of nylon over the hanger. Tie or stitch edges down at top. Add yarn for hair by gluing or stitching. Eyes, ears, mouth, nose can be made from found materials. (buttons, cloth, beads, etc.). Stitch. K-2 will glue.

Evaluate

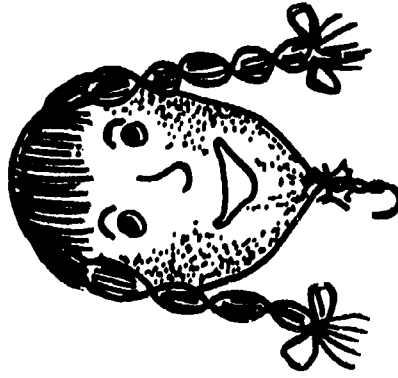

CARDBOARD BOX MASK 3-4

Preplanning

Objectives

See general objectives
To devise features from a variety of objects

Materials

Various sizes and shapes of boxes, tempera paint, brushes, found objects, scissors, glue, masking tape.

Preparation

Assemble materials on a large centrally located table.

Have class consider found items and how they can be used to create features.

Each child will need a box and a small amount of glue. Found materials and paint can be shared.

Motivate

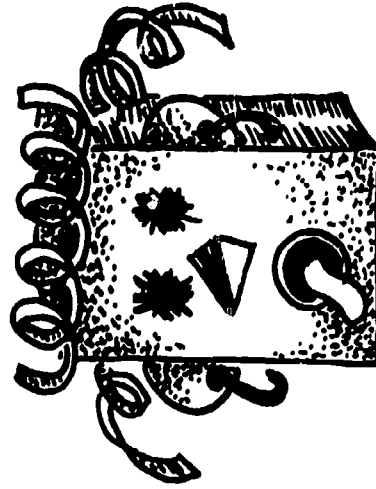

Procedure

Give child large box and glue. Let him choose found items for features. Demonstrate use of masking tape to hold pieces in place until glue sets. When dry, paint all over with one color. Let dry and decorate features with gay colors, feathers, sequins, beads, or whatever you have.

Evaluate

MASKS

PAPIER MACHE MASK 3-4, 5-6

Preplanning

Objectives

To use paper mache
To use modeling technique

Materials

Newspaper strip; paper towelling; wheat paste; newspaper; various thicknesses of string and rope; paints; brushes; sponges; glue; jewelry; feathers; beads; buttons; trim.

Preparation

Assemble materials on a large centrally located table
Find pictures of native and theatrical masks
Discuss uses of masks, historical and ornamental
Have class consider found items and how they can be used to create features.
Cover work area with newspapers.

Motivate

Procedure (See section on Formulas for papier mache methods)

Crumple newspaper into a ball and tape or wrap with twine to make a head-like form. This can be done ahead of time, one for each child.
Cover with wax paper or foil and tape it. Show children how to push in, and to build up with paper towelling to make features. Mask requires minimum of 3 layers of papier mache strips. Set aside to dry.
After mask has dried, remove from newspaper ball, glue on rope, etc, for decoration. Paint; sponge final coat for different effect. Punch holes in sides, attach string.

Variations

Sprinkle fine sand on to mask when still wet — for texture.
Add strips of curled paper for whiskers, ears, etc.
Cover mask with foil, then decorate.
Another way of forming the mask base is to crush foil over one's own face, perforate nostrils for breathing and then cover the foil with criss-crossing strips of masking tape until the form is established. Remove and apply papier mache strips and paper towelling as above.

Evaluate

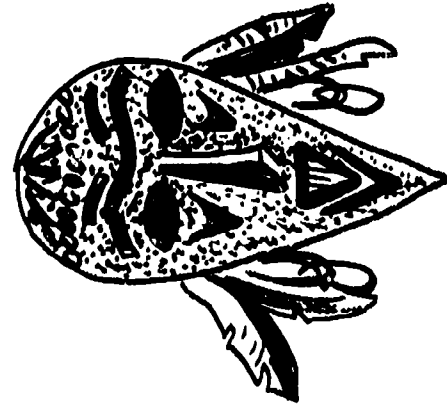

PAPER MASKS 3-4, 5-6

Preplanning

Objectives

To create a mask by cutting out and adding on.

Materials

Construction paper, glue, scissors, found objects, yarn, scrap paper, felt, string

Preparation

Cut ovals from paper, about 19" x 8 1/2", approximately
Helpers pass ovals, glue, scissors.
Put light weight found objects on table for use as needed

Motivate

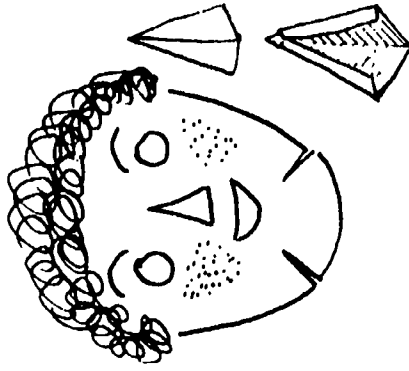

Procedure

By making slits at the chin of the oval, show how these can be overlapped to give roundness to the flat pieces. Glue the overlap and tape on the back or inside to hold in place while drying.

Have children cut holes for eyes. Nose can be made by (1) slicing the shape of the nose along one side and folding it back or (2) by cutting out a hole and gluing a triangular shape over the hole making it "stand out." Create variations in other features using found materials. Punch holes on sides, insert string for tying.

Evaluate

WIRE MASKS 5-6

Preplanning

Objectives

to construct a mask from mesh using stitchery for features

Materials

wire mesh (hardware cloth, screen wire, plastic wire) wire cutters, yarn and needle, scissors, found materials (variety)

Preparation

Cut wire into egg shape.
Slit in two places at bottom to form chin.
Fold slitted places together and run wire in and out to hold.

Motivate

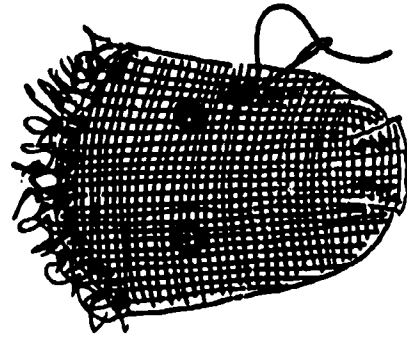

Procedure

Using yarn, ribbon, cloth strips, etc., weave in and out to make face. Eyes can be cut out, stitched, or beads added. Use a variety of methods to stitch and weave face.

Evaluate

NOTES

MOBILES

"Our foremost goals should be to look forward to a society in which all individuals are visually literate and esthetically sensitive to their environment."

Rosemary Beymer
Director of Art Education
Kansas City

MOBILES

- General Objectives: To make 3 dimensional figures that are pleasing when viewed at any angle.
 To learn to balance objects — physically and visually
 To design movement in space
 To observe many kinds of motion: turning, spinning, floating, bouncing, rocking.

Methods of Hanging Mobiles: Hangers may be easily cut and bent. Other materials which may be used are wooden dowel and cardboard.

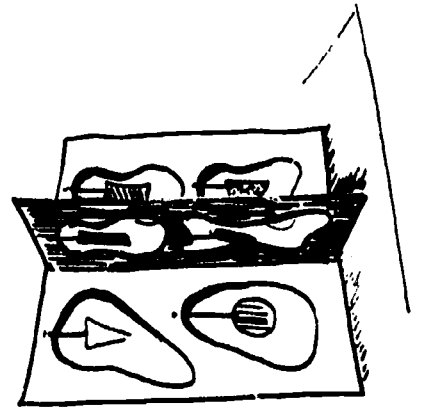
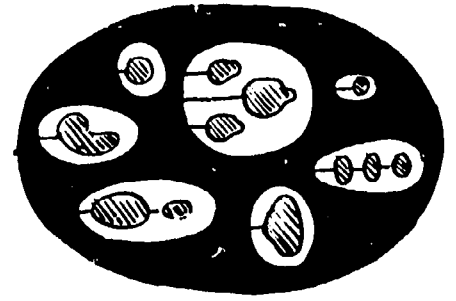
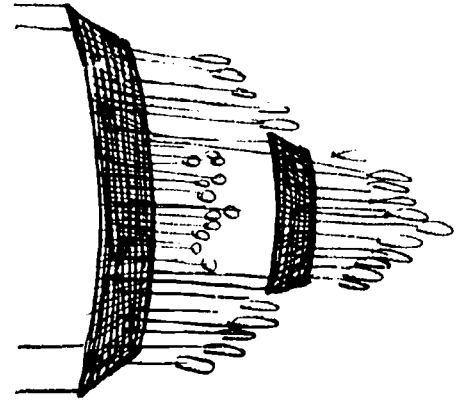
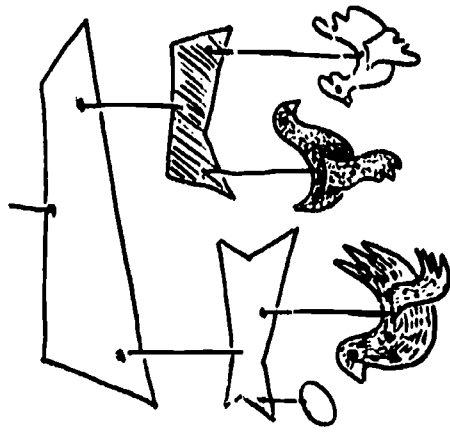
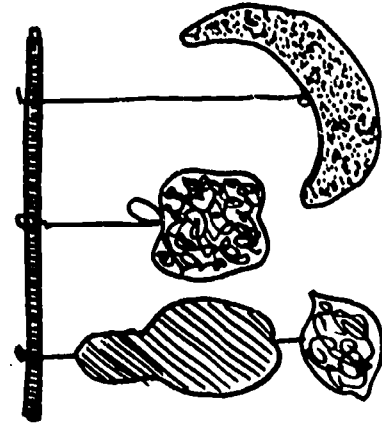
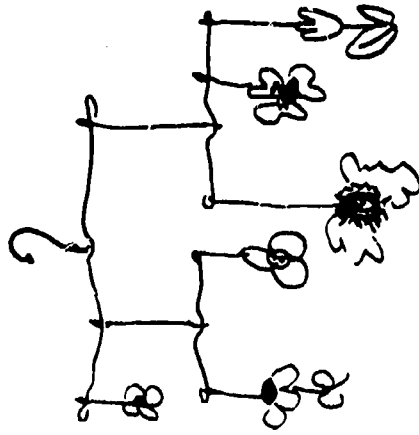
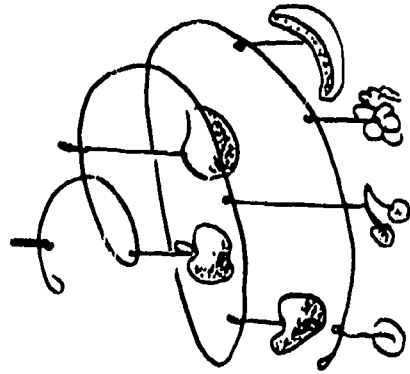

BIRD K-2

Preplanning Objectives

See General Objectives

Materials

Thin cardboard; scissors; glue; tempera paint; brushes; feathers (if possible); yarn; thread; paint containers; newspapers

Preparation

Make a mobile on which to hang finished pieces. Talk about different shapes and colors of birds. Pass out cardboard, scissors, paint equipment. Spread newspapers on desks. Put feathers, yarn and glue in convenient place for use as needed.

Motivate

Procedure

Draw large outline of bird on cardboard. Cut Out. Decorate both sides imaginatively. Make diagonal slit for wings. Cut wing as shown. Insert in slit. Put thread through top. Hang on mobile.

Variation

Body and wing shapes can be done in mosaics by gluing small bits of construction paper over cardboard.

Evaluate

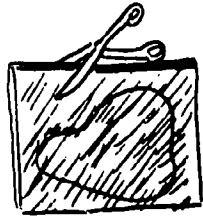
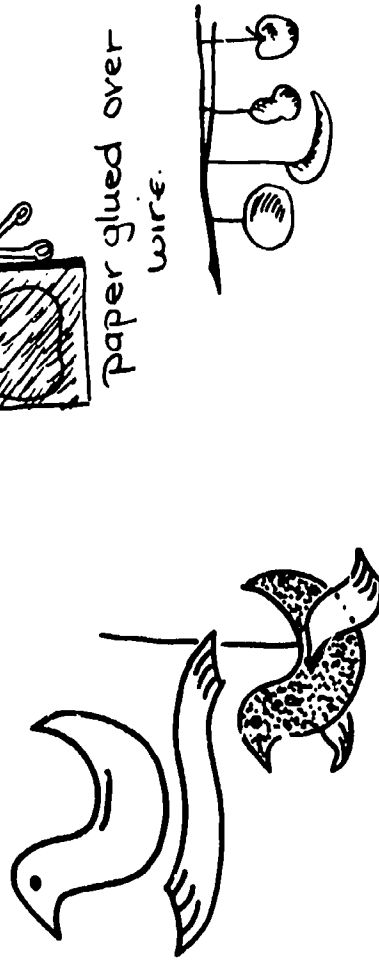

Paper glued over wire.

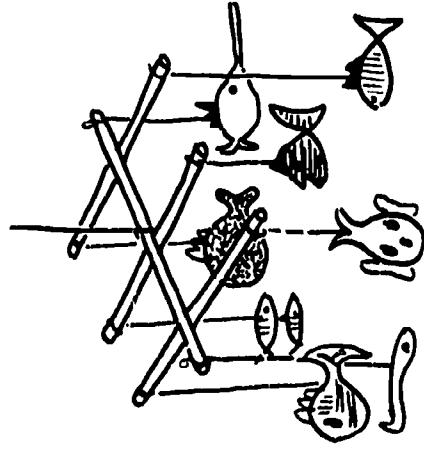

TISSUE MOBILES K-2, 3-4

Preplanning

To visualize movement created by air currents.

To create translucent suspended forms.

Material

Soft wire—18 gauge approx. (stovepipe or aluminum); scissors; tissue, black thread and needle; dowel; white glue (undiluted) wire clippers

Preparation

Cut wire in 9" to 12" lengths.

Lay out sheets of colored tissue, separating by color.

Distribute glue and other needed materials.

Motivate

Procedure

Cover tables with newspaper, and distribute wire lengths. Have pupils bend into shape of fruit, flowers, faces, bells, animals, or some other chosen category. Flatten wire shape against table. If tissue is in large sheets, lay wire shape at one end and fold tissue over wire. Lift wire out, lay on newspaper and apply glue to both sides. Replace glue-covered wire between tissue fold and press tissue firmly to wire. Use scissors and cut tissue around wire contour. Save left over tissue. When glue dries, run a thread through the upper end of shape, just inside the wire. Suspend from dowel, varying lengths of thread.

Evaluate

"The basic issue is a concept that assumes that here you have education and here you have the arts . . . The thing I am urging is that these two become so intertwined that you cannot separate one from another."

John Letson

Superintendent

Atlantic Public Schools

WHOPPER BUGS K-2

Procedure

Decorate and glue covering to towel tubing. Using needle, punch two holes near one end. Run pipe cleaner through for antennae. Glue buttons, or other found objects to make eyes. Cover wire wings with nylon hose, paper, or netting. Secure wings to tubing by (1) slitting the tubing and inserting wing up to the base part or (2) make 2 holes opposite each other at about the central point on tubing. Stick extensions of wire through from sides and wrap around base of wings.

Evaluate

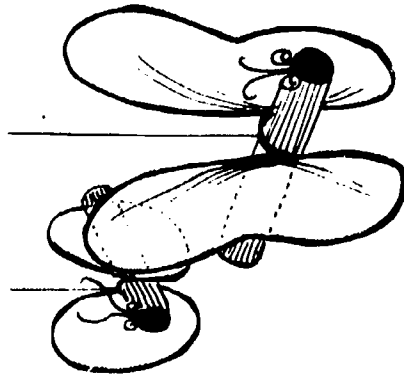

Preplanning Objectives

To develop whimsical creatures.

Materials

Towel tubing, pipe cleaners, stove pipe wire, old nylon hose, bits of cloth, colored papers, button, etc., tape, white glue, newspaper, wire clippers

Preparation

Make wing shapes from wire. These may be triangular, fan shaped, or round. Leave a length of wire projecting. Cut fabric or paper to cover tubing.

Motivate

MOBILES

STYROFOAM MOBILES K-2, 3-4

Preplanning Objectives

To create a different type of art form
To comprehend color overlay

Materials

Styrofoam cups, colored tissue (pomps), newspaper, glue, pins, string, brushes

Preparation

Insert knotted string thru bottom of a cup for hanging. Glue two cups together at rims. Pins will help hold in place till set. Cut colored tissue in circles about 2" across. Keep family colors together; viz. violet, magenta, red, pink, and put in envelopes to prevent mixing.

Motivate

Procedure

Spread newspapers. Place milk container of 50-50 white glue and water for each two pupils. Let each choose an envelope according to his own color preferences. Give each one a brush to apply glue, brushing glue, applying circle, and brushing over it. This is continued, overlapping circles to avoid uncovered spots. When completely covered, trim off edges of projecting tissues at top and bottom. Set aside to dry. Hang from ceiling or brackets.

Evaluate

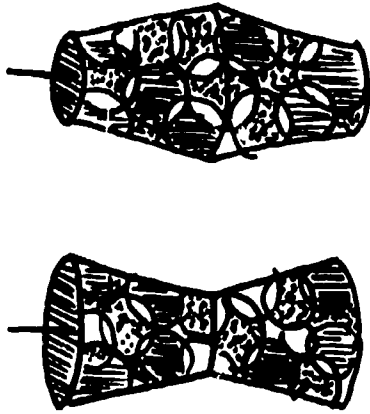

Procedure

Inflate balloons and knot ends tightly.

1. Apply overlapping strips of one color tissue paper with wheat paste. Takes 5 or 6 layers. A second color may be added at the last.
2. Wrap inflated balloon in all directions with yarn saturated in wheat paste. Be sure it is completely dry. Deflate.
3. Combine the above methods, beginning with the tissue. Drying time, approximately 2 days.

Variations

Before balloon dries, sprinkle *lightly* with glitter.
Put balloons together to form animals, angels, Santa Claus, etc.

Evaluate

DANGLE ANGLES 3-4, 5-6

Preplanning

Objectives

To utilize discarded magazines
To create 3-dimensional forms

Materials

Colorful magazines, scissors, clear tape, wire or string

Preparation

Collect plenty of magazines. Tear out brightly colored sheets. Cut short lengths of tape for each child.

Motivate

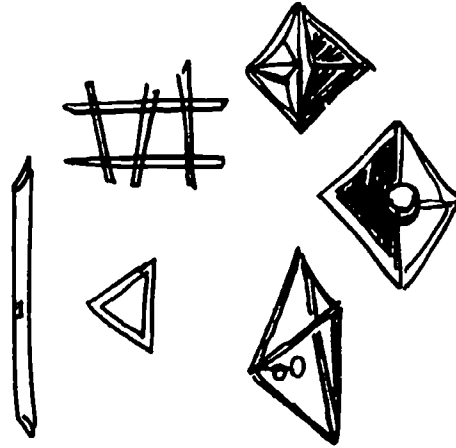

Procedure

Using a paint brush handle, start from one corner of magazine page and begin rolling. As soon as roll is established set brush aside and continue rolling. Tape with clear tape. Roll a number of these tubes. Then begin constructing triangles, and other flat geometric shapes. Join at corners with clear tape. Assemble these flat modules to create 3-D forms. Sides may be covered with tissue or other decorative paper. When completed, hang overhead.

Variation

Short strips of pages, cut to taper to a point, can be rolled starting at wide end. Use white glue on end and glue whole roll.

Evaluate

BALLOON 3-4

Preplanning Objectives

See General Objectives.

Materials

Assorted balloons; newspapers; tissue paper and/or yarn; scissors; wheat paste (see section on recipes); coat hangers, thread, wire cutters

Preparation

Pass out 1 balloon per child, wheat paste in milk cartons, newspapers to spread on desks. Put tissue paper, and/or yarn, and scissors in convenient place; let children file past to choose the colors of paper or yarn they desire. Have children who finish early, make a support on which to hang finished products (see illustration on methods for making mobiles).

Motivate

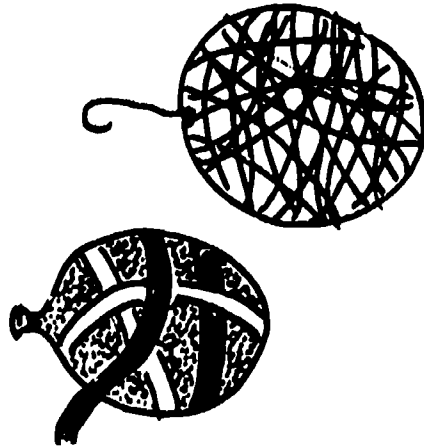

TISSUE PAPER 5-6

Preplanning

Objectives

Materials
Colored tissue paper, black construction, quick-drying glue, scissors; thread, coat hangers (see suggestions for mobile hanging).

Preparation

Make a support on which to hang completed pieces

Motivate

Procedure

Using 2 sheets of black paper, cut both pieces at one time to form geometric shapes, birds, animals, flowers, etc. Cut *inside* the designs to make a border of black about 1". Glue colored tissue paper between the 2 black borders, trimming edges. Insert thread through top. Tie on mobile.

Variation

Use cellophane, foil, or metallic paper.

Use pipe cleaners for border.

Wire may be arranged in loops, or triangles, etc. Spread glue along wire.

Lay piece of tissue over it. Turn over and glue other side of wire. Lay tissue on this. When dry, trim tissue from outer edges of wire.

Evaluate

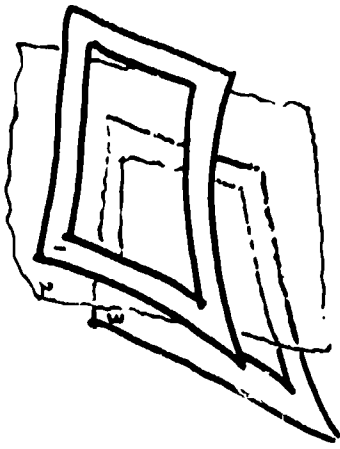

Procedure

Mark two cups around rims with evenly spaced pencil marks. Eight sections should be enough. Take scissors and cut straight down side of cup to within 1/2" of base. Do this at each section mark. Take each strip thus formed, and one at a time press outward slightly between thumb and forefinger sliding from bottom to rim as you do so. Do not press too hard! Go around the cup three times. It should not be forced outward. Insert knotted string from inside one cup for hanging; fasten a yarn tassel thru other end. Cut triangles of tissue somewhat wider and longer than spaces between sections of cups. Glue these to inside of each cup, covering spaces equidistantly. Place cups together, rim to rim, and adjust so that sections meet. This will not be absolutely precise. Glue section edges together and pin till dry. Clip off any projecting tissue. The cup may be painted in contrasting or darker tone by mixing tempera and adding white glue 4/5 to 1/5. Braid, sequins, buttons can be added if done with discretion. Don't overdecorate! Challenge pupils to devise other mobiles from these cups.

Evaluate

CARDBOARD 5-6

Preplanning

Objectives

See General Objectives

Materials

Cardboard; paint, brushes; milk cartons to hold paint; water; pointed scissors; thread

Preparation

Teacher-helpers pass cardboard, scissors, string; put paint on work table to use as needed.

Motivate

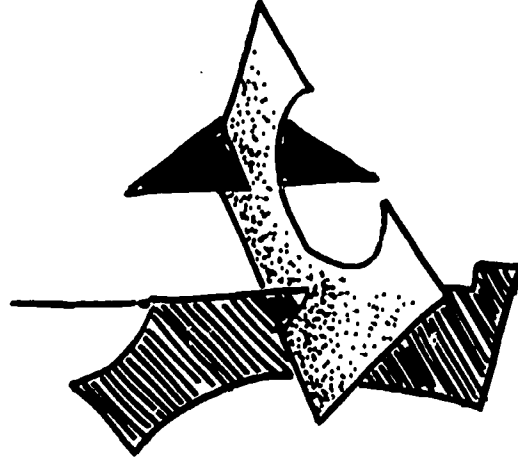

Procedure

Demonstrate how to slit a piece of cardboard and put another piece into it. Let children proceed, using this slitting method to make a mobile. Decorate as desired. Put thread at a point of balance for hanging. Cellophane, magic mending tape will help keep cardboards in right place.

Evaluate

STYROFOAM MOBILES 5-6

Preplanning

Objectives

To make pupils sensitive to new visual possibilities in a familiar form.

Materials

Styrofoam cups, white glue, colored tissue, string, scissors, pins, tempera

Preparation

Demonstrate use of pins to hold till glue sets. Demonstrate bending of styrofoam strips cut in cups. Mix 4/5 tempera and 1/5 glue in small quantities.

Motivate

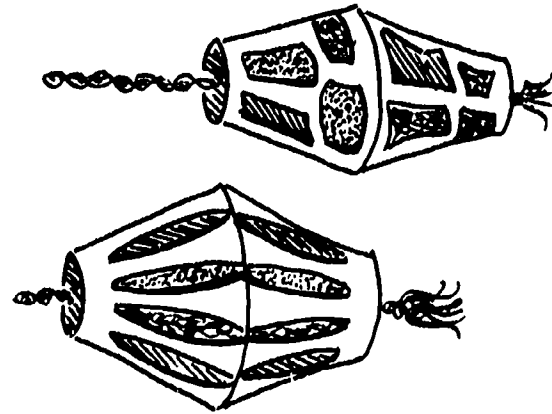

NOTES

MOSAICS

"Creativity is a distinguishing characteristic of outstanding individuals in almost every field."

E. Paul Torrance

Guiding Creative Talent

00052

MOSAICS

Mosaics are made by fixing small pieces of various materials side-by-side to form a design or figure. Many examples of this technique can be found in art history. The design should be kept simple, especially in primary grades. Natural forms provide good ideas for mosaic design. Mosaics can be produced by individuals, groups, or classes.

- General Objectives**
- to learn to manipulate materials
 - to learn to pre-plan
 - to experiment with composition and use of colors

MOSAICS USING PAPER BASES K-2

Preplanning Objectives

- To create a mosaic using paper pieces
- To experiment with different qualities of papers.

Materials

Bits of colored paper (of any kind), seeds, eggshells, beads, grass, leaves, etc., in small containers according to color or object; scissors, envelopes, paste, rubber cement, or quick-drying glue; paper or hard cardboard for mounting.

Preparation

If possible, show examples of mosaics and discuss. Put all materials on table or convenient place. Allow children to file past table to collect what they need and put mosaic pieces in envelopes.

Motivate

Procedure

Make sketch of simple design to be used. Transfer to background paper. If paper is used for mosaic pieces, cut or tear into square or irregular shapes about 1 2" x 1 2". Mosaic materials are pasted down, working from outline of design. Leave tiny gaps between pieces. Pieces may be set in curves parallel to outline of design. Encourage variety of colors in forms — Example: 2 shades of green in grass.

Variation

- Use scraps of contact paper for mosaic pieces.
- Use gummed tape—cut into mosaic pieces and crayon or paint.
- Use cloth, wood, cardboard, etc., for base.
- Use paper circles from hole puncher. Plan sketch in color (crayons).
- Transfer to large cardboard or posterboard. With brush or fingers apply glue (or paste) to small area. Apply circles with fingers or tips of pencils. Overlap to prevent cardboard from showing through. Shellac may be applied to completed work.

Evaluate



DIRECT TECHNIQUE 4-6

Preplanning

- Objective**
- To create a permanent mosaic
 - To learn another approach to making a mosaic.

Materials

Small bits of glass, beads, tiles, etc. Masonite or board bound, white glue, spackling or plaster

Preparation

Have pupils draw design to fit the board. Pass boxes of small bits (called tesserae) for pupils to select pieces. Give out white glue in small bottles if possible. Tack a narrow strip (frame shape) around board to keep spackling from running.

Motivate

Procedure

After design is transferred to the board begin gluing tesserae to their places, leaving a wee bit of space between. When dry, fill spaces with spackling and press into grooves. Wipe off at finish.

Variation

- A. Make a sketch of design to be used. Plan what type of pieces will go where. Pour thick layer of plaster into base. Place mosaic pieces down quickly to form design. Leave small gaps between pieces. The whole or only part of entire base may be covered. Encourage use of variety of materials, colors, and textures.
- B. Use sand-and-paste base. Mix sand with wallpaper paste until fairly thick; takes long time to dry. Pour into plywood base.
- C. Cut powdered paint colors into base mix.

Evaluate

MURALS

“Under our present educational system young people turn off and drop out, yet they are anxious and willing to learn new things if they can learn them visually.”

John L. Debbes III
Coordinator
Education Projects
Eastman Kodak

MURALS

General Objectives: to provide opportunities to bring together many ideas to provide experiences for sharing and working together on a common goal to motivate interest in a subject

Kinds

Border

- A. continuous unit conveying a central theme
- B. composite using a series of separate pictures on a central theme. (There may not be a sequence of ideas.)

Panel

maybe one picture or a series, each picture may depict a different phase of the main theme

ORGANIZING CLASS

Primary:

All children should be given an opportunity to participate
Beginning experiences should be brief and simple
Individually drawn pictures can be cut and assembled
Teacher can give help in use of materials

Intermediate:

Group planning, should include ideas of whole group
Art principles should be considered (light and dark, repetition, colors, lines, texture, space, arrangement).

Note: Mural illustrations that follow are offered solely to clarify techniques and are not suggested for limitations.

BEST COPY AVAILABLE

TEMPERA MURAL

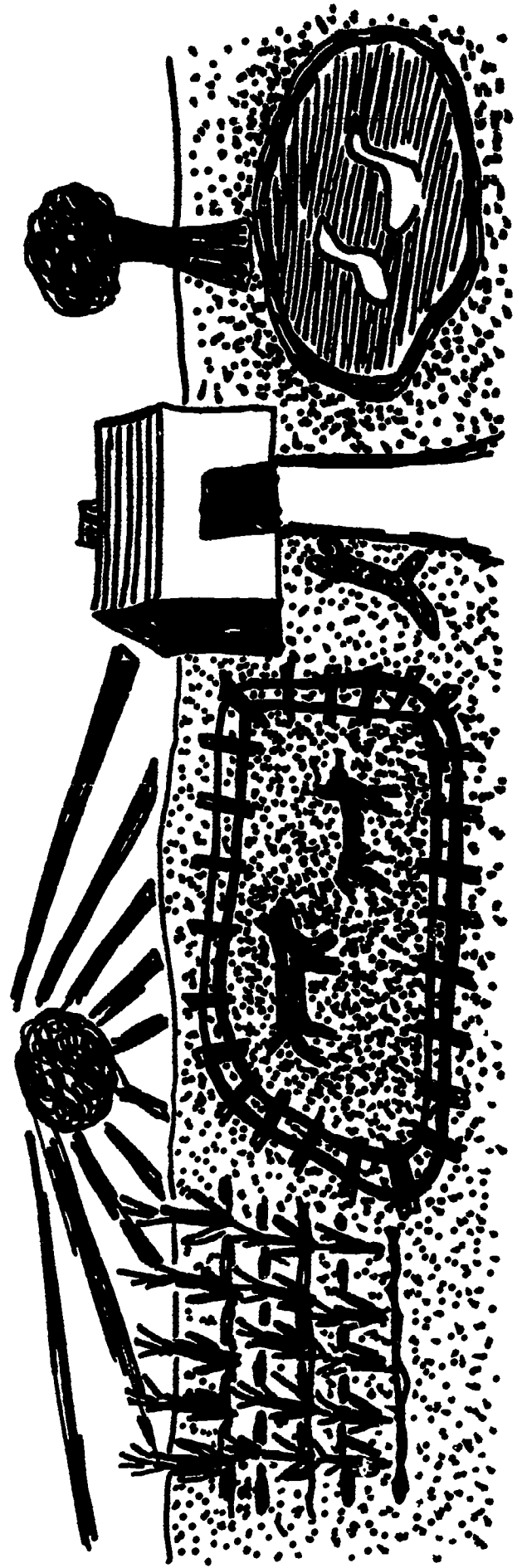

00055

MURALS

TEMPERA K-2

Preplanning Objectives

To unify separate drawings by using an over all background.
To differentiate objects from background by means of color.

Materials

Tempera; charcoal or chalk; brushes; sponges; paper; cardboard; newspapers; milk cartons or muffin tins; rags; smocks or aprons.

Preparation

Discuss theme. Plan drawings, and carry out theme either in small groups or individually. Make sketches on newsprint. Pour paint into small containers, such as muffin tins or milk cartons.

Motivate

Procedure

Measure and cut background. Sketch pictures with chalk. Begin by painting background in subdued tone. Paint around areas sketched. Let dry.
Paint objects over background area. Use brighter, more vibrant colors than in background.

People, objects, and animals may be painted, cut out, and applied to background.

Variation

Dry tempera can be mixed with varnish to make an oil type paint.

Paraffin can be used for drawing and painted over with tempera.

Tempera can be combined with crayon, chalk or ink.

Evaluate

Are the colors clean and bright? Does the mural tell a story? Do all the shapes contrast with the background? Did the figures, etc., come out large enough to fill space?

CRAYON K-2, 3-4

Preplanning Objectives

To cover large areas with crayon.

Materials

Butcher paper, crayons (wax), paper or cloth

Preparation

Discuss theme with class. Organize small groups to illustrate various parts. Plan sequence. Have children plan small sketches first. Put children's sketches up for discussion and then plan arrangement.

Motivate

Procedure

Measure background area, and fit with (mural) paper. Spread newspapers, and lay mural on floor. Sketch directly with light colored chalk. Be sure there are no blank spots. When sketch is completed, fill in with crayon. Use sides of crayons to cover large areas. Use dark colors next to light. Notch crayons for stripes. Rub crayon with cloth. Don't forget to fill in the background. Give the mural a caption. When doing a crayon mural on cloth, the color can be set by ironing between sheets of clean paper.

Evaluate

Is the theme clear? Is the sequence right? Are the figures and action on a subdued background? Is the work clean and bright? Is the effect appealing?

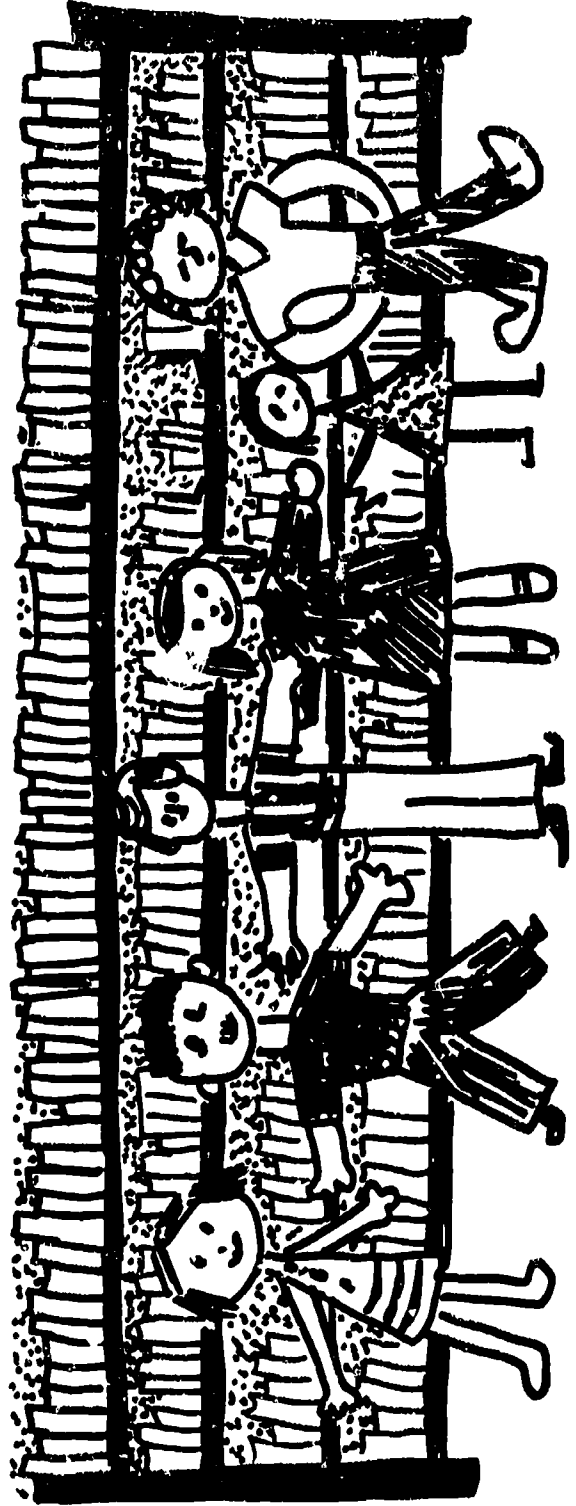

BEST COPY AVAILABLE

YARN 3-4, 5-6

Preplanning

Objectives To achieve forms and movement by using lines (yarn).

Materials

Yarn (different weights and colors); white glue; heavy cardboard for background; chalk; newsprint; scissors; coat hangers; news-papers.

Preparation

Cut mural background into sections to be re-assembled at end of project. Cut yarn in yard long pieces. Discuss subject matter or theme with children. Talk about ways of using yarn to fill in areas (curling, curves and waves, straight lines, etc.) Entire mural should be filled in with yarn. Sky or ground are sometimes painted. Sketches should be done on newsprint with chalk. Adjust to "fit" together, on background.

Motivate

Procedure

Transfer sketches by cutting out shapes and tracing around them. Sketch whole mural, then work on parts in small groups or individually.

Variation

Yarn can be used to outline objects. Tempera, wall paper, chalk, or crayon can be used to fill in areas.

Evaluate

Has the yarn been used with varying directional effect? Such as swirls, zig-zags, curves, straight lines, etc. Do colors harmonize? Have they been repeated? Do figures show up? Is the whole mural well done?

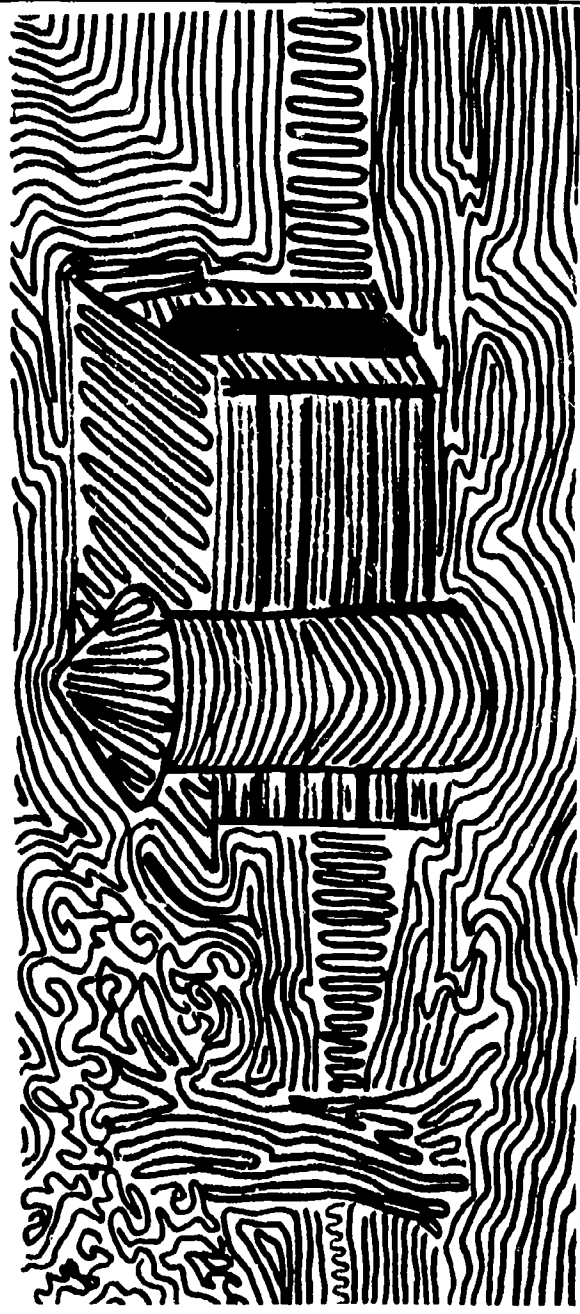

MURALS

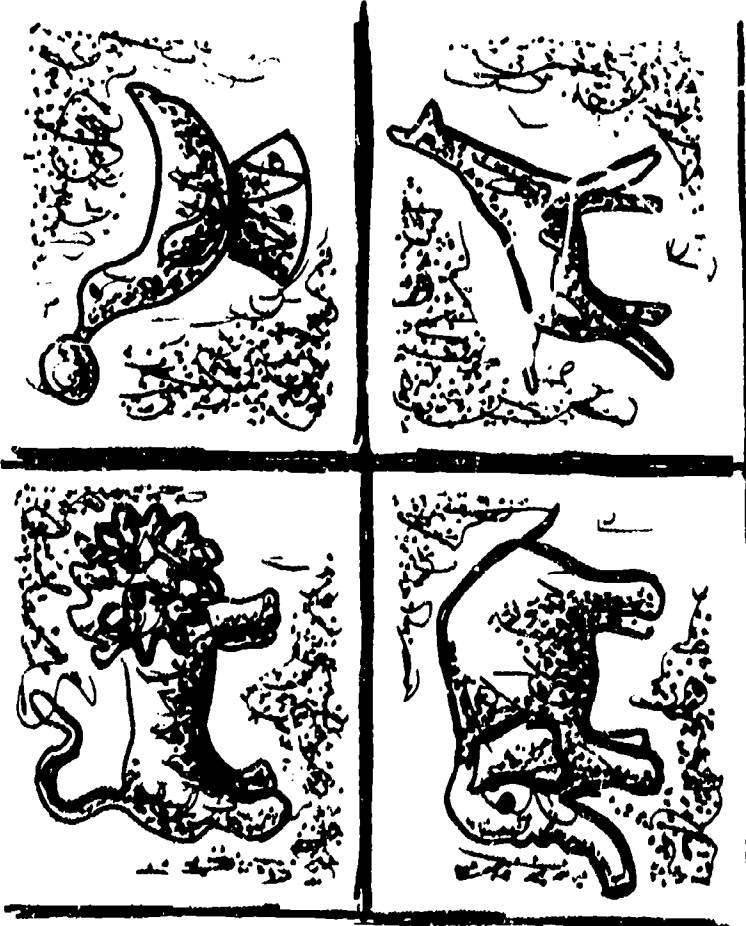

MURAL ASSEMBLAGE 3-4, 5-6

Preplanning

Objective To create a textured, metallic mural. To join small individual projects into a composite.

Materials

Large background of cardboard. Glue, styrofoam trays, scissors, pencil, foil, Tempera, India ink. Small squares cardboard.

Preparation

Cut squares of cardboard not over 9" x 12" for each child. Tear 15" lengths of foil for every cardboard. One container of glue for every two pupils. Brushes, India ink, and thin solution of a light tempera color mixed with 1 tbsp. white glue -- place where they can be distributed later.

Motivate

Procedure

Have pupils select general subject. Give each a 9" x 12" sheet of paper for drawing. Lay on styrofoam tray and trace, impressing with pencil point. Cut out styrofoam shapes and glue to cardboard square. Add parallel toothpicks, buttons, cord, etc. if needed to fill blank areas. Take foil, crush into a ball then straighten out. Do not smooth! Lay over composition and begin pressing to yield the shape forms underneath. Begin at the center and work outward. When the contours are completely fitted, glue foil, get a spoon or tongue depressor and start smoothing the foil until most wrinkles have been removed.

Take the tempera-glue-water mix and paint the foil. Let dry. Paint over with India ink. Wipe lightly. This will reveal the tinted foil, and in places the foil only. When all the pieces have been finished, fasten to the large cardboard with glue.

Evaluate

A useful form of evaluating takes place in the process of deciding how to arrange individual pieces into a pleasing composite.

MURALS

SCRIBBLE MURAL 3-4, 5-6

Preplanning

Objectives

- To create a design with rhythmic relationships.
- To work in individual lines into one whole.
- To experience "drawing out" shapes from abstract lines.

Materials

Background paper; charcoal; chalk, or pencil; tempera; brushes

Preparation

- Discuss making large, sweeping lines with whole arm. Have children use arms in air to encourage large movements.
- Place background paper on flat wall. Each child will need charcoal, chalk, or a pencil.
- Motivate

Procedure

Have each child place lines directly onto background. When each child has had the opportunity to contribute lines, the whole is studied. Discuss central theme again, this time finding shapes in the abstract lines. Some lines will need to be eliminated. "Draw out" objects. Paint in the objects found, then paint background area, following lines already established. Establish a center of interest, and try for repeats of shapes, lines and colors.

Evaluate

Check for theme, color relationships, contrast, unity, textures, sufficiency of recognizable shapes.

COLLAGE 3-4, 5-6

Preplanning

Objectives

- To assemble found materials into a large composition.
- To unify and balance a large arrangement.

Materials

Newspapers, cloth, wire, buttons, sticks, yarn, beads, trim and fringe; artificial flowers, etc.; white glue, brushes, cardboard or masonite for background, small boxes, newsprint, charcoal and pencils, stapler, pins, scissors

Preparation

Discuss overall theme. Plan mural parts so that there is a relationship between materials, balance materials. Have sketches made on newsprint with charcoal or pencils. Pin sketches to background to get a view of the whole. Divide into small groups. Place found materials in open boxes easily accessible to all.

Motivate

Procedure

Create objects and figures by gluing, or stapling materials to background. Large pieces of cloth, trim, etc. will help unify the whole.

Evaluate

Does the mural hold together in design, organization, important shapes? Has every child had a part in it?



MURALS

MOSAIC MURAL 5-6

Preplanning

Objective

To create a large design from small bits and pieces.
To become sensitive to the textural qualities of a mosaic.

Materials

Compatible items should be used in a mosaic. Corn grains, seeds, beans, rice, etc.; shells, pebbles, bits of driftwood; glass, ceramic tiles, bisque ware; paper, tape, stencils, stamps, cloth, beads, buttons.
Depending on the materials used, a suitable adhesive is necessary. Heavy mosaics require sturdy background material. Place eye screw or other attachments on back for hanging. Tiles should have spaces filled with spackling or grout which can be tinted, with tempera. Tiles should be wiped clean. Tools also are determined by type of mosaic. Scissors or knives for lighter materials, tile nippers for glass and ceramic mosaics.

News-papers, news-print, pencil and throw-away containers for mixing cement to plaster.

Motivation and Preparation

After the class has decided upon a theme, divide class into groups, each of which designs a section of mural on news-print.

Procedure

When drawings of sections are completed, assemble them in pleasing order on background. Lay background on floor and proceed to trace design in final form. Arrange adhesives, tesserae (mosaic pieces), tools for the groups working on the mosaic. Elevate colors, shapes and directional effects as the constructing continues. Do figures and objects first, using most colorful tesserae. Save neutral tones for spaces such as sky, space, ground. Do these last.

Elevate

Check directional effects, if any; textures and colors; filling of design; total effect.

RELIEF 5-6

Preplanning

Objective

To create a three-dimensional effect

Materials

News-papers; asbestos and wheat paste (see formula) or paper mache; large cans (for paste); knife or spatula; plywood or masonite; tempera and brushes; newsprint and pencil.

Preparation

Discuss plans for mural. Make sketches on news-print of objects or scenes. This can be done as group work or individually. Spread news-paper, lay background board on floor or table and paint. Let dry. Put sketches together and trace them on background.

Motivate

Procedure

Mix relief medium in large cans or pans. Cover work area with newspaper. Apply medium to background, building up area with fingers to "stand away" from background. When completely dry (several days) the mural can be painted with tempera.

Variation

Shapes or objects for a relief mural can be done by sand casting (see section on sand casting).

Evaluate

Does the 3-D effect seem to invite you to touch or feel it? Is the design effective?

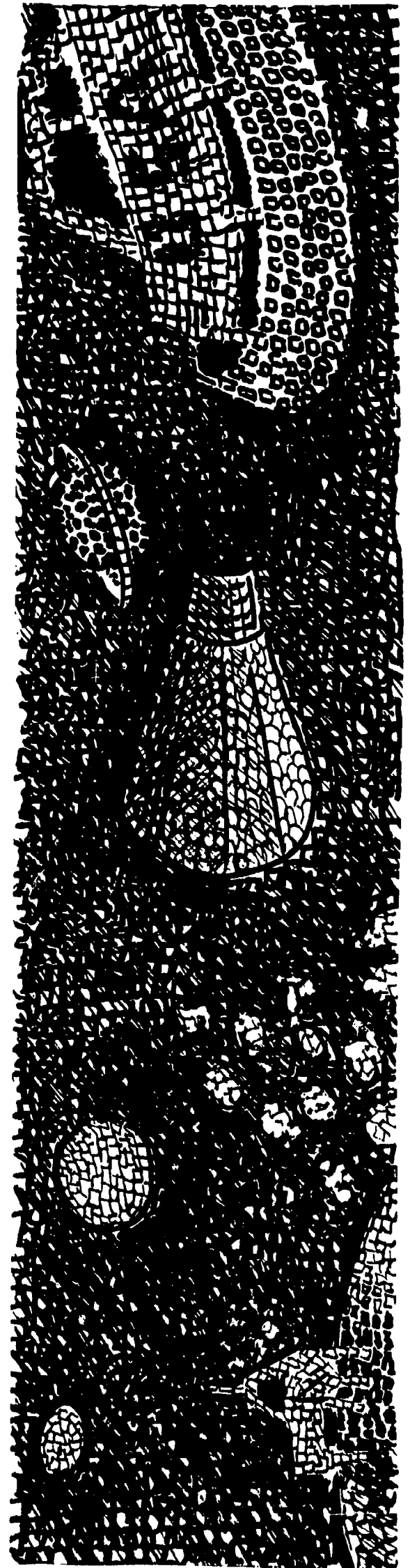

PAINTING

"Aesthetic sensitivity, when attained, is a product of development and learning over the years of childhood, and artistic training seems to shape it significantly."

Dale Harris
Head Psychology Department
Pennsylvania State
University

PAINTING

FINGERPAINT

General Objectives: To utilize the large muscles in painting
To gain a concept of rhythm in painting
To control paint through direct contact

Tools: Whole Hand

Flat Palm

Side of hand (straight and fingers curved)

Clenched Fist

Thumb (base, outer side)

Knuckles

Fingers (flat part)

Fingernails

Controlling fingerpaint

Dark and light areas can be controlled by pressure and by paint consistency.

(Less paint and more water lightens.) (More paint and less water darkens.)

Colors can be mixed on separate surface, then added.

Background color can be removed with cloth, sponge from certain areas.

When doing multicolored painting, work quickly while paint is wet.

Learn not to go over and over areas.

Do background first, middle ground second, foreground last.

Fingerpaint is a medium children enjoy, because they can redesign their painting many times. Also the work is of a large-muscle, rhythmical style. Pupils need encouragement to experiment with many varied strokes. It must be understood however that skilled subtle effects of good fingerpainting come from more mature artists.

Procedure:

Begin with one color, practice, keeping paint movable by adding a little water while you work.

Experiments:

Pat, swing, push, wiggle, zig-zag, smear, scrape, tap, spiral, scallop. Try this with whole hand, palm, side of hand, fist, thumb (side and base), finger tips, fingernails, side of whole arm, wrist to elbow, elbow. This can be continued for several lessons. Have pupil repeat those experiments that turn out well, in order to remember them. When advancing to two colors, begin by having pupil place one color on half the sheet and another color on the other half. Then let him blend the two colors just in the middle. Compare the three effects. Let some of the pupils blend the whole sheet. Then compare with those sheets that still have three colors. Help them see that some of each color should be left like it is.

Follow this by having pupil spread one color over parts of the paper leaving areas of white. Add daubs of another color in the white spaces and let him cover only the white. Then he may blend a little, but not too much to complete his background. Now let him apply his painting techniques sparingly so as not to muddy the background.

Keep reminding him that each color needs to stay partly by itself and doesn't want to be all covered up.

As a last step, let him plan where he wants the colors to go for the composition (content) of his picture.

Variation:

1. Colorful fingerpaintings can be cut into pieces for collage.
2. Boxes, wastepaper baskets, pencil holders are attractive when covered with finger paintings.
3. Long (6") narrow triangular strips cut from fingerpaintings can be rolled over a stitchery needle and glued to make beads. Interspersed with beads from old jewelry they make a nice necklace.
4. Try paper sculpture with fingerpainted papers.
5. Light colored fingerpaints make good backgrounds for styrofoam and cardboard prints.

MONOPRINTING WITH FINGERPAINT K-6

Preplanning

Objectives

to print an impression from a flat surface
to experience reverse printing
to obtain interesting visual textures

Materials

fingerpaint, paper, (fingerpaint paper, newsprint, Manila, construction, oak tag, brown wrapping, newspaper, etc.)

Preparation

Spread newspaper on floor or tables to receive prints, or string clothesline overhead and clip prints to it with clothespins. Have bucket of water and sponge ready for clean-up.

Motivate

Procedure

Make a fingerpainting on a glazed or formica surface (table top, glass). Place paper to be printed on top of the wet painting. Rub gently over the back using hand, scraper, or brayer. Lift print. Second print can be made using more pressure. Third print can be made on wet printing paper.

Variation

1. Lift a print of blots of paint. Add blots of another and repeat. Print one color at a time, or use many colors.
2. Design with leaves, grass, flat materials. Arrange on a wet painting—lift prints.
3. Lift prints on wood, material, styrofoam.
4. Spread thick paint on surface. Place printing paper over it. Rub gently. Using stylus, make picture on back of printing paper. Lift print.
5. Place cardboard shapes on a flat surface. Lay wet finger paint sheet on top. Apply finger paint and scrape paint off with scraper of cardboard or wood. Resulting print will be a scraped monoprint.
6. Ink, crayon or paint accents can be added to the dry print.

It is advisable to have children bring old shirts to protect their clothes. Roll shirt sleeves up, or cut off at the elbow.

Research shows that children who have been strongly admonished about cleanliness feel reluctant to get messy with finger paint. Keep wet paper towels handy as well as sponges and large containers of clean water. Show how easily finger paint comes off hands with a damp sponge.

"By revolutionizing the teaching of art we might well enhance significantly the quality of living and the character of our culture."

Dr. John Goodlad

"I hold that meaningful experience with the arts does help to equip a young person to deal with the problems of life, whether practical, moral, psychological or spiritual."

Wm. Schulman

Pres. Lincoln Center for the
Performing Arts

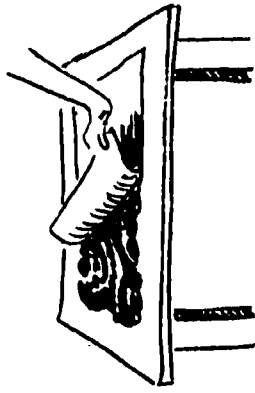

TOOLED FINGERPAINTING 3-6

Preplanning

Objectives

to incorporate various tools in painting to record impressions by rolling

Materials

fingerpaint, sponges, long pan of water, paper, (variety) brushes, (all kinds, sizes) cardboard (different thicknesses, drinking straws, natural materials), ss. bark, fruits, vegetables, etc.), wood, rubber, felt, sponges, plastic, etc., brayer, newspaper.

Preparation

Lay out individual sponges or wet paper towels. Place a long pan of water for easy access for wetting paper. Large cans of tools and paper as needed. Wet paper by rolling into a tube. Immerse in long pan of water. Lift by one edge. Lay directly on table (formica).

Motivate

Procedure

The following variations can be used with fingerpaint

1. Use straws, leaves, grass, etc. under wet paper. Roll over paper with brayer.
2. Use cardboard edges for scrapers on fingerpaint.
3. Place string on wet fingerpainting and fold paper or place a top sheet over first. Pull strings out. Lift top sheet.
4. Use natural materials (wood, bark, etc.) as tools to use on wet fingerpaint. Evaluate

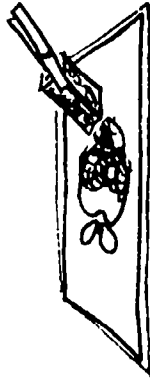
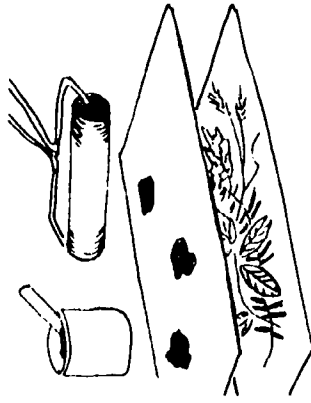
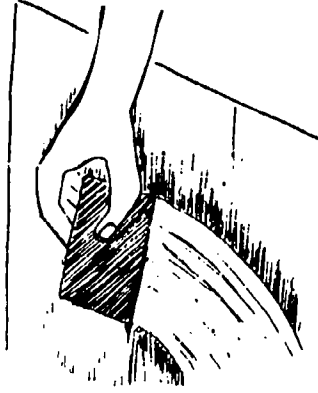

BEADS FROM FINGERPAINTINGS — 4-5-6

Preplanning

Objectives

to create personal, handmade jewelry to make beads that harmonize in color to salvage a fingerpainting to "stretch" art materials

Materials

scissors, pencil, cardboard triangles $1\frac{1}{2}$ " x 12", stitchery or fine knitting needle, white glue, small brushes, wax paper, embroidery needle, heavy thread or small twine, damp sponges or paper towels

Preparation

Have old fingerpaintings on hand. Select those with good color variety and showing many swirls. Cut cardboard triangles $1\frac{1}{2}$ " x 12"

Motivate

Procedure

Use cardboard triangles as patterns to mark off triangles on the fingerpainting. Cut out the triangles marked. Starting with the wide end of the strip, roll a triangle over a needle. Keep the strip centered. Be sure the color side is out. When the strip has been rolled nearly to the tip apply glue with brush inside and outside the tip.

Slip the needle out and set the rolled bead on wax paper to dry. Wipe glue from needle and hands before repeating. 30 beads this size should make a short necklace. String beads with heavy thread or light twine strung through an embroidery needle. Glass or wooden beads interspersed will make necklace longer and more professional. Be sure it is large enough to go over the head. Shellac can be applied to the paper beads for a glossy look.

"Each student in his own way, works to satisfy the innate love of beauty which stimulates him to produce and create artistically."

George von Kantor

Art Chairman

John F. Kennedy Jr. High

"Creativity is a distinguishing characteristic of outstanding individuals in almost every field."

E. Paul Torrance

PAINTING

TEMPERA AND WATER COLOR

General Objectives

- to give creative experiences with color.
- to learn to combine colors into a pleasing composition.
- to gain facility in the use of painting tools (brushes, sticks, cardboard, fingers, etc.).
- to learn to combine many media, techniques.
- to gain experience in preplanning a composition.
- to encourage experimentation with paint.
- to cultivate spontaneity.
- to work boldly without reliance on pencil guidelines.

A WORD ABOUT PAINTING.

Realism comes from long practice in *drawing*.

Painting is about something entirely different.

A painter's chief concern is what happens with his paint. Colors, blends, lights and darks, large areas of color, small areas of color, clean color, transparent color, harmony, brush strokes, textures, mood — these are a part of what he is experimenting with. If it looks realistic, fine. If it doesn't, he is not bothered so long as his design and effect are pleasing.

In children's paintings, many naive effects reach qualities the adult painter is struggling for. Learn to find these: it's a fascinating game.

POINTERS ABOUT PAINTING:

- Tempera pigments are not pure and do not mix into clear blends.
- Tempera should be the thickness of light cream.
- Using the side of the brush to paint along a line works better than using the brush point.
- Brushes should not be held like a pencil but should be grasped at least an inch back of the metal ferrule.
- Brush drawing is bolder and freer than pencil drawing, and much to be preferred.
- Filling in pencil drawings is coloring, not painting.
- Serious painters often spread on color and draw over it, without concern for fitting the color and drawing exactly.
- Wet paper (on both sides) gives beautiful effects if not overloaded with paint.
- Children, K-2, should not have more than 3 colors at a time.

PROCEDURE FOR PAINTING

Get set for painting activities at the beginning of the year, and the actual activity will be simple.

Do this: Have old newspapers on hand.

Cut down cardboard cartons. (Campbell's soup size) to 3" high.

Cut tops from milk cartons to hold paint.

Place 6 milk cartons in foil-lined cardboard box-tray.

Collect large cans from cafeteria to hold water.

If individual water containers are needed, cut tops off plastic milk bottles.

Before the painting activity

Do this: Fill milk cartons with 4 to 6 separate colors $1\frac{1}{2}$ " to 1" deep.

Set paint cartons in cardboard tray and cover with plastic wrap.

Wet a batch of paper towels and wring slightly.

To begin

Do this: Cover tables with newspaper (2 pupils)

Give out paper and brushes (2 pupils)

Set water and paints on tables (Teacher)

Give each child a damp paper towel for keeping hands clean.

To clean up

Do this: Pupils clean brushes in water can and lay them on table.

Teacher collects paint tray and discards all milk cartons that are nearly empty

1 pupil collects brushes

1 pupil at each table empties water cans at sink

Each pupil removes newspapers from table and folds them compactly, leaving painting on table.

1 pupil passes the waste basket to collect newspaper.

Paintings not dry can be spread temporarily on floor or counters. If someone will donate an old hair dryer, the drying can be speeded up.

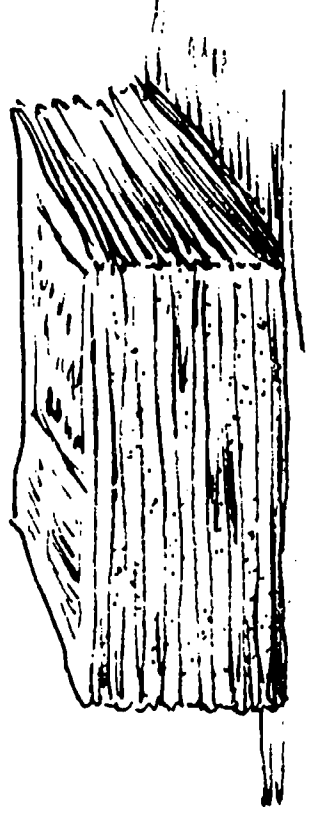
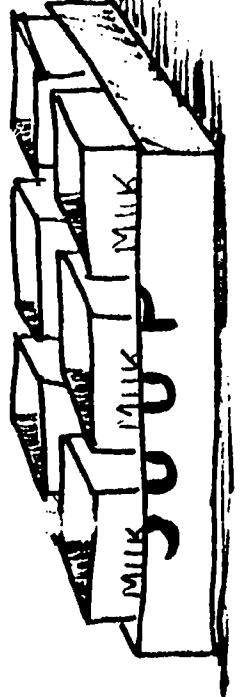
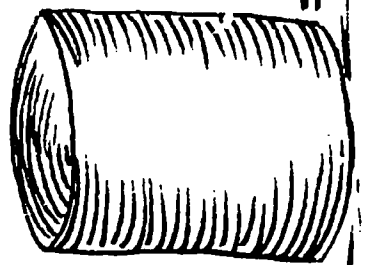

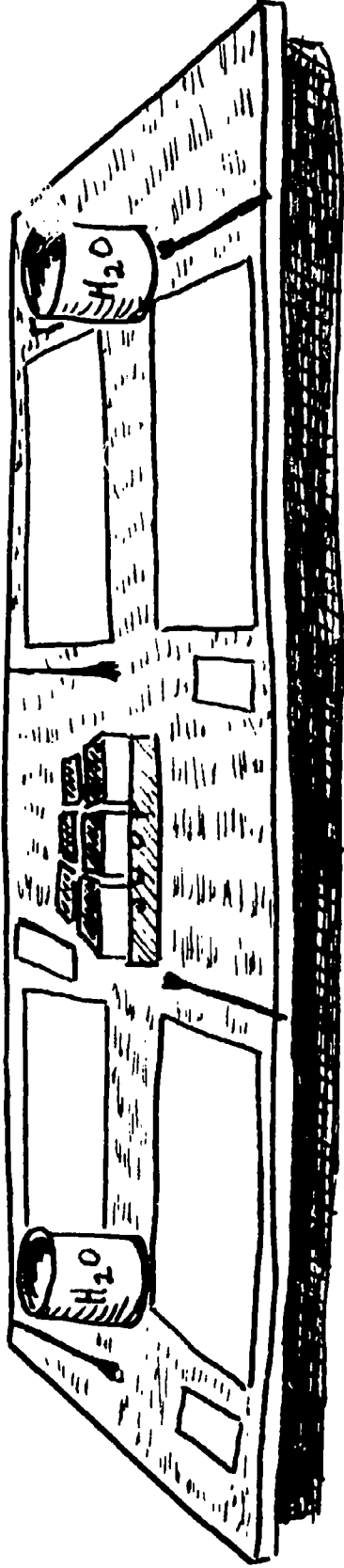

TONED BACKGROUND K-4

Preplanning

Objectives

- To discover wet blending.
- To create a color background for drawing.

Materials

White construction paper or butcher paper, water, tempera, easel, brush, sponge for clean up, muffin tins.

Preparation

Distribute materials. Put 3 thinned colors in each muffin tin.

Motivate

Procedure

Explain that pupils are going to make their own colored paper on which to draw. Have them dip sponge in clear water, and wet paper on both sides. Smooth paper on table and brush colors on the paper to create colorful background. Set aside to dry. Next day, let pupils paint picture on the colored surface.

Evaluate

SPATTER PAINTING K-2, 3-4

Preplanning

Objectives

- To experiment with positive and negative shapes.
- To experiment with many techniques for making a stencil painting.

Materials

Tempera; scissors; charcoal or pencil; brush (toothbrush, vegetable brush, hairbrush); paper (butcher, manila, newsprint); cardboard (file folders); screen wire (piece)

Preparation

Give out scissors, charcoal or pencils and cardboard. Sketches should be made directly on cardboard and cut out. Keep object's large. Cover painting area with newspaper. Children can work in pairs and assist each other with spattering.

Motivate

Procedure

Object is cut out from cardboard. Object may be used as stencil or area from which it was cut. Place stencil on paper and spatter with tempera-filled brush through screen. Several colors can be used. Overlap shapes when repeating the spatter.

Evaluate

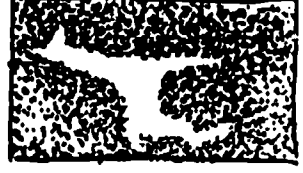

PAINTING

SPONGE PAINTING 3-4

Preplanning

Objectives

To experience mixing colors on the paper.
To achieve various effects by different wetness of areas on paper.

Materials

Sponges (cut various sizes); scissors (to cut sponges); dry tempera; paper (Manila); clothes pins.

Preparation

Cut sponges into small pieces (approximately 1" x 2"). Cover work area with newspaper.
Each child will need paper, sponges and tempera. Sponges can be placed in or near the color to be used. Use a different sponge with each color.
Paint can be placed in a centrally located area.

Motivate

Procedure

Wet paper. Place on smooth surface and remove wrinkles. Use pieces of sponges to dip into dry tempera, then onto paper.
Clothespin holds small sponge.

If dry tempera is not available, liquid tempera poured into a regular sponge will hold enough paint to color small sponges. Use like a stamp pad.

Evaluate

Variation: Cut a stencil from a manila file folder. Lay it on a clean sheet of paper and sponge color in open space. Try two colors and shift stencil for second color. Try sponging around cut out piece.

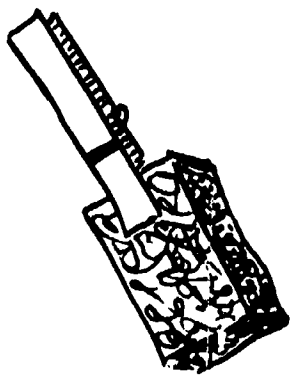

Preplanning

Objectives

To discover a form of resist.

Materials

tempera, paper (construction), rubber cement, brushes

Preparation

Cover work area with newspaper. Cover another area near sink with newspapers for drying. Each child will need paper, brush and tempera. Glue can be shared between several children.

Motivate

Procedure

Paint is applied heavily to areas on paper. When dry, rubber cement is dripped or placed on painted surface. When dry, paper is washed by gently rubbing under running water. Glued areas will remain dark. The process can be repeated after drying the paper.

Evaluate

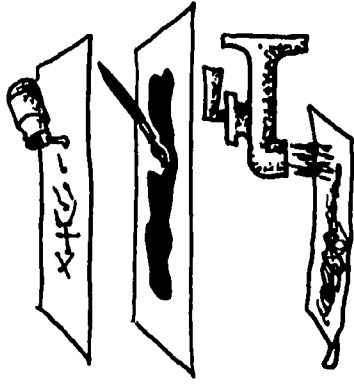

DRIP PAINTING 3-4, 5-6

Preplanning

Objectives

To help develop a feeling for the abstract.
To experiment with a Jackson Pollock technique.

Materials

tempera paint, brush or stick, newspaper, paper (newsprint, Manila).

Preparation

Cover work area with old newspapers. Each child will need paper (newsprint, Manila, or newsprint). Place paint and brushes near children to prevent dripping over each other's work. Put a brush or stick in each color tempera and pass jars around.

Motivate

Procedure

Take a half sheet of newspaper. Tear holes into it. Lay this over paper. Load brush with fluid tempera so that it is dripping. Drip over the newspaper stencil. Change color and repeat with a clean brush. Let dry. A new stencil with smaller holes can be used to repeat the process. When dry draw around shapes with magic marker or black paint.

Variations

- Paint tonal background on paper. Let dry. Dip stick into easy-runni: tempera and drip over background color.
- Paint in rhythmic lines. Then drip colors over original lines.
- Combine technique of dripping and pouring.

Evaluate

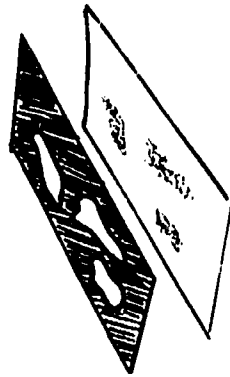

PAINTING

PAPER ENGRAVING 3-4, 5-6

Preplanning

Objectives

To understand the technique of engraving through a simple process.

Materials

Newsprint; pencil or charcoal; darning needles; brush; tempera; cardboard (poster paper, file folders)

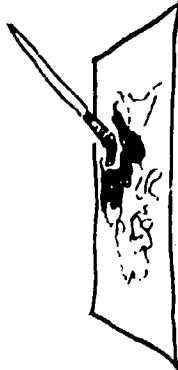

Preparation

Discuss engraving. Have children understand that this is a process of scratching into a surface.

Give out newsprint and charcoal or pencils. Have planning sketches done. When the child is satisfied with his sketch, give out cardboard and darning needles (one of each per child). Paint can be placed in central locations to serve several children. Cover area with newspaper.

Motivate

Procedure

Design is scratched into cardboard with needle. Use simple subjects (animal, tree, house, person). Scratch deeply into cardboard paint over with thinned tempera (evenly). Scratched design will show up as a darker color.

Evaluate

PAINT ON FOIL GR. 3-4, 5-6

Preplanning

Objectives

To experience "pulling out" a picture or design by scratching.

Materials

Aluminum foil; rubber cement; tempera; cardboard (shirtboard or corrugated); brush; scratching tool (dull pencil), scissors, pointed stick, etc.; hair spray; liquid detergent.



Preparation

Cover work area with newspaper. Each child will need a piece of cardboard, foil. Rubber cement and tempera can be placed in centrally located areas. Children can use abstract designs or pictures scratched into foil. Subjects for pictures can be simple objects, trees, animals, landscapes, still life, or figures. Many textures can be produced by scratching thru the paint in various ways (cross-hatch, straight lines, criss-cross, wiggly, broken lines, etc.).

Motivate

Procedure

Glue foil to cardboard with rubber cement. Smooth out wrinkles. Paint surface with tempera. (Add liquid detergent to tempera if it "beads".) Allow to dry. Scratch through tempera to create desired design or picture. Spray with hair spray to help protect surface.

Evaluate

BRAYER 3-4, 5-6

Preplanning

Objectives

to discover different techniques possible with brayers.

Materials

assorted brayers (or rollers)
tempera
flat pan
paper (construction paper, manila)

Preparation

Cover work area with newspaper, children can experiment with rolling brayer in different ways on newspaper before planning pictures. Try various strokes (side) of brayer, twisting, short strokes, long ones).

Motivate

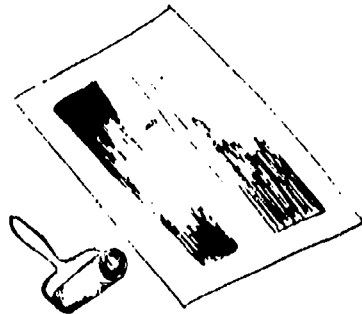

Procedure

Tempera is poured in flat pan and roller is run through paint. Painted roller is then applied directly to paper. Long, extended strokes or short ones can be combined. Roller turned on side can make a narrow line. An entire picture or composition can be done with various strokes.

Evaluate

BEST COPY AVAILABLE

PAINTING

WET PAINTING IN WATERCOLOR 3-4, 5-6

Preplanning

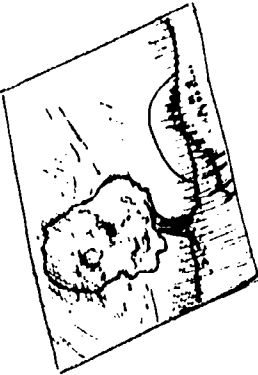

Objectives

To understand the flowing and blending of colors on wet paper.

Materials

White construction paper, large container of water, 1 flat 1 round brush, muffin tins, tempera, pencil, and sponge.

Preparation

Place water containers for every two pupils. Cover tables with newspaper and give out brushes. Have muffin tins and tempera paints at a central location. Have pupils draw picture or design on the sheet of white construction.

Motivate

Procedure

Let each pupil select 5 colors. A spoonful of each will suffice. Put these in muffin tin. Dip sponge in clear water and wet sheet of construction paper thoroughly first on one side, then on the other. While the paper surface is moist paint colors loosely on the forms in the picture. Do not try to fit the shapes, merely spread color flatly over the area. Let some of the colors overlap. Make the colors more intense in some places than in others. Let dry. When the painting is completely dry, (next day) dip the round brush in fluid black tempera, and draw the shapes in on top of the color. The spread of color beyond the margins of forms is a deliberate watercolor technique.

Evaluate

OTHER POSSIBILITIES TO EXPLORE:

1. Straw painting — Apply paint in fluid droplets, a few at a time. Using a soda straw, blow on the droplets, forcing the fluid paint forward to form many small branches.
2. Corrugated cardboard — Use tempera paint on raised surface only. Or, paint into grooves with one color, then paint cross grain with other colors, putting design on raised surface only.
3. Paint prints — Cut simple form out of cardboard. Stretch nylon hose over the opening and tape down. Then paint through the nylon screen onto paper. Using several shapes prepared this way, repeating the painting in different colors produces something similar to a silk screen print.

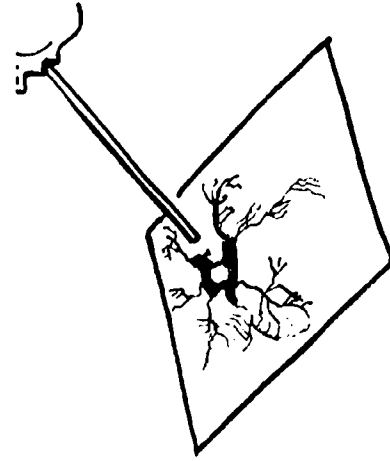

CONTROLLED BLENDING 5-6

Preplanning

Objectives

to use wet blending in limited areas

Materials

White construction or white drawing paper, water, sponge, round brush # 12, muffin tins and tempera, or watercolor box, pencil.

Preparation

Make complete sketch of over all area (omit fine details)

Motivate

Procedure

Dip brush in clean water and wet an area which is to be of one principal color. When the area is all moist, pick up the main color of the area and flow it into the clear liquid. Another color may be added to get variety or to create shade. When the color in this spot is satisfactory move across to another area without any side bordering on the first section colored. Treat this section in the same way. Proceed, moving from one dry spot to another to blend and shade the whole painting. As long as the design is not too complex this approach works very well. When dry, use brush tip to draw in details. A pointer: avoid small thin objects or forms for watercolors.

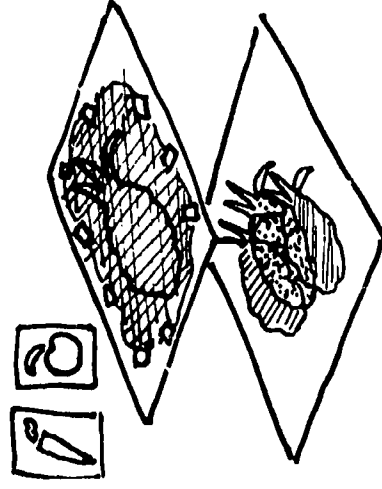
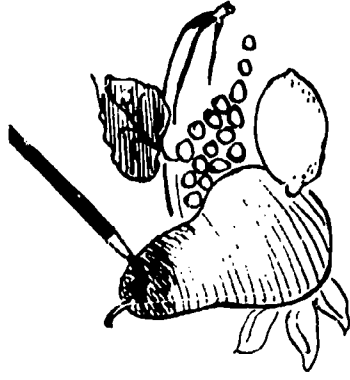

PAINING

TEMPERA BATIK 5-6

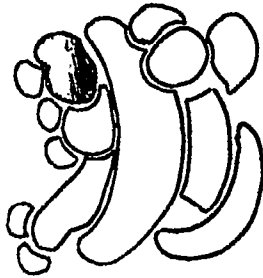

Preplanning

Objectives

- To learn a simple batik effect.
- To create a composition step by step.

Materials

Tempera; brushes; paper (Manila); India ink; running water, charcoal or pencil (for sketch).

Preparation

Several art periods will be needed.

First day: Cover work area with news-paper. Each pupil will need paper and charcoal or pencil. Make sketch on Manila paper. Have tempera placed in easily accessible area since several colors will be needed. Paint.

Second day: Crumple painting. Shake off excess flakes. Apply ink. Have inking area covered with newspapers.

Third day: Cover sink area with newspapers. Wash painting under running water. Spread to dry.

Motivate each day

Procedure

Begin by a planning sketch (suitable subjects include still-life, landscapes, portraits, animals.) Keep objects fairly large. Sketch on paper. Apply tempera thickly, leaving "roadways" around objects. Use whole sheet's. Let paint dry completely. Crumple painting (into ball). Shake off flakes. Coat surface of painting with India Ink. Let dry. (Use brush.) Wash under running water. Remove when painted areas begin to emerge. Gentle rubbing in areas will help.

Evaluate

CARDBOARD PAINTING GR. 5-6

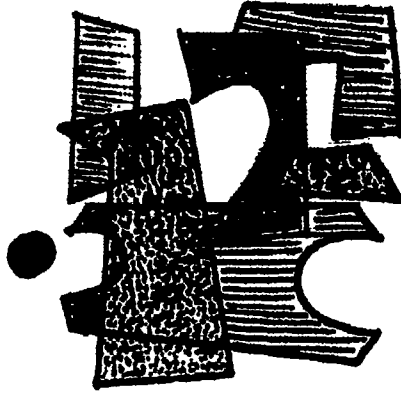

Preplanning

Objectives

- To "build up" a composition step by step.
- To gain experience in repeating shapes and colors in a composition.

Materials

Tempera (thicken with liquid, flake or powdered detergent); brushes; paper (manila or cardboard); cardboard (various thicknesses); milk cartons; scissors; pencils or charcoal.

Preparation

Give each child a piece of cardboard, charcoal or pencil and scissors. Have free form shapes drawn on cardboard and cut out. Be sure to repeat curves and straight lines. Painting area can be prepared by covering a table or several desks with newspaper. Tempera can be mixed and placed in milk cartons in center of work area.

Motivate

Procedure

Shapes are cut out of cardboard. Assorted sizes and thicknesses can be used. Press cardboard shapes (one at a time) into paint or brush paint on. Print on paper. Let dry and repeat with another shape and color. Keep repeating until all shapes are used and sheet is filled. Overlap some areas.

Variation

Cut strips of cardboard. Use edges to draw over printed picture by painting edge with dark colored tempera. Press edge to paper and pull up. Repeat.

Evaluate

TIE DYEING -- 3-4, 5-6

Preplanning

Objectives

- to understand an age-old textile process;
- to experiment with folding and tying.
- to experience procedures for dyeing.

Materials

dye, pot for dye, hot plate, kitchen tongs, pan for rinsing, string, soft washed cotton fabric, newspapers.

Preparation

Make up dye in strong solution and have ready in an enameled pan. Have squares cut or torn for each pupil. Cut 7 or 8 lengths of string 10" long for each child.

Motivate

Procedure

Take a square of cloth, pinch up a small amount, wrap tightly with string and tie, allowing a small tip to show. The wrapped area should not dye. Let pupils follow suit, pinching up large and small bits, making sure of tight winding and tying. When they cannot possibly get hold of another "pinch," let them wet fabric and begin dyeing. The dye must be very hot. Use kitchen tongs and immerse one tied piece of fabric at a time. The longer it stays in the stronger the color. Remember that the color looks much darker when wet. Remove the cloth, rinse, and dry. Paper towels will help speed the drying as will a hair dryer. When dry untie and discover how the tying affected the dye. Press with iron to set color and smooth fabric.

Variation

1. Pleat the fabric lengthwise, then have someone assist in twisting until it curls back on itself. This requires thin fabric. Wet then dip into dye.
2. Tie knots in the fabric, wet and dye.

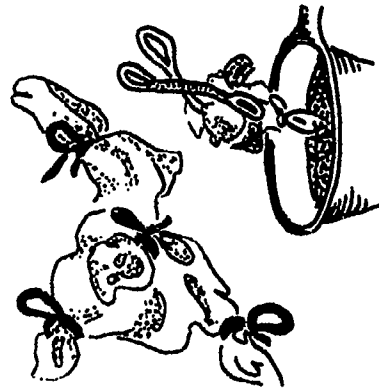

NOTES

PAPER

“ . . . inquire what the art effort does to the recipient. If it affects him in a fine way, then it is art; if the rules have been broken, then the rules will have to be changed.”

Hughes Mearns
Creative Power

PAPER

General Objectives:

- To learn to manipulate paper by cutting, folding, tearing, bending and scoring
- To learn to create two and three dimensional forms from paper
- To discover the versatility of paper and the variety in which it is manufactured.

Simple skills:

Scoring—use a dull point such as the back of a scissors blade and impress along any line which is to become a fold. Do not cut or tear.

Curling—Drawing paper strips over the metal edges of a ruler, or rolling on a pencil in a straight or spiral manner.

Catstairs—(Used for arms and legs on paper figures). Cut two long strips of paper of equal width. Fasten ends at right angles to each other. Fold one strip squarely over the other; then fold the second strip squarely over the first. Repeat until strips are needed length. Clip ends and glue.

Flowers—Fold paper square diagonally; fold resulting triangle in half, fold again. Hold center of square, still folded, in left hand and cut wide end so that radial sides are of equal length. Draw any shape petal desired, retaining the center part, and cut along lines. Open and fringe. curl, notch, or leave as is. Several circles, one over the other, make a full bloom. Fasten to pipe cleaner, wrapped wire, or a thin dowel.

Slashing—Cut slits in paper. Insert end of another piece. Pull through to desired position, and glue. Control size of slits and inserts for desired effect.

Fringing—Multiple slashes along paper's edge, closely and evenly cut. Can be curled for fluffy effect.

Bending—Curves made to create 3 dimensional forms.

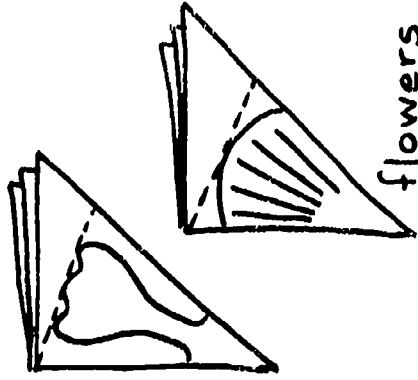

flowers

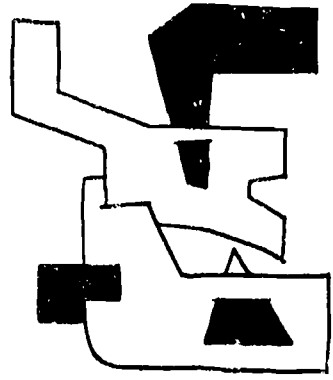

Slashing to join parts

bending

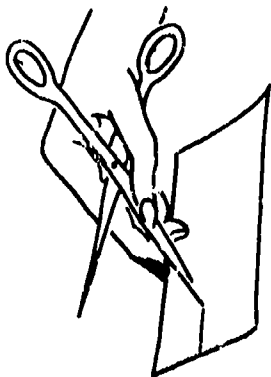
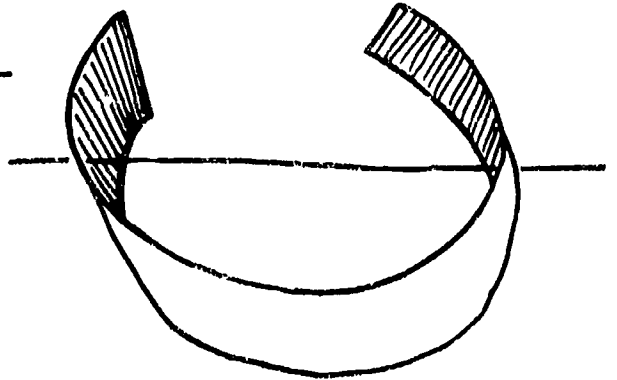

scoring

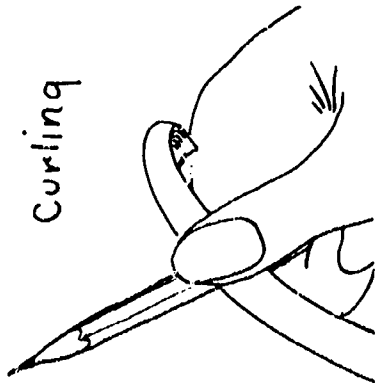

Curling

Cat stairs

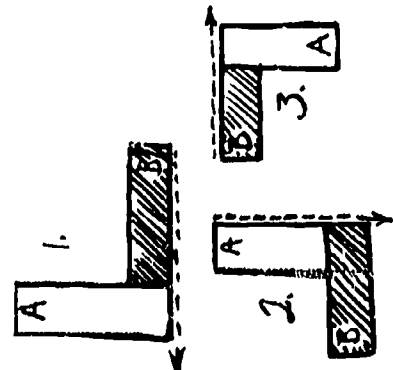

TREES K-2, 3-4

Preplanning

Objectives

To give bilateral practice in cutting.
To create many variations from one idea.

Materials

Construction paper, glitter (optional), clear scotch mending tape, scissors.

Preparation

Teacher helpers pass out needed materials. If children have difficulty in cutting out a pattern, have them trace it first. Be positive that they know bilateral cutting is done on the fold. Talk about why paper trees must be wider at the base.

Motivate

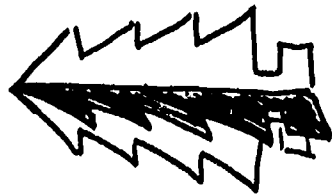
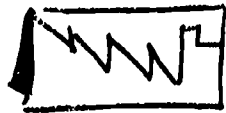

Procedure

Fold a piece of green construction paper lengthwise down the middle. Cut trees on a triangular shape making them larger at base. Christmas tree style. Using the tree just cut, trace around it on another matching sheet, and cut this out. Take these cut-outs and lay the folds on the table, back to back. Tape the folds firmly against each other with clear Scotch tape. Turn over, and do the same on the other side. When finished, the tree should stand alone. Trim with glitter, sequins, or sponge with white tempera for snow, if desired.

Evaluate

Preplanning

Objectives

To create a raised design
To discover a different way to use tissue.

Materials

Colored tissue, cardboard for background, 9" x 12", pencil, white glue, scissors, small boxes, envelopes.

Preparation

Cut or tear tissue into pieces about 3" x 3". Place each color in separate box. Give each child pencil, cardboard, glue.

Motivate

PAPER

TEXTURED PAPER K-2, 3-4

Preplanning

Objectives

To achieve a textural effect by punching holes.

Materials

Corrugated box cardboard, construction paper, nails (assorted sizes).

Preparation

Each child will need a piece of corrugated cardboard, construction paper and nails.

Motivate

Procedure

Place corrugated box cardboard on flat surface (table or desk). Lay construction paper over corrugated board. Punch through construction paper (into corrugated board) with nails. Use a variety of sizes. Group holes to achieve a pleasing design. Remove construction paper and turn over. Hang so that punched side (back) is facing viewer. Punched out places form a relief pattern showing textures.

Evaluate

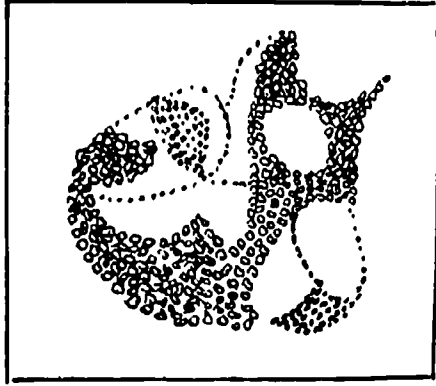

DESIGNING WITH TISSUE BALLS K-2, 3-4

Procedure

Set boxes on tables and let pupils select tissue pieces and roll into balls. Then have pupils draw a design. (turkey, pumpkin, snowman, Santa, map shapes, on cardboard to be covered with tissue balls. Give each child an envelope to hold his tissue balls. Pass the boxes of tissue balls around the room, letting pupils take out colors they need. The tissue balls are to be glued to the design so that colors define specific parts of the picture. In other words, colors are glued on for design.

Evaluate



PAPER

PAPER STRIP CONSTRUCTION 3-4, 5-6



Preplanning Objectives

- To learn another way of manipulating paper
- To make 3-D forms from flat paper strips
- To increase awareness of color and contours.

Materials

- Pre-cut strips of construction paper. For each item all widths should be the same.
- Stapler, scissors, paste.
- Strips of colored construction paper are cut on paper cutter. 1 sheet at a time
- Have pupils distribute stapler and paste to every 4 pupils and scissors to each. Put strips on a centrally located table and let pupils file past, selecting their colors.

Motivate

Procedure

If the subject happens to be birds, show pictures of various kinds. Let pupils do outline drawings. To make bird shapes, arrange the strips so that they lie evenly, one upon the other. Staple at one end. Begin pushing the second strip from bottom toward the staple, push the third a little more than the second, the fourth even more. This creates a bulge which can form the head. Staple at the top of the strip this time working from the top strip down to form body. Strip from tail. Remaining ends may be curled, or fringed for tail, feet, etc., as they are added.

Experiment to create other forms. Strips can be pointed end on end for length.

Evaluate

Preplanning

Objectives

- To create a 3-dimensional form from paper.
- To experience cutting and stapling.

Materials

- Pencil, construction paper, scissors, oak tag or shirt cardboard, paste or staples, jar lid or can.

Preparation

Teacher can cut triangle shape out of oak tag or shirt cardboard to fit inside circle shape. Each child or 2-3 children will need a triangle shape. Each 2-3 children will need a can for circle shape. construction paper, pencil and scissors.

Motivate

CIRCLE DESIGN 3-4

Preplanning

Objective

To create design with circular shapes.

Materials

- Pen, pencil, construction paper, scissors.
- Coins of various sizes; jar tops, etc.

Preparation

Each child will need various sizes of circles, scissors, pencils, construction paper, paste. Spread newspapers over pasting area. Provide individual amounts of paste.

Motivate

Procedure

Use one large sheet of construction paper for background. Try several arrangements of discs on paper to create an interesting design before pasting. Use different sizes. Overlap some.

Variation

Cut free form shapes out of the paper from which discs were cut. Use several colors of paper. Arrange on a background piece of construction paper. Let shapes overlap each other.

Evaluate

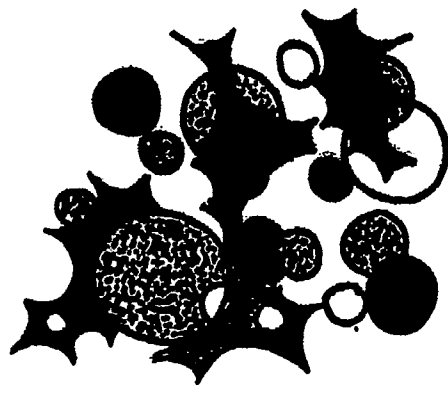

GEOMETRIC STRUCTURES K-2, 3-4

Preplanning

Objectives

- To create a 3-dimensional form from paper.
- To experience cutting and stapling.

Materials

- Pencil, construction paper, scissors, oak tag or shirt cardboard, paste or staples, jar lid or can.

Preparation

Teacher can cut triangle shape out of oak tag or shirt cardboard to fit inside circle shape. Each child or 2-3 children will need a triangle shape. Each 2-3 children will need a can for circle shape. construction paper, pencil and scissors.

Motivate

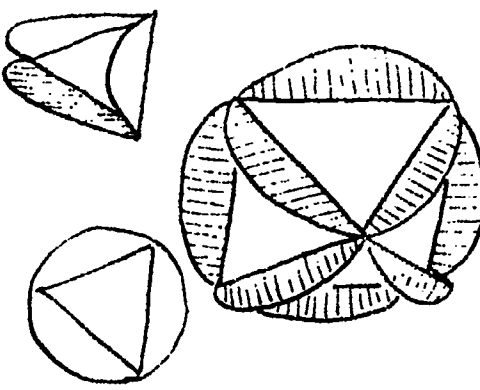

PAPER

PAPER WEAVING IN ABSTRACT DESIGN 3-4, 5-6

*Preplanning***Objectives**

- To achieve variety of pattern
- To produce a novel effect

Materials

construction paper, scissors, paste

Preparation

Distribute 2 sheets of construction paper in contrasting colors. Scissors for each child.

Motivate**Procedure**

Explain that margins must be allowed on all sides of sheet to be woven. Instead of cutting straight lines, the paper is to be cut in lines of varying widths and angles (or curves). Have an even number for this. It will be necessary to cut through one margin which will be pasted together again at finish. After cutting these strips, weaving strips are cut from the other sheet. These are to vary in width also, so as to curve or form angles. The one caution is that the weaving set of strips be kept in sequence. Number them as they are cut. Weave them in correct order, and paste ends on underside. Finish by laying a concealed strip under margin that has been cut, and glue down.

Variations

Animals, people, cut in simple shapes from construction paper can be given interest by weaving paper into the larger areas. On standard paper strip weaving it creates interest to wrap yarn diagonally over and under the strips in a uniform manner.

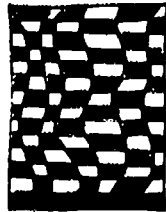
Evaluate*Preplanning***Objectives**

- To create a raised effect.
- To use repetitions of form.

Materials

Sheet cardboard or posterboard, scissors, glue, pencil, newsprint.

Preparation

Put white glue in small dispenser bottles or in paper cups. Let pupil helpers distribute materials to each child.

Motivate**Procedure**

Choose simple objects, and work out possible designs on newsprint to fit cardboard. Begin by tracing design on cardboard and cutting out. Next, trace each piece on cardboard again. This time, cut out, trimming away 1/8" to 1/4" from edge. Repeat, using second forms to trace design. Cut away edges again. Continue until you have 4 to 6 layers. Glue to cardboard in graduated order with smallest piece on top. The finished design may be painted or shellacked.

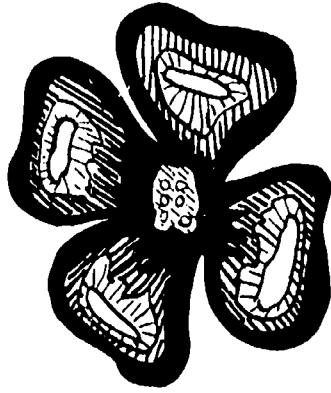
Evaluate

YARN ON CORRUGATED CARDBOARD 3-4 5-6

*Preplanning***Objectives**

- to experience effect of broken color
- to create a linear design

Materials

sheets of corrugated (box) cardboard, exacto knife or ra or blade, yarn, glue, pencil, scissors. Optional: paint, brushes, muffin tins, water jars.

Preparation

Distribute cardboard, place balls of yarn where pupils can select colors. Cut off in yard lengths.

Motivate**Procedure**

Pupils draw simple designs on the thin side of cardboard. Teacher cuts with blade along outlines. Pupils peel out paper layer to expose corrugation. In some places the paper is left as a dividing line between parts. Yarn is then glued into the cardboard grooves, cut to fit each groove. If paint is to be used, distribute these materials. Paint paper surfaces not peeled away.

Variation

Use small pieces of cardboard with grain running horizontally. Pipe cleaners can be pushed through from side to fill grooves. Cardboard from rolls can be decorated with yarn by drawing design and having teacher cut a line around the edges for an outline of yarn to strengthen the design.

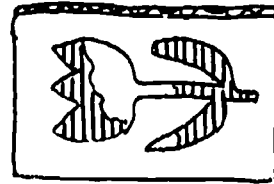
Evaluate

PAPER

POSITIVE — NEGATIVE DESIGN 5-6

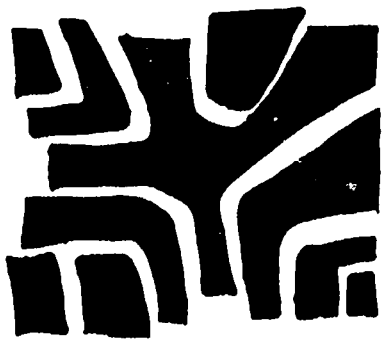

Preplanning

Objectives

to understand positive and negative areas to create simple, dramatic design

Materials

9 x 12 construction paper, assorted; 9 x 12 construction paper, white; scissors; glue

Preparation

Let helpers distribute 2 sheets colored, 1 sheet white construction paper to each pupil. Place glue for every two pupils.

Motivate

Procedure

Halve one sheet of construction paper. Draw an irregular shape along one edge extending from top to bottom. Cut out. Lay the two cut pieces on a white sheet, placing the cut out shape in reverse, as if it had been folded back from the section it was cut from. This creates a positive and a negative form. Glue in position. Small squares may be cut simultaneously in the same way, and arranged in a repeat pattern. Laying cut pieces on a contrasting color can be attractive.

Variation

Begin with a triangle or rectangle. Cut across it in a series of related curves or angles. Lay these cut pieces on another sheet, keeping in sequence. Spread them slightly apart observing effect of open (negative) spaces created. Adjust to most pleasing arrangement and glue. Try this with other simple geometric shapes. Cut a simple geometric shape from both sides of a rectangle. Vary the size of the cut-outs. Lay them outside the rectangle as if folded back from original position.

Evaluate

CUTTING A STAR

Patterns are not creative. However, the star, one of our national symbols, is often required in decorating, and is not easy to cut without directions.

1. Using a folded sheet fold A to B at approximate point shown.
2. Fold C over to A fold, adjusting to point midway of width.
3. Fold D down over C fold.
4. Cut from D to E.

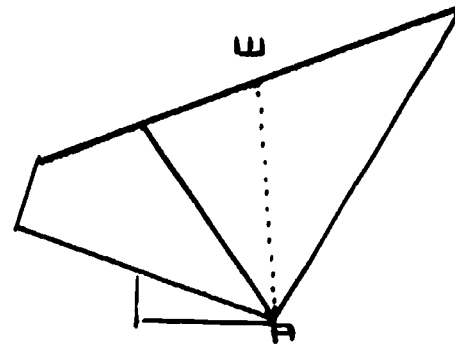
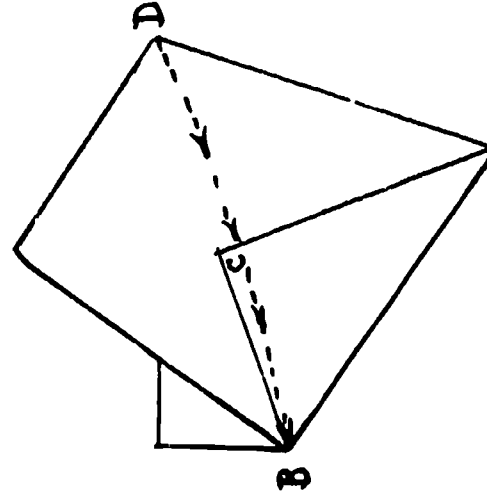
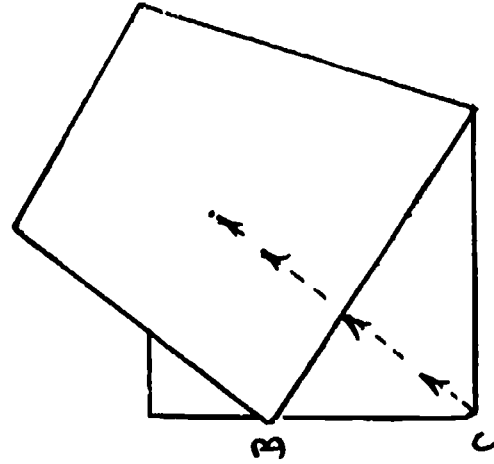
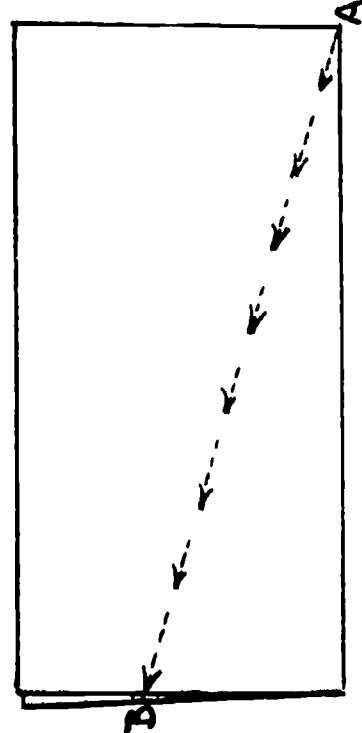

TORN TISSUE FIGURES 5-6

Preplanning

Objectives

To employ a free approach to drawing.
To work with torn paper.

Materials

Sheets of light colored or white construction paper; sheets of colored tissue, white glue and water 50-50, brushes, paper cups, newspaper.

Preparation

Arrange for a pupil to model in costume for the class. Spread newspapers on tables. Put diluted glue in paper cups and distribute, one to each pupil; also a brush per pupil. Spread sheets of colored tissue where pupils may take turns selecting colors needed.

Motivate

Procedure

Pose model in attitude of action. Discuss bending of elbows, knees, body, and effect on clothing. Assure pupils their work does not have to be exact, but to try to show the model's posture.

Let pupils begin tearing tissues to construct figure, starting anywhere they please. Easiest, of course is to begin with largest shape. For those in doubt, suggest beginning with torso, and adding head, arms, legs, etc. Suggest that they add decorative effects such as dots, stripes, buttons, and so on. As they are torn, apply these pieces to background sheets, brushing them in place with brush dipped in glue solution.

Variations

This same approach can be used with construction paper. It can be applied to vehicles, animals, houses, etc.

Evaluate

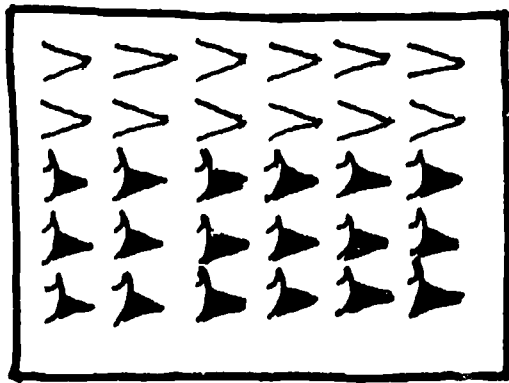
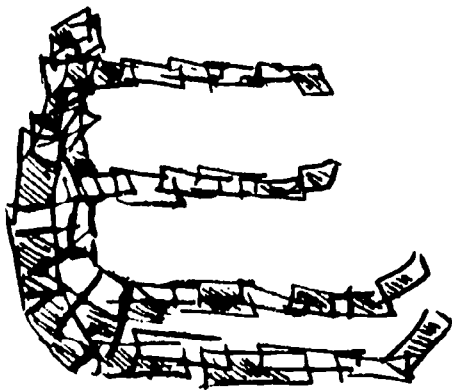

Scoring, folding, slitting, joining, offer innumerable ways of creating three-dimensional forms from paper. Limitations of space allow only a suggestion or two.

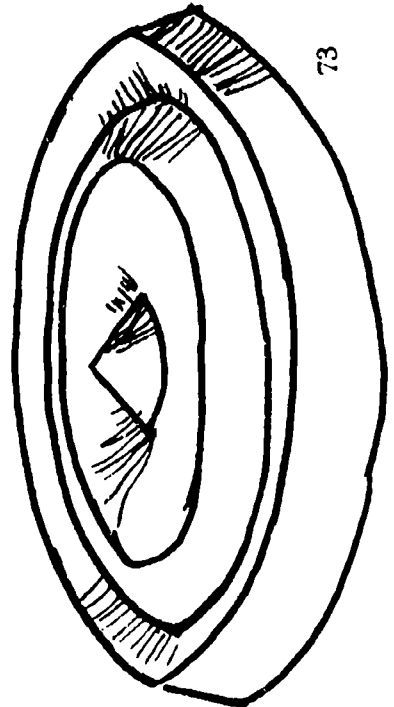
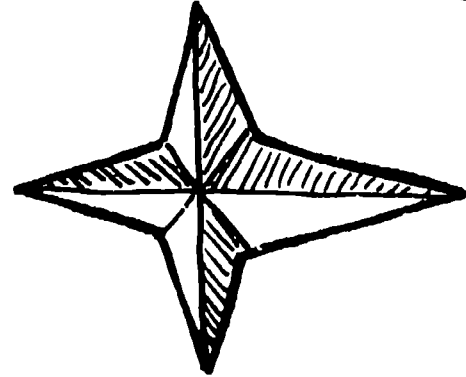
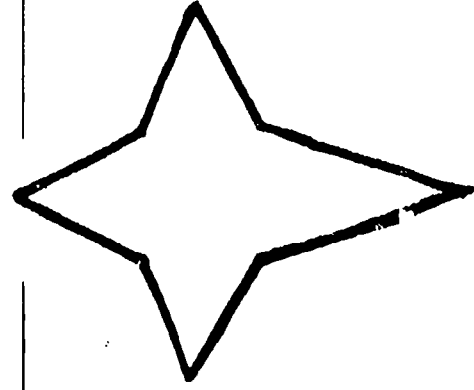
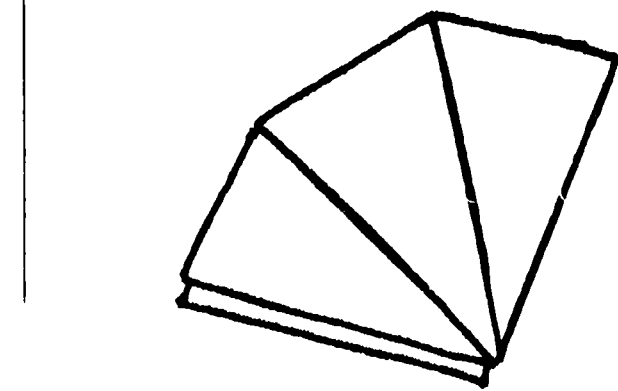

NOTES

PRINT MAKING

“ . . . the main objective of art education today is to assist in the intellectual, emotional, and social growth of the learner according to his needs and capacities.”

Charles D. Gaitskell
Children and Their Art

PRINTMAKING

General Objectives

- To experience many ways of repeating an image.
- To learn to handle many printing techniques.
- To employ repetition and overlapping in making prints.
- To explore effect of print on different surfaces.

Printmaking has innumerable possibilities. There are many ways of printing:

1. Relief—print from a raised surface
2. Intaglio—print from an incised design
3. Serigraph—print through silk screen
4. Stencil—printing through cut-out area
5. Collograph—printing from assemblage of glued-on surfaces
6. Rubbing—impression taken from raised surface by rubbing
7. Photogram—print on light sensitive paper

There is a wide choice of materials:

1. Plates, filed sticks, crumpled paper, boxes, styrofoam, vegetables, spoons, clay, plaster, brayer, linoleum, wood, glass, sponge, eraser, wax. Also multi-plates assembled from cardboard, inner tubing, string, tin cans, pipe cleaners, cement.
2. Inks—Printing ink (water soluble), tempera, finger paint, oil ink.
3. Papers—Finger paint, butcher, colored tissue, gift wrap, wallpaper, shelf paper, paper towels, burlap, fabrics.
4. Engravers—knives, nails, files, scissors, lino-zip tools, linoleum cutters.
5. Pads—Square of vinyl tile, or small cardboard covered with wax paper or foil.

Sensitivity to patterns for printing may be developed . . .

1. taking walks to observe natural patterns (spider's web, mud, cracks in cement, flower petals, rows of telephone poles, wheel tracks, veins in leaves, patterns in butterfly wings, dried seed pods, rings on a stump, textured materials, vines, rocks, . . .)
3. bringing things to feel, smell, hear, taste.
3. showing prints by artists.

STAMP — PRINTING K-2, 3-4

Preplanning

Objectives

- To introduce some of the basics of printing.
- To explore a different form of art expression.

Materials

- Pie tins; tempera; sponges; small boxes, plastic cups, crumpled foil, mesh balls used for dish washing, forks, nylon net, comb.
- Corks, clothes pins, paper clips, cups, spoons, egg cartons, cardboard tubes, paint and pie tins, paper (variety).

Preparation

- Either make or obtain examples of prints.
- Arrange tables for working in groups of four. Arrange materials for each group.
- Cover tables with newspaper. Put thin layer of tempera in pie tins.

Motivate

Procedure

Explain what a simple relief print is. Show how found objects can be used to do stamp printing. Let pupils choose printing materials from collection and print repeat design. These can go in circles, overlap, create staggered lines, form block patterns. Try to fill paper.

Variations

- Print object edge to edge.
- Overprint with string coated with tempera.
- Prepare paper by cutting squares of colored tissue. Glue these to white construction paper with diluted white glue. Let dry before printing.
- Impressions made on flattened balls of clay, then dried; dried shellacked before inking, offer a more inventive kind of stamp for printing.

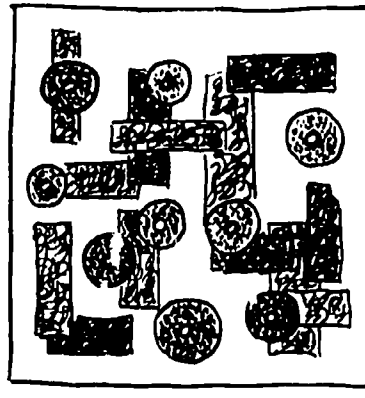
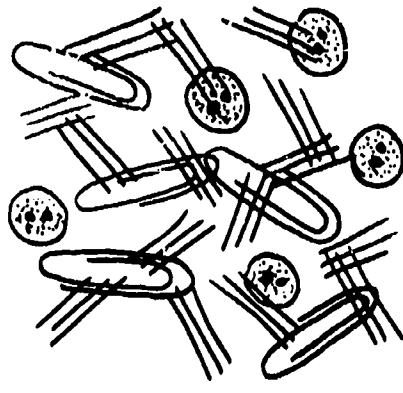

PRINTMAKING

VEGETABLE PRINTS K-2, 3-4, 5-6

Preplanning

Objectives

To combine several prints into a composition.
To overlap in printing.

Materials

onions, celery, squash, green pepper, corn, apples, oranges, etc.; paper (black is effective); newspaper, paint, pie tin and brushes.

Preparation

Cover tables.
Cut some vegetables vertically and some horizontally.
Place several vegetables for every pie tin of paint.
Pass out paper.

Motivate

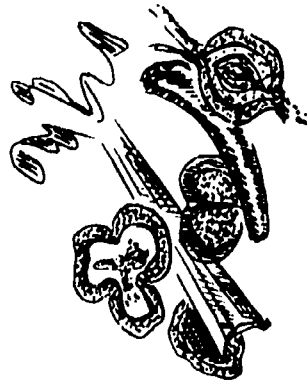

Procedure

Select vegetables, blot moist surfaces on newspaper, paint surface of vegetable and press it on paper with even pressure. With one hand hold paper and other hand carefully lift off vegetable. Select another vegetable and repeat process by printing next to or overlapping first print. Try to print a still-life.

Variation

Dip weeds, grasses, shells, and other natural items in paint and print. Try dragging or pulling the material.

Evaluate

PLASTER BLOCK PRINTING 3-4, 5-6

Preplanning

Objectives

to discover another surface for printing

Materials

wallboard, shellac, ink pad, printing ink, brayer paper (foil or wax paper), paper

Preparation

It must be understood by pupils that there will be an interlude for drying the plaster before a print is made. Cut wall board in sections, distribute cutting tools. Cover tables and floor with newspaper

Motivate

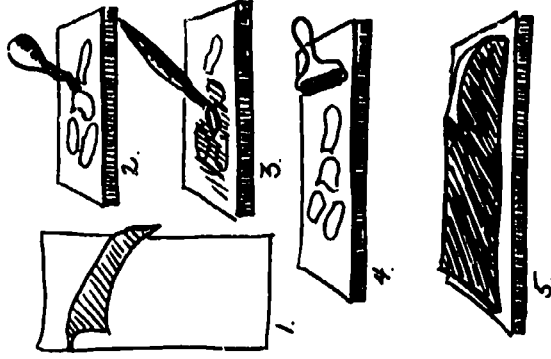

Procedure

1. Have pupils peel cardboard coating back from one side of wall board to expose plaster surface. Dampen remaining bits of cardboard and finish removing.
2. Trace or draw design and cut with linoleum cutters. Let plaster dry completely.
3. Shellac with brush.
4. Ink block with printing ink.
5. Put printing paper over block and rub lightly. Peel print.

Evaluate

PHOTOGRAMS K-2, 3-4, 5-6

Preplanning

Objectives

To learn reactions of light-sensitive paper.
To control printing to obtain gradations in value.
To learn simple developing.

Materials

Printing-off paper or blue print paper; shallow pan (for developing); hypo (developing medium) black construction paper, found objects for printing.

Preparation

Make a black construction paper envelope for each child. In a closet or darkroom, slip a sheet of light-sensitive paper into each envelope and close with tab of tape. Plan for a place to develop papers. If no closet or darkroom is available, perhaps the teacher can develop the photograms at home.



Procedure

Give one envelope to each child. Demonstrate how to take a photogram, and necessity of sealing it in black envelope. Let children have found objects ready. Select a sunlit spot, if possible. Remove paper, lay objects on it, wait until paper is discolored. Remove from light and place immediately in black envelope. Do not open or remove until ready to develop. For developing, follow instructions on container of hypo.

Variations

After object(s) exposure has been lightly recorded on paper, shift the object(s) to a new position and let it finish recording over the first impression. Use a small rectangle of glass. Paint with dark color of tempera. Cover surface completely. When dry, scratch a picture or design into the paint. Place scratch picture over light-sensitive paper. Picture will be recorded.

Evaluate

PRINTMAKING

LINOLEUM PRINT — REGULAR CUTTERS 5-6

HANDS STAY BEHIND THE CUTTER



Preplanning

Objectives

To learn use of regular linoleum cutters.
To design for effective contrast and texture.

Materials

Lino zip cutter, newspapers, *battle ship* linoleum, white tempera, detergent, brayer, water soluble ink, inking plate, paper, (variety), spoon.
Note: linoleum does not have to be mounted on a block.

Preparation

Prepare pieces of linoleum.
Cover tables.

Pass out supplies, prepare inks, spread newspapers, cover pieces of cardboard with foil for inking pad, or use a vinyl tile.

Motivate

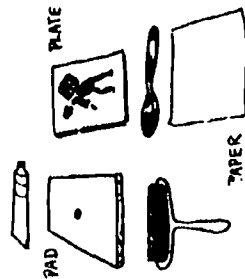

Procedure

1st day—Coat linoleum with white tempera mixed with a drop of detergent. Let dry. Draw simple design on butcher paper. Turn face down on block and rub with spoon until pencil marks transfer to block. (Tracing with carbon paper will do just as well). Remove paper. Take pencil and go over the transferred design, now on the linoleum. Indicate textures and darken areas to be left. Do not wash.

2nd day—Before cutting the design, practice on a scrap of linoleum for variety in line and texture. Hold linoleum with one hand, keeping it always *behind* the point of the cutter! When cutting is complete, wash out paint and pencil marks.

3rd day—Cover pieces of cardboard with aluminum foil, squeeze out ink equaling size of a small bean. Roll brayer, picking it up between contacts so that all sides of brayer get ink. When brayer is completely covered, apply it to the linoleum, rolling from different directions to ensure complete coverage. Lay paper over block and rub paper with back of spoon. Peel paper up slightly from corner and check condition of print. Do not let paper slip. Keep rubbing till print is completed. Lift print and lay in a safe place to dry, or pin to a clothesline with a clothes pin. Hint: Sometimes when a print won't come off well, begin by dampening the paper, blot between newspapers and then lay over inked block. Be careful not to tear when rubbing.

Evaluate

LINOZIP PRINTS 3-4, 5-6

Preplanning

Objectives

To teach young children the use of linozip cutters to cut a block which can be used to make many prints.

Materials

Lino zip cutters, newspaper, *battle ship* linoleum, white tempera, detergent, brayer, water soluble ink, inking plate, paper (variety), spoon

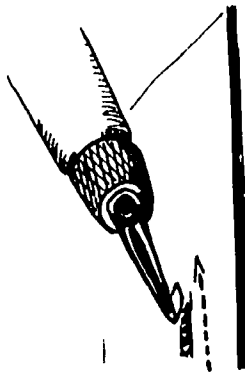

Preparation

Prepare pieces of linoleum cover tables

pass out supplies

prepare inks

spread newspaper

cover piece of cardboard with foil for inking

pad, or use a vinyl tile

stretch clothesline to hang prints for drying

Procedure

Paint surface of linoleum lightly with tempera mixed with detergent. Draw picture on paper and trace or draw picture directly on linoleum. The design is then gouged out by the cutter either along the lines, or to remove spaces. Linozip cutter is pulled toward oneself.

Ink linoleum with brayer and place paper over linoleum. Rub back of paper with spoon. Peel up corners and check to see if print is clear. If so, lay print in safe place to dry—or clip to a clothesline and hang till dry.

Evaluate

PRINTMAKING

SIMPLIFIED SILK SCREEN 3-4, 5-6

Preplanning

Objectives

to understand silk screen process

Materials

firm cardboard box such as hosiery box; masking tape; organdy, hose or sheer silk; butcher paper; stiff cardboard for squeegee; finger paint or tempera; wheat paste; newspaper

Preparation

cut strips of cardboard
prepare paints
cover tables

Motivate

Procedure

Cut rectangle in box lid, allowing a margin for fastening screen. Put an identical opening in bottom of box. Measure organdy, hose or silk, to fit box lid and staple securely inside box lid, all the way around. Press bottom of box into lid. Tape or shellac the whole box interior, tape down over edge of opening and cover a little of the screen's edge. Next, cut a paper stencil with a design that is smaller than the exposed silk screen, and place on bottom side of silk screen and fasten lightly with two pieces of tape. Spread a pad of newspaper and lay a clean sheet of paper on it for printing. Set silk screen and stencil over the paper. Scoop up a table-spoonful of finger paint (or tempera mix) and spread across on inside of screen. Take a stiff piece of cardboard the width of the screen, and using even pressure, pull and press the paint across to the other end. Do the same in the opposite direction. The paint will cause the stencil to stick to the screen. Lift, remove print, place a clean sheet and repeat the process. If the box interior is immediately cleaned with a moist, not soaked, sponge, another color can be used with the next stencil. If not cleaned, stencils may be changed, but color must be kept the same.

Variations

A different kind of silk screen frame can be made from embroidery hoops. Paper plates can be used for very small prints. Tape edges of organdy firmly down over hole cut in plate.
Instead of using a stencil, draw heavily on the screen with wax crayon. Pull squeegee and paint across. Print will color background and leave design clear.
Pull 2 or 3 colors across screen at one time for a multi-colored print.

Evaluate

OTHER VARIATIONS TO EXPLORE: K-2, 3-4, 5-6

Tim can Cut out ends; use metal shears to remove rims. Tape edges to avoid cutting hands. Glue on designs cut from inner tubes (use airplane glue). When glue dries, treat tempera with a few drops of detergent, then pat onto design with the flat of an easel brush.

String can be wrapped horizontally or vertically. Pat tempera on with brush. Roll can on paper to print. A piece of broom handle run through the can helps in rolling.

Towel tubing Coat with glue and roll in rice. Get a good covering, tho' intermittent spaces are all right. When dry, shellac. Apply paint with brush or sponge.

Other materials that can be applied are: spaghetti, strips of vegetable bagging, bits of braid or rick-rack. Always shellac and dry. Be sure raised elements are of same thickness on one tube.

Strips of styrofoam from meat trays can be glued to towel tubes, and shellacked.

Boxes—Small boxes make useful rectangular masses for building. Cardboard edges will supply roofing lines, poles, wire, and other linear elements.

Plastic cups make good circular forms, as will bottle caps, jar lids.

Gemalite sheets, (often found in packing) make an unusual plate. The ink is rolled on the gemalite. A paper is laid on top of the ink. Draw on the back side; rub lightly for shading and pull up the print. Pressing linear forms, such as edges of cardboard, on the print paper will get interesting results.

Bi-que clay (Clay blocks, cut from thick coils of clay, carved out and dried, can be fired, shellacked and used.

Potatoes, carrots, etc.—Designs carved into large sections of these vegetables offer a wide variety of repeat patterns.

Cardboard—Can be used on its edge to get straight lines, curved lines, zig-zag lines. It can be cut into flat shapes, painted and printed.

Cardboard prints are also made by cutting sections of a design and gluing in place on cardboard backing. Shellac on front and back, ink and print.

Brayer—After coating with ink, take cardboard or some other tool and scrape paint away from brayer surface. Roll brayer on clean paper to make print.

Collect papers of varying texture and quality. Paper bags, foil papers, grey packing papers, rice paper, gift-wrap papers, pattern tissue, paper towels, colored tissue, etc.

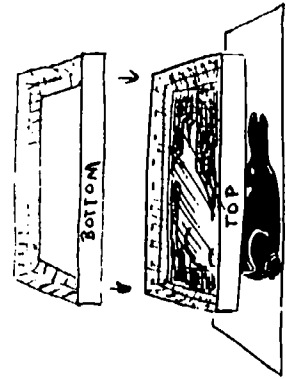

NOTES

PUPPETS

"There is a relationship between creativity and intelligence — highly creative people are always intelligent; highly intelligent people are not always creative."

James A. Smith in
*Creative Teaching of the
Graphic Arts*

00084

PUPPETS

General Objectives

- To explore many different materials for making puppets.
- To learn the effectiveness of art in characterization.
- To create an art form through which free expression can take place.

DRAMATIC SELF-EXPRESSION THROUGH THE USE OF PUPPETS

With younger children more emphasis should be placed on the use of the puppets than on the puppets themselves. After each child has completed his puppet the teacher can develop a play by suggesting the beginning of a story involving two or three characters. The children take over and finish the play which may go on spontaneously for five minutes. The children will adopt the suggested characters and identify with their problems.

Older children should be inspired to develop their own plays. The plays are always more spontaneous if the children are not held rigidly to a script, but are permitted to express themselves within a general framework. After several rehearsals, they will put on a polished performance with no script in hand.

— Condensed from *Meaning in Crafts* — Edward L. Matti

Suggestions for presenting puppet plays

Turned over table. Child can kneel in back of surface and hold puppet up to table edge.

Table and curtain. Attach curtain (or sheet) to front edge of table. Child can sit or kneel at back of table and hold puppet up to edge. Scenery can be taped to table top and made to stand up.

Three-sided screen. Sides can be made of corrugated cardboard or plywood. Appliance boxes from furniture stores need only one side removed. Edges can be taped to open and close or hinged (plywood). Front sides can be painted plain or decorated. Child can sit or kneel behind screen. Paper scenery can be taped to top edge.

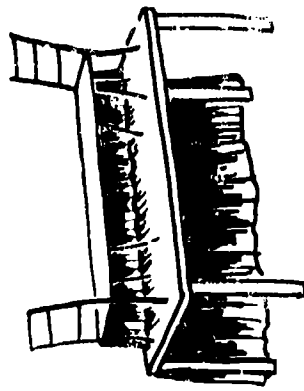
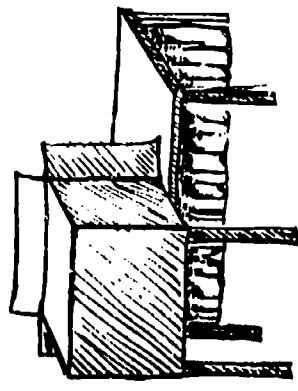

Table and chairs. Attach a curtain or sheet to front edge of long table. Place a chair at each end of the table along front edge. Lay a board or heavy cardboard from the seat of one chair to the other, attach curtain to board. Child can stand behind table and work puppet close to edge of board.



Box and table. Attach a curtain or sheet to front edge of table. Cut one side from box. Place box on back edge of table, open side toward floor. Tape dowels or sticks to box for legs. Child can sit or kneel on floor under opening in box. Scenery can be painted on back of box behind puppet.

THE SELF-REVELATION OF PUPPETRY

Often, the young child's desire for approval leads him to conform to what will meet adult approval. However, through his puppets, he can release the inner self without censorship. The puppet is free to be naughty, to say outrageous things; it can be ridiculous or unreasonable; it can build big fantasies and aspirations; it can comment philosophically about things as they are; — whatever is most important to the child at the moment. The teacher who cares will listen.

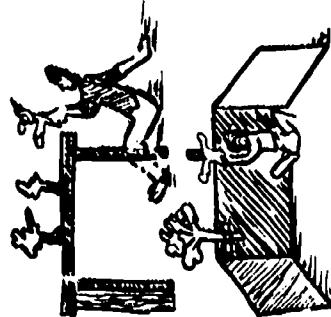
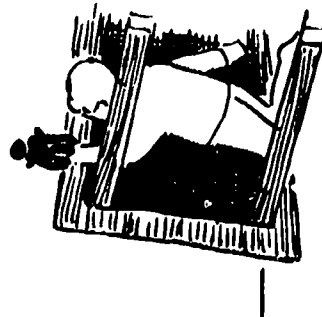

PUPPETS

BUILDING A PUPPET THEATER FROM APPLIANCE BOX

1. Cut back (or one side) off.
2. Cut pieces for top from side removed.
3. Stage opening is cut in front center.
4. Voice opening is cut at kneeling level of child. Cover with cloth and glue on back side.
5. Curtain wire is attached to top of stage opening by brads. (A)
6. Scenery rod is dowel run through holes back of stage opening. (B)
7. Dowel rod (C) in rear of puppet theater holds sides in place.
8. Attach roof by wiring 2 side pieces at top. Clip to theater by clothes pins. Clip front roof on and let rest on back piece.

Theater can be folded flat by removing dowels.

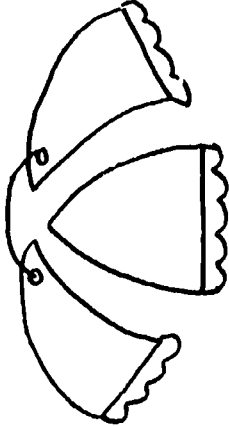
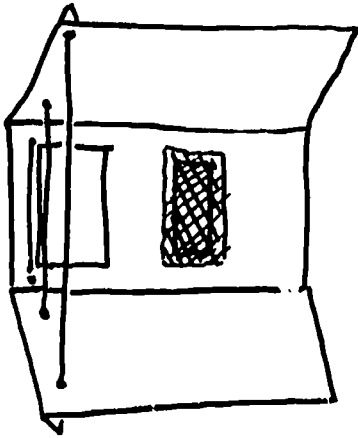
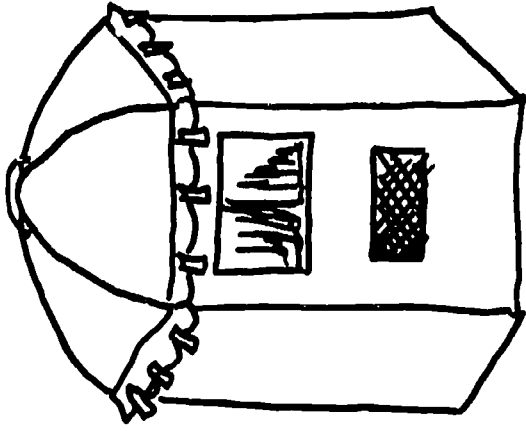

PAPER BAG K-2

Preplanning Objectives

- To provide a simple experience in creating a character.
- To create a form which can be viewed from all sides.

Materials

Newspapers (for stuffing) paper bags—different sizes of scissors, quick-drying glue, tape, crayons, paper and cloth scraps, found objects, yarn, stick, string, rubber bands.

Preparation

Put bags and materials on table. Let children file past table to choose size bag they want and materials. Show a completed puppet.

Motivate

Procedure

Discuss how to attach different materials (sewing, gluing, stapling, etc.) Proceed, using imagination to create puppet faces in bags. Use cloth, crayon, paper, etc. for costumes. Stuff inflated bag with shredded paper or cloth scraps. Put stick inside bag to hold on to. Use string or rubber band and tie securely open end of bag.

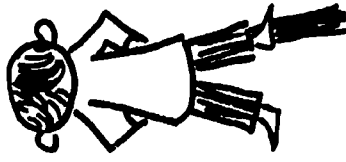
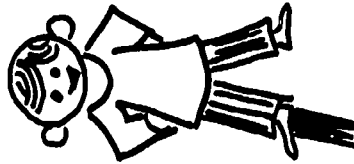
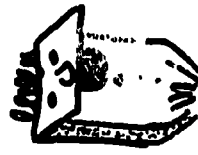
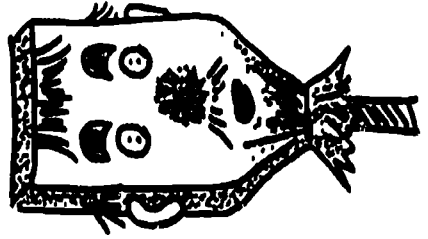

STICK FIGURES K-2

Preplanning Objectives

- See General Objectives
- To create a figure using a back and a front.

Materials

Oaktag, stapler, white glue, paste, popsicle sticks or strips of wood, crayons, paint, found materials—yarn for hair.

Preparation

Helpers pass out paper, crayons, and sticks.

Motivate

Procedure

Draw and color a figure on oak tag. Keep figures large. Cut out. Using cut-out figure as pattern, trace around it on second piece of oak tag. Cut out. Have child color second figure as the back of his first one. (Back view). Secure popsicle stick to one leg (let stick out 4" below leg). Glue two pieces together. Finish by pasting on yarn hair, beads, etc.

Variation

Figure can be stuffed lightly with cotton before gluing or stapling around edges.

Evaluate

PUPPETS

SELF-HARDENING CLAY—CREATURE HEADS K-2

Preplanning

Objectives

to acquire manipulative experiences in working with clay.
to get quick results without firing.
to work in 3-dimensional form.

Materials

self hardening clay, dowels, newspapers, tempera, brushes, and shellac brush.

Preparation

Prepare clay balls about 3" in diameter.

Motivate

Procedure

Discuss imaginary wierd creatures. Talk about exaggerating features. Show how to press cheek and eye contours, to pinch up nose contours, to add clay balls for eyes, coils for eyebrows and mouth. Punch hole for stick on which head is to be supported. It should be $\frac{3}{4}$ the thickness of the ball. Let dry. Paint with tempera and shellac. Mount on stick and add a decorative fringe for collar.

Evaluate

Note: The above may be carried out in plasticine except for painting and shellacking. Plasticine is rather stiff for young hands, and should be warmed to soften it. Do not be surprised if some children make heads without facial features. Some have not reached this developmental stage. Accept whatever they achieve.

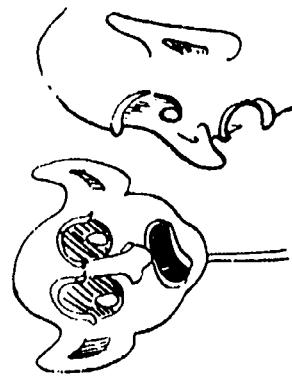

HAND PUPPET 3-4, 5-6

Preplanning

Objectives

To create a puppet with head and body in one piece.

Materials

unbleached muslin, thread, and needle, Manila paper for pattern for puppet, material for stuffing (cotton, stockings, socks, etc.), paint, brushes, found materials, cardboard tubing, scissors milk-containers and water.

Preparation

Assemble for each child muslin, scissors, thread, Manila, oaktag, and needle. Distribute at class time. Mix paint in milk containers. Put other materials on table for later use.

Motivate

Procedure

Have each child sketch his animal or human head. Sketch large enough to fit over hand. When making animal, include ears making head and ears in one piece. On cloth make body pattern as shown large enough to fit over hand. Cut two layers larger than sketch. Cut whole puppet out of a double piece of muslin. Cut $\frac{1}{2}$ " Stuff head. Insert short piece of cardboard tubing in neck. Puppet can be painted with tempera. Facial features can be painted. Yarn hair can be sewn on. Clothes can be painted.

Evaluate

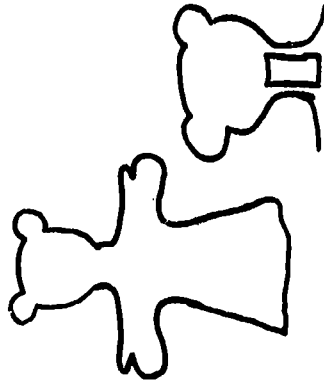

LIGHT BULB 3-4, 5-6

Preplanning

Objective

to utilize the modeling technique with papier mache.

Materials

newspaper or paper toweling, wheat paste, large can for mixing, paper cups for individual use, old burned out light bulbs, razor blade, (teacher use only) wax paper, rubber bands, scrap material, needle and thread, yarn, beads, odd jewelry, tempera, and brushes, white glue.

Preparation

Mix wheat paste. Tear newspapers or paper toweling into small pieces and strips. Cover light bulbs with wax paper and secure with rubber band around base. Pour wheat paste into paper cups for individual use. Spread newspapers over work area.

Motivate

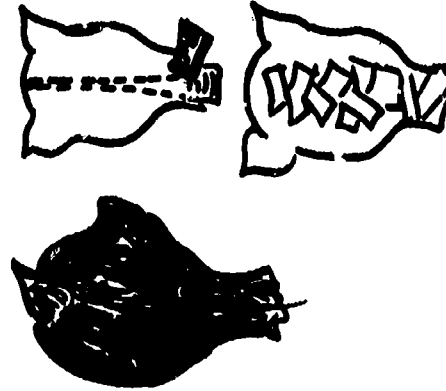

Procedure

Dip newspaper strips into wheat paste and apply to light bulb over wax paper or saran wrap layer. Apply 2 to 3 layers over entire bulb. Let dry. Takes 2 or 3 days. Build up facial features when first layers are dry by placing small wads for nose, chin, flattened pieces for ears. Cover with paper toweling and paste. Secure to light bulb by strips dipped in wheat paste. Smooth out wrinkles and let dry. (May take several days.) When completely dry, teacher slits one side of head and removes bulb. Cover slit with paste and newspaper strips. Body can be made by cutting cloth the shape indicated in sketch. Sew up seams. Glue neck of clothes to neck of puppet (turn clothes inside out over head to glue).

Evaluate

Note: It is also possible to form a ball from newspaper, wrap with twine, and shape papier mache head over this.

PUPPETS

SOCK PUPPETS 3-4, 5-6

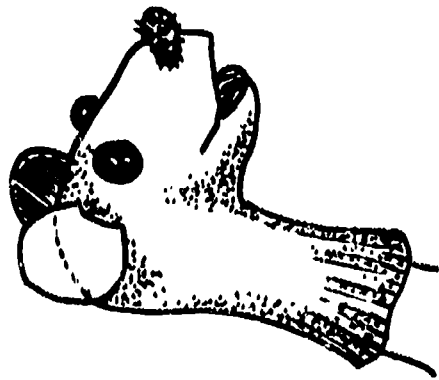

Preplanning

Objectives
to learn several methods of creating puppets from socks and stockings.

Materials
Old, clean socks and stockings, cotton (for stuffing), yarn, felt and cloth scraps, buttons, beads, jewelry, needle and thread, white glue, scissors, cardboard tubing, rubber bands.

Preparation
Each child will need a sock, needle and thread, scissors, variety of found materials.

Motivate

Procedure

Method A—Use whole sock. Have child extend arm full length of sock to 2" of toe end. Push toe inward. Fingers will manipulate mouth of puppet. Pin mouth edges while each child decorates to suit the particular character. Sew buttons, yarn, etc. onto sock. Be careful not to stitch through more than one thickness. Remove pins at mouth when finished.

Method B—Cut sock just below heel. Stuff toe end lightly with cotton and insert short pieces of cardboard tubing for neck. Place rubber band around sock at neck. Decorate by sewing on features. Clothes can be made by cutting cloth scraps doubled, using pattern shape suggested. Glue clothes to neck or attach with rubber band.

Evaluate

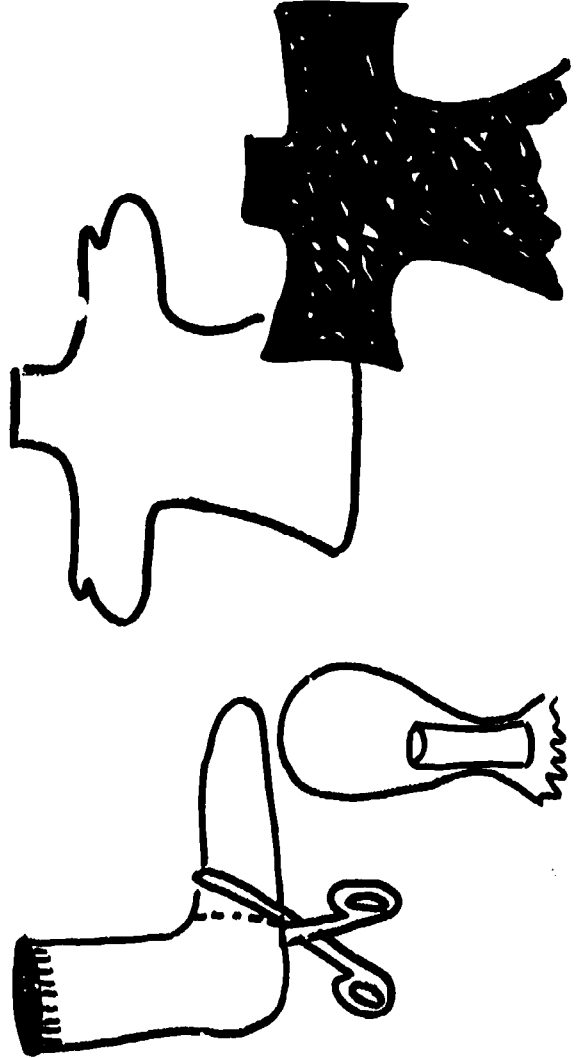

PLASTICENE AND PAPER MACHE 5-6

Preplanning

Objective
To form facial features using a pliable medium.

Materials
Plasticene (modeling clay); sticks; wheat paste and container; vaseline; news-paper or paper toweling strips; cardboard squares; tempera; brush; yarn scraps; beads; felt; cloth; jewelry, etc.; white glue.

Preparation
Spread newspaper over work area. Mix wheat paste in large can or pan. Tear news-paper bits or paper toweling strips (small). Each child will need 2 sticks of clay and 2 cardboard squares (for molding head).

Motivate

PLASTICENE AND PAPER MACHE

Procedure

Work clay into half an egg shape (hollow) for front of head. Work another half for back of head. Place each on a cardboard square. Mold facial features into front view using fingers and sticks. Exaggerate sizes of nose, eyes, mouth. Leave back of head piece plain. Rub both pieces with vaseline. Cover with 2 or 3 layers of newspaper or toweling dipped into wheat paste. Let dry. Repeat 2 or more layers and let dry. Remove from forms. Fit together by attaching slit with strips dipped in wheat paste. Let dry. While head dries make ears by building up paper bits. Fasten to head with paper toweling strips. Trim when dry if needed. Yarn, buttons, beads, etc. can be added by gluing to face with white glue. Clothes and body can be made and secured onto head by using suggestion for stocking puppets.

Evaluate

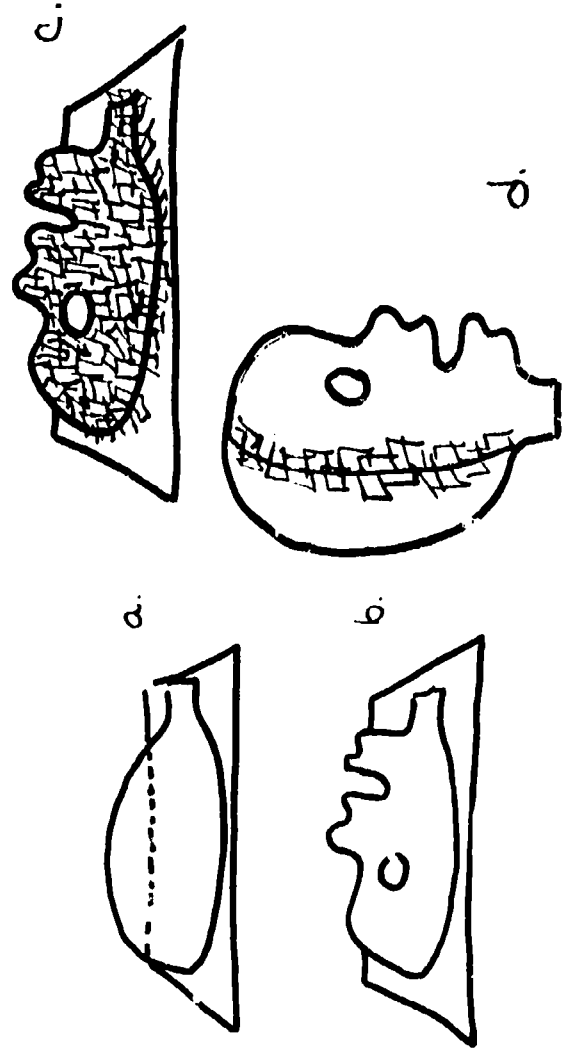

STYROFOAM AND PLASTER 5-6

Preplanning

Objectives
to build up facial features in 3-dimension.
to create unusual facial expressions.

Materials

Styrofoam eggs, styrofoam scraps; dowel, 1 1/2" by 2"; fine sandpaper; toothpicks; white glue; plaster of Paris; large can; tempera; brushes; newspaper; knife, razor blade or scissors.

Preparation

Each child will need a styrofoam egg, dowel, scraps and toothpicks; other materials can be placed in a central location for all.

Note: Mix enough plaster for only 4 or 5 heads at a time.

Motivate

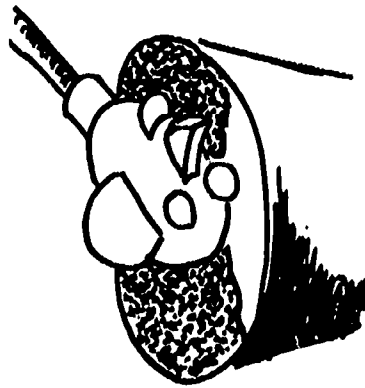
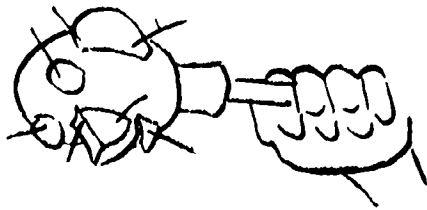

Procedure

Using styrofoam scraps, cut ears, nose, mouth. Attach to egg shape by coating with white glue (undiluted). Secure in place by sticking a toothpick at right angle into egg. Remove toothpick when glue sets. Eye sockets can be punched in by mashing thumbs into egg. Eyes can be added to sockets in same manner as nose and ears. Glue round piece of styrofoam to bottom of head for neck. When glue sets, dig out hole in neck for stick (for finger, eventually). When all features are glued on and set, mix plaster to a creamy thickness.

Dip styrofoam head into plaster until covered. Remove, allow to dry. Paint with tempera. Add yarn hair, beads, etc. by gluing. Gently remove dowel. Clothes can be made by using patterns suggested for light bulb and stocking puppets.

Evaluate

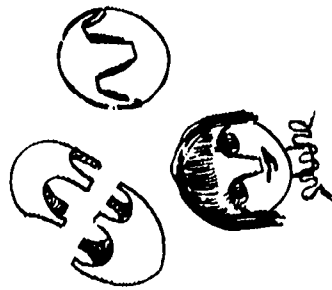

Puppet heads may be made from the deep dividers used in apple chutes. Cut out the cup shapes and join them as shown in illustration. Paint flesh color and add features. Heavy burlap fringe for eyelashes will conceal the joining at the eyes and yarn or ravelled burlap will do for hair. Insert a cardboard tube for neck.

PUPPETS

SHADOW PUPPETS AND THEATER 5-6

Preplanning

Objectives

to create puppets and a puppet stage out of few materials.
to create a 2-dimensional medium.

Materials

newsprint, light weight cardboard (old post cards, oak tag, old file folders) scissors and tape, pencil, sticks (popsicle, etc.), cardboard box, black tempera, brush; tracing paper, (parchment type) or nylon (to show clear shadows), flashlight, knife or razor blade.

Preparation

Characters and scenery can be sketched on newsprint. (Newsprint can be used as a pattern when placed over cardboard). Each child will need scissors, pencil, newsprint and cardboard. Decide what characters and scenery will be needed to tell the story. List those to be made.

Motivate

Procedure

Place newsprint pattern over cardboard and cut out. Tape stick to back at a point where the figure or object will stand erect. Continue using newsprint sketches as patterns until scenery and characters are cut out.

Theater: Paint outside of box black. Cut away one end and one side. Cut out frame for screen on front (see diagram). From inside, tape a sheet of tracing paper or nylon over frame opening. Flashlight or flashlights can be placed on books or boxes in back of box (shining toward screen). Characters and scenery can be manipulated by holding them flat against screen by sticks on the back.



Flashlights
Front view of screen removed

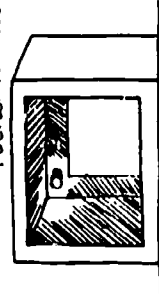

Variation:

Movable parts can be made by placing a brad at the joint and attaching a stick to each movable limb.

Hair can be made by gluing or taping frayed string, twisted wire, raffia, straw or cotton to the edge of the head.

Evaluate

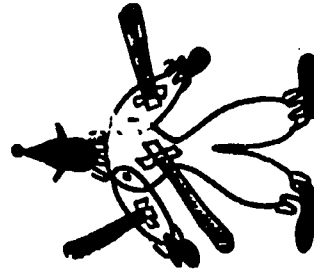
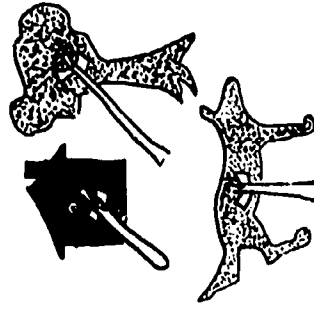

STITCHERY

"The making of art has always been integral to the life of human beings on our earth."

Burton Wasserman
Professor of Art
Glassboro State College
New Jersey

00090

STITCHERY

BEST COPY AVAILABLE

General objectives:

- To appreciate the decorative possibilities in stitching with colored yarns and threads.
- To encourage inventiveness in the use of stitches and their combination with other media.
- To become acquainted with an art of ancient heritage.

Pointers: To thread yarns through narrow needle eyes, place yarn end between two small pieces of cellophane tape. Trim the tape to the width of the thread, and the thread will go through the eye easily. Clip off afterward.

Caution pupils not to pull threads too tightly. It is not necessary for young pupils to tie off their thread. The end can be taped down on the back side of the fabric. Needles are easily cared for if stuck into a styrofoam block when not in use.

Introduce the thimble to students when they begin working on closely woven materials.

While working, put masking tape on the back side of raw edges of material. It prevents raveling.

Appliques can be temporarily pasted or stapled until stitching is done.

IN AND OUT DESIGNS K-2

Preplanning

Objectives

- to teach how to use needles safely
- to learn to use in and out needles

Materials

- large-eyed blunt needles (already threaded for kindergarten)
- colored yarn or heavy thread
- 9" x 12" colored construction paper, glued to shirt board
- paper punches, scissors

Preparation

Work in a small group. Glue construction paper to tagboard or shirt boards. Place all materials on a desk centrally located. Let each pupil file past and select his or her construction paper, yarn or thread.

Motivate

Procedure

Talk about safe way to use needles. Use punches to make border or design on paper. Have children make designs by connecting holes with yarn.

Evaluate

USING STYROFOAM K-2

Preplanning

Objectives

- to make a design with yarn
- to teach in and out stitchery

Materials

- styrofoam meat trays, toothpicks, yarns, raffia, metallic threads, etc.

Preparation

Give each pupil a styrofoam meat tray yarns, toothpicks, and thread. Provide a variety of sizes of meat trays and colored yarn for individual taste.

Motivate

Procedure

Punch holes in tray with toothpicks. Punch yarn through holes with toothpicks. Stretch yarn to next planned point and again punch through. Continue working in this process to form design. Use variety of yarns in one design. Glue beads, sequins, etc.

Evaluate

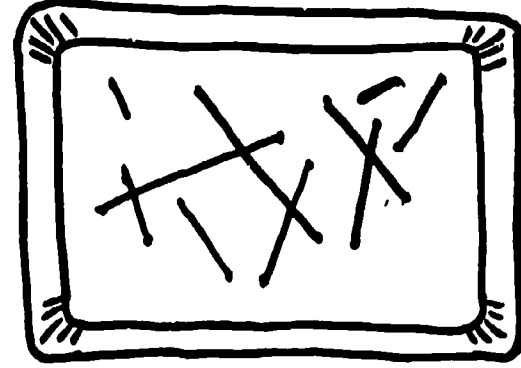
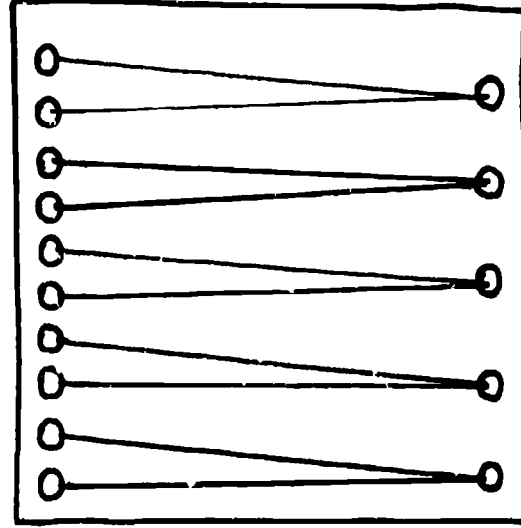

STITCHERY

CRAYON-YARN PICTURE K-2

Preplanning

Objectives

To learn use of needle and thread.
To combine 2 art media.

Materials

White paper; crinoline or netting (crinoline best); crayons; yarns; large-eyed needles with dull points; staples.

Preparation

Give each pupil a needle, a piece of crinoline and a variety of colors of crayon. Teacher-helpers may assist in passing out materials.

Procedure

Use crayons to make bold picture. Staple crinoline or netting to paper. Use yarn to outline and accent drawing. Stitch through paper and crinoline or netting. Demonstrate on piece of cloth stitches as they are needed.

Evaluate

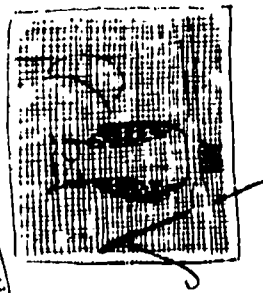

WIRE MESH K-2, 3-4

Preplanning

Objectives

To create a picture with yarn.

Materials

Various colors of yarn; scissors; 1 1/2" hardware cloth (wire mesh); wire cutters.

Preparation

Cut various sizes of hardware cloth. Be sure to snip off any ends and tape edges with masking tape. Tape end of thread on under side of border before child begins.

Procedure

Let children pick shape of mesh and yarn. Show how to draw yarn up through one square, across, and down through another. Let them experiment with making curved lines. Children proceed to "paint" with the yarn, working in a variety of directions.

Variation

Use yarn and needles. Create a mosaic design on hardware cloth by weaving colored yarn in and out through mesh until all areas are filled.

Evaluate

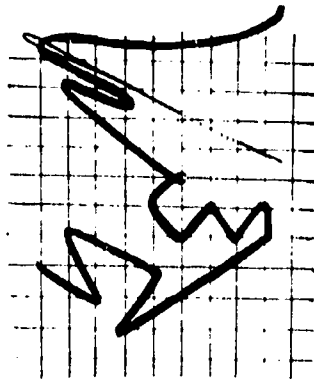

APPLIQUE 3-4

Procedure

Let each child draw a picture of his own design on paper. Trace the design onto burlap rectangle, then cut out each piece of the paper design and pin to cloth scraps. Cut cloth scrap by paper pinned to it. Assemble the pieces on the burlap. Depending on children's abilities, the pieces may be glued, stapled, and or stitched to the burlap. Stapling can be removed after stitching. Bind with bias tape for more finished look. Use dowel and tape loops for hanging.

Variations

Use applique to make a cloth collage. Glue on heavy yarn to give texture.

Evaluate

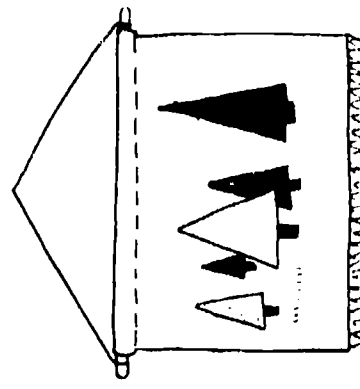
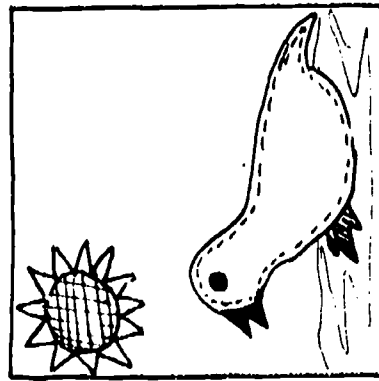

Preplanning**Objectives**

to learn various stitches.

Materials

burlap, yarn, blunt end needle.

Preparation

Set up a table or desk for materials in an easily accessible location and let pupils file past and select materials. Have on hand a variety of colors of burlap and yarn if possible. This promotes creativeness. Demonstrate simple stitches such as—button hole, chain, running cross-stitch.

Procedure

Help child do research to find how to do additional stitches. Help interpret instructions when needed. Child should learn a border stitch to prevent raveling. Use other stitches to make a picture.

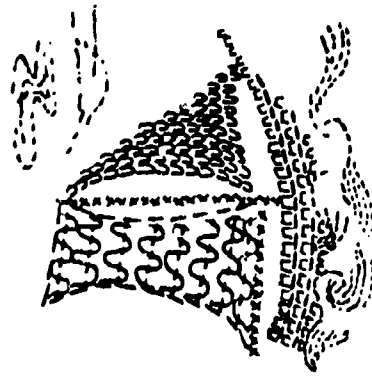
Evaluate**Preplanning****Objectives**

To create a picture from fabric.

Materials

Threads; yarns; needles; white glue; scrap cloth; felt; burlap; monk's cloth; unbleached muslin, etc., for background bricks for doorstop; foam for pillows; wooden dowel for wall hanging, etc.

Preparation

Discuss with pupils what object they want to make; and use of cloth scraps and yarn in making a "picture."

Procedure

If fabric is to be applied to an object such as a brick, draw shape for cutting to fit. Let each child stitch design *before cutting*. Applied bits of fabric can be stapled in place to assist pupil while stitching.

Doorstop: glue onto brick when stitching is completed.

Pillow: Cut back side to match applied top. Sew up 3 sides, wrong side out. Turn, stuff with foam, sew up.

Evaluate**PAINTING WITH YARN 5-6****Preplanning****Objectives**

to make a textural picture using yarn.

Materials

Burlap, monk's cloth, onion sacks, felt or other material for background, large-eyed needles, scissors, various colors and thicknesses of yarn, masking tape.

Preparation

Cut squares of fabric or mesh each child can change shape of fabric if he desires.

Set up desk for materials in a centrally located place. Let pupils file past and select squares of fabric and other materials. Provide a few pairs of scissors for pupils who might want to change shape of fabric.

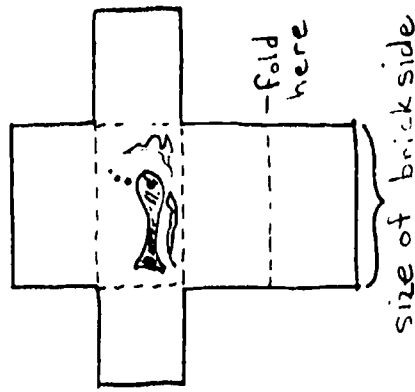
**Procedure**

Tape around edges of fabric to prevent raveling. If material is limp use embroidery hoops or tack to a wooden frame. Let children choose yarn. Proceed to sew a picture. Individual help on stitches may be needed but children can "invent" new stitches to solve their problems. Use scrap material as "doodling" cloth to work out new stitches.

Variations

Pieces of cloth may be applied on. Buttons, beads, etc. may be added.

Evaluate

"MOLAS" OR CUT-THROUGH 5-6

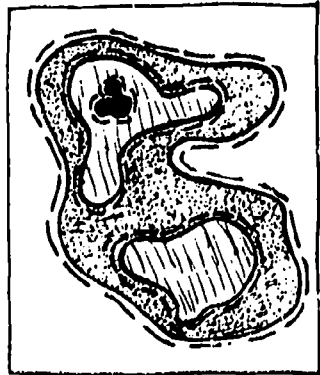

Preplanning

Objectives

- To learn art form of another country.
- To learn a new stitchery process.

Materials

various colors and patterns of cotton, thread, needle, scissors.

Preparation

Cut fabric into 12" x 15" squares. Give each pupil pre-cut squares of material, thread, needle, scissors. Give a brief demonstration using all materials you plan to use.

Procedure

Sew about 4 rectangles/squares together around edge with basting stitch. Cut through top layer—making a large shape. Turn under edge and baste. Cut a smaller shape or several smaller shapes within the large shape. Baste around edges each time. Continue cutting successively smaller shapes within the larger ones until last layer shows. Can be finished by sewing bias tape around edges, making cloth loops on top, and inserting a wooden dowel for hanging.

Variation

Cut out pieces may be appliqued over areas.

Evaluate

GEOMETRIC YARN DESIGNS 5-6

Preplanning

Objectives

To achieve a feeling by using straight lines.

Materials

ruler, compass, pencil, masking tape, yarn, needles (large), stiff cardboard.

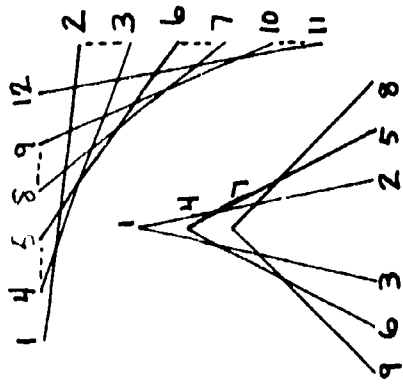

Preparation

Demonstrate a design that can be made by threading yarn from one hole to another. (see illustration).

Ruler, compass, pencil, yarn, large needle and piece of heavy cardboard should be provided for each pupil. Masking tape could be shared. These things should be at pupil's desk before-hand. Demonstrate a design that can be made by threading yarn from one hole to another. Let pupils try out a design first with pencil.

Procedure

Preplan on paper what design will be made. Trace onto cardboard. Punch holes at points (use large needle or do on unthreaded sewing machine). These must be evenly spaced and accurate. Start yarn from back. Come up on front side, cross, go down (back). From back come up in NEXT hole (do not cross over on back). Cross on front, go down, come up in next hole, and so on. Connect holes according to a planned design. Combine triangle design to make a zig-zag. Use a circle—divide in equal parts; connect points.

Variations

Use a leaf motif. Sketch several leaves on cardboard. Make holes with needle and stitch as in geometric designs. Use heavy, hard finish cord to stitch designs. Shellac when completed. Let dry. Paint or ink raised strings and print.

Evaluate

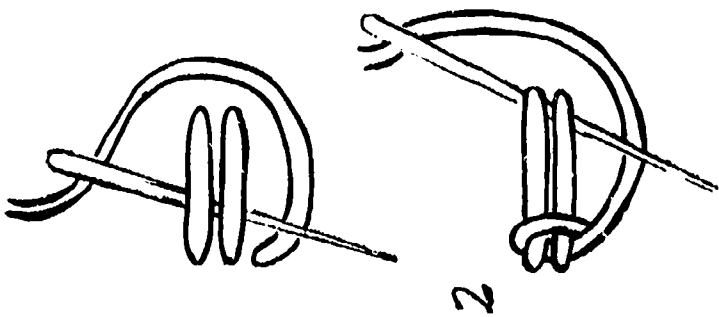

2

3

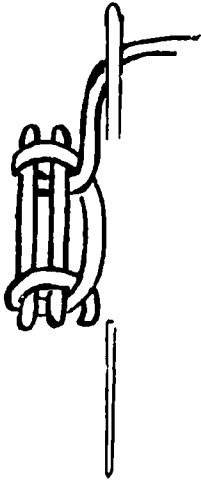

5

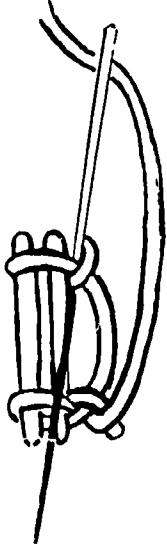

4

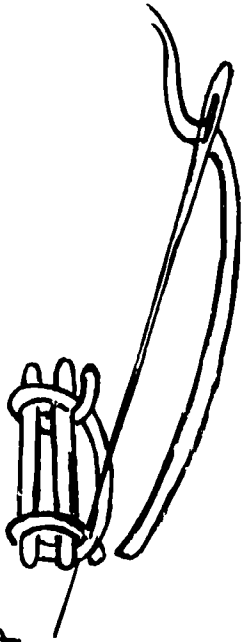

LADDER STITCH

This is best done by following the diagrams. #4 and #5 — the needle goes behind the crossed threads, as shown.

FISHBONE STITCH — leaf design

1. Make a small straight stitch in center top of design.
2. Bring needle up on left line.
3. Insert exactly opposite on right line.
4. Bring out in center a little lower down.
5. Make a stitch over this loop and bring needle out on left line.
6. Keep center stitches equal in length.

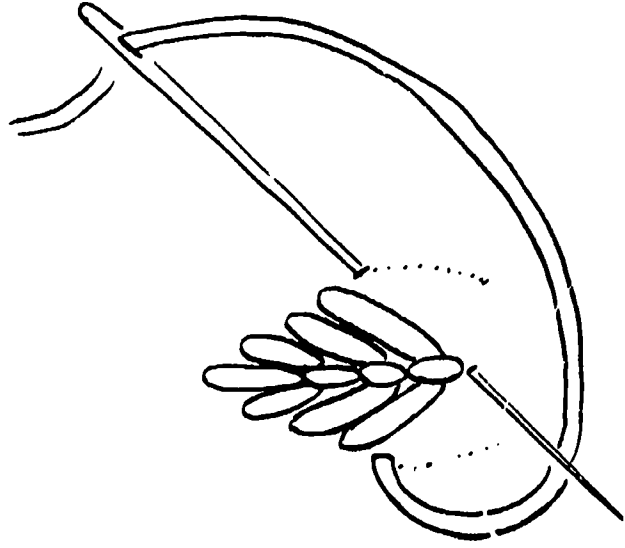

STITCHERY

STITCHERY GUIDE

This is a brief collection of basic stitches. They are *not* intended to be taught as a unit. They *are* intended to be useful to the teacher for helping her students get variety. Many of these stitches are lovely when overlaid in rows of 2 or 3 contrasting colors using the same stitch. Many can be combined into very rich looking borders, etc. Changing the length, width, and spacing of stitches can give dramatic effects.

Combining two or more kinds of stitches is often attractive.

Use of different size threads and different colors, is another way to get variety.

By changing the slant, adding a loop, putting in an extra stitch, all kinds of new ideas can be developed. Encourage older pupils to work out their own.

CHAIN STITCH

1. Bring needle through fabric.
2. Hold thread down with thumb.
3. Insert needle at spot (not same hole) where thread emerged.
4. Bring needle out a short distance below.
5. Draw needle through, over loop.
6. Continue in same manner.

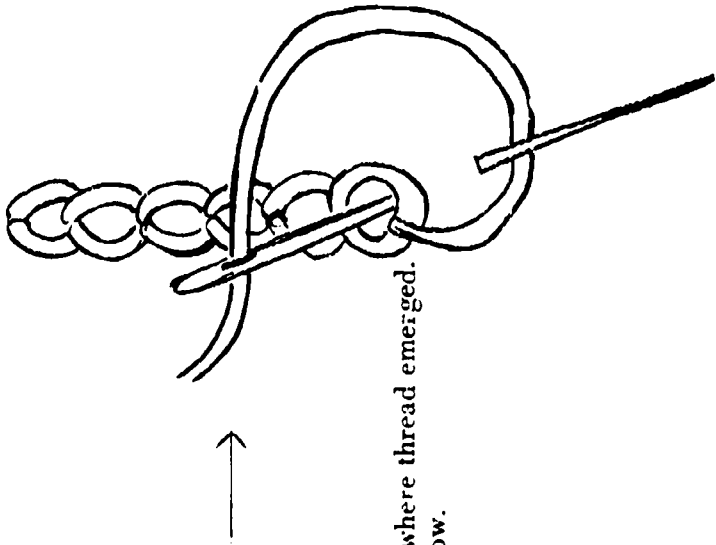

SQUARE CHAIN STITCH

1. Lay out 2 rows of parallel evenly spaced dots. Bring thread through 1st dot on L.
2. Working from top down, stitch on a diagonal. From dot on L without pulling loop taut.
3. Holding loop with thumb, insert needle inside loop at next dot on right. Now make loop snug.
4. Stitch slantwise to left, etc.

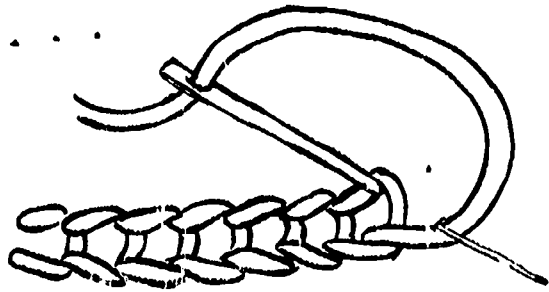

BRAID STITCH

1. Make chain stitch. Tie down with small stitch.
2. Bring needle out a little below this stitch.
3. Thread under chain stitch without going through fabric.
4. Insert needle in fabric where it last emerged, and bring out below this point.
5. Thread it under the tie down stitch and reinsert where it last emerged, bringing out below this point.

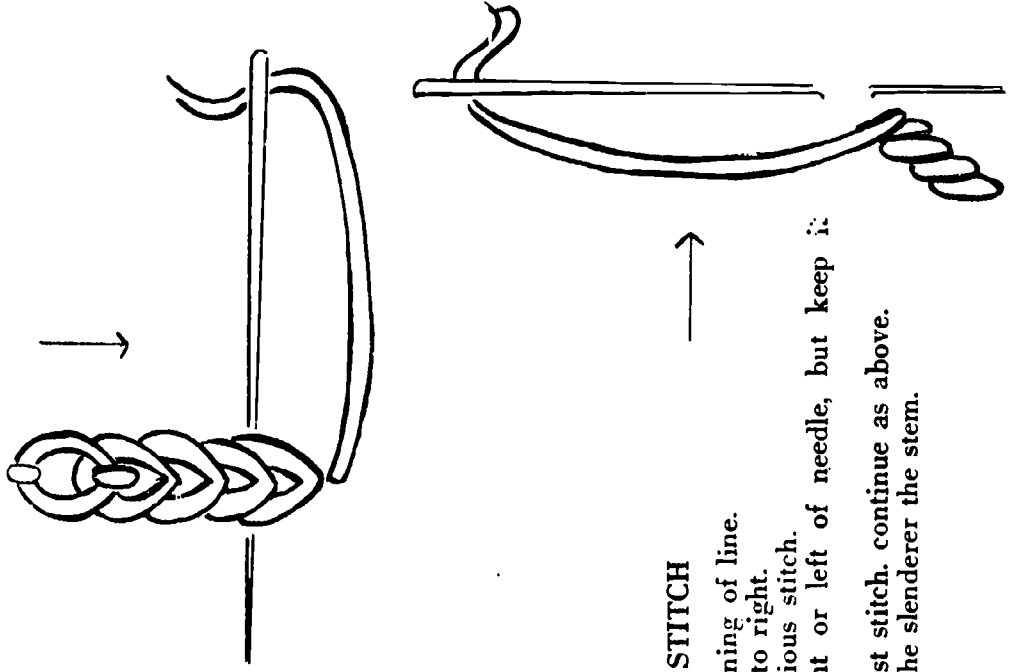

STEM STITCH

1. Bring needle through at beginning of line.
2. Insert needle a short distance to right.
3. Bring out beside base of previous stitch.
4. Thread may be held to right or left of needle, but keep it consistent.
5. Insert needle beside top of first stitch, continue as above.
6. The more diagonal the stitch the slenderer the stem.

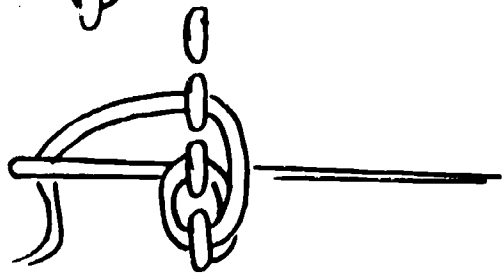
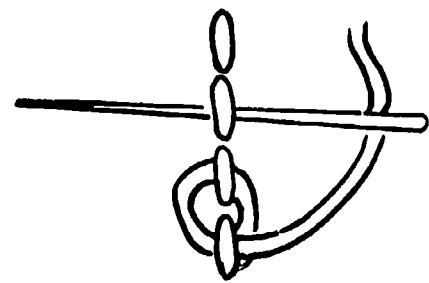
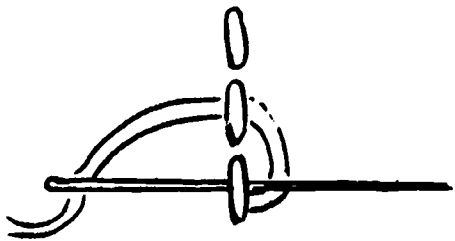
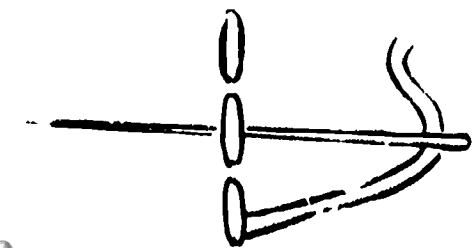

PEKINESE STITCH

1. Put in a row of closely aligned back stitching.
2. Going from L to R go under second stitch without penetrating fabric.
3. Bring needle back under 1st stitch and begin again on 3rd stitch, coming back to 2nd.

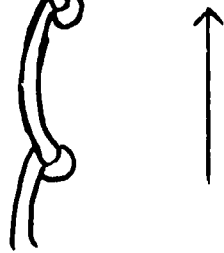
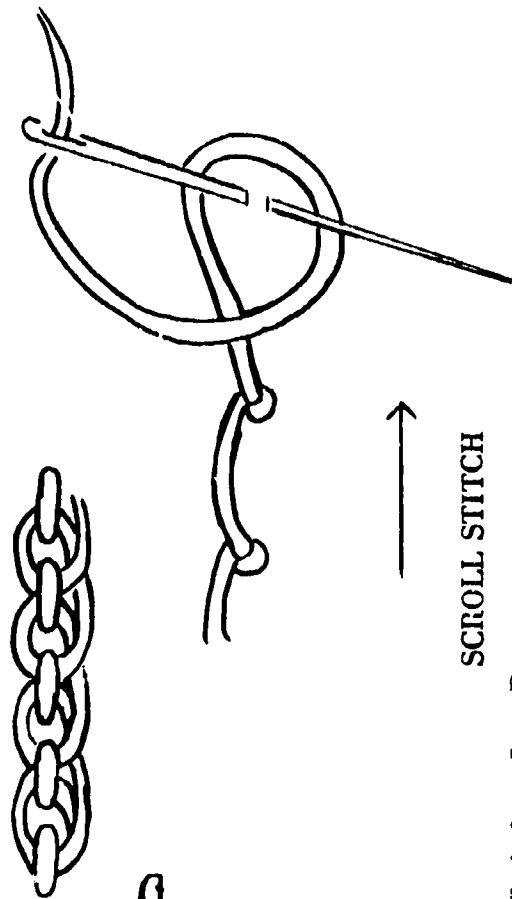

SCROLL STITCH

1. Work from L to R.
2. After inserting needle from underside take a small slanting stitch just above and just below the line.
3. See that the thread is looped under the needle above and below.
4. Pull thread snugly but not too tight.
5. Keep stitches even.

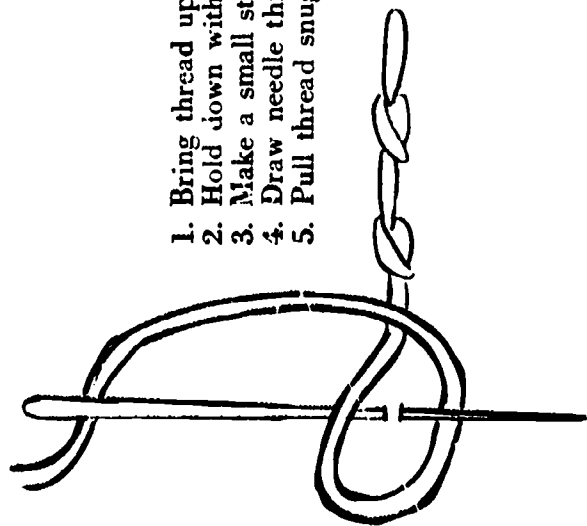

CORAL STITCH

1. Bring thread up at beginning of line.
2. Hold down with thumb.
3. Make a small stitch along line.
4. Draw needle through over thread.
5. Pull thread snug but not too tight.

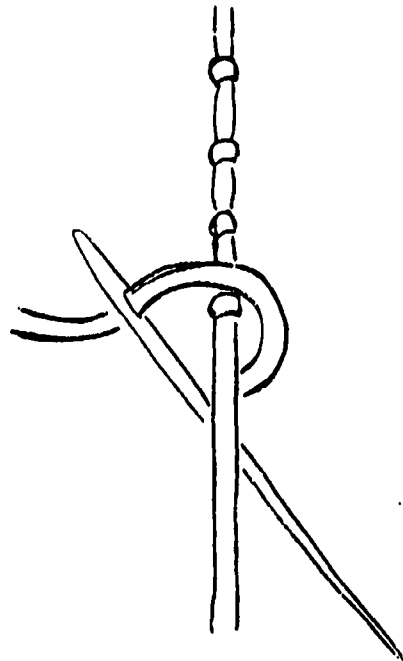

COUCHING STITCH

One thread is overlaid by another.

1. Lay 1st thread along line.
2. Bring needle up beside and below end of 1st thread.
3. Insert needle directly across 1st thread on other side.
4. Bring needle through fabric at desired distance beside and below 1st thread.
5. Insert directly across, etc.

BLANKET STITCH

1. Use two lines parallel.
2. Stitch toward yourself.
3. Begin by bringing needle through on lower line.
4. Hold thread down with left thumb, and insert needle on upper line a little to right of starting point.
5. Bring out directly below on bottom line.
6. Keep needle above thread loop as you draw snug.

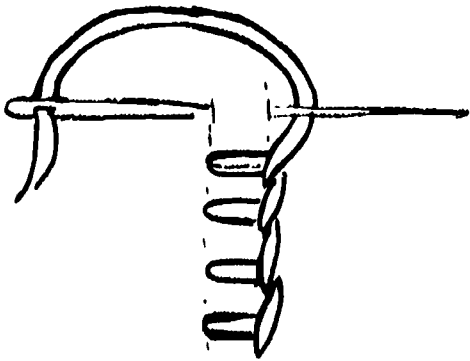

BUTTONHOLE STITCH

This is the blanket stitch done very close together.

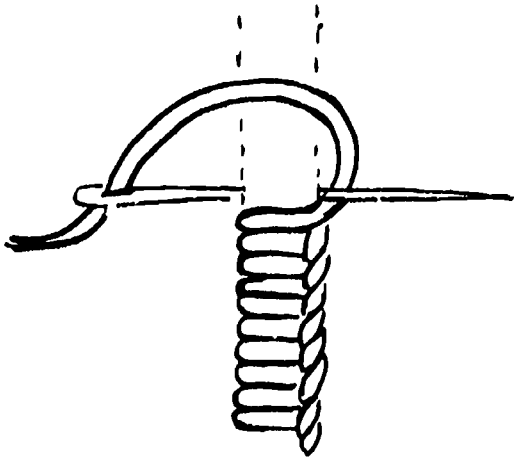

FEATHER STITCH

The feather stitch is really an open chain stitch taken first from the left, then from the right.

1. Work from the top down between parallel lines.
2. If the inside point of each stitch is a little beyond center, first to the L then to the R, the example shown here results.

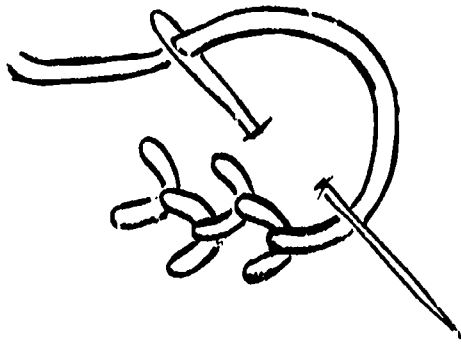

SINGLE FEATHER STITCH

1. Bring thread through material.
2. Take a deep stitch slanting from R to L.
3. Keep loop under needle. Pull snug but not tight.

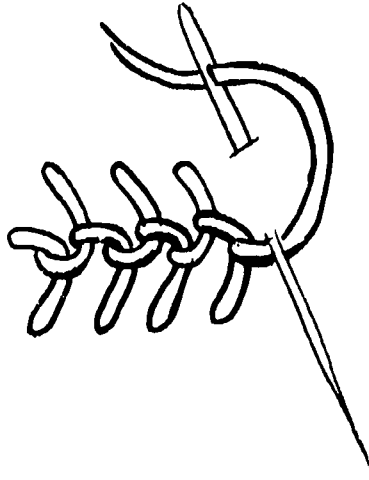
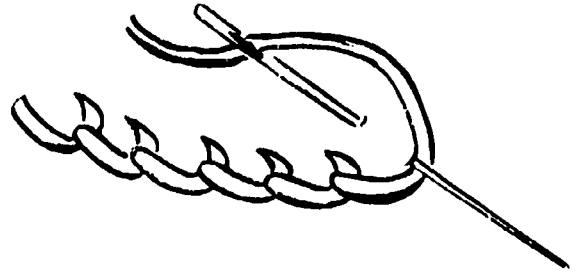

SPINE STITCH

1. Use 3 parallel lines.
2. Start on L line and bring needle through fabric.
3. Insert needle on mid-line, emerge on center line at a point lower than point of entry.
4. Hold thread loop with thumb so that needle comes out over it. Pull snug.
5. Swing needle to L line and stitch downward and toward center line.
6. Hold thread loop with thumb and pull snug.

PLAIN HERRINGBONE STITCH

1. Bring needle up at A
2. Insert at E and bring out at C.
3. Insert at D and bring out at E.

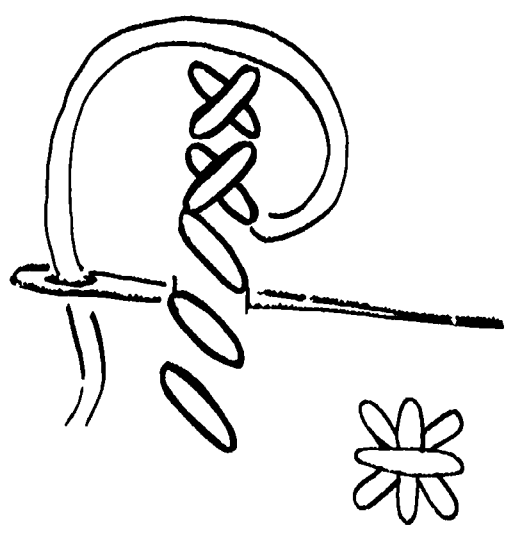
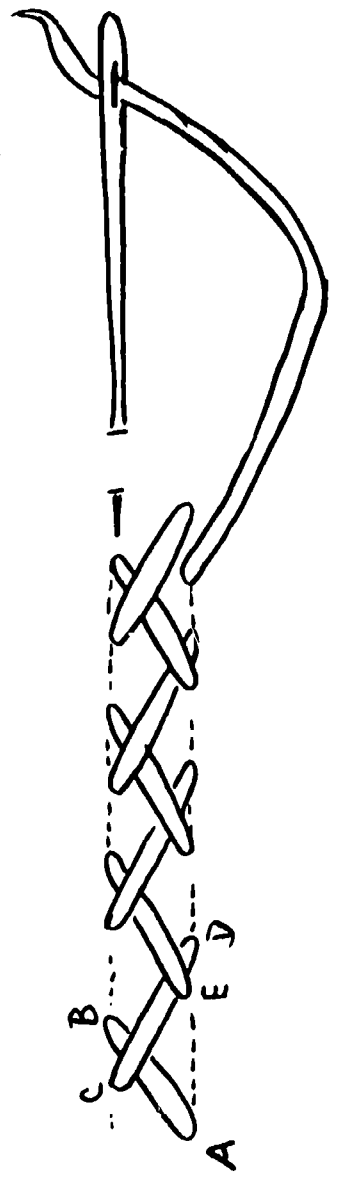

CROSS STITCH

1. Work first from L to R with stitching.
2. Then work from R to L.
3. Insert needle as shown.

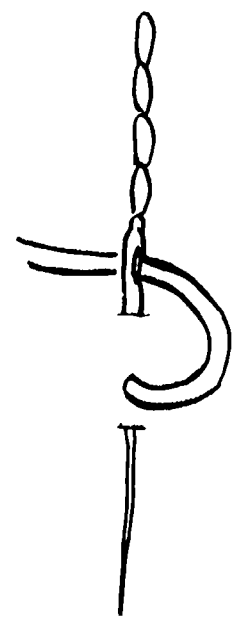

BACK STITCH

1. Bring needle up a short distance from start of line.
2. Insert needle at start of line.
3. Bring out an equal distance ahead of line.

2 Yarns

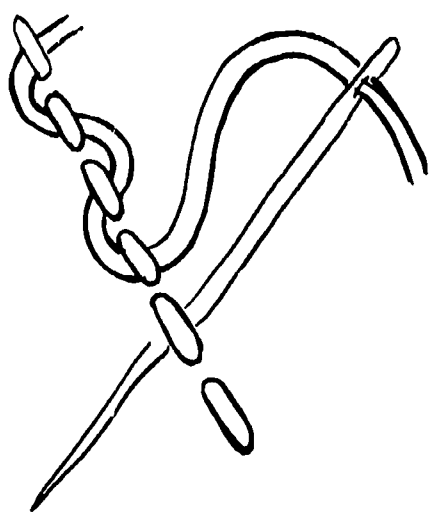

3 Yarns

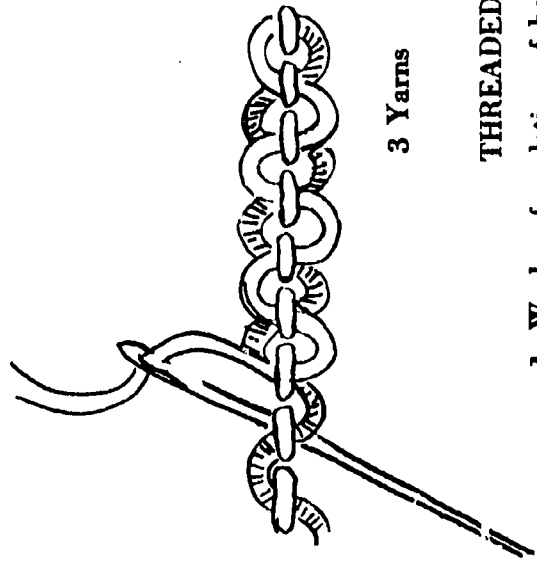

THREADED BACK STITCH

1. Work a foundation of back stitches.
2. Thread another color of yarn through these stitches.
3. A third yarn can be threaded through if desired.

FISHBONE STITCH

1. Work from L to R.
2. Using guidelines based on those indicated, stitch at a sharp diagonal.
3. Keep the stitches close together.

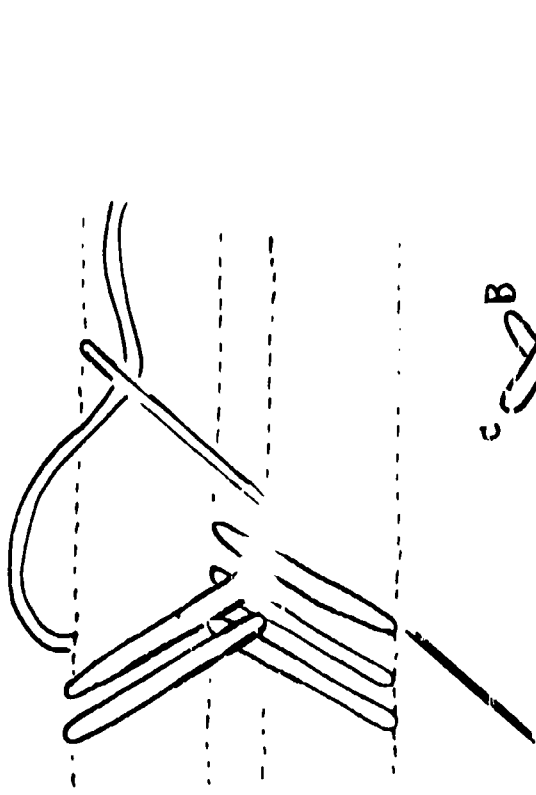

VAN DYKE STITCH

1. Use a blunt needle.
2. Lay out parallel lines.
3. Bring thread through at A.
4. Insert needle at B.
5. Bring out at C.
6. Insert at D and come out at E.
7. For next stitch, insert needle under center-crossed stitches without picking up fabric. Draw through.
8. Insert needle in right margin below last stitch. Bring out directly below on left.

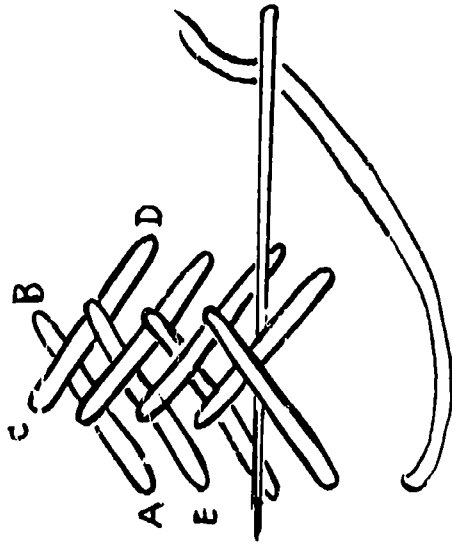

CRETAN STITCH

1. Work from L to R.
2. Using parallel lines as guide make small stitches vertical to these lines. Always point needle inward. Keep thread loop under needle.

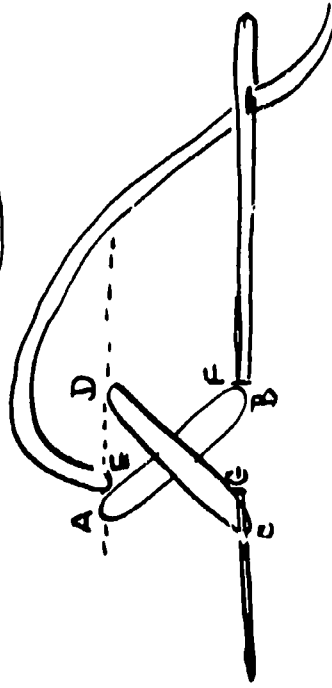
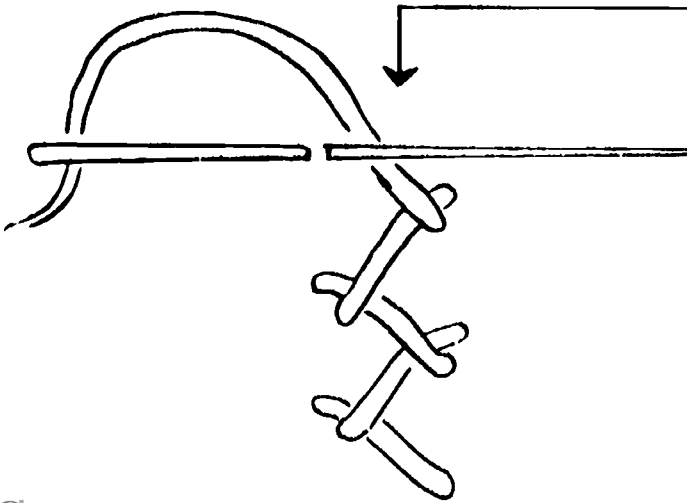

CLOSE HERRINGBONE STITCH

1. Bring needle up at A.
2. Insert at B and bring out at C.
3. Insert at D and bring out at E.
4. Insert at F and bring out at G.
5. Continue as shown.

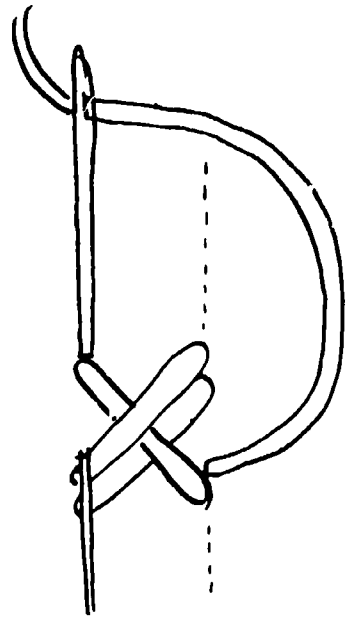

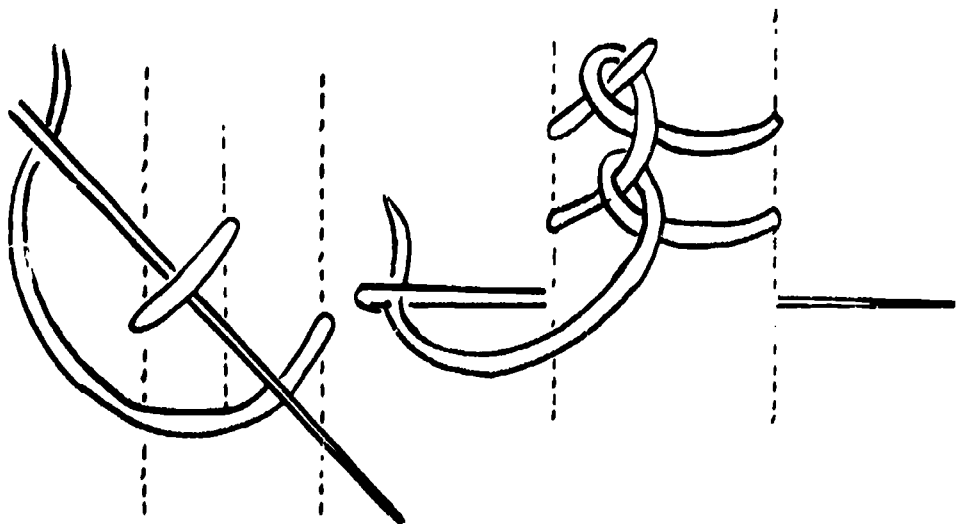

CENTIPEEDE STITCH

1. Use a hoop -- work from left to right.
2. Work between two | | lines.
3. Start in the center, bring needle through material, insert at upper margin and bring through directly across on opposite margin.
4. Loop needle under first stitch.
5. Stitch under and across as before.
6. Loop through diagonal of previous loop.

CRETAN STITCH — leaf design

1. Bring needle through at A.
2. Insert at B, form a loop with thread and emerge at C, over the loop.
3. Insert at D and bring out at E over loop.
4. Repeat above from B through E.
5. Keep outside stitches close together and inside stitches in even line.

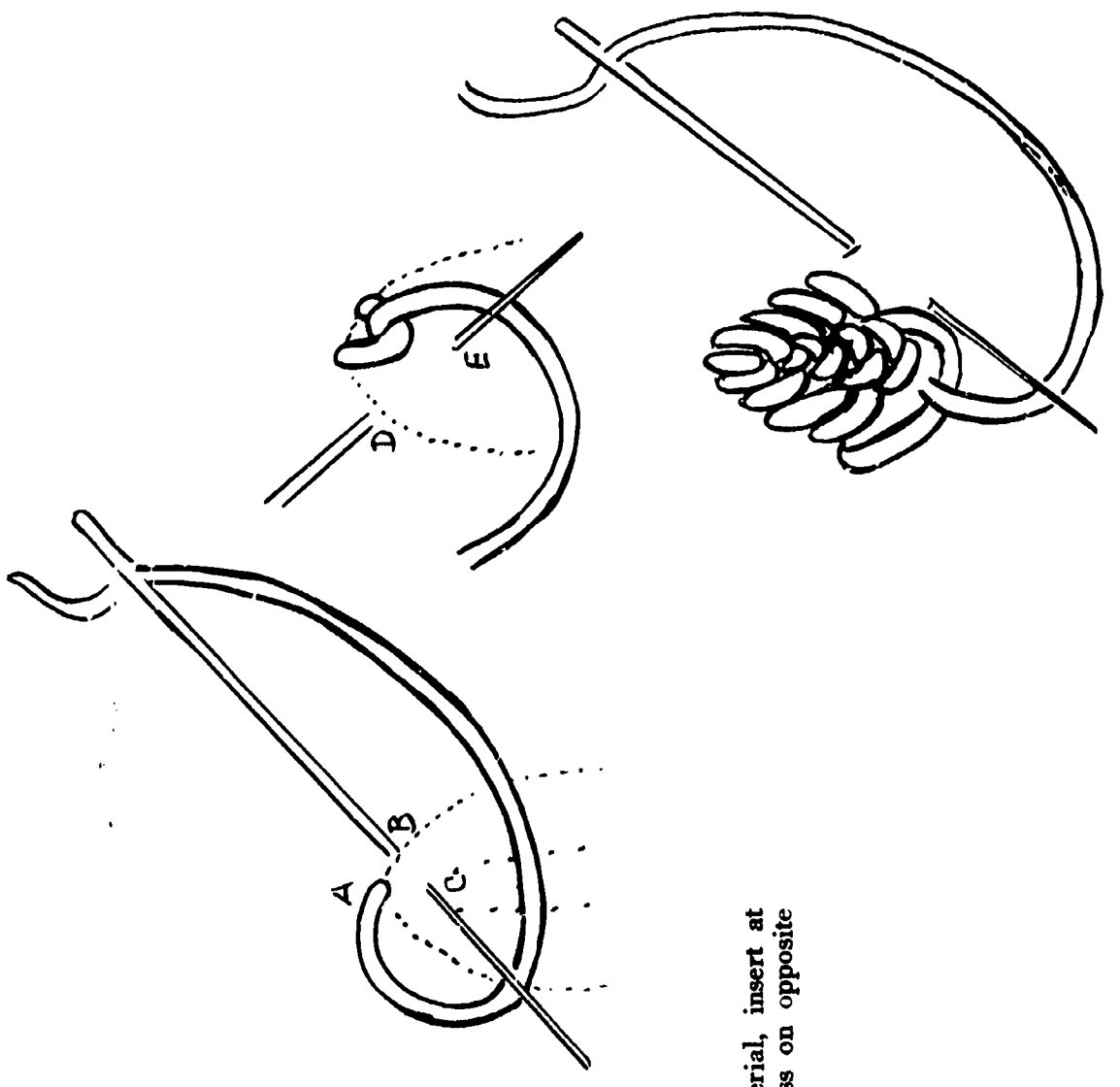

FRENCH KNOT

1. The thread is wound around needle two or three times.
2. Insert needle at emergence point and pull through to back.

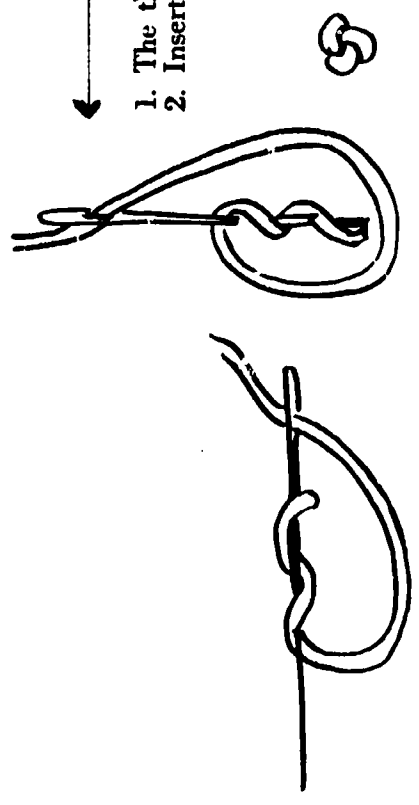

BULLION STITCH

1. The thread is not wound around needle until after inserted for a straight stitch.
2. Before pulling needle through, thread is tightened down to emergence point.
3. Needle is pulled through cloth and through wound thread, then inserted near beginning of stitch.

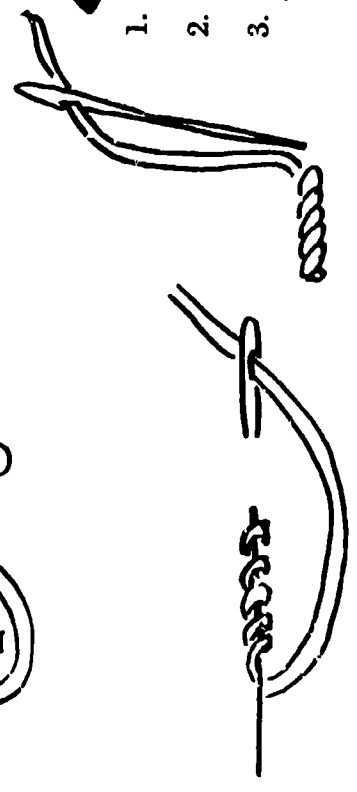

RUMANIAN STITCH

1. Use parallel lines for guide.
2. Stitch all the way across from L to R.
3. Bring needle out a little less than halfway back toward left line. Keep needle point above thread of 1st stitch.
4. Bring needle over 1st stitch and tie halfway toward left line, bringing needle point out on left line.

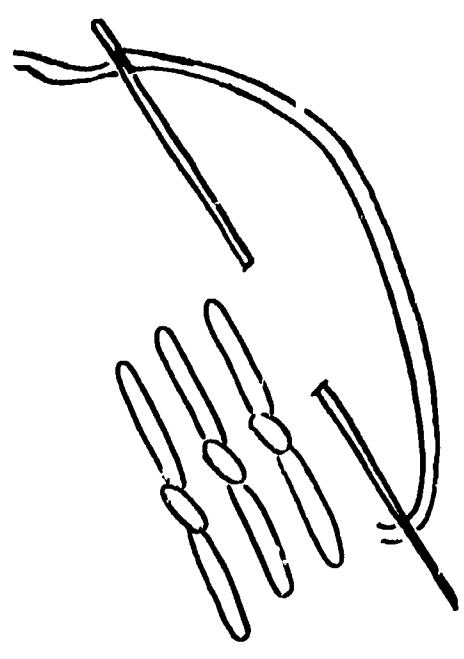

PADDED SATIN STITCH

1. Work a layer of small stitches to serve as padding.
2. Bring needle up at one edge of area and insert at opposite side, using slant stitching.
3. Continue stitches along an even edge, keeping them close and evenly spaced.

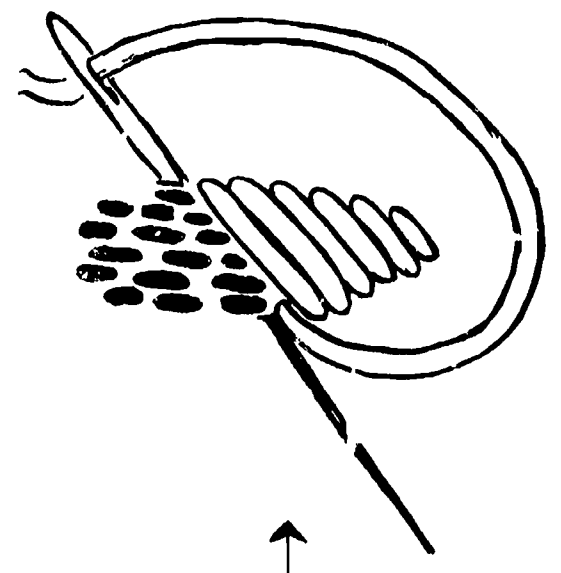

NOTES

3-DIMENSIONAL ART

“Man is searching at last — seeking with renewed vigor — techniques for improving the balance between technology, economics, esthetics, and conditions for living.”

George F. Horn
Art Chairman

John Hopkins Jr. High

3-DIMENSIONAL ART

General Objectives

- To create free-standing forms to be viewed in the round.
- To understand the importance of volume and space in design.
- To relate 3-D effects to sculpture and architecture.

SHADOW BOXES K-2

Preplanning

Objectives

To choose a subject, be creative, make objects that will stand alone.

Materials

Shoe boxes or cardboard foundations. If outdoor scene, paint, brushes, construction paper, found materials; if indoor scene, wallpaper, cloth, construction paper, etc.; scissors; and glue.

Preparation

Have children bring shoe boxes from home or make a folded cardboard foundation. If cardboard foundation is made be sure to score cardboard before folding for wall and floor foundations. Cut construction paper. Collect found objects.

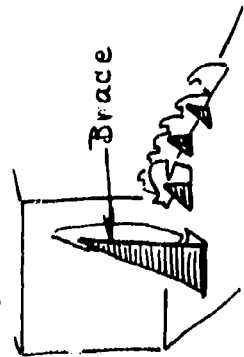

Procedure

Decide on idea for box (paint). Turn box on side. Cut out people, decorate and brace. Cut out other scenery, score where possible and brace.

Evaluate

FOLDED NEWSPAPER FORM K-2, 3-4

Preplanning

Objectives

To discover that newspaper has 3-D potential.
To fold and roll paper.

Materials

Newspaper, glue, tape, rubber bands, paint, brushes.

Preparation

Make samples of rolled forms, thick ones, elongated ones, bendable ones.
Pass out newspapers, tape, paint and brushes.
Cover tables with newspaper.

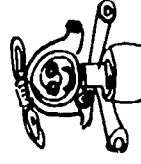

Procedure

Determine the shape or shapes to be made.
Decide what types of rolls will be needed, round, flat, long, fat, etc. Begin with largest basic shape and attach other pieces with glue and tape. When object is completed, paint with tempera.

Variation

Working on a smaller scale, colored tissues can be used to create attractive, gay rolled ornaments.

Evaluate

3-DIMENSIONAL ART

LIGHT BULB PEOPLE K-2, 3-4, 5-6

STONE SCULPTURE 3-4, 5-6

*Preplanning***Objectives**

- To create a simple foundation figure.
- To apply facial features effectively.
- To dress figures imaginatively.

Materials

Styrofoam cups, 60 or 75 watt light bulbs, paper or plastic drinking cups, construction paper, scraps of cloth, yarn, white glue.

Preparation

Cover tables with newspaper. Glue for every 2 pupils. Let pupils help give out paint materials. Teacher will prepare a basic mix of flesh color with a little white glue added to make it stick to bulb. Divide into separate containers. Make small hole in bottom of cups. Push bulbs into upside down cup.

Motivate**Procedure**

First day paint bulbs with flesh color. Cover cups with fabric.

Second day paste cut out features on bulb. These can be painted on by upper grades. Add yarn for hair. Cut paper collar from construction paper, lace, foil, or use fringe. Make hat to suit the character—clown, pilgrim, nurse, woman, child, Indian, etc. Dress to suit the character.

Variation

Stick light bulb into top of stocking. Secure with rubber band around base. Facial features can be sewn on with needle and yarn or glued on. Yarn hair can be sewn.

Evaluate*Preplanning***Objectives**

- To create a 3-dimensional object from stones.
- To observe and utilize the natural beauty of stones.

Materials

Stones, shellac or clear varnish, brushes, solox or turpentine (for cleaning brushes) tempera, epoxy glue.

Preparation

Clean stones (scrub with sand and water). Turn stones over and over studying the shape and color. Cover work area with newspapers.

Motivate**Procedure**

When an idea emerges, paint details (wings, head, features, eyes, etc.) with tempera and brush. Shellac or varnish when dry.

Variation

Glue several stones together to form wings, head, feet, etc. I gave stones natural or paint.

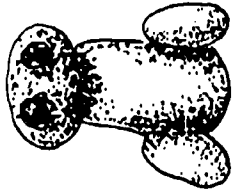
Evaluate

BOX TOTEMS K-2

*Preplanning***Objectives**

- To exercise imagination in creating non-realistic heads.
- To make use of plentiful inexpensive materials.
- To create a large unit from individual projects.

Materials

Boxes: collected from household, such as oatmeal, bisquick, detergent, etc. Smaller 3-dimensional materials, such as egg crates, buttons, bottle caps, feathers, macaroni, towel tubes, etc. paint, brushes, water in jars, scissors, newspaper, several long dowels at least 24".

Preparation

Cut egg cartons and towel tubes into smaller sections. For features prepare a table of miscellaneous boxes and other collected materials.

Prepare a drying area for first day's work.

Mix a bit of detergent into paints. Find informative materials about totems.

Motivate**Procedure**

Discuss totems, their purpose, how made. Challenge pupils to make totems to represent spirits and ancestors of this age, or a future period. Spread newspapers over tables.

First day: Pupils select boxes and found objects to build features. Paint each box in solid color suited to pupil's idea.

Second day: Spread newspapers. Helpers give out glue and scissors. Attach ears with glue. Add other items to complete facial features and paint. Punch holes in boxes, top center and bottom center for slipping onto dowel. Interperse painted paper cups for necks. Set lower end of dowel in pot of dirt, or stand in perforated bricks and stack box totems one above other on dowel.

Variation

Boxes can be treated individually to create a variety of characters or objects. Animals, trains, rocket ships, barns, castles, windmills, houses, cities.

Evaluate

After displaying totems and effect of assembling boxes has been appreciated, children may dismantle totems to carry their own projects home.

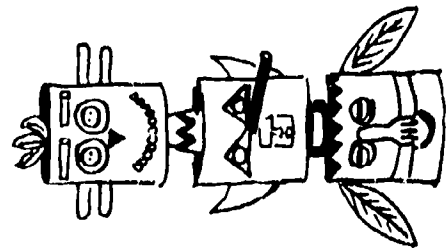

3-DIMENSIONAL ART

FOIL SCULPTURE 3-4, 5-6

Preplanning

Objectives
to find usefulness of foil for modeling.
to build awareness of body structure.

Materials
Foil, wheat paste, newsprint, 18 gauge wire (stove pipe, aluminum, copper), pins, tempera paint, pomps tissue, wire clippers.

Preparation

Tear individual lengths of foil, cut 9 inch lengths of wire. Have pupil helpers give out newsprint and wheat paste, paints when needed. Place other materials within reach. Spread newspaper over tables.

Motivate

Procedure

Crumple foil into large oval. Pinch out body and head from one piece. Add more foil if needed, crushing it evenly over first ball. Add appendages by running wire through body at shoulder and hip point and crushing foil around it. Bend arms, legs, tail, etc. and clip off excess wire and foil. Cover with colored tissue, or to make a stronger figure cover first with newsprint and wheat paste. Colored tissue can be applied over this. Use small pieces to get around contours. Paint face, and hair.

Evaluate

Preplanning

Objectives
to learn to join a group of found materials into an assemblage.
to create an abstract textured composition.

Materials
lids of shoe boxes, glue, construction paper, found objects (beads, cardboard, bottle caps, nut shells, seeds, buttons, wood strips, soda straws, styrofoam, etc.)

Preparation

Collect box lids well in advance; assemble large collection of found materials in advance. Have them ready in low boxes or pans and placed in a central location.

Motivate

Procedure

Glue construction paper to fit inside of box lid. Select pieces of wood, straws or other materials to create partitions within the lid. Glue in place. Use smaller found materials to create design and textures within the partitions.

These lids may be joined into a freize, or mural and if desired, instead of using construction paper the lid and contents may be painted in harmonizing colors or sprayed a single color.

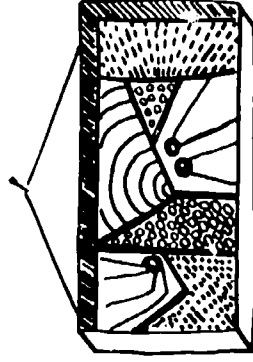

BOX LID ASSEMBLAGES 3-4, 5-6

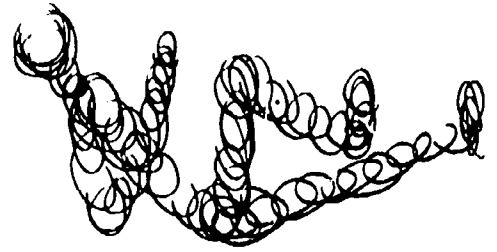

Preplanning

Objectives
to create a 3-D form which shows action.

Materials
assortment of wire (stovepipe, electrical, screen, copper, and brass wires); wire cutters, pliers, pencils and newsprint, cylindrical objects, string, yarn, beads, cement; glue.

Preparation

See that children are thoroughly familiar with gesture sketching. Have sketches made of figure of animal *in action* using circular motion. Each child will need wire and access to cutters, etc.

Motivate

WIRE FIGURES 5-6

Procedure

Using gesture sketches, try to copy action of figure. Skeleton or frame can be formed of a double thickness of wire. Join at joints by cementing and wrapping. When skeleton is solidly put together, begin wrapping (as in gesture sketching). Keep wire loosely wrapped. New pieces can be added by wrapping ends into torso and hiding edges.

Finished piece can be hung as mobile or nailed to wood block (as a base).

Variation

Instead of wrapping wire as a gesture sketch, wire can be attached to skeleton form to round out ribs, skull, hips, etc. Colored tissue can be wrapped.

Evaluate

3-DIMENSIONAL ART

PLASTER CASTING

Mixing Plaster

Use a throw-away container such as a gallon plastic bottle (with the top part removed). Have damp paper towels on hand.

Fill 1/2 with water. Begin sifting plaster into water and continue until a peak stands above the surface and does not continue to slide under. Use a stick and stir slowly until the plaster begins to thicken. For dipping, use at this point. For pouring, continue until you feel a slight resistance to the stirring stick. Use at once. Do not let it get so far that the plaster shows the trail of the stick. This will set too fast. If plaster refuses to thicken, add a little more, it may be old. Patting plaster that is stiffening will make it more fluid for a few moments.

Do none of this near the sink. Throw container and stick away. Wipe hands clean on wet paper towels. Wipe table, etc. Do not wash anything into sink. (Plaster sets in the trap.)

Hemp rope, cheese cloth, old nylons, or rust proof wire embedded in your casting will strengthen your plaster, especially where the parts are fragile.

For hanging, be sure to imbed a wire loop.

For smoothing, #400 sandpaper or emery paper.

Lacquer, shellac, or polymer can be used as sealer. They also make good top coats to protect finishes.

See section on Formulas for plaster mixes that are given attractive texture through the use of vermiculite, sand or sawdust. Plaster can also be made interesting by swirling a bit of color into the plaster just before pouring. Do not stir enough to distribute color evenly all through the plaster. Crayon chips can also lend color to plaster.

SAND CASTING

Preplanning

Objectives

To use a simple mold for 3-d plaster form.
To understand the reverse effect of casting.

Materials

Large box or plastic container filled with fine damp (not wet) sand. Small tools for impressing textures into the sand. Plaster; newspaper; water; damp paper towels; throw-away container for mixing plaster; stick; wire hook.

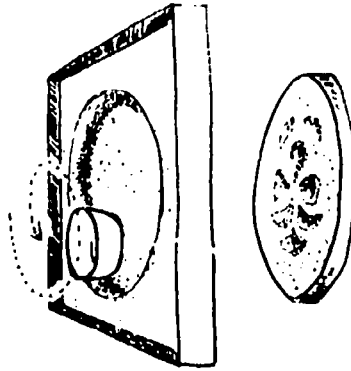

Preparation

Set up a mixing station for plaster away from the sink. Arrange several boxes of damp sand. Pupils can work only in small groups, since the teacher mixes plaster. See formula for mixing plaster. It is advisable to try this project first on your own.

Motivate

Procedure

Using a jar, or bowl, make an impression in the damp sand at least 2" deep. Move the bowl in a circular manner, pressing the sand outward to form firm walls to hold plaster. Pack a little against side of bowl all the way around. Take tool of your choice and having decided upon a motif begin pressing forms into the sand. Call attention to the fact that the deeper the pressure, the more outstanding the projecting surface. After this much demonstration let pupils ask any questions they wish. Spread newspapers on tables. Give boxes of sand to pupils, let them select tools and begin. Some may also watch in preparation for their turn. Follow the procedure for mixing plaster. As soon as plaster reaches a cream-like thickness, begin to pour. Do not splash and if possible dip out with small paper cup to minimize force of pouring which can destroy sand mold. Pour lightly over whole surface and then add plaster until the entire impression is filled at least 1 inch. Have a wire hook prepared. Insert into the plaster correctly for hanging. Allow to set 30 minutes. Brush away sand and test for firmness, if o.k. get finger under the cast and lift. Use a stiff brush to remove sand. Wash if you like, over a bucket, not the sink. Clean all plaster away with wet paper towels. Throw these away. Also the mixing container. Get a new one for the next group.

Evaluate

3-DIMENSIONAL ART

PLASTER SCAFFITO 3-4, 5-6



Preplanning

Objectives

To understand and experience incised design.
To contrive interesting effects of one color against another.

Materials

Butcher paper; pencil; wet paper towels; shoe box; plaster; 3 throw-away containers; stick; water; newspaper; cooking oil; brush; carving tool (screwdriver, fruit knife, spoon)



Preparation

Dip brush in oil and coat inside of box. Put tempera color in two separate containers. Spread newspapers and have wet towels on hand.

Motivate

Procedure

Have pupils draw design to fit their box. Divide dry plaster between two containers with tempera. Mix one colored layer and pour into boxes, let firm, then mix and pour thin layer of other color, 1/16". When set, lay paper design or plaster and trace over it with pencil, using a bit of pressure. Lift paper, take scratching tools and cut design thru the top layer, down to second color. When finished and fully dried, rub to a gloss with wax paper.

Evaluate

BALLOON AND PLASTER SCULPTURE 5-6

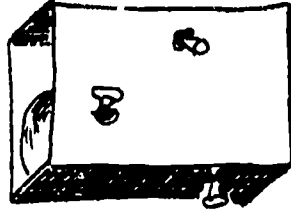

Preplanning

Objectives

To become conscious of interior space in sculpture.

Follow usual preparations for working with plaster. Obtain small balloons, inflate and tie. Use cardboard milk carton for form. Make holes in it here and there to permit ends of balloons to be pulled outside. Tape in place.

Motivate

Procedure

Mix plaster and begin pouring into milk bottle. Add a balloon before plaster gets to first hole, pour more plaster, add another balloon, etc. until carton is filled. Allow to set for about 3 hours. Remove carton. Deflate balloons. With spoon carve the form to a more pleasing shape. Simplify, examining it from all sides. When dry, it may be sanded and given one of the finishes described in this section.

Evaluate

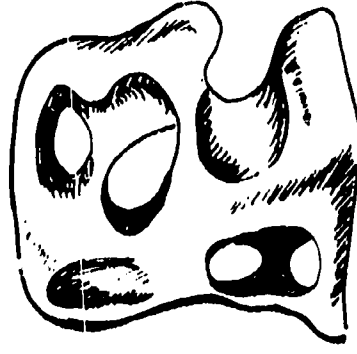

SCULPTURE

COOKIE SCULPTURE K-6

Light Dough

- 1 egg
- 1/2 cup vegetable shortening
- 1/3 cup sugar
- 2/3 cup honey
- 1 tsp. lemon flavoring
- 3 cups sifted all-purpose flour
- 1 tsp. salt
- 1 tsp. soda

350° for about 15 minutes

Directions

Combine first 5 dry ingredients. Sift, then add to first mix, a little at a time. Some more flour may have to be added. Roll dough to 1/4". Cut or mold to desired shape.

By rolling dough into coils and creating an open space design, the open spaces can be filled with crushed sour balls and cooked on a sheet of foil 350° from 3 to 6 minutes.

Strips of dough can be coiled, twisted, pinched and arranged in many shapes.

Various imprints can be made from tools, toys, fingers, bolts, rope or other textured objects.

Dark Dough

- 1/3 cup shortening
- 1 cup brown sugar (firm)
- 1 1/2 cup molasses
- 2/3 cup water
- 6 cup all-purpose flour
- 2 tsp. soda
- 1 tsp. salt
- 1/2 tsp. cinnamon
- 1/4 tsp. nutmeg
- 1/4 tsp. ginger

350° for about 15 minutes

3-DIMENSIONAL ART

PAPER MODULE CONSTRUCTIONS, 5-6

Preplanning

Objectives

- To create small construction units.
- To build a large structure from the units.
- To understand first rudiments of architectural stress and strain (balance).

Materials

Toothpicks, Q-tips, applicator sticks, cardboard strips, spools, woodblocks—any of which can be used to create modules; quick drying glue, scissors, newspaper, ruler, colored tissue, straight pins.

Preparation

Spread newspaper, distribute scissors, module materials and glue. Different pupils may use different sets of modular materials. Have sample modules made from cardboard, spools, applicator sticks, etc., respectively.

Motivate

Procedure

Show sample modules to pupils and explain how they can become building units when joined into a construction. Explain that there are other shape modules possible and to experiment to design their own. Keep it simple. Then let pupils design modules and repeat the construction until a series of similar shapes has been built. These modules may be covered with tissue, cardboard, colored paper if desired.

Let pupils plan how to put shapes together to build a larger form, then let them proceed to join their modules with glue and/or fine wire. Pins can be used to hold glued pieces till dry.

Variation

Wood scraps, imaginatively assembled, are good material for creating buildings and sculptures.

Evaluate



BOX SCULPTURE, 5-6

Preplanning

Objectives

- To create never before seen, imaginative forms.
- To create interest from all sides.
- To maintain balance.

Materials

2 or 3 cardboard cartons, papier mache pulp, newspaper strips and wheat paste; exacto knife, tagboard strips, newspaper, masking tape, crushed foil.

Preparation

If using pulp, prepare in advance. (See formulas). Collect cereal, cake mix, oat meal, etc. boxes. If wheat paste is to be used, mix before class and divide into several containers—one for each four pupils. Group pupils in fours around paste. Distribute two rolls of tape to each group and an exacto knife or scissors to each. Assemble other materials where they are easily accessible.

Motivate

Procedure

Challenge pupils to create strange but simple forms, part solid, part enclosing space. Cartons can have odd shaped holes cut in them. Newspapers can be made into large and/or small cones. These can be trimmed to fit one against the other and taped in place. A box can be attached, and another, using different sizes. Foil can be lightly crushed into crevices to fill in shape. Tape in place. Overlay with newspaper strips dipped in wheat paste, or spread with paper pulp mix. Continue filling out the form in this manner until the pupil is satisfied with his sculpture. Be sure it stands solidly. Be sure to retain some open space. Allow drying time. (2 days for paper strips). Paint with tempera.

Evaluate

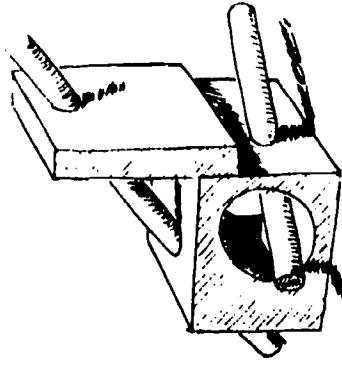

BOX ASSEMBLAGE

Preplanning

Objectives

- To create on more than one plane.
- To be sensitive to penetrating space.
- To be visually aware of view from both sides.

Materials

shoe boxes (or other of equivalent size); dowel, soda straws, heavy cardboard, string, glue, tape.

Preparation

Remove bottom from boxes; cut variety of cardboard strips and shapes on paper cutter; cut dowels into suitable lengths to use in boxes, either diagonally, horizontally or vertically; distribute glue, string, tape to each pupil.

Motivate

Procedure

Using sides of box as a support, begin gluing in dowels or straws or cardboard strips to create verticals, horizontals and/or diagonals. These must be in the central area as well as near the edge of box. Add shorter pieces connecting some of the longer ones. To these smaller sections glue cardboard shapes and strips. Turn the box as you work, checking the design from all angles, to see that the 3-D effect is pleasing from all sides. Colored papers, foils, tissues may be added as desired.

Evaluate

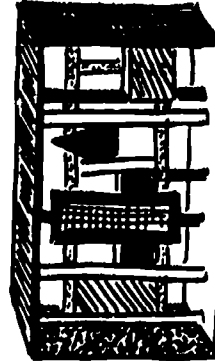

3-DIMENSIONAL ART

PLASTIC BOTTLE SCULPTURE

General information: Plastic bottles can easily be cut with scissors if held under warm running water for a few moments.

The pre-formed curves and contours of plastic containers offer possibilities not obtainable with cardboard or paper.

Direct heat from a flame or electric coil will melt most plastic containers. Plastic surfaces will not glue easily where there is tension. Brass brads through overlapping edges are needed. Puncture plastic first by laying it on a wooden block and piercing it with an ice-pick.

To paint the surface, rough up the plastic with medium coarse sandpaper, and add white glue to the tempera. Acrylic paints and spray paints cling nicely.

Suggested uses:

The following ideas are not written up as projects, but are presented to initiate exploration of plastic bottle sculpture.

It goes without saying that detergent bottles offer excellent bases for making figures.

Add a painted styrofoam ball for the head, then the outer clothing is all you need.

Bits of braid, gift wrap, cloth scraps provide garments. When the character is male, cut the bottom of the bottle to represent legs.

Wrap legs with newspaper and wheat paste. Paint pants and shoes; apply colored paper or fabrics for upper garments. Arms may be avoided by using capes, or they may be cut from cardboard and attached.

The top half of a plastic bottle, inverted and set into an inverted styrofoam cup, is a basic form for creating many kinds of heads. The open top can be filled with a stuffed nylon stocking. A few ice pick holes around the edges of the bottle will do to anchor stocking in place with thread. Yarn can then be tacked to the stocking to form hair. Sometimes a hat or a cap will eliminate need for hair. Facial features are best cut from construction paper and glued on, although yarn can be used.

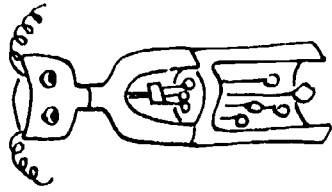
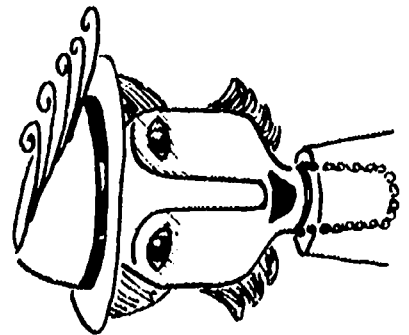

Plastic bottles offer possibilities for fantastic creatures, whose interiors can expose humorous inner workings. Sandpaper thoroughly at glue-points.

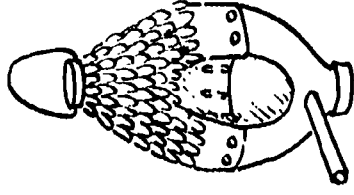

Two tops of milk bottles, with handles removed can be joined and covered with straw, cone "petals," bark, or other materials to make a nice bird house. Cap the top opening.



Cutting out the handle area of a milk carton, and turning the inside up, gives the base for creating all kinds of imaginative insects. Spots, wings, antennae, legs, etc., can be designed by the pupil and attached.

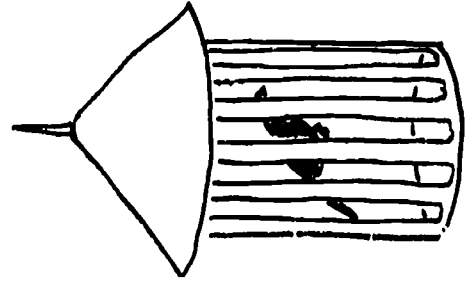
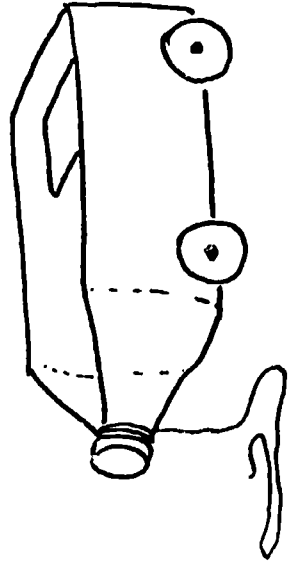

WEAVING

“— What about the visual brain-washing of our kids, who are growing up in the plastic and chrome culture of America today?”

Phoebe K. Scholl
Prof. Art Education
Edinboro State College
Pennsylvania

WEAVING

General Objectives

- To learn a variety of weaving techniques.
 - To provide experience for creating original and novel ways of weaving.
 - To learn to make and use a loom.
- Note: younger children tend to weave without a definite pattern, and should be allowed to do so.

WEAVING INTO MESH, K-2

Preplanning

Objectives

To learn basics of weaving.

Materials

Wire mesh or scrim (cross-stitch rug canvas); yarn or string; blunt-end needles; paper; crayons; wire cutters.

Preparation

Cut scrim or wire into individual pieces. Helps pass crayons, paper, string, needles.

Motivate

Procedure

Design simple object on paper. Place paper under mesh for pattern. Trace design on mesh with crayon. Weave over and under scrim fibers to outline shape or fill in areas. Overlap yarns for texture. Experiment. Children may prefer to weave without design. By all means, give them this choice.

Variations

Use onion sack stretched over cardboard frame. Stretch old textured hose over a piece of cardboard. Weave on this. Plastic berry boxes with square holes or chicken wire can be used for weaving with yarn or string.

Evaluate

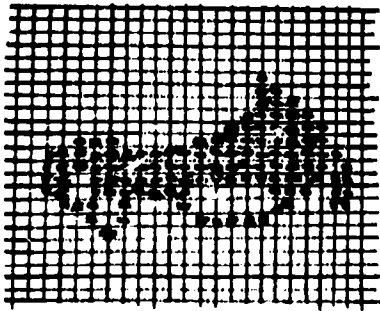

DRINKING STRAW LOOM, 3-4

Preplanning

Objectives

To make a simple loom.
To weave on loom.

Materials

Straws; string; yarns, grass, other materials for weaving; scissors.

Preparation

Cut straws in half; cut strips of yarn. Cut string into several yard lengths. Helpers pass 5 straws and string to each. Demonstrate how to make loom and begin weaving.

Motivate

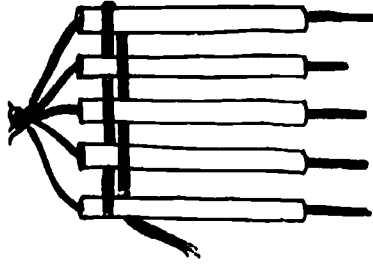

Procedure

Cut 5 pieces of string (approximately 2 ft.). Tie them into big knot at one end. Thread each string through a straw. Push straws up to knotted end. Select a piece of yarn. Tie at knotted end to one end of a straw. Weave back and forth, going over and under. Change yarns after awhile to add new color and texture. Tie new piece to end of old. As weaving progresses, push woven section up and off straws, freeing straws for more weaving. Slip straws off strings when finished weaving.

Evaluate

BASKET WEAVING, 3-4

Preplanning

Objectives

To learn basics of weaving.

To create a decorative, useful object

Materials

Oatmeal box or similar circular container; strips of black paper; yarns; scissors; glue; rulers.

Preparation

See procedure

Motivate

Procedure

Cut black strips 2" longer than height of box. Glue strips to bottom of box. Skip 1/4" spaces between strips. Bring them upward and fold ends over rim of box. Glue. Weave yarn over and under strips. Use for basket or stable.

Evaluate



WEAVING

POPSICLE LOOM, 3-4, 5-6

Preplanning

Objectives

- To experience simple weaving.
- To create a simple inexpensive loom.

Materials

Two pencils or dowels, 10 popsicle sticks, glue, cardboard strip, yarn, pocket comb, hand drill.

Preparation

Use two sticks for top and bottom. Between, glue 7 or 8 sticks with holes. (See drawing). Tie yarn ends at holes. Bring other ends through holes and tie to a pencil or dowel, then continue ends back to slits between sticks. Pass them through and tie evenly to a dowel or pencil. Make a cardboard shuttle and wrap with yarn for weaving.

Motivate

Procedure

Loom should resemble illustration below. The loop attached to a nail will be fastened to your belt. Tie the popsicle end to a chair so that the dowel there can move up or down. Keep yarn taut. Weave with shuttle. Use comb to pull threads close.

Evaluate

Cut off the eighth strand which will not have a slit to go through.

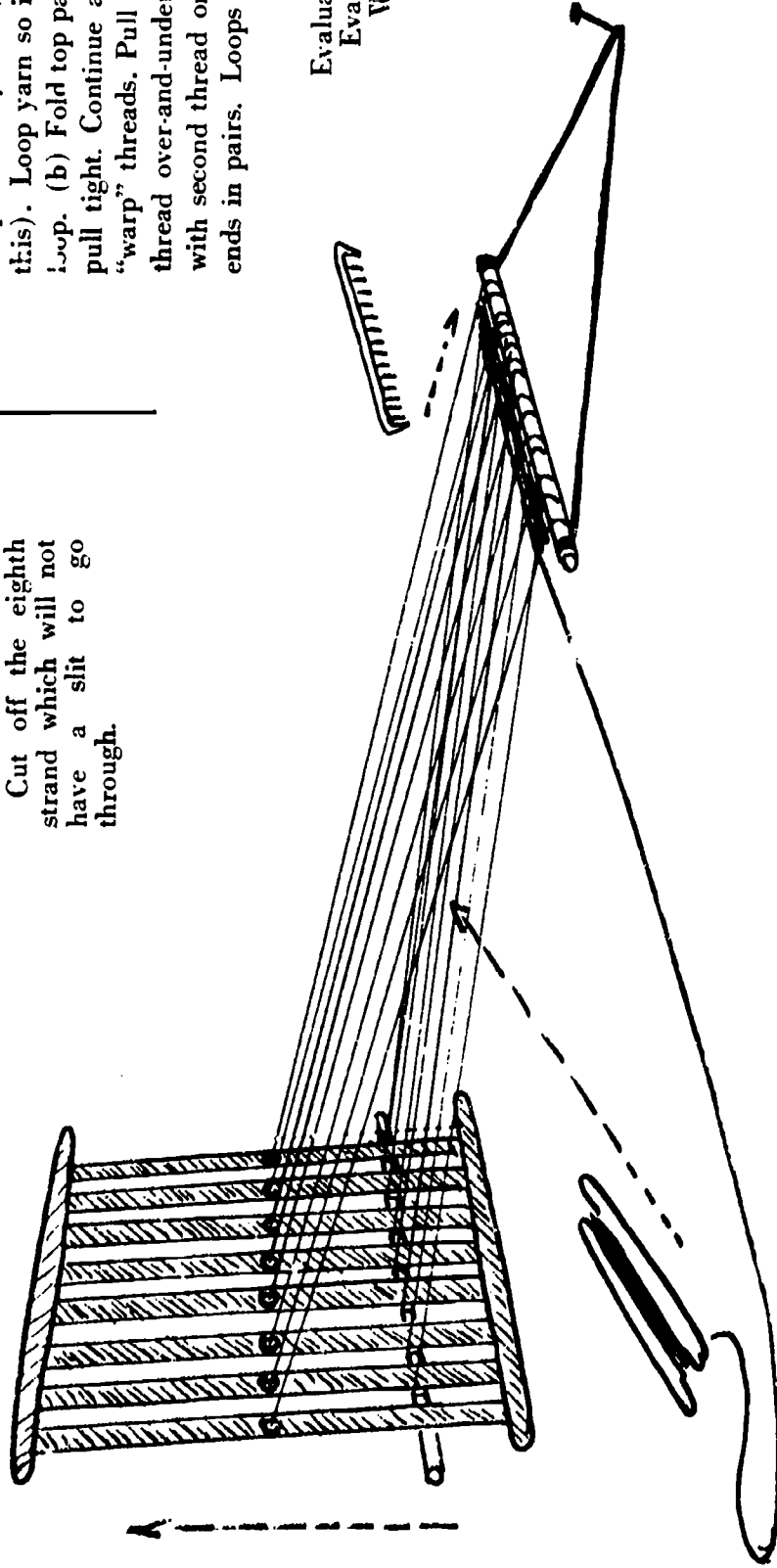

PENCIL LOOM, 5-6

Preplanning

Objectives

- To make a pencil loom
- To learn principles used for loom weaving

Materials

Pencil or dowel; heavy yarn; scissors

Preparation

Cut several yard lengths of yarn for each child.

Helpers pass dowels, scissors, yarn.

Motivate

Procedure

Cut pieces of yarn $1\frac{1}{2}$ times length of finished product (child decides this). Loop yarn so it has a short and long tail. (a) Place pencil across loop. (b) Fold top part of loop over pencil. (c) Pull ends through loop; pull tight. Continue across pencil with other pieces of yarn. These are "warp" threads. Pull short ends over top of pencil. Weave left end loop thread over-and-under to its end. Do same with right end thread. Repeat with second thread on left, and so on. When weaving is completed, knot ends in pairs. Loops are removed from pencil and knotted in same way.

Evaluate

- Evaluate after each has done some work on loom.
- What can be done to give variety to work?

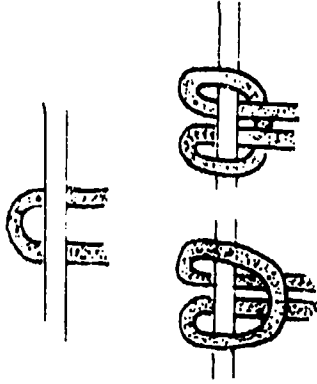

WEAVING

CARDBOARD LOOM, 3-4, 5-6

Preplanning

- Objectives**
To experiment with texture.
To harmonize colors.
To pre-plan weaving pattern.

Materials
Yarn, ribbon, natural materials (grass, weeds, etc.), mohair; heavy cardboard; scissors; ruler; string; needle.

Preparation

Discuss patterns of designs that could be made in weaving (using only straight lines.) Each designs his idea on paper. Have ample cardboard prepared in advance, and begin the anchoring of threads.
Motivate

Procedure

Draw line along top and bottom of cardboard, about 1/2" from edge. Cut slits from edge to line, about 1/2" apart. Anchor thread in top slit, and stretch to bottom. Continue across. Weave yarns over and under in usual weaving fashion. Invent your own techniques. Vertical threads need not be evenly spaced; tie some together, etc. Begin weaving your design after you have experimented. You may want to make changes in it.

Variations

Use circles or other shapes of cardboard as frames.
Evaluate

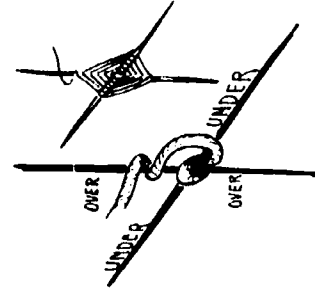
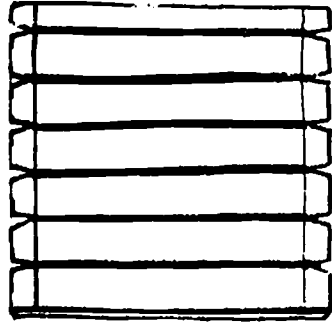

"OJOS DE DIOS" (GOD'S EYES), 3-4, 5-6

Preplanning

Objectives

To work with an art form from another land (God's Eyes are Mexican good luck charms).

Materials

Sticks (ice cream sticks, applicator sticks, Q-tips, tree branches, etc.); yarn; pipe cleaners; scissors; yardstick.

Preparation

Helpers pass out 1 pipe cleaner, 2 sticks per child
Child goes to table where yarn is, selects, and cuts 1 yard piece
Motivate

Procedure

Wrap pipe cleaner around 2 sticks to form a cross. Wind yarn around sticks, starting at center and looping around each spoke, always in same direction. Go under first spoke and wrap once, to next spoke on right; over and wrap once, then under the next, etc.

Variations

Use more than 2 sticks or branches.
Make a sculpture using this technique.
Combine ojos to make a mobile.
Evaluate

BURLAP, 3-4, 5-6

Preplanning

Objectives

To learn basics of weaving.

Materials

Burlap, yarn, colored string, needles, scissors

Preparation

Cut burlap into squares or rectangles.
Each child will need burlap, needles and yarn. Let children choose colors of yarn.
Motivate

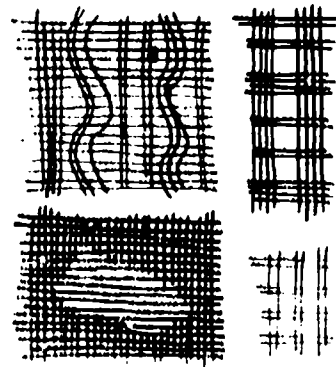

Procedure

Threads should be pulled from the burlap.
Use various combinations of pulling (pull two, skip three, pull two, skip one, pull five skip two, etc.).

Thread needle with yarn and begin weaving in areas where threads have been pulled.

Variations

A. Threads can be tied or cut. Pull from both directions to form squares or designs. Wide rows can be pulled; groups of threads tied together. Cellophane, rick rack, yarns can be woven into panels made by pulling threads. Beads can be attached.

B. Free form shapes can be cut out by cutting all threads in one direction.
Weave into cut-out shapes.

Evaluate

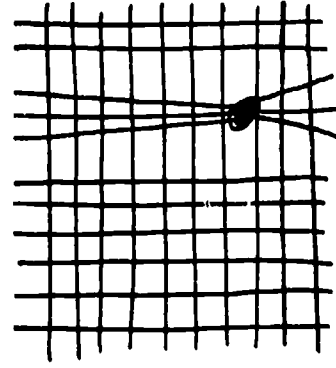

WEAVING

WALL HANGING, 3-4, 5-6

Preplanning

Objectives
 To create a textured hanging of found and regular weaving materials.
 To improvise a simple loom.

Materials
 Two strips of corrugated cardboard cut from a carton, ball of twine, coathanger, yarn, cloth strips, raffia, reed etc.

Preparation
 Punch both cardboard strips lengthwise down the center for warp threads. On the top strip thread twine lengths (36") and tie firmly against one edge. Pass other end of each twine length through matching hole in second cardboard strip. Straighten twine and tie in loose knot about 18" below the top. This knot prevents tangling. It will be loosened and lowered as weaving progresses.

Motivate

Procedure

Select piece of yarn, tie at top to first vertical string. Begin weaving and continue until decision to change weaving material (twist). Ends should be tied off or stitched down on back side, for a neat finish. However, they are sometimes left loose on the sides for a primitive look. Cellophane strips, reed, raffia, and many other materials can be woven into the fabric. Rings, loops, bottle caps, pieces of braid, fringes, cloth scraps can be woven into the hanging, with an eye to the color and textural effect. Use the lower cardboard to act as a beater to keep threads straight. When near the bottom of hanging, decide if it is to be tied off, fringed, weighted or otherwise finished at bottom. Take a knife or razor blade, split the cardboard strips along threads and tear away. Run a pole, dowel, curtain rod through the loops at top and attach cord for hanging.

Evaluate

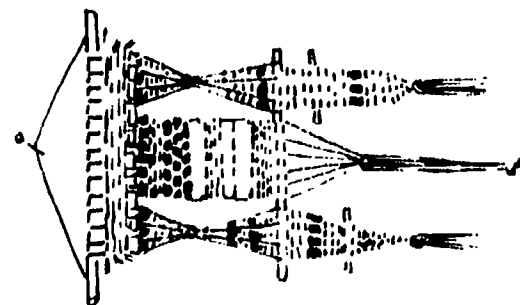
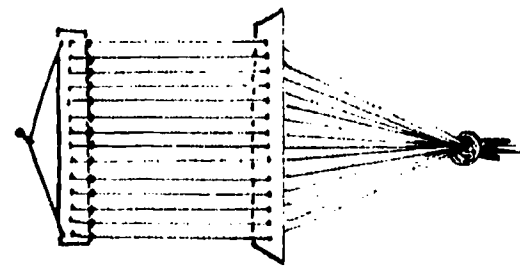

RUG HOOKING, 5-6

Preplanning

Objectives
 To become acquainted with a simple form of rug hooking.
 To enjoy creating texture and pattern.

Materials
 Burlap or cotton monk's cloth, yarn hook, thick wool yarn, pencil, paper, carbon, masking tape.

Preparation
 Cut 12" squares of fabric. Let pupils tape edges to prevent raveling and draw a two inch margin inside the tape. Cut paper for design 10" by 10".

Motivate

For weaving with plenty of room for imagination and fantasy, try weaving on tree branches. Be sure the wood is not too old and brittle.



Procedure

Give each child a sheet of carbon, a square of paper and a pencil. Stress that the design must be large, have a bold outline, and no fine details. Demonstrate use of hook.
 With left hand hold thread on underside, push hook through from top, place yarn in hook and pull to top side again. Length of loop above surface not over one inch. Keep snug against fabric on underside. Continue, placing loops about two threads apart. Let pupils experiment on a scrap of burlap. Have them hook the outlines first, to keep pattern. With yarn, two or three rows are needed for the outline. Then fill in with appropriate colors. Working in circular directions makes the thread hold better. When finished, the margin can be turned under and whipped. Pieces may be stitched together for a rug or wall hanging.

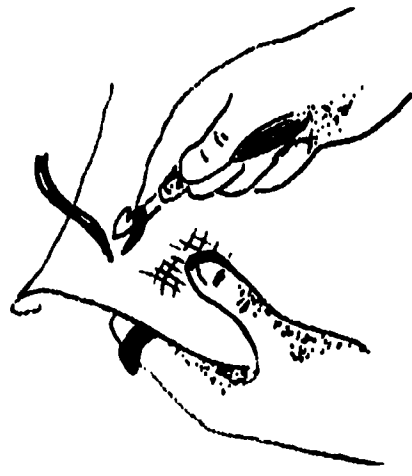

NOTES

FORMULAS

"It is by way of communication that art becomes the incomparable organ of instruction."—*John Dewey*

00118

FORMULAS

Carving Mixture No. 1

Vermiculite and cement
2 parts vermiculite
1 part Portland cement
H₂O

Add water until creamy, stirring constantly. Pour into milk carton. When set, tear away carton. Stay away from sink. Clean up out-of-doors.

Carving Mixture No. 2

Cement and Sawdust
4 parts cement
16 parts sawdust
H₂O

Mix in large pan and pour into milk cartons to harden. Mix dry ingredients and add H₂O to achieve a moist mixture before allowing to set up. Stay away from sink, and wash up out-of-doors.

Asbestos Modeling Material

3 cups asbestos
1 cup flour
1 tablespoon white glue

Add enough water to make a stiff dough for modeling.

Asbestos Cement

3 gallons asbestos
9 cups H₂O
2¼ cups Ready-Mix wheat paste

Add H₂O to asbestos and knead well. Leave asbestos slightly dry. Add lump free wheat paste and mix well until no trace of wheat paste remains.

Carving Mixture No. 3

Vermiculite and Plaster of Paris
3 parts Vermiculite
1 part Plaster of Paris
H₂O

Mix. Pour into milk carton. Let set. Do not get any plaster in the sink. Clean up out-of-doors.

Carving Mixture No. 5

Dirt and Plaster
Dirt
Molding Plaster
H₂O

Sift equal amounts dirt and molding plaster. Mix well. Add warm H₂O and mix. Pour into milk cartons. Keep plaster away from sink.

Carving Mixture No. 6

Zonolite (Vermiculite) and Plaster
2 parts plaster
1 part sand
1 part Zonolite
H₂O

Mix. Pour into milk cartons. Allow 48 hours to dry. No plaster in the sink.

Papier Mache Pulp

Tear newspaper into small pieces. Cover with boiling water and let stand for 24 hours. Squeeze out as much H₂O as possible. Use 3 parts pulp, 1 part flour and ¼ part salt. May be used for contour modeling on heavy cardboard. Dry, then paint.

Sawdust No. 1

3 cups sawdust
1 cup wheat paste
water

Add enough H₂O to mix ingredients. Do not make it stiff.

Sawdust No. 2

2 cups sawdust
1 cup Plaster of Paris
½ cup wheat paste
3 cups H₂O

Add H₂O gradually until molding consistency is reached.

To make very small or delicate objects of papier mache use tissue in small strips soaked in a small quantity of water. Mix with library or homemade paste. Works easily and has smooth surface.

FORMULAS

Dough No. 1

2 cups flour
2 cups salt
H₂O

Add enough H₂O to flour and salt to make a creamy consistency.

Dough No. 2

1 cup salt
1/2 cup cornstarch
1/2 cup boiling water

Beat mixture over slow heat until thick.

Knead until it is the right consistency for modeling. Store in closed jars. Shellac the finished product.

Dough No. 3

4 cups unsifted flour
1 cup salt
1 1/2 cups H₂O

(Recipe should not be doubled or halved.)

Mix--then knead for 5 minutes. Mold into desired shapes. Insert paper clip for figures if hanging is desired. Figures should be baked at 350 degrees for at least 1 hour. Place on cookie sheet to bake. Paint after baking.

Gesso

10 tablespoons whiting

Mix with water to a creamy consistency.

Add 6 tablespoons liquid glue.

Add 1 tablespoon varnish.

Boil in double boiler 10 minutes.

When almost through, add 3 tablespoons linseed oil. For color, use tempera or paint.

Bread Paste

Fresh white bread

Glue

Glycerine and water

Crumble and knead inside portion of 2 slices of bread. Roll into a ball, push the thumb into the center. In the depression just made put 4 drops of glue, 1 drop glycerine. Knead the glue and glycerine into the mass and work until smooth and free from lumps.

This can be used as a cement for jewels on papier mache. It is also fine for making small flowers and fruits to be applied to papier mache products such as bracelets, pendants, boxes and plaques.

Play Clay

1 cup cornstarch

2 cups baking soda

1 1/4 cups water

Mix thoroughly in saucepan. Heat to boiling, stirring constantly. Cook to a dough-like consistency. Cool and knead. Store in plastic bag or in covered jar. Color in portions before kneading, or brush color on dried form. Shellac well when thoroughly dry. This clay is soothing to the skin.

Flameproofing Solution

9 oz. borax and 4 oz. boric acid in 1 gallon warm water.

Apply to fabrics, streamers, other inflammable items by brushing, dipping or spraying. Washing removes solution.

Finger Paint

Mix one box cold starch such as Argo and one cup soap flakes in four quarts water. Cook until clear. Add one oz. oil of cloves or winter-green (preservative).

Use non-toxic powder paint, food coloring, or tempera for color.

Fabric Paint

Put the white of an egg or powdered albumin (one to three parts) with tempera watercolor. Add 1/4 teaspoon vinegar. Paint design on fabric. Place fabric between two papers. Steam with hot iron--damp cloth. This sets the colors and makes them fast.

Textile Paint Substitute

Mix 12 drops vinegar, 6 drops lemon juice, 3 oz. turpentine with tempera or oil paints. After material has been painted and dried, the colors may be set by using a pressing cloth saturated with diluted white vinegar and pressed with a hot iron.

Silk Screen Paint

Beat a small amount of soap flakes in water with an egg beater until thick. Color with small amounts of powder paint or tempera.

Printing Ink from Tempera

Flake Soap

Tempera

Add flake soap to liquid or dry tempera and H₂O.

Mix to a pudding-like consistency.

FORMULAS

Candle Wax: Formula No. 1

Wax from an old candle
(paraffin or beeswax will substitute)
60% by weight of paraffin
35% stearic acid
5% beeswax

Candle Wax: Formula No. 2

10 oz. mutton tallow
4 oz. beeswax
2 oz. alum
½ oz. gum camphor

Soap Paraffin for Candles

Mix 1 cup of soap powder with 1 cup of water. Food coloring may be added for color. Beat at high speed for 10 minutes with hand beater until a thick foamy lather piles up. Save cardboard spools or toilet paper rolls. Coat the spool with a heavy layer of foam decorated with seasonal oddities. Ex. holly leaves and berries for Christmas.

Plastic Foam

6 tablespoons of plastic starch
1 cup dry detergent (for tinting add powder paint).

Mix with water and whip to consistency of marshmallow cream.

Fixatives

1 part shellac with 2 parts denatured alcohol. Spray on chalk, charcoal, pastel, with atomizer or insect spray gun.

Use skim milk (no cream). Lay chalk painting flat on a table, front down. Paint the back side with skim milk. Keep in flat position till dry.

Fixative (Polymer substitute)

Mix 4 parts water to 1 part Elmer's Glue. Use in the same way(s) as Polymer is used.

Note: Portions may vary to get various consistency.

Sawdust Texture

Saw dust
Powder Paint
H₂O

Mix powder paint and H₂O to creamy consistency. Spread it over sawdust and work well. Use it to sprinkle on a glued surface for textured effect.

Drying Flowers

Beach sand, clean and dry, sifted, or Borax and white cornmeal—half and half

Have sand or borax mix ready before gathering flowers. Also have a shoe box or shirt box ready. Pick flowers at noon on a dry day. Stem length is unimportant (wire can be substituted later). Choose light bright colors. Be sure blooms are dry. Strip off leaves. Fill box 2" with sand, place radial blooms face down (zinnias, asters, daisies). Gently sift sand over petals until they are just covered. Remove in 4 or 5 days if the flowers are not heavy—a week otherwise. Hang upside down to finish drying.

DISPLAY

"The arts are so close to our biological and physiological core . . . we must cease to think of them as a luxury. They must become basic experiences in Education."—*Abraham Maslow*

00122

DISPLAY

Display is visual teaching.

- It informs
- motivates
- enriches
- evaluates

Keep it in terms of the learning level.

Displaying art

Children's art needs displaying.

Children should help the teacher in arranging displays, when possible.

In the classroom—Every child's work should be viewed upon completion of a project. An essential part of evaluation. Thereafter, several pieces may be put on display at a time. Pieces may be changed every day or so until the next project.

By using a standard size, the teacher may cut 5 or 6 mats which may be used and reused. Put the mat on the tack board, and simply slip the art piece underneath. Then for changing, keep the mat in place and swap the art.

Each child's work should be displayed intermittently. Every piece he creates does not have to be used.

MATTING A PICTURE

1. Cut a rectangle large enough to mat the picture. Center picture on it and lightly mark corners.
2. Draw an opening which is $\frac{1}{4}$ " smaller on every side than the picture. Lay cardboard on thicknesses of newspaper and cut the reduced opening.

3. Cut another rectangle to match outer edges of the mat.

4. Hinge the two cardboard. Close the frame and move the picture to its best position. Open the frame and tape the picture in place. Close frame and erase pencil marks.

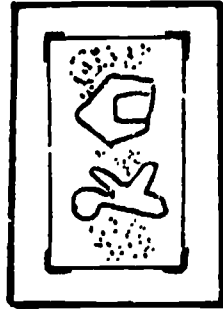

1.

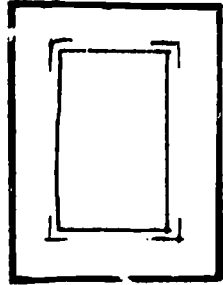

2.

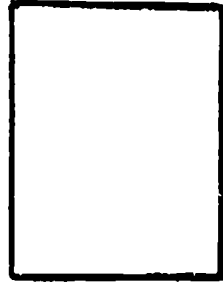

3.

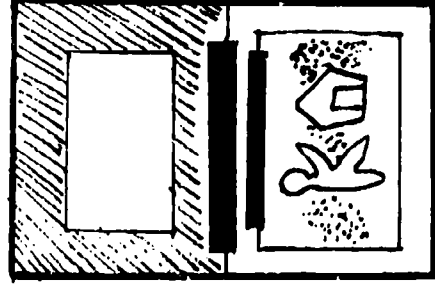

4.

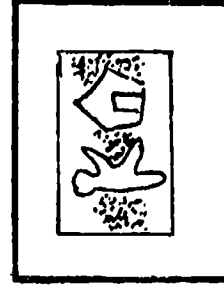

5.

Fancy mountings, off center backgrounds, brightly colored mats steal attention. Avoid them, unless the work you have to exhibit is colorless and lacking in character.

The plain mat is classic. If handled carefully it can be reused. Dry Ajax rubbed lightly over white posterboard will often clean resistant smudges.

Use posterboard or matboard of white or neutral tone. $2\frac{1}{2}$ " to 3" borders, increasing bottom width slightly.

When small odd-shaped items are to be tacked to a background a unified look may be obtained by placing them upon identical cutout shapes.

The same applies to items displayed on a table.

DISPLAY

MOUNTING STITCHERY

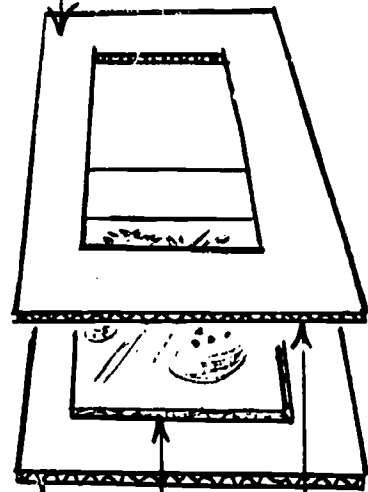

paint this or cover with white posterboard. Occasionally the tan color of the cardboard may look very well unpainted.

sheet of corrugated cardboard backing
stitchery glued or taped on cardboard
corrugated cardboard mat cut to fit exactly around stitchery

BEST COPY AVAILABLE

PREPARING ART WORK FOR EXHIBITION

All flat work must have a 3" mat of white or off-white cardboard. No colors.

It is all right to lay the work on poster board and glue it firmly, but the effect is not as nice as a mat.

When you mat the work, cover the back side with additional cardboard to keep the work rigid, and to prevent punctures.

Be sure that all 3-dimensional work has a base so that it looks finished and can be moved about with minimum handling.

Make every effort to avoid entering flimsy, easily damaged pieces.

Stitchery can be stretched over a piece of corrugated cardboard. Allow enough edge to lap over the cardboard, and tape or staple on the back. A nice way of presenting stitchery is to frame it as shown above.

SELECTING WORK FOR EXHIBITION

When exhibiting for the public, select the most charming, the most original of the children's work. An exhibit has the responsibility of being educational, of being appealing, and of demonstrating aims. Try to represent as many individuals as possible.

SOME CRITERIA

Avoid anything that suggests copywork. Seek originality and uniqueness.

Avoid pieces showing repetitious handling of the same subject.

Select a variety of media.

Choose colorful work.

Look for good composition. This means ample content, related items, good balance, esthetic appeal.

If there is something irresistible about some part of a picture, trim it down and use a smaller mat.

All sculpture, constructions, and mobiles must bear handling without being damaged.

See that 3 dimensional structures have rhythm and design.

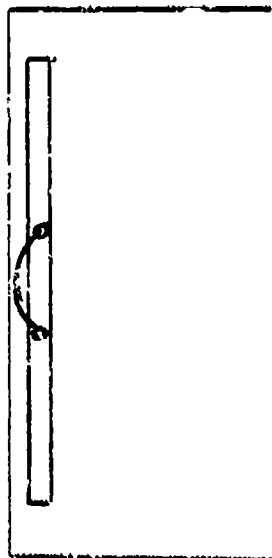

A MUST

Across the top on the back side, glue a heavy strip of cardboard, perforated near the middle and strung for hanging. Do not let string come above edge of mat.

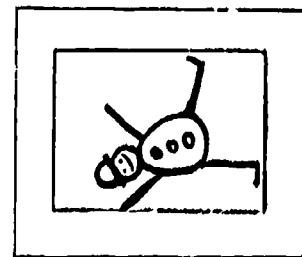
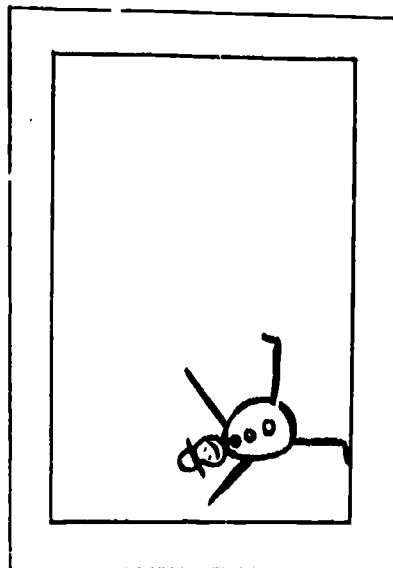

DISPLAY

Select art work that is full and expressive

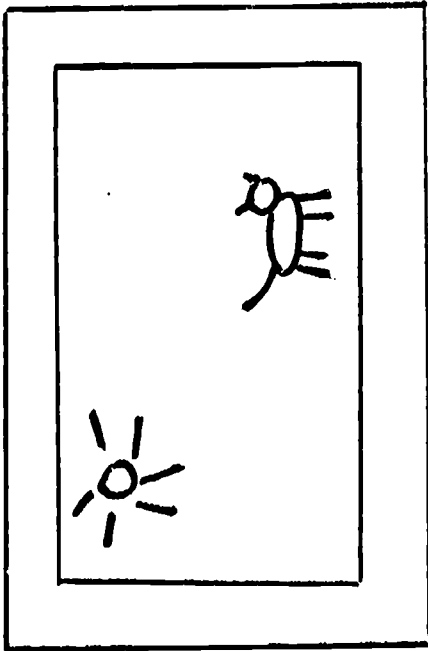

1. Picture content not related to size of sheet.

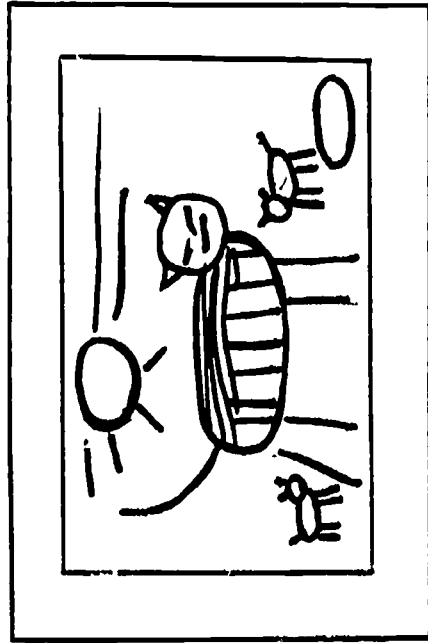

2. Better use of space.

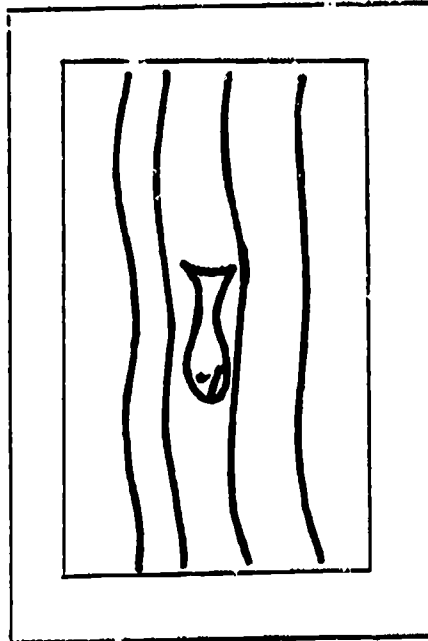

3. Meager expression of ideas.

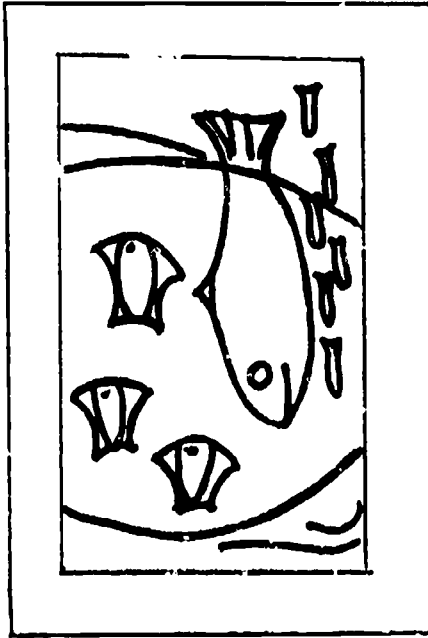

4. Richer association of ideas about subject.

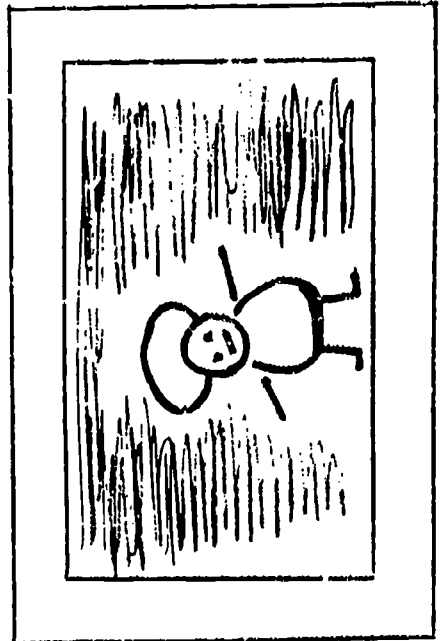

5. A painted background covers blank space but it has little to add to the picture story.

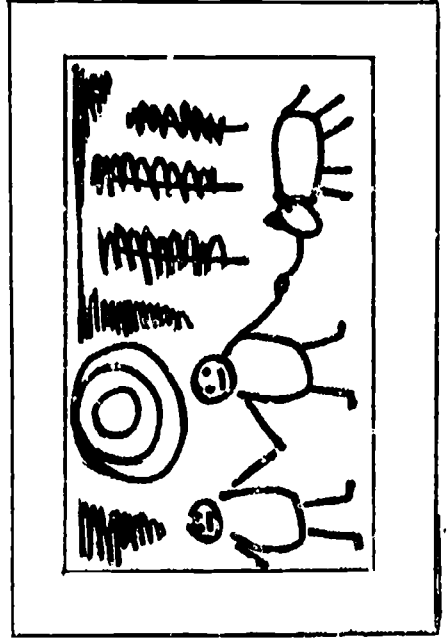

6. The relationships shown here give evidence of more associative thinking.

Mobiles are most easily made by taping against a wall and estimating balance as you assemble. Remove carefully when completed and then make finer adjustments as needed.

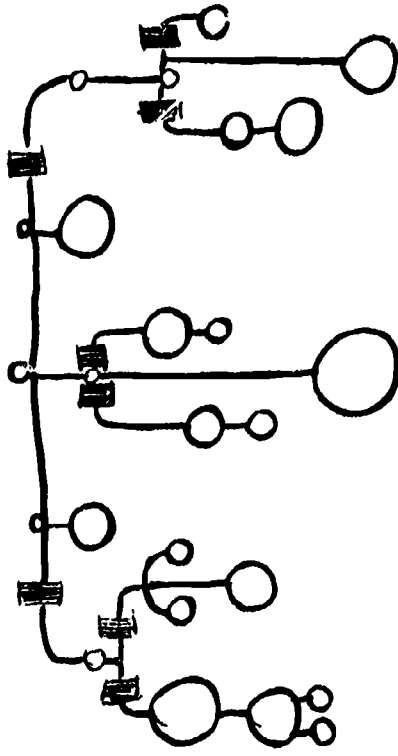

Be sure that papier mache entries are substantially put together, are well painted and have no broken areas. Spraying with clear mat varnish helps keep them clean.

Do not forget to tag every piece. Use standard identification tag and if matted, staple or glue to lower right hand corner on front. Otherwise glue tag to a piece of cardboard and fasten on with fine wire.

Plan for picking up work and returning it to pupils. To neglect this is to imply to the child that his efforts were not important. Parents care too. Disappointments are often accepted silently but they are remembered, and sometimes resented.

DISPLAY

in the building—

Display areas may be found in the library, cafetorium, lounge, office, hallways, and foyer.

There are displays which will benefit from a theme. Examples: "We saw the Parade," "At the County Fair," "It's Snowing," "We Like to Play," "When I Like to Study," etc.

A short, typed explanation, quoted from the child gives meaning to each work, especially for visitors. Wherever possible use mats. Showing the tools used adds interest to the finished work.

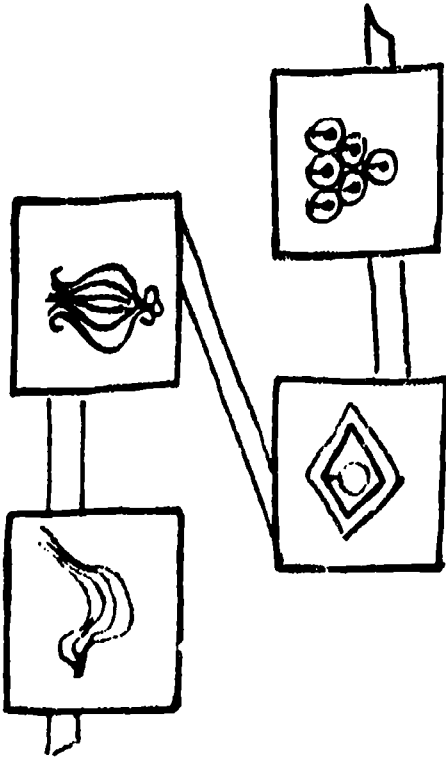
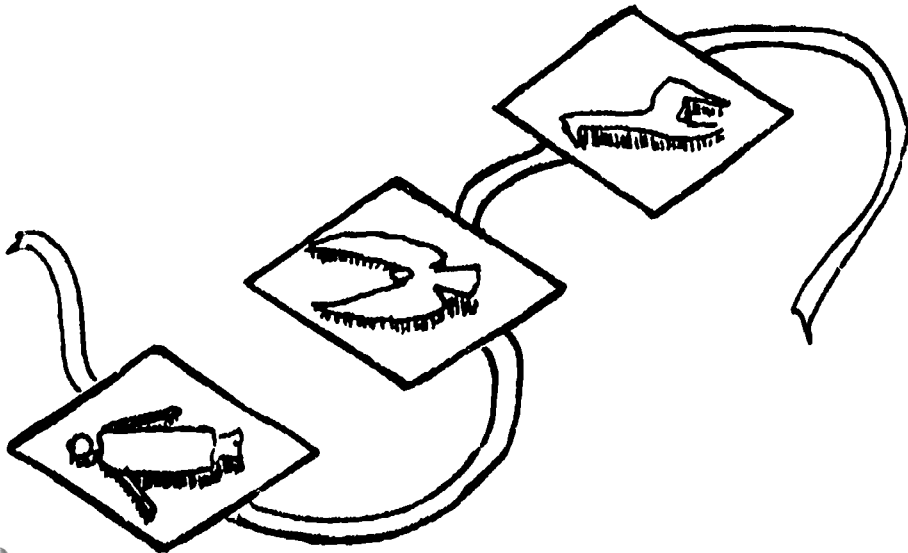

Good arrangement of art work usually follows one of two plans. Line up the top edges evenly, or the bottom edges. If there are two rows, work the pieces into a balanced arrangement, keeping the outer edges in line, top, bottom, and sides. Heavy ornamentation of a display border detracts.

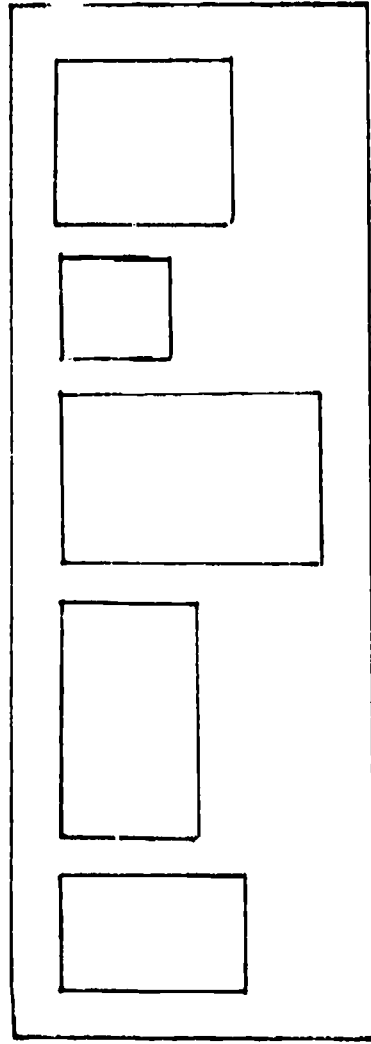
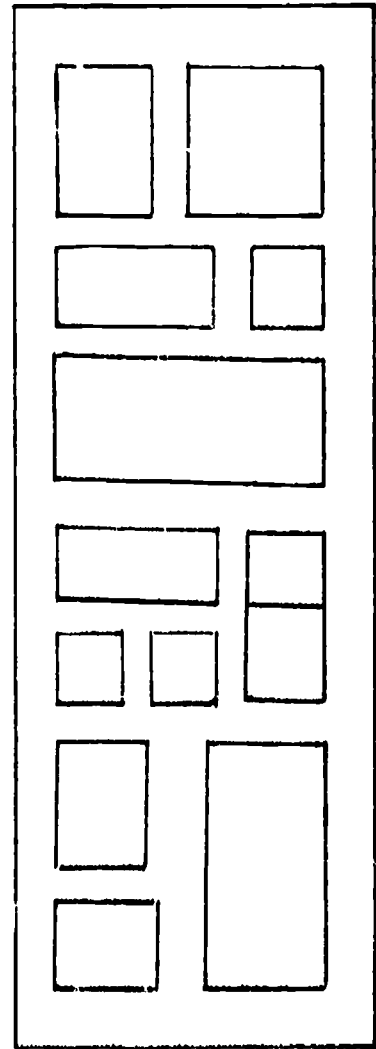
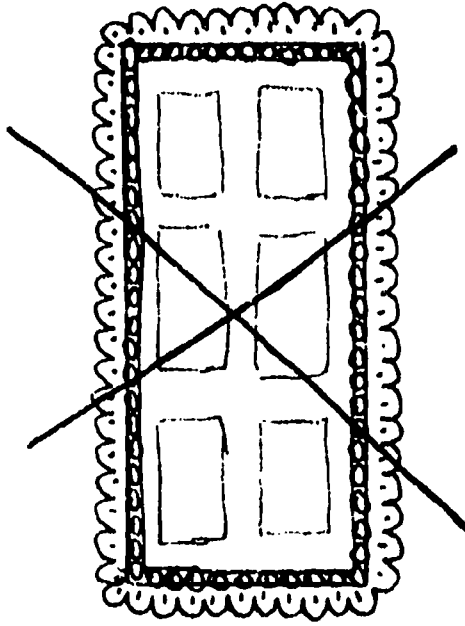

DISPLAY

LETTERING

Lettering should be readable! Horizontal or slightly diagonal. Avoid vertical arrangement.

The simplest answer to lettering for a busy teacher is the commercial lettering made with pin backings.

Stencils are applicable here.

A new product, stick-on letters will peel off, ready to mount. (A bit expensive).

TO MAKE YOUR OWN

Informal lettering can be rapidly laid out between parallel lines that control height. Use colored chalk on the side, broken to right width, draw or write your letters and cut them out.

Or . . .
A 2" house painting brush dipped in tempera can do the same task.

Cover a suitable strip of paper with finger paint and scrape out letters with small piece of cardboard.

Use an opaque projector.

Cut out block letters.

Use speedball steel brush. (Must be cleaned and carefully stored).

Outline letters can be made with bottle caps, colored circles or squares.

Heavy yarn, discarded recording tape, mystic tape, colored Scotch tape can be used.

Good letter textures can be had by cutting letters from—corrugated cardboard, sandpaper, cloth, gift wrap foil, styrofoam.

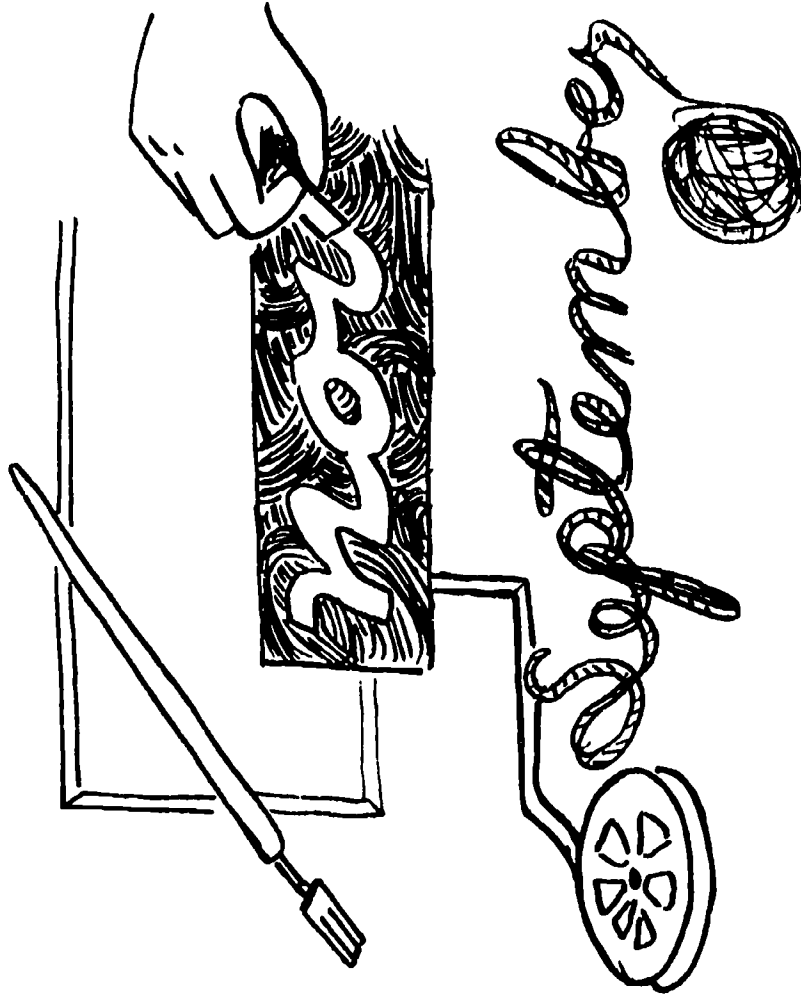

Informational Displays—

A bulletin board is only a large poster

Don't overcrowd

Spotlight the main idea

Subordinate everything else

Remember you are dramatizing

Keep words to a minimum

Vertical layout of lettering does not read well

Use arresting colors—limit for unity, one color dominant

Use strong contrasts

Use simple arrangement

Balance visual material and verbal message

Achieve emphasis by placement, dominant color, dominant shape, leading arrangement, novelty of idea, and size

Subdue the background colors

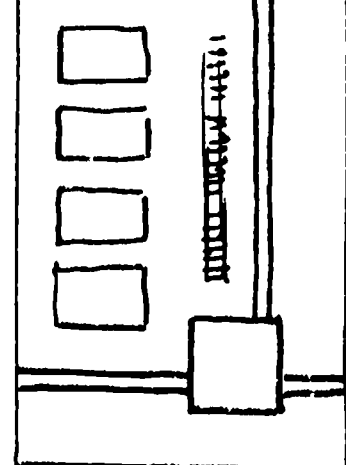
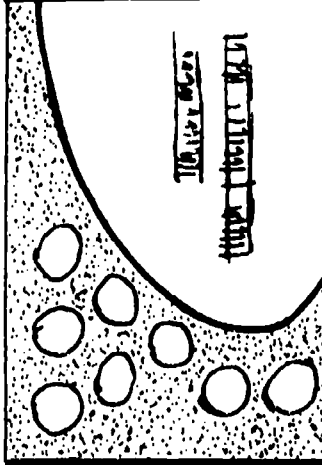
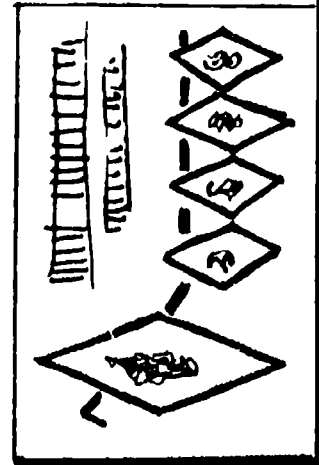
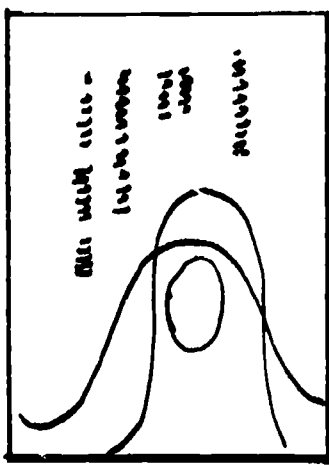
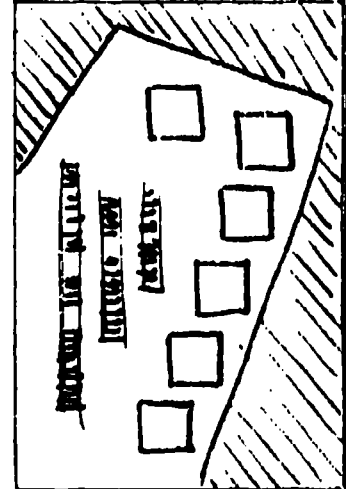
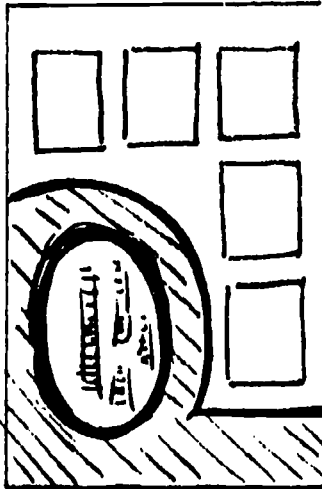
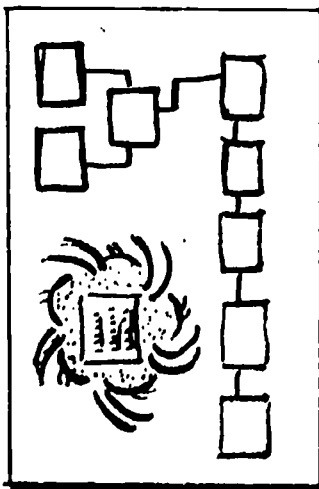
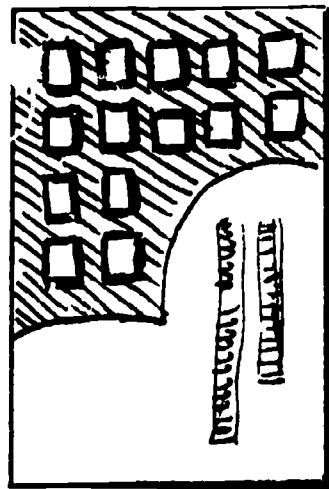
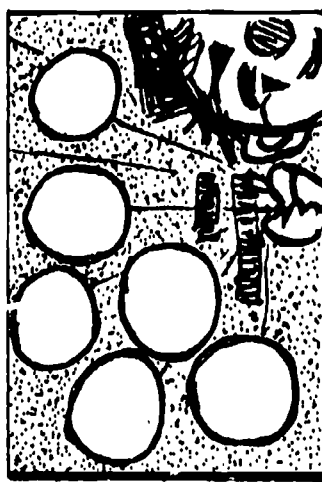
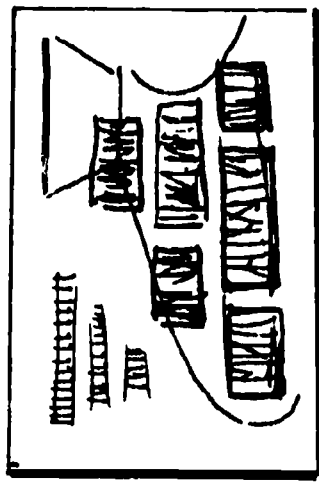
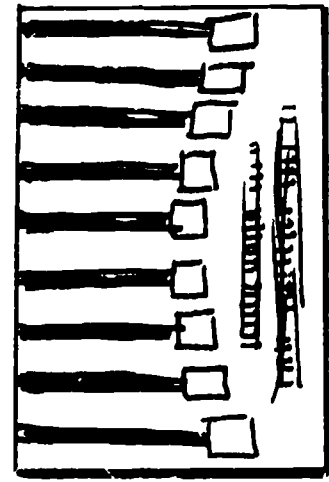

BULLETIN BOARDS

Plan the bulletin board. Decide first upon a line or arrangement to break up the rectangle. Then decide where to place the center of interest. Arrange everything to work around this. The accompanying illustrations are only suggestions. They are given here to demonstrate the importance of simplicity. The styling can be adjusted to size and shape of bulletin. There are many ways of varying the design.

BULLETIN BOARDS (Con't'd)

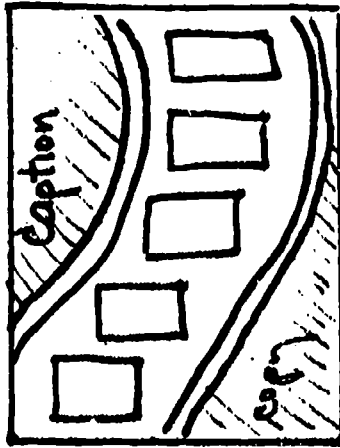
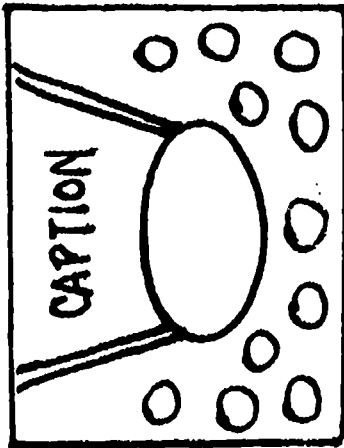
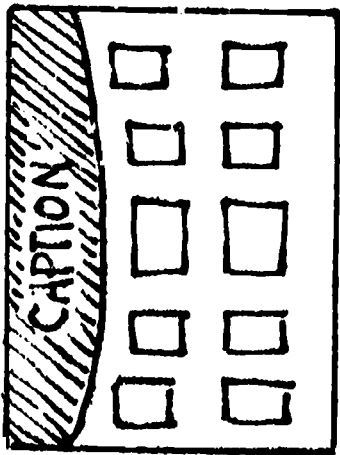

OTHER DISPLAY IDEAS

Boxes, painted or covered, can be used as pedestals, can hang overhead, or can be stacked to make columns.

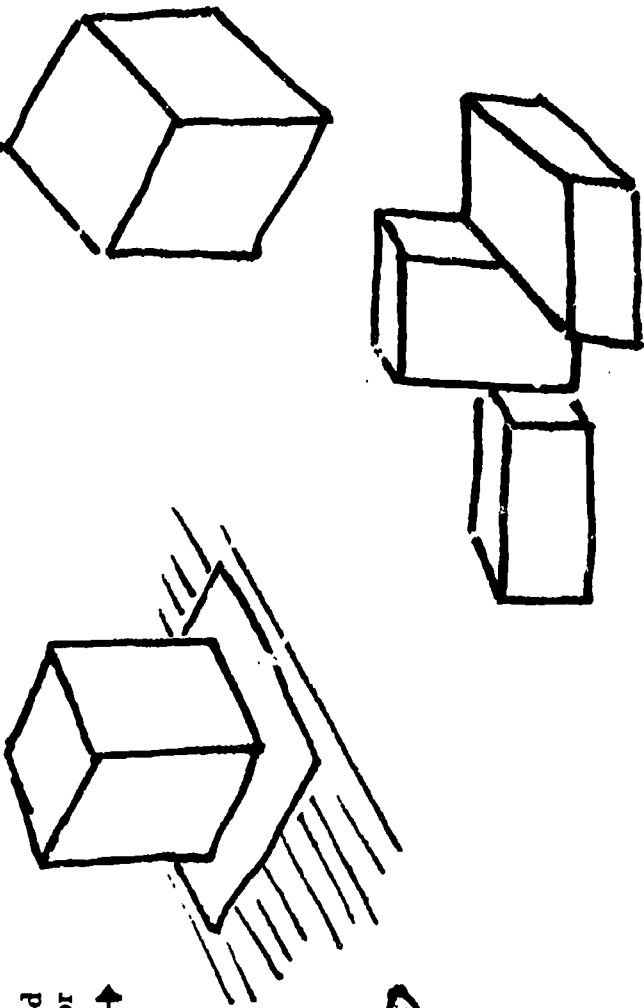

Small mats placed under little pieces help to dramatize and unify the display.

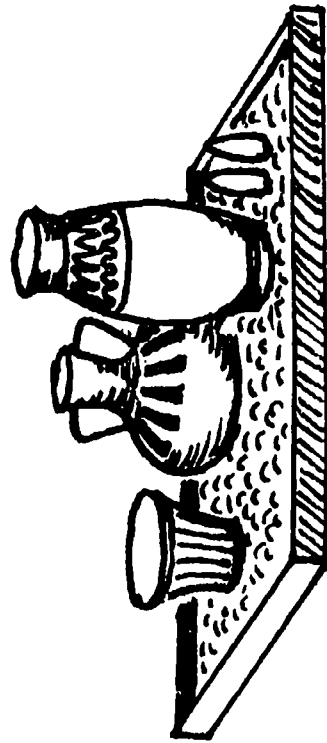
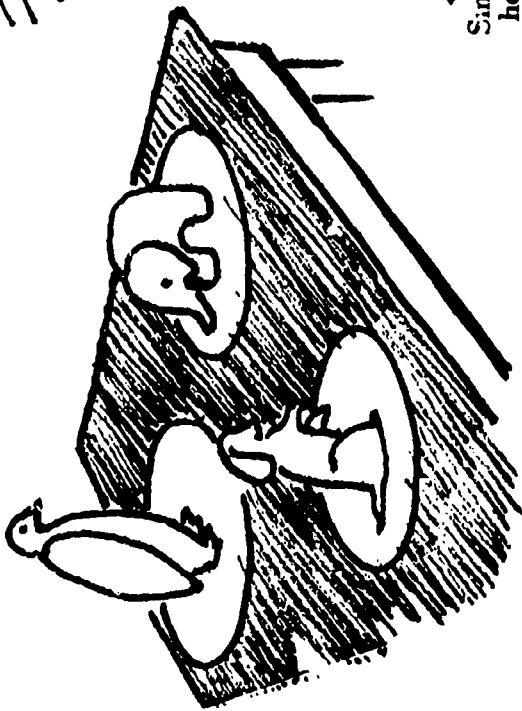

Ceramic pieces display well in tray of pebbles, sand, gravel.

Corrugated cardboard, wrapped around a table will provide a nice pedestal.

Oil drums covered with a circle of cardboard and a cloth make good display tables.

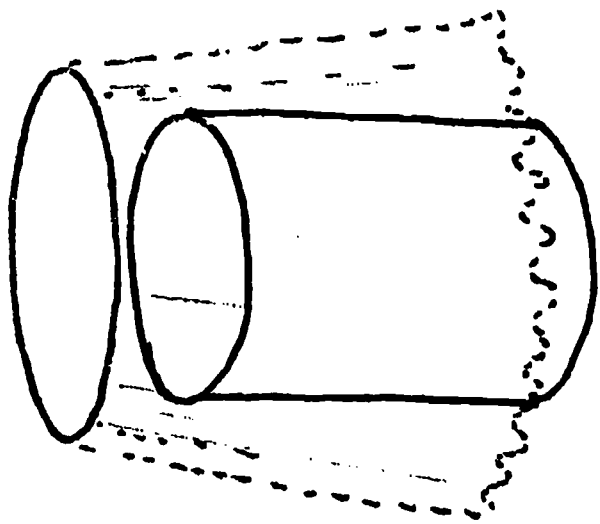

OTHER DISPLAY IDEAS

Large cardboard boxes can serve as hanging display units. Do not cut off flaps; fold them inside to help to brace the box, and tape in place.

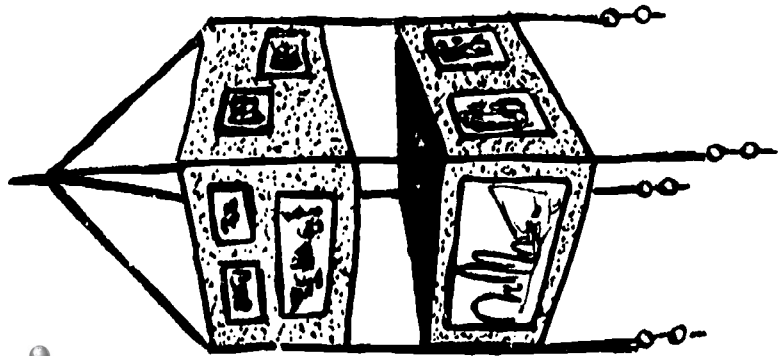

For new schools bulletin boards in halls and classrooms may be hung from 4 picture hooks, using 1 sheet of Celotex suspended by cord.

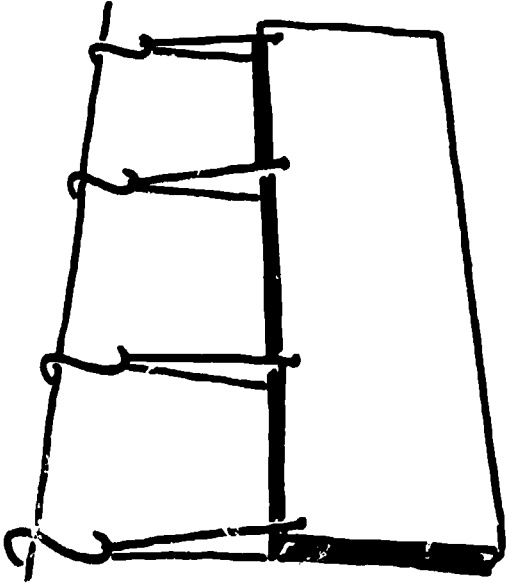

A plumbing flange screwed to a board makes a good base for an upright threaded plumbing pipe. Insert a wooden peg in the top for fastening hooks, nails, etc. The pole thus formed can support a variety of displays.

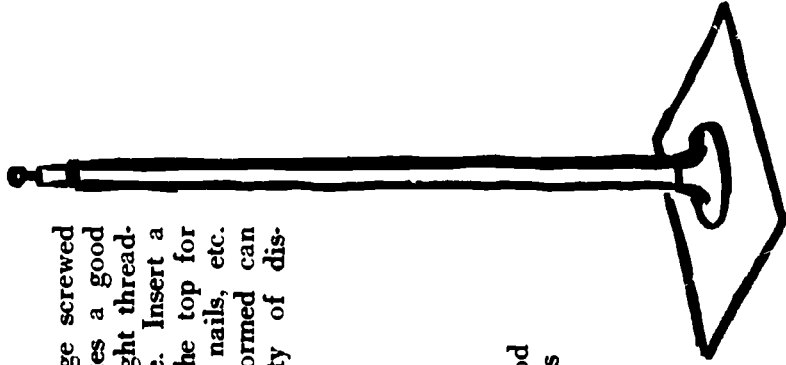

Other props for exhibits:

- masonite circles of various sizes
- adjustable frames for flat work
- reed and straw matting
- bricks, blocks of wood, dowels, driftwood
- panels of glass or plastic, bamboo screens
- potted plants and interesting furniture
- enlarged photos of children at work
- catalogue of exhibitors

BEST COPY AVAILABLE

Dowels to which heavy fabric lengths have been attached.

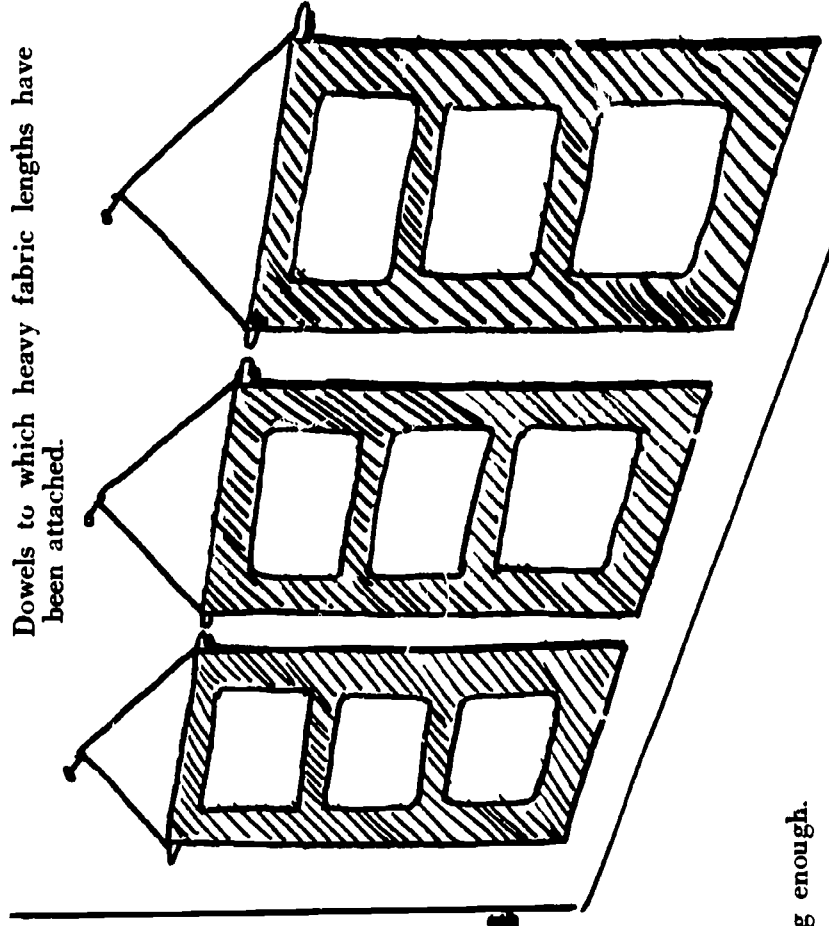

Remove out of date material, 4 weeks is long enough.

OTHER DISPLAY IDEAS

On cement block walls—use double faced tape for light pieces. Four strong cement nails will suspend an inexpensive full length sheet of celotex on which art work can be tacked.

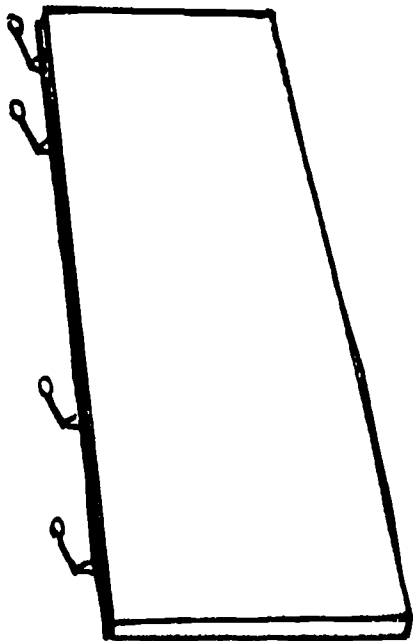

Where nailing is possible, a length of burlap tightly stretched over a frame will do for light weight work. Or it can be taped in place with electrical tape.

From box manufacturers, large 6' sheets of cardboard can be obtained and joined zig-zag fashion to stand on the floor. These do not last too long.

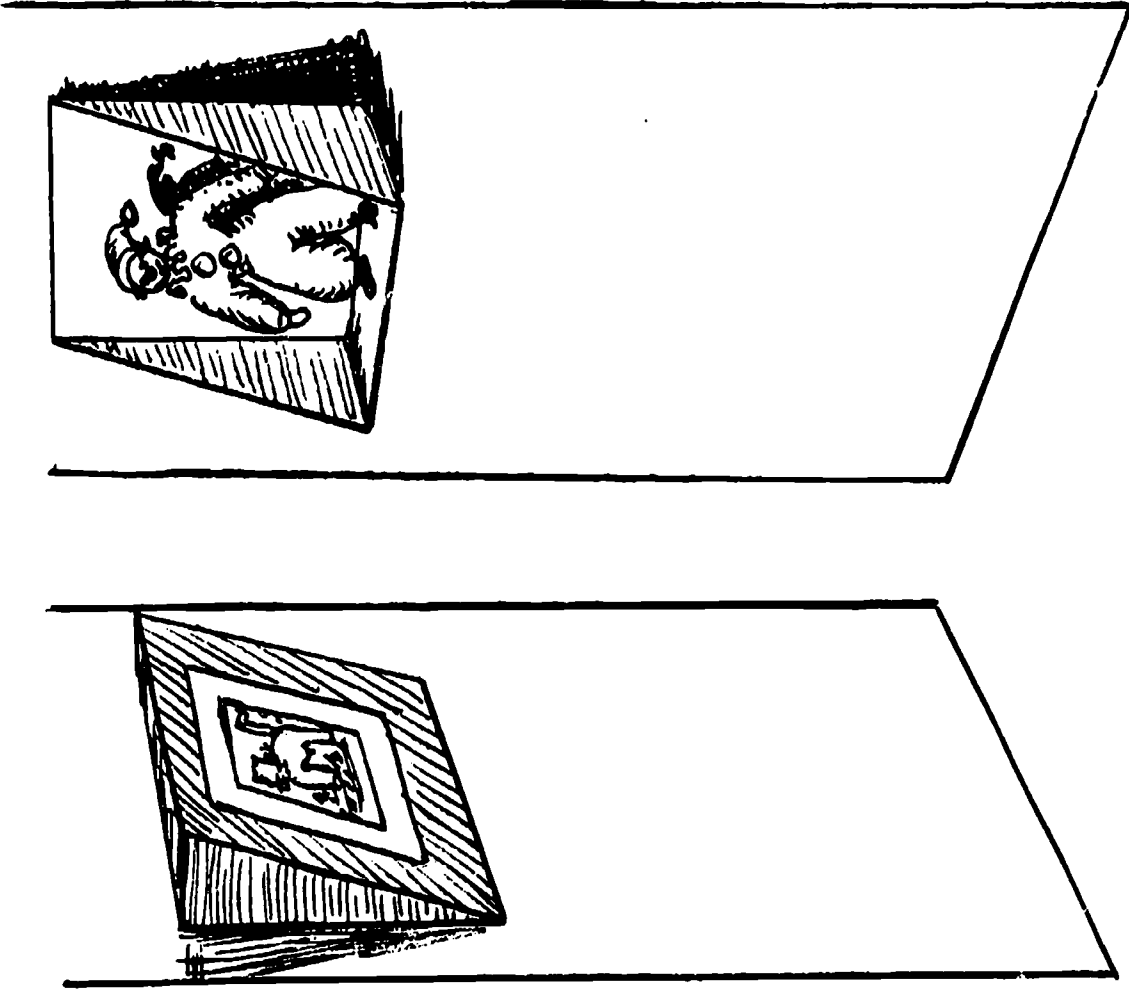
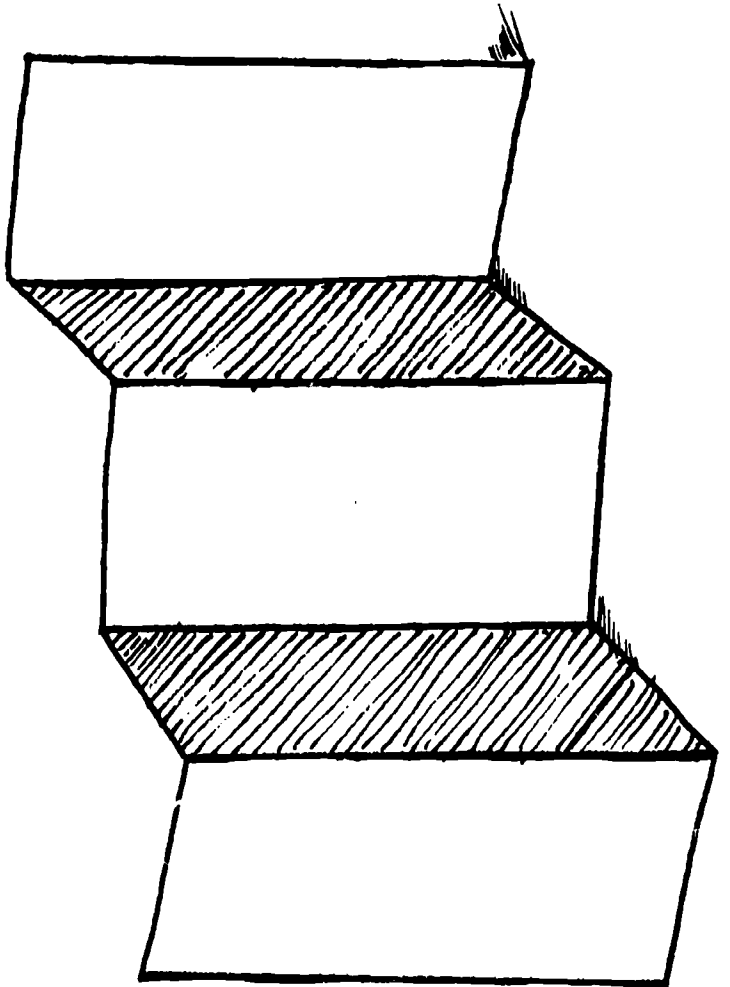

To use small wall spaces, a cardboard box can be cut diagonally, lined with paper or fabric and painted on the outside to support small 3-d objects. Ceiling hooks should be placed overhead for suspending mobiles.

OTHER DISPLAY IDEAS

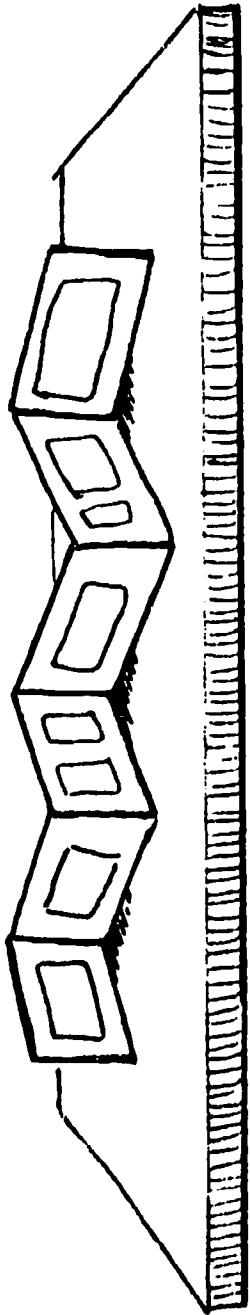

On tables, a zig-zag arrangement of joined cardboard sheets will provide panels for small art work.

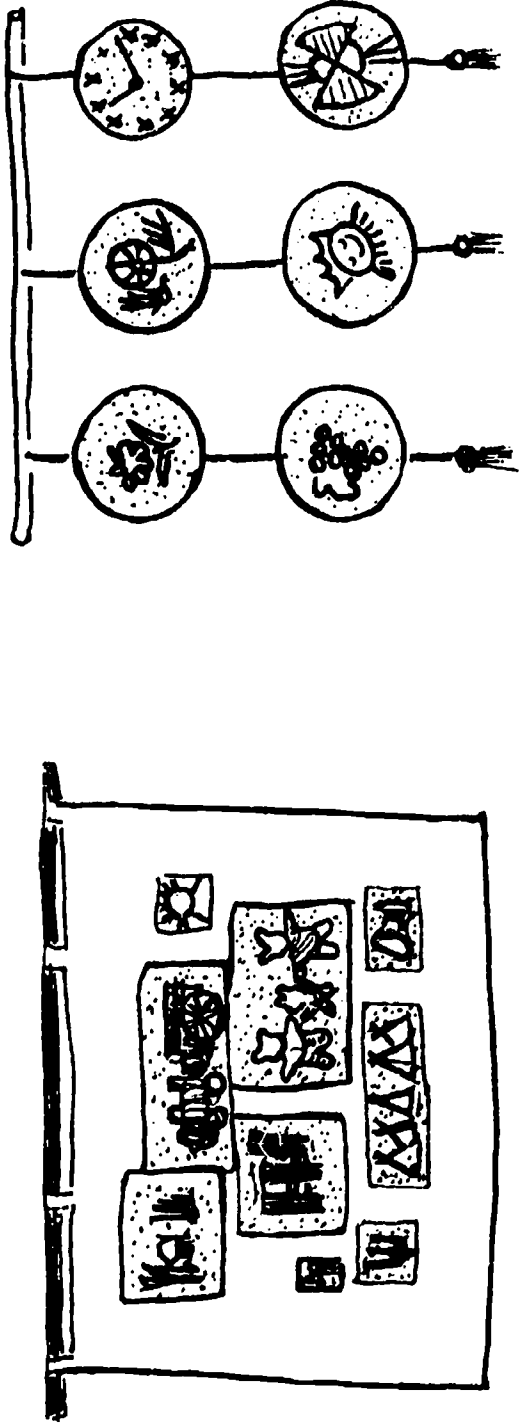

Small stitchery pieces can be assembled on a burlap wall hanging. If the stitcheries are uniform in size, cut cardboard backing, tape raw edges to back and cover back side with matching piece of plain cardboard. Then hang pieces from a dowel.

Display shelves—
are benefited by light paint, light wall paper, light fabric or shelving paper to counteract shadows.
Mural settings can be provided for backgrounds, adding glass for underwater effects.
Shelf or cabinet displays should have groups of related items.

This guide has purposely avoided sophisticated materials. There are many delightful products available with singular qualities much to be desired.

However, for the sake of costs, more exotic media have been by-passed. It is hoped that in time these materials may also join those now within the budget.

BASIC MATERIALS

“Exploring and exploiting the nature of any material will inevitably lead to the thrill of discovery of its potential.”

Nit Krevitsky

BASIC MATERIALS

Without adequate materials there is no art program.

The following lists are compiled to cover major art needs in grades K-6. The items available from the local school district warehouse have been numbered for the teacher's convenience. Items starred (*) have to be purchased from local stores.

Quantities are not indicated because of variations in pupil assignments at different schools, as well as variations in pupil abilities.

Most of the basic tools in the first list may, and should be already on hand in sufficient quantity to meet the needs of every child for 30 art lessons per year.

EXPENDABLE MATERIALS

Available From:
SCHOOL DISTRICT WAREHOUSE CATALOGUE
Request through Principal

- 5100 Applicator sticks (6")
- 7065 Burlap (white, 5 yards to package)
- 7066 Burlap (natural, 5 yards to package)
- 7067 Burlap (black, 5 yards to package)
- 7098-1-7098-12 Ceramic glazes (assorted colors)
- 7100 Chalk (colored, 12 sticks per box)
- 7101 Charcoal (pressed, 1 dozen sticks per box)
- 7104 Clay (modeling, plasticene, 5 lb. package)
- 7110 Clay (moist, natural, 10 lb. bag)
- 7111 Cleaners (pipe, 6" assorted colors)
- 7112 Cleaners, (pipe, 10" assorted colors)
- 7140 Crayons (oil, 12 to box)
- 7145 Crayons (wax, 16 to box)
- 7180 Crayons (pressed, non-wax, 8 to box)
- 7182 Crinoline, (38" wide)
- 8640 Cord (heavy white twine)
- 8645 Cord (light weight, 3 ply)
- 7850-11 Cotton (rug hanks for weaving, 18 colors)
- *Dowel Sticks
- 7230 Eraser (art gum)
- 7260 Fixatiff (for charcoal and chalk)
- 7302 Foil (aluminum in cutter box)
- 7303 Genalite (sheets, 18 by 24, 6 sheets per box)
- 7309 Ink (Pelikan drawing ink, assorted colors)
- 7312 Ink (speedball black drawing—India)
- 7340-1-7340-8 Ink (linoleum printing, water soluble, assorted colors)
- 7360 Kiln cement (powdered, 5 lbs.)
- 7361 Kiln stilts (1½")
- 7362 Kiln stilts (2")
- 7363 Kiln stilts (3")
- 7364 Kiln wash (powdered 5 lb.)
- 7120-3 Kiln cones (03)
- 7120-4 Kiln cones (05)
- 7120-5 Kiln cones (06)

BASIC TOOLS

- 7010 Brayer; for block printing, 4" size
- 7020 Brush; easel paint, A-¼"
- 7030 Brush; easel paint, B-¾"
or
- 7040 Brush; easel paint, C-1"
- 8630 Clips, Bulldog; size 3c
- 8677 Extension cord (25 feet)
- 8728 Knife, utility (cardboard cutter) Garvey No. 3012, adjustable
- 1860 Hammer, bellface, curved claw
- 8820 Punch, hand size
- *Pan, large rectangular baking
- 7368 Linoleum cutter, blades and handle
- Linoleum cutter (contact art director)
- *Muffin tins
- *Plastic tote trays
- 2640 Pliers, combination, slip joint, 6"
- *Rolling pin
- 3040 Screwdriver, 7/32" blade, 8"
- *Saws
- 5790 Needles
- 7397 Needles, blunt (for yarn)
- 8816 Pins (mounting, bulletin board, 300 per box)
- 7742 Pins (straight, 300 per box)
- 7756 Scissors (sharp point 5")
- 7757 Scissors (sharp point 6")
- 7758 Scissors (teacher's shears 8")
- *Spoons (stainless steel)
- 8845 Stapling Machine
- 8847 Staples (standard and Swingline)
- 7779 Sponges (cellulose 3½ by 5½)
- 7780 Sponges (silk for ceramic work)
- 8870 Yardstick
- *Paper Cutter
- 7304 Gun (spatter with bottle)
- Kiln (contact art director)
- 7365 Knife (X-Acto No. 1, Handle with blade)
- 7365-1 Knife blades
- *Local purchase

BASIC MATERIALS

- 7366 Linoleum (unmounted 12" by 12")
 7367 Linoleum (unmounted 24" by 36")
 8735-38 Markers (small, non-refillable, black, red, blue, green)
 8740 Markers (Magic jumbo, black)
 8745-48 Markers (large, non-refillable, black, red, blue, green)
 2410-2440 Nails (common steel)
 2450-2470 Nails (finishing)
 8810 Paste (school, pint jar)
 7696 Paste (White household, 1 gallon)
 7697 Paste (White household, 1 quart)
 7705 Paste (Rubber Cement, 4 oz. bottle)
 7715 Paste (Wheat flour, 2 lb. bag)
 7724-1 Pen (felt marking, black)
 7724-2 Pen (felt marking, blue)
 7724-3 Pen (felt marking, red)
 7724-4 Pen (felt marking, green)
 7724 Pen (felt marking, fine-line, nylon tip)
 7406 Paint (finger, red)
 7407 Paint (finger, yellow)
 7410 Paint (finger, blue)
 7415 Paint (finger, green)
 7420 Paint (finger, orange)
 7425 Paint (finger, purple)
 7430 Paint (finger, black)
 7435 Paint (finger, brown)
 7440 Paint (finger, white)
 7445 Paint (poster, tempera, see assorted colors)
 7490 Paint (powdered tempera, see assorted colors)
 7504-1 Paint (Texture paint, see assorted colors)
 7510 Paint (water color sets)
 7513 Paint (water color refills)
 7522 Paper (colored design paper, matt surface, 8 colors)
 7530 Paper (butcher 18" roll, white)
 7535 Paper (butcher 24" roll, white)
 7565 Paper (construction, 9" by 12" single packages—7577)
 7578 Paper (construction 9" x 12" assorted colors)
 7585 Paper (construction 12" by 18" single packages—7598)
- 7608 Paper (construction 18" by 24" single packages—7623)
 7624 Paper (construction 24" by 36" single packages—7634)
 7645 Paper (finger paint, 100 sheets per package)
 7650 Paper (Manila drawing, 12" by 18")
 7651 Paper (Manila drawing, 18" by 24")
 7670 Paper (newsprint, 18" by 24")
 7671 Paper (newsprint, 9" by 12")
 7691 Paper (art tissue, assorted colors 12" by 18" sheets)
 7692 Paper (art tissue 'pomps,' 6" by 6", assorted colors)
 7097-1-7097-12 Paper (corrugated single roll, 48" by 25", assorted colors, listed under Corrugated)
 7090 Paper (cardboard poster board, 14" by 22")
 7810 Paper (oak tag cardboard, 24" by 36")
 7841 Paper (wax paper in cutter box)
 7743 Plaster (molding, 100 lb. bag)
 7744 Plastic bags (heavy duty, 10 by 8 by 24)
 7745 Plastic dispenser bottles
 7749 Razor blades (single edge)
 7748 Raffia (assorted colors, 1 lb. packages)
 7751 Sand paper (9 by 10, fine)
 7752 Sand paper (9 by 10, medium)
 7759 Shellac (clear white, 1 quart)
 7760 Shellac thinner (1 quart can)
 7811 Tandrotine (paint thinner)
 8856 Tape (masking)
 8858-8862 Tape (Mystic, assorted colors)
 8864 Tape (cellophane "Scotch," large roll)
 8866 Tape (cellophane "Scotch," medium roll)
 5970 Toothpicks
 7813 Varnish (Hyplar gloss, 1 quart)
 7815 Varnish (Hyplar matte, 1 quart)
 7842 Wire (Aluminum, black, 19 gauge, 50 ft. roll)
 7843 Wire (Aluminum, black, 30 gauge, 50 ft. roll)
 7840 Wood scraps (assorted shapes in box)
 7844-1-7844-13 Yarn (mercerized pearl cotton, 2 oz. tube) assorted colors
 7846-1-7846-11 Yarn (filler, assorted colors)

BASIC MATERIALS

FOUND MATERIALS

In the age of technology, art like science, has expanded its horizons. Many new materials, discarded after serving a commercial purpose, are filled with creative possibilities. It does not follow, however, that these products alone will serve the needs of an art program. They can only enrich the variety.

The following are materials which can be collected by teacher, students. Local P. T. A.'s may help with petty cash funds, etc.

balloons
bottle caps
boxes (all sizes)
ceramic and glass tile pieces
cloth scraps, wood scraps (white pine)
coat hangers
colored cellophane
electric iron
enamel and wood stains
foil pie tins

freezer paper
liquid detergent
magazines
masonite
milk cartons
nets from vegetables and fruits
newspapers
orange juice cans with lids
paper bags
paraffin
plastic bottles
plastic bowls and food containers
plywood
sawdust
screen wire (wire mesh)

styrofoam packing
styrofoam cups
thread (nylon fishing filament)
tubes (paper)
vermiculite (zonolite)
smooth river rocks
cement
old costume jewelry
feathers
old movie film
pipe cleaners
spools
old Christmas balls
dried grass, and other things from nature
light bulbs

SUGGESTIONS FOR STORAGE AND CARE OF MATERIALS IN THE CLASSROOM

PAINT, PENCILS, MAGIC MARKERS, ETC., PASTE AND GLUE, CHALK, CHARCOAL, CRAYONS

Paint can be stored in stackable tote trays of the plastic variety. Tote trays may also be improvised from grocery cartons.

Pencils and pens may be stored in orange juice containers. Paste may be divided and placed in small baby food jars for individual use. Children may keep this at their desk or store in tote trays. Wood Coca-Cola boxes also make handy tote trays.

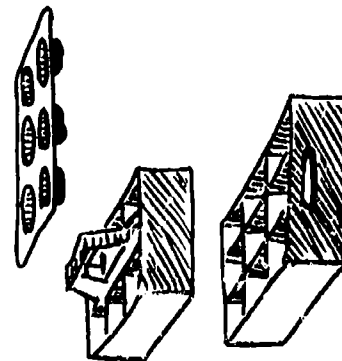

White liquid glue can be diluted with water to 1/3 glue and stored in plastic milk containers with a tight fitting lid. Plastic tempera containers, plastic mustard containers and glue bottles with caps can hold glue for group or individual work.

Loose crayons, chalks, charcoal, etc. may be sorted in muffin tins, tin cans, or cut-down milk cartons. Egg cartons, cigar boxes, plastic margarine containers, small cardboard boxes make good containers for dividing up materials for groups.

Band aid or tobacco tins make good individual containers.

BRUSHES

Brushes should always be cleaned and stored upside down. A shoe box with holes spaced properly will serve as a temporary brush holder. A block of wood about 2" by 4" with holes drilled large enough to support brushes makes a durable container. Any tin can with sand in it will support brushes. Jars or large tin cans will hold brushes erect.

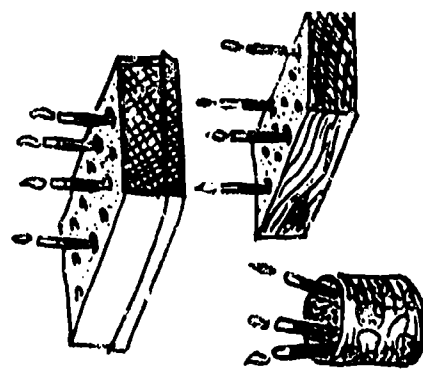

The cleaning and care of brushes is important. Do not use them as mixing spoons or allow them to stand in water for a long time.

The following suggestions are made for the cleaning of brushes:

Use Solox (wood alcohol) when cleaning shellac from brushes.

Use tandroutine when cleaning varnish from brushes.

Use detergent and water when cleaning tempera and glue from brushes.

Use nail polish remover (Acetone) when cleaning acrylic paints from brushes.

Wash again all brushes in soap and water. Shake brushes free of water and with finger tips shape the brush tips.

Store upside down in a container.

SCRAP TISSUE, CONSTRUCTION PAPER, MAGAZINE CLIPPINGS, ETC.

Two large cardboard sheets 15" by 20" cut from a grocery carton and joined along one length with a strip of fabric, mystic tape, or wide mailing tape and faced from the inside with the same makes a durable folder to store paper. Scrap paper may also be stored this way.

SCISSORS

Hang scissors on nails inside of a closet on a wood board. Insert into slots made in thick styrofoam packing material. Insert into inverted egg cartons. Scissors may be inserted behind elastic, stapled at close intervals on a wall strip.

CLAY

Keep clay in tightly closed plastic bags. Clay may be stored in plastic trash cans with covers. If clay project has not been completed during work time the project should be wrapped and stored in plastic bags and put upon a shelf or table till next work period.

FOR TACKS, NAILS, PAPER CLIPS, SHELLS, PEAS, BEANS, BUTTONS AND OTHER SMALL ITEMS

Take a board and firmly nail lids of small jars in 2 rows on underside. Put small items in and screw jars into lids. Leave 5" extending at each end of board. Can be placed between tops of two tables while in use—on shelf, cabinet, or in central storage when not needed.

FOR SCRAPS AND "FOUND MATERIALS"

If possible a central storage space should be available. If not, a large cardboard box covered with inconspicuous paper such as wood grain wallpaper, is an answer. As smaller items accumulate they can be assembled together and stored in partitioned-off sections of the cardboard box, or stored in smaller boxes and labeled. For instance, junk jewelry, cloth scraps, yarn, etc. Storing in plastic bags will make it possible to lift out and see at a glance what you have.

The following suggestions apply to schools that have magnetic walls:

On metallic walls clothes lines can be strung using magnetic hooks or clips. Mobiles, etc., can be suspended from the ceiling by attaching magnetic hooks to the metal part of the light fixture.

UNFINISHED WORK

For 3-D work, shelving of some kind is essential. Boards resting on cement blocks or bricks or apple crates can serve this purpose.

For flat work, a folding clothes-drying rack can be used to lay paper over the dowels for drying. Put newspapers between pieces of work. Another solution, especially good for prints, is a clothes-line and clothes-pins. The clothes-line may be strung across the top of a chalk board.

FINISHED WORK

Construct folders from cardboard boxes. Each child's work should be kept in sequential order for the year. Evaluation of progress is important. The folders can be alphabetized. Posterboard separators may also help to keep children's work apart. A bin for holding art pieces can be made from a large cardboard carton. Cover carton with wallpaper or fabric.

3-DIMENSIONAL

Because of the bulk involved, it is more difficult to keep this work. Tops of cabinets, shelving, library display, overhead suspension, will provide temporary accommodations. After the work has been sufficiently displayed, select a few of the most effective pieces to reserve for community exhibiting and let the rest be taken home.

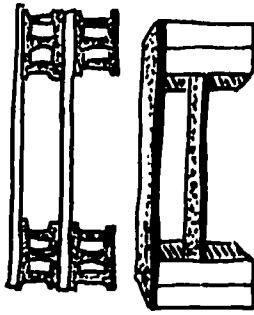
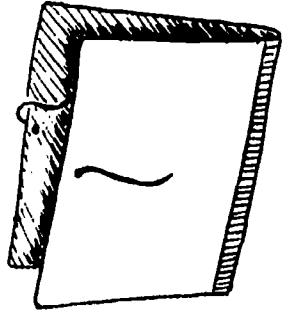
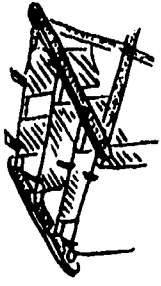

BEST COPY AVAILABLE

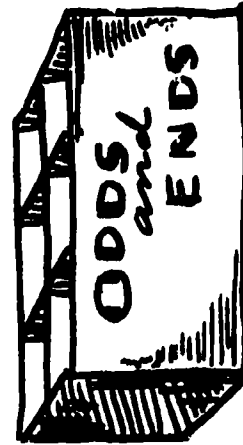
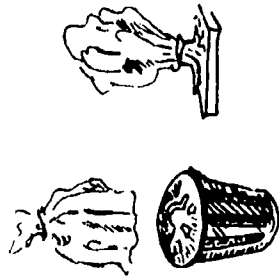
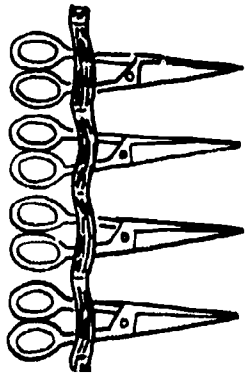

DEALERS IN ART SUPPLIES

Space has been left for additional notations

LOCAL ART SUPPLY DEALERS

Acme Quality Paints 306 Wade Hampton Boulevard	232-5608
Craft Shack 1220-A Laurens Road	232-7175
Glidden Paint and Decorating Centers 626 North Main	242-6192
Hobby House 1715 Augusta Road	235-6181
Munford Do-It Yourself Store 2118 Augusta Road	239-3014
Paintin' Place 2111 Augusta	235-6824
Piedmont Printmakers and Supply Co., Inc. 353 West McRae Avenue	233-5371
Reid Office Supply and Printing Co. Pleasantburg Shopping Center	239-5323
Riddle's Picture Frame Shop 421 South Main	232-5001
Suburban Paint Co. Lake Forest Shopping Center	244-1375
The Framery Pleasantburg Shopping Center	232-9185

**NATIONAL SOURCES OF
ART SUPPLIES**

American Handicrafts 410 Peachtree Street, N. E. Atlanta, Georgia	
Anderson Ceramics Company 1950 South McDuffie Street P. O. Box 3227 Anderson, S. C. 29621	
Arts and Crafts Materials Corp. 9520 Baltimore Avenue College Park, Maryland 20740	
Audio-Visual Library State Department of Education 1513 Gervais Street Columbia, S. C. 29201	
Dick Blick P. O. Box 1267 Galesburg, Illinois 61401	
J. L. Hammett Company Box 4125 Lynchburg, Virginia 24502	
J. C. Larson Company, Inc. 7330 North Clark Street Chicago, Illinois 60626	
Pyramid Paper Company 310 South Morgan Street Tampa, Florida 33602	
Sax Arts and Crafts Division of Sax Brothers, Inc. 207 North Milwaukee Street Milwaukee, Wisconsin 53202	
Triarco Arts and Crafts Department 6602, P. O. Box 106 Northfield, Illinois 60093	

The above listing is not intended to be exclusive. Local listing comes from the yellow pages of the telephone directory. National listing comes from catalogues received.

BIBLIOGRAPHY

"Art education is a vital part of a program for young people."

South Carolina State Department of Education

BIBLIOGRAPHY



- With a few exceptions, the following list of books and periodicals can be found in the Professional Library of the School District of Greenville County. This list is the result of careful examination by the committee on art. It is recommended that each school library purchase these books, as funds permit.
- Anderson, Mildred. *Original Creations with Papier Mache*. New York, Chilton Book Co., 1968.
- Anderson, Warren H. *Art Learning Situations for Elementary Educations*. Belmont, California, Wadsworth Publishing Co., 1965.
- Ballinger, Louise Bowen and Thomas F. Vroman. *Design*. New York, Reinhold Book Corp., 1968.
- Bodor, John. *Creating and Presenting Hand Puppets*. Reinhold Publishing Co., New York, 1967.
- Bodor, John. *Rubbing and Textures*. New York, Reinhold Book Corp., 1968.
- Boehn, Peggy. *Knitting Without Needles*. New York, Sterling Publishing, 1968.
- Bonanza. *Cookies and Bread*. New York, Bonanza Books, 1967.
- Campbell, Ann. *Start to Draw*. New York, Franklin Watts, Inc., 1968.
- Carlis, John. *How to Make Your Own Greeting Cards*. Watson-Guptill Publishers, New York, 1968.
- Cooke, Robert F. *Designing with Light*. Worcester, Massachusetts, Davis Publications, Inc., 1969.
- Conant, Howard, and Randall Arne. *Art in Education*. Peoria, Illinois, Charles A. Bennett, 1963.
- Curriculum Bulletin. *Puppetry in the Curriculum*. New York, N. Y., Board of Education, 1954.
- d'Arbeloff, Natalie. *An Artist's Workbook: Line, Shape, Volume, Light*. New York, Reinhold Co., 1969.
- d'Amato, Janet and Alex. *African Crafts for You to Make*. New York, Julian Messner, 1969.
- Ellis, Mary Jackson and Gene Watson. *Creative Art Ideas*, 3rd and 4th grades. T. S. Denison and Company, Inc., Minneapolis, 1959.
- Enthoven, Jacqueline. *Stitchery for Children*. New York, Van Nostrand Reinhold Co., 1968.
- Gaitskell. *Art Education for Slow Learners*. Peoria, Illinois, Charles A. Bennett Co., 1953.
- Girdler Reynolds, Jr. *Crayon Techniques*. New York, Pitman Publishing Co., 1969.
- Granstrom, K. E. *Creating with Metal*. New York, Reinhold Book Co., 1968.
- Grater, M. *Paper Faces*. Taplinger Publishing Co., 1968.
- Greenberg, Pearl. *Children's Experiences in Art*. New York, Reinhold Publishing Co., 1966.
- Guyler, Vivian V. *Design in Nature*. Worcester, Massachusetts, Davis Publications, Inc., 1970.
- Hart, Florence M. *What Shall We Do in Art?* Maplewood, New Jersey, C. S. Harwood and Co., 1961.
- Hartung, Rolf. *Creative Textile Design*. New York, Reinhold Book Co., 1968.
- Hartung, Rolf. *More Creative Textile Design*. New York, Reinhold Book Co., 1965.
- Hayett, William. *Display and Exhibit Handbook*. New York, Reinhold Book Co., 1967.
- Horn, George F. *Bulletin Boards*. New York, Van Nostrand Reinhold Co., 1962.
- Jackson, Sheila. *Simple Toymaking*. Watson-Guptill Publishers, New York, 1966.
- Jameson, Kenneth. *Art and the Young Child*. New York, The Viking Press, 1968.
- Jefferson, Blanche. *Teaching Art to Children*. Boston, Massachusetts, Allyn and Bacon, Inc., 1959.
- Johnson, Lillian. *Papier Mache*. David McKay Co., New York, 1958.
- Kampmann, Lothar. *Creating with Colored Ink*. New York, Van Nostrand Reinhold Co., 1968.
- Kampmann, Lothar. *Creating with Colored Paper*. New York, Reinhold Book Corp., 1968.
- Kampmann, Lothar. *Creating with Poster Paints*. New York, Reinhold Book Corp., 1968.
- Kampmann, Lothar. *Creating with Crayons*. New York, Reinhold Book Corp., 1968.
- Kampmann, Lothar. *Creating with Printing Material*. New York, Van Nostrand Reinhold Co., 1968.
- Kenny, Carla and John. *The Art of Papier Mache*. New York, Chilton Book Co., 1968.
- Knudsen and Christensen. *Children's Art Education*. Peoria, Illinois, Charles A. Bennett Co., Inc., 1957.
- Kornerup, Ann-Mari. *Embroidery for Children*. New York, Van Nostrand Reinhold Co., 1969.
- Krevitsky, Nik. *Batik, Art and Craft*. New York, Reinhold Book Corp., 1968.
- Krevitsky, Nik. *Stitchery, Art and Craft*. New York, Reinhold Book Corp., 1968.
- Krinsky, Norman. *Art for City Children*. New York, Van Nostrand Reinhold Co., 1970.
- Krinsky, Norman and Bill Berry. *Paper Construction for Children*. New York, Reinhold Book Corp., 1968.
- Kroncke, Grete. *Weaving with Cane and Reed*. New York, Reinhold Book Corp., 1968.
- Labiherte' and McIlhany. *Banners and Hangings*. New York, Reinhold Book Corp., 1969.
- Lammer, Jutta. *Make Your Own Gifts*. Watson-Guptill Publishers, New York, MCMLXIV.
- Lark, Horovitz, and Luca, Lewis. *Understanding Children's Art for Better Teaching*. Columbus, Ohio, Charles E. Merrill Book Company, 1967.
- Laury, Jean Ray. *Applique Stitchery*. New York, Reinhold Book Corp., 1968.
- Linderman, Earl and Henkerholz. *Developing Artistic and Visual Awareness*. Dubuque, Iowa, W. C. Brown, 1964.
- Lindstone, John. *Self Expression in Classroom Art*. Worcester, Massachusetts, Davis Publications, Inc., 1967.
- Loughran, Bernice B. *Art Experiences an Experimental Approach*. New York, Harcourt, Brace and World, 1963.
- Lowenfeld. *Your Child and His Art*. New York, The Macmillan Company, 1954.

- Meilich, Dona Z. *Creating Art from Anything*, Chicago, Illinois, Reilly and Lee, 1968.
- Meyers. *150 Techniques in Art*, New York, Reinhold Publishing Corp., 1963.
- Mitzit, Anna E. Pauli and Margaret S. *Paper Figures*, Peoria, Illinois, Charles A. Bennett Co., Inc., 1957.
- Moseley. *Crafts Design*, Belmont, California, Wadsworth Publishing Co., Inc., 1962.
- McIlhenny, Sterling. *Art as Design: Design as Art*, New York, Van Nostrand Reinhold Co., 1970.
- Orze, Joseph and Carl Reed. *Art from Scraps*, Worcester, Massachusetts, Davis Publications, Inc., 1960.
- Pattemore, Arnel W. *Printmaking Activities for the Classroom*, Worcester, Massachusetts, Davis Publications, Inc., 1966.
- Patterson and Gerring. *Exploring with Paint*, New York, Reinhold Publishing Company, 1964.
- Pearson, Hazel. *Plaster Casting for Fun and Profit*, Rosemead, California, Handicrafts, 1966.
- Rainey, S. R. *Weaving Without a Loom*, Worcester, Massachusetts, Davis Publications, Inc., 1966.
- Randall, Arne W. *Murals for Schools*, Worcester, Massachusetts, Davis Publications, Inc., 1956.
- Randall and Haines. *Design in Three Dimensions*, Worcester, Massachusetts, Davis Publications, Inc., 1965.
- Robinson, Stuart and Patricia. *Exploring Puppetry*, Tappan Publishing Company, New York, 1966.
- Rosenberg, Lilli Ann Killen. *Children Make Murals and Sculpture*, New York, Reinhold Book Company, 1968.
- Rottger, Ernest. *Creative Clay Design*, New York, Reinhold Publishing Corp., 1963.
- Rottger, Ernest. *Creative Paper Design*, New York, Reinhold Publishing Corp., 1961.
- Rottger, Ernest. *Creative Wood Design*, New York, Reinhold Publishing Corp., 1961.
- Schonewolf, Herta. *Play with Light and Shadow*, New York, Reinhold Book Corp., 1963.
- Scrase, Pat. *Let's Start Designing*, New York, Reinhold Publishing Corp., 1966.
- Seidelaan and Mintonye. *Creating with Clay*, New York, Crowell-Collier Press, 1967.
- Snow, Aida Cannarsa. *Growing with Children Through Art*, New York, Reinhold Book Corp., 1968.
- Sproul, Adelaide. *With a Free Hand*, New York, Reinhold Book Corp., 1968.
- State Department of Education. *Arts and Crafts*, for use with mentally retarded students. Columbia, S. C. Dept. of Educ., 1966.
- Suttles, Patricia H. *Elementary Teachers Guide to Free Curriculum Materials*, Randolph, Wisconsin, Educators Progress Service, 1969.
- Thomas, Richard K. *Three Dimensional Design*, New York, Van Nostrand Reinhold Co., 1969.
- Waltner, Willard and Elma. *Holiday Hobbycraft*, Lantern Press, N. Y., 1964.
- Wankelman, Philip R. Wigg, Marietta K. Wigg. *A Handbook of Arts and Crafts*, Wm. C. Brown Publishing Co., Dubuque, Iowa, 1968.
- Wankelman, Karl Richards, Marietta Wigg. *Arts and Crafts*, Wm. C. Brown Publishing Co., Dubuque, Iowa, 1954.
- Weiss, Harvey. *Collage and Construction*, New York, Young Scott Books, 1970.
- Wiener and Lidstone. *Creative Movement for Children*, New York, Van Nostrand Reinhold Co., 1969.
- Wiseman, Ann. *Rag Tapestries and Wool Mosaics*, New York, Van Nostrand Reinhold, 1969.
- Yates, Brock. *Plastic Foam for Arts and Crafts*, Sterling Publishing Co., New York, 1965.
- Yochim, Louise Dunn. *Perceptual Growth in Creativity*, Scranton, Pennsylvania, International Textbook Co., 1967.

ART PERIODICALS, JOURNALS, MAGAZINES

Artist Junior

Published monthly, October through April except December. (Group subscriptions only; 5 or more, \$1.00 each.)

Editor: Rachel Baker, 1346 Chapel Street, New Haven, Connecticut 06511.

Ceramic Monthly

1953 monthly \$6.00.

Editor: Thomas Sellers, Professional Publications, Inc., 4175 North High Street, Columbus, Ohio 43214.

Design

1899 bi-monthly, September-June \$4.50.

Editor: Beurt R. Servas, Review Publishing Co., Inc., 1100 Waterway Boulevard, Indianapolis, Indiana, 46207.

Arts and Activities

1937, Monthly, September-June \$7.00.

Editor: Mary Cole Emerson, Arts and Activities, 8142 N. Lawndale Ave., Skokie, Illinois 60076.

School Arts Magazine

1901, monthly, September-June \$7.00.

Editor: George F. Horn, Davis Publications, Inc., Printers Building, Worcester, Mass. 01608.

BIBLIOGRAPHY

**CURRICULUM GUIDES**

A Guide for the Improvement of the Teaching of Art in the Schools of Arizona

Bulletin Number seven 1951
State Department of Public Instruction
Phoenix, Arizona

Enjoying Pictures

Division of Instructional Services
Los Angeles City Schools, Los Angeles, California
1961

Art K-2

An Instructional Guide
Kindergarten, First and Second Grades
Los Angeles City Schools, Los Angeles, California
1962

Art

Grades 3-6
Los Angeles City Schools, Los Angeles, California
1964

Curriculum Guide for Art

Kindergarten, Primary 1-2-3
Board of Education
Chicago Public Schools
Chicago, Illinois 1966

Curriculum Guide for Art

Grades 4-5-6
Board of Education
Chicago Public Schools
Chicago, Illinois

Art in the Awakening Years

K. 1, 2, 3, 4, 5, 6
The Board of Education of Prince George's County
Upper Marlboro, Maryland
1963

Art Aids

Spartanburg City Schools
Spartanburg, South Carolina 1967

Art

Grades 3-5
Curriculum Bulletin Number 1303
Fort Worth Public Schools
Fort Worth, Texas 1969

Art — Elementary Guides for Grades 4, 5 and 6, Portsmouth Public Schools
Portsmouth, Virginia 1968

*Colorado Art Guide**K-12*

Colorado State Department of Education.
Denver, Colorado, 1964
National Art Education Association — *Exemplary Programs in Art Education*, 1969,
Washington, D. C.

Art Experiences — Indianapolis Elementary Schools. City of Indianapolis
School Commission, 1952.

Elementary Art Guide — Ann Arbor Public Schools, Ann Arbor, Michigan.

Art Education — Elementary Schools of Ohio, Columbus 12, Ohio, 1961.

Children and Art — Pennsylvania Department of Education, Harrisburg,
Pennsylvania, 1969.

IN CONCLUSION

In the community of Greenville, where citizens show a keen awareness and appreciation of artistic expression, many group and individual art activities abound. This interest has engendered the growth of such institutions as The Greenville Art Association, The Greenville Artists Guild, the Greenville Museum of Art, the Bob Jones University Collection of Sacred Art, the Furman University Art Department.

Greenville is also the home of several artists of national acclaim and is the locale of industries and businesses which have established a custom of sponsoring one-man art shows and group exhibitions.

It is in the midst of these and many other evidences of growing artistic consciousness that the art program of the Greenville County School District seeks to stimulate successful early experiences in creative and mental growth.

The development of a sequential art program, grades K-6, will be a welcomed step toward an often expressed need.

It is hoped that this guide will enrich art instruction in every elementary classroom in Greenville County; that the self-concept of each teacher and pupil will be lifted as the result of a more acceptable self-expression.—*Dr. M. T. Anderson*

The art guide is a tool, not an end. It is intended to help the teacher plan ahead, to give confidence when needed, but not to restrict either imagination or exploration.

There will occur many accidental effects or deliberate experiments which add far more pleasure to the basic activities herein provided. "Lose not the nightingale." Whenever a glowing result beckons, encourage breaking away. If it doesn't come off, be comforted; at least there has come a fuller knowledge of the materials.

The true artist expresses himself well because his materials are familiar. He has learned what they will do and how to make them do it.

Doing a project only, does not develop an in-depth comprehension of process or medium. Repeat the project and look for new ways to improve it; try for a different mood, for a change of colors, for saying something different. It takes many encounters to really exhaust the potential of most activities.

Margaret Gilliam
Art Director