

DOCUMENT RESUME

ED 102 126

88

SP 008 907

TITLE Every Child a Winner with Improvised Physical Education Equipment.

INSTITUTION Irwin County Schools, Ocilla, Ga.

SPONS AGENCY Bureau of Elementary and Secondary Education (DHEW/OE), Washington, D.C.; Georgia State Dept. of Education, Atlanta.

PUB DATE 73

NOTE 57p.; For related documents, see SP 008 906 and 908

AVAILABLE FROM P.C.A.W.-Improvisation, Irwin County Middle School, Ocilla, Georgia 31774 (\$5.00)

EDRS PRICE MF \$0.76 HC Not Available from EDRS. PLUS POSTAGE

DESCRIPTORS *Athletic Equipment; *Construction (Process); *Construction Costs; Elementary Education; *Physical Education; Physical Education Facilities; Physical Health

IDENTIFIERS Elementary Secondary Education Act Title III; ESEA Title III; *Project HOPE

ABSTRACT

This booklet describes physical education equipment constructed at the site of Project HOPE (Health and Optimum Physical Education) in the Irwin County School System, Ocilla, Georgia, to provide rural schools a model for elementary physical education and health services. The booklet is divided into three sections: "What To Do with No Money," "What To Do with Some Money," and "What To Do with Enough Money." Equipment described ranges from tire climbs and can stilts to parallel bars and a covered play area. The use, cost, and construction are described for most of the equipment. (PD)

every child a winner with improvised physical education equipment

Compiled by Project HOPE, Title III,
Elementary and Secondary Education Act

Designed and published by Publications
and Information Services, Division of
Business Services, Office of Department
Staff Services, Georgia Department of
Education, Atlanta, Georgia 30334

Jack P. Nix, State Superintendent of
Schools

1973

Irwin County Elementary; School and
Irwin County Middle School, Ocilla,
Georgia, are the sites of the equipment
and facilities described in this booklet.
Project HOPE, Title III, ESEA, welcomes
visitors at all times.

SP 8 P 7

U S DEPARTMENT OF HEALTH,
EDUCATION & WELFARE
NATIONAL INSTITUTE OF
EDUCATION

THIS DOCUMENT HAS BEEN REPRO-
DUCED EXACTLY AS RECEIVED FROM
THE PERSON OR ORGANIZATION ORIGIN-
ATING IT. POINTS OF VIEW OR OPINIONS
STATED DO NOT NECESSARILY REPRESENT
OFFICIAL NATIONAL INSTITUTE OF
EDUCATION POSITION OR POLICY

PERMISSION TO REPRODUCE THIS
COPYRIGHTED MATERIAL BY MICRO-
FORME ONLY HAS BEEN GRANTED BY
ERIC AND ORGANIZATIONS OPERAT-
ING UNDER AGREEMENT WITH THE NA-
TIONAL INSTITUTE OF EDUCATION
FURTHER REPRODUCTION OUTSIDE
THE ERIC SYSTEM REQUIRES PERMIS-
SION OF THE COPYRIGHT OWNER

contents

What to do with NO MONEY	What to do with SOME MONEY	What to do with ENOUGH MONEY
Tire Climb	Parachutes	Apparatus Construction
Newspaper Stacks	Balance Boards	Limited Space Challenge Course
Deck Tennis Rings	Golf Practice Mats	Gym-Jim Set
Arrow Storage Racks	Roller Balance Boards	Perimeter Challenge Course
Wands	Utility Standards	Chinning Bars
Tinkling Sticks	Ping Pong Nets and Tables	Uni-Ladder
Can Stilts	Hoops	Rope Climb
Table Tennis Paddles	Yarn Balls	Giant Ladder
Nylon Badminton Paddles	Individual Jump Ropes	Parallel Bars
Equipment Bags	Tumbling Mats	Covered Play Area
Lummi Sticks	Balance Beams	
Portable Goal Posts	Outdoor Chalkboards	
Badminton Balls	Pinnies	
Rhythm Drums, Targets, Storage Space	Balance Post	
Broad Jump Pit	Box Hockey	
Tires	Tennis Net Supports	
Golf Targets	Golf Bags	
Bean Bags	Rope Ladder	
	Soccer and Field Hockey Goals	
	Tetherball Standards	
	Batting Tees	
	Flickerball Goals	
	Spot Trainers	

project HOPE staff

Administration

Mrs. Martha Owens,
Director
Mrs. Susan Rockett
Program Director
Miss Charlene Varnell
Physical Education Specialist
Mrs. Nellie Jo Spicer
Health Specialist
Mrs. Syd Blackmarr
Evaluation-Dissemination Specialist
Miss Terri Wolverton
Curriculum Writer
Mrs. Allan White
Evaluation Assistant
Mrs. Janiece Brannen
Bookkeeper-Secretary

Physical Education Teachers

Mr. James Anderson
Mr. Douglas Ferguson
Mr. Allen Smith

Physical Education Aides

Mrs. Ida Anderson
Mrs. Vida Dix
Miss Gloria Edwards
Mrs. Myra Griffin
Mrs. Betty Paulk
Mrs. Irishtine Williams

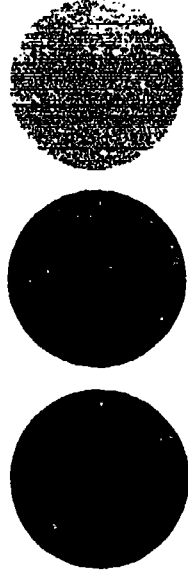

introduction

This booklet is the culmination of three years of effort by parents, school and community to make "Every Child a Winner" through elementary physical education.

Project HOPE (Health and Optimum Physical Education), Title III, Elementary and Secondary Education Act, was implemented in the Irwin County School System, Ocilla, Georgia, to provide rural schools a model for elementary physical education and health services. This booklet describes physical education equipment constructed at the project site. It is hoped that the information contained in the booklet will prove useful to all those

interested in providing better physical education for elementary children.

If your school system has little or no money to spend, you will find useful information in section one. If your system has a modest budget for physical education, both section one and two are appropriate. More expensive apparatus and equipment are contained in section three. We strongly recommend that you give consideration to all three sections and that selections be made based on the needs of the children in the school where equipment will be constructed.

Actual costs to Project HOPE of con-

structed equipment are presented. However, prices may vary from one locale to another. Donations of materials and labor can greatly offset construction costs.

Project HOPE is grateful to the many interested parents, school personnel, community agencies, civic groups and members of the project staff for their contributions.

Equipment and apparatus presented were selected and constructed by the Project HOPE staff. Selections were made based on the developmental needs of Irwin County children in grades one through six.

BEST COPY AVAILABLE

what to do with no money

BEST COPY AVAILABLE

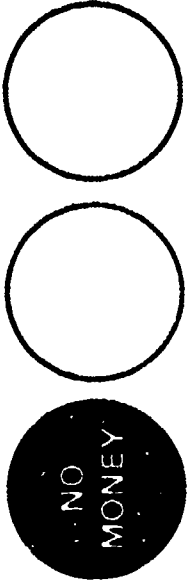
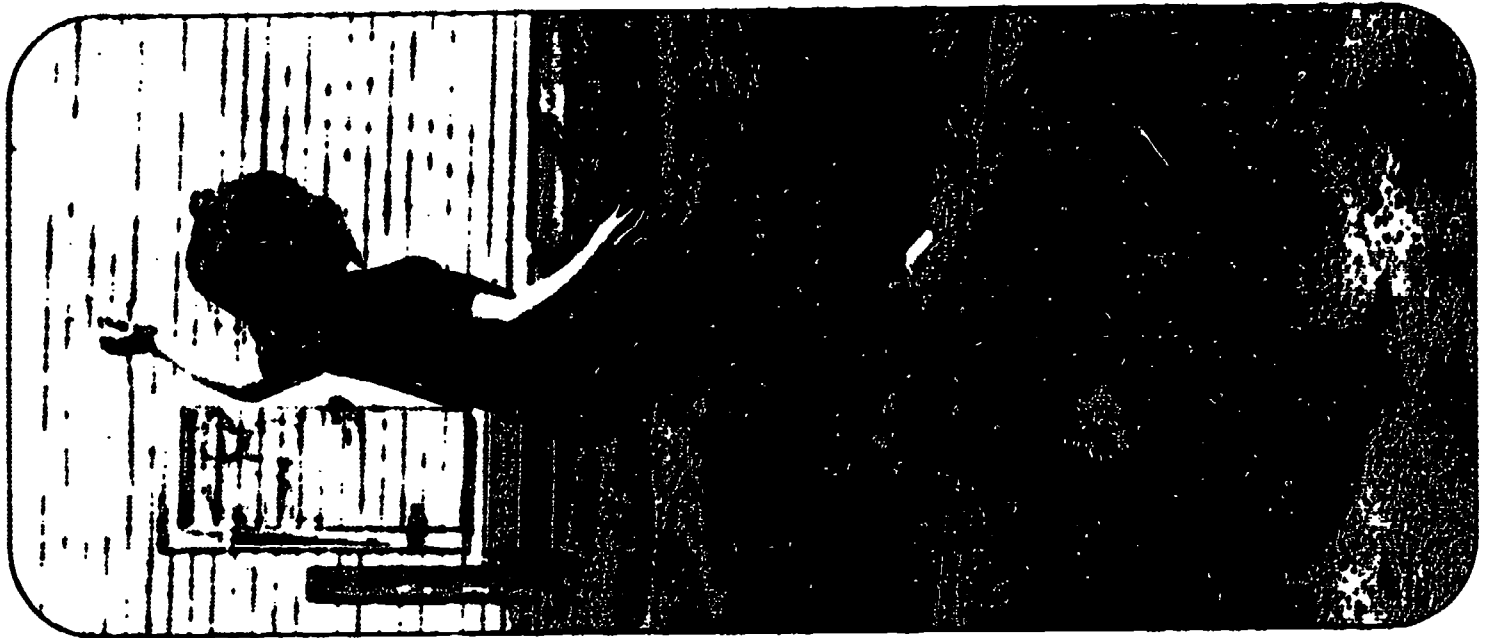

TIRE CLIMB

USE

The tire climb is especially useful in providing experiences in balance, agility and coordination.

COST

Improvised: \$0.00 (Tires were donated from local sources.)

Man-hours: 5

CONSTRUCTION

Dig a ditch 30 feet long, two feet wide

and one foot deep in which to place the tires. (See Figure 1.) Thirty car tires and three tractor tires compose the tire climb. Place the first tire in the ditch horizontally and fill with dirt to provide stability. Place the next eight tires vertically in the ditch and fill the bottom half of the tire with dirt. Next place a tractor tire in the ground sideways. (See Figure 2.) Place six more car tires, a tractor tire, seven more car tires, a tractor tire and finally seven more car tires. Place the last car tire in the ground horizontal. The first car tire was placed. (See Figure 3). Paint the car tire climb with brightly colored paint.

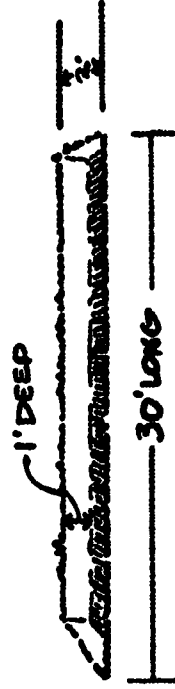

Fig. 1



Fig. 2



Fig. 3

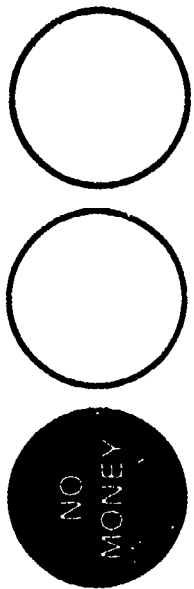

NEWSPAPER STACKS

USE

Newspaper stacks can be used for movement experiences in climbing, leaping, carrying and lifting.

COST

Improved: \$0.00
Man-hours: 2

CONSTRUCTION

Fold newspapers neatly in half. Stack the newspapers evenly to a height of eight inches. Using strong nylon string, tie the newspapers around in both directions. Lock the strings together where they cross to prevent slippage. Use non-slipping knots near the ends of the strings to stop unraveling. The newspaper stack can be covered with an old carpet remnant which reaches completely around the stack.

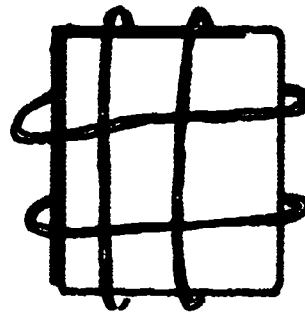

Fig. 1



Fig. 3

DECK TENNIS RINGS

USE

Deck tennis rings can be used in the development and refinement of manipulative skills, such as rolling, throwing, catching and striking.

COST

Improved: \$0.00 (Materials were donated.)
Retail: \$2.00
Man-hours: 1

CONSTRUCTION

Soft hose is best to use for the construction of deck tennis rings because of its pliability. Materials can be inexpensively purchased at local hardware stores.

Cut the hose to a length of 12 inches and bend to form a circle. Insert one three-inch dowel, one-half inch in diameter, into the open ends of the hose to secure

Fig. 2

and complete the circle. (See Figure 1.) Strong tape should be wrapped around the point of closure to further secure the finished deck tennis ring. (See Figure 2.)

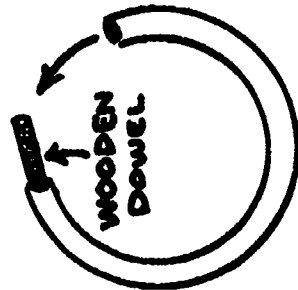

Fig. 1

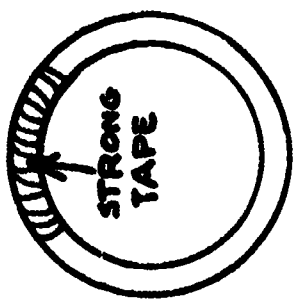

Fig. 2

ARROW STORAGE RACKS

USE

Storage of arrows in arrow storage racks helps keep arrow shafts from becoming warped.

COST

Improved: \$0.00 each
Retail: \$2.49 each
Man-Hours: 30 minutes

CONSTRUCTION

For inexpensive, lightweight storage of arrows use a heavy cardboard box. Glue the top shut. Turn the box upside down, punch holes of a size to hold arrows. With

BEST COPY AVAILABLE

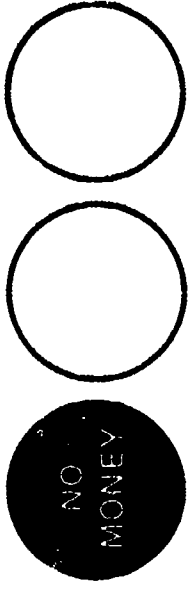

a felt tip pen, mark the arrow length on the cardboard box. Attach a rope to each end for easy carrying.

WANDS

USE

Wands may be used in the development of fundamental movement concepts such as over, under, around and through. Wands can add variety to movement activities while helping the children develop balance, agility, flexibility, eye-hand coordination and striking.

COST

Improvised: \$0.00 each (Materials were

donated.)

Retail: \$11.95 per dozen

Man-hours: 1

CONSTRUCTION

Hoe handles were donated by a local manufacturing company. Old broom handles may be donated by willing parents or any inexpensive source. Cut the hoe handles or broom handles to a length of 30 inches. Smooth off the edges with sandpaper to finish the wand. Painting the wand adds to its attractiveness.

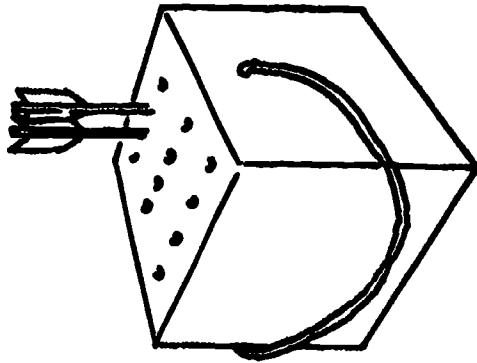

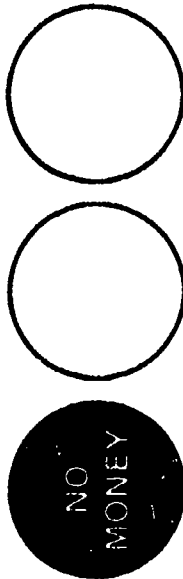

BEST COPY AVAILABLE

TINKLING STICKS

USE

Tinkling sticks are used in the Philippine dance of "tinkling." Through this specific rhythmic activity children improve loco-motor patterns and gain a better understanding of their bodies.

COST

Improvised: \$0.00 (Materials were donated.)

Retail: \$6.00 per pair of 10-foot poles

Man-hours: 1

CONSTRUCTION

Bamboo poles can serve as tinkling sticks and are much less expensive than commercially sold tinkling sticks. Cut the bamboo poles into 20-foot lengths and smooth off the rough edges with sandpaper. (When selecting bamboo poles, choose poles of sufficient width and strength to resist splitting and cracking when stepped upon.) Hoe handle rejects can be used if bamboo is not available. However, bamboo poles are best.



BEST COPY AVAILABLE

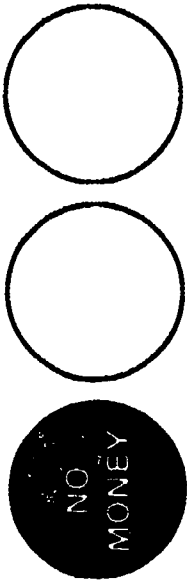

CAN STILTS

USE

Can stilts effectively provide another form of balancing activity to enrich the child's development of motor skills.

COST

Improved: \$0.00 (Materials were donated.)

Man-hours: 20 minutes.

CONSTRUCTION

Gallon cans may be obtained from the school lunchroom. Cut or punch two holes on either side of the can one-half inch from the top of the closed end of the can. Insert a piece of three-eighths-inch rope four feet in length and one-fourth inch in diameter into the holes. After inserting the rope, knot the ends inside the cans. (See Figure 1.) With a can on each foot, children hold one rope in each hand as they move about.

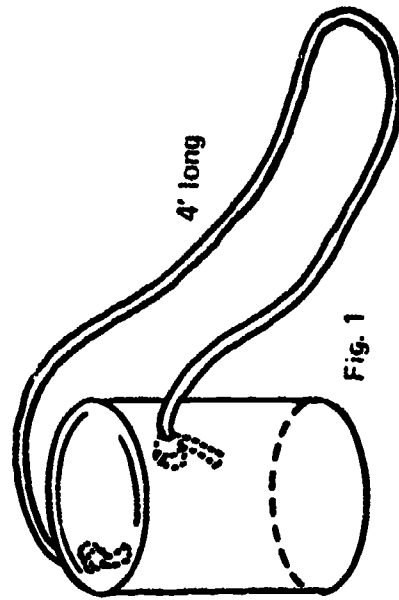

TABLE TENNIS PADDLES

USE

A child's development through the manipulative skill of striking can have greater dimension and variety with paddles. Movement experiences utilizing these paddles contribute to the development of eye-hand coordination, underarm, sidearm and overarm motor patterns.

COST

Improved: \$0.00
(paint for 40 paddles—
\$6.00)

Retail: \$1.10 each
Man-hours: 3

CONSTRUCTION

Paddles can be constructed from large scraps of one-fourth-inch plywood not used in the construction of other improvised equipment. Therefore the cost of the paddles is absorbed by the original cost of the plywood.

From a sheet of one-fourth-inch plywood, cut regulation size table tennis paddles using a coping saw. Cut wooden slats, four inches by two inches, and glue with Weldwood glue to each side of the handle. File the end of the handle and smooth it off to form a rounded end.

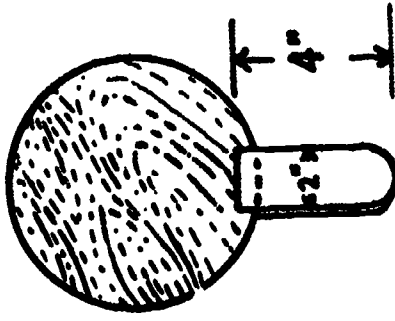

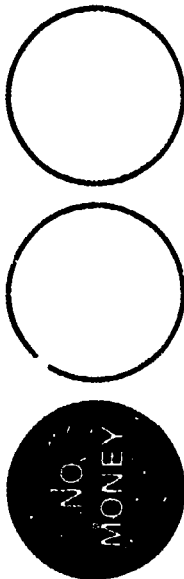

BEST COPY AVAILABLE

NYLON BADMINTON PADDLES

USE

Nylon badminton paddles are light, easy to handle striking instruments for the younger children and very useful in the development of striking patterns and eye-hand coordination.

COST

Improved: \$0.00 (Materials were donated.)
 Retail: \$19.50 (regulation badminton rackets)
 Man-hours: 1

CONSTRUCTION

Bend a wire coat hanger to form a diamond shape. Using pliers, straighten out the curved part of the hanger. Beginning at a point "A" (See Figure 3), insert the hanger into a nylon stocking, pulling it as tight as possible and leaving the foot part of the stocking hanging off at point "A." Twist a "twistem" (the type that comes with food wrap bags) at point "A." Tie several knots in the stocking and cut the rest of the foot part off. Stretch the stocking tight and fasten a "twistem" around the handle at the point where it joins the hanger. Wrap the excess stocking around the handle and secure in three places with "twistems." Bend the "twistems" flat against the handle and wrap with masking tape.

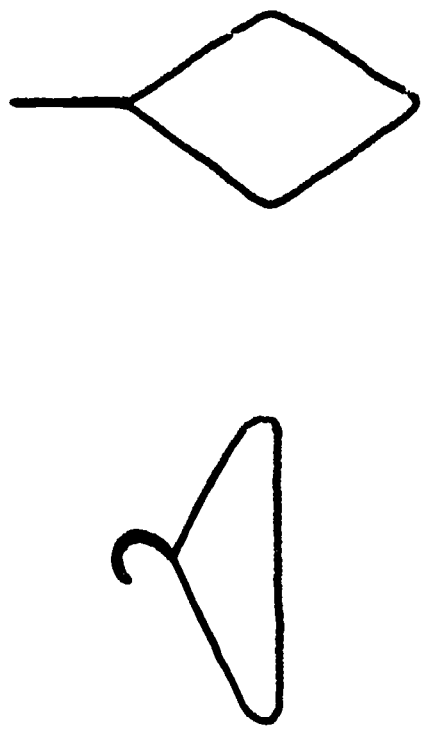

Fig. 1

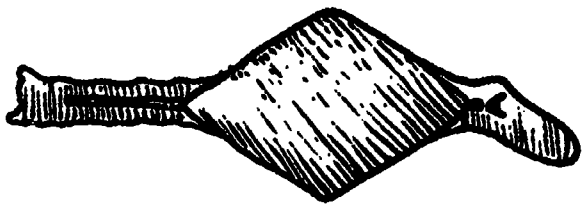

Fig. 2

Fig. 3

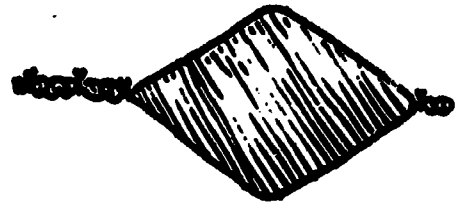

Fig. 4

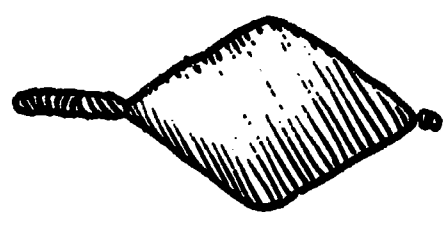
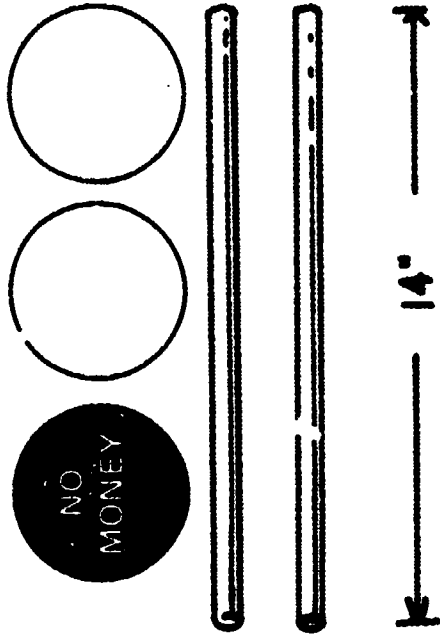

Fig. 5

BEST COPY AVAILABLE



inches. This is the length of one lummi stick. Cut as many pairs of lummi sticks as needed to supply one total class. Sandpaper the edges of the lummi sticks to smooth off the roughness. Paint the lummi sticks various bright colors.

EQUIPMENT BAGS

USE

Army duffle bags can be used for storage of balls and other small equipment.

COST

Cost will vary depending upon your locale.
Man-hours: 0

CONSTRUCTION

Army duffle bags may be easily acquired from government surplus stores.

LUMMI STICKS

USE

Lummi sticks are helpful as tools in child's development of rhythmic "sense" when participating in rhythmic activities.

COST

Improved: \$0.00 (Materials were donated from a local broom factory.)
Retail: \$0.42 a pair
Man-hours: 2

CONSTRUCTION

Cut broom handles to a length of 14



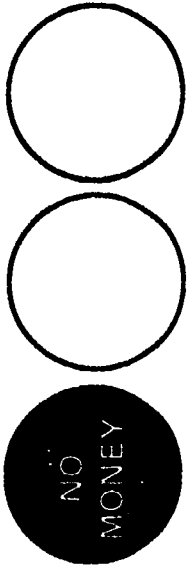

PORTABLE GOAL POSTS

USE

This piece of equipment may be used in games requiring goal posts such as soccer, speedball and football.

COST

Improvised: \$0.00 (Materials were donated.)

Retail: \$40.00 per pair

Man-hours: 1 (depending on availability of tires)

CONSTRUCTION

Goal posts can be constructed very easily.

Stack 50 car tires, 25 on each side as many feet apart as specified in game rules. To complete, string a rope across the top of the car tires. (See Figure 1.)

BADMINTON BALLS

USE

These badminton balls are to be used with badminton rackets to help children in the development of eye-hand coordination and as a lead-up to the hitting of a regulation badminton shuttlecock.

COST

Improvised: (depends on cost and amount

of masking tape used)
Man-hours: 1 per dozen badminton balls

CONSTRUCTION

Crumple one-fourth of a large sheet of newspaper into a tight ball. (See Figure 1.)
1.) Wrap the ball sufficiently with masking tape to form a firm ball. (See Figure 2.)
2.) Press the tape down firmly on all sides.

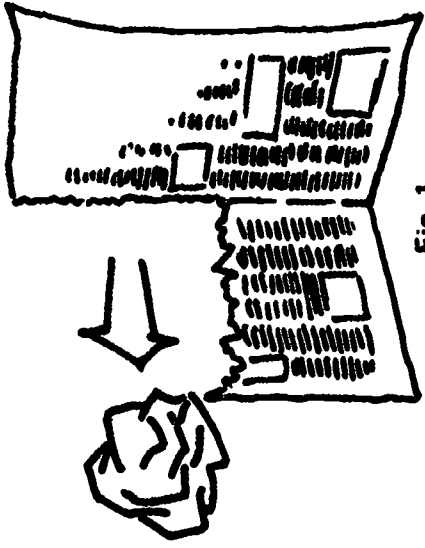
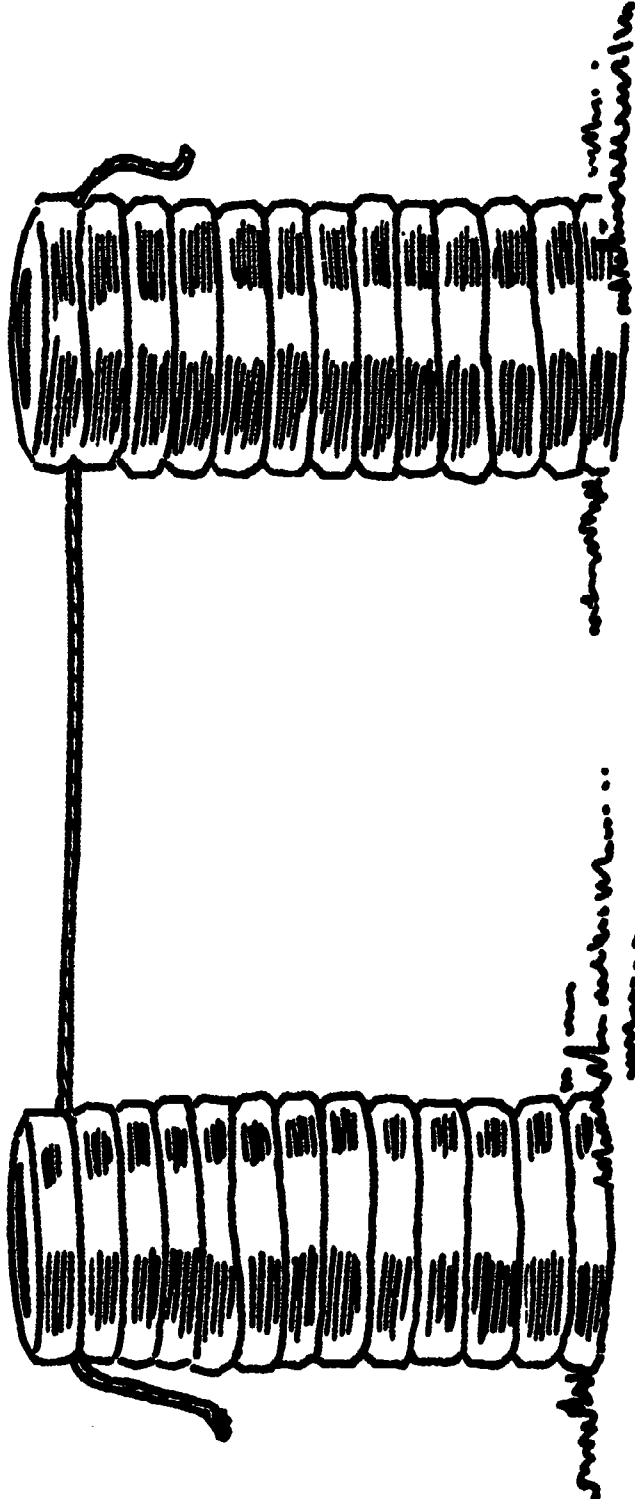

Fig. 1



Fig. 2



RHYTHM DRUMS, TARGETS, STORAGE SPACE

USE

Large and small drums can serve as targets to aid in the development of accuracy, eye-hand coordination and throwing patterns. Small drums add variety to rhythmic activities when used as instruments for the children. (When not in class use, these drums can be used for storage.)

COST

Improved: \$0.00 (Materials were donated.)

Man-hours: 0

CONSTRUCTION

Large 55-gallon or 20-gallon drums can be acquired from plants or factories in your area. Small five-gallon drums are easily obtained at local ice cream stores. Clean the drums thoroughly before using. The drums may be painted with bright colors and designs as a cooperative project with the art classes.

When the large drums are used as storage space and/or targets it is advisable to use the 20-gallon drums for the younger children. Equipment is difficult for them to retrieve from the 55-gallon drums.

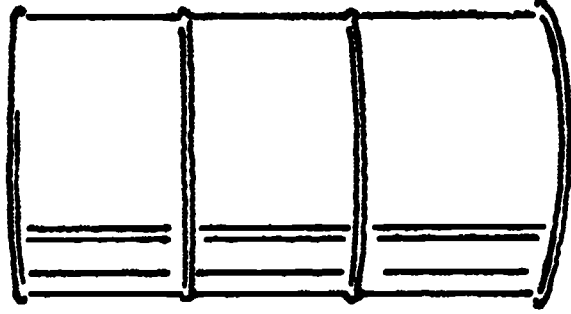
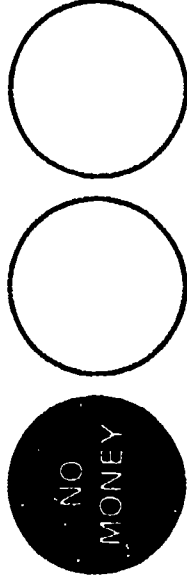

20/OR 50
GALLON DRUM



5 GALLON DRUM

BROAD JUMP PIT

USE

The broad jump pit is primarily designed for use in the field event of broad jumping. It can also be effectively used in the development of jumping and landing skills by providing a safe and resilient surface on which the children can land.

COST

Improved: \$0.00 (Materials were donated and local facilities utilized.)

Man-hours: 1

CONSTRUCTION

A sandy area on the playground, raked smooth provides a broad jump pit suitable for general purposes. If a sandy area is not available one may be built as follows: dig a shallow ditch large enough to accommodate your needs and fill with sand. Boards may be placed on either side of the pit and at the end to prevent the sand from washing away. A measurement device showing inches and feet may be painted on the side of the pit to aid the students in evaluating their own progress.

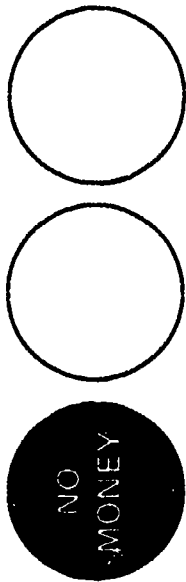

BEST COPY AVAILABLE

TIRES

USE

Equipment can be improvised using tires that will improve balance, leg strength, coordination, agility and flexibility.

COST

Improvised: \$0.00 (Materials are easily obtained from local sources.)

Man-hours: Depends on the piece of equipment built.

CONSTRUCTION

Old tires can be acquired from farmers, parents, students, service stations and tire centers for very little or no cost. Try to find tires of all sizes, automobile tires as well as truck and tractor tires. The use of these tires is limited only by your imagination. Excellent hurdles can be constructed by laying one tire flat and balancing another vertically inside of it. A bridge of tires for children to run over may be easily made by burying a variety of tires vertically side by side. (See tire climb.) This requires the child to make many adjustments while balancing. When laid flat, tires make effective supports for balance beams. Tires may be bolted or tied together in numerous patterns to make climbing apparatus or swinging bridges.

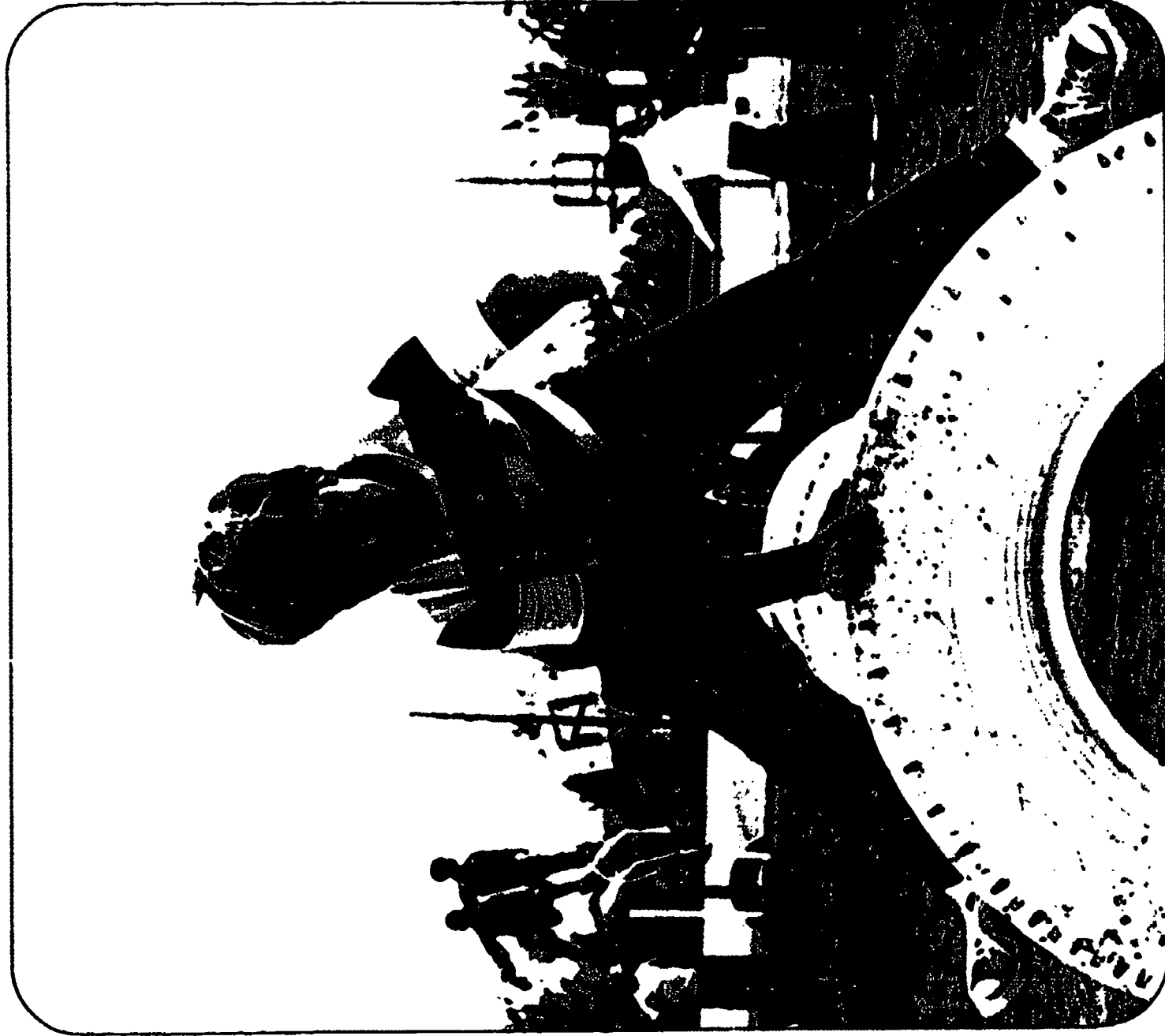

BEST COPY AVAILABLE

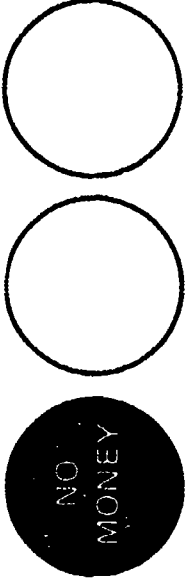

GOLF TARGETS

nated.)

Man-hours: 2

USE

Golf targets serve as measures of accuracy for the development of golf skills.

COST

Improvised: \$0.00 (Materials were do-

CONSTRUCTION

After choosing the site for the golf targets, dig holes in the ground the size of the cans to be used. Number two tin cans work very well. Cut a hole in the bottom

of the can to allow a plywood flag to be inserted in the ground after the can is placed in the ground. Construct flag sticks from scrap plywood strips five feet high and one inch thick. (See Figure 1.) Attach a piece of cloth to the plywood strip. The cloth may be any size or shape desired, the cloth may be stapled or nailed to the plywood strip. (See Figure 2.)

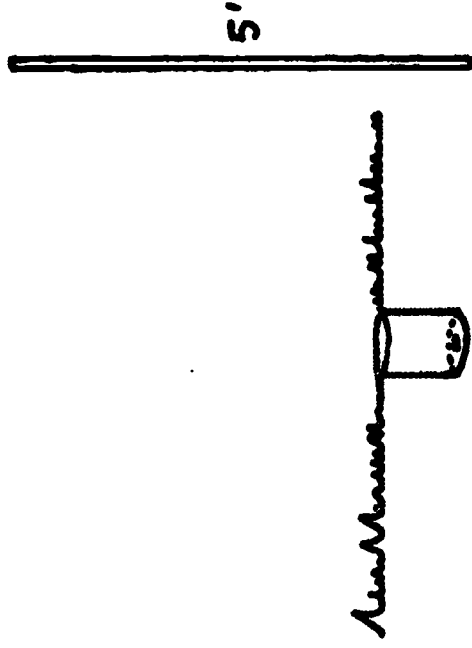
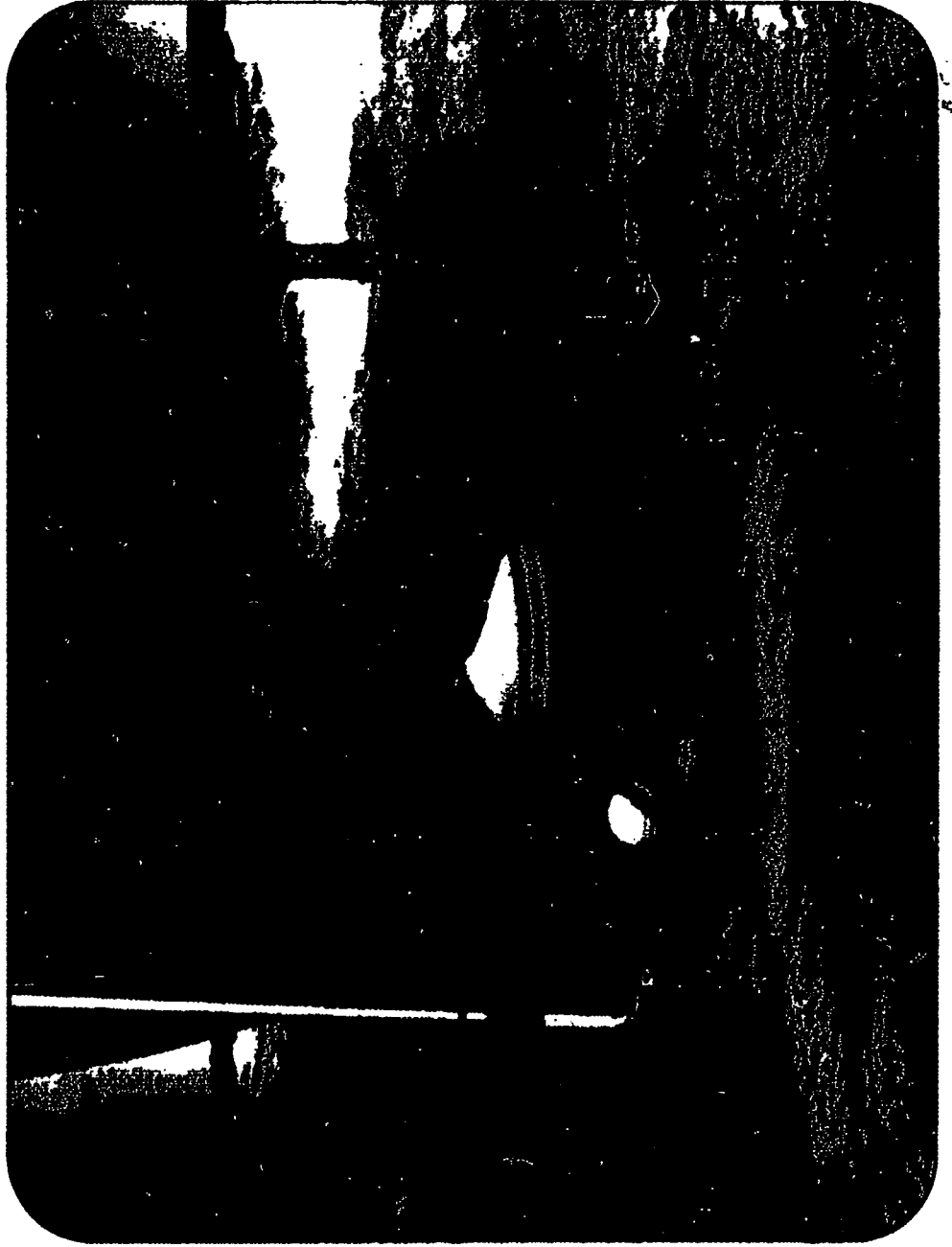

Fig. 1

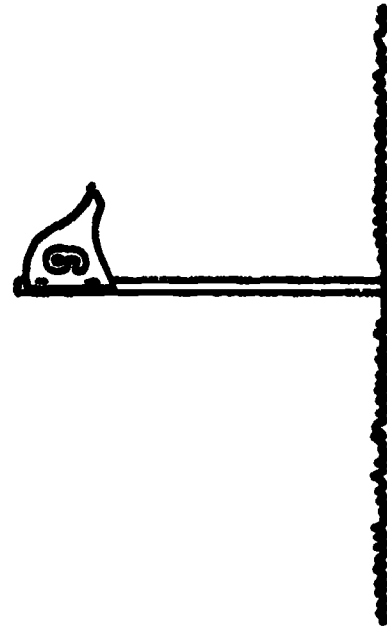
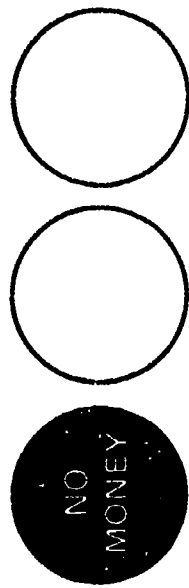

Fig. 2



BEAN BAGS

Man-hours: 1 per dozen

USE

Bean bags add variety to activities that aid a child's development in throwing, catching, striking, eye-hand coordination and accuracy.

COST

Improvised: \$0.00

Retail: \$7.20 per dozen

CONSTRUCTION

Bean bags can be made in various shapes -- squares, circles and polygons. For the construction of bean bags use a strong fabric such as denim or dacron.

When constructing a square bean bag, cut two five and one-half-inch square pieces of cloth (Size of the cloth for bean bags of other shapes must be adjusted accord-

ingly.) Double machine stitch, with right sides together, approximately three-eighths of an inch from the edge of the material on all four sides leaving one-inch opening for filling with beans, peas, or corn. Turn the bag right side out with the sewn edges inside the bag. Fill with two cups of corn, beans or peas. Sew the one-inch opening up by double machine stitching all around the bag about one-fourth inch from the edge.

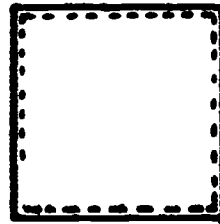

Fig. 1

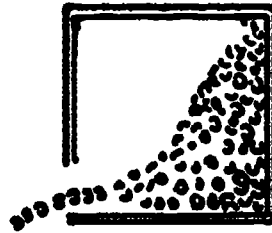

Fig. 2



Fig. 3

BEST COPY AVAILABLE

what to do with
some money



PARACHUTES

USE

Parachutes allow children creative ways to play old games, create new games, build "mountains," make waves and fanciful mushrooms. This vigorous form of play adds variety to rhythmic activities.

COST

Improved: \$3.00

Retail: \$30.00

Man-hours: (depends on the traveling distance from the nearest government surplus store)

CONSTRUCTION

Parachutes can be easily acquired from government surplus stores. Government surplus parachutes are much less expensive than commercially sold parachutes, yet provide children with the same types of valuable experiences.

BALANCE BOARDS

USE

Balance boards serve to increase the child's ability to maintain a balanced position while in motion.

COST

Improved: \$0.72 each

Retail: approximately \$7.00 each

Man-hours: 30 minutes

CONSTRUCTION

One balance board is constructed from two pieces of marine plywood. The platform piece measures 16 inches by 16 inches by one-half inch. The smaller piece of board measures four inches by four inches by one-half inch. (See Figure 1.) The larger piece of plywood is used as the platform on which the child stands. Center, nail and glue the smaller piece of board to the bottom of the larger piece of plywood. (See Figure 2.) This forms the small base of support which offers the challenge in the development of balance and coordination. Paint the balance boards bright colors.

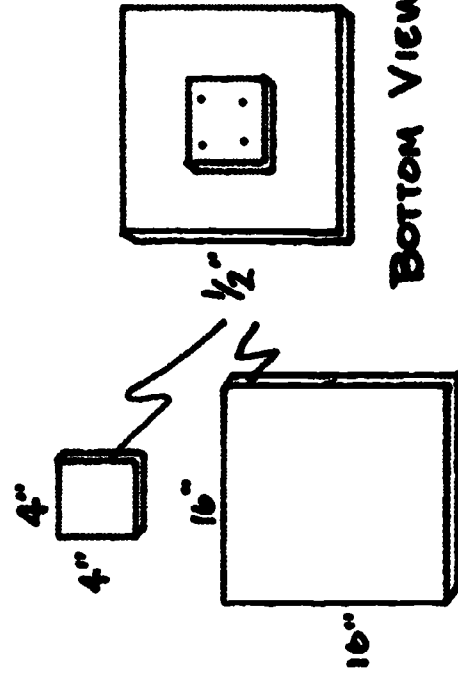
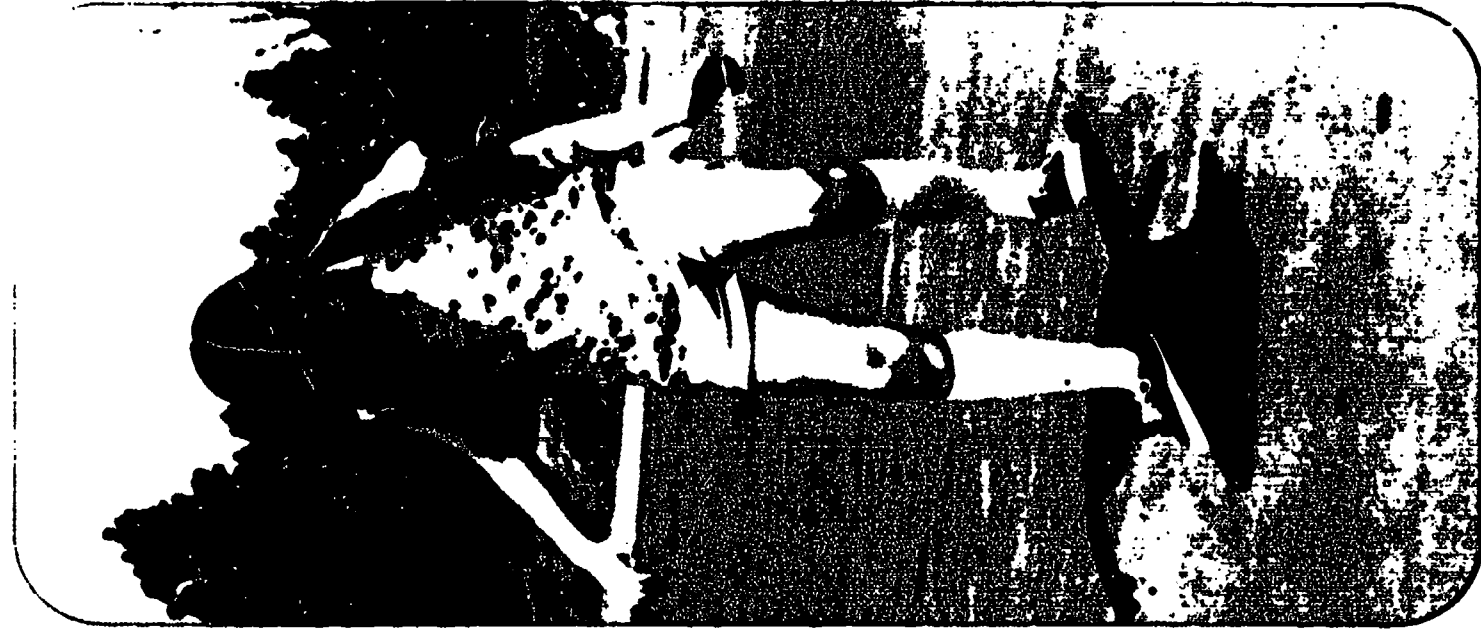

Fig. 1



BEST COPY AVAILABLE



GOLF PRACTICE MATS

USE

Golf practice mats are recommended for use indoors when practicing golf skills. They may also be used outdoors where grassy areas are not available.

COST

Improved: \$0.25 each
Retail: \$3.50 each
Man-hours: 0

CONSTRUCTION

Carpet samples can be obtained from local carpet stores and wholesale houses. Additional sources can be interior decorator establishments or donations of old rugs from parents.



ROLLER BALANCE BOARDS

USE

Roller balance boards can contribute to a child's development of balance and coordination through the manipulation of an external object.

COST

Improved: \$0.89 each
Man-hours: 4

CONSTRUCTION

Twenty-four by 12-inch plywood is used to construct the roller balance boards. Nail small pieces of board, 12 inches by two inches, to the bottom of the plywood boards about two inches from the ends. (See Figure 1.) Cut roller blocks, 12 inches long and three inches in diameter, from six-foot long untreated poles. These roller blocks provide the moving base when they are placed underneath the larger board. The smaller pieces of wood nailed on the ends of the plywood platform prevent the roller block from slipping completely out from underneath the child thereby eliminating unnecessary accidents and injuries. (See Figure 2.)

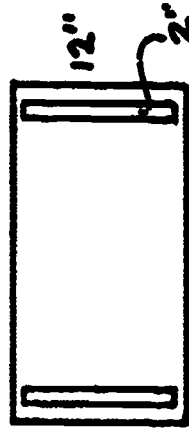

Fig. 1

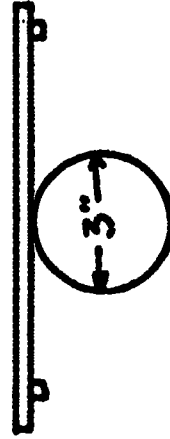
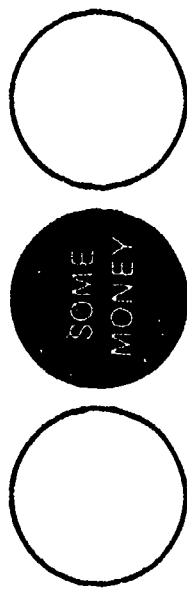

Fig. 2





UTILITY STANDARDS

Man-hours: 1

USE

Utility standards provide inexpensive supports for nets used in games such as volleyball, tennis, etc.

COST

Improvised: \$8.76 per pair
Retail: \$34.95 per pair

CONSTRUCTION

After placing a piece of cardboard on the bottom of an old tire, fill the tires with sacrete. While the sacrete is still wet, insert a seven to eight-foot piece of two-inch pipe into the center of the tires. Brace the pipe so it stands straight and let the sacrete set for two days.

PING PONG NETS AND TABLES

USE

Improvised ping pong nets and tables are used in the recreational game of ping pong.

COST

Improvised: \$1.35 (two-inch by four-inch by eight-foot beam)
Retail: \$45.50
Man-hours: 0

CONSTRUCTION

Select any sturdy, smooth surfaced table. The length and width will depend on skill level of the child and availability of tables. Lunchroom tables may be used. Place a two-by-four or four-by-four board across the table. If balance beams have been made the two-inch by four-inch by eight-foot beam may be used across two tables. (See illustration.)

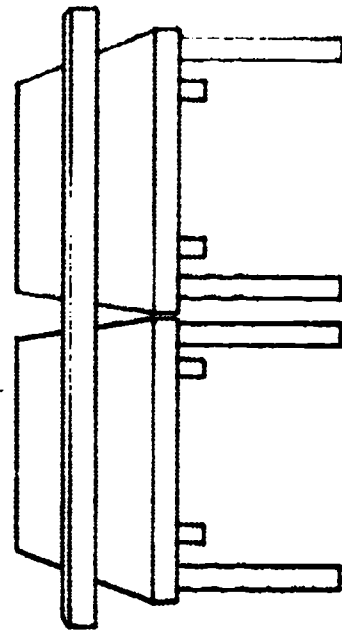

BEST COPY AVAILABLE



HOOPS

with a staple gun. For added strength wind black electrical tape around the closure.

USE

Activities using hoops contribute to the development of flexibility, agility, a sense of rhythm and coordination. Valuable movement experiences can be provided relating to such concepts as balance, jumping and rolling. Hoops can also be useful as targets and game apparatus.

COST

Improvvised: \$0.33 each
Retail: \$1.40 each
Man-hours: 2

CONSTRUCTION

The size of these hoops can be varied according to children's needs. The best length of the plastic pipe used to construct these hoops is seven feet, 10 inches. Black plastic pipe, one-half inch in diameter, may be purchased at most local hardware stores and building supply centers. After cutting the pipe to the desired length, insert half of a three-inch wooden dowel, one-half inch in diameter, into one end of the pipe and secure with a staple gun. Insert the rest of the wooden dowel into the other end of the pipe. Form a circle and close the ends of the pipe tightly against each other. Secure



Fig. 1

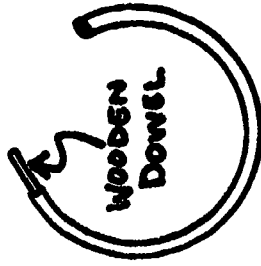

Fig. 2

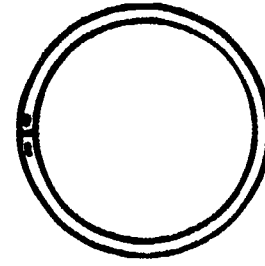
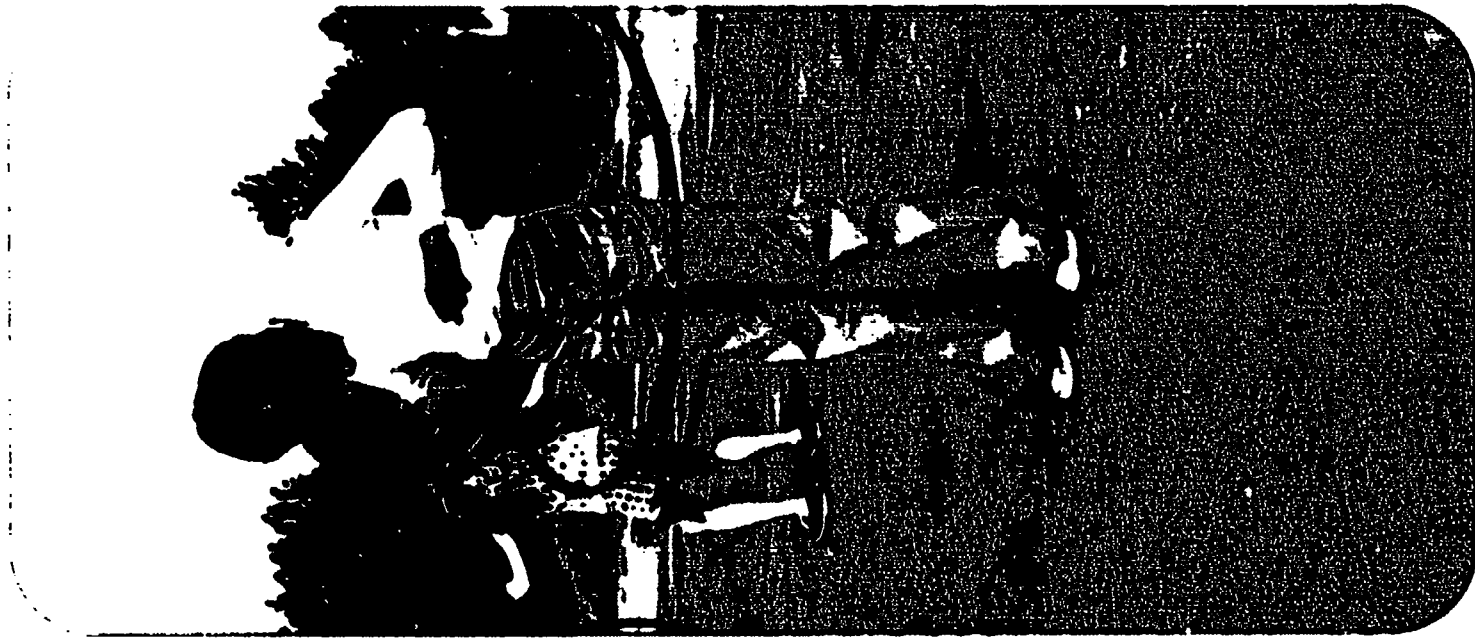

Fig. 3



YARN BALLS

USE

Yarn balls are recommended for use in movement experiences relating to the development of eye-hand coordination, throwing, catching, striking and kicking. The variety of movement experiences is limited only by imagination.

COST

Improvised: \$1.00 (or the cost of one skein of inexpensive cotton yarn)
Man-hours: 1

CONSTRUCTION

Materials needed are one 70-yard skein of cotton yarn and a piece of four-inch wide cardboard. Take one end of the yarn and wrap it loosely around the width of the four-inch cardboard approximately 20 times. Carefully slip the yarn off the cardboard and wrap the center of the yarn tightly with twine several times and tie securely. This forms a looped bundle as illustrated in Figure 1. Continue the first two steps until the entire skein of yarn is tied into separate bundles. Take two looped bundles and tie them together with twine by tightly wrapping the bundles in the center and tying the twine securely. Repeat this last step until all the

looped bundles are tied together in twos. (See Figure 2.) Take two doubled bundles and tie them together. Be sure to tie them securely and tightly in the center of the bundles. Take two double-looped bundles and tie them together. Continue adding the double-looped bundles to those which have been previously tied together until all the bundles are securely tied together. This will make a compact bundle of yarn well secured in the middle with twine. (See Figure 3.) With scissors cut all the looped ends so that the cut makes two equal lengths of yarn. Shape the yarn into a round ball by clipping the uneven ends. (See Figure 4.) The yarn ball is completed.



Fig. 1



Fig. 2



Fig. 3



Fig. 4



BEST COPY AVAILABLE



INDIVIDUAL JUMP ROPES

USE

Activities with jump ropes can be designed to challenge the creative and/or fitness demands of the human body, from first grade to adulthood. Jump ropes serve to increase cardio-respiratory and neuromuscular efficiency while developing balance, agility and coordination. Fundamental movement concepts, such as over, under, around and through, may also be developed using jump ropes as apparatus. In another capacity jump ropes add variety and fun while the child refines and adapts basic locomotor patterns.

COST

Improved: \$0.25 each

Retail: \$1.25 each

Man-hours: 4 (to construct 125 individual jump ropes)

CONSTRUCTION

Cut three-eighths-inch rope into six through 10-foot lengths for grades one through six. One reel of rope 1000 feet in length yields approximately 125 individual jump ropes at an average length of eight feet. Mark the rope at the desired length and pull tightly. Tape one inch on either side of the mark where the rope is

to be cut. Cut the rope on the mark in the middle of the two tape marks. This procedure prevents raveled and frayed ends.



TUMBLING MATS

USE

Tumbling mats provide the proper resilient surface for activities in tumbling, gymnastics, wrestling and as a safety measure when used as padding under apparatus.

COST

Improved: \$22.00 each (size = 38 inches by 76 inches by 2 inches)

Retail: \$65.00 each

Man-hours: 2 (when constructed by a local upholstery shop)

CONSTRUCTION

Twenty-two-inch thick mats can be made from 126 yards of Marine DR plastic cloth purchased from Leon's Fabrics, Inc., P.O. Box 1868, Columbus, Georgia, 31902. Twenty bonded polyfoam pads can be purchased from Tech-Aerofoam Products of Georgia, 6596 Peachtree Road, Doraville, Georgia, 30340, at approximately \$5.62 a pad.

Cut the material in lengths of approximately 156 inches and fold it over the mat lengthwise to eliminate one seam. Sew a 36-inch length of Velcro in place so that it will be in the middle of one end of the mat. Sew the sides of the mat covers

BEST COPY AVAILABLE

with the end folded over. Sew velcro fasteners on the other end of the mat for closing the cover and for connecting the mats lengthwise. This arrangement requires the least amount of special sewing equipment. Stuff the foam pads into the

mat cover from the open end. Close the open end with velcro fastening. If industrial sewing equipment can be used, the last end can be sewn shut with the mat enclosed thereby saving one yard of velcro fastener per mat.

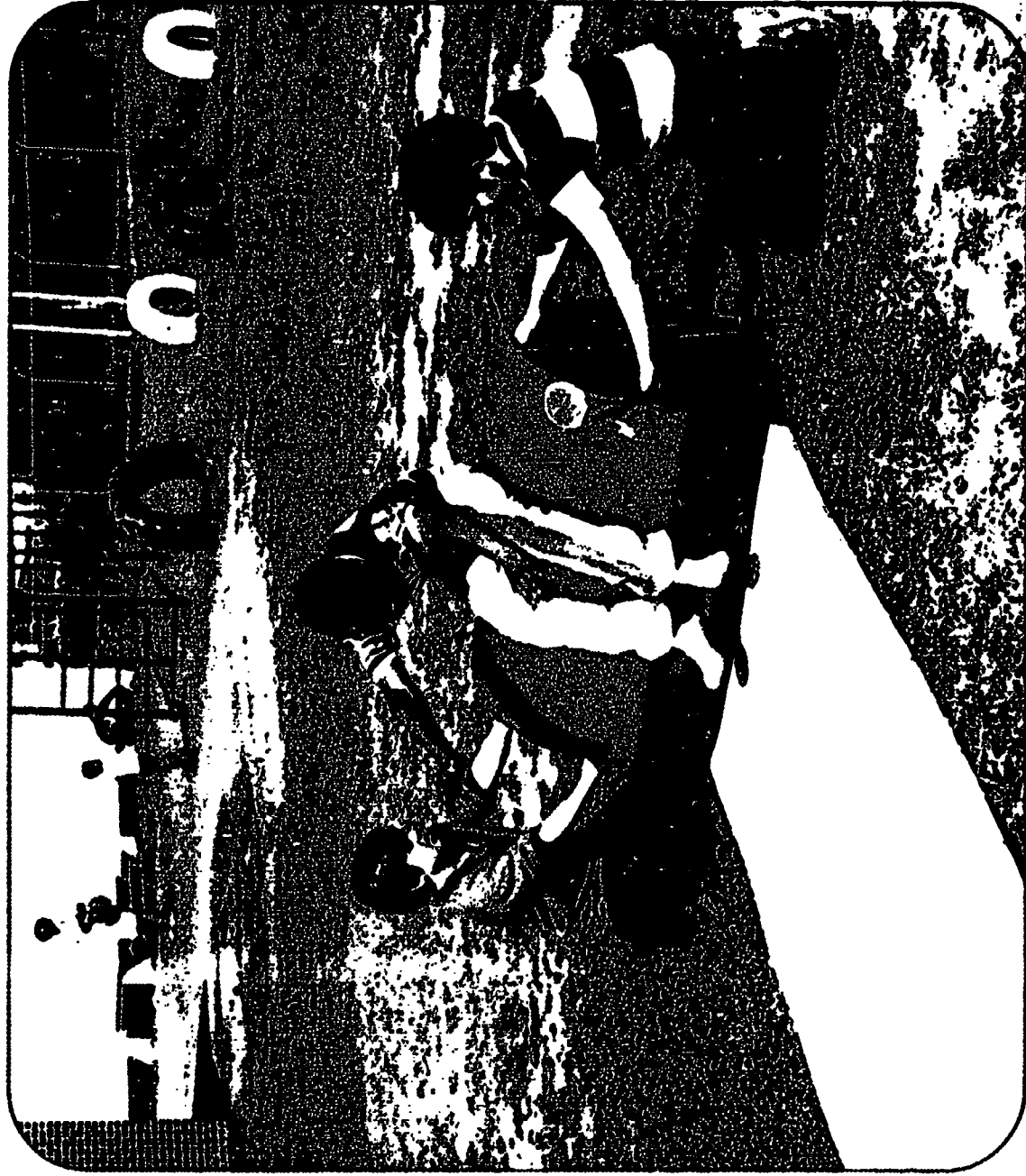
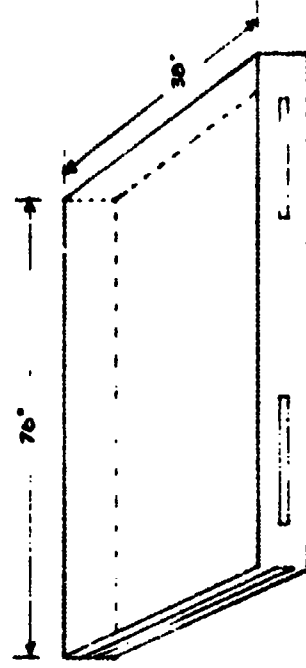

BALANCE BEAMS

USE

Balance beams aid in developing a child's ability to maintain a balanced position, whether stationary or in motion, on a small base of support.

COST

Improvised: \$2.00 per eight-foot balance beam
Retail: \$40.00
Man-hours: 7

CONSTRUCTION

Cut a four-inch by four-inch by three-foot board into two 13-inch lengths to form one of the beam supports. Cut four five and one-half-inch lengths from a two-inch-



by four-inch board. Place two of these lengths with the four-inch side horizontal to one of the sides of the four-inch by four-inch by 13-inch board. Space the two two-inch by four-inch by five and one-half inch pieces so there is a two-inch gap between them. (See illustration.) Glue and nail these two-inch by four-inch by five and one-half-inch pieces in place. These pieces form the slots for a balance beam that is two inches wide. Next cut four pieces of wood four and one-half inches long from a one-inch by four-inch board.

Glue and nail these one-inch by four-inch by four and one-half-inch pieces of wood to the top of the two-inch by four-inch by five and one-half-inch pieces leaving a four-inch slot in the center of the support. These pieces form the brackets for the four-inch wide balance beam. (See Figure 2.) Repeat this process so that there will be a support for each end of the balance beam. Purchase a two-inch by four-inch board of desired length to be used as the beam. An eight-foot beam is a satisfactory length for most balance activities.

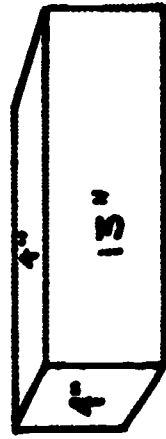

Fig. 1

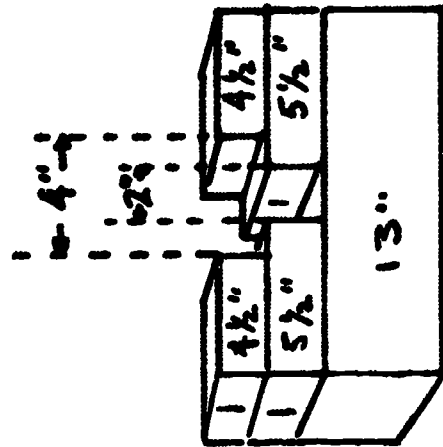

Fig. 2

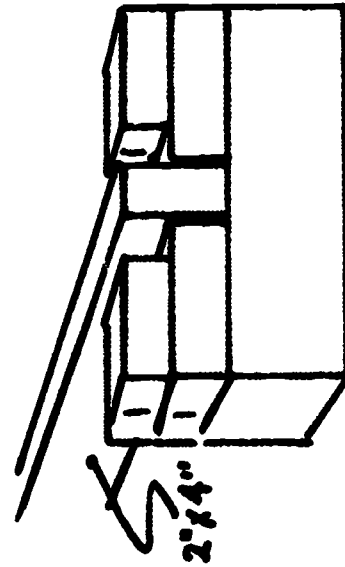

Fig. 3



BEST COPY AVAILABLE



OUTDOOR CHALKBOARDS

USE

Outdoor chalkboards are especially helpful as teaching aids for displaying charts, drawings and team rosters.

COST

Improved: \$8.40 without chalkboard
Man-hours: 2

CONSTRUCTION

Lay two eight-foot treated posts with six-inch diameter ends on the ground four feet apart with the eight-foot lengths parallel to each other. One foot from the top of each eight-foot post nail a one-inch by four-inch by four-foot board. (See illustration.) Continue nailing until there are six one-inch by four-inch by four-foot boards spanning a two-foot area. Nail six one-inch by four-inch by four-foot boards in the same way on the other side. Dig two holes three feet apart and two feet deep. Insert eight-foot posts and stabilize with dirt. Cement may be used.

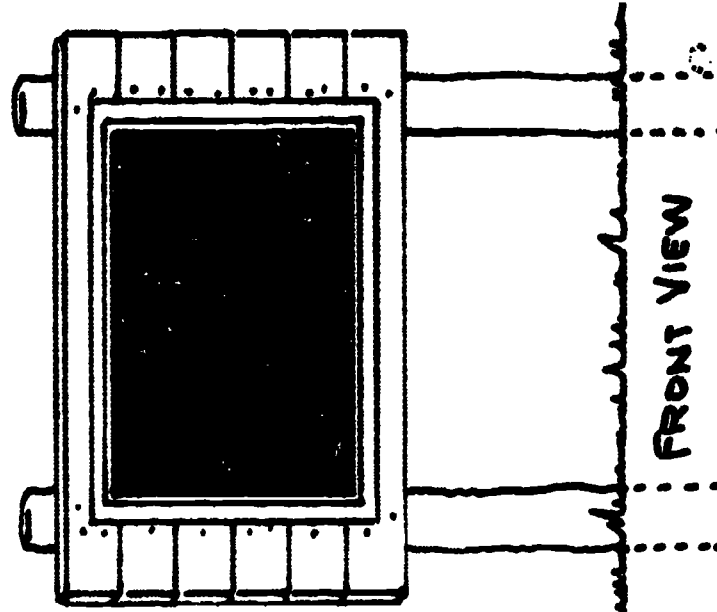
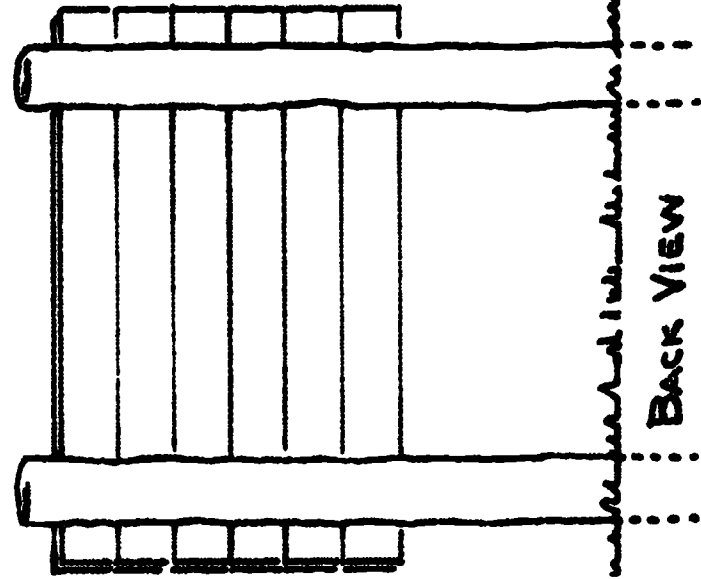

PINNIES

USE

Pinnies provide excellent means of identification when team or group divisions are necessary for class activities.

COST

Improved: \$3.00 per dozen
Retail: \$18.45 per dozen
Man-hours: 1

CONSTRUCTION

One dozen pinnies can be made from six yards of strong durable material. The size of the pinnie body measures eight and one-half inches wide by 10 and one-half inches long. These dimensions include a one-inch hem which should be taken in the material before constructing the pinnie. Two pieces of material as described above are needed, one for the back of the pinnie and one for the front. Cut out two shoulder straps and four side belts 14 inches in length and one inch wide. Each shoulder strap and side belt must consist of two pieces of material. Turn under the ends and sew together with a one-quarter-inch seam all the way around the shoulder straps and side belts. (See Figure 1.) Batack or backtack the shoulder straps and side belts to the body

BEST COPY AVAILABLE



of the pinnie to assure a strong attachment, approximately one inch into the body of the pinnie. (See Figure 2.) When the pinnie is completed it should have a body of two sides, a back and front measuring 10 and one-quarter inches by eight and one-half inches, and two shoulder straps and four side straps each measuring 12 inches long. (See Figure 3 of finished pinnie.)



Fig. 1

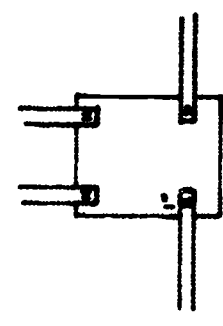

Fig. 2



Fig. 3

BALANCE POST

USE

The balance post offers a unique and interesting way for children to increase their sense of balance and coordination.

COST

Improvised: \$24.00

Man-hours: 6

CONSTRUCTION

Treat 14 six to eight-foot poles with copper-nephalene preservative two or three times. Dig 15 holes two feet deep and eight inches apart. Dig the holes in an "S" shape. The center pole (See Figure 1) is approximately 54 inches tall. Working out from the center, each following pole is approximately five to seven inches shorter than the preceding pole. The poles at each end of the balance post are 16 inches tall. (See Figure 2.)

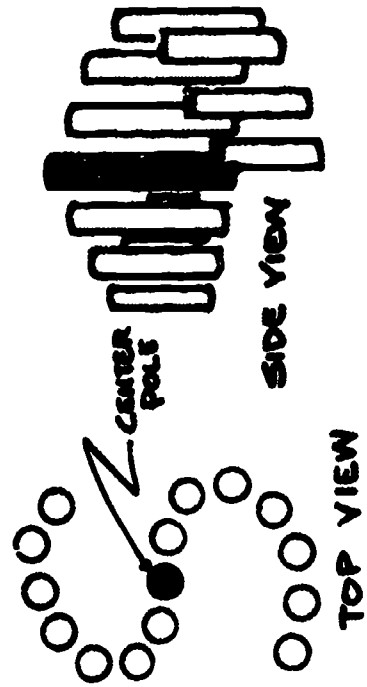

Fig. 1

Fig. 2





BOX HOCKEY

USE

Box hockey is an active recreational game. This equipment is easy to build and box hockey is easy to learn and play.

COST

Improvised: \$6.52
Man-hours: 1

CONSTRUCTION

Construct the frame for box hockey from three pieces of lumber, two inches by six inches by three feet and two pieces of lumber two inches by six inches by 10 feet. Cut a six-inch wide by four-inch high hole in the three smaller pieces of lumber. These pieces are the ends and middle of the box hockey. (See Figure 1.) Nail the frame together as illustrated in Figure 2. The frame may be built without a bottom to be used outdoors or on the floor. Broom sticks and softballs may be used and participants stand in the frame.

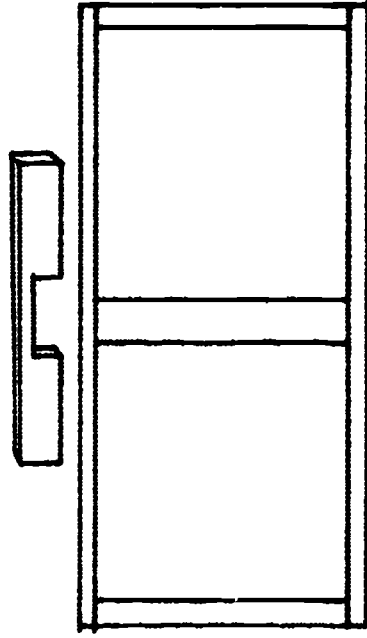

TOP VIEW





TENNIS NET SUPPORTS

USE

Tennis net supports are necessary equipment for the regulation game of tennis.

COST

Improved: \$4.10 each
Retail: \$38.95 per pair
Man-hours: 1½

CONSTRUCTION

Construct tennis net supports in exactly the same manner as the utility standards already described in this booklet. (See utility standards.) However, when constructing the tennis net supports make the following alterations. Cut the two-inch pipe in lengths of five feet each. Drill one-quarter-inch holes in the two-inch pipe at the spots where the tennis net will be attached. Attach a regular size eye bolt into each of the holes. (See Figure 1.)

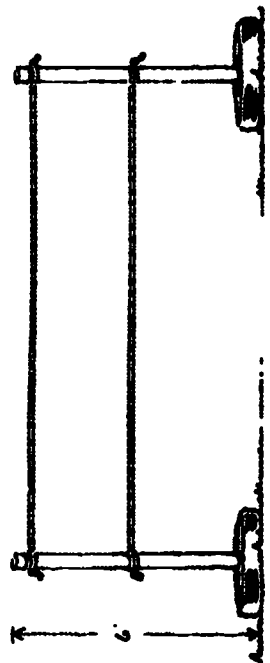

Fig. 1

GOLF BAGS

USE

Golf bags provide a means of transportation and storage for golf equipment.

COST

Improved: \$1.00
Retail: \$12.00
Man-hours: 2

CONSTRUCTION

Lightweight golf bags can be constructed with little expense. Scraps of plastic upholstery material can be acquired from

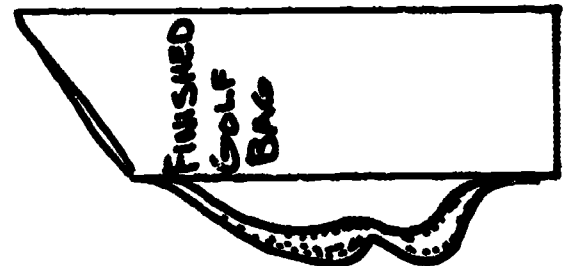
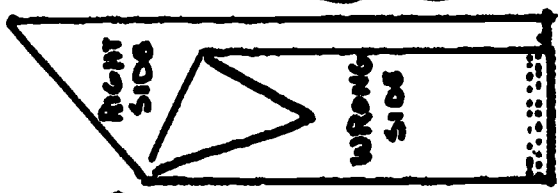
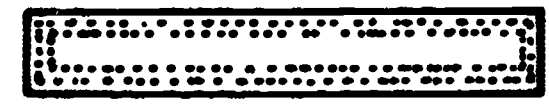
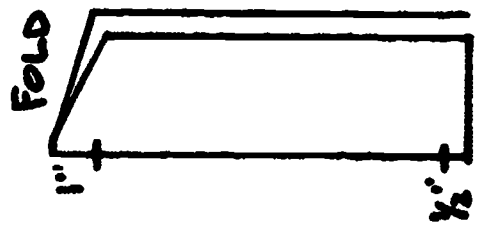
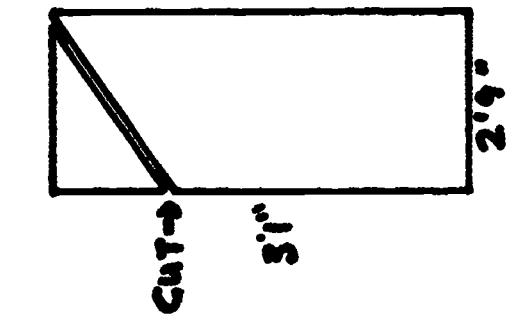

Fig. 2

Fig. 3

Fig. 4

Fig. 5

local upholstery shops. The cost of the burlap strap is \$1.00. The material used to construct the bag is three feet, one inch in length and two feet, nine inches in width. Fold the material lengthwise with the wrong sides together. Mark a margin of one inch from the top of the material and a margin of one-half inch from the bottom of the fold. Cut the material as shown in Figure 1. Stitch the burlap strap several times for durability in a lengthwise direction. Attach the burlap strap to the bag and double stitch to the material on the right side. Turn the material wrong side out with the right sides together. Stitch the bottom and open sides of the bag together. (See Figure 2.)

BEST COPY AVAILABLE



ROPE LADDER

USE

Children will have fun while this rope ladder aids them in the development of arm strength, flexibility, coordination and agility.

COST

Improvised: \$6.00 each
Retail: \$12.00
Man-hours: 2

CONSTRUCTION

Purchase 12 feet of dowel rod. Cut six dowel rods to two-foot lengths. Drill holes into them one and one-half inches from each end. Cut a 24-foot piece of three-eighths-inch nylon rope into two 12-foot lengths. Tie a knot at one end of each piece of rope. String one of the two-foot dowel rods onto the two 12-foot lengths of rope. (See Figure 1.) Measure one foot from the knotted ends of the two pieces of 12-foot rope and tie the second knots. Continue this process until all six dowel rods are in place.

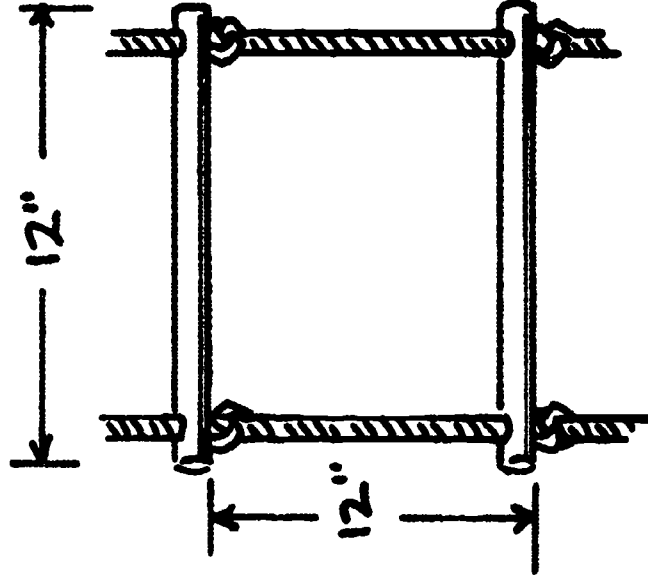



SOCCER AND FIELD HOCKEY GOALS

USE

Goals are necessary to play the regulation games of soccer and field hockey. This piece of equipment may also be used in other games that require goal posts.

COST

Improved: \$8.76 per pair
Retail: \$38.95 per pair
Man-hours: 1 (must dry overnight)

CONSTRUCTION

Construct soccer and field hockey goals using the same method of construction used in building the utility standards. (See utility standards.) When the standards are ready for use, string a rope between two of them. (See Figure 1.) This serves as a very useable, improvised goal for both games of soccer and field hockey.



Fig. 1

TETHERBALL STANDARDS

USE

Tetherball offers children a chance to develop advanced striking skills, while improving eye-hand coordination and arm strength.

COST

Improved: \$5.12
Retail: \$20.00
Man-hours: 2

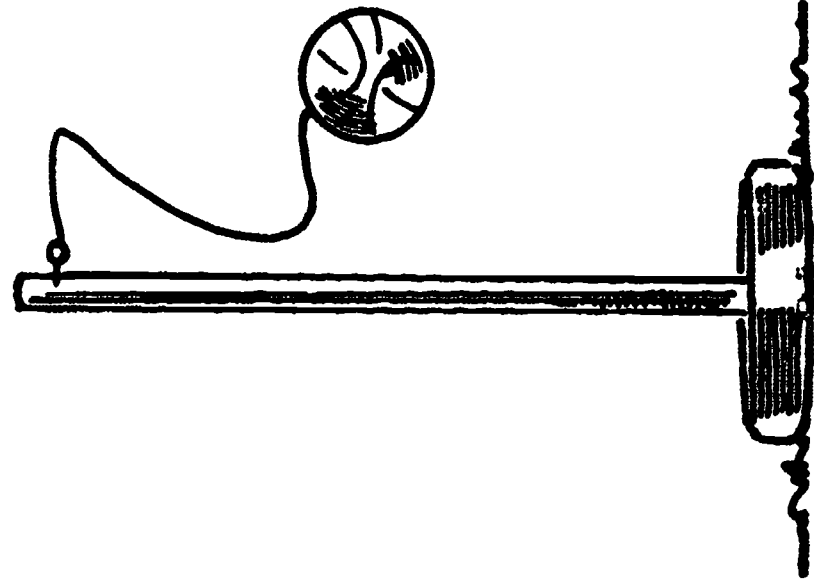

CONSTRUCTION

Cut two-inch pipe to a length of eight feet. Attach a regular size eye bolt about two inches from the top of the eight-foot upright. Place a piece of cardboard over the bottom of the car tire. Center the two-inch pipe in the car tire and fill with cement. Allow to dry overnight.

BATTING TEES

USE

Batting tees offer a stationary placement for balls. These tees are helpful with children who need to develop or improve their striking skill.

COST

Improved: \$2.34
Retail: \$11.00
Man-hours: 2

CONSTRUCTION

Construct the base of the batting tee from a one-inch by 12-inch by 18-inch piece of lumber and a one-inch by six-inch by 12-inch piece of lumber. Glue and nail the smaller piece of lumber on top of the larger piece. (See Figure 1.) Drill a hole large enough to fit a three-quarter-inch pipe nipple. A tight fit is best. This hole

BEST COPY AVAILABLE

should be drilled in the center of the base. (See Figure 2.) Insert the three-quarter-inch pipe nipple into the hole. Slip a piece of one-inch pipe, two feet in length, over the three-quarter-inch pipe nipple and clamp in place with a one-inch clamp. Slip a piece of one and one-quarter-inch plastic pipe, two feet in length, over the one-inch pipe, two feet in length, over the one-inch pipe is left free to slide up and down so that the height is adjustable. (See Figure 3.)

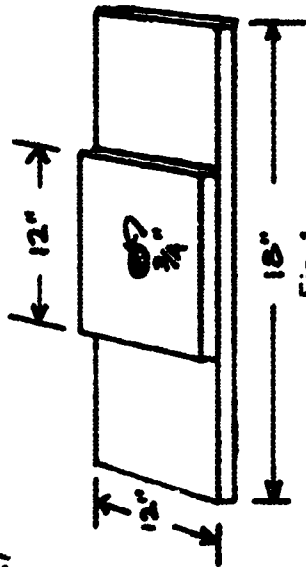

Fig. 1

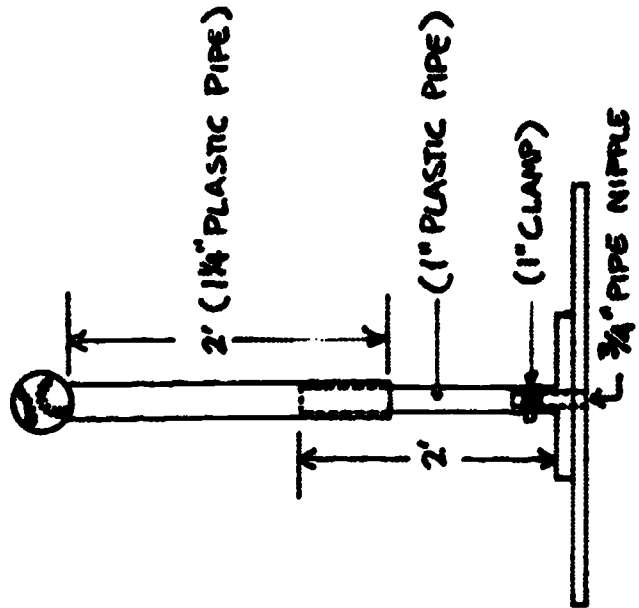
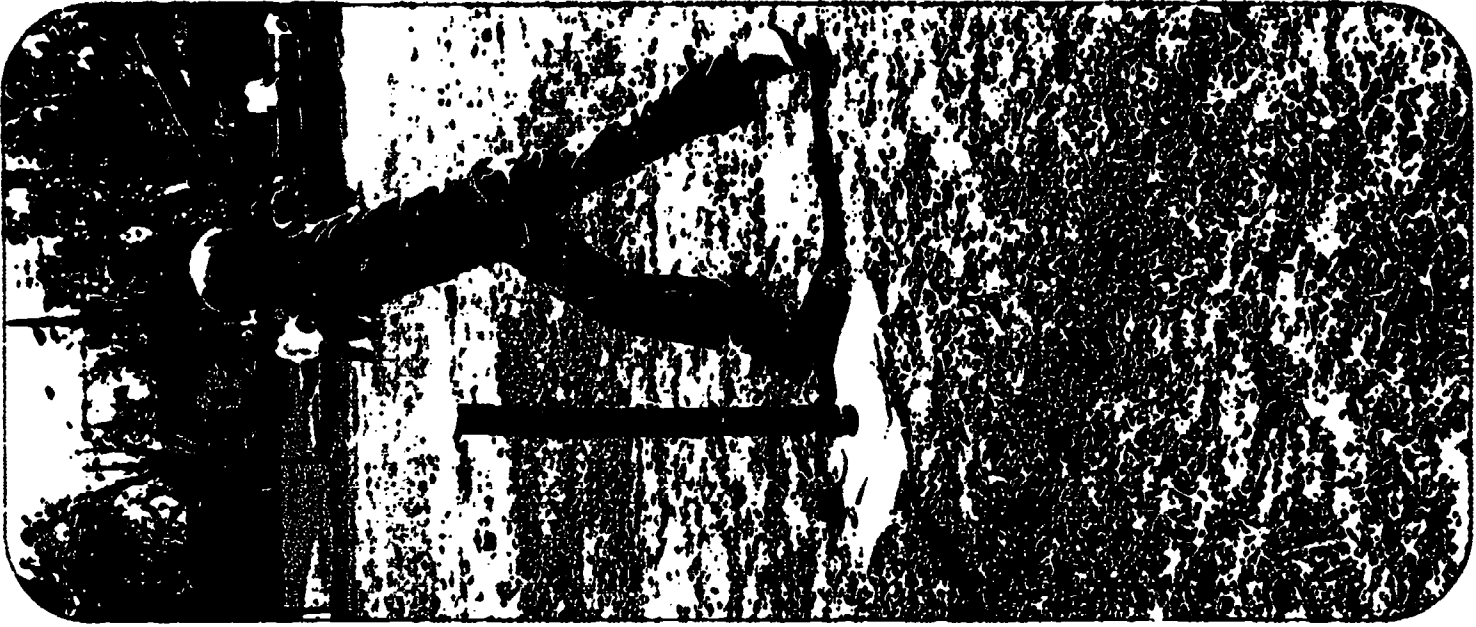

Fig. 2



FLICKERBALL GOALS

USE

Flickerball goals are used in the game of flickerball.

COST

Improvised: \$7.88 per pair

Retail: \$38.95 per pair

Man-hours: 1

CONSTRUCTION

Use the same method of construction for flickerball goals as was used in the construction of basic utility standards. (See utility standards.) However, make these following alterations: cut two-inch pipe to a length of six feet; when standards are ready for use, string two 10-foot ropes between them. In the game of flickerball, the goal counts when it goes through the two ropes. (See Figure 1.)

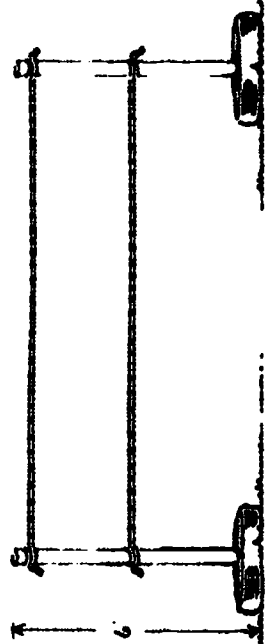

Fig. 1



SPOT TRAINERS

USE

Spot trainers can be used in tumbling activities for such stunts as hand springs, head springs and dive rolls. They also serve in the development of balance, jumping, vaulting and movement exploration experiences.

COST

Improvised: \$1.00 each
Retail: \$45.00 each
Man-hours: 0

CONSTRUCTION

Spot trainers are cylindrical objects, 26 inches long and 14 inches in diameter, and can be purchased at government surplus stores. They were originally used as protective packing for nose cones. They may be spray painted or used as purchased. An olive drab canvas cover is included with the purchase.

BEST COPY AVAILABLE

37

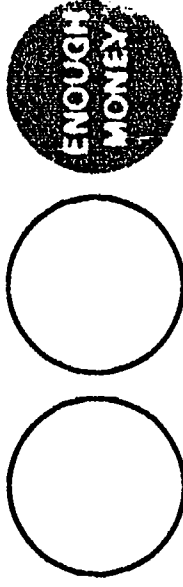

estimate of the cost of pipe you might purchase to make some of the equipment. Prices will vary depending upon your locale, the length of pipe needed and the quantity ordered at one time.

The apparatus which follow cost a great deal when purchased commercially. However, most of it can be made from used pipe obtained cheaply from other structures no longer in use. Such equipment may be made locally at little or no charge by enlisting the cooperation of craftsmen, vocational-technical students, farmers with welding equipment and school industrial arts classes. All metal apparatus should be set in concrete at a depth of two to four feet, allowing for an above the ground height of four to 15 feet. A metal plate on the bottom and/or metal rods through the lower part of the metal post will aid in the installation balance and assure a more secure emplacement.

Resilient material must be kept under the apparatus, such as sawdust, wood shavings, scrap rubber from tire manufacturers or scrap foam from foam or carpet padding manufacturers. The metal should be primed and painted in attractive colors. White or another light color is strongly recommended for bars which will be handled often as these colors will keep unshaded apparatus cooler to the touch. All hollow ends should be filled and all edges and joints welded or filed smooth. Partially buried tires may be used to help shorter students get up on apparatus such as the parallel bars.

The following list comprises a rough

DIAMETER	COST PER FOOT
¾" plain end black pipe	\$0.14
1" plain end black pipe	.20
1¼" plain end black pipe	.25
1½" plain end black pipe	.32
2" plain end black pipe	.44
2" extra heavy black pipe	.72
3" plain end black pipe	.82
4" plain end black pipe	1.23
5" plain end black pipe	1.80

LIMITED SPACE CHALLENGE COURSE

USE

The challenge course is a great contributor to physical fitness. Overall fitness may be stressed or specific components of fitness can be emphasized.

COST

Improved: \$384.00
Retail: \$1,335.00
Man-hours: 49

CONSTRUCTION

The arrangement of equipment in this

challenge course is suitable for those with limited space. The equipment may be changed according to needs, budgets or space available.

Parallel Bars	(6)	\$ 25.00
Graduated Tires	(6)	.00
Horizontal Ladder	(8)	152.00
Balance Beams	(7)	6.00
Uni-Ladder	(8)	111.00
Rope Climb	(8)	65.00
Chinning Bars	(6)	25.00
		<u>\$384.00</u>

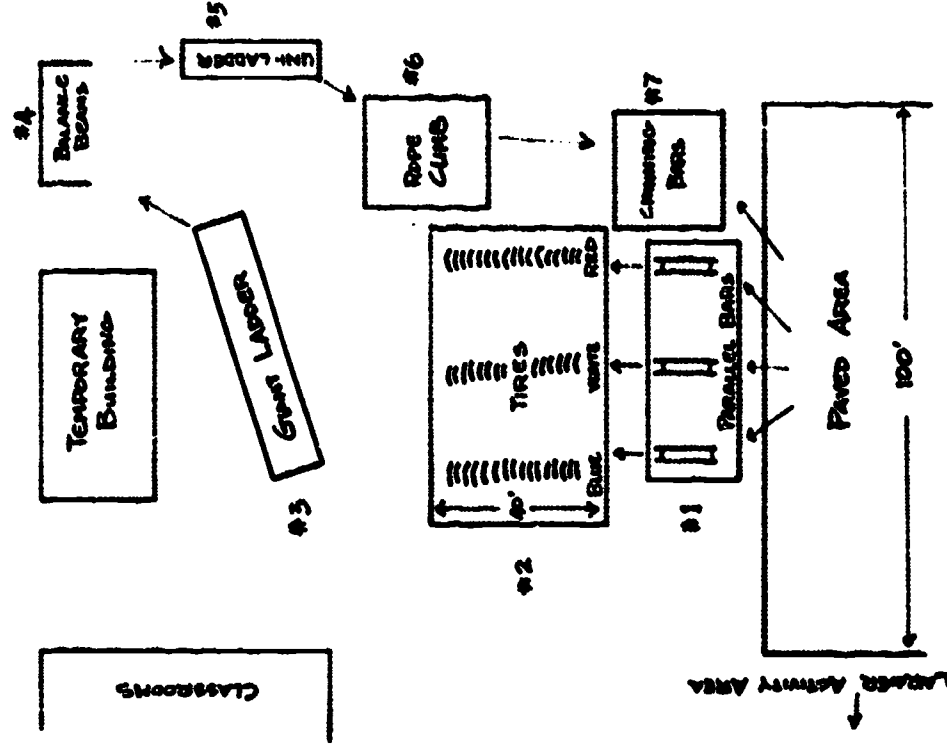

GYM JIM

USE

The Gym-Jim set offers varied experiences in climbing, balance, exploration and physical fitness.

COST

Improved: \$120.00*
Retail: \$800.00 to \$2,000.00
Man-hours: 9

CONSTRUCTION

Left Ladder

Construct the upright posts of the left ladder from two 13-foot lengths of two-inch pipe. Weld an eight-inch round steel plate to one end of each pipe. Cut a U-curve in the opposite ends of these two pipes that will allow a two-inch pipe to fit snugly within. Fit an eight-foot, 10-inch length of two-inch heavy duty pipe into the U-curves allowing a three-inch extension of pipe on each side. Weld securely Place a four-foot, six-inch length of one-inch pipe four-feet, eight inches from the opposite end of the welded crossbar and weld in place to make the first rung of the ladder. Space five more four-foot, six-inch lengths one foot, two inches apart measuring upward toward the crossbar and weld securely. (Figure 1)

*This does not include labor.

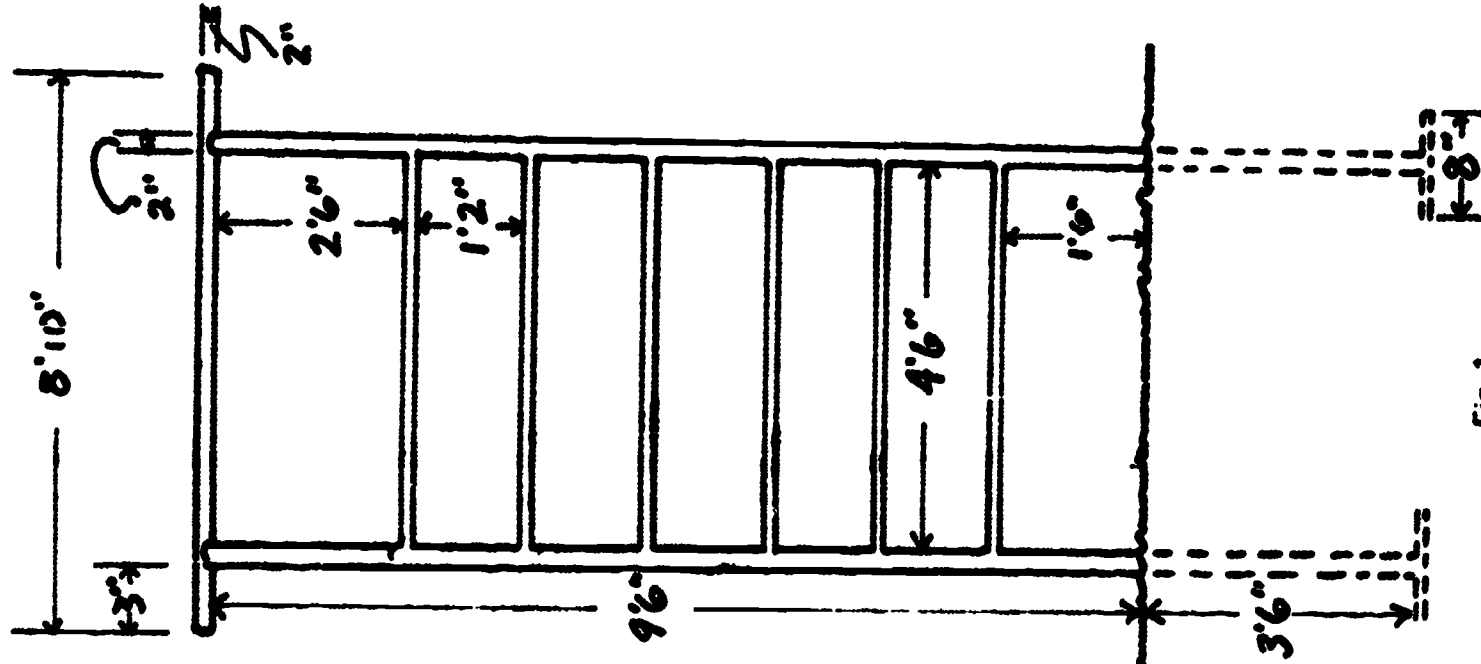
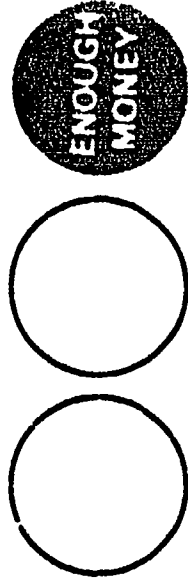

Fig. 1



Top Arch of Left Ladder

The arch is composed of six pieces of 15-inch by two-inch pipe welded together. Cut a U-curve in the ends of two of the 15-inch pieces. Fit the remaining ends of all six pieces at 18 degree angles. Fit the angles together to form a 180 degree angle. Fit the U-curves of the arch on the overhead crossbar directly above the ends of the two upright posts and weld securely. (Figure 2)

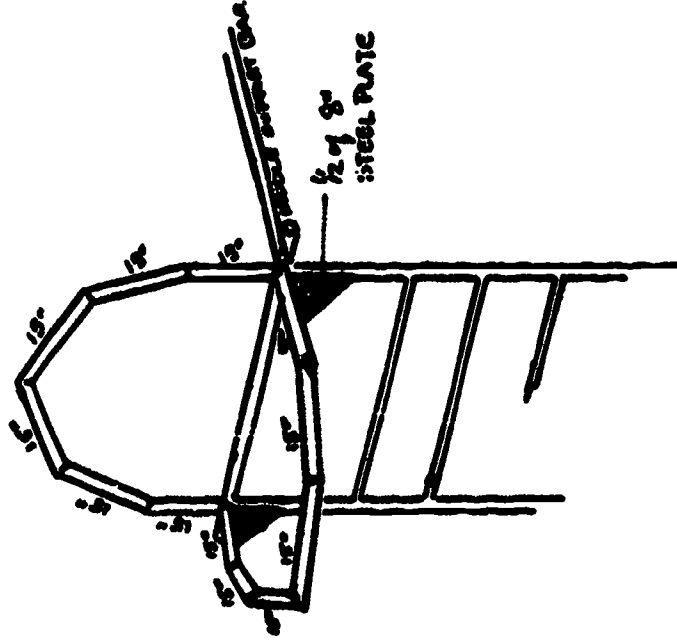
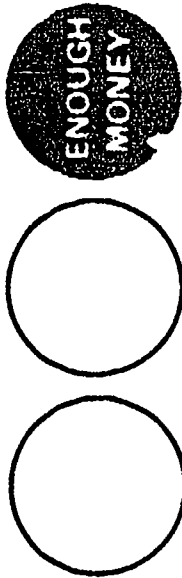

Fig. 2



Left Arch of Overhead Ladder

Construct this arch exactly like the top arch and weld in position as shown in Figure 2. Cut an eight-inch steel plate into two triangles and weld as supports under the first 15-inch extension.

Right Ladder

Repeat all directions given for left ladder.

Middle Support Bars

Cut U-curves in all four ends of two 10-foot lengths of two-inch pipe so they will weld snugly to the three-inch extensions of the crossbar. Connect the left and right ladder by fitting the U-curves of the 10-foot lengths from the end of the left and right crossbar and welding. (See illustration.)

Portable Ladders

Construct the first portable ladder from two 14-foot lengths of two and one-half inch pipe. Space the three-quarter-inch pipe rungs nine-inches apart and weld. Weld the first rung at the end of the 14-foot length. (See Figure 3.)

Construct the second portable ladder the same as the first except space the three-quarter-inch pipe rungs 11 inches apart.

These two portable ladders may be used at the ends of the apparatus or in vertical and/or horizontal arrangements in the middle of the apparatus. This makes the

apparatus easily adjustable to vary the challenge and keep the appeal high.

After installing the apparatus, place resilient materials underneath. Anchor

posts may be set in concrete about 10 to 15 feet from the sides of the apparatus if desired for the attachment of cargo nets at an angle. All four uprights should be set in concrete.

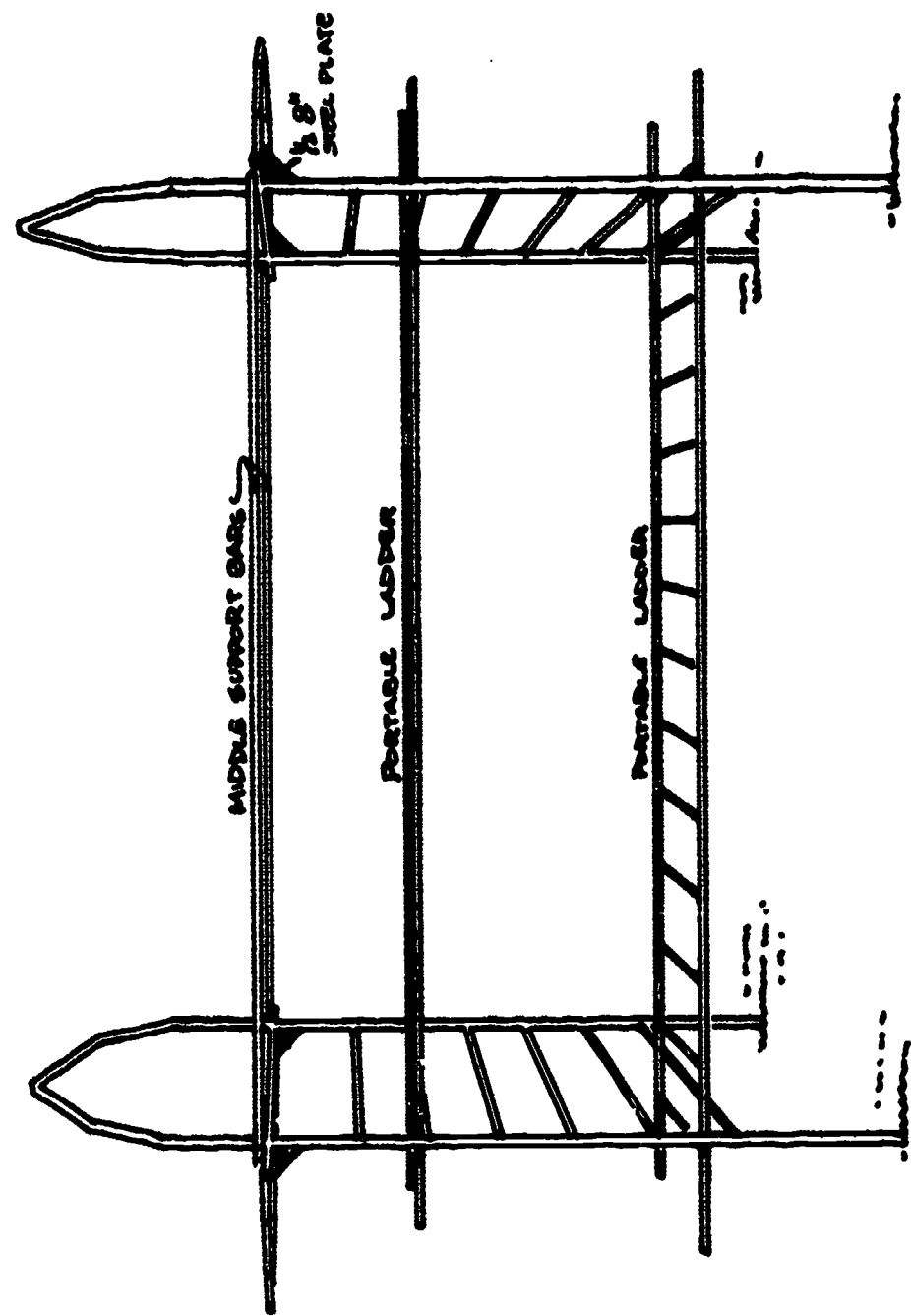

BEST COPY AVAILABLE

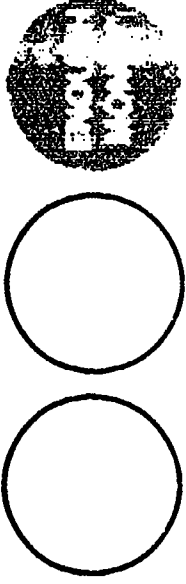

COST

Improvised: \$200.00

Elementary School play field, leaving maximum open space for other activities.

USE

The challenge course can provide interesting experiences during the physical education class while contributing in all areas of physical fitness. The obstacles on the course may be run at the beginning of the class. Concepts such as high, low, along side of and beneath may be taught as children move through the course.

CONSTRUCTION

The construction of the course includes various pieces of equipment described in this manual. The construction of these pieces will be referred to rather than repeated. The perimeter course is located around the periphery of the Irwin County

The course may be constructed in totality or specific obstacles may be used depending on available materials and/or funds. The numbers of the following explanation indicate our starting point. Groups of students may be placed at various points along the course to help eliminate long waiting lines. When the course is being utilized primarily as a "fitness-lap", students may be sent through the course as



BEST COPY AVAILABLE

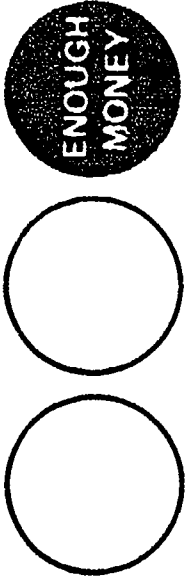

they arrive for class.

- 1 Uni-Ladder
- 2 Scaling Walls
- 3 Parallel Bars
- 4 Vertical Tire Obstacles
- 5 Rope Climb
- 6 Horizontal Tractor Tires
- 7 Chinning Bars
- 8 Board Fence

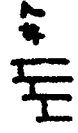
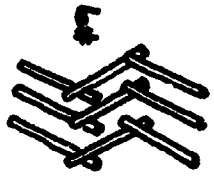

#12

PLAYING FIELD



#6



#5

#4

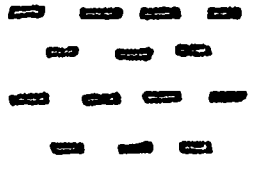

#13



#3



#2



#1

- 9 Telephone Pole Balance Beams
- 10 Telephone Pole (on ground)
- 11 Board Fence
- 12 Hills
- 13 Tire Climb
- 14 Balance Beams

Equipment may be spaced according to space available.

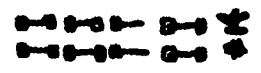
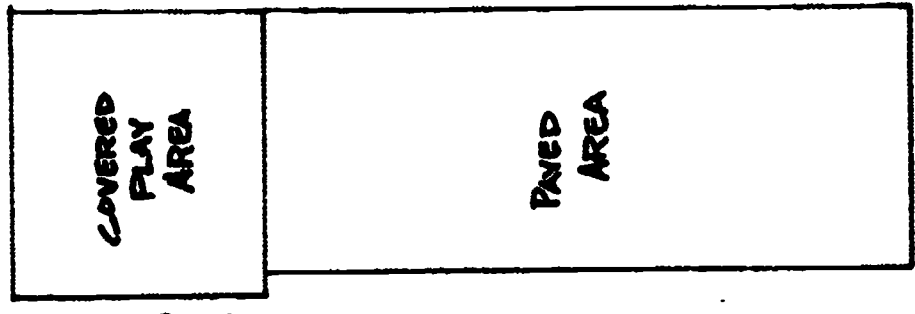

BEST COPY AVAILABLE

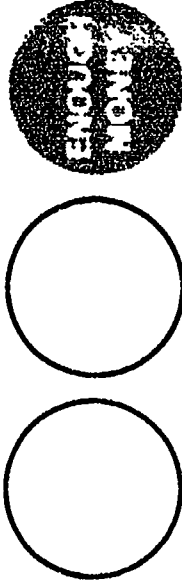

CONSTRUCTION

Construct the upright post of the chinning bars from one seven-foot length of two-inch pipe, one seven and one-half-foot length of two-inch pipe and two eight-foot lengths of two-inch pipe. Construct the crossbars from three five-foot lengths of one-inch pipe. Weld one six-inch by six-inch by one-eighth-inch twelve-gauge steel plate to each piece of two-inch pipe. Cut 45 degree angles on the unplated end of each of these pieces. Cut 45 degree angles at one end of each of the three five-foot lengths of one-inch pipe. Cut a

45 degree angle on the opposite end of one of these pieces. Cut U-curves in the uncut ends of two of these five-foot lengths. (See illustrations.) Weld the 45 degree angles of the five-foot lengths of one-inch pipe to the 45 degree angles of the upright post to form 90 degree angles. Weld the U-curve ends to the seven and one-half-foot length of two-inch pipe and the eight-foot length of two-inch pipe. Using concrete sink the upright post two and one-half feet into the ground. Resilient materials should be placed underneath the bars. Paint with attractive colors.

USE

Chinning bars are especially effective in developing shoulder girdle, arm, hand grip and abdominal strength. The horizontal bars may be also used in horizontal bar gymnastic stunts.

COST

Improved: \$25.00 per set
Retail: \$85.00 to \$200.00 per set
Man-hours: 6

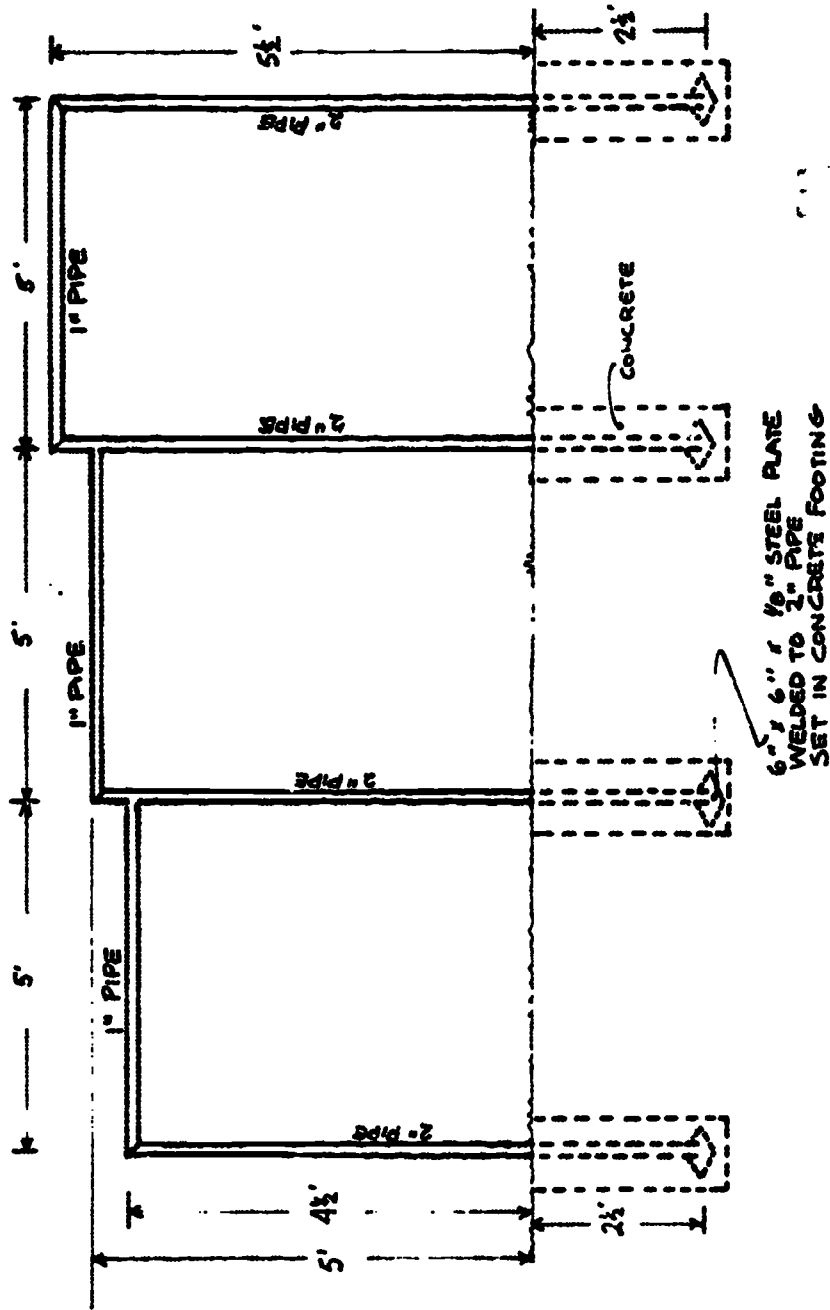

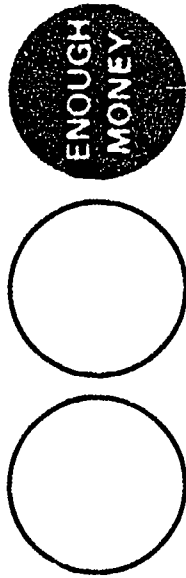

UNI LADDER*

USE

The uni-ladder is a piece of apparatus which develops arm and shoulder girdle strength along with coordination and courage.

COST

Improved: \$111.00

Retail: \$342.00

Man-hours: 8

CONSTRUCTION

Left Ladder

Construct the left ladder from two 10 and one-half-foot lengths of five-inch pipe for the posts, one 40-inch section of five-inch pipe for the crossbar and one 12-foot, six-inch piece of one-inch pipe for the rungs. Cut one end of both 10 and one-half-foot posts of five-inch pipe to 45 degree angles. Cut the 45 degree angles at both ends of the 40-inch crossbars. Weld the 45 degree angles of the 40-inch section to the 45 degree angles of the two 10 and one-half-foot lengths to form 90 degree angles at the top of the ladder. Measure four feet from the opposite end

* Suwanee Area Physical Education Project, Title III, ESEA, *Innovations in Elementary Physical Education Equipment*, 1970, Lake City, Florida.

of the cross bar and weld the first 30-inch rung. Now weld the four remaining rungs spacing them one foot apart upward toward the crossbar.

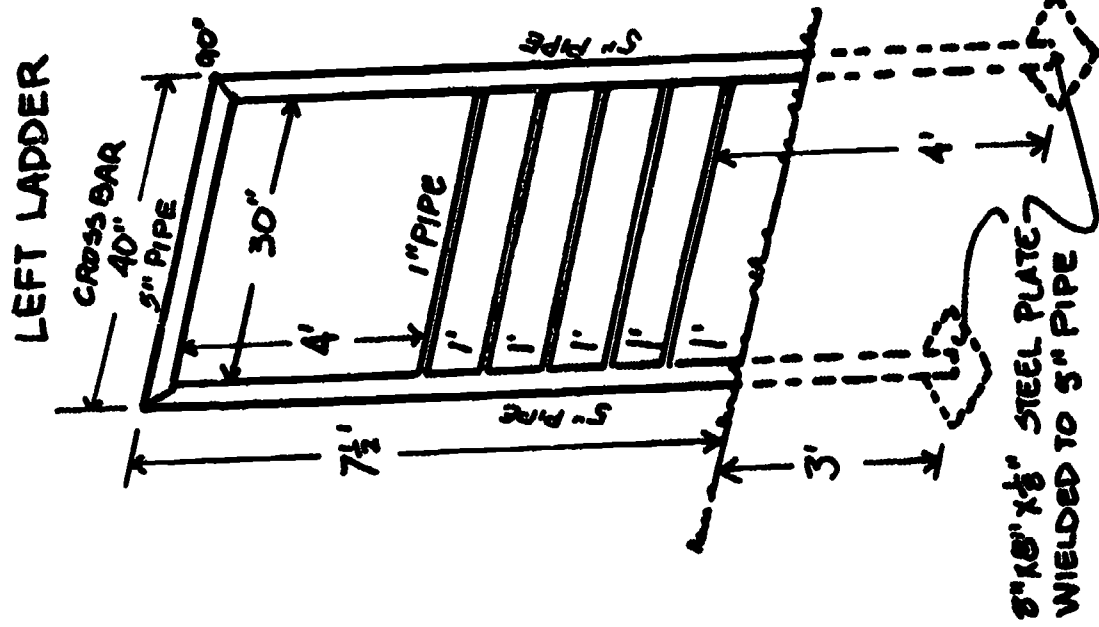

Materials for Overhead Ladder

Construct the overhead ladder from two eight-foot lengths of five-inch pipe and one eight-foot, six-inch length of one-inch pipe. Cut the eight-foot, six-inch pipe into 17 pieces of six-inch pipe for hand bars.

Left Side of Overhead Ladder

Cut the end of one of the eight-foot, six-inch pieces of pipe in a 79 degree angle. This 79 degree angle will join with the right overhead ladder to form the arch of the Uni-ladder. Cut the other end of this eight-foot, six-inch piece of pipe into a U-curve that will fit snugly around the five-inch pipe of the crossbar. Measure one foot from this U-curve end and begin welding the hand bars as illustrated in the drawing.

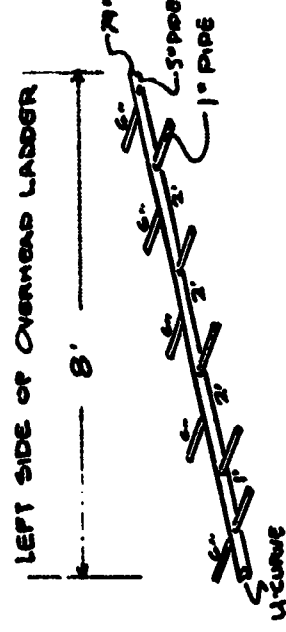

Right Side of Overhead Ladder

Construct this side of the overhead ladder exactly as you did the left side, except cut the opposite end of the 79 degree angle into a 50 degree angle.

BEST COPY AVAILABLE

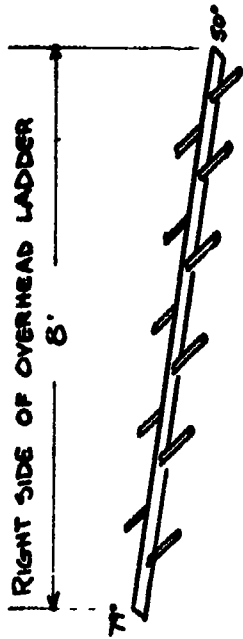

Finished Right Side

Cut one end of a 10 and one-half-foot piece of five-inch pipe to a 50 degree angle. Weld the 50 degree angle of the

right side of the overhead ladder and the 50 degree angle of this piece of pipe together to form a 100 degree angle.

Weld eight-inch by eight-inch by one-eighth-inch steel plates to the bottoms of the three 10 and one-half-foot pieces of pipe to aid in stability. At the site weld the two 79 degree angles which form the middle of the uni-ladder or arch together. Weld the last hand bar into the gap created when the two 79 degree angles

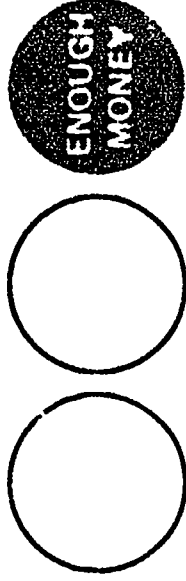

were welded. This hand bar is two feet from the closest bar.

Sink the three 10 and one-half-foot pieces of five-inch pipe into the ground three feet and cement them in place. This will give a nine and one-half-foot height at the arch of the uni-ladder.

The ground should be built up with resilient materials placed underneath for safety.

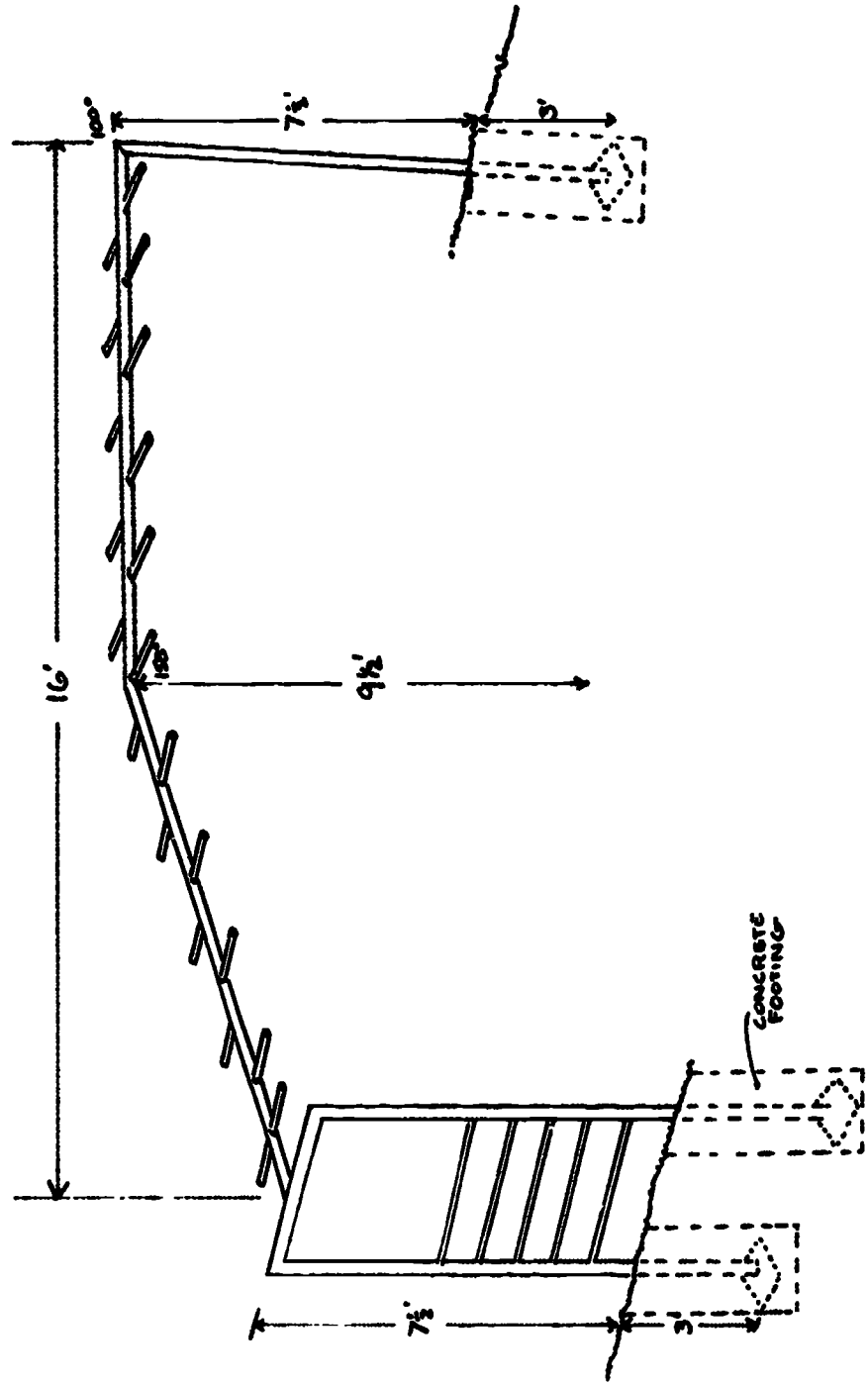

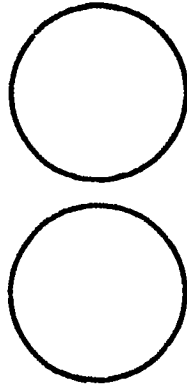

BEST COPY AVAILABLE

ROPE CLIMB*

USE

The rope climb is excellent in developing upper arm, hand and general body strength. Knotted ropes or rope ladders may be used on this apparatus until children can achieve success on the standard rope climb.

COST

Improved: \$65.00

Retail: \$150.00

Man-hours: 8

CONSTRUCTION

Notch and spot weld four lengths of three-quarter-inch pipe into a six-foot by six-foot square frame. From each of the four corners of the frame, spot weld diagonal sections of one and one-half-inch pipe. Insert a 21-foot piece of five-inch pipe as seen in illustration and spot weld these diagonal sections of one and one-half-inch pipe one foot below the inserted end. Weld four one-half-inch H.R. round steel bars from each corner of the six-foot by six-foot square frame to the top of the 21-foot piece of five-inch pipe. Weld all

spots securely. Weld eight hooks of three-quarter-inch C.F. round steel bar equally along the diagonal crossarms for attaching ropes. Weld these hooks with a four inch opening from 15-inch lengths of steel.

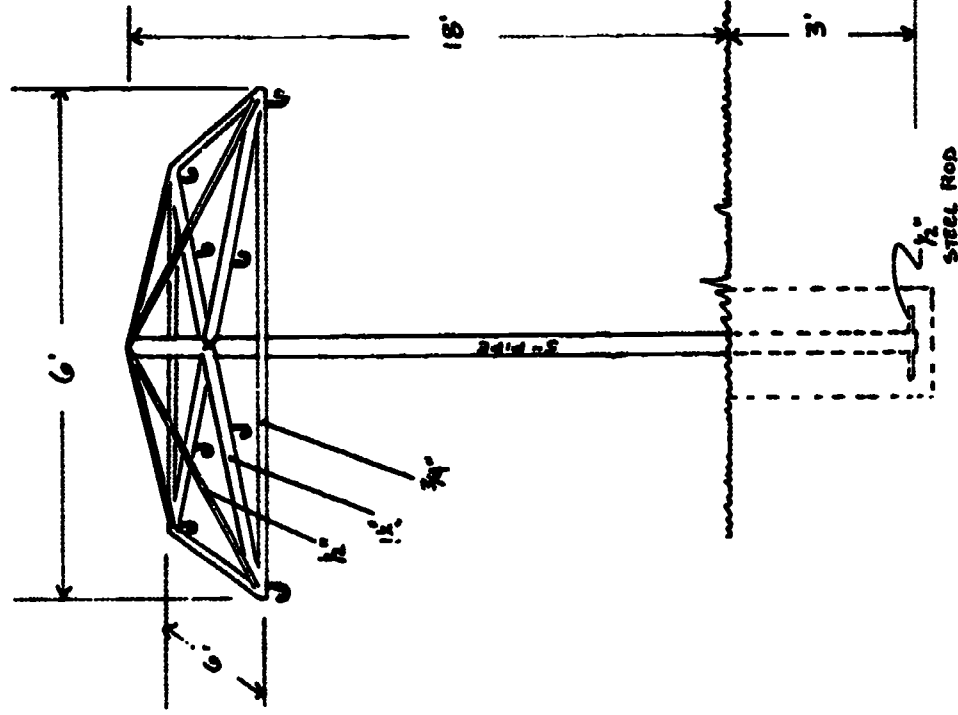

*Suwannee Area Physical Education Project, Title III, ESEA, *Innovations In Elementary Physical Education Equipment*, 1970, Lake City, Florida.

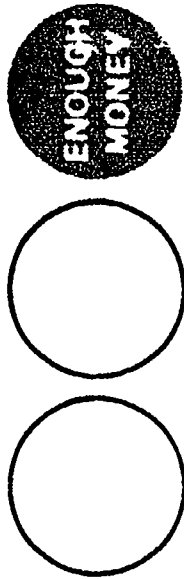

GIANT LADDER*

COST

Improved: \$152.00
Retail: \$458.00
Man-hours: 8

USE

The giant ladder is an excellent piece of apparatus to aid children in developing arm, leg and shoulder girdle strength.

CONSTRUCTION

Left Ladder

Construct the left ladder from two 12-foot lengths of two-inch pipe and five pieces of one-inch pipe 44 inches long.

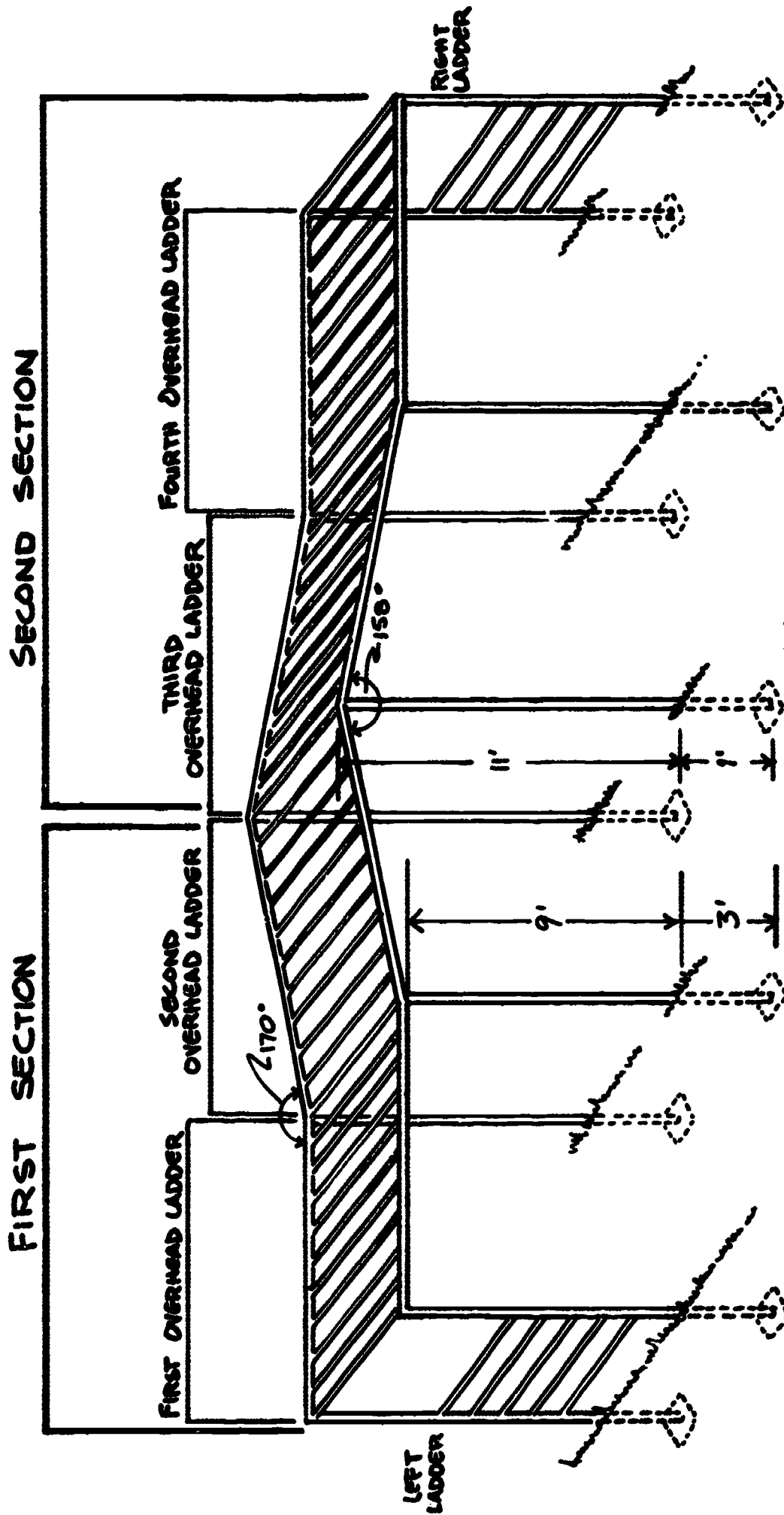

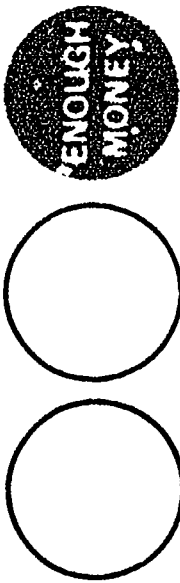

Weld six-inch by six-inch steel plates on the bottom of each 12-foot length. Cut the two ends of this 12-foot pipe opposite these plates in 90 degree angles. Measure four feet upward from the welded plates toward the 90 degree angle and weld the first one-inch by 44 inch rung. Measure upward one foot from the first rung toward the 90 degree angle and weld the second rung in place. Space and weld the remaining three rungs the same way. (See Figure 2.)

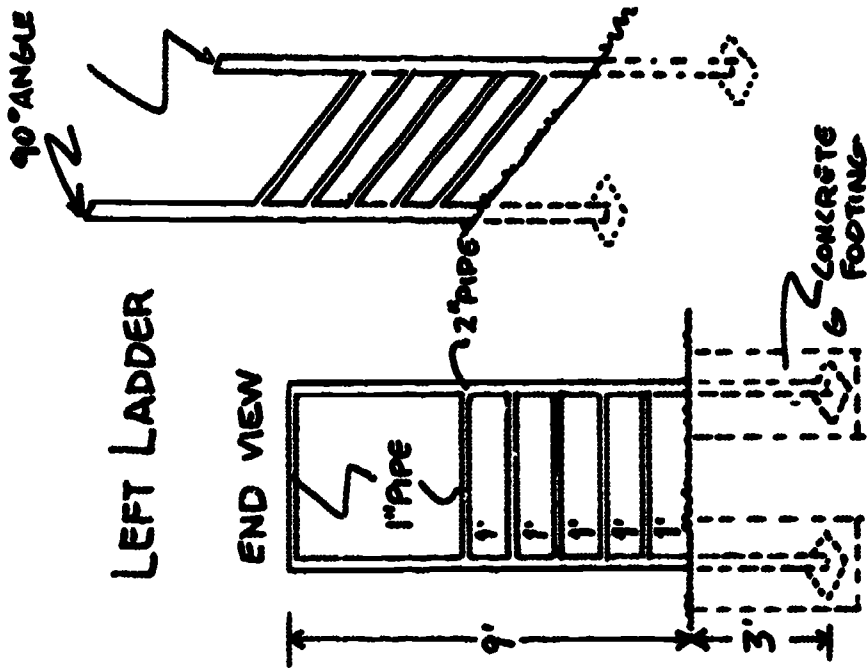

Fig. 2

First Overhead Ladder

Construct the first overhead ladder from two 10-foot pieces of two-inch pipe, two 12-foot lengths of two-inch pipe and 11 44-inch pieces of one-inch pipe. Weld a six-inch by six-inch steel plate to one end of each of the 12-foot lengths of two-inch pipe. Lay the two 10-foot pieces of two-inch pipe parallel to each other and weld nine of the 44-inch pieces of one-inch pipe to the inside of these pipes starting one foot from one end and spacing them one foot apart. (See Figure 3.) Cut 90 degree and 85 degree angles at the end of the ladder. (See Figure 3.)

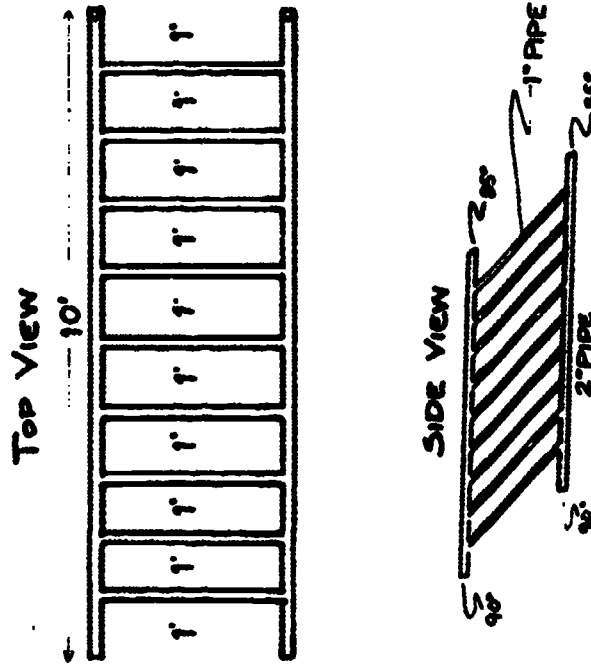

Fig. 3

overhead ladder. Cut left ends of the 10-foot pieces into 85 degree angles and the right ends into 79 degree angles. (See Figure 4.)

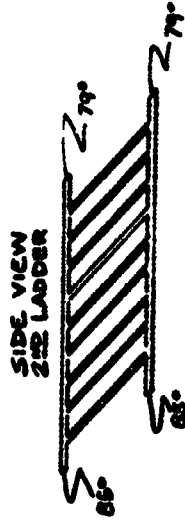

Fig. 4

First Section

Weld the 85 degree angles of the first overhead ladder to the 85 degree angles of the second overhead ladder to form a 170 degree angle. Weld the 90 degree angles of the overhead ladder to the 90 degree angles of the left ladder to form 180 degree angles (See Figure 5.)

Weld a six-inch by six-inch steel plate to one end of a 12-foot by two-inch length of pipe. Repeat this with a second piece of 12-foot by two-inch pipe. Cut a U-curve in both pieces of 12-foot by two-inch pipe on the free end. Fit the 170 degree angles into the U-curve and weld securely. Weld a 44-inch piece of one-inch pipe in the gap at the top of the left ladder and one in the gap where the 170 degree angles are welded. (See Figure 6.)

Second Overhead Ladder

Using the directions above build a second

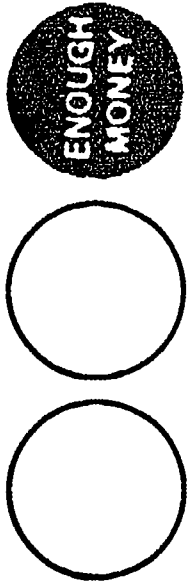

Second Section - Right Ladder

Repeat instructions given for left ladder.

Third and Fourth Overhead Ladder

Repeat instructions for first and second overhead ladder.

Middle Arch

Construct this arch from two 14-foot lengths of two-inch pipe. Weld the 79 degree angles of the first and second section together to form the 158 degree angles of the middle arch. Weld a 44-inch piece of one-inch pipe in the gap formed where the angles are welded and at the top of the right ladder. Sink plates of the ladder three-foot into the ground and cement for stability. Place resilient materials under the ladder for protection.

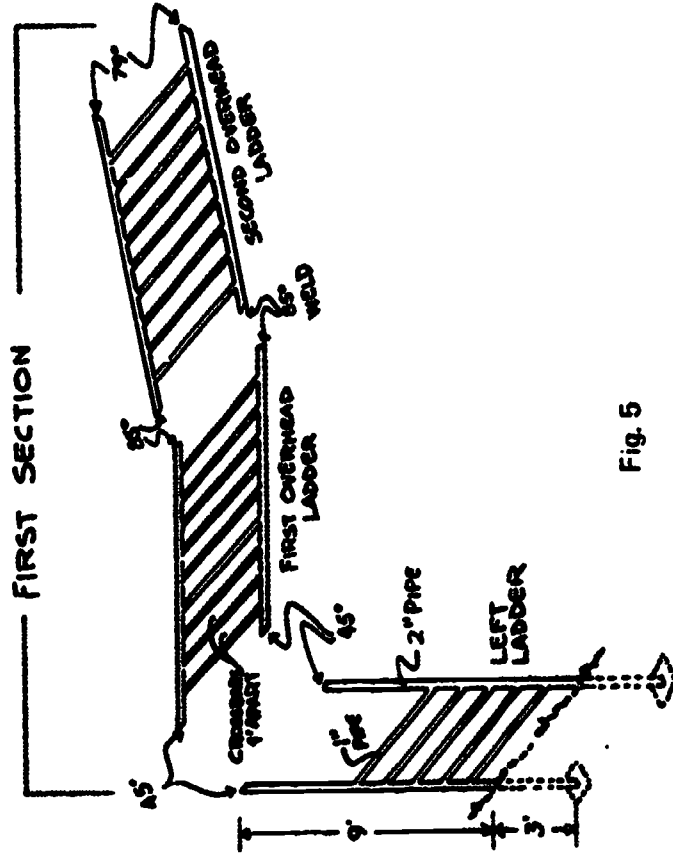

Fig. 5

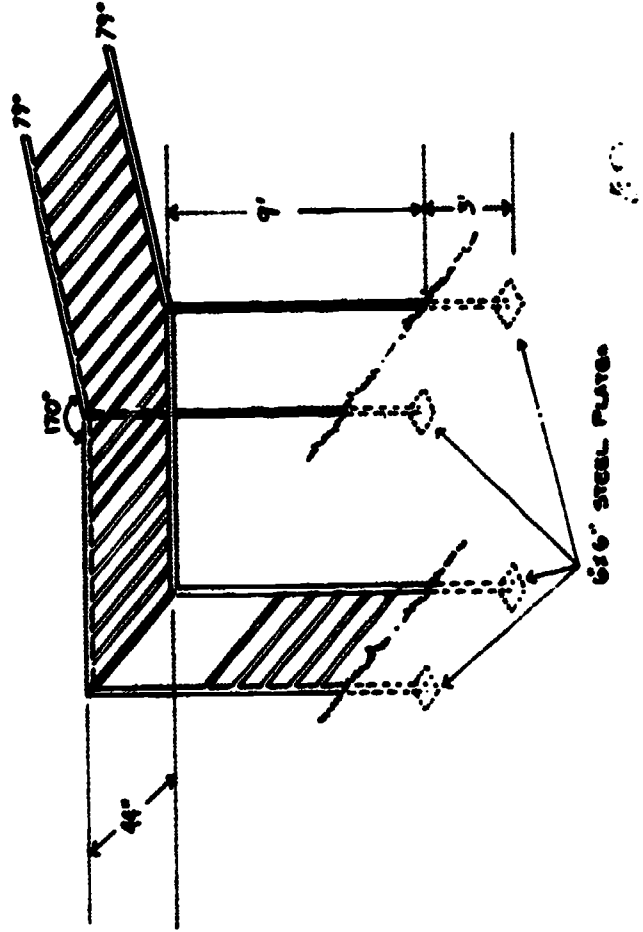

Fig. 6

PARALLEL BARS

USE

Parallel bars contribute to the development of arm, shoulder girdle and abdominal strength.

COST

Improvised: \$25.00
Retail: \$75.00 to \$150.00
Man-hours: 6

CONSTRUCTION

Construct the four upright posts from 10 and one-half-foot by two-inch pipe. Cut one end of each 10 and one-half-foot post into a U-curve. This curve will be welded to a one and one-fourth-inch pipe. Weld six-inch by six-inch steel plates to the bottom of each 10 and one-half-foot post. Construct the crossbars from two 10-foot by one and one-fourth-inch pipes. Fit crossbars into U-curve of 10 and one-half-foot pipes and weld so there is a one and one-half-foot extension on each end. Space the bars at an inside width of 16 to 20 inches depending on ages of children. Sink four upright posts into ground three feet and cement for stability. If desired the bars may be placed so that they increase or decrease in width from one end to the other or they may be placed so that they slope.

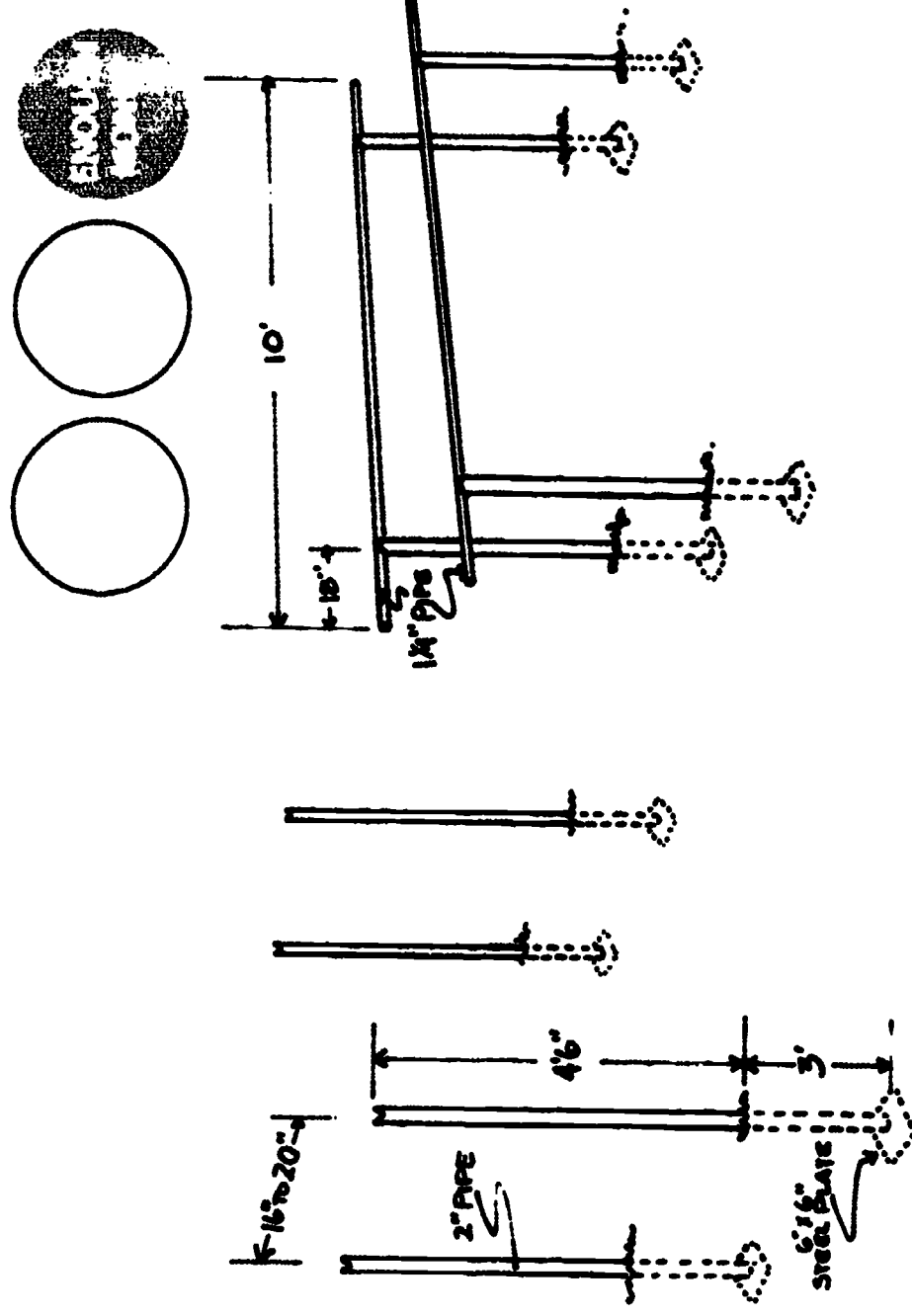

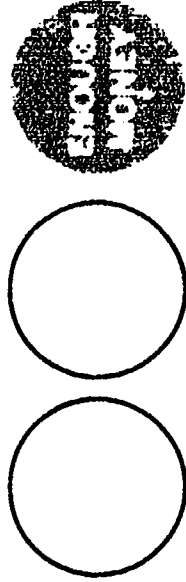

This facility can be built to provide a covered area for elementary physical education on rainy days.

The plan utilizes a basic 26-foot by 26-foot design which can be increased in length and width. Project HOPE's facility is approximately 150 feet long and 49 feet wide. Future plans call for enclosing one side to provide storage space for equipment and an office.

Labor for Project HOPE covered play area was donated by the Irwin County Young Farmer Organization. Many rural areas have this organization which could be contacted for assistance. The plan utilized was prepared by a group of teachers in District I of the Vocational Agriculture Office and is reprinted here with their permission. While the cost of construction will vary from locale to locale, the estimated cost for a 26-foot by 26-foot shelter is \$300. If labor is added, an additional \$300 should be budgeted.

BUILDING THE FARM STRUCTURE

STEP BY STEP PROCEDURE FOR BUILDING A POLE FRAME TYPE BUILDING

1. Laying out the Building – 26 feet by 26 feet.

1. Establish one of the ends of the building by locating two stakes under existing conditions such as drives, fences, trees, etc. These stakes are located 26 feet apart from outside to outside.
2. Locate the other two stakes 26 feet from outside to outside all the way around the building.
3. Check the distance diagonally across both ways; relocate the second two stakes to get square.

NOTE: The stakes should be square and not more than six inches long. This is so you can get them straight up.

4. Set up batten boards at each corner and pull a line all the way around. Then pull the line so it is in line with outside edges of two of the stakes, and put a saw mark in the boards where the line crosses. Repeat for all four sides. (Check diagonal before sawing.)
 5. Mark the place for the center poles by measuring 13 feet from the outside of one stake.
 6. Mark around each stake to determine the size of the hole to be dug. The edge of the hole must be outside the line. Where this is done the line can be moved until the holes are dug.
- Do Not Move The Batten Boards.*

7. When the holes are dug three and one half feet deep, stand the poles in the holes. Pull the line back, locating in the saw marks.
8. Set the poles straight using a level or plumb bob. Pack sand or dry dirt around the poles only half full at this time. (The rest of the filling and packing will be done after the tops of the poles are tied together by the two inch by four inch plates and the trusses.)
9. Select four two-by-fours, square one end of each. Measure 13 feet from the square end and mark all the way around, but do not saw this end.
10. Locate the lowest pole in the six around the building, measure 12 inches down from the top of this pole and drive a small nail straight in leaving three or four inches sticking out. Attach a line to this nail, and using a line level, go all the way around the building and locate 3 nail in each pole. (The higher poles may need cutting off after the trusses are attached.)
11. Take the two-by-fours that have been prepared and nail them to the poles. The square ends are joined at the center of

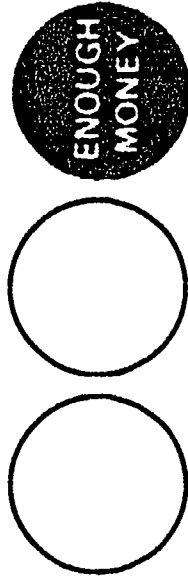

the center pole. The mark near the other end is lined up with the outer edge of the end poles. The two-by-fours are held up to the nails in the poles. Use three 20-penny stronghold nails, nail at each end.
NOTE: When the poles have been set and packed half full, the batten boards may be removed.

11. Procedures for Constructing a Truss for a Pole Frame Type Building

1. Square the two-by-tens to 16 feet.
2. Check each two-by-ten and decide which end should go to the top and which edge should be up. (In rough lumber sometimes one end will be a little wider than the other. The bottom ends should be as near the same width as possible. The best square edge should be up so that purlin can be nailed to it. *Bow should always be up.*)
3. When the top edge has been selected, put saw mark as follows. (1) At the top end, put a mark one inch from the end. (2) Put another mark 10 inches down from the one inch mark. (3) Go to the bottom end and put a mark one and one-half

inches from the end. (4) Starting at the one and one-half-inch mark — put a mark at 16-inch intervals, except the last one will be 17 inches. (5) When the marks have been made on the top edge, go to the bottom end — turn the bottom edge up and place a saw mark two feet from the end. (6) When one two-by-ten has been marked, use it for a pattern to mark the others.

4. To assemble, set three saw horses in a triangle with two of the two-by-tens on them with the top ends on the center one. (Be sure the top edges are on the outside with one person keeping the one inch marks lined up. Two other people, one at each saw horse, measure with a tape from one two-foot mark on the bottom side of one two-by-ten to the two-foot mark on the other two-by-ten. This measurement should be 26 feet.)

- 5 (If this truss is to be used in the middle, it can be nailed together in this position; or if it is to be used at the end, it can be marked for sawing by marking from the one-inch mark to where the bottom edges bisect. Then cut along these lines and fit the two two-by-tens back

together.)

6. With the two by tens in the position first described, lay a one-inch by six-inch by 12-foot board across, checking to make sure the ends are the same distance from the top and do not stick over the top edge of the two-by-ten. Using 20-penny stronghold nails, nail the lapped two-by-tens together, five nails each side. Now nail the ends of the one-by-six (five nails driven half-way). Then lay a 16-foot one-by-six below that. (Check to get it straight with the one above.) Nail it the same way. Turn the truss over and nail a 12-foot one-by-six and a 16-foot one-by-six to match the two on the other side. Take a piece of two-by-four and fit it between the one-by-sixes and to where the two-by-tens join. Square in place and nail. Cut off at bottom edge of one-by-six. Turn the truss back over, nail the two-by-four from the other side. Finish driving the other nails.
7. If the two-by-tens were cut at the top as described above, assemble the same, except cut two one-by-sixes 24 inches long and nail one on each side where the two-by-tens join. Use five nails at each end of each board. (A/

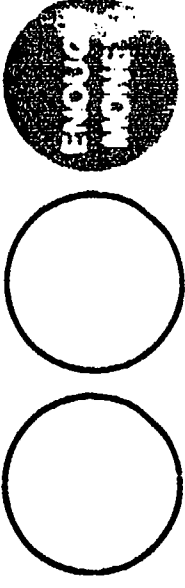

ways Keep Check On 26-foot Span With Tape.)

III. Putting Up Trusses

Using trucks with high bodies to stand on (if you have enough labor) lift the truss up and place each end on the plates. Stand the truss up by the poles. Adjust either the poles or the truss so that the saw mark which two feet from the end on the under side is at the inside edge of the two-by-four plate. Adjust one end and nail with one 60-penny nail, then adjust the other end and nail. NOTE: Use five 60-penny nails and one one-half inch bolt in each end. Repeat until all trusses are up.

IV. Finish Filling Holes and Packing

Check each pair of poles to see if they are plumb after adding all the weight of the trusses. Also check the plumb for the other direction. If need be, use tractor to push the poles into plumb. Finish filling the holes and pack thoroughly.

V. Adding Other Plates

Using the four two-by-sixes, square one end so they may be joined at the center of the center pole. Using 20-penny stronghold nails, nail to the inside of the poles, and being held up against the two-by-tens, use four nails in each end.

VI. Attaching Purlin to the Trusses

Select four good straight two-by-

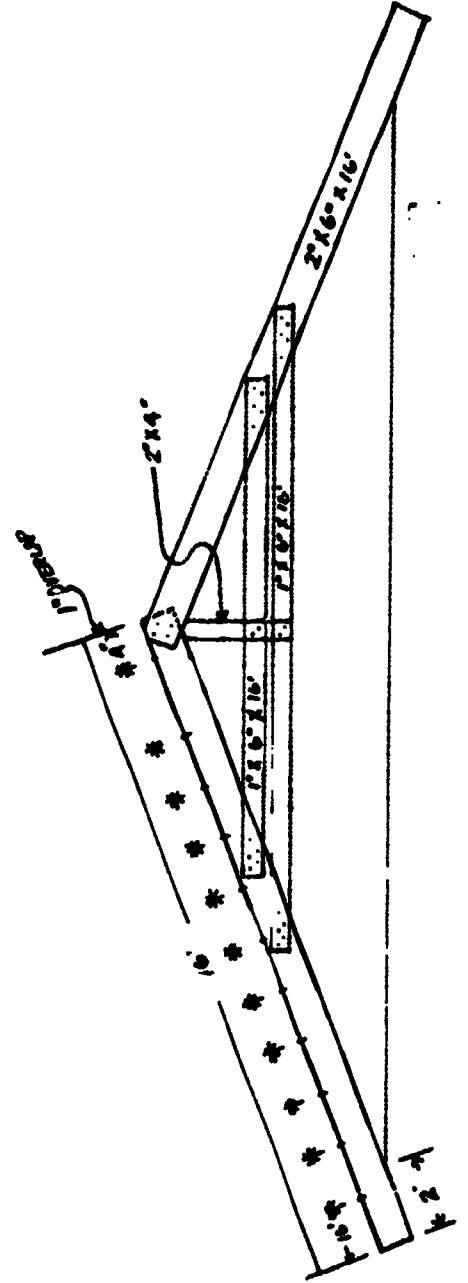
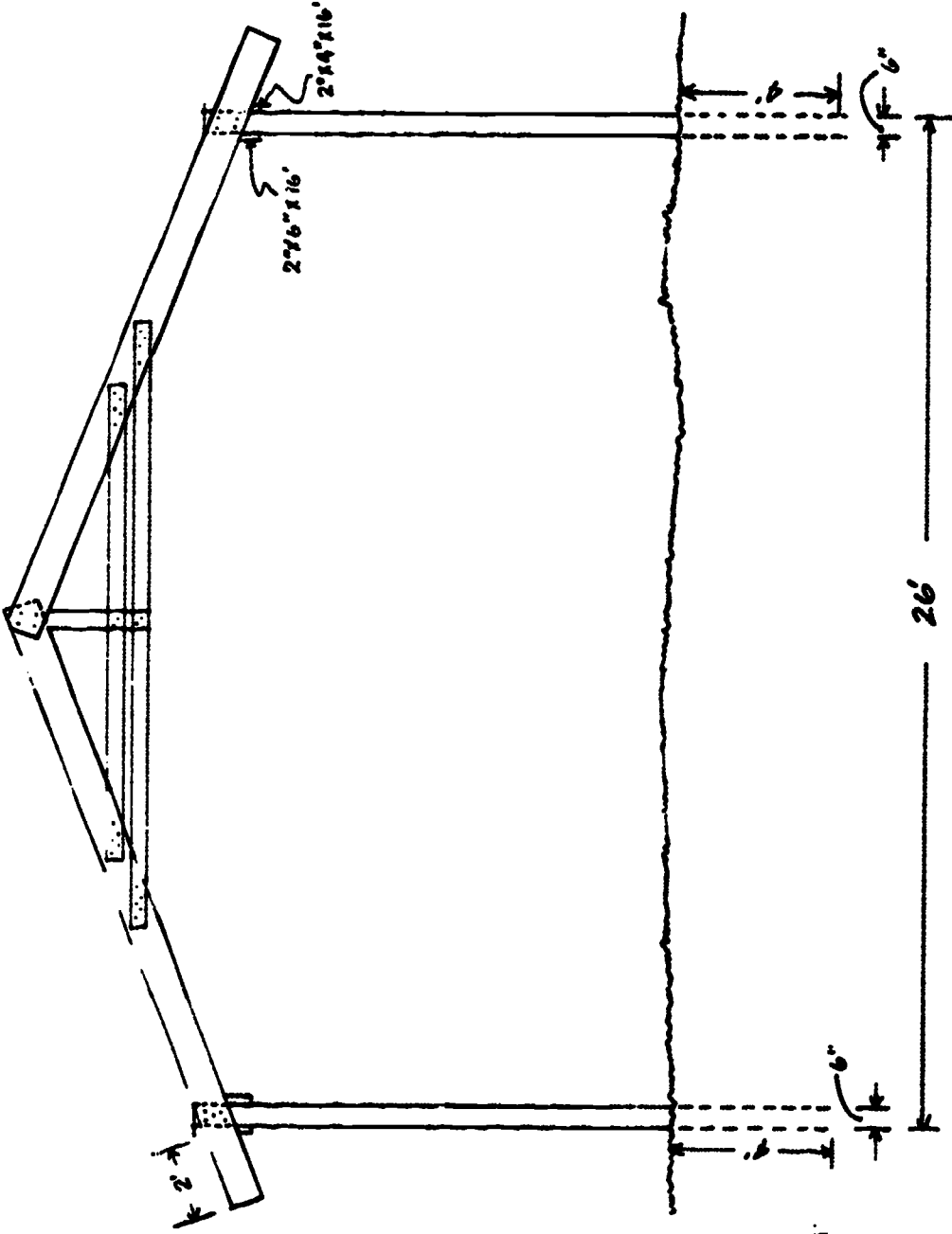

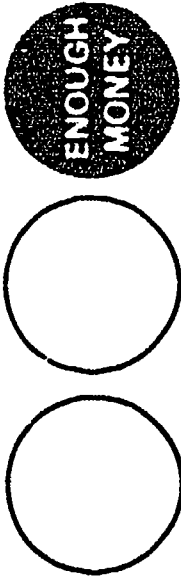

fours and square one end, using two of these two-by-fours joined in the center of the truss. Toe-nail (20-penny nails) one nail from each side with the two-by-fours above the one and one-half inch marks on the top edges of the trusses. Where the two-by-fours join, use a two-by-four block 20 inches to 24 inches long to splice this joint. This should be nailed above the purlin. Toe-nail with one nail and one nail driven straight through each end. When you get up to it, the top purlin is attached the same way except it is attached *below* the 10-inch marks near the top of the trusses.

All other purlins are attached alike. The purlin on one bay is nailed *below* the marks and the purlin in the next bay is *above* the marks. Allow enough of the purlins to stick over each end so that a 24-inch overhang may be left when they are cut off for fascia board. The rest will lap in the middle. NOTE: Toe-nail on each side with one 20-penny nail at the lap, one nail through each end.

VII. Braces

Using one-by-sixes, 16 feet long, nail one diagonally (in each bay, on the under side of the purlins, one nail in each purlin. Make sure the corners are braced against the two-

by-ten trusses. Nail another diagonally across in the other direction in each bay. NOTE: All nails in this building are stronghold.

VIII. Cutting Ends of Purlin for Facia Boards

Working on the end of the barn that is to be the front, all purlins should be squared and cut to 23 inches in length. To do this *measure* from the *outer edge* of the truss on the bottom purlin on one side of the building and mark. Drive a nail in the top of the purlin and in the mark. Attach a cord to the nail and carry the other end over the top of all purlins. Measure out 23 inches on the bottom purlin on the other side and mark. Drive a nail in the mark here. NOTE: Do not measure all purlins from the truss. The truss may not be straight up.

After the two bottom purlins are marked, draw the line tight and get it straight across the building. This may be done by attaching a plum bob on a short line to one of the nails and lining up the line with the plum line across the building. Each purlin should be squared by the line, then cut. NOTE: Do not mark and cut purlins on the other end of the building until all roofing has been attached except the last pieces.

IX. Facia Boards

Select two of the one-by-four 16-foot pieces and mark one end of the board using seven inches on the tongue and 24 inches on the blade of the square. Cut along this line. Measure from the longest point, mark and cut 16 feet long. This end is squared.

Attach these two fascia boards to the sawed ends of the purlins. Using two 20-penny nails in each purlin, start at the top purlin and nail as you move down so that fascia board may be kept level with top of purlins.

X. Attaching Line at Ends of Trusses

for Checking Overhang of Roofing
Using two pieces of two foot long one-by-fours squared on one end, place a mark four inches from the square end. Drive a nail into the square end leaving enough of the nail to attach a line. Nail these two pieces, one at each end of the building, to the bottom side of the two lower purlins with the four inch mark at the lower edge of the first purlin. Attach a line to the two nails. This line should be pulled tight because the lower edge of the roofing will be aligned with it.

XI. Attaching Roofing

When attaching roofing, it is a good plan to begin so that you can attach

the roofing from your left to right.

The eight-foot pieces of roofing are used at the top of the roof and the 10-foot pieces at the bottom. Place both the eight-foot and 10-foot pieces of roofing on the purlins with the narrow V-shaped groove to your left and the wide V-shaped groove to your right. Align both pieces of roofing so that the bottom edge will be even with line. You should have about one to two inches over the edge to bend down over the fascia board. You should have not less than nine inches of lap of the two pieces. The bottom edge of the eight-foot piece of roofing should be lapped so that the end can be nailed to a purlin. When aligning these two pieces, the center crimp should be kept straight. When all this is accomplished, nail in the top of the center crimp to each purlin from top to bottom. After the second run of tin is put on and nailed in place, then the outer edge may be nailed. (Do not nail before at least the second run is nailed.) Bend the two-inch overhang down over the fascia board, flatten down and nail, every six to eight inches, into the fascia board.

When attaching succeeding pieces of roofing, the 10-foot piece should be placed so that the narrow bottom V

will be down in the wide V of the previous piece. The upper left corner should be placed between the previous two pieces. The eight-foot piece of roofing should be placed so that it will lap over the previous pieces. When both pieces are in place, nail in the top of the left crimp and the center crimp. Nail in all purlins. Care should be taken to keep the bottom edge straight as the roofing is being put on.

To attach the roofing on the other side, attach a line as for the first side to be used for lining bottom edge of roofing. This time work from right to left, which puts the wide bottom V to the right. The roofing is aligned and nailed the same as the roofing on the other side of the building except after the first run is attached the right edge of additional pieces will be slipped *under* the edge of the previous pieces. This is to get the narrow bottom groove down in the wide bottom groove.

When all roofing is installed except the last two pieces on each side, measure, square and cut each purlin 21 and one-half inches from the edge of the tin. This will allow for adding the fascia board, also the two to three inches to bend down over

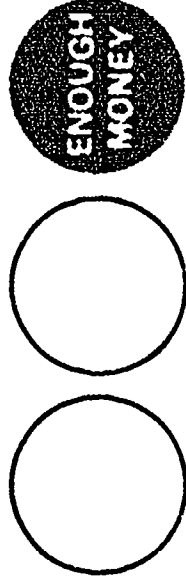

the fascia board for nailing.

The fascia boards should be cut and installed the same as for the other end.

XII. *Installing Ridge Roll*

Place the three remaining pieces of 10-foot tin and the one remaining piece of eight-foot tin on the ridge of the building. Lap the pieces one on top of the other about one foot. To install the ridge tin, there should be at least five men to do the job, one man at each end, plus at least one man at each lap. The end pieces should extend over the fascia board about three to four inches. A man on the ground sights through the ridge "gap" to see if the center V of each piece of tin is aligned with the next piece of tin and the ends of fascia to see if the bottom V of each side of the tin is lined up with the purlin that was nailed on (below) the 10 inch mark on the trusses.

Holding ridge tin down *firmly*, now nail tin on the bottom V at each lap and at each end *on* the V of the piece of tin underneath. *Do Not Nail Between the V's. Nail V On V Only.* Nails should be set so as to enter the two-by-four purlin at a 180 degree angle to the two-inch side. After all V's are nailed tap up on outer edge of tin used for ridge,

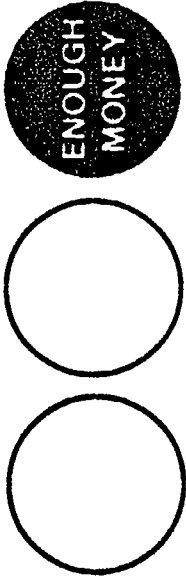

so as to completely seal out water from entering between V crimps. Now go to ends and bend over ridge and nail to fascia board.

NOTE: This building is designed *without* any knee braces. However, if any sizes of lumber /ess than those specified are used, or if *any* dressed lumber is used in this building, knee braces should be used.

BILL OF MATERIALS FOR A POLE STRUCTURE

(Use only rough green lumber.)

26 foot by 26 foot structure

- Six 6" x 14' creosoted Poles (6" -- 7" minimum)
- Six 2" x 10" x 16' boards
- Fifteen 1" x 6" x 16' boards
- Eight 1" x 6" x 12' boards
- Four 2" x 6" x 14' boards
- Sixty 2" x 4" x 16' boards
- Four 1" x 4" x 16' creosoted boards
- Thirty three pieces of 10' tin
- Thirty-one pieces of 8' tin
- Six ½" x 10" bolts
- Twelve ½" large washers

EQUIPMENT AND MATERIAL FOR THE FARMER TO FURNISH

- Two 1½-ton trucks with high bodies

- Three or four pairs of hand hole diggers
- One power digger if available
- Lumber for batten boards
- Two 20-foot ropes
- Labor for Digging holes and setting poles

- One carpenters level
- One chalk line if available
- One 100-foot extension cord

NAILS (American made)

- Three pounds 60-penny nails (Holdfast)
- Twenty-five pounds 20-penny nails (Holdfast)
- Fifteen pounds lead head nails (holdfast)
- One pound 10-penny common nails

LIST OF TOOLS AND EQUIPMENT FOR THE AGRICULTURE TEACHER TO FURNISH FOR BUILDING POLE BARN.

- Five strong saw horses
- Two 10' or 12' step ladders
- One skill saw
- One electric drill with 5/8" or 1/2" ship auger bit
- Eight hammers
- Two hand saws
- One chain saw or bow saw
- Two framing squares
- Two wrecking bars
- One pair tin snips
- Hatchet or axe
- Two six-foot rules
- Two adjustable end wrenches -- 10" or 12"
- One brace with bits

