

DOCUMENT RESUME

ED 098 404

CE 002 509

**AUTHOR** O'Brien, Ralph D.  
**TITLE** Fuel System: Automotive Mechanics Instructional Program. Block 4.  
**INSTITUTION** Kentucky Univ., Lexington. Vocational Education Curriculum Development Center.  
**SPONS AGENCY** Kentucky State Dept. of Education, Frankfort. Bureau of Vocational Education.  
**PUB DATE** 73  
**NOTE** 140p.; For other curriculum guides in the series, see CE 002 506-511  
**AVAILABLE FROM** Curriculum Development Center, Room 151, Taylor Education Building, University of Kentucky, Lexington, Kentucky 40506 (Single copies only, \$4.00)

**EDRS PRICE** MF-\$0.75 HC-\$6.60 PLUS POSTAGE  
**DESCRIPTORS** \*Auto Mechanics; Auto Mechanics (Occupation); Behavioral Objectives; Course Content; Course Descriptions; \*Curriculum Guides; Engines; Exhausting; \*Fuels; Industrial Arts; Instructional Materials; Job Skills; Mechanics (Process); \*Motor Vehicles; Post Secondary Education; Resource Materials; Secondary Education; Skilled Occupations; \*Trade and Industrial Education; Vocational Education  
**IDENTIFIERS** Kentucky

**ABSTRACT**

The fourth of six instructional blocks in automotive mechanics, the lessons and supportive information in the document provide a guide for teachers in planning an instructional program in automotive fuel systems at the secondary and post secondary level. The material, as organized, is a suggested sequence of instruction within each block. Each lesson is stated in terms of a specific teaching objective, teaching aids, references, and an outline of information. Upon completion of the 58 lessons in this block of work, students will be able to: (1) describe the processes of producing and adapting gasoline as a modern automotive fuel and relate the technology required for its efficient utilization, (2) identify the major components of typical automotive fuel systems and exhaust systems, (3) relate the functional significance of the components to the operation of the total system, (4) analyze the condition and performance of the components to determine their functional effect within standardized specifications and legal requirements, and (5) correct diagnosed malfunctions by proper adjustment and necessary repair and replacements. Included with the course outline are transparency masters and a reference guide listing related books, texts, and other publications. (HW)

ED 098404

# **AUTOMOTIVE MECHANICS INSTRUCTIONAL PROGRAM**

## **BLOCK IV Fuel System**

PREPARED FOR

**Kentucky Industrial Education Teachers**

IN COOPERATION WITH

**Bureau of Vocational Education  
State Department of Education  
Frankfort, Kentucky**

**Ralph D. O'Brien, Curriculum Specialist  
Curriculum Development Center  
151 Taylor Education Building  
University of Kentucky  
Lexington, Kentucky**

U.S. DEPARTMENT OF HEALTH,  
EDUCATION & WELFARE  
NATIONAL INSTITUTE OF  
EDUCATION  
THIS DOCUMENT HAS BEEN REPRO-  
DUCED EXACTLY AS RECEIVED FROM  
THE PERSON OR ORGANIZATION ORIGIN-  
ATING IT. POINTS OF VIEW OR OPINIONS  
STATED DO NOT NECESSARILY REPRESENT  
OFFICIAL NATIONAL INSTITUTE OF  
EDUCATION POSITION OR POLICY

E002509

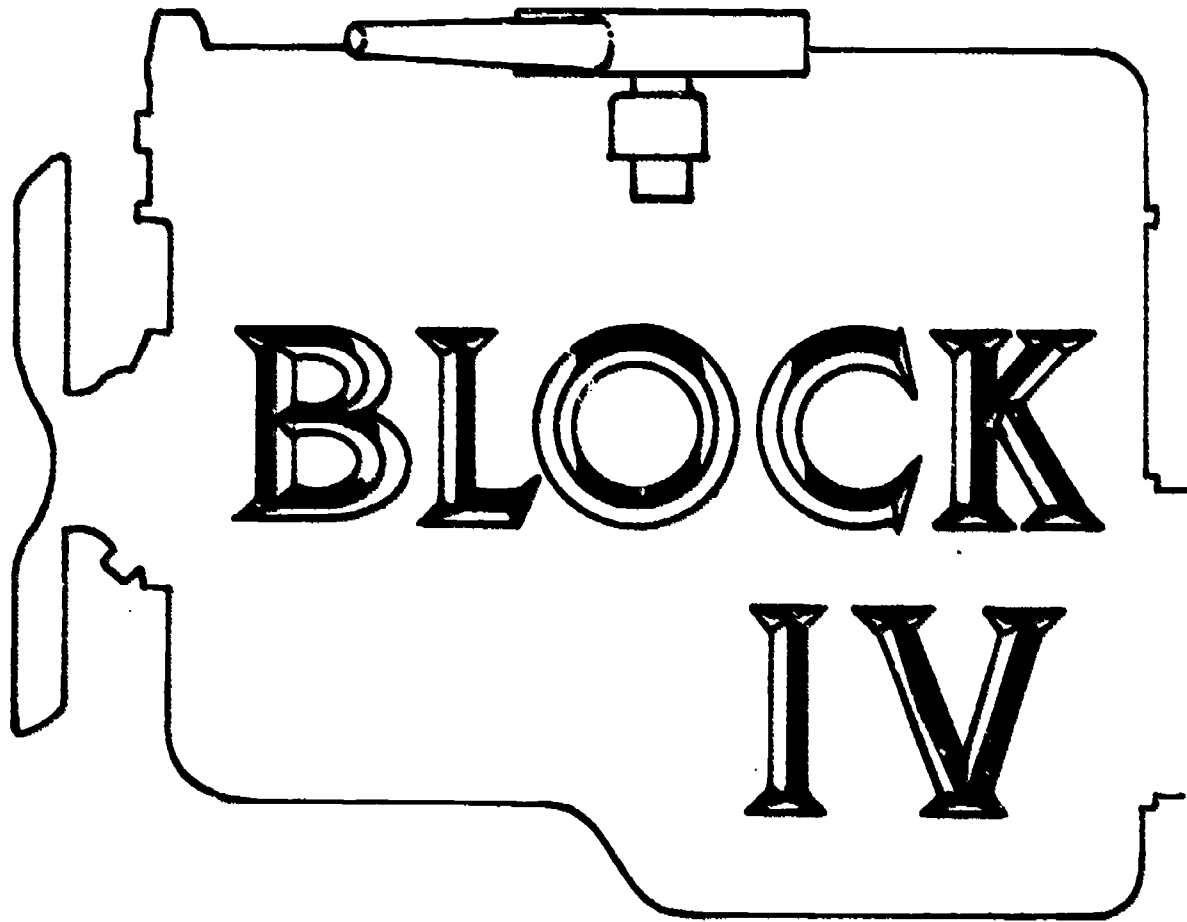

# *Fuel System*

## General Teaching Objectives

Upon completion of the fifty-eight lessons in this block of work, students will be able to:

1. Describe the processes of producing and adapting gasoline as a modern automotive fuel and relate the technology required for its efficient utilization.
2. Identify the major components of typical automotive fuel systems and exhaust systems.
3. Relate the functional significance of the components to the operation of the total system.
4. Analyze the condition and performance of the components to determine their functional effect within standardized specifications and legal requirements.
5. Correct diagnosed malfunctions by proper adjustment and necessary repair and replacements.

## CONTENTS - BLOCK IV

### FUEL SYSTEM

Gasoline as Automotive Fuel . . . . .	1
Facts About Fuel and Combustion . . . . .	3
Chrysler Transparency on Mixtures . . . . .	5
Gasoline - Air Mixtures . . . . .	6
Gasoline and Air Are Fluids . . . . .	8
Total Energy in Gasoline. . . . .	9
Proving the Necessity of Oxygen to Support Combustion . . . . .	10
Demonstrating the Fuel-Vapor Igniting Unit. . . . .	11
Constructing a Vapor Igniting Demonstration Unit. . . . .	13
Constructing the Fuel-Vapor Igniting Unit . . . . .	14
Function and Components of the Fuel System. . . . .	15
Gasoline Fuel System. . . . .	16
Fuel Tank Design and Construction . . . . .	17
Gasoline Tank . . . . .	18
Removing and Replacing a Fuel Tank. . . . .	19
Fuel Gauges . . . . .	20
Fuel Gauge (Thermostatic) . . . . .	21
Fuel Gauge (AC) . . . . .	22
Fuel Gauge (Balancing Coil) . . . . .	23
Testing a Fuel Tank and Dash Gauge Units. . . . .	24
Replacing a Fuel Tank Gauge . . . . .	25
Fuel Filters. . . . .	26
Fuel Line and Fittings. . . . .	27
Compression Fitting - Flared Fitting. . . . .	29
Replacing Fuel Filters. . . . .	30
Installing a Compression Fitting in a Gas Line. . . . .	31
Installing a Fuel Line. . . . .	32
Flaring Copper Tubing . . . . .	34
Fuel Pump Purpose and Operation . . . . .	35
Fuel Pump . . . . .	36
Facts About the Fuel Pump . . . . .	37
Electric Fuel Pump. . . . .	38
Removing and Replacing a Fuel Pump. . . . .	39
Positions of Fuel Pumps . . . . .	40
Fuel Pump Testing Results and Indications . . . . .	41
Testing a Fuel Pump Pressure and Volume . . . . .	42
Testing Fuel Pump Vacuum. . . . .	43
Testing Vacuum Booster Pump . . . . .	44
Testing Fuel Pump Pressure and Vacuum . . . . .	45
Air Cleaners. . . . .	47
Facts About Air Cleaners. . . . .	48
Dirty Air Cleaner. . . Mixture Too Rich . . . . .	49
Servicing an Air Cleaner. . . . .	50
Principles of Carburetion . . . . .	52

Facts About Carburetors .....	53
Atmospheric Pressure, Partial Vacuum .....	55
Temperature, Speed, Load .....	56
Same Amount Through All Parts of Tube .....	57
Construction and Function of a Carburetor .....	58
Carburetors .....	59
Pump Faster, More Spray .....	60
For Starting, After Starting, Engine Warm .....	61
Removing Air Horn .....	62
Carburetor Circuits .....	63
Choke Circuit and Linkage .....	64
Float Circuit .....	65
Fuel Level High, Mixture Too Rich .....	66
Pump Delivers Constant Pressure .....	67
Adjusting Float .....	68
Float adjustments .....	69
Adjusting Float Alignment .....	70
Adjusting Float Drop .....	71
Idle Circuit .....	72
Carburetor Adjustments .....	73
Idle Port .....	74
Adjusting Idle Mixture .....	75
Idle Mixture Screw .....	76
Adjusting Curb Idle and Fuel-Air Mixture .....	77
Adjustable Air Screw, Limiter Screw .....	78
Adjusting Fast Idle .....	79
Adjusting Idle Vent .....	80
Low Speed Circuit .....	81
Idle Tube, Main Metering Jet, Metering Restriction, Idle Port .....	82
Air Bleeds .....	83
Servicing a Carburetor Low-Speed Circuit .....	84
Accelerator Circuit .....	86
Air Flow Reduces Pressure .....	87
Air Flow Increases Faster Than Fuel Flow .....	88
Adjusting Accelerator Pump Linkage .....	89
Power Circuit .....	90
Rich Mixture for More Power .....	91
Vacuum Piston .....	92
Servicing the Power Circuit .....	93
High Speed Circuit .....	94
Power Valve Open .....	95
Power Valve Closed .....	96
Lean Mixture .....	97
Servicing a Carburetor High-Speed Circuit .....	98
Servicing a Carburetor Pump Circuit .....	100
Arm Lifts Plunger .....	101
Pump Rod, Pump Nozzle, Pump Plunger .....	102
Spring Provides Sustained Flow .....	103
Automatic Choke .....	104
Vacuum Diaphragm .....	105
Automatic Choke Assembly .....	106
Automatic Choke Adjustments .....	107
Rich Mixture for Starting .....	108

Servicing a Carburetor Choke Circuit. . . . .	109
Automatic Choke Housing and Parts Identification. . . . .	110
Choke Rotates Fast-Idle Cam . . . . .	111
Replacing Automatic Choke . . . . .	112
Adjusting Choke Vacuum Break. . . . .	113
Increase Choke Opening, Decrease Choke Opening. . . . .	114
Adjusting Choke Unloader. . . . .	115
Exhaust System. . . . .	116
Exhaust System. . . . .	118
Mufflers. . . . .	119
Inspecting Exhaust System . . . . .	120
Service Techniques for Exhaust System Repairs . . . . .	121
Pneumatic Muffler Gun Kit . . . . .	123
Multi-Angle Steel Saw . . . . .	124
Pipe Cutter - Pipe Peeler . . . . .	125
Pipe Shaper - Pipe Spreader . . . . .	126
Crankcase Emissions . . . . .	127
Crankcase Ventilation Systems . . . . .	129
PCV Testing and Service . . . . .	130
Exhaust Emission Control Systems. . . . .	131
Exhaust Emission Control Systems. . . . .	132
Without Exhaust Emission Control. . . . .	133

## INFORMATION

Block: Fuel System

Block IV

Lesson: Gasoline as Automotive Fuel

Job \_\_\_\_\_

Lesson \_\_\_\_\_

---

Teaching Objective: Upon completion of this lesson, students will be able to discuss, fundamentally, the processes of obtaining, refining and adapting gasoline as a fuel for modern internal combustion engines.

Teaching Aids: Transparencies:

- Facts About Fuel and Combustion, pp. IV-3, IV-4
- Chrysler Transparency on Mixtures, p. 1V-5
- 60 Hour Gasoline Engine Test, Block II

References: Automotive Engine Design, Crouse, Chapter 10  
Related Science-Automotive Trades, Jensen, Brazier, Section IV

Outline of Information:

1. Gasoline is the most commonly used fuel in internal combustion engines.
  - a. Chemically a hydrocarbon, gasoline is a complex blending of various compounds of hydrogen and carbon.
    - Hydrogen alone will not burn, however, when mixed with air it is very volatile.
    - Carbon must be mixed with air to become combustible.
    - The heat value (BTU content) of carbon is high.
  - b. Produced from crude oil by:
    - Thermal cracking - applying heat and pressure
    - Catalytic cracking - separation via addition of a catalytic agent
    - Reforming - process which reshapes molecular structure
2. The internal combustion engine is a heat converter.
  - a. Nature has provided generous deposits of fuel from which heat energy can be obtained.
  - b. Automotive engines convert heat energy to mechanical energy.
3. Gasoline must have many characteristics or properties in order to satisfy various engine operating requirements.
  - a. Volatility
    - Ease of liquid evaporation

## Gasoline as Automotive Fuel (continued)

**Note:** The various engine operating circumstances such as easy starting, quick warm up, acceleration variances, economy, etc., requires a gasoline blended from basic fuels of many different volatility ratings.

- b. Octane Rating - antiknock qualities
  - Achieved by chemically changing the carbon structure of the fuel
  - Adding tel (tetraethyllead)
- c. Resistance to rust, icing and gum formation
  - Achieved through use of various additives



## **FACTS ABOUT FUEL AND COMBUSTION**

- 1. Fuel for an internal combustion engine is composed principally of hydrogen and carbon.**
- 2. Gasoline must be vaporized before it will burn.**
- 3. The major characteristics of gasoline are: Volatility, purity and anti-knock quality.**
- 4. The mixture ratio for engine operation must vary to meet changing engine requirements.**
- 5. Very hot weather may produce vapor lock in the fuel system.**

## **FACTS ABOUT FUEL AND COMBUSTION (CONTINUED)**

- 6. Detonation is caused by the rapidly burning flame front compressing the unburned portion of the mixture to the point of self-ignition.**
- 7. Engines are designed to operate on a fuel within a certain octane range.**
- 8. As fuel burns in the combustion chamber, pressure is increased.**
- 9. Gasoline is composed of both light and heavy fractions.**
- 10. Chemicals may be added to gasoline to raise the octane rating.**

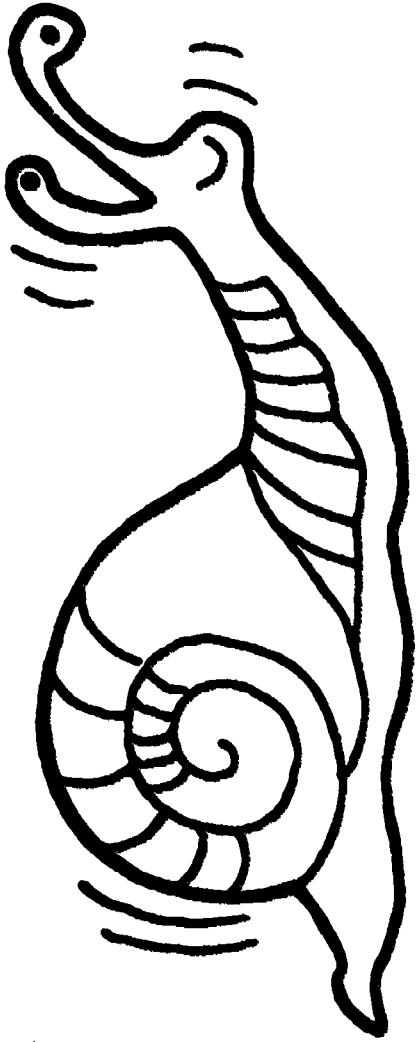

**LEAN  
MIXTURE  
REQUIRED**

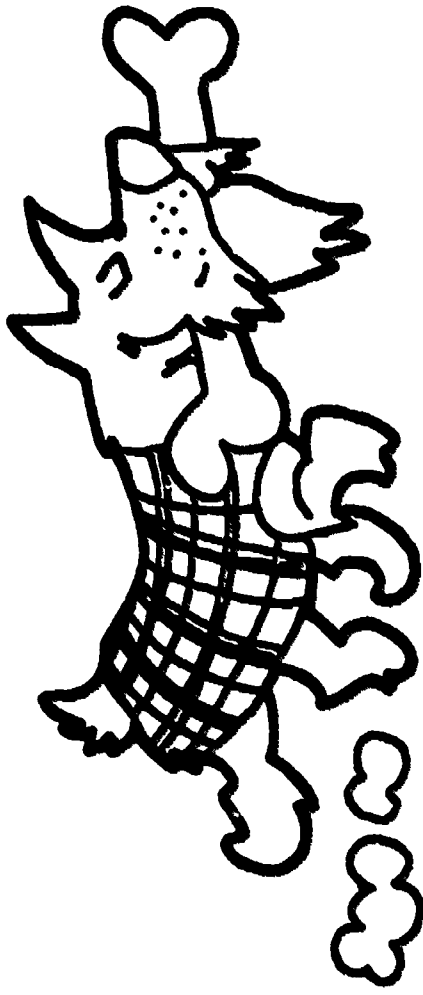

**LEANER  
MIXTURE FOR  
ECONOMY**



**RICH  
MIXTURE  
NEEDED**

## INFORMATION

Block: Fuel System

Block IV

Lesson: Gasoline - Air Mixtures

Job \_\_\_\_\_

Lesson \_\_\_\_\_

---

Teaching Objective: Upon completion of this lesson, students will be able to describe the chemical characteristics of gasoline-air mixtures and resulting exhaust gasses of commonly used internal combustion engines.

Teaching Aids: Transparencies:

- Gasoline and Air Are Fluids, p. IV-8
- Total Energy In Gasoline, p. IV-9

References: Automotive Engine Design, Crouse, Chapter 10  
Related Science-Automotive Trades, Jensen, Brazier, Section IV

### Outline of Information:

1. Air is made up of 20% oxygen, 78% nitrogen and minute portions of other gases.
2. Without air, no fuel will burn; therefore, no energy is released and no power produced.
  - a. Air-fuel ratio in modern engines is approximately 15 to 1 by weight.
  - b. Gasoline weighs 600 times as much as air at sea level.
  - c. About 9000 cubic feet of air are required to burn 1 cubic foot of gasoline.
3. During combustion most of the oxygen is consumed, however, some combines with hydrogen to form water ( $H_2O$ ), some with carbon to form carbon dioxide ( $CO_2$ ), and some with carbon to form carbon monoxide ( $CO$ ).
4. The nitrogen introduced in the combustion process remains unchanged.
5. Of the total 86 lbs. of fuel-air mixture (consisting of 1009 cubic feet of air and 1 gallon of gasoline) passing through the combustion process, 968.62 cubic feet of exhaust gas is produced.

## Gasoline-Air Mixtures (continued)

6. Without improved exhaust control devices, the chemical components and approximate percentages of automotive exhaust gas are as follows:

Nitrogen	71%
Oxygen	None
Hydrogen	1.2%
Water	9%
Carbon dioxide	16%
Carbon monoxide	3.8%

7. U. S. Federal clean air regulations require that vehicle exhaust gases contain not more than 1.5% Carbon Monoxide nor more than 275 PPM Hydrocarbon.

Note: Carbon monoxide is a colorless, odorless, tasteless, highly toxic gas. If breathed, it enters the lungs and the bloodstream and can cause headaches, dizziness, nervous system impairments, paralysis and death. It has a residual life in the bloodstream.

Caution: Always vent exhaust gases from an internal combustion engine.

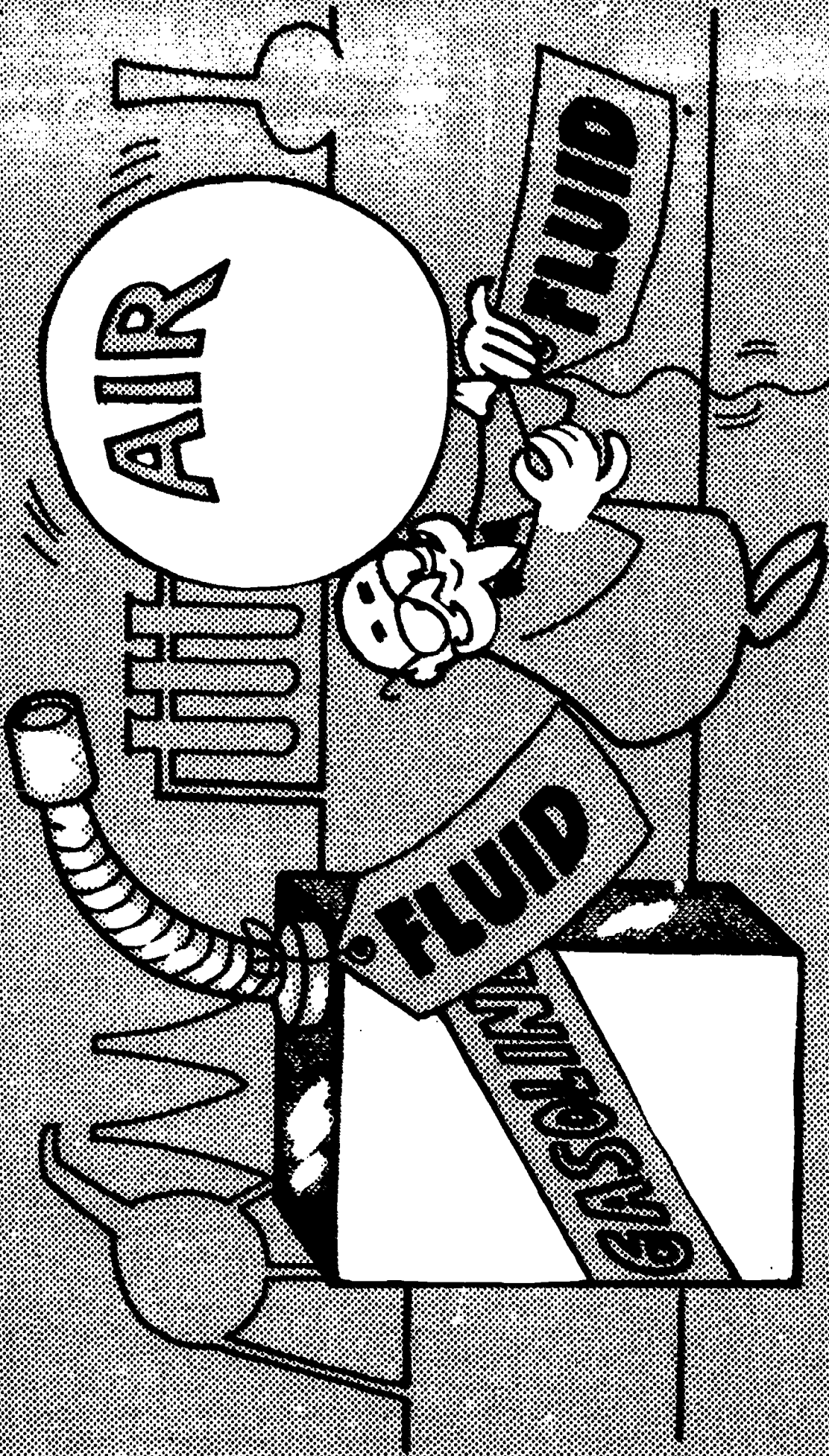

**GASOLINE AND AIR ARE FLUIDS**

Courtesy - Chrysler Corporation

# TOTAL ENERGY IN GASOLINE

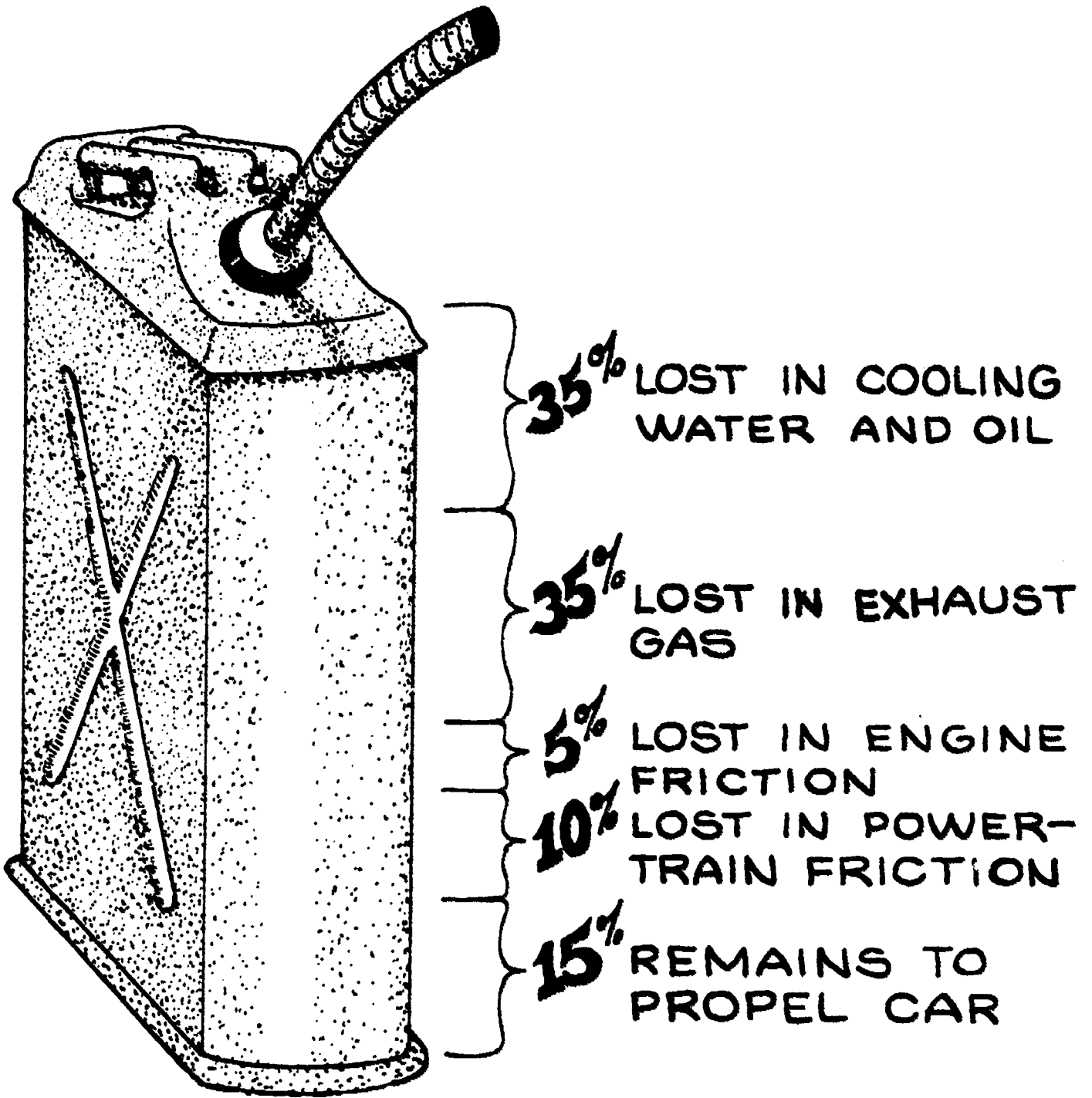

## OPERATION

Block: Fuel System

Block IV

Operation: Proving the necessity of oxygen to support combustion

Job \_\_\_\_\_  
Operation \_\_\_\_\_

---

Teaching Objective: To demonstrate that oxygen is necessary for gasoline combustion

Tools: Spark plug tester or other ignition power supply, funnel, CO<sub>2</sub> fire extinguisher

Materials: Gasoline, wipe cloths

Teaching Aids: Transparencies:

- Demonstrating the Fuel-Vapor Igniting Unit, pp. IV-11, IV-12
- Vapor igniting unit (unit should be placed on metal or other non-flammable surface for demonstration)

Note: Refer to pages IV-13, IV-14 for directions on constructing this demonstration unit.

References: Automotive fuel and Ignition Systems, Frazee and Bedell, Chapter 1

### Steps:

1. Connect ignition wire from spark plug tester to spark plug on demonstration unit
2. Switch on power supply pointing out the arc in the unit cup
3. Fill cup with gasoline

Caution: Remove gasoline supply container (with cap sealed) away from demonstration area

4. Switch on power supply and point out the visible ignition spark submerged in the fuel (page IV-11)

Note: Discuss with students that the gasoline could burn on the surface but will not ignite beneath surface--proving that an air supply (oxygen) is essential for combustion.

5. Empty fuel from unit (into container to be sealed)
6. Switch on power supply (page IV-12)

Note: Gasoline will ignite and burn safely in unit cup. Allow fuel to burn itself out before repeating demonstration.



# DEMONSTRATING THE FUEL-VAPOR IGNITING UNIT

NOTE:  
TURN POWER SUPPLY  
OFF BEFORE EMPTYING  
FUEL CUP

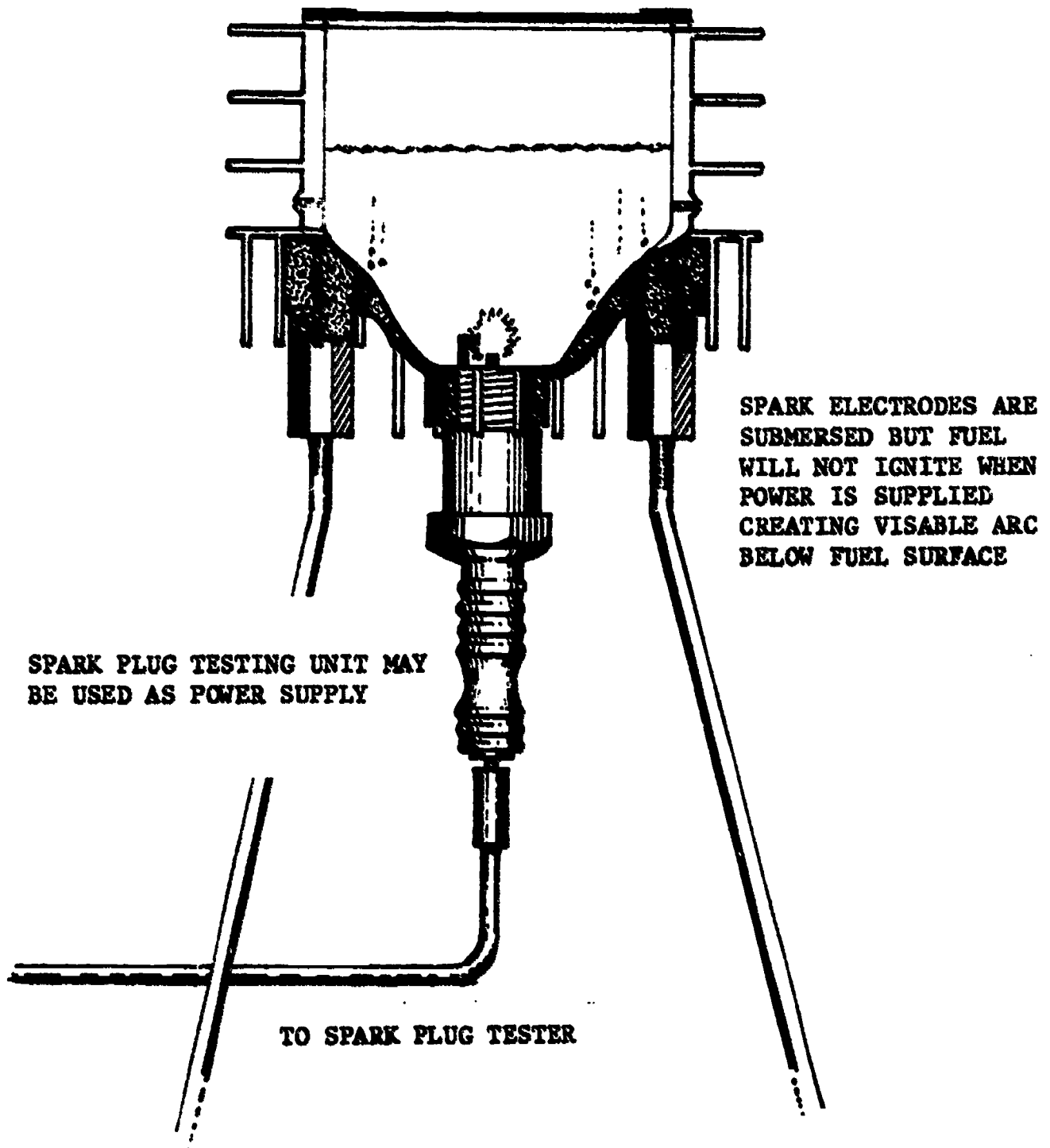

# DEMONSTRATING THE FUEL-VAPOR IGNITING UNIT

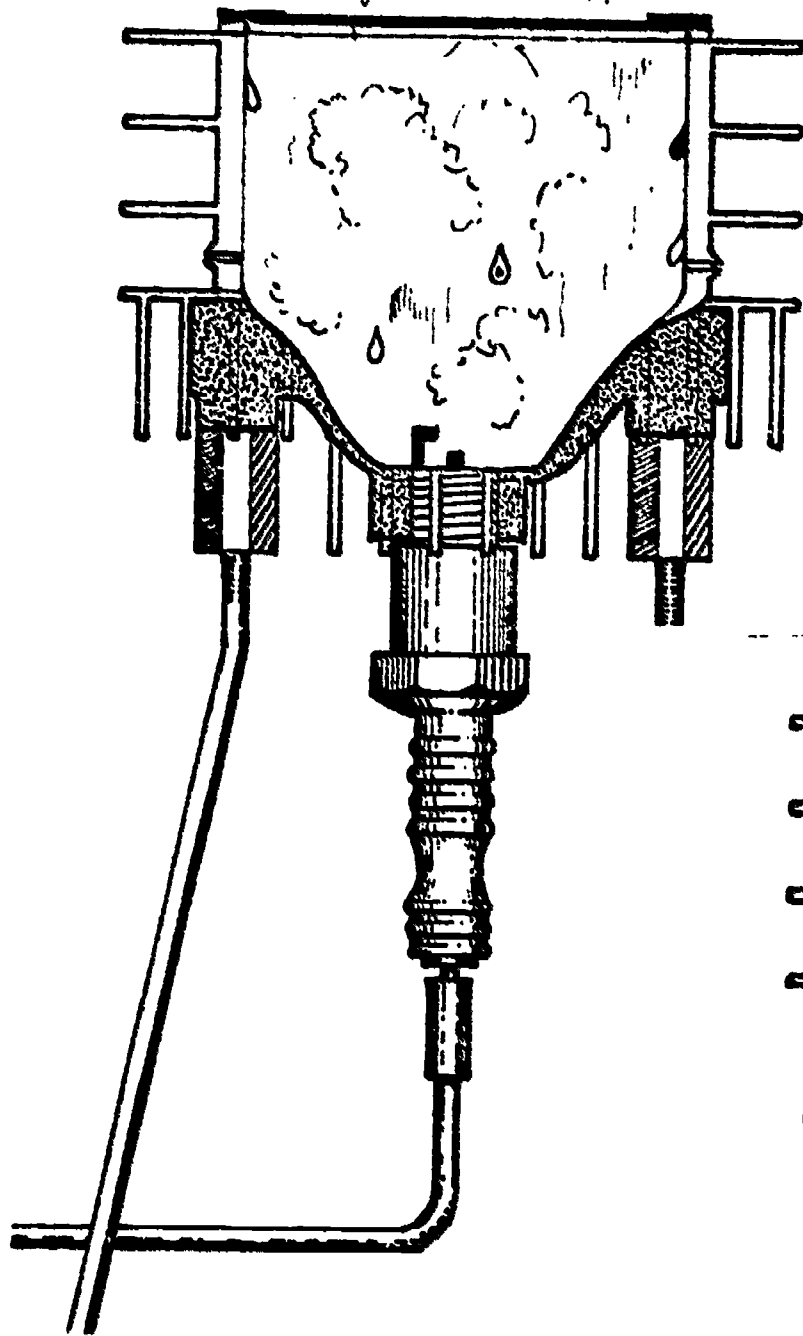

WHEN POWER SUPPLY IS ON PROVIDING SPARK, THE FUEL-AIR MIXTURE IGNITES - - PROVING THE NECESSITY OF OXYGEN TO SUPPORT COMBUSTION.

WHEN THE FUEL CUP IS EMPTIED, AIR COMBINES WITH FUEL VAPORS TO PRODUCE A COMBUSTIBLE MIXTURE.

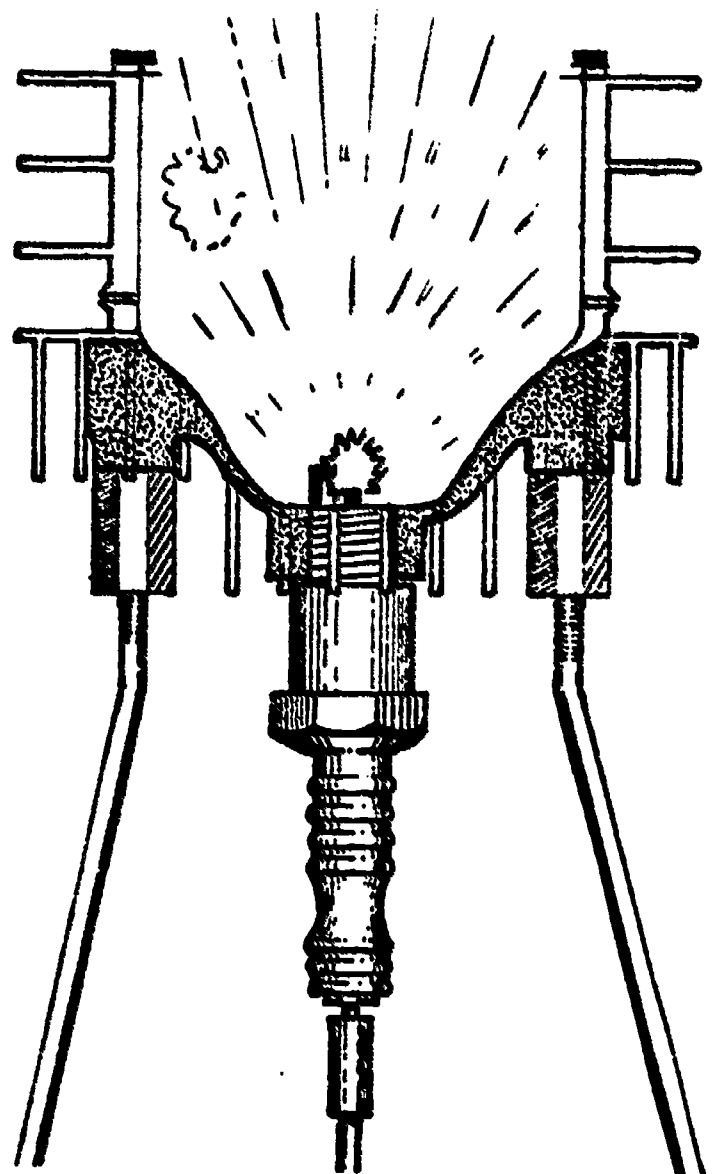

## OPERATION

Block: Fuel System

Block IV

Operation: Constructing a Vapor Igniting  
Demonstration Unit

Job \_\_\_\_\_

Operation \_\_\_\_\_

---

Teaching Objective: To construct a demonstration unit

Tools: Hacksaw, screwdriver, spark plug wrench, drill, tap, tap wrench

Materials: Discarded, single-cylinder engine, four 5"x $\frac{1}{4}$ " - 20 (or other appropriate size) stove bolts, gasket cement, wipe cloths

Teaching Aids: Transparency:  
- Constructing the Fuel-Vapor Igniting Unit, p. IV-14

Steps:

1. Separate upper portion (about 1") of cylinder with gasket and head intact (Fig. 1, p. IV-14)
2. Alter spark plug by shortening ground lobe (removing 1/2 length) (Fig. 2, p. IV-14)

Note: This will allow for a longer arc when power is supplied.

3. Install bolts for legs into shroud mounting holes and bend outward sufficiently to balance and level unit (Fig. 3, p. IV-14)

Note: Drill and tap holes into head for installing legs, if necessary

4. Clean excess grease and oil from unit.
5. Check unit to make sure that it does not leak. If a faulty gasket permits leaks, it must be repaired or replaced.

# CONSTRUCTING THE FUEL-VAPOR IGNITING UNIT

**1**

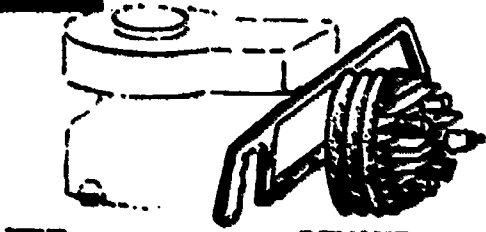

REMOVE UPPER CYLINDER PORTION (WITH HEAD INTACT) OF A DISCARDED LAWNMOWER OR OTHER SMALL ENGINE

**2**



SHORTEN GROUND ELECTRODE OF AN OPERABLE SPARK PLUG SO AS TO INCREASE GAP LENGTH SIGNIFICANTLY

**3**

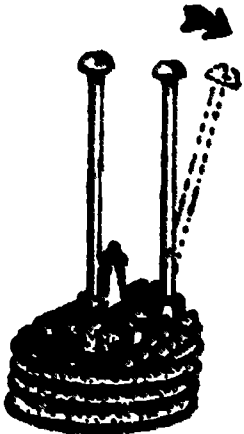

INSTALL STOVE BOLTS (OR OTHER DEVICES) TO SERVE AS LEGS ON UNIT. (SHROUD MOUNTING HOLES MAY BE SUITABLY SPACED.)

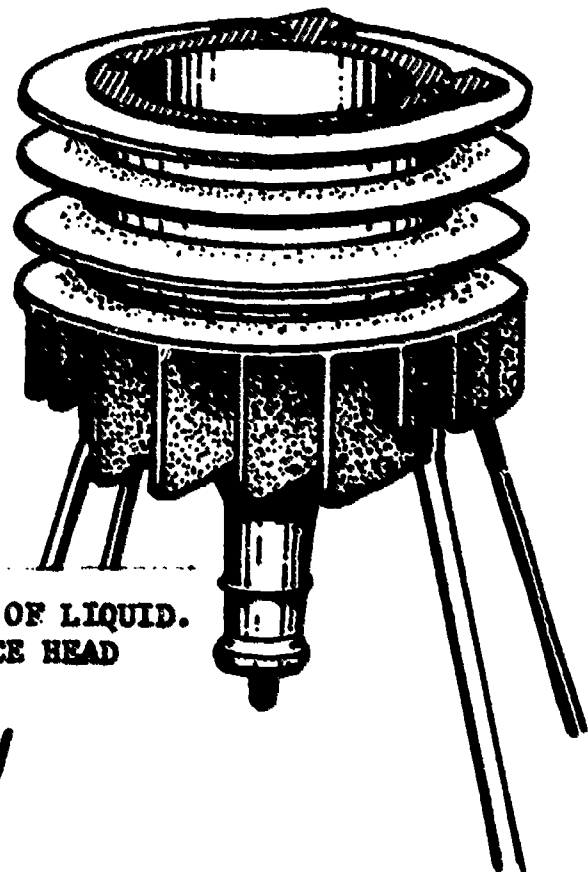
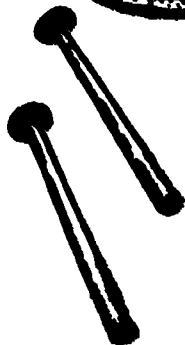

TEST COMPLETED UNIT FOR LEAKAGE OF LIQUID. IF LEAKS EXIST, REPAIR OR REPLACE HEAD GASKET OR SPARK PLUG GASKET

## INFORMATION

Block: Fuel System

Block IV

Lesson: Function and Components of the Fuel System

Job \_\_\_\_\_

Lesson \_\_\_\_\_

---

Teaching Objective: Upon completion of this lesson, students will be able to define the function of the fuel system, identify each major component and relate its function.

Teaching Aids: Transparency:  
- Gasoline Fuel System, p. IV-16

References: Automotive Mechanics, Crouse, Chapter 9  
Automotive Fuel and Ignition Systems, Frazee and Bedell, Chapter 1  
Technical Training Manual, Vol. 2, Automotive Fuel Systems  
Automotive Electric Association

### Outline of Information:

1. **Function:** The fuel system supplies a combustible mixture of air and fuel to the engine.
2. **Components of the fuel system**
  - a. **Fuel tank**  
-- Stores fuel supply
  - b. **Fuel gauges**  
-- Measure fuel supply
  - c. **Fuel lines**  
-- Convey fuel from storage tank to carburetor
  - d. **Fuel Filters**  
-- Protect system from foreign elements
  - e. **Fuel pump**  
-- Provides pressure to deliver fuel to carburetor
  - f. **Air cleaner**  
-- Protects system from foreign elements
  - g. **Carburetor**  
-- Adapts and prepares fuel-air mixture for combustion  
-- Supplies intake manifold with proper mixture  
-- Regulates supply
  - h. **Intake manifold**  
-- Distributes mixture for acceptance into intake valve parts

# GASOLINE FUEL SYSTEM

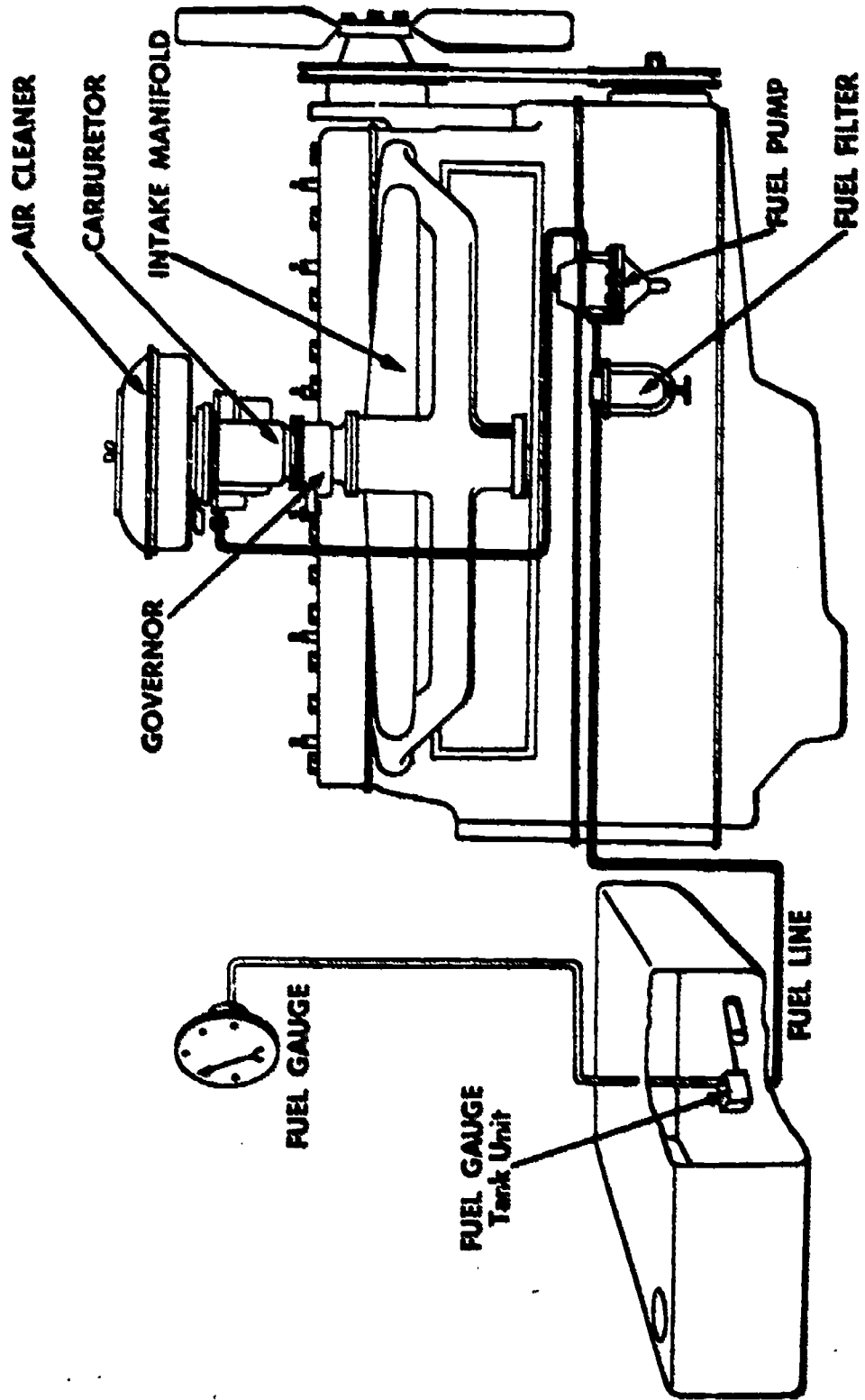

IV-16

COURTESY- AUTOMOTIVE ELECTRIC ASSOCIATION  
INST. MATL LAB, UK R.G. 729-39

## INFORMATION

Block: Fuel System

Block IV

Lesson: Fuel Tank Design and Construction

Job \_\_\_\_\_

Lesson \_\_\_\_\_

---

Teaching Objective: Upon completion of this lesson, students will be able to describe the design and construction of typical automotive fuel tanks.

Teaching Aids: Cut-away fuel tank  
Transparency:  
- Gasoline Tank, p. IV-18

References: Automotive Mechanics, Chapter 9  
Automotive Fuel and Ignition Systems, Frazee and Redell, Chapter 1

### Outline of Information:

1. Function
  - a. Fuel storage
2. Design
  - a. Seamed steel
  - b. Integral baffles to prevent splashing and surging
3. Components of the fuel tank
  - a. Pickup pipe and screen
  - b. Tank gauge unit
  - c. Vent pipe
  - d. Drain plug
4. Mounting
  - a. Attached to frame members strap-type supports
  - b. Flexible mounting
    - Absorbs stresses caused by vehicle motion and frame movement
    - Flexible filler tube

# GASOLINE TANK

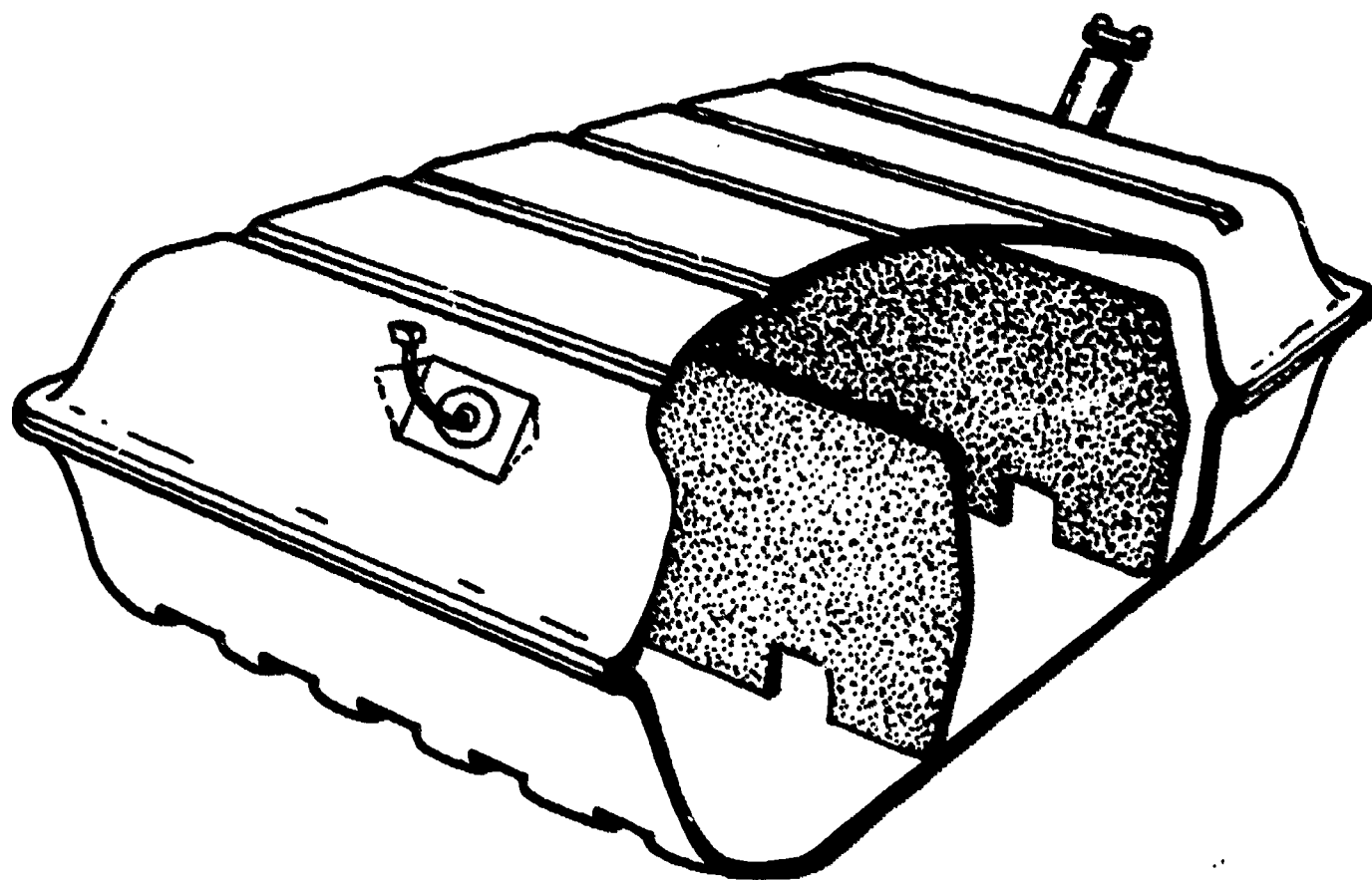



## OPERATION

Block: Fuel System

Block IV

Operation: Removing and Replacing a Fuel Tank

Job \_\_\_\_\_

Operation \_\_\_\_\_

---

Teaching Objective: To teach students the proper methods and safety precautions when handling fuel tanks

Tools: Screwdriver, 1/4" ratchet set, 7/16", 1/2", 9/16" combination wrenches, drain pan, safety can for gasoline, fire extinguisher, funnel

Materials: Wipe cloths

Teaching Aids: Actual fuel tank

References: Vehicle Service Manual  
Automotive Fuel and Ignition Systems, Frazee and Bedell, Chapter 1

### Steps:

1. Drain fuel from tank into pan

Caution: Keep fire extinguisher near. Keep all sparks, heat, and open flames away from tank.

2. Pour from pan into can, using funnel. Avoid spilling and seal container

3. Disconnect fuel line, and gauge unit wire

4. Remove filler pipe if necessary to free tank

5. Loosen nuts, holding tank supporting straps

6. Remove straps from brackets

7. Remove tank

8. For installation, reverse procedure

Caution:

1. Wipe up any spills immediately
2. Never leave gasoline in an open container
3. Do not store close to open flame or near heating unit
4. Have plenty of ventilation when in an area where gasoline vapors are present

## INFORMATION

Block: Fuel System

Block IV

Lesson: Fuel Gauges

Job \_\_\_\_\_

Lesson \_\_\_\_\_

---

Teaching Objective: Upon completion of this lesson, students will be able to identify the two common types of fuel gauging systems by relating the components and functions unique to each system.

Teaching Aids: Transparencies:

- Fuel Gauge (Thermostatic), p. IV-21
- Fuel Gauge (AC), p. IV-22
- Fuel Gauge (Balancing Coil), p. IV-23

References: Automotive Encyclopedia, Tolboldt and Johnson, pp. 263-264  
Fundamentals of Service, Engines, John Deere, Chapter 5  
Automotive Mechanics, Crouse, Chapter 9

Outline of Information:

### 1. Balancing Coil type system

#### a. Tank unit

- Sends electrical resistance to dash unit
- Float lowers - resistance reduces
- Float raises - resistance increases

#### b. Dash unit

- Receives current flow from tank unit
- Current flow through coils creates magnetic pattern which influences armature
- Armature rotation controls pointer direction towards "E" (empty) or "F" (full) positions

### 2. Thermostatic type system

#### a. Tank unit

- Float and cam
- Thermostat blades with heating coil
- Cam opens and closes contact points which actuates heating coil.
- Blades bend as coil heats.

#### b. Dash units

- Thermostat blades and heating coil
- Linkage from blades to pointer
- Reacts in direct proportion to like impulse received from tank unit

# FUEL GAUGE (Thermostatic)

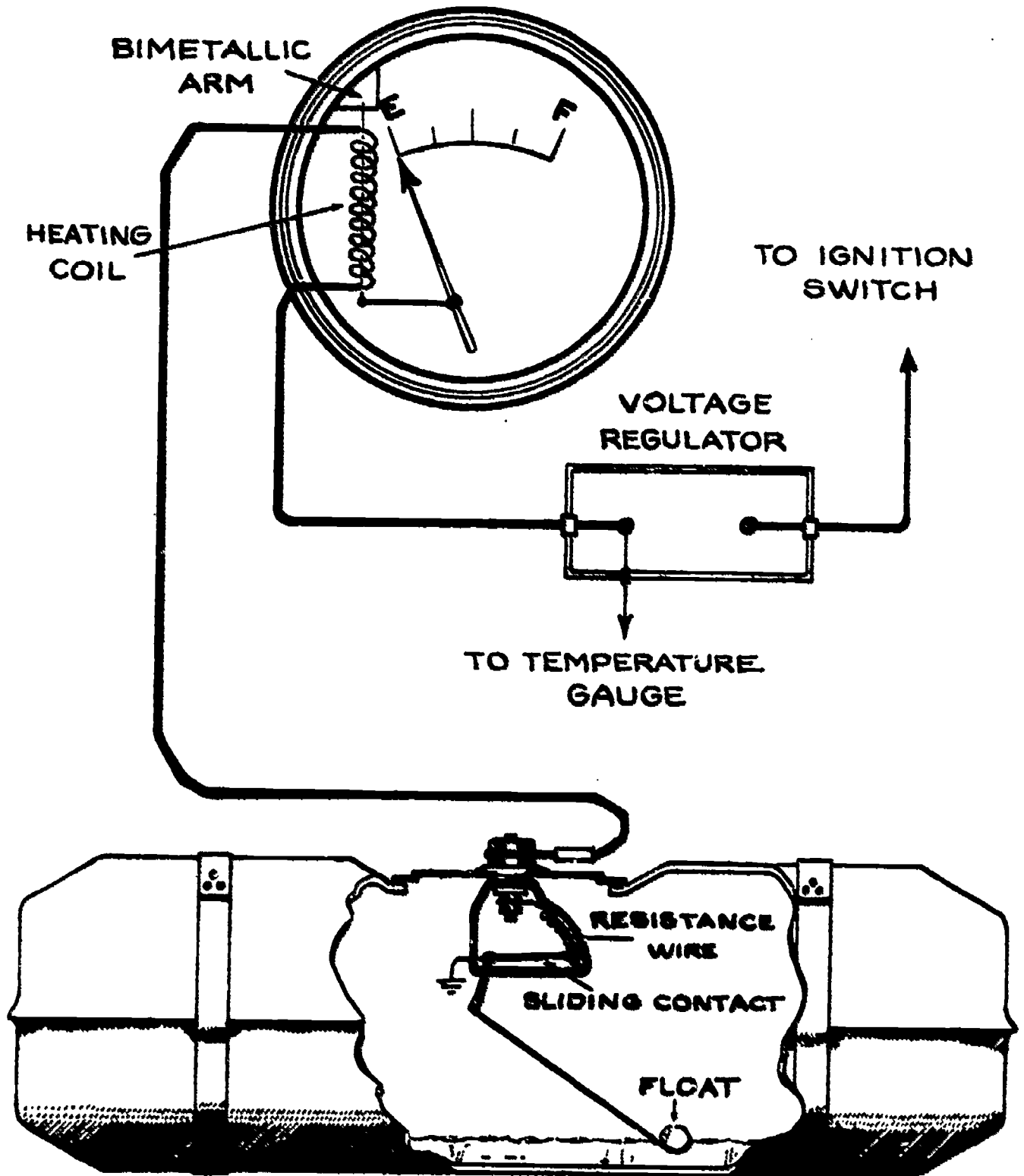

# "FUEL GAUGE" (AC)

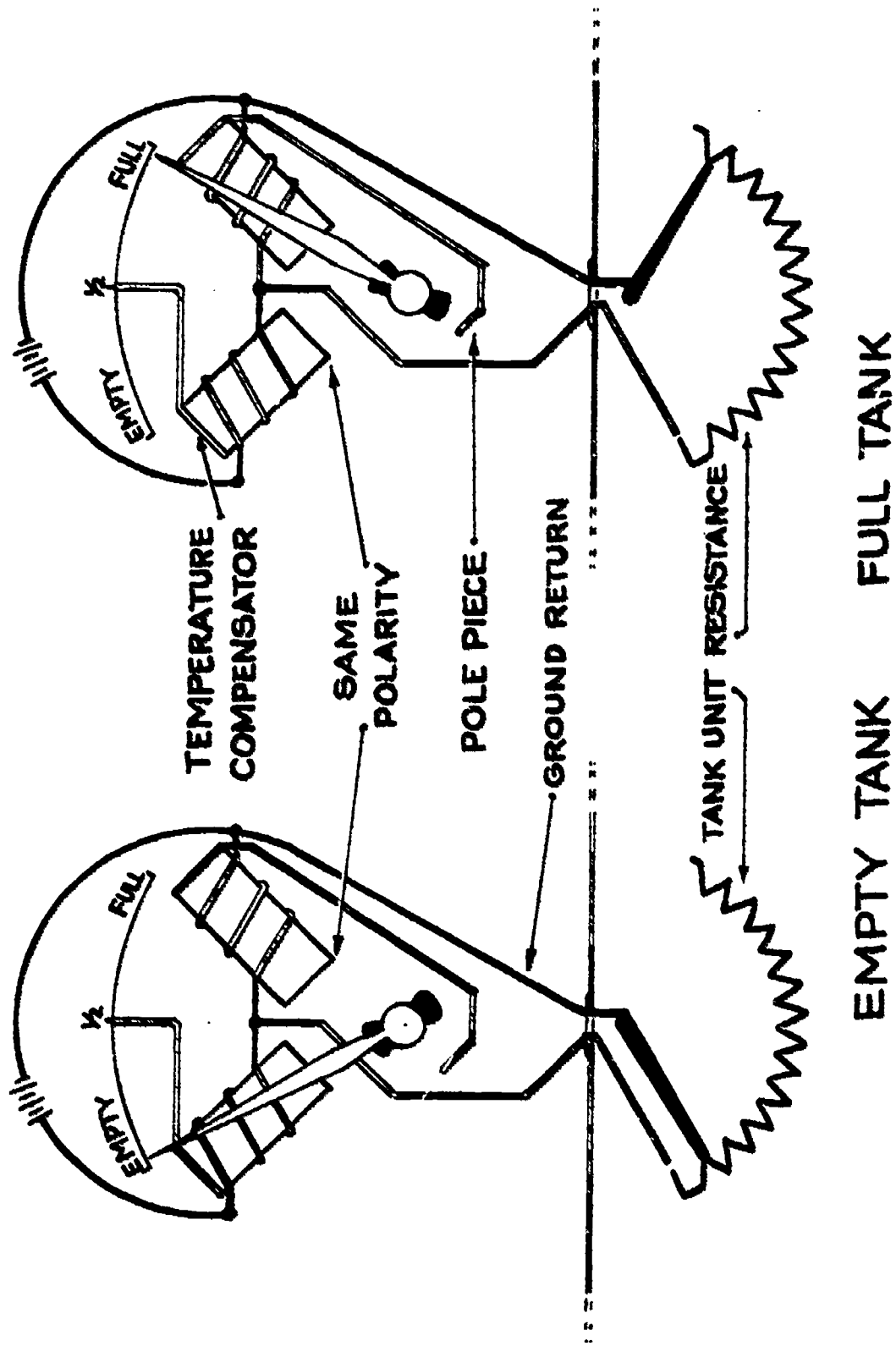

# "FUEL GAUGE" (Balancing Coil)

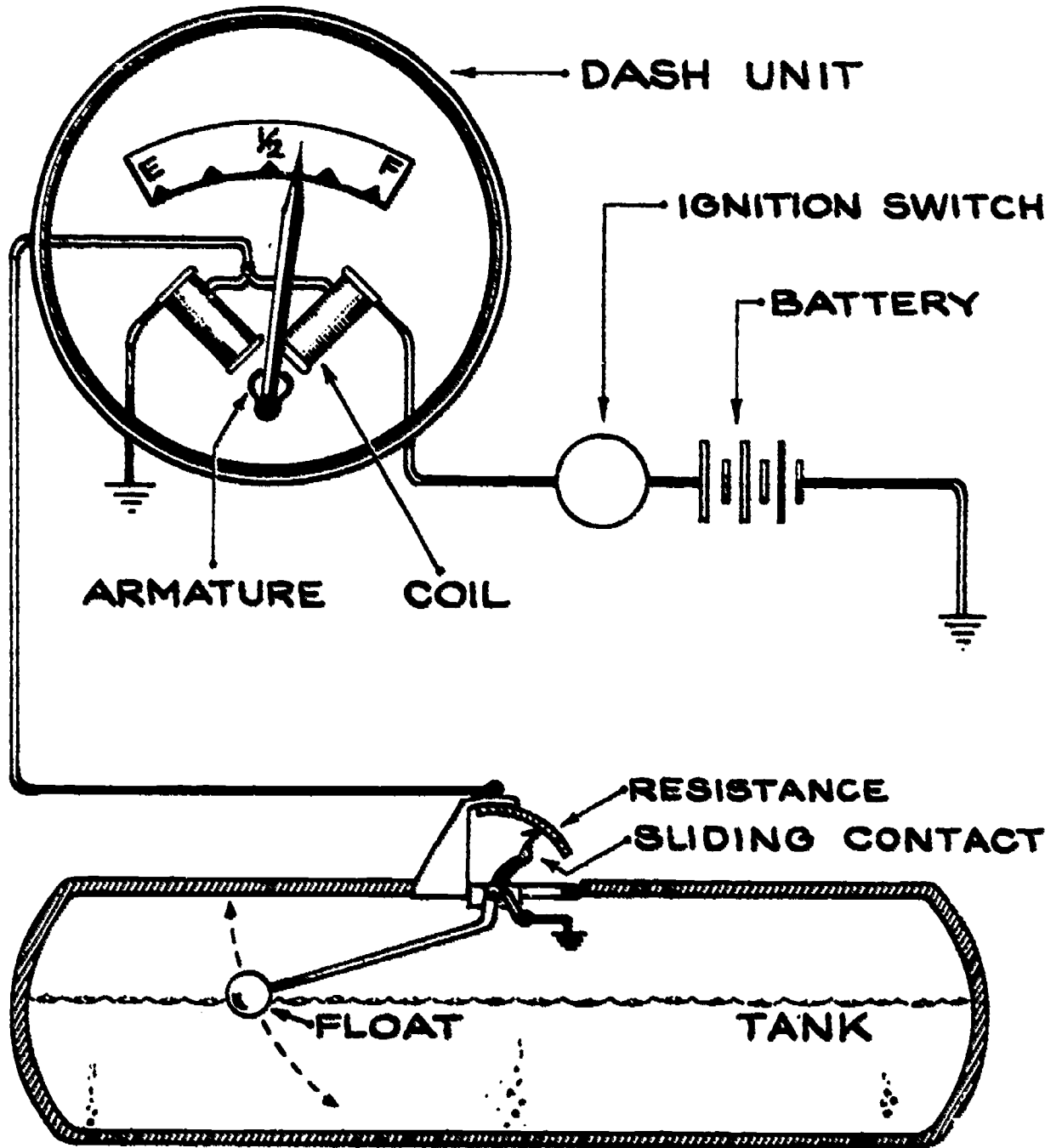

## OPERATION

Block: Fuel System

Block IV

Operation: Testing a Fuel Tank and Dash Gauge Units

Job \_\_\_\_\_

Operation \_\_\_\_\_

---

Teaching Objective: To teach students how to test fuel gauges

Tools: Socket set (1/4"), screwdriver, gauge tester unit, practice gauge unit

Materials: Wipe cloths

Teaching Aids: Gas tank and complete gauging system

References: Automotive Mechanics, Crouse, Chapter 9  
Vehicle Service Manual

### Steps:

Note: Refer to manufacturer's service manual for different methods of testing

1. Disconnect terminal at tank sending unit
2. Connect one lead of tester to disconnect wire and the other to a solid ground
3. Turn ignition switch on
4. Turn knob on tester to "H" and observe dash gauge. It should read "Full" plus or minus 3/32".
5. Turn knob on tester to "M" and observe dash gauge. It should read 1/2.
6. Turn knob on tester to "L". The dash gauge should read "Empty", plus or minus 3/32".
7. Turn off ignition switch
8. Remove tester and connect wire

## OPERATION

Block: Fuel System

Block IV

Operation: Replacing a Fuel Tank Gauge

Job \_\_\_\_\_

Operation \_\_\_\_\_

---

Teaching Objective: To teach students how to replace a fuel tank gauge

Tools: Socket wrench set (1/4"), screwdriver, fuel storage can, special tools for specific make

Materials: Wipe cloths

Teaching Aids: Fuel tank with gauge intact

References: 1970 Chevrolet Service Manual

Steps:

1. Drain fuel tank

Caution: Refer to operation of removing a fuel tank

2. Remove tank

Note: On some vehicles, it is not necessary to remove tank to service tank gauge unit.

3. Disconnect fuel line and gauge unit wire

4. Refer to manufacturer's service manual for proper removal of tank unit

Caution: Carefully remove unit so as not to damage the filter screen on end of pipe

5. Clean screen by blowing out with compressed air

6. For installation, reverse procedure

## INFORMATION

Block: Fuel System

Block IV

Lesson: Fuel Filters

Job \_\_\_\_\_

Lesson \_\_\_\_\_

---

Teaching Objective: Upon completion of this lesson, students will be able to define the function of automotive fuel filters and to identify the common types according to design characteristics.

Teaching Aids: Samples of filter types

References: Automotive Encyclopedia, 1968 ed., pp. 241-242  
Automotive Fuel and Ignition Systems, Frazee and Bedell, Chapter 1

### Outline of Information:

1. **Function:** To prevent dirt particles, lint, and water in the fuel from entering the fuel pump or carburetor
2. **Types of fuel filters**
  - a. **Sediment bowl**
    - In line
    - Integral part of fuel pump
      - (1) Made of glass or metal
      - (2) Strainer screen in top
      - (3) Sediment and water settle in bottom of bowl
  - Note:** Specific gravity of gasoline is less than water - gasoline floats - water sinks.
  - b. **Porous bronze (oilite)**
    - Fits into housing at fuel entry fitting at carburetor
      - (1) As final filter, prevents fine foreign particles and water from flowing with fuel
    - Fuel tank type prevents lint and water accumulated in tank from entering lines.
      - (1) Filter is washed with sloshing of gasoline in tank.
  - c. **Ceramic filter**
    - Made of baked, porous clay
      - (1) Water and dirt particles are suspended.
  - d. **Disc filter**
    - In-line between fuel pump and carburetor
      - (1) Traps fine particles which might pass through sediment bowl



## INFORMATION

Block: Fuel System

Block IV

Lesson: Fuel Line and Fittings

Job \_\_\_\_\_

Lesson \_\_\_\_\_

---

Teaching Objective: Upon completion of this lesson, students will be able to define the uses and function of fuel lines and necessary fittings and discuss the advantages and disadvantages of commonly-used types.

Teaching Aids: Transparency:

- Compression Fitting, Flared Fitting, p. IV-29

References: Automotive Fuel and Ignition Systems, Frazee and Bedell, Chapter 1  
Automotive Encyclopedia, 1968 ed., p. 23

### Outline of Information:

#### 1. Function of fuel lines

- a. Carry fuel from supply tank to engine compartment (generally directly to fuel pump)

#### 2. Mounting of fuel lines

- a. Positioned along frame with metal clips

#### 3. Types of fuel lines

##### a. Steel

- Usually used in original construction of vehicle
- Rigid
- Susceptible to cracking or splitting as a result of vibration

##### b. Copper

- Sometimes used in replacing sections
- Types
  - (1) Standard - used with fittings
  - (2) Annealed (soft) - can be shaped using sharper bends where necessary

## Fuel Line and Fittings (continued)

### c. Flexible

- Neoprene and other suitable plastics
  - (1) Resistant to gasoline
  - (2) Absorbs vibration
  - (3) Used for connections and joints
  - (4) Used for bends, curves, short sections
  - (5) Clean fittings, tight clamps necessary

## 4. Types of fittings

### a. Compression

### b. Flared

### c. Flexible hose and tubing with clamps

Note: Rubber tubing is not suitable as automotive fuel line since gasoline and resulting vapors deteriorates rubber.

**COMPRESSION FITTING**

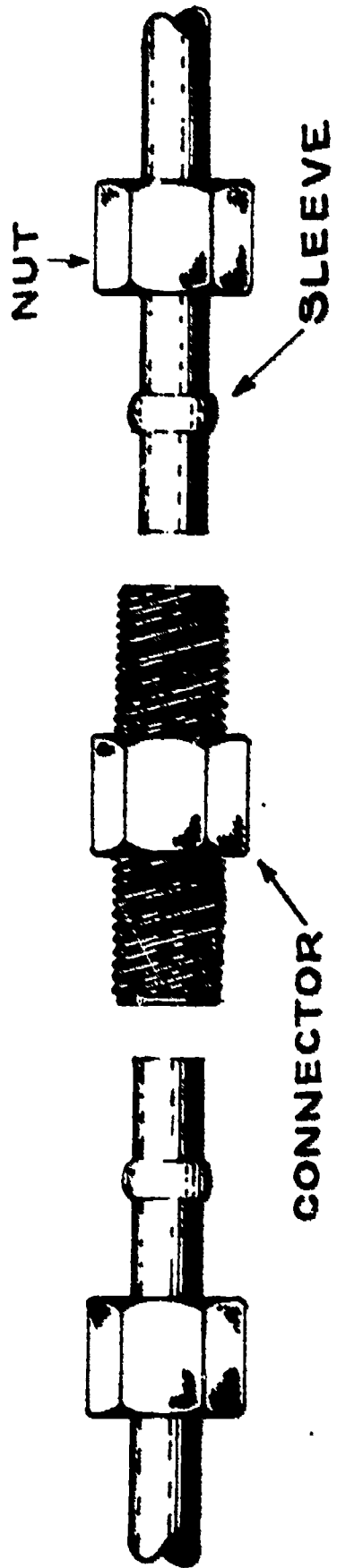

**FLARED FITTING**

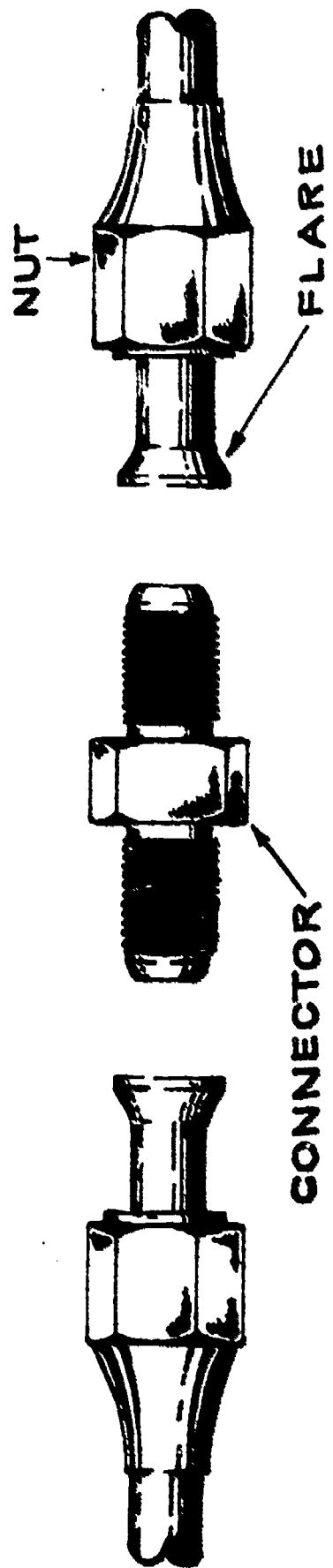

## OPERATION

Block: Fuel System

Block IV

Operation: Replacing Fuel Filters

Job \_\_\_\_\_

Operation \_\_\_\_\_

---

Teaching Objective: To teach students how to replace a fuel filter

Tools: Box wrench (1"), hose clamp pliers, combination wrench (1/2" x 9/16")

Materials: Fuel filter, wipe cloths

Teaching Aids: Engine on stand

References: Vehicle Service Manual

Steps:

1. Remove fuel line connection
2. Remove filters

Note: On some makes the filter is behind the inlet fuel filter nut.

3. Check element for restriction by blowing into fuel pump side. Element should allow air to pass freely.

Note: Element should be replaced if plugged or if flooding occurs. A plugged filter will result in a loss of engine power or rough engine feel, especially at high engine speeds.

4. Install filter, reversing procedure

## OPERATION

Block: Fuel System

Block IV

Operation: Installing a Compression Fitting in a Gas Line

Job \_\_\_\_\_

Operation \_\_\_\_\_

---

Teaching Objective: To teach students how to install a compression fitting in a fuel line

Tools: Tubing cutter, tapered hand reamer, flat file (smooth-cut), open-end wrench set

Materials: Compression fitting, copper tubing, wipe cloths

Teaching Aids: Transparency

- Compression Fitting-Flared Fitting, p. IV-29

References: Automotive Fuel and Ignition Systems, Frazee and Bedell, Chapter 1

### Steps:

1. Cut the tubing to necessary lengths

2. Ream the ends to remove any burrs

Note: If possible hold ends down, so metal chips will not drop into the tubing

3. Place the nuts with threaded ends toward the cut

4. Place the ferrel over the two ends

5. Place the fitting into the line and tighten nuts by hand

6. While holding the fitting with a wrench tighten both nuts

Caution: To avoid cross-threading it is sometimes necessary to lightly reverse direction (counter-clockwise for right-hand threads) for proper alignment. Do not apply wrench pressure until proper thread-alignment is assured by hand-threading.

## OPERATION

Block: Fuel System

Block IV

Operation: Installing a Fuel Line

Job \_\_\_\_\_

Operation \_\_\_\_\_

---

Teaching Objective: To teach students to install a fuel line

Tools: Tubing cutter, flaring tool, open-end wrench set, shears, clamp pliers, screwdriver, 12" scale, steel tape

Materials: Cooper or steel tubing, fittings for connections, line mounting clips, neoprene tubing and clamps

Teaching Aids: Automobile or engine on stand

References: Automotive Fuel and Ignition Systems, Frazee and Bedell, Chapter 1

### Steps:

1. Select fittings needed
2. Determine diameter and length of line sections to be used
3. Shape contours and necessary bends in line
4. Determine types of connections necessary
5. Cut line to proper lengths
6. Remove burrs from line ends
7. Install fittings on line
8. Flare ends if using flared fittings
9. Connect rigid line to flex lines

Caution: When connecting lines use proper wrench on each connecting nut to prevent twisting. Do not allow stationary connections to turn.

## Installing a Fuel Line (continued)

10. Install unit fittings where necessary - (pump, filters, carburetor, etc.)
11. Install connecting sections and/or flex lines to unit fittings
12. Be sure connections and line clamps are tight and secure

**Note:** When making connections make certain that lines, tubing threads are free of dirt, burrs, filings and grease or oil

**Caution:** Wipe dry any gasoline spills that may occur when working with fuel lines and components

## OPERATION

Block: Fuel System

Block IV

Operation: Flaring Copper Tubing

Job \_\_\_\_\_  
Operation \_\_\_\_\_

---

Teaching Objective: To teach students how to flare copper tubing

Tools: Flaring tool set, tubing cutter, open-end wrench set

Materials: Practice pieces of copper fuel line, flared fittings, light lubricating oil

Teaching Aids: Transparencies:

- Compression Fitting-Flared Fitting, p. IV-29
- Tubing Cutter, p. I-22
- Flaring Tools, p. I-23

References: Automotive Fuel and Ignition Systems, Frazee and Bedell, Chapter 1

### Steps:

1. Ream ends of tubing
2. Place nuts on tubing
3. Place tubing in proper tubing hole in flaring block, allowing approximately 1/8" to extend above block
4. Mount yoke
5. Put some oil on the spinner of yoke and tighten spinner in an oscillating motion

Note: Do not overtighten threads. The flare-seating area of the copper can become work-hardened and susceptible to cracking.

6. Assemble the tubing to fittings and test for leaks



## INFORMATION

Block: Fuel System

Block IV

Lesson: Fuel Pump Purpose and Operation

Job \_\_\_\_\_

Lesson \_\_\_\_\_

Teaching Objective: Upon completion of this lesson, students will be able to discuss the purpose of automotive fuel pumps and describe the operation of the two basic types.

Teaching Aids: Transparencies:

- Fuel Pump, p. IV-36
- Facts About the Fuel Pump, p. IV-37
- Electric Fuel Pump, p. IV-38
- Positions of Fuel Pumps, p. IV-40

References: Automotive Encyclopedia, 1968 ed., p. 255  
Automotive Mechanics, Crouse, Chapter 9  
Automechanics, Glenn, Chapter 6

Outline of Information:

### 1. Purpose

- a. The fuel pump draws gasoline from the tank and supplies it to the carburetor in sufficient quantity to meet engine requirements under all operating conditions.
- b. The combination fuel pump increases vacuum for operation of vacuum-type windshield wipers.

### 2. Operation

- a. Power supplied from camshaft rotation to fuel pump rocker arm directly from eccentric or via push rod.
- b. Rocker arm operates diaphragm for vacuum action (from tank) and reverse stroke, pressure action (to carburetor).
  - Atmospheric pressure in fuel tank forces fuel into vacuum displacement area in fuel pump.
- c. Electric fuel pump
  - Heavy duty use and optional replacement
  - Three types
    - (1) Diaphragm
    - (2) Bellows
    - (3) Impeller

# FUEL PUMP

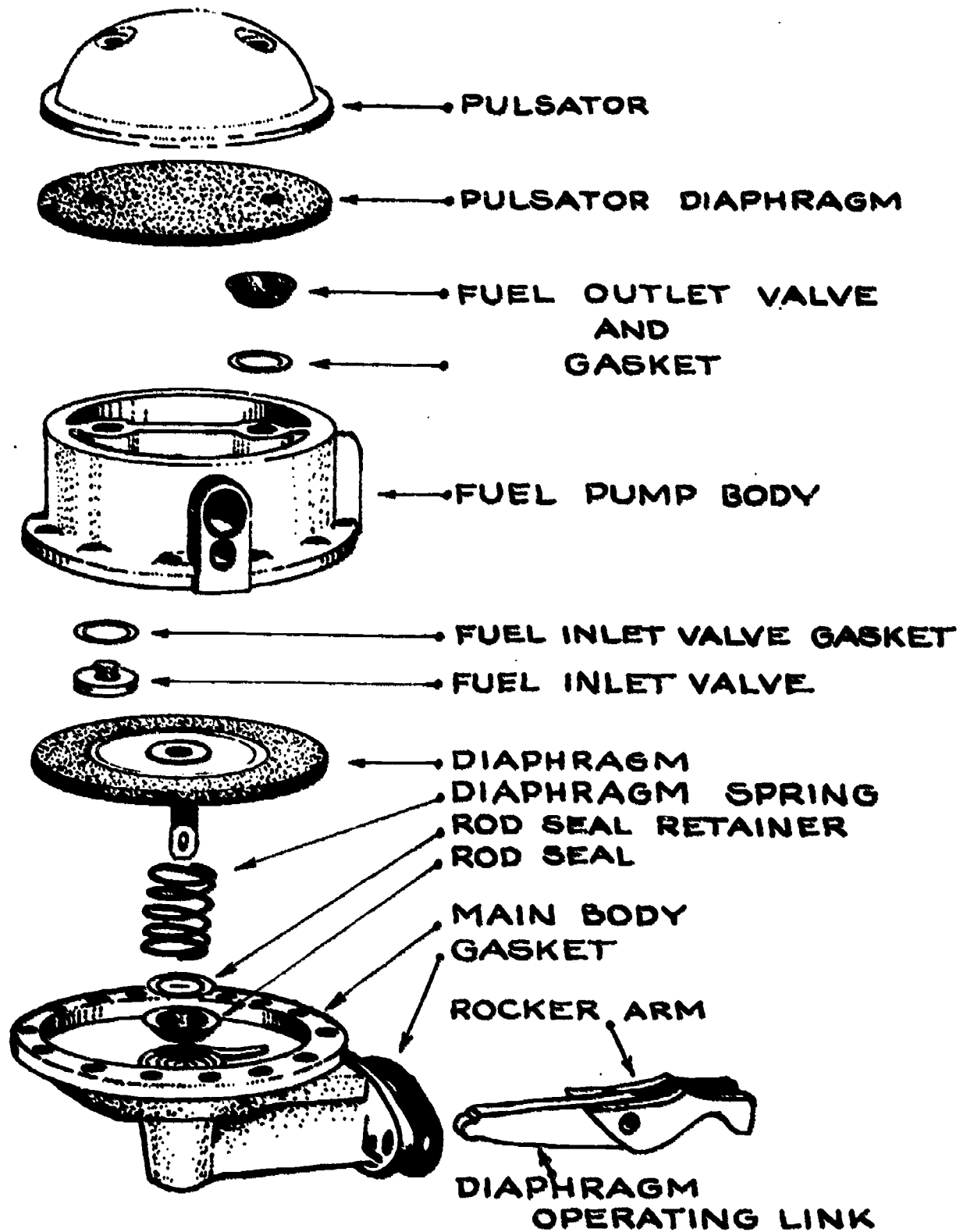

## **FACTS ABOUT THE FUEL PUMP**

- 1. The fuel pump transfers fuel from the tank to the carburetor.**
- 2. Fuel may also be transferred to the carburetor by means of gravity feed.**
- 3. Fuel pumps may be actuated either mechanically or electrically.**
- 4. Mechanical fuel pumps have a diaphragm actuated by a lever.**
- 5. Electric fuel pumps operate independent of the engine.**
- 6. There are various types of electric fuel pumps but all accomplish the same purpose.**
- 7. Any fuel pump must furnish sufficient pressure to minimize vapor lock.**
- 8. Electric fuel pumps should be of the same voltage and polarity as the electrical system.**

# Electric Fuel Pump

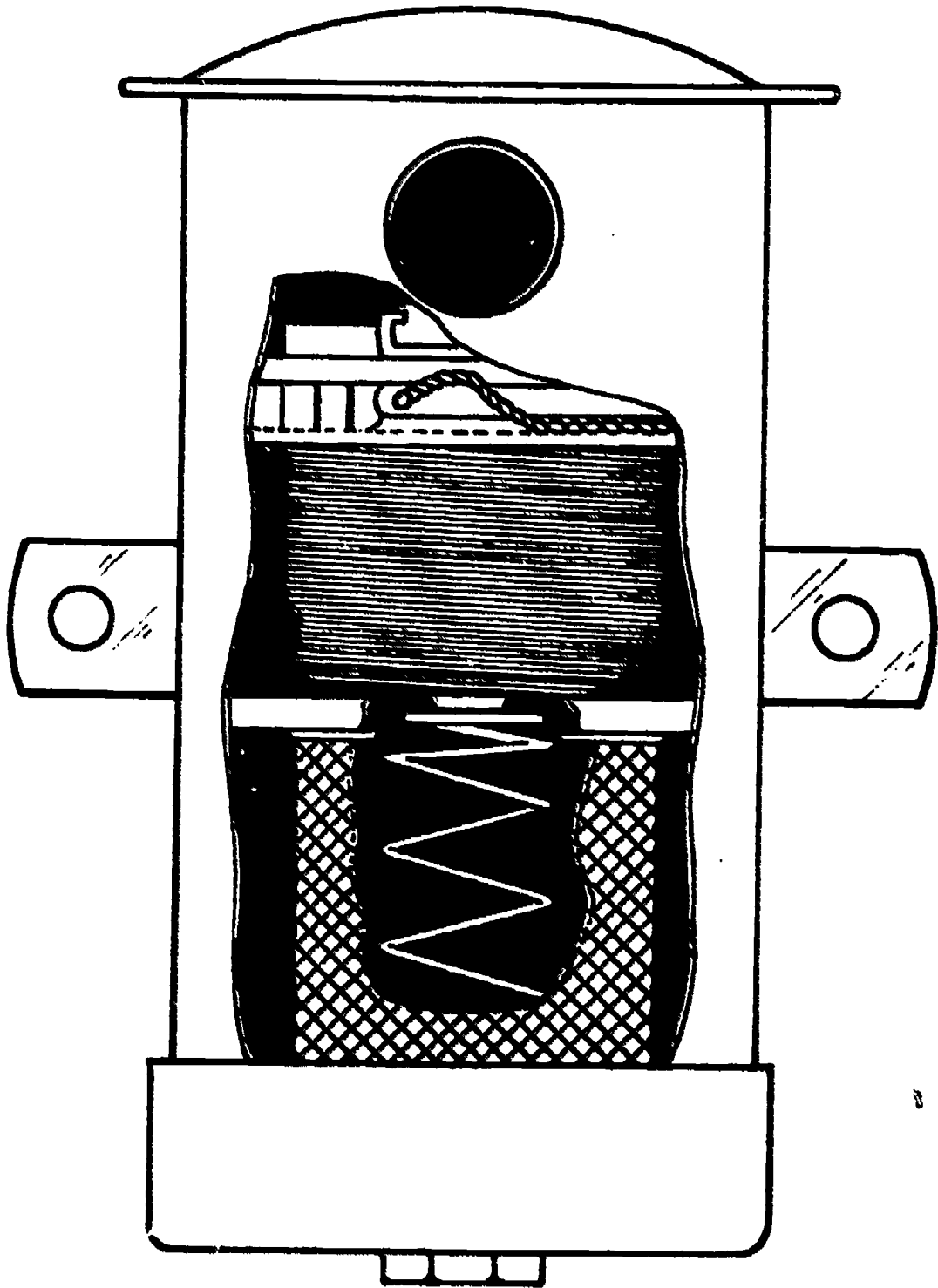

## OPERATION

**Block:** Fuel System

Block IV

**Operation:** Removing and Replacing a Fuel Pump

Job \_\_\_\_\_

Operation \_\_\_\_\_

---

**Teaching Objectives:** To teach students how to remove and replace a fuel pump

**Tools:** Ratchet set (3/8" drive), open end wrenches (1/2" and 9/16")

**Materials:** Fuel pump, mounting gasket, wipe cloths

**Teaching Aids:** Automobile or engine on stand

Transparency:

- Positions of Fuel Pumps, p. IV-40

**References:** Automotive Mechanics, Crouse, Chapters 9 and 20

AC Fuel Pump Shop Manual

Vehicle Service Manual

### Steps:

1. Wipe dirt and accumulated grease from this engine area to prevent particles from entering engines
2. Remove fuel and vacuum lines
3. Remove attaching bolts

**Note:** On some engines the pump is mounted to the engine with a thick gasket or spacer. These spacers must be re-used or replaced to prevent pump damage.

4. Remove pump carefully working gently from side to side
5. For pumps so operated, push rod should be removed to check for wear or sticking
6. Clean old gasket from machined surface on block where pump mounts
7. Install pump, reversing procedure

**Caution:** When inserting rocker arm make sure proper alignment and centering with push rod is achieved (or rocker arm contacts proper side of camshaft). Do not force a secure fitting until proper mounting is assured.

# POSITIONS OF FUEL PUMPS

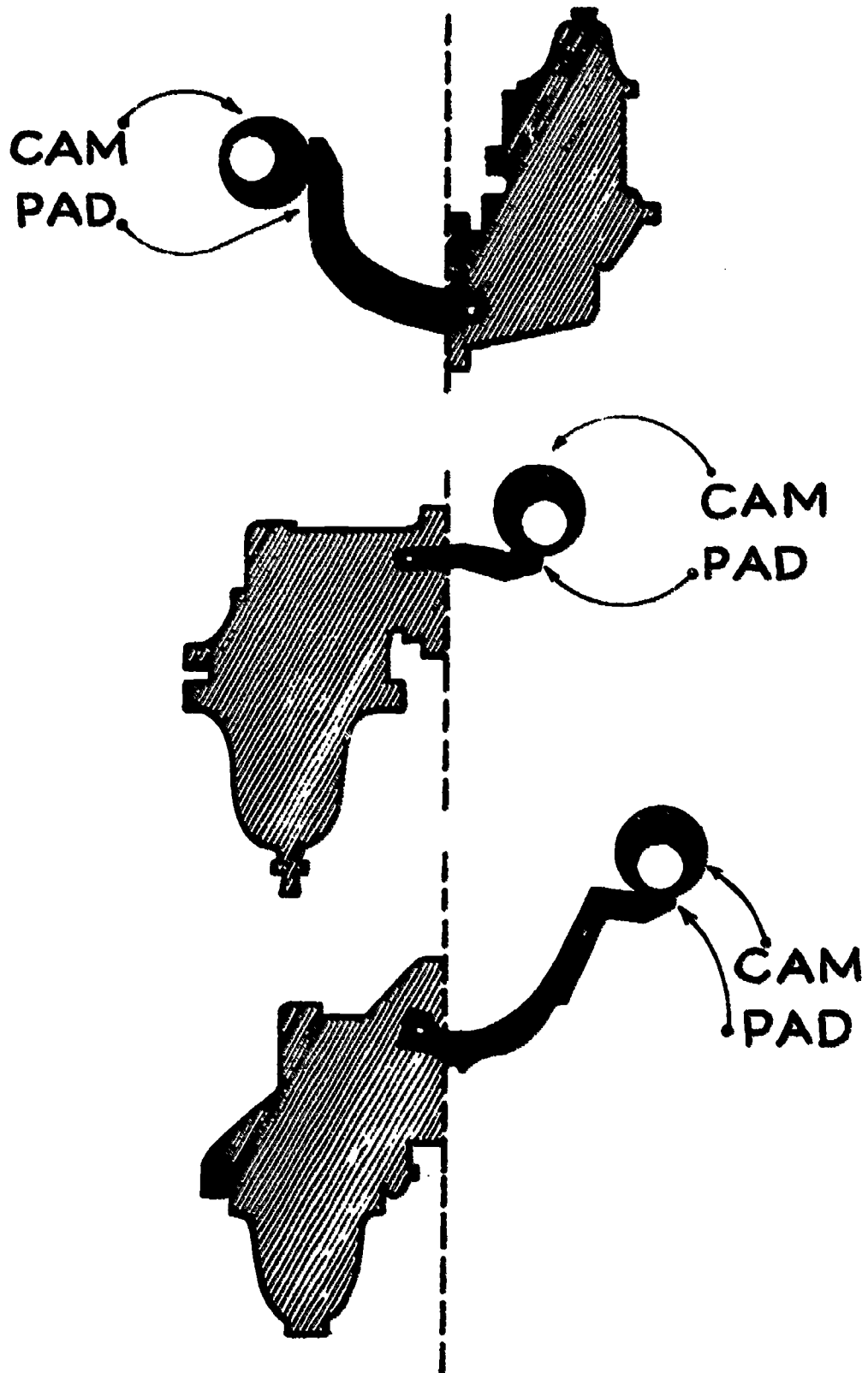

## INFORMATION

Block: Fuel System

Block IV

Lesson: Fuel Pump Testing Results and Indications

Job \_\_\_\_\_

Lesson \_\_\_\_\_

---

Teaching Objective: Upon completion of this lesson students will be able to diagnose, by comparing test results with indicated operating symptoms, correct and incorrect fuel pump functioning.

Teaching Aids: Transparency:  
- Fuel pump, p. IV-36

References: 820 Sun Manual, p. 52  
Motor's Auto Repair Manual, 1969, pp. 1-20 - 1-123

### Outline of Information:

1. Volume and pressure are within manufacturer's specifications.
  - a. Fuel lines and pump are satisfactory
2. Volume and pressure low
  - a. Restricted or leaking line
  - b. Defective pump
3. Air bubbles on volume test
  - a. Leaking pump
  - b. Leaking fuel line
4. Correct volume with low pressure
  - a. Defective pump
  - b. Weak pressure spring
5. Insufficient volume with normal pressure
  - a. Leaking or restricted fuel line
  - b. Defective pump

## OPERATION

Block: Fuel System

Block IV

Operation: Testing a Fuel Pump Pressure and Volume

Job \_\_\_\_\_

Operation \_\_\_\_\_

---

Teaching Objective: To teach students how to test a fuel pump pressure and volume

Tools: Pressure gauge, open-end wrench set, hose, pint measuring can

Teaching Aids: Automobile or engine on stand

References: Sun 820 Electronic Engine Tester Manual  
Vehicle Service Manual

### Steps:

1. Disconnect the fuel pipe at the carburetor inlet
2. Attach the pressure gauge and hose between the carburetor inlet and the disconnected fuel pipe
3. Check specifications for pressure limits
4. Check gauge for pressure limits
5. CAPACITY TEST: Connect hose from gauge so the pump will deliver gasoline into the pint measure held at carburetor level
6. Run engine at idle speed and note time it takes to fill the measure
7. Check specifications for capacity rating
8. Connect all lines properly



## OPERATION

Block: Fuel System

Block IV

Operation: Testing Fuel Pump Vacuum

Job \_\_\_\_\_

Operation \_\_\_\_\_

---

Teaching Objective: To teach students how to test fuel pump vacuum

Tools: Combination wrenches (1/2", 9/16")

Materials: Vacuum gauge with fittings, wipe cloths

Teaching Aids: Automobile or engine on stand

References: Sun 820 Electronic Engine Tester Manual  
Vehicle Service Manual

### Steps:

1. Disconnect line from carburetor
2. Disconnect fuel pump flexible line from tank fuel delivery line
3. Install proper adapter fitting and attach vacuum gauge hose
4. Start engine and operate at idle speed
5. Run engine for a period of time sufficient to permit vacuum gauge to reach its maximum reading
6. Stop engine and observe vacuum gauge for approximately fifteen seconds
7. Observe reading and refer to specifications
8. Remove vacuum gauge
9. Install lines

Note: Start all fitting with fingers to avoid cross-threading

## OPERATION

Block: Fuel System

Block IV

Operation: Testing Vacuum Booster Pump

Job \_\_\_\_\_

Operation \_\_\_\_\_

---

Teaching Objective: To teach students how to test vacuum booster pump

Tools: Combination wrenches, (3/8" and 7/16"), tachometer, vacuum gauge with fittings

Materials: Wipe cloths

Teaching Aids: Automobile or engine on stand

References: Sun 820 Electronic Engine Tester Manual  
Vehicle Service Manual

### Steps:

1. Disconnect vacuum line between booster pump and intake manifold
2. Remove windshield wiper hose from inlet of booster pump and connect vacuum pressure hose to pump inlet
3. Connect a tachometer to the engine
4. Operate engine at 1000 RPM. Vacuum reading generally should be 8.5 inches or more if the booster pump is operating satisfactorily.
5. Stop engine and observe vacuum gauge for a short period of time

Note: A rapid fall off of the vacuum gauge reading would indicate air leaks in pump, pump valves, tester connection, etc.

6. Remove vacuum gauge and tachometer
7. Connect vacuum line and windshield wiper hose

## OPERATION

Block: Fuel System

Block IV

Operation: Testing Fuel Pump Pressure and Vacuum

Job \_\_\_\_\_  
Operation \_\_\_\_\_

---

Teaching Objective: To teach students to test fuel pump pressure and vacuum

Tools: Pressure gauge, screwdriver, hose clamp, pliers, open-end wrench set

Materials: Wipe cloths

Teaching Aids: Automobile or engine on stand

References: Auto Service and Repair, Stockel, Chapter 20  
Motor's Auto Repair Manual, 1969

### Steps:

1. Secure the manufacturer's specifications for the fuel pump
2. Disconnect the main-tank fuel line at the fuel pump
3. Connect the vacuum-gauge hose to the fuel pump at the main-tank-line fitting
4. Start the engine and run it at normal idling speed; check the vacuum reading; stop the engine
5. Compare the pump vacuum reading with the manufacturer's specifications
6. Connect the main-tank fuel line to the fuel pump being careful to avoid cross-threading
7. Run the engine for a brief period to get gasoline back in the carburetor bowl to be ready for the next pressure test
8. Connect the pressure-gauge hose to the carburetor fuel line at the fuel pump
9. Start the engine and run at normal idling speed: check the fuel pump pressure quickly; stop the engine

## Testing Fuel Pump Pressure and Vacuum (continued)

10. Compare the pump pressure reading with the manufacturer's specifications
11. Connect the carburetor fuel line to the fuel pump being careful to avoid cross-threading the fitting
12. Replace the accessories that were removed to make the test

**Note:** When checking pressure and vacuum, make certain that connections are tight. Leakage will result in inaccurate readings.

## INFORMATION

Block: Fuel System

Block IV

Lesson: Air Cleaners

Job \_\_\_\_\_

Lesson \_\_\_\_\_

Teaching Objective: Upon completion of this lesson, students will be able to identify four types of carburetor air cleaners and list essential services.

Teaching Aids: Samples of each type of air cleaners and filter elements  
Transparencies:

- Facts About Air Cleaners, p. IV-48
- Dirty Air Cleaner...Mixture Too Rich, p. IV-49

References: Automotive Encyclopedia, 1968 ed., pp. 241-242  
Auto Service and Repair, Stockel, Chapter 20

### Outline of Information:

#### 1. Types and Servicing

- a. Oil wetted
  - Wash copper screen in kerosene or other solvent
  - Dipped in engine oil at frequent intervals
- b. Oil bath
  - Wash wire mesh portion with kerosene or other solvent
  - Clean the oil bath portion and refill with SAE motor oil
- c. Paper element
  - Clean by removing and tapping it against some hard surface
  - Blowing air through it from inside out
  - Replace according to manufacturer's specification
- d. Polyurethane
  - Wash in kerosene or mineral spirits
  - Squeeze out excess solvent
  - Dip in engine oil and replace

## **FACTS ABOUT AIR CLEANERS**

- 1. An air cleaner is an important part of the complete fuel system.**
- 2. Air cleaners require frequent periodic servicing.**
- 3. An air cleaner is also designed to serve as a silencer.**
- 4. The two common types of air cleaner are: wet type and dry type.**
- 5. There are many different materials used as filtering elements.**
- 6. Clogging of the air cleaner can affect the operation of the carburetor.**
- 7. Care must be used in installing an air cleaner so that it is not tightened on the carburetor air horn sufficiently to cause distortion.**
- 8. The air cleaner must permit the flow of sufficient air for maximum engine demands.**

# DIRTY AIR CLEANER... MIXTURE TOO RICH



## OPERATION

Block: Fuel System

Block IV

Operation: Servicing an Air Cleaner

Job \_\_\_\_\_

Operation \_\_\_\_\_

---

Teaching Objective: To teach students how to service an air cleaner

Tools: Combination pliers, screwdriver, parts cleaning pan

Materials: Solvent, oil, wipe cloths, replacement filter cartridge

Teaching Aids: Automobile or engine on stand

References: Vehicle Service Manual  
Auto Service and Repair, Stockel, Chapter 20

### Steps:

1. Remove wing nut, clamp, or other attaching devices
2. Lift out the filter element (wire-mesh ring)  
Note: If the air cleaner is of the replacement cartridge type, install a new element
3. Clean the filter element by immersing it in cleaning fluid. Agitate it in the fluid until it is clean
4. Drain off the excess fluid and dry the filter element with compressed air at low pressure
5. Loosen clamp holding the air-filter case to carburetor. Remove the air-filter case
6. Wash the case thoroughly in solvent. Allow to drain and wipe dry
7. If the filter case has an oil reservoir, fill it to the required oil level with the correct grade of clean engine oil
8. Replace the filter case on the carburetor. Tighten the clamp screw securely
9. Re-oil the mesh of the filter element with clean engine oil. Drain the excess oil, and install the element in the filter case
10. If the element is polyurathene type, carefully remove the element from the mesh support



**Servicing an Air Cleaner (continued),**

11. Immerse the element in a cleaning solvent

12. Squeeze out the solvent

**Caution:** Do not wring, as the element might tear

13. Dip the element in clean engine oil (S.A.E. 10W-30) and squeeze out most of the oil

14. Clean the housing, and replace the element

15. Wipe the cover clean, and install it

16. Tighten the wing nut

**Caution:** If the filter cover has a felt pad attached to the underside, do not immerse the cover or pad in the cleaning fluid. Simply wipe the cover clean.

## INFORMATION

**Block:** Fuel System

Block IV

**Lesson:** Principles of Carburetion

Job \_\_\_\_\_

Lesson \_\_\_\_\_

---

**Teaching Objective:** Upon completion of this lesson, students will be able to describe the basic principles and relate the functioning of modern gasoline automotive carburetors.

**Teaching Aids:** Transparencies:

- Facts About Carburetors, pp. IV-53, IV-54
- Atmospheric Pressure, Partial Vacuum, p. IV-55
- Temperature, Speed, Load, p. IV-56
- Same Amount Through All Parts of Tube, p. IV-57

**References:** Automotive Mechanics, Crouse, Chapter 9  
Automotive Encyclopedia, 1968, pp. 205-207

### Outline of Information:

#### 1. Principles

- a. Vaporization
  - Air-evaporated fuel mixture necessary for efficient combustion
- b. Atomization
  - Liquid broken up into small droplets for rapid evaporation
- c. Venturi Principle
  - Constricted (reduced) opening produces partial vacuum
  - Increases air velocity

#### 2. Functioning

- a. Fuel-Nozzle Action
  - Atmospheric pressure in float bowl pushes fuel.
  - Nozzle feeds fuel into venturi.
  - Fuel delivery increases as vacuum increases.
- b. Fuel-Air Flow
  - Air-fuel ratio must vary for changing operating conditions.

<u>Conditions</u>	<u>Approx. lbs. air to lbs. fuel</u>
Starting	9:1
Idling	12:1
Traffic Speeds	15:1
Highway Speeds	13:1

- c. Throttle-Valve Action
  - Butterfly valve controlled by linkage to accelerator pedal
  - Controls volume of fuel air flow

## **FACTS ABOUT CARBURETORS**

- 1. A carburetor mixes fuel with air and meters the mixture.**
- 2. Atmospheric pressure forces air through the carburetor into the lower pressure area of the combustion chamber.**
- 3. A venturi increases the velocity of air passing through a carburetor and creates a low pressure area.**
- 4. The fuel-air mixture must be vaporized before introduction into the combustion chamber.**
- 5. The carburetor systems are: Float System, Idle or Low Speed System, Main Metering System, Power System, Accelerating System, and Choke System.**

## **FACTS ABOUT CARBURETORS (CONTINUED)**

- 6. The Float System controls the level and supply of fuel.**
- 7. The Idle or Low Speed System furnishes the proper mixture for the engine idle, light load and slow speeds.**
- 8. The Main Metering System controls the fuel mixture from the transfer range to full throttle.**
- 9. The Power System provides a richer mixture for maximum power and high speed operation.**
- 10. The Accelerating System controls a small amount of fuel discharged into the air stream for sudden acceleration.**
- 11. The Choke System delivers additional fuel to the manifold for cold engine starting.**

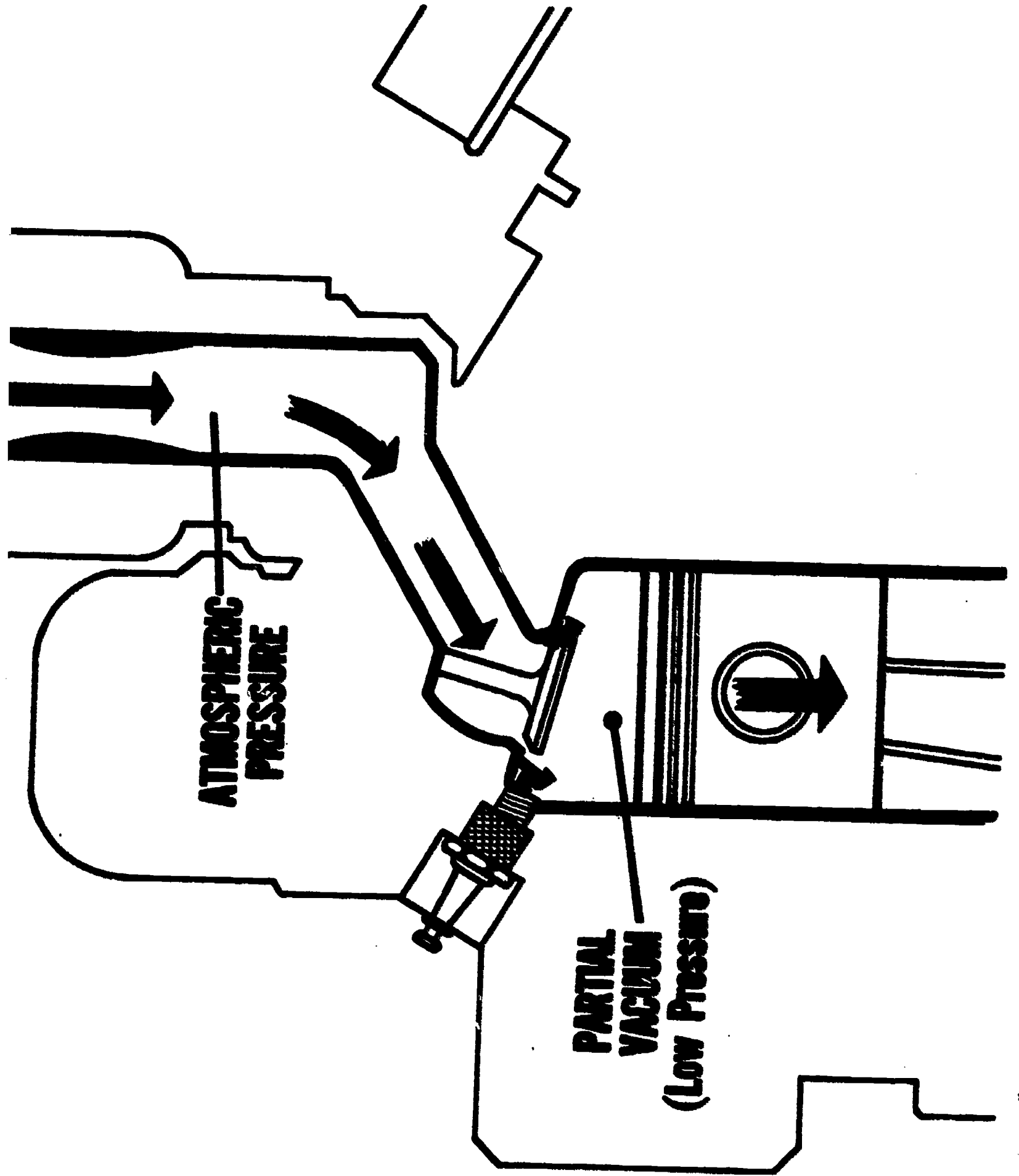

# TEMPERATURE

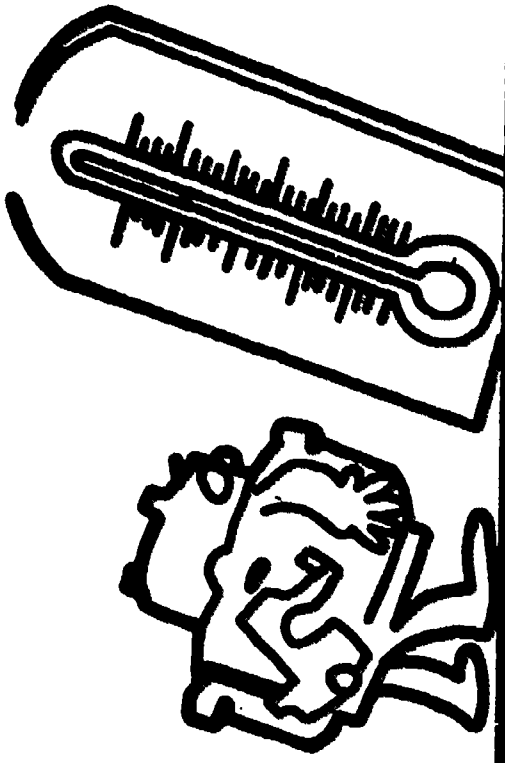

# SPEED

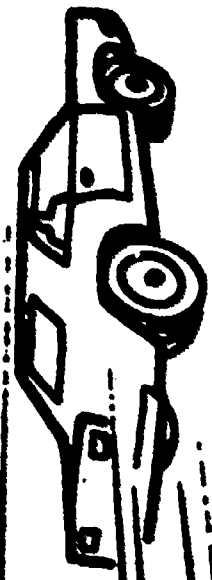
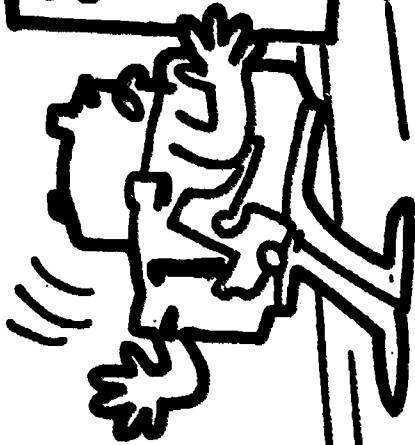

# LOAD



**SAME AMOUNT THROUGH ALL PARTS OF TUBE**

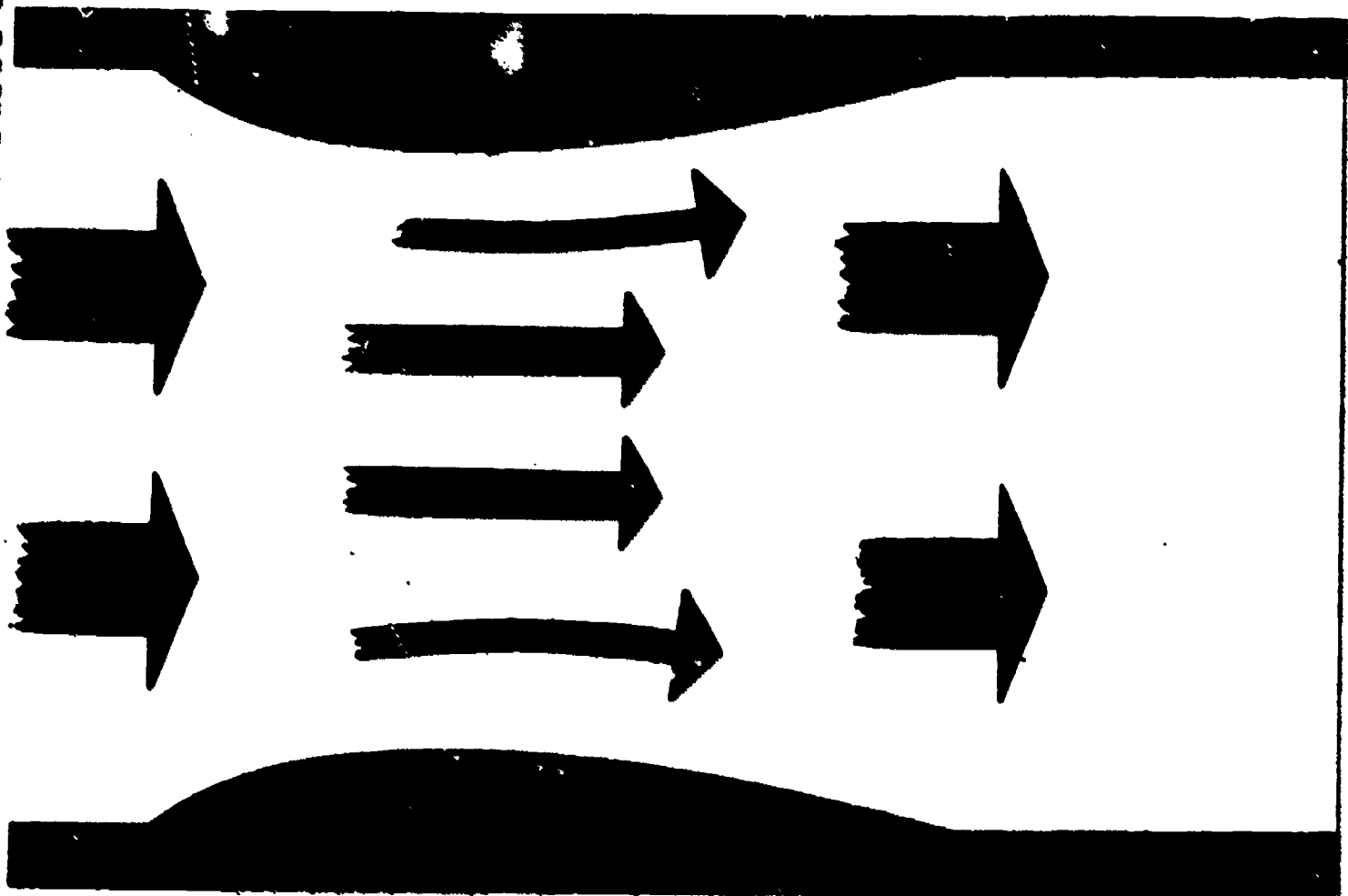

**FASTER  
THROUGH  
VENTURI**

## INFORMATION

Block: Fuel System

Block IV

Lesson: Construction and Function of a Carburetor

Job \_\_\_\_\_

Lesson<sup>no</sup> \_\_\_\_\_

---

Teaching Objective: Upon completion of this lesson, students will be able to describe the major operating functions of the carburetor and identify its basic component units.

Teaching Aids: Transparencies:

- Carburetors, p. IV-59
- Pump Faster, More Spray, p. IV-60
- For Starting, After Starting, Engine Warm, p. IV-61

References: Automotive Mechanics, Crouse, Chapter 9  
Automotive Encyclopedia, 1968, pp. 205-207

Outline of Information:

1. The main functions

- a. To measure the fuel and air in correct proportions for all operating conditions
- b. Atomize the fuel
- c. To mix the fuel and air thoroughly for proper distribution to the cylinders

2. Construction

- a. Three main components
  - Air horn
  - Bowl
  - Throttle body



# Carburetors

## AUTOMATIC CHOKE

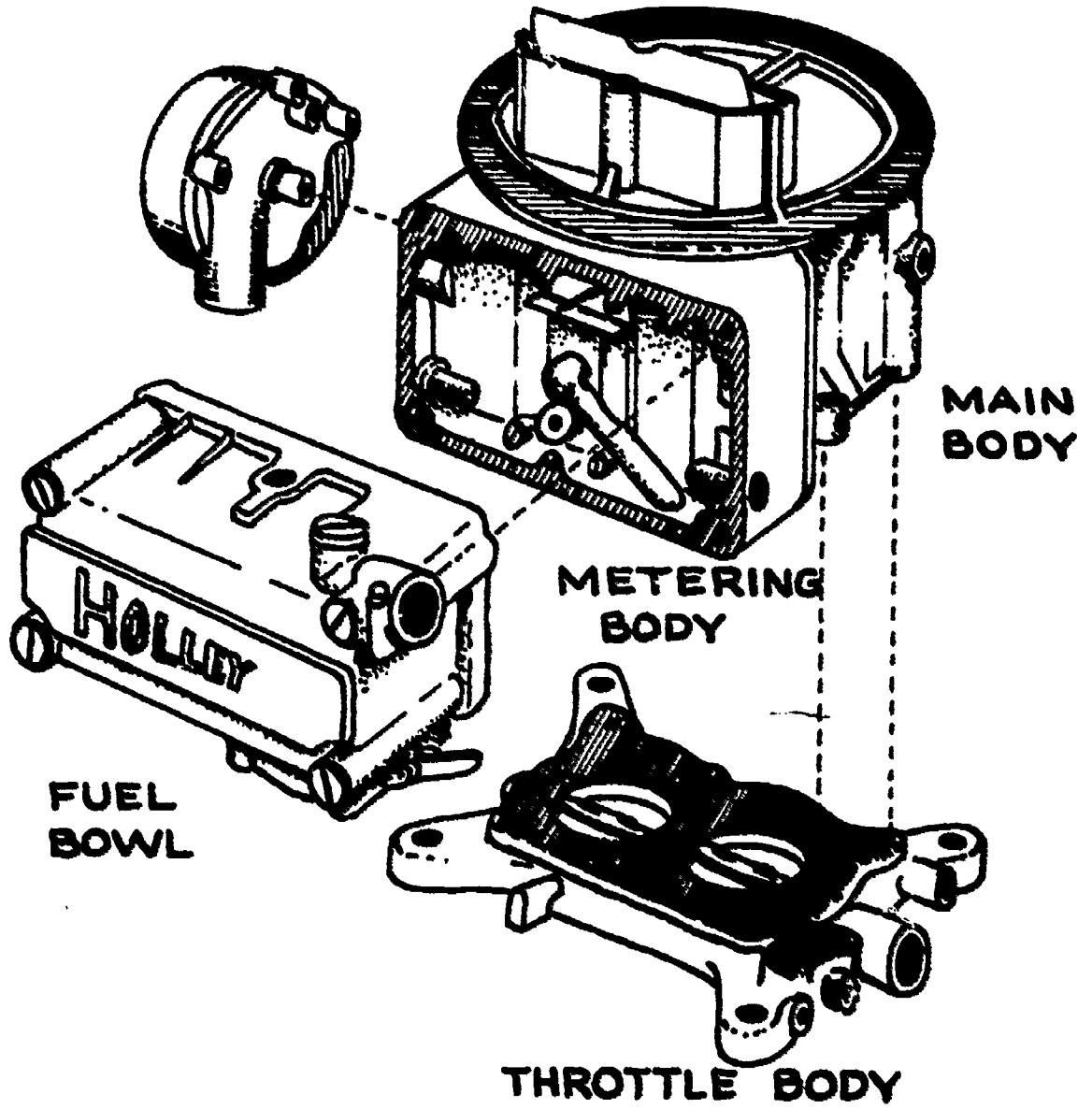

**PUMP FASTER . . . MORE SPRAY . . .**

**NOZZLE . . .  
LOWER PRESSURE**

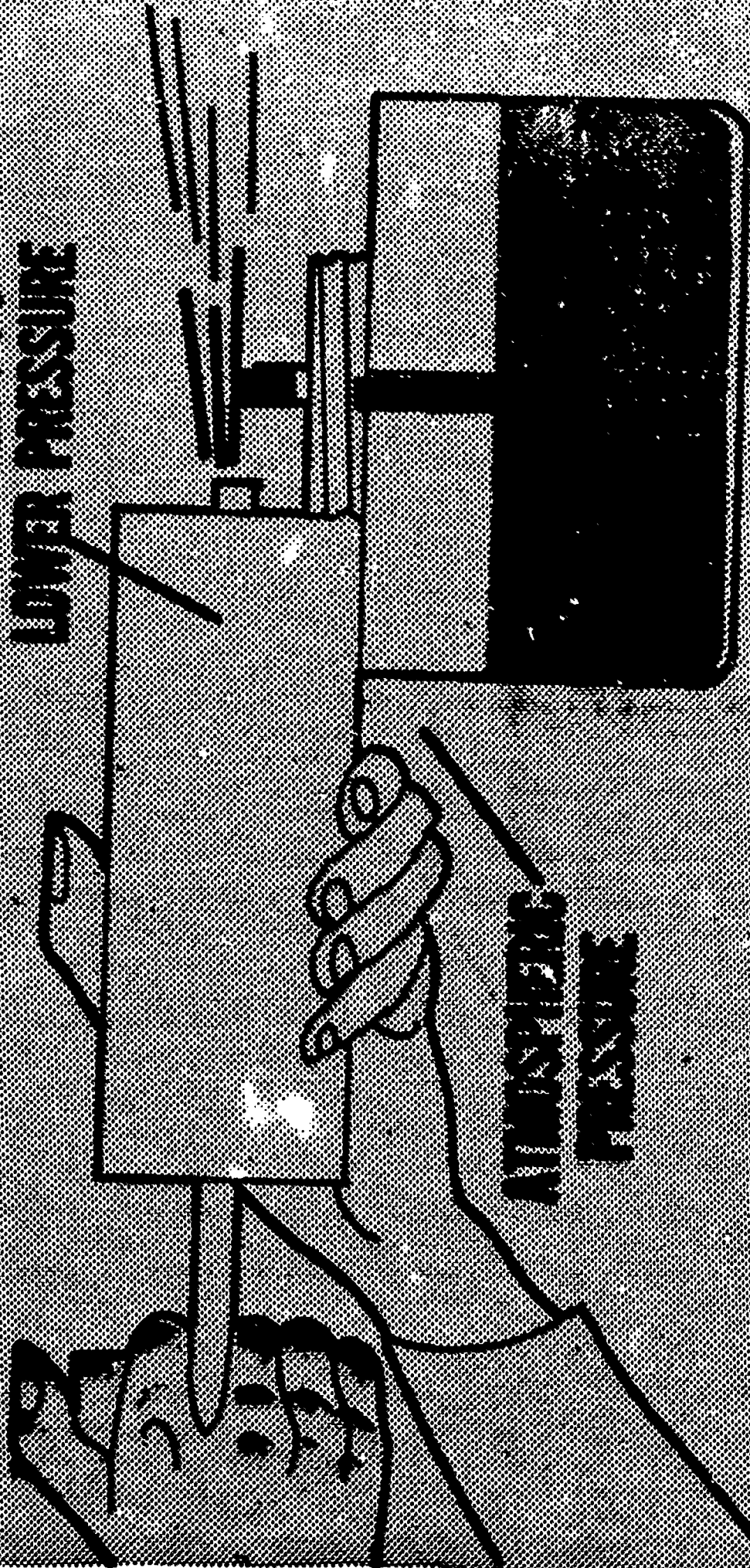

**FOR  
STARTING**

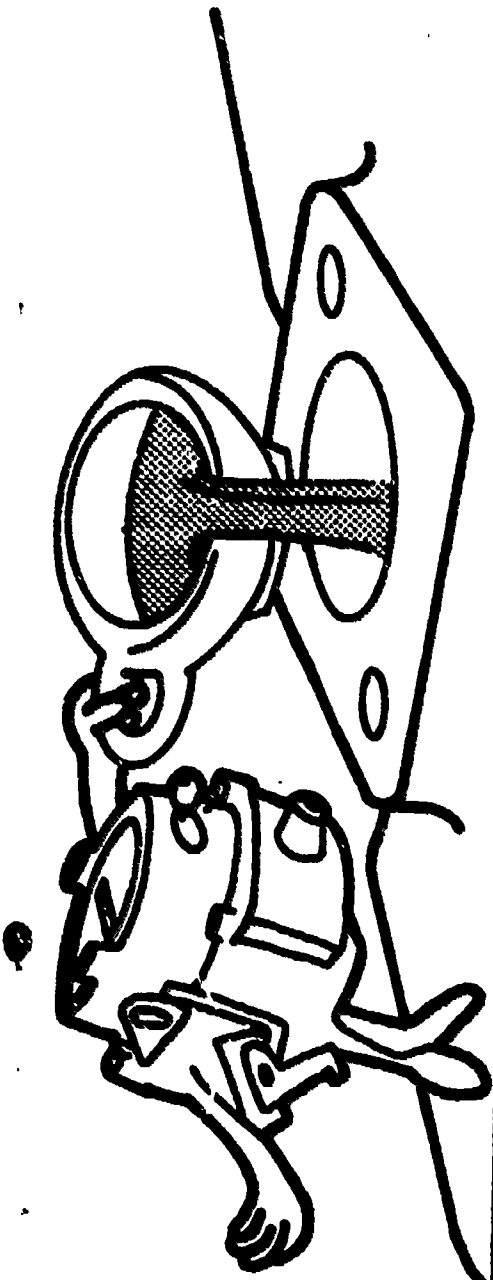

**AFTER  
STARTING**

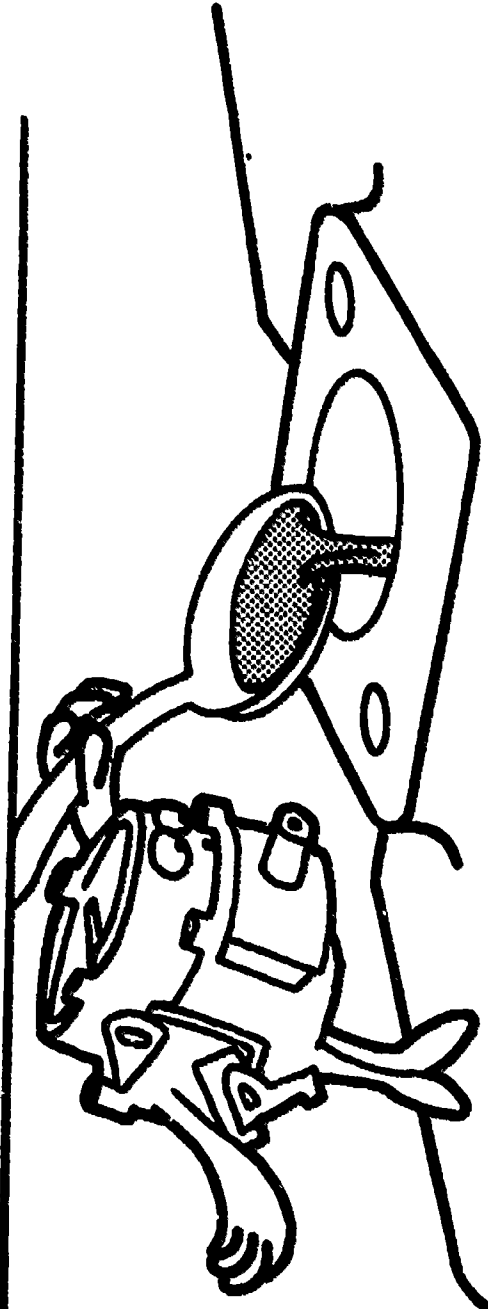

**ENGINE  
WARM**

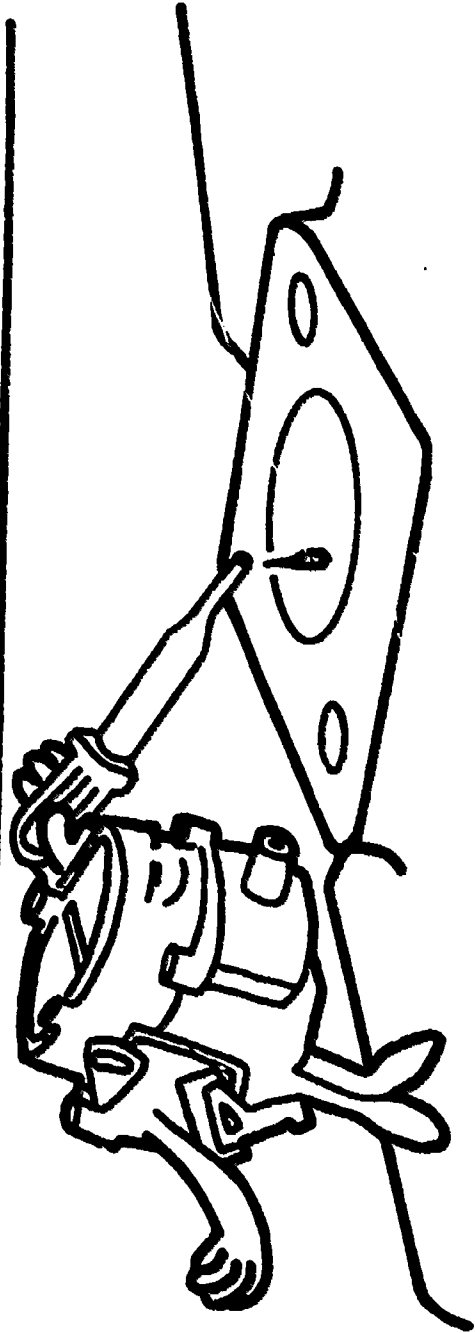

## OPERATION

Block: Fuel System

Block IV

Operation: Removing Air Horn

Job \_\_\_\_\_

Operation \_\_\_\_\_

---

Teaching Objective: To teach students how to properly remove the air horn

Tools: Screwdriver, needle-nose pliers, adjustable wrench, box and wrench (7/16")

Materials: Wipe cloths, Carburetor kit

Teaching Aids: Practice carburetors

References: Vehicle Service Manual

### Steps:

1. For units using fuel inlet filter, remove fuel filter inlet nut and gasket. Then remove filter, filter spring and gasket
2. Remove four air horn attaching screws. Lift air horn straight up from bowl so as not to damage float. Place air horn, inverted, on a flat surface
3. Remove float hinge pin and lift float assembly from air horn. Float needle may now be removed.
4. Remove float needle seat and gasket
5. Remove main metering jet from bottom of main well support
6. Remove hex head power valve check ball retainer from bottom of support. Then remove power valve spring and ball

Note: Use care when removing power valve so as not to lose small spring and ball

7. Remove screw at base of main well support. Then remove the main well support from the air horn
8. Remove power piston and power piston spring from air horn.
9. Remove air horn gasket

## INFORMATION

Block: Fuel System

Block IV

Lesson: Carburetor Circuits

Job \_\_\_\_\_

Lesson \_\_\_\_\_

---

Teaching Objective: Upon completion of this lesson, students will be able to list seven circuits of a modern carburetor and relate basic functions and simple mechanical operations pertinent to each.

Teaching Aids: Transparency;  
- Float, Choke, p. IV-64

References: Automotive Mechanics, Crouse, Chapter 9  
Automotive Encyclopedia, 1968, p. 207  
Chrysler Reference Book, p. 70-8

### Outline of Information:

#### 1. Basic circuits

- a. Float circuit
  - Regulates constant level of fuel in float bowl
- b. Idle circuit
  - Provides air-fuel mixture through separate circuit passages when throttle is closed or nearly closed
- c. Low speed circuit
  - Partly open throttle allows more air whereby fuel passages (in addition to those for idling) are activated
- d. High speed circuit
  - Additional vacuum in venturi due to fairly-well open throttle causes main nozzle to begin fuel discharge.
- e. Power circuit
  - Throttle wide-open for high speed requires adequate air supply for fuel mixture demand.
  - Various systems designed for specific applications
- f. Accelerating circuit
  - Pump systems activated by throttle linkage operation
    - (1) Piston pump system
    - (2) Diaphragm pump system
- g. Choke circuit
  - Rich mixture for starting and warm-up
    - (1) Mechanical type
    - (2) Automatic type

# CHOKE CIRCUIT AND LINKAGE

END OF ROD FITS IN NOTCH

CHOKE VALVE

BEND ROD TO ADJUST

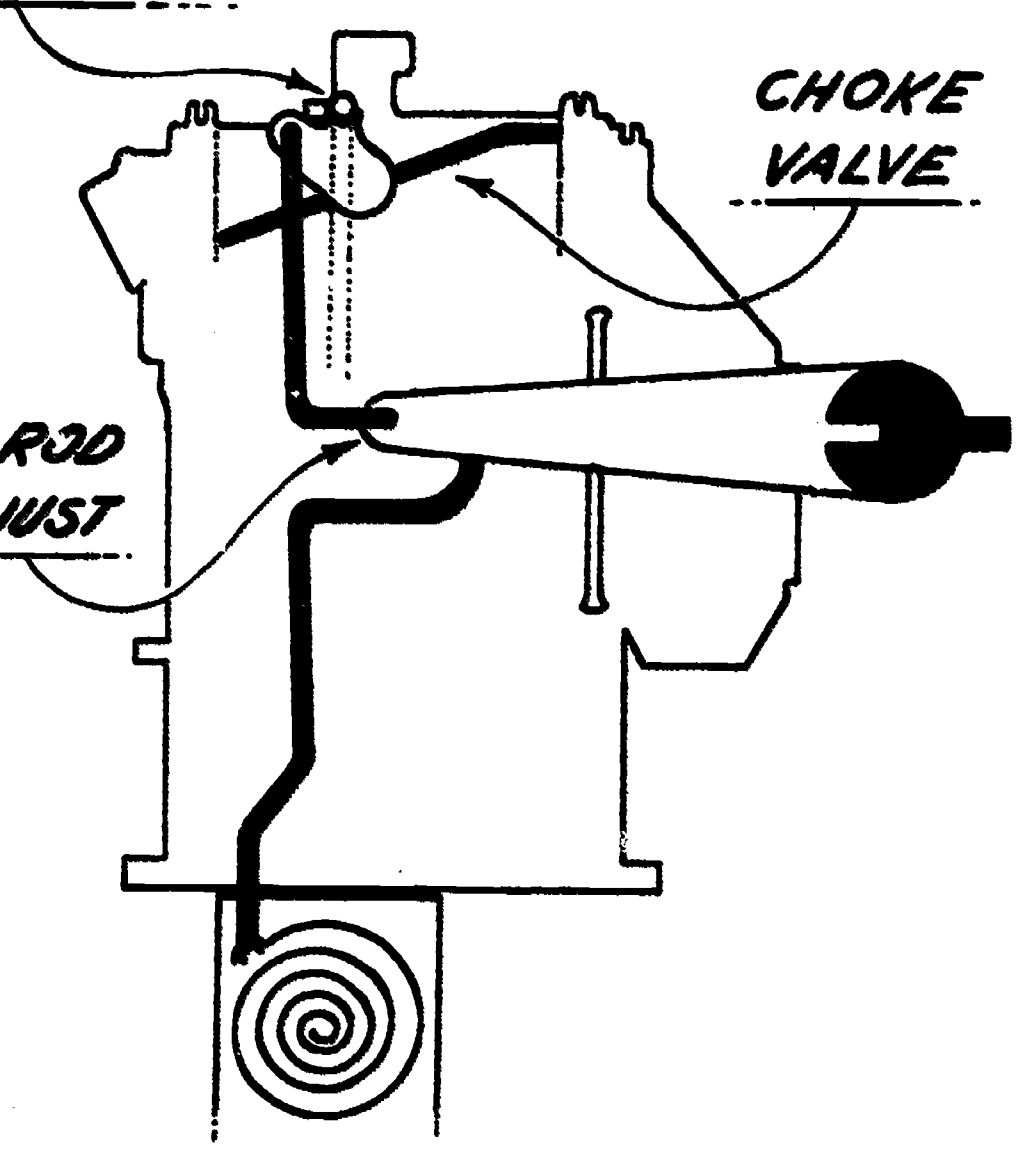

## INFORMATION

Block: Fuel System

Block IV

Lesson: Float Circuit

Job \_\_\_\_\_

Lesson \_\_\_\_\_

---

Teaching Objective: Upon completion of this lesson, students will be able to define the purpose of the carburetor float circuit and relate the components thereof to its systematic operation.

Teaching Aids: Transparencies:

- Fuel Level High, Mixture Too Rich, p. IV-66
- Pump Delivers Constant Pressure, p. IV-67
- Float Adjustments, p. IV-69

References: Automotive Mechanics, Crouse, Chapter 9  
1968 Automotive Encyclopedia, pp. 207-208

Outline of Information:

1. Purpose

- a. Maintains a precise level of fuel to assure that there will be an ample supply of fuel to be delivered for all operating conditions

2. Float and Pump Control Valve

- a. Opening of needle valve
- b. Closing of needle valve

3. Float Setting

- a. Float level
- b. Float drop

4. Pressure balance

- a. The bowl is always at or near the atmospheric pressure.
- b. Balance tube
- c. Outside vent

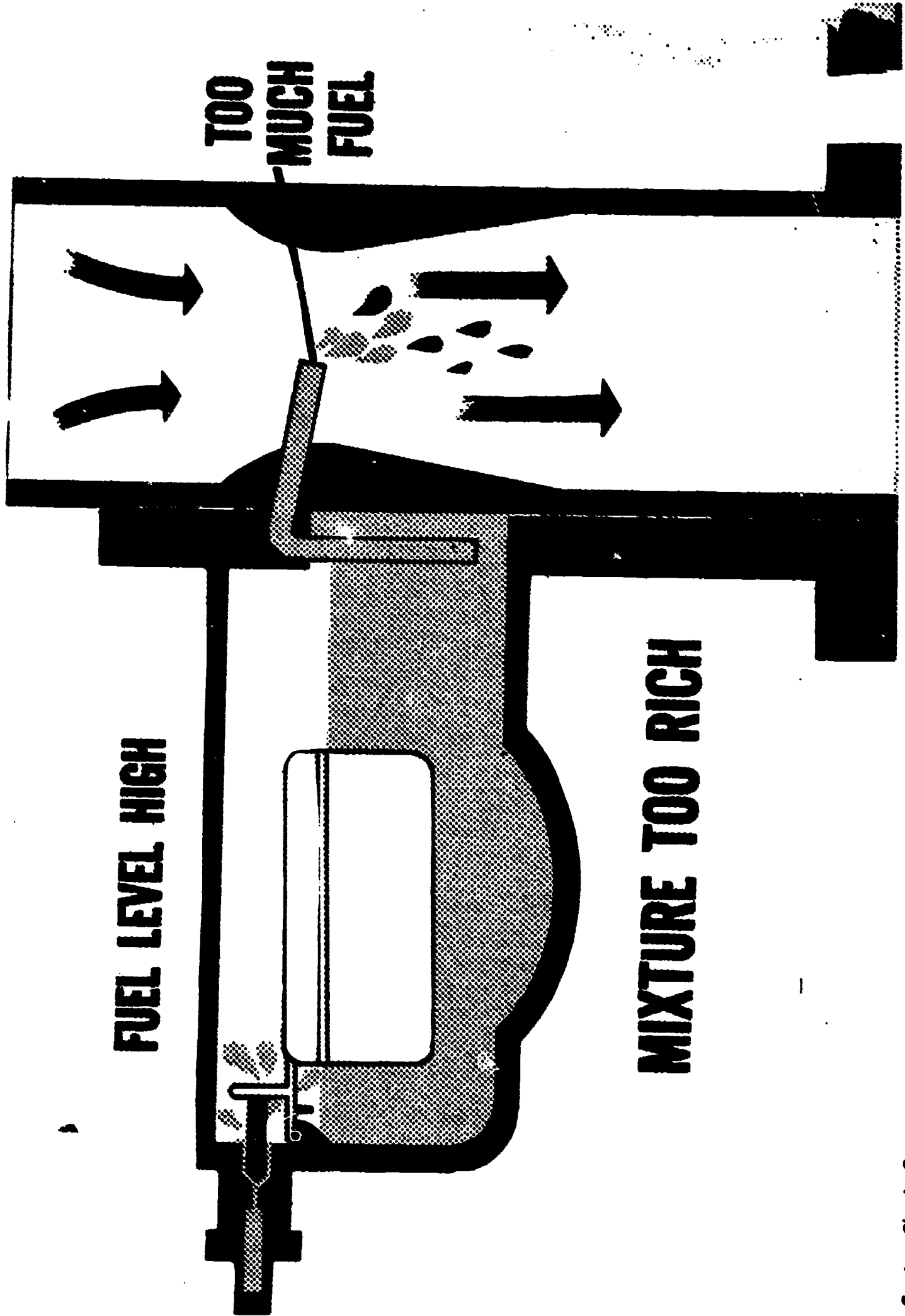

**TOO  
MUCH  
FUEL**

**FUEL LEVEL HIGH**

**MIXTURE TOO RICH**



**PUMP DELIVERS CONSTANT PRESSURE**

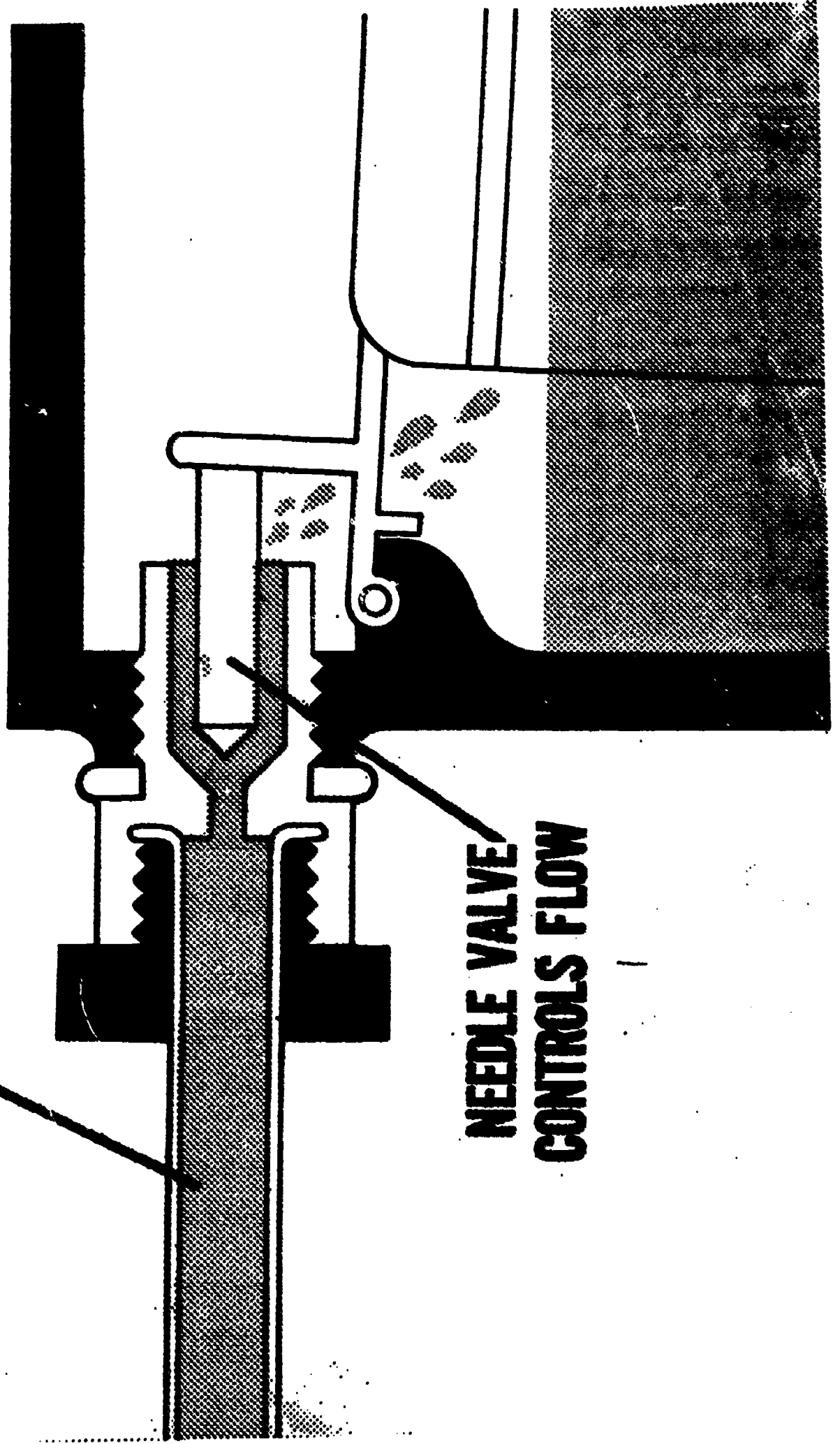

**NEEDLE VALVE  
CONTROLS FLOW**

IV-67

## OPERATION

Block: Fuel System

Block IV

Operation: Adjusting Float

Job \_\_\_\_\_  
Operation \_\_\_\_\_

---

Teaching Objective: To teach students how to adjust float level

Tools: Float gauge or rule

Materials: Wipe cloths

Teaching Aids: Practice carburetors  
Transparency:  
- Float Adjustments, p. IV-69

Reference: Vehicle Service Manuals

Steps:

1. With air horn inverted and air horn gasket in place, check measurement between outer end of float and air horn gasket

Note: Refer to manufacturer's specifications for correct clearance

2. To adjust, bend float lever
3. Check float setting by holding bowl or air horn at eye level height in a level position
4. After any adjustments, recheck float alignment

# Float Adjustments

THE BOWL IS PLACED  
UPSIDE  
DOWN  
FOR  
ADJUSTMENT

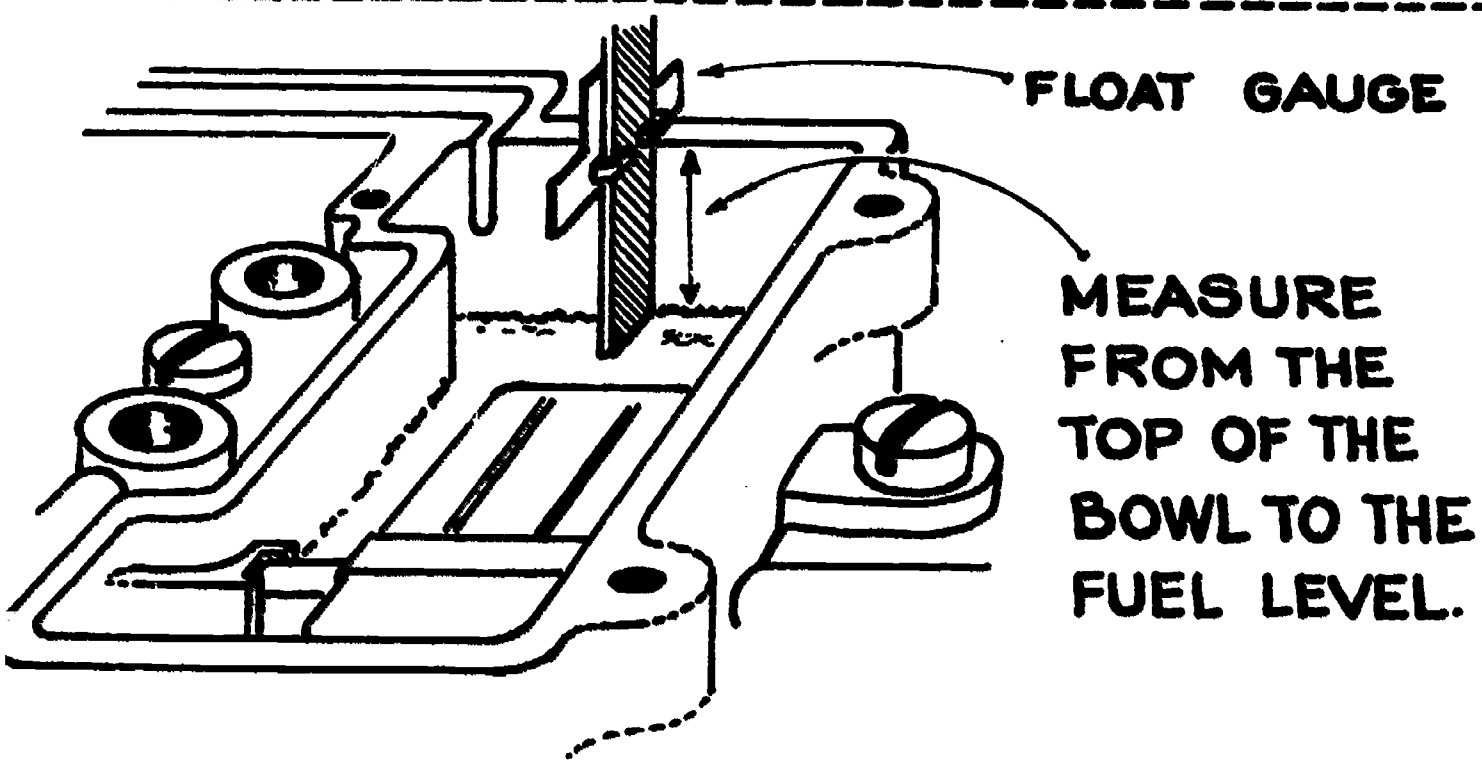
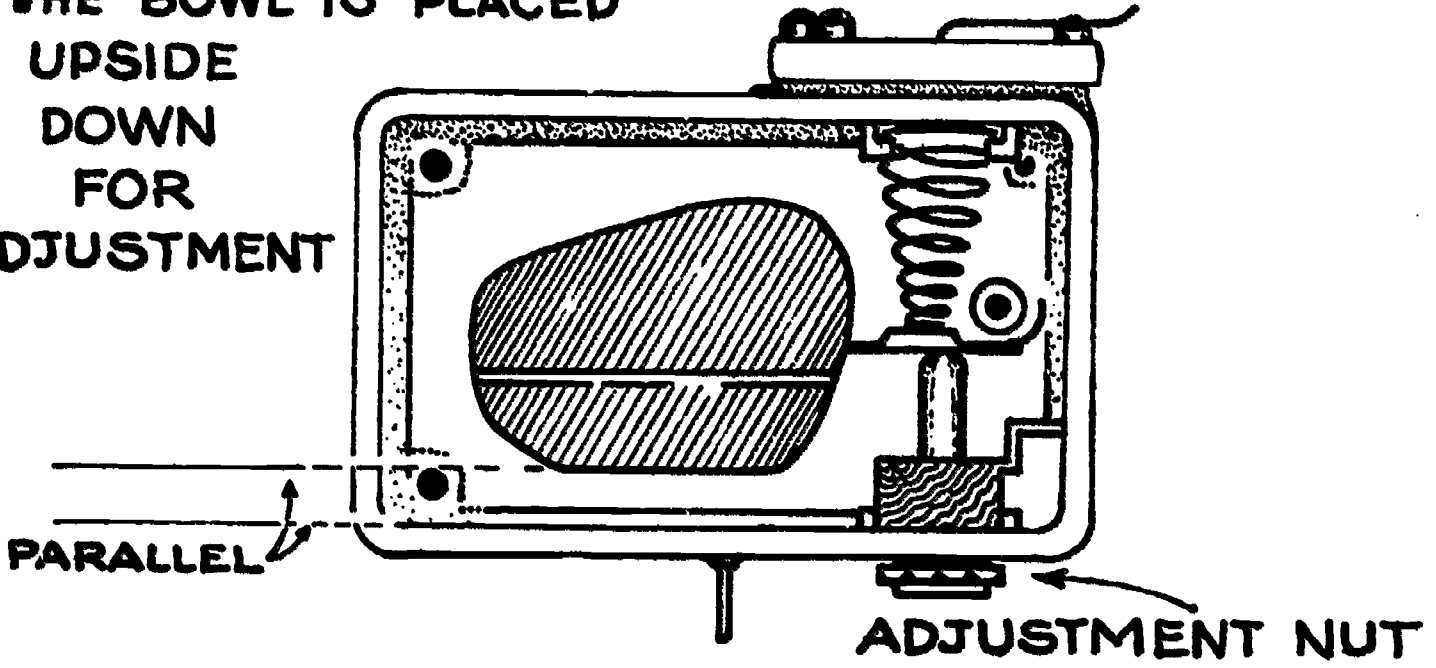

## OPERATION

Block: Fuel System

Block IV

Operation: Adjusting Float Alignment

Job \_\_\_\_\_

Operation \_\_\_\_\_

---

Teaching Objective: To teach students how to properly align a float

Tools: Flat end screwdriver, float alignment gauge, needle-nose pliers, open end wrenches, 1/2" and 9/16"

Materials: Wipe cloths

Teaching Aids: Practice carburetors

References: Vehicle Service Manuals

### Steps:

1. Remove Air Horn assembly
2. Sight down the side of the float shell to determine if the side of the float is parallel to outer edge of air horn casting or to bowl sides
3. To adjust, bend float lever by applying pressure to the end of the float shell with the finger, while supporting the float lever with the thumb
4. After aligning float, remove as much clearance as possible between arms of float lever and lugs on air horn or bowl by bending float lever
5. Arms of float lever should be as parallel to the inner surfaces of lugs on air horn or bowl as possible

Note: Floats must operate freely without excess clearance on its hinge pin. Do not install air horn assembly until other adjustments are made

## OPERATION

Block: Fuel System

Block IV

Operation: Adjusting Float Drop

Job \_\_\_\_\_  
Operation \_\_\_\_\_

---

Teaching Objective: To teach students how to check and adjust float drop

Tools: Needle-nose pliers, float gauge or rule

Materials: Wipe cloths

Teaching Aids: Practice carburetors

References: Buick Service Manual  
Chevrolet Overhaul Manual

### Steps:

1. Hold the air horn in the upright position
2. Measure from the air horn gasket to the bottom outer end of the float

Note: Refer to carburetor specification for the correct measurements

3. To adjust, bend stop tabs on float brackets.

## INFORMATION

Block: Fuel System

Block IV

Lessor: Idle Circuit

Job \_\_\_\_\_

Lesson \_\_\_\_\_

---

Teaching Objective: Upon completion of this lesson, students will be able to describe the operation of the carburetor idle circuit by relating the system components to pertinent functioning.

Teaching Aids: Transparencies:

- Carburetor Adjustments, p. IV-73
- Idle port, p. IV-74

References: Automotive Mechanics, Crouse, Chapter 9  
Carburetion Facts and Fundamentals, Ref. Book 70-8, Chrysler Corp.  
Carburetion Fundamentals, Ref. Book 66-5, Chrysler Corporation

### Outline of Information

1. The purpose of the idle circuit is to provide a fuel passage to bypass the closed throttle valve.

2. Components and functioning

a. Main metering jet

- Permits fuel flow into idle tube

Note: Manifold vacuum creates pressure differential between idle port and float bowl to draw fuel into carburetor bore. Float bowl pressure is same as atmospheric pressure.

b. Idle tube

- Provides fuel passage to idle port
- Contains idle metering restriction

c. Idle air bleeds

- Provide necessary air to be mixed with liquid fuel

d. Transfer port

- Located above throttle valve, it provides additional air for the idle circuit.

3. Adjustments

a. Idle speed

- Stop screw setting throttle lever to gauge valve opening
- Provides additional air flow

b. Idle Mixture

- Screw setting that meters amount of fuel-air mixture introduced into air stream

# CARBURETOR ADJUSTMENTS

## IDLE MIXTURE SCREWS ADJUSTMENT

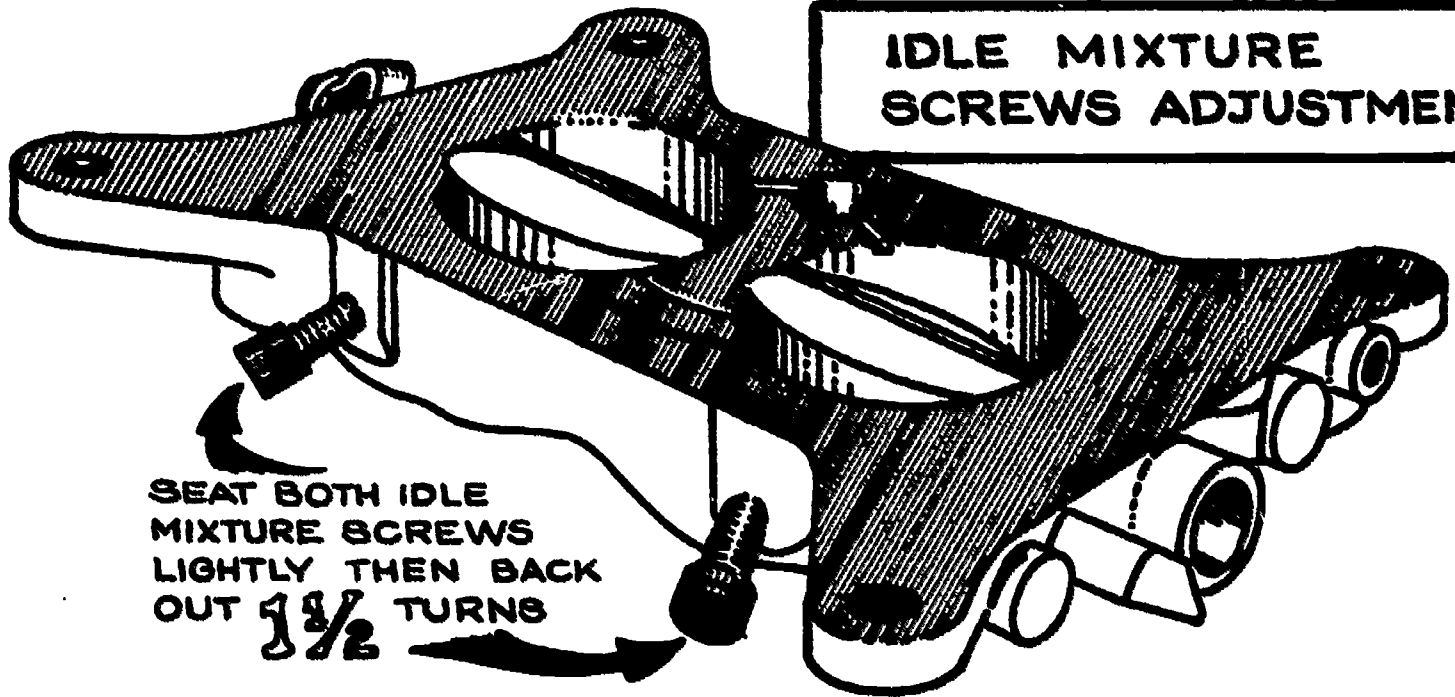

## FAST IDLE SPEED SCREW ADJUSTMENT

- 1 BACK SCREW OUT TO CLEAR CAM.
- 2 TURN SCREW IN TO JUST TOUCH CAM.
- 3 TURN SCREW IN ONE COMPLETE TURN.

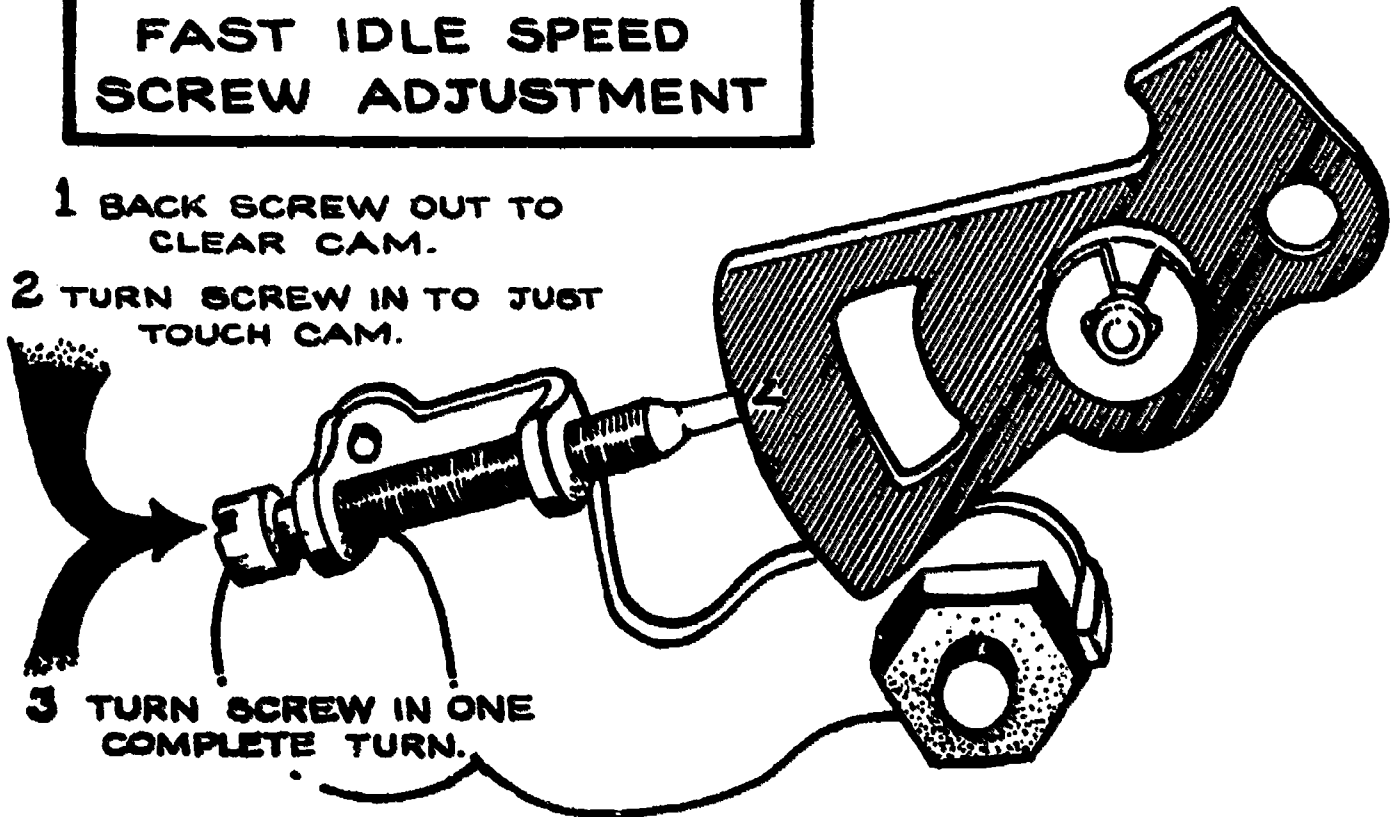

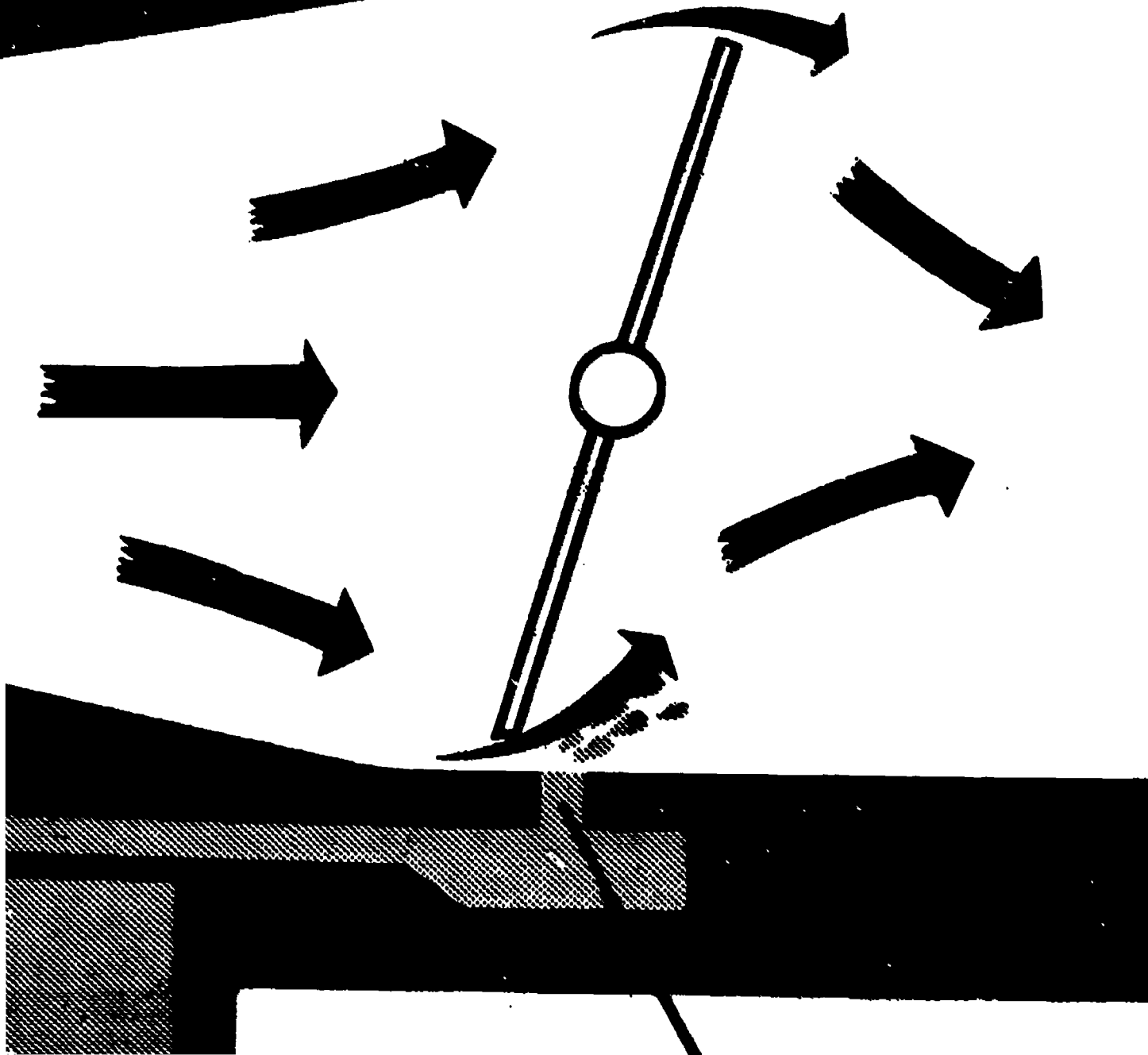

**IDLE  
PORT**



## OPERATION

Block: Fuel System

Block IV

Operation: Adjusting Idle Mixture

Job \_\_\_\_\_

Operation \_\_\_\_\_

---

Teaching Objective: To teach the students how to properly adjust idle mixture

Tools: Screwdriver

Materials: Wipe cloths

Teaching Aids: Practice carburetors

Transparencies:

- Idle Mixture Screw, p. IV-76

- Adjustable Air screw, Limiter Screw, p. IV-78

References: Vehicle Service Manual

### Steps:

Note: This adjustment should be performed with engine at operating temperature and parking brakes applied.

1. Remove air cleaner
2. Connect tachometer and vacuum gauge to engine then set hand brake and shift transmission into neutral
3. As a preliminary adjustment turn idle mixture screws lightly to seat and back out 1 1/2 turns

Caution: Do not turn idle mixture screw tightly against seat or damage may result

4. With engine running (choke wide open) adjust idle speed screw to specified idle speed. (Check manufacturer's specification)

Note: Automatic transmission in drive, synchronized transmission in neutral

5. Adjust idle mixture screw to obtain highest steady vacuum at specified idle speed

Note: On air conditioned vehicles, turn air conditioner to the on position and hold the hot idle compensator valve closed while adjusting idle speed and idle mixture screws

6. Repeat steps 4 and 5 as needed for final adjustment
7. Turn engine off, remove gauges and install air cleaner

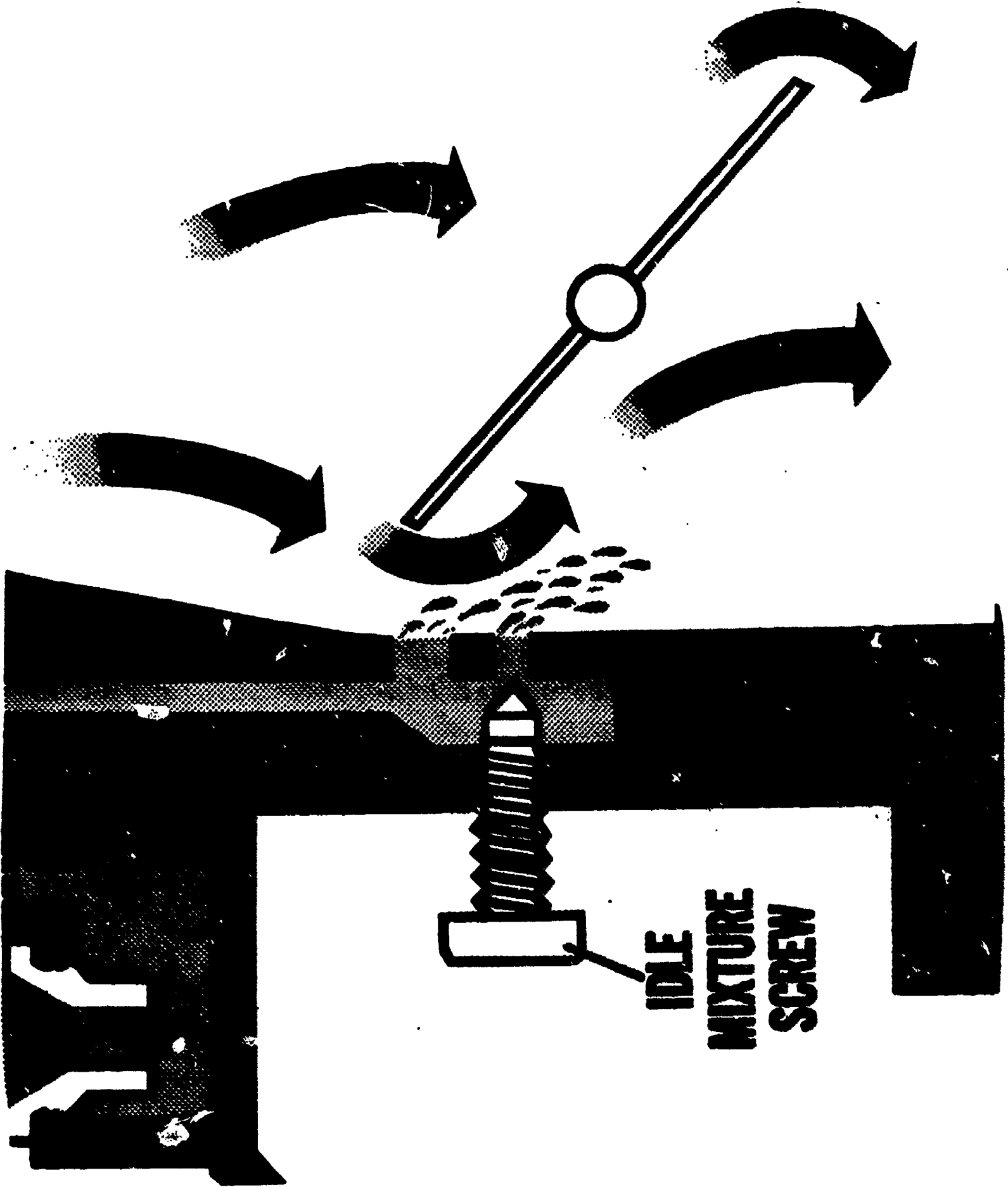

**IDLE  
MIXTURE  
SCREW**

## OPERATION

Block Fuel System

Block IV

Operation: Adjusting Curb Idle and Fuel-air Mixture

Job \_\_\_\_\_

Operation \_\_\_\_\_

---

Teaching Objective: To teach the student how to adjust curb idle and fuel-air mixture

Tools: Tachometer, vacuum gauge, flat end screwdriver

Materials: Wipe cloths

Teaching Aids: Automobile or engine on stand

References: Vehicle Service Manual  
Motor's Auto Repair Manual, 1969, pp. 1-124 - 1-258

### Steps:

1. Engine is to be running at normal operating temperature.

Caution: When servicing vehicle with engine running, always set parking brake and block wheels.

2. Attach tachometer and vacuum gauge

3. Check to determine that choke valve is wide open

4. Adjust curb idle to manufacturer's specification

5. Turn mixture screw clockwise until vacuum gauge needle starts to drop

Note: Observe the position of the slot in the screw

6. Turn mixture screw counter-clockwise until vacuum gauge needle starts to drop

7. Observing the slot in the mixture screw from the clockwise to counter-clockwise; split the slot position difference

8. Adjust the curb idle screw to manufacturer's specification

9. If the carburetor has two idle adjustments, repeat procedure

Note: Above procedure is applicable to vehicles not equipped with Exhaust Emission Control devices.

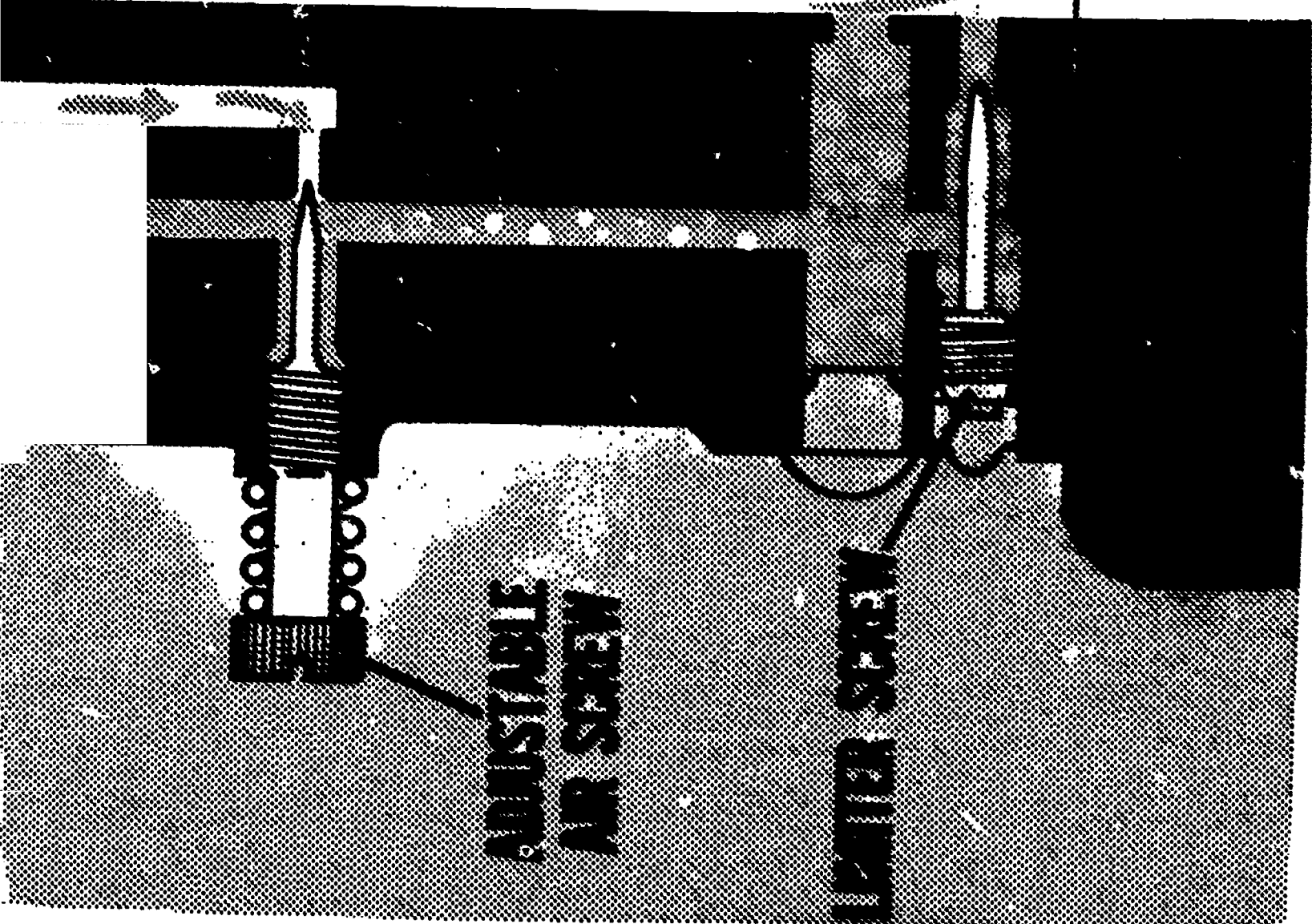
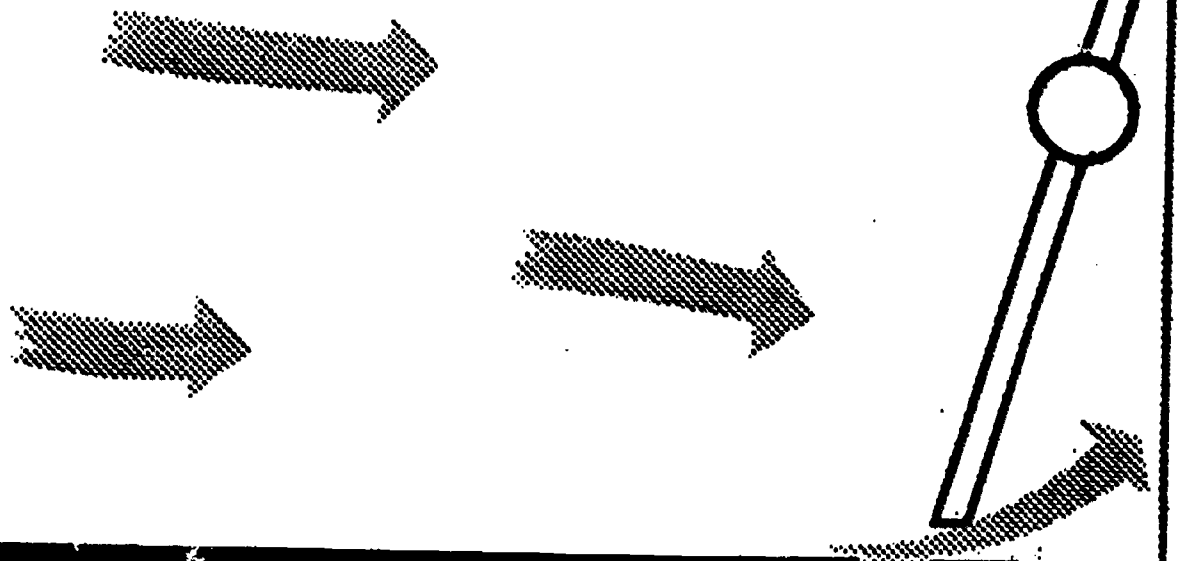

## OPERATION

Block: Fuel System

Block IV

Operation: Adjusting Fast Idle

Job \_\_\_\_\_

Operation \_\_\_\_\_

---

Teaching Objective: To teach students to adjust fast idle

Tools: Drill bit or specified gauge

Teaching Aids: Motor on stand

References: Vehicle Service Manual

Steps:

1. Remove air cleaner
2. Turn stop screw in until it contacts bottom step of fast idle cam
3. Then turn screw in one (1) full turn
4. Place idle screw on second step of fast idle cam against shoulder of high step
5. With screw in this position, hold check clearance between upper edge of choke valve and air horn wall
6. Adjust to specified dimension by bending tang on choke lever and collar assembly
7. Install air cleaner

## OPERATION

**Block:** Fuel System

Block IV

**Operation:** Adjusting Idle Vent

Job \_\_\_\_\_

Operation \_\_\_\_\_

---

**Teaching Objective:** To teach students how to adjust carburetor idle vent

**Tools:** Screwdriver, feeler gauge, needle-nose pliers

**Materials:** Wipe cloths

**Teaching Aids:** Carburetor Service Manual

**References:** Automotive Mechanics, Crouse, Chapter 9  
Vehicle Service Manual

**Steps:**

1. Close throttle valve tightly
2. Measure the clearance between the vent and the air horn

**Note:** Refer to specifications for the carburetor make and model to determine measurement location and amount of clearance necessary

3. To make the adjustment, carefully bend the lip on the vapor vent arm.

**Note:** Only the slightest bend will significantly change the clearance. Therefore, it is necessary to make only minute adjustments and careful, frequent clearance checks.

## INFORMATION

Block: Fuel System

Block IV

Lesson: Low Speed Circuit

Job \_\_\_\_\_

Lesson \_\_\_\_\_

---

Teaching Objective: Upon completion of this lesson, students will be able to describe the operation of the carburetor low speed circuit by relating the system components to pertinent functioning.

Teaching Aids: Transparencies:

- Idle Tube, Main Metering Jet, Metering Restriction, Idle Port, p. IV-82
- Air Bleeds, p. IV-83

References: Automotive Mechanics, Crouse, Chapter 9  
Automechanics, Glenn, Chapter 6  
Vehicle Service Manual

Outline of Information:

1. Air horn
  - a. Main cover assembly of carburetor body
  - b. Provides for passage of air supply
2. Throttle Valve
  - a. Controls fuel-air supply to intake manifold entry
  - b. Alignment
  - c. Adjustment
3. Main metering jet
  - a. Regulates gasoline flow
4. Idle tube
  - a. By-pass main nozzle as supply route
5. Transfer port
  - a. Provides for fuel entry into air horn
6. Vacuum drop
  - a. Achieved through closing of throttle valve which diminishes venturi effect

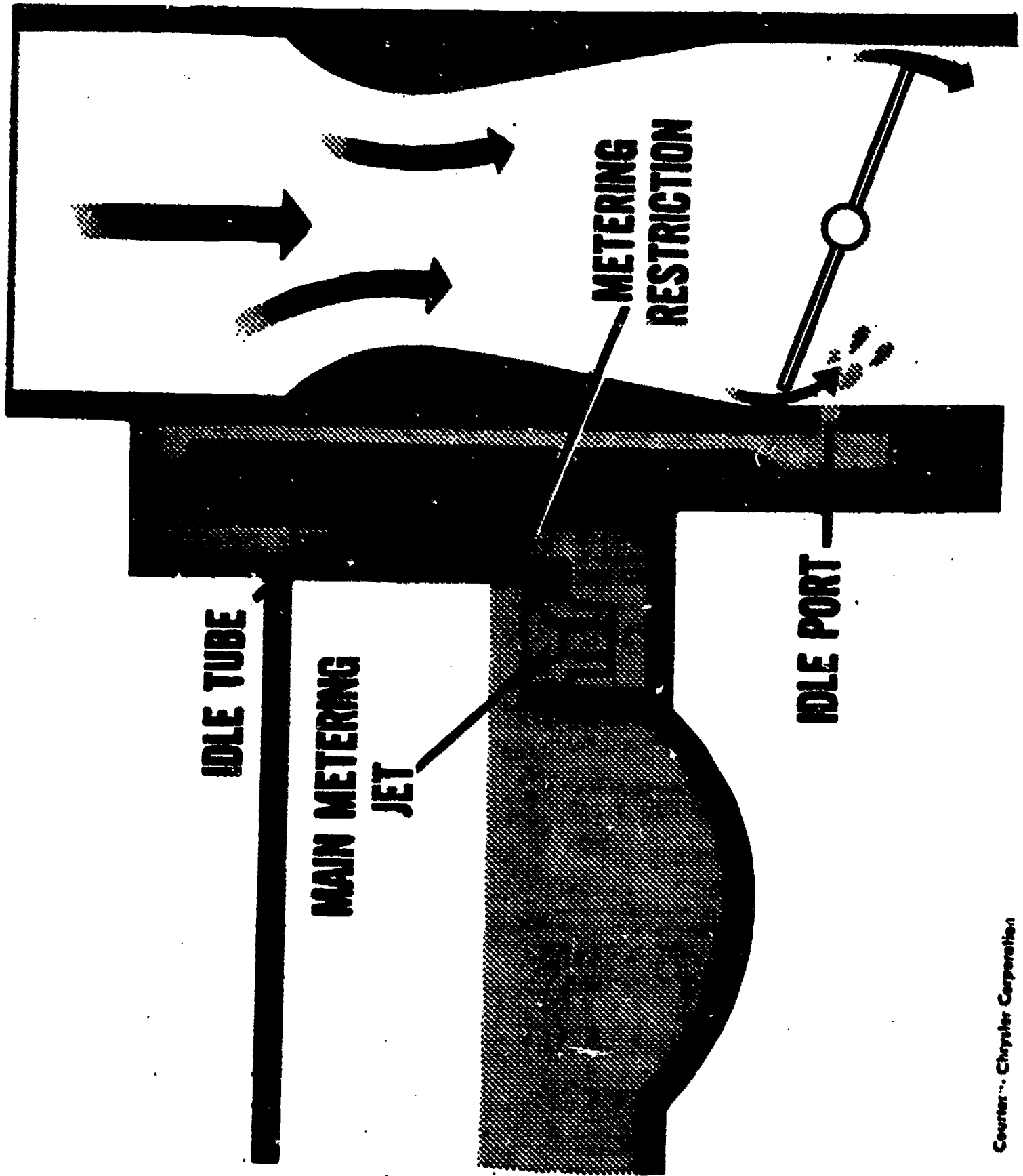



**AIR BLEEDS**

**BLEEDS HELP  
FUEL MIX  
WITH AIR**

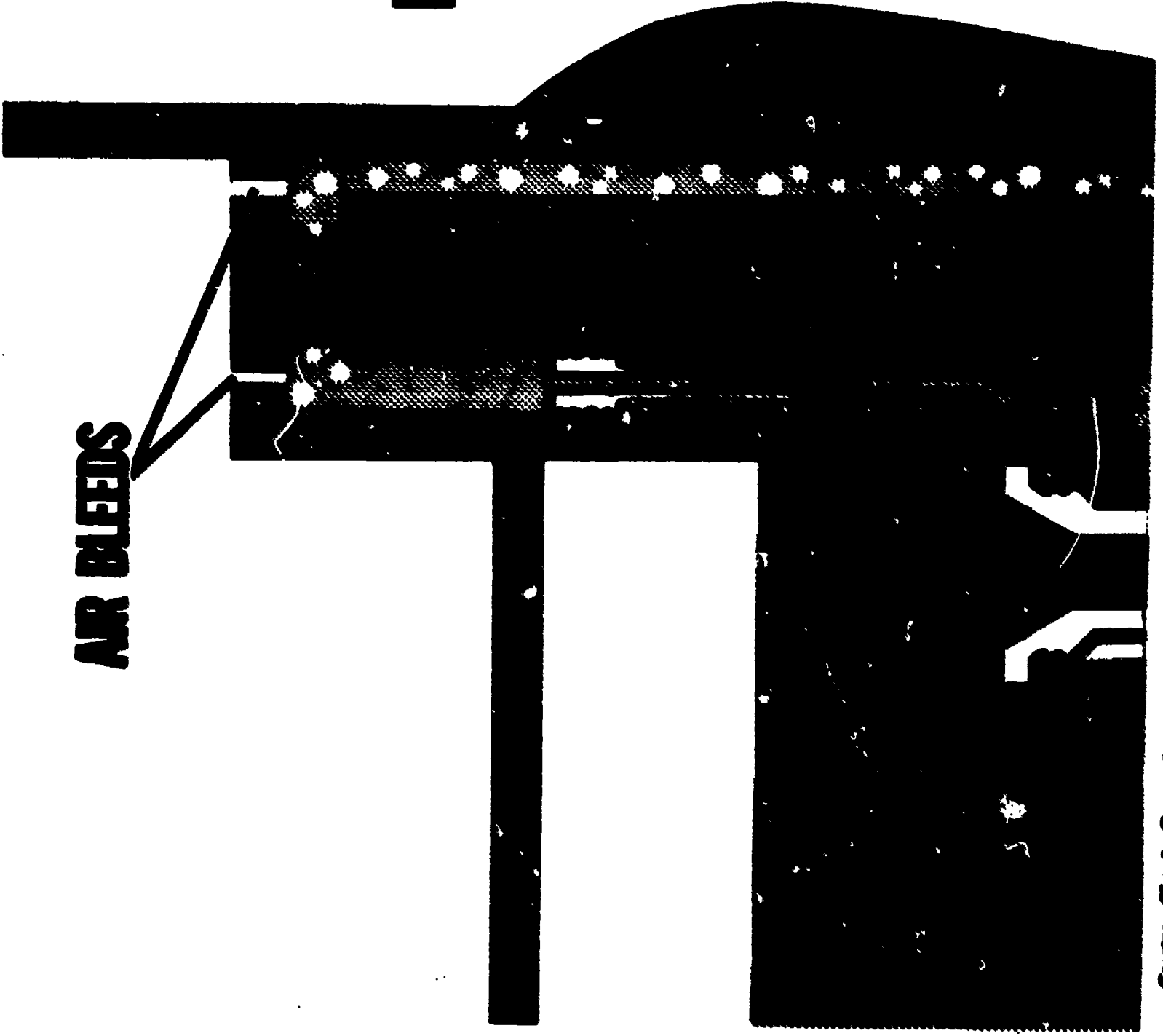

*Courtesy - Chrysler Corporation*

## OPERATION

Block: Fuel System

Block IV

Operation: Servicing a Carburetor Low-Speed Circuit

Job \_\_\_\_\_

Operation \_\_\_\_\_

---

Teaching Objective: To teach students to service a carburetor low-speed circuit

Tools: Screwdriver, needle-nose pliers

Materials: Necessary gaskets, cleaning solvent, wipe cloths

Teaching Aids: Carburetor specifications

Reference: Vehicle Service Manual

Steps:

1. Remove idle adjusting screws and spring from the carburetor body
2. Remove plug from idle passage using a plug tool
3. Remove the low speed jet, or the idling orifice tube
4. Remove the pump arm from the throttle shaft
5. Remove the screws that fasten the throttle valve to shaft
6. Mark the throttle valve on the side toward the idle port to insure correct assembly
7. Remove throttle shaft and lever. Unscrew the idle adjusting screw in throttle lever two full turns at this time
8. Clean and inspect all parts for wear. Replace any worn or defective parts
9. Clean the carbon from the carburetor body. Be sure that the idle port is free from carbon.
10. Install throttle shaft and lever
11. Install throttle valve on the shaft. Do not tighten the screw until the valve is centered in carburetor body.

## **Servicing a Carburetor Low-Speed Circuit (continued)**

12. Install pump arm on the throttle shaft and tighten securely
13. Adjust throttle lever screw to specifications
14. Adjust pump operating rod to specifications
15. Install low-speed jet and gasket or washer. Tighten with jet wrench
16. Install idle port plug and gasket if used
17. Install idle adjusting screw and spring. Set to specifications

## INFORMATION

**Block:** Fuel System

Block IV

**Lesson:** Accelerator Circuit

Job \_\_\_\_\_

Lesson \_\_\_\_\_

---

**Teaching Objective:** Upon completion of this lesson, students will be able to describe the operation of the carburetor accelerator circuit by relating the system components to pertinent functioning.

**Teaching Aids:** Transparencies:

- Air Flow Reduces Pressure, p. IV-87
- Air Flow Increases Faster Than Fuel Flow, p. IV-88

**References:** Automotive Mechanics, Crouse, Chapter 9  
Carburetor Fundamentals, Ref. Book 66-5, Chrysler Corporation

### Outline of Information:

#### 1. Purpose

- a. High-speed system alone cannot supply the extra fuel immediately.
- b. Provides more fuel directly into carburetor bore

#### 2. Construction and function

##### a. Pump well

- Separate compartment within float bowl
- Contains supply of fuel ready for pump action

##### b. Accelerator Pump

- When throttle opens, pump spring is activated to provide a smooth, even flow of fuel into carburetor air stream.

##### c. Linkage and arms

- Lifts pump to operate only during first half of full throttle potential

**Note:** High-speed system accomodates top half of full throttle.

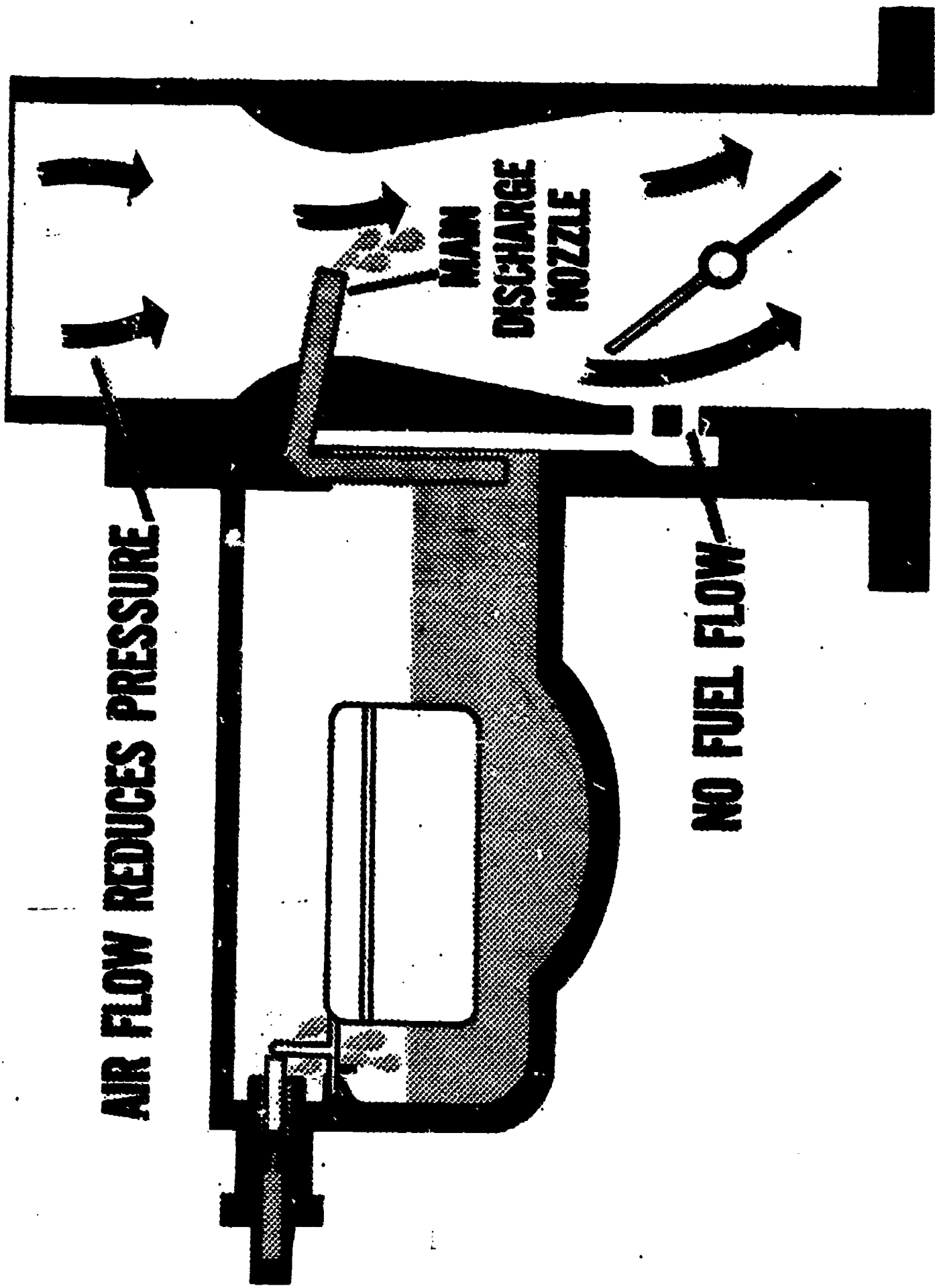

**AIR FLOW REDUCES PRESSURE**

**MAIN  
DISCHARGE  
NOZZLE**

**NO FUEL FLOW**

# AIR FLOW INCREASES FASTER THAN FUEL FLOW

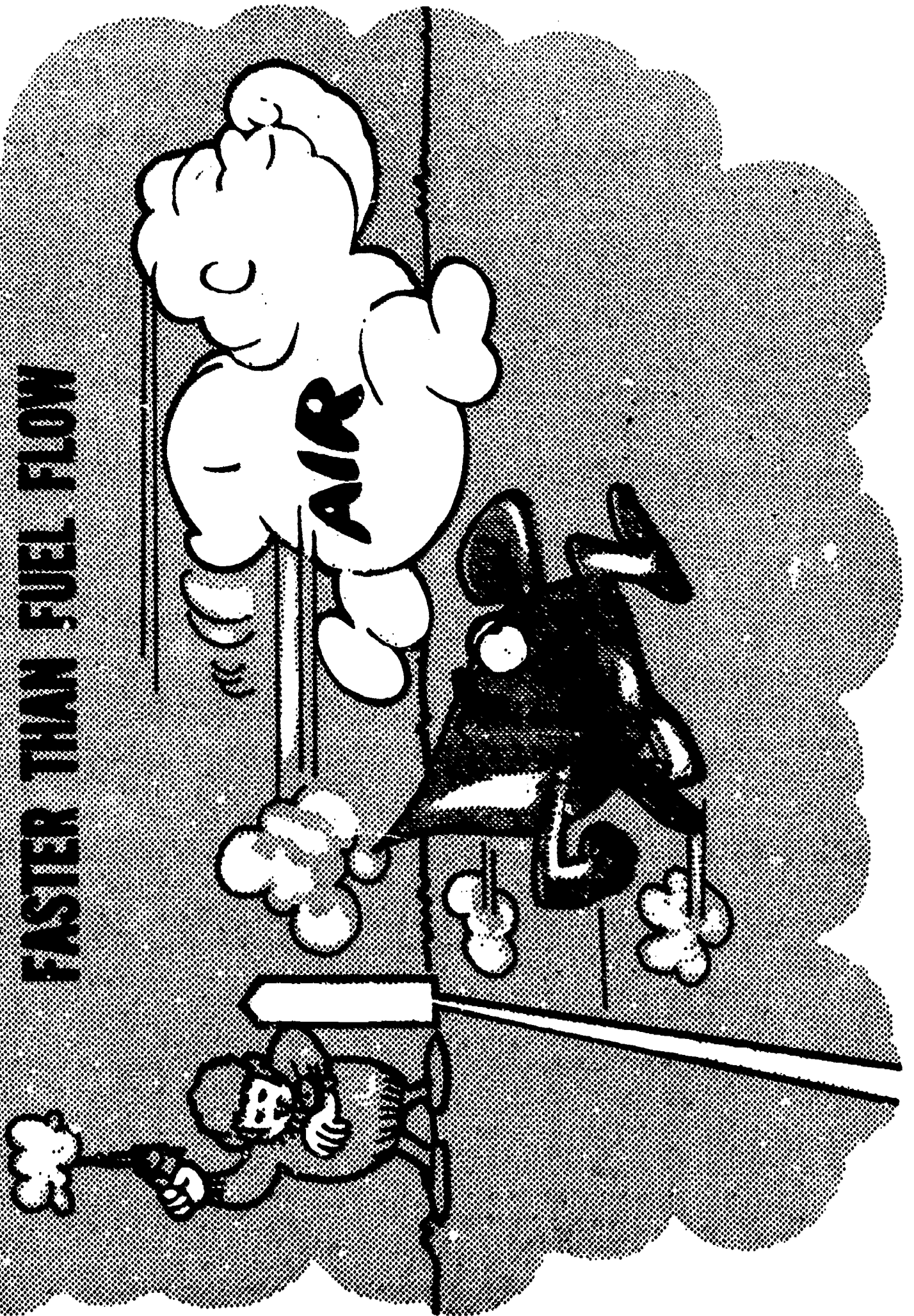

Courtesy: Chrysler Corporation

## OPERATION

Block: Fuel System

Block IV

Operation: Adjusting Accelerator Pump Linkage

Job \_\_\_\_\_

Operation \_\_\_\_\_

---

Teaching Objective: To teach students how to adjust accelerator pump linkage

Tools: Pliers or proper bending tools

Materials: Specification chart, wipe cloth

Teaching Aids: Automobile or engine on stand

Reference: Vehicle Service Manual

Steps:

1. Install pump connection link in outer hold (longstroke) of pump arm with end extending toward counter shaft arm
2. Back out throttle levers set screw until throttle valves seats in bores of carburetor
3. Hold straight edge across top of dust cover base at pump arm

Note: The flat surface on top of pump arm should be parallel to straight edge.

4. Adjust by bending throttle connector rod at lower angle
5. Adjust curb idle

INFORMATION

Block: Fuel System

Block IV

Lesson: Power Circuit

Job \_\_\_\_\_

Lesson \_\_\_\_\_

---

Teaching Objective: Upon completion of this lesson, students will be able to describe the operation of the carburetor power circuit by relating the system components to pertinent functioning.

Teaching Aids: Transparencies:

- Rich Mixture for More Power, p. IV-91
- Vacuum Piston, High Vacuum, Main Jet, p. IV-92

References: Automechanics, Glenn, Chapter 6  
Automotive Mechanics, Crouse, Chapter 9  
Motor's Auto Repair Manual, 1969, pp. 1-124 - 1-261

Outline of Information:

1. Purpose: Provides extra fuel mixture through special systems for extra power
2. Operating conditions
  - a. Open throttle
  - b. Low manifold vacuum
  - c. Opening by-pass routes
  - d. Richer mixture made available to intake manifold
3. Types of systems
  - a. Mechanical
    - Metering rod and companion jet supplies full fuel flow through main nozzle.
    - Operated by throttle linkage
  - b. Vacuum operated
    - Piston-controlled in by-pass circuit operated by intake-manifold vacuum.
    - Metering rod and jet activated by vacuum piston
  - c. Combination
    - Operated by throttle linkage with compensating action of vacuum piston spring



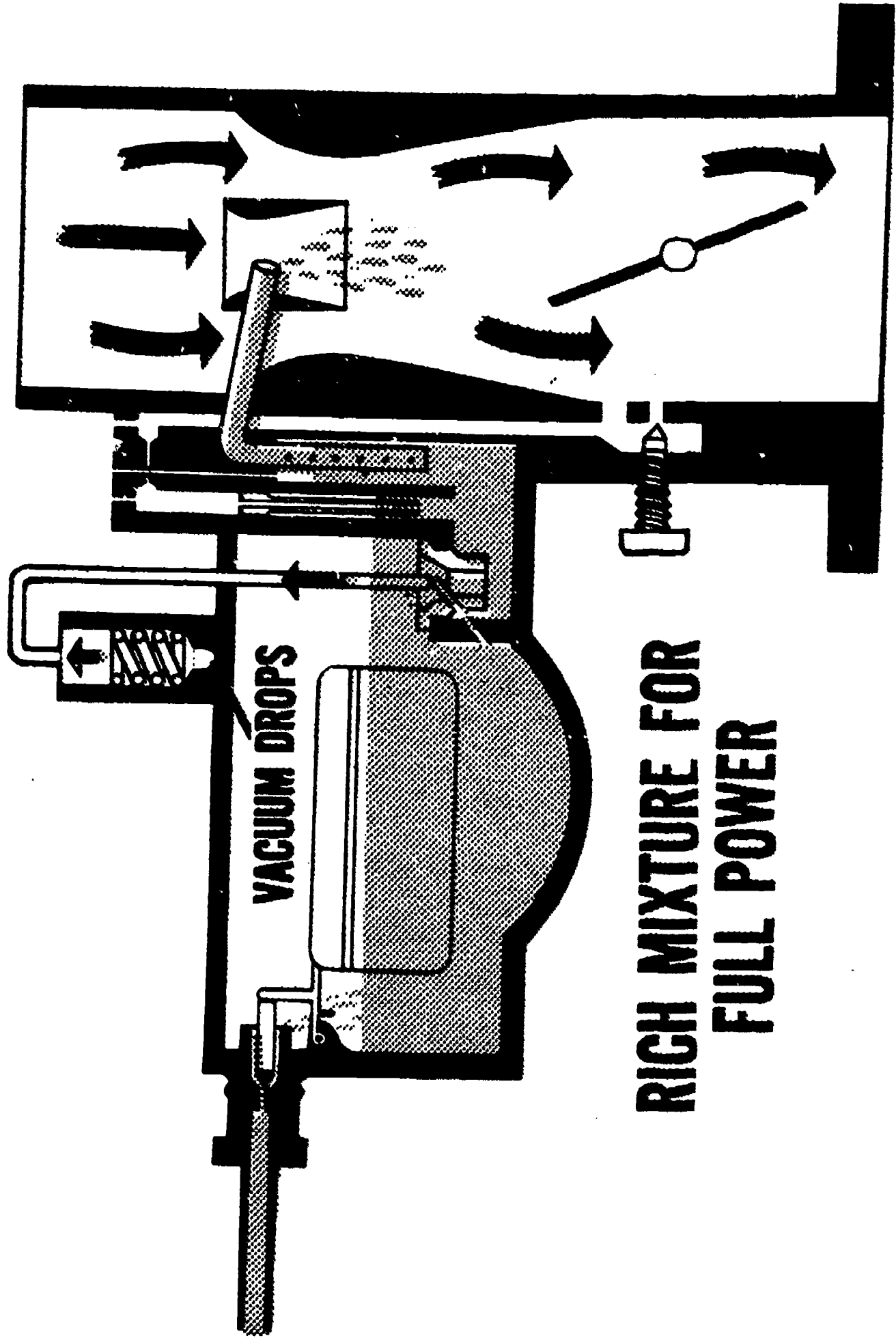

# RICH MIXTURE FOR FULL POWER

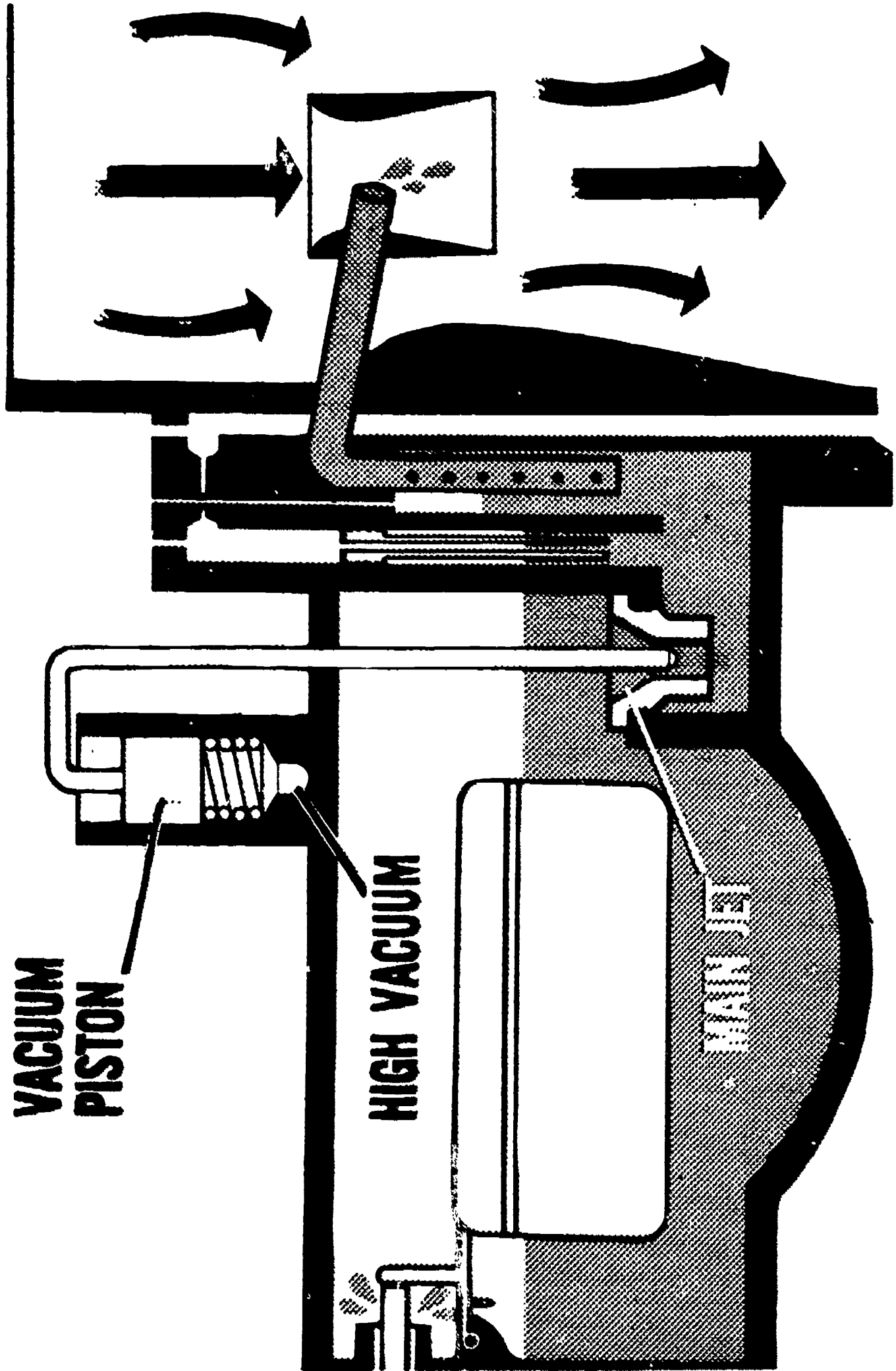

Courtesy - Chrysler Corporation

## OPERATION

Block: Fuel System

Block IV

Operation: Servicing the Power Circuit

Job \_\_\_\_\_

Operation \_\_\_\_\_

---

Teaching Objective: To teach the students to service a power circuit

Tools: Carburetor tool kit

Materials: Carburetor cleaner, wipe cloths

Teaching Aids: Practice carburetors, Automotive or engine on stand

References: Vehicle Service Manual  
Motor's Auto Repair Manual, 1969

### Steps:

1. Remove air horn
2. Remove vacuum piston and metering rod  
Note: Check parts for wear, gum and fuel deposits
3. Remove power valve or jet  
Note: Check size and refer to specifications
4. Remove plug in power circuit
5. Soak parts in carburetor cleaner
6. Wash parts with water after removing from cleaner
7. With air pressure blow through the power circuit
8. Reverse procedure during installation

## INFORMATION

Block: Fuel System

Block IV

Lesson: High Speed Circuit

Job \_\_\_\_\_

Lesson \_\_\_\_\_

---

Teaching Objective: Upon completion of this lesson, students will be able to describe the operation of the carburetor high speed circuit by relating the system components to pertinent functioning.

Teaching Aids: Transparencies:

- Power Valve Open, p. IV-95
- Power Valve Closed, p. IV-96
- Lean Mixture, Richer Power Mixture, p. IV-97

References: Automotive Mechanics, Crouse, Chapter 9  
Automechanics, Glenn, Chapter 6

Outline of Information:

1. Purpose
  - a. Supply fuel for part or full throttle operation
  - b. Air-fuel ratio remains fairly constant
2. Main Nozzle
  - a. Point at which liquid fuel is introduced into venturi
3. Venturi
  - a. Vacuum intensity controls fuel supply route and volume
4. Compensating system
  - a. Provides secondary fuel supply when vacuum drop affects venturi action
  - b. Air bleed system
    - Air bubbles introduced into liquid fuel before discharge into air horn

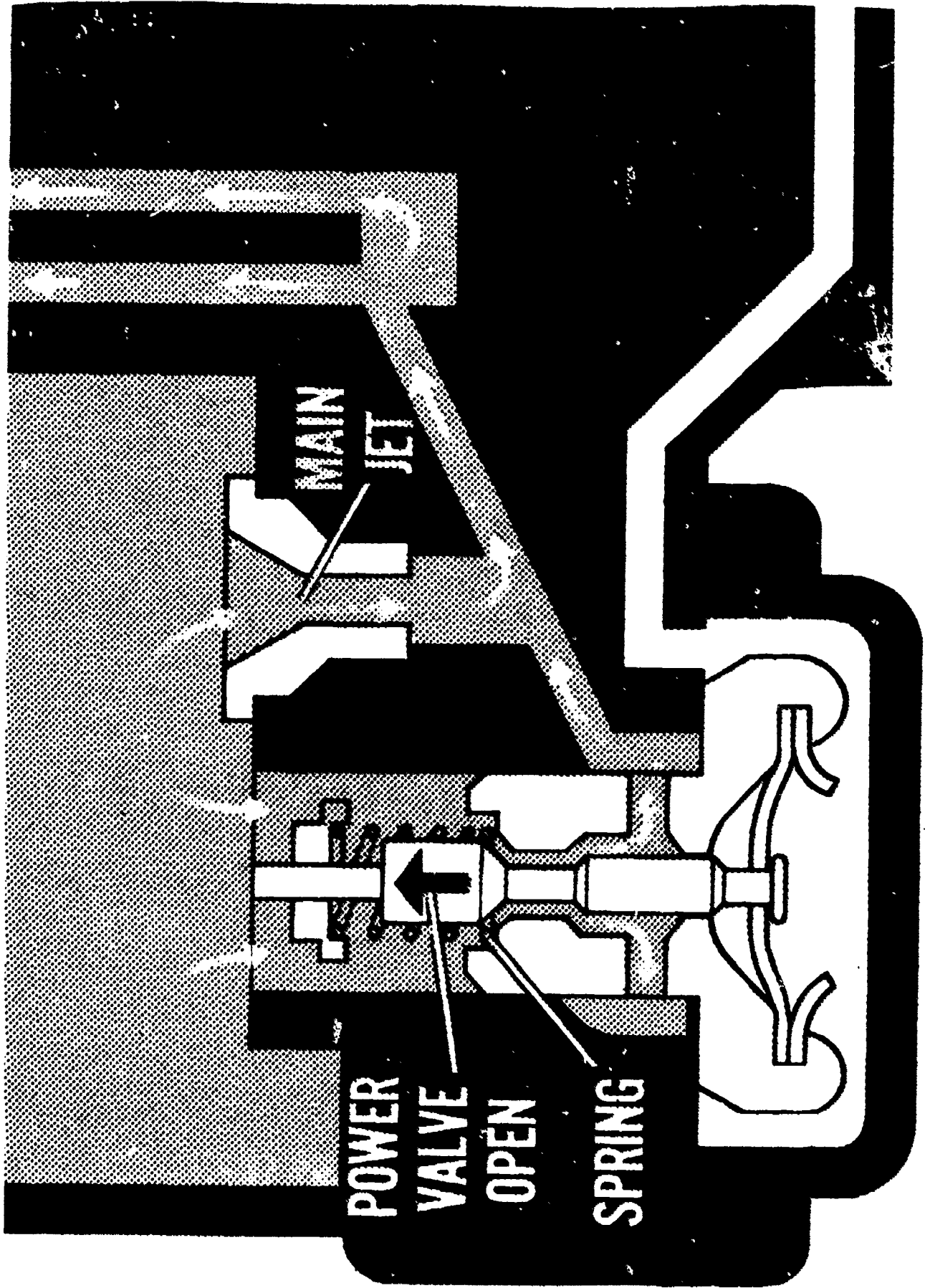

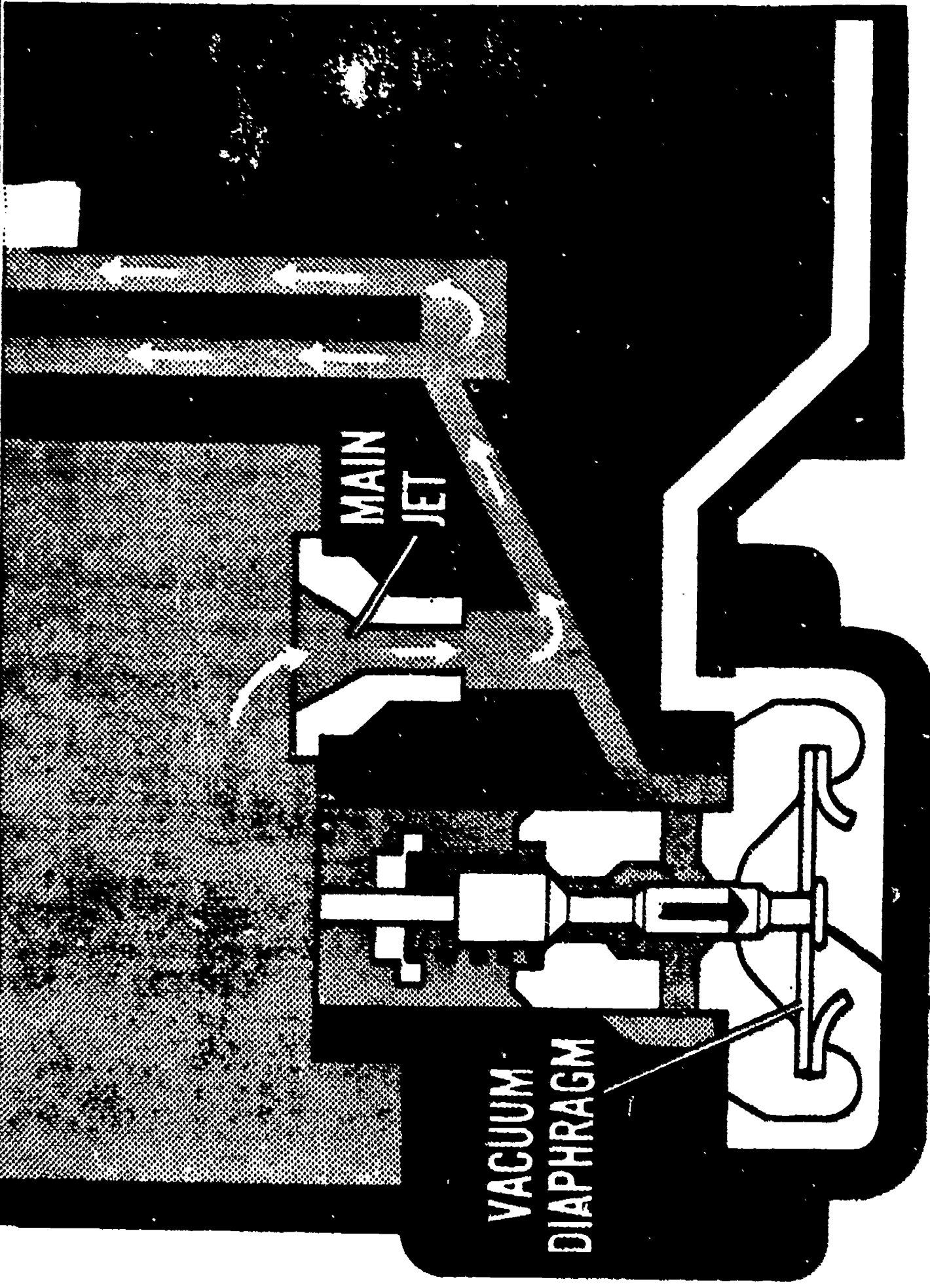

**POWER VALVE CLOSED**

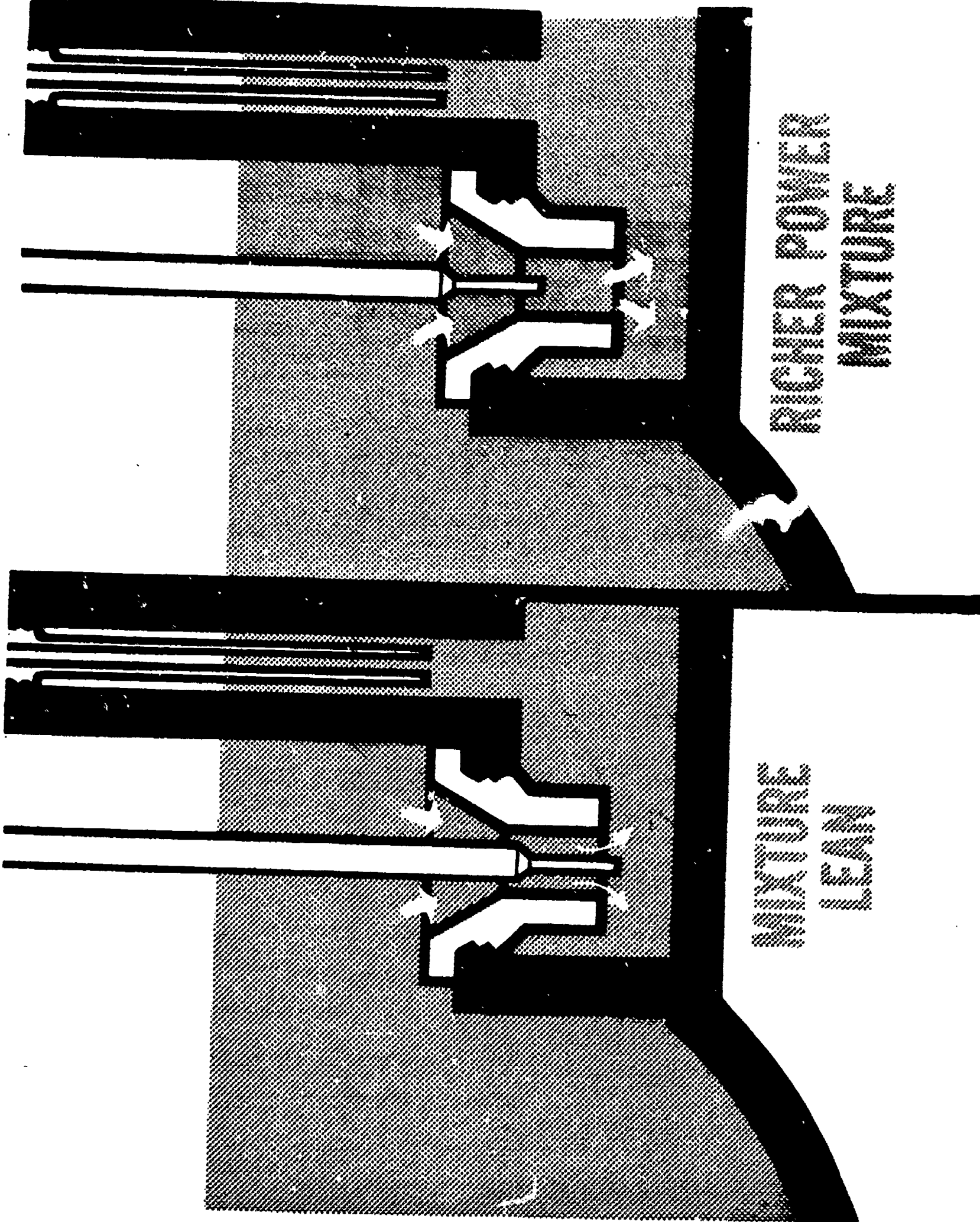

XXXXXXXXXX

XXXXXXXXXX

## OPERATION

Block: Fuel System

Block IV

Operation: Servicing a Carburetor High-Speed Circuit

Job \_\_\_\_\_

Operation \_\_\_\_\_

---

Teaching Objective: To teach students to service the h<sup>igh</sup> speed circuit

Tools: Carburetor tool kit, screwdriver, needle-nose pliers

Materials: Bowl cover gasket, gaskets for high speed jets, wipe cloths

Teaching Aids: Automobile or engine on stand

References: Manufacturer's Service Manual  
Automotive Mechanics, Crouse, Chapter 9  
Automechanics, Glenn, Chapter 6

### Steps:

1. Remove the carburetor air horn, bowl cover, gasket, and (metering rod, if used)
2. Remove float needle valve if not attached to bowl cover
3. Using a jet wrench, remove metering jet and gasket
4. Remove plug or screw in high speed jet passage
5. Remove high speed jet and nozzle, if used
6. Using an air hose, clean the high-speed jet
7. Clean thoroughly the parts removed and inspect them for wear. Replace worn or defective parts
8. Install the plug in the high-speed jet passage and nozzle if used. Use a new jet gasket and tighten the jet securely with a jet wrench
9. Install the plug in the high-speed jet passage
10. Install the filter element using a new gasket. Tighten with jet wrench



## **Servicing a Carburetor High-Speed Circuit (continued)**

11. Install the float and needle-valve assembly (if it is not attached to the bowl cover)
12. Install the carburetor bowl cover. Use a new gasket and tighten the cover screws securely. Check float level
13. Install the carburetor air horn
14. Install metering rod, if used. Adjust to specifications
15. Connect or install any accessories that were removed with the air horn and bowl cover; then adjust to specifications

## OPERATION

Block: Fuel System

Block IV

Operation: Servicing a Carburetor Pump Circuit

Job \_\_\_\_\_

Operation \_\_\_\_\_

---

Teaching Objective: To teach students how to service a carburetor pump circuit

Tools: Needle nosed pliers, carburetor tool kit

Materials: Bowl cover gaskets, passage plugs or gaskets. Necessary parts, manufacturer's specifications, wipe cloths

Teaching Aids: Practice carburetors

Transparencies:

- Arm Lifts Plunger, p. IV-101
- Pump Rod, Pump Nozzle, Pump Plunger, p. IV-102
- Spring Provides Sustained Flow, p. IV-103

Reference: Vehicle Service Manual

### Steps:

1. Remove the carburetor bowl cover and disconnect the pump operating rod
2. Using a plug tool, remove the plugs from the pump check-valve passage
3. Remove the pump intake and discharge jets or ball checks and spring, if used
4. Remove pump plunger and spring
5. Clean all the parts thoroughly and inspect them for wear. Replace all worn or defective parts
6. Clean the pump discharge, check valves or ball checks, and spring if used
7. Install the intake and discharge check valves, or ball checks and spring, if used
8. Replace the plugs in the pump check-valve passages
9. Install the pump-plunger assembly and spring. Use the pump leading tool to avoid damaging the pump leather
10. Install the carburetor bowl cover and gasket. Tighten screws evenly
11. Connect pump operating rod and adjust to manufacturer's specification
12. Replace and adjust any accessories which were removed

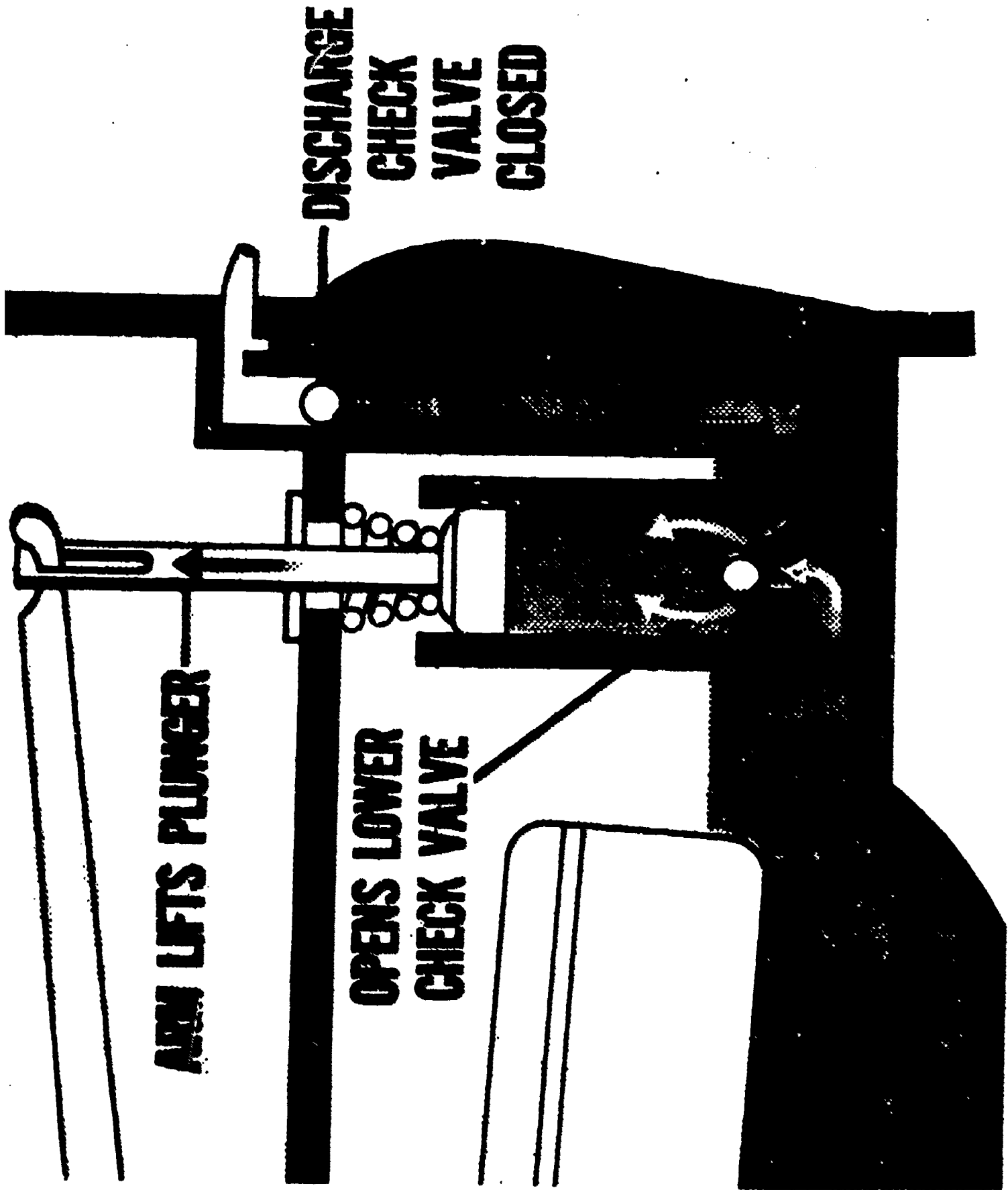

Courtesy - Chrysler Corporation

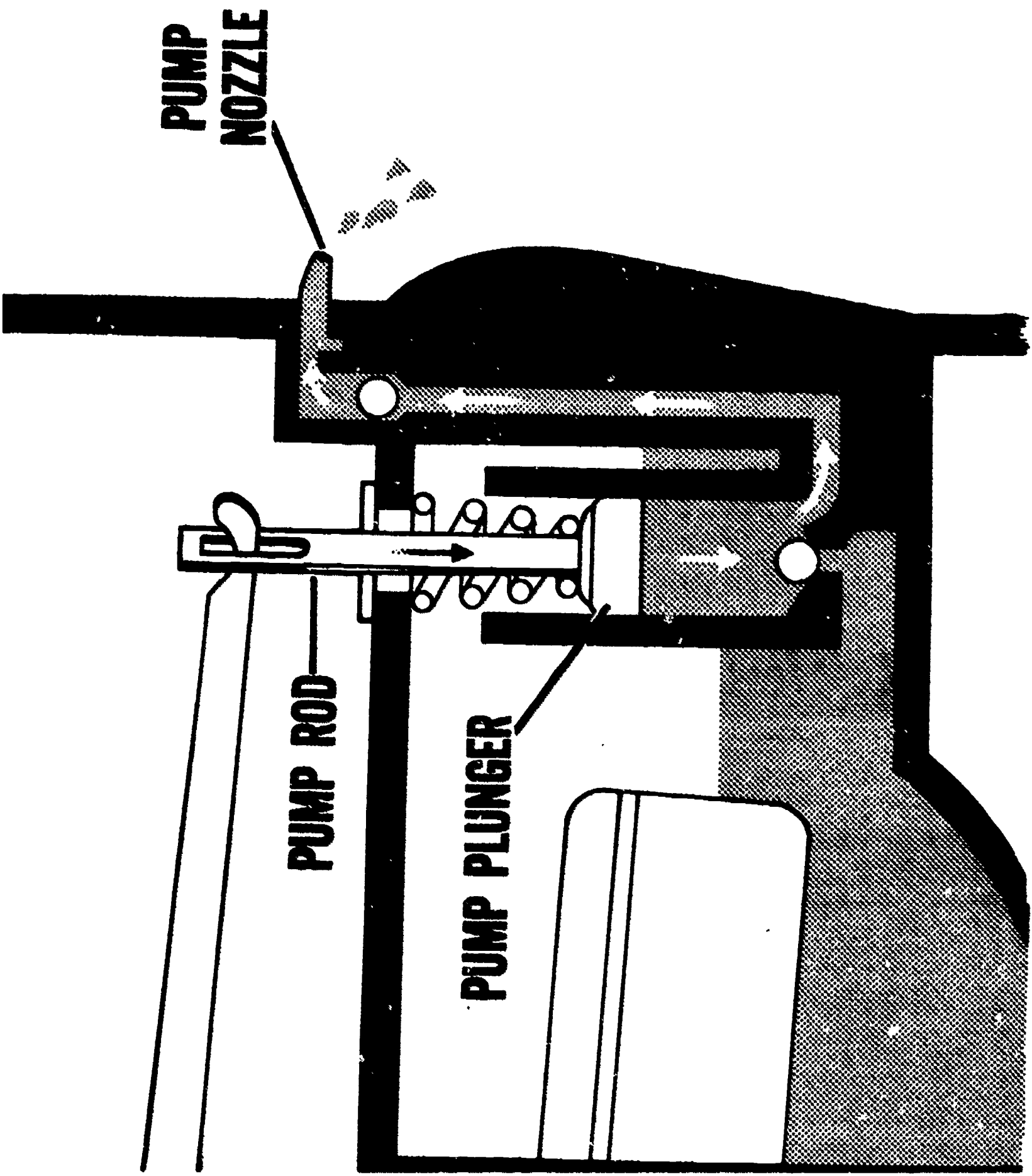

Courtesy - Chrysler Corporation

# SPRING PROVIDES SUSTAINED FLOW

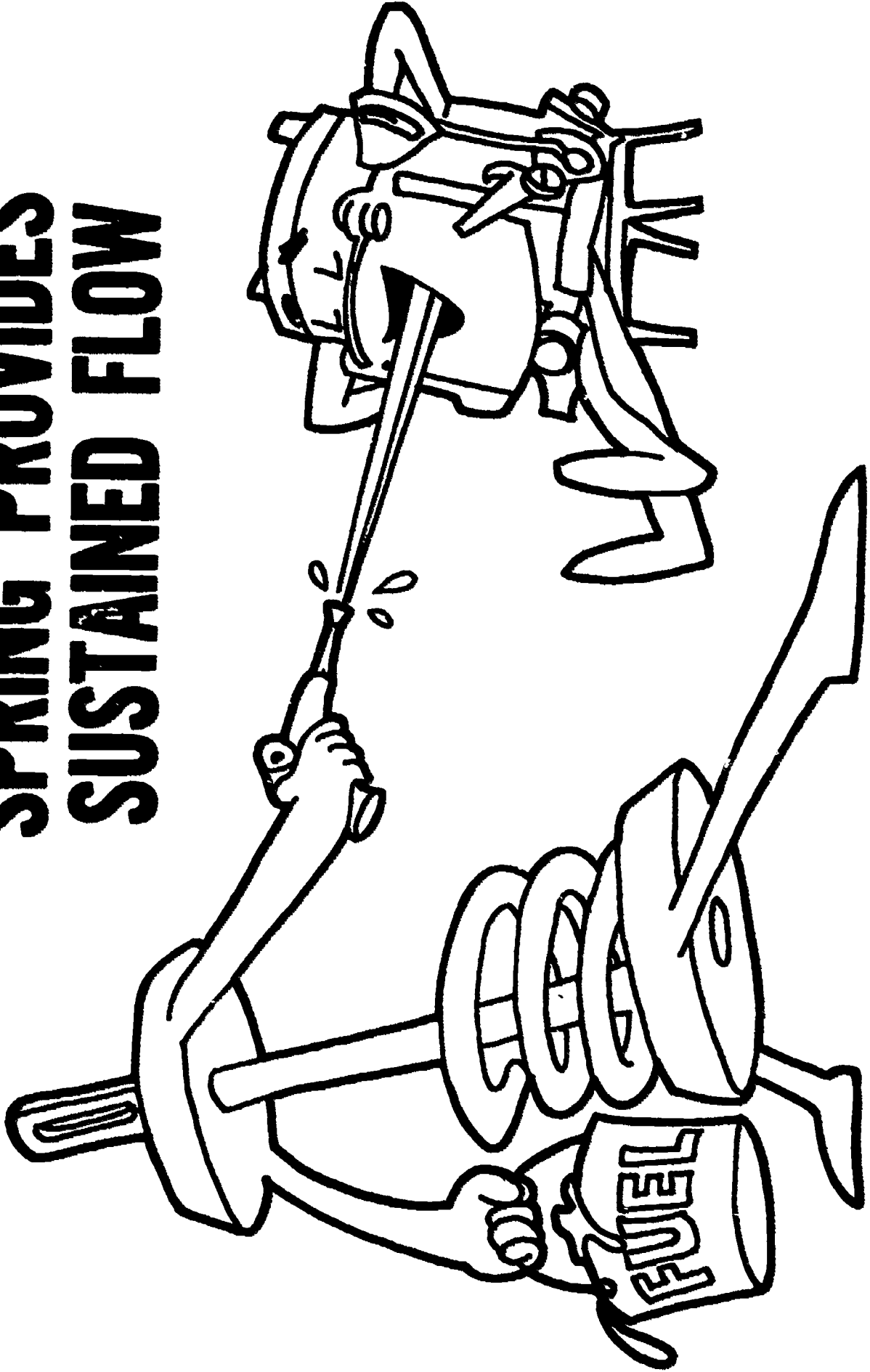

IV-103

## INFORMATION

Block: Fuel System

Block IV

Lesson: Automatic Choke

Job \_\_\_\_\_

Lesson \_\_\_\_\_

---

Teaching Objective: Upon completion of this lesson, students will be able to list two basic types of automatic chokes and typical components.

Teaching Aids: Sample types of chokes

Transparencies:

- Vacuum Diaphragm, Choke Valve, Thermostatic Coil, p. IV-105
- Automatic Choke Assembly, p. IV-106
- Automatic Choke Adjustments, p. IV-107
- Rich Mixture for Starting, p. IV-108

References: Automotive Mechanics, Crouse, Chapter 9  
Motor's Auto Repair Manual

### Outline of Information:

#### 1. Types

- a. Thermostatic Coil
  - Water heated
  - Exhaust-Manifold heated
- b. Vacuum-operated diaphragm

#### 2. Components

- a. Thermostatic spring
- b. Vacuum piston
- c. Choke valve
- d. Linkage
- e. Vacuum
- f. Choke lever
- g. Adjusting screw and cam
- h. Housing

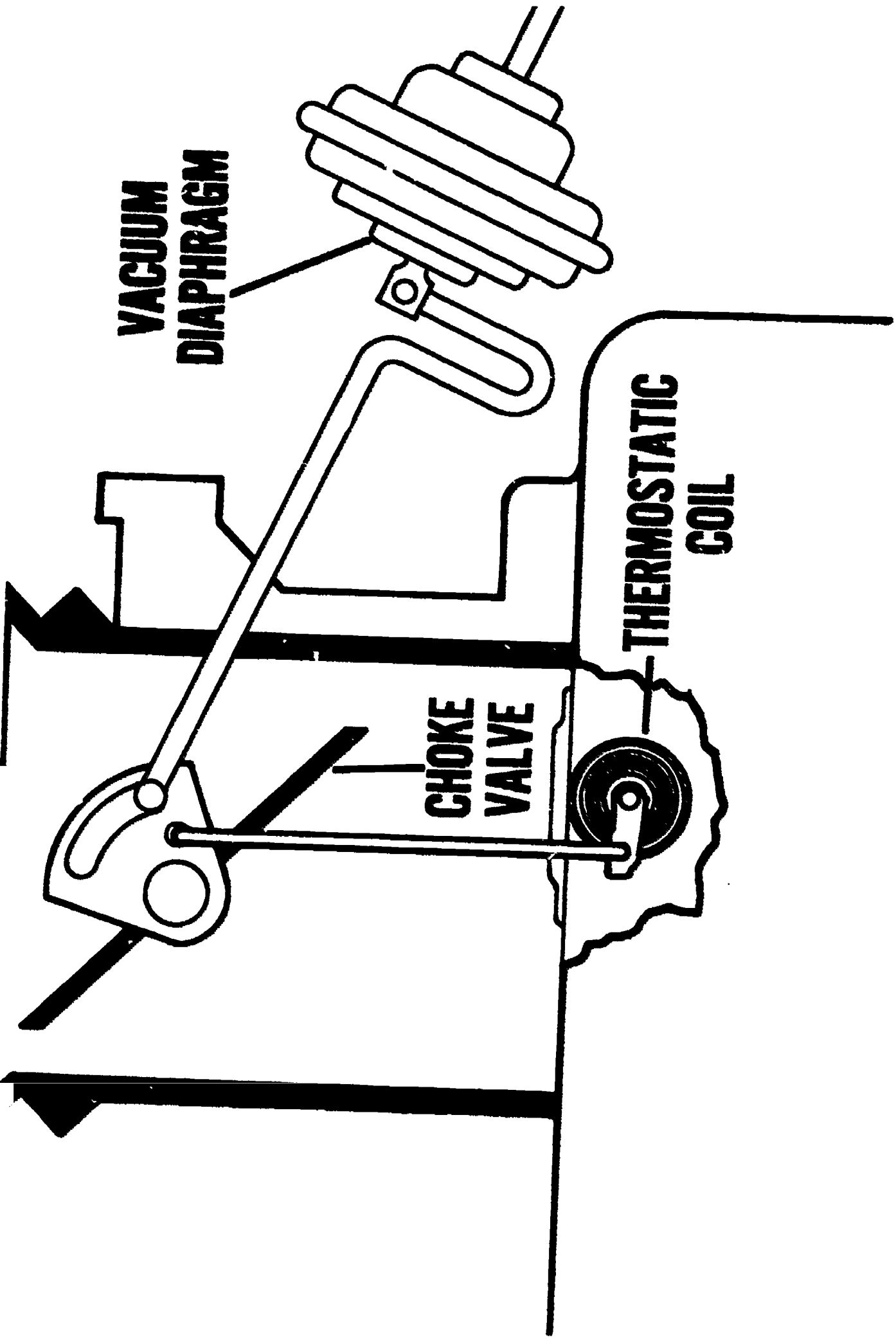

Courtesy - Chrysler Corporation

# AUTOMATIC CHOKE ASSEMBLY

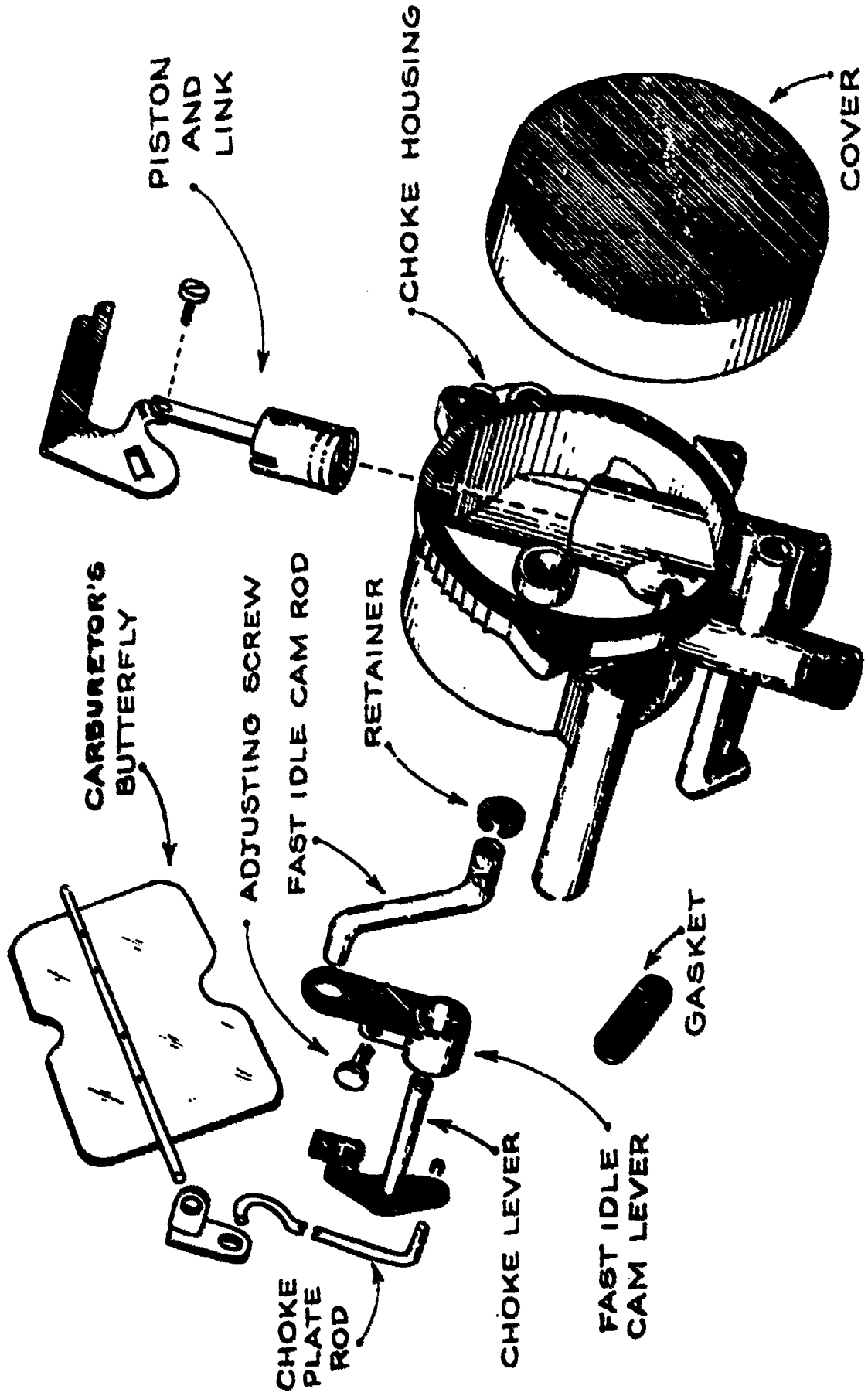



# AUTOMATIC CHOKE ADJUSTMENTS

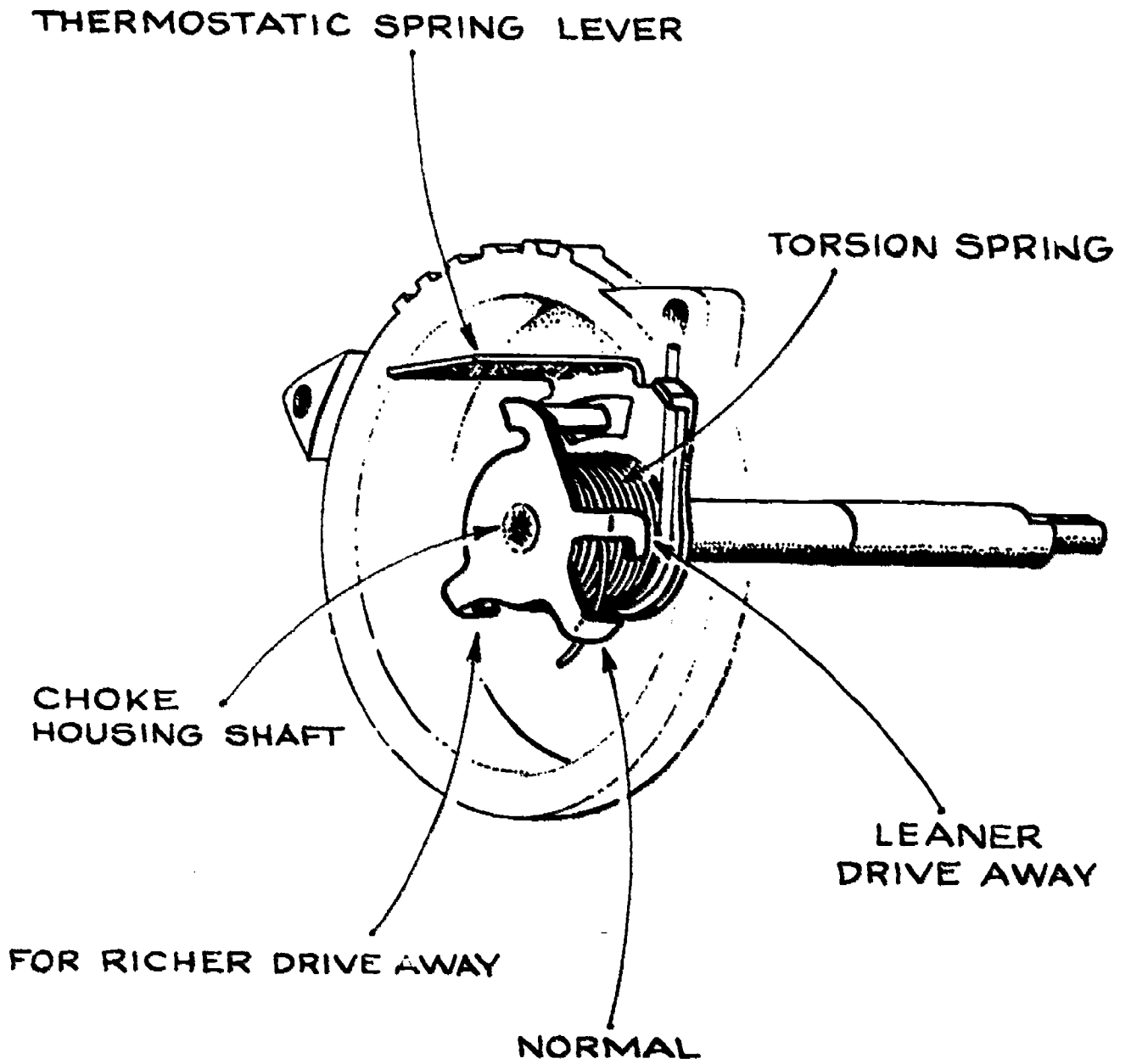

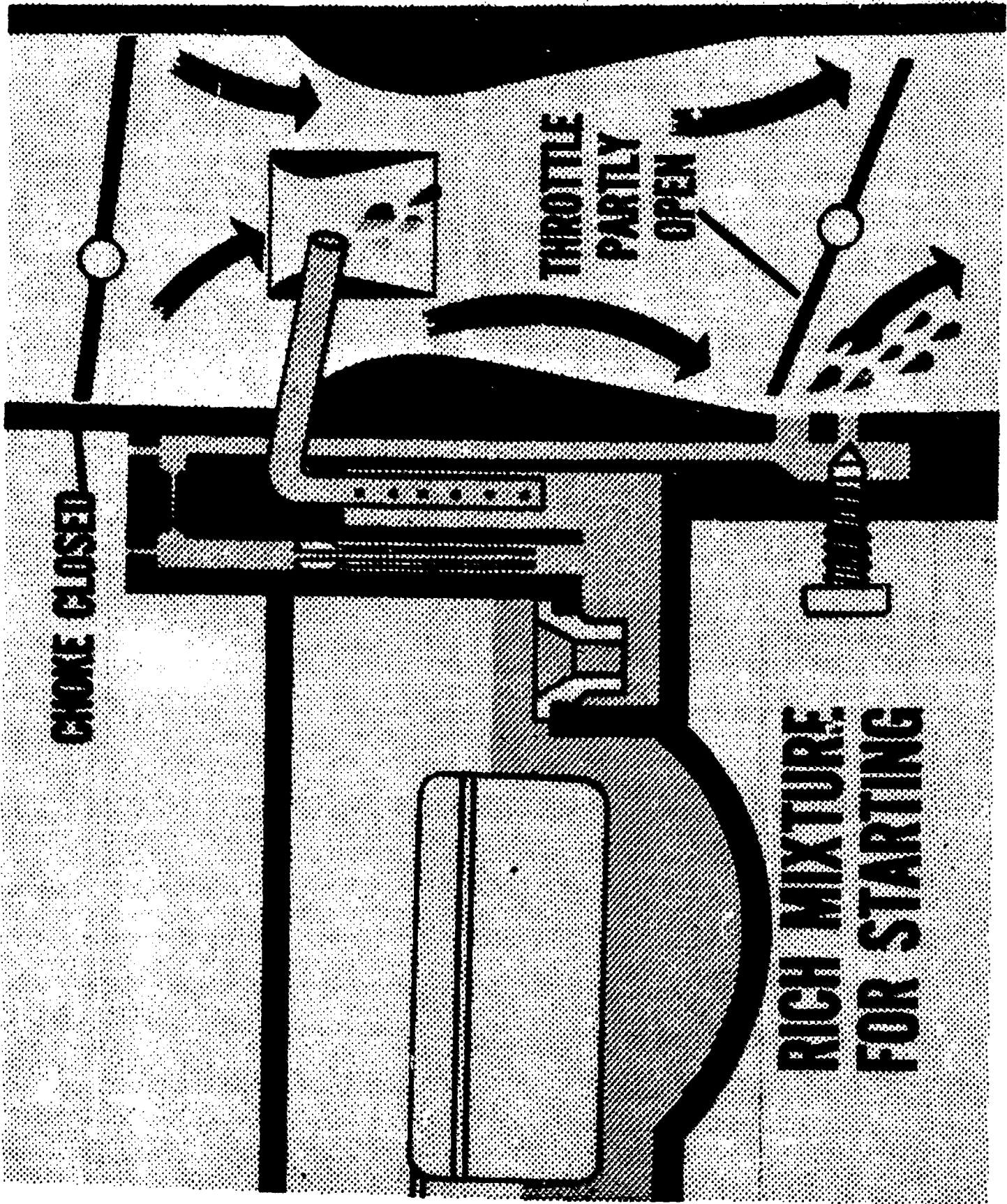

Courtesy - Chrysler Corporation

## OPERATION

Block: Fuel System

Block IV

Operation: Servicing a Carburetor Choke Circuit

Job \_\_\_\_\_

Operation \_\_\_\_\_

---

Teaching Objective: To teach students how to service the choke circuit

Tools: Needle-nosed pliers, carburetor tools and gauge

Materials: Manufacturer's specifications, parts for replacement

Teaching Aids: Engines on stands, practice carburetors

Transparencies:

- Automatic Choke Housing and Parts Identification
- Choke Rotates Fast-Idle Cam, p. IV-111

Reference: Motor's Auto Repair Manual

### Steps:

1. Disconnect the choke operating rod or wire at the carburetor
2. Remove the coil spring connecting both halves of the choke valve disc (Omit this step if the choke valve disc is in one place)
3. Mark the choke valve disc and carburetor throat to insure correct assembly
4. Remove the screws that fasten the choke valve disc to the choke shaft
5. Remove the choke valve disc which in one piece
6. Disconnect the fast-idle linkage at the choke shaft, if used
7. Remove the choke shaft and lever assembly
8. Clean all parts and inspect for wear. Replace worn or defective parts
9. Install the choke shaft and lever assembly
10. Install the choke valve. Line up the location marks and center the choke valve in the carburetor bore. Tighten the screws
11. Install the choke spring if used
12. Connect the fast idle linkage if used, and adjust it to the manufacturer's specifications
13. Connect the choke operating rod or wire to the choke shaft lever
14. Lubricate the choke operating parts lightly with oil

# AUTOMATIC CHOKE HOUSING AND PARTS IDENTIFICATION

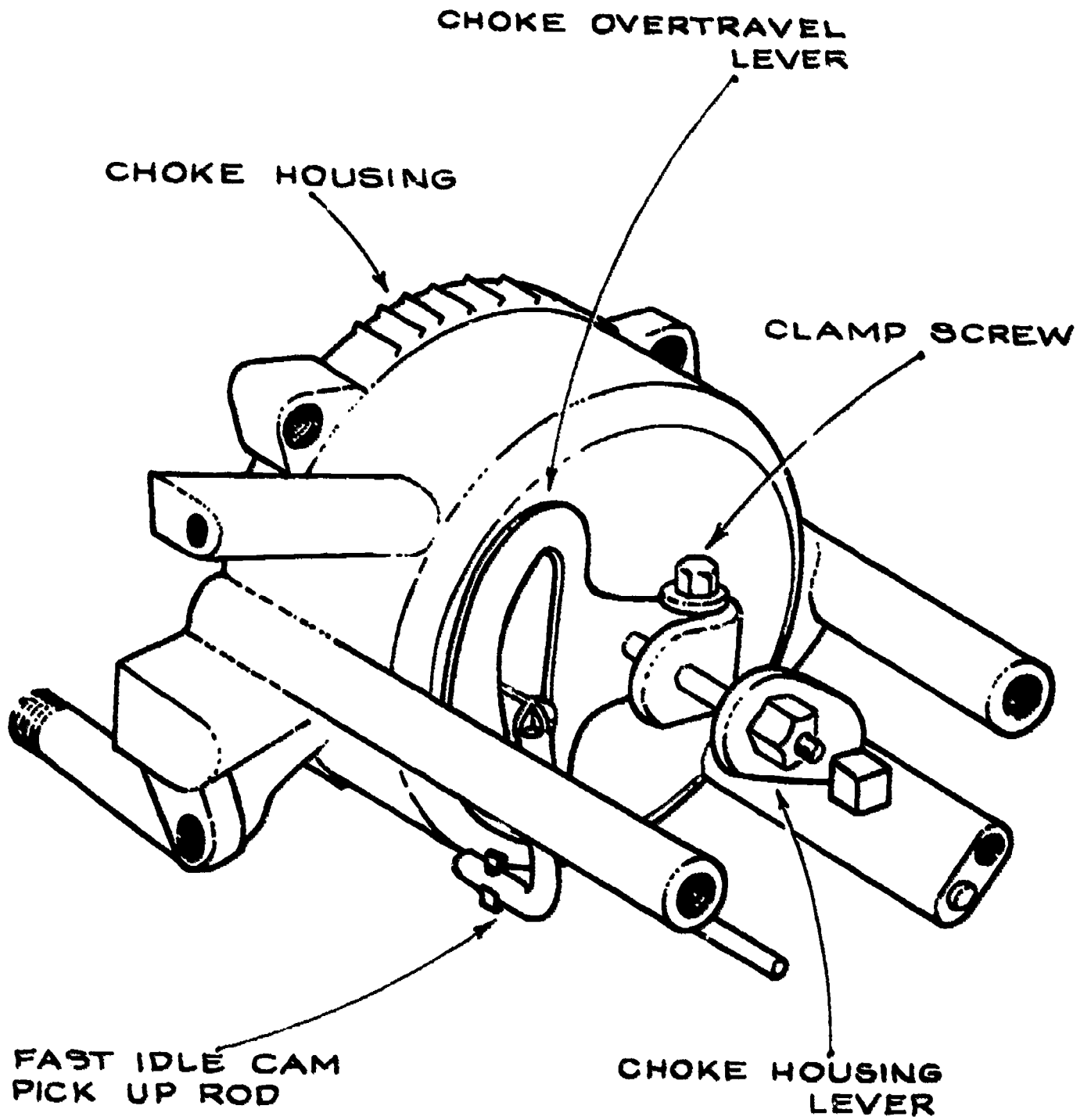

**CHOKER  
ROTATES  
FAST-IDLE  
CAM**

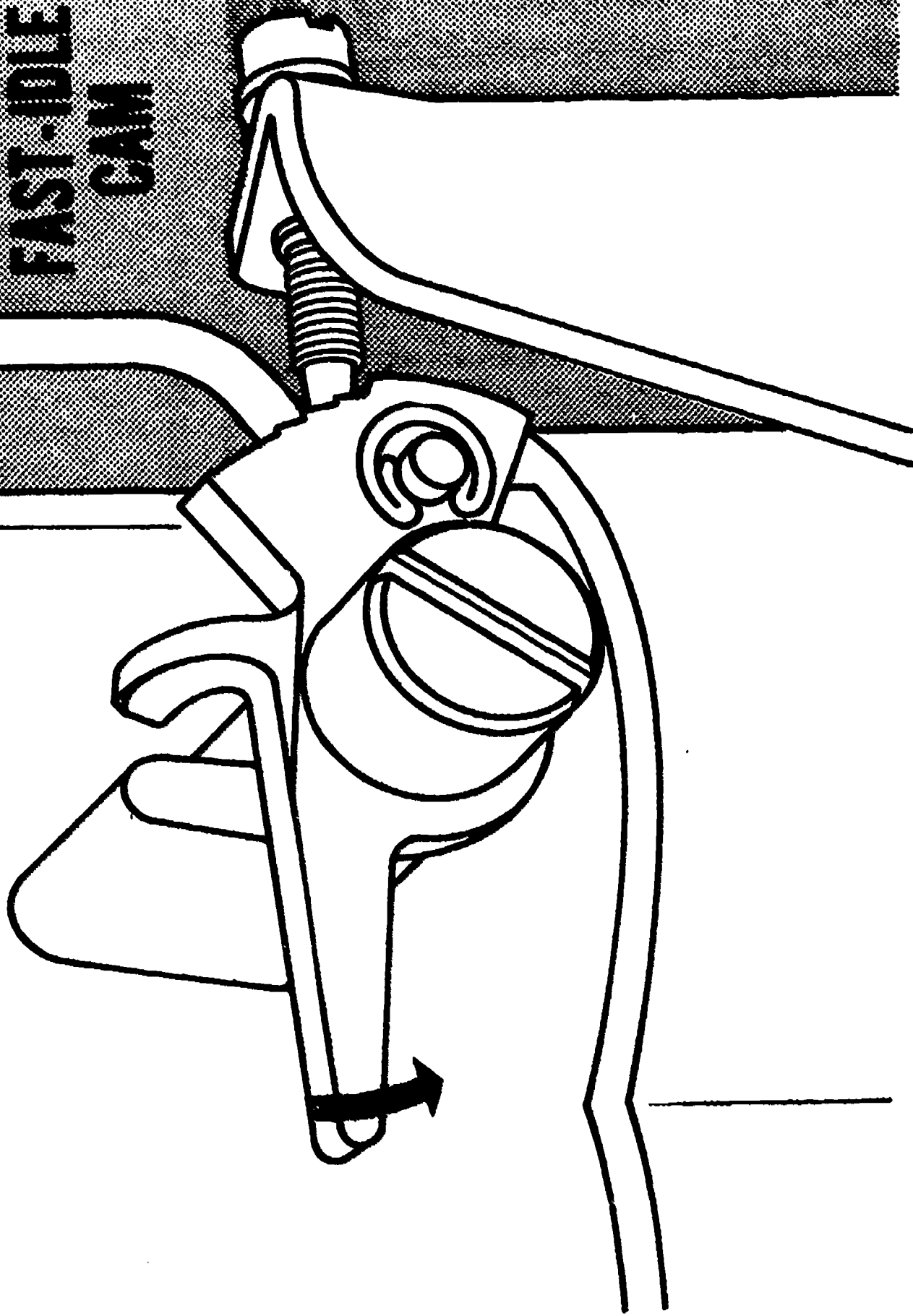

## OPERATION

Block: Fuel System

Block IV

Operation: Replacing Automatic Choke

Job \_\_\_\_\_

Operation \_\_\_\_\_

---

Teaching Objective: To learn to remove and replace an automatic choke

Tools: Flat end Screwdriver, needle-nose pliers, combination wrenches, (7/16" and 1/2")

Materials: Gasket material, wipe cloths

Teaching Aids: Engines on stands, practice carburetors

References: Manufacturer's Service Manual  
Motor's Auto Repair Manual

### Steps:

1. Remove air cleaner
2. Disconnect choke rod upper clips
3. Remove attaching bolts
4. Remove choke coil and choke rod as an assembly
5. Disconnect choke rod from choke coil
6. Reverse procedure for installation
7. Start and warm up engine
8. Check the operation of the choke
9. Install air cleaner

## OPERATION

Block: Fuel System

Block IV

Operation: Adjusting Choke Vacuum Break

Job \_\_\_\_\_

Operation \_\_\_\_\_

---

Teaching Objective: To teach students to adjust the choke vacuum break

Tools: Specified drill bit or gauge, pliers

Materials: Wipe cloths

Teaching Aids: Automobile, engine on stand, Practice carburetors

Transparencies:

- Increase Choke Opening, Decrease Choke Opening, p. IV-114

References: Vehicle Service Manual  
Motor's Auto Repair Manual

### Steps:

1. Remove air cleaner
2. Push the vacuum break diaphragm plunger in until seated
3. Hold the choke valve toward closed position
4. Bend vacuum break line so that specified gauge will fit between the upper edge of the choke valve and inside wall of air horn
5. Start engine and note the movement of the diaphragm and rod
6. Install air cleaner

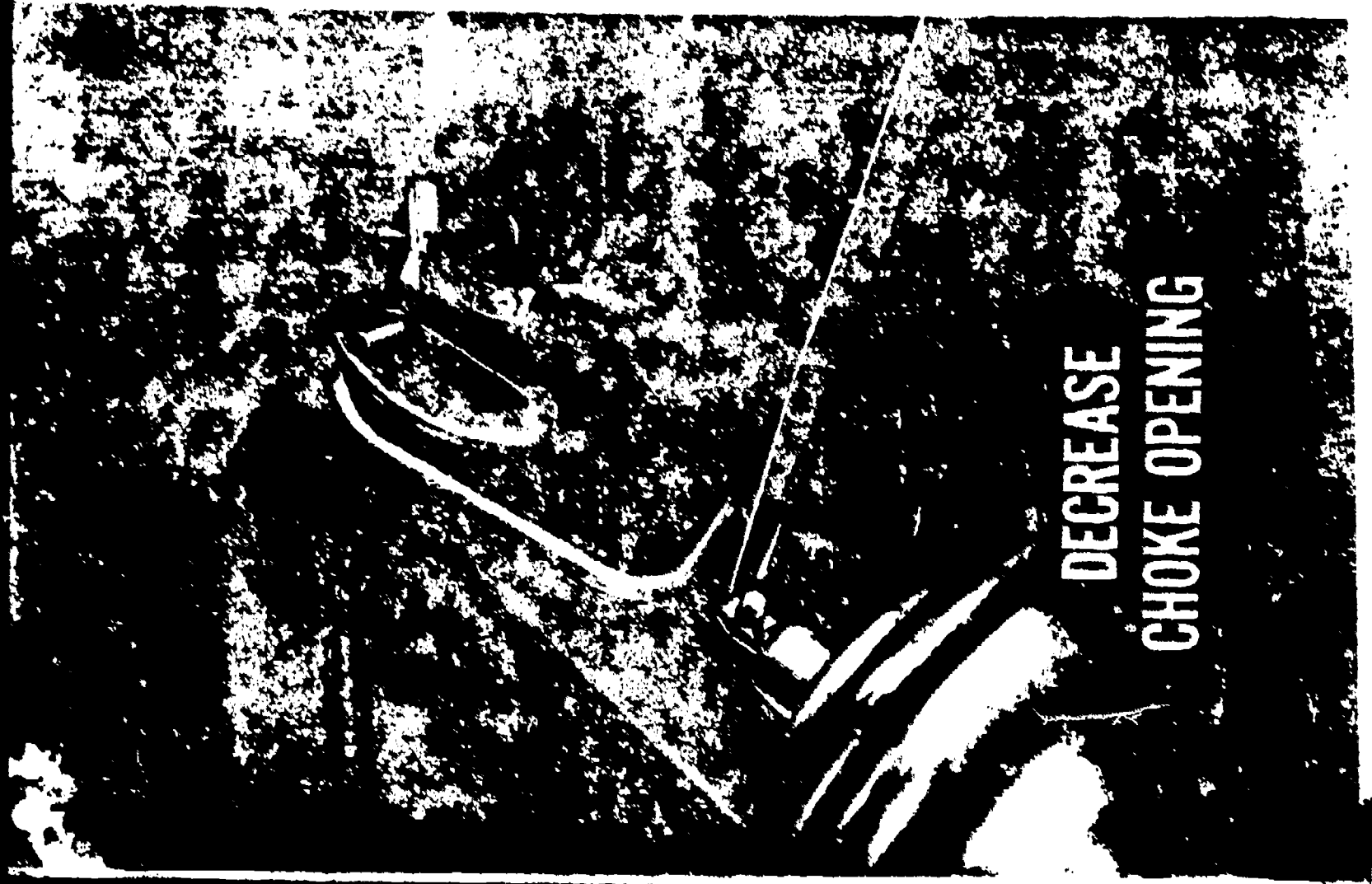

**DECREASE  
CHOKE OPENING**



**INCREASE  
CHOKE OPENING**

Courtesy Chrysler Corporation



## OPERATION

Block: Fuel System

Block IV

Operation: Adjusting Choke Unloader

Job \_\_\_\_\_

Operation \_\_\_\_\_

---

Teaching Objective: To adjust an automatic choke unloader

Tools: Specified gauge on drill bit, needle-nosed pliers or bending tools

Materials: Wipe cloths

Teaching Aids: Automobile engine on stand or practice carburetors

References: Automotive Mechanics, Crouse, Chapter 9  
Motor's Auto Repair Manual  
Carburetion Fundamentals and Facts, Chrysler Corp. Manual, 70-8

### Steps:

1. Hold throttle valve in wide open position
2. Insert specified drill or gauge between upper edge of choke valve and inner wall of air horn

Note: Refer to service manual for specifications

3. With finger lightly pressing against valve a slight drag should be felt as drill is being withdrawn. If adjustment is necessary, bend unloader tang on throttle lever until opening has been obtained

## INFORMATION

Block: Fuel System

Block IV

Lesson: Exhaust System

Job \_\_\_\_\_

Lesson \_\_\_\_\_

---

Teaching Objective: Upon completion of this lesson, students will be able to define the purposes of the exhaust system, list the components and relate the functions of each.

Teaching Aids: Transparencies:

- Exhaust System, p. IV-118
- Mufflers, p. IV-119

References: Auto Service and Repair, Stockel, Chapter 33  
Automechanics, Glenn, Chapter 11  
Exhaust System Service Manual, Motor Magazine, Hearst Corporation

Outline of Information:

1. Purposes of the exhaust system
  - a. To lessen engine noise
  - b. To provide for safe elimination and removal of exhaust fumes
  - c. To regulate engine back pressure
2. Types of exhaust systems on different engines
  - a. V-type engines
  - b. In-line engines
  - c. Single exhaust
  - d. Dual exhaust
3. Exhaust system components and functions
  - a. Exhaust manifolds
    - Collect exhaust gases from valve parts
  - b. Manifold heat riser valves
    - Regulates flow of exhaust gases to circulate around intake manifold passages during warm-up

## Exhaust System (continued)

- c. Exhaust pipes
  - Carry exhaust gases from manifolds to mufflers
- d. Muffler
  - Muffles noise
  - Regulates exhaust flow
- e. Tail pipes
  - Carry exhaust from muffler to safe discharge from under vehicle

**EXHAUST SYSTEM**

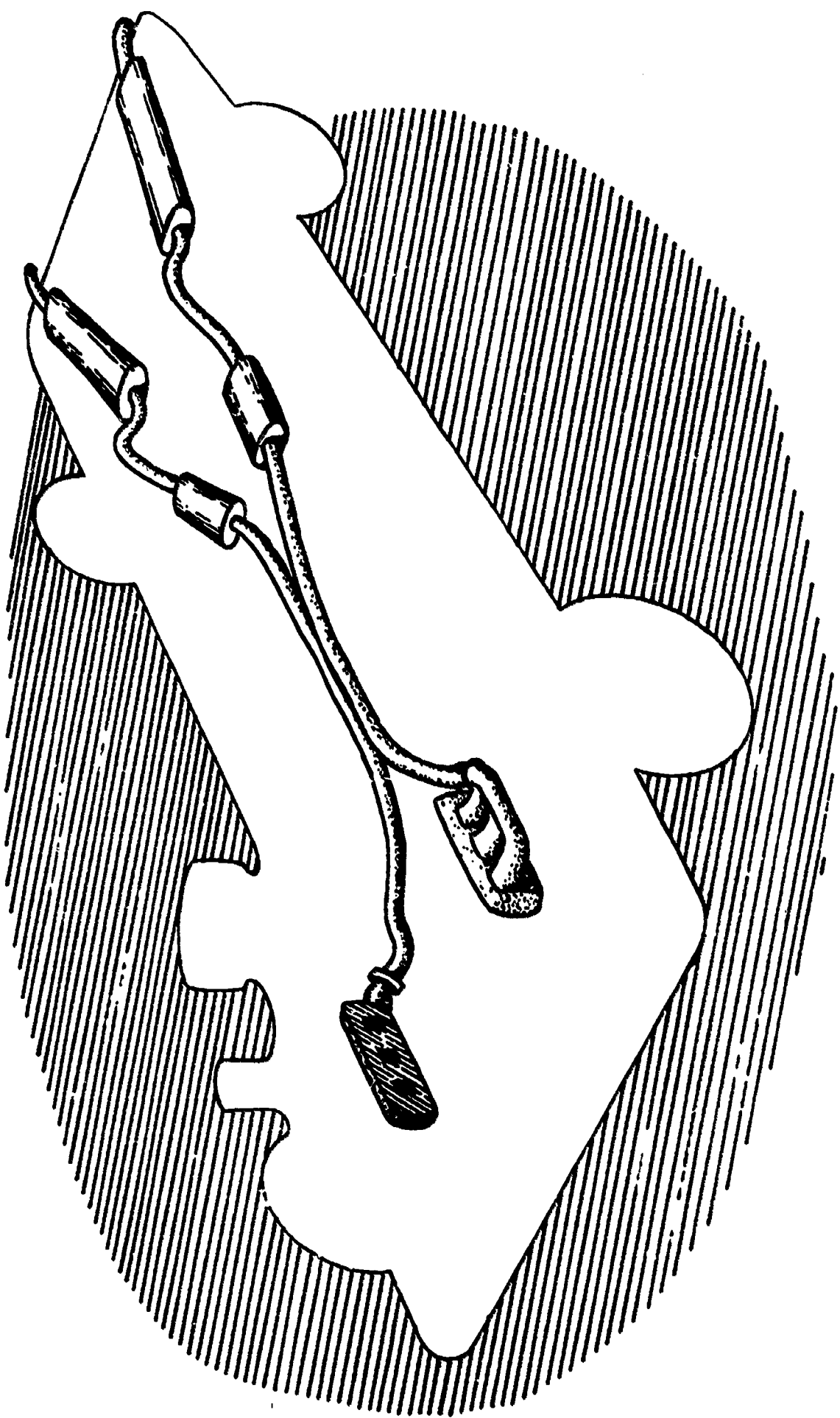

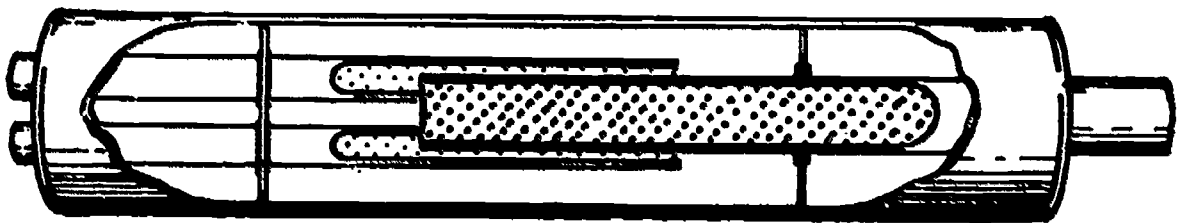
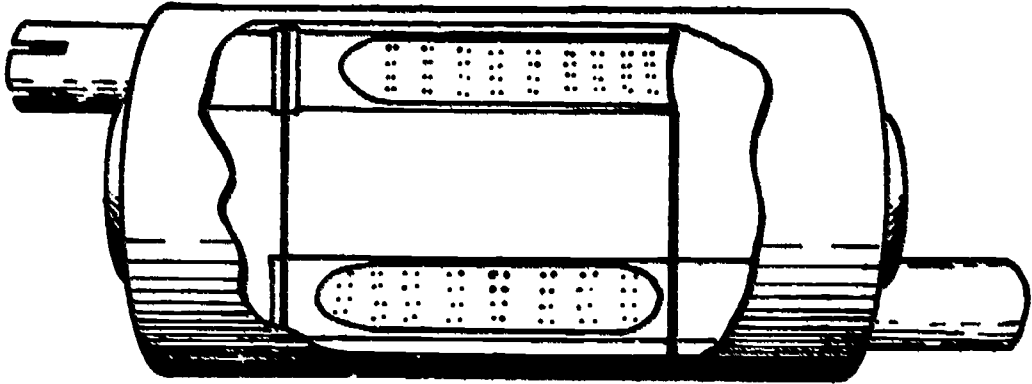
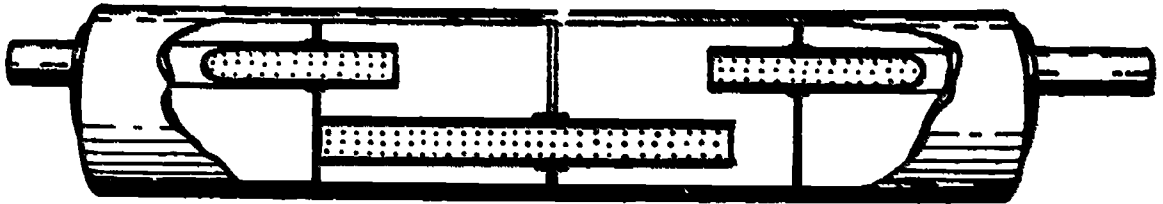

## OPERATION

Block: Fuel System

Block IV

Operation: Inspecting Exhaust System

Job \_\_\_\_\_

Operation \_\_\_\_\_

---

Teaching Objective: To teach students to properly inspect the automotive exhaust system

Tools: Jacks, wheel blocks, screwdriver

Materials: Wipe cloths

Teaching Aids: Samples of defective exhaust components

References: Exhaust System Service Manual, Motor Magazine, Hearst Corporation  
Vehicle Service Manual

### Steps:

1. Raise vehicle using lift or jacks and blocks

Note: Check service manual or other reference for proper lift points and jack points

2. Check for faulty manifold gaskets

3. Inspect heat-riser valve to determine that it operates freely

4. Check exhaust pipe for severe damage due to rusting

5. Check all connections to determine that they are sound and sealed

6. Check for bent or collapsed pipes

7. Check the shell and heads of the muffler for holes

8. Move muffler slightly (up and down and side to side) to check for breaks in necks

9. Tap on muffler to check for internal deterioration

10. Check entire system for clearances from frame, cables, arms, other points of contact

11. Check heavily scaled or rusted areas for subsurface holes

12. Check hanger straps and clamps for signs of damage and weakness

Note: Advise vehicle owner of the condition of the exhaust system

## INFORMATION

Block: Fuel System

Block IV

Lesson: Service Techniques for Exhaust System Repairs

Job \_\_\_\_\_

Lesson \_\_\_\_\_

---

Teaching Objective: Upon completion of this lesson, students will be able to describe and relate service techniques and information to general exhaust system repairs.

Teaching Aids: Transparencies:

- Pneumatic Muffler Gun Kit - Pipe Splitter, p. IV-123
- Multi-Angle Steel Saw, p. IV-124
- Pipe Cutter - Pipe Peeler, p. IV-125
- Pipe Shaper - Pipe Spreader, p. IV-126

Reference: Exhaust System Service Manual, Motor Magazine, Hearst Corporation

Outline of Information:

1. Manifolds and exhaust pipes
  - a. Avoid snapping off manifold connector studs by using penetrating oil on rusted stud nuts
  - b. If a stud is broken, saw it off flush, drill a pilot hole and remove with screw extractor
  - c. Proper bolt replacement torque is 40 foot pounds
2. Pipe-muffler connections
  - a. End connections should have 1 1/2" to 2" of overlap
  - b. Do not re-use rusty muffler clamps
3. Gaskets
  - a. Do not re-use old gaskets
  - b. Clean gasket seating area thoroughly before reassembly
  - c. Tighten bolts alternately for proper flange alignment
4. Heat-Riser Valves
  - a. One sign of an inoperative heat-riser valve is excessive early deterioration of system components on same side (dual systems) as valve.

## Service Techniques for Exhaust System Repairs (continued)

- b. Replace spring to stop excessive rattle
- c. Replace valve if shaft is worn and causing leakage
- d. If valve is stuck, apply solvent or penetrating oil to free it

Note: If new heat-riser is installed, the counterweight must be pointing up.

### 5. Severing pipes

- a. When sawing pipes, always saw at an angle using pressure on forward stroke. This provides for extra metal cutting surface with less chance of saw binding.
- b. An adjustable pipe cutter will leave a clean, straight cut.



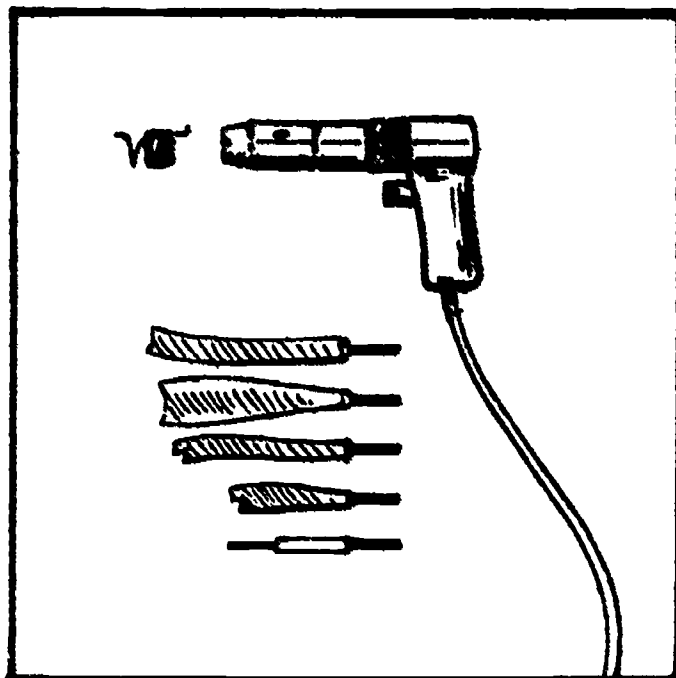

**PNEUMATIC  
MUFFLER  
GUN KIT**

*CUTTING CHISELS  
FOR EASIER  
REMOVAL*

**PIPE  
SPLITTER**

*FOR REMOVING  
RUSTED  
PORTIONS*

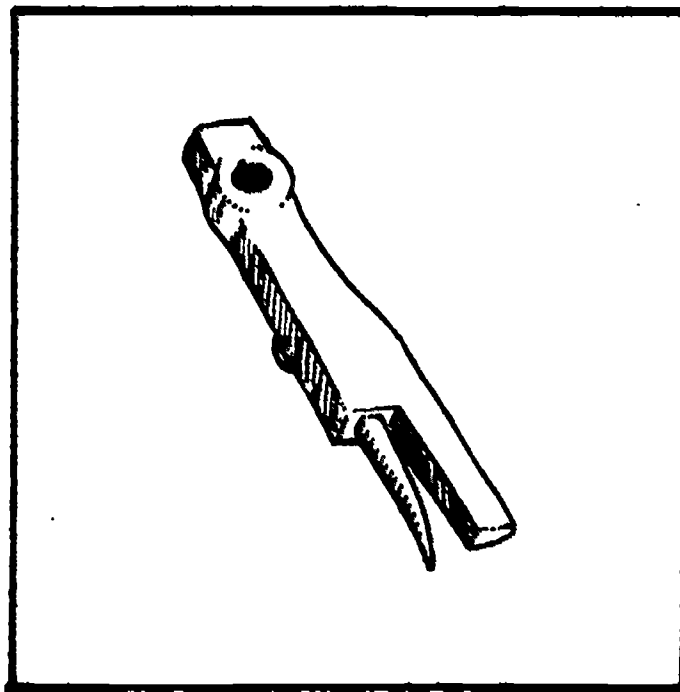

# MULTI-ANGLE STEEL SAW

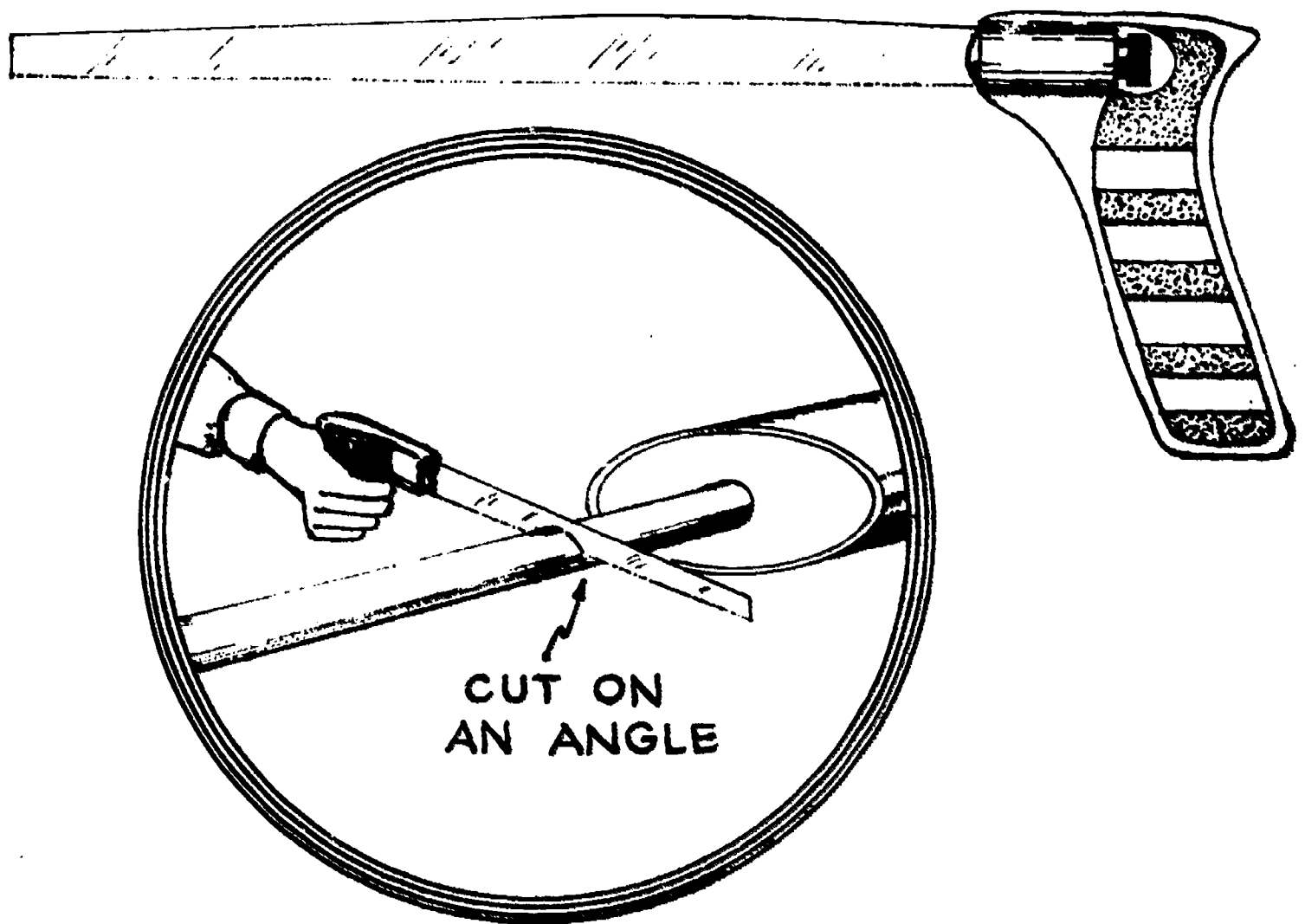

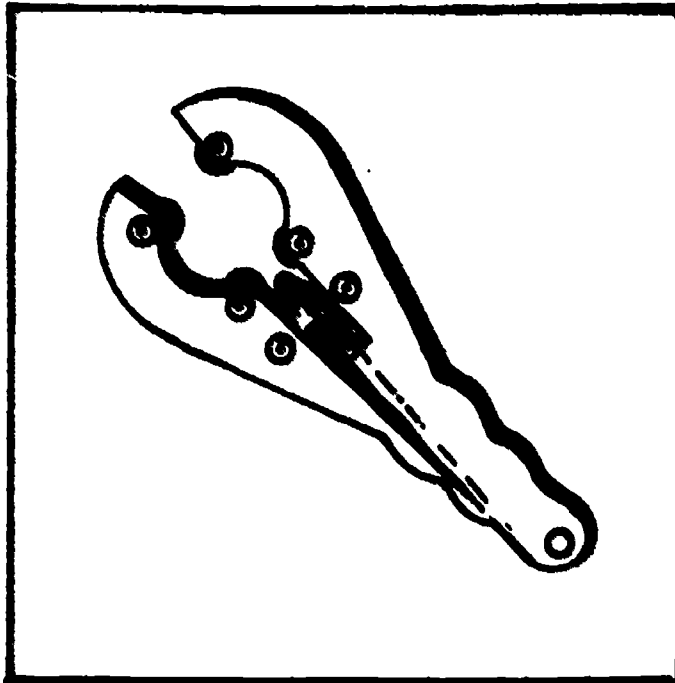

## PIPE CUTTER

*ADJUST FOR ANY  
DIAMETER TAIL  
PIPE, EXHAUST  
PIPE, MUFFLER  
NECK*

## PIPE PEELER

*STRIKE WITH  
HAMMER FOR  
SPLITTING AND  
REMOVING  
RUSTED PORTIONS*

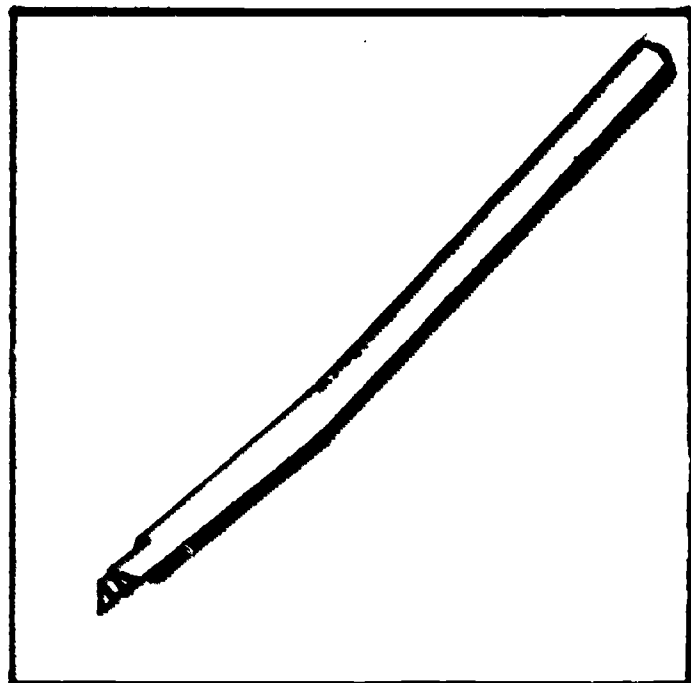

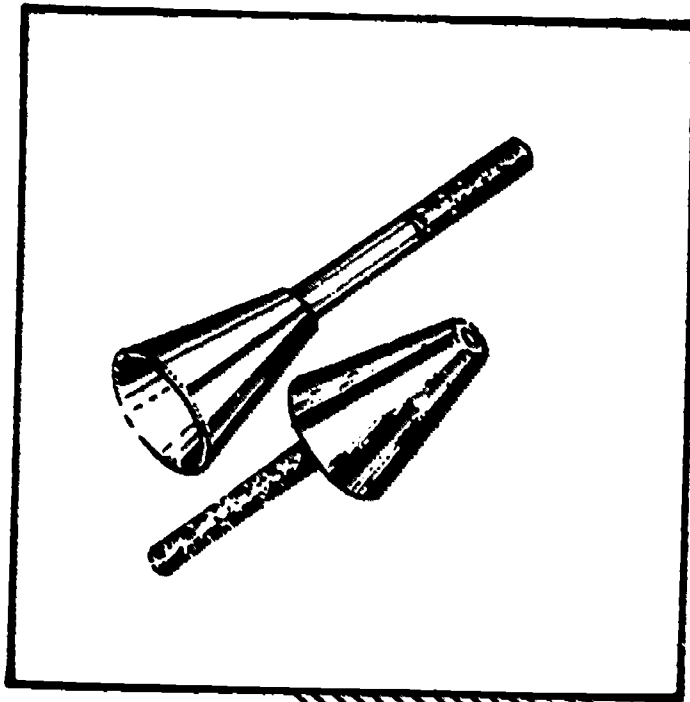

## PIPE SHAPER

*FOR ROUNDING-OUT  
DAMAGED OR DIS-  
TORTED PIPE AND  
TUBE ENDS*

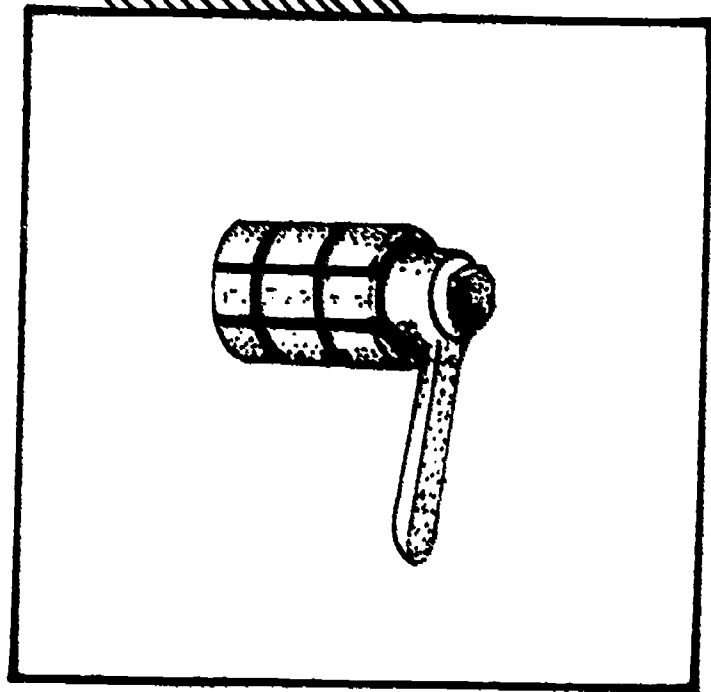

## PIPE SPREADER

*FOR REMOVING  
CLAMP RIDGES  
AND RESTORING  
ROUNDNESS*

## INFORMATION

Block: Fuel System

Block IV

Lesson: Crankcase Emissions

Job \_\_\_\_\_

Lesson \_\_\_\_\_

---

Teaching Objective: Upon completion of this lesson, students will be able to list the factors responsible for crankcase emissions, cite the reason for their control and describe the common control systems.

Teaching Aids: Transparencies:

- Crankcase Ventilation Systems, p. IV-129
- Cleaner Exhaust Regulations, p. IV-133

References: Crankcase and Exhaust Emission Systems, Service Manual,  
AC Division, General Motors Corporation  
Motor's Auto Repair Manual

### Outline of Information:

1. Combustion gases which seep past piston rings accumulate in the crankcase.
  - a. Condition is result of several factors
    - Normally high pressures
    - Necessary ring clearances
    - Normal ring shifting and lining up of clearance gaps
    - Worn rings and cylinders
  - b. Gases must be removed to prevent condensation and oil fouling.
  - c. Older cars (pre-1963) used road draft tube to remove gases.
    - Insufficient draft under 20 mph
    - Emitted gases contribute to air pollution.
    - Federal law requires 100% elimination of crankcase emissions.
2. Positive Crankcase Ventilation (PCV)
  - a. Open system
    - Uses manifold vacuum to draw gases from crankcase and meter them into intake manifold for delivery into combustion chamber
    - PCV valve regulates introduction of crankcase gases into intake manifold.

## Crankcase Emissions (continued)

### b. Closed system

- Introduces fresh air via air cleaner or PCV breather filter
- Prevents air pollution more effectively than open system
- No leakage due to pressure build-up in crankcase
- Utilizes PCV valve
- Required on all vehicles beginning with 1968 model production

### c. Some signs that PCV valve may be defective

- Oil around oil filler cap
- Oil dipstick develops film of rust
- Engine missing at high speed
- Strong oil odor
- Ruptured gaskets and seals (oil leakage)

# Crankcase Ventilation Systems

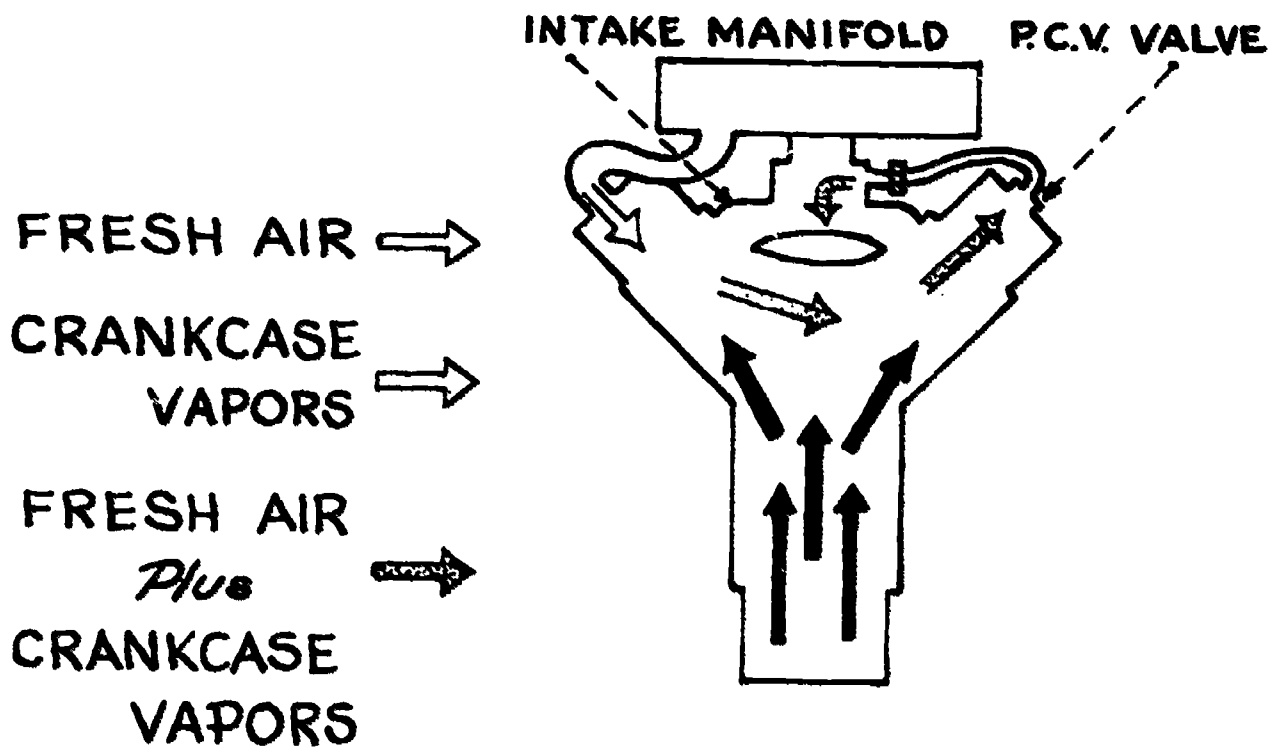
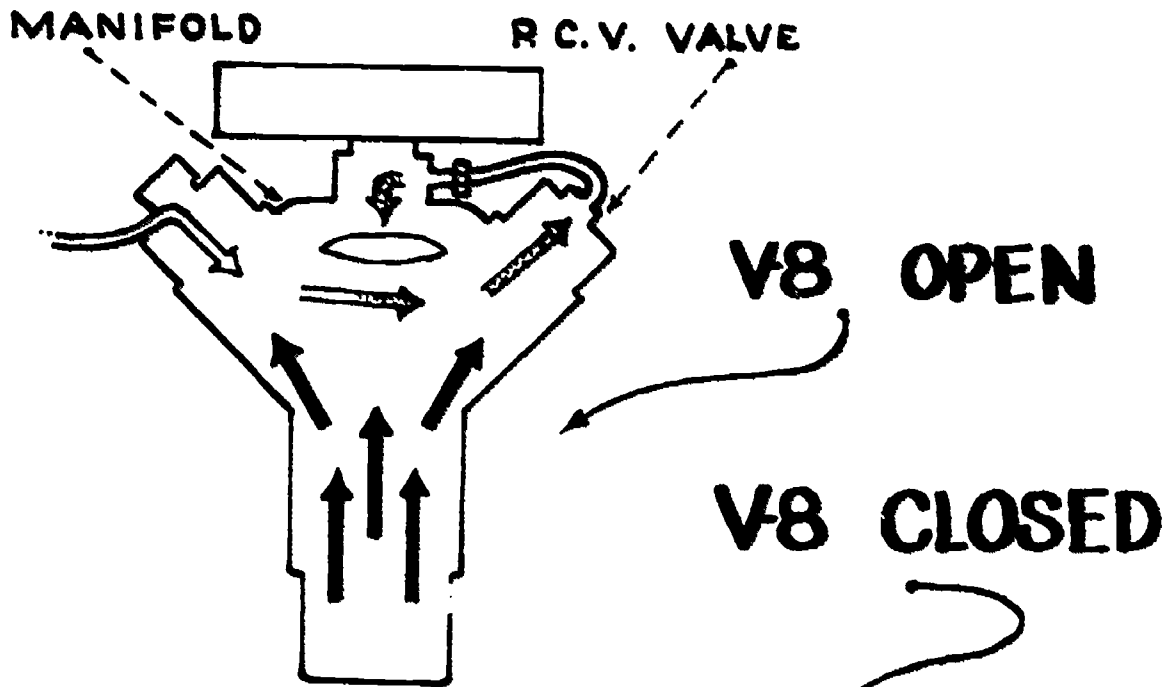

## OPERATION

Block: Fuel System

Block IV

Operation: PCV Testing and Service

Job \_\_\_\_\_

Operation \_\_\_\_\_

---

Teaching Objective: To teach students to test and service the PCV valve

Tools: Hoseclamp pliers, screwdriver

Materials: Solvent, wipe cloths, replacement PCV valve

Teaching Aids: Transparency:  
- Crankcase Ventilation Systems

References: Vehicle Service Manual

### Steps:

1. With the engine idling, remove the PCV valve from the valve cover. You should be able to hear a hissing sound. If you do not, the valve is probably clogged.
  2. Turn engine off and shake the valve. If you hear a click the valve is probably good.
  3. Replace or clean PCV valve every 12,000 miles
  4. To clean valve, remove from valve cover and soak in an approved carburetor cleaning compound. Blow it out with compressed air
  5. Shake the valve again and listen for click
  6. Check breather filter
- Note: Replace if dirty, do not re-use
7. Inspect, clean, replace hoses, fittings, tubes
  8. If flame arrester is used (located in air cleaner), it should be inspected and cleaned, if necessary.



## INFORMATION

Block: Fuel System

Block IV

Lesson: Exhaust Emission Control Systems

Job \_\_\_\_\_

Lesson \_\_\_\_\_

---

Teaching Objective: Upon completion of this lesson, students will be able to discuss the basic technology underlying exhaust control systems and will note major differences unique to systems currently in use.

Teaching Aids: Transparency:  
- Cleaner Exhaust Regulations, p. IV-133

References: Crankcase and Exhaust Emission Systems, Service Manual, AC Division, General Motors Corporation  
Vehicle Service Manuals

### Outline of Information:

1. Present exhaust emissions regulations are the result of public demands, legal regulations and manufacturer's desire to control air pollution.
  - a. Tremendous growth in number of motor vehicles and other applications of internal combustion power
  - b. Hazardous amounts of carbon monoxide and hydrocarbons present in earth's atmosphere
  - c. Federal regulations will continue to intensify.
2. Vehicle exhaust control systems
  - a. The air pump was first used as a control in 1966-67.
    - Forces fresh air to blend with unburned gases for recirculation
  - b. CCS (Controlled Combustion System - G.M.Corp.)
    - Hotter thermostats for better warm-up and more complete combustion
    - Revised timing for initial retardation
    - Modified distributor
    - No vacuum advance at idle
    - Leaner fuel-air ratio
    - Idle fuel limiter
    - Air temperature control

## Exhaust Emission Control Systems

- c. CAP (Clean Air Package), CAS (Clean Air System - Chrysler Corp.)
  - Leaner fuel-air ratios
  - Revised ignition timing
  - Hotter thermostats
  - Controlled spark advance
  
- d. IMCO (Improved Combustion System - Ford Motor Co.)
  - Similar to CCS
  - Controlled idle mixtures
  - Controlled air temperature into carburetor
  
- e. Engine MOD (American Motors)
  - Similar to other systems
  - Modified carburetion and ignition systems

WITHOUT EXHAUST EMISSION CONTROL

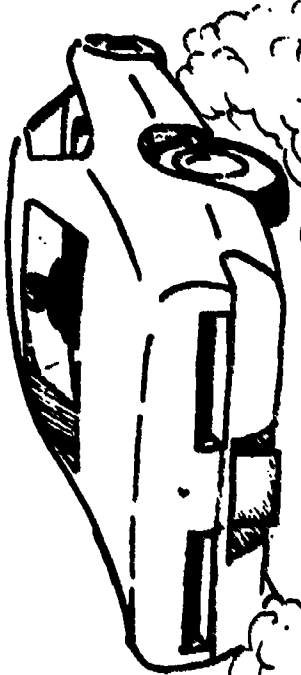

CRANKCASE EMISSIONS

NITROGEN	=	71%
OXYGEN	=	0%
HYDROGEN	=	1.2%
WATER	=	9%
C O <sub>2</sub>	=	16%
C O	=	3.8%



ELIMINATION OF CRANKCASE EMISSIONS

REDUCTION OF:  
CARBON MONOXIDE TO 1.5% Max.  
HYDROCARBONS TO 275 PPM.

FEDERAL LAW REQUIRES



## References - Block IV

### Books and Texts

1. Crouse, William H. Automotive Engine Design. New York: McGraw-Hill Book Company, 1970.
2. Deere, John. Fundamentals of Service Engines. Moline, Illinois: Deere & Company, 1968.
3. Crouse, William H. Automotive Mechanics, 6th ed. St. Louis: McGraw-Hill, 1970.
4. Frazee, Irving, and Earl Bedell. Automotive Fuel and Ignition Systems. Chicago: American Technical Society, 1965.
5. Glenn, Harold T. Automechanics. Peoria, Illinois: Charles A. Bennett Company, Incorporated, 1962.
6. Jensen, L.E., and William A. Brazier. Related Science-Automotive Trades. Albany, New York: Delmar Publisher Inc., 1958.
7. Motor's Auto Repair Manual. New York: Motor's Publishing Company, 1968.
8. Stockel, Martin W. Auto Service and Repair. Homewood, Illinois: The Goodheart-Wilcox Co., Inc., 1969.
9. Tolboldt, William K., and Larry Johnson. Motor Service Automotive Encyclopedia. Homewood, Illinois: The Goodheart-Wilcox Co., Inc.
10. Technical Training Manual, Volume 2. Automotive Fuel Systems, Automotive Electric Association.

### Other Publications (Manuals, Bulletins, Booklets)

1. "AC Fuel Pump Shop Manual." Flint, Michigan: AC Spark Plug Division, General Motors Corporation.
2. "Carburetion Facts and Fundamentals." Reference Book 70-8, Chrysler Motors Corporation.
3. "Carburetion Fundamentals." Reference Book 66-5, Chrysler Corporation, Master Technicians Service.
4. "Crankcase and Exhaust Emission Systems." Flint, Michigan: AC Spark Plug Division, General Motors Corporation, 1969.

References - Block IV  
(continued)

Other Publications (Manuals, Bulletins, Booklets)

5. "Exhaust System Service Manual." Motor Magazine, Hearst Corporation.
6. "Sun 820 Electronic Engine Tester Manual." Chicago, Illinois: Sun Electric Corporation.
7. "Vehicle Service Manual." (Refer to appropriate manual for vehicle)