

DOCUMENT RESUME

ED 097 460

CE 002 224

TITLE Illustrator Draftsman 1 and C. Rate Training Manual.
Revised 1973.
INSTITUTION Naval Training Publications Detachment, Washington,
D.C.
REPORT NO NAVTRA-10470-A
PUB DATE 73
NOTE 158p.
AVAILABLE FROM Superintendent of Documents, U.S. Government Printing
Office, Washington, D.C. 20402 (Stock Number
0502-052-3510)

EDRS PRICE MF-\$0.75 HC-\$7.80 PLUS POSTAGE
DESCRIPTORS Cartoons; Color Presentation; Design Crafts;
*Drafting; Freehand Drawing; *Graphic Arts;
Instructional Materials; Layout (Publications);
*Manuals; Military Personnel; Production Techniques;
*Technical Illustration; *Trade and Industrial
Education; Training; Visual Aids; Visual Arts

ABSTRACT

The training manual is intended to serve as an aid for men who are seeking to acquire the theoretical knowledge and the operational skills required of candidates for advancement to Illustrator Draftsman First Class (DM 1) or Chief Illustrator Draftsman (DMC). It includes subject matter that is related to both the knowledge factors and the practical factors of the advancement qualifications. Not designed to provide information on the military requirements for petty officers, the manual is divided into six major training areas: (1) administration, (2) cartooning, (3) screen process, (4) color, (5) visual presentations, and (6) typography and layout. Figures and illustrations are used throughout to illustrate procedures. A glossary of selected technical terms and index conclude the document. (MW)

CE

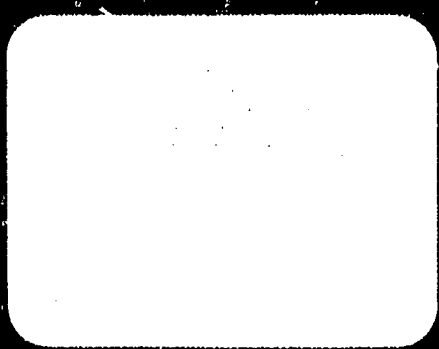
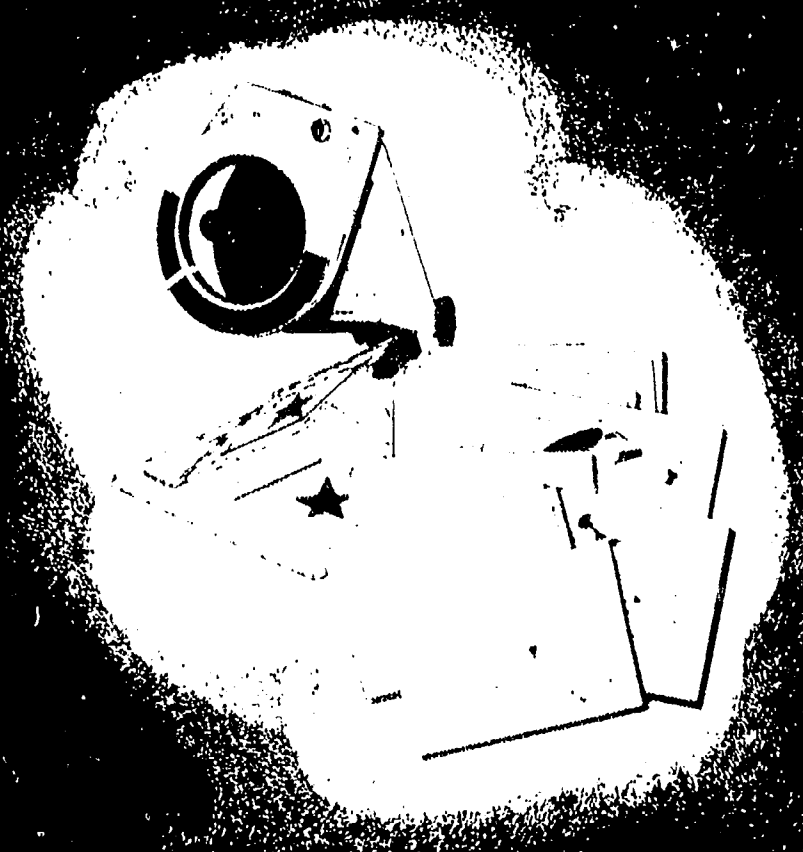

ILLUSTRATOR DRAFTSMAN 1 & C

NAVAL TRAINING COMMAND

RATE TRAINING MANUAL

NAVTRA 10470-A

PREFACE

This manual is intended to serve as an aid for men who are seeking to acquire the theoretical knowledge and the operational skills required of candidates for advancement to Illustrator Draftsman First Class or Chief Illustrator Draftsman.

This manual was prepared by the Naval Training Publications Detachment, Washington, D.C. Technical assistance was provided by Naval Examining Center, Great Lakes; Fleet Intelligence Center, Atlantic; Commander, Amphibious Force, U.S. Atlantic Fleet; Recruit Training Command, Orlando, Florida; Naval Security Station, Washington, D.C., and Naval Schools Construction, Port Hueneme.

Revised 1973

Published by
NAVAL EDUCATION AND TRAINING COMMAND

Stock Ordering No.
0502-052-3510

UNITED STATES
GOVERNMENT PRINTING OFFICE
WASHINGTON, D.C.: 1973

THE UNITED STATES NAVY

GUARDIAN OF OUR COUNTRY

The United States Navy is responsible for maintaining control of the sea and is a ready force on watch at home and overseas, capable of strong action to preserve the peace or of instant offensive action to win in war.

It is upon the maintenance of this control that our country's glorious future depends; the United States Navy exists to make it so.

WE SERVE WITH HONOR

Tradition, valor, and victory are the Navy's heritage from the past. To these may be added dedication, discipline, and vigilance as the watchwords of the present and the future.

At home or on distant stations we serve with pride, confident in the respect of our country, our shipmates, and our families.

Our responsibilities sober us; our adversities strengthen us.

Service to God and Country is our special privilege. We serve with honor.

THE FUTURE OF THE NAVY

The Navy will always employ new weapons, new techniques, and greater power to protect and defend the United States on the sea, under the sea, and in the air.

Now and in the future, control of the sea gives the United States her greatest advantage for the maintenance of peace and for victory in war.

Mobility, surprise, dispersal, and offensive power are the keynotes of the new Navy. The roots of the Navy lie in a strong belief in the future, in continued dedication to our tasks, and in reflection on our heritage from the past.

Never have our opportunities and our responsibilities been greater.

CONTENTS

CHAPTER	Page
1. Introduction	1
2. Administration	5
3. Cartooning	14
4. Screen Process	44
5. Color	65
6. Visual Presentations	81
7. Typography and Layout	99
APPENDIX	
1. Glossary	136
INDEX	150

CREDITS

The illustrations indicated below are included in this edition of ILLUSTRATOR DRAFTSMAN 1 & C through the courtesy of the designated companies. Permission to use these illustrations is gratefully acknowledged.

<u>Source</u>	<u>Figures</u>
Advance Process Supply Company	4-2; 4-4; 4-15; 4-16
Art Instruction Inc.	7-28; 7-29
International Typographical Union	7-2; 7-13
NAZ-DAR Company	4-6; 4-7; 4-10
Reproductions Review	7-33

CHAPTER 1

INTRODUCTION

At this stage in your naval career, you must be aware of how important training is to the accomplishment of your own goals and the Navy's mission. Neither objective can be attained unless you continue to acquire the specific knowledges and skills for doing, or doing better, your assigned tasks. When combined with practical experience, the instruction provided by this Rate Training Manual will help you become a proficient worker, and enable you to accept greater responsibilities. The Navy, too, will benefit from your technical competence and sense of personal responsibility.

Your own contribution to "victory at sea" depends largely on your willingness and ability to accept increasing responsibilities. When you became a Third Class Illustrator Draftsman, you began to accept a certain amount of responsibility for the work of others. Advancement to Second Class meant more responsibility. By studying this manual, you indicate a desire to take on even more.

With each advancement, you acquire increased responsibility not only in matters relating to the occupational requirements of your rating, but in military matters as well. You will find that your responsibilities for military leadership are about the same as those of petty officers in other ratings, since every petty officer is a military person as well as a technical specialist. Your responsibilities for technical leadership are special to your rating and are directly related to the nature of your work. This work requires a special kind of supervisory ability that can only be developed by personnel who have a high degree of technical competence and a deep sense of personal responsibility.

YOUR RESPONSIBILITIES WILL EXTEND BOTH UPWARD AND DOWNWARD. Both officers and enlisted personnel will expect you to translate the general orders given by officers into detailed, practical on-the-job language that

can be understood and followed even by relatively inexperienced personnel. In dealing with your juniors, it is up to you to see that they perform their work properly. At the same time, you must be able to explain to officers any important needs or problems of the enlisted men.

YOU WILL HAVE REGULAR AND CONTINUING RESPONSIBILITIES FOR TRAINING. Even if you are lucky enough to have highly skilled and well trained men in the graphics shop, you will still find that more training is necessary. Some of your best workers may be transferred and inexperienced or poorly trained personnel may be assigned to you. Or a particular job may call for skills that none of your personnel have. These and similar problems require you to be a specialist who can train others to perform their assigned tasks.

YOU WILL HAVE INCREASING RESPONSIBILITIES FOR WORKING WITH OTHERS. You will find that many of your plans and decisions affect a large number of people, some of whom are not in the graphics shop and some of whom are not even in the same division. It becomes increasingly important, therefore, to understand the duties and responsibilities of personnel in other ratings. Every petty officer in the Navy is a technical specialist in his own field. Learn as much as you can about the work of other ratings, and plan your own work so that it will fit in with the over-all mission of the organization.

AS YOUR RESPONSIBILITIES INCREASE, YOUR ABILITY TO COMMUNICATE CLEARLY AND EFFECTIVELY MUST ALSO INCREASE. The basic requirement for effective communication is a knowledge of your own language. Use correct language in speaking and in writing. Remember that the basic purpose of all communication is understanding. To lead,

ILLUSTRATOR DRAFTSMAN I & C

supervise and train others, you must be able to speak and write in such a way that others can understand exactly what you mean.

A second requirement for effective communication in the Navy is a sound knowledge of the Navy way of saying things. Some Navy terms have been standardized for the purpose of ensuring efficient communication. When a situation calls for the use of standard Navy terminology, use it.

Still another requirement of effective communication is precision in the use of technical terms. A command of the technical language of the Illustrator Draftsman rating will enable you to receive and convey information accurately and to exchange ideas with others. A person who does not understand the precise meaning of terms in connection with the work of his own rating is at a disadvantage when he tries to read official publications relating to his work. He is also at a great disadvantage when he takes the written examinations for advancement. Although it is always important for you to use technical terms correctly, it is particularly important when you are dealing with lower rated men; sloppiness in the use of technical terms is likely to be very confusing to an inexperienced man. Appendix I of this manual is a glossary that defines technical terms and trade names commonly used by illustrators and printers.

YOU WILL HAVE INCREASED RESPONSIBILITIES FOR KEEPING UP WITH NEW DEVELOPMENTS. Practically everything in the Navy—policies, procedures, equipment, publications, systems—is subject to change and development. As a DMI, and even more as a DMC, you must keep yourself informed about all changes and new developments that might affect your rating or your work.

Some changes will be called directly to your attention, but others you will have to look for. Try to develop a special kind of alertness for new information. Keep up to date on all available sources of technical information.

YOUR JOB

As an Illustrator Draftsman First or Chief you will normally be assigned duty in the graphics shop of a staff, training command, or submarine

tender. Here you will prepare signs, posters, charts, graphs, and training aids. As a senior Illustrator Draftsman you will have administrative duties to perform, such as planning, scheduling, assigning, and releasing work. Additionally you will supervise the training of the personnel assigned under you.

SCOPE OF THIS TRAINING MANUAL

Before studying this manual, you should know its scope and purpose. Go over the table of contents and note the arrangement of topics. Subject matter can be organized and presented in many different ways. You will find it helpful to get an overall view of this manual's organization before starting to study. Here are some points of interest concerning this manual:

- It must be satisfactorily completed before you can advance to DMI or DMC, whether you are in the Regular Navy or in the Naval Reserve.

- It is designed to provide information on the occupational qualifications for advancement to DMI and DMC.

- The occupational qualifications that were used as a guide in the preparation of this manual were those promulgated in the *Manual of Qualifications for Advancement*, NAVPERS 18068-C (1971). Changes in the Illustrator Draftsman's qualifications occurring after this edition of the *Quals Manual* become effective may not be reflected in the topics of this training manual.

- It includes subject matter that is related to both the **KNOWLEDGE FACTORS** and the **PRACTICAL FACTORS** of the qualifications for advancement to DMI and DMC. No training manual, however, can take the place of on-the-job experience for developing skill in the practical factors. When possible, this manual should be used in conjunction with the Record of Practical Factors, NAVPERS 1414/1.

- It is **NOT** designed to provide information on the military requirements for petty officers. Such information is contained in specially prepared Rate Training Manuals, which are described briefly later in this chapter.

SOURCES OF INFORMATION

It is very important for you to have an extensive knowledge of the references to consult for detailed, authoritative, up-to-date information on all subjects related to the military requirements and to the occupational qualifications of the Illustrator Draftsman rating.

Some of the references are changed or revised at regular intervals, others as the need arises. When using any publication that is subject to change or revision, be sure you have the latest edition. When using any publication that is kept current by means of changes, be sure you have a copy in which all official changes have been entered.

NAVAL TRAINING (NAVTRA) PUBLICATIONS

Effective 15 January 1972, the Naval Training Support Command and its field activities came directly under the command of the Chief of Naval Training instead of the Chief of Naval Personnel. Training materials published by the Naval Training Support Command after the above date are designated NAVTRA in lieu of NAVPERS; in most cases, the numbers remain as originally assigned. The designators of publications printed before the above date will be changed as each publication is revised.

The naval training publications described here include some that are absolutely essential for meeting your job requirements and some that are extremely helpful, although not essential.

Bibliography for Advancement Study, NAVTRA 10052

This pamphlet provides a working list of material for enlisted personnel who are studying for their advancement examinations. It is revised and issued annually by the Naval Training Support Command. Each revised edition is identified by a letter following the NAVTRA number. When using the bibliography, be sure you have the most recent edition.

The working list contains required and recommended Rate Training Manuals and other refer-

ences. A Rate Training Manual marked with an asterisk (*) in NAVTRA 10052 is MANDATORY at the indicated rate level. You are responsible, however, for all references at lower levels, as well as those listed for the rate to which you are seeking advancement. A mandatory Rate Training Manual may be completed by (1) passing the appropriate correspondence course based on the manual, (2) passing locally prepared tests based on the manual, or (3) in some cases, successfully completing an appropriate Navy school.

All references, whether mandatory or recommended, listed in NAVTRA 10052 may be used as source material for the written advancement examinations, at the appropriate levels. In addition, references cited in a mandatory or recommended Rate Training Manual may be used as source material for the examination questions.

Rate Training Manuals

These manuals help enlisted personnel fulfill their job requirements as expressed by the practical and knowledge factors that they must acquire for advancement. Some manuals are general, and intended for more than one rating; others, such as this one, are specific to the particular rating.

Rate Training Manuals are revised from time to time to bring them up to date. The revision of a Rate Training Manual is identified by a letter following the NAVTRA number. You can tell whether a Rate Training Manual is the latest edition by checking the NAVTRA number and the letter following the number in the most recent edition of the *List of Training Manuals and Correspondence Courses*, NAVTRA 10061 (revised).

The current editions of *Basic Military Requirements*, NAVPERS 10054, *Military Requirements for Petty Officer 3&2*, NAVPERS 10056, and *Military Requirements for Petty Officer 1&C*, NAVPERS 10057, provide information mostly on general military subjects. The manuals also contain information on the enlisted rating structure; how to prepare for advancement; how to supervise, train, and lead other men; and how to meet your increasing responsibilities.

The Rate Training Manual, *Mathematics*, Volume I, NAVPERS 10069, provides the fundamentals of algebra, trigonometry of the right triangle, and the use of the slide rule.

For a complete listing of Rate Training Manuals, consult the *List of Training Manuals and Correspondence Courses*, NAVTRA 10061 (revised).

Correspondence Courses

Naval correspondence courses are self-study media for providing instruction to personnel in professional naval subjects. They play an important role in helping enlisted personnel train for advancement and in meeting their job requirements. Enlisted personnel may enroll in two kinds of correspondence courses: Non-resident Career Course (NRCC) and Officer-

Enlisted (OCC-ECC). There is an NRCC based on this Rate Training Manual.

TRAINING FILMS

Training films are valuable sources of information on many technical subjects. The *United States Navy Film Catalog*, NAVAIR 10-1-777, lists titles and descriptions of films which have been authorized for training and information in the Naval Establishment. This catalog also contains instructions on how to obtain film prints. Catalog supplements are published periodically to provide new listings and corrections.

When selecting a film, be sure to note its year of production which is given in the catalog. Procedures sometimes change rapidly, thus some films become obsolete rapidly. If obsolete only in part, a film may be shown effectively if before or during its showing you point out to trainees the parts that have changed.

CHAPTER 2

ADMINISTRATION

The higher you climb the enlisted rating ladder, the more valuable you will be to the Navy. This is understandable since you have more experience in your particular rating, you have had considerable training, and your attitudes are generally well oriented to Navy life. In a sense, you are now in a position and better qualified to impart your knowledge and experience to the men under you. Your bearing, actions, and disposition will be under scrutiny not only by your seniors, but also by your subordinates. To function efficiently (or perhaps even to function at all) individuals engaged in group endeavor must be **ORGANIZED, TRAINED, AND SUPERVISED**. As a DM1 or DMC, you will be increasingly concerned with administration and human relations. You must have a sound concept of what **ADMINISTRATION** means, and what your administrative responsibilities are. To an increasing degree you will be fulfilling your duties through the effective use of people rather than your personal work, skill, and talent.

PRINCIPLES OF ADMINISTRATION

The process of administration of any job consists of four basic steps:

- Planning
- Organizing
- Coordinating
- Supervising

These steps are closely interrelated and often overlap, so it may be difficult to distinguish one from the other.

PLANNING

Every orderly process begins with planning and the graphics shop work is no exception.

Planning is determining in advance:

- What is to be done
- How it shall be done
- In what order various steps shall be completed
- Who shall do it
- How much time it will take

Whenever you are given a job to be done, your planning process begins.

The first step in planning is to set the goal of the project. This goal should clearly define the final product of the work, the standards to be met, and any other requirements such as deadlines.

The second step is to compare your resources in equipment and personnel with the requirements of the job, taking into consideration other work in progress and further expected assignments. With a good concept of your shop capabilities for doing the job; you can schedule and assign the details of the job, fitting it in with the other work of the shop.

To plan work properly you must collect all the information you need in advance and analyze each job thoroughly. You must try to foresee all problems that may arise and solve them ahead of time if at all possible.

One important part of planning is your consideration of the capabilities of your men. For instance, what should you think of when you give an inexperienced man a difficult assignment? If you leave him alone to muddle through, he may do alright, and learn something from the experience. On the other hand, you will have to check his final work carefully, it may have to be done over, and he may learn bad work habits. Usually when a man is assigned work which strains his capabilities, he should have close supervision, and receive on-the-job training as he works. Difficult assignments are good for training, and can be used when the

work load is light. When the shop has all the work it can handle, it is much more efficient to have all hands working at their levels of competence.

ORGANIZING

Organizing is the first step in putting a plan into effect. Whether the plan is for the overall operation of the graphics shop or for the accomplishment of a single job, you must organize your physical resources and personnel before production can start.

The factors you must consider in creating an organization are:

- Unity of command
- Division of labor
- Clear definition of individual's duties and responsibilities

The first principle of organizing, unity of command, may be defined as the principle which ensures that each individual in an organization is responsible to **ONLY ONE** superior. The principle should be applied in two ways:

1. Each man must know from whom he receives orders, and to whom he reports results.
2. Each man must know who the people are (if any) over whom he has control.

To achieve unity of command, lines of communication in the organization must be definite, clear cut, and **SHORT**. Organization charts should be prepared, as well as a list of the duties and responsibilities of each individual in the organization. Never decide that an organization is complete once it is on paper. Always be ready to change when you see parts of the organization are not working.

The second principle, division of labor, involves breaking a job down into logical tasks capable of accomplishment by individuals. Then these tasks are arranged into a logical order, and assigned in a way to equalize the work.

Division of labor may be exemplified by assemblyline methods used in industry. By dividing the labor, that is, assigning each task to an individual who repeats this task on each job

that comes along, the production of a number of complete jobs turned out in a period of time is high.

The major advantage of assembly-line methods is specialization. By concentrating on a single phase of work, personnel soon gain the specialized knowledge and skills that enable them to do the work professionally and complete it quickly.

One disadvantage of the assembly line is that DMs sometimes develop a narrow or limited point of view. Specialists who concentrate their efforts in only one area may one day find themselves in a position where they are expected to perform in another and cannot. Therefore, you should make certain that all your men have the opportunity to cross-train in the major functions of their career field.

In a small shop with only two or three DMs, it is usually not practical to employ assembly-line methods. In the small shop each worker, working independently, turns out a complete product by going through all the required steps. This makes a more flexible work force, much higher worker interest, and each man will be able to replace another when leave, illness, or other events require it. However, this system requires workers with broader skills. A disadvantage with this system is that some of the time of skilled workers is used for work which doesn't require skill.

Both methods can be combined, using small teams to develop a project or a subdivision of a project. This technique can be very effective if well used, since less experienced men can be incorporated in the team both to do some of the routine work and learn from the more experienced men. In small groups men tend to keep each other going, and unless personality clashes develop, the working relations are harmonious.

The third principle of organizing covers selecting, assigning, and instructing the individuals who will perform the subphases. One question to be answered in this step is how many men are required to accomplish the job? Too many men working on the same job is sometimes worse than not enough. Each job will have to be analyzed and then the required number of men assigned.

Before making individual work assignments you should consider the tasks to be done and

the conditions under which they are to be accomplished. Since your shop will usually have more than one job "working", your considerations should include not only who is best for a given job, but also who is presently working on a job, and what work will be coming up in the future, since it is not desirable to take a man off a job once begun.

As a supervisor you must have the ability to give accurate estimates of the time that each of the jobs assigned to your shop will consume. In making time estimates, you will rely heavily on past experience and the experience of your leading petty officers. Experience is an excellent teacher of things that may go wrong during a job. When planning and estimating a job the possible difficulties that may arise should be carefully considered, and extra time allowed for them. Also you should estimate the non-productive manhours that will be required to meet your shop's obligations to provide for working parties, mess cooks, special liberty, etc.

When support services are involved in a proposed job, the supervisors of the supporting shops should be consulted before making an estimate.

When estimating it will help you to divide the job into the tasks required to complete it, and to estimate a time for each task. For instance, the tasks involved in preparing a typical viewgraph are: (1) prepare the master, (2) develop the foils, and (3) assemble the viewgraph.

After estimating a time for each task, add the times together and multiply the result by the number of viewgraphs required. Then allow time for error corrections and personal time allowances, such as head calls, meals, etc.

After making an *estimate* of time required to complete the job, make a record of it so that you may refer to it later. Once the job is completed, compare the actual time expended with your estimate. The comparison will indicate how good (or bad) your estimate was, and how much of an adjustment, if any, to make the next time you estimate the job.

COORDINATION

Coordination is one of the chief goals of all administrators. It deals with unifying and

synchronizing everybody's actions towards achieving a common objective. Although listed here separately, coordination is not a distinct and separate function. Coordination actually is a part of all four administrative processes.

The best time to bring about coordination is at the planning level. It is only common sense that in determining what is to be done, you also take into consideration how it will be done and who will do it (so as to attain maximum efficiency with a minimum of effort from all concerned).

In a graphics shop, a good administrator will see to it that the right man is suited to the right job, that the machinery to do the work is kept in good operating condition, and that sufficient supplies and equipment are on hand to keep the work moving smoothly and efficiently.

An important part of good coordination is proper timing. Everybody involved in a project must not only do his share, but each one must do it on time. If one man or one department drops the ball, the entire project may come to a standstill. Planning a project in many cases is like setting up the machinery for an assembly line in a manufacturing plant. The speed of the assembly line must be geared to the capabilities of the machinery and workers, and to the availability of parts. You don't want one group of workers standing around idle while another group farther down the line finishes one job after another without a break. And of course if you run out of parts—that is, supplies and equipment—the entire assembly line will close down.

SUPERVISING

As a petty officer, the job of supervising should be nothing new to you. Good supervision is nothing more than good leadership. It means that you will guide your men intelligently and check the progress of their work regularly to see that it conforms as nearly as possible to your plans. Directions should be given simply, clearly, and completely. They should be given in such a way that the men know what is to be done and when to do it. Depending on the job or situation, you may also have to tell them how to do it, why it must be done in a professional

manner, and when the required action must be completed.

Supervision can range from almost no direct supervision of the highly experienced, to close supervision of the young and inexperienced DMs. If your men are capable and experienced and have demonstrated their ability on the same job previously, leave them alone. It would be foolish to supervise them too closely. They may resent it, and their work may suffer.

Keep your men informed. Make sure they understand the importance of their work and the good will to be derived from it for the Navy and the command. If they have to work late or do something out of the ordinary, make sure they know the reason why. But be careful not to belabor an obvious point. Some things just do not require explanations.

Training

The factor which contributes most to the superior accomplishment of any mission is the training of personnel. Training challenges the ingenuity of, and requires enthusiasm from, all persons in the naval service. As a supervisor, you must always find time to train the men under you, in order to improve their skills, knowledge, and attitudes. You will accomplish various tasks through the effort and cooperation of your subordinates. It follows that each subordinate must be given the proper training required for the efficient performance of his own particular part of the overall task.

The *Manual for Navy Instructors*, NAVPERS 16103 (series) contains methods and principles of instruction that are effective in Navy training. Additionally training is discussed in *PO I&C*, NAVPERS 10057 (series). You should study the information covered in these manuals so that you will be able to prepare and administer an effective training program.

No two jobs are exactly the same. A DM3 who has spent two years making flip charts will have to acquire new knowledge and readjust a little to make 35 mm slides. Take this into consideration in directing your men in their assignments. All DMs must have certain basic qualifications, but those qualifications may have been adapted to different jobs and different

billets. Two men in the same pay grade may have had such widely different careers and backgrounds that it would be unfair to expect identical results from them on any given job.

Here is where training comes in. As a senior DM in charge of a shop, you stand in the chain of command in the Navy where practical instruction takes place. Your position makes you the natural channel for giving the men new information, methods, and requirements. Your greater knowledge of the Navy, the command, and the skills of your rating make you the natural teacher of the men under you. Moreover, your proximity to the men enables you to understand them, and, in turn, to be understood by them.

Criticism and Praise

As a senior DM, you will have to think carefully about whether a job is done well or not. Never be too quick to criticize a man. Sometimes the man may have had a good reason for doing what he did. Avoid making unfavorable remarks just for the sake of being critical. You don't want your men to expect trouble every time you're around. It creates a feeling of hostility and may even be the cause of more mistakes because of a man's nervousness.

Use constructive criticism habitually. This means not only pointing out why you think a piece of work is wrong, but also explaining how it can be made better. This spreads the idea around that you're trying to help and give direction. Before you criticize at all, be sure you're right. If you're not sure, ask a few questions to get the whole picture.

As with criticism, there is some art in giving praise or encouragement. Public commendation is an excellent aid in developing a man's morale, but don't overdo it or it loses its value. Don't repeatedly pat a man on the back because he's doing his job. The enlisted evaluation report is the place for this. But never hesitate to thank or praise a man, and in such a way that the other men know about it, when he makes a good suggestion, or goes out of his way to do a better job. Even if a suggestion isn't very practical, let him know you appreciate the thought behind it.

Be courteous to your juniors, as well as your seniors, and encourage this trait in your men.

Work Control

As a supervisor it will be your duty to accept the assignments and assign them to your men. You decide when the work is to be completed. Of course, your decision will be based on information given to you by the requesting authority. In making this decision, you must consider the type of work being requested, the type of medium to use and the type of possible reproduction desired. But, most important of all, you must know the capabilities of your men and their ability to complete the assignment.

The work request form is your tool for conveying information to the worker. Also you may be required to account for such things as work in progress, work completed, workload trends, supply expenditures, and manhours. Your work request will serve as a set of accurate records on which to base your reports to management.

Work request forms serve as a checklist to ensure that all information pertaining to the assignment is obtained. Normally the requestor will have a rough drawing of what he wants, or be able to explain his ideas well enough to enable you to sketch a quick rough. These roughs should be thoroughly checked. The best layout, best method of rendering, correct spelling, and the best means of reproduction should be determined. Too often this is not done, and completed work must be redone.

After the specifications for the job are agreed on, you should be able to discuss the job in detail, offering suggestions on how the job may be completed, and complete filling out the work request.

Work request forms may be specifically designed for your shop. Figure 2-1 is a sample work request designed for the purposes of this manual. You may wish to add or delete items from this form depending on your own needs.

Request numbers serve as an easy means of identifying a particular job and are especially useful when you have a large number of jobs. The request number can consist of the date the job was accepted and the sequence number—for

example, the first job taken in on 7 November 1972 would be job number 7 11 72 (1).

Requesters should be identified along with their units and telephone numbers.

Jobs are generally turned out in the order in which they are received, although urgent or important jobs may be given priority over the more routine work. This information goes in the **DATE REQUIRED** block. Only you, your designated assistant, or division officer should have the authority to assign priorities and completion dates.

Keep your division officer informed as to your workload, especially when schedules are tight, to give him an idea of the status of all important jobs and to help him assign priorities to rush jobs.

The request should show the name of the person accepting the job. This will show the worker who he can consult with if there are any questions. When the job is assigned, the worker's name should be written in the appropriate block. This will show you who has what jobs.

Classifications should always be indicated, even if the job is unclassified.

Any existing artwork should be indicated by its file number. If there is no existing artwork the file number should be filled in after the job is complete.

The number of copies should be filled in. If any amplifying information is needed on the number of copies it may be written out in the job description block.

Special instructions or remarks should be shown in the **JOB DESCRIPTION** block. When you design your request form make the block space large enough to indicate the type of work (viewgraph, poster, copy prep, etc), size, color, lettering style, and any other amplifying information. This space may also be used to make a rough drawing, or it should carry information directing the worker to any roughs that may be attached to the work order.

The **SUPPORT REQUESTED** block is used to write directions to the photographer or lithographer. Room should be allowed in this block for sizes or other special requirements. In addition you may be required to submit a requisition for local duplicating service, figure 2-2 shows a sample of this type of request form.

REQUEST NUMBER		REQUESTERS NAME, UNIT & PHONE	
DATE REQUIRED	ACCEPTED BY	ASSIGNED TO	
CLASSIFICATION	FILE NUMBER	NUMBER OF COPIES	
JOB DISCRPTION			
SUPPORT REQUESTED			
MATERIALS		MAN-HOURS	
AMOUNTS	COST	NAME	TIME
_____	_____	_____	_____
_____	_____	_____	_____
_____	_____	_____	_____
TOTAL		TOTAL	
NOTIFIED	TIME PICKED UP	RECEIVED BY	

5.144

Figure 2-1.--Sample work request.

The amount and cost of materials used for a job may be helpful if you need to indicate what a job costs.

Personnel working on the job and the amount of time each spends may be shown. Normally time can be given in 1/2 hour segments thus avoiding complicated figures.

To avoid any misunderstandings about when an assignment was completed and delivered the work order should include time notified, time picked up, and the signature of the person receiving the completed assignment.

An original and two copies of the work request form will be needed with each job. The two copies will accompany the job when it is assigned. One copy stays with the workman until the job is completed. The second copy should remain with the job when support services are required such as photostats. The original work request is retained by the supervisor and is used to determine who has been assigned the job and what the shop workload is.

After the job is picked up you should retain the work request as a receipt. These completed

REQUISITION FOR LOCAL DUPLICATING SERVICE				DATE OF REQUEST	DATE REQUIRED	JOB NUMBER
TO:				FROM: (Organization and room number)		
1. FOR REFERENCE CONSULT				3a. DELIVER TO		
2. DESCRIPTION (Title, form number, etc.)				b. NAME AND PHONE NUMBER OF PERSON TO CALL IF TO BE PICKED UP		
4. NO. OF ORIGINALS	5. NO. COPIES EACH	6. TYPE OF REPRODUCTION <input type="checkbox"/> OFFSET <input type="checkbox"/> MIMED <input type="checkbox"/> OTHER (Specify)		7. SECURITY CLASSIFICATION		8. DISPOSITION OF ORIGINALS <input type="checkbox"/> RETURN <input type="checkbox"/> DESTROY
9. PAPER KIND SIZE COLOR		10. COLOR INK	11. PRINT <input type="checkbox"/> ONE SIDE <input type="checkbox"/> HEAD TO HEAD <input type="checkbox"/> HEAD TO FOOT <input type="checkbox"/> HEAD TO <input type="checkbox"/> L <input type="checkbox"/> R		12. COLLATE <input type="checkbox"/> YES <input type="checkbox"/> NO STAPLE <input type="checkbox"/> YES <input type="checkbox"/> NO	
13. ADDITIONAL SPECIFICATIONS (Including distribution, punching, padding, location of staples, etc.)				14. SIGNATURE OF REQUESTER (This requisition contains no copyrighted material other than that indicated on attached copyright release.)		
				15. SIGNATURE OF APPROVING OFFICIAL		
FOR REPRODUCTION UNIT USE ONLY						
16. DATE RECEIVED		17. PRIORITY		18. OPERATOR		22. DATE REQUESTER NOTIFIED JOB IS COMPLETE
19. NO. OF COPIES REPRODUCED		20. DATE DELIVERED		21. JOB RECEIVED BY		

DD FORM 844
1 DEC 61

GPO 885-686

149.94

Figure 2-2.—Requisition for local duplicating service.

work requests then may be referred to when you make your reports to management.

Files

If you take charge of a graphics shop, one of your responsibilities will be to have a workable filing system that all personnel can understand and use. If you have ever tried to locate information in files someone is keeping by his own, nonstandard system, you can appreciate the value of a standard filing system. In the Navy's standard filing system the material is arranged by subject, rather than chronologically or alphabetically, so it is possible to quickly find all material related to a certain subject.

The Department of the Navy Standard Subject Identification Codes, SECNAV Instruction 5210.1A, sets forth a standard subject scheme

for filing and retrieval systems. This standard subject scheme and basic filing methods are described in Chapter 2, DM 3 & 2, NAVTRA 10469-A. It should be emphasized, however, that virtually every Navy graphics shop has filing peculiarities which can be resolved only by adapting the standard filing system to suit the needs of the shop.

Supplies

Most assignments coming through your shop will require the expenditure of supplies. As the leading petty officer, you must ensure that enough supplies are on hand to accomplish the jobs assigned to your shop. It will be your responsibility, for example, to estimate the sensitized diazo material required over a given period. Be as accurate as possible. Don't order

too much and run the risk of having an excess which will spoil before it can be consumed. Furthermore, you want to avoid the trying situation in which you have an assigned task and you haven't enough material on hand to finish the job.

To maintain a reasonable supply level, inventory your supplies and equipment periodically. If possible, appoint one PO in the section to perform supply functions as a collateral duty. This supply PO maintains the stock levels, prepares requisition for supplies as needed, and keeps you informed of any equipment that needs repairs or replacement. Supplies and equipment are your primary tools for production; hence, they should be kept at the proper level at all times.

Although normal channels of supply must be used whenever possible, some of the articles used in the graphics shop cannot be acquired directly from all supply ships or supply depots, but will have to be ordered or purchased on the open market.

If your activity has an imprest fund, you can make open-market purchases across the counter and pay for them with cash. The imprest fund provides a simple and economical way to buy materials up to \$100.00. It is similar to the petty cash fund of private industry. In emergency situations the purchase amount may be extended to \$250.00.

The imprest fund is in the custody of a member of the supply department who acts as the "imprest fund cashier." When a purchase is required, he will advance these funds to the man who is to pick up the merchandise (you or your representative) and will require him to sign a receipt for the money. The cashier will retain this receipt and will give the man a receipt for Cash-Subvoucher, Standard Form 1165, which must be filled in by both the man and the supplier at the time the purchase is made.

Before trying to purchase supplies in this manner, you should contact the supplier to determine their availability and approximate selling price. You should then make up a DD Form 1348 or NAVSUP Form 1250 (see *PO 3 & 2*, 10056) and take it to the supply office a day or two in advance if time permits. It is better to make arrangements to pick up the money at 0800 in the morning so that the supplies can be

obtained and the Standard Form 1165 can be returned to the cashier the same day.

The man who picks up the money should carry the money and Standard Form 1165 to the supplier. Once the purchase is completed, he must have the supplier fill in certain information on the form. After returning to his activity he must turn the form over to the cashier (as evidence of the expenditure) along with any change from the amount which was advanced to him.

Shop Layout

Chances are your shop layout was arranged long before you took over. However, to make sure that all operations are functioning properly, you should analyze them occasionally to see if each step gives you the most efficient use of space and equipment. A good method for planning shop layout is to make a scale drawing of your shop spaces. Additionally draw and cut out templates of the equipment and furniture. As you place each piece of equipment and furniture on the plan, determine how each will be used, the steps involved in their use, and the amount of noise or disturbance which may be caused.

Equipment and furniture must be placed so as to be accessible, save waste motion, and reduce walking distance. Your men will turn out more work in less time when their equipment is close at hand.

In arranging the graphics shop, try to separate work areas, reproduction areas, and storage spaces. See that each area has enough room to enable a worker to move around comfortably without interfering with his neighbor. In the ideal situation, noisy reproduction equipment is located in a separate room. Keep infrequently used materials and instruments in easily accessible storage areas. Try to locate storage areas so that a worker will not have to walk around another to reach them.

Make sure there is enough light of the proper intensity. Never locate working areas where they will be in direct sunlight. Too much light, as well as inadequate light, causes severe eyestrain.

Aboard ship, of course, you are likely to find other limitations besides the obvious lack of

space. Don't overlook the effect that pitching and rolling of the ship may have on materials and equipment.

Checking

If one of your men submits a job, it is up to you to check it or have it checked before it goes to the requester.

A checker should be thoroughly familiar with both the standard techniques for rendering illustrations in any medium, established line drafting standards and also standard shop practices. The checker should be a person who is able to concentrate and has a high regard for thoroughness, accuracy, and quality.

When an original is to be checked give it the maximum protection against pencil marks, finger marks, spilled coffee, rips, etc. If possible make a quick print, such as a diazo or Xerox, so that the checker can note his corrections on this print. Thus the original will not have to be marked up or handled excessively. Where you have no quick print, place an overlay over the original, then note all corrections on the overlay. After all corrections have been made on the original, the checker can compare it with either the print or overlay to ensure that all corrections have been made. If errors still exist the checker can use a different color of pencil to indicate them on the print or overlay, or make a new print or use a new overlay. When a check print or overlay is made of a classified drawing insure that security regulations are followed.

Use a short list of questions, such as the one below, to help you do a thorough job of checking. Such a list will apply to many drawings.

1. Is the drawing the correct size?
2. Is the drawing size proportional if it is to be reduced?
3. Will the drawing reproduce?
4. Does the drawing carry the correct classification, if any?
5. Is the drawing adequate to show all the information necessary?
6. Is the spelling correct?
7. Is standard terminology used?

When checking mechanical drawings a more detailed list is required:

1. Is the method of projection the proper one for the job?
2. Are the views adequate to clearly show all the information necessary and are they arranged properly?
3. Are sectional views constructed correctly and is the section lining correct?
4. Are the line conventions and symbols consistent with JAN and MIL-STD requirements?
5. Is the proper drawing scale used? Also is that scale properly indicated on the drawing?
6. Is the drawing drawn to scale? When a drawing has been revised it may no longer be to scale, but this should be indicated by an underlined dimension and a note in the revision block.
7. Do the dimensions agree with the original layout or information?
8. Do the dimensions agree with corresponding dimensions on adjacent parts?
9. When the dimensions carry tolerances, are the tolerances correct to give proper manufacturing tolerances and allowance for fits?
10. Are the dimensions properly indicated so that the man using the drawing will need to do an absolute minimum of addition and subtraction?
11. Are there enough dimensions shown so that the job can be done? Note also that dimensions should not be repeated unnecessarily, because there is the danger of one being revised, while the other is left unchanged.
12. Are all necessary explanatory notes given and are they properly placed?
13. Are all figures and letters properly formed?
14. Are standard terminology and standard abbreviations used?
15. Is the kind of material of each part specified?
16. Are the numbers required of each part given?
17. Is the finish specified where it is needed?

CHAPTER 3

CARTOONING

Cartoons are natural attention getters. They attract and hold the attention of viewers long enough to deliver short written messages. Cartoons can also liven up dreary subject matter. On the other hand, they can subdue the real tragedy of an accident and still get the message across without being repulsive.

The ability to draw cartoons is an important part of any Illustrator Draftsman's "bag of tricks". His civilian counterparts have long realized the potential of the cartoon for purposes other than sheer amusement. You can see cartoons being used for advertising and information purposes in television, newspapers, magazines, booklets, billboards, posters, and illustrated brochures. This list of uses should give you an idea of the value placed on cartoons as a form of communication. It should be easy to see how valuable they can be in training, public relations, briefings, recruiting, and other naval functions.

Cartoonists are always being asked to divulge the so-called secret of their trade. In a word, the secret is **PRACTICE!** Though this may sound like an attempt to avoid more questions by offering oversimplified advice, practice is the key to the success enjoyed by any cartoonist.

Though being original is also important, you can get good results by studying others, just as the fine artists study the old masters. But do not copy the work of someone else because, in doing so, there is the danger of being so taken up by his style or technique that you will completely ignore the actual key to his success—**PRACTICE**. The best you can hope for in copying the work of others is a reasonable facsimile. Copying, then, prevents you from learning the fundamentals of construction so essential to the development of your own style and technique. Without a doubt, practice is the best cartooning tip of all.

This chapter deals with the fundamentals of cartoon construction. Study the fundamentals carefully, they will get you started in cartooning. You must continue to seek out additional information on your own. Read all you can find about cartooning, especially books on figure drawing. Though not held to the same strict rules of anatomy as illustrators, cartoonists must know how the human body works.

TOOLS AND EQUIPMENT

Tools of the cartoonist are few and simple. Each cartoonist, of course, has his favorite. Unfortunately, the skill to use a tool cannot be passed on by mere description. You must master the tools of the trade through practice and experimentation.

Cartooning is done freehand, not with drafting tools. Though 60- and 40-degree ellipse templates were used to maintain symmetry in figures 3-2 and 3-3, this is a problem peculiar to the preparation of the rate training manual itself and not one that you will ordinarily deal with. The tools described below are those which were used to draw the cartoons in this chapter.

- Drawing board: 18 by 24 inches, made of soft pine or similar soft wood. You will find it more maneuverable than a drafting table.
- T-Square: 24-inch; used for layout.
- Triangle: 30°-60°, 16-inch; used for drawing vertical lines.
- Masking tape: 1/4-inch roll; for maintaining the position of your drawing when laying out.
- Ruler: 12-inch, wood, beveled, (school variety) with metal straightedge.

- Ink: black, waterproof, india.
- Opaque white water color: Dr. P. H. Martin's Flow-White; for covering inking mistakes.
- Pencils: (1) Eagle Verithin, sky blue, No. 740 1/2 (eraseable); used for sketching and layout. (2) Hardmuth "sketching pencil" No. 355-6B; used for blackening the reverse side of the sketching paper. (3) Hardmuth Mephisto, brick red, No. 1340; used for tracing over blue-lined sketches and making notes to the printer on tissue overlays. (4) Eagle Prismacolor, black, No. 935; used for graded and halftone effects on coquille board.
- Erasers: hard rubber or vinyl (for difficult spots); soft rubber (general work); art-gum or kneaded eraser (final clean-up chores).
- Pens: Speedball No. B4, B5, and B6; used for lettering.
- Penholder: Koh-I-Noor No. 116-1/2.
- Brushes: Red sable, water color, No. 3 and 5; used for inking.
- Tracing paper: 8 1/2 by 11 inches.
- Bristol board: 2 or 3 plies; plate finish for pen and ink, kid finish for brush and ink.
- Coquille board: Rough stipple pattern; used for graded and halftone effects.

DRAWING THE CARTOON HEAD

The cartoon head is the primary means of relating expression or emotion in the cartoon. Your character's face is the mirror that reflects upon the viewer the desired mood.

Think of the cartoon head as a highly flexible balloon, slightly elliptical in shape. Practice drawing this shape (fig. 3-1A) so you are able to quickly construct it freehanded. Do not try to draw a perfect ellipse. Keep your sketching loose by holding your pencil between thumb and index finger, letting it pass under your palm. Do not hold the pencil in the normal writing position.

Sketch several ellipses rapidly, one atop the other. None will match the others precisely. Pick out the ellipse that suits you most; erase the others when you finish the cartoon.

To avoid a flat lifeless appearance in your cartoons, try to draw them so that they will appear three dimensional. Add guidelines to the basic ellipse, as shown in figure 3-1B. The guidelines help you locate features, such as eyes, nose, mouth, and ears. Note that they do not go straight up and down or straight across the ellipse, but are contoured around the ellipse to form other ellipses.

In figure 3-1C the features of the character have been drawn in place along the guidelines. Your cartoon is now complete except for the finishing touches, which are rendered with brush and ink. As you draw with your brush you must visualize the unwanted parts of your sketch, and eliminate them. Vary the pressure on the tip of the brush to obtain the thick and thin strokes that give depth and character to your figure. Figure 3-1D is the finished cartoon head. Try drawing the cartoon head many times over for practice.

POSITIONING THE HEAD

After you have mastered the simply constructed cartoon head, try drawing it in various positions and angles as illustrated in figures 3-2A and 3-2B. You can turn the head sideways, up or down. To change the head's position, change the position of the guidelines. Notice how the position of the head can be turned by locating guidelines in different positions along the surface of the balloon. The three-quarter view is quite common because it has the most depth and character. Though used less often, the other views and positions are just as important when required. Therefore practice drawing the head in all positions.

The left-side and right-side views of figure 3-2A are flat and lifeless, reason enough to be shunned by professionals.

By drawing the front view, as shown in figure 3-2B, you apply a technique called mugging. It is used only to develop a direct relationship between your character and the viewer. This technique is more useful in television than in any other medium.

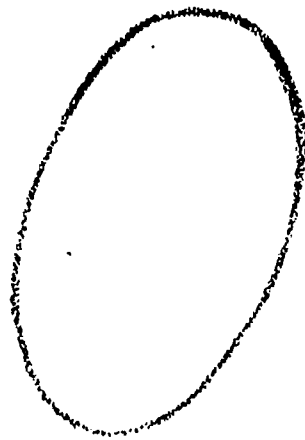

A. DRAWING THE BALLOON



B. ADD THE GUIDELINES



C. LOCATE THE FEATURES



D. INK FINISH

Figure 3-1.—Drawing the cartoon head.

149.75

FACIAL EXPRESSIONS

Facial expressions are produced by the movable parts of the face, such as the mouth, the eyes, and the eyebrows. You can express many emotions simply by changing the shape or posi-

tion of these parts. See figures 3-3A and 3-3B. Note that some of the expressions could do double duty. For example, the love-daydream expression could show innocence as well. In creating expression, let the eyes and mouth carry most of the load. The hair, nose, and ears

are window dressings that add little to expression although they help to develop character (discussed later). These basic figures are subject to wild exaggeration. Compare the expression of surprise in figure 3-3B to its counterpart in figure 3-6.

A good method of learning how to draw facial expressions is to study your own face in a mirror as you imitate various emotions. Sketch what you see and try to capture each emotion. Also be alert for opportunities to study and sketch the people near you; try drawing the different moods they express. Deal with each expression imaginatively as you draw, and put the most you can muster into each.

CREATING THE CARTOON CHARACTER

Figures 3-4A and 3-4B illustrate how the basic cartoon head can be squeezed, stretched, flipped, flopped, or inverted at will to develop character. Raising or lowering the eyeline also works. In other words, do not settle for one particular head shape or technique.

Figures 3-5A and 3-5B show other ways of developing character in the cartoon head. Character is made up of the various features and how they are combined. Everyone has preconceived ideas of what some characters look like (called typecasting). These ideas enable the cartoonist to add to a particular head shape the features he needs to develop a certain character.

In real life, for example, a professional wrestler may look like a movie star from the neck up—but we know different, don't we? Of course we do! All wrestlers are bull-necked, heavy-jowled, cauliflower-eared, pug-nosed, heavy-browed, beady-eyed, and pinheaded, and have little or no hair to hide the thickness between their ears. There is no other way to portray them.

Study all the illustrations in this chapter; take them apart mentally to see what brings out their character. Also study persons who, in your opinion, typify their occupations.

Features

Here are a few tips on facial features to get you started.

HAIR.—Draw hair so that it conforms to the contours of the head. An abundance of hair belongs on the heads of moppets and heroes or playboys. Hair can stand on end when scared, be tousled with frustration, or drop with despair. Even the lack of it is a sign of many characteristics, such as old age, worry, and wisdom.

EYEBROWS.—You have already seen what the ups and downs of eyebrows have done in figures 3-3A and 3-3B. Now consider who the skinny brows and the bushy ones belong to. As a rule, the brush piles go to the heavies or tough guys, the boss, the man with the baton in the orchestra pit, and those with lots of hair on their heads, such as white-haired southern gentlemen.

EYES.—Eyes may be drawn as simple dots, or the dots may be circled to represent eyeballs. Again the figures on facial expressions point out some of their versatility. Then too there are beady-eyed varmints, wide-eyed innocent youths, and more.

EARS.—Most ears are simple, excepting the outlandish jug-ears of country youth and the cauliflower-adornments of the tough guy.

NOSE.—The four basic nose "jobs" shown in figure 3-5A belong to a variety of characters. Take a good look at their opposites in figure 3-5B. Never mistake a singular feature as making up all the character of a cartoon head.

MOUTH.—Figures 3-3A and 3-3B give you some idea of the part that the mouth plays in developing character. So will many of the other figures in this chapter.

CHIN.—The chin, or lack of it, is a good indicator of character. Heroes always have chins, quite handsome ones, but so does "grandpaw" in figure 3-5B. To be sure, his is rather bony and loose (no teeth, you see).

To sum up, be sure to observe and typecast, and then think character when you draw cartoon features! Of course, the more you practice and the more you observe, the quicker you will assemble the right set of features for your character.

Head Gestures

A facial expression can be emphasized by drawing the head at the appropriate angle or attitude, as shown in figure 3-6. Notice that the dejected head slumps and the angry or aggressive

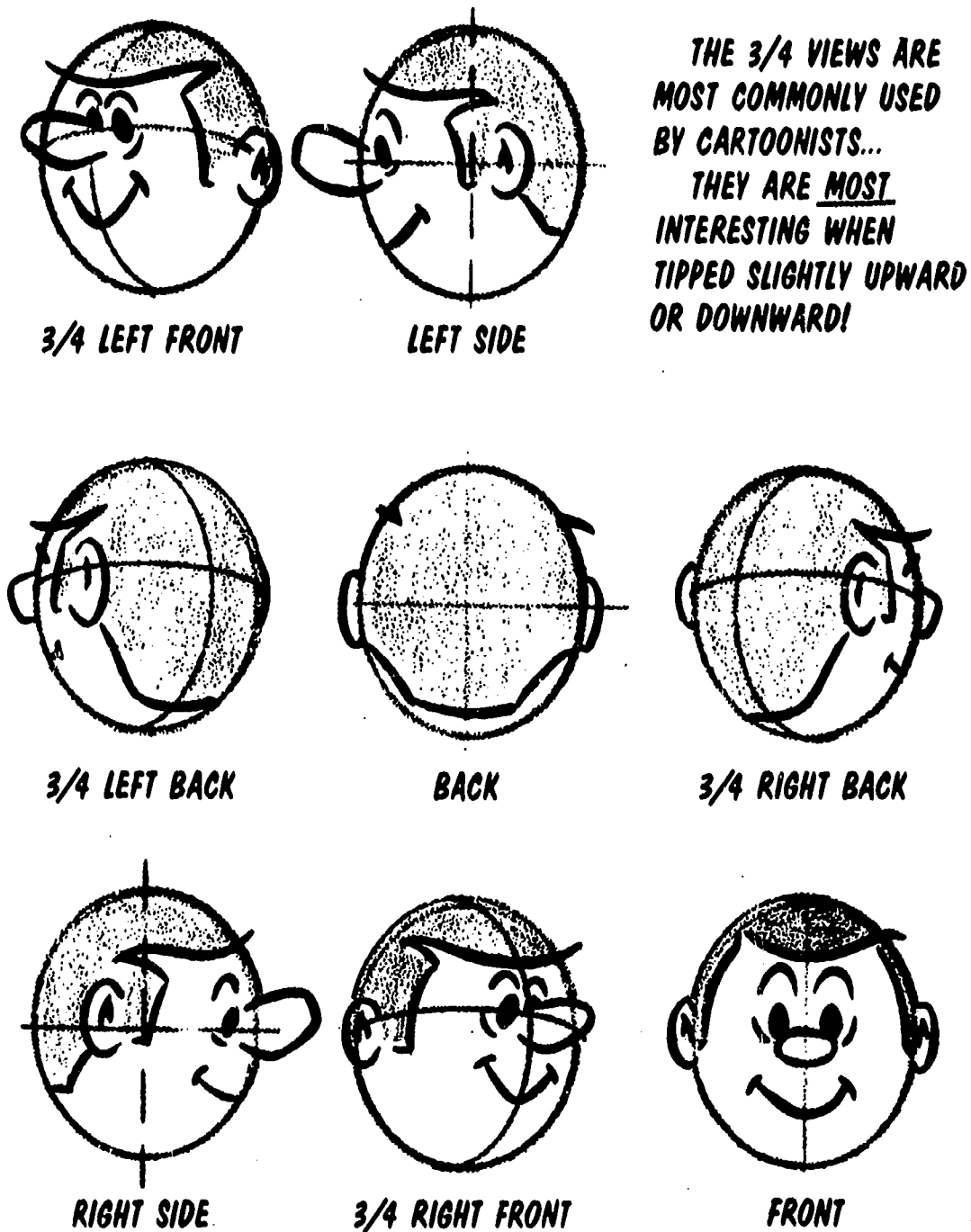

Figure 3-2A.—Revolving the cartoon head.

149.76.1

head is thrust forward chin first. In surprise the neck stretches and leans forward. Heads are thrown rearward in alarm or laughter. It is up to you to capture the action.

CARTOON TYPES

Figure 3-7 points out the differences between semirealistic and exaggerated cartoon types.

In drawing a semirealistic type, obey the same principles of anatomy as in drawing "true to life." But make sure you simplify the actual rendering. On the other hand, when drawing exaggerated cartoons there seems to be no limit when it comes to exaggerating the stock-in-trade features. A word of advice: Never put the two types together in the same drawing. If you do, they will still seem separate and distinct.



HEADS TURN UP AND DOWN AS WELL AS AROUND. PRACTICE DRAWING THEM IN EVERY POSSIBLE POSITION... YOUR GUIDELINES ARE THE "KEY" TO YOUR SUCCESS.

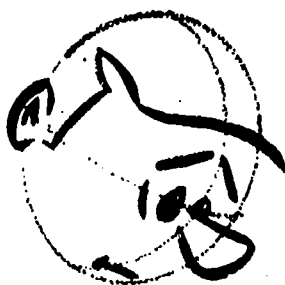

SAVE THOSE "MUG SHOTS"... FOR TH' TIME AND PLACE YOU NEED A LITTLE UNDERSTANDING FROM THE VIEWER... LIKE SYMPATHY MAYBE?

Figure 3-2B.—Revolving the cartoon head (continued).

149.76.2

THE CARTOON FIGURE

Cartoons are built like houses; you start with a foundation and work your way up. In this section you will be shown a construction technique for the cartoon figure. This figure, like the

head, should appear three dimensional. Cartoon figures may be drawn by the so-called stick-figure, or action-line, method in which a solid three-dimensional cartoon figure is built on a stick frame.

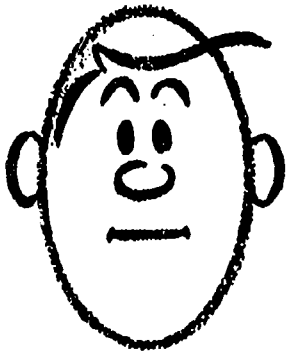

EASE

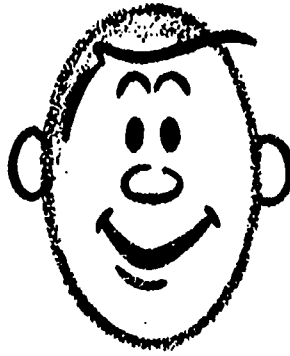

**HAPPY
AMUSED**



LAUGHTER



ANGER



HATE



AGGRESSIVE



SAD



BORED

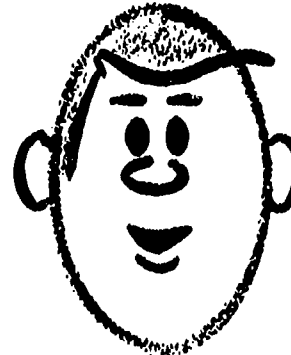

MILD

Figure 3-3A.—Basic facial expressions.

149.77.1



**SMUG
VAIN**

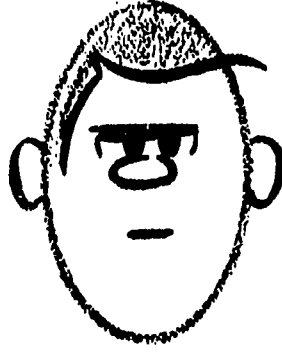

**DOUBT
DISINTEREST**

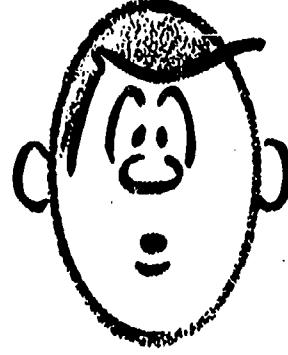

**SURPRISED
AMAZED**

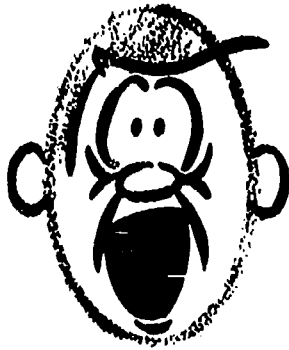

**FEAR
SHOCK**

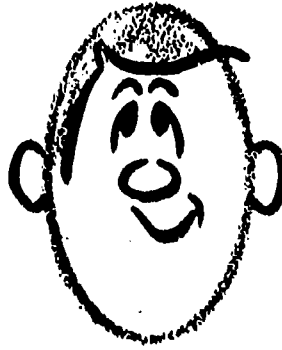

**LOVE
DAYDREAM**



**PUNCHY
DRUNK**



**SUSPICION
FLIRTATION**



**PAIN
STRAIN**



MIXED EMOTION

Figure 3-3B.—Basic facial expressions (continued).

149.77.2

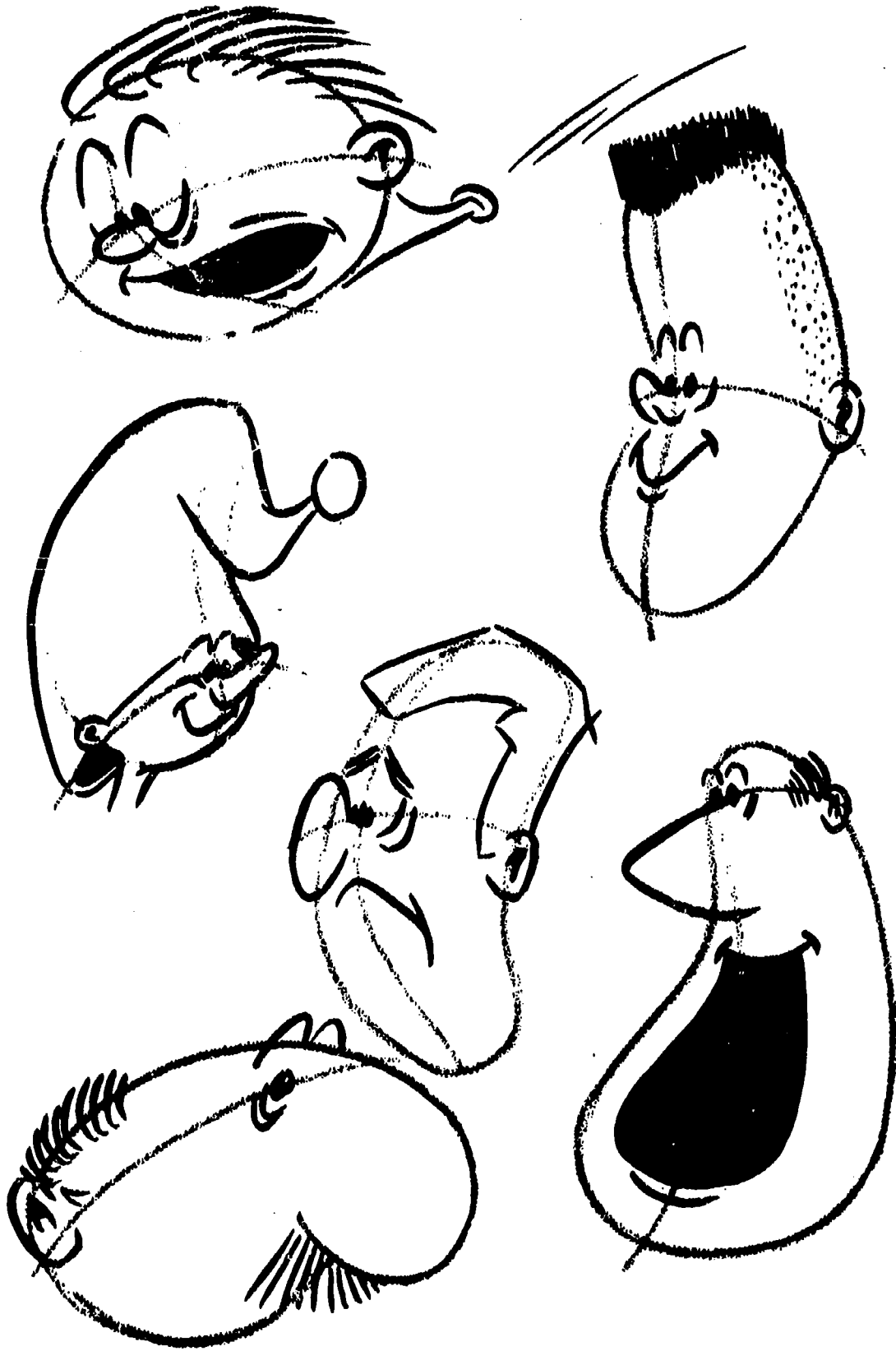

Figure 3-4A.—Changing the balloon shape.

149.78.1



**SHAPES CAN BE DRAWN
AND THEN "FLIPPED"
AS YOU DESIRE**



**EYELINES CAN
BE LOW ON TH'
"BALLOON"**

OR THEY CAN BE HIGH



**THESE ARE ONLY A FEW
"POSSIBILITIES" OUT OF MILLIONS...
MEANWHILE TH' BALLOON" IS ALL
YOURS - SO SQUEEZE TH' LIVIN'
DAYLIGHTS OUT OF IT!**

149.78.2

Figure 3-4B.--Changing the balloon shape (continued).

Figure 3-8A illustrates the basic stick figure. It gives you the framework that you will build the cartoon figure around. As figure 3-8A shows, simple lines indicate the action of the figure and general placement of its arms, legs, hands, and

feet. When sketching the cartoon head, apply the lessons already learned.

Action or gestures of the entire cartoon figure must be constructed at the time you start sketching. The stick-figure method will help



**ROMAN NOSE, BALD, CHUBBY, WELL-FED
CHEEKS & BAGGY-EYES... SENATORS HAVEN'T
CHANGED SINCE ROME BURNED...**



**GRECIAN NOSE,
STRONG JUTTING CHIN & FAIR HAIR -
HERO, ACTOR & SOPHISTICATE...**



**ALL PARTS ARE IN THE RIGHT PLACES.
STRAIGHT, REGULAR NOSE. THIS FIGURE
LOOKS VERY PLAIN - A "STRAIGHT MAN"
THAT DOESN'T COMPETE WITH "HEAVY"
CHARACTERS...**



**THE PUG NOSED, JUG EARED,
POINTED HEADED WEAK CHINNED,
"BORN LOSER"-EVERYTHING ABOUT
HIM INDICATES A WEAK CHARACTER...**

149.79.1

Figure 3-5A.—Typecasting.

because it allows you to show quickly the figure's overall action before you concentrate on other details, such as body features.

Figure 3-8B is the result of having selected and given more specific directions to the action lines to form the loose sketch. At this point a

general sketch of the type body form you desire should be added to the stick figure.

Figure 3-9A shows how to add the main parts of the body to the stick figure, using the basic forms.



**TH' ROMANS DIDNT
CONQUER TH' WHOLE
MARKET ON BENT
BEEZERS...**



**AND SOMETIMES
"PUG" IS JUST PLAIN
"PUGNACIOUS"**

**TH' GRECIAN NOSE
WENT TO SEA**



**"A STRONG JAW DO
NOT A HERO MAKE!"**



**AND THE
LACK OF A
CHIN DON'T MEAN A TOTAL
LACK OF CHARACTER...**

**YOU MUST STUDY "REAL LIFE" CHARACTERS FOR SUCCESSFUL
TYPE CASTING... DON'T DEPEND ON ONE PARTICULAR FEATURE
TO "GET YOU BY" - LEARN THE PROPER COMBINATIONS BY
OBSERVATION... THEN THINK BEFORE YOU DRAW!**

149.79.2

Figure 3-5B.—Typecasting (continued).

In figure 3-9B, clothing and props are added to complete the cartoon figure. For more on basic forms, look closely at figure 3-10. The cartoon figure is made of these five main parts: head, arms, legs, upper torso, and lower torso. Of course, the head has the now-familiar balloon shape, but see what happened below the neck! The arms and legs are tapered cylinders, the

hands and feet are wedges, the lower torso is a half-sphere, and the upper torso is—well, you describe it. Later on there will be some details about hands and feet since they need special attention.

Though the basic forms can be stretched, condensed, and otherwise exaggerated to your heart's content, always begin with those shown

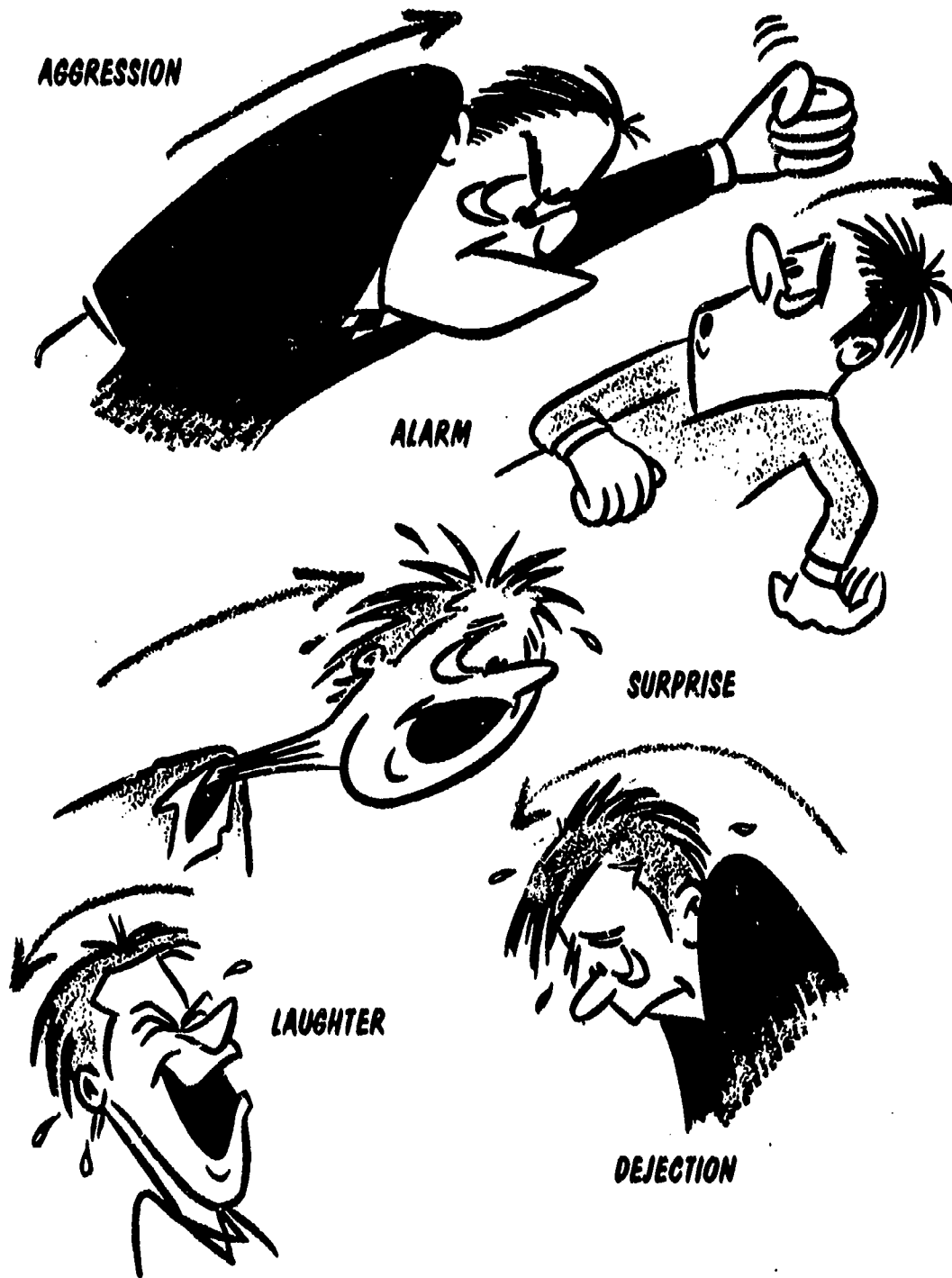

Figure 3-6.—Attitudes and gestures.

149.80

in figure 3-10. A case in point is figure 3-11, which puts together two characters whose proportions are quite different. The drawing of each character began with sketching and laying out a form similar to the one in figure 3-8. The legs and torso of "Shorty" have been scaled down in proportion to his head to give him a dumpy appearance. In contrast, "Stretch" has spindly

legs and an overly long torso. Both however, are in proportion to themselves despite being exaggerated.

Except in extreme cases, the upper arm remains proportional to the lower arm and the upper leg to the lower leg. It doesn't matter how much you stretch or squeeze them.



**IN THE SEMIREALISTIC
CARTOON, ALL OF THE
ELEMENTS "ARE THERE...
BARELY!**

**KEEP LINES SIMPLE AND
SUBORDINATE AS MUCH
DETAIL AS POSSIBLE -
DON'T GET TOO "ARTY"
WITH THIS TYPE**

**THE CONTRAST
BETWEEN THE TWO
TYPES IS QUITE
APPARENT**

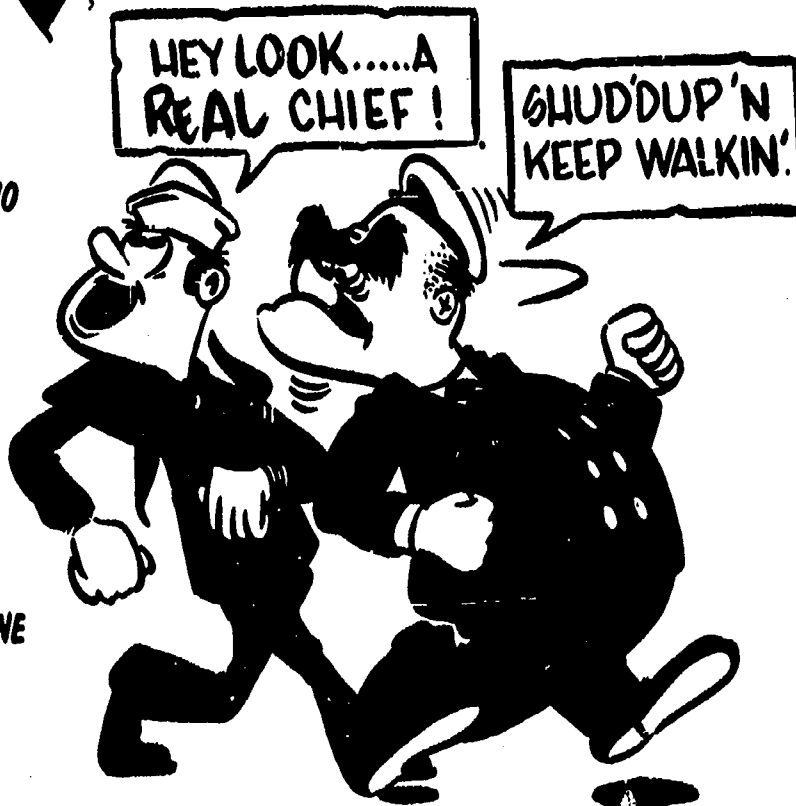

**DON'T MIX THE
TWO TYPES IN ONE
DRAWING - THE
RESULT IS
"UNBELIEVABLE"**

149.81

Figure 3-7.--Semi-realistic vs exaggerated figures.

Muscles are rarely exhibited on the cartoon figure except to suggest violent action (lifting, pulling, etc.), toughness, or masculinity. This calls for exaggeration of the muscles. However don't forget to bend all parts where they are supposed to bend.

FORESHORTENING

When an object is slanted toward or away from you, it is foreshortened. In foreshortening, you apply the principle of perspective in which the object seems to diminish in size and change

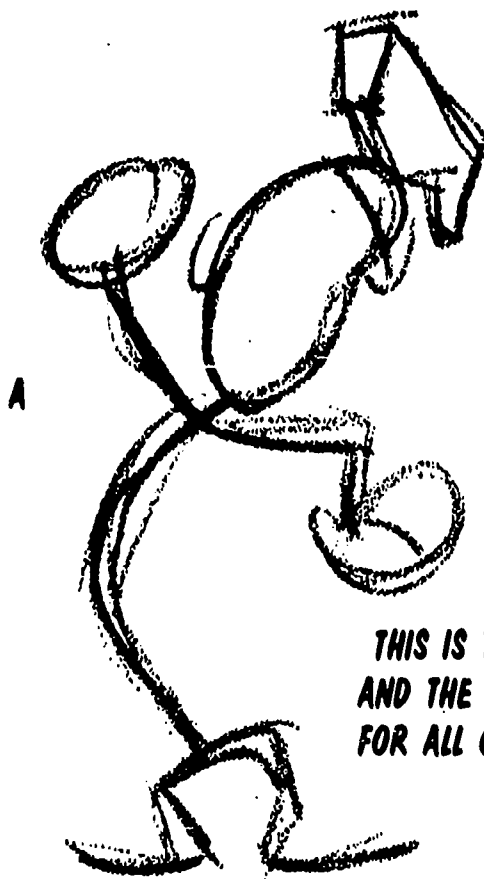

**LOOK AT THE FINISHED
CARTOON FIGURE IN FIG 9B .
THIS IS HOW YOU "VISULIZE"
YOUR FINISHED PRODUCT...**

**HAVING "VISULIZED" THE TYPE
OF CHARACTER AND ITS ACTION,
SKETCH IN THE GENERAL FORM
SHOWN TO THE LEFT...**

**THIS IS THE FAMILIAR "STICK FIGURE"
AND THE BASIC "STARTING PLACE"
FOR ALL CARTOON FIGURES...**

**STEP TWO - INDICATE MORE
SPECIFICALLY THE ACTION OF
THE ARMS, LEGS, HANDS, AND
FEET...**

**ADD A GENERAL SKETCH OF
THE TORSO TO YOUR STICK
FIGURE...**



Figure 3-8.—Drawing the cartoon figure.

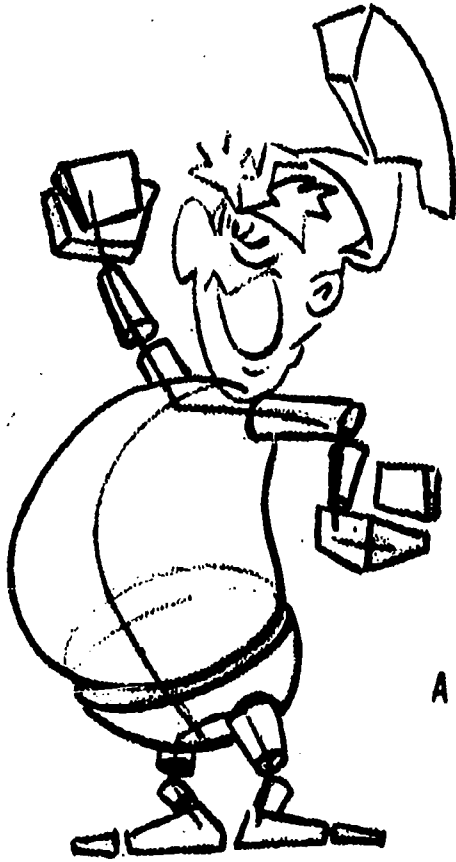

**STEP THREE - DETAIL IS
ADDED TO THE HEAD. FORM
IS GIVEN TO THE STICK
"FRAME WORK" BY ADDING
CYLINDER, SPHERE, AND CUBE
SHAPES FOR TORSO, ARM, LEG,
HAND, AND FOOT...
MORE IN DETAIL ABOUT THIS
LATER**

**THE COMPLETED CARTOON
SKETCH WITH CLOTHING AND
DETAILS ADDED...**

**JUST THE WAY YOU "VISULIZED"
IT IN YOUR MIND - WE HOPE!**



Figure 3-9.—Drawing the cartoon figure.

149.83



**FORM IS EVERYWHERE IN THE CARTOON - EVEN IN THE FIGURE...
YOU CAN ADD TO IT, OR SUBTRACT FROM IT - BUT YOU CAN'T
GET AWAY FROM IT!**

Figure 3-10.--Form and the cartoon figure.

149.84

in shape as it goes back. Figure 3-12 shows how to apply this principle to create depth and interest in the cartoon figure. Notice the figure points out how the arms and legs of the sailor have been constructed as foreshortened cylinders. This helps give the drawing a convincing

three-dimensional character. There is nothing more uninteresting or amateurish than a flat figure.

To locate the position of arms, legs, and other parts which are on the far or opposite side of the body use the drawing through method and

THERE ARE AS MANY "BODY TYPES" IN REAL LIFE AS THERE ARE PEOPLE. AS A CARTOONIST, YOU ARE AT LIBERTY TO MODIFY OR EXAGGERATE ANY AND ALL PROPORTIONS THERE TO AT WILL! THESE TWO FIGURES REPRESENT TWO EXTREMES IN DRAWING THE CARTOON FIGURE, BUT BY NO MEANS ARE THEY THE "LIMIT" TO VELOPING NEW SHAPES...

TH' SKY'S TH' LIMIT!

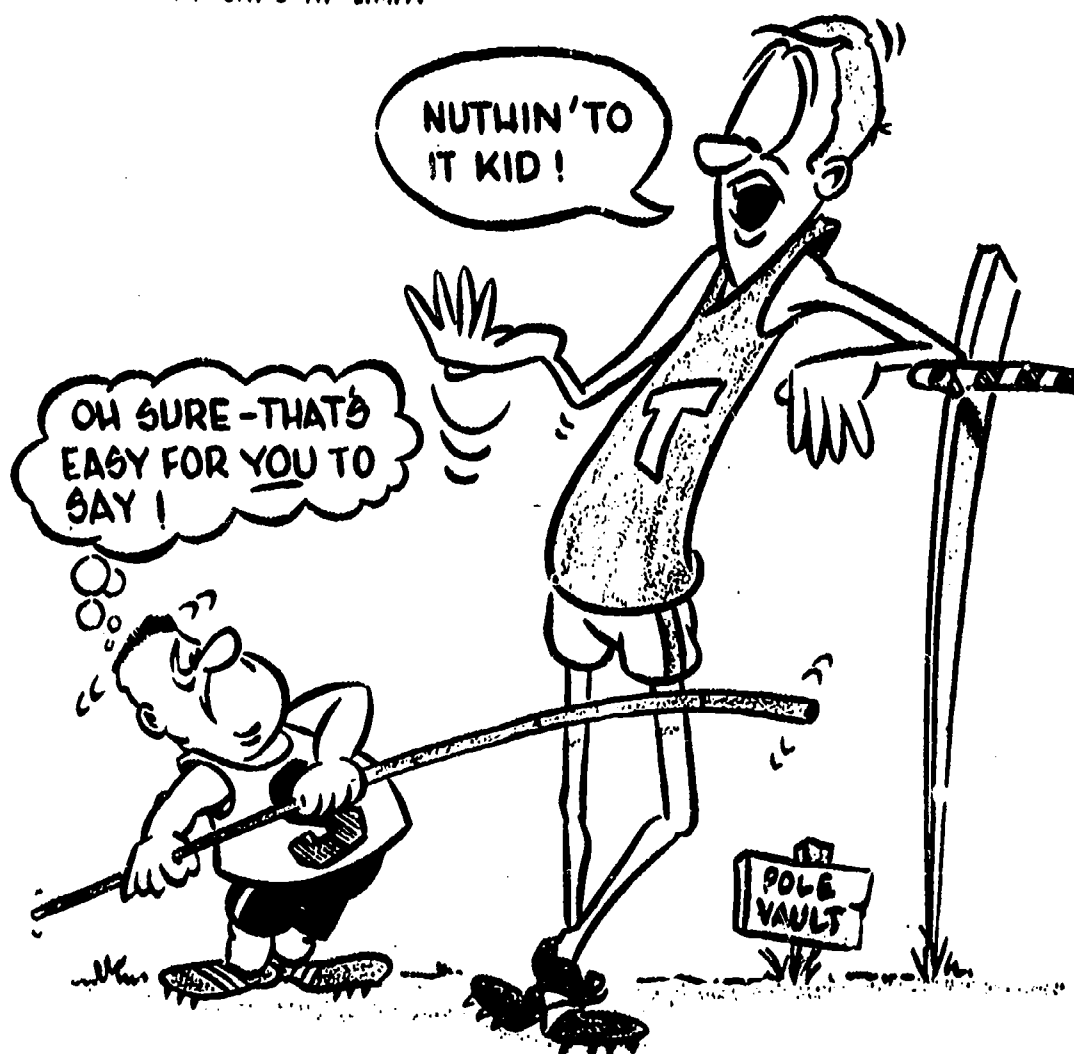

Figure 3-11.—Variations in anatomy.

149.85

remember foreshortening. You simply cannot make one arm or leg longer than its mate in order to stick it where you'd like on the drawing.

Here's a tip in drawing arms: First locate the hands where you want them. Then sketch in the upper and lower arm (in proportion to one another) from the shoulder to the hand. Con-

trary to what you may suppose, the arms will have the right shapes, unless you have located the hands too far from the body.

The hands fall midway between the knees and the crotch. Using the shoulder as a pivot point, describe an arc from the midpoint between knee and crotch away from the body. This arc sets

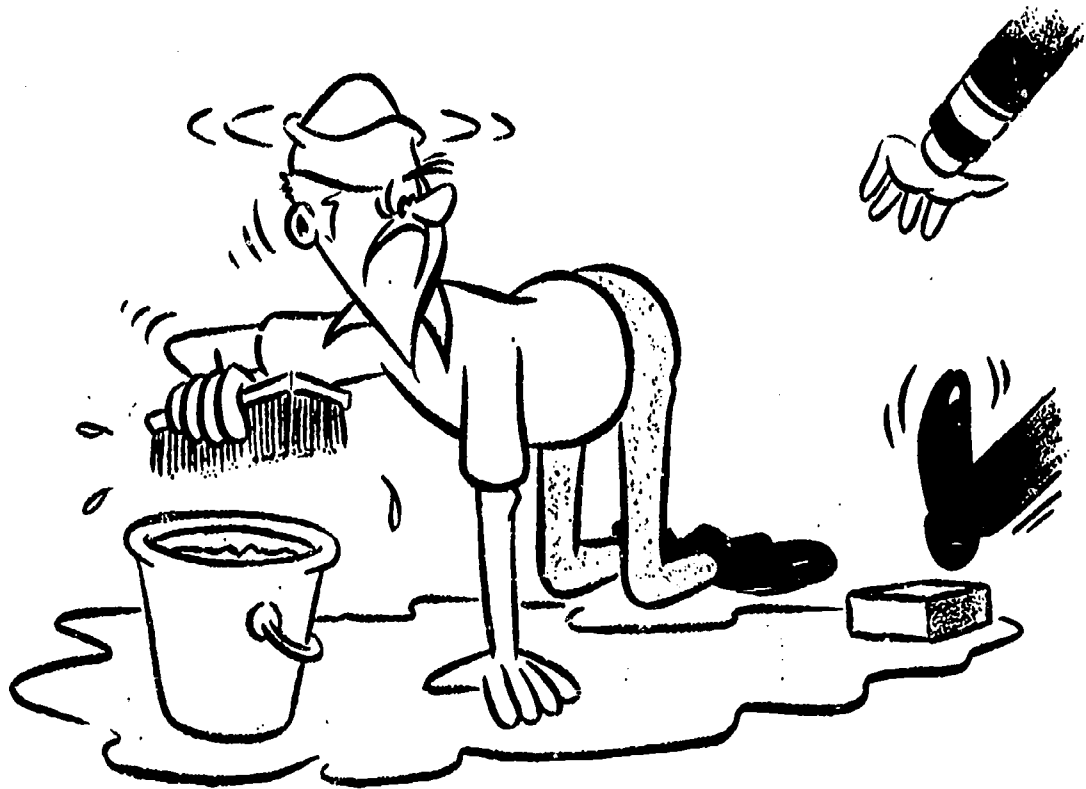

FORESHORTENING HELPS GIVE YOUR FIGURE A REAL "THREE DIMENSIONAL" APPEARANCE... USE IT TO CREATE INTERESTING FIGURES... THE BODY IS ALWAYS ACTIVE... NEVER FLAT...

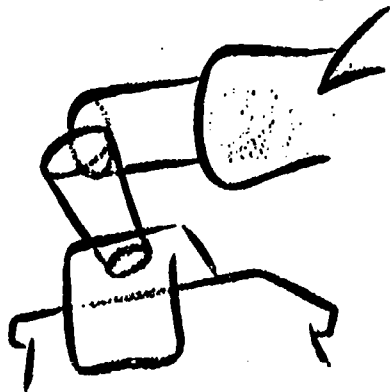

"DRAW THROUGH" TO GET BODY PARTS LOCATED IN TH PROPER PLACES...

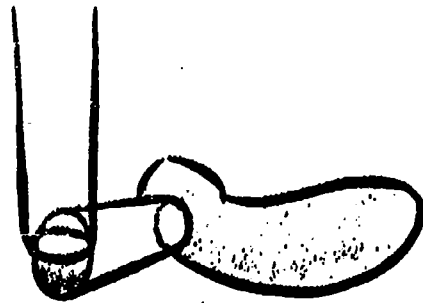

149.86

Figure 3-12.--Foreshortening.

the limit that the hand can extend away from the body.

You will discover that when the arms are kept within the limits of this arc, you must foreshorten the arms and hands to a degree, depending on the position of the body.

Don't try to fake it! There is nothing less convincing than a poor job of foreshortening.

Figure 3-13 is a good example of the cartoon character in action. He is convincing because all the basic steps in drawing him were taken. If any one of them had been left out, he would have been less convincing. The basic steps are:

- Visualizing the character you wish to draw. Think about each of the five major parts of the body and their viewing angles.

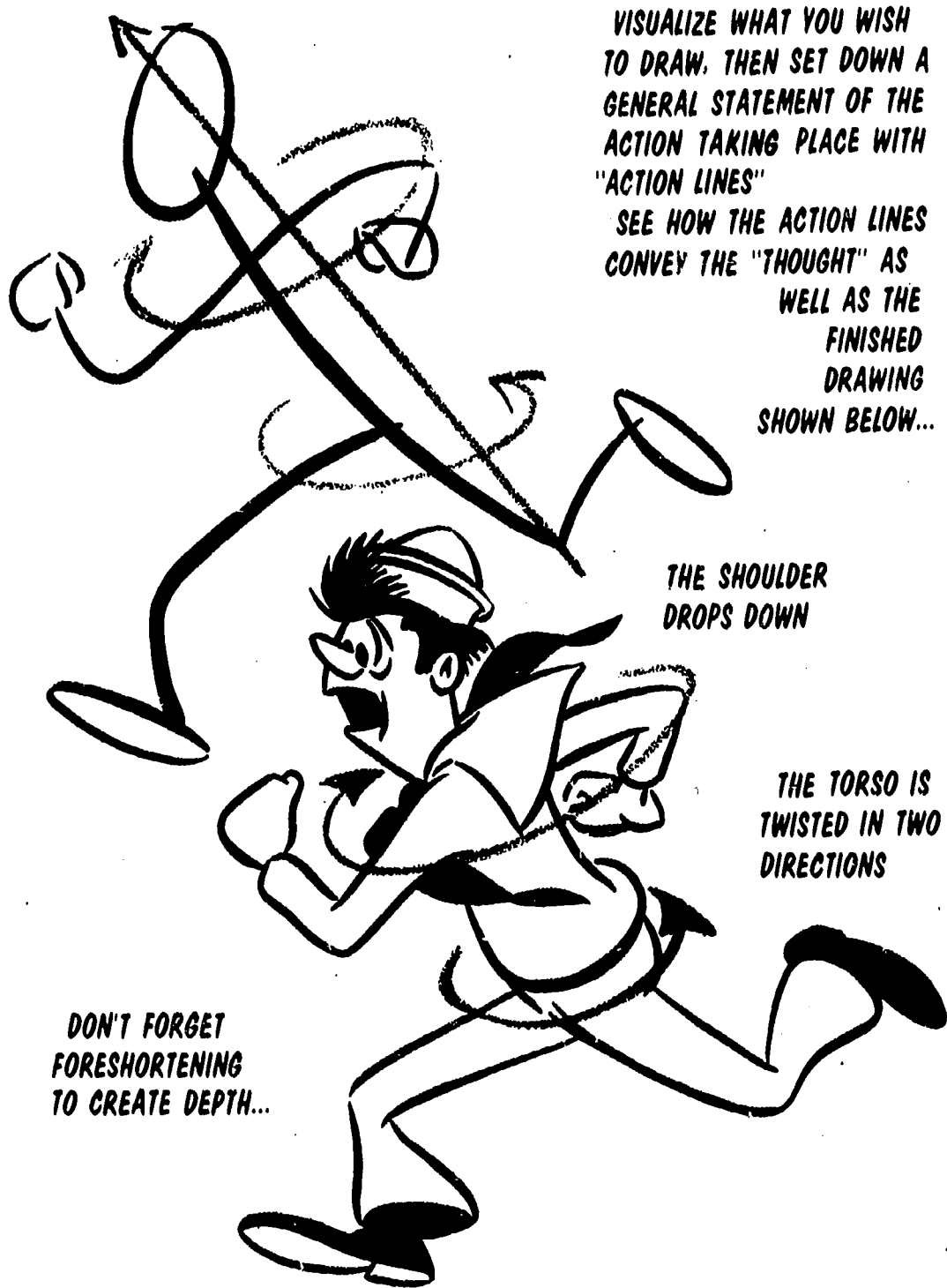

149.87

Figure 3-13.--The cartoon figure in action.

- Loosely sketching the action lines. Place hands and feet first if they are especially troublesome to you.

- Building on the action lines with the basic

forms. Draw through and foreshorten as you progress.

- Dressing the figure. The importance of dress will be given later.



Figure 3-14.—Cartooning th' ladies.

149.88

THE FEMALE FIGURE

The female forms in figure 3-14 are exaggerated to say the least. Whether the cartoon is semirealistic or exaggerated, you must know about the normal female anatomy and do lots of figure sketching before you can consider draw-

ing even simplified versions of the female form.

Drawing pretty girls is perhaps the most demanding task for the cartoonist. Though they have the same cartoon frameworks as men, you can help "glamorize" your pretty girl type by giving her a long narrow waist, rounder hips, narrower shoulders, slightly bigger than normal

breasts, long gently curved legs, long tapering fingers, and smaller feet. Keep her form softly rounded—especially the legs. They are never as straight as a line drawn from point to point.

Breasts on the pretty girl should be placed higher than normal. Her nipples should be about one head's length below her head. Draw through to locate the breasts correctly. Drawing through will also help you create the three-dimensional effect. Don't skimp, make sure to have plenty of fullness. Clothing patterns and folds help to emphasize their shapes. Hair is important stuff to the glamorous female. So after drawing her pretty head, give her a modern hairdo or one that fits the period. Usually, a long hairdo adds to her glamor.

HANDS

Three methods of constructing hands are shown in figure 3-15. The basic form in each is a hinged, two-piece element; the thumb is regarded as an extension of the hand.

Observe the way people use their hands to express themselves. Gestures made with the hands are linked directly with the emotions and expressions. Try using a small mirror to study your own hands and set down what you see in a simple statement of form.

When drawing silhouettes of hands, keep the fingers separated so the hands will be lifelike and not like black blobs. Though each hand usually has four fingers and a thumb, you'll find that the number does vary in cartoons. The hands drawn by one well-known cartoonist have three to twelve fingers.

Aging hands become drawn and their bones are prominent. The hands of a baby are fat and the dimpled digits seem to protrude from his flesh.

Learn to draw hands since they play an important role in telling a story. Don't stick them in pockets or hide them behind the back of a cartoon character.

FEET

The feet, believe it or not, are expressive and deserve as much attention as the hands. You

have heard of expressions, such as "curled my toes" and "wiggle my toes", that describe action. Put your toes in motion; make them curl, wiggle, flop, bend, etc. See figure 3-16. Each foot is basically a wedge hinged to a small block that represents the toes. It moves easily from side to side because of the way the ankle is made.

CLOTHING

Clothing plays an important part in creating your characters. Figure 3-17 puts together these techniques of clothing the cartoon figure:

- Match the type of clothing to the character and setting, especially footwear and hats.
- Make the clothes conform to the contour of the body. Use the foreshortening technique described earlier for arms or legs.
- Show the patterns moving in the same directions as the body lines. Note the checks and stripes in the shirt and pants.
- Don't draw every single line of a pattern; just enough to recognize the pattern.

CARTOON ANIMALS

Cartoon animals are fun to draw. The more humanlike you make them, the more interesting they become. Give them as much character as any other cartoon figure. But it helps to know animal anatomy.

Figure 3-18 illustrates some basic cartoon animal heads and their balloon shapes. As you can see, more than one balloon was used to construct each head. Prominent upper and lower jaws, full cheekbones, and other outstanding features must be emphasized by separate construction. For example, the bills of birds or the ears of dogs call for the use of triangles.

Figure 3-19 illustrates the balloon shapes of a cartoon horse. Note the use of three, instead of two, overlapping balloons in the head. Though two balloons may have been enough, the animal was originally drawn in a Roman setting. Horses

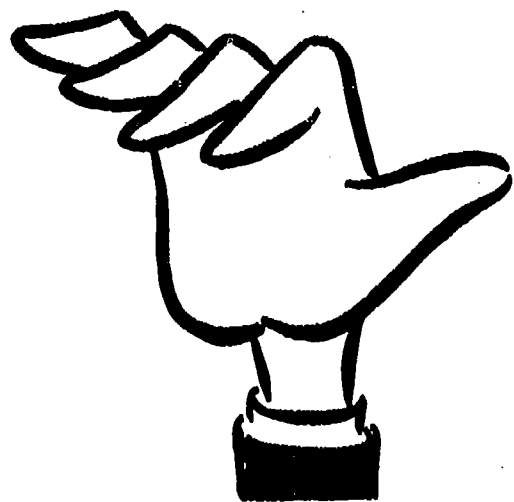
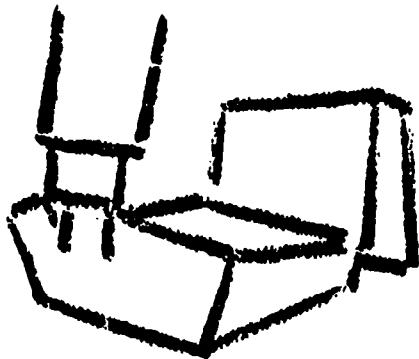
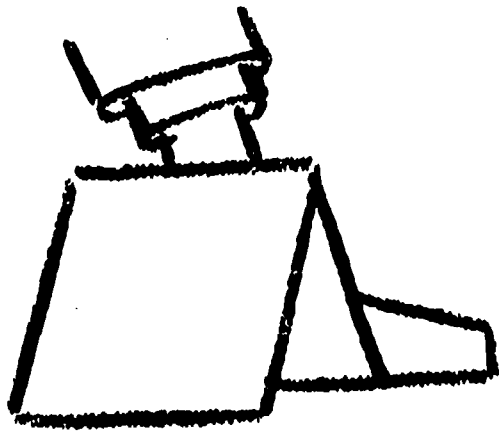

Figure 3-15.—Drawing the cartoon hand.

149.89

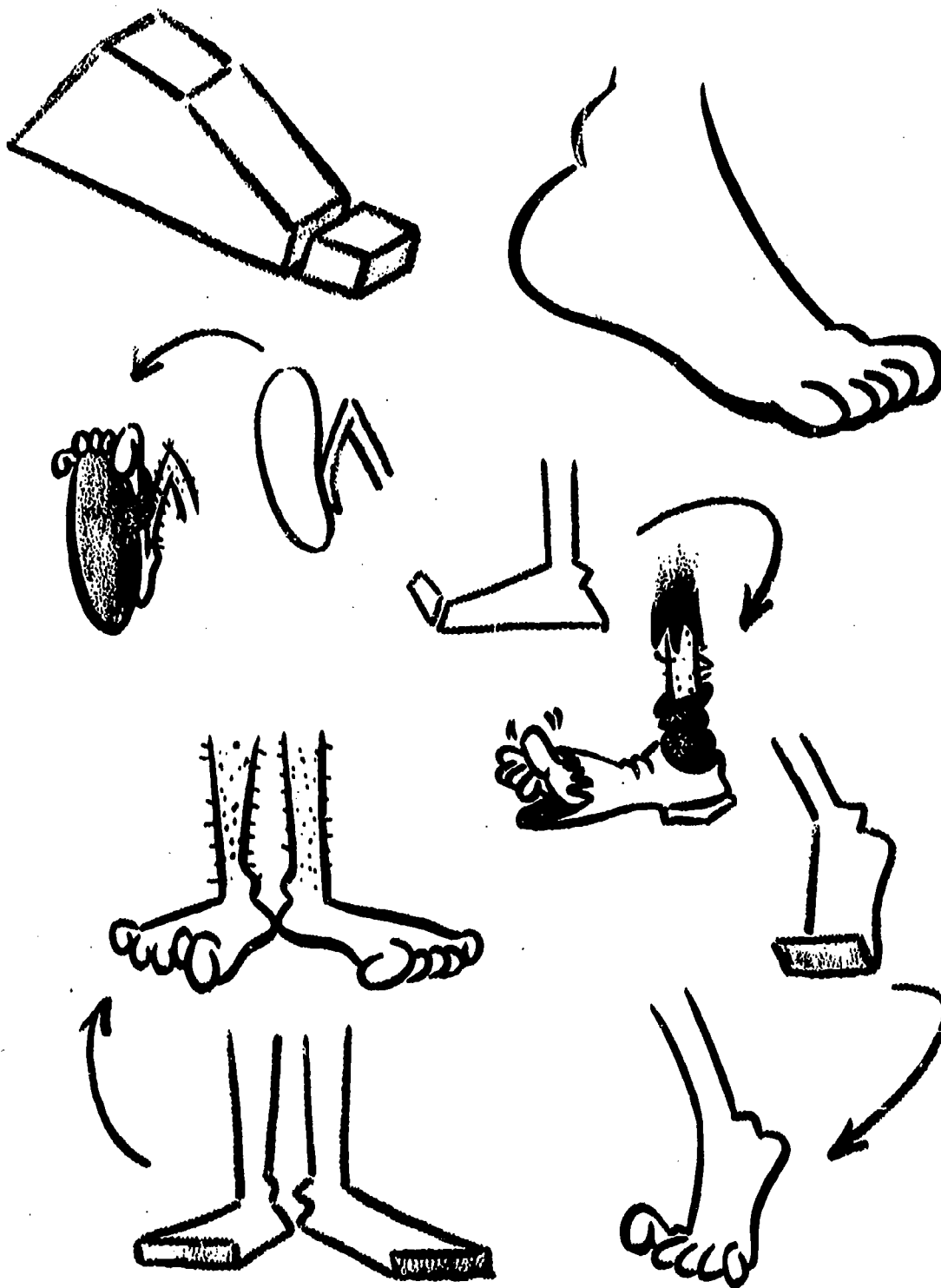

Figure 3-16.—Cartooning feet.

149.90

have Roman noses (as any farmboy will testify) and since this was a Roman horse, on well!

Take a look at the horse's feet. Draw them as the clodhoppers they are. This horse looks quite capable of tripping over his own feet.

The body of the horse is drawn in kidney-bean fashion, which is typical of cartoon animals. Notice how the undercarriage hangs from the spine as a blanket on a clothes line. The legs are attached to the spine, not poked into the body as toothpicks into a tomato.

ASIDE FROM THE OBVIOUS "PROPER COSTUME FOR THE PROPER CHARACTER" PAY CLOSE ATTENTION TO..

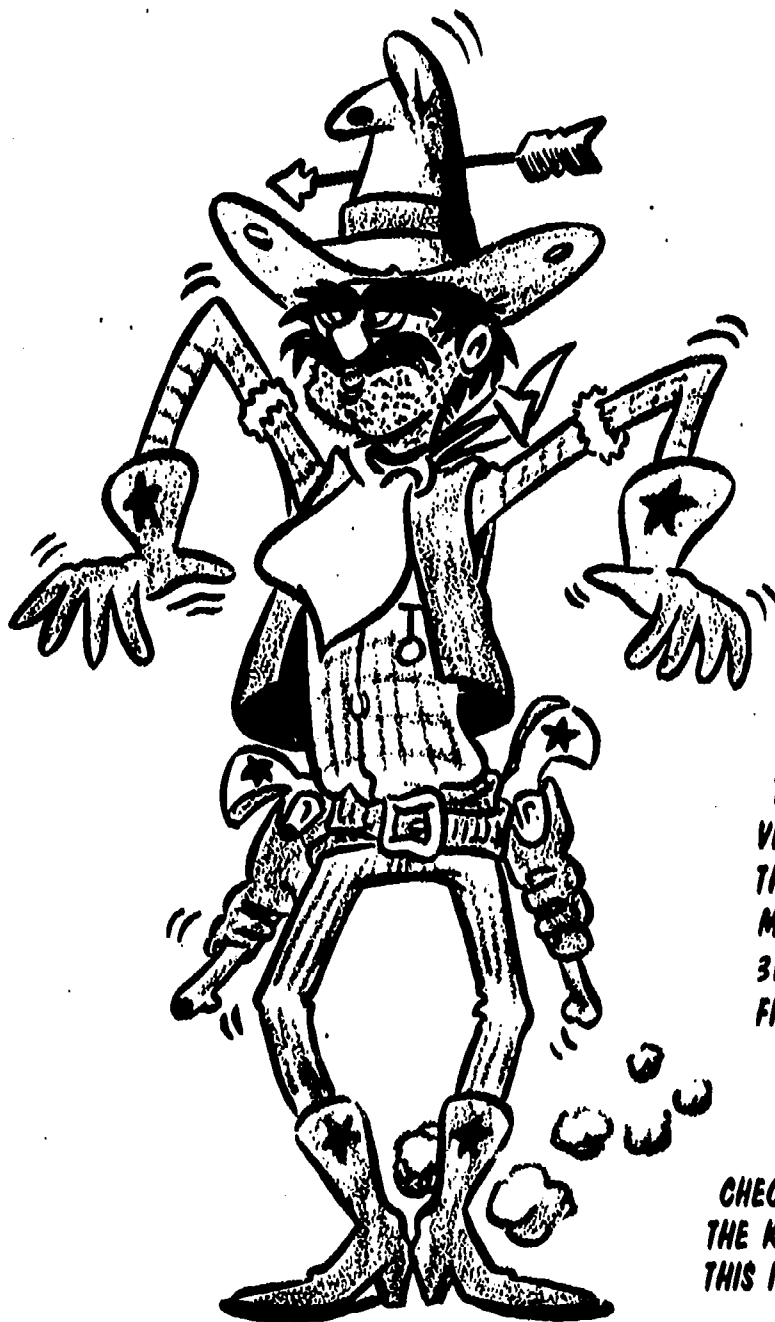

PATTERNS - DO THEY FOLLOW THE CONTOURS OF THE BODY? LOOK AT TH' SHIRT AND TROUSERS!

EVEN TH' STARS CONTOUR AROUND TH' GLOVES!

THE HAT, GUNBELT, VEST, ETC. GO AROUND THE BODY - THIS HELPS MAKE A CONVINCING 3RD DIMENSION TO YOUR FIGURE!

CHECK THE "BREAK" AT THE KNEES IN TH' PATTERN THIS INDICATES "SHINE"!

149.91

Figure 3-17.--Clothing the cartoon figure.

Figure 3-20 highlights other techniques of drawing bodies of cartoon animals. As you draw them it is hard to go wrong if you think "human being." In the upright dog, his spine is nearly straight and the weight of his body shifts to his hips as it does in humans. (Notice the change in

the shape of the bean.) Along with his upright stance the cartoon dog has hands instead of paws to make him more humanlike, although his feet remain more animallike. He can think too, as indicated by his efforts to hide his leash from the cat. And those itching fingers, combined

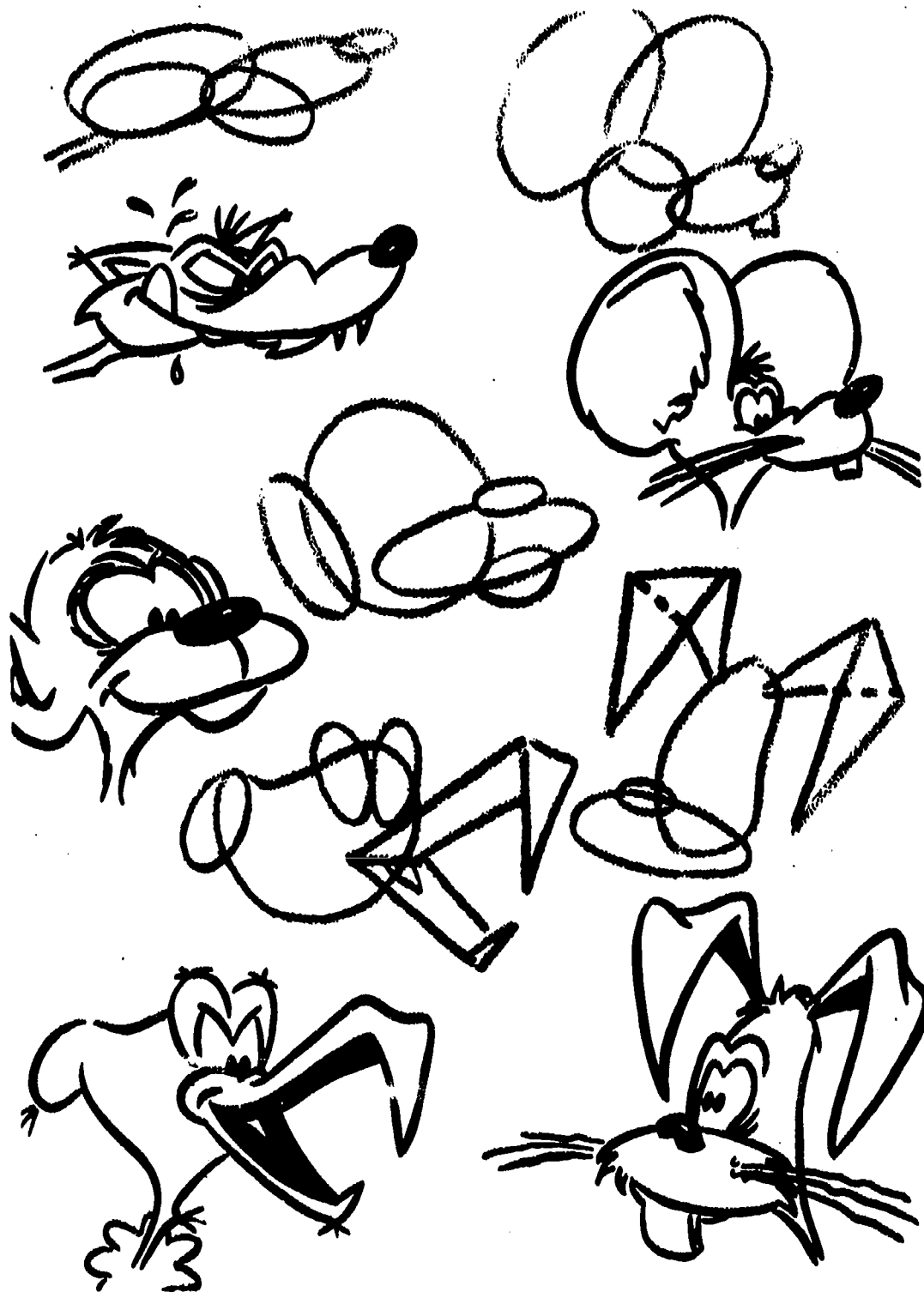

Figure 3-18.—Construction of the animal head.

149.95

with a rather satisfied smile of anticipated pleasure, also tell us that the cat will soon be aware that the dog's leash has parted.

The bean shape can be stretched and squeezed just like the balloon head. Inverting the bean, as in figure 3-20, helps to shape the cat's body so that the back is arched and the stomach is drawn upward against the ribs.

Study the cat, with all four on the floor, see how the front legs stretch rearward nearly parallel to the neck, while the hind legs appear relaxed. Also relaxed is the disjointed tail. Would you say, our cat is showing disrespect?

Just as with human cartoon figures, do not mix exaggerated cartoon animals with semi-realistic ones.

NUTHIN NEW
HERE... SAME
BALLOON
CONSTRUCTION .
ONLY MORE OF EM

DEFINITELY A BROKEN DOWN, POT
BELLIED HAY BURNER... SEE HOW THE
SPINE SAGS UNDER THE WEIGHT
OF THIS NAG'S BOUNTIFUL BELLY!

THAT IS A HORSE?

THE BASIC
KIDNEY BEAN!

ROMAN
NOSE

THE LEGS HOLD
UP TH' SPINE
&
THE SPINE
HOLDS UP THE
TUM - TUM!

CLOD HOPPER FEET
INDICATE A LACK
OF GRACE

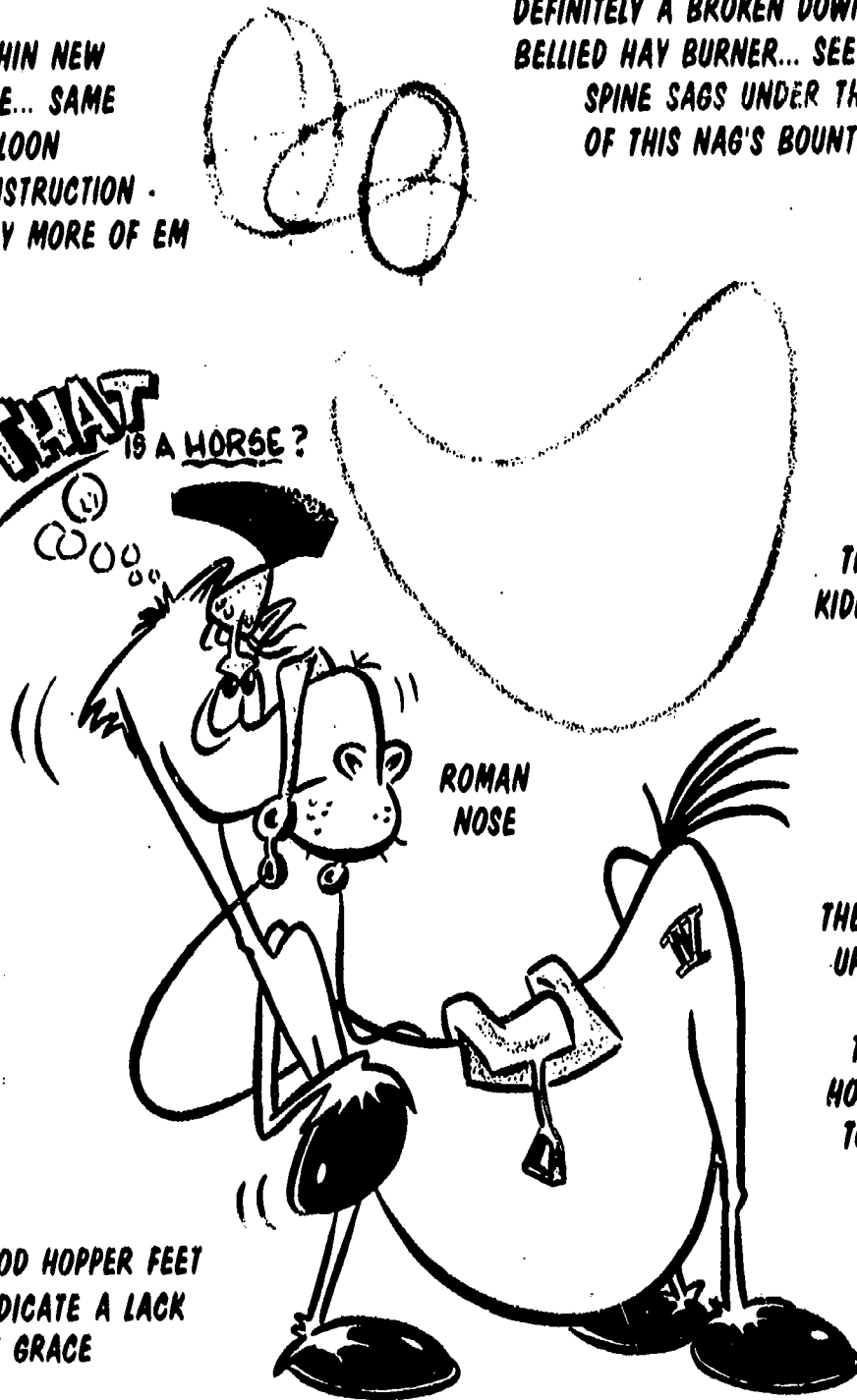

149.96

Figure 3-19.—Drawing cartoon animals.

FORM AND THE CARTOONIST

The four basic forms (sphere, cylinder, cube, and cone) are all the successful cartoonist has, or needs for that matter. They are about as simple as can be, but with a little embellishment here

and there, he quickly changes them to suit his own purpose.

The old marooned-on-a-desert-island situation serves to prove this point. Refer to figure 3-21. Do you see that the cloud is made up of six small spheres, the tree tops are half-spheres, the

THE SPINE IS ALMOST STRAIGHT AS THE DOG LEANS FORWARD.

WEIGHT SHIFTS TO THE HIPS - AS IN HUMANS...

THE CAT'S SPINE IS ARCHED.

THE "BEAN" IS INVERTED - DRAWING THE STOMACH MUSCLES UPWARD!

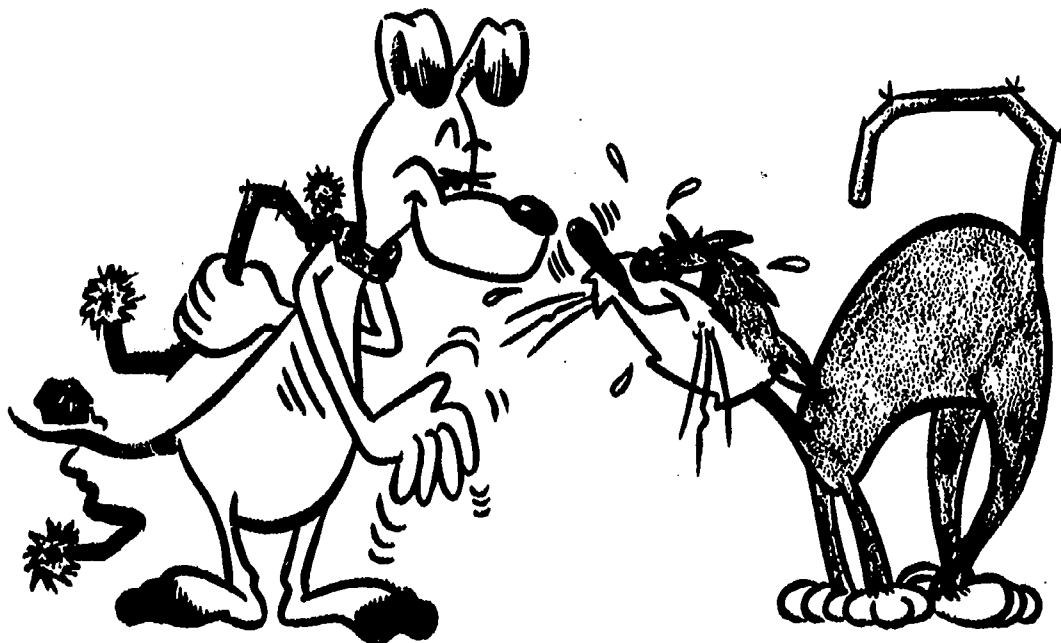
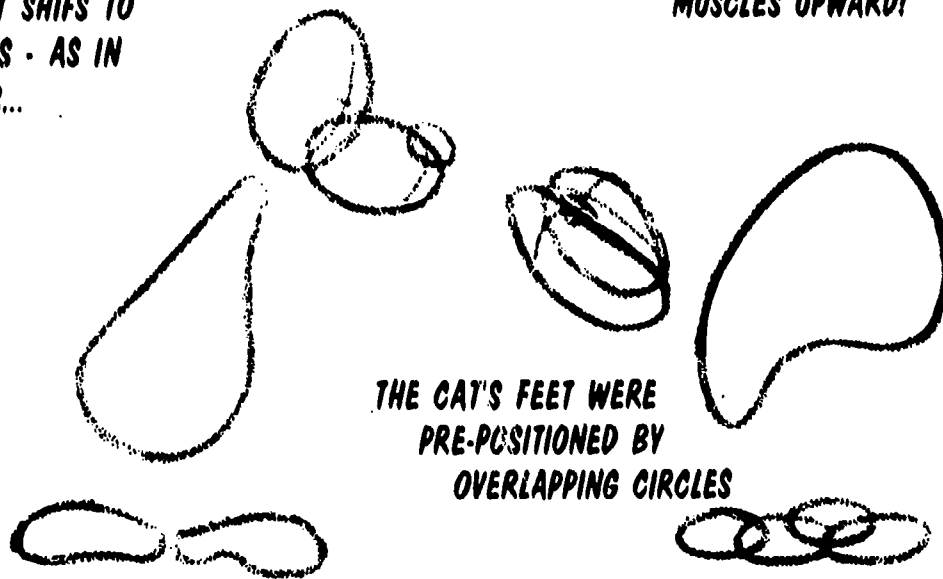

149.97

Figure 3-20.--Drawing cartoon animals.

tree trunks are elongated cylinders, the island is the top of a sphere, the floating bottle is a set of different-size cylinders, the boxes are cubes, and the parachute is a half-sphere and an inverted cone?

A basic form or a variation of it appears in the figure 18 times, excluding the sailor and his clothing. Too many artists, illustrators, and car-

toonists try to draw the outline first, but the outline has to surround something, and that something is FORM.

PROPS

The term "prop" comes from the theater and is short for property, which refers to any item

used as part of a stage setting. In cartooning, any item that helps set the stage of the cartoon is called a prop. Except for the sailor in figure 3-21, every item within the cartoon panel is a prop. Cartoon figures never serve as props.

Keep your props simple in construction, stick to basic forms. Remember that backgrounds are props too, and must also be kept simple.

Props help tell a story, but don't use too many of them since they will make the story

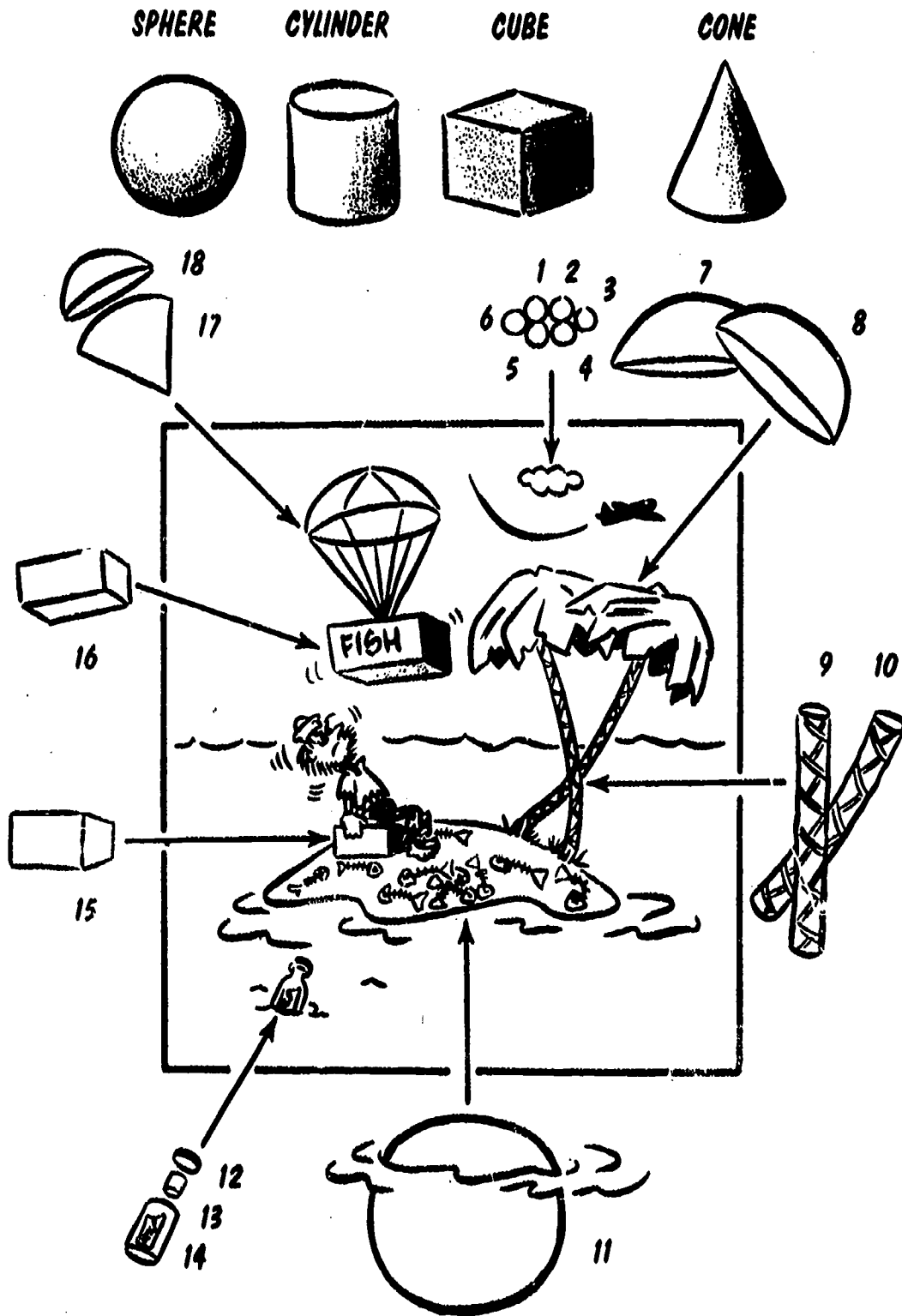

Figure 3-21.—“Form and the cartoonist.”

hard to read. The human eye cannot see them all in the same detail, and what's more important, they take up valuable space and will compete against each other in trying to be the center of attraction. The competition tends to subdue the

action in the cartoon panel. The only exception here is in the case where the cartoon character is not as important as the scene or where an elaborate prop is meant to be the center of interest.

CHAPTER 4

SCREEN PROCESS

Screen printing offers a relatively simple and inexpensive technique for producing many copies of color prints, charts, viewgraphs, intricate designs, small lettering, decals, instrument panels, dials, and many other jobs too numerous to mention. The screen processes are described briefly in *Illustrator Draftsman 3 & 2*, NAVTRA 10469-A.

This chapter will provide you with the techniques of the screen process. More information may be obtained from the many books that describe specific applications, and which are available at most screen process supply dealers or in your library.

Some of the best sources of information concerning screen printing are the screen printing supply catalogs published by the manufacturing companies. These catalogs contain descriptions of materials, such as inks, thinners, extenders, washups, screen fabrics, and stencils that are best suited for each specific task. With this information you should be able to select the materials best suited to meet the requirements of your shop.

Three manufacturers of screen printing supplies are:

NAZ-DAR Company
1087 N North Branch Street
Chicago, Illinois 60622

ADVANCE PROCESS SUPPLY Company
400 North Noble Street
Chicago, Illinois 60822

ULANO Company
210 E 86th Street
New York, New York 10028

Additional information concerning the most recent developments in screen processes and sup-

plies can be found in *Screen Process Magazine*, which is published monthly by the signs of the Times Publishing Co., 407 Gilbert Ave., Cincinnati, Ohio 45202.

EQUIPMENT AND MATERIALS

To produce various types of screen prints, you must know the types of equipment and materials that are available or can be constructed, and how these items are used.

BASE

You can make a good base by covering a table top or sheet of plywood with illustration board. A drafting table is an ideal base because it allows you to adjust the angle of the working surface. In either case the flat working surface of the base should be smooth enough to allow passing a squeegee over the screen with an even, uninterrupted stroke.

FRAMES

In many instances you will construct your own frames. Here is a description of a sturdy, practical, frame that has proven to be one of the best. This frame has on its printing side a square groove into which you can force cord (common sash cord) that will hold the screen fabric firmly to the frame (figure 4-1).

The frame is made of soft wood, usually white pine. The size of the wood stock will depend on the overall size of your frame. To prevent bowing, 1 5/8-inch square stock is recommended for frames measuring 18 by 20 inches or larger; for smaller frames use 1 1/8-

THIS VIEW OF A FRAME SHOWS THE BOTTOM OR PRINTING SIDE WHICH IS GROOVED SO THAT THE FABRIC MAY BE ATTACHED

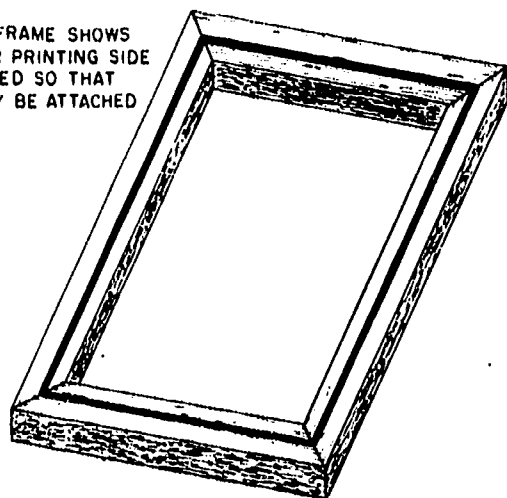

142.286(149A)A

Figure 4-1.--Frame.

inch square stock. Where greater dimensional stability is required, obtain aluminum frames.

Your own frames may be made by cutting a groove in wood stock and then cutting the desired lengths from the grooved stock. Remember frames should be at least six inches greater than the size of the print to provide extra space at the ends for ink. Cut the stock at a 45 degree angle so that each corner will form a mitered joint which will enable the grooves to line up when the sides are put together.

You may purchase assembled frames with or without fabric, or ready-to-assemble frames that are pre-mitered and grooved.

SCREEN FABRICS

Organdy has been referenced as a screen fabric in commercial publications and is still carried in stock by screen process suppliers. However, it has several undesirable characteristics, not the least of which is stretching during production. Therefore, organdy is considered unsuitable for quality production.

Silk has enjoyed a long run of popularity and is suitable for low-cost production with handcut and photo stencils which adhere readily to its surface. A natural fiber spun by silkworms, silk is not uniform in construction. Inks saturate its multifilament fiber (several strands make up a single thread) and limit passage by buildup and drying in. In addition, silk is very vulnerable to

commercial solvents used to remove certain stencil materials.

Dacron is similar to silk in construction, being multifilament; however, it is more durable and, being man made, more uniform in construction than silk.

Nylon is of monofilament (single thread) construction. Inks will not build up or cling to the surface of the singular thread. It delivers quality prints and may be used with a wide variety of inks and stencils.

Polyester, another monofilament fabric, offers the same quality and advantages as nylon. In addition, polyester features excellent registration due to its superior dimensional stability. Temperature and humidity changes are negligible.

Man made fabrics are also subject to damage by the continued use of some solvents. Therefore, if you reclaim your screens often you should use a good safe stencil remover that has been recommended in the manufacturer's catalogs.

Stainless steel, called wire mesh, is used to obtain the ultimate in print registration. This fabric should be used for extra long runs and permanent lasting screens. However, it is too expensive for general use.

After you have chosen the fabric most suited for your purpose, you must consider the size of the mesh opening, that is, the space between the threads or filaments. The deposit of ink will vary with the thread diameter and the percentage of mesh open area.

A rule-of-thumb for making your selections is the finer the detail, the finer the mesh required. Check the manufacturers' catalogs for the correct number of fibers per inch because mesh designations vary among fabrics and manufacturers.

Table 4-1 is a comparative chart of mesh openings which will help you make your selections. Some general applications, using here the designation given silk fabrics, are as follows:

- | | |
|---------------------|--|
| 6XX . . . 8XX . . . | Coarse handcuts, overprint-
int large areas, coating card
stock. |
| 10XX . . 12XX . . . | Finer handcut stencils and
open photo stencils |

Table 4-1.—Comparative Chart of Mesh Equivalents

COMPARATIVE CHART OF MESH EQUIVALENTS

SILK NO.	DACRON	NYLON	POLYESTER
0-1XX	—	—	—
2XX	—	—	—
6XX	6XX-8XX	157	—
8XX	8XX-10XX	166	160
10XX	10XX	185	160
12XX	12XX-14XX	196	200
14XX	14XX	230	220-230
16XX	16XX	240	230-245
18XX	18XX	283	265-285
20XX	21XX	306	285
25XX	25XX	330	305-335
30XX	30XX	380	380

149.60

14XX .. 16XX ... Photo stencils

18XX .. UP. Detailed photo work

Remember, these are only general guidelines. Your final selection of fabric and mesh should be based on quantity of production, degree of registration required, and quality to be obtained in your final print.

After selecting a fabric, you can stretch it tightly across your frame, using the following method:

1. Cut your screen fabric at least 2 inches larger than the overall dimensions of the frame.
2. Place the fabric loosely over the bottom of the frame with the threads parallel to the sides of the frame.
3. Place one end of the cord over the fabric and force it into the groove of the frame at one corner. Using a mallet, and a thin piece of wood, plastic, or metal, work the cord into the groove along the full length of one side. See figure 4-2.

Work the cord into the groove of the second side as you did with the first side. Ensure that the threads remain parallel to the side of the frame. Stretch the fabric evenly over the third side of the frame and continue forcing the cord into the groove. Force the cord into the fourth

side. Stretch the fabric as before and finish forcing the cord into the groove so that it completely encircles the frame. After the final step the screen should be drum tight. If not, go around the frame once more, forcing the cord deeper into the groove. Cut off any excess fabric after stretching has been accomplished.

When rounding corners use less force to prevent tearing the fabric. Should a tear occur, prevent it from running by applying a small amount of varnish.

This method of stretching fabric on a frame has advantages over methods which required staples to attach the fabric. Advantages include: no staples protrude from the printing surface, fabrics may be retightened as required, and fabrics may be dismantled with a simple pull of the cord.

4. Be sure to wash and dry a fabric after it has been stretched on the frame. Wash silk fabric with hot water and mild soap, then scrub well with a pair of good stiff brushes from both sides at the same time. After a good scrubbing, wash again with hot water, rinse in clear water, and dry thoroughly. Nylon and polyester fabrics should be scrubbed gently with a soft rag and scouring powder, followed by rinsing in clear water. For new material, repeat this procedure two or more times.

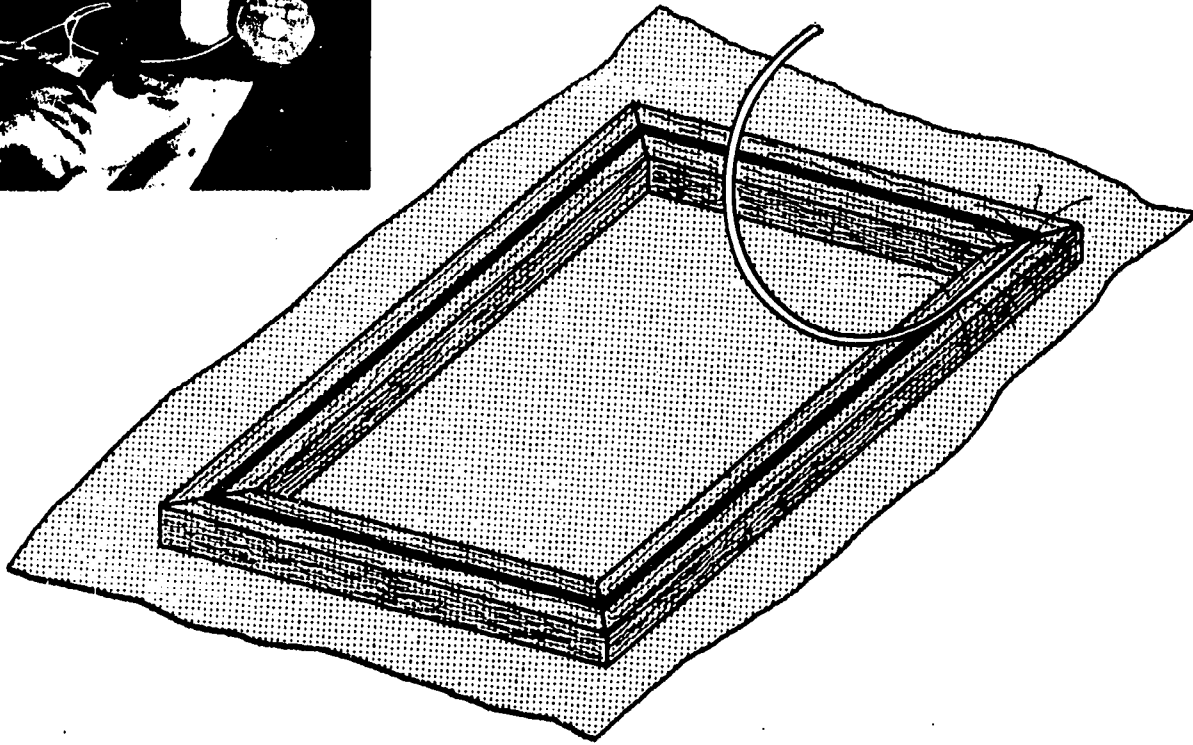
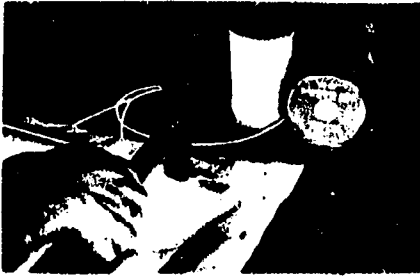

Figure 4-2.—Applying fabric to the frame.

149.61

The sole purpose of washing is to remove any sizing or foreign matter present in the fabrics. Should the screen not be used immediately, wash it again before use. Just before using the screen, wash it with adhering thinner to remove any greasy fingermarks.

STENCILS

Stencils are used to block out the nonprinting areas of the screen. The following discussion will cover various materials used to make handcut stencils and photo stencils.

Handcut Stencils

The term handcut stencil is self-explanatory. Handcut stencils are made of paper or film.

Use signwriters bond, drafting paper, or white butcher paper to make paper stencils. Make sure the paper is free of wax or slick surfaces, otherwise the inks used in screen printing will draw or puddle during the printing process.

Paper stencils are most useful for short-run jobs (5 to 50 copies) composed mainly of large designs which are free of intricate detail, such as large lettering. If more than 50 copies are desired, coat the stencil paper with shellac.

Handcut film stencils consist of two parts: a water-soluble, or lacquer-based emulsion and a backing sheet made of paper, polyester, or vinyl which holds the cut design in place until it is transferred to the screen. Film stencils are better than paper stencils in that they are easier and faster to cut, allow for better registration, and produce tougher, better quality screens.

Water-soluble film has advantages over lacquer-based handcut film, such as its ability to print all inks except those containing water, it is removable from the screen with water, and is less expensive. On the other hand, water-soluble film is prone to curl away from the backing sheet when temperature and humidity are high. Therefore, consider the conditions under which it is to be used and stored.

Water-soluble film is made to adhere to the screen with a solution of vinegar and alcohol

(2:1 ratio), or water and alcohol (3:1 ratio). Water alone is a poor adhering solvent for several reasons, the main one being that it does not evaporate fast enough, causing burned edges (burned edges are described in this chapter under the heading of lacquer film).

Lacquer-based film is used only with oil-based ink or inks containing water.

It is adhered to the screen with a special lacquer-adhering thinner recommended by the film manufacturer. Lacquer thinner must be used to remove this film. **CAUTION:** Lacquer thinner is flammable and must be stored in a safe place. Also, prolonged exposure to lacquer thinner fumes may cause nausea, dizziness, muscle spasms. Be sure your working place is well ventilated.

Photo Stencils

Presensitized photo film is one of the best stencil materials for most jobs because it is simple to prepare, can produce small detail with a high degree of quality, and is faster than handcut film. It is similar in construction to both water-soluble film and lacquer-based film in that an emulsion is coated on a temporary backing sheet. Because the emulsion of presensitized photo film is light sensitive, it differs from that of handcut film.

Also, the screen fabric can be coated directly with a light sensitive emulsion, which gives the screen a tough long-lasting photo stencil suitable for producing very fine detail. Direct photo emulsions have three advantages over other types of stencils:

- (1) The image quality is excellent
- (2) Long runs of over 100,000 impressions can be made
- (3) Shelf life of exposed screens is unlimited

INKS

Colors used in screen printing are properly classified as inks, regardless of composition. Inks may be further classified as poster inks, enamels, lacquers, vinyls, and others according to composition and end use.

Extensive coverage of these materials is given in manufacturers' catalogs. The four basic inks and ink modifiers will be discussed here.

Poster Inks

Nonoxidizing resins or ethyl cellulose poster inks can be used with any type of stencil and any mesh screen fabric. They are used primarily for printing on paper and cardboard displays. Flat and gloss finishes may be obtained. Drying time is approximately twenty to thirty minutes. Thinning and washing up may be done with mineral spirits. Other thinners may be specified for especially formulated inks.

Enamels

Formulated of an alkyd resin base, enamels may be used with any type of stencil and any mesh screen fabric and on metal, wood, masonite, glass, anodized aluminum, paper, cardboard and certain plastics. A glossy finish is common to all enamels. Drying time varies from 1 to 16 hours, dependent on type and composition, temperature, humidity, and whether forced drying machinery is used. Some compositions wash up with mineral spirits, others require special thinners and washup solvents.

Lacquers

Made of cellulose and nitrocellulose, lacquers are used for printing on lacquer-coated surfaces, wood, paper, and cardboard. These inks are especially useful for printing pyroxylin coated book covers and decalomania (decals). When printing with lacquers use only photographic or water-soluble film stencils. Glossy finishes are common to all lacquers. Drying time is 20 minutes to 2 hours, dependent on type and composition. Special washup and thinners are required.

Vinyls

Composed of stabilized vinyl resins, vinyl inks are used for printing on cellulose acetate, cellu-

lose butyrate, and polystyrene surfaces. This type of ink is used, for example, to print transparent colors on acetate for viewgraphs. A 50-50 mixture of the basic transparent vinyl color and a clear vinyl ink are necessary to produce transparent colors. Any type of fabric may be used, but film stencils must be photographic or hand cut and water soluble.

Glossy and flat vinyl finishes are available. Drying times for these finishes vary 20 minutes to one hour. Special thinners and washups are required.

Ink Modifiers

Transparent base modifiers, binder varnishes, retarding thinners, fast thinners, reducers, and extenders are kinds of modifiers which may be added to printing inks. The transparent base modifiers produce transparent colors, reduce ink flow, reduce squeegees drag, and increase ink bulk. Binder varnishes improve the flexibility of inks and ensure adhesion and freedom from rub off. Retarding thinners stretch drying times; where as fast thinners do the opposite. Retarding thinners also help keep color from drying in the screen and produce sharp printing of extremely fine details. Reducers are used to thin ink to printing consistency and also to help prevent screen clogging. Extenders make inks go farther, thus reducing cost.

Follow closely the instructions of ink manufacturers when using modifiers because any substance may reduce color strength and opacity. Be sure the inks and their solvents are compatible to the stencil so they will not destroy it during the printing or cleaning process. In general, poster and enamel inks may be used with any stencil material; lacquer and vinyl inks with water soluble or photo stencils only. Do not use water-based inks with photo or water-soluble stencils.

SQUEEGEES

Squeegees are used to force ink through the mesh openings in the screen fabric, leaving a deposit on the material to be printed.

Assembled squeegees may be purchased in sizes that are cut to order, or the handle and blade may be purchased separately in lengths up to 144 inches, then assembled with aluminum telescopic bolts as follows: First install a bolt close to each end of the handle (figure 4-3). Then install the remaining bolts, spacing them evenly along the length to prevent the blade from folding over or warping along the printing edge.

There are many types of squeegee handles available to the screen printer, with the one shown in figure 4-3 being preferred by most hand operators. Notice how the handle is formed to fit the hand. A fat round top with contoured sides for palm and fingers permits a natural grasp and enables the operator to make long continuous runs with little fatigue. He can choose a metal or wood handle. Metal is easy to clean should accidents occur. Wood is less expensive and provides a firmer grip for those whose hands tend to perspire.

The squeegee blade is commonly 2 inches high and 3/8-inch thick. The blade should be at least 2 inches longer than the print.

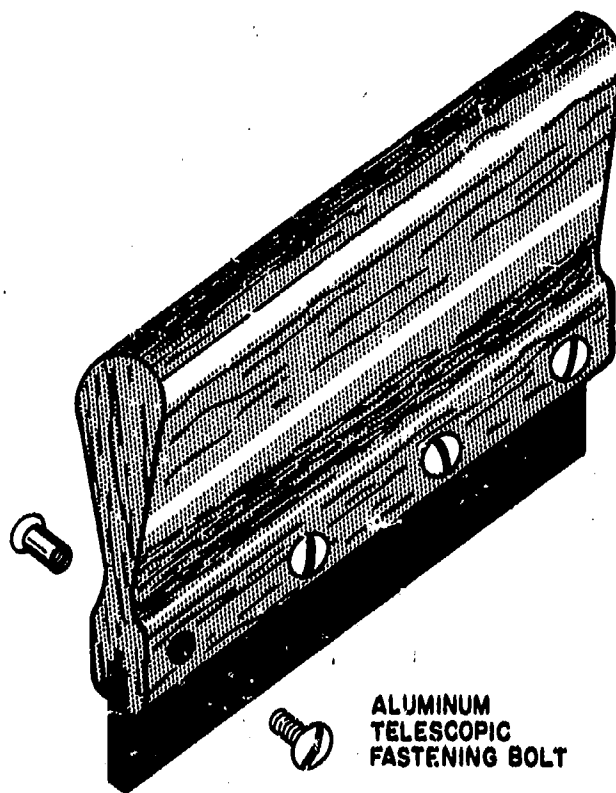

142.287(149A)

Figure 4-3.—Squeegee.

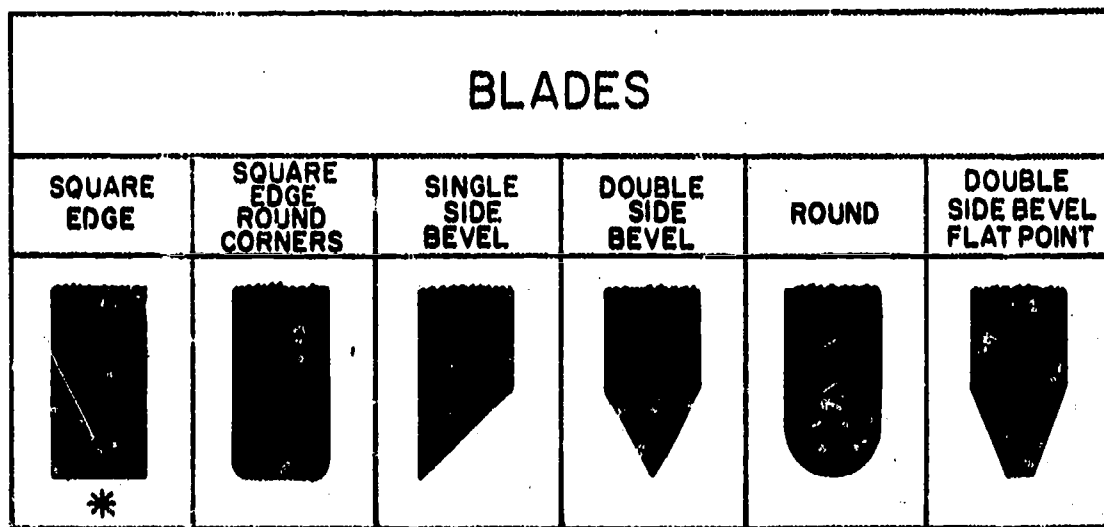

*IN GENERAL USE A SQUARE EDGE HARD NEOPRENE BLADE

149.62

Figure 4-4.—Squeegee blade shapes.

Squeegee blades are available in several shapes as illustrated in figure 4-4.

Square-edged blades are used for printing flat objects. Square-edged blades with rounded corners are used for leaving extra heavy deposits of ink when light colors are printed over dark. With fluorescent inks on glass, use single-side, bevel-edge blades. Double-side bevel edge blades are used for uneven surfaces and printing delicate textile designs. Rounded edge blades leave heavy deposits on textiles. The double-sided, bevel edge flat point blade is used for printing ceramics.

Square and bevel edge squeegees must be kept sharp. Clean the blade carefully with the same solvent used for washing up your screen. You can keep a blade sharp by drawing it over a strip of garnet cloth, holding the flat portion of the blade parallel to the cloth.

When selecting the hardness of the blade take into consideration the surface to be printed. Generally soft, dull, squeegees deposit more color and are recommended for printing on rough surfaces. Hard, sharp squeegees deposit less color which speeds up drying.

Blade hardness is measured with a device called a durometer. When ordering blades, specify hardness, as follows:

Extra soft blade	45-50 durometer
Soft blade	50-55 durometer

Medium blade	60-65 durometer
Hard blade	70-75 durometer
Bone hard blade	75-80 durometer

In making your final choice of blades, you must also consider its chemical composition. Standard squeegee blades are black in color and composed of neoprene rubber. They are suitable for printing with vinyls, lacquers, oil base colors, and poster enamels.

Hycar rubber blades outlast neoprene rubber. They are tan-grey in color and are recommended for printing lacquers.

Polyvinyl plastic blades are extra durable and transparent yellow in color. Choose them when printing with vinyl or where strong solvents, such as acetone, are used.

Polyurethane plastic blades are transparent amber in color, resist abrasion, chemicals and solvents, and retain their sharp edges.

In general the best blade for most of your needs will be one with a square edge and made of hard neoprene rubber. This blade will produce a good sharp print on flat objects, and may be used with every screen printing ink.

ACCESSORIES

The frame must be raised and lowered into the same position on the base for each print

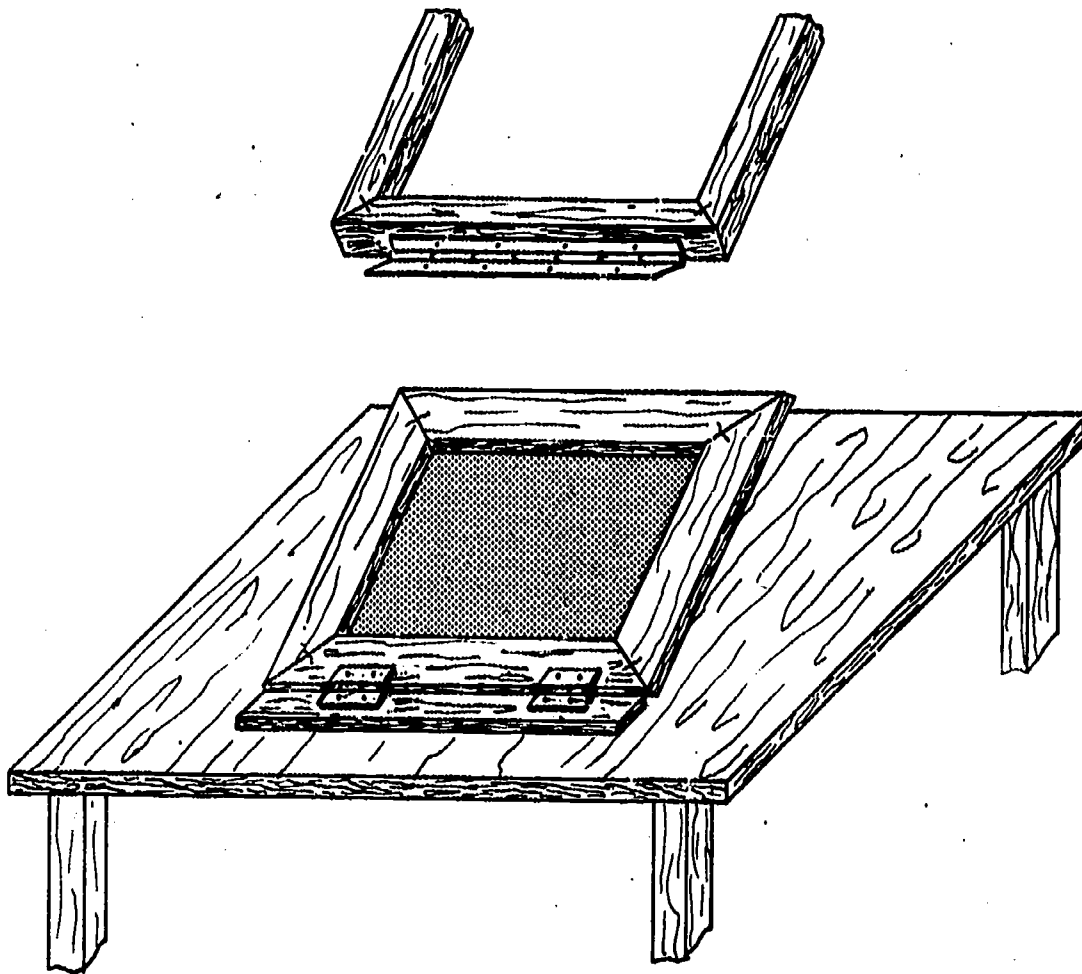

142.286(149A)B

Figure 4-5.--Hinges.

made. To make the task easy, frames are attached to the base with hinges.

One method of fastening uses a piano hinge, or two door hinges. To insure good registration the hinges must be arranged to permit very little side-to-side movement of the frame. For good stability, hinges should be positioned approximately two inches from each end of the frame (figure 4-5).

A second type of hinge, shown in figure 4-6, is more suitable for quick changes from one screen to another and allows for some horizontal adjustment.

A third arrangement (figure 4-7) is not a hinge at all, but a screen carriage, which permits adjustment of the screen in all directions as well as quick changes. This carriage is useful in printing multi-color matter where accurate registration must be maintained. You may be able to make your own adjustable screen

carriage (figure 4-8) if your command does not have sufficient funds to purchase a commercial type.

When printed, flat, thin materials have a tendency to adhere to the screen. Removing each print is unnecessary and time consuming, often resulting in a smeared finished product. You can avoid this by using the off-contact method in which you elevate the screen frame from one-eighth to three-sixteenths of an inch from the printing base. Strips of wood or illustration board are attached to the bottom of the frame (figure 4-9). These strips will help support the frame and stabilize it.

Screen printers have long sought a third hand during printing operations to raise and lower the screen; many methods have been invented or improvised with reasonable success.

One device for performing this operation, called a side kick, is shown in figure 4-10. The

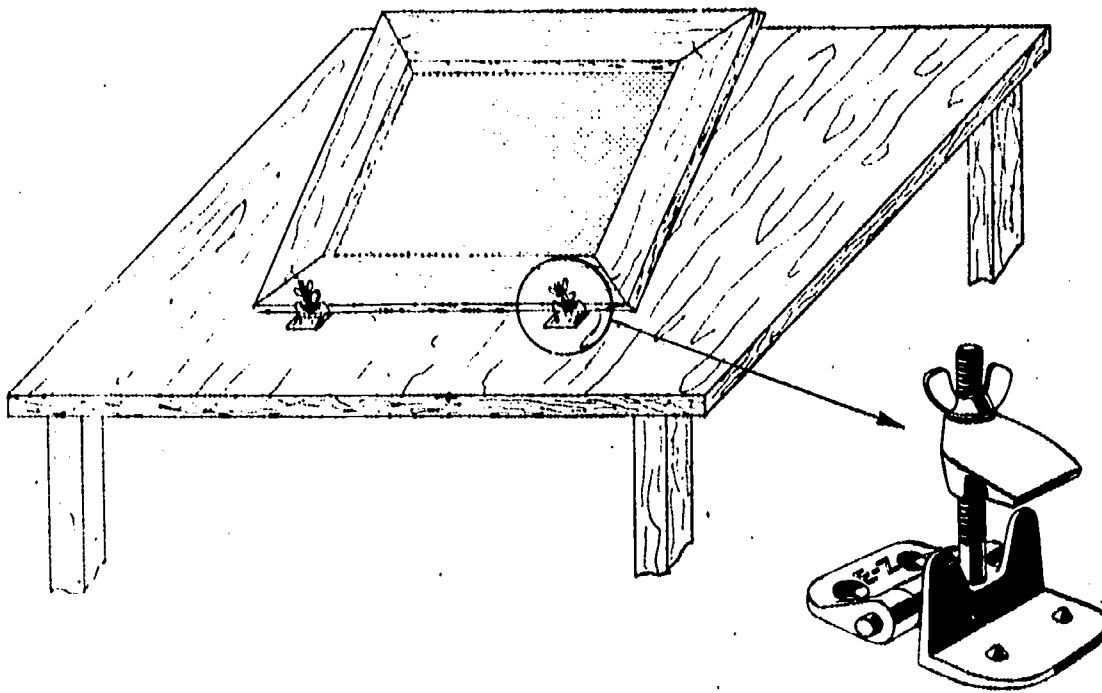

Figure 4-6.—Adjustment type hinge.

142.286(149A)C

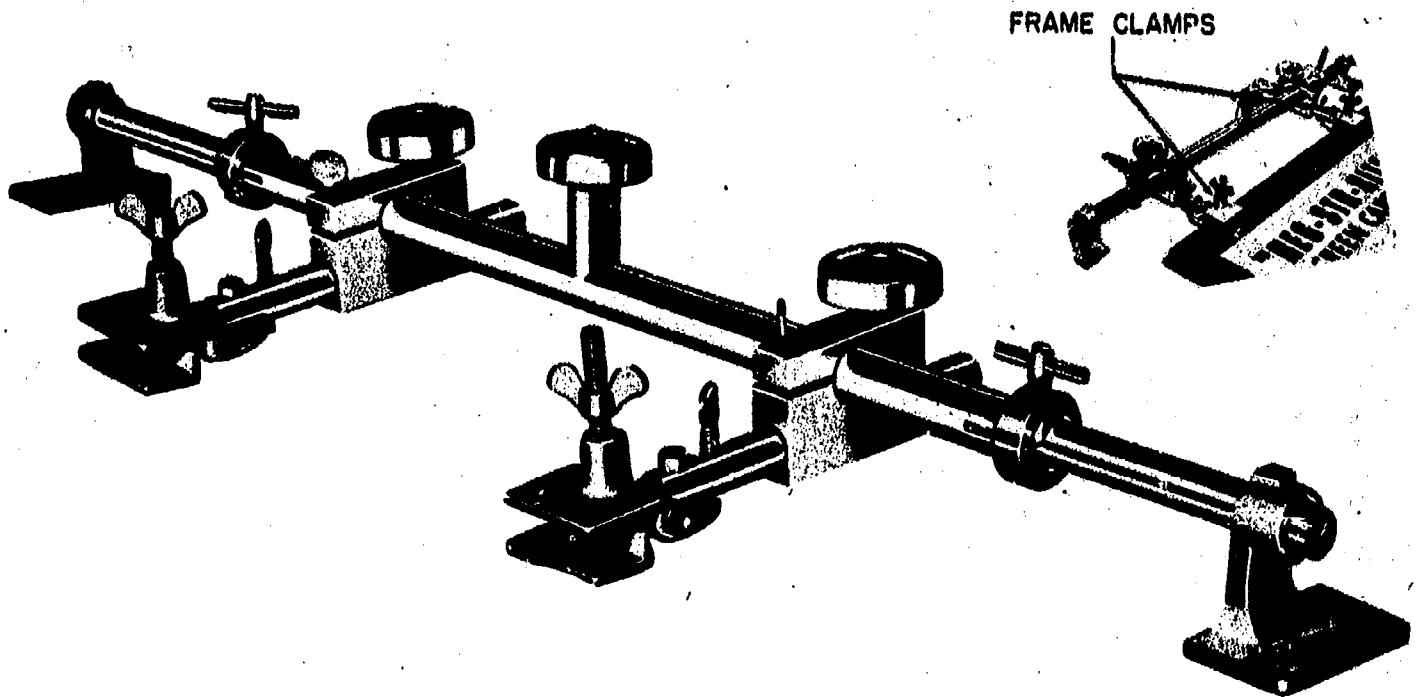

Figure 4-7.—Screen carriage.

149.63

side kick is easily removed and transferred from one screen to another during changeover operations.

Side kicks are available in right- or left-hand models, and can be adjusted along the frame to

control the amount of opening between frame and base.

Notice that the table top in figure 4-10 has been tilted so that when the screen is raised it will be in a horizontal position, now the ink will

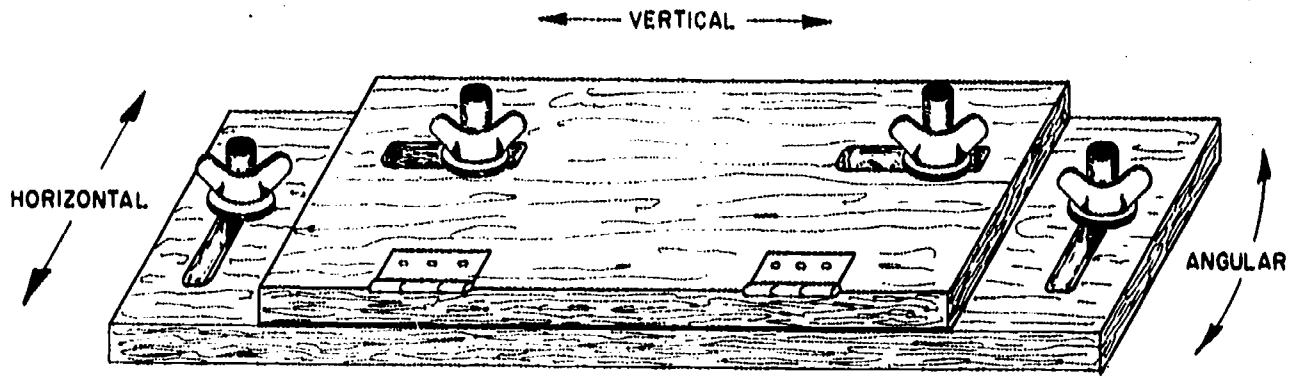

- USE WING NUTS IF AVAILABLE.
- CUT SLOTS LARGE, SO THAT ANGULAR ADJUSTMENTS CAN BE MADE.
- USE 1" STOCK.
- USE PIN TYPE DOOR HINGES.

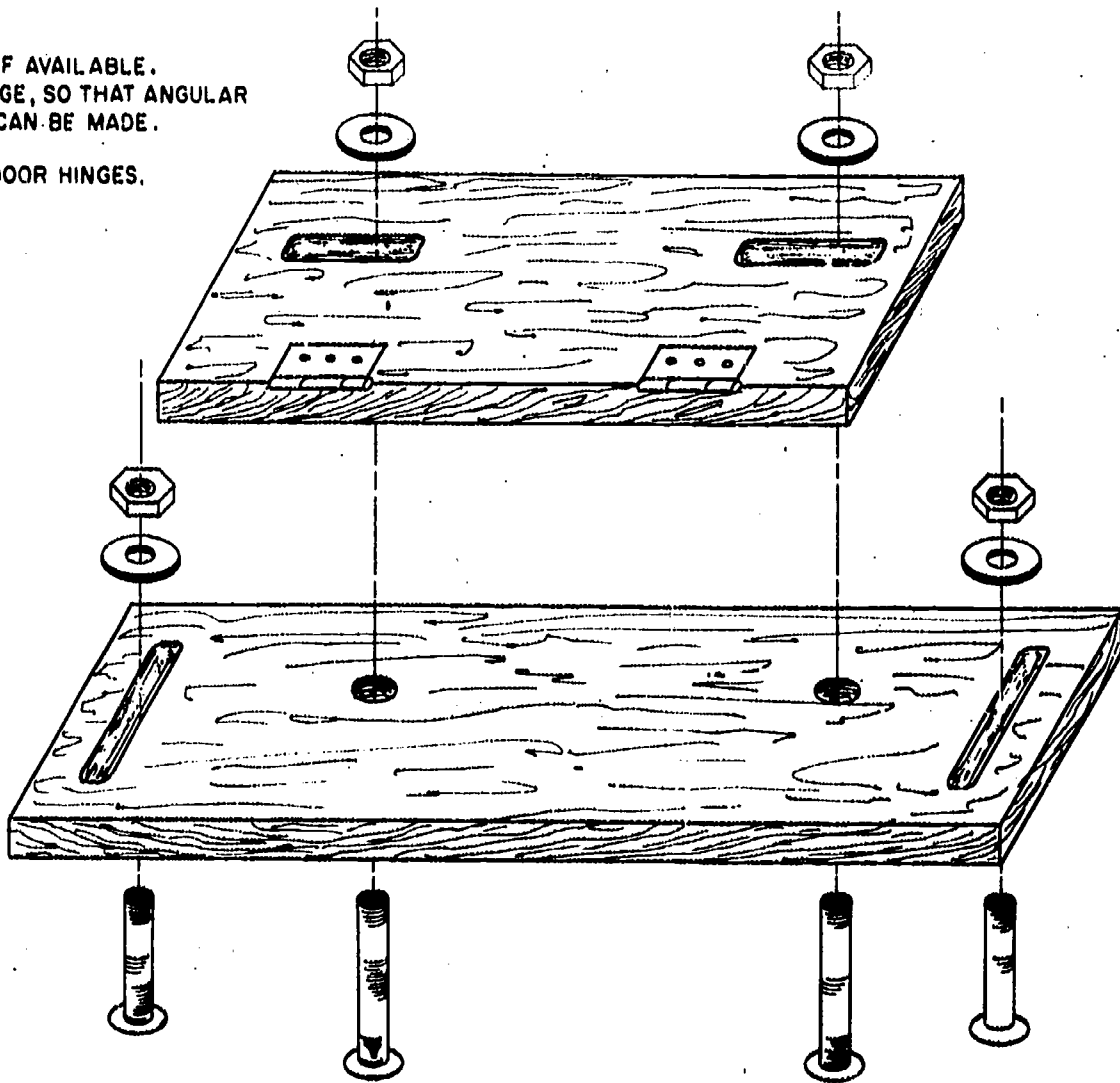

Figure 4-8.—Homemade screen carriage.

149.64

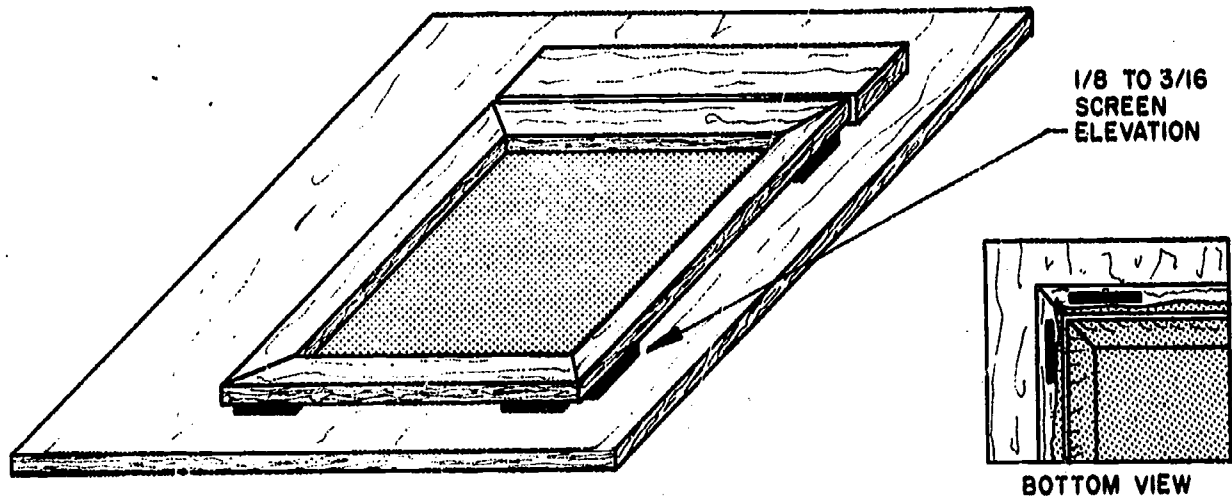

Figure 4-9.—Off contact printing.

149.65

not run as you remove the print and place a new sheet on the base.

TECHNIQUES

The following discussion will cover various techniques used to transfer designs from your master to the printed copy.

MAKING THE STENCIL

Assuming that you have made the master and assembled the frame, fabric, and base. The next step is to make a negative image stencil of the work to be printed, this stencil is adhered to the bottom side of the fabric and serves to block the ink from all the nonprinting areas.

Paper Stencils

Layout can be done directly on the stencil material. Do your cutting on a smooth surface using a sharp blade, such as an Xacto No. 11, to avoid ragged edges or tearing the stencil. When cutting irregular curves you may prefer a swivel knife.

Save the center of each cut letter, numbering the center as you remove it and putting a corresponding number on the stencil in the area from where the center was removed. Since no

two handcut centers will be exactly alike, this is very important. (Figure 4-11).

Tick marks at the corners of your layout will enable you to line up the cut stencil on the material to be printed. Replace the centers in their proper locations and lower the blank screen into position. Pour paint into the basin and make your first pass. The paint will adhere the stencil to the screen, and you are ready for production.

There is little opportunity for proofing the screen or making correction to it after printing has commenced. However, Scotch 810 magic mending tape can be used in some instances for minor repairs. Apply the tape to only the basin side of the screen.

Cleaning processes will remove the stencil. This stencil may be saved for further use. However, the value of reclaiming the stencil is dubious, as other screen materials are more suitable where repeated orders are anticipated.

The following is suggested to extend the useful life of your paper stencil. Prior to cutting, coat the stencil paper with shellac, allow to dry, and then cut as before. Lay the stencil on a flat base, replace the letter centers and place the clean screen over the stencil. Line the basin side of the screen with news print (not news paper with ink on it) and with a warm iron, iron the newsprint. This will soften the shellac which will stick the stencil to the screen.

The degree of success you will have in keeping the lacquered stencil attached to the

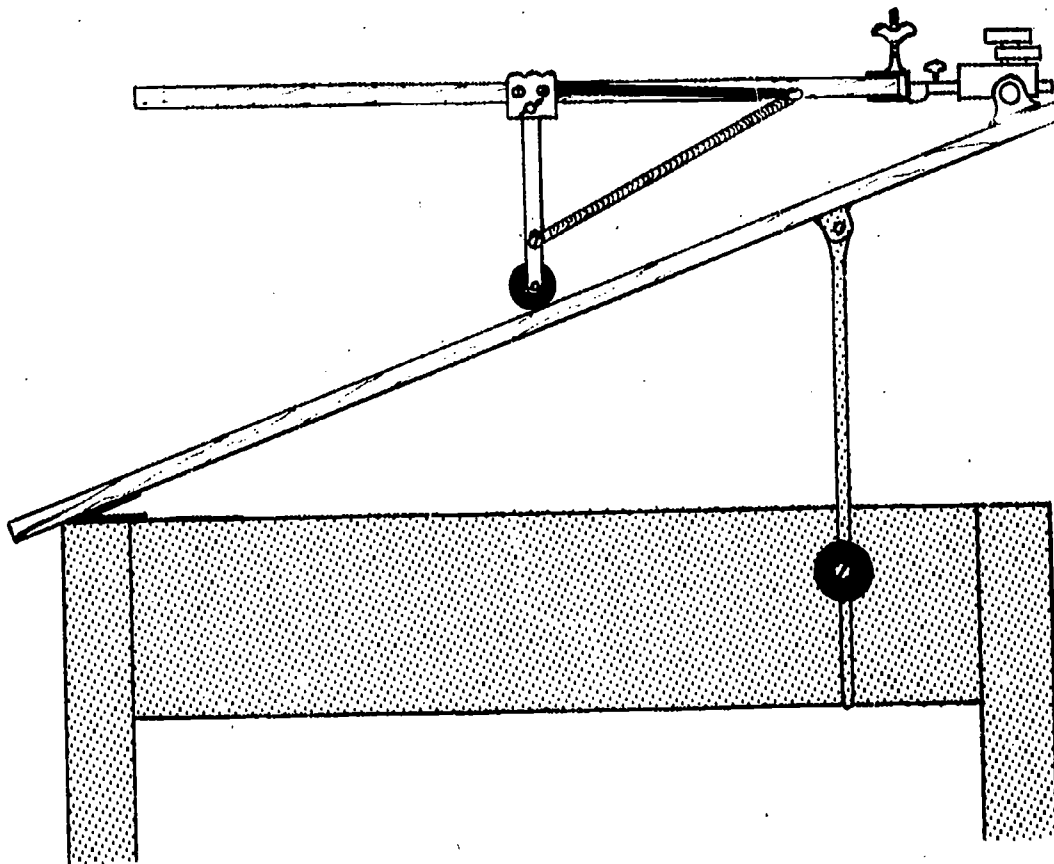
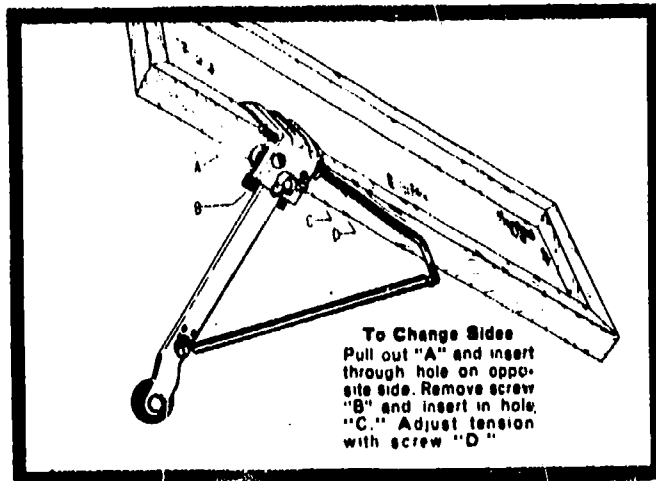

Figure 4-10.—Side kick.

149.66



Figure 4-11.—Numbered letter centers.

149.67

screen depends entirely on the type of printing inks used, since the ink dictates the clean-up solvent. Some of the stronger solvents will loosen the stencil from the screen.

Water-Soluble Films

When making water-soluble film stencils follow this procedure; place a sheet of film,

emulsion side up, over your master and cut out those areas to be printed. Do not cut through the backing sheet. Cut past corners where lines intersect; this will insure a clean edge when the letter is lifted from the backing sheet. These minute cuts at the intersections will fuse together during the adhering process and leave no visible trace during printing.

Next, lay your stencil material (emulsion side up) in register on the base. Paper towels placed under the stencil will aid in absorbing excess liquid during the adhering process. Place a clean screen over the stencil, basin side up.

Using two cotton rags, one dampened with the adhering solution (vinegar and isopropyl alcohol) the other dry, alternately wet the stencil through the screen and rub the same area dry immediately until the entire stencil area has been covered.

Cover a small area, approximately 10 inches square, beginning at one corner and working in one direction to force out any air pockets. In large areas the backing sheet may be slit to permit trapped air to escape during the adhering process.

When using water and isopropyl alcohol as the adhering solution the technique will be slightly modified. Wet a 12-inch square area with a liberal amount of the solution. Blot quickly with newsprint (two or three changes should be enough). Continue this process until the entire screen is adhered. Work fast with this method; do not allow the solution to remain on too long.

The adhering process is obvious, as the stencil material works its way into the apertures of the screen it will take on a darker appearance.

Drying time varies with temperature and humidity. Usually drying takes only a few minutes. Drying can be forced, using a fan. Don't heat the stencil, as this can cause the material to craze or separate from itself and leads to poor adhesion.

A good indication that the stencil is dry is when the backing sheet becomes lighter in color, indicating that it has started to separate from the stencil. Carefully lift one corner of the backing sheet away from the stencil with a fingernail until a firm grip on the backing sheet can be obtained.

Remove the backing sheet slowly and with caution. Areas which have failed to adhere may

be re-wet and dried accordingly. After removal of the backing sheet, the stencil is ready to be masked and blocked out.

Blocking out can be accomplished in most cases with Scotch 810 magic mending tape from the basin side and will not interfere with printing operations. Do not use water soluble blockouts on this type of stencil as they will burn out the stencil.

Remember, water based inks are unsuitable for use with this type stencil.

After masking and blocking out procedures, your screen is ready for production.

After clean up, the stencil can be removed with hot water, preferable sprayed on the stencil from the basin side. A second clean up may be desired after stencil removal to insure all screen apertures are open.

Lacquer Films

Cutting and adhering operations are as described for water soluble films.

Masking and blockout procedures differ only in that either commercially available block out may be used, or your own block out may be prepared by dissolving the stripped film from the open areas of the stencil with a small amount of lacquer thinner.

The screen may be reclaimed with appropriate washup and stored for further use.

To remove the stencil completely, place it basin side up on several sheets of newspaper. Saturate a rag with lacquer type cleaning solvent and scrub the screen well. Allow the screen to sit for a few minutes, then lift the newspaper away from the silk. The stencil will adhere to the newspaper, clearing the screen.

Reclean the screen with the same thinner, using two rags, rubbing the screen rapidly from both sides. Dry with two clean rags, using the same procedure. The screen can now be reused.

A problem that results from using handcut films is an effect called "burned edges". This effect is produced by ragged edges on the stencil, and gives the resulting print an imperfect appearance. There are several causes of the "burned edge" effect which occurs during the cutting process and during the adhering process.

One of the causes is cutting the film with a dull knife. You should use a knife that is sharp enough to cut the film with no pressure. The weight of the knife itself should be almost sufficient to do the cutting.

If your knife becomes dull it will cause a groove in the backing sheet. As you are cutting the film edges are forced into this groove. When you attempt to adhere the film to the screen these edges will not contact the screen correctly and will cause burned edges.

Another common cause of burned edges is poor contact between film and screen during the adhering process. If the screen has any movement up or down it may cause the edges to dissolve faster than the rest of the film. One cause of poor contact is a loose screen. Make sure your screen is drum tight. Also in the adhesion step use soft rags or absorbent cotton. Rough rags can cause burned edges by causing friction between the screen and film.

When handling the film do not crease it. Creases also cause burned edges.

Care should be taken in the cutting process to keep the film surface clean. Use a sheet of mylar under your hand so as not to get the film dirty and greasy. If dirt does get on the film clean it off with a rubber cement pick-up.

Film should adhere readily to the screen with the first touch of adhering fluid. If it doesn't you may have to wet and re-wet the film many times which may cause burned edges. One cause of poor film adhesion is a dirty screen. New screens sometimes have sizing or other foreign matter, whereas old screens may have been carelessly washed, leaving a deposit of dried color. In either case the dirty screen will prevent good film adhesion.

Don't use the wrong adhering thinner on lacquer films. Use only the film manufacturers recommended thinner, otherwise you may end up with burned edges.

Follow the proper adhering technique. To adhere properly you should have perfect contact between the film and the fabric, then moisten the film through the fabric with the thinner, and wipe the thinner quickly with a dry rag. Do not soak the film with thinner for this will cause burned edges.

If thinner is left on too long during the adhering process the film will become very soft

and too easily dissolved, again causing burned edges. To prevent leaving the thinner on too long you may use a fan. The fan will blow air over the screen helping the thinner to evaporate quickly.

Presensitized Screen Process Photo Films

Making a photo screen using the presensitized film is a contact photographic process. First a master must be prepared, then the image of the master is photographically transferred to the film. After the film is developed the image is transferred to a screen. Since the film is negative, its transferred emulsion blocks out all non-printing areas. The film's backing sheet is then stripped away leaving a stencil on the screen.

Masters for contact printing must be constructed at a one-to-one ratio. Image areas of the master should be opaque so that they will block light passage while the nonimage areas should be able to transmit light. Many graphic techniques may be used to make these masters. For a review of some of these methods refer to *DM 3 & 2*, NAVTRA 10469-A.

Photographic film positives, both line and halftone, may also be used as masters. These film positives permit enlargement or reduction only while they are being made. Once the film positive is made and is used in contact to expose the stencil film, neither enlargement nor reduction is possible.

After the master has been prepared the next step is expose the stencil film. No dark room is required. However, insure that the film is not subjected to direct sunlight, or bright florescent lights. Place the film emulsion side down on a backing sheet (dull black paper). This backing sheet helps prevent reflections which may cause undercutting. Next place the master emulsion side down on top of the film. To insure the master and film are in close contact with one another they may be placed in a vacuum frame (8 to 10 pounds pressure is adequate), or you may use a simple sun frame.

Several light sources may be used to make the exposure. A single movie camera flood lamp will suffice for small copy. Place the lamp about 30

inches from the master and film for a duration of several minutes. To illuminate larger copy evenly, two photo flood bulbs with large reflectors will work well. Arc lamps are more efficient and are a commonly utilized light source. Exposure may also be made on a diazo machine by running the master and film through the light source. To obtain the correct exposure make a few test strips.

In all cases a long exposure will result in a thicker emulsion. Overexposure is possible, burning out extremely thin lines or detail. However underexposure is more common, resulting in a thin emulsion which is susceptible to pinholes, and is useful for only a few prints due to rapid wear.

After exposure the film must be developed. Developing solution may be acquired commercially as recommended by the film manufacturer or you may make your own from 1 part of 3% hydrogen peroxide to 9 parts water.

Immerse the film in the solution, emulsion side up, and agitate for about 90 seconds or as directed by the manufacturers instructions. At this point a faint image may appear on the film.

Next wash out the image area of the film with warm water about 92 to 96 degrees F. The areas to be printed will appear as the washing takes place. A moderate spray is recommended. When the image is clean flush the stencil with cold water.

A tray of developing solution is good for one day's use, and should be disposed of at the end of that day. Under no circumstances should the used developer be placed in a sealed container as it will form a gas under pressure and cause the bottle to explode.

The next step is the adhering process. Place your film in register on the base, emulsion side up. Position a clean screen over the film and press down gently. With newsprint or soft paper towels, blot the basin side to remove all excess water. Do not scrub or press too hard during this operation. Allow the film to dry. Drying can be forced with a fan. While the film is drying block out undesirable open areas from the basin side.

Remove the backing sheet. This can be accomplished when the stencil backing takes on a milky appearance indicating the stencil has adhered and is dry. Should the backing resist removal allow more drying time.

After areas around the edge of the screen have been masked the screen is ready for use.

After use the screen may be washed and stored. To completely remove the stencil, use hot water. Should a residue remain, soften the emulsion with a chlorine bleach. After using chlorine bleach, wash the screen with vinegar to neutralize the bleach. A special enzyme solution is used on silk screens which cannot withstand the chemical action of bleach. A final cleaning with wash-up solvents may be desirable to insure all screen apertures are open after removal of the stencil material.

Direct Contact Photo-Screens

To prepare a direct photo-screen, first prepare a sensitizing solution according to the directions listed on its container. Second, place this mixture on a piece of cardboard (illustration board). Place the cardboard against the bottom edge (basin side) of the screen. Tilt the screen until the mixture comes in contact with the screen. Draw the cardboard up towards the top of the screen so the fabric is coated with the mixture. Third, dry the screen thoroughly. Then apply a second coat on the printing side of the screen exactly in the same manner as the first coat. Coat the printing side again and then allow the screen to dry. When coating and drying work under a yellow or red safe light as most direct photo emulsions become light sensitive when mixed. When the screen is dry to the touch you may contact expose it to your master. Fourth, wash out the screen with water (110°F) from the basin side. Then wash the printing side until more detail opens up. You should be constantly rotating the screen while washing it out. Go back to the basin side and finish washing it out. Finally, rinse both sides of the screen in cool water.

Complete instructions for the use of this technique are included with every purchase of direct emulsion sensitizing solution or in the manufacturer's catalog. For this reason and the fact that most Navy graphic shops will find presensitized film much easier to work with, the direct emulsion method is only briefly described in this manual.

REGISTRATION

To ensure the item to be printed on is aligned with the image on the screen, registration guides are placed on the base as shown in figure 4-12. These registration guides must be no thicker than the material to be printed and no sharp edges must protrude from the guides which may injure the screen. As a rule guides need only be along two sides of the material. For thin paper registration guides may be made of tape or thin paper. With thicker items guides may be made of illustration board or similar material.

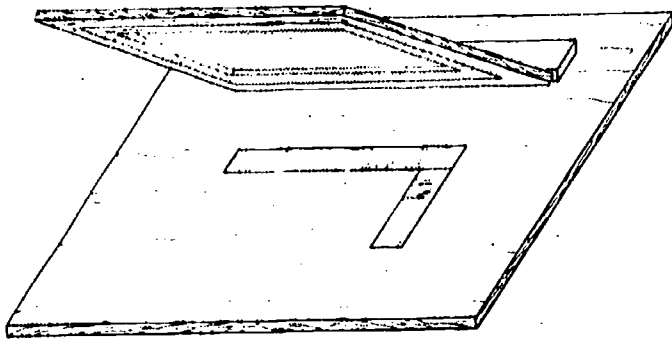

149.68

Figure 4-12.--Registration guides.

For odd shaped items, such as note books, special jigs must be improvised to conform to the shape of the material, leaving the printing surface exposed and parallel to the screen.

Registration guides may be fixed to the base before the stencil is transferred to the screen. To set the guides--first place one of the sheets of paper to be printed on the base. Next affix the guides. Build up the paper to be printed on with a thickness of the same size paper or other material so that the fabric and paper contact each other when the frame is lowered to the print position. Register the stencil over the paper. Then lower the screen and adhere the stencil. Remove the paper or other material after the stencil is adhered and printing is about to begin.

An alternate method of registration is to adhere the stencil to the fabric before attaching the frame to the base. Using this method:

First, place the stencil on a flat surfaced table. Second, place the frame over the stencil

and adhere the stencil. Third, attach the frame to the base. Fourth, register one of the sheets of paper or whatever is to be printed on under the stencil. Fifth, place the registration guides carefully without moving the item to be printed on.

If registration is not correct you may have to loosen the hinges from the base and correct the frame's position. Hinges such as the quick-change type do permit some degree of correction without loosening. Screen carriages allow the frame to be moved up to one and one-half inches to correct registration. Initial registration should be within $3/4$ inch of the desired position. Final registration may be made utilizing the adjustment knobs.

MASKING

Masking the screen in open areas beyond the stencil saves stencil material and helps keep ink from building up between the frame and fabric. For long runs it is recommended that all open areas beyond the stencil be masked on the basin side of the screen. Never mask with tapes on the under, or printing, side because liquids used in printing tend to soften or loosen the tape.

For small areas, strips of paper (kraft) tape may be used. Masking tape must be used on water soluble films to prevent burn-out and seepage where tape and film come into contact.

To mask large borders, prepare a paper mask and tape it to the basin side around where the stencil is located.

In all cases fold strips of tape lengthwise and mask the intersection along the sides where frame and screen meet. This will prevent seepage and build-up of ink between the screen and frame. (See figure 4-13).

The masking step may be eliminated when short runs are to be made, providing you have allowed sufficient stencil material to extend beyond the image area to prevent seepage.

PRINTING

Place the material to be printed in the register guides. Pour enough ink into the basin so that it will spread out in a long even line, approximately $1/2$ inch thick, across the top of the

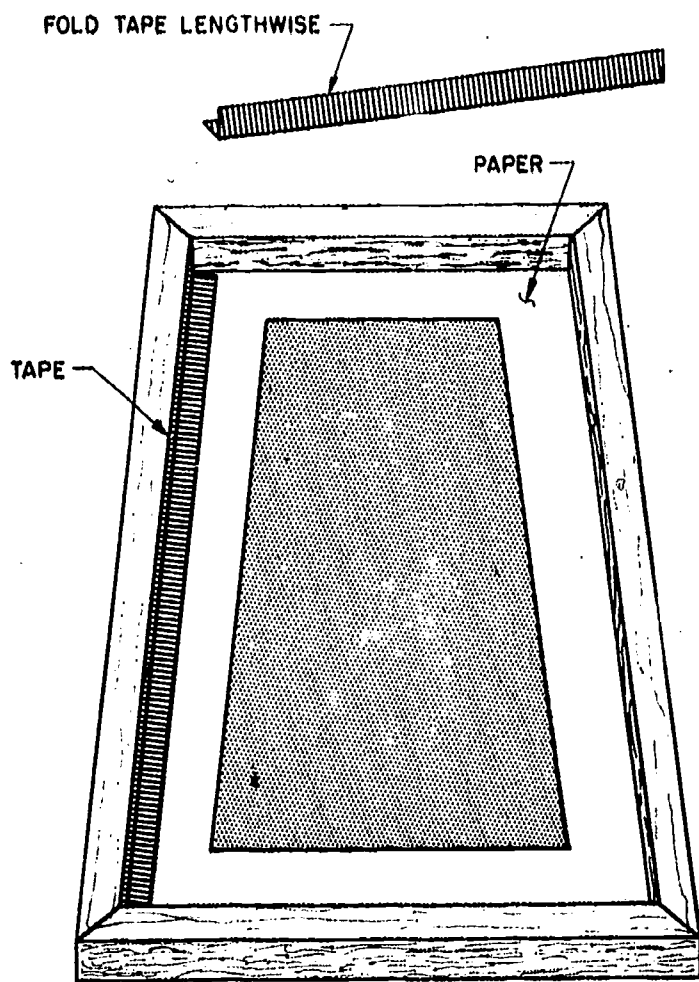

Figure 4-13.—Masking.

149.69

screen. Lower the screen and squeegee the ink to the opposite end. Hold the squeegee at an angle of about 60 degrees and scrape the paint along with the sharp edge. (Figure 4-14). Always draw the squeegee in the same direction. Do not squeegee first one way then back the other way. Use a firm downward pressure which will force the paint through the fabric as you move the squeegee from one end to the other. After making the print scoop up the ink with the squeegee and place it in the opposite end.

Ensure that you have a sufficient amount of ink for each successive print. If the ink supply is allowed to fall below a certain level it may dry in the open areas of the screen and thus stop the even flow of ink.

Raise the screen and remove the print. Any corrections and changes should be made to the screen at this time. Leaks and pin-holes not previously discovered should be blocked out. Printing is now a continuous operation.

After each print is removed place it in a safe place so that it won't get smeared while it is drying. Devices such as drying racks are available for this purpose. If a rack is not available you should be able to make your own without too much trouble. See figure 4-15.

WASHUP

Remove excess ink from the squeegee and screen basin with pieces of cardboard. Replace the excess ink back into the can. Next, remove tape or masks and dispose of them. Place paper (newsprint is ideal for this purpose) under the screen and lower to printing position. Pour washup solvent into basin and over the squeegee blade. Wipe clean with rags. Cotton serves this purpose best. Repeat this step as necessary using clean papers and rags.

When the screen is free of all paint tilt it on one side and using two clean rags, one with a small amount of solvent, scrub the screen from both sides keeping the rags in close contact with one another. This should remove any residue from the mesh openings. When dry, the screen is ready for re-use.

See figure 4-16 for an illustrated summary of screen printing.

SCREEN PRINTING HALFTONES

Occasionally, the need will arise to reproduce a one color halftone such as a photograph by the screen printing method.

For the purposes of our discussion we shall assume that you are supplied such a photograph to reproduce, and that you will obtain the required halftone positive from the photo lab.

The halftone positive is best shot with a 65 line screen, although the screen may vary from 30 lines for very coarse work to 85 lines which is about maximum for the average hand screen printer. The mesh of the screen fabric used limits the screen size of the halftone that may be reproduced. For instance, a 65 line halftone positive has 65 dots per inch which would adhere nicely to 12XX silk or its equivalent since there are 125 threads per inch in the fabric.

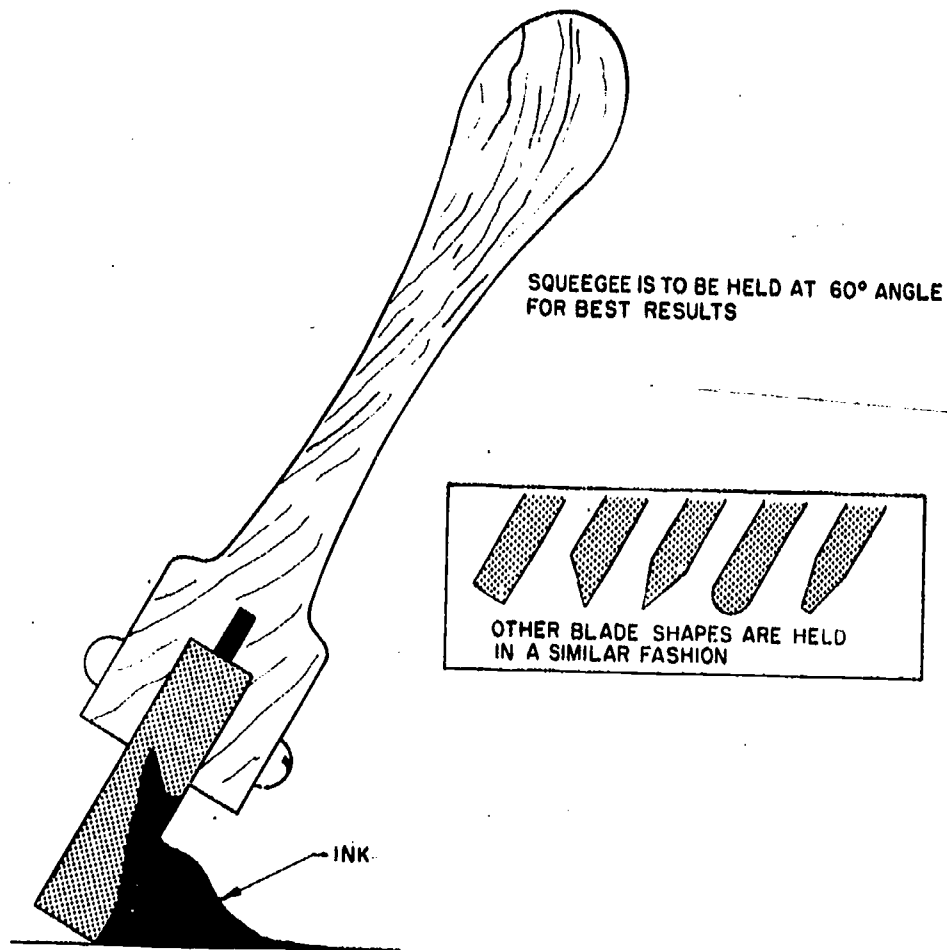

149.70

Figure 4-14.--Squeegeeing.

In short, to prevent dropping out, the half-tone dots must have a sufficient area to adhere to.

Moire occurs in screen printing exactly as in any other process where already screened material is screened again.

To eliminate the undesirable moire patterns, place your halftone positive on a light table and mark each corner with a registration mark. Place the screen over the halftone positive basin side up, and rotate the screen until the moire pattern disappears. Mark the screen with registration marks corresponding to the photo positive. Be careful not to damage the filaments while marking the screen.

After the photo stencil is made you should be able to place it on the screen in register so that a moire pattern will not be evident.

When making the print use special finely ground halftone inks. Also ensure that the

squeegee is sharp. Pull the squeegee lightly over the fabric, using the off-contact printing method.

MULTICOLOR PRINTING

Though similar to the process for registering single-color stencils, registering multicolor work requires the second and succeeding stencils to be accurately registered to the first. The two registering methods described earlier in this chapter may be used in multicolor work.

In the first of these methods the stencil is first registered over the paper to be printed on. A copy of the original artwork should be placed on the base (in place of the paper) and the guides fixed in place. Then the first stencil is placed over the original and transferred to the fabric. The original copy is removed and the color is

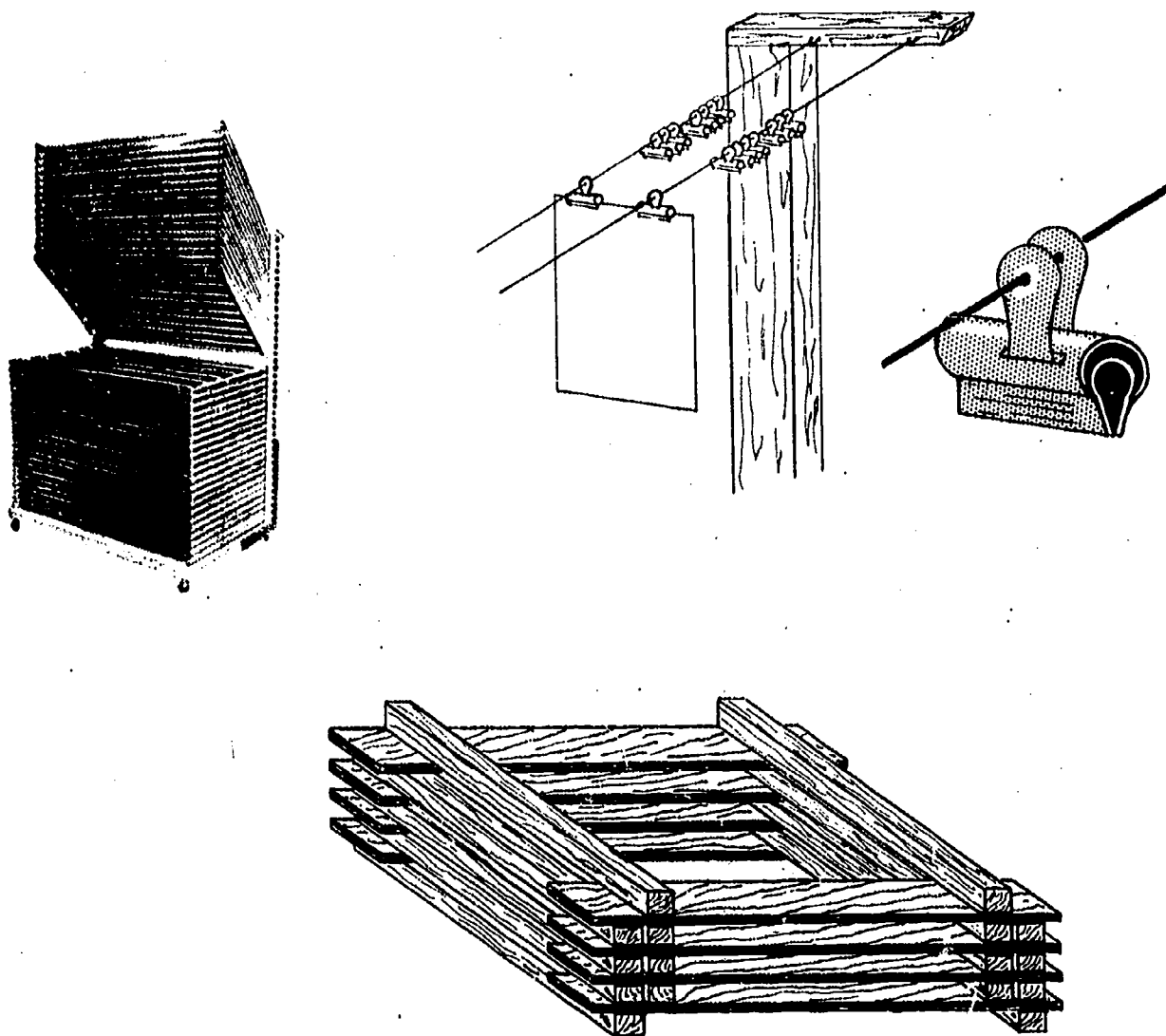

Figure 4-15.—Drying racks.

149.71

run. For the second color, the original copy is placed in the same position (using the guides), and the second stencil is positioned. Remaining stencils are registered, transferred, and run in the same manner. This method may be used for color runs that do not require pinpoint accuracy.

In case accurate registration is required, use the alternate method of adhering the stencil to the fabric then adjusting the frames position on the base. You must have an adjustable screen carriage. Usually each color stencil is transferred to its own frame. When using this method, run enough extra prints to allow for correcting the register. Allow the first color to dry. Replace the frame and register the second color. Adjust as

necessary to print the colors in register; then proceed in this way with the remaining colors.

The sequence in which the colors are printed is important. Light colors should be printed before the dark colors. Thus the normal series would be yellow, red, blue, and black.

When printing with opaque inks of more than one color, you should plan for a slight overlap of adjoining colors so that slight misregisters do not create white spaces between the colors. Additionally, to make sure the register is proper, cut all successive color stencils in position over previously cut stencils. Stencils should be cut in the same order that they will be run, making the light colors slightly oversize where they contact the dark. When the print is run the dark colors

HOW TO SCREEN-PRINT BY HAND

1. HINGE SCREEN TO BASE

Place hinge clamps on level, smooth base approximately 2" from each end of screen. Fasten hinges in center of slotted holes using screws and washers. Lock screen in registration by simply tightening thumb screws on clamps.

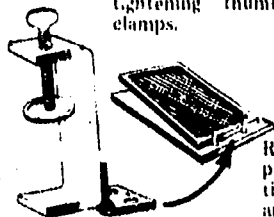

Register screen in final position and lock screws tightly. If loose pin hinges are used, setting of screen follows same procedure.

2. SET GUIDES

FOR RIGID PIECES



Set feeding guides for card-board, masonite, glass, metal, etc. Guides must be thinner than piece to be printed. No screws, nails or sharp edges should protrude.

FOR PAPERS



For light weight papers set paper guides or thin piece of tape. A suction base is very important for holding down stock when printing large areas.

FOR COLOR REGISTER



Exercise extra care when printing multiple colors. Hinges must be fastened securely and frame register guides keep screen securely in printing position.

3. FASTEN SIDE KICK

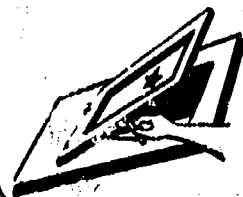

A sidekick is a simple device for holding screen in up position when feeding, setting guides or cleaning screen. Mechanical side-kicks save extra operations. A sturdy drilled lath however will perform satisfactorily.

4. PROOF SCREEN

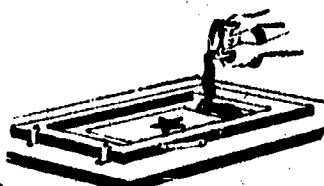

Place a piece to be printed in the guides. Proper color is poured in reservoir area of the screen. Squeegee color to hinge side of screen leaving squeegee in this position.

5. CHECK PRINT

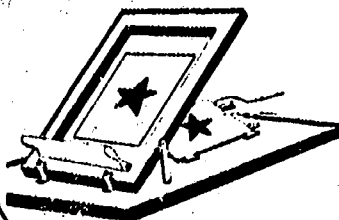

Raise screen. Remove printed piece and examine print carefully. Any corrections or changes should be made at this time. Leaks and pin-holes can also be blocked out on the screen.

6. PRODUCTION

The printing operation is now continuous. Color is scooped up with squeegee and brought to opposite end of screen.

Hold squeegee at slight angle and print with sharp edge. Printed piece is removed and new sheet inserted in guides. Rack printed pieces until color is completely dried.

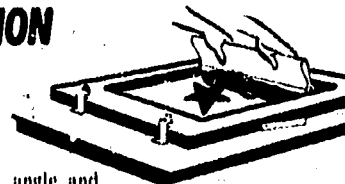

7. WASHUP

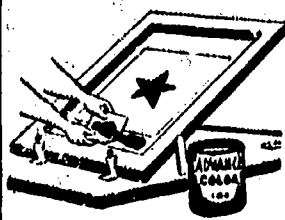

When printing run is finished, scoop up all unused color with ink knife or hard cardboard and replace in ink can. Place newspaper under screen and lower to base as in printing position. Pour washup solvent in screen and proceed to loosen all color. With clean cloth mop dry. Repeat this procedure once again. Screen is now ready to be stored for reuse.

8. SPECIAL SET-UPS

The true versatility of screen process is based upon the various sizes, thickness and shapes of materials which can be simply and economically printed. Take care to protect the screen from all sharp edges by building a "chase" about irregular shapes as illustrated. Masking tape, placed underneath the screen also prevents wear. Ingenuity will be necessary in many applications. Curved and round objects require special mechanisms.

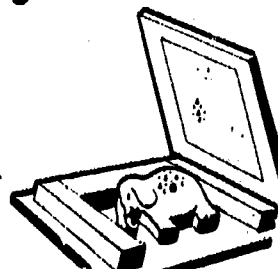

ADDITIONAL HELPFUL HINTS

- Screen should be set 1/8" to 3/16" off contact from piece to be printed.
- Textile printing is best accomplished by printing on contact.
- Flooding screen keeps color from drying in open areas of screen.
- Keep squeegee sharp for best printing.
- A nail placed upright on hinge end of frame keeps squeegee handle upright.
- For large runs tape placed inside screen prevents paint seepage.

Figure 4-16.—Screen printing.

will block out the light ones and thus form a clean edge between them. When this color run process is reversed, a different color may result where the two colors overlap because the light colors do not cover the dark colors as well.

Here is an example of how to make a sign with yellow lettering on a black background: (1) Make the original art. (2) Lay the first sheet of stencil material over the artwork and cut it to overlap the black background. (3) With the first stencil still in place, lay a second sheet of stencil material over the original and cut the black

stencil out accurately. (4) Adhere the stencils to two screens. (5) Run the yellow first, then the black.

When printing multicolor halftones you should use special transparent halftone inks which are available in process colors: yellow, magenta, blue, and black. When these colors are superimposed, other colors are formed; here too the light-to-dark color sequence should be followed because a red printed over a yellow undertone produces a certain shade of orange, whereas a different shade of orange results from printing yellow over red.

CHAPTER 5

COLOR

As an Illustrator Draftsman, you will be called upon to use color in your drawings. To use color effectively, you must know what color is, how color is organized, and how color can be employed to best advantage. This chapter will point out facts about color that can serve only as guidelines in the use of color. As usual, experience will prove to be your best teacher.

COLOR THEORY

What is color? Where does color come from? We find that color is the sensation experienced through the eyes when the eyes are struck by light waves of varying lengths. The sun gives off rays of light called "white light." White light from the sun contains all of the colors that can be seen by the human eye. This is readily demonstrated when there is a rainbow, or when the rays of white light shine through a piece of glass called a prism. In 1667, Sir Isaac Newton, with the use of a prism, discovered that pure white light could be divided into different colors.

Other investigators of light made additional contributions to our knowledge of light and color. After experimentation with pigments and color glasses it was discovered that there were three primary colors: red, yellow, blue, and that all other colors are formed by overlapping and mixing these primary colors. However, working with light, other investigators conceived the theory that the true spectral color primaries were red, green, and blue (blue-violet). A scientist named Helmholtz also discovered that every color has three different qualities or dimensions; hue (name of a color), value (lightness or dark-

ness of a color), and intensity (purity of a color).

The important factor learned from these theories is that the laws that apply to light do not apply to pigments. Obtaining different colors by means of light is an additive process, while obtaining colors from pigments is a subtractive process. An example of the additive process may be shown by using the principles of color television. All colors are produced from the primary colors red, green, and blue. When the red dots of the screen are illuminated, you see the area as red. If the green dots in this area are also illuminated, the combination of red and green appears yellow. If the blue dots are also illuminated, the area appears white. By adding the colors red, green, and blue, in the correct proportions, all colors can be produced.

The subtractive process of pigment is entirely different. The three primary colors: red, yellow, and blue—when mixed in the proper proportions, produce the remaining colors. Since pigment is not light, mixtures of pigment will not produce white, as light does. When all three primary colors are mixed together in the subtractive process the result is a brown or gray.

The important fact to remember about light and color is that we see by means of light, and paint by means of pigment. Color by pigmentation is a separate and distinct process. When used in this chapter, the term color will mean pigmentation color unless otherwise defined.

As an Illustrator Draftsman you must develop a precise method of controlling the differences in the three dimensions of color: hue, value, and intensity. These dimensions are essential in analyzing and mixing color for your illustrations.

HUE

Hue is the term used to name a color. Red, yellow, blue, violet, red-orange, etc. are different hues. Each hue has its own place on the color wheel as shown in figure 5-1. Hue however, has nothing to do with how light or dark a color may be.

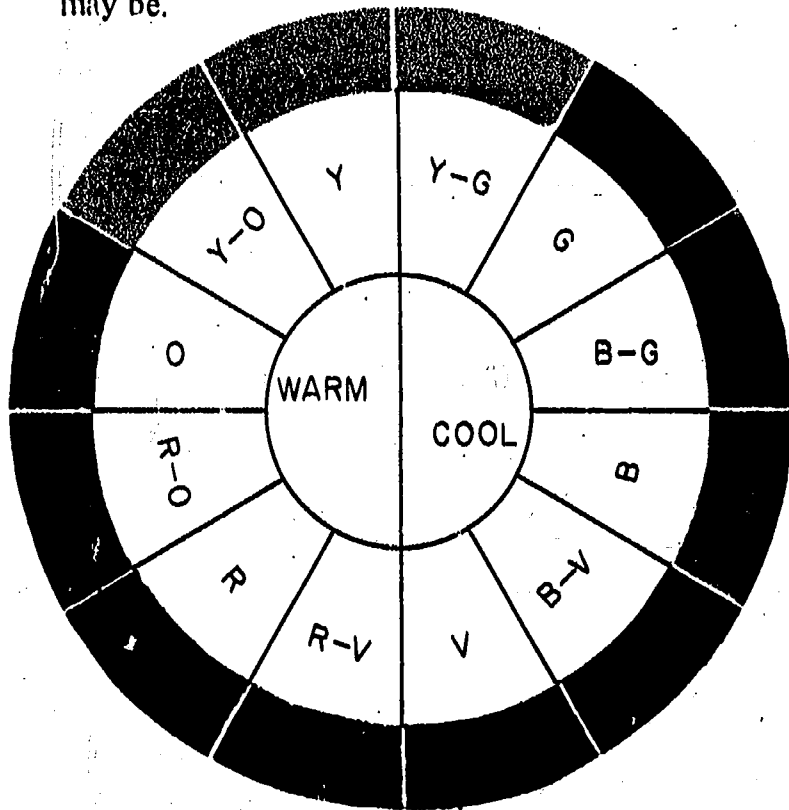

57.446(149A)

Figure 5-1.—Color wheel.

As you know red, yellow, and blue are the primary pigment hues. From these three primary colors, almost any desired hue can be mixed. For example if you mix red with blue you will produce violet, a change in hue. By mixing any two primary colors, you can produce a full range of intermediate hues. The hue which is midway between the two primaries is called a secondary or binary color. For example, if you mix varying proportions of red and yellow, you obtain a full range of oranges. In the same way you can produce green by mixing yellow and blue in the right proportions. Secondary or binary colors—violet, orange, and green—together with the three primaries give you six fundamental colors.

By continuing the mixing process further, you can obtain six tertiary colors: red-orange,

yellow-orange, yellow-green, blue-green, blue-violet, and red-violet. In compounding these names, as "red" with "orange" to make "red-orange", the primary name is placed first, indicating an excess of red over the other component.

Hues which are close together on the color wheel are related and HARMONIOUS because they contain some part of the colors lying next to them. The more separated the colors become, the more distantly related they are. A color situated directly opposite another is referred to as a COMPLEMENTARY color. Complementary colors, for instance red and green have nothing in common, but are used to form sharp contrast, or they can be mixed to create neutral grays.

The color wheel is a simple scale for measuring hues. Although there is no rule as to the number of colors in the wheel, a 12-hue wheel is convenient since it accommodates the primaries, secondaries, and tertiaries. The approximate position of any hue can be judged by eye by referring to the color wheel. Also color wheels help you locate harmonious hues and complements.

VALUE

Value is the dimension by which we distinguish between lightness or darkness in a color. An easy approach to the study of color value relationships may be through the comparison of black and white. In black we have the lowest of all values; in white, the highest value which paper and pigments permit. This gives the two extremes. By mixing black with white in varying proportions, you can obtain innumerable intermediate values of gray. When painting however, it is customary to establish a limited number of progressive value steps or intervals. If you use six steps of gray plus black and white, you form a value scale like the one shown in figure 5-2. This same type of scale can be prepared for each color you will use. Value scales may be used to compare the relationships of values within a hue.

The words TINT and SHADE refer to the value of a color. To create a tint, you add white to a hue, to create a shade, you add black to a hue. In neither case has the hue changed, only the value has changed.

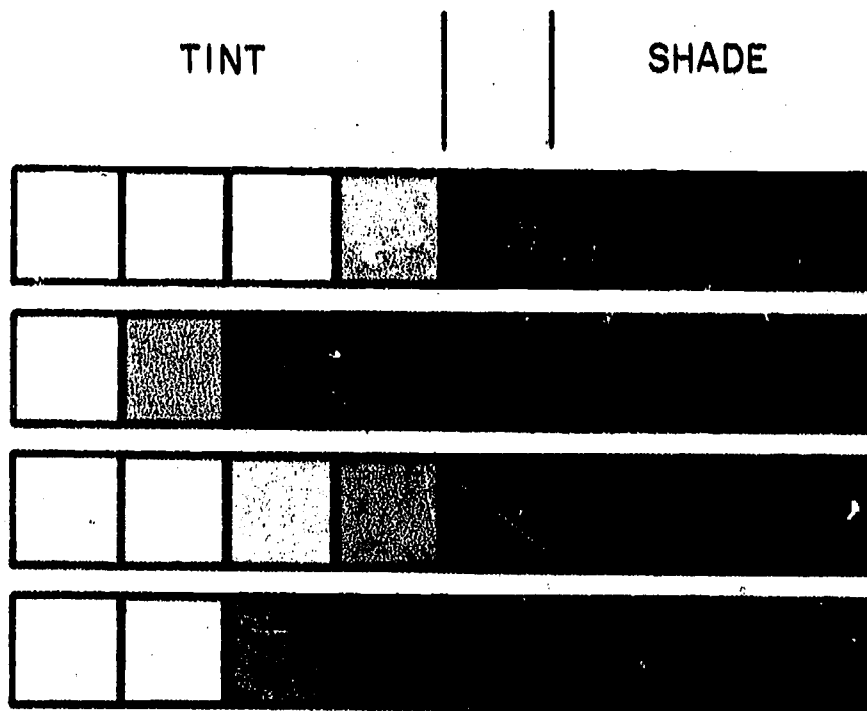

57.183(149A)

Figure 5-2.—Value scale.

To handle color effectively you must be able not only to see and recognize the differences of value in your subject, but also to interpret those differences on your palette. Because the range of values in nature are far greater than your range of hues, you will not be able to merely match nature's colors with those on your palette. You can readily see that your purest white is many times darker than sunlight reflected from a shiny surface.

As an illustrator, you must be able to decide which area is the lightest and which area is the darkest, and then decide how light it is to be, or how dark it is to be. You must relate all of the other values around this decision. You must also decide if the area is to include the whole range of values from white to black. The choice should depend largely on the effect you desire to create. When a key (value range) has been decided upon which appears to be appropriate, try to keep it consistent throughout the whole picture.

INTENSITY

When there is a change in value, color becomes weaker in intensity, the third dimension

of color. Intensity, also known as chroma, refers to the degree of strength, saturation, or purity of a color.

When you squeeze a colored pigment from its tube, it is for the most part of maximum intensity. By adding any other color, such as black, white, gray, etc., you reduce the intensity of the pure color. For instance, adding white or black to change the color value will also change the color intensity.

You can reduce the intensity of a color by adding the color directly opposite on the color wheel. As you know directly opposite colors are known as complements. For example, the complement of red is green, that of yellow is violet, and that of blue is orange. When a complement is added to a color, its intensity is weakened.

Although you change the intensity of a color by mixing a color which will dull or gray it, it may be changed without changing the value or hue by adding a neutral gray of equal value.

In figure 5-3, starting with purity at the center, the intensity of the three primary colors has been reduced by adding greater quantities of gray to the colors until an almost pure gray is reached. The value of each color has remained the same, only the intensity has been changed.

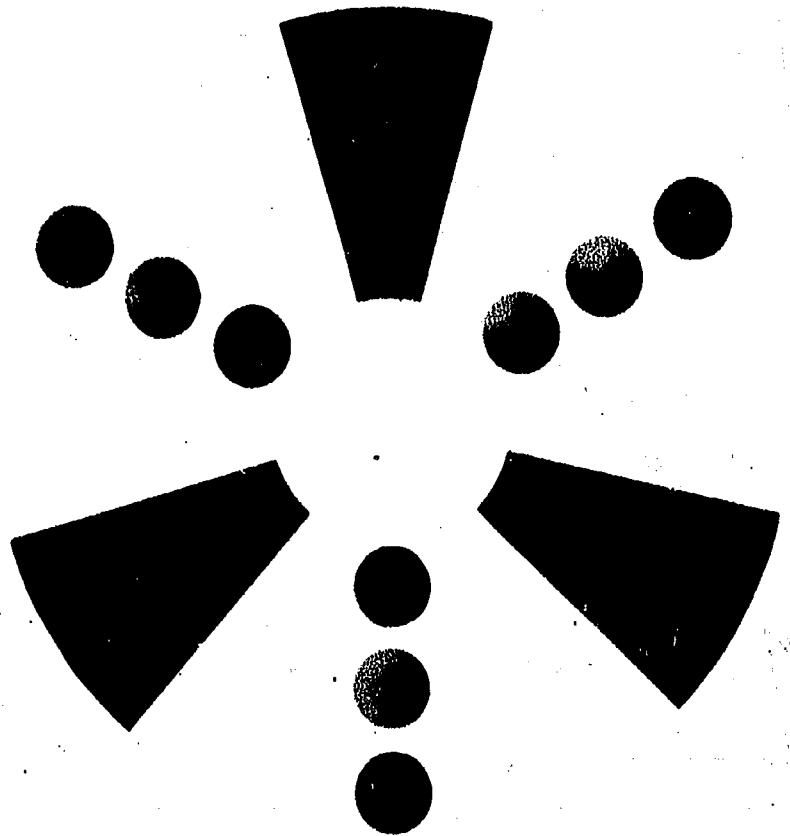

142.252

Figure 5-3.—Intensity.

You can observe changes in intensity in familiar objects. Notice that the color of a pair of dungarees is most intense when new, but the color becomes dull and faded and less intense after repeated washings.

When you mix colors, you will rarely change just one of the dimensions; you will usually alter the hue, value, and intensity simultaneously. For example, if you mix yellow with red-violet the resulting color is a reddish orange, which is lighter and grayer than the original red-violet.

WARM AND COOL COLOR CHARACTERISTICS

Warm and cool colors are qualities of hue rather than value or intensity. To distinguish between warm and cool hues, imagine the color wheel to be divided in half by a line running between yellow and yellow-green, and extending across the color wheel to divide red-violet and violet. Hues on the half that contain the reds,

oranges, and yellows are associated with heat, flame, or sunshine and are considered warm. Hues on the other half are associated with water, sky, and ice; and are considered cool. Warm and cool color characteristics are based on our experiences and how we feel about certain colors.

Single hues can have both warm and cool characteristics. Colors may be considered warmer or cooler depending upon which direction they lean on the color wheel. A red containing some yellow seems warmer than a red containing some blue. Yellows, blues, greens, violets, etc. all may have warm and cool variations depending on which direction they lean. Any hue may be cooled by adding blue or warmed by adding yellow.

Warm or cool color variations can suggest the location of an object. Different types of lighting that illuminate an object or scene will imply its location as being indoors or outdoors. An outdoors scene is likely to be more realistic if the planes receiving the direct light of the sun are painted with warm colors. Shadow planes on the

other hand may be painted cool because of the reflected color from the blue sky.

Indoors, warm and cool colors are opposite the outdoor scheme. In a graphics shop, for example, light entering through northern windows will be a cool blue because of reflections from the sky. Therefore, the planes receiving the reflected light are painted with cool colors and the shadow planes are painted warm.

Warm and cool color variations give a picture a striking contrast which tends to stimulate the viewer's interest.

ACHROMATIC COLORS

The neutral colors (white, gray, and black) are achromatic and considered to be colors in only a broad sense because they lack two essential color dimensions: hue and intensity. Black is far from being negative, because it affects the appearance of such hues as orange and yellow, turning them to brown and olive. Remember, the neutral colors are useful in modifying the values and intensities of all hues.

INFLUENCING COLORS

Local color is the color of an object that is not modified by light, reflections, weather, or distance. However, colors are relative to all surrounding color influences; they are not independent. For example, when strong sunlight and reflecting colors illuminate an outdoors object it will be further removed from its local color than the same object indoors. By understanding what happens to a color when it is influenced by other colors, you can use color more effectively.

NATURE'S COLORS

A colored object contains pigment, that quality which gives the object the ability to absorb certain rays of light while reflecting other rays. Light falling on surfaces differing in texture and consistency is reflected and absorbed in different ways. For example, hard-textured objects, such as those having metal surfaces, reflect many different rays of light while soft-textured

objects tend to reflect only a few. Since on any object the absorption of light rays is never complete, the color is never flat. Also some of the white light is usually reflected as a highlight. As a consequence, a natural color is made up of many hues. If an artist paints a red table with a single red pigment, his painting will be lacking in color compared with the red of the table. Variations of light produce many subtle variations of hues, so the painting of the table must have similar variations of hues, as well as values, if it is to be a realistic likeness of the table.

EFFECTS OF LOCAL COLOR, LIGHT, AND REFLECTIONS

When you see a colored object its hue, value, and intensity are affected by three factors: the object's own local color, the light source which illuminates it, and any color reflecting surfaces near the object. Thus, to paint a realistic picture of the object, you must adequately portray these factors in your picture.

In figure 5-4 consider each of the letters in the top row as if it were painted in its local color, and set under a white light. You will notice that each plane of the letters differs slightly from the others in value. This is because the color of each plane is affected by the amount of light striking it. The top planes are in the light and somewhat diluted. The front planes are more intense in color while the visible sides, or shadows, are somewhat grayed. The local color of the letters in the top row can be seen best in the front planes, where they are least affected by light or reflection.

In the second row, the letters are the same but they are set under a warm yellow light. The light changes the colors in the top and front planes. You can see that in the second row, the colors under the influence of yellow tend to appear warmer. A cool blue light would have the opposite effect on these letters.

The bottom row of letters were all painted red, then each was placed on a different colored surface with a white light shining on it. On the side planes, the shadow area is altered by the reflection from the colored surfaces. The red reflecting surface intensifies the red color in the shadow plane. The yellow has created an orange

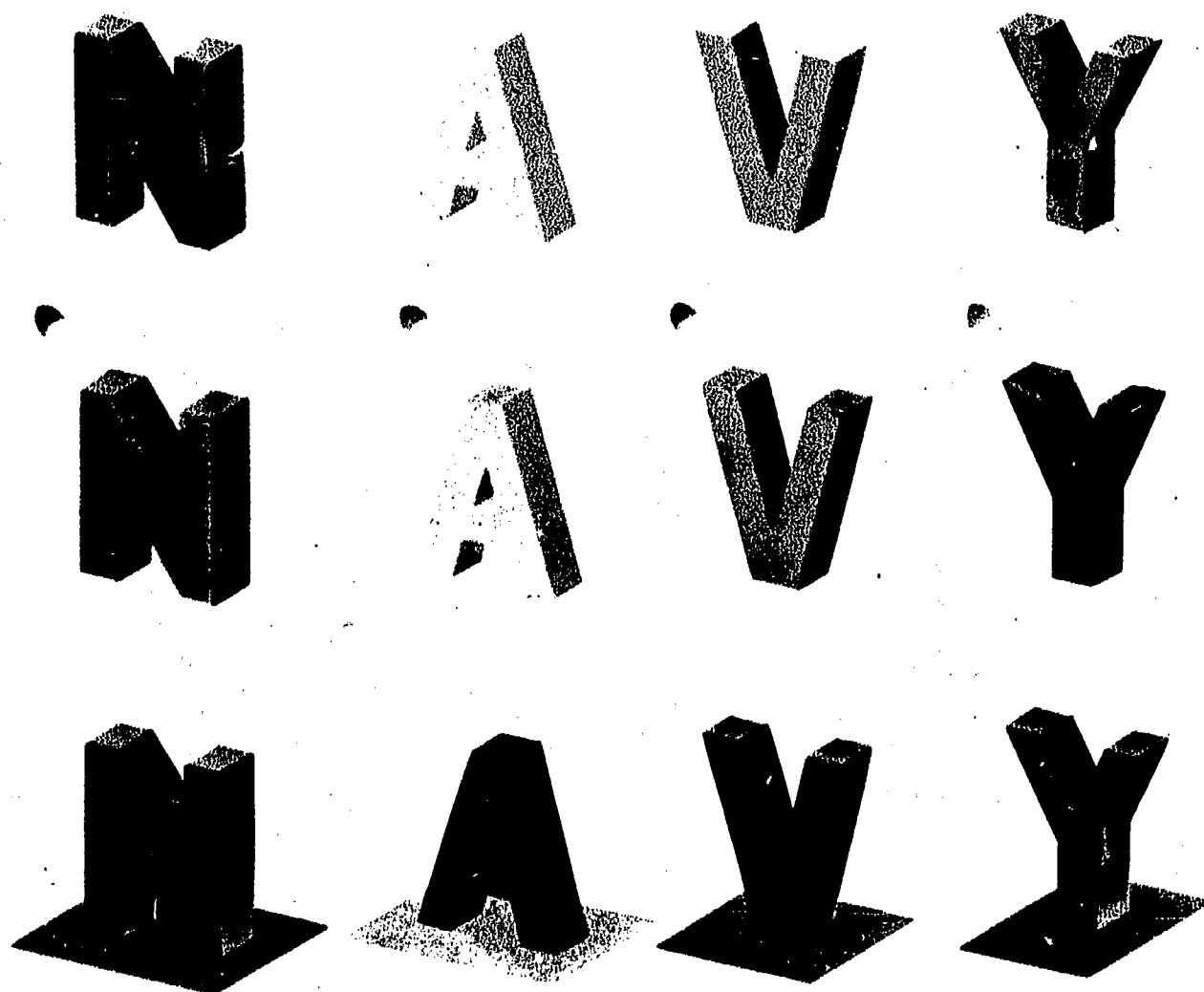

142.254

Figure 5-4.--Effect of one color on another.

tone in the shadow plane. The blue has created a violet tone in the shadow plane. The shadow plane from the gray surface is neutral and the light has not changed the hue of the shadow plane.

With each letter, the reflecting light has not affected either the top plane or the front plane; they have remained the same throughout. The local color of a shadow plane, even when it receives a large amount of reflected color, should not be allowed to lose its original identity.

To summarize you must keep in mind the local color of the object itself, the color of the light shining upon the object, and the color of any nearby surface which may reflect light on the object.

ONE COLOR'S EFFECT ON ANOTHER

If you place colors side by side in your drawing so that one is seen against the other, there will be a tendency for the colors to modify each other. Because they are opposites, complementary colors used side by side will seem more intense than if they stood by themselves. Also a highly intense color will seem brighter and more intense against a grayed color than it will against another color of a similar high intensity. See the sailor in figure 5-6.

Because of the way that one color will affect the appearance of another, don't make the mistake of comparing colors on your palette. Compare colors as you paint and make adjustments as you work.

Intense hues may be compared to a value scale as shown in figure 5-5. Notice on this scale that the values have been given names. Also notice that yellow has the same value as the gray which is identified as high light; yellow-orange and yellow-green have the same value as light; orange and green match with low light; red-orange and blue-green with middle gray; red and blue compare with high dark; red-violet and blue-violet compare with dark; and violet has the value of low dark. Remember that the colors shown are at full intensity. By using tints and shades of the various colors, you can create separate scales for each color.

Value differences between hues are useful when you wish to emphasize a part of a picture. For instance, to emphasize the center of interest, you could place a yellow against a dark background, such as black, which would create the most contrasting color combination. To reduce the degree of contrast between the center of interest and the background, place the yellow against a white or similar light value background which would make it more difficult to see. Other combinations of color from the scale may be used to obtain the effects you want.

COLOR SCHEMES

Certain combinations of colors, whether in nature or art, are agreeable to the eye and mind, whereas others are offensive. We call the former harmonies and the latter discords.

The following methods of combining color have been devised to achieve color harmony. Do not consider them as rigid methods to follow because they are only suggestions. As your ability to work with color develops, you may discover a color scheme which fits your own tastes and works best for you.

MONOCHROMATIC

The simplest color scheme is that of a single hue used in various tints, shades, and intensities. You might say that the use of one color does not constitute color harmony, since there is nothing with which the color can possibly agree or disagree. Though this may be true, colorful

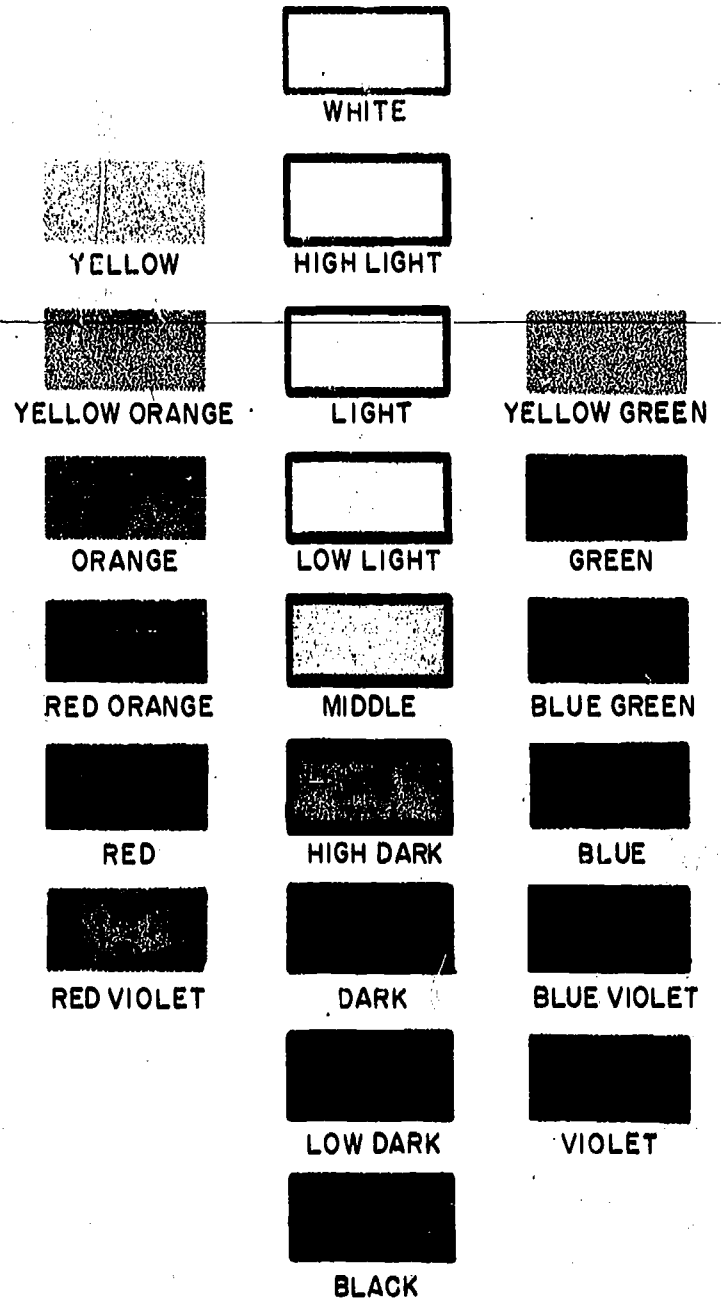

Figure 5-5.—Colors compared to a black and white color scale.

149.73

arrangements are possible. For example, the drawing on white paper with sepia, having values ranging from light tints to dark shades.

ANALOGOUS

An analogous, or related, color scheme is made up of hues which are near each other on the color wheel. For example orange, red, and

violet form an analogous scheme, since they all contain the common hue red.

A glance at the color wheel shows you which groups of colors are analogous. If you start with red, you see that red-orange and red-violet (both made up largely of red) are closely related. To these colors add orange and violet, each of which contains some red. Now you have an analogous group of five hues. You may even include yellow-orange and blue-violet, both of which contain a slight amount of red. Thus out of the 12 hues on the wheel, seven are related by their red content. However, as you include more of the wheel in arranging analogous schemes, the greater your difficulties become. Therefore, typical analogous schemes should not take in more than one-third or one-fourth of the color wheel.

Although analogous schemes are often among the most pleasing and are as easy as any to handle, the very relationship which makes them harmonious may at the same time make them too quiet and monotonous. You must develop enough hue interest as well as variety of value, intensity, and arrangement to prevent monotony.

One of the easiest means of obtaining interest in an analogous scheme is by placing emphasis on a dominant hue. There are various ways of making a particular hue dominant; you can give it a large area, a dark value (against a lighter background); or make it the most intense color. Unless there is a good reason for doing so, avoid placing bright colors next to each other. If bright colors cannot be separated, add a small amount of one color to the other.

You can also prevent analogous schemes from becoming monotonous by introducing complementary accents. Such accents, particularly if brilliant, generally have a power out of all proportion to their size. A single touch of color complementary to one hue—usually the dominant—can give surprising life to an analogous scheme.

COMPLEMENTARY

Complementary schemes, sometimes known as harmonies of contrast, include pleasing schemes which conspicuously introduce op-

posite colors. In fact, the majority of all color schemes are to an extent contrasting, the contrast usually being developed by means of complements. However, you should not base a color scheme on complementary colors in equal areas and full strength. A large red area and a small green area, for instance, often seem harmonious because the dominant red gives unity to the combination. Likewise, a brilliant red can be employed successfully with a neutralized green, even though the areas are equal, since the red will dominate because of its superior intensity. Two complementary colors may be in harmony if one contains some of the other.

Complementary color schemes are effective for any type of display where you want to create interest and attract the viewer's attention. However, these color schemes may be offensive to some viewers. Usually you can keep the schemes from being offensive by using a primary for the center of interest, and the primary's complement for the background. If primaries must be used for background, tone down their color by adding either gray or the color's complement. Equal amounts of complementary colors may distract instead of focus interest; therefore if the areas appear to be almost equal, use contrasting light values against dark values, or dull colors against bright colors. In this way you will give variety to your color scheme and help create interest.

SPLIT COMPLEMENTS

Complements which are only approximate, commonly called split complements, seem more pleasing than those which are true complements. Violet, for example, is the true complement of yellow, whereas blue-violet and red-violet are split complements, that is, they are split or separated by the true complement.

If you base a color scheme on a color and its split complements, or on hues mixed from them, you can obtain a fairly wide range of hues; but none of them will be brighter than the color itself and the split complements in their full intensity. Sometimes such a range proves too limited; so in place of split complements which are closely related to the complement itself, you can use other split complements, each a step fur-

ther removed. Suppose you take yellow as a hue to dominate a color scheme, but the split complements red-violet and blue-violet prove too dull to hold their own; you can substitute red and blue. Here you are using a scheme of three colors equally spaced on the color wheel. This scheme is called a triad.

TRIADS

Mixtures obtained from triads can be very rich and beautiful, but triads do not guarantee color harmony. Harmony in a triad scheme is created by pleasing mixtures of three equidistant colors.

Triads may be made up of the three primaries red, yellow, and blue, but the result is not effective because the primaries have no harmony. The primaries compete for the viewer's attention and, as a result, each color is less brilliant. Therefore, you should select one of the hues to be dominant and mix a little of it with the other two.

SET PALETTE

When working in color, beginners create a problem by wanting to put every pigment available on their palettes into the picture rather than taking advantage of the infinite number of color differences created by the variations of value and intensity.

A good way to overcome this problem and achieve color harmony and unity in your pictures is to use a set palette. A set palette is obtained by adding a small amount of any one color or a gray tone to all the colors you will use. You will find that the added color will have a greater effect on its complementary color than on the colors adjacent to it on the color wheel. Adding one color to all light areas and another color to all shadow areas is another way of obtaining variation. The added color may be warm or cool, depending upon the effect you are trying to achieve. When you want to emphasize one color in a picture, you should add a color to every other color except the color you want to emphasize. Bright advancing colors normally serve their purpose best in small areas attracting

attention or as accents. Several intense colors used in the same size areas compete with each other, and their effectiveness is canceled out.

Figure 5-6 shows how an illustrator with an arranged palette of colors will follow the same pattern throughout.

PLANNING

Before you start to paint make small color thumbnail roughs, try several color schemes that might fit the subject. Don't worry about detail at this point; use only general shapes and flat tones, as you do with penciled thumbnail sketches. It only takes a few minutes of work per rough. From these color thumbnail roughs you should be able to pick one that best fits the picture. Be imaginative. Try to use the colors that will add interest to your work.

COLOR MIXING

Because you will seldom use a color straight from the tube for a painting, try to form good color mixing habits. Here is a list of useful pointers:

(1) Keep your mixtures simple. With only two or three colors at a time, plus white and black, you can create almost any color you will ever need. By mixing more than two or three colors you will usually wind up with a muddy or dirty gray or brown.

(2) Mix dark hues into lighter hues for economy; it takes a small amount of blue into yellow to get green hues. Large amounts of yellow are required when mixed with blue to obtain the desired green hue.

(3) Take care when using white paint; it neutralizes the color with which it is mixed. Too much white gives the color mixture a washed-out chalky look.

(4) Use a clean palette knife or brush to scoop up yellow when mixing it with other colors. Yellow is the most sensitive color on the palette. Dabbing a brush that you have been using with other colors into the yellow may stain it.

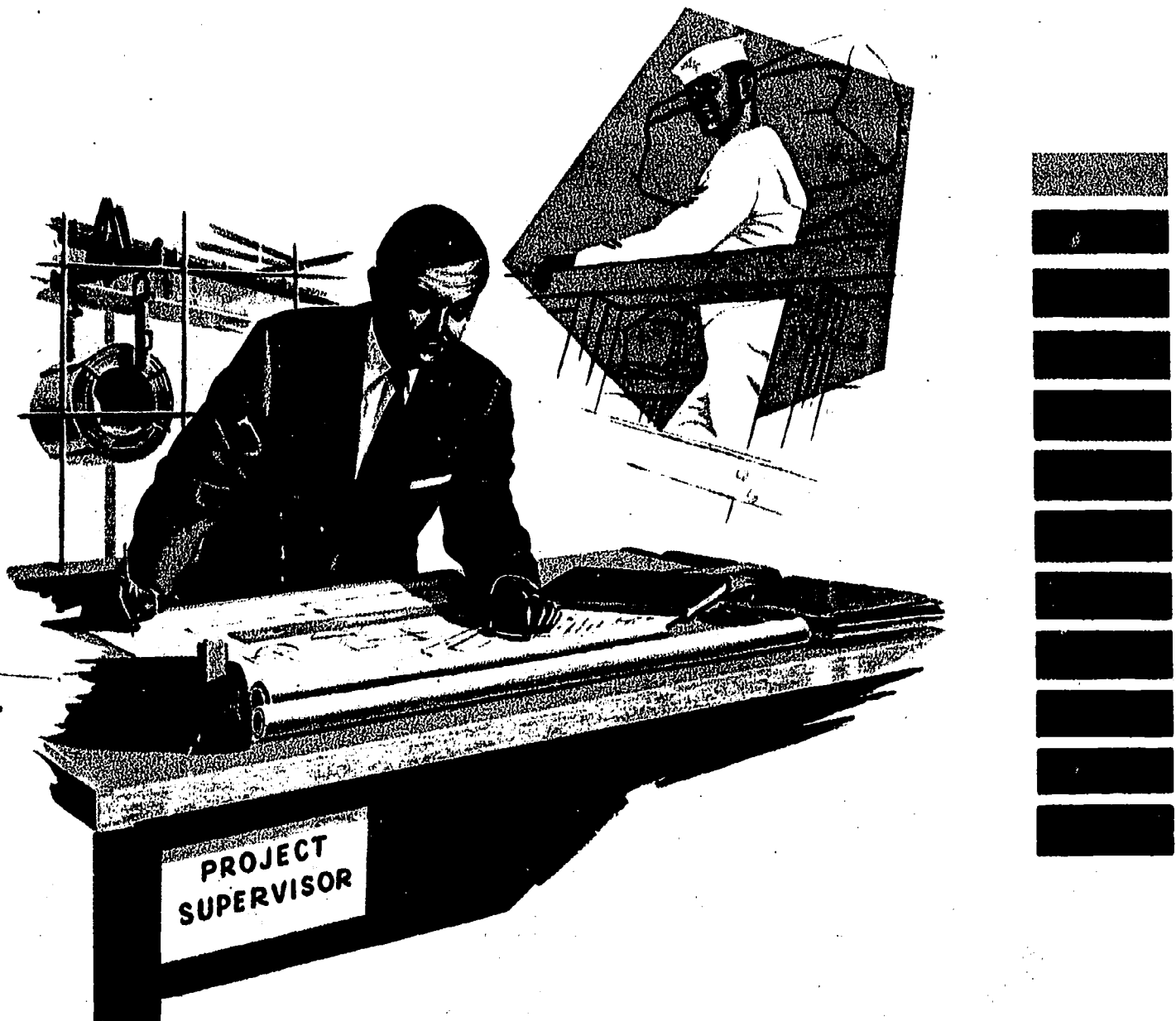

Figure 5-6.—Set palette.

142.255.1-2

(5) Always clean your brush before you pick up any color.

(6) If you use a brush to mix the paint, use only the tip of the brush hairs. Never allow the paint to seep up to the metal ferrule. If possible, use an old brush for mixing.

(7) Try dipping a brush into two colors, and without stirring the mixture on the palette, apply the brush directly to the drawing. The technique produces an interesting broken-color effect.

(8) Keep two jars of water handy when mixing watercolor or acrylics. Use one jar to rinse color from your brush, the other will remain clear for mixing.

(9) Darken a color by using its complement. Complements mixed in the proper proportions become neutralized grays, which may be considered warm or cool depending upon whether they contain more of the warm complement or the cool complement. A mixture of blue and umber will result in a deep black. If white is

added the result will be gray. A color resembling gold may be mixed by combining white, raw sienna, orange, and a slight amount of umber and green.

(10) Form a series of intense orange hues by mixing intense red-orange with a warm yellow-orange; a series of vivid yellow-greens and greens by mixing intense blue-green and a cool yellow; and rich violets by mixing a purplish red and an intense blue-violet.

Colors are made less brilliant when they are mixed together.

CREATING EFFECTS THROUGH COLORS

It is a known fact that color can and will affect a person's emotions. Learning why it does will enable you to create more interesting and dramatic work in color.

EMOTIONAL EFFECTS

It is difficult to set down rules governing an individual's psychological response to color. A color may bring to mind different images to different people. To present a piece of artwork which evokes the viewer's feeling or attitude toward the subject, you must choose the appropriate color. Is the subject happy or sad, strong or weak, hot or cold? The sensitivity needed to select the right color, however, cannot always be taught in a textbook; sometimes, it comes naturally. The list below contains some generally accepted color-emotion relationships which may be useful.

Color-Emotion Relationship:

Dark cool	strength, restraint
Dark warm	dignity, power
Light cool.....	freshness, calmness
Light warm.....	gaiety, excitement
Yellow.....	warmth, brilliance
Red	gaiety, fear, alarm, warmth, anger, excitement
Orange.....	sparkle, warmth, autumn moods

Blue.....	quietness, serenity, coolness, joy, emptiness
Green	rest, freshness, safety, summer moods
Violet and black.....	sadness, mystery, grief, suspense, disgust

ADVANCING AND RECEDING COLOR

In creating the impression of depth in your pictures, you will find that warm colors will tend to appear to be nearer the viewer than will cool colors. As colors become less intense, grayer, and cooler they appear to fall off into the distance giving the feeling of atmosphere being between the viewer's eye and the object being viewed.

In figure 5-7, notice that the colors lose their intensity as they recede to the background. Although the soil is pretty much the same throughout the area in the picture, realism was added by reducing the intensity and warmth of the colors as they fall off toward the horizon. The use of colors to simulate distance and depth in a picture is known as **AERIAL PERSPECTIVE**, or **COLOR PERSPECTIVE**.

LUSTROUS EFFECT

To accomplish a lustrous effect in color, the larger areas of the drawing must be composed of slightly shaded hues which are suppressed uniformly in value, and the smaller areas of the drawing are painted in pure hues. The suppressed colors will appear natural enough, although slightly on the dark side, as if seen in moderate illumination. When touches of pure intense colors are added, the pure colors will appear exceptionally brilliant in comparison with the suppressed colors. The added colors are said to be lustrous since they appear brighter than normal. The added paints do not have to be shiny; the effect is a visual illusion as in figure 5-8.

One method of creating a lustrous effect is to prepare a drawing with pure red, yellow, green or turquoise tempera paints on a white or gray background. Then, with an airbrush, coat the entire drawing with a uniform thin layer of

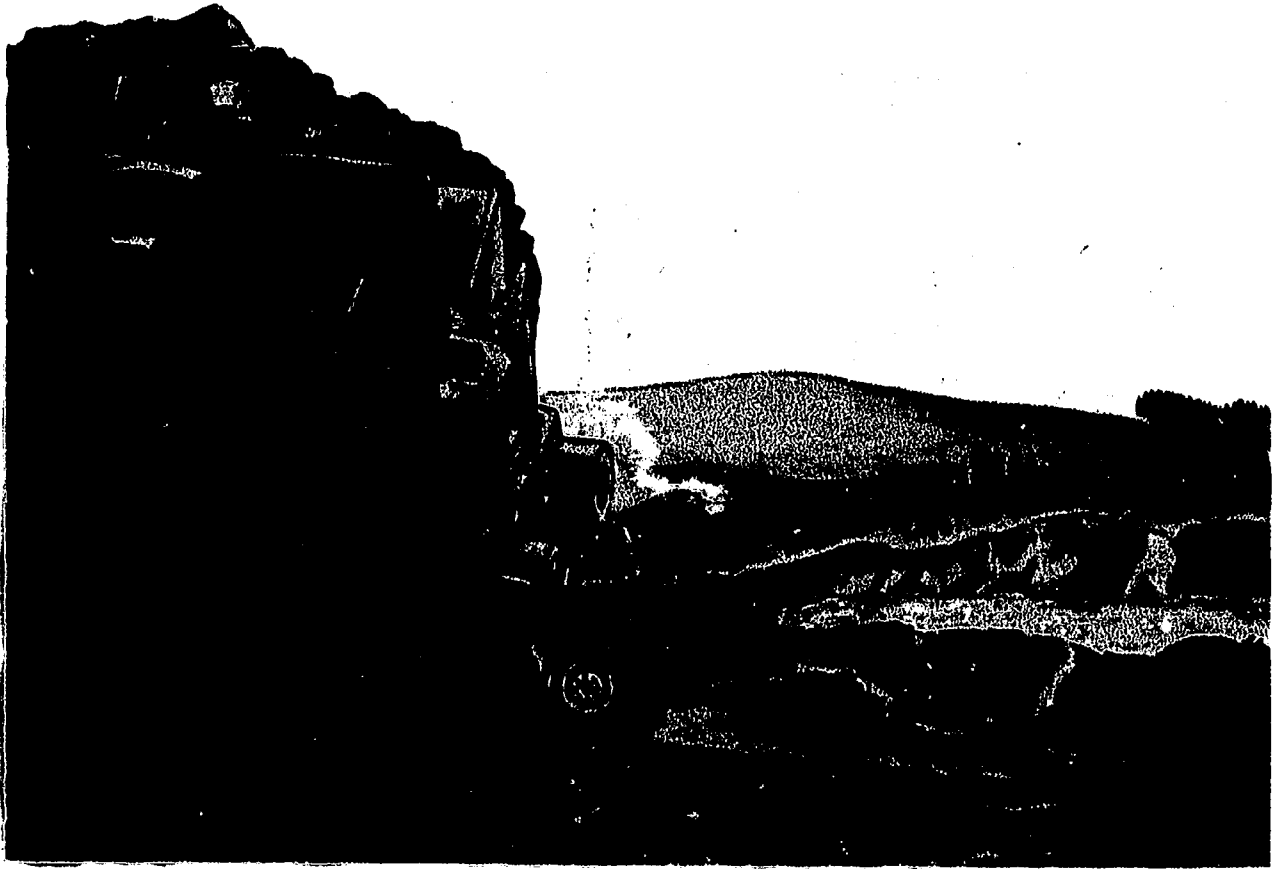

142.253

Figure 5-7.—Receding color.

black to reduce the intensity of the colors. Small touches of the original pure hues are then replaced on the drawing. These added touches will appear lustrous and shine forth with striking purity. They often appear to have a metallic sheen to them.

Another, and more impressive method of achieving a lustrous effect, is to work in a dark background. With a selection of pure tempera colors, prepare a shade scale of three or four steps of value from purity to almost black for each basic hue. Vermilion red, oranges, yellow, vivid yellowish green and turquoise blue are best (avoid deep reds, blues and violet). Working the scale from the darker tones to the brighter and purer tones, paint a simple picture. The largest areas of the drawing should be in the deep tones. When the light pure tones are added to the foreground after the background is completely covered, the pure tones should appear extremely lustrous and far more brilliant than they actually are, as seen in figure 5-8.

The luster perceived by the viewer varies in type and each luster is visually unique. Luster may appear as translucent as a fine metallic cloth or the feathery edge of a silk scarf. Luster may also appear as bold and sharp as a solid polished metal with sharp highlights and shadows.

You do not paint lustrous surfaces realistically and you do not copy nature. The actual color value of a lustrous object is too bright to capture with a pigment. You have to contrast the purest hue of your value scale with the surroundings of the lustrous object by darkening the surrounding area until the effect appears realistic. For example, if you were to paint a red vase, you would not use a soft pink for a highlight since this would not achieve the lustrous effect, but would ruin it. The proper method would be to suppress the red or maroon color of the object and paint the highlight with a pure vermilion to achieve the greatest contrast. The highlight would then appear to shine brightly.



142.256

Figure 5-8.—Lustrous effect.

IRIDESCENT EFFECT

Iridescence is defined as a rainbow-like play of colors, such as is found in a soap bubble, in an opal, or in mother-of-pearl. To simulate the phenomenon of iridescence, our uniform suppression is in terms of a gray field in contrast to the blackish field we used in creating the lustrous effect.

In nature, iridescence is an elusive quality. Iridescent colors in nature owe their existence to diffraction (bending of light rays) rather than to the pigments inherent in the object. The surface of an iridescent object splits a ray of light into its components, and the viewer sees the various spectral hues separated from one another. The color of an iridescent object tends to change in

value and hue when seen from different angles. This is a dynamic quality which seems to defy duplication in a static design such as a painting.

The effect of iridescence in a design is more subtle and softer than the effect of luster. Iridescence features the beauty of delicate tints and pastels against gray. The viewer will be given an illusion of mistiness as he views an iridescent effect. Incidental touches of pure hues or clean tints to this mistiness will take on a fascinating glint as it appears to shine as though endowed with an inherent luminosity; a quality which will seem quite separate from any characteristic of the paint itself.

Using tempera colors, prepare a series of medium valued tints (about halfway between purity and white) such as pink, peach, soft yellow, pale green, pale blue and lavender. Keep the tints as clear as possible, avoiding grayness or darkness. Paint a simple design confining the original tints to relatively small areas and imparting a gray cast to the larger areas. You may achieve the gray cast by adding neutral gray of lower value to the original colors, or by combining opposites. Adding neutral gray is the simplest method.

After completing the painting and the paper's surface is completely covered, (no white paper exposed) use an airbrush to apply a delicate coat of opaque pale gray over the entire surface until the painting appears misty. The final step is to replace touches of the original clean tints.

An alternate method for achieving an iridescent effect is to mix a series of clean tints. To these original clean tints, add equal amounts of a medium gray. Each of the original tints should have about three or four steps of graying from a clean tint to a neutral gray. Scale the color on the drawing gradually from the grayed tints into the clean tints, which should be placed as small touches, highlights or details. A general overall gray cast will establish and fix the illumination quality. This will, by comparison, lend unusual glory and iridescence to the minor areas occupied by the clean tints.

LUMINOUS EFFECT

A luminous object is an object which emits light or appears to have an inner glow (shining).

The moon is said to be luminous although it is actually reflecting the sun's light. The effect of luminosity in a painting may be easily and effectively achieved through a carefully established arrangement of color tones and values. The viewer may be convincingly led to believe that light is being emitted from a painting's surface if the proper color tones and values are used throughout the painting, as shown in figure 5-9.

There are several methods for accenting the luminous quality of a hue. The simplest and the traditional methods are to surround the rich pure hue with dark values or with its opposite color on the color wheel. The result may prove disappointing if the color which is to appear luminous is lacking in purity.

There are several conditions which must be met before a color in a painting will provide the viewer with an illusion of the color's luminosity. They are:

1. The luminous area must be relatively small.

2. The color which is to appear luminous must be purer than its surroundings.

3. The color which is to appear luminous must be of a higher value than its surroundings.

4. The luminous hue must seem to prevail over all the other colors in the painting.

5. The other objects in the painting should appear soft and hazy as though the viewer's vision has been blurred by the relative brightness of the luminous object.

USING COLOR MEDIUMS

Dry pigment matter from animal, vegetable, chemical, or mineral sources is used by paint manufacturers to produce the paints that you buy. Accordingly, many paints are named after and identified by their pigments instead of their hues. Paints are also identified by other means, such as the name of the painter. Table 5-1 shows hues, common names, and characteristics of paints which you are likely to use.

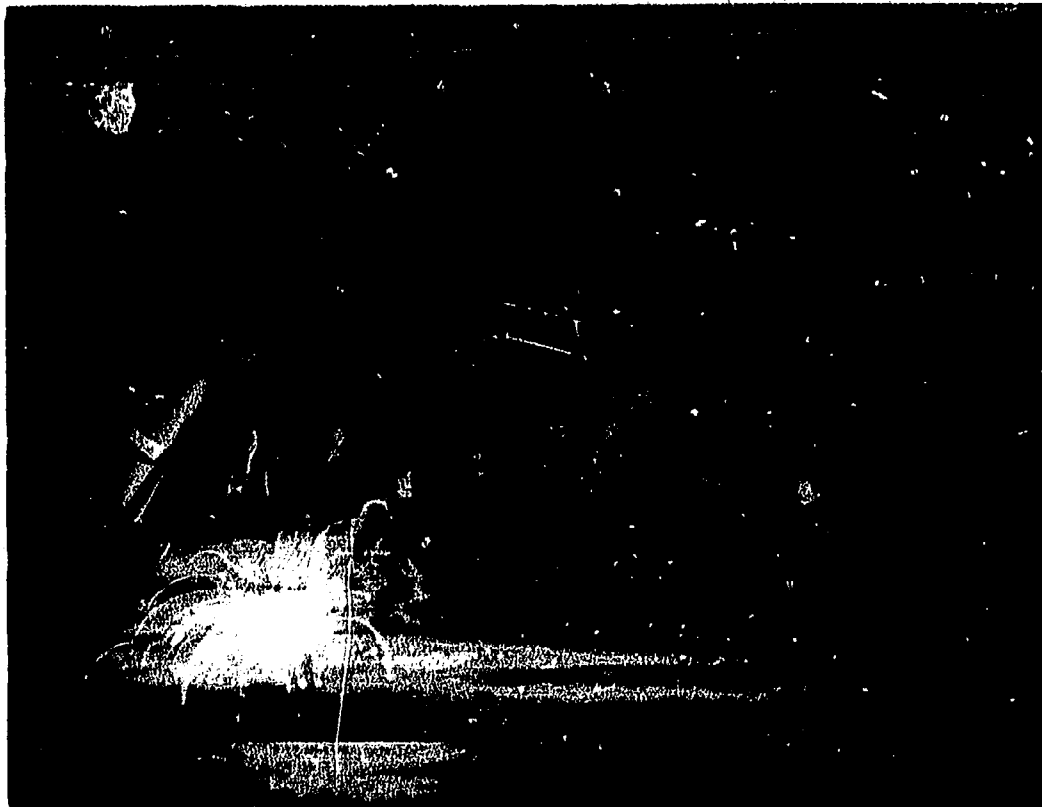

Figure 5-9.--Luminous effect.

BEST COPY AVAILABLE

142.257

Table 5-1.—Hues, Names, and Characteristics of Paints

HUE	NAME OF PAINT	CHARACTERISTICS
RED	Alizarin crimson*	deep rich red; cool
	Cadmium red*	toward orange; warm
	Vermillion, light	toward orange; warm
	Cadmium orange	toward red; warm
YELLOW	Cadmium yellow medium*	brigh: yellow; warm
	Yellow ochre*	dull yellow toward orange, warm
	Cadmium yellow, lemon	pale yellow toward green; cool
BLUE	French ultramarine blue*	intense blue; cool
	Cobalt blue	toward violet; cool
	Cerulean blue*	toward green; warm
	Thalo blue	intense blue; warm
GREEN	Viridian green*	intense green; cool
	Hooker's No. 2	intense green; cool
	Thalo green	blue green; cool
BROWN	Raw sienna	dull yellowish brown; warm
	Burnt sienna	reddish brown; warm
	Raw umber	gray orange; cool
	Burnt umber	gray reddish borwn; warm
BLACK	Ivory black	
	Lamp black*	
WHITE	Flake white	
	Titanium white*	
	Chinese white	
	Zinc white	

*Recommended for a basic or starter palette.

In painting, you work with colors that have the special property of reflecting the particular color waves you want. When primaries are mixed, however, they tend to neutralize one another. Therefore, you should have a double set of primary colors (one warm and one cool) to enable you to retain brilliance for better reproductions. For example, a cool red and a cool blue to get a brilliant violet or mix a warm red and a warm blue to get a neutral violet.

Paints, such as watercolor, tempera, and acrylics, use water as a vehicle or carrier and are a popular color medium. Techniques for using these as color media are similar to the techniques described in *Illustrator Draftsman 3 & 2* for using wash and opaque black and white.

PASTELS

A dry and almost pure pigment, pastel is compressed into stick form and made in soft, medium, and hard grades. Because of its purity, pastel can be obtained in extremely brilliant colors as well as in subdued hues.

Pastels work well on paper with a slight tooth. You should use pastels when experimenting with various color schemes because they are quick and easy to apply. Use the end of the stick for line effects and the side of the stick for broad strokes of flat overall tones. Spray a finished pastel illustration with a fixative to prevent smearing and dusting.

WATERCOLORS

Transparent water color paints come in three forms: cakes, pans, and tubes. The tube form should prove to be easiest to work with because tube paints are semiliquids that mix easily and quickly with water.

You may use any method of preparing your wash that works best for you. One method calls for a strong value base wash; which you can lighten by adding water. When preparing a wash, mix enough to last through the entire picture; it is better to prepare too much wash than not enough.

Because watercolor washes are transparent you may darken the value, change the hue, or

weaken the intensity by laying one wash over another. Speed is an important factor in using watercolors. If you stop in the middle of a wash you are almost sure to end up with streaky uneven blends.

TEMPERA

The term, tempera, refers to opaque watercolors, such as gouache and casein. Gouache is a manufactured mixture of transparent watercolor and white pigment. Designer's color and poster color are product names for gouache. Designer's color is of good quality and may be used for opaque watercolor painting; poster color is suitable for showcard lettering. Casein may be used as an opaque medium or a transparent medium, depending upon the amount of water added. Tempera mediums are being replaced by acrylics.

ACRYLIC POLYMER PAINTS

Acrylic polymer is a name for paints that have a binding vehicle of polyvinyl acetate or acrylic resin. Most commercial brands of acrylic polymer paints are water based and handle with the ease of watercolors. They dry quickly and, when dry, become water insoluble.

Acrylics may be used as a watery transparent wash or an opaque paint, depending on how much water is added. There is no need to change your style, method, or technique when you use acrylics. Use the familiar techniques of painting with watercolors or opaques, except that wet brush blending is not possible with opaques. However, dry brushing techniques will work for softening edges. Use soft hair brushes with watery acrylics; stiffer bristle brushes and nylon brushes with opaques. Due to the quick drying property of acrylic paint, you should dip your brushes in water frequently as you work, and at all times when you have stopped for a moment. If the paint dries in your brush, remove it with a paint remover or acetone. Acrylic paint manufacturers also supply a special solvent for removing dried paint.

CHAPTER 6

VISUAL PRESENTATIONS

As an Illustrator Draftsman, you will be preparing visual aids to support instructional activities, command briefings, conferences, and lectures. Techniques for preparing projectuals were covered in *Illustrator Draftsman 3 & 2*, NAVTRA 10469-A. This chapter will further describe some basic principles and techniques for designing training aids, arranging presentation rooms, preparing television graphic material, and designing display materials.

DESIGNING TRAINING AIDS

As a senior DM it will be your responsibility to aid the job requestor in planning effective training aids. Many things determine the appropriate training aid for any lesson. Obviously the aid used must be specific to the topic of the lesson.

Examination of a wide variety of training aids shows that they can be divided into two major families. The first, "demonstrative aids" are those used in knowledge instruction; the second, "manipulative aids" relate to skill instruction. Of course your primary concern will be with the demonstrative type which the trainee looks at and from which he acquires knowledge.

Demonstrative training aids should be designed to show those things, processes, or concepts about which the trainee must acquire knowledge and which are naturally invisible (gases, electrons), hidden (internal parts), or obscure (difficult to understand, such as tables or figures). Also training aids may be used in place of things and processes that are physically dangerous, or others that are so few in number or costly as to be rarely available for classroom instruction.

Training aids employing overlays may be designed to present a series of ideas, points, or steps in a process. This type of training aid is a good teaching tool because it progresses from the known to the unknown.

The following information describes some fundamental points that you should consider when designing training aids. Designing and constructing training aids that simulate motion will also be covered.

SIMPLICITY

Simplicity is essential. Training aids that are too complicated may not be understood, and aids that offer too much information at one time may not be completely read. People in general will pass up an aid with too much detail on it. Remember the rule: Bold and simple.

LEGIBILITY

All copy or lettering must be legible. Fancy lettering may "look good" on paper, but might not permit the audience to understand what is written. After all, lettering is used only when necessary, and the audience should be able to read it.

The size of the written material in a training aid is important to legibility. Try to keep main subjects or centers of interest large. Try to limit each visual to no more than 5 or 6 lines of lettering. This practice will allow you to make all lettering large and bold. If you use letters that are too small, they will not be seen or will not be noticed. The boldness of lettering is also important because thin letters and lines may not appear clear to the trainee.

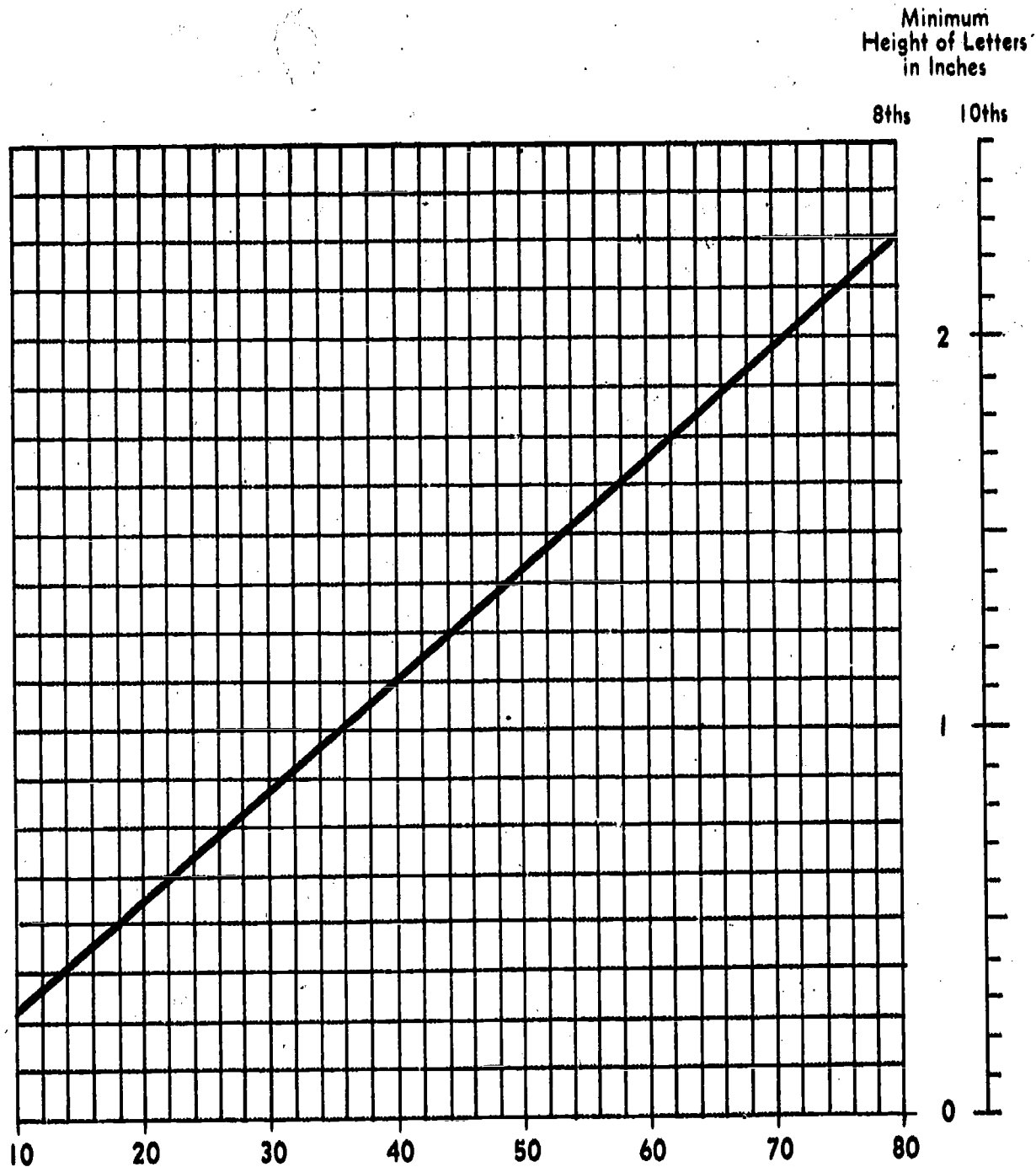

149.93

Figure 6-1.--Minimum lettering height for persons with approximately 15/20 vision.

Figure 6-1 shows the minimum height of lettering and the distance it can be seen by a person with approximately 15/20 vision. For example, if the farthest viewer sits 40 feet from the training aid the minimum lettering height should be 1-1/8 inches. This figure is found by finding 40 on the horizontal scale at the bottom of the graph running a straightedge from the 40

up to the point where it crosses the inclined straight line, and then horizontally to the right to the vertical scale.

In summary, to ensure legible training aids make samples and view them in the room in which they are to be presented. Thus you may determine which looks best and how large the lettering should be.

EFFECTIVENESS

Coordinate the development of the graphic or series of graphics with the instructor to be sure that your work illustrates the points that he wants presented. Some of the factors you would want to explore with the instructor are what, specifically, he wants to illustrate or emphasize; if any details should be enlarged or made more clear; and if there are any technical elements, such as colors or symbols, which you should use. If color is desired, keep in mind the added expense and methods of preparation or reproduction available.

The instructor may want to show a particular part of some equipment, and emphasize this part while showing its relation to the rest of the equipment. You can help him by drawing the part in a bold manner, or with greater contrast, and the rest of the equipment with a softer appearance. See figure 6-2. If reproducing from a photograph or existing art, use a masking technique.

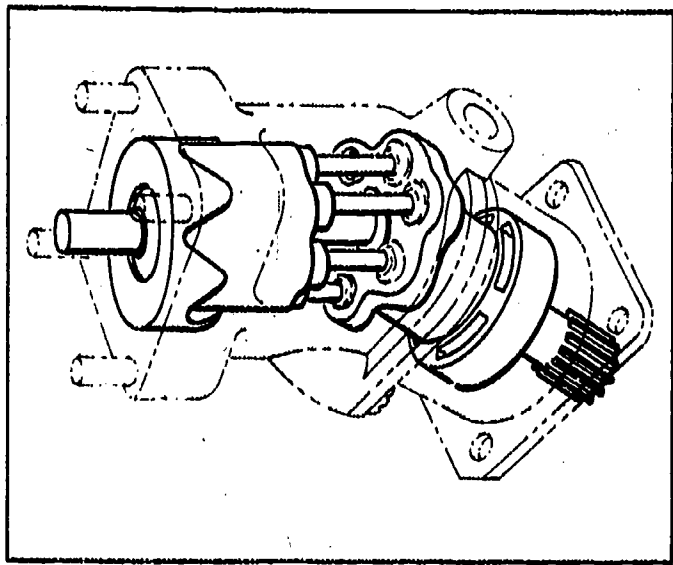

142.312.4

Figure 6-2.—Phantom view.

If some element should be enlarged to show detail you can show it on another graphic, or as an inset on the basic graphic. You can separate an inset from the main drawing, or make it seem to be part of the drawing, by making it appear to be seen through a magnifying glass, or as a

perspective that rises from the drawing to be seen in a closer plane. See figure 6-3.

Often colors will have to be selected for technical rather than artistic reasons. Many electrical and hydraulic systems use color codes which the instructor may want consistently represented in his aids. When drawing pictures of equipment, always pay attention to details, such as the shape and color of knobs, valve handles, and controls. Many of these are coded as to shape and color, and the men viewing your picture are expected to be able to identify these controls instantly by sight or feel, so do not confuse them.

EFFECTS OF MOTION

Often an instructor will want his training aids to demonstrate either an illusion of motion or the effects of motion. The most suitable training aid for the purpose is a motion picture, but if a film is not available to show the desired action, you may be asked to develop training aids which will achieve the same result.

When you see that some form of motion should be expressed in the training aid, you must analyze the training objective and determine whether the trainees are to be impressed that motion does occur, as in fluid flow diagrams, or if they are to be shown what the result or effect of the motion is.

One way of producing an illusion of motion with a viewgraph is to actually have some element of the illustration move. The parts to move can be cut to shape and arranged so that the instructor can move them on the stage of the projector.

Another, and more sophisticated, way of showing motion is to use an effect produced by polarized light. A polarized filter orients the direction that light waves vibrate. When light travels through two polarized filters, the amount of light transmitted will depend on how the two filters are oriented toward each other.

As polarized light travels through a transparent material that has been stressed, the axis of the light is turned. Assume you have two polarized filters, such as the lenses of polarized sunglasses, and hold a piece of cellophane between them. If turned to the correct angle,

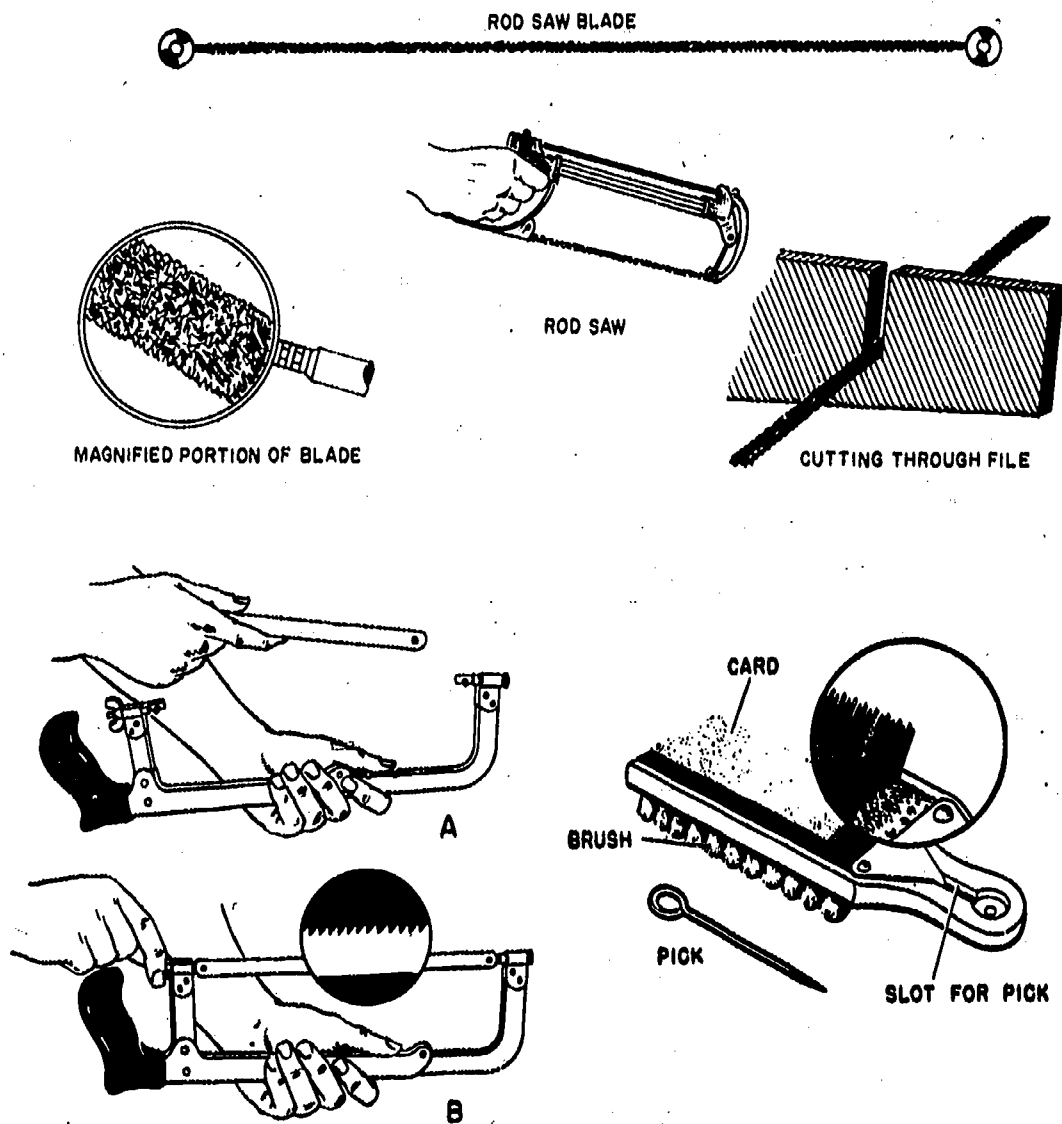

Figure 6-3.--Insets.

29.15:44.11:168

the cellophane will permit light to come through, when the lenses are blocking other light, or may block light, when the lenses are transmitting it. This effect can be used in a viewgraph by placing a sheet of polarized filtering material on the stage of an overhead projector and a rotatable polarized filter (analyzer) on the projector-head (fig. 6-4). Cellophane pieces are cut to the desired shape at changing angles to the stress axis of the cellophane piece, and pasted on the viewgraph.

As the analyzer filter is rotated the cellophane shapes will go dark and light; as one appears and another disappears, they seem to change position.

Polarized motion material, made to apply to viewgraphs, is commercially available under the tradename of Technamation. This material is constructed with an adhesive-backed polarizing filter and piecut cellophane strips. The cellophane strips are attached to the filter in parallel, shingle-like columns. They are cut at specific

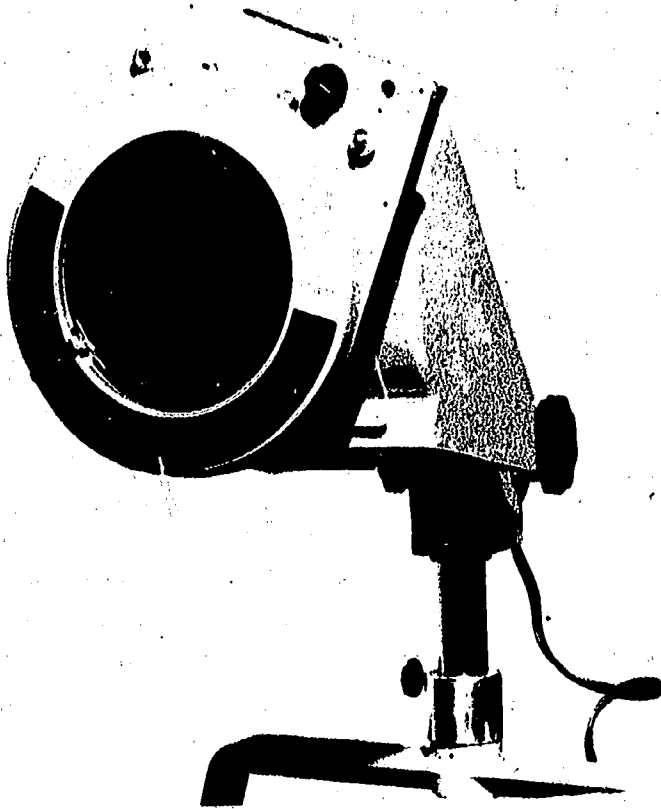

142.116(149A)

Figure 6-4.—Overhead projector with analyzer in place.

angles of deviation (0, 5, 10, and 15 degrees) from the direction of stress and attached to the filter in increasing order of angle size. This series of angles can be repeated over and over, thus creating the illusion of movement. Technamation materials that are available include linear (straightline motion), circular (rotary motion), turbulence (combustion or gas action), radiation, and blinking.

The projected light from the overhead projector is dimmed considerably by the filters that have been added to the viewgraph. To overcome the dimming, use a reversal or "negative" type of viewgraph. Another advantage of using a reversal is that you may cut the filter larger than the image it covers, thus making the cutting task simpler.

Technamation is applied to a viewgraph while it is face up, assuming the front projection method will be used. To make it easy to see, place the viewgraph on a light table. Follow the steps as described in Figure 6-5. Heat from the

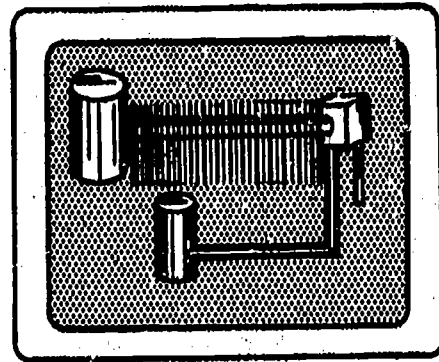

1. PLACE A SHEET OF TECHNAMATION OVER THE AREA WHERE MOTION IS DESIRED.

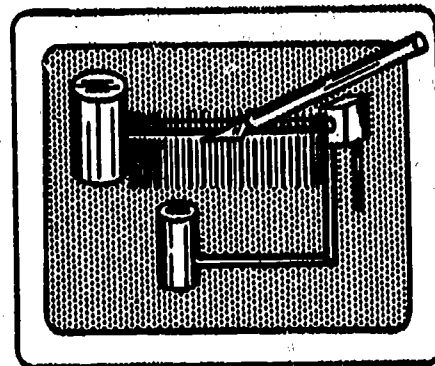

2. SCRIBE THE OUTLINE OF THE AREA WITH AN X-ACTO KNIFE. DO NOT CUT COMPLETELY THROUGH THE PROTECTIVE BACKING PAPER.

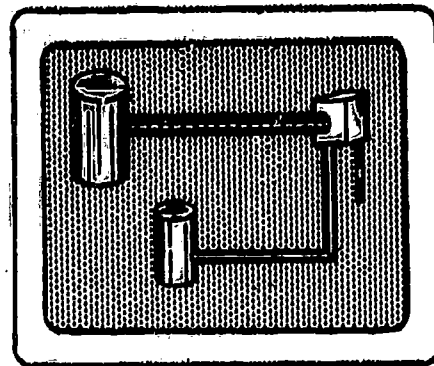

3. REMOVE THE DESIRED OUTLINE, AND ATTACH IT TO THE VIEWGRAPH. THE VIEWGRAPH IS NOW READY FOR PROJECTION.

149.92

Figure 6-5.—Steps used to apply technamation.

projection lamp can cause polarized strips to blister and peel. Therefore, burnish them in place firmly and carefully.

A polarized hand spinner enables you to simulate the functions of an analyzer when producing the viewgraph. When you use this hand spinner, be sure to rotate it in the same direction the analyzer rotates.

When the analyzer is rotated, motion seems to occur where the material was applied. If the material is applied so that the flow is in the wrong direction, it may be removed and inverted if its shape is symmetrical. Reversing the rotation of the analyzer will also change the direction of apparent motion. Additionally, cellophane will act as a reversing sheet by refracting (bending) the light rays in the opposite direction. Thus any foil or tape added for color may affect the apparent direction of flow. Color variations may be introduced by overlapping several layers of stressed cellophane. Again the direction of flow may be reversed so you should check the color effects and direction flow with the hand spinner.

To create the effect of motion the analyzer must rotate continuously at a fixed speed. Analyzers are available in two types: motorized and hand operated. An analyzer is marked with an index code (numbered 1 through 9) representing 180 degrees of turn. If necessary, the operator can control where the motion effect will start on each viewgraph. To key each viewgraph to the analyzer, you will have to preview each one. Place a viewgraph on the projector and set the locator at 1. Look at the screen to see if the desired effect is starting at the point you wish. If so, mark the viewgraph "1". If not, try the next setting, repeating the procedure until the desired effect appears. If the effect starts at "1" and ends at "3", the viewgraph should be marked "1-3".

A motion picture film is a series of still pictures, showing a sequence of relocations of objects, people, and so on. A series of viewgraphs or slides can show the same sequence, although the series does not produce an illusion of motion as a motion picture does. The difference between one picture and the next will be much greater than the difference between successive frames of a motion picture film. Even

with rapid slide changing it is not possible to make the features shown appear to move.

The things you can illustrate with series pictures range from simple two-position actions, such as the open and closed positions of a valve, to progressive actions, such as the procedures for lighting off a boiler. Series pictures can also show conceptual developments, such as how target information is processed from initial acquisition, through evaluation, and to intercept.

In summary, to develop effective training aids which illustrate motion, you must analyze the effect that must be produced, coordinate the development with the instructor, and use your knowledge of techniques and materials as well as your imagination.

ARRANGING A PRESENTATION ROOM

The use of visual aids greatly increases one's ability to communicate. Visual aids are often used for presentations that are similar to, but not directly directed to, training. You may have to prepare aids for staff presentations of various sorts. If you are in charge of preparing the visual aids you may also be in charge of preparing the physical arrangements of the presentation room. You can improve the staging of a presentation by controlling the environment. The following aspects of environment can usually be controlled: space arrangement, lighting, and mechanics. Careful planning of each aspect pays off by increasing audience attentiveness.

SPACE ARRANGEMENT

Important factors to consider in space arrangement are the screen and the line of vision. The location of the narrator and screen in relation to the audience should assure each person in the audience a clear view of both.

The screen should be high enough so that the audience has an unobstructed view. From the person nearest to the front to those in the rear, there should be no obstacle to vision.

In most situations, particularly in rooms where the floor does not slope and there is no platform, the bottom edge of the screen should

be at least 4-1/2 feet from the floor. With the screen at this height, most people will have an unobstructed view.

The screen should be tilted as necessary to eliminate "keystoning" (that is, a distortion of the image in which the top of the picture is enlarged out of proportion). The principle involved is that the plane of the screen should be at a right angle to the centerline of projection; otherwise the image will be distorted (see figure 6-6).

Two general types of screens are available for projection use: front projection screens, which are opaque surfaces; and rear projection screens, which are made of translucent material.

Front projection screens fall into three categories: beaded, mat finish, and lenticular. The lenticular screen is made up of tiny lens elements that confine the reflection of transmission of light and permits wide-angle viewing.

Rear projection screens are of two general types: the translucent mat finish and the lenticular type. If the screen has a finish on one side and a polished surface on the other, turning the polished surface to face the viewer will

afford good contrast but will reflect room light and will probably necessitate complete darkening of the room. If the mat finish side is turned to face the viewers, contrast will be slightly less but room lights can be used, which is a desirable feature.

Wide horizontal angles of vision should also be avoided. In an oblong room, the screen should preferably be parallel to the shorter dimension. If the screen is set parallel to the longer dimension, the angle of vision at either side becomes too great for easy viewing.

For optimum viewing, the accepted standards for audience placement in relation to the screen are:

- Distance to the closest viewer: Two times the width of the screen.
- Distance to the farthest viewer: Six times the width of the screen.
- Widest angle of view:
 1. Beaded screen— 22° from the centerline of projection.

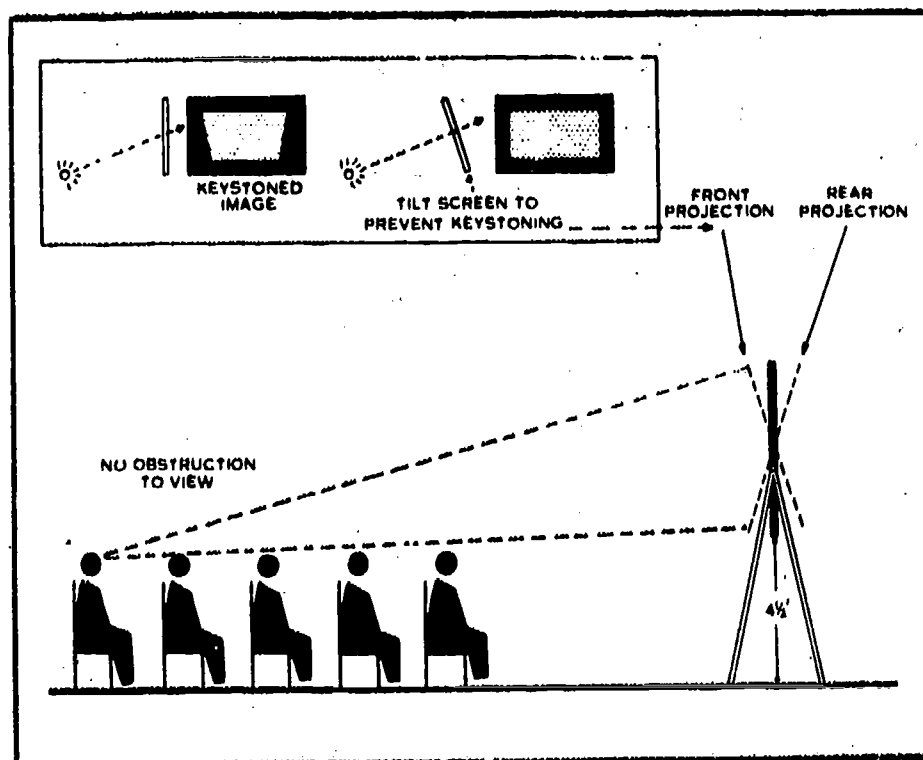
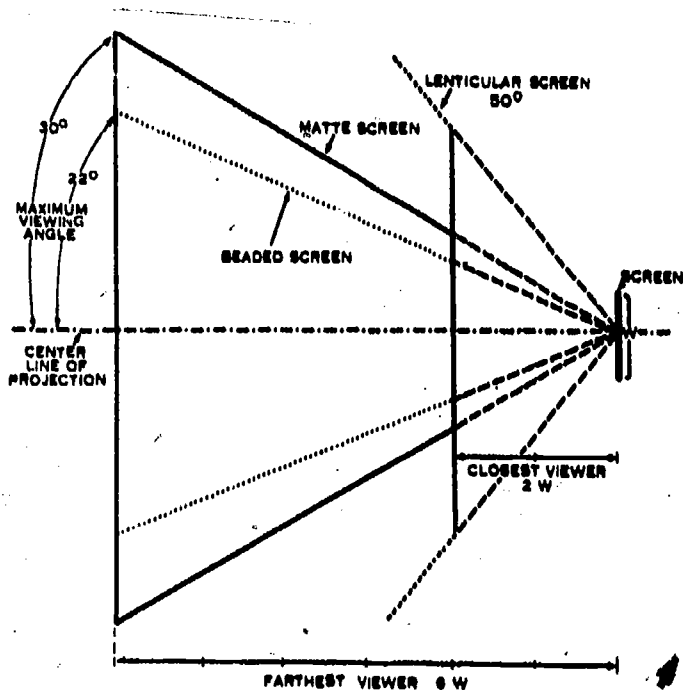

Figure 6-6.—Proper screen positioning is very important in staging a speaking area.

2. Mat-finish screen— 30° from the centerline of projection.
3. Lenticular screen— 40° to 50° from the centerline of projection. See figure 6-7.



174.21

Figure 6-7.—Accepted standards for audience placement in relation to the screen.

When faced with a situation where a screen is not available, you may project the image from the overhead projector directly on a wall. You may cover the wall with illustration board or some other type of white material for good color viewing. If the wall is a light color, the covering is not essential.

Another important principle in planning the space arrangement is that the narrator should not stand in the line of vision. The lectern should be set to one side of the screen, leaving a clear view of two-thirds of the stage area and only partially blocking the remaining third. On the opposite side of the screen from the lectern, A-frames, flipcharts, chalkboards, and so forth can be set up for optimum visibility.

LIGHTING

Proper lighting is important to relaxed viewing. Without question, the less the room

light, the more brilliant the image on the screen and the greater the contrast. But, brilliance and glare can be annoying and can cause eyestrain. A proper level of room light reduces the contrast and permits viewing with a minimum of strain. There should be enough light, but not so much as to distract the audience.

Room light should have its source behind or, at least, to the rear of the audience (see fig. 6-8). In this way, glare spots in competition with the screen are avoided, and the intensity of extraneous light on the screen, which would tend to reduce contrast, is also avoided.

Front lights produce too much light on the screen, and their glare is distracting. Also, never schedule an overhead projector presentation in a room which has windows that cannot be draped if the sun will be shining against the windows.

MECHANICS

A well setup presentation area with smooth-working equipment can add immeasurably to the narrator's confidence and poise. At the same time, nothing can ruin a presentation more than equipment that functions incorrectly or audio-visual devices that can't be seen or heard. The operation and noise of a projector can be distracting influences, and should be kept to a minimum.

Projectors should be set up with the lens parallel to the screen to prevent sideway keystoneing. Allow sufficient distance so that the image fills as much of the screen as possible while retaining sharp focus and good brilliance.

Front projection has certain advantages in that the narrator is able to operate the equipment, thereby eliminating the need for an additional operator. However, when possible, the mechanical equipment used in a presentation should be kept in the background (either behind the screen to the rear of the audience or in an enclosed projection booth) to eliminate a potential source of distraction. In the latter case, an additional operator will almost certainly be needed.

The rear projection arrangement has several advantages (fig. 6-9): (1) it hides the projector and its operator, (2) room light falling on the screen does not deteriorate or wash out the

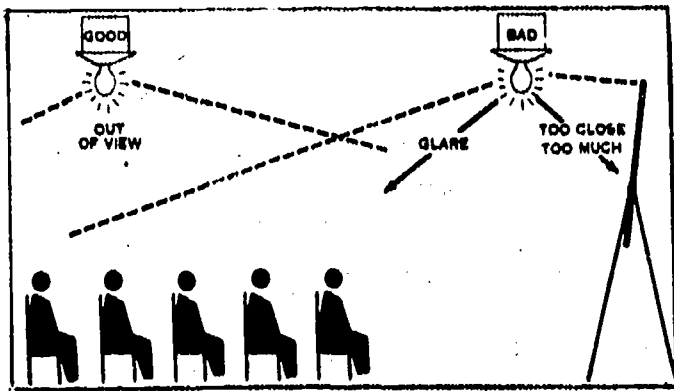

174.22

Figure 6-8.—Room light should have source to rear of audience.

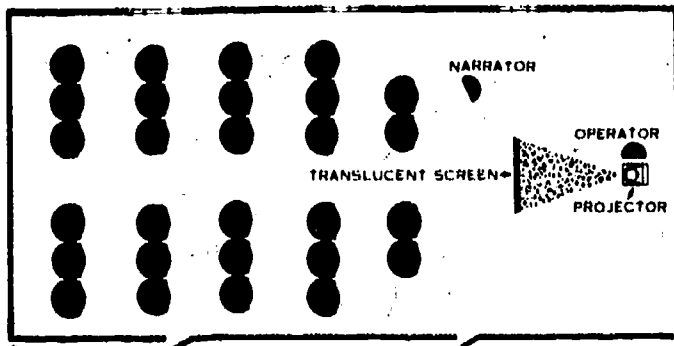

174.24

Figure 6-9.—The mechanics of a presentation should be kept in the background.

projected picture (assuming the mat finish side of the screen is facing toward the viewers), and (3) the narrator may work close to the projected picture with no worry about blocking the light from projector to screen. Television shows often make use of the rear projection method for the foregoing reasons.

When using more than one type of projector for a presentation (using the rear of audience or projection booth method) stagger the heights of each projector (fig. 6-10). This will ensure that each machine will not project the silhouette of the projector in front.

After your projectors are in position, take the following steps:

- Connect power cords, making sure all connections are firm and cables placed so people will not trip over them causing damage to themselves and to the machinery.
- Turn on machines, check for proper operation, and familiarize yourself with all controls. Always keep a spare lamp or bulb by each machine.
- Run through material to be projected, checking for relevance of material, quality of projection, and focus.
- Set each machine for immediate cue in.

Speakers should be placed as far forward from the lectern as possible (while still remaining in front of the audience) to avoid microphone squeal or feedback.

TELEVISION GRAPHICS

Many ships now have closed circuit television systems, and several Navy bases operate their own television stations. As the Navy uses more television for entertainment and training, there is a greater chance that you will be preparing

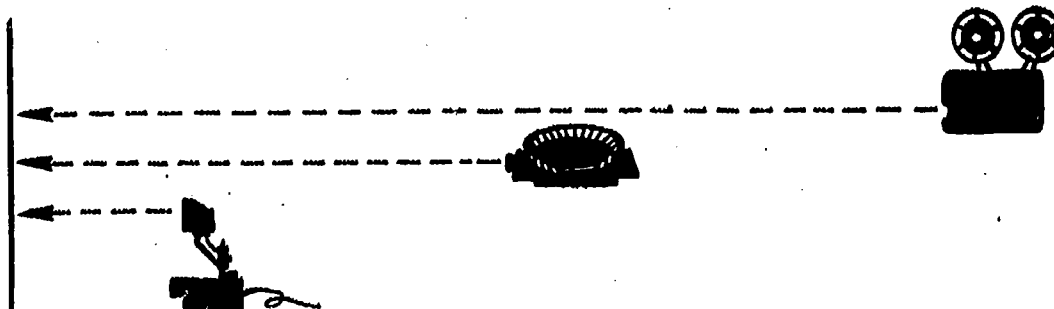

Figure 6-10.—Stagger the height of each projector.

174.26

graphic material to support television programming.

All television shows use graphic materials, such as title cards, photographs, and charts. These materials greatly enhance news and feature productions, spot announcements, and nearly all television programs. Keep in mind that in television, it is important that visual information be presented as often as possible. Without visuals, the program might as well be on radio. People tend to be "visual prone." Generally, they remember this type of information better and longer than just the spoken word. The basic reason for having television is to see what you formerly could only hear.

SHAPE OF TELEVISED PICTURE

The shape of the television picture tube conforms to an established formula. The proportions of this standard shape, called the aspect ratio, are three units high and four units wide. This ratio approximates the dimensions of the normal range of vision, our horizontal range being about one third greater than our vertical range. Pictures that do not conform to this aspect ratio are said to be "out-of-ratio". If you are starting with an out-of-ratio rectangular picture, part of it would not be sent out over the system without "overshooting" (showing the sides of the graphic). Only the 3- by 4-unit shape will be transmitted regardless of the original format of the picture information—unless special shooting techniques are used.

SIZE OF VISUALS

There is no unique card size for all television artwork or pictures. However, a generally accepted standard size for cards is 10 by 13-1/3 inches; the copy occupies a space nearly 7.5 inches wide and 10 inches long. The use of this size card offers the following advantages:

- Easy to handle without danger of damaging the artwork.
- Easier to handle one size on a card stand than a variety of sizes.

- Fits into a standard file cabinet where it can be kept in good condition.

- Can be cut from standard-size board stock (30 by 40 inches) without waste. When cut properly, each piece of this stock makes 9 cards.

- Accommodates photographs and pictures in sizes through 8 by 10 inches, including pictures from most magazines.

ART AREA LIMITATIONS

Regardless of the size of the visual, you must keep in mind three very definite area limitations when designing or preparing artwork for television. They are called the scanning, essential (safe title), and border areas. Standards for these areas were developed by the Society of Motion Picture and Television Engineers and the major television networks to guard against loss of lettering and other essential information. Refer to figure 6-11.

Scanning Area

The total picture or area that the camera "sees" is called the scanning area. However, there is a peripheral loss of picture area caused by transmission and reception. The actual amount of loss depends on camera adjustment and the condition of the television receiver, but is usually about 10-15% of the total scanning area.

Essential Area

The part of the picture that is seen by the viewer should be no less than the total amount of essential information to be put across to the viewer, so this portion of the visual is called the essential area. In the case of program titles or credits, for example, the essential area includes all of the title or other lettering.

Border Area

Every visual needs a scanning area and an essential area. However, the border area is

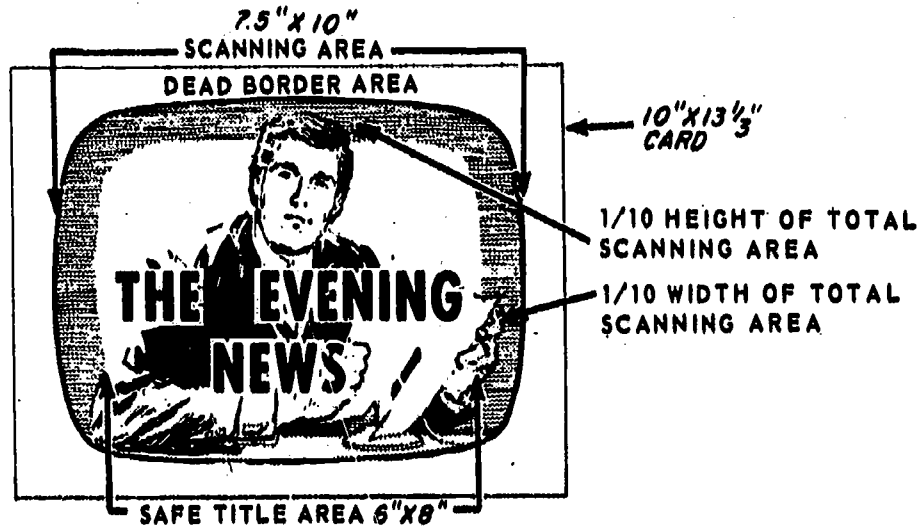

Figure 6-11.—Area limitations for TV graphics.

174.84

sometimes almost as important as these two. There should always be a border around the scanning area for several reasons:

- A border helps protect a picture from damage if dropped.
- A border protects artwork from fingerprints and smudges by providing a "handling area."
- A camera may have to turn quickly to a card. The border may prevent the audience from seeing past the card at some behind-the-scenes activity if by chance the camera did not have the time necessary to properly frame on that picture.

TYPES OF VISUALS

Visuals come in various forms, each having a name that makes it easily identifiable to production and graphics personnel.

Card Types

One type of card frequently used in the studio is the **STANDARD STUDIO CARD**. It

offers only illustration or pictorial type information—never with lettering. The picture may be a mounted photo or an illustration. Thirty-five millimeter slides and other transparencies are usually made from standard cards.

Most of the other cards fall into a general section—the title cards.

- The **PLAIN TITLE CARD** has printed information only. This card may be dark or light with contrasting letters, and must give the needed information in the fewest possible words. People watch television to look at pictures, not to read long messages.

- The title card that has both printed material and pictorial information is the **ILLUSTRATED TITLE CARD**. The picture may be either artwork or photography. The lettering may be either on the card itself or on an overlay.

- A **SUPER TITLE CARD** is one that has white lettering on a dark background. This image is "superimposed" over another picture from another camera. This technique is good for placing the name of a person on the air at the same time he is talking. Don't superimpose titles over faces. Use the lower third of the super card. The super card is an example of an application of two extreme shades.

Whenever possible, put motion into your visuals. For example, you could prepare a pull card to make lettering or graphs appear gradually. It's a simple technique. Assume that you would like to have the line "Read along with me" superimposed, letter by letter. First prepare a super card with the sentence on it. Then take a plain black studio card and darken the lefthand edge where the board has been cut so that the white of the edge will not bleed through during a super. This card will cover the super card. By pulling this cover card from camera left to camera right, you will gradually reveal the letters of the title. Variations of this "pull-off" method can be used to show graphs and a variety of motions. See figure 6-12. For smooth handling, you'll find it helpful to put a "pull tab" on the edge of each pull card. Such tabs can easily be made of masking tape.

A card that has a picture in either a vertical or horizontal format must be handled differently:

- The TILT CARD is a vertical card in which the camera will tilt up and down to cover the information.
- The PAN CARD involves the side-to-side panning on a card with a horizontal format. This is another method for getting motion from an otherwise static visual.

Flat Picture

The flat picture, or still, is used in some situations. It may be any size according to production needs. Maps on walls or large "poster type" drawings are considered to be stills, the

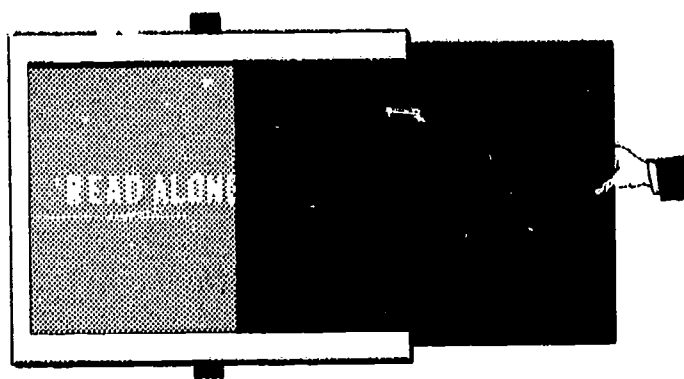

174.85

Figure 6-12.—The title card pull-off technique.

same as the smaller 10- by 13-1/3-inch cards. Stills are shot "live" in the studio in front of the cameras.

35-mm Slides

The most common means of presenting still visual information on television is the 35-mm slide. It is generally introduced into the system via the projection room (or film chain as it is sometimes called). The changing of slides is done from the control room, and there is no delay between pictures which eliminates the need to tie up a studio camera with artwork. These slides are extremely convenient and economical in color television.

Polaroid Slides

Slides may also be made with a Polaroid Land camera and positive transparency film. Polaroid Land cameras are available that can make pictures 3-1/4 by 4 inches in size, in color, or black-and-white print; print-and-negative combinations; and transparencies. These transparencies are a popular means of acquiring fast visuals for television. Pictures may be taken and shown almost immediately afterward. Plastic frames for mounting the transparencies are also available.

Polaroid slides work well for rear projection during news and other information productions. In addition, rear projection enables a variety of background settings in other types of productions.

Viewgraphs

Viewgraphs are quite useful in the television studio. They can be shown by placing them on a light box, which need only contain a low wattage bulb and a good piece of frosted plastic or glass to diffuse the light, or by using the overhead projector for either a frontal or rear projection screen. Either way of televising viewgraphs works well.

Drop Cards

Drop-out, drop-in, or crawl title cards are often convenient when you must present lots of lettered information, such as sports scores and closing credits.

The drop-out or drop-in cards must be specially rigged. They work on the same principle as loose-leaf folders, except that the ring binders are mounted horizontally on a board or stand. Perforations are made along the bottom of each drop-out card and along the top of each drop-in card. See figure 6-13. When changing from one drop-in card to another, the card seems to fall "into" the camera shot and therefore seems to "appear" on the screen. Drop-out cards seem to fall "out" of camera range or "disappear" from the screen.

Crawl Devices

Many TV shows use crawl titles in displaying closing credits. Typically, a series of titles, credits, or sports scores is reverse lettered (light on dark) on a long strip of paper, which is then fastened to a drum (called a crawl). The drum can be rotated manually—usually by some sort of hand crank—or is motor-driven. See figure 6-14. As the drum turns past a fixed camera shot, the lettering moves slowly.

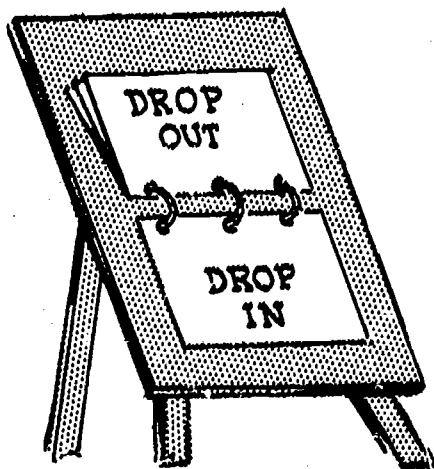

Figure 6-13.—Drop cards.

174.86

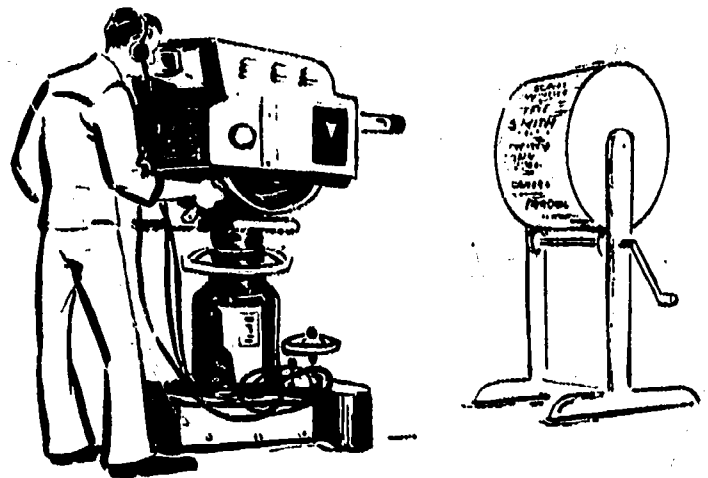

Figure 6-14.—Crawl device.

174.87

CONTRAST

Contrast is probably the most important quality involved in good reproduction of a televised picture. Good contrast means that the picture has enough dark and light areas to make the subject matter stand out well. An all-over gray picture of about the same shade will not show well over TV.

Assuming that a black-and-white TV receiver is properly adjusted, a maximum of eight distinct values of gray plus black and white are distinguishable. However, because of transmission restrictions you must be careful in using grays. If you place two only slightly different gray values side by side, they will probably look alike when reproduced on the screen. You should compensate for this by using well separated grays when making illustrations. In general, you should use only three or four plus black and white.

Your first thought may be that the use of black and white would give the best combination for your illustrations. However, this is not so in television. Too much contrast can cause "halo" (glare effect) and horizontal streaking when the two extremes are used adjacent to each other. Thus, it is better to save the black and white for small center-of-interest items that need emphasizing.

Although using black and white in all your illustrations may not always be appropriate from your viewpoint as an illustrator, the video

engineer finds it most desirable because he sets his video levels on a black-white basis. Therefore to help him establish the video levels, black and white should be present in your illustrations.

When preparing visuals for color TV, use similar principles of contrast. Hues normally reproduce just as they look to the eye. However, grays are hard to reproduce. They may turn into another color because of misadjustments in the TV receiver.

The number of values you may use for color TV is limited just as in black-and-white TV. To enable color visuals to be reproduced in black and white, your color must have sufficient value contrasts. To be safe, limit your palette to about three tints and two shades of each intense hue. More than six values of a single hue will be hard to distinguish when reproduced. For good color reproduction from cards use a mat finish paint rather than a glossy, shiny paint.

Tints of hues, such as yellow, will not reproduce well and will look white. Shades of blue or red hues may turn black. Therefore, you will be further limited when using these colors. The best way to determine the limitations of colors on TV is by actually experimenting with them.

POSTERS

The poster is a distinct art form. Too often it is treated as an illustration with text. Such treatment ignores the purposes of the poster, which are to attract attention and to get a message across quickly. The lettering on a poster should be a part of the design and the message should be as brief and clear as possible.

There are a number of simple techniques which are very effective for posters. Even if you are not an accomplished illustrator, you can compose excellent posters using these techniques.

First decide how your poster is to be reproduced. Its purpose and the number of copies required will have a lot to do with that decision. If only one is needed for classroom use

in a training program, you can use any art technique you desire in rendering it, but the simplest and quickest is preferable. If a dozen or more are needed for local use, it may be best to design the poster for reproduction with a stencil and airbrush or some other quick rendering technique. Or it may be reproduced by diazo on one of the poster boards available, in which case you need to draw the original on translucent paper and to the correct size to fit the board. If more are needed, they may be reproduced by the screen printing process or lithography.

One of the simplest techniques consists of drawing a simplified silhouette, such as a silhouette of a couple dancing for a party poster. You can work from an illustration or a photograph to get the correct proportions and the action. When you have a silhouette you like, trace its outline on a piece of colored paper or make several silhouettes on different colored paper and try these out on your poster board. Combining them with cutout letters, which are available commercially, you can make a very interesting poster.

The silhouette may also be used as a pattern for a painted or printed object on the poster, or indicated by stripple or airbrush effects. Figures 6-15 and 6-16 show effective and simple posters of the type in which flat shade areas were used to add interest. This type of poster may be reproduced effectively by the screen printing process.

To create a poster of this type, start with a photograph of the subject. You may enlarge it to the desired size by using a projector. Then trace outlines of the subject, including the outlines between different value areas. The result may look something like a jigsaw puzzle. It is usually best to use no more than five or six colors. When a figure is to be reproduced, three of the colors may be flesh graded from light to dark.

Figure 6-17 shows two Navy recruiting posters which are good examples of effective poster layouts. Figure 6-18 shows that photographs can be used to create very effective and stimulating poster designs.

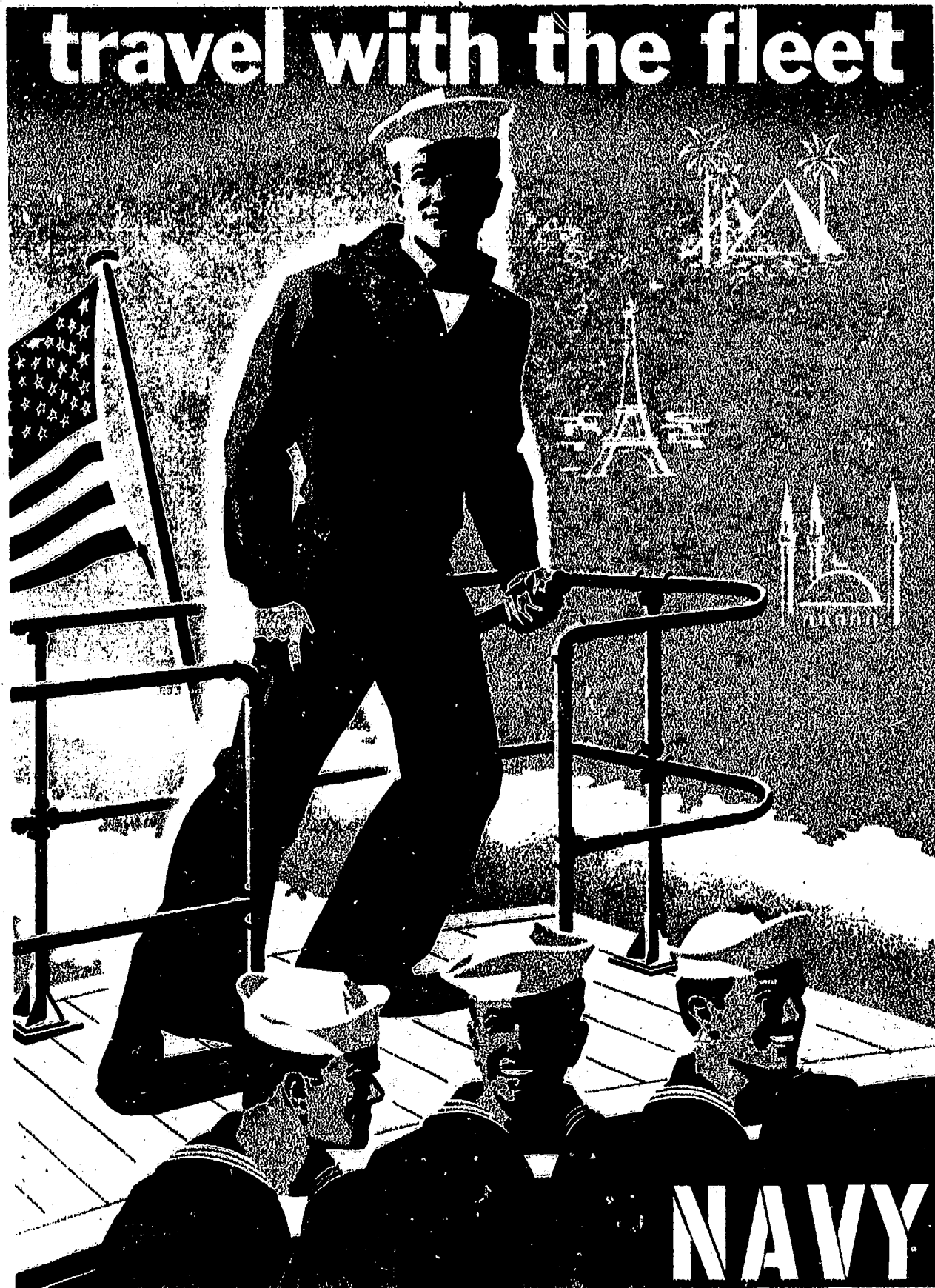

Figure 6-15.—The flat patch technique.

149.50.0

travel with the fleet



Figure 6-16.—The flat patch technique.

149.51

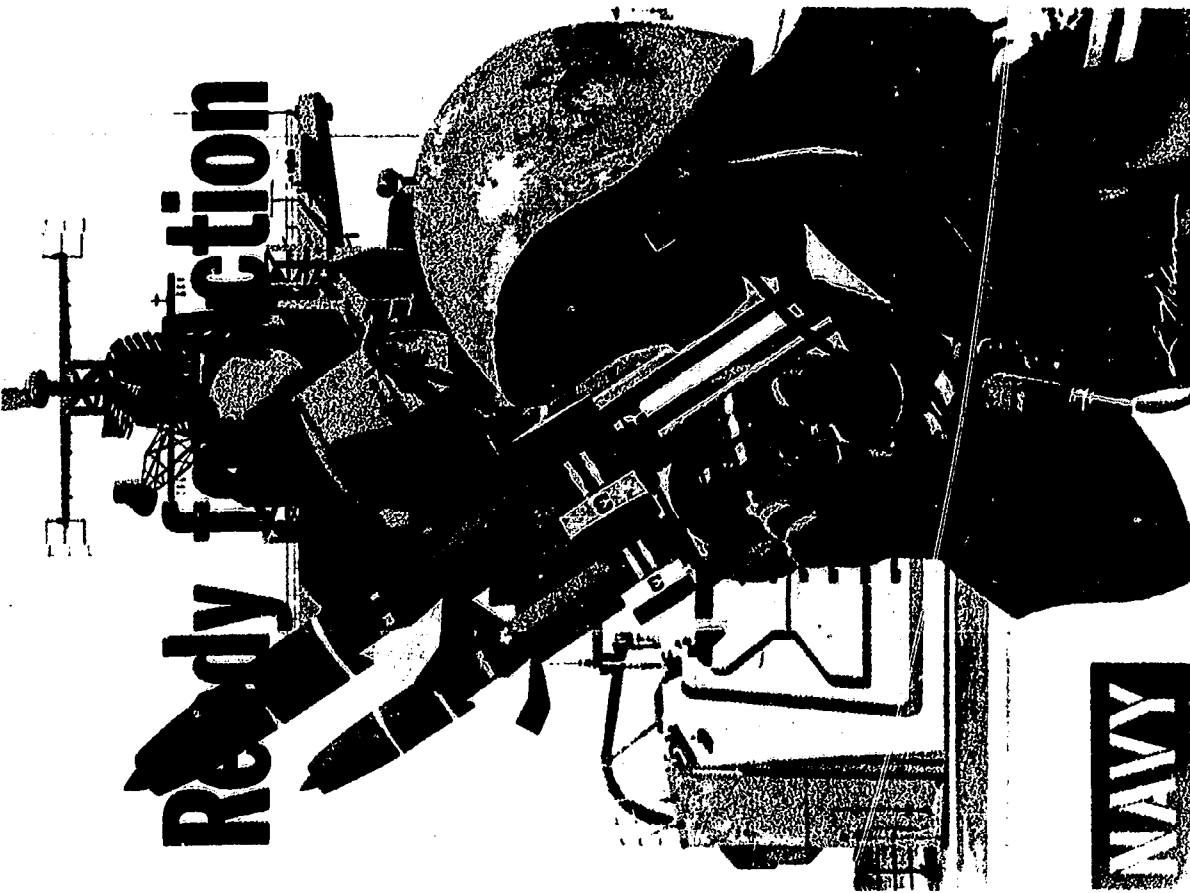
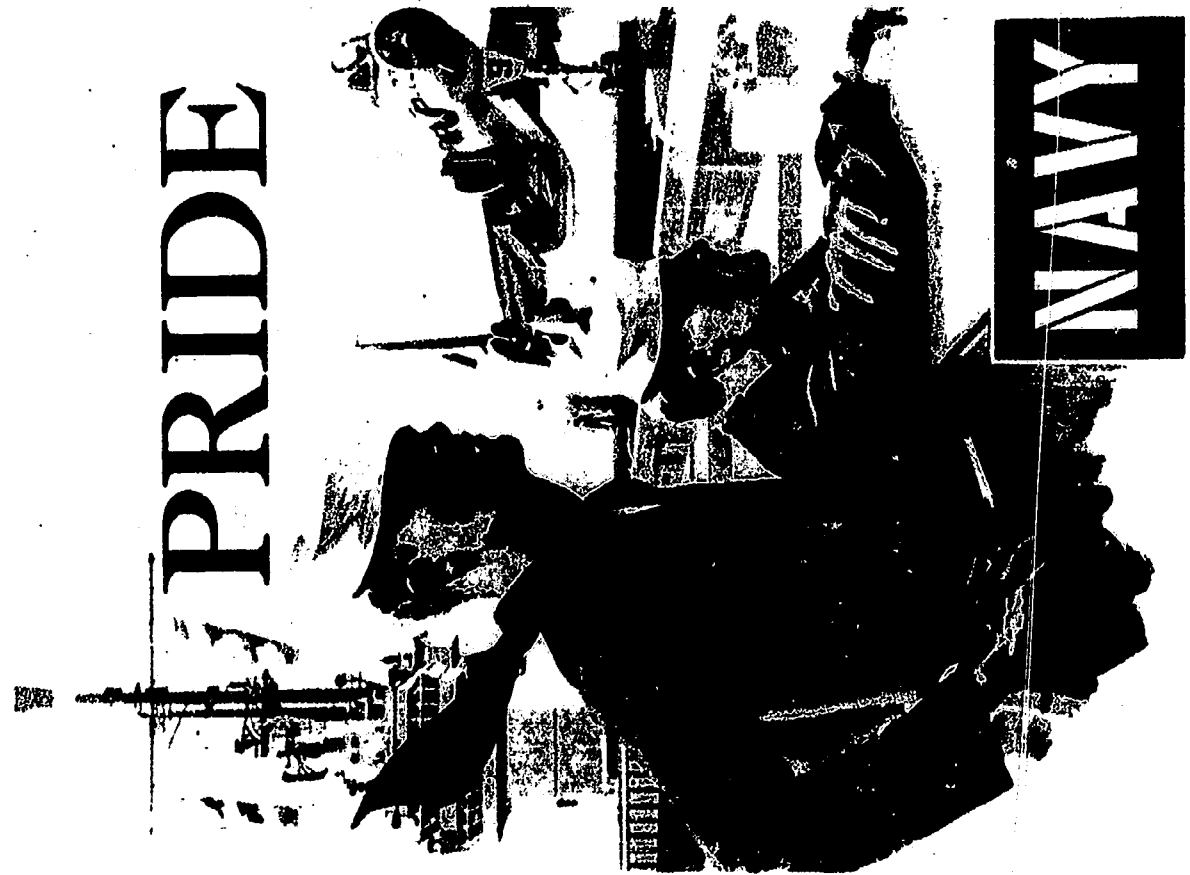

149.52

Figure 6-17.—Poster examples.

READY TEAM



NAVAL and MARINE CORPS RESERVES

149.53

Figure 6-18.—Photographs used for posters.

CHAPTER 7

TYPOGRAPHY AND LAYOUT

This chapter will cover the subject of typography which is defined as the art of selecting and arranging type and layout, which is the art of organizing copy to be printed. You as a supervisor in a graphics shop should find this knowledge helpful. Even if you are not directly connected with making layouts for printing, this information will help you in your communications with printing and photo supervisors and the job requester.

In the first part of this chapter you will be shown how to select the proper printing process, paper stock, cover stock, page size, type size, type area, and in addition you will be shown how to copy fit, plan, and construct layouts for books and pamphlets.

As the PO in charge of a graphics shop you will find it necessary to supervise the preparation of artwork for reproduction. Your knowledge of printing and reproduction methods will enable you to judge this artwork more intelligently and enable you to eliminate poor work before it reaches the printer. A discussion of halftone reproduction, retouching, cropping, scaling, combination printing, color reproduction, marking, and checking pasteups will be the last subjects covered. Be sure to refer to the glossary of lithographic terms in Appendix 1 of this manual.

PLANNING

Good planning is little more than proper organizing. You must determine the operations involved and estimate the time, men, and materials that will be required to produce the job. And you must look ahead to see the problems that are likely to arise in each department and

try to work out a solution for these problems before the job gets underway.

Planning for the purposes of this chapter will cover the process necessary to layout copy that is to be printed. Your first step on receiving the copy is to determine the proper form for the job. If it is to announce a fund drive or a change of command it will likely require display layout. But if there is a considerable amount of copy, it may fit into the form of a bulletin or pamphlet.

Besides determining what the job will be used for, you should also determine who will use it, under what conditions it will be used, and the amount of use it will receive. The results of this analysis will help you to decide on the materials that should go into the job and the amount of planning that must be done.

You can then reach a decision on matters, such as the printing process to be used—whether letterpress or offset; the kind of stock; the size and shape of the page; the type faces and sizes, the dimensions of the blocks of type; the size and kind of illustrations; the color of ink needed; and the finishing operations required.

SELECTING THE PRINTING PROCESS

If the print shop is equipped with letterpress as well as offset equipment, you may find it better to use the letterpress process for printing tickets, menus, programs, and gummed labels. Letterpress may also be used for work that requires numbering and perforating as well as for jobs that require changes during the run or jobs that are too small to be run on the offset press.

Offset printing is generally quicker and more economical if the job is long and rather complicated in makeup—particularly if it has been

printed before and a good, clean copy is available for the camera. Offset is also better for jobs requiring a number of rules and boxes and for jobs requiring a number of illustrations or tonal effects.

SELECTING THE PAPER STOCK

You can run offset stocks on letterpress as well as offset presses, but newsprints and some coated stocks are not suited to offset printing. So you must keep the printing process in mind when you are selecting the paper for a particular job.

You must also consider the kind of illustrations to be used. Line drawings and type reproduce well on all kinds of paper regardless of the printing process. But halftones are a different story. They reproduce fairly well on most kinds of paper in offset printing, but in letterpress work, it is almost impossible to run a fine screen halftone on a rough stock.

The purpose of the job also enters into the selection of the stock. If the job is to be saved, you should use a good durable paper. But if it is to be read once and then thrown away, you should use the least expensive stock that will serve the purpose. Thin stocks are generally more economical than heavy stocks, but if the stock is too thin, it may allow the printing to show through on the back. This is objectionable—particularly if two sides are to be printed.

If you are printing pamphlets or booklets, you must also consider the bulk of the stock. Large publications may call for thin sheets, but small pamphlets generally require a paper whose bulk will give the publication adequate thickness and rigidity.

For additional information on selecting paper stock refer to *L1 3 & 2*, NAVPERS 10452-B.

SELECTING THE COVER STOCK

Sometimes the same stock that was used for the text will be used for the cover. Such a cover is known as a self-cover. Self-covers are satisfactory for small pamphlets that are likely to be discarded, but pamphlets that are to undergo

considerable handling generally require a separate cover printed on a heavier stock

Cover stock should be rigid enough to protect the inside pages, and be attractive and pleasing to the eye.

HOW TO CHOOSE A PAGE SIZE

Once you have decided on the paper to be used and the process by which the job is to be printed, your next step is to decide on the size and shape of the page. The maximum dimensions are usually determined by the size of the stock available, the size of the presses, and the capacity of the bindery equipment.

Within these limits, the actual size will be determined by the nature of the publication and how the paper stock can be most economically used. For economy's sake, you should select a page size that will enable stock sheets to be cut out with the least amount of waste. And, in case you decide the booklet should be printed in signatures (any multiple of four pages, printed and folded as a unit), you must work out a size that will coincide with the dimensions of the plate. In some cases, it may also be necessary to consider the capacity of the copy camera and folding machine to avoid using a size too large to handle with your equipment.

Layout men have found that some rectangular forms are more pleasing to the eye than others. They often use a rectangular page that is two-thirds as wide as it is long, such as 6 by 9 inches and 4 by 6 inches which are common page sizes for booklets and pamphlets. This kind of rectangle, known as a Regular Rectangle, is popular since much book paper comes in stock sheets that cut out to these rectangular dimensions.

Besides the Regular Rectangle which has a ratio of 2:3, you can also use the Golden Mean Rectangle with a ratio of 3:5 or the Hypotenuse Rectangle with a ratio of 5:7. Of course, you can vary these proportions if necessary in order to arrive at a shape that cuts best from the stock sheet. See figure 7-1.

In the Navy, regulations require that you select a page or signature size which is a multiple or division of the basic 8- by 10 1/2-inch sheet, such as the 16- by 21-inch or 8- by 10 1/4-inch sheet.

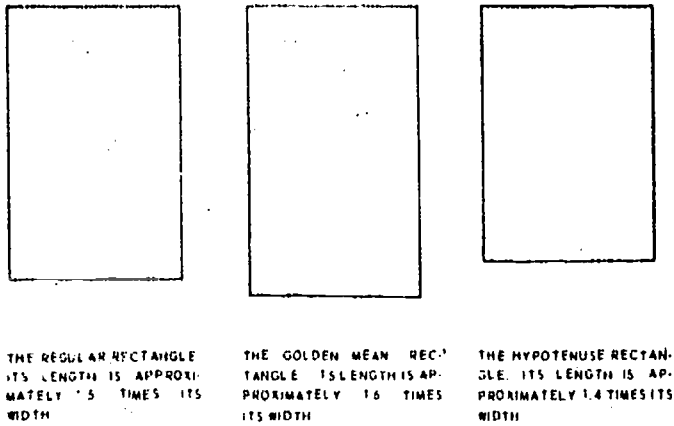

113.1

Figure 7-1.—Rectangles of different proportions.

SELECTING THE TYPE STYLE

When you choose typefaces for display work, you should select styles that are appropriate and that seem to match the mood expressed by the copy. As you know, typefaces reflect certain characteristics, such as refinement, dignity, boldness, or strength; and you can use them to emphasize or suggest the thoughts expressed by the copy.

The agreement of the type style with the subject matter of the copy is less important in the selection of body typefaces. In selecting a typeface for the text or body of a job, you need simply select a style that is legible and pleasing in design.

The factors that contribute to legibility are the style of letter; the type size; the line length; the spacing between lines, words, and letters; the indentations; and the margins around the job.

Style of Letter

Roman faces are generally used for body type, because they are the easiest to read. Unusual faces, such as Old English; Script, or even Sans Serif, are difficult to follow and are generally used only for headings and display work. Figure 7-2 shows several type styles. Notice how legibility is affected. The eye will not tire from reading a few words set in unusual typefaces, but it will rebel against masses of type set in unusual faces. Samples of body typefaces are shown in figure 7-3.

Much hath printing wrought for the well-being and for all mankind. So movable types, thou art debtor for the knowledge, the liberty, and the prosperity or the hope of prosperity. The foremost human benefactor is Johann Gutenberg.

To begin with, the design of a piece of printing should be considered in its relation to the idea of the thing itself, its sale, and use. Obviously, the type faces, color scheme, and illustration should be keyed to the end of making it easy for the reader.

Matchless in power among the arts of men is our art of printing. In its higher influence, it is the chief servant of all that is divine in man. If we would, we may, through printing types, confer with all the choice spirits of preceding ages and learn all the knowledge acquired by men from the dawn of civilization.

Beautiful printing is an educator, the same as is any art. The thoughts of an author take on added values by reason of it. The mind is always receptive in proportion as it is helped to comprehend the real meaning of the writer. Nothing will assist more than an effective page of type in enabling the reader to arrive at that meaning quickly and easily.

Good typography is the selection of type faces which are feelingly expressive of both caption and copy, the choice of borders in which lurk a seemingly motive and a silent meaning, ornaments, if necessary, which fit the theme just as felicitously as a scabbard fits its blade.

113.3X

Figure 7-2.—Effect of type styles on legibility.

Type Size

The size of the type also affects its legibility with 12-point type and 14-point type being the most legible sizes. They are often used for the text of children's books and books that must be read under adverse conditions. Ten-point type is more practicable, however. It is large enough for comfortable reading, yet small enough to allow a reasonable number of words to the page. Eight-point type is less legible than 10-point type, but it is used in some cases where space is an important factor. Six-point type is rather difficult to read, and sizes smaller than 6-point type are very tiring on the eye. (See fig. 7-4.)

Sizes above 12-point type are used mainly for display work; they are too large to be used for

EIGHT POINT BASKERVILLE AND ITALIC. Type does more than provide the letters to spell the words that make a message. The feel of the message is conveyed by the type face itself, properly used. Whether the tone is to be warm or brisk, friendly or business-like, modern or old-fashioned, there is a type to say it. Therefore, add "character" to those other two considerations of type-selection, readability and economy of space.

Eight Point Cairo and Bold. Type does more than provide the letters to spell the words that make a message. The feel of the message is conveyed by the type face itself properly used. Whether the tone is to be warm or brisk, friendly or business-like, modern or old-fashioned, there is a type to say it. Therefore, add "character" to those other two considerations of type-selection, readability and economy of space.

EIGHT POINT CLOISTER AND ITALIC. Type does more than provide the letters to spell the words that make a message. The feel of the message is conveyed by the type face itself, properly used. Whether the tone is to be warm or brisk, friendly or business-like, modern or old-fashioned, there is a type to say it. Therefore, add "character" to those other two considerations of type-selection, readability and economy of space. As a typographer you will

EIGHT POINT BODONI BOOK AND ITALIC. Type does more than provide the letters to spell the words that make a message. The feel of the message is conveyed by the type face itself properly used. Whether the tone is to be warm or brisk, friendly or business-like, modern or old-fashioned, there is a type to say it. Therefore, add "character" to those other two considerations of type-selection, readability and economy of space.

EIGHT POINT CASLON AND ITALIC. Type does more than provide the letters to spell the words that make a message. The feel of the message is conveyed by the type face itself, properly used. Whether the tone is to be warm or brisk, friendly or business-like, modern or old-fashioned, there is a type to say it. Therefore, add "character" to those other two considerations of type-selection, readability and economy of space.

EIGHT POINT GARAMOND AND ITALIC. Type does more than provide the letters to spell the words that make a message. The feel of the message is conveyed by the type face itself, properly used. Whether the tone is to be warm or brisk, friendly or business-like, modern or old-fashioned, there is a type to say it. Therefore, add "character" to those other two considerations of type-selection, readability and economy of space.

Eight Point Bodoni Bold and Italic. Type does more than provide the letters to spell the words that make a message. The feel of the message is conveyed by the type face itself, properly used. Whether the tone is to be warm or brisk, friendly or business-like, modern or old-fashioned, there is a type to say it. Therefore, add "character" to those other two consid-

EIGHT POINT CENTURY AND ITALIC. Type does more than provide the letters to spell the words that make a message. The feel of the message is conveyed by the type face itself, properly used. Whether the tone is to be warm or brisk, friendly or business-like, modern or old-fashioned, there is a type to say it. Therefore, add "character" to those other two consid-

Eight Point Vogue and Vogue Bold. Type does more than provide the letters to spell the words that make a message. The feel of the message is conveyed by the type face itself, properly used. Whether the tone is to be warm or brisk, friendly or business-like, modern or old-fashioned, there is a type to say it. Therefore, add "character" to those other two considerations of type-selection, readability and economy of space. As a

113.4

Figure 7-3.—Samples of body typefaces.

This paragraph is designed to show how the size of the type affects its legibility. It is set in 8-point type and as you can see it is more difficult to read than the following paragraphs.

This paragraph has been set in 8-point type. It is easier to read than the preceding paragraph, but it is still not as legible as a paragraph set in 10 point.

This paragraph is set in 10-point type. It is legible enough for easy reading and small enough to allow for a sufficient number of characters to the line.

This paragraph is set in 12-point type. It is the most legible of all the paragraphs shown here. Twelve and fourteen point are the sizes generally chosen for children's books and books that are to be read under adverse circumstances.

113.5

Figure 7-4.—How size of type affects legibility.

text. Ten-point type is the maximum size authorized for body type in Navy publications.

Length of Line

Since the eye can see only so much at a time, there is a limit to the number of characters that should be used in each line. The length of line depends on the size and style of type and the amount of leading (spacing) between the lines. (See fig. 7-5.) (The term leading is pronounced as if spelled ledding.)

Some typographers believe that the (pica) length of the line should be equal to twice the (point) size of the type if the copy is set solid. And if the copy is leaded, they add 1 or 2 picas to the length for each point of leading. For example, if the text of a book is set in 10-point type, the ideal length of line would be 20 picas if the type is set solid and 22 to 24 picas if 2-point leading is used between the lines.

You can use longer lines if you lead the composition proportionately. Extra leading separates

The length of the line in body composition depends upon the size and style of the type and the amount of leading between the lines. You can use longer lines if the copy is leaded proportionately.

The length of the line in body composition depends upon the size and style of the type and the amount of leading between the lines. You can use longer lines if the copy is leaded proportionately.

The length of the line in body composition depends upon the size and style of the type and the amount of leading between the lines. You can use longer lines if the copy is leaded proportionately.

The length of the line in body composition depends upon the size and style of the type and the amount of leading between the lines. You can use longer lines if the copy is leaded proportionately.

113.6

Figure 7-5.—How length of lines affects legibility.

the lines and helps the eye to keep its place as it moves from the end of one line to the beginning of the next one.

Of course, lines that are too short are just as undesirable as lines that are too long. Short lines tire the eye by making it jump too often from one line to another.

Leading

You have just seen that the amount of leading required in body composition depends to some degree on the style of type used and the length of the line. For the average run of work, most typographers simply separate the lines with a 2-point lead. However, some typefaces look better with less spacing between the line and others look better with more. For example, a small face like Baskerville looks good with 1-point leading or even set solid (without leading). On the other hand, commercial printers sometimes lead Bodoni faces by an amount equal to one-third of the point size of the type. Two-point leading, however, is the maximum allowed in Navy composition. (See fig. 7-6).

This paragraph is designed to show how leading affects legibility. Some type faces, such as the 8-point Century Expanded, shown here, are difficult to read when they are set solid. Leading should be used to achieve tone and legibility; not to space out the type to fit the page.

This paragraph has also been set in 8-point Century Expanded. However, two-point leads have been used between the lines in this case to show you how leading increases the legibility of text matter.

This paragraph is set in 8-point Century type, but too much leading has been used between the lines. Too much leading invariably weakens the paragraph and makes the lines difficult to read.

113.7

Figure 7-6.—How leading affects legibility.

Spacing Between Words

Typographers generally use 3-em spaces between the words. An em is a standard space for the typeface being used. A 3-em space is a third of this em, or 4 points for a 12-point type. See figure 7-7. When spacing adjustments are necessary to justify the lines for optical effect, using 3-em spacing when one word ends and another begins with lower case letters, such as "a" or "m" and wider spacing when one word ends and the next one begins with a tall letter, like "I" or "N". If it is necessary to steal space from a line, they use less spacing between words which begin

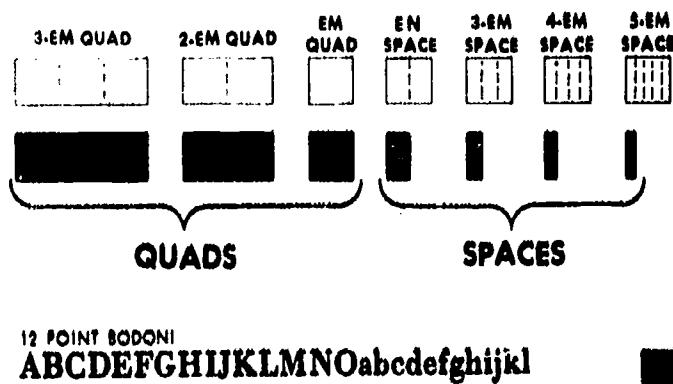

45.207:57.19

Figure 7-7.—Comparison of spaces and quads.

or end with letters, such as "o", "l", "v", "T", or "A", since the construction of these letters give the illusion of extra white space. They also take advantage of the optical illusion created by the period and use a regular 3-em space between sentences.

Too much space between words causes a disturbing break in the composition and may create "rivers" of white space on the printed page.

Letterspacing

Although adding additional space between letters sometimes improves the legibility of words set in capital letters, it usually makes lowercase letters more difficult to read. (See fig. 7-8.) You can letterspace headings, but you should not letterspace body type unless a line is so short that letterspacing is absolutely necessary in order to justify it.

When you letterspace a line, it is better to divide the spacing evenly between the letters in all the words, than to put all the space between the letters of just 1 or 2 words. When words are letterspaced, you must also allow extra spacing between them so that they will not appear to run together.

Indentions

Because they give the eye a new starting point, paragraphs break up the page and make the text more readable. One-em quad paragraph indentions are generally used if the lines are

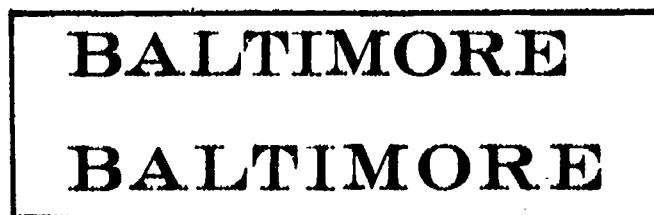

This line is letter-spaced.
This line is not letter-spaced.

113.9

Figure 7-8.—How letterspacing affects legibility.

short, but 2- or 3-em quad indentions may be used for longer lines, depending on the size of the type. Some typographers use wider indentions with the smaller sizes of type (as much as 3 or 4 em quads with 6 point), and smaller indents (1 or 2 em quads) with the larger faces.

Long quotations or quotations requiring special emphasis should always be placed in a new paragraph. They may be set full measure in a smaller size of type or they may be indented on both sides as in the example which follows:

Michael Scott Henry's humor was typical of that prevalent in the thirties. You may remember this passage from his *Crime on My Hands*:

In the dead man's pocket, the detective found a cut-glass stopper, the keys to the First National Bank, a bottle of beer, and a picture.

"These may be important clues," he said as he laid them on the counter. But a moment later he had sold one of the clues to a lady for a quarter and had drunk one of the others.

"Well, so much for that," he said, finally settling back in the most comfortable chair in the shop. "They say a murderer always returns to the scene of his crime. So I'll just wait here for him."

In quoted material, when a new paragraph begins with quotation marks, the quotation marks are sometimes set to project into the space allowed for the indention, as shown in the example above, so that the first letter in the paragraph will align with those in other paragraphs. Thin spaces are sometimes used between quotation marks and square letters, such as "T", "H", and "M".

As a rule, short quotations are not set off in a separate paragraph, but are buried in the text, as shown below.

According to Robert's report, Dudley "is just eating up our food and doing us no good. He even gets seasick swinging in a hammock."

Hanging indentions, like the one shown in the example below, are sometimes used when the copy requires special emphasis. They are used frequently in tabular work, listings, and in legends in manuals, such as this one, when the copy exceeds two lines.

When a hanging indention is used, the amount of space that the copy should be indented depends upon the length of the line and the size of the type. One em will be sufficient for the average size, but very large faces or very small faces may require more indention.

Besides the hanging indention, there are also stepped or staggered indentions which are used mostly for newspaper headings.

**Wife Charges That
Sailor Husband Has
Visited Too Many Ports**

Irregular indentions are often used in modern layouts:

*Everyone agrees that
Dixon Springs is the
ideal spot for a
vacation. Leave
your cares behind.
Visit us this summer.*

*Everyone agrees that
Dixon Springs is
the ideal spot for a
vacation. Leave your
cares behind. Visit
us this summer.*

Poetry has its own style of indention. When setting poetry, you should follow the style of indention set by the author.

Margins

The well-designed page is one that contains a mass of type pleasingly framed in white space. In high quality bookwork, typographers often divide the page half and half between the type and white space. However, most jobs call for more text area and less marginal space. The important thing to remember is that the page should never have a crowded look. Narrow margins make reading difficult.

In bookwork, the back or inner margin of the page is often made narrower than the others so that when the book is opened, the gutter of white space down the center will appear to be equal to the width of either of the outside margins. The top margin is slightly larger than the back margin; the outside margin is larger still; and the bottom margin is the largest of the group. If you are dealing with a single page, the right and left margins should be even, but the bottom margin should be slightly larger than the top. This relieves the monotony created by even margins and improves the page balance.

HOW TO DETERMINE THE TYPE AREA

An area of type should follow the proportion of the page it is printed on, that is, long lines on wide pages and short lines on narrow pages. Type may be spaced out lengthwise to fit the page.

COPYFITTING

Planning the layout of a publication requires that you know how much space the type will fill. Copy fitting (casting) is a process by which you may plan and specify the setting of a given body of copy (text). It includes selecting the desired typeface and specifying its size, the width it is to be set, and other details of instruction.

There are several methods of casting or copy fitting. Each method is useful in certain situations. The words-per-square-inch method, for one, is inaccurate and should be used only for rough calculations. Another method, the character-count method, is based on the number of typewritten characters in the manuscript, and permits accurate calculations.

Words Per Square Inch

When exact copy figuring is not required, the words-per-square-inch method will do very well. The following table shows the approximate number of words per square inch for different sizes of type.

Size of type	Words per square inch	Size of type	Words per square inch
6 pt., solid	47	12 pt., solid	14
6 pt., 2 pt. leaded	34	12 pt., 2 pt. leaded	11
8 pt., solid	32	14 pt., solid	11
8 pt., 2 pt. leaded	23	14 pt., 2 pt. leaded	7
10 pt., solid	21	18 pt., solid	7
10 pt., 2 pt. leaded	16	18 pt., 2 pt. leaded	5

An example will help to make the use of this table clear. Suppose you have 750 words of copy to be set 10 point, solid. If you divide the 750 by 21 (the number of words to the square inch for that size of type) you will find that the copy will require approximately 36 square

inches of space. So you can set it 4 by 9 inches or 3 by 12 inches or in any other combination of width and depth that will make up the 36 square inches.

You can also use this table to find the number of words that will fit into a given space. Suppose you have a space 24 picas (4 inches) wide and 8 inches deep to be filled with 10-point type with 2-point leading.

From the table you will see that there are approximately 16 words to the square inch when the copy is set 10-point leaded. Your space is 4 inches wide and 8 inches deep, which is a total of 32 square inches. Multiplying 32 by 16 gives you 512 words as the approximate number that will fit into the space.

Actually, you could get closer to 530 words in this amount of space. Therefore, you should keep in mind that the words-per-square-inch method of copy casting does not give you a completely accurate estimate.

Character Count

The character-count method is the best system for determining the amount of space your printed material will fill. To use it, you must determine the number of typewritten characters (and spaces) contained in the manuscript. In addition, you must know how many characters (and spaces) will go into a line set to the proper width in the size and style of type desired, and how many lines of this size of type will be required to fill a column inch.

1. Find the number of characters (and spaces) on each page of the typed manuscript, using the method shown in figure 7-9. After you have found the number of characters (and spaces) on each page, add them all together to get the total number of characters in the manuscript.

2. Next determine the number of characters that will go in one line set to the proper width in a suitable type face.

- a. Find a printed specimen composed in the size and type style that you wish to use.

- b. On this specimen measure off the width you wish to use and draw a line down the right side.

- c. Count the characters (and spaces) in five representative lines to see how many characters occur between the left margin and the pencil line on the right.

- d. Divide the total number of characters found in the five lines by 5 (the number of lines counted). This will give you the average number of characters per line for this style and size of type.

- e. Divide the total number of characters in the manuscript by the average number of characters that will go into the line of type. The result will be the number of lines that the copy will fill.

3. Now determine how many lines (of the selected type size and spacing) will go in 1 inch. Divide this number into the total number of lines to find the length of the copy in inches.

4. Finally make allowance for headings and illustrations in determining the total amount of space that your copy will fill.

If you find that the copy will not fit into the amount of space allotted to it, you may select a smaller type face, vary your spacing, or have the copy reduced.

Measuring the Copy

You can vary the process just described by measuring the typewritten copy with a ruler. (The standard "elite" typewriter has a 10-point face and types 12 characters to the inch; while the standard "pica" typewriter has a 12-point face and types 10 characters to the inch.) Measure off a distance from the left margin of your copy and draw a line down the right side, as was shown in figure 7-9.

If your typewriter types 10 characters to the inch, and if your pencil line is 5 inches from the left margin of the copy, your average line will contain 50 characters.

To find the number of lines per page, you simply measure the depth of the copy. If the copy is single spaced, there will be six lines to the inch; if it is double spaced, there will be three lines to the inch. Thus, if your copy is double spaced and is 7 inches from top to bottom, you will have 21 lines on the page.

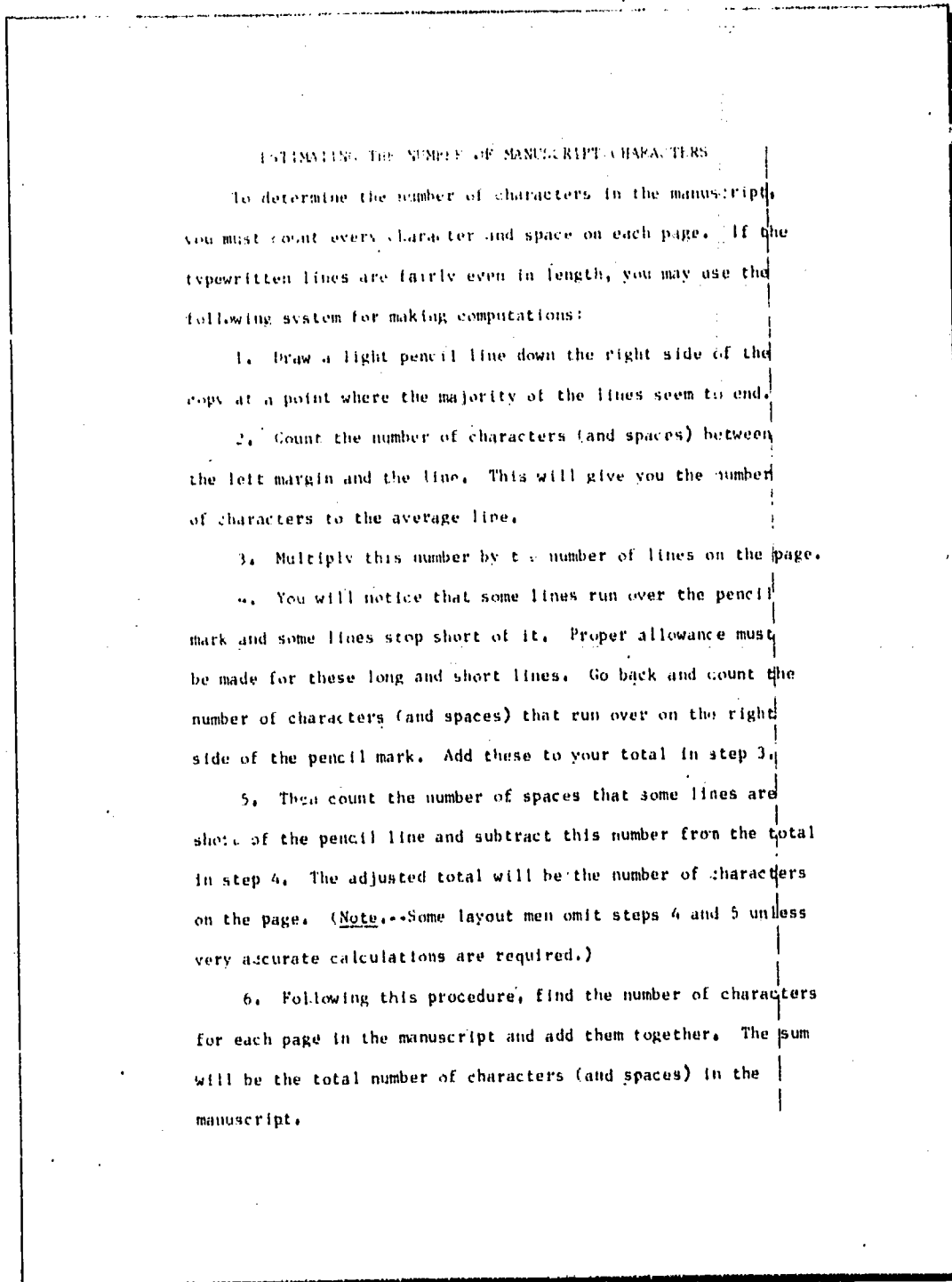

Figure 7-9.—Finding the number of characters on a typewritten page.

57.17.0

To find the number of characters on the page, multiply the 21 lines by 50 (the number of characters in the average line) and you will get 1,050 characters. But you aren't through yet. You must add to this the number of characters and spaces that the long lines run beyond the pencil line, and you must subtract from the total the

number of spaces that are required to fill out the short lines. When this has been done, you will have the total character count for the page.

By reversing the procedures just described, you can determine the amount of copy that will be needed to fill a given space.

1. Determine the number of characters that will fit into the average line set to the proper width in the desired size and style of type.

2. Determine how many lines of the desired type size and leading will be required to fill the space.

3. Set the marginal stops of your typewriter so that each typewritten line will contain the same number of typewritten characters as the average typeset line (step 1). The typewritten copy will then agree almost line for line with the typeset material, and you can simply type enough copy to fill the number of lines arrived at in step 2.

Copy-Fitting Aids

There are still other methods of copy fitting involving the use of slide rules, circular rules, line gages, and typewriter scales. The manufacturers of the Linotype, Intertype, and Monotype machines also put out copy-fitting manuals. If you wish to pursue the subject further, you should try to obtain one of these booklets.

LAYOUTS FOR BOOKS AND PAMPHLETS

In general, layouts of books will be done by Lithographers or personnel who have experience in arranging written material for printing. You may be called to lay out illustrated material, such as posters, leaflets, and some pamphlets.

Layouts of booklets and pamphlets are generally called dummies. There are two types of dummies—preliminary dummies which are made up before the book is set in type, and pasteup dummies which are made from proofs pulled after the type is set.

If the copy is rather long, it will be difficult for you to determine how many pages it will fill when it is set in type. So you can simply make layouts for keys pages, such as the title page and one or two of the text pages to guide the compositor in setting the job, and leave the actual page-by-page layout until you get the proofs from the type. You can then use the proofs to make a pasteup dummy showing the actual location of the type and illustrations on each page of the book.

Of course, if the copy is short, you may be able to "copyfit" it to determine in advance the number of typeset pages it will fill. You can then make a preliminary dummy for each page before the type is set.

PRELIMINARY DUMMIES

In making a preliminary dummy, you can begin with any page in the publication, just so long as you follow the same pattern or theme for the other pages.

First make a series of thumbnail sketches, building your design around the most important elements on the page, just as you would in making a display layout. Choose the best of your thumbnail sketches and draw it up to full size. Then work the full-sized rough into a finished layout.

In working with text pages, you may indicate type areas by ruling in a rectangle on the page or by ruling in a series of lines. Trace or rough in principal display lines and sketch or trace illustrations or rule in an outline and indicate the photograph or illustration that is to go there. (See fig. 7-10.)

Illustrations should be placed close to the section of the text to which they apply. Single illustrations are generally placed at the top or just above the optical center of the page. If an illustration is narrower than the type or if it does not have a square outline, you should run 4 or 5 lines of type above and below it to square up the page. If the illustration is extremely narrow, you may have the type set on a narrow measure and placed in the column beside it.

In display work you are generally dealing with a single page, but in bookwork, you must consider the facing pages as the unit in planning your design. The right page generally predominates or "outweighs" the left, so when you have only one illustration place it on the right page. If you have two large rectangular illustrations, you may use one at the top of each of the two facing pages. (See fig. 7-11.)

Bleed illustrations (printed pictures with no margin between the picture and the page edge) add interest to a page, but don't bleed all the illustrations in a book. If you have several small

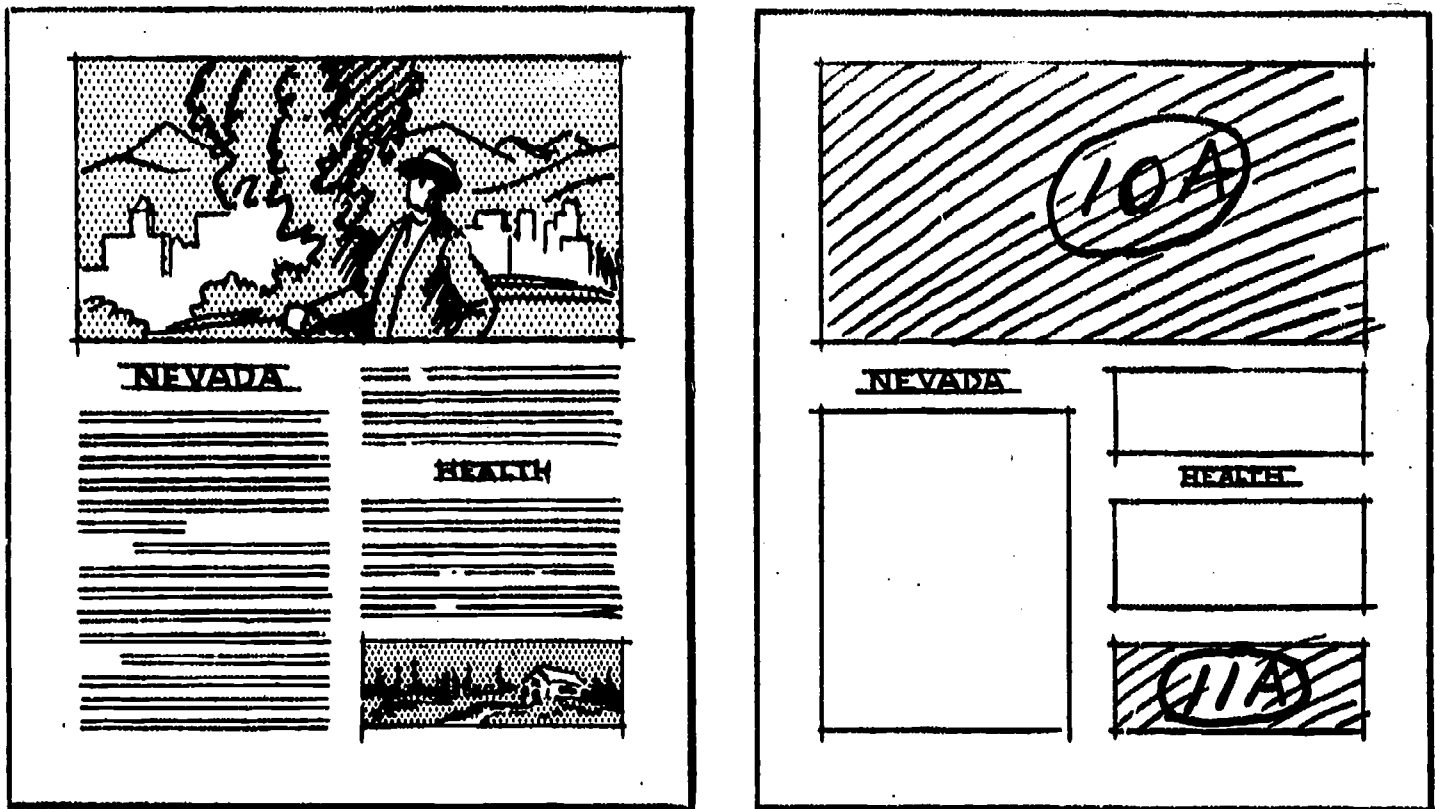

Figure 7-10.—Methods of indicating type and illustrations on the layout sheet.

113.22

illustrations, you may group them in a panel and let the panel bleed.

Cutlines (captions or legends) below the illustrations are normally set full-column width regardless of the width of the illustration. If a legend consists of only 1 or 2 lines, you should center it; otherwise set the first line flush (even) with the left margin and indent the following lines 1 em. This, as you have already seen, is known as a hanging indentation.

Cover Design

The cover design may consist of illustrations and type, hand lettering and type, or type alone. (See fig. 7-12.) If the publication is one of a series, the cover should match the others in series. It may be run on a different color of stock, but it should have the same general characteristics as its sister publications.

If the type is well arranged and of a size sufficient to give the display required, you can use almost any typeface on the cover. The choice is

sometimes affected, of course, by the historical period or the mood of the text.

If a title consisted of more than 5 or 6 words, its appearance can be improved by varying the type size. Usually the longer titles lend themselves to this treatment, or at least you can use a smaller type for words, such as articles and conjunctions.

Title Page

The type used for the title page is usually from the same series or family as that used for the text unless a different face is required for distinctiveness. (See fig. 7-13.)

The type generally follows the inverted pyramid, block, or fluctuating-line arrangements, although off-centered arrangements may be used for some types of work. Set the title in the largest size of type and display the other lines according to their importance. The dimensions of the title page are usually the same as those of the regular text page.

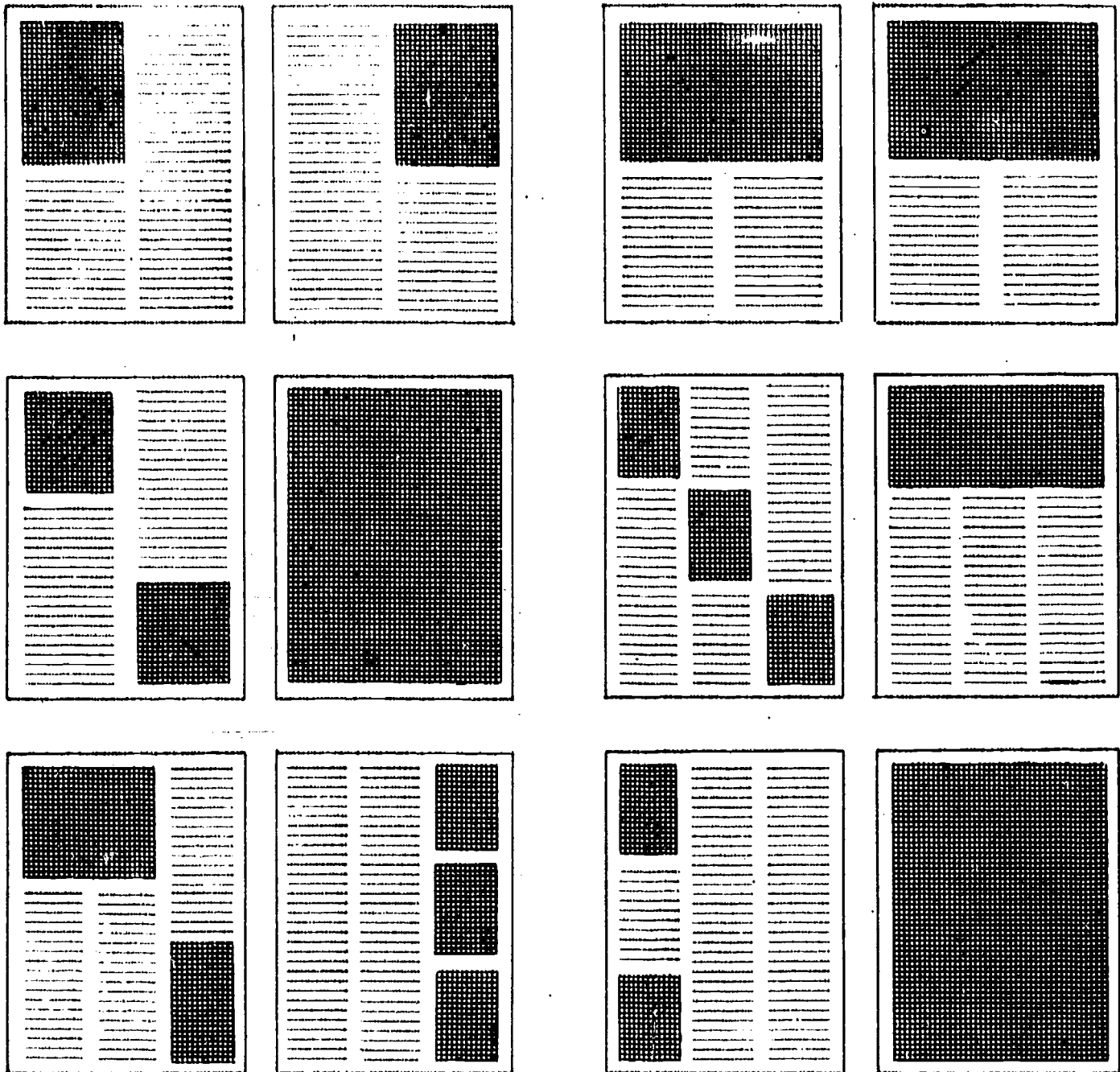

Figure 7-11.—How to position illustrations on facing pages.

149.47

Other Pages

The principal requirements for the other pages, such as the preface or contents is that they be legible and attractive.

In planning an index, you should place convenience to the reader ahead of artistic design. These pages generally call for short lines, set in 8-point type with hanging indentions and initials

or words set in caps or boldface type. The page is often divided into 2 or 3 columns.

After all the pages have been laid out, you should mark up the job, writing printer's instructions on both the manuscript copy and the layout sheets. Figures 7-14 and 7-15 show two ways to mark the layout and manuscript, and figure 7-16 shows proofs of pages made up according to these instructions.

Chapter 7—TYPOGRAPHY AND LAYOUT

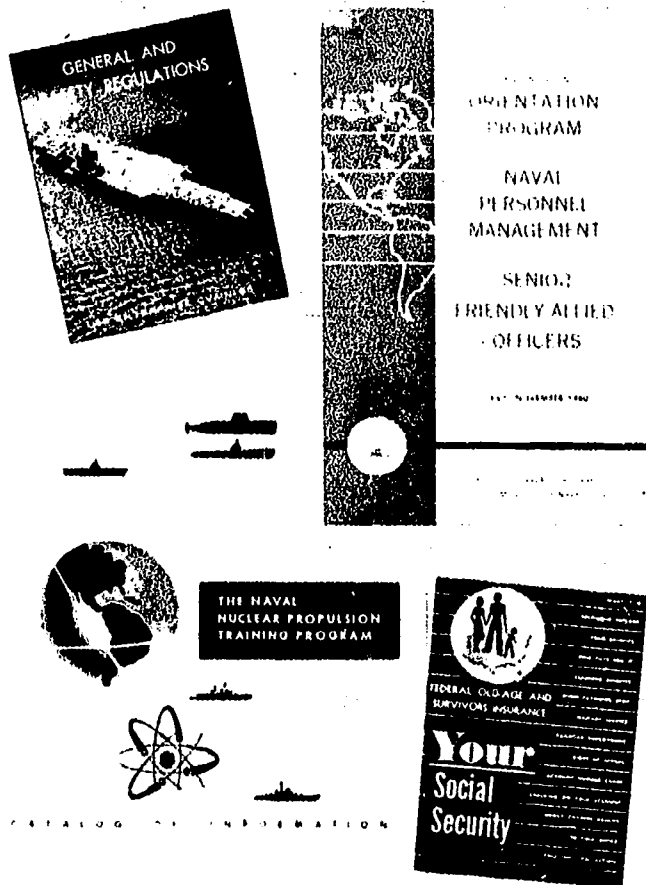

149.49

Figure 7-12.—Interesting cover designs.

PASTEUP DUMMIES

If the copy is so long that you cannot accurately determine the number of pages it will fill, you should prepare layouts for key pages (to set the style for the publication) and leave the actual page-by-page layout until the type has been set.

You can then trim the type proofs and paste them in place on the layout sheets, along with proofs of the illustrations.

Printed layout sheets showing the outline of the page and an outline for the type area are generally used for pasteup dummied. They may consist of single pages, as shown in figure 7-17 or they may be printed two up, since facing pages are used as the unit in layout work. If single sheets are used, the facing pages should be placed side by side when they are laid out and pasted. In all cases, you should use only one side of the sheet.

THE LETTERS
OF
SIR EDMUND GOSSE
BY
EVAN CHARTERIS

WITH ILLUSTRATIONS BY
RENE CLARKE

NEW YORK
THE LIMITED EDITIONS CLUB

Zadig
M. DE VOLTAIRE

AN INTRODUCTION BY
DAVID GARNETT
AND ILLUSTRATIONS BY
VALENTI ANGELO



NEW YORK, RIMINGTON OF HOOPER

THE POEMS OF
CATULLUS

TRANSLATED BY HORACE GREGORY
WITH DRAWINGS BY ZHENYA GAY



COVICKI FRAEDE, INC., PUBLISHERS
NEW YORK, NCM 10011

Strange case of

Dr. JEKYL and Mr.

HYDE. *Robert Louis*

Stevenson. With illustrations

by W. A. DWIGGINS.



RANDOM HOUSE - NEW YORK 1929

113.24X

Figure 7-13.—Title pages designed by leading typographers.

Before starting the pasteup, you should number each galley proof. Use a heavy lead or grease pencil and make the number conspicuous, repeating it several times throughout the column, as shown in figure 7-18. In this way, the printer can tell instantly what galley the type is in when he makes up the pages. Notice also that the galley number is set in type at the head of the proof. Proofs intended for dummy purposes are sometimes pulled on colored stock. Extra sets of proofs are supplied for catching typographical errors. You can then trim your proofs and begin the pasteup. Some layout men use rubber cement for mounting proofs on the layout sheets. Others use a coating of wax or scotch tape, since either of these make it easier to shift the proofs if changes are necessary.

Unfortunately type doesn't always measure out the way you would like it to, and you may find yourself with too little or too much space.

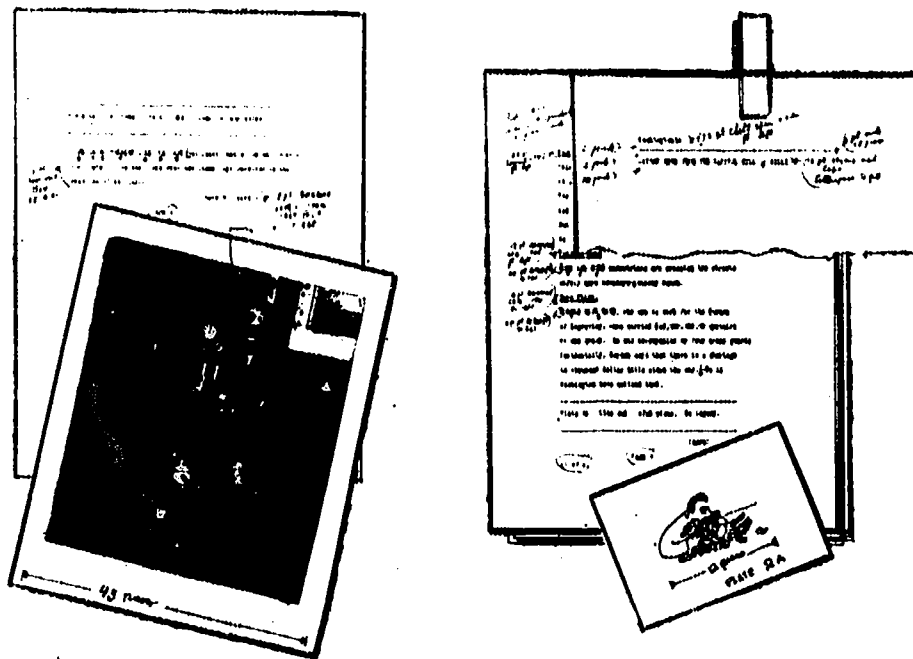

PREPARED COPY

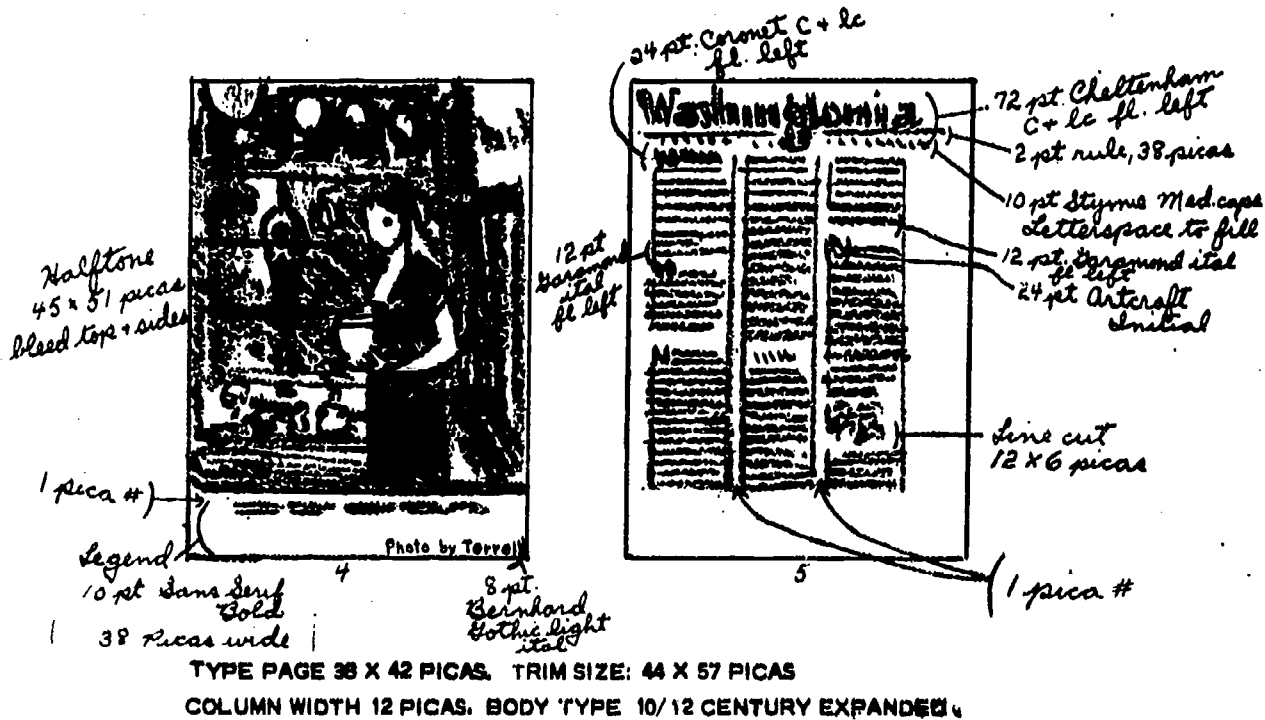

TWO-PAGE LAYOUT

149.50.1

Figure 7-14.--One method of indicating areas for illustrations and type.

Therefore, it is a good idea to keep several pages laid out in advance so that you can see how the copy and illustrations fit the space before you begin pasting them in place.

Pasteup dummies, like those just described, are frequently used in magazine and newspaper work. Figure 7-19 shows a page from

Chapter 7 - TYPOGRAPHY AND LAYOUT

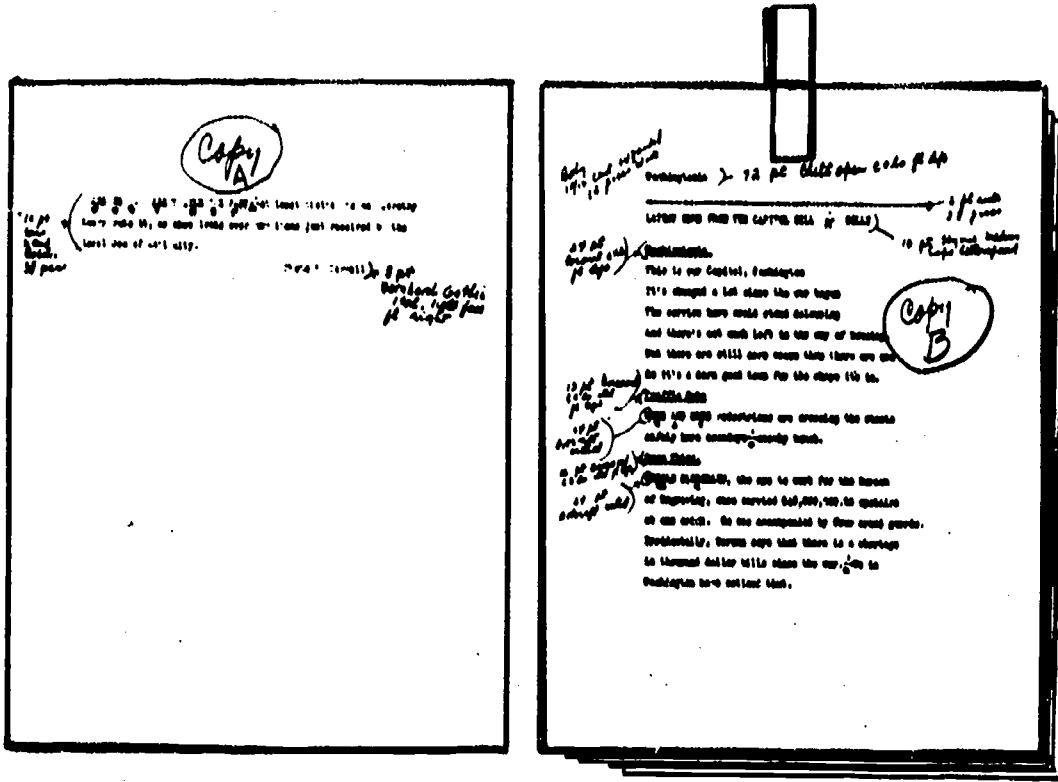

Prepared copy.

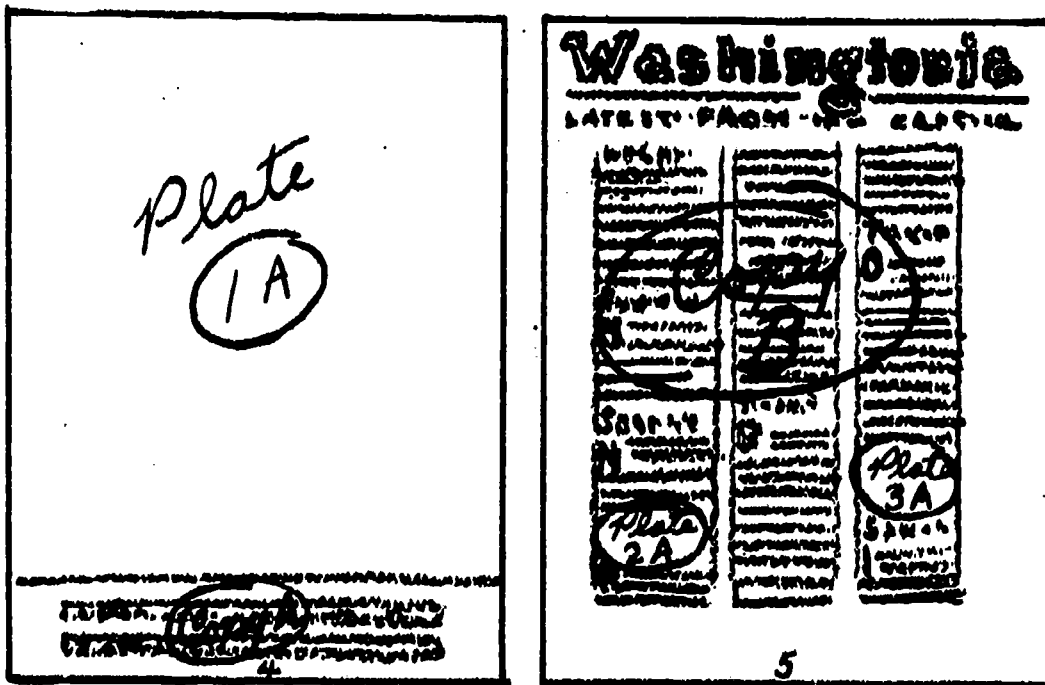

Two-page layout.

Figure 7-15.—Another method of indicating areas for illustrations and type.

149.50.2



149.48
 Figure 7-16.—Proof from pages made up according to the layouts shown in figures 7-14 and 7-15.

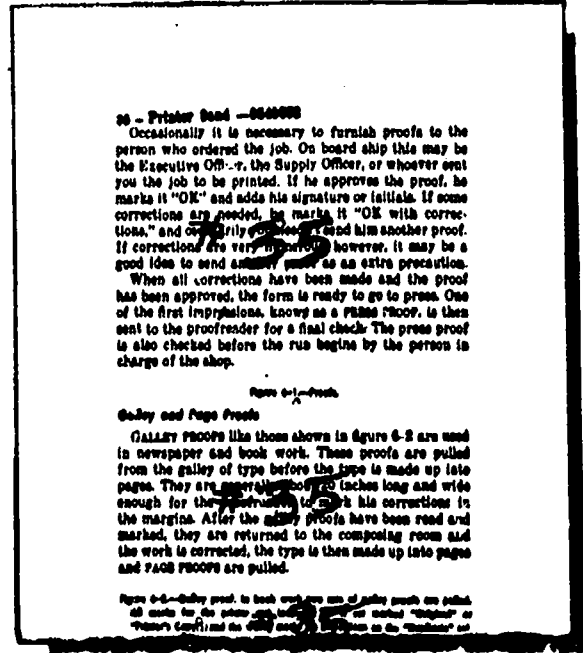

113.26
 Figure 7-18.—Example of a numbered galley proof.

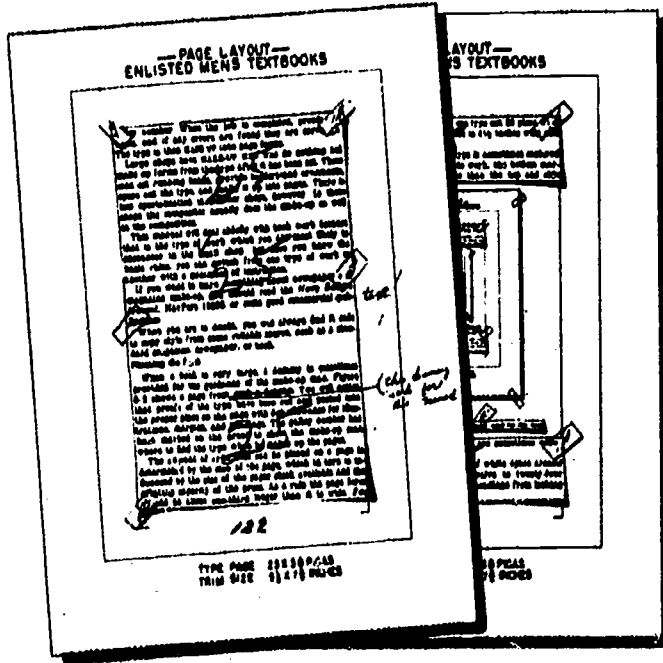

113.25
 Figure 7-17.—Pages from a paste-up dummy.

a pasteup dummy used for "All Hands" magazine; and figure 7-20 shows how the pasteup is used in the production of a Navy newspaper.

MARKING THE LAYOUT SHEET

Spacing instructions and other information, such as folio numbers and running heads, are

always written on the layout sheet. The size of the type page, the trim size of the page, and the column widths are also indicated on the layout sheet. But typographic corrections should be marked on the proofreader's galley proofs, since the printer does not use the dummy in making typographical corrections.

MARKING MANUSCRIPT COPY FOR THE PRINTER

When a printer sees a word underlined with a typewriter or pencil, he knows that it is to be set in italics. This applies whether he is a Navy printer in Norfolk or a commercial printer in San Francisco. The copy preparation symbols shown in figure 7-21 have been accepted by the printing trade and are standard all over the United States.

These symbols are used by editors as well as printers, but they are not purely editorial. They are used to indicate elements related to production as well as to correct spelling and grammar. You should study these symbols and use them in your work, whether you copy is to be set in type or composed on the Varityper. They enable you to quickly convey your instructions to the compositor.

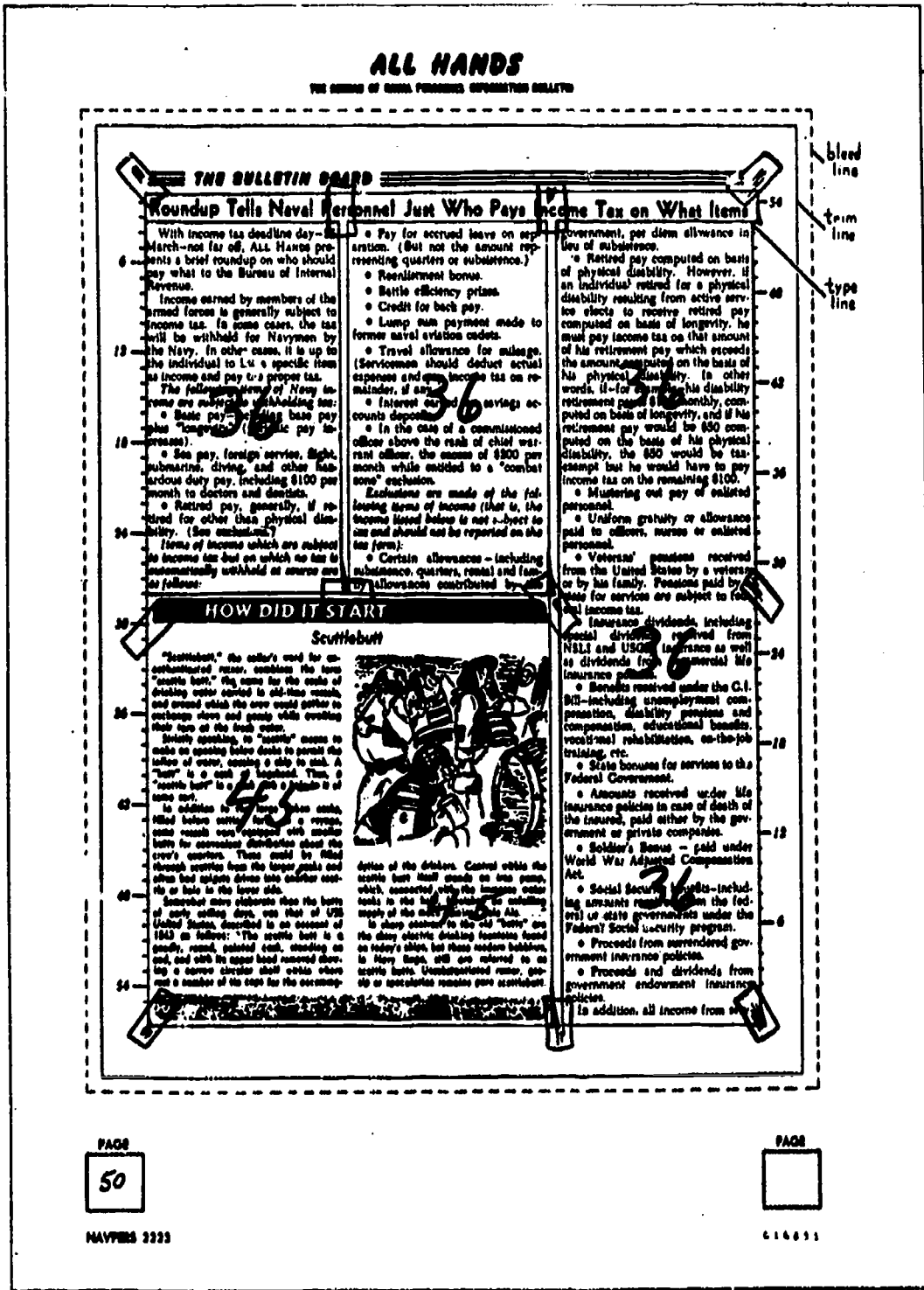

Figure 7-19.—Pasteup dummy for a magazine.

113.27

Proofreader's marks (fig. 7-22) and editorial marks are, for practical purposes, the same. The main difference is in their usage. As a rule, editorial corrections to manuscript are made directly in the body of the copy. If this is not possible, the corrections are inserted above or

below the line and the place where they are to go is indicated by an insert caret (∧). Proofreading symbols are placed in the margins of hot type proofs so the printer can see them readily, and a caret is placed within the text to show where the correction is to be made. If there are



The printer follows the pasting dummy as he makes the page. The page forms are made up, represented in photo at left as they are pasted together.



Paste-up by the newspaper staff sets the pattern and size for making of the page. This page setup is done on layout sheets with original for its submission by the printer.



After the stripping and opaquing operations are completed, the negative assembly is printed on an offset plate. The plate is then put on the press and printed in reverse under way.



Same size line artwork may be attached to the top edition proofs, but some copy and copy requiring reductions must be set separately and stripped into the page negatives.

113.28

Figure 7-20.—How the pasteup dummy is used in the production of a Navy newspaper.

Lieutenant William Brown ----- ABBREVIATE, OR MAKE FIGURES
 (forty-five) destroyers -----
 (Capt.) Overby ----- (CONVERSELY) SPELL OUT
 (6) enlisted men -----
 tradition ----- BOLDFACE
 tradition ----- BOLDFACE CAPS
 there [were] three ----- BRACKETS
 yeoman Wilson ----- CAPITALIZE: LETTER
 com Three ----- WORD
 the SEA Watch ----- SMALL CAPS
 the Welfare officer ----- (CONVERSELY) LOWER CASE
 torpedoes ----- CLOSURE
 Jones, who saw action at Saipan ----- COMMA
 Seaman Smith not without effort climbed ----- DASH
 scuttlebutt ----- DELETE LETTER
 He said ~~that~~ Jones would receive the award. ----- DELETE WORD
 Lieutenant Smith, who is well fitted ----- DELETE SEVERAL WORDS
~~by experience and training to perform his new duties reported aboard today.~~
 Lieutenant Smith, who is well fitted ----- DELETE ENTIRE PARAGRAPH
~~by experience and training to perform his new duties, reported aboard today.~~
note ----- END OF PAGE
 (30) or (#) ----- END OF STORY
 pellmell ----- HYPHEN

Brownie was exhausted ~~at the end of~~ ----- IGNORE CORRECTION
 the day ----- Word "stet" means "let it stand."
 The ship's company reported on the ----- INDENT
 quarterdeck for inspection of 1300. ----- INSERT LETTER
 the forward area -----
 Essex class carrier ----- WORD SECTION
 Welsh added another ribbon to -----
 his collection yesterday. -----
 gallantry in action ----- ITALICIZE
 gallantry in action ----- BOLDFACE ITALICS
 gallantry in action ----- ITALIC CAPS
 McCloskey looks good. He is the best ----- PARAGRAPH
 pitcher in many seasons. -----
 Here is proof: ----- (CONVERSELY) NO PARAGRAPH
 McCloskey has been pitching no-run
 games consistently since he hit the league.
 he said nuts (sic) ----- PARENTHESES
 (X) or (O) ----- PERIOD
 "Spik" Jones ----- QUOTES
 ball game ----- SEPARATE
 Dickey, who never had a club in ----- SUBSTITUTE
 his hands, hit -----
 experience, drove one 230 yards. -----
 specialist ----- TRANSPOSE LETTERS
 striker yeomen ----- WORDS

Figure 7-21.—Marks used in copy preparation and editing.

113.29

several errors in the same line, the marks should be placed in the proper sequence in the margin of the proof and should be separated by diagonal lines. If the lines are long, the proofreader divides each line mentally and marks corrections for the left side of the line in the left margin and corrections for the right half of the line in the right margin. In marking coldtype composition for corrections, the proofreader tapes a sheet of tissue over the proof and marks his corrections on the tissue overlay at the point where they occur in the text, in much the same manner as a copy preparer.

Preliminary Operations

In marking or preparing copy for typesetting or coldtype composition, it is best to complete one function at a time. This means that you must run through the copy several times, doing only one operation each time, until all have been completed. A checkoff list will help to insure that you don't forget any of the important steps.

Most jobs will come to you as a stack of loose manuscript pages and artwork. And your first

Figure 7-22.—Proofreader's marks.

PROOFREADER'S MARKS

- ⊙ Insert period
- ↖ Insert comma
- : Insert colon
- ∫ Insert semicolon
- ? Insert question mark
- ! Insert exclamation mark
- ~ Insert hyphen
- ∪ Insert apostrophe
- ∩ Insert question marks
- ⊥ Insert 1-em dash
- ⊥ Insert 1-em dash
- ≠ Insert space
- ℓ Insert lead
- ℓ Insert virgule
- ∨ Superscript
- ∧ Inferior
- (P) Parentheses
- ∫ Brackets
- Indent 1 em
- Indent 2 ems
- ¶ Paragraph
- ¶ No paragraph
- to Transpose 1—used in margin
- ∩ Transpose 2—used in text
- Spell out
- italics—used in margin
- italics—used in text
- ℓf Balance—used in margin
- ℓf Balance—used in text
- A.G. Small caps—used in margin
- Small caps—used in text
- Reverse type
- eq # Equitize space—used in margin
- Equitize space—used in text
- Let it stand—used in margin
- Let it stand—used in text
- ⊗ Dirty or broken letter
- Turn over
- Turn back
- out, see copy
- Question to author to delete²
- ∧ Caret—General indicator used to mark exact position of error in text.

¹ In lieu of the traditional mark "V" used to indicate letter or number transpositions, the striking out of the incorrect letters or numbers and the placement of the correct matter in the margin of the proof is the preferred method of indicating transposition corrections. (See rule 2.75.)
² Corrections involving more than two characters should be marked by striking out the entire word or number and placing the correct form in the margin. This mark should be reserved to show transposition of words.
³ The form of any query carried should be such that an answer may be given simply by crossing out the complete query if a negative answer is made or the right-hand (question mark) portion to indicate an affirmative answer. (See example, p. 2.) (See rule 2.71.)

TYPGRAPHICAL ERRORS

It does not appear that the earliest printers had any method of correcting errors before the dawn was on the press. The learned the learned correctors of the first two centuries of printing were not proofreaders in our sense; they were rather what we should term office editors. Their labors were chiefly to see that the proof corresponded to the copy, but that the printed page was correct in its ~~astinity~~ ^{stet}—that the ~~correct~~ ^{stet} and that the ~~same~~ ^{stet} was right. They cared ~~not~~ ^{stet} little about orthography, had letters or purely printed errors, and when the text seemed to them wrong they consulted fresh authorities or altered it on their own responsibility. Good proofs in the modern sense were ~~impossible~~ ^{stet} until professional readers were employed ~~men~~ ^{stet} who had first a printer's education, and then spent many years in the correction of proof. The orthography of English, which for the past century has undergone some little change, was very fluctuating until after the publication of Johnson's Dictionary, and captions, which have been used with considerable regularity for the past 80 years, were previously used on the ~~miss~~ ^{stet} of ~~the~~ ^{stet} plan. The approach to regularity, so far as we have, may be attributed to the growth of a class of professional proofreaders, and it is to them that we owe the correctness of modern printing. More eyes have been found in the Bible than in any other one work. For many generations it was frequently the case that Bible-errata were brought out stealthily, from fear of governmental interference. They were frequently printed from imperfect texts, and were often modified to meet the views of those who published them. The story is related that a certain woman in Germany, ~~was~~ ^{stet} the wife of a Printer, had become disgusted with the continual assertions of her husband, a man over whom which she had heard, hurried into the composing room while her husband was at supper and altered a sentence in the Bible, which he was printing, so that it read ~~Nay~~ ^{stet}, instead of ~~Herr~~ ^{stet}, thus making the verse read "And he shall be thy lord" instead of "and he shall be thy lord." The word ~~not~~ ^{stet} of ~~and~~ ^{stet} he shall be thy lord." The word ~~not~~ ^{stet} was omitted by Barker, the King's printer in England in 1632, in printing the seventh commandment. He was fined ~~£1000~~ ^{stet} on this account.

¹ The system of making proofs can be made easier by the use of an imaginary vertical line through the center of the type area. The placement of corrections in the left-hand margin for those errors found in the left-hand portion of the proof and in the right-hand margin for right-side errors prevents overlooking of marks and facilitates corrections. (See also rule 2.74.)



step on receiving the copy is to run through it to see that all pages are in their proper sequence and that all the art is on hand.

If you have been furnished copy for the cover, write the word "cover" in the upper left corner of the cover page and encircle the word so the compositor will not confuse it with the copy. If the cover happens to be artwork, write on a blank piece of paper the same size as the manuscript page, "Cover—see artwork submitted." This page will then become No. 1 when you begin numbering the pages in the manuscript.

Next, number the pages so that it will be easy to keep them in proper order. At the end of the last page, write "all" and encircle it.

If the manuscript bears a classification, such as "Confidential," check to see if this classification is stamped properly on each page. It may be necessary to stamp a number or some other form of identification on each page of the manuscript.

Marking Type Styles and Sizes

Once these preliminaries have been done, you can begin marking the type styles and sizes. Either stamp or write in the upper left corner of each page, the type style and size, the leading desired, and the width of the line, as shown in figure 7-23.

The headings, legends, and other display lines must be marked separately. In most cases, heads follow a certain pattern, similar to the outline of a book. For example, the main heads may be set in 10 point caps; and subheads may be set in 10 point caps and lowercase and 8 point caps in the order of their importance.

Mark all legends for type size and length of line. Check legends against artwork for accuracy. Key the artwork into the manuscript by inserting a notation, such as "Illustration No. _____ to be inserted here." Or simply write and encircle in the margin of the legend the plate number assigned to the artwork.

If you are preparing material for coldtype composition, you may also wish to include the size of each illustration and whether it is line or tone. This notation will show the compositor

how much space to leave for the illustration when he prepares the text.

Always check each piece of artwork to make sure that it doesn't happen to be copyrighted material. Never use copyrighted material without permission. If you have permission to use a copyrighted illustration, be sure to insert a credit line to indicate its source. (See fig. 7-23.)

For further information on copyrights consult SFCNAVINST 5870.1A.

Marking Indentions and Tables

After this, you should run through the copy and mark all indentions. It is not necessary to mark paragraphs if they have been clearly indicated in typing. Lines that are to run flush should be marked "fl."

Any unusual indentions should be marked, as shown in figure 7-24. In marking paragraphs, you can use the paragraph sign (¶) or the em square (■). Two em squares (■■) mean that the paragraph should be indented 2 ems. It is not necessary to mark every paragraph on the page if the indentions follow a set pattern. In the page of figure 7-24, the numbered listings 1 through 4 have been marked for a 1-em indention. In some cases, numbers 1 through 9 are indented a "nut" (or en) space and numbers beginning with 10 are set flush. This arrangement provides for the alignment of the figures when they are set in type. The "3" written through the quoted matter is actually one side of the figure "8". It is used to call the printer's attention to the fact that the material is to be set in 8-point type.

Figure 7-25 shows one way to mark a table for the printer. Tables are often set in one size of type smaller than that used for the text of the book, and boxheads are set in one size smaller than that used for the body of the table. Tables should be numbered consecutively throughout a publication. Most printers use a parallel rule at the top of the table and a single hairline rule at the bottom.

Figure 7-26 shows how footnotes and headings are marked. In this case the copy preparer has used a number code for designating display type. Instead of writing "10 pt. Sans Serif Caps" he has marked the heading "C. 822 Caps." The

783561

WEATHER 10

10/12
Century Exp
26 Picas

¶ Sure enough, the next day was a scorcher. And as the temperature rose and the store began filling with people, the atmosphere became stuffy.

"Go back and open the door to the cold storage room," said the boss. "Maybe that will lower the temperature in here."

And I, not understanding the science of air conditioning, went back and swung the door wide open. You can guess what happened. The cold air rushed out into the room all at once. It was so cold that it practically took my breath away.

¶ I tried to shut the door, but I was too late. The damage had already been done. When the cold air rushed out into the store, it met the hot, July air head-on. A cloud formed near the ceiling, and in a few minutes it was raining all over the store. None of us minded the rain so much; it was such a hot day. It was good for business in a way, too. In less than 5 minutes, we were completely sold out of rain coats and umbrellas. But when it began thundering and lightning from the ceiling, the customers got panicky and made for the door.

¶ A zig-zag streak of lightning shot from the cloud at the ceiling and took one fat old lady right in the back. She went "Umph" like a big bear. Another bolt of lightning dropped from the ceiling and rolled down the counter in a huge ball of fire. I saw it coming and got out of its way; but just as it got even with me, it exploded in a mighty clap of thunder. A moment later, it was snowing. I made my way

Plate
3A

Courtesy of Mike Henry) - 6 pt Ital.

Figure 2. She went "Umph" like a big bear. - 8 pt Ital etc. fl right

Figure 7-23.--How to mark copy for the printer.

113.30

printer's cases carry similar numbers, and when he sees this marking he will set the heading from the case with the corresponding number.

Marking for Clarity

Be sure all words that are to be set in italics, small caps, and caps are properly designated.

10/12
Modern
23 picas

LITHOGRAPHER 1 & C

☐ Short quotations are usually buried in the paragraph, but long quotations, or quotations requiring special emphasis should be placed in a new paragraph. If the quotation consists of several paragraphs, use quotation marks at the beginning of each paragraph and at the end of the last one.

☐ Instead of enclosing them with quotation marks, you may have long quotations set in smaller type and indented. (See example below.)

☐ Editor Woo clears up these points in his book, "My Life and How I escaped with It."

☐ I was born when I was very young. At first I was plagued with baldness. (I'm having the same trouble today). But at the age of two, I started using a new type of hair tonic. Wonderful stuff, that hair tonic. I dropped some on my comb and now it's a brush. But if you think ^{that} this is hair-raising, keep reading. You ain't heard nothing yet.

At the age of ③, I was so mean that my family ran away from home. At the age of six, I attended school for one day and then became a drop-out.

☐ In general, quotation marks should be used as follows:

- ☐ 1. To set off direct quotations (the exact words of the speaker).
2. To set off sections quoted from other books or writings.
3. To set off quoted poetry.
- ☐ 4. To set off words and phrases accompanied by a definition or an explanation.

N32PI

8/10

Figure 7.24.—Paragraph marking.

113.31

You can indicate to the printer that you want his to set a word in italics by underlining the word with pencil. Two underlines means that the word should be set in small caps, and three underlines means that it should be all caps. Four underlines signify italic caps, and a wavy underline means set it in boldface.

You should also mark those things which are not readily understood so that there will be nothing left for the compositor to question. Emphasize such things as mathematical symbols, Greek letters, and so on, by writing a brief explanation in the margin of the page where each

8 Pt Century Exp. (Table 1. $\frac{1}{M}$ Printer's Measures)

Measurement	In inches	In points	In nonpareils)
1 point.....	1/72
1 nonpareil.....	1/12	6
1 pica.....	1/6	12	2
6 picas.....	1	72	12

8/10 Cent. Exp. 23 picas

Para. rule
6 pt box heads
Single hairline rule

113.32

Figure 7-25.—How to mark tables.

occurs. Encircle the marginal note (so the compositor will not confuse it with the copy) and draw a tie line or an arrow from the explanation to the word, symbol, or letter to which it applies.

The figure one (1), the cipher (0), the multiplication sign (X), the dash (—), and so on, should be clearly marked. Words that do not follow the usual spelling or capitalization, or words that the printer might mistake for typing errors and change under the impression he is doing you a favor, should be marked “set” or “follow.”

In marking an abbreviation or figure that is to be spelled out, you may simply encircle it. However, if the abbreviation is uncommon or might be misunderstood, it should be written out.

After the copy preparation is complete, you should run through the entire job once more to make sure that the marking is consistent. You may also check over the copy to see that it is consistent in punctuation, capitalization, compounding, spelling, and so on, but this is really an editor's job and is unnecessary if the work has been properly edited.

REVIEWING ARTWORK

You must be able to tell if artwork will reproduce properly. As you know, line drawings should have dark black lines contrasted against a white background for the best reproduction

results. Continuous tone copy, such as watercolor paintings or photographs, must be crisp and clear if they are to reproduce well. Also, value contrast in the original tone copy should exceed the contrast desired in the final reproduction.

If possible, the original art should be submitted for reproduction. If originals are not available, use copies of suitable quality. Copies of line drawings should also have a good black image. Check thin lines on the copy to see that they have not been lost in reproduction. Also check to see that lines close together have not filled in. For continuous-tone copy, halftone clippings from newspapers and books may be used; however, a clipping will never reproduce as well as the original.

HALFTONES

It was nearly the end of the 19th century before photographs and continuous tone drawings could be reproduced. All printed illustrations before this time consisted of line drawings, such as shown in figure 7-27, or wood cuts, such as shown in figure 7-28.

Early wood engravers has the first idea for producing tone, but their process was slow and tedious. Since the turn of the 20th century, lithographers have been able to reproduce continuous tone copy. As you know, in order to be printed, continuous tone copy must be photographed

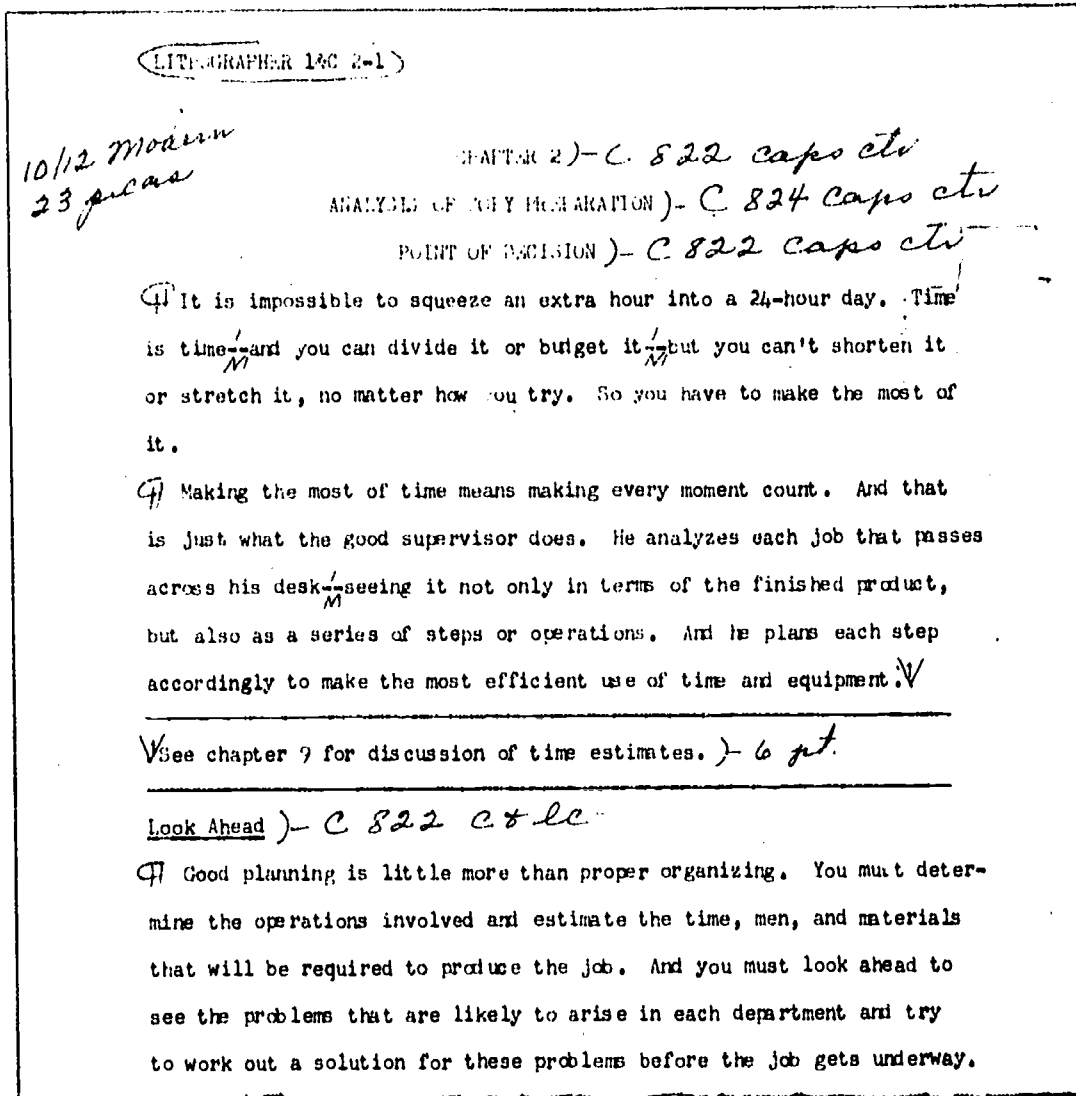

Figure 7-26.—How to mark footnotes and headings.

through a halftone screen. The halftone screen breaks the copy down into a series of small dots. These dots enable the lithographer to print tone copy as if it were line copy. When printed, these dots blend together giving the appearance of continuous tone. Figure 7-29 shows a comparison of line and halftone printing.

The Halftone Screen

A halftone screen consists of two sheets of optical glass, each of which has fine, parallel lines etched on one side. The lines are filled with pigment to make them opaque and the sheets of

glass are sealed with the etched surfaces together, with the parallel lines crossing each other at right angles to form a kind of cross-hatch. (See fig. 7-30.)

Halftone screens are available in standard rulings of from 50 to 400 lines per inch. The lines on the screen are generally the same width as the space between them. This means that a 50-line screen has 50 lines and 50 open spaces to each inch. The openings between the lines are therefore 1/100 of an inch wide. Halftones taken with a 50- or 60-line screen show more evidence of the dot formation than screens of 133 or 150 lines. Small differences in the number of lines per inch are almost unnoticeable to the naked

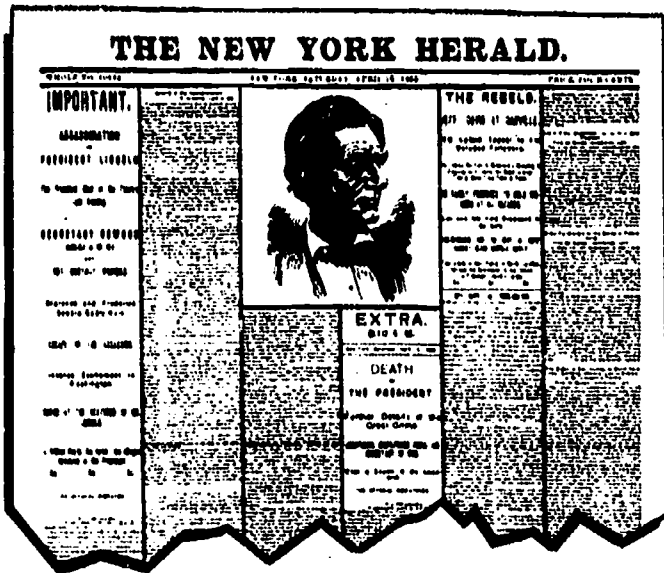

57.118

Figure 7-27.—Printed line drawing.

eye. Screens come in rectangular and circular forms and in a variety of sizes and rulings. Six different rulings were used to make figure 7-31. Rectangular screens are used for straight black-and-white work; circular screens are generally used for color-separation work where the angle of the ruling must be changed for each color.

The angle of the ruling must be set on circular screens; rectangular screens are built with rulings automatically set at a 45° angle to the camera. The 45° angle is chosen because it makes the dot pattern produced by the screen less noticeable to the eye.

How the Halftone Screen Works

The halftone screen is always positioned in the camera a short distance in front of the negative in such a manner that the light projected from the lens must pass through the openings in the screen before it reaches the film. The cross-lines of the screen form a pattern that breaks up the light and causes it to register on the film as a series of small individual dots, each varying in size according to the amount of light being reflected from the copy at that particular point. Because these dots are of varying sizes, they produce an illusion of tone ranging from light gray to black. (See fig. 7-32.)



57.119X

Figure 7-28.—Wood engraving.

Rescreening Halftones

Occasionally, you may want to copy a clipping—a halftone which has been previously printed. If the screen used for the clipping was coarse and open, the job may be shot as line copy; if it is not, the copy must be shot again through a halftone screen.

When the job is rescreened, the new dot formation may overlap the old, and a disturbing pattern called a *moiré* is formed. If the halftone must be rescreened, the lithographer can reduce this pattern or eliminate it by reducing the image or by tilting the copy to about a 30° (off vertical) angle on the copyboard. Sometimes a screen 50 lines coarser or 50 lines finer than the screen used on the original will eliminate *moiré*.



57.117X

Figure 7-29.—Examples of line and halftone printing.

45° ENGRAVED LINES
ON 3/32" COVER GLASS

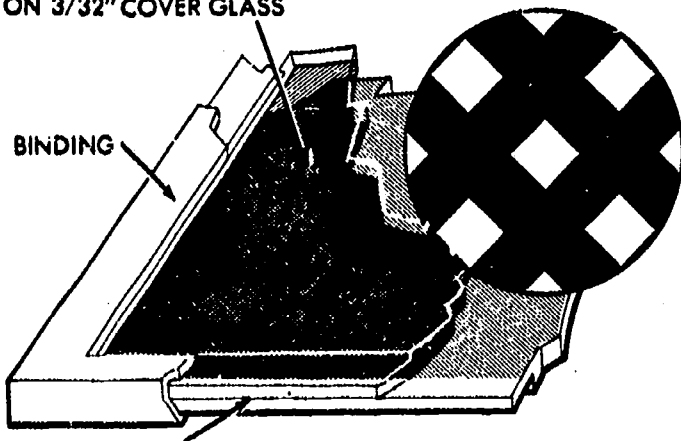

135° LINES ENGRAVED
ON 5/32" BASE GLASS

57.120

Figure 7-30.—Section of a glass halftone screen.

A diffusion filter, known as a rescreener, is sometimes used over the lens in copying halftone clippings. Since the rescreener diffuses the old dot, the cameraman can use it to make continuous tone negatives from clippings or he can rescreen the clippings and make halftone negatives without danger of moiré.

Special-Effect Screens

The illustrations shown in figure 7-33 were produced by shooting continuous-tone copy through special effect contact screens. Special-effect screens are available in rulings of 50 lines up. They are often used for advertising copy and for other types of work where it is desirable to simulate line drawings, engravings, and so on. They are available in a number of different patterns, including wavy line, cross line, steel engraving, etching, congour, circle (which produces an image consisting of concentric circles), and mezzograin (which produces a stippled image).

Not every continuous-type original can be used to advantage with these screens, of course. Best results are obtained when the copy has sufficient contrast to allow the dropping of whites (elimination of dots or lines in the extreme high-light areas) during the exposure.

RETOUCHING

Photographs are rarely used for reproduction without some work being done to them. This work can range from simple silhouetting or cropping to the more precise retouching. Most photographs are retouched to bring out important features or to suppress undesirable features.

A photograph must be handled with care because the surface is extremely sensitive. You should avoid making fingerprints around the areas to be painted. The skin will leave an oily film which prevents the paint from adhering to the surface of the photograph.

The surface of a glossy photograph usually has a light film or oil on it which is resistant to water color. This film is easily removed by carefully rubbing the surface with fuller's earth (a fine white powder).

A series of 6 opaque retouch grays plus black and white are available in a premixed form so that photographic values may be matched. Whenever white is used it must be pure or it will reproduce as a light gray. Opaques are applied with either an airbrush or a water-color sable brush.

You may eliminate small spots by using a photo retouching pencil. When using the pencil,

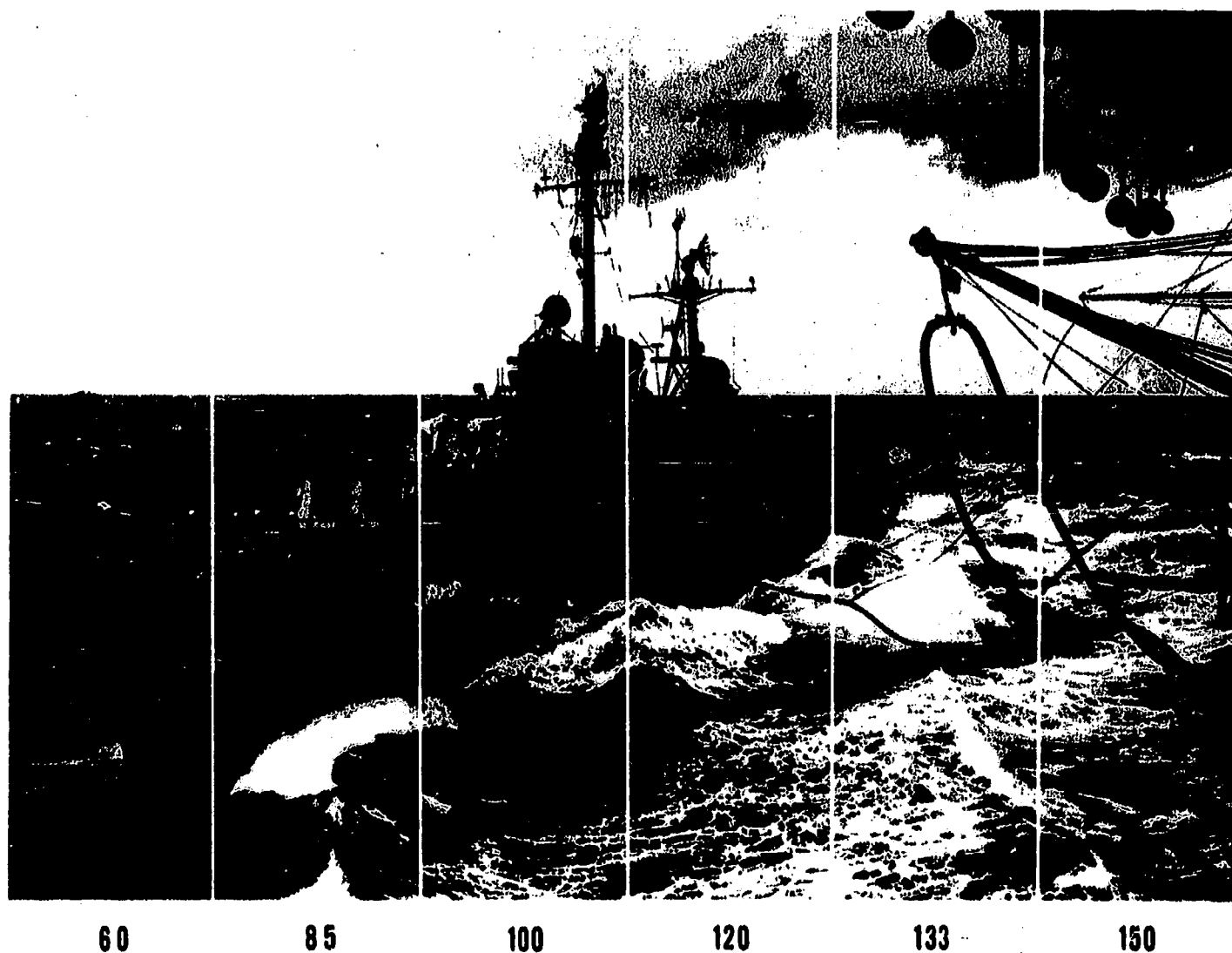

Figure 7-31.—Variety of screen rulings.

57.121

avoid digging into the picture. Use a slow, fine, circular motion to match the gray values.

will be reproduced with the complete elimination of the original background. Figure 7-34 shows silhouetting.

Silhouetting

When a portion of a photograph is to be reproduced without the background, the desired object is outlined with white opaque. The first steps are to mount the photo, rub the surface with fuller's earth, and blow away the residue. Then the opaque white should be painted accurately against the object being silhouetted. It is not necessary to white out the entire background. A line about 1/4 to 3/8 inches wide around the object is sufficient. When printed, it

Removing an Object from the Photograph

It is sometimes necessary to completely remove an object from a photograph before it is suitable for reproduction. See figure 7-35. If the area to be covered is a simple flat tone, use an airbrush; if it contains details and textures, however, the sable brush may be necessary. Try to match the detail and textures as closely as possible. Paint the light values first, then the middle values. Hold the dark values for last.



57.123
Figure 7-32.—How the halftone dots blend together to produce an illusion of continuous tone.

Removing or Softening the Background

Sometimes you must remove or soften distracting backgrounds by overlaying the entire photo with a shading sheet, then cutting and removing the sheet from the object you wish emphasized. It may be more appropriate to replace the entire background with a flat gray tone. To do this, the subject is silhouetted as

described before, and the platemaker is instructed to fill in a gray tone over the background. Another method is to apply a stencil, called a frisket over the area to be retained and use the airbrush to apply an even coat of gray, either light or dark, whichever is needed, over the undesired area. After removing the frisket, any excess paint which may have seeped underneath may be wiped off the subject with small wads of moist cotton that have been twisted onto the end of a brush handle (fig. 7-36). The edges of the subject may need to be retouched to avoid the subject's edges from being too sharp and unnatural.

The Velox

You can produce the type of illustration shown in figure 7-37 by retouching a photographic halftone print. The type of photographic print used for this purpose is called a velox. A velox is made from the screened negative which would be used to make the plate. Thus it contains the halftone dot image and may be considered as line copy. You may retouch the print by simply painting directly on it with opaque black or white. Also you may add lettering or other line work since a velox will be handled as line copy by the Lithographer.

CROPPING AND SCALING

If you want to reproduce only a portion of an illustration or photograph, the unessential parts should be cropped (marked off). There are several methods of cropping. The most common method is to mark the picture in the margins with ink, in the manner shown in figure 7-38. Ink crop marks should never run into or through the copy, of course. If the copy does not have margins, you should mount it on a larger sheet and make your crop marks in the margins of the larger sheet. Sizing should be marked at the bottom or along the right margin. You can also indicate the area of a photograph or tone drawing to be used by covering the copy with a piece of white paper and cutting a window to expose the desired area. Grease pencil may also be used in drawing crop marks, but it is not recom-



Figure 7-33.—Results produced by copying the same photograph through various special-effect contact screens. 57.597X

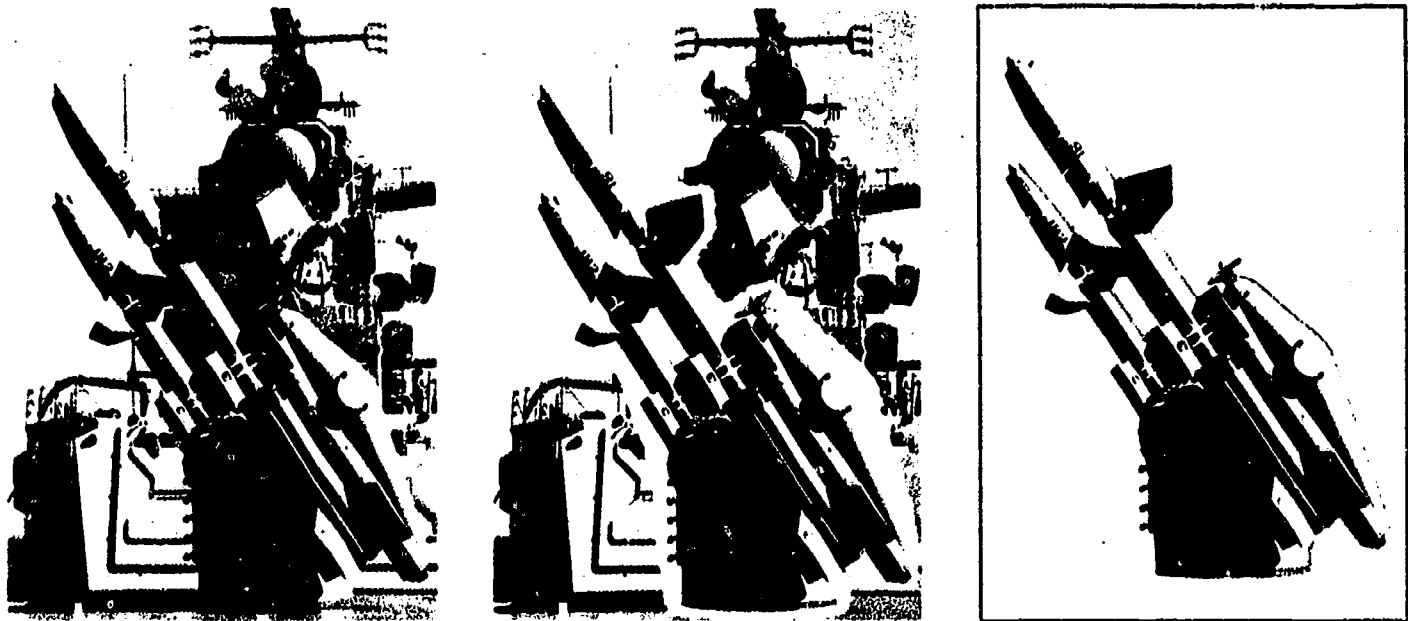

Figure 7-24.—Silhouetting. 142.277

mended because the grease marks may smear and transfer to other artwork or to the glass on the copyboard.

If an illustration is to fit into a given space, you should scale it to calculate its dimensions after enlargement or reduction so that you can be sure that it will fit into the space allotted to it. Once you have the new width or depth, you can calculate the remaining dimension mathematically, with a scaling wheel, a slide rule, or by the diagonal line method described in *Illustrator Draftsman 3 & 2*, NAVTRA 10469-A.

If the art is to be reduced or enlarged, the new dimension must be marked in the margin, as shown in figure 7-37. If no reduction or enlargement is required, write "SS" (same size) in the

margin. Continuous tone drawings may be prepared for one-half to one-third reduction. They are seldom enlarged because enlarging magnifies defects in the work. Original photographs may be enlarged if necessary; but halftones are rarely enlarged, because enlarging increases the size of the halftone dots.

Line drawings may also be prepared for one-half to one-third reduction. Ink lines should be clear and open so that they will not fill in when the drawing is shot down. Charts and lettering should be planned so that they will match the size of the other drawings and lettering in the publication when they are reduced.



142.279

Figure 7-35.—Removal of objects by retouching..

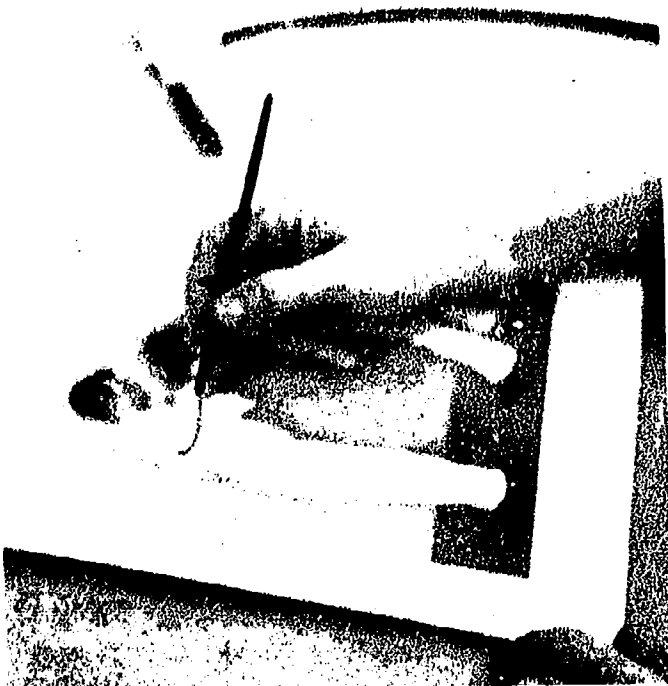

142.280

Figure 7-36.—Removing excess paint with moist cotton.

COMBINATION

If you will study figure 7-39 you will see just what happens when tone copy is shot as line.

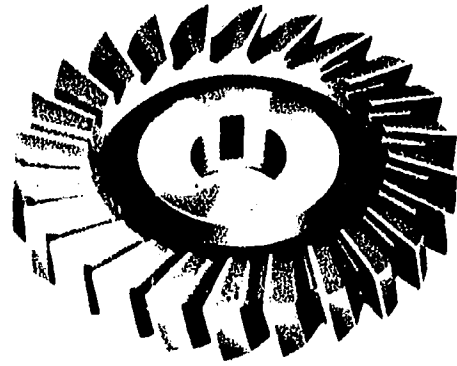

28.7(57)

Figure 7-37.—A velox.



113.34

Figure 7-38.—Crop marks made in the margins of the copy.

and you will also see what happens when line copy is photographed through the halftone screen. Figure 7-39a shows a photograph properly reproduced. Figure 7-39b shows a line shot of the same photograph. Notice that the print is sharp and contrasty with abrupt breaks between the shadows and highlight areas, and that practically all of the middletones have been lost. Figure 7-39c shows a screened line drawing. Notice that the lines are soft and feathery. Figure 7-39d shows the same line drawing properly reproduced. By comparing the results, you will see that a photograph cannot be reproduced successfully by the line process and a line drawing is not at its best when it is shot as a halftone. In other words, each type of copy

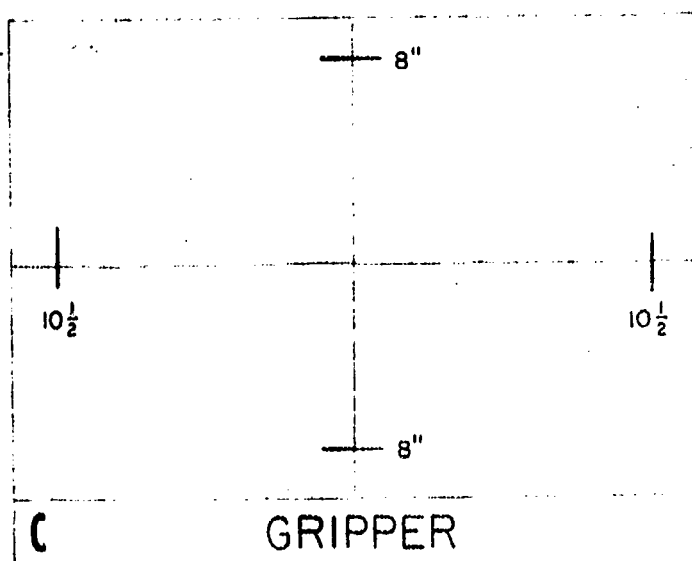
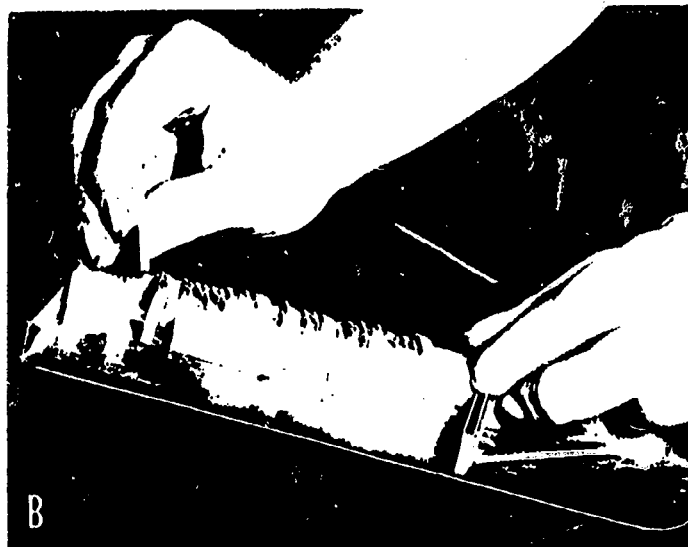
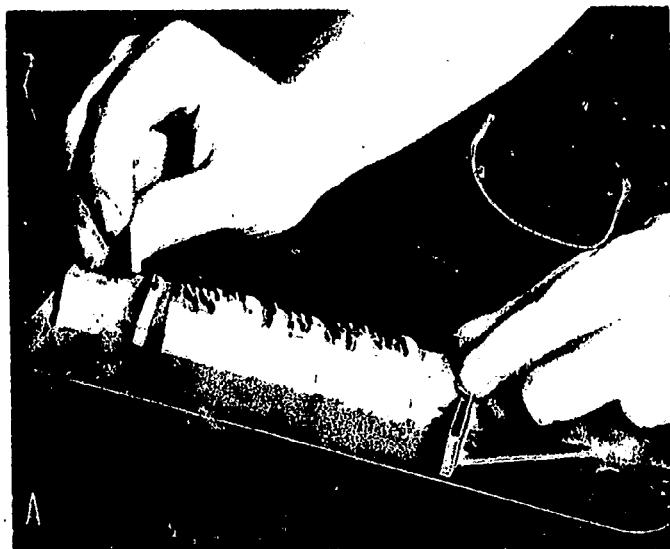

C GRIPPER
MASTER LAYOUTS FOR HARRIS LTE

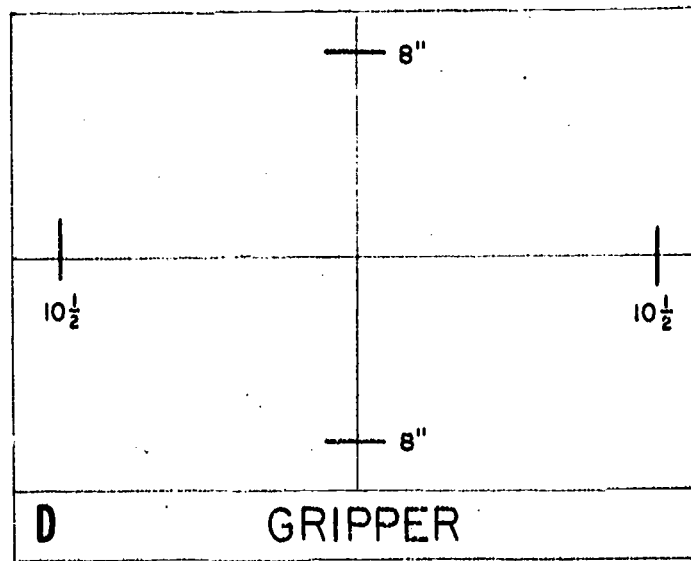

D GRIPPER
MASTER LAYOUTS FOR HARRIS LTE

57.134

Figure 7-39.—Graphic representation of what happens when tone copy is shot as line, and line copy is shot as tone.

must be processed properly if satisfactory results are to be obtained.

Suppose that you have an illustration which consists of a combination of a photograph or halftone drawing with lettering and other line work, such as shown in figure 7-40. How is this type of combination art reproduced? If it is shot as line the details of the halftone copy will drop out, and if you screen it the halftone copy will drop out, and if you screen it the lines and lettering will lose their sharpness. This problem is best solved by preparing the line copy as an overlay and registering it to the halftone copy. The two are then shot separately, the halftone copy is photographed as halftone, and the line

copy is photographed directly. The platemaker then combines the two resulting negatives by successively printing them in register on the printing plate.

To make white lines on a black or tone background a slight variation of the combination platemaking process described previously is used. Artwork is prepared in the same manner; that is, the line copy is prepared on an overlay. Negatives are then made. However, instead of using the line negative to make the printing plate a film positive is made and then is stripped over the halftone negative. Both the halftone negative and film positive are then printed on the plate at the same time. Figure 7-41 shows the end result.

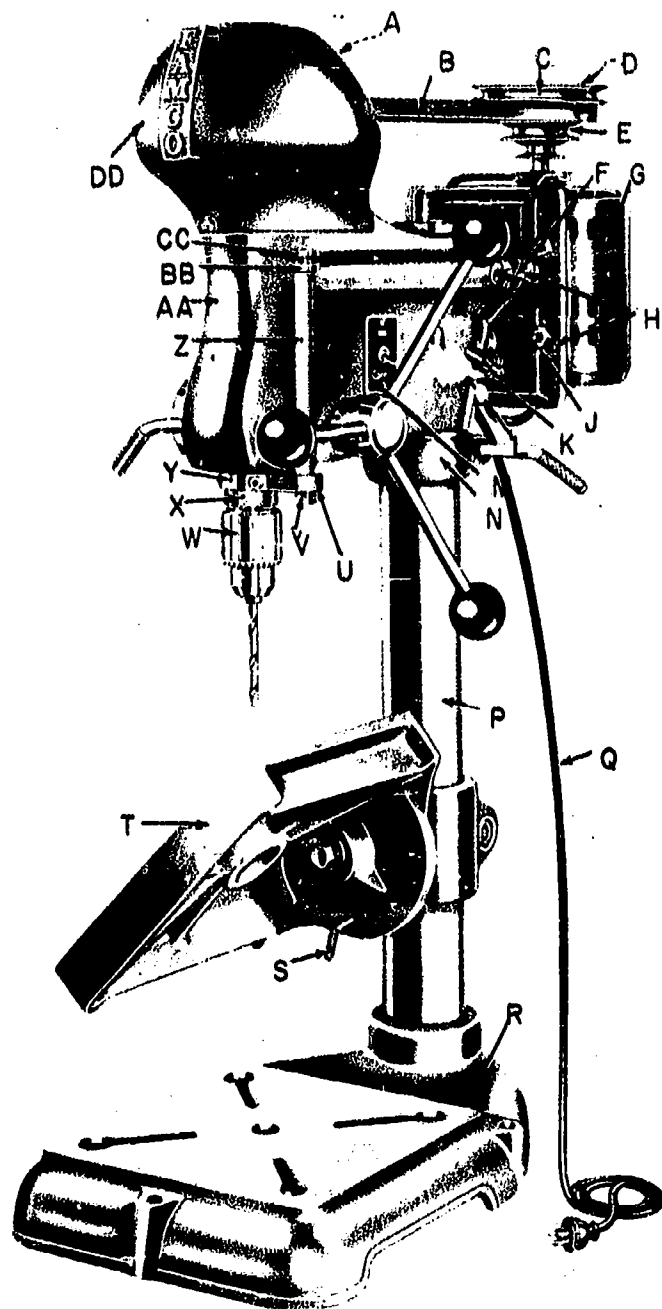

- A SPINDLE DRIVEN PULLEY
- B V-BELT
- C MOTOR DRIVE PULLEY
- D 1/8 SQ x 1 SQ-END KEY
- E NO 10-24 x 5/8 HDLS SET SCREW
- F MOTOR BRACKET STUD THUMBSCREW
- G MOTOR
- H MOTOR BASE AND BRACKET ASSEMBLY
- J 1/4-20NC 2 x 1 SQ-NECK RD-HD CARRIAGE BOLT AND 1/4-20NC-2 SQ NUT
- K DRILL CHUCK KEY
- L DRILL CHUCK KEY BRACKET
- M TOGGLE SWITCH PLATE
- N HEAD COLLAR SUPPORT
- P BENCH COLUMN
- Q CORD
- R BENCH BASE
- S TILTING TABLE LOCKPIN
- T TILTING TABLE ASSEMBLY
- U DEPTH GAGE ROD BRACKET
- V HEX NUT
- W DRILL CHUCK
- X CHUCK KNOCKOUT COLLAR
- Y SPINDLE AND QUILL ASSEMBLY
- Z DEPTH GAGE ROD
- AA HEAD ASSEMBLY
- BB DEPTH GAGE ROD ADJUSTING NUT
- CC DEPTH GAGE ROD LOCKNUT
- DD SPINDLE DRIVEN PULLEY GUARD

Figure 7-40.—Combination art.

4.29(44B)

Be sure the overall dimensions of the film positive produce an area larger than the halftone area which it is to cover, so that no ragged line or shadow is left after printing on the plate.

COLOR REPRODUCTION

Full-color drawings or photographs may be reproduced by the process color method, which

calls for artwork to be submitted in full color and for color separation to be done by photographing the copy through colored filters. The copy is shot four times and recorded on four separate negatives. Three negatives are made, one for each primary color, and one additional negative is made for the black. The negatives are then made into separate plates. Color is restored when the plates are run on the press.



57.37.0

Figure 7-41.—Example of reverse lettering on a halftone background.

When simple line illustrations are to be printed in color, a black-and-white drawing may be all that is required. You should ensure that this type of illustration has an overlay attached that indicates to the platemaker what and where the color is to be.

In the case of complicated or detailed line illustrations, you should make the color separation. The method requires an overlay for each primary color, and each overlay should be registered to the master and marked with the color it is to be.

When line copy is printed the image will have one single flat value. However, it is possible to regulate this value by screening the image, thus changing the ratio of color to white space. The

Lithographer may accomplish this with a screen method known as the benday process.

The benday process involves placing special screen patterns, similar to halftone screens, in front of the film in the camera. The resulting image is broken into dots of equal size and will print as a flat tint. The amount of tint is controlled by the benday screen that is used. Screens are rated as percentages of a solid color; that is a 20-percent screen would be light, whereas an 80-percent screen would be dark. See figure 7-42. Screens are available in dots, lines, and patterns. You may prepare overlays containing the tint image only. If the image is an uncomplicated shape, such as a rectangle or square, you may simply outline the area in red on the original and indicate to the Lithographer that this area is to contain a tint of a certain color.

In a variation of the benday process, the platemaker adds a dot pattern to the line negative before the plate is made. Transparent plastic shading sheets containing reverse value dot patterns are cut to match the tint image and placed over the line negative.

You can obtain tints simply by using a Format or Zip-a-tone type shading sheet when preparing the original.

MARKING ART

Besides checking to see that the artwork has been properly prepared, you should also check the cameraman's instructions to see that they are clear and complete. Crop marks should be plainly indicated, and illustrations should be properly scaled and marked for size. Remember that photographs may be shot same size or they may be enlarged or reduced, but practically all other types of work are at their best only when they are shot same size or reduced.

Be sure that special instructions for tint blocks, reverses, and so on, are clear and that overlays have been properly marked. If illustrations are to go in color, the acetate overlays should be marked with the proper color designations, as red plate, blue plate, and so on. The original drawings and the overlays should carry registration marks so that the plates can be registered in printing. Color swatches may be

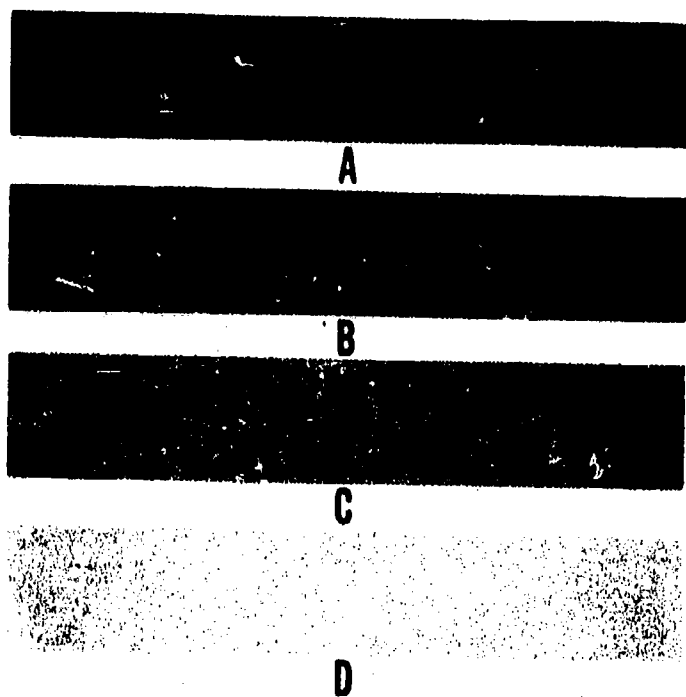

C149.54

Figure 7-42.—A. Flat color printed full strength.
 B. With 80% screen.
 C. With 50%.
 D. With 20%.

attached to the original drawing to show the colors to be used.

Each piece of art should be marked or stamped line, halftone, or combination, according to the preferred reproduction treatment. Tone copy should also be marked outline, or square finish.

The art should be marked for identification by the title of the job and a figure number. Plate numbers are assigned to the art independent of the figure numbers. For example, if the cover of a pamphlet consists of artwork, it will be plate Assemble all the pieces of art in sequence and then number them consecutively, writing the plate numbers on the flap or cover attached to the illustration.

If you are ordering letterpress cuts from an engraver mark the word "block" on the art that you send him, so that he will mount the cut on wood to make it type high.

CHECKING PASTEUPS

Work is generally assembled and pasted into pages or into the largest possible units before it is passed on to the cameraman. All pieces of same-size line copy can be pasted together on a layout sheet, but halftone copy or line copy that requires enlargement or reduction must be submitted separately.

Coldtype composition is generally pasted on a sheet of illustration board that has been ruled with blue pencil to show the type area, trim size, bleed, and column widths. Column rules, borders, and other elements that are to be retained when the copy is photographed should be ruled in with a ruling pen and india ink before the pasteup is begun. Line copies that do not require enlargement or reduction may be mounted in their proper place along with the type.

If the coldtype composition has been prepared on a wide measure so that it can be reduced when it is photographed, all elements of the layout must be enlarged proportionately, because a reduction in the width will also result in a reduction in the length of the columns. You should scale such work to see that it will come down to the proper dimensions.

A piece of black paper is sometimes placed over areas where halftone copy and linework that requires a change in size are to go. If a dummy has not been provided, attached a tissue overlay to the master copy and indicate on the tissue which illustration is to go in each masked area. (See fig. 7-43.) If marks are made directly on the black patches they may reflect light and show up in the negative.

Besides checking the pasteup layouts for spacing and general appearance, you should also examine the lettering on the proofs to see that there are no smears or imperfect letters. Imperfect letters should be touched up with india ink or chinese white water color.

If you are working on a publication which uses a standard format, you may print layout sheets on the offset press, using a light blue or gray ink and a paper stock equal in bulk and rigidity to 28-pound ledger.



Figure 7-43.—A pastep layout, containing masked-out areas for halftones.

113.35

FOLLOWING UP THE JOB

Figure 7-44 shows a layout sheet of a cold-type repro page on which a same-size line illustration was pasted in place, and space was left for halftone illustrations. Halftones and line cuts which must be enlarged or reduced cannot be pasted on repro pages. Instead, they must be shot separately and spliced into the master negative. The compositor types the copy directly on the layout sheets, leaving blank spaces where the illustrations are to appear.

Your job involves more than just laying out the work and reviewing it for reproduction qualities. You must also follow up the job, making sure that the illustrations are properly made and stripped in place and that each department follows your instructions in producing the work.

In letterpress work, you can look over page proofs and revise them if necessary in the interest of good spacing and layout. But in off-set work, you must check all these things carefully before the plate is made.

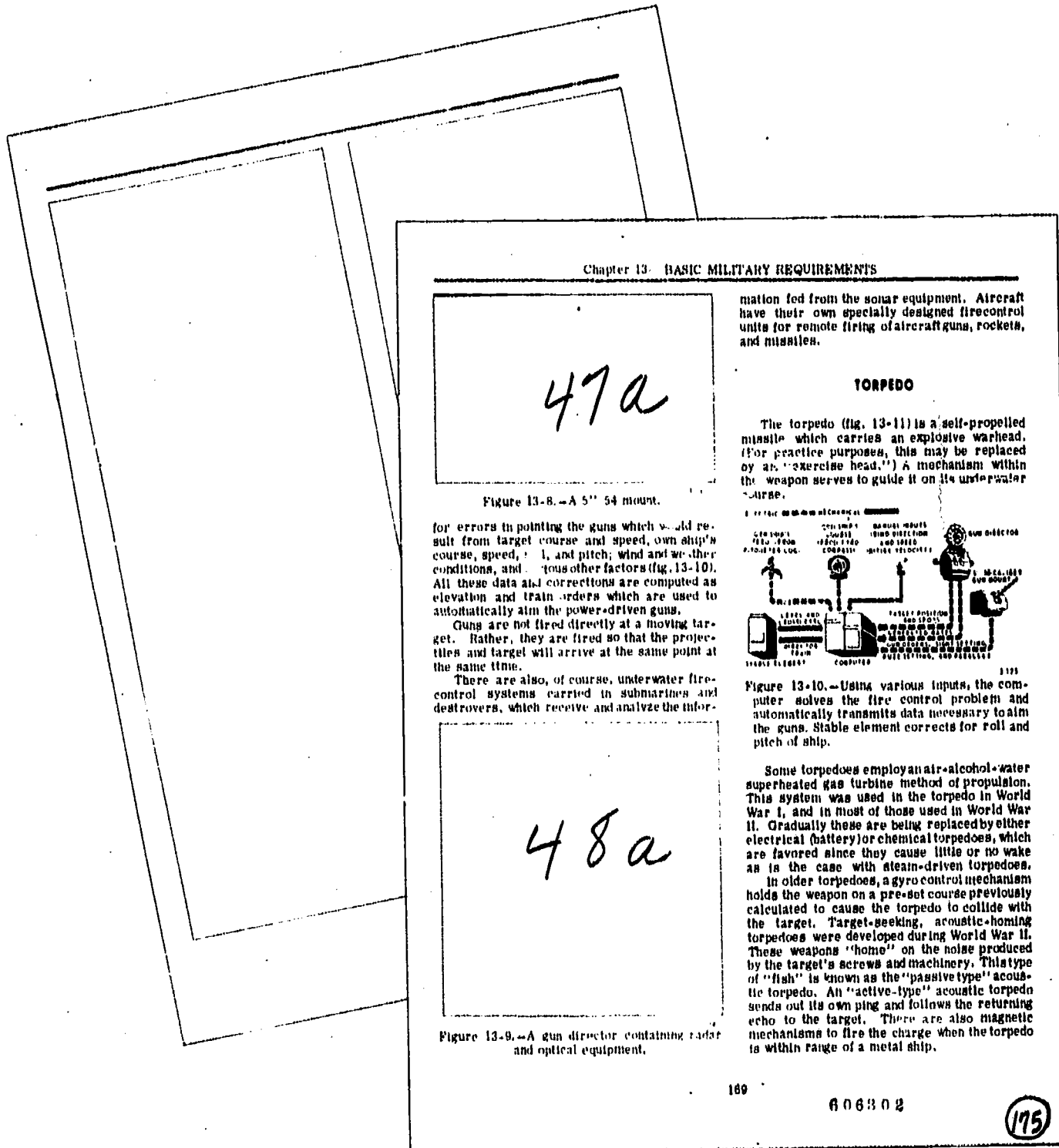

Figure 7-44.—Layout sheets.

113.36

APPENDIX 1

GLOSSARY

This glossary consists of selected technical terms and their meanings as applied to the work, equipment, and areas of responsibilities of the Illustrator Draftsman rating.

A

- absorption—the taking of one into another, as ink into paper to facilitate drying; or as in light rays, a filter passing its own color and holding or absorbing others.
- accordion fold—in binding, two or more parallel folds which open like an accordion.
- actinic light rays of light, especially the short waves of the spectrum, such as green, blue, and ultraviolet, which cause chemical changes in light-sensitive photographic emulsions.
- additive process—process by which white light can be produced by starting with darkness and combining colored lights until white is obtained.
- Adlux film—trade name for slow-speed continuous-tone emulsion on frosted acetate; used for making transparencies and for photographically converting screened copy to continuous tone.
- affinity—having a natural attraction for.
- agate—a unit of measure in printing; approximately 5 1/2 points.
- air eraser—miniature sand-blasting apparatus, sometimes used by artists and lithographers for touch-up erasing on artwork.
- alcohol—volatile liquid solvent.
- align—to position type and cuts in a straight line.
- ammonia process—development of a diazo image by the use of heated ammonia fumes; the Ozalid process, for example.
- ammonium hydroxide—ammonia gas dissolved in water; used to alkalize the light-sensitive coating in platemaking and in diazo development.
- anhydrous—waterfree or without water, as anhydrous alcohol.
- animal blacks—ink pigments made by charring animal bones from which the oily and fatty matter has been extracted.
- antique finish paper—natural, rough surface on book and cover papers; may be clothlike or be ladderlike in appearance.
- aperture—opening through which light enters a camera.
- apochromatic lens—lens corrected to focus all the primary colors on the same plane.
- arc lamp—light source in which an electric arc is formed between two carbon electrodes when current is applied.
- Art Type—trade name for acetate lettering or shading sheets.
- author's alterations (AA's)—changes made by the originator after the material has been typeset.
- automated cameras—cameras which load the film, make the exposure, and develop the film automatically.
- autopositive—emulsion which produces a positive image from positive copy. A yellow filter is generally used in making the exposure.
- Autoscreen—trade name for an orthochromatic film which is designed to produce a screened image from continuous-tone copy without the use of a half-tone screen.

B

- background—nonimage area of a print; also discoloration or scum in that area. Photographically, the area surrounding the central object in a photograph.

- back gage - on paper cutters, a fingered metal bar against which the paper is squared.
- back light - in process camera work, to illuminate the copy from behind.
- back matter - the back pages of a book, such as the appendix, glossary, bibliography, and index.
- back up - to print the reverse side of a sheet having printing on the front.
- base color - first down color printed on the press.
- basis weight - weight of a standard size of printing paper in lots of 500 sheets (commercial standard) or 1000 sheets (Government standard).
- bastard size - not to standard dimensions.
- bed - flat part of a letterpress press on which type form rests.
- bellows - flexible, light-tight enclosure connecting the lensboard and the camera back.
- bellows extension - see camera extension.
- benday - tint effects, such as lines, dots, or patterns, applied to art, negatives, or plates.
- bind - to join pages of a book together with thread, wire, adhesive or other means; also to enclose them in a cover.
- bite - (1) the amount of space by which the press grippers overlap the leading edge of a sheet; (2) the action of etch on metal, as in photo-engraving; and (3) the affinity of paper for ink.
- black printer negative - in color-separation work, a negative made with a yellow filter or a combination of filters. The plate made from this negative is run on the press in black ink.
- blanks (paper) - paper boards ranging in thickness from 0.012 to 0.078 of an inch.
- bleed - in trimming printed matter to final size, (1) to position illustrations, solids, etc., so that one or more of their edges are cropped, also, part which is to be cut from an illustration when a page is trimmed to final size (2) to cut off (as prescribed by the page layout) one or more edges of an illustration, or appropriate image area.
- block out - to mask or paint over with opaque the transparent portions of a negative that should not image on the plate.
- blow up - enlarge photographically.
- blue line - photographically-prepared image in blue lines on acetate, metal plates, or paper; used for paste-up or color-separation work.
- blue key - a blueprint on glass or vinyl plastic of a design containing all elements with register marks; used as a guide for stripping a flat of photographic elements of other colors to register.
- blueprint - quick proof made from a negative or flat on blueprint paper; yields a blue image.
- book paper - paper suitable for printing books, catalogs, magazines, etc; may be coated or uncoated, in a variety of finishes; may or may not be sized for offset printing.
- border-ornamental or finishing rule around the edge of printed matter.
- box - to enclose a paragraph or heading with borders or rules.
- broad - in layout, placing the top of the image at right angles to the greater dimension of the page. Generally in publications work, the head is placed at the left side of the page on both right and left hand pages.
- brochure - pamphlet or booklet.
- brownprint - a photographic print or silverprint which produces a brown image; not to include a sepia print or a contact print that has been toned. See also blueprint.
- bulk - number of paper sheets per inch of a given paper weight.
- bullets - dots used as ornaments in composition.
- burn - to print (expose) a photolithographic plate with bright light in a vacuum frame.
- burn out - to overexpose when printing a plate with a positive so that sufficient exposure can be achieved through dirty or less than totally transparent areas of the positive.
- business papers - paper used for administrative uses, such as bonds, punchcards, safety papers, and mimeograph and duplicator papers.

C

- camera extension - distance from film to lens.
- camera-processor - automated process camera and platemaker combined into one machine.
- camera-ready - copy that is complete and ready to be photographed.
- candle power - unit of measure of a light source.

- carbons compressed carbon rods of varying thickness and length used to produce arc illumination in camera and platemaking equipment.
- carbon blacks (ink) ink pigments consisting mainly of the element carbon made by partial combustion of natural gas.
- carbon tetrachloride colorless nonflammable fluid used as a solvent. It is dangerous when used without adequate ventilation and its use is prohibited aboard naval vessels.
- cartography the art of making maps or charts.
- case drawer for storage of type.
- casting copy to calculate the space that manuscript copy will occupy when set in type.
- centerline a short line applied to the copy, negative, or a flat and used to indicate the center of the trim margins of a form or all the forms on a press sheet; also used for registration.
- character count an estimate of the number of characters including spaces between words in manuscript copy. It provides the means of determining how much space the text will occupy when set in type.
- chase metal frame into which the type form is wedged (locked) before being placed on the press.
- chemical fog see fog.
- chipboard rough surfaced cardboard used as backing for pads and tablets.
- chromatic aberration failure of lens to focus all colors on the same plane, causing a colored outline or blur.
- circular screen glass halftone screen, circular-shaped to allow for rotating it to various screen angles in color work.
- coated blanks cardboards of two or more plies coated on one or both sides, used for signs, posters, tickets, etc.
- cold colors colors like blue and green which are restful to the eye.
- cold shot shooting a screened original without using a halftone screen; also a screened pickup.
- coldtype composition any composition prepared by methods that do not include materials produced with letterpress typesetting equipment, such as typewritten or Varityped copy.
- collating gathering single sheets or leaves in sequence.
- color correction any technique which alters the density in specific areas of a negative or positive and thus provides for more accurate color rendition; as dot etching or masking.
- colorblind emulsion photographic emulsion sensitive only to blue and violet.
- Color-key (3M) thin, light-sensitive color-coated acetate sheets used in making artwork for 35-mm slides and proofing multicolor jobs; colored coatings on these sheets match standard process colors. The sheets are exposed through separation negatives and developed with a chemical which dissolves the unexposed coating leaving a colored image.
- color patch sample usually attached to the original to show the precise color of ink required in printing the job; also called color swatch.
- color separation process of photographing each primary color of a full color original on a separate sheet of film; also preparation of artwork for a multicolor job whereby an overlay is made for each color.
- color transparency transparent, full color photograph on film, as a color slide.
- column inch a space 1 inch deep by 1 column wide.
- column rule dividing line between two columns of type.
- combination art artwork containing both line and tone work.
- combination layout line and halftone negatives or positives stripped onto the same flat; also a flat containing a number of unrelated jobs.
- combination plate an offset plate imaged with both halftone and line work; also a plate on which there are two or more unrelated forms for simultaneous printing.
- compositor sets letterpress type or prepares coldtype composition.
- comprehensive a detailed layout with illustrations carefully drawn and type positions; also called a "comp".
- contact negative same size duplicate made by exposing a sheet of film to a film positive.
- contact positive same size duplicate made by exposing a sheet of film to a film negative.
- contact printing frame a glass-topped frame used to bring a film into perfect emulsion-to-emulsion contact with another film or plate; usually vacuum operated.

contact screen halftone screen made on safety base film; used in absolute contact with the film emulsion.

continuous tone image consisting of blacks and intermediate shades of gray; not produced by a pattern of varying-size dots.

contrast tonal range of photographs, negatives, artwork, etc; the degree of difference between the darkest shadows and the brightest highlights.

contrasty—having sharply-defined light and dark tones and limited or no medium tones.

copy—strictly, only manuscript or text; loosely, anything submitted for reproduction, such as an original that is better defined as line copy or tone copy.

copy fitting—calculating the proper type size and line width to accommodate copy within a given space.

copy plane—surface on which copy is attached for photographing; the copyboard of the camera.

cover stock—paper used chiefly for booklet covers, tickets, etc.

Craft-Tint—trade name for a chemically impregnated drawing paper whose pattern of lines and dots is brought out by brushing with chemicals.

crop marks—marks on an illustration to show which portion is to be reproduced.

cross-hatch—criss-cross lines in a line drawing that give the effect of value or shading.

crossline screen—a glass halftone screen having opaque lines which cross at right angles, as distinguished from single line screens that have lines in one direction only.

cut—metal plate having an etched image for letterpress printing; also any illustration used in a printing job.

cutlines—legends and captions.

cyan—blue-green color.

D

darkroom camera—process camera with back built into the darkroom wall.

dead—cancelled; finished; not to be used again; as a dead form.

deep-etch lithographic platemaking process in which the image areas are slightly etched into the plate surface.

density measure of opacity, or the ability of a film to stop light.

densitometer an instrument for measuring the reflection and/or transmission density of opaque copy or negatives.

density range (of halftone screen)—the range of tone which the screen can produce; determined by subtracting the density reading of the shadows areas from the highlight density on the negative.

desiccated—completed dried; having all moisture removed.

detail exposure—halftone exposure capturing all the minute detail of the copy.

diaphragm—device used to control the amount of light admitted through the lens to the camera.

diaz compound—light-sensitive, coal-tar derivative used in coating presensitized materials.

diaz materials—paper, card stock, clothbacked paper, continuous tone paper, sepia, foils, etc., coated with a diazo compound; usually developed by ammonia.

diffused light—light waves thrown back or reflected in several different directions.

dingbats—stars or ornaments used in type composition.

direct-image plates—plates which are imaged by typing, drawing, lettering or imprinting directly on the plate.

direct method (in color-separation)—a method which consists of making the halftone negative for each color directly from the original copy. See indirect method.

display type type larger than body type used to draw attention.

double printing—combining details of two negatives by successively exposing both on the press plate in register.

double spread—facing pages in a publication laid out in such a manner that both pages combine to form a spread. A double spread is sometimes called a “two page spread” or a “center spread” (when located in the exact center of a booklet).

draw—the the action of a dull knife in cutting paper which draws the sheet away from the

back stop of the cutter thus producing a somewhat concave rather than vertical slice.
 drop-out—halftone negative in which dots have been eliminated (dropped out) from highlight and background areas, by exposure or development.

dry brush—a drawing made on rough paper with very little ink in the brush.

dummy—in layout, a preliminary sketch showing position of text and illustrations; in bindery; a blank sample showing size, shape, folding, and collating order.

duotone—a halftone that has its shadow detail printed in a dark color and its highlight detail in a lighter color.

E

electrostatic copiers—machines which produce plates and paper copies electrostatically.

electrostatic plates—plates produced by an electronic process. See xerographic printing.

Electrofax—trade name for an electrostatic printing process.

elliptical dot halftone screen—contact screen which produces an elliptical dot instead of the conventional square dot.

em—a printer's measure, the square of the body of the type; 8 points by 8 points, for example.

en quad—half the width of an em quad; also called "nut". Properly called a space as it is smaller than an em.

enamel stock—paper to which has been applied a smoothed coating; may be dull finished or high gloss.

English finish—uncoated book stock with relatively high bulk and smooth surface.

exposure meter—a device used to measure light intensity.

F

f-numbers—fixed values at which the aperture of the lens can be set. The values are determined by the ratio of the aperture to the focal length of the lens.

fake process—process by which color-separation negatives can be made from a set of retouched

black-and-white photographs by changing screen angles.

felt side (of paper) smooth or top side; preferred side for printing. See wire side.

filling in (or filling up) filling of areas between halftone dots or small letters caused by excessive ink or thin ink.

film processor—machine which automatically develops, washes, and fixes film in one continuous operation.

film speed—relative sensitivity of film to light.

filter—piece of colored glass, film, or gelatin used to separate colors, reduce glare, or vary contrast; also a material, such as cheesecloth, that allows certain dissolved materials to pass while holding back insoluble particles.

filter factor—the number of times an exposure must be increased when a filter is used.

fixer—photographic solution which stops the action of the developer, dissolves unexposed silver salts in the emulsion, and hardens the colloids. Commonly called hypo.

flare—nebulous patches of light caused by internal reflection in the lens.

flash—a supplementary halftone exposure of short duration made to introduce a fine, pinpoint dot into the shadow areas.

flat—sheet of acetate or paper on which negatives or positives have been mounted in proper position for printing.

flatbed press—press on which type form or lithographic stone rests on a flat bed.

flat negative—negative with little contrast.

flat stitch—to staple or stitch along the edge; to side stitch. See saddle stitch.

fluorescent lamps—low pressure mercury arc lamps.

flush—even with the margin or even with the widest line in the column or page.

focal length—the distance from the lens to negative when the camera is focused on an object at infinity (100 feet or more). Also $1/4$ the total distance between the film and copy when a process camera is focused for a same-size reproduction.

focal plane—position at back of the camera at which the image is focused and the film is placed.

focus—point at which light rays passing through a lens meet to form a sharp image.

focusing dial—device used to calculate proper camera settings for reductions and enlargements; also to determine proportional dimensions.

fog—silver deposit clouding all or part of the transparent areas of film.

fold-in—large sheet folded to fit into a bound book.

folio—page number.

font—complete assortment of type of one size and style.

form—type and cuts arranged in one or more pages, locked in a chase and ready for printing.

format—size, shape, and general style of makeup of a publication.

Forms design machine—Vartyper with leader-line assembly (forms attachment) which enables the operator to type continuous rules or leaders when preparing copy.

Foto-type—trade name for cardboard letters used in copy preparation.

foundry type—type cast on hard metal for hand setting.

French fold—an arrangement in which all of the pages are printed on one side of the sheet, the other side being left blank. The blank side is folded inward before making the other fold, as a greeting card.

front matter—in publications work, that matter which precedes the actual text, such as the title page, preface, foreword, and table of contents.

frontispiece—ornamental drawing or illustration facing the title page of a book.

fuser—in Xerographic printing, heating or vapor unit used in fusing the image to the plate or paper.

G

gallery camera—horizontal camera, not connected to the darkroom.

galley—metal tray in which type is placed after being set; also proof taken from galley of type before type is made up into page form.

galley press—proof press suitable for proofing long galleys of type.

galley proof—proof pulled from type contained in a galley.

ganging—combination of unrelated jobs on a single press plate to save press time.

gather—assemble printed sheets in proper order.

goldenrod—paper or plastic support for negatives used by the stripper in making flats.

gothic—class of type, usually a business-like letter with serifs.

gray contact screen—halftone screen used for both black-and-white and color-separation work.

gray scale—a strip of paper containing tones ranging from pure white to black with intermediate shades of gray; used as a tool in contrast control.

gripper bite—the distance the grippers overlap the press sheet as they clasp it to draw it through the press.

gripper edge—the leading edge of the press sheet; the edge that is caught by the grippers as the paper is drawn into the press; also the leading edge of the goldenrod layout or plate.

gripper margin—on the goldenrod layout, an amount of space allowed for the grippers to clasp the press sheet.

grippers—on offset presses, short, curved fingers which grip the paper and carry it through the printing unit; on platen presses, the long metal fingers which strip the paper from the type after the impression.

ground glass—frosted glass used at the back of the camera in focusing.

guide marks—a method of using crossline marks on the offset press plate to indicate trim, centering of the sheet, centering of the plate and so on, as well as press register in multicolor work. Not to be confused with register marks used for stripping elements to register.

gutter—(1) the inside margin of a bound page extending from the image area to the binding edge (2) white space between the columns or pages of a publication.

H

hairline rule—in letterpress work, a rule producing a fine printing line, approximately 0.003" thick.

halftone—a film, print, or plate in which details and tone value are recorded as photographically-created dots.

halftone ink—soft, fluid, letterpress ink used for printing halftones and for reducing stiffer inks.

halftone negatives—photographic negatives made by photographing the copy through a ruled screen. The screen breaks the image into a series of small dots of varying sizes which combine to give the appearance of continuous tone.

halftone screen—cross-ruled glass or film used in the platemaker's camera to create halftone negatives from continuous-tone copy.

hanging indention—style of indention in which the first line is set flush left and the remaining lines of the paragraph are indented.

hard copy—an enlarged print made from a micro-film image; also the copy produced on a cold-type composing machine, such as the Justowriter at the time the tape is prepared.

Headliner—a photo-lettering machine.

highlight—lightest areas on the copy; darkest on the negative.

highlight exposure—one of of the multiple halftone exposures made when copy has considerable tonal range.

highlight printer—in duotone work, the negative for the color plate, as distinguished from the shadow printer negative which is generally used for the black plate.

highlighting method—method of producing halftone negatives with a contact screen in which a highlight or bump exposure is used in addition to the flash and detail exposures.

high negative—dense, very contrasty halftone negative; has no pinhole openings in the darker portions.

horizontal camera—process camera whose bellows extends horizontally.

hypo—see sodium thiosulfate.

I

imposition chart—a piece of blank paper the size of the sheet to be printed, numbered and folded as it will be in the bindery after printing; used in makeup to show where each page should go in relation to the other pages.

indirect method (in color separation)—method in which continuous-tone positives are made from the separation negatives. These positives are corrected as necessary and then copied as transparencies in producing the final halftone negatives or positives.

inferior—a figure or letter which is smaller and lower than other characters in a line of composition.

initial letters—large capital letters used at the beginning of a paragraph.

insert—in binding, collecting and inserting signatures one into another for saddle stitched books; also a small negative stripped into a large one.

insert—a small picture inserted into a larger one.

intaglio printing—type of printing done from plates which have the image etched below the printing surface as in engraving and gravure.

integrate^d tone density—in halftone work, the density or tone created by the halftone dots and the transparent areas around them.

intermediate—something utilized between two stages in the process of production, as a film negative being the intermediate between camera copy and the plate.

iodine quartz lamps—incandescent light bulbs filled with iodine vapor.

iris diaphragm—see diaphragm.

italics—a class of type consisting of slanted letters.

J

jog—to jar paper to aline sheets and stack them in an even pile.

justify—to adjust the space between words (or letters) to make all lines come out to the same length.

Justowriter—a coldtype composing machine.

K

kern—a part of the face of a type-cast letter that projects beyond the body.

L

lamine—material made up of two or more layers pressed together, usually with an

adhesive, as plastic laminated to a sheet of paper.

latent image--dormant image which becomes visible during film or plate processing.

layout--preliminary sketch, showing size, position, color of text, and/or illustrations.

lead (pronounced led)--a thin (2-point) strip of metal used for spacing between lines of type. Leads are available in 1-, 3-, and 4-point thicknesses also.

leader--a row of dots or dashes (.....).

legend--words entitling, defining, or explaining an illustration in one or more lines below the illustration.

lens--a piece of optical glass or a series of glass elements arranged to focus the rays of light.

Leroy--a mechanical lettering set.

letterpress printing--printing from raised surfaces, such as type and cuts.

letterset--dry offset printing from plates having a relief image.

letterspacing--inserting a space between each of the letters in a word.

line copy--copy, either text or art, suitable for photographing without the use of a halftone screen.

line gage--rule graduated in picas used by printers for taking measurements.

line negative--a negative made from line copy containing only solid blacks and whites.

linoleum cut--hand-carved letterpress cut, consisting of a wooden block with a surface layer of linoleum in which the design is carved in relief.

low negative--a halftone negative that is too thin with no opaque pinpoint dots in the shadows.

lower case--small letters as distinguished from the capitals or upper case.

luminous objects--objects, such as the sun, which generate light.

M

M--designation for 1,000 sheets or impressions.

magenta--cold, bluish red.

magenta contact screen--a magenta colored contact screen used for making halftone negatives. See contact screen.

Magnetic Tape Selectric Typewriter--electric typewriter which produces a magnetic tape

when the hard copy is typed. See Selectric typewriter.

makeup--arrangement of type and cuts into columns and pages by the printer.

margin line--a line ruled on a layout to denote the limits of the work on the page.

mark up--to write up instructions, as on a dummy.

mask--to protect areas of a sensitized film or plate from exposure to actinic light by the use of such materials as goldenrod or red paper, aluminum foil, etc. Also a controlled, low density continuous-tone positive or negative used to correct the tone range or color errors in a negative in color-separation work. The negative and its masks are registered together and then photographed as a unit when making a corrected halftone positive.

masking--protecting or blocking out parts of the copy or negative.

master--an original from which copies can be made.

matte-finish--in photography, photo having a rough or textured surface, as opposed to a glossy finish. On acetate, a frosted or ground glasslike appearance.

mechanical--(1) a complete piece of copy for reproduction that consists of an accurate assembly of pasteups of text, display matter, line drawings, and illustrations. (2) Pasteup of the job with repros pasted in place and rules and reverses drawn in with guidelines to show where artwork is to be stripped in or job is to be broken for color.

mercury vapor lamp--an enclosed light source containing mercury; sometimes used to expose plates or as an illuminant for cameras.

middletone--any of the various tones in photographic copy ranging between black and white; also a halftone exposure.

Moiré--a disturbing dot formation caused by rescreening a printed halftone.

monochromatic film--film whose emulsion is sensitive to the blue and violet end of the spectrum only; also called regular or blue-sensitive film.

monochrome combination--in presswork, a two-color job, one of the colors being a dark color and the other a tint of the first, as blue and light blue ink.

montage--see photomontage.

multicolor presses—presses capable of printing more than one color in a single run.
Multilith—trade name for a small offset press.

N

NCR paper—no carbon required paper; has a chemical coating on the back of one sheet which combines with the coating on the front of another sheet to produce a duplicate copy on the second sheet when pressure is applied to the first.

O

offset paper—book paper, made for offset printing. Offset paper may be printed by letterpress, but not all book papers may be printed by offset.

one-to-one (1/1 or 1:1) shot—see same-size shot.
opaque—a substance used to paint out areas of negatives.

opacity—a direct measurement of the extent that a photographic image will prevent the passage of light.

open—slight underexposing and developing a halftone negative so that the dots will be slightly smaller than those normally obtained. An open negative will result in a fuller or darker printed illustration.

optical center—spot which the eye first sees; about two-fifths of the way from the top of a page.

original—copy submitted to the printer for reproduction.

orthochromatic—applied to photographic emulsions which are sensitive to green, blue, and ultraviolet light,

outline halftone—a halftone from which the background has been cut away or eliminated.

overlay—a sheet of acetate or tracing paper fastened over the original copy to indicate position and color or various elements.

overlay cell—a sheet of clear material with mask areas, or artwork; used in preparing camera-ready copy or masking negatives.

overprint—in platemaking, the exposure of a second negative on an area of the plate previously exposed to a different negative. A

method of combining a line and halftone image on the plate.

Ozalid machine—trade name for an ammonia process print-making machine which produces same-size copy from translucent or transparent originals on diazo-coated materials.

Ozalid materials—see diazo materials.

P

page spread—two adjacent pages creating a single unit for the reader, as an illustration covering two facing pages.

panchromatic film—film having an emulsion sensitive to all colors, but least sensitive to green.

parallel folds—one or more folds made in the same direction, as an accordion fold.

parallel rule—double hairline rule.

Paratone—trade name for acetate lettering or shading sheets.

pasteup—assembly of all elements in proper position before photographing. See mechanical.

Payzant pen—a type of lettering pen.

photoengraving—process of etching metal plates to cause the image area to stand in relief; also a cut made by this process.

photolettering machines—composing machines that use a photographic process to turn out finished lettering.

photomontage—a composite picture made from separate photographs pasted together.

photo-type—see foto-type.

pica—printer's measure equal to 1/6 of an inch or 12 points. See point.

pica gage—same as line gage.

pigment—ingredient supplying color to ink or paint.

pinholes—small transparent holes in the opaque portions of a negative.

planography—form of lithography.

plate—in offset work, the grained zinc or aluminum sheet carrying the image; in letterpress work, a cut or duplicate in one piece of metal of a form, page, or illustration.

ply—(1) refers to the number of layers of paper pasted together. (2) A measure of the thickness of card stock, bristols, or blanks.

point--printer's unit of measure equal to one seventy-second of an inch. Twelve points equal one pica.

Polaroid screened print--halftone photographic print made with a Polaroid camera having a halftone screen inserted between the lens and sensitive material. Prints are generally pasted together with line copy and shot as line in making the final lithographic plate.

printer--a processed lithographic plate. Each plate in a multicolor job is described according to the color it will print, such as the "blue printer" that will be printed on the press with blue ink.

process camera--copying camera used in reproduction work.

process color--full color printing.

progressive proof--set of proofs generally run on the same paper stock as the finished job, in which each color is shown by itself and in the proper printing sequence. In full-color printing, the series would normally be yellow; red; red on yellow; blue; blue on red and yellow; black; black on blue, red, and yellow.

proof--a trial printed impression for correcting errors.

proofreading--checking proofs against copy to assure the accuracy of composition and all details of typography.

proportional spacing machine--a composing machine having a standard typewriter keyboard, but differing from a typewriter in that it gives each letter only the amount of space it actually requires.

Q

quad--a piece of metal less than type high used as spacing material in typesetting.

R

rag paper--high grade paper made from rags.

ream--a quantity of paper, usually 20 quires or 480 sheets, but sometimes 500 sheets. A printer's perfect ream is 516 sheets.

red printer negative--in color separation work, a negative made through a green filter. The plate made from this negative is run on the press in red ink.

reference marks--registration marks.

reflection copy--any copy that is photographed by light reflected from the copy into the camera. Includes all types of opaque copy. See also transmission copy.

reflex negative--diffusion-transfer negative produced by contact printing.

refraction--bending of light rays as they pass obliquely from one transparent material to another.

register--agreement in location of successively printed images.

register marks--marks, usually crosses, placed on original art or photographic negatives or positives to aid in positioning the images in multicolor or double printing. Also called "cross marks" or "reference marks."

regular film--film having a colorblind emulsion.

relief printing--method of printing in which the printing surfaces are raised; letterpress, for example.

repro--a page of reproduction copy, as a repro proof.

reproduction proofs--proofs which are to be copied with the process camera for use in making plates or cuts.

rescreener--diffusion filter used in copying halftone clippings to diffuse old halftone dots and eliminate danger of moire.

Respi halftone screen--gray or magenta contact screen which produces a double dot on the negative. Respi screens are also available in glass.

retouching--process of painting in details, painting out backgrounds, etc., in photographic copy.

reverse combination--white lettering against a dark background.

roman--class of type with open, clean cut letters and serifs; vertical type, as distinguished from italics.

Ross board--illustration board with a pebbled or roughened surface.

Rubylith--see Ulano Rubylith.

rule--a thin strip of metal the height of ordinary type, used to print lines and borders on a letterpress job.

ruling--the number of lines per inch in a halftone screen.

run--the number of copies to be printed on a particular job.

runaround—type set to fit around an illustration in a column.

runover—to carry words from the end of one line to the beginning of the next.

running head—publication or chapter title appearing at the top of the pages in a publication.

S

saddle stitch—to bind a publication along the center fold.

safelight—a colored light used for darkroom illumination.

same-size shot—a negative image that is the same size as the original copy.

sans serif—type faces having no serifs; also a particular face of type.

screen angle—the angle at which the halftone screen is turned to avoid a noticeable dot pattern. A 45° angle is generally used for black-and-white work. In color work, the angle must be changed for each color.

screen compensator—a sheet of glass having the same refractive qualities as the glass halftone screen. Used in the camera during the exposure for the line portion of combination negatives.

screen tint—a halftone film having a uniform dot size over its area and rated by its approximate printing dot size value, as 40%, 50%, etc.

script—class of type that resembles handwriting or hand lettering.

seasoned—paper which has been brought to proper moisture balance.

secondary color—color formed by mixing two primary colors.

Selectric typewriter—electric typewriter with a type font in the form of a metal ball which skims across the page to bring the proper character into printing position. Type faces are interchangeable on these machines, but they do not have proportional spacing.

self-cover—cover of the same paper as the text; usually printed at the same time.

separation negative—negative made through appropriate filter. Its density represents the value of one of the primary colors used in full color printing.

sensitized—any material coated with an emulsion that is sensitive to light.

serifs—the fine cross strokes or feet at the top and bottom of letters.

shading sheet—a transparent sheet with a uniform pattern of dots or other shapes used in the preparation of artwork and camera copy.

shadow—darkest areas of copy; lightest areas of negative.

shadow printer—negative for printing the black plate in duotone work. See also highlight printer.

shelf life—period of time before deterioration renders a sensitized material unusable.

show through—the condition where printing on one side of a sheet can be seen from the other side.

shutter—a mechanical blade which may be opened to admit light to the camera or closed to shut it out; regulates the length of exposure.

side stitch—to flat stitch along the edge of a booklet.

signature—a sheet having a number of pages printed on both sides, usually in multiples of 4.

silhouette halftone—an outline halftone.

silver bromide—a light-sensitive salt in photographic emulsions. Generally used for enlarging papers.

silver chloride—a light sensitive salt in photographic emulsions. Generally used for contact papers.

silver iodine—a light sensitive salt in photographic emulsions to modify sensitivity of other salts.

silver nitrate—compound used for sensitizing wet-plate emulsions.

silverprint—photographic proof on silver chloride paper; produces a brown print. Also called Vandyke.

sizing (of paper)—treatment of paper to resist penetration of writing or printing ink.

slug—a line of type cast in one piece on a letterpress typesetting machine. Also a strip of metal (6 to 12 points thick) used in spacing.

small caps—letters having the form of capitals and the height of the body of lowercase letters. Used in text to show emphasis.

snake slip—an abrasive stick used for removing spots and unwanted lines from the offset plate.

sodium carbonate—accelerator for photographic developer.

sodium thiosulfate (hypo)—a salt whose water solution dissolves the silver halides. It is used to remove the silver salts remaining in film and paper after development.

soft low photographic contrast; halftone dots or fine printing detail with noticeably vignettted edges.

solid matter—lines of type not separated by leads or space.

space—a blank piece of type used in letterpress printing to produce white space between words.

speed (emulsion)—degree of sensitivity to light.

Speedball pen point—artist's lettering pen point.

spotting out—fine opaquing to remove pinholes or other small transparent defects from a negative.

square finish halftone—a square or oblong halftone.

square serif—a modernistic style of type.

stapling—see stitching.

static—electrical charge caused by friction in dry paper stock.

step-and-repeat work—two or more exposures made on the same plate from a single negative by moving it about. Also done with a photo-composing machine.

stitching—fastening the pages of a book together with wire stitches. Staplers use individual staples while the stitcher is fed from a continuous roll of wire.

stock sheet—a standard-size sheet which is kept in stock and cut to smaller sheets as required.

straight matter—type composition consisting of line after line set to the same width in the same size and style of type.

strip—to fit two or more negatives together on a goldenrod flat; also to remove a film emulsion from its base.

strip in—same as insert.

subtractive color process—process of forming colors by mixing pigments which absorb certain colors and reflect others. See also additive process.

superimpose—to position negatives or positives on a new flat that is prepared directly over another flat to obtain exact agreement and registration between them; frequently done when stripping up complementary or color flats.

surprint—a print from a second negative superimposed over a print from the first.

T

tabular matter—type set in table or statistical form.

text—(1) main body of a story or publication, (2) a class of type, such as Old English.

thicken—to make dense or viscous in consistency.

thin negative—negative low in photographic density.

throwing in—distributing type.

thumbnail sketches—small sketches, quickly drawn to determine the best layout for a job or piece of artwork.

tint—(1) a reduction of a color; the result of adding white to a color. (2) an area covered with a tint pattern.

toner—a liquid or powder containing chemically charged carbon particles which are attracted to the electron static image as the paper passes through an eletrostatic copying machine.

tooth—pitted or rough surface, as tooth in metal plate or drawing paper.

translucency—the ability of certain material to transmit light without being actually transparent.

transmission—the percentage of light permitted to pass through the negative.

transmission copy—copy, such as slides and transparencies, which is photographed by light transmitted through (rather than reflected from) the copy. See reflection copy.

transparency—a positive copy on glass or film in color or in color or in black-and-white.

transparent proofs—proofs pulled on acetate or cellophane.

trim line—the line ruled on a layout to denote the limits of the finished page.

tusche—a liquid greasy ink used for handwork and correction of lithographic plates.

two-up—two identical printing images on a press plate; usually made by preparing the flat so it can be exposed successively in the two required locations.

type—blocks of metal or wood having raised characters which may be inked and reproduced by pressing against a sheet of paper.

type family—group of type faces which are similar though not exactly alike in design.

type-high—standard height of all type and letterpress cuts. (0.918 inch.)

type series—different sizes of the same type face.

typography—the art of printing with type, involving the style, arrangement, and appearance of the printed page.

U

Ulano Rubylith—trade name for an acetate sheet having a colored coating which can be peeled off in image areas; used instead of goldenrod paper in stripping operations.

undercutting—process of passing light rays at a slight angle through the transparent areas of a negative so that they extend slightly under the opaque portions of the negative, causing thickening of lines and fine detail on the film positive.

uppercase—the capital letters of a type face.

V

vacuum back—a hinged flat metal plate attached to the back of the camera with a series of concentric vacuum channels which hold the film in place by suction during the exposure.

value—measure of lightness and darkness of color.

Vandyke—see silverprint.

Varityper—a composing machine having a keyboard similar to that of a typewriter which gives typed matter an appearance similar to printer's type.

vertical camera—process camera used in reproduction work. Its bellows extend vertically instead of horizontally.

vignette—type of halftone which has softened “feathered” outlines that blend into the surrounding white space.

viscosity—measure of resistance of fluid to motion; sluggishness.

Visi-type—alphabet printed on acetate; used for stickup lettering.

volatile—readily evaporated when exposed to air.

W

warm colors—colors like red, orange, and yellow which excite the eye.

Warnold process—method of diffusing halftone dots on negatives to give a continuous-tone effect when copying halftone clippings.

wash drawing—a rendering made with transparent watercolors; must be reproduced as a halftone.

waxing machine—machine used for waxing the back of material to be pasted up for camera copy. Wax is used instead of rubber cement.

wet-strength paper—a paper which retains more than 15 per cent of its dry strength when completed wetted with water.

window—a clear, usually rectangular or square panel in a negative. Halftone negatives are positioned in this window, usually with tape.

wire side—rough side of paper stock; faces the wire mesh in the paper making machine. See felt side.

work and flop or work and tumble—printing the second side of the sheet (using the same press form) by turning the sheets over from gripper to back, using the same side guide for the second run.

work and turn—printing the second side of the sheet, using the same press form, by turning the sheets from left to right, using the same gripper edge.

work order—specification sheet attached to the job.

Wrico—mechanical lettering device.

wrong font—a piece of type inserted by error which does not match the style or size of the other letters in a line or a word; usually marked “wf” by the proofreader.

X

xenon arc light—light emitted from a xenon gas-filled tube. It is pulsed at 120 times a second but appears as continuous light.

Appendix 1--GLOSSARY

xerography--an electrostatic duplicating process in which photographic images are recorded on a charged surface, then reproduced on paper. Xerox--trade name for equipment used in xerographic printing.

with electricity; used as plate coating in some electrostatic platemaking processes.
Zip-A-Tone--a waxed sheet of cellophane on which benday or other shading patterns have been printed; used as a shading medium for line drawings.

Z

zinc-oxide coating--photoconductive material which becomes light-sensitive when charged

INDEX

A

Achromatic colors, 69
Acrylic polymer paints, 80
Administration, 5-13
 checking the job, 13
 coordinating, 7
 files, 11
 organizing, 5
 planning, 5
 principles of, 5
 shop layout, 12
 supervising, 7-8
 supplies, 11
 training, 8
 work control, 9
Advancing color, 75
Aerial perspective, 75
Analogous schemes, 71
Animals, cartoon, 35
Artwork, reviewing, 122-135
 checking pasteups, 133
 color reproduction, 131
 combination, 129-131
 cropping and scaling, 127
 halftones, 122-125
 marking art, 132
 retouching, 125-127

B

Bibliography for Advancement Study, 3
Border area, 90

C

Cartooning, 14-43
 animals, 35-39
 clothing, 35
 creating the character, 17
 drawing the head, 15-18
 facial expressions, 16
 positioning, 15

Cartooning — Continued

 feet, 35
 female, 34
 figure, 19-35
 form, 40
 foreshortening, 27-33
 gestures, 17
 hands, 35
 props, 41-43
 tools and equipment, 14
 types, 18
Checking, 13
Checking pasteups, 133
Color, 65-80
 creating effects through colors, 75-78
 advancing and receding color, 75
 emotional effects, 75
 iridescent effect, 77
 luminous effect, 77
 lustrous effect, 75
 influencing colors, 69-7
 mixing, 73
 schemes, 71-75
 theory, 65-69
 achromatic, 69
 hue, 66
 intensity, 67
 value, 66
 warm and cool characteristics, 68
 using mediums, 78-80
Color perspective, 75
Color reproduction, 131
Combination, 129
Complementary schemes, 72
Contrast, 93
Cool colors, 68
Coordination, 7
Copyfitting, 105-108
 character count, 106
 copy-fitting aids, 108
 measuring the copy, 106
 words per square inch, 105
Correspondence courses, 4
Cover design, 109

INDEX

Cover stock, 100
Crawl devices, 93
Cropping and scaling artwork, 127

D

Designing training aids, 81
Direct contact photoscreens, 58
Drop cards, 93
Dummies,
 pasteup, 111
 preliminary, 108

E

Emotional effects, color, 75
Enamel inks, 48
Essential area, 90
Expressions, 16

F

Figures,
 cartoon, 19
 female, 34
Files, 11
Flat picture (still), 92
Foreshortening, 27
Form, 40
Front projection screens, 87
Fuller's earth, 125

G

Gestures, 17

H

Halftone screen, 123
Halftones, 122-125
Handcut stencils, 47
Head, cartoon, 15
Hinges, 51
Hue, 66

I

Illustrated title card, 91
Influencing colors, 69-71
 effect of one color on another, 70
 effects of local color, light, and reflections,
 69
 nature's color, 69

Ink modifiers, 49
Inks, 48
 enamels, 48
 lacquers, 48
 poster, 48
 vinyls, 48
Indentions, 104
Intensity, 67
Iridescent effect, 77

L

Lacquer films, 56
Lacquer inks, 48
Layout, 108-122
 cover design, 109
 marking layout sheet, 114
 marking manuscript for printer, 114-122
 pasteup dummies, 111-114
 title page, 109
Leading, 103
Letterspacing, 104
Local color, 69
Luminous effect, 77
Lustrous effect, 75

M

Margins, 105
Marking, 114-122
 indentions and tables, 119
 layout sheet, 114
 manuscript copy, 114
 marking for clarity, 120
 preliminary operations, 118
 proofreader's marks, 118
 type styles and sizes, 119
Marking art, 100
Masking, 59
Moiré, 124
Monochromatic scheme, 71
Motion, effects of, 83-86
Multicolor printing, 61

N

Nature's colors, 69
Naval training publications (NAVTRA), 3

O

Organizing, 6-7

P

Page size, 100
 Pan card, 92
 Paper stencils, 54
 Paper stock, 100
 Pastels, 80
 Photo-screen, 58
 Photo stencils, 48
 Planning, 5
 Polaroid slides, 92
 Poster inks, 48
 Posters, 94
 Presensitized screen process photo films, 57
 Presentation room, arranging, 86-89
 lighting, 88
 mechanics, 88
 space, 86
 Printing, 59
 Printing process, selecting, 99
 Proofreader's marks, 117
 Props, 41

R

Rate training manuals, 3
 Rear projection screen, 87
 Receding color, 75
 Registration, 59
 Rescreening halftones, 124
 Retouching, 125-127
 removing an object, 126
 removing or softening, 127
 silhouetting, 126
 velox, 127
 Reviewing artwork, 122

S

Scaling, 127
 Scanning area, 90
 Schemes, color, 71-75
 analogous, 71
 color mixing, 73-75
 complementary, 72
 monochromatic, 71
 planning, 73
 set palette, 73
 split complements, 72
 triads, 73
 Screen carriage, 51
 Screen fabrics, 45
 Screen process, 44-64
 accessories, 50
 equipment and materials, 44-54

Screen process — Continued

inks, 48
 masking, 59
 multicolor printing, 61-64
 printing, 59
 registration, 59
 screen printing halftones, 60
 squeegees, 49
 stencils, 47, 54
 washup, 65
 Set palette, 73
 Side kick, 51
 Silhouetting, 126
 Slides, 35-mm, 92
 Spacing, words, 103
 Split complements, 72
 Squeegees, 49
 Stencils, 47
 direct contact photo-screens, 58
 lacquer, 56
 making, 54-58
 paper, 54
 presensitized photo films, 57
 water-soluble films, 55
 Still picture, flat, 92
 Super title card, 91
 Supervising, 7
 Supplies, 11

T

Technamation, 84
 Television graphics, 89-94
 art area limitations, 90
 contrast, 93
 shape of televised picture, 90
 size of visuals, 90
 types of visuals, 91
 Tempera, 80
 Tilt card, 92
 Title card, 91
 Title page, 109
 Tools and equipment, 14
 Training, 8
 Training aids, designing, 81-86
 effectiveness, 83
 effects of motion, 83-86
 legibility, 81
 simplicity, 81
 Training films, 4
 Triads, 73
 Type style, 101-106
 indentions, 104
 leading, 103
 length of line, 102

INDEX

Type style -- Continued

- letterspacing, 104
- margins, 105
- spacing between words, 103
- style of letter, 101
- type size, 101

Typography, 99-108

- copyfitting, 105-108
- cover stock, 100
- page size, 100
- paper stock, 100
- planning, 99
- printing process, 99
- type area, 105
- type style, 101-105

Visual presentations, 81-98

- arranging a presentation room, 86-89
- designing training aids, 81-86
- posters, 94
- television graphics, 88-94

Visuals, types of, 91-93

- card, 91
- crawl devices, 93
- drop cards, 93
- flat picture, 92
- polaroid slides, 92
- 35-mm slides, 92
- viewgraphs, 92

W

V

- Value, 66
- Velox, 127
- Viewgraphs, 92
- Vinyl inks, 48

Warm colors, 68

- Washup, 60

- Watercolors, 80

- Water-soluble film stencils, 55

- Work control, 9