

DOCUMENT RESUME

ED 095 660

EA 006 393

AUTHOR Spencer, Darrell
TITLE Facilities for Occupational Education, Grades 7-12.
School Planning Guide Series--8.
INSTITUTION North Carolina State Board of Education, Raleigh.
Div. of School Planning.
PUB DATE Sep 74
NOTE 49p.; Revised version of ED 042 232
EDRS PRICE MF-\$0.75 HC-\$1.85 PLUS POSTAGE
DESCRIPTORS Climate Control; Community Involvement; Educational
Specifications; *Facility Planning; *Facility
Requirements; High Schools, Illumination Levels;
Junior High Schools; Safety; *School Planning; Space
Classification; Teacher Participation; Utilities;
*Vocational Education
IDENTIFIERS North Carolina; *Occupational Education

ABSTRACT

This publication was developed to assist educators, engineers, and architects in planning facilities for occupational education. The first section is primarily concerned with the educator's responsibilities for involving staff and community in orderly planning. The second part is concerned with the technical characteristics of occupational facilities. (Author/MLF)

Facilities for OCCUPATIONAL EDUCATION GRADES 7-12



U.S. DEPARTMENT OF HEALTH
EDUCATION & WELFARE
NATIONAL INSTITUTE OF
EDUCATION

OFFICE OF OCCUPATIONAL EDUCATION
1200 K STREET, N.W.
WASHINGTON, D.C. 20004

BEST COPY AVAILABLE

E4-006 393

Developing educational specifications for the design and construction of school facilities always presents creative and exciting challenges. The provision of desirable learning environments for the myriad of ever changing programs in Occupational Education is an especially significant test of effective educational and facilities planning.

This school planning guide has been designed to suggest ways in which various groups can join forces to help assure that the varied programs in Occupational Education are provided for properly. We commend it to you for your study and consideration, and express appreciation to the staff of the Division of Occupational Education who assisted the Division of School Planning in its preparation.



W. O. Fields, Jr.
Assistant State Superintendent
Administrative Services

PREFACE

This publication, a revision of *Planning for Shops and Laboratories*, was developed by the Division of School Planning to assist educators, engineers, and architects in planning facilities for Occupational Education. The first section of this guide is primarily concerned with the educator's responsibilities for involving staff and community in orderly planning. The second part of the publication is concerned with the technical characteristics of occupational facilities. No attempt has been made to illustrate standard or model plans but rather to outline good planning procedures as facilities should be designed to meet the needs of students rather than to echo the conventional laboratories of the past.

This publication was prepared by Dr. Darrell Spencer, Educational Consultant, Division of School Planning. I also would like to acknowledge the contributions made by architects, engineers, and educators throughout the state who assisted with this publication. Special appreciation is extended to the staff members in the Division of Occupational Education for their help and counsel.



**J. L. Pierce, Director
Division of School Planning**

CONTENTS

Foreword	i
Preface	ii
Introduction	1
Planning Procedures	4
Pre-planning	5
Situation analysis	5
Developing alternatives	6
Selecting a plan	8
Preparing educational specifications	8
Classification of Facilities	10
General Space and Cost Requirements	11
General Considerations	14
Aesthetics	14
Location	16
Flexibility (for day-by-day use)	17
Flexibility (for semi-permanent change)	19
Sonic and vibration control	21
Utilities and Services	23
Thermal control and ventilation	23
Lighting	25
Electrical power	29
Plumbing	30
Dust collection systems	32
Auxiliary Rooms and Facilities	34
Offices	34
Conference rooms	35
Classrooms	35
Storage rooms	35
Spray and finishing room	37

BEST COPY AVAILABLE

Auxiliary Rooms and Facilities	38
Toilets and dressing areas	38
Display centers	38
Floors	39
Finishes	39
Machine mountings	39
Drains	39
Safety	40
Bibliography	42

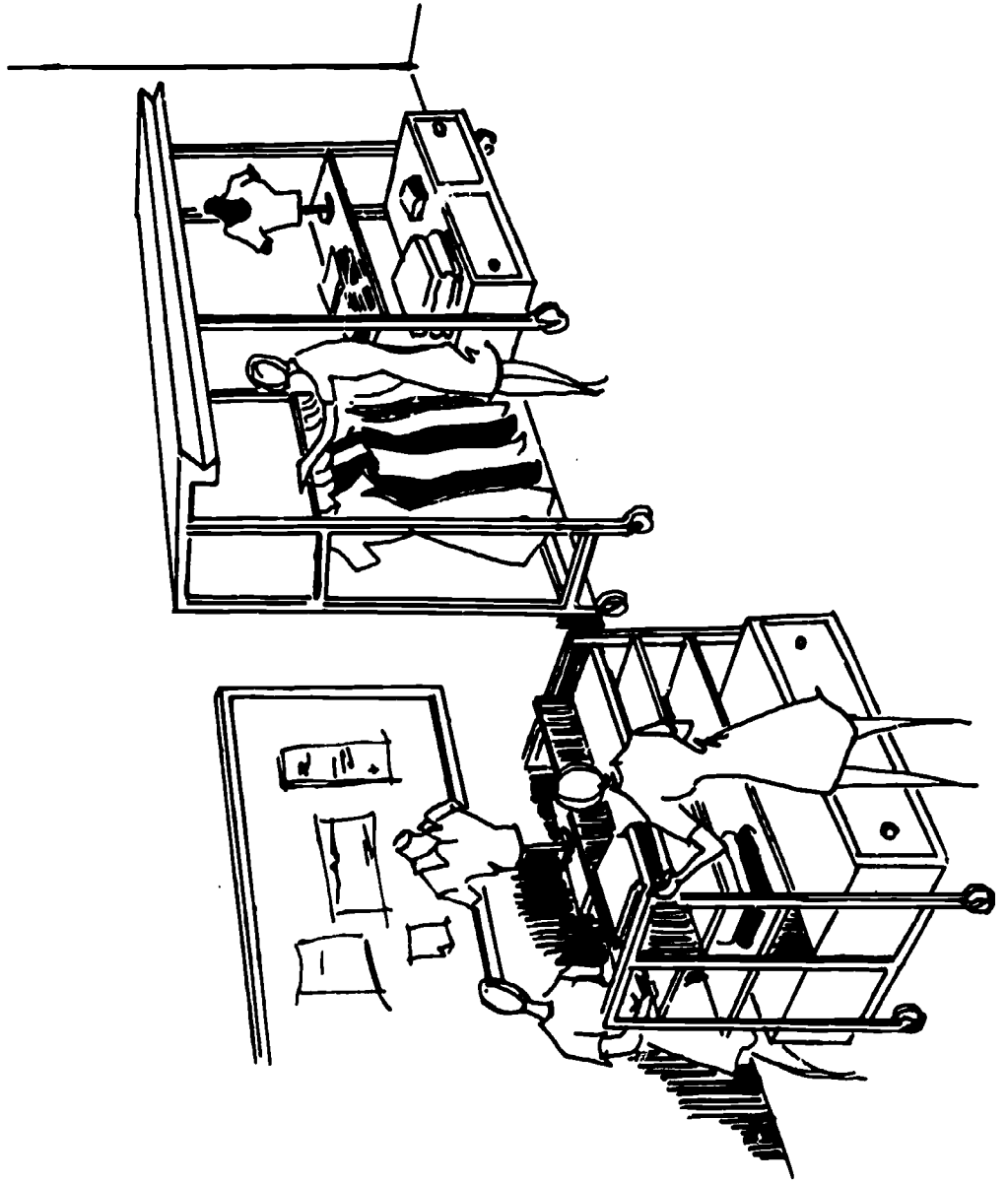

BEST COPY AVAILABLE

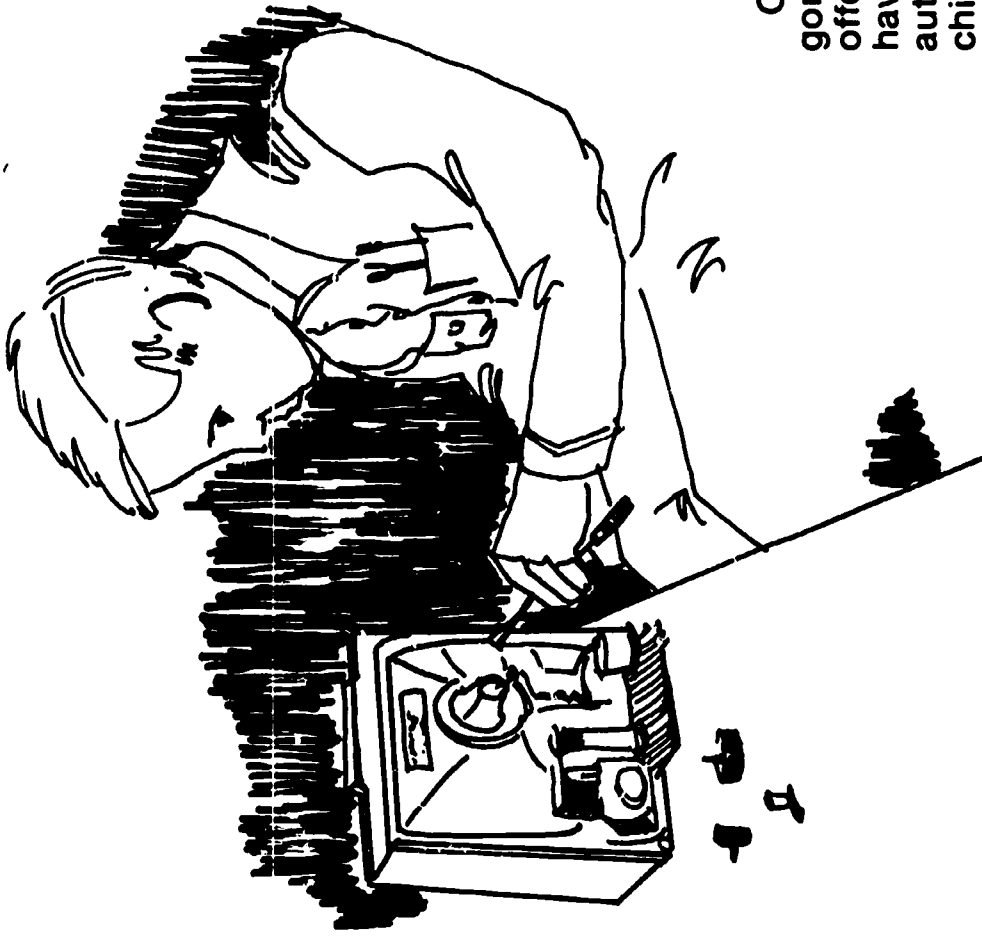

INTRODUCTION

Occupational programs for high school students have undergone many changes since the early 1950s. Schools that once offered only general agricultural production and homemaking have broadened their curriculum to include such programs as auto mechanics, business education, distributive education, child care services, commercial sewing, health occupations, drafting, electronics, data processing, marine ecology, and agri-business, including ornamental horticulture, recreation and ecology, and forestry.

Of particular interest to the facility planner is the trend at the high school level toward cooperative work experience programs whereby students attend school for one-half day and work under the joint supervision of the school coordinator and an employer for the remainder of the day. The cooperative work experience programs may require fewer special facilities as students learn in a business or industrial setting rather than in a school laboratory.

Prior to 1970, career oriented exploratory programs for junior high or middle grade students were generally limited to industrial arts, homemaking, and agriculture. The present trend is to provide the same exploratory experiences for boys and girls with the curriculum organized around clusters of occupations. A junior high or middle school with a membership of one thousand students should ideally have four Occupational Education laboratories and a career information center. These facilities could accommodate the occupational clusters as follows:

Business and Office Occupations Laboratory—Business and office occupations, distributing and marketing occupations, and some aspects of communications and media occupations.

Environmental Occupations Laboratory—Agri-business and natural resources occupations, environment control occupations, marine science occupations, and certain aspects of hospitality and recreation occupations.

Construction and Industrial Occupations Laboratory—Construction occupations, manufacturing occupations, public service occupations, transportation occupations, some aspect of communications, media, and fine arts occupations.

Service Occupations Laboratory—Consumer and homemaking occupations, health occupations, personal services, and some aspects of hospitality, recreation, and fine arts occupations.

Career Information Center—This room, which is used for group and individual guidance, can be standard in size but should have adequate electrical service for individual cassettes, film strip projectors, and record players. Adequate storage cabinets will also be required for pamphlets, tapes, books, and test materials. This special classroom could be adjacent to, or a part of, the school's media center.

In the middle grades, students are scheduled into exploratory occupational programs on a rotating basis. For example, students in grade seven may receive only 72 sessions of instruction during the year; students in grade eight may receive 108 sessions per year; and students in grade nine may receive 180 sessions or five days per week of instruction. The rotating schedule must be considered when determining the number of teaching stations which will be needed.

While planning is important in the development of all school facilities,

two factors are unique to Occupational Education laboratories which make good planning a must. The first factor is the high cost of space and equipment. The cubic footage required for some laboratories may be more than six times that required for an academic teaching station; the equipment cost for a program such as machine shop may be one hundred times that required for an academic teaching station.

The second factor is the inflexibility of some occupational laboratories. Facilities designed for metal working, auto mechanics, or carpentry, for example, will require a large area with a high ceiling and special wiring, plumbing, and acoustical treatments. Such a facility may be very expensive to renovate and poorly located in the school for some other use. Generally, laboratories can more easily be converted to a different type of laboratory than converted for academic use.

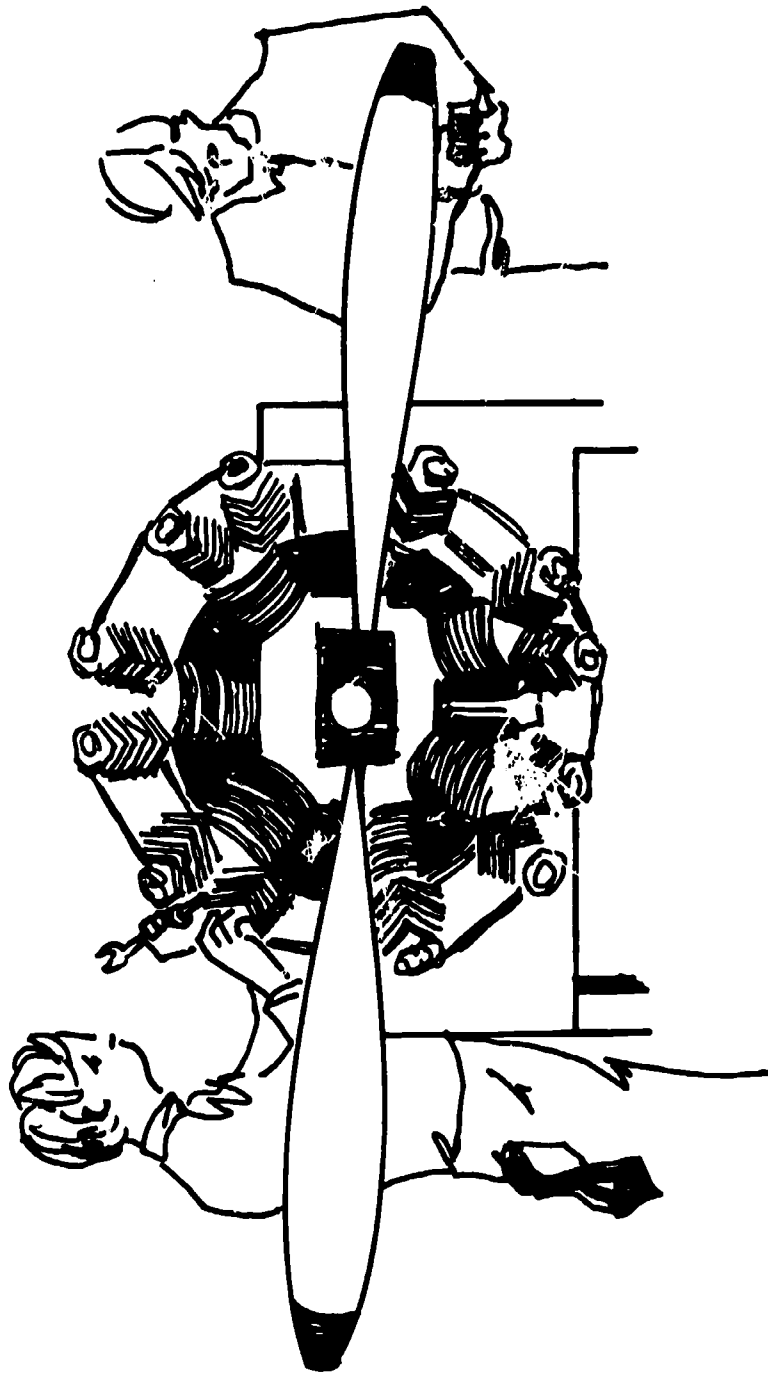

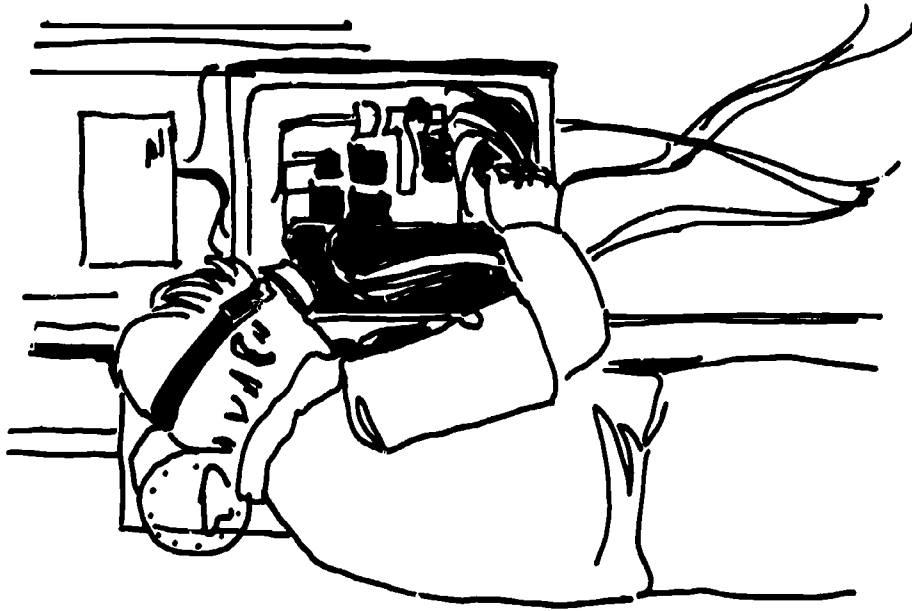

PLANNING PROCEDURES

Planning facilities for Occupational Education should be an integral part of the long-range planning process for the school and the school system.* Planning at the administrative unit level should already have established certain parameters for the school such as:

- Maximum membership, short-range
- Maximum membership, long-range
- The geographic area to be served

The philosophy or beliefs which are developed by the total school staff likewise establish certain parameters for the Occupational Education facilities. Consideration must be given to the degree of staff commitment to:

- Occupational Education
- Independent study
- Individualized instruction
- Team teaching
- Multi-media/resource center concepts
- Scheduling flexibility

The following procedure is suggested for orderly planning. This process which involves the students, staff, and community should result in better facilities and a commitment to the decisions which have been made.

*See *Planning for Education, People and Processes*, Division of School Planning, 1973.

Phase I - Pre-planning

The first step in the planning procedure, upon the recommendation of the superintendent, is for the Board to appoint an *ad hoc* advisory committee of students, staff members, business and professional people, community representatives and one or more board members to offer advice and counsel regarding the Occupational Education program and facilities. The Board and administrative staff should also consider the advisability of securing outside consultative services from the State Department of Public Instruction, from local colleges and universities, or from private firms. As part of pre-planning, the committee should establish a definite procedure for the entire planning process and develop a time schedule for the completion of each phase or step. The committee will need a minimum of three months time to complete its tasks before the architect can begin preliminary drawings.

Updating or developing the philosophy, goals, and objectives for Occupational Education is an important function of the committee. This is an opportunity to share ideas and to identify general areas of agreement. This discussion can be especially helpful to students and lay members on the committee.

Phase II - Situation Analysis

This phase of planning involves gathering and analyzing data regarding the past and present situation. The following areas should be included in the situation analysis:

- School membership
- Projected membership
- Geographic areas to be served
- Socioeconomic data for the area to be served
- Community, region, and national employment needs
- Job projection needs for five, ten, and fifteen years

BEST COPY AVAILABLE

- Student interest in program
- Adult interest in program
- Employer interest in program
- Trends in Occupational Education programs
- Private schools and public agencies offering similar programs
- Present program offerings
- Program offerings in comparable-size schools
- Resource persons available from the community
- Occupational Education facilities presently available for short- and/or long-range use
- Potential sources of funds for buildings, equipment, materials, and staff

Data gathered in the situation analysis should be synthesized and used to draw basic conclusions regarding the type of programs which are needed for the community.

Phase III - Developing Alternatives

Developing the first plan may be a rather mechanical process with little imagination or innovation. This plan should include the following:

- Programs to be offered
- Course loads
- Student contact hours per day, week, and year
- Maximum class sizes
- Number of laboratories required
- Staff

This first plan may be impractical. For example, it may propose a foods laboratory for only five students. Subsequent plans might eliminate this laboratory and place these students in a cooperative program. This first plan might also specify two complete auto mechanics laboratories because of the program demand. The alternative plan might propose one facility for two instructors with a common area and specialized areas for engine overhaul, engine tune-up, transmission overhaul, and body work. The third alternative might propose only one auto mechanics shop to be used by beginning students with advanced students being enrolled in a cooperative-program or a community college.

The following are examples of alternatives which may be considered in planning facilities:

Construct additional Occupational Education laboratories OR initiate a cooperative program which would not require additional laboratories.

Offer only two Occupational Education programs in a small high school OR develop general laboratories and use individualized instruction to offer several programs to a limited number of students.

Eliminate advanced courses because of limited course demand OR teach advanced students concurrently with beginning students by using independent study and individualized instruction.

Offer a limited program at several small high schools OR allow small high schools to exchange students OR construct a facility in a central location to serve several schools.

Schedule middle grade students for an exploratory program two days per week for an entire year OR schedule students for one hour each day for fourteen weeks.

Build more facilities for a certain program OR stagger the school day for certain students to improve facility utilization.

Divide a class of fifty students into two classes OR add a teacher's aide to adequately accommodate a class of fifty students.

The examples above illustrate how alternatives allow for different use of facilities, staff, and resources. The committee, for example, may find that through schedule changes, the use of cooperative programs, or the deletion of courses, that new facilities may not be needed. Good planning requires that all reasonable alternatives be examined before making a decision;

good planners seldom grasp the first solution that promises a reasonable degree of success.

Phase IV - Selecting a Plan

The best alternative plan is the one that most nearly accomplishes the goals and objectives but still remains within the legal structure, expectations of the community, and funds available. If Phase III, Developing Alternatives, was properly and thoroughly accomplished, the best alternative may be apparent. If no alternative is clearly superior, it must be assumed that there is no "best" way and that several alternatives promise a comparable degree of success.

The committee should select a plan and make recommendations to the superintendent. The superintendent should review all the data and alternatives and make recommendations to the Board of Education. The legal responsibility for adopting a facility plan must rest with the Board of Education; consequently, it is suggested that the superintendent or his representative and one or more board members serve on the *ad hoc* planning committee.

Frequently, the needs are greater than the funds available. If this is apparent during the planning process, the committee may want to establish priorities or recommend that the plan be implemented in phases.

Phase V - Preparing Educational Specifications*

After the committee has determined that certain laboratories will be needed (and after the Board has approved the plan), educational specifications should be prepared. Educational specifications may be defined as a written means of communication between the Board and the design professionals. Generally, the educational specifications will include the following:

- Philosophy, goals, and objectives
- Trends
- Program offerings
- Course demand
- Activities
- Special tools and equipment
- Storage requirements

- Space requirements
- Special requirements
- Space relationships

Educational specifications are based on the instructional program and should state the Board's concept of facility and program needs. The responsibility of the design professionals is to translate these needs into architectural and engineering plans of buildings which can satisfy the needs. The educational specifications should not be rigid prescriptions but rather allow the design professionals the freedom to be imaginative and innovative.

To be most effective, the educational specifications should be completed and published as formal documents. While the primary purpose is to communicate the Board of Education's facility needs to the design professionals, educational specifications should also:

- Congeal the thinking of staff, students, and lay persons
- Provide an avenue for public relations
- Interpret the facility to persons who were not involved in the planning process.

The *ad hoc* planning committee should review preliminary and working drawings to ensure that the design professionals have properly interpreted the educational specifications. Generally, it is advisable for the committee to work through a member of the professional staff rather than directly with the architect. When the Board approves the working drawings, the work of the planning committee is complete.

*See *Educational Specifications*, Division of School Planning.

BEST COPY AVAILABLE

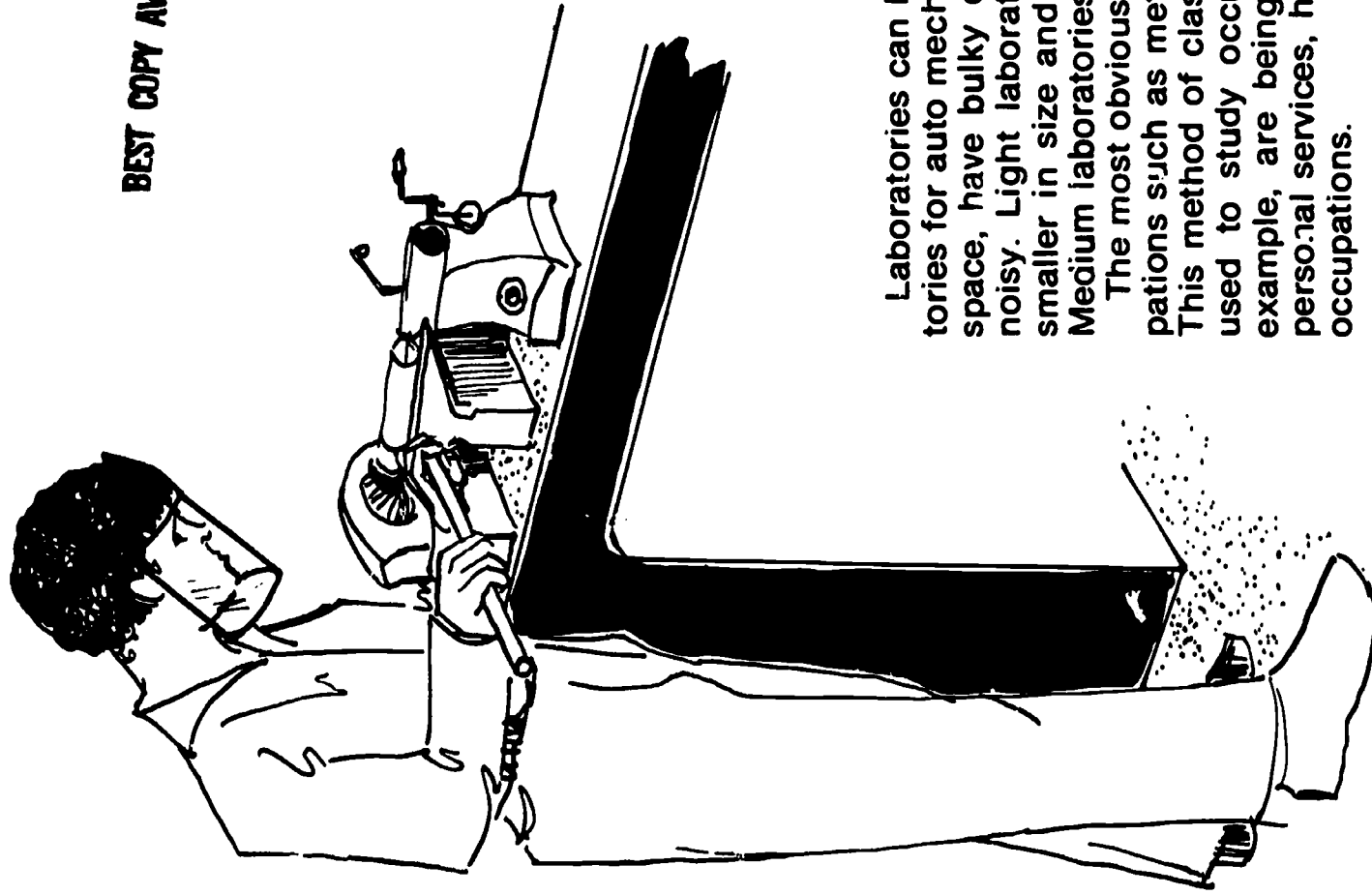

CLASSIFICATION OF FACILITIES

Laboratories can be classified as heavy, medium, and light. Heavy laboratories for auto mechanics, metal work, and construction trades require more space, have bulky equipment, require special utilities, and are frequently noisy. Light laboratories for typing, drafting, and health occupations are smaller in size and may be located in an academic area of the building. Medium laboratories fall between these two extremes.

The most obvious and most used classification of laboratories is by occupations such as metalworking, carpentry, business, child care services, etc. This method of classification may become less useful as the laboratory is used to study occupational clusters. Home economics laboratories, for example, are being used to teach consumer education, health services, personal services, hospitality, and some aspects of recreation and fine arts occupations.

GENERAL SPACE AND COST REQUIREMENTS

Space requirements for an activity should be based on the educational program; however, planners frequently request general guidelines in the initial planning stages. Table 1 should be useful until the curriculum and activities have been clearly identified. An electricity laboratory, for example, can be classified as medium but could be heavy if the activities include transformer or large motor repair.

**TABLE 1
GENERAL SPACE REQUIREMENTS FOR HEAVY,
MEDIUM, AND LIGHT LABORATORIES**

CATEGORY OF LABORATORIES		SQUARE FEET PER STUDENT
I. Light - Drafting, Health Occupations, Commercial Sewing, Office Occupations, Homemaking	Desirable	85
	Average	70
	Minimum	60
II. Medium - Electricity, Exploratory Programs, Data Processing, Graphics and Industrial Communication	Desirable	120
	Average	90
	Minimum	75
III. Heavy - Auto Mechanics, Construction, Carpentry, Agriculture, Metals	Desirable	200
	Average	120
	Minimum	100

The cost of tools and equipment for Occupational Education Laboratories, like the space requirements, will vary with the activities which are planned. Table 2 indicates the relative cost differences for tools and equipment for various programs.

BEST COPY AVAILABLE

**TABLE 2
ESTIMATED EQUIPMENT AND TOOL COSTS FOR
OCCUPATIONAL EDUCATION LABORATORIES
(1974)**

LABORATORY	MINIMUM COSTS	MAXIMUM COSTS
General Laboratories		
Exploratory	\$ 8,000	\$ 20,000
Industrial Arts	12,000	25,000
Unit Laboratories		
Agriculture	10,000	20,000
Auto Mechanics	10,000	40,000
Cabinetmaking and Furniture	8,000	30,000
Carpentry	8,000	15,000
Cosmetology	12,000	15,000
Data Processing	3,000 (Initial Purchase)	10,000 (Initial Purchase)
	10,000 (Annual Rental)	20,000 (Annual Rental)
Distributive Education	8,000	12,000
Graphic and Industrial Communications	20,000	50,000
Home Economics	12,000	20,000
Horticulture	5,000	15,000
Industrial Cooperative Training	5,000	10,000
Machine Shop	50,000	200,000
Health Assistant	6,000	10,000
Office Occupations	20,000	30,000
Plumbing	5,000	20,000
Tailoring	10,000	20,000
Trowel Trades	1,500	12,000
Typing	9,000	15,000
Upholstering	8,000	15,000
Welding	8,000	20,000
Drafting	3,000	10,000

The cost of tools and equipment in the table above was appropriate in 1974. In the initial planning stages, this data can be used to study the relative cost differences of programs. After a program is selected for more intensive study, cost estimates should be based on current prices for the tools and equipment which are needed.

In addition to the initial capital outlay costs, consideration should also be given to operational costs. For example, data processing, dental, and computer equipment may be less expensive to lease than to purchase and maintain. Supplies for commercial cooking and baking, cosmetology, horticulture, and upholstering are expensive but some of the cost can be offset by selling products and services; supplies for machine shop, welding, and plumbing are expensive and little of this cost can be recouped. A data processing or graphic arts program can provide an excellent learning situation while performing a vital service to the school system.

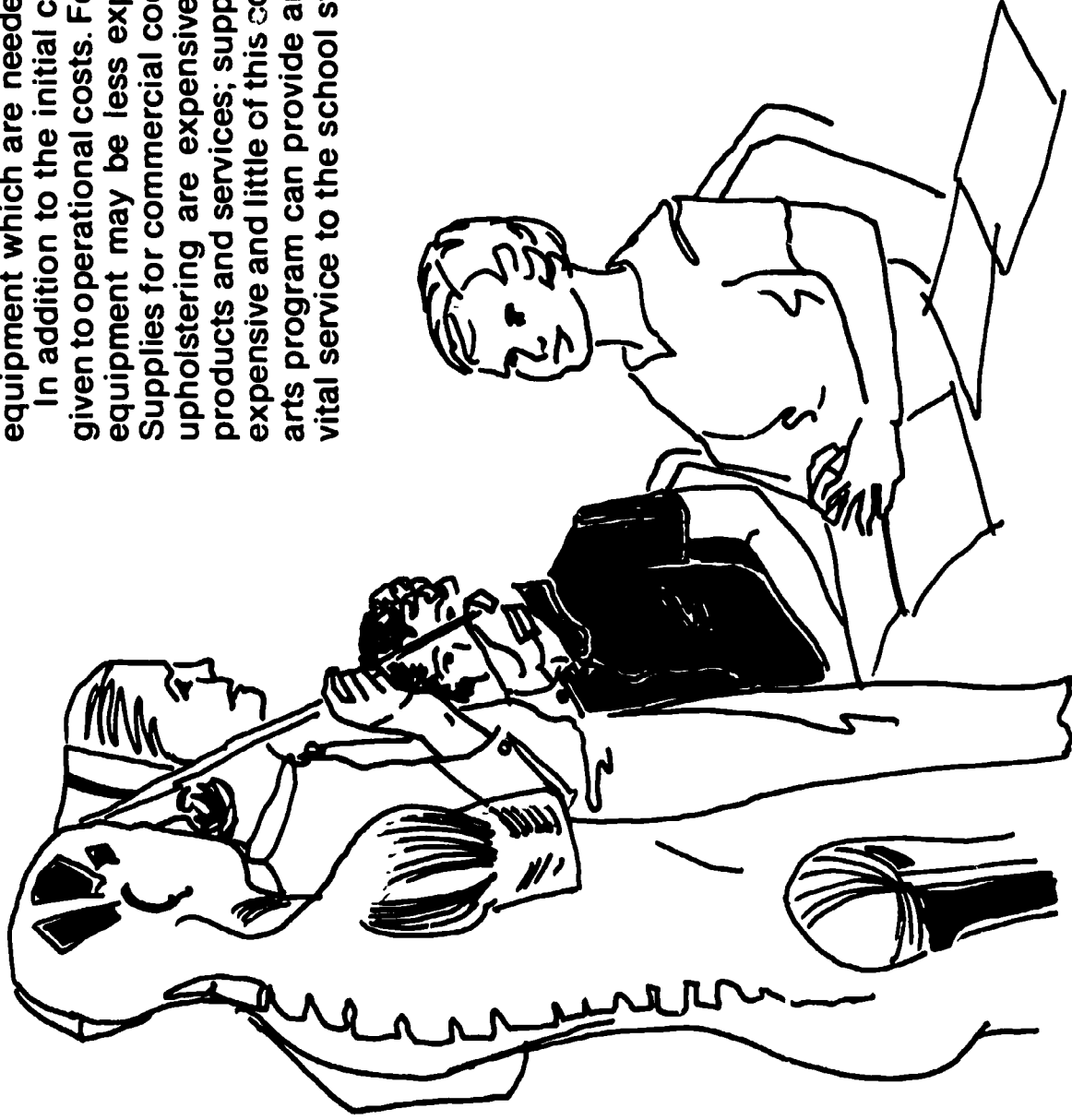

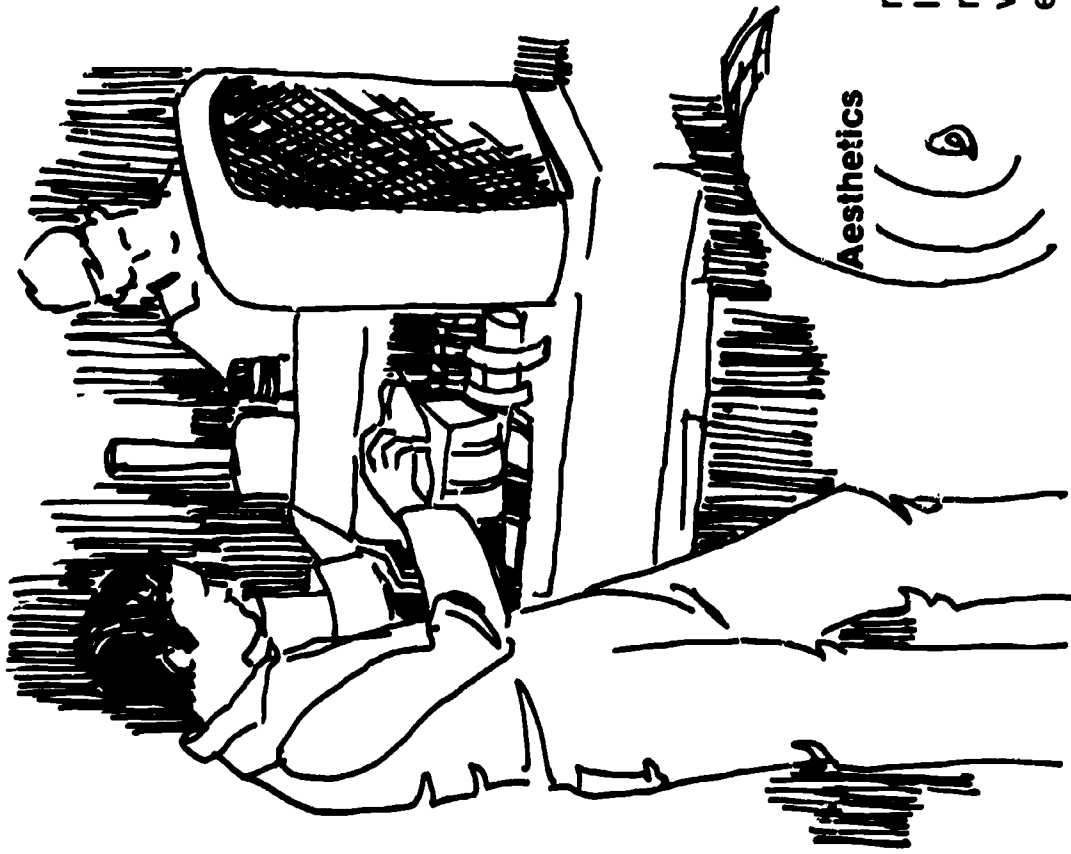

BEST COPY AVAILABLE

GENERAL CONSIDERATIONS

In the early 1900s, the "shop" was often found in the basement, near the boiler room and coal bin. The attitude toward laboratories has changed during the years. Laboratories in modern educational plants are designed to be attractive as well as functional. Like industrial and commercial leaders, educators realize that beauty and orderliness improve student and teacher attitudes, increase productivity, and encourage safe practices.

The use of "pre-engineered", metal buildings is discouraged as they seldom blend aesthetically with other buildings on the campus and deteriorate rapidly in appearance. Facilities for Occupational Education should convey to students and community that a study of occupations has the same dignity and value as the study of academic subjects.

Aesthetics



ERIC
Full Text Provided by ERIC

Boards of Education generally give consideration to pre-engineered metal buildings on the assumption that they can be constructed more quickly and are less expensive. Before comparing the cost of metal buildings to conventional construction, consider the following items which may not be included in the quotation:

Insulation	Grading	Additional lighting
Partitions	Additional electrical service	A code-approved heating, ventilating, and cooling system
Protective inner walls	Communication system	
Large doors	Emergency alarm system	Toilets and perhaps showers

While pre-engineered metal buildings can be attractive, they generally deteriorate rapidly in appearance. Planners should be aware that the life expectancy of conventional construction is approximately fifty years; consequently, the life-cost of the building as well as the initial cost should be considered. In several instances cost figures obtained through competitive bidding on conventional versus pre-engineered construction of this type indicate that a simple building using masonry walls and an open-web steel roof structure can be less expensive.

The practice of building occupational facilities with the maintenance staff or trade classes is questionable. State statutes require that all buildings which house pupils must be approved by the State Superintendent of Public Instruction and conform to specified building codes (G.S. 115-130). Buildings estimated to cost more than \$45,000 must be designed by an architect or engineer (G. S. 133-1.1). Construction or materials estimated to cost more than \$1,000 must be bid in accordance with State regulations (G.S. 128-132). Construction costing less than \$45,000 for which an architect or engineer was not employed must be certified as to compliance with the State Building Codes by a city or county inspector or by a registered architect or engineer.

Location

Shop-type facilities are frequently located in a separate building behind the school; however, many educators feel that a separate building tends to imply that things occupational and things academic are worlds apart. A

compact building with laboratories integrated into the main school plant is consistent with the philosophy which attempts to bridge the gap between Occupational Education and academic education. The trend toward air conditioning and the conservation of energy is also a reason to construct a compact, total plant. In planning a self-contained plant, however, the following should be considered:

Medium and heavy laboratories may require:

- long structural spans
- a high ceiling
- a reinforced floor
- a special ventilation system
- a service drive
- an overhead door and loading dock
- special utilities
- outside work areas
- special acoustical treatments

Medium and heavy laboratories may be:

- noisy
- dusty
- odorous
- difficult to air condition

No attempt will be made in this publication to specify the location of laboratories; however, the following should serve as guiding principles:

- Heavy Occupational Education laboratories should not be located in such a manner as to limit or complicate the further expansion of the quiet areas of the building.
- Avoid a location which will require a long service drive which wraps around the building. Provision should be made to receive heavy supplies and equipment during the school day with a minimum of disturbance to other areas of the school. Service drives should not separate the main building from play areas, parking, or major traffic arteries.
- Heavy and medium laboratories should be located in one-story buildings because of noise and vibration.
- Laboratories should be located so as to be used by night classes without opening or disturbing the remainder of the building.

BEST COPY AVAILABLE

- Certain Occupational Education laboratories should be grouped in close proximity to encourage the sharing of facilities, staff, equipment, and materials. The drafting laboratory, for example, could be used by students in agriculture, machine shop construction, etc. The following laboratories should be closely related and have inter-connecting doors, where feasible:
 - auto engine repair - auto body work - welding
 - general agriculture - agriculture mechanics
 - cabinetry - construction trades
 - general construction trades - trowel trades - plumbing - heating and air conditioning
 - electronics - electricity - radio and TV repair

Flexibility (for day-by-day use)

Flexibility is one of the most important concepts in facility planning. While a standard classroom could be used by several subject areas, laboratories planned for a more specific purpose are frequently used only part of the school day. Flexibility encourages space sharing and thereby increases utilization and reduces costs. A standard classroom, for example, can serve two or three laboratory programs. Sharing a common work area is another means of improving space utilization. As illustrated in Figure 1, a plumbing laboratory and an electrical laboratory can share a common work or fabrication area.

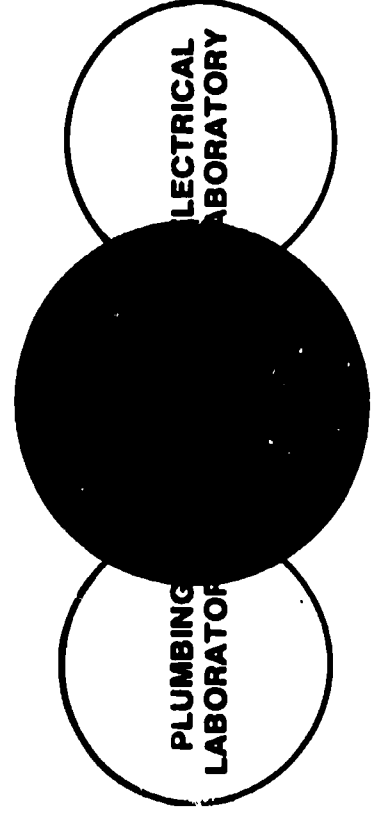

FIGURE 1: SHARED WORK AREA

A second means of improving flexibility is through sharing special equipment. As illustrated in Figure 2, a welding area could be shared by the auto mechanics laboratory and the agriculture laboratory.

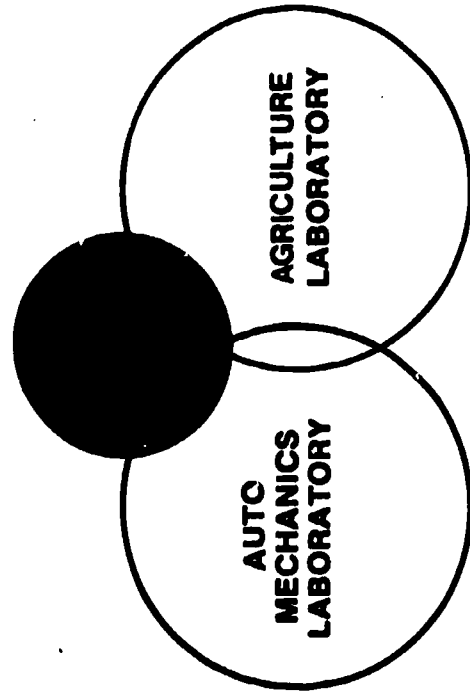

FIGURE 2: SHARED SPECIAL AREA AND EQUIPMENT

BEST COPY AVAILABLE

A third method of space sharing requires that one laboratory be used for several purposes, but with materials and storage rooms for each occupational cluster. This concept, which is illustrated in Figure 3, is practical where the conventional laboratory would have been used only one or two periods per day. Using this concept, the general laboratory might be used as an electrical laboratory in periods 1-2, as a plumbing laboratory in periods 3-4, as a construction laboratory in periods 5-6, and by the adult night class after school.

Flexibility for day-by-day use can increase the utilization of facilities, reduce cost, and enable a school to greatly expand program offerings. Space sharing should not be confined to Occupational Education laboratories. An occupational ceramics area could serve industrial arts; a general work area could be shared by art and dramatics; a hothouse could be shared by science and horticulture.

FIGURE 3: COMMON LABORATORY WITH STORAGE FOR OCCUPATIONAL AREAS.

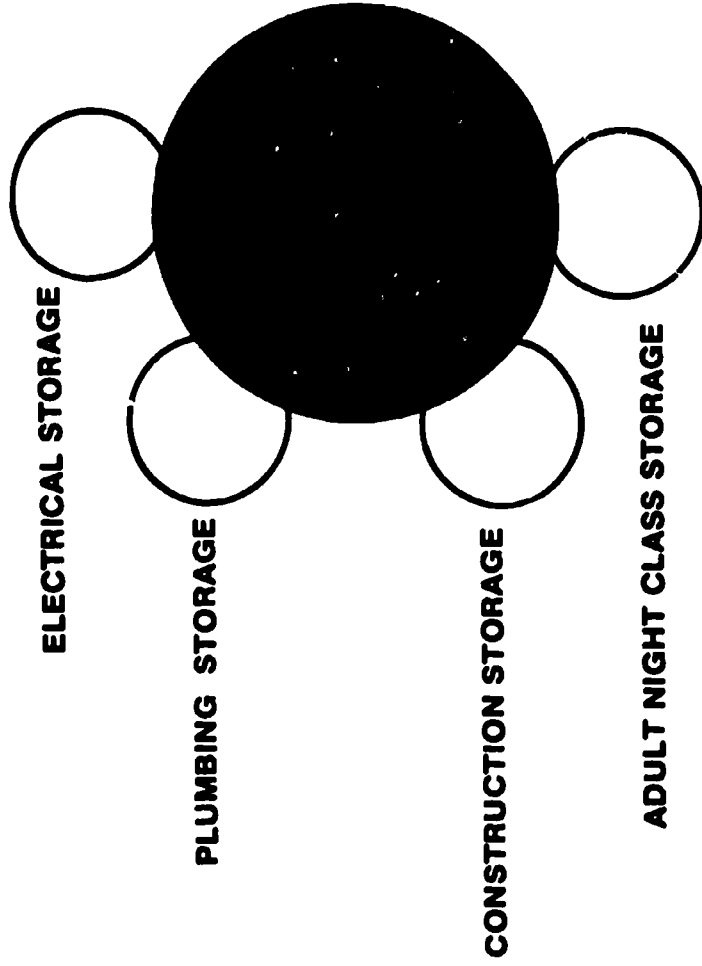

BEST COPY AVAILABLE

**Flexibility
(for semi-permanent change)**

Flexibility to reduce, expand, or modify educational spaces is also an important consideration in facility planning. With changing course demands and program requirements, walls and partitions become the prime target; however, moving walls may affect the thermal environment, utilities, and structural integrity of the building.

To improve flexibility for semi-permanent change, the following should be considered:

- Avoid load-bearing, interior walls—consider a framed, structural system.
- Avoid locating plumbing, gas, air, and electrical services in interior walls. (Services may be located on vertical structural members which are unlikely to be moved.)
- Lighting, heating, air conditioning, and ventilation should be planned on a modular basis which will allow spaces to be reduced or expanded without affecting the environment.
- Assume that there will be change—examine the location of each space to determine if it is “locked in”.

The ultimate in flexibility for semi-permanent change can be achieved with laboratories in an open space, separated only by shelves, equipment, or if necessary, a low chain-link fence. This concept is illustrated in Figure 4.

BEST COPY AVAILABLE

FIGURE 4: LABORATORIES IN OPEN SPACE

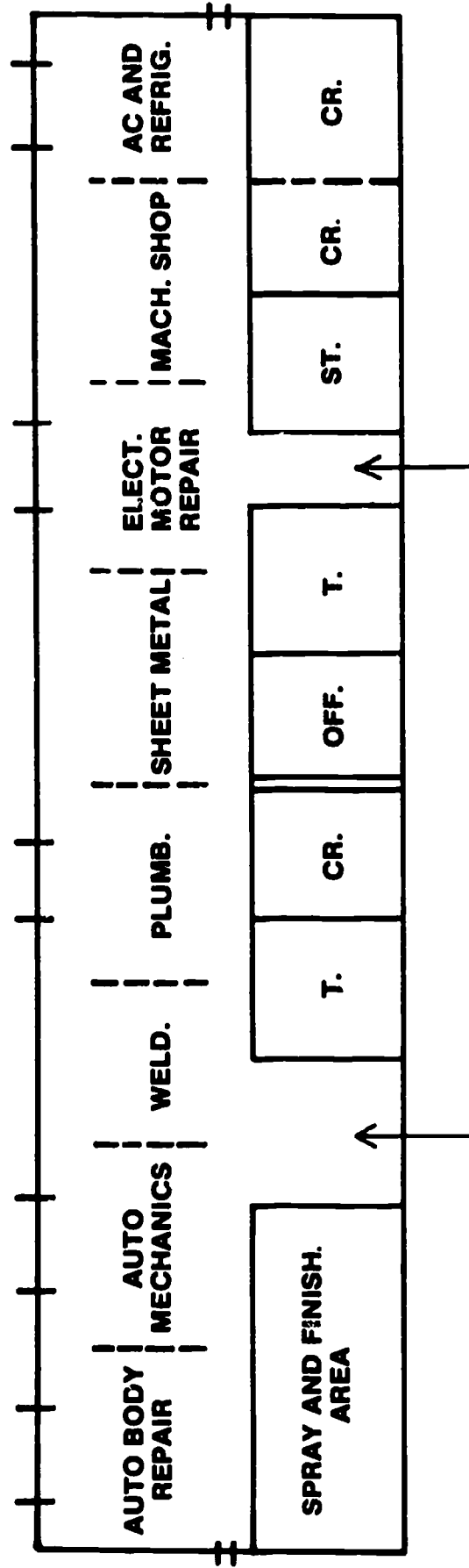

The following laboratories in each group are compatible and, with provisions for safety, noise, and perhaps visual barriers, could be located in an open space:

cabinetmaking
carpentry
furniture construction
construction

horticulture
forestry
wildlife management
crop and soil technology

auto mechanics
machine shop
welding
plumbing
electric motor repair
air conditioning and refrigeration
sheet metal
aerospace mechanics

general home economics
food services
clothing services
commercial sewing
child care services
health occupations
cosmetology
home furnishing services

The open space concept may not be practical in all situations but should be evaluated in light of local requirements. The open space plan will allow the program to respond to changing program requirements, changing course loads, and changing community employment patterns. Without flexibility, the educational program may be determined by the facilities which are available.

Sonic and Vibration Control

Sound and vibration control is important for the students within the laboratory and for students in adjacent areas. The concrete floors and smooth masonry walls generally found in medium and heavy shops contribute to poor acoustical conditions. The following are considerations which should be helpful in controlling sound and vibrations:

- Locate noisy laboratories in one-story buildings.
- The walls separating noisy from quiet areas should extend to the roof.
- A double masonry wall with a sand-filled cavity will reduce sound transmissions.
- Storage rooms and toilets can be used to isolate noisy laboratories from quiet areas.
- Sound traps should be installed in ventilation ducts.
- A sound absorbent ceiling is necessary in noisy areas; additional acoustical treatment may be needed on the walls.
- Separate floor slab in noisy areas from remainder of the building to isolate vibrations.
- Rotating, vibrating, and impacting machinery should be located on sound-absorbing pads.

- Windows should face open areas rather than classrooms.
- Auto mechanics and construction laboratories frequently have out-of-door work areas which should be isolated from the quiet areas of the building.

Sound control is a problem in office machine areas. A typing or key punch room can reach a sound level which is not only distracting and tiring but reduces effectiveness. Carpet is one of the most effective acoustical treatments. Carpeted floors are strongly recommended; carpeted walls are worthy of consideration. A medium-priced, nylon or acrylic, 25-32 oz., level loop pile carpet is recommended for wall installations.

Carpet should also be considered in other Occupational Education laboratories such as home economics, industrial cooperative training, distributive education, cosmetology, and drafting. Carpet will not only reduce the noise level but provide an attractive atmosphere and reduce maintenance costs.

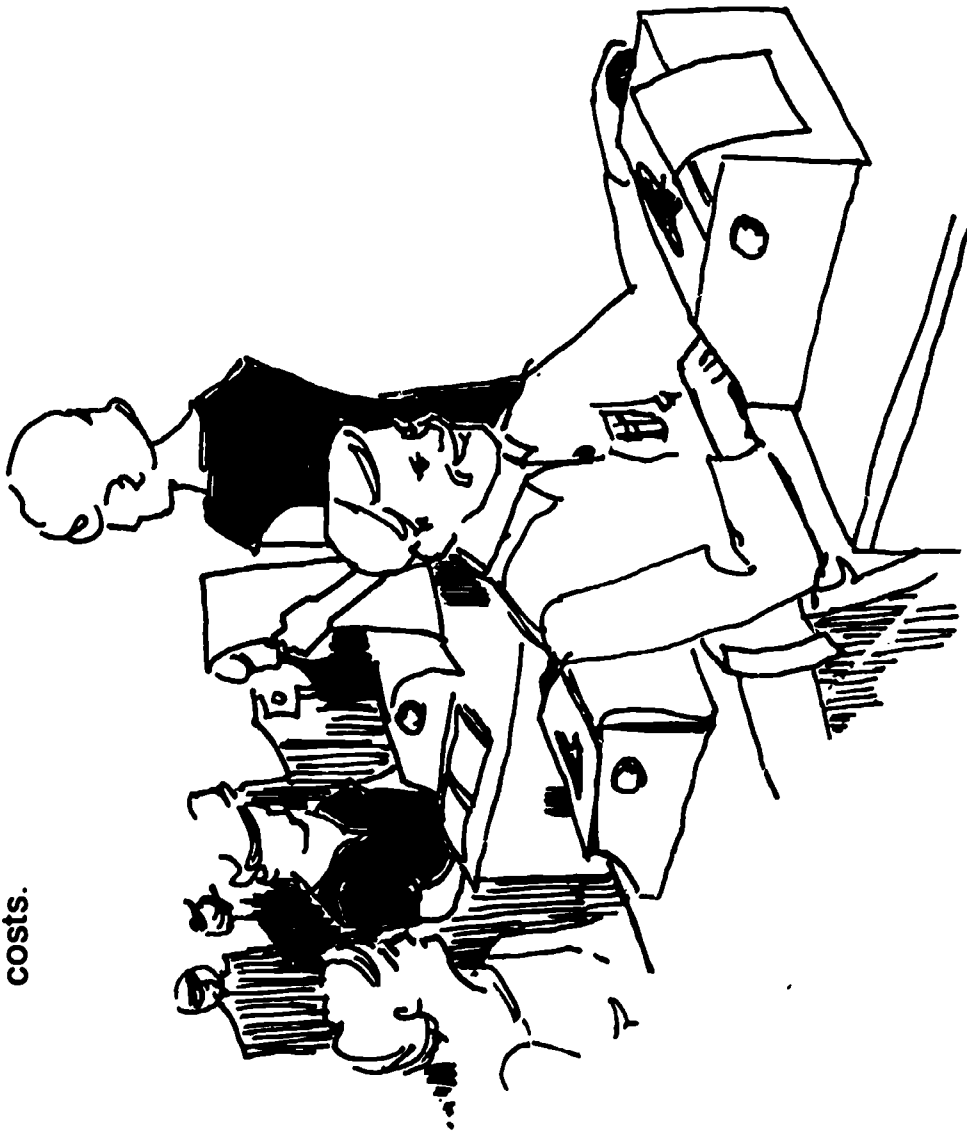

BEST COPY AVAILABLE



UTILITIES AND SERVICES

Thermal Control and Ventilation

School facilities are frequently planned with sophisticated heating, ventilating, and cooling systems in the academic areas but with primitive systems in the medium or heavy laboratories. Where economically feasible, all areas of a school plant should be heated, ventilated, and cooled by quiet, unobtrusive systems. The use of noisy overhead unit heaters is discouraged; the use of gas fired or oil fired unit heaters with an open flame is forbidden by the State Building Codes (Section 2902). In planning for thermal control and ventilation, the following should be considered:

- Occupational Education laboratories may be used for adult programs when the remainder of the building is vacant and, therefore, should have controls independent of other areas.
- Laboratories with overhead doors or large exhaust fans require extra heating and cooling capacity for a quick recovery.

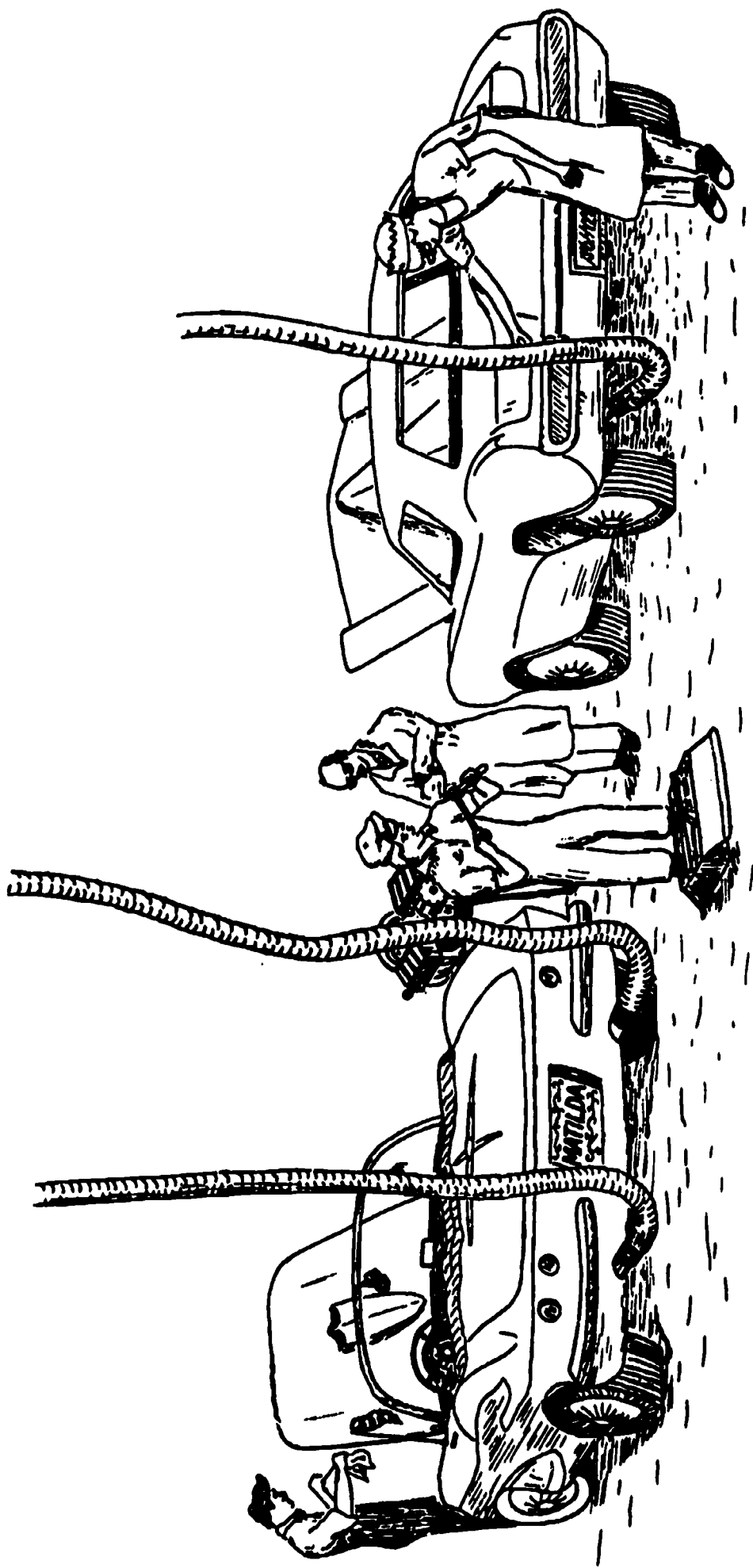

**PLATE I
AUTOMOTIVE EXHAUST SYSTEM**

- Ventilation should be positive with a system for fresh air intake.
- In automotive laboratories, where students frequently work on the floor, supplementary radiant heat in the floors may be desirable.
- Special ventilating systems are required for certain areas to exhaust noxious odors, dust, fumes, and gases. Exhaust hoods will be required for heat-treating furnaces, welding booths, darkrooms, and cooking areas. A special system is required to exhaust internal combustion engines.
- Ventilation systems to exhaust noxious odors, dust, fumes, and gases should be separate from regular ventilation systems so as not to distribute their contents throughout the building.
- In some locals, humidity must be controlled to prevent the surface oxidation of tools and equipment. Humidity control is necessary in textile laboratories and desirable in greenhouses.
- Large quantities of fresh air should be tempered or heated as it enters the building.
- Paint spray facilities are a fire hazard. Special precautions must be taken to ensure that the installation and the equipment meet the North Carolina State Building Codes. (NFPA - 33)

Lighting

There is disagreement over the use of windows in laboratories, especially in medium and heavy laboratories, and those which house expensive tools and equipment. The following are offered as rationale for eliminating windows:

- Windows create security problems.
- Windows cause excessive glare on working surfaces.
- Blinds and drapes are not practical as a means of controlling glare in a dust-laden atmosphere.
- Since laboratories are generally deeper than classrooms, natural lighting is effective in only part of the space.
- Windows consume valuable wall space.
- Providing outside walls for all laboratories is a restraint in planning.

The following are offered as a rationale for providing windows in laboratories:

- On some occasions, natural light will be sufficient, thereby saving electricity.

- Fluorescent lights distort colors; consequently, natural lighting is desirable in certain laboratories.
- Natural ventilation is adequate much of the year, but is necessary when mechanical systems fail.
- Some individuals become uncomfortable when they cannot see the out-of-doors.
- Windows provide light for egress during power failures.

No position will be taken in this publication regarding the need for windows; however, if windows are used, the following should be considered:

- The orientation of the building should reduce glare.
- Window coverings are impractical in dust-laden areas.
- In dust-laden areas, window sills should be sloped so as not to accumulate debris.
- Glare-reducing glass may be required.
- Window sills should generally be placed a minimum of 48" above the floor so as not to interfere with work benches or low furniture. High windows beginning 72" above the floor should also be considered where wall space is valued.

If regular windows are considered undesirable, small windows, high above the floor, will provide light for egress during power failures. These small windows can be inoperable and glazed with wire glass or covered with a grill to ensure maximum security. Skylights or clearstory construction are not recommended due to maintenance and security problems.

Since Occupational Education laboratories are frequently used at night, an artificial lighting system which provides a uniform distribution of shadow-free, glare-free illumination is required. The illumination level will vary with the activities. A spray booth, drafting, or sewing area, for example, will require more illumination than a general work area. In addition to the ceiling-mounted fixtures, supplementary lighting may be necessary for machines such as lathes, drill presses, and sewing machines. Equipment which is generally mounted against a wall such as a range may require a local light for shadow-free illumination.

The following chart should be helpful in determining illumination levels for typical laboratory situations:

**TABLE 3
RECOMMENDED ILLUMINATION LEVELS***

	Footcandles
General classrooms	70
Drafting rooms	100
Sewing rooms	150
Typing rooms	70
Conference rooms	50
Toilets and locker rooms	30
Kitchens	70
Shop-type laboratories	70
Storage rooms	30

*Additional supplementary lighting may be needed for specific activities.

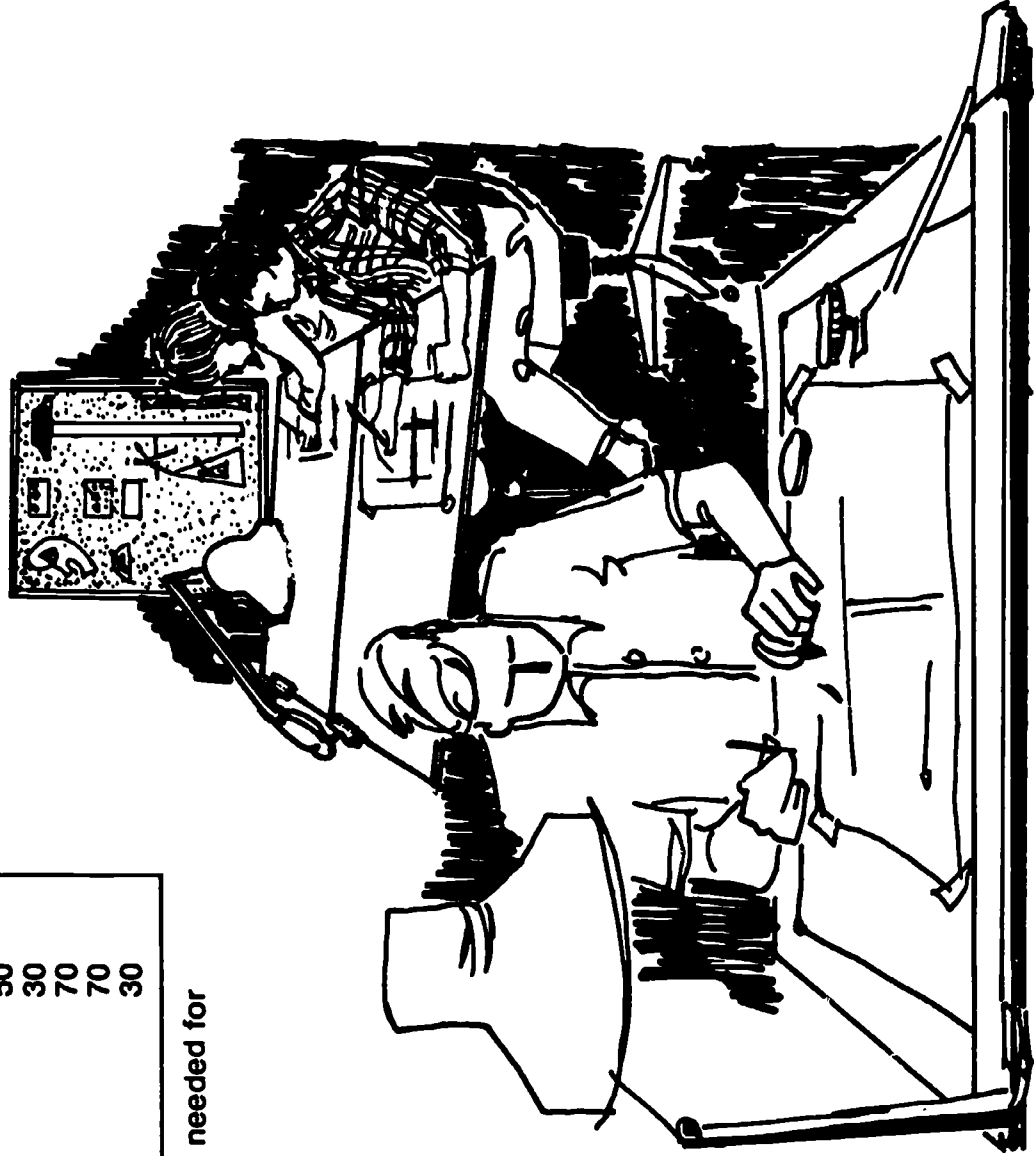

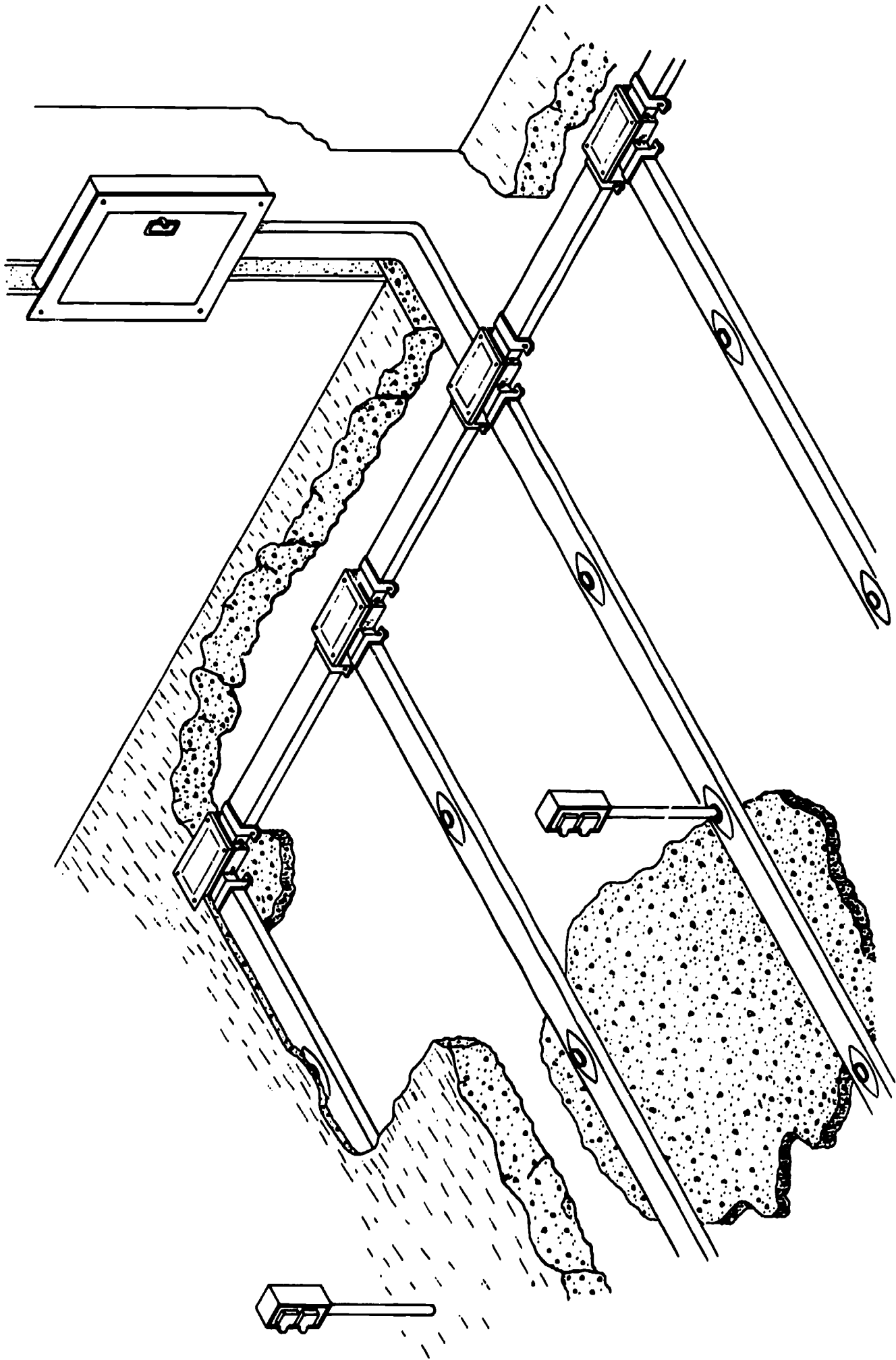

**PLATE II
UNDERFLOOR ELECTRICAL
DUCT SYSTEM**

Electrical Power

No attempt should be made to plan the electrical system for a laboratory until the equipment has been selected and the location has been determined. There should likewise be an assumption that changes will be made in the future which will require electrical power in additional locations.

Double convenience, 115 volt outlets should be located on laboratory walls at fifteen foot intervals. These outlets should be placed forty-eight inches above the floor if work benches are to be placed along the wall. Double convenience outlets should also be placed on columns. Due to the presence of sand, dust, and metal chips in medium and heavy laboratories, outlets should not be mounted flush with the floor. Floor outlets should, instead, be mounted in cast metal boxes on rigid conduit, approximately twelve inches above the floor (eighteen inches where gasoline is present). In sewing and business office education areas, where outlets must be placed on the floor under student desks, surface-mounted, tombstone fixtures are recommended.

Medium and heavy shops will have equipment driven by electric motors. If the laboratory has several motors over ¼ HP in size, a 208 or 240 volt, three phase system should be provided. Generally, all motors in excess of ¼ HP should be operated on 208 or 240 volts, three phase current. Magnetic switches should be installed on machines with large motors such as lathes, table saws, milling machines, planers, and grinders.

For medium and heavy shops, 208 or 240 volts, three phase power outlets should be surface-mounted on the walls to allow for future installations. Service to equipment away from the walls can be provided through underfloor electrical ducts placed on four to six foot intervals throughout the laboratory or on vertical structural members. Electrical ducts should have knockouts located twenty-four inches on-center which can be tapped as needed. The duct system will provide flexibility to add equipment at a later date. Generally, underfloor ducts should not be located in areas where large quantities of liquids are likely to be spilled or where floor drains are needed.

An alternative to the underfloor ducts is an overhead bus-bar system. This system is rather expensive and may be justified in a manufacturing plant where machinery is moved each day; however, the underfloor duct system is satisfactory for Occupational Education laboratories.

Since students frequently assist in the maintenance of laboratory equipment, the instructor should be able to physically disconnect the equipment from its power source. The use of power outlets for each machine is recommended. Power outlets also enable the instructor to move equipment throughout the laboratory.

BEST COPY AVAILABLE

As a safety factor, the instructor should be able to disconnect and lock the electrical service to all equipment from a master power panel which is easily accessible. All machinery should be coded at the power panel so that students or instructors can kill the circuit quickly in an emergency.

Automotive or other shops where gasoline will be used require special safety considerations. The North Carolina State Building Codes should be consulted in this regard.

Plumbing

Hot and cold water should be available in all laboratories. If water is to be used for instructional purposes, a study may be required to determine the volume. The following should be considered when planning the plumbing system:

- Acid resistant or at least heavy cast iron fixtures and waste lines will be needed where chemicals are used for photographic processing, metal etching, electroplating, etc.
- A clay or plaster sediment trap should be installed in the waste lines in ceramics areas.
- Floor drains are not allowed in power mechanics areas unless there is a volatile liquid interceptor to prevent oil and gasoline from entering the sewage system.
- Drinking water is needed in medium and heavy laboratories. The drinking fountain should be installed near the sink, but not on the sink.
- Conventional wash sinks with standard faucets are recommended. Circular or semi-circular wash fountains with special fittings are frequently unsatisfactory.

Natural or bottled gas may be needed; however, the volume will vary with the use. Household-type cooking equipment, soldering furnaces, and clothes dryers may require only a small gas line but ceramic kilns or foundry furnaces will require a larger line.

Compressed air for several laboratories can be supplied from a central compressor. Air can be tapped off at any point if "quick disconnects" are provided. Air transformers or variable pressure reducers will be needed in spray rooms. Air lines should be pitched so that condensation can be collected and released at certain points. Air, water, and gas may be needed in demonstration areas as well as in the laboratories.

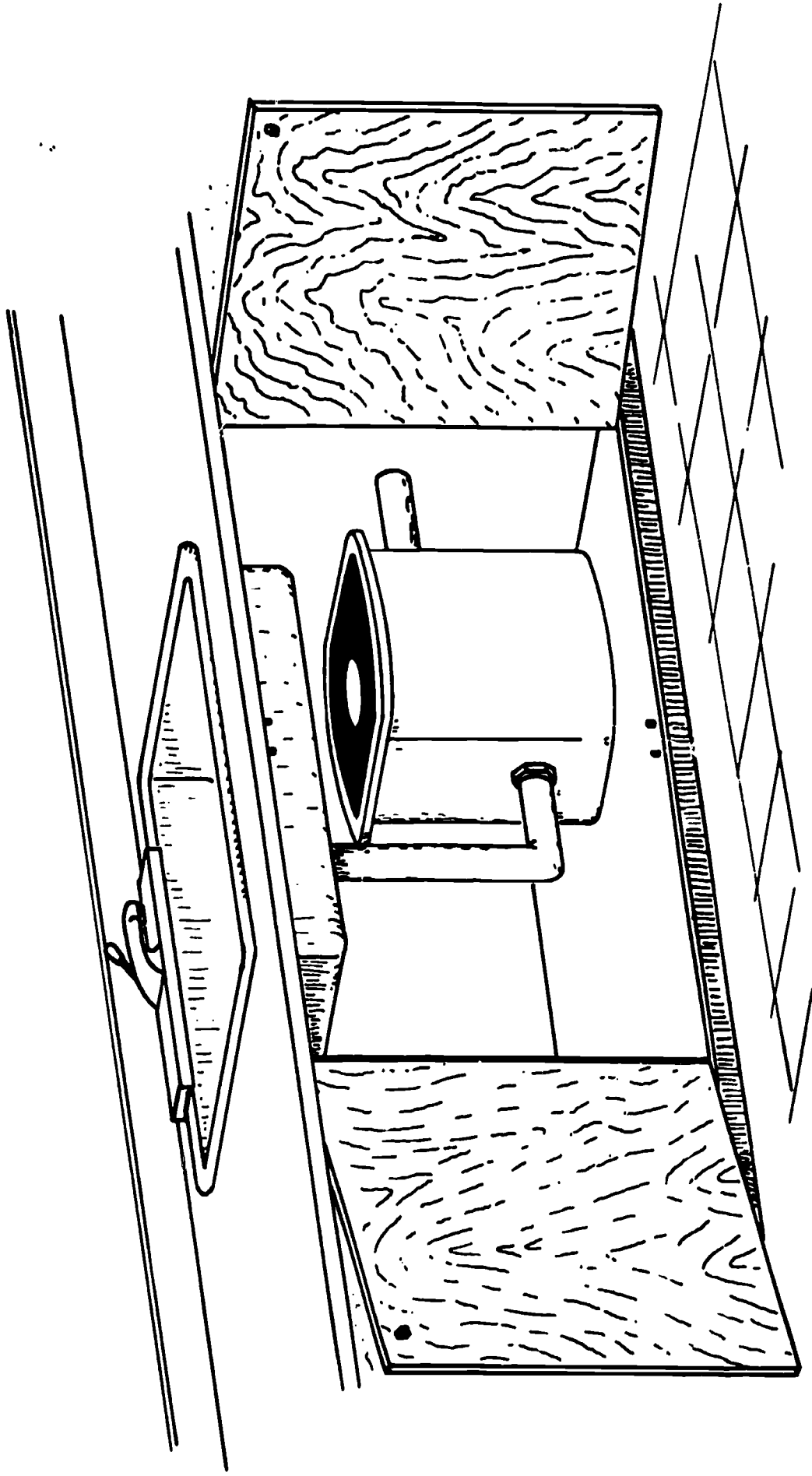

**PLATE III
CLAY OR PLASTER SEDIMENT TRAP**

Dust Collection Systems

A dust collection system is essential in a wood working laboratory and highly desirable in a general laboratory with wood working equipment such as a planer, sander, radial saw, and jointer. There are two types of collection systems. The first is a filter system; the filters must be cleaned frequently and may constitute a fire hazard. The second type is a cyclone or centrifugal system in which the sawdust and debris precipitates out in the separator. An after-filter bag is placed on the clean air return but the cyclone effect will eliminate 99% of the dust and debris. The separator should be located out-of-doors to reduce noise and facilitate emptying, but the after-filter bag can be located on the inside, thereby returning the air to the laboratory. The cyclone or centrifugal system is recommended because of the lower initial cost, reduced fire hazard, lower maintenance, and quieter operation.

Collector ducts for a dust collection system may be located in the floor or overhead. Generally, an overhead system is preferred since in-the-floor ducts collect moisture and become clogged. The overhead system is also more flexible as ducts can be moved with less expense.

BEST COPY AVAILABLE

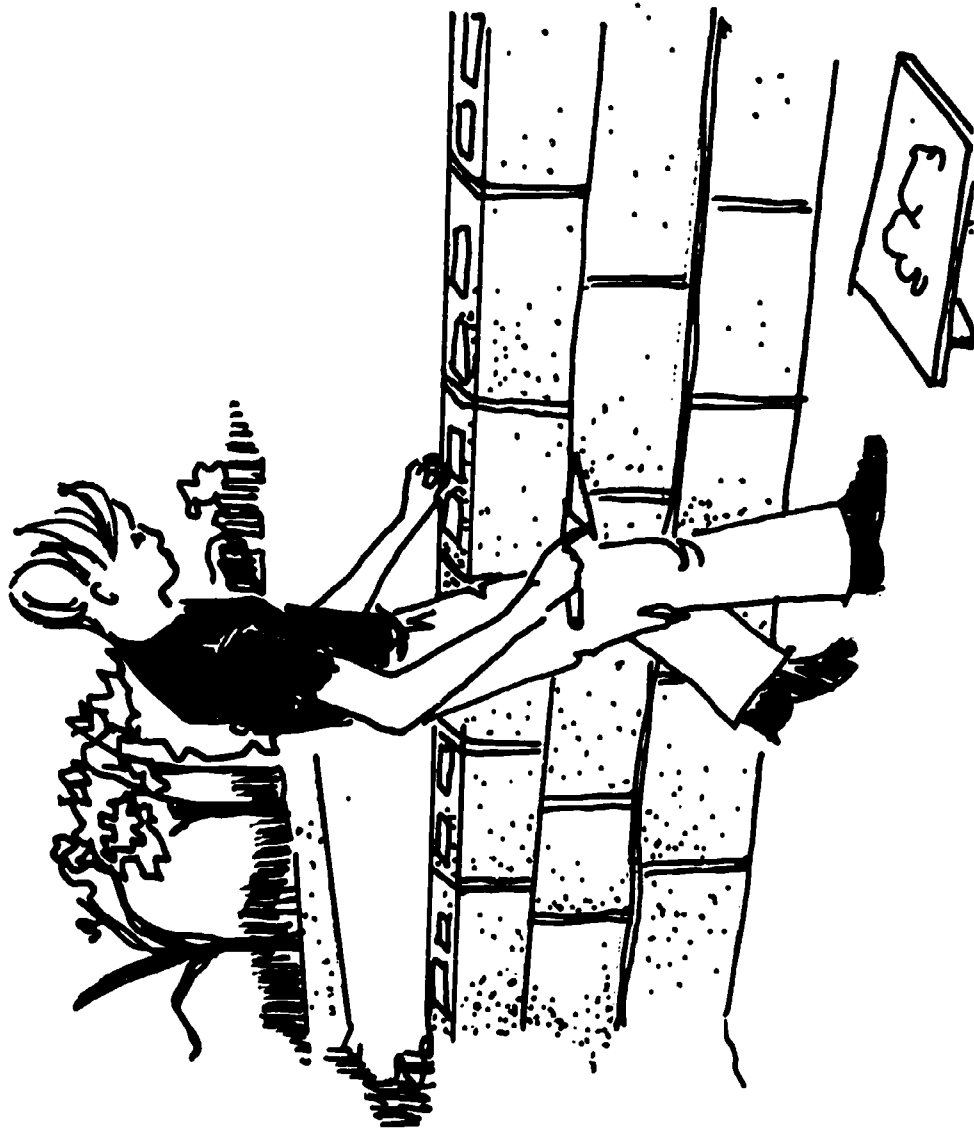

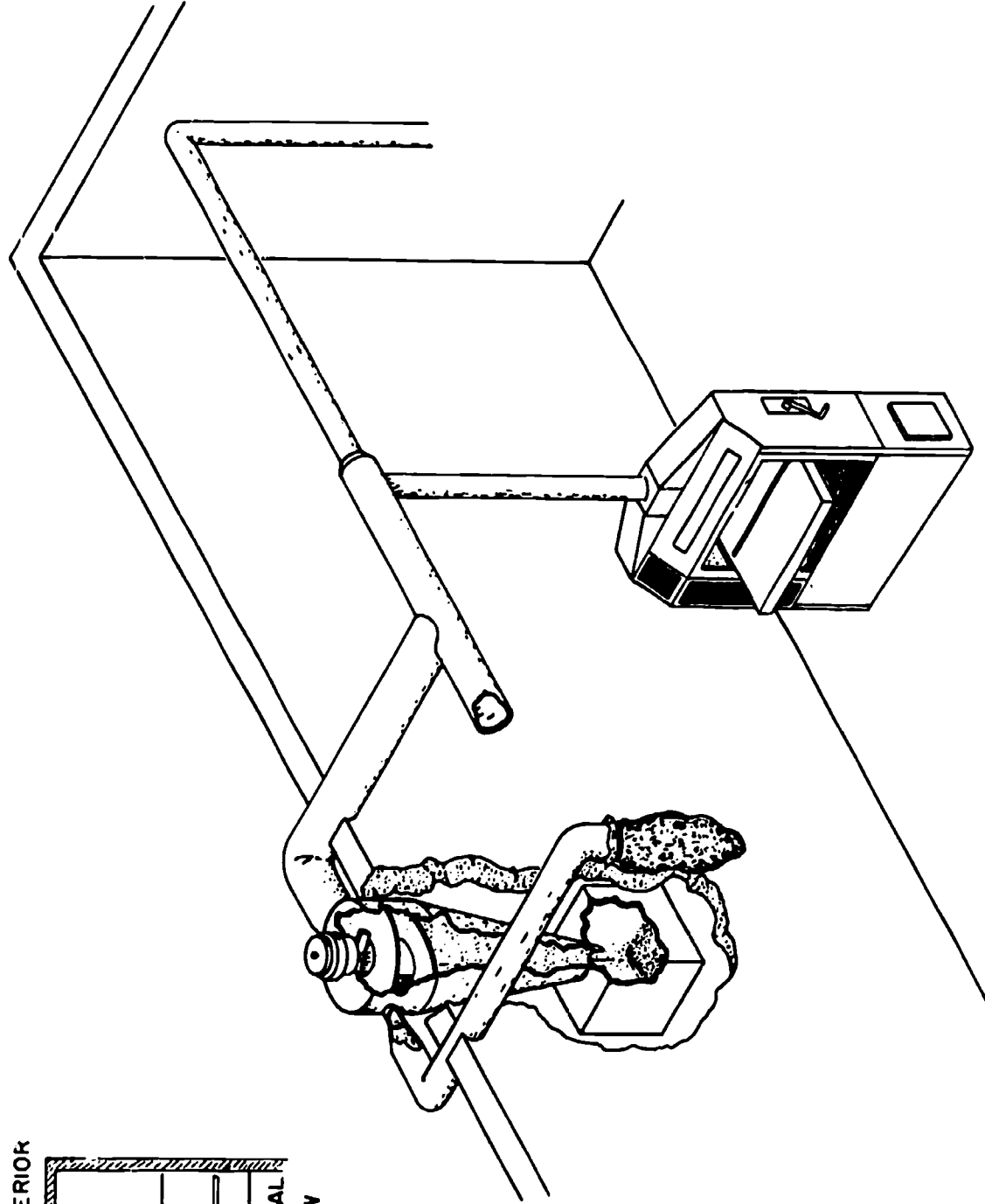
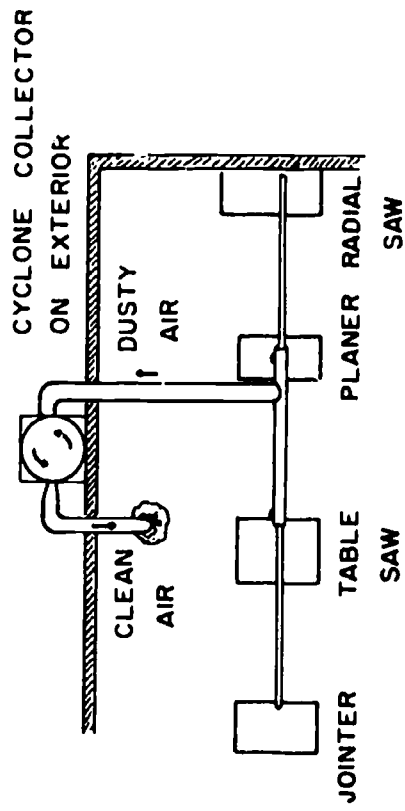

**PLATE IV
CENTRAL DUST COLLECTION SYSTEM**

BEST COPY AVAILABLE

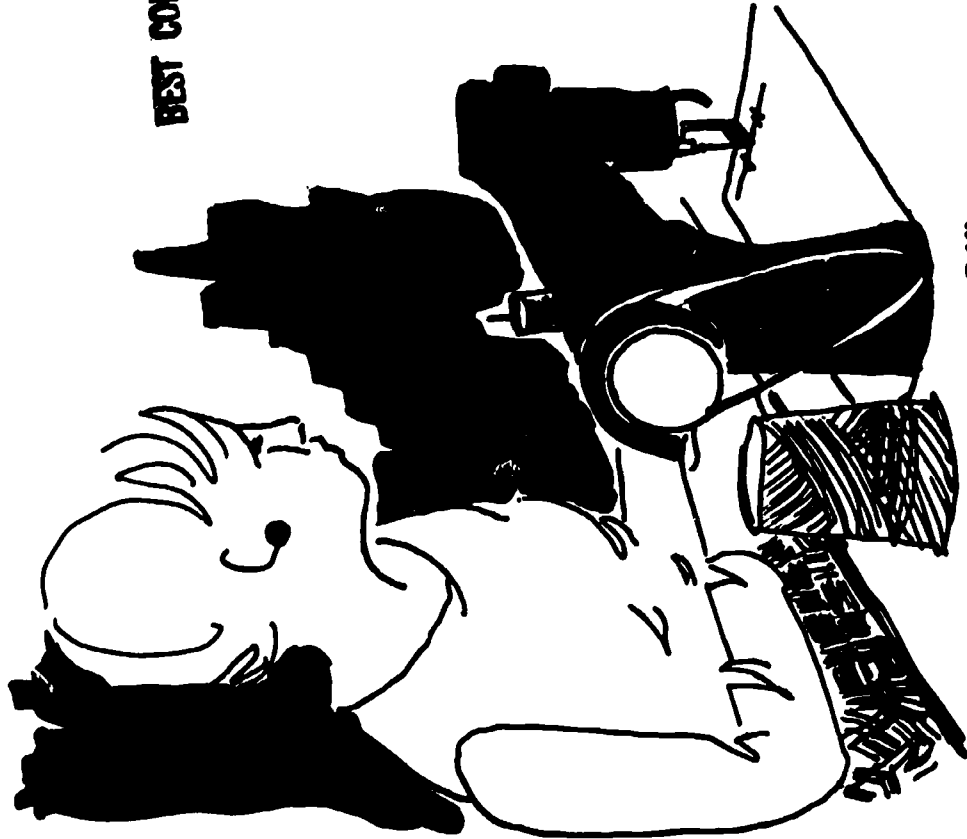

AUXILIARY ROOMS AND FACILITIES

Offices

An enclosed teacher's office is recommended for laboratories that are dusty or noisy. The office should be located in such a manner as to allow the instructor to observe the laboratory. In some situations, two or more teachers may share the same office, but only if visual contact of all laboratories can be maintained. The following should be considered in planning offices:

- A minimum of 125 square feet of floor space is needed for each teacher.
- Each teacher should have a desk or table, chair, and legal file cabinet. Each office should have adequate space for a typewriter and typing table and two conference chairs. A 30" x 60" table would be desirable.
- Offices should be equipped with shelf space for reference books and bulletins. Storage for films, filmstrips and other audiovisual aids is also needed.

- Storage space should be provided in the office or in a nearby storage room for teaching aids and devices.
- The office should be located adjacent to the classroom.
- The office should have adequate heat, air conditioning, ventilation, electrical outlets, lighting, and sound control. The office should be connected to the school communications and bell systems.
- Offices for work/study coordinators must have telephones.
- The office should be located in such a manner as to allow the teacher to observe the activities in the laboratory.

Classrooms

Every laboratory should have access to a classroom or assembly area where students can assemble, receive group instruction, plan, and use reference and audiovisual materials. The following are suggestions for planning the classroom area:

- Windows are needed between the classroom and the laboratory for teacher supervision.
- The natural light must be controlled if films, filmstrips, and television are to be used effectively.
- The classroom may be the planning area, consequently, one or more drafting tables may be needed.
- The classroom may double as a satellite library and may require bookcases and adequate storage for materials.

In situations where several related laboratories are located in close proximity, only one classroom, as described above, may be needed. This classroom can be shared by students in adjoining laboratories; however, a student assembly area is needed in each laboratory. Generally, discipline is improved and teachers are more encouraged to teach related material if the class can be assembled at the beginning of the period. An assembly area may require as little as 300 square feet of floor space, a desk or table and chair for each student, and a chalkboard.

Storage Rooms

Many years ago, in schools as in industry, tools were stored in tool rooms or tool cribs. In recent years the trend has been toward making tools and equipment more accessible. The inexpensive tools and equipment, which are

used daily, are mounted on panels for easy accessibility and inventory. A tool and equipment storage area, either a room or lockable cabinet, is still necessary for expensive items, especially those that receive occasional use.

Storage for materials will vary with the type of activities; however, the following suggestions should prove helpful:

- The material storage area should be convenient to the materials receiving door.
- The material storage areas should be located to allow an orderly flow into the production area. For example, the wood storage area should be near the radial saw; the metal storage area should be near the power hack saw.
- Storage should be designed to accommodate the materials. Steel is received in 20 foot lengths; wood is received in lengths up to 16 feet. Wood and steel can best be stored in horizontal racks.
- For security reasons, tool and material storage rooms should not have windows or skylights. Doors should be solid-core; walls should be masonry.
- Storage rooms can be used to isolate noisy laboratories from adjoining quiet areas.

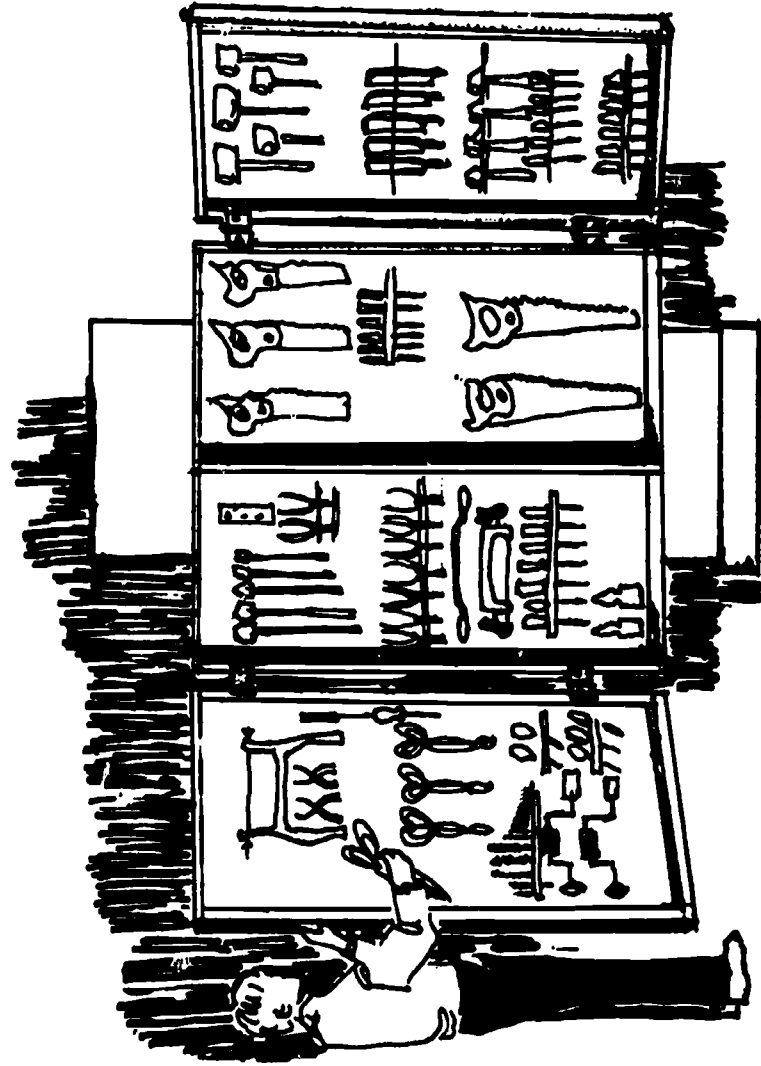

Teachers of Occupational Education generally use many teaching aids and devices. Adequate storage must be provided for these items which are frequently heavy and bulky. Where feasible, teaching aids and devices should be stored near the office and classroom.

Students need lockers or trays for storing small projects, but a project storage room may be required for larger items. There is some advantage in dividing project storage rooms into class lockers (4' x 4' x 8' for example) as students seldom vandalize or steal projects from their classmates.

If adult night classes are to be conducted in the laboratory, a separate material and project storage area may be required. This separate storage will be essential if accounting and purchasing procedures require a separation of day and night school receipts and expenditures or if a different instructor is employed for the night school program.

Spray or Finishing Room

A spray booth may be needed for a furniture-making or auto body repair laboratory. The cost of spray equipment, exhaust fans, special lights, etc. can vary considerably; consequently, a study should be made of the quality of equipment needed and the funds available.

The following should be considered in planning the finishing room:

- A finishing room should be relatively dustfree.
- The electrical equipment such as motors, switches, and lights must be explosion-proof in accordance with the North Carolina Building Codes (NFPA - 33).
- Large amounts of filtered air are required for a spray booth. This air is generally drawn from the laboratory, and places a burden on the heating, air conditioning, and ventilating systems.
- The fan in the spray booth should exhaust toward an open area. Parking should be prohibited in the vicinity of the spray exhaust.
- Code-approved metal storage cabinets should be provided for volatile materials.
- The door to the finishing room should be a minimum of 48" wide. The finishing room for auto body repair should accommodate the largest vehicle to be painted.

BEST COPY AVAILABLE

- Spraying combustible and flammable paints and finishes is hazardous. School personnel planning a spray facility should get advice from a qualified specialist in this area. The National Fire Codes (Section 33), which have been incorporated into the North Carolina Building Codes, should be observed in planning and operating this facility.

Spray booths and spray rooms are available as packaged units which can be installed inside the building or outside the building. For safety reasons, the packaged unit should be considered.

Toilets and Dressing Areas

Toilets for men and women should be accessible from all laboratories. There are many advantages to having toilets in each laboratory, however, the duplication of facilities is expensive.

Dressing areas are needed for heavy laboratories. Students should have lockers to store coveralls or other work clothing. Showers are sometimes provided; however, they are seldom used.

Students tend to congregate in toilets, wash-up areas, and dressing areas. This situation can be minimized if the three areas are separated. The wash-up area can be centrally located in the laboratory, in full view. The dressing areas could be screened by a partition, but located within the laboratory. The toilets should be removed from the wash-up and dressing areas. By separating the three problem areas, students will have less opportunity to congregate.

Display Centers

A display center for the Occupational Education programs should be located in the foyer or main corridor of the school. The recessed displays should have adjustable shelves, electrical outlets, adequate lighting, and if feasible, access from the rear. The display case is important for good public relations and should be planned to serve the programs. Several display cases may be needed to exhibit projects from unrelated laboratories.

FLOORS

Finishes

Medium and heavy laboratories generally have sealed concrete floors as they are subjected to abuse from heavy objects and may become impregnated with oils and acids. A minimum slab-on-grade thickness of five inches is generally accepted practice for exposed concrete floor slabs; special use or loadings may require more. Special emphasis should be placed on the quality of exposed concrete floor slabs. A higher quality concrete, such as is standard practice for exposed industrial floors, should be installed. A minimum of 4,000 psi concrete and special precautions in finishing and curing is recommended. Concrete floors should be hardened and sealed.

Carpet is recommended for business education, sewing, cosmetology, drafting; industrial cooperative training, distributive education, and health occupations laboratories; vinyl tile is recommended for light cooking, graphic industries, electronics, and tailoring laboratories; ceramic or quarry tile is recommended for commercial cooking laboratories.

Woodworking machines such as the planer jointer, circular saw, and shaper are very dangerous when the operator is standing on a slippery floor. The area around these machines should be treated with an abrasive finish. Such a finish can be produced by sprinkling silica into the freshly-painted sealer; a commercially prepared non-skid finish is also available.

Machine Mountings

Machines such as lathes, planers, jig saws, platen presses, etc. which have a tendency to vibrate should be bolted to the floor. Machine mounting pads, placed under the machine feet, will also reduce vibration and compensate for some unevenness of the floor. Care should be taken not to warp the machine frames or compress the pad unnecessarily when drawing the feet down.

Drains

Floor drains are needed in areas where liquids are frequently spilled or where the floors must be scrubbed or hosed down. Automotive laboratories should have floor drains with a suitable volatile liquid interceptor in the area where gas or oil may be spilled. Floor drains should not be located in an area with underfloor electrical ducts.

BEST COPY AVAILABLE

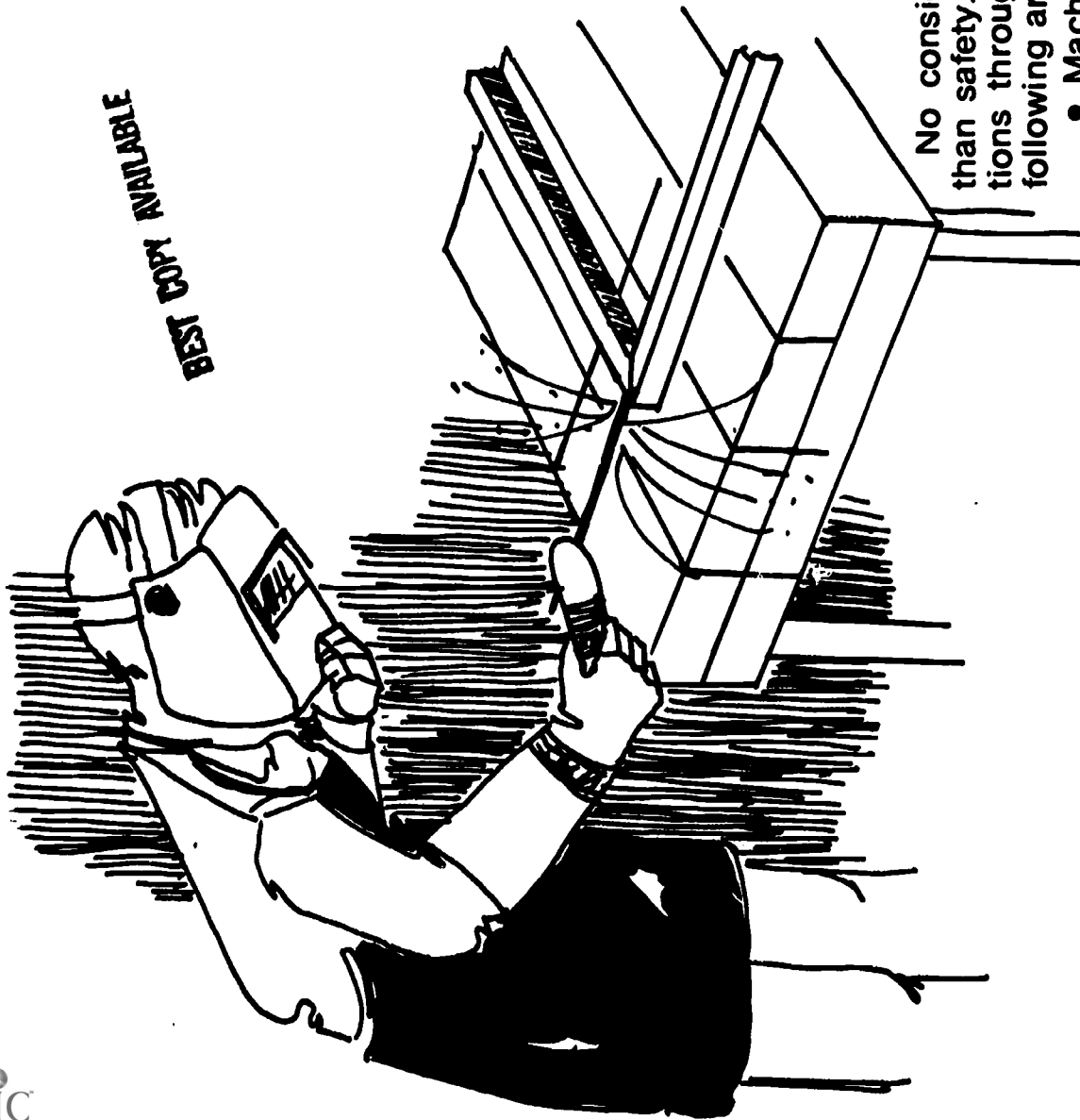

SAFETY

No consideration in laboratory planning is more important than safety. While many of the suggestions and recommendations throughout this publication were related to safety, the following are specific points to be considered:

- Machinery must be located to allow the operator some protection from traffic patterns. Serious injuries can occur when a passer-by jostles a machine operator.
- The "kick-back" area for machines such as table saws, planers, etc. should be aimed toward walls rather than student work areas.
- Wood lathes must be oriented so that work exploding on a face plate will not endanger another lathe operator.
- Electrical equipment must not be placed near sinks or water fountains.

- Welding booths and curtains must be fireproof or fire-resistant. Exhaust hoods must be provided in welding areas.
- Curtains on booths must adequately screen the welding area, as the arc-flash will damage the eyes of persons in other areas of the laboratory.
- Foundry areas should be well ventilated.
- An engine exhaust system must be provided in automotive shops.
- Light fixtures, motors, and switches located in spray booths must be explosion-proof.
- Safety containers, listed and labeled by the Underwriter's Laboratories, must be provided for flammable liquids and rags.
- Safety goggles and face shields, which meet the requirements of North Carolina General Statutes 115-258 to 260.1, must be provided. A storage cabinet for the eye protection devices should also be provided.
- Eyewash fountains are required in areas where students are likely to get chemicals or debris in their eyes. Emergency showers may be needed in some areas.

The Williams-Steiger Occupational Safety and Health Act of 1970 (OSHA) went into effect in April, 1971. Under this federal safety law, states are required to submit a plan to the U. S. Department of Labor for approval. On May 1, 1973, the General Assembly ratified Senate Bill SB-342 which allows the North Carolina Department of Labor, Office of Occupational Safety and Health to administer the OSHA program within the state. Educators, architects, and engineers are urged to keep abreast of these developments.

BIBLIOGRAPHY

ERIC

- Meckley, Richard F., and others. *A General Guide for Planning Facilities for Occupational Preparation Programs. Final Report. Research Series No. 38.* Columbus: Ohio State University, The Center for Vocational and Technical Education, 1969. 87 p. (ED 030 771)
- Nerden, Joseph T. *Vocational-Technical Facilities for Secondary Schools. A Planning Guide.* Columbus, Ohio: Council of Educational Facility Planners, 1968. 102 p. (ED 029 984)
- Nerden, Joseph T. *Vocational-Technical Facilities for Secondary Schools. A Planning Guide.* Columbus, Ohio: Council of Educational Facility Planners, 1970. 46 p. (ED 043 102)
- Oregon State Department of Education. *Guide for Planning Industrial Arts Laboratory Facilities.* Salem: the Department, Division of Community Colleges and Vocational Education, 1968. 55 p. (ED 028 301)
- New York State Education Department. *A Pictorial Guide to Aid in Planning Business and Distributive Education Classrooms and Facilities.* Albany: the Department, Bureau of Business and Distributive Education, 1965. 54 p. (ED 021 991)

Others

- Collins, Walter E., D. V. M., and Wilbur M. Farnsworth. *A Guide for Planning Facilities for Occupational Preparation Programs in Laboratory Animal Science Technology.* Columbus: Ohio State University, The Center for Vocational and Technical Education, January 1969. 118 p.
- Educational Facilities Laboratories, Incorporated. *Career Education Facilities.* New York, N. Y.: the Laboratories, 1973. 47 p.
- Larson, Milton E. *A Guide for Planning Facilities for Occupational Preparation Programs in the Machine Trades.* Columbus: Ohio State University, The Center for Vocational and Technical Education, September 1968. 71 p.

- McIntosh, William A. *A Guide for Planning Facilities for Occupational Preparation Programs in Data Processing*. Columbus: Ohio State University, The Center for Vocational and Technical Education, November 1968. 67 p.
- Meckley, Richard F., and others. *A Guide for Planning Facilities for Home Economics Occupational Preparation Programs*. Columbus: Ohio State University, The Center for Vocational and Technical Education, September 1968. 83 p.
- Meckley, Richard F., and others. *A Guide to Systematic Planning for Vocational-Technical Schools*. Columbus: Ohio State University, The Center for Vocational and Technical Education, December 1968. 23 p.
- Nair, Ralph K., ed. *Planning Industrial Arts Facilities* (Eighth Year Book, 1959, American Council on Industrial Arts Teacher Education). Bloomington, Illinois: McKnight and McKnight Publishing Company, 1959. 247 p.
- New York State Education Department. *A Planning Guide for Vocational-Industrial and Vocational Technical Building Facilities for Comprehensive High Schools*. Albany: the Department, Division of School Buildings and Grounds, 1950. 36 p.
- North Carolina Department of Public Instruction. *Educational Specifications. School Planning Guide Series-3*. Raleigh: the Department, Division of School Planning, May 1968. 24 p.
- North Carolina Department of Public Instruction. *Planning for Education: People and Processes. School Planning Guide Series-1R*. Raleigh: the Department, Division of School Planning, March 1973. 49 p.
- Schmitt, Marshall L., and James L. Taylor. *Planning and Designing Educational Facilities for Industrial Arts Education*. Washington, D. C.: Office of Education (DHEW), 1968. 55 p.
- Selden, William. *A Guide for Planning Facilities for Occupational Preparation Programs in Business and Office Occupations*. Columbus: Ohio State University, The Center for Vocational and Technical Education, November 1968, 86 p.
- Trimpe, Adrian, and others. *Facilities and Equipment for Distributive Education Programs*. Kalamazoo: Western Michigan University, Department of Distributive Education, 1968. 72 p.

PUBLICATIONS OF THE DIVISION OF SCHOOL PLANNING

SCHOOL PLANNING GUIDE SERIES

- A Digest of Educational Planning* (June, 1963)
Educational Specifications (May, 1968)
Minimum Check List for Mechanical and Electrical Plans and Specifications (August, 1969)
Facilities for Early Childhood Education (March, 1970)
Planning for Education: people and processes (March, 1973)
Planning for Built-Up Roofing (May, 1974)
Facilities for Occupational Education: grades 7-12 (September, 1974)

North Carolina Laws Relating to Public School Construction (1966)
Planning for Shops and Laboratories
Procedures for Review and Approval of School Building Plans and for Inspection of Building Projects by the Division of School Planning (January, 1971)

Public Schools and Highways (June, 1971)
Planning for New School Sites (November, 1971)
Schools of Interest: additions and renovations (July, 1973)

TECHNICAL SERIES

- 1 - *Roofing-Planning, Specifications, Construction, Problems* (September, 1969)
- 2 - *Specifications for Structural Concrete for Buildings* (October, 1970)
- 3 - *Considerations for Fire Alarm Systems, Sprinkler Systems, and Ventilation Control Systems in Public Schools* (March, 1971)
- 4 - *Moisture Protection* (August, 1971)
- 5 - *Pre-Fabricated, Pre-Engineered Rigid Frame Buildings* (April, 1972)
- 6 - *Pre-Coated Roofing Felts* (June, 1972)