

DOCUMENT RESUME

ED 093 617

SE 017 099

AUTHOR Chapman, Robert D.
TITLE Comet Kohoutek, 1973-1974, A Teachers' Guide with Student Activities.
INSTITUTION National Aeronautics and Space Administration, Greenbelt, Md. Goddard Space Flight Center.
PUB DATE Sep 73
NOTE 47p.
EDRS PRICE MF-\$0.75 HC-\$1.85 PLUS POSTAGE
DESCRIPTORS *Astronomy; *Earth Science; Instruction; *Instructional Materials; *Science Activities; Science Education; *Teaching Guides

ABSTRACT

This teacher's guide provides background information, curriculum source materials, and suggested class activities for class discussion and study. Information related to the discovery of the comet is presented as well as photographic and schematic pictures showing the sky through which the comet travels. Historical data regarding comets of the past and both ancient and modern views of comets is presented. The booklet presents a summary of the Comet Kohoutek events, a bibliography and a glossary. (EB)

SE

UNIVERSITY OF
MICHIGAN LIBRARY

ED 0170

077

ED 093617

COMET KOHOUTEK
(KŌ HŪ' TEK)

A Teachers' Guide
With Student Activities

by
Robert D. Chapman, Ph.D.
Solar Atmosphere Branch
Laboratory for Solar Physics
NASA/Goddard Space Flight Center

September 1973

Educational Programs Branch
Office of Public Affairs
NASA/Goddard Space Flight Center
Greenbelt, Maryland



Comet Bennett on April 16, 1970. Note the division of the tail into two tails. (J. C. Brandt, R. G. Roosen, S. B. Modali, Goddard Space Flight Center.)

PREFACE

A rare and spectacular celestial visitor, called "Comet Kohoutek 1973f," is expected in the fall and winter of 1973. This guide is designed to provide curriculum source material on this event for teachers. Also included are suggested projects for students.

The author, Dr. Robert D. Chapman, is an astronomer in the Laboratory for Solar Physics at the NASA/Goddard Space Flight Center. His teaching experience in astronomy was gained at the University of Maryland, University of Michigan and at the University of California, Los Angeles. In preparing this guide, he worked closely with the staff of the Operation Kohoutek Special Office, as they planned NASA's extensive research program for this comet.

The author wishes to thank Mr. William Kenney, Goddard Educational Programs Office and former director of the Washington County, Maryland, Space Science Center, for his assistance. Mr. Kenney's advice and counsel in preparing this material to meet the needs of elementary and secondary school teachers of science concepts was invaluable.

Suggestions for improvements in the presentation have also been made by Dr. Robert Hobbs and Dr. Stephen P. Maran, Goddard's Laboratory for Solar Physics; and Mr. Elva Bailey and Mr. Richard Crone, Goddard Educational Programs Office.

This booklet was published and distributed by the Educational Programs Branch, Office of Public Affairs, NASA/Goddard Space Flight Center, Greenbelt, Maryland. Educators are encouraged to share this document with their colleagues and to duplicate any or all of the material.

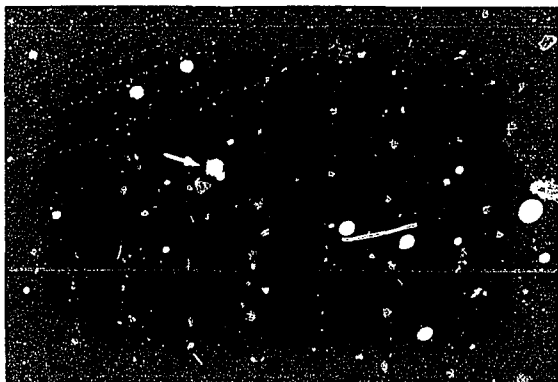
CONTENTS

	Page
The Discovery of Comet Kohoutek	1
How Comets are Found and Named	3
Cometary Orbits	5
How and When Can the Comet Best be Viewed?	8
What will Comet Kohoutek Look Like?	9
Ancient View of Comets	12
Modern View of Comets	13
Comets of the Past	25
Rapid Changes in Comets	26
What will NASA do About the Comet?	30
Projects Students Can Do	32
-- Plot the Position of the Comet	
-- Drawing an Ellipse	
-- Drawing the Comet (Students can help the scientists)	
-- Photographing the Comet	
-- Do you want to find a Comet?	
Appendices	35
-- Ephemeris of Comet Kohoutek Events	
-- Bibliography	
-- Glossary	

THE DISCOVERY OF COMET KOHOUTEK

Dr. Lubos Kohoutek is a well-known Czechoslovakian astronomer who works at the Hamburg Observatory in West Germany. On the night of March 7, 1973, he took several photographs of a portion of the sky in the direction of the Constellation Hydra, the sea serpent, using the 32-inch Schmidt telescope at the Observatory. Later, when he studied the developed photographic plates, he noticed a very faint, fuzzy spot of light on the plates. Two nights later he photographed the same region of the sky and again the faint, fuzzy spot appeared on his photographic plate, only it had moved a fraction of a degree to the west-northwest of its original position.

28 APRIL 1973



03:57 UT

05:34 UT

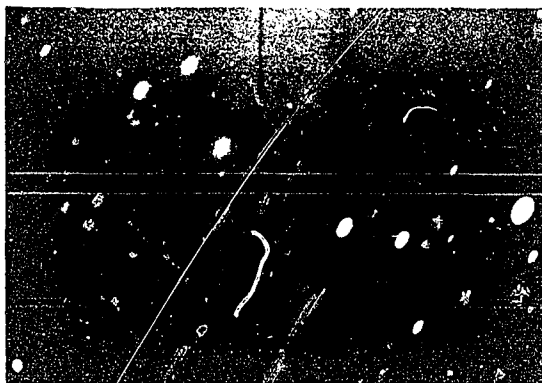


Figure 1: Two photographs of Comet Kohoutek taken on April 28, 1973. These photographs were made by H.-Y. Chiu, R. W. Hobbs, and S. P. Maran, using the Kitt Peak National Observatory's 36" telescope, and a special television camera known as a storage vidicon. Note the motion of the Comet during the 97 minutes between exposures.

Could it be that Dr. Kohoutek had discovered his second comet in a little over a week? On February 28 he had discovered a comet while taking photographic plates for a similar project as on March 7. Verification of the discovery would have to wait, however, since the waxing moon moved into the vicinity of Hydra, and photography of faint objects became impractical. By March 21 the moon had moved far enough away from the suspected comet that Dr. Kohoutek could obtain another series of plates. Sure enough, the fuzzy image was again visible, but during the intervening time, not only had it moved, it had also increased in brightness. Indeed, a new comet had been discovered. At this point, Dr. Kohoutek checked back to photographs taken on January 28 and found another faint image, a “pre-discovery” observation of the comet.

With accurate measurements of the comet’s position among the stars on the photographic plates, astronomers were able to make a preliminary calculation of the comet’s path through space. Imagine their excitement when their predictions



Figure 2: Dr. George Van Biesbroeck of the Lunar and Planetary Laboratory, University of Arizona, finding the accurate position of an image on a photographic plate, using a Mann Measuring Engine. (Courtesy R. B. Minton, Lunar and Planetary Laboratory, University of Arizona.)

showed that when it passes closest to the sun (perihelion) around Christmas, 1973, it could be one of the brightest comets of the century. As is customary, the comet was named Comet Kohoutek after its discoverer.

HOW COMETS ARE FOUND AND NAMED

Many comets have been discovered by the amateur astronomers who spend hours sweeping the sky with the wide field, low magnification telescopes called "comet seekers." If successful, they are rewarded when the comets are named for them. Occasionally, two or even more observers find the same comet nearly simultaneously, in which case up to three independent discoverers will have their names attached to the comet. For example, Comet Ikeya-Seki, which became visible to the naked eye in 1965, was discovered by two Japanese amateurs.

Not all comets have been found by amateurs, of course, although this is one field where the layman can assist and even compete with the professional. The most successful comet seeker of all time, Jean Louis Pons (1761-1831) started his career in astronomy as caretaker at the Marseilles Observatory in 1789. In his active lifetime, he discovered *over* thirty-seven comets and worked his way up in the astronomy profession until he was appointed director of the Marlia Observatory.

One of the most incredible stories of the discovery of a comet is the following. An astronomer at the Lick Observatory, Perrine, discovered a comet in 1896, and on subsequent nights continued to make routine observations of the object. At one point, he received a telegram from Kiel, also reporting the position of the comet. However, unknown to him, there had been an error in the transmission of the telegram resulting in an incorrect position being listed. The incorrect position was only two degrees from the correct position, so he did not notice the difference. When the astronomer looked at that wrong position, there was a new comet.

The method of naming comets after the discoverer leads to some tongue twisters. Names such as Comet Honda-Mrkos-Pajdušáková take a while to spell out. The astronomers A. Schwassmann and A. A. Wachmann together have discovered several comets, so we must speak of Comet Schwassmann-Wachmann I, Comet Schwassmann-Wachmann II and so forth. Of course, we mentioned earlier that Kohoutek discovered two comets within eight days. The first, and fainter, Comet Kohoutek passed perihelion a few months after discovery and is now receding from the sun. It never became a conspicuous object, even near the sun.

To avoid confusion, comets are numbered as well as named. There are two numbering systems. First of all, when a comet is found, it is designated according to the order of discovery. Thus the first comet discovered in 1973 is termed 1973a, while Kohoutek's two comets, being the fifth and sixth found in 1973, are called 1973e and 1973f. (Because of the great attention attracted by 1973f, it is simply referred to as "Comet Kohoutek" in this book and in most popular articles.) The second comet-numbering system is based on the order in which comets reach the perihelion points in their orbits. The first comet to pass perihelion in 1973 is termed

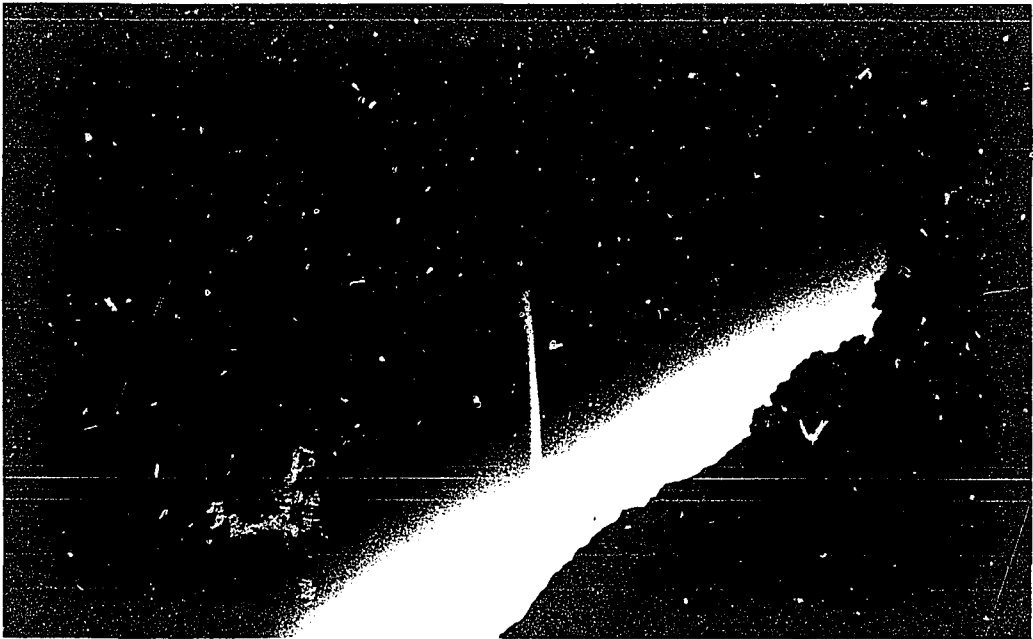


Figure 3: Comet Ikeya-Seki on October 29, 1965. The camera was tilted to make the image of the Comet vertical, thereby giving a tilt to the twilighted horizon. (Kitt Peak National Observatory photograph, courtesy of Michael Belton.)

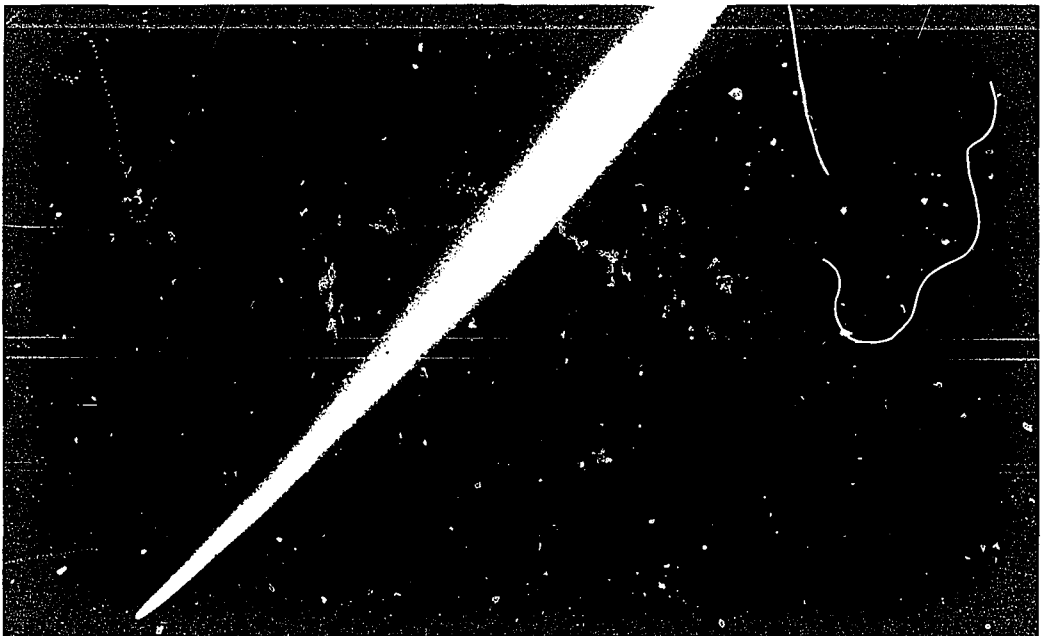


Figure 4: Telescopic view of Comet Ikeya-Seki on October 29, 1965. (Kitt Peak National Observatory photograph, courtesy of Michael Belton.)

Comet 1973 I, the second one Comet 1973 II, etc. On this system, Comet Schwassmann-Wachmann I is also called Comet 1925 II and Comet Honda-Mrkos-Pajdušáková is also called Comet 1954 III.

COMETARY ORBITS

The orbit of a comet will be a conic section, that is, an ellipse, a parabola, or a hyperbola. If the orbit is an ellipse, the comet will return periodically to the vicinity of the sun. A comet in a hyperbolic orbit, on the other hand, is not bound to the solar system. Such a comet will zip by the sun and head off into interstellar space never to return again. According to Dr. N. B. Richter in his book on comets (see bibliography) of the 843 comets with orbits accurately determined up to 1962 only 67 had hyperbolic orbits and the rest are elliptical or parabolic.

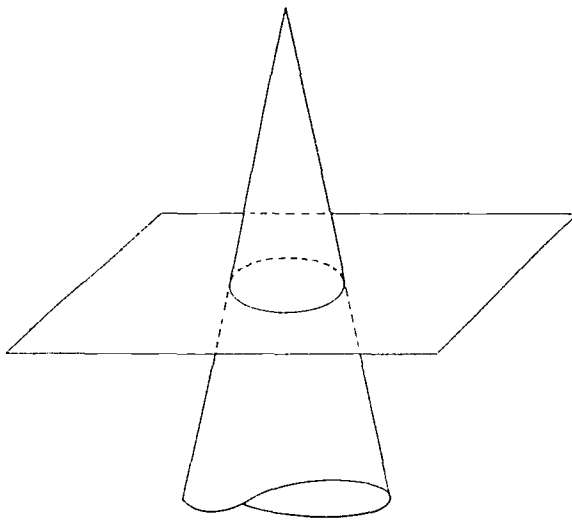
The ellipse is a closed figure obtained by intersecting a circular cone with a plane. When the plane is perpendicular to the axis of the cone one obtains, of course, the limiting case of a circle (Figure 5a). When the plane is tipped at an angle to the axis, one obtains an ellipse (Figure 5b). The greater the intersecting plane is tipped, the more the ellipse is elongated, until a point is reached where the curve resulting from the intersection is no longer a closed curve. Then the plane is parallel to a generatrix* of the cone, and the curve is a parabola (Figure 5c). If the plane is made parallel to the axis of the cone, then the conic section generated is a hyperbola (Figure 5d).

The shape of the comet's orbit and the orientation of the orbit in space are specified by six quantities known as the orbital elements of the comet. Once the orbital elements are determined a table of the future positions called an *ephemeris* can be computed. An initial calculation of the orbital elements can be carried out once three separate position determinations have been made. Usually, only a small arc of the orbit is included between the three initial positions, and a calculation of the elements of the whole orbit is inaccurate. An ephemeris calculated from the initial orbital elements is usually only a rough approximation to the expected cometary motion. However, as more position observations become available, the orbital elements can be successively refined, and more accurate ephemerides can be calculated.

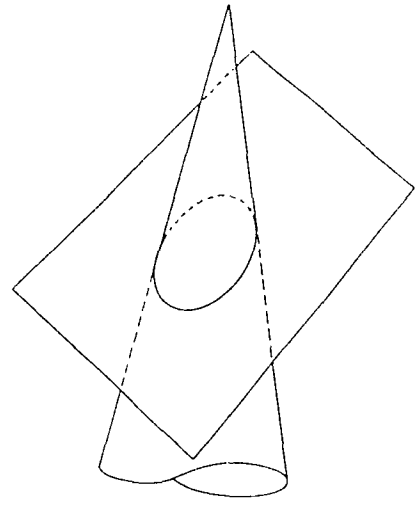
By May, Comet Kohoutek set before twilight thus ending observations until early October. However, good orbital elements had been calculated. When the Japanese amateur Seki found the comet again on September 23 and 26, it was where the ephemeris said it should be.

One of the most uncertain facts about the comet is the magnitude it will have when it is at its brightest. The factors determining the brightness are, (1) the distance from the sun to comet, which tells how much light reaches the comet, (2) the size of the comet, which determines how much light it produces, and (3) the distance from the comet to the earth, which tells how much of the reflected light we

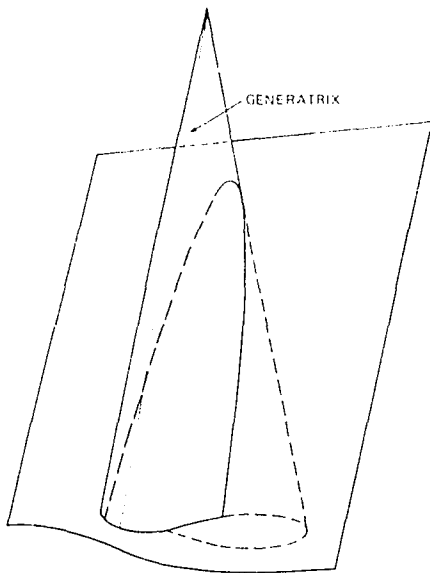
*A straight line through the apex of the cone and on the surface of the cone. A pole in a tepee is a generatrix.



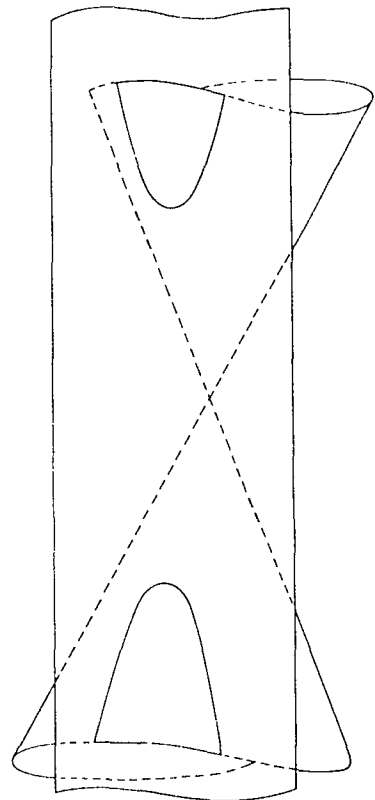
(a)



(b)



(c)



(d)

Figure 5(a): A circle resulting from the intersection of a cone and a plane. (b) An ellipse resulting from the intersection of a cone and a plane. (c) A parabola resulting from the intersection of a cone and a plane. (d) A hyperbola resulting from the intersection of a cone and a plane.

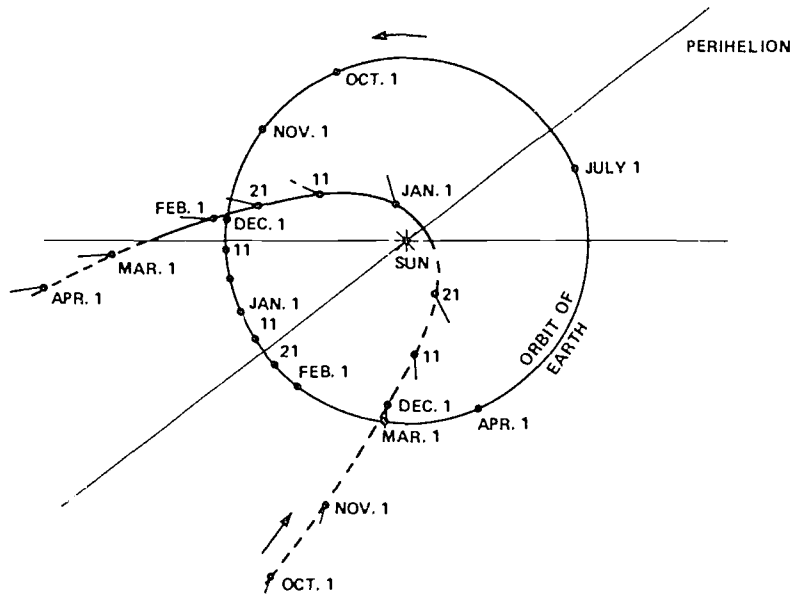


Figure 6: Relative positions of the earth and Comet Kohoutek between October 1, 1973 and April 1, 1974. The dashed portion of the Comet's orbit is "below" the plane of the earth's orbit.

receive. Of these three factors, the second is most uncertain. Estimates of Comet Kohoutek's greatest brightness have it at least as bright as the brightest planets, for example, Jupiter. This light will be spread over the diffuse area of the comet. If the comet becomes as bright as the most extreme estimates mentioned, then it will be as bright as the quarter moon, and will be easily seen in broad daylight if the viewers screen their eyes from the direct sunlight.

Comet Kohoutek is a long period comet, with a period of revolution around the sun estimated at 80,000 years. (This uncertain value is likely to be revised by future observations.) Like the planets, the comet moves in an elliptical orbit. However, there the resemblance to planetary orbits ends. While planetary orbits are nearly circular, the orbit of Comet Kohoutek, and for that matter, the orbit of any other long period comet, is an extremely elongated ellipse. If the period of the comet is 80,000 years, then the long axis of its orbit, the major axis, is 2400 astronomical units in length. That is, 2400 times the distance from the earth to the sun. Observations of the comet made near the sun cannot easily distinguish between such an elongated ellipse and a true parabola. (Figure 6)

The solar system, as defined by the region where the planets move, is a flat system. With the exception of that of Pluto, none of the planets' orbits are tilted by more than a few degrees from the plane of the earth's orbit. In addition to the flatness of the solar system, there is also a common direction of almost all motions in the system. For instance, all the planets revolve in the same direction around the sun (counterclockwise as seen from above the earth's north pole) and all planets except Venus and Uranus rotate in the same direction in which they revolve. In addition, of the 32 known planetary satellites in the solar system, 21 revolve about their parent planet in the counterclockwise, or *direct*, sense.

In contrast to the flat, regularly moving system of planets, the system of the long period comets is a hodgepodge. The inclinations of the comet's orbits to the ecliptic can be anything from 0° to 90° and their orbital motion can be either direct or retrograde.

Long period comets are those comets whose orbital revolution period exceed 200 years. They are the majority; only about 20% of all comets with well observed orbits (or about 100 comets) fall into the short period group. In fact, all comets that have well established periods are short period comets. The exact size of very elliptical orbits, and therefore the period of revolution of the comets are difficult to ascertain even from a series of good observations.

The group of short period comets as a whole has a mean revolution period of seven years. The orbital planes of this group of comets are near the ecliptic and the comet's motions are usually direct. Thus, the short period comets have orbits much like the planets' orbits. Comet Encke has the shortest known period of 3.3 years.

HOW AND WHEN CAN THE COMET BEST BE VIEWED?

Comet Kohoutek will first be observed as a naked eye object in the morning sky. According to most recent predictions, the comet should reach 5th magnitude about the first of November, and by the end of the month it should have brightened to first magnitude. (See Time Table of Events in appendix.) During December if one goes outdoors about an hour before sunrise the comet will be observed in the southeast about 20° above the horizon. At the beginning of November, a pair of binoculars will aid in the observation of the comet. By early December, however, no optical aid should be needed to see it. Starting about December 1, the motion of the comet will become predominantly eastward, so that on successive mornings, one hour before sunrise, the comet will be nearer the horizon, and by December 19, it will rise only one hour before the sun.

For the next nine days the comet will be observed in morning twilight as it moves toward its December 28 perihelion passage. It is during this period that the comet may be its most spectacular. (Figure 7)

From perihelion passage until January 2, the comet will set less than an hour after the sun. Beginning January 2, it will set more than one hour after the sun, and then will be observed in dark skies, somewhat south of west. Each successive night at one hour after the sun sets, the comet will be higher in the sky, until in the first week of February it reaches an altitude of about 50° and begins to move more northward. During February, while in constellation Aries, its brightness should fade from first magnitude to about 4th magnitude and further observation will require binoculars.

New moon occurs on January 23, 1974. For the following week a waxing crescent moon will appear in the evening sky. We should have a lovely scene at that time, with the comet, the moon, Jupiter and Venus in the western sky. (Figure 8)

COMET KOHOUTEK (1973f)

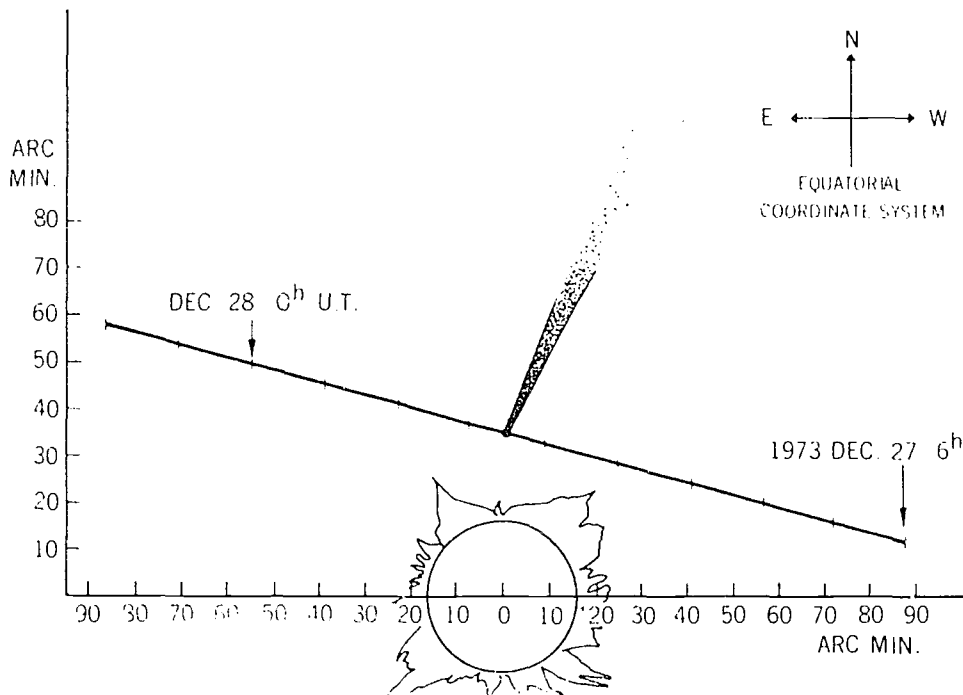


Figure 7: Relative positions of Comet Kohoutek and the sun as the Comet passes perihelion. The scales are divided in 10 arc minute increments. Note that the diameter of the sun is about 30 arc minutes. (Based on calculations by Dr. D. K. Yeomans, Computer Sciences Corporation.)

WHAT WILL COMET KOHOUTEK LOOK LIKE?

When Comet Kohoutek was discovered in March, it was somewhat over 640 million kilometers (400 million miles) from the sun, which was between the orbits of Mars and Jupiter. At that time, as we have mentioned, the comet appeared as a faint, fuzzy patch of light. This fuzzy spot of light is a cloud of gas called the *coma*. As the comet approaches the sun, the coma will grow in size and brightness. There is some possibility that the coma may shrink somewhat when the comet gets very near the sun. Typical coma diameters range between 19,000 and 190,000 kilometers (12,000 and 120,000 miles).

During the few days that Comet Kohoutek is at its brightest, around December 28, a bright, starlike point of light may appear in the coma. This small object is the *nucleus* of the comet. Cometary nuclei are estimated to be between 10 and 200 km. (6 and 120 miles) in diameter. They are far too small to be seen as anything more than a point of light even in the largest telescopes. The coma and nucleus make up the head of the comet.

The most spectacular characteristic of the comet will be its tail, which will develop as it nears the sun, and could become as long as 160 million kilometers (100

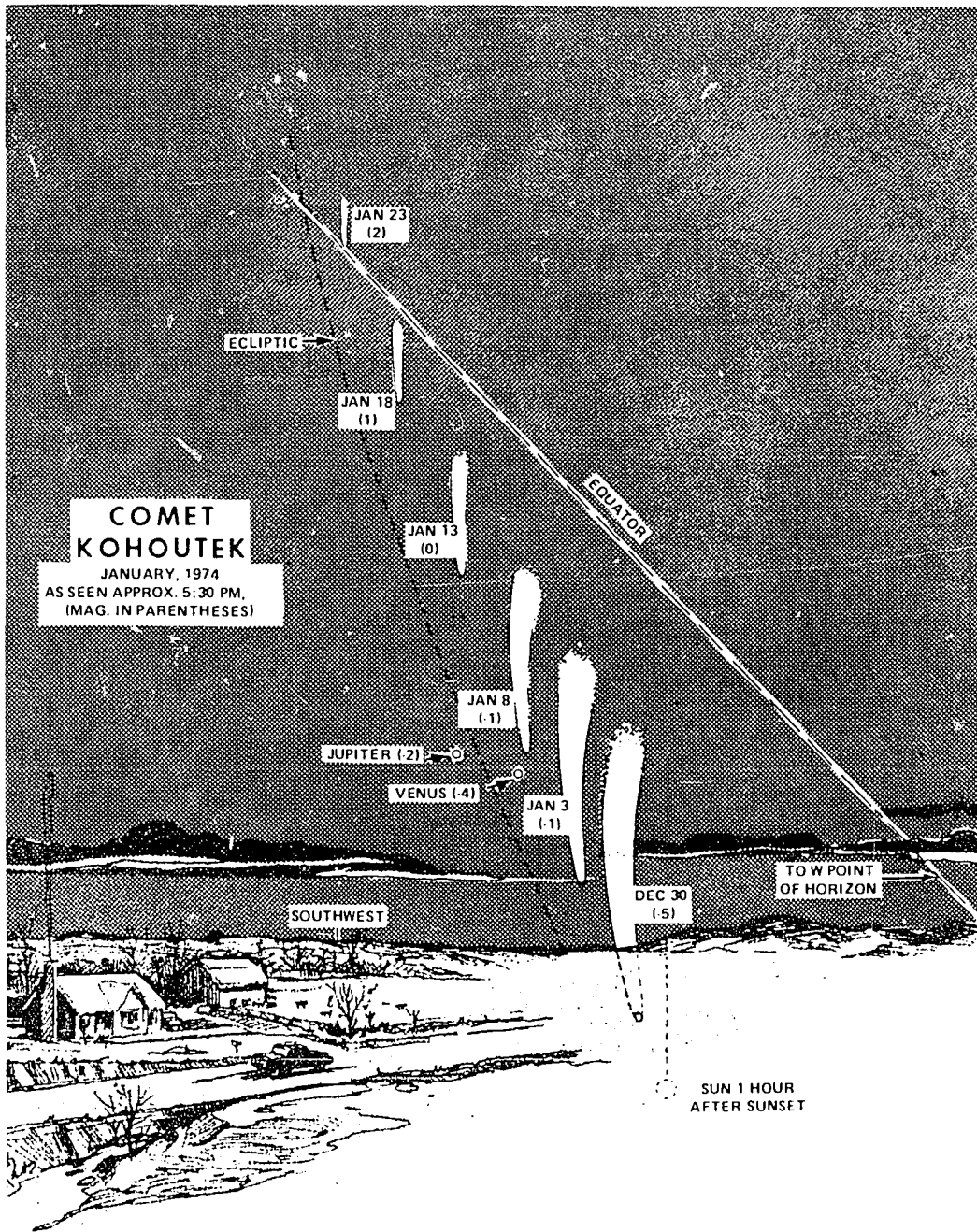


Figure 8: Comet Kohoutek as seen in the southwest during January, 1974. (Based on sketch by W. Liller, Harvard College Observatory.)

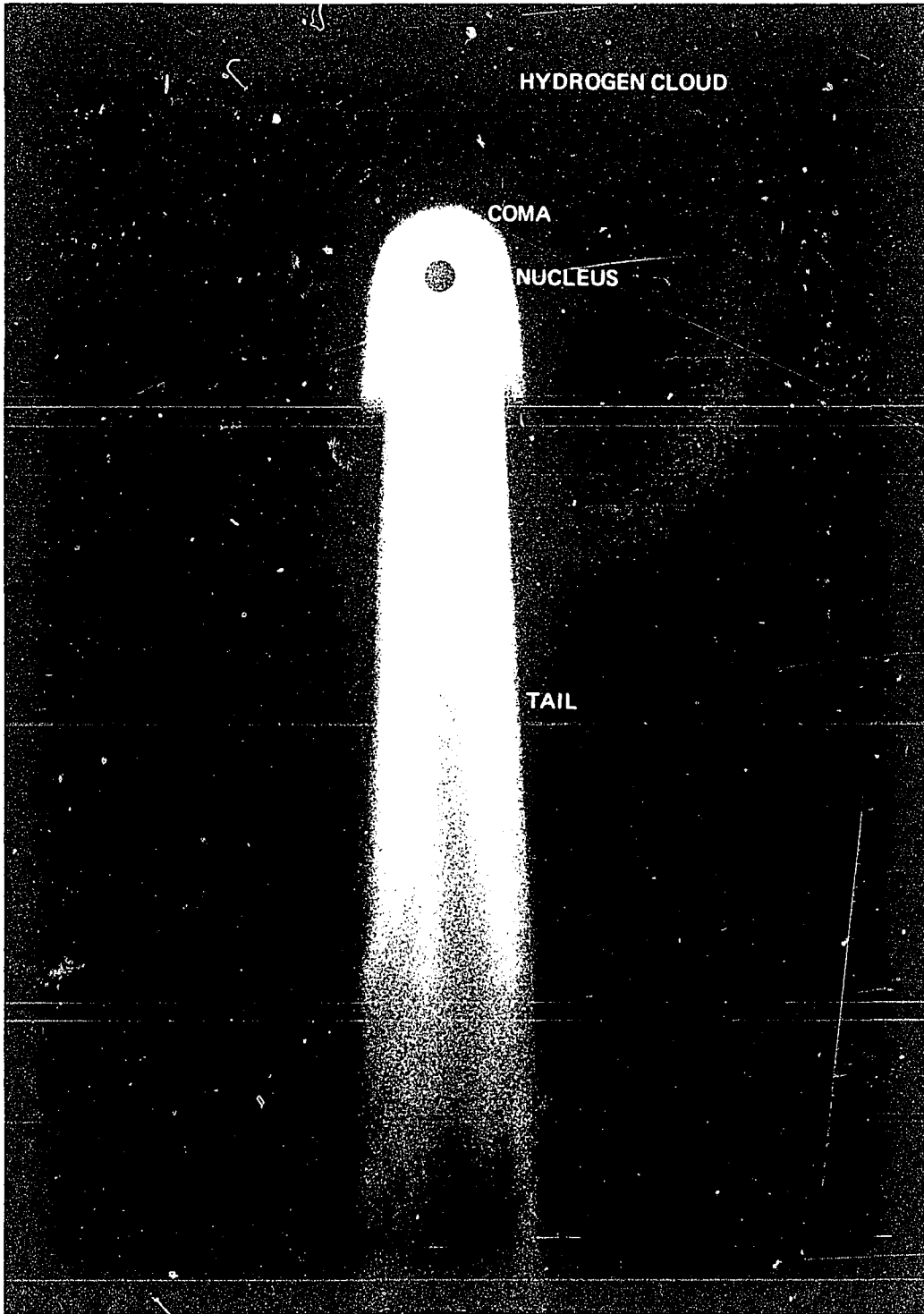


Figure 9: Artist's conception of a typical comet.

million miles), although typical lengths are more like a few million kilometers. The tail will always point away from the sun. (Figure 10)

How can we be sure that Comet Kohoutek will look like what we have described? The answer is simply that, with only a few exceptions, all the great comets observed in the past have looked like this.

In the following pages we will describe our present view of the physical makeup of comets and tell you how that view developed. We will then discuss observations of comets of the past. Finally, we will describe NASA's research program, and conclude with some suggestions of comet observing programs you can carry out.

ANCIENT VIEW OF COMETS

Aristotle, the great Greek philosopher of the 4th century B.C., discussed his view of comets in the treatise *Meteorologia*. He asserts that comets are an "exhalation" in the outer reaches of the earth's atmosphere. This view was also held by the later thinker, Claudius Ptolemy who lived in the first century A.D. at Alexandria. Ptolemy's book, the *Almagest*, must be considered one of the great astronomical treatises of all time. It is interesting that the Roman Stoic philosopher Lucius Seneca held the view that comets are celestial objects which travel through space in elongated orbits. Before we are tempted to give Seneca a pat on the back for his great insight, we should realize that his statement was as much a guess as that of Aristotle. It was not until the 16th century that Tycho Brahe, with the very accurate instruments he developed and built, could make observations that established that comets are celestial objects. He observed the position of a comet which appeared in the year 1577 from various sites in Europe. If the comet were in the earth's atmosphere, then it would have a measurable parallax, that is, it would shift against the background of the stars by a measurable amount as he moved his equipment about on the earth viewing it from different angles. He could not measure a parallactic shift, so he concluded that the comet had to be at least several times further away from the earth than the moon, whose parallax shift he could measure.

During most of history, the appearance of a naked-eye comet has been regarded as an omen for one event or another, frequently calamities, and as a result datable records of the appearances of comets are rather common. The astronomers of medieval China kept accurate chronicles of celestial events. Many of these observations have proved valuable to modern day astronomers. A comet, which we now know to be Halley's Comet, is pictured on the Bayeux tapestry. Undoubtedly the comet was considered an omen related to the outcome of the Battle of Hastings in 1066 A.D.

In 1665, the Great Plague closed down Cambridge University, and a 23-year old student by the name of Isaac Newton was forced into a two-year hiatus in his formal studies. With few responsibilities, Newton had little to do other than contemplate the mysteries of the Universe. The results of his contemplations were formidable. He arrived at a formalized system of mechanics and a law of gravitation that together put the study of motions in the solar system on a firm mathematical footing.

Among his other accomplishments, Newton found a way of determining the orbital paths of comets from a series of observations of the comet's position. He did this by assuming that the orbits were parabolic in shape. A young friend and contemporary, Edmund Halley, applied the method to a series of comets during the 14th through the 17th centuries. Among the surprises he turned up was the fact that the comets observed in 1331, 1607 and 1682 all had very similar orbits. He concluded that the three comets were repeated appearances of the same comet which had a 75-year period of revolution, and he predicted that it would return in 1758. The comet passed perihelion on March 12, 1759, after being picked up in December, 1758, by an amateur astronomer. The return provided a proof of Newton's Theory. Halley did not live to see the return he predicted. As we all know, the comet now bears his name. In checking back over old records, scientists have found references to observations of every return of Halley's Comet back to 467 B.C.

We now understand the *motions* of comets through the additional efforts of many of the great pioneers in celestial mechanics. We know, for instance, that the planets can perturb the motions of the comets. Jupiter, with a mass second only to the sun in the solar system, can have a very profound influence on cometary motions. In fact, Jupiter has collected a whole family of about 70 comets whose points of greatest distance from the sun are near that planet's orbit.

It was not until the 19th century that cometary research evolved from the study of dynamics and began to concentrate on the internal structure of the nucleus, coma and tail. Some of the biggest strides forward in our knowledge of cometary structures have come since the chemical makeup has been studied by spectroscopic means. We will address that point later.

MODERN VIEW OF COMETS

We now jump forward in time to the early 1950's when Dr. F. L. Whipple of the Harvard College Observatory presented a picture of the structure of a comet which seems to fit all the observed characteristics. Whipple proposed that the nucleus of comets is in effect a dirty iceberg, a large mass of frozen water, methane, ammonia, carbon dioxide and perhaps other constituents, in which is imbedded meteor-like solid particles of various sizes. The ices of the nucleus constantly sublime, and as a result the nucleus is surrounded by a cloud of gas and dust particles. This cloud, of course, is the coma.

When one turns a spectrograph on the coma of a comet, the spectrum is found to contain lines or bands which indicate the presence of simple constituents such as *H, OH, O, CN, C₂, C₃, CO, NH, NH₂, CH, N₂ as well as others. This list, incidentally, is roughly ordered from the most abundant to the least abundant components. With only a very few exceptions, these constituents will not exist as such when frozen in the nucleus. Instead, they must arise from chemical changes to the frozen molecules that are found there. We refer to the molecules frozen in the

*These simple radicals are similar to the complex ions found in solutions.

nucleus as "parent" molecules, and the observed constituents as "daughter" molecules. Astronomers believe the parent molecules to include water (H_2O), ammonia (NH_3), methane (CH_4), as well as C_2 , N_2 and CO_2 .

When the parent molecules are exposed after subliming from the nucleus, the ultraviolet photons from the sun can break them apart (photo-disassociate them) into the daughter molecules. The solar wind particles also have an effect on the constituents. The complete story is far from fully understood. We hope a thorough study of Comet Kohoutek will shed further light on these problems.

According to current scientific theory, a light beam consists of a stream of small particles called photons. A beam of photons reflecting off one side of a small dust particle exerts a small force on it, and if the dust particle is small enough the photons can push it along. The intense sunlight falling on the minute dust particles in the coma of a comet, when the comet is near the sun, push the dust particles out of the coma, producing the comet's tail which points *away from the sun*. If you look at the figure on the inside of the title page showing Comet Bennett on April 16, 1970, you will notice two tails. Though it is not easy to see in the reproduction, one tail is gently curving and appears smooth. This tail is the dust tail, caused by the mechanical action of solar radiation. The other tail is more nearly straight and has a turbulent appearance like cigarette smoke in a light breeze. This tail is composed of ionized molecules blown out of the coma by the *solar wind*, a stream of ionized atomic particles constantly blowing away from the sun. A color picture of Comet Bennett shows the dust tail to be yellowish which is the color of sunlight reflected from the small particles. The gas tail is blue, on the other hand, caused by characteristic emissions of the ionized molecules present (predominantly CO^+).

As a comet approaches the sun, the coma is observed to grow. Clearly, this growth occurs because of the increased sublimation of the ices of the nucleus. However, a point is reached when the coma may actually begin to shrink as the comet approaches even nearer to the sun. This shrinkage may occur when a point is reached when gas and dust is blown into the tail faster than it sublimates from the nucleus.

If an expert had been asked before 1969 to describe a comet, he would have told you about the nucleus, coma and tail. However, in 1969 and 1970 an unexpected discovery was made when the Orbiting Astronomical Observatory, OAO-2, was turned on Comet Tago-Sato-Kosaka and Comet Bennett. Each was found to be surrounded by a tenuous but giant cloud of hydrogen gas. The observations of Comet Bennett were subsequently verified by the Orbiting Geophysical Observatory. The hydrogen cloud around Comet Tago-Sato-Kosaka was as *large as the sun*, and the cloud around Comet Bennett was *even larger*. It is believed that the hydrogen arises when ultraviolet photons from the sun break up water molecules sublimed from the nucleus, producing hydrogen and free OH radicals. (Figure 9)

Since cometary nuclei slowly sublime while the comet is in the vicinity of the sun, it is clear that a comet must have a finite lifetime. Estimates are that a comet cannot exist for more than about 100 close approaches to the sun. (Figure 11)

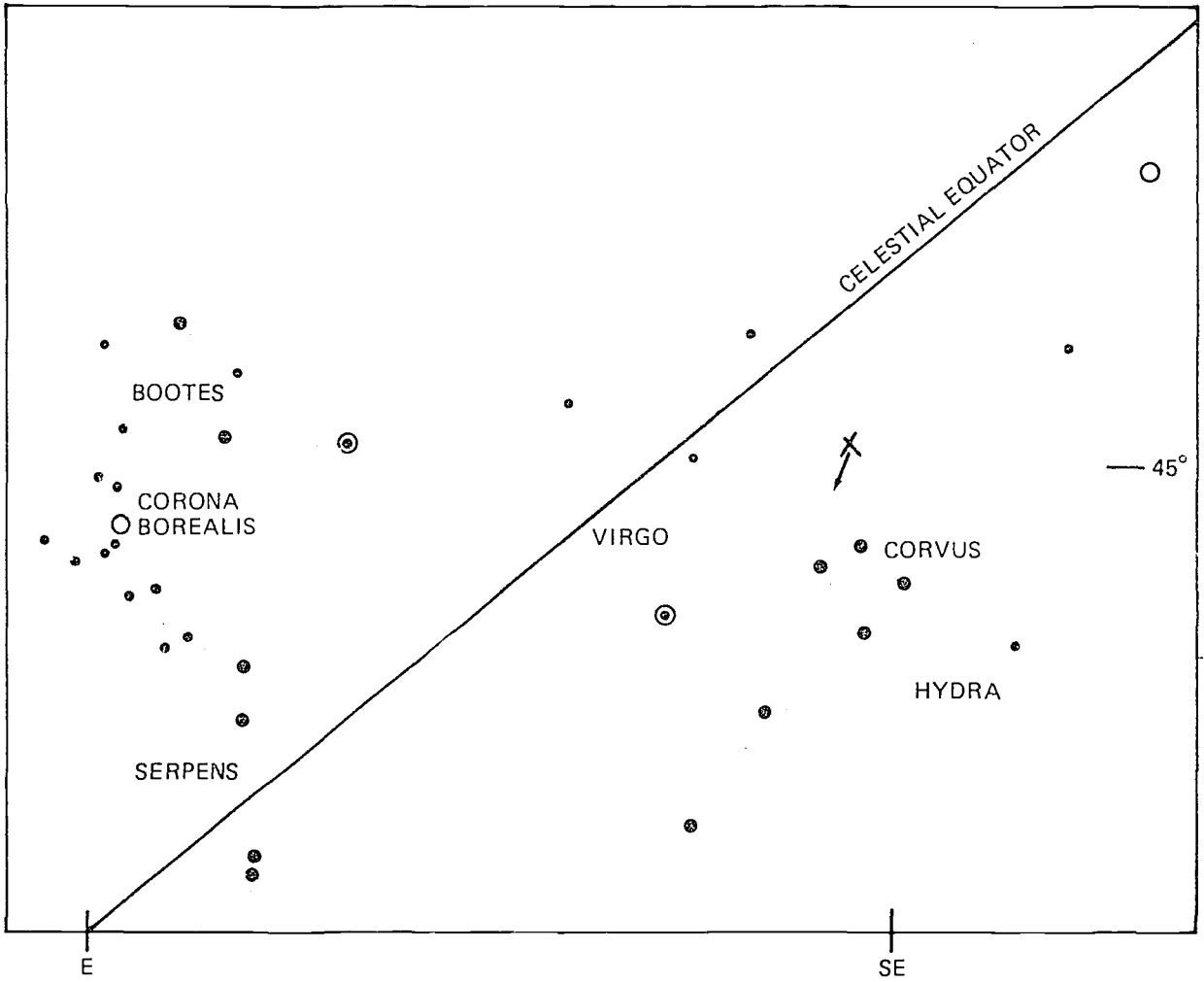
What happens to the material blown out of the cometary nucleus? Each dust particle circles the sun in an orbit similar to the parent comet's orbit. Eventually the



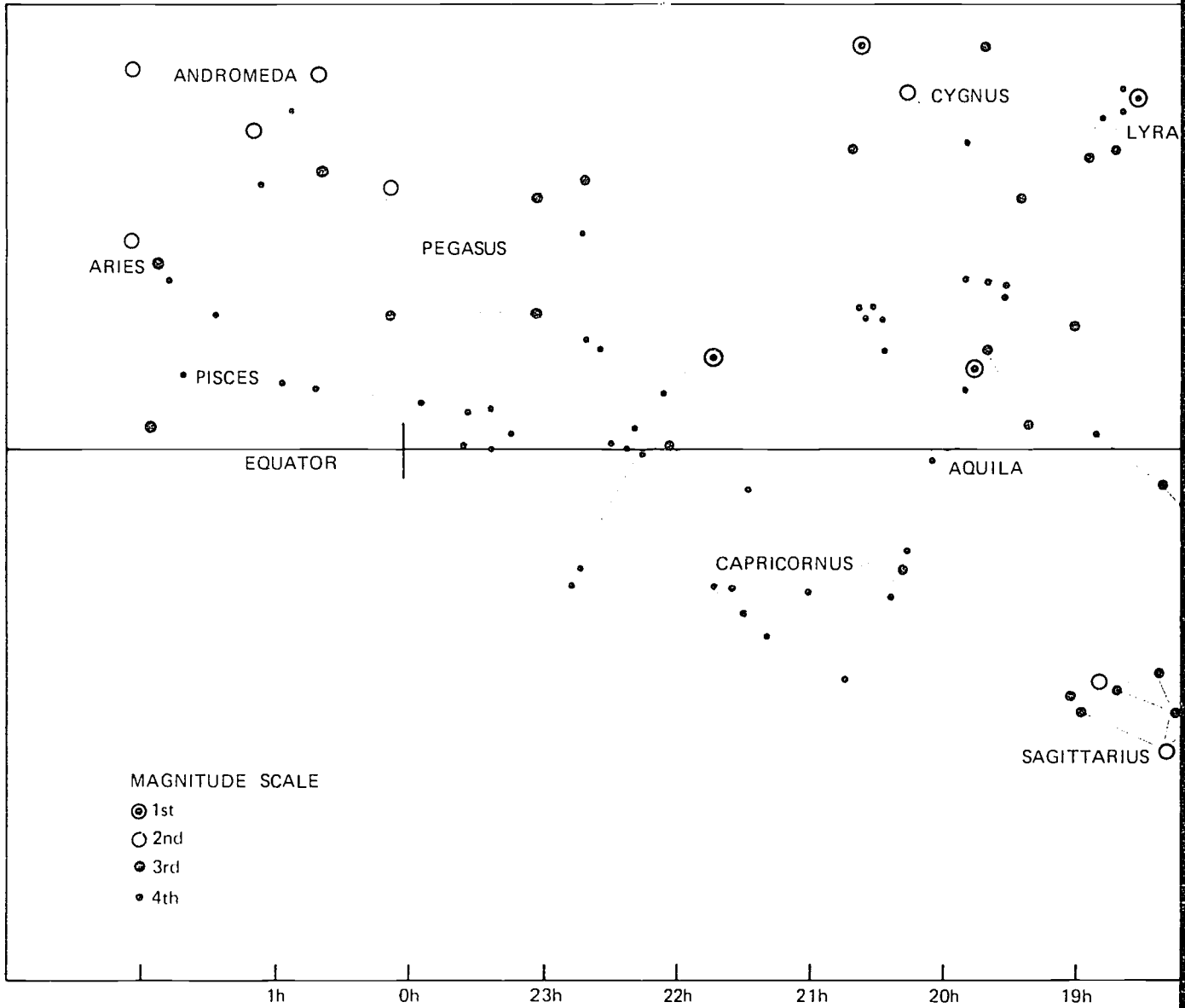
Figure 10: As the comet passes perihelion, its tail swings around and always points away from the sun.

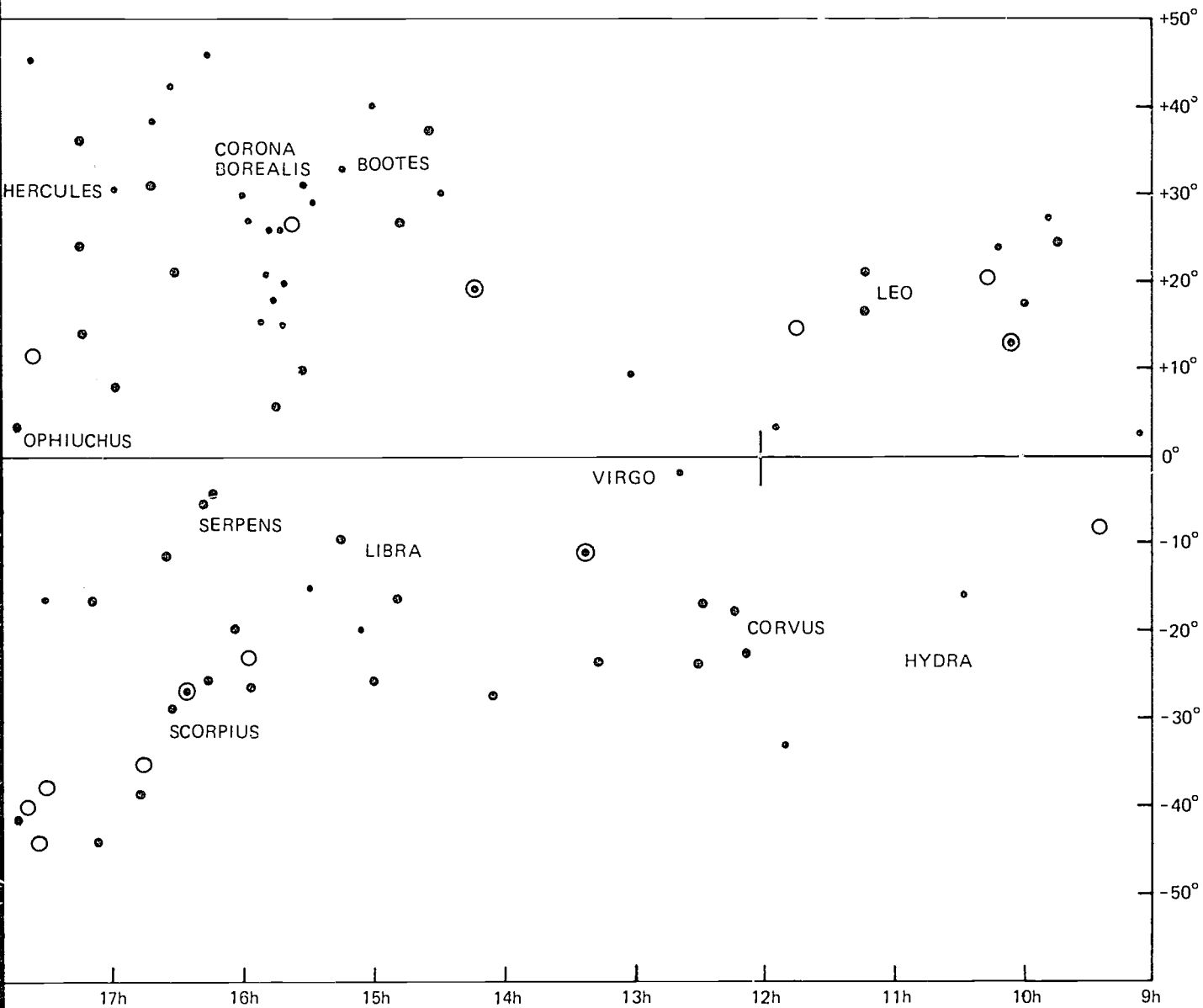


Figure 11: Comet Tago-Sato-Kosaka on January 11, 1970. (University of Michigan photograph, courtesy of F. D. Miller.)

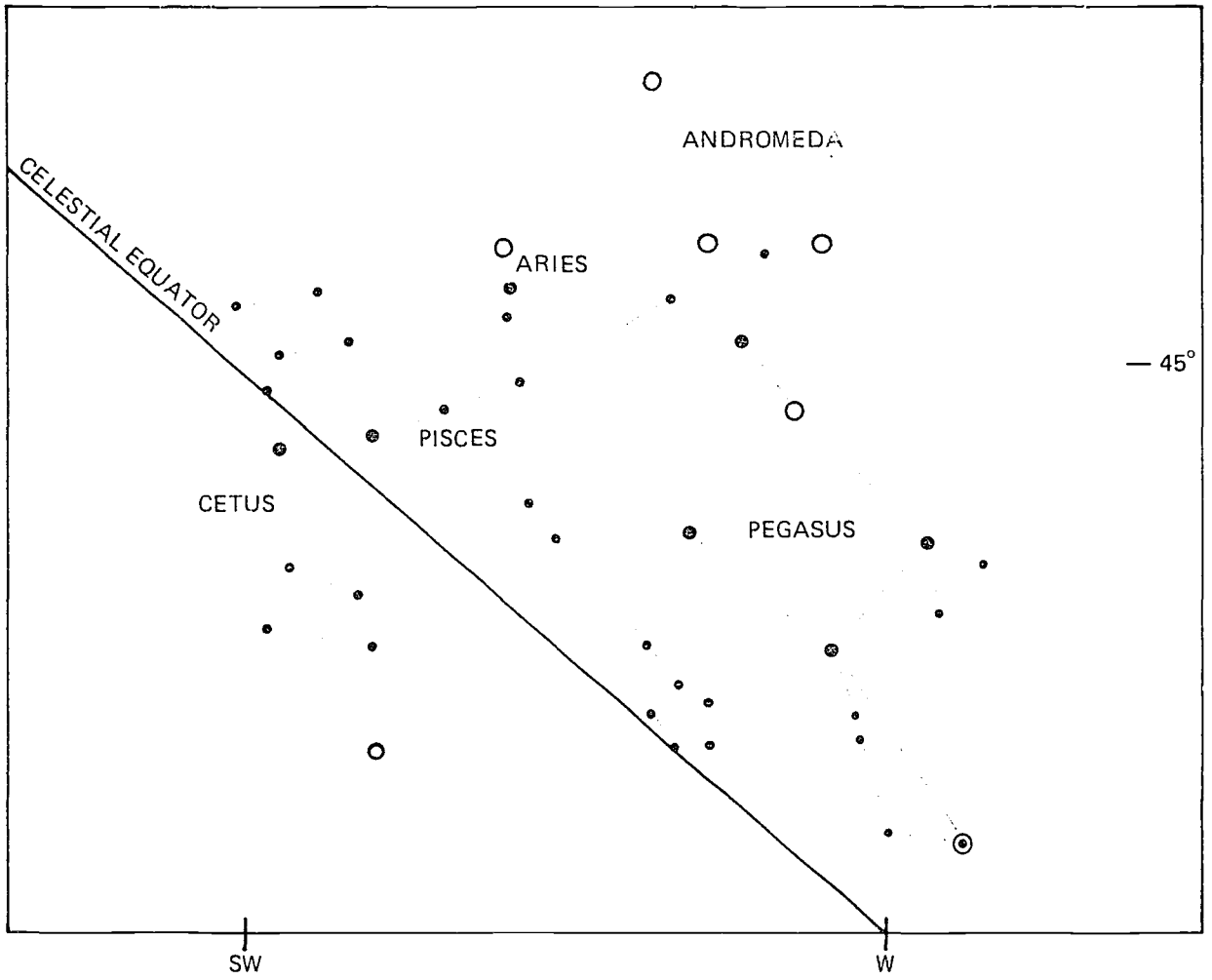


The sky as seen at 6:00 a.m. on the morning of November 1.





Constellation chart showing the region of the sky through which the comet will pass between early November and late January. (See Project I, page 32.)



The sky as seen at 5:30 p.m. on the evening of January 1.

entire path of the comet is outlined with dust. Figure 12 is a photograph of Comet Arend-Roland taken during April, 1957, when the earth passed through the plane of the comet's orbit. The apparent spike pointing from the comet's head toward the sun is actually sunlight scattered by the layer of dust in the comet's orbit plane which is seen on edge. When seen from above or below, the layer of dust is too thin to be apparent. However, when seen on edge it is quite visible.

Occasionally, the earth passes not merely through the plane of a comet's orbit, but actually across the very path of the comet. Then the dust particles make their presence known as a shower of meteors (shooting stars). The particles are burned up in the earth's atmosphere due to the heat generated by friction between the air and the particles which may speed through the atmosphere as fast as 45 km/sec. For instance, the earth crosses the orbit of Halley's Comet in May and again in October



Figure 12: Comet Arend-Roland on April 24, 1957, as the earth crossed the orbital plane of the Comet. Note the sunward spike or "antitail". (University of Michigan photograph, courtesy of F. D. Miller.)



Figure 13: Comet Bennett on March 16, 1970. Compare this photograph with picture on the inside of the title page, which was taken one month later. (University of Michigan photograph, courtesy of F. D. Miller.)

each year, and each time a meteor shower is observed. The Eta Aquarid shower occurs in May and the Orionid shower occurs in October. At the 1910 return the earth was to pass through the tail of Halley's Comet. Some panic was generated by the announcement because of the noxious gasses in the tail. However, only the usual meteor shower resulted.

In some cases, the debris is bunched up into a clump which moves around the comet's orbit. In these cases when the earth crosses the orbit only a few meteors are observed while at other times a spectacular meteor show is observed. In 1866 the earth crossed the orbit of the Comet 1866 I, and a meteor shower (the Leonid Shower) with a rate of 100,000 meteors per hour was observed. As it turns out the

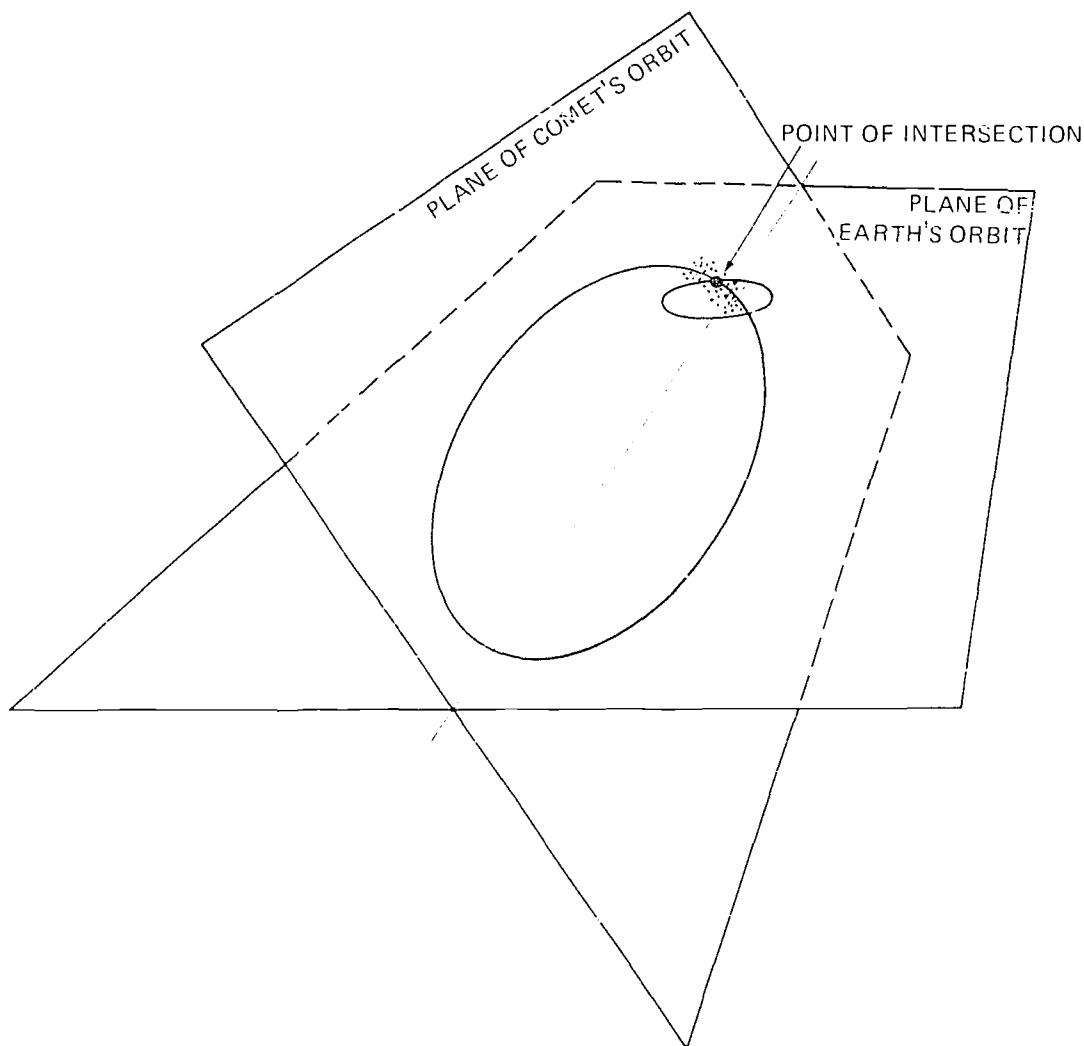


Figure 14: Idealized picture of the intersection of a comet's orbit and the earth's orbit. The bunched-up debris (dots) produces a meteor stream whenever the earth intersects the path of the comet.

earth had also passed through the comet's orbit and met a dense meteor stream in 1833, but in orbital crossings between the 1833 and 1866 dates no such spectacular show was observed. The period of the comet in question is 33 years. In this case the cometary debris is highly bunched up.

We have arrived at a mystery. A comet like Halley's with a 75-year period will disintegrate in something like 7500 years. Even a comet like Kohoutek with a period estimated at 80,000 years will disintegrate in no more than eight million years, a seemingly long time, but short compared to the four billion year age of the solar system. Why do we see comets at all? Should they all have disintegrated long ago? Especially, why do we have short period comets?

One possible answer to this puzzle was suggested by the modern Dutch astronomer Jan Oort. He suggested that there exists a giant spherical shell of perhaps as many as 100 billion comets at a distance from the sun at least as great as 150,000 times the earth's distance. This distance is a large fraction of the average distance between the sun and other nearby stars. Occasionally, according to this theory a star will exert a gravitational tug on a comet in the cloud and send it plunging toward the sun. The comet will then become a long period comet, and will spend a few million

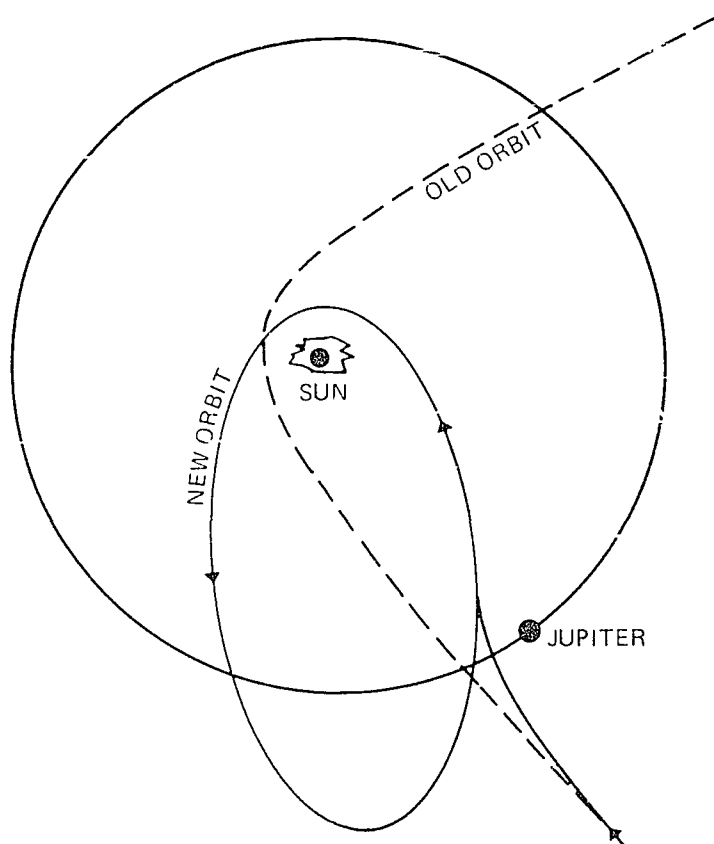


Figure 15: Idealized example of Jupiter perturbing a comet from a near parabolic orbit into an elliptical orbit.

years or more completing its hundred or so passes around the sun before it disintegrates. If in its motion through the inner solar system the comet passes very near Jupiter, then the gravitational attraction of the planet can profoundly change the orbital parameters of the comet. The effect of Jupiter can either be to slow down the comet, in which case it can become a short period comet, forever remaining in the inner reaches of the solar system, or Jupiter can whip the comet into a hyperbolic orbit and propel it from the solar system into interstellar space. Perhaps some comet seen near the sun could have been propelled from a planetary system around another star. Who knows? (Figure 15)

The most fascinating aspect of Oort's theory is the thought that the comet cloud may actually be frozen chunks of the nebula out of which the sun and planets formed, in which case comets consist of the primordial material of the solar system. What better reason than this do we need for the most careful possible scrutiny of any comet? Certainly, this is one of the main reasons that NASA plans to make a major effort out of the study of Comet Kohoutek. Hopefully, we can shed some light on the origin of the solar system.

COMETS OF THE PAST

Many comets that have been observed in recent centuries have exhibited unexpected behavior in various ways, and others have been spectacular because of their great size or brilliance. Let us look at some unusual and magnificent comets of the past, as their behavior may give us a glimpse of what Comet Kohoutek might have in store for us.

Among the most unusual occurrences in the annals of cometary study is the behavior exhibited by Comet Biela. This comet, which had an orbital revolution period of 6.75 years, was observed for several passes in the late 18th and 19th centuries, during which time it appeared to be a fairly ordinary comet. A few days after the comet was picked up on its return in 1846, it actually split into two distinct comets. For several months the two pieces followed one another in almost the same orbit, but with one trailing the other by 250,000 kilometers (160,000 miles) or so. Each piece had a nucleus, coma and tail; in short, each was a complete comet. However, they underwent remarkable changes in brightness, with first one then the other being the most brilliant. In 1852, the comets returned on schedule, but were now about 2,400,000 kilometers (1,500,000 miles) apart. The year 1866 was to be a particularly favorable one for viewing the comets, and astronomers awaited their return with great anticipation. But alas, they have never been seen again.

Those of us sitting on the edges of our chairs awaiting the appearance of Comet Kohoutek should take cognizance of Comet Enser which was discovered in 1906, and Comet Westphal which was discovered in 1913. Both comets were predicted to be spectacular when they passed perihelion, based on their orbits and an early observation. However, both comets grew very rapidly as they approached the sun and as they grew they became increasingly diffuse and faint, until they completely

faded from view. By the time the comets should have passed perihelion they were nowhere to be seen.

These examples of comets disrupting or vanishing from sight sound at first like great mysteries. However, let us remember that a comet is supposed to be a giant iceberg. If it is fluffy like a snowball, rather than rigid like an ice cube then it has no internal strength. It has very little even if it is an ice cube, and, therefore, the intense tidal forces acting on it due to the sun's gravitational pull could disrupt the cometary nucleus weakened by repeated meltings at a series of perihelion passages. If the earth approached near enough to the sun, even it could be torn apart by the tidal forces.

Let's now turn from the odd-ball comets to some of the spectacular comets of the recent century or so.

In June of 1858 the Florentine astronomer G. B. Donati, discovered a comet which appeared as a faint spot of light -- not unlike the appearance of Comet Kohoutek, when first seen. It was not until the end of August of that year that the comet showed a tail, and then it was only as long as the diameter of the full moon. During September the comet increased remarkably in brightness as it approached the sun, and reached greatest brilliance in early October. The comet then had a tail which stretched one-fourth of the way across the sky, was very bright and easily visible to the unaided eye. After the comet passed perihelion, it moved very far south in the sky and could only be followed by southern hemisphere astronomers. It remained visible to large southern telescopes until March, 1859.

Comets that are bright enough to be seen in broad daylight are few and far between. Estimates of the number range around four or five each century. The great comets of 1843 and 1882 were both daylight comets. If one would screen out the sun's full glare with a hand, one could easily have seen these comets. Both comets fall into the class of "sun-grazing" comets. The comet of 1843 passed only 120,000 kilometers (80,000 miles) above the solar surface and the comet of 1882 passed about 480,000 kilometers (300,000 miles) above the solar surface. These distances seem like a comfortable margin until we remember that the sun is 1,400,000 kilometers (864,000 miles) in diameter, so in fact the distances are small compared to the size of the sun. If the orbit of the comet of 1843 had been only slightly different it might have plowed into the sun and disappeared in a tiny (by solar size standards) puff of vapor. The comet of 1882 broke into four chunks as it passed near the sun.

What will Comet Kohoutek look like? As of this writing in early September, it is still too early to predict with certainty. If the most optimistic predictions come to pass, it will rank with the great comets of all time. It will be interesting to watch and see how it changes as it approaches the sun.

RAPID CHANGES IN COMETS

A wealth of fine detail has been observed in the inner coma and the tail of many comets. When comets are near perihelion, there are frequent and rapid changes in these structures.

One interesting type of feature frequently observed in the coma is streamers which seem to originate at the nucleus and which are almost always on the sunward side of the nucleus. It is very unusual for these streamers to show up clearly on photographs of comets for several reasons. In the first place, photographs are frequently exposed long enough to bring out the faint tail of the comet. Such a long exposure will overexpose the coma and make it look like a white structureless blob. The other reason is more interesting. When we described the two tails of comets, we pointed out one tail appears blue due to the emission of CO^+ . Actually, the CO^+ molecule fluoresces most strongly at a deep violet wavelength (3883 Angstroms), where the eye is very insensitive; in fact, many people* cannot see at this wavelength. The entire coma also glows with light of this wavelength. Most photographic emulsions are sensitive to violet, so this glow will overexpose the photographic images thus hiding detail in the coma, even though the eye cannot see the glow directly. All this discussion is to emphasize that here is one area where visual observations have an advantage over photographic observations. The drawings of Comet Tebbutt (1861 II) in Figures 17 and 18 clearly illustrate the streamers that can be seen in the coma and the rapid changes that can take place in their appearance. Moving knots and streamers are also frequently observed in the tails of comets. We will return to these points when we discuss observations you can make.



Figure 16: Photograph of Comet Bennett made by the 154 cm (61") telescope of the Catalina Observatory on March 28, 1970. A special combination of photographic emulsion and filters was used to block out the intense CO^+ radiation. (Lunar and Planetary Laboratory, University of Arizona.)

*I have tested my eyesight at this wavelength and cannot see it.

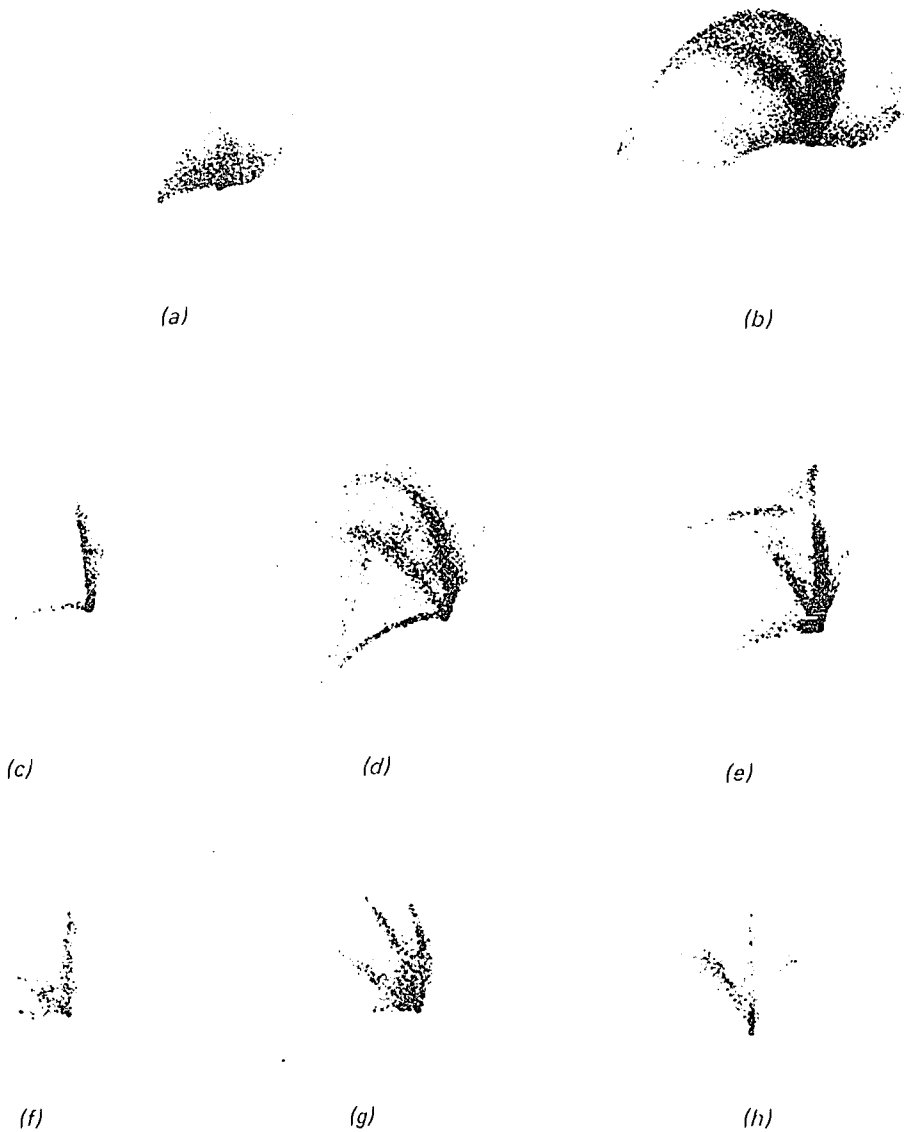


Figure 17: Drawings of Comet Tebbutt 1861 II by J. F. Julius Schmidt at the Athens Observatory in 1861.

(a) July 3 at 22:28

(b) July 4 at 1:38

(c) July 4 at 19:08

(d) July 4 at 19:19

(e) July 4 at 19:43

(f) July 4 at 21:45

(g) July 4 at 22:05

(h) July 5 at 2:12

Note the rapid changes in the appearance of the comet. (From Atlas of Cometary Forms by J. Rahe, B. Donn and K. Wurm.)

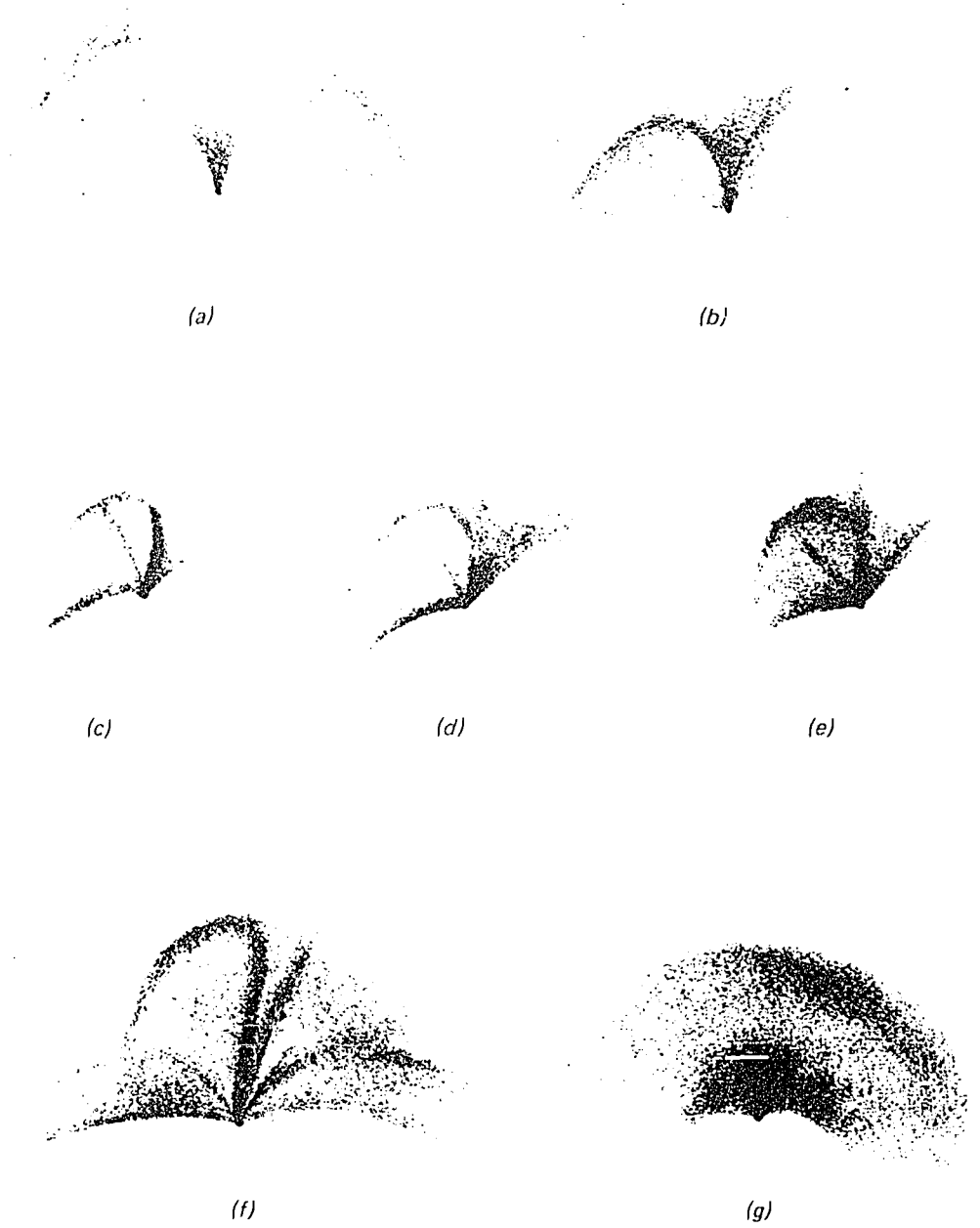


Figure 18: Drawings of Comet Tebbutt following those of Figure 17.

- | | |
|---------------------|---------------------|
| (a) July 5 at 19:19 | (e) July 6 at 21:19 |
| (b) July 5 at 3:49 | (f) July 7 at :30 |
| (c) July 6 at 19:38 | (g) July 7 at 19:05 |
| (d) July 6 at 20:10 | |

WHAT WILL NASA DO ABOUT THE COMET?

NASA has organized an "Operation Kohoutek" under the management of the Goddard Space Flight Center to coordinate space and ground based studies of the comet.

Subject to revision based on the condition of the orbiting Skylab space station, NASA plans to launch the last Skylab crew on November 11, 1973. The crew will then be in orbit until early January and will be able to watch the perihelion passage of the comet. While the comet is very near the sun, astronauts using the instruments in the Apollo Telescope Mount (ATM) portion of the Skylab complex will be able to make observations. These instruments were designed for solar work, and can be



Figure 19: Skylab photographed by the first crew as they began their return to earth. The windmill-like solar cell array is on the Apollo Telescope Mount part of the complex. The instruments point toward the sun through the white disk at the hub of the windmill. The Skylab instruments are located in the complex with the missing solar cell paddle. Note the makeshift sunshade over the main compartment.

pointed slightly away from the sun to see the comet. The other instruments on board Skylab cannot be used to observe the comet near the sun. They will observe it until December 23 and again after January 2. (Figure 19)

Near the time of the perihelion passage, it is possible that there will be rapid changes in the internal structure of the comet. The Skylab astronauts will be able to make clear observations without the hindrance of the glare of sunlight on the earth's atmosphere. And, of course, they can make observations at ultraviolet wavelengths, where the radiation cannot penetrate through the earth's atmosphere.

The other question that needs much attention is the one mentioned in our brief outline of cometary chemistry. What are the parent molecules that make up the nucleus, and what processes break up these molecules into the observed daughter products? The Skylab and ATM instruments have the capability of gathering data that will shed much light on this subject.

Will Comet Kohoutek have a hydrogen halo like Comet Bennett? Only spaceborne ultraviolet instruments can tell. If it does, astronomers will want to make a careful series of observations to study its structure and evolution. To check on this possibility, the Naval Research Laboratory is building a special "far ultraviolet camera", which is to be brought up to Skylab in the command module for operation by the crew.

The Orbiting Solar Observatory, OSO-7, may be able to observe the comet when it is near perihelion and the Orbiting Astronomical Observatory "Copernicus" will be able to observe the comet in late January as it recedes from the sun. Both spacecraft can make observations at ultraviolet wavelengths that do not penetrate the earth's atmosphere. However, neither have the capability of *quick reaction* observations to transient events in the comet. It takes many hours to plan and execute a set of observations which are to be made by these unmanned satellites.

Here Skylab has a decided advantage with its "astronaut response capability." Already the first two Skylab astronaut crews have demonstrated this kind of skill by recognizing the occurrence of solar flares and rapidly moving the ATM instruments to observe the events.

Incidentally, by studying motions in the comet's tail we can turn the tables and let the comet become a probe for monitoring the solar wind. The direction of the tail as well as motions of "gaseous knots" can be used as indicators of the velocities and directions of the solar wind. Thus, observations of Comet Kohoutek, when it is near perihelion 20,000,000 kilometers (13,000,000 miles) from the sun, may give us the first measurements of the solar wind so close to the sun.

NASA will also launch several sounding rockets to observe the comet. Specially developed instruments on the sounding rockets will search for evidence of the presence of the hydrogen molecule, H_2 , in the coma, and will also look for helium.

The Mariner Venus-Mercury space probe is scheduled for launch toward these two planets on November 3, 1973. It will be possible to turn the television camera on board the satellite toward the comet. Combining these pictures with Skylab pictures, or ground based pictures, will give a stereoscopic view, the first true determination of a comet's shape.

Observations of the comet at infrared wavelengths will be carried out by balloon-borne telescopes and from aircraft. A new "Airborne Infrared Observatory," consisting of a 36-inch reflecting telescope mounted in a C141 aircraft, will be used to search for the infrared "signatures" of cometary molecules. A smaller telescope mounted in a Lear Jet will also be used. Dr. Frank Low of the University of Arizona will look for infrared radiation from the comet with an 8-inch balloon-borne telescope.

Of course, we cannot end without mentioning all the many ground based efforts within and outside NASA. The Laboratory for Solar Physics of NASA's Goddard Space Flight Center is erecting a Schmidt telescope at an altitude of 10,600 feet near Socorro, New Mexico, in a cooperative program with the New Mexico Institute of Mining and Technology. This telescope has a wide angle field of view and is specially designed for comet observations.

High altitude observatories in Arizona, Colorado and Hawaii will concentrate on Comet Kohoutek, and at Goldstone, California, the 210-foot radar "dish" of the Jet Propulsion Laboratory may be used in an attempt to "bounce" a signal off the nucleus of the comet.

PROJECTS YOU CAN DO

Here are some suggestions for class projects. You will find them useful in understanding comets in general and especially Comet Kohoutek. In addition to these activities, a trip to a planetarium would be most helpful. With the aid of the table of events located in the appendix of this booklet, it will be possible to show the path of Comet Kohoutek through the stars.

I. Plot the Position of the Comet

The centerfold of this pamphlet is a constellation chart of the region of sky the comet will traverse between early November and late January. During this time the Comet Kohoutek will be visible to the naked eye or can be viewed using a common binocular. The figures on the backs of the centerfold pages show how the constellation will be positioned on the day when morning and evening observations start.

Have your students first identify the constellations, and then using the brightest stars as a guide, plot the comet's position on a photocopy of the chart. You will find the results quite rough, but the students will be excited to discover the motion of the comet for themselves. If the comet is as bright as expected you will be able to trace it all the way across the chart.

II. Drawing an Ellipse

A method of drawing an ellipse is shown in Figure 20. The tools needed are two pins, a loop of string, pencil and paper. Drive the pins through the paper and a board, loop the string around the pins and trace the figure keeping the

string taut. Since the loop of string does not change in total length it is clear that the sum of the distance at any point on the perimeter of the ellipse to the two pins is the same at every point along the ellipse. This equality provides one definition of an ellipse. The pins are located at the foci of the ellipse. In an orbit the sun is at one of the foci, the other being empty. (Figure 20)

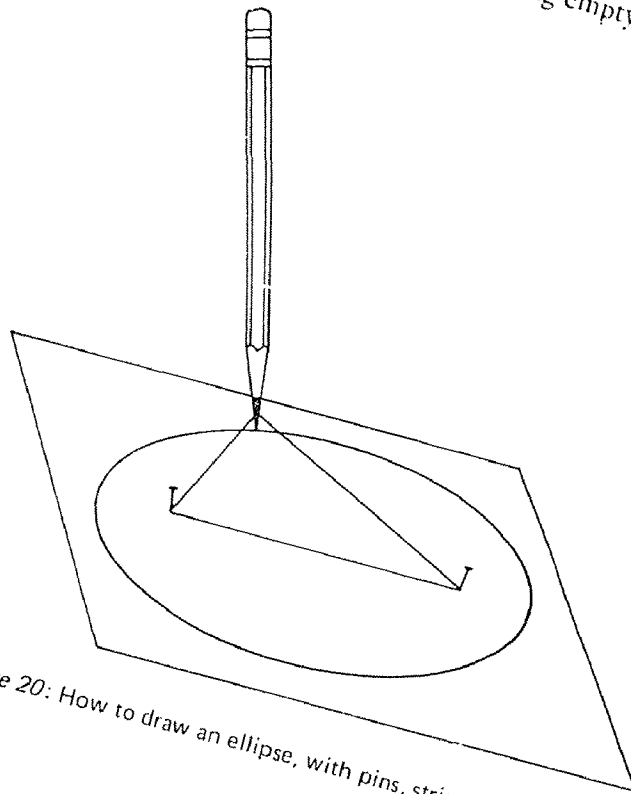


Figure 20: How to draw an ellipse, with pins, string and pencil.

It is not possible to draw an ellipse as extreme as the highly elongated orbit of Comet Kohoutek by the pin and string method. It is always dangerous to say *impossible*, but consider the facts: if the loop were made of a piece of string 24 inches long, then the pins would have to be *seven ten-thousandths* of an inch less than 12 inches apart to draw the ellipse. You might want to try to draw a more possible ellipse by putting the pins say 11½ inches apart.

III. Drawing the Comet

In the section on rapid changes in comets, we talked about structures one can observe near the nucleus. Here is an area of cometary study where your students can have some fun, and possibly help the professional astronomers too. The tools required are paper, pencil, a low power field glass (or small telescope) and some patience. Carefully observe the head of the comet, and make a draw-

ing of what is seen. Note the date and time the observations are made. Teachers, please collect your students' drawings and send them as a set to the author at this address.

Dr. R. D. Chapman
Laboratory for Solar Physics, Code 680
NASA/Goddard Space Flight Center
Greenbelt, Maryland 20771

All the sets of drawings will be acknowledged with an appropriate certificate. Be sure to include the name of your school and class. Some of the drawings may be forwarded to the Comet Section of the Association of Lunar and Planetary Observers.

If you collect a series of drawings over the lifetime of the comet you will undoubtedly be able to see changes in the structure.

IV. Photographing the Comet

Unlike the preceding projects, photographing the comet requires special equipment. We recommend starting with a fast black and white film. Even so, it will require many minutes to record an image of the comet on the film, during which time the rotation of the earth will smear the comet's image and the images of the stars. To avoid this smearing, it is necessary to impart a motion to the camera to counteract the earth's rotation. If your school has a clock driven telescope, the camera can be mounted by tape on the upper end of the telescope tube. It will probably be necessary to experiment with exposure times. When the comet is just barely visible to the naked eye, a five or ten minute exposure may be a good starting place.

If the comet becomes spectacularly bright, of course, a few second exposure with a camera held stationary on a tripod will probably record an image of the comet. If the sky shows traces of dawn or just fading dusk, a color picture will show a lovely red glow along the horizon.

It is recommended that the exposures be bracketed between 1/50 and 2 seconds using black and white or color high-speed films. Set the "f" stop wide open and use a cable release to decrease the chance of movement of the camera. Exact settings cannot be determined at this time since the brightness of the comet has not been determined. One should attain satisfactory results by using these guidelines.*

V. Do you want to find a Comet?

The ultimate experience for a science class would be to discover a new comet. A good comet seeker instrument would be a six-inch f/10 telescope with a low power eyepiece, having 20 power magnification, giving a 1° field of view. The telescope should be mounted on an equatorial mount. To search for a comet, slowly sweep the telescope around the sky, without changing the

*Photographs taken at Mount Wilson and Palomar Observatories of recent comets can be purchased from California Institute of Technology Bookstore, 1201 East California Boulevard, Pasadena, CA 91109.

declination setting (the distance from the celestial pole). Each sweep around the sky should overlap the previous one. The position of any faint diffuse object should be noted, and compared with a catalog of nebulae and star clusters. (The French comet searcher Charles Messier compiled a catalog in 1781 of faint objects he found while searching for comets. The objects in his catalog are among the brightest and most famous celestial sights.) The acid test, of course, is *motion*; if the fuzzy blot moves over a period of time it is most likely a comet. Comet seeking requires incredible patience. But a dozen or so new comets are found each year -- so you have a fighting chance. Good luck!

EPHEMERIS OF COMET KOHOUTEK EVENTS

The following two tables give a summary of the events in the pass of Comet Kohoutek near the sun according to the calculations of Dr. D. K. Yeomans of the Computer Sciences Corporation. The first table refers to the time before perihelion passage when the comet will be visible in the morning sky. The second table refers to the time after perihelion passage when the comet will be visible in the evening sky.

The following quantities listed in the table have values that would be measured if the comet were observed at 7:00 p.m. EST on the date listed.

Constellation -- The comet lies within the boundaries of this constellation.

DELTA -- The distance from the earth to the comet in astronomical Units.

R -- The distance from the sun to the comet in astronomical Units.

MAG -- The stellar magnitude of the comet.

THETA -- The angle between the center of the solar image and the head of the comet, as seen from the earth.

R.A. & DEC. -- The right ascension and declination of the comet referred to the mean equator and equinox of date. These numbers are included for those people who might be able to use them.

Sunrise or sunset times and comet rise or set times listed are times for the latitude of Washington, D.C. As one changes latitude, the rising and setting times change as given in the table below. The table is very approximate, and is only good for the rough time period that such times are listed in the main tables.

latitude

45° N	Add 15 minutes to rise times, subtract 15 minutes from set times.
35° N	Subtract 15 minutes from rise times, add 15 minutes to set times.
30° N	Subtract 30 minutes from rise times, add 30 minutes to set times.

EPHEMERIS OF COMET KOHOUTEK
BEFORE PERIHELION PASSAGE

Date (1973)	Constellation	Delta	R	Mag.	Theta	R.A.	Dec.	Comet Rises	Sun Rises	Comments
Oct. 9	Sextans	2.65	1.90	8.8	33.8	10 ^h 46 ^m	- 2° 32'			Comet can be seen in small telescope.
Oct. 14	Sextans	2.53	1.82	8.4	36.0	10 56	- 3 37			
Oct. 19	Leo	2.40	1.73	7.9	38.0	11 08	- 4 47			
Oct. 24	Leo	2.27	1.64	7.5	39.8	11 18	- 6 03			
Oct. 29	Virgo	2.15	1.55	7.0	41.3	11 30	- 7 26			
Nov. 3	Virgo	2.02	1.45	6.5	42.6	11 43	- 8 57			Comet can be seen in field glasses in East-South-East.
Nov. 9	Virgo	1.89	1.35	5.9	43.5	11 58	-10 37			
Nov. 13	Corvus	1.76	1.25	5.2	43.8	12 15	-12 26	3:30 am	6:40 am	
Nov. 19	Corvus	1.64	1.15	4.5	43.7	12 35	-14 26	3:40	6:48	
Nov. 23	Virgo	1.52	1.04	3.7	42.7	12 58	-16 36	3:45	6:55	Comet should reach naked-eye visibility.
Nov. 28	Virgo	1.41	0.93	2.8	40.9	13 25	-18 55	4:10	7:00	
Dec. 3	Virgo	1.31	0.81	1.7	37.9	13 57	-21 17	4:25	7:05	
Dec. 8	Libra	1.23	0.68	0.5	33.6	14 36	-23 32	4:50	7:10	Comet will dominate Southeastern sky.
Dec. 13	Libra	1.17	0.55	-1.1	27.7	15 23	-25 20	5:15	7:15	
Dec. 18	Scorpius	1.14	0.46	-3.2	19.9	16 19	-26 07	5:45	7:18	
Dec. 23	Serpens	1.14	0.24	-6.5	9.9	17 26	-25 11	6:50	7:20	
Dec. 28	Sagittarius	1.11	0.14	-9.9	4.1	18 47	-21 33	7:30	7:21	Perihelion — Never look directly at sun.

Comet rises about three hours before sun

EPHEMERIS OF COMET KOHOUTEK
AFTER PERIHELION PASSAGE

Date 1974	Constellation	Delta	R	Mag.	Theta	R.A.	Dec.	Comet Sets	Sun Sets	Comments
Jan. 2	Sagittarius	0.96	0.27	-6.0	16°1	19 ^h 58 ^m	-17°22'	5:50 pm	4:45 pm	Comet may be visible in daylight.
Jan. 7	Capricornus	0.86	0.43	-3.3	25.9	20 57	-13 17	7:00	4:50	Remember to protect your eyes.
Jan. 12	Aquarius	0.81	0.58	-1.6	35.8	21 56	- 8 38	8:00	4:55	Comet will dominate West-South- Western sky.
Jan. 17	Aquarius	0.81	0.71	-0.2	45.3	22 51	- 3 45	8:45	5:00	
Jan. 22	Pisces	0.85	0.83	1.0	53.5	23 41	0 51	9:30	5:08	Comet fades rapidly in brightness.
Jan. 27	Pisces	0.93	0.95	2.0	59.7	00 24	4 44	10:15	5:15	Crescent moon near comet.
Feb. 1	Pisces	1.02	1.06	3.0	64.1	01 00	7 50	10:30	5:18	
Feb. 6	Pisces	1.13	1.17	3.8	66.8	01 30	10 15			
Feb. 11	Aries	1.26	1.28	4.6	68.1	01 55	12 07			Comet nears limit of naked-eye visibility.
Feb. 16	Aries	1.39	1.38	5.3	68.5	02 17	13 36			Comet can be seen with field glasses.
Feb. 21	Aries	1.52	1.47	5.9	68.1	02 35	14 48			
Feb. 26	Aries	1.66	1.57	6.5	67.1	02 51	15 46			
Mar. 3	Aries	1.80	1.66	7.0	65.7	03 06	16 35			
Mar. 8	Taurus	1.94	1.75	7.6	63.9	03 19	17 15			
Mar. 13	Taurus	2.08	1.83	8.0	61.8	03 31	17 50			Comet can be seen with small telescope.
Mar. 18	Taurus	2.22	1.92	8.5	59.6	03 42	18 20			
Mar. 23	Taurus	2.36	2.00	8.9	57.1	03 53	18 46			

Comet sets 5 hours
after sun

BIBLIOGRAPHY

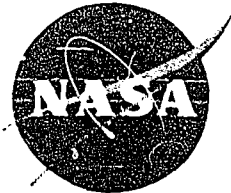
- Abell, George O. EXPLORATION OF THE UNIVERSE, 2nd Edition, New York: Holt, Rinehart and Winston, 1971.
- Bergamini, David. THE UNIVERSE, New York: Time, Inc.
- Brandt, John C. and Maran, Stephen P. NEW HORIZONS IN ASTRONOMY, San Francisco: W. H. Freeman and Company, 1972.
- Chebotaiev, G. A., Kozimerchak-Polonskoya, E. I., and Marsden, B. G., ed. THE MOTION, EVOLUTION OF ORBITS AND ORIGINS OF COMETS, International Astronomical Union Symposium Number 45.
- Dixon, Robert T. DYNAMIC ASTRONOMY, Englewood Cliffs, New Jersey: Prentice-Hall, Inc., 1971.
- Hawkins, Gerald S. THE PHYSICS AND ASTRONOMY OF METEORS, COMETS AND METEORITES, New York: McGraw-Hill, 1964.
- Jastrow, Robert and Thompson, Malcolm H. ASTRONOMY: FUNDAMENTALS AND FRONTIERS, New York: John Wiley and Sons, 1972.
- Konopleva, V. P., ed. ASTROMETRY AND ASTROPHYSICS-PHYSICS OF COMETS, Kiev: Nauka Dumka Press, 1969. (Available from NASA, TTF-599 at the Clearing House for Federal and Technical Information, Springfield, Virginia 22151).
- Menzel, Donald H., Whipple, Fred L., and de Vaucouleurs, Gerard. SURVEY OF THE UNIVERSE, Englewood Cliffs, New Jersey: Prentice-Hall, Inc., 1970.
- Oliver, Charles P. COMETS, Baltimore: The Williams and Wilkins Company, 1930.
- Oster, Ludwig. MODERN ASTRONOMY, San Francisco: Holden-Day, Inc., 1973.
- Polgreen, John, Mayall, R. Newton, Mayall, Margaret and Wyckoff, Jerome, THE SKY OBSERVERS GUIDE, New York: Golden Press, 1971.
- Rahe, J., Donn, B., and Wurm, K., ATLAS OF COMETARY FORMS, NASA SP-798, 1969.
- Richter, Nikolas B. THE NATURE OF COMETS, London: Methuen and Company, 1963.
- Proctor, Mary and Crommelin, A.C.D. COMETS, London: The Technical Press, 1937.

Schmidt telescope. A fast, specially corrected telescope (or strictly speaking, camera) for photographing large areas of the sky.

Solar wind. The solar wind is a stream of charged particles blowing away from the sun due to the slow evaporation of the outer solar atmosphere, the solar corona. The solar wind was first detected by instruments on board the Soviet satellites Lunik III and Venera I in 1959, and was verified by experiments on the American satellite Explorer 10 in 1961. The existence of the solar wind had actually been suggested a few years earlier by the German Astrophysicist Ludwig Biermann, based on his extensive studies of the behavior of comet tails, and by E. N. Parker of the University of Chicago based on his theoretical studies of the solar corona. The solar wind consists of around 5 particles per cubic centimeter moving at 500 kilometers each second, by the time it reaches the earth's distance from the sun.

Spectroscope. A device for dispersing the light of a source into its constituent colors. A spectroscope is used in the study of the chemical composition of celestial objects that cannot be brought into the laboratory for test tube analysis.

Sublime. To pass from the solid state to the gaseous state without first becoming a liquid.



Goddard Space Flight Center, Greenbelt, Maryland
National Aeronautics and Space Administration