

DOCUMENT RESUME

ED 091 153

SE 016 464

TITLE Skylab Experiments, Volume I, Physical Science, Solar Astronomy.

INSTITUTION National Aeronautics and Space Administration, Washington, D.C.

REPORT NO EP-110

PUB DATE May 73

NOTE 81p.; For related documents, see SE 016 465, SE 016 991, SE 017 106, and SE 017 788-790

AVAILABLE FROM Superintendent of Documents, Government Printing Office, Washington, D.C. 20402

EDRS PRICE MF-\$0.75 HC-\$4.20 PLUS POSTAGE

DESCRIPTORS \*Aerospace Technology; \*Astronomy; Demonstrations (Educational); \*Instructional Materials; \*Interdisciplinary Approach; Science Activities; Science Education; \*Science Experiments; Science Materials; Secondary School Science

IDENTIFIERS NASA; \*Skylab Education Program

ABSTRACT

Up-to-date knowledge about Skylab experiments is presented for the purpose of informing high school teachers about scientific research performed in orbit and enabling them to broaden their scope of material selection. The first volume is concerned with the solar astronomy program. The related fields are physics, electronics, biology, chemistry, and photography, especially dealing with electromagnetic spectra, atomic structures, x-ray absorption, radiation, and kinetic theory. The content includes discussions of basic scientific background, a description of the sun and of the energy characteristics associated with each zone, and experiments with hydrogen-alpha telescopes, white light coronagraphy, extreme ultraviolet spectrograph and spectroheliograph, scanning polychromator, x-ray spectrographic camera, solar photography, and x-ray telescopes. Related curriculum topics and classroom demonstrations and activities are provided in detail. (CC)

EP-110



SURPLUS  
DUPLICATE

U.S. DEPARTMENT OF HEALTH,  
EDUCATION & WELFARE  
NATIONAL INSTITUTE OF  
EDUCATION

THIS DOCUMENT HAS BEEN REPRODUCED EXACTLY AS RECEIVED FROM THE PERSON OR ORGANIZATION ORIGINATING IT. POINTS OF VIEW OR OPINIONS STATED DO NOT NECESSARILY REPRESENT OFFICIAL NATIONAL INSTITUTE OF EDUCATION POSITION OR POLICY.

ED 091153

# Skylab Experiments

## Volume I Physical Science, Solar Astronomy

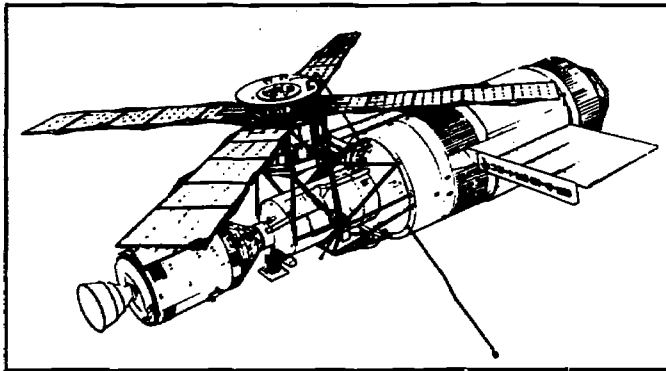

Information for Teachers, Including Suggestions  
on Relevance to School Curricula.

NATIONAL AERONAUTICS AND SPACE ADMINISTRATION

464  
716



ED 091153

# Skylab Experiments

## Volume I Physical Science, Solar Astronomy

Produced by the Skylab Program and NASA's Education Programs  
Division in Cooperation with the University of Colorado

NATIONAL AERONAUTICS AND SPACE ADMINISTRATION  
Washington, D.C. 20546, May 1973

## PREFACE

The most immediate benefits that derive from a multidisciplined scientific program such as Skylab are a large volume and wide range of scientific information. A secondary benefit is that this very large amount of up-to-date information can be related in a timely manner to high school curricula. The time lag between the generation of new information and its appearance in text books is often measured in years rather than in months.

It is the intent of the Skylab Education Program to eliminate this characteristically long delay by timely presentation of scientific information generated by the Skylab program. The objective is not to teach Skylab to the schools, but rather to use Skylab science as a focus for science education in the high schools. Readers are urged to use the descriptions of investigations and scientific principles, and the demonstration concepts contained herein as stimuli in identifying potential educational benefits that the Skylab program can provide.

National Aeronautics and Space Administration  
Washington, D.C. 20546  
May 1973

# CONTENTS

INTRODUCTION .....	v
<b>SECTION 1—THE SUN .....</b>	<b>1</b>
Importance of Solar Astronomy .....	1
History of Solar Space Research .....	2
Solar Zones .....	3
Scientific Considerations .....	7
Skylab Solar Observatory .....	8
Experiment Schedules .....	9
Crew Activities .....	9
Data Availability .....	9
<b>SECTION 2—HYDROGEN-ALPHA TELESCOPES .....</b>	<b>13</b>
Experiment Background .....	13
Definition of Scientific Objectives .....	14
Experiment Description .....	15
Experiment Data .....	18
Crew Activities .....	19
Related Curriculum Topics .....	19
Suggested Classroom Demonstration .....	19
<b>SECTION 3—WHITE LIGHT CORONAGRAPH (S052) .....</b>	<b>21</b>
Experiment Background .....	21
Definition of Scientific Objectives .....	22
Description of Coronagraph .....	23
Experiment Data .....	25
Crew Activities .....	26
Related Curriculum Topics .....	26
Suggested Classroom Demonstrations .....	27
<b>SECTION 4—EXTREME ULTRAVIOLET SPECTROGRAPH (S082B)</b>	
<b>EXTREME ULTRAVIOLET SPECTROHELIOGR. PH (S082A) .....</b>	<b>29</b>
Experiment Background .....	29
Definition of Scientific Objectives .....	30
Description of Experiment Hardware .....	31
Experiment Data .....	34
Crew Activity .....	35
Related Curriculum Topics .....	35
Suggested Classroom Demonstration .....	36
<b>SECTION 5—ULTRAVIOLET SCANNING POLYCHROMATOR—</b>	
<b>SPECTROHELIOMETER (S055) .....</b>	<b>39</b>
Experiment Data .....	39
Definition of Scientific Objectives .....	39
Description of Experiment Hardware .....	39
Data .....	41
Crew Activities .....	42
Related Curriculum Aspects .....	42
Suggested Classroom Demonstration .....	42

<b>SECTION 6—X-RAY SPECTROGRAPHIC CAMERA (S054)</b> .....	<b>45</b>
Experiment Background .....	45
Scientific Objectives .....	46
Equipment .....	47
Experiment Data .....	48
Crew Activities .....	49
Related Curriculum Topics .....	49
Related Classroom Demonstration .....	49
 <b>SECTION 7—X-RAY ULTRAVIOLET SOLAR PHOTOGRAPHY (S020)</b> .....	 <b>51</b>
Experiment Description .....	51
Definition of Scientific Objectives .....	51
Description of Equipment .....	52
Experiment Data .....	53
Crew Activities .....	54
Related Curriculum Aspects .....	54
 <b>SECTION 8—EXTREME ULTRAVIOLET AND X-RAY TELESCOPE (S056)</b> .....	 <b>55</b>
Experiment Background .....	55
Scientific Objectives .....	56
Equipment .....	57
Experiment Data .....	59
Crew Activities .....	60
Related Curriculum Topics .....	60
Related Classroom Demonstration .....	60
 <b>SECTION 9—GLOSSARY</b> .....	 <b>61</b>
Suggested Reference for Further Study .....	63

## INTRODUCTION

### The Skylab Education Program

This year the United States' first manned scientific space station, Skylab, will be launched into orbit and will be the facility in which successive crews of astronauts will perform investigations in a number of scientific and technological disciplines. The program of investigations can be divided into four broad categories: physical sciences, biomedical sciences, Earth applications, and space applications.

The Skylab scientific program will produce information that will increase our understanding of science and will extend our knowledge of subjects ranging from the nature of the universe to the structure of the single human cell. It is one of the objectives of the National Aeronautics and Space Administration that the knowledge derived from its programs be made available to the educational community for application to school curricula in a timely manner.

For this reason, the Skylab Education Program was created to derive the maximum educational benefits from Skylab, assist in documentation of Skylab activities, and enhance the understanding of scientific developments.

This document is one of several volumes prepared as a part of the education program. It has the dual purpose of informing high school teachers about the scientific investigations performed in orbit, and enabling teachers to form an opinion of the educational benefits the program can provide.

In providing information on the Skylab program, these books will define the objectives of each scientific investigation and describe its scientific background. The descriptions will include discussions of the scientific principles applied in the investigations and the types of data generated, and the types of related information and data available from other sources in the Skylab program.

In the preparation of these descriptions of the Skylab activities, a continuing goal has been to build a bridge between Skylab science and high school science. Discussions of the scientific background behind the Skylab investigations have been included to illustrate the scientific needs for performing those investigations in the Skylab environment. Wherever possible, concepts for classroom activities have been included that use specific elements of Skylab science as focal points for the increased understanding of selected subjects in the high school curricula. In some areas, these endorse current curriculum topics by providing practical applications of relatively familiar, but sometimes abstract, principles. In other areas, the goal is to provide an introduction to phenomena rarely addressed in high school curricula.

It is a goal of the Skylab Education Program that these volumes will stimulate the high school teacher to the recognition that scientific programs such as Skylab produce information and data that neither are, nor were planned to be, the exclusive domain of a small group of scientists, but rather that these findings are available to all who desire to use them.

## Application

Readers are urged to evaluate the investigations described herein, in terms of the subjects they teach and the text books and classroom aids they use. Teachers will be able to apply the related curriculum topics as stimuli for application of Skylab program-generated information to classroom activities. This information can be in the form of film strips, voice tapes, experiment data, etc, and can be provided to fulfill teachers' expressed needs. For example, the teacher may suggest educational aids that can be made available from these information sources, which would be useful in classroom situations to illustrate many of the principles discussed in high school curricula. These suggestions could then serve as stimuli for development of such aids.

As information becomes available, periodical announcements will be distributed to teachers on the NASA Educational Programs Division mailing list. Teachers wishing to receive these announcements should send name, title, and full school mailing address (including zip code) to:

National Aeronautics and Space Administration  
Washington, D.C. 20546  
Mail Code FE

The basic subject of this volume is the solar astronomy program conducted on Skylab. In addition to descriptions of the individual experiments and the principles involved in their performance, a brief description is included of the Sun and of the energy characteristics associated with each zone. Wherever possible, related classroom activities have been identified and discussed in some detail. It will become quite apparent to the reader that the relationships rest not only in the field of solar astronomy but also in the following subjects: physics—optics, the electromagnetic spectrum, atomic structure, etc; chemistry—emission spectra, kinetic theory, x-ray absorption, etc; biology—radiation and dependence on the Sun; electronics—cathode ray tubes, detectors, photomultipliers, etc; photography; astronomy; and industrial arts. The multiple educational relationships and interrelationships identified in this volume are shown in the table on the following page.

## Acknowledgements

Valuable guidance was provided in the area of relevance to high school curricula by Dr. James R. Wailes, Professor of Science Education, School of Education, University of Colorado; assisted by Mr. Kenneth C. Jacknicke, Research Associate on leave from the University of Alberta, Edmonton, Alberta, Canada; Mr. Russell Yeany, Jr., Research Associate, on leave from the Armstrong School District, Pennsylvania; and Dr. Harry Herzer and Mr. Duane Houston, Education and Research Foundation, Oklahoma State University.



### Related Curriculum Topics

EXPERIMENTS	SUBJECT	ASTRONOMY	BIOLOGY	CHEMISTRY	ELECTRONICS	INDUSTRIAL APPTS	PHOTOGRAPHY	PHYSICS
SECTION 1 PHYSICAL SCIENCE SOLAR ASTRONOMY		General background, spectral analysis, fine solar structure	The sun as an energy source, sun spot cycles				Scientific use of photography as a data recording medium	Nuclear, thermal, and energy con siderations, emission spectra
SECTION 2 HYDROGEN-ALPHA TELESCOPES		Cyclic nature of sunspots, Aurora Borealis, energy levels for H $\alpha$ radiation		Electron configuration, ionization energy, atomic structure, fusion and fission reactions, emission spectrum changes, changes in levels by electrons	Cathode-ray tube-TV display for astronaut	Vacuum de position	Film, data return, use of absorption filters, and interference filters	Ionization energy, light matter, electricity, spectrum, filters, optics, atomic structure, energy level transitions, force length, images, lens systems, electron configuration, electrochromatic spectrum, wave behavior, monochromatic filters, nuclear reactions
SECTION 3 S052 WHITE LIGHT CORONOGRAPH		Solar corona, solar eclipse cause, prediction benefits, Van Allen radiation, solar winds		Production of ozone, absorption of UV			Film, polarizing filters	Optics, magnetic fields, light scattering, Van Allen radiation, gas laws in relation to kinetic molecular theory
SECTION 4 S05A EXTREME ULTRAVIOLET SPECTROGRAPH S05B EXTREME ULTRAVIOLET HELIOGRAPH		Solar storms and flares, chromosphere, photosphere	Protection of earth flora and fauna by atmosphere, effect of radiation on life forms				Films, filters, cameras	Optics, magnetic fields, protons, diffraction gratings, photoelectric effect, wave atmospheric absorption, spectrum, light mechanics
SECTION 5 S055 POLYCHROMATOR- SPECTROHELIOMETER		Chromosphere			Photomultiplier, data interpretation, data scanning			Energy and temperature of chromosphere, corona and convex mirrors, diffraction gratings, spectrum, light meters
SECTION 6 S054 X-RAY SPECTROGRAPHIC CAMERA		Solar corona, x-ray energy, x-ray sources		Absorption and transmission of x-rays, characteristics of XUV		Use of x-rays, crystal formation, non-invasive and synthetic	Film characteristics	Nature of x-rays, optics, filters, spectrum, crystal excitation by waves
SECTION 7 S020 X-RAY ULTRAVIOLET SOLAR PHOTOGRAPHY		Extreme ultraviolet (XUV) energy, x-ray energy		Absorption and transmission of XUV			Film, curved focal plane	X-rays, optics, lens geometry, spectrum
SECTION 8 S056 EXTREME ULTRAVIOLET AND X-RAY TELESCOPE		X-ray energy, ultraviolet energy			Ion formation, anode, cathode, pulse height analyzer, proportional counter tube			Photons, quantum theory, ion formation by electric field, x-rays, matter, spectrum, energy

## The Skylab Program

The Skylab orbiting space station will serve as a workshop and living quarters for the astronauts as they perform investigations in the following broad categories: physical sciences, biomedical sciences, Earth applications, and space applications.

During the eight-month operational lifetime of Skylab, three crews, each consisting of three men, will live and work in orbit for periods of up to one month, two months, and two months, respectively.

The objectives for each of the categories of investigation are summarized as follows.

**Physical Science**—To perform observations away from the filtering and obscuring effects of the Earth's atmosphere in order to increase man's knowledge of the Sun and of its importance to Earth and mankind, to provide information in the field of stellar and galactic astronomy, and to increase man's knowledge of the radiation and particle environment in near-Earth space and of the sources from which these phenomena emanate.

**Biomedical Science**—To make observations under conditions different from those on Earth and thereby increase man's knowledge of the biological functions of living organisms, and of the capabilities of man to live and work for prolonged periods in the orbital environment.

**Earth Applications**—To develop techniques for observing from space and interpreting Earth phenomena in the areas of agriculture, forestry, geology, geography, oceanography, air and water pollution, land use and meteorology, and the influence man has on these elements.

**Space Applications**—To develop techniques for operation in space in the areas of crew habitability and mobility, and use the properties of weightlessness in materials research.

## The Skylab Spacecraft

The five modules of the Skylab cluster are shown in the illustration.

The orbital workshop is the prime living and working quarters for the Skylab crews. It contains living and sleeping quarters, provision for food preparation and eating, and personal hygiene equipment. It also contains the equipment for the biomedical science experiments and for many of the physical science and space applications experiments. Solar arrays for generation of electrical power are mounted outside this module.

The airlock module is the prime area in which control of the cluster internal environment, and workshop electrical power and communications systems, is located. It also contains the airlock through which suited astronauts emerge to perform their activities outside the cluster.

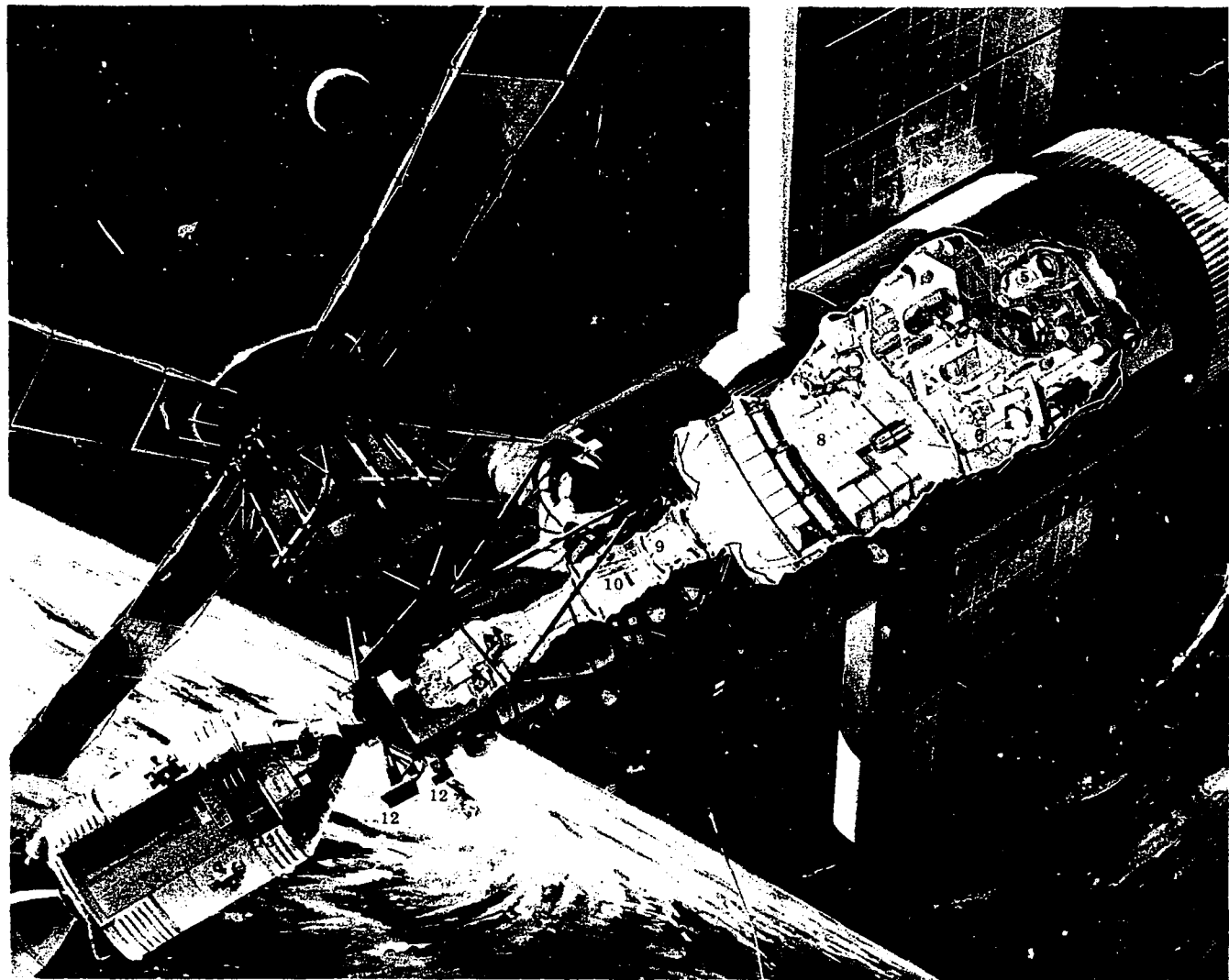

- |   |                               |    |                             |
|---|-------------------------------|----|-----------------------------|
| 1 | Apollo telescope mount        | 7  | Orbital workshop            |
| 2 | Solar arrays                  | 8  | Experiment compartment      |
| 3 | Sleeping quarters             | 9  | Airlock module              |
| 4 | Personal hygiene              | 10 | Airlock external hatch      |
| 5 | Biomedical science experiment | 11 | Multiple docking adapter    |
| 6 | Ward room                     | 12 | Earth resources experiments |
|   |                               | 13 | Command and service module  |

Skylab Orbiting Station

The multiple docking adapter provides the docking port for the command/service modules that transport the crews, and contains the control center for the telescope mount experiments and systems. It also houses the Earth applications experiments and space technology experiments.

The Apollo telescope mount houses a sophisticated solar observatory having eight telescopes observing varying wavelengths from visible, through near and far ultraviolet, to x-ray. It contains the gyroscopes and computer of the primary system by which the flight attitude of Skylab is maintained or changed, and it carries solar arrays by which about half of the electrical power used by the cluster is generated.

The command and service module is the vehicle in which the crew travels from Earth to Skylab and back to Earth, and in which supplies are conveyed to Skylab and experiment specimens and film are brought to Earth.

Skylab will fly in a circular orbit about 436 kilometers (235 nautical miles) above the surface of Earth, and is planned to pass over any given point within latitudes  $50^{\circ}$  north and  $50^{\circ}$  south of the equator every five days. In its orbital configuration, Skylab will weigh over 44,100 kilograms (200,000 pounds) and will contain nearly 370 cubic meters (13,000 cubic feet) for work and living space (about the size of a three-bedroom house).

# Section 1

## The Sun

The Skylab solar astronomy program uses a carefully chosen set of eight instruments in the Apollo telescope mount and one other located in another part of the laboratory. The Skylab solar instruments are several times larger than any that have been flown before and consequently possess greater spectral resolution and higher angular resolving power. The cluster of instruments is capable of simultaneously observing a wide range of spectral bands. These instruments are controlled by a trained observer who can analyze the data presented and alter the observing program as required by the changing solar conditions. He will be assisted by an extensive staff of ground based observers and analysts who will aid him in determining the most productive observations to make with the Skylab instruments. In addition to providing an observer to operate the instruments, the presence of astronauts also allows the use of high resolution photographic film to record data because the astronaut can change cameras and return the film to Earth at the end of the mission. The solar astronomy program will be augmented by ground based observations of the Sun and the geophysical phenomena resulting from its activity. While Skylab is in orbit, a series of solar observatories around the world will keep the Sun under continuous surveillance to warn of impending solar disturbances and acquire data to complement the Skylab observations.

The phenomena observable on the Sun can be detected by Skylab with a resolution down to the limiting resolution of ground based instruments. These phenomena vary on a timescale of seconds and minutes in size, shape, and composition.

## IMPORTANCE OF SOLAR ASTRONOMY

There are three major reasons why the study of the Sun is important:

- 1) Solar phenomena have a *great* influence on the Earth. The Sun is the ultimate source of all energy on the Earth, and all terrestrial life depends on it. Solar activity can adversely affect radio communication by causing ionospheric disturbances and may have an effect on atmospheric circulation patterns that cause changes in the weather, although the exact mechanisms are not understood. Changes in the total energy radiated by the Sun over long periods of time may have been responsible for past ice ages.
- 2) Because our knowledge of the Sun is greater than for any of the stars, many of our theories of stellar structure and evolution are dependent upon solar data to provide a

known reference point; therefore, any deficiencies in our knowledge of the Sun will result in corresponding errors in stellar theory. Since the Sun is the only star on which surface features can be distinguished, study of its structural features will lead to insight into the processes that we infer may be happening on other stars. Studies of the stars spectra show magnetic fields, flares, and other phenomena such as we see on the Sun.

- 3) By observing solar phenomena we can study atomic, nuclear, and plasma physics, aerodynamics, hydrodynamics and magnetohydrodynamic phenomena that are unobservable on Earth. The stellar atmosphere has a range of temperatures, pressures, and magnetic field intensities extending over volumes several times the size of the Earth that could never be duplicated for study in any laboratory on Earth. Such knowledge could help us to achieve controlled thermonuclear reactions.

## HISTORY OF SOLAR SPACE RESEARCH

Using sounding rockets, balloons, and small unmanned spacecraft, solar astronomers have studied the Sun, the upper atmosphere, and near Earth space since the end of World War II. These studies have revealed much about the general nature of the Sun in the x-ray and ultraviolet regions.

Until satellites and sounding rockets were developed it was possible to observe solar emissions only at wavelengths in the radio, infrared, and visible portions of the spectrum that could penetrate the Earth's atmosphere. Thus, the ultraviolet and x-ray radiations, which are important to the study of high energy solar phenomena, could not be studied. In addition, the daytime atmospheric scattering of visible light causes the sky to be so much brighter than the solar corona that this phenomenon is only visible during the rare solar eclipses and then only for relatively short distances from the solar surface. Atmospheric turbulence causes shimmering of the observed image limiting the resolution with which detail can be observed on the surface of the Sun.

Use of orbital spacecraft, such as Orbiting Solar Observatories (OSO), Orbiting Geophysical Observatories (OGO), and the U.S. Navy SOLRAD satellites, has resulted in a steadily increasing understanding of the explosive and energetic solar processes. However, the ability to obtain observations of sufficiently high resolution in energy, time, and space is still limited by the size of the instruments that can be carried by unmanned spacecraft and the need to communicate with the spacecraft through a telemetry system.

## SOLAR ZONES

The general structure of the Sun is illustrated in Figure 1.

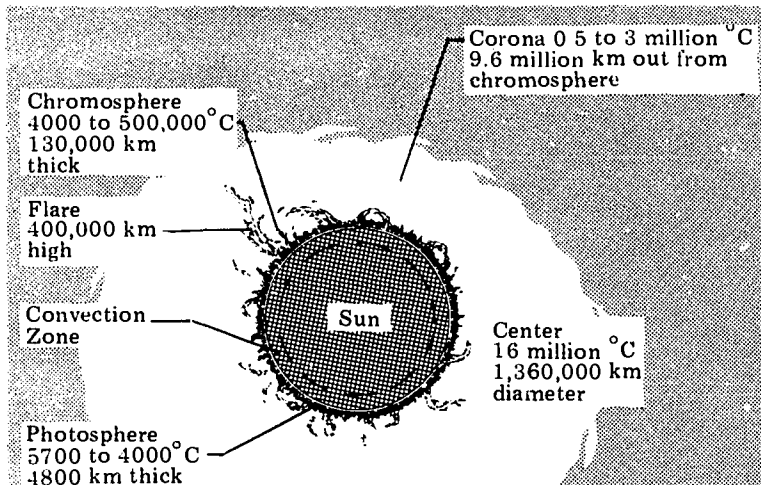

With acknowledgement to the National Geographic Society

Figure 1 Solar Zones

The energy source of the Sun is at its center when hydrogen nuclei are converted to helium at a temperature of approximately 16 million degrees. Electromagnetic energy generated at the center requires 10 million years on the average to diffuse outward to the cooler surface where it is radiated into space. In the last 64 thousand kilometers (40 thousand miles), the energy is transmitted by the convective motion of solar material that extends into the photosphere, which is the deepest level into the Sun that we can optically observe and the region from which energy is radiated. The photosphere is approximately 5 thousand kilometers (3 thousand miles) thick and has temperatures as high as 6000°C.

Overlying the photosphere is a layer in which the density is decreasing but the temperature increases with increasing height. It is in the chromosphere that the absorption that produces the famous Fraunhofer dark lines in the solar spectrum takes place. At the top of the chromosphere is a very steep temperature gradient that marks the transition into the solar corona which is characterized by its low density and very high temperature of several million degrees. Determination of the variation of the temperature, density, electron pressure, and other physical parameters in the transition region between the chromosphere and corona is one of the current problems of solar physics. Another problem that must be theoretically explained is how energy is transmitted into the corona from lower layers to cause the large temperature gradient. It is theorized that mechanical energy from the convective zone is converted into sound



waves in the chromosphere that dissipate the energy when they enter the low density corona and cause the high coronal temperature. A search will be made with the Skylab instruments for changes in the chromosphere and corona associated with an oscillation with a 300-second period that has been observed in the photosphere.

Surrounding the chromosphere is the corona which extends visibly outward from the chromosphere for several million miles. The corona is very faint in comparison with the luminosity of the solar disk. The only time that its outer reaches can be observed from Earth is during a solar eclipse. The coronal material is of very low density and is highly ionized because of temperatures up to several million degrees that exist in the region. As a consequence, most of the light emitted from the corona is caused by scattering from the free electrons that have been ionized from the coronal material.

The accurate measurement of the intensities of the solar radiation over the wide wavelength range made possible by the Skylab solar observatory instrument cluster will be used by solar scientists to determine the variation of temperature and other physical properties with depth in the solar atmosphere. The fact that different types of radiation are formed at different depths enables us to probe at different levels into the Sun and reconstruct the solar atmosphere. In general, the shorter wavelength radiation will be emitted from the hotter plasma which is at higher altitudes in the solar atmosphere. For example, extreme ultraviolet radiation comes from the region where the upper chromosphere is blending into the lower corona, while x-rays are formed in the high temperature corona.

The most spectacular solar phenomena are the flares that originate in the chromosphere and lower corona and extend outward in some cases ejecting material from the Sun. Solar flares are associated with the strong magnetic fields found in sunspots and transfer the energy stored in the magnetic field into electromagnetic radiation, high energy particles, bulk physical motion of the gas, and radio frequency emission in a catastrophic event that is not totally understood. A solar flare begins very rapidly and is characterized by a sudden increase in the H-alpha emission as well as a rapid build-up in the x-ray and ultraviolet emission. The flare spreads rapidly from a small origin across the surface covered by a sunspot group, reaches a maximum intensity in a few minutes, and then declines. A medium sized flare lasts perhaps half an hour while a large flare may last four or five hours. In addition to the electromagnetic radiation, large clouds of solar material are ejected outward from the flare and high energy cosmic ray particles are generated. The total quantity of energy released in a large flare is many times the energy generated by all man made sources, but is only a small fraction of the total

energy produced by the Sun. For example, it has been estimated that in a one-hour period during the massive solar storm which occurred in August 1972, the storm produced enough energy to meet the electrical power demands of the United States for 100 years at present consumption rates.

The classification of the many geometrical forms observed in flares and the associated structures observed in the solar atmosphere around sunspots where flares take place, shows the phenomena to be a very complicated set of interactions involving plasma instabilities, electrodynamic and hydrodynamic effects.

Skylab will try to observe a number of solar flares with as many of the solar experiments operating simultaneously as is feasible. The objective is to obtain a diverse and extensive collection of data which can be used to determine the point where the flare started, physical conditions such as the temperature, density, magnetic field strength, and particle velocities in the flare plasma and the surrounding medium, and to determine how these conditions change before, during, and after the flare.

One of the primary scientific objectives is to obtain a comprehensive set of observations of a solar flare from its earliest detectable stages with the Skylab high resolution instruments. It is hoped that the ultraviolet and x-ray observations will provide the information required to determine the mechanism responsible for triggering flares and will enable better predictions to be made of future flares. Obtaining flare data should be facilitated by the five-month time the Skylab instruments can operate in orbit. Flare data from sounding rocket instruments is difficult to obtain because of the difficulty of launching the rocket at the proper time to obtain data during the early phases of the flare.

Large solar flares can cause geophysical disturbances. X-rays and ultraviolet radiation greatly increase the ionization of the upper layers of the atmosphere on the sunlit side of Earth, resulting in disrupted radio communications. About an hour after the flare, high energy cosmic rays from the Sun arrive at Earth. In a day a large cloud of low energy plasma ejected from the flare arrives and causes magnetic storms. High energy particles enter the atmosphere at the magnetic poles and cause auroral displays and cosmic ray effects.

Associated with data taken on solar flares is a longer duration study of active regions. The three-dimensional structure of the active regions will be investigated to determine the horizontal and vertical variation of the temperature, density, velocity, and magnetic field. The structure of the

photosphere, chromosphere, transition region and corona above sunspots will be given careful attention to determine how it relates to the production of flares and other transient phenomena. Both short-term (minutes to hours) and long-term (days) changes will be documented. The velocity fields in the chromosphere and corona over sunspots and active regions will be mapped by means of the Doppler shift in spectral data and the mass motion shown in the coronagraph pictures.

Several types of structures are visible on the solar surface when viewed through an appropriately filtered telescope. Large sunspot groups with complicated structures are quite noticeable and persist for weeks undergoing changes in size and form. The spots are regions where strong magnetic fields exist and inhibit the convective motion of the photospheric material so that the sunspots are cooler than the surrounding photosphere. The magnetic field forms large loops up into the corona from sunspot groups. Condensations of coronal material form in these loops that are visible as arch-shaped prominences when viewed against the limb and as filaments when projected against the disk. Regions of enhanced emission in the spectral lines of certain elements are called plages and often surround sunspot groups. Most of the solar disk shows a mottled appearance as the tops of convective cells that are heated in the solar interior appear, rise, radiate away energy, and sink below the visible solar surface. The extensions of these patterns into the chromosphere and corona will be investigated with the ultraviolet and x-ray instruments on Skylab. The variations of temperature and density as a function of height and the velocities of the gas will be obtained.

Because the Skylab solar observatory instrument operation consumes a considerable portion of the astronaut's working time, it is essential to combine the observation requirements of the scientific investigations in as compact a sequence of data-taking operations as possible. This is accomplished by defining eleven Joint Observing Programs that investigate solar phenomena such as prominences and filaments, coronal transients, and the solar wind. The observations on prominences and filaments will study their evolution as they cross the disk as the Sun rotates and determine the three-dimensional structure (temperature and density) of the filaments and the surrounding material of the chromosphere and corona. The solar wind will be investigated by studying the evolution of the chromospheric network and its extension into the corona and the rate of expansion of various parts of the corona. Transient coronal phenomena will be observed in the visible, ultraviolet, and x-ray regions to determine the spatial and temporal development of the features, the velocity of propagation, and the correlation with surface and inner coronal features.

## SCIENTIFIC CONSIDERATIONS

Skylab will carry two telescopes to observe the H-alpha spectral line at 6563 angstroms. H-alpha is red light emitted by the hydrogen gas from the photosphere. The intensity of the emission varies with structural features on the solar disk and displays many fine scale features in the solar atmosphere. Solar flares are easily observed in H-alpha light because there is a large change in the intensity of this emission while the total visible radiation varies very little. By tuning the filter slightly off of the center of the line, the Doppler shifted radiation from gas in motion towards or away from the observer may be viewed. The H-alpha telescopes will be the principal aiming device the astronaut will use to point the other instruments, and will give him a common reference with the ground-based observers during the mission. The telescopes will gather data of uniform high quality taken simultaneously with data from the other instruments.

The ultraviolet spectrographs will develop high resolution spectra of very small areas of the Sun in a wavelength range that cannot be observed from the ground. This is an important region because the ultraviolet lines arise from the regions of the chromosphere, and transition region into the corona, where analysis of the wavelength and intensities of the emission spectral lines permits determination of the temperature, density, and electron pressure of the level in the Sun where the radiation originated. The ultraviolet radiation is strongly enhanced in solar flares as the temperature increases.

Skylab spectrographs use both photographic and electronic methods of data recording: photographic techniques give high spatial resolution and can gather large amounts of data in a short period of time; electronic detectors are used to obtain high accuracy in measuring the intensity of the emitted lines.

High energy x-rays are formed in the corona where million degree temperatures strip the electrons from the atoms and produce a high degree of ionization. Low resolution spectra and photographic imaging will be obtained by the two Skylab x-ray telescopes. The spectra will enable temperatures of the emitting regions to be determined, and the imaging will be correlated with images taken in other wavelengths to determine the spatial and temporal development of a solar region that produces a flare.

Another form of electromagnetic radiation from the corona is viewed in white light scattered from the free electrons. The intensity of the scattered light is a measure of the electron density of the corona and displays arcs, rays, and streamers that trace the magnetic field structure. Observation of the corona after a flare shows the response of this large, low

density medium to a disturbance in its lower layers. Because the radiation from the corona is a million times weaker than the radiation from the solar disk, a coronagraph must be designed with special optics to block out the intense light from the solar disk. The Skylab coronagraph will be able to observe higher detail and greater distances from the Sun than similar instruments operating from the ground because it will be above the scattering effects of the Earth's atmosphere.

## SKYLAB SOLAR OBSERVATORY

The Skylab solar observatory contains the eight telescopes mounted on a common structure (the Apollo telescope mount)—

- 1) white light coronagraph (S052),
- 2) ultraviolet spectrograph (S082B),
- 3) ultraviolet scanning spectroheliometer-polychromator (S055),
- 4) extreme ultraviolet spectroheliograph (S082A),
- 5) x-ray telescope-spectrographic camera (S054),
- 6) x-ray spectrograph (S056),
- 7) two H-alpha telescopes,
- 8) and another extreme ultraviolet spectrograph (S020) which is operated from an airlock in another part of Skylab.

The first eight instruments are mounted in a canister so that all of the telescopes can point to the same area of the solar surface. The complete observatory is rigidly attached to the body of Skylab the mass of which provides the stable base necessary for maintaining the pointing stability required for astronomy. The common pointing axis of the assembly is not expected to drift more than 1/700 of a degree during a 15-minute period-equivalent to about 4000 kilometers (2500 miles) on the Sun's surface. [The diameter of the Sun is 1,390,000 kilometers (864,000 miles) and sunspots vary in size from 800 to 80,000 kilometers (500 to 50,000 miles) in width.]

With its eight telescopes observing the Sun in several spectral bands, Skylab provides the first opportunity to perform long duration, highly detailed studies of the Sun in the visible ultraviolet, extreme ultraviolet, and x-ray spectral regions simultaneously. (See Figures 2 and 3.) The operating lifetime of Skylab will also permit the observations of solar events through their life cycles. A sunspot may persist through several 27-day rotations of the Sun.

## EXPERIMENT SCHEDULES

The solar telescopes are scheduled to operate more than 100 hours during the first manned mission of Skylab. The second and third missions will schedule additional operations so that several hundred hours of solar observation will be achieved during the entire Skylab flight program.

The complement of solar observing telescopes will usually be operated in unison; however, they may also be operated individually or in partial groupings. The selection of telescopes used for an observational period is at the discretion of the astronauts, the flight control center at the Johnson Space Center in Houston, and the principal investigators associated with the investigations.

Another Skylab experiment program, the Earth resources experiments (EREP), requires a pointing attitude in which solar observation is not possible. If, during one of the EREP observation sequences, a significant solar event commences, this sequence may be interrupted in favor of solar observation.

Since a major Skylab scientific objective is to observe and record the onset of solar flares which are not predictable and of short life, one x-ray telescope is equipped with an x-ray alarm. The x-ray alarm will alert the crew to an impending solar event and permit adjustment of flight operations to observe the solar flare.

## CREW ACTIVITIES

The solar telescopes are operated by an astronaut from a control and display panel equipped with the necessary switches, meters, and with television displays by which the crewman may point the telescopes to the desired solar feature.

Photographic exposure speeds, camera, and telescope adjustments and selection of individual telescopes to be used for observation are also controlled by the astronaut.

The end of the first manned mission and at the beginning, middle, and end of the two later missions, two astronauts in EVA space suits will emerge from Skylab to retrieve the exposed film or to install new film.

## DATA AVAILABILITY

The data which accrue from the solar telescopes, are in three forms: television, photographs, and tape-recorded digital data (similar to computer tape.)

The television pictures from those telescopes equipped with television cameras may be transmitted to ground for use by ground-based personnel to evaluate and direct telescope performance. Television pictures are also used by the astronaut at the control and display panel. Some of the television pictures may be released to the public during Skylab flights.

Photographic data are returned to Earth at the conclusion of each mission. These data represent pictures of the Sun in the various spectral wavelengths and scientific data in the form of spectrographs; both types are required by interested scientists to conduct studies of solar events.

The tape-recorded digital data which result from the extreme ultraviolet scanning spectroheliograph and the x-ray event analyzer is transmitted to ground through the radio communication system. As received these data cannot be used. It must be processed by a computer which will then provide tabular and/or graphic outputs for analysis.

The principal investigators and scientists retain proprietary rights to the data from their experiments for a period of one year to provide adequate time for data analysis and study before the findings are made public.

Aside from that information which NASA may release during the Skylab flight, it may be expected that results of the Skylab solar observations will be made public early in 1975.

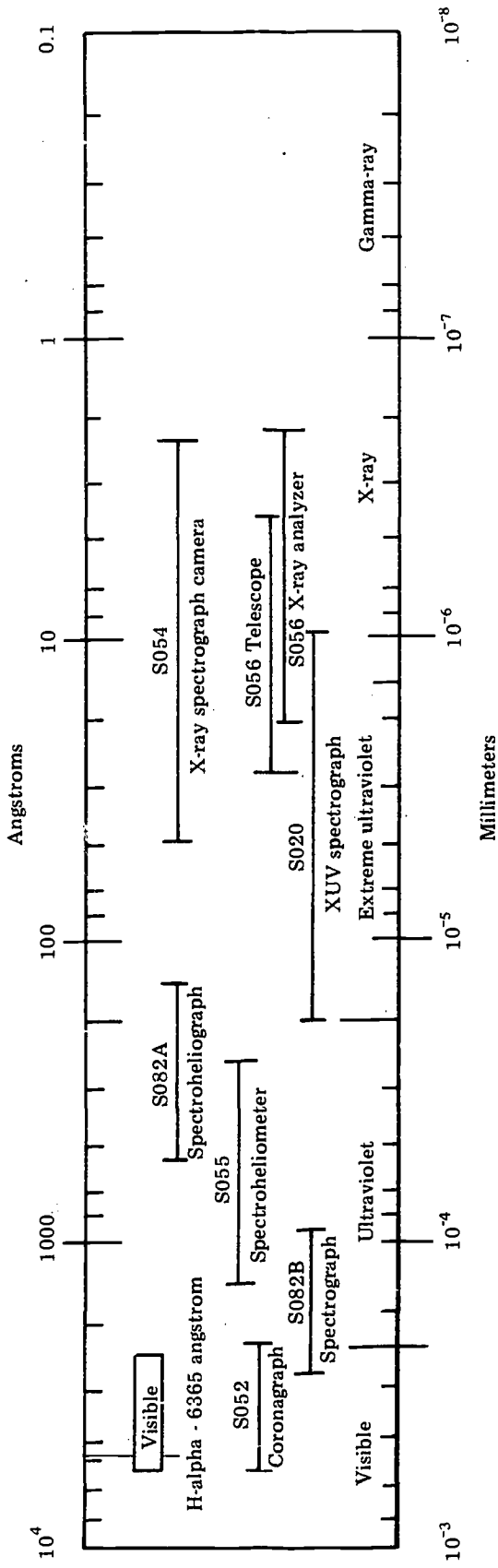

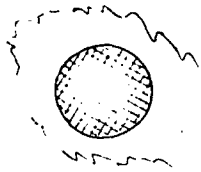
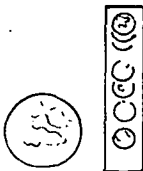
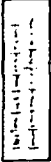
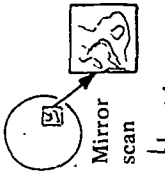





Figure 2 ATM Spectral Range



Prime scientific data	H-alpha telescopes	S052 White light coronagraph	S082A Extreme ultraviolet spectroheliograph	S082B Extreme ultraviolet spectrograph	S055 Ultraviolet scanning spectroheliograph	S054 X-ray spectrographic camera	S056 X-ray telescope and event analyzer	S020 Extreme ultraviolet and x-ray spectrograph
								
	Photographic	Photographic	Photographic	Photographic	Grating scan line photo electric	Photographic	Event analyzer photographic & photo electric	Photographic
Field of view	4.5 min to 35 min	6 solar radii	Full Sun 56 min	3 sec	5 sec	48 min	40 min	3 to 4 min
Spectral range	6365 ± 1 angstrom	White light 0.3 to 0.7 microns	150 - 625 angstrom	970 to 3940 angstrom	300 to 1350 angstrom	3 to 60 angstrom	5 to 35 angstrom Telescope 2.5 to 20 angstrom	20 to 200 angstrom

1 arc-sec approximately 450 miles on Sun  
 1 arc-min approximately 26,000 miles on Sun  
 32 arc-min apparent diameter of Sun

Figure 3 ATM Summary

# Section 2

## Hydrogen-Alpha Telescopes

## EXPERIMENT BACKGROUND

### Hydrogen Alpha

The hydrogen-alpha (H-alpha) telescopes are designed to view and record images of the Sun in the unique red light produced by hydrogen.

The hydrogen atom has only one electron. In the normal state the electron orbits the nucleus in an orbit called the ground energy level. When the atom is stressed by an external energy, either electrical or thermal, the electron absorbs energy and assumes a new orbital energy level. A number of distinct energy levels in which the electron may orbit have been discovered. The largest energy level that can be achieved is that at which the electron is removed completely, leaving the nucleus (or a positive hydrogen ion).

When the external energy that drove the electron to higher orbital levels is removed, the electron gives up energy which it had absorbed and returns to a lower level. The energy which the electron gives up is radiated at a unique wavelength depending on the energy level which it leaves and to which it returns. A series of transitions can be defined for the various energy levels. Those energy transitions for which the radiated energy is in the form of visible light are known as the Balmer series, of which H-alpha is the transition from the third to second energy level. Other series are the Lyman series involving transitions to ground level and radiations of ultraviolet light, and the Paschen series involving higher energy levels, and production of infrared radiation.

The hydrogen atom and the various energy levels and transitions which can occur in the hydrogen atom are shown in Figure 1. When the electron returns from the third to the second energy level, it emits H-alpha light, which is a unique red light at a wavelength of 6563 angstroms.

Å—angstrom units are the international unit for measuring light wavelengths—

$1 \text{ \AA} = 10^{-8} \text{ cm.}$

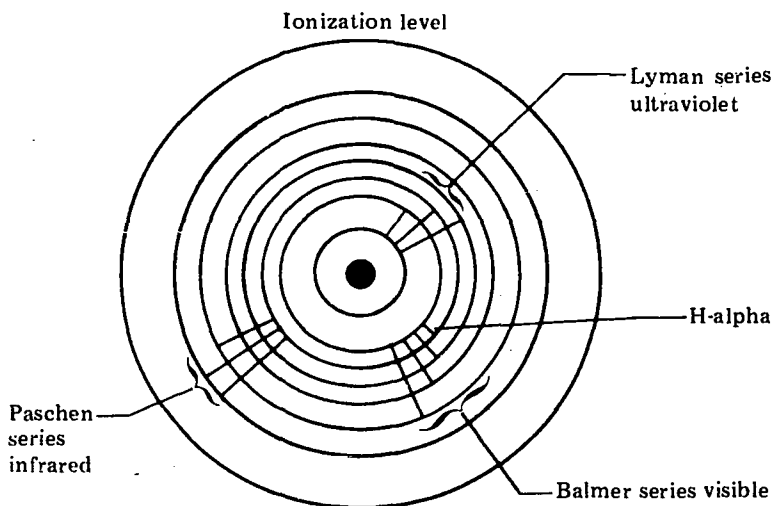

Figure 1 Hydrogen Series

## H-alpha of the Sun

Thermal and magnetic conditions of the Sun are of such magnitudes that H-alpha radiation is a prominent component of the spectrum. Observation of the Sun with a telescope fitted with a filter that transmits only H-alpha red light ( $6563 \pm 1$  angstrom), reveals details of the solar surface and its activity which are obscured by the many other wavelengths that comprise white light. Figure 2 is a typical H-alpha photograph of the Sun.

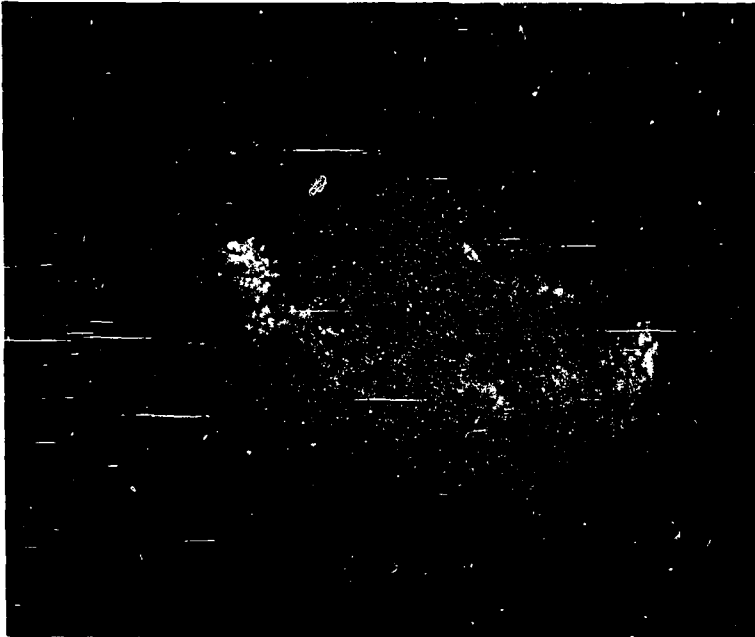
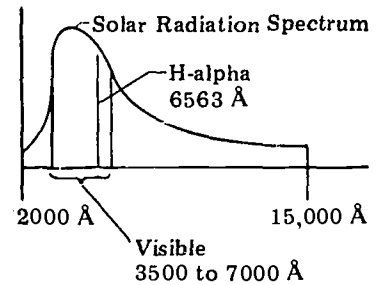

Figure 2 Solar Image in H-Alpha

## Ground Based H-alpha Observation

Through a worldwide network of ground based telescopes with H-alpha filters, maintaining continuous surveillance of the Sun and monitoring solar activity (sunspots, flares, etc), it is possible to predict when the radiation from the solar disturbance will arrive at Earth to cause geomagnetic disturbances and ionospheric storms that disturb radio communication and navigation systems, and affect wind and weather patterns.

The solar wind which causes storms on Earth is composed of ions and cosmic particles (materials of the Sun) whose arrival is heralded by electromagnetic radiation. The velocity of the solar wind is less than the speed of light since it is composed of material and is not energy.

## DEFINITION OF SCIENTIFIC OBJECTIVES

## H-alpha Characteristics of Sun

When observations are made with a H-alpha filter, features of the Sun's chromosphere are seen. The change that occurs in H-alpha radiation relative to various solar features is presented in Figure 3. The contrast between these features has been used by solar astronomers for many years.

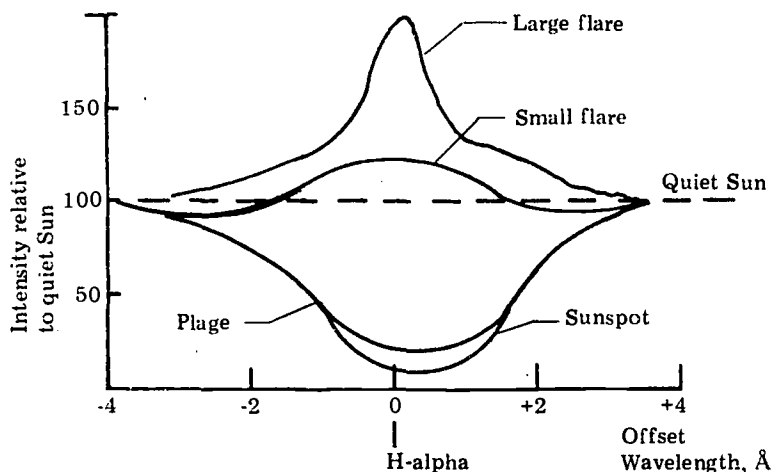

Figure 3 H-Alpha Across Solar Phenomena

H-alpha Telescope Function

The H-alpha telescopes of the Apollo telescope mount are used to identify features on the Sun which can be examined with the other instruments of the cluster (see Sections 3 thru 8). The camera on the H-alpha telescope will record where these other instruments are pointing. Significant sources of ultraviolet and x-ray emission can then be correlated with features recognized in the H-alpha telescopes.

Images of the Sun in H-alpha light are provided for astronaut use on a television monitor. The crewman will then be able to point the other instruments accurately at a feature of interest.

Terrestrial H-alpha telescopes are beset with a shimmer in their images because of air turbulence and scattering. The H-alpha telescopes of Skylab will be above the atmosphere and will provide H-alpha photography of greater resolution than can be obtained from the ground.

EXPERIMENT DESCRIPTION

Basic Telescope

Ground based telescopes for H-alpha observation are usually refracting telescopes in which lenses are used to focus an image. These telescopes are necessarily long when a small field of view is required. In the Skylab cluster, the telescope must have a short physical length but still retain a narrow field of view (approximately 1 degree). A Cassegrain telescope is used for this purpose.

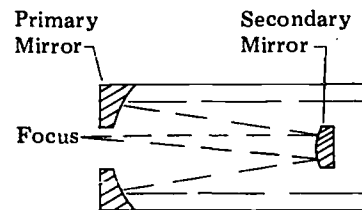

Cassegrain Telescope

Light entering the telescope is reflected by a spherical concave mirror. The reflected light is intercepted by a secondary convex spherical mirror which reflects the light through an aperture in the primary mirror and is brought to a focus behind the primary mirror. Thus, while the optical length of the telescope is retained by the multiple reflections, the physical length is shortened.

H-alpha  
Filter

Since H-alpha light is energy at a unique and discrete wavelength, a filter that transmits only a very narrow band about that wavelength is required to isolate that wavelength from the other components of white light. The spectral transmission of the H-alpha filters in Skylab telescopes is  $6562.8 \pm 0.35$  angstroms. This filter is properly called a Fabry-Perot interferometer.

Fabry-Perot

The Fabry-Perot interferometer is developed from the concepts of constructive and destructive interference of radiating waves. When two waves of the same wavelength arrive at the same point in space and are in phase, they will reinforce each other, or *constructively interfere*. If the two waves are out of phase they will cancel each other, or *destructively interfere*.

The Fabry-Perot interferometer is constructed from a disk of fused silica which is 125 microns thick. The disk is optically polished and is coated with a semireflective surface on both faces. The faces of the disk are also maintained in parallel.

White light is composed of many wavelengths. At some wavelengths, the thickness of the disk will be equal to an odd number of wavelengths; at other wavelengths, the disk is an even number of wavelengths thick.

Light that enters the interferometer is multiply-reflected between the internal faces of the disk. For those wavelengths for which the disk is an even number of wavelengths thick, the internal reflections will constructively interfere with the incident light, and those wavelengths will be transmitted through the interferometer. At wavelengths for which the disk is an odd number of wavelengths thick, the internal reflections will destructively interfere with the incident light and no transmission through the interferometer will result. Between these two extreme conditions, partial destructive interference takes place and the incident light is attenuated. Figures 4 and 5 illustrate the construction and operation of the Fabry-Perot interferometer and the resultant filter transmission characteristics.

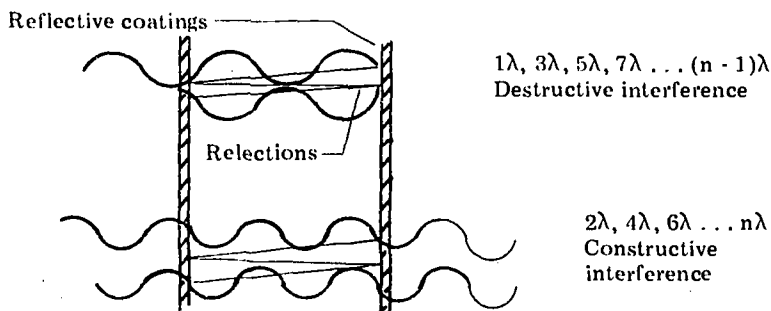

Figure 4 Interferometer Reflections

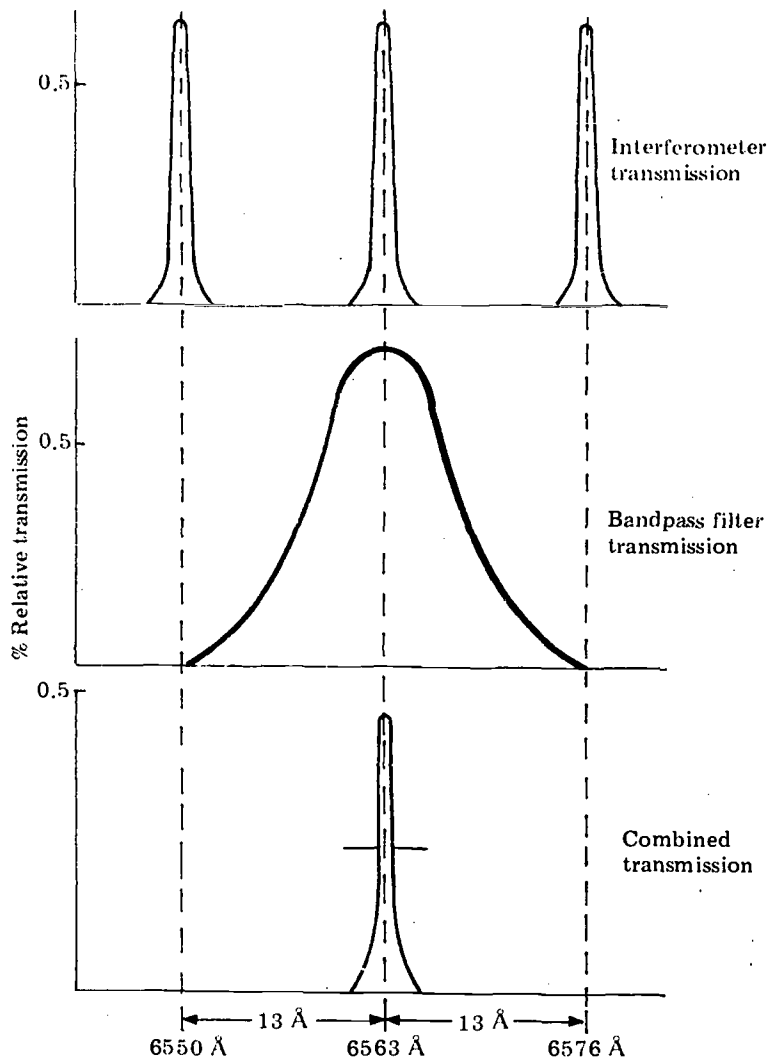
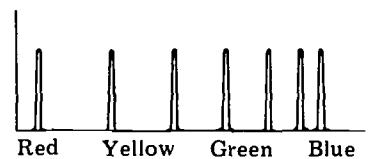

Figure 5 Interferometer Transmission

Throughout the spectrum of white light, there are many wavelengths that satisfy the conditions for constructive interference. Thus, in white light the output of the interferometer will be light which is composed of wavelengths at discrete intervals throughout the spectrum.



Interferometer Output in White Light

To make the interferometer wavelength selective in the H-alpha red light only, a bandpass red glass filter is placed in front of the interferometer so that only red light in the spectral region of H-alpha is admitted to the interferometer. The addition of the red bandpass filter is shown in Figure 5.

The complete Fabry-Perot interferometer H-alpha filter passes 20% of the light within the very narrow bandpass which it provides.

The thickness of the fused silica disk (125 microns) is temperature-dependent; thus close temperature control to within 1.0°C is required to maintain the wavelength selectivity. Temperature control can also be used to tune the filter +1 angstrom either side of 6562.8 angstroms. This tuning is useful in detecting motion of solar events by utilizing the Doppler wavelength shift. H-alpha radiation sources moving toward the telescope will exhibit a wavelength shorter than usual. Events receding from the telescope will exhibit longer wavelengths.

The H-alpha solar image transmitted by the Fabry-Perot interferometer is sent to a beam splitter which divides the light into two paths. Ninety percent of the light is directed into the television camera and ten percent is directed to the film camera for photography.

Beam splitter—a lightly coated, partially transparent mirror, which reflects part of the light incident on it and transmits the remainder.

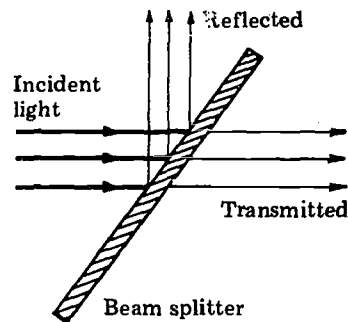

## EXPERIMENT DATA

**Type** Experiment data are in two forms: television and photographs. The television circuits are used primarily by the monitoring astronauts; the television data are transmitted to Johnson Space Center for use by ground flight control personnel. Some of the H-alpha television images may also be supplied to TV networks for public information during the mission.

Photographic data are returned to Earth after the mission. While the data will be used primarily for correlation of solar events with the data from other instruments, it is expected to be of higher resolution than that obtained from ground based telescopes; thus, it may be of scientific merit.

**Highlights** The H-alpha photography shows details of solar phenomena; plages, filaments, flares, and sunspots are clearly defined.

**Analysis** Correlation of H-alpha photographs with data from ultraviolet and x-ray images and corona photographs (Sections 3 thru 8) are expected to yield information on the energy-producing mechanisms of the Sun and the manner in which that energy is radiated to Earth and space.

**Availability** Other than some TV pictures which may be released during the mission, data from the H-alpha telescopes may not be available for public use before 1975. Procedures for requesting copies of flight data will be announced at a later date. Section 1 describes planned data uses and requirements.



## CREW ACTIVITIES

The astronaut will use the TV display from the H-alpha television camera to point other telescope mount instruments. He will also evaluate the image to decide which of the other instruments will provide the most useful data and to determine those to be used for a particular observation. Other related crew activities are discussed in Section 1.

## RELATED CURRICULUM TOPICS

Concepts employed in the design and application of the H-alpha telescopes may be related to a number of subjects which are discussed in high school science programs. Subjects in astronomy and physics are readily apparent topics:

### Astronomy

Details of sunspots, filaments, spicules, and plages;

Relationship between sunspots and other features;

Life cycle of sunspots.

### Physics

Optics—constructive and destructive interference, interferometers, spectral analysis;

Nuclear, thermal and energy considerations of the Sun.

## SUGGESTED CLASSROOM DEMONSTRATION

### Interferometer

While the isolation of the single wavelength of H-alpha radiation at 6563 angstroms is important in the H-alpha telescope, the principle employed is also found in other fields where spectral isolation or analysis is performed. Laser technology also employs wavelength interferometers. This demonstration will show how the interferometer is used to separate a single wavelength in comparison with a full spectrum.

Materials required for the demonstration are a—

- 1) Sun screen with two pinhole apertures;
- 2) 6-inch long triangular dispersing prism. Two small prisms may be used but their dispersed spectra must be aligned;
- 3) at least three colored (red, green, blue) bandpass filters. These are 2-inch squares of colored glass;

- 4) two optically flat 2-inch diameter interferometer elements (optical flats);
- 5) suitable white projection screen.

Components of the demonstration are arranged as shown in the accompanying sketch.

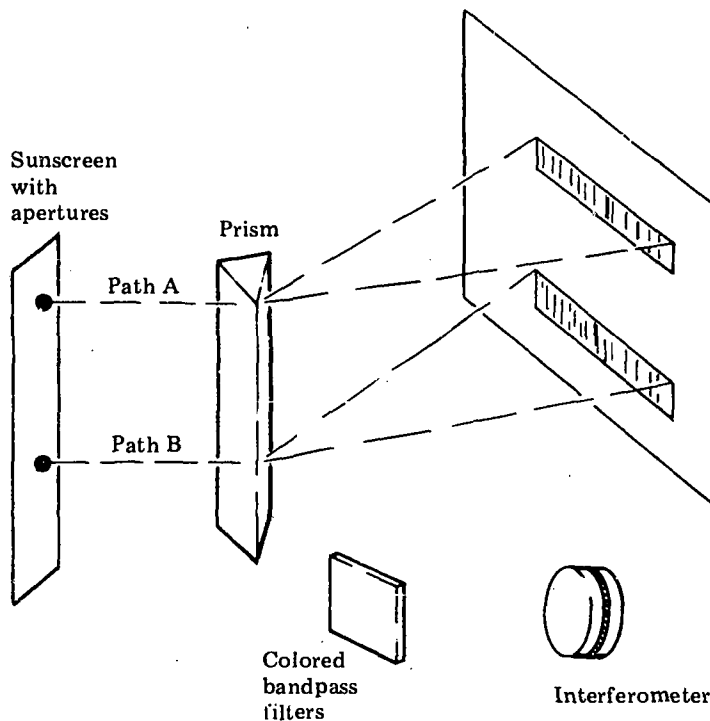

Construction of interferometer—the interferometer is constructed from two optical flat interference flats and a ring of 1-mil steel shim stock. The shim stock ring is of the same diameter as the interference plates. The inside diameter of the ring is 0.5-inch less.

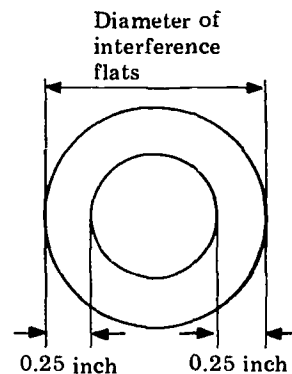

The shim stock ring is now sandwiched between the optical flats to form a 0.001-inch spacer.

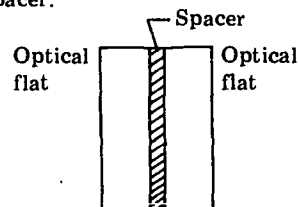

- 1) Pass the sunlight through the apertures of the Sun screen to the prism to obtain two identical spectra of the Sun.
- 2) Insert the colored bandpass filters, one at a time, into light path B. As each of the filters is inserted, only its particular color will remain in the spectrum on the screen. The other colors have been rejected by the filters.
- 3) Insert the interferometer into light path B and compare the resulting spectrum with that from light path A. The resulting spectrum will show bright lines at the wavelengths where constructive interference occurred in the interferometer.
- 4) Insert both the red bandpass filter and the interferometer in path B and compare the resulting spectra. The spectrum of light path B will be a few red lines. The number of lines is dependent on the range of wavelengths passed by the bandpass filter.
- 5) Repeat step 4 for the green and blue bandpass filters, respectively. Note that there will be more blue lines than red lines. Why? What is the difference between red and blue light?

#### SUGGESTED SOURCES

Prisms and optical flats may be obtained from:

Edmund Scientific Co.  
Barrington, New Jersey

Bandpass filters may be obtained from:

Special Optics  
Cedar Grove, N.J. 07009

# Section 3

## White Light Coronagraph

## EXPERIMENT BACKGROUND

Solar  
Physics

The white light coronagraph has been designed to gather extensive photographs of the Sun's corona during the 7-month lifetime of Skylab.

The Sun is surrounded by a great cloud of hot gases and ionized atoms of solar materials. This cloud, called the corona, extends visibly for millions of miles outward from the Sun. Temperatures of the corona vary from approximately 500,000°C at the chromosphere to 3,000,000°C at the outer fringes.

Corona—a zone of hot gases and ionized atoms radiating from the Sun for millions of miles. Very little of the corona is visible from Earth.

Although the corona is very luminous, it is  $10^{-10}$  (1/10,000,000,000) times as bright as the Sun. Normally light from the brighter solar disk is scattered and diffused by Earth's atmosphere and obscures the corona. Consequently the only way the corona can be seen from Earth is during brief periods of total eclipse. At these times the Moon passes between Earth and Sun to occult the Sun and eliminates the source of atmospheric scattering. It is important to note that the occulting object (Moon) is outside of the atmosphere.

Occult, occulting—the disappearance of one heavenly body behind another.

Above Earth's atmosphere where scattering is no longer present, an artificial eclipse can be created with an occulting disk. A disk with a diameter slightly larger than the apparent Sun is used to occult the Sun. The disk of the Sun subtends (forms) an angle of 32 minutes (approximately 0.5 degree). A small disk of 15 mm (0.6-inch) diameter at a distance of 152 cm (5 feet) from the eye, subtends the same angle and will provide an artificial eclipse. This concept is the basis of the design of the white light coronagraph.

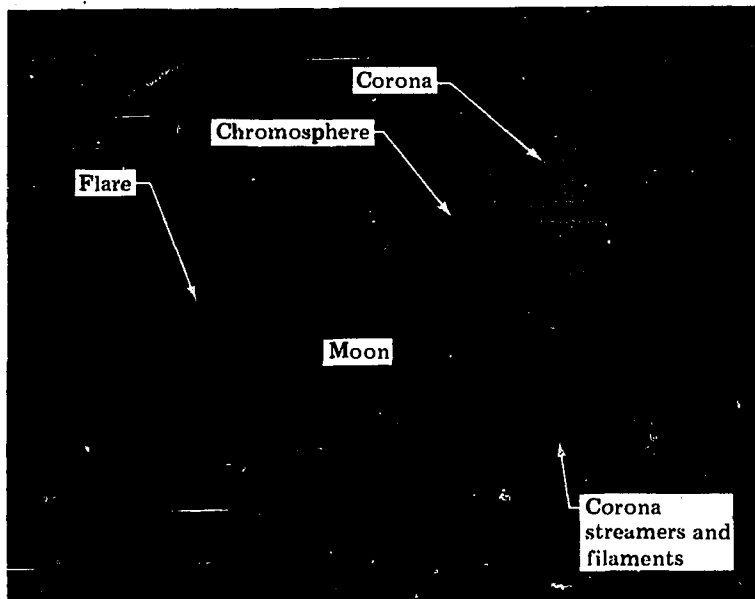

Near Corona Out 1 Solar Diameter Recorded during Eclipse

**Coronagraph  
Uses**

Very few extended studies of the corona have been possible because of the short duration of total eclipse. Seven or eight minutes is the maximum time of total eclipse in the few localities of Earth over which totality occurs. As was noted earlier, during eclipse the occulting disk (Moon) is outside of Earth's atmosphere and effectively eliminates atmospheric scattering. When the occulting disk is located on Earth and inside of the atmosphere, scattering still occurs and prevents observation of the corona. Also coronal light is severely attenuated (reduced) as it passes through the atmosphere. The sunlight on Earth has only 75% of the intensity of the light shining on the upper atmosphere. Therefore, even during an eclipse, much of the faint light of the corona is lost.

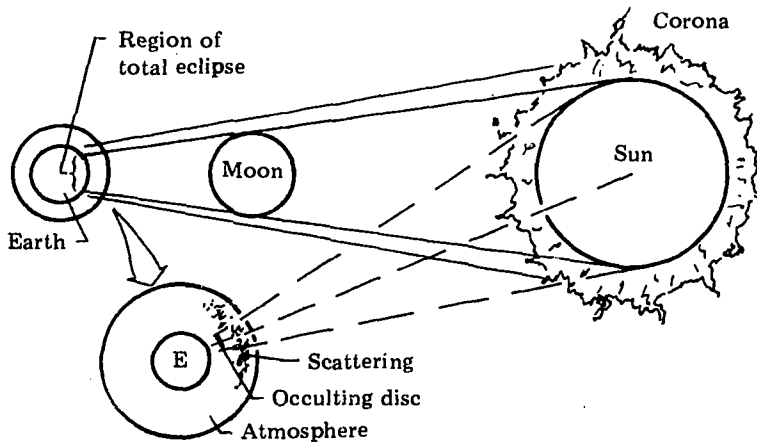

**Principles of Eclipse Versus Occulting  
Disk for Corona Observation**

The coronagraph is useful on Earth-based telescopes to observe the chromosphere and solar flares. In this usage, the luminance of the chromosphere is brighter than the attendant scattering. Also H-alpha light is prevalent in the chromosphere so that a coronagraph equipped with an H-alpha filter permits observation of these events. The concepts of H-alpha filters with regard to H-alpha telescopes are discussed in Section 2 of this volume.

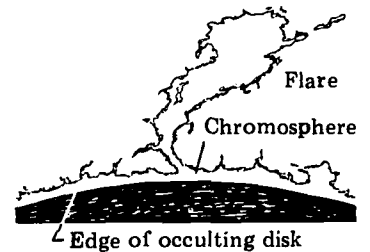

Flare observation using a coronagraph.

**DEFINITION OF SCIENTIFIC OBJECTIVES**

Despite the meager data on corona observations that are available, it has been found that the corona varies with sunspot activity and solar magnetic fields.

**Limits**

A coronagraph situated above Earth's atmosphere will not be affected by the scattering and attenuation of the atmosphere. It will view the corona to the sensitivity limits of the photographic film that records the image.

Recording Intervals

Over the extended time available during Skylab, the coronagraph will record photographs at varying intervals. Intervals as short as 13 seconds will permit analysis of rapid motion of material in the corona.

Since the Sun rotates on an average of 28 days, observations of the corona with relation to solar rotation will also be provided. The coronal features associated with surface features observed by H-alpha telescopes (Section 2) can be correlated as the solar features appear at one solar limb or the other.

Polarization Factors

The light radiating from the corona is polarized; that is to say the waves are highly oriented in a given plane. The polarization of the corona results from interaction of the ionized atoms emanating from the Sun and the magnetic fields of the Sun and solar storms. Polarizing filters in the coronagraph will permit the polarization of the corona to be determined and its relationship to the sunspot activity and magnetic fields that affect the corona.

Solar rotation is not uniform; rotation is 25 days at the equator and 30 days at the poles.

Solar limb—the extreme edges of the solar disk.

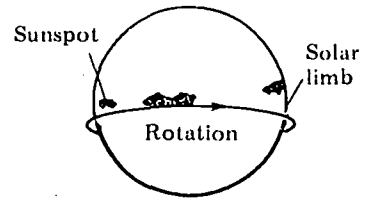

Polarization—a distinct orientation of the wave plane and travel of electromagnetic radiation.

DESCRIPTION OF CORONAGRAPH

Occluding Disks

The white light coronagraph is a long tube having several occluding disks coaxially mounted in its length. A single occluding disk will have light diffracted about its circumference. The diffraction of a single disk would create a diffused light ring and poorly defined image at the image plane of the coronagraph. Consequently, additional disks, which are slightly larger than the first disk, are used to intercept the undesirable diffracted light.

Diffraction—when a ray of white light passes over the edge of an opaque surface, the components of the light are bent in proportion to their wavelength. White light is diffracted into a spectrum.

Light diffraction over an opaque edge is shown in the illustration. When a beam of white light impinges on an opaque material, light passing over the edge of the material is diffracted. The light of the longer wavelengths (red) is bent to a greater extent than the shorter blue wavelengths. Diffraction is discussed more fully in Section 4.

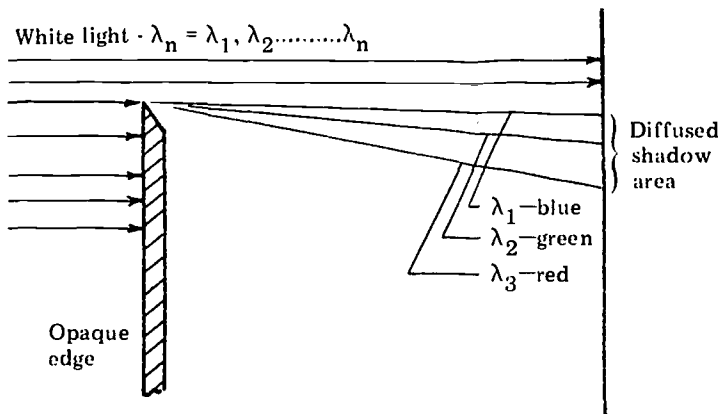

Diffraction of White Light Passing Over an Opaque Edge

One of the occulting disks is adjustable in its position along the length of the tube and laterally in the tube to provide fine adjustment of the occulting. This disk has electronic photosensors positioned about it so as to detect the edge of the shadow of the other disks and provide pointing signals for manual or automatic operation of the instrument.

**Field of View**

The space or annulus formed by the occulting disks and the inside wall of the tube defines the field of view of the coronagraph. The field of view permits observation of the corona from 1.5 to 6 solar radii (4 million kilometers plus,—the solar radius is almost 700,000 kilometers). Light from the corona travels down the tube to the field lenses and folding optics which focus the image of the corona at the image plane of the camera.

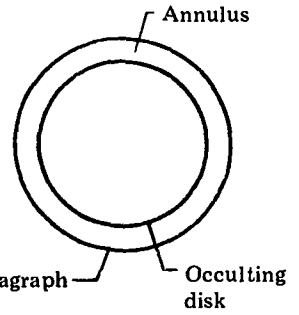

Folding optics—a system of mirrors that reduces physical length of a telescope while maintaining optical length.

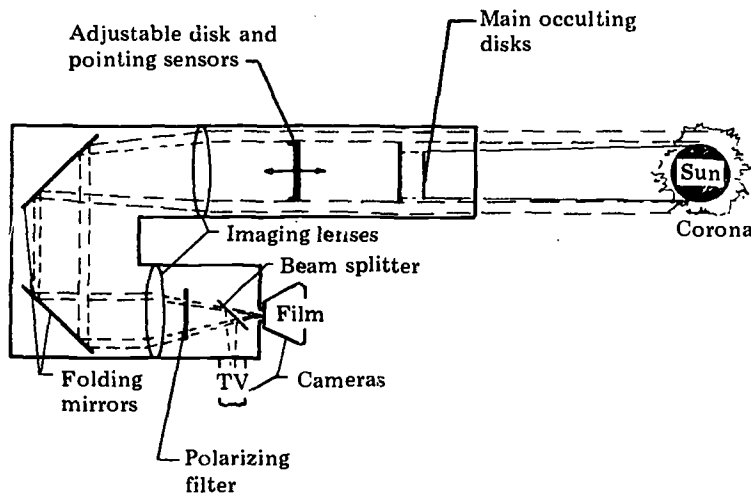

**Optical Scheme of White Light Coronagraph**

**Polarizing Filters**

By using a series of polarizing filters in front of the image plane, the orientation or polarization of various areas of the corona can be determined. The coronagraph uses three filters having different polarizing orientations. High intensity images of parts of the corona indicate polarization of the coronal light in the orientation direction of the specific filter used. As sunspots and solar magnetic fields vary, the polarization will also vary.

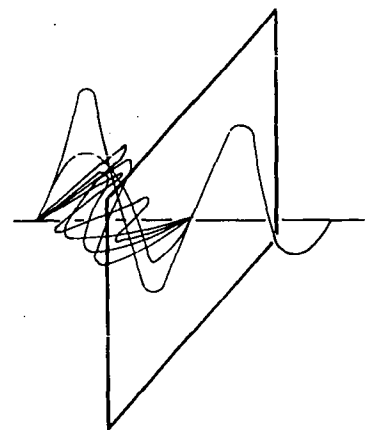

**Polarizing filter**

**Camera**

After the light has passed through the polarizing filter, it is transmitted through a beam splitter (Section 2) which divides the light into two paths: one path presents an image of the corona on a TV camera which displays the corona to the astronaut; the other path provides an image of the corona on the film camera which records the images on 35 millimeter film. The film magazine has a capacity for 8025 exposures.

## EXPERIMENT DATA

Type

Data obtained by the coronagraph will be in the form of photographs of the Sun out to 6 solar radii. The characteristics of the expected photographs are shown in the illustrations; picture A was taken from Earth during the solar eclipse of 1966; picture B shows the solar eclipse of 1970. The variation in shape and filament and streamer structure illustrates the changes that occur in the corona. The white spot in picture A is the planet Venus.

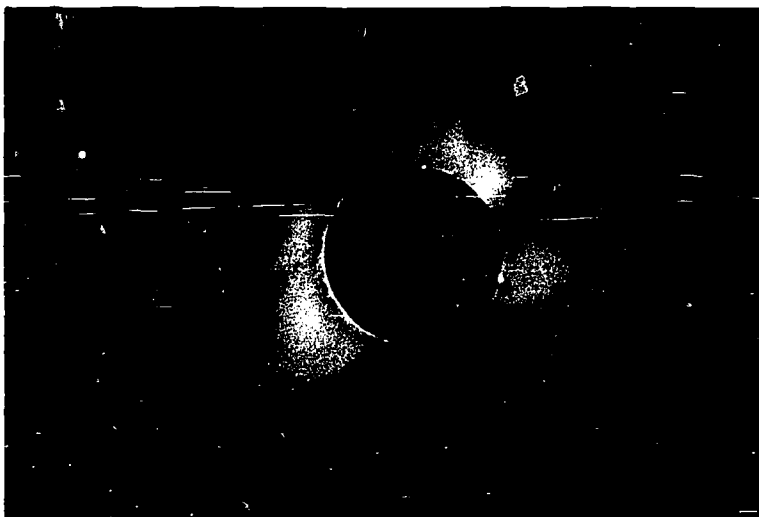

**A 1966 Eclipse**

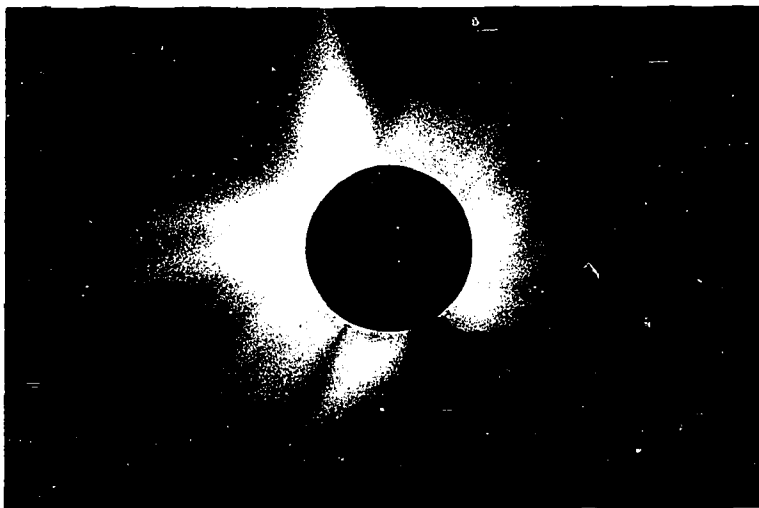

**B 1970 Eclipse**

Highlights

The photographs from the coronagraph will have much greater clarity and definition because of the absence of atmospheric scattering and attenuation. Details of the corona structure, with its tenuous streamers and filaments, will be evident through the use of the polarizing filters.



**Analysis**

When corona photographs are correlated with the H-alpha images of the solar surface (Section 2) and the ultraviolet spectrographs (Section 4), much of the mechanisms and energy characteristics of solar phenomena will be revealed. The H-alpha photos will show the location of solar surface features and the intensity of solar activity. Correspondingly, coronagraph photos will show the magnetic field activity through the polarization of the streamers of ionized materials in the corona. Spectrographs of corona streamers will identify the ions comprising the corona and the energy levels necessary to cause the ionization. These combined factors are the source of the solar wind that arrives on Earth and affects our atmosphere, weather, and environment.

**Availability**

The data from the coronagraph will not be available for public use before 1975. Procedures for requests for copies of flight data will be announced at a later date. Section 1 describes initial data uses and requirements.

**CREW ACTIVITIES**

The coronagraph will be operated for several hours daily during Skylab missions. Section 1 describes crew activities with regard to the complement of telescopes for solar observation.

**RELATED CURRICULUM TOPICS**

The concepts employed in the design and application of the coronagraph may be related to a number of subjects discussed in high school science programs including astronomy, physics, and photography.

**Astronomy**

Solar corona—energies, motion of materials, solar wind, variations with solar storms;

Eclipses—cause, frequency, regions of total eclipse.

**Physics**

Optics—diffraction, lenses, reflection, mirrors, polarization, light scattering;

Gas laws—pressure and temperatures, thermal velocity, kinetics;

**Photography**

Film—reciprocity and sensitivity, photographic resolution;

**Mathematics**

Trigonometry—angles and sizes of apparent Moon, Sun, and occulting disks.

## SUGGESTED CLASSROOM DEMONSTRATIONS

### Occulting

A demonstration of the use of occulting disks may be provided in the following manner:

- 1) Prepare a slide for 35mm or overhead projector. The slide will have a circle in its center and may have faint areas around the circle, to simulate the Sun and corona.
- 2) In a darkened room, project the slide so that a 6-inch diameter circle is shown on the screen.
- 3) Using a small disk of 5/8-inch diameter located approximately 3 feet from the eye, demonstrate that the small occulting disk will hide the illuminated circle, but still permit viewing of the areas surrounding it.
- 4) A nighttime demonstration using the full Moon may be performed. Locating the occulting disk so that the full Moon is occulted (a) measure the distance from the eye to the disk; (b) calculate the angle subtended by the disk and the eye; and (c) using the calculated angle and a distance of 250,000 miles, calculate the approximate diameter of the Moon.

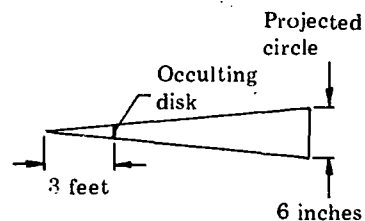

**WARNING: DO NOT ATTEMPT OCCULTING DEMONSTRATIONS USING THE SUN. EYE DAMAGE MAY RESULT.**

### Diffraction

This demonstration illustrates the diffraction of white light passing over a sharp opaque edge.

- 1) Use a laboratory grade lens to focus sunlight on a white surface. The Sun should be focused to a small circle.
- 2) Insert the edge of a knife or razor blade into the focused beam of sunlight so that some sunlight falls on the knife and some passes beyond.
- 3) Inspection of the shadow of the knife will show that the shadow is diffused and is not as sharp as the blade edge.
- 4) The diffused shadow will result from diffraction of light over the knife edge.
- 5) This demonstration may be extended to a discussion of its application in determining the quality of parabolic or spherical concave mirrors for use in telescopes. The test is known as the Foucault knife edge test.

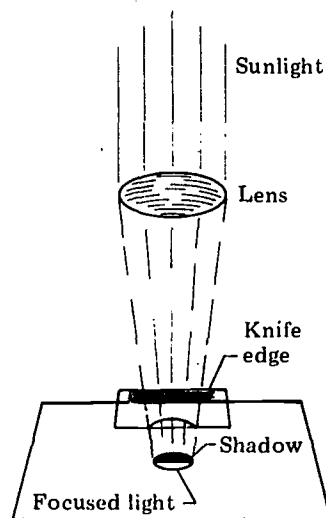

Magnetic Field  
Effects on  
Ion Trajectories

The direction in which an ion is moving will be affected by the presence of a magnetic field. The trajectory of the ion will be altered in a direction perpendicular to the magnetic field. This demonstration shows how the variations of the solar magnetic fields affect the trajectory of ions in the corona to cause the streamers and filaments that are observed. The magnetic fields act to either concentrate the ions or to disperse them, depending on the relationship between the ion motion and magnetic field orientation. A concentration of the ions produces an increase of light. A dispersion of ions reduces the light.

- 1) Obtain a neon- or argon-filled tube, similar to a neon sign tube. A suggested size would be 1/2-inch diameter x 6 inches long. A neon sign transformer is also required.
- 2) Obtain a strong bar magnet; any shape is adequate.
- 3) Connect the tube and transformer; ignite the tube.
- 4) Locate the magnet in any position along the tube; note the change in light intensity near the magnet as the ion trajectories are altered.
- 5) Alter the position and orientation of the magnet; observe that the light changes with changes in the magnetic field.

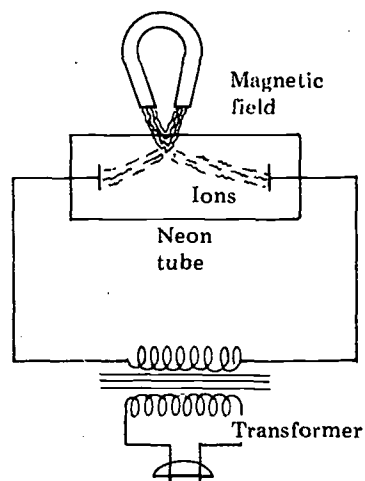

# Section 4

Extreme Ultraviolet  
Spectrograph

Extreme Ultraviolet  
Spectroheliograph

## EXPERIMENT BACKGROUND

The extreme ultraviolet spectrograph and the extreme ultraviolet spectroheliograph are designed to record photographs and spectra in a region of the solar spectrum that is not available on Earth because of atmospheric absorption.

## Basic Optics

The extreme ultraviolet spectrograph and the extreme ultraviolet spectroheliograph are similar in their basic operation; consequently, they will be considered together in their basic optical considerations. Differences in their operation are discussed separately.

White light with wavelengths between 3000 and 10,000 angstroms can be resolved into its spectrum by passing a ray through a prism. However, at wavelengths shorter than 3000 angstroms, the energy in the light ray is absorbed by the prism. Wavelengths shorter than 3000 angstroms are known as ultraviolet (UV), extreme ultraviolet (XUV), and x-ray.

In the discussion of the white light coronagraph (Section 3) the diffraction of white light passing over the edge of an opaque surface was illustrated. This concept is extended in the diffraction grating. By using an opaque plate in which a number of parallel slits are cut, diffraction of light will occur at the edge of each slit as white light is passed through the grating. It may further be shown that because of the spacing of the slits, the wavefront emerging from the grating will constructively interfere in some directions and destructively interfere in other directions as a function of wavelength. Because of the wave interference, white light passing through the grating is resolved into its spectrum. Transmission gratings are formed by ruling parallel opaque lines on glass. A transmission grating also requires a lens to focus the diffracted light to a well defined spectrum.

To circumvent the difficulty of absorption of ultraviolet and shorter wavelengths in the grating material, the grating is made reflective. Several thousand parallel lines per inch are scribed on a reflective base material. The grooves are specially shaped in a sawtooth form. Due to the shape of the grooves, energy reflected from the many facets is reflected at various angles. The shape of the groove is called the blaze. Variations of the blaze angles permit the reflective grating to be designed for greatest efficiency at specific spectral regions; thus the blaze for ultraviolet is different from the blaze for red visible light. Even with a flat reflecting grating a lens is still required to focus the diffracted light into a spectrum.

A concave spherical mirror will focus radiation falling on it to focal point. If a diffraction grating is ruled on a spherical mirror, the diffracted light will also arrive at a focal point.

Extreme ultraviolet is generally considered to be the region of the electromagnetic spectrum between 150 and 700 angstroms.

**Spectrograph**—A system for resolving electromagnetic energy into its component wavelengths.

**Spectroheliograph**—A picture of the Sun in a particular wavelength of the spectrum or a device for producing spectroheliograph

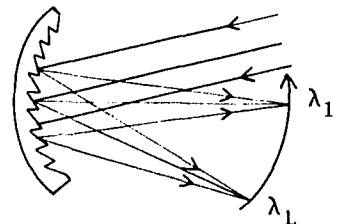
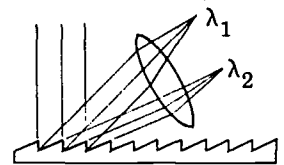
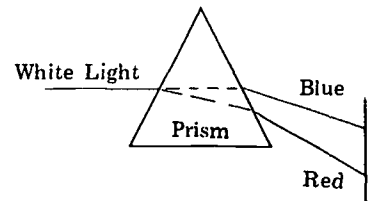

However, the focal point for each wavelength is different because of the blaze of the grating. The spherical concave grating produced eliminates the requirement for a focusing lens.

**Experience**

Spectrographs have been in use in astronomy for many years. They are commonly used to analyze the visible light from the Sun and stars. Most of our current knowledge of the composition of heavenly bodies has been derived from spectrographic analysis of their light. However, radiations at shorter wavelengths than visible light are absorbed in Earth's atmosphere and are not available to ground based telescopes.

The solar chromosphere and lower corona are much hotter than the surface of the photosphere, which is characterized by the white light it emits. To observe these hotter regions of the solar atmosphere, one must observe in the ultraviolet or even x-ray spectral regions. Because these radiations are absorbed in Earth's atmosphere, spacecraft or satellites are necessary to transport the instruments away from Earth, to the regions of space where this radiation is available.

Short term observations in these spectral regions have been performed from balloons and sounding rockets and orbiting solar observatory (OSO) satellites. However, these data are limited to small spectral sections.

Figure 1 shows the various layers of Earth's atmosphere and the types of solar radiation that are absorbed in the respective layers.

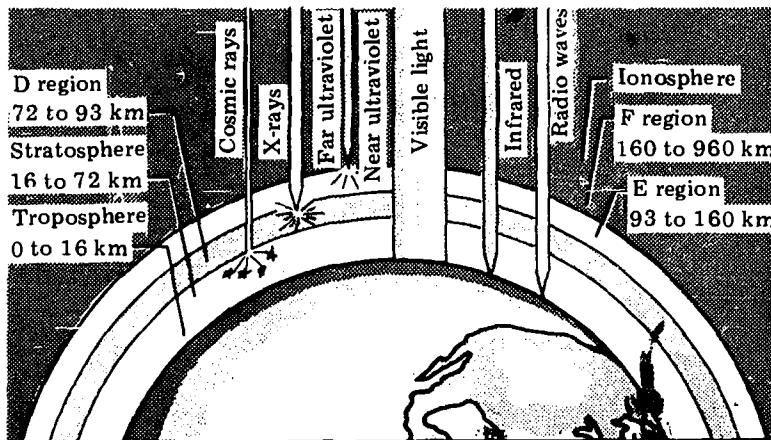

With acknowledgement to the National Geographic Society

Figure 1 Atmospheric Absorption of Radiation

**DEFINITION OF SCIENTIFIC OBJECTIVES**

**Spectrograph**

The extreme ultraviolet spectrograph will obtain ~~obtained~~ line spectra of small selected areas of the Sun and across the limbs in two wavelength bands: 970 to 1970 angstroms or 1970 to 3940 angstroms.

Spectro-  
heliograph

The extreme ultraviolet spectroheliograph will photograph the solar chromosphere in extreme ultraviolet wavelengths between 150 and 625 angstroms.

Because the extreme ultraviolet region of the spectra does not penetrate Earth's atmosphere, observations have been quite limited in this region. Data obtained by these Skylab telescopes will provide information on the material composition of the chromosphere and the energy characteristics of the Sun. These pieces of the solar puzzle, in turn, will provide clues to the mechanisms by which solar flares occur.

DESCRIPTION OF EXPERIMENT HARDWARE

Spectrograph

In a spectrograph, light is admitted to the diffraction grating through a narrow entrance slit. The entrance slit of the extreme ultraviolet spectrograph is 10 microns wide and 300 microns long (0.0004 in. wide x 0.012 in. high).

Micron = 0.000001 meter  
= 0.00004 inches

The light admitted to the grating is an image of the slit. The diffraction grating then reflects the diffracted image to the film plane. Since the diffraction grating is a spherical reflector, the diffracted slit image is focused at the film plane.

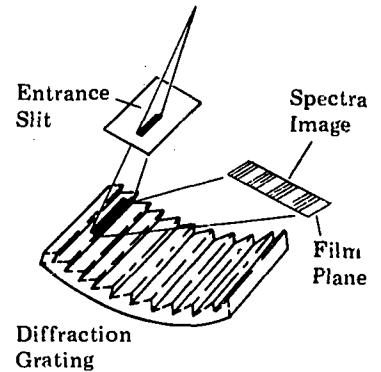

Optical Path

Figure 2 depicts the complete optical system of the extreme ultraviolet spectrograph. Light enters the spectrograph through an aperture and falls on the primary spherical mirror.

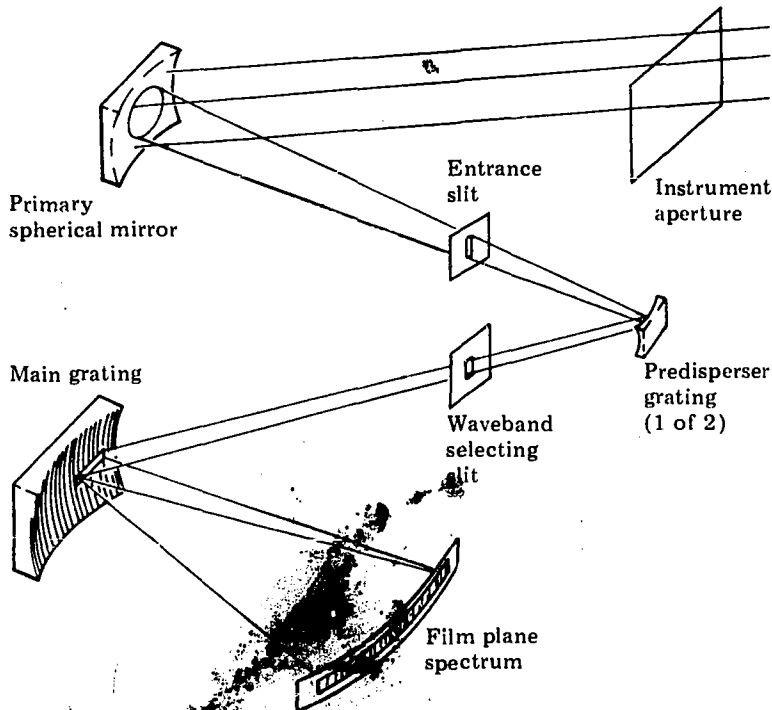
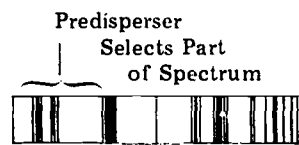

Figure 2. Optical system of the Extreme Ultraviolet Spectrograph

BEST COPY AVAILABLE

The primary mirror focuses the full image of the Sun (approximately 10 millimeters diameter) on the spectrograph entrance slit. Because of the small size of the slit, only a small section of the solar image is passed through. The section passed by the slit corresponds roughly to 1000 miles wide x 30,000 miles long of the solar surface. This segment of sunlight is passed on to a predisperser grating.

If only one diffraction grating were used in the spectrograph, the entire solar spectrum would be focused at the film plane, with the result that the spectrum would be very crowded and details could not be detected or resolved. However, by using a predisperser grating and waveband selecting slit, the crowding of the desired spectrum is eliminated. The predisperser diffracts the entire solar spectrum and the waveband selecting slit is located so that only the desired section of the predispersed spectrum is passed to the main grating. Two different predisperser gratings are used which have a different blaze and number of lines. Thus, either of two sections of the solar spectrum may be sent to the main grating. One predisperser grating is ruled with 150 grooves per millimeter and resolves the spectrum from 1940 to 3940 angstroms. The other is ruled with 300 grooves per millimeter and resolves from 970 to 1970 angstroms.



Predisperser—A means of selecting small sections of a spectrum for further diffraction.

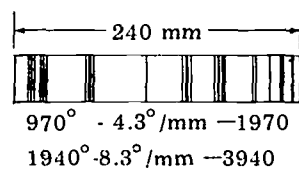

The waveband selecting slit passes the predispersed portion of the spectrum to the main grating. The main grating diffracts the predispersed spectrum and focuses it on the film plane. The final spectral images are diffracted over 240 millimeters length on the film. For the long wavelength spectrum this yields a scale of 8.3 angstroms per millimeter; the short wavelength spectrum has a scale of 4.2 angstroms per millimeter.

The resulting spectrum is a band of irregularly spaced lines and bands spread out over the 240 mm of film. Each line indicates a unique state of ionization of a particular kind of atom. In the visible spectrum ionized sodium vapor radiates two distinct lines about 6000 angstroms. Mercury vapor radiates 10 different wavelengths depending on the energy state of the mercury atom. In the discussion of H-alpha in relation to H-alpha telescopes, it was noted that hydrogen emits radiation peculiar to the particular energy level to which it was excited. Every element when energized to particular states emits a unique radiation. Thus, when the spectrum is analyzed, the constituent atomic emissions which comprise the spectrum become evident.

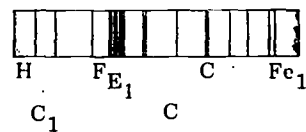

Typical spectrum

Spectro-heliograph

The extreme ultraviolet spectroheliograph photographically records images of the solar chromosphere in the various spectral lines throughout the spectrum from 150 to 625 angstroms. Figure 3 depicts the optical system of the spectroheliograph.



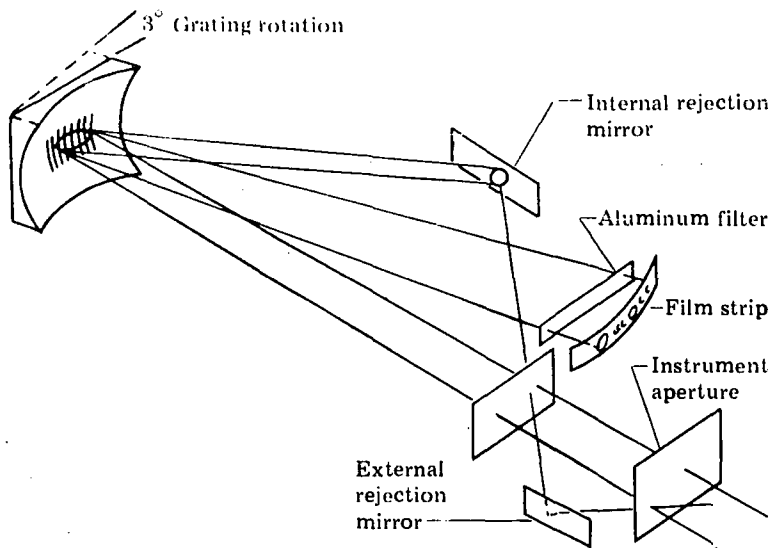

Figure 3 Optical System of the Spectroheliograph

In this instrument the entrance slit of the spectrograph is deleted to permit the spherical concave diffraction grating to view the entire Sun. The grating diffracts the full solar image into its spectral components. However, as a spherical mirror it also focuses the diffracted images onto the film strip. The resulting photograph is a series of pictures of the solar chromosphere. Where the spectrum is continuous the solar images run together and are blurred. Where a distinct radiation line occurs in the spectrum, a distinct picture of the Sun is recorded in the light of that particular radiation. The appearance of the diffracted solar images on the film is shown in Figure 4.

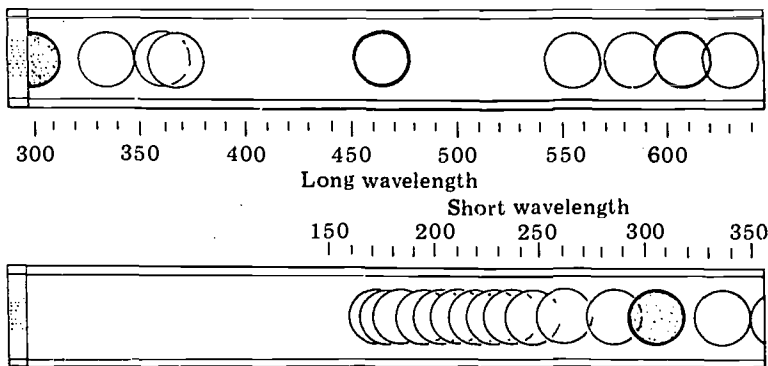

Figure 4 Diffracted Solar Images

Since the full image of the Sun falls on the grating, the fully diffracted spectrum is wider than the length of the film strip. To accommodate the desired spectrum width on the film strip, the diffraction grating is rotated through an angle of 3 degrees. This rotation focuses either the short wavelength, 150 to 350 angstroms, or long wavelength, 300 to 650 angstroms, bands on the film strip.

In addition to the desired portions of the solar spectrum, the white light spectrum also falls on the grating and is diffracted. This portion of the spectrum could cause unwanted heating of the instrument. For this reason a mirror is located in a position to intercept the diffracted visible spectrum and reflect it back to the entrance aperture and out of the instrument.

#### Cameras

The cameras of the spectrograph and the spectroheliograph are similar in design, each camera containing 200 film strips. The film strips are 258 millimeters long and 35 millimeters wide and are mounted in holders. A film changing mechanism, removes one holder at a time to locate the film in the image plane. After exposure the mechanism places the holder in the exposed stack and places a new one in the film plane.

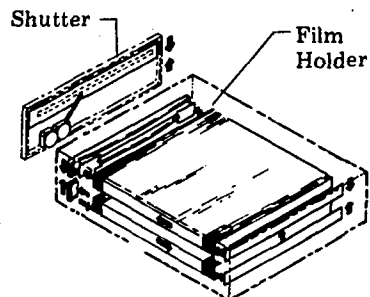

The shutter of the camera is a rectangular blade which is moved down by sliding in guides to uncover the camera aperture. After exposure the shutter slides upward to cover the aperture.

Because the spectroheliograph may have a considerable amount of scattered white light in the film plane, a 1000 angstrom thick aluminum foil filter is placed over the camera aperture. The aluminum filter rejects long wavelengths but transmits wavelengths of 150 to 625 angstroms.

#### EXPERIMENT DATA

#### Type

The data from the extreme ultraviolet spectrograph and the extreme ultraviolet spectroheliograph are recorded on 35-mm film strips in the form of a strip of varying intensity having numerous dark or light lines across it. The appearance of the spectrograph is illustrated in Figure 5.

#### Highlights

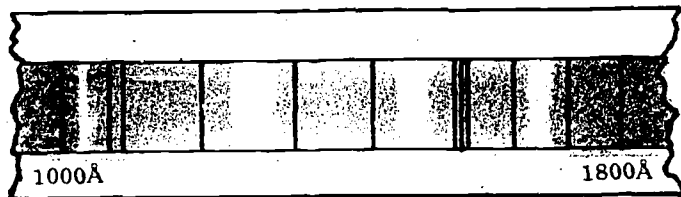
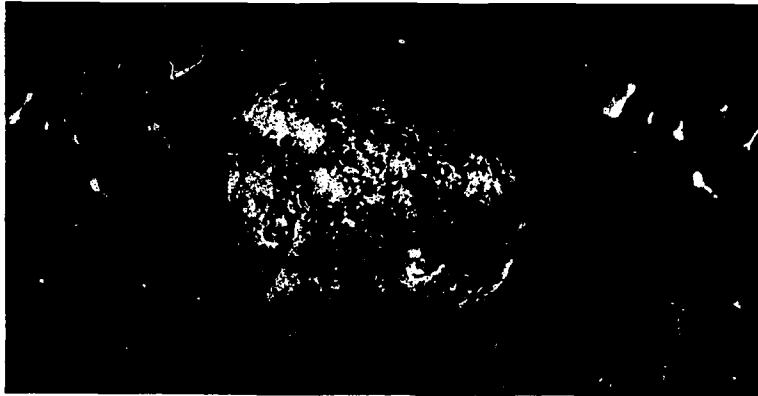

Figure 5 Spectrograph Data

A bright line in the spectrograph indicates that a particular chemical element is radiating at that wavelength. A dark line indicates that the solar atmosphere is absorbing radiation at that wavelength.

The format of the data of the extreme ultraviolet spectroheliograph is shown in Figure 4. On September 22, 1968 a spectroheliograph was flown on a high altitude rocket to obtain Figure 6. This is a photograph of the Sun in the

wavelength of ionized helium (304 angstroms). Note that images of the Sun are present also at wavelengths of iron (Fe XV and Fe XVI) 284 and 335 angstroms. The light of Fe XV is strong enough to slightly overlap the helium image. Note that the recorded Fe XV and Fe XVI emissions occur in the same area of the solar disc as the high energy He II emissions.



**Figure 6 Spectroheliograph Data (from High Altitude Rocket Flight 9-22-68)**

**Analysis**

These spectrograph and spectroheliograph data will identify the constituents of the solar atmosphere and show the relative abundance and energy state of each constituent.

When these data are correlated with data from H-alpha (Section 2) and x-ray (Sections 6, 7, 8) data, information on the complete energetic state of the Sun will be obtained.

**Availability**

The return of data, data analysis procedures, and availability of data for public use is discussed in Section 1.

**CREW ACTIVITY**

The astronauts will select spectral ranges to be used in the respective instruments and will also control the pointing of the instrument to select the most advantageous subject for observation at a given time.

General crew activities are discussed in Section 1.

**RELATED CURRICULUM TOPICS**

The identification of chemical compounds by the application of spectrography is employed in many industries. The extreme ultraviolet spectrograph and spectroheliograph are applications of similar instruments in solar research. Related curriculum topics on spectrography are listed.

**Astronomy—**

- 1) Chromosphere—material constituents of the solar atmosphere;

- 2) Energy considerations of identified constituents.

#### Physics—

- 1) Optics—diffraction gratings.

#### Chemistry—

- 1) Ionization states and energy levels of chemical elements.

### SUGGESTED CLASSROOM DEMONSTRATION

This demonstration will show how chemical identification is accomplished through spectrography. It will also show that spectral components of the Sun may be identified by comparison with spectra from known chemicals.

Materials for this demonstration are—

- 1) Concave diffraction grating blazed for visible light;
- 2) Lens—laboratory type;
- 3) Spectrograph entrance slit (2-in. square aluminum plate with a slit 0.5 mm x 10 mm);
- 4) Laboratory Bunsen burner;
- 5) Holder to burn chemicals in Bunsen burner flame;
- 6) Small quantities of table salt, sugar, soda bicarbonate, and powdered pencil lead;
- 7) White cardboard, 18x6 in., for spectrum plane.

#### Procedure

- 1) From the radius of curvature of the grating, draw on a large flat surface, the Rowland circle, the radius of which is  $R = \frac{1}{2} r$  where  $r$  is radius of curvature of the grating.
- 2) Locate the diffraction grating, entrance slit, and spectral plane about the Rowland Circle as shown in Figure 7. The angle,  $\theta$ , should be between 20 and 40 degrees.
- 3) Use the lens to focus a beam of sunlight onto the entrance slit, and observe the resulting solar spectrum in the spectral plane; especially note the location of bright lines and dark bands in the spectrum.
- 4) Replace the beam of sunlight, with light from the Bunsen burner and focus the flame on the entrance slit. Note the

Suggested sources—  
Concave Diffraction Grating:

Bausch & Lomb  
Analytical Systems Division  
820 Linden Avenue  
Rochester, New York 14625

Catalog NR 35-52-11-040.

differences between the solar spectrum and the flame spectrum. What differences now are evident in the bright lines?

- 5) Burn a sample of each of the material specimens in the flame of the burner. For each of the chemical compositions analyzed, make a note of locations of bright lines in the spectrum, for example, the sodium in salt will exhibit two bright closely spaced yellow lines. Sugar will exhibit bright lines characteristic of carbon and hydrogen.
- 6) Compare the spectra obtained from the samples with the spectra from the flame and sunlight. What lines in the sunlight and flame can be identified with lines from the samples? Make a list of the elements which can be identified in sunlight.
- 7) Remove the entrance slit and position the Bunsen burner and lens so that an image of the flame is formed on the grating.
- 8) Observe the diffracted spectra in the spectral plane. In what colors are images of the flame seen?
- 9) Burn some of each of the sample materials in the flame. Note the location of each of the bright images in the spectrum. What differences are apparent between images in green light and red light? What do the differences indicate?

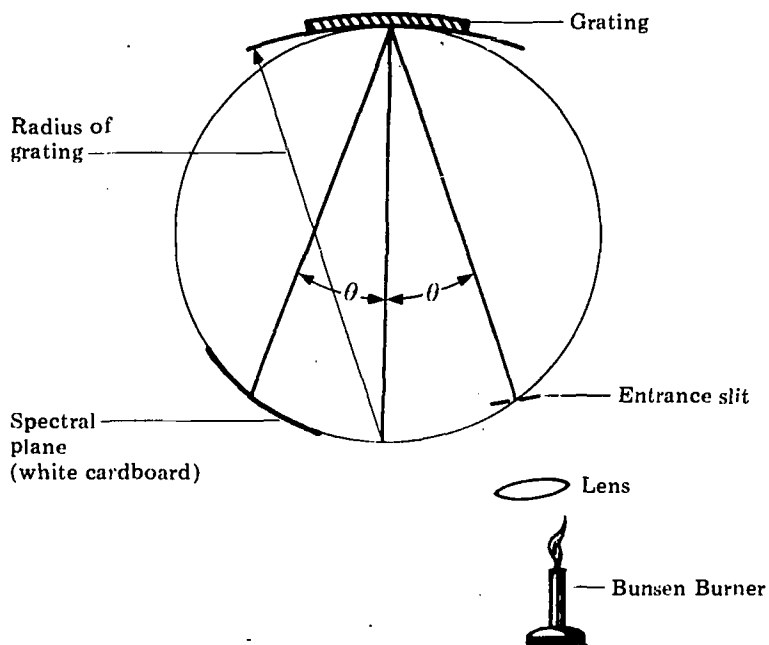

Figure 7 Experiment Layout

# Section 5

## Ultraviolet Scanning Polychromator- Spectroheliometer

## EXPERIMENT BACKGROUND

Physics

The optical concepts of the ultraviolet scanning polychromator-spectroheliometer are similar to the extreme ultraviolet spectrograph discussed in Section 4. A concave spherical mirror is used to focus the solar image on an entrance slit that passes a segment of the image to a concave diffraction grating in order to resolve a spectrum of the Sun. However, this instrument employs a system of moving either the mirror or the diffraction grating to effect scanning of the solar image, and electronic measurement of spectral radiance intensity instead of photographic records.

**Spectroheliometer**—An instrument to measure the intensity of spectral wavelengths of the solar spectrum

**Polychromator**—A device to produce colors from a single light source; similar to a spectrograph

History

Similar experiments have been flown successfully on the orbiting solar observatory (OSO) family of spacecraft. However, these instruments have only afforded a field of view corresponding to the full solar disc. The instrument in the Skylab solar observatory has a somewhat longer focal length which will permit detailed analysis of smaller segments of the solar surfaces. Spectral details of solar phenomena such as sunspots, flares, and plages will be available.

## DEFINITION OF SCIENTIFIC OBJECTIVES

The ultraviolet spectroheliometer will obtain data from the solar atmosphere in the spectral region of 300 to 1350 angstroms. Small segments of the solar surface having active phenomena will be analyzed at discrete spectral intervals within the overall range of the instrument.

One operating mode of the spectroheliometer will provide spectral analysis, at seven different wavelengths, of a square area of the solar surface subtended by an angle of 5 seconds at Skylab (about 6000 kilometers on the Sun's surface). The alternative operating mode of the spectroheliometer will provide a spectrograph from 300 to 1350 angstroms of a single selected point within the above square area.

These two operating modes will permit individual detailed analysis of spectral energies of sunspots, plages, filaments, and spicules.

## DESCRIPTION OF EXPERIMENT HARDWARE

The ultraviolet scanning polychromator-spectroheliometer has the basic form of a spectrograph; however, the spherical mirror and the diffraction grating are both mounted in a movable fashion, to permit raster scanning of the solar surface.

The spectroheliograph operates in either of two modes. These are the mirror scan mode and the grating scan mode. Mirror scan is used to scan an area of the solar surface; grating scan is used for detailed analyses of a selected line of the mirror scan.

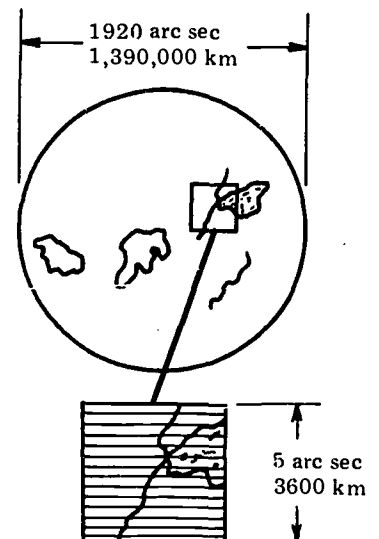

Scanning  
Modes

**Mirror Scan**—The optical system of the ultraviolet scanning polychromator-spectroheliometer is depicted in the illustration. The primary mirror is mounted in a 2-axis gimbal which permits the mirror to be driven or positioned to view any point in a given area. To scan in a raster fashion, the mirror is rotated about the horizontal axis to scan one line of the raster. It is then returned to its original position and rotated about the vertical axis which positions the mirror to scan the next line. The mirror then rotates again on the horizontal axis to scan a second line. This process is repeated 60 times to create a 60-line raster image of the scanned area.

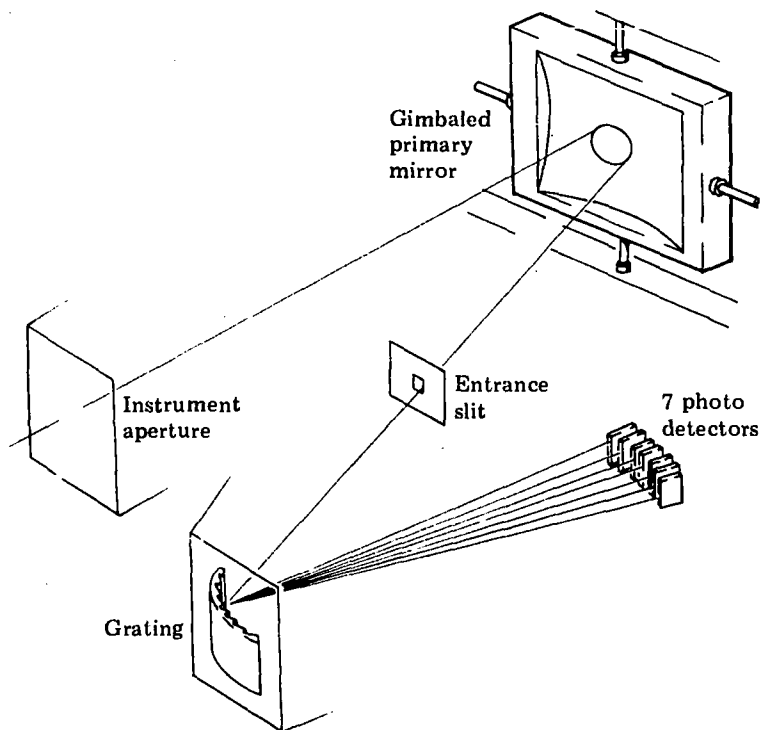

**Optical Scheme of Ultraviolet Scanning Polychromator—Spectroheliometer**

**Image Movement**

The image of the Sun formed by the spherical mirror is focused on the entrance slit of the diffraction grating. However, the image on the entrance slit moves in accordance with the movement of the mirror. Thus, the light admitted to the grating by the slit changes as the image on the slit moves, reflecting variations in the characteristics of the light emitted along a specific traverse of the Sun's disc.

**Diffraction Grating**

The diffraction grating is a concave grating with 1800 lines per millimeter, i.e., it is blazed to resolve the spectrum from 300 to 1350 angstroms. The diffracted spectrum is focused on an array of seven photodetectors that generate an electric signal in proportion to the intensity of radiation falling on them. The seven photodetectors are located at the following wavelength positions of the projected spectrum representing the following emissions:



	<u>Angstroms</u>	
1	1335	Carbon II
2	1219	Lyman Alpha
3	1031	Oxygen VI
4	977	Carbon III
5	912	Lyman Continuum
6	625	Magnesium X
7	554	Oxygen IV

As the spectrum changes with mirror movement, each of the photodetectors will generate a signal proportional to the variations of intensity of solar emission at its assigned spectral wavelength. The signals from the photodetectors are recorded on a tape recorder and later transmitted to Earth by the Skylab telemetry system.

Telemetry—A system for transmitting data by radio

**Grating Scan Mode**—A detailed examination of any selected line of the mirror raster scan may be performed when desired. To accomplish this mode, the spherical mirror is positioned and stopped to focus the particular point of the solar image on the entrance slit. The diffraction grating is then driven back and forth in a horizontal direction, which causes the diffracted spectrum to sweep over the photodetectors. In this mode, only the third photodetector is used and the others are turned off. Since the diffracted spectrum is being swept across this detector, its output now represents the intensity of all wavelengths of the spectrum and is a detailed spectral analysis of a unique solar area.

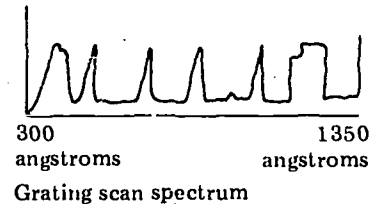

## DATA

Type  
Mirror  
Scan Data

The data from the mirror scan mode are composed of seven channels of digital data and recorded on magnetic tape. The tape will be analyzed by computer. The computer output may be in a tabular form or it may be graphic, in which case raster scans will be reconstructed to produce maps of spectral radiation in the square area scanned, for each of the seven wavelengths.

Grating  
Scan Data

The data from the grating scan mode are provided by one channel of recorded digital presentation of the output of one photodetector, and represents the spectrum, between 300 and 1340 angstroms of a single point in the raster scanned area. Computer output of this data may be in tabular or graphic form.

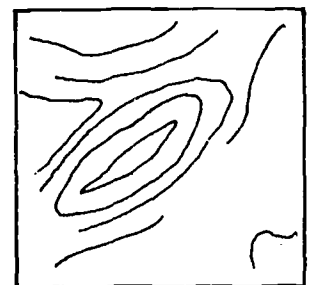

Reconstructed  
ultraviolet-scanning  
image

- Highlights** The resolution provided by the ultraviolet spectroheliograph will permit evaluation of individual parts of solar phenomena and provide information with regard to energy variations within parts of a solar event.
- Availability** The basic raw data require computer analysis to be useful. Reproduced computer outputs will not be available until 1975. (Section 1 describes data distribution and use.) Procedures for requesting copies of reduced data will be announced at a later date.

### **CREW ACTIVITIES**

The astronaut will determine the area to be observed and perform instrument pointing, and selection of the scanning mode to be used.

Other crew activities are described in Section 1.

### **RELATED CURRICULUM ASPECTS**

The ultraviolet spectroheliometer applications and design have relevance to several aspects of a science curriculum. Related subjects for study are—

#### **Astronomy**

Spectra, energy, and temperatures in the chromosphere.

#### **Physics**

Concave and convex mirrors; light meters and luminance.

#### **Electronics**

Photodetectors  
Analog-to-digital conversion  
Telemetry

### **SUGGESTED CLASSROOM DEMONSTRATION**

The application of photodetectors and electronics to analyze optical data is shown in this demonstration. The materials which were required for the spectrograph demonstration in Section 4 are also used for this demonstration. Additional materials required are tabulated.

#### **Suggested Source:**

Allied Radio Corp  
2400 W. Washington Blvd  
Chicago, Illinois 60612

- 1) Photodetectors and associated circuitry;
- 2) Vacuum tube type sensitive voltmeter.

**NOTE:** Numerous combinations of photodetectors, circuits, and meters are possible. No recommendation for specific parts is given.

Procedure

Set up the spectrograph as described in Section 4.

- 1) Cut a 3mm (1/8 in.) wide slit in the white cardboard spectral plane. The length of the slit should be as long as the spectrum obtained in the demonstration in Section 4. The slit should be positioned so that the sunlight spectrum appears above and below the slit.
- 2) Move a photodetector along the spectrum and record the average meter reading for each color.
- 3) Position the photodetector at each bright line in the spectrum and record the meter reading on each line. NOTE: Meter readings will indicate relative intensities only, not luminance values.
- 4) Burn some of each of the materials suggested in Section 4 and record the color and meter reading for each bright line for each material, respectively.
- 5) Compare the relative meter readings from the spectral lines with the meter readings of the spectral lines of sunlight. What do the differences in the readings mean?
- 6) Using only the Bunsen burner flame, position the photodetector on a bright spectral line in the flame spectrum. Slowly slide the Bunsen burner about so that the flame is scanned from side to side by the entrance slit. Record the meter reading for several positions of the flame. How do the meter readings compare with the flame position? How might this compare with spectral lines in a sunspot?

# Section 6

## X-Ray Spectrographic Camera

### EXPERIMENT BACKGROUND

The ability of x-rays to penetrate or be absorbed in solid materials is well known. Thus it will be appreciated that x-rays cannot be reflected in the normal fashion from a mirror; x-rays can only be reflected at grazing incidence, which means that the energy is traveling on a path that is less than 10 degrees from the plane of the mirror. The energy grazes the reflecting surface.

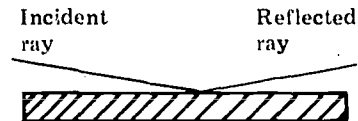

The first section of the optical imaging section, shown in the illustration, is a cylinder in which the inner wall is shaped to form a paraboloid of revolution. The second section is similarly formed from the figure of revolution of a hyperboloid. Radiation that arrives at the telescope and impinges on the paraboloid section is reflected at grazing incidence to the hyperboloid section. It is again reflected from this section to the image plane. Because of the curvature of the walls of the sections, it may be shown that radiation impinging at any place in the paraboloidal section will be brought to focus at the image plane.

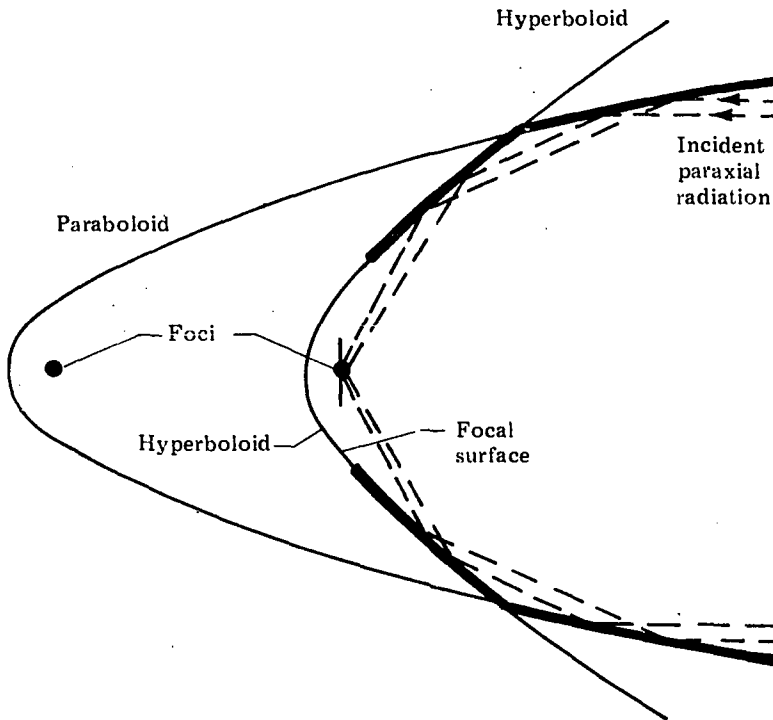

Grazing Incidence Telescope Geometry

Since the reflective surface of the telescope optic system is on the inner wall of a tube, the central area of the aperture is not used; rather, the true aperture is a narrow ring or annulus. Consequently the central area is stopped off for heat and light rejection, or it may be used for other purposes.

Entrance Aperture

**Transmission  
Gratings**

The use of reflecting diffraction gratings has been discussed for other instruments earlier in this volume. It will be readily appreciated, that a reflection grating cannot be used for x-rays because x-rays would either pass through the grating or be absorbed by it. If, on the other hand, a grating is ruled on a thin membrane which is transparent to x-rays but possibly opaque to visible light, diffraction will still occur but the energy will be transmitted through the grating.

**Experiment  
History**

X-ray images of the Sun have been obtained from telescopes flown in sounding rockets. However, the field of view of these images has been the full solar disk and the resolution has been limited. Long focal length telescopes to obtain detailed x-ray images have not been possible. The data that are available, such as the x-ray photograph, indicates that x-ray radiation results from solar activity such as sunspots, flares, plages, prominences, and from the corona.

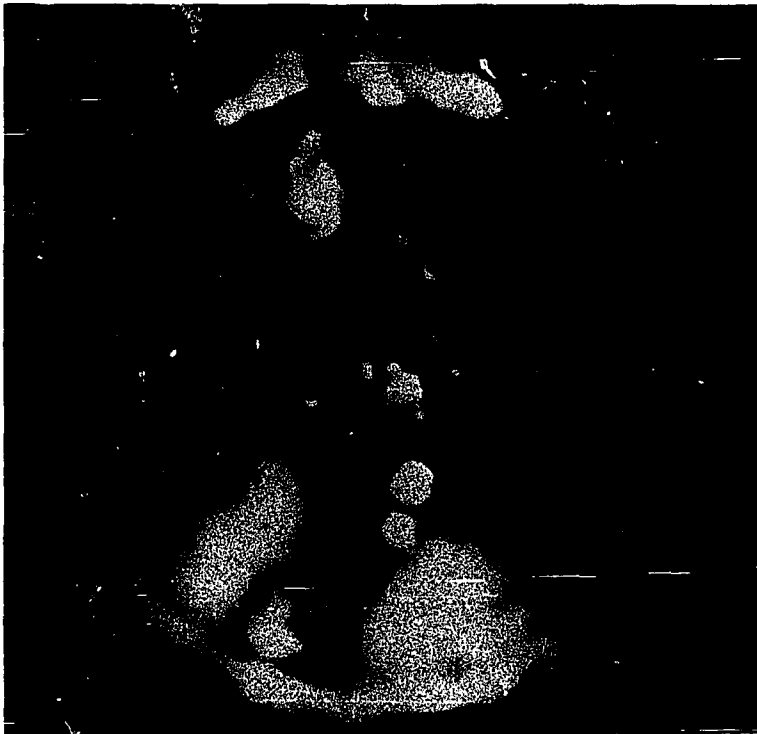

**The Sun, Viewed Only as a Source of X-Rays**

**SCIENTIFIC OBJECTIVES**

The study of x-ray radiation from the corona and various solar active regions will increase our understanding of the structure of the corona and the processes that cause solar flares. By photographing the Sun at intervals of small angles of rotation, it is expected that effective stereo pair photographs will be obtained to permit three-dimensional analysis of solar x-ray activity. This data will be correlated with the ultraviolet spectra so that further understanding of thermonuclear energy mechanisms can be derived.

## EQUIPMENT

The x-ray spectrographic camera photographs x-ray images of the Sun in the spectral region from 3 to 60 angstroms. The illustration shows the experiment configuration and will be used to describe salient features.

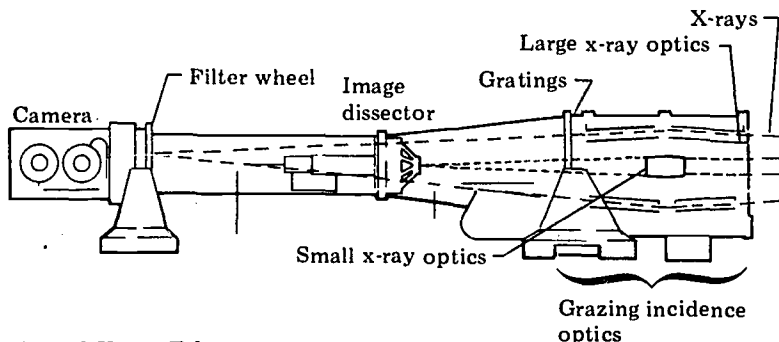

Plan of X-ray Telescope

The grazing incidence optics section of the x-ray spectrographic camera consists of two concentric grazing incidence mirrors. The outer mirror has a diameter of 34.5 cm (12 in.); the inner mirror a 22.9 cm (9 in.) diameter. Both mirrors have a focal length of 233.4 cm (84 in.). This nested configuration provides an increased mirror aperture for collecting x-ray energy.

As noted in the basic physics discussion, the central area of the grazing incidence optics is not effective for x-ray imaging and may be stopped off. This central section is used for a second 7.6 cm (3 in.) diameter grazing incidence mirror. This mirror, used for x-ray alarm and astronaut TV display, will be discussed later. The central core also permits the inclusion of a visible light telescope for data reference purposes.

### Transmission Grating

Directly behind the grazing incidence optics, there is a transmission grating that serves two functions: (1) it diffracts x-ray energy to produce x-ray spectroheliograms; (2) it functions as an iris to control the amount of x-ray energy at the camera. The grating may be moved out of the optical path when desired.

### Filters

A six-position filter is used to select the exact spectral region to be photographed. The various materials, thicknesses, and filter responses are listed:

<u>Filter Material</u>	<u>Transmitted Wavelengths (angstrom)</u>
0.013 mm (0.0005 in.) beryllium	3 to 18
0.003 mm (0.000125 in.) Teflon	3 to 14, 18 to 30
Blank (i.e., no filter)	3 to long wavelength optic limit
0.0057 mm (0.00023 in.) Parylene	3 to 18, 44 to 70
0.05 mm (0.002 in.) beryllium	3 to 11
0.025 mm (0.001 in.) beryllium	3 to 14

A 3-angstrom short wavelength is the response limit of the grazing incidence optic system.

Camera

The telescope is equipped with a camera that uses 70-mm, Panatomic-X aerial film. The film magazine has a capacity of 7200 photo frames. Exposure time of the camera is variable from 1/64 to 256 seconds. Data recorded on the photographs are: the x-ray image, visible light image, fiducial marks, and time. The camera x-ray aperture is a window of 0.0003 cm aluminized polypropylene. This window prevents any radiation (ultraviolet and visible) from entering the camera.

Fiducial marks—marks placed on film images to define scale factors.

As discussed earlier, a 7.62 cm (3 in.) diameter grazing incidence mirror is located in the center of the main system. This small mirror has a 81.3 cm (32 in.) focal length. At its focal plane the x-ray image is focused on a 0.45 cm (3/8 in.) thick crystal of sodium iodide. This crystal scintillates in the presence of x-rays; that is to say, it produces visible light in the image of the x-rays. This scintillating crystal is in direct contact with the photocathode of an image dissector which is one form of a TV camera tube. This system provides an x-ray image of the Sun, which is displayed on the astronaut's control and display panel, and serves as an x-ray viewfinder for the astronaut. It is used as an x-ray flare alarm when the control and display panel is unattended.

A visible light telescope is mounted in the central section of the main grazing incidence optics. The visible light image is transmitted through a very dense neutral density (no color) filter. The filter reduces the visible light to a level suitable for photography in the camera.

## EXPERIMENT DATA

Type

Experiment data are provided in two forms—television and photographs. The television circuits are used primarily for astronaut monitoring purposes; photographic data are returned to Earth following the mission.

Highlights

The x-ray spectrographic camera will provide low resolution spectra that will measure the intensity of emission of x-ray lines from elements such as iron, silicon, oxygen, and magnesium. The time-related development of the line intensities during a solar flare is of importance in determining the mechanism responsible for initiating a solar flare.

Analysis

The density of the spectral line images will be measured to determine the intensity of the radiation emitted by each element. This information will be correlated with other data taken in ultraviolet and visible light. The data will be analyzed to determine the time-related development of the temperatures and densities of the region of the solar atmosphere emitting the radiation, and their relation to the solar magnetic field.



The quiescent corona will be studied to determine the mechanism of coronal heating. Such problems as the location of the energy transfer across the chromosphere-corona interface, the influence of the magnetic field on coronal heating, and the geometrical structure of the chromosphere-corona interface will be investigated.

**Availability**

Data from the x-ray spectrographic camera will not be available for public use before 1975. Procedures for requesting copies of flight data will be announced at a later date. Section 1 describes planned data uses and requirements.

**CREW ACTIVITIES**

The astronaut will use the TV display from the x-ray spectrographic camera to locate the regions on the solar disk that are emitting x-rays. He will decide what x-ray and other wavelength observations are required in the area. The TV display will then be used to point the other Apollo telescope mount instruments to the proper area.

Other related crew activities are discussed in Section 1.

**RELATED CURRICULUM TOPICS**

Several topics of a science curriculum are related to the study of solar x-rays and equipment.

**Astronomy**

Energy levels of sunspots, filaments and plages, and flares of the chromosphere.

**Physics**

Energy levels associated with ions that exhibit x-rays

Ionization states of elements to produce x-rays.

**Mathematics**

Foci of paraboloid and hyperboloid functions.

**RELATED CLASSROOM DEMONSTRATION**

**X-ray Filters**

X-ray telescopes are equipped with various materials that act as spectral filters for x-rays. This demonstration will compare the x-ray filtering qualities of these materials and thicknesses.

Materials required for this demonstration are—

A - Polyethylene film - 6x10 in.

B - Aluminum Foil - 6x10 in.

- C - 0.001 in. thick steel - 6x10 in.
- D - Copper foil - 6x10 in.
- E - Balsa wood - 10x12 in.
- F - X-ray film - 10x12 in. (4 required)

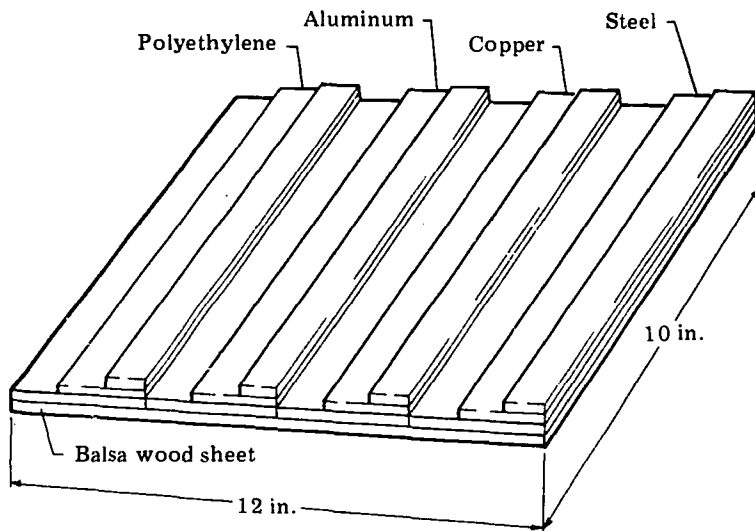

**Procedure**

- 1) Cut a 3x10 in. strip from materials A, B, C, and D;
- 2) Cut 2x10 in. and 1x10 in. strips from the respective materials;
- 3) Assemble the various strips of material on the balsa wood sheet as shown in the illustration. Drops of household epoxy cement at the ends of the strips will bond the assembly;
- 4) Arrange with a local hospital or clinic to x-ray the assembly on a sheet of x-ray film. Use four different exposure times (It is advisable to discuss plans with the hospital administration early in the project.);
- 5) Compare the x-ray absorption properties of the materials for the different thicknesses and exposure times.

# Section 7

## X-Ray Ultraviolet Solar Photography

## EXPERIMENT DESCRIPTION

### Physics

The x-ray/ultraviolet solar photography experiment will photographically record the x-ray and extreme ultraviolet solar spectra between 10 and 200 angstroms.

A diffraction grating is suitable for resolving very short wavelength spectra such as extreme ultraviolet and x-ray; however, to avoid penetration of the grating by x-rays, it must be used in a grazing incidence configuration. In this configuration, the radiation impinges on the grating at an angle of incidence less than 10 degrees from the plane of the grating. Grazing incidence also provides greater dispersion and thus better resolution of the short wavelengths.

Consideration of the optical geometry of a concave spherical diffraction grating shows that optimum performance is obtained when the grating, the spectrograph slit, and the film plane or spectrum surface are all on the circumference of a circle, known as the Rowland Circle, which has the same diameter as the radius of curvature of the diffraction grating. The Rowland Circle is also tangent to the face of the grating. The illustration shows the optical schematic of the grazing incidence spectrograph.

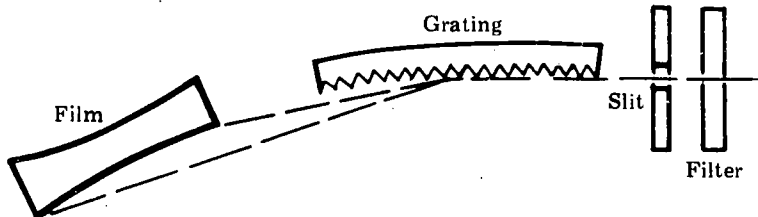
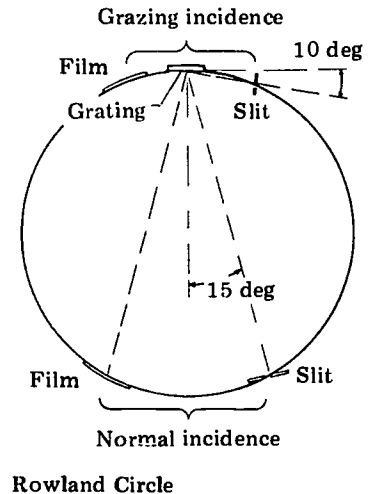

Optical Scheme of Extreme Ultraviolet Spectrograph

### History

Solar spectra in the region of 10 to 200 angstroms have been obtained from many sounding rocket and balloon flights. These data have provided valuable information with regard to basic solar composition and energy levels. When solar flares and phenomena occur, the composition of the flare is characterized by a change in the predominance of certain types of ions and by the attendant emission energy levels.

## DEFINITION OF SCIENTIFIC OBJECTIVES

The objective of the x-ray/UV solar photography experiment is to photograph the extreme ultraviolet and x-ray spectra of quiet and active Sun conditions in the wavelength region ranging from 10 to 200 angstroms.

Spectra of the full disc will be obtained during periods of minimal solar activity (quiet Sun). Spectral data of a solar flare will be obtained by centering the experiment on that region of the disc. The x-ray and extreme ultraviolet

radiation originates in normally quiet regions and increases rapidly in intensity above active regions. The radiation consists of emission lines of highly ionized ions produced by a combination of thermal and nonthermal processes.

The development of active regions and flares on the solar disc results in a large increase in the total x-ray and extreme ultraviolet emission. In general, the increase in radiation is greater for the shorter wavelengths; the emission levels may increase by a factor of 10 for the flux below 10 angstroms. X-ray bursts are thought to be produced by nonthermal and quasithermal processes associated with flares. These bursts significantly contribute to the overall x-ray flux from an active region.

The x-ray and extreme ultraviolet data acquired by this experiment will contribute to understanding of the characteristics of the solar atmosphere and its distortion by active regions and flares. The data will expand knowledge of the solar spectrum, contribute to solar flare prediction studies, and aid in predicting the quality of radio communications at various frequencies during solar storms.

## DESCRIPTION OF EQUIPMENT

The experiment equipment consists of two sections, the spectrograph and a boresighted viewfinder. The spectrograph resolves the solar spectrum between 10 and 200 angstroms. The boresighted viewfinder enables the astronaut to center the entrance slit of the spectrograph on a given area of the Sun.

The elements of the spectrograph are filters, entrance slit, diffraction grating, and film magazine.

The diffraction grating, a spherical concave mirror that has two grating surfaces, is positioned to lie on the Rowland Circle. One half of the mirror is ruled at 2400 lines per inch; the other half is ruled at 1200 lines per inch. The half that is ruled at 2400 lines per inch provides a spectrum of 10 to 100 angstroms with a resolution of 0.05 angstrom. The other half of the mirror yields a spectrum of 20 to 200 angstroms with a resolution of 0.08 angstrom. (Resolution may be defined as the ability to distinguish individual spectral lines.) The resultant spectra are spread over a 15 cm (6 in.) film plane.

The diffracted spectrum is focused on a plane tangent to the Rowland Circle. To achieve satisfactory focus on the film, it must fall on the curve of the Rowland Circle. The illustration shows how 10 strips of film are mounted on the film magazine, and an example of the two spectra imaged on the film. The optical schematic of the x-ray/ultraviolet solar photography experiment is presented in the illustration.

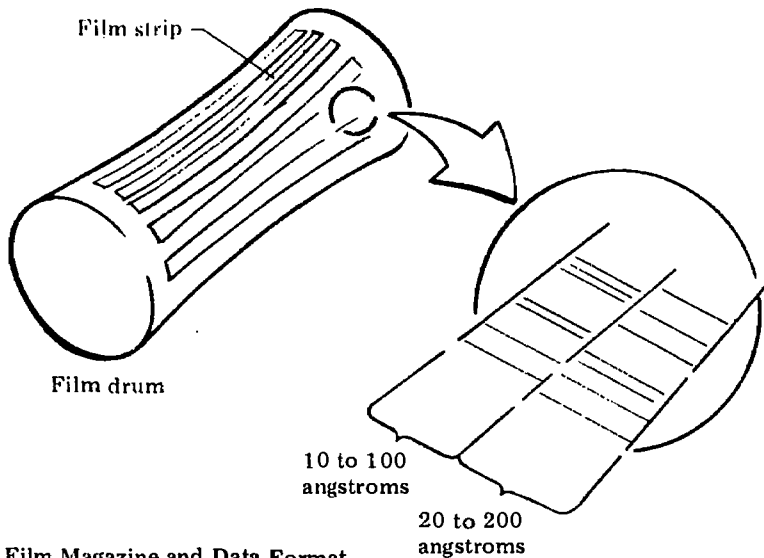

Film Magazine and Data Format

Two filters are used with the spectrograph. Visually opaque metal films that transmit only the x-ray and ultraviolet energy are used, thereby preventing visible light and near ultraviolet from entering the instrument. One filter is made from indium and beryllium and passes from 0 to 110 angstroms in the indium section and 110 to 200 angstroms in the beryllium portion. The other filter is half indium, half boron. The spectral response of the boron is 66 to 200 angstroms. The sections are mated to the spectral response of the halves of the diffraction grating.

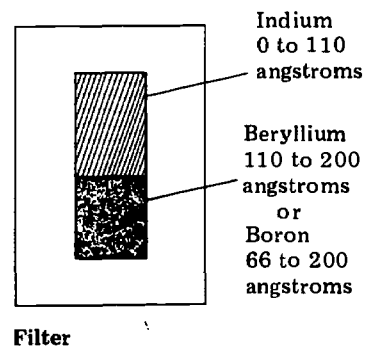

## EXPERIMENT DATA

- Type** Data from the x-ray ultraviolet solar photography experiment is in the form of film strips of the solar spectra. Its appearance is similar to the ultraviolet spectrographs which are discussed in Section 4, the only difference being the spectral range.
- Highlights** X-ray and extreme ultraviolet radiation of the solar spectrum are portrayed. The radiation lines will show which ions are present in the chromosphere and the ionization state in which they exist.
- Analysis** These spectra, when correlated with the x-ray images of the Sun recorded by the x-ray telescopes and the x-ray event analyzer (Sections 6 and 8), will show the sources of the x-ray/ultraviolet energy, the distribution of the energy in the Sun, and the spectral composition of the solar materials acted on by the x-ray/ultraviolet energy.
- Availability** The x-ray/ultraviolet solar photography data are of great scientific value and will be studied intensely. Information on the results of the experiment will not be available for public

consumption until 1975, as discussed in Section 1. Procedures for requesting copies of data will be announced at a later date.

### **CREW ACTIVITIES**

The x-ray/ultraviolet solar photography experiment is performed in a scientific airlock of the Skylab orbital workshop module. During operation of the experiment, the crewman will be in communication with the astronaut stationed at the Apollo telescope mount control and display panel. The crewman, using the boresighted viewfinder in the equipment as an aiming device, will be able to advise the second crewman how to maneuver the spacecraft into position to center the solar flare in the entrance slit of the spectrograph.

This experiment is performed within the spacecraft and therefore will not require extravehicular activity for data retrieval.

### **RELATED CURRICULUM ASPECTS**

The x-ray/ultraviolet solar photography experiment is related to several aspects of a science curriculum. Topics in astronomy, chemistry, and physics are subjects for additional discussion.

#### **Astronomy**

- 1) Solar sources of x-ray and ultraviolet radiation;
- 2) Energy levels of solar x-ray/ultraviolet radiation;
- 3) Solar x-ray/ultraviolet spectra compared with stellar sources.

#### **Chemistry**

- 1) Absorption and transmission of x-rays;
- 2) Ionization states of elements.

#### **Physics**

- 1) Energy of x-rays;
- 2) Spectrography—identification of materials.

# Section 8

## Extreme Ultraviolet and X-Ray Telescope



## EXPERIMENT BACKGROUND

This experiment is comprised of two different instruments: (1) a grazing incidence x-ray telescope very similar to the one discussed in Section 6 and used in the x-ray spectrograph to photograph x-ray images of the Sun in the spectral region of 5 to 35 angstroms; (2) an electronic x-ray event analyzer that analyzes the spectrum between 2.5 and 20 angstroms.

Physics

At very short wavelengths of the x-ray spectrum a diffraction grating can no longer provide sufficient dispersion to yield good resolution of the spectrum. Wavelengths shorter than 20 angstroms require the application of electronic sensors and techniques.

A variation of the Geiger-Mueller tube, used for determining radio activity levels, is the basis of an x-ray spectrometer. The illustration shows the basic configuration of a proportional counter tube.

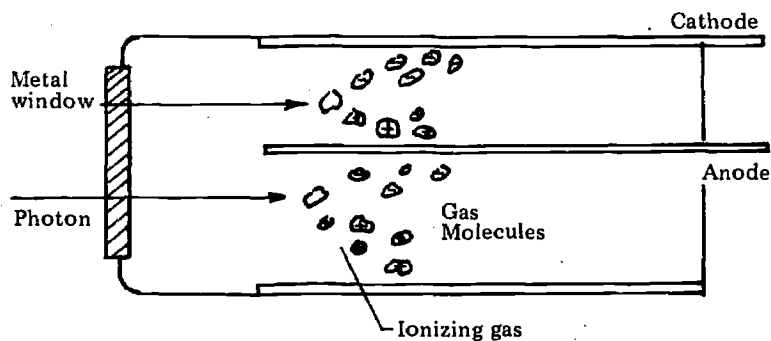

**Proportional counter tube**

An x-ray photon of energy enters the tube through a window made of a very thin metal sheet. On entering the ionizing gas volume, the photon's energy is dissipated by ionizing one or more gas molecules. The gas-ions are then attracted by the electric field to the cathode which produces an electric pulse in the associated circuits.

The energy of the entering photon determines the extent of ionization that results. The shorter wavelength photons have greater energy than longer wavelength photons. Consequently, short wavelength photons generate larger amplitude electric pulses at the cathode.

By electronically sorting the amplitudes, the pulses can be classified to represent the spectra of the x-ray energy entering the tube. Also by using different window materials and different ionizing gas mixtures, the wavelength or spectral response of the tube may be controlled. The illustration shows the different spectral responses of aluminum and beryllium.

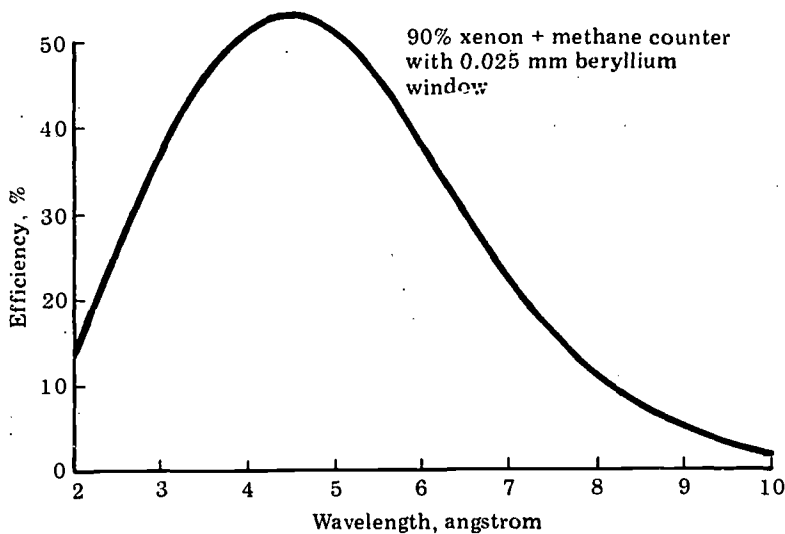
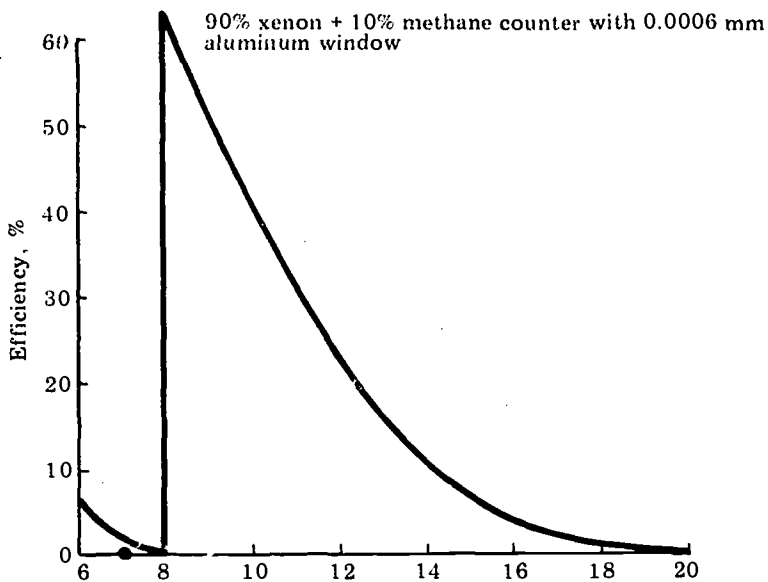

Spectral Response of Aluminum and Beryllium

**History**

Since 1960 satellite, rocket, and high altitude balloon flights have provided data on the x-ray radiation from the Sun. However, instruments carried on these flights are short lived and have limited fields of view and spatial resolution. Models of the solar flare mechanisms based on available data have been postulated, but detailed analyses of the x-ray spectra are needed to verify these models.

**SCIENTIFIC OBJECTIVES**

Correlation between x-ray spectroheliograms and the data in H-alpha and ultraviolet wavelengths are expected to reveal

the spatial and temporal relationships of solar events. Because the shorter wavelengths are indicative of higher temperatures in the emitting gas, additional pictures will permit analysis of the development of an active region as it proceeds from the solar surface to the chromosphere and to the corona. Of primary interest is the determination of the location of the initiation of a flare in the solar atmosphere, and of the mechanisms involved.

## EQUIPMENT

The extreme ultraviolet and x-ray telescope comprise two independent instruments: (1) a grazing incidence telescope and camera that photographs x-ray events in the 5 to 33 angstrom spectral region; (2) an x-ray event analyzer or x-ray spectrograph that analyzes the x-ray spectrum from the entire solar disk between 2.5 and 20 angstroms.

The x-ray telescope is a grazing incidence telescope of approximately 25 cm (10 in.) diameter aperture and 190 cm (75 in.) focal length. The x-ray image is focused on the focal plane of the camera. A six-position filter provides for spectral selectivity in the camera. Filter characteristics are listed:

<u>Filter Material</u>	<u>Spectral Response, angstrom</u>
Beryllium	5 to 11
Aluminum	5 to 8 and 8 to 20
Titanium	5 to 12 and 27 to 33
Beryllium	5 to 12
Aluminum	5 to 8 and 8 to 18
Neutral density	Visible light.

The neutral density filter is used to photograph the Sun in white light for data correlation purposes.

A variable speed rotating blade shutter provides variation of film exposures between 1/3 and 288 seconds. The shutter is of sufficient thickness to absorb and stop x-rays that impinge on it in the closed position.

The x-ray event analyzer operates independently of the x-ray telescope, to provide a 10 wavelength analysis of spectral intensities between 2.5 and 20 angstroms.

Two proportional counter tubes are used to divide the spectrum into two parts. The counter tube characteristics are tabulated.

X-ray  
Telescope

X-ray Event  
Analyzer

<u>Window Material</u>	<u>Ionizing Gas Mixture</u>	<u>Wavelength Response, angstrom</u>
Beryllium 0.025 mm thick, 1.27 cm diameter	Xenon/Methane	2 to 8
Aluminum 0.0006 mm thick, .32 cm diameter	Argon/Methane	8 to 20

The simplified flow diagram of the x-ray event analyzer shows that the outputs from the two proportional counter tubes are fed to two pulse height analyzers, one having four channels, the other having six channels.

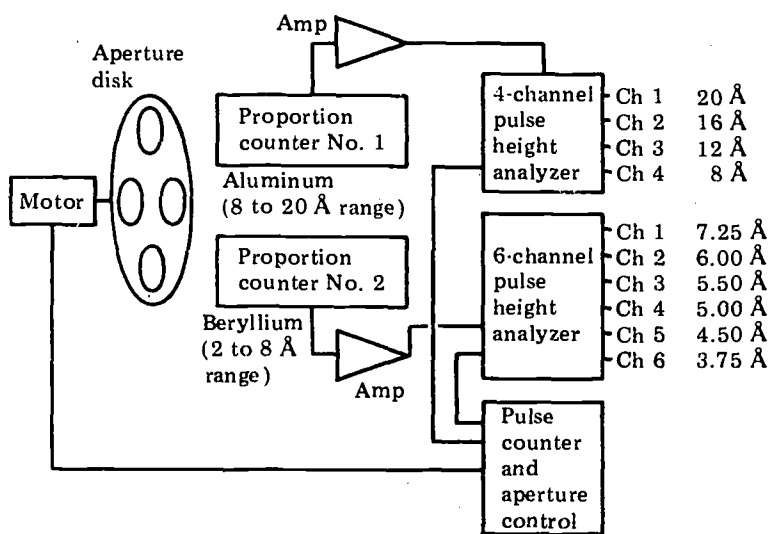

X-ray Event Analyzer

#### Pulse Height Analyzer

Each channel of a pulse height analyzer is biased to accept a larger voltage pulse level than the preceding channel. An input pulse of small amplitude may be only large enough to exceed the bias of the first channel and would register a count there. A larger pulse might be able to appear in two or three channels and a large enough pulse will drive all channels. When pulses appear in two or more channels simultaneously, redundancy circuits reject the pulse from the channels that have the smaller bias voltages and allow it to enter only that with the largest bias. In this manner, the pulse amplitudes are sorted into their proper channels.

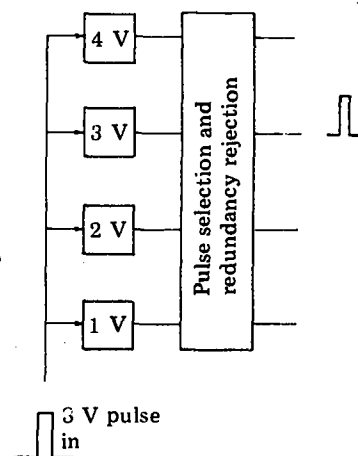

Because short wavelength photons entering the counter tube are more energetic than long wavelength photons, they will produce larger pulses in the counter tubes. Thus, pulses entering the respective channels of the pulse height analyzer are classified as to the wavelength ranges of the photons that produced them.

Counter circuits in the pulse height analyzer, count the number of pulses appearing in each channel over an interval of time. The count rate generated indicates the intensity of the radiation that produced the pulses.

One of the limitations of proportional counter tubes is their sensitivity to counting rate. In normal range, pulse amplitude is proportional to photon energy. However, if the number of photons entering the tube becomes too great, the proportionality no longer exists. To eliminate this factor, the count rate circuits of the pulse height analyzer are used to control a motor driven disc having four different sized apertures. The aperture disc is located in front of the proportional counter tube window to limit the radiation entering the tube. The scale factors of the instrument are adjusted for each of the apertures.

The outputs of the pulse height analyzer, pulse rate counter, and aperture disc position are transmitted to ground over the telemetry system. In addition, the data are displayed on a digital count display and a strip chart recorder located on the control and display panel in Skylab so that the astronaut may determine the level of solar activity.

## EXPERIMENT DATA

**Type** Experiment data is in two forms--photographs and electronic x-ray spectra. The electronic data is processed and displayed in real time to warn the astronauts of an impending solar flare, and is also transmitted to ground for later analysis. Photographic data is returned to Earth following the mission.

**Highlights** The photographic images will act as a filter photometer to determine the location and spectral region of the x-ray emission. The x-ray event analyzer measures the intensity and "hardness" of the spectrum, or ratio of high energy to low energy x-rays. In the early stages of a solar flare, the intensity will show a rapid increase and the high energy x-rays will become more abundant.

**Analysis** Several rocket- and balloon-carried instruments have indicated that flares consist of very energetic short wavelength processes, but because of the limited observation time available and insufficient spectral and spatial resolution, it has not been possible to develop and verify detailed models. The spectral data obtained by the experiment will be analyzed to give flare temperatures, densities, and chemical abundances. The filtergrams will indicate both the temporal and spatial variations of these quantities in flare regions. Of particular interest will be the processes occurring during the initial stages of flare development and the influence of the magnetic field in sunspots on flare development.

**Availability**

The x-ray event analyzer information is transmitted to the Johnson Space Center for use by ground flight control personnel. It is also displayed to the astronauts on counters and on a history plot (strip chart recorder). Photographic data from the extreme ultraviolet and x-ray telescope will not be available for public use until 1975. Procedures for requesting copies of flight data will be announced at a later date. Section 1 describes planned data uses and requirements.

**CREW ACTIVITIES**

The astronaut will use the x-ray event analyzer information to anticipate solar flare occurrence and begin an appropriate observational sequence. Other related crew activities are discussed in Section 1.

**RELATED CURRICULUM TOPICS**

The x-ray event analyzer can be related to the following topics in electronics: (1) data sensing tubes, (2) pulse and gate circuits, (3) biasing circuits, (4) general computer circuits, (5) data processing, and (6) telemetry.

# Section 9

## Glossary

<b>Arc-Minute</b>	Minute—1/60 of a degree of angle
<b>Arc-Second</b>	Second—1/3600 of a degree of angle
<b>Balmer Series</b>	The series that results from radiation versus energy levels which progressively pull electrons from other shells of the hydrogen atom; all radiations of the Balmer series are at visible light wavelengths.
<b>Beam Splitter</b>	A semitransparent mirror which transmits part of the light and reflects the remainder, to divide the incident light into two beams.
<b>Blaze</b>	The shape and angles of the sawtooth-shaped grooves of a reflecting diffraction grating. The blaze and fineness (number of lines per millimeter) determine spectral response and resolution of the grating.
<b>Chromosphere</b>	The region between the apparent solar surface and the base of the corona. It is the source of solar prominences.
<b>Corona</b>	The envelope of hot gases and ionized materials which surrounds the Sun. The corona extends from the chromosphere (approximately 6000 miles from the solar surface) outward for several millions of miles.
<b>Coronagraph</b>	An instrument employing occulting discs to form an artificial eclipse of the Sun to permit study of the solar corona.
<b>Diffraction</b>	When a ray of white light passes over a sharp opaque edge, it is broken up into its spectrum. The ray of light is bent from its previous path and the degree of bending is proportional to its wavelength.
<b>Extra Vehicular Activity</b>	Activities in which an astronaut, wearing a space suit, performs work in space outside of his spacecraft.
<b>Extreme Ultraviolet</b>	The region of the spectrum between wavelengths of 100 and 700 angstroms.
<b>Fabray-Perot Interferometer</b>	A form of filter that operates by destructive interference on all wavelengths except that which it is designed to pass.
<b>Faculae</b>	Filamentary streamers of hot brighter material associated with sunspots.
<b>Fiducial Marks</b>	Reference marks superimposed on photographic images for data correlation and scale factors.
<b>Folding Optics</b>	A mirror system used to reduce the physical length of a telescope or optical instrument while maintaining optical length.



<b>Gimbals</b>	A device consisting of two frames pivoted on axes at right angles to each other, so that one frame may move within the other.
<b>Granules - Rice Grain</b>	Elements comprising the mottled visible surface of the photosphere.
<b>Grazing Incidence</b>	Light arriving at a reflecting surface from an extreme oblique angle.
<b>Hydrogen-Alpha, H-alpha</b>	Hydrogen-alpha is the particular radiation at 6563 angstroms which results when the electron returns from energy level three to level two after having the orbit distorted by an external force, usually electrical.
<b>Lyman and Paschen Series</b>	These series are similar to the Balmer series but involve energy levels that differ from the Balmer series. The Lyman series provides ultraviolet radiation from higher energy levels; the Paschen series produces infrared radiation from lesser energy levels.
<b>Monochromator</b>	A device to isolate a single color or spectral wavelength from a spectrum.
<b>Nautical Mile</b>	1.15 statute miles, 6076 feet.
<b>Neutral Density Filter</b>	A filter that attenuates or reduces all regions equally; it is not spectrally selective (no color).
<b>Occult, Occulting</b>	Occulting is the disappearance of one heavenly body behind another. An eclipse is natural occulting of the Sun by the Moon. Artificial occulting is used in the coronagraph.
<b>Photocathode</b>	A cathode that releases electrons in proportion to light flux shining on it.
<b>Polarization</b>	A distinct orientation of the wave motion and travel of electromagnetic radiation.
<b>Polychromator</b>	A device to produce colors from a source of white light; synonymous with spectrograph.
<b>Predisperser</b>	A secondary diffraction grating used to preselect a portion of a spectrum to be dispersed by the main diffraction grating.
<b>Prominences</b>	Jets of luminous matter ejecting from the chromosphere for thousands of miles.
<b>Proportional Counter Tube</b>	An electron tube that produces an electric pulse which is proportional to the energy of a photon entering the tube.
<b>Pulse Height Analyzer</b>	An electronic device that sorts and classified electric pulses applied at its input.

<b>Rowland Circle</b>	A circle whose radius equals the radius of curvature of a spherical diffraction grating and is tangent to the grating.
<b>Solar Limb</b>	The extreme edges of the apparent solar disk.
<b>South Atlantic Anomaly</b>	A region over the South Atlantic Ocean in which the Van Allen Radiation Belts are nearest Earth.
<b>Spectrograph</b>	A system for resolving light of electromagnetic radiation into its component wavelengths.
<b>Spectroheliograph</b>	A picture of the Sun in a particular spectral region or a device for producing spectroheliographs.
<b>Spectroheliometer</b>	A device for producing and measuring the spectrum of the Sun.
<b>Spectrum</b>	Distribution of electromagnetic energy as a function of wavelength; for example, visible light has a spectrum of 3500 to 8000 angstroms (blue—red).
<b>Strip Chart Recorder</b>	An instrument that records events of data represented by electrical signals on a moving paper scroll.
<b>Sunspots</b>	Darker areas of photosphere, thought to give rise to solar storms.
<b>Telemetry</b>	A system for transmitting data and measurements over extended distances—transmission is often by radio means.
<b>Transmission Grating</b>	A diffraction grating in which energy is resolved to spectral components on transmission through the grating.
<b>Ultraviolet</b>	The spectrum of wavelengths of electromagnetic radiation between 700 angstroms and visible light of 3500 angstroms.
<b>Video Display</b>	A television-like display of data (pictures).
<b>X-ray</b>	The region of the electromagnetic spectrum of approximately 3 to 100 angstrom.

#### **SUGGESTED REFERENCES FOR FURTHER STUDY**

##### **Astronomy—Solar Research**

Larousse Encyclopedia of Astronomy, Prometheus Press, New York, New York 1968

The Solar Corona, John W. Evans; Academic Press, New York, New York 1963

##### **Optics**

Geometrical and Physical Optics, R. S. Longhurst; John Wiley & Sons, Ltd, New York, New York, 1968

Fundamentals of Optics, F. A. Jenkins and H. E. White, McGraw-Hill Book Company, New York, New York, 1957.