

## DOCUMENT RESUME

ED 088 693

SE 016 455

TITLE Quartermaster 1 and C, Rate Training Manual.  
INSTITUTION Bureau of Naval Personnel, Washington, D. C.; Naval Personnel Program Support Activity, Washington, D. C.  
REPORT NO NAVTRA-10151-D  
PUB DATE 72  
NOTE 201p.; Revised 1972  
EDRS PRICE MF-\$0.75 HC-\$10.20  
DESCRIPTORS \*Instructional Materials; \*Manuals; Meteorology; Military Personnel; \*Military Science; \*Military Training; \*Navigation; Post Secondary Education; Reading Materials; Science Education

## ABSTRACT

The technical subject matter of the Quartermaster rating is presented in this training manual written to prepare men of the Navy and Naval Reserve for advancement examinations. The manual includes eleven chapters. Discussed are commonly used methods and procedures of operating magnetic compasses and gyrocompasses, determining a ship's position, accomplishing the duties of a petty officer in charge and a navigator assistant, and observing the weather. Special topics are included to acquaint the reader with the publishing and issuing activities in navigation; knowledge of administering security; fundamentals of electronic and celestial navigation and dead reckoning; information about working for advancement; and international, inland, and pilot regulations for prevention of collision at sea. An edited reprint of an article published on the reverse side of the June 1966 Pilot Chart of the North Atlantic is also given as an appendix under the heading of navigational hints. (See ED 070 571 for the 1969 edition.) (CC)

ED 088693

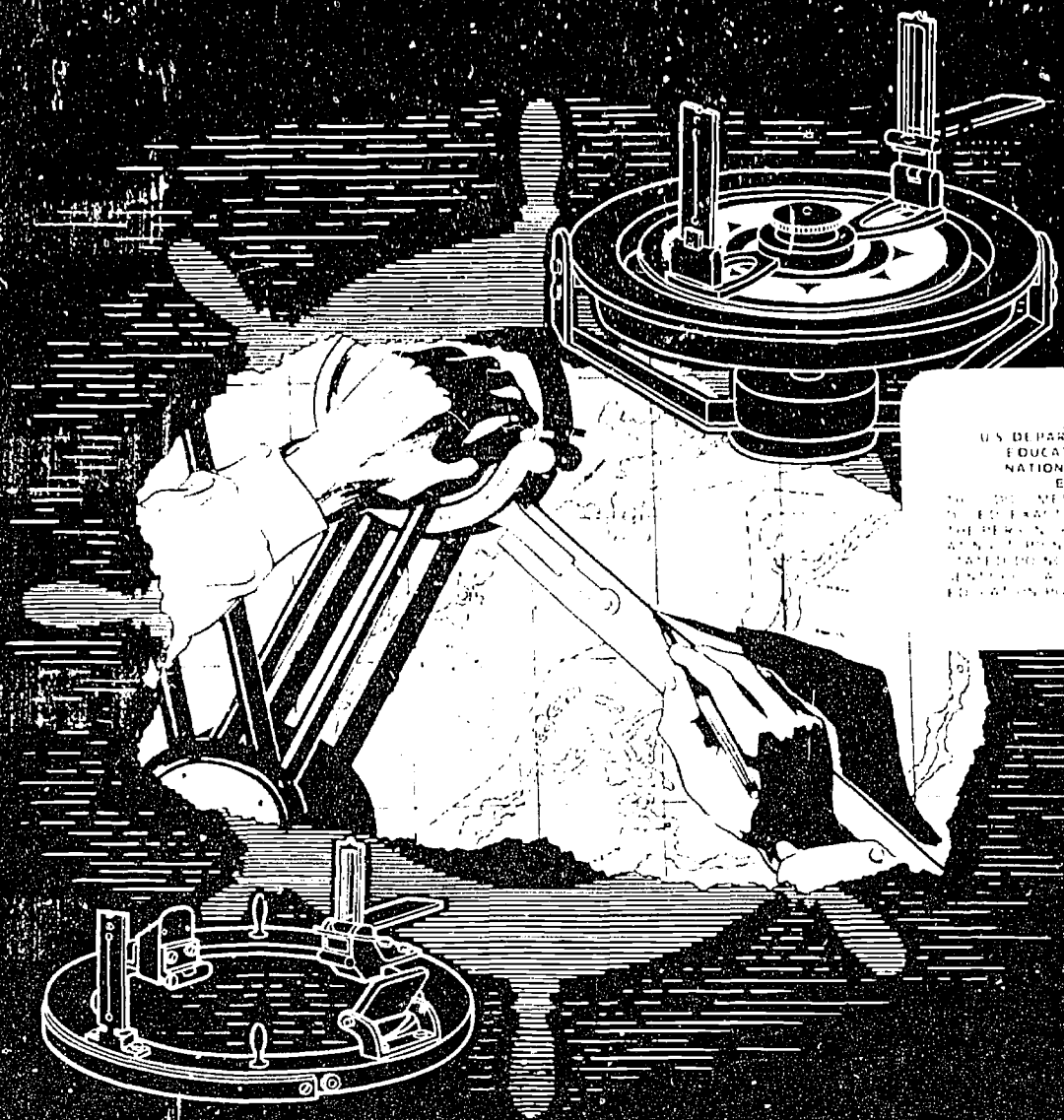

U.S. DEPARTMENT OF HEALTH  
 EDUCATION & WELFARE  
 NATIONAL INSTITUTE OF  
 EDUCATION

THIS DOCUMENT HAS BEEN REPRODUCED EXACTLY AS RECEIVED FROM THE PERSON OR ORGANIZATION ORIGINATING IT. POINTS OF VIEW OR OPINIONS STATED DO NOT NECESSARILY REPRESENT THE NATIONAL INSTITUTE OF EDUCATION, BUREAU OF POST OFFICE BOX 358, WASHINGTON, D.C. 20540-0358.

# QUARTERMASTER 1 & C

NAVAL TRAINING COMMAND

RATE TRAINING MANUAL

NAVTRA 10151-D

551 916 455



# PREFACE

This training manual was written for men of the Navy and Naval Reserve who are studying for advancement to the rates of Quartermaster First and Chief Quartermaster. Combined with the necessary practical experience and a thorough study of the related basic Rate Training Manuals, the information in this manual will help the reader prepare for Navywide advancement examinations.

Quartermaster 1 & C was prepared for the Naval Training Support Command by the Training Publications Division, Naval Personnel Program Support Activity, Washington, D.C. Technical assistance was provided by the Fleet Training Center, Newport, Rhode Island; the Naval Examining Center, Great Lakes, Illinois; the Fleet Training Center, San Diego, California; and the Naval Oceanographic Office, Washington, D.C.

Published by  
NAVAL TRAINING SUPPORT COMMAND

Original edition 1949

Revised 1964

Revised 1969

Revised 1972

UNITED STATES  
GOVERNMENT PRINTING OFFICE  
WASHINGTON D.C. :1972

# **THE UNITED STATES NAVY**

## **GUARDIAN OF OUR COUNTRY**

The United States Navy is responsible for maintaining control of the sea and is a ready force on watch at home and overseas, capable of strong action to preserve the peace or of instant offensive action to win in war.

It is upon the maintenance of this control that our country's glorious future depends; the United States Navy exists to make it so.

## **WE SERVE WITH HONOR**

Tradition, valor, and victory are the Navy's heritage from the past. To these may be added dedication, discipline, and vigilance as the watchwords of the present and the future.

At home or on distant stations we serve with pride, confident in the respect of our country, our shipmates, and our families.

Our responsibilities sober us; our adversities strengthen us.

Service to God and Country is our special privilege. We serve with honor.

## **THE FUTURE OF THE NAVY**

The Navy will always employ new weapons, new techniques, and greater power to protect and defend the United States on the sea, under the sea, and in the air.

Now and in the future, control of the sea gives the United States her greatest advantage for the maintenance of peace and for victory in war.

Mobility, surprise, dispersal, and offensive power are the keynotes of the new Navy. The roots of the Navy lie in a strong belief in the future, in continued dedication to our tasks, and in reflection on our heritage from the past.

Never have our opportunities and our responsibilities been greater.

# CONTENTS

CHAPTER	Page
1. Advancement . . . . .	3
2. Compasses . . . . .	8
3. Piloting—dead reckoning . . . . .	28
4. Electronic navigation. . . . .	47
5. Celestial navigation . . . . .	57
6. Assisting the OOD and ship handling. . . . .	78
7. Assisting the navigator . . . . .	100
8. Rules of the road . . . . .	112
9. Weather . . . . .	127
10. Records, reports, and publications . . . . .	153
11. Security . . . . .	168
APPENDIX	
A. Navigational hints . . . . .	176
INDEX . . . . .	190

# CHAPTER 1

## ADVANCEMENT

This training manual is designed to help you meet the occupational qualifications for advancement to Quartermaster First Class and Chief Quartermaster. Chapters 2 through 11 and the appendix of this training manual deal with the technical subject matter of the Quartermaster rating. The present chapter provides introductory information that will help you in working for advancement. It is strongly recommended that you study this chapter carefully before beginning intensive study of the chapters that follow.

### REWARDS AND RESPONSIBILITIES

Advancement brings both increased rewards and increased responsibilities. The time to start looking ahead and considering the rewards and the responsibilities is right now, while you are preparing for advancement to QM1 or QMC.

By this time you probably are well aware of many of the advantages of advancement—higher pay, greater prestige, more interesting and challenging work, and the satisfaction of getting ahead in your chosen career. By this time, also, you have probably discovered that one of the most enduring rewards of advancement is the personal satisfaction you find in developing your skills and increasing your knowledge.

The Navy also benefits by your advancement. Highly trained personnel are essential to the functioning of the Navy. By each advancement, you increase your value to the Navy in two ways. First, you become more valuable as a technical specialist in your own rating. And second, you become more valuable as a person who can supervise, lead, and train others and thus make far-reaching and long-lasting contributions to the Navy.

In large measure, the extent of your contribution to the Navy depends on your willingness and ability to accept increasing responsibilities as you advance. When you assumed the duties of a QM3, you began to accept a certain amount of responsibility for the work of others. With each advancement, you accept

an increasing responsibility in military matters and in matters relating to the occupational requirements of the Quartermaster rating.

You will find that your responsibilities for military leadership are about the same as those of petty officers in other ratings, since every petty officer is a military person as well as a technical specialist. Your responsibilities for technical leadership are special to your rating and are directly related to the nature of your work. Operating and maintaining the ship's navigational equipment is a job of vital importance, and it's a teamwork job; it requires a special kind of leadership ability that can be developed only by personnel who have a high degree of technical competence and a deep sense of personal responsibility.

Certain practical details that relate to your responsibilities for bridge administration, supervision, and training are discussed in various chapters of this training manual. At this point, let's consider some of the broader aspects of your increasing responsibilities for military and technical leadership.

Your responsibilities will extend both upward and downward. Both officers and enlisted personnel will expect you to translate the general orders given by officers into detailed, practical, on-the-job language that can be understood and followed even by relatively inexperienced personnel. In dealing with your juniors, it is up to you to see that they perform their work properly. At the same time, you must be able to explain to officers any important needs or problems of the enlisted men.

You will have regular and continuing responsibilities for training. Even if you are lucky enough to have a highly skilled and well-trained bridge force, you still will find that training is necessary. For example, you will always be responsible for training lower rated men for advancement. Also, some of your best workers may be transferred, and inexperienced or poorly trained personnel may be assigned to you, or a particular job may call for skills that none of your personnel have. These and similar problems require you to be a training specialist who can conduct formal and informal training programs

to qualify personnel for advancement and who can train individuals and groups in the effective execution of assigned tasks.

Because of the relationship between the Quartermaster and Signalman ratings, you will have a special problem to consider when you are training lower rated men for advancement. At the E-4 level, Quartermasters are required to learn the Morse code and the semaphore characters. They are further required to transmit and receive flashing light at a rate of 8 words per minute, and to transmit and receive semaphore at the rate of 8 words per minute.

You will have increasing responsibilities for working with others. As you advance to QM1 and then to QMC, you will find that many of your plans and decisions affect a large number of people, some of whom are not in the bridge force and some are not even in the navigation department. It becomes increasingly important, therefore, to understand the duties and responsibilities of personnel in other ratings. Every petty officer in the Navy is a technical specialist in his own field. Learn as much as you can about the work of other ratings, and plan your own work so that it will fit in with the overall mission of the organization.

As your responsibilities increase, your ability to communicate clearly and effectively must also increase. The basic requirement for effective communications is a knowledge of your own language. Use correct language in speaking and in writing. Remember that the basic purpose of all communications is understanding. To lead, supervise, and train others, you must be able to speak and write in such a way that others can understand exactly what you mean.

A second requirement for effective communications in the Navy is a sound knowledge of the Navy way of saying things. Some Navy terms have been standardized for the purpose of ensuring efficient communications. When a situation calls for the use of standard Navy terminology, use it.

Still another requirement for effective communications is a precision in the use of technical terms. A command of the technical language of the Quartermaster rating will enable you to receive and convey information accurately and to exchange ideas with others. A person who does not understand the precise meaning of terms used in connection with the work of his own rating is at a disadvantage when he tries to read official publications relating to his work. He is also at a great disadvantage when he takes the written examinations for advancement. Although it is important for you to use technical terms correctly, it is particularly important when you are dealing with lower rated men; sloppiness in the use of technical terms is likely to be very confusing to an inexperienced man.

You will have increased responsibilities for keeping up with new developments. Practically everything in the Navy—policies, procedures, equipment, publications, systems—is subject to change and development. As a QM1, and even more as a QMC, you must keep yourself informed about all changes and new developments that might affect your rating or your work.

Some changes will be called directly to your attention (as for example, *Notice to Mariners* is sent direct to all commissioned ships on a distribution list); others you will have to look for. Try to develop a special kind of alertness for new information. Keep up to date on all available sources of technical information. Above all, keep an open mind in regard to methods and procedures for obtaining, computing, and/or plotting the ship's position. New tables are compiled from time to time both to speed up and increase the accuracy of solving the astronomical triangle. Electronic navigational equipment is being developed at a phenomenal rate. Oceanographic and meteorological data collection and dissemination methods are being improved; and with this improvement, charts and publications are more accurate than ever.

You were promoted to your present grade not only because of your superior knowledge of the specialties of the Quartermaster rating but also because you demonstrated your ability to handle men. Now that you are preparing for advancement, even greater emphasis will be placed on leadership. The performance of men throughout the Navy depends largely on the precepts and examples of you and other Navy petty officers. Your conscientious leadership and discipline, reliability, and military etiquette will contribute immeasurably toward establishing the proper attitudes, promoting morale, and maintaining the traditions of the Navy. Your reward, in addition to the traditional "Well done" of your superiors, will be the pride and satisfaction you receive as your men perform their jobs well. You are, in effect, a "guide" because you must channel the efforts of your men toward productive labors and worthwhile activities.

## QUARTERMASTER RATING

The Quartermaster rating is a general rating. The duties of a Quartermaster deal with supervision of personnel, maintenance of all spaces assigned to the navigation department, quartermaster of the watch, keeping charts up to date, mastery of operational techniques of electronic aids to navigation, use of navigational instruments (such as the sextant, alidades, parallel rulers, and dividers), use of navigation tables, and security of classified material.

You have stood QM watch on many occasions, and the duties of this watch should be familiar to you. You must be responsible for maintaining a neat, legible, and accurate log of all the required evolutions and routines. At every opportunity you should scrutinize the entries made in this log and point out to the QM of the watch any errors, discrepancies, or omissions. You should further ensure that all new personnel of the navigation department are instructed in the proper procedures for keeping the quartermaster's notebook, and that they are completely familiar with this job before they are assigned to stand the watch unassisted.

Quartermaster is one of the few ratings for which billets exist in virtually all types of Navy ships, from the largest to the smallest—both surface craft and submarines. The nature of the First Class or Chief Quartermaster's work depends mainly on the type of ship to which he is assigned. Aboard carriers, cruisers, and other deep draft ships, the Quartermaster force is likely to be quite large; the senior Quartermaster spends much of his time on administrative duties and supervision. Aboard medium size ships, the senior Quartermaster frequently is the assistant to the navigator, and most of his time is taken up in actual navigation duties. Aboard very small ships, the senior Quartermaster usually is the navigator's assistant, and may have the additional responsibility of supervising the ship's signal force. At the first class and chief level, Quartermasters may also be assigned to sea duty as petty officer in charge of tugboats or other types of yard craft.

Various shore duty billets are available to Quartermasters. They include recruit procurement, recruit training, instructor, master at arms, and perhaps assisting in writing advancement examinations, correspondence courses, or training manuals—such as the one you are now reading.

### REQUIREMENTS FOR ADVANCEMENT

In general, to qualify for advancement, you must—

1. Have a certain amount of time in grade.
2. Complete the required military and occupational training courses.
3. Demonstrate the ability to perform all the practical requirements for advancement by completing the Record of Practical Factors, NavPers 1414/1 (formerly NavPers 760).
4. Be recommended by your commanding officer.
5. Demonstrate your knowledge by passing a written examination based on (a) the military requirements for advancement and (b) the occupational qualifications for advancement in the Quartermaster rating.

### FINAL MULTIPLE

Advancement is not automatic. Meeting all the requirements, makes you eligible for advancement but does not guarantee your advancement. The number of men in each rate and rating is controlled on a Navywide basis. Therefore, the number of men that may be advanced is limited by the number of vacancies that exist. When the number of men passing the examination exceeds the number of vacancies, some system must be applied to determine which men may be advanced and which ones may not. The system used is the "final multiple" and is a combination of three types of advancement systems: Merit rating system, Personnel testing system, and Longevity or seniority system.

The Navy's system provides credit for performance, knowledge, and seniority, and, while it cannot guarantee that any one person will be advanced, it does guarantee that all men within a particular rating will have equal advancement opportunity.

The following factors are considered in computing the final multiple

<i>Factor</i>	<i>Maximum Credit</i>
Examination score	80
Performance factor (Performance evaluation)	50
Length of service (years x 1)	20
Service in pay grade (years x 2)	20
Medals and awards	15
PNA (Maximum 3 per exam cycle)	<u>15</u>
	200

All of the above information (except the examination score) is submitted to the Naval Examination Center with your examination answer sheet. After grading, the examination scores, for those passing, are added to the other factors to arrive at the final multiple. A precedence list, which is based on final multiples, is then prepared for each pay grade within each rating. Advancement authorizations are then issued, beginning at the top of the list, for the number of men needed to fill the existing vacancies.

### KEEPING CURRENT ON ADVANCEMENT

Remember that the requirements for advancement may change from time to time. Check with your division officer or with your training officer to be sure you have the most recent requirements when you are preparing for advancement and when you are helping lower rated men to prepare.



## QUARTER MASTER 1 & C

To prepare for advancement, you need to be familiar with (1) the military requirements and the occupational qualifications given in the Manual of Qualifications for Advancement, NavPers 18068-B (with changes); (2) The Record of Practical Factors, NavPers 1414/1; (3) appropriate rate training manuals, and (4) any other material that may be required or recommended in the current edition of *Training Publications for Advancement*, NavPers 10052. These materials are discussed later in this section of this chapter that deals with sources of information.

### SCOPE OF THIS TRAINING MANUAL

Before studying any book, it is a good idea to know its purpose and scope. Here are some pointers you should know about this training manual

\* It is designed to give you information on the occupational qualifications for advancement to QM1 and QMC.

\* It must be satisfactorily completed before you can advance to QM1 or QMC, whether you are in the Regular Navy or in the Naval Reserve.

\* It is not designed to give you information on the military requirements for advancement to PO1 or CPO. Rate training manuals that are specially prepared to give information on the military requirements are discussed in the section of this chapter that deals with sources of information.

\* It is not designed to give you information that is related primarily to the qualifications for advancement to QM3 and QM2. Such information is given in *Quartermaster 3 & 2*, NavPers 10149.

\* The occupational Quartermaster qualifications that were used as a guide in the preparation of this training manual were those promulgated in the Manual of qualifications for Advancement, NavPers 18068-B, change 5. Therefore, changes in the Quartermaster qualifications occurring after this change may not be reflected in the information given in this training manual. Since your major purpose in studying this manual is to meet the qualifications for advancement to QM1 or QMC, it is important for you to obtain and study a set of the most recent Quartermaster qualifications.

\* This training manual includes information that is related to both the knowledge factors and the practical factors of the qualifications for advancement to QM1 and QMC. However, no training manual can take the place of actual on-the-job experience for developing skill in the practical factors. The training manual can help you understand some of the whys and wherefores,

but you must combine knowledge with practical experience before you can develop the required skills. The Record Of Practical Factors, NavPers 1414/1 should be utilized in conjunction with this training manual whenever possible.

\* This training manual deals almost entirely with navigation and the associated equipment found on the conventional ships. In general, it does not cover navigation of submerged submarines; nor does it cover the newer, more sophisticated navigational methods that are not yet in widespread use.

\* Chapters 2 through 11 and the appendix of this training manual deal with the occupational subject matter of the Quartermaster rating. Before studying these chapters, study the table of contents and note the arrangement of information. Information can be organized and presented in many different ways. You will find it helpful to get an overall view of the organization of this training manual before you start to study it.

### SOURCES OF INFORMATION

It is very important for you to have an extensive knowledge of the references to consult for detailed, authoritative, up-to-date information on all subjects related to the military requirements and to the occupational qualifications of the Quartermaster rating.

Some of the publications discussed here are subject to change or revision from time to time—some at regular intervals, others as the need arises. When using any publication that is subject to change or revision, be sure you have the latest edition. When using any publication that is kept current by means of changes, be sure you have a copy in which all official changes have been entered.

### BUPERS PUBLICATIONS

The BuPers publications described here include some that are absolutely essential for anyone seeking advancement and some which are not essential, but extremely helpful.

The *Quals Manual*. The Manual of Qualifications for Advancement, NavPers 18068-B (with changes) gives the minimum requirements for advancement to each rate within each rating. The *Quals Manual* lists the military requirements which apply to all ratings and the occupational qualifications that are specific to each rating.

The *Quals Manual* is kept current by means of numbered changes. These changes are issued more

frequently than most rate training manuals can be revised; therefore, the training manuals cannot always reflect the latest qualifications for advancement. When preparing for advancement, you should always check the latest Qualls Manual and the latest changes to be sure that you know the current requirements for advancement in your rating.

When studying the qualifications for advancement, remember these three things:

1. The quals are the minimum requirements for advancement to each rate within each rating. If you study more than the required minimum, you will of course have a great advantage when you take the written examination for advancement.

2. Each qual has a designated pay grade: E-4, E-5, E-6, E-7, E-8, or E-9. You are responsible for meeting all quals specified for advancement to the pay grade to which you are seeking advancement and all quals specified for lower pay grades.

3. The written examinations for advancement to E-6 and above contain questions relating to the practical factors and the knowledge factors of both military/leadership requirements and occupational qualifications. Personnel preparing for advancement to E-4 or E-5 must pass a separate military/leadership examination prior to participation in the Navy-wide occupational examination. The military/leadership examinations for E-4 and E-5 levels are given according to a schedule prescribed by the commanding officer. Candidates are required to pass the applicable military/leadership examination only once.

A special form known as the Record of Practical Factors, NavPers 1414/1, is used to record the satisfactory completion of the practical factors, both military and occupational, listed in the *Qualls Manual*. This form or its predecessor, NavPers 760, is available for each rating. Whenever a person demonstrates his ability to perform a practical factor, appropriate entries must be made in the date and initials columns. As a QM1 or QMC, you will often be required to check the practical factor performance of lower rated men and to report the results to your supervising officer. To facilitate recordkeeping, group records of practical factors are often maintained aboard ship. Entries from the group records must, of course, be transferred to each individual's Record of Practical Factors at appropriate intervals.

As changes are made periodically to the *Qualls Manual*, new forms of NavPers 1414/1 are provided when necessary. Extra space is allowed on the Record of Practical Factors for entering additional practical factors as they are published in changes to the *Qualls Manual*. The Record of Practical Factors

also provides space for recording demonstrated proficiency in skills which are within the general scope of the rating but which are not identified as minimum qualifications for advancement. Keep this point in mind when you are training and supervising lower rated personnel. If a man demonstrates proficiency in some skill that is not listed in the Quartermaster quals, but which falls within the general scope of the rating, report this fact to the supervising officer so that an appropriate entry can be made.

The Record of Practical Factors should be kept in each man's service record and should be forwarded with the service record to his next duty station. Each man should also keep a copy of the record for his own use.

NavPers 10052.0 Training Publications for Advancement, NavPers 10052, is a very important publication for anyone preparing for advancement. This publication lists required and recommended rate training manuals and other reference material to be used by personnel working for advancement. NavPers 10052 is revised and issued once each year by the Bureau of Naval Personnel. Each revised edition is identified by a letter following the NavPers number. When using this publication, be sure you have the most recent edition.

The required and recommended references are listed by rate level in NavPers 10052. It is of importance to remember that you are responsible for all references at lower rate levels, as well as those listed for the rate to which you are seeking advancement.

Rate training manuals that are marked with an asterisk (\*) in NavPers 10052 are mandatory at the indicated rate levels. A mandatory training manual may be completed by (1) passing the appropriate enlisted correspondence course based on the mandatory training manual, (2) passing locally prepared test based on the information given in the mandatory training manual, or (3) in some cases, successfully completing an appropriate Navy school.

It is of importance to notice that all references, whether mandatory or recommended, listed in NavPers 10052, may be used as source material for the written examinations, at the appropriate rate levels.

Rate Training Manuals. Rate Training Manuals are written for the specific purpose of helping personnel prepare for advancement. Some courses are general in nature and are intended for use by more than one rating; others (such as this one) are specific to the particular rating.

Rate training manuals are revised from time to time to bring them up to date. The revision of a rate training manual is identified by a letter after the NavPers number. You can tell whether a training manual is the latest edition by checking the NavPers

number and the letter after it in the most recent edition of the *List of Training Manuals and Correspondence Courses*, NavPers 10061 (revised).

There are three rate training manuals that are specially prepared to present information on the military requirements for advancement. They are:

*Basic Military Requirements*, NavPers 10054.

*Military Requirements for Petty Officer 3 & 2*, NavPers 10056.

*Military Requirements for Petty Officer 1 & C*, NavPers 10057.

*Military Requirements for Senior and Master Chief Petty Officer*, NavPers 10115 (soon to be available)

Each of the military requirements manuals is mandatory at the indicated rate levels. In addition to giving information on the military requirements, these three books give a good deal of useful information on the enlisted rating structure; how to prepare for advancement; how to supervise, train, and lead other men; and how to meet your increasing responsibilities as you advance.

Some of the rate training manuals that may be useful to you when you are preparing to meet the occupational qualifications for advancement to QM1 and QMC are discussed briefly in the following paragraphs. For a complete listing of rate training manuals, consult the *List of Training Manuals and Correspondence Courses*, NavPers 10061. *Quartermaster 3 & 2*, NavPers 10149-E: Satisfactory completion of this training manual is required for advancement to QM2 and QM3. If you met this requirement by satisfactorily completing an earlier edition of *Quartermaster 3 & 2*, you should at least glance through the latest revision of the training manual. Much of the information given in this edition of *Quartermaster 1 & C* is based on the assumption that you are familiar with the contents of *Quartermaster 3 & 2*.

Rate training manuals prepared for other ratings are often a useful source of information. Reference to these training manuals will increase your knowledge of the duties and skills of other men with whom you will be working. Portions of the training manuals prepared for Boatswain's Mates, Signalmen, Radiomen, and Radarmen are likely to be of particular interest to you.

The special-purpose publication, *The Navigation Compendium*, NavPers 10494, and the Officer Correspondence Course *Marine Navigation, Course 1*,

NavPers 10921-4, will prove beneficial in learning navigation. Both publications concern themselves with the fundamentals of surface navigation, including chart projections, instruments used by the navigator, magnetic compass errors, Mercator and great circle sailings, dead reckoning, piloting, and electronic navigation.

Most rate training manuals and officer texts are the basis for correspondence courses. Completion of a mandatory training manual can be accomplished by passing the correspondence course that is based on the training manual. You will find it helpful to take other correspondence courses, as well as those based on mandatory training manuals. For example, the completion of the correspondence course on *Marine Navigation* is strongly recommended for personnel preparing for advancement to QMC. Taking a correspondence course helps you to master the information given in the training manual or text and also gives you a good idea of how much you have learned from studying the book.

Additional BuPers publications that you may find useful in connection with your responsibilities for leadership, supervision, and training include the *Manual for Navy Instructors*, NavPers 16103-C and the *Naval Training Bulletin*, NavPers 14900 (published quarterly).

## NAVSHIPS PUBLICATIONS

A number of publications issued by the Naval Ship Systems Command will be of interest to you. While you do not need to know everything that is given in the publications mentioned here, you should have a general idea of where to find information in the NavShips publications.

The *NavShips Technical Manual*, NavShips 0901-000-0002 is the basic doctrinal publication of the Naval Ship Systems Command. The Manual is kept up to date by means of quarterly changes. All copies of the *Manual* should have all changes made in them as soon as possible after they are received.

Beginning with the quarterly changes dated 15 July 1963, the Naval Ship Systems Command began to renumber individual chapters in the NavShips Technical Manual according to the Navy-Marine Corps Standard Subject Classification System. Under this system, all chapters of the *Manual* will eventually be part of the 9000-series, which identifies ship design and ship's material subject groups. When all chapters are renumbered to conform to the 9000 numbering system, the old chapter numbers will be eliminated. In the meantime, you must consult the sheets in the front of the first volume of the *Manual* which cross-reference the new numbering system and the old. Some of the *Manual* chapters remain in their old positions, so the new and old

numbers have a definite relationship to each other. For example, old chapter 51 will in time be renumbered 9510, and old chapter 48 will be renumbered 9480. However, some chapters, will be moved to new locations, as well as being renumbered; in these cases, there is no clear relationship between the old numbers and the new. For example, the old chapter 6 has been moved to a new location and is now numbered 9004.

Information on chronometers, deck clocks, compasses, and other navigational instruments is given in the *Manual*. It should be noted that chapters of the *Manual* are referred to throughout this training manual by either the old chapter number or the new chapter number, depending upon which number was in use at the time of writing this training manual. If you have any trouble locating the chapter by the number given in this book, check the cross-reference sheets in the front of the first volume of *NavShips Technical Manual*.

The manufacturers' technical manuals, furnished with most machinery units and many types of equipment are valuable sources of information on operation, maintenance, and repair. The manufacturers' technical manuals are assigned NavShips numbers.

### TRAINING FILMS

Training films available to naval personnel are a valuable source of supplementary information on many technical subjects. Training films are listed in the *United States Navy Film Catalog*, NavAir 10-1-777 (formerly NavWeeps 10-1-777), published in 1966. Copies may be ordered in accordance with the *Navy Stock List of Forms and Publications*, NavSup 2002. Monthly supplements to the Film Catalog are distributed to catalog holders.

When selecting a film, note its date of issue listed in the Film Catalog. As you know, procedures sometimes change rapidly. Thus some films become obsolete rapidly. If a film is obsolete only in part, it may sometimes be shown effectively if, before or during its showing, you carefully point out to trainees the procedures that have changed. For this reason, when you are showing a film to train other personnel, take a look at it in advance, if possible, so that you may spot material that may have become obsolete and verify current procedures by looking them up in the appropriate sources before the formal showing.

## CHAPTER 2

# COMPASSES

You are aware that there are two general types of compasses used aboard all commissioned naval vessels. They are the magnetic compass, which depends on the earth's magnetic field for its directive force; and the gyrocompass, which is essentially one or more gyroscopes with special mountings made into a compass, utilizing two properties of the gyroscope (inertia and precession) and the earth's rotation and gravitational field.

As leading Quartermaster you will be required to determine compass error, make adjustments to the magnetic compass, make recommendations for corrections to the gyrocompass, and prepare deviation tables. This chapter will acquaint you with commonly used methods and procedures for accomplishing these ends.

### MAGNETIC COMPASS

Most ships carry two or more magnetic compasses like the one shown in figure 2-1. The principal magnetic compasses are the standard compass and the steering compass.

The standard compass usually is the most accurate magnetic compass aboard ship. It normally is located on the ship's centerline at a point where it will be least affected by unfavorable magnetic influences. On combatant ships, except aircraft carriers, the usual location for the standard compass is at secondary conn. On minesweepers and many of the auxiliaries, it frequently is found on the navigating bridge or the flying bridge. On many small ships, however, it is located in the pilothouse and is used as a steering compass, although it is in fact the standard compass. The indications of the standard compass are expressed as per standard compass (psc).

The steering compass is located on the ship's centerline—except aboard aircraft carriers—just forward of the wheel where it can best be seen and used by the helmsman. Normally, it is in the ship's pilothouse. The indications of the steering compass are per steering compass (pstgc).

### COMPASS NOMENCLATURE

In the *Quartermaster 3 & 2* training manual you learned the major parts of a magnetic compass: magnets, compass card, compass bowl, fluid, float, expansion bellows, lubber's line, and gimbals. For compass correction, you must be familiar with many additional components, the principal one of which is the binnacle.

The compass binnacle shown in figure 2-2 is designed chiefly for mounting the U.S. Navy standard 7 1/2-inch magnetic compass. This binnacle is made of nonmagnetic material and stands approximately 3 1/2 feet high. The top of the binnacle is fitted to accept the compass and its gimbals. The various components of the binnacle, which are identified by letter designation in figure 2-2, are as follows:

- A—Trays for fore-and-aft magnets;
- B—Trays for athwartship magnets;
- C—Binnacle hood;
- D—Magnets for fore-and-aft and athwartship trays;
- E—Heeling magnets;
- F—Flinders bar spacers;
- G—Flinders bar;
- H—Dip needle;
- I—E-link;
- J—7-inch spherical quadrantal correctors;
- K—9-inch spherical quadrantal correctors;
- L—Cylindrical quadrantal correctors;
- M—Compass with azimuth circle.

The purpose of most of the parts listed, as well as their actual use and physical placement will be discussed later in this chapter.

### LIMITATIONS OF MAGNETIC COMPASS

The magnetic compass, as you know through experience, is a reliable instrument. Normally, it must be severely damaged or destroyed to make it

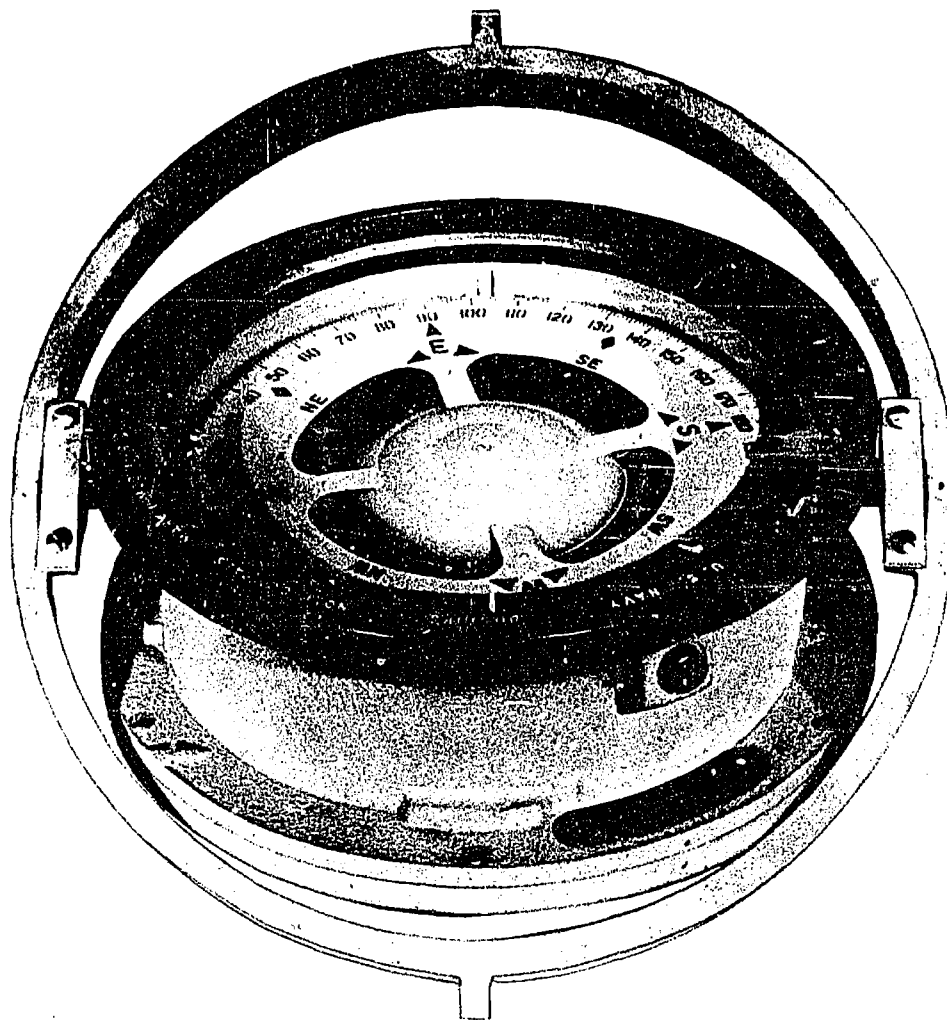

Figure 2-1. U.S. Navy 7 1/2-inch compass.

45.595(69)

completely inoperable. The magnetic compass is not a perfect instrument however, and it does have some drawbacks. Many shortcomings are discussed in the current edition of *Quartermaster 3 & 2* (NavPers 10149), hence they are not mentioned further here.

One of the limiting factors of a magnetic compass not stressed in QM 3 & 2 is that only the horizontal component of the earth's magnetic field exerts a directive force on it. This force is greatest at the magnetic equator, but as the distance from the magnetic equator increases, the angle of dip becomes greater, resulting in a decreasing horizontal component. Within a few hundred miles of the magnetic poles, the compass becomes sluggish; over the magnetic poles, it loses its directive force altogether. With increased operations in polar regions, the in-

adequacy of the magnetic compass becomes a matter of prime importance. Chief reliance, then, must be placed upon the gyrocompass in higher latitudes. When you approach latitudes greater than  $70^\circ$ , however, neither the magnetic compass nor the gyrocompass is entirely accurate.

#### CAUSES OF DEVIATION

The magnetic properties of your ship cause a deviation in the magnetic compass. Ship magnetism is of two types: permanent magnetism (magnetism in steel or hard iron that acts as a permanent magnet) and induced magnetism (magnetism of soft iron, which is only temporary and is changing constantly, depending upon ship's heading and latitude).

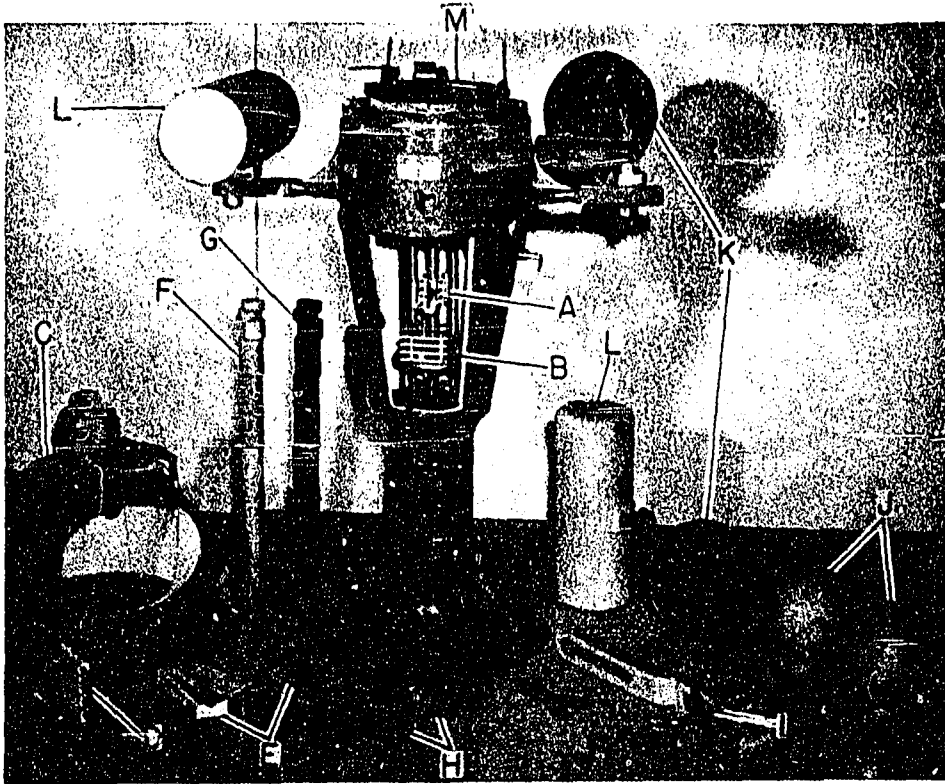

Figure 2-2. Magnetic compass binnacle with correctors. 112.2

In discussing deviation in the following topics, you may become confused when using the terms “north and south magnetism.” To avoid this confusion, and to clarify magnetism in the following illustrations, the earth’s magnetism found in the Northern Hemisphere is called blue magnetism; that in the Southern Hemisphere is termed red magnetism. Likewise, the north-seeking end of a bar magnet has red magnetism, and the south-seeking end has blue magnetism.

#### Permanent Magnetism

Because the majority of ships are built of magnetic material that is continually under the influence of a magnetic field, they acquire some permanent magnetism. By way of illustration, let’s say that the ship in figure 2-3 was built in the Northern Hemisphere at a northeast magnetic heading. No matter how the ship is turned, the distribution of permanent magnetism is always the same. The amount of permanent magnetism, however, may undergo rapid changes after building, most notably immediately after launching, and during the first few months of operation. The compass error changes as the amount of magnetism changes.

Permanent magnetism has both vertical and horizontal components, but the magnetic compass is designed to respond to horizontal forces only. The vertical component of permanent magnetism does not cause deviation as long as the ship remains on an even keel. When the ship rolls or pitches, however, the vertical component causes an unsteadiness of the compass. The compass also is affected if the ship has a permanent list. The compass error produced by rolling, pitching, or listing is called heeling error. (The correction for heeling error is discussed later in this chapter.)

Deviation due to uncorrected permanent magnetism varies with each change in latitude. The horizontal intensity of the earth’s magnetic field decreases as your ship moves ever farther from the magnetic equator. Consequently, the magnetic force acting on the ship changes, and the deviation varies accordingly.

If your ship is proceeding toward the magnetic equator, the uncorrected deviation owing to permanent magnetism decreases. If your ship is proceeding toward either of the magnetic poles, the uncorrected deviation caused by permanent magnetism increases. In other words, when you are

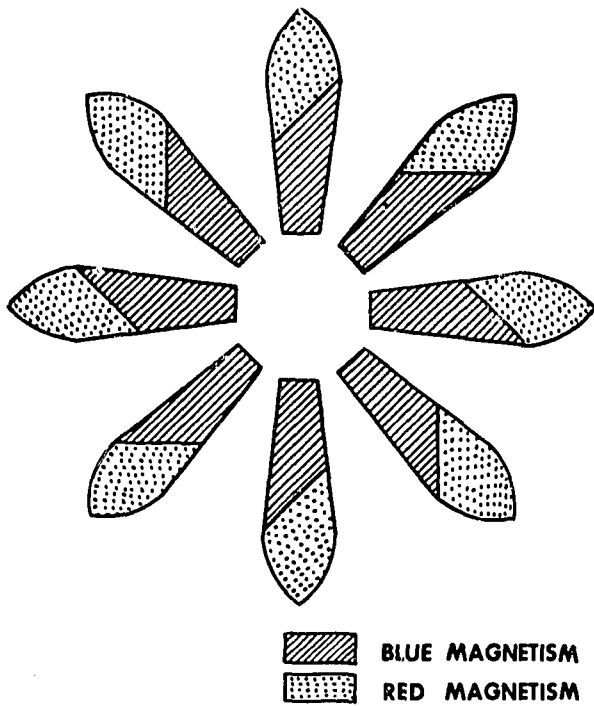

Figure 2-3. Ship built on northeast heading. 112.1

traveling near the equator, the magnetic compass is most accurate; deviation is greatest when you are near the poles, and the magnetic compass is least accurate.

**Correcting Deviation Caused by Permanent Magnetism:** A large single bar magnet could be placed near the magnetic compass to neutralize the effects of the ship's permanent magnetism. This method presents too many practical difficulties, however, and is not used. Correction must be made separately for both the fore-and-aft and athwartship components of permanent magnetism. This correction is made by placing magnets in the compass binnacle (see fig. 2-2). The fore-and-aft magnets are inserted east and adjusted when your ship heads magnetic west. Athwartship magnets are inserted and adjusted when your ship heads magnetic north or south. Thus, the deviation caused by permanent magnetism is reduced by means of these permanent magnets, placed either in trays under the compass bowl inside the binnacle or in magnet holders mounted beside the binnacle in shelf-mounted installations.

To illustrate how the correction might be made, look at the ship in figure 2-4. In part A of the illustration, the ship is heading magnetic north. The permanent magnetism of the ship is indicated by the red and blue poles marked with the letter P. Small poles, marked Pb and Pc, represent the fore-and-aft and athwartship components of the permanent magnetism. The fore-and-aft component Pb has no effect on the compass. Hence, permanent magnets are placed athwartships under the compass bowl to correct the deviation caused by component Pc.

In part B of figure 2-4, the ship is heading magnetic east, and you can see that Pc has no effect. Permanent magnets then are placed fore and aft under

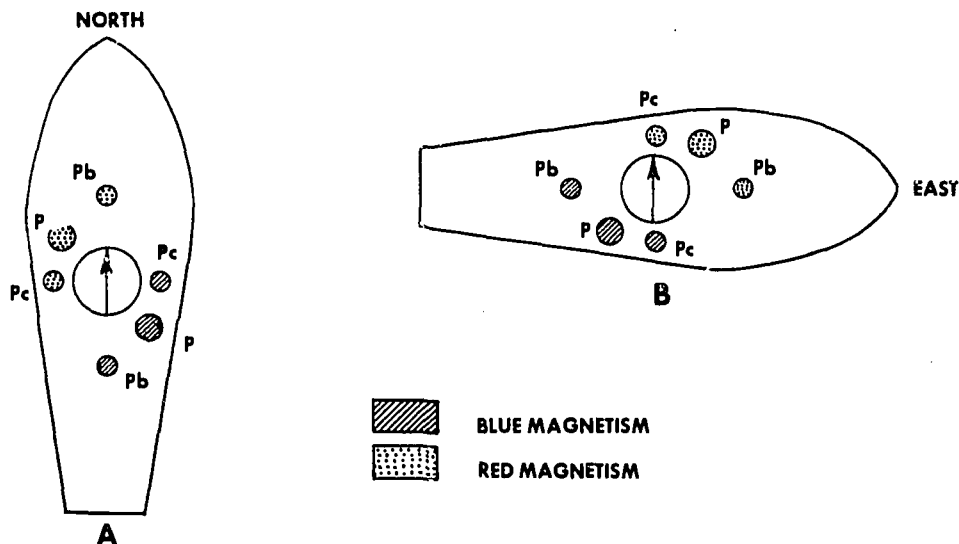

Figure 2-4.—Correcting permanent magnetism.



the compass bowl to correct the deviation caused by component Pb.

### Induced Magnetism in Vertical Soft Iron

You already know that the earth's field induces a certain amount of magnetism in the iron and steel of a ship. This magnetism induced in the vertical structures of your ship (bulkheads, stanchions, etc.) is called induced magnetism in vertical soft iron. It is so named because the effect is most notable in soft iron, although induced magnetism is present in both soft and hard iron. At high latitudes, the vertical component of the earth's magnetic field is greatest; therefore, the magnetism induced into vertical soft iron is greatest. Near the magnetic equator the vertical component of the earth's magnetic field is small so that there is very little vertical induced magnetism.

You must make a distinction between the poles of induced magnetism and the poles of the ship's permanent magnetism. The exact location or position of the poles of the ship's permanent magnetism is different on practically every ship, depending largely upon the headings on which the ship was built. Your sister ship may be identical to your ship in every respect (concerning concentration and amount of iron or steel) but, because she was built in ways of a different heading from your ship, her concentration or poles of permanent magnetism differ from your ship. The intensity of permanent magnetism does not change with changes of latitude.

In the majority of steel ships the poles of magnetism induced in vertical soft iron are located on the fore-and-aft centerline of the ship, regardless of the heading on which the ship was built. Induced magnetism on all ships varies in intensity with changes of latitude.

For the foregoing reasons, uncorrected deviation due to magnetism induced in vertical soft iron changes with every change in magnetic latitude. The horizontal intensity of the earth's magnetic force increases when proceeding toward the magnetic equator, thus exerting greater force to pull the compass needle into line with the meridian. The actual strength of the pole of induced magnetism in vertical soft iron decreases as your ship proceeds toward the magnetic equator; it increases when it travels toward one of the magnetic poles. The complete absence of a vertical magnetic field at the magnetic equator leaves no induced magnetism in the vertical soft iron of the ship. If your compass is adjusted at the magnetic equator, and the permanent magnetism remains constant, any deviation when you are on an east or west heading after leaving the magnetic equator can be attributed to vertical induced magnetism alone.

**Correcting Deviation Due to Vertical Soft Iron:** Adjustment for deviation caused by induced magnetism in vertical soft iron is made by placing a metal bar (in which magnetism can be induced) near the magnetic compass. This metal rod or corrector is called a Flinders bar. (See fig. 2-2.) The Flinders bar, consisting of several segments of various lengths, is inserted in a holder mounted on the binnacle. Wooden or brass fillers, which come in segments the same length as the Flinders bar, are inserted in the bottom of the holder so that the top of the bar is even with the top of the holder. The top of the holder for the Flinders bar is exactly 2 inches above the plane of the compass card. Because the pole of vertical induced magnetism usually is abaft the compass, the Flinders bar normally is mounted on the forward side of the compass binnacle.

### Induced Magnetism in Symmetrical, Horizontal Soft Iron

On the majority of ships, both the standard and the steering compasses are located on the amidships line. Thus, the steel or iron on most ships is arranged uniformly and symmetrically around the magnetic compass. As a result, the compass is surrounded by a symmetrical distribution of soft iron in which magnetism can be induced horizontally. This induced magnetism occurs mainly in the bulkheads and decks of your ship. The bulkheads and decks, then, can be considered to be horizontal induced magnets.

The horizontal induced magnetism can be visualized as two magnets, one running fore and aft and the other running athwartships. The fore-and-aft magnet has a larger magnetic moment than the athwartship magnet, but the athwartship magnet has its poles closer to the magnetic compass, and therefore has a much greater effect on the compass. For simplification, only the effect of the athwartship magnet is considered in this text.

From figure 2-5 you can see that there is no deviation when the ship is at a cardinal heading. At all other headings there is deviation. You will notice also that deviation is easterly at headings NE and SW. When you are heading SE or NW the deviation is westerly. Thus, it is seen that the deviation changes direction with every 90° change of heading. *It is caused by induced magnetism in horizontal soft iron, and is called quadrantal deviation. Uncorrected quadrantal deviation does not usually change with a change in latitude.*

**Correcting Quadrantal Deviation:** Quadrantal deviation is corrected by means of two hollow spheres or cylinders of soft iron called quadrantal correctors. These correctors usually are installed one on either side of the magnetic compass on the athwartship line through the compass. (See fig. 2-2.)

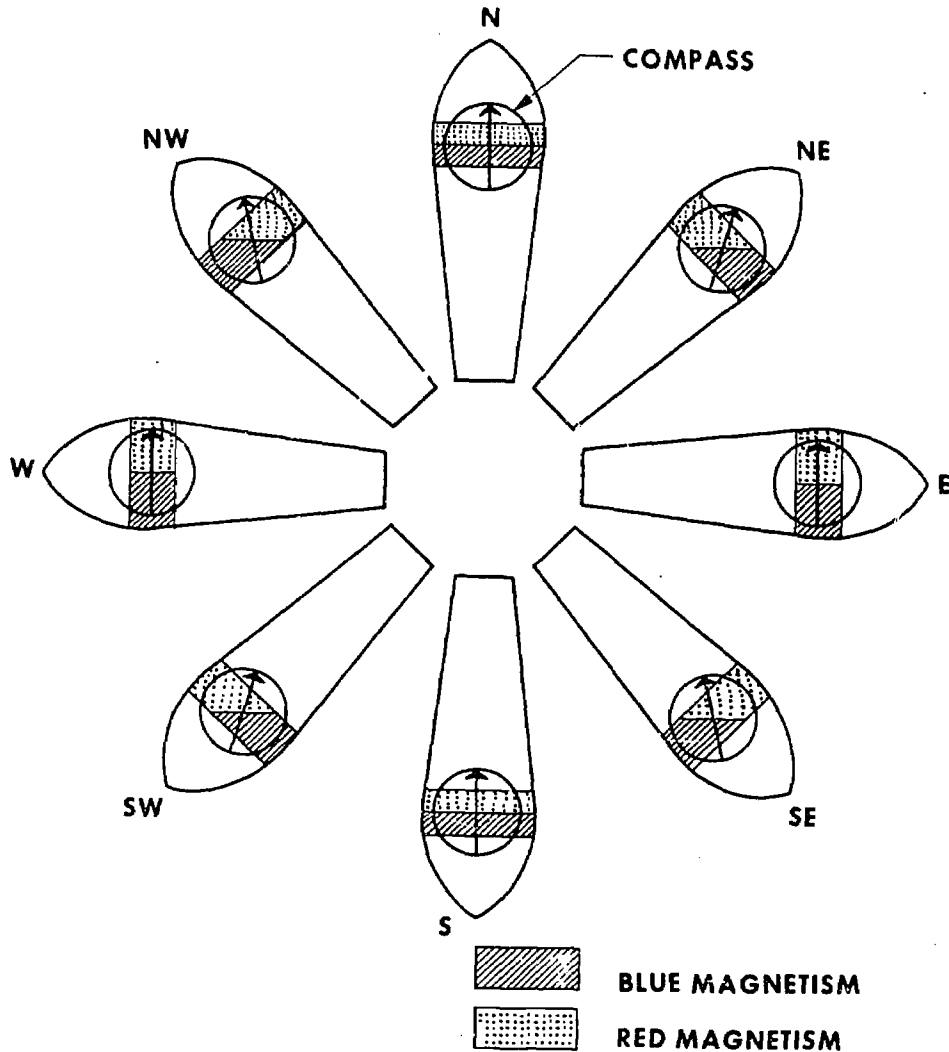

Figure 2-5.—Quadrantal deviation.

112.4

The earth's magnetic field magnetizes these spheres by induction. The induced magnetism of the spheres counteracts the induced magnetism of the ship, forcing the compass needle to align itself with the magnetic meridian. (When quadrantal spheres are in use, deviation may change somewhat with latitude because of induction in the spheres.)

The magnetic force exerted by the spheres can be altered by changing their distance from the compass or by exchanging the spheres for ones of larger or smaller size. These spheres are extremely effective in correcting quadrantal deviation on all headings.

### Heeling Error

All adjustments for deviation thus far were made on the assumption that your ship has been on an even keel. As noted earlier, when your ship heels to one side or the other, the metal of the ship changes its relative position with respect to the magnetic compass because the compass, mounted in gimbals, remains horizontal. The main causes of heeling error are vertical permanent magnetism, vertical induced magnetism, and horizontal induced magnetism.

In view A of figure 2-6, you see the magnetism of horizontal soft iron in a ship on a north heading. Ini-

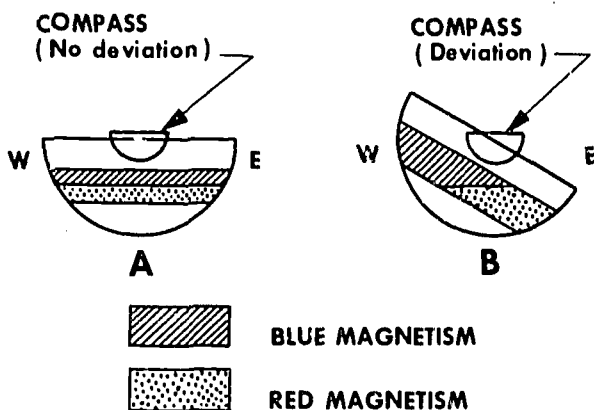

Figure 2-6.—Heeling error. 112. 5

tially, there is no deviation. Then, when the ship heels (fig. 2-6, view B), the poles are realigned east and west, causing deviation.

Heeling error is maximum on north and south headings because, as the ship heels, the poles of induced magnetism lie to the east and the west of the compass, causing deviation. On an east or west heading, however, the poles are in line with the compass magnets and merely increase or decrease the directive force on the compass. Heeling error on these east or west headings is caused more by the pitch of the ship than by list or roll.

If your ship has a permanent list, a constant deviation occurs, but when your ship rolls, this deviation is first in one direction and then in the other. This unsteadiness, resulting in an unsteady and oscillating compass, is undesirable and should be corrected by placing a heeling magnet beneath the compass. (This adjustment is described later.)

### COMPASS ADJUSTMENT

Of the several basic reasons for adjusting the magnetic compass, the most important is to make the compass as accurate as possible by eliminating as much deviation as practicable. A second reason for compass adjustment is to make whatever residual deviation there is as nearly constant as feasible with changes of magnetic latitude. A third objective is to improve the directive force of the magnetic compass by making it as strong as possible under all conditions. Improving the directive force improves both the accuracy and reliability of the magnetic compass.

Adjusting the compass to correct for deviation usually entails swinging the ship through different headings. The ship should be on an even keel when you prepare to swing her. All movable masses of

metal near the compass must be secured in the positions they normally occupy when at sea. The degaussing coils should also be secured.

All your binnacles should be as near the amidships line as possible and should be secured solidly. On the standard 7 1/2-inch compass, the compass bowl must be adjusted by the screws at the ends of the outer gimbal knife edges until it is in the exact center of the binnacle. In this position, with the ship heading north or south, raising or lowering the heeling magnet has no effect on the compass card. The compass should be secured in this position by setting the screws so as to prevent it from sliding back and forth athwartships.

Exact fore-and-aft position of the lubber's line must be verified by sighting with a bearing circle or an azimuth circle on straightedges erected on the midships line at some distance forward and abaft the compass. Lubber's lines on peloruses should be checked also. They are checked either by bearings taken simultaneously on a distant object by compass and pelorus, or by computing (from the ship's plans) the angle the flagstaff or jackstaff should bear from the lubber's line of the pelorus, then verifying the angle by observation.

The quadrantal spheres and the Flinders bar should be tested for residual magnetism. To test the quadrantal spheres, place them as close to the compass as possible and rotate each one separately. Any change in the compass reading of 2° or more resulting from this rotation indicates residual magnetism in the spheres. To test the Flinders bar, put the ship on an east or west heading. Insert the Flinders bar in the holder and note the compass reading. Now invert the Flinders bar in the holder and again note the compass reading. Any difference of 2° or more in the two readings indicates residual magnetism in the Flinders bar. Residual magnetism in either the spheres or bar should be removed by annealing, that is, by heating them to a dull red and allowing them to cool slowly.

### Preliminary Adjustments

Several adjustments and corrections can be made to the magnetic compass before going to sea. They include placing (1) the Flinders bar, (2) quadrantal spheres, and (3) the heeling magnet.

Placing Flinders bar: Because the Flinders bar is subject to induction from other correctors, it has been found best to place the Flinders bar in position first. Certain information must be available beforehand, however. For instance, if you know the deviation at two widely separated magnetic latitudes on east and west headings, the amount of Flinders bar

**MAGNETIC COMPASS TABLE** NAVSHIPS RP: 3530-2  
 NAVSHIPS 3120/4 (REV. 6-67) (FRONT) (Formerly NAVSHIPS 1104)  
 S/N 0105-601-9520

U. S. S. Truckee NO. AO 147  
(RR, CL, DD, etc.)

PILOT HOUSE  SECONDARY CORNING STATION  OTHER

BINNACLE TYPE  NAVY ST'D  OTHER

COMPASS 7 1/2 MAKE Lionel SERIAL NO. 1592

TYPE CC COILS "X" DATE 30 October 1970

**READ INSTRUCTIONS ON BACK BEFORE STARTING ADJUSTMENT**

SHIPS HEAD MAGNETIC	DEVIATIONS		SHIPS HEAD MAGNETIC	DEVIATIONS	
	DG OFF	DG ON		DG OFF	DG ON
0	0.5E	0.5E	180	0.5W	0.0
15	1.0E	1.0E	195	1.0W	0.5W
30	1.5E	1.5E	210	1.0W	1.0W
45	2.0E	1.5E	225	1.5W	1.5W
60	2.0E	2.0E	240	2.0W	2.0W
75	2.5E	2.5E	255	2.0W	2.5W
90	2.5E	3.0E	270	1.5W	2.0W
105	2.0E	2.5E	285	1.0W	1.5W
120	1.5E	2.0E	300	1.0W	1.0W
135	1.5E	1.5E	315	0.5W	0.5W
150	1.0E	1.0E	330	0.5W	0.5W
165	0.0	0.5E	345	0.0	0.0

DEVIATIONS DETERMINED BY  SUN'S AZIMUTH  GYRO  SHORE BEARINGS

B 4 MAGNETS RFO  FORE  AFT AT 14 " FROM COMPASS CARD

C 4 MAGNETS REO  PORT  STBD AT 10 " FROM COMPASS CARD

D 2-7"  SPHERES AT 12  ATHWART-SHIP  CTR. CLOCKWISE  
 CYLS  SLEWED  CLOCKWISE

HEELING MAGNET  RED UP  BLUE UP 10 " FROM COMPASS CARD FLINDERS BAR  FORE  AFT 14 "

LAT 36° 10' N  LONG 75° 20' W  
 H  Z

SIGNED (Adjuster or Navigator) T. PARRISH APPROVED (Commanding) R. MOSS

Figure 2-7. Deviation table (front). 69.13.1

formation be unavailable, it is best to use no Flinders bar until later in the adjustment process.

The sections of Flinders bar used should be continuous, that is, with no spacers separating sections. The Flinders bar should be placed at the top of the holder, with the longest section at the top. Spacers should be placed at the bottom of the tube. You should record the amount of Flinders bar on the space provided for such information at the bottom of the front side of the form titled Magnetic Compass Table (Deviation Table), NavShips 3120/4. (See fig. 2-7.)

**Placing Quadrantal Spheres:** The next step in adjusting the compass is to place the quadrantal spheres in their approximate positions. If the compass was adjusted previously, the deviation table should show the size and positions of the spheres. If this information was not recorded, or if the compass was never adjusted in the past, then the quadrantal spheres should be placed in the middle of their braces or arms.

**Placing Heeling Magnet:** The correct position of the heeling magnet can be determined by means of a dip needle or by approximation. If your ship is equipped with a dip needle, refer to H.O. 226, chapter XV to learn about its use. If your ship is not equipped with a dip needle, place the heeling magnet in the bottom of its tube, with the north end (marked N and painted red) up in north magnetic latitudes, unless you know from experience that it should be the other direction. Later, when your ship is headed north or south and has a steady roll, you should observe the oscillations of the compass, and raise the heeling magnet until the compass steadies.

It should be noted that, even when the compass is adjusted completely, the heeling magnet may have to be readjusted if the compass becomes unsteady, especially after large changes of magnetic latitude.

Normally, heeling magnets are not required on wooden ships, such as the new minesweepers.

**Final Adjustments**

Now you are ready to swing the ship and make the final adjustments. To adjust for permanent magnetism, semicircular deviation, and quadrantal deviation, the ship must be at specific headings.

**Adjusting for Permanent Magnetism:** When you are correcting permanent magnetism, the first step (step 1) is to head your ship magnetic east or west.

Note the deviation, then reduce this deviation to zero by placing permanent magnets in the fore-and-aft trays of the binnacle. You can determine by trial and error the correct direction in which to place the red and blue ends of the magnets, or you can follow the general rule that the red end normally is placed in the direction of the error. The magnets should be

to use can be determined readily by consulting the *Handbook of Magnetic Compass Adjustment and Compensation*, H.O. 226, which describes this procedure. If you do not have a record of these readings, then the amount of Flinders bar to use can be estimated if you know the correct amount other the same class are using. Should even this in-

Table 2-1. Mechanics of Magnetic Compass Adjustment

Fore-and-aft and athwartship magnets		Quadrantal spheres		Flinders bar	
Deviation → Magnets ↓	Easterly on east and westerly on west. (+B error) Place magnets red forward.	Deviation → Spheres ↓	E. on NE, W. on SE, E. on SW, and W. on NW. (+D error) Place spheres athwartship.	Deviation change with latitude change → Bar ↓	E. on E. and W. on W. when sailing toward equator from north latitude or away from equator to south latitude.
No fore and aft magnets in binnacle.	Place magnets red forward.	No spheres on binnacle.	Place spheres fore and aft.	No bar in holder.	Place required amount of bar forward.
Fore and aft magnets red forward.	Raise magnets.	Spheres at athwartship position.	Move spheres toward compass use larger spheres.	Bar forward of binnacle.	Increase amount of bar forward.
Fore and aft magnets red aft.	Lower magnets.	Spheres at fore and aft position.	Move spheres outward or remove.	Bar aft of binnacle.	Increase amount of bar aft.
Deviation → Magnets ↓	Westerly on north and easterly on south. (-C error) Place athwartship magnets red port.	Deviation → Spheres ↓	E. on N, W. on E, E. on S, and W. on W. (+E error) Place spheres at starboard and port at intercardinal positions.	↑ Bar	W. on E. and E. on W. when sailing toward equator from south latitude or away from equator to north latitude.
No athwartship magnets in binnacle.	Place athwartship magnets red starboard.	No spheres on binnacle.	Place spheres at starboard foreward and port at intercardinal positions.	Deviation change with latitude change →	E. on E. and W. on W. when sailing toward equator from south latitude or away from equator to north latitude.
Athwartship magnets red starboard.	Raise magnets.	Spheres at athwartship position.	Slew spheres clockwise through required angle.		Heeling magnet (Adjust with changes in magnetic latitude)
Athwartship magnets red port.	Lower magnets.	Spheres at fore and aft position.	Slew spheres counter-clockwise through required angle.		If compass north is attracted to high side of ship when rolling, raise the heeling magnet if red end is up and lower the heeling magnet if blue end is up.
			Slew spheres counter-clockwise through required angle.		If compass north is attracted to low side of ship when rolling, lower the heeling magnet if red end is up and raise the heeling magnet if blue end is up.
					NOTE: Any change in placement of the heeling magnet will affect the deviations on all headings.

used in pairs, from the bottom up. When overcorrection occurs, remove the two uppermost magnets and raise the trays until the deviation is zero.

After you reduce deviation to zero on an east or west heading, your ship should be turned and headed north or south for step 2. Deviation should be reduced to zero in like manner by using permanent magnets in the athwartship trays.

**Adjusting for Semicircular Deviation:** The next step (step 3) is to change course to the heading opposite the initial heading (step 1) used when adjusting for permanent magnetism. In other words, if you headed east during step 1, you should now head west. During step 3, using fore-and-aft magnets, remove only half of any deviation found. Record in the deviation table (1) the number of magnets in the fore-and-aft trays, and (2) whether the red ends are forward or aft.

For the final step (step 4) of this semicircular deviation phase, change course to the heading opposite that used in step 2. (Depending on the heading used in step 2, you should now be on a north or south heading.) The headings used for the four steps must be the cardinal points. Repeat the step 3 procedure, using the athwartship magnets, and record the necessary information in the deviation tables.

Table 2-1 is a worthwhile guide for proper placement of magnets when correcting semicircular deviation.

**Adjusting for Quadrantal Deviation:** The last adjustment is made with the use of the quadrantal spheres. For this adjustment, your ship should be headed on one of the intercardinal magnetic headings. Move the quadrantal spheres along their arms, either away from or toward the compass, until all deviation is removed. Remember that the spheres must be equidistant from the compass. In order to remove all deviation, it may also be necessary for you to use larger or smaller spheres than the ones mounted. Table 2-1 shows which direction to move spheres for any given quadrantal deviation.

The next step is to change course exactly 90° to either adjacent intercardinal magnetic heading, and remove half of the deviation found. Record in the deviation table the size of the quadrantal spheres used and their distance from the compass.

Although the foregoing method is accurate for all practical purposes, even more accurate results usually can be obtained. Head the ship on all four of the intercardinal points, obtaining the average of the deviation of these four points, and remove this deviation on only one of the intercardinal headings.

## Frequency of Compass Adjustment

The deviation of the various compasses aboard your ship should be checked often. Results of these checks should be recorded on the magnetic compass table (fig. 2-7). Deviation in excess of tolerance can be ascertained readily and the compass adjusted as required. Always check the deviation of your magnetic compasses carefully and adjust them (as necessary) after—

1. Any structural changes are made in your ship, i.e., addition of gun mounts, modifications to houses or mast, removal of structures, etc., or any welding done in the vicinity of a compass.

2. Steaming for long periods on the same course, or laying alongside the dock on the same heading for long periods of time.

3. A radical change in magnetic latitude.

4. Removal or addition of any magnetic material near a magnetic compass.

5. Deperming and flashing treatment.

6. Reaching the magnetic equator.

7. Removal or addition of any cargo of magnetic nature.

8. A heavy gunnery exercise, or battle damage, i.e., bomb, shell, torpedo hits or atomic explosions, or being struck by lightning.

After any of the preceding events, but not less frequently than every 12 months, your ship should be swung in order to obtain a new deviation table. If the deviation obtained is excessive, the magnetic compass should be readjusted.

## Methods of Finding Deviation

The most convenient method of determining deviation, and the one most commonly used, is to check your compass on each 15° heading against a properly functioning gyrocompass. Because your ship must be on a magnetic heading when determining deviation, gyro error and local variation must be applied to each true heading.

Now it is necessary only to station personnel at each magnetic compass and have them record the amount of deviation for each compass upon signal from an observer at the gyrocompass or repeater.

Some other methods of finding deviation follow.

1. By comparison with a magnetic compass of known deviation: This method is similar to comparison with a gyrocompass except that it is unnecessary to know the local variation. This method is used frequently by ships not equipped with gyrocompasses.

2. By reciprocal bearings: One observer is stationed ashore with a spare compass, which is placed where it is free from local magnetic influences. An observer aboard the ship stands by the compass to

## QUARTER MASTER 1 & C

be checked. When the ship is steady on the desired heading, a prearranged signal is made, and each observer notes the bearing of the other. The reverse bearing of the compass ashore, which has no deviation, is the magnetic bearing of the ship. The difference between this bearing and the bearing indicated by the compass on board is the amount of deviation on that particular heading. This method is not very convenient and probably will never be used on your ship until all other methods of determining deviation are exhausted.

3. By ranges: This method uses a range whose magnetic bearing is known. The ship steams on the various headings, and notes the bearing of the range on her compasses for each heading as she crosses the range. The deviation for each compass is the difference between the known magnetic bearing of the range and the bearing indicated on the compass.

4. By azimuths of the sun or other celestial body: In this method the magnetic azimuth of the body is determined by applying local variation to the body's true azimuth. The difference between the body's magnetic azimuth and its compass azimuth is the deviation for that particular heading.

5. By distant objects: In this method the ship must be a considerable distance from a conspicuous object, with a clearly defined point on which to take bearings. If the ship is being swung at anchor, the object should be at least 6 miles away. If she is steaming on different headings, the fact that she does not remain on the same spot requires that the object be at least 10 miles away. The ship is steadied on successive headings, and the compass bearing of the object is taken on each heading. Magnetic bearings may be found from a chart. As before, deviation on each heading is the difference between compass and magnetic bearing of the object. This method has been almost completely discarded in favor of the other methods. It is described here so that it can be used in extreme circumstances.

### DEVIATION TABLE

The compass now has been adjusted. As much deviation as possible has been removed, and all that remains is the unremovable residual deviation. This remaining deviation is not the same on every heading, therefore the deviation that exists on the various headings must be recorded so that the correction for compass error will be known. To determine and record the residual deviation, your ship is headed through every 15° of the compass, a process called swinging ship. Your ship is steadied for several minutes on each 15° heading to allow the Gaussin error to dissipate (there are 24 of them around the compass). The

navigator usually is stationed at the standard compass, and ship's personnel are stationed at the other magnetic compasses. As your ship steadies up on one of the 15° increments of the compass, and the compasses themselves settle down, the navigator gives the signal to record the deviation on that heading. When

VERTICAL INDUCTION DATA <i>(Fill out completely before adjusting)</i>	
RECORD DEVIATION ON AT LEAST TWO ADJACENT CARDINAL HEADINGS	
BEFORE STATING ADJUSTMENT: N <u>4.5E</u> E <u>3.5E</u> S <u>2.0W</u> W <u>3.0W</u>	
RECORD BELOW INFORMATION FROM LAST NAVSHIPS 3120/4 DEVIATION TABLE:	
DATE <u>21 January 1969</u>	<input checked="" type="checkbox"/> H LAT <u>36° 25' N</u> <input checked="" type="checkbox"/> Z LONG <u>75° 05' W</u>
<u>6</u> FLINDERS BAR	<input checked="" type="checkbox"/> FORWARD <input type="checkbox"/> AFT
DEVIATIONS	
N <u>0.5E</u> E <u>3.0E</u> S <u>1.2W</u> W <u>2.5W</u>	
<small>RECORD HERE DATA ON RECENT OVERHAULS, GUNFIRE, STRUCTURAL CHANGES, FLASHING, DEPERMING, WITH DATES AND EFFECT ON MAGNETIC COMPASSES</small>	
<b>ON RECENT YARD OVERHAUL, STRUCTURAL CHANGES WERE ACCOMPLISHED WHICH CHANGED THE CONFIGURATION OF THE SUPERSTRUCTURE.</b>	
PERFORMANCE DATA	
COMPASS AT SEA:	<input type="checkbox"/> UNSTEADY <input checked="" type="checkbox"/> STEADY
COMPASS ACTION:	<input type="checkbox"/> SLOW <input checked="" type="checkbox"/> SATISFACTORY
NORMAL DEVIATIONS:	<input checked="" type="checkbox"/> CHANGE <input type="checkbox"/> REMAIN RELIABLE
DEGAUSSED DEVIATIONS:	<input checked="" type="checkbox"/> VARY <input type="checkbox"/> DO NOT VARY
REMARKS	
INSTRUCTIONS	
1. This form shall be filled out by the Navigator for each magnetic compass as set forth in Chapter 9240 of NAVAL SHIPS TECHNICAL MANUAL.	
2. When a swing for deviations is made, the deviations should be recorded both with degaussing coils off and with degaussing coils energized at the proper currents for heading and magnetic zone.	
3. Each time this form is filled out after a swing for deviations, a copy shall be submitted to the Naval Ship Engineering Center. A letter of transmittal is not required.	
4. When choice of box is given, check applicable box.	
5. Before adjusting, fill out section on "Vertical Induction Data" above.	
<small>NAVSHIPS 3120/4 (REV. 6-67) (REVERSE)</small>	

Figure 2-8. Deviation table (back). 69.13.2

the process of swinging ship is completed and the deviation for the 24 headings recorded, the deviations are transferred to the deviation table. (See fig. 2-7.)

The deviation table contains much important information that is necessary for future compass adjustment as well as for computing compass error. (Refer to figs. 2-7 and 2-8.)

Three copies of the deviation table are prepared for each magnetic compass. One copy is posted at the compass itself, one is maintained in the back cover of the Magnetic Compass Record, NavShips 1101, and one is forwarded to NavShips. (A forwarding letter is not required.)

Before swinging the ship to record residual deviations, the following information should already be recorded

1. Amount of Flinders bar, and whether the bar holder is forward or abaft the binnacle.
2. Number of fore-and-aft magnets, whether their red ends are forward or aft, and the distance in inches between the fore-and-aft tray and the compass card.
3. Same as step 2 for the athwartships tray.
4. Size of the quadrantal spheres and their distance from the compass card.
5. Which end of the heeling magnet is up, and its distance from the compass card.

#### Check on Deviation Table

Actual deviation of the compass may change enough to render the deviation table inaccurate. Frequent comparison with the gyrocompass must be made, and a record of actual deviation must be kept in the Magnetic Compass Record. This record indicates both the accuracy of the deviation table and the need for swinging ship again to establish a new deviation table. Provisions of *Navy Regulations* require that comparisons be made after every change of course, and at every half-hour thereafter.

Comparisons may also give warning of any erratic performance of the gyro. Frequent azimuths of celestial bodies should be taken to use as a standard of comparison.

#### DEGAUSSING

Magnetic mines and torpedoes have firing mechanisms so constructed that they are actuated by a ship's magnetic field. Degaussing reduces the strength of this magnetic field. Consequently, some measure of protection against these weapons is afforded by degaussing. Degaussing currents have a strong effect on a ship's magnetic compass, however, the deviation caused by these currents is

usually larger than that caused by the ship's residual magnetism. This effect on the magnetic compass, if present, must be neutralized by the process called compensation. Before discussing compensation, let us first discuss briefly the principles of degaussing.

#### Principles of Degaussing

Normally, degaussing is accomplished by permanently installed cables in the form of coils through which electric current is passed, thus setting up a magnetic field that tends to neutralize the ship's field. Sometimes it also is necessary to give the ship a magnetic treatment consisting of the application of large magnetic fields so as to change the ship's magnetism in order that the coils can neutralize the ship's magnetic fields more adequately. This treatment is known as deperming.

The type of degaussing system discussed here is the one equipped with only the M, FI-QI, and FP-QP coils. The principal degaussing coil used is called the M-coil, or main coil. It encircles the ship, inside the skin of the hull, in a horizontal plane approximately at the waterline. The M-coil compensates for the ship's vertical permanent and induced magnetism. The M-coil current is changed with changes in latitude.

The FI and QI loops of the FI-QI coils are located at opposite ends of the ship in horizontal planes and are connected in series. The FI loop encircles the forward part of the ship and is just beneath the forecabin or uppermost deck. The QI loop encircles the afterpart of the ship and is located just beneath the main or uppermost deck. The FI and QI loops are connected in series with each other, and usually have polarities in opposite directions. The FI-QI coils develop strong fields below the bow and stern of the ship, to neutralize (approximately) the induced longitudinal magnetism at those points. The FI-QI coil currents change with changes in heading and latitude.

The FP-QP coil is located the same as the FI-QI coil. This coil, however, compensates for the ship's permanent magnetization. The FP-QP coil currents are changed when it is determined that a change occurs in the ship's permanent magnetism. This determination is made at a degaussing station.



Compass Compensation

The fundamental principle of compass compensation is to create magnetic fields at the compass that are at all times equal in strength but opposite the magnetic fields of the degaussing system. Creation of such magnetic fields is accomplished by appropriate arrangements of electrical coils around the binnacle. (See fig. 2-9.)

In each type of compass coil installation around the binnacle is a set of three coils, one coil for each component. Each coil includes an individual winding for each degaussing coil. The coil is so connected that when the current in the degaussing coil is changed, the compensating coil current changes automatically to the correct amount to maintain compensation. Information on compensation is contained in the Degaussing Manual published by Naval Ship Systems Command.

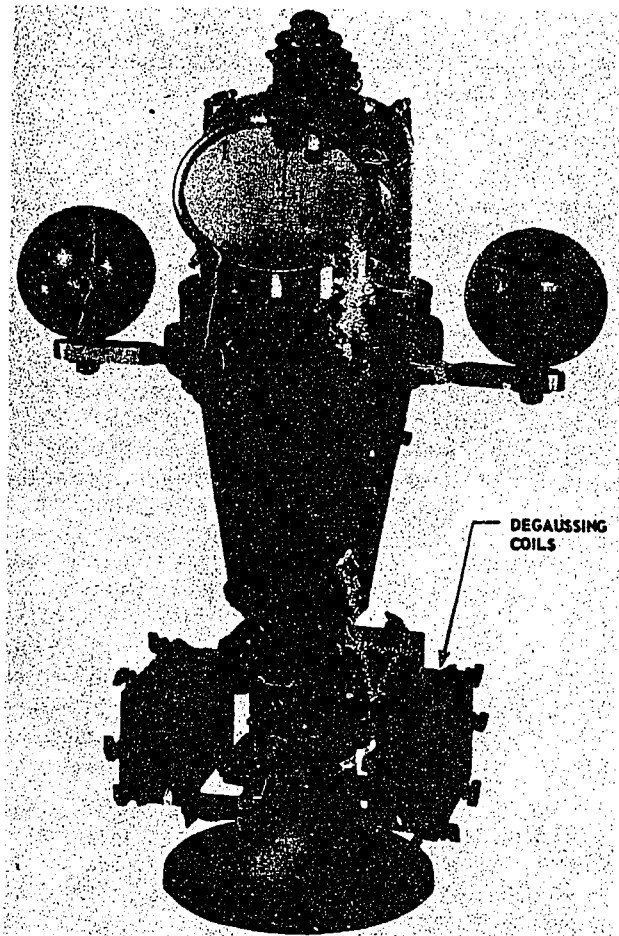

Figure 2-9. Binnacle with degaussing coils. 112.7

Operation of Degaussing System

Although the engineering department aboard ship actually controls the current setting of each degaussing coil, this setting of the coils is done under the direction of the navigator, who must understand the particular installation aboard his ship. For this purpose he is provided with a degaussing folder. The folder contains instructions for operating the ship's degaussing system, charts indicating the current values for different magnetic latitudes, charts giving the current values for different ship headings, diagrams of the installation, and log sheets for keeping a record of the ship's degaussing system. As Quartermaster, you must use this folder occasionally, therefore you should study it until you understand its contents thoroughly. It should not be removed from the ship unless its removal is requested by a degaussing officer.

Control of Degaussing Currents

Both the amount of degaussing current and its polarity must be correct if maximum protection to the ship is to be obtained. It is as dangerous to use too much current as too little. Energizing a degaussing coil with the wrong polarity does not reduce the danger to the ship; rather, the danger increases greatly.

The correct degaussing currents to use at a given magnetic latitude are established by taking measurements of the ship's magnetic field at a degaussing station. There, the ship's magnetic field is measured as the ship passes over a series of magnetic measuring instruments installed on the bottom of the ship channel and connected electrically to recording instruments on shore.

The correct currents to use in all magnetic latitudes and for all headings, based on the magnetic measurements obtained, are found on the degaussing charts provided by the degaussing stations. Thus, at any given magnetic latitude or heading, you can determine, by consulting your degaussing charts, the information required by the Electrician's Mates to make the proper settings to the degaussing coils for that latitude or heading.

Degaussing Deviation Table

After compensation, as after adjustment, some deviation usually remains. The total deviation from all causes must be no more than 5°. The residual deviation due to degaussing alone should not exceed 2° on any heading, however. After the ship is adjusted or com-

pensated, she should be swung first with degaussing OFF (as already described), then with it ON. Deviations for each condition should be recorded.

Additional information on degaussing is available in the *NavShips Technical Manual*, chapter 9813.

**MAGNESYN COMPASS**

The magnesyn compass (fig. 2-10) was designed principally for use by aircraft. Because of its relatively small size, however, it was quickly adapted by the Navy for small craft not equipped with gyrocompasses. Primarily, the magnesyn compass filled the need of various landing craft for a small, accurate, remote indicating compass. Today, many of the new construction ships, as well as landing craft, are equipped with the magnesyn compass as the sole magnetic compass located in the pilothouse.

The magnesyn compass is a remote indicating magnetic compass; that is, movement of the master indicator is transmitted electrically to one or two repeaters. For this reason, it becomes possible to locate the master in a place on the ship where deviation is the least. In many instances the master indicator is mounted on the mast, high above the ship's hull and superstructure. To some extent, the magnesyn compass can be considered an electrical compass using electrical coils for partial compensation. Actually, however, it is a magnetic compass, using the earth's magnetic field as its directive force and also incorporating corrective magnets. It is less accurate than the magnetic compass, and is much smaller. With space in pilothouses becoming more limited, the space factor is an important consideration.

Magnesyn repeaters are similar in appearance to direction indicators. The compass repeater has a

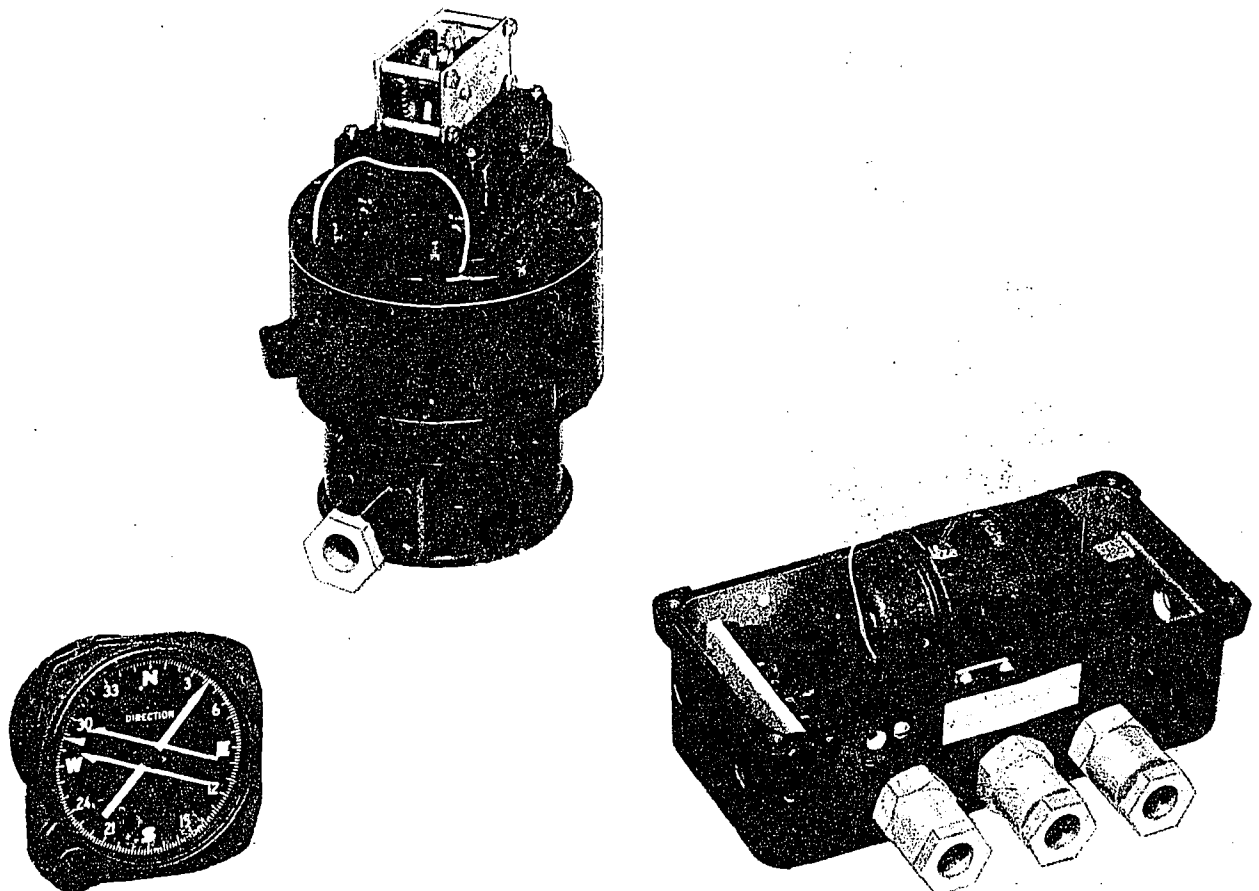

Figure 2-10. Magnesyn compass. 7.161

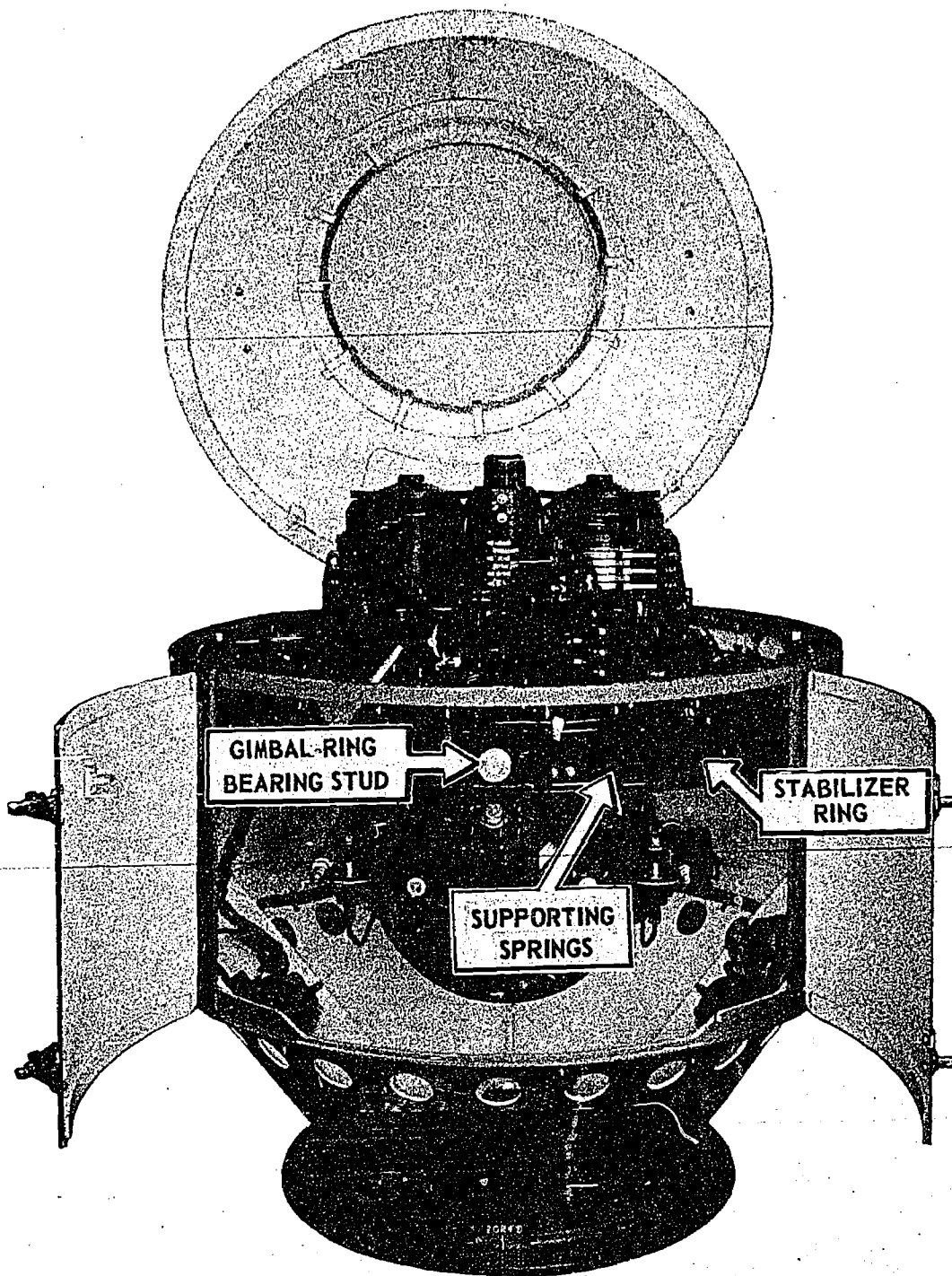

Figure 2-11. Sperry gyrocompass Mk 11 Mod 6.

40.35

parallel line grid whose function is the same as the direction indicator.

The magnesyn compass is stable enough to serve (to some extent) the same purpose as a gyrocompass. Its indications can be used as a reference in maintaining a constant heading or as a substitute reference to show changes of direction. Turning errors are reduced, although a little lag and overswing still remain. Heavy rolling of the ship also causes oscillations in its readings.

The magnesyn compass has the same disadvantages as the magnetic compass, but, if it is used properly and its limitations are realized, it will produce reliable and fairly accurate readings. The instruction manual for the magnesyn compass gives full details on adjustment as well as other pertinent information concerning its use.

### GYROCOMPASS

As pointed out previously in this chapter, many and varied conditions affect the magnetic compass, and they must be taken into account when using the magnetic compass for navigation. Normally, only true courses are employed when using navigational charts. For the magnetic compass, true courses must be converted to compass courses. Temporary or accidental deviation affects the magnetic compass, creating additional factors that must be considered.

The gyrocompass, developed a number of years ago, does not possess the inherent disadvantages of the magnetic compass. It is used as the primary navigational compass on the majority of ships. Because it is unaffected by either variation or deviation, the gyrocompass was designed to point steadily to the true geographic pole instead of the magnetic pole.

It is unnecessary for you to know all the principles of gyrocompass operation. Suffice it to say that by making use of gyroscopic principles, gravity, and the earth's rotation, the gyro's spinning axis is maintained in a horizontal plane parallel to the earth's own axis and thus points to true north. You must always bear in mind that the gyrocompass is a complex electromechanical device and, like any complicated device, it can malfunction. Even when performing properly, it may become subject to slight errors. These errors, when of a constant value, can easily be determined and applied to the readings obtained from the gyrocompass.

### ADVANTAGES AND DISADVANTAGES OVER MAGNETIC COMPASS

The gyrocompass possesses the following advantages over the magnetic compass

1. It is independent of the earth's magnetic field, and is unaffected by magnetism in the ship or in the earth.
2. It can be used when navigating in polar regions where the magnetic compass is relatively useless.
3. It always seeks the true meridian instead of the magnetic meridian.
4. It is more convenient and accurate than the magnetic compass when used in connection with fire control and dead reckoning equipment, and with course recording and automatic steering devices.

The gyrocompass possesses the following disadvantages

1. It requires a continuous and steady flow of electrical power.
2. It requires expert care and attention to give accurate results.
3. Its accuracy decreases when used in latitudes above 75°. (*This inaccuracy is common to both gyrocompasses and magnetic compasses; however, the gyrocompasses may still be used, whereas magnetic compass accuracy and reliability become marginal.*)

Regardless of the advantages of the gyrocompass, and the knowledge that it will give you reliable and satisfactory service if you care for it properly, you should not neglect your magnetic compass. When and if your gyrocompass does become inoperative because of power failure, battle damage, or mechanical malfunctionings, a properly adjusted magnetic compass, with an accurate deviation table, will prove its worth many times over and may save you serious difficulties.

### TYPES OF GYROCOMPASSES

Several types of gyrocompasses may be found aboard U.S. Navy ships, two of which are the non-pendulous and the pendulous types, manufactured by the Sperry Corporation and the Arma Corporation, respectively. Most small combatant ships and auxiliary ships have one gyrocompass. Large combatants and fleet-type submarines have two.

The compass you have aboard may be one of several different marks and models. The most common compass for destroyers is the Sperry Mk 11 Mod 6 (fig. 2-11). The Arma Mk 8 (fig. 2-12) is prevalent aboard large combatant ships. Newer ships are employing the Sperry Mk 19 gyrocompass (fig. 2-13), which is an entirely different design.

### GYROCOMPASS ERRORS

When a gyrocompass is mounted ashore it is affected only by gravity and the earth's motion. When mounted aboard a ship it is subjected to many motions that tend to produce errors in the compass,

## QUARTER MASTER 1 & C

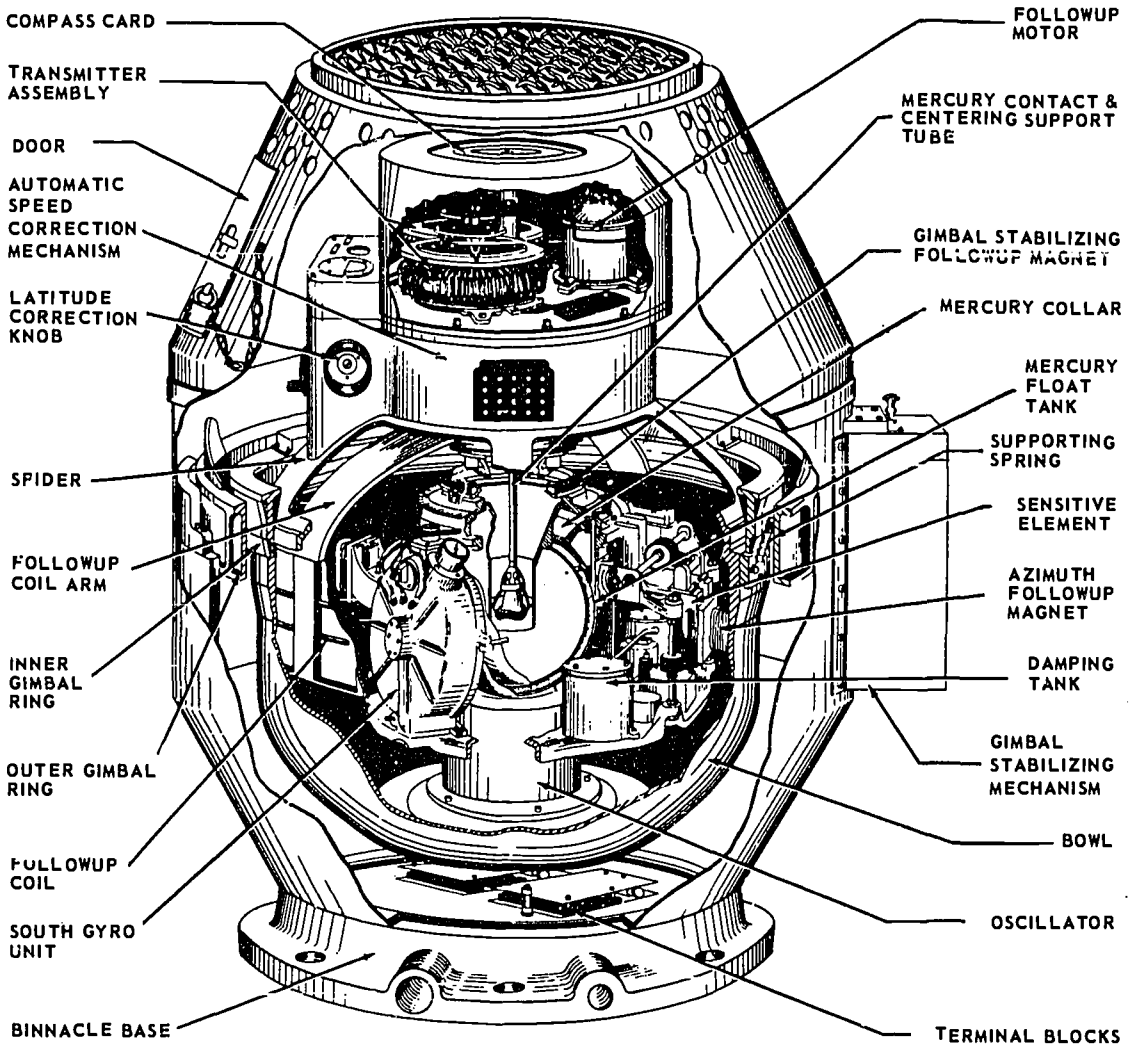

77.214

Figure 2-12.—Arma gyrocompass.

such as ship's speed in the water, course being steered, turning, roll and pitch, and the latitude. Effects of these factors differ in compass design; i.e., linear speed over the surface of the ocean tends to produce constant motion errors, change in course and speed tends to produce oscillating errors, and roll and pitch tend to produce quadrantal errors. Some errors can be eliminated by designing the compass to neutralize the influences that cause them. Other errors can be removed by calculating the amount of the error and correcting the compass to the true reading.

The latitude error, occurring in the Sperry Mk 14 and Mk 18, but not in other makes and types of compasses, actually results from special design characteristics of the compass in the sense that it is incident

to the method of damping used in the Sperry gyrocompasses. This error is computable, however, and may be corrected by the latitude corrector mechanism on the master gyro.

Although you normally will not be expected to make corrections to the gyrocompass yourself, a Quartermaster should know what corrections can be made so that you can provide the I.C. Electrician with the necessary information.

### GYROCOMPASS EQUIPMENT

Gyrocompass equipment consists of repeaters, gyropilot, course recorder, DR equipment, speed corrector, and latitude corrector. A description of each apparatus follows.

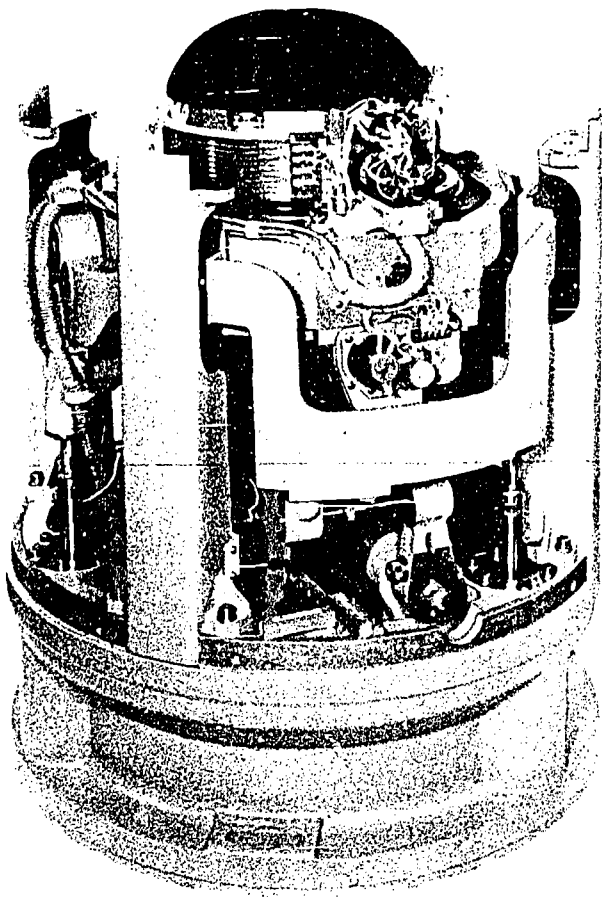

Figure 2-13. Sperry gyrocompass Mk 19. 27.170

### Repeaters

Every commissioned naval vessel equipped with a master gyrocompass also has one or more gyro repeaters (fig. 2-14). These repeaters are synchronized exactly with the master gyrocompass and, consequently, the repeater compass card always follows the master gyrocompass card. Even if there should be a failure in the power supply to the repeater (or a mechanical failure), the synchro-type (self-synchronous) repeater will again align itself with the master gyro upon restoration of power or repair. For nonsynchro-type repeaters (step-by-step, d-c), if the repeater should become misaligned with the master gyro, you may readily realign the repeater compass by turning the repeater synchronizer knob on the side of the repeater bowl (with the repeater deenergized), energizing the repeater when it is aligned properly. You must have direct communication with the gyro room so that you are able to

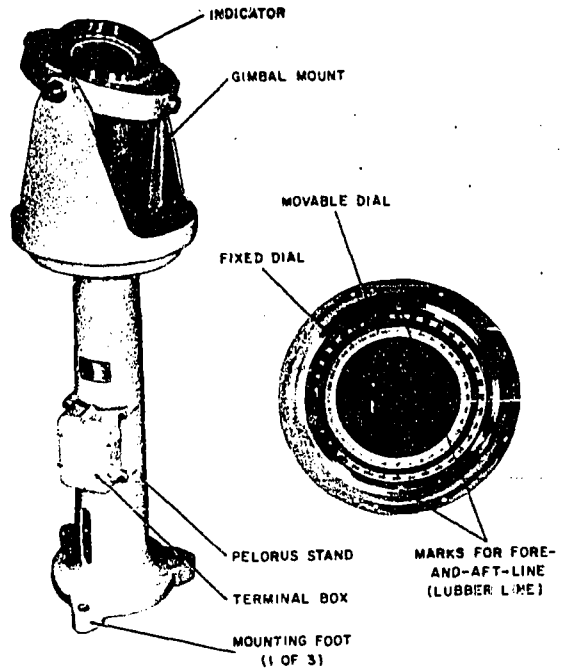

Figure 2-14. Gyro repeater. 51.131

obtain an exact "Mark" when the master gyro is on the precise reading you wish to set into the repeater. Normally, however, all the repeaters are synchronized before they are energized. Synchronization is part of the normal compass system lighting off procedure, thus the difficulties of aligning each repeater individually is avoided.

Repeaters usually are found in the pilothouse, bridge wings, secondary conn, after steering, charthouse, and many other spaces, depending on the type of ship you may be serving aboard. The number of repeaters that could conceivably be installed in conjunction with one master gyrocompass is, for all practical purposes, unlimited.

### Gyropilot

Many of the large auxiliaries in the Navy are equipped with a gyropilot (fig. 2-15). This equipment is actually an automatic steering device receiving direct impulses from the master gyro.

With respect to the earth's surface the master gyrocompass establishes a reference line so accurate and so stable that even the slightest yawing of the ship is indicated simultaneously by a relative movement of the repeaters. The function of the gyropilot in automatic steering is to pick up this relative movement and convert it into corrective applications to the rudder.

DR Equipment

The dead reckoning analyzer (DRA), which provides an input to the dead reckoning indicator (DRI) and the dead reckoning tracer (DRT), must receive ship's course from the master gyrocompass and ship's speed from the electromagnetic log for proper operation. This DR equipment is discussed in detail in chapter 3.

Speed and Latitude Corrector

When your ship is at sea, true indications for any heading at any latitude are obtained by setting the speed and latitude correctors to correspond to the ship's speed and latitude. When the ship is alongside a dock or at anchor, true indications for all headings and at all latitudes are obtained by setting the latitude corrector to correspond to the ship's latitude. The range of the correctors is from 0° to 70° latitude. Speeds are from 0 to an excess of 30 knots. Thus, correct compass indications can be obtained over all navigable waters of the world (with the exception of areas lying in latitudes higher than 70°) and at all the speeds your ship is capable of making.

When the compass is in operation, the corrector should be set for both the approximate speed and latitude of the ship. These settings need not be changed for small variations in speed and latitude, but should be kept within 3 knots and 3° respectively.

OPERATING THE GYROCOMPASS

Detailed instructions for operating the gyrocompass are contained in the equipment technical manual issued for each type and model of gyrocompass. These manuals should be consulted for complete details regarding the actual operation and maintenance of a gyrocompass. No adjustments should be attempted without first consulting the manual for your gyro. Only a few general remarks on this phase of gyrocompass work are included here.

It is preferable to start the gyrocompass at least 4 hours before it is required for use. This length of time is sufficient for the gyrocompass to come up to running temperature and align itself with the meridian. If you start the gyrocompass close to the meridian, however, it will settle down in a considerably shorter time. This method of starting is required to get underway on short notice. Continually bear in mind that, until the gyro settles, all courses and bearings taken from the gyro will be inaccurate. The magnetic compass should be substituted.

If your stay in port is under 24 hours, it is best to leave the gyrocompass energized, instead of securing it. Whether to secure the gyro or not, however, should be left to the discretion of the commanding

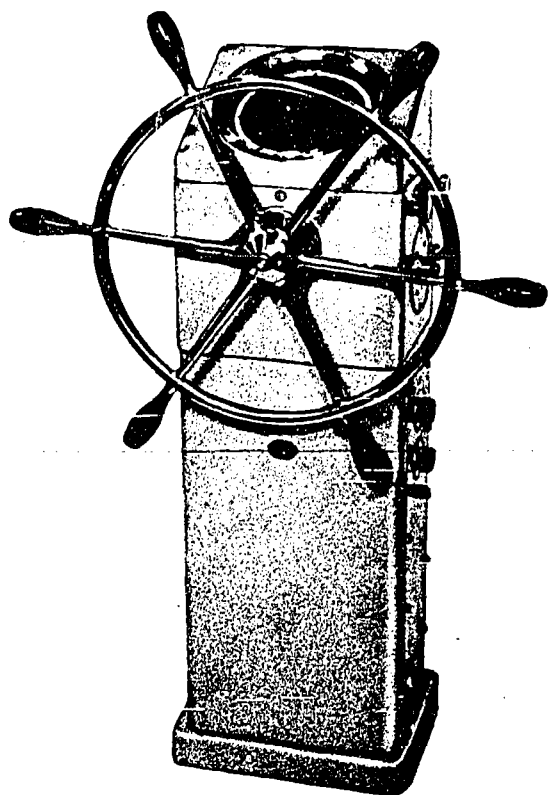

Figure 2-15. Gyropilot. 112.10

The gyropilot is set to the desired course, then is locked in position. Thereafter, the gyropilot automatically steers the ship and applies corrective rudder angles to keep the ship on the desired course within 1/6°, depending on the sensitivity setting.

The gyropilot is also equipped with weather adjustments that regulate the amount of rudder applied to any departure of course by the ship. Thus, even in heavy seas, an extremely accurate course can be steered.

Course Recorder

On a few ships a course recorder may be found. In appearance it is similar to the sonic depth finder recorder. It uses special chart paper and, with the aid of styli (pens) and gyro input, records exactly the course being steered. In everyday use it provides a ready visual check upon the quality of the steering, giving a permanent record of every angular movement of the ship's head at the time such movement takes place.

officer. In this manner, any emergency that may arise will find you ready in all respects to proceed to sea. You won't have to wait for your gyrocompass to settle down, nor have to rely only on your magnetic compass.

### FINDING GYRO ERROR

Gyro error can be determined in any of the ways previously described for finding magnetic compass error. It can be found also by means of a three-arm protractor, in conjunction with horizontal sextant angles.

Right and left angles for any three well-defined objects are taken with a sextant at the repeater you are using for checking gyro error. Simultaneously, bearings are taken with the repeater. From the angles obtained with the sextant, the position of the re-

peater is plotted on the chart with a three-arm protractor. Comparison of bearings on the chart with bearings taken from the repeater will reveal any gyro error. Care must be taken to check the repeater against the master gyrocompass each time a set of observations is made.

Gyro error is computed as either easterly or westerly, depending on its direction. If the  $0^\circ$  point on the gyrocompass card is to the west of true north, then true north is to the east of the  $0^\circ$  point of the compass, and the error is said to be west gyro error. If the  $0^\circ$  point on the gyrocompass card is to the east of true north, the opposite situation is true, and it is said to be east gyro error.

When converting from gyro to true, add easterly and subtract westerly gyro error.



## CHAPTER 3

# PILOTING—DEAD RECKONING

The various methods of determining a ship's position and directing her movements from one point to another must be understood thoroughly by Quartermasters because ship navigation is one of their principal concerns. This chapter, the first one relating directly to methods of navigation, discusses and illustrates two phases of navigation: piloting and dead reckoning.

Piloting is navigation involving the frequent or continuous determination of position or a line of position relative to geographical points, to a high order of accuracy. Dead reckoning, on the other hand, is the determination of approximate position by advancing a previous position for courses and speeds.

### PILOTING

In piloting, a position usually is established by bearings taken on visible objects on the earth. If your ship is being navigated by piloting, she ordinarily is in restricted and often dangerous waters. You are well aware that on the open sea there frequently is ample time to discover and correct an error. In pilot waters, however, a navigational error may mean a collision or grounding. As leading Quartermaster and perhaps assistant navigator, you must always keep these possibilities in mind, and impress upon the men of your division the importance of precise and accurate information.

### CHANNEL PILOTING

During your career you have seen many a pilot come aboard your ship to take her into port. He was a highly competent specialist, and knew the hazards of the waters being traversed. A pilot usually stations himself in the optimum conning position so that his observations and ship control orders can be given with the least effort and confusion. He continuously determines the ship's course and speed, and at all times knows her position. The pilot, perhaps more than anyone else, realizes that channel piloting requires not only an accurate appraisal of present

conditions, but planning for the future as well. This constant awareness and concern on his part must be fully understood and appreciated by you because, as assistant navigator, you must possess this same awareness and concern.

When you establish your position and set your course for a specific point you cannot go below for coffee and relax with an unconcerned mind until you reach your destination. You may have erred in determining your original position, or current may have a detrimental effect on your course, or the helmsman may be off course, or any number of circumstances might arise. In a matter of minutes the situation may change to such an extent that, instead of arriving on schedule at a specific point, you may find yourself hard aground on a specific rock—not on schedule.

You must constantly be alert, taking advantage of every opportunity to check and recheck your bearings. You must use the most detailed and up-to-date chart available, and ensure that it is completely corrected. Well in advance of entering port you should avail yourself of the information contained in *Sailing Directions*, *Coast Pilots*, and *Fleet Guides*. Carefully select from them the landmarks and navigational aids you will be able to use most effectively. You also should choose alternate aids in the event that your primary choices prove unreliable or impossible to identify. On order from the OOD, the special sea detail should be set, and anchors should be made ready for letting go before entering port. The fathometer should be energized and kept in readiness for immediate use. Also, the chains should be manned any time you may be entering pilot waters.

When possible, you should use ranges for steering. You should mark on your chart the courses to be steered and the distances between points. Danger bearings for hazardous spots and shoal areas should be established, and these danger bearing lines plotted when no range is available for steering. Danger circles should be plotted, and regular courses should be planned. Never attempt to run haphazardly on the indications of the danger angle

alone, hoping to avoid trouble by random steering at critical points.

Even when entering port through channels that are considered safe, your ship's exact position must never be in doubt, but must be plotted accurately and continually on your chart. Otherwise, if a sudden squall or fog sets in, your ship could be in serious danger of grounding. Through experience, you have learned that it always is best to steer planned courses and to change courses only at predetermined specific points. Such a practice facilitates piloting successively from buoy to buoy in limited visibility. If your ship fails to make a buoy on schedule, only one safe alternative remains: Stop, then anchor or proceed with caution.

Course changes usually are made in exact amounts. That is, orders to the helmsman are stated in the amount of change or the new course to be steered, instead of merely ordering the wheel put over. In the latter instance, the order to steady may be forgotten or, still worse, your ship may be swinging and this condition may not be realized until too late to take corrective action. Even if corrective action is taken in time, a great deal of wild steering probably will result before she can be steadied again, and in pilot waters there usually isn't that kind of room for maneuvering. To avoid such a predicament if the new course is not given (or during large changes of course), the helmsman should call out the ship's heading; for example, "Passing 130, passing 135," and the like.

When piloting in waters where coral reefs or banks are numerous, it is helpful to select a time when the sun is astern. Normally, your ship is conned from aloft or from an elevated position forward. The line between deep water and the edges of coral shoals usually shows up in green patches, and it is readily seen from a height. On the other hand, green patches may indicate only the presence of vegetation, and there may be little or no difference between depths in the dark and light colored water.

When piloting, as stated previously, the special sea detail is set, and ordinarily a complete piloting team is stationed. Aids to navigation are used whenever and wherever possible. Several navigational methods may be utilized by your ship to fix her position. These methods, which may be used either separately or collectively, are as follows

1. Bearings: visual, radar, sonar.
2. Ranges: visual, radar, sonar.
3. Depth of water: fathometer, lead line.

## COAST PILOTING

The preceding information is useful in both coast piloting and channel piloting. Several additional techniques, applicable chiefly to coast piloting, are

mentioned here. One of the better methods, from a navigational point of view, is to steam along a well-defined and well-surveyed coast instead of steaming out to sea. This plan enables you to keep visible landmarks continually in sight to determine your ship's position accurately and maintain a continuous check of that position. Moreover, such a procedure presents a more accurate and detailed radar picture to assist you in transit.

By steaming too far offshore you may lose sight of prominent landmarks or other aids to navigation. Consequently, you must make a landfall from a doubtful position, and such a task can give you some anxious moments. Additionally, your radar picture is not as detailed when steaming too far offshore. If you encounter fog, squalls, or any inclement weather where visibility is reduced, you may have serious difficulty making a predetermined landfall. If, however, you encounter conditions of restricted visibility while steaming along the coast, you know your position, and you also know the speed you are making good. Thus, you are in an ideal spot to navigate by dead reckoning. (This method of navigation is discussed later in this chapter.) This mode does not, of course, preclude the use of the other navigational aids available to you. In this connection, radar and the fathometer will prove their worth as navigational aids.

If your charts are known to be accurate, and you should encounter heavy weather, it is advisable to skirt the coast as closely as safety permits, thus gaining the advantage of quieter waters usually found along the coast. This same procedure ordinarily will avoid strong adverse currents running offshore. Naturally, your track along the coast should be planned for normal weather conditions, but provision should be made well in advance for any possible variations. If you make frequent runs over the same route, you should note and retain the courses and distances laid down on your charts, as well as the effects of current or tides. Record the data in a notebook for immediate reference.

All ranges along the coast are plotted whenever they may be useful for determining position, for purposes of safety, or for checking compass deviation and gyro error.

Course changes quite often occur when a preselected point along the coast comes abeam. (Position for a new departure is determined most easily at this instant.) If your ship is not equipped with gyro repeaters, you should ensure that your pelorus (dumb compass) is set to the ship's true heading and is ready for taking bearings at all times. The navigational chart should be readily available for reference by all pertinent bridge personnel. A sextant also should be set to the danger angle and be ready for immediate use. You should see that a

recorder keeps a complete record of all bearings on specific points, the time they are taken, and the distance when they come abeam, and that he records all the data in the bearing book.

Although coastwise piloting becomes a matter of routine—not requiring the constant presence of the captain or navigator—you nevertheless must bear in mind continually, and impress upon your men, the consequences of any laxity on their part. The wrecks marked on your chart attest to the consequences of errors. Groundings occur all too frequently, but they usually are avoidable. A well-trained and conscientious Quartermaster gang ordinarily can detect any impending danger. It is your duty, as leading Quartermaster, to see that your men are trained to detect these dangers.

## TAKING BEARINGS

The gyro repeater normally is used to take bearings on the stationary visible objects that help to fix the position of your ship when piloting. These bearings also may be taken by utilizing the magnetic compass or a dumb compass. The gyro repeater is considered the best method and is the one used most commonly. As you know, all bearings taken with the gyro repeater may be plotted directly on your chart without conversion except for gyro or repeater error.

Ships not equipped with a gyrocompass (district and small craft) normally take bearings with a pelorus. If the dumb compass card in the pelorus is set to the ship's heading, bearings obtained are the same as they would be by magnetic compass, provided that the ship is exactly on course.

You should instruct your men to take bearings only when your ship is on an even keel, not yawing, and when the bubble in the spirit level on the azimuth or bearing circle is centered. Only by constant practice can your men develop the ability to take exact bearings in a seaway.

### Bearings by Gyro Repeater

The master gyro usually is situated below-decks in the IC room, and consequently is unavailable for taking bearings. Located on both wings of the bridge, however, are gyro repeaters, which are synchronized with the master gyro. When the master gyro and the repeaters function properly, all bearings taken on the gyro repeaters are true bearings. Hence, there is no necessity for applying the ship's heading or converting compass bearings to bearings.

If, for any reason, a gyro repeater should become inoperative, it can be disengaged from the master gyro and used as a dumb compass.

### Bearings by Pelorus

When your ship is not equipped with a gyro (as already mentioned), the dumb compass card in the pelorus is set to the ship's heading, and the bearing by pelorus is the same as it would be by magnetic compass, provided the ship is exactly on course. This ideal situation seldom exists at the instant the bearing is taken, hence the bearing obtained by pelorus must be corrected by the number of degrees the ship was off course. It follows, then, that the ship's actual heading at the instant of taking a bearing must be known. The common method of taking bearings by pelorus is described in *Quartermaster 3 & 2*, Nav-Pers 10149, and is not discussed here.

### Bearings by Magnetic Compass

When your magnetic compass is so situated that your vision is unobstructed, it may be used to take bearings. But, because the magnetic compass is mounted on the centerline of the ship and usually is surrounded by superstructure, your arc of visibility is rather narrow.

When using the magnetic compass, make sure that your men take bearings directly from the compass and that they note the time. Compass bearing is then converted to true bearing and plotted. Your men should determine compass error before taking the bearing, so that no time is lost in converting from compass bearing to true bearing. Ordinarily the helmsman is so close to the course that deviation is not affected. During heavy weather, for instance, if the ship at the time of bearing is radically off course, it may become necessary for your men to work another correction problem, using a different deviation from that expected. To determine correct deviation, they should instruct the helmsman to note the ship's heading when they sing out "Mark!" as they take their bearing. As leading Quartermaster, you should hold frequent drills in this procedure. Then, you will ensure that your Quartermaster gang is thoroughly familiar with the procedures and mechanics of taking bearings with the magnetic compass.

## PLOTTING BEARINGS

Before proceeding to the various methods of fixing a ship's position in piloting, some discussion of plotting bearings on a chart is necessary. As Quartermaster First, perhaps you already have acted as

assistant navigator and are aware of the procedures in plotting. For you, this topic is a review; but, for others, this is the first time you have actively and continually plotted own ship's position.

Bearings are always plotted as true. If you don't have a gyrocompass, all bearings must be converted to true before they are plotted. It is the outer ring on the compass rose of your chart that registers true bearings. Only that ring is used in plotting.

Assume that you are steaming along the coast and you visually sight lighthouse X off your starboard bow. You take a bearing on the lighthouse through an alidade, using the starboard wing repeater. In the Standard Bearing Book (S. P. 87), record the bearing and time, as well as the identity of the light, before you plot the bearing on your chart. If you are using a drafting machine (fig. 3-1), make sure it is aligned accurately with the parallels and meridians of your chart. Rotate the protractor arm to the bearing obtained from the alidade. Lay the straightedge of the protractor arm across the symbol for the lighthouse on your chart. Along the straightedge, draw a short line extending across your course line in the vicinity of your assumed position. This line is not a fix, but a line of position along which your ship lies. If you are using parallel rulers in lieu of a drafting machine, align the parallel rulers on the compass rose of your chart to the bearing obtained from the alidade. Then walk the rulers across the chart until the edge of one passes through lighthouse X, and draw a line intersecting your

course line. Below the line, label your line of position with the bearing; above the line, indicate the time the bearing was taken.

As stated previously, you still do not know the position of your ship. You know only that you are somewhere along the plotted line of position at the time of the bearing. If you were able to take a bearing of another object at the same time you obtained a bearing of lighthouse simultaneously with your bearing, then the intersection of the two lines of position, or the intersection of the line of position and the radar range, would give you a fix. This fix establishes the exact location of your ship. These and other methods of fixing position are described later in this chapter.

The method of plotting a bearing by means of parallel rulers is shown in figure 3-2. At 0915 your ship obtains a magnetic compass bearing of  $288^\circ$  on lighthouse C. Variation is  $15^\circ$  E; deviation is  $3^\circ$  W. The algebraic sum of variation and deviation is  $12^\circ$  E. You are correcting, so you add easterly compass error. Add  $12^\circ$  to  $288^\circ$  and you obtain a true bearing of  $300^\circ$ .

To go through the procedure of plotting the bearing shown in figure 3-2, place the parallel rulers with their upper edge passing through the center of the compass rose and the  $300^\circ$  mark on the outer ring (AB). Walk the rulers across the chart and draw your line along the straightedge. Mark above the line the time of the bearing (0915); and below the line, the

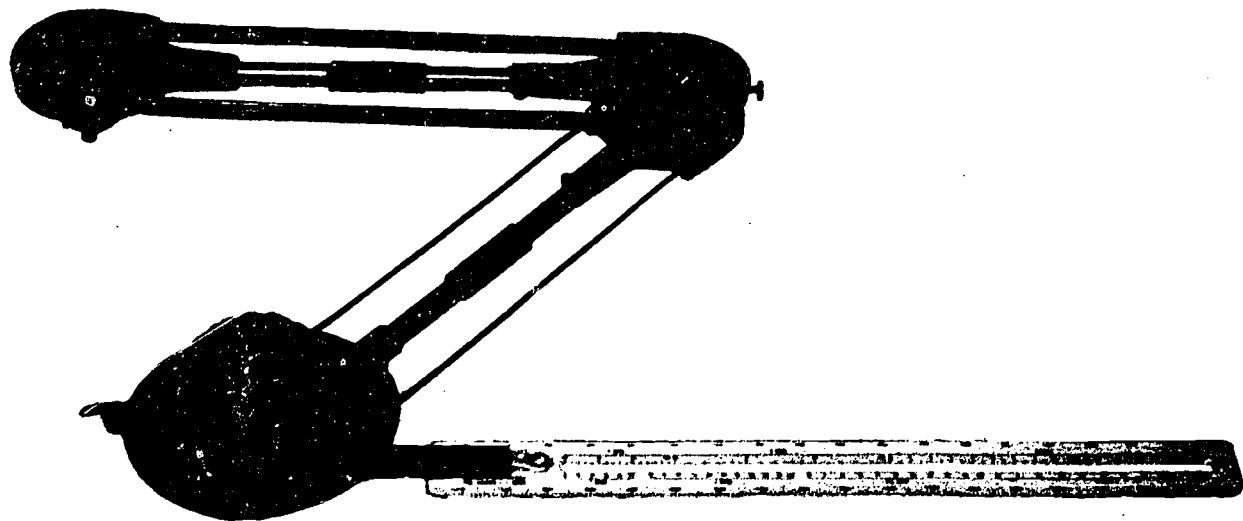
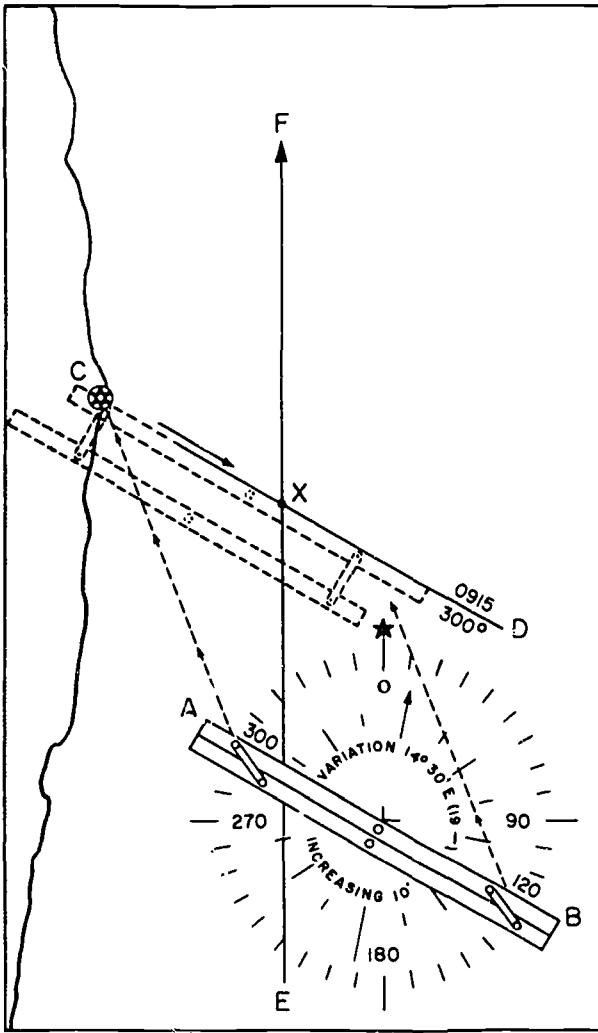

Figure 3-1. Drafting machine. 59.57A



112.12

Figure 3-2.—Plotting bearings.

number of degrees of the bearing ( $300^\circ$ ). At 0915 your ship was somewhere on this line of position (LOP). The line EF is the ship's course. If your ship has made good her course and speed and has not made any leeway, point X (where the line of position intersects the course line) is your actual position. Making good the exact course and speed is considered an ideal condition, but it rarely happens in practice. Accordingly, this intersection at point X cannot be considered an accurate fix.

### FIXING POSITION IN PILOTING

Proper labeling of all points and lines made on charts or plotting sheets is essential in order to avoid

confusion. Immediately after drawing a line or plotting a point, label it. The label for any fix should be at that fix instead of along a line leading to it. For instance, above the course line put a C, followed by the three figures indicating your true course in degrees. Below the line place an S and your ship's speed in knots.

You know that a single line of bearing gives you an LOP, and somewhere along that LOP is your ship's position. You also know that you cannot fix your ship's location accurately by a single line of position. To obtain an accurate fix, you must plot two or more intersecting LOPs or radar ranges. Needless to say, the greater the number of lines of position or ranges intersecting at the same point, the greater the confidence in the fix.

An additional LOP for establishing a fix may be obtained by several methods. As leading Quartermaster, you must know all the methods, and you should ensure that your men also know them. If you should take a bearing at the same time your ship crosses a range, the point where the bearing crosses the true bearing of the range is a fix. You must observe that the forward and after range marks are lined up when the bearing is taken. Another way of obtaining a fix is by using a range (distance) to the same object on which you took a bearing. This range may be obtained by using radar, rangefinder, or stadimeter. If the stadimeter is used, the height of the object must be known.

The range to the object on which you obtained a bearing is a radius of a circle swung as an arc. This arc is your second line of position; your bearing is the first LOP. Thus, the point where the arc intersects your bearing is a fix.

### METHODS OF FIXING POSITION

Four general methods ordinarily are employed to fix your position in piloting. These methods are described in detail in the next four subtopics.

#### Cross Bearings

In figure 3-3, points A and B represent the two well-defined objects on which bearings may be taken. Using a bearing circle or an alidade, take bearings on each object, one as quickly as possible after the other. If two alidades are manned, bearings on two objects should be taken simultaneously. If you are using a dummy pelorus, make sure your men convert the bearings to true before they are plotted. Plot these two bearings as AD and BC. Their point of intersection, X, is a fix and thus is your ship's position.

A more reliable fix may be obtained by taking a third bearing on another well-defined object, E, and plotting bearing EF. As shown in figure 3-3, the

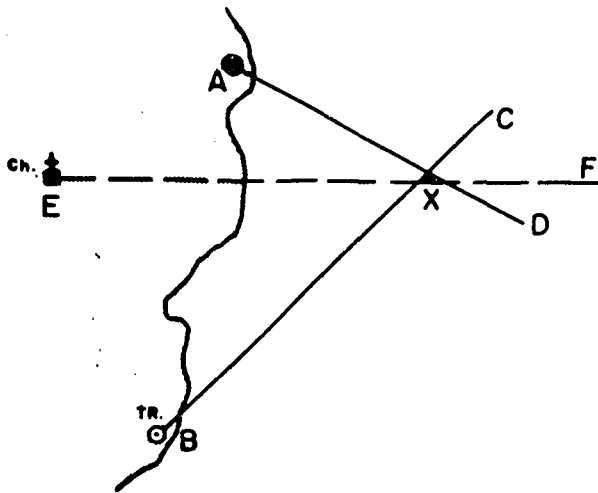

Figure 3-3.—Cross bearings.

58.76

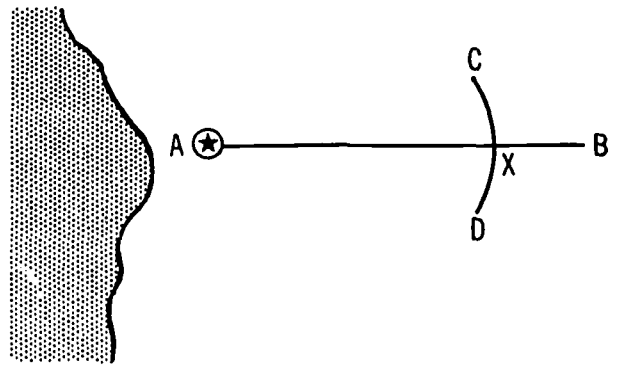

Figure 3-4.—Bearing and distance of a single known object.

58.77

three lines of position frequently form a small triangle instead of a pinpoint fix. Your ship's position is then considered to be in the center of the triangle.

Depending on height of tide, draft of ship, and contour of bottom, you may further verify the reliability of your fix by taking a sounding at the instant of bearing. If you obtain approximately the same depth of water as shown at point X on your chart (after taking the ship's draft into account), in all probability you have an accurate fix.

The most reliable fixes are obtained from cross bearings that differ by approximately  $90^\circ$  ( $120^\circ$  if three bearings are used). Two bearings differing by  $30^\circ$  or less, or by more than  $150^\circ$  are undesirable in obtaining a fix, because they are too nearly parallel to result in an accurate fix. They should be used, however, if they are the only bearings available.

### Bearing and Distance

We learned earlier that a bearing and a range on the same object will give you a fix. With radar or an accurate range finder, you can determine the distance to the object on which you originally obtained a line of position. The intersection of this range swung as an arc with the original line of position gives you a fix. Figure 3-4 shows a fix using a bearing and distance of a single known object. Line AB represents the bearing of lighthouse A. Arc CD represents the range to the lighthouse. Point X on the chart is your actual position or fix. When using this method to obtain a fix, remember to obtain your bearing and range simultaneously.

Obtaining radar ranges and bearings on a small, well-defined object whose width is appreciable (such as a small island), as well as finding range by using the stadimeter, are covered in sufficient detail in Quartermaster 3 & 2, NavPers 10149, and are not elaborated on here.

### Two Bearings Separated by an Interval

Another procedure for locating your position in piloting is by two bearings separated by an interval. This method, known commonly as bow and beam bearings, or doubling the angle on the bow, is considered routine in piloting. In using this method, your ship must be held on the same course and at a constant speed between bearings. Otherwise, the results of your computations will be inaccurate. Figure 3-5 illustrates the basic principles included in the bow and beam method. You are on course  $000^\circ$ . As your ship passes point Y, you pick up a bridge bearing  $315^\circ$ . The distance you run to bring the bridge to  $270^\circ$  is the same as your distance from the bridge when it comes abeam. From figure 3-5, line BY is the same length as AB. The bow and beam method of piloting has been proven mathematically, hence the explanation is unimportant. It is of importance, though, that the method works and is of valuable assistance when piloting.

Sometimes it may be advisable to know in advance how far you are going to pass an object abeam before you actually are abeam of the object. You can determine this distance by extending your DR track based on the course made good, or by applying a variation of the

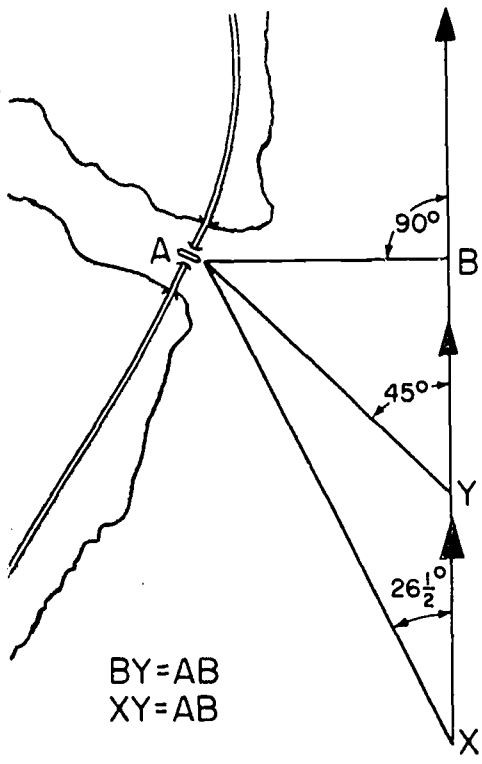

BY=AB  
XY=AB

112.13

Figure 3-5.—Two bearings separated by an interval.

bow and beam method. The distance run on the same course between the time an object bears  $26\text{-}1/2^\circ$  relative and the time when it bears  $45^\circ$  relative is equal to the distance at which the ship will pass the object abeam. In figure 3-5, assume you are at point X and on course  $000^\circ$ . At that time you observe the bridge at  $26\text{-}1/2^\circ$  off the port bow. Measurements on figure 3-5 will show that when your ship reaches point Y, line XY is equal to AB.

TABLE 7, BOWDITCH.—It isn't always convenient or possible to obtain bearings at exactly  $26\text{-}1/2^\circ$  or  $45^\circ$ . Also there may be times when you need to know what your distance off the object will be when abeam, without having to steam all the distance necessary to double the angle. For this reason, table 7 in Bowditch has been computed to give you all this necessary information. Regardless of when you take your first bearing, if there is an appreciable angle between it and the second bearing, and if you know how far you have traveled, you can determine from table 7

both the distance of the object at the time of the second bearing and the distance you will pass when abeam.

The distance run between bearings can be computed by using your known speed in knots multiplied by the time run. Your nautical slide rule is of valuable assistance in finding distance when speed and time are known. Once you compute the distance run, consult table 7 for the multipliers needed to find the required distances.

In figure 3-6, church A bears  $26^\circ$  on the bow at the first bearing and  $48^\circ$  at the second bearing. The angle between the first and second bearings has not been doubled. You compute that you have run 5 nautical miles between the bearings, and you wish to know (1) the distance your ship will pass the church when abeam, and (2) the distance to the church at the time of the second bearing. The multiplier to be used for the first query is found from table 7 to be 0.87; for the second, 1.17. Multiplying 5 by 0.87, you find that your ship will pass abeam 4.35 miles off. The distance from the church at the time of the second bearing is computed by multiplying 5 by 1.17, which gives an answer of 5.88 miles.

A running fix may be obtained also from two lines of bearing on the same object. After plotting your two lines of bearing, compute the distance run between the time of the two bearings. Set your dividers to the distance, using the proper latitude

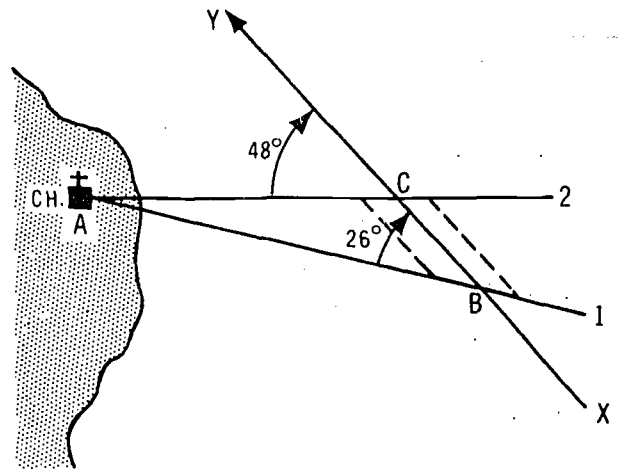

Figure 3-6. Graphic fix from two bearings. 112.14

scale to measure the distance. Then set your mechanical protractor or parallel rulers to the course you are steering, and move toward or away from the object on which you took your bearings until the distance of the dividers fits exactly between the lines of bearing. There is only one position where it will fit at the angle of the course, and the points where it intersects the lines of bearing are running fixes, one at the time of the first bearing and one at the time of the second bearing. The accuracy of this method depends entirely on your ship making a constant true course and speed. Because the speed and course made good of your ship are, in themselves, dependent upon set and drift of current, wind, condition of the ship's bottom, trim, and the like, you know that this method is not considered completely accurate.

### Sextant Angles Between Three Known Objects

The method of piloting by establishing sextant angles between three known objects is quite simple. Three objects are chosen, and the horizontal angles between the object in the middle and that on either side of it are taken by the sextant. Position is then plotted by using a three-arm protractor. Angles must be taken as nearly simultaneously as possible, preferably by two people on a predetermined signal.

Make sure that neither the three objects chosen nor your ship's position lie on the arc of a circle. No fix is possible in such an example, which is known as a "revolver" or "swinger."

Piloting by this method gives the most accurate fix of any of the techniques described. Compass error, error in determining distance run, and error due to erroneous estimation of leeway are all eliminated. Other details of this method of determining position are given in Quartermaster 3 & 2.

### DANGER BEARING

In the past when you stood wheel watches, or if you stand them now under special details, you know that the order "Nothing to the left" means that you should not allow your ship to swing to the left of the course. Usually, the reason is because of danger of some kind to port, which would make a set in that direction disastrous. A danger bearing may be plotted to ensure safe passage in such situations.

In figure 3-7 you see a shoal that presents a hazard to navigation, a prominent landmark at point A, and a ship proceeding along the coastline on course BC. To construct a danger bearing, line AX is drawn from point A tangent to the outer edge of the danger. If the bearing of point A remains greater than the danger bearing, the ship is in safe water, as in the case of Z and ZA. The reverse is true when the

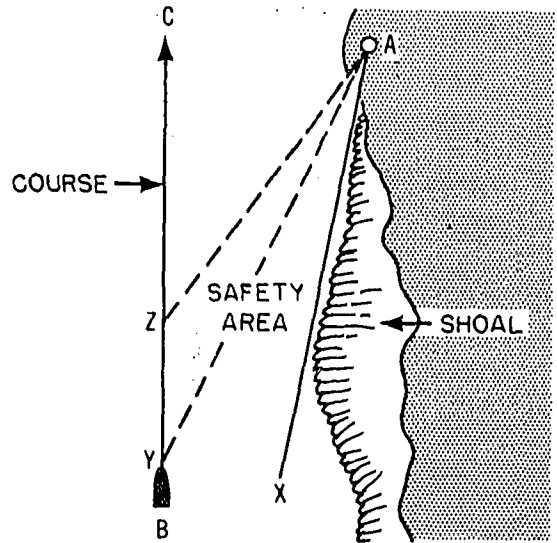

Figure 3-7.—Danger bearing.

58.82

danger is to port; the danger angle must remain greater than the angle to point A.

Wind or current could, conceivably, set the ship toward the shoal. Even before a fix could be taken, however, this situation would be indicated by repeated bearings of point A.

### DANGER ANGLE

To avoid rocks, shoals, or some other obstruction, you may have to plot a danger angle. In figure 3-8, ABC represents the coastline along which a vessel is steaming on course DE. Two dangerous areas are indicated by  $M_1$  and  $M_2$ . In order to pass outside  $M_1$ , take as a radius the center of  $M_1$  and the distance from the center it is desired to avoid, and draw a circle. Then draw a circle so that it passes through points A and C and the seaward side of the circle around  $M_1$ . Such a circle is formed by drawing a line between points A and C, drawing a perpendicular bisector of line AC, then (by trial and error) determining the center of the circle that will pass through points A, C, and the seaward side of the circle drawn about danger  $M_1$  (which will be point F). After you establish the position of point F, measure angle AFC. You can avoid danger  $M_1$  if the angle formed by your ship and points A and C does not become greater than AFC.

Danger  $M_2$  is handled much the same as  $M_1$ . You can avoid  $M_2$  so long as your angle becomes no smaller than angle AGC.



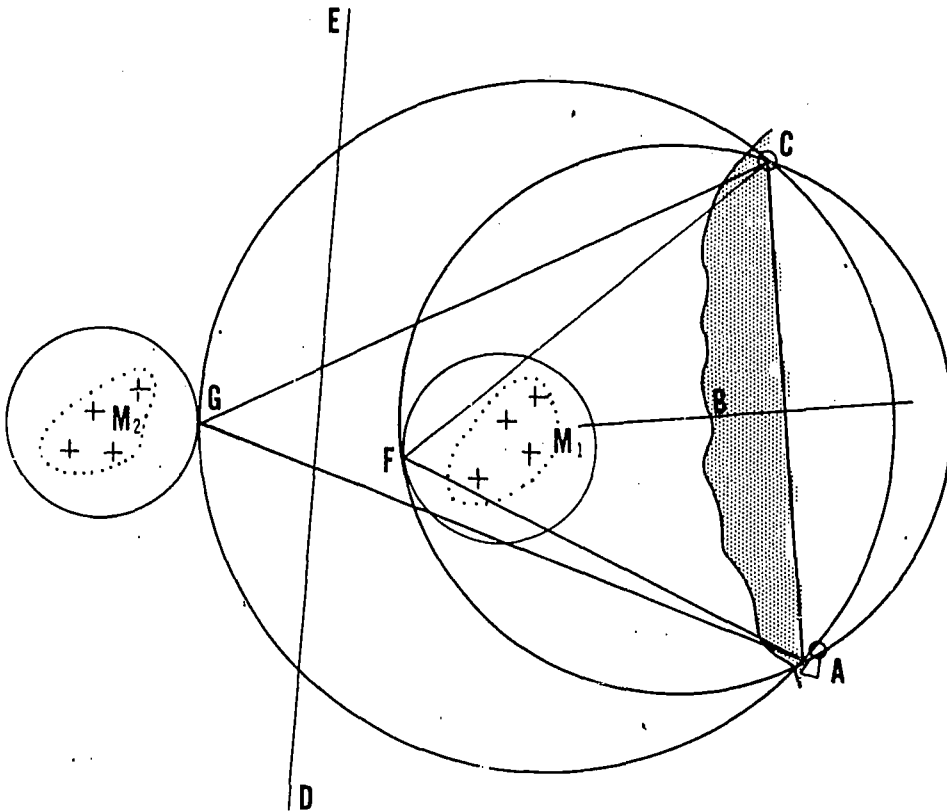

Figure 3-8.— Danger angles.

112.15

To avoid both dangers, you must maintain a position so that the angle formed by sextant readings on A and C is less than angle AFC but greater than angle AGC.

security. You must impart your awareness to your men. When they possess it, safe navigation will, in fact, become a reality. Thus, a routine situation becomes routine only in respect to built-in dangers and the steps taken to avoid them.

### LEADERSHIP RESPONSIBILITY

It is not the intent of this chapter merely to describe the importance of reliable navigation nor the methods of navigation employed in piloting. Rather, it is the purpose of the text to impress upon you the ease with which safe navigation may be accomplished under ideal conditions. In connection with safe navigation, your responsibilities as leading Quartermaster never permit laxity of any sort to appear in the procedures utilized by your men in what erroneously is considered routine navigation.

Piloting is routine only insofar as it concerns piloting methods. It must never be considered routine in the attitudes of your men. Piloting demands a keen appreciation of all the limitations of the equipment, as well as a knowledge of the inherent dangers of piloting from being lulled into a false sense of

### DEAD RECKONING

Dead reckoning, to repeat, is the method of establishing your ship's approximate position by running a course line from your last well-determined position, using only courses being steered, and computing the distance run by using engine speed. A DR position is plotted on the course line drawn from your last well-determined position (point of departure or fix). A dead reckoning position will be as far along the course line as you find you have traveled. In other words, it is the place where you would be if you had made no leeway whatever and if you had steamed exactly at engine speed. Unfortunately, this ideal is seldom true, because your ship is affected by many of the elements found at sea.

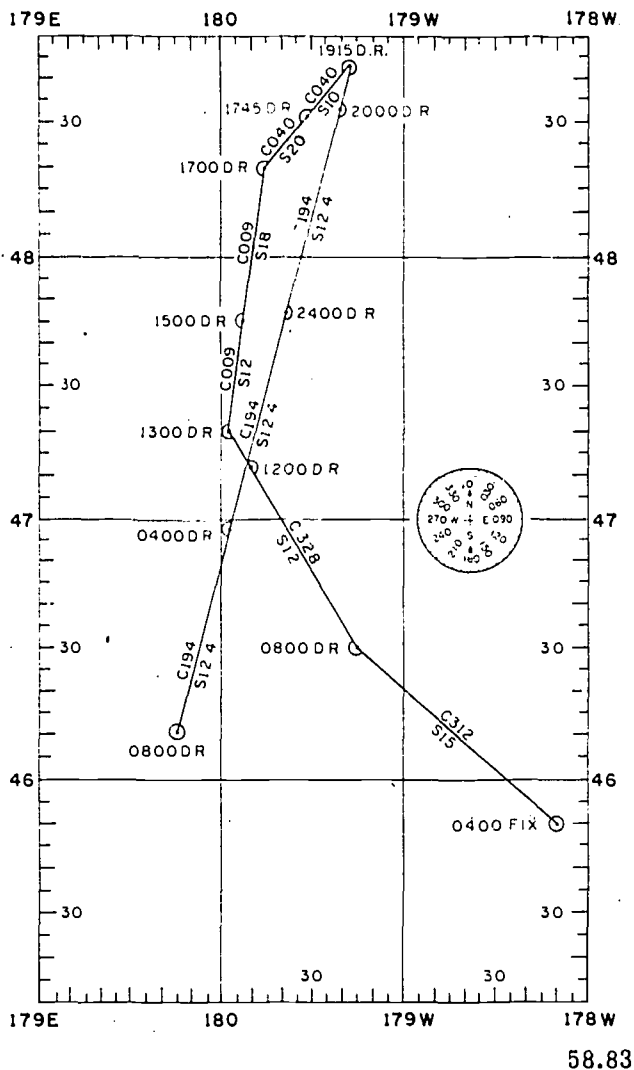

Figure 3-9.—Plotting DR position.

At 0800, course is changed to 328° and speed is reduced to 12 knots.

At 1300, course is changed to 009°.

At 1500, speed is increased to 18 knots.

At 1700, course is changed to 040° and speed is increased to 20 knots.

At 1745, speed is reduced to 10 knots.

At 1915, course is changed to 194° and speed is increased to 12.4 knots, in order to arrive at 0800 the following morning at a rendezvous in latitude 46°10'N and longitude 179°46'E.

### PLOTTING SHEETS

In all probability you will do all of your dead reckoning on the chart itself or on a plotting sheet. If you haven't seen plotting sheets before, or don't recall seeing any, you will learn about them from the following description.

A plotting sheet is no more than a chart, with everything removed except the latitudes, compass roses, and lines on which the longitude may be indicated. The graphic method, by which you plot directly on your chart, is less likely to contain mathematical errors than a computed solution, and certainly requires much less time. It enables you readily to visualize your work and your ship's position in relation to dangers and aids to navigation.

The navigator's notebook is used to record time and other data connected with course, speed, bearings, soundings, and the like. Time of getting underway, anchoring, the ship's draft, and any data needed for solving problems of celestial navigation are recorded also.

### ADVANTAGES OF DEAD RECKONING

Dead reckoning cannot, of course, locate your position as accurately as can the methods employed in piloting, celestial navigation, or electronic navigation. Nevertheless, it remains a valuable aid to the navigator, the OOD, and to you as assistant navigator. Dead reckoning affords a means of plotting your ship's position at any time between accurate fixes, and also gives you the approximate position of your ship at the time you are obtaining an accurate fix—a necessity in celestial navigation. Excluding electronic systems and aids, it is the only method for plotting your approximate position during periods when weather conditions are unsuitable for visual observations.

It is practically an impossibility for your ship to steam continually along a set track, at a predetermined speed, endlessly hour after hour, day after day, without making adjustments to the speed and to the course being steered.

Figure 3-9 illustrates a dead reckoning situation wherein a ship desires to arrive at a rendezvous point at a specific time. The maneuvering, shown graphically, is described as follows

The USS Concord, engaged in maneuvers, fixes her position at 0400 in latitude 45°50'N and longitude 178°09'W. This position is her point of departure on course 312°, speed 15 knots.

## DR TRACK LINE

The course line laid out from a fix is a line generated by the constantly moving DR position, called the DR track line. Until another fix is obtained, the DR track line continues as a graphic history of the course that was steered and the speed that was used. Meanwhile, winds, currents, steering errors, etc., combine to set your ship to one side or the other of the course, and to vary the actual distance traveled. You readily can understand, therefore, that it frequently is necessary to fix your ship's position, commencing a new DR track from each new fix.

When no fix can be obtained, you should continue your DR track for an entire watch or until you get a new fix, then start a new DR track. You may be unable to obtain a fix for as long as 12 hours or more. If you cannot, the DR track is continued for the entire period. Necessity for continuing the track is especially true when you are steaming in restricted waters, where dangers exist near your ship's track. Even in unrestricted waters, one of your shipmates may go overboard, or some other casualty may occur, necessitating that you plot your ship's approximate position instantly. If your DR track is not up to date, you may have to plot your DR track from your last known position. You may also have made course or speed changes in the interim, making it necessary to consult logs to obtain the information to continue your DR track, which exhausts valuable and perhaps unavailable time.

## DEAD RECKONING EQUIPMENT

The NC-2 plotting system is gradually replacing the Arma DRA-DRT combination as plotters; however, the takeover is not nearly complete. This section begins with a description of the DRA-DRT and ends with information on the NC-2 system. The senior petty officer will, upon completion of this material, be capable of explaining the operation of components in both systems.

The majority of the Navy's combatant ships, as well as some of the larger service vessels, are equipped with a device commonly called the dead reckoning tracer (DRT). The DRT provides a graphical record of the ship's position with respect to a fixed starting point. Three components of the dead reckoning equipment supply extremely valuable information: the analyzer, indicator, and tracer.

The Dead Reckoning Analyzer (DRA) (fig. 3-10) gives you the north-south and east-west components of your ship's travel. Counters tell you exactly how far you have run in each of the three components. Another counter gives you the total distance traveled from the time you commenced

your DR track with dead reckoning equipment. The indicator (fig. 3-11) affords a continuous indication of your position in longitude and latitude. The tracer (fig. 3-12) furnishes a graphical record of the distance and direction traveled by your ship.

The indicator and tracer are mounted in a single unit, known as the DRT navigational plotting table (fig. 3-13). The analyzer is mounted separately, usually on a bulkhead nearby.

When preparing to use the DRT, you must notify the IC Electrician on watch. He then will cut in both gyro and electromagnetic log inputs (course and speed). If you are in shallow water, or for any reason cannot use the electromagnetic log, the engine room will adjust speed settings by using the dummy log. After you receive both course and speed inputs to the analyzer, you will have to set on the indicator the initial longitude and latitude at departure. When this step is accomplished, you are ready to use the tracer for navigating. The actual scale settings available for your use are presented in *Quartermaster 3 & 2*, NavPers 10149. As you know, the illuminated DRT, with compass rose attached (normally referred to as the bug), can be positioned anywhere under the glass top of the navigational plotting table.

The DRT moves across the plotting table in a manner that approximates the motion of your ship's DR position across the chart. Either tracing paper or a chart is placed over the glass top, and the compass rose of the bug shows through. Thus the bug moves along, giving your ship's position in relation to the coast or channel. If used in unrestricted waters, you can plot continuously on the center of the bug. As it moves, the bug gives you a complete DR presentation of your ship's movements.

The compass rose of the bug itself contains range rings that may be used if the scale of the bug corresponds to the scale of your chart or the scale settings you selected. In the majority of instances, however, even when these range rings are accurate, the distance is too great for their practical use. For this reason, a drafting machine is of assistance both for ranges and for extending the bearings of the compass rose. The bug's movement represents your DR course, consequently all bearings plotted by the compass rose attachment are true bearings.

If your ship's DRT is located in CIC, and thus is not readily available for your use (because the DRT and the indicator are used exclusively by the Radarmen, whereas the analyzer usually is placed in the charthouse), your responsibility becomes twofold. First, you and the leading Radarman should make arrangements to ensure that your position at point of departure (in latitude and longitude), and any subsequent fixes, are provided to the Radarmen on watch to be set into the DR indicator. Second, the Radarmen on watch should, by the same token and

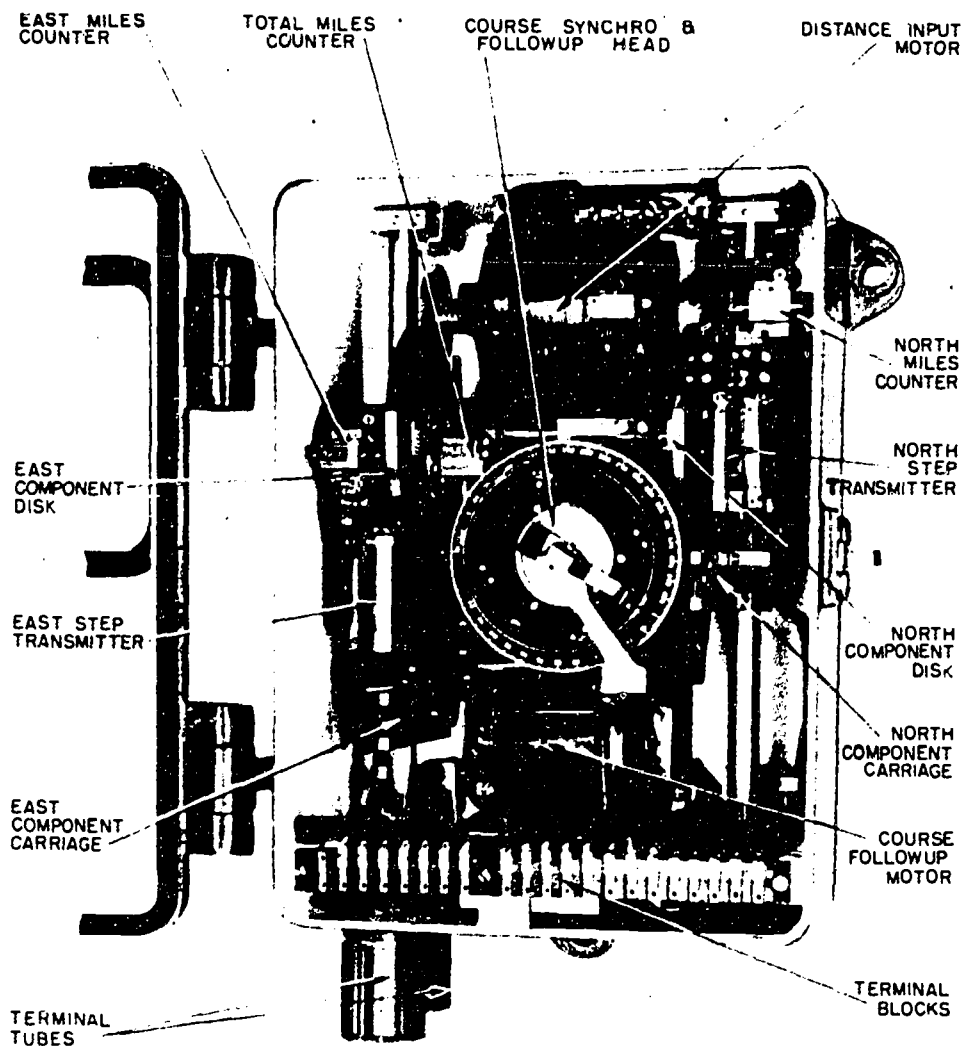

Figure 3-10. DR analyzer. 40.57

upon request, furnish you the recorded DR latitude and longitude for your position reports whenever you are unable to obtain an accurate position, and in any event at 0800, 1200, and 2000. This position should be checked by plotting it on a navigational chart before submitting it on a position report.

#### ESTIMATED POSITION

The information available to you for accurately fixing the position of your ship may at times be inadequate. Often, however, it is possible to improve on the DR position by utilizing additional data already on hand. A position obtained under these conditions is called an estimated position (EP).

One of the acceptable methods of estimating position is by means of soundings. The value of a position found in this manner depends largely on the contour and nature of the bottom and on your ability to interpret and apply this information. In general, soundings of a flat bottom are worthless in fixing your EP unless samples of the bottom are taken. Often, however, when the bottom contours are irregular a fairly accurate position (EP) can be determined.

#### Use of Soundings

To make use of soundings in locating the position (EP) of your ship, you should proceed as follows:

## QUARTER MASTER 1 & C

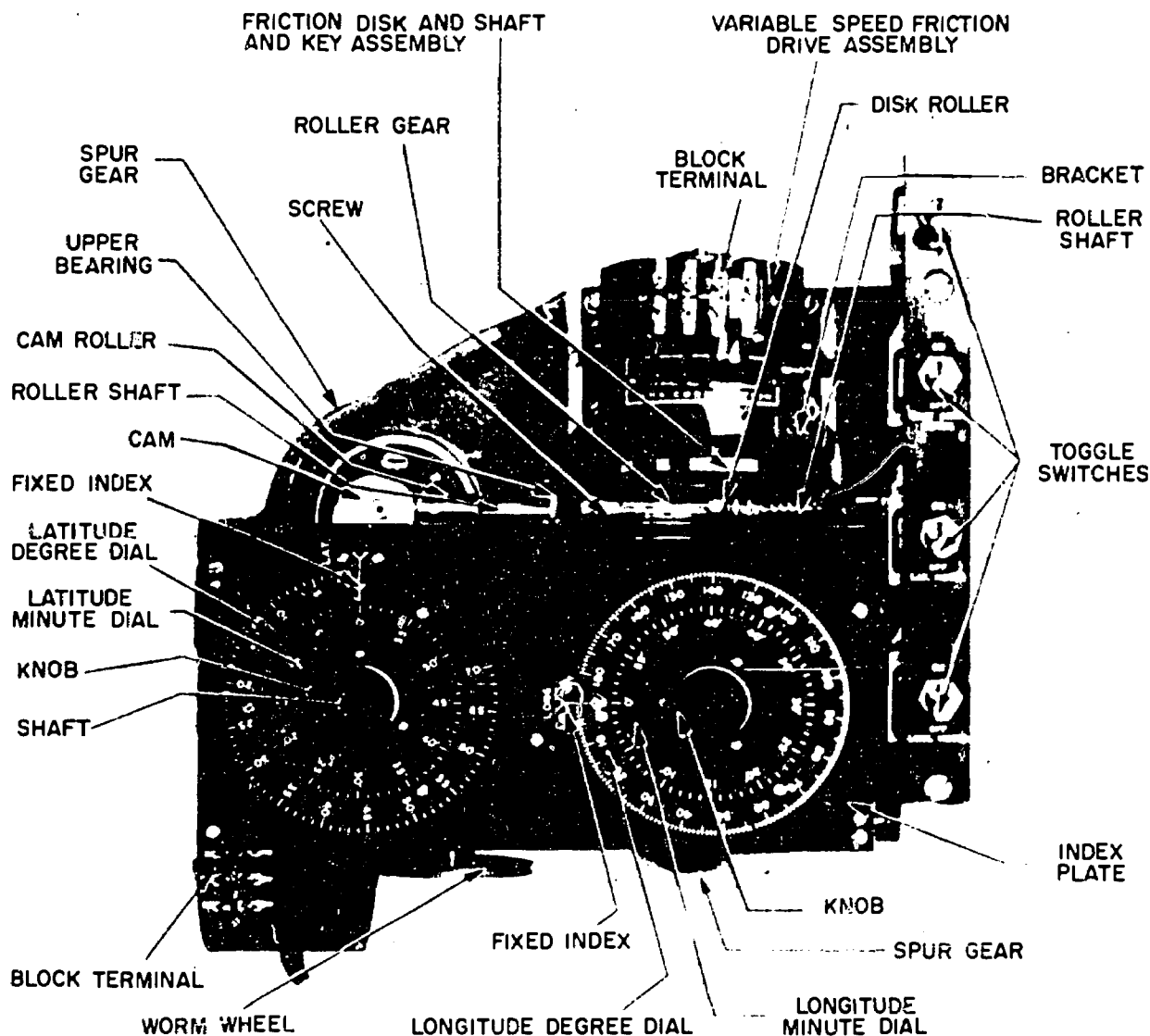

Figure 3-11. DR indicator. 40.59

(1) Draw a straight line on a piece of transparent paper or plastic. (2) Along this line mark off the distance between soundings (compute the distance run between the times you anticipate taking your soundings) to the scale of the chart you are using. Usually it is best to record soundings at regular intervals, say every 5 or 10 minutes, or every mile. (3) Record the times of the soundings and depths obtained at the marks along the line. (4) Place your transparency over your chart with the line of EPs corresponding to your DR track line.

Your DR track should be used only as a guide because it does not take into account the set or drift. When the soundings recorded on your transparency correspond to those on your chart at the same or nearly the same time as those on your DR track, you have a fairly accurate EP.

Because an EP is not a well-determined position, it is not customary to run a new DR track line from such a position. A line representing the estimated course and speed being made good should, however,

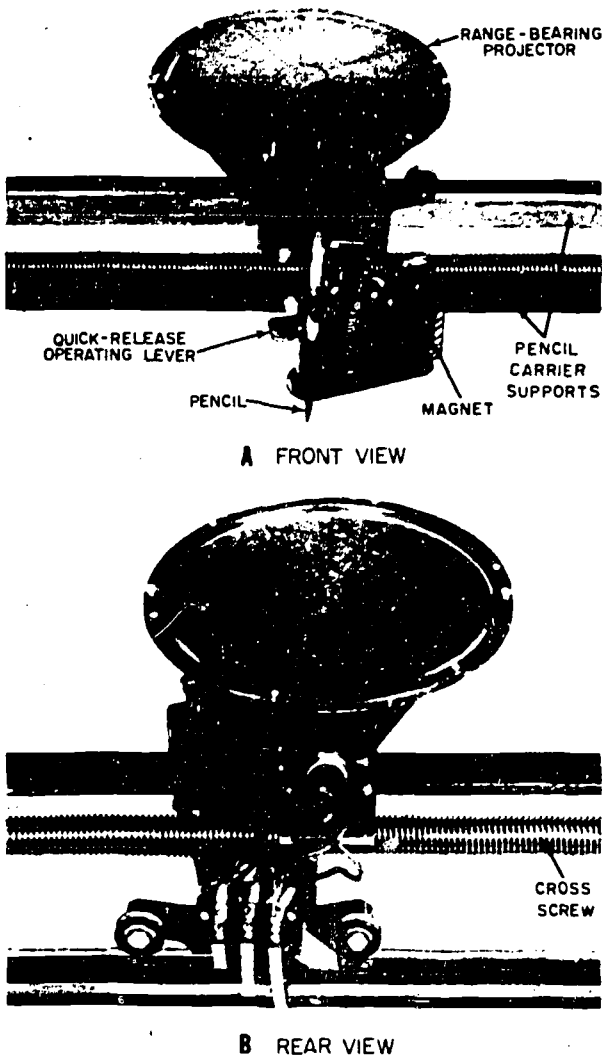

Figure 3-12. DR tracer. 40.62

be run from an EP to indicate the possibility of the ship standing into danger.

### Current Sailing

Current sailing is the method of computing course and speed through the water, making full allowances for the effects of current so that, at the end of your travel, the intended track and the actual track made good are the same.

The difference between the dead reckoning position and an accurate fix is the result of the action of forces on the ship, plus any errors in the cal-

culuation of course and speed. Regardless of the actual components that make up this difference, it is always referred to as the effect of current.

The following discussion of current sailing, however, relates to real currents in the oceans, harbors, and various inland waterways. Before continuing further, two simple definitions should be understood.

\* **Set:** The direction in which a current acts; that is, the direction toward which it flows. Usually the set is expressed in degrees true.

\* **Drift:** The speed of the current in knots.

In working set and drift problems, you must allow for current, and compensate for its effects. This allowance for current, as well as compensating for its effects, is accomplished by using a vector diagram. From this diagram you can find: (1) the course and speed your ship will make good when steaming a given course at a given speed; and (2) the course you must steer and the speed at which you must steam in order to have your ship make good a desired course and speed.

Both solutions may be obtained by drawing the vector diagram on your chart or on a separate piece of paper.

\* **Example 1:** Your course and speed, as well as set and drift, are known. Find the course and speed that actually will be made good.

Your ship is on course  $211^\circ$  (T), speed 12 knots. Set of the current is  $075^\circ$ , drift 3 knots. In figure 3-14 let line NS be the meridian, with your ship at point A. Lay off, clockwise, the angle NAB, which is  $211^\circ$ . Using the scale of the chart, or an arbitrary scale, make line AB equal 12 miles (which means you travel for 1 hour). The scale used in figure 3-14 is  $1/4$  inch = 1 mile.

From point B draw line BD in the direction of the set ( $075^\circ$ ), and make BD equal 3 miles. Angle NAD, clockwise, is  $199^\circ$ , which is the course actually made good. Speed made good is 10 knots (length of line AD).

• **Example 2:** You wish to make good a certain course and speed; set and drift are known. Find the necessary course to steer and the speed at which you must steam.

It is necessary to make good a course of  $300^\circ$  and a speed of 10 knots in order to make a rendezvous. Set of the current is  $180^\circ$ , drift 3 knots. In figure 3-15 let line NS be the meridian, with your ship at point X. Lay off, clockwise, the angle NXY, which is  $300^\circ$ . Using the scale of the chart, or an arbitrary scale, make line XY equal 10 knots. Again, the scale used in the illustration is  $1/4$  inch = 1 mile.

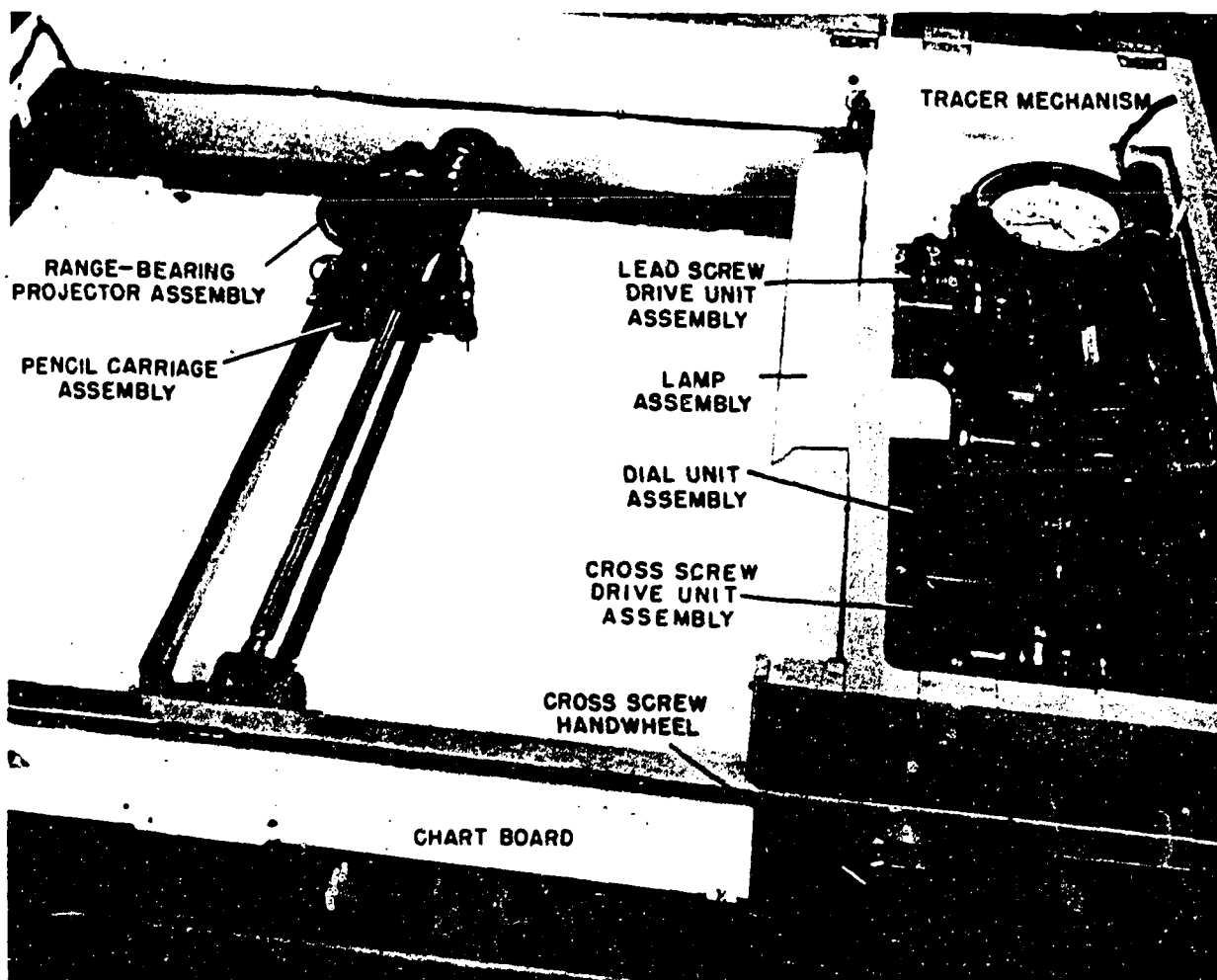

Figure 3-13. DRT plotting table. 40.61

From point Y draw line YZ, the reciprocal of the set (reciprocal of  $180^\circ$  is  $000^\circ$ ), and make YZ equal 3 miles. Angle NXZ, clockwise, is  $313^\circ$ , which is the course you must steer. The speed at which you must steam, line XZ, works out to be 12 knots.

#### PLOTTING SYSTEM MK NC-2

The NC-2 Plotting System (fig. 3-16) is an electromechanical-optical navigational aid for shipboard use. It provides continuous information on the positions of the ship and of two targets. For purpose of explanation, the original NC-2 Mod 0 will be discussed, however, the basic NC-2 plotting table

has undergone many modifications and improvements which have made it a highly sophisticated unit in ASW, navigation, radar, and air operations. There is less than one percent overall error in the plotting system in a working temperature range which is approximately  $60^\circ$  to  $88^\circ$  Fahrenheit.

The NC-2 Plotting System comprises four units: plotting table, target plot attachments (TPA), data converter, and dead reckoning indicator. A brief description of each unit follows.

#### Plotting Table

Basically the plotting table (fig. 3-17) consists of a projection screen mounted above three movable

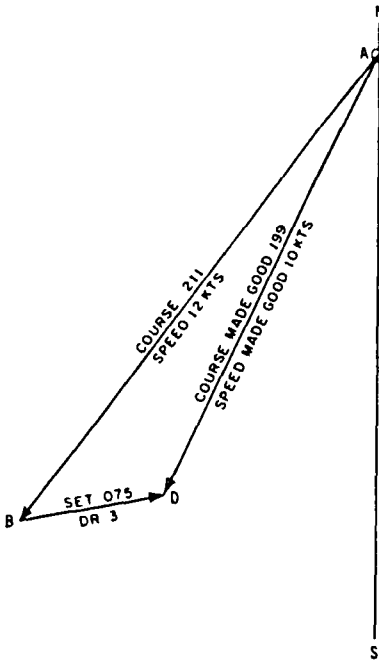

58.84.1  
 Figure 3-14.—Set and drift problem: Solving for course and speed actually made good.

projectors. The table is used to display, graphically, the positional information provided by the plotting system. The projection indicating own ship's position is a polar diagram. The plotting surface is made of 3/8-inch shock armorplate glass recessed 3/8 inch below the top of the table. A piece of 3/8-inch plastic is inserted to make a smooth plotting surface.

The plotting table has two control panels. The main control panel is located on the south side of the table. A smaller one, known as the north control panel, is situated on the north side of the table. The main control panel houses all the controls that directly affect the functioning of the plotting system. The north control panel houses auxiliary controls. A storage compartment is also located on the north side of the table. It is used for storing books, rulers, plotting scales, and projector graticules.

Target Plot Attachments (TPA)

The target plot attachments provide information on the positions of two selected targets, relative to the own-ship position. The information is derived from the ship's radar and sonar equipment through the data converter, and is processed in the TPA system and displayed on the plotting table's plotting surface in a similar way to that indicating the ship's position. The TPA assembly consists of a movable spotlight projector and the associated driving mechanism. The TPA's are mounted on the bridge and carriage assembly and, therefore, follow the motion of the plotting table's main projector, which indicates own-ship position. Each TPA operates independently and simultaneously to process and display the target data derived from its particular source. The projections, are colored spots of light approximately 1/8 inch in diameter. One TPA is fitted with a red filter lens and is referred to as the RED or No. 1 TPA. The other is fitted with a green filter lens and is referred to as the GREEN or No. 2 TPA.

Data Converter

The data converter receives range and speed information from the ship's radar indicators, sonar, and log, and then converts this information into a form usable by the plotting table and target plot attachments systems.

Dead Reckoning Indicator

The dead reckoning indicator Mk 2 Mod 0 is an electromechanical computer which is used in conjunction with the plotting table to provide a counterindication of the calculated geographical position of the ship. Information passed from the plotting table is processed and resolved into the

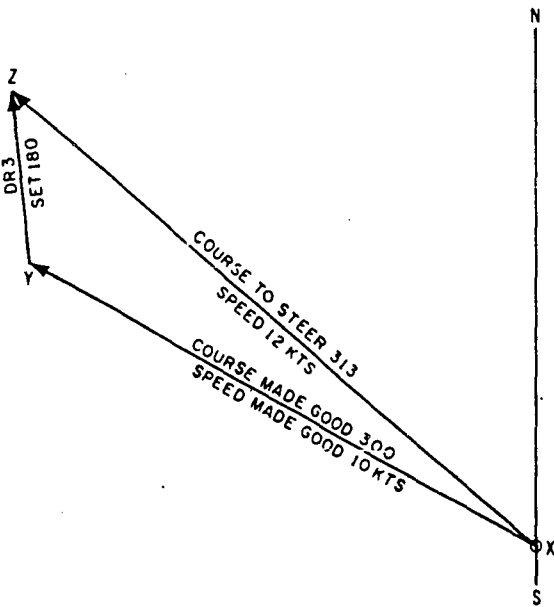

58.84.2  
 Figure 3-15.—Set and drift problem: Solving for course to steer and steaming speed.



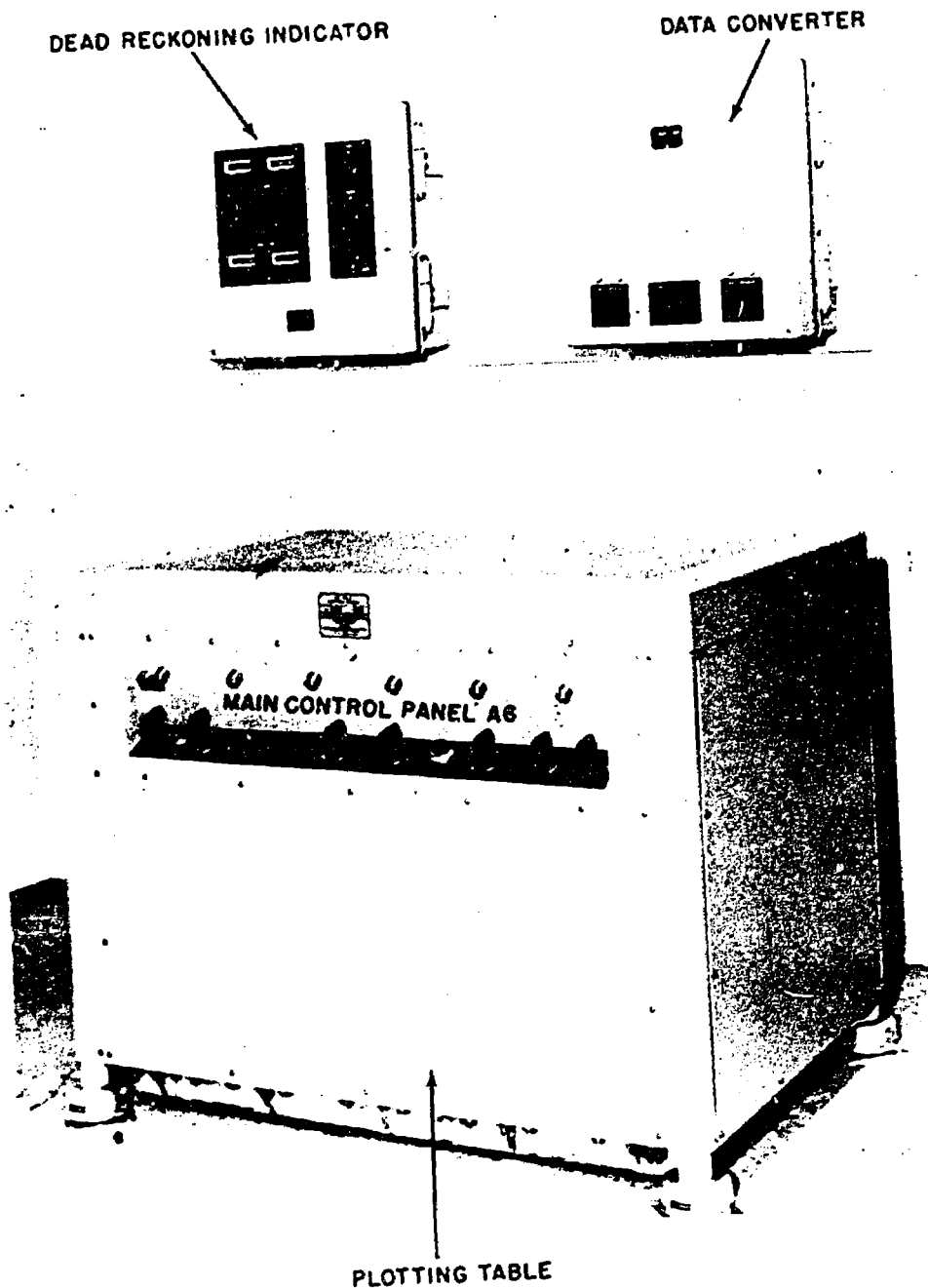

Figure 3-16. Plotting system USN Mk NC-2.

74.28

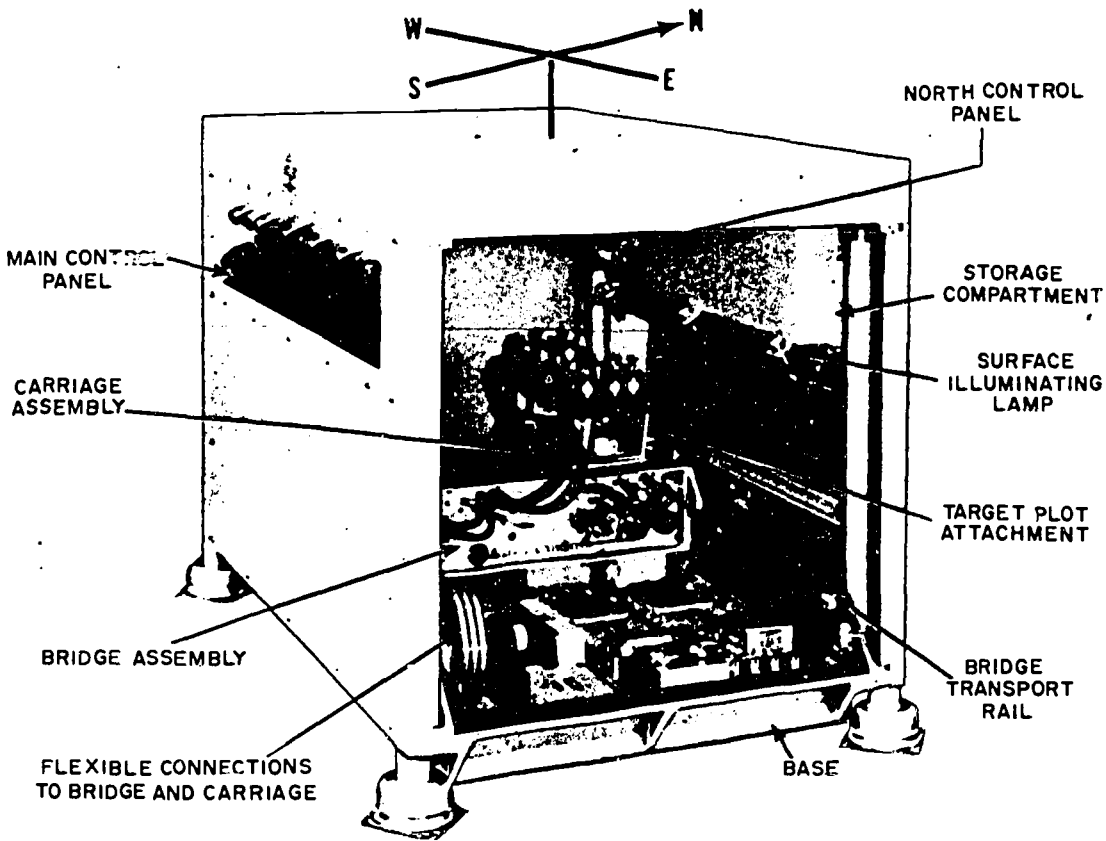

Figure 3-17. Plotting table Mk NC-2.

74.29

movement of two counters which indicate the ship's position in terms of degrees, of latitude and longitude.

#### MODIFICATION TO THE NC-2

Mod 1 of the NC-2 plotter made several changes on the original design. Physically it is reduced to two units: a plotting table and a dead reckoning indicator cabinet.

The functions of the plotting table were expanded to plot own ship's position and four targets on the plotting surface. Red, green, white, and yellow targets now can be plotted from external radar or sonar sources. The data conversion performed by a separate unit in the Mod 0 is now done inside the plotting table or in the DRI.

#### Modification 2A

Modification 2A of the plotter required the dead reckoning indicator to be replaced with a dead reckoning analyzer-indicator (fig. 3-18). This DRAI has the capability of being used independently as a navigational aid and is currently being employed as such under the DRAI Mk 9 Mod 0 (Mod 2 silent operation) designation.

The DRAI is an electromechanical computer which receives, as synchro signals, inputs of own ship's speed (OSS) and own ship's course (OSC). From these values, the north-south and east-west components of ship's speed are computed for internal use within the DRAI and for transmission to external equipment. In addition, OSS is integrated with respect to time to display total distance-traveled information by a counter. Each of the two speed com-

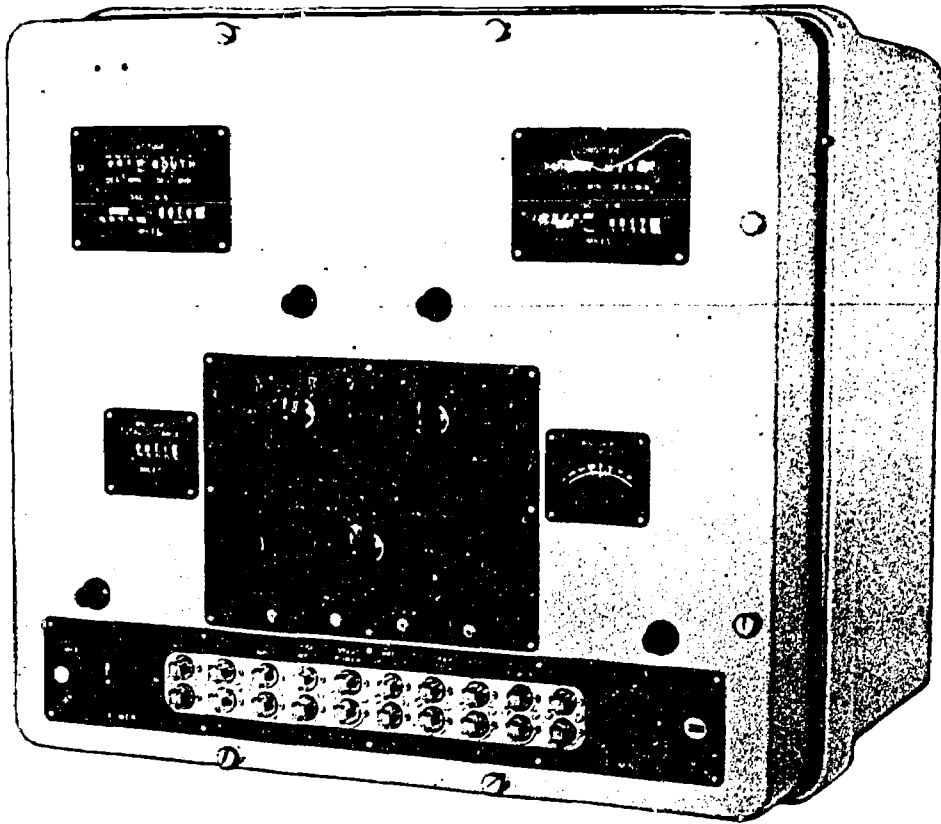

Figure 3-18. Dead reckoning analyzer-indicator Mark 9 Mod 0.

40.147

ponents is also integrated to provide distance traveled in the coordinate, which is displayed as front panel information by means of a counter. Latitude and longitude are computed from the two integrated speed components and distance-traveled counters. The DRAI also transmits computed values of latitude, longitude, and present position in north-

south and east-west components. Change of position values are computed with respect to manually established starting references, one for each coordinate. The DRAI also has the capability of accepting two independent relative bearing input signals from the NC-2 Mod 2 plotting table and converting these inputs to true bearing signals.

## CHAPTER 4

# ELECTRONIC NAVIGATION

The expression "electronic navigation" comprises all types of navigation that use electronic equipment to aid in determining a ship's position. You have navigated by means of various electronic aids to navigation, and you are well aware of the accuracy that may be achieved with these aids when they are employed properly and their limitations are understood.

Celestial navigation, dead reckoning, and piloting remain the principal methods of navigation. Both celestial observations and piloting depend on visibility, however; and dead reckoning gives you only an approximate position. Thus, electronic aids to navigation have proved to be a boon to the safe navigation of your ship. When they are used in conjunction with other methods available to you, or independently when the need arises, they supply an accurate determination of your ship's position. Unfortunately, electronic equipment, like other pieces of complex machinery, can become inoperative. Atmospheric conditions also may adversely affect the reliability of information obtained from this equipment. You must therefore continually utilize all available methods of—and aids to—navigation, and never place your complete reliance on one aid alone if others can be used.

Some of the limitations of radar and loran are covered in this chapter, together with a brief discussion of consol, decca, and omega navigation systems.

### RADAR

The principle of radar is, simply, that radio waves are reflected from a solid or a liquid surface or target. The time required for the waves to reach a target and return is measured; and, by a simple mathematical formula, the range can be determined. Because the waves emitted by the radar antenna are directional in nature, the bearing to the target can also be determined.

### ADVANTAGES OF RADAR IN NAVIGATION

When used for navigational purposes, radar has distinct advantages over other types of navigational equipment. Several of these benefits are given in the following list.

1. Normally, you can use radar when other methods are unavailable; for example, at night and during periods of low visibility.
2. Because both a range and a bearing are provided by radar, you can obtain a fix from a single object.
3. With the PPI, a continuous position is available to you, and radar fixes can be obtained quite rapidly.
4. At times you will find radar navigation to be more accurate than other methods of piloting.
5. Usually you can use radar at greater distances from land than nonelectronic methods used in piloting.
6. Radar is a helpful anticollision device, giving you a presentation of the surrounding area on the PPI scope, even during periods of reduced visibility. The use of radar alone, however, does not prevent collisions nor modify the Rules of the Road.
7. You can use radar to locate and track squalls and nearby tropical storms.

### DISADVANTAGES OF RADAR IN NAVIGATION

When used in navigation, radar has certain limitations and disadvantages that you should keep in mind. Following are some of the disadvantages.

1. Radar is subject to mechanical and electrical failure.
2. There are limitations to both minimum and maximum ranges.
3. Proper interpretation of information presented on the scope is not always easy, even after you become proficient at it.
4. Sometimes radar is not as accurate as other methods of piloting. A visual bearing, for example, is more accurate than a radar bearing.

5. During unusual atmospheric conditions, radar may be unreliable.

6. Information necessary for identification of radar targets is not always given on charts.

7. Small boats, buoys, or rocks, and the like, cannot be detected easily by radar, especially if a high sea or surf is running or if the objects are near the shore.

## ACCURACY OF RADAR

The accuracy of positions obtained by radar, when used in navigation, varies with the different types of radar and the skill of the operators. You will be using radar directly for navigation, and you should understand the problems influencing its accuracy.

In the majority of circumstances, the accuracy of radar fixes compares favorably with fixes obtained by other means. The limitations of each radar set should, however, be understood thoroughly by everyone who is depending on it for information. Some of the factors affecting the accuracy of specific radar information follow.

1. **Beam width:** Although radar signals are directional, they are transmitted as fan-shaped narrow beams. Echoes are received continuously by your radar as its beam sweeps across a target.

2. **Pulse length:** Pulse length affects the apparent thickness or depth of the pip as it appears on the PPI.

3. **Mechanical adjustment:** Radar sets, although rugged, are nevertheless rather sensitive instruments, and they require accurate adjustment. Remember, error in adjustment usually causes error in readings obtained.

4. **Interpretation:** Even with proper training, a person operating a radar may not always find it easy to interpret an echo properly. Three of several influences that make this problem difficult are bearing resolution, range resolution, and shoreline interpretation.

a. **Resolution in bearing:** If two or more targets are very close together and are at about the same range and bearing, their pips may come together, appearing as a single target on the PPI. The minimum difference in bearing between two objects at the same range that can be detected by a radar is called its resolution in bearing. Always bear in mind, and impress upon your men, that a number of piles, rocks, small boats, or other small objects near a shore may appear as a solid line, giving you a false impression of the position of the shoreline, and making inaccurate the radar bearings of points along the

b. **Resolution in range:** The minimum difference in range between two objects close together on the same bearing that can be distinguished by a radar is called resolution in range. You may falsely identify a point when two or more targets appear as a single long one, or when a ship, buoy, or rock is near a point and not separated. False shorelines may appear on your scope because of a pier, several small boats, or because of heavy surf over a shoal.

c. **Shoreline interpretation:** The shoreline may appear some distance inland at bluffs or cliffs back of a low, flat, or sloping beach. False shorelines also make inaccurate the radar ranges or bearings from points along the shore. Never let yourself or your men be lulled into a false sense of security merely because you obtain the closest range to land. You may have a false shoreline, and there may be several hundred feet of low beach extending your way, none of which was shown by your radar.

## LIMITATIONS IN RANGE

For all practical purposes, radar has both minimum and maximum ranges. Minimum ranges are determined by obstructions in the vicinity of the antenna, sea return, and certain technical features that are beyond the scope of this course. Maximum range usually is limited by the curvature of the earth to the line of sight and depends to some extent on the height of the radar antenna above the surface of the water. Such technical features as output power, pulse width, and frequency also affect maximum range.

## PILOTING BY RADAR

Well-determined positions by radar are labeled fixes. Positions that are not well-determined, or less reliable ones, are labeled EPs (estimated positions), depending on the judgment of the navigator. You know that radar bearings are always less accurate than visual bearings. Radar ranges, however, are relatively accurate. Consequently, a fix obtained by a method in which one or more of the lines of position is determined from range is always more accurate than one obtained from radar bearings alone.

The three most common methods of determining position by radar are—

1. Two (or more) ranges.
2. Range and bearing of a single object.
3. Two (or more) bearings.

### Two or More Ranges

Two or more radar ranges provide the most accurate fix that can be determined by PPI scope. When this method is used separately or in connection with visual bearings, it produces reliable fixes.

When piloting, always remember that the ranges taken from a coastline may be inaccurate for the reasons stated previously. For these same reasons, then, always try to use a small, well-defined object that can be plotted accurately from the exact point of echo. Whenever practicable, try to supplement radar ranges with visual bearings. Chances are slim that your fixes will be erroneous when two or more radar ranges and visual lines of position are used. Impress upon the minds of your men that the more methods used simultaneously in obtaining a fix, the more accurate will be your position.

### Range and Bearing of a Single Object

As you know, both a bearing and a range are obtained from a single observation by radar. The intersection of the bearing and range is a fix. Because of the inherent inaccuracies of radar bearings, a more accurate fix can be obtained if we use a visual bearing intersecting a radar range. If only a single small object is available, however, a radar range and bearing may be the only method of determining your position. If the target is a small, well-defined island or a point of sufficient width, you can obtain a more accurate fix by plotting tangent bearings and range. But, because of beam width distortions, tangent bearings usually intersect at a point less than the measured range, thus forming a small triangle. Your position is then considered to lie on the measured range midway between the bearing lines—not in the center of the triangle, as in other types of fixes.

### Two or More Bearings

Two or more bearings by radar are plotted in the same manner as visual bearings. This method is the least desirable and least accurate method of obtaining a radar fix. Hence, this method should be avoided if a more accurate method can be utilized.

### RADAR BEACONS

Two types of radar beacons are in limited use. These types are the ramark (formed from the term *ra dar mark*), which is used by ships, and racon (formed from *ra dar beacon*), which is used primarily by aircraft.

The ramark beacon is simply a transmitter that transmits a continuous signal on a radar frequency. The signal appears on the PPI as a bright line each time the radar antenna points toward the beacon. Thus, a bearing is readily available to a known point. Radar beacons are portable and may be established on a specific shoreline for use in amphibious and mine countermeasure operations.

Racon consists of a transponder, which returns a signal when triggered by a signal from a radar

transmitter. The beacon is identified by dot and dash signals. The range and bearing are indicated by the position of the first character of the code as it appears on the PPI.

### LORAN

Whereas radar is used primarily for piloting and as an aid in coastal navigation, loran is used primarily to supplement celestial navigation when at sea. Undoubtedly you have experienced days when the sky was overcast and the heavenly bodies were not visible for observation. At those times you had to rely on your ship's loran equipment. How loran functions, how to obtain readings, and plot loran lines of position are discussed in detail in *Quartermaster 3 & 2*, NavPers 10149. Only uses and limitations of loran are described in this chapter.

### ADVANTAGES OF LORAN

Loran has several advantages over other methods of navigation, some of which are listed here.

1. Through frequent practice, you can obtain a single line of position in less than 1 minute by loran.
2. You can train your men to operate loran in a relatively short time.
3. Normally, you can obtain readings during the most adverse weather conditions.
4. You can receive signals at any time of day or night.
5. Loran has an advantage of relatively long range. Loran-A normally can be received 700 to 800 miles during the day and up to 1400 miles at night.
6. Although their range decreases, loran signals can travel overland without loss of accuracy.
7. Precise time is not as important a factor as in celestial navigation.
8. Because there is no transmission by your own ship, radio silence is maintained.
9. Ordinary jamming methods usually are unsuccessful.
10. Compass and/or gyro course is not essential for a loran fix.

### DISADVANTAGES OF LORAN

The following disadvantages of loran in navigation are cited.

1. Mechanical or electrical failure is always possible both aboard your ship and at individual transmitting stations.

2. Many areas of the world do not have loran stations, consequently the area of coverage is limited.
3. Identification of signals at extreme ranges is not always reliable.
4. Although shore transmitting stations are a necessity, they not only are expensive to operate but are subject to damage by weather or capture by an enemy.

## RELIABILITY OF LORAN

Like other forms of electronic navigational equipment, loran is subject to outside interference. Consequently, its reliability is proportionally affected. Ordinary static, for instance, appears as "grass" on the traces. A loran-A reading can be made only if signals are strong enough to appear above the grass. Flashes of lightning and radio CW transmissions cause interference that may momentarily obscure loran signals being received. Loran may be used between these disturbances and a reading may be obtained. Radar produces a series of signals somewhat resembling loran signals, but you easily can distinguish between them because they are spaced regularly across the traces and should not interfere with obtaining an accurate reading.

Two other forms of interference affecting the reliability of loran come from loran itself. These extraneous signals are commonly known as spillover and ghost pulses.

- **Spillover:** When you are near one loran station and you are tuned to a different station considerably distant, weak signals may appear from the nearer of the two stations. You might make the mistake of trying to match a signal from the nearer station with one from the station to which you are tuned. You must keep alert to recognize such interference when you are in an area where it is likely to happen. If you suspect spillover, you should shift to the frequency of the nearer station and use it to determine your LOP.
- **Ghost pulses:** If your loran set is tuned to the incorrect basic pulse repetition rate, ghost pulses appear. They usually become visible as normal loran signals, but they flicker, and the trace itself looks unbroken at the pip. With the true pulse, the trace normally appears interrupted across the base of the pip. You know from experience that these ghost pulses can be matched, any reading you obtain is meaningless.

## TRANSMISSION INACCURACIES

The synchronization of loran stations is monitored constantly to ensure accuracy. Should the timing of the signals become inaccurate by as little as 2 microseconds, you are warned by the blinking of one or both of the signals being received on your loran receiver. The signals on your loran-A receiver are made to blink or shift to the right about 1000  $\mu$ sec and back at intervals of about 1 second. Either station of a pair may blink. You should not take readings at this time. Usually the signals are synchronized within a few minutes, and the blinking ceases.

## LORAN-C

Loran-C is an advanced long-range navigational system using low frequency transmissions. It operates in much the same manner as standard loran (loran-A), but has a greater range and accuracy. Standard loran receivers can be modified to permit reception of loran-C signals. (After modification they are known as loran A/C receivers.) The modified receivers, however, are not as accurate as the standard loran-C receivers. More sophisticated receivers exist today which can automatically track two Loran-C pairs, discriminate skywaves and provide digital outputs for integration with a shipboard computer.

The usual groundwave range of loran-C is 1200 nautical miles. First hop skywaves during daylight and darkness have a normal range of 2300 nautical miles. Second hop skywaves have a range of approximately 3400 nautical miles. Figure 4-1 shows the day and night coverage of some loran-C stations. The chart may show some stations that no longer are operative, or stations not yet operative, hence you should consult the weekly *Notice to Mariners* for any changes.

## CONSOL

Consol is a long-range navigational aid. Several consol installations are located in the coastal European countries. On many occasions a good dead reckoning position is as reliable as a position obtained by consol. The average accuracy by consol is  $0.3^\circ$  during the day and  $0.7^\circ$  at night. The method is most useful, therefore, when your position is in doubt or when you wish to check other navigational methods for gross errors. Normal shipboard radio receiving equipment can be utilized to determine ship's position by consol. Cross-reference for cover-

# Chapter 4 — ELECTRONIC NAVIGATION

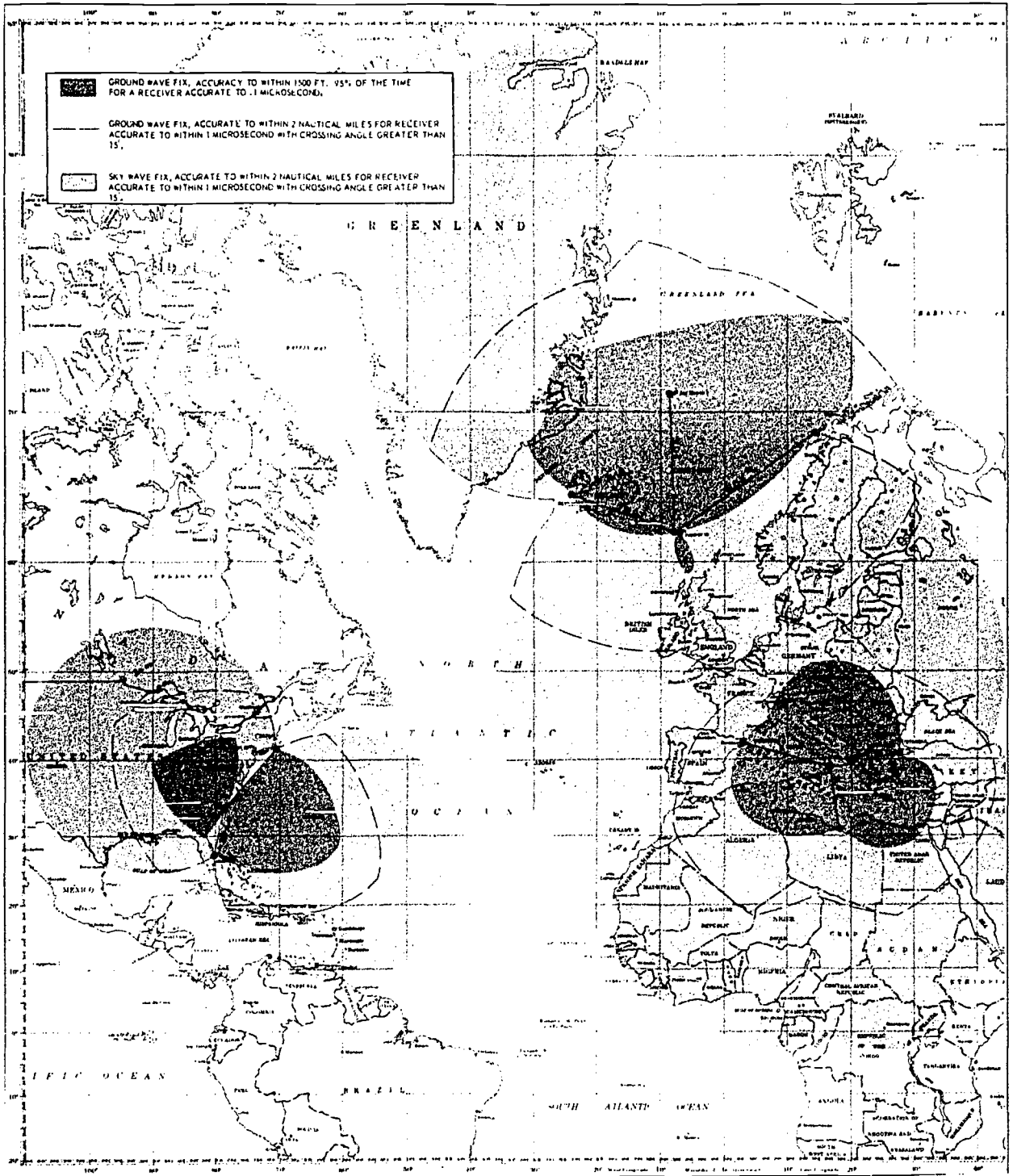

Figure 4-1. Some loran-C stations. 112.37



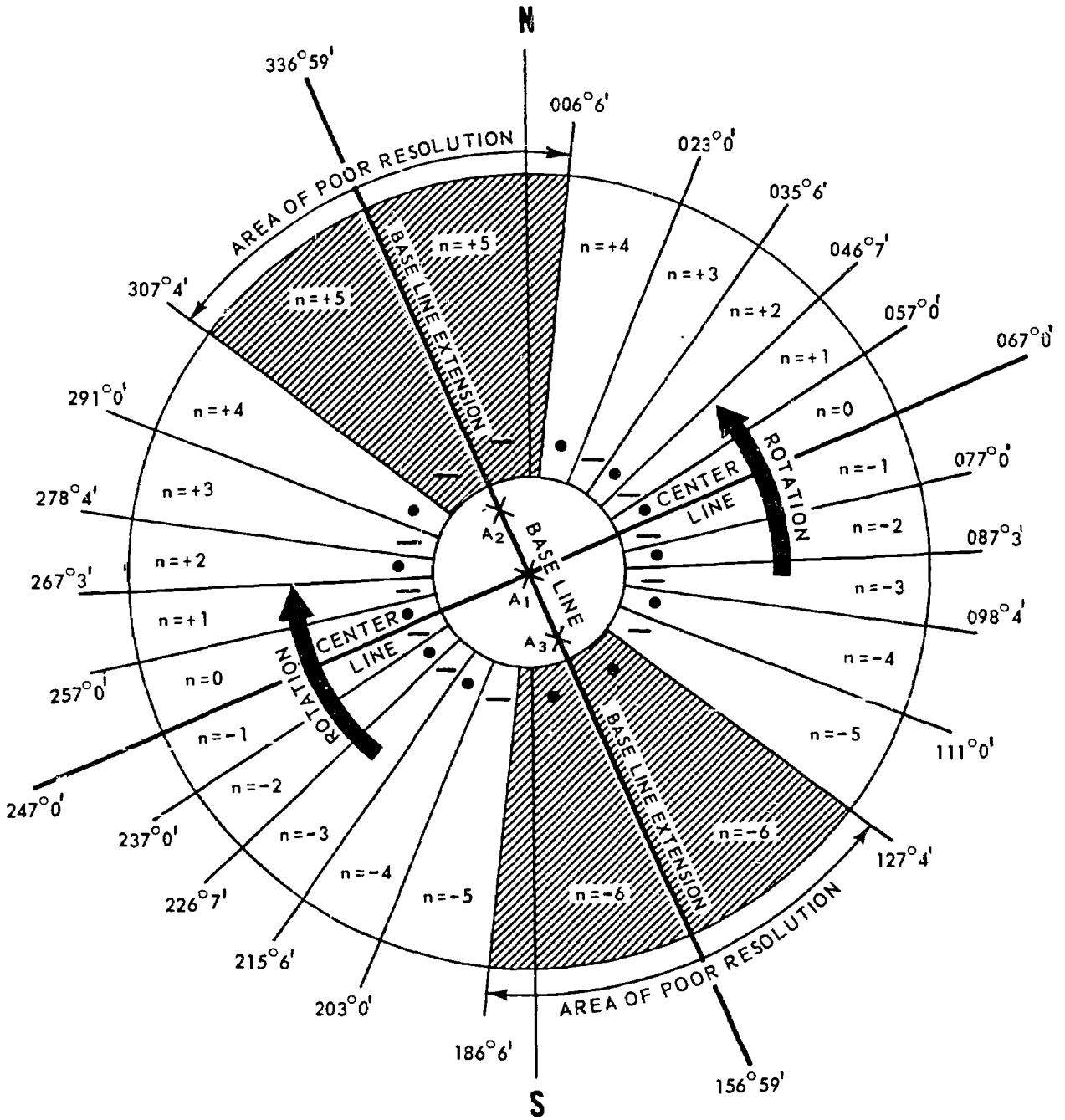

Figure 4-2. —Transmission pattern of consol stations.

age of consol/consolan system is contained in H.O. Pub. 117A.

### USING CONSOL

Figure 4-2 shows the transmission pattern of one of the consol stations. You will note that there are 24 sectors 12 sectors transmitting dots, and 12 sectors transmitting dashes. The accuracy of consol is maximum along the perpendicular bisector of the baseline. The accuracy decreases as the baseline extension is approached. In fact, useful coverage is limited to two areas of about  $140^\circ$  to  $150^\circ$ .

Consol operates in cycles. One cycle consists of an allotted amount of time to transmit a dot or a dash identification signal, followed by a rotation of the sectors. Depending on the sector, either 60 dots or 60 dashes will be transmitted during each rotation through a sector.

### Obtaining a Bearing

You now should have a rough idea about the operation of consol. In order to obtain a fix, you need to obtain a bearing from two consol stations. Their intersection gives a rough fix.

In figure 4-3 you see 2 sectors taken from the entire pattern of 24 sectors. Sector AOB is a dot sector and BOC is a dash sector. After the transmission indicating the identity of the consol station, you count 15 dashes (part A of fig. 4-3), then you hear the equisignal (continuous tone located on the line between adjacent sectors). Next, you hear 45 dots (part B of fig. 4-3). This information enables you to locate your line of position along line OS.

The aforementioned example is illustrative in nature. Most of the time, an operator does not hear all of the dots and dashes. In the illustrative case mentioned you probably heard 12 dashes and 42 dots. You did not hear 6 signals. You must then assume that half of these 6 signals are dots and half are dashes. The true count, therefore, is 15 dashes and 45 dots. Tables for converting the count of dots or dashes into true bearings from the station are contained in H.O. Pub. 117. (The British Admiralty and the U.S. Navy Oceanographic Office publish consol charts that are used much like loran charts.) Normally, you should have no trouble determining the sector in which you are located. If you do, a rough bearing can be taken by a direction finder. A rough DR position usually is sufficient for determining the proper sector.

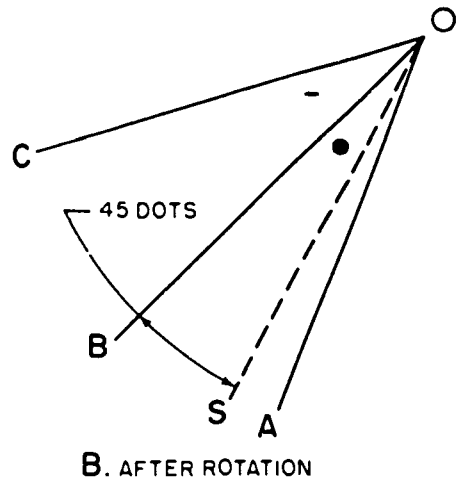
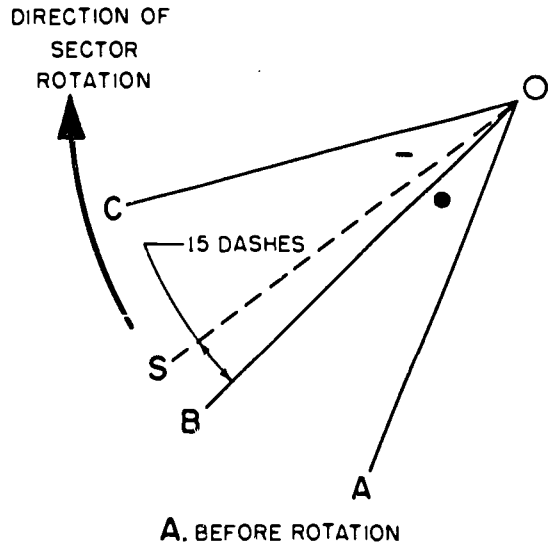

Figure 4-3.—Reading the consol signal. 112.36

### DECCA

Decca is the British equivalent of standard loran. It is extremely accurate at short ranges—even more so than loran.

Like loran, decca utilizes master and slave stations. Decca employs one master station and three slave stations in each chain. The three slave stations are named for the colors of the lines representing them on the decca charts. Although three lines of position can be obtained from each chain, normally only the two LOPs are used that give the highest degree of accuracy for the area in question.

In order to receive decca signals, a ship must have three decometers (receiver indicators employed aboard ships for displaying decca signals). From information taken from the decometers, the LOPs can be plotted on the decca charts. You probably will have little opportunity to use this system.

### OMEGA

The Omega system is an outgrowth of the loran A and loran C systems. The system provides eight position-fixing transmitting stations located around the earth to accommodate aircraft, ships, and submarines (at moderate antenna depths). The system has been made possible by recently uncovered facts concerning the propagation of very low frequency (VLF) radio signals over substantial distances.

The Omega Navigation Receiver AN/SRN-12 (fig. 4-4) is a single frequency, phase-locked superheterodyne receiver with a whip antenna and coupler for the reception of Omega navigational signals. The receiver operates in the VLF (10 to 14 kHz) range to provide a position readout in hyperbolic coordinates. To understand the hyperbolic system, first it must be realized that the Omega stations, being phase locked to a nearly absolute time standard, provide a signal field where the phase is everywhere stationary. Therefore, the measured phase difference of a particular pair of signals observed at a given position depends solely upon how much farther the observer is from one station than another. Also, the same phase angle measurement will be observed at all points which have the same difference in distance from two stations. The locus

of such points is a contour of constant phase (isophase contour) which is fixed on the surface of the earth with respect to the positions of the pair of transmitters.

The relative phase of every pair of signals observed at any point on earth defines a known isophase contour containing that point, the intersection of two such isophase contours established by different pairs of stations, defines the location of the point.

### OMEGA TRANSMISSION

The eight Omega stations all transmit at 10.2 kHz and always in the same order, with the duration of transmission varying by station from 0.9 to 1.2 seconds. The duration of transmission of each station, in accordance with the implemented Omega station identification code, is as follows:

STATION	A	B	C	D	E	F	G	H
DURATION OF TRANSMISSION	0.9	1.0	1.1	1.2	1.1	0.9	1.2	1.0

The basic 10.2 kHz transmission generates hyperbolic lanes 8 nautical miles wide on the baseline. In order to initially position himself within this system, the navigator must know his position to within plus or minus 4 nautical miles. Omega is a lane counting system and once the lane count is established and the equipment is running continuously no reference to other systems is necessary. Lane count is determined for each line of position from the applicable Omega navigation chart. In the event of receiver or transmitter failure, lane count would have to be reestablished.

The transmitting stations, in the Omega system, are located approximately 6,000 miles from one another. Of the eight stations, at least four stations are available to the navigator at any point on earth, allowing a minimum of six possible LOPs, on a 24-hour basis, under all weather conditions.

### NAVIGATION BY SATELLITES

The navigational satellite system is a global all-weather system. With its use navigators in ships on or below the ocean surface can obtain a fix to within a fraction of a mile, night or day, in all parts of the world. Although it is usable worldwide, fix informa-

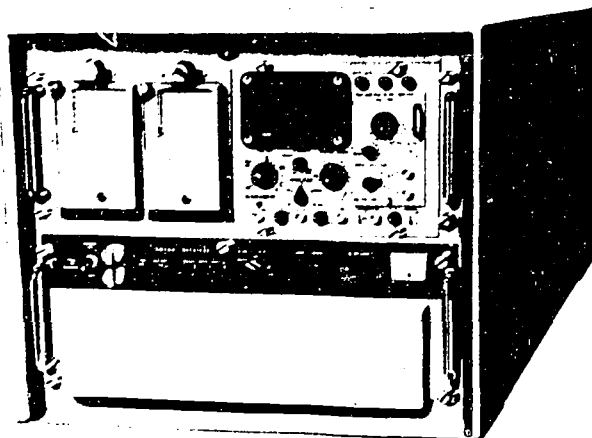

120.48

Figure 4-4. Omega Receiver AN/SRN-12.

tion is available only during a satellite pass, which may occur every 45 to 150 minutes, more often at high latitudes than on the equator. On some occasions satellites may interfere with one another due to the close proximity of their orbits. This is especially true at high latitudes as the satellites are all in polar orbits.

The system operates on the doppler principle. Doppler can best be described by example. Suppose, as you stand at a railroad crossing a train approaches with its whistle sounding. As the train comes nearer, the pitch of the whistle becomes higher until the train passes you. At this time the pitch drops, and as the train goes off into the distance, the pitch of the whistle gradually grows lower. The changes in pitch is called doppler shift. A satellite approaching and passing over a ship likewise has a change in pitch, or doppler shift. Analysis of the doppler shift enables the navigator to calculate his position relative to the satellite. The position of the satellite is radioed from the satellite so that the navigator can take the doppler information, along with the satellite position information, and determine his ship's position.

The navigational satellite system requires five groups of equipment: several satellites, tracking stations, a computing center, an injection station, and shipboard navigational equipment. Following is a brief explanation of how the system works. (Referring to fig 4-5 may help you understand the system.)

As each of the navigational satellites orbits the earth, the tracking stations receive and record the doppler shifts radiated by each satellite as it passes within receiving range.

Doppler information is transmitted to the computing center, and there the information is used to calculate the satellite's position as a function of time. From the computing station the satellite's position (as a function of time) is transmitted to the injection station.

The injection station transmits orbital data to the satellite as it passes into range. The information sent from the injection station erases former data and allows the correct data to be transmitted by the satellite. The injection station sends corrective data to each satellite twice a day.

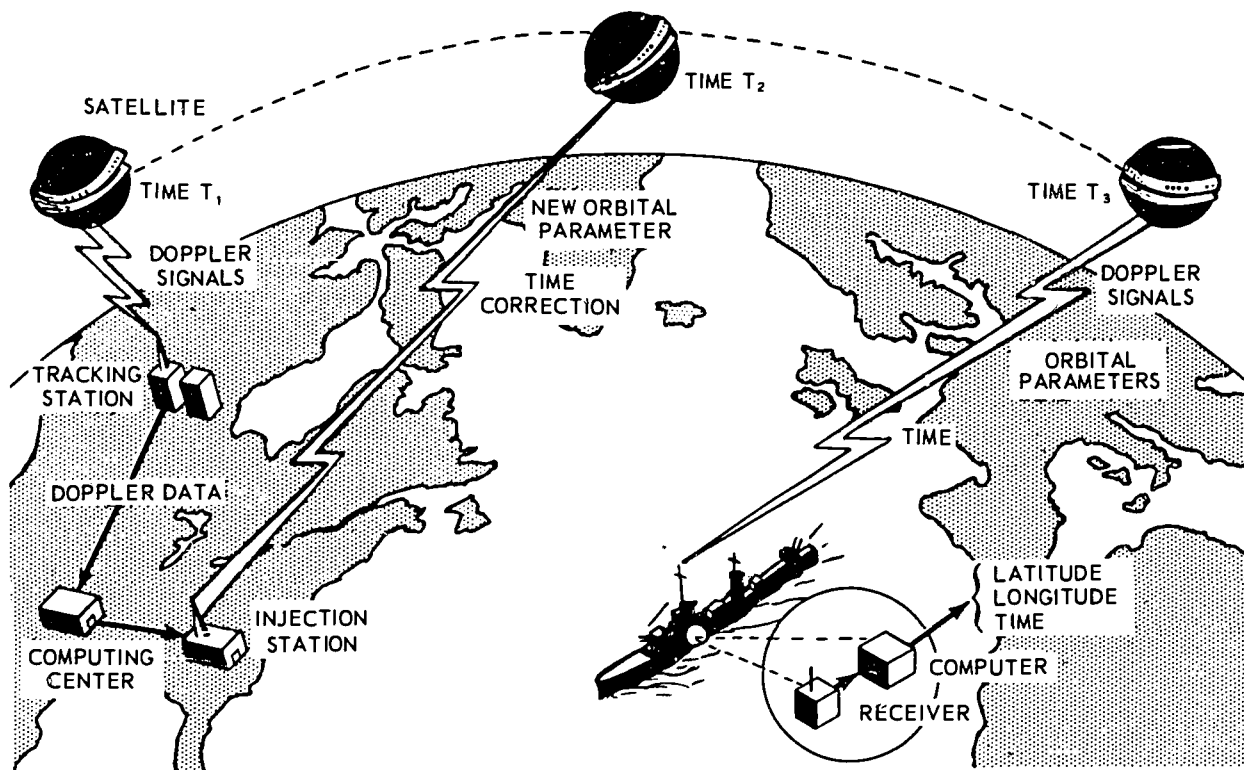

Figure 4-5. Navigational satellite system. 69.55

Meanwhile, the satellite continues to radio information every 2 minutes. Any ship within receiving range of the satellite can record the doppler shift, orbital position, and time as they are radioed from the satellite. By means of this information, the navigator of the ship can compute the latitude and longitude of his ship.

### SHORAN

Shoran (from the underlined letters of the term short-range navigation), employed principally in surveying, uses ranges rather than bearings. Signals from own ship's radar automatically trigger two fixed transmitters ashore. The signals emitted by these transmitters are in the form of pips and are received simultaneously. You measure the ranges to these pips in the same manner as you would any contact, and then plot the ranges on your chart. The point where these two ranges intersect is your position. Although shoran is relatively short-ranged, it is extremely accurate, so that your fix can be relied on to about 50 feet.

### STAR TRACKER

Star tracker is an extremely sensitive optical telescope with radio or infrared components that calculate elevation (altitude) and azimuth data from celestial bodies, including the sun. The star tracker may be used even during periods of poor visibility. With the sun it may be used effectively in heavy overcasts with a high degree of accuracy. The radio sextant is similar to the radio telescope and is included in the same category as the star tracker.

### SHIP'S INERTIAL NAVIGATION SYSTEM

At present, the ship's inertial navigation system (SINS) is chiefly a navigational aid for submarines

and aircraft carriers. It soon should be operational on most surface vessels.

This SINS provides ships with an accurate and continuous dead reckoning position. The DR position is displayed continuously on a chart, along with the desired track. Because SINS is a self-contained system, it is a valuable wartime navigational aid. When the loran systems and other similar systems are knocked out, SINS remains operable.

The SINS operates on an arrangement of gyros and accelerometers. This arrangement is called the sensitive element. Three gyros and two accelerometers make up this sensitive element. Two of the gyros give absolute values, one gyro for latitude and the other for the vertical. The third gyro is for longitude, but it cannot give an absolute value. A requirement for the third gyro is the initial ship's longitude, with which ship's position can be computed at any time thereafter.

The accuracy usually obtained by SINS is on the order of about 1 mile per day. The degree of accuracy can be greater, however, because more accurate position data can be obtained by other navigational methods and inserted into the SINS.

### NAVDAC

Among the advanced components to navigational systems that assist the navigator in solving navigational problems is navdac (navigation data assimilation computer). The navdac combines, evaluates, and stores data received from navigational systems, i.e., SINS and star tracker. In effect, it is a memory bank of highly accurate navigational data, capable of rejecting solutions of poor quality and accepting only those of a high degree of probable accuracy.

## CHAPTER 5

# CELESTIAL NAVIGATION

You were given an introduction to celestial navigation in the Quartermaster 3 & 2 manual, which was sufficient for most celestial navigation duties encountered in the lower pay grades. As a First Class or Chief Quartermaster, and perhaps assistant navigator, however, your knowledge of celestial navigation must be much more extensive than for the QM 3 and 2 levels.

Celestial navigation is a science requiring rigid adherence to rules, constant practice, and experience. This chapter will build on the information presented in the *QM 3 & 2* training manual, and will describe the steps necessary for obtaining a celestial line of position or fix. The actual practice, naturally, is up to you. It is recommended that while studying this chapter, you refer to Bowditch or Dutton for elaboration on points that may be unclear.

### USE OF SEXTANT

The instrument of chief importance in celestial navigation is the sextant. It is used to measure the altitude of a heavenly body above the visible horizon. Sextant altitude is corrected for various factors in order to determine the body's true (or corrected) altitude above the celestial horizon. Before going into the correction problem, the definition of these terms must be thoroughly understood:

- The sextant altitude, or altitude of a body above the visible horizon, is the sextant reading without correction.
- The observed altitude (true altitude) is the altitude of the center of the observed body above the celestial horizon. It is obtained by applying certain corrections to the sextant altitude.

### ALTITUDE CORRECTIONS

Of the following five altitude corrections, the first three apply to observations of all celestial bodies. The last two corrections are applicable only when the observed body belongs to the solar system.

Figure 5-1 illustrates the correction problem. To obtain the true altitude, then, the sextant altitude of any celestial body must be corrected for—

1. Index error, which is the constant amount by which the sextant angle between two objects differs from the true angle.

2. Refraction, which is the deviation of rays of light from a straight line caused by the earth's atmosphere.

3. Dip of the horizon, which is the difference in direction between the visible and celestial horizons caused by the observer's height above the surface.

If the observed body belongs to the solar system, corrections must also be made for—

4. Parallax, which is caused by the proximity of bodies of the solar system to the earth, resulting in a difference in altitudes measured from the surface of the earth and from the center of the earth. Such an occurrence is not true of other heavenly bodies whose distance from the earth is considered infinite.

5. Semidiameter, resulting from the nearness of bodies of the solar system, making it necessary to consider the observed bodies as of appreciable size instead of as mere points of light (stars, for example). The sextant altitude of such a body is obtained by bringing its disk tangent to the horizon. Semidiameter correction must be applied to find the altitude of the center.

### Index Correction

An error, known as the index error, is introduced if there is a small lack of parallelism of the horizon glass. Index correction is resolved by the following procedure.

Set the sextant near zero. Hold the sextant vertical and sight toward the horizon. Use the micrometer drum to bring the direct horizon and reflected horizon exactly in line. (See fig. 5-2). If the sextant reading is zero, there is no error. If the reading is not zero, the amount of error is the index correction. If the index mark is to the left of the zero on the arc of the limb, then the reading is too large, and this index correction must be subtracted from the sextant al-

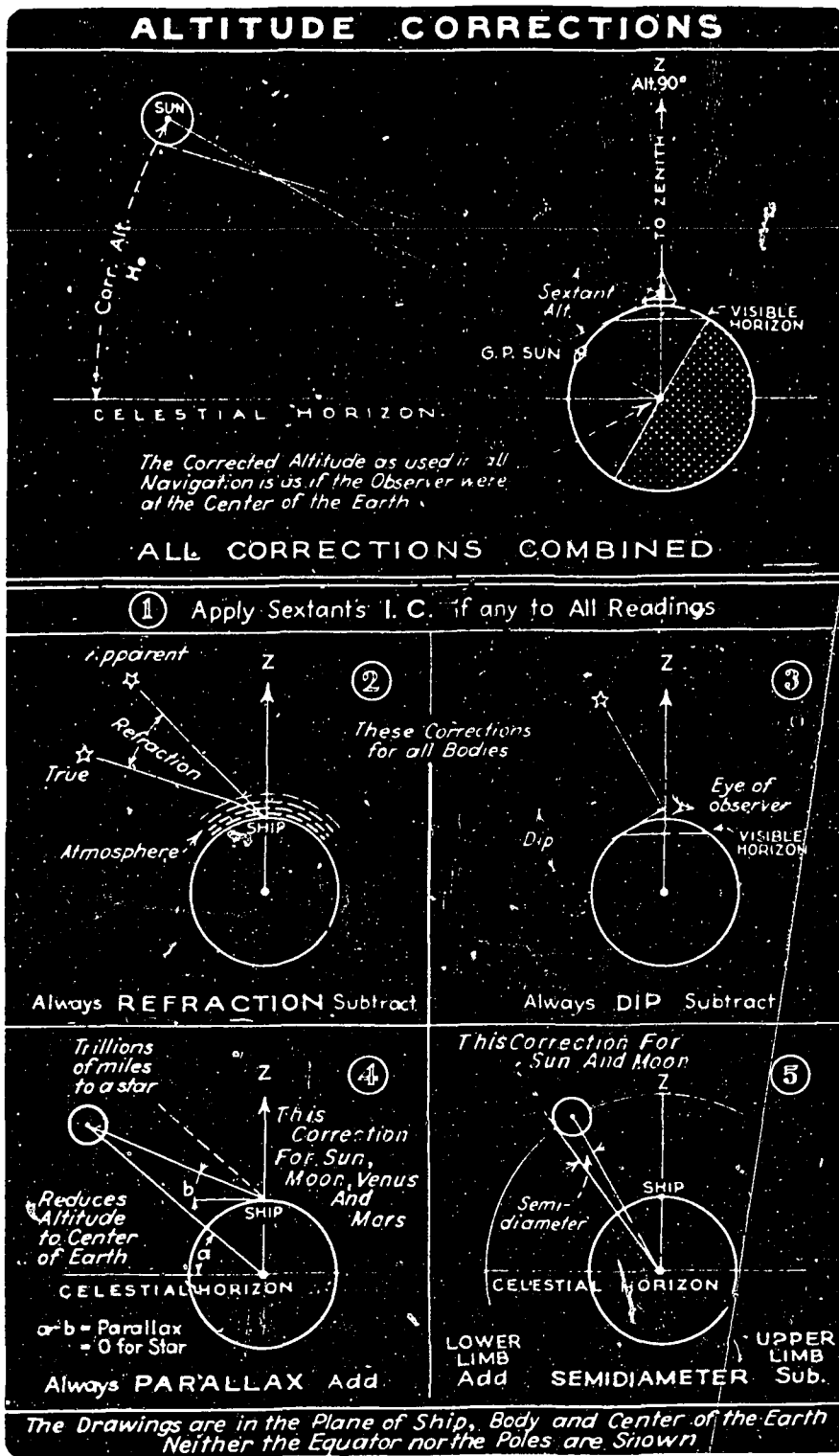
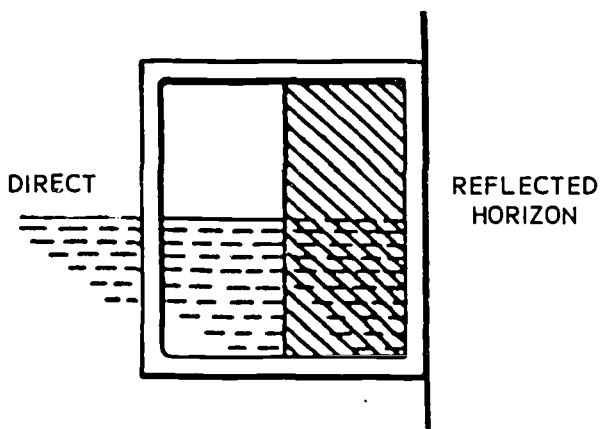

Figure 5-1.—Altitude corrections.

112.16



THE ALTITUDE OF THE HORIZON = 0

112.17

Figure 5-2.—Direct and reflected view of the horizon.

altitude. If the index mark is to the right of zero (off the arc), the reading is too low, and this amount must be added to the sextant altitude.

The amount of index correction is obtained as follows: If the index mark is on the arc, the sextant is read in the usual way. The reading is the index correction to be subtracted. Always read the degree graduation mark of the limb to the right of the index mark, whether the index mark is on or off the mark. In figure 5-3 the index mark points to the right of the zero (off the arc) to a spot between the 1° and 2° mark.

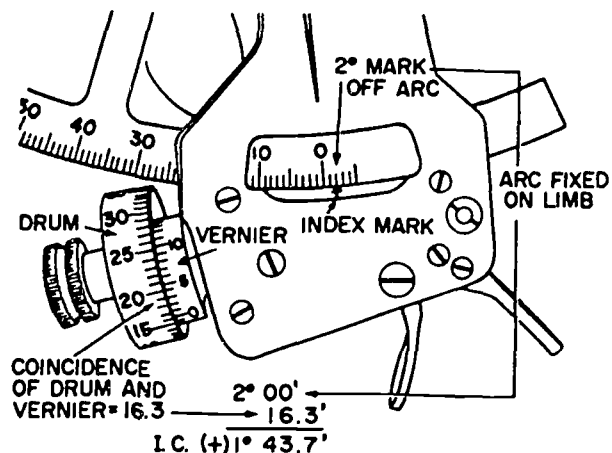

29.268

Figure 5-3.—Reading off the arc.

The 2° mark must be used. On the drum the 16 mark lies below the 0 mark on the vernier, hence the reading in minutes is 16. The mark above the 0 mark on the vernier that coincides most nearly with a mark on the drum is the 3 mark. Thus, the remainder of the reading is 0.3 minute. The combined drum and vernier reading tells you how much the index mark is to the left of the 2° mark on the arc of the limb. The result obtained by subtracting 16.3' from 2° is your index correction of 1°43.7'. Because the reading is off the arc, 1°43.7' must be added to the sextant altitude. (NOTE: This index correction is abnormally large and is used here for illustrative purposes only.)

### Refraction

The earth is wrapped in a blanket of atmosphere more than 50 miles deep. Density of the atmosphere, like that of the ocean, increases with depth and is greatest at the bottom, next to the earth's surface. Light rays do not follow a straight line when passing obliquely through atmospheric strata of different densities, but are slightly bent into a gentle arc. This phenomenon is called refraction. Refraction is defined as the deviation of light rays from a straight line caused by their passage obliquely through mediums of different density. The measure of refraction is the angular difference between the apparent rays of light from an observed celestial body and its true direction.

The effect of refraction is always to make the observed altitude greater than the true altitude. Consequently, refraction correction is always subtracted from the sextant altitude. Inasmuch as refraction is caused by the oblique passage of rays through the atmosphere, rays from a body in the observer's zenith, intersecting the atmospheric strata at right angles, are not refracted. Maximum refraction occurs when a body is on the horizon, amounting then to between 34' and 39'; the amount depends on atmospheric conditions. Density of the atmosphere varies with barometric pressure and temperature. Refraction varies with density and also with the body's altitude.

Because refraction varies with atmospheric conditions, and the effect of atmospheric conditions at low altitudes cannot be estimated with complete accuracy, observations of bodies below 10° should be regarded with suspicion. Refraction has no effect on the azimuth of a celestial body, because it takes place entirely in the vertical plane of passage of the light rays.



### Dip of the Horizon

The higher an observer's position is above the surface, the more he must lower (or dip) his line of vision to see the horizon. Logically, then, all altitude observations must be corrected for height of eye. Refer again to figure 5-1, and you will see why a dip correction is always subtracted.

Failure to correct for dip from a height of 10 feet would result in an error of 3 miles in line of position. From the bridge of the average destroyer, the resulting error would be approximately 7 miles.

### Parallax

Parallax is the difference between the altitude of a body, as measured from the earth's center, and its altitude (corrected for refraction and dip), as measured from the earth's surface. Altitude from the center of the earth is bound to be greater than from the surface. Consequently, parallax is always a plus correction.

Parallax increases from 0° for a body directly overhead to a maximum for a body on the horizon. In the latter instance, it is called horizontal parallax (HP). Parallax of the moon is both extreme and varied, because of its changing distance from the earth in its passage through its orbit. Parallax of the sun is small; that of the planets is even smaller. For the stars, parallax is so tiny it is negligible.

### Semidiameter

The true altitude of a body is measured to the center of that body. Because the sun and moon are of appreciable size, the usual practice is to observe the lower limb. The semidiameter correction must therefore be added. It follows, then, that if the upper limb of either body is observed, the semidiameter correction is subtractive. Semidiameter correction amounts to about 16' for either the sun or moon. Stars are considered as points, and, as such, they require no semidiameter correction. When observing a planet, the center of the planet is visually estimated by the observer, so that there never is a semidiameter correction.

In concluding the subject of altitude corrections, mention should be made that some tables for altitude corrections (the *Nautical Almanac*, for example) combine two or more of the corrections for refraction, parallax, and semidiameter. The correction for height of eye (dip) appears in a separate table for use with all bodies. Index error, which is impossible to include in such tables, should always be determined, recorded, marked plus or minus, and applied before any of the tabulated corrections.

### OBSERVING THE SUN

At this point, a few words on the general technique of observing the sun with a sextant might not be amiss. Experience, of course, is the only way to gain real proficiency in shooting the sun or any other body.

First, either one or both eyes may be left open while observing the sun. Some navigators feel that there is less eye strain if both eyes are open; however, if it is easier for you, you may close one eye and aim as if firing a gun. No loss of accuracy will result. Focus the telescope properly before you start. This adjustment is accomplished by observing a distant object and moving the eyepiece in or out until the image is clear. Then, check the index correction.

Next, select the shade glasses you want to use, and turn them into position in front of the index glass. Sometimes they are slightly prismatic, so it would be well for you to recheck the index error after they are set. If the telescope is equipped with polarizing filters instead of shade glasses, adjust the filters as necessary.

Hold the sextant vertical, and train the line of sight on that point of the horizon just below the sun. Beginning with zero position, move the index arm slowly outward until the image of the sun appears in the mirror of the horizon glass. Continue moving the arm until the sun's lower limb is nearly tangent to the horizon, as in figure 5-4, and set the clamp.

Before moving the micrometer drum in order to bring the sun's lower limb exactly tangent to the horizon, you must ascertain whether you actually are holding the sextant vertically. Rotate the sextant

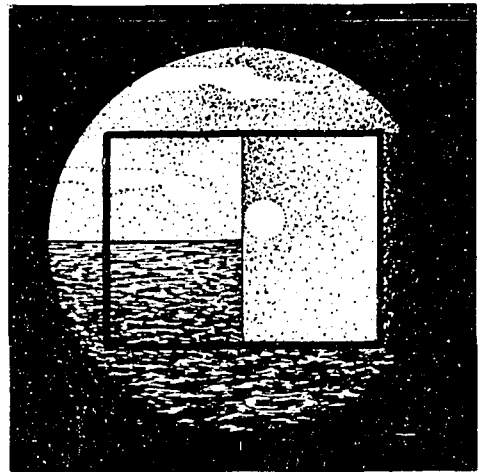

Figure 5-4.—Observing the sun's lower limb. 69.19

slowly through a small arc about the line of sight. As you do so, the sun's image moves in a small arc convex to the horizon. At the point where the image is lowest, the sextant is held vertically. This procedure, called swinging the arc, should be followed every time an observation is taken. If the sextant is not held vertically, the angle measured will be between the observed body and a point on the horizon that is not exactly below it, so that the altitude measured will be inaccurate.

If you have an assistant taking the time, warn him to stand by with the watch. Move the micrometer drum until the sun's lower limb is in contact with the horizon, and at the instant of contact sing out "Mark!" At this word, your helper notes the time to the second.

Until you become fairly proficient, you'll find it a good idea to take a series of observations (at least three), as rapidly as you can get them, with an accurate time on each. All computations for the line of position can then be made from a mean of the observed altitudes together with a mean of the recorded times. Any obviously erroneous observation (based on comparison with the others) should be discarded before a mean is taken. Consider the computation for the following observations, for example.

Watch Time			Sextant Altitude		
09h	10m	32s	48°	10.0'	
09h	11m	16s	48°	17.5'	
<u>09h</u>	<u>12m</u>	<u>06s</u>	<u>48°</u>	<u>26.2'</u>	
27h	33m	54s	144°	53.7'	Total
09h	11m	18s	48°	17.9'	Mean

The foregoing method of obtaining accurate observations is especially useful when the ship is rolling or pitching heavily, or when other conditions make observation difficult and uncertain. Don't use it when the observed body is near the meridian, though, because then the change of altitude varies as the square of the hour angle. A method called reduction to the meridian is suitable for that situation.

### OBSERVING THE MOON

Formerly, considerable prejudice existed against the moon as a navigational body because of the difficulty in trying to reduce lunar movements to a definite pattern. Recent tabulations now make it

possible to calculate the moon's declination and hour angle without any difficult interpolation.

Using the moon for observations has definite advantages, however. It often gives you a line of position when one cannot be obtained by means of another celestial body. Frequently, the moon may be observed during daylight, at twilight, or occasionally after dark, when its light illuminates the horizon. But, because of the varying shape of the moon's disk, it is often necessary to observe the upper limb instead of the lower limb.

### OBSERVING STARS AND PLANETS

The technique of bringing down or pulling down a star or planet is similar to shooting the sun, except that no shade glasses are required and usually a telescope is needed to increase the body's size and ensure against losing sight of it. Use of the telescope reduces the field of vision somewhat, making it harder to "pick up" stars originally, but because the stars are magnified, fixes obtained are normally more accurate.

Once you identify the star you want, the chief difficulty in pulling down the star stems from the likelihood of losing sight of it when you direct your line of sight to the horizon. Often the star is a dim one whose reflection may not be easy to identify. Besides, during early morning or late twilight, more than one star may appear in the field of the telescope, and you may be unable to tell which one you intended to observe.

To keep track of your star, the following procedure is recommended. Set the sextant at approximately zero, and direct the line of sight toward the star. The star should then be nearly coincident with its image (fig. 5-5). Hold the sextant approximately in the plane of the star's vertical circle, and move the index arm slowly outward, causing the star's image to move downward. As you move the arm outward, move the horizon glass downward so as to keep the star's image in the glass. When the index arm moves to the reading of the star's approximate altitude, the horizon shows up in the clear half of the horizon glass. Set the index arm clamp, and proceed as described for the sun. To avoid bringing down the wrong star, you may keep both eyes open while observing.

Many navigators prefer a second method of bringing down a star. It consists essentially of bringing the horizon up instead. For this method, set the arm near the zero mark, invert the sextant, and direct the line of sight at the star. You will see the star in the clear part of the horizon glass. Move the index arm until you bring the horizon up to the star, then clamp the arm.

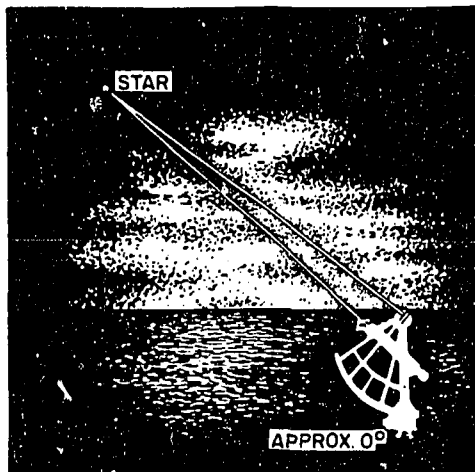

112.18

Figure 5-5.—Shooting a star.

With the index arm set at the approximate altitude, the sextant is turned right side up, and the altitude is observed in the usual manner. In this method, the desired star is kept constantly in direct view as opposed to reflected view. You may have some slight difficulty picking up the star again after you right the sextant, but if you train on the proper bearing, it should appear in the horizon mirror. Most navigational stars are far enough apart so that no other bright star is likely to show up near the same azimuth at the approximate altitude set.

Brightness of the reflection from the horizon glass may be varied by moving the telescope toward or away from the plane of the instrument. Slacken the setscrew of the telescope carrier, adjust the telescope as desired, and set up the screw again. Moving the telescope away from the plane of the limb causes more light to enter from the unsilvered part of the horizon glass and less light from the mirrored part. This movement, in turn, makes the horizon relatively brighter and the reflected celestial body dimmer. Such a state of affairs is helpful in the darker twilight, when the horizon is difficult to see but the stars are bright.

Moving the telescope toward the plane of the limb reverses the effect just described. As a result, more light is reflected from the mirrored part of the horizon glass. This procedure is desirable during the brighter twilight, when the horizon is clear but the stars remain faint.

Whenever possible, you should plan the order of taking sights so that you can take maximum advantage of horizon conditions. During morning sights, for example, you should observe dimmer stars

to the east before the horizon becomes too bright; then observe stars to the west while that horizon still is good.

### STAR IDENTIFICATION

As navigator's assistant, you frequently are required to obtain a fix from two or more stars. You may wonder how anyone except an astronomer can distinguish one star from the other. Actually, only a few of the multitudes of stars are used regularly for celestial navigation, and they are not too difficult to locate and identify. No matter where you may be navigating, you can manage very well if you are able to recognize 20 or so. *The Nautical Almanac*, however, lists 57 principal stars as well as tables for finding latitude by the North Star (Polaris).

Relative brightness of stars is called their magnitude; the lower the magnitude, the brighter the star. Sirius, brightest of them all, has a magnitude of -1.6; Acamar, dimmest of the navigational stars, is listed at 3.1 magnitude. First magnitude stars range from magnitude -1.6 to magnitude 1.50. Second magnitude stars are those from 1.51 to 2.50. Stars of third magnitude range from 2.51 to 3.50, and so on. Stars of the sixth magnitude are barely visible to the unaided eye.

Man's imagination has given fanciful names to various groups of the brighter stars. The stars of each of these groups are said to form a constellation. Constellations are named according to objects they are thought to resemble in outline. Orion, the hunter, with his belt and sword, is a good example.

One or more of the stars in a constellation may be navigational stars. Obviously, if you can recognize a constellation and know which of its stars may be used, you can identify them whenever the group is visible in the sky. The constellation familiarly called the Big Dipper (from its striking resemblance to a dipper with a handle) is known to astronomers as Ursa Major or Great Bear. Its resemblance to a bear puts considerable strain on the imagination, but the important fact about the Dipper is that three of its seven stars are useful for navigational purposes. Moreover, the two stars, called Pointers, which form the side of the Dipper away from the handle, point constantly to the North Star, brightest star in the constellation of Ursa Minor (Little Bear). The Pointers are a valuable aid to navigators.

The familiar stars and constellations are not always visible from where you may happen to be. For this reason, you must have some means of identifying navigational bodies when nothing you know by sight can be seen overhead. One method by which you can identify those celestial bodies is to use the Star Finder and Identifier (No. 2102-D). An example of such a star finder is seen in figure 5-6. The

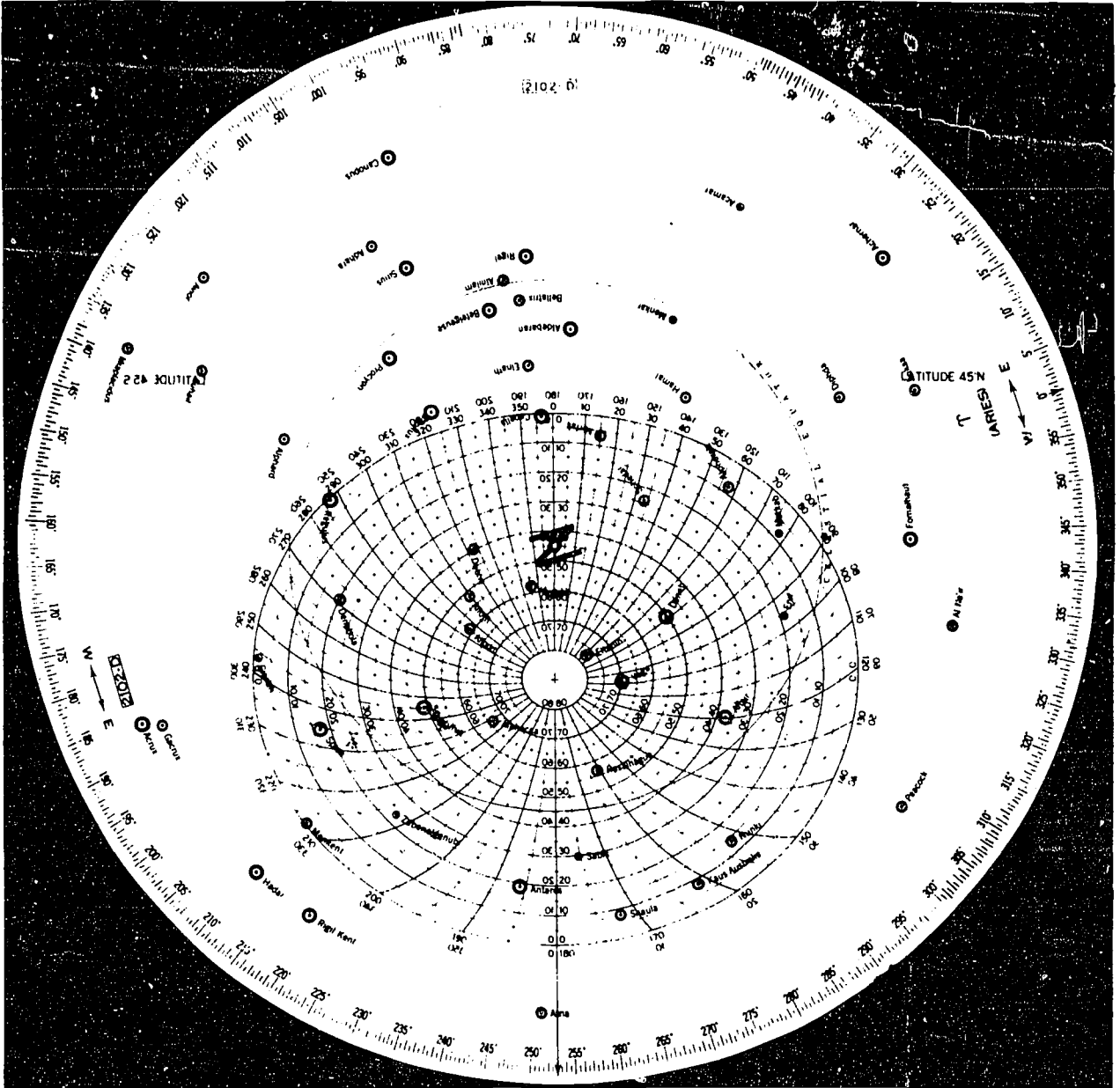

Figure 5-6.—Star finder with template.

69.67(112)

Star Finder and Identifier is now issued by the Navy Ships Parts Control Center, Mechanicsburg, Pa.

### STAR FINDER AND IDENTIFIER

The star finder shows the positions of the common navigational stars listed in the nautical almanac. (The British Nautical Almanac and

the American Nautical Almanac are identical in content.) The star finder consists of a flat disk with two sides. On one side is a star base of the northern latitudes. The other side has a star base of the southern latitudes. This identification device has nine transparent templates with grids by which latitude in tens of degrees from 5° to 85° may be selected. (A tenth

template is available for special use.) Each of the nine templates has a series of altitude and azimuth curves. Reversing the templates makes possible their use in either northern or southern latitudes. In figure 5-6, the oval-shaped part near the center of the template contains the altitude and azimuth curves. Looking through this template, you observe the star symbols and names (Antares, Arcturus, etc.) printed on the star base.

The circumference of the star base is graduated in degrees to the east from the first point of Aries from  $0^{\circ}$  through  $359^{\circ}$ . These numbers represent, in effect, the right ascension of each of the bodies on the template.

### Using Star Finder

The star finder may be used either to—

1. Make a list of the bodies available for observation at a given time; or to
2. Identify an unknown body whose altitude and azimuth have been observed.

To use the starfinder, first determine  $GHA_{\text{r}}$  for your time of observation from the Nautical or Air Almanac. Next, determine  $LHA_{\text{r}}$  by subtracting your longitude from  $GHA_{\text{r}}$  if in west longitude or by adding  $GHA_{\text{r}}$  to your longitude if in east longitude. Select the template nearest your DR latitude and place it on the northern or southern base, depending on whether you are north or south of the equator. Ensure that the proper side of the template is up. Rotate the template until the  $0^{\circ}$ — $180^{\circ}$  arrow on the template is over the  $LHA_{\text{r}}$  on the base plate. Your zenith then is represented by the cross at the center of the open space on the template.

The sky overhead is now shown in the part of the base covered by the curves on the template. Moreover, the approximate azimuth and altitude of any navigational star within these curves can be found by following the lines on the template. For instance, to locate Antares in figure 5-6, merely follow the grid lines, and you will see that its azimuth is about  $186^{\circ}$  and its altitude about  $18^{\circ}$ . Step out on the bridge wing, follow the horizon around to  $186^{\circ}$ , raise your line of sight up about  $18^{\circ}$ , and you should be gazing directly at Antares—that is, of course, if you haven't gone askew somewhere in setting the star finder.

Any number of the stars located within the field may be listed and used for observation. If

there are a sufficient number to choose from, you might choose only first magnitude stars. On the other hand, you might select stars suitably placed to give lines of position that will intersect at optimum angles.

After a long period of heavy weather, you have often seen the navigator out on the bridge wing, eagerly scanning the heavens, his sextant at hand. He undoubtedly was hoping that the overcast would break long enough for him to have a shot at even a single star.

If he should manage to pull a star down, how does he know which one it is? This is where the second use of the star finder comes into play. An azimuth of the body should be taken at the instant of observation. When the correct template is oriented properly on the star base, the name of the body can be read at the intersection of the azimuth and altitude lines on the grid.

If no star appears on the star base at the observed altitude and azimuth, perhaps a planet has been observed. Because their apparent positions relative to the stars change, planets are not shown on the star base. They may be plotted easily, however, by using the special template mentioned earlier. (See fig. 5-7.) For this purpose, extract the sidereal hour angle (SHA) and declination of any planet from the correct daily page of the Nautical Almanac. Find the body's right ascension by use of the formula  $RA=360\text{-SHA}$ . Place the special template over the star base and align the arrow on the template with the graduation at the edge of the star base so that the arrow corresponds to the body's RA. The template has an open slot with declination graduations along one side. Plot the planet at its declination, measuring from the zero mark toward the center if both the pole and declination have the same name (north or south), or away from the center if they have contrary names. The planet's approximate altitude and azimuth may now be read from the star base in the same manner as stars. Periodically, the positions of planets must be replotted.

### Star Identification by H.O. 249

Perhaps the least complicated method of star identification is by use of Vol. I of the Sight Reduction Tables for Air Navigation, H.O. Pub. No. 249. The principal disadvantage in using this publication is that it lists altitude and azimuth for only seven stars for each entry of  $LHA_{\text{r}}$ . This small number of stars will be no hindrance, however, unless the sky is partially overcast or, if for some other reason, the listed bodies cannot be observed. Selection of the seven stars listed



for each LHAR was based on consideration of their azimuths, magnitudes, altitudes, and continuity.

To use the table for star identification, determine from the almanac the GHAR for the approximate mid-time of observation. Using your DR longitude, determine the LHAR. Enter the tables at the proper latitude and LHAR. Read directly from the tables the name of the star and its computed altitude and azimuth.

**SELECTING BODIES FOR OBSERVATION**

Before going further into problems and tables, mention should be made of a few items concerned with selecting astronomical bodies for observation.

Observing two heavenly bodies in rapid succession is the most convenient method of finding two lines of position necessary to establish a fix. Noting three bodies gives three lines. These three lines define the fix more accurately (as in piloting).

Accuracy of the fix established by intersecting lines of position depends largely on the angle between the lines. The nearer this angle approaches  $90^\circ$ , the more accurate is the fix. In figure 5-8 lines AB and XY intersect at  $90^\circ$ . The dotted lines show the effect of a 2-mile error in one or both sights. If only one line is in error, the position obtained is at the intersection of a full and a dotted line only 2 miles from the true position. If both lines are inaccurate, the maximum error is only about 2.8 miles.

Notice the difference in figure 5-9, where two lines intersect at only  $30^\circ$ . A 2-mile error in one line produces an error of about 4 miles in

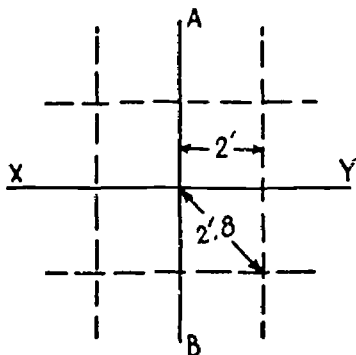

112.22

Figure 5-8.—Error at a  $90^\circ$  intersection.

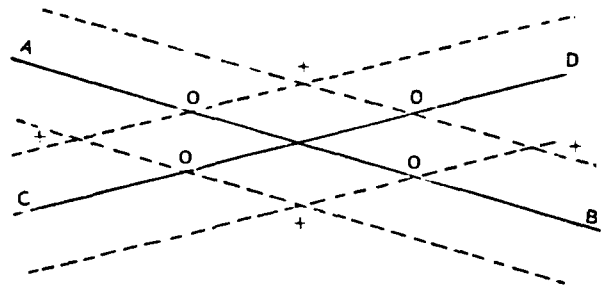

112.23

Figure 5-9.—Error at a  $30^\circ$  intersection.

the fix. Error caused by inaccuracy in both lines may be from 2.2 to 8 miles, depending on the direction of the error. Lines intersecting at less than  $30^\circ$  should be avoided whenever possible.

The ideal situation for lines of position established by observing three bodies would be one in which the bodies lie  $120^\circ$  apart in azimuth. An ideal fix using four bodies would include two north-south lines and two east-west lines of position to form a box. As already mentioned, lines perpendicular to the course are frequently valuable for checking the run; those parallel to it are helpful in deciding the accuracy of the course made good.

Concerning altitude, best results are obtained by observations of bodies whose altitudes are between  $15^\circ$  and  $65^\circ$ . In general, observations are taken from bodies whose altitudes are between  $10^\circ$  and  $80^\circ$ .

Actually, sights seldom are taken on two or more bodies simultaneously. Instead, the navigator decides which bodies he wants to observe, then he takes a round of sights, each one timed exactly. Resulting lines of position are advanced or retired the amount of the ship's run between the time of observation and the time of the desired fix.

Figures 5-10 and 5-11 show you a couple of examples of plotting lines of position. Figure 5-12 demonstrates that if the navigator of the ship in figure 5-11 had assumed a different AP, the LOP still would have plotted in the same place; the azimuth also should have remained practically the same. This knowledge enables navigators to use the same AP for more than one sight, thus reducing the required amount of tabular reference.

In figure 5-13 you see how an 1800 LOP, obtained by observing Venus, was advanced to 1815. Note that the 1800 line was plotted as a dashed line, then was drawn in solid after it was advanced. Also note that the advanced line carries both the time of

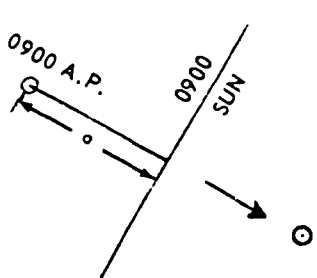

112.24  
Figure 5-10.—Plotting a sun LOP.

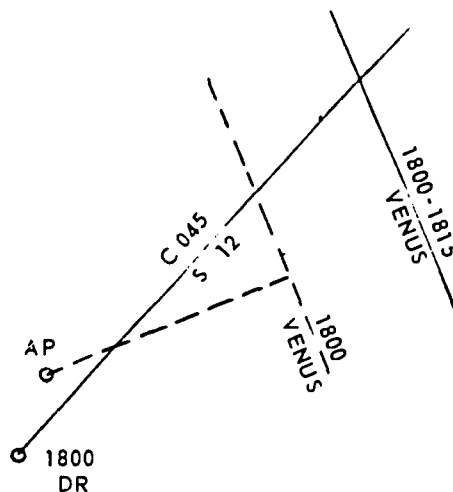

112.27  
Figure 5-13.—Advancing an LOP.

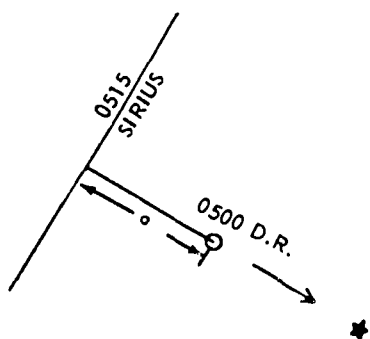

112.25  
Figure 5-11.—Plotting a star LOP.

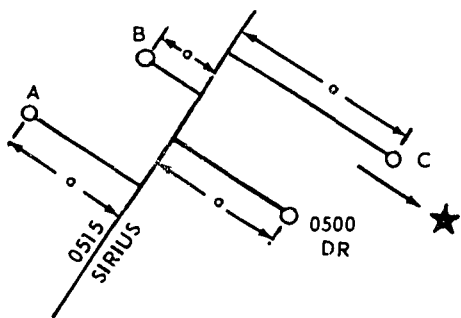

112.26  
Figure 5-12.—An LOP from several APs.

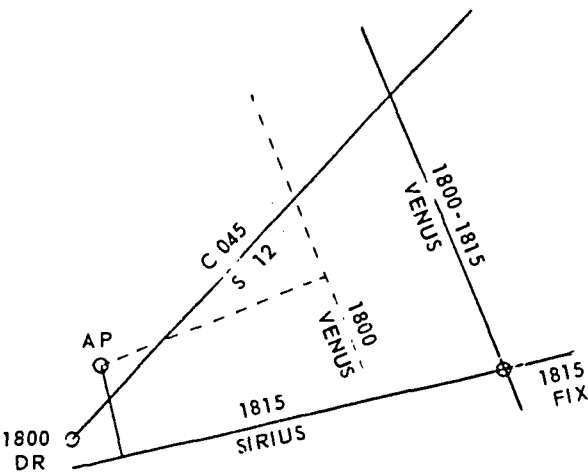

112.28  
Figure 5-14.—A fix by advancing an LOP.

### LOP FROM CELESTIAL OBSERVATIONS

You have seen how lines of position, obtained through bearing on terrestrial objects, are used to fix a ship's position in piloting. You know that a line of position is a locus of possible positions of the ship. In other words, the ship's position must be somewhere along that line. A fix, by definition, is a relatively accurate determination of latitude and longitude. In practice, this position is the intersection of two or more lines of position; but often it is not the ship's exact position, because one can always assume some errors in observation, plotting, and the like.

observation and the later time, which is equivalent to saying: "This line is an 1815 LOP, based on an observation made at 1800." Figure 5-14 shows you how another line of position, obtained by observation of Sirius at 1815, was intersected with the advanced line to obtain a fix.



The celestial navigator must establish his lines of position by applying the results of his observations of heavenly bodies. A line of position obtained at one time may be used at a later time. All you need to do is move the line paralleled to itself, a distance equal to the run of the ship in the interim, and in the same direction as the run. Such a line of position cannot be as accurate as a new line, because the amount and direction of its movement can be determined only by the usual DR methods. If two new lines cannot be obtained, however, an old line, advanced and intersected with a new one, may be the only possible way of establishing a fix. Naturally, the distance an old line may be advanced without a substantial loss of accuracy depends on how closely the run can be reckoned.

In celestial navigation, as in piloting, you essentially are trying to establish the intersection of two or more lines of position. A single observation is insufficient to obtain a fix.

### CIRCLES OF EQUAL ALTITUDE

Observation of two bodies at the same time gives the navigator two circles of equal altitude. The circles intersect each other at two points, and, because the ship is somewhere on each one of them, she must be at one or the other points of intersection. In figure 5-15, circles of equal altitude have been determined by observations of the stars Alphard and

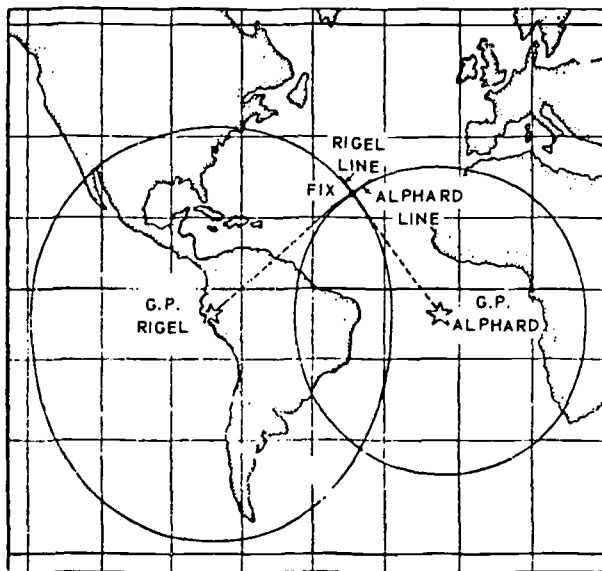

112.19

Figure 5-15.—Circles of equal altitude.

Rigel. The navigator of the ship in this example knows that he cannot be at the southern point of intersection, consequently the northern point, illustrated, must be the fix.

### LINE OF POSITION

It is neither practical nor necessary to plot the whole of a circle of equal altitude. The position is always known within 30 miles at the most—probably it is considerably less than that distance. Inside these limits, the curve of the arc of a circle of equal altitude is hardly perceptible, and the arc is plotted and regarded as a straight line. Such a line, comprising enough of the arc of a circle of equal altitude to cover the probable limits of a position, is called a Sumner line of position or just a line of position.

Although a single line of position cannot establish a fix, it is (as mentioned earlier) a locus of possible positions of the ship. In modern celestial navigation, a line of position is determined by first locating an assumed position (AP) on the chart, drawing from it a line along the azimuth of the observed body, and intersecting that line with the LOP. The LOP is always perpendicular to the line of the azimuth. But that LOP is a single line of position, hence you still must plot another one intersecting it in order to obtain a true fix.

Because the LOP is always at right angles to the line of the azimuth, it follows that when an observed body bears due east or west, the line of position coincides with a meridian of longitude. When the body bears due north or south, the line coincides with a parallel of latitude. That is why the sun is always observed at local apparent noon, when it is on the meridian, to determine the ship's latitude. It follows, too, that by observing a celestial body bearing dead ahead or dead astern, the navigator can establish a single line of position that will tell him whether the ship has overrun his DR position. Taking observations on an object abeam, he can discover whether he is right or left of his course line.

### INTERSECTING LINES

The preferable method of establishing two lines of position is by observing two different bodies, although two lines may be obtained from the same body by observations taken at different times. As mentioned previously, the nearer the two lines approach a right angle to each other, the more accurate is the fix.

When two lines are determined by observing the same body, the first line established is brought forward the distance run on the course steered. If a ship steams 27 miles on course

315° between the first and second observations, for example, it is obvious that her position is on a line parallel with the first one established, but drawn 27 miles away (to scale) on the course line 315°. Intersection of the line established by the second observation with the advanced line of the first observation is a fix. The fix progressively decreases in accuracy, depending on how far the first line is advanced. It is not considered good practice to advance such a line for more than 5 hours of run.

**DETERMINING LINE OF POSITION**

You might be entitled to complain that much has been said concerning what a line of position tells you, but very little has been told about how you determine it in the first place. We are coming to that part now.

You probably have grasped the idea already that what you want to find out is which circle of equal altitude you are on, and what this altitude is. But you have seen that to draw such a circle

you would need a chart covering an extensive area, unless the heavenly body's altitude approached 90°. Consequently, you do not determine the entire circle but merely a portion of its arc, so small that it is plotted and regarded as a straight line.

Figure 5-16 illustrates the method used in establishing a single line of position by observing a star. An assumed position (AP) is selected according to certain requirements of convenience in calculating (described later). Observation of a star provides sextant altitude (hs). Sextant altitude is then corrected to obtain observed altitude (Ho). The star's altitude from the assumed position (called the computed altitude (Hc)) and its azimuth angle are determined from tables by a procedure you soon will learn. The azimuth angle is then converted to azimuth.

After selecting an AP, draw the azimuth through the AP. Along the azimuth, measure off the altitude intercept (difference between the observed altitude and the computed altitude). At the end of this measurement, draw a perpendicular line, which is the LOP.

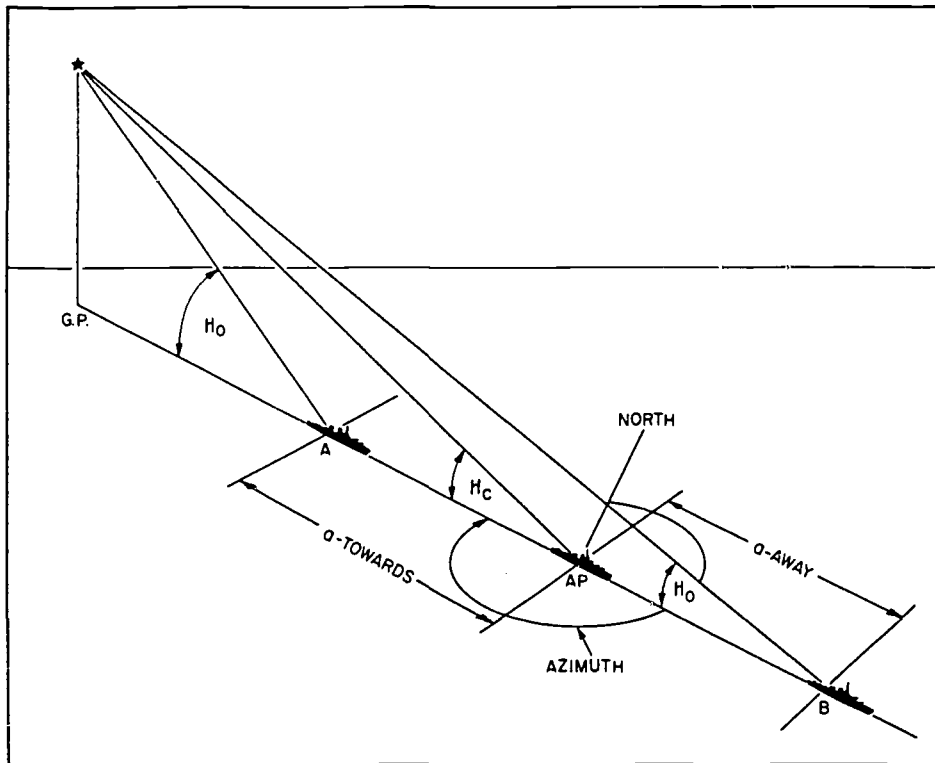

Figure 5-16.—Determining an LOP.

You must know whether altitude intercept (a) should be measured from AP toward the star or from AP away from the star. (Frequently, the initials for Coast Guard Academy (CGA) are found to be helpful.) If the computed altitude is greater than the observed altitude, altitude intercept (a) is measured away from the star. (In other words, applying the CGA memory aid you have *c* omputed, *g* reater, *a* way (or CGA).)

Actual plotting of the line of position, then is as follows:

1. Plot the AP (you already have taken your sight) and obtain the azimuth from tables.
2. Lay off the azimuth line from the AP toward or away from the body, depending on whether the observed altitude is greater or less than the computed altitude.
3. Measure in the proper direction, along the azimuth line, the difference between the observed and the computed altitude in miles and tenths of miles.
4. Draw a line at the extremity of altitude intercept (a), perpendicular to the azimuth line. At the time of observation this perpendicular is a line of position.
5. Label the line of position with the time of observation and the name of the observed body.

**ADVANCING THE LOP**

Several methods may be utilized to advance a line of position. The most frequent method consists simply of advancing the AP in the direction of and for the distance of the run, as shown in figure 5-17, and drawing the new LOP.

Figure 5-17 illustrates a situation where the AP was advanced paralleled to the course line for the distance run, and a new LOP was plotted for its new position. The new LOP was necessary because the same AP would have produced an LOP that would have intersected the course line beyond the limits of the chart. In this illustrative case it is unnecessary to draw the first dashed construction on the chart.

The manner of advancing lines of position from sights of the moon, Venus, and Sirius (previously illustrated) to obtain an 1815 fix is seen in figure 5-18.

Three lines of position by observation, like those obtained in piloting, do not always intersect exactly. Quite often a triangle is formed. If one or more of the LOPs must be advanced, the triangle is likely to be larger. Frequently, the center of the triangle is assumed to be the fix (see figs. 5-18 and 5-19). If, however, one or more lines have been advanced, more

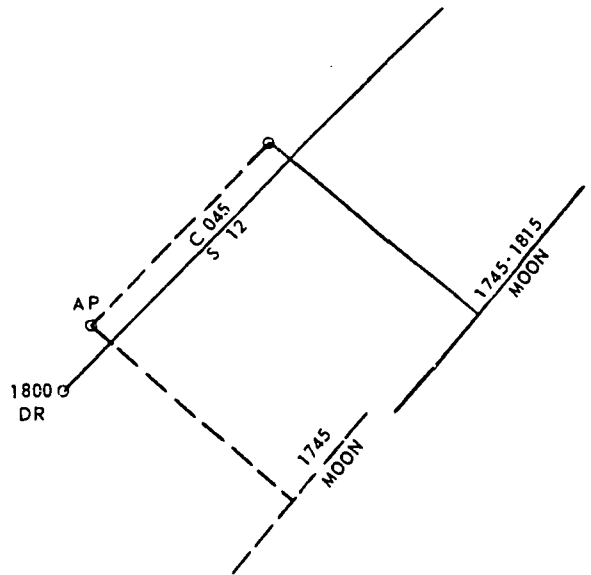

112.29

Figure 5-17.—Advancing an LOP parallel to the course line.

weight may be given to a line that has not been advanced, or to a line that the navigator has more confidence in (e.g., favoring a first magnitude star over a third magnitude star). In figure 5-18, note that the plots are made from three separate APs, using the same assumed latitude but different assumed longitudes.

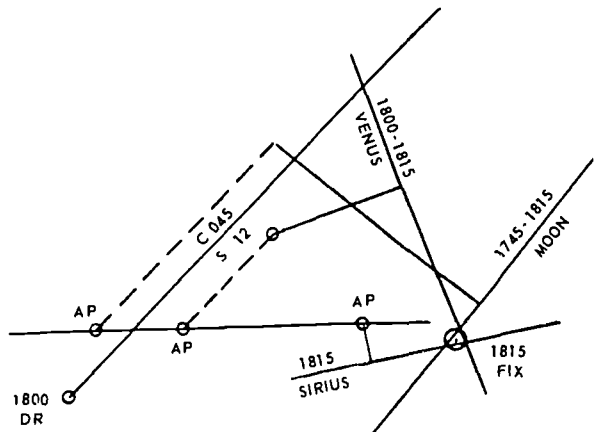

112.30

Figure 5-18.—A fix from several LOPs.

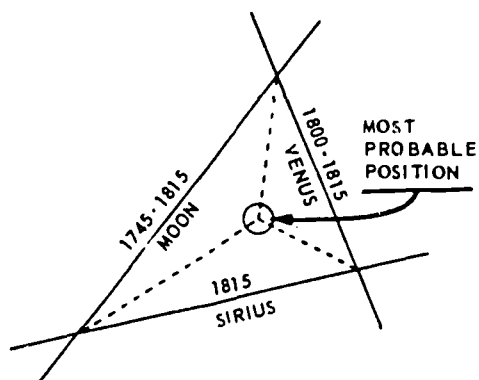

112.31

Figure 5-19.—Enlargement of plot of 1815 fix.

### NOON SIGHT

In *Quartermaster 3 & 2* it is pointed out that the purpose of determining watch time of local apparent noon (LAN) is merely to enable you to arrive on the bridge within a few minutes of the time you should take your sight. Inasmuch as watch time of LAN is founded upon your DR longitude, it seldom coincides with the exact instant of transit of the sun when it is at its meridian altitude.

Under most circumstances, there is a period in which the change of altitude, as the sun approaches or recedes from the meridian, is too slight to be perceptible. With altitudes up to about  $50^\circ$  the sun may appear to “hang” for several minutes. With altitudes above  $80^\circ$  the change is much more perceptible. Tables 29 and 30 in Bowditch give the exact rise and fall of the altitude, under various conditions, before and after LAN.

Meridian altitude of the sun is ascertained in several ways. Three of these methods are discussed in the ensuing topics.

### FOLLOWING TO MAXIMUM ALTITUDE

The oldest method of determining meridian altitude of the sun, and the one used most commonly, is known as following to maximum altitude. It is recommended because of its adaptability to various conditions, and because its use develops an insight into how the altitude varies near the time of apparent noon.

At approximately 10 minutes before watch time of LAN, the observer contacts the sun's lower limb with the horizon in his sextant. He then swings the

sextant from side to side, and adjusts it until the sun, seen moving in an arc, just touches the horizon at the lowest part of the arc. You doubtless recognize this procedure as swinging the arc, described earlier in this chapter.

As the sun continues rising, a widening space appears between its lower limb and the horizon. By adjusting the tangent screw, the observer keeps this space closed, and maintains the sun in contact with the horizon. The change in altitude becomes slower and slower, until the sun “hangs.” While it is hanging, the observer swings the sextant to make certain of accurate contact with the horizon. He continues his observation until the sun dips, which is a signal that the sun is beginning to lose altitude. The sextant then shows the maximum altitude attained.

### INSTANT OF TRANSIT

The method of determining the exact instant of transit is explained by Dutton in connection with Todd's method of finding the interval to LAN. An observation taken at the exact instant of transit gives the maximum altitude. Under ordinary conditions, an error of 1 minute (more or less) does not affect the result.

### NUMEROUS SIGHTS

The method of taking numerous sights is a modification of the maximum altitude method. It is useful under conditions where heavy sea, clouds, and the like may make steady observation impossible. Well before watch time of LAN, the observer begins taking a series of altitudes. Their number depends on the difficulties of the situation and the possible error in computed time of transit. He reads off the altitudes to a recording assistant, turning the tangent screw slightly after each observation to ensure that the next altitude is an independent sight. Observations are discontinued when the altitude definitely shows signs of decreasing.

Under favorable conditions, even a series of skillfully taken observations may show an occasional erratic deviation from the normal gradual rise and fall. After sights showing a radical difference from the preceding or succeeding series are discarded, however, the hang should become evident, and it should be possible to judge the maximum altitude. The figure selected will probably be less than the altitude shown in one observation and more than that next below it. The result should give latitude with an error no more than 1'. This reading is considerably more accurate than could be obtained by a single sight under the conditions described.

SOLVING ASTRONOMICAL TRIANGLE

When you calculate and plot your line of position, you are, in effect, solving the astronomical triangle. Thirty-odd methods of arriving at solutions have been devised since the first edition of Bowditch appeared in 1802. Although the methods may vary, two basic premises remain the same.

1. A single observation gives only a single LOP, which is at right angles to the azimuth of the observed body.
2. To establish the LOP, the observer must observe, time, and correct the altitude. From an almanac he then must determine either the declination and GHA of the observed body or the GHAR (depending on the sight reduction tables he plans to use). He then calculates either the meridian angle of the body or the LHAR. With these values he enters tables to find the azimuth and the altitude intercept. The principles on which the tables are based are the result of years of development in the science of navigation. In the Navy, most tables have been superseded in favor of H.O. 214 or H.O. 249, which are described in this section.

H.O. 214 METHOD

The publication H.O. 214 is made up of nine volumes containing about 1 1/4 million solutions to the astronomical triangle. The tables are arranged so as to give tabulated altitude and azimuth angle by inspection.

To work a sight with H.O. 214, you must enter the tables with the following three values

1. Assumed latitude (L)(to the nearest whole degree).
2. Declination ( $\delta$ )(from *Nautical Almanac* or the *Air Almanac* ).
3. Meridian angle ( $t$ )(called HA in H.O.214).

The assumed longitude of your AP should be the longitude that is closest to the DR longitude. The minutes and seconds of the longitude, however, are selected with reference to the GHA so as to produce an LHA in whole degrees. This value, in turn, gives a meridian angle ( $t$ ) in whole degrees. Assume that the DR longitude actually is  $157^{\circ}32'$  W., and the GHA of a star is  $196^{\circ}25.2'$ . (The GHA of a star is determined by adding GHAR to the SHA of the star.)

You know that in west longitudes the assumed longitude is subtracted from the GHA to obtain

LHA. To arrive at an LHA in whole degrees, then, it is necessary to alter the minutes and seconds of the assumed longitude as follows:

$$\begin{array}{r} \text{GHA} \dots\dots\dots 196^{\circ}25.2' \\ \text{Assumed longitude} \dots\dots 157^{\circ}25.2' \text{ W. (subtract)} \\ \hline \text{LHA} \dots\dots\dots 39^{\circ}00.0 \end{array}$$

In east longitudes the assumed longitude and GHA are added to obtain LHA. For an LHA in whole degrees, therefore, the minutes and seconds for an east longitude would be altered as follows:

$$\begin{array}{r} \text{GHA} \dots\dots\dots 196^{\circ}25.2' \\ \text{Assumed longitude} \dots\dots 157^{\circ}34.8' \text{ E (add)} \\ \hline \text{LHA} \dots\dots\dots 353^{\circ}60 \text{ or } 354^{\circ} \end{array}$$

Examples of an observer in east longitude and of another in west longitude are shown in figures 5-20 and 5-21. These illustrations are called time diagrams, and their use is helpful in resolving whether it is east or west of the meridian. This information must be known before the true azimuth can be computed. Merely by looking at the diagrams, it is obvious in both examples that the sun is east of the local meridian, and that  $t$ , consequently, must be marked E.

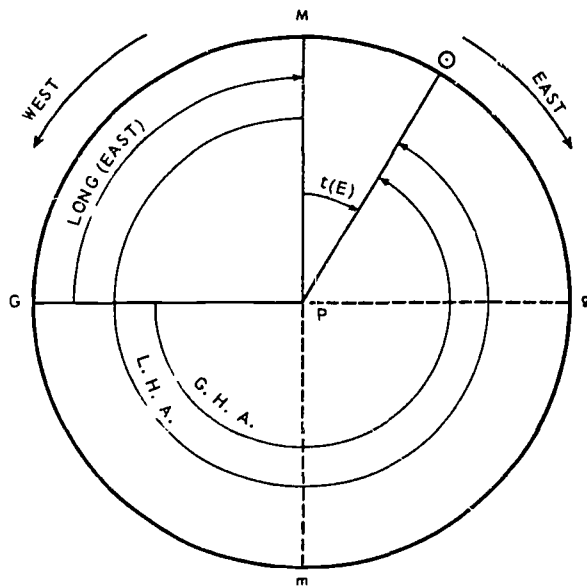

Figure 5-20.—The LHA observed from east longitude. 112.32

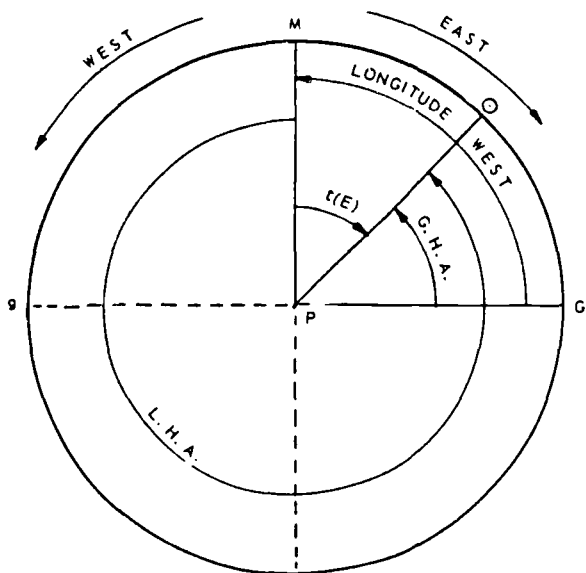

Figure 5-21.—The LHA observed from west longitude. 112.33

Rules for determining the exact value of  $t$  are given later. To discover whether value  $t$  is east or west, it is necessary in each instance to draw a time diagram similar to those in figures 5-20 and 5-21. First, draw a circle, and mark the counterclockwise direction westward. Drop from your zenith the perpendicular  $Mm$ , which is your local meridian. By means of the assumed longitude, locate the Greenwich meridian, and draw line  $Gg$  (fig. 5-21) so that the angle  $GPM$  equals your longitude. Next, locate the observed body on the circle by measuring from  $G$ , westward, the amount of the GHA obtained from the tables. Once the body is located, you can tell at a glance whether it is east or west of the meridian.

#### Exact Value of Meridian Angle

You already know that in west longitude you subtract the assumed longitude from GHA to find LHA; in east longitude, you add them. In the first instance, if the longitude is greater than the GHA, add  $360^\circ$  to GHA before subtracting. If your result is greater than  $360^\circ$  in the second instance, subtract  $360^\circ$  from it.

From the LHA you obtain the exact value of meridian angle  $t$  by the following rules:

1. If the LHA is greater than  $180^\circ$ , subtract it from  $360^\circ$ , and the result is the meridian angle ( $t$ ), which is east.
2. If the LHA is less than  $180^\circ$ , then its value is the same as  $t$ , and is west.

#### Using the Tables

Now you have all the values you need to enter the tables and come out with the computed altitude and azimuth. You must remember, however, that the azimuth angle listed in the tables is not necessarily the true azimuth, that is, azimuth reckoned from north. In the form filled out in solving sights, the tabulated azimuth angle is referred to as  $Z$ , and the true azimuth as  $Z_n$ . The azimuth angle ( $Z$ ) column in H.O. 214 is labeled "Az."

To find the true azimuth, you must know whether the latitude is N. or S., and whether  $t$  is E. or W. As soon as you solve for  $t$ , place the signs for latitude and  $t$  on a form thus:

Z N . . . W.  
Z<sub>n</sub> . . .

Insert between N. and W. the tabulated azimuth angle,  $Z$ . As used here, N. and W. are only examples. Depending on the situation, they might also be N. and E., S. and W., or S. and E.) at  $0^\circ$  latitude the azimuth angle takes the name of the declination; e.g.,  $000^\circ$  W. To determine true azimuth ( $Z_n$ ), observe the following rules:

1. If the latitude is N. and the meridian angle E., the true azimuth is the same as the tabulated azimuth angle; in other words,  $Z_n$  is the same as  $Z$ .
2. If the latitude is N. and the meridian angle W., subtract  $Z$  from  $360^\circ$  to get  $Z_n$ .
3. If the latitude is S. and the meridian angle E., subtract  $Z$  from  $180^\circ$  to obtain  $Z_n$ .
4. If the latitude is S. and the meridian angle W., add  $Z$  to  $180^\circ$  to find  $Z_n$ .

Rules such as applied here are not easy to remember. Consequently, it is better each time to draw a diagram like that in figure 5-22, making it unnecessary for you to memorize the afore mentioned rules. Figure 5-22 represents a compass card, with only the cardinal points indicated. You know that bearings are measured on the card from N. clockwise through  $360^\circ$ .

The tabulated azimuth angle ( $Z$ ) of star  $a$ , shown in the illustration, is N.  $45^\circ$  W. With the star roughly in place on the circle,  $45^\circ$  W. of N.,

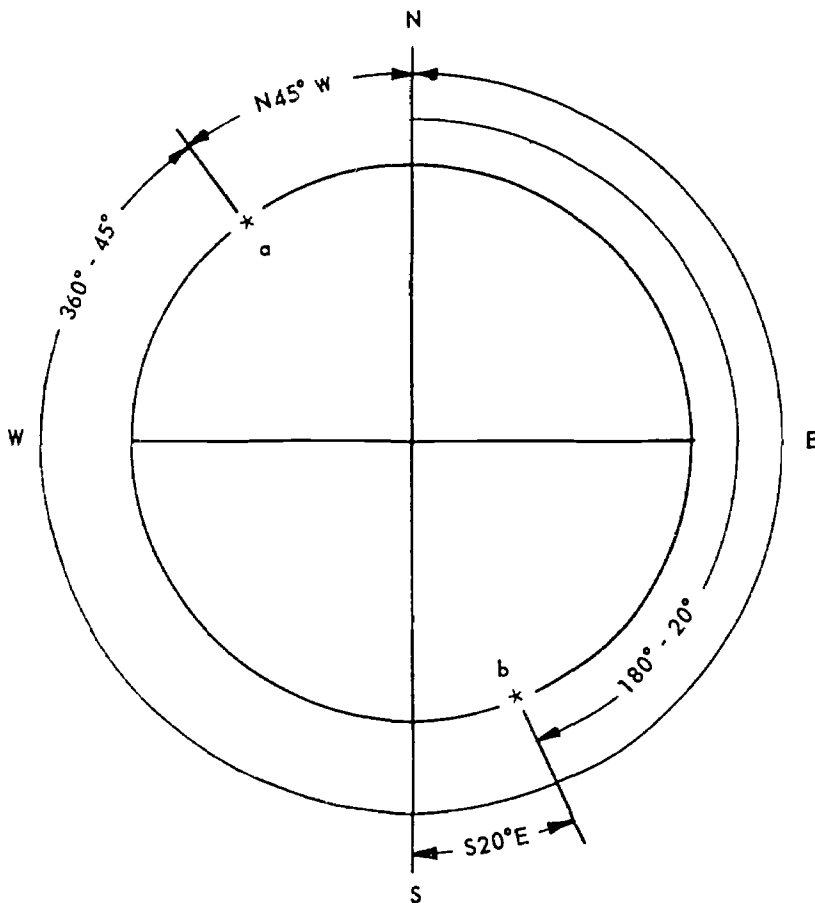

Figure 5-22.—Finding  $Z_n$ .

112.34

it is easy to see that  $Z_n$  should be  $360^\circ$  minus  $45^\circ$ . Or take star  $b$ , for which  $Z$  is  $S.20^\circ E$ . Obviously, in this example,  $Z_n$  would be  $180^\circ$  minus  $20^\circ$ . The other two situations covered by the rules solve just as easily in the diagram.

### STEPS IN WORKING A SIGHT

Summarizing what you have learned so far, you work a sight by the following steps:

1. First, take the sight and record the time. You now have the name of the body, its sextant altitude, the date and watch time of the observation, and the latitude and longitude of the DR position.
2. From portions of the data in step 1, convert watch time of the sight to GMT.
3. In the *Nautical Almanac* (or *Air Almanac*), enter the correct tables for the date, GMT, and the body observed, and find its declination ( $d$ ) (and sidereal hour angle (SHA) if the body is a star).

4. From special tables in the same publication, correct the sextant altitude ( $h_s$ ) to observed altitude ( $H_o$ ).

5. Apply an assumed longitude to the GHA that is nearest the DR longitude and will result in a whole number for LHA. From LHA, determine meridian angle ( $t$ ).

6. With meridian angle ( $t$ ), assumed latitude ( $aL$ ), and declination ( $d$ ), enter the tables of H.O. 214 and find the computed altitude ( $H_c$ ) and the azimuth angle ( $Z$ ).

7. Determine true azimuth ( $Z_n$ ), and draw the azimuth line through the AP.

8. Determine the difference between  $H_c$  and  $H_o$ . This difference is the altitude intercept ( $a$ ). Measure value  $a$  toward or away from the observed body, depending on the result of your application of the CGA formula, and draw a perpendicular to the azimuth line at its extremity. The perpendicular is a line of position (LOP).

## H.O. 249 METHOD

Use of Vol. I of H.O. 249 reduces considerably the number of steps required in working star sights. Originally intended for aviators, H.O. 249 is rapidly replacing H.O. 214 as the most popular sight reduction tables used by marine navigators. The table is designed for use with the Air Almanac. The *Nautical Almanac* may be used with only slight variations, however.

In H.O. 249, stars are tabulated by name, eliminating the need for finding declination. Azimuths rather than azimuth angles are listed, making conversion unnecessary. Local hour angle of Aries (LHA<sub>r</sub>) is used instead of meridian angle ( $t$ ), thus SHA need not be found or applied. Because of this tabular arrangement, fewer table entries and fewer mathematical steps are required than when using H.O. 214.

Following are the steps necessary for determining an LOP by using H.O. 249.

1. Make an accurately timed sextant observation of a star previously selected from the tables and make the usual corrections to find  $H_o$ .
2. Determine GHA<sub>r</sub> from the Air Almanac for the proper time.
3. Apply assumed longitude to GHA<sub>r</sub> to determine LHA<sub>r</sub>. As with the H.O. 214 method, LHA<sub>r</sub> must be the nearest whole degree (nearest even whole degree if in latitudes higher than  $69^\circ$ ).
4. Using DR position, enter the tables at the nearest whole degree of latitude.
5. Extract the  $H_c$  and  $Z_n$  listed under the name of the star and opposite the proper LHA<sub>r</sub>.
6. Determine the difference between  $H_o$  and  $H_c$ , keeping in mind the memory aid CGA.
7. Plot the line of position by using the  $Z_n$  taken from the tables and the altitude intercept found in step 6.

After two or more lines are plotted and the fix is determined, the accuracy of the position may be further refined by applying the precession and nutation correction found in table 5 of H.O. 249. Instructions for using the correction are given in the tables and in Bowditch. Remember that this correction is applied to the fix itself—not to the individual altitudes.

## H.O. 229 METHOD

H.O. Pub. No. 229, entitled "Sight Reduction Tables for Marine Navigation," referred to as H.O.

229, is a series of inspection tables. The tables were designed, developed, and prepared through the joint collaborative accomplishments of the U.S. Naval Oceanographic Office, the U.S. Naval Observatory and Her Majesty's Nautical Almanac Office, Royal Greenwich Observatory.

The purpose of the tables is to effect all solutions of the astronomical or navigational triangle, making it possible to find the third side and the adjacent angle of the triangle when given two of the sides and the included angle. These tables are applicable in the solution of sights of all celestial bodies, at any altitude, even those with negative value, for latitude and declination of both same and contrary name. Altitudes and their differences are tabulated to the nearest tenth of a minute; azimuth angle to the nearest tenth of a degree. The tables are intended for use with The Nautical Almanac.

The tables are published in six volumes, each arranged by latitude with an overlap of  $1^\circ$  existing between volumes. Each volume covers  $16^\circ$  of latitude (e.g.,  $75^\circ$ - $90^\circ$ , inclusive) arranged in two zones of  $8^\circ$  each.

To use the H.O. 229, select the volume which includes the assumed latitude. The primary entering argument is the local hour angle (LHA), which is prominently displayed at the top and bottom of each of the two pages listing the required (LHA) within the latitude zone of the selected volume. The correct page is selected for a declination having the same or contrary name as the latitude. On the outer edges of each page, declination is listed in vertical columns. The latitudes of a zone are listed horizontally above and below each column on the page. In each latitude column three set of numerical values are tabulated under the subheadings  $H_c$ ,  $d$ , and  $Z$ , respectively. " $H_c$ " is the calculated (or computed) altitude stated to the nearest  $0'.1$ ; " $d$ ", with sign, is the actual tabular difference, in minutes, to the tabulated altitude for the next higher degree of declination; and " $Z$ " is the tabulated azimuth angle to the nearest  $0^\circ.1$ . The rule for converting azimuth angle ( $Z$ ) to the true azimuth ( $Z_n$ ) is given on each page.

The interpolation table is designed to make possible a reasonably high degree of precision in the interpolation of the altitude to the nearest  $0.1$  of declination. The argument (one of the values used for entering a table or diagram) for entering these tables is the excess of the actual declination over the integral degree of declination used to enter the main body of the tables. The tables are printed on four pages located inside the front cover and facing page and the inside back cover and facing page. The range of these tables is  $0'.0$  to  $59'.9$ .

A full explanation of the Sight Reduction Tables for Marine Navigation, including their concept, format, arrangement, and method of interpolation is





OPNAV FORM 3530/1A (7-69)	OPNAV FORM 3530/1B (7-69)	OPNAV FORM 3530/1C (7-69)	OPNAV FORM 3530/1D (7-69)	OPNAV FORM 3530/1E (7-69)	OPNAV FORM 3530/1F (7-69)	OPNAV FORM 3530/1G (7-69)	OPNAV FORM 3530/1H (7-69)	OPNAV FORM 3530/1I (7-69)
H.O. 214 ALL CELESTIAL BODIES	H.O. 249 AND AIR ALMANAC	LATITUDE BY POLARIS	POLARIS	WATCH TIME OF L.A.N.	LAN	AZIMUTH BY H.O. 214	LORAN	SUNRISE SUNSET LHA OF ARIES
Body (nome)	Body (nome)	Body - POLARIS	Body - Polaris	DRA	Body - Sun	Body (nome)	TIME	DATE
GMT		I.C. (±)	i.c. (±)	STD. MERIDIAN		GMT	STATION	DR LAT
I.C. (±)	GMT	D (-)	DIP (-)	dλ	I.C. (±)	GHA (h)	TG/TS	DRA
D (-)		ho (-)	App. Alt. Corr (-)	MER. PASS.	DIP (-)	Corr (m/s) (+)	READING	LATITUDE DEGREES/TENTHS
ho (±)	I.C. (±)	TOTAL Corr (±)	TOTAL Corr (±)	dλ X 4m (±)	App. Alt. Corr (±)	TOTAL GHA	TS Corr (±)	LONGITUDE DEGREES/TENTHS
P Corr MOON HP (+)	DIP (-)	Hs	Hs	WT of L.A.N.	TOTAL Corr (±)	DRA (+E -W)	TGS/TSG Corr (±)	STANDARD MERIDIAN
TOTAL Corr (±)	App. Alt. Corr (-)	Ho	Ho	ZD	Hs	LHA	RATE Corr (±)	SUNRISE/SET LAT ( )
Hs	TOTAL Corr (±)			GMT of L.A.N.	Ho	"t" ( )		LAT ( )
Ho	Hs	GMT		MER. ALT. of SUN		Dec. ( )	TG Plot	1° LAT = _____ M X _____ = LAT. Corr
GHA (h)	Ho	GHA Y (h)	GHA Y (h)	Body - SUN	d#	d#/d Corr (±)	TAB	DIFF λ X 4M = LONGITUDE Corr (±)
Corr (m/s) (+)		Corr (m/s) (+)	Corr (m/s) (+)	GMT	d Corr (±)	True Dec. ( )	DIFF (±)	TOTAL Corr (±)
SHA (+)/v Corr (±)	GHA Y	TOTAL GHA Y	TOTAL GHA Y	I.C. (±)	Tob. Dec.	"d" ( )		BASE TIME
TOTAL GHA	Corr (m/s) (+)	DRA (+E -W)	DRA (+E -W)	D (-)	True Dec.	Tob "d"/ ( )	LAT/LONG	SUNRISE/SET
oλ (+E -W)	TOTAL GHA	LHA Y	LHA Y	ho (±)		"d" diff (±)	TAB LAT/LONG	TWILIGHT CORR (±)
LHA	oλ (+E -W)			TOTAL Corr (±)		"t" ( )	Δ CORR (±)	LMT TWILIGHT
COMPARE TO 360 or 720	LHA Y	o <sub>1</sub> Corr (+)	o <sub>1</sub> Corr (+)	Hs	B9° 60'	Tob "t"/ ( )	PLOT	ZONE DESCRIPTION
"t" ( )		o <sub>1</sub> Corr (+)	o <sub>1</sub> Corr (+)	Ho	Ho (-)	"t" diff (±)		LONG
Tob. Dec. ( )	He	o <sub>2</sub> Corr (+)	o <sub>2</sub> Corr (+)	d#	ZD (±)	"L" ( )		GHA Y
d# / d Corr (±)	Ho	Sum	Sum	d Corr (±)	True Dec.	Tob "L"/ ( )	LAT/LONG	Corr (m/s) (+)
True Dec. ( )	o (INTERCEPT)	1°-00' (-)	1°-00' (-)	Tob. Dec. ( )	LAT	"L" diff (±)	TAB LAT/LONG	TOTAL GHA Y
oDec. ( )	ZN	TOTAL Corr (±)	TOTAL Corr (±)	True Dec. ( )		"d" Corr (±)	Δ CORR (±)	DRA (+E -W)
d diff = Δd	Adv./Ret.	Ho	Ho	B9° 60'		"t" Corr (±)	PLOT	LHA Y
H Corr (±)	PRECESSION	LAT	LAT	Ho (-)		"L" Corr (±)		LONG
Ht				ZD ( )		TOTAL Corr (±)		
Hc				True Dec. ( )		BASE AZ	Adv./Ret.	
Ho				LAT ( )		( ) AZ ( )		
o (INTERCEPT) ( )						ZN		
( ) AZ ( )						GB		
ZN						GE ( )		
Adv./Ret.								
Fix (Time)	Fix (Time)							
Lot	Lot							
Long	Long							
Sounding	Sounding	Sounding	Sounding	Sounding	Sounding	Sounding	Sounding	

Figure 5-24. Strip inserts. 112.119

OPNAV FORM 3530/1D (7-69)	OPNAV FORM 3530/1E (7-69)	OPNAV FORM 3530/1I (7-69)	OPNAV FORM 3530/1G (7-69)	OPNAV FORM 3530/1H (7-69)	OPNAV FORM 3530/1I (7-69)	OPNAV FORM 3530/1J (7-69)	OPNAV FORM 3530/1K (7-69)	OPNAV FORM 3530/1L (7-69)	
POLARIS	WATCH TIME OF L.A.N.	LAN	AZIMUTH BY H.O. 214	LOLAN	SUNRISE SUNSET LHA OF ARIES	MOONRISE MOONSET COMPUTATION	TIDE AT ANY TIME	VELOCITY OF CURRENT	
Body - Polaris	DRA	Body - Sun	Body (nome)	TIME	DATE	DATE	DATE	DATE	
(±) i.c. (±)	STD. MERIDIAN		GMT	STATION	DR LAT	DR LAT	PLACE DESIRED	PLACE DESIRED	
(-) DIP (-)	dλ	I.C. (±)	GHA (h)	TG/TS	DRA	DRA	TIME	TIME	
(-) App. Alt. Corr (-)	MER. PASS	DIP (-)	Corr (m/s) (+)	READING	LATITUDE DEGREES/TENTHS		REFERENCE STATION	TIME CORR TO SLACK (±)	
(±) TOTAL Corr (±)	dλ × 4m (±)	App. Alt. Corr (±)	TOTAL GHA	TS Corr (±)	LONGITUDE DEGREES/TENTHS		HIGH WATER CORR (TIME)	TIME CORR TO MAX	
H <sub>s</sub>	WT of L.A.N.	TOTAL Corr (±)	DRA (+E -W)	TGS/TSG Corr (±)	STANDARD MERIDIAN	MOONRISE/SET LAT ( )	HIGH WATER CORR (HEIGHT)		
H <sub>o</sub>	ZD	H <sub>s</sub>	LHA	RATE Corr (±)	SUNRISE/SET LAT ( )	LAT ( )	LOW WATER CORR (TIME)	VELOCITY CORR TO FLOOD (±)	
	GMT of L.A.N	H <sub>o</sub>	"y" ( )		LAT ( )	1° LAT = ____ M	LOW WATER CORR (HEIGHT)	VELOCITY CORP TO EBB (±)	
	MER. ALT. of SUN		Dec. ( )	TG Plot	1° LAT = ____ M X ____ = LAT, Corr	DIFF. LAT X ____ = ____ M		FLOOD DIRECTION	
GHA Y	Body - SUN	d#	d# / d Corr (±)	TAB	DIFFA × 4 <sup>M</sup> = LONGITUDE Corr (±)	LAT Corr (±)	REFERENCE STATION TIME	EBB DIRECTION	
(+) Corr (m/s) (+)	GMT	d Corr (±)	True Dec. ( )	DIFF (±)	TOTAL Corr (±)		HIGH/LOW TIME CORR		
TOTAL GHA Y	I.C. (±)	Tab. Dec. ( )	"d" ( )		BASE TIME	MOONRISE/SET DESIRED DAY	SUBORDINATE STATION TIME	REF. STATION SLACK WATER TIME	
(+/-) DRA (+E -W)	D	(-) True Dec. ( )	Tab "d"/ ( )	LAT/LONG	SUNRISE/SET	PRECEDING DAY EA		SUBORDINATE STA. CORRECTION	
LHA Y	ha (±)		"d" diff (±)	TAB LAT/LONG	TWILIGHT CORR (±)	FOLLOWING DAY WA	REFERENCE STATION HEIGHT	SLACK WATER AT SUB. STA.	
	TOTAL Corr (±)		"y" ( )	Δ CORR (±)	LMT TWILIGHT		HIGH/LOW HEIGHT CORR		
(+) a <sub>0</sub> Corr (+)	H <sub>s</sub>	89° 60'	Tab "t"/ ( )	PLOT	LAT	ZONE DESCRIPTION	CORRECTION FROM TABLE IV (±)	SUBORDINATE STATION HEIGHT	REF. STATION MAX. CURRENT TIME
(+) a <sub>1</sub> Corr (+)	H <sub>o</sub>	H <sub>o</sub> (-)	"t" diff (±)		LONG	GMT TWILIGHT	LAT Corr (±)		SUBORDINATE STA. CORRECTION
(+) a <sub>2</sub> Corr (+)	d#	ZD (±)	"L" ( )		GHA Y	TOTAL Corr (±)	DURATION OF RISE/FALL	MAX CURRENT AT SUB. STA.	
Sum	d Corr (±)	True Dec. ( )	Tab "L"/ ( )	LAT/LONG	Corr (m/s) (+)	BASE TIME			
(-) 1°-00' (-)	Tab. Dec. ( )	LAT	"L" diff (±)	TAB LAT/LONG	TOTAL GHA Y	MOONRISE/SET	TIME FROM NEAREST HIGH OR LOW	REF. STA. MAX CURRENT VEL.	
(±) TOTAL Corr (±)	True Dec. ( )		"d" Corr (±)	Δ CORR (±)	DRA (+E -W)			SUBORDINATE STA. VELOCITY CORR.	
H <sub>o</sub>	89° 60'		"t" Corr (±)	PLOT	LAT	LHA Y	HEIGHT OF HIGH WATER	MAX CURRENT VEL. AT SUB. STA.	
LAT	H <sub>o</sub> (-)		"t" Corr (±)		LONG	Body/Alt/A <sub>2</sub>		HEIGHT OF LOW WATER	
	ZD ( )		TOTAL Corr (±)				RANGE OF TIDE	INTERVAL BETWEEN TIME DESIRED AND SLACK WATER	
	True Dec. ( )		BASE AZ	Adv./Ret.					
	LAT ( )		( ) AZ ( )				HEIGHT OF BASE TIDE		
			ZN				CORR FROM TABLE 3		
			GB				HEIGHT OF TIDE (±)	INTERVAL BETWEEN SLACK WATER AND MAX CURRENT	
			GE ( )				CHARTED DEPTH		
							DEPTH OF WATER		
								MAX CURRENT VELOCITY	
								FACTOR FROM TABLE 3 (MULT.)	
								VELOCITY AT DESIRED TIME	
Sounding	Sounding	Sounding	Sounding	Sounding	Sounding			DRIFT	

Figure 5-24. Strip inserts. 112.119



may be identified from tables or the star finder. Azimuths for identification purposes need not be as accurate as those used in determining compass error.

The Navigation Workbook (OPNAV Form 3530/1) was printed to meet the recognized need for a standard computation book. The page format (fig. 5-23) is intended to provide optimum utility, economy, and flexibility, by providing strip inserts (OPNAV Forms 3530/1A thru 1L) to assist the naviga-

tor in computations. (See fig. 5-24.) The strip inserts, marked to size for cut out, are used by placing the proper computation strip beside a blank column and aligning it so that entries will correspond with the information on the strip. Ensure that the name of the celestial body or "LORAN" is entered at the top, and that the fix is entered for appropriate celestial sights or LORAN LOPs. Any modified strip form is to become an official part of the record. Space is provided at the bottom of each page for required signature of the navigator.

## CHAPTER 6

# ASSISTING THE OOD AND SHIP HANDLING

As a First Class or Chief Quartermaster, you are eligible for assignment to virtually any type of naval vessel. Aboard ship you may be given watches as OOD or JOOD. You could be assigned to a tugboat, patrol boat, or other yard or district-type craft where you would be petty officer in charge.

Both the OOD/JOOD watches and PO in charge of a craft are positions of high responsibility and authority. It is the intent of this chapter to acquaint you with some of the duties and responsibilities inherent in these jobs.

### OFFICER OF THE DECK

The officer of the deck (OOD) is the officer on watch designated by the commanding officer to be in charge of the ship. The OOD is responsible for the safety of the ship and for the performance of the duties prescribed in *Navy Regulations* and by the ship's commanding officer.

Some of the duties of the OOD are applicable only while the ship is underway, others only in port, and still others whether underway or in port. Given in the ensuing paragraphs are some of the duties prescribed by *Navy Regulations*. For a more complete description of the OOD's duties, you should consult that publication and your ship's standing orders, and *The Watch Officers' Guide*.

The officer of the deck must keep himself informed concerning current operating plans and orders, as well as the intentions of the officer in tactical command. Additionally, the OOD must carry out the established routine and any special orders for the ship, following (as practicable) the motions of the senior officer present.

When underway, the officer of the deck may not change course or speed except as prescribed by *Navy Regulations* or as authorized by the commanding officer. Two specific occasions listed in *Navy Regulations* in which the OOD may change course without prior permission of the commanding officer are: (1) when necessary to avoid collision or immediate danger, and (2) when selecting a safe course to steer, based on the advice of the navigator.

In either of these events, however, prompt notification must be given the commanding officer that a change has been made.

When at sea, the officer of the deck must keep himself informed of the position of the ship and of all other particulars that may be of use in keeping the ship out of danger. He must be thoroughly familiar with the laws to prevent collision and must comply strictly with those laws. He must ensure that the ship is skillfully steered, and, when in formation, that proper station is maintained.

When visibility is restricted, as by fog, rain, or falling snow, the OOD must have additional lookouts posted as required by circumstances. He must also ensure, by frequent checks and reports, that the lights required by the *Rules of the Road* are kept burning from sunset till sunrise.

The OOD is responsible for having frequent inspections made of watertight integrity, condition of armament, condition of ground tackle or mooring lines in use, good order and discipline of the crew, ship's boats, and any matter or circumstance that might affect the safety or operation of the ship. These inspections must be made and reported to the OOD either by a watch established for that purpose or by a member of the OOD's watch crew.

Other duties and responsibilities assigned to the OOD by *Navy Regulations* include taking necessary action to prevent accidents; controlling signals sent out from the ship; loading and unloading of the ship's boats; tending the side; rendering salutes, honors, and ceremonies; making prescribed reports to the commanding officer; and keeping the deck log.

### JUNIOR OFFICER OF THE DECK

The junior officer of the deck (JOOD) is the principal assistant to the OOD. Routine matters that occur on watch may be handled by the JOOD. Frequently, the JOOD is in training to become a qualified OOD; accordingly, he may be assigned by the OOD to any duty that the OOD normally would perform. Any JOOD, in anticipation of assuming

those duties himself, is well advised to learn as much as he can about the OOD's duties.

In the following topics concerning the OOD, remember that the information applies equally to the JOOD whenever he has been assigned the particular duty under discussion.

## THE OOD UNDERWAY

Under ordinary circumstances the OOD underway concerns himself with carrying out the ship's routine. This routine usually is spelled out in the ship's organization and regulations manual, standing orders, captain's night order book, and the ship's plan of the day. Normally, the ship's organization and regulations manual and the standing orders contain standardized procedures. Basic changes to these instructions are relatively infrequent. The plan of the day, published daily by the executive officer, lists specific times and events that are to take place during the day. These events may be in addition to the normal routine outlined in the ship's organization and regulations manual or they may be in contravention to it.

The captain's night order book is written by the commanding officer near the close of each day. In it he describes the expected general situation for that night and lists any special orders that apply to the night watches. Before assuming their respective watches the OOD, JOOD, and CIC watch officer are required to read and initial the current night orders. Other personnel may be required to read the night orders so that the maximum number of personnel on watch may be apprised of the operating situation.

## Formations

It is not unusual for naval ships to steam in company, that is, for two or more ships to proceed together from one locality to another. For mutual protection and to reduce the risk of collision, these ships usually arrange themselves in a "formation." Numerous types of formations exist, including column and line formations, replenishment formations, surface action formations, and miscellaneous formations. In general, the type of formation chosen by the OTC for a group of ships depends on the number and classes of ships participating and on the type of operation being performed. Types of formations, numbering systems, and information concerning the stations in a particular formation are given in ATP 1(A), Vol. I.

## Station Keeping

Regardless of the type of formation being maintained, each participating ship has her own definite position with respect to the guide and to other ships

in the formation. Inasmuch as ships react differently to such conditions as wind, current, rudder drag, and water resistance, ships that are theoretically steaming on exactly the same course and speed will not indefinitely retain their positions relative to each other. The guide assumes the course and speed designated by the OTC, and other ships retain their positions by what is known as station keeping. Because a station is located by its bearing and range from the guide, the basis of good station keeping is the continuous and accurate determination of the guide's range and bearing. Risk of collision is always a threat when ships are in formation, consequently the importance of exact station keeping cannot be overemphasized.

Insofar as bearing is concerned, three situations may exist: a ship may be in line (column) with the guide, i.e., directly ahead or astern of the guide; she may be abreast of the guide, i.e., directly on one or the other of the guide's beams; or she must be on a bearing other than in line or abreast. In each of the situations, different rules apply for keeping ships on station. These rules are discussed later in this chapter, but first, some basic information on stations is given.

- Bearings prescribed for the type of formation or by specific signal are reckoned either true or relative from the guide. For a ship that is keeping station on the guide, the prescribed bearing from the guide is converted (by use of a maneuvering board and known gyro error) to bearing by gyro repeater, and the reciprocal of this bearing is used continuously to check position.
- Range prescribed in a particular formation is the distance to be maintained between the guide and each ship of the formation. Range is checked repeatedly, using either a stadimeter (in clear daylight) or radar (during reduced visibility and at night). Radar ranges may also be used in clear daylight, particularly if the range is great.
- Courses and speeds are included in the operation order; or they are signaled. As mentioned before, the guide assumes the signaled course and speed. Individual ships must make adjustments in their courses to correspond to the guide's. Numbers of revolutions for various speeds may be found in the engine revolution table, but numbers of turns must be altered to suit the circumstances.

- It is much easier to maintain a reasonably accurate station than to regain position after losing it. It is better, therefore, to make immediate small changes of course and speed to cor-

rect position than to wait until position error is so great that radical changes are required.

When a ship is in line with the guide (either directly ahead or astern) stationkeeping is relatively simple. Distance is adjusted by changing own ship's speed. Bearing is adjusted by altering own ship's course.

When in a line abeam (directly abeam) of the guide, distance is adjusted by changing own ship's course. Bearing is adjusted by changing own ship's speed. In this situation a course change will have a slight effect on bearing; a speed change will have a slight effect on distance. These effects usually are so small as to be negligible. If, however, they become appreciable, they may be corrected by using a combination of course and speed changes. (In this situation, a maneuvering board solution may be advantageous.)

Adjusting bearing or range is somewhat more complex when the station is neither directly ahead or astern nor abeam of the guide, because a combination of course and speed changes usually is necessary to adjust either bearing or range. A keen understanding of relative movement and the ability to visualize the ship's situation are essential to this type of stationkeeping.

Turning away from the guide usually opens the range, but the effect on bearing depends on whether the ship is to port or starboard of the guide and whether forward or abaft the beam. Figure 6-1 shows ships in various positions relative to the guide. The arrows indicate the effects of a 20° course change with no change in speed. Note that a different result in range and bearing is obtained from each relative position. (It will probably never be necessary to change course 20° solely to maintain station. In figure 6-1, 20° is used only for illustrative purposes.) As can be seen, a speed change is needed to offset each course change. The situation is similar when speed is changed; then, each speed change must be offset by a course change.

### Formation Diagram

Maneuvering board problems in change of station and closest point of approach (CPA) are described in Quartermaster 3 & 2. The problems in that training course deal exclusively with a guide (or target) and one other ship. Formations, on the other hand, usually are composed of a guide and several other ships. The methods of changing station when numerous ships are involved are the

same as when only one ship must maneuver, except that when more than one ship is maneuvering, each must avoid risk of collision with the others.

In plotting formations on a formation diagram, the position of the guide usually is plotted first. Ranges and bearings of other stations are plotted from the guide.

In circular formations, the station in the center is called station zero. Circles (on the status board or maneuvering board) are numbered consecutively outward from the center. Unless otherwise ordered, circle spacing is 1000 yards. Thus, a circle of radius 5000 yards is known as circle 5; one of 5200 yards, as circle 5.2. The location of a station is described by the number of the circle on which it lies, followed by its direction, relative to the axis, measured clockwise from 000° to 359°. (The axis is the true bearing from the center around which a formation is oriented. It may or may not coincide with the formation course. An example of a station designation is station 2A; 4.5090. In this example, station 2A would be plotted 4500 yards (to scale) from the center of the circle, 90° clockwise from the axis.

Formations may be plotted with station zero or the guide in the center, or with own ship in the center as it would ordinarily appear on a PPI scope. Figure 6-2 is an example of a formation diagram with station zero at the center. Figure 6-3 shows the same formation on a status board with own ship at the center. When formations are plotted as in figure 6-3, the range and bearing from own ship to any other ship may be obtained by inspection alone.

### Preparations for Entering Port

The OOD of a ship entering port directs that entry plans be made suitably in advance. Entry plans differ, depending on whether the ship intends to anchor, moor alongside a pier or another ship, moor to a buoy, or merely lie to temporarily before leaving port. Accordingly, the OOD—

1. Notifies the engineer as far in advance as possible, of the time of anchoring or mooring. He also notifies the executive, weapons, and engineer officers.
2. Ensures that appropriate radio circuits are up; establishes communications with port control; and obtains permission to enter port.

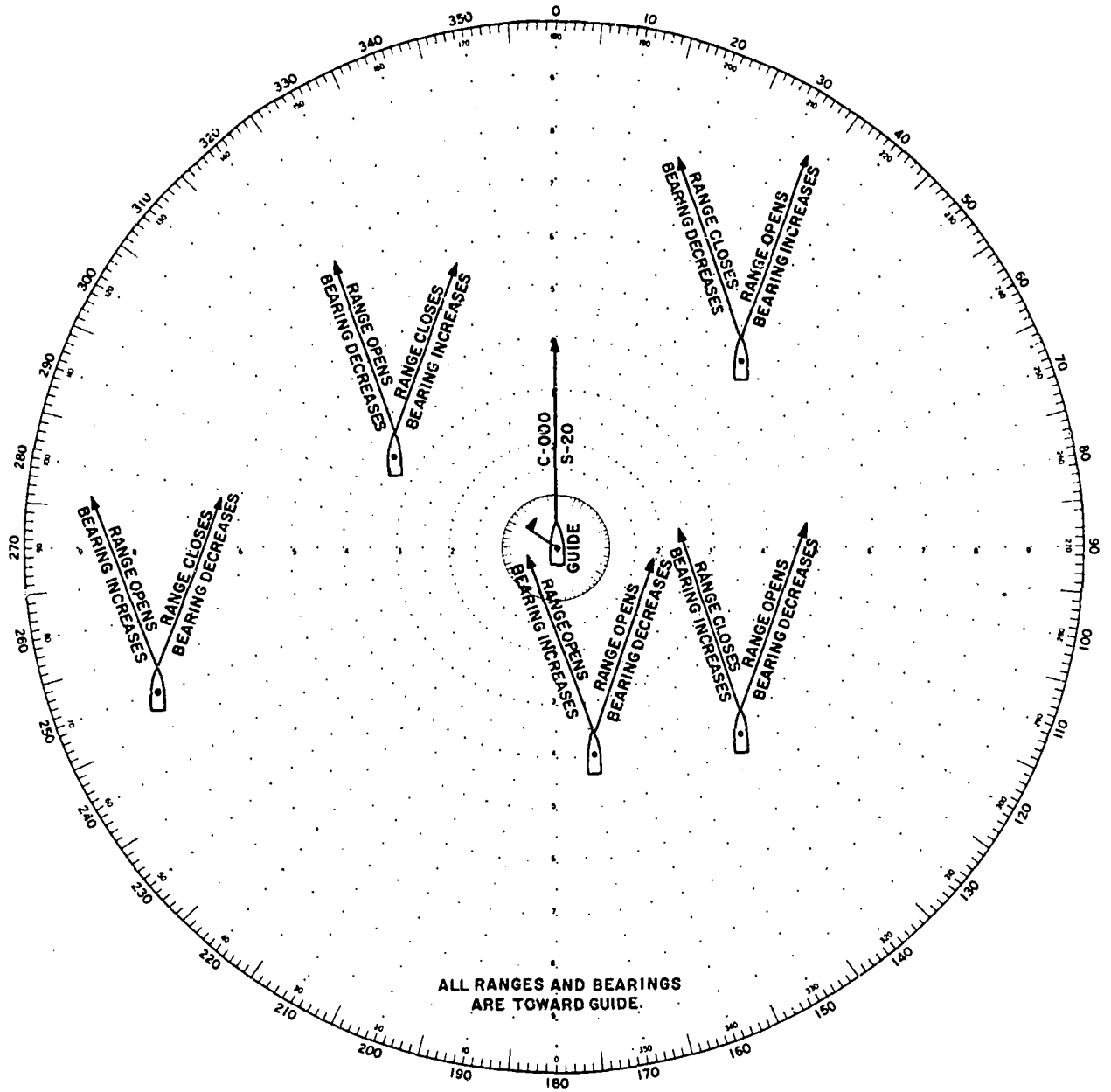

36.65 (112A)A

Figure 6-1.—Result of course change in station keeping.



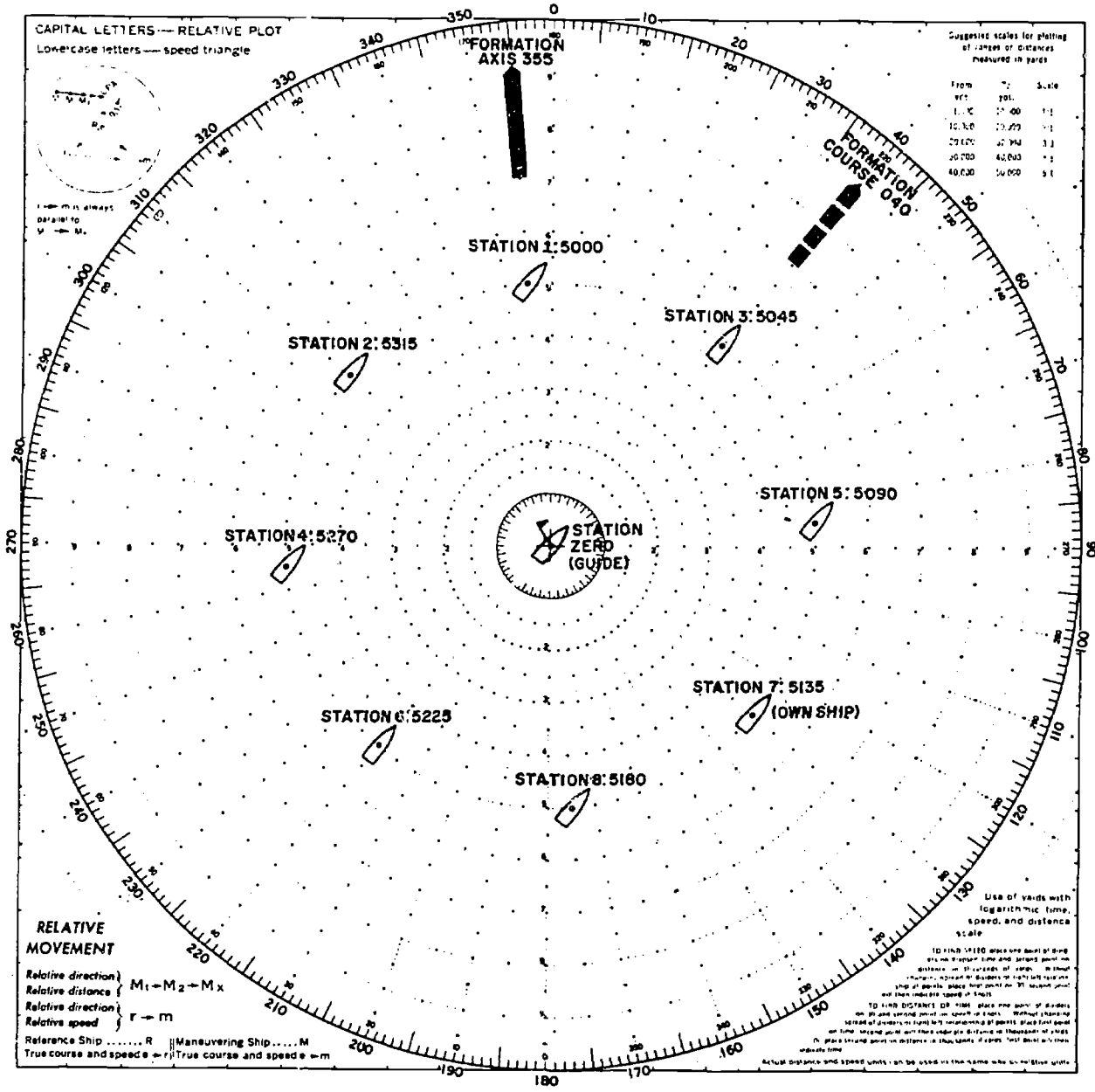

Figure 6-2.—Formation plotted on a maneuvering board.

36.65(112A)B

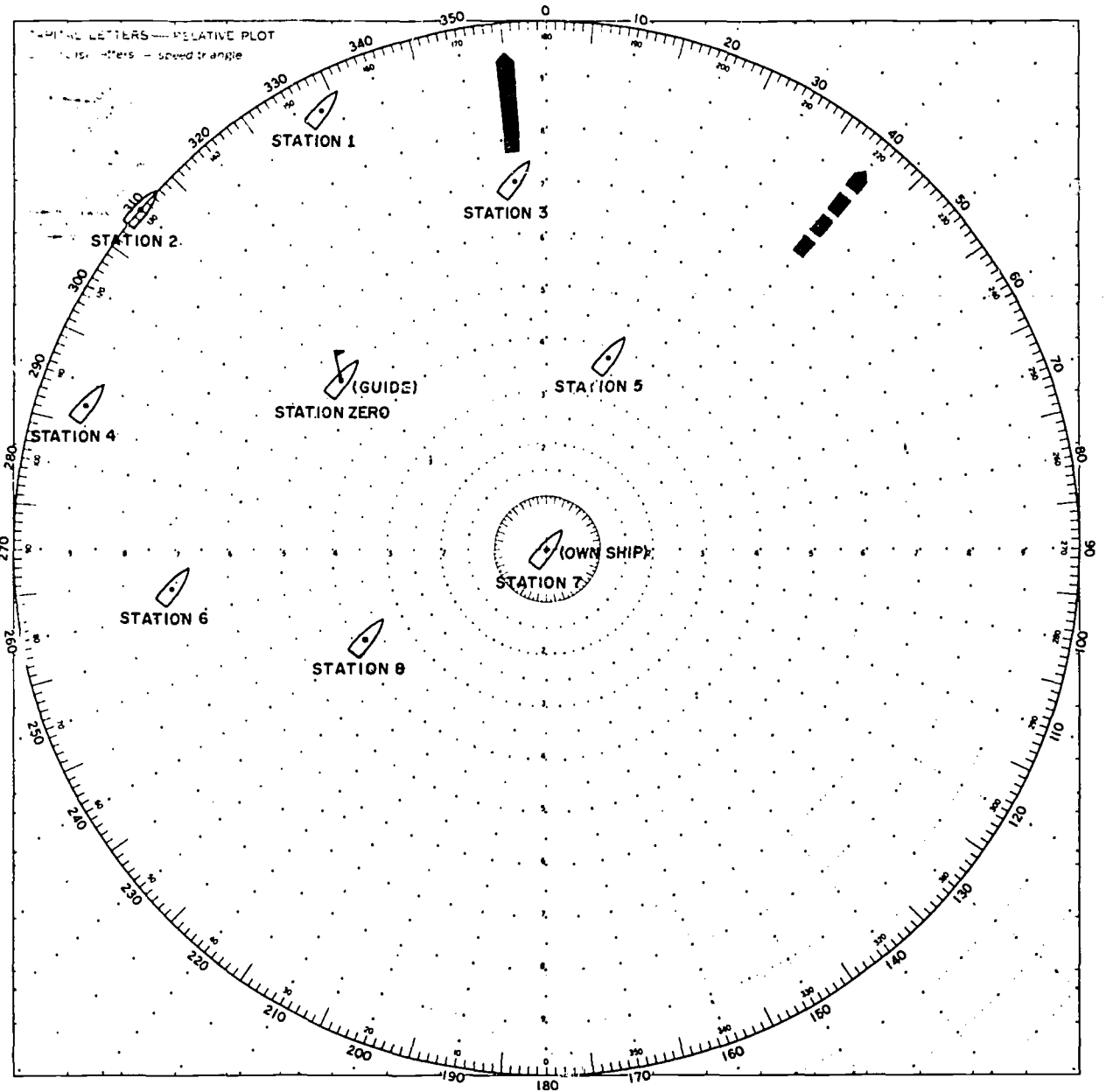

Figure 6-3.— Formation plotted on a status board.

36.65(112A)C

3. Directs disposal of garbage and other refuse that should be thrown overboard.
4. Orders boats prepared for lowering, with running lights ready, if necessary.
5. Stations the special sea and anchor detail.
6. Makes sure that ground tackle and fore-castle are prepared for anchoring, mooring, and the like, as appropriate.
7. Announces which side is going to the dock, if the ship is going alongside, and orders lines, fenders, heaving lines, and line-throwing guns prepared on that side.
8. Instructs that accommodation ladders and booms be rigged and prepared for going out immediately upon anchoring.
9. Orders batteries, searchlights, booms, cranes, and other equipment not in use, secured in the prescribed position for entering port.
10. Ensures that boat covers, hatch covers, awnings, and other canvas are stowed properly, and that slack rigging is hauled taut.
11. Directs that the boatswain's mate of the watch pipe down all bedding and see that nothing is hanging over the side or dangling on the lifelines.
12. Passes the word for the crew to shift into the uniform of the day. Personnel not working are sent to quarters in advance of time of arrival.
13. Directs preparations for rendering honors, as necessary.
14. Stations details at the colors for returning salutes, shifting colors, and hoisting the jack upon anchoring or mooring. If entering port at night, stations detail ready to turn on anchor lights.
15. Ascertains that working parties, stewards mail orderlies, and others who are to leave the ship upon anchoring, are ready to depart immediately.

Each ship will normally have an entering port and departing port check-off sheet. Be sure to consult this to establish the correct time that each of the above preparations should be made.

#### THE OOD IN PORT

The OOD in port is no less responsible for the safety and operation of the ship than when underway. Because the ship in port is not so likely (as

at sea) to encounter danger from grounding, collision, weather hazards, and the like, the commanding officer is able to choose OODs from a wider variety of personnel. Depending on the type of ship, enlisted personnel and/or Marine officers may be assigned to OOD watches. As with the OOD underway, the in-port OOD is charged with the responsibility of having the ship's routine carried out. Before assuming the watch, he should make himself aware of the following specific items

1. Anchor in use and scope of chain.
2. Depth of water and condition of the chain in the hawse.
3. If alongside, what lines are in use.
4. Anchorage bearings.
5. Weather conditions to be expected, and preparations to be made.
6. State of tide.
7. Boiler and auxiliaries in use.
8. Senior officer present afloat, and other ships present.
9. Location of flag officer (if any), captain, executive officer, and department heads.
10. Senior officer aboard and senior duty officer.
11. Boats in the water and their location; boat officers available.
12. Absentee, prisoner, and duty lists.
13. Appearance of ship.
14. Orders for the day and special orders.
15. Liberty section, time of expiration of liberty, and number of men ashore.
16. Guardship.
17. Status of planes.
18. Work or drills in progress or scheduled.
19. Visitors on board or expected, and the orders concerning same.
20. Workmen on board, if any.
21. If at night, the ready lifeboat designated and the anchor watch morning orders.
22. Boat schedule.

During his watch, the OOD must keep himself apprised of the items in the foregoing listing, updating the information as appropriate. He is then responsible for the safety and security of the ship; safety of personnel, boats, planes, and other material; readiness of the ship for duty; smart appearance of ship, boats, and crew; and comfort of crew.

#### Getting Underway

A typical checkoff list from a ship's organization book gives you a good idea of the duties of the OOD in getting underway. In general, he must—

1. Notify department heads.
2. Pass the word: "all hands make preparations for getting underway at \_\_\_\_\_(time)".
3. Order the word passed: "Set material condition \_\_\_\_\_(appropriate material condition)."
4. Make certain that all boats, mail clerks, stewards, etc., have returned or have been notified to return to the ship. Make the general recall signal, if necessary.
5. Direct that boats be hoisted in. (The last boat is to be aboard approximately 15 minutes before getting underway. Permission to pick up last boat should be obtained from the executive officer.)
6. Station the special sea detail 30 minutes before getting underway. Order all hands to change into uniform of the day before setting the sea detail.
7. Order boat booms and ladders hoisted aboard.
8. Ascertain that the persons responsible test the steering gear, engine room telegraph, telephone circuits, and other ship control equipment. Obtain permission from commanding officer to test the main engines.
9. Ensure that all department heads have made readiness reports for getting underway 20 minutes before sailing time.
10. Shift the watch from quarterdeck to bridge.
11. Ensure that the required number of boilers are in use.
12. Report immediately to the executive officer or commanding officer any delay in getting underway. Report readiness for getting underway to the executive officer who, in turn, reports readiness to the CO.
13. Ascertain, if at night, that searchlights are manned and ready for use.
14. Ensure that all service connections are broken from the pier and other ships.
15. Test the whistle (if SOPA regulations permit and permission is obtained from the commanding officer).

### SHIP HANDLING

Ship handling, like most phases of seamanship, can be learned thoroughly only through experience. Your duties as OOD/JOOD underway—but more especially as petty officer in charge of a craft of considerable size—probably will require an extensive amount of ship handling.

Yard craft usually are single-screw vessels, which are more difficult to maneuver than are twin-screw ships of comparable size. Many of the advantages of twin-screw ships are not present in single-screw ships; for example, by backing down on one screw and going ahead on the other, a twin-screw ship can maneuver in a small space. For the foregoing reasons, the following discussion applies to single-screw ships. Remember, however, that the same operations and maneuvers can be performed with greater ease with a twin-screw ship.

### SHIP'S PHYSICAL CHARACTERISTICS

A new skipper should be enthusiastic about his billet (and the petty officer in charge of a district craft is in essence that craft's skipper). He should be interested in learning everything he can about his ship; in fact he should know more about the ship than any man on board. Many details in which a new skipper is interested—such as material condition, personnel, logs, and records—are not too closely allied with ship handling. A wealth of material is available, however, in a ship's characteristic cards, damage control books, and the like. When the newly assigned PO in charge makes his first inspection, he should take along the ship's blueprints. They will be a help in becoming oriented. Some of the more important characteristics the PO in charge must learn about his ship follow.

1. Dimensions: The reason for ascertaining a ship's overall length and beam is to know the minimum dimensions of the berth she requires. Besides, if she's a tug or other type that frequently goes alongside large ships, the height of masts must be known to tell how high the ship's overhang must be for the craft to fit under it.

2. Draft at various loadings: Draft determines minimum depth of water a ship may safely navigate, and the load stability condition at all times.

3. Freight and passenger capacity: For freight, this information is necessary to ensure that the vessel is not overloaded, that she is full and down but with no list, sagging, or hogging, and that she has the desired trim and stability. Passenger capacity for ship type is decided by higher authority, based on adequacy of messing and berthing facilities.

4. Main engines—

- a. Capability: Capability includes maximum speed, best cruising speed, economical cruising speed, maximum backing power, and maximum

propeller line pull. A skipper should also know the time required and power necessary for stopping his vessel from any given speed. Acceleration and deceleration time rates, in tabular form, should be available for his use on the bridge.

b. Engine controls: The PO in charge should have accurate knowledge of the location and operation of all types of engine controls and all means of communication between engineroom personnel and himself, as conning officer.

c. Logistics: He should know the capacities of various fuel tanks—crude, diesel, gasoline, or any combination that may be installed. This information is vital in computing cruising radius and in damage control or preparing for heavy weather when it may be necessary to ballast or shift fuel.

5. Rudder: He should know the space required for a turn at various speeds, which involves knowing the turning effect of the rudder at various angles.

Much can be learned about the aforementioned ship characteristics by questioning the skipper being relieved. From him can also be learned any characteristic of the ship that may be a departure from the norm—such as tendency to sheer in the wind, cranky steering at certain speeds, or sluggish answering of the rudder.

## MANEUVERING CHARACTERISTICS

Before delving into the mechanics of ship handling, it is necessary to understand the forces that act on a ship under various speed and rudder angle conditions. If aware of these maneuvering characteristics, a ship handler can compensate for undesirable effects and utilize helpful effects advantageously. Without knowledge of these forces, ship handling at best would be a trial-and-error procedure.

## FORCE FACTORS

It is beyond the scope of this training manual to discuss hydrodynamic principles. Experts are not in complete agreement among themselves why forces created by a ship's propeller and rudder react as they do on the ship. They do agree, however, that forces so generated result from pressure differences. To understand how these pressure differences occur, consider the following definitions.

- **Dynamic pressure:** For all practical purposes, water is incompressible. If force is applied to water, thereby causing high pressure, water flows to a lower pressure area, producing a force known as dynamic pressure.

- **Propeller thrust:** High- and low-pressure areas beneath a ship are created by propeller and rudder. As a propeller revolves to go forward, the shape and pitch of each blade develop a thrust derived from a low-pressure area on the forward face of the blades and a high-pressure area on their after face. As the ship moves in the direction toward the low-pressure area, the force set up by this displacement of water is transmitted along the propeller shaft to thrust the ship ahead or astern. This force is known as propeller thrust.

- **Rudder force:** The rudder exerts its force in somewhat similar fashion to propeller thrust. When the rudder is set at an angle on a moving ship, a high-pressure area is built up on the leading surface, and a low-pressure area forms on the trailing surface. Through this difference in pressure areas, the water exerts a force against the leading surface of the rudder. In turn, the rudder forces the stern in the direction opposite that to which the rudder is set. This force is known as rudder force.

**SIDE FORCE AND SCREW CURRENT.**—Before discussing screw and rudder combinations and how they affect a ship, some additional force factors must be understood.

- **Side force:** In maneuvering a single-screw ship, side force ranks next in importance to pro-

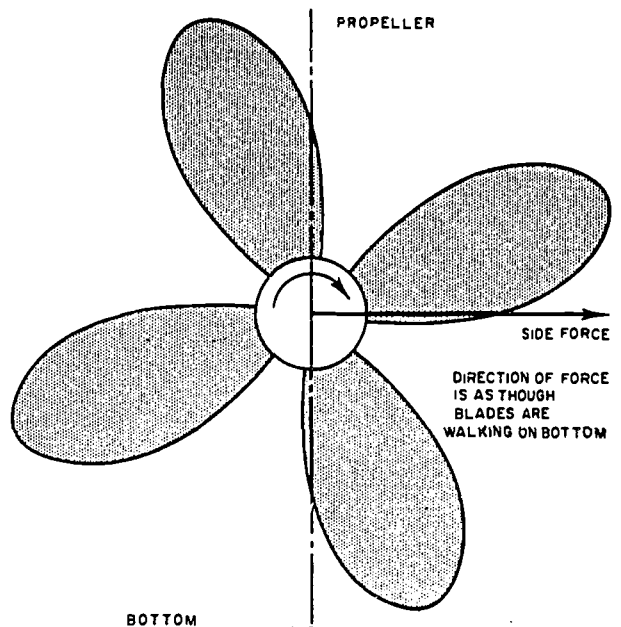

Figure 6-4.—Side force.

112.49

propeller thrust. Side force is defined as a force that moves (walks) the stern of a ship to one side or the other. The causes of side force are somewhat involved. All that a conning officer needs to know is that, as a result of the rotating propeller, a force is created moving the stern of the ship in the direction of propeller rotation. The effect is as though the lower blades of the propeller were touching the bottom and pushing the stern to the side. (See fig. 6-4.) Side force is at its maximum when the ship is dead in the water. It decreases rapidly with an increase in ship speed. Likewise, side force is greater when the ship is backing than when moving ahead.

- **Screw current:** Screw current, caused by action of a rotating propeller, consists of two parts. The portion flowing into the propeller is the suction current; that flowing away from the propeller is the discharge current. Suction current is a relatively minor force in ship handling. Discharge current is a major force in ship handling in two main respects. First, it produces a large force on the rudder with the screw going ahead. Second, because of the part of the discharge current that acts against the ship's counter, it is a strong component of side force when the screw is backing.

### Turning Circle

A ship's turning circle is the path described by the ship in completing a full 360° turn with a constant rudder angle. Such a turn is illustrated in figure 6-5. The diameter of the turning circle decreases with any increase in rudder angle. High speed also has noticeable effect on turning circle, the amount of change depending on the ratio of speed to the square root of the length of the ship. The greater the ratio, the greater is the diameter of the turning circle. Small changes in speed, however, do not significantly alter the diameter. The following definitions relate to various aspects of the turning circle.

- **Advance:** Distance gained toward the direction of the original course after the rudder is put over.
- **Transfer:** Distance gained at right angles to the original course when turning. Figure 6-5 shows transfer for a 90° turn. For a 180° turn, transfer equals tactical diameter.
- **Tactical diameter:** Perpendicular distance between the path of a ship on her original course and the path of a ship when a 180° turn is completed at a constant rudder angle.

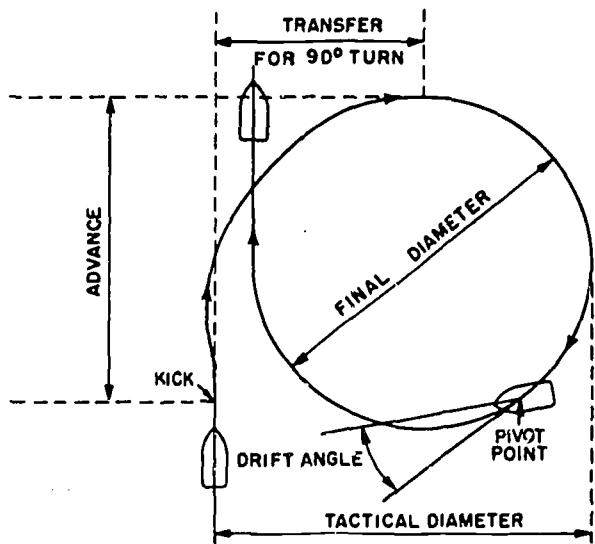

Figure 6-5.—Turning circle. 58.71

- **Standard rudder:** Rudder angle necessary to turn a ship in a prescribed tactical diameter.
- **Final diameter:** Diameter of a circle ultimately scribed by a ship that continues to circle with a constant rudder angle.
- **Drift angle:** Angle at any point on a turning circle between intersection of the tangent at that point and a ship's keel line.
- **Kick:** (1) Swirl of water toward the inside of a turn when rudder is put over. (2) The momentary movement of ship's stern toward the side opposite the direction of turn.
- **Pivot point:** (1) The point of the centerline about which a ship pivots when rudder is put over. (2) It may also be the point of a ship upon which she turns and which scribes the turning circle.

**MAKING A TURNING CIRCLE.**—When the rudder is put over in making a turn, the stern is forced away from the direction of the turn. For several lengths, because of momentum, the ship turns very slowly from her original course. She then commences to gain ground in the new direction, while moving sidewise through the water. This movement naturally results in loss of speed. Because of speed loss when a column turn is made, a vessel gains rapidly on the ship ahead while that ship is turning, but loses this distance during her own turn when the first ship completes her turn and steadies on her new course.

A ship's pivot point is nearly always about one-third the ship's length abaft her bow when moving ahead, and at or near her stern when moving astern. Location of a pivot point varies with ship's speed. An increase in speed shifts the pivoting point in the direction of ship movement. In close waters, the conning officer must always bear in mind the position of his pivot point before starting a turn. This position is especially important when moving ahead, in order to prevent the stern from swinging to an undesirable location.

### Rudder Effect

Basically, a ship's rudder is used to attain or maintain a desired heading. Force necessary to accomplish this heading is created by dynamic pressure against the flat surface of the rudder. Magnitude of this force, as well as the direction and degree to which it is applied, produces the rudder effect that controls stern movement and, through it, ship's heading. Factors that have a bearing on rudder effect include rudder size, rudder angle, headway, sternway, propeller direction, suction current, discharge current, and side force. As can be seen, the degree of each factor and the possible combinations are virtually limitless.

## FUNDAMENTALS OF SHIP HANDLING

To better understand the effect of various rudder and screw combinations upon a ship, assume these ideal ship-handling conditions no wind, no current, no tide, plenty of sea room, and no interference from other vessels. Further assume that the ship being conned is a YO with a single rudder and single right-handed screw (turns clockwise going ahead).

### Going Ahead

In going ahead from a stopped position, the first noticeable effect is that the ship's stern swings to starboard because of side force. To counteract this swing, right rudder is applied, forcing the discharge current against the rudder surface. As the ship gathers headway from propeller thrust, the ship reaches a speed where the wake current overcomes side force to a great extent, and right rudder may be removed. Now the ship will continue straight and respond equally well to either left or right rudder. Rudder effect is obtained from action against the rudder surface of both the dynamic pressure of the discharge current and the pressure of the water through which the ship is moving.

With the ship going ahead at a good speed, suppose the conning officer wants to stop. The screw is

backed. Propeller thrust is in direct opposition to the forward motion of the ship, causing her to start slowing. Side force and part of the discharge current tend to force the stern to port. This direction of movement can be compensated for by left rudder so long as the ship has sufficient forward motion to retain steering effect. As forward motion is reduced, however, steering effect is reduced to zero. Furthermore, side force and that part of the discharge current acting against the ship's counter cause the stern to swing to port. This trend can be compensated for partially by shifting to right rudder to take advantage of the force of the suction screw current acting against the rudder surface.

### Backing Down

Backing down in a straight line with a single-screw ship is virtually impossible without alternating the direction of the screw and the position of the rudder.

In going astern from a stopped position, the stern swings to port because of side force and a portion of the discharge current. This force cannot be counteracted, even with full right rudder, because the suction current acting against the rudder surface is a relatively weak force. As the ship gathers sternway, the water through which the ship is moving acts against the rudder surface, augmenting suction current force. This force slows, but probably will not stop, the stern's continued swing to port. The best way to straighten out is to go ahead on the screw and, as discharge current builds up, shift rudder to left full.

Two forces now are working to stop port swing and bring the ship to her proper heading. These forces are side force and the discharge current acting against the rudder surface. When the heading of the ship is satisfactory, continue the backing procedure used initially.

### Casting

Casting is the maneuver that often arises wherein ship's heading must be altered radically without allowing any appreciable change in her initial position. Casting is referred to also as turning short, twisting ship, turning her on her pivot point, and by other terms. All these terms have the same meaning.

The rudder-screw combination employed depends on the direction chosen to turn the ship; the shortest arc of turn is the simplest and quickest. The key to this maneuver is to apply all available forces to start the stern swinging before the ship gathers headway or sternway. If desired to pivot the ship to a heading on the port side, go ahead on the screw with

full left rudder. Side force and discharge current acting against the rudder surface force the stern to swing rapidly to starboard before propeller thrust imparts forward motion to the ship. When the ship starts to gain headway, back the screw and shift the rudder. Side force from the backing screw slows the stern's swing, but this action is unavoidable. To remain in the ship's initial area, take way off the ship. When forward motion stops completely, go ahead on the screw and shift rudder to left full. Repeat these screw-rudder combinations until the ship is on the desired heading.

A pivot to starboard is accomplished by a different sequence of screw-rudder combinations. Start the maneuver by backing the screw with full left rudder. Side force and suction current against the rudder surface start the stern swinging rapidly to port. As the ship gathers sternway, shift rudder and go ahead on the screw. Repeat these screw-rudder combinations until the ship is on her desired heading. With a single-screw ship, it is easier and quicker to cast to starboard than to port.

Going Alongside

From the foregoing descriptions of handling a single-screw ship using various rudder-screw combinations, a conning officer should have a good idea what to expect of a ship under ideal conditions. Now, let's consider some of the more common ship-handling situations encountered--going alongside, for example.

● Port-side-to: It is always easier to bring a single-screw craft alongside port-side-to than starboard-side-to. The reason is that when the bow is eased in alongside the berth and the engine

is backed down to kill headway, side force of the backing screw swings the stern in alongside the berth. Figure 6-6 illustrates the effect of side force when backing.

● Starboard-side-to: In a starboard-side-to landing, side force swings the stern away from the berth when backing down. Approach for a starboard-side-to landing, consequently, must be made at slow speed to avoid having to back hard to kill headway. Another disadvantage of a starboard-side-to landing engendered by a slow approach is that the less headway, the less will be the steering effect of ship's rudder, thus making her harder to control.

Wind and Current

Often, advantage can be taken of what may appear at first to be adverse conditions of wind and current. It is in such a situation that the art of ship handling enters the picture. Plan a maneuver so that all known factors are taken into account. A time loss of a few minutes may be unimportant, but the Navy is highly critical of unnecessary damage to ships and installations resulting from lack of planning or poor judgment.

CURRENT FROM AHEAD.—If the ship has plenty of room and a fairly strong current from ahead, her bow can be eased alongside, and the forward bow spring line put out. The current will bring her in to the dock, as diagrammed in the first view of figure 6-7.

CURRENT FROM ASTERN.—When current is from astern, putting out the after quarter spring line (second view in fig. 6-7) produces

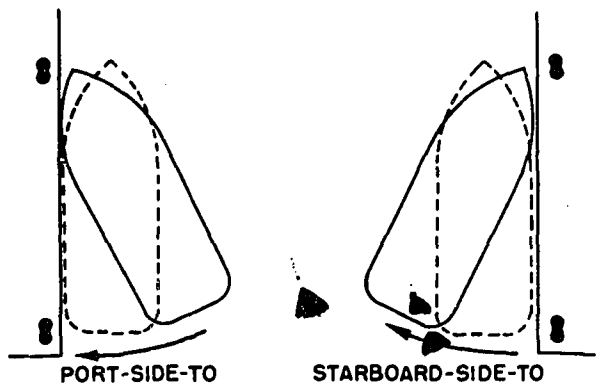

3.227(58)F

Figure 6-6.—Effect of side force when backing.

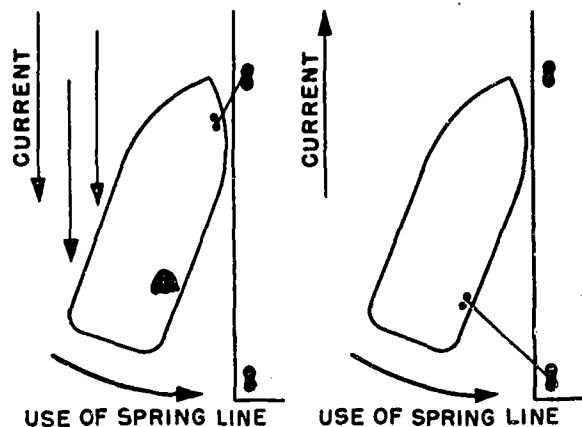

3.227(58)G

Figure 6-7.—Making use of current.



the same result as when current is from ahead. Going alongside with a current from astern is more difficult, however, because the following current makes rudder effect erratic.

- Using current only: Going alongside by means of current alone is impracticable unless there is plenty of room to range ahead or astern. Often the berth will be restricted in size, so that the bow must be eased in to go alongside, leaving no room to move ahead. This situation is no particular threat when the current is from ahead; but, in easing the stern alongside, screw and rudder must be used carefully. A following current in an approach to a small berth is much more serious, not only because of the lessened steering effect of the rudder but also because side force from the backing screw combines with current to swing the stern away from the berth. A stern line is imperative in this situation. Outside assistance may possibly be needed.

- Short berth: Most single-screw ships maneuvering into a short berth prepare the No. 2 line (after bow spring) on the dockside and get its eye out to the dock as soon as possible. (See fig. 6-8.) The line is belayed on the No. 2 bitts on board and is checked carefully as the ship makes headway. The ship should then go ahead on the screws with left rudder on. This combination will swing the stern toward the dock. Care must be taken to avoid parting the spring at this point. If there is too much headway, the screw must be backed to save the spring. Don't forget: Backing will force the stern further off a starboard-side-to berth.

**WIND EFFECT.**—Wind effect is another element to contend with when going alongside. Wind is usually erratic in velocity, and a greater safety margin must be allowed. Remember that the bow and stern may not be equal in sail area, hence wind effect on the ship as a whole will not be distributed uniformly. Another consideration is that, when approaching the lee side of a berth or another vessel, wind effect at the bow is reduced greatly while wind effect on the stern continues to act with full force. As with current, however, advantage can be taken of the wind if it is blowing toward a berth. Approach should be made so as to stop farther out from the berth than in a no-wind situation, and let the wind bring the ship alongside. Some use of screw and rudder may be required to keep the ship parallel to her berth.

When the wind is setting a ship off her berth, the situation is more difficult. For a port-side-to landing, the pier should be approached at a greater angle than that normally used with slightly more headway. A line should be put out to hold the bow, and side force of the backing screw should be used to bring the stern in. To make a starboard-side-to landing, with the wind setting the ship off her berth, again the pier should be approached at a greater angle than normally used and with slightly more headway. The bowline and No. 4 (after quarter spring) line should be put out. By going ahead slow on the screw (with full left rudder), side force, rudder effect, and No. 4 line (acting as a spring) will force the stern in against the wind. In such a situation, experienced ship handlers may drop the port anchor to hold the bow. If it is desired to use this method, always check the ship's chart first to ensure that dropping anchor in that area is not prohibited.

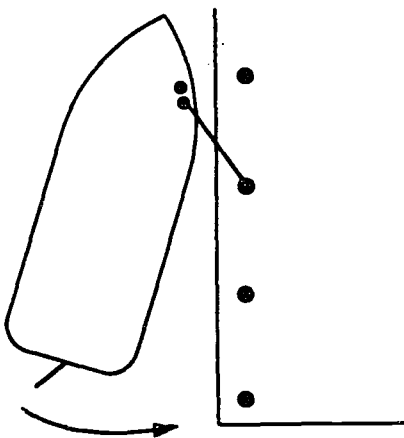

GOING AHEAD WITH LEFT RUDDER

3.227(58)H

Figure 6-8.—Use of spring line.

**Getting Away From a Berth**

The next operation to consider is getting underway. Take time to evaluate existing conditions, then plan a line of action. Wind effect should be apparent from the bridge. Current effect, on the other hand, is more difficult to judge. If the ship is moored in a slip, current effect in the immediate vicinity may be completely different from that out in the stream. Throwing a block of wood over the side and noting how it is affected by the current should give an approximate idea what to expect from current action.

**STARBOARD-SIDE-TO BERTH.**—When possible, the best way to clear a starboard-side-to berth is to back with left rudder. Side force

and suction current on the rudder will swing the stern out from the berth so that the ship can back clear safely. If there is no room astern, the stern can be moved out from the dock by using the No. 2 line as a spring and going ahead slow with full right rudder.

**PORT-SIDE-TO BERTH.**—Unlike the method of clearing a starboard-side-to berth, trying to back away from a port-side-to landing has a tendency to send the stern against the dock. The best procedure for getting away is to let the No. 2 (after bow spring) line remain out and go ahead with hard left rudder until the stern is clear. The left rudder and the lever effect of the No. 2 line will bring the stern far enough out for the ship to get away, at the same time restricting her forward motion. When the stern is clear, take in the No. 2 line, shift rudder, and back.

**CURRENT FROM AHEAD.**—With a strong current running from ahead, a ship probably could clear either starboard-side-to or port-side-to by slacking her head line and letting the current send the bow off. Once it is well off, let go all lines and go out ahead. When the rudder is turned away from the pier, the stern will swing in that direction as the ship goes ahead, especially when leaving a starboard-side-to landing. Only small amounts of rudder should be used until the ship is well clear.

**CURRENT FROM ASTERN.**—With a current from astern, slacking the stern lines will carry the stern off in the same manner as in the preceding situation. If the ship is in a set direction off the pier, letting go all lines will allow the current to carry the ship broadside out into the stream.

#### Bank Cushion; Bank Suction

Two other factors that are fundamental in ship handling are bank cushion and bank suction.

With a ship going ahead close and generally parallel to a bank, seawall, or another ship, bank cushion forces the bow out, and suction pulls the stern in. These forces are easily understood if one considers (1) how the bow funnels water into a narrowing area and (2) how screws suck in water from ahead and discharge it astern.

When backing down, the bank effect is reversed. Discharge current from the screws builds up a cushion at the stern, with the result that the stern goes out and the bow goes in.

When going ahead, bank cushion and bank suction can be counteracted by intelligent use of the

rudder. Going astern, however, a combination of speed and rudder is required.

#### Single-Screw Peculiarities

The preceding topics on ship handling merely give an idea of some well-known idiosyncrasies of single-screw vessels. This training manual cannot go into detail concerning unusual circumstances wherein a ship will act in a noncharacteristic manner. Habits peculiar to a particular ship must be learned from other conning officers and from experience.

#### TOWING

To fulfill a battle readiness requirement, every naval vessel is equipped to take another ship in tow or be taken in tow. Each ship is furnished with rigging plans for towing or being towed, for which vessels of the same class are outfitted with the same arrangement. The leading Quartermaster should be familiar with these rigging plans, because they provide detailed information covering the accepted rigging method for his ship.

#### Towing Problem

Alongside towing is confined to harbors and inland waterways. Practically all seagoing tows, however, are taken astern. The chief problem in towing on the high seas arises from the alternate straining and slacking of the towing hawser, caused by the pitching of the ships and the tendency of the tow to sheer off or range up on the towing vessel. To compensate for this towing problem, the Navy has devised an automatic tensioning towing machine. A towing machine is installed in all ships whose primary mission is towing. Most vessels, such as tenders, repair ships, and salvage and submarine rescue vessels, also carry one of these towing machines.

#### Towing Machine

The electric, automatic tensioning towing machine is the type provided on modern ships. (Steam types, both automatic and nonautomatic, are obsolescent and are not discussed here.) The electric machine must be provided with a minimum of 300 fathoms of 2-inch wire rope. It is also equipped with an automatic spooling device. Operation of the drum can be controlled either manually or automatically. By automatically paying out and recovering the towing hawser, the automatic tension control relieves the shocks and variations in tension that occur while towing in a seaway. When connected to the

tow, the drum can be disengaged from the source of power for free spooling.

The automatic tension range of the machine is greatest when only one layer of hawser remains on the drum; range decreases about 10 percent for each succeeding layer. A long hawser, consequently, has the advantage of increasing the capacity range of the towing machine, in addition to other advantages described later.

The function of the automatic towing machine is to cushion and relieve surges on the towing hawser caused by the pitching and yawing of the vessel and the sheering of the tow. In rough weather, when surges are frequent, the automatic feature is particularly advantageous, because then its constant operation avoids serious overloads and shocks on the hawser. Higher safe towing speeds (with correspondingly higher average tensions) may be maintained than are practicable with fixed towing hawsers of the same size.

During normal operation in a moderate sea, when the hawser tension is less than the tension control setting, the driving motor is deenergized and the hawser load is held by a magnetic brake. The rotary motion of the drum assembly is then resisted by heavy springs. These springs absorb considerable shock. When the tension control setting is exceeded, however, an automatic rotary drum switch causes the magnetic brake to be released, permitting the motor to be overhauled. When tension on the hawser has relaxed, a reclaiming device heaves in until the amount of hawser payed out is recovered. The motor is deenergized automatically again, and the magnetic brake is reset.

Fixed towing should be employed when towing in smooth seas. It is desirable that the towing vessel steam at speeds that will produce towline tensions consistently in excess of the automatic recovery pull of the machine. Fixed towing is accomplished by engaging a pawl with ratchet teeth on the hawser drum. Structurally, the machine is designed to withstand a pull equal to the breaking strain of the 2-inch hawser when the pawl is engaged.

Most automatic towing machines are provided with a quick hawser release. When towing in automatic control or on the clutch brake with the motor shut down, the hawser can be released simply by rotating the clutch brake handwheel in a counter-clockwise direction. The load on the hawser can then turn over the drum to meet a desired increase in scope. In an emergency, releasing the hawser permits the entire length of the hawser to pull free of its bitter end connection.

## Ship's Towing Gear

A ship that is not specially designed for towing—in other words, one that doesn't have a towing machine—can tow another vessel by the fixed towing method only. In this method the sole means of cushioning stresses on the towing hawser is by veering the tow to a scope of hawser long enough to provide a good catenary in the line.

For combat ships, past practice was to use a towing bridle bent in a bight around a gun mount or turret and then connected to the towing hawser. Later practice is to secure the towline to a towing pad conveniently located for that purpose.

## Towing Approaches

The approach to a disabled ship depends in part on how she lies in the water. How she lies is contingent on size, draft, extent of damage affecting stability or trim, state of wind and sea, extent and location of superstructure sail area, and ocean current. If stability is not altered greatly, most ships will wallow in the trough in a rough sea. In a strong breeze and a moderate sea, the high part of the superstructure may serve as a sail and cause the ship to present her opposite end to the wind. For example, a destroyer comes around with her stern to the wind because the superstructure is forward. Ships with a deep draft and low superstructure are relatively unaffected by the wind, and probably will lie broadside to the sea.

One common approach is for the towing ship to determine her rate of drift relative to the disabled ship and take a position ahead and to one side of the other. If the disabled ship drifts faster, for example, the towing ship will station herself downcurrent or downwind. If the reverse is true, she will station herself upcurrent or upwind from the tow. The idea, of course, is that with one ship drifting down past the other, more time is allowed for connecting the towline before the towing ship has to reposition herself. (See fig. 6-9.)

The best way to determine which ship is drifting faster is to place your ship across the wind in line with the other vessel, lie to, and observe which vessel goes down to leeward ahead of the other.

Figure 6-10 illustrates another position to take while the towline is being connected. This position is useful in rough sea with the tow wallowing in the trough. The towing ship approaches from leeward and passes the messenger as she crosses the bow of the other ship. She then takes the position shown. Chief advantage of this method is that the towing ship can maintain her position with very little

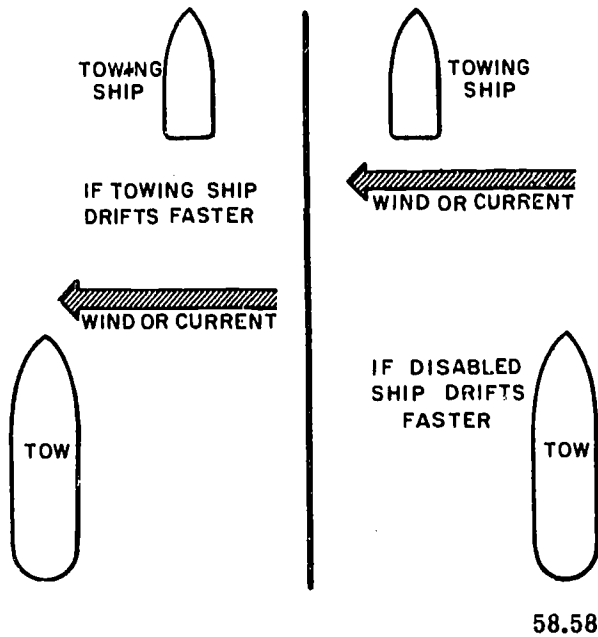

58.58

Figure 6-9.—Using drift to gain time while connecting towline.

maneuvering. Considerable care must be taken, however, not to drift down on the towline and foul the screws.

Another approach method may be used under good weather conditions when the disabled vessel's

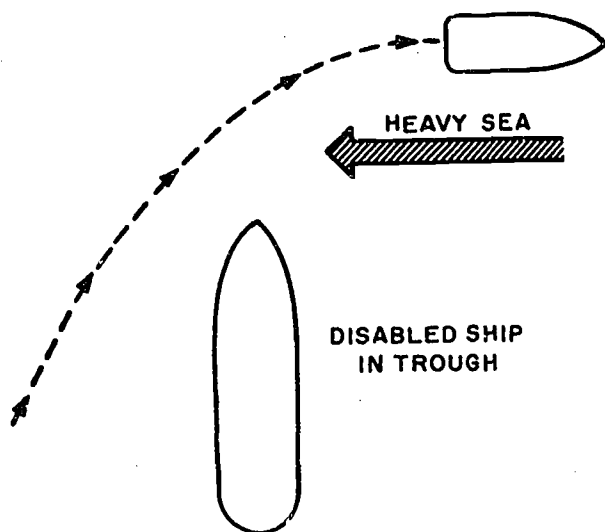

58.59

Figure 6-10.—A good position in a rough sea.

velocity of drift is small. Here the towing ship approaches the tow from astern on the windward side. Lines are passed to the forecandle of the tow as the towing ship steams past. This method requires expert ship handling, because the towing ship must pass close enough to send over a messenger line and then back down and stop a short distance ahead of the tow. The recommended distance ahead is one-third the length of the towline. If your ship is to pick up a tow in danger of being washed ashore, or if for any other reason the time required for a second pass would be disastrous, you must get the towline messenger over on the first pass. Otherwise, the disabled vessel will be in jeopardy. Having a fully equipped party near the stern, however, will give you a second chance to get the towline over. If you resort to this technique, it will be necessary to have a second section of 21-thread manila faked down on the fantail to bend onto the messenger after cutting from the messenger the section stopped off on the lifelines. This section of 21-thread must be tended and payed out carefully so that it does not wrap around a screw.

Regardless of the approach method, a messenger is the first line to be run. Towline messengers usually are made up of around 300 feet of 21-thread line spliced to a 300-foot length of 2-1/2-inch manila. For larger ships using a heavier towline, another section of 4- or 5-inch manila may be added to the towline messenger. Once the towline is shackled to the anchor chain of the tow, the chain is veered to about 30 fathoms to provide a good catenary. The weight of this scope of chain acts as a shock absorber for the towline, and is your best safeguard against excessive strain on the towline. Now you are ready to commence the tow. Bear in mind that this is the most crucial point in the entire operation. Using the least practicable number of propeller revolutions per minute, go ahead for brief periods. When the inertia of the tow is overcome and the tow is moving through the water, you can build up gradually to a steady towing speed. Do not be concerned with the initial course of the tow unless navigational hazards in the vicinity interfere. The main objective is to start the tow moving. Course can be adjusted in small increments after reaching a steady towing speed.

#### Towing Signals

Sound signals are used as a means of communication between the towing vessel and the tow. The accompanying list gives towing signals and their meanings. Make sure you learn them. In timing the blasts, a short blast must not exceed 2 seconds in duration. A long blast must be no less than 6 seconds in duration.

<u>Towing Signals</u>	
<u>Signal</u>	<u>Meaning</u>
1 short blast	I am putting my rudder right.
2 short blasts	I am putting my rudder left.
2 short, 1 long blast	Haul away.
2 long, 5 short blasts	Let go.
2 long blasts	Go ahead.
1 short, 2 long blasts	Pay out more line.
1 long, 2 short blasts	Stop.
3 short blasts	Avast hauling.
2 long, 1 short blast	All fast. (Lines are secured.)
3 groups of 5 short blasts	I am letting go.

**Scope of Hawser**

While towing in a seaway, try to keep the ships "in step," that is, adjust the scope of the towline, if possible, so that the ships meet and ride over the water simultaneously. If the length of hawser is such that one vessel is in the trough and the other is on a crest, the towline slackens for an instant and then tautens with a sudden jerk, producing a stress much heavier than normal.

To bring the ships into step, minor adjustments in the scope are easily made with a towing machine. Adjustments are almost impossible with the fixed method, except when the towed vessel has her anchor chain shackled to the hawser. In that event, veering or heaving in on the windlass will accomplish the necessary adjustment.

Where the scope of hawser veered out is within the control of one ship or the other, it should be veered to a scope sufficient to provide a good catenary, but not long enough to permit the towline to drag on the bottom. When towing a large vessel, the minimum for a good shock-absorbing catenary is about 200 fathoms. Speed must be reduced if circumstances make it impossible for you to provide a sufficiently long scope. There should never be enough stress on the towline to hoist its entire length clear of the water.

**Towing Speeds**

The speed at which a vessel can be towed depends upon her size and type, sea and weather conditions, whether she can provide any assistance with her own screws, and whether a towing machine is

used. In general, a large vessel may be towed at from 5 to 9-1/2 knots under good conditions.

An increase in speed may be obtained when towing a vessel if her screw is allowed to turn. In such an instance, or where a vessel with an unlocked screw is being towed, the main engine lubrication system must be in operation to prevent bearing failures when the propeller starts to turn.

In ascertaining the towing speed, the towing hawser is the principal consideration. Speed of the vessels must be kept at a point where the towing hawser will not be overstressed.

**Alongside Towing**

Most harbor and inland waterway towing is accomplished by tugs by means of the alongside method. In this procedure, the tug is secured alongside the tow. The reason for the alongside method is the greatly increased maneuverability of a tug with her tow alongside instead of astern. If made fast properly, she can steer both herself and the tow. Moreover, the space required for maneuvering is much less than that required for a stern tow.

For alongside towing, the tug normally secures to one side of the tow, with her own stern abaft the

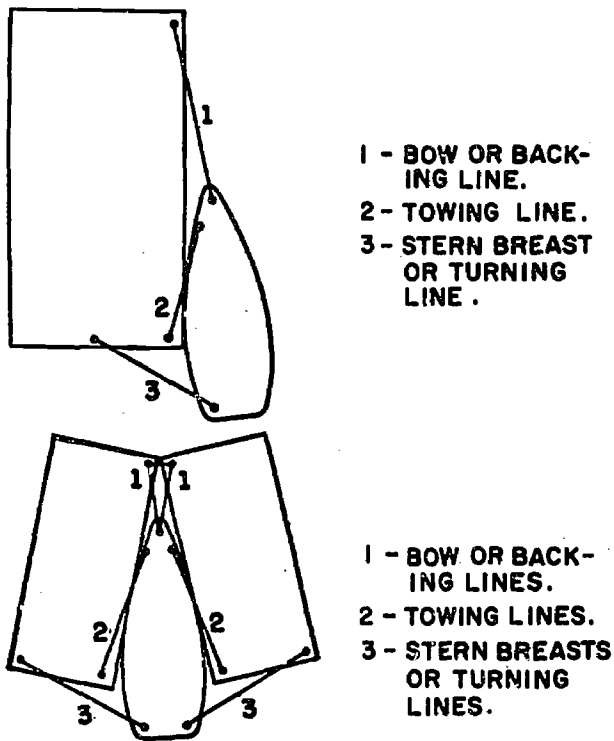

3.227(58)D  
Figure 6-11.—Alongside towing.

stern of the tow to increase the effect of her screw and rudder. The side chosen depends upon the amount of maneuvering the towing ship must accomplish with the tow. If a sharp and difficult turn is to be made under headway, the tug should be on the inboard quarter, that is, the side toward which the turn is to be made. In this position she is placed properly for backing to assist the turn. Because as she slows, the tow's bow turns toward the side the tug is on.

If a turn is to be made under no headway, the tug is more efficient on the starboard side of the tow. When the tug backs to turn, the port side (side force) of her screw combines with the drag of the tow to produce a turning effect greater than could be obtained with the tug on the port side. The best position for a long back in a straight line is to have the tug on the port side, because then the drag of the tow tends to offset the swing of the stern to port.

If all turns are made with the tug's screw going ahead, she is more favorably placed on the outboard side of the tow. This side is away from the direction toward which most turns are to be made.

In the upper view of figure 6-11, a tug is secured to a tow's starboard quarter. The towline, usually 8-inch (or larger) manila, leads from the forward (shoulder) bitts on the tow side of the tug to the after bitts on the tow. The tug secures this line first, then ranges ahead to take up the slack. Another manila headline, called the backing line, is led out one of the tug's bow chocks to a forward point on the tow. The tug end of this line is taken to the capstan and heaved until the towline is taut. This procedure brings the tug to her proper position, slightly bow-in to the tow. A stern breast line, leading from aft on the tug to aft on the tow, is used to keep the tug's stern from drifting out.

The bottom view of figure 6-11 illustrates how a tug can take two small tows alongside, one on either side.

Areas of the harbor that are subject to wave action should be avoided whenever possible. The tug and tow seldom pitch in the same tempo, so that when they start pitching out of harmony, the lines take a heavy strain and may part. When equipped with a rudder, the tow assists in steering.

Size and loading of the tow may be such that the view of the tug's conning officer is obstructed. For that eventuality, a lookout is stationed aboard the tow to keep the conning officer fully informed of activity and hazards in the blind area.

**SHIFTING THE TOW.**—Occasionally it is necessary to shift a tow from one side to the other or from alongside to astern.

One method of shifting a tow from one side to the other is to drop it astern and haul it up on the other side by means of a hook rope. The following method is faster and more seamanlike.

With the tow on the starboard side (as shown in view A of fig. 6-12), run a bowline out the port forward chock, around the bow, and to the after inboard corner of the tow. Cast off the stern breast, and fake it down on the port side.

Pick up a good forward speed (about 6 knots) and apply left rudder. When the tow is in the turn (view B), stop the engine, cast off the towline, and begin to back down. With the tow crossing the tug's bow as in view C, slack the original bowline, shift the rudder, and kick ahead. As the tow comes down on the port side, steady the tug, keeping way on and allowing the tow to swing around broadside to the tug (view D). Pass towline and stern breast and set taut on all lines.

Shifting a tow from alongside to astern usually is necessary when a tug is to tow a barge or other vessel from port to port. The tow is taken alongside within the harbor and shifted astern outside.

The shifting procedure is simple. The towing hawser is connected to the towing bridle before getting underway. Outside the harbor, the lines used for towing alongside are cast off, allowing the tow to drift away from the tug. Then, slowly accelerating, carefully altering course, and judiciously paying out the towing hawser, the tug gets underway with the tow and comes to the required course.

### Towing Astern

Towing barges astern is referred to as tandem towing. In the broad sense, tandem means one behind the other. In towing, the term frequently is used to distinguish a particular rig for towing two or more barges or lighters in a single line. Here, tandem is used in the latter sense to differentiate between this rig and another called the Christmas tree.

Both the tandem and the Christmas tree methods of rigging for towing are illustrated in figure 6-13. In the Christmas tree rig, notice that all the barges tow from a single hawser by means of pendants shackled to flounders (sometimes called bails or fish plates) inserted in the towing hawser. In the tandem method, each barge tows by a line secured directly to the barge ahead.

For the most part, the Christmas tree method is preferred over the tandem rig. It is stronger, more units can be towed, and any unit can be taken from the tow at any time without disrupting the entire tow.

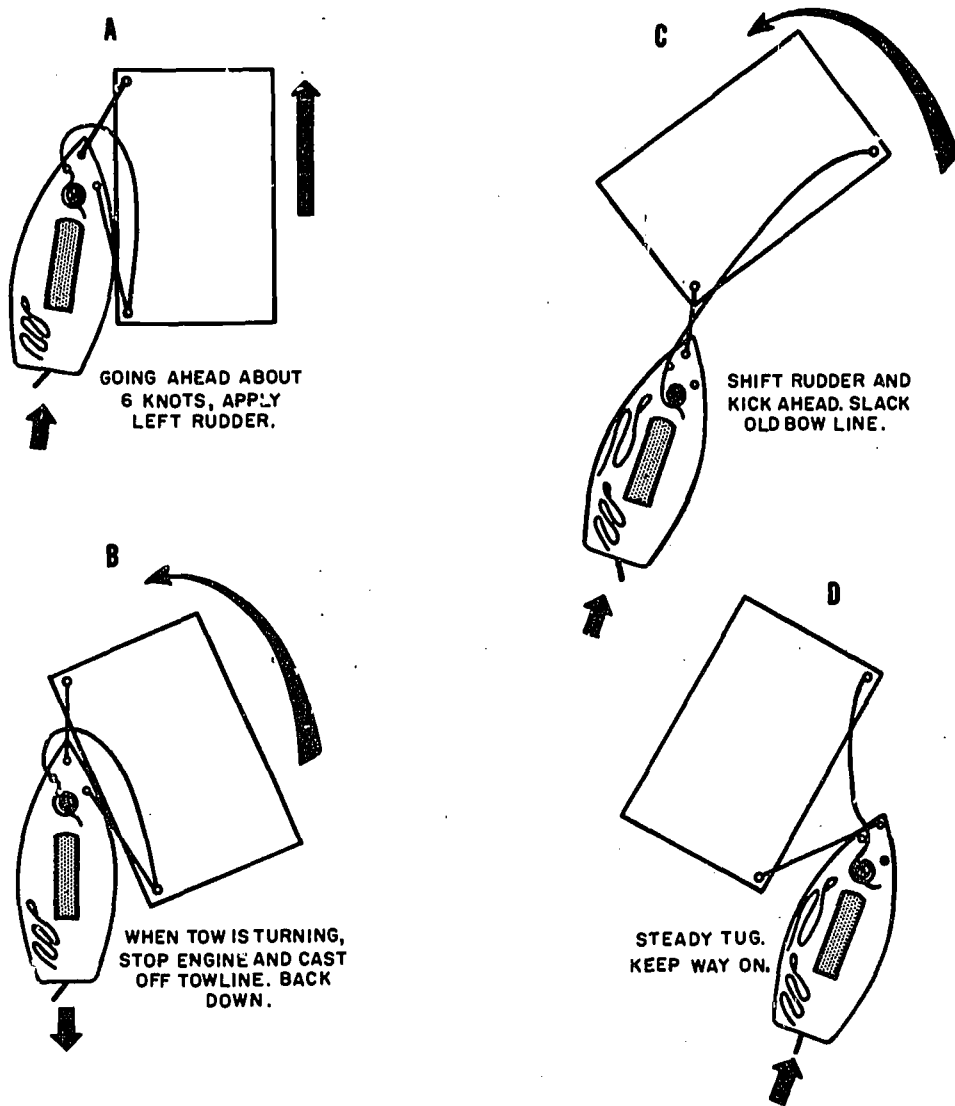

Figure 6-12.—Shifting tow to other side.

3.227(58)E

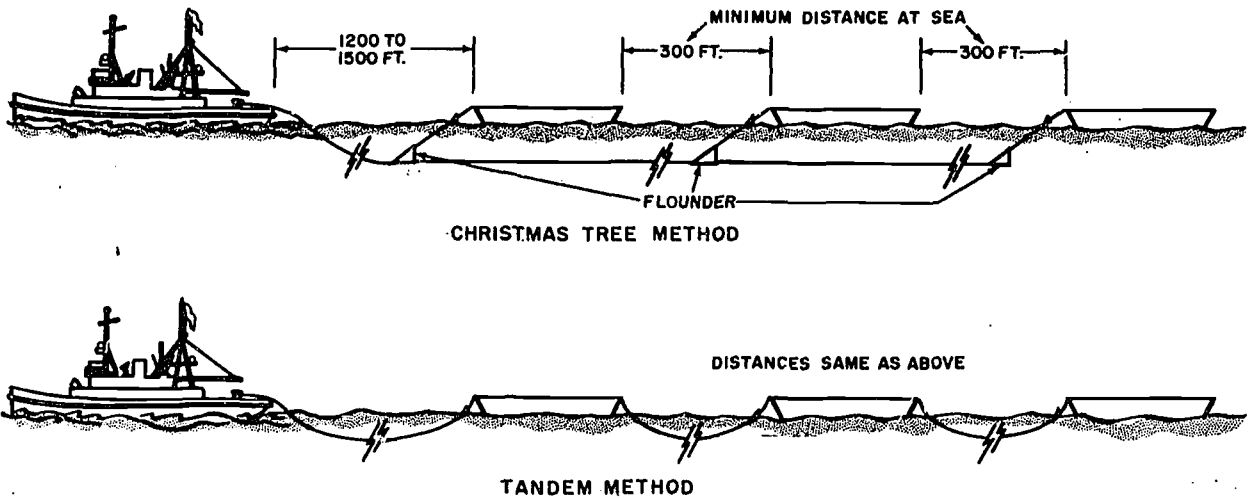

Figure 6-13.--Towing barges astern.

58.60



**Safety Precautions**

The following safety precautions are of greatest concern to you in towing operations. Don't forget that the long catenary in a towline acts as a spring inserted in the hawser. Until the towline rises out of the water and becomes taut—that is, the spring reaches its total extension—there is no danger of parting the towline unless it hangs up on the bottom.

**Safety Precautions**

Always—

- Step up speed three to five turns at a time until towing speed is reached.
- Use a bolt-type safety shackle or a plate shackle to connect towline to anchor chain. (A screw pin shackle may be used in an emergency. The pin must be moused with seizing wire for short tows. For long tows, it must be welded in place.)
- Have anchor on tow ready for letting go.
- Set towing watch on both ships.
- Provide emergency means for cutting tow wire, such as large bolt cutters or cutting torch.
- Keep unnecessary personnel from vicinity of towline.

Never—

- Rig a towline that cannot be cast off quickly.
- Make a sharp turn in shallow water with a long scope of towing hawser out, except to avoid collision or grounding.
- Let tow get forward of the beam.
- Tow in a heavy sea with a short scope.
- Use towing hawser that is kinked or badly frayed.
- Fail to cast off tow if there are definite indications that it will sink.
- Abandon a tow lest it become a menace to navigation.
- Take a tow without thoroughly inspecting bridle, towing pads, chafing pads, retrieving wire, cargo (safe and properly secured), and watertightness of vessel.
- Allow propeller of tow to turn unless the lubrication system is working.
- Trust inexperienced personnel to splice towline.

**DOCKING LARGE VESSELS**

Every Navy tug is equipped with a large bow fender, called the bow pudding, which makes it possible for her to get her nose against a large craft and shove her along the way she should go. All that is necessary to hold her alongside the larger craft is a single bowline from the tug.

Whenever the tow's bow or stern must be pulled instead of pushed around, the towline should lead from the towing bits of the tug to enable her to use her rudder.

For tugs alongside, docking pilots usually have a system of whistle signals by which they order specified tugs on the bow or quarter to go ahead, stop, or back. As a rule, tug skippers also go over the docking with the pilot ahead of time, so that each of them knows which side of the tow he is going alongside, where his boat is to take station, and what she probably will have to do.

Tugboat Docking Signals

<u>Meaning</u>	<u>Blast on hand whistle</u>
From stop to half speed ahead.	1 blast.
From half speed ahead to stop.	1 blast.
From half speed ahead to full speed ahead.	4 short blasts.
From full speed ahead to half speed ahead.	1 blast.
From stop to half speed astern.	2 blasts.
From half speed astern to full speed astern.	4 short blasts.
From half or full speed astern to stop.	1 blast
Cast off, stand clear.	1 prolonged, 2 short blasts.

Standardized tugboat docking signals and hand signals, adopted by the Chief of Naval Operations, must be used by U.S. Navy ships and tugs during periods when a pilot is not embarked. Whenever possible, the tugboat docking whistle signals are aug-

The hand signals in the accompanying list are illustrated in figure 6-14.

<u>Hand Signals</u>	
<u>Meaning</u>	<u>Signal</u>
1. Half speed ahead or astern.	Arm pointed in direction desired.
2. Full speed (either)	Fist describing arc (as if "bouncing" an engine telegraph).
3. Dead slow (either)	Undulating movement of open hand (palm down).
4. Stop	Open palm held aloft facing tug.
5. Tug to use right rudder.	Hand describing circle as if turning wheel to right (clockwise, facing in the same direction as the tug).
6. Tug to use left rudder.	Hand describing circle as if turning wheel to left (counter-clockwise, facing in the same direction as tug).
7. Tug to put rudder amidship.	Arm at side of body with hand extended and swung back and forth.
8. Cast off, stand clear.	Closed fist with thumb extended, swung up and down.

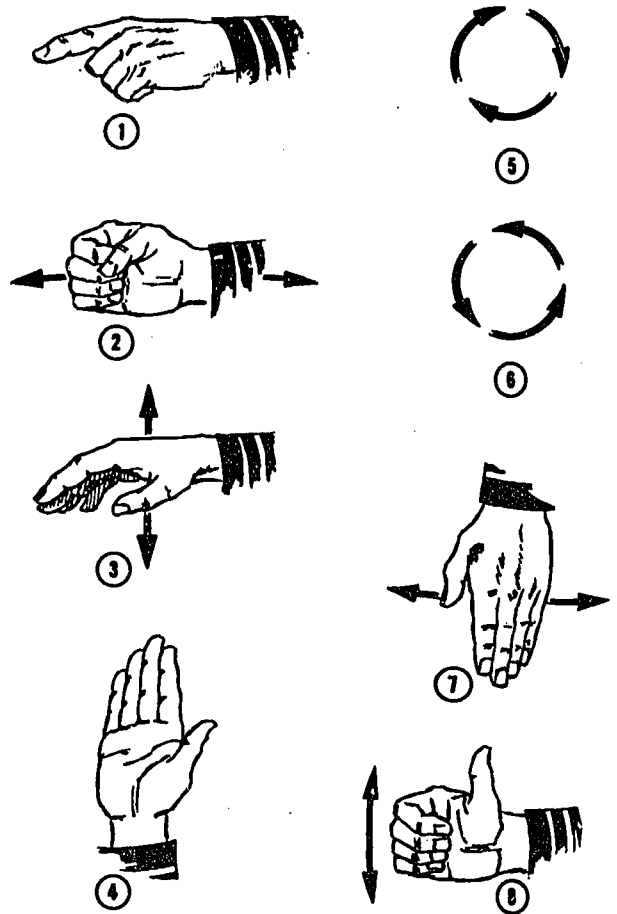

Figure 6-14.—Tugboat hand signals.

37.7

mented by the hand signals. It is expected that these signals will be adopted by other agencies besides the Navy.

The tug is to acknowledge all of the signals with one short toot (1 second or less) from his whistle. Excepted from this rule are the backing signal,

which is acknowledged with two short toots, and the castoff signal, which is acknowledged by one prolonged and two short toots.

NOTE: The blast on the hand whistle should be of 2 or 3 seconds' duration, the short blast about 1 second, and the prolonged blast 4 or 5 seconds.

## CHAPTER 7

# ASSISTING THE NAVIGATOR

As a senior Quartermaster you will be more closely associated with the navigator than you were formerly. As a QM1 on destroyer types and auxiliaries, or as a QMC on large ships, you may be assistant navigator and, in the navigator's absence, you may have to take over operation of the navigation department. This chapter describes the duties of the navigator and your responsibilities as his assistant.

### DUTIES OF NAVIGATOR

The head of the navigation department of a ship is called the ship's navigator. He normally is senior to all watch and division officers aboard. An officer is assigned to large combatant ships as navigator by the Bureau of Naval Personnel. Aboard other ships, the commanding officer may assign any qualified officer as navigator.

The navigator is responsible, under the commanding officer, for the safe navigation and piloting of the ship. He receives all orders relating to his navigation duties from the commanding officer, and makes reports in connection therewith directly to the CO.

Specific duties of the navigator, as listed in Navy Regulations, are to—

1. Advise the commanding officer and officer of the deck regarding the ship's movements and, if the ship is running into danger, concerning a safe course to be steered. To this end, he must—

a. Maintain an accurate plot of the ship's position by astronomical, visual, electronic, or other appropriate means.

b. Before entering pilot waters study all available sources of information concerning the navigation of the ship therein.

c. Give careful attention to the course of the ship and depth of water when approaching land or shoals.

d. Maintain record books of all observations and computations made for the purpose of navigating the ship, with results and dates. Such books form a part of the ship's official records.

e. Report in writing to the commanding officer, when underway, the ship's position at 0800, 1200, and 2000 each day, and at such other times as the commanding officer may require.

f. Procure and maintain all oceanographic and navigational charts, sailing directions, light lists, and other publications and devices required for navigation.

g. Maintain records of corrections affecting such charts and publications.

h. Correct navigational charts and publications, as directed by the commanding officer, and in any event before any use for navigational purposes from such records, and in accordance with such reliable information as may be supplied to the ship.

2. Operate, care for, and maintain the ship's navigational equipment. To this end, he must—

a. Determine daily, when the ship is underway and weather permits, the error of the master gyrocompass and standard magnetic compass, and report the result in writing to the commanding officer. He orders frequent comparisons of the compasses and recordings of the results. He adjusts and compensates the magnetic compasses when necessary, subject to the approval of the commanding officer. He also prepares tables of deviations, and keeps correct copies posted at the appropriate compass stations.

b. Ensure that the chronometers are wound daily, that comparisons are made to determine their rates and error, and that the ship's clocks are set properly, in accordance with the standard zone time of the locality or in accordance with the orders of the senior officer present.

## Chapter 7 — ASSISTING THE NAVIGATOR

c. Make certain that the electronic navigational equipment assigned to him is kept in proper adjustment and, if appropriate, that calibration curves or tables are maintained and checked at prescribed intervals.

3. Ensure the proper care and operation of the steering gear in general, except the steering engine and steering motors.

4. Prepare and maintain the deck log. Daily, and more often when necessary, he should inspect the deck log and the quartermaster's notebook, and take such corrective action as required and within his authority to ensure that they are kept properly.

5. Prepare reports and records required in connection with his navigational duties, including those pertaining to the compasses, hydrography, oceanography, and meteorology. He will also make the following reports logistics requirements (LOGREQ), situation (SITREPTS), casualty (CASREPT), casualty correction (CASCOR), and movement (MOVREP) to conform with instructions in NWIP 10-1.

6. Relieve the officer of the deck as authorized or directed by the commanding officer. Navy Regulations further state that the navigator must perform the duties prescribed for him, regardless of whether a pilot is on board.

### DAY'S WORK AT SEA

To be able to assist the navigator effectively, or possibly to act as navigator of a small vessel yourself, it is essential that you know every phase of a navigator's typical day's work at sea. The day's work may be logn and arduous. It usually begins before sunrise and lasts long past sunset. The navigator whose work is well organized follows a set routine that ensures completion of his day's work with maximum effectiveness and a minimum of confusion.

### Morning Stars

As mentioned in chapter 5, the Quartermaster on the evening watch computes the time of sunrise and twilight for the following day and informs the navigator. The navigator has his name placed in the morning call book so that he will be called early enough to allow him to arrive on the bridge well in advance of the time to shoot morning stars.

The morning star sights are taken as early as the condition of twilight permits, to ensure that a sufficient number of observations can be made while the stars still are visible. Observation of at least three stars or planets should be made. Whenever possible, sights of more than three bodies should be taken.

Determination of ship's position is based on the results of the star sights. This position is compared with the ship's dead reckoning (DR) position, which has been carried forward from the last fix. From this comparison, set and drift are determined, and a new DR track is laid out.

At approximately 0730, the navigator gathers the necessary information for filling out the 0800 position report. (See fig. 7-1.) At this time he corrects his DR track for course and speed changes that may have taken place since the morning position was determined. Based on

NAVSHIPS 1111 (Rev. 11-54)			
<b>SHIP'S POSITION</b>			
U. S. S. <u>NORTHAMPTON OCL</u>			
TO: COMMANDING OFFICER			
AT (time of day)	0800		DATE
LATITUDE		LONGITUDE	DETERMINED AT
36-21.1N		44-10.4W	0550
BY (indicate by check in box)			
<input checked="" type="checkbox"/> CELESTIAL	<input checked="" type="checkbox"/> D. R.	<input type="checkbox"/> LORAN	<input type="checkbox"/> RADAR
<input type="checkbox"/> VISUAL			
SET	DRIFT	DISTANCE MADE GOOD SINCE (time) (miles)	
352	1K	2000 136	
DISTANCE TO	MILES	ETA	
RONDEZVOUS	40	1200	
TRUE WCD.	SECTOR	VARIATION	
271°	FWD OYAN 0° AFT OYRO 0.5° E	20° W	
MAGNETIC COMPASS HEADING (check one)			
<input type="checkbox"/> STD	<input checked="" type="checkbox"/> STEERING	<input type="checkbox"/> REMOTE IND	<input type="checkbox"/> OTHER
			289°
DEVIATION	1104 TABLE DEVIATION	DO: (indicate by check in box)	
2E°	2° E	<input type="checkbox"/> ON <input checked="" type="checkbox"/> OFF	
REMARKS			
RESPECTFULLY SUBMITTED: (navigator)			
<u>K. M. Gail</u>			
CC:			
U. S. GOVERNMENT PRINTING OFFICE: (1970-7-41129)			

112.97  
Figure 7-1.—Ship's position report.

this DR position, the navigator makes out the position report and submits it in time to have it reach the commanding officer by 0800.

### Sunlines

Most navigators try to get at least two sunlines during each morning and two each afternoon. When possible, one morning sunline should be taken when the sun's azimuth is  $090^\circ$ , and an afternoon sunline when the sun bears  $270^\circ$ . For this purpose the sun's altitude should not be less than  $15^\circ$ . A line of position from a sun shot taken at either of these times results in the ship's longitude.

When the sun is observed at local apparent noon (LAN)— as explained in chapter 5—the morning sunlines are advanced, by the usual DR methods, the distance traveled by the ship in the interim. If LAN occurs after 1200 local time, the morning sunlines may be advanced along the DR track to 1200 and the LAN sunline retired to 1200. Usually the morning sunlines and the LAN line intersect and form a small triangle. The center of the triangle is considered the fix.

If LAN occurs before noon local time, the 1200 position report is made out using the information obtained in the LAN fix. When LAN does not occur until some time after noon, the 1200 position report must be made, using the information obtained from the morning sunlines, DR position, electronic navigational aids, or any combination of these methods.

Ordinarily, the afternoon sunlines are not used to determine a fix unless no evening stars nor electronic fix can be obtained. These sunlines serve principally as a check on the DR position. Depending on the ship's course, the sunlines may reveal whether the ship is to the right or left of her proposed track, or whether she is ahead of or behind her DR position.

### Azimuths

Navy Regulations, as mentioned previously, require the navigator to determine daily the gyrocompass error and report the results to the commanding officer. Normally the error is determined by taking a morning or afternoon azimuth of the sun. Azimuths may be taken at any time, provided the sun is visible and its altitude is not too high; the best time, however,

is early morning or late afternoon. When the sun is near the observer's meridian, its apparent motion (speed of change in bearing) is faster than at other times, and azimuths observed are likely to be less accurate. Errors determined by azimuths are applied to the gyrocompass readings when determining the course to be steered, taking bearings, or comparing magnetic compass with gyrocompass readings. A gyro error is reported to the commanding officer as a part of the 0800, 1200, and 2000 position reports.

### Evening Stars

Times of sunset and evening twilight usually are computed at the time of the last afternoon sunline. The approximate azimuths and altitudes of the stars expected to be observed during twilight are listed in the navigator's sight book; and the navigator and his assistant make plans to arrive on the bridge before the appearance of the first stars.

Evening stars are observed and plotted, and the position determined, using much the same procedure as for taking morning sights. The 2000 position report is based on the fix obtained. Occasionally, especially when on daylight saving time, evening stars cannot be observed and plotted until after time for submission of the 2000 position report. In that event, the commanding officer may require that a verbal report of the ship's position (from the DR or electronic means) be made at 2000 and that a position report based on the evening star sights be submitted as soon as it is prepared.

Before he secures for the night, the navigator leaves instructions with the QM of the watch and/or the OOD concerning aids to navigation expected to be sighted, changes of course or speed, and electronic fixes to be taken. He then ensures that proper preparations are made for observing the next morning's stars, and has a call recorded for himself in the morning call book.

### Additional Duties Underway

During the course of a day, the navigator has many additional duties not mentioned in the preceding topics. These duties are not accomplished at any specific time and do not necessarily follow any set routine. Circumstances usually dictate whether and when the duties are performed. Following is a partial listing.

1. Dead reckoning is carried forward continuously from the last fix until another fix is obtained.

2. Fixes by electronic navigational aids are obtained at frequent intervals.

3. Weather reports are submitted in accordance with the ship's operation order.

4. Instruments used in navigation, including depth-finding equipment, are tested daily.

5. During maneuvers on large ships, the navigator remains on the bridge, advising the conning officer regarding courses and speeds necessary to complete particular evolutions, and keeping the ship's navigational position available at all times.

6. Before entering a harbor or anchorage, determination is made of the state of the tide, state of current, depth of water, and type of bottom to be expected. The OOD and QM of the watch are informed of visual aids to navigation expected to be sighted so that they may watch for and recognize them.

7. When the ship enters a new time zone, the navigator directs that the ship's clocks be reset.

8. The deck log is checked daily and signed by the navigator. He ascertains that entries are complete and in proper form.

#### Quartermaster's Responsibility

From the foregoing topics you can see that the navigator's day can be rather full. Timely completion of many phases of his work depends on the help of an efficient assistant. As leading Quartermaster, you will be expected to provide this needed assistance. Obviously, all of the duties of the navigator's assistant cannot be listed, but a few of the more important ones are discussed in the ensuing paragraphs.

● **Ship operations:** Review current local OP orders, OP plans, and SOPA instructions, especially the sections concerning underway operations, for example, emergency sortie situations and search and rescue operations (SAR). See chapter 6 of The Operations Officer, NavPers 10777-A (C).

● **Assisting at observations:** Before taking a star sight, sunline, or azimuth, the navigator's assistant must assemble the necessary apparatus. (The proper equipment for this purpose includes sextant, azimuth circle, comparing watch, almanac, and sight reduction tables.) He must also take and record the time for observation. Usually he extracts information

from the almanac and the tables during computations.

On occasions when the navigator is not available to make observations himself, the assistant must make them. He is aided by one of the other Quartermasters who records time and renders other necessary assistance. For this reason, you should have your men well trained in celestial navigation.

● **DR position:** The navigator's assistant frequently is assigned responsibility for keeping the ship's dead reckoning position up to date, particularly during maneuvers when numerous changes of course and speed are made. Keeping the DR position current is simplified if the person drawing the track is knowledgeable concerning chart scales and the relationships between the chart scale and the latitude or distance scale printed on the chart. Proficiency in the use of parallel rules, drafting machines, dividers, and nautical slide rules or nomograms also helps to make this task more accurate and less difficult.

● **Electronic navigation:** When electronic navigational aids are available, the navigator may require his assistant to fix the ship's position electronically at intervals during the day. Such fixes may be used to verify the DR position, as a check against gross error in celestial fix, or to establish the ship's position when out of sight of land and no celestial observations can be made.

● **Supervision and training:** Probably the most important jobs of the assistant navigator are to supervise and train other personnel of the navigation department. Supervision is a necessary part of leadership. The work of your men should be supervised to the extent required to ensure accuracy and efficiency.

Classes and drills should be held daily when possible. Training in any phase of departmental responsibility will, of course, contribute to the overall efficiency of the department. Particular emphasis should be given to—

Keeping the quartermaster's notebook and the deck log.

Solving basic maneuvering board problems.

Rendering honors and ceremonies.

Rules of the road.

Keeping time during observations and care of timepieces.

- Observation of weather and weather reports.
- Use of electronic aids to navigation.
- Use and care of charts, tables, publications, and classified matter.
- Winding and checking chronometers.

### EXTENDED CRUISE

During your tenure as senior Quartermaster, you probably will participate in cruises that will take your ship out of home port for extended periods. Such cruises differ from routine daily operations and short cruises principally in the lack of availability of supplies, repair facilities, and replacement equipment. For these reasons, planning and preparation for such a cruise should be thorough.

### PLANNING A CRUISE

During peacetime, ships usually operate on long-range employment schedules (promulgated by fleet commanders), which tell, broadly, a ship's operating schedule for a year. Each ship also has a quarterly employment schedule which gives more specific details concerning the ship's operations for each fiscal quarter. As soon as the quarterly operating schedule is received aboard, plans and preparations may be started for any extended cruise listed therein. If the operating schedule has a security classification for which you do not have clearance, or if for some other reason the schedule is not available to you, the navigator will give you any information from it that is necessary for completion of your job. Occasionally, ships make extended cruises on shorter notice than is provided by the quarterly operating schedule. If this situation arises, you must—insofar as possible—follow the same planning procedures as when advance notice is received.

No set order of making advance preparations can be prescribed except that, logically, the tasks that will take longest to complete—such as ordering and receiving supplies—should be started first. Only those items that cannot be accomplished in advance should be left to the last minute.

Expected ports of call and operating areas should be determined early in your planning. You should ensure that the latest editions of charts for these areas are aboard and corrected up to date. Likewise, Notice to Mariners, classified NNM, sailing

directions, light lists, and radio aids for these areas should be checked and corrected. If any of the general sailing charts (including position plotting sheets), approach charts, or harbor charts are not aboard, they should be ordered from the Oceanographic Distribution Centers immediately. If plans call for the ship to operate in one area for an extended period, several charts of that area should be ordered. When sufficient space is available, charts pertaining to the waters the ship will enter should be stored in a special drawer left empty for that purpose.

You should study the sailing directions for the localities your ship will visit to see whether any special equipment, not normally aboard your ship, is required. Before sailing, you must ensure that you have aboard all necessary books, tables, and forms, and even such minor items as pencils, erasers, and scratch paper.

### Ensuring That Equipment Is Operable

In addition to having on hand the necessary supplies for a cruise, it is necessary that the navigational equipment be in its best operating condition. This equipment includes timepieces, depth sounder, azimuth circles, binoculars, drafting machine, stadimeter, sextant, bearing circle, and telescopic alidades.

Actual repairs on the equipment in the foregoing listing are made (usually) at a repair activity or by qualified technicians aboard ship. For instance, chronometers should be turned in to a chronometer pool if their overhaul due dates will be approached during the cruise; Sonar Technicians usually make necessary repairs to the depth sounder, and azimuth circles and binoculars should be sent to a tender or repair ship for repairs. Simple adjustments to appropriate equipment, however, can and should be made by operating personnel. Some of these adjustments are discussed in the following paragraphs.

- **Drafting machine:** Normally the only adjustment that operating personnel should make to a drafting machine is to tighten the endless belt of the parallel motion mechanism. This belt must be kept taut if rigidity of the ruler is to be preserved. To tighten the belt, it is necessary only to turn the adjusting nut between the loose belt. For this purpose, an open end wrench is provided with each drafting machine.

- **Sextant (fig. 7-2):** Sextants should be adjusted only when necessary, because frequent manip-

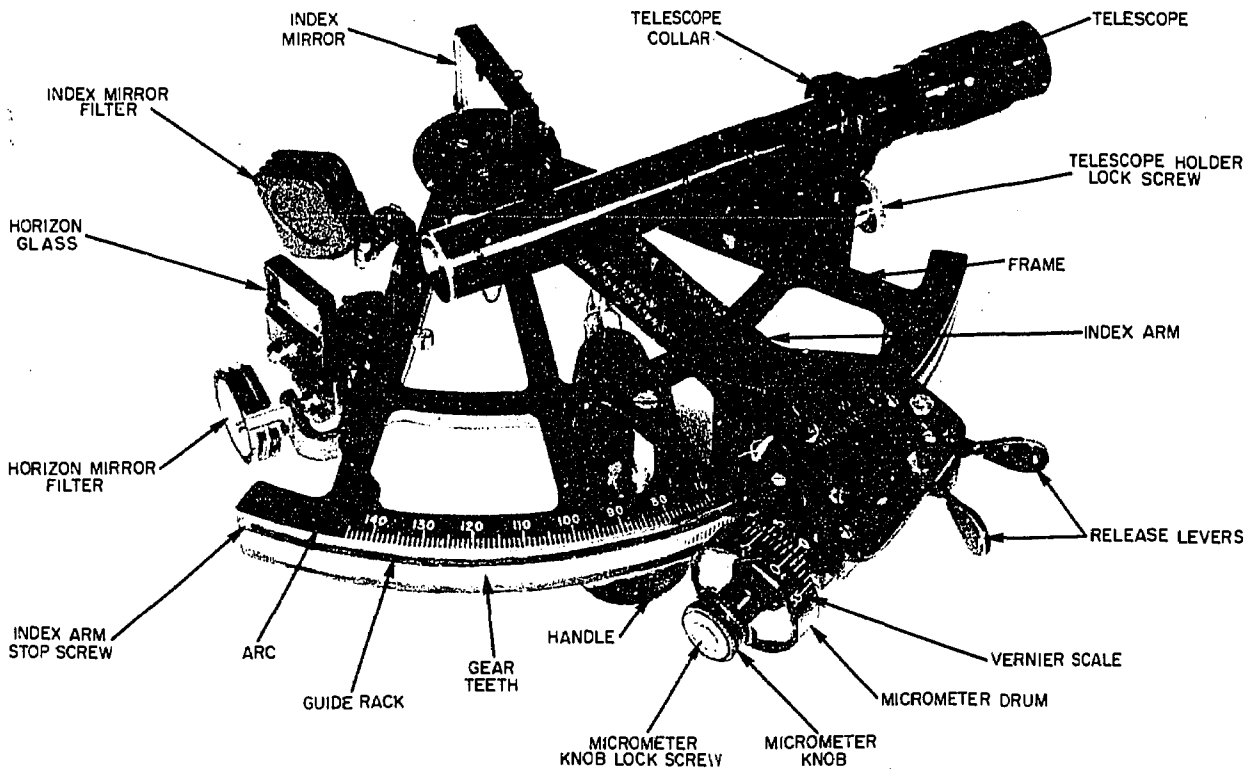

Figure 7-2. Endless tangent screw sextant. 29.268

ulation of the adjusting screws may cause excessive wear. Sextants should be checked before every cruise, but it should be adjusted only when errors are excessive. When making adjustments, never tighten one adjusting screw without first loosening the other screw that bears on the same surface. Sextant adjustments that the user can make are listed here in the order in which they should be made.

1. Perpendicularity of the index mirror: To test for perpendicularity, place the index arm at about  $35^\circ$  on the arc, and hold the sextant on its side, with the index mirror up and toward the eye. Observe the direct and reflected views of the sextant arc. If the two views do not appear to be joined as a straight line, the index mirror is not perpendicular. (See fig. 7-3.) If the reflected image is above the direct view, the mirror is inclined forward. If the reflected image is below the direct view, the mirror is inclined backward. Misalignment is corrected by loosening one of the two adjusting screws at the back of the mirror and tightening the other.

2. Perpendicularity of the horizon glass: To test for this type of perpendicularity, set the index arm at zero and direct the line of sight at a star. Rotate the tangent screw back and forth so that the reflected image passes alternately above and below the direct view. If, when changing from one position to the other, the reflected image passes directly over the star as seen without reflection, the horizon glass is perpendicular. If the reflected image passes to one side or the other, the glass is not perpendicular and side error is said to exist. For this test, the sextant need not read zero when the star and its reflected image are in coincidence. Side error is corrected by adjusting the two screws (fig. 7-4) near the base of the horizon glass.

3. Parallelism of horizon glass and index mirror: The horizon glass and index mirror should be parallel when the index arm is set exactly at zero. To test for parallelism, set the instrument at zero and direct the line of sight at the horizon. Because the side error has been



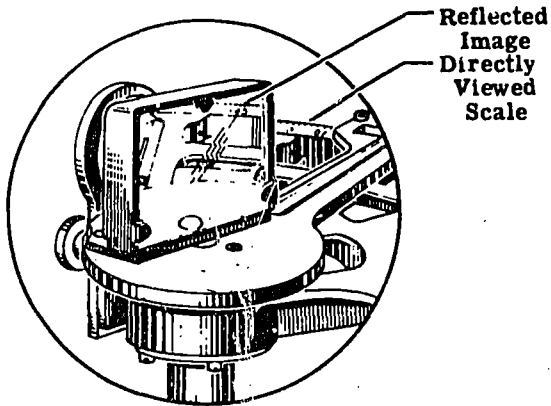

A. Index Mirror leaning forward  
(Reflected image high)

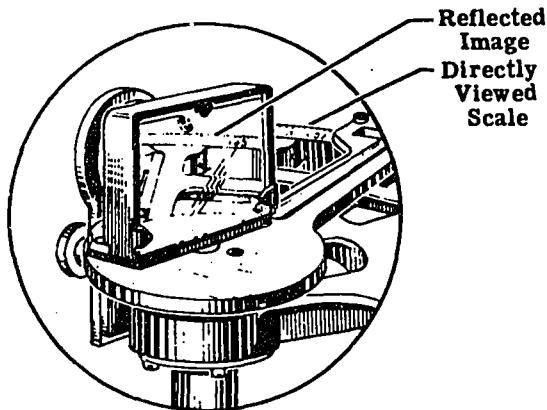

B. Index Mirror leaning backward  
(Reflected image low)

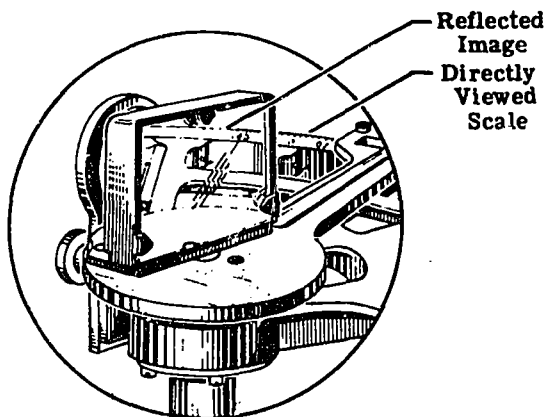

C. Index Mirror perpendicular to  
the plane of the Sextant Frame  
(Reflected image level with  
directly viewed scale)

137.359

Figure 7-3.—Perpendicularity of the index mirror.

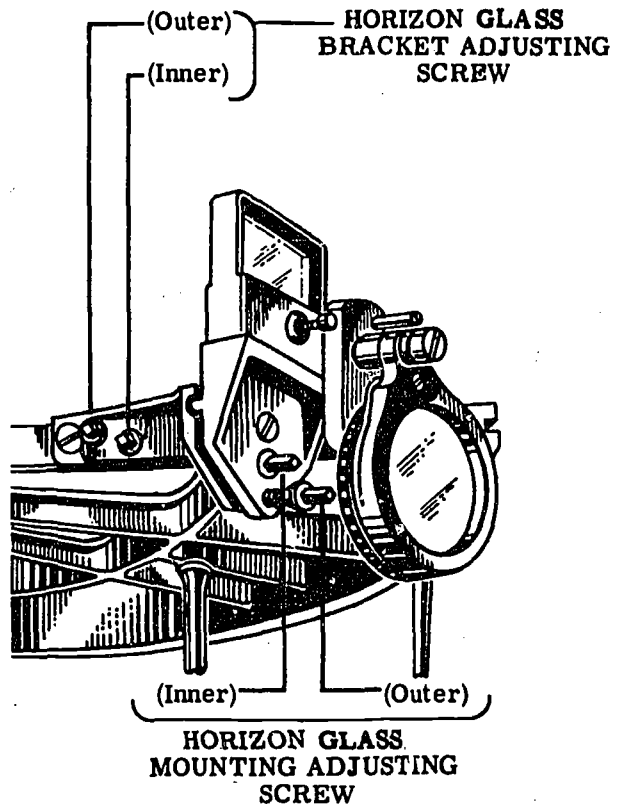

137.361

Figure 7-4.—Horizon glass mounting and adjusting screws.

eliminated, the direct view and reflected image of the horizon should appear as a straight line. If they appear as a broken line—one edge higher than the other—the mirrors are not parallel. This error need not be removed, however, particularly if it is small and constant. When not removed, it becomes the principal component of index error. (Index error, as you know, is the difference between the true angle formed by a line intersecting three points and the same angle as measured by a particular sextant.) The index error (with sign reversed) becomes the index correction (IC) and must be applied to all sextant readings.

If it is decided that the horizon glass and the index mirror should be made parallel, this correction is accomplished by adjusting two screws near the base of the horizon glass. Because both the second and third corrections entail adjustments to the horizon glass, it is good practice to recheck for side error after

index error has been removed. Index error should always be checked after adjustment for side error.

4. **Parallelism of the telescope:** The line of sight through the telescope must be parallel to the plane of the sextant, otherwise an error of collimation exists. This error results in altitudes being measured at greater than their actual values. Parallelism of the telescope is checked by inserting the telescope in its collar and observing two stars that are  $90^\circ$  or more apart. The reflected image of one star should be brought into coincidence with the direct view of the other, near the right or left edge of the field of view. (If the sextant is horizontal, the upper or lower edge should be used.) The sextant should then be tilted so that the stars appear near the opposite edge. If the stars remain in coincidence, the telescope is parallel to the frame; but if they separate, it is not. Adjustment for nonparallelism is made to the collar by means of the two screws at the rear of the collar provided for this purpose.

● **Stadimeters (fig. 7-5):** The type II Fiske stadimeter is the one used most extensively by the Navy, and only adjustments to that type are discussed in this text. As you will see, adjustment to the stadimeter are similar to adjustments to the sextant. An adjusting screw wrench to be used when making adjustments is

included in the carrying case of each instrument. Three adjustments may be made by the user as follows:

1. **Perpendicular adjustment of the horizon mirror:** The top edge of the silver on the horizon mirror and the center of the small peephole in the telescope holder have the same height above the frame of the stadimeter. Thus, if the mirror is perpendicular to the plane of the instrument, you can see the reflection of half of the peephole in the silvered portion of the mirror. (See fig. 7-6.) If you cannot see half of the peephole in the mirror, turn the vertical adjusting screw in the direction necessary to enable you to see it. If you cannot see both the peephole and the telescope holder in the horizon mirror, the mirror may be at an incorrect angle. Adjust it by turning the radial adjusting screws located on top of the frame above the horizon mirror.

2. **Perpendicular adjustment of the index mirror:** If the index mirror of a stadimeter is not perpendicular to the frame, the directly viewed object and its reflected image will not be aligned. To check for perpendicularity, hold the stadimeter with its frame vertical and look through the telescope holder at a small vertical object, such as a mast or flagpole, to determine whether the directly viewed object and the

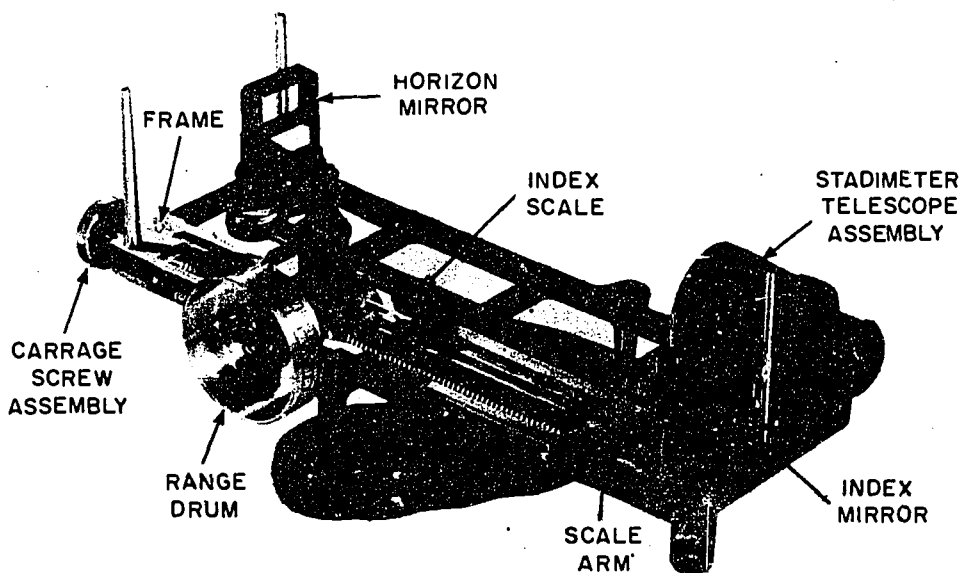
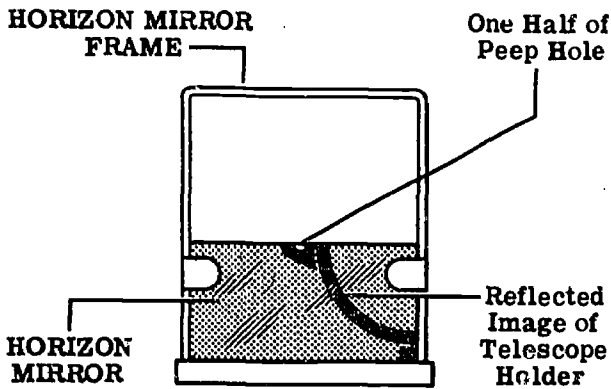

Figure 7-5. Type II Fiske stadimeter.



137. 417

Figure 7-6. —Perpendicular adjustment of the horizon mirror.

reflected image coincide. (See fig. 7-7.) If they do not coincide, use an adjusting screw wrench to turn the index mirror adjustable base, as necessary, to make them coincide. Wobble the stadimeter while holding it in a vertical plane and check to determine whether the directly viewed object appears to wiggle. If it does, the mirror is not adjusted properly. If adjustment of the mirror does not remove the wiggle, repeat the procedure for perpendicular adjustment.

3. Parallel adjustment of mirrors: With the range drum set at infinity, make the horizon and index mirrors perpendicular to the frame and parallel to each other in the following manner:

a. With the stadimeter held vertically, look through the telescope holder at a distant horizontal object. If the directly viewed and reflected image of the object are not continuous (as in the left view of fig. 7-8), loosen one of the horizon mirror radial adjusting screws and tighten the other screw enough to make the horizontal line appear continuous.

b. Rock the instrument along the horizon to check the alignment of the object and its reflected image. If the line appears to wiggle, the mirrors are not exactly parallel.

c. As an overall check on the adjustment of the mirrors, hold the stadimeter diagonally at a 45° angle and wobble the stadimeter as you sight the horizon. If there is a wiggle, the mirrors are not vertical to the frame or parallel to each other. Readjust according to previously outlined steps.

#### LAYING OUT THE TRACK

Several days before the start of an extended cruise, the navigator and his assistant should lay out the ship's proposed track and submit it for approval to the commanding officer. The proposed track that

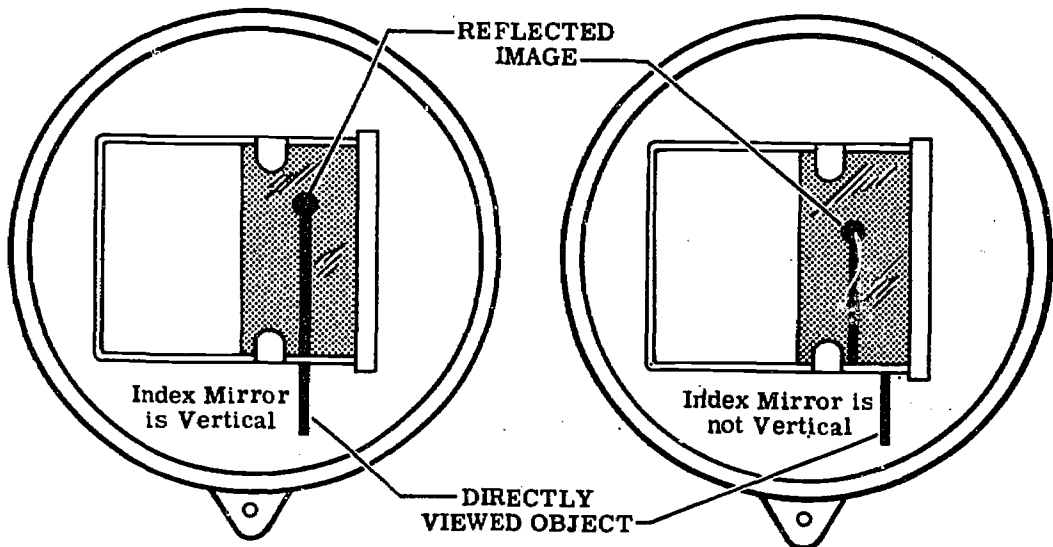

Figure 7-7.—Directly viewed object and reflected image in perpendicular alignment (coincidence).

137.419

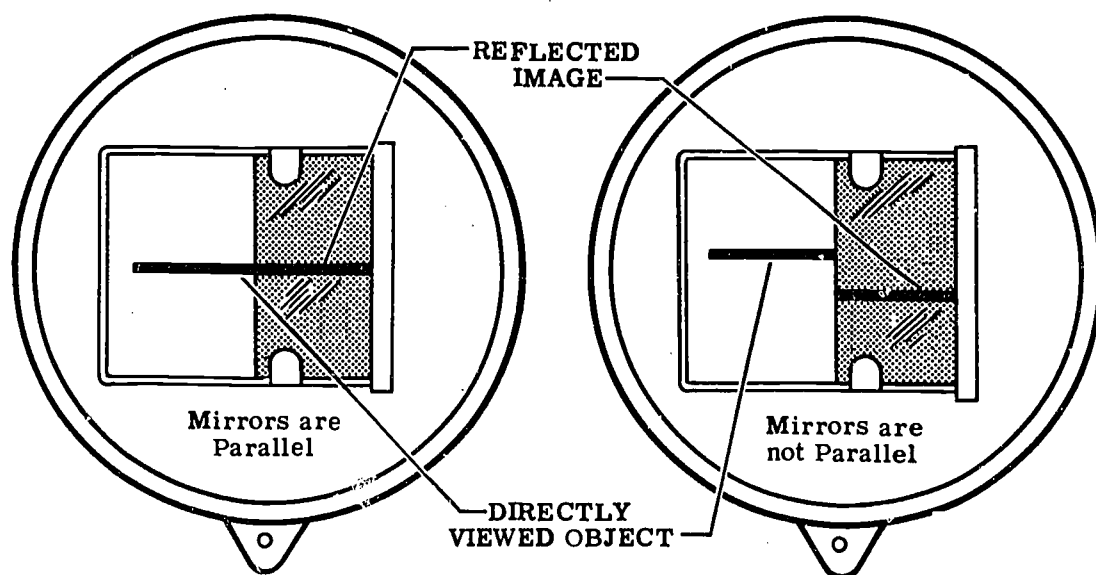

Figure 7-8. Parallel adjustment of the horizon and index mirrors.

137. 420

is submitted for approval should be laid out on a corrected chart and should include notations regarding all danger points.

The entire track should first be laid out on a small-scale chart so that the entire cruise can be visualized. Points along the track (especially near the approaches to land) should be measured and transferred to charts of successively larger scales. This method is an aid in ensuring that (1) all the necessary charts for the cruise are aboard; (2) aids to navigation and navigational dangers not shown on the smaller scale charts will be discovered; and (3) charts of the largest scale will be used in and around ports or harbors.

Courses (and speeds, if known) should be indicated along each leg of the track. Points of departure and proposed turning points should be marked on appropriate charts. When possible, these points should be based on a range and bearing of a point of land. After approval of the proposed track, the charts should be arranged in the order in which they will be used and should be stowed so as to be readily accessible.

### MAINTENANCE AND MATERIAL MANAGEMENT

As leading petty officer/assistant navigator, you will be either fully or partially in charge of operation and maintenance of equipment used in the navigation department. This section of the chapter discusses various reports and records required in connection with that responsibility.

### CUSTODY OF EQUIPAGE

The question of custody may prove baffling sometimes, but you must have a working knowledge of the various procedures concerned with custody if you are to carry out effectively your responsibilities as leading Quartermaster.

As used in the Navy, custody relates to the physical possession of material and the assumption of responsibility for its use and care. Custody may be either actual or theoretical. To illustrate, the department head having theoretical custody is liable for such supply functions as procurement (from or through the supply officer), issue, and accounting for the material within his department. The department having actual custody or physical possession is responsible for the care and stowage of the material. It is with this latter duty that you are mainly concerned.

Many ships have a custody card for every item of equipage shown in the allowance list for the navigation department, whether it actually is aboard or not.

The supply officer keeps a list of all equipage on board. When there is a change in department heads, the oncoming officer signs the custody cards and acknowledges receipt from the officer relieved. Division officers sign subcustody receipts for division equipage, and then usually hold petty officers accountable in the same manner for items they receive. The person signing a custody receipt for any article must realize that he is personally responsible for that article, regardless of who has it in his im-

mediate possession. Always bear in mind that loss of any article of equipage must be reported at once to your division officer.

### SURVEY OF EQUIPAGE

A survey is the determination of the disposition and expenditure from the stock records and accounts of naval material that has deteriorated, been lost, damaged, stolen, or otherwise rendered unavailable for its intended use, under circumstances requiring administrative examination into the causes of the loss.

Surveys may be either formal or informal. If disciplinary action is not called for in the circumstances—such as losses caused by weather, unavoidable breakage, wear, or other circumstances beyond control—or if the case presents no complications, it is customary for the commanding officer to order the department head to perform an informal survey. If it appears that loss was due to neglect, carelessness, or other culpability, however, the commanding officer orders a formal survey, conducted by one officer or a three-member board headed by a commissioned officer. This officer or board attempts to fix responsibility for the loss. Disciplinary action, if warranted, may be taken against the responsible party or parties.

Despite the circumstances, the end result of a survey is to provide a method for removing unusable or lost material from records so that new material, not in excess of allowance, may be ordered.

### SHIPBOARD MAINTENANCE

Maintenance of ships is divided into two broad categories: preventive maintenance and corrective maintenance. Preventive maintenance consists of routine shipboard procedures designed to increase the effective life of equipment or forewarn of impending troubles. Corrective maintenance includes procedures for analyzing and correcting material defects and troubles. The main objective of shipboard preventive maintenance is prevention of breakdown, deterioration, and malfunction of equipment. If this objective is not reached, however, the alternative objective of repairing or replacing failed equipment—corrective maintenance—must be accomplished.

Formerly, shipboard preventive maintenance ms have varied from one command to

another, resulting in various degrees of operational readiness. As you know, a uniform system is now used for scheduling, recording, reporting, and managing ship maintenance. This system, called the Standard Navy Maintenance and Material Management (3-M) System, is intended to upgrade the operational readiness of ships.

Complete instructions on the 3-M system are contained in the Maintenance and Material Management Manual (OpNav 43P2). Additional information on the 3-M system can be found in *Military Requirements for PO 3&2*, and *Military Requirements for PO 1&C*. Careful study of those three publications will reveal that some ratings (such as Quartermaster) are much less involved in the system than are others (e.g. Electronics Technicians). You must, however, be familiar with those portions of the system for which you are responsible.

### Planned Maintenance Subsystem Operation

Planning and scheduling of preventive maintenance are accomplished through the Planned Maintenance Subsystem (PMS). Additionally, the PMS defines the minimum preventive maintenance required, controls its performance, describes methods and supplies to be used, and aids in prevention and detection of impending casualties. These factors should prove to be a definite asset to you in forecasting future material requirements and in properly utilizing available manpower.

The planned maintenance subsystem is designed to provide the means by which each ship, each department, and each supervisor is enabled to plan, schedule, and effectively control shipboard maintenance. In establishing minimum planned maintenance requirements for each equipment, the *NavShips Technical Manual*, manufacturer's technical manuals, and applicable drawings are critically examined. If preventive maintenance requirements are found to be unrealistic or unclear, they are modified or revised before being incorporated into the PMS.

It is possible that planned maintenance prescribed in the PMS may conflict with that laid down in other documents such as the *NavShips Technical Manual*. In such an event, the PMS supersedes and takes precedence over any document that may be in conflict with it. All tests, inspections, and planned maintenance actions should ultimately be incorporated into the PMS.

### Planned Maintenance System Manual

Each ship should have its own planned maintenance system manual. When complete, the

INSTRUCTIONS ON BACK OF GREEN PAGE		
FROM: DDO 46	SERIAL #	
TO: NAVY MAINTENANCE MANAGEMENT FIELD OFFICE	DATE: 10 Oct 67	
VIA: COMCRUDESANT		
SUBJECT: PLANNED MAINTENANCE SYSTEM FEEDBACK REPORT		
SYSTEM Communications and Control	COMPONENT 12" incandescent signal searchlight	
SUB SYSTEM Navigation equipment	M R NUMBER C-9 M-1	
DISCREPANCY:	CONTROL NO 65 B029 M	
<input checked="" type="checkbox"/> M. R. Description	<input type="checkbox"/> Equipment Change	<input type="checkbox"/> Typographical
<input type="checkbox"/> Safety Precautions	<input type="checkbox"/> Missing Maintenance Index Page (MIP)	<input type="checkbox"/> Technical Publications
<input type="checkbox"/> Tools, Etc.	<input type="checkbox"/> Technical	<input type="checkbox"/> Miscellaneous
<input type="checkbox"/> Missing Maintenance Requirement Card (MRC)	<input checked="" type="checkbox"/> Procedure	
Recommend change M.R. description to read:		
"2. Lubricate trunnion bearings, stanchion socket, vane hinges and links."		
and amplify item 2 of procedure block accordingly.		
Reason: Socket, hinges, and links should be lubricated periodically, depending on use. There is no current provision for this action.		
 SIGNATURE		
DONAV FORM 4700-7 (Rev. 8-64)		1

40.101

Figure 7-9.—PMS feedback report.

manual should contain a separate section for each department of the ship. This manual is used by the department head and maintenance group supervisors (leading petty officers) to plan and schedule maintenance for each group. Each department's section of the manual contains a list of effective pages and a section for each division or maintenance group within the department. Each divisional section of the manual contains index pages for each system, subsystem, or component that requires a planned

maintenance action. These pages are referred to as maintenance index pages (MIPs). Each MIP gives a brief description of maintenance requirements and the frequency with which maintenance is to be effected. The frequency code is as follows: D-daily, W-weekly, M-monthly, Q-quarterly, S-semiannually, A-annually, C-once each overhaul cycle, and R-situation requirement (e.g., 100 hours of operation).

An index page also includes the rate(s) recommended to perform a task, as well as average time required. Manpower available for performing maintenance varies from one ship to another. For this reason, information found on MIPs regarding rates recommended to perform a maintenance task and the average time taken for the task must have certain clarification. Maintenance tasks are actually performed by personnel available and capable, regardless of the rating listed on the MIP. The average time required, as listed on the MIP, does not take into consideration the time needed to assemble tools and material to accomplish the maintenance action nor the time necessary for cleaning the area and putting away tools at the end of the task.

That portion of the PMS manual containing maintenance index pages applicable to equipment, under a specific division or maintenance group is called the group maintenance manual. A copy of the group maintenance manual is kept as a ready reference in each working space affected. This copy is in addition to the one in the departmental PMS manual.

### Feedback Report

Through the use of a feedback report (fig. 7-9), the planned maintenance subsystem enables correction of discrepancies in the system. A feedback report should be originated immediately by the person who discovers a discrepancy, if one is found in the system as installed aboard ship.

A feedback report is useful only if all information concerning the discrepancy is correct and complete, including the reason for any recommended change. Before forwarding a feedback report to the appropriate systems command maintenance management field office, it should be checked for completeness and accuracy by the division leading petty officer.

## CHAPTER 8

# RULES OF THE ROAD

Your study of the *Quartermaster 3 & 2* training manual acquainted you with the International Regulations for Prevention of Collision at Sea (commonly called the International Rules of the Road) and the Inland Rules of the Road. As a senior Quartermaster, you should be cognizant of the regulations called pilot rules.

### INTERNATIONAL, INLAND, AND PILOT RULES

The general rule for establishing the boundary between international and inland waters is found in Rules of the Road, International—Inland (CG-169). Briefly, the rule says that at buoyed entrances to rivers, bays, harbors, etc., an imaginary line may be drawn through the outermost buoy or other aid to navigation, approximately parallel to the shore. Waters inshore of this imaginary line are inland; waters outside the line are international.

Waterborne craft in international waters must obey the International Rules of the Road, and those in inland waters must adhere to Inland Rules of the Road and Pilot Rules. Inland Rules of the Road apply to all United States inland waters except those covered by Rules of the Road—Western Rivers (CG-184) and Rules of the Road—Great Lakes (CG-172). Both CG-184 and CG-172 contain Pilot Rules for the Western Rivers and the Great Lakes and their connecting and tributary waters, respectively.

Preliminary proposals to unify the Inland, Great Lakes, and Western Rivers rules of the road have been drafted by the Coast Guard. Once these proposals are adopted, nearly all of the navigable waters of the United States will be governed by a single set of rules, and the necessity for memorizing several different sets e eliminated.

### PILOT RULES

Pilot Rules for Inland Waters are listed and explained in CG-169, a copy of which is required to be kept available on all vessels over 65 feet in length. That pamphlet defines the areas covered by the inland pilot rules as: “. . . inland waters of the United States, except the Great Lakes and their connecting and tributary waters as far east as Montreal, the Red River of the North, the Mississippi River and its tributaries above Huey P. Long Bridge, and that part of the Atchafalaya River above its junction with the Plaquemine-Morgan City alternate waterway.” Obviously, much of the area covered by Pilot Rules is the same as that covered by Inland Rules. The Inland Rules are statutes passed by Congress. The Pilot Rules, however, are regulations established and promulgated by the Commandant, U.S. Coast Guard to supplement the applicable rules. They may not conflict with Inland Rules. Any disagreement between the two sets of rules must be resolved in favor of the Inland Rules.

### DEFINITIONS

Many of the terms used in the Pilot Rules are the same as those used in International and Inland Rules. They are repeated here for clarity and emphasis.

**Vessel:** Every description of watercraft used or capable of being used as a means of transportation on the water.

**Steam vessel:** Any vessel propelled by machinery. A vessel propelled by machinery, even though she may also be under sail, is considered a steam vessel.

**Underway:** A vessel is underway anytime she is not at anchor, or made fast to the shore, or aground.

**Visible (in correction with lights):** Capable of being seen on a dark night with a clear atmosphere.

**Whistle:** An appliance capable of producing tones whose length can be controlled. (For a steam vessel, a whistle or siren may be used. For a sailing

vessel or a vessel being towed, a foghorn may be used.) In any event, the noisemaking apparatus used must be capable of producing blasts of the lengths required by the rules.

**Short blast:** A blast on the noisemaking apparatus of about 1-second duration.

**Prolonged blast:** A blast on the noisemaking apparatus of from 4- to 6-seconds' duration.

**Long blast:** Not actually defined but generally considered to be a blast of from 8 to 12 seconds' duration.

**Risk of collision:** The converging of vessels at such an angle that if one or both do not change course and/or speed, collision will result.

### WHISTLE SIGNALS

Unauthorized sounding of whistles is prohibited within any harbor limits of the United States. Additionally, some ports have rules requiring ships to obtain permission from SOPA before testing the whistle.

The meanings of whistle signals under the Inland Pilot Rules are as follows:

- One short blast signifies intention to direct the ship's course to her own starboard, except when two steam vessels are approaching each other at right angles or obliquely, in which event one short blast means that the ship having the other to port intends to hold her course and speed.
- Two short blasts of the whistle indicate a ship's intention to direct her course to port.
- Three short blasts of the whistle mean that the ship's engines are going full speed astern.

### Cross Signals

Cross signal means answering one blast from a ship's whistle with two blasts, or answering two blasts with one. Cross signals are specifically forbidden by the Pilot Rules. Whenever a ship realizes that cross signals have been exchanged between herself and another vessel, or if for any reason one approaching ship fails to understand the intentions of the other, the ship in doubt must immediately sound the danger signal consisting of at least four short and rapid blasts on her whistle.

The whistle signals for crossing, passing, meeting, or overtaking must be used only when steam vessels are in sight and will approach within 1/2 mile of each other. "In sight" means that the vessel, her

daytime by sight of the vessel herself, or at night by sight of the vessel's running lights. In fog, mist, falling snow, or heavy rainstorms, when vessels cannot see each other, only fog signals may be sounded.

### MEETING HEAD AND HEAD

Vessels are said to be meeting head and head, or end on, when they are on converging courses so as to involve risk of collision. The vessels must be so nearly head and head that (in daylight) each can see the masts of the other in a line with her own, or (at night) each vessel is in such a position as to see both side lights of the other. (See fig. 8-1.) The rule for meeting end on does not apply when one vessel sees another crossing her own course; nor does it apply when (at night) the red or green side light of one vessel is opposed to the red or green side light, respectively, of the other; or where both red and green lights are seen anywhere except dead ahead. (See fig. 8-2.) Obviously, if only the green or red light (but not both) of a vessel can be seen, the vessels are not meeting end on; and if both red and green side lights are seen any place except dead ahead, it is not a head and head situation.

When vessels are actually meeting head on, either must sound one short blast on her whistle, which the other vessel must answer with one short blast. After the exchange of these whistle signals, each ship adjusts her course so as to pass port to port.

When vessels on opposing courses are so far to starboard of each other that it cannot be considered a head and head situation, one of the vessels must immediately sound two short and distinct blasts on her whistle, and the other must answer with two blasts. The vessels may then pass starboard to starboard.

### BENDS, CURVES, AND LEAVING BERTHS

Whenever a steam vessel approaches a short bend or curve in a channel and, because of the height of the banks or some other reason, she



17.29  
Figure 8-1.—Vessels meeting head and head.



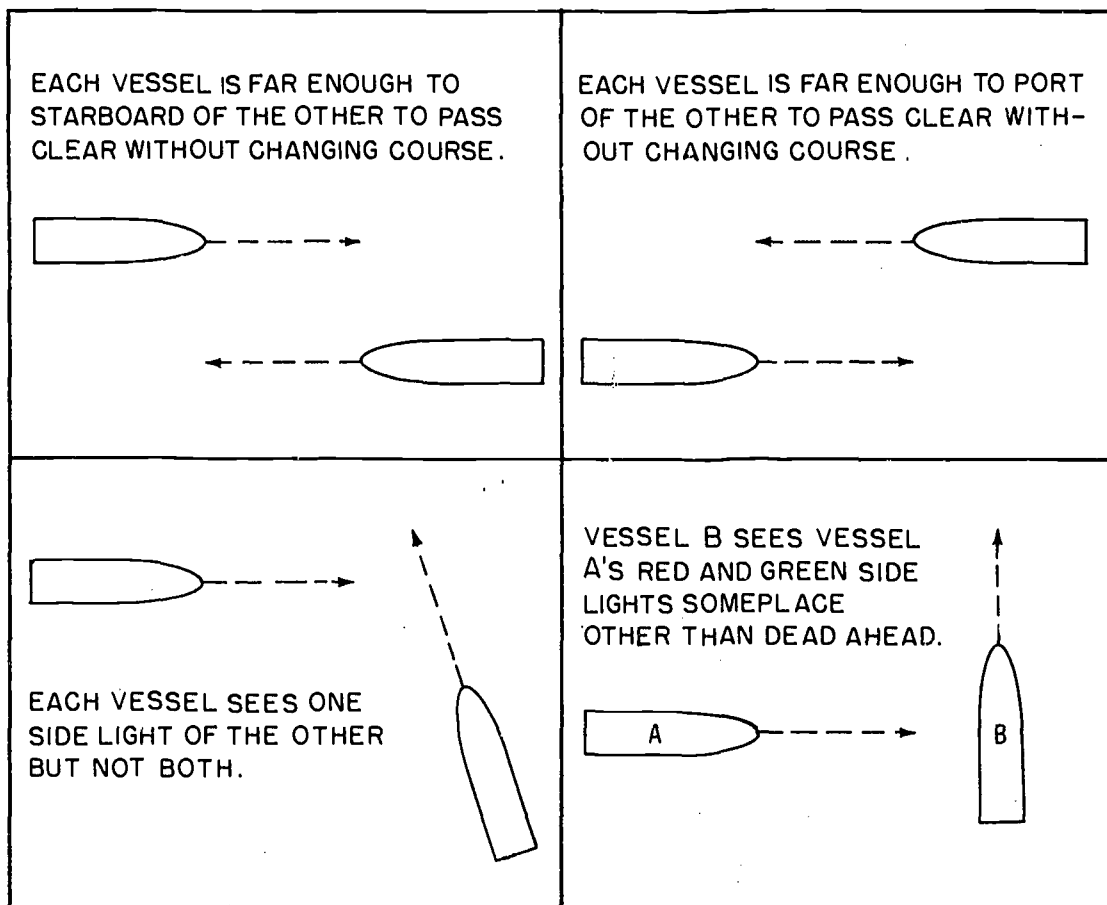

17.30 (112A)

Figure 8-2.—Vessels passing in other than head and head situation.

cannot see a vessel approaching from the opposite direction for a distance of at least 1/2 mile, she must—when she is within 1/2 mile of the bend or curve—sound one long blast on her whistle. Any vessel approaching the bend or curve from the opposite direction must answer such signal with a similar blast. When these signals have been exchanged, the usual signals for meeting and passing should immediately be sounded and answered. If the original long blast is not answered, the ship that originated the signal is to consider the channel clear and govern herself accordingly.

Ships being moved from their docks or berths—when other shipping is liable to pass close aboard—must sound one long blast on the whistle in the same manner as a ship nearing a bend or curve.

Pilot Rules do not strictly define a "long blast," but by tradition and usage it has come to mean a blast of from 8 to 12 seconds' duration.

### RIGHT-OF-WAY

The right-of-way of ships in inland or international waters is discussed in the *Quartermaster 3 & 2* training manual. Right-of-way, privileged vessel, burdened vessel, and in extremis are all terms used in connection with risk of collision. Under Inland and International Rules, right-of-way refers to the legal precedence which allows one ship (privileged) to pass ahead of, or cross in front of another (burdened) if she can do so without altering either her course or speed. The same meaning holds true for

Pilot Rules. Further explanation of this term is given in ensuing paragraphs.

Right-of-way connotes ships on converging courses, one of which must hold its course and speed until risk of collision is passed or the ships are in extremis. (In extremis actually means "in dire circumstances" or "at the point of death." In the Rules of the Road it is used to mean: at that point where action by the burdened vessel alone will not avert collision.) Several situations involving risk of collision are discussed in this chapter. In each situation, remember that it is the duty of the burdened vessel to keep out of the way of the privileged vessel except when in extremis, at which point each vessel is responsible for avoiding collision with the other. Unless actually in extremis, the privileged vessel must hold her course and speed.

#### Crossing Situation

Whenever two steam vessels are approaching each other at right angles or obliquely, so as to involve risk of collision, the vessel that is to starboard of the other is privileged and must hold her course and speed. The vessel to port, then, is burdened and must maneuver to avoid collision with the privileged vessel. This maneuvering is usually accomplished by altering course to starboard, in order to pass astern of the privileged vessel. When a change of course alone is not sufficient action (or if a course change is impracticable under existing circumstances), the burdened vessel must slacken her speed, stop, or reverse her engines.

#### Overtaking Situation

An overtaking situation exists whenever two steam vessels are proceeding in the same, or nearly the same, direction and the vessel that is astern desires to pass the vessel that is ahead. In this usage, astern means that the overtaking vessel is more than 2 points abaft the beam of the forward vessel. In overtaking situations the overtaking vessel is always burdened and has the onus of keeping clear of the overtaken vessel.

If the overtaking vessel desires to pass the vessel ahead on that vessel's starboard side, she must indicate this desire by sounding one short blast on her whistle. If the vessel ahead answers by sounding one short blast, the overtaking vessel may alter her course and pass to starboard. If the overtaking vessel desires to pass to port, she must indicate this desire by sounding two short blasts on the whistle. If the vessel ahead answers with two short blasts, the overtaking vessel may pass to port. (See fig. 8-3.)

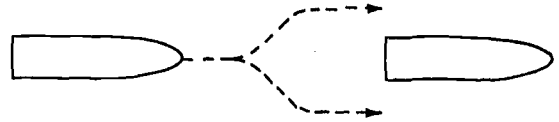

112.98

Figure 8-3.—Steam vessel overtaking from more than 2 points abaft the beam.

Whenever the vessel ahead (privileged) considers it unsafe for the overtaking (burdened) vessel to pass at that point, she immediately indicates that fact by sounding the danger signal. When the danger signal has been sounded, the burdened vessel must make no further attempt to pass the ship ahead until the ship ahead considers it safe to do so, and signifies this fact by sounding one or two blasts on her whistle.

NOTE: Because a vessel cannot always tell with certainty whether she is more than 2 points abaft the beam of another vessel, she should resolve all questionable situations or conditions of doubt by assuming herself to be an overtaking vessel and govern herself accordingly.

#### Steam and Sailing Vessels

The Pilot Rules state quite clearly that when a steam vessel and a sailing vessel approach each other so as to involve risk of collision, the steam vessel is burdened and must keep clear of the sailing vessel. In obeying this rule, however, consideration must be given to article 20 of the Inland Rules of the Road and to part 80.6(b) of the Pilot Rules. Article 20 says, in part: "This rule shall not give to a sailing vessel the right to hamper, in a narrow channel, the safe passage of a steam vessel which can navigate only inside that channel." Part 80.6(b) says, in effect, that any vessel, regardless of its description, overtaking another vessel is burdened and must keep clear of the privileged vessel.

In applying the rules concerning steam and sailing vessels where risk of collision is involved, it must be remembered that sailing vessels always have the right-of-way over steam vessels except (1) when in a narrow channel outside which the steam vessel cannot operate, and (2) when the sailing vessel is overtaking the steam vessel.

#### DEPARTURE FROM RULES

Both the International and Inland Rules of the Road have what is known as a General Pru-

dential Rule. The Inland Pilot Rule covering the same subject is part 80.11—Departure from Rules. The wording of the rules differs, but the meaning in each one is identical. The Pilot Rule concerning departure from the rules is quoted.

"In obeying and construing the rules in this part due regard shall be had to all dangers of navigation and collision, and to any special circumstances which may render a departure from said rules necessary in order to avoid immediate danger."

The effect of the Pilot Rule version is to preclude a privileged vessel's escaping responsibility for standing into an obvious danger when a departure from the letter of the rules would have avoided the danger. Remember, when in extremis both vessels are burdened.

## CONDUCT IN FOG

Like the International and Inland Rules of the Road, the Pilot Rules for Inland Waters have special rules governing the actions of vessels when they are in fog. In the following discussion, the word "fog" is used to mean visibility reduced by fog, mist, falling snow, or heavy rain. The rules pertaining to fog are applicable both during daylight and at night.

### Fog Signals

When a steam vessel is underway in fog, except when she is towing another vessel, or herself being towed, she must sound a prolonged blast on her whistle at intervals not to exceed 1 minute.

When a steam vessel is towing other vessels she must sound one prolonged blast on her whistle, followed in succession by two short blasts. The interval between each series of three blasts must not exceed 1 minute.

When a vessel is being towed, she may sound on her foghorn one prolonged and two short blasts at intervals not to exceed 1 minute. A vessel being towed must not give any other signal.

When a vessel is anchored in a fog she must rapidly ring her bell for about 5 seconds. The interval between bell signals must not exceed 1 minute. Though not a requirement of the rules, U.S. Navy ships frequently ring the bell the number of times that corresponds to the ship's hull number.

### Speed in Fog

The rules require that in a fog, every steam vessel must proceed at a moderate speed, having careful regard for the existing circumstances and condi-

tions. The terms "moderate speed" and "existing circumstances and conditions" are vague, but their meanings must be determined in each case either by the ship's commanding officer or by the conning officer. (Inasmuch as radar cannot always be depended upon to detect small objects in the water, a ship is not relieved of her responsibility for consequences resulting from her reliance on radar information alone. A ship using radar might, in fact, consider "moderate speed" to be slower than a ship not so equipped because the ship having radar might detect objects that would not be visible to a mariner not having radar.) One frequently used criterion is to proceed at a speed that will permit the ship to be stopped in half the distance of visibility. If such a rule were used on all ships, each ship would be able to take her way off in time to avoid collision with other ships whether they were anchored or underway.

Regardless of the speed at which a ship is traveling, she is required by the rules to stop her engines—if permitted by the circumstances to do so—any time she hears the fog signal of another vessel apparently forward of her beam, and the actual location of the vessel originating the signal cannot be ascertained. After stopping her engines, the ship must navigate with caution until danger of collision is over.

## NAVIGATION LIGHTS

In general, the navigation lights for ships underway in pilot waters are the same as the lights required for vessels of similar class under the Inland Rules of the Road. That is: a green light on the starboard side fitted with screens so that it cannot be seen across the bow on the port side nor more than 2 points abaft the beam on the starboard side; a red light on the port side fitted with screens so that it cannot be seen across the bow on the starboard side nor more than 2 points abaft the beam on the port side; and white lights on the centerline of various arcs of visibility.

Before going into specific details concerning the lights to be shown in pilot waters, a few general comments on lights are appropriate.

1. All so-called "navigation lights" must be shown in all weathers between sunset and sunrise.
2. The carrying of any light not required by law, which might be confused with the lights required by the Pilot Rules, is prohibited.
3. Flashing the rays of a searchlight or other blinding light onto the bridge or into the pilothouse of any vessel underway is prohibited. All floodlights

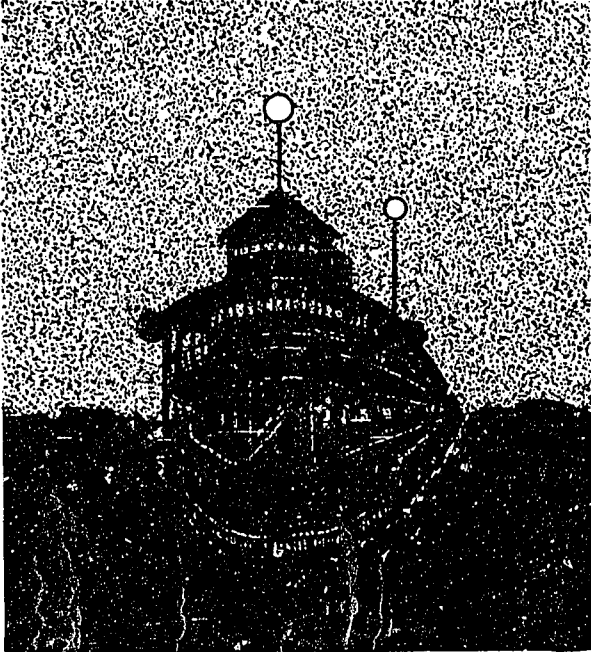

Figure 8-4. Double-end ferry. 112.63

### Ferryboats

Steam-driven ferryboats in pilot waters must carry the same range lights and colored side lights required by law for other vessels. An exception to this rule is double-end ferryboats, which must carry a central range of white lights showing all around the horizon. (See fig. 8-4.) These white lights must be at equal heights above the uppermost deck forward and aft.

### Lights for Nondescript Vessels

The term “nondescript vessels” is used in this topic to include barges, canalboats, scows, carfloats, lighters, and vessels not otherwise provided for. Different arrays of lights as outlined in succeeding paragraphs must be displayed by nondescript craft, depending on the particular pilot waters in which the craft are operating.

- On the harbors, rivers, and other inland waters of the United States, except the Great Lakes and their connecting and tributary waters as far east as Montreal, the Red River of the North, the Mississippi River and its tributaries above the Huey P. Long Bridge, and that part of the Atchafalaya River above its junction with the Plaquemine-Morgan City alternate waterway, nondescript vessels being towed by steam vessels must display the following lights:

1. Barges and canalboats towing astern of a steam vessel, either singly or in tandem, must each carry a green light on the starboard side, a red light on the port side, and a white light on the stern. The white light must be a 12-point light showing from dead astern to 6 points on either side. It must be visible for at least 2 miles. When more than one vessel is being towed, as in figure 8-5, the last vessel of the

or headlights that may interfere with the proper navigation of another vessel must be so shielded that they will not blind the pilot of such vessel.

4. Unless otherwise indicated, the colored lights mentioned in the succeeding topics must be visible on a dark night with clear atmosphere for a distance of at least 2 miles, and the white lights must be visible for at least 5 miles.

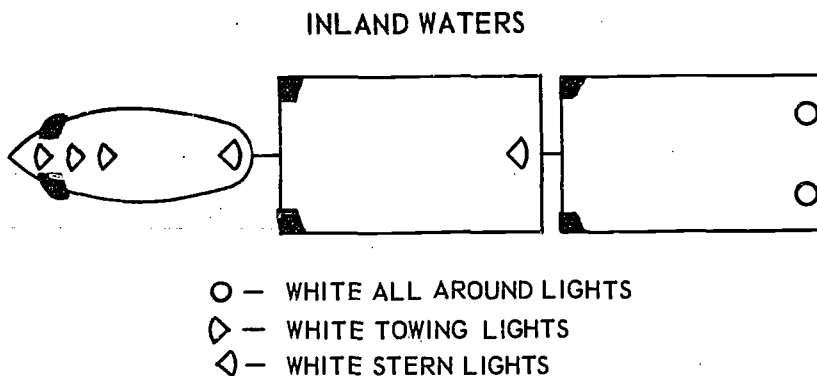

Figure 8-5. A tow in tandem. C80.121

tow must carry two lights on her stern, athwartships, horizontal to each other, not less than 5 feet apart and at least 4 feet above the deck house. These two lights must be visible all around the horizon. When the tow consists of only one vessel, that vessel must be lighted as though it were the last vessel of a group.

2. When two or more boats are towed abreast, the colored lights must be carried on the outboard bows of the outermost boats. Each of the outboard boats in the last tier of a hawser tow must carry a white light on her stern. (See fig. 8-6.)

3. When nondescript craft are being towed alongside a steam vessel and the height of the tow obscures the side lights of the towing vessel, the outboard vessel of the tow must carry side lights appropriate to the side on which they are being towed: green if to starboard and red if to port.

4. Nondescript vessels being pushed ahead of steam vessels display a green light on the starboard bow and a red light on the port bow of the lead vessel. If more than one vessel is abreast, the colored lights are displayed from the bow of the outermost vessel(s). Regardless of the number of vessels in the tow, the sidelights must be high enough above the superstructure to be visible. As usual with colored side lights, those mentioned in this and preceding paragraphs must be fitted with screens that prevent their being seen across the bow or more than 2 points abaft the beam on their respective sides. The minimum size of glass globes used for these lights must be not less than 6 inches in diameter and 5 inches in height.

5. Scows and other nondescript craft not otherwise provided for in this topic must carry a white light at each end. If the scows are massed in tiers, two or more abreast, each of the outside scows must

carry a white light on the outer bow. Additionally, the outside scows in the last tier must each carry a white light on the outer part of the stern. The lights must be 32-point lights, at least 8 feet above the surface of the water.

● Nondescript vessels operating on the Gulf Intracoastal Waterway and on other inland waters connected therewith or with the Gulf of Mexico from the Rio Grande, Texas to Cape Sable (East Cape), Florida must, when being towed, carry the lights specified as follows:

1. When nondescript vessels are being pushed ahead of the steam vessels or are in tow through a combination of being pushed ahead and towed alongside, they must be lighted by an amber light at their extreme forward ends. The tow must also show a green and a red light. The amber light must be, as nearly as practicable, on the tow's centerline, and the green and red lights must mark the maximum projection of the tow's starboard and port sides, respectively.

2. When nondescript vessels are being towed alongside a steam vessel, they must display a white light from each of their outboard corners. If one or both of the towing vessel's side lights are obscured by the deck, deckhouse, or cargo of the tow, then a light of the appropriate color must be exhibited from the tow (outboard tow if the tow consists of more than one vessel); i.e., green to starboard and red to port.

3. When one vessel of nondescript type is being towed singly by a steam vessel, the vessel towed must carry four white lights, one on each of its corners or at the outermost projection on each side.

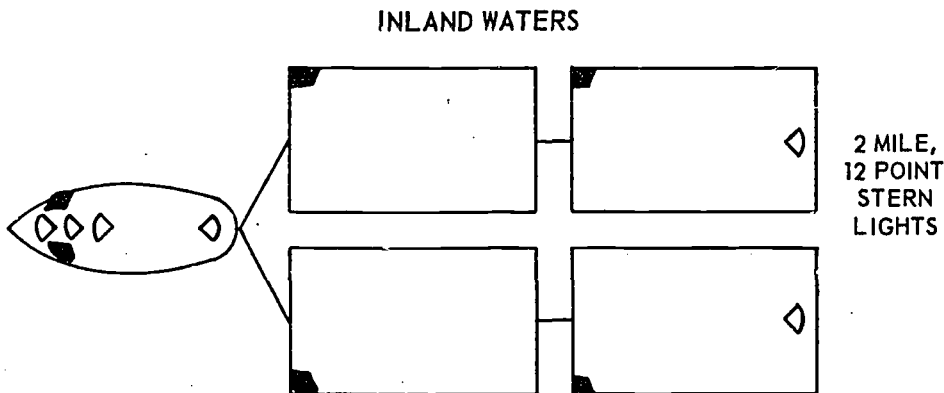

Figure 8-6. Barges abreast in tiers. C80.122

When more than one such vessel is being towed in tandem behind a steam vessel with a hawser 75 feet or more in length, the tows must carry white lights as follows:

- a. The first vessel must carry one light on each corner or outermost projection of the bow and one light at the stern amidships.
- b. Vessels between the first and last vessel must carry one white light at each end amidships.
- c. The last vessel of the tow must carry a light amidships at the bow and one light at each corner or outermost projection of the stern.

When two or more nondescript vessels are being towed in tandem behind a steam vessel and the length of the tow between vessels is less than 75 feet, such vessels must carry white lights as follows:

- a. The first vessel in tow must carry three white lights, one light on each corner or outermost projection of the bow and one light at the stern amidships.
  - b. Intermediate vessels carry a light at the stern amidships.
  - c. The last vessel of the tow must carry one light on each corner or outermost projection of the stern.
4. When nondescript vessels, not otherwise provided for are being towed behind a steam vessel two or more abreast, regardless of the number of tiers, the outermost vessel in each tier must carry a white light on the outboard corner of the bow. Additionally each of the outermost vessels in the last tier must carry a white light on the outboard corner of the stern.

5. When nondescript vessels not otherwise provided for are moored in or near a fairway, they are required to carry two white lights at least 4 feet above the surface of the water, as follows

- a. On a single nondescript craft, a light at each outboard or channelward corner.
- b. On nondescript craft moored in a group, a light on the upstream outboard or channelward corner of the outer upstream craft, and a light on the downstream outboard or channelward corner of the outer downstream boat. Any craft projecting from the group toward or into the channel must have two white lights similarly placed on its outboard or channelward corner.

6. The colored side lights mentioned in this topic must be screened so as not to show more than 1/2 point across the bow of the tow. The amber light must be a 20-point light, showing from dead ahead to 2 points abaft the beam on each side and visible for a distance of at least 2 miles. The white lights must be visible all around the horizon for a distance of at least 2 miles. Except where previously indicated, all the lights must be carried at approximately the same height above the surface of the water and should be clear of all obstructions which

might tend to interfere with the prescribed arc or distance of visibility.

Nondescript vessels frequently are towed into or through waters where the rules for towing lights differ from the rules for the waters in which the vessels normally operate. In such an instance, the rules do not require the tows to change their lights while in transit. On the other hand, if the craft engage in local employment on waters requiring different lights from those where they customarily are employed, the craft must comply with the local rules for lights.

- Nondescript craft being towed by steam vessels on the waters of the Hudson River and its tributaries from Troy to the boundary lines of New York Harbor off Sandy Hook, the East River and Long Island Sound (and the waters entering thereon, and to the Atlantic Ocean), to and including Narragansett Bay, R.I., and tributaries, and Lake Champlain, must carry the lights defined as follows:

1. Nondescript vessels being towed singly (as in fig. 8-7) astern of steam vessels must carry a white light on the bow and a white light on the stern.

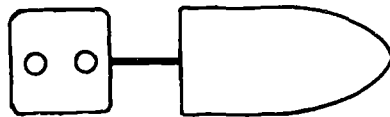

112.99

Figure 8-7.—Nondescript vessel being towed singly.

2. Nondescript vessels being towed in tandem with a hawser length between vessels of less than 75 feet must each carry a white light on the stern. Moreover, the first hawser boat must carry a white light on its bow. (See fig. 8-8.)



112.100

Figure 8-8.—Tandem tow with hawser length less than 75 feet.

When towing in tandem and the hawser length between the various craft of the tow is 75 feet or more, each craft except the last craft in tow must carry a white light on the bow and a white light on the stern. The last vessel of the tow must carry a white light on the bow and two white lights on the stern. The two stern lights must be at least 5 feet apart and 4 feet above the deckhouse, placed so as to show all around the horizon. (See fig. 8-9.)

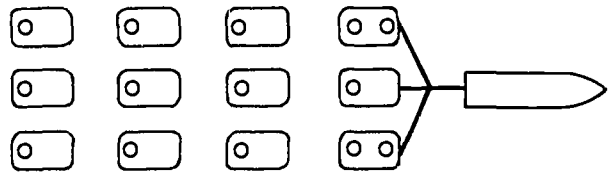

112.103

Figure 8-11.—Two or more abreast in multiple tiers.



112.101

Figure 8-9.—Tandem tow with hawser length 75 feet or more.

Seagoing nondescript vessels are not required to make any change in their seagoing lights on waters coming within the scope of this section except that the last vessel of a tow must carry two white lights on her stern, just as do vessels that customarily operate in those waters.

3. Nondescript craft towed astern in one tier, two or more abreast, must each carry a white light on the stern; further, each of the outside vessels must carry a white light on the bow. (See fig. 8-10.)

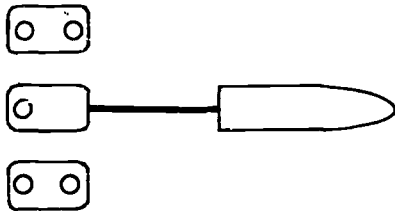

112.102

Figure 8-10.—Towing astern, two or more abreast in one tier.

When vessels are towed in tandem, two or more abreast and in more than one tier, every vessel of the tow must carry a white light on the stern. Additionally, the outside vessels in the first tier must each carry a white light on the bow. (See fig. 8-11.)

The bow lights referred to herein must be between 10 and 30 feet abaft the stem or extreme forward end of the vessel. Nondescript vessels required to show both a bow and a stern white light must have these lights so placed that they show an unbroken light all around the horizon, visible for a distance of at least 2 miles.

4. Nondescript vessels being towed alongside a steam vessel must have a white light displayed at each of the outboard corners.

5. The head barge or barges of a tow must display green and red side lights on their starboard and port sides, respectively. The sidelights, as usual, must be 10-point lights, so screened as to make them visible from dead ahead to 2 points abaft the beam on the appropriate side.

6. Dump scows (used in transporting and disposing of garbage, trash, and other waste material) navigating on the Hudson River or East River or their tributaries must, when towing in tandem, carry 10-point red and green side lights on the appropriate sides, not less than 8 feet above the highest deckhouse, and in addition thereto, must carry the white light that overtaken vessels are required to show. These lights must be shown in lieu of the white lights described for other nondescript vessels. This rule for scows applies only between loading points and dumping grounds.

Nondescript vessels in tow of steam vessels passing through these waters are not required to change from their normal lighting arrangement while in transit but must, if they engage in local employment, comply with all requirements for lights in the area while locally employed.

### VESSELS UNABLE TO MANEUVER, OR MANEUVERING WITH DIFFICULTY

The rules given in ensuing topics are applicable on the harbors, rivers, and inland waters along the Atlantic and Pacific coasts, and the coast of the Gulf of Mexico. Similar regulations exist to cover craft on the "western rivers" and craft on the Great Lakes.

### Vessels Towing Submerged Objects

When a vessel is towing a submerged or partially submerged object by hawser and no signal can be displayed from the object being towed, the tow must display the following signals:

- By day: Two shapes, one above the other, not less than 6 feet apart, with the lower shape at least 10 feet above the deckhouse. Each of the shapes must be in the form of a double frustrum of a cone, base to base, not less than 2 feet in diameter at the center. The ends of the cones must be at least 8 inches in diameter, and the shapes must be at least 4 feet in length. The upper of the two shapes is to be painted in alternate horizontal black and white stripes 8 inches wide, and the lower shape is to be painted a solid bright red. (See fig. 8-12.)

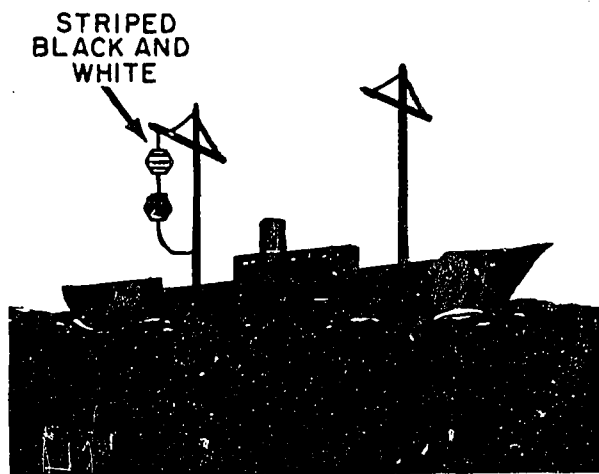

Figure 8-12. Day shapes for vessel with submerged tow. 112.58

- By day: Two shapes of the same character and dimensions as are displayed by a vessel towing a submerged object, except that both shapes must be painted a solid bright red. If more than one vessel is engaged in the operation, the shapes need be shown from only one vessel on each side of the wreck from which they can best be seen from all directions.

- By night: A white light from the bow and stern of each outside vessel or lighter. These white lights must be at least 6 feet above the deck. Additionally, there must be displayed, where they can best be seen from all directions, two red lights in a vertical line, 3 to 6 feet apart, and at least 15 feet above the deck. Refer to figure 8-13.

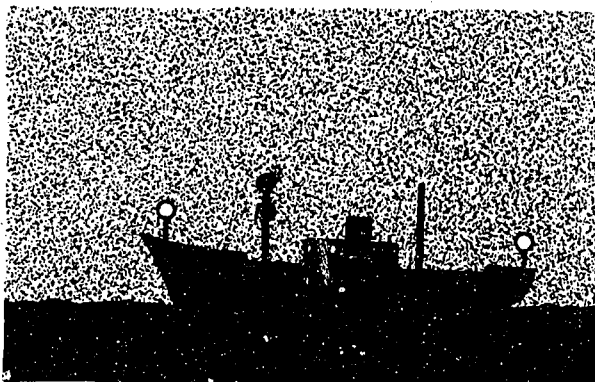

Figure 8-13. Vessel made fast over a wreck. 112.59

- By night: The regular red and green side lights. Instead of the regular white towing lights, however, the towing vessel displays four lights vertically, 3 to 6 feet apart. The upper and lower lights are white; the two middle lights are red. If these towing lights are 20-point lights carried forward on the towing vessel, an additional all-around after range light is proper. Usually, however, the special towing lights are carried aft and are visible all around the horizon.

#### Mooring Over or Alongside Wrecks

The discussion in this topic refers to steam vessels, derrick boats, lighters, or other types of vessels made fast alongside a wreck, or moored over a wreck that is on the bottom or partly submerged, or which may be drifting. When such an operation is taking place, the involved must display—

#### Stationary Dredges

Dredges that are held in stationary position by moorings or spuds must, during daylight, display two red balls not less than 2 feet in diameter. The balls must be carried in a vertical line, 3 to 6 feet apart, at least 15 feet above the deckhouse and in a position where they can best be seen from all directions. At night they must display a white light in each corner at least 6 feet above the deck. In addition to the lights just described, two red lights must be displayed in a position where they can best be seen from all directions. (See fig. 8-14.) The red lights must be in a vertical line 3 to 6 feet apart and at least 15 feet above the deck. When scows are moored alongside a dredge in this situation, each scow must display a white light on each outboard corner, at least 6 feet above the deck and visible for at least 2 miles.



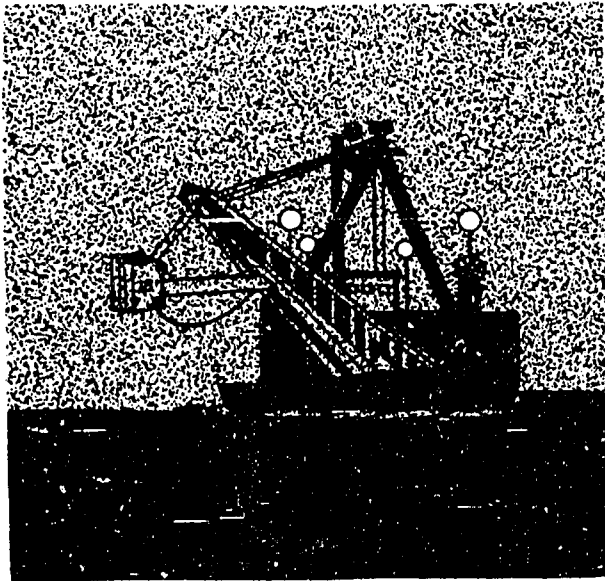

Figure 8-14. Stationary dredge. 112.60

### Dredges Underway

Dredges underway and engaged in dredging operations, including maneuvering into and out of position at the dredging sight must, by day, display two black balls at least 2 feet in diameter. The black balls must be carried in a vertical line, 3 to 6 feet apart, and in such position as can best be seen from all directions.

The rules for lights to be shown by dredges at night differ, depending on whether the dredge is self-propelled or being pushed ahead by a towboat. At night, a self-propelled dredge must carry her regular running lights, and in addition, two red lights in a vertical line beneath the white masthead light. These three lights must be of the same character. The upper red light must be 3 to 6 feet below the masthead light, and the red lights must be 3 to 6 feet apart. On or near the stern, two additional red lights must be displayed vertically. These stern lights must show through 12 points, from dead astern to 6 points on either quarter, and they too must be 3 to 6 feet apart.

A non-self-propelled dredge underway and engaged in dredging operations at night must, while being pushed ahead of a towboat, be considered along with the towboat as a single vessel. The foregoing statement is applicable in connection with the showing of lights and shapes. This vessel must carry the lights prescribed for a self-propelled

dredge except that the dredge and towboat must carry the sidelights normally required by a barge being pushed ahead and a vessel towing, respectively. When this unit is not engaged in dredging, the usual lights for towing and being towed must be displayed.

### Cable Laying, Excavation, Bank Protection, Etc.

The day and night signals discussed in this topic are to be used by vessels that are moored or anchored and are engaged in laying cables or pipes, submarine construction, excavation, mat sinking, bank grading, dike construction, revetment, or other bank protection. By day, vessels engaged in such operations must display two balls not less than 2 feet in diameter. The balls must be in a vertical line, 3 to 6 feet apart, at least 15 feet above the deck, and located where they can best be seen from all directions. The upper ball must be painted in alternate black and white vertical stripes 6 inches wide; the lower ball must be painted a solid bright red. (See day signal, fig. 8-15.)

Vessels engaged in the aforementioned operation at night must carry three red lights in a vertical line, 3 to 6 feet apart, as shown in the nighttime view of figure 8-15. The lowermost light must be at least 15 feet above the deck, and placed in a position where the lights can best be seen from all directions. When a stringout of moored craft is engaged in these operations, the red lights must be displayed from the channelward end of the stringout. If the stringout crosses the navigable channel and must be opened to allow vessels to pass through, the three red lights must be displayed at each side of the opening, rather than at the outboard end of the string. On a stringout there must also be displayed a row of amber lights at least 6 feet above the deck (or deckhouse if the craft has a deckhouse) in such position that they can best be seen from all directions. The amber lights must be placed no more than 50 feet apart so as to distinctly mark the entire length and course of the stringout.

### Pipelines

Pipelines attached to dredges, and either floating or supported by trestles must display at night a row of amber lights along its entire course. The lights must be 8 to 12 feet above the water and about equally spaced. If the pipeline crosses a navigable channel, the interval between lights near the crossing point must be no more than 30 feet.

At the shore or discharge ends of pipelines, two red lights must be displayed in a vertical line, 3 feet apart. The lower of the two lights must be at least 8 feet above the water. If there is an opening in the

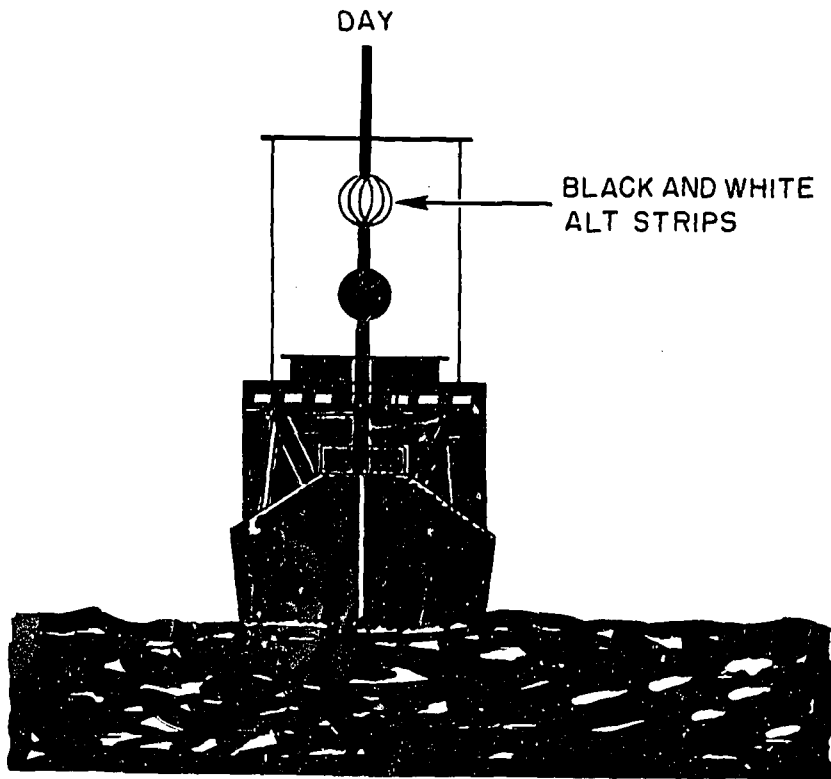

Figure 8-15. Cable laying, excavation, etc. 112.61

pipeline for the passage of vessels, a similar arrangement of red lights must be displayed on each side of the opening.

#### Vessels Moored or at Anchor

Any vessel more than 65 feet in length must, when anchored in a fairway or channel, display one black ball not less than 2 feet in diameter. The ball must be displayed between sunrise and sunset in the forward part of the vessel and in a position where it can best be seen from other vessels.

#### Rafts and Other Craft

Any vessel propelled by hand power, horsepower, or by the current of the river (except rafts and rowboats) must carry one 32-point white light forward on the vessel. The light must be at least 8 feet above the surface of the water and must be visible for a distance of at least 1 mile.

Any raft being propelled by one of the methods mentioned in the preceding paragraph, or while anchored or moored in or near a channel or fairway

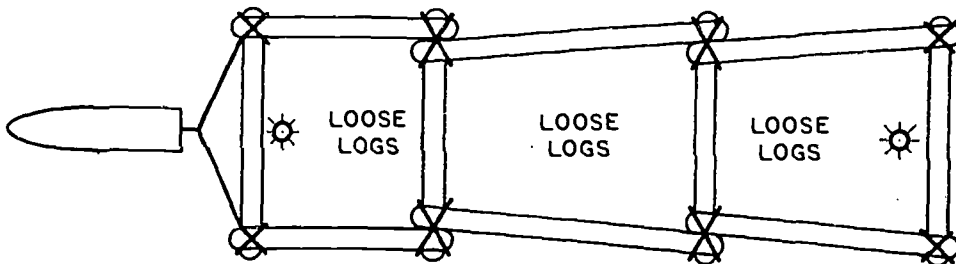

Figure 8-16.—Raft of one crib width.

112.104

must carry 32-point white lights, visible at least 1 mile, as indicated in the following listing.

1. A raft of one crib width (fig. 8-16): One light at each end of the raft.
2. A raft of more than one crib width: Four lights, one at each outside corner.
3. An unstable log raft of one bag or boom in width (fig. 8-17): At least two but not more than four lights aligned fore and aft with one of the lights on each end.

4. An unstable log raft of more than one bag or boom in width: Four lights, one at each outside corner. These lights may be closely grouped in clusters of not more than three lights, rather than a single light.

The white lights discussed in this section must be displayed from sunset to sunrise. The lights for rafts must be suspended from poles high enough that the lights will be at least 8 feet above the surface of the water. Unstable rafts are an exception to this rule; their lights need be only 4 or more feet above the water.

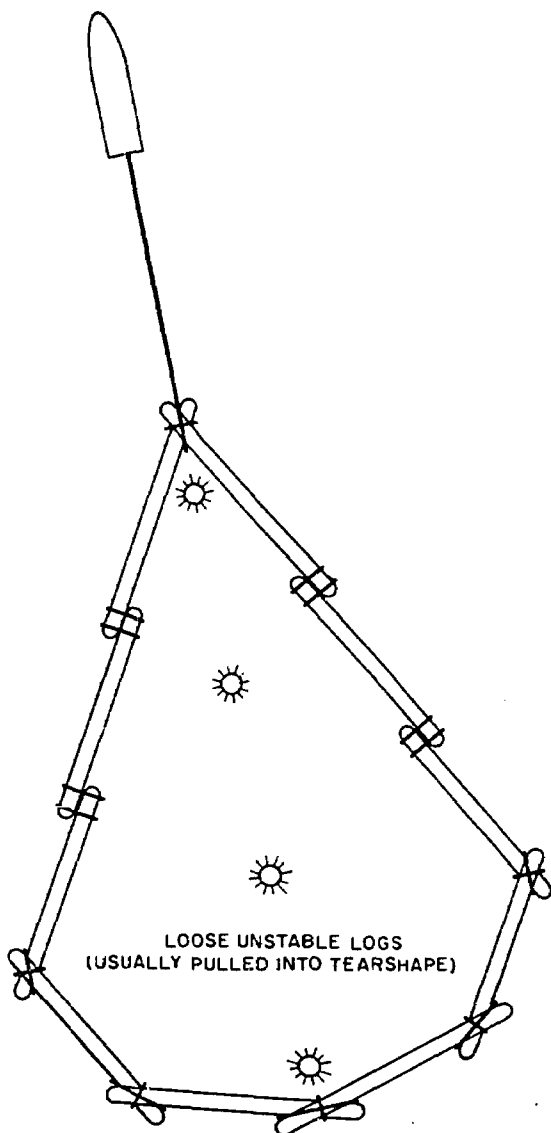

112.105

Figure 8-17.—Bag or boom of logs.

### FLOATING PLANT

The craft referred to in this topic include dredges, derrick boats, snag boats, drill boats, piledrivers, maneuver boats, hydraulic graders, survey boats, working barges, and mat sinking plant. To avoid repetition of each type, all of the craft mentioned are referred to as "floating plants."

#### Signal for Passing

Vessels intending to pass a floating plant that is working a navigable channel must indicate such intention by one long blast of the whistle. The signal should be sounded when the vessel is within a reasonable distance of the plant but no farther distant than 1 mile. The passing vessel is directed to the proper side for passage by the plant's sounding of the signal prescribed in local pilot rules for vessels approaching each other from opposite directions. The approaching ship answers the plant's signal in the usual manner. If the channel is not clear, the floating plant sounds the danger signal and the approaching ship must slow down or stop and await further signal from the plant.

When the pipeline from a dredge crosses the channel so that vessels cannot safely pass around it, the dredge must immediately sound the danger signal, and upon hearing the signal, the passing vessel must slow down or stop and await further signals from the dredge. The pipeline must then be moved and the channel cleared as soon as practicable.

When the channel is clear for passage, the dredge so indicates by sounding the usual passing signal. The approaching vessel must answer with a corresponding signal and pass promptly. After the dredge gives the signal that the channel is clear, the dredge must straighten out within the cut for the passage of the vessel.

### Speed When Passing

Vessels either with or without a tow must, when passing a floating plant, proceed at such a speed as to ensure the safety of both the plant and themselves. When vessels pass within 200 feet of a floating plant, their speeds must not exceed 5 knots. While passing over lines of a floating plant, propelling machinery must be stopped. Vessels whose draft permits must keep outside of the buoys marking the ends of mooring lines of floating plants working in channels.

### Aids to Navigation

Floating plants working in navigable channels must mark their breast, bow, and stern anchors by barrels or other suitable buoys. Vessels are forbidden to run over or anchor on the range of anchor buoys, or buoys, stakes, or other marks placed for the guidance of floating plants. Upon the approach of a vessel, adjacent buoys may be indicated to the vessel by shining a beam of light on successive buoys until the vessel has passed. As an alternative, buoys may be lighted by a red light, visible in all directions for a distance of at least 2 miles. This rule is not applicable in certain areas of New York Harbor and adjacent waters.

### Obstruction of Channel

Floating plants are forbidden to obstruct a channel unnecessarily. Whenever vessels are passing a floating plant that has lines running from the plant, across the channel on the passing side, the lines must be slackened to the bottom of the channel if necessary to prevent interference with or obstruction of navigation.

When special or temporary regulations are not prescribed, and none of the methods mentioned previously will permit a vessel to safely pass a floating plant in a narrow channel, the entire plant must move a sufficient distance out of the way to allow clear passage. In such circumstances, however, a vessel requiring passage must give the master of the floating plant ample advance notice of the time she expects to pass.

### SPECIAL DAY OR NIGHT SIGNALS

The Pilot Rules for Inland Waters lists three situations under the heading "Special Day or Night Signals": vessels fishing with gear out; vessels employed in hydrographic surveying; and Coast Guard vessels handling or servicing aids to navigation. It should be noted that the signals for fishing vessels are mandatory; some of the signals for hydrographic

and the signals for vessels handling aids to navigation are optional.

### Fishing Vessels

All vessels fishing with nets, lines, or trawls must, when underway during daylight, indicate their occupation to approaching vessels by displaying a basket where it can best be seen. If an anchored fishing vessel has its gear out, it must display—on the approach of another vessel—the basket in the direction from the anchor back toward the nets or gear.

### Vessels Employed in Hydrographic Surveying

Special signals are prescribed for vessels of the Coast and Geodetic Survey when actually engaged in hydrographic surveying operations. By day, vessels so employed may show, where they can best be seen, three shapes in a vertical line. The shapes must be at least 2 feet in diameter, the highest and lowest of which must be globular in shape and green in color, and the middle one must be diamond-shaped and white.

When at anchor in a fairway, surveying vessels must, during daylight, display two black balls not less than 6 feet apart. At night, two red lights must be displayed in the same manner. The distance between the lights or between the balls may be reduced to 3 feet on vessels so small as to make such placement necessary. The vessels must also have at hand a flareup light, to be shown when necessary to attract attention.

### Coast Guard Vessels

While engaged in handling or servicing navigational aids during daylight, Coast Guard vessels may display two balls from the yardarm. The balls must be painted with orange and white vertical stripes. They must be suspended one below the other 3 to 6 feet apart. At night these vessels may display, where they can best be seen, two red lights in a vertical line 3 to 6 feet apart.

Any vessel passing a Coast Guard vessel that is displaying one of the signals described in the preceding paragraph must reduce her speed sufficiently to ensure the safety of both vessels. When passing within 200 feet of a vessel displaying either the day or night signal, the speed of the passing vessel must not exceed 5 knots.

### DISTRESS SIGNALS

Only one signal for a ship in distress is prescribed by the Pilot Rules. The signal is for daytime use and

consists, simply, of slowly and repeatedly raising and lowering arms outstretched to each side. This rule supplements the Inland Rules for distress which may, of course, be used in pilot waters, with no conflict between the two sets of rules. A day or night distress signal under Inland Rules is the continuous sounding of any fog-signal apparatus or firing a gun; and a distress signal for nighttime use consists of flames on the vessel, as from a burning tar barrel, oil barrel, etc. In addition to the foregoing signals, the International Rules for a vessel in distress may be assumed to be valid distress signals in pilot waters if no other use for the same signal exists under the Inland or Pilot Rules.

### TRANSFERRING DANGEROUS CARGOES

Vessels handling dangerous or hazardous cargoes while fast to a dock or while at anchor are required to indicate this fact by the use of flags or lights. The term "dangerous or hazardous cargoes" includes explosives, combustible or inflammable liquids or gases, and certain chemicals in bulk.

Whether moored to a pier or at anchor, ships handling dangerous cargoes must display a red flag during daylight. It is well known that U.S. Navy ships hoist flag Bravo. At night, when alongside a pier, the ships must show a red light.

(No special warning signal is prescribed for ships anchored at night.)

### PASSING UNDER BRIDGES

The Pilot Rules provide an exception to the statutory and regulatory requirements for lights, day signals, or other navigational means when craft are passing under low bridges. Any vessel passing under a bridge that affords the craft restricted vertical clearance may lower its lights, day shapes, or other navigational means and appliances until it has passed and is clear of the bridge. Immediately upon clearing the bridge, however, the lights or day signals must be reestablished and exhibited as required by law or regulation.

### SUMMARY

The Pilot Rules for Inland Waters are long and somewhat complicated. Only experienced pilots can be expected to memorize all of the rules concerning lights, shapes, speeds, etc., for a given location. This fact is one of the principal reasons for the requirements that vessels over 65 feet in length carry a copy of the pamphlet containing the rules (CG-169). A good rule to follow is to give a wide berth to any ship or craft that is displaying an unfamiliar array of lights or shapes. The vessel is probably indicating that she cannot maneuver to keep clear of you.

## CHAPTER 9

# WEATHER

The tremendous horsepower of the modern ship makes it a rare occurrence for a ship to be lost at sea because of adverse weather. But even the largest ships have much to fear when engulfed in a severe storm. A severe North Atlantic gale, for example, is capable of straining rigging, springing seams, bending plates, smashing equipment, and tearing loose the topside equipment on a ship the size of an 84,000-ton aircraft carrier. Winds of over 100 knots and waves 60 feet and higher are respected by the hardiest seamen on the largest of ships. Whenever practicable, the prudent mariner always maneuvers to stay clear of storms.

Before the days of radio communication and the Weather Bureau, seafarers became weather-wise through experience. Today, a ship at sea is regularly advised by radio concerning weather conditions in her vicinity. Nevertheless, it still is possible for a hurricane or typhoon to originate suddenly, without any warning except a sharply falling barometer and other local indications described in this chapter. A first-rate navigator should be able, by means of certain characteristic signs, to recognize what weather disturbance is coming. He should know how to tell what kind of a storm it is, how bad it may be and—most important of all—how to maneuver so as to avoid its full impact.

The ship's Quartermaster is not directly concerned with her maneuvering; but, as assistant to the navigator, he should know enough about the laws of storms to be able to assist in intelligent observation of the weather.

### WINDS AND PRESSURE AREAS

To review what you learned in your **QM 3 & 2** manual, the atmosphere in which we live has definite weight called atmospheric pressure. This pressure, measured by a barometer, varies with the presence of water vapor. Water vapor, in amount according to temperature.

When a large volume of air is heated, it becomes light and rises. Then the adjacent heavy air rushes over to seek its own level, so to speak, and results in a flow of air called wind. The actual circulation of the air is influenced greatly by the earth's rotation and other factors. Consequently, winds do not always blow continuously and steadily from cool areas of high atmospheric pressure to warmer regions where pressure is lower.

Winds tend to follow closely the seasonal variations of pressure areas. From the relation of pressure to temperature, these pressure areas are inclined to follow the movement of the sun in declination. Study and observation over a long period have located various well-defined pressure areas on the earth's surface.

First, along the equator lies a belt of relatively low pressure where the average barometer reading is about 29.90. On either side of this area is a belt where pressure is higher. This belt lies between 30° and 40° in the Northern Hemisphere, and it is about the same in the Southern Hemisphere. Above and below the high-pressure belt, average atmospheric pressure diminishes toward the poles. In the Southern Hemisphere this decrease in pressure is regular and definitely obvious. It is less regular and not so obvious in the Northern Hemisphere. There are local centers of low pressure near the Aleutian Islands in the North Pacific and near Iceland in the North Atlantic. Pressure in these areas averages 29.70 inches, increasing again to the northward.

### WORLD WINDS

The general (surface) circulation with prevailing winds and nearby permanent pressure systems or belts will now be mentioned. Remember that the circulation about high-pressure areas is clockwise in the Northern Hemisphere and counterclockwise about low-pressure areas. The reverse is true in the Southern Hemisphere.

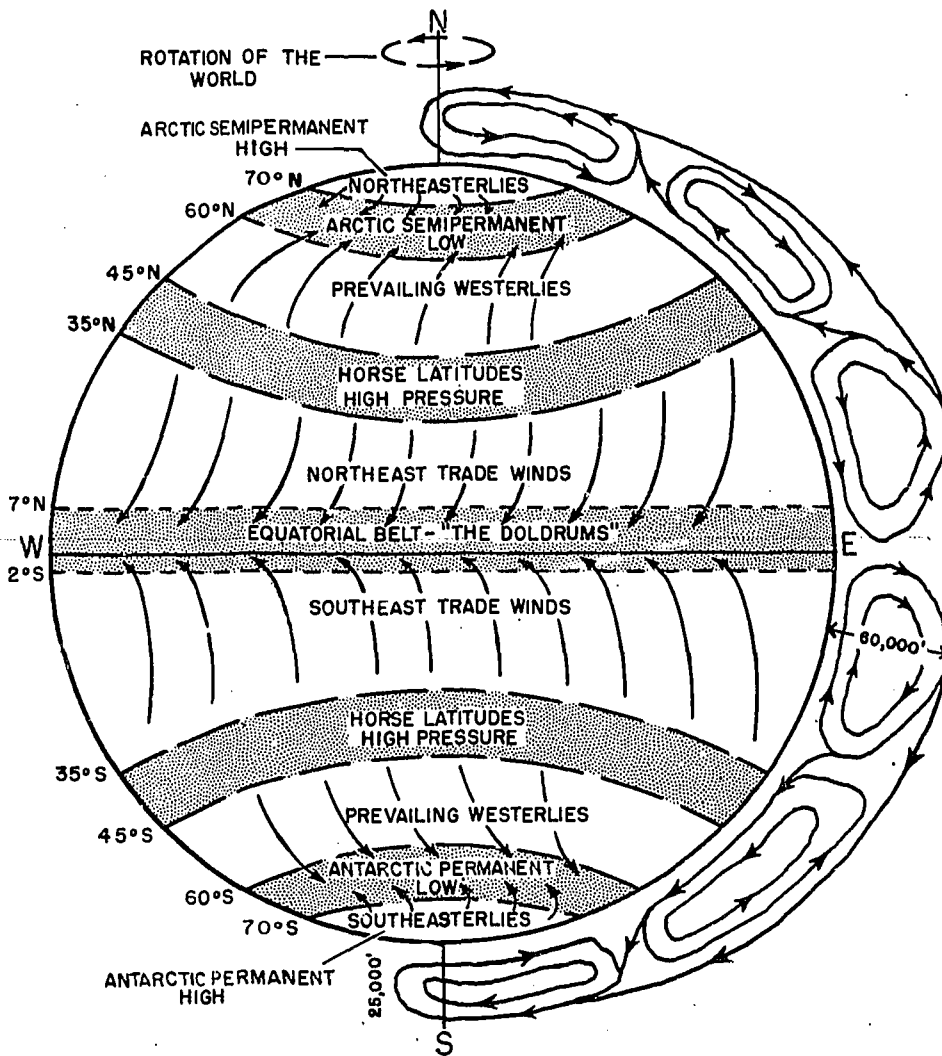

58.93

Figure 9-1.—General circulation of air.

At times confusion arises from the meaning of wind direction. Wind is always named by the direction from which it is blowing. (See fig.9-1.)

The equatorial belt of light and variable winds between the northeast trade winds of the Northern Hemisphere and the southeast trade winds of the Southern Hemisphere is called the doldrums or the intertropical convergence zone.

The doldrums vary in position and tend to move north and south of the equator with the sun, though more of the area is generally located slightly to the north of the equator. In

the region of the doldrums the temperatures are high, and the wind is convergent (a net inflow of air into the area), which results in excessive precipitation.

On the poleward side of the doldrums the trade winds are found. Whenever the doldrums are absent in some part of the equatorial region, the trade winds of the Northern and Southern Hemispheres converge, causing heavy rain squalls. A noticeable feature of the trade wind belt is the regularity of these systems, especially over the oceans. (The wind blowing above and counter to the trade wind is the antitrade. Formerly it was called the countertrade.)

The areas of the subtropical high-pressure cells, where the winds are light and variable, about 35° to 40° N. and S. latitude, are referred to as the horse latitudes. Due to the descending air, fair weather is characteristic of this region.

The pressure decreases outward from this area, and the prevailing westerlies are on the poleward side, with the trade winds on the equatorial side.

The prevailing westerlies, which are on the poleward side of the trade winds, are persistent throughout the midlatitudes. In the Northern Hemisphere their direction at the surface is from the southwest, and in the Southern Hemisphere from the northwest, due to the deflection caused by the Coriolis effect as the air moves poleward.

Poleward of the prevailing westerlies lies a belt of low pressure known as the polar front zone.

In the polar cells, poleward of the polar front zone, the surface winds are known as the polar easterlies. They move from the northeast in the Northern Hemisphere and from the southeast in the Southern Hemisphere. They are very shallow due to the low temperatures and are overlain by the westerlies. This circulation pattern is temporarily disrupted by migratory pressure systems in all areas but returns to the original pattern.

### LAWS OF STORMS

Ordinary prevailing winds can become strong enough to raise some really respectable seas (as the North Atlantic gale). A modern ship, though usually suffers no serious damage from weather unless she encounters winds of the force of a tropical cyclone. A cyclone is a circular or nearly circular area of low atmospheric pressure around which the winds blow counterclockwise, in the Northern Hemisphere, and clockwise in the Southern Hemisphere. Currently the term "tropical cyclone" is subdivided into three categories. These are distinguished in terms of wind speed as follows:

1. Tropical depression—Maximum depression—Maximum wind less than 34 knots
2. Tropical storm—Maximum wind 34 to 63 knots
3. Hurricane/Typhoon—Maximum wind 64 knots

Although the velocities associated with these storms are less than in a tornado, the tropical

cyclone covers hundreds of times the area and lasts many times longer than the tornado. The total damage, as a result of these storms, is many times that of tornadoes. The tropical cyclone is the most destructive of all weather phenomena. A tropical cyclone has its beginning in the tropical oceans, near (but not directly over) the equator. It first moves westward, then curves to the northeast (toward the southeast in the Southern Hemisphere). (See fig. 9-2.) The pressure at the center of a mature tropical cyclone averages 950 millibars; the lowest pressure ever recorded is approximately 890 millibars. These storms vary in diameter from 60 to 1000 miles. At their outer edges the wind velocity is moderate, but it increases toward the center where velocities higher than 175 knots (200 m.p.h.) have been recorded. At the center is an area that averages about 14 miles in diameter. In this area, called the eye of the storm, the winds are very light, the seas are confused and mountainous, the sky often is clear, and drizzle may occur.

The elements of wind, temperature, pressure, humidity, and rain vary little in the different quadrants of a tropical cyclone. Winds increase from the outer limits to the eye of the storm; the temperature rises and the humidity falls at the center. Precipitation is in the form of showers at the outer limits, becomes heavier toward the center, and is usually heaviest in the right front quadrant. These storms are often attended by great wind-caused tides that inundate the land and cause more damage than do the wind and rain of the storm itself.

Tropical cyclones, which occur in many localities throughout the world, are known by various names. They form over all tropical oceans (except that none have been reported over the South Atlantic), but do not form over continents. They are common in the West Indies, ranging up the east coast of the United States and the Gulf of Mexico where they are called hurricanes. In the Western Pacific, off the coast of China, they are called typhoons. Off the west coast of Australia they are called willy-willies, and off the Philippines they are called baguios. Through usage, all tropical cyclones occurring east of the 180th meridian in the Pacific have also become known as hurricanes.

Within the equatorial trough low-pressure area (almost completely circling the globe) is a belt of either light and easterly winds or no winds. Rainfall comes in sheets, with frequent thunderstorms and squalls. This belt of baffling winds and rain, called the doldrums, is the breeding place of the majority of tropical cyclones.



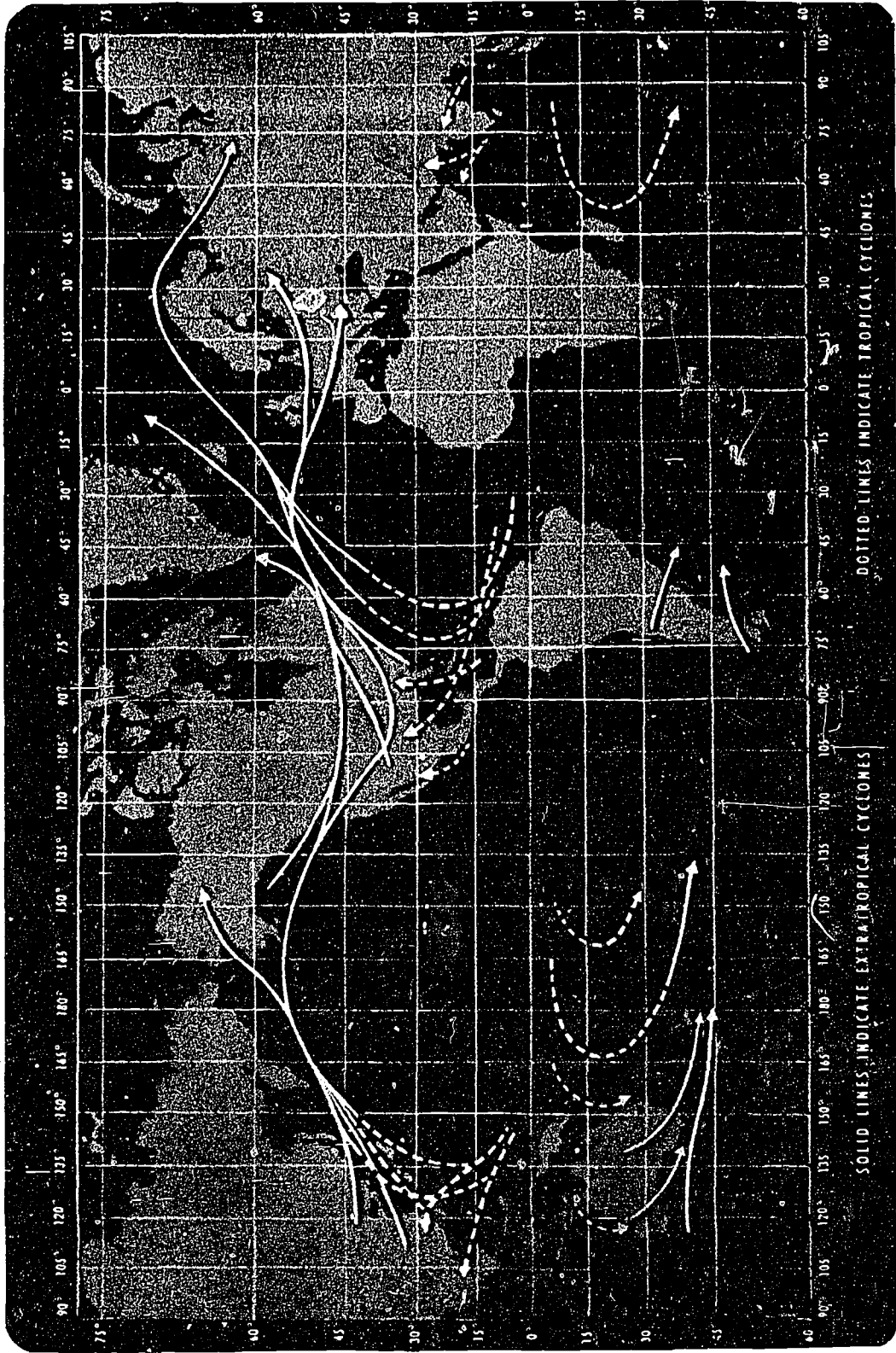

Figure 9-2. Tropical and extra tropical storm tracks. 58.97

## TORNADOES

A tornado, one of the most destructive types of storms known, is a violent, whirling storm of small diameter (usually a quarter of a mile or less) which travels across the country and leaves great devastation along a narrow path. It is known popularly as a twister or a cyclone in the Central United States, where it occurs most frequently. Following are the chief characteristics of a tornado.

1. A heavy cumulonimbus cloud under which hangs a funnel-shaped cloud that marks the vortex and, as the storm moves along, may or may not touch the earth.

2. A heavy precipitation accompanied by thunder and usually hail. (In addition to the thunder, a roar attends the tornado cloud whenever it touches the surface of the earth.)

3. Winds blowing spirally upward around the axis of the tornado clouds. Their speeds have been calculated to be as high as 300 miles per hour, and in rare instances even higher. Data from recent tornado studies indicate that the velocities of tornadic winds are in the general range of 150 to 300 miles per hour. A large reduction of pressure in the center, due to the spiraling of the air, seems to cause buildings in the path of the storm to explode.

4. The speed of the storm over the earth's surface is comparatively slow, usually 25 to 40 miles per hour. The length of the track of a tornado on the ground may be from a few hundred feet to 300 miles; average is less than 25 miles.

Along the West Coast of Africa squalls accompanying thunderstorms are also called tornadoes; but they possess few of the qualities of the true tornado.

## SQUALLS

A squall is a wind of considerable intensity caused by atmospheric instability. A squall comes up and dies down quickly, and sometimes is accompanied by thunder, lightning, and precipitation. Often a squall is named after the special weather phenomenon that accompanies it. Thus, there are rain, snow, and hail squalls. Squalls are most common over the ocean in the doldrums, where several may be visible from your ship at the same time. Squall winds differ greatly in intensity, from moderately heavy to violent. A violent squall is capable of capsizing small ships when they are und.

## MONSOONS

Steady winds somewhat similar to the trades, called monsoons (of Arabic origin meaning "season"), exist in the China Sea and Indian Ocean. The air over the land is warmer in summer and colder in winter than that over the ocean, producing a consequent variance in atmospheric pressure. Seasonal temperature changes induce a seasonal character in the monsoon. The northeast (winter) monsoon usually blows in the China Sea from October to April. It is known as the dry or fair weather monsoon, although its force often reaches moderate gale proportions. The southwest (summer) monsoon normally occurs from May to September, and breaks with great severity on some coasts. Also known as the wet monsoon, it usually is accompanied by heavy squalls and thunderstorms, and by an average rainfall that is much heavier than that of the northeast monsoon season.

## WATERSPOUTS

A waterspout is a small whirling storm occurring over the oceans or inland waters. Its chief characteristic, in a fully developed spout, is a funnel-shaped cloud extending from the surface of the water to the base of a cumulus-type cloud. The water in a spout is confined mostly to its lower portion. Waterspouts usually rotate the same direction as do cyclones (counterclockwise in the Northern Hemisphere and clockwise in the Southern Hemisphere), but the opposite rotation is occasionally observed. They ordinarily are found in tropical regions, but may develop in higher latitudes too.

Waterspouts are divided into two classes, according to their origin and appearance. One category is the true waterspout, in which the vortex forms in the clouds by the interaction of air currents flowing in opposite directions. This type of waterspout is similar to a tornado in formation and aspect. The second class of "pseudowaterspouts" is of a different nature. It originates just above the water surface in convectively unstable air, and builds upward, frequently under clear skies. This type of waterspout has the same wind characteristics as whirling pillars of sand and dust often seen on the deserts.

Waterspouts vary in height from a few hundred feet to several thousand feet, and in diameter from a few feet to several hundred feet. The highest waterspout on record is one of 5014 feet, observed in New South Wales, Australia.



## HURRICANES

As stated previously, tropical cyclones peculiar to the Atlantic, Northeastern Pacific, and West Indies are called hurricanes. Although their exact cause is somewhat obscure, the fact that they soon dissipate over land areas seems to indicate that their existence depends somehow upon water vapor, a large amount of which is present in the air over the doldrums. The whirling cyclonic wind apparently starts when warm, vapor-laden air is underrun and forced upward by convergence of the wind flow.

Once the storm develops, it normally follows the current of free air northward or southwestward until it arrives at the boundary of the adjacent higher pressure region. Here, where the prevailing winds turn eastward, the storm changes course, moves for some distance toward the pole, and then veers toward the northeast or southeast.

In general, the track of a hurricane in the Northern Hemisphere, Atlantic and Pacific Oceans, is northwesterly from the starting point in the doldrums. At the western edge of the high-pressure area, the storm usually veers to the northeast, and either dissipates itself in the middle latitudes or takes on the form of the less severe extra-tropical cyclone.

Hurricanes of the Central South Pacific follow a similar track to the southward, moving west and south for the first branch of the parabola, then veering southeastward.

Typhoons and baguios of the Western Pacific may follow a course similar to that of a West Indian hurricane, or they may expend their force on the South China Coast.

Figure 9-3 shows you a typical track of a hurricane in the Northern Hemisphere of the Atlantic. Figure 9-4 shows a hurricane track in the Southern Hemisphere of the Central Pacific.

## CYCLONIC WIND DIRECTION

Cyclonic winds in the Northern Hemisphere circulate in a counterclockwise direction. Those in the Southern Hemisphere circulate clockwise. It is most important to remember this direction when it becomes necessary to maneuver out of the path of a hurricane. Study closely figure 9-3 and you will see that as you face the same direction the storm is moving, winds in the right (called the dangerous) semicircle of the storm are circulating so as to draw a ship in that semicircle and into the path of the storm. Moreover, the winds carry her along with the storm as it moves along its track. On the other hand, winds in the left (called the navigable) semicircle

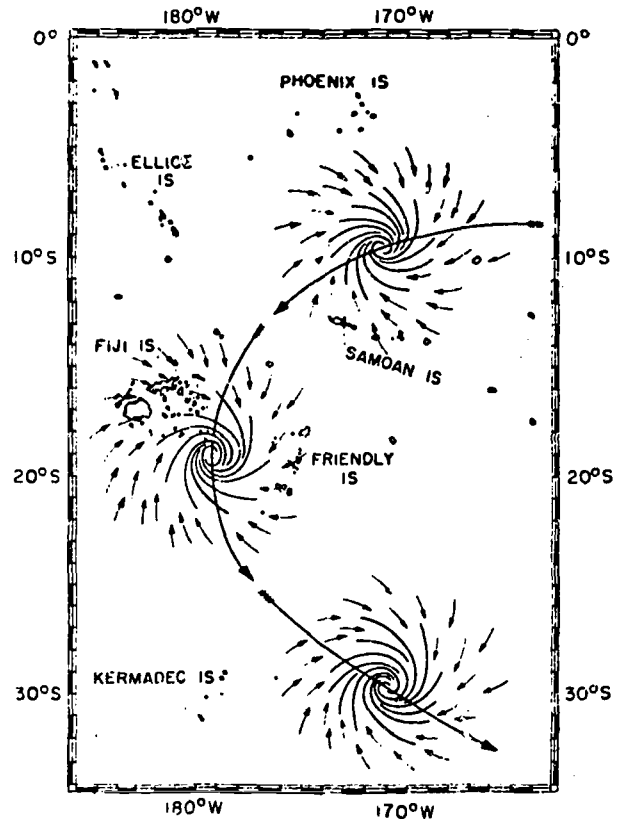

58.95

Figure 9-4. Track of a tropical cyclone originating in the Southern Hemisphere of the Central Pacific.

tend to drive the ship out of the path of the storm, and likewise help her to get behind it.

In figure 9-4 the situation is the opposite to that just described. As you look along the storm track, winds in the right semicircle tend to force the ship out of the storm's path and help her to get behind it. Winds in the left semicircle draw her into the track, and also blow her along with the storm. As you face the direction in which the storm is moving in the Southern Hemisphere, the dangerous semicircle is to your left, the navigable semicircle to your right.

Maneuvering a ship in a hurricane consists mainly of determining whether she is in the dangerous semicircle and, if she is, finding the best method of working her out of it.

## TROPICAL CYCLONE APPROACHING

A tropical cyclone, as mentioned before, can form quite suddenly, and a ship may find herself in one before she receives any radio warning of its ap-

proach. Navigators should know the signs that indicate the approach of a storm of tropical cyclone proportions.

During the hurricane or typhoon season, any interruption of the regular diurnal oscillation of the barometer should be considered as a warning of an approaching change in the weather. Although the barometer is not absolutely reliable in this respect, its indications should always be taken into consideration. Once a storm begins, the barometer indicates with considerable accuracy both its speed of approach and your distance from the storm center.

A long, low swell rises well in advance of the area of violent winds, and the direction of the swell, if unaffected by intervening land masses, indicates the bearing of the storm center. Light, feathery plumes of cirrus cloud appear shortly after the swell begins, fanning out from a whitish arc on the horizon. Next, the sky becomes more and more densely overcast, until the fearsome-looking dark mass of the true hurricane cloud appears on the horizon. The barometer begins a steady fall, and the air becomes heavy, hot, and moist, and the wind begins to pick up. You may or may not hear a humming sound, caused by the

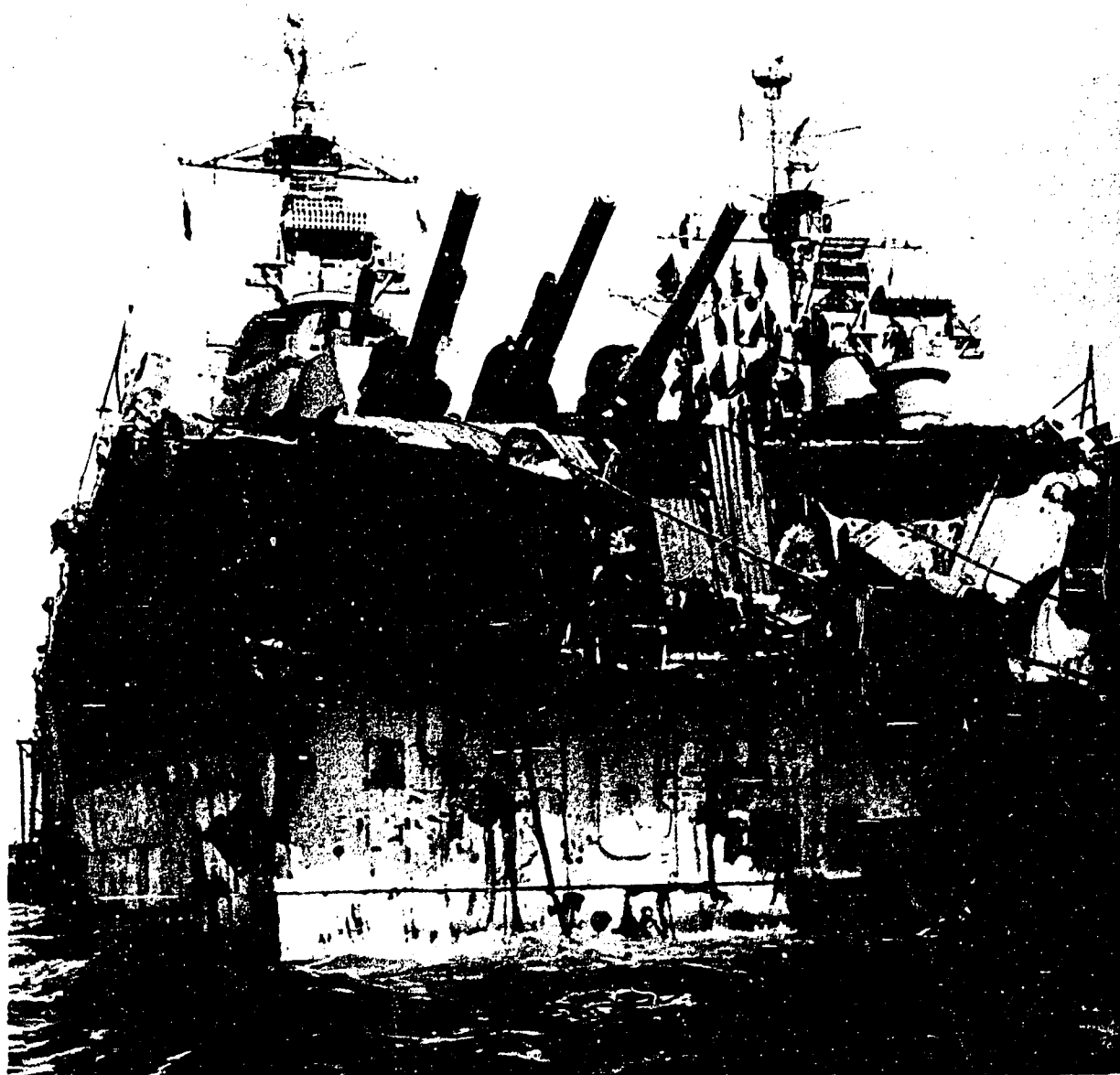

Figure 9-5. Bow of USS Pittsburgh ripped off in a typhoon. 112.66

speeding up of the velocity of the wind. Fine, misty squalls of rain break off from the main cloud bank. These rain squalls increase to heavy showers, and finally to torrents at the center. The barometer starts falling rapidly; occasionally it becomes erratic. The seas begin to roll in mountainous waves, which can completely engulf a large ship. The Pittsburgh in figure 9-5 is an example of the destruction caused by a tropical cyclone.

### DETERMINING BEARING OF THE CENTER

In the Northern Hemisphere, as you know, a cyclonic wind whirls in a counterclockwise direction. If you face the wind, the center bears about 113° or 10 points to your right. In the Southern Hemisphere, the center is on about the same bearing to your left. It has been found that the storm center almost always bears close to 90° from the direction of movement of the storm's lower clouds. If this direction can be determined, the storm's center bearing can be indicated more accurately than by wind direction.

As the storm passes along its track, the wind hauls in one direction or the other, depending upon which semicircle you are in. In either the Northern or the Southern Hemisphere, if the wind hauls to the right as you are facing it, you are in the right semicircle, which means that in the Northern Hemisphere you are in the dangerous semicircle, but in the Southern Hemisphere it is the navigable semicircle. If the wind continues steadily from the same direction, you most likely are directly in the path of the center.

When you determine the bearing of the center, you must try to ascertain how far away it is.

Although the average fall of the barometer is insufficiently accurate for you to rely upon it completely, it gives you an idea of the speed with which the center is approaching. A tropical cyclone advances at from 5 to 20 miles per hour. In the North Atlantic, speed of advance may reach as high as 50 miles per hour.

The accompanying table assumes a ship hove to in the track of the storm.

Average fall of barometer (per hour)	Distance from center (in miles)
0.02 to 0.06 inch	250 to 150
0.06 to 0.08 "	150 to 100
0.08 to 0.12 "	100 to 80
0.12 to 0.15 "	80 to 50

### MANEUVERING IN A TROPICAL CYCLONE

Once the bearing and distance of the storm center are determined, the next step is to plot the track along which the storm is expected to advance. Two or three bearings of the center, taken at intervals of 2 to 3 hours, should be sufficient for establishing the probable track.

In the Northern Hemisphere, as stated previously, if the wind hauls to the right, the ship is in the dangerous semicircle; if it hauls to the left, it is in the navigable semicircle. If it continues from the same direction, with falling barometer, the ship probably is in the path of the storm. This situation, of course, occurs only when the ship is laid to and kept on the same heading. When course and speed are changed so as to maintain a constant relative bearing between the ship and the storm center, the wind does not shift. In that event, only the barometer can tell you whether you are approaching or drawing away from the center. A vessel might actually be getting into trouble by overtaking the center of a slowly traveling storm. Then, a decrease in speed probably would allow her to ride it out.

The general rules for maneuvering a ship in a tropical cyclone in the Northern and Southern Hemispheres are described in the following two sub-topics.

#### Northern Hemisphere

**Right or dangerous semicircle:** Bring the ship around so that the wind is on the starboard bow, and make as much headway as possible. If obliged to heave to, do so head to sea.

**Left or navigable semicircle:** Bring the wind on the starboard quarter and hold her on that heading. If obliged to heave to, do so stern to sea.

**On track ahead of center:** Bring the wind 2 points on the starboard quarter, and run on that heading for the left semicircle.

**On track behind center:** Avoid the center by the most practicable route, with due consideration that the storm eventually will curve northeastward.

#### Southern Hemisphere

**Left or dangerous semicircle:** Bring the wind on the port bow, and make as much headway as possible. If obliged to heave to, do so head to sea.

**Right or navigable semicircle:** Bring the wind on the port quarter, and hold her on that heading. If obliged to heave to, do so stern to sea.

**On storm track ahead of center:** Bring the wind 2 points on the port quarter, and run on that heading for the right semicircle.

On storm track behind center: Avoid the center by the most practicable route, realizing that the storm eventually will curve southeastward.

### WEATHER MESSAGES

Ships on the high seas receive long-range weather forecasts from radio stations ashore. These shore stations compile weather messages based on local observations and on weather information received from other shore stations and from ships at sea. The remainder of this chapter is a discussion of the reports and other information concerning weather, exchanged between ships and shore stations.

In the interest of brevity, information on weather is broadcast by the Navy, Coast Guard, and civilian agencies in synoptic form; that is, according to a pattern designed to give a general picture of the situation in a specific area. By international agreement, peacetime weather broadcasts are sent in international code forms. These codes consist of a system of symbols that refer to various tables from *Radio Weather Aids* (H.O. 118). This publication contains a list of stations, frequencies and schedules for broadcasting marine, synoptic and facsimile weather information.

### COMPONENTS OF WEATHER BULLETINS

Detailed weather bulletins, received at scheduled times, are made up of several parts. The different parts vary in sequence and content. Each bulletin contains such general information as—

1. Gale, storm, and hurricane warnings.
2. Weather forecasts.
3. Upper wind reports.
4. Upper air soundings (temperature, pressure, and humidity).
5. Synoptic reports from land stations.
6. Synoptic reports from ships.
7. Aircraft reports.
8. Analysis.

**Remember:** Information received from a land station describes only conditions in the area covered by that particular station. General weather information is provided in H.O. Pub. 118, *Radio Weather Aids*. This publication contains a complete list of symbolic weather codes and attendant tables.

All weather code tables needed by you are contained in H.O. 118. Changes thereto are received regularly on board all commissioned ships of the Navy. Changes are distributed in advance of effective dates to permit you to keep your tables and broadcast information up to date. Interim corrections to H.O. Pub. 118 are found in the weekly *Log* to Mariners, Section IV.

### SHIP-TO-SHORE WEATHER REPORTS

All commissioned vessels of the Navy are required to observe and record weather information in accordance with the *Manual for Ship's Surface Weather Observations, OpNavInst P3140.37*. Additionally, the *Instructions for Keeping Ship's Deck Log, NavPers 15876*, requires logging all unusual meteorological phenomena, extraordinary refractions, waterspouts, meteors, shooting stars, auroras, halos, fata morganas, and icebergs. The observations are made hourly and recorded on the Ship Weather Observation Sheet, OpNav form 3144-1. Synoptic observations are recorded in message form at 0000, 0600, 1200, and 1800, GMT and delivered to the ship's main communication center for transmission.

### ENTRIES ON OPNAV 3144-1

Many times you have completed the columns contained in OpNav 3144-1. In a discussion of synoptic weather charts and symbols it is appropriate to review the proper entries to be made. The following instructions apply in completing the respective columns.

**Wind:** Enter the true wind direction in degrees, indicating direction from which the wind is blowing. Enter the computed true windspeed in knots for the respective hours. In the absence of an anemometer, estimate the windspeed from the Beaufort scale of wind velocity, contained in the effective edition of OpNavInst P3140.37.

**Visibility:** Enter the average visibility in miles. For less than 2 miles, enter the visibility to the nearest 1/5th mile, as 1-2/5. For less than 1 mile, enter to the nearest 1/10th mile; e.g., 1/10, 2/10, 5/10. Enter 0 for less than 100 yards.

**Weather:** Enter the symbol(s) indicating the distinctive characteristics of the weather, in conformity with symbols contained in OpNav Instruction P3140.37.

**Barometer:** Enter the reading of the aneroid barometer reduced to sea level pressure. Sea level pressure is obtained by adding a constant pressure factor to the barometer reading (station pressure). This constant is determined by multiplying the height of the barometer (in feet) above the ship's load line by 0.001 inch or 0.034 millibar. For aneroid barometers scaled in inches, enter the pressure to the nearest 100th inch; e.g., 29.92, 30.01. For barometers scaled in millibars, strike out inches in the column heading and enter the pressure to the nearest 10th millibar; e.g., 999.8 or 1001.4.

**Temperature:** Enter the temperature of the air as shown by an exposed dry bulb thermometer and by an exposed wet bulb thermometer.

**Clouds:** Enter the portion of the sky obscured by clouds in parts from 1 to 10. Thus, 0 represents entirely clear; 3 means that 3/10th of the total sky is obscured. Enter the height of the base of the lowest cloud in feet; e.g., 50, 200, 1000, 11000. In conformity with the cloud forms and symbols in OpNav Instruction P3140.37, enter the distinctive low, middle, and high cloud forms. Do not enter more than one low cloud form, one middle cloud form, and one high cloud form for any hour. When no clouds are present, enter the word "Clear."

**Sea Water Temperature:** Enter the temperature of the sea water from the main injection thermometer.

**Waves:** Enter the true wave direction, in degrees, indicating the direction from which the waves are coming, and the period (in seconds) between the passing of successive wave crests. Enter the estimated average wave height (in feet).

### SHIPBOARD WEATHER CHARTS

By plotting the data obtained from broadcast synoptic weather bulletins, the navigator creates a weather chart for the area in which the ship is operating, and predicts the probable weather the ship will encounter. When a ship is beyond the areas covered by official weather forecasts, analysis of the weather chart usually is the only means of determining what conditions the elements are likely to produce in the near future. A great deal of information, helpful in the preparation and interpretation of weather charts, is contained on pilot charts.

#### Facsimile

Use of facsimile equipment eliminates the need, in many instances, for the navigator to construct his own weather chart. Facsimile (FAX) is a process for transmitting pictorial and graphic information by wire or radio and reproducing it in its original form at the receiving station. Two forms of FAX are utilized. One transmits photographs, the image being reproduced on photographic film or paper. The other is employed for such matter as weather charts and blueprints that lack the detail of a photograph and can be received on a special electrographic paper. It is with this latter that a Quartermaster is most concerned.

Facsimile is a relatively late addition to military communications, although commercial firms have used this method for a number of years to provide pictorial service to newspapers.

The most useful application of facsimile—transmitting fully plotted weather charts—has been under development since the close of

World War II. The National Meteorological Center Facsimile (NMC Fax) network, sponsored by the Weather Bureau and the coordinated planning committees of the military services, is devoted exclusively to this work.

The NMC Fax network covers the entire continental United States. The NMC Fax network does not meet the Navy's need for weather data on areas outside the continental United States, however. Most of the current FAX traffic, consequently, is prepared in the Navy's weather centrals. They have facilities for correlating weather observations from all over the world and making usable charts. Completed charts are distributed by radio and wire line to hundreds of ships and stations and to other services. Because weather forecasts usually are out of date when no more than 6 hours old, and require revision, completion and distribution of FAX is a 24-hour job.

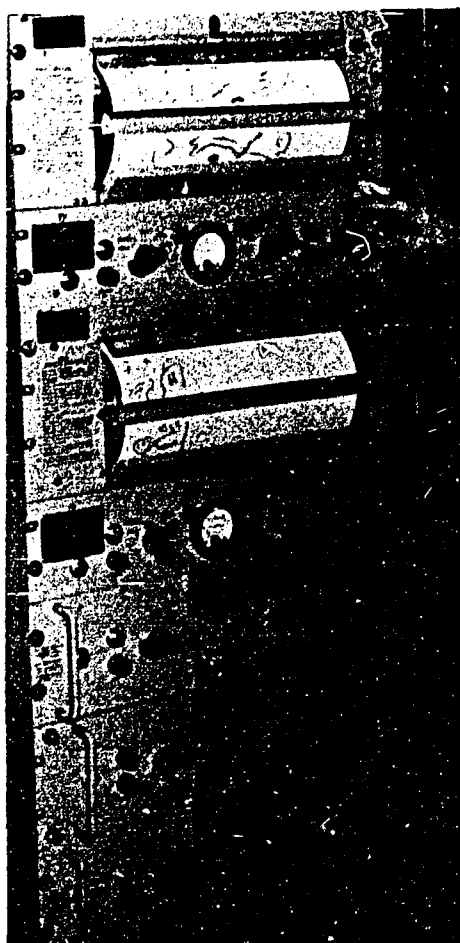

Figure 9-6. FAX receiver employing high-voltage recording stylus. 112.67



QUARTER MASTER I & C

Symbol	Description and remarks	Symbol	Description and remarks
TT	Temperature of the air to the nearest whole degree Fahrenheit. (A temperature of 107° F. would be encoded as 07 and a temperature of -15° F. would be encoded as 85); col. 14.		
N <sub>L</sub>	Amount of cloud whose height is reported by "h" (col. 15); (Code Table 3 on p. 11-1). (NOTE.—When cloud of C <sub>L</sub> type is present, the fraction of the celestial dome covered by the type of C <sub>L</sub> cloud reported for C <sub>L</sub> will be reported for N <sub>L</sub> . When there are no low clouds present, the fraction of the celestial dome covered by middle clouds (C <sub>M</sub> type) will be reported by N <sub>L</sub> . When only high clouds (C <sub>H</sub> TYPE) are present, "0" will be reported for N <sub>L</sub> ).		
C <sub>L</sub>	Clouds of genera (types) Stratocumulus, Stratus, Cumulus, and Cumulonimbus (low clouds), col. 16; (Code Table 8 on p. 11-5).		
h	The height above ground of the base of the cloud (whose amount is reported by N <sub>L</sub> ), col. 17; (Code Table 9 on p. 11-5).		
C <sub>M</sub>	Clouds of genera (types) Altocumulus, Altostratus, and Nimbostratus (middle clouds), col. 18; (Code Table 10 on p. 11-6).		
C <sub>H</sub>	Clouds of genera (types) Cirrus, Cirrostratus, and Cirrocumulus (high clouds), col. 19; (Code Table 11 on p. 11-6).		
D.	Ship's course made good during the 3 hours preceding the time of observation (true), col. 20; (Code Table 12 on p. 11-7).		
v.	Ship's average speed made good during the 3 hours preceding the time of observation, col. 21; (Code Table 13 on p. 11-7).		
a	Barometric tendency (barometer change characteristics during the 3 hour period ending at the time of observation), col. 22; (Code Table 14 on p. 11-7).		
pp	Amount of barometric pressure change in the 3 hours preceding the time of observation (tendency). Encoded in units and tenths of millibars, Col. 23; (Code Table 15 on p. 11-7).		
8	Indicator figure for 8N <sub>L</sub> Ch,h, group.		
N <sub>L</sub>	The fraction of the celestial dome covered by the individual cloud layer or mass reported by C (significant cloud layer), col. 25; (Code Table 3 on p. 11-1). The selection of cloud layers to be reported by this group will be made according to the following rules: (1) The lowest individual layer of cloud of any amount greater than zero; (2) The next higher layer which covers 4/10 or more of the celestial dome; (3) the next higher layer which covers 6/10 or more of the celestial dome. The 8-group will be included in the message as many times as may be required to report the layers of cloud that exist in accordance with the above specifications. The 8-groups will appear in the message in ASCENDING ORDER.		
		C	Genus (type) of significant cloud whose amount is reported by N <sub>L</sub> , col. 26; (Code Table 16 on p. 11-8).
		h,h.	Height of base of cloud (significant) whose type is reported by "C", col. 27; (Code Table 17 on p. 11-8).
		O	Indicator figure for OT,T,T <sub>4</sub> T <sub>4</sub> group.
		T,T.	Difference between air temperature and sea temperature in whole degrees Fahrenheit (col. 29). When the air temperature is higher than the sea temperature, enter the actual difference; when the air temperature is lower, add 50 to the difference before entering in column 29; e. g., when the air temperature is 5° above the sea temperature, enter 05; when the air temperature is 5° below the sea temperature, enter 55.
		T <sub>2</sub> T <sub>4</sub>	The temperature of the dewpoint to the nearest whole degree F. col. 30. (For temperatures of dew point above 100, subtract 100 before entering in col. 30; for values below 0 degrees, subtract the actual numerical value from 100 and enter the difference; e. g., -15 would be encoded as 85.
		1	Indicator figure for 1d,d,P,H, group.
		d,d.	True direction, in tens of degrees, FROM which waves are coming. Cols. 32 and 36 (Code Table 4 on p. 11-2).
		P.	Period of the waves Cols. 33 and 37 (Code Table 18 on p. 11-8).
		H.	Mean maximum height of the waves. Cols. 34 and 38 (Code Table 19 on p. 11-9).
		c.	Description of kind of ice. (Col. 39); (Code Table 20 on p. 11-9).
		K	Effect of the Ice on Navigation. Col. 40 (Code Table 21 on p. 11-9).
		D <sub>i</sub>	Bearing of Ice Edge. Col. 41 (Code Table 22 on p. 11-9).
		r	Distance to Ice Edge from reporting ship. Col. 42 (Code Table 23 on p. 11-9).
		e	Orientation of Ice Edge. Col. 43 (Code Table 24 on p. 11-10).

Figure 9-7.—Standard weather codes.

Use of facsimile for distributing weather charts eliminates the need for duplicate plotting aboard each ship and station requiring weather information. Significant economies have been effected, as well as more uniform, accurate, and rapid weather service.

The Navy has numerous facsimile equipment units in service. All operate in much the same way. The most common type of receiver records on a specially prepared paper by what is literally a burning process, similar to that used on the depth sounder (fig. 9-6). A stylus is connected to the output of the recorder amplifier in such a way that a high voltage is developed at the stylus point as the signals are received. The electrified stylus burns a white surface coating on the paper, which has a black undercoating that is conducting. One type of this paper may be used for making copies by the gelatin-ink transfer (hectograph) process.

### Markings on Weather Chart

Weather data received in code form from a land station or ship at sea are plotted on the chart at the symbol representing the location of the station or ship. Thus, you have available at a glance a complete and readily understandable graphical representation. Some standard codes used for this purpose are shown in figure 9-7. A complete explanation of all weather codes is contained in the *Federal Meteorological Handbook 02* (NAVAER 50-1D-2) Synoptics Codes.

Standard procedures for entering data (called the station model) at any station or ship on the chart are as follows:

Wind direction is indicated by an arrow pointing the way the wind is blowing. That is, the arrow points to the west if it's an east wind. Each full barb on the wind arrow represents 10 knots of mean velocity; each half barb represents 5 knots of mean velocity. For an exact breakdown of barbs on the wind arrows, in miles per hour and in Beaufort force, see figure 9-8.

Cloud types, cloud height, and sky coverage are denoted by the symbols contained in figure 9-9, 9-10 and 9-11, respectively.

Temperature is given in degrees Fahrenheit/Celsius.

Atmospheric pressure is represented to the tenth of a millibar, with only the last three figures plotted.

Barometric tendency for any changes over the previous 3 hours is indicated also on the station model. Directly below this symbol is the sign for past weather. (See fig. 9-12.)

Dewpoint temperature is designated in degrees Fahrenheit/Celsius.

Present weather is shown by an appropriate symbol on the station model. (See fig. 9-13.) Directly to the west of this symbol is the visibility in miles.

Figure 9-14 shows you how to enter data from weather broadcasts on a weather chart. An explanation of the symbols and map entries also appears in the illustration. Complete descriptions of all weather symbols used in the construction of a station model are included in figures 9-7 through 9-14.

### WEATHER MAPS

Once each week the U.S. Weather Bureau, Department of Commerce, prints and distributes, in pamphlet form, weather maps for each day of the week. Pamphlets contain an explanation of all the symbols used on the daily weather maps. This explanation includes the symbolic form of message, sample coded message, symbolic station model, sample plotted report, and other data. You may obtain copies from the Printing and Publication Section of the Department of Commerce.

### ISOBARS

Isobars define the boundaries of areas of equal pressure. In this respect, isobars are similar to fathom curves, which define boundaries of equal depth. Isobars likewise are much like contour lines, because the closer they are together, the steeper is the barometric slope over that particular area. It is this latter aspect that makes isobars an especially valuable aid in determining the horizontal motion of low layers of atmosphere that produces wind. Isobars are drawn on daily weather charts to indicate the instantaneous pressures over a certain area for the same time of day.

Isobars are drawn for intervals of 4 millibars from 25° latitude poleward, and 2 millibars from the equator to 25° latitude, using 1000 millibars as a base. Table 9-1 is a table for converting inches of mercury to millibars and vice versa.

### Isobars and Charts

Drawing isobars accurately, in accordance with the reports on atmospheric pressure received, is not as easy as it might appear at first glance. If the isobars are drawn incorrectly, predictions based on their analysis will be completely erroneous. The first principle to remember is that every isobar must form a closed curve. In other words, your pencil must eventually work back to its starting point, provided the chart is on a sufficiently small scale. If it isn't, you must wind up in the margin. If you find your line crossing another, or stopping in the middle of the chart, you have done something wrong.

Mean velocity in knots	Beaufort No. (force)	Descriptive term	Appearance of sea
<1	0	Calm	Sea like a mirror.
1-3	1	Light air	Ripples with the appearance of scales are formed, but without foam crests.
4-6	2	Light breeze	Small wavelets, still short but more pronounced. Crests have a glassy appearance and do not break.
7-10	3	Gentle breeze	Large wavelets. Crests begin to break. Foam of glassy appearance. Patches scattered whitecaps.
11-16	4	Moderate breeze	Small waves, becoming longer; fairly frequent whitecaps.
17-21	5	Fresh breeze	Moderate waves, taking a more pronounced long form; many whitecaps are formed. (Chance of some spray.)
22-27	6	Strong breeze	Large waves begin to form; the white foam crests are more extensive everywhere. (Probably some spray.)
28-33	7	Moderate gale	Sea heaps up and white foam from breaking waves begins to be blown in streaks along the direction of the wind.
34-40	8	Fresh gale	Moderately high waves of greater length; edges of crests begin to break into the spindrift. The foam is blown in well-marked streaks along the direction of the wind.
41-47	9	Strong gale	High waves. Dense streaks of foam along the direction of the wind. Sea begins to "roll." Spray may affect visibility.
48-55	10	Whole gale	Very high waves with long overhanging crests. The resulting foam, in great patches, is blown in dense white streaks along the direction of the wind. On the whole, the surface of the sea takes a white appearance. The rolling of the sea becomes heavy and shocklike. Visibility affected.
56-63	11	Storm	Exceptionally high waves (small and medium-sized ships might be for a time lost to view behind waves). The sea is completely covered with long white patches of foam lying along the direction of the wind. Everywhere the edges of the waves are blown into froth. Visibility affected.
64 and over	12	Hurricane	The air is filled with foam and spray. Sea completely white with driving spray; visibility very seriously affected.

Figure 9-8. --Windspeed in knots and Beaufort scale.

## Chapter 9—WEATHER

Code Number	<b>C<sub>L</sub></b>	Description (Abridged From W.M.O. Code)	Code Number	<b>C<sub>M</sub></b>	Description (Abridged From W.M.O. Code)
1		Cu of fair weather, little vertical development and seemingly flattened.	1		Thin As (most of cloud layer semitransparent).
2		Cu of considerable development, generally towering, with or without other Cu or Sc bases all at same level.	2		Thick As, greater part sufficiently dense to hide sun (or moon), or Ns.
3		Cb with tops lacking clear-cut outlines, but distinctly not cirriform or anvil-shaped; with or without Cu, Sc, or St.	3		Thin Ac, mostly semi-transparent; cloud elements not changing much and at a single level.
4		Sc formed by spreading out of Cu; Cu often present also.	4		Thin Ac in patches; cloud elements continually changing and/or occurring at more than one level.
5		Sc not formed by spreading out of Cu.	5		Thin Ac in bands or in a layer gradually spreading over sky and usually thickening as a whole.
6		St or Fs or both, but no Fs of bad weather.	6		Ac formed by the spreading out of Cu.
7		Fs and/or Fc of bad weather (scud)	7		Double-layered Ac, or a thick layer of Ac, not increasing; or Ac with As and/or Ns.
8		Cu and Sc (not formed by spreading out of Cu) with bases at different levels.	8		Ac in the form of Cu-shaped tufts or Ac with turrets.
9		Cb having a clearly fibrous (cirriform) top, often anvil-shaped, with or without Cu, Sc, St, or scud.	9		Ac of a chaotic sky, usually at different levels; patches of dense Ci are usually present also.

Code Number	<b>C<sub>H</sub></b>	Description (Abridged From W.M.O. Code)	Cloud Abbreviation
1		Filaments of Ci, or "mares tails," scattered and not increasing.	St or Fr-Stratus or Fractostratus
2		Dense Ci in patches or twisted sheaves, usually not increasing, sometimes like remains of Cb; or towers or tufts.	Ci-Cirrus
3		Dense Ci, often anvil-shaped, derived from or associated with Cb.	Cs-Cirrostratus
4		Ci, often hook-shaped, gradually spreading over the sky and usually thickening as a whole.	Cc-Cirrocumulus
5		Ci and Cs, often in converging bands, or Cs alone; generally overspreading and growing denser; the continuous layer not reaching 45° altitude.	Ac-Alto cumulus
6		Ci and Cs, often in converging bands, or Cs alone; generally overspreading and growing denser; the continuous layer exceeding 45° altitude.	As-Altostratus
7		Veil of Cs covering the entire sky.	Sc-Stratocumulus
8		Cs not increasing and not covering entire sky.	Ns-Nimbostratus
9		Cc alone or Cc with some Ci or Cs, but the Cc being the main cirriform cloud.	Cu or Fc-Cumulus or Fractocumulus
			Cb-Cumulonimbus

Figure 9-9.—Cloud types.

112.70

h	Height in Feet (Rounded Off)	Height in Meters (Approximate)
0	0 - 149	0 - 49
1	150 - 299	50 - 99
2	300 - 599	100 - 199
3	600 - 999	200 - 299
4	1,000 - 1,999	300 - 599
5	2,000 - 3,499	600 - 999
6	3,500 - 4,999	1,000 - 1,499
7	5,000 - 6,499	1,500 - 1,999
8	6,500 - 7,999	2,000 - 2,499
9	At or above 8,000, or no clouds	At or above 2,500, or no clouds

112.71  
Figure 9-10.—Cloud height.

N	Nh	Sky Coverage
	0	No clouds
	1	Less than one-tenth or one-tenth
	2	Two and three-tenths
	3	Four-tenths
	4	Five-tenths
	5	Six-tenths
	6	Seven and eight-tenths
	7	Nine-tenths or overcast with openings
	8	Completely overcast
	9	Sky obscured

112.72  
Figure 9-11.—Sky coverage.

Code Number	W	Past Weather
0		Clear or few clouds
1		Partly cloudy (scattered) or variable sky
2		Cloudy (broken) or overcast
3		Sandstorm or dust-storm, or drifting or blowing snow
4		Fog, or smoke, or thick dust haze
5	,	Drizzle
6	•	Rain
7	*	Snow, or rain and snow mixed, or ice pellets (sleet)
8		Shower(s)
9		Thunderstorm, with or without precipitation

112.73  
Figure 9-12.—Past weather.

112.76

Table 9-1.—Conversion Table, Inches to Millibars

In.	Milli-bars	In.	Milli-bars	In.	Milli-bars	In.	Milli-bars	In.	Milli-bars	In.	Milli-bars	In.	Milli-bars
27.50	931.3	28.00	948.2	28.50	965.1	29.00	982.1	29.50	999.0	30.00	1,015.9	30.50	1,032.9
27.51	931.6	28.01	948.5	28.51	965.5	29.01	982.4	29.51	999.3	30.01	1,016.3	30.51	1,033.2
27.52	931.9	28.02	948.9	28.52	965.8	29.02	982.7	29.52	999.7	30.02	1,016.6	30.52	1,033.5
27.53	932.3	28.03	949.2	28.53	966.1	29.03	983.1	29.53	1,000.0	30.03	1,016.9	30.53	1,033.9
27.54	932.6	28.04	949.5	28.54	966.5	29.04	983.4	29.54	1,000.3	30.04	1,017.3	30.54	1,034.2
27.55	933.0	28.05	949.9	28.55	966.8	29.05	983.7	29.55	1,000.7	30.05	1,017.6	30.55	1,034.5
27.56	933.3	28.06	950.2	28.56	967.2	29.06	984.1	29.56	1,001.0	30.06	1,018.0	30.56	1,034.9
27.57	933.6	28.07	950.6	28.57	967.5	29.07	984.4	29.57	1,001.4	30.07	1,018.3	30.57	1,035.2
27.58	934.0	28.08	950.9	28.58	967.8	29.08	984.8	29.58	1,001.7	30.08	1,018.6	30.58	1,035.6
27.59	934.3	28.09	951.2	28.59	968.2	29.09	985.1	29.59	1,002.0	30.09	1,019.0	30.59	1,035.9
27.60	934.6	28.10	951.6	28.60	968.5	29.10	985.4	29.60	1,002.4	30.10	1,019.3	30.60	1,036.2
27.61	935.0	28.11	951.9	28.61	968.8	29.11	985.8	29.61	1,002.7	30.11	1,019.6	30.61	1,036.6
27.62	935.3	28.12	952.3	28.62	969.2	29.12	986.1	29.62	1,003.1	30.12	1,020.0	30.62	1,036.9
27.63	935.7	28.13	952.6	28.63	969.5	29.13	986.5	29.63	1,003.4	30.13	1,020.3	30.63	1,037.3
27.64	936.0	28.14	952.9	28.64	969.9	29.14	986.8	29.64	1,003.7	30.14	1,020.7	30.64	1,037.6
27.65	936.3	28.15	953.3	28.65	970.2	29.15	987.1	29.65	1,004.1	30.15	1,021.0	30.65	1,037.9
27.66	936.7	28.16	953.6	28.66	970.5	29.16	987.5	29.66	1,004.4	30.16	1,021.3	30.66	1,038.3
27.67	937.0	28.17	953.9	28.67	970.9	29.17	987.8	29.67	1,004.7	30.17	1,021.7	30.67	1,038.6
27.68	937.4	28.18	954.3	28.68	971.2	29.18	988.2	29.68	1,005.1	30.18	1,022.0	30.68	1,038.9
27.69	937.7	28.19	954.6	28.69	971.6	29.19	988.5	29.69	1,005.4	30.19	1,022.4	30.69	1,039.3
27.70	938.0	28.20	955.0	28.70	971.9	29.20	988.9	29.70	1,005.8	30.20	1,022.7	30.70	1,039.6
27.71	938.4	28.21	955.3	28.71	972.2	29.21	989.2	29.71	1,006.1	30.21	1,023.0	30.71	1,040.0
27.72	938.7	28.22	955.6	28.72	972.6	29.22	989.5	29.72	1,006.4	30.22	1,023.4	30.72	1,040.3
27.73	939.0	28.23	956.0	28.73	972.9	29.23	989.8	29.73	1,006.8	30.23	1,023.7	30.73	1,040.6
27.74	939.4	28.24	956.3	28.74	973.2	29.24	990.2	29.74	1,007.1	30.24	1,024.0	30.74	1,041.0
27.75	939.7	28.25	956.7	28.75	973.6	29.25	990.5	29.75	1,007.5	30.25	1,024.4	30.75	1,041.3
27.76	940.1	28.26	957.0	28.76	973.9	29.26	990.9	29.76	1,007.8	30.26	1,024.7	30.76	1,041.7
27.77	940.4	28.27	957.3	28.77	974.3	29.27	991.2	29.77	1,008.1	30.27	1,025.1	30.77	1,042.0
27.78	940.7	28.28	957.7	28.78	974.6	29.28	991.5	29.78	1,008.5	30.28	1,025.4	30.78	1,042.3
27.79	941.1	28.29	958.0	28.79	974.9	29.29	991.9	29.79	1,008.8	30.29	1,025.7	30.79	1,042.7
27.80	941.4	28.30	958.3	28.80	975.3	29.30	992.2	29.80	1,009.1	30.30	1,026.1	30.80	1,043.0
27.81	941.8	28.31	958.7	28.81	975.6	29.31	992.6	29.81	1,009.5	30.31	1,026.4	30.81	1,043.3
27.82	942.1	28.32	959.0	28.82	976.0	29.32	992.9	29.82	1,009.8	30.32	1,026.8	30.82	1,043.7
27.83	942.4	28.33	959.4	28.83	976.3	29.33	993.2	29.83	1,010.2	30.33	1,027.1	30.83	1,044.0
27.84	942.8	28.34	959.7	28.84	976.6	29.34	993.6	29.84	1,010.5	30.34	1,027.4	30.84	1,044.4
27.85	943.1	28.35	960.0	28.85	977.0	29.35	993.9	29.85	1,010.8	30.35	1,027.8	30.85	1,044.7
27.86	943.4	28.36	960.4	28.86	977.3	29.36	994.2	29.86	1,011.2	30.36	1,028.1	30.86	1,045.0
27.87	943.8	28.37	960.7	28.87	977.7	29.37	994.6	29.87	1,011.5	30.37	1,028.4	30.87	1,045.4
27.88	944.1	28.38	961.1	28.88	978.0	29.38	994.9	29.88	1,011.9	30.38	1,028.8	30.88	1,045.7
27.89	944.5	28.39	961.4	28.89	978.3	29.39	995.3	29.89	1,012.2	30.39	1,029.1	30.89	1,046.1
27.90	944.8	28.40	961.7	28.90	978.7	29.40	995.6	29.90	1,012.5	30.40	1,029.5	30.90	1,046.4
27.91	945.1	28.41	962.1	28.91	979.0	29.41	995.9	29.91	1,012.9	30.41	1,029.8	30.91	1,046.7
27.92	945.5	28.42	962.4	28.92	979.3	29.42	996.3	29.92	1,013.2	30.42	1,030.1	30.92	1,047.1
27.93	945.8	28.43	962.8	28.93	979.7	29.43	996.6	29.93	1,013.5	30.43	1,030.5	30.93	1,047.4
27.94	946.2	28.44	963.1	28.94	980.0	29.44	997.0	29.94	1,013.9	30.44	1,030.8	30.94	1,047.8
27.95	946.5	28.45	963.4	28.95	980.4	29.45	997.3	29.95	1,014.2	30.45	1,031.2	30.95	1,048.1
27.96	946.8	28.46	963.8	28.96	980.7	29.46	997.6	29.96	1,014.6	30.46	1,031.5	30.96	1,048.4
27.97	947.2	28.47	964.1	28.97	981.0	29.47	998.0	29.97	1,014.9	30.47	1,031.8	30.97	1,048.8
27.98	947.5	28.48	964.4	28.98	981.4	29.48	998.3	29.98	1,015.2	30.48	1,032.2	30.98	1,049.1
27.99	947.9	28.49	964.8	28.99	981.7	29.49	998.6	29.99	1,015.6	30.49	1,032.5	30.99	1,049.5

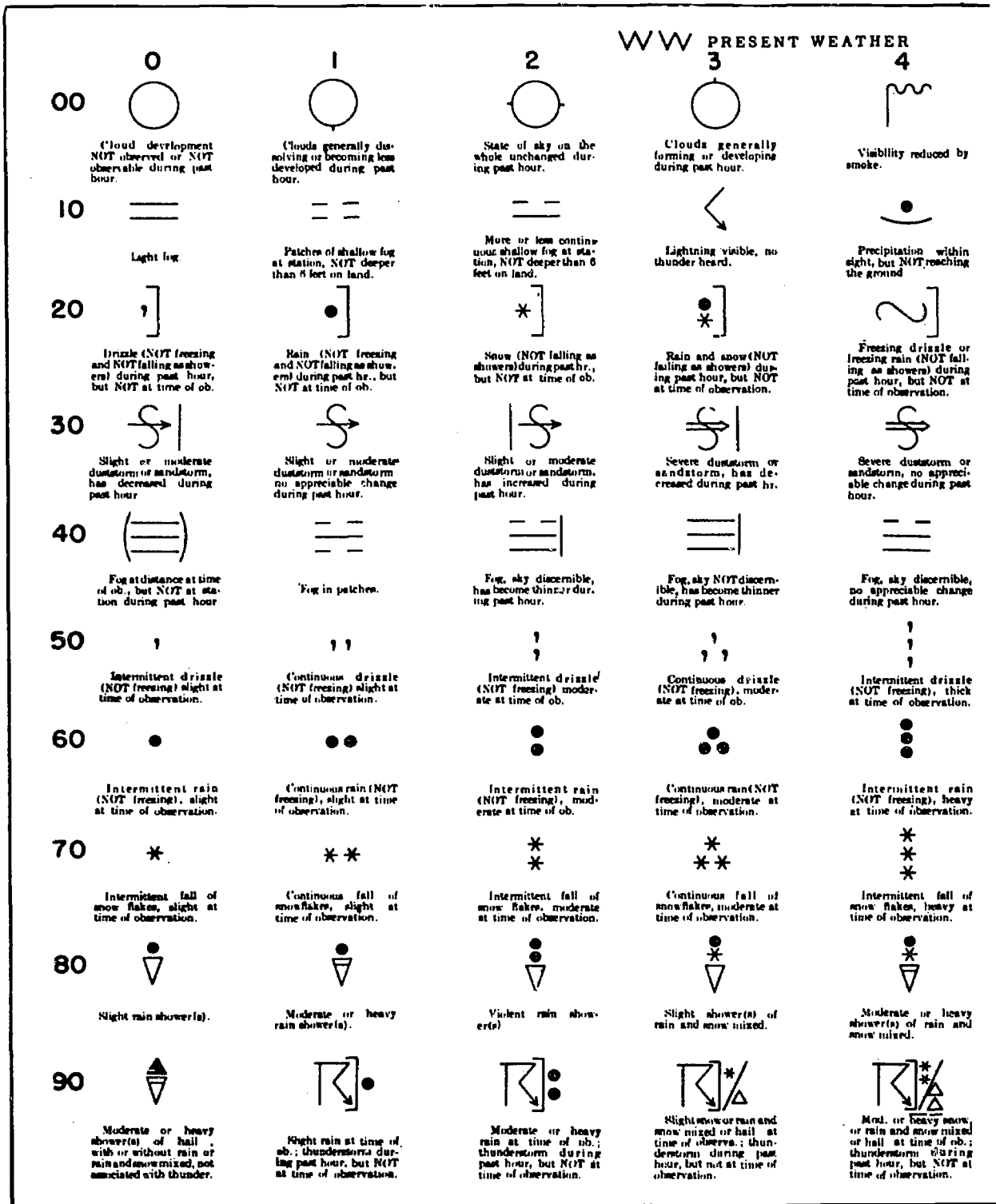

Figure 9-13.—Present weather.

(Descriptions Abridged from W.M.O. Code)

5	6	7	8	9
 Haze.	 Widespread dust in suspension in the air, NOT raised by wind, at time of observation.	 Dust or sand raised by wind, at time of ob.	 Well developed dust devil(s) within past hr.	 L. storm or sandstorm within sight of or at station during past hour.
 Precipitation within sight, reaching the ground, but distant from station.	 Precipitation within sight, reaching the ground, near to but NOT at station.	 Thunder heard, but no precipitation at the station.	 Squall(s) within sight during past hour.	 Funnel cloud (or vortex) in sight during past hour.
 Showers of rain during past hour, but NOT at time of observation.	 Showers of snow, or of rain and snow, during past hour, but NOT at time of observation.	 Showers of hail, or of hail and rain, during past hour, but NOT at time of observation.	 Fog during past hour, but NOT at time of ob.	 Thunderstorm (with or without precipitation) during past hour, but NOT at time of ob.
 Severe duststorm or sandstorm, has increased during past hour.	 Slight or moderate drifting snow, generally low.	 Heavy drifting snow, generally low.	 Slight or moderate drifting snow, generally high.	 Heavy drifting snow, generally high.
 Fog, sky NOT discernible, no appreciable change during past hour.	 Fog, sky discernible, has begun or become thicker during past hr.	 Fog, sky NOT discernible, has begun or become thicker during past hour.	 Fog, departing rime, sky discernible.	 Fog, depositing rime, sky NOT discernible.
 Continuous drizzle (NOT freezing), thick at time of observation.	 Slight freezing drizzle.	 Moderate or thick freezing drizzle.	 Drizzle and rain, slight.	 Drizzle and rain, moderate or heavy.
 Continuous rain (NOT freezing), heavy at time of observation.	 Slight freezing rain.	 Moderate or heavy freezing rain.	 Rain or drizzle and snow, slight.	 Rain or drizzle and snow, moderate or heavy.
 Continuous fall of snowflakes, heavy at time of observation.	 Ice needles (with or without fog).	 Granular snow (with or without fog).	 Isolated starlike snow crystals (with or without fog).	 Ice pellets (sleet, U. S. definition).
 Slight snow shower(s).	 Moderate or heavy snow shower(s).	 Slight shower(s) of silt or small hail with or without rain or snow mixed.	 Moderate or heavy shower(s) of silt or small hail with or without rain or snow mixed.	 Slight shower(s) of hail, with or without rain or rain and snow mixed, not associated with thunder.
 Slight or mod. thunderstorm without hail, but with rain and/or snow at time of ob.	 Slight or mod. thunderstorm, with hail at time of observation.	 Heavy thunderstorm, without hail, but with rain and/or snow at time of observation.	 Thunderstorm combined with duststorm or sandstorm at time of ob.	 Heavy thunderstorm with hail at time of ob.

Figure 9-13.—Present weather—Continued.



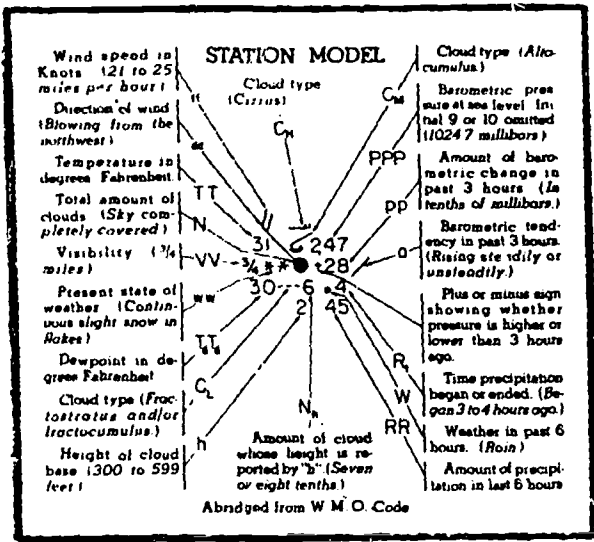

112.75

Figure 9-14.—Model of a weather station.

Because of the scarcity of stations from which barometric information is received, remember that, for large areas of the chart, your pencil must be guided by the rules that follow.

- Rule 1: Guide your pencil so as to keep all points of pressure higher than the value of the isobar on the same side of the line. Failure to follow this rule is a common error that frequently leads the pencil of the beginner off the track when he is drawing isobars. If you observe that there are higher and lower readings on both sides of the line, you may be sure that you have run off the track somewhere. Remember that the isobar has a certain value and, in reference to two points—one with a lower pressure and the other with a higher pressure—the line of the isobar must run between them.
- Rule 2: In the Northern Hemisphere, if the isobar is traced into the wind, it must be kept to the right of all points where pressure is higher than its value. If it is traced with the wind, it must be kept to the left of all such points.

In general, rule 2 holds over sea areas, but does not always apply over the land. The reason is that wind directions observed locally at land stations do not always conform because of topographic effects to the general pattern of large-scale atmospheric motion stated in Buys' Ballot's law. (When you stand

with your back to the prevailing wind in the Northern Hemisphere, the high-pressure area is to your right, and the low-pressure area is to your left. The reverse is true in the Southern Hemisphere.)

With Buys' Ballot's law in mind, study figure 9-15. Both Key West and Miami report 1014 millibars and a northwest wind. The region of lower barometer readings must, therefore, be to the eastward or right of these stations. If we trace the isobar from St. Thomas with the wind, all barometer readings higher than 1016 millibars must be to the right. You can see that ships A and B report 1016.5 millibars and a southeast wind. As a result, your line should curve around to follow the wind and pass just to the left of both ships.

Ship C to the north-northwest of ship B reports 1016 millibars, wind northeast. Between ship B and ship C the wind evidently backs from south to northeast. Then the isobar must back, too, counterclockwise, so that it takes a trend to the southwest in passing through the position of ship C. Hatteras reports 1016 millibars and a northeast wind. The isobar follows the wind southwestward to Hatteras, with readings of more than 1016 millibars lying to its right. Then the rule still is observed that, when the isobar is traced with the wind, it is kept to the left of all points where pressure is higher than its assigned value. Continuing with the wind, it passes through Charleston, to the north of Jacksonville, and thence through the Gulf to its starting point.

Ship D reports 1016 millibars and a northwest wind. It is evident, then, that another isobar must start here. Tracing it into the wind this time, we must remember that in this example it must be kept to the right of all points where pressure is higher than its assigned value. Thus it runs through ship D, curving northwestward to pass in that direction from Nantucket to Halifax.

### ISOBARIC ANALYSIS

From the preceding description of elementary principles, you can see that, in drawing isobars, much depends upon a proper analysis of the situation by the person filling in the chart. If barometric observations were unlimited in number, it would be necessary merely to connect the points of equal pressure. Unfortunately, such observations are scarce and not always completely reliable.

Following is a description of analytical methods used to compensate for scarcity of observations or possible errors in observations, and to avoid illogical or impossible results.

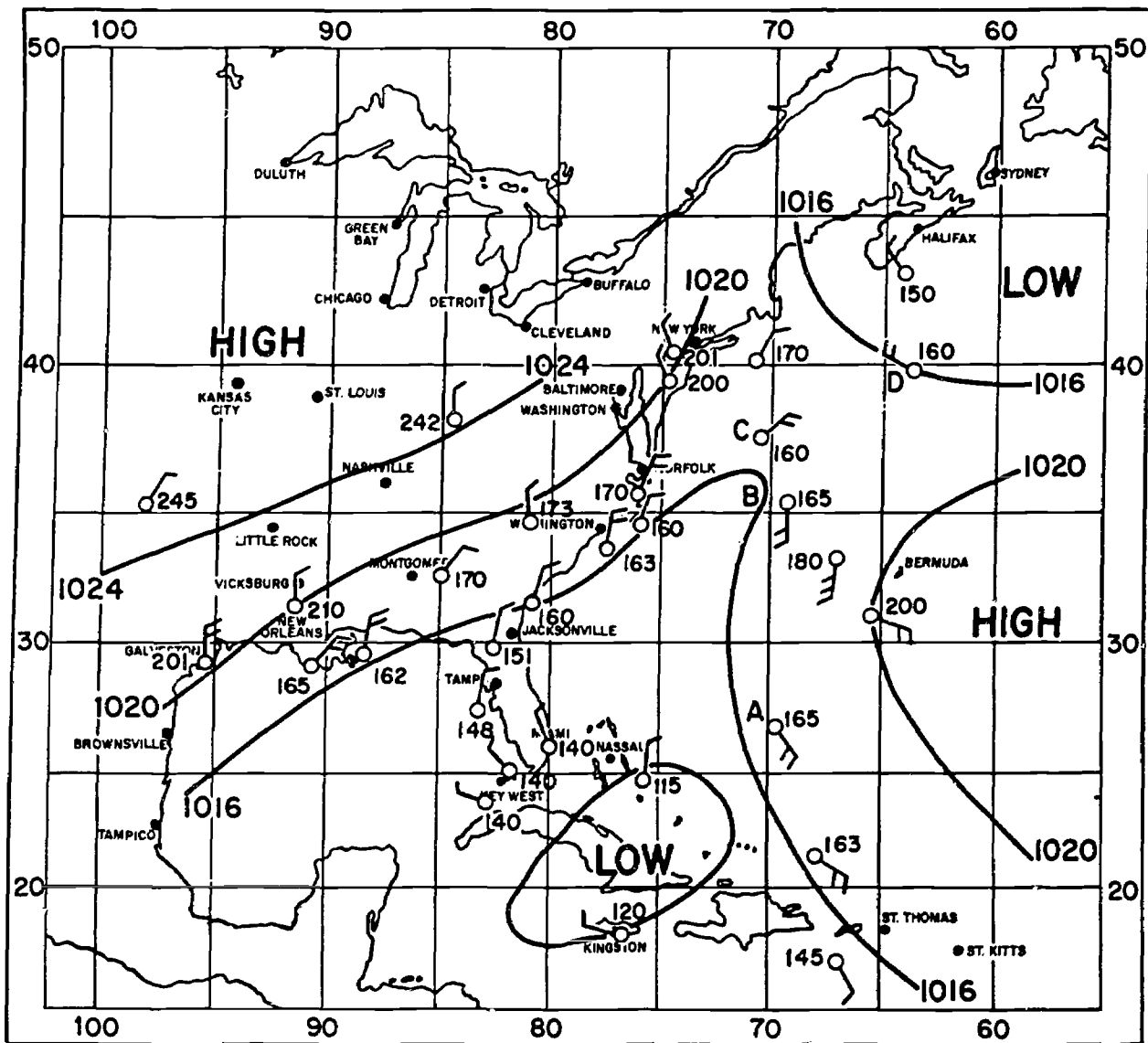

Figure 9-15.—Weather map (1).

112.77

**Errors in Barometric Reports**

A barometric report may be incorrect for one or more of the following reasons:

1. Inaccuracy of the instrument used;
2. Incorrect reading of the barometer;
3. Error in applying corrections to observed readings;
4. Error through failure to make observation at the exact GMT;

5. Error in coding or transmission;
6. Error resulting from limitations of the code.

You cannot identify an instrumental error positively unless you can compare three or four observations from one ship with those from a nearby ship or land station.

Small errors in readings are difficult to detect. Depending on the scale of the instrument, large errors usually are the result of misreading inches or

millibars. In these instances, it is possible, ordinarily, to deduce what the reading should have been.

Errors in coding usually result from (1) entering the last two figures into the coded message in inches instead of millibars, or (2) selecting the wrong figures in the code table. If two ships in the same locality report readings that are in agreement with each other but drastically different from those of a third ship nearby, it often is possible to determine just how the observer on the third ship made his error.

Errors in transmission nearly always are the result of changing a figure by one unit, or of transposing two or more figures in a group. If an error of the first type occurs in the last figure of the report, it will not be especially significant. Such an error in the first figure, however, produces an error in the result of 10 millibars (approximately 0.30 inch). Transposition of figures, of course, produces large errors.

A special kind of error is caused by incorrectly reporting the ship's position. In that event the barometric reading does not "fit" the reported position, and you are likely to assume that the reading is erroneous instead of the position. Likewise, errors of position throw other elements of the weather report out of harmony with the vicinity. They usually amount to 1° or even 10° in latitude or longitude. If the reporting ship's position is tracked carefully from chart to chart, position errors usually can be detected.

Errors resulting from necessary limitations of the international code are comparatively insignificant. The code is accurate to within 1 millibar (0.03 inch), so that the error will be no greater than 0.5 millibar (0.015 inch).

Errors caused by a mistake in decoding or in plotting the ship's position usually can be identified and corrected by the analyst himself.

### RULES FOR DRAWING ISOBARS

When an isobar is drawn to fit an incorrect or misplaced barometric reading, the resulting error is smaller if the pressure gradient is steep than if it is flat. Effects of all errors previously described may be minimized by observing the following rules when drawing isobars.

1. Remember that simple isobaric patterns are much more probable than complicated ones. This rule is especially true when the wind circulation is strong. The principle is based upon experience. We know that small-scale disturbances and eddies do exist and that they are at variance with the prevailing situation laid down in Buys' Ballot's law, but they tend to be absorbed by the large-scale movements, especially if the latter disturbances are vigorous.

Consequently, you should avoid sudden or angular deviation in drawing the isobars, and "fair" the isobars by eliminating irregularities that show no systematic arrangement. Any irregularity that does show a systematic arrangement must not be overlooked, because it is likely to result in a major disturbance later.

2. Draw the isobars so as to place them in the best possible agreement with both the available barometric reports and Buys' Ballot's law. Remember the relationship between the wind direction and the direction of the isobars. From Buys' Ballot's law it follows that the wind customarily blows along the path traced by the isobars, with relatively low pressure to the left of its course in the Northern Hemisphere. Because of the effect of friction and other surface forces, the wind direction does not exactly parallel the isobars, but usually is deflected toward the side of the lower pressure. Over the ocean the angle ordinarily is about 15° between the isobars and the wind direction. Wind direction reports from ships at sea are more reliable than their barometric reports. For this reason, if you cannot make the isobar fit both the barometric reading and the wind direction, it is best to assume that the barometric report is in error. Never draw an isobar in such a manner as to have the wind blow across it from a low to a higher pressure area.

3. Space the isobars so that they agree with the observed wind velocities. Crowded isobars indicate a steep isobaric surface, exactly as crowded contour lines indicate a steep slope on the earth. Speed of the wind is directly proportional to steepness of the isobaric slope, the same as the speed of a running stream would be on a slope ashore. Wind velocity, then, is inversely proportional to the distance between isobars. Table 9-2 is based upon this rela-

112.78

Table 9-2.—Wind Force and Distance Between Isobars Over Ocean

Observed wind force (Beaufort)	Approximate distance (in nautical miles) between isobars drawn for every 0.10 inch			
	Lat. 30°	Lat. 40°	Lat. 50°	Lat. 60°
4	230	180	150	135
5	170	135	110	95
6	130	100	85	75
7	105	80	70	60
8	85	65	55	50
9	70	55	45	40
10	60	45	40	35
11	55	40	35	30
12	50 or less	38 or less	32 or less	28 or less

tionship. It shows the approximate distances between adjacent isobars that represent various forces of wind. The table is computed for isobars drawn for every 0.10 inch. If they are drawn for every 5 millibars, distance in the table must be multiplied by 3/2. It should be mentioned that the table also applies to straight isobars or to those whose curvature is very slight. For isobars near the center of a round cyclone, distances corresponding to various forces of wind are smaller than those shown in the table. Near the center of a round anticyclone they are larger.

4. Begin drawing isobars at the point where their probable pattern is easiest to detect. Delay the difficult parts of the chart to the last. The isobaric pattern can be determined easiest in the locality where observations are most numerous. In charts of coastal areas, isobars should be started on the land and drawn out over the water. In high-pressure regions they usually are more symmetrical than in areas where pressure is low. Consequently, if observations are no more numerous in one part of the chart than another, it is a good idea to begin them in a locality where pressure is relatively high.

5. If isobars were drawn correctly on a preceding chart, those on the succeeding chart must follow a logical sequence. Successive positions of high- and low-pressure regions represent the paths of large-scale eddies in general circulation through the atmosphere. Their size and inertia prevent them from any rapid motion or sudden stop, so that radical speeding up or slowing down during a given 12-hour period is a highly improbable occurrence. If isobars on successive charts indicate such phenomena, they are quite certain to be the result of either insufficient observations or failures to observe rules 2 and 3. Any abrupt or erratic fluctuation in direction of movement is also unlikely. If the isobars indicate that a center has traveled 300 miles to the southeast on one 12-hour chart, 600 miles to the north-northeast on the next, and 300 miles to the east-southeast on the third, it is practically certain that you have gone adrift somewhere. Often, an apparent irregularity in the process of a cyclonic center is actually the rapid development of a new cyclone in the southwest quadrant of the system. This secondary may become so conspicuous that it is mistaken for the original center appearing on previous charts. If this mistake is made, the sequence of charts becomes illogical. The identity of the original center, therefore, must be preserved until it is absorbed entirely by the new one.

6. When an isobar in the Northern Hemisphere approaches intersection with another that follows an abrupt clockwise turn of the wind, the former line must be drawn so as to produce an **an** corner. The vertex of this angle al-

ways points toward higher pressure. You already have noticed that strict conformity to Buys' Ballot's law frequently makes it necessary to curve isobars abruptly in this manner. This statement is not as illogical as it might appear at first glance. For instance, you know how abruptly the wind can veer in the Northern Hemisphere from southwest to northwest. Often, it shifts in less than 1 minute. This shift means that there will be a 90° change in direction of the isobars in a distance of less than 1 mile. The small scale of the weather chart requires a radical alteration of direction of the isobar at this point. As the wind shifts clockwise in the Northern Hemisphere, and counterclockwise in the Southern Hemisphere, it follows that corners in the isobars always point toward higher pressure. Provided the shift of wind is in the characteristic clockwise direction (Northern Hemisphere), there is no conceivable situation where angular isobars may be drawn pointing away from high pressure. Naturally, there can be a counterclockwise backing of the wind, but it always occurs more or less gradually, never with the suddenness of a veering line squall. Thus, the isobar that follows a backing wind will travel through a gradual curve instead of an angle.

To summarize: Isobars may be either rounded or V-shaped through the axis of a trough of low pressure. They must be rounded through the axis of a wedge of high pressure.

## ILLUSTRATIVE EXAMPLES

Figure 9-16 shows a system of isobars drawn to fit each barometric report. The rule requiring that all points of high pressure should be on the same side of the line has been observed.

The rule states that the isobars should be drawn in such a way as to cause them to be in the best possible agreement not only with the barometric readings but also with Buys' Ballot's law. In this instance they are in agreement and conformity with the principle that requires spacing isobars so as to agree with reported wind velocities.

Examination of the wind reports here seems to indicate a normal situation. That is to say, a uniform airstream is flowing southwest, fairly rapidly between Bermuda and Hatteras, decreasing in speed and curving to the westward off the east coast of Florida. Because wind observations normally are more accurate than barometric reports, you must fair these isobars to agree with the wind reports. To accomplish this agreement, it is clear that you must reject one or more of the barometric reports.

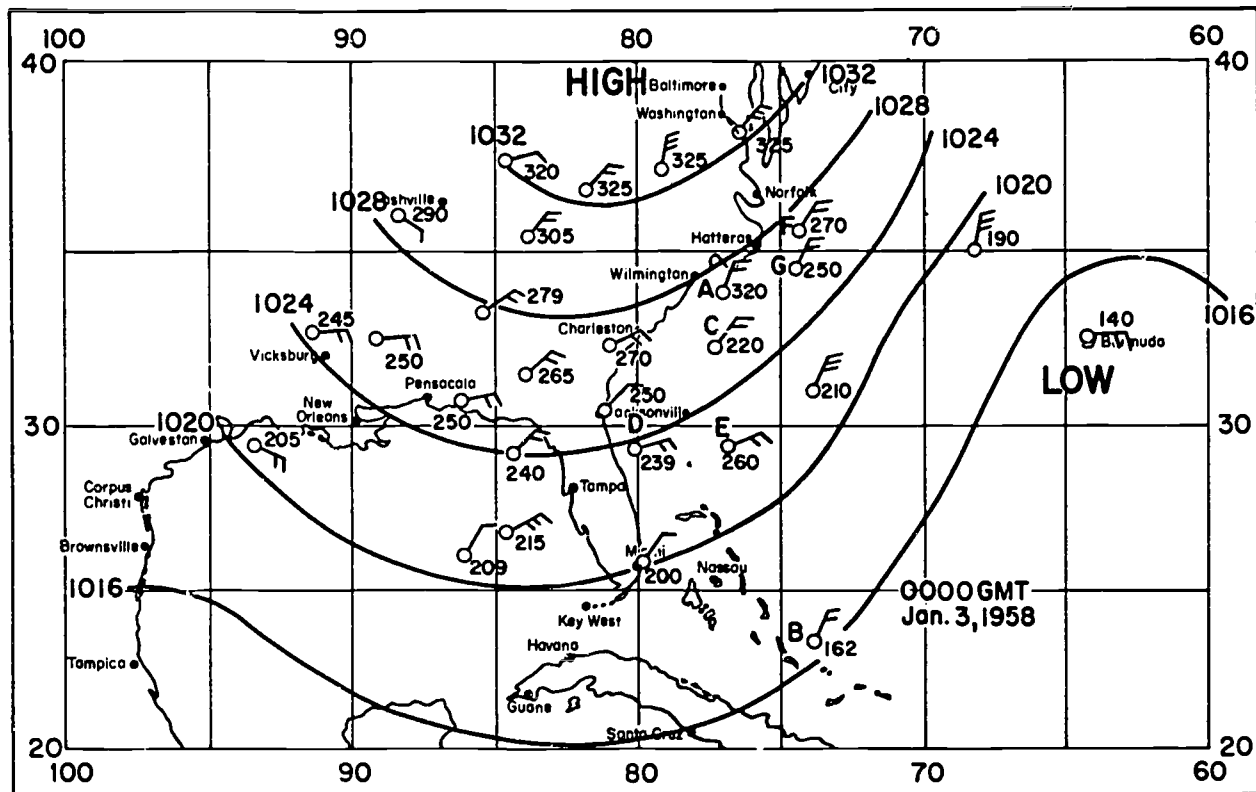

Figure 9-16.—Weather map (2).

112.79

It is safe to assume that barometric reports from shore stations are fairly accurate. Miami reports 1020 millibars. Considering the wind direction, then, the 1020 isobar should run east-northeast from Miami, and the barometric reading from ship E is too high. Assuming that ship D's barometric report is probably correct, then ship C's is too low and should be rejected. Continuing the isobar into the wind, it appears that properly the 1025 report for ship G will lie to the left on the side of the higher pressure.

Now consider the 1024 isobar. It should run eastward from a point just south of Jacksonville, because that station reports 1025 millibars, wind northeast. Obviously, then, the barometric report from ship A must be too high. When the line is extended toward ship F, it becomes apparent that, although G's reading fits in fairly well, drawing the line south of ship F to conform to a report of 1024 millibars will make the isobars crowded near Bermuda and widely separated near Hatteras. This spacing would indicate a radical difference in wind velocity at these

two points. The wind reports, however, indicate a uniform velocity over the entire stretch between Hatteras and Bermuda, requiring that the isobars here be spaced evenly. Ship A's barometric reading, then, is too high, so you ignore it in fairing the isobars. The distance between isobars as drawn is in excellent agreement with table 9-2 for a force 6 wind in the same latitude.

Figure 9-17 shows you how the proper fairing of the isobars indicates clearly an area of low pressure that soon developed into a hurricane. Here the barometric reports from ships A and B are in good agreement with each other. To harmonize with them, the 1004 isobar has been extended north from Nassau, and carried just to the west of ships A and B. Barometric and wind reports at Jacksonville indicate that the line should curve sharply to the southwest from a point just northwest of ship A, as in figure 9-17. The 1008 isobar is curved to the north near ship C to agree.

The report of a light west wind and high barometer from ship D fits in logically and indicates the presence of a separate anticyclonic center. Also,



## Occluded Front

An occluded front is formed when the cold front of an extratropical cyclone overtakes the warm front. In general, conditions preceding the arrival of an occluded front are similar to those prevailing during the approach of a warm front. Weather in the wake of an occluded front is equivalent to that left behind by a cold front.

## Fronts and Isobars

The pronounced weather changes that accompany a front are caused by the air currents on its opposite sides. These air currents originate in more or less widely separated geographical areas that have contrasting meteorological properties. For this reason, careful study of wind and pressure fields is essential in drawing isobars correctly, especially in ocean areas where weather reports are widely scattered. Isobars drawn in a conventional circular pattern around a cyclone, for instance, fail to give the observer a true picture of the motion of existing fronts. Consequently, he is unable to tell when the sky is likely to clear, or when a pronounced shift of wind may be expected. Isobars that locate weather

fronts properly afford a tangible basis for detailed forecasting.

The speed of movement of a cold front depends on the speed at which the air on the left side of the front (as you face toward low pressure) is advancing in the direction perpendicular to the front. Speed of movement of a warm front is slower than cold fronts. Their average speed is usually between 10 and 20 knots. The rule for determining the movement of warm fronts states that a warm front will move with a speed of 60 to 80 percent of the component of the geostrophic wind normal to the front in the warm air mass. Hence, it is not difficult to calculate, from wind observations alone, the rate at which a front is moving. If wind reports are lacking, the distance between isobars must be relied upon. You can see how important it is to have them spaced correctly.

If correctly drawn isobars are crowded at one portion of a front and widely spaced at the other, it is obvious that the latter portion is lagging behind, causing a wavelike deformation of the front. A new cyclone is quite likely to be developing at this point. It may be said that, in general, a front remains stationary or moves very slowly when the winds on the cold side are blowing parallel (or nearly so) to the front.

## CHAPTER 10

# RECORDS, REPORTS, AND PUBLICATIONS

A popularly held axiom is that the higher a person goes up the ladder of success, the more involved he becomes in "paperwork." No reasonable person really wants to build a paperwork empire, but certain records and reports are essential to almost all kinds of work.

Some of the records and reports required of navigation department personnel, as well as the correct procedure for filling out, handling, and filing them, are described in this chapter. This chapter also specifies various publications used in navigation, and lists the publishing and issuing activities of individual publications. Portions of the material in this chapter were mentioned previously in this book or in the *QM 3 & 2* training manual. Because of its importance, that material is partially repeated. Other portions of this chapter may be completely new to you and should be given special attention in your study.

### OCEANOGRAPHIC OBSERVATIONS

Obtaining detailed and accurate sounding data for immediate and future use is of prime importance to the fleet and merchant marine. For this reason, many ships are required to take soundings while underway, and frequently must take intensive soundings over selected areas. Careful attention to navigation, plotting corrected ship's tracks, recording soundings, and correctly marking the echograms are of utmost significance.

It is not within the scope of this chapter to cover all the various aspects of oceanographic surveys; but, in view of the importance of accurate navigation and sounding information to oceanographic observations, some general instructions are given. These instructions apply to Navy ships conducting oceanographic surveys, and may be added to or modified by specifications for a particular cruise when circumstances so demand.

### NAVIGATION DURING SOUNDINGS

Navigation of the ship is not expected to present the usual problems. The value of the data

collected is much greater if the ship's position is determined so accurately as to leave no questions for the future. No matter how accurately the depth of the water is measured, the resulting sounding data are of little value unless they are located accurately.

The need for information concerning the ocean floor is so great that the Oceanographic Office has requested the cooperation of every ship of the U.S. Navy in recording and reporting soundings. When several ships are traveling in company, it is suggested that the following procedure be used.

1. The ships take station abeam on line of bearing at 5-mile intervals.
2. Only one ship of the group maintains navigational control.
3. Each ship takes radar ranges and pelorus bearings on adjacent ships every 30 minutes.
4. Record in the sounding log the name of the ship, dates, times of each observation, and ranges and bearings observed.

After all observations for the cruise are made, the tracks of all vessels should be plotted on one track chart in proper relation to the guide ship. When submitted to the Oceanographic Office, these reports constitute the only method (except by costly special surveys) by which such sounding data are obtained.

### Plotting Sheets

Sounding reports should be made on bottom contoured position plotting sheets (if available). An index to published BC plotting sheets is in H.O. Pub. 1-N. If no BC plotting sheets are available, it is recommended that the track be plotted on the H.O. 3000 series of plotting sheets. The track chart should contain the following data

1. The actual fixes, plotted with full information, including the time and type of fix. The 0800, 1200, and 2000 positions are not sufficient. (A navigator's worksheets may be submitted.)
2. The ship's track, adjusted so that it reflects the most probable position of the ship at all times.



3. The course and speed on each segment of the track, with the time of each change. (This information can be shown on the navigator's worksheet, if desired.)

4. Short dashes across the course line, dividing the line into hours. The hours should be subdivided into approximately 1/4-inch intervals. For most operating speeds, this measurement is equivalent to a time interval of 15 minutes. The echo sounding trace should then be scaled and a sounding read for each time marked along the track. These soundings are entered opposite the dash marking the time, and at an angle to the track. Maximum and minimum readings obtained from the echo sounding trace should be plotted on the track in their correct time relation.

5. Correct values for latitude and longitude coordinates.

6. The name of the ship making the observations, with the month, day, and year clearly indicated at least once on each sheet.

A navigator's worksheet and a smooth track chart are shown in figures 10-1 and 10-2, respectively.

## ECHOGRAM

The echo sounder should be operated continuously while underway, and every attempt should be made to record a continuous profile of the ocean bottom. The echograms should be carefully annotated with the correct time at least once hourly. If the recorder is equipped with an event marker, this marker should be used to indicate the correct time. If the echo sounder has no marker button, the position of the stylus at the time should be indicated with a pencil mark. (NOTE: all notations on the echogram should be made with a red or black grease pencil, because ordinary graphite pencil blends too well with the finish of the paper. If grease pencils are unavailable, any dark red pencil is satisfactory.)

Regardless of how the time is indicated on the echogram, the time should be written alongside the mark but well clear of the sounding trace. The date (including the day, month, and year) should be noted at least once every watch. The name of the ship making the observations should be inserted at both ends of the roll. If the markings specified in this paragraph are not made, and the echogram is separated from the rest of the report, there will be no way to identify it. Any changes of time zone should be noted at the time the clocks are changed. A sample echogram is shown in figure 10-3.

As indicated in figure 10-4, the echogram sometimes shows returns for double and triple depth, in addition to the true depth. These are recorded most

frequently when the ship passes over an area of sea bottom unusually favorable for sound reflection. Although it is possible to adjust the gain on the fathometer to eliminate these multiple returns, it is unnecessary to do so. The traces showing multiple returns may prove of value in the study of the composition of the ocean floor.

## SOUNDING LOG

Whenever soundings are not being recorded on an echogram, or if a clear graph is not available, it is essential that visual soundings be entered in a sounding log every 6 minutes. Intervals no greater than 5 minutes are necessary so that sufficient data may be obtained for completing the track chart. A sample sounding log is illustrated in figure 10-5. Soundings should be logged by date and time, and the original log should be submitted. Typewritten lists are neither necessary nor desirable.

## REPORTS TO OCEANOGRAPHER

Information gathered is of little use until it is submitted to the Oceanographic Office where it is analyzed and compared with known data. After analysis and compilation, the data are used in revising charts and publications.

Reports submitted to the Oceanographic Office should contain the corrected track chart, the echogram or log of soundings, and a letter containing supplemental information. The letter should state where the soundings were taken; any difficulties or adverse weather and sea conditions encountered in soundings or navigation; type of equipment used; frequency error, if any; an estimate of the reliability of the data; and any other information that might be helpful in data evaluation.

## SEA AND SWELL OBSERVATIONS

Because of the almost complete lack of quantitative reports concerning wave conditions in all parts of the world, it is most important to take observations of wind waves and swell whenever possible while afloat or airborne. The data may be used for planning air-sea rescue or aircraft carrier operations; selecting seaplane landing areas; studying local and distant wind systems and their effect on sea conditions; determining drift and breakup of ice floes; and moving supplies and personnel through surf zones.

Every effort should be made to standardize visual observational procedure so that different observers studying similar waves reach the same conclusions concerning what they see, and record identical data.

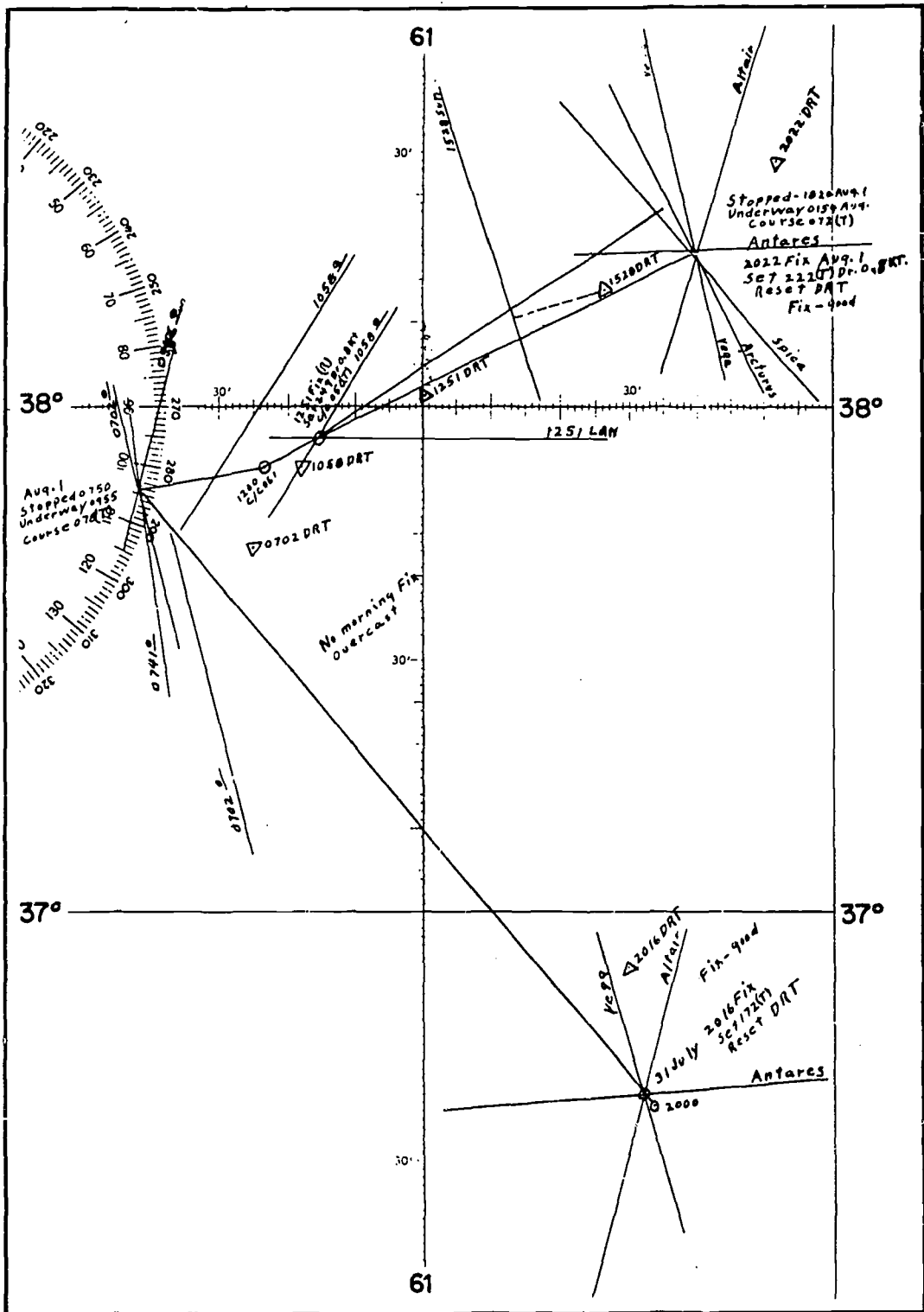

Figure 10-1.—Navigator's worksheet.



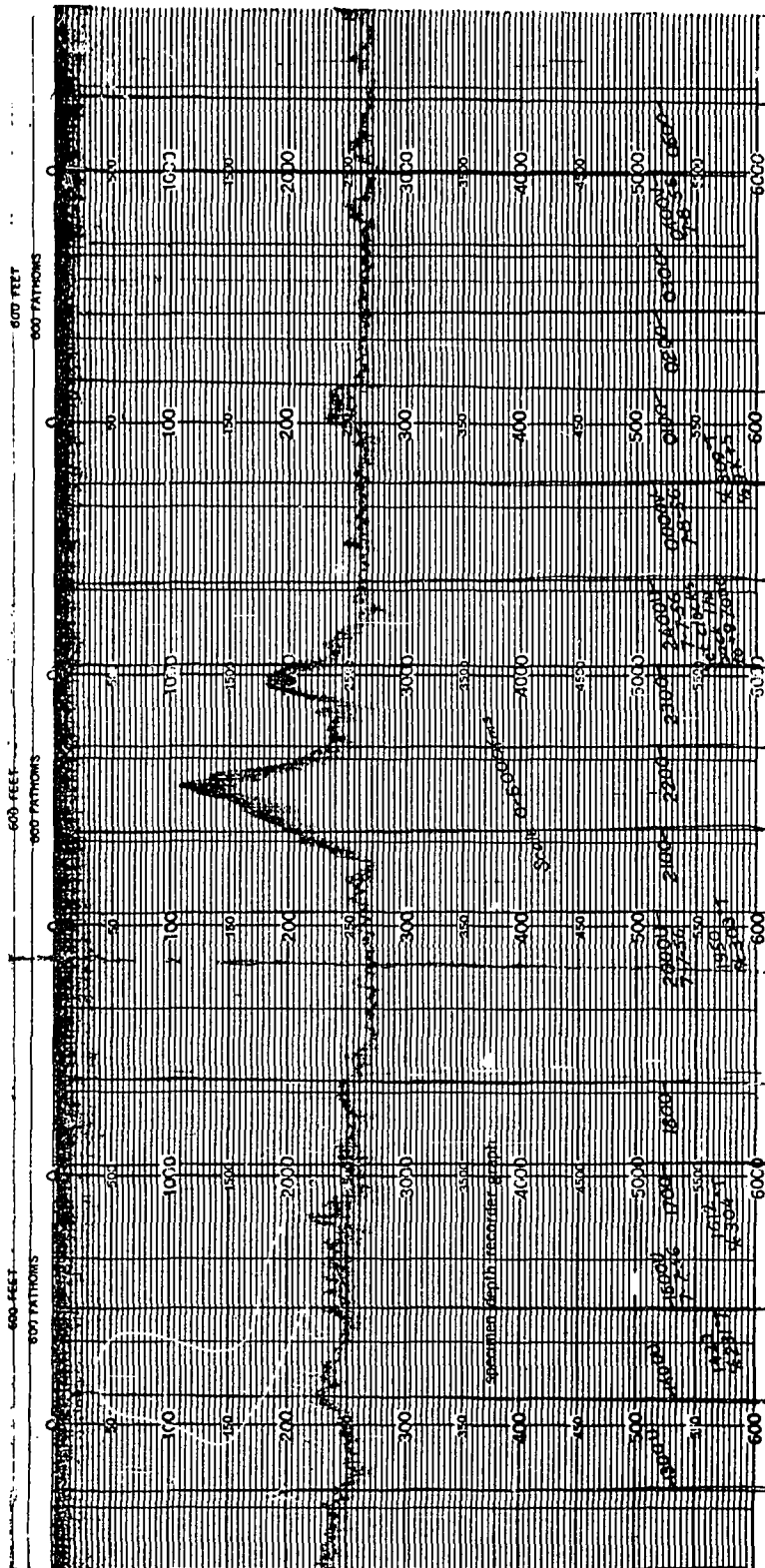

Figure 10-3.—Sample echogram.

62.10(112A)

QUARTER MASTER 1 & C

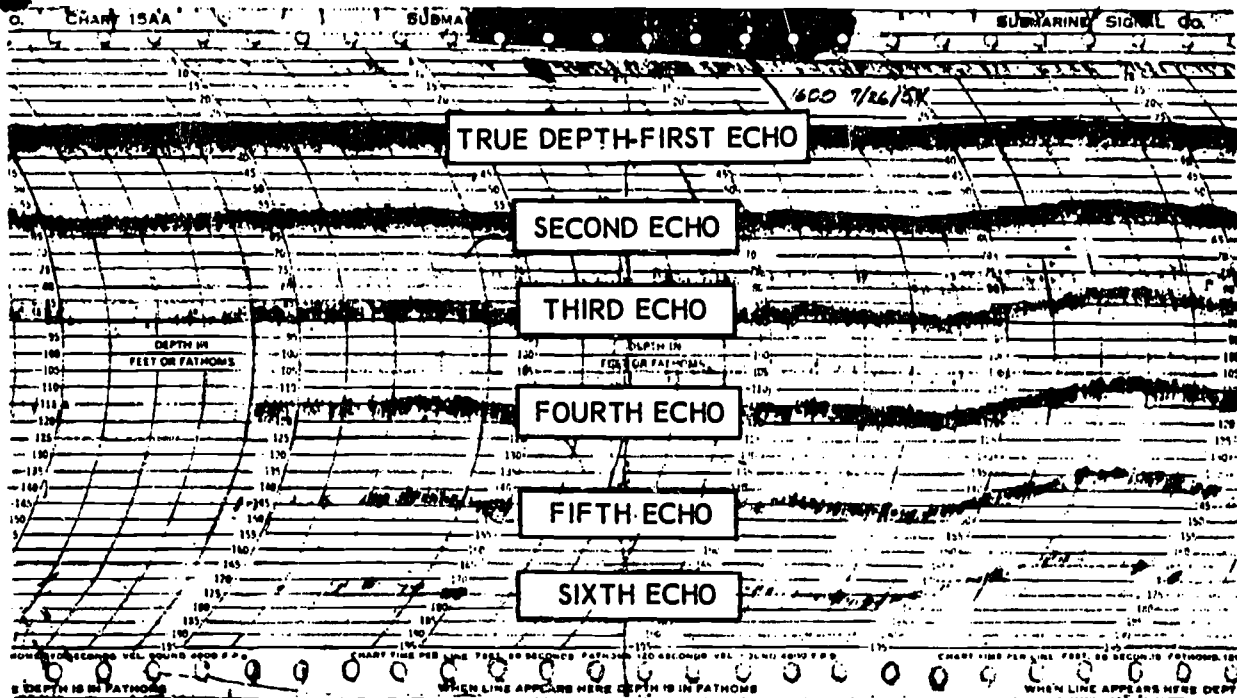

Figure 10-4.—Echogram showing multiple returns.

62.10(112)

Page No. \_\_\_\_\_

TIME				Pec. No.	FINAL Sdg.	Obs. Sdg.	SCALED Sdg.	CORRECTIONS IN FEET					FIELD Rcd. Sdg.	COURSE AND DRIFT	READINGS AND SIGNALS			NOTES		
h	m	s	s					Total	Zero	Obs. Tide	Freq.	Draft			Pred. Tide	17	18		19	20
07	55	0	0			2785														
08	00	0	0			2780														5 12 KTS
08	05	0	0			2775														0800 POSIT.
08	10	0	0			2770														045-20.44-215°36.0W
08	15	0	0			2760														0815 OPERATING #2
08	20	0	0			2750														RECORDER
08	25	0	0			2720														0830 STOPPED
08	30	0	0			2700														OPERATING #1 RECORDER
08	35	0	0			2690														
08	40	0	0			2690														
08	45	0	0			2685														
08	50	0	0			2650														
08	55	0	0			2600														
09	00	0	0			2575														
09	05	0	0			2590														
09	10	0	0			2600														
09	15	0	0			2605														
09	20	0	0			2630														
09	25	0	0			2635														
09	30	0	0			2625														
09	35	0	0			2670														
09	40	0	0			2685														
09	45	0	0			2690														
09	50	0	0			2695														
09	55	0	0			2700														
10	00	0	0			2705														
10	05	0	0			2720														

Figure 10-5.—Sounding logbook page.

112.84

Unless a standardized procedure is agreed upon, an observer might have difficulty in comparing two of his own observations made at separate times, or in deciding whether the waves have changed since the last observation. As a result, conscientious attention to the observations is required.

Instructions for recording visual sea and swell observations on a logsheet are given in H.O. Pub. No. 606e, *Sea and Swell Observations*. The information is recorded on the shipboard wave observation log form, illustrated in figure 10-6. Required data for the log are—

**Wave forecasting:** Recent developments in wave forecasting theory indicate that a much more thorough description of the sea surface is needed than is possible by visual observations alone. Consequently, automatic wave recorders of various types are now available for producing a height-versus-time profile of the sea surface at a given point.

Automatic shipboard equipment, designed to provide wave data on a continuing and scheduled basis, is in the developmental stage. Eventually, this equipment will enable the Oceanographic Forecasting Central of the Oceanographic Office to predict sea conditions over large portions of the ocean on a round-the-clock basis. The immediate need, however, is for accurate observational data, preferably instrument data, to be used in checking and improving forecasting procedures.

**Wind waves:** The character of the sea surface caused by the action of the local wind can be described in terms of height, period, length, and direction of the waves being formed. Waves still growing under the force of the wind are known as wind waves. These waves travel in a direction within about  $20^\circ$  of the local wind, and their dimensions are determined by three factors: (1) the strength of the wind; (2) the duration of time the wind has been blowing; and (3) the fetch or distance of the sea surface over which the wind has acted.

If the waves are newly formed and have not had a chance to consolidate themselves in a series of regularly connected crests and troughs, the sea surface will be choppy and make description difficult. As the waves grow, however, they group themselves into a regular series of connected troughs and crests with the H/L ratio (wave height/wave length) customarily ranging from 1/12 to 1/35, or 12 to 35 times their height.

**Swell:** Swell is a system of waves that moved out of the generating area into a region of weaker v calm, or opposing winds. Thus, swell

usually travels in a direction more than  $20^\circ$  from the direction of the wind (not necessarily always true). Swells decrease in height with travel, and although there may be difficulty in distinguishing between wind waves and swell, the latter usually possesses a more or less smooth, well-rounded profile, has greater wave length and period, and disturbs the water to a greater depth. The H/L ratio for swell normally ranges from 1/35 to 1/200. Under certain conditions, extremely long and high swells cause a ship to take solid water over her bow in a glassy sea.

Reporting a swell is of special significance, because its presence in the local area indicates that recently there may have been a very strong wind, possibly even a severe storm, hundreds or thousands of miles away. The direction from which the swell is coming tells in what direction the strong wind was located. In certain instances the onset of a swell is the first indication of an approaching storm.

**Wave height:** The vertical distance from the trough to the crest of a wave, measured in feet or meters, is termed wave height. Regarding the considerable variation in height between waves observed in a 7-minute period, reference is conveniently made to the significant wave height, which is the average of the higher, well-defined waves present during the observation. Statistically, significant waves are defined as the average of the highest one-third of the waves observed in a given time. From the operational point of view, height is the most important wave characteristic, hence care should be taken to observe and report it accurately. Although this value for height is about the best that can be expected from visual observations, efforts are being made to perfect instrument analysis and recording, which will be more valuable for forecasting purposes.

**Wave period:** The time interval between successive wave crests as the wave passes a fixed point, measured in seconds.

**Wave length:** The horizontal distance between successive crests, measured in feet or meters.

**Wave velocity:** The rate of travel of the waveform through the water, measured in feet or meters per second.

**Whitecaps:** In deep water the wind may blow strong enough to raise steep and choppy wind waves. When the ratio of height to length becomes too large, the water at the crest moves faster than the wave itself, causing the water at the crest to topple forward and form whitecaps. The term whitecaps is confined to deep-water waves, whereas breaker describes waves breaking in shoal water or in strong



tidal currents that oppose wave motion. Whitecaps owe their instability to a too rapid addition of energy from the wind to the waveform. Breakers owe their instability to the restrictive effect of the sea bottom or opposing currents upon the water movement in the waveform.

**Breakers:** A breaker is an ocean wave, either wind wave or swell, which has traveled over a gradually shoaling bottom and reached the point in its transformation where it no longer is stable, and plunges over or breaks. As a rule, when swell is definitely predominant, the breakers are regular with smooth profiles. When wind waves are predominant the breakers are choppy and confused. Swell coming into a beach increases in height up to the point of breaking. Wind waves, on the other hand, are already so steep that there is little if any increase in height just before breaking. Thus, swell often defines the period of the breakers even though the wind waves appear to predominate in deep water. A long, low swell in deep water may be obscured by choppy wind waves and may be detectable only on the beaches.

**Surf:** The zone of breakers, termed surf, includes the region of white between the outermost breaker and the waterline on the beach. During a storm, it may be difficult to differentiate between surf inshore and whitecaps in deep water just beyond.

## ICE OBSERVATIONS

Ice observations are made from aboard ship, from land stations, and from aircraft. Each type of observation offers specific information. A comprehensive description of ice conditions requires a combination of the three types of observations.

Only ice observations from aboard ship are discussed in this chapter. Shipboard observers are in a position to examine closely the ice immediately around their vessel. From this vantage they can determine accurately the texture and solidity of the ice, variations in thickness, state of deterioration, and other features requiring actual contact with the ice.

Because ship observations are limited to small areas immediately surrounding the stations, the information from any one observer is local in nature. The helicopter has done much, however, to enlarge the ship observer's horizon.

Ice in the sea consists, for the most part, of either sea ice, formed by the freezing of top layers of the ocean, or icebergs, originating from glaciers or continental ice sheets. Sea ice accounts for probably 95 percent of the area of ice encountered, but bergs are important because of the manner in which they drift from their point of origin, constituting navigational hazards. A certain amount of ice encountered at sea

originates as fresh water ice in rivers or estuaries. Because it already is in a state of deterioration by the time it reaches the open sea, however, its importance is local.

**Sea ice:** The first sign that the sea surface is freezing is an oily opaque appearance of the water. This occurrence is caused by the formation of spicules (minute ice needles) and crystals of ice, known as frazil, which increase in number until the sea is covered by slush of a thick, soupy consistency. Except in wind-sheltered areas, the slush, as it thickens, breaks up into separate masses, frequently in pancake form. The raised edges and rounded shape of this form result from collisions of the cakes. With the continuation of low temperatures, the cakes freeze into a continuous sheet.

Ice may grow to a thickness of 4 or 5 inches in the first 48 hours. Afterward growth becomes progressively slower. Sea ice seldom becomes more than 5 to 7 feet thick the first winter. Sometimes greater thicknesses are formed by rafting (overriding of one piece onto another), tidal overflow, and similar causes. Under the influence of winds, tides, currents, and pressure, the ice is torn apart in some localities and crowded together in others. As stresses are relieved, long cracks develop, permitting movement of segments within the pack. With the shifting of the ice, crowding may cause the ice to pile up onto pressure ridges and hummocks. See figure 10-7 for an example of the three types of ice topography.

In spring or summer, as snow or the surface of the ice melts, the ice becomes covered with water. Continued thawing of the ice develops honeycomb passages and holes into which the surface water drains. Sea ice less than 1 year old (first year ice), which is somewhat salty, melts more readily than older, less saline floes. Fast ice (ice connected to the shore) usually melts near shore first because of the relatively warm water that runs onto it from the land. Winds, waves, tides, currents, and outflows from rivers aid breakup and melting by mechanical means. As melting progresses, the ice farther from shore becomes crisscrossed with cracks caused by tides, winds, air temperature changes, and ice pressure.

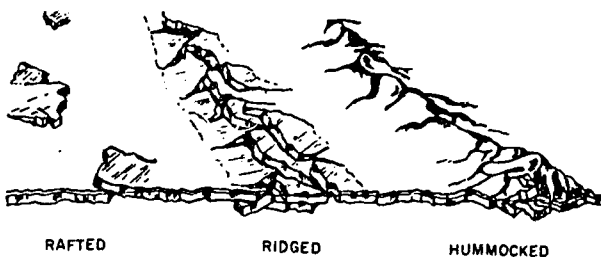

Figure 10-7.—Types of ice topography. 112.86



Table 10-1.—Ice Concentration

Type of Concentration	Description
Open water	A large area of freely navigable water in which sea ice is present in concentration less than 1/8. When no sea ice is present, the area should be termed ice free, even though icebergs are present.
Very open pack ice	Pack ice in which the concentration is 1/8 to less than 3/8 and water preponderates over ice.
Open pack ice	Pack ice in which the concentration is 3/8 to less than 6/8, with many leads and polynyas, and the floes are generally not in contact with one another.
Close pack ice	Pack ice in which the ice concentration is 6/8 to less than 7/8, composed of floes mostly in contact.
Very close pack ice	Pack ice in which the ice concentration is 7/8 to less than 8/8.
Consolidated and/or compact pack ice.	Pack ice in which the ice concentration is 8/8 and no water is visible. Floes are frozen together.

Ice of land origin: Ice of land origin in the sea, though often spectacular, is of minor importance in arctic operations except in localized areas.

Icebergs are large masses of ice detached from the fronts of glaciers, from glacier ice tongues, or from the shelf ice of the Antarctic. Smaller masses, termed growlers and bergy bits, originate (like bergs) from glaciers. They also may be formed from the disintegration of icebergs and other masses of land-formed ice.

**Characteristics of Ice**

Certain properties of ice in the sea should be measured and recorded by shipboard observers. The ice characteristics that are observed and reported to the Oceanographic Office are described briefly in the following paragraphs. These characteristics can be coded in the ship-shore ice log (described later).

● **Concentration:** The observer should determine the total ice concentration as well as the concentration of brash and block, small and medium floes, and giant floes and fields. Concentration is estimated to the nearest eighth. (See table 10-1.)

● **Relief and Topography:** Relief is the vertical distance between the highest and lowest points of the ice. The topography, or configuration of the ice surface, is described by such qualitative terms as rafted, flat, or hummocked (fig. 10-7). Heights of ice features can be estimated most accurately from the lower weather deck of a ship. Accurate measurements can be made by ship observers when on the ice.

● **Stage of Development:** Whenever possible, older, harder ice should be distinguished from newer, softer ice. Old, or multiyear ice often appears in fields of first year ice as a light blue island surrounded by light green or gray-blue. Both the dominant and secondary ages should be ascertained if more than one age is present.

● **Depth of Snow Cover:** The depth of the snow should be estimated or measured directly by shipboard observers.

● **Stage of Melting:** Both frozen and unfrozen puddles are identified easily by any observer. Frozen puddles appear to shipboard observers as greenish "ground glass" patches against a lighter background. To the shipboard observer, puddles that melt through appear the same shade and color as the open water.

● **Water Features:** The number, type, and orientation of water features may be determined readily for particular areas. Shipboard observers, because of their limited scope, probably will be unable to determine the overall characteristics of distant leads, cracks and polynyas (large areas of open water besides leads). All open and newly frozen features should be noted. Artificially formed cracks and leads should not be considered.

● **Fast Ice:** Any sea or fresh water ice that is attached to the shore by stranding or by other means is called fast ice. Glaciers fronting the sea are considered as part of the land.

● **Thickness of Ice:** Ice thickness can be measured accurately by ship observers if such tools as augers or saws are available. As the ice is turned on its edge by the progress of the ship through the ice, shipboard observers can make a reliable estimate of the thickness from the lower weather decks.

● **Ice of Land Origin:** The number of bergs, bergy bits, and growlers can be decided readily for a particular area. If the observer has difficulty deciding whether a number of small ice fragments are blocks or growlers, he should class them as growlers.

### SHIP-SHORE ICE LOG

Ice reporting codes for ship and shore station observations are almost identical; observing procedures, too, are similar. Consequently, a single log (fig. 10-8) has been devised for use with both types of observations. The ship-shore ice log is a self-contained log complete with instructions for taking observations, encoding tables, definitions of pertinent symbols, and other required information.

The code used in completing the ice log has been tentatively adopted by the World Meteorological Organization (WMO). The WMO code is a numerical "spot" code; that is, the observations depict conditions at a given location. A spot, for ship observation, is defined as a circular area of 1 kilometer in radius. Provision is also made for reporting ice observed outside the boundaries of the spots by use of optional groups. These optional groups are exceedingly important because they permit the observer to record large-scale features that do not fit within the spot.

In order to complete a log that will be of maximum value, each observer should become fully acquainted with the WMO ice nomenclature, which can be found in H.C. Pub. No. 606-d. In filling out the shipboard log, the message-identifier group ICESH appears as the symbol. Groups through column 22 are mandatory. Columns 23 through 52 are supplemental, and are included only if the phenomena are present and observed. The groups comprising columns 53 through 69 are optional and are for reporting ice conditions outside the spot.

Completed logsheets should be mailed at the ship's next port of call to: National Oceanographic Data Center, Washington, D.C. 20390.

### CHARTS AND PUBLICATIONS

Your duties as leading Quartermaster, in relation to charts and publications, are fourfold: (1) to ensure receipt of all publications and charts required by your ship, (2) to ascertain the correctness of all applicable charts and publications, (3) to train your men in correcting and using charts and publications, and (4) to assure your own thorough familiarity with applicable charts and publications.

You should make certain that you are on the distribution list for all applicable publications and that you are receiving, at frequent intervals, those publi-

cations and changes to which you are entitled. If not, you should immediately notify your ship's navigator, and attempt to obtain the needed publications from the nearest branch of the Oceanographic Office. You must then initiate correspondence to ensure future receipt of these publications.

You should bear in mind that nonreceipt of pertinent publications and changes endangers your ship. If your publications and charts are not kept up to date, dangerous conditions may exist of which your navigator is unaware. To prevent such an occurrence, you should maintain a rigorous training program to ensure that your men are indoctrinated properly in the procedures for maintaining, correcting, and using all applicable publications and charts.

### OCEANOGRAPHIC OFFICE

The Oceanographic Office continually is working toward the improvement of navigation for all ships and aircraft. Through oceanographic observations by ships at sea, other stations and agencies, survey ships, and from information obtained from foreign governments, the Oceanographic Office is improving navigational data on which safe navigation is dependent. Constant shifting and changing of oceanographic conditions require corresponding alterations in routes and anchorages. They also require relocations of buoys, lights, ranges, and other aids to navigation. For these reasons, it is essential that information contained in publications of the Oceanographic Office reflect changes in navigational data. These changes usually are accomplished by issuing oceanographic publications and bulletins. Pertinent publications and bulletins are supplied regularly, free of charge, to all naval ships and other U.S. Government vessels and also to merchant ships that cooperate with the Oceanographic Office by sending in oceanographic reports.

Because of the extensive quantity of information provided by the Oceanographic Office, it should be mentioned that some navigators and Quartermasters develop the habit of ordering everything available, regardless of need or subject matter. Don't be a pack rat. Order and maintain only the media actually needed by your particular ship.

The Oceanographic Office issues all charts and publications used by the Navy, including those of certain foreign governments. Nautical charts and publications are listed in N.O. Pub. No. 1-N *Catalog of Nautical Charts and Publications*. Aeronautical charts and publications are listed in the *DOD Catalog of Aeronautical Charts and Flight Information Publications*.





## NATIONAL OCEAN SURVEY

The National Ocean Survey (formerly Coast and Geodetic Survey), Department of Commerce, is responsible for the hydrographic and topographic surveys of coasts and waterways in the United States and in areas under U.S. jurisdiction. It determines heights and geographical positions at which to establish points for surveys, and continually engages in research into such subjects as terrestrial magnetism, tides, currents, and gravity.

The National Ocean Survey produces detailed charts of coasts and waterways in the United States, Alaska, Hawaii, Puerto Rico, and the Virgin Islands. These surveys entail considerable exhaustive and painstaking scientific labor. The information furnished by the National Ocean Survey is essential to coastwise and inland waterway navigation.

National Ocean Survey's *Coast Pilots* are the counterpart of Sailing Directions, which are published by the Oceanographic Office. Coast Pilots contain extensive information on coastlines, harbors, and navigable rivers and sounds of the United States and its possessions. They are published in 9 volumes; 4 are for the Atlantic Coast, 1 for the Pacific Coast, 2 for Alaska, 1 for the Hawaiian Islands, and 1 for the Gulf of Mexico and Caribbean Sea. *Tide Tables* and *Current Tables* are also produced by the National Ocean Survey.

## NAVAL OBSERVATORY

Functions of the Naval Observatory, as discussed here, are in relation only to *The Nautical Almanac*. With its precision equipment, the Naval Observatory observes celestial bodies, determines their positions in the heavens, and gathers other amplifying information required by ship's navigators when navigating by celestial bodies. *The Nautical Almanac* is an annual publication. Because astronomers are able to predict accurately the positions of the heavenly bodies, normally no corrections are issued during the year of its effectiveness. Thus, your responsibility regarding this publication is simply to ensure that you have on board the effective edition and that it is kept in a usable condition. It contains data, indispensable to the navigator, on the sun, moon, stars, and planets. *The Air Almanac*, published quarterly, is similar to *The Nautical Almanac*, and contains much the same information. Although this publication was intended originally for aviators, it now is found on most ships, and many navigators prefer to use it. Make sure you have one aboard.

It is recommended that more than one copy of both *The Nautical Almanac* and *The Air Almanac* be retained on board, one of each marked for the navigator's exclusive use, one or more to be used by

personnel being trained, such as junior officers doing a day's work in navigation, and one for your own men.

## U.S. COAST GUARD

One of the functions of the U.S. Coast Guard is the manning and/or maintenance of the many thousands of lighthouses, beacons, ranges, buoys, and other aids to navigation under its jurisdiction. Information concerning these aids, and other navigational data applying to areas under its control, are published annually by the Coast Guard in *Light Lists*.

Another equally important function of the Coast Guard is the maintenance and operation of the various loran stations throughout the United States and its possessions. The Coast Guard is also responsible

for the promulgation and enforcement of *Rules of the Road, International-Inland, CG-169; Rules of the Road, Great Lakes, CG-172; and Rules of the Road, Western Rivers, CG-184*. These publications are issued periodically, and are brought up to date by changes that reflect additions, deletions, or revisions promulgated by international agreement, local pilot authorities, or by Federal law (in the case of Inland Rules). *Rules of the Road* should be kept current at all times and referenced continually. It is indispensable to the officers of your ship, as well as to your men and yourself. Just a general knowledge of the *Rules of the Road* will not suffice; you must have a thorough knowledge of the rules set forth therein. You should maintain a complete and comprehensive training program to familiarize your men with these rules.

## USEFUL PUBLICATIONS FOR QUARTERMASTERS

A leading Quartermaster should be thoroughly familiar with the publications described in this chapter. Each publication meets a specific requirement in navigation. Although the following list of publications may appear lengthy, you are not required to memorize the contents of each one. Rather, you should know only the information that may be required and the publication in which the information may be found.

The publication schedule of each memorandum, pamphlet, bulletin, and the like, varies with the type of information it contains and the urgency of the information as required by ship's navigators. The dates on which these publications are issued range from daily to weekly, monthly, or quarterly. By this means, a complete and comprehensive picture of oceanographic and meteorological conditions in any given area is kept up to date and readily available to

the navigator. This knowledge enables the navigator to select, at a moment's notice, information from which he may derive and evaluate any constant or variable condition affecting the safe navigation of his ship.

● H.O. Pub. No. 214, Tables of Computed Altitude and Azimuth: This publication is now in the process of being superseded by H.O. Pub. No. 229, Sight Reduction Tables for Marine Navigation, which is a series of 6 volumes, each covering 15° of latitude.

● H.O. Pub. No. 249, Sight Reduction Tables for Air Navigation: This publication contains 3 volumes and is designed for (but not limited to) air navigation. It is, in fact, widely used in surface navigation. Volume I has tabulations of altitude (to the nearest minute) and azimuth (to the nearest degree) of selected stars. In general, Volumes II and III are similar to H.O. 214, except for the format of the books. Volume II covers latitudes 0° to 39°, and Volume III covers latitudes 40° to 89°. This publication is used also for star identification.

● H.O. Pub. No. 260, Azimuth Tables, and H.O. 261, The Azimuth of Celestial Bodies: These publications, popularly known as Red Azimuth Tables and Blue Azimuth Tables, are of special importance when you are navigating in polar regions. In those areas where the declination does not exceed 23°N. or S., H.O. 260 is used. For declinations that exceed 23° but are not more than 70°N. or S., H.O. 261 is used.

● H.O. Pub. No. 151, Table of Distances Between Ports: This publication contains the information implied by its name and is ex-

tremely useful for obvious reasons. It is referenced frequently.

● H.O. Pub. Nos. 117A and 117B, Radio Navigational Aids: These publications contain a listing of marine direction finder stations, radar stations, radiobeacons, time signals, navigational warnings, distress signals, medical advice and quarantine stations, long-range navigational aids, radio regulations for territorial waters, emergency procedures, and communications instructions for U.S. Merchant Ships.

● H.O. Pub. No. 118, Radio Weather Aids, and H.O. 119, Weather Station Index: These publications list general weather information, broadcast schedules, and international index numbers, with locations of stations, key groups, and call signs.

Besides the publications listed, there are many other publications with which you will want to become better acquainted. It must be emphasized that the foregoing list contains just a few of the many publications that are available to you through the Oceanographic Office distribution system.

● H.O. Pub. No. 606-a, Obtaining and Reporting Navigational Information: This publication contains the information implied by its name. The purpose of this publication is to assist the observer in preparing reports that will be most valuable in keeping the charts and publications up-to-date.

● Farwell's Rules of the Nautical Road, "Principles of marine collision law" (chapter 13, current edition) is a valuable aid for the study of Admiralty court interpretations of the Rules of The Road as they pertain to international waters and navigational waters of the United States, its territories, and possessions.

# CHAPTER 11

## SECURITY

### INTRODUCTION

The security of the United States in general, and of naval operations in particular, depends in part upon the success attained in the safeguarding of classified information. It is of paramount importance that all who engage in administering security preserve a balanced and commonsense outlook toward the subject.

As a Quartermaster you will hear a great deal about the security of classified material, because you will have access to and utilize classified information in connection with your responsibilities. For this reason, all activities brief newly arrived Quartermasters in security and require them to sign a statement attesting to the fact that they have received the brief and understand the contents. Further, as a part of each command's security program, you will be required to read and indicate your understanding of several of the most important national laws and regulations related to security. Two such sources, containing detailed information on the responsibility of security are; the OPNAVINST 5510.1C (current edition) *Department of the Navy Security Manual for Classified Information*, referred herein as the Security Manual, and, ONI 63-2, *Guide for Security Orientation, Education and Training*.

Maintaining the security of classified material, however, requires more than a briefing, a regulation, or a law. Security will only be as effective as you make it. There is no one whom you can transfer your responsibility for protecting this information. The security of classified material is not an extra job. Security is a basic part of your assignment just as is operating navigational equipment. You must be security conscious to the point that you automatically exercise proper discretion in the discharge of your duties and do not think of security of information as something separate and apart from other matters. In this way, security of classified information becomes a natural element of every task and not an additionally imposed burden.

Security is more than a matter of being careful; it requires both study and practice. Thorough understanding of this chapter will not provide full

knowledge of all the finer points concerning security, but it will provide you with a good fundamental background upon which security is built.

### RESPONSIBILITY

The job the Navy must do, or the mission it must accomplish, depends on the many well-performed functions of its members. Not the least of these functions is the secure handling of vital defense information by each individual in the Navy who has access to it. SECURITY, the single word which describes this particular function, is so significant that anyone who ignores it on purpose or who treats it indifferently does so to the detriment of the Navy, his shipmates and himself. Security is, therefore, an important part of every Navyman's responsibilities. Because you, as a prospective senior Quartermaster, will have access to vital defense information in the performance of your duties security is not only important, it is crucial.

It follows naturally that, if security is crucial, your security practices must be effective. Effective security requires that you constantly and continually handle classified materials and other information in an efficient manner. In other words, the principles of logical and rational management should be applied to the receipt, control, reclassification and ultimate destruction of materials bearing security classification markings.

As you can see, it is not only necessary to follow regulations governing the handling of defense information it is also necessary to develop a positive attitude, otherwise known as security-mindedness. Security mindedness is a goal toward which everyone in the Navy must strive. It is the central aim of education and instruction in security. For it you must develop certain fundamental habits from your study of this subject and unceasingly teach your shipmates and subordinates of its significance.

There are many persons in the Navy who have responsibilities that are peculiar to their functions and to the positions they occupy. For example, a commanding officer is responsible for safeguarding all classified information within his command. He instructs his men in security practices and procedures.

He establishes security orientation, education and training programs also. The *Security Manual* covers his responsibilities in some detail and it should be consulted to improve your knowledge of this facet of security. As you read the *Manual* you will not find a specific reference to a Quartermaster, however. Nevertheless, you do have definite responsibilities. You, as a responsible petty officer and a part of your commanding officer's team, will be called upon to assist him in security training programs, as well as helping him in security management.

## OBJECTIVE

The objective of the Security Orientation, Education and Training Program is to develop optimum security discipline by creating in each individual a sense of personal responsibility.

## PRINCIPLES

The security orientation, and education and training program shall include all personnel entrusted with classified information regardless of their position, rank or grade. The program will be designed to

a. Familiarize all personnel with the security requirements with which they have to comply for proper performance of their duties and assignments.

b. Remind all echelons of command of their responsibility for assuring that classified defense information is effectively and economically safeguarded.

c. Insure willing, conscientious compliance with security regulations, procedures and practices.

d. Remind all echelons of command of their responsibilities in the classification management program to include classification, upgrading, downgrading and declassification processes as set forth in Chapter 4 of the *Security Manual*.

e. Advise all personnel who have access to classified information of the hazards of its disclosure to any person not authorized to receive it and of their responsibility for exercising personal vigilance for its protection.

f. Inform all personnel of the techniques and devices employed by foreign intelligence activities in attempting to obtain U.S. classified defense information and of their responsibility for reporting such attempts.

g. Advise all personnel of the hazards involved in, and the strict prohibition against, discussing classified information over the telephone.

h. The attention of all personnel shall be directed to the disciplinary action that may result from violation of security regulations.

## INDOCTRINATION

Persons being assigned to duties requiring access to classified information, prior to being granted access, shall be indoctrinated on the security aspects and responsibilities of their assignment or position. This indoctrination will as a minimum, cover the principles cited in the preceding section.

The indoctrination briefing shall include the strict prohibition against discussing classified information over the telephone. This is especially important because of the fact that a high proportion of DOD telephone conversations are being transmitted through microwave transmitters. Such conversations can be easily and surreptitiously recorded and analyzed. The types of situations to be avoided when talking on the telephone are

1. Allowing classified information to slip into conversations through carelessness;

2. Disclosure of classified information in order to expedite the completion of a "rush project;"

3. Use of codes, "double talk" or attempt to talk around classified information. It should be noted that private codes and "talking around" classified matters presents no real protection against the abilities of a trained analyst.

As part of the indoctrination program, personnel will be instructed to report promptly any of the following types of information

a. Attempts by representatives or citizens of communist controlled countries to cultivate friendships or to place personnel under obligation.

b. Attempts by representatives or citizens of foreign governments to

(1) Cultivate a friendship to the extent of placing them under obligation, which they would not normally be able to reciprocate, or by money payments or bribery to obtain information of intelligence value.

(2) Obtain information of intelligence value through observation, collection of documents, or by personal contact.

(3) Coerce personnel by blackmail; by threats against or promises of assistance to relatives living under their control, especially those in a communist country.

(4) Appeal to personnel on a racial, nationalistic, or ideological basis.

(5) Exploit personnel who may be disaffected or in personal difficulties.

(6) Intimidate, harass, entrap, discredit, search, spy on, or recruit for intelligence purposes personnel traveling in communist countries.

(7) Induce personnel to defect or to induce those who have fled from communist countries to redefect.



c. Attempts by Department of the Navy personnel to provide unauthorized services, information, or documents to anyone believed to be in contact with a foreign intelligence service.

d. Attempts by persons living in communist countries to obtain information of intelligence value from personnel by correspondence (including "Pen Pal" correspondence), questionnaires, "ham radio" activity, naval cachets (request to service postal covers), or other forms of communications.

Commanding officers or superiors to whom information of the above nature becomes known will

a. Instruct the reporting individual to take no action to exploit, apprehend, restrict, or simulate further contact until appropriate guidance or instructions are received.

b. Report full details expeditiously to the nearest Naval Investigative Service Office with a copy to the Chief of Naval Operations (ACNO Intelligence), referencing article 0304(4.b.) Security Manual. A message report with a parallel detailed letter report is recommended. The report will be classified according to content. The message report will include sufficient details to permit an initial evaluation. Details to be reported will, as far as possible, include the following

(1) Date, place, and nature of the encounter or incident.

(2) Complete identifying data on foreign personnel, methods of operation, targets, and information sought.

(3) U.S. Navy personnel involved; name, grade, service number, social security number, position, duty assignment and degree of its sensitivity, access to classified information, and security clearances.

(4) Source of information.

(5) Evaluation of source and information.

(6) Action taken.

(7) Any additional pertinent comments.

The Naval Investigative Service Office will advise promptly what additional action should be taken. General guidance cannot be supplied as each case is apt to present individual and often unique situations, and must be handled on a case-by-case basis. The Naval Investigative Service Office will effect liaison and coordination with other members of the U.S. intelligence community as appropriate. Liaison in the field with local representatives of other U.S. intelligence agencies is authorized, if deemed advisable, because of the time element involved or other practical considerations.

## BRIEFINGS

Security Briefings. Positive programs shall be established to provide periodic security briefings for

all personnel having access to classified information. These briefings shall place special emphasis on the following

a. No person having knowledge, possession or control of classified defense information has authority to disseminate it, unless he has determined that the prospective recipient has an appropriate security clearance and needs the information in order to perform his official duties. The responsibility for making these determinations rests upon the person having knowledge, possession or control of the information and not upon the prospective recipient.

b. No person has authority to receive classified defense information unless he has been cleared for access by appropriate authority and his need for the information in connection with the performance of official duties has been established to the satisfaction of the person having knowledge, possession or control of the information. This principle applies whether the prospective recipient is an organizational entity, a command of another Federal agency, a foreign government, or an individual.

c. Persons having knowledge, possession or control of classified information are personally, morally and legally responsible for its protection at all times in accordance with applicable regulations and procedures.

d. Personnel must be alert to recognize and defend themselves against possible espionage and subversion. The Guide for Security Orientation, Education and Training (ONI 63-2) provides information for such briefings, the content and detail of which may vary depending upon the specific nature and classification of the information possessed by the persons being briefed, the level of the office or position occupied, and the nature or threat to which their position, particular knowledge, background, or activities might expose them. Dependents may also be given appropriate briefings when considered necessary in the interests of national security.

The strict prohibition against discussing classified information over the telephone as set forth in the second paragraph entitled "Indoctrination," should be emphasized periodically.

## Foreign Travel Briefings

Commanding Officers will assure that military and civilian personnel (including civilians under personal service contract) are given a Foreign Travel Briefing as a defensive measure to alert them of their possible exploitation by others whose interests may be inimical to those of the United States, prior to travel under the following conditions

(1) Travel to or through communist controlled countries for any purpose (2) Attendance at international, scientific, technical, engineering, or other professional meetings, in any country outside the United States where it can be anticipated that representatives of a communist controlled country will participate or be in attendance, and;

(3) As otherwise appropriate.

The Foreign Travel Briefing should contain information on various areas of interest to hostile intelligence services, the techniques used by these services, and on the nature of conduct or activity that could result in U.S. personnel being placed in compromising situations. The Guide for Security Orientation, Education, and Training (ONI 63-2) Chapter 6, provides information for such briefings, the content and detail of which may vary depending upon the specific nature and classification of the information possessed by the persons being briefed, the level of the office or position occupied and the scope and nature of the threat to which their proposed activity might expose them. Dependents may also be given appropriate briefing, when considered necessary in the interests of national security, and when they desire such briefings.

#### Potential Hostage Briefings

When a person has close ties with relatives residing in a communist controlled country, a potential security problem exists because of the possibility that communist authorities will threaten reprisal against the "hostage" relative unless the individual cooperates with the communist intelligence collection effort. Certain relatives of an individual's spouse also pose a potential hostage problem. The mere fact that a person has relatives residing in an unfriendly country does not in itself represent a potential hostage situation. There must exist a close emotional bond between the individuals concerned.

Close relatives are considered to be an individual's parent, child, brother or sister of the individual's spouse at the present time. (A spouse or a spouse's relatives shall not be included in cases of legal separation, termination, i.e., by death, divorce, etc.)

Those countries which are considered as having interests inimical to those of the United States are

Albania, Bulgaria, Chinese Peoples Republic (Communist China) (including Tibet), Cuba, Czechoslovakia, Democratic Peoples Republic of Korea (North Korea), Democratic Republic of Vietnam (North Vietnam), German Democratic Republic (G.D.R.) (East Germany) (including the Soviet Sector of Berlin), Hungary, Mongolian Peoples Republic (Outer Mongolia), Poland, Rumania, Union of Soviet Socialist Republics (U.S.S.R.) (in-

cluding Estonia, Latvia, Lithuania, and all other constituent republics) Yugoslavia.

In order to lessen the risks involved, a program of defensive briefing has been established for alerting individuals subject to probable hostage pressures and for ensuring that attempts at such coercion are promptly reported to appropriate authority. Procedures will be established by commanding officers to identify those personnel within their commands who have relatives living in communist countries and may require defensive briefing before they are granted security clearance and/or access to classified material. If an investigation for security clearance is being initiated or is in progress when a command discovers that an individual has relatives living in a communist country, the commanding officer will ensure that the Naval Investigative Service is notified and a representative of the Naval Investigative Service will administer the briefing, if appropriate, as part of the investigation. If an investigation is not being conducted by the Naval Investigative Service, the commanding officer will make a security determination in accordance with Article 1515 of the Security Manual and take the necessary action to

(1) Terminate or deny clearance. A defensive briefing will not be given. Reporting and processing will comply with the requirements of Article 1524, of the Security Manual, or

(2) Continue or grant clearance. If there is no evidence that a defensive briefing has been given previously, the nearest Naval Investigative Service Office will be notified. The Naval Investigative Service Office will determine whether a briefing is appropriate by considering the communist country involved and the degree and closeness of the relationship between the people concerned. If the Naval Investigative Service Office determines that a briefing is appropriate, the necessary forms will be forwarded to the command and the command will give the defensive briefing, or

(3) Request additional investigative coverage before making a final determination. A representative of the Naval Investigative Service will conduct the briefing, if appropriate, as part of the investigation.

Military personnel who receive the command-administered defensive briefing will sign three certified copies of the briefing form supplied by the Naval Investigative Service. The command will make one copy of the form a permanent part of the individual's service record and forward one copy to the Chief of Naval Personnel. The third copy will be forwarded to the Director, Naval Investigative Ser-

vice. The Naval Investigative Service Office will forward the copy to the Director, Naval Investigative Service in each case in which its representative administers the briefing.

## DEBRIEFINGS

**Debriefing Statement (Security Termination Statement).**

Military and civilian personnel who have had access to classified defense information and persons who have been granted Limited Access Authorizations, shall turn in all classified material and execute security termination statements under the following conditions

(1) Prior to termination of active military service. In the case of persons who have been granted Limited Access Authorizations, at the conclusion of the access period.

(2) Upon reassignment from such significant sensitive duties that involved access to information for which special access procedures have been established (e.g. Special Intelligence, Crypto, Critical Nuclear Weapon Design Information, and Single Integrated Operational Plans).

(3) When an individual's security clearance is terminated for cause in accordance with Article 1524 of the Security Manual.

The Security Termination Statement, executed by the individual concerned, shall become a part of the individual's permanent file, for naval personnel, as follows

Copy to be filed in terminating command files for a period of two years.

Original to be filed in individual's service record.

Original to be forwarded to the Chief of Naval Personnel (Pers E) in the close-out service record when the individual is separated from the naval service.

## Oral Debriefings

When considered appropriate by commanding officers, military and civilian personnel and persons who have been granted Limited Access Authorizations will be given oral debriefings when they have had access to

(1) Top Secret information.

(2) Classified defense information for which special access procedures have been established (e.g., Special Intelligence, Crypto, Critical Nuclear Weapon Design Information and Single Integrated Operational Plans).

(3) Other sensitive information considered to make debriefing necessary.

Oral debriefings of military and civilian personnel who have had access to classified defense infor-

mation and persons who have been granted Limited Access Authorizations shall be prior to

(1) Reassignment to other duties not requiring the same access;

(2) Change of duty station; or

(3) Separation from active military service or civilian employment.

The content of the oral debriefing will be directed solely toward protecting classified defense information and shall include the following

(1) The purpose to be accomplished by the debriefing.

(2) The serious nature of the subject matter which requires protection in the national interest.

(3) The need for caution and discretion.

(4) Advice concerning any travel restrictions which may be applicable.

Oral debriefings shall be acknowledged by signature of the recipients on Security Termination Statement (OPNAV Form 5511-14), or termination debriefing forms developed for special access programs as appropriate.

## CLASSIFICATION MANAGEMENT

Classification shall apply only to official information which requires protection in the interests of national defense and which is classified for such purposes by a responsible classifying authority.

Unnecessary classification and higher than necessary classification shall be scrupulously avoided. Higher than necessary classification burdens security channels and facilities, and detracts from the importance of classification in the minds of personnel. Furthermore, it can undermine our security system and jeopardize the protection required for important military matters. Classification may not be used for the purpose of concealing administrative error or inefficiency, to prevent personal or departmental embarrassment, to influence competition or independent initiative, or to prevent release of official information which does not require protection in the interests of national defense.

## CLASSIFICATION ACCORDING TO CONTENT

Official information of any nature requiring protection in the interests of national defense, including extracts therefrom, shall be classified, downgraded and declassified according to its own content and not according to its relationship to other classified information.

The relationship of individual items, classified or unclassified, when combined or considered together within a program or project, or in combination with different programs or projects, may have cumulative

effect requiring assignment of an initial classification or of a higher classification. In such cases, an appropriate overall classification will be assigned. Extracts from RPS distributed publications shall be classified in accordance with RPS-4.

### DISSEMINATION CONSIDERATIONS FACTORS

The factors which might be considered are, the degree of intended or anticipated dissemination and use of material, and whether the end purpose to be served renders effective security control impractical.

These factors do not necessarily preclude classification, but they do force consideration of the extent to which classification under such circumstances may degrade the classification system by attempting to impose security controls in impractical situations.

Determination significantly dependent upon these factors shall not be made below the level of the official having classification authority over the particular plan, program, project, or item.

### SPECIFIC CLASSIFYING CRITERIA

A determination to classify shall be made only when one or more of the following considerations are present and the unauthorized disclosure of information could result in a degree of harm to the national defense.

The information provides the United States, in comparison with other nations, with a scientific, engineering, technical, operational, intelligence, strategic, or tactical advantage related to the national defense.

Disclosure of the information would weaken the international position of the United States, create, or increase international tensions contrary to U.S. interests, result in a break in diplomatic relations, or lead to hostile economic, political, or military action against the United States or its allies, thereby adversely affecting the national defense.

Disclosure of the information would weaken the ability of the United States to wage war or defend itself successfully, limit the effectiveness of the armed forces, or make the United States vulnerable to attack.

There is sound reason to believe that other nations do not know that the United States has, or is capable of obtaining, certain information or material

which is important to the international posture or national defense of the United States vis-a-vis those nations.

There is sound reason to believe that the information involved is unique, and is of singular importance or vital to the national defense.

The information represents a significant breakthrough in basic research which has an inherent military application potential in a new field or may involve a radical change in an existing field.

There is sound reason to believe that knowledge of the information would (1) provide a foreign nation with an insight into the war potential or the war or defense plans or posture of the United States (2) allow a foreign nation to develop, improve, or refine a similar item of war potential; (3) provide a foreign nation with a base upon which to develop effective countermeasures; (4) weaken or nullify the effectiveness of a defense or military plan, operation, project, or activity which is vital to the national defense.

### INDIVIDUAL ACTION

Each individual who originates a document or other material is responsible for identifying the items of information which, in his opinion, based upon available guidance or upon his own evaluation, require security protection through classification. He then shall classify the document or material or, if he does not have the requisite authority to classify, he shall refer the matter to the nearest knowledgeable classifying authority for appropriate action.

### CHANGE IN CLASSIFICATION

When classified information is determined in the interests of national defense to require a different level of protection than that presently assigned, or no longer to require any such protection, it shall be regarded or declassified.

The Secretary of Defense established a continuing program for the Department of Defense, based on a time schedule, for automatically downgrading, and in most cases automatically declassifying, documents originated within the Department of Defense. Determination of specific dates or passage of events that will provide early downgrading or declassification should be made as a matter of practice. When this is not possible, classified material shall be categorized into one of the four groups described as follows

QUARTER MASTER 1 & C

Group Number	Material IS/or/ MAY BE:	Reason
1	<p>Completely excluded from automatic downgrading and declassification provisions.</p> <p>Downgraded or declassified only by the originating authority or by an official higher in the same chain of command.</p>	<p>Because it has been removed from such provisions or it contains information not subject to the classification jurisdiction of the Executive Branch of the U. S. Government.</p>
2	<p>Exempt from automatic downgrading and automatic declassification.</p> <p>NOTE: The authority for designating material as Group 2 is granted only to those officials empowered to exercise original TOP SECRET classification authority. This authority may not be delegated and shall be exercised only when required in the interest of national security. It is intended that the number of Group 2 documents be kept to an absolute minimum.</p> <p>Downgraded or declassified only by the originating authority or by an official higher in the same chain of command.</p>	<p>Because it contains extremely sensitive information originally classified TOP SECRET or SECRET.</p>
3	<p>Exempt from automatic declassification. Unless the originator specifies a shorter interval, they shall be downgraded automatically as follows:</p> <ul style="list-style-type: none"> <li>a. TOP SECRET material will be downgraded to SECRET 12 years from date it was created to CONFIDENTIAL 24 years from date it was created, and will remain CONFIDENTIAL.</li> <li>b. SECRET material will be downgraded to CONFIDENTIAL in 12 years and will remain CONFIDENTIAL.</li> <li>c. CONFIDENTIAL material will remain classified.</li> </ul> <p>Declassified only by the originating authority or by an official higher in the same chain of command.</p>	<p>Material in this Group warrants some degree of classification for an indefinite period.</p>

Chapter 11—SECURITY

Group Number	Material IS/or/ MAY BE:	Reason
4	<p>Automatically downgraded and declassified as follows:</p> <ol style="list-style-type: none"> <li>1. TOP SECRET material will be downgraded to:               <ol style="list-style-type: none"> <li>a. SECRET 3 years from date it was created.</li> <li>b. CONFIDENTIAL 6 years from date it was created; and</li> <li>c. Declassified 12 years from the date it was created.</li> </ol> </li> <li>2. SECRET material will be downgraded to:               <ol style="list-style-type: none"> <li>a. CONFIDENTIAL 3 years from the date it was created; and</li> <li>b. Declassified 12 years from the date it was created.</li> </ol> </li> <li>3. CONFIDENTIAL material will be automatically declassified 12 years from the date it was created.</li> </ol>	<p>All classified material which does not qualify, or is not assigned to, one of the first three Groups.</p>

## APPENDIX A

# NAVIGATIONAL HINTS

Pilot charts are described in the *QM 3 & 2* course book. By the time you are ready for advancement to first class or chief, you have probably made use of them on numerous occasions. In addition to the hydrographic, meteorological, and navigational information printed on the face of the charts, much information of interest to navigators appears on the reverse sides. This appendix is an edited reprint of an article published on the reverse side of the June 1966 Pilot Chart of the North Atlantic.

### INTRODUCTION

A primary function of the U.S. Naval Oceanographic Office is the improvement of its products used for navigating safely the vessels of the United States Navy, the mercantile marine, and others engaged in waterborne endeavors. The fulfillment of this function is a continuing and ever-expanding task as new knowledge of the worlds of inner and outer space is acquired.

The era of modern navigation is generally considered to have been ushered in by Captain James Cook of the British Royal Navy during his three historic voyages of discovery into the Pacific Ocean between 1768 and 1779. This new era fostered the first steps in the transition of navigation from an art to a science. Today, with nuclearpowered vessels laden with highly sophisticated electronic navigation equipment and with experimental positioning satellites orbiting brightly in outer space, one might be tempted to say the transition is all but complete. Yet, we are all aware that the toll taken by groundings, collisions, and other marine casualties continues to rise despite all our electronic gadgetry. It thus appears that some of the old art, the seamen's sense, is still very much needed by 20th century mariners.

There are many excellent works on navigation principles and techniques, such as the *American Practical Navigator* (Bowditch), where the navigator can find complete descriptions and solutions to about every known system of navigation. All too often, however, many of the little hints making up part

of the art are buried so deeply within the text that they are overlooked. This appendix explores a few of these hints in an effort to stir new interest in them or even, perhaps, bring them to light for the first time.

### DEPTHS-SHOALS-CURRENTS

The most important features of any chart are the soundings and depth curves by which the main characteristics of the bottom configuration are represented. The origin of the hand lead, the oldest known means of measuring depths, is lost in antiquity, but mention of soundings has been found in Egyptian records dating back several millenniums before Christ. An interesting account of the use of soundings and the danger they foretold is found in the 27th chapter of Acts of the Apostles.

The present-day mariner faces many of the same problems of his ancient predecessors when navigating off a strange and relatively unsurveyed coast. As the lead or echo sounder can only give the depth under or near the keel, there is no way to forecast the depth ahead for any substantial distance.

With this point in mind, the navigator should carefully examine each chart he uses. If there are no fathom lines shown on the chart, it is probably due to insufficient data or a highly irregular bottom relief. A coast so shown should be given a wide berth. The same caution is to be exercised in areas where only isolated soundings, especially when those marked "doubtful sounding" or those enclosed in a dotted ring are shown. Invariably, the rule to be followed is: Consider a coast to be foul unless it is shown to be clear. The only positive way of determining that every pinnacle and obstruction has been found in an area is for survey vessels to wire-drag the area to a predetermined depth. Unfortunately, very few areas of the world have been surveyed so carefully.

What constitutes a safe sounding will vary with different vessels, so that no hard and fast rule can be laid down. Generally, however, when only scattered sounding data are shown on the chart, particularly along rocky coastlines, 10 fathoms should be re-

garded as a caution against the possible near approach to shallower water. When operating off a coast known to be well surveyed or when navigating inshore waters, as a useful aid, sketch in magenta ink or pencil a depth curve on the chart somewhat greater than the maximum possible draft of the vessel. This aid will provide the navigator with a meaningful danger line. The 10-fathom curve, if charted, can be traced with blue ink or pencil, or sketched in, and served as a warning line.

Charts made from surveys conducted by the Oceanographic Office are reduced to a plane of reference, with due regard to tides, which present the hydrography in its least favorable aspect. The datum planes most often used are mean low water, mean low water springs, and mean lower low water. The datum of charts based upon those of other nations is that of the original authority.

Even with the charted soundings reduced to the lowest practicable plane of reference for the area, it should be remembered that local conditions will at times cause the actual water level to be lower than the chart datum.

A change in wave formation is often an indication of shoaling as waves close up and heighten when running from deep to shoal water. A deeply laden vessel, especially during heavy weather, should, when possible, avoid transiting areas of abrupt changes in depths, because the seas running from the deeper water will follow the bottom rise and become sharper.

In tidal estuaries, without marked irregularities of bottom, the maximum current velocity will occur at about half tide. The surface current is usually greater than that near the bottom, a condition which may enter into the navigation calculations of light and deep draft vessels.

### ECHO-SOUNDING

Submarine topography is becoming increasingly important to the mariner as a means of navigation. With the development of the modern sonic sounding equipment found on most naval vessels and many merchant ships, it is possible to record depths up to 6000 fathoms with an error of approximately 1 fathom. These sounding devices have made the profile of the ocean floor potentially the most universally accessible aid to navigation yet envisioned. Recent hydrographic surveys have given special prominence to this work and, as adequate bathymetric charts become available, navigation by underwater features may become as common as coastal piloting. Few bathymetric charts have been developed, however, for full reliance in navigation.

The standard velocity of sound waves as

feet per second. Although the true velocity varies with local values of temperature, water pressure, and salinity, the difference is not considered important except in highly technical research work. It is the policy of the Oceanographic Office to chart all soundings on the basis of this standard value. Soundings obtained by equipment not calibrated to the American standard will not agree with the depths shown on H.O. Charts.

Echo sounding equipment, like any aid, is subject to errors if the navigator is not fully familiar with equipment operating characteristics and limitations. The routine checks outlined in the instruction manual should be carefully conducted at least once a watch.

The phenomenon known as "phantom bottom" has caused considerable confusion among many navigators. The phantom bottom appears on the trace as a bank between 125 and 375 fathoms below the surface and is only detected during daylight hours. The exact reasons for the occurrence of this phantom bottom return are not definitely known, but it has been experienced in most parts of the world. One theory offered is that concentrations of marine life descend to this area during daylight hours and then rise nearer the surface during the night. The navigator can often rule out these false returns by carefully checking them against known charted depths.

Excessive underwater turbulence which aerates the water can distort the outgoing signal (sound waves) to the point of preventing any echo from being received. Usually, this condition is only a problem when the vessel is rolling or pitching in heavy seas, backing down, or steaming in column formation.

Another cause of significant error is fluctuation of the current supply driving the depth-indicator motor. The accuracy of soundings is directly related to the revolutions per minute of this motor, which normally operates on a 60-cycle supply. A change of 1 cycle, say 61 cycles, would cause an error of about 33 fathoms in a recorded depth of 2000 fathoms. The navigator should be alert for this problem at all times.

### NIGHT VISION HORIZON

During World War II, with our submarine forces operating along hostile shores for prolonged periods of time, an urgent need arose for fixing position without revealing presence to the enemy. The use of electronic aids was too risky in most cases and had to be forsaken in favor of celestial observations taken late at night.



Confronted with this situation, the submariners soon developed a highly reliable skill of observing stars against a night-vision horizon. The technique requires some preparation, which at first may seem somewhat foreign to the surface mariner, but its usefulness should not be overlooked.

The observer's eyes must be completely "dark adapted." Proper dark adaptation can best be accomplished by wearing red goggles for at least 30 minutes before going on the bridge for observations. Once on the bridge, and in complete darkness, the observer must spend an additional 20 minutes further adapting his eyes to the sky and horizon. Great care should be taken not to look at any light or to use binoculars, because, by so doing, dark adaptation can be instantly lost and the entire time-consuming procedure would have to be repeated.

When the observer can see the horizon, he should send for a reliable assistant. The assistant brings the sextant, hack chronometer, and a flashlight fitted with a red lens emitting only a very dim light. It is also advisable for the assistant to dark adapt his eyes.

Once on the bridge, the assistant hands the observer the sextant set at the approximate altitude of the first star to be observed. He then stations himself behind the observer, back to back, illuminates his hack chronometer and waits for the "Mark!" (See fig. A-1.)

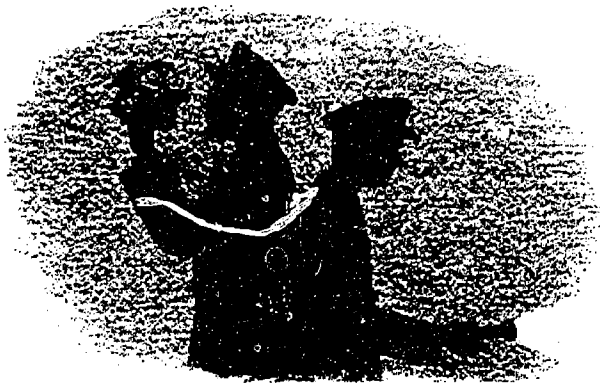

112.107  
Figure A-1.—Taking sights against a night vision horizon.

The observer holds the sextant upside down, pointed at the star, and brings the horizon up to the star. Next, the sextant is reversed and the star is adjusted to the horizon in the normal manner. During the observation it is extremely

important that the observer does not look directly at the horizon. Instead, he should look up about  $20^\circ$ , keeping both eyes open and dim the star with a filter until it can scarcely be seen. When the observer is ready to "Mark", both eyes are closed for about 5 seconds. The eyes are then opened wide and the sight taken when in focus.

After the first sight is taken, the observer must be careful not to look at any light source until he has taken all the other sights he needs. The sights may then be worked by any method suitable to the observer.

### SIGHT ERROR COMPENSATION

When possible, the navigator should take star sights both north and south of the zenith. It will tend to eliminate all systematic errors from the results. For example, one navigator might consistently bring his stars down too low, while another might tend to keep his too high; the horizon might be abnormally elevated or depressed; the actual refraction might be somewhat different than tabulated; or the sextant error allowed for incorrectly.

If the total effect of these errors makes the altitude too high, a northern star will give a latitude too far north and a southern star too far south.

In figure A-2, the sum of the systematic errors, in each case, gives altitudes that are too high, which result in apparent positions for the ship at  $N'$  in the case of the northern star and at  $S'$  for the southern star. The actual position lies about halfway between  $N'$  and  $S'$ , at  $A_p$ .

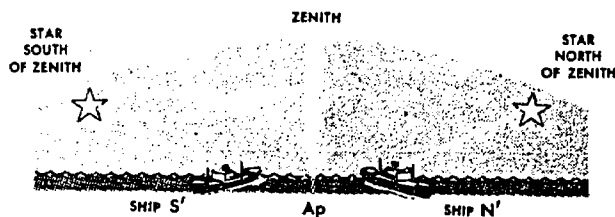

112.108  
Figure A-2.—Sum of navigator's systematic errors result in observed altitudes that are too high.

In figure A-3, the sum of the systematic errors gives altitudes that are too low. The actual position, however, still lies at  $A_p$ , about halfway between the apparent positions,  $N'$  and  $S'$ .

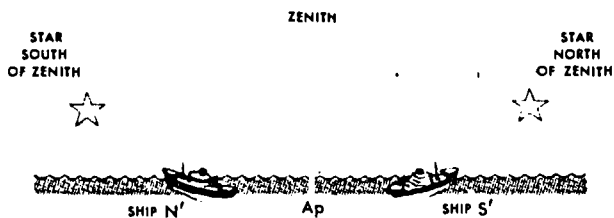

112.109

Figure A-3.—Sum of navigator's systematic errors result in observed altitudes that are too low.

### LATITUDE BY MERIDIAN ALTITUDE BELOW THE POLE

Polaris is probably the most useful of all the stars in the higher northern latitudes and provides the mariner with his latitude, under reasonably favorable conditions, at any hour of the night. There is also another excellent, but seldom-used, method of obtaining a much-desired latitude. This method involves finding the altitude of a circumpolar star when it is on the observer's meridian below the pole. Although the method can be used in both the higher northern and southern latitudes, it is especially useful in the southern hemisphere where no guardian of the south celestial pole, such as Polaris, is available.

A circumpolar star is by definition a star which revolves around the elevated pole without setting. This situation occurs when the polar distance of the star is less than the observer's latitude and both have the same name.

In figure A-4, AWBE is the diurnal circle of a circumpolar star in the southern hemisphere. Line AB is the observer's meridian. At A the star is on the observer's meridian, bears south and has reached its

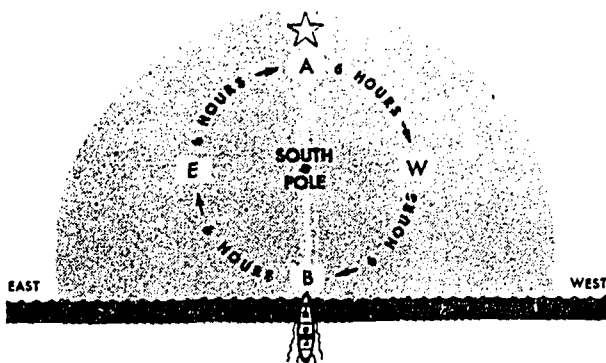

112.110

A-4.—Sight on a circumpolar star.

highest altitude. During the next 6 hours, the star will fall toward the west. Then, continuing to fall, the bearing will curve eastward for 6 hours until the star reaches point B. At B the star is again on the observer's meridian, bears south, and has reached its lowest altitude. From point B the star will rise toward the eastward for 6 hours, then while still climbing, it will curve westward, completing 1 day's revolution when it again reaches point A.

To find the latitude, subtract the star's declination as tabulated in the *Nautical Almanac* for appropriate date from  $90^\circ$ . The result is the star's polar distance. Add, to the polar distance, the corrected observed altitude when the star was at point B; the sum equals the latitude. The following example demonstrates the ease of the process

On 4 July 1965, after several days of squally, overcast weather, conditions improved and the navigator observed Achernar close to being on his meridian below the pole. A series of observations were taken and finally a low reading of  $20^\circ 12.1'$  was obtained. Knowing the height of eye was 44 feet and having no instrument correction, the navigator laid out the work:

#### MERIDIAN ALTITUDE OF ACHERNAR BELOW POLE

OBSERVED ALTITUDE	$20^\circ 12.1'$	DECLINATION JULY 4	$(-) 57^\circ 24.5'S$
ALTITUDE CORRECTION (-)	$02.6'$		$(+) 90^\circ 00.0'$
HEIGHT OF EYE	$(-) 06.5'$		
TRUE ALTITUDE	$20^\circ 03.0'$	POLAR DISTANCE	$32^\circ 35.5'S$
		TRUE ALTITUDE	$20^\circ 03.0'S$
		LATITUDE	$52^\circ 38.5'S$

NOTE: Corrections obtained from Nautical Almanac

### FIX RELIABILITY

The pinpoint fix, whether obtained by stars, cross bearings of terrestrial objects, radio bearings, or other means, is always a source of confidence to the navigator in that he knows his exact position at a specific time. Unfortunately, this single point is often elusive, and a round of stars or bearings leaves the navigator with a triangle or square for a fix. Some interesting hints about the latter method merit review.

First, let us look at star sights. As previously mentioned, a constant error is often introduced in the observation of stars. Based on the assumption that this error is equal for each star, a reasonable assumption, it becomes apparent that we can improve the fix reliability by properly adjusting the various lines of position.

Proper adjustment means that each line of position must be moved equally in distance and direction, either all toward or away from the bearings of the observed bodies. Then, the navigator

many times is able to completely close the triangle or square. The amount of adjustment necessary is found by trial and error. Occasionally, the actual position will be found to be outside the original fix shape altogether.

In figure A-5, the solid lines represent the position lines of three stars after being advanced to a common time. The bearings of the observed bodies are indicated by the small arrows. The dashed lines represent the new lines of position after the navigator has shifted them equally toward the bearings, figure A-5, (A) and (C), or away (B), in order to make them cross at a common point. Looking at (A) and (B), it is at once apparent the actual position does lie within the original triangle. In (C), however, it is obvious that the lines will cross only at some point outside the original triangle. The value of placing the small arrows on the various position lines, to indicate bearing, cannot be overemphasized.

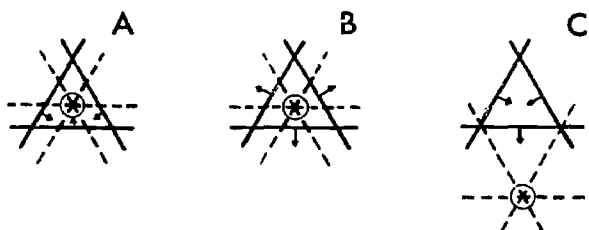

112.111

Figure A-5.—Lines of position, shifted to intersect at a common point.

The desirability of taking stars to the north and south of the zenith has already been discussed. If, in addition, it is possible to take sights to the east and west of the observer, the best possible indication of fix reliability is obtained. In figure A-6, the position lines of four stars are shown, with their bearings lying in the direction of the arrows. Looking at (A) and (B), it is again apparent that the actual position lies within the square and that the fix is reliable in both latitude and longitude. In (C), however, the latitude is reliable but the longitude is doubtful.

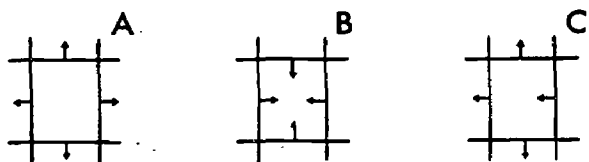

112.112

Figure A-6.—Position lines of four stars.

Before looking at the problems of reliability of terrestrial fixes, let it be stated with the utmost emphasis that whenever three or more charted objects are available, a fix should consist of a minimum of three cross bearings. Even if the compass error is known, there is no check that a two-bearing fix has been properly plotted on the chart. The third bearing will make any error in plotting immediately apparent. Frequently, a round of bearings, properly observed and plotted on an accurate chart, still do not cross at a common point. There is only one answer under these circumstances and that is compass error. This unknown compass error will affect each bearing by the same amount. By trial and error, the navigator can shift all the bearings clockwise, then counterclockwise until the bearing lines do cross at a common point. Often the vessel's actual position will be outside the original triangle. The navigator not only has accurately determined his position, but also has obtained the compass error which equals the number of degrees necessary to adjust the bearings. This hint is based on two important factors: (1) the chart is accurate, and (2) the bearings were accurately taken within a few seconds of each other.

In figure A-7, the solid lines represent the observed bearings of three fixed objects on an accurate large-scale chart. The navigator had properly observed and laid off the bearings and realized that the triangle formed was the result of juggling the bearings, equally clockwise and counterclockwise, the navigator found that, by adding 4° to each bearing, the lines of position

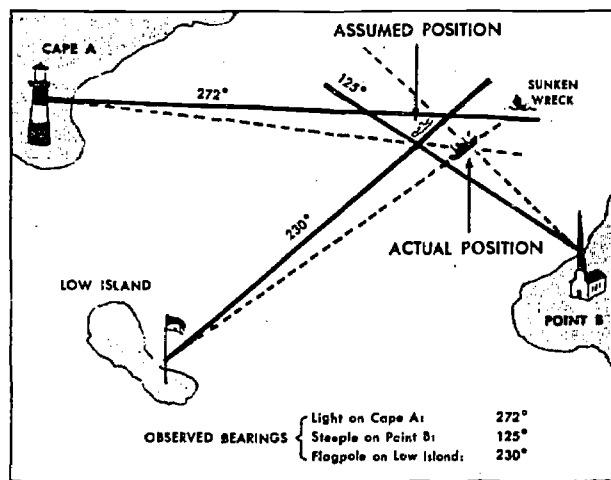

112.113

Figure A-7.—Determining compass error by adjusting bearings.

crossed outside the original triangle (the dashed lines). The  $4^\circ$  adjustment revealed a previously unknown error of  $4^\circ$  E. in the compass.

### THE FRANKLIN PILOTING TECHNIQUE

In A MARINE PILOTING situation in which the navigator is not getting good fixes, he must take immediate steps to verify whether there is an unknown systematic error. Of prime importance is the fact that if a systematic error appreciably larger than the net value of random observational and plotting errors is incorporated in the plot, the fix position will be outside the fix triangle if the spread of bearing observations is less than 180 degrees. Even when piloting within enclosed waters, the navigator is frequently limited to bearing spreads of less than 180 degrees. This may be because of a scarcity of aids to navigation or an inability to identify charted features or aids to navigation which could otherwise be used to provide good angles of cut and assurance that the fix would be inside the fix triangle. With an outside fix, in general the larger the fix triangle the greater will be the discrepancy between a fix assumed at the center of the triangle and the position of the intersection of the bisectors of the appropriate exterior angles and opposite interior angle.

In the environment of operation in hazardous waters, the navigator must have feasible means to both verify the existence of appreciable systematic error and to determine the necessary correction to observed data. The means should be rapid, positive, and simple to avoid human error as much as possible and to expedite fixing the ship's position accurately and frequently.

Where the navigator cannot account for an erratic plot or excessively large fix triangles being due to mistakes in identification of charted features, inaccurately observed compass bearings, or mistakes in recording and plotting of data, there is a good probability that there is a systematic error in the plot resulting from compass error. The Franklin Piloting Technique is used to verify and correct compass error, either magnetic or gyro. In the magnetic compass application, specific values of magnetic variation or compass deviation are not required in the solution. A significant feature of the Franklin technique is that on encountering systematic or variable errors in a piloting situation, neither drastic changes in procedures nor the need for breaking out and employing additional navigational equipment are required. Such features enhance the feasibility of the technique.

Practical considerations preclude the general application of the bisector theory during piloting,

except of course, the taking of the center of the fix triangle as the fix when such position is valid, i.e., there are no appreciable systematic errors or the bearing spread is greater than 180 degrees. Also, trial and error procedures are generally too slow. If the navigator assumes an incorrect sign, East or West (plus or minus) for the trial error, appreciable time may be lost under hazardous conditions before the correct sign is determined. Any attempt to analyze the plot to determine the sign of the error by visualizing the effects of systematic rotation of the various bearing lines is extremely subject to human error in the environment of piloting.

### THE FRANKLIN TECHNIQUE

The Franklin technique provides what may be described as a positive, mechanistic approach to the problem which may be employed under severe distractions and multiplicity of duties and functions with relatively little chance for human error as compared to the trial and error or analytical techniques previously described.

In figure A8, so far as navigational conditions permitted, aids to navigation were selected for both good angles of cut of the bearing lines and distances from the observer. Relatively close objects were selected for observation to minimize the displacements of the bearing lines from the observer's true position resulting from bearing errors and plotting errors. The Franklin technique utilizes this effect of bearing errors to determine both the sign of the compass error and the magnitude of the error within practical limits.

In figure A9, a distant charted object at Z has been selected for observation and plotting for the express purpose of indicating graphically the effect of bearing error. This object has been selected at a distance at least three times the distance to the most distant aid to navigation, Y, of normal selection. Normal observations of relatively close aids at X and Y, plotted as true bearing, will intersect at a point, P, relatively close to the observer's true position,  $T_2$ , as compared to the offset of the bearing line plotted as a true bearing through Z. Assuming relatively small random errors, the relative offsets are indicative of compass error for the most part. The relationship of the bearing line through Z to the intersection at P is indicative of the sign of such compass error. With direction being determined relative to the direction of Z from the observer, if the bearing line through Z, designated the Indicator, plots to the right of the intersection at P, the compass error is East or plus; otherwise it is West or minus.

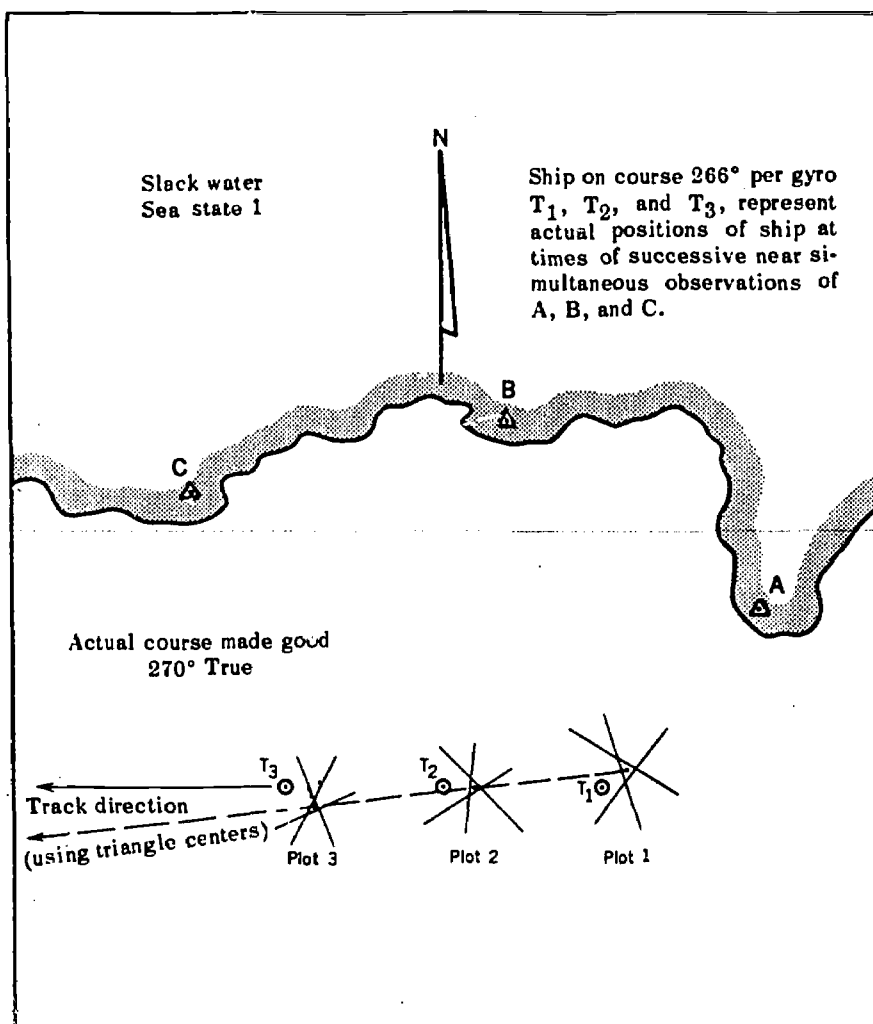

Figure A-8. Unknown compass error triangles.

112.120

### GYRO COMPASS APPLICATION

In the gyro compass application where the errors are normally small and the compass card is quite steady, the relative offsets as illustrated in figure A9 provide practical means of determining the gyro error to be applied to subsequent observations of normally selected aids to navigation or other charted features. Specifically, the error is determined by assuming that the intersection at P is the observer's true position at the time of observation. Therefore, the magnitude of the error is the angle formed at Z by the Indicator and a straight line constructed through P and Z. This error determination is of course approximate in that random errors have been disregarded and the observer is actually at T<sub>2</sub> rather than P at the time of observation. But this approximate error

determination should provide the navigator with a reasonably small fix triangle on plotting the next round of bearings.

### MAGNETIC COMPASS APPLICATION

In the magnetic compass application with large errors, iteration will generally be required, particularly in those cases where the bearings have not been corrected for magnetic variation before plotting as true bearings. In this application the technique should be particularly valuable in those cases where the ship or craft does not have an up to date deviation table or the ship has undergone recent changes in its magnetic condition as a result of pounding in heavy seas, changes in magnetic cargo, changes in location of magnetic material, etc. While charted ranges for checking the accuracy

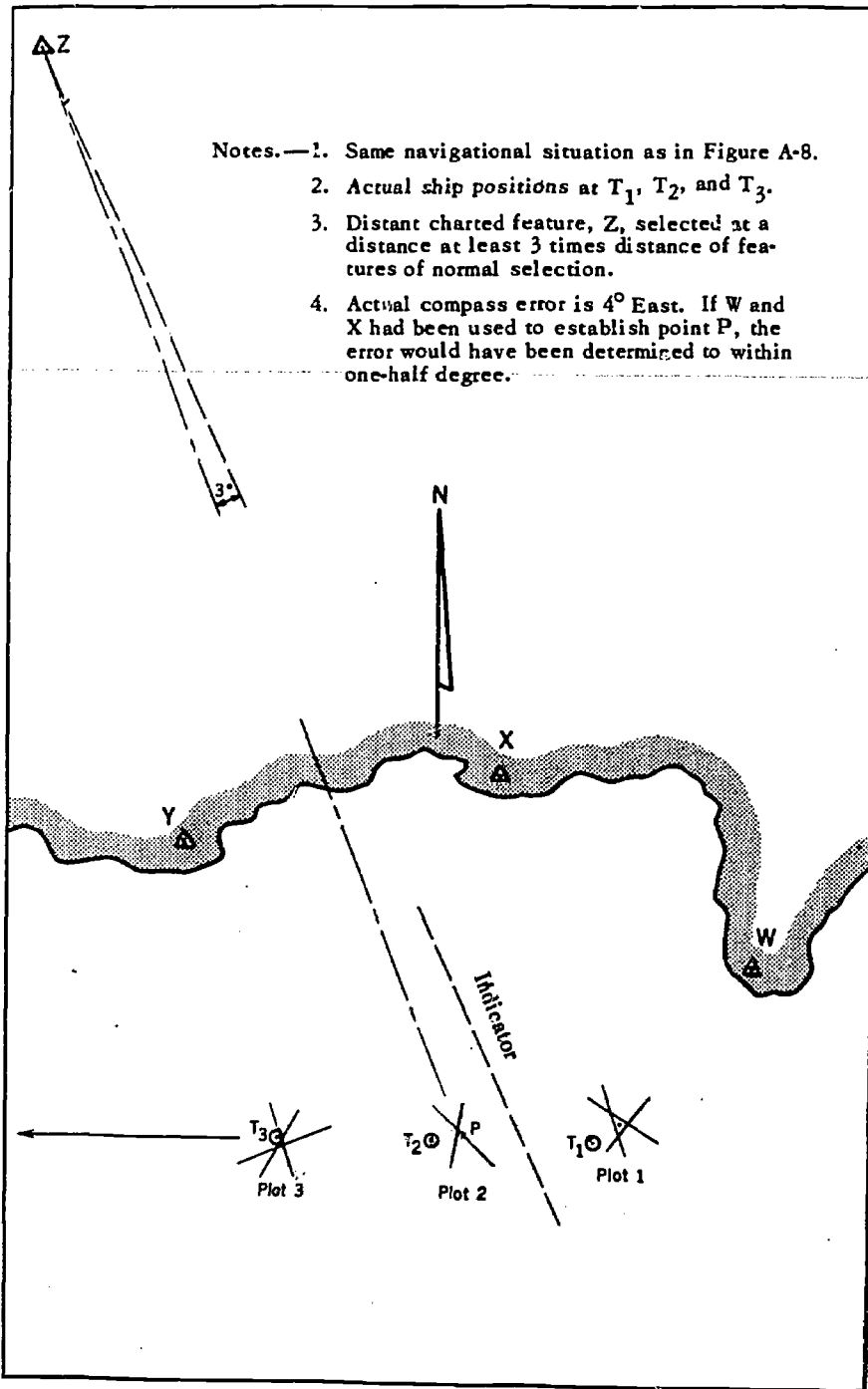

Figure A-9. Direction and approximate magnitude of compass error.

112.121

of the compass are extremely valuable, they are not always available when most needed. Also the sun is not always available or observable for the taking of azimuth observations to check the error of the compass. Except for coastal piloting, because of the time factor it is not generally feasible to take an azimuth of the sun while piloting.

#### ACCURACY

The accuracy of the Franklin technique in a particular application is dependent upon the geometry of the plot or the angular relationships and relative distances of observed objects. Practical experience reveals that the technique does provide a rapid means of determining an approximate error correction to significantly reduce the error in the pilot.

After obtaining both the sign of the error and the approximate magnitude with the technique, some navigators may prefer to refine the correction by a trial and error process rather than preparing the technique. If the application of the technique were limited to determining the sign of the error, this would serve to expedite any trial and error process.

The simplicity and rapidity of the technique is particularly valuable in those situations where variable gyro errors are experienced. In using gyro compasses which are subject to excessive acceleration errors on changes of course or speed, appropriate corrections to observed data are readily determined.

#### AN ALTERNATE TECHNIQUE

Fixing by horizontal sextant angles is an alternative technique to use when the cross-bearing plot is unsatisfactory. While such technique is the most accurate fixing means generally available to the marine navigator, the method does not satisfy general feasibility requirements. The method requires an undesirable interruption of the piloting process while breaking out sextants and three-arm-protractor and redirecting the tasks of the various members of the piloting team. The method introduces drastic changes in procedures under what may be emergency or near emergency conditions. Because of the general reliability of the marine gyro compass and the broader applicability of gyro bearings, navigators today have less proficiency in the use of horizontal sextant angles than in the past. Without doubt under conditions where such sextant observations are feasible, they should be used more frequently as a check on the accuracy of inshore navigation by other means, including

radar navigation, crossbearing piloting, and compass error corrections derived from the Franklin technique.

#### SPECIAL CASE

There is a special case to be guarded against in the selection of terrestrial objects to be used in the cross bearing fix. A geometrical peculiarity which should be recalled is that through any three points not in a straight line, a complete circle can always be drawn, and only one. Now, if by chance the vessel itself is on or near this circle, a seemingly perfect fix can always be obtained. This situation is possible inasmuch as compass error will in no way prevent the lines of bearing from crossing at a common point.

#### COMPASS ALIGNMENT

The true fore-and-aft alignment of the lubber's line on the standard compass and pelorus is relatively quick and easy to determine. Alignment is accomplished by comparing the relative bearing of a distant object with that obtained by careful measurement on the chart when the vessel is alongside the dock and its true heading is known. The correct alignment of the lubber's line on the steering compass, as a rule, is more difficult to ascertain. Some mariners take for granted that the alignment is correct and fail to check it. This situation, however, should always be investigated when first reporting aboard for duty and after yard repair or layup.

Instances have been recorded where the lubber's line of the steering compass was off the longitudinal axis by  $5^{\circ}$  or  $6^{\circ}$ . Although azimuths reveal errors of the compass card, they do not disclose the error of a misaligned compass bowl. When the steering compass is so located that it is difficult or impossible to line up with the jackstaff, the error in alignment, if any, may be determined by the following method.

Ascertain the deviation on the cardinal points by careful comparison with the standard compass or pelorus. Assign a (+) when the deviation is easterly or a (-) when westerly. Add the four figures together algebraically, retaining the sign of the larger sum. Next, divide the result of the addition by 4. The remainder thus obtained is known as coefficient A and, if the compass is well made, is due for the most part to a misaligned compass bowl. When coefficient A is (+), the lubber's line should be moved to the right the number of degrees indicated, or if (-) moved to the left.

## Appendix A — NAVIGATIONAL HINTS

### CALCULATION FOR DETERMINING COEFFICIENT A

DEVIATION HEADING NORTH $-14^{\circ}$	DEVIATION HEADING SOUTH $+ 8^{\circ}$
DEVIATION HEADING EAST $-18^{\circ}$	DEVIATION HEADING WEST $+12^{\circ}$
TOTALS $-32^{\circ}$	$+20^{\circ}$
$\begin{array}{r} -32^{\circ} \\ +20^{\circ} \\ \hline -12^{\circ} \end{array}$	
$\begin{array}{r} 4 \overline{) -12^{\circ}} \\ -3^{\circ} \end{array}$	
COEFFICIENT A $- 3^{\circ}$	

In the preceding example, the lubber's line should be moved  $3^{\circ}$  to the left to place it on the longitudinal axis of the vessel.

### MECHANICAL DEFECTS

The compass, like any precision instrument, is subject to various mechanical defects, which can easily go undetected for some time. Most common defects are broken or blunted pivot points, punctures or roughness of the jeweled cap, card not moving freely in the bowl, and excessive weight on the card itself.

The mariner, with the aid of a small magnet, can quickly check his compass for defects of this nature by the following simple procedure.

Note the compass heading; then, using the small magnet, draw the north point of the compass card about  $15^{\circ}$  to the right. Next, remove the magnet and record the heading when the card comes to rest. Repeat the process, this time drawing the card about  $15^{\circ}$  to the left. If the card comes to rest each time on the original heading, the compass is free of the mechanical defects mentioned. A final heading differing from the original indicates one or more defects are present and that repair is needed.

### RETAINED MAGNETISM

A change in course after a vessel has been steaming or lying on the same heading for some time is always attended by compass error. This error is caused by the retained magnetism induced while the vessel was on that heading. The exact amount of error can only be determined by observation, but can be expected to throw the vessel in the direction of the last course. The general rules regarding the error to be expected are—

2. After steering for some time on easterly courses, expect:

- a. Easterly error if you turn north;
- b. Westerly error if you turn south.

1. After steering for some time on westerly courses, expect:

- a. Westerly error if you turn north;
- b. Easterly error if you turn south.

### LOCAL MAGNETIC DISTURBANCE

In a few locations in the world the charts show areas, usually very small in extent and located in relatively shallow water, where local magnetic disturbance of the compass is caused by magnetic mineral deposits on the bottom. Although numerous reports have been received concerning local magnetic disturbances, it is often impractical to definitely establish whether the cause was external to the vessel. Therefore, only the most probable of these reports are shown on the charts, subject to later verification or disproval.

Because magnetic force diminishes rapidly with distance, a magnetic center in the visible land would have to be of unprecedented intensity to affect the compass of a vessel  $1/2$  mile from it. Mariners may note a temporary deflection of the compass when very close to another vessel, a large mass of iron or steel, or when passing over a wreck in shallow water. The influence radius in such instances will be very small. If the compass continues to show erratic behavior, the cause is probably within the vessel itself. In most instances, trouble is attributable to some source of artificial disturbing influence, such as swinging booms, change in location of iron or steel gear near the compass, or defective electrical wiring in the bridge area. The ordinary phenomena of static electricity will not cause any noticeable deflection of the compass. Severe magnetic storms, often associated with sunspots or auroral displays, cause no more than a degree or so of deflection. Flashes of lightning, however, have been known to derange many compasses to the point of requiring complete readjustment.

Regardless of how well the gyro is operating or how well adjusted the compass may be, routine observations to detect abnormal deviation should be made once every watch and after a course change of  $15^{\circ}$  or more.

### SOUND SIGNAL CAUTION

The whistle, horn, and bell serve as the principal means of communications for vessels to indicate or learn presence and intent or fact. The transitory nature of sound transmitted by these devices has a significant bearing on their reliability as a navigational aid and a communication link. As now used, the



various coded signals indicate not only presence but type of vessel (such as tug with tow, sail, or power-driven) and nature of the vessel's activity (such as underway, at anchor, backing down, or approaching a bend). Considerable evidence indicates that the failure to correctly hear or respond to sound signals is a major contributing factor in ship collisions.

A study of the testimony given after numerous collisions, with damage in excess of one million dollars, occurring in good visibility under inland rules, reveals that the significant factor resulting in many of these collisions was the watch officer's belief that he had heard a signal other than that actually sounded. Inland rules require not only establishment of intent, but also agreement by the vessel signaled. With such a built-in safety factor in the rules, collision must then be the result of either human failure or overconfidence.

Let us look at the cause of one collision where the main ingredient responsible has been experienced by almost every watch officer. A vessel approaching another desired to take the starboard side of the channel for a port-to-port passing situation and so indicated this intent by sounding one short blast. The blast, however, amounted to little more than a wisp of steam and a rather sick gasping cough barely audible on the vessel's own fore-castle head. The watch officer, realizing that the approaching vessel could not possibly have heard the signal, sounded another short blast. This second blast was very clear and audible. Unfortunately, the watch officer on the signaled vessel observed the wisp of steam from the first attempt, but due to noise on deck had concluded that he had just not heard it. Then, both seeing and hearing the second short blast, he assumed that the other vessel had sounded two short blasts, answered in kind, and altered his course into a costly collision.

Overconfidence in the old saying "seeing is believing" certainly spoiled his day! The officer initiating the signals also lacked good judgment in sounding the second blast so soon after his unsuccessful attempt. There appears to be a definite reluctance on the part of many watch officers to sound the danger signal, as required by the inland rules, when the intentions of the other vessel are in doubt. This reluctance probably stems from the desire not to unduly alarm the master, but the sounding of four or more short, rapid blasts to indicate uncertainty is much less alarming than maneuvering a vessel on assumption and guesswork.

### RADAR LANDFALL

One of the more hazardous situations confronting the mariner involves the approach to land during

poor visibility, especially after several days of overcast weather conditions when sights of doubtful value have been obtained and uncertain currents encountered.

The situation is further aggravated when the approach course makes a small angle with the coastline; where, due to depth of water, soundings are of little avail; and there are offshore shoals and reefs to be avoided. The mariner's main objective in this situation will be to identify, without any doubt, some feature and determine the vessel's position relative to it.

Charts are constructed with the emphasis placed on depicting the most prominent visual features for identification, such as conspicuous spires, domes, tanks, towers, and so on. These objects may be excellent visual landmarks, but may be extremely poor radar contacts, particularly if previous radar experience in the area is lacking.

Preparation is therefore desirable when approaching land in poor visibility with the aid of radar, so that the mariner may make a sound prediction of what should be seen and when. To do this, he must acquire a thorough understanding of the capabilities and limitations of his radar equipment, knowledge of the meteorological factors (either favorable or unfavorable) which will cause anomalous wave propagation, and some means of determining the distance at which features of various heights will begin to appear above the radar horizon.

Radars operate in the frequencies that are essentially line-of-sight. But, due to barometric pressure, relative humidity, and temperature gradient variations, the waves are subject to some bending, either up or down, under certain atmospheric conditions.

The normal radar horizon is approximately 15 percent greater than the visual horizon at the same height. (See fig. A-10.) The approximate distance at which a feature will be on the horizon of the radar set is found by adding the distance of the radar horizon of the antenna to that of the feature. It can be computed by the formula—

$$D = 1.23\sqrt{H_a} + 1.23\sqrt{H_t}$$

D=distance in nautical miles  
 H<sub>a</sub>=height of antenna, in feet  
 H<sub>t</sub>=height of target (feature), in feet

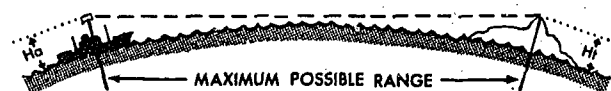

112.114

Figure A-10. Radar horizon is 15% greater than visual horizon.

## Appendix A — NAVIGATIONAL HINTS

### CALCULATION FOR DETERMINING COEFFICIENT A

DEVIATION HEADING NORTH $-14^{\circ}$	DEVIATION HEADING SOUTH $+ 8^{\circ}$
DEVIATION HEADING EAST $-18^{\circ}$	DEVIATION HEADING WEST $+12^{\circ}$
TOTALS $-32^{\circ}$	$+20^{\circ}$
$\begin{array}{r} -32^{\circ} \\ +20^{\circ} \\ \hline -12^{\circ} \end{array}$	
$4 \overline{) -12^{\circ}}$	
COEFFICIENT A	$- 3^{\circ}$

In the preceding example, the lubber's line should be moved  $3^{\circ}$  to the left to place it on the longitudinal axis of the vessel.

### MECHANICAL DEFECTS

The compass, like any precision instrument, is subject to various mechanical defects, which can easily go undetected for some time. Most common defects are broken or blunted pivot points, punctures or roughness of the jeweled cap, card not moving freely in the bowl, and excessive weight on the card itself.

The mariner, with the aid of a small magnet, can quickly check his compass for defects of this nature by the following simple procedure.

Note the compass heading; then, using the small magnet, draw the north point of the compass card about  $15^{\circ}$  to the right. Next, remove the magnet and record the heading when the card comes to rest. Repeat the process, this time drawing the card about  $15^{\circ}$  to the left. If the card comes to rest each time on the original heading, the compass is free of the mechanical defects mentioned. A final heading differing from the original indicates one or more defects are present and that repair is needed.

### RETAINED MAGNETISM

A change in course after a vessel has been steaming or lying on the same heading for some time is always attended by compass error. This error is caused by the retained magnetism induced while the vessel was on that heading. The exact amount of error can only be determined by observation, but can be expected to throw the vessel in the direction of the last course. The general rules regarding the error to be expected are—

2. After steering for some time on easterly courses, expect:

- a. Easterly error if you turn north;
- b. Westerly error if you turn south.

1. After steering for some time on westerly courses, expect:

- a. Westerly error if you turn north;
- b. Easterly error if you turn south.

### LOCAL MAGNETIC DISTURBANCE

In a few locations in the world the charts show areas, usually very small in extent and located in relatively shallow water, where local magnetic disturbance of the compass is caused by magnetic mineral deposits on the bottom. Although numerous reports have been received concerning local magnetic disturbances, it is often impractical to definitely establish whether the cause was external to the vessel. Therefore, only the most probable of these reports are shown on the charts, subject to later verification or disproval.

Because magnetic force diminishes rapidly with distance, a magnetic center in the visible land would have to be of unprecedented intensity to affect the compass of a vessel 1/2 mile from it. Mariners may note a temporary deflection of the compass when very close to another vessel, a large mass of iron or steel, or when passing over a wreck in shallow water. The influence radius in such instances will be very small. If the compass continues to show erratic behavior, the cause is probably within the vessel itself. In most instances, trouble is attributable to some source of artificial disturbing influence, such as swinging booms, change in location of iron or steel gear near the compass, or defective electrical wiring in the bridge area. The ordinary phenomena of static electricity will not cause any noticeable deflection of the compass. Severe magnetic storms, often associated with sunspots or auroral displays, cause no more than a degree or so of deflection. Flashes of lightning, however, have been known to derange many compasses to the point of requiring complete readjustment.

Regardless of how well the gyro is operating or how well adjusted the compass may be, routine observations to detect abnormal deviation should be made once every watch and after a course change of  $15^{\circ}$  or more.

### SOUND SIGNAL CAUTION

The whistle, horn, and bell serve as the principal means of communications for vessels to indicate or learn presence and intent or fact. The transitory nature of sound transmitted by these devices has a significant bearing on their reliability as a navigational aid and a communication link. As now used, the

## Appendix A—NAVIGATIONAL HINTS

Table A-1 gives the approximate distance to the radar horizon for a standard radar under normal conditions for various heights of either Ha or Ht.

HEIGHT (ft.) Ho or Ht	DISTANCE OF RADAR HORIZON (N. M.)	HEIGHT (ft.) Ho or Ht	DISTANCE OF RADAR HORIZON (N. M.)
18	5	215	18
24	6	240	19
32	7	265	20
42	8	320	22
54	9	380	24
66	10	445	26
80	11	520	28
95	12	595	30
111	13	680	32
130	14	770	34
150	15	860	36
170	16	960	38
190	17	1060	40

Table A-1.—Approximate Distance to Radar Horizon

112.117

Inspection of table A-1 would indicate to the mariner whose radar antenna was 60 feet above the water that a coastal bluff 80 feet high would not be visible on his radarscope until the vessel was within a maximum range 20.5 miles, and the chances are that the bluff would have to rise above this maximum radar horizon distance before the reflected echo was strong enough to show upon the radarscope. The knowledge of the probable distances at which various objects can be expected to appear on radar will greatly assist in the accurate identification of various landfall targets. A more graphic means of showing target range can be had by constructing a simple curve on a piece of graph paper using the height of the mariner's own antenna based on table A-1.

As with all other aids to navigation, the use of radar in good weather to check out target identification, ranges, and skill of the operator will return valuable dividends when visual identification is not possible.

Regardless of how simple and direct the radar presentation may appear, it is essential that the navigator continue to employ all normal navigational techniques when in coastal waters. The navigator cannot afford the luxury of not maintaining a good dead reckoning position plot, a sharp eye on the soundings, and awareness of the effects of set and drift conditions upon the vessel.

### ICEBERG DETECTION

Any suggested signs, warnings, or proposed methods of detecting the proximity of icebergs may prove of great assistance, yet they can be but supplementary to the eyes of an alert lookout. The old

phrase that the only sure sign of an iceberg is to see it is still a valid one. Over-reliance on any other means could be extremely dangerous. (See fig. A-11.)

The distance at which a lookout can sight a berg varies, of course, with the state of visibility, height of eye, and height of berg. On a very clear day a lookout stationed 70 feet above the water could sight a large berg up to 18 miles; in clear weather, with low-lying haze on the horizon, the top of a berg at 9 to 11 miles; in light fog or drizzling rain, at 1 to 3 miles; and in dense fog, about 100 yards. In light fog the lookout could sight a berg sooner if aloft, but in dense fog a position in the bow would be best. On a clear starlit night, a lookout will not sight a berg more than 1/4 mile away. If the bearing is known, however, this distance could be increased to 1 mile, with the aid of binoculars, by picking up the occasional spots of light as the swells break against it. On a bright moonlit night, a berg could probably be sighted up to 3 miles away.

As a general rule, there is no appreciable change in the air temperature near a berg nor in the water temperature surrounding it.

The presence of growlers and other pieces of detached ice usually indicates that a berg is in the vicinity and probably to windward. Because growlers can cause considerable damage to a vessel, it is always best to pass a known berg on its windward side, especially at night or in low visibility.

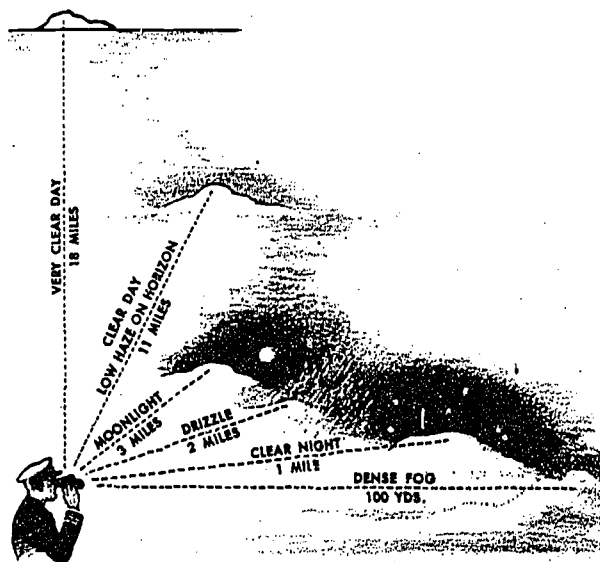

112.115

Figure A-11. Distance at which a lookout can sight icebergs under various atmospheric conditions.

The use of radar to detect the presence of bergs and growlers is certainly helpful, but often a large berg that has been sighted visually will not appear on the radar scope probably because the berg has a very smooth sloping side or because of sub-refraction, which often occurs in ice areas. Many times, a berg detected by radar will disappear again from the scope as the relative positions of the berg and the ship change.

The detection of growlers by radar is even less certain. The echoes returned by these small bergs, which show only a few feet above the surface, are difficult to distinguish from strong sea clutter on the scope.

The following table shows the approximate maximum range at which bergs can be detected by radar with the antenna located 50 feet above the water.

	HEIGHT ABOVE WATER	RANGE (N.M.)
Large icebergs	40-50 feet	12
Medium-sized icebergs	10-20 feet	9
Growlers	6-10 feet	2

### PINPOINT ANCHORING

The following method of instantaneous plotting of a ship's position approaching and anchoring in an assigned berth has been found to be valuable in crowded anchorages.

A chart, preferably an anchorage chart of the area is prepared in the following manner:

Three or four prominent points or objects are selected—preferably good radar targets, which give a coverage of the entire anchorage area as well as furnish the widest possible angles of bearing. From these selected points, lines of position are drawn at 1° intervals covering the entire anchorage area, using a different colored ink for the lines drawn from each point or object. The bearing lines are extended beyond the anchorage area and the true bearing from the objects or targets marked on the extremities of the lines. Upon assignment of an anchorage berth, range lines in any desired increments are laid down in arcs with pencil from the selected points to the assigned berth. The prepared chart is now ready for use, overlaid with inked lines of position from the selected objects for bearing purposes and penciled arcs in the vicinity of the assigned berth for ranging purposes.

As the vessel approaches the assigned berth, instantaneous fixes may be obtained, as rapidly and frequently as desired, merely by noting the

bearings as the observer at the bearing circle gives them to the navigator at the prepared chart. The navigator simply marks the ship's position where the bearing lines cross. The radar ranges are also given at the same time as a further check on the ship's position. By setting a universal drafting machine or parallel rules on the ship's course line and placing on the latest fix, any course changes are immediately apparent. A further refinement could be made by placing red-penciled range rings in increments of 100 yards from the center of the assigned anchorage berth in order to rapidly read off the remaining distance to the berth.

(Figure A-12 is a simplified chart which shows only bearing limits passing through the desired anchorage. In practice, bearing lines at 1° intervals would be drawn from selected landmarks in different colors and marked at their extremities. Range circles, at suitable scale, would be drawn from the center of anchorage to indicate distance remaining.)

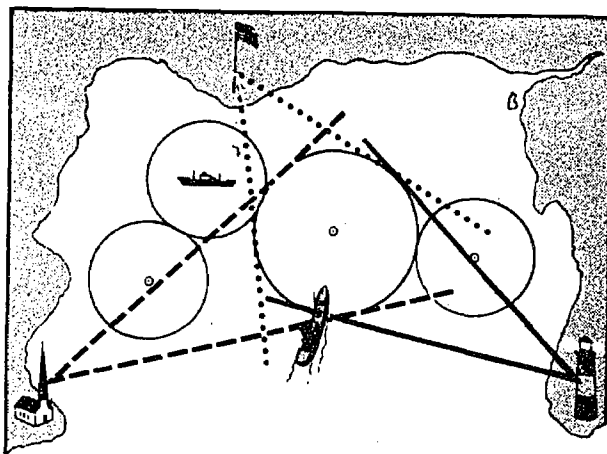

112.116

Figure A-12. Simplified chart of pinpoint anchoring.

This method requires a navigation staff normally found on board a naval vessel. It may, however, be useful to the merchant navigator when assigned to a congested anchorage berth. It could also be used by a vessel regularly running a congested channel or restricted maneuvering area for obtaining positions, requiring only a minimum amount of time in the chartroom.

### CONCLUSION

When one stops to consider that the art and science of navigation are a coalescence of astronomy, cartography, mathematics, geography, history, and man's unquenchable desire to explore the unknown, it is easy to see that the skillful mariner must

have a tremendous reservoir of facts, hints, and commonsense to fulfill his mission. The Oceanographic Office endeavors to assist the mariner in every possible field of safe navigation and solicits the mariner's comments and suggestions for the improvement of its products in a mutually beneficial program of maritime safety.

# INDEX

## A

- Air Almanac, 166
- Altitude corrections, 57-60
  - dip of the horizon, 60
  - index correction, 57
  - parallax, 60
  - refraction, 59
  - semidiameter, 60
- Astronomical triangle, solving, 72-76
  - H.O. 214 method, 72-74
  - H.O. 229 method, 75
  - H.O. 249 method, 75
  - steps in working a sight, 74
- Azimuth of celestial bodies, 167
- Azimuth tables, 167
- Azimuths, 102

## B

- Bag or boom of logs, 124
- Bank cushion, bank suction, 90
- Bank protection, 122
- Barges abreast in tiers, 118
- Bearing and distance, 32
- Bearing, danger, 35
- Bearings,
  - by gyro repeater, 30
  - by magnetic compass, 30
  - by pelorus, 30
  - plotting, 30-32, 35
  - plotting, 30-32
  - taking, 30
- Beaufort scale and windspeed in knots, 140
- Bends, curves, and leaving berths, pilot rule for, 113
- Berth, getting away from, 90
- Bow ditch, 34
- Breakers, 161
- Bridges, passing under, 126

## C

- Cable laying, excavation, bank protection, etc., 122
- Cargoes, transferring dangerous, 126
- Catalog of Nautical Charts and Publications, 165
- Celestial navigation, 57-77
  - assisting at observations, 76
  - astronomical triangle, solving, 72-76
  - LOP from celestial observations, 67-71
  - noon sight, 71
  - sextant, use of, 57-62
  - star identification, 62-67
- Channel piloting, 28
- Charts and publications, 165-167
  - National Ocean Survey, 166
  - Naval Observatory, 166
  - Oceanographic Office, 165
  - U.S. Coast Guard, 166
  - Useful publications for Quartermasters, 166
- Classification management, security, 172
- Cloud types, 141
- Coast Guard vessels, 125
- Coast piloting, 29
- Coast Pilots, 166
- Compass alignment, 184
- Compasses, 8-27
  - gyro, 23-27
  - magnesyn, 21-23
  - magnetic, 8
- Components of weather bulletins, 136
- Conduct in fog, pilot rule for, 116
  - fog signals, 116
  - speed in fog, 116
- Consol, 50-53
- Conversion table, 145
- Course recorder, gyrocompass, 26
- Cruise, extended, 104-109
  - laying out the track, 108
  - planning, 104-108
- Current Tables, 166
- Currents, 176
- Cylonic wind direction, 133

## D

Danger angle, 35  
 Danger bearing, 35  
 Dangerous cargoes, transferring, 126  
 Dead reckoning, 36-46  
   advantages of, 37  
   DR track line, 38  
   equipment, 38  
   estimated position, 39-42  
     current sailing, 41  
     soundings, use of, 39  
   plotting sheets, 37  
   plotting system MK NC-2, 42-46  
 Decca, 53  
 Degaussing, 19-21  
   compass compensation, 20  
   control of currents, 20  
   deviation table, 20  
   operation of system, 20  
   principles of, 19  
 Depths, 176  
 Deviation table, compass, 18  
 Dip of the horizon, 60  
 Dissemination considerations factors, security, 173  
 Distress signals, pilot rule for, 125  
 Docking large vessels, 98  
 DOD Catalog of Aeronautical Charts and Flight Information Publications, 165  
 Dredges underway, 122  
 DR equipment, gyrocompass, 26  
 DR track line, 38  
 DRT plotting table, 42  
 Dynamic pressure, 86

## E

Echo sounding, 177  
 Echogram, 154  
 Electronic navigation, 47-56  
   consol, 50-53  
   decca, 53  
   loran, 49  
   loran-C, 50  
   NAVDAC, 56  
   navigation by satellites, 54-56  
   omega, 54  
   radar, 47-49  
   ship's internal navigation system, 56  
   shoran, 56  
   star tracker, 56  
 Entering port, preparation, 80

Equipage,  
   custody, 109  
   maintenance, 110  
   survey, 110  
 Equipment, checking and adjusting, 104  
 Evening stars, 102  
 Excavation, 122  
 Extended cruise, 104

## F

Facsimile equipment, 137  
 Farwell's Rules of the Nautical Road, 167  
 Fast ice, 162  
 Feedback report, 111  
 Ferryboats, 117  
 Fishing vessels, 125  
 Fix reliability, 179  
 Fixing position in piloting, methods of, 32-35  
   bearing and distance, 33  
   cross bearings, 32  
   sextant angles between three known objects, 35  
   two bearings separated by an interval, 33  
 Flinders bar, 14  
 Floating plant, pilot rule for, 124  
   aids to navigation, 125  
   obstruction of channel, 125  
   signal for passing, 124  
   speed when passing, 125  
 Fog signals, 116  
 Force factors, 86  
 Forecasting weather from isobars, 151  
 Foreign Travel Briefings, 170  
 Formation diagrams, 80  
 Formations, 79  
 Franklin piloting technique, 181-184  
   accuracy, 184  
   alternate technique, 184  
   gyro compass application, 183  
   magnetic compass application, 183  
 Fronts, weather, 151  
 Fundamentals of ship handling, 88-91  
   backing down, 88  
   bank cushion; bank suction, 91  
   casting, 88  
   getting away from a berth, 90  
   going ahead, 88  
   going alongside, 89  
   single screw peculiarities, 91  
   wind and current, 89

## G

General Prudential Rule, 115  
 Getting underway, 84

Ghost pulses, 50  
 Going alongside, 89  
 Graphic fix from two bearings, 34  
 Gyro repeaters, 25  
 Gyrocompass, 23-27  
     advantages and disadvantages over magnetic  
     compass, 23  
     equipment, 24  
     errors, 23, 27  
     operation of, 26  
     types of, 23  
 Gyro compass application, 183  
 Gyropilot, 25

H

Heeling error, magnetic compass, 13  
 H.O. publications, 167  
 Horizontal soft iron, 12  
 Hurricanes, 133  
 Hydrographic surveying, vessels employed in, 125

I

Ice, characteristics of, 162  
 Ice condensation, 162  
 Ice observations, 161  
 Ice topography, types of, 161  
 Isobaric analysis, 146  
 Isobars, 139  
 Isobars, rules for drawing, 148  
 Isobars, weather forecasting from, 151  
 Iceberg detection, 187  
 Index correction, 57  
 Induced magnetism in vertical soft iron, 12  
 Instant of transit, 71  
 International, inland, and pilot rules, 112  
 Intersecting lines, 68

J

Junior officer of the deck, 78

L

Latitude by meridian altitude below the pole, 178  
 Laws of storms, 129-133  
     cyclonic wind direction, 133  
     hurricanes, 133  
     monsoons, 131  
     squalls, 131

Laws of storms — Continued  
     tornadoes, 131  
     waterspouts, 131  
 Laying out the track, 108  
 Light Lists, 166  
 Line of position, 68  
 Local magnetic disturbance, 185  
 Log, sounding, 154  
 LOP from celestial observation, 67-71  
     advancing the LOP, 70  
     circles of equal altitude, 68  
     determining line of position, 69  
     intersecting lines, 68  
     line of position, 68  
 Loran, 49  
     advantages, of, 49  
     disadvantages of, 49  
     reliability of, 50  
     transmission in accuracies, 50  
 Loran-C, 50

M

Magnesian compass, 21-23  
 Magnetic compass, 8  
     adjustments, 14-18  
     causes of deviation, 9-14  
     degaussing, 19-21  
     deviation table, 18  
     limitations of, 8  
     nomenclature, 8  
 Magnetic compass application, 183  
 Magnetic compass table (deviation table), 18  
 Magnetic disturbance, local, 185  
 Maintenance and material management, 109-111  
     custody of equipment, 110  
     PMS feedback report, 112  
     shipboard maintenance, 111  
     survey of equipment, 111  
 Maintenance, shipboard, 110  
 Maneuvering characteristics of ship, 86  
 Manual of Qualifications for Advancement, 4  
 Maps, weather, 139-152  
 Maximum altitude, following, 71  
 Mechanical defects in the compass, 185  
 Meeting head and head, pilot rule for, 113  
 Meridian angle, exact value of, 73  
 Monsoons, 131  
 Moon, observing, 61  
 Mooring over or alongside wrecks, 121  
 Morning stars, 101

N

National Ocean Survey, 166  
 Nautical Almanac, 166



Naval Observatory, 166  
 NAVDAC, 56  
 Navigation during soundings, 153  
 Navigation, electronic, 47-56  
 Navigation lights, pilot rule for, 116-120  
     ferryboats, 117  
     nondescript vessels, 117-120  
 Navigational Hints, 176-189  
     compass alignment, 184  
     depths, shoals, currents, 176  
     echo sounding, 177  
     fix reliability, 179  
     Franklin piloting technique, 181  
     iceberg detection, 189  
     latitude by meridian altitude below the pole,  
         178  
     local magnetic disturbance, 185  
     mechanical defects, 185  
     night vision horizon, 177  
     pinpoint anchoring, 188  
     radar landfall, 186  
     retained magnetism, 185  
     sight error compensation, 178  
     sound signal caution, 185  
     special case, 184  
 Navigational satellites system, 55  
 Navigator, 100-111  
     day's work at sea, 101-104  
         azimuths, 102  
         duties underway, additional, 102  
         evening stars, 102  
         morning stars, 101  
         Quartermaster's responsibility, 103  
         sunlines, 102  
     duties of, 100  
     extended cruise, 104-109  
     maintenance and material management, 109-  
         111  
 Navigator's worksheet, 155  
 Night vision horizon, 177  
 Noon sight, 71  
     following to maximum altitude, 71  
     instant of transit, 71  
     numerous sights, 71

O

Observations,  
     assisting at, 76  
     celestial, LOP from, 67-71  
 Observations, oceanographic, 153-165  
 Obtaining and Reporting Navigational Information,  
     167  
 Occluded front, 152

Oceanographic observations, 153-165  
     echogram, 154  
     ice condensation, 162  
     ice observations, 161  
     ice topography, types of, 161  
     navigation during soundings, 153  
     navigator's worksheet, 155  
     reports to oceanographer, 154  
     sea and swell observations, 154-161  
     shipboard wave observation log, 160  
     ship-shore ice log, 164  
     smooth track chart, 156  
     sounding log, 154  
 Oceanographic office, 167  
 Officer of the deck, 78-85  
     junior officer of the deck, 78  
         getting underway, 84  
         OOD in port, 84  
     OOD underway, 79-84  
         formation diagram, 80  
         formations, 79  
         preparations for entering port, 80-84  
         station keeping, 79  
 Omega, 54  
 OpNav 3144-1, entries on, 136

P

Parallax, 60  
 Passing under bridges, pilot rules for, 126  
 Pelorus, 30  
 Permanent magnetism, 10-12  
 Phantom bottom, 177  
 Physical characteristics of ships, 85  
 Pilot rules, 112  
     bends, curves, and leaving berths, 113  
     conduct in fog, 116  
     definitions, 112  
     departure from rules, 115  
     distress signals, 125  
     floating plant, 125  
     meeting head and head, 113  
     navigation lights, 116-120  
     passing under bridges, 126  
     right-of-way, 114  
     special day or night signals, 125  
     summary, 126  
     transferring dangerous cargoes, 126  
     vessels unable to maneuver, or maneuvering  
         with difficulty, 120-124  
     whistle signals, 113  
 Piloting, 28-36  
     channel piloting, 28  
     coast piloting, 29  
     danger angle, 35

Piloting—Continued  
 danger bearing, 35  
 fixing position in, method of, 32-35  
 leadership responsibility, 36  
 plotting bearings, 30-32  
 taking bearings, 30  
 Piloting—dead reckoning, 28-46  
 Pinpoint anchoring, 188  
 Pipelines, 122  
 Planned maintenance subsystem operation, 110  
 Planned maintenance system manual, 110  
 Plotting sheets, 153  
 Plotting sheets, dead reckoning, 37  
 Plotting system MK NC-2, 42-46  
     data converter, 43  
     dead reckoning indicator, 43  
     modification to, 45  
     table, 42  
     target plot attachments (TPA), 43  
 PMS feedback report, 112  
 Potential Hostage Briefings, 171  
 Preparations for entering port, 80-84

Q

Quadrantal deviation, 12  
 Quadrantal spheres, 14  
 Qualls Manual, 4  
 Quartermaster's responsibility, 103

R

Racon, 49  
 Radar, 47-49  
     accuracy of, 48  
     advantages of in navigation, 47  
     beacons, 49  
     disadvantages of in navigation, 47  
     limitations in range, 48  
     piloting by, 48  
 Radar landfall, 186  
 Radio Navigational Aids, 167  
 Radio Weather Aids, 167  
 Rafts and other craft, 123  
 Records, reports, and publications, 153-167  
 Refraction, 59  
 Repeaters, gyro, 25  
 Reports to oceanographer, 154  
 Retained magnetism, 185  
 Right-of-way, pilot rule for, 114  
     crossing situation, 115  
     overtaking situation, 115  
     steam and sailing vessels, 115  
 Rudder effect, 88

Rules of the Road—Great Lakes, 112-167  
 Rules of the Road—International-Inland, 112, 166  
 Rules of the Road—Western Rivers, 112, 166

S

Safety precautions in towing, 98  
 Satellites, navigation by, 54-56  
 Screw current, 87  
 Sea and swell observations, 154-161  
 Security, 168-175  
     briefings, 170  
     change in classification, 173  
     classification according to content, 172  
     classification management, 172  
     debriefings, 172  
     dissemination considerations factors, 173  
     individual action, 173  
     indoctrination, 169  
     introduction to, 168  
     objective, 169  
     principles, 169  
     responsibility, 168  
     specific classifying criteria, 173  
 Semidiameter, 60  
 Sextant, use of, 57-62  
     altitude corrections, 57-60  
     observing the moon, 61  
     observing stars and planets, 61  
     observing the sun, 60  
 Ship handling, 85-99  
     docking large vessels, 98  
     force factors, 86  
     fundamentals of, 88-91  
     maneuvering characteristics, 86  
     physical characteristics, 85  
     towing, 91-98  
 Ship maneuvering characteristics, 86  
 Shipboard maintenance, 110  
 Shipboard wave observation log, 160  
 Shipboard weather charts, 136-139  
 Ship-shore ice log, 164  
 Ship's interval navigation system, 56  
 Ship's position report, 101  
 Ship-to-shore weather reports, 136-139  
     entries on OpNav 3144-1, 136  
     shipboard weather charts, 136-139  
     standard weather codes, 138  
 Shoals, 176  
 Shoran, 56  
 Side force and screw current, 86  
 Sight error compensation, 178  
 Sight Reduction Tables for Air Navigation, 167  
 Signal for passing floating plant, 124  
 Smooth track chart, 156

Sound signal caution, 185  
 Sounding log, 154  
 Special day or night signals, pilot rule for, 125  
     Coast Guard vessels, 124  
     fishing vessels, 125  
     vessels employed in hydrographic surveying, 125  
 Speed and latitude correction, gyrocompass, 26  
 Sperry gyrocompass, 22  
 Squalls, 131  
 Star identification, 62-67  
     finder and identifier, 63-66  
     selecting bodies for observation, 66  
 Star tracker, 56  
 Station keeping, 79  
 Stationary dredges, 121  
 Storms, laws of, 129-133  
     cyclonic wind direction, 133  
     hurricanes, 133  
     monsoons, 131  
     squalls, 131  
     tornadoes, 131  
     waterspouts, 131  
 Sunlines, 102  
 Symmetrical, horizontal soft iron, induced magnetism in, 12

T

Table of Distances Between Ports, 167  
 Tables of Computed Altitude and Azimuth, 167  
 Tide Tables, 166  
 Tornadoes, 131  
 Towing, ship, 91-98  
     alongside towing, 94  
     approaches to ship, 92  
     astern towing, 95  
     gear, 92  
     machine, 91  
     problem, 91  
     safety precautions, 98  
     scope of hawser, 94  
     signals, 93  
     speeds, 94  
 TPA (target plot attachments), 43  
 Tropical cyclone approaching, 133-136  
     bearing of the center, determining, 135  
     maneuvering, 135  
 Transferring dangerous cargoes, pilot rule for, 126  
 Turning circle, ship's, 87

V

Vertical soft iron, induced magnetism in, 12  
 Vessels moored or at anchor, 123  
 Vessels towing submerged objects, 120  
 Vessels unable to maneuver, or maneuvering with difficulty, 120-124  
     cable laying, excavation, bank protection, etc., 122  
     dredges underway, 122  
     mooring over or alongside wrecks, 121  
     pipelines, 122  
     rafts and other craft, 123  
     stationary dredges, 121  
     vessels moored or at anchor, 123  
     vessels towing submerged objects, 120

W

Waterspouts, 131  
 Wave forecasting, 159  
 Wave height, 159  
 Wave length, 159  
 Wave observation log, 160  
 Wave period, 159  
 Wave velocity, 159  
 Weather, 127-152  
 Weather bulletins, components of, 136  
 Weather charts, shipboard, 136-139  
     markings on, 139  
 Weather codes, 138  
 Weather forecasting from isobars, 151  
 Weather maps, 139-152  
     cloud types, 141  
     conversion table, 145  
     illustrative example, 149-151  
     isobaric analysis, 146  
     isobars, 139  
     rules for drawing isobars, 148  
     weather forecasting from isobars, 151  
     windspeed in knots and Beaufort scale, 140  
 Weather messages, 136  
     components of weather bulletins, 136  
 Weather reports, ship-to-shore, 136-139  
 Weather Station Index, 167  
 Whistle signals, pilot rule for, 113  
 Whitecaps, 159  
 Wind waves, 159  
 Winds and pressure areas, 127  
 Working a sight, steps in, 74  
 World winds, 127-129