

DOCUMENT RESUME

ED 085 911

EA 005 821

TITLE Technical and Occupational Shops.
INSTITUTION Ontario Dept. of Education, Toronto. School Planning and Building Research Section.
PUB DATE Jan 68
NOTE 39p.; A related document is EA 005 822
AVAILABLE FROM Ontario Government Publications Centre, Macdonald Block, Queen's Park, Toronto, Ontario M7A 1N8 (Canada) (\$2.00, payable to Treasurer of Ontario)

EDRS PRICE MF-\$0.65 HC-\$3.29
DESCRIPTORS Agricultural Education; Auto Mechanics; Drafting; Environmental Education; Facility Guidelines; *Facility Requirements; Greenhouses; Horticulture; Illustrations; Interior Design; *School Planning; *School Shops; Secondary Schools; *Technical Education; *Vocational Education; Welding

ABSTRACT

This booklet presents suggested plans and specifications for and discusses facilities common to technical and occupational shops. Drawings, room plans, and text illustrate specifications for drafting rooms, a welding shop, an automechanics shop, an auto body shop, and a high school greenhouse. Also included are facility designs for agricultural science, environmental science, and horticultural instruction in secondary schools. (Author/MLF)

Technical and Occupational Shops

ED 085911

U S DEPARTMENT OF HEALTH,
EDUCATION & WELFARE
NATIONAL INSTITUTE OF
EDUCATION

THIS DOCUMENT HAS BEEN REPRO-
DUCED EXACTLY AS RECEIVED FROM
THE PERSON OR ORGANIZATION ORIGIN-
ATING IT. POINTS OF VIEW OR OPINIONS
STATED DO NOT NECESSARILY REPRESENT
OFFICIAL NATIONAL INSTITUTE OF
EDUCATION POSITION OR POLICY.

Prepared by
Ontario Department of Education
School Planning and Building Research Section

In conjunction with
The Department of Education's
Technical and Occupational Shop Committees

January 1968

EA 005 821

F 2.00

Contents

Preface

Technical and Occupational Shops 1

1. Chalkboards
2. Tackboards
3. Acoustics
4. Heating and Ventilation
5. Services
6. General

Drafting Rooms 4

The Welding Shop 7

The Auto Mechanics Shop 12

The Auto Body Shop 17

Facilities for Agricultural Science, Environmental
Science and Horticultural Instruction
in Secondary Schools 22

The High School Greenhouse 28

Preface

The plans and specifications for technical shops should reflect the aims of technical education. The following are two basic objectives with regard to the student:

- a) development of basic technical skills so that employment may be readily secured on graduation;
- b) development of basic academic skills which will provide a sound preparation for further education and/or training.

Since technical subjects, in themselves, can and do fulfill the above objectives, it is quite possible to design technical laboratories and shops to suit these requirements. It is hoped that the plans in this brochure will suggest suitable and practical designs and are presented as guide lines only.

The basic objectives indicate the need for adequate space and equipment to permit the practical exercises which develop technical skills. Most of these skills involve the use of tools and machines. Therefore, liberal bench areas, an ample supply of tools, adequate tool storage and sufficient equipment for 20 students and for 16 students in the occupational shops should be provided. Such facilities take up the bulk of the floor area in most technical laboratories and shops.

Consistent with the second objective, provision should be made for instruction and discussion of the theoretical aspects of each subject. Many shops include a teaching area designed to create good acoustic and visual conditions. Within this clean area, students may be seated comfortably as they listen to the instructor, discuss a problem as a class or small group, or work individually at various assigned calculations and laboratory reports.

It is important to realize that language, mathematics and science, which comprise an important part of the courses, are not only possible within a technical course, but that these academic skills are an essential basis for technical competence.

With one or two exceptions such as the greenhouse, all technical shops have a number of facilities in common. The drawings and text in this book, which describe some suggested designs of individual shops, do not cover heating or ventilating systems unless the particular shop shown has unique requirements. These designs are indicative of the facilities considered desirable by educational authorities, but should not be considered as standard requirements. The information common to all the shops is listed below.

1. Chalkboards

Chalkboards are necessary in the shop itself and in shop classrooms, although they will vary in length and position according to individual requirements. Standard sizes as produced by most manufacturers can be fitted underneath with 14½ inch deep storage units for instructional aid sheets.

2. Tackboards

Tackboard should be cork faced and may in some cases be combined with chalkboard units.

3. Audio – visual Aids

In all cases, a projection screen should be provided for an overhead or other projector. If a suspended ceiling is to be installed in the room, the screen can be recessed. Otherwise, surface mounting above the chalkboard will be adequate. Electrical 110 volt/15 ampere outlets will be required to run the projectors. The outlet for the overhead projector should be at the front of the room. The other outlet should be at the rear of the room.

Provision for future TV installations can be made by installing conduit if funds permit.

4. Acoustics

Four factors can be taken into account in dealing with acoustical problems:

- a) location of shop wing in relation to the quieter activities in the school;
- b) grouping together of noisy shops, such as sheet

metal and automotive shops, within the technical wing;
c) local treatment of walls and ceilings;
d) type of heating and ventilating systems.

Where separate teaching areas within shops are provided, the partitions should have a minimum rated decibel reduction value of not less than 40. Windows may require double glazing to meet this standard.

5. Heating and Ventilation

Considerable trouble has resulted in existing schools from the use of unit heaters in shop areas. Even where they are supplied with two-speed motors, the noise in the shop makes the teacher's job a difficult one. Convection type heating systems would solve this problem, but they occupy valuable wall space. This makes them impractical and sometimes inadequate for heating a large room. Convectors can be used in an enclosed teaching area or other auxiliary room.

Serious consideration should be given to placing heating and ventilating fans in one or more enclosed mechanical rooms remote from, or adequately separated from the shops. Extension of duct runs may also be necessary to achieve the required acoustical conditions within rooms. In all shop areas where the instructor will talk to a group of students, reasonably quiet conditions are needed.

When overhead doors are opened in the winter and heat loss must be allowed for, unit heaters mounted close to the doors are satisfactory since the doors will be open for only a short time.

6. Services

Compressors supplying air outlets in the shops are also a serious source of noise interference. In order to overcome this problem compressors can be centrally located in a mechanical room and lines run to the various rooms in the school that require compressed air. Regulating valves will be necessary to control pressures and the volume of air distributed.

7. General

Ceiling heights—For reasons of economy and for educational purposes, it is desirable in most instances to reduce the ceiling heights of vocational shops, and as far as possible make even the heaviest industrial shops more like normal classrooms. Such an arrangement allows flexibility. Ceiling height in most shops can now be 10 ft., not 14 ft. as formerly recommended. One shop where a 10 ft. ceiling might be insufficient is the construction area which is now under further study.

Fire regulations and building by-laws. All drawings included in this publication have the approval of the Ontario Fire Marshal and are designed in accordance with the National Building Code. However, school boards and architects are warned that they should check carefully with their own local authorities to ensure that school designs comply with applicable regulations.

Adult education – No provision has been made in the designs shown for any additional facilities which may be required in the shop areas for adult education. Local education authorities should consider this possibility.

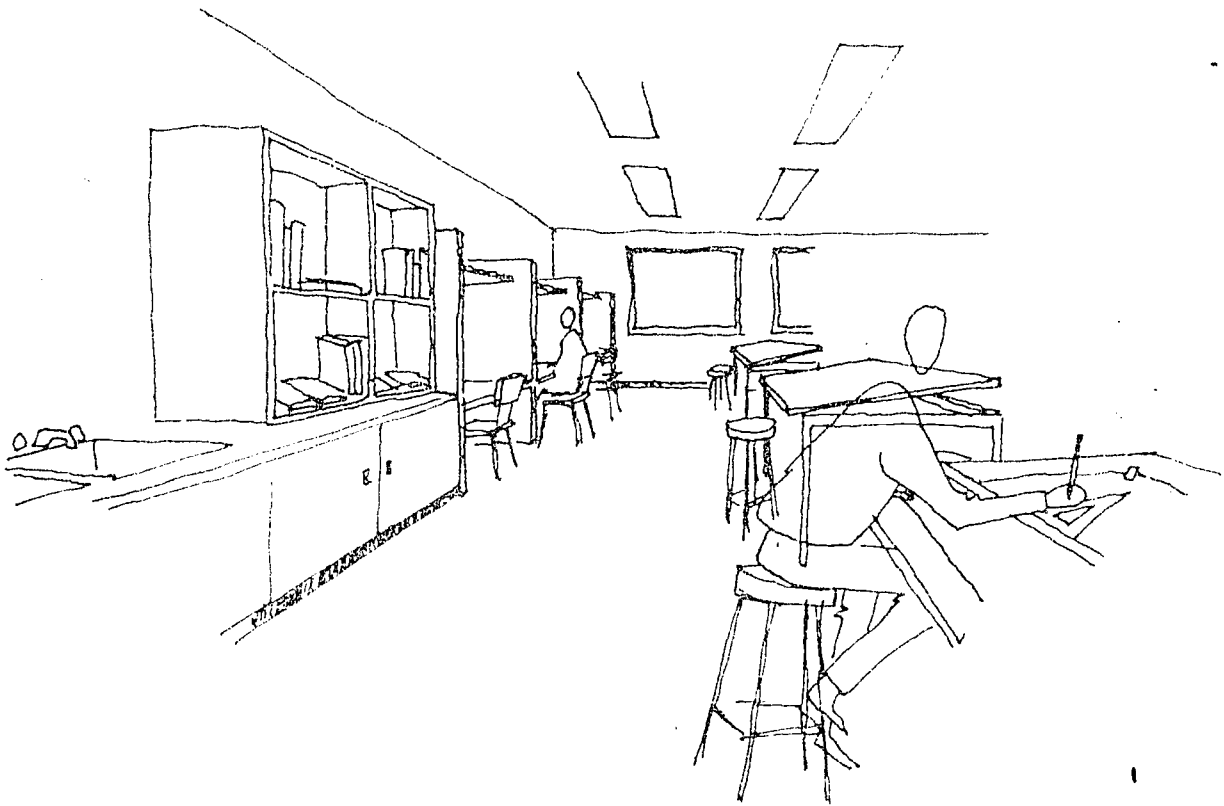

a) Function

The role of the draftsman in industry and in the professional office has become increasingly important. Training received at school, however, should aim not at specialization but should be directed towards working experience in as many areas as possible through practical work. In order to promote co-operation between the drafting and shop activities, the drafting room should be placed near the technical shops. It should be designed for a maximum of 20 students. Additional space for four senior students working on special projects is desirable. Study carrels can be allotted for research.

Equipment for drawing reproduction is necessary. Students have to be trained in the use of printing machines. A separate room should be provided for this purpose. A work room for storage of paper and supplies is required. It may also be used for model work, as a special project area, or even as a seminar room if made large enough to accommodate a table and 8 to 10 chairs. Where two drafting rooms adjoin, the work room and printing room facilities can be shared.

b) Location

Although drafting rooms should be situated near the shops, they should not be too close to noisy areas such as the sheet metal shop. They might conveniently be located across a corridor from the shops or next to a relatively quiet area such as the electronics room.

c) Facilities

The area of the drafting room shown in the accompanying drawing is approximately 900 sq. ft. This is sufficient for 20 students at tables each 2 ft. by 3 ft. The room width of 27 ft. allows aisles of 27 in. between tables and a main passageway of 39 in., plus space for cupboards. Along the wall at the rear of the room is a bench height cupboard with sinks and a magazine and book rack. Four study carrels, each about 3 ft. wide, are suggested for the remainder of this space. The sinks should be of stainless steel, one about 8 in. deep and fitted with a bubbler type drinking fountain. The other

sink should be deep enough for washing equipment and should be fitted with spring-loaded faucets. The paper towel dispenser should be recessed if possible.

The space set aside for senior students to undertake special projects should allow for large drawings, and should also simulate the facilities found in industry. Four large tilt-top tables with a minimum area of 12 sq. ft. should therefore be included. In this layout they are shown at the rear of the room. They should be adjustable so that a large flat surface can be obtained for panoramic work, half plan, half graph, open display or round table discussions.

Two filing cabinets for drawings will be required. For easy access they should be placed in the main drafting room. The demonstration tables should be moveable. Instruction aid sheets can be located under the chalkboard in compartments 14½ in. deep.

Charts can be stored in two large cupboards each 18 in. deep, one with adjustable shelves, the other with a pegboard back.

d) Finishes

Walls, floor and ceiling – All materials can be similar to those used in a regular classroom, i.e. concrete block or hollow clay tile for walls; vinyl asbestos tile, linoleum (sheet or tile), hardwood, etc., for floor; acoustic panels for ceilings. Ceiling height need be no more than in the normal classroom, i.e. 9 ft. to 10 ft.

e) Lighting

At the working level, 85 to 100 footcandles are adequate for drawing purposes. Fluorescent fixtures should be fitted with commercial ballasts.

Natural light is no longer necessary in drafting rooms. The development of efficient and economical lighting systems means that all tables, even those furthest from a window, can receive sufficient light for the finest work.

f) Services

Electrical outlets, 110 volt/15 ampere, are required, one near the demonstration desk and two on each wall.

Outlets should also be placed in a suitable position for overhead, movie or slide projectors. Black-out equipment should be installed at windows. Hot and cold water supplies and drainage for the sinks are also needed.

g) Heating and Ventilation

There is some justification for the installation of air conditioning since perspiration can damage drawings and other work. Each school board should consider this problem in the light of its own circumstances and local conditions.

h) Print Room and Work Room

The combined area of the print room and work room need be no more than about 200 sq. ft. The print room should contain a printing machine and cutting table, the printing machine requiring separate exhaust facilities which are usually specified by the manufacturer. The size of the machine will determine the size of the room. The size should be carefully checked before drawings are completed. A separate ventilation system might be considered. Location of the room as illustrated would, in fact, make this necessary. At least one electrical outlet should be provided in addition to the electrical installations required for the printing equipment.

The work room should be separate from the print room and should contain open shelves and a work counter. Two electrical outlets, one on each side of the room and at bench height, should be installed.

Lighting arrangements for both rooms should be similar to those provided in the drafting room.

Student work positions should provide:

- i) drafting table drawing surface at least 24 in. by 36 in.;
- ii) space for instruction aid sheets, textbooks and drawing instruments in use;
- iii) storage space for drawing and school books.

Drafting tables have a sloping or adjustable drawing surface. They should be higher than the conventional desk to allow the student to assume a half-sitting, half-standing position. The drawing surface of the desk is best covered with a vinyl material which is resilient,

long-wearing, and easily cleaned. An adjustable table top is probably more practical. Students' stools at work positions should have back rests.

The equipment described above is available from manufacturers, but school boards may wish to design their own drafting tables and have them made locally.

Drafting Rooms – plan and interior elevations

Drawing 3

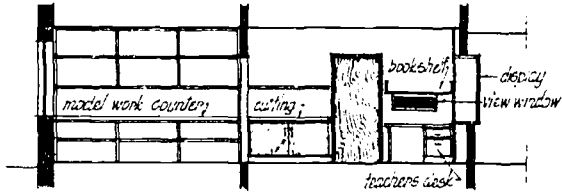

elevation C work and print room

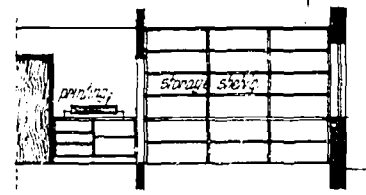

elevation A print and store room

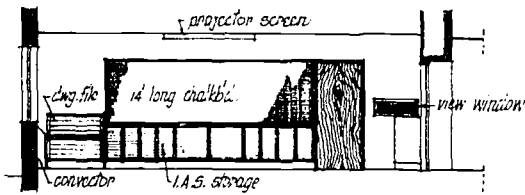

elevation C drafting room

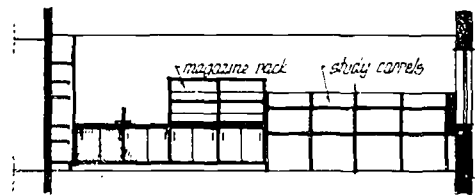

elevation A drafting room

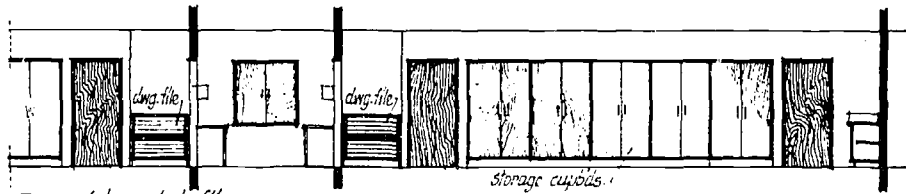

elevation D print and drafting room

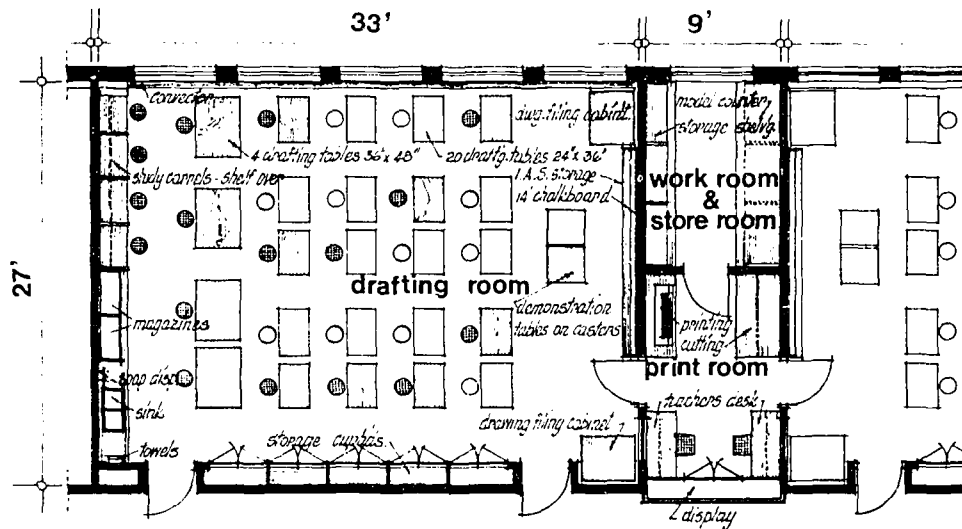

floorplan

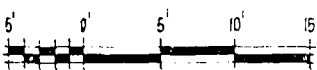

a) Function

Welding is a valuable course for the occupational and the four-year science, technology and trades program, and has a close relationship to drafting and machine and automotive courses.

Neither the suggestions made in this text nor the layout shown in the drawings are intended to be in any way restrictive. They are meant to show principles of good design and suitable equipment for welding facilities, in line with trade practices. The plan shown is for day school courses. If the shop is also to serve for adult education, additional equipment may be necessary. This drawing indicates a layout for classes of no more than 20.

b) Location

Because of its relationship to the machine and automotive activities, the welding shop is best placed adjacent to them in the technical area. Interconnecting doors however are not recommended.

c) Facilities

The area of the welding shop shown in the drawings is approximately 2,450 sq. ft., including gas storage rooms of about 25 sq. ft. each. In this space are ten arc welding booths, each 4 ft. by 4 ft., acetylene welding benches for ten students, and benches for 20 student positions.

Arc welding booths should be constructed of angle iron framework with panels of asbestos cement. Each partition will end 7 ft. above floor level, and for easy cleaning should start 16 to 18 inches above the floor. The welding tables, of $\frac{3}{8}$ in. boiler plate, are best supported from the booth frame to keep the floor area free. It is also suggested that each booth contain an equipment board to store helmets, hammers, wire brushes, gloves and aprons, each article having the booth number painted on it. Windows in the side panel of the welding booths are desirable but with stacked welding machines they will be ineffective.

These secondary leads from the welding machine should be kept as short as possible and should be clamped to the underside of the welding table as far to the rear as

possible, thus avoiding the danger of the electrodes being taken out of the booth while making adjustments to the welding machine.

It is suggested that the welding booths be in the main building contract. Acetylene welding benches should be about 42 in. wide by 2 ft. deep and should be constructed from 2 in. x 2 in. x $\frac{3}{16}$ in. steel angles, with $\frac{1}{4}$ in. steel plate placed in the angle iron rectangle. Fire bricks can then be placed on the table, the angle iron holding them in place. This work might also be included in the construction contract.

A detail of a student bench is shown in the drawing accompanying this text.

The cutting table is a custom design and should be included in the main building contract. There are two cutting tables required in a welding shop – a manual cutting table and a machine cutting table. The manual cutting table should be 24 in. x 36 in. by 30 in. high. The frame work should be $1\frac{1}{2}$ in. x $1\frac{1}{2}$ in. x $\frac{3}{16}$ in. angle iron. The top surface should consist of parallel flat bar stock welded on edge with a spacing of 2 in. between the bars. This allows the molten particle to drop through the work and the flame to project beyond the metal being cut. A spark shield should be installed directly under the grating. This shield should be tapered from the inside dimensions of the table to a 6 in. square opening at the bottom and terminating 6 in. above the floor. The machine gas cutting tables are of varying design. The overall size of the table should be 5 ft. x $1\frac{1}{2}$ ft. x 30 in. The framework for the table should be made of 2 in. x 2 in. x $\frac{3}{16}$ in. angle iron. The top should be parallel flat stock welded on its edge across the top. A track should be welded to the table top to accommodate the motorized cutting machine. The spacing and track design will vary with type of motorized cutter being used.

Testing and layout tables can be constructed of angle iron frames and light gauge metal bonded to a wooden bench top in the sizes indicated in the drawings. The cutting table must have its own exhaust system.

d) Finishes

Floor – A concrete floor with an iron oxide hardener is suitable. Before floors are poured, however, various services must be installed and "poured in" with the slab. Gas lines, electrical conduit, water, drains and compressed air lines will all be required.

Walls – Concrete block walls are suitable but the high quantity of impurities in the air demands that they be finished with enamel or epoxy paint for maintenance purposes. All walls should be finished in this way, the exception being the interior of the arc welding booths which should be painted a flat black.

Ceiling – Although this will inevitably be a noisy shop, the installation of a ceiling can hardly be justified. Acoustic problems may be dealt with by spraying asbestos fibres or other suitable material on the underside of the roof deck or slab above.

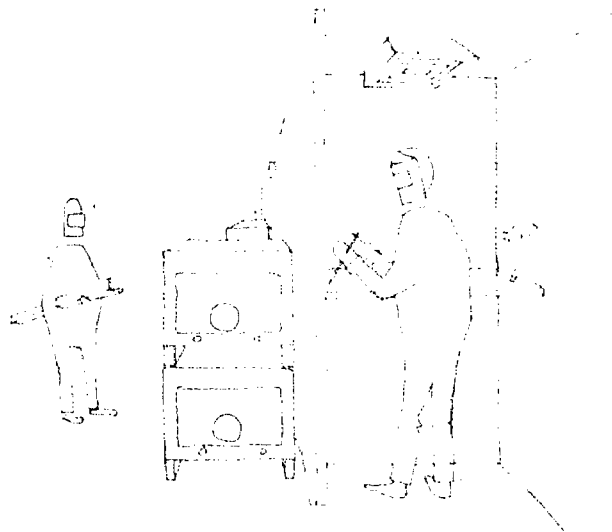

e) Gas Storage

The oxygen and acetylene stores should each be only large enough to hold six gas cylinders and must be of fire-proof construction, the National Building Code rating being a two-hour fire separation. A fire-proof wall should also separate the two gas rooms. Both rooms should be fitted with explosion-proof electrical fittings and blow-out doors.

f) Storage

Details of the storage unit for welding rods and tools are shown in the drawings. Additional facilities are required for horizontal and vertical storage of steel, horizontal for stock, vertical for short end storage. Mobile bins for scrap metal are useful. Instruction aid sheets can be stored in shelves under the chalkboard. Storage cupboards for periodicals and books are also desirable.

g) Lighting

Windows can be installed in the welding shop as long as the sills are no lower than 7 ft. above the floor. The value of providing sashes is doubtful since the ventilation system for the shop equipment may be affected.

Fluorescent fixtures must ensure about 85 footcandles for general lighting and should be fitted with commercial ballasts.

Individual lighting should be provided for the welding booths with one 3 ft. fluorescent fixture mounted on each hood over the work area. An alternative would be a reflector spotlight in a similar position. The same lighting arrangements should also be made for the oxy-acetylene benches.

The hood over the cutting tables should be fitted with two 4 ft. fluorescent tubes, one on each side of the hood.

Exterior light fixtures are necessary for access to the gas storage rooms.

h) Services

The electrical power must be a 120/208 volt, 3 phase, 4 wire system with a 400 ampere capacity. Circuit breakers should be provided for each machine. It is essential that the feeders for the 10 arc welding machines be run in an under-floor duct system.

Electrical outlets of 110 volts should be placed close to work areas for portable power tools. Outlets will also be necessary for both a slide projector or film strip viewer and an overhead projector.

Water – A supply of water is required for the TIG and MIG units as a coolant. A spot welder also needs water and a floor drain. For this reason, the TIG and MIG instruction table should be close to the spot welder. Hot and cold water will be needed for washing facilities, in this case a Bradley type. A drinking fountain can form part of the Bradley or be installed as a separate unit.

Gas – If natural gas is available, a pilot light at each oxy-acetylene welding station should be installed for lighting of torches. If it is placed near the exhaust system, the major portion of the carbon expelled during the lighting of the torches will be easily removed.

Gas storage rooms collect and store gas from the gauged bottles. From there the gases are piped to each oxy-acetylene welding station and to the cutting area. This system must be designed in accordance with the

requirements of the Canadian Underwriters Association and tested, purged and colour-coded accordingly. Line pressure gauges should be installed inside the welding shop to indicate the line pressure on the manifold at all times.

Air – Compressed air from the school's central system is required. One outlet with a quick coupler and shut-off valve, regulator and pressure gauge is needed at the cutting table.

Compressed air outlets for blow guns and arc gauging are required, the pressure being 100 lbs. per sq. in. within a ½ in. copper line.

The various pipes in the shop must all be identified by colour coding or other suitable marking.

i) Ventilation

Ventilation is the major consideration in the design of a welding shop because of the large quantity of fumes from both types of welding. A separate exhaust system with pre-heated "make-up" air will be required for this area, with the ventilation controls located within the room. Hoods over work areas must be brought down as close as is practical to working surfaces. For arc welding, it is necessary to have the overhead hood type of exhaust, while, as already mentioned, the pilot light for igniting oxy-acetylene torches should be as close as possible to the exhausts to get rid of the carbon waste.

Welding Shop – plan and interior elevations

Drawing 6

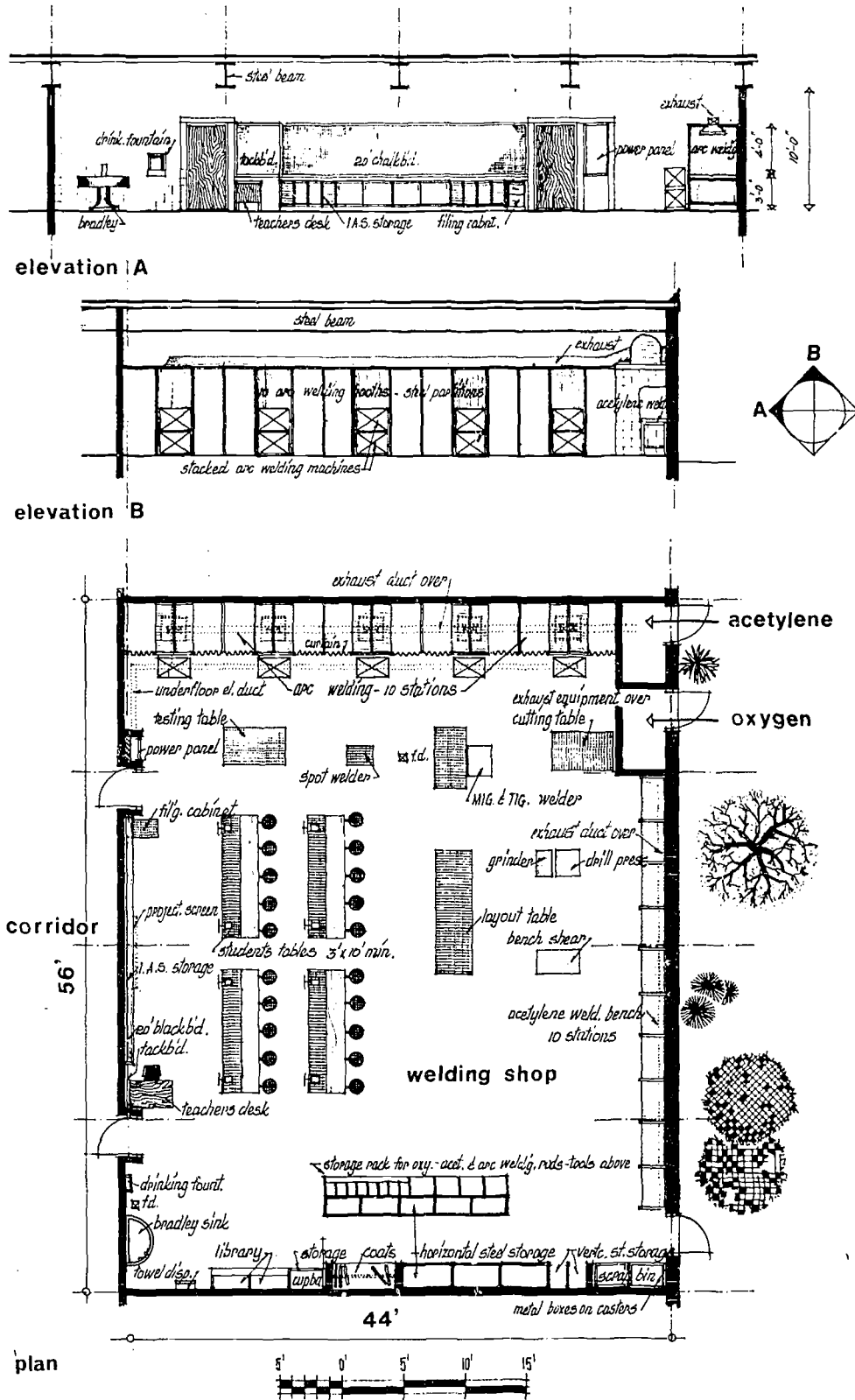

Drawing 6A

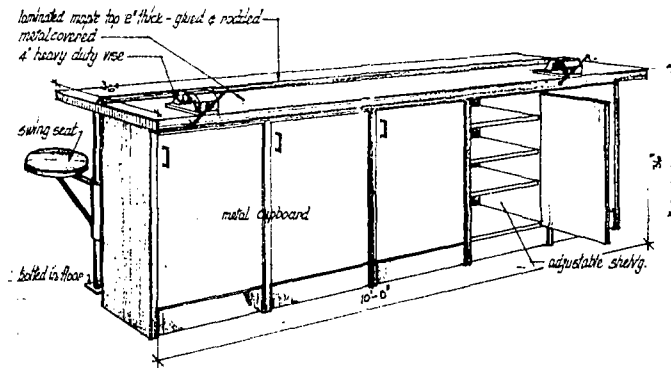

combination desk and work bench

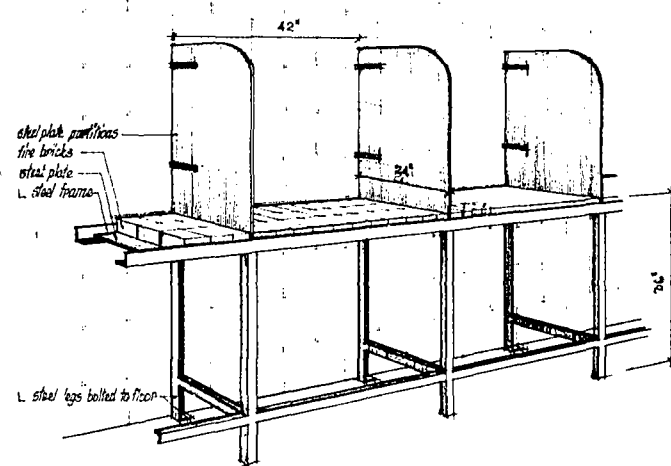

oxy - acetylene welding bench

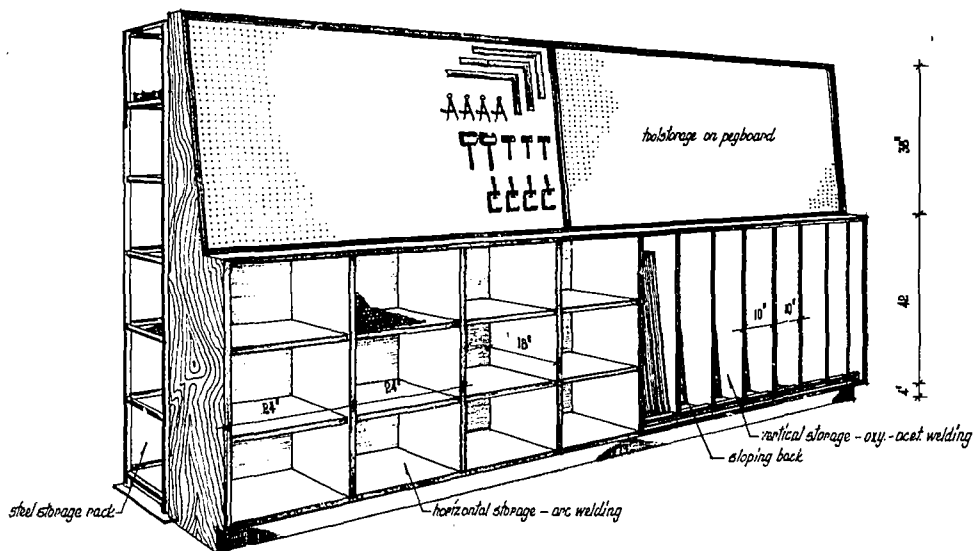

storage rack for welding rods and tools

a) Function

As developments are made in technology, the character and layout of shop facilities will undoubtedly alter. The main consideration in the planning of the auto mechanics shop must therefore be flexibility. Where possible, equipment should be portable, and ample service outlets should be provided, preferably on the perimeter walls.

The junior grades offer instruction in the use of tools, the function of basic engine parts and the design of suspension systems. In grade 11, students disassemble and re-build an engine to specific tolerances using testing equipment and correct testing procedures. Grade 12 students are concerned with diagnostic test equipment, wheel alignment, tune-up and the procedures related to the operation of a service garage. It is recommended that the shop be laid out with these three study areas in mind, with the junior area closest to the main entrance and classroom.

b) Location

The most functional location for the auto mechanics shop is adjacent to the auto body shop and near the welding, sheet metal and machine shops. All of these shops are noisy areas and should be placed where they will cause a minimum of interference with other school activities.

A fenced outdoor work or parking area is sometimes included, but since glass breakage and other damage to parked cars often occur, it is not advisable to provide parking.

c) Facilities

The size of vocational shops depends, of course, on the requirements of individual educational programs. But it is unlikely that the area of the auto mechanics shop will be less than 3,000 sq. ft. including the classroom, parts store and a room for test equipment. The width of 44 ft. shown in the drawing allows three cars to be angle-parked for servicing, with a satisfactory working area between each car.

A sufficient number of carbon monoxide exhaust ducts must be provided to allow running of engines at the parking positions, on trolleys and on test benches. The duct system must be very carefully designed if the exhausts are to operate efficiently, and the fan and collector duct must be of a size to induce sufficient flow of gases. Condensation in the under-floor ducts will almost certainly occur. To take care of this and any other water which may enter, a sump box and drain should be placed to allow efficient drainage of all duct runs.

The overhead door must also be carefully positioned and of such dimensions as to allow entrance and parking in selected positions in the shop. An insulated sectional door with wire glass lights is suitable.

A twin post type hoist, recommended for safety purposes, should be located opposite the overhead door. Only one hoist is necessary in most shops. It is important that drains should be provided at the bottom of each of the holes for the hoist cylinders to carry away water which otherwise would interfere with the operation of the hoist. The maximum stroke of a hoist cylinder is approximately 73½ in. If the hoist is positioned between the main structural beams, the height of the underside of the beams need be no more than 10 ft. as shown in the drawing.

Note: The hoist should not be located immediately in front of the overhead door. This would restrict access to and from the shop, and might also interfere with the operation of the overhead door. Care should be taken to avoid ducts, pipes, doors, etc. interfering with the operation of the hoist. A monorail is necessary for removing engine blocks and moving them to test benches. It must be designed for a minimum loading of 1½ tons and must be equipped with an electric hoist.

d) Finishes

Floor – A concrete floor with non-metallic hardener makes a suitable working surface and should be well sloped towards the floor drains. A grill in the floor located immediately inside the overhead door will take



care of the ice and melting snow from cars entering the area. It is essential that all drains in the auto mechanics shop be fitted with grease and sand traps. Floor pits are not recommended.

Walls – Concrete block is suitable, but it is suggested that the interior wall surfaces be finished with a hard-wearing material such as epoxy paint to ease maintenance problems. A pre-finished metal wall panel system might be considered for exterior walls. Insulated metal partitions for walls between shops will allow easy re-arrangement of shop facilities as required.

Ceiling – No suspended ceiling system is necessary in the main shop area. In the classroom, however, a suspended acoustic tile ceiling is desirable and should be installed if financial conditions allow. If noise is a problem in the shop area, the application of sprayed asbestos fibres to the underside of the steel deck might be considered. Acoustic plasters are not satisfactory.

e) Lighting

The National Building Code minimum of 70 footcandles is a desirable lighting level. In the shop area, four re-wind extension light reels should be installed on 50 ft. of wall track. Electrical service is of course required for these.

If windows are to be installed in the exterior wall, the sill height should be not less than 7 ft. Skylights or domes in the roof should be avoided.

f) Services

It is preferable that all controls, electrical panels and switches be grouped in one area near the principal entrance from the corridor.

Electrical – Power should be supplied from a 3 phase, 4 wire, 208/120 volt distribution panel. A 15 h.p. capacity is required for the shop equipment. Switching for equipment is best done with a keyed contactor. 15 ampere electrical outlets should be placed about every 10 ft. around the walls of the shop. 220 volt outlets are required at the test benches.

For washing cars, a water outlet with a hot and cold mixing valve should be provided close to the overhead door.

Air – Ample outlets should be placed on the perimeter walls of the shop, all outlets being equipped with a shut-off valve and quick release to avoid interference from noise. For acoustical reasons, the compressor should be located in the school mechanical room or boiler room. A centralized system may be provided for all the shops. The requirement for auto mechanics is 150 lbs. per sq. in., with a capacity of 75 c.f.m. Air outlets will be necessary for the spark plug cleaner, chassis dynamometer, hoist and de-greasing tank.

g) Classroom

Because the auto shops are extremely noisy it is recommended that a separate enclosed classroom of about 400 sq. ft. be provided with tables and seats for 20 students. The partition can be of hollow metal construction, but attention should be given to suitable sound insulation and the vision panels should be double glazed. This room can also contain the teacher's desk, either as a separate unit or built in, with magazine and book storage, and possibly three or four study carrels. Book shelves and racks for periodicals should be of the open, slotted type. Glass doors are to be avoided.

A legal size filing cabinet is recommended for trade catalogues, illustrations and reference sheets.

A suspended ceiling is not mandatory, but would help the acoustics of the room. Ballasts for the light fixtures should be of the commercial type.

The floor can be concrete or finished with vinyl asbestos tile.

h) Parts, Storage and Test Equipment Room

A small storage room about 100 sq. ft. in area and fitted with adjustable steel shelving is necessary for keeping spare parts. A test equipment room of about 50 sq. ft. fitted with a bench and shelving should also be provided.

i) General

Tool storage – The building contract should include a tool cupboard 7 ft. high and 2 ft. deep equipped with adjustable steel shelves. This unit should not be built in for, with changes in curriculum, it may be necessary to move it to another location. In this cupboard will be stored the more valuable tools.

Open storage for small tools hung on pegboard should be in a position where tools may be easily checked by the instructor.

Benches – The benches in the shop area should be of steel with storage cupboards below. Where the benches are accessible from both sides, the cupboard should extend the full width of the bench so that doors may be opened in either direction.

Cleaning fluid storage – The Ontario Fire Marshal requires that solvents and flammable liquids be stored in a separate fire-proof room. This room can be in a central location convenient to the shop wing since other shops also use these supplies.

The Auto Mechanics Shop - plan

Drawing 5

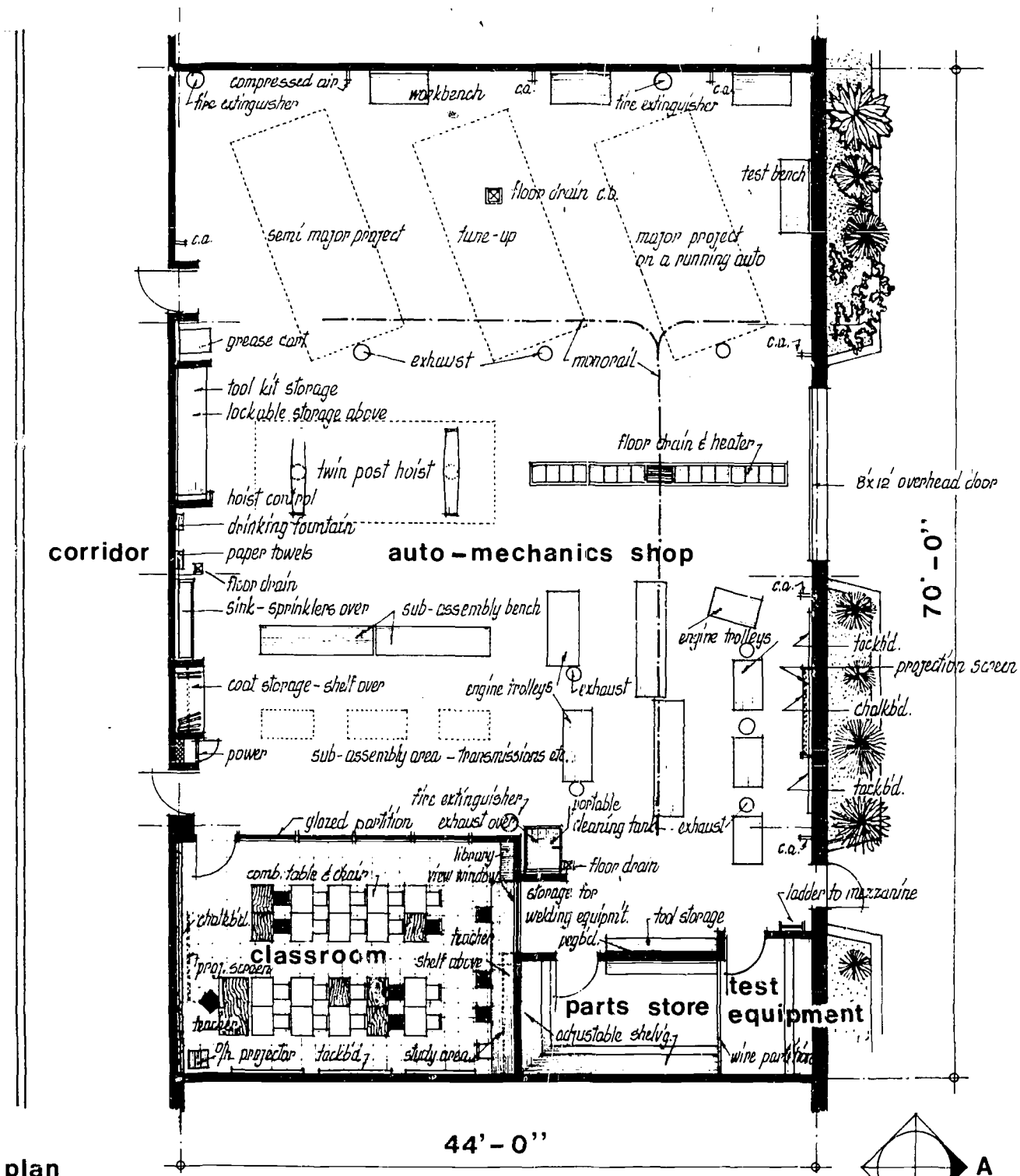

Drawing 5

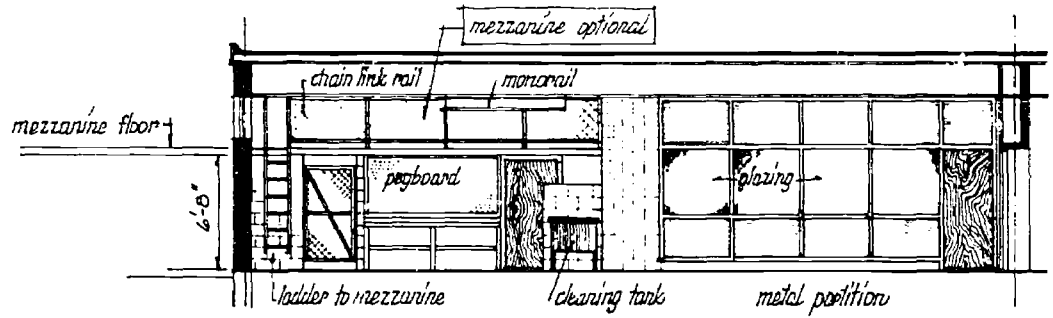

elevation B

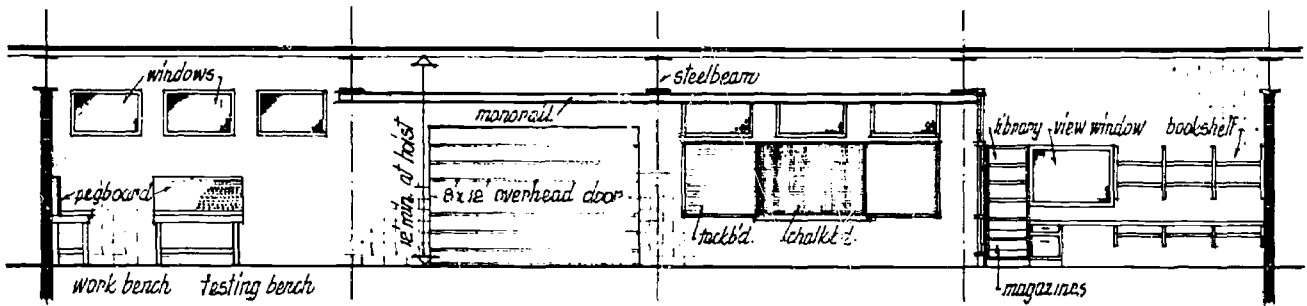

elevation A

a) Function

The auto body shop provides facilities for theoretical and practical instruction in motor vehicle body work. The course of study for the four-year program is described in Curriculum RP-27. The course is also being used more and more in occupational classes. Welding, sheet metal work and auto mechanics are closely allied subjects, and consideration should be given to this in the planning of the shop wing.

The shop consists of a large unobstructed floor area for motor vehicles, a classroom for 20, storage facilities and a paint shop.

b) Location

The auto body shop is necessarily noisy and dirty. For this reason, it should be placed at the end of the shop wing, preferably next to the sheet metal shop, and in such a position as to ensure that noise from it does not interfere with other activities.

c) Facilities

The area for auto body instruction, including the classroom and paint shop, should not be less than about 3,000 sq. ft. The main shop must have space for a minimum of four cars and should be equipped with a hoist to allow work on lower body and rocker panels, facilities for washing cars in preparation for painting, and an area for work on bulky sub-assemblies. If the hoist is located between the structural members, the clear height from the floor to the underside of beams need be no more than 10 ft. The overhead doors should be manually operated, insulated, sectional garage type doors, each 10 ft. wide and 8 ft. high, with wire glass lights or translucent plastic panels.

d) Finishes

Floor – The concrete floor should be finished with a non-metallic hardener, and must be given enough slope to the drain so that no pockets of water remain after it is washed.

Walls – Walls can be of concrete block, but it is recommended that the block be finished with a material such

as enamel or epoxy paint which is hard wearing and easily washed. Alternatively, pre-finished metal panels might be considered, where used with a metal wall panel system. This has the advantage of being removable for use in another location, if need be.

Ceiling – Although it can prove too expensive, a ceiling installed in the shop would absorb some of the noise of operational activity. A perforated metal pan ceiling, which would allow easy maintenance, might be considered.

e) Lighting

An illumination level of 70 footcandles at the floor is sufficient. Fluorescent light fixtures with commercial ballasts should be left flush with the underside of the main roof beams. One row of fixtures should be controlled from two positions, one at the entrance to the corridor, the other at the outside exit.

f) Ventilation

A major problem in the auto body shop is the dust created by sanding equipment. This area should have its own re-circulated air filtering system with water-wash filters. By arranging the air intake and filters close to floor level, and the exhaust at the roof, dust can be kept close to the floor.

g) Services

All services should be located in or under the floor. Drainage must be provided under the cylinders of the hoist.

Air – Compressed air outlets must be provided, one on each wall, with a pressure of 150 lbs. and 75 c.f.m., preferably from a central system. An air regulator and filter must control all outlets.

Electrical – The electrical service should be a 3 phase, 4 wire system. Portable, hand tool electrical power equipment with a total capacity of 10 h.p. should be sufficient. In addition, a 220 volt/30 ampere outlet will be required at a central location to provide power for a spot welder or lamp bank. Two convenience outlets on each wall are also necessary.

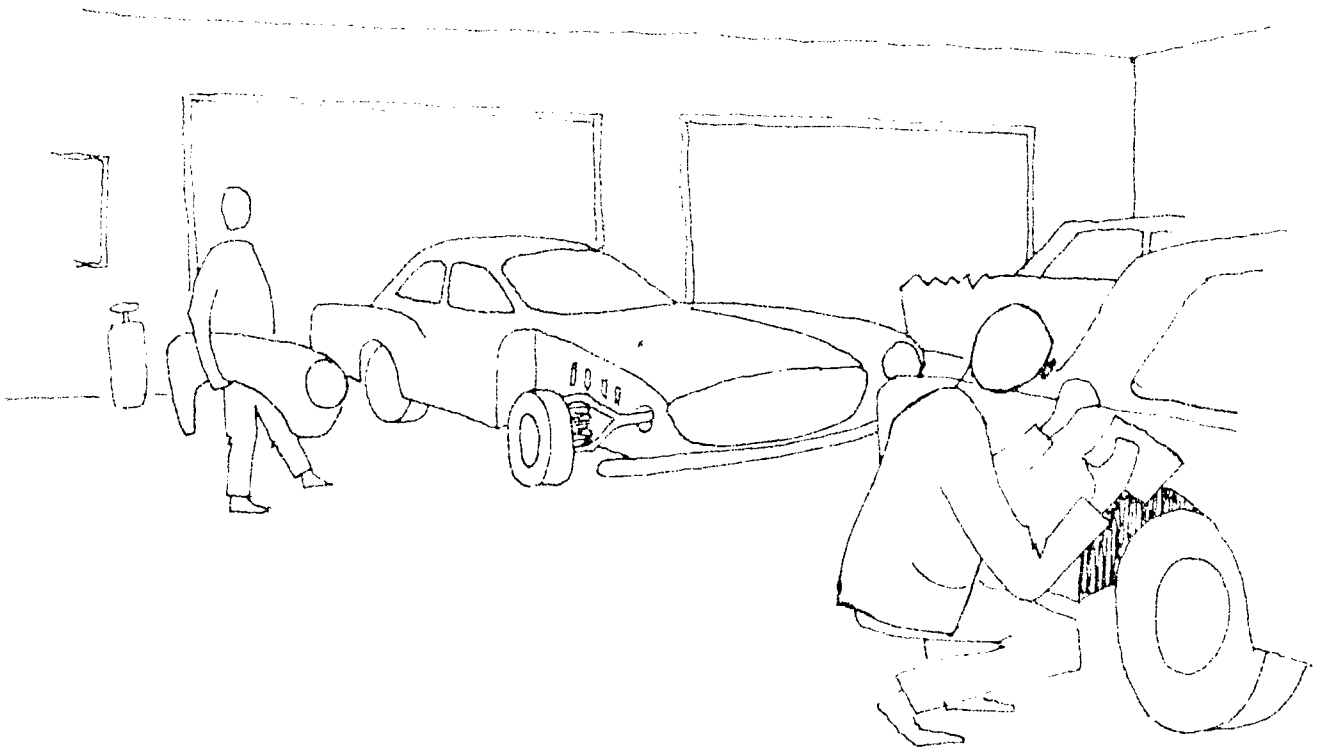

h) Classroom

Because of the noise and dust, it is recommended that the classroom be separate from the shop. This teaching room should have a minimum area of 400 sq. ft., and tables and chairs for 20 students.

A library is an important part of the teaching area. Open shelves for reference books, and slanting shelves for periodicals should be provided. Storage space for instruction aid sheets may be provided in a unit under the chalkboard.

Convection heating is recommended for the classroom because unit heaters are too noisy. For the same reason, ballasts for the light fixtures in this room should be of the commercial type.

i) Paint Shop

A paint shop is essential so that students may follow auto body work through to completion. The structure, walls, ceiling and doors of the paint shop must be designed for a three-hour fire rating. The arrangement shown in the accompanying drawing has the approval of the Ontario Fire Marshal, but individual designs should be checked. Regulations cover glazed vision panels, ventilation requirements etc., and should be carefully followed.

The paint shop should be equipped with a water outlet and an explosion-proof floor drain. To avoid dust during the paint operation, it is general practice to flush wash the floor before beginning to work.

A paint storage room is an integral part of the paint shop. It also should have a three-hour fire rating. Paint tinting equipment is often supplied by a paint manufacturer.

In both the paint shop and the storage room, explosion-proof fixtures, switches and convenience outlets are mandatory.

Auto Body Shop - plan

Drawing 11

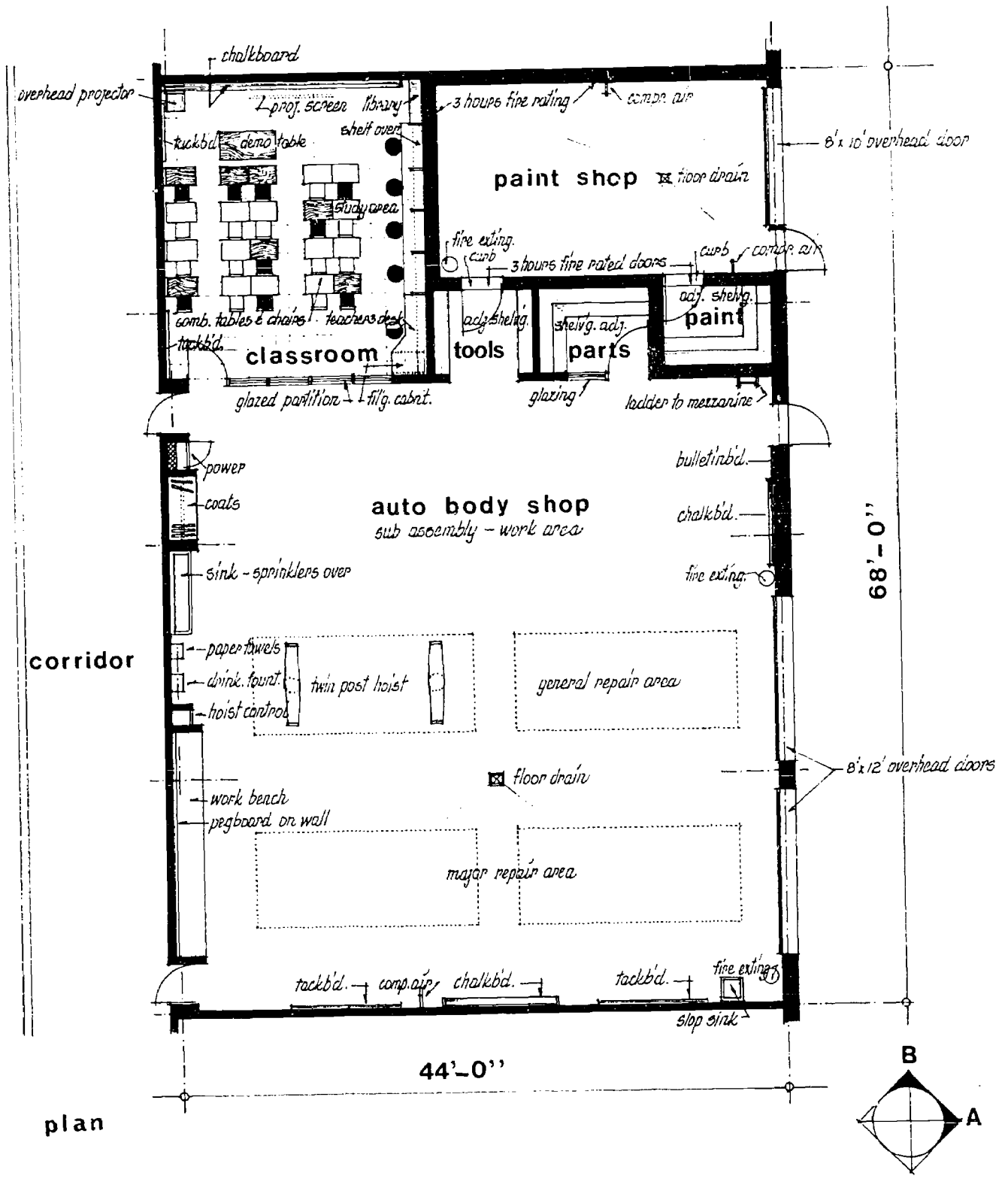

plan

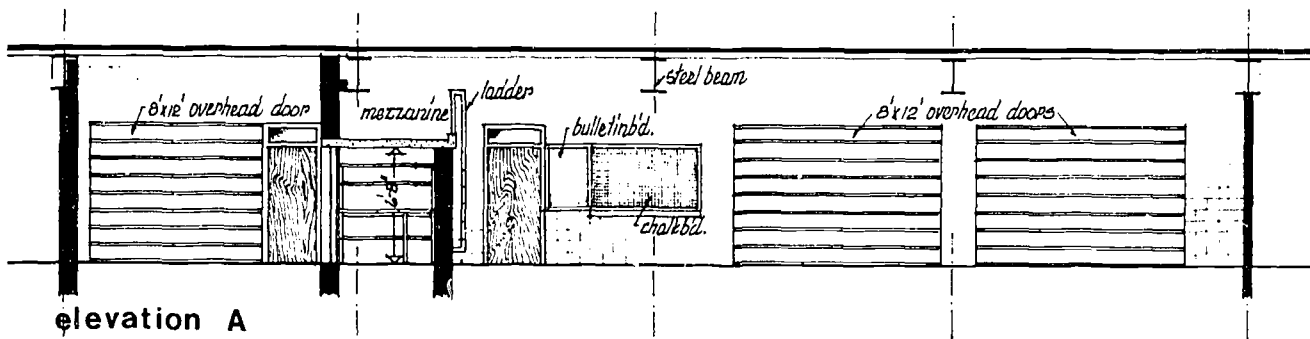
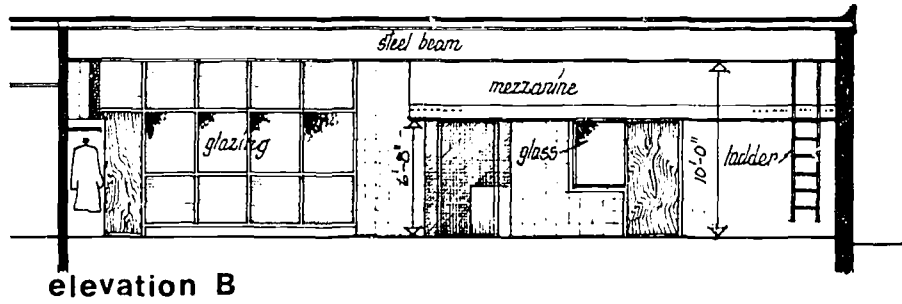

a) Function

Agricultural and horticultural instruction in our schools incorporates a study of other sciences and their application to man's understanding and use of nature in order to provide his basic needs.

The student's work is carried out through observation and discovery methods. Instruction therefore centres around a well equipped agricultural science laboratory.

A greenhouse and workroom are necessary adjuncts to the laboratory and should be located adjacent to it. The course includes experiments, dissection, and various individual and group projects. As a general rule, any associated mechanical instruction will be offered in the technical shops of the school, eliminating any duplication of facilities.

b) Location

Since a greenhouse and workroom are closely allied to the agricultural laboratory, the location of the laboratory may well be determined by a suitable site for the greenhouse. It is also wise planning to have another laboratory, such as biology or general science, near the agricultural laboratory. The use of available occupational shop facilities might also be considered.

c) Facilities

Area – The ideal agricultural laboratory should provide 40 to 45 sq. ft. of floor space per student. The area of the agricultural laboratory would therefore range between 800 and 900 sq. ft. for the standard vocational class of 20 students. A preparation room may be required, depending on the availability and amount of additional storage space in the laboratory preparation room.

Layout – While a traditional laboratory design with standard, permanently fixed benches is satisfactory, it allows very little flexibility. A "perimeter" laboratory, allowing about 2 ft. 6 in. of bench space for each student and with table space in the centre of the room is much more satisfactory and enables students to conduct experiments. Knee-holes and seats at work benches

are not required. Tables, 24 in. to 30 in. wide, in the centre of the room, each seating two or three students are much more valuable than conventional desk furniture. They can be rearranged for individual and group activities as well as for large projects and displays. Each table should be fitted with a book shelf. The shelf may be of mesh and should have no front, in order to prevent accumulation of dust and paper. Chairs or stools should have back rests.

The instructor's demonstration desk should be about 30 in. wide and long enough to accommodate the large materials commonly used. The desk will provide readily accessible storage space and may serve also as an additional student work station. An additional sink will provide more free area on the perimeter work surface. Storage or magazine racks may be installed on the front of the desk. Having the desk on a raised platform is desirable.

Chalkboards – The front and side walls should be mounted with as much chalkboard as possible, with a minimum surface of 50 linear feet. Sliding vertical chalkboards have proved satisfactory. A portion of the chalkboard on the side wall may be used for material required for more than one day and for a list of projects, assignments and general instructions. Book cupboards, tackboard and other items which reduce chalkboard area on the front wall should be removed to the side or rear wall.

d) Storage

Lack of adequate storage space is a common problem in a laboratory. Conventional laboratory storage space does not always allow for large charts, bristol board, illustrative materials, overhead projector, audio-visual equipment, model supplies, filing cabinets and other supplies.

Perimeter laboratory counters – A set of small drawers may be placed near the sinks to hold commonly used apparatus. The area below the counters can be fitted for various types of storage. At least one set of wide drawers should be provided for materials such as landscape model supplies, bristol boards and illustrative charts.

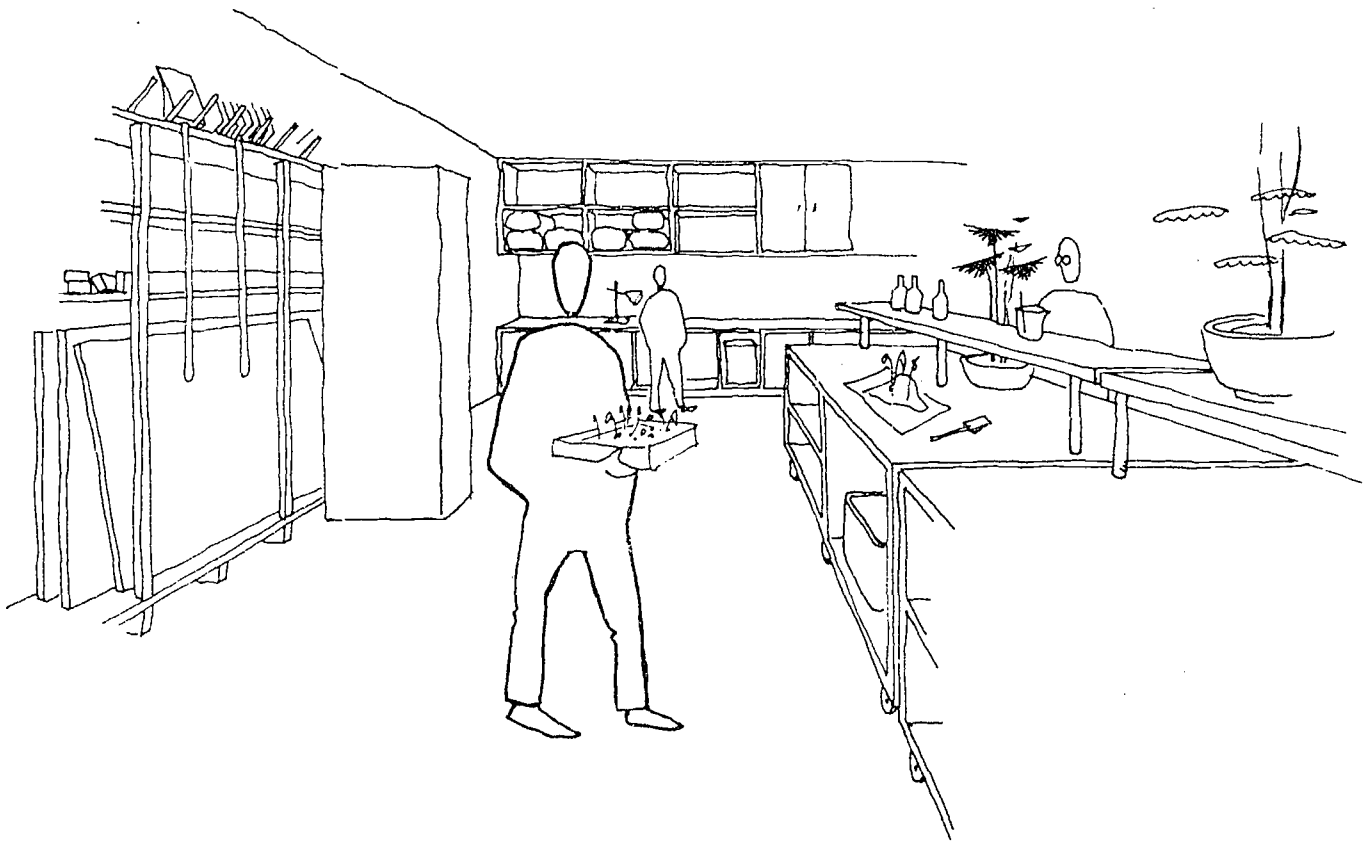

Cupboards with a depth of up to 1 ft., and equipped with sliding doors, may be placed below the chalkboards at the front of the room to store frequently used reagents, lesson aid sheets and other apparatus. Shallow cupboards may be placed below the chalkboards at the side of the room. Magazine racks, bulletin files and book shelves would also fit well in this area. Shelves located along the top of the side chalkboards may be used to display models.

Tackboards – A sufficient amount of tackboard should be provided across the rear of the room as well as all around the room above the chalkboard. Tackboards which extend to the ceiling make maximum use of the walls for the display of student projects and soils and topographical maps.

Magazine racks – Efficient use of the areas under chalkboards and at the front of the instructor's desk will reduce the amount of wall space needed for magazines. This wall space is better used for chalkboards and work counters.

Book shelves – Open shelves should be provided at a location convenient to teacher and students for the reference books used in the classroom. The shelves are best located on the side wall near the teacher's desk or above the perimeter work counter on the side wall, facing either the centre or rear of the room. Deeper cupboards may be built below the book shelves.

Audio-visual – Suitably placed screens, convenience outlets, black-out curtains for windows and glazed doors, storage and operating areas should be provided to meet audio-visual requirements. The location of the overhead projector in relation to the demonstration desk is especially important. The projector should be readily accessible to the instructor whether he is at the chalkboard or demonstration desk.

e) Preparation and Storage Room

The preparation and storage room should be adjacent to the laboratory since it is used for storing equipment, supplies, student projects and teaching materials. Bulky teaching materials such as plant and insect collections,

surveying equipment and landscape models should not be stored in the greenhouse workroom because of the dust problem. Since the preparation room may also be used as a work area for a limited number of senior students involved in special projects, it should be fitted with gas, electricity and a sink.

Where the agricultural science laboratory adjoins another laboratory, the preparation room can be shared and can be conveniently planned along with the workroom and greenhouse as shown in the drawings.

f) Finishes

Floor – Vinyl asbestos tile is adequate.

Walls – Conventional materials, such as concrete block, are suitable. But for maintenance purposes, concrete block in a laboratory is best finished with a hard, durable paint that can be easily cleaned.

Ceiling – Both the preparation room and the laboratory should have a lay-in type acoustic ceiling.

g) Lighting

A few windows are desirable. Fluorescent lighting must provide a minimum of 70 footcandles at bench level.

h) Services

Laboratory benches should be provided with gas and electrical outlets (110 volt), and sinks with both hot and cold water. If a centralized system is available, one or two air outlets would be useful in the laboratory. Similar arrangements are necessary in the preparation room. One sink for each four students is sufficient. One electric and gas outlet should be provided for each two students.

i) Heating and Ventilation

The same conventional heating provided elsewhere in the school is sufficient. Two-speed exhaust fans are desirable for ventilation. They should be designed for 1 and 1½ c.f.m. per sq. ft., similar to those used in the chemistry laboratory. If small animals are likely to be used, suitable ventilation should be provided.

Agricultural Laboratory preparation and storage workroom plan

Drawing 17

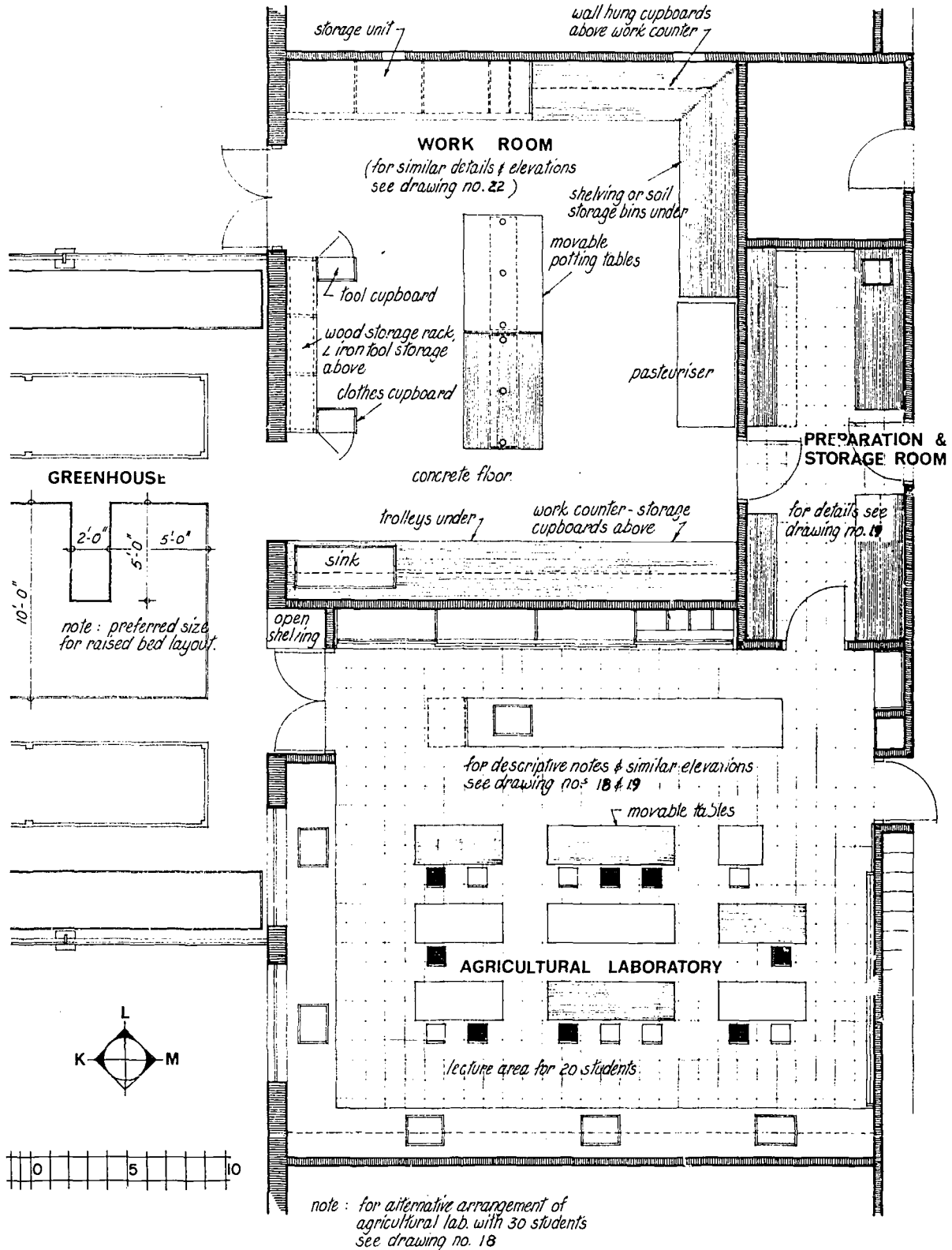

Agricultural laboratory preparation room– biology laboratory plan

Drawing 18

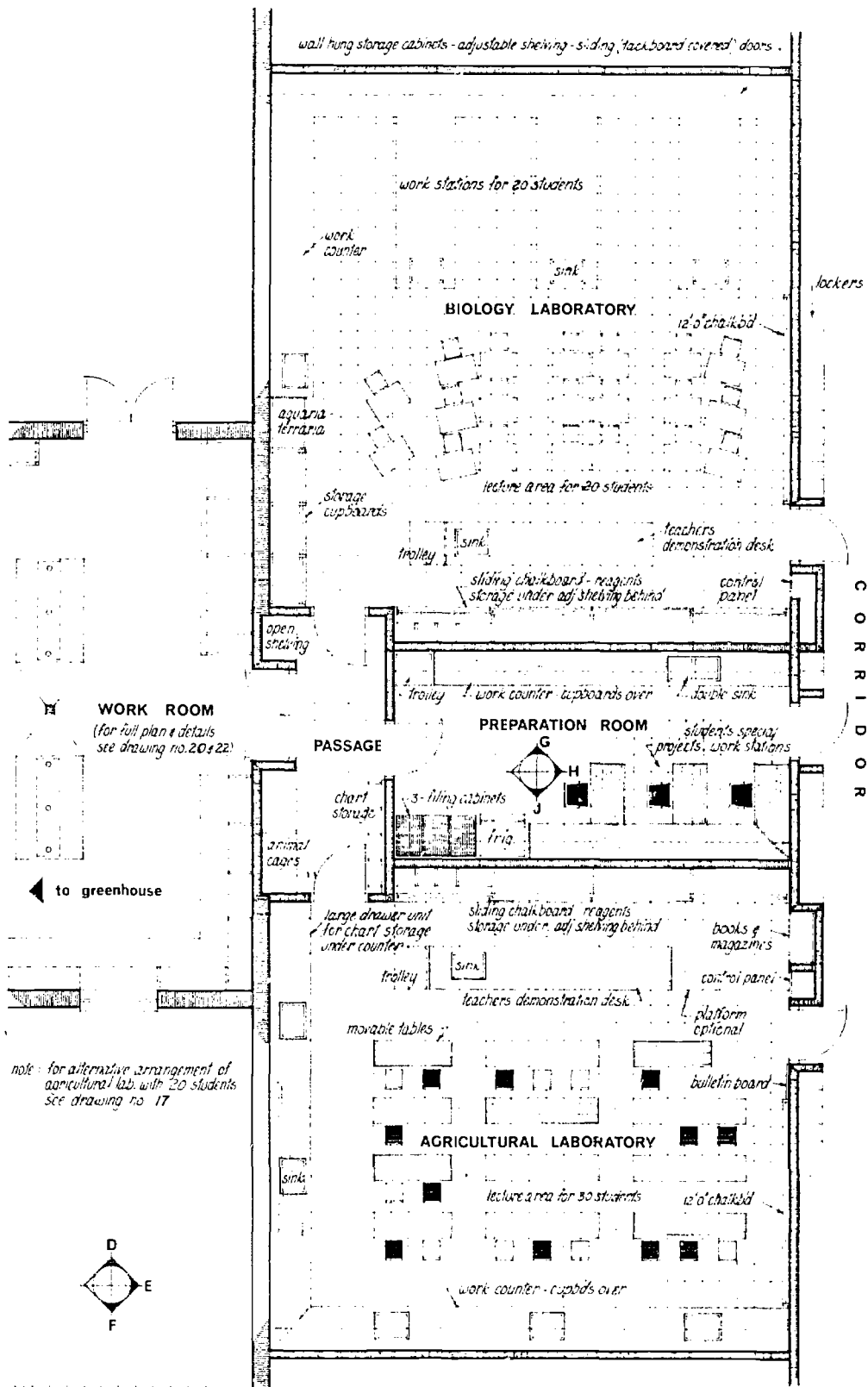

note - for alternative arrangement of agricultural lab with 20 students see drawing no 17

Agricultural Laboratory preparation and storage workroom and elevations

Drawing 19

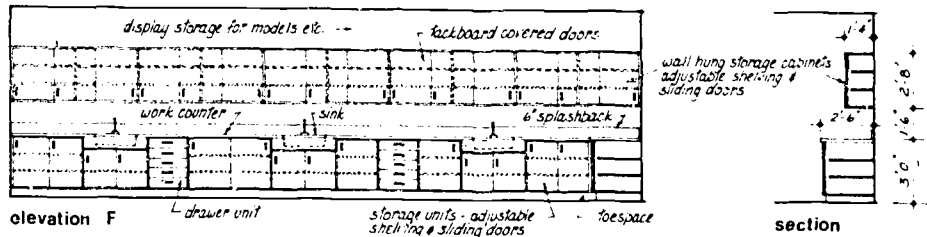

elevation F — drawer unit — storage units - adjustable shelving & sliding doors — toe space

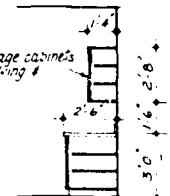

section

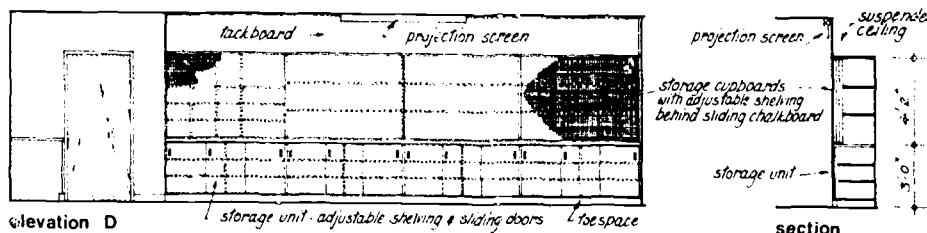

elevation D — storage unit - adjustable shelving & sliding doors — toe space

section

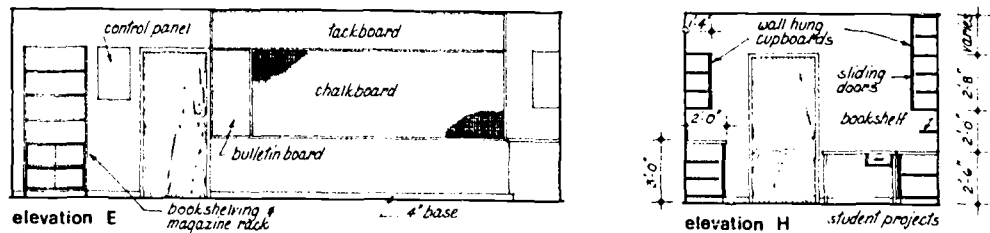

elevation E — book shelving & magazine rack — 4\"/>

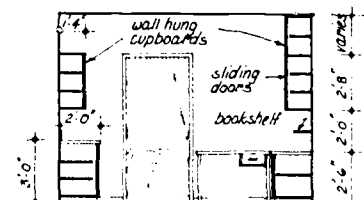

elevation H — student projects

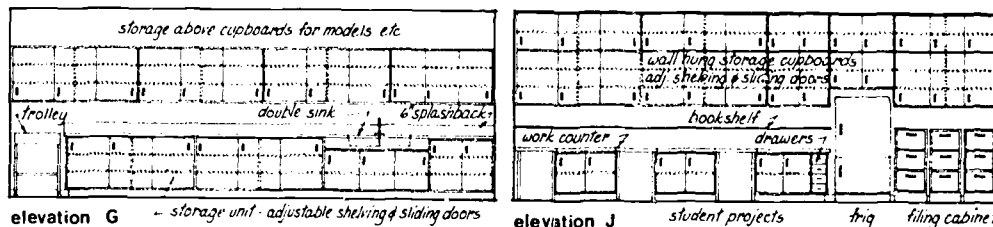

elevation G — storage unit - adjustable shelving & sliding doors

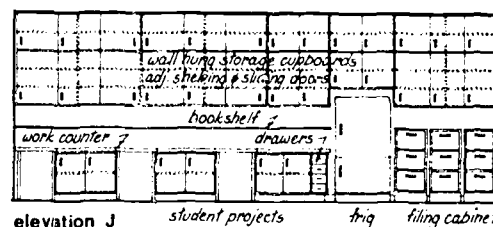

elevation J — student projects — frig — filing cabinets

agricultural laboratory & preparation room dwg.no.18

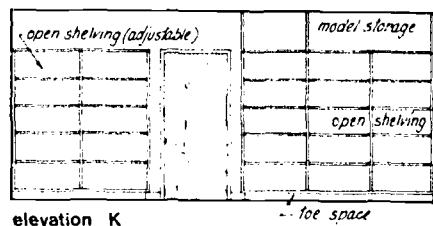

elevation K — toe space

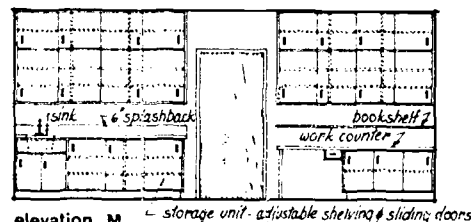

elevation M — storage unit - adjustable shelving & sliding doors

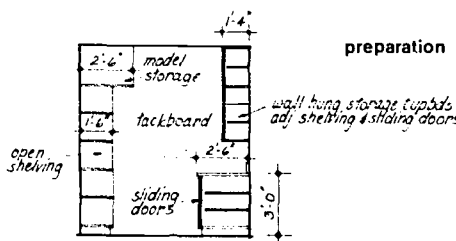

elevation L

preparation & storage room dwg.no.17

a) Function

Together with a well equipped laboratory, the greenhouse and its workroom are today's most useful teaching and experimental areas for environmental science, agriculture and horticulture in secondary schools. Operation throughout the entire school year is possible. Since the environment is at least partially controlled, the experiments and demonstrations made possible by artificial environments may be carried out together with classroom teaching. Nearly all basic biological principles of growth, nutrition, genetics and response to stimuli apply equally to plants and animals, but in many cases they can be more easily demonstrated through the use of plants.

An adequately designed greenhouse should afford space for student participation in projects and experiments using living material, and for the development of an interest in nature, the use and care of plants and the biological principles of growth. The greenhouse should allow the student to apply some of the principles of the related sciences of chemistry, physics and biology. Their interaction with horticultural sciences may be seen through the use of fertilizers, the effects of light and temperature and the study of insect and disease control.

b) Location

In order to allow easy access and supervision, the greenhouse should be at ground level, attached directly to the laboratory or to a workroom adjacent to the laboratory. A ground level location also allows for future expansion.

The greenhouse should not be shaded by trees or buildings since the installation of supplementary light is expensive. Excess light is easily reduced by shading. High temperatures due to direct sunlight can be controlled by spraying the outside of the glazed roof with a special preparation available from greenhouse manufacturers. This coating is affected by rain so that in winter, when light intensities are reduced, it will have been washed from the glass.

If some shade is unavoidable, modifications must be made in the types of crops grown in the greenhouse, and in the use of the greenhouse. Some artificial light-

ing will be necessary for plant growth.

c) Design and Construction

Greenhouses fitted with many different types of controls and equipment are produced by several manufacturers. Since elaborate or specially designed units are expensive, it is suggested that conventional greenhouses, similar in shape, size and structure to those used in industry, be provided.

The following are the three most commonly used greenhouses:

i) Free standing – The free standing greenhouse, commonly used in industry, is reasonable in cost and offers effective use of space and ease of management.

ii) Lean-to – While lean-to greenhouses can be attractive additions to the school, it is suggested that they be built only if a free standing unit proves impractical. Lean-to greenhouses are more expensive than the free standing because of the framing required. They do not provide sufficient space and auxiliary work areas. If they are located against a large building, wide fluctuations in temperature result, making it difficult for a school to maintain a suitable climate without extensive mechanical ventilating and humidifying equipment.

iii) Tower – Tower greenhouses have not been used widely in Canada and it is doubtful if they should be recommended for schools.

Various framing materials are used for greenhouses, ranging from expensive aluminum to galvanized steel frames and having wooden bars capped with aluminum. Framing can be clear-span trusses, post and purlin or rigid frame. This last method is quite expensive and should be used only when other solutions are not possible. The post and purlin method somewhat limits flexibility of bench arrangement.

Glass is still the most widely used cover, but rigid plastics such as fiberglass merit consideration. Glass gives, of course, excellent light transmission, but it is subject to breakage. Fiberglass, on the other hand, is durable, but no long term tests have been done to determine the efficacy of light transmission over a long period. Corrugated materials allow more surface for heat

loss than does glass. Wide glass panels, from 24 to 30 in., are more flexible and resistant to breakage. They also cause less shade from framing. The glazing bars may be of aluminum or wood capped with aluminum.

The most practical and economical school greenhouse is the free standing, standard width type, with a clear-span truss frame of either galvanized steel or aluminum, and fitted with aluminum or aluminum capped wood glazed bars with straight sides.

"Ridge and furrow" greenhouses present problems of ice and snow accumulation, condensation and ventilation and therefore should not be used.

Concrete post foundations are recommended for grade level construction rather than the expensive masonry foundations and walls. Curtain walls below the side wall glass may be of single or double layers of asbestos cement board attached to the frame members.

Single section greenhouses are recommended for school use. They ensure ease of management and supervision. Polyethylene curtains may be used as temporary partitions if necessary.

d) Facilities

Area – The area of a greenhouse should be from 1,600 to 2,000 sq. ft., depending on the nature of the program and the total number of students.

The cost of heating, ventilation and automatic control equipment represents a major part of the building costs. Since these costs are the same for greenhouses within a reasonable range of sizes, larger greenhouses are proportionately much cheaper to build than smaller ones.

The operation and maintenance costs for a larger greenhouse are proportionately less. A larger size also offers better growing conditions and more work areas. Larger units facilitate demonstrations, student participation by more students and improved teaching methods.

Manufacturers of greenhouses have available standard widths and bay lengths. The recommended standard modules of width are 28 ft., 32 to 33 ft., 36 to 38 ft. and up. The lengths vary in width from 8 to 11 ft., depend-

ing on the widths of the panes of glass, whether 20, 24 or 30 in. A greenhouse 36 to 38 ft. wide is most satisfactory, although one 32 to 33 ft. wide is adequate.

Floor – Greenhouses on ground level should have earth floors to absorb and evaporate moisture. The earth under the benches should be treated to kill weeds, and then covered with stones. Aisles should be paved. The walls around the ground beds should be poured at the same time as the aisles. There should be no floor in the base of the beds.

If the greenhouse has to be built over other rooms, a heavy waterproof membrane will be required before the final layer of the floor is poured. Concrete floors must have drains, with "falls" in the floor towards them.

Main aisles in a high school greenhouse should be 30 in. wide and formed with a "fall" for drainage. Other aisles need be only 2 ft. wide.

Benches and beds – 50 to 60 per cent of the floor area should be allotted to the beds. Floor beds with thin, 20 in. high concrete walls may be used for bed production or for pot work. Benches which can be reached from both sides should be at least 4 ft. wide. If used for pots only, they can be as wide as 5 ft. Floor beds should have wiring frames set in sleeves. If floor beds are built on a concrete slab, they must have drains with protection from silting.

Cedar, redwood, asbestos cement and concrete slab benches are available from greenhouse manufacturers. Asbestos cement benches are easiest to keep clean. However, wood or concrete slab benches are recommended if steam sterilizing or electric soil pasteurization is to be carried out on the benches. Wooden benches should be treated with copper or zinc naphthanate.

Benches should be arranged so as to make the most efficient use of available space. Standard benches run lengthwise, as does a combination of standard benches and "peninsula" type benches. Standard benches can also run crosswise. This arrangement, not shown in the drawings, can be very effective. For this arrangement, a 3 ft. aisle should run along one side of the greenhouse, with cross aisles 24 to 30 in. wide.

An alternative to floor beds are benches containing 6 to 8 in. of soil, and set on legs so that the surface is about 20 in. above floor level. The bottoms of these benches may be of treated boards, no more than 4 in. wide, and set $\frac{3}{4}$ in. apart for proper drainage. Screening may be laid in the benches to prevent soil falling through.

e) Lighting

A simple lighting system will do for general illumination of the greenhouse. Industrial fixtures, either incandescent or fluorescent, of 15 to 20 footcandles and with commercial ballasts, are adequate. Vapour-proof fixtures are not required.

Lamps used to extend daylight hours for plant growth should not be hung from the greenhouse roof. Use a portable string of 100 watt reflector neck bulbs in bakelite pin type sockets and spaced 3 feet apart along a pair of stranded wires. Mount the string on pipe wiring frames over the floor beds or low benches.

Light from floodlights or morality lights outside the school building should not drift into the greenhouse. Stray light, even at low intensities, affects plant growth.

f) Services

A water outlet is needed at the end of each bed or bench. One is also needed at a central point in the greenhouse for the liquid fertilizer proportioner attachment. Alternatively, this attachment can be placed on the main line as it enters the greenhouse, so fertilizer is fed to all water lines. A bypass should be provided.

110 volt electrical outlets should be placed at intervals along the walls. One 220 volt outlet is needed at a central point on the wall for the soil pasteurizer. Outlets need not be waterproof but must have covers.

Where steam heating is used, a 1 to 2 in. lip steam outlet for soil sterilization should be placed in front of the heat control valve.

The greenhouse should have a mist propagation system with solenoid valve, strainer, 3 to 3½ gal./hr. nozzles spaced 3 feet apart and controls such as a clock timer or

electronic leaf. This system should be installed for 20 to 30 feet along the top of a suitable bench.

g) Heating

Conventional radiation does not provide adequate distribution of heat for greenhouses. Architects and engineers should therefore consult a greenhouse manufacturer about the general arrangement, type of equipment and location of heating runs. Alternatively, most manufacturers will design or install a system based on performance specifications as part of the contract or sub-contract.

Steam or hot water heating systems using black iron pipe or fin radiation without cabinets are usually used. The choice depends on the type of heat source available in the school. Since most greenhouses are designed for a 60 degree minimum night temperature, shut-off is not usually a problem and it is unusual for separate heating systems to be required. Greenhouse type forced air unit heaters are occasionally used, but should not be the main source of heat. Placement of radiation to prevent ice build-up and glass breakage at the eaves is important. Higher daytime temperatures require no special consideration.

h) Ventilation

Good ventilation is important for humidity and temperature control. Advice on ventilation may be had from suppliers of greenhouse accessory equipment. Methods of ventilation:

- i) sidewall vents, automatically controlled;
- ii) exhaust fans, automatically controlled and designed to give one air change per minute;
- iii) fan jet or poly plastic convection tubes running the length of the greenhouse under the ridge. A louvred shutter is mounted in the gable end of the greenhouse. A perforated polyethylene tube, 18 in. in diameter, carries air from there to the other end of the greenhouse. A fan may be installed at the louvre to help circulation. Greenhouses over 30 ft. wide require two systems running lengthwise;

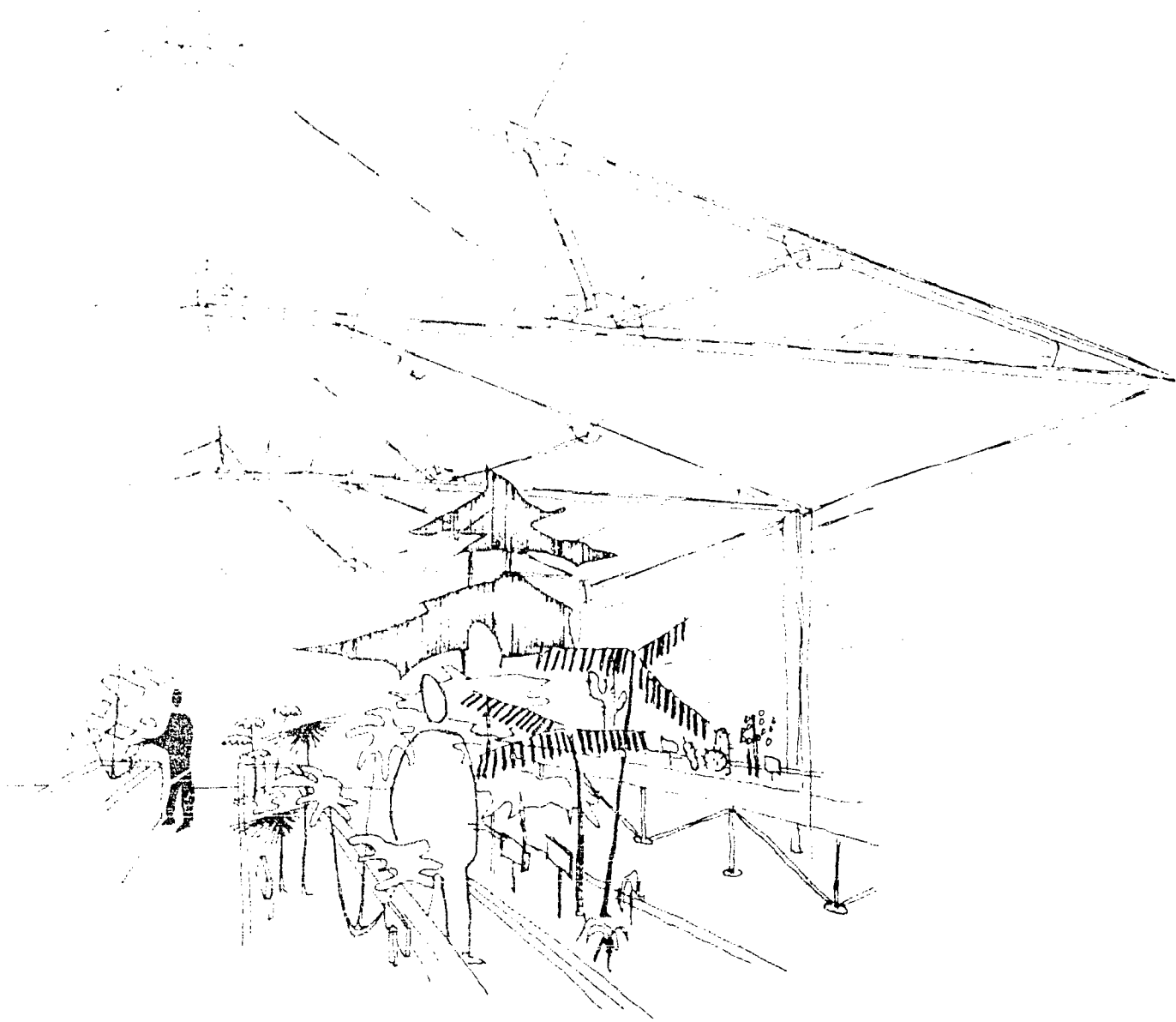

iv) combinations of the above methods.

For a school, a combination is preferable. Such a system might use automatically controlled eave sidewall vents down one side of the greenhouse above the bench, also automatically controlled greenhouse exhaust fans on the opposite wall and a poly convection tube. In winter, the sidewall vents would not be used, and air would enter only through the convection tube. Roof vents, even though automatically controlled, are considered obsolete in modern greenhouses.

i) Cooling

Cooling is not absolutely necessary, since school greenhouses are not in use in the summer, but may be added at reasonable cost if forced fan ventilation is being used. Several systems are available:

- i) evaporating pads at air intake on the opposite wall to ventilating fans. With this system, water trickles over aspen pads and evaporates as air is drawn through them;
- ii) water mist over the air intakes used in place of aspen pads;
- iii) high pressure fog at about 600 lbs. per sq. in. creating a very fine mist. When this system is placed high above the beds, moisture will evaporate before reaching the plants.

Controls – Sensing elements for controls should be located just above plant level in the centre of the greenhouse and not on the walls.

For the heating system, use thermostatically controlled valves of the modulating type, which open and close gradually. For the ventilation system, thermostatic controls may be arranged to allow vents and poly convection tube louvres to open before fans come into operation.

j) Workroom

All equipment and supplies for the greenhouse should be stored in an adjacent workroom. This room should contain soil storage bins below work counters, tool storage cupboards, an electric pasteurizer and sufficient counter space as a work area and for wrapping. At least

50 linear feet of work counter is required for 20 students. Moveable work tables, as seen in the drawings, can be used as additional potting benches, which are more convenient for teaching and demonstration purposes. New soil is not required from year to year. The old soil is simply modified by the addition of organic matter and is sterilized before being used again. Even if the greenhouse is above ground level, a hoist is therefore unnecessary.

Because of the number of students, the area of the workroom (sometimes called "head house") will be larger than in a commercial house and should form the "neck" between the greenhouse and the laboratory.

An area of 700 sq. ft. is the minimum requirement for agricultural science classes. If horticultural science stresses grounds maintenance, tree climbing or landscaping, a larger open area should be provided.

Where cost or available space is a limiting factor, the workroom may become part of the greenhouse structure by lengthening the greenhouse by two bays and roofing these sections with a solid material.

Services – 110 volt electrical outlets will be required around the work counters, as well as a 220 volt outlet for the pasteurizer. Lighting arrangements and levels should be the same as for a classroom.

If the school has a compressed air system, one or two outlets in the workroom are useful.

A large 6 in. deep, lead lined sink with hot and cold water is usually provided. Such a sink is preferable to slop sinks or other types since it can serve for washing hands, pots and flats, as well as for sub-irrigation of flats of seedlings. Bradley sinks are not recommended in this area.

Sufficient cupboard storage should be provided for chemicals, insecticides, plant labels and similar materials. Hanging space should be available near work counters, for trowels and small tools. Rakes and hoes should be hung on angle iron frame racks mounted high on the wall, so that tools may be stacked. Wall space should be provided to hang other large tools individually.

Drawing 20

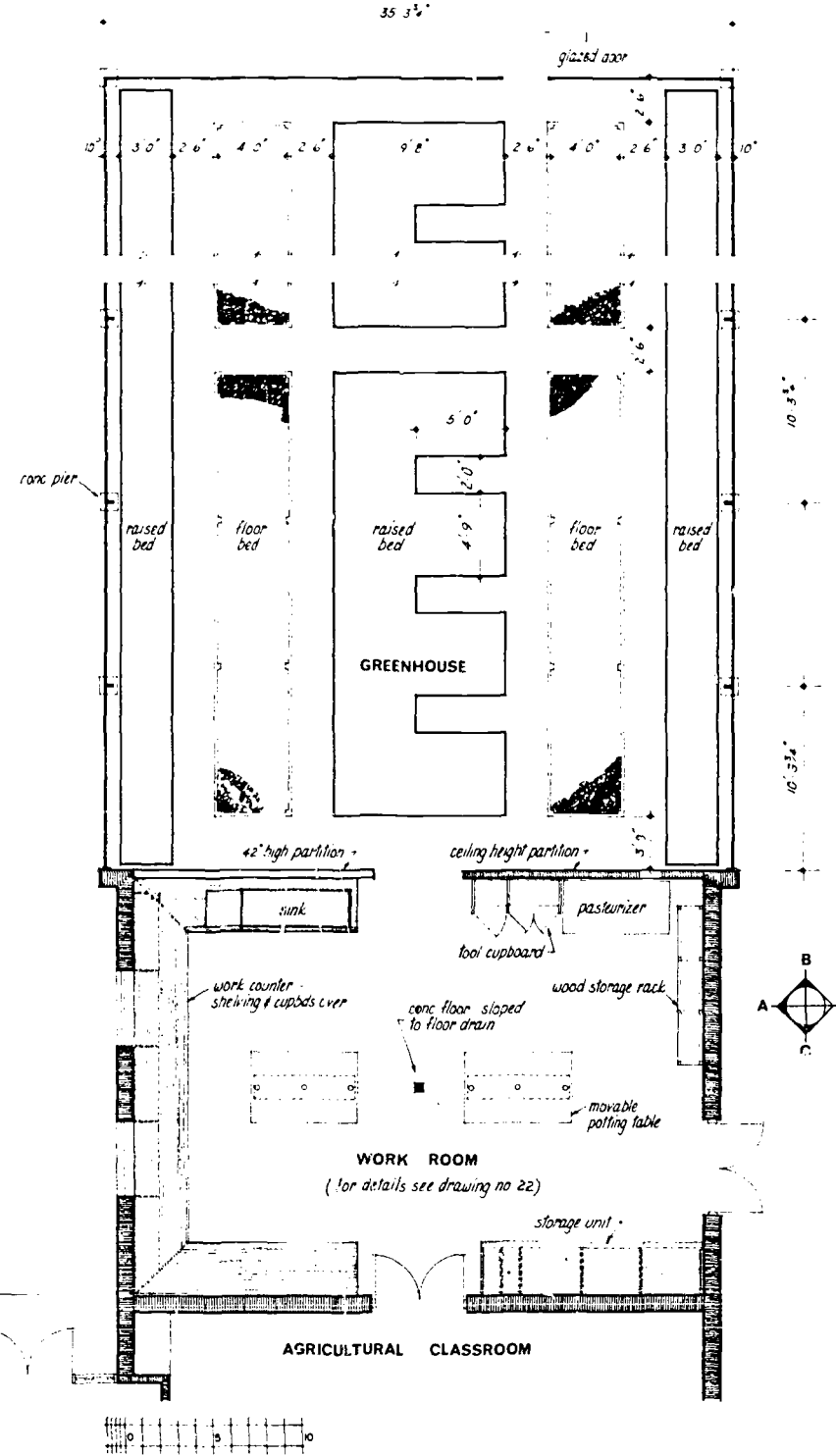

Drawing 21

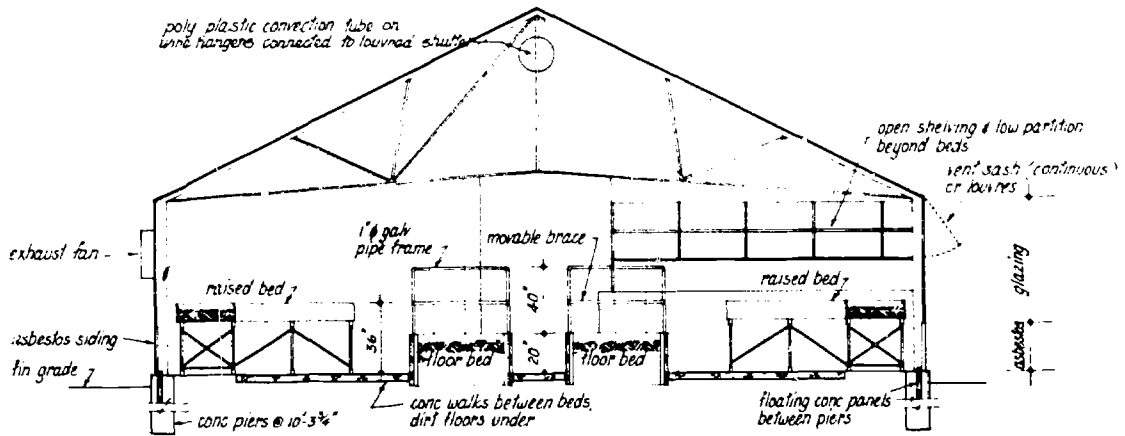

section A-A

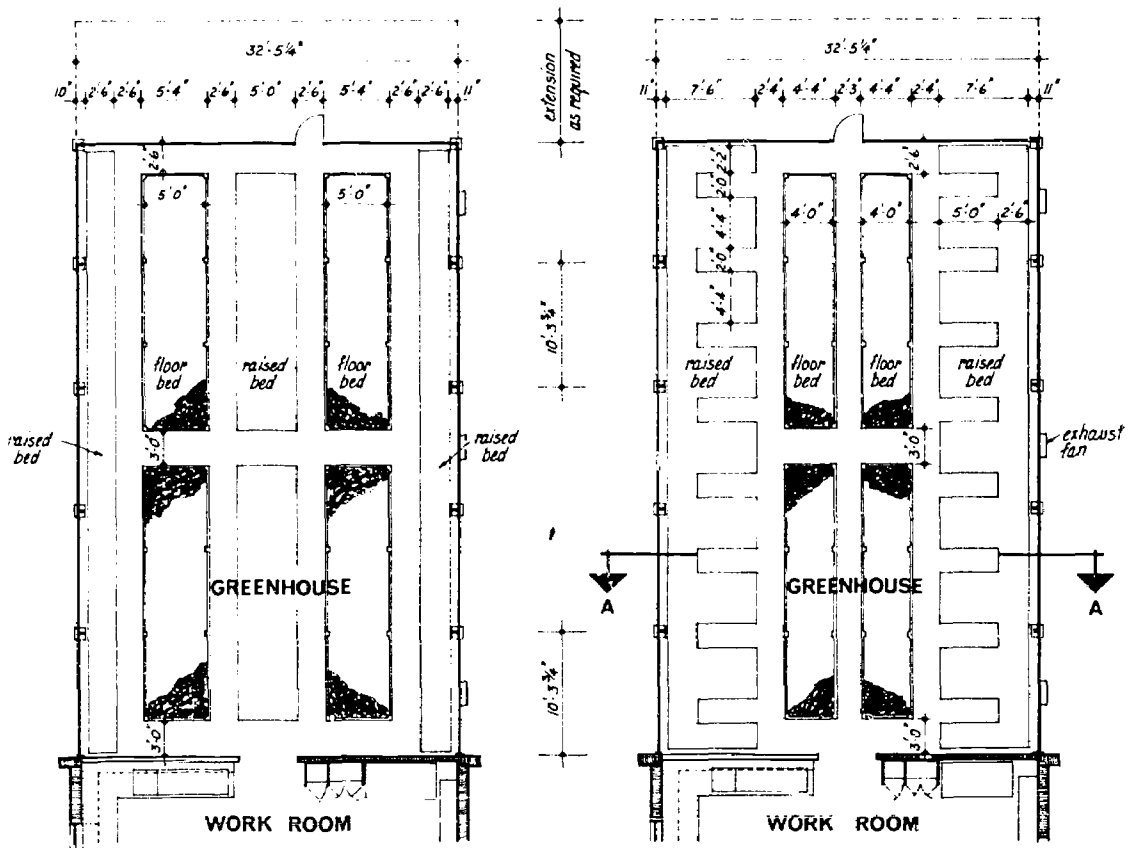

alternative plans of bed arrangements in greenhouse



Drawing 22

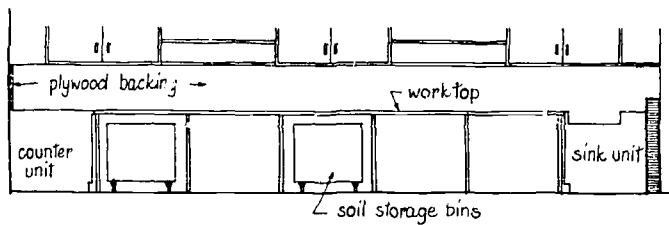
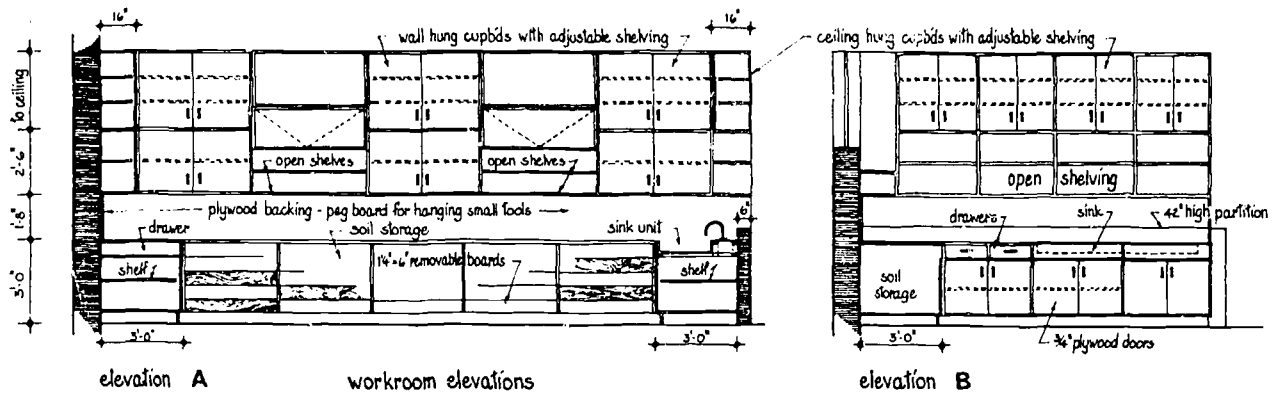
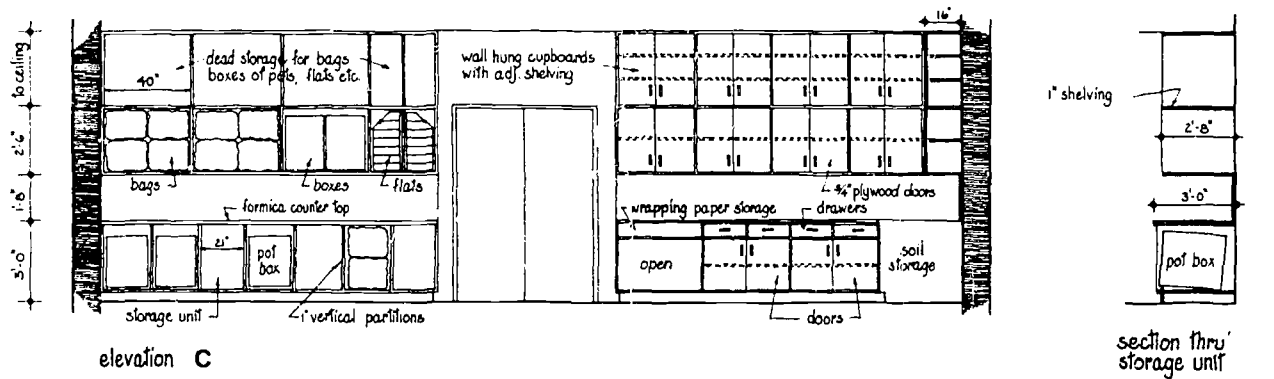

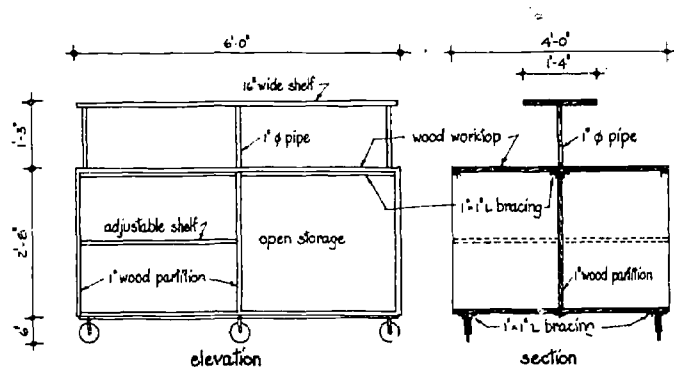

details - movable potting tables in workroom

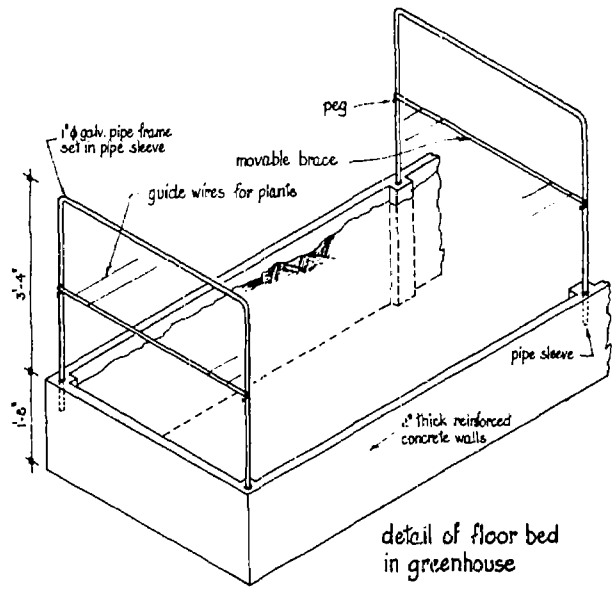

detail of floor bed in greenhouse

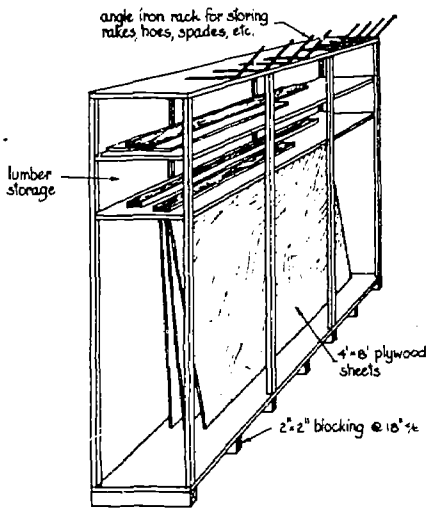

wood storage rack in workroom

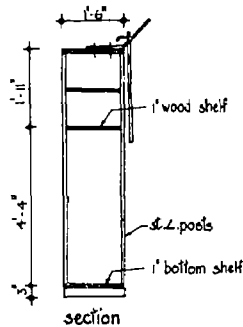

section

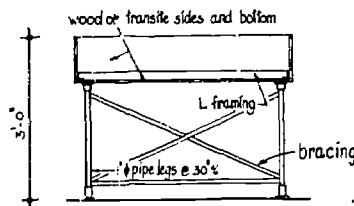

detail of raised bed in greenhouse

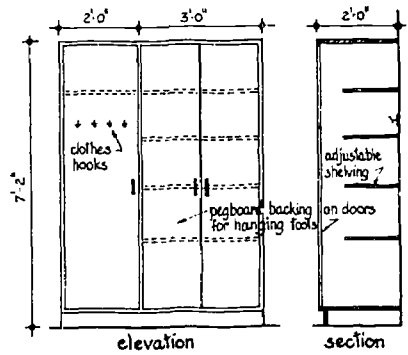

detail of clothes-tool cupboard in workroom