

DOCUMENT RESUME

ED 082 808

PS 006 677

AUTHOR Segal, Marilyn M.
TITLE You Are Your Baby's First Teachers.
INSTITUTION Nova Univ., Fort Lauderdale, Fla.
SPONS AGENCY Children's Bureau (DHEW), Washington, D.C.
REPORT NO OCD-CB-138
PUB DATE 73
NOTE 214p.

EDRS PRICE MF-\$0.65 HC-\$9.87
DESCRIPTORS Child Development; *Guides; *Infants; *Learning Activities; Manipulative Materials; *Parent Child Relationship; *Parent Education; Psychomotor Skills; Sensory Experience; Socialization; Stimulation

ABSTRACT

This easy-to-read manual for parents describes what a baby learns in the first year of life and suggests specific things parents or caregivers can do to encourage a baby to use his body, senses, and mind to communicate. Each chapter is concerned with 1 month of the infant's life and includes sections on (1) Baby's Viewpoint (discussion of the infant's developments during the month; (2) Motor Skills; (3) Seeing, Hearing, and Feeling; (4) Socialization; (5) Suggested Motor Activities; (6) Suggested Seeing, Hearing and Feeling Activities; and (7) Suggested Socializing Activities. Each chapter includes age-appropriate games, cutouts, and toys (with building instructions). A checklist for parents to record their baby's activities is also included. (SET)

U.S. DEPARTMENT OF HEALTH,
EDUCATION & WELFARE
NATIONAL INSTITUTE OF
EDUCATION

THIS DOCUMENT HAS BEEN REPRO-
DUCED EXACTLY AS RECEIVED FROM
THE PERSON OR ORGANIZATION ORIGIN-
ATING IT. POINTS OF VIEW OR OPINIONS
STATED DO NOT NECESSARILY REPRESENT
OFFICIAL NATIONAL INSTITUTE OF
EDUCATION POSITION OR POLICY.

YOU



**ARE YOUR BABY'S
FIRST TEACHERS**

FILMED FROM BEST AVAILABLE COPY

ED 082808

PS 006677

ED 082808

YOU ARE YOUR BABY'S FIRST TEACHERS

Written By

Marilyn M. Segal

Nova University
Ft. Lauderdale, Florida

Illustrated By

John Romanovich, III

University School of Nova University
Ft. Lauderdale, Florida

Developed under Grant #OCD-CB-138
Children's Bureau
Office of Child Development
Department of Health, Education & Welfare

Copyright © 1973

All Rights Reserved

PERMISSION TO REPRODUCE THIS COPY-
RIGHTED MATERIAL HAS BEEN GRANTED BY

*Marilyn M.
Segal*

TO ERIC AND ORGANIZATIONS OPERATING
UNDER AGREEMENTS WITH THE NATIONAL IN-
STITUTE OF EDUCATION. FURTHER REPRO-
DUCTION OUTSIDE THE ERIC SYSTEM RE-
QUIRES PERMISSION OF THE COPYRIGHT
OWNER."

PS 00667Z
229900

No part of this manual can be reproduced
without written consent of the author.

ACKNOWLEDGEMENTS

My thanks to Mrs. Elizabeth Zausmer, Director of Training and Physical Therapy Developmental Evaluation Clinic, Children's Hospital Medical Center, Boston, for her constructive criticisms and creative suggestions, to Betty Bardige for her conscientious editing, and to Nancy Smith, secretary, for her patience with rewrites and her remarkable ability to decipher my handwriting.

TABLE OF CONTENTS

I. INTRODUCTION.....	1
Color Code.....	2
Guidelines for Activities.....	3
Tips for Toy Makers and Scraps for Scroungers.....	4
II. NEWBORN	
Baby's Viewpoint.....	5
Motor Skills.....	6
Seeing, Hearing and Feeling.....	7
Socializing.....	9
"Motor" Activities.....	11
"Seeing, Hearing and Feeling" Activities.....	12
"Socializing" Activities.....	14
<i>Mobile</i>	15
<i>Japanese Wind Chime</i>	16
<i>Shadow Box</i>	17
III. ONE MONTH OLD	
Baby's Viewpoint.....	21
Motor Skills.....	22
Seeing, Hearing and Feeling.....	23
Socializing.....	24
"Motor" Activities.....	25
"Seeing, Hearing and Feeling" Activities.....	26
"Socializing" Activities.....	27
<i>Covers for Baby Bottles</i>	28
<i>Pin Wheel</i>	29
<i>Plate Puppets</i>	30

IV. TWO MONTHS OLD

Baby's Viewpoint.....	31
Motor Skills.....	32
Seeing, Hearing and Feeling.....	34
Socializing.....	35
"Motor" Activities.....	36
"Seeing" Activities.....	38
"Socializing" Activities.....	39
<i>Bell Mitten</i>	40
<i>Finger Puppet</i>	41
<i>Textured Mittens</i>	42
<i>Foot Socks</i>	43

V. THREE MONTHS OLD

Baby's Viewpoint.....	44
Motor Skills.....	45
Seeing, Hearing and Feeling.....	46
Socializing.....	48
"Motor" Activities.....	49
"Seeing, Hearing and Feeling" Activities.....	50
"Socializing" Activities.....	52
<i>Cradle Gym</i>	53
<i>Maypole</i>	54
<i>Feel Ball</i>	55

VI. FOUR MONTHS OLD

Baby's Viewpoint.....	56
Motor Skills.....	57
Seeing, Hearing and Feeling.....	58
Socializing.....	59

"Motor" Activities	60
"Seeing, Hearing and Feeling" Activities	62
"Socializing" Activities	63
<i>Cardboard Tube Slide</i>	64
<i>Slide Bar</i>	65
<i>Bean Bag</i>	66
<i>Mirror</i>	67

VII. FIVE MONTHS OLD

Baby's Viewpoint.....	68
Motor Skills.....	69
Seeing, Hearing and Feeling.....	70
Socializing	72
"Motor" Activities.....	73
"Seeing, Hearing and Feeling" Activities.....	75
"Socializing" Activities	77
<i>Merry-Go-Round</i>	79
<i>Horse Puppet</i>	80
<i>Busy Board</i>	81

VIII. SIX MONTHS OLD

Baby's Viewpoint.....	84
Motor Skills.....	85
Seeing, Hearing and Feeling.....	86
Socializing.....	87
"Motor" Activities.....	88
"Seeing, Hearing and Feeling" Activities.....	90
"Socializing" Activities.....	92
<i>Pillow</i>	94
<i>Rag Doll</i>	95

	<i>Tin Can Cymbals</i>	100
IX.	SEVEN MONTHS OLD	
	Baby's Viewpoint.....	101
	Motor Skills.....	102
	Seeing, Hearing and Feeling.....	103
	Socializing.....	104
	"Motor" Activities.....	105
	"Seeing, Hearing and Feeling" Activities.....	107
	"Socializing" Activities.....	109
	<i>Drum</i>	111
	<i>Paper Bag Puppet</i>	112
	<i>Picture Book</i>	113
X.	EIGHT MONTHS OLD	
	Baby's Viewpoint.....	115
	Motor Skills.....	116
	Seeing, Hearing and Feeling.....	117
	Socializing.....	118
	"Motor" Activities.....	119
	"Seeing, Hearing and Feeling" Activities.....	121
	"Socializing" Activities.....	122
	<i>Spindle Toy</i>	124
	<i>Caterpillar</i>	125
	<i>Jingle-Jangle Fish</i>	126
XI.	NINE MONTHS OLD	
	Baby's Viewpoint.....	127
	Motor Skills.....	128
	Seeing, Hearing and Feeling.....	129
	Socializing.....	130

"Motor" Activities.....	131
"Seeing, Hearing and Feeling" Activities.....	133
"Socializing" Activities.....	135
<i>Telephone</i>	137
<i>Family Album</i>	138
<i>Wash Cloth Mit</i>	139
XII. TEN MONTHS OLD	
Baby's Viewpoint.....	140
Motor Skills.....	141
Seeing, Hearing and Feeling.....	142
Socializing.....	143
"Motor" Activities.....	144
"Seeing, Hearing and Feeling" Activities.....	145
"Socializing" Activities.....	147
<i>Blocks</i>	148
<i>Poke Box</i>	150
<i>Mitten Puppet</i>	151
<i>Boat</i>	152
XIII. ELEVEN MONTHS OLD	
Baby's Viewpoint.....	153
Motor Skills.....	154
Seeing, Hearing and Feeling.....	155
Socializing.....	156
"Motor" Activities.....	158
"Seeing, Hearing and Feeling" Activities.....	160
"Socializing" Activities.....	162
<i>Feed-the-Horse Game</i>	164

	<i>Carry-All</i>	165
	<i>Can-Man</i>	166
	<i>Bell Boy</i>	167
XIV.	TWELVE MONTHS OLD	
	Baby's Viewpoint.....	169
	Motor Skills.....	170
	Seeing, Hearing and Feeling.....	171
	Socializing.....	172
	"Motor" Activities.....	173
	"Seeing, Hearing and Feeling" Activities.....	175
	"Socializing" Activities.....	177
	<i>Toy Box</i>	179
	<i>Coffee Can Game</i>	180
	<i>Cookie Mouse Game</i>	181
XV.	KEEPING UP WITH BABY.....	183
XVI.	A CLOSING THOUGHT.....	193



You are your baby's first teachers

AN INTRODUCTION

Every parent has his own set of dreams for his child, dreams about what his child will become and what he will do; about how he will live his life.

"I don't care what my child accomplishes," one parent will say, "as long as he's happy and secure."

"In this world of ours," says another parent, "a child has to fend for himself. He's got to learn to solve his own problems, and pull himself up by the bootstraps. When the going is rough, I want a kid that can cope."

"I only hope and pray," states a third parent, "that my child grows up to be himself; expressing himself, fulfilling himself, doing his own thing in his own way."

Every parent, when he tells of the dreams he holds for his child, expresses his own value system. Some dreams will be shattered and others fulfilled. What makes the difference? When does it happen?

When does learning begin? Does it begin with the first grade, in kindergarten, in nursery school? Who are the child's first teachers; his school teacher, his friends, his sisters and brothers, his mother and father? **THE MORE WE LEARN ABOUT LEARNING, THE MORE WE REALIZE THAT LEARNING BEGINS WITH THE FIRST DAY OF LIFE, AND THAT YOU, AS PARENTS, ARE YOUR BABY'S FIRST TEACHERS.**

This manual may be thought of as an inservice guide for parents. It follows a typical baby through his first year of life, as he learns to use his body, his senses, and his mind to communicate with other people. It describes the important learnings that take place in these early months, and suggests specific things that you can do with your baby to help him learn.

As you use this manual, remember that it is **ONLY A GUIDE**. Don't be alarmed if your baby doesn't exactly fit the schedule. Babies develop differently. Take your cue from your child. Do the activity that is right for him, that he is ready for and enjoys.

Think of baby care as a family affair. Each family member can share in the joy of watching baby grow and helping him learn. Even a three-year-old can help with making the toys or fixing up the room. And as you and your family play games with baby, you are capitalizing on his unique ability to learn.

Remember, what you don't give your baby in this first year can never be made up.

WHAT YOU DO GIVE YOUR BABY IN THIS FIRST YEAR CAN NEVER BE TAKEN AWAY.

COLOR CODE

Viewpoint	Mint Green
Motor Skills, Seeing, Hearing and Feeling, and Socialization	Green
Activities	Buff
Things to Do	Goldenrod
Keeping Up With Baby	Ivory

GUIDELINES FOR ACTIVITIES

The "Ten Commandments" for Parents

1. The activities listed in the manual are only suggestions. Choose the activities that you and baby enjoy doing together and feel free to introduce substitutes and variations.
2. Choose a time for your lessons when baby is happy and rested.
3. Keep your lesson periods short. The time to end an activity is when you and baby are having a good time.
4. Give baby many chances for success. Every success that baby experiences makes him feel good about himself.
5. Let baby know how much you enjoy him and how pleased you are with the things he does.
6. Be selective - be easy-going and don't overdo. Too much stimulation is no better than too little.
7. Don't compare your baby with other babies. He is his own special self.
8. Keep your baby records up to date. According to a Chinese proverb, "The faintest ink is better than the greatest memory."
9. Let the family join in the fun. When baby care is a family affair the whole family circle is strengthened.
10. *Remember - the best gift you can give your baby is time, and the greatest investment is love.*

TIPS FOR TOY MAKERS



- 1) Plan on everything going into baby's mouth.
- 2) Make sure the toys you make are just as safe in pieces as they are whole.
- 3) Read labels. All craft supplies, paint, paste, felt pens - must be lead-free and non toxic.
- 4) When you use bells, "eyes", or buttons, sew with heavy nylon thread. Sew very very securely. Each button should be sewed with not less than ten threads.
- 5) Watch out for sharp edges. Hammer or sandpaper rough edges, and cover with heavy adhesive cloth.
- 6) Use only all aluminum cans for construction.
- 7) Never let your baby play with plastic bags.

SCRAPS FOR SCROUNGERS

Plastic bottles and containers	Small rubber balls,
Scraps of fabric	large wheels, and
Bits of yarn	other safe parts of toys
Empty spools	Coat hangers
Spindles from paper towels, toilet paper	Wires
Bits of aluminum foil	Pipe cleaners
Translucent containers	Paper cups
Adhesive paper scraps	Plastic straws
Greeting cards	Cardboard
Shoe boxes	Rice
String	Beans
Cardboard cans and caps	Sponge
Coffee cans	Popsicle sticks
Aluminum cans	Wrapping paper
Buttons	Hook and eyes
Zippers	Pieces of elastic
Straws	Door handles
Styrofoam balls	Hinges
Bells	Hooks
Ribbons	Pencils
Keys	Paper clips
Aluminum dishes	Nylon stockings
Pieces of carpet	Ping pong balls
Old magazines	Egg cartons
Calendars	Milk cartons
Old socks, mittens, gloves	Wallpaper
Jelly jars and tops	Match boxes



Newborn

BABY'S VIEWPOINT

NEWBORN

The newborn baby knows the world as a set of fleeting sensations. He sees light, he hears sounds, he senses the position of his body, but he cannot make connections. He has no sense of time, no awareness of space, no way of differentiating between "me" and "not me." Cause-effect has no place in the baby's scheme of things. Things happen because they happen -- baby feels a pang of hunger and hears his own cry. Did the cry come from somewhere inside him? Is the cry somehow connected with the pang of hunger? Did Mother's arrival have something to do with the feeling of comfort? The infant cannot know the answers, nor even pose the questions. Slowly, over time, as cry follows hunger pang and comfort follows cry, the baby develops feelings of expectancy, intuitions of order and sequence. The baby builds a view of his world as a safe and orderly place. He develops a sense of trust for his mother, and she, sensing her own ability to respond to this trust, develops new confidence in herself, and new pleasure in her role of mother.

229900SF

MOTOR SKILLS

NEWBORN

The baby is born with automatic built-in behavior patterns, called "reflexes." He sucks when the inner part of his lips is touched, he turns his head when his cheek is stroked, he flings out his arms and stiffens his whole body in response to a loud noise, he tightens his fingers when an object is placed in his palm. Some of an infant's reflexes will disappear in time. Others, like sucking and grasping, will be modified by learning, and will be the basis for more sophisticated behavior.

The newborn has no way of reaching out and exploring his surroundings. He must wait for things to happen to him and for people to do things for him. The new baby's head must be supported at all times. He can turn it from side to side, however, so he is perfectly safe on his stomach. He is also capable of vigorous movements with his arms and legs. In the beginning, most babies kick their legs in a kind of random pattern. Rhythmic or reciprocal kicking is a skill usually learned when the baby is about three weeks old. During the first month, most babies learn to hold their heads up momentarily when carried in an upright position. Some strong month-old babies will lift their heads up off the sheet when lying on their stomachs. A very active baby may wriggle up to the corner of the crib by the time he is three or four weeks old.

SEEING, HEARING AND FEELING

NEWBORN

SEEING

A baby begins to see from the very moment of birth. The new baby blinks his eyes in response to a white light but fixes his gaze on a soft yellow or red light. He stares at a patterned surface for a longer time than a plain surface, and prefers a human face to any other sight. He is particularly fascinated by things that move, and focuses best when things are between one to three feet away.

FEELING

Even very young babies are aware of pain, pressure, and temperature change. The ability to identify objects by their feel is learned over time. In the beginning the child is not aware that the rattle placed in his hand is an object. He knows the feeling he gets but he doesn't know that there is something giving him that feeling. When the rattle is taken away he doesn't miss it because for him it no longer exists. Nor does the infant make a distinction between what is a part of his body and what is outside his body. He doesn't distinguish between his mother's hand and his hand. *"Only through experience will he learn the limits of his body, and become aware of his separateness."* The parent who gives the infant a variety of experiences involving touch and feel helps the infant gain an understanding of things in his environment, and enables the baby to formulate an image of himself.

HEARING

Not only are we certain that a baby hears from the moment of birth, but there is strong evidence to suggest that the baby hears in the womb. A sudden noise near baby will cause him to startle. In the beginning, although the baby is able to hear sounds, he does not associate what he hears with what he sees. He knows the world as a jumble of sensations, and makes no distinction between what comes from outside of his body and what comes from inside. The newborn baby instinctively turns his head toward a sound, but within a few weeks he learns to associate what he hears with what he sees. This represents his first very tentative recognition that things do exist apart from his own sensations. *By giving the baby experiences with things that both look interesting and sound interesting, we lay the groundwork for the association of sound and sight.*

SOCIALIZING - NEWBORN

From the moment of birth, babies are individuals -- differing from each other in many ways. A particular baby could be described on a continuum from quiet to restless, from contented to discontented, from easy to soothe to difficult to soothe, from predictable to erratic, from responsive to unresponsive, from an eager eater to a reluctant eater, from active to passive.

The baby who is happy and responsive most of the time inspires confidence in his parents, and gets the family off to a good start. The parents trust their own intuition, and baby trusts and loves his parents. This love and trust are the basis of later socialization, where the child will learn to please, then to imitate, and eventually to internalize his parents' values.

The restless and irritable baby, the baby who is not easily soothed by the nurturant behaviors of his parents, may be off to a rougher start. Often parents do not realize that babies are constitutionally different. Because their baby is not "as good" as the neighbor's, these parents may question their own adequacy as parents, and may keep trying new ways to right the problems. The baby may react to the inconsistency in his parent's behavior, and his irritability or lack of responsiveness may increase rather than lessen. The parents who recognize and accept their baby's special reaction patterns will manage these first rough weeks with a minimum of stress. They will find out special ways of quieting their baby -- perhaps swaddling or vigorous rocking, or perhaps just allowing the baby to fuss for a while until he falls asleep. Most important,

they will not look on the baby's problem as a reflection of their own inadequacy as parents. The parents' confidence in their own ability to cope with baby minimizes the problems and emphasizes the opportunities.

Whether the baby is active or quiet, good or bad, every parent feels some mixture of emotions toward his child, particularly if it is a first baby. The young mother, perhaps suffering from postpartem blues, may find herself sliding into a mysterious depression, or getting snappish or unduly angry with other members of the family. The father, on the other hand, despite his proud smile and his vows to the contrary, may think of the baby as an intruder, taking away not only a portion of his freedom, but also a portion of his wife's concern. *As the new baby settles into the routines of the household, these first tensions disappear, and the stage is set for a mutually rewarding relationship between parents and baby.* The baby learns that he can call his parents with his crying, and, by the time he is three weeks old, they can recognize the different cries he uses when he is hungry, tired, hurt, frightened, or uncomfortable. The baby learns that his parents can be trusted to meet his needs, and, somewhere around four weeks old, reward his parents with the most beautiful gift they will ever receive: his first smile.

Suggested "Motor" Activities - Newborn

Place baby on a firm mat (a crib mattress or play-pen mat is fine). This will give baby a chance to practice kicking his legs and moving his arms. As long as he isn't cold, the less he wears the better.

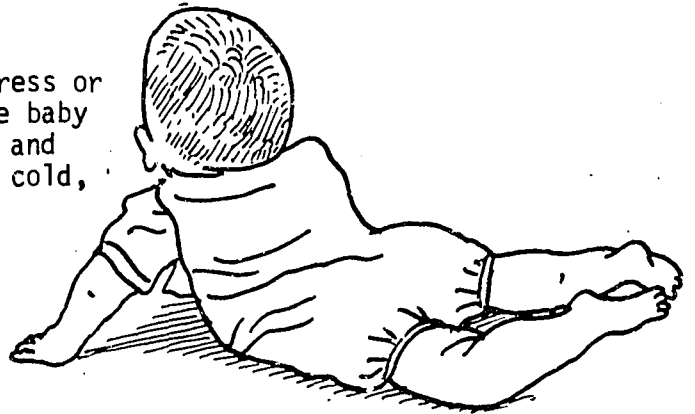
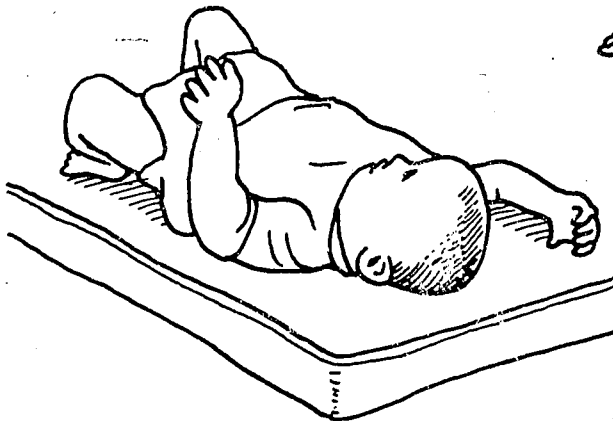

Place baby in different positions in the crib when he is awake. Sometimes he can be on his stomach, sometimes on his back, sometimes in a carry-all. Baby will practice moving his arms and legs in different positions.

Hang toys on both sides of baby's crib. This will encourage baby to turn his head.

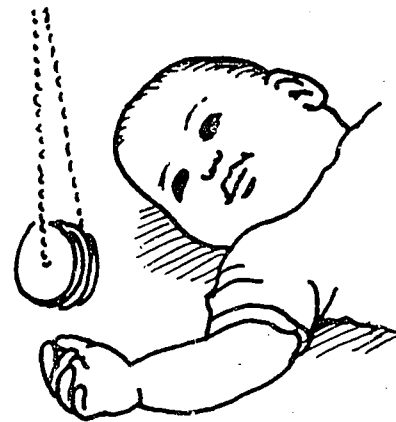

Place your own finger or a rattle in the palm of baby's hand. Baby will tighten his fingers around it.

Suggested "Seeing, Hearing and Feeling" Activities - Newborn

Although we have traditionally used soft pinks and pastel blues for the newborn infant, babies are much more attracted to bright reds and yellows, and gay designs. Use patterned sheets on baby's crib, or bassinet or baby carriage.

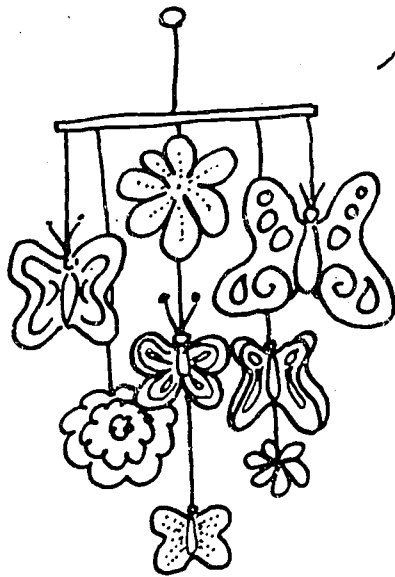

Hang mobiles over crib - the more practice baby has with seeing the better he becomes at it. Remember, baby enjoys variety, so have the family make a few different mobiles, so that you can change mobiles every few days.

Cover penlight with red or yellow cellophane. While baby is on his back, move the light very slowly from side to side. At first baby will look at it just for a second, but after a while he will follow it with his eyes.

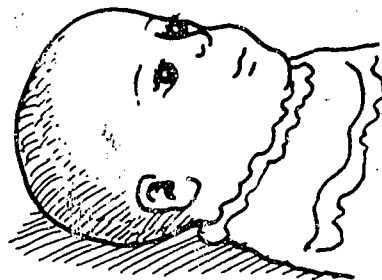
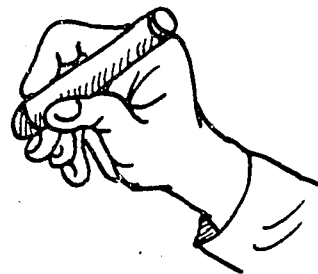

Make a "picture frame" out of plastic and hang it over the back of baby's crib. Cut out some bright pictures from a magazine or let your children make some. Clown faces or smiley faces are particularly appropriate. Change the picture in the frame whenever you change the sheet on the crib.

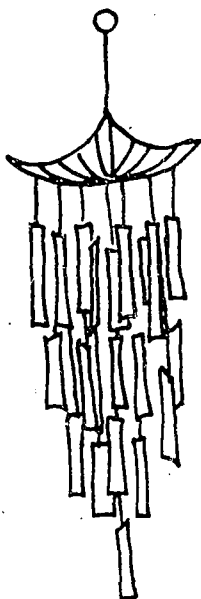
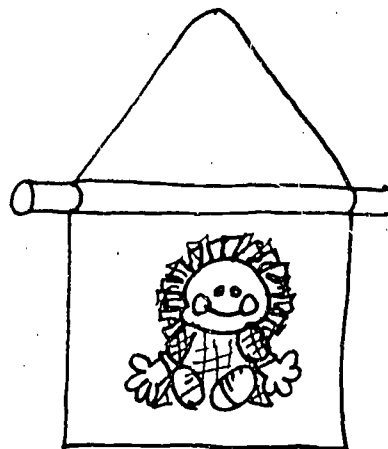

Make a Japanese wind chime. Hang it where baby can both see and hear it. This will give baby an early opportunity to connect a pleasant sound with a pretty sight.

Play a radio for short periods of time beside the crib.

Shake a rattle first on one side of baby's head, then on the other. First shake it slowly--then vigorously. After awhile, baby will realize that the sound he hears comes from somewhere outside of himself. He will search with his eyes for the thing that is making the sound. (an aluminum juice can half filled with beans makes an excellent rattle)

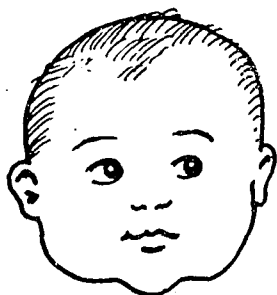
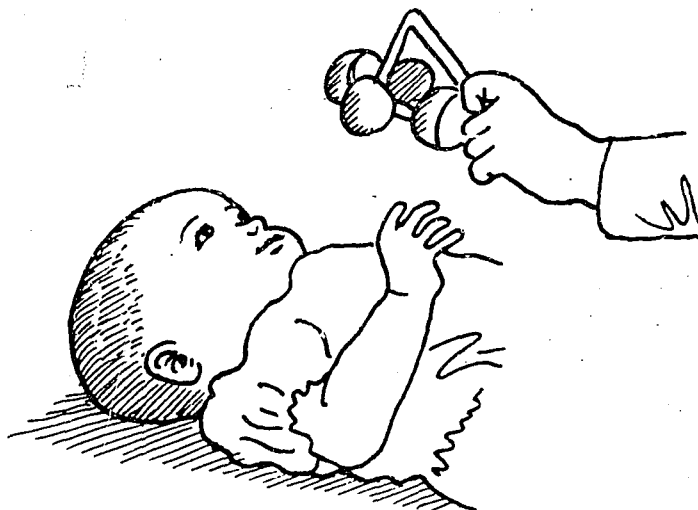

Whisper first in one of baby's ears, and then in the other. Baby will learn to connect a pleasant feel with a comforting sound.

Suggested "Socializing" Activities - Newborn

NEWBORN



Respond quickly to your baby's needs. If you give a baby appropriate attention when he needs it, he will not ask for attention when he doesn't need it.

Smile and laugh with baby. A baby seems to be able to tell when you are having fun with him.



Judge how much handling your baby enjoys. Some babies get tense and irritable from too much handling. Most babies get dull and listless from too little handling.

Make baby's feeding time special for both you and baby. Relax, get comfortable, watch baby's face and let him watch yours. When baby is full, take the bottle away and talk awhile. Your baby knows how much milk he needs, so don't ever push him to take a little more. Feeding time is fun time. Tension is "catching" and so is confidence.



MOBILE

PURPOSE: First experience with seeing.

MATERIALS: Florist's wire, coat hangers, pencils, thin dowels, cardboard, tubes. Objects to hang--bells, balls, mirrors, painted cardboard shapes, spools, large beads, plastic tops from bottles or cans, Christmas tree ornament.

PROCEDURE: Plan the basic mobile on paper before you begin cutting the wire or dowels. Remember that your mobile should balance evenly. The arrangement of objects need not be the same on both sides of the middle.

Cut the wire, sticks, or tubing to the length you want.

Attach your objects with strings, so that the mobile balances. Usually, the lighter the objects, the easier they are to balance.

NOTE: Many mobiles may be purchased for less than \$1.00. These can be found in gift shops and hobby stores. You may want to buy several and change them often.

FOR THE OLDER CHILD:

Designing and creating mobiles is fun for children of all ages.

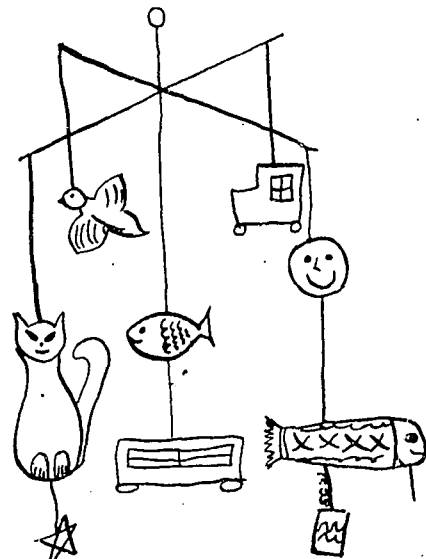
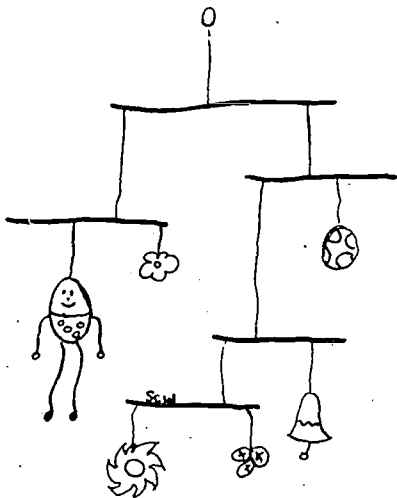

JAPANESE WIND CHIME

PURPOSE: Help baby associate sight and sound.

MATERIALS: Plastic cup, thread, string, tape, "odds and ends" (plastic tableware, key rings, safety pins, popsicle sticks, bobby pins, etc.)

PROCEDURE: String "odds and ends" using thread. Punch hole in cup. Thread string in hole, knot, and tape. Tape free ends of thread to inside of cup. Hang over crib or on carriage handle.

PLAY: Open window or set fan so that the wind chime moves.

FOR THE OLDER CHILD:

Making wind chimes is a fun activity for children of all ages.

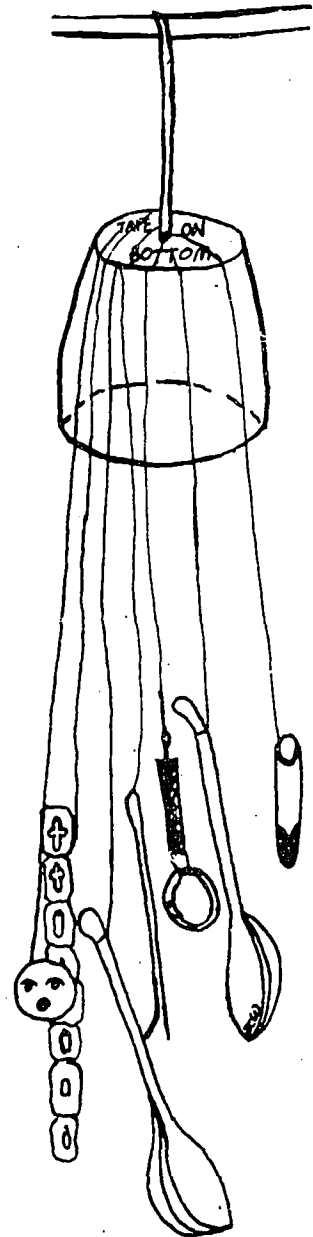

SHADOW BOX

PURPOSE: Practice in focusing eyes.

MATERIALS: Box top (shoe box size is fine), construction paper, glue, crayons, tape, and thread.

PROCEDURE: Line inside of box top with construction paper. Color coral, rock and seaweed picture. Cut out and glue on construction paper. Color and cut out fish. Glue threads to each of the fish. Glue other ends of thread to the flap of box top so that the fish "swim" in front of the background.

FOR THE OLDER CHILD:

Children love making their own shadow boxes. You don't have to use only ocean scenes. A child may want a shadow box zoo, a scene at the beach, in school, in a store or on a bus, or perhaps a shadow box Christmas tree.

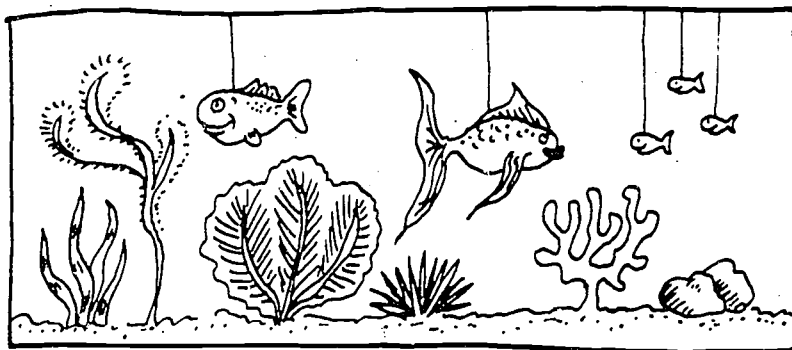

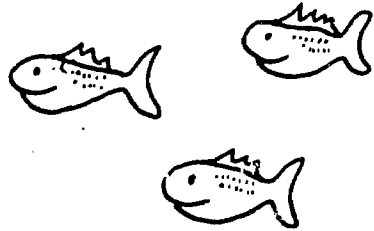
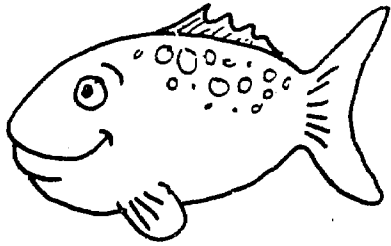

FISH

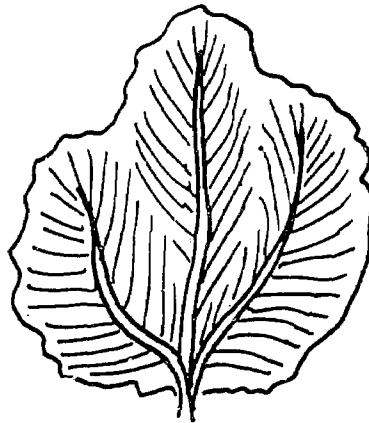
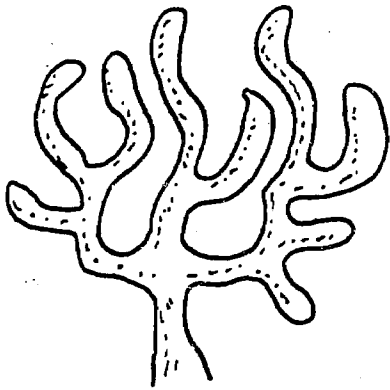
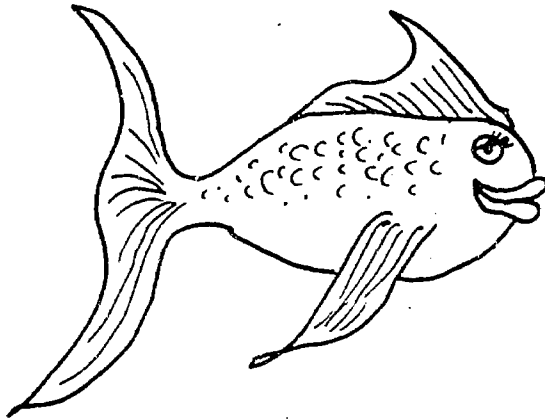
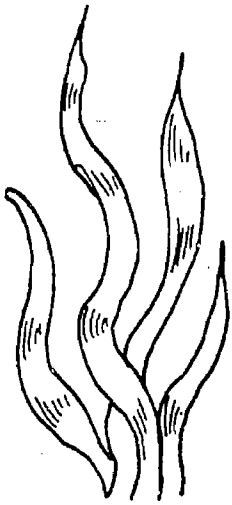

ROCKS

CORAL

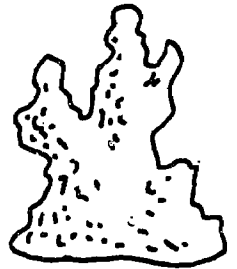
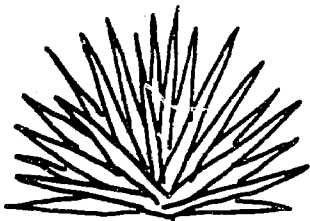

Color, cut out and paste on inside lid of box.

Color; cut out, and string up for shadow box.

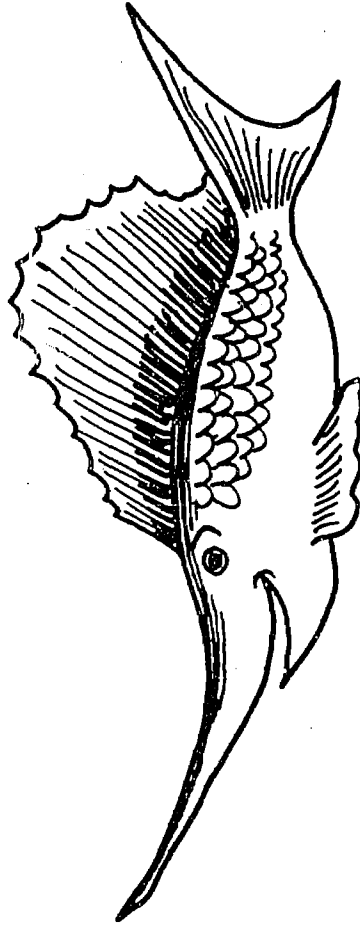
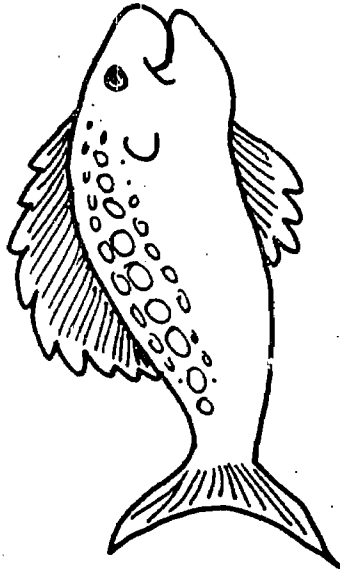

FISH

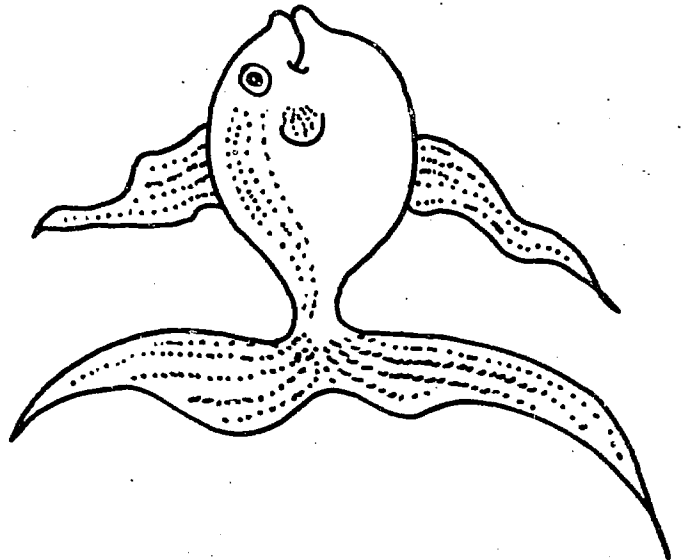
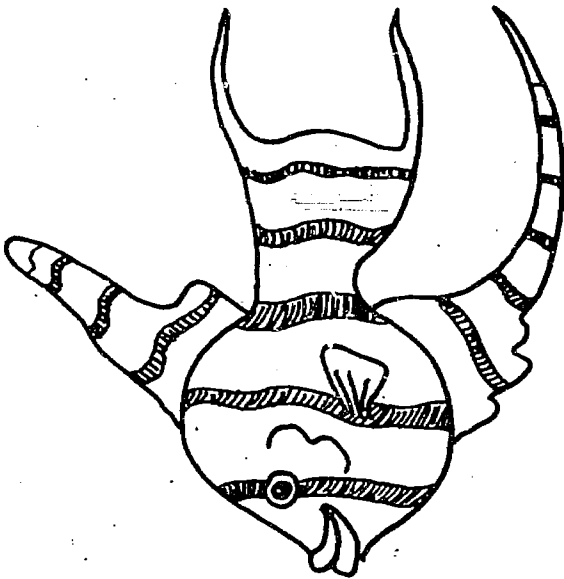

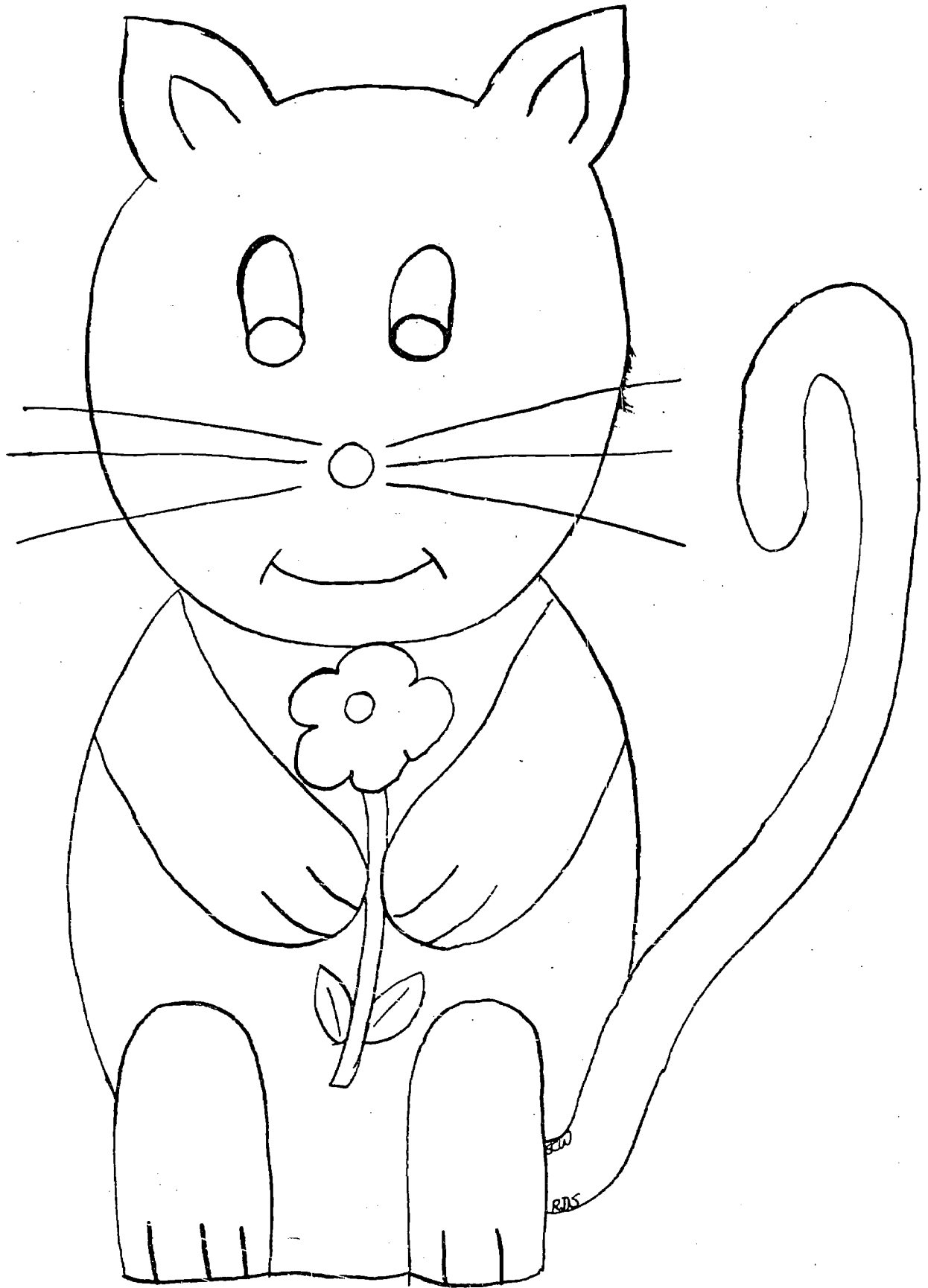

Color this picture and use for plastic picture frame on baby's crib.



One Month

BABY'S VIEWPOINT

ONE MONTH OLD

At one month old baby has lost his sleepy newborn look. He stays awake for short periods of time before and after feedings and is likely to have a particular period during the day when he is somewhat restless and irritable. Many babies, during this period of restlessness, respond to cuddling, rocking, or rhythmic pappings on the back-side. Others will stop their crying and settle down if they are wrapped in a blanket or tucked snugly in a bassinet. A very active or restless baby may not respond to any of these techniques, and parents often resort to the old-fashioned remedy of letting baby "cry it out." For certain babies this works very well. After a period of crying, baby seems to have worked out his tensions, and settles down to a deep and peaceful sleep.

MOTOR SKILLS - ONE MONTH OLD

The one month old appears more mature than the newborn in many different ways. He has probably lost many of the jerky, spasmodic movements of the newborn, and is moving his arms and legs in a much more rhythmic pattern. He has achieved better control of his head, and may be able to raise it up for a moment, when he is held against his parent's shoulder. Head control, however, is still far from perfect. The parent must continue to "cradle" baby's head in his hand when he lifts him out of the crib, or carries him around the room.

Although most month old babies are not able to move around as yet, occasionally we will find an active month old baby who will "wriggle" up to a corner of his crib or even turn from stomach to back. With any month older you can't predict when he's going to make a sudden move. To be on the safe side, it's better not to leave even the tiniest baby by himself on a high place.

SEEING, HEARING AND FEELING

ONE MONTH OLD

SEEING

At one month old, baby can follow a moving object with his eyes, and can distinguish between something novel and something that he has seen before. All things being equal, he gazes at a novel object longer than a familiar object. If something comes into his view that is new and interesting enough, he will stop what he is doing just to look at it.

FEELING

Baby is quite aware now of differences in texture. A gentle stroking with a soft fabric soothes him. A vigorous rubbing with a terry cloth awakens him, and gets him ready for play. When you tickle his arm with a feather, he reacts with a squirm or a smile. In a few more weeks he will realize what part of him is being tickled and will move his arm away.

HEARING

At one month old, baby is beginning to associate the things he hears and the things he sees. He becomes better at discovering where a sound comes from, and with a little practice he will be able to look up at his rattle as soon as he hears it tinkle. Baby can tell the difference between different kinds of sounds. Music quiets him, a loud noise startles him, and an interesting tinkle will hold his attention.

SOCIALIZING - ONE MONTH OLD

By the time baby is one month old, parents begin to really know their own baby, and are able to respond to his special needs. They have found out the position he enjoys being in for eating, the way he likes to be held, and the position he finds comfortable for sleeping. They can also distinguish his pain cry, his hunger cry, and the cry that means, "There is nothing really wrong - I'm just irritable; and want to be cuddled." As parents learn to understand and interpret baby's signals, baby responds to their confidence and the household settles down.

The one-month-old baby is not ready yet for too much stimulation. When he is exposed to too much noise, too much light, too much jostling around, he cannot sort out all of the separate sensations. Overwhelmed by it all, he reacts with irritability, or tunes out everything and falls asleep.

Although baby certainly is not ready to face a crowd, he does enjoy people. He will stare back at any face that looks down at him, and will return a smile with a smile. Inevitably, there is an argument over baby's first smile. Was it really a smile or was it just a gas pain? By about six weeks old most babies will smile genuinely at anything that has eyes.

Suggested "Motor" Activities - One Month Old

Turn baby on his stomach. Move his legs up and down. After a while he will learn to hold his head up while kicking.



Hold baby upright in your arms with head resting on your shoulder. Talk to him. After a while he will pick up his head to listen, a first step in developing head control.

With baby lying on his back, lift his arms gently up and down over his head, and then in and out. As he exercises he will develop free arm movement.

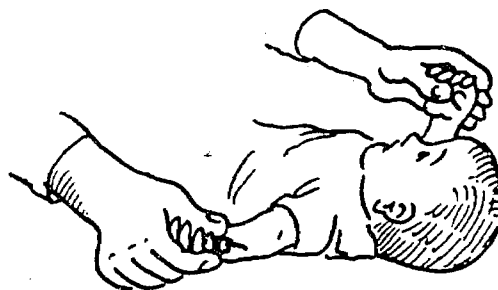

Place baby on his side on a flat surface. Baby will learn to make a half turn on his own.



Play music for baby while he is lying on his back, kicking his legs. His kicks will become more rhythmic as he listens to the music and practices his kicking.

Place baby at an angle in his carry crib. Put your fingers in his palm, and pull his arms toward you. (Take it easy and do not pull him up by his arms. When baby is ready he will lift his head by himself.) This exercise will give him practice in grasping and will help develop muscles in his arms and neck.



Suggested "Seeing, Hearing and Feeling" Activities - One Month Old

Tape a pin wheel to one side of the crib or bassinet for a few days and then change it to the other side. When you feel that baby can focus on the pin wheel for a few moments, place pin wheels on both sides of the crib at the same time. After a while baby will learn to shift his gaze from one pin wheel to the other.

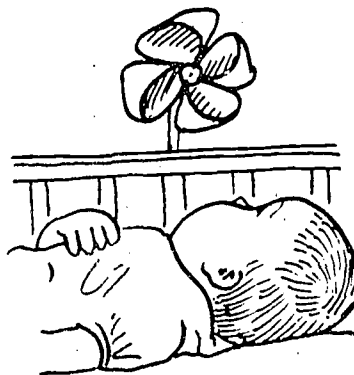

Move crib to different positions in the room. This gives baby a change of scenery.

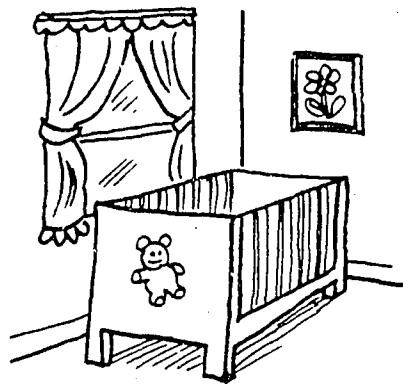

Use see-through crib bumpers. As baby gets older he enjoys looking out.



With baby lying on his back, move a plate puppet in and out and back and forth making sure that baby follows it with his eyes. After awhile, baby will not only follow the puppet with his eyes, but will greet it with a smile.

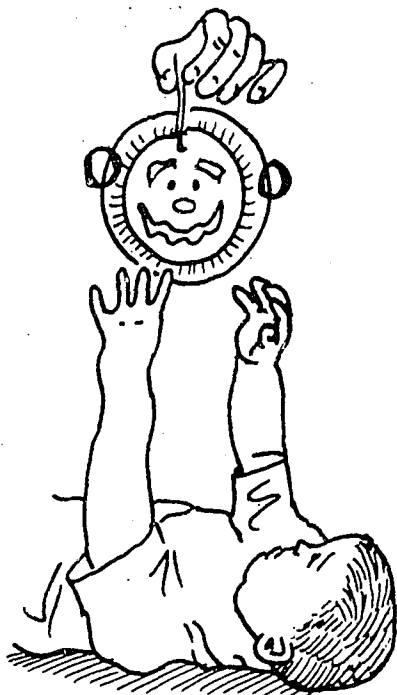

Suggested "Socializing" Activities - One Month Old

Place a brightly colored towel or receiving blanket over your shoulder while feeding baby.

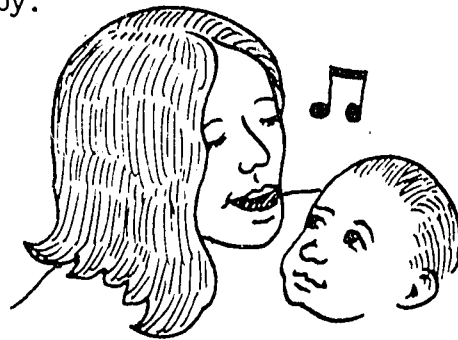

Sing softly during feeding.



Speak to baby in a high voice for soothing and a low voice for stimulating.



Tickle gently.

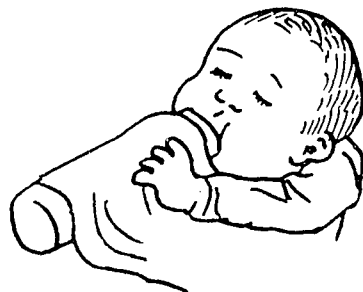

Place a flannel cover on baby's bottle and let him feel the bottle as he sucks.



Rub fingers and toes one at a time. As we let baby experience a variety of sensations, we give him the opportunity to "feel out" his world.

Blow warm breath on arms, tummy and back through a straw. As baby focuses attention on different parts of his body, he learns more and more about himself.



COVERS FOR BABY BOTTLES

PURPOSE: Give baby experience with different kinds of feel.

MATERIALS: Scissors, thread and needle (or sewing machine), an assortment of fabrics (colors and textures), and snaps.

- PROCEDURE:**
1. Cut a piece of fabric 6 x 8 inches.
 2. Roll fabric to form a cylinder (tube) shape.
 3. Be sure to try your bottle inside the "tube" to see that it fits.
 4. Stitch along line A-B (or attach snaps along this section).
 5. Decorate with applique, or glued on scraps.

PLAY: Place baby's hand on the bottle so that he feels the fabric as he drinks.

COVER FOR BABY BOTTLES

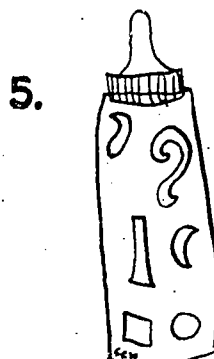
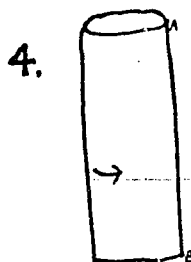
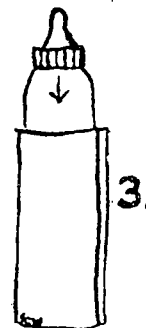
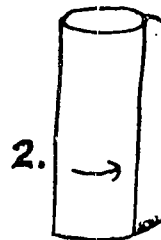
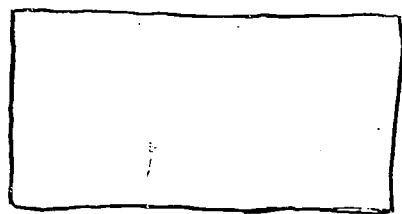

PIN WHEEL

PURPOSE: Practice in focusing eyes.

MATERIALS: Pencil or wood, dowel, pin-up board tack, light paper, and crayons.

PROCEDURE: Color paper in rainbow strips. Cut out pin wheel by tracing pattern. Tack to side of dowel.

PLAY: Blow pinwheel or place in front of window or fan.

FOR THE OLDER CHILD:

All children love to make pinwheels.

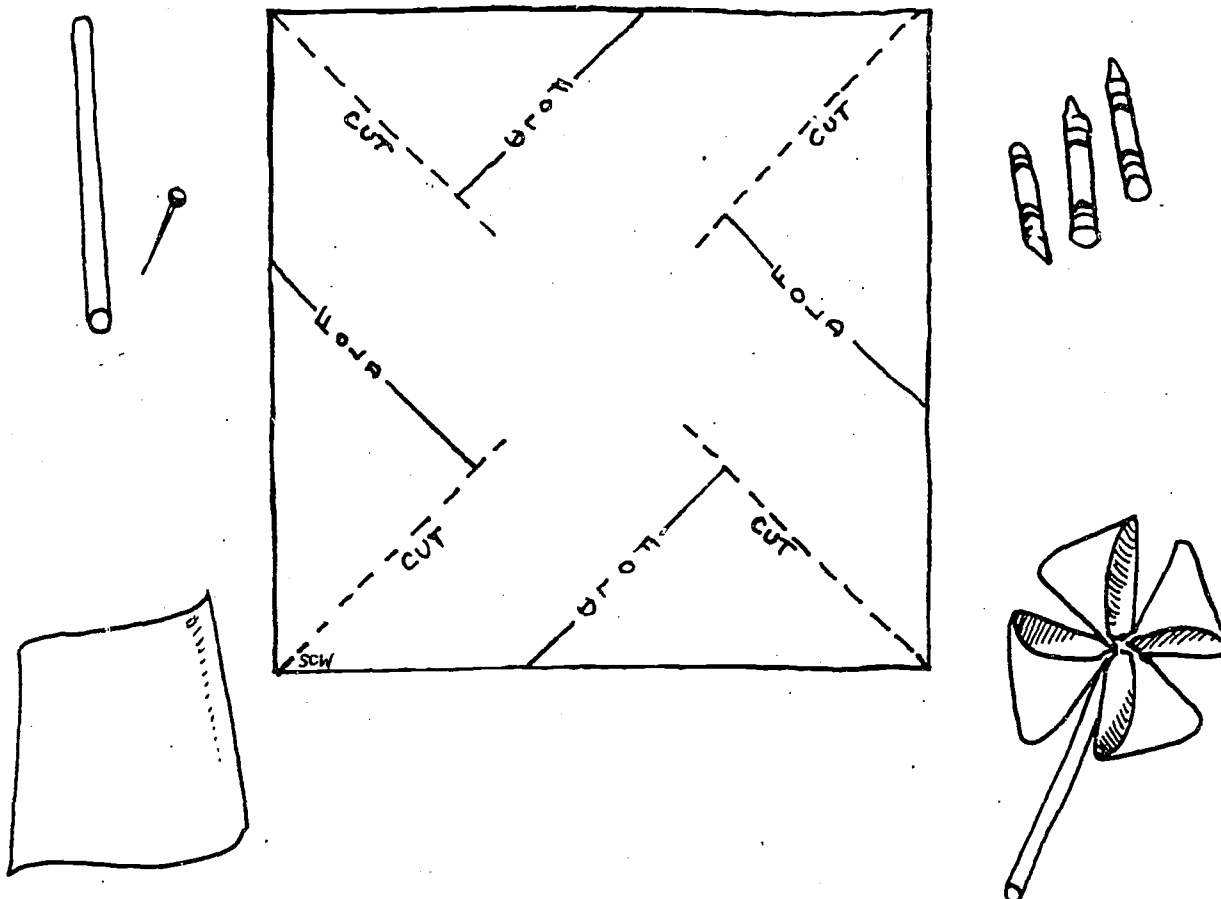
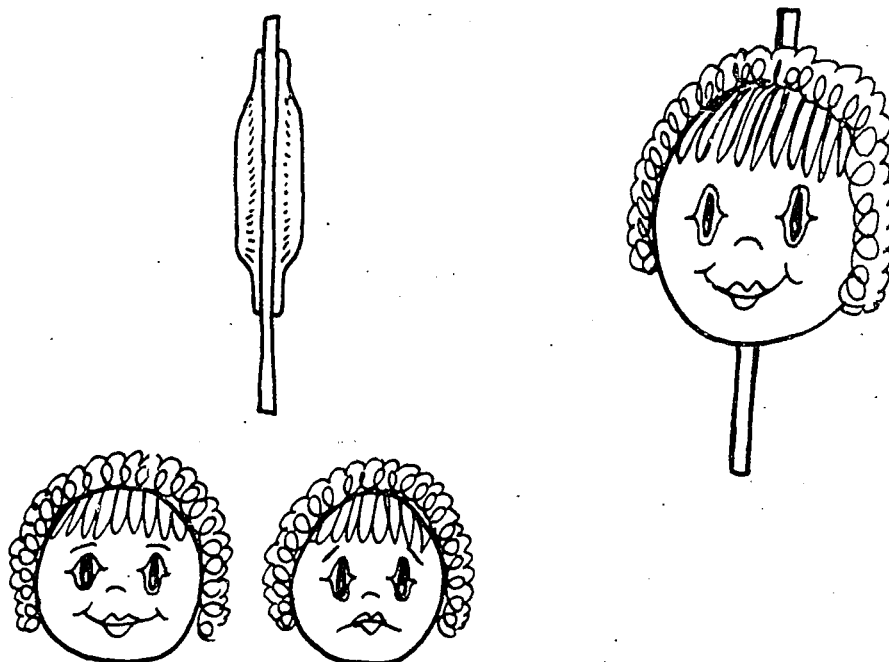

PLATE PUPPETS

- PURPOSE:** Give baby experience focusing on a face.
- MATERIALS:** Dowel, 2 paper plates, glue, crayon or indelible felt markers.
- PROCEDURE:** Draw faces on underside of plate. Try drawing a happy face on one side and a sad face on the other. Glue plates together placing dowel in the center.
- PLAY:** Move plate in and out over baby's crib. Spin it around so that he can see the other side.

FOR THE OLDER CHILD:

Use longer dowels so that dowel sticks out both ends. Let child use as a spin toy. Children can develop their own rules. For example, one point for a sad face "landing" and two points for a happy face "landing."





*Two
Months*



BABY'S VIEWPOINT

TWO MONTHS OLD

Compared to the newborn, the two-month old baby is quite sophisticated. He is no longer under the complete control of a set of built-in reflexes. Now he has become his own master, observing his world with fixed attention and modifying his behavior on the basis of what he observes.

At some time during the third month, your baby discovers his own hand. He examines it very much as he would a new mobile -- looking it up and down, inspecting the fingers, the thumb, the sleeve of his nightgown. Gradually, baby discovers that he can increase the fun of "hand-watching" by moving his hand around, another important discovery about himself.

By now, baby has learned to associate sight and sound. When he hears a noise, he will do more than just turn toward it. He will look for the thing that made the sound. Baby is just barely beginning to learn that there is a real world outside himself. He is learning that what he sees, hears, and feels are connected, and that there are things outside himself that give him sensations. But he still doesn't know that things exist in their own right, apart from the sensations they give him.

MOTOR SKILLS

TWO MONTHS OLD

Compared to the newborn, the baby at two months old is quite sophisticated. No longer the slave of built-in reflexes, the baby has by now modified these reflexes to serve his own purposes. His sucking is no longer a trial and error groping after the nipple. It is an organized and directed effort. Put to his mother's breast, he places his head immediately in the appropriate position and goes about sucking with efficiency and gusto. He is also getting better at sucking things that don't give him nourishment, like hands and pacifiers. When the baby was a month old he would suck his hand if he happened to find it in his mouth. He seemed to have no awareness that the thing his mouth was sucking was also a part of him. Now, the baby brings his hand to his mouth in a quick and efficient maneuver. This purposeful placement of hand in mouth, of course, is not an all-at-once achievement. At first, baby gropes with both his hand and his mouth before he can get them together. Next, the baby learns to place his fist in his mouth in one deliberate movement when his hand is resting near his mouth. The real moment of triumph comes when baby succeeds in bringing his fist to his mouth while lying on his back.

One of the outstanding changes parents notice in the first two months of life is a marked increase in their infant's ability to hold up his head. Around two months, most babies will lift their heads up when lying on their stomach. When you hold him upright,

baby will lift his head off your shoulder for a few brief seconds. A strong baby may be able to support himself on his arms when lying on his stomach.

At two months old, baby also shows the very beginning of hand control. His hand is no longer held in a tight-fisted position with thumb tucked in. Baby now holds his hand open during most of his waking hours. He wiggles his thumb, opens and closes his fingers, and focuses his whole attention on watching one of his hands in action. It seems that baby is now aware that the hand he is looking at belongs to him, and that he can make it perform.

Arms and legs are much more active now. The baby's arms are extended above his head in play. His head and body twist from side to side. He moves his arms and legs up and down in a kind of rhythmic motion. Some babies, when lying on their stomachs, will begin to make crawling movements with their knees, using first one knee and then the other.

SEEING, HEARING AND FEELING

TWO MONTHS OLD

SEEING

The baby now has become more sophisticated at taking in the world with his eyes. He is able to follow an object with his eyes when it is as much as 8 - 10 feet away. He is particularly adept at this if the "object" he is watching happens to be an older sister or brother. Some babies, by the end of the second month, have mastered the art of coordinating seeing and hearing. They associate a pleasant sound with a bell, and, when they hear the tinkling, will turn to look at what is making it.

FEELING

Now that baby keeps his hands open most of the time, he has more opportunity to learn about his world through the way things feel. He seems already to notice the difference between hard and soft, and enjoys the feeling of something soft placed in his hand.

HEARING

Hearing, like vision, becomes more sophisticated in the second month. Baby becomes attentive to sounds, even soft ones - the telephone ring, the window shade flopping, the sound of mommy's footsteps. When he first notices an interesting sound, he gives it his full attention. His legs stop kicking, his arms stop waving, his eyes seek out its source. Then, as baby continues to listen, he resumes the active movement of arms and legs.

SOCIALIZING

TWO MONTHS OLD

By the third month, baby has mastered the art of smiling, and will smile at anyone who bends over the crib. In fact, he smiles at anything that looks like a face. A Pinocchio puppet, a witch's mask, a plate with two eyes, will be greeted with the same smiling response. At about the same time baby learns to smile, he begins to make talking sounds. He will start by saying ah-ah-ee-ee or eh-eh as a sort of experiment. Just as he kicks for the sheer joy of kicking and smiles for the sheer joy of smiling, he "talks" just because he can. If someone copies the sounds he makes he will make them again, and a kind of "conversation" begins.

Now baby needs adults for more than food and comfort. A propped up bottle is no substitute for a talking, laughing, singing, touching parent. Baby needs people to play with him and to respond to what he does. The parent who finds time to talk with, smile with, and coo back to baby during each of his waking periods is helping his baby develop important social skills.

Suggested "Motor" Activities - Two Months Old

When baby begins an activity period make sure that his clothing is loose - the less he wears - the better. Remember that a baby is more active when he is a little cool.

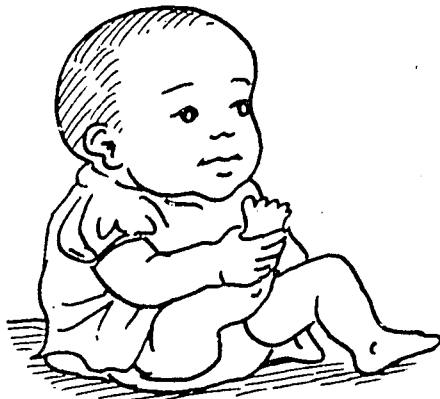

Help baby play with his toes.



Place baby on his stomach on a smooth, colorful mat for a portion of every day. (A piece of linoleum can work very well). Put a large colorful toy like a stack of tin cans, or a clown doll, in front of him. Position the toy so that baby sees it best when he holds his head in the air. This will help baby develop strength and body control.

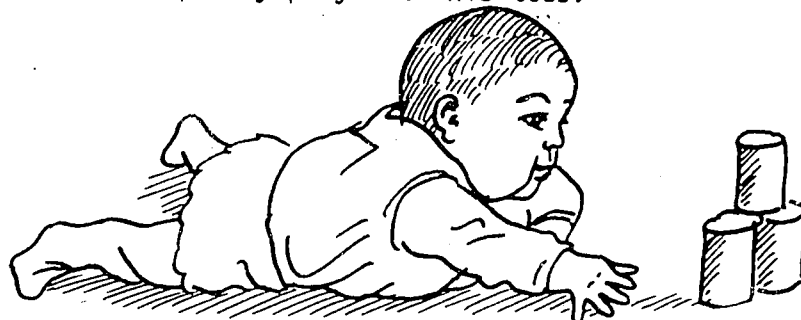

Move baby's arms over his head and down again, one at a time, both together, and then alternately. Repeat with arms going out to the side. Sing-song this jingle:

Little bird, little bird, fly about
First fly in and then fly out.
Start down low and go up high
Little bird, little bird, learn to fly.

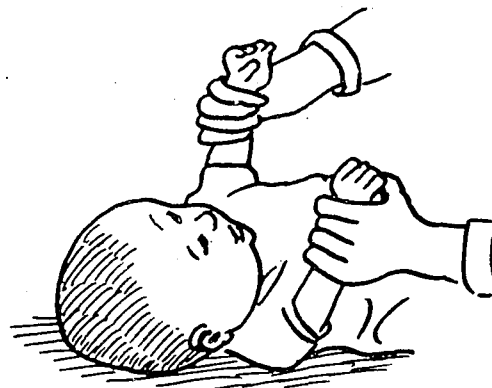

Give baby an opportunity to hear different kinds of sounds. Tap the bottle with a spoon, ring a bell, crinkle paper, whistle. If you are careful to introduce him to just one sound at a time, you will find that he will pay attention to a new sound. Baby learns to listen through practice.

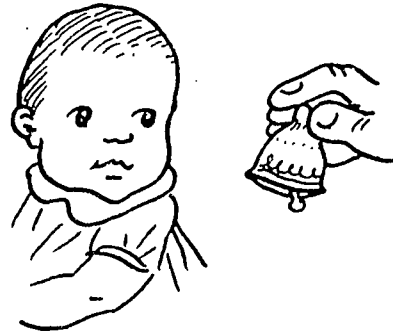

Place baby on his back. Push his legs up to knee bend position, one at a time, and then both together. This helps baby develop a sense of his own body, or "body image."

"Chug-chug-chug-chug
Down the Street
Up and down go baby's feet.

Chug-chug-chug-chug
One two three
I love you
And you love me."

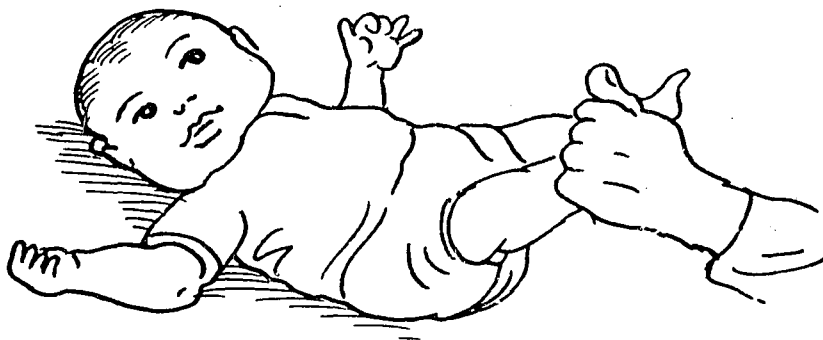

Rub baby's arms and legs with different "textured mittens" - silk, velvet, satin, wool, flannel, or terry cloth.

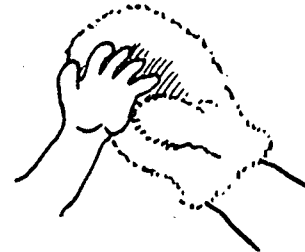

Splash hands and feet in warm water. Pat dry with towel after bath. Baby learns about his world through his sense of feel.

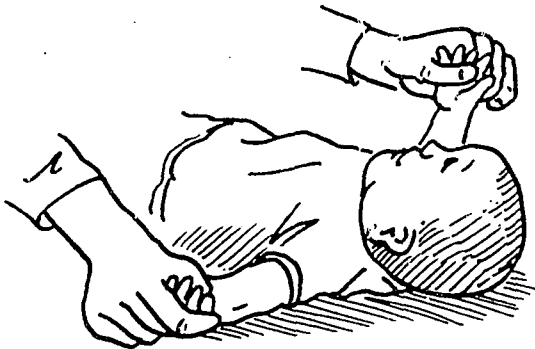

Suggested "Seeing" Activities

Two Months Old

Make sure that your baby has something interesting to look at during all his waking hours. Change the mobile on his crib every few days.



Change the pictures on the wall by crib or feeding chair. (A pin-up board is ideal).

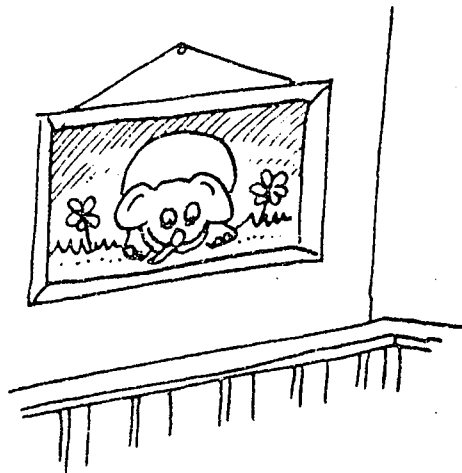

String a cradle gym over his crib or cradle. Change the objects that are attached to the gym. Remember that the baby enjoys bright colors, interesting shapes and things that move easily.

Pin some brightly colored ribbons onto mother's dress or daddy's shirt.



Make baby a pair of "bell mittens" Make sure that the bells are sewn on very securely and placed on the underside so that baby will not mouth them. Sometimes put the right mitten on, sometimes the left, sometimes both. The bell will encourage baby to look at his hand. He will learn that he can make his mitten ring and will come to connect the sight, sound and feel of it.



Move hand puppet up and down, back and forth, and around in a circle within the baby's line of vision. The more practice baby has with using his eyes, the better he learns to see.



Suggested "Socializing" Activities - Two Months Old

Imitate the sounds your baby makes. Listen for him to repeat the sound and then respond again. Make sure to look in baby's eyes during these conversations.

Learn some little jingles to go along with different activities such as bathing, feeding, and exercising.



"Splash splash splish, my little fish
Make a big splash if you wish
Splash the water all around
Listen to the splashing sound."

If you happen to have a tape recorder it's fun to use with baby. Tape record the sounds your baby makes. Play back the tape to baby. The sound of his own voice encourages baby to keep up the talking.

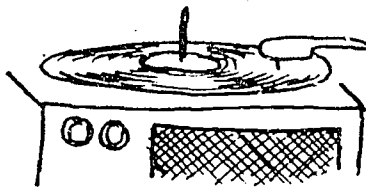
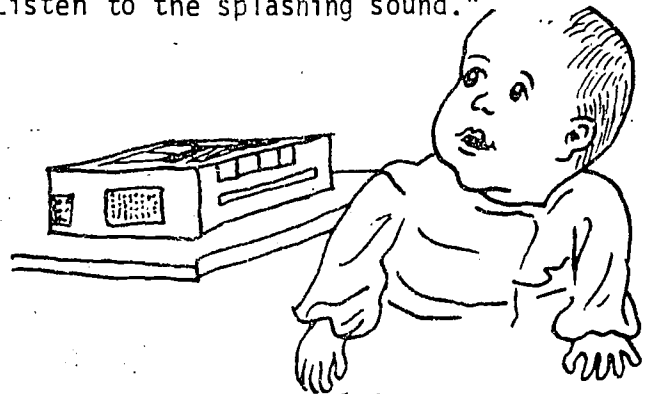

Play a special record to signal feeding time. Before long, baby will learn what the record means.

Move a plate puppet (see page 30) back and forth in front of baby. Show him the sad side and then the happy side. You will find that baby loves to look at a face, and will soon begin to talk to it. The fact that the face keeps changing, keeps up baby's interest.

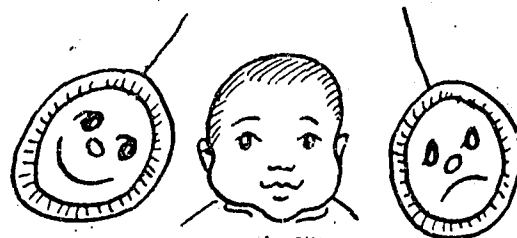

Put a home-made puppet on your finger and let baby watch it dance. The sillier looking the puppet, the more baby seems to enjoy it.



BELL MITTEN

PURPOSE: Development of body awareness; association of sight and sound.

MATERIALS: Scissors, bell, needle and thread, and elastic material.

PROCEDURE: Cut the cuff of a sock, or a piece of wide elastic so that it will fit loosely around baby's wrist or ankle.

Sew a bell very securely to the middle of the strip.

Join the ends of the elastic strip to form a band or "bracelet."

Sew the ends together.

PLAY: Place bands on first one hand and then the other. Place bands on alternate feet as well. After a while place bands on each hand and on each foot.

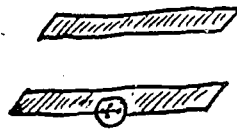
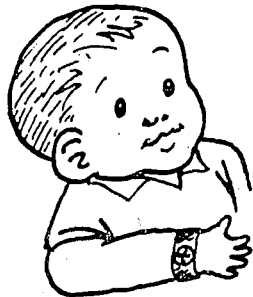

FINGER PUPPET

PURPOSE: Body awareness, social play.

MATERIALS: Odd glove, embroidery thread, wooden doll head or plastic bottle top, and glue.

PROCEDURE: Sew eyes, nose and mouth on bottle top or glue wool on doll's head. Attach head or bottle top to finger tip of glove.

FOR THE OLDER CHILD:

Make story book characters by rolling letter weight paper into a cone, drawing on faces, and attaching to glove with strong thread.

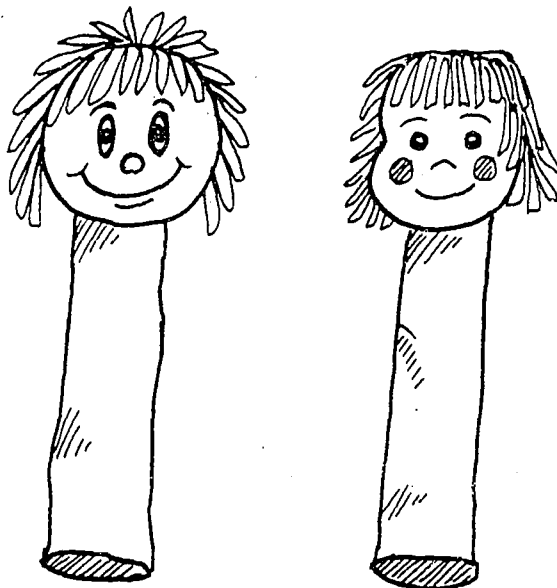

TEXTURED MITTENS

PURPOSE: Provide child with different feel experiences.
Help child develop body image.

MATERIALS: Pinking shears (or scissors); needle and thread (or sewing machine); several kinds of fabric -- felt, flannel, old wash cloths, broadcloth (burlap), satin, nylon, etc. Suggested colors are red and/or yellow.

PROCEDURE: Take a piece of fabric and fold it in half.

Place your hand flat on the fabric with your fingers spread. Trace around it, about an inch away, so the mit will fit loosely. (You don't have to trace between the fingers).

Cut out the mitten, keeping the fabric folded so that you cut both sides at once.

Sew your mitten together along the edges.

Each member of the family can have his own textured mitten. Scraps can be used to make "two-tone" mittens, with a different texture on each side.

PLAY: Rub baby's arms, legs, back, belly. Count fingers and toes while wearing mitten.

FOR THE OLDER CHILD:

Make into policeman mit for a traffic control game.

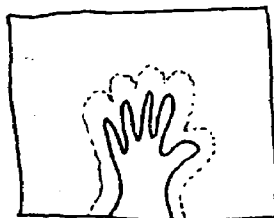
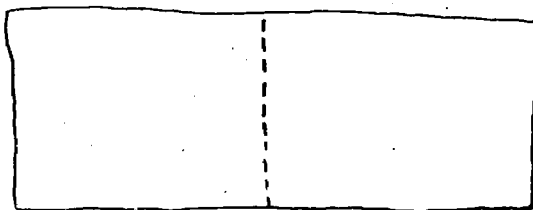

FOOT SOCKS

- PURPOSE:** Encourage foot-play, develop body image.
- MATERIALS:** Odd socks (preferably different colors), buttons, embroidery thread, and bells.
- PROCEDURE:** Securely sew on button eyes and bell nose. Embroider mouth or sew on strip of red fabric.
- PLAY:** When baby first "discovers" his toes, put on face socks to encourage foot play.

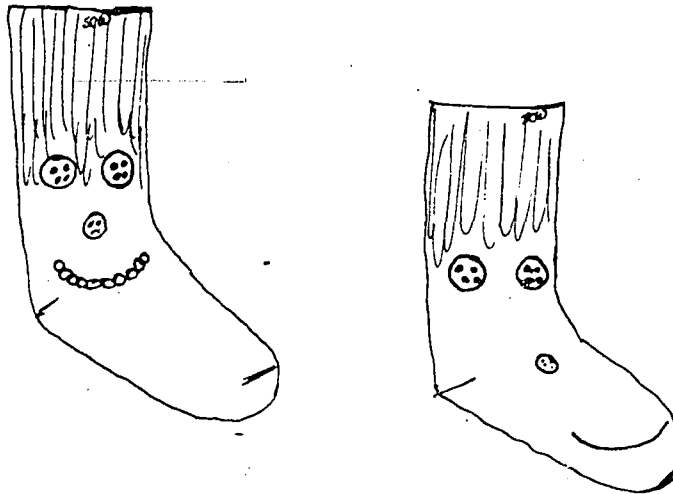



Three Months

BABY'S VIEWPOINT

THREE MONTHS OLD

The fourth month is exciting for baby and parent alike. As the infant spends more and more time awake each day, he has more time and energy to actively explore his surroundings. His eyes catch sight of the mobile hanging over his crib. He looks from right to left, then from left to right, outside to inside, inside to outside. If his father moves a rattle across the crib, he follows it intently with his eyes. When it disappears from sight, baby continues to stare at the place where it was. Is baby registering surprise because it disappeared, or does he believe that looking will bring the rattle back?

Baby's favorite toy at this time is himself. He seems to be constantly trying to discover what he is, where he is, and what he feels like. His fingers explore his eyes, nose, mouth and chin. He rubs his hand along his cheeks, patting, pinching, and sometimes scratching. Many babies at this age will join their hands together and let each hand take a turn playing with the other.

MOTOR SKILLS

THREE MONTHS OLD

Differences in rates of development, particularly in the motor area, are very evident during the fourth month. While an active baby may already be turning from back to stomach, most babies limit their motor activity to energetic bicycle movements with legs and arms. Sometime during the fourth month, most babies will bat at a cradle gym if it is strung over their crib. This batting activity follows a regular pattern. Baby bats at the gym, stops and then resumes his batting with increasing vigor. Piaget, a Swiss psychologist who has studied infant behavior, would insist that the first time the baby bats at the gym, it is accidental. But when he hits it, the gym moves up and down in an interesting way. The baby bats some more trying to make this interesting event happen again. In this effort to make something interesting happen again, we see the baby's first purposeful behavior.

SEEING, HEARING AND FEELING

THREE MONTHS OLD

SEEING

During the fourth month, baby shows an increased interest in his own hands and anything that they happen to be holding. He will lay awake on his back staring intensely first at one hand and then the other. If you place a rattle in his hand he will inspect it with his eyes before bringing it up to his mouth for further exploration. Baby is really beginning, too, to recognize familiar objects. Just a few weeks ago he continued to cry with hunger until the nipple was in his mouth. Now, as soon as he sees the bottle, he reacts. His crying may stop or it may get louder. In a sense, baby is attaching a meaning to a "visual stimulus." The bottle he is looking at is more than a sensation. It represents comfort or the end of his hunger pangs.

HEARING

Association between sight and sound is now well established. Baby turns his head toward the sound of his mother's voice. A jingling rattle attracts his attention, and he will turn his head completely around in order to keep it in sight. He particularly enjoys musical toys, radio, records, or even the beat of a metronome. He will turn toward the thing that makes noise even when it isn't moving.

FEELING

With his hand open most of the time now, baby uses his fingers for active exploration. The soft border of the blanket slips between his fingers and he rubs his thumb up and down to continue the pleasant sensation. He tells the difference now between rough and smooth, and will prefer satin to muslin, silk to corduroy.

SOCIALIZING

THREE MONTHS OLD

By the fourth month, the infant has become quite a social little being. His response to attention, his delight with imitative play, his active vocalizations, are all signs of a need and readiness for social interaction.

Communication between parent and child takes place in a very real sense during this fourth month of life. Mother can now identify her own baby's cry, and can interpret a whole range of sounds that baby makes -- the whimper of hunger, a scream of pain, the laugh of delight, the gurgling of vocal play.

By now, too, baby is beginning to show a real interest in what is happening beyond his body. When his rattle is taken away or the bell stops ringing, baby continues to look at the spot where it was. It is as if baby can recognize that there really is a world out there that he somehow has to sort out.

Suggested "Motor" Activities - Three Months Old

Place baby on his stomach on a hard surface. Standing behind him, place the palms of your hands against the soles of his feet. Baby will ease himself forward by pushing first against one of your hands and then the other. Practice with this pushing exercise will get baby ready to crawl on his own. (If baby is already crawling on his own, encourage him to do more by placing him on a slippery surface with toys just out of his reach).

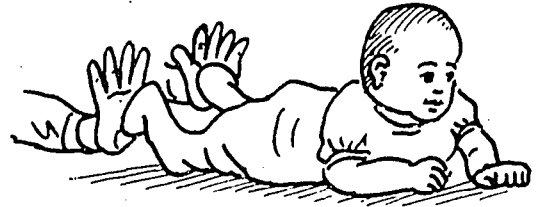

The playpen is an ideal spot for an infant during the fourth month. String a colorful wooden bead or spool necklace across the playpen so that the baby's batting and kicking will produce a noise. (A cradle gym can also be strung between two chairs, if you don't have a playpen).

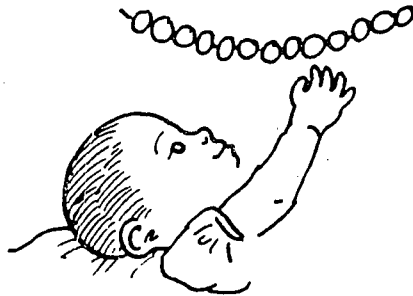

Pull the baby up gently and slowly by his arms in a "see-saw" game. Here's a chant to use with the game:

Up my little bundle comes
Down my bundle goes,
Peek around, have you found
Baby's wiggly toes.

This game strengthens baby's stomach, and at the same time lets him see the world from different points of view.

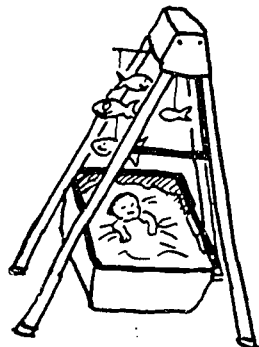

The most effective cradle gym jingles and spins when baby hits it. Position baby so that he can activate the cradle gym with his arms and then with his feet.

Suggested "Seeing, Hearing and Feeling" Activities - Three Months Old

Make baby a maypole with ribbons and bells. Spin it around at different speeds, allowing baby to watch. As you give baby opportunities to watch and listen to moving things, he learns to coordinate his eyes with the movement of his head.

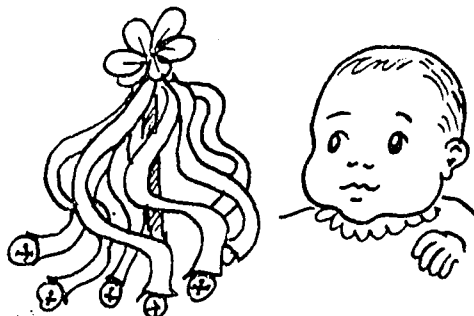

Using a coffee can and a wooden spoon, play different rhythms for baby. After awhile he will recognize a marked change in rhythm.



Make masks out of paper bags. Let the family join you in a peek-a-boo game with baby. Most babies enjoy even a funny looking face, and will smile at a mask that might terrify a toddler.



Place a rattle in baby's hand as he lies on his back. Even though baby may not be able yet to grasp the rattle on his own, he enjoys looking at it once it is in his hand.

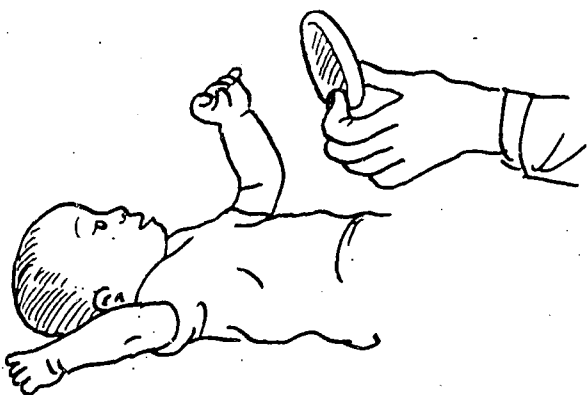

Give baby a feel ball, made out of different textured materials. Baby will learn to recognize differences in feel through this kind of experience.

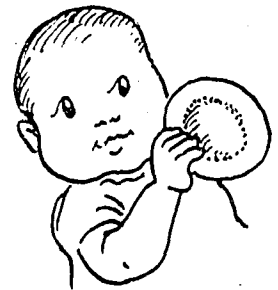

Place the crib in front of an open window so that the wind moves a mobile creating movement, rustling and shadow.

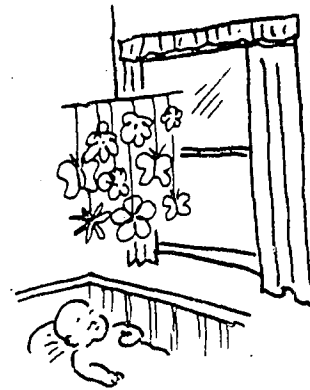

Place baby under a tree. He enjoys listening to the rustle of leaves, and watching the play of light and shadow as the leaves move with the wind.



Suggested "Socializing" Activities - Three Months Old

Carry on conversations with baby at every opportunity. Use different tones of voice, high, low, loud, soft, giggling, laughing, soothing. When baby "talks" to you, wait until his "sentence" is over and then imitate his sounds. The more you talk with baby, the more babbling he will do.

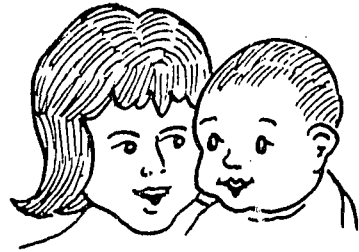

Play "this little piggy went to market" with baby's toes.

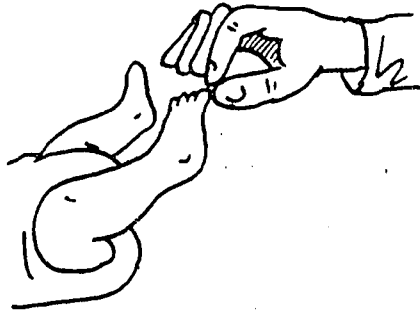

Call the baby by name. Substitute his name for "baby" when reciting rhymes.

Lift baby up and down in your arms so that he can watch your face from different perspectives first he looks up and then down.

Play a "wiggle" game with baby using these rhymes.

"Where is baby's nose?
Where are baby's eyes?
Touch the part that blows
Now touch the part that cries."

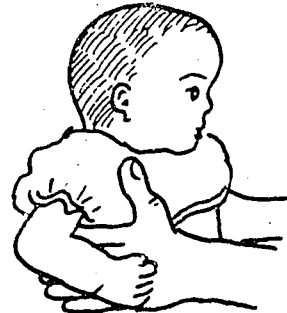

Good morning, Mr. Thumb-0
How do you feel today?
Jump around and take a bow
Then run, run, run away.

Good morning, Finger One-0
How do you feel today?
Jump around and take a bow
Then run, run, run away.

Good morning, Mr. Toe One-0"

Lift up baby's legs and then let them fall as you recite.

Hippety Hippety Hippety-Hop
Hippety-Hip and then we flop.

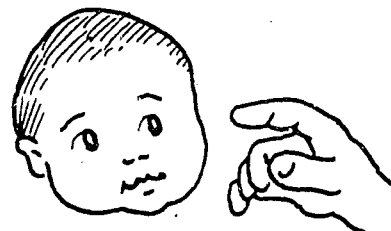

CRADLE GYM

PURPOSE: Give baby practice in grasping.

MATERIALS: Heavy cord or gro-grain ribbon, plastic bracelets, or pipe cleaners, curtain rings, spools, cloth tape, colored beads are optional.

PROCEDURE: Cut ribbon or cord to width of crib. Tie on to curtain rings on each side. Make rings out of pipe cleaners by twisting into a circle and protecting ends with cloth tape.

Cut elastic to four inch length. Loop one end and sew on pipe cleaner rings or bracelet. Loop the other end and sew.

String the cradle gym by interspersing beads, elastic with rings and spools.

PLAY: Allow baby to reach the gym with his hands when lying on his back or stomach. Add variety by turning baby around in the crib and letting him kick with his feet. Make the cradle gym more interesting by attaching ribbons, rattles, bells, or keys.

FOR THE OLDER CHILD:

Make an exercise gym. Use double curtain rings, rope and cloth scraps. Make rings out of rope, winding the cloth around it to protect child's hand. Attach to a tree branch; let child use it for pull ups or swinging.

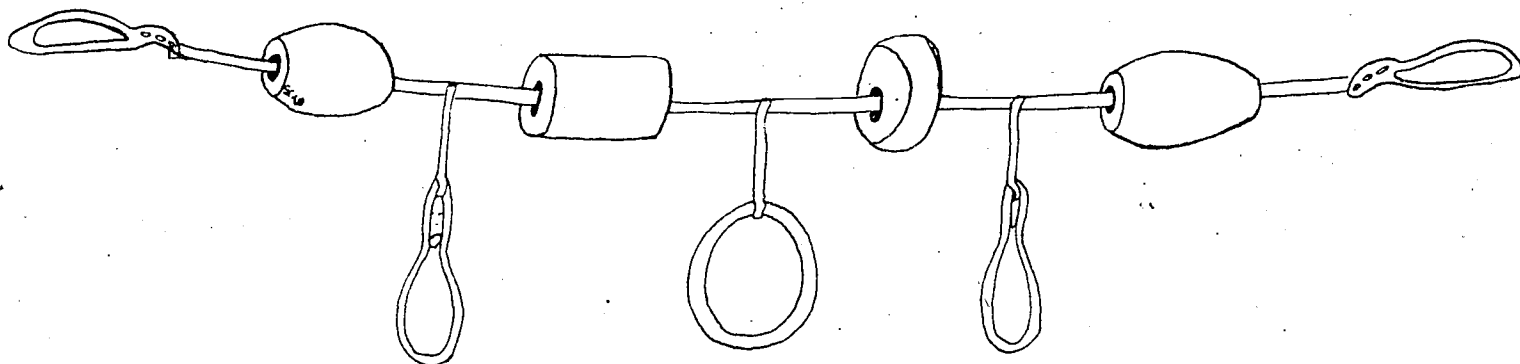

MAYPOLE

PURPOSE: Give baby practice with following movement with his eyes and coordinating sight and sound.

MATERIALS: Pole (cardboard tubing), dowel, stick, ribbon and bells.

PROCEDURE: Cut pole to about 12-14 inches (or use cardboard tube as is).

Sand and paint with NON-TOXIC paint. Use bright colors.

Cut several ribbons about 10" long.

Attach bells to the end of the ribbons.

Attached about 4-5 ribbons to one end of the pole.

PLAY: Spin maypole over babies crib when he is wide awake.

FOR THE OLDER CHILD:

Use broom stick and crepe paper streamers. Provide one streamer for each child in the maypole dance. Let the children skip to music until the streamers are wound around the pole. Then let them skip in the opposite direction to unwind the streamers.

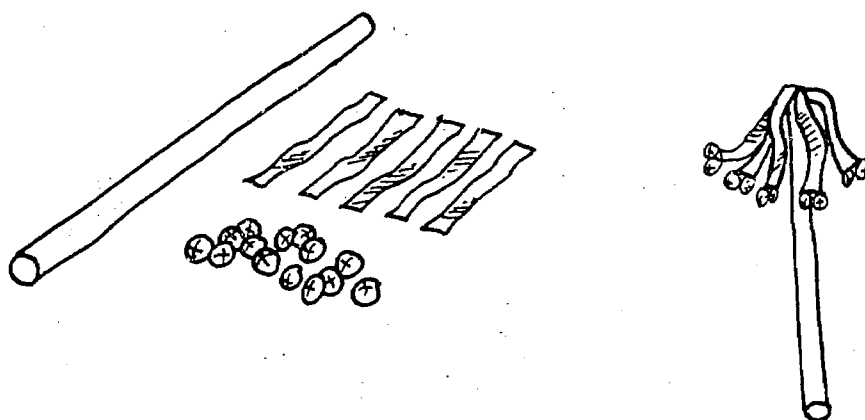

FEEL BALL

PURPOSE: Experience with texture, throwing, catching, pushing, rolling. Following movement with eyes.

MATERIALS: Fabric scraps (felt, flannel, silk, burlap, cotton, corduroy, satin, fur, silk), foam rubber or nylon stockings.

PROCEDURE: Cut 4 pieces of pattern A and 2 pieces of pattern B.

Sew patterns a together along flat side.

Sew on end (pattern B)

Stuff ball with stocking or foam and sew second piece of pattern B.

FOR THE OLDER CHILD:

All children love to play ball with a feel ball.

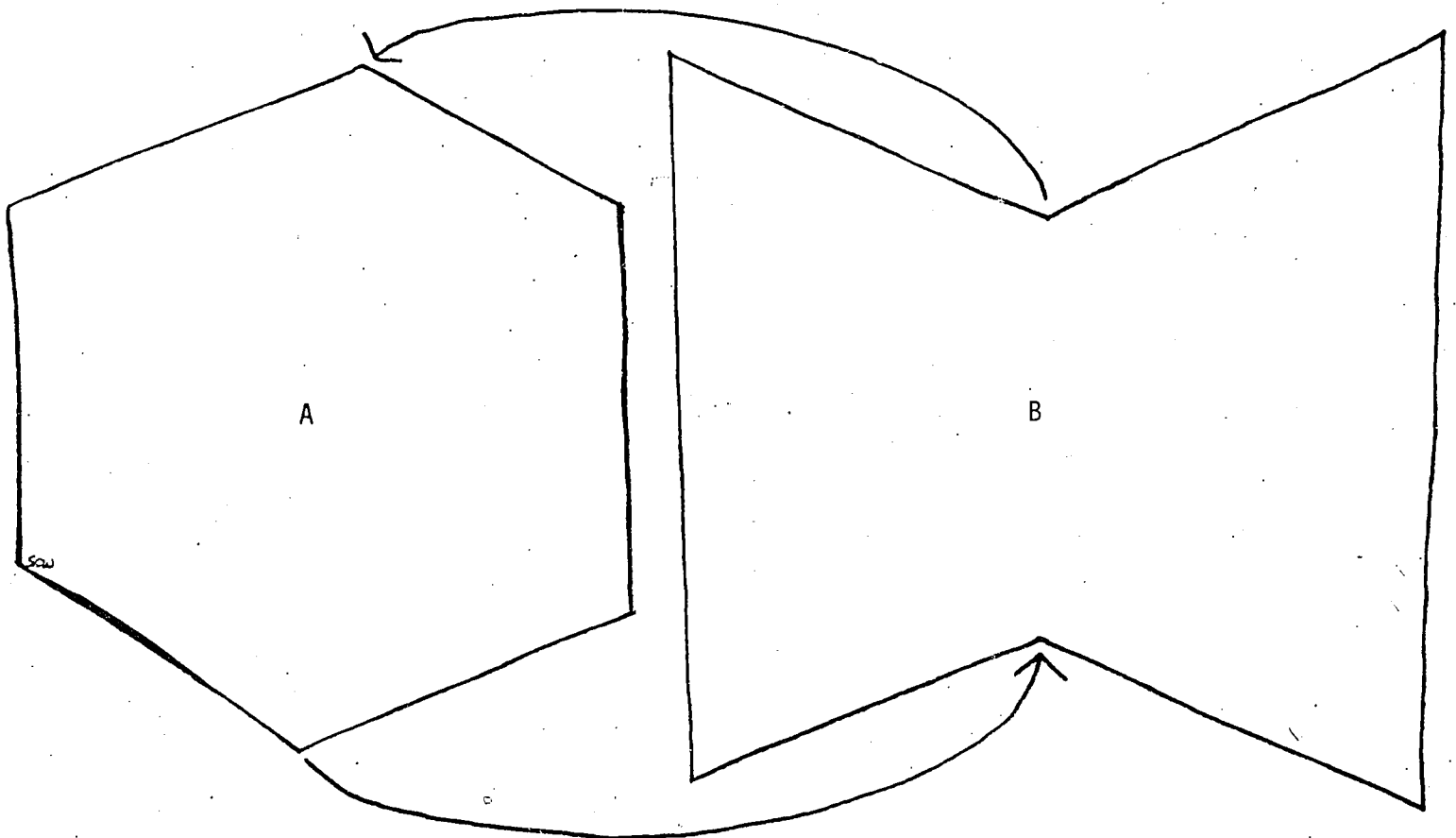



Four Months

BABY'S VIEWPOINT

FOUR MONTHS OLD

For most babies, the major milestone of the fifth month is a new-found ability to reach out and grasp. This important learning allows the baby to manipulate the objects in his world. He can get things he wants and he can make things happen. By the end of the fourth month, baby is quite good at reaching up and batting the "gym" strung over his playpen. One day, while he is batting, his hand happens to grasp onto the ring of the gym. The result is exciting. The gym rattles and the toys attached to it jump up and down. Baby is all eyes and ears. Then, while his attention is focused on the toys, his hand opens up and the ring slips out. Baby wants to play the game again. He reaches toward the ring, but it slips out of his hand. Baby persists. Sometimes he closes his hand too soon, sometimes too late, but eventually he succeeds in capturing the ring. By practicing this game over and over, baby becomes quite skillful. Soon he learns to aim straight for the ring and grasp it with a single try. With just a little more practice, he will learn to grasp a whole new set of things -- a rattle, a bottle, the string of beads on Mother's neck, the glasses on Daddy's nose. As the baby learns new ways of controlling the objects around him, he develops his very first notions of space, time and causality.

MOTOR SKILLS

FOUR MONTHS OLD

For many babies, the fifth month marks the beginning of mobility. The baby learns to crawl, stomach down, on a slippery surface, pulling himself along with his arms or pulling his legs up in a frog-like position and pushing forward with his feet. Often the baby learns to crawl backwards before he manages to crawl forward.

Most babies can roll now from stomach-to-back. Some babies can also manage a back-to-stomach roll. The baby now sits up quite successfully when propped on pillows, and takes some tentative steps when held on his feet. Contrary to popular belief, standing a baby on his feet before he can successfully bear his weight does not produce a bow-legged baby.

Babies' hands are now busy reaching and grasping. As long as baby is able to see both his hand and the object at the same time, baby is able to grasp at just about anything he sees. This grasp, however, is quite crude. The thumb is not yet an "independent agent." Baby holds an object by pressing his fingers against the palm of his hand. An object lying on a table is "scooped" up rather than picked up.

SEEING, HEARING AND FEELING

FOUR MONTHS OLD

An unbreakable mirror hanging from a cradle gym or attached to the side of his crib is very exciting for the four-month-old. He is now able to recognize his own image in the mirror and smiles when he sees himself.

Baby's main means of exploring objects is with his mouth. He mouths an object as soon as he grasps it. Seeing, grasping, and mouthing seem to happen in rapid succession. After awhile he will add visual inspection to this routine. He will look at the object he has grasped before bringing it to his mouth.

By the end of the fourth month, baby seems to devote most of his energy to exploring with hands, mouthing things that he looked at and listened to more passively at an earlier age. When Mommy leans over to speak, he tries to grasp her lips as if to physically capture her words.

SOCIALIZING - FOUR MONTHS OLD

At four months old, babies are delighted with visitors and welcome a stranger with the same enthusiasm as they do a parent or sibling. As a matter of fact, they are delighted with faces in just about any form. The scariest looking mask or the oddest looking puppet are delightful playmates from the baby's point of view.

Babbling reaches a high point during the fourth month. Baby's repertoire of sounds undergoes a rapid expansion. He masters most of the vowel sounds as well as a few of the consonants. Although the four-month-old may carry on a fine conversation with a bird mobile or a bright colored rattle, he seems most enthusiastic when faced with a responsive audience. Mommy imitates his babbling sounds and baby's babbling increases in volume and intensity. A surprise response from Mom or Dad will initiate a chuckle and sometimes, even a belly laugh. The four-month-old baby with his constant babble and ready laugh is usually easy to live with and fun to take on visits.

Suggested "Motor" Activities - Four Months Old

Mild rough-housing is very much in order now. Hold baby at the waist, raise him in the air, jostle him up and down, then hold him upright in a standing position.

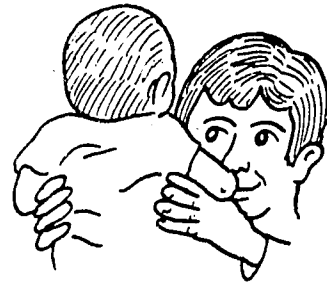

Place toys out of baby's reach. If he wants something badly enough he'll find a way to get to it.



Let baby play on a firm, flat surface wearing only a diaper. Free from the restrictions of clothing and covers, he is able to perform his finest gymnastics.



Now that baby is learning to grasp, give him lots of opportunities to practice. Hand him a rattle from one side and then the other. Hold it close to him and then make him reach for it.

Give him different kinds of toys to hold. Let him grasp a bean bag, for instance, so that he will learn to adjust his grasp according to the toy he is holding.

Place a small pillow under baby's tummy while he is on a rug. This will strengthen neck and arm muscles.

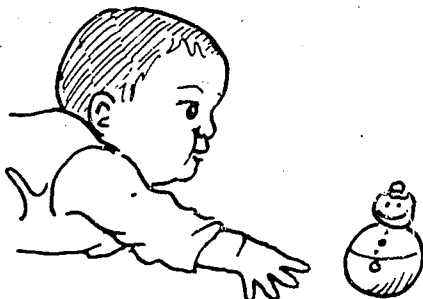

Put sock puppets on baby's feet.
At first baby will just look at
his feet, but after awhile, he
will succeed in catching a foot -
a very important "conquest" in
his young life.

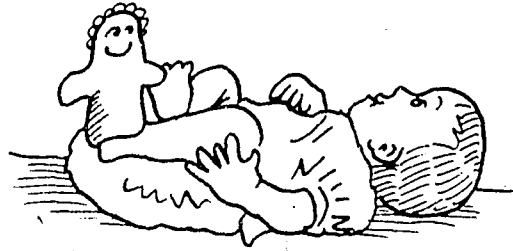

Keep baby propped in a sitting
position for part of every day.
A baby bounce chair or carry-all
can be used for this purpose. The
world looks new and different
to baby when he sees it from a
different angle.

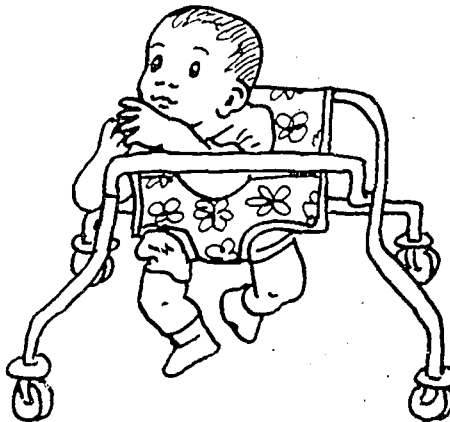

Suggested "Seeing, Hearing and Feeling" Activities - Four Months Old

Stand a bamboo pole or cardboard spindle at an angle in the corner of the baby's playpen. Place colored rings over the pole and let them drop from the top to the bottom. Baby will enjoy watching the rings fall. As he becomes efficient at watching the rings fall slowly, increase the speed of their fall by straightening up the pole. As baby watches how the rings behave, he is gaining his first experience with the "laws of nature."

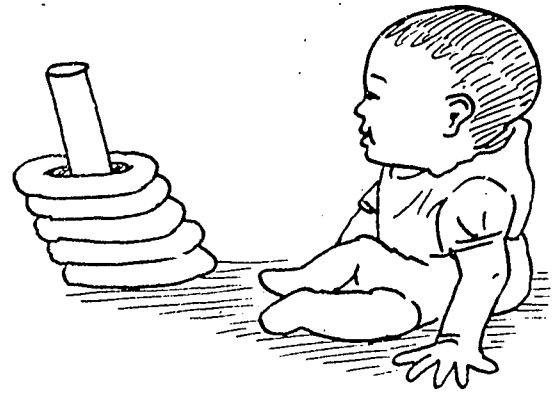

Place a soft squeak toy under the sheet. Hit it with baby's hand so that it makes a squeak sound. Baby will soon learn to squeak the toy by himself.



Build a cardboard "hill" in baby's playpen. Let baby watch a small wheel-toy slide down the hill. Before baby can really understand cause and effect, he needs to have many different experiences with cause and effect "at work."

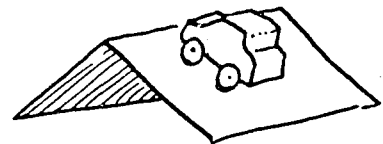

Hold out a colorful rattle for baby to grasp. First let him grasp with one hand and then with the other. Allow the baby to reach the rattle at different heights and from different positions. As baby practices his grasping, he gets better and better at coordinating hands and eyes.

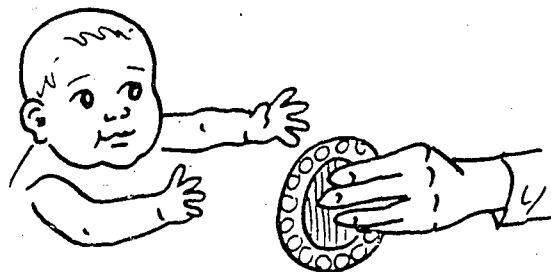

Keep cradle gym over playpen. Make sure that the rings on the gym are adjusted to a height that will allow baby to grasp them easily. Attach bells and sound makers to the gym so that baby will be rewarded with different sounds when he succeeds in grasping the ring.

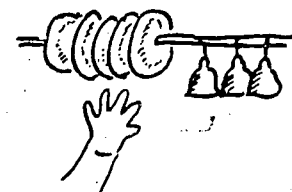

Suggested "Socializing" Activities - Four Months Old

Tape record baby's babbling and play it back to him. Tape record Mommy's and Daddy's voice, and play this back as well.

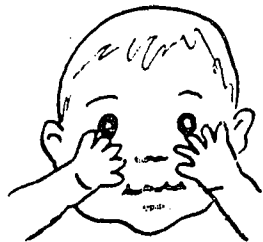
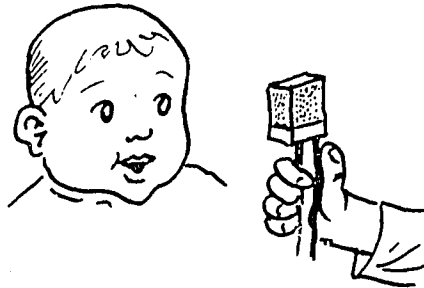

Play peek-a-boo with baby. Try placing your hands over your eyes, then over baby's eyes. Place a blanket over your head and come out with a "boo." Baby will enjoy all variations of the game.

Show baby himself in a non-breakable mirror. Give him the mirror to hold. (You can make a fine mirror out of foil).

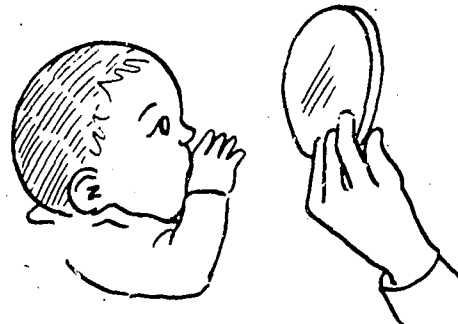

Play a record for baby and hold him up so he can dance to it.



Move baby's hands up and down - in and out, as you recite this jingle.

Up-up-up
My baby goes
Reach way up
And touch my nose

Down-down-down
My baby goes
Reach way down
And touch your toes

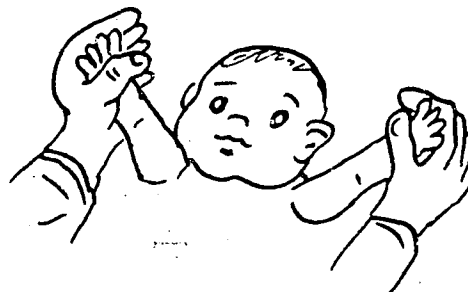

CARDBOARD TUBE SLIDE

PURPOSE: Increase eye movement efficiency.

MATERIALS: Cardboard tubing (from Christmas wrapping)
or Scrap Wood

PROCEDURE: Use long (2-3 feet) cardboard tubing from
holiday gift wrapping paper.

Cut the tube in half through the center.
(Be sure to cut both sides)

You should now have two slides. These can be
painted or covered with colorful paper.

Make a stand with a shoe box, by cutting a
half moon in one side or prop up on a pillow.

WOODEN SLIDE:



This slide will be more durable. It's great
for small toy trucks and cars.

Cut one piece of wood (1/2" pine or plywood)
2-3 feet long

Nail or glue two thin strips of wood (yardsticks
work very well) to the sides of the base to serve
as guides for the rolling objects.

Be sure the wood is smoothly sanded. Then paint
with a bright, NON-TOXIC paint.

Slide toys, cars, or other wheel toys down the
slide and let baby watch it.

FOR THE OLDER CHILD:

An older child will learn to slow or speed up his
toy car by changing the slope of the slide.

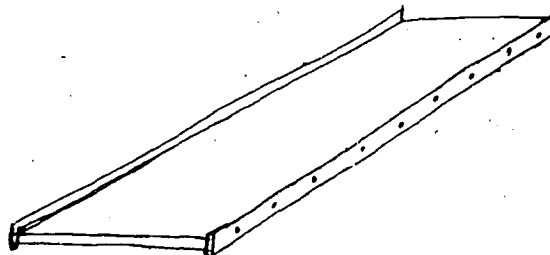

SLIDE BAR

PURPOSE: Coordinate seeing with hearing. Help child anticipate direction of movement.

MATERIALS: For the rings, use curtain rings, plastic bracelets, cardboard tubing cut into short pieces
For the bar, use a bamboo pole, dowel, or cardboard tubing
2 jar tops or small paper plate
Ribbon
Pipe Cleaners

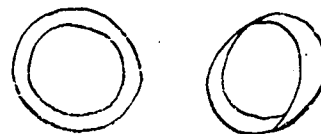

PROCEDURE: Cut the dowel, pole or tubing to length. It should be 2 - 3 feet long. Sand and paint with a NON-TOXIC paint, or cover with adhesive backed paper. If you are using cardboard tubing for rings, cut in two inch slices. Tie on ribbons or attach bells to the rings to make them more interesting. Place rings on dowel. Cut hole in jar top or small paper plate and jam cylinder through. Tie ribbons with pipe cleaner ring attached to each end of the cylinder. String cylinder from crib. Insert bells or beans to make musical "sound" appeal.

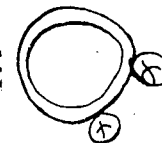

PLAY: Place in playpen at an angle. Lift rings to the top of dowel, and let baby watch them fall. When baby has learned to follow the rings down a slow slope, make the slope steeper by changing angle of dowel.

FOR THE OLDER CHILD:

Use as a rhythm instrument by tilting dowel back and forth.

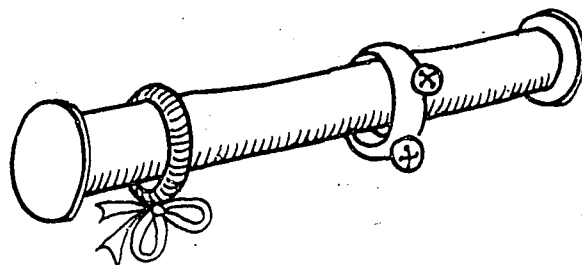

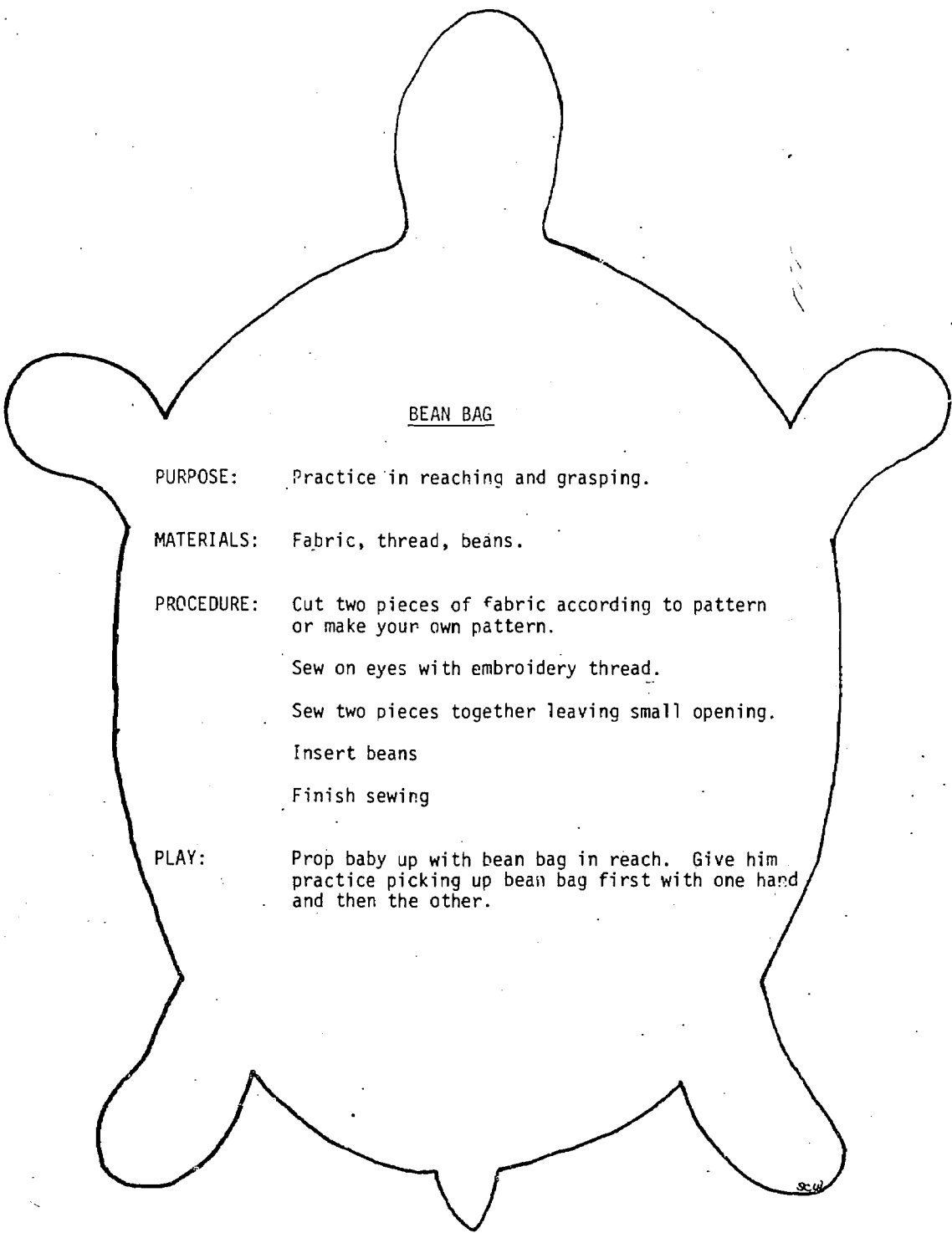

BEAN BAG

PURPOSE: Practice in reaching and grasping.

MATERIALS: Fabric, thread, beans.

PROCEDURE: Cut two pieces of fabric according to pattern or make your own pattern.

Sew on eyes with embroidery thread.

Sew two pieces together leaving small opening.

Insert beans

Finish sewing

PLAY: Prop baby up with bean bag in reach. Give him practice picking up bean bag first with one hand and then the other.

MIRROR

PURPOSE: Baby learns to recognize himself in the mirror.

MATERIAL: Aluminum foil, shoe box, tape

PROCEDURE: Cut aluminium foil so that it covers back and side of box.

Stretch aluminum foil over the box. Use rolling pin or wooden spoon to make it very smooth.

Tape in place.

Cut handle to size and tape to inside of box.

PLAY: Loop over cradle gym or side of crib where baby can see it easily.

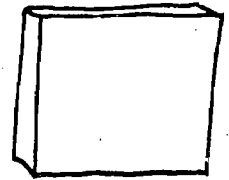

BOX

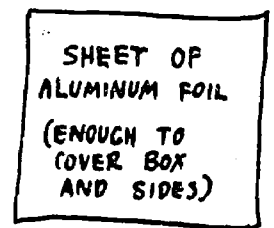

FOR OLDER CHILD:

Let child make doll house dresser by glueing together two kitchen match boxes, making mirror to size out of heavy tag board and foil, and glueing to match box dresser.

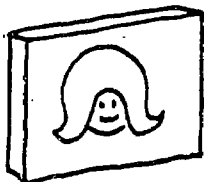

COVER BOX WITH FOIL (SMOOTH-OUT FOIL WITH ROLLING PIN, OR ANY FLAT, SMOOTH OBJECT)

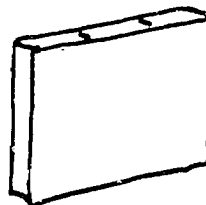

MAKE TWO SLITS IN BOX - CUT A PIECE OF CARDBOARD AT LEAST 7" LONG AND 1" WIDE



TURN ENDS OF STRIP AS ABOVE, INSERT IN SLITS OF BOX ON THE INSIDE

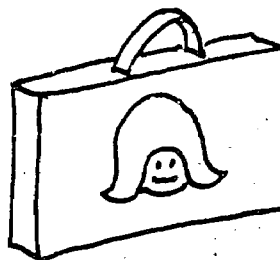



Five Months

BABY'S VIEWPOINT

FIVE MONTHS OLD

Baby keeps his hands busy all the time during most of his waking hours. His reach and grasp are now under his complete control. He can not only scoop up a rattle or a ring, but can also release it at will. If a toy happens to be out of his reach, he looks at the toy and opens and closes his hand in a kind of abbreviated, almost symbolic, movement. It is as if the rattle by now has developed a special meaning. "A rattle is something to grasp, to hold, and to shake." The baby is trying to make sense out of his world. He has learned to define the things around him by what he can do to them.

Baby seems to realize now that there are two sides to his body. Some babies are able to hold a toy in one hand, transfer it to the other, and then change back again. As baby looks from one hand to the other, or passes a rattle from hand to hand he seems to be just as interested in what his hands are doing as he is in the toy itself.

MOTOR SKILLS

FIVE MONTHS OLD

At five months, motor skills may be developing rapidly. Although the pace is different for different youngsters, many babies at five months old will be crawling around the room, making their first attempts to sit up, kicking their legs rapidly when placed on their stomachs in the bath, rocking, and swaying back and forth in their cribs. It is important to realize that the baby who has not achieved these motor feats at five months old is not in any way less capable. First, babies mature at different rates. Second, babies have different styles of learning and different ways of dealing with their world. The baby who is unable to move off a mat in the middle of the floor may be taking in the whole scene with his eyes.

Most babies by now have become quite adept at reaching and grasping. This feat can be performed with one hand and then the other. Most babies have also learned to rotate their wrists in order to inspect the object they have grasped. This wrist rotation, combined with a new ability to use his thumb, makes it easier for baby to pick up small objects and even hold a spoon.

A jump chair is very popular with many five month old babies. Baby loves to push against the floor with his feet and bounce himself up and down. Make sure that the jump chair you use is strong, and well-balanced. A robust baby in an active moment, can tip his jump chair over.

SEEING, HEARING AND FEELING

FIVE MONTHS OLD

SEEING

"Seeing" plays a much more important role now in baby's play than it did at an earlier age. At first, baby grasped because he wanted something exciting to happen again. Next, he used this grasping skill to get objects into his mouth where he can explore their taste and feel. Now, at five months old, baby appears to be grasping in order to see. The rattle in his hand is twisted, turned and carefully inspected before it finds its way into baby's mouth.

As baby takes visual stock of his environment, he devotes particular attention to following the movements of his mother. When mother steps out of the room, baby continues to gaze for a long time at the spot where mother was. As she steps back into the room he follows every movement with his eyes.

HEARING

At five months old, the baby will not only turn his head toward a sound, but will follow a sound in a darkened room. He is particularly sensitive to the sound of footsteps and becomes alert and attentive when somebody enters the room. He loves to listen to music and often becomes more active when the music is rhythmic and lively.

FEELING

By the sixth month, bath time may become one of the highlights of the day. Most babies by now have discovered how to splash and will start a splashing game as soon as they get in the water. This game usually involves batting the water with both hands. When he is really going at it, baby will splash water in his own face and eyes, scream with surprise, and then go back to his splashing. He seems to be trying to find out whether his splashing has something to do with the water that gets in his face.

SOCIALIZING

FIVE MONTHS OLD

Baby has now mastered many of his consonant sounds, including Ma-Ma, Da-Da, and possibly Na-Na. Interestingly enough, he almost never utters a single syllable: It is never just Ma, but always Ma-Ma, or Ma-Ma-Ma-Ma. When baby makes a meaningful sound such as Ma-Ma or Da-Da, his parents and brothers and sisters inevitably catch it and repeat it, showing their obvious delight. Baby responds to their enthusiasm by repeating those syllables over and over again. It is this sort of "reinforcement" that eventually turns babbling into talking.

Although the five-month-old baby does not associate meaning with his babbles, even when they sound like words, he does learn to use language for his own purposes. He finds ways of calling his Mommy into the room and ways of bringing her back when she starts to turn away. By responding to baby's call, Mother is teaching her baby the power of language.

Suggested "Motor" Activities - Five Months Old

Place baby on a carpeted floor for a portion of the day, with a favorite toy just out of reach. The carpet provides traction so that baby can begin to balance on his knees in a creeping position.



Hand baby a toy, first to one hand and then to the other. Soon, baby will learn to transfer the toy from one hand to the other.

Attach rings to the head of the crib. Baby will learn to grasp the rings and pull himself forward.

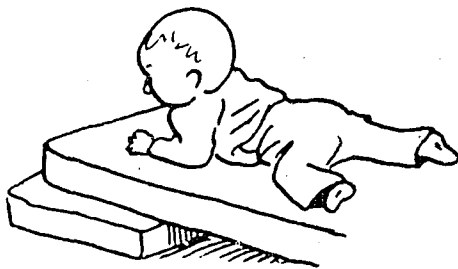
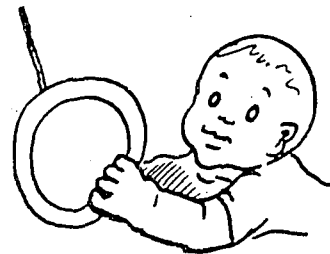

Allow baby to hold a cup. Some babies enjoy drinking from a cup at five months.



Create a hill for baby to slide down or roll down by elevating one end of a mattress or linoleum strip. Baby enjoys the feeling of movement, and at the same time gains balance and control.

Let baby spend a part of his day in a bounce chair or a swing. He loves the feeling of motion, particularly when he is the one to produce it.

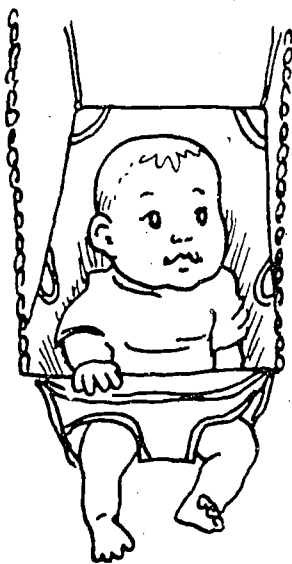

Play "How big is the baby -- so big!", pulling baby's arms high over his head. If you play this game often enough, baby will learn to associate the game with the words.



Suggested "Seeing, Hearing and Feeling" Activities - Five Months Old

Keep a collection of small toys in the crib with the baby--rattles, rubber balls, rubber squeeze toys and rag dolls are particularly good. Baby will learn to tell his toys apart, and even choose a favorite toy or recognize a new toy that has been placed in his crib.



Put "finger gloves" on baby's hands. Baby loves to explore his own fingers, particularly if they look interesting.

Place a busy box on one side of the playpen or crib. Baby will enjoy it most if something happens (a bell rings or a clown pops up). With a little ingenuity, parents can make their own busy boxes which can be modified appropriately as baby learns new skills. The busy box should be interesting to feel, to look at, to listen to, and to manipulate.

Bounce a large ball up and down while baby is watching. He will get better and better at following the bounce with his eyes.

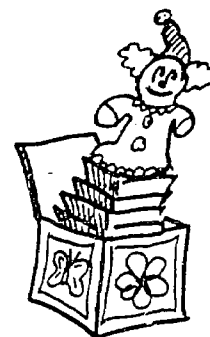
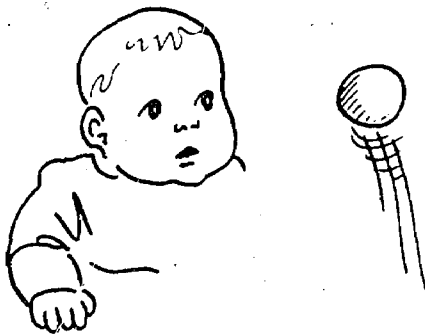

Take down mobiles that are not within baby's reach. Baby needs to manipulate everything now and is frustrated when he sees something exciting that he can't reach.

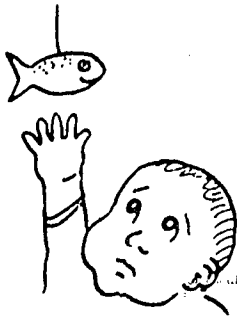

Cover up a part of baby's bottle when you bring it to him. See if he can still recognize it.



Give baby a large shiny pan he can see himself in. Let him pat it, roll it, bang it, or hit it with a spoon. Baby loves to play with Mommy and Daddy's "toys."

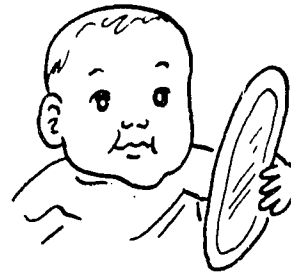

Suggested "Socializing" Activities - Five Months Old

Hold baby up in front of a full-length mirror. Give him an opportunity to observe and respond to his own image. Point out Mommy and Baby in the mirror.

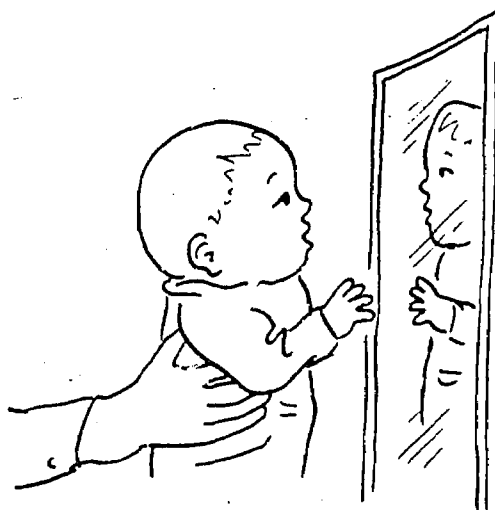
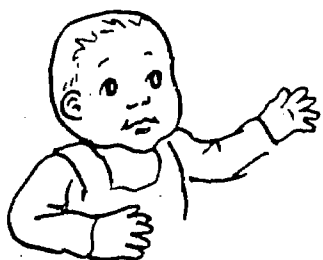

Hold out your arms toward baby when you go to pick him up. After a while, baby will stretch his arms out to you.

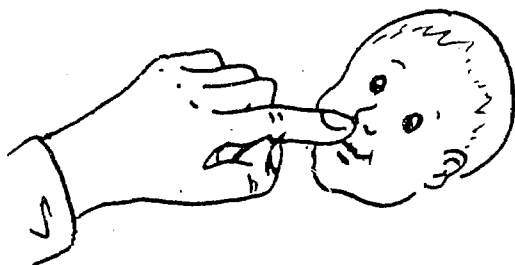

Carry baby on your back (papoose-style), while you are doing household chores.



Name the parts of baby's body during bath time, or make up little rhymes about eyes, nose and mouth. Try out this rhyme on baby:

Here is baby's eyes,
Here is baby's nose,
Touch the part that sees,
Touch the part that blows!

Baby slings that attach in the front are better for taking him out, because he can see your face when you talk to him.

Sing "rock-a-'bye baby" to your baby, rocking him vigorously as you do.

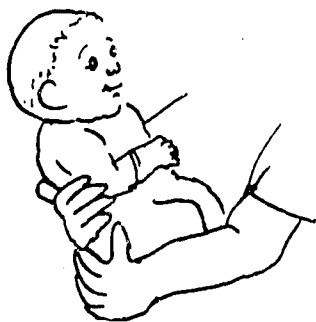

Show baby a big rag doll. Let him manipulate doll's arms and legs.



Give baby his own spoon during feeding time. Feeding will go more smoothly and baby will learn a new skill.



Whisper to baby. The more ways you can find to communicate with baby, the better you know each other.



MERRY-GO-ROUND

PURPOSE: Give baby practice with grasp and release.

MATERIALS: Aluminum foil or paper pie plate
Frozen juice can with top (1/2 gallon size)
Bells
2 feet of gro-grain ribbon
Sewing elastic (1/2 inch wide)
Scotch tape
Several bright colored ribbons or pieces of
yarn or cloth
Pipe cleaner

PROCEDURE: Place can on center of plate and trace around. Cut out center of plate and push can halfway through. (Make it fit tightly.) Cut 1/2 inch slot in bottom and top of can and string elastic through. Sew or tie bells and ribbons around rim of plate. Tie ribbon tightly around can. Tape short end to can. Tie pipe cleaner ring to other side of ribbon. Roll ribbon around can, use about half of it. Tie ends of elastic tightly to sides of baby's crib.

PLAY: As baby pulls and releases the ring the plate will spin.

FOR THE OLDER CHILD:

Make it into a dancing puppet. Decorate plate and insert can as above. Use stocking egg or stuffed sock as head and plate as a skirt. String elastic through sock "head" and can and knot at the bottom. Make a loop at the top. Child can hold the loop and make the puppet dance.

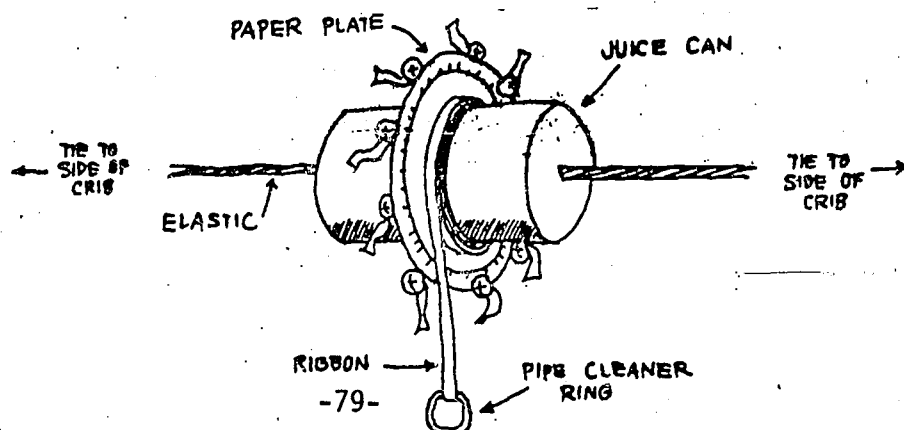

HORSE PUPPET

PURPOSE: Produce body awareness.

MATERIALS: Felt scraps, embroidery thread.

PROCEDURE: Cut out two sides of head according to pattern.

Sew eyes on each side with black embroidery thread.

Sew two pieces together with embroidery thread.

Use a loop stitch for horses mouth and mane.

PLAY: Slip horse on your finger and make it dance for baby. When baby is a little older he will enjoy having the puppet on his own finger.

FOR THE OLDER CHILD:

Make a puppet stage out of a box by standing it on end. Make a hole in the back of the box for child's arms to go through. With an animal puppet on each forefinger, the older child can put on a one man puppet show.

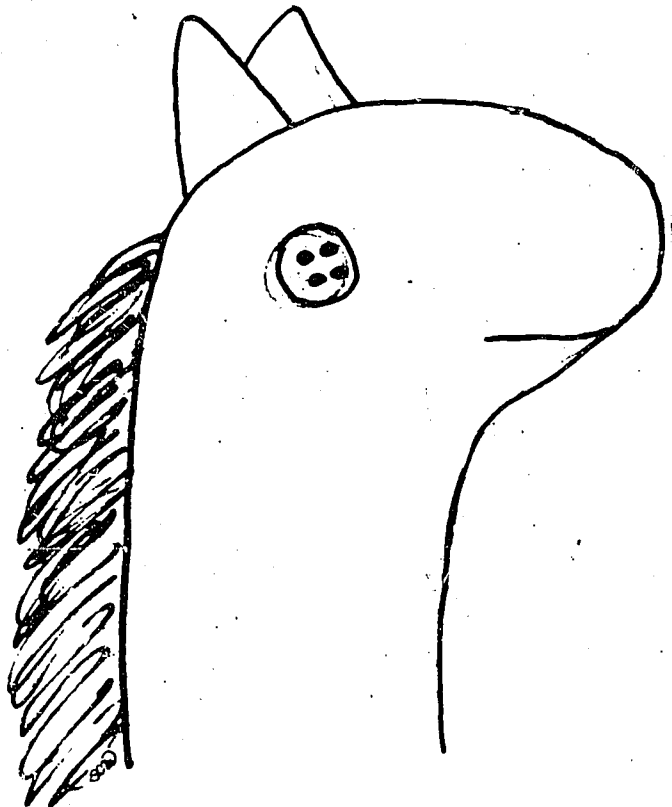
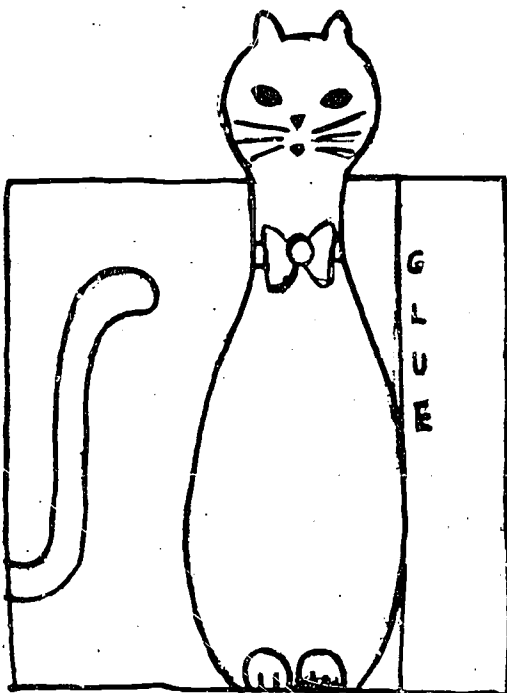

BUSY BOARD

PURPOSE: Develop small muscle coordination and eye-hand coordination.

MATERIALS: Pegboard - 1' by 2'
Heavy tagboard - red and yellow
2 juice can tops
Elastic thread
Aluminum foil
Clear adhesive backed paper
Ribbon
Pipe cleaners
Brass fasteners
String
Tongue depressors

PROCEDURE:

BOARD: Cut pegboard to size. String ribbons through board to attach securely to side of crib.

MIRROR: Cut out two rectangles 3" by 2" and cover one with aluminum foil to make a mirror. Glue mirror to pegboard. Fold second rectangle as shown on diagram, cover with clear contact, and attach string 1" below fold. Attach rectangle along fold directly over mirror so that it overlaps. Thread string through pegboard over the rectangles, allowing the other end to fall behind the pegboard. Attach spool to this end. As baby pulls on the spool the flaps lift up and baby can see himself in the mirror.

BANG TOY: Attach one juice can top to the center of the tagboard with a brad. Punch hole in center of lids. Thread ribbon through the second lid, knotting it to keep in place. Attach pipe cleaner ring to one end of string. Tie the other end of string to the top of tagboard so that baby can bang the lids together when he grasps the ring.

DANCING BOY: Attach tagboard body to pegboard with brads. Attach tongue depressors to tagboard body with brads. Attach pipe cleaner ring to one end of elastic thread. Attach elastic thread to arms and legs as shown in diagram so that the arms and legs move as child pulls the string. Before mounting board on crib, turn over, and cover all the brads with adhesive cloth so that all ends are protected.

"BUSY BOARD" AT REST

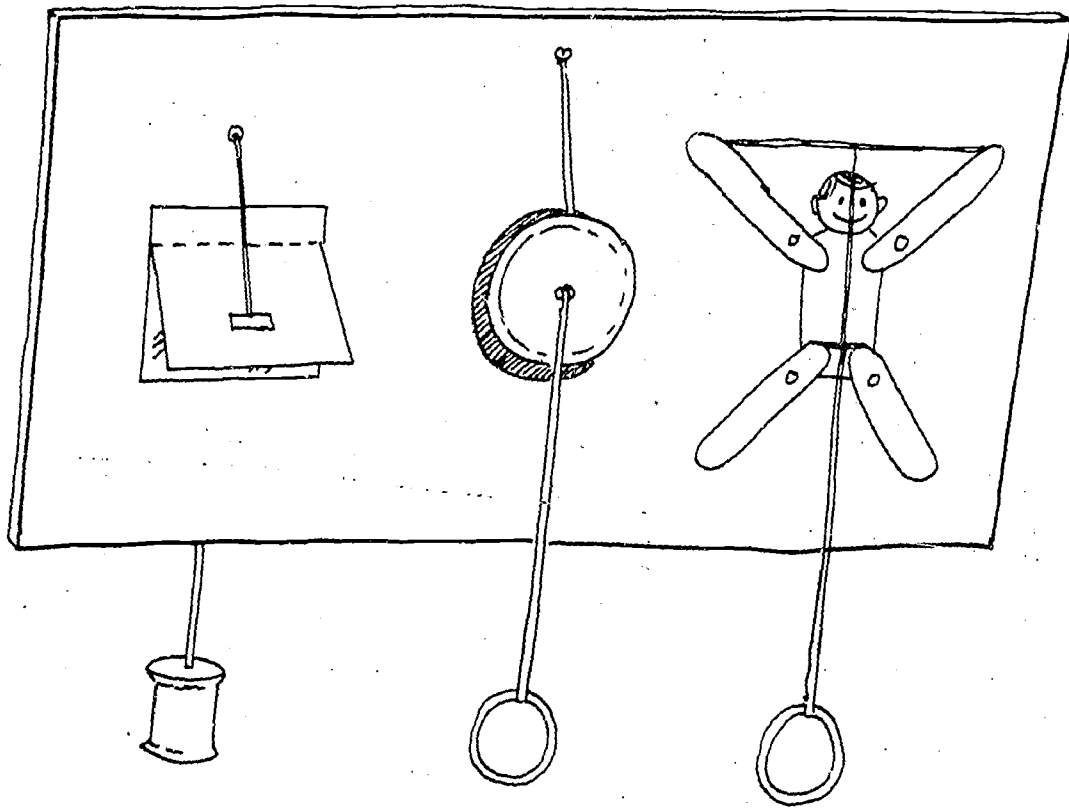

"BUSY BOARD" IN ACTION

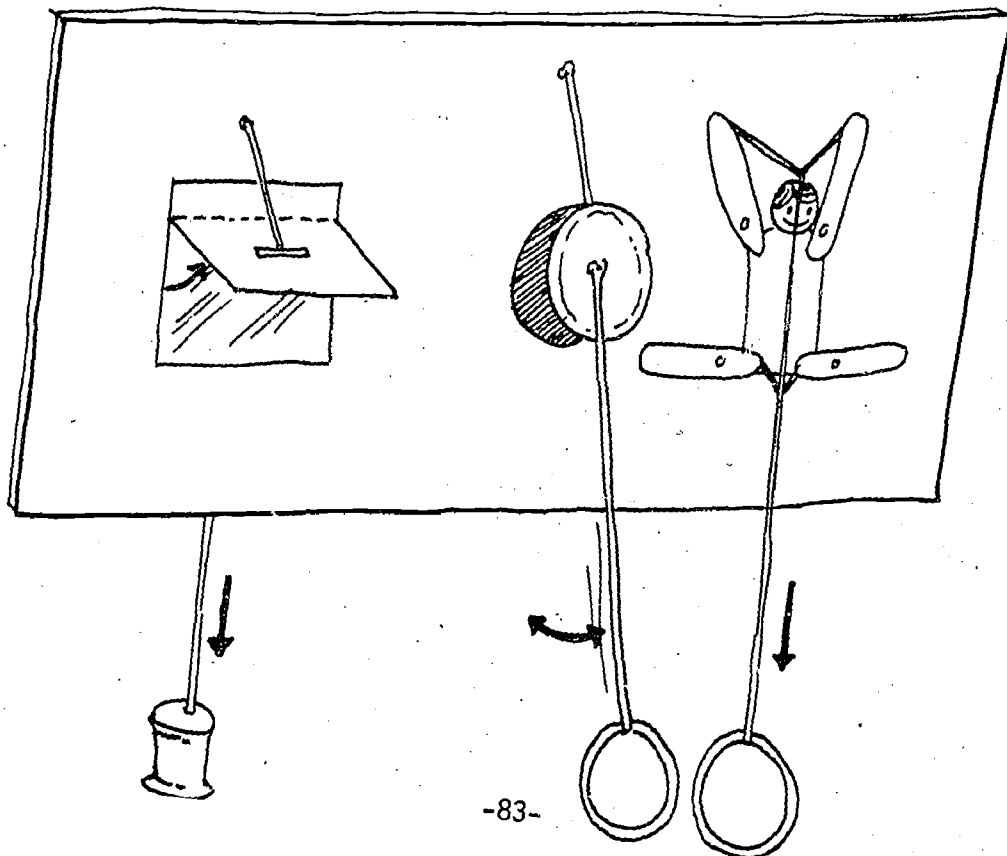



Six Months

BABY'S VIEWPOINT

SIX MONTHS OLD.

The parents of a six months old may notice a sudden and somewhat dramatic change in baby's personality. Their nice, outgoing baby, has become wary of new people. When grandma comes to the house for a visit, instead of greeting her with the usual broad smile, he might scream in outrage.

Why does this sudden change take place? Has baby really lost his pleasant disposition? Actually, baby is just demonstrating the fact that he is growing up. He can tell the difference between a familiar face and an unfamiliar one. The familiar face belongs to someone whom he knows well. It represents safety, comfort, and pleasure.

Once baby has gotten used to a new visitor he is apt to be a very good entertainer. The sixth month old seems to be aware of himself and his effect on other people. He will act silly or play the clown and get even sillier when his antics produce a laugh.

MOTOR SKILLS

SIX MONTHS OLD

At six months, many babies have learned to sit up by themselves, with their hands planted firmly on the floor in front of them to help them hold their balance. When sitting in a bouncer, most babies can put their feet on the floor and stand themselves up. Remember the active baby may need to have his bouncer chair weighted or anchored down so he won't tip over.

Babies at this age may try out different ways of getting around. Some babies are creeping quite well on their hands and knees, some squirm along on their buttocks in a sitting position, some do a kind of elephant walk on their hands and feet, with their buttocks high in the air. Other babies move from place to place with a combination of rolling, squirming, and bouncing.

Grasp and reach are more precise now. Baby seems to enjoy holding something in each of his hands. If you present him with a third object when both his hands are full, he may not realize yet that he can't gather the latest toy without letting go of one that he already has. Hopefully, as he extends a hand toward the next toy, the toy he is holding will drop and his problem will be solved. It may take a while for baby to realize that he has to put down the first toy before he can reach for the second.

SEEING, HEARING AND FEELING

SIX MONTHS OLD

At six months, baby is able to recognize many different sounds and sights. He pays attention to relatively small details and tells the difference between a happy and sad face. Baby enjoys playing with lots of different objects, particularly those objects that combine sight, sound and feel appeal. A ball with different textures, a soft rubber toy with a loud squeak, blocks with bells inside, keys, spoons, pots and pans, and bright colored old-fashioned clothespins are all favorite toys at this age.

Baby's interest in different sounds makes wrapping paper very exciting. He loves to crinkle tissue paper or squash tin foil. Because baby's exploration might involve stuffing the paper in his mouth, his paper playing activities have to be supervised. Don't let baby put newspaper or magazines in his mouth. The ink contains lead.

A major development at this age is the ability to recognize a familiar object when it is partly covered up. When a felt square or a wool cloth is placed over his rattle so that it is partly hidden from view, baby will reach for his toy with obvious excitement. It seems that baby is getting closer to realizing that an object can exist, even when he can't see it completely. He still, however, will probably not search for his rattle if it is totally hidden.

SOCIALIZING

SIX MONTHS OLD

Despite his wariness of strangers, the sixth-month-old is quite a socialable youngster. He loves to play with his sisters and brothers, or visit other babies. When two six-month-old babies are put together, they notice and imitate each other. If one laughs, so does the other. If one cries, the other does too. It seems as if the baby identifies with a playmate without really recognizing that his playmate is a baby like himself.

Many six-month-old babies love to play the clown. They are aware of the reactions of their audience, and will be quick to act silly or take part in a social game. Daddy may come up to baby with a loud "I'm going to catch you", and baby will respond with a noisy laugh, or a mock attempt at escape.

The mirror is now one of baby's favorite toys. He will sit himself in front of a long mirror and talk incessantly to his own reflection. When his image remains silent, he may pat the mirror as if to investigate the problem.

Suggested "Motor" Activities - Six Months Old



Hand baby a third toy when he has a toy in each hand. At first he will try to grasp the third toy with his hands full. But with lots of practice he will learn how to put one toy down before he grasps for a new one.

Let baby ride "piggy-back" on Daddy's shoulders. This helps baby develop balance and control and gives him a chance to look at the world from a different perspective.



"POP"



Play pop-goes-the-weasel with baby. Say the rhyme slowly. When you reach the "pop," raise baby's arms high up in the air. He will learn to anticipate the "pop" and will laugh when you reach the last line.

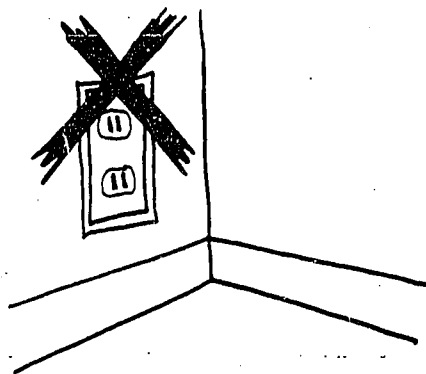

If baby has learned to crawl or creep, make one room in your house "baby proof." Be particularly careful to plug up electrical outlets and pull up lamp cords. Then, let baby free to get around and explore.

Put baby in a highchair or baby-tender at feeding time. Let him pick up finger foods -- bits of cereal or small bits of bacon are very good.

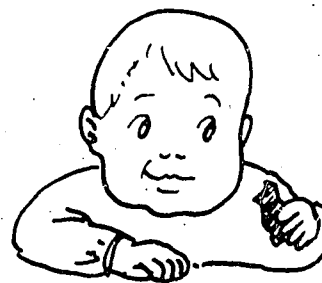

Play on the floor with baby. A chase game is a favorite at this age.

Suggested "Seeing, Hearing and Feeling" Activities - Six Months Old

Blow up different shape balloons and bat them around with baby. This will give baby practice in "tracking," that is, following movement with his eyes.

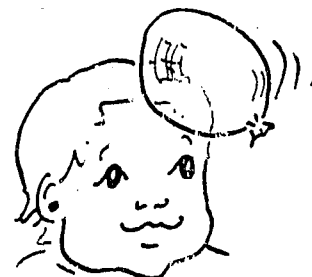

Fill plastic bottles with different amounts of water. Hit the bottles with a spoon to produce different sounds. Baby will notice the differences in sound. After awhile he will join in the game.

Slide a rag doll across a table so that baby can watch it fall off. After a while he will anticipate the fall and look down on the floor before the doll falls off.

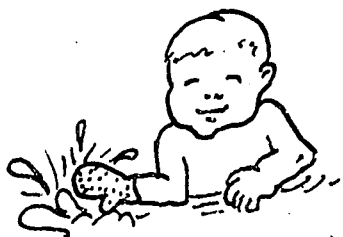
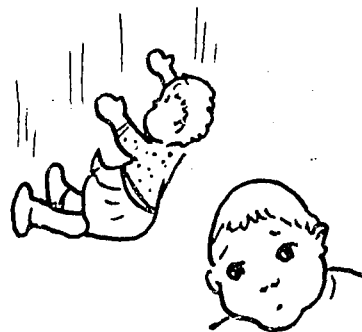

Make a bath-mitten for baby out of a washcloth or foam rubber. Put it on baby when he goes in his bath. Baby will enjoy the sensation of splashing the water with his mitten on.

Partially hide a favorite toy under a blanket or square of material. Baby will learn to pull at the part of the toy he sees. Eventually, he will learn to remove the blanket.

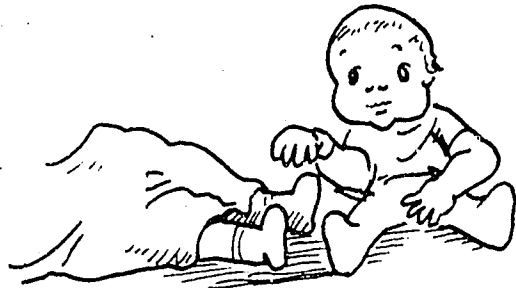

Make baby a happy-sad pillow. Show him one side and then the other. This will help baby notice differences in facial expressions. When he shows interest in the two sides of the pillow, let him play with his happy-sad plate puppet.

Give baby a turtle bean bag that has contrasting colors on each side. Baby will become aware of differences in color.

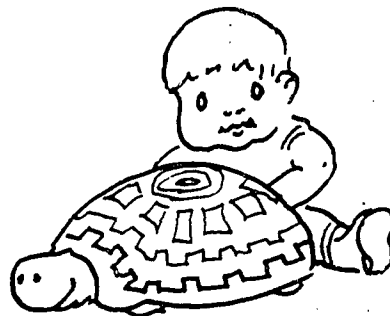

Suggested "Socializing" Activities - Six Months Old

Before he was six months old, parents let baby begin most of the conversations. By copying the sounds baby made, they encouraged his interest in talking and his development of a repertoire of sounds. Now, at six months, baby is ready to associate words with meanings and his parents take a more active role in initiating conversation. When bathing baby, name each part of his body in a loud, clear voice.

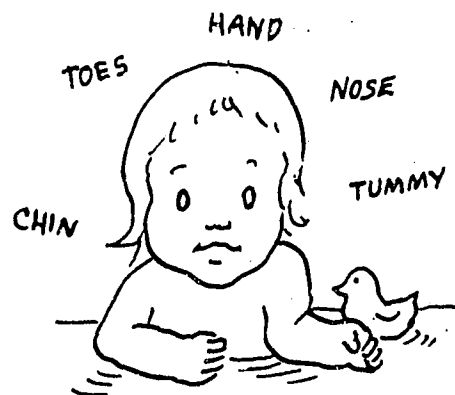

Put baby's hand on your nose and say "nose" in a loud, clear voice. Do the same with eyes, mouth, teeth.

Give baby a large rag doll and allow him to move the legs and arms up and down. Using a complete sentence, talk to baby about what he is doing.

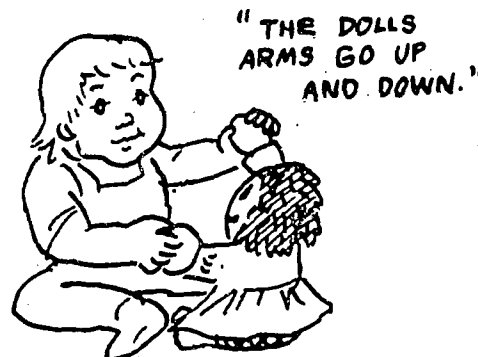

Play pat-a-cake with baby over and over again.



Wave bye-bye everytime you leave the room.

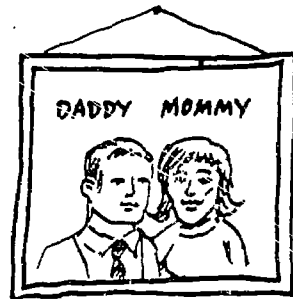

Name Mommy and Daddy at every opportunity. Place a large picture of Mommy and Daddy near baby's crib or high chair.

DA-DA MA-MA



When baby accidentally says "Ma-Ma" or "Da-Da", answer baby immediately. Point to the picture on the wall and say, "There is Daddy."

Bring another baby over to visit.

PILLOW

PURPOSE: Give baby experience with focusing eyes.
Give baby experience with seeing differences.

MATERIALS: Pieces of felt or other fabric, foam rubber stuffing or nylon stockings, needle and thread, and pinking shears.

PROCEDURE: Cut two pieces of fabric approximately 8 x 10 inches.

Cut several shapes from the fabric. Sew these shapes onto the pieces of fabric. Make a happy face.

Repeat this procedure on the other piece of fabric. This time use different shapes and make a sad face.

Sew these two 8 x 10 pieces of fabric together leaving one side open.

Stuff the pillow through the open end, using the old nylon stockings or rubber foam.

Sew the open side.

FOR THE OLDER CHILD:

Cut out letters of child's first name for one side of the pillow and last name for the opposite side.

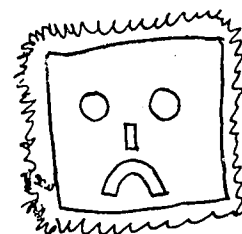
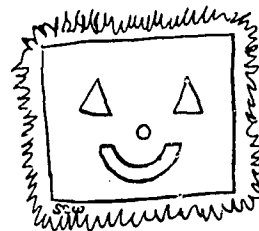
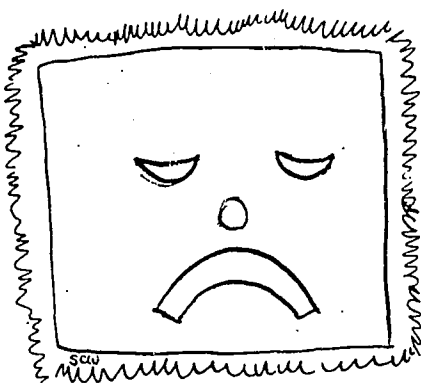
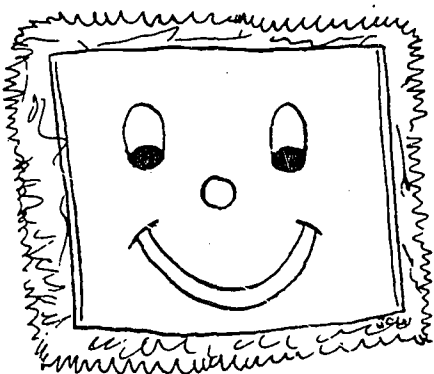

RAG DOLL

- PURPOSE:** Language development - recognition and naming of body parts.
- MATERIALS:** Several yards of yarn, two buttons, embroidery thread, rubber foam scraps, and fabric.
- PROCEDURE:** Doll. Cut fabric according to pattern. Embroider face and sew on buttons. Sew body parts leaving small opening.
- Stuff with foam rubber scraps. Complete sewing.
- Cut wool into 2 inch lengths, loop and tack on doll's head.
- Clothes. Cut according to pattern and sew.

FOR THE OLDER CHILD:

Make button-pinafore with very large buttons so that child can learn to button. Sew two ribbons (different colors) onto doll's head. When your child first learns to tie a ribbon, it is easier to teach him if the ends are different colors.

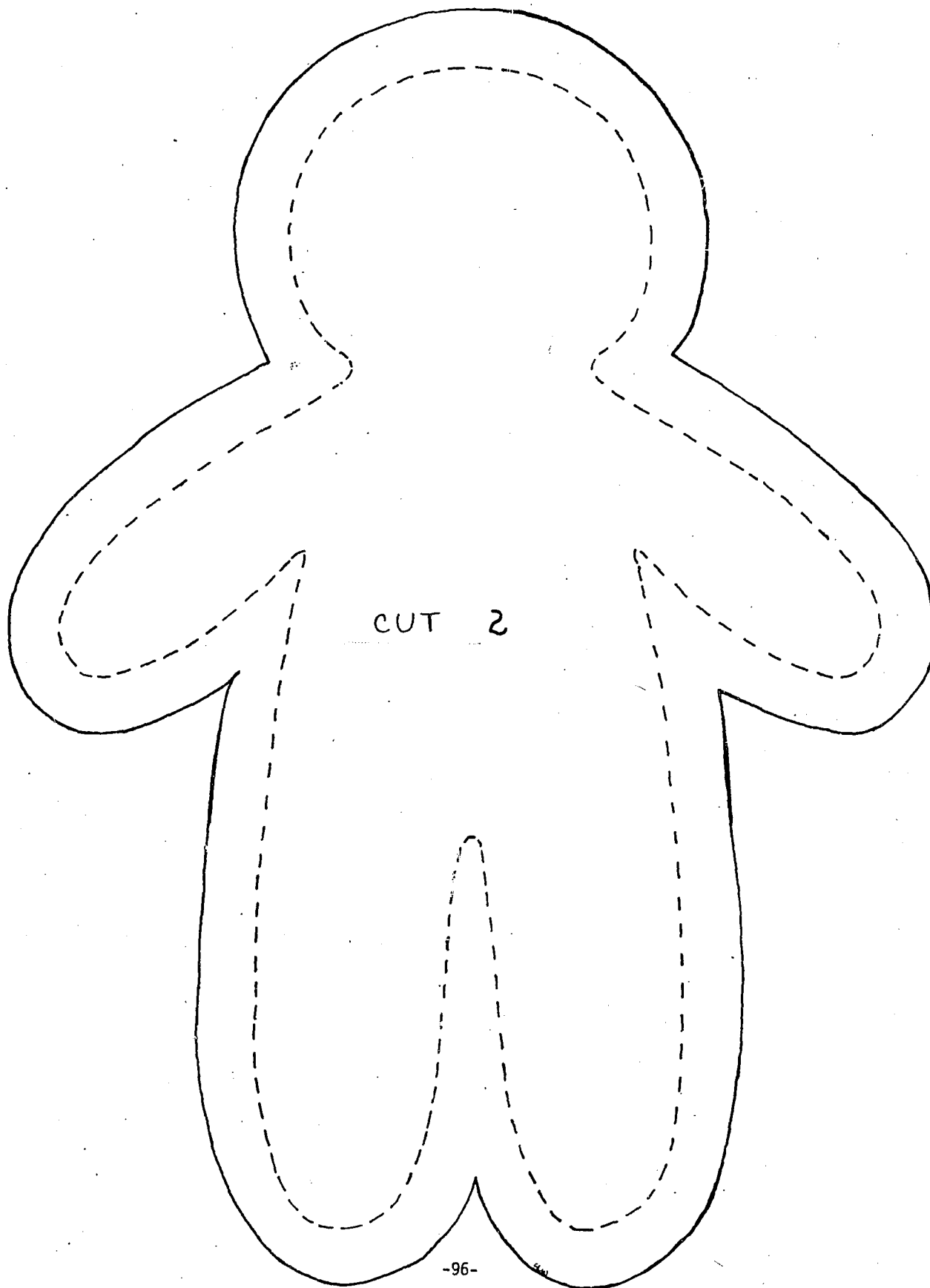

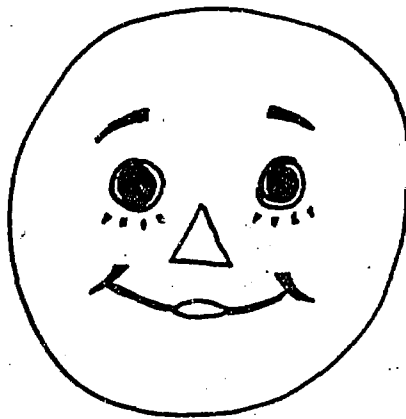

EMBROIDER FACE
BUTTONS CAN BE USED
FOR EYES

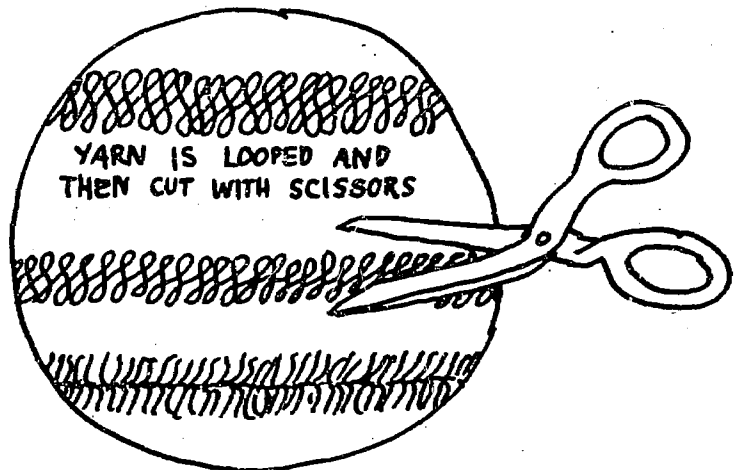
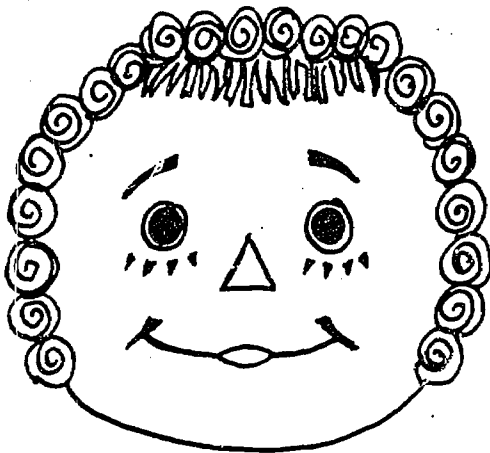

WHEN CUT, THE YARN
SHOULD COVER
THE WHOLE HEAD

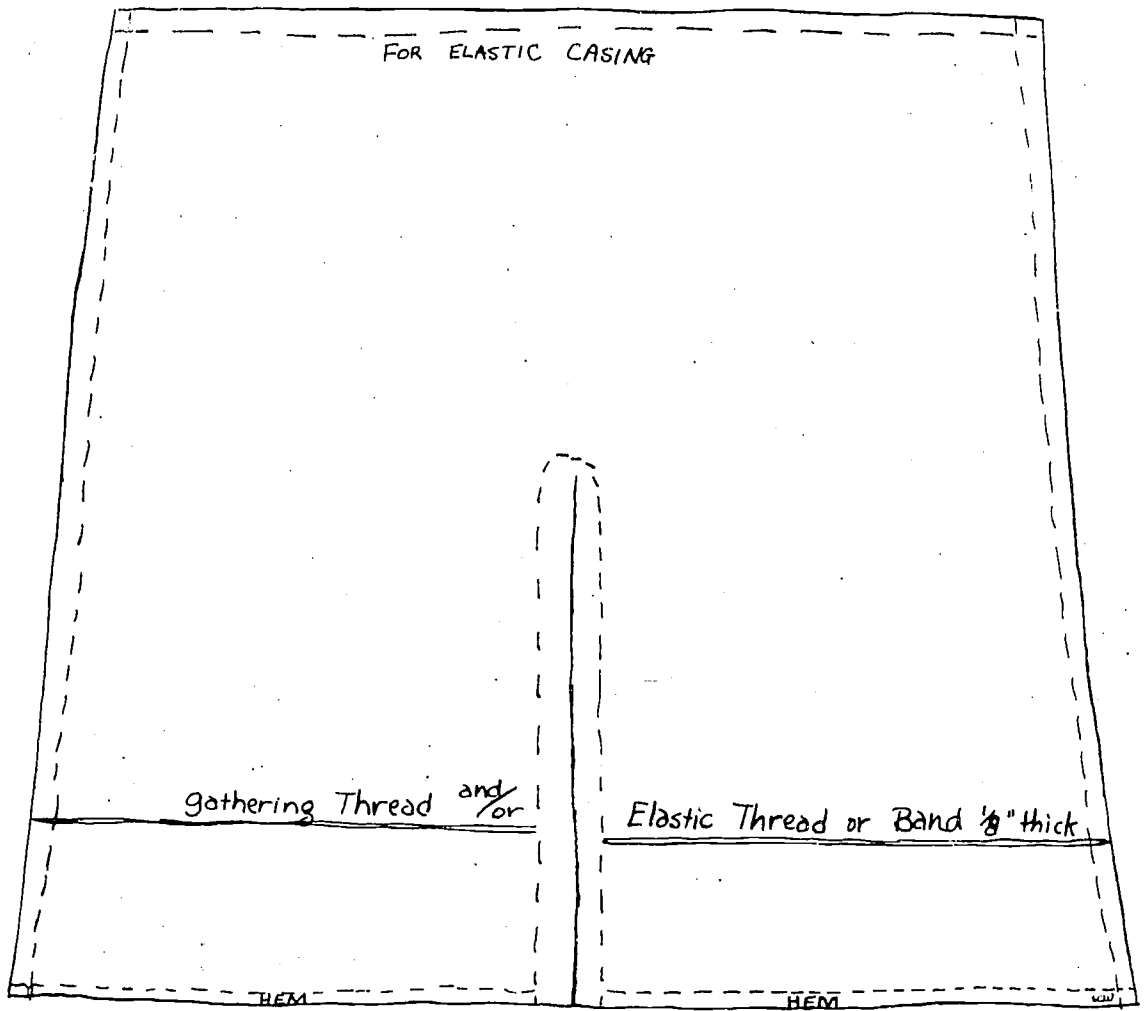

Bloomers

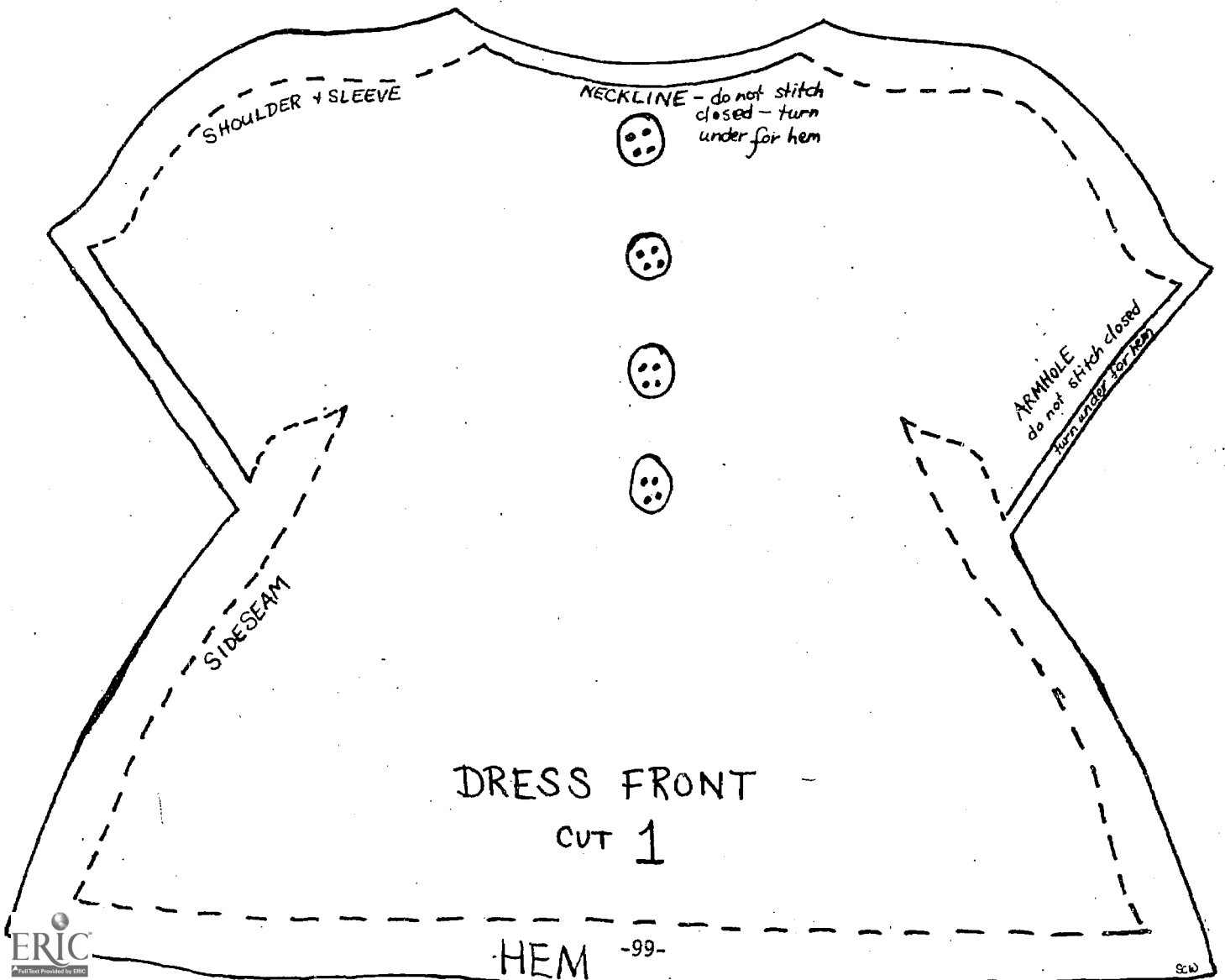
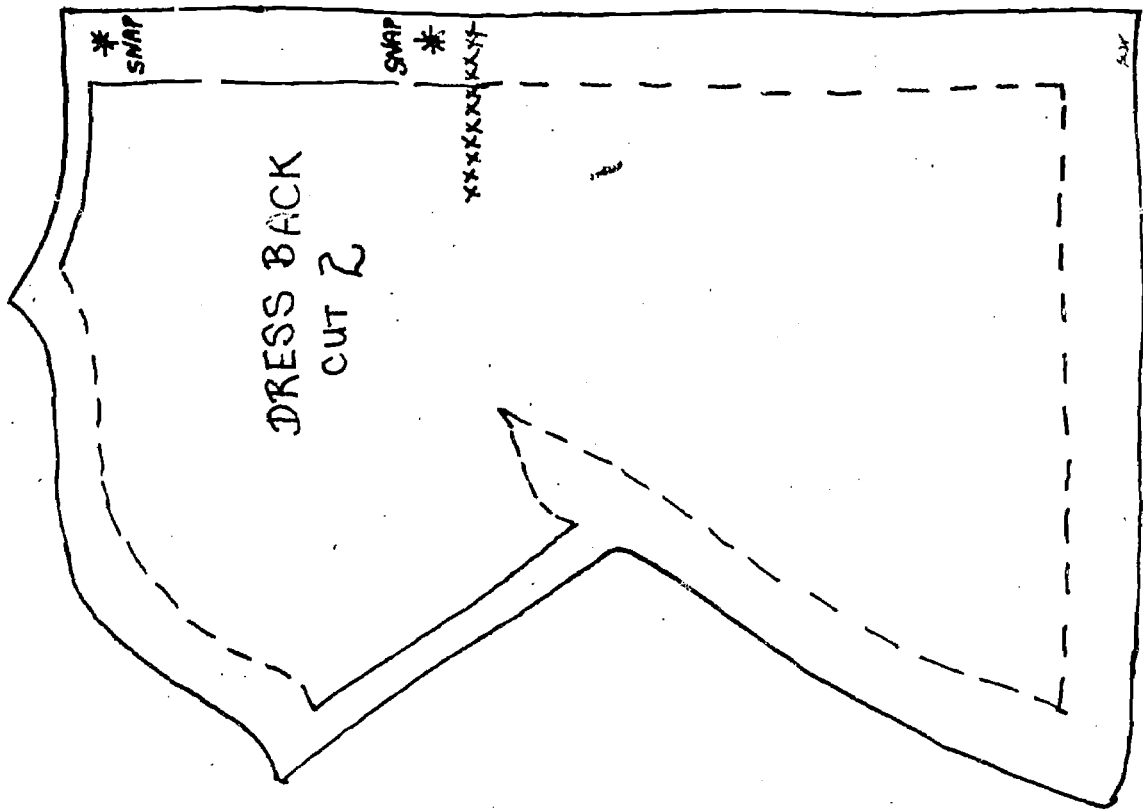

TIN CAN CYMBALS

PURPOSE: Give baby practice using both hands in a grasping activity.

MATERIALS: 2 small cans without lids (cardboard frozen orange juice cans are easiest to work with)
Ribbon string
2 pipe cleaners

PROCEDURE: Make two pipe cleaner rings. Turn can sideways and punch two holes on sides of can as indicated below. String ribbon through the can and tie on ring. Repeat with second can. Tie about ten inches apart on cradle gym or on sides of crib with can bottoms facing each other.

PLAY: Baby can grasp both rings and bang the cans together.

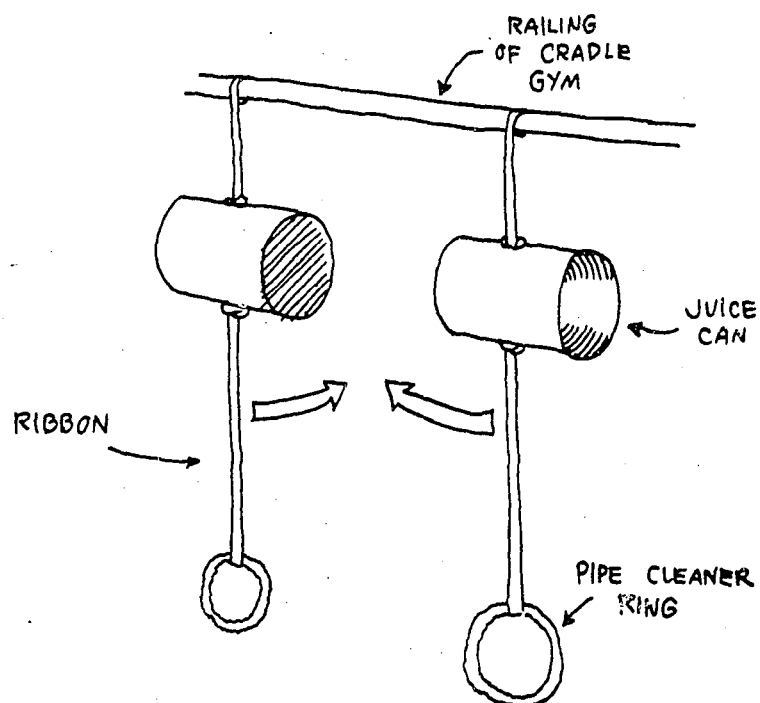

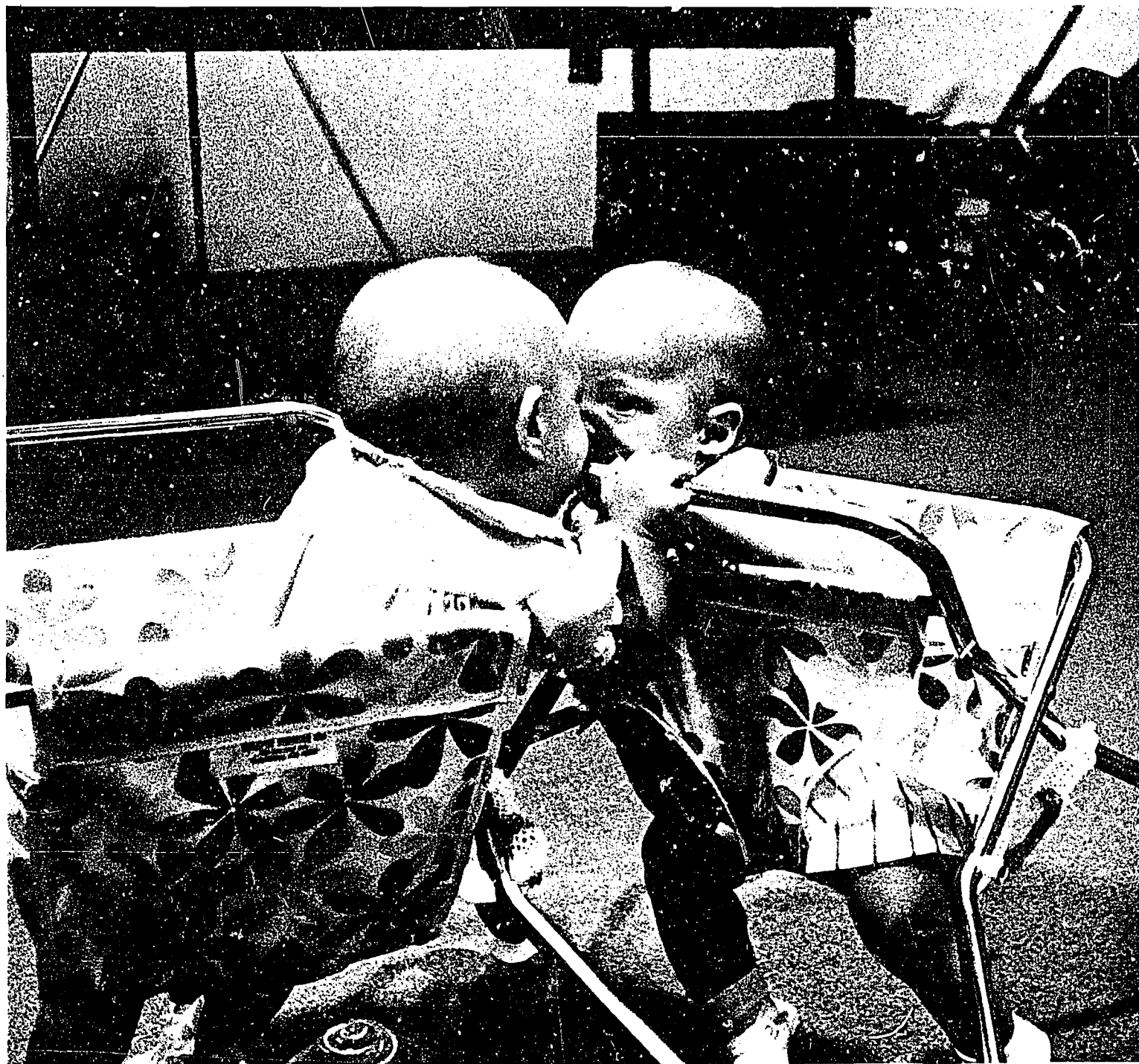

Seven Months

BABY'S VIEWPOINT
SEVEN MONTHS OLD

The six-month-old baby showed some realization that objects are permanent when he searched for the rattle that was partly hidden under his blanket. Now, at seven months, he has developed still another insight into the nature of objects. When baby drops a toy off his feeding table now, he looks down on the floor to see where it is. Remember, just a few months ago, he continued to look in the place where he saw it last as if his looking could make it reappear. By looking to see where his toy has landed, baby demonstrates his understanding that the rattle still exists even though he doesn't see it.

Another evidence of increased understanding of the permanence of objects is baby's ability to go back to an activity that has been briefly interrupted. For example, baby may be banging two blocks together when his mother enters the room. He'll stop and look at her for a moment and then go back to his banging. The baby is certain that the object continues to be, even when he stops paying attention to it.

MOTOR SKILLS

SEVEN MONTHS OLD

Many babies are able to sit alone at seven months old. They no longer need their hands for balance and can use them to reach, grasp, bang, shake and poke.

An active seven-month-old baby may be able to pull himself up to a standing position. Getting back down, of course, is another story. It is not unusual for a baby to pull up to a standing position, and then cry in panic until someone comes to pull him back down again.

Baby is beginning to grasp more efficiently now. He can pick up a raisin or cracker crumb with a kind of pincer movement - (thumb pushing against forefinger). This is an important event. He has achieved a uniquely human skill that will eventually enable him to hold a pencil, or master a fork.

The seventh-month-old does not usually demonstrate a hand preference. He will play with a toy first with one hand and then with the other, with one hand mirroring what the other hand has just done. If a baby does use one hand more often than the other, it doesn't mean he is right-handed or left-handed. He may change preferred hands several times before he makes a permanent choice.

SEEING, HEARING AND FEELING

SEVEN MONTHS OLD

At seven months old, baby's eyes are better coordinated. He is becoming aware of the position of objects in space. He shows a new interest in the relationship of one object to another. He picks a block up in one hand, examines it with his eyes, picks up another block in the other hand, puts it through the same kind of examination and then bangs the two together. He loves to look at objects upside down and will squirm around in his playpen in order to look behind. His interest in his own vocalizations is as keen as ever. His repertoire of sounds now is much closer to the adult repertoire. Interestingly enough, baby produces fewer vowel sounds now than he did at three and four months. He seems to enjoy practicing the sounds that he hears in his parents' language.

SOCIALIZING
SEVEN MONTHS OLD

Baby can now recognize mommy and daddy's voices even when they are in another room. Baby is contented to play alone for an hour or more if his mother talks or calls to him every few minutes.

A real forward step is baby's ability to recognize his own name. Baby will demonstrate this new learning by interrupting what he is doing and looking toward the caller.

Baby continues to be wary of strangers. He not only objects to the sudden appearance of a new face, but even when the stranger stays around for a while, he may act shy and somewhat frightened.

Baby at this age seems to know the difference between approval and disapproval. He reacts to a "no" by stopping what he's doing - at least for a moment. He continues to like silly games, blowing bubbles with his food, or dunking his fingers in a soup bowl to get a laugh from his audience.

Peek-a-boo is now one of his favorite games. He is just learning that things don't disappear just because he doesn't see them, but peek-a-boo still contains an element of surprise.

Suggested "Motor" Activities - Seven Months Old

Give baby several small rubber balls to pick up. Now that the baby is developing the ability to use his thumb independently, it is important to provide opportunities for him to practice this skill.

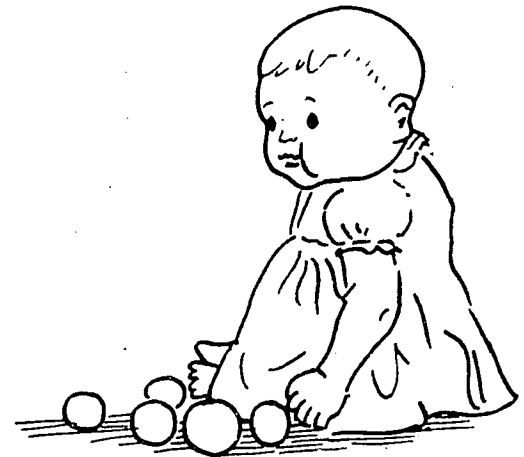

Give baby some food with every meal that he can pick up with his fingers -- diced carrots, peas, bits of hamburger work very well.

Attach a ribbon to the head of a small rag doll or clown. Show baby how to hold the clown up by the ribbon in order to make him dance.



Hold baby by the hands and let him practice deep knee bends.

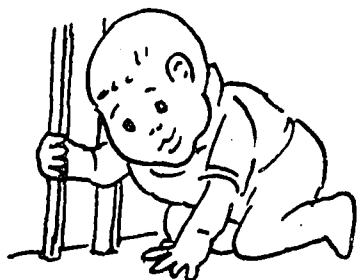

If baby is just learning to pull himself to a standing position, place him in a playpen that will give him a chance to practice.

Bang two toys together. Then let baby try it.

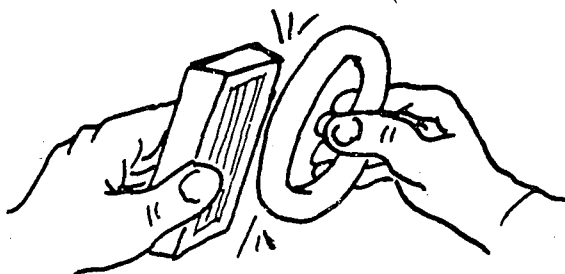

Suggested "Seeing, Hearing and Feeling" Activities - Seven Months Old

Give baby toys to play with that can be easily named: cup, telephone, doll, kitten, spoon, dog, block, rattle, banana, clown.

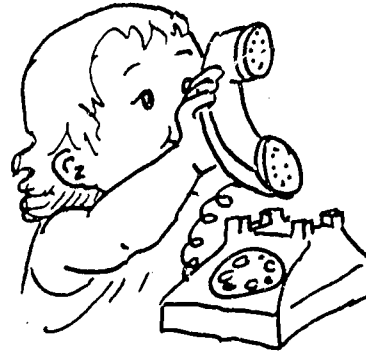

Let baby feel what you are wearing. If you are, for instance, wearing velour, say, "Soft" while baby's hand strokes it.

Make one of baby's toys squeak, then hide it under a blanket while baby is watching you. Let him try to find it.



Make baby a cereal box drum.
Give baby a wooden spoon
to use as a drum stick.
Encourage him to use it
for banging.



Cut large plastic containers
in half. Line them with
different materials--rubber,
felt, plastic, corduroy.
Place toys inside so baby
can retrieve them.

Put several different floating
toys in baby's bath. Each
time he retrieves one, examine
it with him and talk about it.

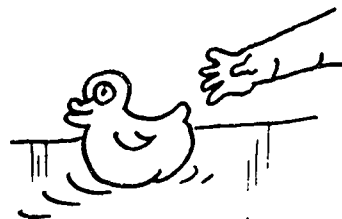

Suggested "Socializing" Activities - Seven Months Old

Take baby outside in a carriage or stroller. Point out airplanes, birds, trucks. Name them for baby.

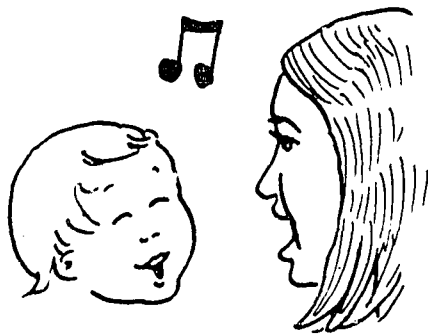
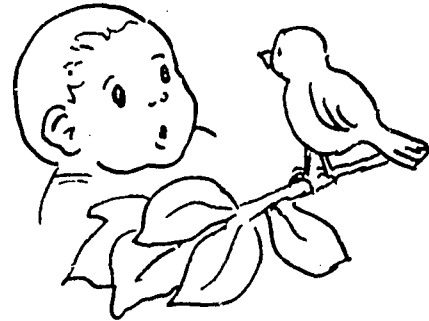

Turn on a record with baby watching. Sing along with the record.

Sing ride-a-cock-horse to baby while bouncing him on your knee.

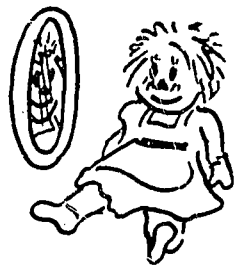

Show baby a rag doll in the mirror.

Sing rock-a-bye baby with Daddy holding baby under his arms and Mommy holding his feet.

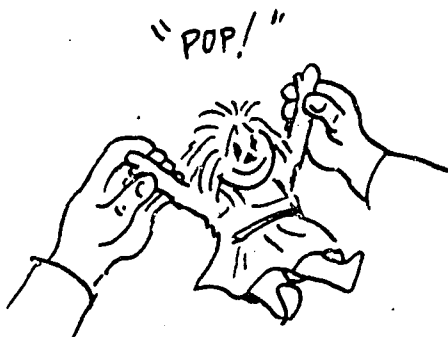
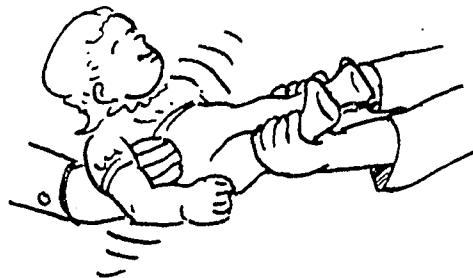

Play rock-a-bye baby, pop-goes-the-weasel, and ride-a-cock horse with baby's rag doll while baby is watching.

Cut out large pictures from magazines--a telephone, a dog, an airplane, a spoon, a teddy bear. Sit baby on your lap and "read" to him, talking about the pictures.

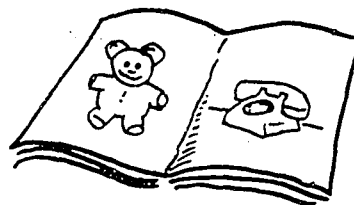

Play see-saw with baby, rocking him back and forth.

DRUM

PURPOSE: Give child practice in beating; develop rhythm.

MATERIALS: Round cardboard cereal box, bits of yarn or string, bits of felt or tape, wooden spoons or dowels.

PROCEDURE: Tape around top and bottom of oatmeal box.

Make a design with string or rope, felt or tapes, as shown in picture.

FOR THE OLDER CHILD:

Let him beat out rhythm of songs, or keep time with a record, or play "Simon says" with drum beats.

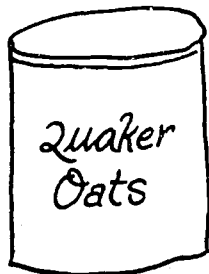

CEREAL BOX
(OATMEAL) WITH
LID

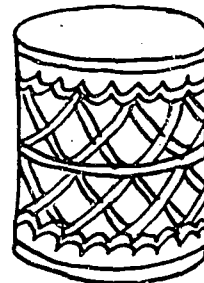

COVERED BOX
(DECORATED WITH
STRINGS, FELT, ETC.)



USE WOODEN
SPOONS FOR
DRUM STICKS

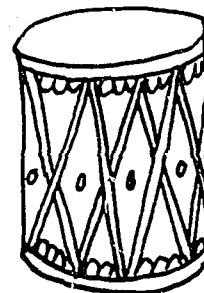

PAPER BAG PUPPET

PURPOSE: Hand-eye coordination, spatial relationships.

MATERIALS: Paper bag, newspaper, spindle, piece of ribbon, crayon or paint, scissors, yellow, red, brown, or black construction paper, and glue.

PROCEDURE: Paint or crayon face on paper bag.
Curl strips of paper for hair and paste on.
Stuff paper bag with newspaper.
Tie on spindle.

PLAY: Hold puppet by the handle and let baby watch the puppet move back and forth in front of him. Give baby a turn. Because baby's at this age enjoy tasting their toys, reserve this puppet for times when you and baby can play together.

FOR THE OLDER CHILD:

Paper bag puppets are easy to make. Help your child make storybook characters and act out a play.



PICTURE BOOK

PURPOSE: Picture recognition. Language development.

MATERIALS: Construction paper, yarn, and simple outline pictures from magazine or coloring book.

PROCEDURE: Fold sheets of paper in half so that each sheet makes four pages.

Paste one large picture on each page. Find pictures of things that baby knows about-- bottle, sock, banana, teddy bear, bell, baby food jar, spoon.

Punch two holes down center fold. Thread yarn through holes and tie. Fold in half and press between 2 heavy books to make the crease firm.

PLAY: Hold baby in your lap. Name the picture on each page. Let baby touch the picture as you name it. Show him an object that matches the picture.

FOR THE OLDER CHILD:

Let your child dictate a story to you. Write it down on the pages of your book. Leave room on each page for your child to illustrate his story. Use heavier paper for the cover. Make several books and let your child begin his own library.

STRINGING UP BOOK

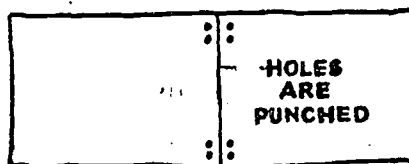

PAGES ARE OPEN

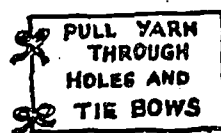
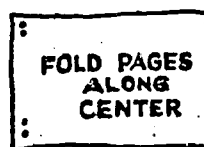

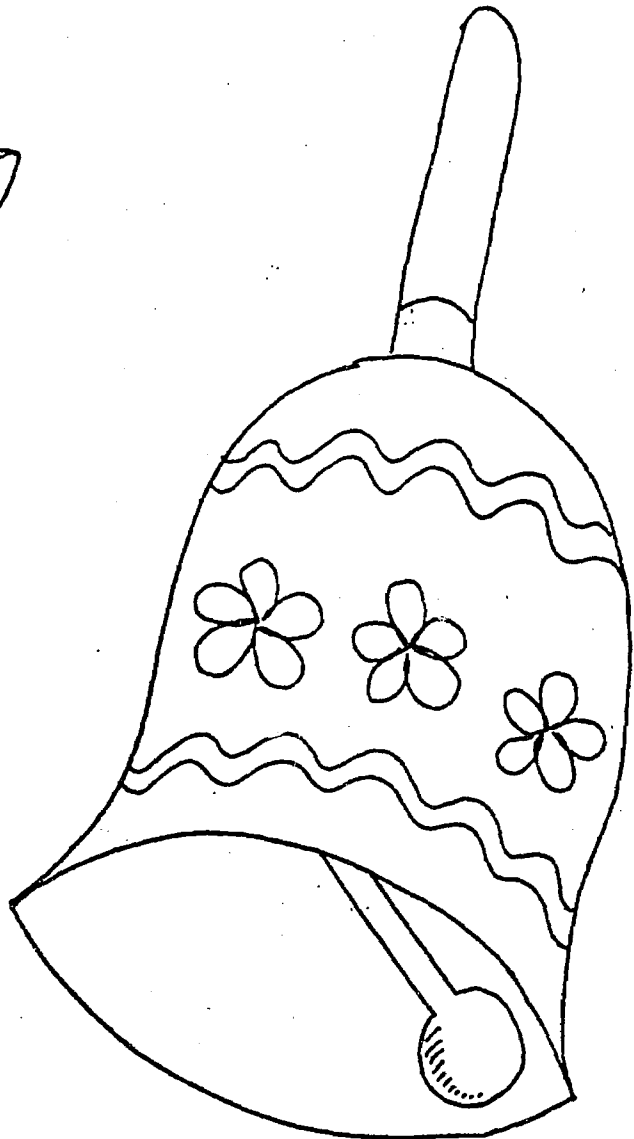



Eight Months

BABY'S VIEWPOINT - EIGHT MONTHS OLD

At eight months old, many babies are quite fearful. They are afraid of new people, new places and new situations. A visit from grandmother, a ride on the bus, or a trip to the shopping center, can send baby into an unexpected panic. Because all parents like their children to be friendly and outgoing this kind of outburst is disturbing.

Interestingly enough, baby's fearfulness does not represent an underlying personality trait. It means, simply, that he has developed a keener awareness of his immediate surroundings. He is noticing the difference between things that are familiar and therefore predictable, and things that are new and strange. From baby's point of view, only the familiar is trustworthy.

Along with this keener awareness of his immediate surroundings, baby is showing a greater understanding of spatial relationships. As he creeps around the house, he anticipates obstacles, and goes around them. If he crawls into a closet, he finds a way to get himself out. If he is placed on a table, he will recognize that he is up high, and is not apt to jump off on purpose.

MOTOR SKILLS

EIGHT MONTHS OLD

At eight months of age, most babies are able to move about readily. Many are pulling themselves up to a standing position and walking sideways along the furniture. By now babies are usually able to turn around and have learned to get out of tight places.

Pincer movement is perfected now and baby can pick up small bits of food without difficulty. This is the age when it is particularly important to keep beads and buttons away from baby. Things that get picked up are still quite likely to find their way to baby's mouth.

Baby enjoys a game of ball now, according to his own rules. He will retrieve the ball that you throw across the room and expect you to retrieve the ball that he tosses. Another version of the game is sweeping all toys off the high chair and watching Mommy pick up. Mothers, of course, get tired of the game long before babies.

SEEING, HEARING AND FEELING

EIGHT MONTHS OLD

Baby's delight with mirror play continues at eight months of age. He will perform for himself in front of the mirror and laugh out loud at his own antics.

He is very conscious of the source of sounds at this age. When a fire engine sounds, he will look out the window. When an airplane flies overhead, he looks up. When the telephone rings, he tries to answer it. He might even experiment with dialing, and inevitably leaves the telephone off the hook.

Baby now really enjoys a hiding game. If he sees you hide a toy under a blanket he will lift the blanket and get the toy.

Many eight-month-olds are able to solve simple problems. Baby can pull a string to make a bell sound or push away a transparent screen in order to get the toy he sees behind it. He is also learning to predict certain things. If you swing a flashlight back and forth above his head, baby will get the idea of the pendulum motion and will anticipate with his eyes where the flashlight is going to be. When he drops a cup on the floor, he will screw up his face and may even place his hands over his ears in anticipation of the crash.

SOCIALIZING
EIGHT MONTHS OLD

At eight months, baby's babbling has reached its peak. He has mastered almost all the sounds of his language, and will repeat the same sound over and over again. Talking on a toy telephone is apt to be his favorite game. Some babies prefer the real telephone, while others seem frightened when a familiar voice that usually comes from Daddy's mouth is all of a sudden inside the phone.

Comings and goings are particularly interesting to baby. He notices when Mommy or Daddy leaves in the morning and watches out the window when Mommy or Daddy come home. He learns all the signs of his parents coming and going. He knows, for example, that if Mother puts on her hat and coat, or Daddy puts the leash on the dog, they are about to go outside.

Baby is very attached to his parents at this time, and enjoys playing with them. Peek-a-boo, pop goes the weasel, hide and seek, and "horsey" are favorite games for many babies.

Suggested "Motor" Activities - Eight Months Old

Place toys on the top rail of playpen so that baby is encouraged to pull himself up.

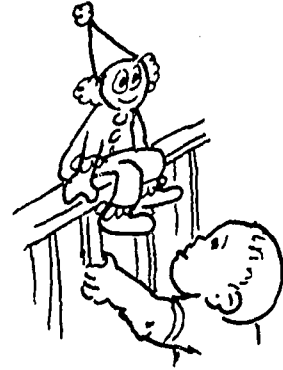

Swing baby in your arms or on a swing, or ride him up and down on your knee. These games help baby develop balance and control.

Place a cup upside down on a table. Let baby turn it over.

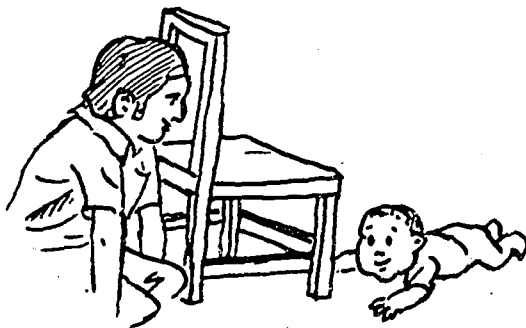
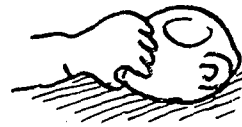

Hide behind a chair. Let baby come and find you. (Call to him from your hiding place).

Give baby a spindle toy. Help him place rings on the spindle. This is a good game for helping baby learn about spatial relations.

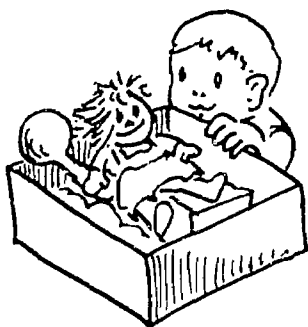
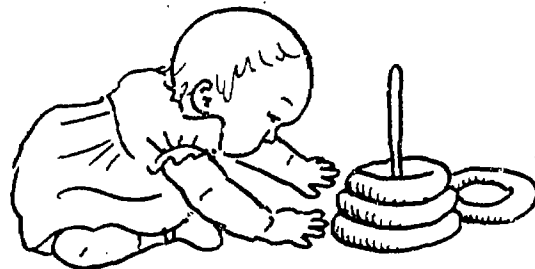

Place baby's toys in a box he can reach into.

Place a toy on a blanket out of baby's reach so he has to pull the blanket in order to retrieve the toy.

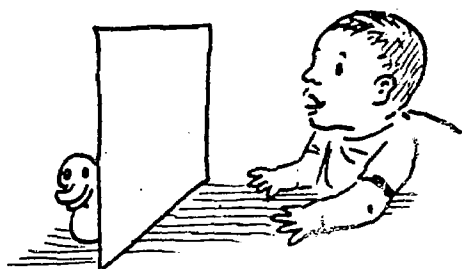

Let baby watch you place a toy behind a screen. See if he can retrieve it. If he doesn't get it right away, let half of it show.

Suggested "Seeing, Hearing and Feeling" Activities - Eight Months Old

Give baby a "hat" that he can put on his head. As he tries to find his head, he is learning more about himself.



Put bells on babies shoes when he is first pulling himself up. It's fun for baby, and at the same time lets you know where baby is and what he's up to.

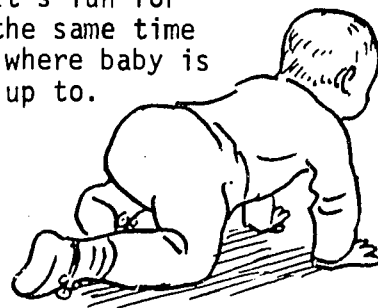

Put a caterpillar through a tunnel. Let baby watch it come out the other side. Baby will learn to anticipate the movement and will "wait" with his eyes at the end of the tunnel. After baby has watched you play with the caterpillar he will want to take his turn.



Make "pat" pictures, using different materials and textures - pussy willows, satins, rubber carpet ends all produce interesting sensations.

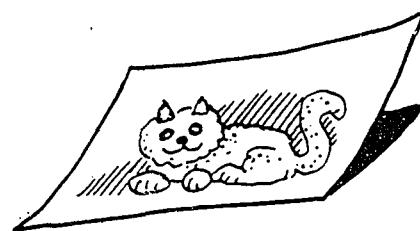

Hide a toy under a blanket while baby is watching. Let him lift up the blanket, and find his toy. Because baby is just learning that objects exist, even when he doesn't see them, there is an element of surprise in this game, that adds to the fun of playing it.



Call baby's attention to different sounds by naming them, such as the telephone, door bell, Daddy's footsteps, rain, running water, dog barking. As baby pays attention to sounds, he is learning the habit of listening - important for development of speech.



Suggested "Socializing" Activities - Eight Months Old

Make a family album. Cover the individual pictures with contact paper so that baby can touch them as you talk about them.

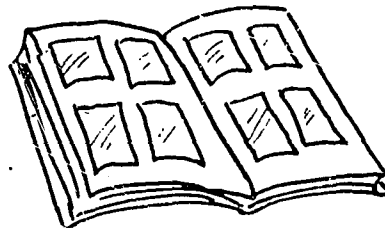

Dance and sing with baby in front of a mirror. Talk about what you are doing.

Talk to baby in full sentences. Carry on a running commentary about everything you and baby are doing.

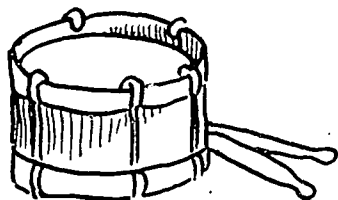

Play "follow the leader" games with baby. Bang a drum, knock, clap your hands, wave, blow, lead an orchestra.

Imitate baby's gestures and encourage him to imitate yours.

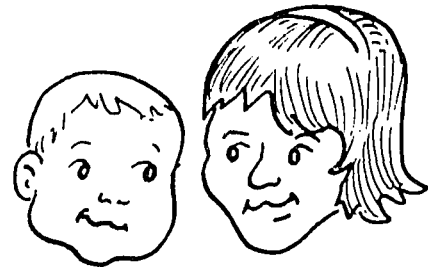

Place baby at the window so that he can watch for Daddy to come home at night.

"JACK AND JILL WENT...."

Play short nursery rhyme records or sing nursery rhymes to baby.

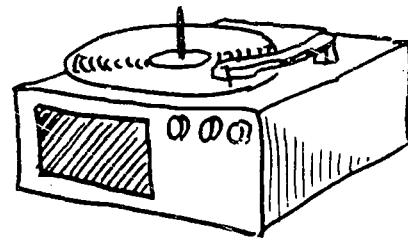

SPINDLE TOY

PURPOSE: Develop hand-eye coordination and spatial awareness.

MATERIALS: Coffee can with plastic lid
Paper towel spindle
3 pipe cleaners or 3 plastic bracelets
Adhesive-backed paper or fabric

PROCEDURE: Cut strip of fabric or adhesive backed paper to size so that you can wrap it around the coffee can. Glue.

Cover spindle with different paper or fabric.

Cut slits (X-shaped) into plastic lid of coffee can.

Place lid on can and put spindle in slit. Make rings out of pipe cleaners. Tape the ends together to protect your baby from the pipe cleaner wire or use plastic bracelets.

PLAY: Show baby how to place the rings on the spindle.

FOR THE OLDER CHILD:

Use as a ring toss game. Make some rings smaller than others and develop a point system that gives more points for getting the smaller rings on the spindle. (It's a great way to practice addition).

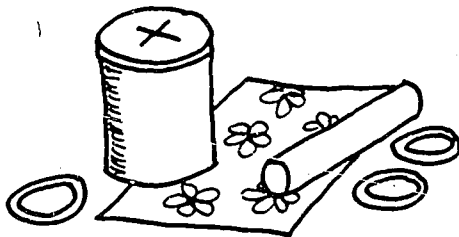

CATERPILLAR

- PURPOSE:** Develop understanding of object permanence.
Language development.
- MATERIALS:** Spools or beads, pipe cleaner, string, dental floss
or telephone wire, paper towel spindle.
- PROCEDURE:** Paint spools, string, cut out pipe cleaners & tape on as
antennae.
- PLAY:** Pass the caterpillar through the tunnel several times,
talking to baby as you do it. After a while baby will
learn to watch the other end of the tunnel where
caterpillar will reappear.
- FOR THE OLDER CHILD:**
- Ask him to predict the order of the colors as they
come through the tunnel.

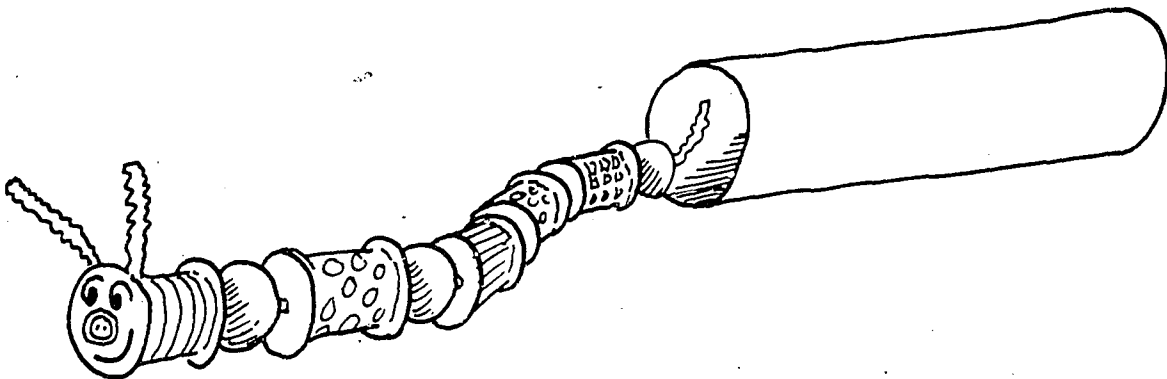

JINGLE-JANGLE FISH

PURPOSE: Practicing "shaking." Early experience with cause-effect relationship and spatial relationship.

MATERIALS: Large empty plastic bottle (a cider bottle is ideal)
Shoe lace
Aluminum juice can lids
Tape
Felt pen

PROCEDURE: Punch holes in the center of the juice can lids, string on shoe laces and cover with tape to protect sharp edges. Paint eyes and fins on fish body (bottle) with felt pen. Make a hole in the bottom of bottle and attach tail. Put something heavy like a large bead or spool inside bottle to add to the noise appeal.

PLAY: Show child how to hold jingle-jangle up high so that it's tail will rattle.

FOR THE OLDER CHILD:

Use as a rhythm band instrument.

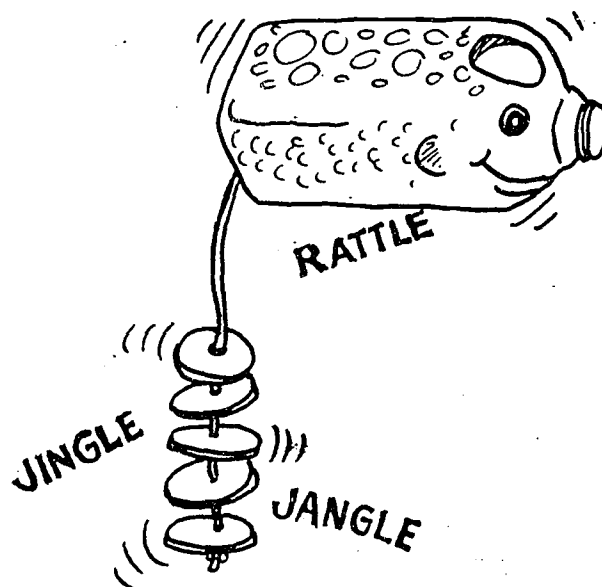



Nine Months

BABY'S VIEWPOINT

NINE MONTHS OLD

One of the most exciting things about the nine-month-old is that he is learning to solve simple problems. In his younger days, baby had practiced a series of action routines-- grasping, shaking, batting, banging, stroking, letting go, pushing, pulling. The more he practiced, the more efficient he became with each of them. Now, at nine months of age, baby is beginning to put these action routines together, that is, to use one routine in the service of another. If you put a bead inside a wide mouthed container, baby closes his fist in order to fit it into the container before opening his hand to pull out the bead. If you cover a bottle with a blanket, baby pulls the blanket away in order to grasp the bottle. By now, too, baby may be able to solve the problem of reaching an object that is placed behind a see-through screen. When first presented with this problem, babies usually tries to reach the rattle through the screen. The baby who can use one routine "in service of another" will find a way to get at the rattle.

MOTOR SKILLS

Nine Months Old

While some babies at nine months are developing many important new motor skills--standing, cruising, climbing up stairs, sliding off sofas--others seem to be at a standstill. All babies have peaks and plateaus in their development. They learn quite rapidly for awhile, and then need time to practice and consolidate before going on to new things. Often, however, when baby appears not to be progressing in one area of development, he is making important gains in another area.

By now, baby is able to use his thumb and finger to perform certain "skilled operations," such as standing up a toy or picking up a pencil. A quiet and intense baby may devote all his attention to the act of balancing one block on top of another. This requires baby to hold the block up with his thumb and forefinger, and then let go at just the right moment. If baby succeeds with this task, chances are that he will not rest on his laurels. Instead, he will place a third block on top of the second with the outcome, of course, the inevitable crash of the tower. At this point, baby will probably not be too perturbed. He will either switch to an active block-throwing game, or go off on a new exploration.

SEEING, HEARING AND FEELING

NINE MONTHS OLD

Many babies at age nine months will search selectively for a favorite toy or blanket. This is the period where a dirty teddy bear tossed in with the morning wash can start a family crisis. Despite the potential problems the "favorite toy" creates, this kind of object attachment is an important developmental event. It shows that baby can make fine distinctions, (a substitute blanket is rejected forcefully), and can retain the visual image of an object which is out of sight.

Baby's ability to make fine discriminations is as noticeable with sounds as it is with sights. He is particularly attentive to familiar signs--the closing of the front door as Daddy leaves, the buzz of a razor meaning Daddy is awake, the closing of the refrigerator door meaning breakfast is ready, the patter on the window meaning rain.

Most nine month olds develop a special love for silk and fur. Baby will rub the silk binder of his blanket on his way to sleep, pat a kitten, or stroke the fur of a stuffed animal. This stroking is not just a part of his usual investigation of things. It seems to give baby a special kind of pleasure.

SOCIALIZING

NINE MONTHS OLD

At nine months, many babies show a new ability to understand language. Baby will look from one parent to the other in response to "Where's Mommy?", "Where's Daddy?" and will give Mommy the spoon in answer to a simple command. Baby is more apt to follow a verbal command such as "give Mommy the spoon" if he is looking at the spoon when Mother makes the request. Once he has achieved success with a simple give and take game, baby will enjoy playing it over and over again.

Although many babies have overcome their fear of strangers by now, new fears may emerge. A loud, sudden noise, or strange new clothes (a Halloween mask or party hat) might send baby scurrying for the safety of Mother's lap.

Suggested "Motor" Activities - Nine Months Old

Set aside a daily dance time when you and baby listen to music and dance together. Now that baby is spending so much of his time on the floor, he needs to have special opportunities to feel physical closeness with his parents.



Continue playing hide and seek with baby. Pretend you can't find him sometimes and hunt all over, calling his name until he finds you.

Give baby his own washcloth at bath time and his own towel for drying. Encourage baby to help wash and dry himself. Self-help takes lots of time and preparation.

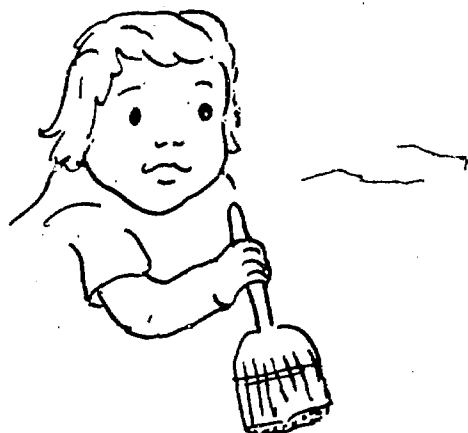

Give baby a small clean plastic whisk broom to play with. Show him how to hold it by the handle and "sweep."

If baby is an early walker, let him push his own stroller. It's a great balance exercise and gives baby practice with starting and stopping.

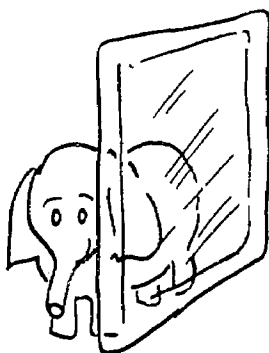

Place a brightly colored toy behind a plastic tray. See if baby can find it. If he has trouble, move the toy so that it is only half behind the tray.

Put some of baby's toys in a plastic see-through shoebox. Let baby try to take the cover off himself. If he can't do it, take the cover half off for him.

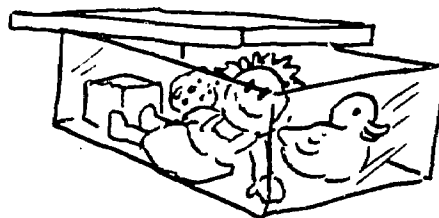

Suggested "Seeing, Hearing and Feeling" Activities - Nine Months Old

Give baby his own box of "feel" materials. Make sure that it includes rough materials as well as smooth ones. A good collection of feel items might include sandpaper, plastic, fur, satin, carpet, foil and velvet. Cut the borders of the fabrics with pinking shears so they won't ravel. As baby empties and fills his feel box, he learns to distinguish between kinds of feel.

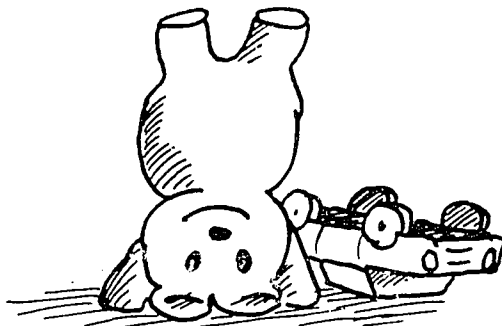
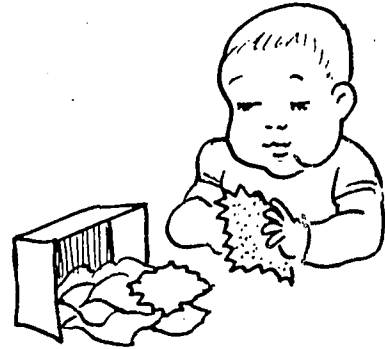

Line up baby's toys upside down. (Teddy bear standing on his head, etc.) Encourage baby to turn the toys right side up.

Describe the sounds that you hear to baby. Talk about the ringing of a bell, the rumbling of thunder, the whistling of wind, the banging of shutters, tapping of fingers, clapping of hands, the squeaking of wheels.

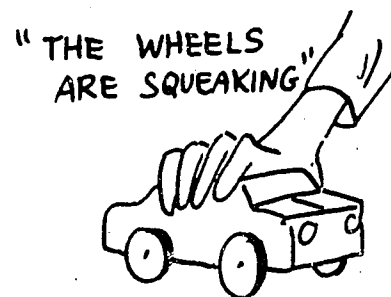

Find a toy with a handle.
Hand it to baby upside down
so that he has to turn it
over in order to make it
work.

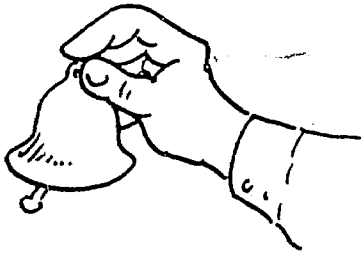
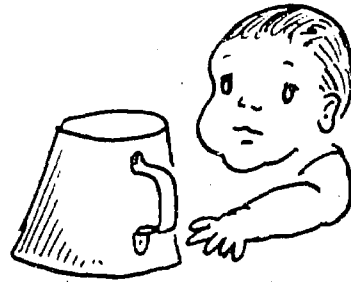

Give baby a bell and show
him how to ring it.

Give baby a pile of very large
wooden beads and a plastic
container. Show him how to fit
the beads into the container.
After awhile baby will learn how
to reach in and get the beads.



Suggested "Socializing" Activities - Nine Months Old

"Reading" a book with baby is very important at this age. Point out all the familiar pictures--a cup, a teddy bear, a safety pin, a brush, a shoe, a sock, a washcloth, a toy duck, a dish. Read the book over and over while baby is in your arms. The more experiences baby has with words, the sooner he will learn to talk.

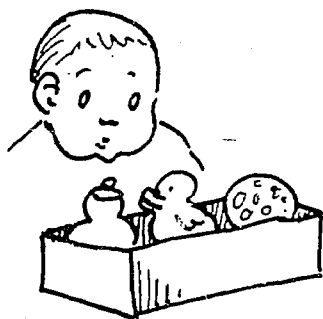

Place three different toys in a box. Name one of the toys and ask baby to hand it to you. Make a fuss over him when he gets it right.

Roll a "feel ball" back and forth to baby. Let the family join the game.

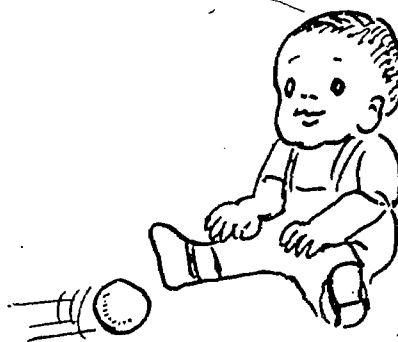

Talk to baby on his home-made telephone--give him a turn. As baby plays the telephone game, he learns the fun of carrying on a conversation.



CLAP
CLAP



Play a clap hands game with baby. Clap his hands together and then hide them under a blanket. Here is a jingle to go with the game.

"Clap your hand, one-two-three
Play a clapping game with me.
Now your hands have gone away,
Find your hands so we can play."

Pretend to give baby's teddy bear a cup of milk. Hand the empty cup to baby and help him give the teddy bear some milk.



TELEPHONE

PURPOSE Encourage talking and provide opportunities for imaginative play.

MATERIALS: Shoe box, paper towel spindle, 2 paper cups, construction paper, string, and brads.

PROCEDURE: Paint shoe box or cover with adhesive backed paper.

Turn box over, and cut slit between a and b.

Using shoe box cover, cut circle to pattern C for dial, and punch ten holes.

Cut out larger circle (pattern D) from construction paper and number.

Attach dials and numbered circle to box with brad.

Cut holes in two sides of paper cups so that spindle fits tightly.

Tie string "from underside" of one cup to side of box.

FOR THE OLDER CHILD:

An older child will enjoy making his own phone.

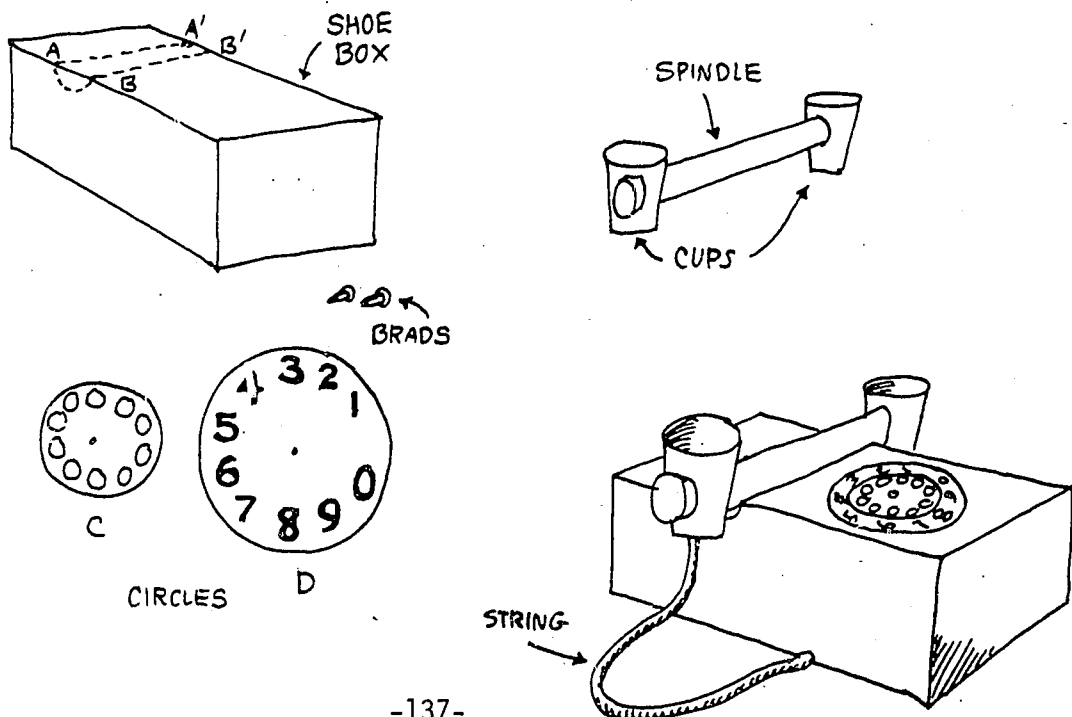

FAMILY ALBUM

- PURPOSE:** Help baby recognize pictures of family members.
- MATERIALS:** Envelopes (8 1/2" x 10"), family photos, loose leaf notebook rings.
- PROCEDURE:** Label outside of envelope. Have an envelope for each member of the immediate family and one envelope for group pictures. Attach bottom of envelopes with rings.
- PLAY:** Take pictures out of the envelopes one at a time and talk about them with baby.
- FOR THE OLDER CHILD:**
- Let him take his own photos and make his own album.

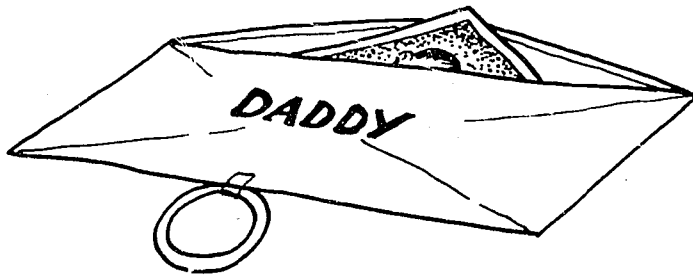

WASH CLOTH MIT

PURPOSE: Give baby early experience in self-help.

MATERIALS: Terry cloth wash cloth and thread.

PROCEDURE: Cut two pieces of mitten to size of baby's hand.

Sew together and decorate.

(If mit slips off baby's hand, slip a wide elastic bracelet over it.)

PLAY: Let baby wash himself with his "mitcloth" while you are bathing him. Talk about the parts of the body you are washing.

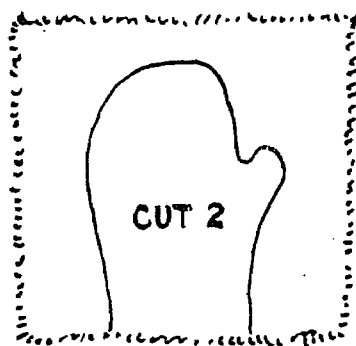

WASH CLOTH

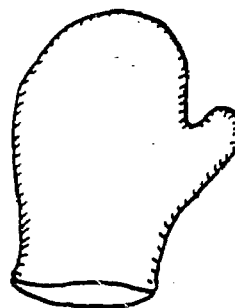

**SEW TOGETHER
AND DECORATE**



Ten Months

BABY'S VIEWPOINT

TEN MONTHS OLD

Watching a ten-month-old at play is a rewarding experience. Baby is no longer contented with simple manipulative activity -- stroking, turning, pushing or pulling. His playing now appears purposeful and directed. As a matter of fact, at times he seems to be at work rather than at play. Given a plastic milk bottle and a handful of clothespins, baby picks up the clothespins one by one and drops them systematically into the milk bottle. When the pile of clothespins is depleted, baby knocks over the bottle with his hand, dumps out the pins, and begins the task again. Baby is quite aware now that the clothespins continue to exist even when he can't see them.

Another favorite game with the ten-month-old is pulling a toy by a string. Like the bottle filling activity, this pull toy game signifies a new advance in baby's understanding of his physical world. Baby recognizes that the string is attached to the toy and that by pulling the string, he can make the toy move. Whether baby is creeping, hand walking, or walking alone, he will begin this activity by moving backwards so that he can see the string and the toy at the same time. Is he intrigued by the fact that the string moves the toy and, is therefore, compelled to watch? Or is he watching just to make sure that the string and the toy are moving the way they are supposed to?

MOTOR SKILLS

TEN MONTHS OLD

At ten months of age individual differences in motor development are very apparent. While one ten-month-old baby might just be learning to creep well, the second may already be a good walker, capable of climbing a stair or dragging a pull toy along the floor.

Most ten-month-olds are quite efficient with reaching and grasping. They can carry on tasks involving coordination of shoulder, arm, wrist and fingers such as taking the cover off a box or standing up a toy dog. When an object is placed in front of a baby he reaches for it directly, and picks it up deftly with forefinger and thumb. This smooth grasp movement seems to be associated with a slight turning or tilting of the wrist that takes place in the first phase of the reach. At a younger age baby had learned to use a pincer movement for picking up crumbs from his high chair. He had also learned to rotate his wrist, inspecting a toy in his hand. Now we see baby gaining new control and efficiency by pulling these skills together.

As he maneuvers around the room, or redistributes the toys in his playpen, the ten-month-old gives the impression of knowing exactly where he is going or what he is trying to do. Part of this look of assurance stems from a marked increase in motor control. Baby is efficient now with opposing muscle movement. When he pulls himself up, he can let himself down. When he grasps for a block, he can release it easily at will. During his waking hours, he is constantly on the go, practicing newly acquired skills and exploring his own capacities.

SEEING, HEARING AND FEELING

TEN MONTHS OLD

An adult recognizes that, despite appearances, things really don't get small as they move further away. We have no trouble, for instance, recognizing a matching coffee cup on the other side of the table. The ability to compensate for distance when we estimate size is called constancy and is learned during infancy through experiences with size and distance. Most babies have developed size constancy, at least with familiar things, by the time they are ten-months-old. Baby realizes, for instance, that the teddy bear over on the sofa is his teddy bear, even though it looks so much smaller than it did in his crib. Nor will he confuse a pair of doll shoes with his own shoes, even if the doll shoes are way across the room.

The ten-month-old demonstrates this awareness of the way things are supposed to look in many ways. If you hand him his drinking cup upside down he immediately turns it over. When his sister does a head stand, he watches her and laughs. He can also recognize a familiar object when he sees just a small part of it. He picks up a spoon almost covered by a napkin and puts it directly into his mouth.

With sound as with sights, baby's perceptions continue to sharpen. He's getting quite good at telling which direction a sound is coming from. If a sound is made behind his back, he turns around immediately and looks at the place it came from. He continues to pay special attention to voice. He can recognize members of the family by voice alone, and can identify subtle differences in voice tone that show anger, teasing, calm, joy, or annoyance.

SOCIALIZING

TEN MONTHS OLD

The ten-month-old is usually quite friendly and outgoing. He uses his vocabulary of babbles to carry on a "conversation" and enjoys experimenting with new sounds and sound effects. He is an excellent mimic and can imitate some sounds and words that he hasn't used before. Most exciting of all, he is learning to understand the meaning of words. The more opportunities baby is given to hear words spoken, and respond to simple commands, the faster he will learn to speak.

The intense attachment to parent that characterizes the infant from six to nine months may show some signs of change. As creeping becomes easy and automatic, and as baby finds that he can get about in his spatial world, he finds out that he can creep in one direction, turn around, and get back to his starting point. This gives him a new feeling of self-sufficiency. He sees himself now as an independent agent, venturing across the room or even the house, exploring new terrain. During his longer expeditions, baby may take along a favorite blanket or toy. An understanding parent recognizes the importance of the security blanket, as baby strives to break old ties and establish his own identity.

Despite baby's growth in self reliance, the interplay with family members is more important than ever. The play experiences of infancy are critical for the more structured and organized play of the older child. As baby engages his parents in a game of peek-a-boo, or hide and seek, he is learning to sequence events, to recognize relationships; and to value the feeling of exhilaration that a play situation provides.

Suggested "Motor" Activities - Ten Months Old

Develop an obstacle course for baby with chairs, pillows and boxes. Wait at the end of the course and greet baby enthusiastically as he reaches you.



Give baby a safe dresser drawer that he can open and close. Keep exciting things in this drawer so that baby will be encouraged to come to this drawer and leave other drawers alone. (Babies can pull high dressers over on themselves by opening a drawer too wide and hanging on it. So, take handles off the bottom drawers of "high boys" or weigh them down so they can't topple over.)

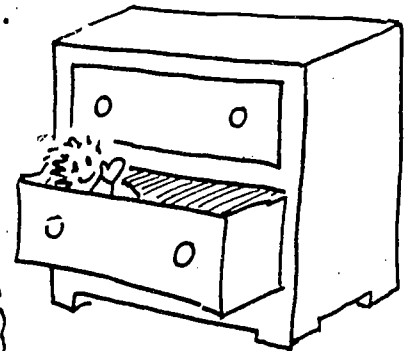

Play a stretching and squatting game with baby.

"Up my arms go,
Now I'm tall,
Down I go,
Now I'm small!"

Hide one of baby's toys and help him search for it.

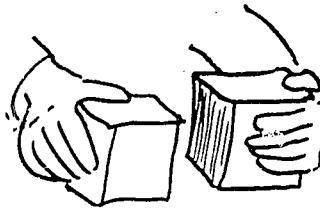

Hit two blocks together and let baby have a turn.

Tie a "leash" to one of baby's toys and let him pull it around.



Give baby a plastic bottle and clothes pins. Show him how to fill and empty the bottle. He will need help for awhile.



Suggested "Seeing, Hearing and Feeling" Activities - Ten Months Old

Hand things to baby upside down so that he will have an opportunity to right them.

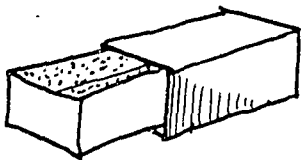

Line large match-boxes with different fabrics. Show baby how to slide them open and feel inside.

Give baby measuring cups or tin cans of graduated sizes so that he can experiment with size and fit.

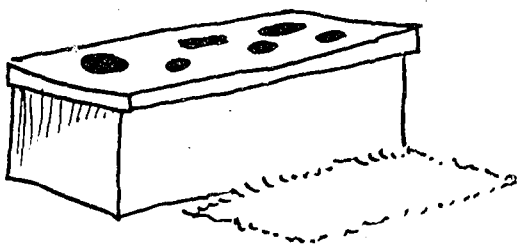

Make a series of different size holes in a "poke" box, and line the box with a soft, furry fabric. Show baby how to poke his fingers into the holes.

Cover three boxes, two square ones and one round one, with the same contact paper. Place cracker crumbs inside the round box. See if baby can learn to choose the round box.

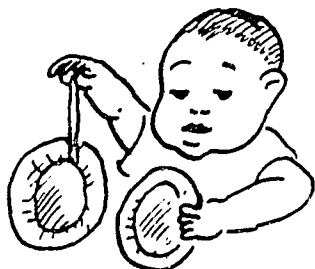
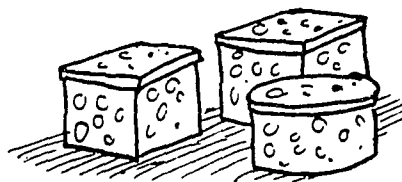

Tie ribbons to aluminum pie plates to use as cymbals. Show baby how to bang them from different distances to produce different sounds.

Make a series of red cardboard blocks. Make a yellow block of the same size and place a bell inside it. See if baby can learn to discriminate color by picking out the block with the bell.

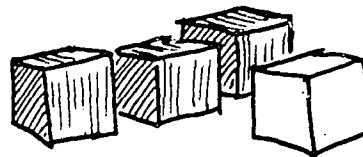

Suggested "Socializing" Activities - Ten Months Old

Encourage baby to go on short messages for you. This will help with language development and, at the same time, will help baby feel independent and important.

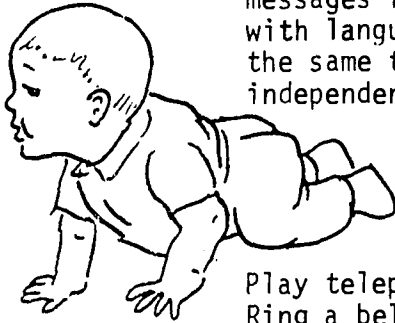

Play telephone games with baby. Ring a bell, let him answer his play phone and talk to you.



This is an age where baby loves to imitate. Play follow the leader with baby, using simple gestures or hand play. Tap the table, scratch your ear, twirl your hair, open and close your fist, roll your hands. Always talk about the things you are doing.



"I AM
SCRATCHING
MY EAR."

Encourage baby to imitate sounds that you make by speaking slowly, repeating frequently, and showing him how pleased you are when his vocalizations match yours.

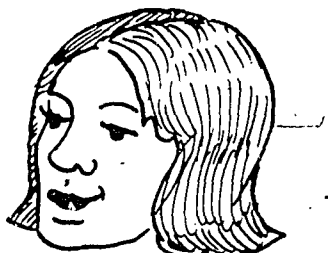

Play records for baby. He really enjoys music at this age and will begin to recognize familiar tunes. As soon as he seems interested, give him a stick so that he can beat time with the music.

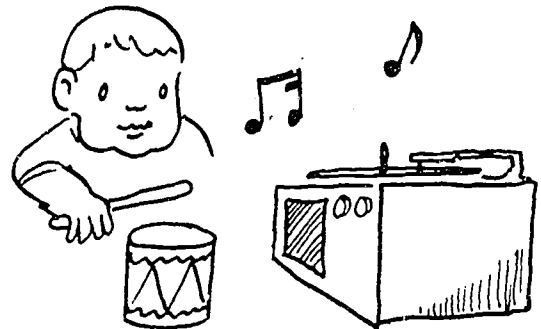

Baby loves any kind of hiding game. Try hiding an object in full view of baby, first in one place and then, in another. For a while, baby will go back to the place where he originally found the object. He may not be quite old enough to keep track of an object that is hidden in a new place.

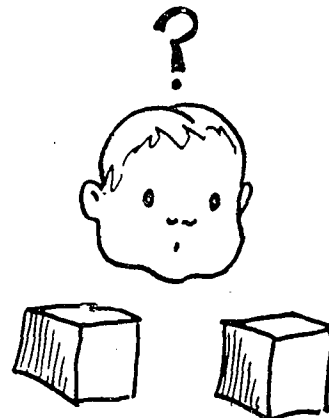

BLOCKS

PURPOSE: Small muscle control, language development.

MATERIALS: Heavy construction paper, glue, and clear adhesive back paper.

PROCEDURE: Trace block pattern on tag board.

Cut out letter or use pictures (cut-outs from magazines, catalogs, or comic books work fine).

Cover with clear contact (adhesive back paper) for extra protection.

Cut, fold, and glue to make a block.

Fold down all flaps, fold down sides 1, 3 and 4. Glue flaps $A_1A_2A_3$. Fold up sides 5 and 6. Glue flaps $B_1B_2B_3$ and C_1C_2 and C_3 .

FOR THE OLDER CHILD:

Make enough blocks to spell his name. Combine letters and numbers so that the first letter of his name is on the one block, the second on the number two block, etc.

Make enough blocks so that your child can "write" his telephone number.

CARDBOARD BLOCK

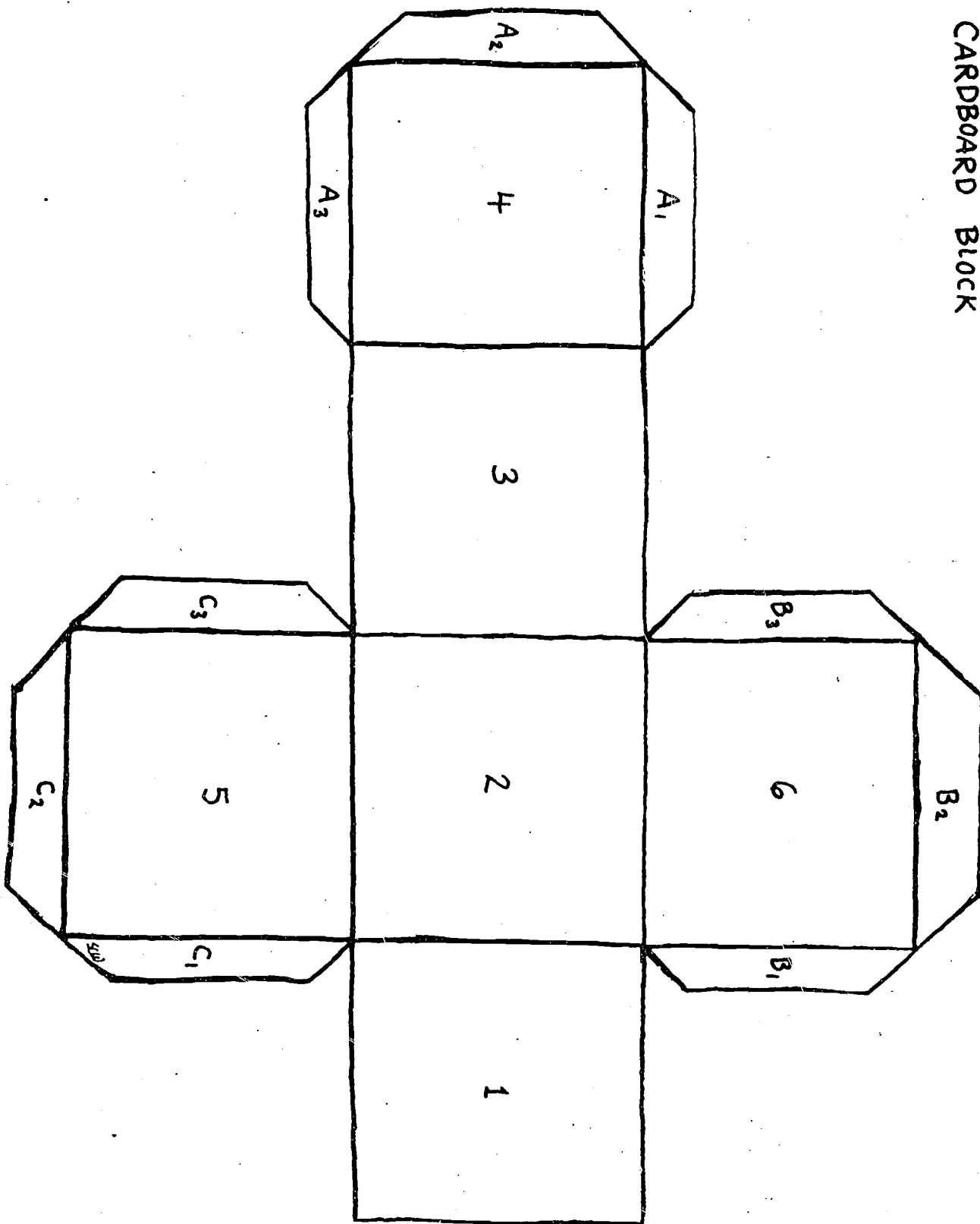

POKE BOX

PURPOSE: Develop small muscle control. Give baby experiences with different "feel" sensations.

MATERIALS: Flat box, cotton balls, and fabric scraps.

PROCEDURE: Take cover off box.

Draw four parallel lines on box bottom.

Glue cotton balls on one section and fabric strips on the other four. (Find fabrics with different textures--corduroy, burlap, carpet scraps, wool, satin, fur, velvet, rubber foam).

Punch 10 holes in box top and cut around. Make holes large enough for baby to poke his finger through.

Place lid on box, and tape securely.

PLAY: Let baby poke his finger through the holes. He will enjoy feeling the different textures on the bottom.

FOR THE OLDER CHILD:

Enlarge the holes and number each of the holes with a magic marker. Place numbers on popsicle sticks. Let the child place the sticks in the matching holes.

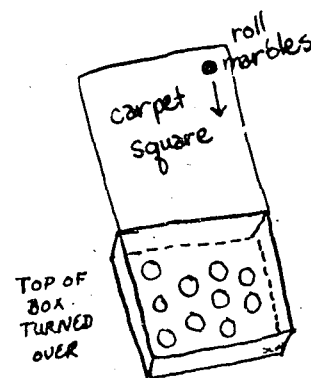
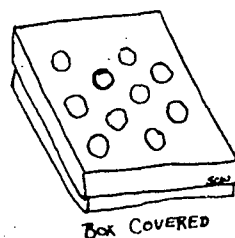
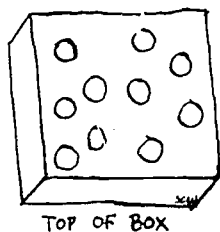
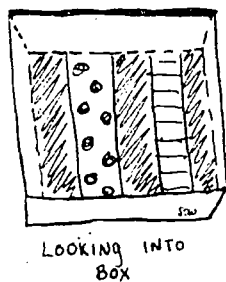

MITTEN PUPPET

PURPOSE: Social play, language development.

MATERIALS: Odd mitten, sew on eyes, embroidery thread.

PROCEDURE: Sew on eye and embroider nose on mitten.

Place the mit on your hand.

PLAY: Recite rhyme to baby.

Watch Mr. Frog
Getting off of the stump
With a hop and a plop
And a very big jump.

When you say "jump", let frog jump on baby. Baby will learn to anticipate the jump and laugh out loud.

FOR THE OLDER CHILD:

Let him make a different kind of animal out of an odd mitten by sewing on a felt tongue and cardboard or buckram.

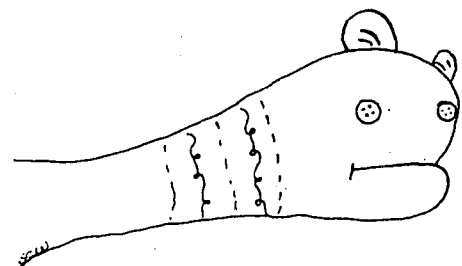
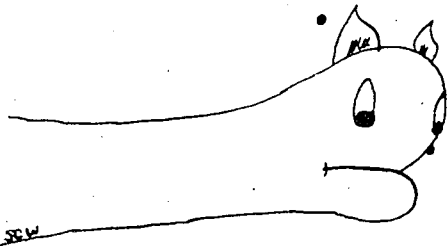

BOAT

PURPOSE: Help child recognize differences in size.
Develop eye hand coordination.

MATERIALS: Paper towel spindle, milk carton, straws, fabric scraps, and tape.

PROCEDURE: Cut spindle into three unequal parts.

Cut three straws so that each straw is a little longer than one of the spindle pieces.

Tape fabric flag on each straw.

Cut holes in the side of milk carton and insert spindles.

Tie on string.

PLAY: Show baby how to put the flag in the spindle or "smoke stack." Baby will find out by trial and error that the long straw fits best in the highest stack, and the shortest straw in the shortest stack.

FOR THE OLDER CHILD:

Cut smoke stacks of equal length and paint each stack a different color. Make a flag to match each smoke stack, and let child match by color. You can also change the flags and stacks so that child learns to match by shape, number, letter, or name.

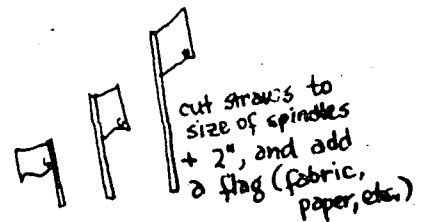
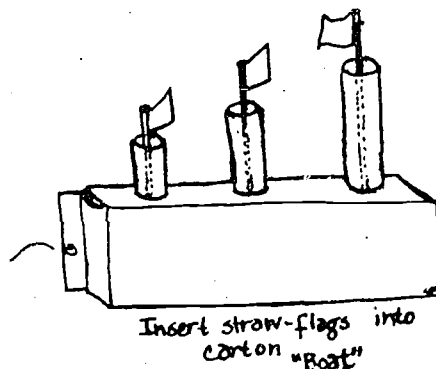
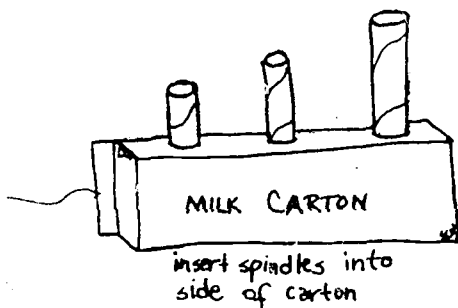



Eleven Months

BABY'S VIEWPOINT

ELEVEN MONTHS OLD

At eleven months old many babies have developed a sense of object permanence. The parent can hide an object in one place, take it out, and rehide it while baby is watching. By now, baby will look directly in the last place the object was hidden. When baby finds the object in the last place, he ignores the first hiding place. At an earlier age, he would have peeked under the first place where he found the object, though he had watched you move it away. Baby's greater conceptual awareness is also apparent in his understanding of physical relationships. He pushes aside a screen if the object he wants is behind it and pulls a toy toward him by its string when he can't reach it directly.

The eleven-month-old is doing quite well now on "social" visits. He has developed his own repertoire of social graces. He may have learned to kiss, to wave bye-bye, or to hold out his hands. At times, however, just when a parent is most anxious to have him show off, baby will put his thumb in his mouth and remain completely detached. This may be a reaction to either the particular situation, or to his parents' anxiety in the situation.

MOTOR SKILLS
ELEVEN MONTHS OLD

While some babies at eleven months are still getting around on their hands and knees, and others are walking by themselves, most babies by this time can walk holding on, pulling themselves up on furniture and cruising around. When baby first begins to walk, he holds both hands out like wings to help him balance. After some practice, he learns to use only one hand for balance and holds a toy or two with the other. It may take several months before baby can walk with both hands down, and several more months before he can swing his arms.

Placing tin cans inside each other is a major accomplishment for the eleven-month-old baby. The decision as to which tin can fits into another is almost always accomplished on a trial and error basis. Baby may be quite persistent in his tries. The larger can may be banged against the smaller with a real show of strength before baby is convinced that it will not fit inside. Under and over, inside and outside seem to be central concerns. Baby will place a toy in a box, take it out, and place it back, time and time again. The adult recording the activity may lose interest in the task, while the infant repeats the activity with obvious purpose and enjoyment.

SEEING, HEARING AND FEELING

ELEVEN MONTHS OLD

The eleven-month-old baby enjoys new sights and sounds. A trip to the supermarket is an exciting experience, particularly if you are unhurried and can talk about each item as you choose it. Baby understands many words now, and can point out the more familiar items on the store shelves, such as milk, bananas, bread, or cereal.

Eleven-month-old babies love music and respond to the rhythm as well as the words of simple songs. They will act out key phrases like, "pop goes the weasel", or "all fall down."

Most babies enjoy feeling different textures with their feet as well as their hands. Some babies at this age, however, develop a strong dislike for certain kinds of "feel." For instance, they do not like the feel of sand on their feet and will refuse to walk barefoot on a beach or in a sandbox. Other babies are disturbed if something sticky gets on their fingers. Because baby learns so much about his world through a sense of feel, different feel experiences are important for him. Unless it is really cold, baby should not wear socks and shoes in the house. Contrary to popular belief, baby does not need shoes for support when he first begins to walk.

SOCIALIZING
ELEVEN MONTHS OLD

Although individual differences in temperament are apparent from birth, the development of personality is a gradual process. Personality is usually thought of as a characteristic way of behaving. It implies an element of choice. At birth, every infant instinctively cries when he's hungry, so we don't think of crying as a personality trait. As the child grows older he learns different ways of behaving, and can react in different ways to different situations. When we talk about the kinds of choices that baby makes in response to situations, we can describe different dimensions of personality. The eleven-month-old baby could be described as active or passive, moody or even-tempered, careful or daring, noisy or quiet, fun-loving or serious-minded, friendly or shy, independent or clinging. He might enjoy playing alone with toys or he might prefer playing with people. No one is really quite sure of all the determinants of personality, though it is generally agreed that nature and nurture play their respective roles.

In other words, the temperament he is born with, and the experiences he accumulates combine to make a baby his own unique self.

Many important experiences that baby accumulates quite early in life are associated with sex role identity. Every culture has its own sex role stereotypes-that is, it's own set of expectations about the way girls should behave and the way boys should behave.

In American culture, the little girl is expected to be cute and coy and the boy is supposed to be mischievous. Therefore, when the girl baby covers her face with her hands and looks up for a moment with a shy half smile, everyone comments on her cuteness. The boy baby, on the other hand, finds his audience tolerantly amused by his "Dennis the Menace" antics.

As the baby practices the behaviors that work for him, and abandons the ones that don't, he develops a unique set of patterns of behavior that constitute personality.

Suggested "Motor" Activities - Eleven Months Old

Make a round cylinder out of aluminum or a piece of linoleum and cover it with felt. To fasten, tie with twine or cloth strip or use heavy cloth adhesive tape. Show baby how to climb on it, how to roll it, and how to push things into one end and pull them out the other.



If baby is walking, show him how to hold on to a chair and push it around the room.

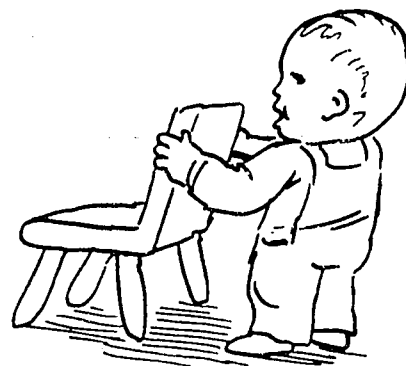

If baby is walking, give him a child's mop, broom or carpet sweeper and let him help clean the house.



Show baby how to roll down an incline.

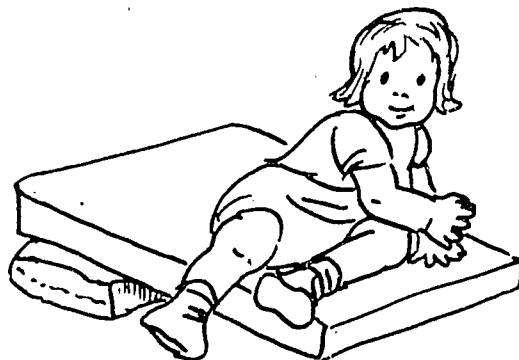

Roll a ball to baby and encourage him to roll it back. This activity can be done rhythmically with a chant:

We roll the ball, it's rolling,
Now roll it down the track.
We roll it down to baby,
And baby rolls it back.

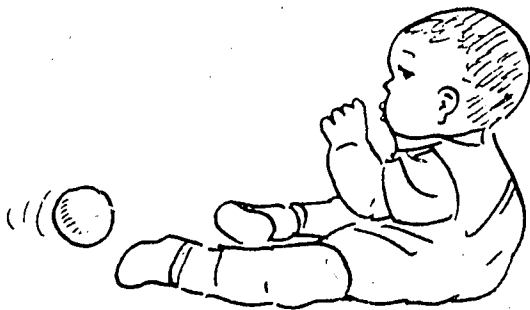

Place bits of crackers or cereal inside a small, screw-top film container or plastic jar. Place the lid on top loosely (do not turn). Show baby how to take off the lid and retrieve the crumbs.

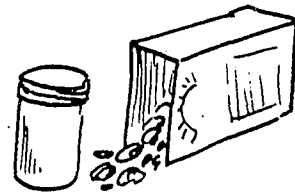

Give baby empty containers when he is in his bath. He will love filling the containers with water and then pouring it out. (avoid giving baby bottles that held chemicals or strong cleaning compounds).



If baby has learned how to climb upstairs, show him how to slide downstairs on his stomach, feet first. (It is always better to teach baby the safe way to come down stairs than to count on keeping a gate closed).

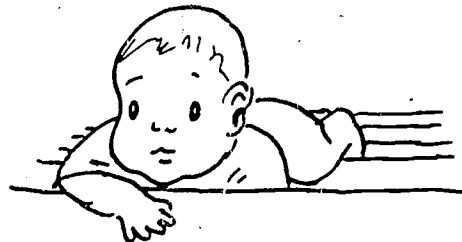

Let baby set the table.

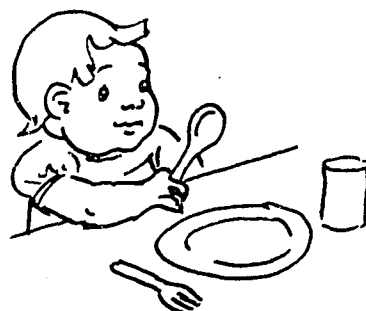

Suggested "Seeing, Hearing and Feeling" Activities - Eleven Months Old

Wrap up toys in foil or tissue paper and allow baby to unwrap. Do not use tape or ribbon.



Roll a toy car through a Cardboard tube. See if baby will watch for it to come out the other end.

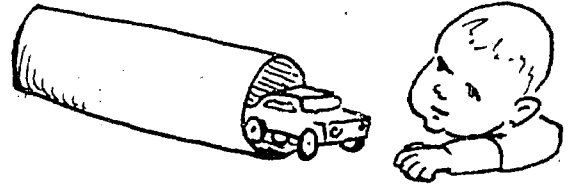

Let baby beat out rhythms with a wooden spoon on the back of a pan or a pie plate.



Give baby a hand puppet and let him manipulate it.

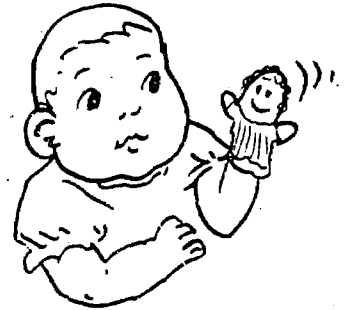

Make baby a flannel tote bag to wear over his shoulder. Let him reach inside and get different toys.



Play a hide and seek game with a loudly ticking alarm clock or pocket radio. Baby has to find out where it is hidden by listening for the sound.

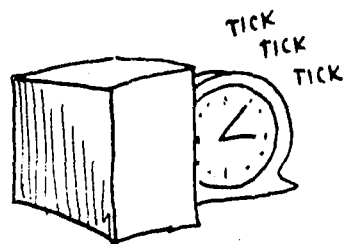

Make baby a squeaking picture book. Read it, letting baby squeak the pictures. (Squeaks can be bought at novelty stores and glued under pictures in your home made picture books.)

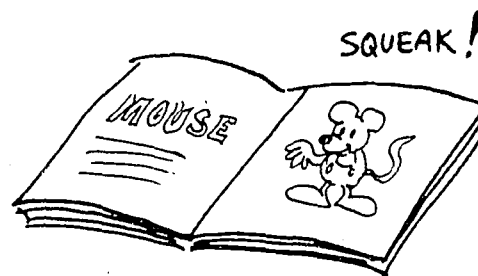

Place a toy on a pillow so that baby can reach the pillow but not the toy. See if he will pull the pillow towards him. Now hold the toy above the pillow. Does baby still pull the pillow to get the toy?

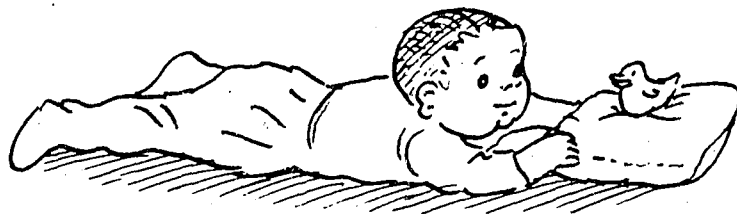

Suggested "Socializing" Activities - Eleven Months Old

Teach baby how to kiss by letting him watch you kiss. Once he has learned to make a kissing noise with his mouth, show him how to raise his arm to his mouth and "throw" a kiss.

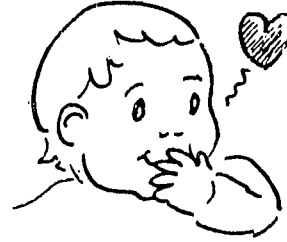

As baby "helps" with simple tasks, talk about what you and baby are doing. "We are pouring milk in the cup." "We are opening the refrigerator door." "We are drying the dish with a dish towel."

Use complete sentences.

DO NOT TALK BABY TALK.



Talking to baby is critical for language development. Look baby straight in the eye when you talk with him. Accompany actions with words and names.



Read books to baby. Home-made books are often a baby's favorite, particularly when different textures are used in the book so that baby can feel the picture.



Tie different color ribbons to two of baby's favorite toys, e.g. car and teddy. Put the toys in front of him so that he has to pull the ribbons to get them. Ask him to give you the teddy- then the car. When he learns to pull the right strings with the toy in view - try the game with first one toy hidden, and then both toys hidden.

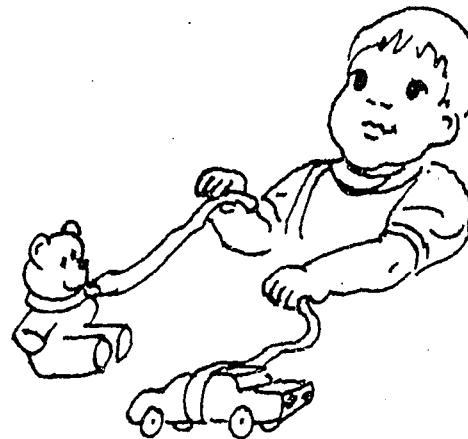

FEED-THE-HORSE GAME

PURPOSE: Give child experience with an object disappearing and reappearing.

MATERIALS: Tagboard apple, plastic egg, or rubber ball
Juice can (without top)
Elastic string
Magic marker
Adhesive backed paper

PROCEDURE: Cut paper to size of juice can and wrap around. Draw eyes and mouth with magic marker. (You may glue on felt ears to make your animal more realistic.) Loop one end of string and string through bottom of can. Attach to ball or "apple." Tie can to high-chair arm or crib side.

PLAY: By pulling the string child makes the apple disappear in animal's mouth. When he lets go the apple reappears.

FOR THE OLDER CHILD:

Child tries to catch the ball with the can.

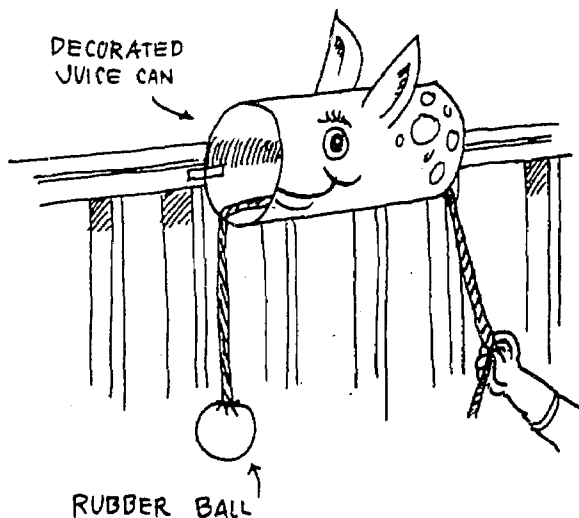

CARRY-ALL

PURPOSE: Provide experience with placing toys inside a bag, and with finding things that are out of sight.

MATERIALS: Felt cloth approximately 24" by 16"
Felt scraps
(Burlap works almost as well)

PROCEDURE: With pinking shears - cut two strips 12" long and 2" wide for handle. Cut remaining fabric in half. Sew up three sides. Sew on handles. Glue on appliques.

FOR OLDER CHILD:

Make a pouch on the outside for crayons and change.



CAN-MAN

PURPOSE: Develop wrist rotation, give child experience in using a special schema to accomplish a task.

MATERIALS: Metal film container, wooden head, yarn, pipe cleaners, tape, adhesive paper.

PROCEDURE: Cover container with adhesive paper. Cut pipe cleaner to make 2 arms about an inch long. Tape arms to container. Tape other end to make hands.

Glue wooden head to top of can. Glue yarn on head for hair. Twist pipe cleaner and glue on head as a hat.

PLAY: Put raisins or cereal inside can. Show baby how to twist open can, and tip over to get raisins or cereal.

FOR THE OLDER CHILD:

Half fill a series of cans with beans, rice, sand, pebbles and macaroni. Allow child to shake cans and match according to sound. He may check himself by opening up cans.

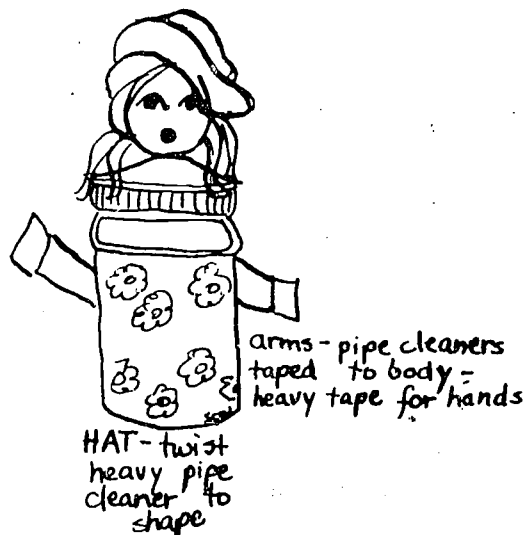
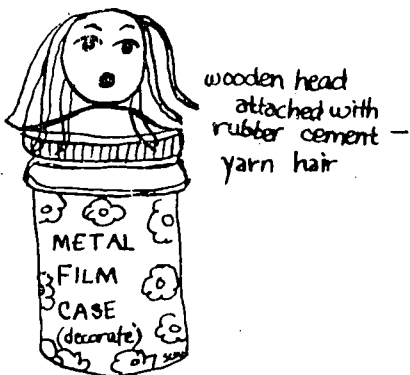

BELL BOY

PURPOSE: Give child experience in using a special schema to accomplish a task. Help child understand cause-effect relationship.

MATERIALS: Wooden cigar box, or sturdy cardboard box, 3 spools, 3 bells, 3 wooden heads, thin wire, 3 popsicle sticks, 3 bottle tops, 3 small springs, (from ball point pens).

PROCEDURE: Cut top and bottom off cigar box. Drill holes in sides of cigar box 1/4 of an inch from bottom.

String wire through popsicle stick, spool, spring, head, bottle top and bell. Tape end of wire to top of box, and other end to bottom wire. (See diagram.)

PLAY: Show baby how to press down tongue depressor to make dolls head pop up and hit bell.

FOR THE OLDER CHILD:

String bells at different heights to make musical instrument.



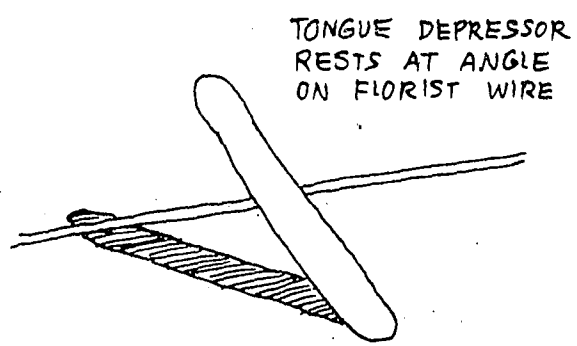
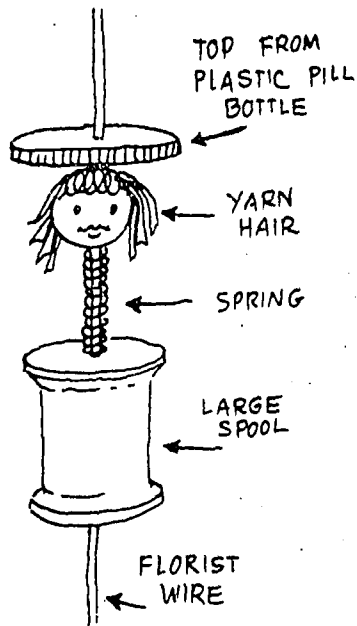

CIGAR BOX IS TURNED ON ITS SIDE.

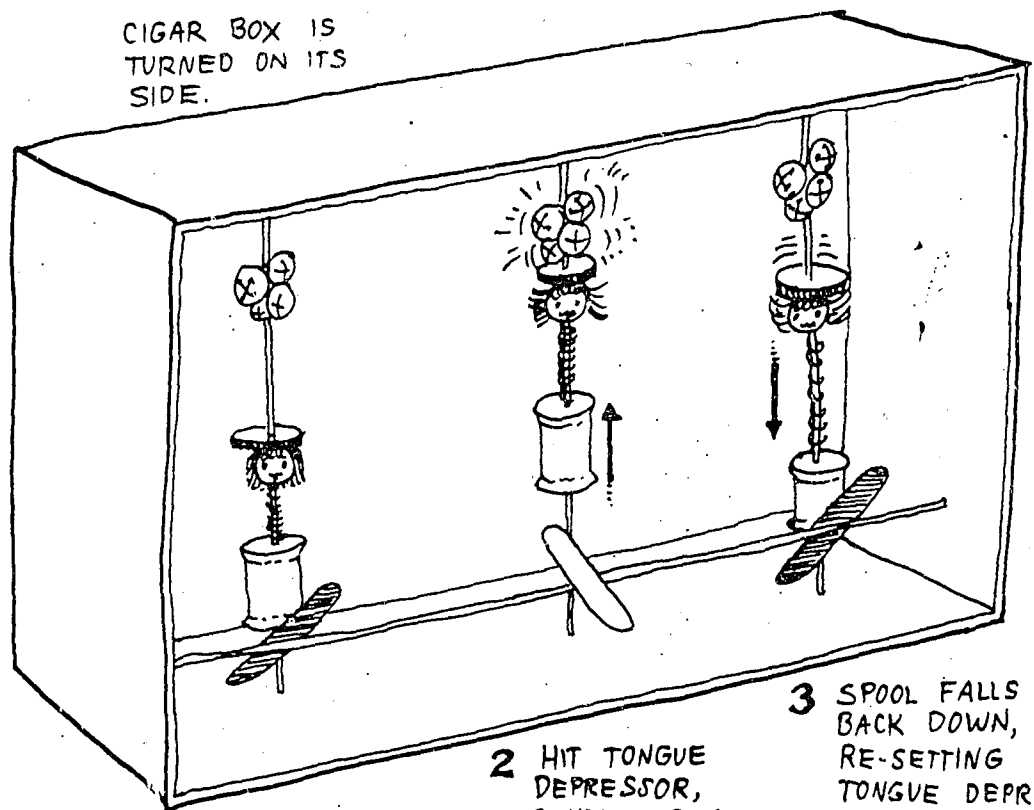

1 STARTING POSITION

2 HIT TONGUE DEPRESSOR, SENDING SPOOL UP TO HIT BELLS.

3 SPOOL FALLS BACK DOWN, RE-SETTING TONGUE DEPRESSOR IN ORIGINAL POSITION.



Twelve Months

BABY'S VIEWPOINT

TWELVE MONTHS OLD

A favorite photo in many a family album is the picture of baby on his first birthday with both hands plunged into the cake.

The need for active exploration that prompted that dive into the icing explains much of baby's behavior. Baby is now experimenting. At a younger age, he would throw a ball for the sheer joy of it. Now, he wants to find out some things about this ball. He throws the ball gently to Daddy two or three times, and then tries a bigger throw in a different direction. With rapt attention, he watches the ball hit a lamp or knock down a glass from the table.

Baby plays with the same toy for longer periods now. Even a familiar toy is inspected with new interest, as if baby is trying to figure out what makes it work. Instead of playing with the suction toy on his highchair, he will pull and push at it until he can finally yank it off.

A careful observation of the year old baby may give us glimpses of imaginative play. A baby who has experienced a warm relationship with adults may hug, kiss and rock a doll. A baby who has recently been spanked might pass the spanking onto his teddy bear, accompanying each spank with a vigorous "no-no." This ability to reenact a familiar scene or experience represents an important advancement in the development of thought.

MOTOR SKILLS

TWELVE MONTHS OLD

At a year old, most babies have become quite adept at getting around the house, even if they haven't learned to walk. Babies seem interested not only in what is in front of or behind them, but also in things that are out of reach. Many babies climb as soon as they walk--although they are never as good at getting down from things as they are at getting up. As they become more adept at climbing up on things, they may become increasingly fearful about getting down. This is not a regression. It is just that baby's explorations have given him a new awareness of space, and with this awareness comes a new respect for high places, and a new awareness of danger.

Even a quiet baby at this age tends to stay on the go. Baby enjoys pulling out drawers, re-arranging table tops and taking things off shelves when they are just about out of his reach.

If he has an older brother and sister to imitate, a baby may indulge in experimental gymnastics. He will climb chairs, roll down an incline, and attempt a forward somersault. He is unlikely to get too far with this last feat, but seems quite pleased with himself anyway.

Many year old babies are learning to feed themselves, although most of what gets in the spoon may not make it to baby's mouth. Baby enjoys meal time most when he can do some of it himself.

SEEING, HEARING AND FEELING

TWELVE MONTHS OLD

As the baby actively explores and experiments with all the things around him, he notices fine differences in the ways things sound, look, and feel. As he "reads" a book, he can point to the comb, or the telephone, and may even be able to match a toy car with a picture of a car.

Baby is alert now to fine differences in sound. He will tap a spoon against a glass, a plate, a bowl, and his shoe, as if studying sounds that a spoon can make.

Some babies at a year old are ready for simple bag games. If you put two objects, let's say a ball and a toy car, inside a bag, baby will reach in, and get you the toy you ask for.

As baby explores the shape, the color and the feel of objects he develops an awareness of likeness and difference. Soon he will be ready to play sorting games, where he places "like" things together.

SOCIALIZING

TWELVE MONTHS OLD

By a year old, most babies have mastered their first word, and will use it on every possible occasion. This word is really more than just a word. It represents a whole sentence. "Mommy" means, "Mommy, come in and get me." "Ba-Ba" may mean, "I want my bottle--right now !"

Although few babies at this age can say more than three or four words, the 12 month old understands language quite well. His response to "would you like a cookie?" is quite different from his response to "time for your medicine", and parents may resort to spelling, instead of saying "bed-time" or "going out".

Baby now knows the names of everyone in the family and will look toward the person whose name is called. Some babies can even point out pictures of each family member in a photograph album.

The year old baby is an excellent mimic. He repeats just about any sound that he hears, and is great at copying gestures. He enjoys making funny faces, and will copy a facial expression even when he can't see his own face in the mirror. His readiness to imitate and his emerging sense of humor make him a fun companion for children and adults alike.

Suggested "Motor" Activities - Twelve Months Old

Make a tunnel out of a cereal box. Show baby how to push a car through the tunnel. Baby will watch for his car at the other end.

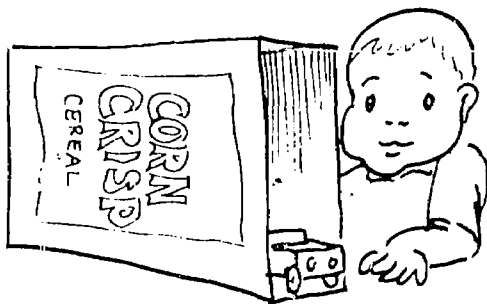

Give baby a brush, wash cloth and a rag doll with yarn hair. Let baby comb the doll's hair and wash its face.



Make a block tower with baby. It's a great way to develop small muscle control.

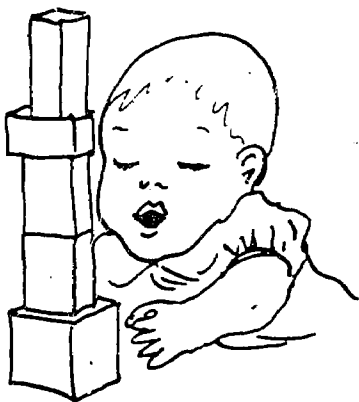

Fold a piece of cardboard to make a hill. Show baby how to place the car on top of the hill and let it roll down.

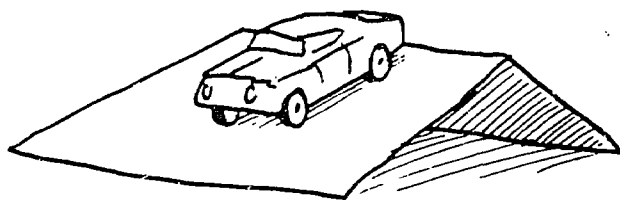

Hand baby a block when both his hands are full. He will find his own solutions to the problem.



Let baby rim a coffee can with clothes pins.



Cut out a square hole in the top of a shoe box and show baby how to drop a block through it. When he becomes adept at this, cut a round hole that an empty spool will fall through.

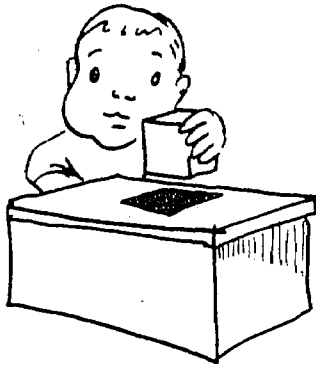

Put a door hook or latch on a cigar box. Show baby how to open it.

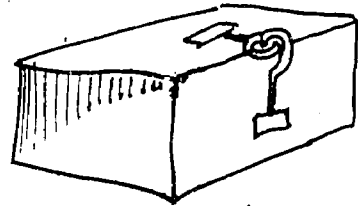

Make baby a "cookie mouse" or give him a bean bag and a large pail. Show him how to throw the bean bag into the pail.



Make baby a rake out of a stick and a comb. Sit him at a table and show him how to use the rake to gather out-of-reach toys.

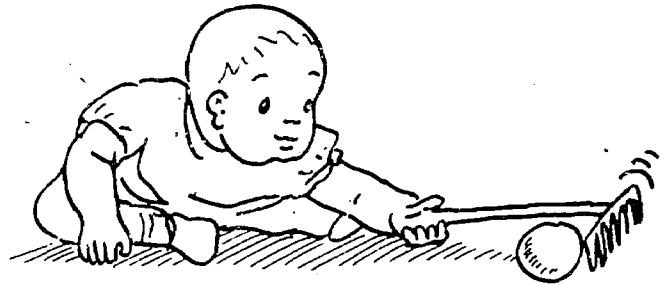

Suggested "Seeing, Hearing and Feeling" Activities - Twelve Months Old

Take baby out on a sunny day and show him shadows. Stand on his shadow and let him stand on yours.



Give baby a heap of red spools, one blue spool, and a plastic bottle. Show him how to put all but the blue spool in the plastic bottle.



Make baby a bell toy that he can ring himself. He will experiment with different tones and rhythms.



Play a picture sort game with baby. Cut out pictures of familiar objects. Glue onto a piece of cardboard and cover with clear contact or cellophane. Put in a felt lined toy and ask baby to find the object you name.



Paste pictures of small objects on the bottom of plastic butter containers. Give baby a few small objects that match the pictures, (a toy telephone, doll's spoon, a cup, a small car, a whistle) and let him place the objects in their appropriate containers.

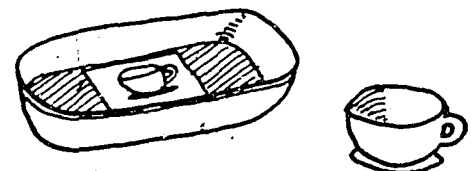

Give baby a boat toy and some straws of different lengths. By trial and error he will learn to put the right straws in the right smoke stacks in the right smoke stacks so that they all will fit.



Fill some juice cans with pebbles and leave others empty. Seal the hole on top of the cans. Paint the ones with pebbles in red, and paint the others blue. (Use a non-toxic paint or cover with contact paper). After a while, baby will learn to identify the cans that make noise.



Suggested "Socializing" Activities - Twelve Months Old

During the second year of life, baby recognizes and expresses his individuality. It is the quality of time rather than the quantity of time he spends with his parents that makes the difference.

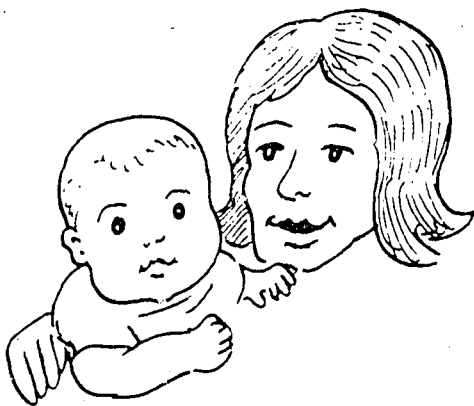

When baby finds something that seems to capture his interest, a shadow on the wall, a piece of foil that makes a crinkling sound, a smooth warm stone, talk about it with baby. The more enthusiasm you show about baby's discoveries, the more he is encouraged to explore and investigate.

"SEE THE SHADOW
ON THE WALL"



Allow baby time to be by himself in an environment that invites exploration. Place cartons with interesting things inside around the room. Hide a toy behind a chair, or tie ribbons onto toys that he can pull. Baby needs to spend time on his own, to explore, discover and invent. Make sure that you "babyproof" the house now, so that baby can't get hurt as he takes his first steps toward independence.



Talking with baby now is absolutely critical. Encourage baby to use the word or words he knows. If, for instance, baby's first word is "hi", take him out on a walk where he will find people to say "hi" to.



Read picture books with baby.
Encourage baby to touch each
picture as you say its name.



Encourage imitation by having
the whole family clap in unison,
raise their hands over their
heads, or pull their ears.

Make baby his own "toy box" -
picking up his toys and putting
them in the box is a fine game
now and can be the start of a
life-long habit.

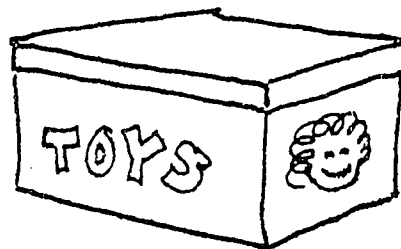

TOY "BOX"

PURPOSE: Give child experience in filling and emptying a container, develop language and develop the habit of putting toys away after play.

MATERIALS: Tagboard, eight styrofoam egg cartons, thread.

PROCEDURE: Take back off egg cartons, and stand on end. Sew cartons together. Cut base in octogan shape (8 sides) and sew on.

PLAY: Show child how to put his toys away in the carton.

FOR THE OLDER CHILD:

Paint cartons to make a waste paper basket. Makes an ideal gift item.

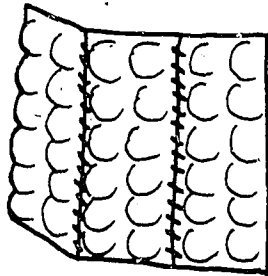

**SEW CARTONS
TO EACH OTHER**



**THEN SEW
CARTONS TO BASE**

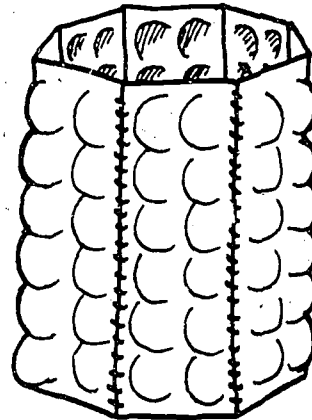

COFFEE CAN GAME

PURPOSE: Small muscle coordination, color matching.

MATERIALS: Coffee can, clothespin, colored cloth tape, and paint.

PROCEDURE: Place colored tape in strips around the rim of the can.

Paint clothespins same color as strips.

PLAY: Show baby how to put clothespins around the rim of the can.

FOR THE OLDER CHILD:

Number the clothespins. Let child line them up in order of number. If he is correct all the colors will match. After he has learned to line the clothespins up counting forward, let him try the same thing starting from 10 and going backwards.

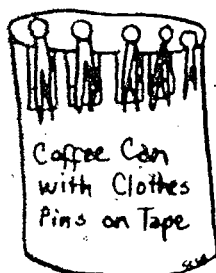
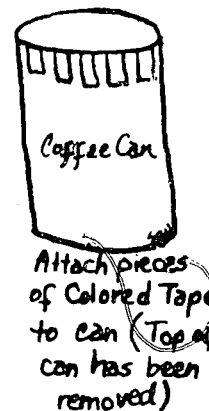
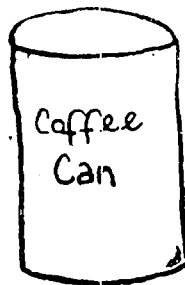
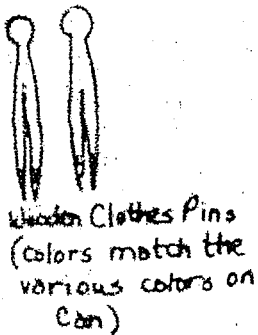

COOKIE MOUSE GAME

- PURPOSE:** Help child realize that an object continues to exist even though it disappears from sight.
Develop eye-hand coordination.
- MATERIALS:** 2 shoe boxes
2 sheets of tagboard or carton tops
Fabric scraps
Beans
Poster paint
Glue
- PROCEDURE:** To make mouse, draw mouse on 2' by 2' tagboard according to the pattern. Cut out circles in mouth area large enough for cookie to fall through. Glue mouse to shoe boxes so that the shoe boxes serve as a stand.
- To make Mouse Cookies cut two circles (about 2" in diameter) sew together - Fill with beans just before sewing is completed.
- PLAY:** With mouse on the floor, let baby drop cookies into his mouth, find them, and drop them through again.
- FOR THE OLDER CHILD:**
- Stand mouse up against the wall and let your child throw the cookies into the mouse's mouth.

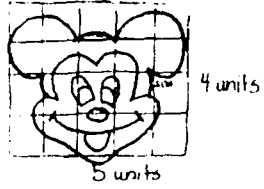

Scale Drawings for
"Cookie Mickey"

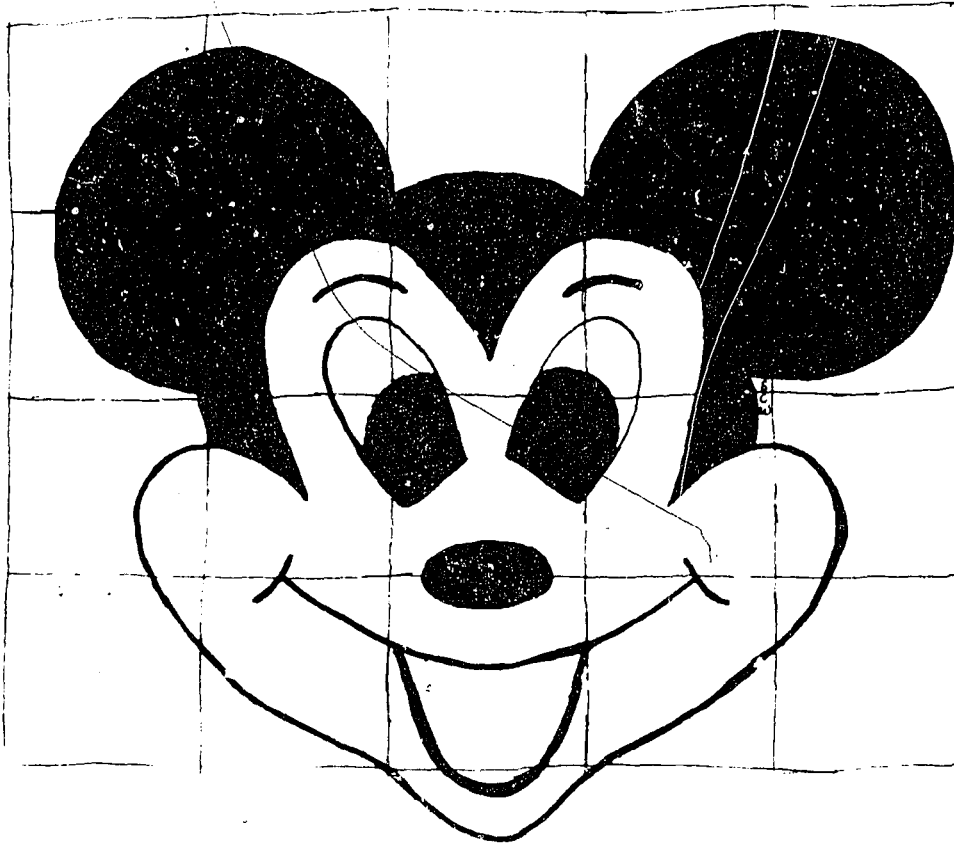



Keeping up with baby

KEEPING UP WITH BABY

It's fun to keep track of what your baby does. These ivory pages list some of the things you will notice your baby doing. Write in the date when you first notice a new accomplishment. Remember - every baby is different. The rate at which your baby grows and develops depends on many things - his pre-natal history, his age at birth, his weight at birth, the family history, his own unique time-table. There is never an exact time when a baby is supposed to accomplish a certain feat. The right time for your baby to accomplish a particular feat is exactly the time when he does it!

WHAT BABY DOES

MOTOR DEVELOPMENT

WRITE DOWN THE DATE WHEN YOU NOTICE
YOUR BABY DOING THESE THINGS:

Kicks rhythmically when lying on back

Squirms up to corner of crib

Lifts head up while lying on stomach

Thrusts arms out to the side in play

Holds head up when pulled to a sitting position

Turns from stomach to back

Holds head steady when propped in sitting position

Holds head up while lying on stomach with elbows straight

Bats mobile with arms

Clasps own hands

Raises hands to reach for something

Crawls on stomach - pushing with legs and pulling with arms

MOTOR DEVELOPMENT

DATE

Opens hand before it hits ring on cradle gym

Grasps ring and cannot let go

Grasps ring and lets go

Reaches, grasps, brings toy to mouth

Intentionally grasps toys one after another

Kicks and bats at mobile

Pulls to sit

Sits on floor, balanced on hands

Plays with fingers

Bangs toys

Sits unsupported on the floor, balancing without use of hands

Stands up in bouncer chair

While sitting unsupported on floor can use two hands together to pick up a toy or cup

Sits unsupported on floor, and balances self while picking up a cup or toy and bringing it up to his mouth

Creeps forward at will on hands and knees

MOTOR DEVELOPMENT

DATE

Scoops up very small objects

Pulls self up to standing

Transfers toy from hand to hand

Picks up bits of food from tray and puts them in mouth

Uses hand-over-hand motion to pull himself up by a table leg

Walks, both hands held

Stands leaning against furniture without holding on

Gets down from standing position

Pulls self up, and cruises along the furniture using a side step

Opens drawers

Walks, one hand held

Deliberately puts down one object in order to pick up another

Walks alone

Places one block on top of another

MOTOR DEVELOPMENT

DATE

Walks, carries things

Walks downstairs, one hand held

Squats

Walks downstairs, unaided

WHAT BABY DOES

SEEING, HEARING, FEELING AND KNOWING

DATE

Cries "tears"

Follows soft yellow or red light
with eyes only

Turns head to look directly at a
rattle or bell when he hears it

Turns head in direction of light
when it is turned on

Glance clearly lingers where colorful
toy disappears

Touches own face, eyes and mouth
with his hands

Shows recognition of bottle (some
babies show recognition by crying
harder, others stop crying)

Shown two toys, looks from one to
another

Sitting in chair, when toy falls,
looks for it after it disappears

When lying on back, twists backward
to look at things upside down

SEEING, HEARING, FEELING AND KNOWING

DATE

Lying on floor mat, follows a falling toy,
and reaches out toward the place where
it comes to rest

Reaches for toy when it is partially
covered with cloth

Pulls at mother's hand to make her
repeat an action

Presented with an object, shakes it

Continues to look in a direction after
someone who has just disappeared

Imitates a familiar gesture

Deliberately drops things from chair
and watches them

Explores by poking

Picks up blanket to find a hidden toy

Develops a memory of timing--anticipates
time it takes for a cup to hit the floor
and looks down

Imitates adults' use of telephone--removes
receiver and dials randomly

Imitates sound of fire truck

Looks up at airplane

SEEING, HEARING, FEELING AND KNOWING

DATE

Understands using a means to achieve a desired end--e.g. pushes away screen to retrieve a toy, or pulls string to bring object within reach

Searches actively for a vanished object, but in the first place seen, not in the second place, to which it had been removed

Rocks and sways in time to music

Partially imitates horizontal hitting of two blocks together by hitting a block in someone's hand or on some other surface

Selects the object of his or her choice out of many

Examines an object by turning it and feeling it while looking it over-

Imitates horizontal hitting of two blocks together

Places rings on spindle

Can find a toy that is hidden first under one screen and then another

Imitates hand-waving

When cannot make a toy work, hands it to someone else to operate it

WHAT BABY DOES

SOCIALIZING AND LANGUAGE DEVELOPMENT

DATE

Stares at mother's face when nursing

Searches for food when held in a feeding position

Stops crying when picked up

Makes sucking sounds

Smiles in response to a soft, high voice

Quiets, gurgles, and smiles when stroked

When held at the shoulder, the baby holds head back to get a look at the face of the person holding him

Smiles when an object is suddenly brought into sight (surprised)

Responds with smiles and mouth-movement when someone imitates sounds made by baby

Tries to make sounds in answer to soft, high-pitched voice

Differentiated crying

Babbles - vowel sounds

Stops to smile or play during feeding

SOCIALIZING AND LANGUAGE DEVELOPMENT

DATE

Sings

Deliberately coughs in a playful way

Laughs in response to laughter--"exchanges laughter"

Shouts

Prefers mother to stranger

Smiles at mirror image

"Greet" mother when she approaches

Repeats a single consonant sound over and over

Recognizes mother's voice from another room

Likes to play "surprise" games like having someone jump out at him

Spits food and blows bubbles playfully

Helps feed himself by picking up lumps of food and putting them in his mouth

Obeys the command, "no!"

Anticipates a happening - e.g. likes to play pop goes the weasel

Responds to own name

SOCIALIZING AND LANGUAGE DEVELOPMENT

DATE

Plays peek-a-boo by uncovering someone else's face

Plays "retriever"--creeps after toy or ball thrown by someone else

Holds arms up to be picked up

Watches for Mommy or Daddy out the window

Enjoys mirror image, vocalizes in front of mirror

Plays "so big"

Pat-a-cakes

Waves good-bye

Offers toys to others

Shows shyness with strangers

Hums

Imitates feeding doll

Mimics speech - "echolalia"

Performs for visitors

Throws ball to another-catches and throws again

Uses one-two words appropriately

Uses three-four words appropriately

A CLOSING THOUGHT

You are your baby's first teachers - but in a manner of speaking baby is your teacher too. Every baby that comes into this world is a unique personality - making an indelible impression on the people that care for him, enriching their lives in a thousand subtle ways. As you watch your baby grow and learn in these early months of life you, his parents, share in the learning experience.

This book includes a variety of games and activities. Be selective - choose the activities that seem right for you and your baby. If he tends to be inactive you might want to choose games that encourage movement. If he does not pay attention to sounds, you might want to choose games that involve listening. Most important, make sure that you and your baby have fun with the activities you select. Only through a succession of happy experiences can baby develop the confidence in himself that will allow him to explore and investigate his world.

Perhaps you have noticed that some of the suggested activities are repeated in different months. This kind of repetition is important for infants. An old experience "revisited" can provide a new opportunity to learn as baby brings new capabilities into the learning situation.

Remember, too, that even at a very young age your baby will enjoy the company of another baby. Invite some friends over with their baby. As you try out the activities together, you will double the fun of "baby watching."