

DOCUMENT RESUME

ED 073 732

FL 004 078

AUTHOR Masciantonio, Rudolph; And Others  
TITLE Look for the Latin Word: A Gamebook on English Derivatives and Cognates to Accompany "How the Romans Lived and Spoke (Romani Viventes et Dicentes): A Humanistic Approach to Latin for Children in the Fifth Grade".  
INSTITUTION Philadelphia School District, Pa.  
PUB DATE 72  
NOTE 87p.; Tentative edition  
EDRS PRICE MF-\$0.65 HC-\$3.29  
DESCRIPTORS Childrens Games; Classical Languages; \*Educational Games; English; \*Fles; Grade 5; Instructional Materials; \*Latin; \*Vocabulary Development; \*Word Study Skills; Workbooks

ABSTRACT

This gamebook is intended to assist the elementary school Latin teacher in introducing the reading and writing of English derivatives and cognates after these have been mastered audiolingually in the Latin course "How the Romans Lived and Spoke (Romani Viventes et Dicentes): A Humanistic Approach to Latin for Children in the Fifth Grade." (For the Teacher's Guide to this course, see ED 044 066.) Fifty games relating to Units 1-9 are contained in the text. (Author/RL)

ED 073732

# Look For The Latin Word

A Gamebook on English Derivatives and Cognates to  
Accompany HOW THE ROMANS LIVED AND SPOKE  
(ROMANI VIVENTES ET DICENTES): A HUMANISTIC  
APPROACH TO LATIN FOR CHILDREN IN THE FIFTH  
GRADE

Tentative Edition  
For Experimental and Evaluative  
Use Only.

U. S. DEPARTMENT OF HEALTH, EDUCATION & WELFARE  
OFFICE OF EDUCATION

THIS DOCUMENT HAS BEEN REPRODUCED EXACTLY AS RECEIVED FROM THE  
PERSON OR ORGANIZATION ORIGINATING IT. POINTS OF VIEW OR OPINIONS  
STATED DO NOT NECESSARILY REPRESENT OFFICIAL OFFICE OF EDUCATION  
POSITION OR POLICY.

**CURRICULUM**  
**PLANNING AND DEVELOPMENT**  
**1972**  
**THE SCHOOL DISTRICT OF PHILADELPHIA**

004 078

Copyright 1971

The School District of Philadelphia

(Revised Edition 1972)

"PERMISSION TO REPRODUCE THIS  
COPYRIGHTED MATERIAL HAS BEEN GRANTED  
BY The School District  
of Philadelphia  
TO ERIC AND ORGANIZATIONS OPERATING  
UNDER AGREEMENTS WITH THE U.S. OFFICE OF  
EDUCATION. FURTHER REPRODUCTION OUTSIDE  
THE ERIC SYSTEM REQUIRES PERMISSION OF  
THE COPYRIGHT OWNER."

## ACKNOWLEDGMENTS

This gamebook was written by the following members of the School District's Latin Curriculum Committee:

Rudolph Masciantonio, Curriculum Specialist for Classical Languages, Curriculum Planning and Development, Chairman

James A. Villarreal, Itinerant Teacher of FLES Latin, District 6

Roland Laramee, Itinerant Teacher of FLES Latin, Districts 1 and 4

Patricia Walsh, Teacher of FLES Latin, Henry School

Donald Danser, Itinerant Teacher of FLES Latin, Districts 2 and 4

Mary Jane Coates, Itinerant Teacher of FLES Latin, Districts 2 and 3

Eleanor L. Sandstrom, Director of Foreign Languages, Curriculum Planning and Development

Curriculum Planning and Development acknowledges with gratitude the help of FLES Latin pupils throughout the city who used these materials in experimental form in 1970.

## INTRODUCTION TO THE TEACHER

This gamebook is intended to assist the elementary school (FLES) Latin teacher in introducing the reading and writing of English derivatives and cognates after these have been mastered audio-lingually in the Instructional Services' Latin course HOW THE ROMANS LIVED AND SPOKE (ROMANI VIVENTES ET DICENTES): A HUMANISTIC APPROACH TO LATIN FOR CHILDREN IN THE FIFTH GRADE.

Each exercise or opus without an asterisk (\*) contains practice on derivatives and cognates actually listed in the Teachers' Guide for HOW THE ROMANS LIVED AND SPOKE. Each opus with an asterisk contains practice on derivatives and cognates which may be taught from the Latin roots occurring in a particular unit but which are not specifically listed in it. A special effort has been made to make the exercises meaningful and attractive to a broad spectrum of the children in our schools. The reading of the derivatives and cognates precedes the writing; the easier type of exercise precedes the more difficult. Emphasis is placed on using the derivatives and cognates in context.

Every teacher of FLES Latin should observe the following guidelines in utilizing this gamebook:

1. The children must be taught to understand and speak the English derivatives and cognates before any reading or writing exercise in the gamebook is attempted. Suggestions for teaching understanding and speaking skills are found in the Teachers' Guide, HOW THE ROMANS LIVED AND SPOKE.
2. The exercises should ordinarily be done during the Latin period under the guidance and supervision of the Latin teacher and without impinging upon the time of the cooperating classroom teacher.
3. The Latin teacher should focus attention of the pupils on only one opus at a time.
4. Each opus should be approached in the spirit of fun and adventure. Contests should be devised by the Latin teacher to stimulate this spirit among the pupils.
5. Ordinarily pupils should be called upon to read items in the opus aloud while other pupils provide the answers. With some classes, however, silent reading during which the Latin teacher's role becomes tutorial may be desirable occasionally, but answers should be checked toward the end of the period.
6. The teacher should involve the tactile skills of the pupils in some of the exercises. For instance in Opus 2, the teacher may ask the pupils to cut or tear out Fred Flintstone's rocks and paste them into place in the sentences.

7. The exercises should be used selectively according to the needs and interests of the children involved. The use of the gamebook should in no way destroy the primarily oral thrust of the FLES Latin program. In general no more than one exercise should be used per week with classes that receive daily instruction in Latin.

LOOK FOR THE LATIN WORD will help to extend the English vocabulary of the pupils in a uniquely efficient way through the Latin roots of our language.

I. EZRA STAPLES  
Associate Superintendent  
for Curriculum Planning  
and Development

RUDOLPH MASCIANTONIO  
Curriculum Specialist for  
Classical Languages

ELEANOR L. SANDSTROM  
Director of Foreign Languages

Let's look into some make-believe Roman word houses. The roof of the house is the Latin root. The relatives visiting the house are the English words. Underline the part of each English word that shows it belongs in that house.

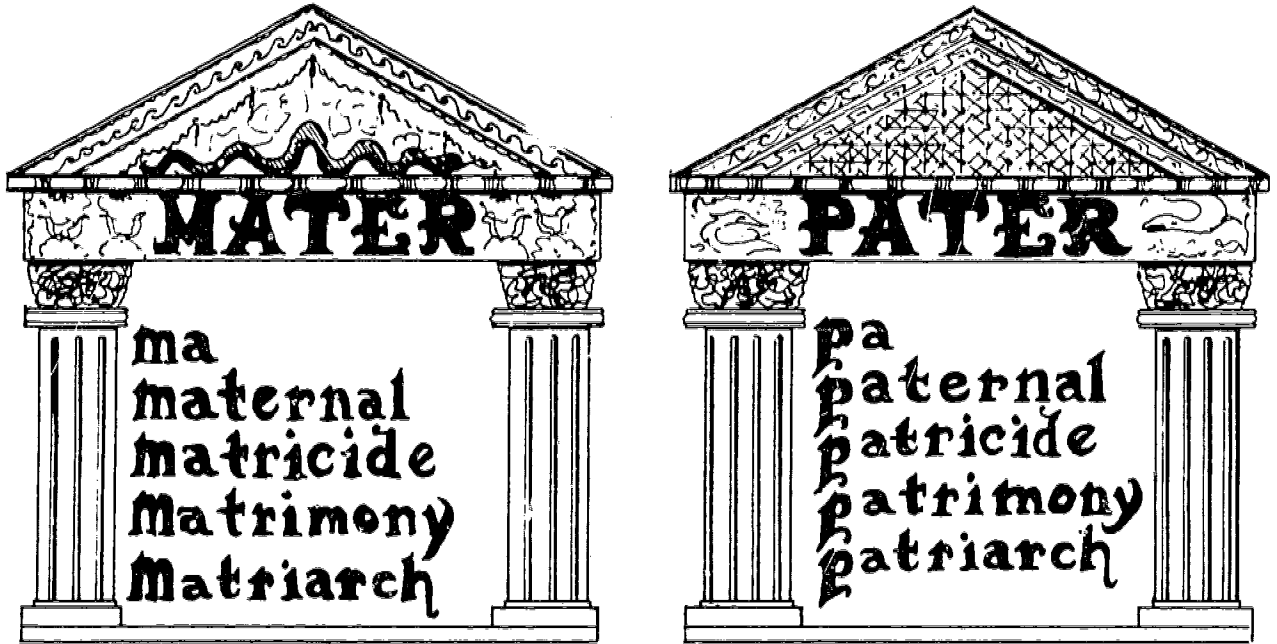

To complete these sentences, underline the correct words.

1. The newlyweds were joined in holy (patricide, matrimony).
2. A ruling father can be called a (maternal, patriarch).
3. The whole family obeyed the grandfather who ruled like a (patriarch, matrimony).
4. Miss Smith, the first grade teacher, wiped Johnny's tears with (patricide, maternal) care.
5. By killing his mother, Nero committed (matricide, patriarch).
6. My father died and left me a (matriarch, patrimony) of \$500.
7. Your mother's sister is your (maternal, patriarch) aunt.

(UNITS 1, 2)

8. The crime of killing your father is called (maternal, patricide).
9. The taxi driver calmed the lost boy with (paternal, matrimony) kindness and drove him home.
10. Your father's sister is your (matricide, paternal) aunt.



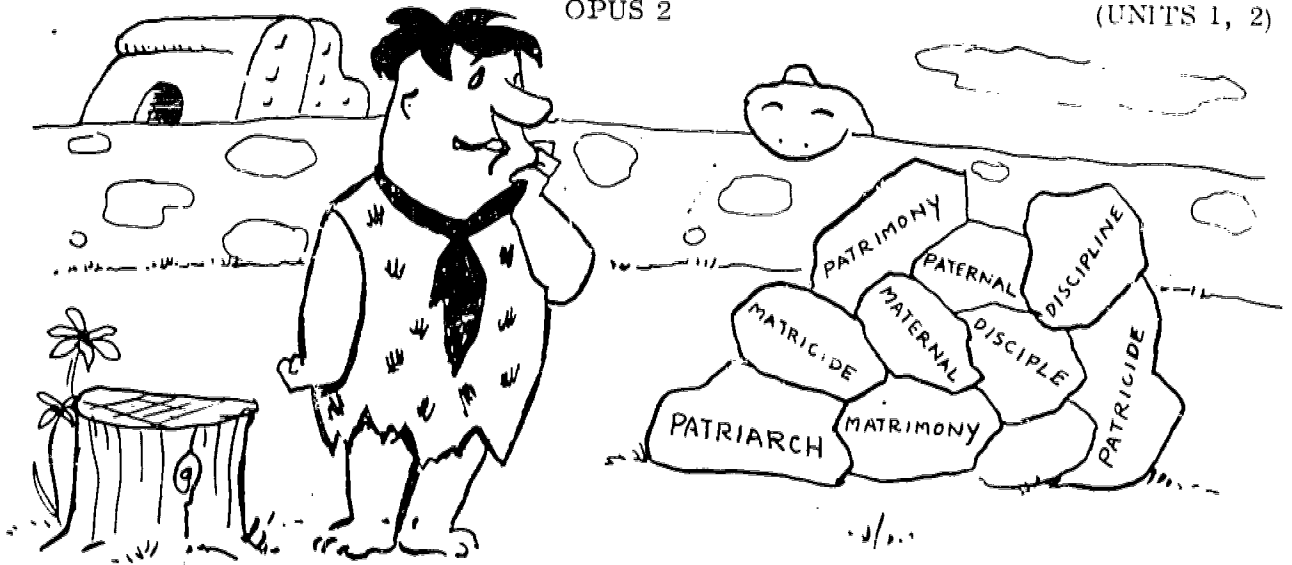

Help Fred Flintstone sort his pile of rocks. In each sentence below, the word in parenthesis gives you a hint of what rock to use. Write the word you select in the rock in the sentence.

Here are your first five rocks and sentences.

matrimony

paternal

discipline

patricide

patriarch

1. The father of the new baby took his son into his arms with (fatherly)  pride.
2. My father was raised in a home with strict (rules and training) .
3. The (old leader of the tribe)  used his power justly and wisely.
4. Tiny Tim and Miss Vicki were joined together in holy (wedlock) .
5. The young man was found guilty of (killing his own father) .

Turn to next page for more rocks:

maternal

patrimony

disciple

matricide

6. My rich uncle died and left me a large (inheritance)  .
7. Mrs. Weldon watched her small daughter cross the street with (motherly)  concern.
8. Many people have become (followers)  of Martin Luther King.
9. Nero was guilty of (killing his mother)  .

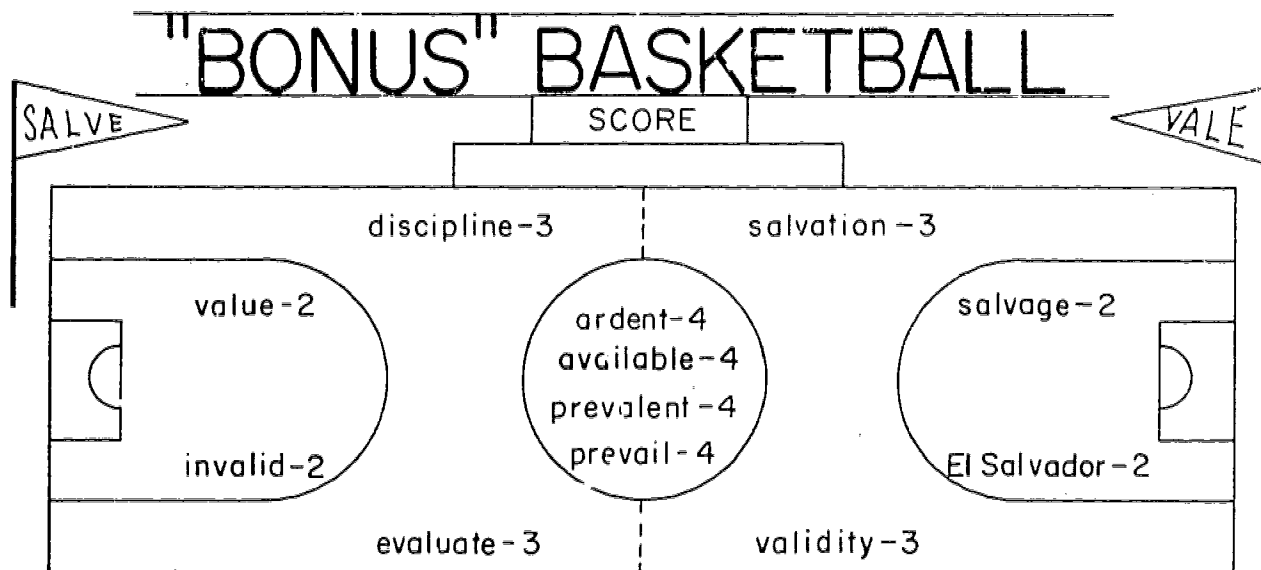

"Bonus" Basketball is the name of the game. Sink your shots for two, three or four points by matching the English derivatives in Column B with the sentences in Column A. The basketball court shows you that the words closest to the basket are the easiest shots and those at half-court are the hardest. Get ready! Get Set! Play Bonus Basketball!

COLUMN A

COLUMN B

TWO POINT SHOTS

- |  |   |
|--|---|
| <p>1. High school graduates know the<br/> <u>    ( )    </u> of an education.</p> <p>2. <u>    ( )    </u> is a country in Central<br/>         America.</p> <p>3. A fireman who risks his life<br/>         shows great <u>    ( )    </u>.</p> <p>4. A person who is sick for a long<br/>         time is an <u>    ( )    </u>.</p> | <p>A. El Salvador</p> <p>B. value</p> <p>C. invalid</p> <p>D. valor</p> |
|--|---|

COLUMN A

COLUMN B

THREE POINT SHOTS

5. Most religions preach about eternal ( ). E. evaluate
6. You must have a ( ) excuse for being absent. F. discipline
7. The ( ) at our school is strict. G. salvation
8. The Iowa Tests help to ( ) your progress in school. H. valid

FOUR POINT SHOTS

9. "We shall overcome" is the same as "we shall ( )." I. available
10. The Afro hair style is ( ) among young blacks. J. prevail
11. You should always have a pencil ( ) in class. k. ardent
12. Many young people were ( ) supporters of John F. Kennedy. l. prevalent

Match the letter of the word in Column B with the picture in Column A. The word should describe the picture.

COLUMN A	COLUMN B
	A. inflammable B. matron C. patriotism D. studio E. non-flammable
	
	
	
	

COLUMN A



6. \_\_\_\_\_

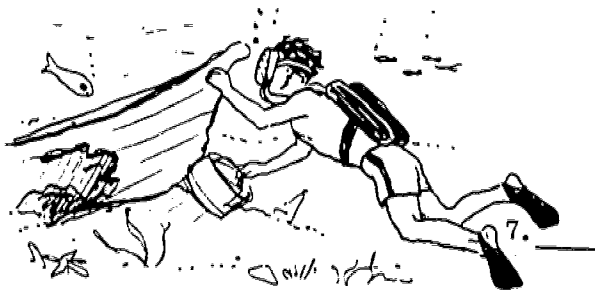

7. \_\_\_\_\_

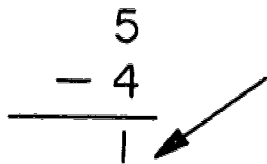

8. \_\_\_\_\_

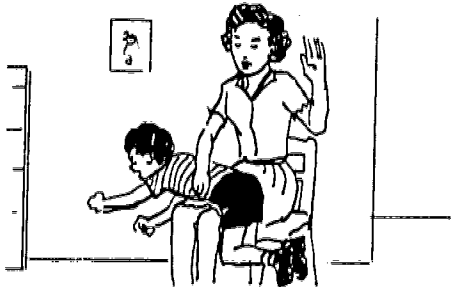

9. \_\_\_\_\_

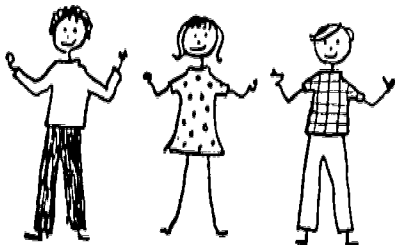

10. \_\_\_\_\_

COLUMN B

F. disciplinarian

G. remainder

H. flower

I. plural

J. salvage

COLUMN A

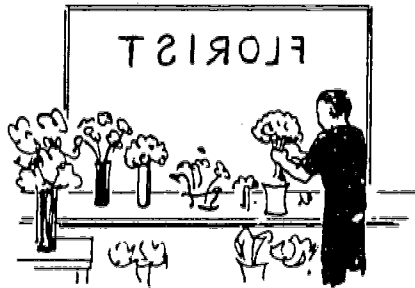

11. \_\_\_\_\_



12. \_\_\_\_\_

$$\begin{array}{r} \downarrow \\ 2 \\ + 2 \\ \hline 4 \end{array}$$

13. \_\_\_\_\_

ABCDEFGHIJKLMNOPQR



14. \_\_\_\_\_



15. \_\_\_\_\_

COLUMN B

K. plus

L. valiant

M. student

N. florist

O. maternity

Help Little Iodine and her teacher to say what they want to say. Underline the word that correctly completes each sentence.

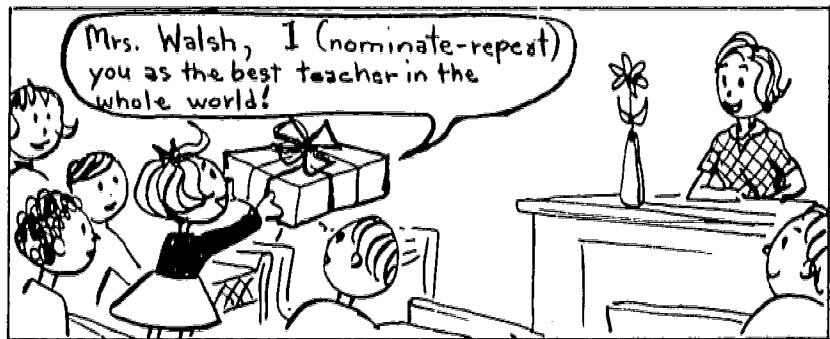
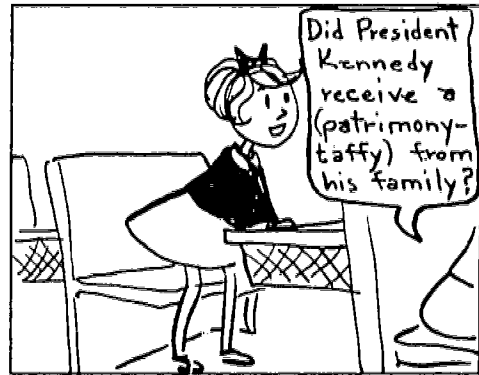
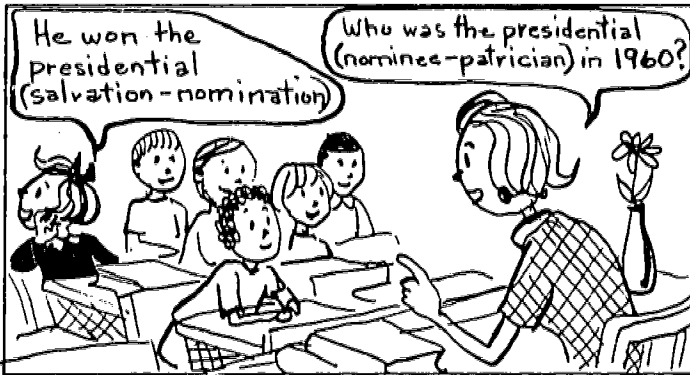
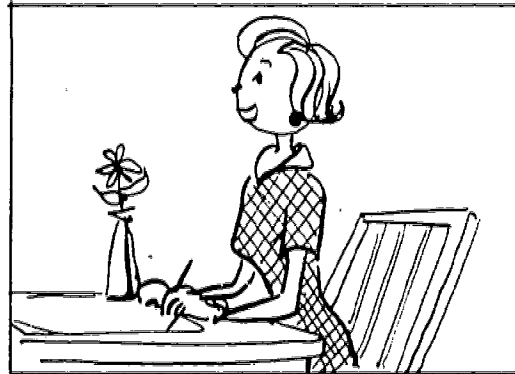
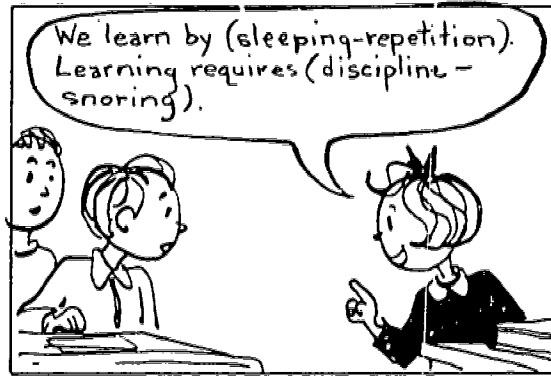
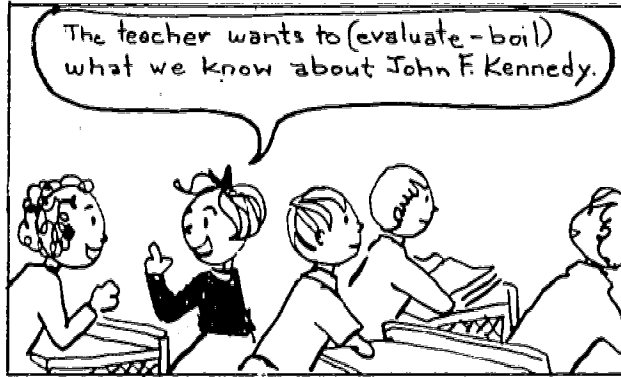



CROSSWORD PUZZLE: LATIN STYLE

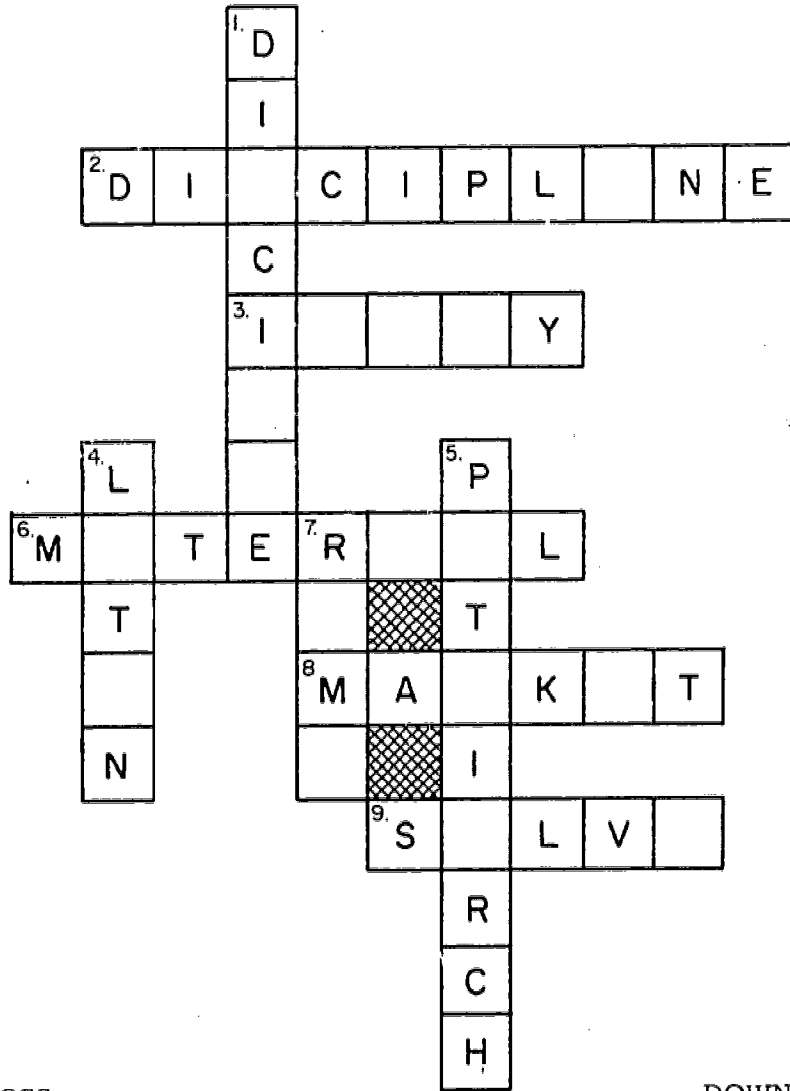

ACROSS

- 2. Training in good behavior.
- 3. Rome is in \_\_\_\_\_.
- 6. Motherly.
- 8. The Roman forum was once a \_\_\_\_\_ place.
- 9. A round of shots fired together.

DOWN

- 1. Student or follower.
- 4. Language that the Romans spoke.
- 5. Ruling head of a family or tribe.
- 7. Capital of the Roman Empire.

discipline  
salvo  
market  
maternal  
Italy

patriarch  
Latin  
disciple  
Rome

## PROSPECTOR SAM

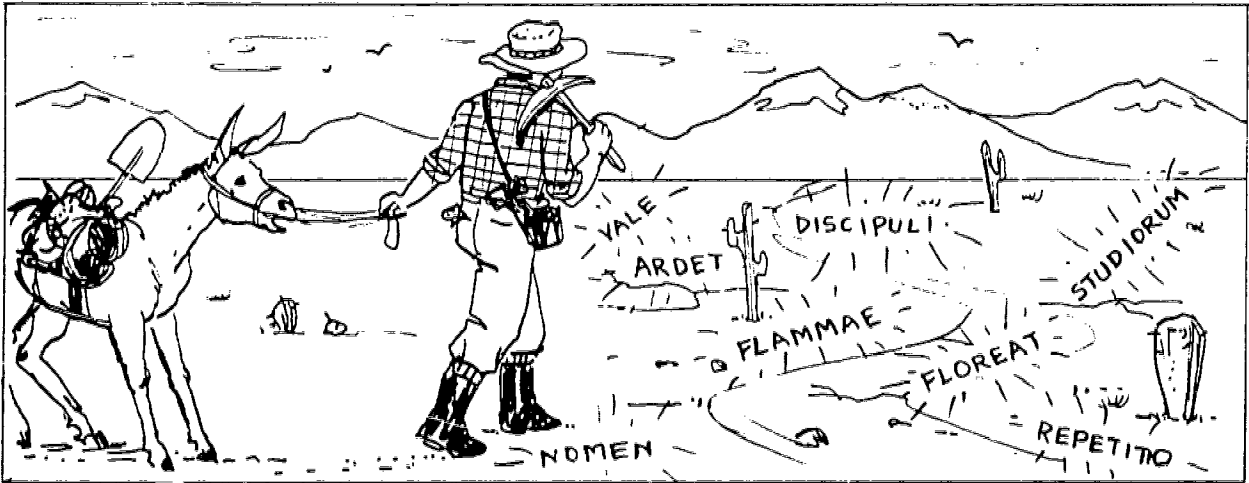

Prospector Sam is digging for gold. You can strike it rich with him by writing the correct answer, true or false, next to each sentence.

- \_\_\_ 1. The Sahara desert is a florid place.
- \_\_\_ 2. If your mother reminds you to do your homework ten times in one night, she is being repetitious.
- \_\_\_ 3. A studious person never does his homework.
- \_\_\_ 4. Flora is the plant life of an area.
- \_\_\_ 5. Spanking is a disciplinary action.
- \_\_\_ 6. Repetition means saying something once.
- \_\_\_ 7. Lying is of no avail when you are caught misbehaving.
- \_\_\_ 8. Roses will flourish with sunshine and water.
- \_\_\_ 9. A lazy boy works with ardor.
- \_\_\_ 10. Picking berries is repetitive work.
- \_\_\_ 11. A burning match will inflame water.
- \_\_\_ 12. Ten cents is a nominal fee to pay for a good movie.
- \_\_\_ 13. A floral wreath was placed on the soldier's tomb.
- \_\_\_ 14. To nominate means to select or name someone for a political office.

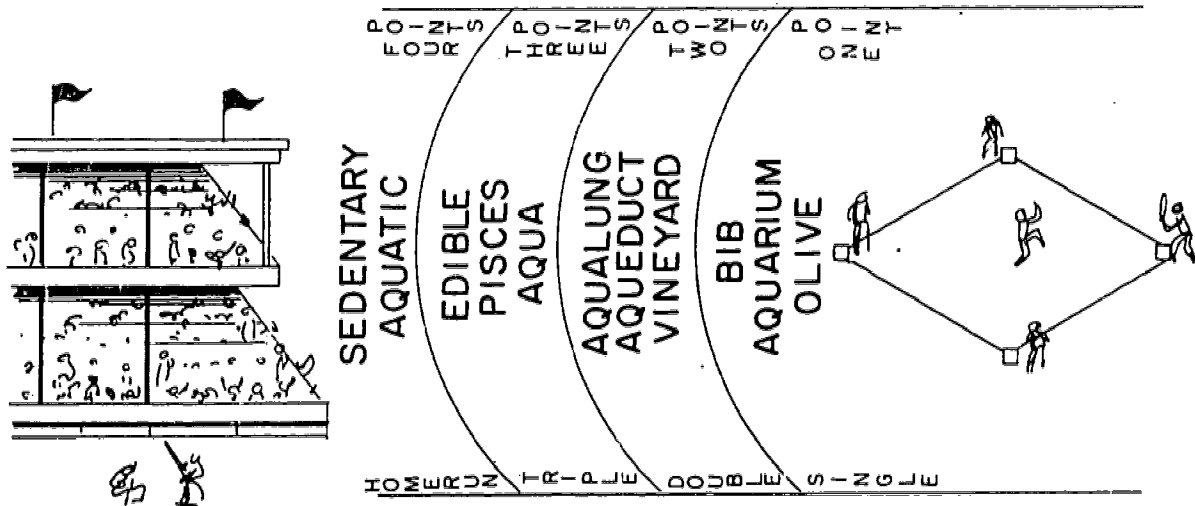

"Bonus" Baseball is the name of the game. Get a hit worth one, two, three or four points by underlining the word that correctly completes the sentences. The baseball field shows that words in the "single area" are the easiest and those in "home run" are the hardest. Get ready! Get Set! Play Ball!!

- |  |  |
|--|--|
| <p>1. A place where grapes are grown is a _____.</p>   | <p>a. aquarium<br/>b. vineyard<br/>c. aqueduct</p> |
| <p>2. Something that can be eaten is _____.</p>  | <p>a. edible<br/>b. sedentary<br/>c. aquatic</p>   |
| <p>3. A place where you keep fish is an _____.</p>   | <p>a. vineyard<br/>b. olive<br/>c. aquarium</p>    |
| <p>4. A sign of the zodiac that looks like fish is _____.</p>                                | <p>a. sedentary<br/>b. Pisces<br/>c. aqualung</p>  |
| <p>5. Sports like swimming and sailing are _____ sports.</p>                                 | <p>a. edible<br/>b. aquatic<br/>c. sedentary</p>   |
| <p>6. The ancient Romans brought water from far away into the city by means of an _____.</p> | <p>a. aqueduct<br/>b. vineyard<br/>c. Pisces</p>   |

7. Since she sits down most of the day, a secretary has a \_\_\_\_\_ job.
- a. edible
  - b. aquatic
  - c. sedentary
8. On the TV show "Sea Hunt," Lloyd Bridges wears an \_\_\_\_\_ when he goes underwater.
- a. olive
  - b. bib
  - c. aqualung
9. Mother puts a \_\_\_\_\_ on the baby before she feeds him.
- a. Pisces
  - b. bib
  - c. aqualung
10. On my salad, I like just plain vinegar and \_\_\_\_\_ oil.
- a. bib
  - b. aqualung
  - c. olive
11. The color of Peggy's blue-green dress is called \_\_\_\_\_.
- a. sedentary
  - b. aqua
  - c. edible

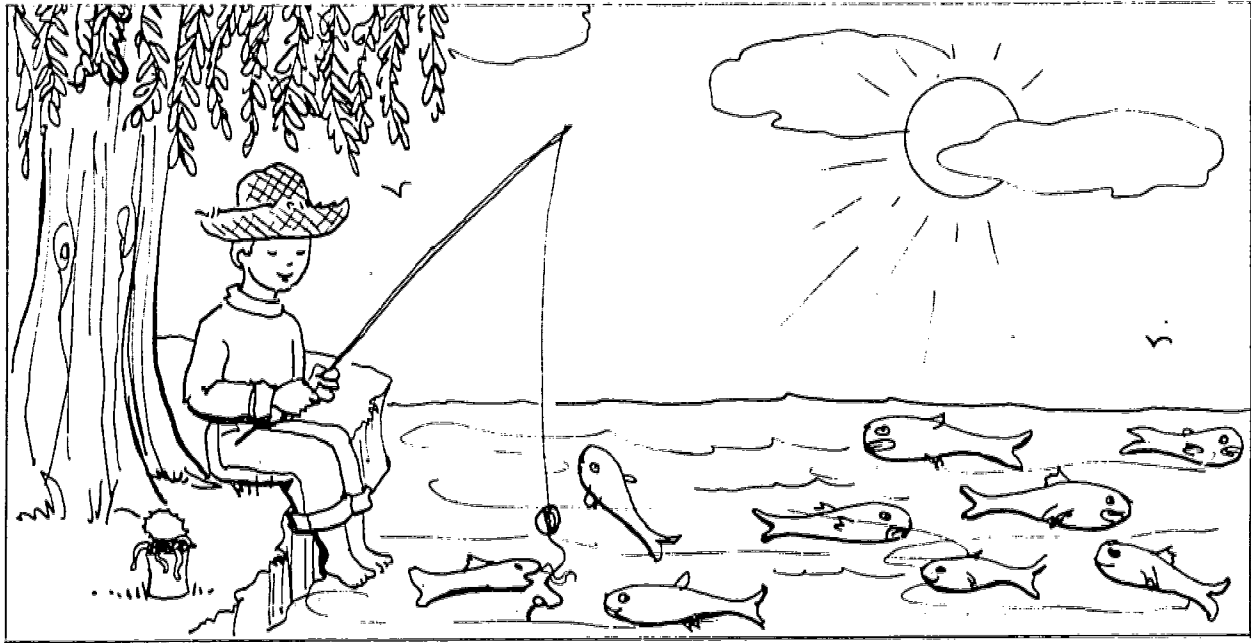

The boy on the bank of Cobbs Creek is fishing for "word-fish." Can you help him catch the fish? Fill in the fish in the sentences with the correct word. The clues are in parenthesis.

Here are your first five words and sentences.





aquarium

aqualung

aqueduct

aquatic

aqua

1. My brother and I take turns changing the water in our (fish tank) 
2. Water lilies are (grown in water)  plants.
3. The scuba divers work underwater with their (air tanks) 
4. We will paint our lake cottage (bluish-green) 
5. Some of the most beautiful ancient Roman ruins are the (bridges for water) 

bib  
edible  
vineyard  
Pisces  
sedentary

6. The baby's milk ran down his chin onto his (neck-apron)
7. Many wild berries and plants are (good to eat)
8. Julio Gallo grows grapes in his (field of grapevines)
9. A secretary who types all day is a good example of a (sitting) worker.
10. Most people born in March come under the zodiac sign called (Fishes)

Help Daryl and his nine friends get free trolley tokens. Underline the word in parentheses that completes each sentence. Daryl and his friends get one token for every correct answer. See if you can get a token for all ten!

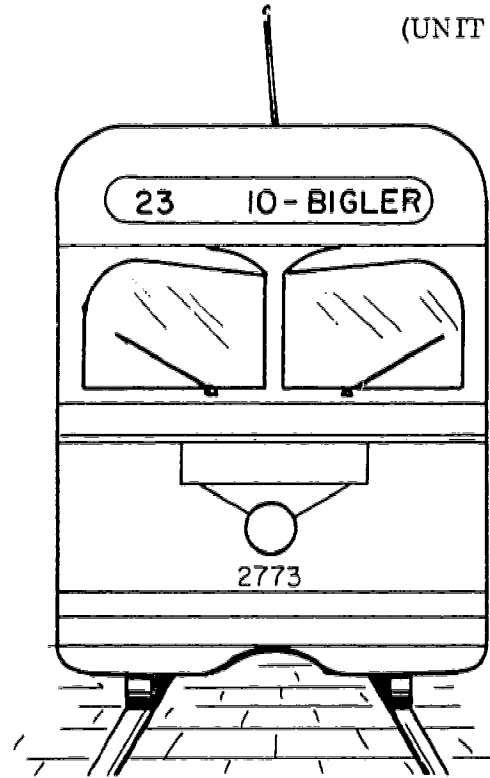

1. Many statues in Fairmount Park have developed a green coating called a (patina, optimist).
2. In cowboy movies a piece of land with a flat top bound by high rock walls is called a (vineyard, mesa).
3. In a state store people can buy wines of rare (vintage, pantry).
4. The narrow part of the kitchen where your mother stores canned goods is called the (pantry, asparagus).
5. The Home and School Association often serves coffee from a coffee (urn, vineyard).
6. Salad dressing is often made from oil and (vinegar, vintage).
7. Romans like to (spill, imbibe) wine.
8. Coca Cola doesn't normally have (sediment, flavor) at the bottom of the bottle.
9. Soft pretzels sold in town are (edible, aqua-colored).
10. Trolley tokens are certainly (inedible, worthless).

There are trees from a Latin word-orchard. The make-believe trees have Latin words as their roots. The fruits on the trees are English relatives. "Pick the fruit" by writing TRUE or FALSE before each sentence.

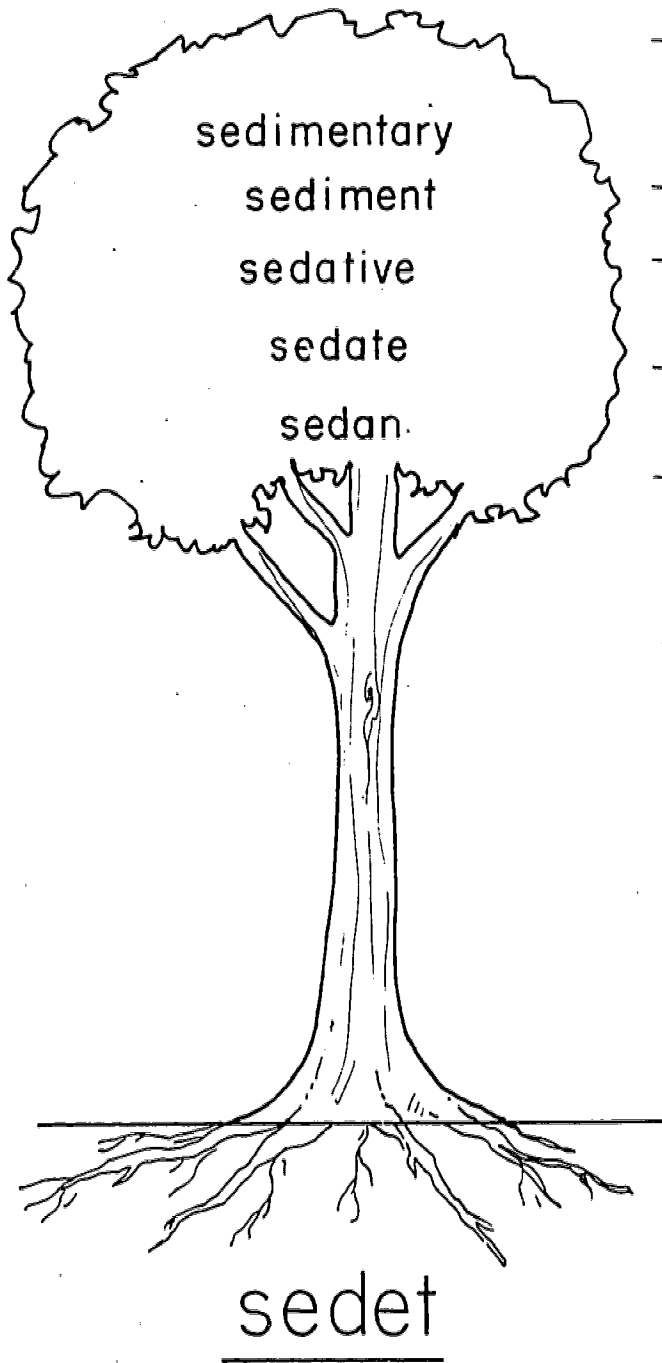

- \_\_\_ 1. Ten spoonfuls of sugar in a cup of coffee leave sediment at the bottom of the cup.
- \_\_\_ 2. A "go-go" dancer is sedate.
- \_\_\_ 3. The doctor gave the wild man a sedative to calm him down.
- \_\_\_ 4. A sedan is a car that has a hard top and a front and back seat.
- \_\_\_ 5. In some coal mines, you can see levels of sedimentary rock.



(UNIT 3)

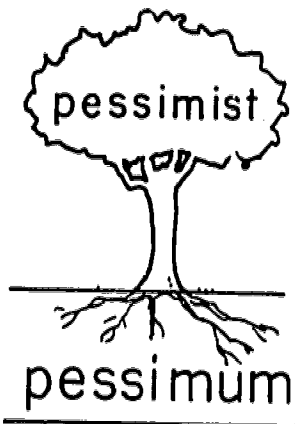
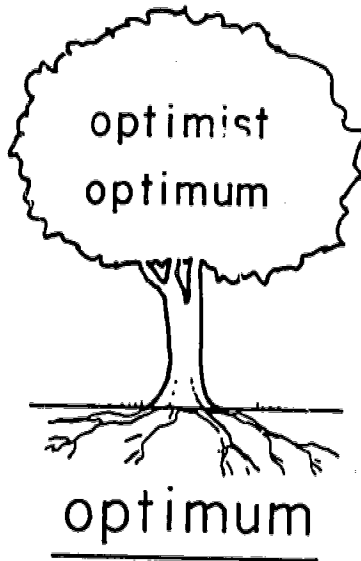
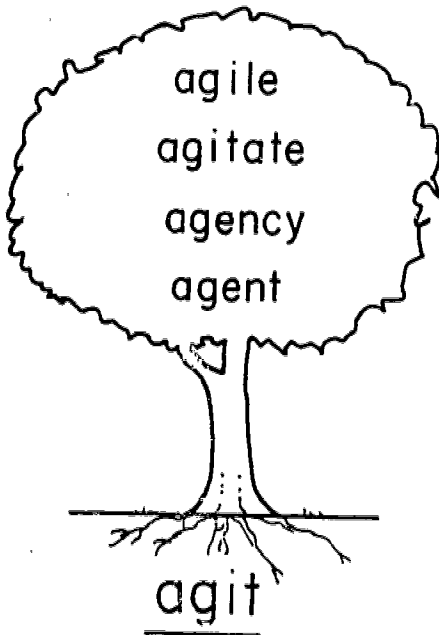

- \_\_\_ 6. A man with a broken leg is agile.
- \_\_\_ 7. Many Blacks agitate for civil rights.
- \_\_\_ 8. Sand is a good cleaning agent for teeth.
- \_\_\_ 9. A ticket agency sells seats for baseball games.
- \_\_\_ 10. A man who always expects the best is an optimist.
- \_\_\_ 11. A man who always expects the worst is a pessimist.
- \_\_\_ 12. The optimum conditions for studying are noise, lots of people, and poor light.

## "DANNY DREAMS"

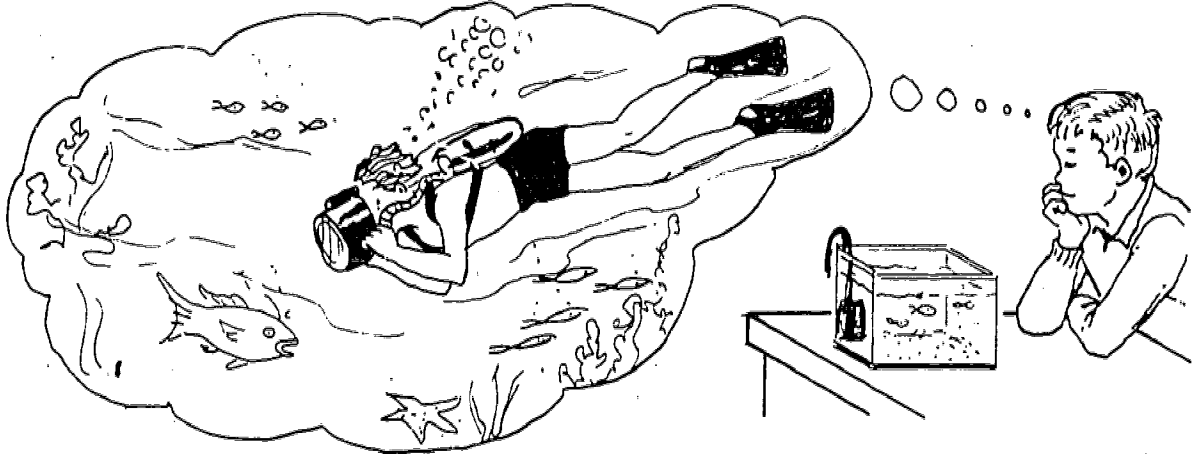

In the paragraph below, Danny daydreams an underwater adventure. Dream along with him by filling in the missing words. The parentheses will give you a clue to each answer.

As Danny sat looking into the \_\_\_\_\_ at the goldfish, he imagined  
(fish-tank)

that he was an \_\_\_\_\_ diving deep into the \_\_\_\_\_ - colored  
(underwater explorer) (blue-green)

water. The bubbles from his \_\_\_\_\_ made him look like Lloyd Bridges  
(air-tanks)

from "Sea Hunt." He saw \_\_\_\_\_, the zodiac sign for March swim by. He  
(fish)

searched for \_\_\_\_\_, the old man with his pitcher of water. All  
(zodiac sign for February)

around him \_\_\_\_\_ plants swayed in the moving water. Small fish were  
(growing in water)

eating the \_\_\_\_\_ plants. As their tails hit the sand, they stirred up the  
(able to be eaten)

\_\_\_\_\_. Suddenly Danny's sister tapped him on the shoulder and broke the  
(settled sand)

spell of the daydream.

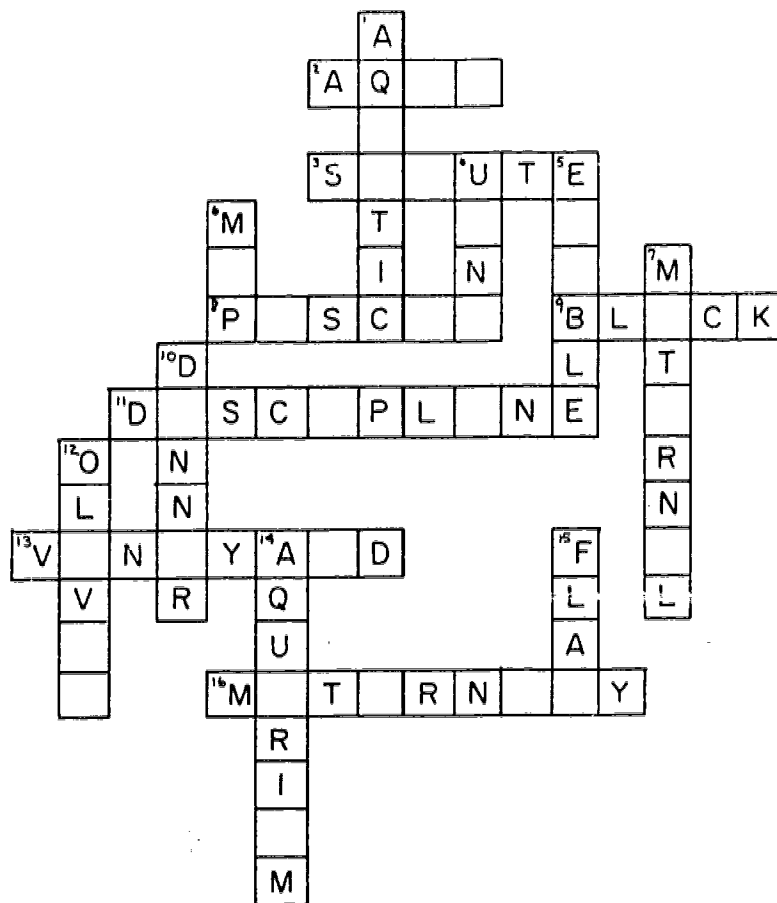

DOWN

1. Taking place in or on water.
4. Another word for VASES.
5. Able to be eaten.
6. Countries, rivers, cities are shown on a \_\_\_\_\_.
7. A mother's love is \_\_\_\_\_ love.
10. Main meal of the day.
12. Used to make olive oil.
14. Place to keep fish.
15. Most Romans thought the earth was \_\_\_\_\_, not round.

ACROSS

2. Blue-green color.
3. To greet.
8. Fish sign of the zodiac.
9. "\_\_\_\_\_ is beautiful."
11. Training in good behavior.
13. Place where grapes are grown.
16. \_\_\_\_\_ ward (where babies are born).

vineyard	flat
urns	edible
salute	discipline
Pisces	dinner
olives	black
maternity	aquatic
maternal	aquarium
map	aqua

Words to Use

## SCRAMBLED EGGS



Scrambled eggs? Not really, just scrambled sentences. Circle the letter of the correct sentence.

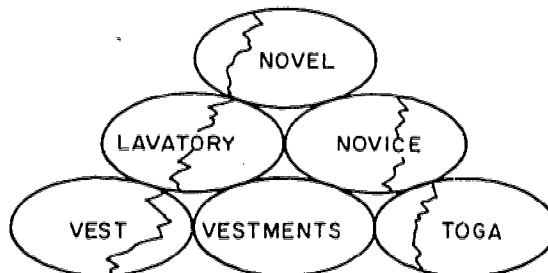

1. a. Lava watched the boy pour down the slope.  
 b. Down the slope pour watched the lava boy.  
 c. The boy watched lava pour down the slope.
2. a. He washed his hands in the lavatory.  
 b. In the lavatory washed his hands he.  
 c. He his hands washed in the lavatory.
3. a. Tennis a novice at playing he was.  
 b. Tennis was a novice he at.  
 c. He was a novice at playing tennis.
4. a. Hung his vest on a hanger in the closet.  
 b. His vest hung on a hanger in the closet.  
 c. On a hanger hung his vest in the closet.
5. a. The minister black vestments wore.  
 b. Wore black vestments the minister.  
 c. The minister wore black vestments.

(UNIT 4)

6.
  - a. Of doing her hair a novel way she has.
  - b. She has a novel way of doing her hair.
  - c. She a novel way of doing her hair has.
7.
  - a. Roman boys began wearing togas between the ages of 12 and 16.
  - b. Began wearing Roman boys between the ages of 12 and 16 togas.
  - c. Between the ages of 12 and 16 Roman boys toga began wearing.

Match the letter of the words in Column B with the picture in Column A.

COLUMN A

COLUMN B



1. \_\_\_\_\_



2. \_\_\_\_\_

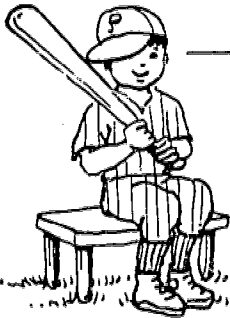

3. \_\_\_\_\_



4. \_\_\_\_\_

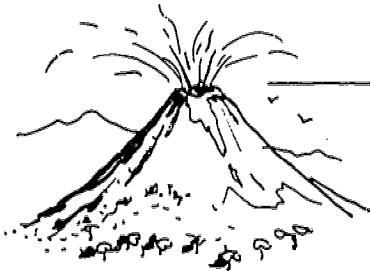

5. \_\_\_\_\_

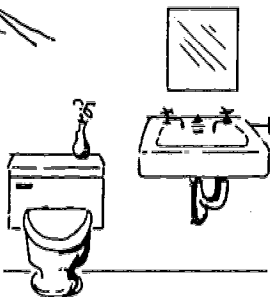

6. \_\_\_\_\_



7. \_\_\_\_\_

A. novel

B. vest

C. toga

D. novice

E. lavatory

F. vestment

G. lava

WORD-POWER AQUEDUCTS

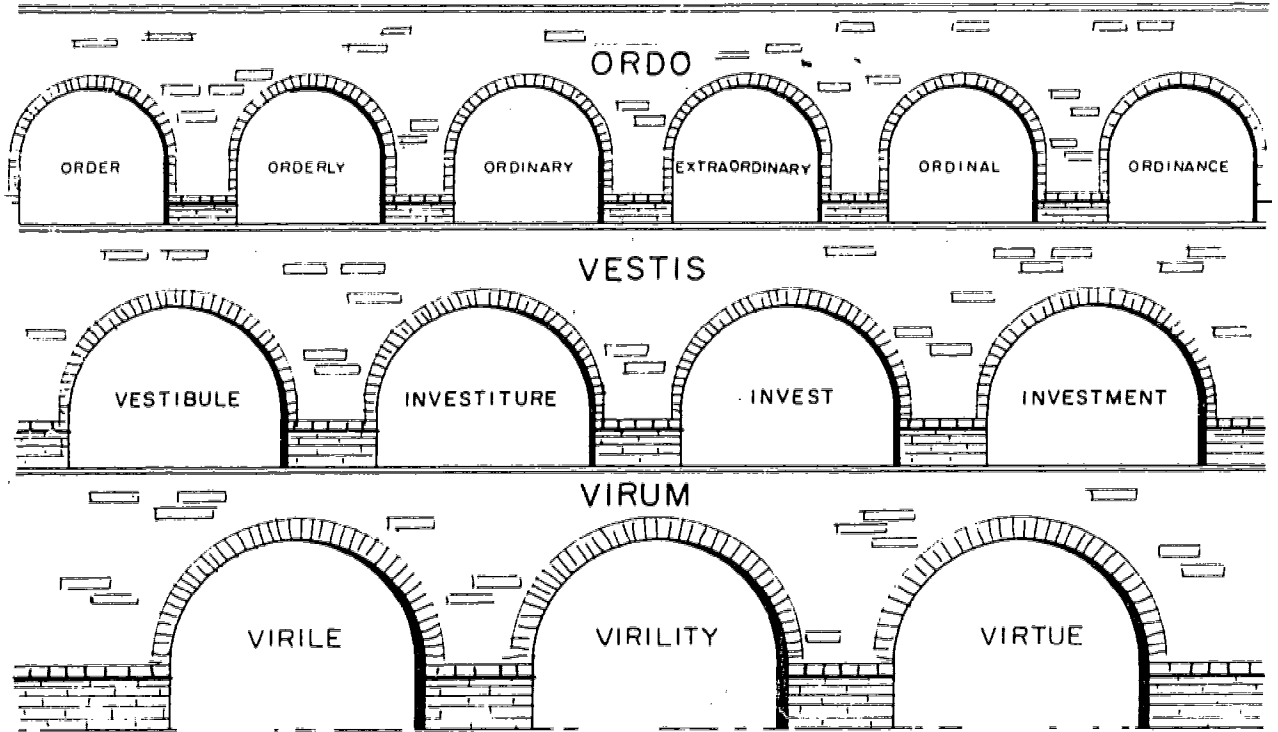

This make-believe aqueduct is supported by English relatives on the arches. Can you get across the aqueduct by correctly matching the sentence parts?

ordinary--order--extraordinary

- \_\_\_1. The ordinary way to drive a car is
- \_\_\_2. The soda machine was
- \_\_\_3. An extraordinary way to drive a car is
- a. out of order.
- b. with your feet on the wheel.
- c. with your hands on the wheel.

ordinance--orderly--ordinal

- \_\_\_4. Students should walk
- \_\_\_5. Thirteenth (13th) is the ordinal number for
- \_\_\_6. The ordinance on the bus read
- a. thirteen (13).
- b. "No Smoking".
- c. to the auditorium in an orderly manner.

investment--vestibule--investiture--invest

- \_\_\_7. I invest
- \_\_\_8. Hang your umbrella and rain-coat
- \_\_\_9. The boy scout
- \_\_\_10. U. S. Savings Bonds are
- a. was received into the explorers at the investiture.
- b. a good investment.
- c. my money in PSFS.
- d. on a hook in the vestibule.

virile--virility--virtue

- \_\_\_11. Hercules was
- \_\_\_12. Virility
- \_\_\_13. Gentleness
- a. is a virtue needed in holding a baby.
- b. known for a virile appearance.
- c. means manliness.



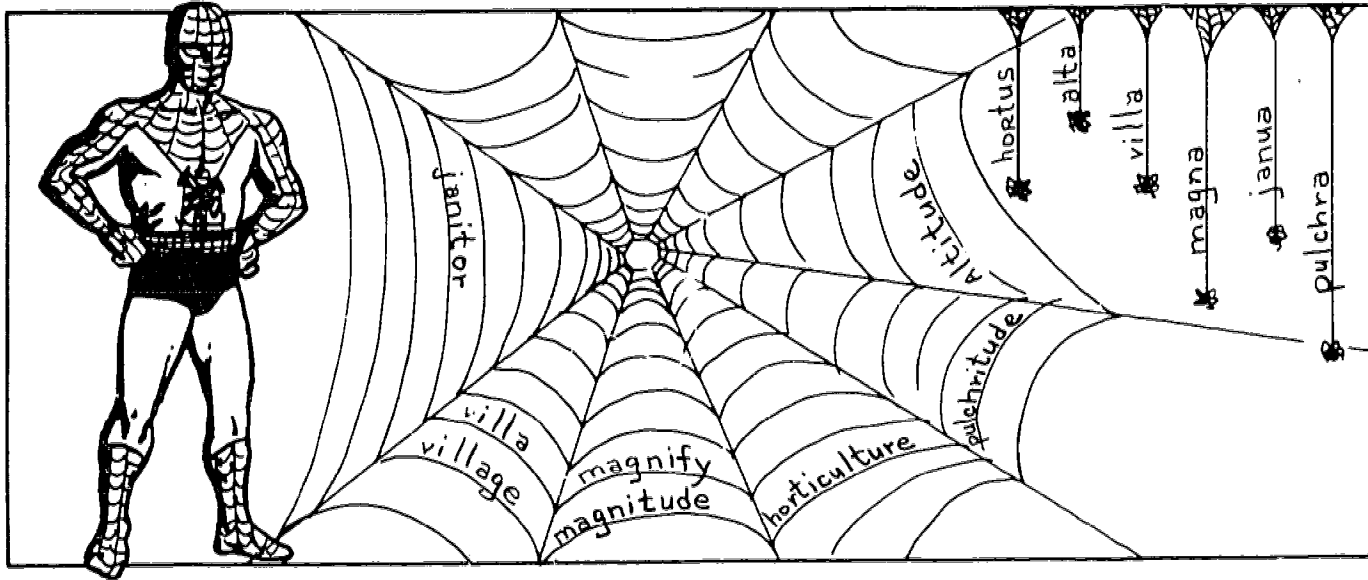

Help Spiderman complete his web. Underline the word that best completes each sentence.

1. At one time Germantown was a small (village, villain).
2. The rich merchant left Rome in summer for his country (hut, villa).
3. An expert in (horticulture, construction) knows a great deal about flowers.
4. The (plumber, janitor) locked the doors to the school.
5. The plane climbed to (a depth, an altitude) of twenty thousand feet.
6. With his microscope, the scientist (magnified, destroyed) the small grains of sand.
7. The mayor said, "A problem of such (virtue, magnitude) calls for the help of all our citizens."
8. The (pulchritude, shadow) of the statue attracted many visitors.
9. Mount Everest, the highest mountain in the world, soars to an (altitude, arc) of 29,000 feet.
10. The old man wore thick glasses to (clean, magnify) the small print.

Words to Use

- villa
- village
- janitor
- altitude
- magnify
- magnitude
- horticulture

Match the words with the pictures. Use the dotted lines.  
The first letter of each word is given.

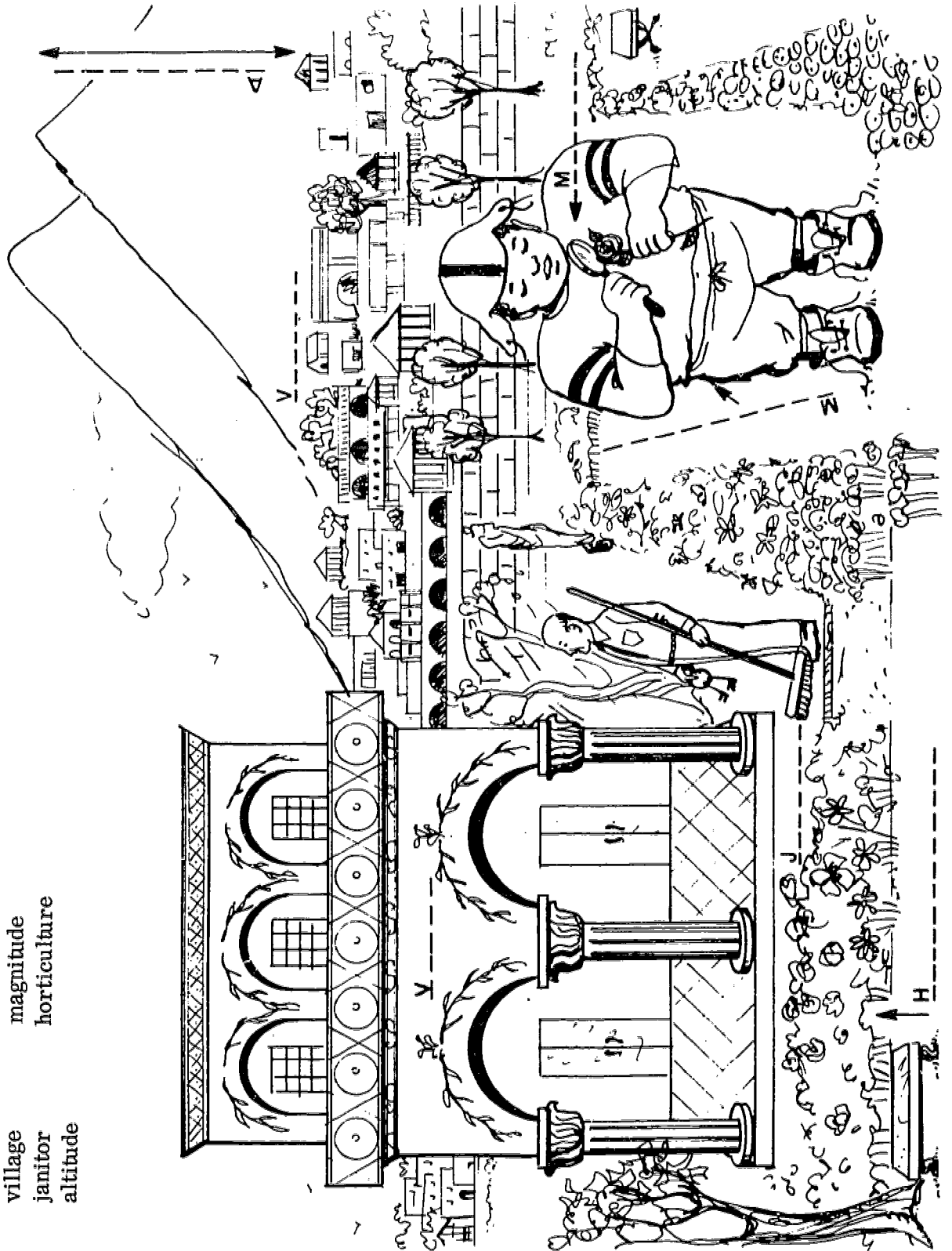

PSFS

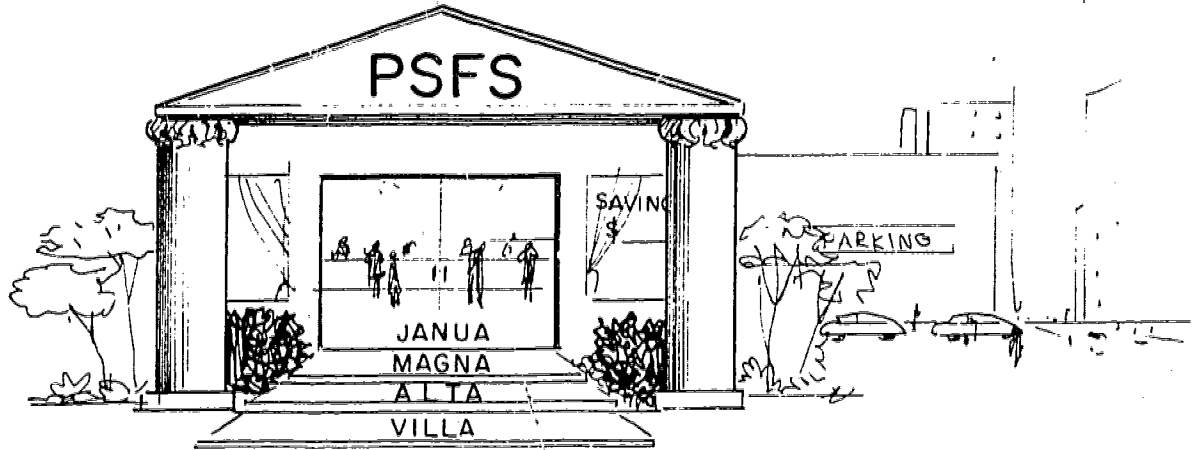

Here is an easy way to save money fast. The sentences below are worth \$10, \$20, or \$30. Mark each sentence True (T) or False (F). Choose carefully and watch your bank account grow. Use the space in the bank window for recording your savings.

- \$10    \_\_\_    1. A villain is the "good guy" in a story.
- \$20    \_\_\_    2. An alto is one of the voices in a choir.
- \$10    \_\_\_    3. Niagara Falls is magnificent.
- \$20    \_\_\_    4. The Magna Carta is a ballpoint pen.
- \$10    \_\_\_    5. A villager is a person who lives in New York City.
- \$10    \_\_\_    6. January is the last month of the year.
- \$10    \_\_\_    7. Villanova is a college near Philadelphia.
- \$20    \_\_\_    8. A villager is a person who lives in one of a small group of houses.
- \$20    \_\_\_    9. A pile of trash looks lonely and magnificent.
- \$20    \_\_\_    10. Magnavox means "big mouth."
- \$10    \_\_\_    11. January is the first month of the year.
- \$20    \_\_\_    12. Villanova means "new house."
- \$10    \_\_\_    13. A villain is the "bad guy" in a story.
- \$30    \_\_\_    14. The Magna Carta was an English "Bill of Rights."

(UNIT 5)

\$20 \_\_\_\_ 15. An alto is lower than a bass voice.

\$10 \_\_\_\_ 16. Magnavox is a brand name for some TV sets.

ENGLISH TARGETS

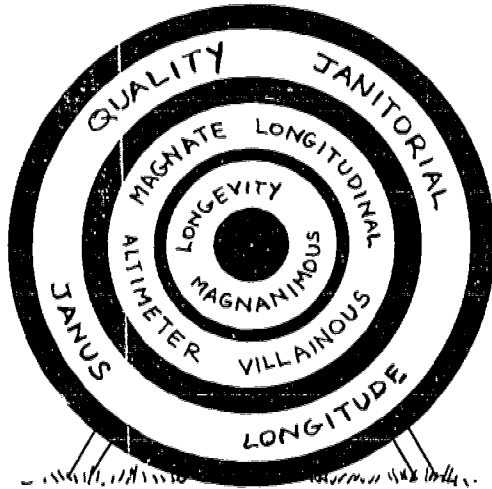

LATIN WORD-ARROWS

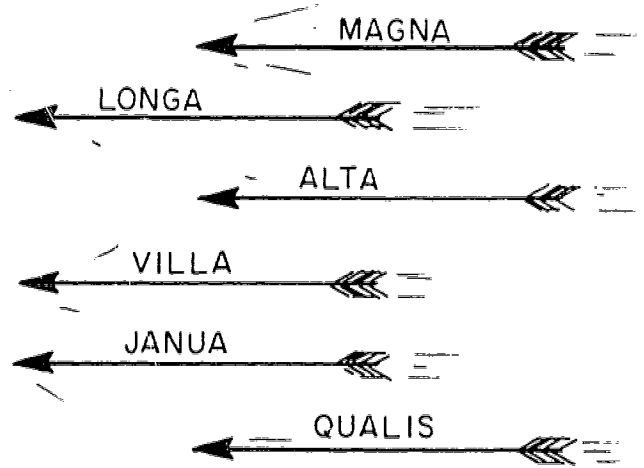

Bull's-eye is the name of the game. Score a direct hit by correctly matching the sentence parts. The words closest to the center are worth the most points. Ready! Aim! Fire!

Points

quality--magnate--longevity

- |    |     |                                    |                                  |
|----|-----|------------------------------------|----------------------------------|
| 10 | ___ | 1. Meat stamped "U. S. Grade A" is | a. an automobile magnate.        |
| 20 | ___ | 2. Henry Ford is                   | b. has longevity.                |
| 30 | ___ | 3. A ninety-year old man           | c. the best quality you can buy. |

janitorial--altimeter--longitudinal

- |    |     |                                   |   |
|----|-----|-----------------------------------|---|
| 10 | ___ | 4. Cleaning and repairing         | a. how high an airplane flies.                |
| 20 | ___ | 5. An altimeter measures          | b. run from the North Pole to the South Pole. |
| 20 | ___ | 6. On a globe, longitudinal lines | c. are janitorial jobs.                       |

(UNIT 5)

Points	Janus--magnanimous--longitude--villainous	
20	7. Frankenstein	a. distance east or west.
10	8. Janus	b. was a magnanimous man.
30	9. John F. Kennedy	c. is a villainous character.
10	10. On a globe, longitude measures	d. is a two-faced Roman god.

CROSS-ROOTS

- |           |              |
|-----------|--------------|
| altitude  | novice       |
| battles   | laws         |
| baths     | races        |
| slave     | horticulture |
| janitor   | togas        |
| lava      | vest         |
| lavatory  | vestment     |
| magnitude | villas       |
| magnify   | village      |
| novel     |              |

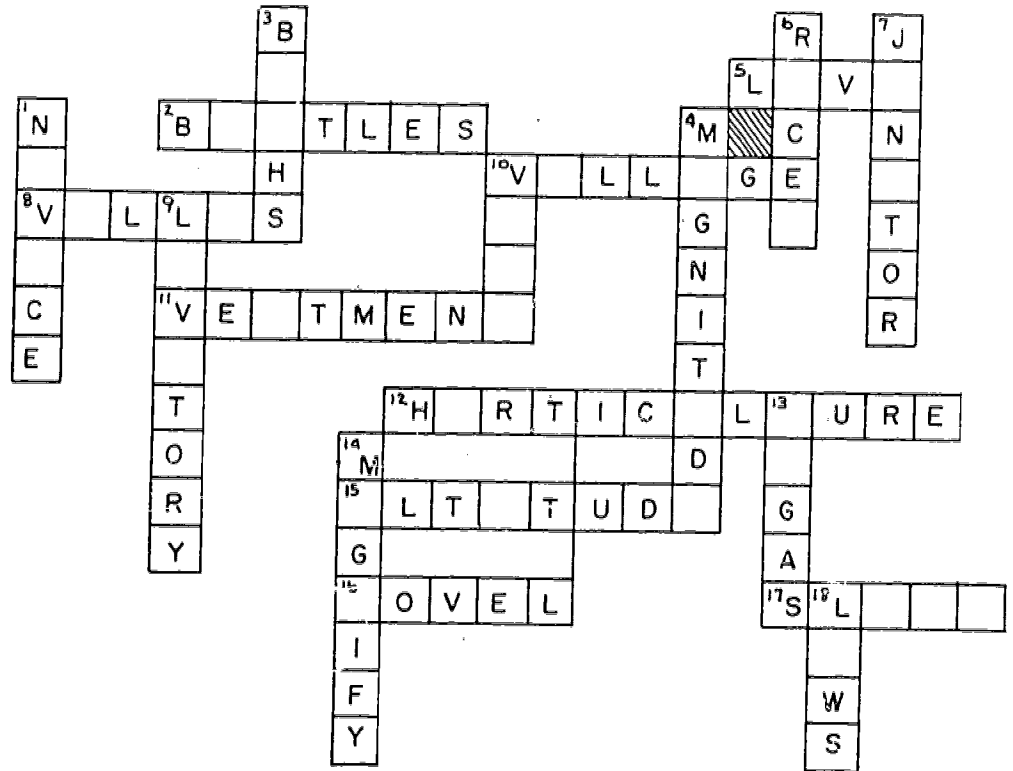

ACROSS

2. The Roman army won many \_\_\_\_\_.
5. Molten rock.
8. Country houses.
10. Small group of houses.
11. Garment worn in religious ceremony.
12. Gardening.
15. The airplane rose to an \_\_\_\_\_ of 20,000 feet.
16. New and different.
17. A servant owned as property.

DOWN

1. A beginner; one who is new at a job.
3. A Roman citizen bathed in the public \_\_\_\_\_.
4. A star of the first \_\_\_\_\_ (size).
6. Romans attended chariot \_\_\_\_\_.
7. Has charge of keeping building clean.
9. A room for washing up.
10. A sleeveless, shirt-like garment.
13. Garments worn by Roman men.
14. To make larger.
18. The Roman senate passed \_\_\_\_\_.

TO TELL THE TRUTH

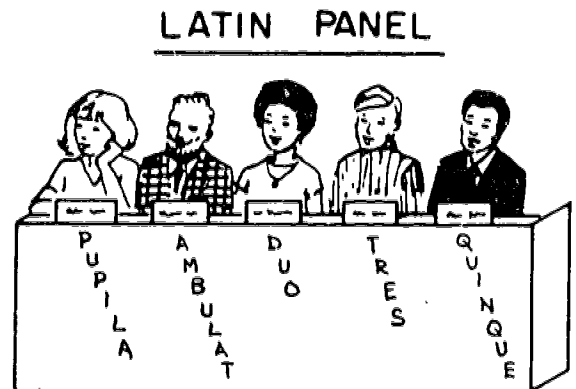
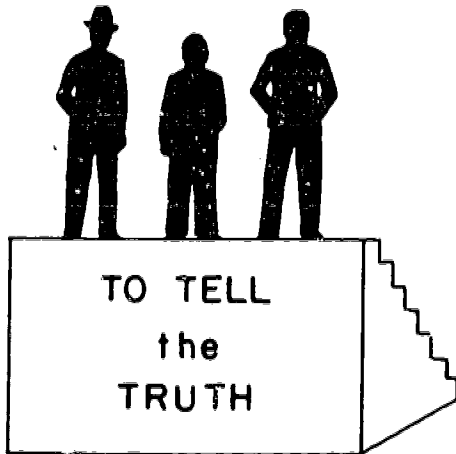

Have you watched "To Tell the Truth" on TV? In the sentences below, it is up to you to decide which sentence is telling the truth. Place the letter of the true sentence in Column B next to the word in Column A.

COLUMN A

COLUMN B

\_\_\_ 1. PUPIL

- a. I am a student in school.
- b. I am a dogcatcher.
- c. I am a fisherman.

\_\_\_ 2. PUPPET

- a. I am a fireman
- b. I am a slave
- c. I am a doll worked by hand.

\_\_\_ 3. SOMNAMBULIST

- a. I am a watchman.
- b. I am a student in a school.
- c. I am a sleepwalker.

\_\_\_ 4. DUET

- a. I am the Supremes (3).
- b. I am Tom Jones (1).
- c. I am Ike and Tina Turner (2).

\_\_\_ 5. TRIO

- a. I am the Everly Brothers (2).
- b. I am the Beatles (4).
- c. I am the Supremes (3).

\_\_\_ 6. TRIPLE

- a. I am a three-base hit in baseball.
- b. I am a two-base hit.
- c. I am a home run.



COLUMN A

COLUMN B

\_\_\_7. TRIANGLE

- a. I am a four-sided figure.
- b. I am a five-sided figure.
- c. I am a three-sided figure.

\_\_\_8. QUINTET

- a. I am the Temptations (5).
- b. I am the Monkees (4).
- c. I am the Three Dog Night (3).

\_\_\_9. OCTOPUS

- a. I am a lion with eight legs.
- b. I am a sea creature with eight tentacles (arms).
- c. I am a turtle.

\_\_\_10. DECIMAL

- a. I am an animal with ten legs.
- b. I am a fish with ten eyes.
- c. I am a number like this: 2.05.

\_\_\_11. CANINE

- a. I am cat-like.
- b. I am dog-like.
- c. I am fish-like.

\_\_\_12. FELINE

- a. I am cat-like.
- b. I am fish-like.
- c. I am dog-like.

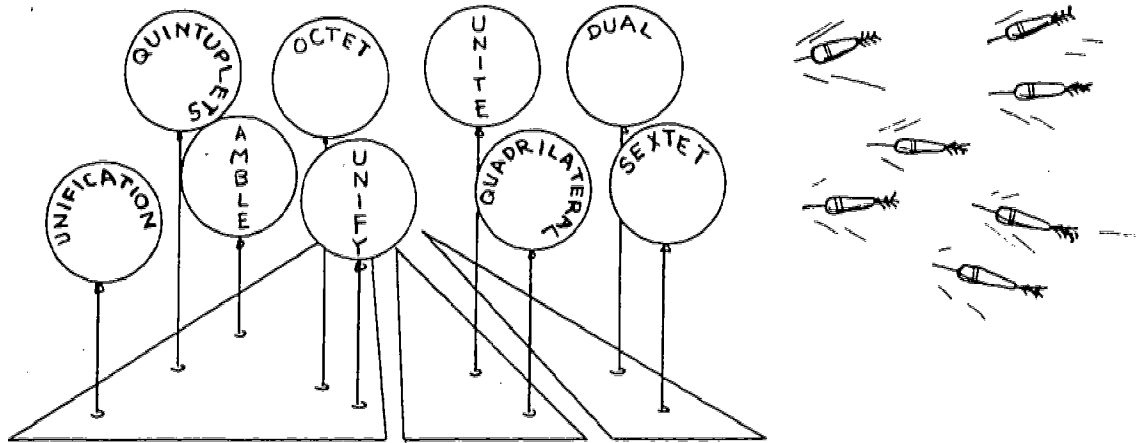

Have you ever wanted to throw a dart at balloons? Here is your chance. Pop the balloons by marking the sentences True (T) or False (F).

- \_\_\_ 1. The relief pitcher ambled to the pitcher's mound.
- \_\_\_ 2. Dr. Martin Luther King wanted to unite blacks and whites.
- \_\_\_ 3. Quintuplets are two children born at the same time to the same mother.
- \_\_\_ 4. Abraham Lincoln tried to unify the North and the South.
- \_\_\_ 5. A quadrilateral is a two-sided figure.
- \_\_\_ 6. A sextet is a group of five singers or musicians.
- \_\_\_ 7. A stereo record player has dual speakers.
- \_\_\_ 8. An octet is a group of six singers or musicians.
- \_\_\_ 9. The unification of two countries means they become one.
- \_\_\_ 10. A hammer has a dual purpose: its two uses are driving nails in and pulling them out.

MISSION IMPOSSIBLE

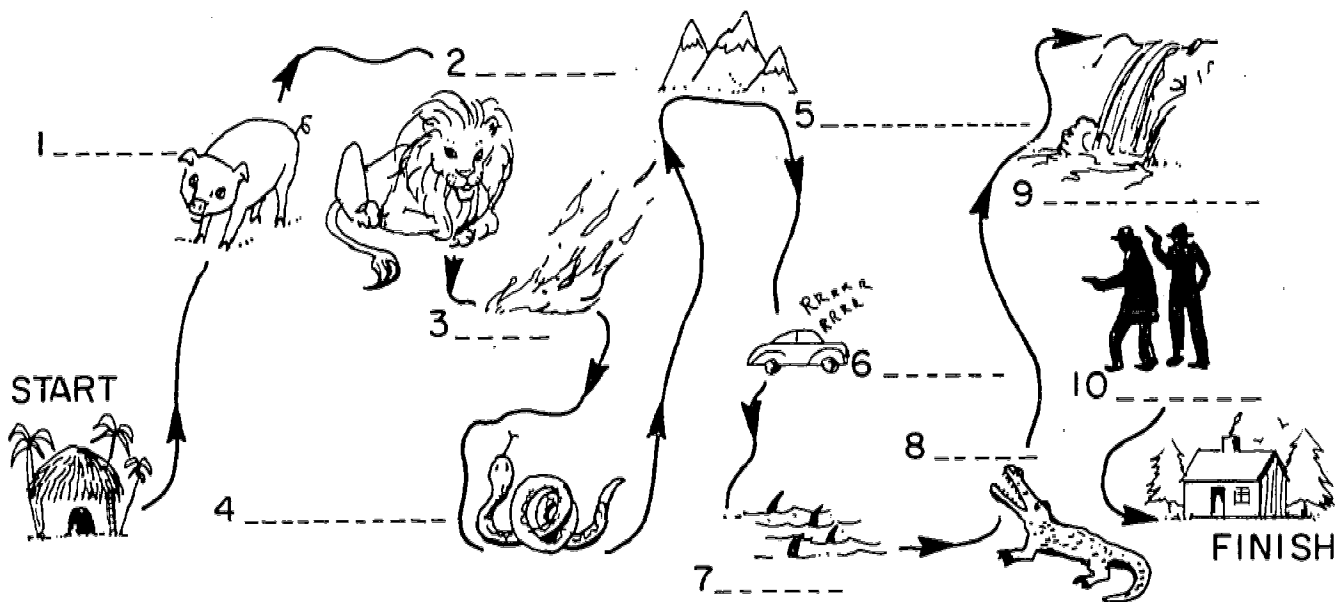

WORDS TO USE

- |       |               |        |        |             |
|-------|---------------|--------|--------|-------------|
| dual  | quintuplets   | ambled | octet  | ambled      |
| unify | quadrilateral | united | sextet | unification |

The Mission agents have just rescued an important prisoner. But their work is not done yet. They must make their way home through enemy country. Can you help them? Fill in both blanks (in the sentence and on the map) with the correct word for each number. You are on your own. Good luck!

1. The cowboy (strolled) \_\_\_\_\_ down the streets of Dodge City.
2. Abraham Lincoln tried to (join together) \_\_\_\_\_ the North and the South.
3. The sports car was equipped with (twin) \_\_\_\_\_ exhaust pipes.
4. "Five diapers to change!" exclaimed the mother of (five babies) \_\_\_\_\_.
5. A square is a (four-sided figure) \_\_\_\_\_.
6. Three boys and three girls got together to form a (group of six singers) \_\_\_\_\_.
7. \_\_\_\_\_ (together) we stand, divided we fall.

(UNIT 6)

8. Three singers and five musicians form an (group of eight) \_\_\_\_\_.
9. The people of Vietnam would like to see the (joining together) \_\_\_\_\_  
of North and South Vietnam.
10. The young couple (strolled) \_\_\_\_\_ through the park.

OPUS 25  
LOST IN SPACE

(UNIT 6)

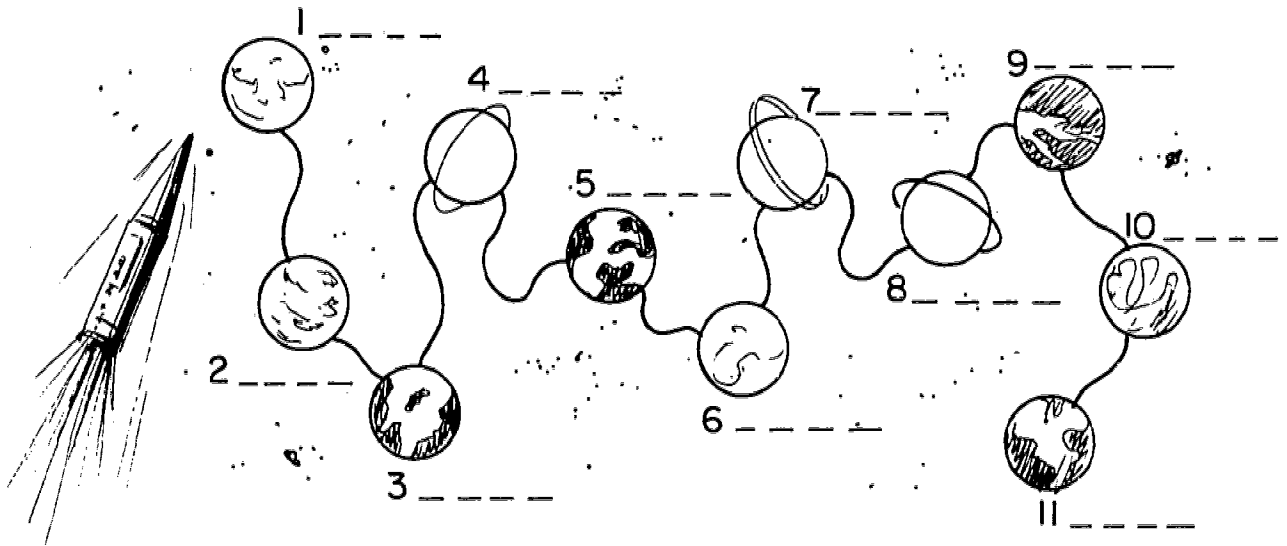

WORDS TO USE

duet	puppet	student	triple	octopus	feline
trio	quintet	canine	decimal	somnambulist	

Will and Penny Robinson are lost in their spacemobile. Help them get back to earth by correctly filling in the blanks below. Each time you use a word, check the picture above. Draw an arrow to the planet containing the same word. To rescue Will and Penny, you must visit every planet.

1. A \_\_\_\_\_ show uses dolls on strings.
2. The two Everly Brothers are a \_\_\_\_\_.
3. The three Supremes are a \_\_\_\_\_.
4. A boy or girl in school is called a \_\_\_\_\_.
5. The five Temptations are a \_\_\_\_\_.
6. Willie Mays got to third base on a \_\_\_\_\_.
7. A German shepherd is a \_\_\_\_\_.

8. The \_\_\_\_\_ wrapped his eight tentacles around the drowning sailor.
9. A lion is a \_\_\_\_\_ animal.
10. In \$5.10, the \_\_\_\_\_ point separates the five dollars from the ten cents.
11. A sleepwalker is a \_\_\_\_\_.

## LATIN FOOTBALL

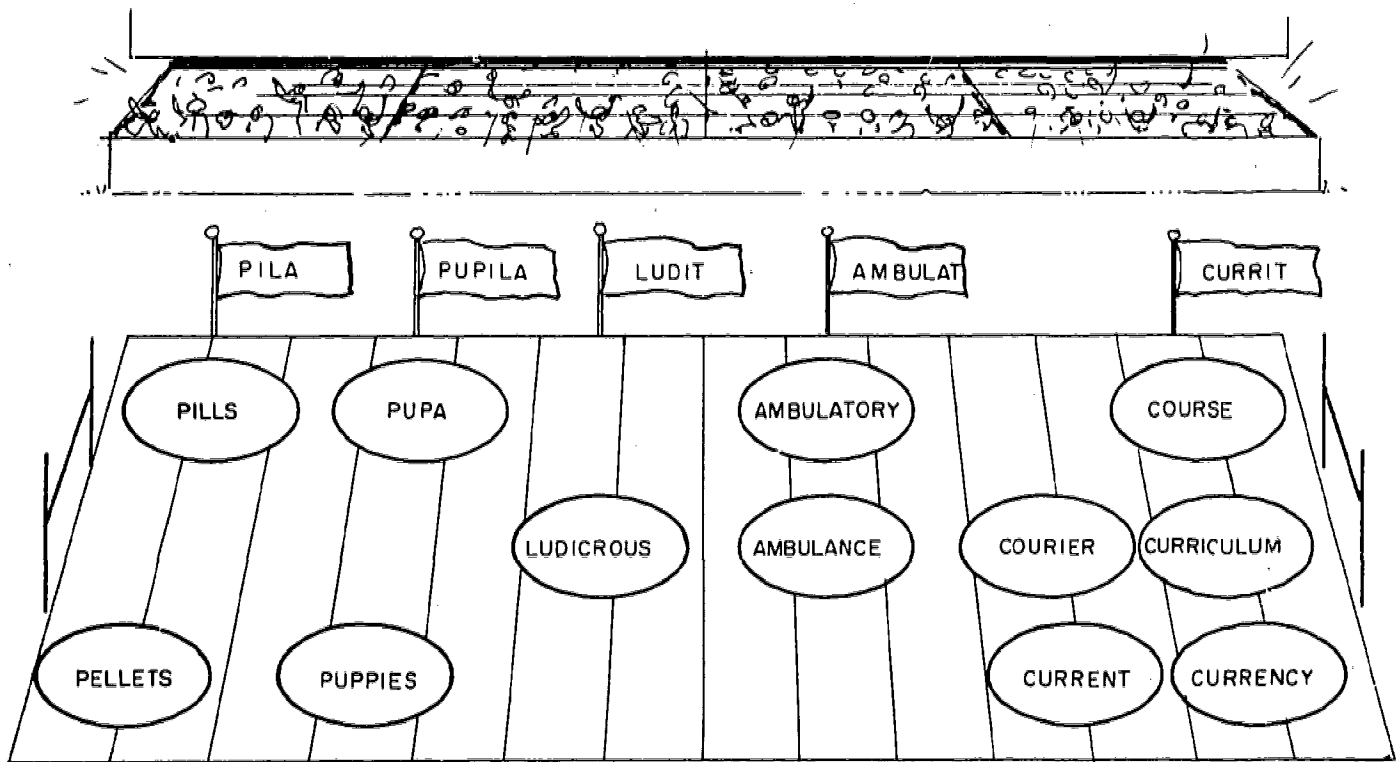

Here is your challenge. Make as many touchdowns as you can by underlining the correct word for each sentence. As you use the words in the sentences, draw a line connecting the words on the football field. Use four words and you have a touchdown. Can you make all three touchdowns?

1. He bought a bottle of (pupils, pills).
2. A (pupa, courier) is a young insect.
3. After his operation, he took only a few days to become (ambulatory, elected).
4. A fifth-grade (curriculum, truck) includes reading, mathematics, and writing.
5. The toy gun shot plastic (combs, pellets).
6. Our dog Princess had three (puppies, kids).
7. You can read the latest article on cats in the (current, ancient) issue of Life.
8. He had fifty dollars in (flour, currency) in his pocket.
9. The old man looked (friendly, ludicrous) shaking his cane at everyone.

(UNIT 6)

10. We heard the siren of the (ambulance, milk truck).
11. The (corpse, courier) brought the message.
12. There are usually eighteen holes on a full-size golf (course, bed).



BOWLING

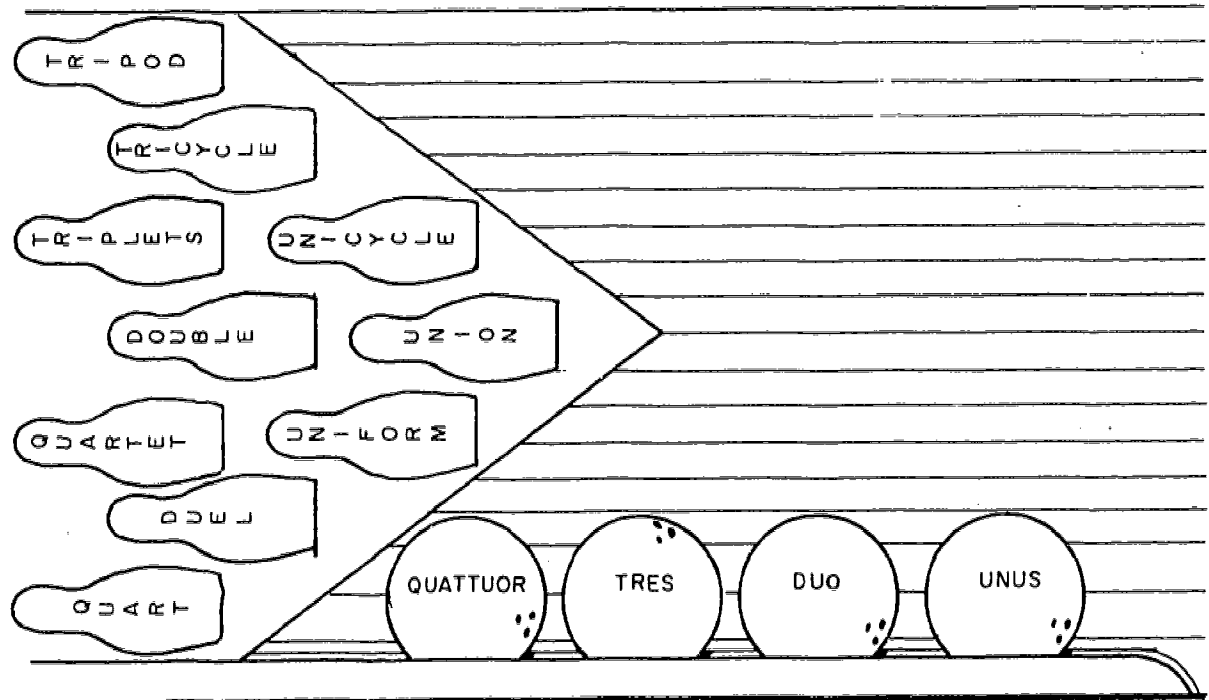

Get a perfect bowling score! For every correct sentence, score a strike. All you need to do is place the letter of the correct word in the space given in each sentence.

1. Marriage is a ( ) of two people.
  - a. dance
  - b. union
  - c. meal
2. A ( ) has only one wheel.
  - a. career
  - b. dune buggy
  - c. unicycle
3. A nurse wears a white ( ).
  - a. uniform
  - b. flower
  - c. ring
4. The two men fought a ( ).
  - a. visit
  - b. duel
  - c. ring
5. The hungry boy asked for a ( ) portion of meat.
  - a. doubtful
  - b. florid
  - c. double

(UNIT 6)

6. Three-year olds ride  
\_\_\_\_(\_\_\_\_)\_\_\_\_.
- a. unicycles  
b. tricycles  
c. unicorns
7. A photographer places his  
camera on a \_\_\_\_ (\_\_\_\_) \_\_\_\_ to  
keep it steady.
- a. pillow  
b. cloud  
c. tripod
8. Three children born at one  
birth are called \_\_\_\_ (\_\_\_\_) \_\_\_\_.
- a. twins  
b. choices  
c. triplets
9. Four boys at school formed  
a singing \_\_\_\_ (\_\_\_\_) \_\_\_\_.
- a. quartet  
b. lyric  
c. orchestra
10. It takes four \_\_\_\_ (\_\_\_\_) \_\_\_\_  
to make a gallon.
- a. ounces  
b. quarts  
c. tablespoons

MINIATURE GOLF

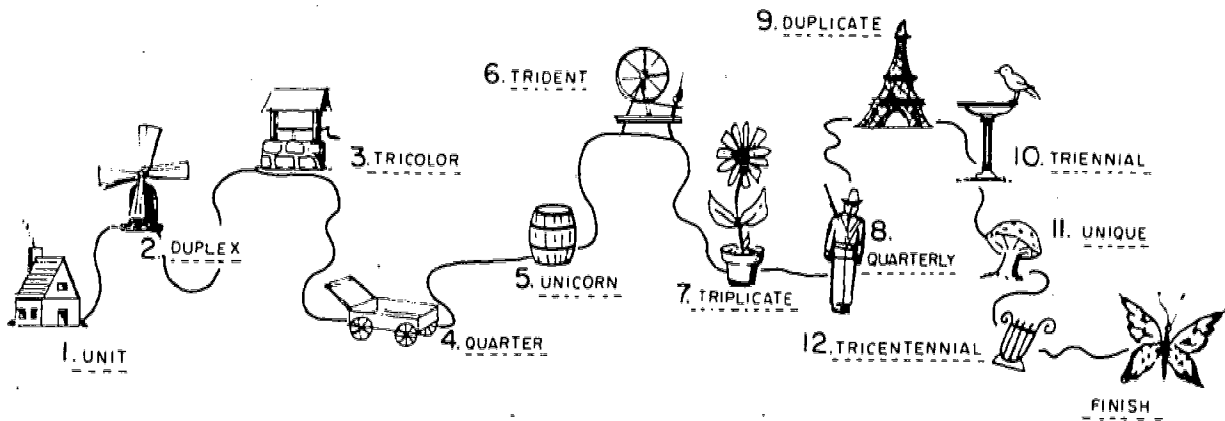

Miniature golf is the game we are playing. Move from one hole to the next by matching the sentence parts below. Place the correct number from Column A next to the letter in Column B. Draw an arrow from word to word as you move ahead on the course.

Column A

Column B

- |  |  |
|--|--|
| <p>1. The first <u>unit</u></p> <p>2. A house made up of two apartments is a</p> <p>3. The three-colored flag of France is</p> <p>4. Twenty-five cents (\$.25) is</p> <p>5. A <u>unicorn</u> is</p> <p>6. Neptune's <u>trident</u> has</p> | <p>_____ A. called the <u>tricolor</u>.</p> <p>_____ B. in our math book is easy.</p> <p>_____ C. a <u>duplex</u>.</p> <p>_____ A. a horse with one big horn on its head.</p> <p>_____ B. three points.</p> <p>_____ C. a <u>quarter</u> of a dollar (\$1.00).</p> |
|--|--|

(UNIT 6)

Column A

Column B

- |     |                                      |       |   |
|-----|--------------------------------------|-------|---|
| 7.  | To do your homework<br>in triplicate | _____ | A. to make two copies.                  |
| 8.  | At school, quarterly<br>report cards | _____ | B. come four times a year.              |
| 9.  | To duplicate means                   | _____ | C. means to make three copies<br>of it. |
| 10. | A triennial celebration comes        | _____ | A. singing style.                       |
| 11. | Dionne Warwick has a unique          | _____ | B. every three years.                   |
| 12. | A tricentennial celebration comes    | _____ | C. every three centuries.               |

Here are more trees from a Latin word orchard. The make-believe trees have Latin words as their roots. The fruits on the trees are English relatives. "Pick the fruit" by writing True (T) or False (F) before each sentence.

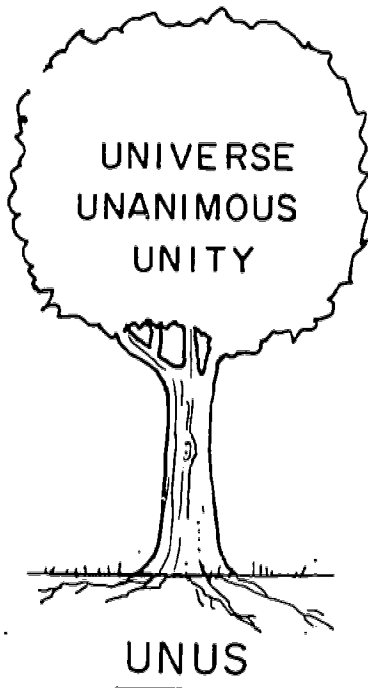

- \_\_\_\_\_ 1. A class shows unity when it works together.
- \_\_\_\_\_ 2. The President of the United States is the leader of the whole universe.
- \_\_\_\_\_ 3. A divided vote is unanimous.
- \_\_\_\_\_ 4. A duplicator is a machine that makes copies.
- \_\_\_\_\_ 5. The second crash on the same spot was a duplication of the first accident.
- \_\_\_\_\_ 6. Trivia are very important papers.
- \_\_\_\_\_ 7. A trillion is a number.
- \_\_\_\_\_ 8. A trinity is the union of three parts into one.
- \_\_\_\_\_ 9. Triceps are muscles on a leg.
- \_\_\_\_\_ 10. Eyeglasses can have trifocal lenses.
- \_\_\_\_\_ 11. A quadruped is a two-legged animal.
- \_\_\_\_\_ 12. When John spends four times more than usual, he quadruples his spending.

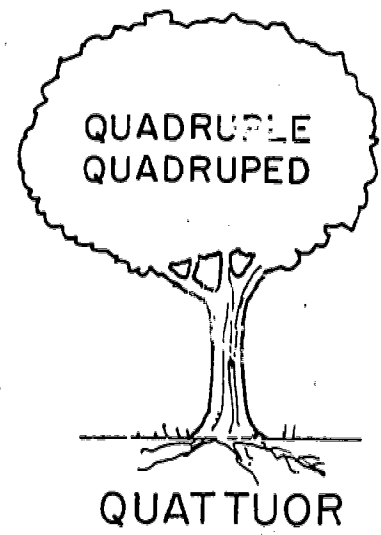
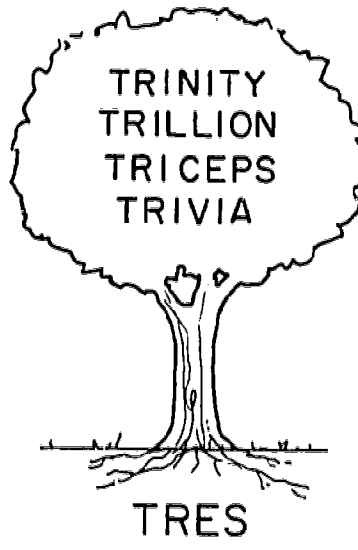
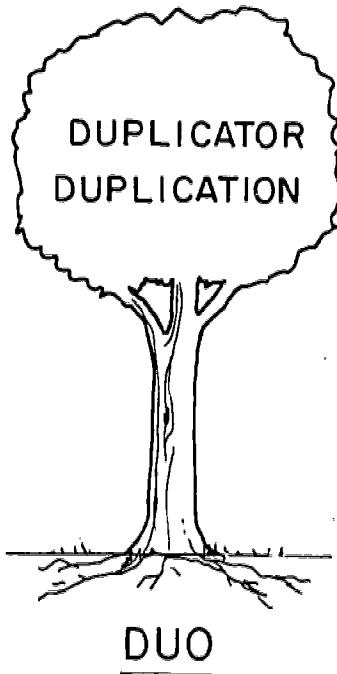

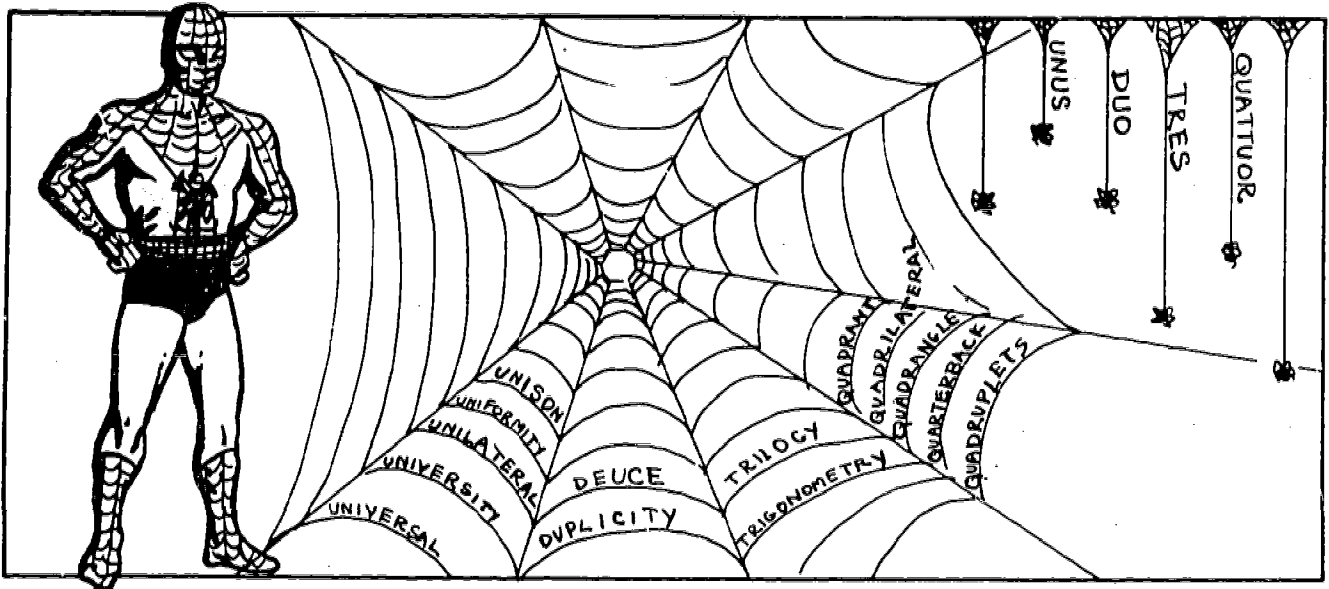

Help Spiderman complete his web. Underline the word that best completes each sentence.

1. Many Philadelphians study at Temple (restaurant, University).
2. In a deck of cards, the number two card is called a (jack, deuce).
3. On a football team, the passer is called the (guard, quarterback).
4. Four babies born to a mother at the same time are called (quadruplets, trio).
5. The marines marched together in (separation, unison).
6. A (quadrilateral, quarterback) is a four-sided figure.
7. All the boys wore Afro cuts to have a (uniformity, orchard) of hair style.
8. One-fourth of a circle is called a (deuce, quadrant).
9. We study about measuring the three angles of a triangle in (history, trigonometry).
10. Candy is a (universal, rare) favorite with children.
11. A person who lies shows (duplicity, quarterback).
12. Three stories with the same hero are called a (parade, trilogy).

(UNIT 6)

13. A one-sided cease-fire is a (unilateral, dual) action.
14. The four school buildings formed a (quadrangle, triangle).

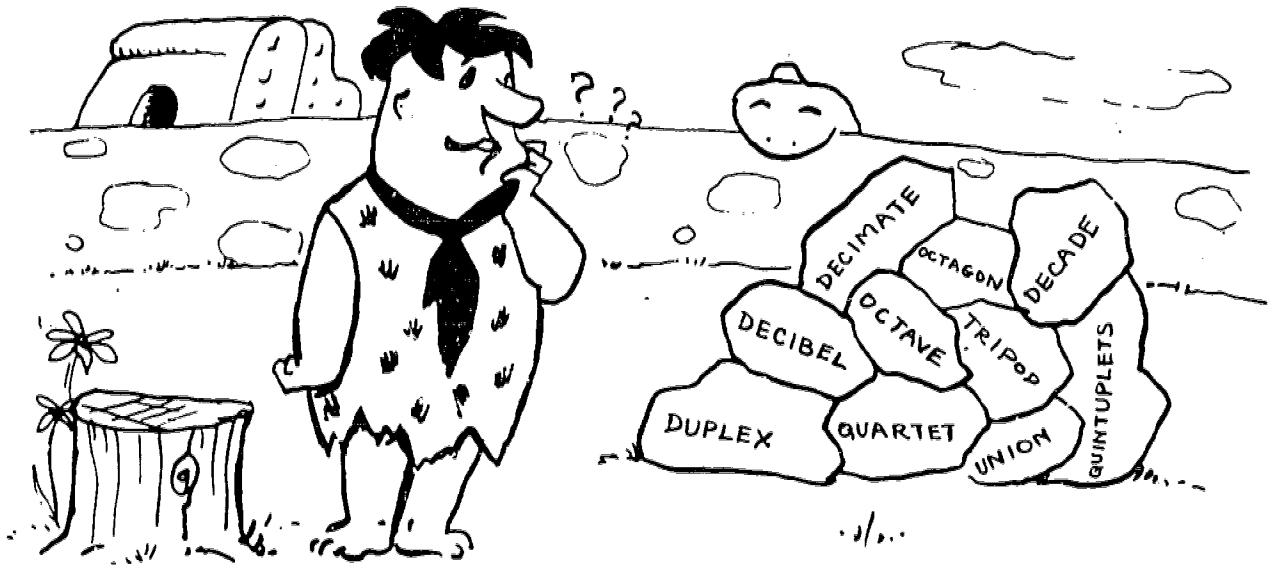

Help Fred Flintstone sort his pile of rocks by circling the letter of the correct sentence below.

1. A. A labor union is many workers joined together as one group.  
B. Joined together as a one many workers a labor union is.  
C. Is joined together as one group a labor union many workers.
2. A. 1960-1970, a period of ten years, in America a difficult decade was.  
B. 1960-1970, a period of ten years, was a difficult decade in America.  
C. Was 1960-1970, of ten years a period, a difficult decade in America.
3. A. Called a tripod the photographer put his camera on a three-legged stand.  
B. His camera put the photographer on a three-legged stand called a tripod.  
C. The photographer put his camera on a three-legged stand called a tripod.
4. A. The Beatles sang the world famous quartet, "Yellow Submarine," a song.  
B. The Beatles, a world famous quartet, sang the song, "Yellow Submarine."  
C. "Yellow Submarine," the Beatles, sang the song, a world famous quartet.



5. A. A stop sign is shaped like an octagon.  
B. A stop sign like an octagon shaped is.  
C. Like an octagon shaped is a stop sign.
6. A. Of loudness is a measure a decibel.  
B. Measure of a decibel is a loudness.  
C. A decibel is a measure of loudness.
7. A. The names of the eight notes in an octave the song uses "Do Re Mi ."  
B. The song, "Do Re Mi," uses the names of the eight notes in an octave.  
C. In an octave uses the names of the eight notes.
8. A. Said the battle report that the enemy decimated was.  
B. The battle report was decimated said the enemy.  
C. The battle report said that the enemy was decimated.
9. A. All five of Mrs. Jones' quintuplets were boys.  
B. Were boys of Mrs. Jones' quintuplets all five.  
C. Boys of Mrs. Jones' quintuplets were all five of.
10. A. The second floor apartment rented we in the duplex.  
B. We rented the second floor apartment in the duplex.  
C. The duplex rented we in the second floor apartment.

## TO TELL THE TRUTH

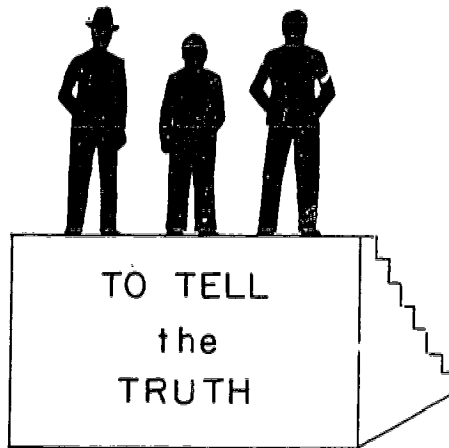

Have you ever watched "To Tell the Truth" on TV? In the sentences below, it is up to you to decide which sentence is telling the truth. Place the letter of the true sentence in Column B next to the word in Column A.

## Column A

1. unilateral
2. December
3. octane
4. quadrilateral
5. quintet

## Column B

- A. I put out fires.
  - B. I mean "one-sided."
  - C. I am a food.
- A. Easter comes at my time.
  - B. I am a warm month.
  - C. Christmas is my time.
- A. I am a part of gasoline.
  - B. I am a fish with eight arms.
  - C. I am a stop sign.
- A. I am a turtle.
  - B. I am good to eat.
  - C. I am a four-sided figure.
- A. I am a group of five, like the Jackson Five.
  - B. I am a square.
  - C. I taste like fish.

Column A

Column B

- |                   |  |
|-------------------|--|
| 6. sexagenarian   | A. I am used to guide ships.<br>B. I am sixty years old.<br>C. I am a part of gasoline.                    |
| 7. septuagenarian | A. I am part of the Bible.<br>B. I live in the zoo.<br>C. I am seventy years old.                          |
| 8. octogenarian   | A. I am eighty years old.<br>B. I am eight feet tall.<br>C. I am like a camel.                             |
| 9. November       | A. I am a warm summer month.<br>B. I come at Easter time.<br>C. Thanksgiving comes at my time.             |
| 10. Decalogue     | A. I am a tree with ten branches.<br>B. I am the tenth month.<br>C. I am also called the Ten Commandments. |
| 11. uniform       | A. I am worn by a policeman.<br>B. I am in Jello mold.<br>C. I am a one-horned animal in fairy tales.      |
| 12. sextant       | A. I am sixty years old.<br>B. I am a worker in a church.<br>C. I am used to guide ships.                  |

LATIN WORD-ARROWS

ENGLISH TARGETS



LATIN WORD-ARROWS

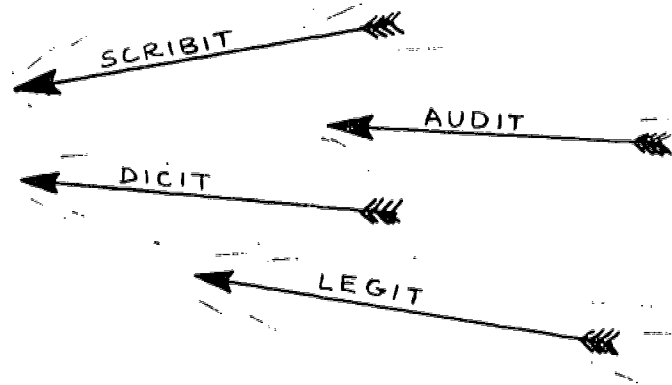

Sharpen your aim for a bull's eye! You get one, two, or three points for each word used. Match sentence halves below by writing the letter beside the words in Column B that complete the sentence begun in Column A in the space shown.

Column A

Column B

- |   |  |
|---|--|
| 1. He <u>scribbled</u> the phone number _____     | A. without the <u>audio</u> portion.       |
| 2. The dying man's voice _____                    | B. on the cover of the phone book.         |
| 3. The late show looked like a silent movie _____ | C. was barely <u>audible</u> .             |
| 4. The senator's well-worked speech _____         | A. still <u>legible</u> .                  |
| 5. The writing on the old tombstone was _____     | B. <u>audible</u> across the room.         |
| 6. The pupil's whispering was _____               | C. was an example of good <u>diction</u> . |

Column A

Column B

- |  |                                       |
|--|---------------------------------------|
| 7. A person can take a course in <u>diction</u> _____              | A. she could only <u>scribble</u> .   |
| 8. The program was held up while the <u>audio</u> technician _____ | B. even though he sprained his wrist. |
| 9. His handwriting was <u>legible</u> _____                        | C. to improve his speaking.           |
| 10. When the girl started to write _____                           | D. repaired the microphone.           |

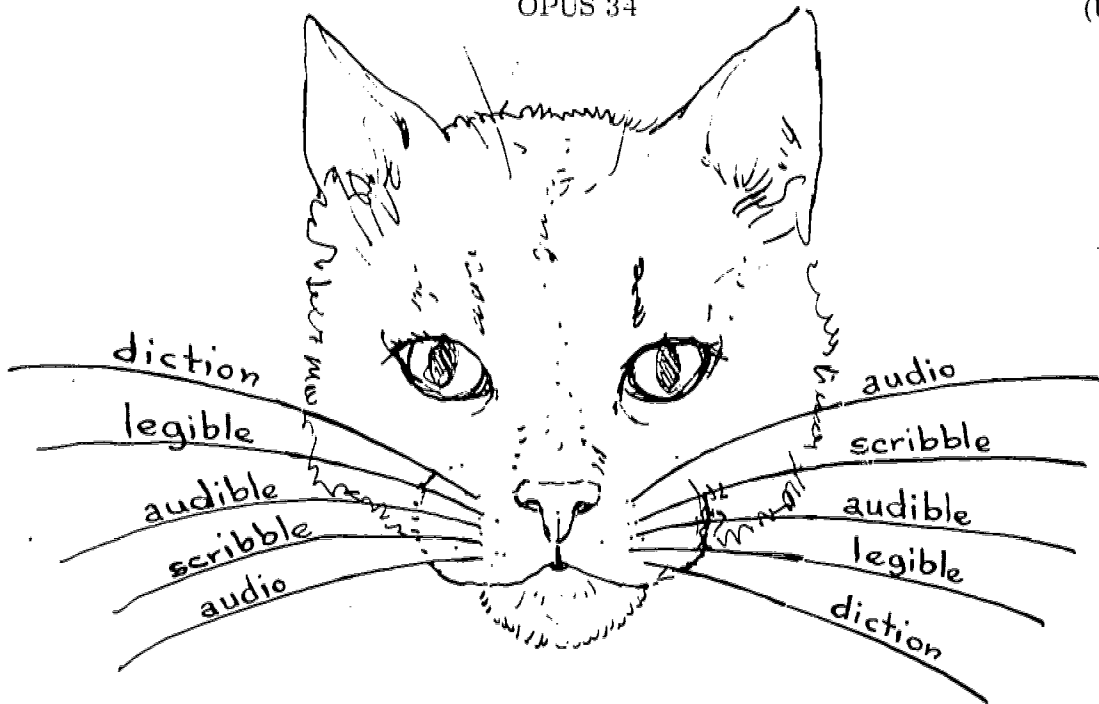

### Whiskers T. Pussycat

This poor pussy cat has words stuck to his whiskers! Help remove the words by crossing each one out in his whiskers as you put it into a blank in each sentence. Clues on which word to use are in parenthesis.

1. The teacher asked me not to \_\_\_\_\_ (write sloppily).
2. The rock-and-roll record was so low that it was barely \_\_\_\_\_ (able to be heard).
3. Clear handwriting is \_\_\_\_\_ (able to be read).
4. The \_\_\_\_\_ (sound) portion of the TV program was interrupted.
5. Rev. Dr. Martin Luther King had excellent \_\_\_\_\_ (choice of words).
6. The wet newspaper was still \_\_\_\_\_ (readable).
7. Gang members sometimes \_\_\_\_\_ (write carelessly) on the sides of school buildings.
8. Poor listeners often have \_\_\_\_\_ (hearing) problems.
9. Her excellent choice of words showed good \_\_\_\_\_ (vocabulary use).
10. The distant subway train was still \_\_\_\_\_ (able to be heard).

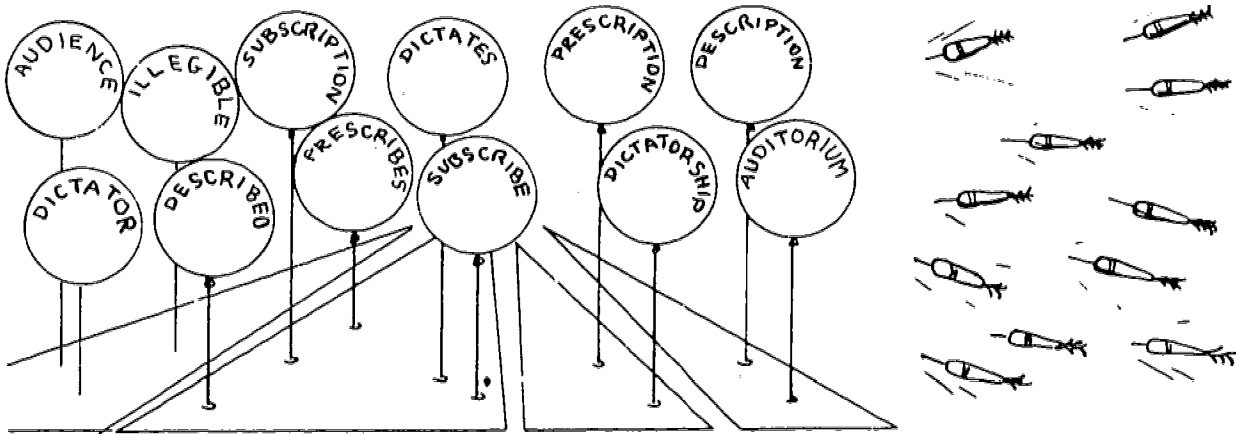

Pop the balloons by underlining the correct word in the sentences below. You can't miss - pop them all!

1. After his act the singer bowed to the (audience, curriculum).
2. The (dictator, sweeper) ruled with an iron hand.
3. The writing on the old paper had faded so much that it was (useful, illegible).
4. Mary (described, watered) her favorite movie in great detail.
5. Robert went to the drugstore to have a (tooth, prescription) filled.
6. The (auditorium, automobile) could seat five hundred people.
7. The witness gave a (description, result) of the robber.
8. He bought a two-year (allowance, subscription) to Life magazine.
9. The teacher (dictates, begs) the sentences and the students write them.
10. All students may (subscribe, bow) to the school newspaper.
11. Fidel Castro heads a (battleship, dictatorship) in Cuba.
12. The doctor (prescribes, conducts) aspirin for the patient's fever.

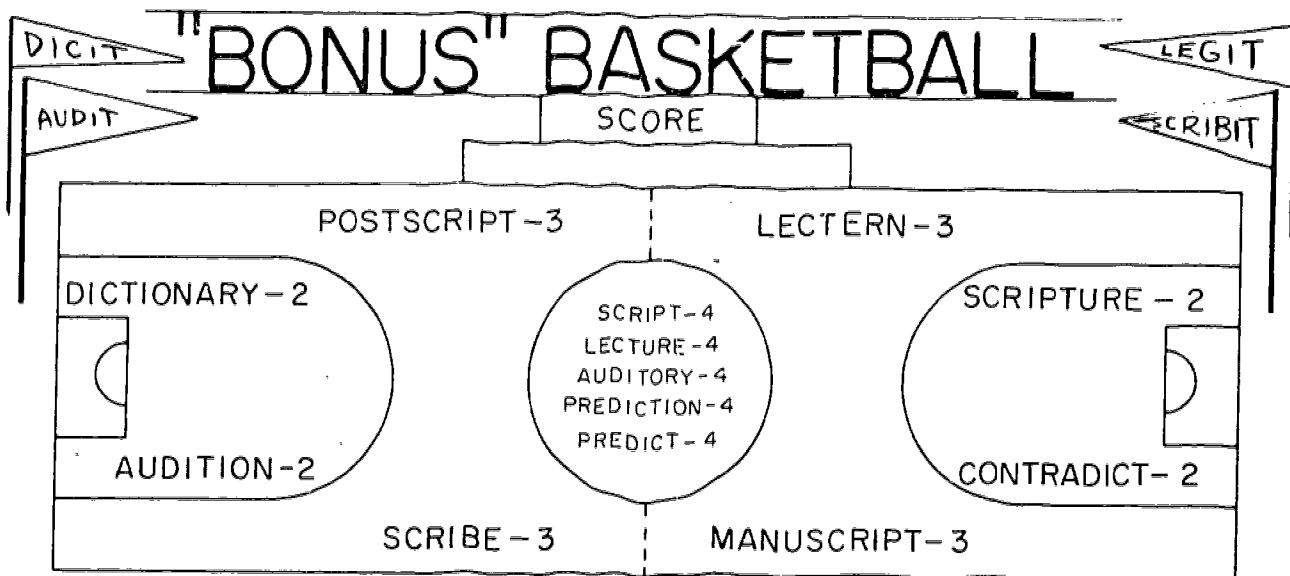

Sink your shots for two, three, or four points by matching the English derivatives in Column B with the sentences in Column A. The basketball court shows that the words closest to the basket are the easiest shots and those at half-court are the hardest. Get ready! Get set! Play Bonus Basketball!

Column A

Column B

For Two Points

- |  |  |
|--|--|
| <p>1. Walter looked up the word in his<br/>    <u>    ( )    </u>.</p> <p>2. On many issues, Democrats<br/>    <u>    ( )    </u> Republicans.</p> <p>3. <u>    ( )    </u> is holy writing.</p> <p>4. The <u>    ( )    </u> for the class<br/>    play lasted two hours.</p> | <p>a. contradicted</p> <p>b. audition</p> <p>c. dictionary</p> <p>d. scripture</p> |
|--|--|



For Three Points

- |    |  |               |
|----|--|---------------|
| 5. | She added a <u>( )</u> to her letter.              | a. scribe     |
| 6. | The <u>( )</u> of the book needed few corrections. | b. lectern    |
| 7. | The speaker leaned against the <u>( )</u> .        | c. postscript |
| 8. | The <u>( )</u> copied the text of the old scroll.  | d. manuscript |

For Four Points

- |     |  |               |
|-----|--|---------------|
| 9.  | The doctor gave a <u>( )</u> on food and vitamins.             | a. auditory   |
| 10. | The <u>( )</u> nerve goes from the ear to the brain.           | b. lecture    |
| 11. | The fortune teller made a <u>( )</u> about my friend's future. | c. prediction |
| 12. | The actor studied his lines from the <u>( )</u> .              | d. predict    |
| 13. | Weathermen <u>( )</u> the weather.                             | e. script     |

TEMPLE TREASURES

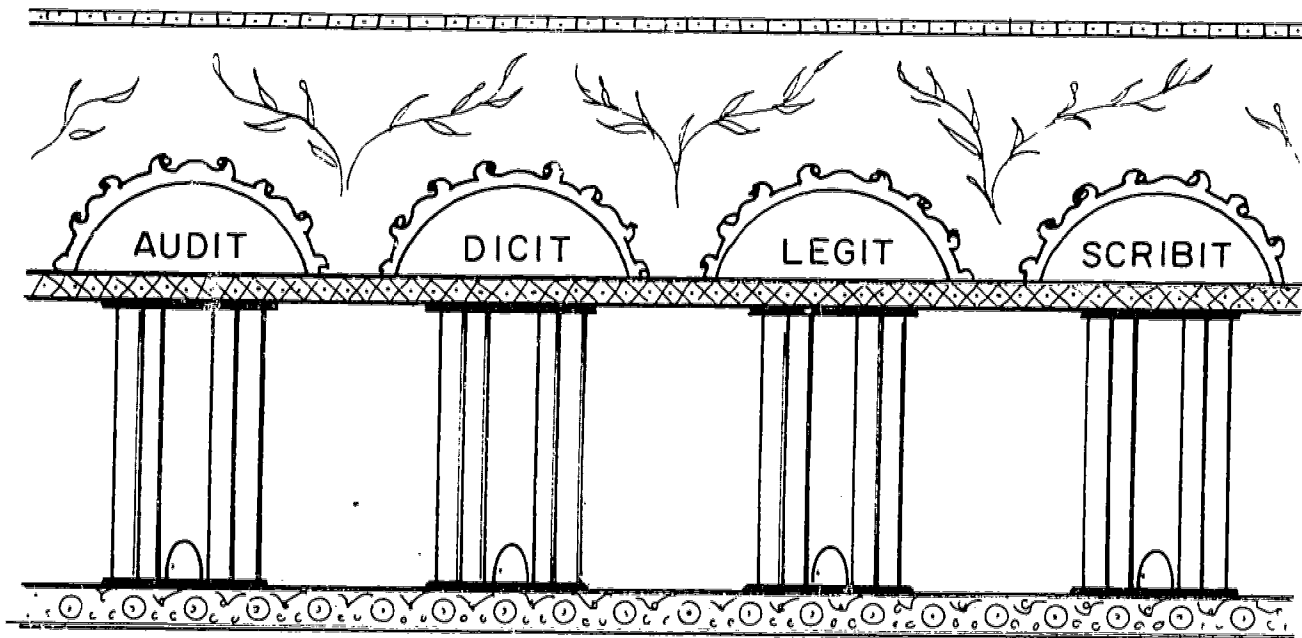

The four temple doors of this make-believe treasury hide English words. Unlock the doors by circling the letter of the correct sentence.

1.   A. The financial records examined the auditor.  
      B. The auditor examined the financial records.  
      C. Examined the financial records the auditor.
  
2.   A. Davy Crockett made the legend of Walt Disney very famous.  
      B. Made the legend of Davy Crockett very famous Walt Disney.  
      C. Walt Disney made the legend of Davy Crockett very famous.
  
3.   A. The secretary wrote down the dictation.  
      B. The dictation wrote down the secretary.  
      C. The dictation the secretary wrote down.

(UNIT 7)

4.
  - A. The inscription on the school 1950 A.D. says.
  - B. The school on the inscription says 1950 A.D.
  - C. The inscription on the school says 1950 A.D.
  
5.
  - A. Ellen filled the druggist's prescription.
  - B. The druggist filled Ellen's prescription.
  - C. Filled Ellen's prescription the druggist.
  
6.
  - A. Legible writing on tests only acceptable is.
  - B. Acceptable only is on tests legible writing.
  - C. Only legible writing is acceptable on tests.
  
7.
  - A. Fidel Castro rules as the dictator of Cuba.
  - B. Of Cuba, Fidel Castro rules as dictator.
  - C. Dictator of Cuba as Fidel Castro rules.
  
8.
  - A. The name of Wilt Chamberlain is inscribed on the list of sports champions.
  - B. Of Wilt Chamberlain is inscribed on the list the name of sports champions.
  - C. Inscribed the name of Wilt Chamberlain on the list of sports champions is.
  
9.
  - A. The books completed the inspector of the audit.
  - B. The inspector completed the audit of the books.
  - C. Of the books the inspector completed the audit.

10.
  - A. Became John F. Kennedy a legendary figure in American history.
  - B. In American history a legendary figure became John F. Kennedy.
  - C. John F. Kennedy became a legendary figure in American history.
  
11.
  - A. To Superman many powers children ascribe.
  - B. Children ascribe many powers to Superman.
  - C. Superman ascribes many powers to children.
  
12.
  - A. Business offices use a dictaphone to record letters.
  - B. To record a dictaphone business offices use letters.
  - C. Letters use a dictaphone to record business offices.

WORD-POWER TREES

Pick "fruit" from the make-believe word trees by writing true or false next to each sentence.

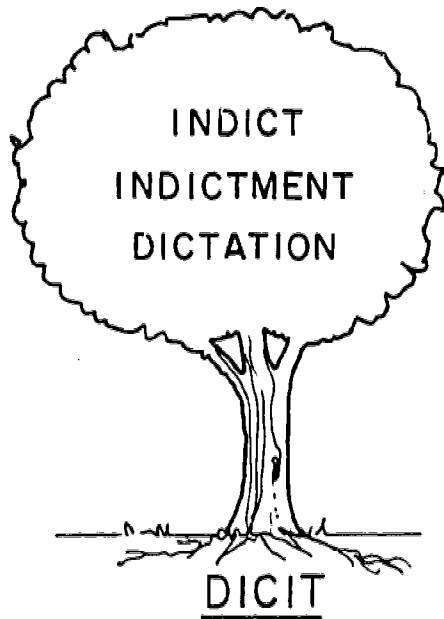

1. \_\_\_\_\_ Dictation is a chocolate dessert.
2. \_\_\_\_\_ The Grand Jury will indict the accused people.
3. \_\_\_\_\_ The newspaper story of the gangster's indictment was interesting.

4. \_\_\_\_\_ Scripto is a brand name for yo-yo's.
5. \_\_\_\_\_ A scrip is a piece of paper.
6. \_\_\_\_\_ We learn about Holy Scripture in math class.

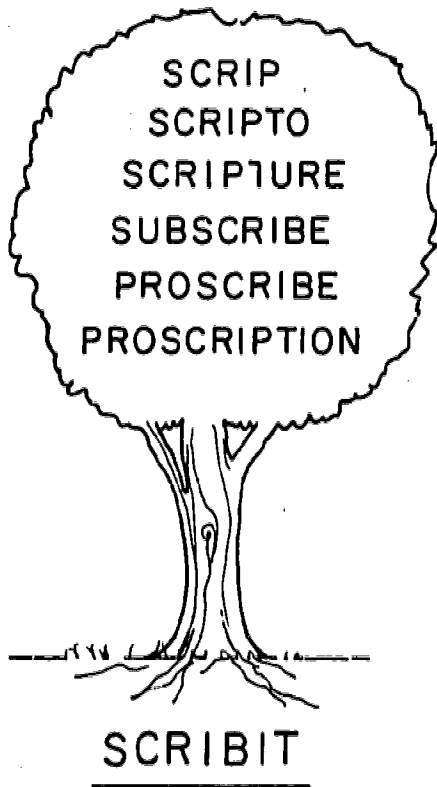

7. \_\_\_\_\_ To proscribe someone means to declare him an outlaw.
8. \_\_\_\_\_ The proscription of the Jews in World War II was a horrible thing.
9. \_\_\_\_\_ To subscribe means to dance.

(UNIT 7)



10. \_\_\_\_\_ Daniel Boone is a legendary hero of America's past.
11. \_\_\_\_\_ The words on this page are illegible.
12. \_\_\_\_\_ At the airport, the jets are very audible.

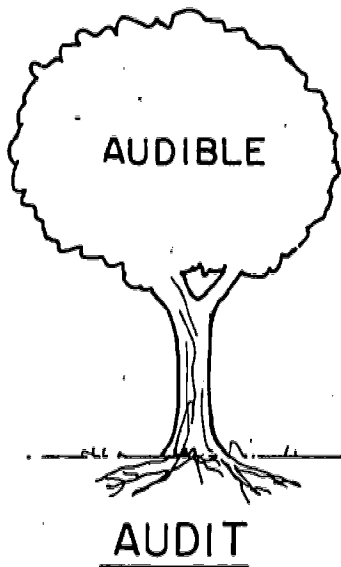

CROSSWORD PUZZLE: FROM ONE TO TEN

Across

- 3. A small doll.
- 6. One of five children born at one time.
- 8. Having two parts.
- 10. \_\_\_\_\_ is making into a unity.
- 12. In the number 2.5 there is a \_\_\_\_\_ point.
- 13. Group of eight performers.
- 14. Cat-like.
- 15. Group of six performers.
- 16. A three-base hit in baseball is a \_\_\_\_\_.

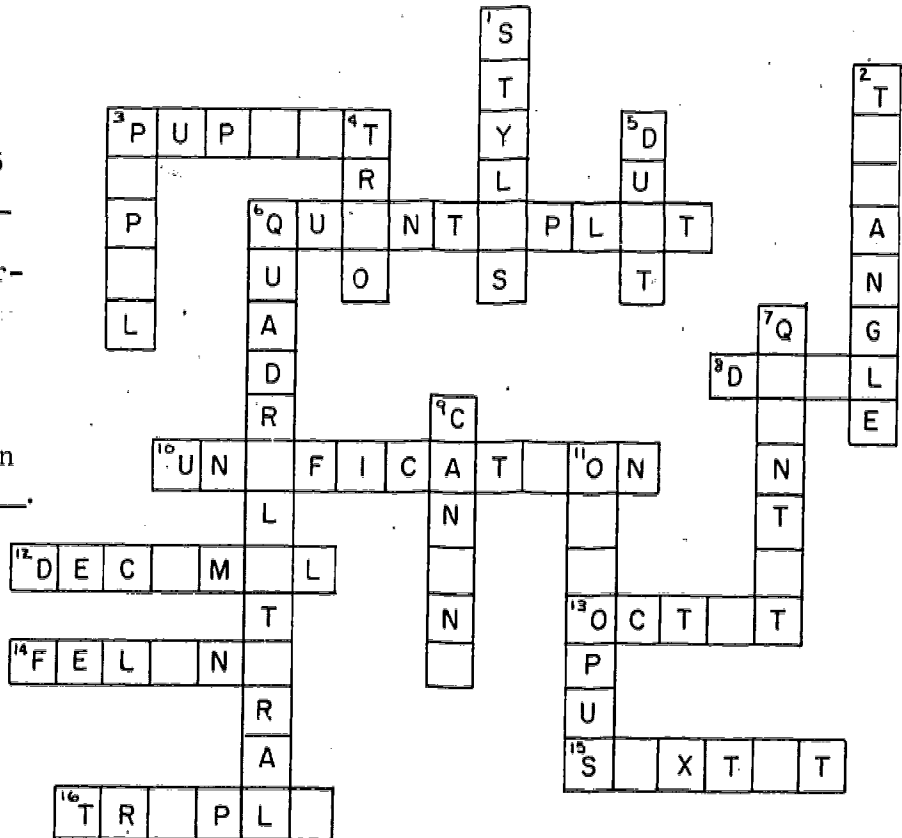

Down

- 1. Marcus used a \_\_\_\_\_ to write on a wax tablet.
- 2. A three-sided figure, like a pyramid.
- 3. Student.
- 4. A group of three musicians.
- 5. Two performers working together.
- 6. Four-sided figure, like a square.
- 7. Group of five musicians.
- 9. Dog-like.
- 11. Sea creature with eight arms.

- canine
- decimal
- dual
- duet
- feline
- octet
- pupil
- puppet
- quadrilateral

- quintet
- quintuplet
- sextet
- stylus
- triangle
- trio
- triple
- unification

## THE ROMAN WALL

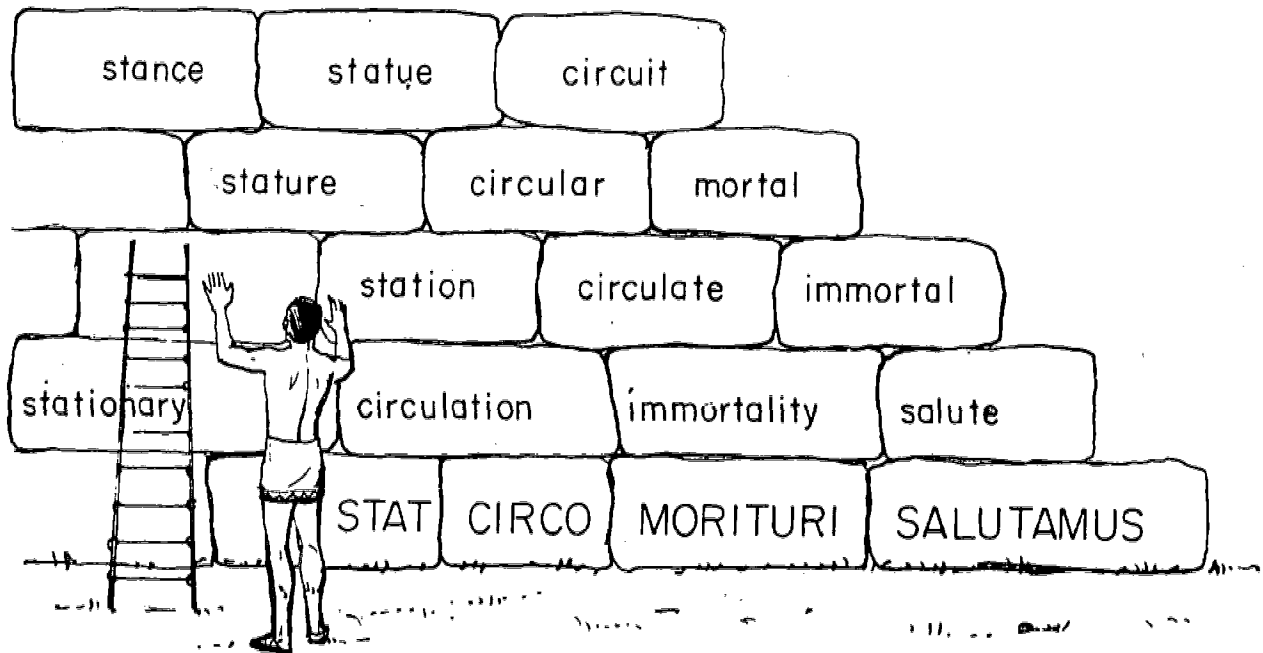

Help Marcus build his make-believe word-wall by underlining the correct word in each sentence.

1. Philadelphia City Hall is a (stationary, moving) object.
2. Blood (freezes, circulates) in your veins.
3. Romans believed that their gods were (immortal, mortal).
4. The teen-age girl had a sloppy (foot, stance).
5. Shoes tied too tight will cut off the (circulation, salutation) in your toes.
6. Inside the Lincoln Memorial, there is a huge (movie, statue) of Abraham Lincoln sitting in an armchair.
7. When a man dies, it proves that he is (mortal, immortal).
8. Privates in the army (salute, scratch) a general.
9. A basketball is a (square, circular) object.
10. John F. Kennedy was a man of great (stature, weight).



11. The train stopped at the (sewer, station).
12. "Dear John" is a (salutation, ending) of a letter to a friend.
13. Electricity that runs in a circle is called an electric (circuit, plug).
14. Jupiter, king of the Roman gods, had (measles, immortality).

LATIN BOWLING

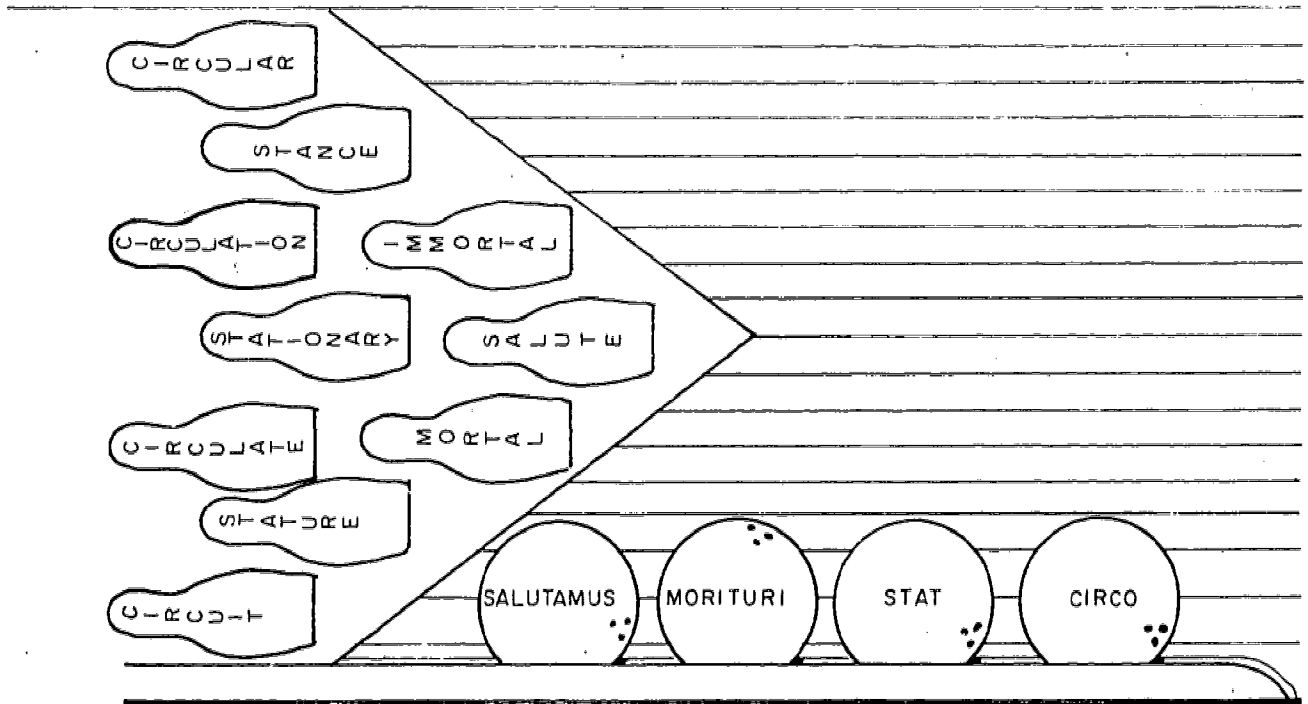

Word-Bowling can be fun. Knock down an English pin with a Latin ball by filling in the blanks below. The clues are in parenthesis.

1. The earth is \_\_\_\_\_ (round).
2. The Rocky Mountains are \_\_\_\_\_ (not moving).
3. \_\_\_\_\_ (going around) of the blood is very important to life.
4. The sea god, Neptune, was said to be \_\_\_\_\_ (unable to die).
5. Wilt Chamberlain is an athlete of great \_\_\_\_\_ (height).
6. The federal judge made six stops on his \_\_\_\_\_ (regular rounds).
7. Roman emperors pretended to be gods but they were \_\_\_\_\_ (able to die).
8. To \_\_\_\_\_ (raise your hand to your forehead) the flag is patriotic.
9. Cowboys have a special \_\_\_\_\_ (way of standing).
10. Blood \_\_\_\_\_ (goes around) in your veins.

PROSPECTOR SAM

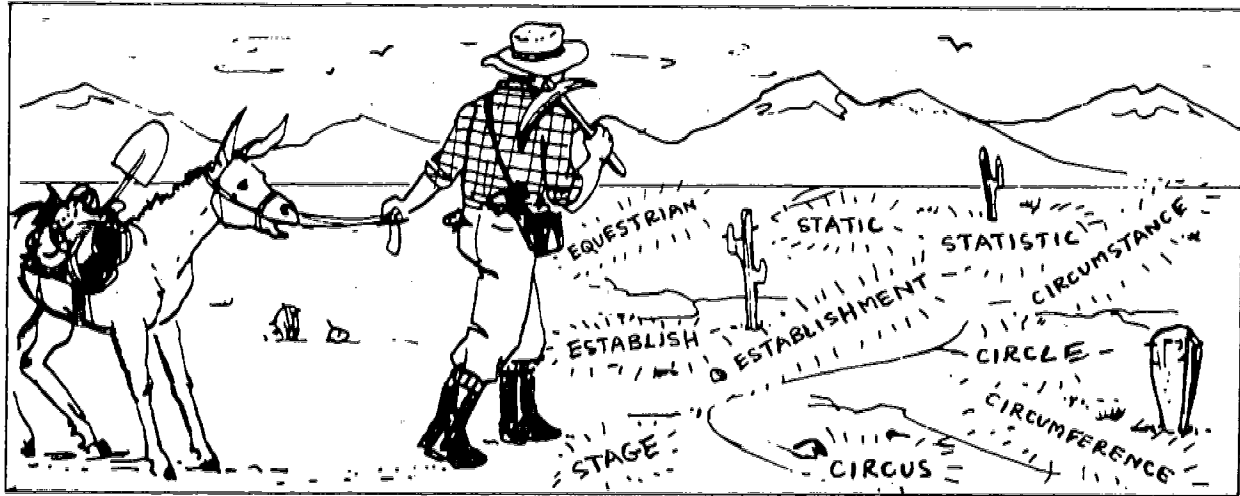

Help Prospector Sam strike it rich by matching the words in Column A to the sentences in Column B.

Column A

Column B

1. \_\_\_\_\_ equestrian

A. The \_\_\_\_\_ said one out of five people smoke.

2. \_\_\_\_\_ statistics

B. The red \_\_\_\_\_ was one of the three rings at the circus.

3. \_\_\_\_\_ circle

C. The \_\_\_\_\_ show had many beautiful horses.

4. \_\_\_\_\_ establish

D. The \_\_\_\_\_ of the earth at the equator is 25,000 miles.

5. \_\_\_\_\_ stage

E. The Founding Fathers of America said they wanted to \_\_\_\_\_ a democratic country.

6. \_\_\_\_\_ circumference

F. A place where actors stand and "do their thing" is called a \_\_\_\_\_.

Column A

- 7. \_\_\_\_\_ establishment
- 8. \_\_\_\_\_ static
- 9. \_\_\_\_\_ circus
  
- 10. \_\_\_\_\_ circumstances
- 11. \_\_\_\_\_ statistics
- 12. \_\_\_\_\_ establishment

Column B

- G. You could not hear the radio because there was too much \_\_\_\_\_.
- H. Many young people rebel against the \_\_\_\_\_, the way things are run today.
- I. The \_\_\_\_\_ had lion tamers and clowns in the show.
- J. The baseball \_\_\_\_\_ showed the Phillies in first place.
- K. The government, the police and the schools are parts of the \_\_\_\_\_.
- L. Rain, fog and darkness can easily be \_\_\_\_\_ of an accident.

SCRAMBLED EGGS



Scrambled eggs? Not really, just scrambled sentences. Circle the letter of the correct sentence.

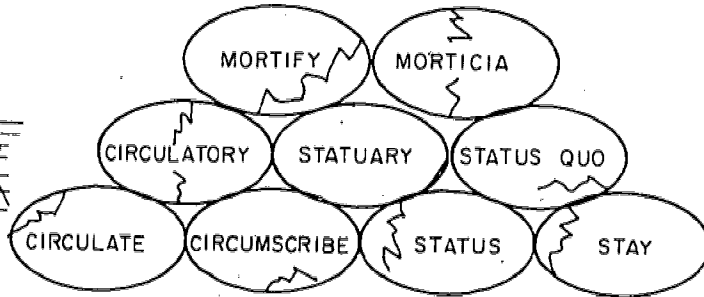

1.
  - A. Don't stay, drop out in school.
  - B. Drop out don't, in school stay.
  - C. Don't drop out, stay in school.
  
2.
  - A. Your circulatory system distributes blood to all parts of your body.
  - B. Your circulatory system distributes your body to all parts of your blood.
  - C. Of your body to all parts your circulatory system distributes.
  
3.
  - A. Is called a place where statues are made a statuary.
  - B. A place where statues are made is called a statuary.
  - C. Statuary where statues are made is called a place.
  
4.
  - A. Your mother will mortify bad behavior in school.
  - B. Bad behavior in school your mother will mortify.
  - C. Bad behavior in school will mortify your mother.
  
5.
  - A. The messenger the principal's note to all the classes in the school will circulate.
  - B. The messenger will circulate the principal's note to all the classes in the school.
  - C. The principal's note will circulate the messenger to all the classes in the school.

6.
  - A. The man in the new Cadillac had a lot of status.
  - B. A lot of status had the man in the new Cadillac.
  - C. The man in the new Cadillac a lot of status had.
7.
  - A. A good role in the "Addams Family" on TV Morticia plays.
  - B. Plays a good role in the "Addams Family" on TV Morticia.
  - C. Morticia plays a good role in the "Addams Family" on TV.
8.
  - A. By sending his troops around all sides of the enemy camp, the Roman general circumscribed the invaders.
  - B. By sending his Roman general around all sides of the enemy camp, the troops circumscribed the invaders.
  - C. By sending his troops around all sides of the enemy camp, the Roman general the invaders circumscribed.
9.
  - A. In America to maintain the status quo many do not wish blacks and whites.
  - B. The status quo do not wish many blacks and whites in America to maintain.
  - C. Many blacks and whites do not wish to maintain the status quo in America.

ROMAN "WORD-AQUEDUCT"

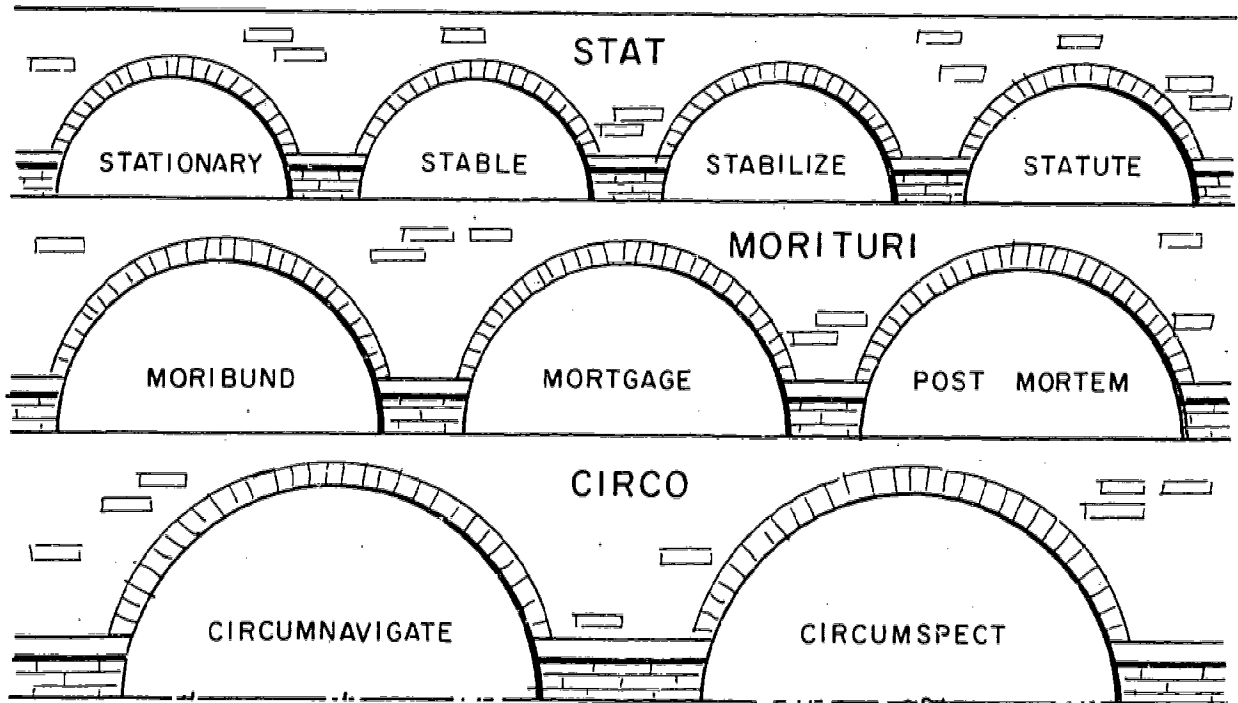

Help support the make-believe aqueduct by writing TRUE or FALSE next to each sentence.

1. \_\_\_\_\_ Airplanes are kept in a stable.
2. \_\_\_\_\_ When you buy a house, you pay for it with a mortgage.
3. \_\_\_\_\_ Good children disobey statutes.
4. \_\_\_\_\_ Magellan was on the first ship to circumnavigate all the way around the world.
5. \_\_\_\_\_ A rose bush with plenty of water and sunshine will soon be moribund.
6. \_\_\_\_\_ To stabilize a seesaw, put the same weight on both sides.
7. \_\_\_\_\_ "Johnny Lightning" makes cars for stationary races.
8. \_\_\_\_\_ Because of the athlete's mysterious death, the doctor performed a post mortem examination.
9. \_\_\_\_\_ In the jungles of Vietnam, a soldier must always be circumspect.

## MARCUS AT THE HARBOR IN CARTHAGE

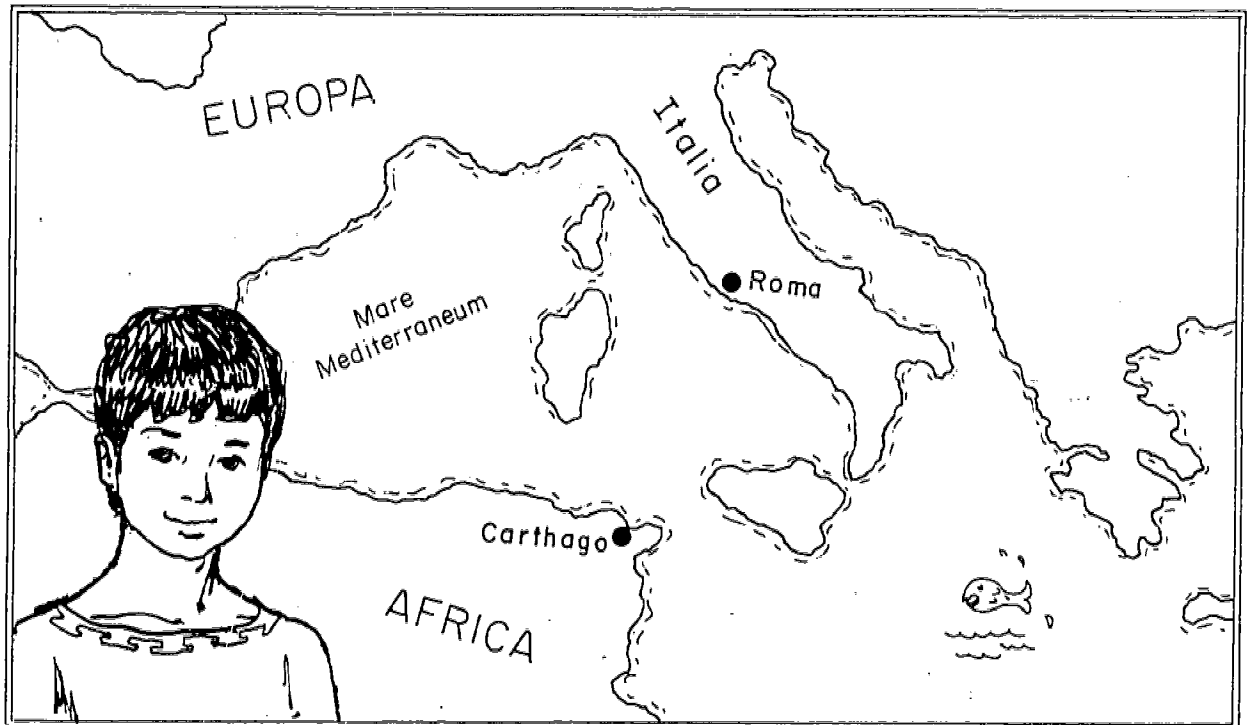

Underline the word that correctly continues the story.

---

When Marcus was 10 years old he visited his uncle in Carthage. He arrived from Rome at the harbor of the great African city of Carthage. He had just been (transported, destroyed) across the Mediterranean Sea by boat. He was thrilled and excited by the things he saw at the harbor.

Marcus sees many beautiful ships in the harbor. These ships (transport, fugitive) spices from Africa and far-off lands to many parts of the Roman Empire. Just as the docks on Delaware Avenue in Philadelphia are busy places, the harbor in Carthage bustles with ships unloading and loading. Carthage imports and (exports, buries) many different products.

Marcus sees a group of Roman soldiers guarding a (fugitive, ice cream man) who was trying to sneak on board a ship. The soldiers caught the fugitive trying to steal money from a fruit (vendor, aqueduct). In Marcus' time there were no pretzel vendors like those we have in Philadelphia because pretzels had not yet been invented! Also there were no (vending, repairing) machines that sold candy and chewing gum like those on our subway platforms.



(UNIT 9)

Marcus has some baggage with him. Fortunately it is (portable, indestructible) and Marcus needs no help in carrying it from his uncle who has just met him at the harbor. Marcus looks forward to an interesting visit in Carthage. Though it is a city that is similar to Rome in some ways, in other ways it is very different.

Randy is listing some Latin roots while Oliver gives the English words that come from the Latin roots. Help the guys to fit Oliver's English words into the sentences. Clues are given in parenthesis.

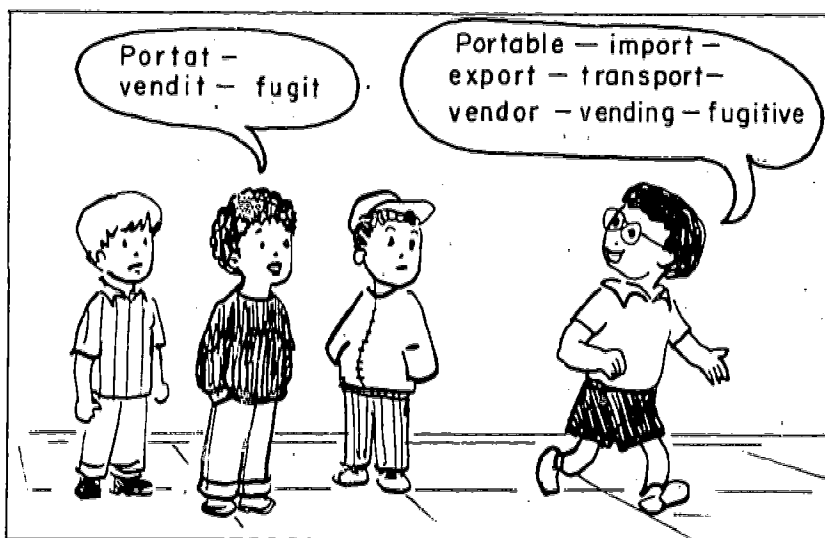

1. Many children have a \_\_\_\_\_ (light enough to carry) TV in their bedroom.
2. An escaped prisoner is a \_\_\_\_\_ (runaway).
3. Freight trains \_\_\_\_\_ (carry across) oranges from California to Pennsylvania.
4. A man who sells pretzels on a street corner is called a \_\_\_\_\_ (seller).
5. Hollywood \_\_\_\_\_ (sends out) many cowboy movies to Europe.
6. At a movie theatre, you can buy candy from a \_\_\_\_\_ (selling) machine.
7. Each year Americans \_\_\_\_\_ (bring in) many Volkswagens from Germany.
8. Bonnie and Clyde, the famous bank robbers, were \_\_\_\_\_ (runaways) from the law.
9. In the summer "Mr. Softee" ice-cream trucks are run by a \_\_\_\_\_ (seller).
10. America has to \_\_\_\_\_ (bring in) bananas from South America.

MINIATURE GOLF

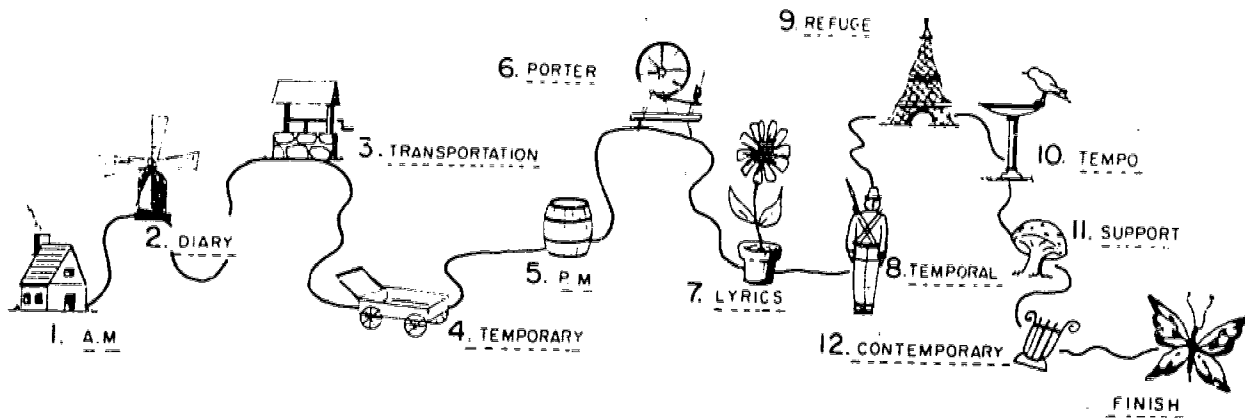

Miniature Golf is the name of the game. Move past each obstacle by correctly matching the sentence-halves in Columns A and B.

Column A

Column B

- |  |  |
|--|--|
| <p>1. _____ 10:00 A.M. comes</p> <p>2. _____ A diary is</p> <p>3. _____ A bus is</p> <p>4. _____ A temporary classroom</p> <p>5. _____ 4:00 P. M. comes</p> <p>6. _____ A porter</p> | <p>A. a good method of transportation.</p> <p>B. before noon.</p> <p>C. a personal daily notebook.</p> <p>D. after noon.</p> <p>E. carries suitcases.</p> <p>F. is used only for a short time.</p> |
|--|--|

Column A

Column B

- |           |                             |    |                                  |
|-----------|-----------------------------|----|----------------------------------|
| 7. _____  | The lyrics of a song        | G. | a place to hide.                 |
| 8. _____  | A make-believe time machine | H. | are the words.                   |
| 9. _____  | A refuge is                 | I. | can pass by temporal boundaries. |
| 10. _____ | Songs by the Jackson Five   | J. | is a contemporary problem.       |
| 11. _____ | The United Fund needs       | K. | usually have a fast tempo.       |
| 12. _____ | Pollution                   | L. | your support.                    |

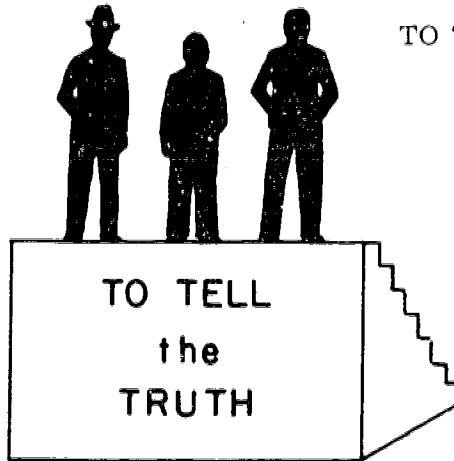

TO TELL THE TRUTH

LATIN PANEL

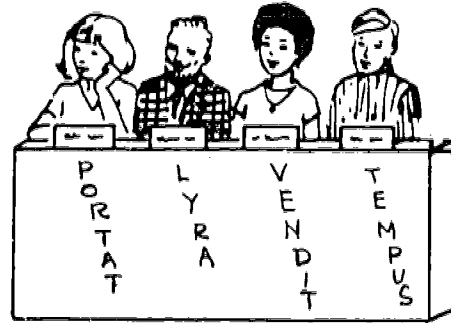

Have you watched "To Tell the Truth" on TV? In the sentences below, it is up to you to decide which sentence is telling the truth. Place the letter of the true sentence next to the word in Column A.

COLUMN A

COLUMN B

\_\_\_ 1. report

- a. I am a kind of boat.
- b. I tell your school marks.
- c. I am a musical instrument.

\_\_\_ 2. important

- d. I am a "nobody."
- e. I am a drop of water in the ocean.
- f. I am the President of the United States.

\_\_\_ 3. exporter

- g. I drive a truck.
- h. I send goods out of a country.
- i. I build houses.

\_\_\_ 4. reporter

- j. I play music.
- k. I send goods out of a country.
- l. I write for a newspaper.

\_\_\_ 5. temporary

- m. I only last a short while.
- n. I am a mountain.
- o. I sell things.

\_\_\_ 6. deport

- p. I behave or carry myself a certain way.
- q. I write for a newspaper.
- r. I build houses.

\_\_\_ 7. vend

- s. I mean "to play music."
- t. I mean "to sell things."
- u. I mean "to tell marks to parents."

COLUMN A

\_\_\_ 8. importer

\_\_\_ 9. portfolio

\_\_\_ 10. lyre

COLUMN B

- v. I am a case to carry things in.
- w. I bring things into a country.
- x. I am a musical instrument.

- y. I am a case to carry papers in.
- z. I send goods out of a country.
- aa. I only last a short while.

- bb. I am a ship.
- cc. I am a musical instrument like a harp.
- dd. I am a case to carry papers in.

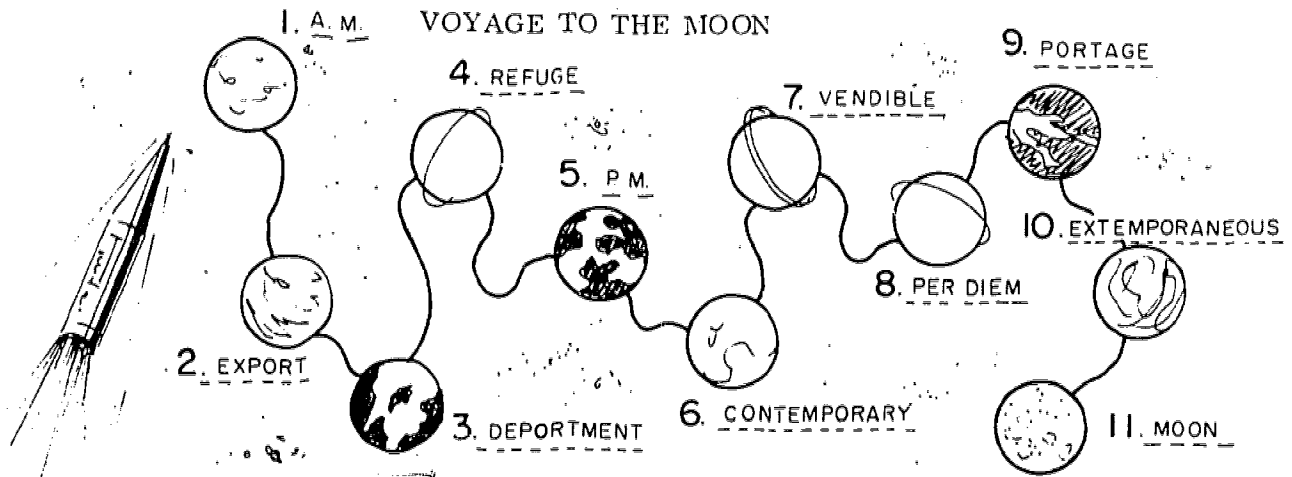

The rocket ship above is from a hidden planet. Its journey to the moon carries it past many planets. Help it complete the voyage to the moon by writing true or false next to each sentence.

1. \_\_\_ 7:00 A.M. comes after noon.
2. \_\_\_ America exports Volkswagens to Germany.
3. \_\_\_ Department means behavior.
4. \_\_\_ When it rains, you can take refuge in a building.
5. \_\_\_ The sun is shining at 11:00 p.m.
6. \_\_\_ Blacks and whites learning to live together is a contemporary job.
7. \_\_\_ An automobile is vendible in a candy machine.
8. \_\_\_ Per diem means day by day.
9. \_\_\_ Portage by ship through a frozen sea is almost impossible.
10. \_\_\_ An extemporaneous speech is an unprepared speech.

CROSSWORD PUZZLE

- |          |           |
|----------|-----------|
| audible  | Greek     |
| audio    | holiday   |
| chariot  | import    |
| clock    | ita       |
| diction  | legible   |
| export   | minime    |
| fugitive | ovens     |
| scribble | transport |
| sword    | vendor    |
| vending  |           |

HINT

Underline each word as you find a place for it.

DOWN

ACROSS

- |   |  |
|---|--|
| 1. Foreign language studied by Romans.                          | 3. A word for saying <u>yes</u> in Latin.                                    |
| 2. Not at all (in Latin).                                       | 4. Two ways to tell time in Rome<br>a. with a sundial b. with a water _____. |
| 5. Bread is baked in _____ (plural).                            | 8. One who flees.  |
| 6. The sound of a TV program is the _____ portion.              | 9. A Roman soldier used a short _____ as a weapon.                           |
| 7. Loud enough to be heard.                                     | 12. Write too fast.  |
| 10. Good _____ is part of good speaking.                        | 14. You can buy a candy bar from a _____ machine.                            |
| 11. Romans went to _____ races.                                 | 15. To bring into a country.   |
| 13. Written clearly enough to be read.                          | 17. To carry from one place to another.                                      |
| 14. A seller. For example, a pretzel seller is a pretzel _____. | 18. To ship out of a country.  |
| 16. A day off from work or school.                              |  |