

DOCUMENT RESUME

ED 071 204

EA 004 818

TITLE Food Storage Guide for Schools and Institutions.  
INSTITUTION Food and Nutrition Service (DOA), Washington, D.C.  
Div. of Child Nutrition.  
PUB DATE Nov 59  
NOTE 45p.; Reprinted October 1972 without change in  
text

EDRS PRICE MF-\$0.65 HC-\$3.29  
DESCRIPTORS Administrative Principles; \*Equipment Standards;  
\*Food; \*Food Handling Facilities; Food Service; \*Food  
Standards; Guides; Management Systems; Nutrition;  
Performance Specifications; Physical Design Needs;  
Planning (Facilities); Refrigeration; Sanitation;  
\*Storage

ABSTRACT

This booklet has been prepared as a guide to show good methods of handling and storing USDA-donated and locally purchased foods. The information was drawn from many resources and includes latest research data available on types of storage facilities and equipment needed for handling and storing foods. The material is organized in five parts: (1) receiving areas, (2) dry food storage areas, (3) refrigerated food storage area, (4) management practices, and (5) housekeeping practices. In many instances, food losses resulting from deterioration and infestation are the result of inadequate storage facilities, undesirable handling practices, and other conditions that can be corrected by following the preventive and control measures outlined in this handbook.  
(Author)

U.S. DEPARTMENT OF HEALTH  
EDUCATION & WELFARE  
OFFICE OF EDUCATION

**FOOD STORAGE GUIDE  
for SCHOOLS  
and INSTITUTIONS**

Food and Nutrition Service  
U.S. DEPARTMENT OF HEALTH, EDUCATION & WELFARE

004 818

ED 071204

## CONTENTS

	Page
INTRODUCTION .....	1
EFFICIENT ARRANGEMENT OF VARIOUS AREAS .....	2
PART I--RECEIVING AREA .....	3
Loading Platform .....	3
Receiving and Checking Area .....	4
Receiving Equipment .....	5
PART II--DRY FOOD STORAGE AREA .....	7
Location of Storeroom .....	7
Storage Space .....	7
General Construction Features .....	7
Ventilating Systems .....	7
Thermometers .....	9
Shelving .....	9
Aisle Spaces .....	10
Storeroom Equipment .....	10
PART III--REFRIGERATED FOOD STORAGE AREA .....	13
Location of Refrigerated Facilities .....	13
Refrigerated Space .....	13
General Construction Features .....	14
Reach-in Refrigerators .....	14
Walk-in Refrigerators .....	17
Freezer or Frozen Food Storage Cabinets .....	22
Milk Coolers .....	23
Milk Dispensers .....	23
Thermometers .....	25
PART IV--MANAGEMENT PRACTICES .....	28
Inspection of Foods Upon Arrival .....	28
Recordkeeping .....	28
Temperature Requirements .....	32
Recommended Storage Practices .....	34
Suggestions for Care of School Lunch Foods and Food Storage Facilities During the Summer Months .....	39
PART V--HOUSEKEEPING PRACTICES .....	40
Importance of Sanitation and Cleanliness .....	40
Care of Dry Food Storage Facilities .....	40
Care of Refrigerated Food Storage Facilities .....	41

First issued November 1959  
Reprinted October 1972 without change in text

Prepared by the Child Nutrition Division,  
Food and Nutrition Service  
In cooperation with  
Agricultural Research Service

## ILLUSTRATIONS

Figures	Page
1—Food flow chart .....	2
2—Loading platform .....	4
3—Floor model automatic indicating-type scales .....	5
4—Floor model beam-type scales .....	5
5—Two-wheel handtruck .....	6
6—Four-wheel handtruck .....	6
7—Storeroom layout showing leuvered vents in outside wall .....	8
8—Exhaust fan with automatic shutters .....	8
9—Oscillating fan .....	9
10—Wall thermometer .....	9
11—Shelf-type trucks for assembling and delivering food supplies .....	11
12—Lift jack and semilive skids for storing and moving foods .....	11
13—Platform and open-frame dollies .....	12
14—Metal food containers .....	12
15—Commercial-type reach-in refrigerator .....	15
16—Commercial-type pass-through refrigerator .....	16
17—Commercial-type walk-in refrigerator .....	17
18—Built-in walk-in refrigerator showing flush floor entrance .....	18
19—Stationary shelving for use in walk-in refrigerators .....	19
20—Portable shelving for use in walk-in refrigerators .....	20
21—Portable tray rack for use in walk-in refrigerators .....	21
22—Commercial-type upright freezer or frozen food storage cabinet .....	22
23—Commercial-type chest freezer or frozen food storage cabinet .....	22
24—Chest-type milk cooler .....	23
25—Upright compartment-type milk cooler .....	24
26—Refrigerator-freezer thermometer .....	25
27—Remote-reading thermometer .....	26
28—Single-pen recording thermometer .....	27
29—Methods of stacking bags of flour, rice, beans, cornmeal, potatoes, sugar, etc. ....	34
30—Methods of stacking cased and boxed foods .....	35
31—Date or number new foods .....	36
32—Place oldest stocks out front—use them first .....	36
33—Store foods away from walls and off the floor .....	36
<b>Tables</b>	
1—Suggested space for platform area .....	3
2—Suggested space for receiving and checking areas .....	4
3—Can and cartou measurements for estimating shelf capacity and vertical clearance .....	10
4—Suggested space for shelf area .....	10
5—Suggested guides for refrigerated food storage space .....	14
6—General temperature guides for storing foods .....	32
7—Foods that give off and/or absorb odors .....	37
<b>Forms</b>	
1—Perpetual inventory card .....	29
2—Daily withdrawal form .....	30
3—Physical inventory sheet .....	31

# FOOD STORAGE GUIDE FOR SCHOOLS AND INSTITUTIONS

## INTRODUCTION

This handbook has been prepared as a guide for schools and institutions, to show good methods of handling and storing USDA-donated and locally purchased foods.

The information was drawn from many sources and includes latest research data available on types of storage facilities and equipment needed for handling and storing foods. It is recognized that not all schools and institutions have the ideal types of storeroom facilities and handling equipment. However, this should present a challenge and inspire constant attention to improving existing facilities and planning for adequate food storage facilities in the future. In using the guide, consider the geographic location of the storage facilities, giving particular attention to climatic conditions and other local situations prevailing in the area.

The terms "dry food storage" or "storeroom" used in this handbook apply to any dry food storage facility maintained by schools and institutions where foods are received and stored until they are prepared and served. The term "refrigerated food storage" applies to both normal refrigeration and freezer or frozen food storage.

Good storage facilities—both dry and refrigerated—help keep foods safe, wholesome, and appetizing. Meals taste better, and are better nutritionally, if all foods used to prepare them are at the peak of quality. Careful menu planning, good buying practices, and good storage all help to provide well-balanced meals at reasonable prices.

In many instances, food losses resulting from deterioration and infestation are the result of inadequate storage facilities, undesirable handling practices, and other conditions that can be corrected by following the preventive and control measures outlined in this handbook.

All USDA-donated foods are of good quality, and are purchased under Government inspection. Careful consideration must be given to providing the needed storage facilities to insure that all foods—whether USDA-donated or locally purchased—will have adequate storage facilities to maintain their high quality and nutritive value until consumed. Temperature, humidity, ventilation, rodents, and insects must be controlled *throughout the storage period*.

Schools and institutions that accept USDA-donated foods also accept the responsibility to handle and store them properly. Failure to do so may result in the Department's withholding further donations of foods or requiring restitution for foods that are lost or become spoiled. It is equally important that locally purchased foods be properly handled and stored.

## EFFICIENT ARRANGEMENT OF VARIOUS AREAS

Efficient arrangement of the receiving and food storage areas in relation to other areas is of major importance in an economical operation. Orderly arrangement of functions and equipment and planning of routes will save workers both steps and time. If routes of operation are confused with backtracking and cross-travel, then accidents, costly mistakes, and delays may result.

The distance from the receiving and food storage facilities to the kitchen area influences the length of the food preparation route. Other factors are the size of the areas, the arrangement of equipment, and the distance between preparation and serving areas.

The following diagram (fig. 1) illustrates the interrelationship of various areas, suggesting the flow of food from receiving and food storage to the preparation and serving areas. It also shows the relationship of the dining area to the serving and dishwashing areas.

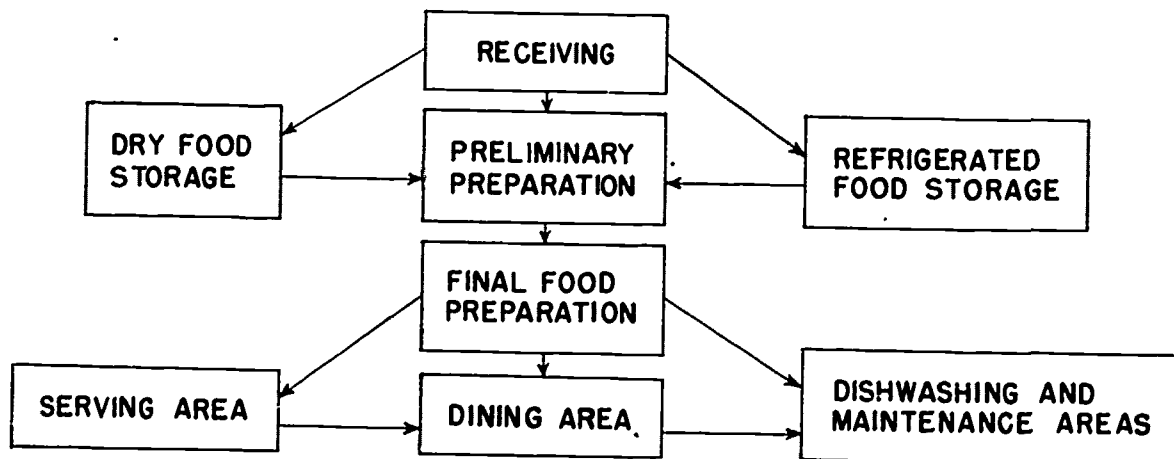

FIGURE 1.—Food flow chart.

## Part I—RECEIVING AREA

A loading platform is needed to facilitate handling of foods and to protect them from the elements during the course of unloading. A receiving area inside the building is also needed to provide temporary storage until deliveries are checked for quality, weight, and count.

### Loading Platform

The loading platform should be located on the ground floor level, near the service driveway, adjacent to the storeroom and kitchen, and away from playgrounds and student traffic.

The space needed for the loading platform will vary depending on the delivery service, volume of deliveries, etc. The width of the platform should be at least 6 feet from front to back. The recommended size for number of meals served daily is shown in table 1.

TABLE 1.—Suggested space for platform area

Total meals served daily			
100-200	200-350	350-500	500-750
60 sq. ft. ....	60 sq. ft. ....	80-100 sq. ft. ....	100-160 sq. ft.

The floor of the loading platform should be of concrete with integral hardener; slip resistant. Heavy steel angle iron is needed to reinforce the edge; a wood bumper is optional. The floor should be at the same level as the entrance to the inside receiving area. It is important that State and local authorities having jurisdiction over applicable regulations be consulted.

A roof extending over the entire platform is desirable; it must be high enough to clear any delivery truck, generally 12 feet 6 inches. Provide steps with a handrail from the platform to the driveway level. (See fig. 2.)

The lighting and wiring should comply with National Electrical Code requirements (an American standard) together with other local requirements. For the loading platform a minimum of 150- to 200-watt lighting unit should be provided. If the platform is unprotected, the lighting fixture should be weatherproof.



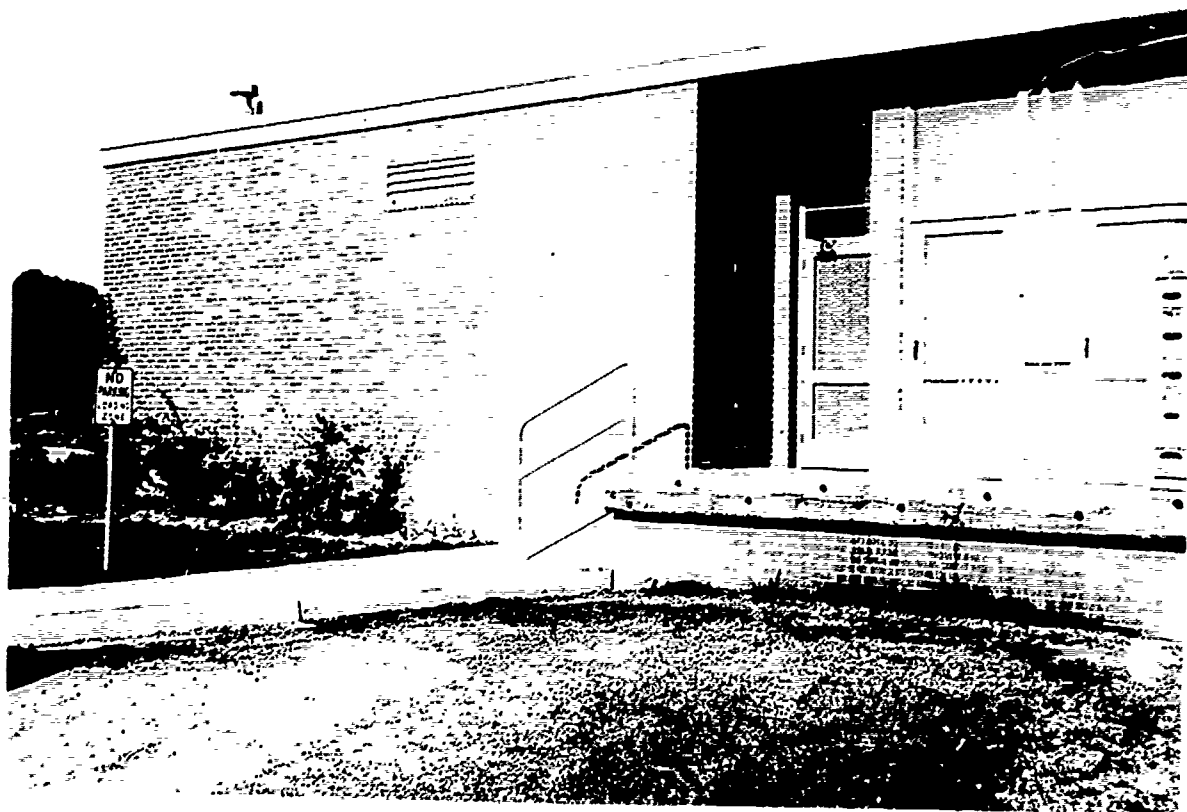

FIGURE 2.—Loading platform.

### Receiving and Checking Area

The receiving area inside the building needs to be adjacent to the outside loading platform (separate from the kitchen and storeroom, if possible); it may serve as a vestibule.

The space needed for the receiving area will also vary depending on the delivery service, volume of deliveries, etc. The recommended size for number of meals served daily, exclusive of traffic aisles, is shown in table 2.

The floor of the receiving area should be slip resistant. Terrazzo, quarry tile, or concrete with integral hardener are preferable. Local regulations regarding floor drains need to be checked.

TABLE 2.—Suggested space for receiving and checking area

Total meals served daily			
100-200	200-350	350-500	500-750
32-48 sq. ft. ....	48-60 sq. ft. ....	48-60 sq. ft. ....	60-80 sq. ft.



The walls and ceiling of the receiving area should be light in color, smooth, impervious to moisture, and easy to wash and keep in good repair. Glazed tile is the most desirable finish; however, painted plaster or masonry is acceptable. Plasterboard or wood are not desirable because they are not vermin-proof. Coved bases are needed at the floor line. Local regulations may require coved vertical corners.

Heavy-duty doors between the outside loading platform and the receiving area inside the building are important. A minimum clear opening of 3 feet 4 inches width is needed. The door must be self-closing with locking devices. A kick plate from 8 to 12 inches high is needed on both sides of the door.

The need for windows in the receiving area can be determined from State and local regulations. If windows are provided, they should not interfere with equipment.

It is important to check local regulations regarding fly and pest control; i.e., screened doors, blowdown fans, etc.

The lighting needed for the receiving area is a minimum of 15 foot-candles. This lighting can normally be achieved by about 2 watts per square foot of floor area.

### Receiving Equipment

A desk or shelf should be provided in the receiving area for checking the foods. A built-in standup desk or shelf approximately 12 inches by 18 inches by 42 inches high is ideal.

Automatic indicating- or beam-type scales are needed in the receiving area for weighing in the foods. Portable floor model type scales are desirable, with a minimum of 400 pounds capacity and  $\frac{1}{4}$  to  $\frac{1}{2}$  pound graduations. (See figs. 3 and 4.)

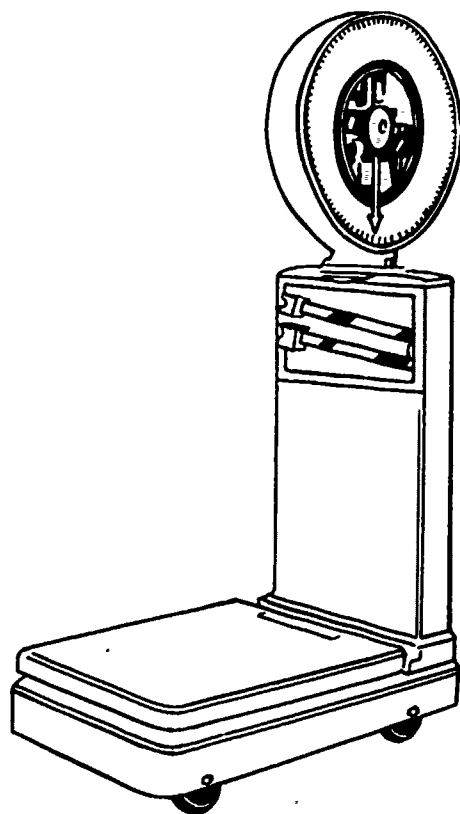

FIGURE 3.—Floor model automatic indicating-type scales.

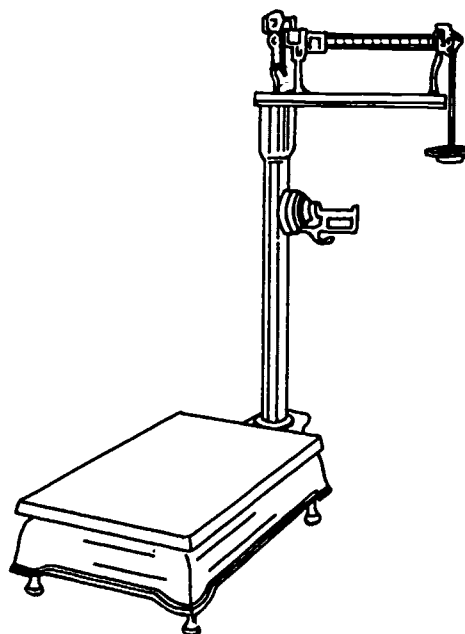

FIGURE 4.—Floor model beam-type scales.

A table will be useful in the receiving area for receiving and checking foods before they are transferred to the storeroom. A heavy metal frame is desirable. The tabletop should be of metal, or a dense-grained hardwood (a minimum of 1¼ inches thick), and the table itself on casters for ease in moving. A work drawer is a convenience.

A two-wheel handtruck and a four-wheel handtruck are useful in the receiving and food storage areas.

The two-wheel handtruck has the following advantages: Initial cost is low, maintenance cost is low, and it can be used in narrow storeroom aisles. Its main disadvantage is that only a limited amount of weight and bulk can be handled per trip. The frame size recommended is approximately 48 inches high and at least 14 inches wide with the bottom angle nose at least 14 inches by 7 inches. Rubber-tired wheels are desirable. Optional features include: Curved brace bars for handling round containers and glides for negotiating steps. (See fig. 5.)

The four-wheel handtruck has the following advantages: Initial cost is low, maintenance cost is low, and it can hold about three or four times as much weight and bulk per trip as the two-wheel handtruck. A metal frame and rubber bumpers are desirable. The platform may be of wood or metal. Rubber-tired ball-bearing wheels with two swivel and two rigid forks, with the handle on the swivel end, are desirable. Recommended sizes are: 36 or 48 inches long by 24 inches wide by 8 inches to 12 inches high. (See fig. 6.)

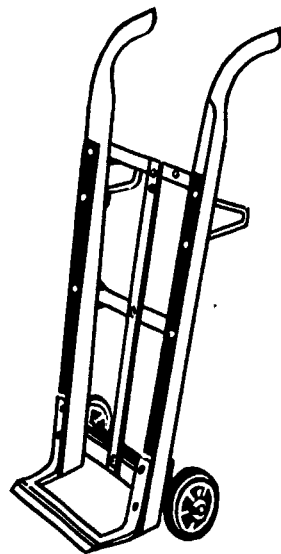

FIGURE 5.—Two-wheel handtruck.

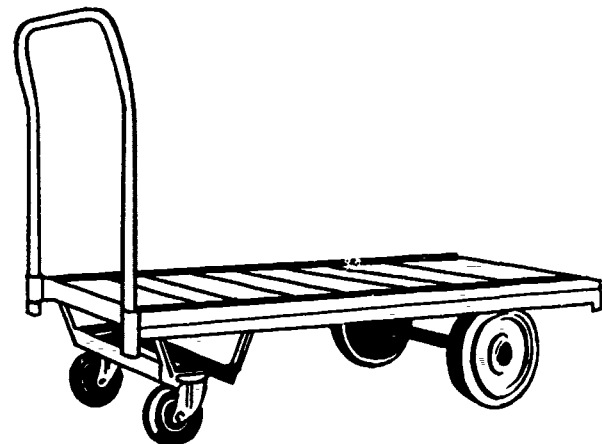

FIGURE 6.—Four-wheel handtruck.

## Part II—DRY FOOD STORAGE AREA

The dry food storage area provides orderly storage for food not requiring refrigeration. It should also provide protection of the foods from the elements, fire, insects, rodents, spoilage organisms, or other causes, and safeguard them from theft.

### Location of Storeroom

The dry food storage area should be conveniently located to the receiving area and adjacent to the food preparation center.

### Storage Space

Allow at least one-half square foot (up to 1 square foot) floorspace per meal served daily, based upon 2 weeks' supply of food. If the school or institution is part of a large system with a central warehouse used for the storage of foods, space requirements will depend on the frequency of deliveries from the central source. If large quantities of foods are bought at one time or if large quantities of USDA-donated foods are requested, additional space may be needed.

### General Construction Features

The floors should be slip resistant, preferably of terrazzo, quarry tile, or concrete with integral hardener. Local regulations need to be checked regarding floor drains.

The exterior walls and subfloors need to be tightly constructed, vapor-sealed below ground, rodent- and insect-proof, and, if necessary, insulated to insure protection of foods from the elements.

The walls and ceiling of light colors, smooth, impervious to moisture, easy to wash and repair, are preferable. Glazed tile is the most desirable finish. However, painted plaster or masonry are satisfactory. Plasterboard and wood are not desirable because they are not vermin-proof. Covered bases should be provided at the floor line. Local regulations may also require covered vertical corners.

A heavy-duty door is needed, at least 36 or 40 inches wide. The door should lock from the outside, but always open from the inside without a key.

No windows are necessary unless required by State and local regulations. If windows are provided, they should be equipped with security-type sash and screens, painted opaque to protect foods from direct sunlight, and placed to avoid interference with shelving.

Good visibility in the storage area makes it easier for employees to locate foods, and also eases the job of accurately checking paperwork associated with recordkeeping. Good lighting contributes to better housekeeping by employees. When the light is fairly uniform throughout the storeroom it is easier to see areas that require cleaning. Experience shows that employees will keep working areas cleaner and neater under these conditions.

Lighting and wiring must comply with National Electrical Code requirements (an American standard) together with other local requirements. In order to provide adequate lighting for the storage area, illumination levels of approximately 15 foot-candles are desirable. This is normally achieved by about 2 watts per square foot of floor area. For best distribution of light, have the fixtures centered over each aisle.

### Ventilating Systems

Good ventilation in the dry food storage area is essential to the proper storage of any type of food. By assisting in controlling the temperature and humidity, ventilation retards growth of

various types of bacteria and molds, prevents mustiness and rusting of metal containers, and minimizes caking of ground or powdered foods. Reliable thermometers will indicate temperatures prevailing in the storage area.

Temperatures of 50° to 70° F. are recommended for the dry food storage area. However, during some months it may be possible to maintain temperatures between 40° to 45° F., and this is desirable for many foods normally kept in the dry food storage area.

In cooler climates, the recommended temperatures can usually be held by proper insulation and by natural and/or mechanical ventilation. Natural ventilation is obtained by proper construction of the storeroom to permit entrance of fresh cool air through louvers at the floor level and the escape of warm air through louvers at the ceiling or roof level. (See fig. 7.)

Mechanical, or forced-air ventilation, with intake and/or exhaust fans, keeps fresh air circulating. (See fig. 8.)

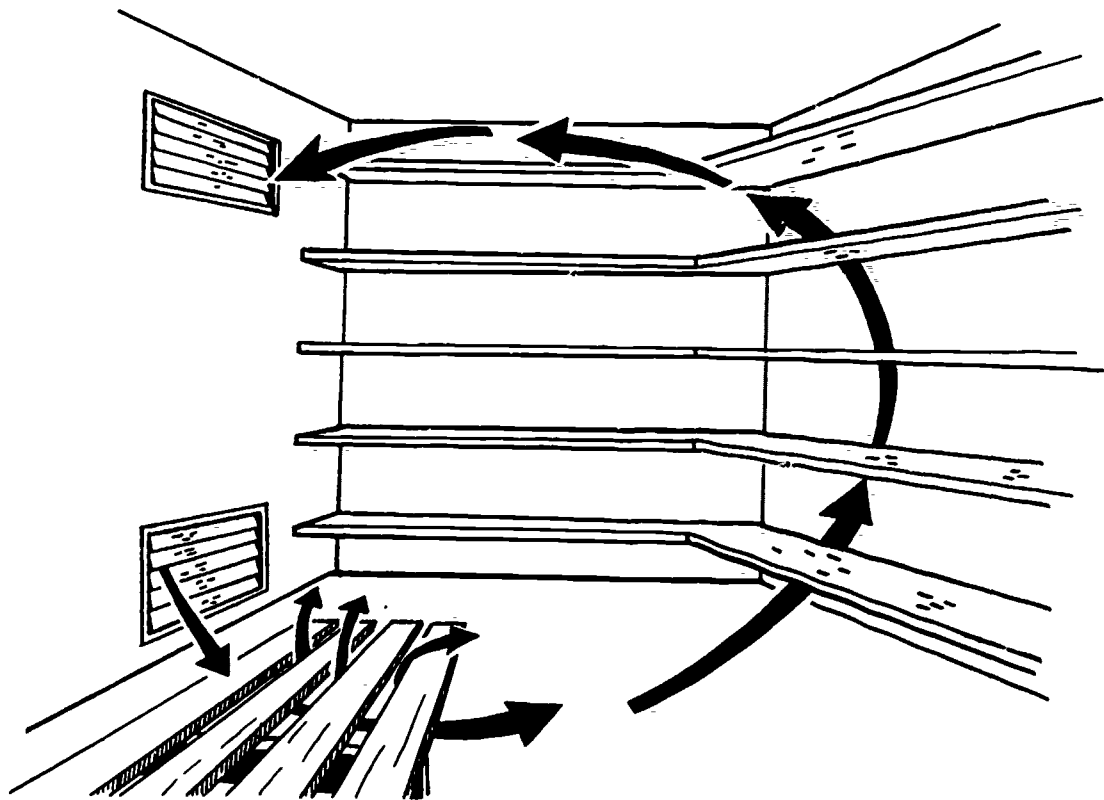
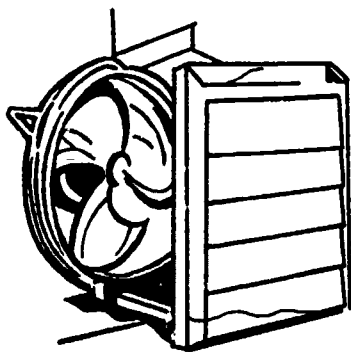
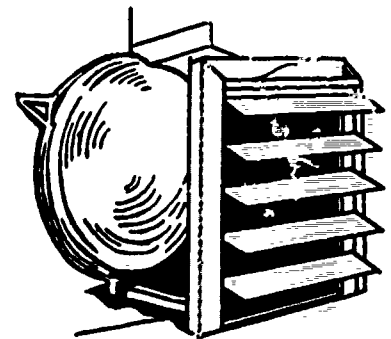

FIGURE 7.—Storeroom layout showing louvered vents in outside wall.



Fan not operating—  
shutters closed.



Fan operating—  
shutters open.

FIGURE 8.—Exhaust fan with automatic shutters.

An oscillating fan may be of some help. (See fig. 9.)

Generally four air changes per hour will be adequate. During the winter months, it may be necessary to use heating equipment to keep certain foods from freezing.

In hot, humid climates, where the recommended temperatures cannot be maintained by natural or mechanical ventilation, and humidities are consistently high (over 80 percent), it may be necessary to install artificial refrigeration to keep the temperature from going above 70° F. If this facility cannot be provided, a dehumidifier will be of some help.

The storeroom should be free of uninsulated steam and water pipes, water heaters, refrigeration condensing units, or other heat-producing devices.

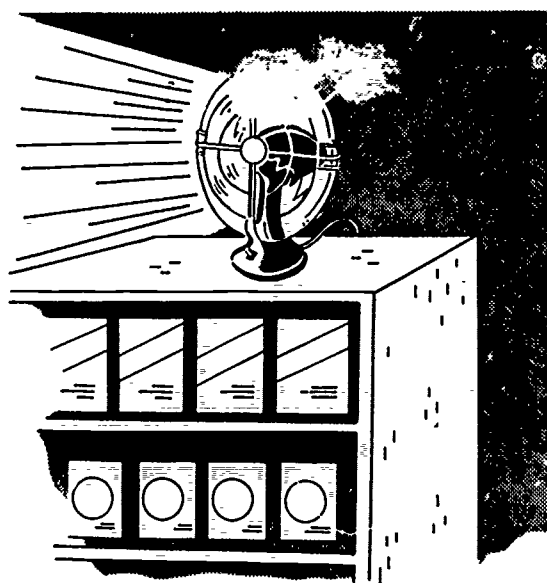

FIGURE 9.—Oscillating fan.

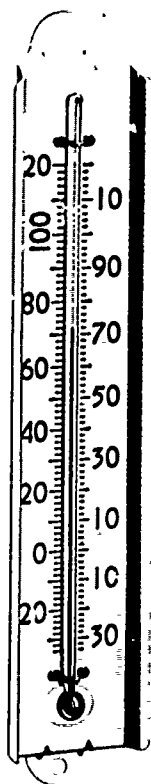

FIGURE 10.—Wall thermometer.

### Thermometers

Wherever foods are stored, a reliable thermometer is essential to make sure that proper temperatures are maintained in order to prevent spoilage and deterioration. Take thermometer readings at least once a day, and more frequently if there is difficulty in maintaining the desired temperatures. Corrective measures should be taken to lower or raise the temperature.

Wall thermometers such as the one shown in figure 10 are suitable for both the dry food storage area and the refrigerated area. Some of the characteristics of a good wall thermometer are: Overall length of at least 12 inches, mounting holes at top and bottom, a temperature range of minus 30° F. to plus 120° F. in 2°-scale divisions, a red-liquid-filled or mercury-filled magnifying glass tube for easy reading, a rust-resistant scale, thermometer bulb and tube fully protected by side flanges on the frame to minimize breakage.

Mount the thermometer in the vicinity of the door, where there is less danger of breakage from bumping, and at about eye level for easy reading. It should not be mounted on the door, near a light bulb, or in a recessed pocket.

### Shelving

Storeroom shelving may be of wood or metal. Upright supports should be not more than 48 inches apart. The maximum practical height is 7 feet 6 inches. Allow vertical adjustments of 1

inch for shelf supports so that shelving can be adjusted to accommodate various foods. See table 3 for estimating shelf capacity and the vertical clearance needed for storing cans and cartons.

TABLE 3.—*Can and carton measurements for estimating shelf capacity and vertical clearance*

Size can	Approximate diameter of can	Clear height per tier	Cans per carton	Size of carton
	Inches	Inches	Number	Inches
No. 2.....	3½	5	24	14 x 10½ x 9¼.
No. 2½.....	4	5	24	17 x 12¾ x 10¼.
No. 3 (cylinder).....	4¼	7½	12	17½ x 13½ x 7¾.
No. 10.....	6¼	7½	6	19 x 12¾ x 7¼.

The shelving should be well braced against tipping. Allow 1 to 2 inches minimum clearance from all walls for cleaning and air circulation. The bottom shelf may be 24 to 30 inches deep; other shelves 18 to 20 inches deep. Standard shelving is available in various widths.

Clearance between the bottom shelf and the floor ought to be adequate to permit storing foods in covered metal containers on dollies, and sacked and cased foods on portable platforms.

Guides for determining shelf area needed for total meals served daily are in table 4.

TABLE 4.—*Suggested space for shelf area*

Total meals served daily			
100-200	200-350	350-500	500-750
120-210 sq. ft. shelf area.	210-240 sq. ft. shelf area.	240-384 sq. ft. shelf area.	384-675 sq. ft. shelf area.

### Aisle Spaces

For access to shelving only, aisles at least 30 inches wide are needed. For movement of trucks, skids, dollies, and portable platforms, aisles 42 inches wide are the minimum.

### Storeroom Equipment

Portable equipment is needed for efficient handling and storing of foods. The kinds and volume of foods to be handled determine the types of equipment. In addition to the two-wheel and four-wheel handtrucks described in the "Receiving Area" section it is desirable to provide shelf-type trucks, skids, and dollies.

Shelf-type trucks are helpful in assembling food supplies from the storage area and delivering them to the preparation area. (See fig. 11.)

Semilive skids may be used for storing sacks of potatoes, cartons of cased foods, etc., under storeroom shelves or in the center of the room, if space is sufficient. They may also be used in place of handtrucks for moving foods from the receiving area to the storeroom or from the storeroom to the kitchen. Semilive skids are operated by the use of a lift jack. (See fig. 12.)

Platform and open-frame dollies are also useful for storing foods. Construction may be of heavy-gage steel or wood with caster mountings. A can dolly is needed for each food storage container unless the containers are equipped with casters. (See fig. 13.)



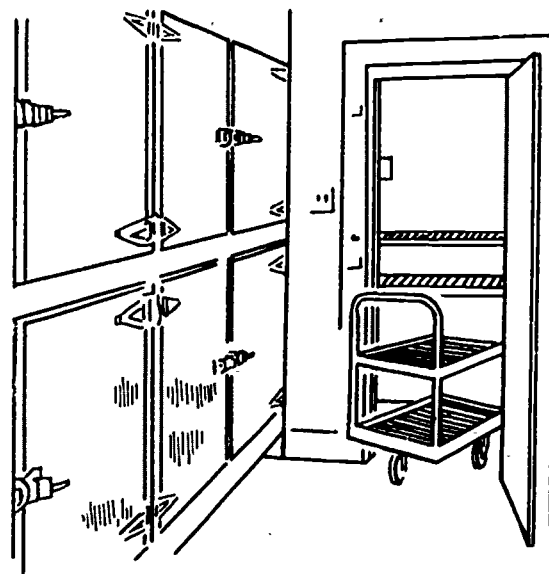
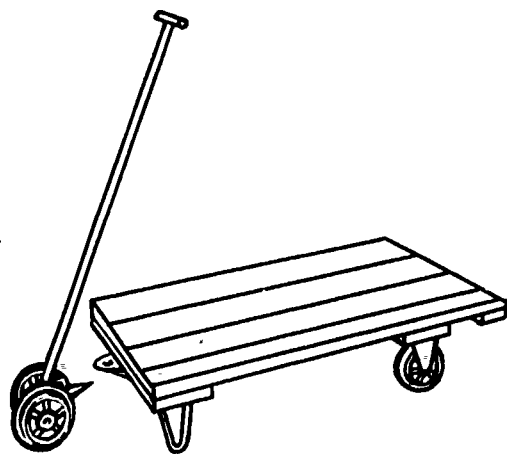

FIGURE 11.—Shelf-type trucks for assembling and delivering food supplies.



Unassembled skid.



Assembled skid.

FIGURE 12.—Lift jack and semilive skids for storing and moving foods.

Metal containers with tight-fitting covers should be used for storing broken lots of such items as flour, cornmeal, sugar, dried beans, rice, and similar foods. The number needed will depend on the number and types of foods to be stored, delivery practices, etc. Containers with casters are available in 50- or 100-pound sizes. They may also be obtained without casters for use on dollies. (See fig. 14.)

Grocers' scoops are needed for each food storage container in use. Scoops are available in 1- to 1½-pound capacity. They should be of corrosion-resistant material.

Power- or hand-operated fire extinguishers should be available in the storeroom or nearby in the kitchen. They need to be inspected regularly and kept in usable condition.

NOTE: Handwashing facilities for all personnel located near the storeroom are essential.



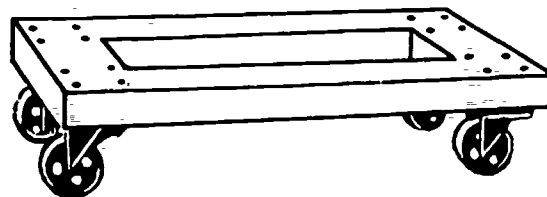
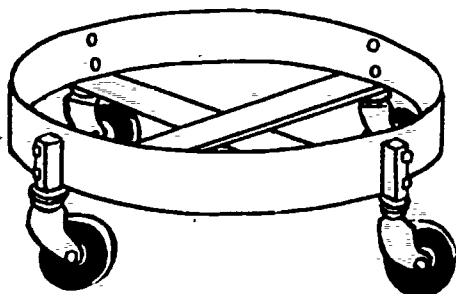
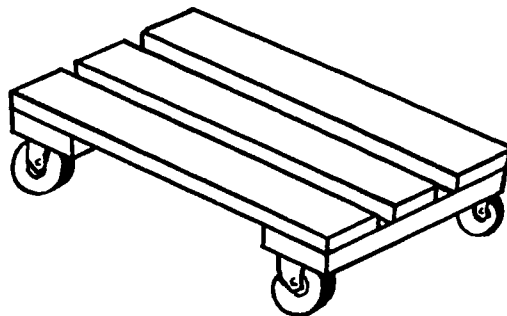
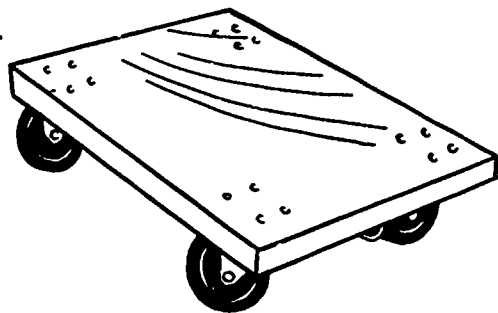
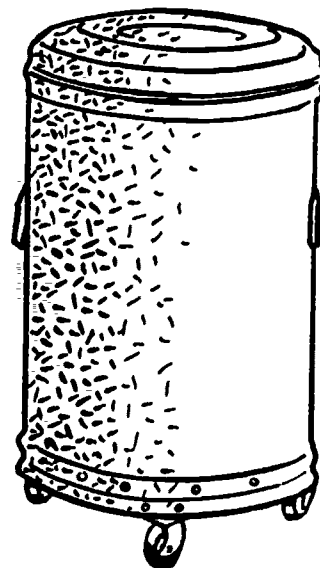

FIGURE 13.—Platform and open-frame dollies.



Can on dolly.



Can equipped with casters.

FIGURE 14.—Metal food containers.

### Part III—REFRIGERATED FOOD STORAGE AREA

Two types of refrigerated storage space are needed:

*Normal refrigeration*, maintained at a temperature of 32° to 50° F.

*Freezer or frozen food storage*, maintained at 0° F. or below.

A refrigerated storage space can be any artificially cooled, properly insulated area where the desired temperature and humidity can be maintained by the use of refrigeration unit. If standard refrigeration facilities are limited, it may be desirable to partition off and insulate a section of the dry food storage area and to install an air-conditioning unit. If this is not practical, a separate room may be used for this purpose. Humidities in refrigerated storage areas may range from 65 to 95 percent, depending on the requirements of the food. In freezer storage areas, humidity is less critical, especially if the frozen food is well packaged. But, even here, it is essential to have rather high humidities to prevent excessive moisture loss.

An auxiliary refrigeration unit for the walk-in refrigerator or freezer should be available and ready for use to maintain proper temperatures in an emergency, particularly with respect to frozen food storage. All refrigeration units must meet State and local building codes and inspection requirements for refrigerated food storage areas.

#### Location of Refrigerated Facilities

The refrigerated food storage space should be convenient to the receiving area and adjacent to the food preparation center in the kitchen.

Reach-in refrigerators and freezers or frozen food cabinets with built-in motors and compressors operate best when placed away from walls so that air can circulate freely around and above them. Don't fit them into a tight niche with walls on three sides, or under a shelf. Such a location cuts off air circulation needed to carry away the heat that is generated and thus increases operating costs. They should be level, and away from sources of heat such as sunny windows, radiators, hot pipes, and ranges.

If motor and compressor units are not built into the refrigeration equipment, place the separate units where they, too, can have a good flow of air around them. Do not put them in a room where food is stored because they give off heat.

#### Refrigerated Space

The capacities and the combinations of refrigeration facilities suggested in table 5 may need to be varied depending on such factors as location of the school or institution, food purchasing practices, frequency of deliveries, use of central storage, etc.

TABLE 5.—Suggested guides for refrigerated food storage space

Type of refrigerated storage	Total meals served daily			
	100-200	200-350	350-500	500-750 *
Reach-in refrigerators (minimum size, 25 cu. ft.).	Approximately $\frac{1}{4}$ to $\frac{1}{2}$ cu. ft. per meal served. Consider reach-in, walk-in combination when total capacity exceeds 60 cu. ft.			
Walk-in refrigerators	May be desirable		1 (approximately 8 by 10 ft.). (May be combination walk-in, reach-in.)	1 (approximately 40-60 cu. ft.). 1-2 (approximately 8 by 10 ft. or larger).
Freezer or frozen food cabinet	1 cu. ft. stores approximately 30 to 35 lb.			
Milk service	Needed in addition to above refrigeration. Usually located adjacent to serving counter.			
Cooler (for individual 8-oz. containers).	1 cu. ft. net capacity for 50 to 75 half pints of milk, depending on size and shape of containers.			
Dispenser (for bulk milk in 3-, 5-, or 10-gal. containers).	Check State and local regulations governing use.			

NOTE: If the refrigerated space at the school or institution is limited, it may be necessary to rent space occasionally in a locker plant or some other local facility where refrigeration is provided.

### General Construction Features

*Reach-in refrigerators* recommended are the commercial self-defrosting type, constructed to maintain temperatures of 32° to 50° F. (See figs. 15 and 16.) Interiors and exteriors may be of aluminum, stainless steel, or porcelain enamel with vermin-proof insulation. Doors may be hinged or sliding with rotproof gaskets and plated or stainless steel hardware. Interiors fitted with door-operated electric lights, adjustable plated wire shelves, or noncorrodible slides for trays are best. Blower-type cooling units should be connected to self-contained or remote refrigeration equipment.

Optional features: Locking hardware, doors on both sides for pass-through, portable tray racks.

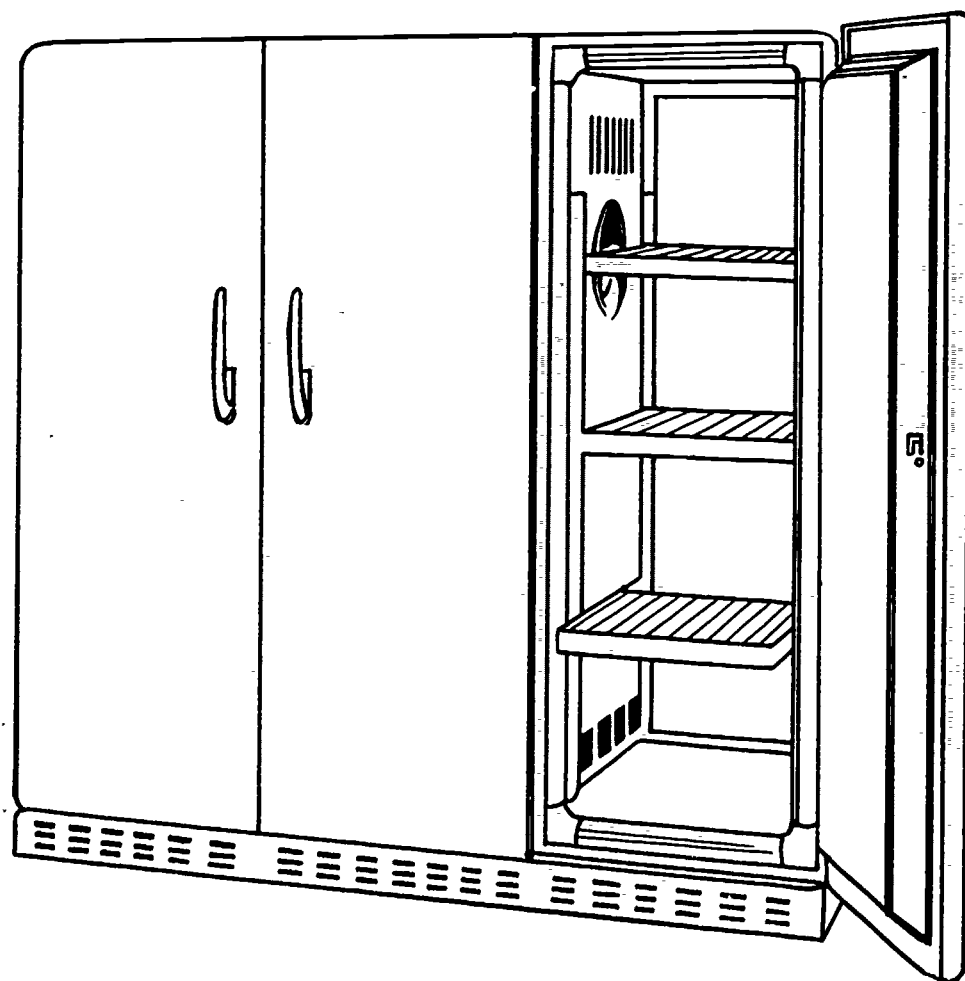

FIGURE 15.—Commercial-type reach-in refrigerator.

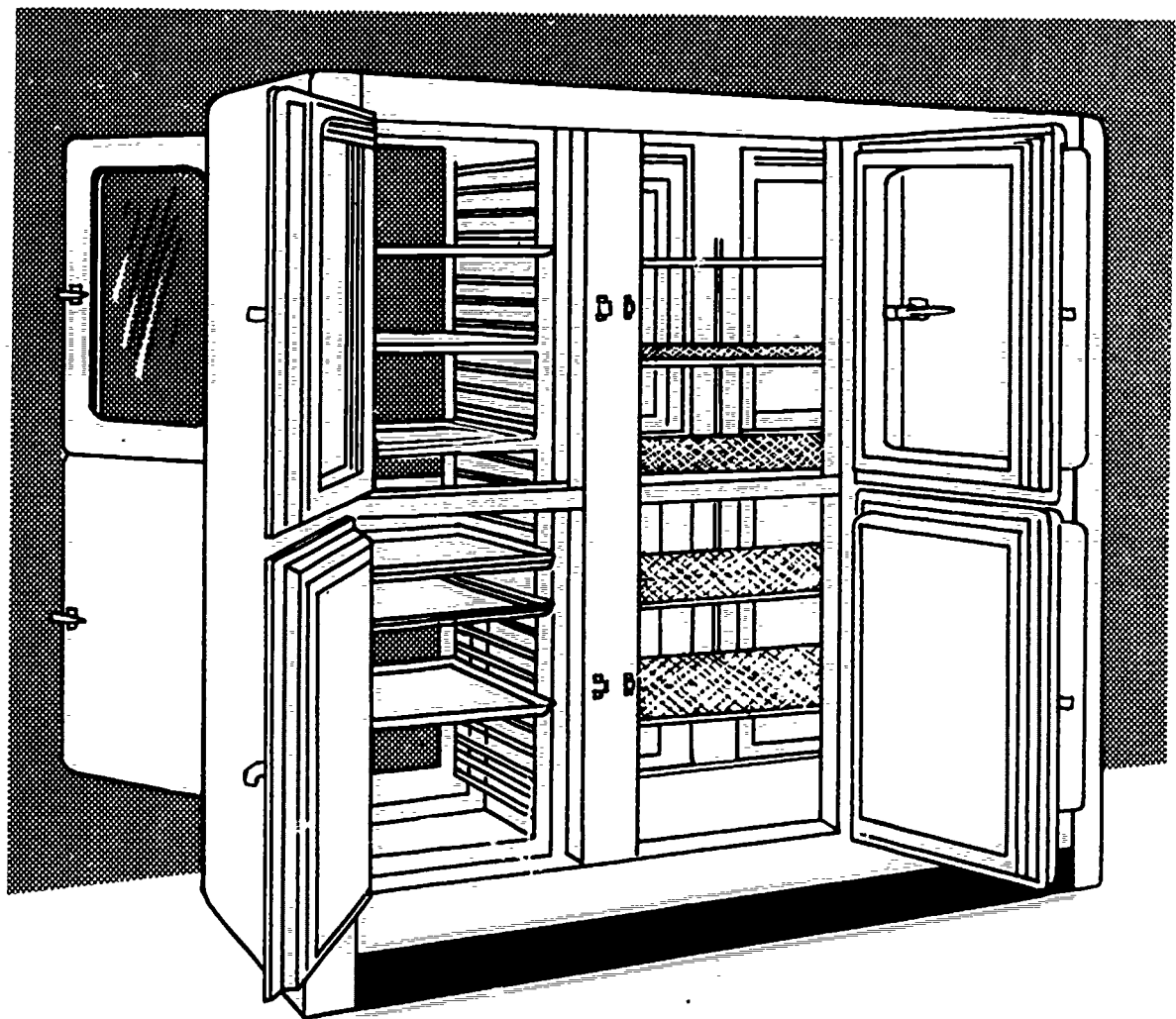

FIGURE 16.—Commercial-type pass-through refrigerator.

*Walk-in refrigerators* may be the sectional commercial type or built in as part of the building contract. (See figs. 17 and 18.) They should be designed to maintain temperatures of 32° to 50° F. Several separate rooms with varying temperatures and humidity conditions may be used. They should have vermin-proof insulation on the walls, floor, and ceiling. Interiors may be of stainless steel or preferably glazed tile; portland cement plaster is acceptable.

The floor of walk-in refrigerators, if flush with the outside floor, permits easy access for portable equipment such as portable shelves, tray racks, dollies, etc. Doors need heavy hinges with compression-type gaskets. Door latches should have an integral keyed lock and interior safety release that can be opened from inside. Half-height reach-in doors are also available; if used, arrange for opening into the kitchen area.

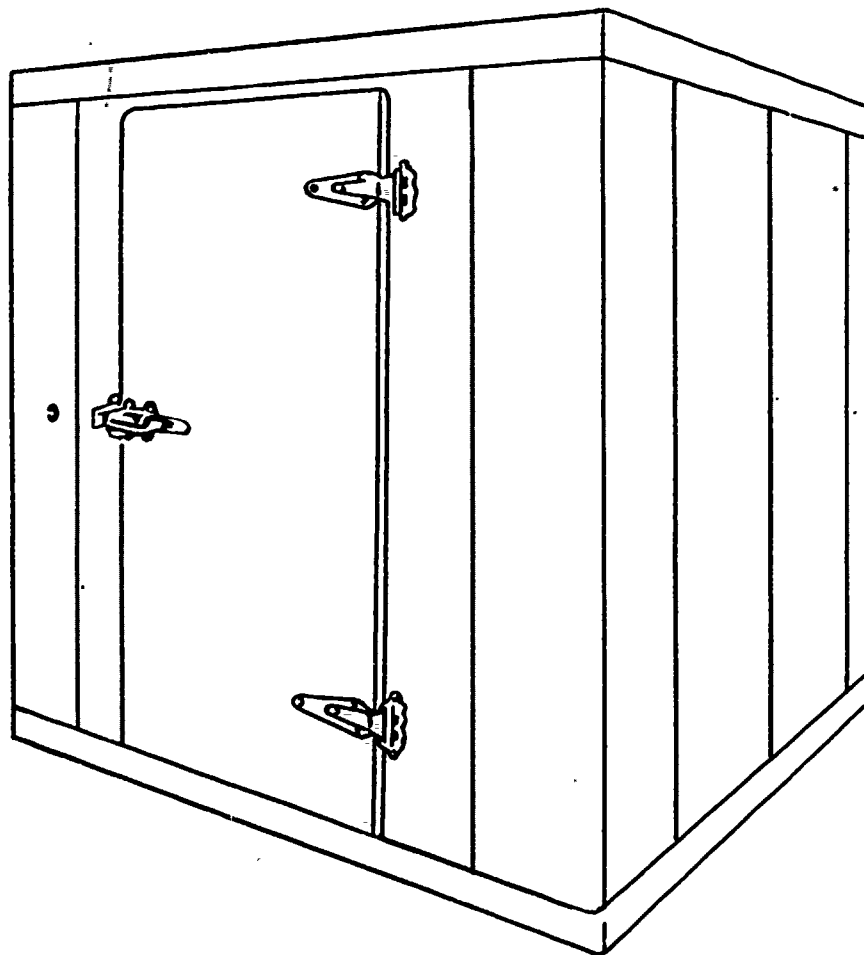

FIGURE 17.—Commercial-type walk-in refrigerator.



FIGURE 18.—Built-in walk-in refrigerator showing flush floor entrance.



Storage shelves for use in walk-in refrigerators may be the stationary or portable type. (See figs. 19 and 20.) Portable shelving with casters is preferable for ease in moving equipment for cleaning. Portable tray racks are also desirable; they may be loaded with food at the preparation area and wheeled into the walk-in refrigerator until serving time. (See fig. 21.) Blower-type refrigeration coils should be connected to remote refrigeration equipment. Service and maintenance features are important as part of the purchase contract. Again, State and local regulations need to be checked regarding floor drains.

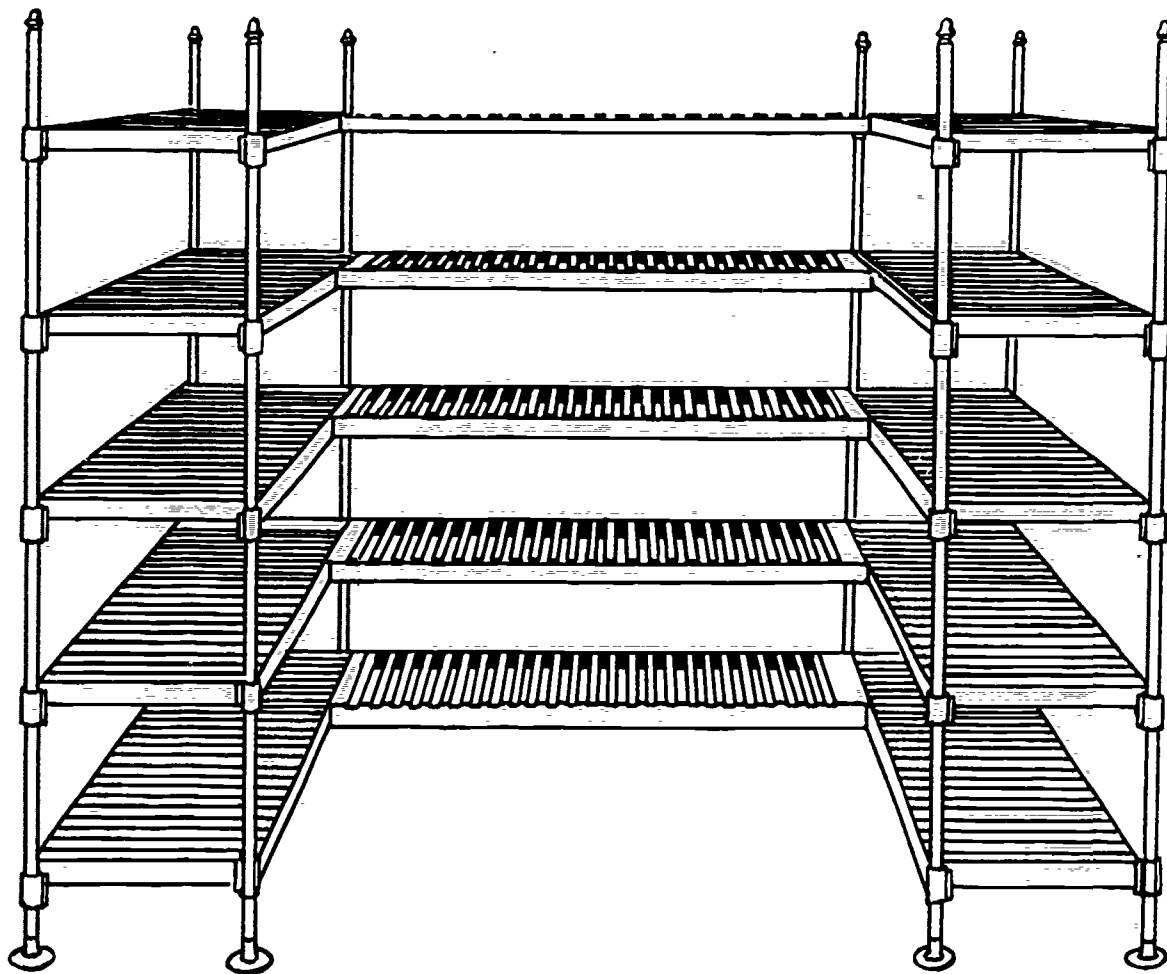

FIGURE 19.—Stationary shelving for use in walk-in refrigerators.

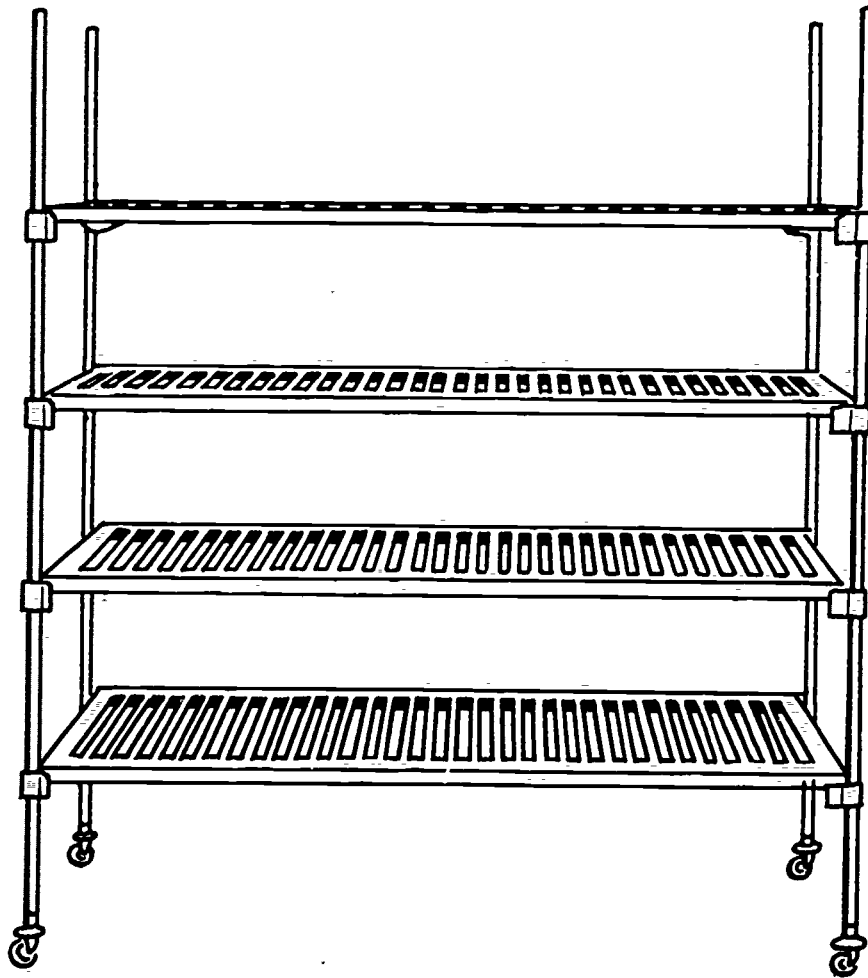

FIGURE 20.--Portable shelving for use in walk-in refrigerators.



FIGURE 21.—Portable tray rack for use in walk-in refrigerators.

*Freezer or frozen food storage cabinets* should be the commercial type, adequate for maintaining a temperature of 0° F. or below. Frozen food storage cabinets are designed primarily for the storage of frozen foods. Either the upright- or chest-type freezer may be used. (See figs. 22 and 23.) The upright type with removable and/or adjustable shelves is preferable.

Since it is often expedient to freeze small lots of prepared foods, it is desirable to select a freezer that is equipped with a freezer plate or shelf for quick freezing of such foods at 0° F. or below.

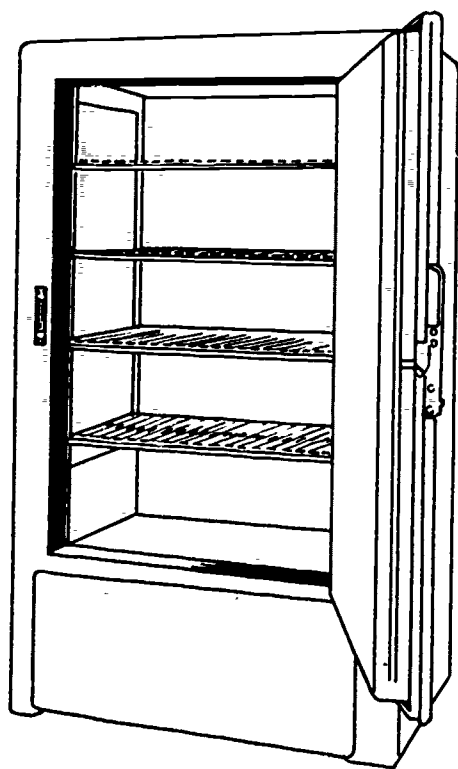

FIGURE 22.—Commercial-type upright freezer or frozen food storage cabinet.

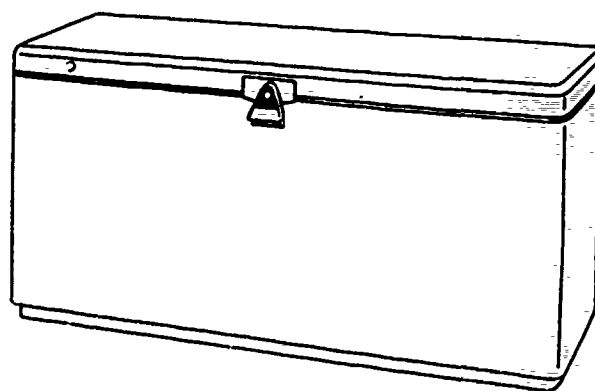

FIGURE 23.—Commercial-type chest freezer or frozen food storage cabinet.

*Milk coolers* should be the commercial type, constructed to maintain temperatures of 32° to 45° F. The most commonly used cooler is the self-service horizontal chest-type with built-in fans to circulate the air uniformly. (See fig. 24.)

Some chest models have an automatic elevating device to keep containers at the top of the cooler. Since milk coolers are usually placed in the serving line, they ought to be similar in height to the serving counter. Upright compartment coolers are also available. They are usually built into the serving counter with flush entrance at floor level to accommodate loaded milk dollies. (See fig. 25.)

*Milk dispensers* are available in 1-, 2-, or 3-can capacities to accommodate bulk milk supplies in 3-, 5-, and 10-gallon containers. Constructed with self-contained mechanical cooling equipment, they are designed to maintain temperatures of 32° to 45° F. An automatic measuring device is recommended to assure the 8-ounce serving of milk required for a Type A lunch.

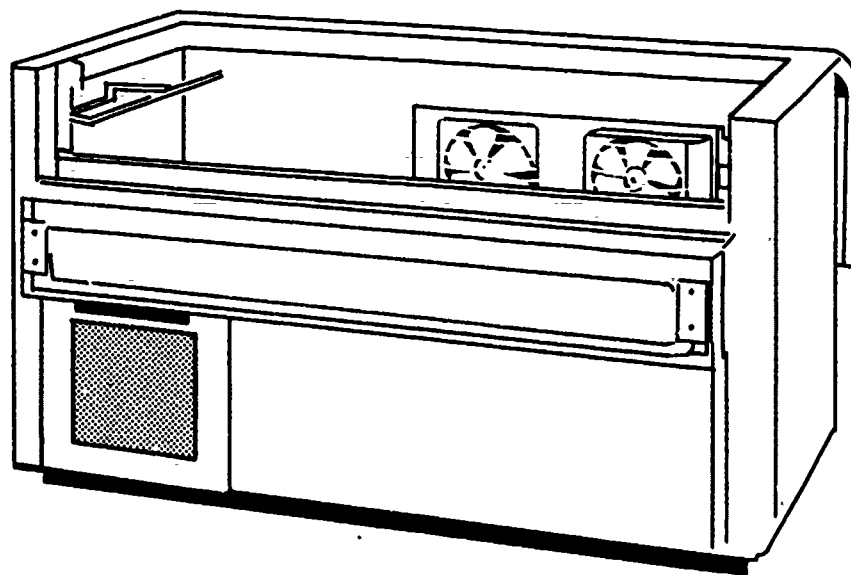

FIGURE 24.—Chest-type milk cooler.

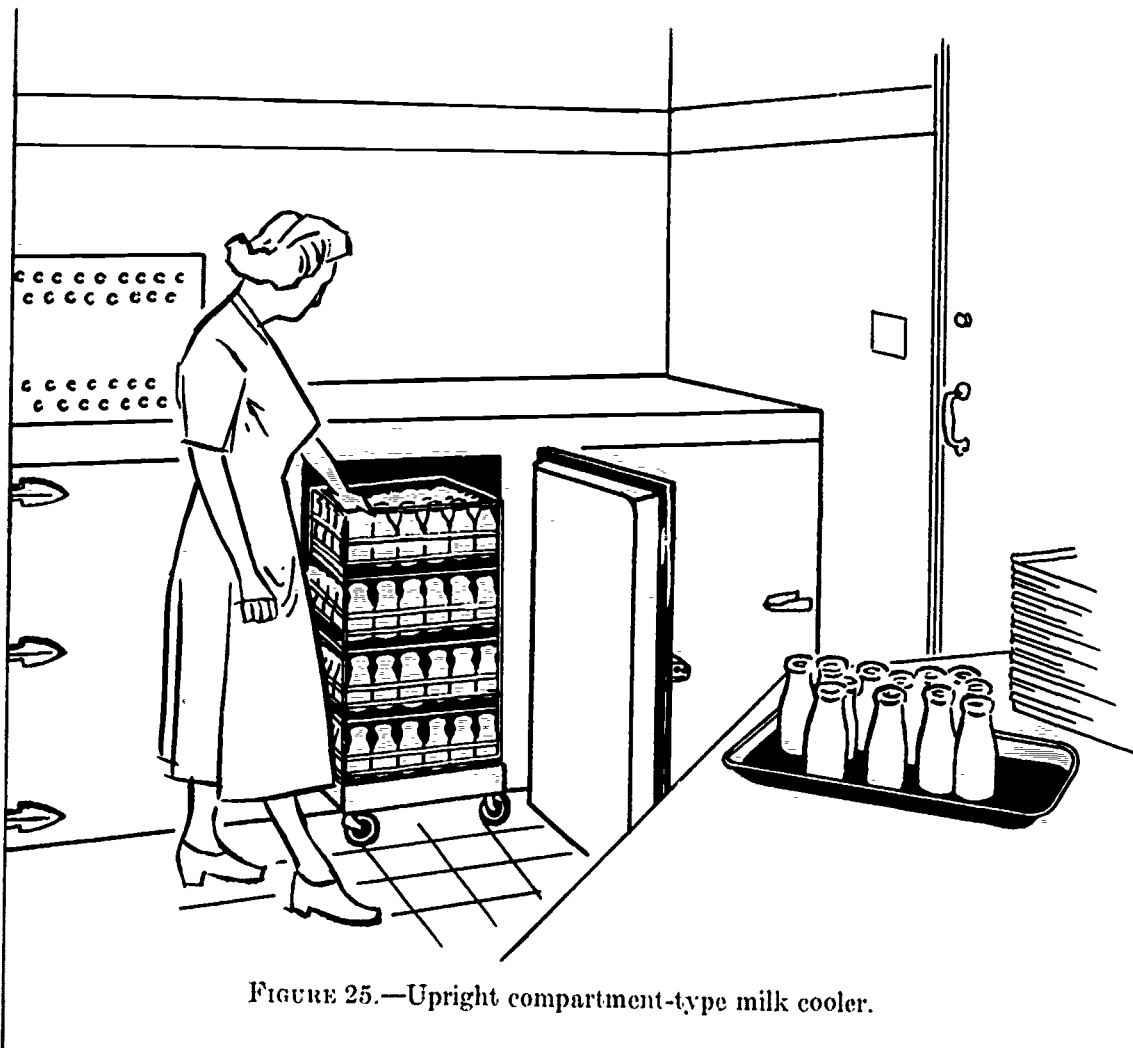

FIGURE 25.—Upright compartment-type milk cooler.

## Thermometers

Reliable thermometers are essential inside refrigerated facilities to make sure that proper temperatures are maintained. Thermometer readings should be taken every day, since *the quality of both fresh and frozen food is adversely affected by exposure to temperatures above the ideal.* Therefore, every school and institution should equip their refrigerated facilities with a portable or remote-reading refrigerator-freezer thermometer and/or a recording thermometer.

*Refrigerator-freezer thermometers* are suitable for use in reach-in refrigerators and freezers or frozen food cabinets. A refrigerator-freezer thermometer of the type shown in figure 26 is designed to hook on wire baskets, shelves, or partitions, or to be placed on any flat surface. Some of the characteristics of a good refrigerator-freezer thermometer are: A temperature range of at least minus 40° to plus 60° F. in 2°-scale divisions, a red-liquid-filled or mercury-filled magnifying glass tube for easy reading, a rust-resistant scale and frame with scale completely encased to protect the thermometer bulb and slow down changes in temperature indications when the door is opened for readings.

The coldest and warmest areas in a refrigerator vary with the type. To determine where these areas are in a given refrigerator, place thermometers in different locations, and keep the door closed for about an hour before taking readings. When the warmest area is determined, the thermometer should be placed there and the thermostat adjusted as necessary to obtain the recommended storage temperature. The warmest area in a freezer can be determined in the same manner.

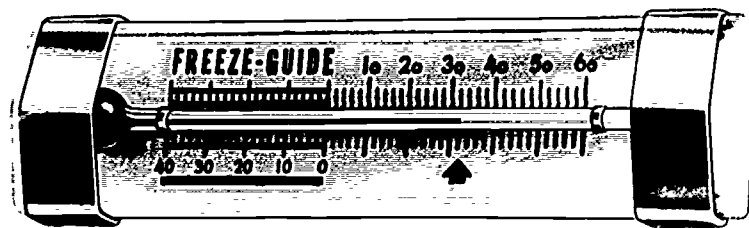

FIGURE 26.—Refrigerator-freezer thermometer.



*Remote-reading thermometers* of the type shown in figure 27 are designed for use in walk-in refrigerators and freezers or frozen food cabinets. They permit the reading of temperatures from the outside of the facility. The capillary tube permits placing the thermometer scale outside the refrigerated facility so that the temperature can be checked without opening the door. This type of thermometer should have the following construction characteristics: A minimum temperature range of minus 40° to plus 60° F. in 2°-scale divisions, a red-liquid-filled magnifying-glass tube with 4 feet of capillary tube and temperature-sensitive bulb attached, enameled scale completely encased to protect thermometer tube, and mounting holes in metal back.

The temperature bulb is placed inside the regular storage compartment of the refrigerator or freezer, away from packages of food, and where air can circulate freely around it. The capillary tube fits easily between the door and the frame without affecting the efficiency of the freezer or refrigerator.

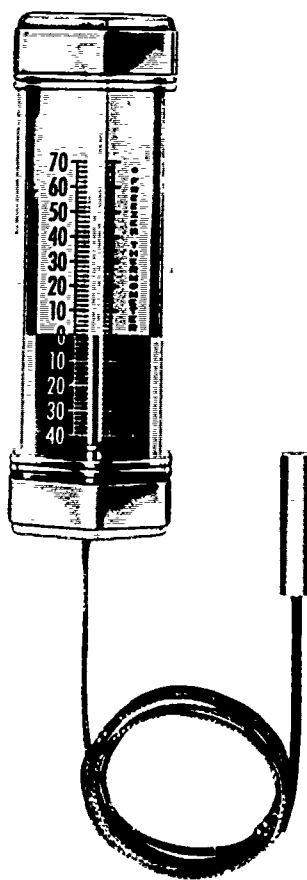

FIGURE 27.—Remote-reading thermometer.

*Single-pen recording thermometers* of the type shown in figure 28 are designed to record continuously the temperatures of walk-in refrigerators and freezers. The chart rotates once in 7 days, providing a complete weekly record. Such instruments have the following characteristics: Rectangular aluminum dustproof case, smooth stainless capillary between bulb and case, 7-day revolution chart graduated from at least minus 40° to plus 70° F. in 1°-scale divisions, mercury-actuated thermal system with temperature-compensated capillary, and a lock in door of case to eliminate tampering with recorder calibration and mechanism.

This type of instrument eliminates guesswork as to how high or for how long temperatures may have risen. The recorder is usually mounted outside the refrigerated space, with the temperature-sensitive bulb mounted near the center and toward the top.

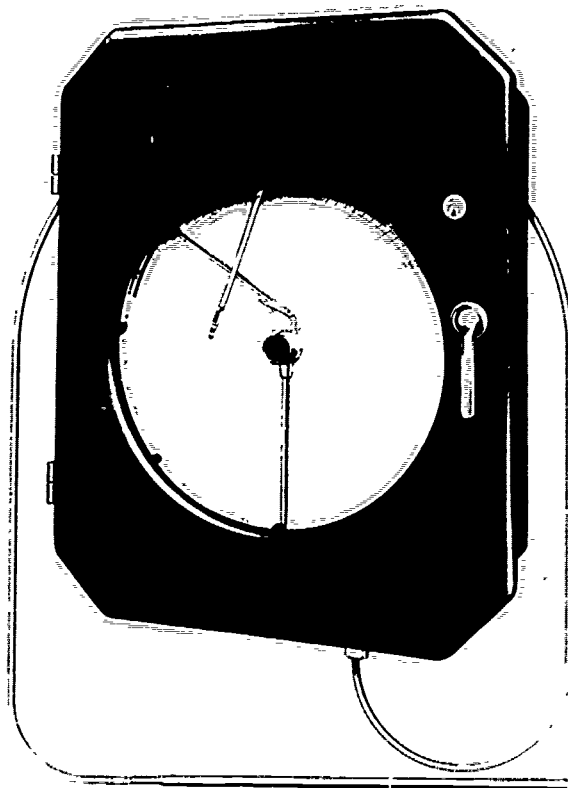

FIGURE 28.—Single-pen recording thermometer.

## Part IV—MANAGEMENT PRACTICES

### Inspection of Foods Upon Arrival

Each delivery of food should be carefully checked for possible shortages and damage before the foods are accepted. Thoroughly inspect all foods before they are put in storage.

Examine refrigerated products upon arrival to be sure that temperatures are adequate and that the products are in good condition. This is especially essential for frozen foods.

Canned foods should be examined to determine if there are any damaged, disfigured, or discolored cases or cans, which might indicate spoilage or deterioration.

Foods subject to insect infestation need to be thoroughly inspected. Even though foods are free of infestation when shipped, they may arrive badly infested due to the use of an infested freight car or truck.

Any foods that are found to be out of condition at time of receipt must be segregated from other foods. (USDA-donated foods found to be out of condition are to be recorded and reported to the State distributing agency.)

### Recordkeeping

It is essential that all schools and institutions keep accurate records on the amounts of food in stock and the quantities of food moving into and out of storage over given periods of time. To keep satisfactory food controls, it's important to establish a system with one person designated to keep the records. Methods used to maintain this information will vary with the individual school or institution.

#### *Perpetual inventory*

It is recommended that a perpetual inventory record be kept for all foods in stock. Form 1 illustrates the type of card that may be used for keeping such an inventory record. Separate cards should be kept for each food item. If different size containers of the same food item are being stocked, separate cards are needed for each size—for example, separate cards would be needed for No. 10 and No. 2½ cans of tomatoes. The perpetual inventory cards show at a glance for each food item: The dates of all transactions, the record of action, the quantity of food received, the quantity of food withdrawn, and the balance of food in storage.

The person designated to keep the inventory record will find it best to set aside a specific time for posting the entries daily. As a matter of convenience, colored riders may be attached to cards to indicate stock that is low or that should be used at once.

Food Item: <u>Tomatoes, canned</u>		Unit Size: <u>No. 10 cans</u> <u>(6 per case)</u>		
Date	Record of Action	Quantity of Food (Cases, cans, pounds, etc.)		
		Received	Withdrawn	Balance
		<u>cans</u>	<u>cans</u>	<u>cans</u>
Sept. 1	On hand			12
4	To kitchen		9	3
8	Purchased (Invoice No. 9466)	18		21
9	To kitchen		6	15
16	U.S.D.A.-donated	108		123
18	Transferred to Elyria School		36	87
19	To kitchen		9	78

FORM 1. Perpetual inventory card

*Daily withdrawal form*

In larger schools and institutions it is usually desirable to use a daily withdrawal form to record each food item as it is taken from storage. (See form 2.)

For convenience, separate forms may be used at the dry food storage area, and at refrigerators and freezers. The use of these daily withdrawal records will facilitate the posting of the perpetual inventory cards. The information from these forms should be posted to the perpetual inventory card.

Date	Record of Action	Food Item	Amount of Food (Cases, cans, pounds, etc.)
<i>Sept. 4</i>	<i>To Kitchen</i>	<i>Turkeys (frozen)</i>	<i>2 (18# each)</i>
		<i>Tomatoes</i>	<i>9 (No. 10 cans)</i>
		<i>} etc.</i>	
	<i>Transferred to Elyria School</i>	<i>Peaches</i>	<i>3 cases (18 No. 10 cans)</i>

FORM 2.—Daily withdrawal form

### Physical inventory

In small schools or institutions, if a perpetual inventory record does not seem to be justified, it will be necessary to take a complete physical inventory of all foods on hand before the monthly financial statement can be made. It is also wise for larger schools and institutions to take a monthly physical inventory for use in making the financial statements. In addition, it serves as a check on the accuracy of the perpetual inventory record. This is especially important for USDA-donated foods. The physical inventory includes all food on hand in the kitchen as well as that in storage. In calculating the value of the inventory, it is customary to use the original purchase cost of the items rather than the current market price.

For ease in taking a physical count of all foods in storage, arrange the items according to food groups, with each group arranged in alphabetical order. For example, canned fruits—apples, apricots, etc. This system makes for ease in counting at the time of taking the inventory as well as giving an orderly appearance to the storeroom. The procedure for taking a physical inventory is simplified and made more accurate by listing once, in a bound notebook, all items in the order or sequence in which they are stored and providing lines for 12 monthly entries such as suggested in form 3. Space should be left between the listings for additional items that may be added during the year.

The count of each food item taken during the physical inventory may be recorded in red on the corresponding perpetual inventory card to provide a simple means of comparing the two inventories. Minor differences are sometimes found when more than one person is responsible for keeping the records. If this occurs, the figures should be adjusted. Any major differences in the two inventories should be investigated thoroughly.

PHYSICAL INVENTORY												
Name of School or Institution: <u>Wakefield Institution</u>										Year: <u>1958</u> <sup>1/</sup>		
Food Item	January 31					February 28					March 31	
	Brand	Quantity	Size Pkg.	Unit Cost	Total Cost	Brand	Quantity	Size Pkg.	Unit Cost	Total Cost	Brand	Quantity
<i>Applesauce</i>												
<i>Apple slices</i>												
<i>Apricots</i>												
<i>} etc.</i>												

<sup>1/</sup> Schools should use the school year rather than the calendar year.

FORM 3.—Physical inventory sheet

### Temperature Requirements

Table 6, based on current research findings, is a *general guide* for storing various types of foods. The fact sheets issued by the U.S. Department of Agriculture to the State distributing agencies will furnish more specific information on temperature requirements and other storage guidelines for USDA-donated foods.

As used in table 6, "satisfactory" means this type of storage is acceptable. "Preferred" means this type of storage maintains quality of the product for a longer period of time. "Required" means that this type of storage is essential—there is no alternative to it.

TABLE 6.—*General temperature guides for storing foods*

Food	Dry storage (50°-70° F.)	Refrigerated storage (32°-50° F.)	Freezer storage (0° F. or below)
<b>DAIRY PRODUCTS</b>			
Butter		Satisfactory up to 2 weeks (maximum 45° F.).	Required over 2 weeks.
Cheese, Natural		Required (maximum 45° F.).	
Cheese, Processed		Required (maximum 45° F.).	
Milk, Canned	Satisfactory	Preferred	
Milk, Fluid Whole		Required (maximum 45° F.).	
Milk, Nonfat Dry	Satisfactory	Preferred	
<b>EGGS</b>			
Shell		Required	
Dried		Required	
Frozen			Required
<b>MEAT AND MEAT PRODUCTS</b>			
Frozen meats, such as Ground Beef; Hams and Shoulders; Pork Loins; Turkeys; etc.			Required
Cured Hams and Shoulders; Bacon; etc.		Required	
Canned Hams		Required	
Other canned meats, such as Beef and Gravy; Pork Lunchcon Meat; Pork and Gravy, etc.	Satisfactory	Preferred	
<b>FATS AND OILS</b>			
Cottonseed Oil; Lard; Olive Oil; and Vegetable Shortening.	Satisfactory	Preferred	
<b>CANNED VEGETABLES</b>			
Green Beans; Beets; Carrots; Corn; Green Peas; Tomatoes; Tomato Juice; Tomato Paste; Tomato Puree; etc.	Satisfactory	Preferred	



TABLE 6.—General temperature guides for storing foods—Continued

Food	Dry storage (50°-70° F.)	Refrigerated storage (32°-50° F.)	Freezer storage (0° F. or below)
<b>CANNED FRUITS</b>			
Orange Juice, Concentrated.	-----	Required-----	-----
Other canned fruits, such as Apples; Apple-sauce; Apricots; Blackberries; Cherries; Cranberry Sauce; Figs; Grapefruit Sections; Grapefruit Juice; Peaches; Purple Plums (prunes); etc.	Satisfactory-----	Preferred-----	-----
<b>FRESH VEGETABLES</b>			
Onions-----	Satisfactory-----	Preferred-----	-----
Potatoes, Irish-----	Satisfactory-----	Preferred (minimum 40° F.)-----	-----
Sweetpotatoes-----	Required (minimum 55° F.)-----	-----	-----
Other fresh vegetables, such as Green beans; Beets; Cabbage; Carrots; Spinach; etc.	-----	Required-----	-----
<b>FRESH FRUITS</b>			
Apples; Peaches; Pears; Purple Plums; etc.	-----	Required-----	-----
<b>DRIED VEGETABLES</b>			
Beans, High Moisture...	Satisfactory for 60 days.	Required over 60 days.	-----
Beans, Low Moisture...	Satisfactory-----	Preferred-----	-----
<b>DRIED FRUITS</b>			
Apples; Apricots; Peaches.	Satisfactory for 2 weeks.	Required over 2 weeks.	-----
Figs; Prunes; Raisins; etc.	Satisfactory-----	Preferred-----	-----
<b>CEREAL PRODUCTS</b>			
Regular Cornmeal; Whole Wheat Flour.	Satisfactory for 60 days.	Required over 60 days.	-----
Degermed Cornmeal; All-purpose and Bread Flour; Rice; etc.	Satisfactory-----	Preferred-----	-----
<b>MISCELLANEOUS</b>			
Honey-----	Satisfactory-----	-----	-----
Nuts-----	-----	Required-----	-----
Peanut Butter-----	Satisfactory-----	Preferred-----	-----

### Recommended Storage Practices

The importance of storing food properly cannot be overemphasized. Improper storage may cause spoilage which is not only wasteful but increases food costs. Of even greater importance is the health hazard involved. Food that is even slightly tainted because of improper care may cause illness.

In storing foods, it is important not only to consider the use of proper storage methods to reduce food spoilage, but also to consider efficient methods of storage which will save space and make for ease in handling the foods. The following storage practices are recommended.

#### *Stack Bagged Foods on Dollies or Skids*

Quantity lots of bagged foods such as flour, rice, beans, cornmeal, potatoes, sugar, etc., may be stacked on dollies or skids, using one of the methods shown in figure 29. Either method permits the necessary circulation of air. To make the most effective use of the storage area, stack the foods as high as safely practicable for ease in handling.

Protect current supplies of flour, rice, beans, cornmeal, and sugar in metal food containers equipped with tight-fitting covers. The cans should be plainly labeled, and equipped with dollies or casters so that they can be moved easily.

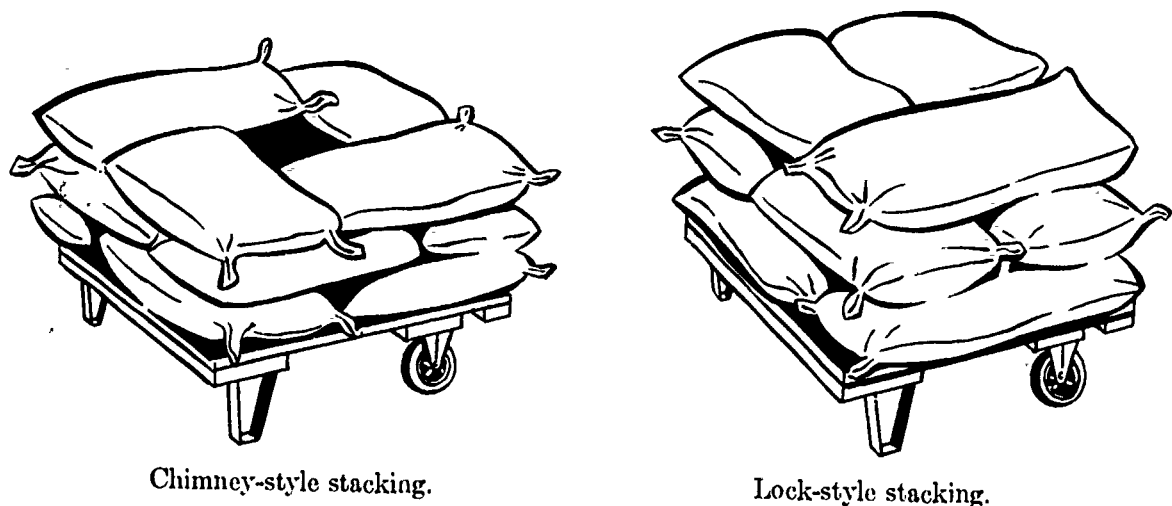

FIGURE 29.—Methods of stacking bags of flour, rice, beans, cornmeal, potatoes, sugar, etc.

*Stack Cased and Boxed Foods on Dollies or Skids*

Quantity lots of cased and boxed foods, stacked in alternating patterns on dollies or skids, make a stable load for storing and handling. Methods of stacking these foods are shown in figure 30. If desired, smaller lots of canned foods may be stored on shelves in or out of the cases.

*Stack Foods of a Kind Together*

Arrange the foods in the storage space according to type, such as canned foods, dried fruits, etc., to facilitate the taking of inventories.

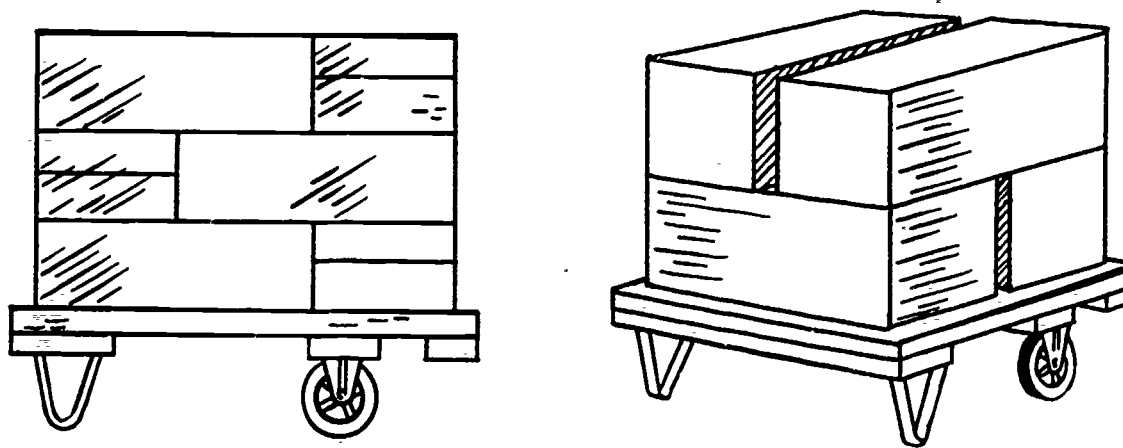

FIGURE 30.—Methods of stacking cased and boxed foods.

***Date or Number the Foods for Easy Identification***

Date or number the new stock to provide a record so that the old stocks may be used first. (See fig. 31.)

***Place Oldest Out Front***

The placing of oldest stocks out front will assure the use of the foods on a "first-in, first-out" basis. (See fig. 32.)

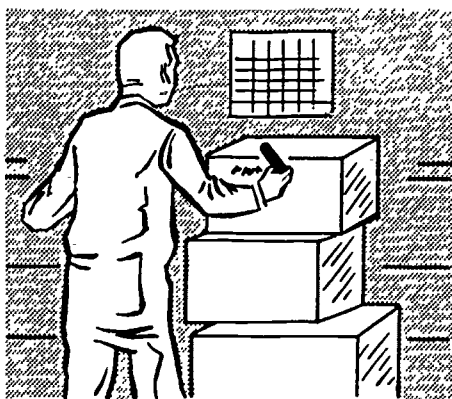

FIGURE 31.—Date or number new foods.

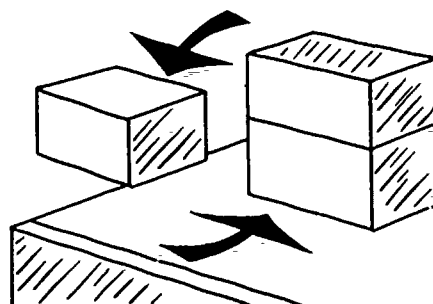

FIGURE 32.—Place oldest stocks out front—use them first.

***Store Foods Away From Walls and Off the Floor***

All foods should be stored away from the walls and off the floor. This keeps them from absorbing moisture that will cause cans to rust, package seams to burst, and foods to mold or rot. (See fig. 33.)

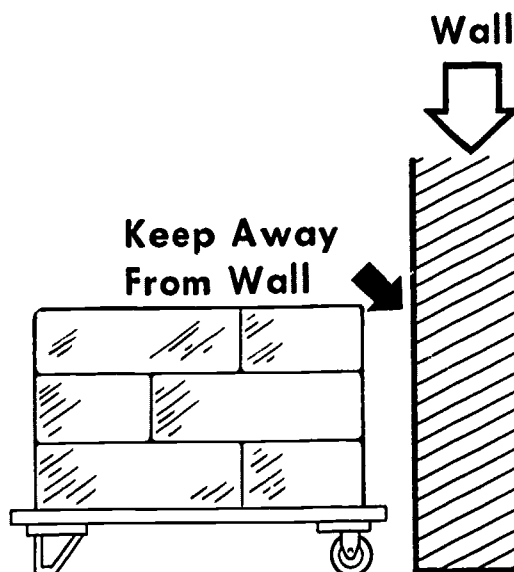

FIGURE 33.—Store foods away from walls and off the floor.

### *Store Foods That Absorb Odors Away From Those That Give Off Odors*

Foods that absorb odors must be stored away from foods that give off odors. A representative listing of typical foods that give off and/or absorb odors is shown in table 7.

TABLE 7.—*Foods that give off and/or absorb odors*

Food	Gives Off Odors	Absorbs Odors
Apples, Fresh.....	Yes.....	Yes.
Butter.....	No.....	Yes.
Cabbage.....	Yes.....	No.
Cheese.....	Yes.....	Yes.
Cornmeal.....	No.....	Yes.
Eggs, Dried.....	No.....	Yes.
Eggs, Fresh Shell.....	No.....	Yes.
Flour.....	No.....	Yes.
Milk, Nonfat Dry.....	No.....	Yes.
Onions.....	Yes.....	No.
Peaches, Fresh.....	Yes.....	No.
Potatoes.....	Yes.....	No.
Rice.....	No.....	Yes.

Do not store items such as paint, kerosene, gasoline, oils, naphthalene, soap, wax, polishes, mops, wearing apparel, etc., in the same area with foods. Provide a separate storage room for such items.

#### *Refrigerate Fresh Meats, Poultry, and Fish*

Fresh meats such as ground meat and liver, poultry, and fish must be refrigerated immediately. These highly perishable foods lose quality fast, even when refrigerated. Therefore, they need to be used on the day they are delivered or within 24 hours. Remove outside paper wrappings from fresh meats before they are placed in the refrigerator. The meats should be spaced to allow for air circulation.

Large cuts of meat keep best if hung on hooks in the walk-in refrigerator. This method will result in slight drying of the meat, helping to preserve it.

#### *Refrigerate Dairy Products and Eggs*

Milk, cheese, butter, and eggs must also be refrigerated immediately. Prompt and continual refrigeration is as important for these products as for meats. Wrap cheese tightly to prevent drying out. It is also important to avoid freezing cheese, since freezing breaks the grain and causes the cheese to crumble. Butter also needs to be wrapped to prevent absorption of odors and to protect it against exposure to light and air, which hasten rancidity. If possible, store cheese and butter in the original shipping containers. Egg crates should be cross-stacked to allow circulation of air. Don't move the crates more than necessary during storage.

#### *Refrigerate Fresh Fruits and Vegetables*

Fresh fruits and vegetables require immediate refrigeration. This helps to preserve their color, flavor, texture, and nutritive value. Examine fresh produce for ripeness before storing; very ripe items should be removed and used immediately. Leave paper wrappings on fruits to help keep them clean and to prevent spoilage and loss of moisture. The products should be stored in a manner which will allow cold air to circulate around them.

### **Refrigerate Cooked Foods**

Cooked foods must be refrigerated at 45° F. or lower in clean, covered containers. Use these foods within 2 to 3 days, preferably within 24 hours. Avoid refrigerating cooked foods a second time after they have been removed from refrigeration and reheated for serving. Prepared and precooked foods that are served cold, such as cream- or custard-filled pastries, cream- or custard-type puddings, salads, sandwiches, and cold meats need to be kept under refrigeration until serving time.

Cooked foods require quick cooling—within 2 to 3 hours—to refrigeration temperature to avoid danger of food poisoning. This is especially important for liquid or semisolid food preparations, such as custards and custard-filled products, foods in cream sauce or gravies, stews and soups, which favor rapid growth and spread of bacteria; and for foods where handling during preparation is likely to induce general bacterial contamination; i.e., cooked sliced ham and boned poultry.

Small quantities of cooked foods can be cooled satisfactorily by refrigerating immediately. When refrigeration facilities are limited, large quantities of cooked foods may need to be partially cooled before they are refrigerated to avoid raising the temperature of the refrigerator. Such pre-refrigeration cooling should be limited to 2 hours or less. Cooling of large roasts, etc., may be speeded by placing them in front of a fan.

Large quantities of slow-cooling foods, such as gravies, stews, and noodles, may take too long to cool unless special steps are taken to hasten heat transfer. If precooled outside the refrigerator, such foods can be placed in a sink or vat of cold water and stirred frequently to hasten cooling. Even if placed directly in the refrigerator, occasional stirring may be necessary to assure cooling to near-refrigeration temperature within 2 to 3 hours. Check local health laws regarding the care of perishable foods. Ordinances may require that all perishable food and drink be kept under refrigeration except when being prepared and served.

### **Storing Frozen Foods**

Store frozen foods in the freezer in the original shipping containers. This will reduce the possibility of freezer burn and drying out of the foods.

If space does not permit storing these foods in the original shipping containers, or if the containers have been damaged, the individual packages of food will need an additional overwrap in moisture-vapor-proof packaging material before being placed in the freezer.

Check to see that the freezer maintains a temperature of 0° F. or below. Temperatures above 0° F., even for brief periods of time, will cause products to lose quality. Some quality losses are easy to see; others are invisible. These losses include browning or darkening of the product, loss of flavor and color, off flavors, undesirable change in texture, and loss of vitamin C.

*If frozen foods have thawed, do not refreeze. If in good condition, use immediately or refrigerate them and use within 24 hours.*

### **Freezing Freshly Cooked Foods**

Freshly cooked foods may be frozen. The food must be chilled promptly and thoroughly, then packaged in moisture-vapor-proof materials or containers to exclude air and prevent loss of moisture. The foods should be placed on a freezer plate or shelf for quick freezing at 0° F. or below. To assure uniform and rapid freezing, the packages must come in contact with the freezing surface and not with each other.

Some of the packaging materials and containers that may be used, depending upon freezer space available, are: No. 10 cans with tight-fitting plastic lids; 5- and 10-pound cans with tight-fitting, slipcover lids; polyethylene freezer bags; polyethylene-coated or laminated freezer paper; heavy freezer aluminum foil; heavily waxed cardboard boxes.

## Suggestions for Care of School Lunch Foods and Food Storage Facilities During the Summer Months

Make every effort to *use up all foods on hand before the end of the school year*. Put inventories to work by planning menus around the foods on hand. The money saved by using such foods can be used to restock the storeroom in the fall.

If, in spite of careful planning, some foods are left on hand at the end of the school year, make arrangements to store them properly during the summer months. Many foods lose nutritive value during storage, and all foods will spoil if not stored properly. For information on proper temperatures at which various foods need to be stored, see table 6. In addition, the following suggestions will be helpful in taking care of foods and storage facilities during the summer months:

### Dry Food Storage

*Keep storeroom cool and dry, at temperatures around 50° F., if possible (not above 70° F.).*

*Clean storeroom thoroughly as described in Part V, "Housekeeping Practices."* Consult the local health department or a reputable licensed exterminating or fumigating company regarding the use of insecticides and fumigants.

*Keep storeroom well ventilated.* Make some provision for airing the storeroom several times during the summer months.

*Keep storeroom rodent- and insect-proof.* Check and repair any holes or openings where rodents and insects may enter.

*Keep storeroom theftproof.* Be sure that locks on doors and windows are secure.

### Refrigerated Food Storage

During the summer months when schools are closed, it is best to transfer foods requiring refrigerated storage to a locker plant or commercial cold storage plant.

*Disconnect* reach-in refrigerators, freezers or frozen food storage cabinets and walk-in refrigerators at the plug or by removing the fuses, rather than just turning them off at the switch. This may prevent a burned-out motor if lightning should strike nearby.

*Clean* all refrigerated equipment thoroughly as described in Part V, "Housekeeping Practices."

*Prop refrigerator and freezer doors so that they will remain open.* If an inoperative reach-in refrigerator, food freezer, or walk-in refrigerator is left tightly closed and the inside is at all damp, the metal parts will corrode in a short time.

*Compressors, condensers, and motors* need to be serviced by a competent refrigeration mechanic.

If foods requiring refrigeration are kept on the school premises, check refrigerated units periodically to be sure that proper temperatures are being maintained.

### Before Storing School Lunch Food During the Summer Months

- Check all food to be sure it is in good condition.
- Dispose of any canned food that is bulged or leaking.
- Open samples of food packaged in paper cartons and boxes to be sure that it is in good condition.
- Dispose of any food that is moldy or otherwise spoiled.
- Repackage broken lots of food in metal containers with tight-fitting lids.
- Store food on shelves, dollies, or skids—do not put directly on the floor.
- Store food so that air can circulate around it. Leave a 1- to 2-inch space between the walls and the food.
- Label and date all food that is placed in storage. Use this food *first* in the fall.
- Make a record of all food in storage, to be used when planning the food supplies needed in the fall.



## Part V—HOUSEKEEPING PRACTICES

### Importance of Sanitation and Cleanliness

Good housekeeping practices need to be followed *daily* to insure cleanliness and orderliness in all food storage areas. Sanitation and cleanliness are a *must* in food handling and storage.

Most of the food-poisoning outbreaks are caused by failure of food handlers to follow good sanitary practices. This places the responsibility directly upon the food service personnel in schools and institutions to adopt good practices of sanitation and cleanliness.

### Care of Dry Food Storage Facilities

To keep the dry food storage area in good condition, foods must be inspected regularly, and cleaning schedules established and followed.

Check all food frequently for evidence of spoilage, such as bulging or leaking cans. Where spoilage has occurred, remove the food immediately and clean the area thoroughly to prevent contamination of other foods.

Inspect also for such damage as torn sacks and broken cartons. If the food is in good condition, use it immediately or repackage it and use as soon as possible. All empty containers and sacks should be removed from the storeroom; USDA-donated food containers are to be disposed of in accordance with instructions from the State distributing agency.

The storeroom floors need to be swept daily and mopped at least once a week. For sweeping floors, nonpungent sweeping compounds are recommended. If these are not available, the floor should be lightly sprinkled with water before sweeping. Skids or dollies, on which foods are stored, should be removed as needed to permit thorough cleaning of the floors. The walls, shelves, skids, or dollies, etc., should also be cleaned and washed regularly. Any foods dropped or spilled on the floor should be cleaned up immediately to prevent rodent and insect infestation.

### *Insect and Rodent Control*

Insects destroy or render unfit for human consumption enormous quantities of food each year. The following foods are susceptible to insect infestation:

- Dried beans and peas.
- Grain products (flour, cornmeal, rice, cereals, etc.).
- Dried fruits (prunes, raisins, apricots, etc.).
- Nonfat dry milk.
- Cheese.

There are many ways in which insect infestation may occur in a storeroom. Insects or insect eggs may be harbored in floor cracks, baseboards, or in storeroom walls, in freight cars and trucks in which foods are transported, or in shipping containers, especially where the containers are reused without proper cleaning or fumigation. Insect infestation is evidenced by the presence of webbing, beetles, moths, larvae, holes in grain, or partly consumed foods. Since insects are seldom found on the outside of containers, it is necessary to inspect the inside of bags and cases. In bagged foods, insects are usually found in the creases of the bags, along seams, or in the ears of the bags. In cased foods, they may be found in the dark, closed sections of the boxes. It may be necessary to examine several bags or cases of foods before any infestation is noticed.

Insect infestation may occur even under ideal storeroom conditions; therefore, constant vigilance must be maintained for any sign of infestation, particularly during warm weather. Insect infestation

of such foods as cornmeal, flour, beans, rice, dried fruits, and nonfat dry milk can be prevented by keeping these foods stored at temperatures below 50° F.

Rodents also destroy or render unfit for human consumption enormous quantities of food each year. They are carriers and transmitters of such diseases as typhus fever, cholera, tuberculosis, bubonic plague, and rabies. Rodents enter buildings through holes or openings around pipes and wires and they frequently burrow under floors and enter through ventilation and drainpipes. Therefore, all such openings need to be covered or sealed with ¼-inch-mesh galvanized hardware cloth or sheet metal. All fan and ventilation openings, doors, and windows require screens.

The most effective ways of eliminating and controlling both rodents and insects are by extermination and fumigation. Both of these services can be rendered by a reputable licensed company. However, the services of such a company should not be relied upon completely. It is also important to have an organized program of good housekeeping with a designated responsible employee in charge.

Any contracts made with fumigating companies should contain a statement to the effect that the contractor will comply with all Federal, State, and local laws and regulations and that proper aeration of the building will be accomplished after fumigation. The improper use of some fumigants may result in an explosion or a fire, or in ill effects to workmen from exposure to the chemicals used. Therefore, a fumigating company must show evidence of public liability, property and fire insurance, and workmen's compensation. Since it is possible that the first fumigation will not effect a complete kill and may have to be followed with a second fumigation, a 100-percent-kill guarantee should be included in any contract entered into with a fumigating company. Poisons are dangerous to use around food items and must be used only by experienced and trained exterminators or under their supervision.

### Care of Refrigerated Food Storage Facilities

All refrigeration equipment needs to be checked frequently to see that it is kept in good condition. It is important to retain a reliable serviceman for periodic service and cleaning of all compressors, condensers, and motors. Cleaning schedules should be posted and followed for the checking and cleaning of all refrigerated equipment.

*Reach-in and walk-in refrigerators* require thorough cleaning at least once a week. Some suggestions for cleaning follow: Remove food supplies and portable equipment to do a thorough job of cleaning. Defrost when necessary, following the manufacturer's instructions. Cover the food or wrap it to minimize temperature changes. Wash shelves, meathooks, skids, dollies, etc., with hot water containing a good detergent. It may be necessary to scrub with a pot brush to remove grease and food particles. Rinse well with hot water. Wash the interior with warm water and baking soda, using one tablespoon of baking soda to each quart of water. Walk-in refrigerator walls and floors may need to be scrubbed with a hot detergent solution; rinse thoroughly. Wash the exterior with warm water and a good detergent. Flush drainpipes with hot water and baking soda. Wash rubber door gasket with warm water and mild soap; this increases its life. Foods should be carefully inspected for quality and put in clean containers before replacing in the refrigerator. *Milk coolers and dispensers* also need cleaning at least once a week, using similar procedures.

*Freezers or frozen food storage cabinets* should be defrosted and cleaned as needed, when the frost becomes three-eighths inch to one-half inch thick on the sides or coils. Follow the manufacturer's instructions. Ordinarily, defrosting once or twice a year is enough. If humidity is high or if the freezer is opened often, another defrosting or two during the year may be necessary. If possible, defrost when the quantity of food in the freezer is relatively low. If the freezer is not too full, food packages need not be taken out; they can be moved from one part of the freezer to another as work progresses. A broad stiff spatula, a putty knife, or a sharp-edged wooden paddle may be used, or special tools for removing frost may be purchased.

If a complete job of cleaning is needed, the following procedure is recommended: Remove all food packages and disconnect the freezer. Place the packages on trays or in baskets that have been thoroughly cooled in the freezer. Pile the packages as compactly as possible to reduce the amount of exposed surface, and cover with insulating material such as newspapers. Scrape as much frost as possible from the surfaces so there will be less to melt off. Cold water may be run over the refrigerated surfaces to hasten the melting. Hot water should never be used, since refrigerant pressure would be built up in the evaporator and cause difficulty in starting the compressor. An electric fan placed so that it will blow room air into the freezer, or cold air out, will help to melt the ice. Removing the ice from the surface at intervals, as it loosens, will speed the defrosting process. Do not chip the ice off with an icepick or other sharp tool that might damage the liner surface or coils. When defrosting is completed, wash the interior and exterior as described above.

Connect the freezer and let it run for half an hour or so to bring the temperature down somewhat before putting the food back in. When returning the food to the freezer, it is a good idea to take an inventory and to place the older packages at the front or top of the freezer, or earmark them in some way for first use.