

DOCUMENT RESUME

ED 070 581

SE 014 139

TITLE Principles of Guided Missiles and Nuclear Weapons.
INSTITUTION Bureau of Naval Personnel, Washington, D. C.; Naval Personnel Program Support Activity, Washington, D. C.
REPORT NO NAVPERS-10784-A
PUB DATE 66
NOTE 370p.; Revised 1966
EDRS PRICE MF-\$0.65 HC-\$13.16
DESCRIPTORS Instructional Materials; Mechanical Equipment; *Military Schools; *Military Science; Military Training; Nuclear Physics; *Nuclear Warfare; *Post Secondary Education; *Supplementary Textbooks; Textbooks

ABSTRACT

Fundamentals of missile and nuclear weapons systems are presented in this book which is primarily prepared as the second text of a three-volume series for students of the Navy Reserve Officers' Training Corps and the Officer Candidate School. Following an introduction to guided missiles and nuclear physics, basic principles and theories are discussed with a background of the factors affecting missile flight, airframes, missile propulsion systems, control components and systems, missile guidance, guided missile ships and systems, nuclear weapons, and atomic warfare defense. In the area of missile guidance, further explanations are made of command guidance, beam-rider methods, homing systems, preset guidance, and navigational guidance systems. Effects of nuclear weapons are also described in categories of air, surface, subsurface, underwater, underground, and high-altitude bursts as well as various kinds of damages and injuries. Besides illustrations for explanation purposes, a table of atomic weights and a glossary of general terms are provided in the appendices. (CC)

ED 070581

PRINCIPLES OF GUIDED MISSILES AND NUCLEAR WEAPONS

U.S. DEPARTMENT OF HEALTH,
EDUCATION & WELFARE
OFFICE OF EDUCATION

THIS DOCUMENT HAS BEEN REPRODUCED EXACTLY AS RECEIVED FROM THE PERSON OR ORGANIZATION ORIGINATING IT. POINTS OF VIEW OR OPINIONS STATED DO NOT NECESSARILY REPRESENT OFFICIAL OFFICE OF EDUCATION POSITION OR POLICY.

Prepared by
BUREAU OF NAVAL PERSONNEL

014 139

NAVPER 10784—A

1966

LAVRITSEN. GR 70

PREFACE

This book is intended primarily as a classroom training text for NROTC and OCS students. Other principal users will be officers enrolling in the correspondence course based on this text, and NROS students.

This is the second volume of a three-volume series dealing with naval weapons. The first volume, Principles of Naval Ordnance and Gunnery, NavPers 10783-A, deals with shipboard naval weapons systems, including guns, rockets, bombs, torpedoes, mines, and depth charges, but not guided missiles and nuclear weapons. The basic sciences as applied to naval weapons, including fire control, are explained.

The present volume deals with many basic principles and theories needed for understanding guided missile flight and control, and basic nuclear weapons information. The fundamentals of the different types of missile guidance are discussed.

Because its distribution is not limited by security regulation, it is necessarily general in nature with minimum reference to actual weapons in current use. Considerable detail is given on the effects of nuclear weapons but not on the construction or operation of the weapons.

The user should bear in mind that this text is not designed for maintenance or for operating personnel, nor for use as a manual on operations or tactics.

The third volume, Navy Missile Systems, NavPers 10785-A, describes specific Navy missile systems, illustrating the application of the principles explained here.

The text and illustrations of this book were prepared by the Training Publications Division, Naval Personnel Program Support Activity, Washington, D. C. 20380, for the Bureau of Naval Personnel. Credit for technical assistance is given to the Bureau of Naval Weapons, Officer Candidate School, Newport, R. I., NROTC Unit, University of Texas, Austin, Texas, and NROTC Unit, University of Oklahoma, Norman, Oklahoma.

Original Edition 1959
Revised 1966

THE UNITED STATES NAVY

GUARDIAN OF OUR COUNTRY

The United States Navy is responsible for maintaining control of the sea and is a ready force on watch at home and overseas, capable of strong action to preserve the peace or of instant offensive action to win in war.

It is upon the maintenance of this control that our country's glorious future depends; the United States Navy exists to make it so.

WE SERVE WITH HONOR

Tradition, valor, and victory are the Navy's heritage from the past. To these may be added dedication, discipline, and vigilance as the watchwords of the present and the future.

At home or on distant stations we serve with pride, confident in the respect of our country, our shipmates, and our families.

Our responsibilities sober us; our adversities strengthen us.

Service to God and Country is our special privilege. We serve with honor.

THE FUTURE OF THE NAVY

The Navy will always employ new weapons, new techniques, and greater power to protect and defend the United States on the sea, under the sea, and in the air.

Now and in the future, control of the sea gives the United States her greatest advantage for the maintenance of peace and for victory in war.

Mobility, surprise, dispersal, and offensive power are the keynotes of the new Navy. The roots of the Navy lie in a strong belief in the future, in continued dedication to our tasks, and in reflection on our heritage from the past.

Never have our opportunities and our responsibilities been greater.

CONTENTS

CHAPTER		Page
PART I. —GUIDED MISSILES		
1.	Introduction to guided missiles	1
2.	Factors affecting missile flight	24
3.	Components of guided missiles	51
4.	Missile propulsion systems	69
5.	Missile control components and systems	97
6.	Principles of missile guidance	145
7.	Command guidance	169
8.	Beam-rider guidance	181
9.	Homing guidance	205
10.	Other guidance systems	225
11.	Guided missile ships and systems	249
PART II. —NUCLEAR WEAPONS		
12.	Fundamentals of nuclear physics	268
13.	Principles of nuclear weapons and their handling	290
14.	Effects of nuclear weapons	302
APPENDIX		
A.	Table of atomic weights and bibliography	345
B.	Glossary	347
INDEX	359

PART I.-GUIDED MISSILES

CHAPTER 1

INTRODUCTION TO GUIDED MISSILES

GENERAL

DEFINITION

A **GUIDED MISSILE** is an unmanned vehicle that travels above the earth's surface; it carries an explosive warhead or other useful payload; and it contains within itself some means for controlling its own trajectory or flight path. A glide bomb is propelled only by gravity. But it contains a device for controlling its flight path, and is therefore a guided missile.

The Navy's guided missiles, including Terrier, Tartar, Talos, Sidewinder, Sparrow, Bullpup, and Polaris, meet all the requirements of the above definition.

The Army's Honest John (now obsolete) is a 3-ton rocket that is capable of carrying a nuclear warhead. Because it contains no guidance system, Honest John is not a guided missile. The Navy's homing torpedoes are self-propelled weapons with elaborate guidance systems. The homing torpedo can hunt for a target and, when it finds one, steer toward it on a collision course. Because it does not travel above the earth's surface, the homing torpedo is not a guided missile.

A **MISSILE** is any object that can be projected or thrown at a target. This definition includes stones and arrows as well as gun projectiles, bombs, torpedoes, and rockets. In current military usage, the word **MISSILE** is gradually becoming synonymous with **GUIDED MISSILE**. It will be so used in this text; we will use the terms **MISSILE** and **GUIDED MISSILE** interchangeably. This permits inclusion of the Asroc, which is not a guided missile, but is a missile, an important one in ship missile weapon systems. Another missile is Subroc, which is fired underwater from a torpedo tube, is guided during its air flight, returns to the water, and acts as a depth charge.

SCOPE OF THE TEXT

Part I of this book is a brief introduction to the basic principles that govern the design, construction, and use of guided missiles. Part II deals with nuclear weapons. Many of the principles we will discuss apply to all missiles; most of them apply to more than one. The treatment will necessarily be general. Security requirements prevent any detailed description of specific missiles in an unclassified text. This text will therefore contain very little information about specific missiles; they will be described in some detail in a supplementary volume, Navy Missile Systems, NavPers 10785-A.

The reader will find some repetition in this text; this is intentional. The subject is complex; it deals with many different phases of science and technology. The beginning student of guided missiles faces a paradox. We might say that you can't thoroughly understand any part of a guided missile unless you understand all the other parts first. We will deal with this problem by first discussing the guided missile as a whole, with a brief consideration of its propulsion, control, guidance, and launching systems. Each of these subjects will then be treated at some length in one or more later chapters.

All guided missiles contain electronic devices; some of these devices are very complex. A sound understanding of the operating principles of missile guidance is very difficult without some background in basic electricity and electronics. Students who have no background in electronics should use Introduction to Electronics, NavPers 10084; it should, if possible, be supplemented by further reading in basic texts on electricity and electronics.

PRINCIPLES OF GUIDED MISSILES AND NUCLEAR WEAPONS

WEAPONS SYSTEMS

The missiles alone are useless for defense or offense without the remainder of the weapons system. A weapons system is vitally dependent on search radar inputs, command and control devices, and power supplied from other equipments. A missile weapons system consists of a weapon direction system, one or more fire control systems, the launching system, and the missiles. The missiles may be all of one type or there may be two or more types in the system on a ship.

A mere listing of the components of a weapons system would be rather lengthy. Many trained men are needed to operate the various parts. The coordination and cooperation required to make all components and personnel work together properly is not a simple task. It requires a thorough knowledge of the interrelationship and interactions involved. Intensive technical training is necessary for the technicians who operate and maintain the equipment, each in his own specialty. A network of communication facilities is necessary for communication between the men operating the different units.

Officers must have a good background knowledge of how a weapons system operates, and the interaction and dependence of the various parts. This book will not describe the components of a weapons system, other than the missiles, nor their functioning. Officer texts and correspondence courses are available for specialty study, such as Combat Information Center Officer, NavPers 10823-B.

PURPOSES AND USES OF GUIDED MISSILES

The primary mission of our Navy is control of the seas. We propose to keep the sea lanes open for our own and for friendly commerce; in time of war, we propose to deny use of the sea to our enemy. Historically, this mission has been accomplished by the use of warships armed with the most advanced weapons of their time. When John Paul Jones challenged the British control of the seas, his warships carried guns having an effective range of a few hundred yards. In the Civil War, the Union Navy maintained a successful blockade of southern ports with the help of guns that could shoot a little more than a mile. The battleships of World War I carried rifled guns with an effective range in the order of 15 miles. When aircraft became more effective weapons than guns, in both range and striking

power, aircraft became the primary weapon of the Navy. The battle of the Coral Sea, in 1942, was the first major naval engagement in which surface ships did not exchange a single shot.

When a navy so controls the seas that it can safely approach the enemy coast, it can extend its striking power inland to the distance its weapons can reach. A heavy cruiser can bombard enemy installations about 15 miles inland. Carrier-based aircraft extend the Navy's force for hundreds of miles over enemy territory. Thus, during the Korean War, the whole of North Korea was subject to attack by carrier-based aircraft of the U. S. Navy.

The Navy's Regulus guided missile had a range comparable to that of a carrier-based aircraft. It was designed so it could also be launched from a submarine, even where we did not control the surface of the sea. Although Regulus is being phased out, it gave valiant service as a forerunner of Polaris. Some of the missiles will be used as drones for training purposes.

The Polaris missile, called the Fleet Ballistic Missile (FBM), also submarine-launched, extends the Navy's striking power far inland. Early models of the Polaris had a range of 1500 miles; advanced Polaris has a range of about 2500 miles. With such a range, even the most remote place on earth can be reached by its fire power, while the submarine that fires it remains submerged, undetected by the enemy.

One of the strongest elements in our national defense is the Strategic Air Command (SAC), which can launch a devastating nuclear attack against any enemy within a few minutes after notice. But SAC bases are large, and expensive to build and maintain. Their position is known to our possible enemies. At the outbreak of war, they would probably be the first objective in a surprise attack.

The intercontinental ballistic missile (ICBM) carries a nuclear or thermonuclear warhead. It can reach its target on another continent within minutes after launching. It can approach the target at such a speed that any countermeasures may be very difficult. Its shore-based launching sites are small, relatively cheap to build and maintain, and relatively easy to conceal. Because they can be widely dispersed, they are difficult to attack even if their location is known. ICBMs launched from shipboard would have a mobile base, of course, which could be maneuvered as necessary to evade the enemy or to come within range of the target.

Chapter 1—INTRODUCTION TO GUIDED MISSILES

The ICBM does not face the problem of returning safely to friendly territory after completing its mission, for guided missiles are expendable by design, while our strategic bombers and their crews are not. SAC has been supplemented by the ICBM.

An Intercontinental Ballistic Missile (ICBM) has a range of over 3000 nautical miles. In this class are the Atlas (5500 to 9000 nautical miles), Minuteman (over 5000 nautical miles), and Titan (about 5000 nautical miles). These missiles were developed by the Air Force, and are shore-launched.

An Intermediate Range Ballistic Missile (IRBM) has a range up to 1500 nautical miles. This term is now applicable only to Thor and Jupiter, both of them Air Force Missiles, and both being phased out.

Some missiles have a range in the interval 500 to 3000 nautical miles. The Navy's Regulus I is in this range group. Its successor, the Polaris, has a greater range, but is still in this group. Hound Dog, Mace, and Matador are Air Force missiles in this range.

Each of the services has several short-range missiles that are operational. The Navy missiles in this group include Bullpup, Sidewinder, Sparrow III, Talos, Tartar, and Terrier. Others are under development. One of the aims in the development of advanced types of missiles is to increase their range as well as their accuracy and dependability.

Modern military aircraft can fly so high and so fast that conventional antiaircraft guns are ineffectual against them during high flights. As you know, a gun is not aimed directly at a moving target; it must be so aimed that both the projectile and the target will reach a predicted point at the same time. During the flight time of the projectile, a high-speed aircraft will travel several miles. The projectile cannot change its trajectory after it is fired; the aircraft can, and a slight change of course can take it beyond the lethal range of the projectile burst.

The surface-to-air guided missile can intercept attacking aircraft at greater heights and greater ranges than any projectile. If the aircraft changes its course or takes evasive action to escape the missile, the guidance system of the missile will change its course accordingly to follow the aircraft up to the instant of interception.

Aircraft attacking a ship headon, or low-flying slower speed aircraft and helicopters used for strafing and spotting, could come within range of

the AA guns if not brought down by missiles. High-speed aircraft flying at low altitudes (possibly to avoid radar detection and tracking) are susceptible to AA guns and conventional gunfire.

Guided missiles are becoming increasingly important in aircraft armament. When two jet aircraft are approaching each other head-on, the range closes at a speed between one-half and one mile per second. Under these conditions it is difficult even to see an enemy aircraft, and hitting it with conventional aircraft weapons is largely a matter of luck. But the air-to-air missile can "lock on" the hostile aircraft while it is still miles away, and can pursue and hit the target in spite of its evasive maneuvers.

The defense of a naval task force against air attack is somewhat similar to that of defending an American city or industrial area against air attack. The enemy attack will be detected by long-range search radar while the attacking planes are hundreds of miles from the target. Ashore, the early warning radars, called Ballistic Missile Early Warning System (BMEWS), are located at distant outposts in Canada and Alaska. At sea, they are aboard picket ships at some distance from the main body of the task force. The first line of defense will probably be interceptor aircraft, which will attack the enemy planes with air-to-air missiles. A second line of defense may consist of moderate range surface-to-air missiles, which will intercept the attacking planes at ranges from about 20 to more than 65 miles. A third line would consist of shorter range missiles, designed to intercept at ranges between about 5 and 20 or 30 miles, and anti-aircraft guns with ranges up to 10 miles.

Protection against underwater attack is afforded by missiles, such as Asroc, homing torpedoes, and depth bombs, all of which are included in the antisubmarine warfare (ASW) arsenal. A study of the statistics of submarine devastation in past wars might convince you ASW is more important than anti-air warfare. Although there is a difference of opinion as to the relative importance of these two types of defenses, the Navy has not neglected either one. We have antisubmarine weapons to be dropped from airplanes, to be fired from surface ships, and to be fired from submarines.

Because the defense system outlined above is formidable, it is improbable that enemy aircraft will try to bomb our cities, or attack a task force with bombs or torpedoes. Enemy attacks are more likely to be with air-to-surface missiles, launched at a range of perhaps a hundred

PRINCIPLES OF GUIDED MISSILES AND NUCLEAR WEAPONS

miles or more, and submarine or surface-fired missiles.

The question remains: how do we defend ourselves against enemy intercontinental ballistic missiles, air-to-ground missiles, and submarine-launched missiles? We must assume that the enemy has weapons as swift and lethal as ours. The early mods of Nike and Terrier missiles were designed to shoot down jet aircraft. They were swift enough for that, but with the development of ICBMs, which can be launched from foreign shores, or possibly from hidden submarines, defense requires shooting down the missiles launched by our enemies. The answer is antimissile missiles. They must be capable of launch on very short notice, extremely fast, and extremely maneuverable. They can be relatively small, just big enough to explode the enemy missile high in the air (or in the water) before it can reach its target. Such antiballistic missiles (ABMs) are being developed and means are being explored for rendering enemy missiles ineffective within range of our shores or ships.

When the antimissile missile becomes operational, it will probably lead to further developments. Our aircraft carry air-to-air missiles for defense against enemy aircraft; an intercontinental ballistic missile might carry air-to-air missiles for defense against other missiles. These might be called anti-antimissile missiles, though if we have the ingenuity to develop such weapons we may be able to think of a shorter name for them.

Such speculations about the future are not very instructive. But this prediction is safe: the effort to develop faster and better missiles, and the race between missiles and missile countermeasures, will continue as long as the threat of war exists, or until some new and unforeseen weapon makes guided missiles obsolete.

INTRODUCTION TO MISSILE TYPES

To perform the various functions outlined above, missiles of many different types must be developed. A list, later in this chapter, will show the number of missile types now operational or in various stages of development. It can be assumed that other missiles, not yet announced, are being developed.

The Navy's Sidewinder is a relatively small air-to-air missile with a range of a few miles. A Sidewinder costs about as much as a good

used car. It resembles an ordinary aircraft rocket; it differs, of course, in having a guidance system, and movable control surfaces by which the guidance system can control its flight path. At the other extreme, the ICBM has a range of thousands of miles, with size and weight in proportion; its proportional cost is even higher. The ICBM, like most missiles, has the familiar rocket shape. Some of the earlier missiles resembled conventional aircraft; they differed from aircraft in having a guidance system rather than a pilot. They were designed to dive into their targets rather than release a bomb load and return.

Guided missiles are classified in a number of different ways, perhaps most often by function, such as air-to-air, surface-to-air, or air-to-surface. The new designation symbols for missiles and rockets classify them according to the launch environment (R for ships), mission (G for surface attack; U for underwater attack), and vehicle type (M for missile).

A nonballistic missile is propelled during all or the major part of its flight time; the propulsion system of a ballistic missile operates for a relatively short time at the beginning of flight; thereafter, the missile follows a free ballistic trajectory like a bullet (except that this trajectory may be subject to correction, if necessary, by the guidance system). Some missiles are designed to travel beyond the earth's atmosphere, and reenter as they near the target. Others depend on the presence of air for proper operation of the control surfaces, the propulsion system, or both.

Missiles may be further classified by type of propulsion system, such as turbojet, ramjet, or rocket; or by type of guidance, such as command, beam-riding, or homing.

INTRODUCTION TO MISSILE GUIDANCE

The missile guidance system keeps the missile on the course that will cause it to intercept the target. It does this in spite of initial launching errors, in spite of wind or other forces acting on the missile, and in spite of any evasive actions that the target may take. The guidance system may be provided with certain information about the target before launching. During flight it may receive additional information, either by radio from the launching site or other control point, or from

Chapter 1—INTRODUCTION TO GUIDED MISSILES

the target itself. On the basis of this information, the guidance system will calculate the course required to intercept the target, and it will order the missile control system to bring the missile onto that course.

From the paragraph above, it might be inferred that the guidance system is an intelligent mechanism that can think. This, of course, is untrue. The missile guidance system is based on a relatively simple electronic computer. But even the most complex computers, such as Univac and other "giant brains," cannot think. Thinking is a conscious process, confined to man and few of the higher animals. No matter how complex it may be, a computer is simply a machine built so that when certain things happen, certain other things will result. The design of a computer is nothing more than an advanced exercise in the logic of cause and effect. A computer can take no action that isn't built into it by its designer (except, of course, the erratic action that might result from a bad connection or a faulty component).

In the later chapters of this text you will find statements such as this: "When Terrier detects an AM signal, it knows it is off the beam center, but it does not know, from the AM signal, which way to go to get back to beam center." We make such statements without further apology, but it is essential that the students understand what we are doing. We are using a convention, because it saves time and space. Remember that a missile doesn't "know," or "see," or "think," or "decide."

Several distinct types of guidance are possible; a given missile may use one type, or a combination of two or more. These types include preset, homing, command, beam-riding, and inertial guidance, besides some less-known ones such as celestial, celestial-inertial, terrestrial-reference, and stellar guidance systems.

Although it cannot be called a guided missile, the air-steam torpedo has a simple guidance system. Before launching, its gyro is set for a predetermined course; the gyro holds the torpedo on that course throughout its run to the target. The torpedo is capable of steering itself, but it receives no information after the instant of launching. This is **PRESET** guidance. The German V-1 is another example. Before launching, it was set to follow a given course, and to dive on its target after traveling a preset distance.

The German V-2 used a combination of preset and **COMMAND** guidance. Before launching, it was set to climb vertically for a certain distance, and then turn onto the desired course. Speed and position of the V-2 were determined by a radar at the launching site. This information was analyzed by a computer, which determined when the missile had reached a position and speed that would carry it, along a ballistic trajectory, to its target. At that instant, the missile propulsion system was shut down by radio command.

The Army's Nike surface-to-air missile is a more modern example of command guidance. Throughout the missile flight, radars at the launching site track both the missile and its target. A computer continuously calculates the course that the missile must follow to reach the point of intercept. Throughout its flight, Nike is steered along the desired course by radio commands from the ground.

Sidewinder has a **HOMING** guidance system, sensitive to infrared (heat) radiation. It will steer itself toward any strong source of infrared. The exhaust of a jet aircraft is such a source, and Sidewinder can steer itself "right up the tailpipe" of an enemy jet.

Infrared is not the only basis for homing guidance. A missile can be designed to home on light, radio, or radar energy given off by, or reflected from, the target. It could also, like a homing torpedo, be designed to home on a source of sound waves; but because a guided missile travels at from one to a dozen times the speed of sound, such a system would not be practical. However, sound waves are used for detecting underwater targets. The word "Sonar" means Sound Navigation and Ranging systems, and includes all types of underwater sound detection devices. The Asroc torpedo uses sonar detection in its underwater phase.

Because its source of information is energy given off by the target itself, Sidewinder guidance is an example of **PASSIVE** homing. Other missiles carry a radar transmitter, "illuminate" the target with a radar beam, and home on the radar energy reflected from the target. This is an **ACTIVE** homing guidance system. A **SEMI-ACTIVE** system is also possible; the target is illuminated by a radar beam from the launching site or other control point, and the missile homes on energy reflected from the target.

The Navy's Terrier is similar to Nike in both function and performance; but its guidance

PRINCIPLES OF GUIDED MISSILES AND NUCLEAR WEAPONS

system is entirely different. Terrier uses BEAM-RIDER guidance. A radar transmitter at the launching site keeps a narrow beam of radar energy continuously trained on the target. Terrier simply rides up the beam.

Intermediate-range (around 1500 miles) and long-range (3000 miles or more) missiles may use a NAVIGATIONAL guidance system. The missile determines its own position in relation to the target, calculates the course required to reach the target position, and steers itself along that course. A missile may be designed to navigate with the help of radio or radar beacons, just as a ship may navigate with the help of Loran. A missile may navigate by dead reckoning, through the use of an INERTIAL guidance system. It may navigate by taking star fixes through a telescope (celestial navigation), or by examining the ground with radar and comparing what it sees with a map. Or it may use a combination of two or more of these methods.

As previously stated, a missile may have more than one type of guidance system, and switch from one to another during its flight. For example, a long-range missile may climb to a preset height and turn onto a preset course shortly after launching, then navigate to the target vicinity, and finally home on the infrared or other energy given off by the target. Or a surface-to-air missile may ride a radar beam until it gets near the target, then switch over to homing guidance.

COMPONENTS OF GUIDED MISSILES

In the course of the discussion thus far, some of the components of guided missiles have been mentioned. Every missile has a framework, called the airframe, to contain the components. In the airframe is the warhead, the propulsion system (including the fuel), guidance system, control system, and an auxiliary power system. Chapter 3 defines each component; fuller descriptions are given in other chapters. Each system has many parts, some of them intricate and delicate, with a network of electrical, hydraulic, and mechanical connections linking all parts. The next section describes the development of some of the components and ways in which the changes affected the missiles. The improvement of missiles is a continuing process to increase the reliability, simplicity, range, and lethality of the weapons. As significant improvements are achieved, older missiles are phased out and new ones are installed.

HISTORY OF GUIDED MISSILES

INTRODUCTION

The brief sketch that follows will enable the student to view the present day guided missile in a historical perspective, and to consider the most recent developments in their relation to early experiments. It serves no other purpose; it is not necessary to memorize the dates listed here.

Guided missiles, as defined at the beginning of this chapter, were first used in World War II. But they could not have been built at that time without previous experiments in both propulsion systems and guidance. We will look briefly at early developments in both of those fields. Our latest missiles, of course, are based also on developments in many other fields, including mass production techniques, metallurgy, aerodynamics, radar, and electronic computers; but we cannot describe the evolution of those developments here.

PROPULSION SYSTEMS

Weapon propulsion systems are usually classified as gun type, reaction type, and gravity type. Gun type propulsion systems are also called impulse propulsion systems and include all weapons in which a projectile is ejected from a container, such as a gun barrel or a launching tube. The only application of this type of propulsion in missiles is for the "ship-clearing" portion of the journey of some missiles and torpedoes.

Older type glide bombs and other gravity-powered missiles are obsolete. Although propeller-driven aircraft, under radio control, have been used as target drones, a propeller-driven guided missile would be too slow to be effective. Most current missiles depend on some form of jet or rocket propulsion (reaction type propulsion system). An exception is the Walleye, a glide bomb type under development.

The development of present day guided missiles was dependent on the development of jet propulsion, although the experimental work was done for the purpose of developing a jet engine for planes.

In France, in 1909, Guillaume outlined the basic theory of turbojet propulsion. In 1927, the Italian Air Ministry built and tested a plane driven by a form of mechanical jet propulsion. The fuselage of this plane was shaped like a

Chapter 1—INTRODUCTION TO GUIDED MISSILES

tube, with flaring ends. A conventional propeller was mounted in the throat of the tube, forming a "ducted propeller" installation. This craft had good maneuverability and good stability, but in other respects its performance was poor. In 1932, Campini, an Italian, designed and later flew the first plane powered by a thermal jet; it differed from modern jets in using a piston engine, rather than a turbine, as a compressor.

After Campini's successful flight, development of improved jet engines was undertaken in several countries. In England, in 1930, Frank Whittle patented a jet engine based on the principles used in modern jet aircraft. After combustion, the exhaust gases of the jet were used to spin a turbine; the turbine, in turn, drove the compressor. The first successful flight of a turbojet powered aircraft was made in England in May 1941. In the U. S., development of jet engines was turned over to General Electric Company because of its experience with turbine-driven superchargers. At present, nearly every manufacturer of aircraft engines is developing and building turbojet engines.

The pulsejet engine uses the forward motion of the missile or aircraft, rather than a turbine, to compress the air and fuel vapor before combustion. The pulsejet principle was patented by a German engineer in 1930, and further developed by Bleeker, an American, in 1933. The pulsejet engine was much improved by the Germans during World War II, and was used to power their V-1 guided missile.

The ramjet also depends on forward motion for compression, but it differs from the pulsejet in having no moving parts. The basic idea of a ramjet was patented by Rene Lorin, a French engineer, in 1913. This was followed by a Hungarian patent in 1928, and another French patent, by Leduc, in 1933. None of these patents resulted in a workable ramjet engine. The basic ideas were sound; but successful development of a ramjet engine had to wait for extensive data on the behavior of fluids at extremely high speeds. The first successful ramjet flight was made in June of 1945 at the Applied Physics Laboratory of the Johns Hopkins University in the course of developing a power plant for the Navy's Talos missile.

Turbojets, pulsejets, and ramjets all depend on the presence of air for the combustion of their fuel. Consequently, none of them can operate beyond the earth's atmosphere. Rockets, on the

other hand, carry their own source of oxygen for combustion, and they operate even more efficiently in a vacuum than they do in air.

The principle of rocket propulsion has been known for nearly 2000 years. In the Far East, rockets were used in warfare as early as the 13th century. Several western armies used rocket projectiles in the early part of the 19th century, but not very effectively. They seem to have been of more value in frightening the enemy than in doing physical damage. The British used rockets in their attack on Washington in 1812; and in the Star Spangled Banner, Francis Scott Key referred to the "rocket's red glare" during the bombardment of Fort Mifflin. (Some historians believe that the British were using rockets as signals, rather than weapons.) Military interest in rockets lapsed after the middle of the 19th century, because developments in gunnery made gun projectiles superior to rockets in range, and far superior in accuracy.

Among rocket engineers, Robert H. Goddard is known as the "Father of Rocketry." Goddard was born in Massachusetts in 1882. By the time he earned his Bachelor of Science degree in 1908, he was obsessed by thoughts of rockets and rocket propulsion. He believed, quite correctly, that rocket propulsion would be the most suitable means for sending measuring instruments to the top of the earth's atmosphere, and eventually to the moon. Up to that time no one had investigated the physics of rocket propulsion, and no one had worked out the necessary mathematics. Goddard decided to do both.

Before Goddard's experiments, rockets consisted of a quantity of propellant packed in a cylindrical tube. Goddard discovered that by forming the after end of the tube into a smooth, tapered nozzle, he could increase the ejection velocity of the combustion gases eight times without increasing the weight of the fuel. According to Goddard's calculations this would, for a given weight of fuel, drive the rocket eight times as fast and sixty-four times as far.

Goddard was given a Navy commission in 1917, and assigned to the job of improving the Navy's signal rockets. This assignment enabled him to continue his development of rocket theory. After the war he summarized his theories and experience in a paper called A Method of Reaching Extreme Altitudes. This report, published by the Smithsonian Institution in 1920, consisted almost entirely of equations, formulas, and tables, but it contained one statement of general interest. It proposed the idea

PRINCIPLES OF GUIDED MISSILES AND NUCLEAR WEAPONS

of multi-stage or step rockets—that is, one rocket carrying another—and said that by this means a rocket could be sent to the moon, where it could explode a charge of flash powder to make a light visible from the earth.

During the twenties and early thirties, Goddard continued his experiments with the help of a small salary (as professor of physics at Clark University) and grants from the Guggenheim and Carnegie Foundations. His list of accomplishments is impressive. We have mentioned his idea of multi-stage rockets, and his design of the tapered nozzle. He was the first to suggest that a liquid-fueled rocket could provide the sustained thrust necessary for sending a vehicle into space. He was the first to actually launch a successful liquid-fueled rocket. (That was on 16 March, 1926; the rocket reached an altitude of 184 feet.) He proved, first by calculation and later by experiment, that rocket propulsion can be used in a vacuum. He was the first to fire a rocket that traveled faster than sound; he was the first to develop a gyroscopic steering mechanism for rockets; and he was the first to use vanes in the jet exhaust stream to stabilize the rocket during the first phase of its flight.

But Goddard was forced to end his experiments in 1935, for lack of funds. During World War II he again worked for the Navy, this time to develop rockets to aid the takeoff of the Navy's flying boats. He died in 1945. NASA's (National Aeronautics and Space Administration) Goddard Space Flight Center at Greenbelt, Md. is just one of many activities named in his honor.

A group of rocket enthusiasts, inspired by Goddard's experiments, formed the American Rocket Society in 1930. During the thirties this group performed a number of important experiments with rocket motors, but their work was limited in scope by lack of money.

Hermann Oberth is a German counterpart of Goddard. Like Goddard, he worked on the physics and mathematics of rocket propulsion during the first World War. There is good evidence that he independently conceived the idea of multiple-stage liquid fuel rockets. He read Goddard's report shortly after it was published, and in 1923 published a book of his own, called The Rocket into Interplanetary Space. Goddard's principal interest was in scientific exploration of the upper atmosphere, but to Oberth, every improvement in rocketry was simply a step toward the eventual develop-

ment of space ships. Oberth's book discussed the possibility of putting an artificial satellite into orbit around the earth. (Except for a science-fiction story published in 1870, that was the first time this idea had been expressed in print.) Oberth believed that passengers could travel to and from the satellite in smaller "landing rockets." In this way, the satellite could be transformed into a manned space station, which could ultimately serve as a launching point for space ships. Neither Goddard nor Oberth mentioned the possible use of rockets as military weapons.

The German "Society for Space Travel, Inc." was organized in 1927, with Oberth as president and Willy Ley as vice president. (Willy Ley is still probably the world's most popular author on the subjects of rockets, missiles, and space travel.) The society began at once to experiment with liquid-fueled rocket engines. The rockets carried two tanks—one gasoline and one of liquid oxygen. These two liquids had to be fed simultaneously and in the right proportions to the combustion chamber, where they were mixed and burned. Most of the attempted launchings ended in failure, for one of two reasons. First, liquid oxygen is extremely cold; it froze the valves, so that they refused to open or close at the proper time. Second, the combustion temperature was so high that the rocket burned up after a few seconds. In later experiments, the combustion chamber was surrounded by a cooling jacket filled with water. With this model, the society launched a number of rockets that burned for about thirty seconds, and reached an altitude of half a mile or more. The next step was to omit the water from the cooling jacket, and circulate the fuel through the jacket before burning it. When the society tried to launch such a rocket, using gasoline as fuel, it immediately exploded. Ley suggested using ethyl alcohol, slightly diluted with water, in place of gasoline. This system worked very well. The same system and the same fuel combination were later used in the German V-2 missiles, the American Viking rockets, and the rocket-propelled experimental planes X-1 and X-1A.

The Versailles peace treaty (1919) limited the German army to 100,000 men; it was forbidden to have aircraft or antiaircraft guns, or field artillery of more than 3-inch caliber. This may explain why the German army took an early interest in rocket development; the treaty of Versailles didn't mention rockets at all. In

Chapter 1—INTRODUCTION TO GUIDED MISSILES

1932, the army established a small research project under the direction of Captain (later General) Walter Dornberger to develop liquid-fueled rockets for use as weapons. No one in Germany had any experience with rocket propulsion, except the members of the Society for Space Travel. Dornberger visited the society and hired a very young member named Werner von Braun.

The team of Dornberger and von Braun, with a small staff of assistants, began to test rocket motors on an artillery testing range near Berlin. In December of 1934, they succeeded in firing two rockets to a height of about 6,500 feet. This news eventually filtered up to the high command. In 1936, General von Fritsch went to the test range for a demonstration. The general was impressed. The result was a new and much bigger research institute—the Peenemunde Project, which became the center for German research, development, and manufacture of robot bombs. After the war, von Braun came to the United States, where he has become a leader in this field.

GUIDANCE SYSTEMS

The history of guidance systems is short. All of the significant developments are recent, principally because the state of electronics before the nineteen forties was relatively primitive. Many of the pioneers in the fields of missile guidance and propulsion are still actively at work on guided missile development.

The Americans developed a flying bomb called the Bug, during the first World War. It was simply a pilotless aircraft, with a range of about 400 miles. The Bug was ready for production by the middle of 1918, but by that time it was apparent that the war would be over in a few months, and the Bug was never produced. Its accuracy would have been poor; it had no guidance system. But the Bug led to the suggestion that pilotless aircraft could be controlled by radio. Beginning in 1924, both the Army and Navy experimented with radio-controlled planes. Several moderately successful flights were made, with the pilotless plane controlled by radio from a parent plane that flew nearby. This project was dropped in 1932 for lack of money.

In 1935, an American high-school student named Walter Good built and flew a radio-controlled model airplane. This was the first time on record that a plane of any kind had been successfully launched, flown, and landed

while under complete radio control from the ground. One of the problems that plagued the armed forces was stabilization—keeping the aircraft on an even keel so that it could respond properly to radio commands. Because a well-built model airplane is inherently stable, Good didn't have to worry about this problem. His contribution was to design and build a miniature radio receiver coupled to the control surfaces through a miniature servo-system.

The Army and Navy resumed their experiments with radio command during the late thirties, and by 1940 both had developed radio-controlled planes for use as target drones. Missiles with elementary preset and command guidance were used during World War II, but successful beam-riding, radar and infrared homing, and inertial guidance systems are all postwar developments.

Although the Germans had the most spectacular tactical success with guided missiles, our own Government made considerable progress in research on radar homing, aerodynamics, control of glide bombs, and pilotless aircraft. The first homing guided missiles to be used successfully by any nation were flying BAT bombs, launched from Navy planes (fig. 1-1). The code name BAT suggests the principle on which it operated. Like bats, which give out short sound pulses and guide themselves by reflected echoes, the BAT missile was directed by radar echoes from the target. The missile was equipped with a radar transmitter and receiver which enabled it to home on the target. Figure 1-1A shows the BAT mounted in a glider type of airframe.

The Azon missile (fig. 1-1B) was controlled in AZimuth ONLY. It was a standard 1000-lb bomb fitted with an extended tail that carried a flare, a radio receiver, a gyro stabilizer to prevent roll, and rudders for steering right and left. This air-launched missile was used with great success in destroying bridges, canal locks, and similar targets.

The Felix bomb (fig. 1-1C) was automatically guided by means of an infrared homing device located in its nose. WW II ended before it was used in combat.

The Roc missile (fig. 1-1D) combined television equipment for transmitting a picture of the target to the launching plane and a radio-control system for guiding the missile. This was the first use of television as a method of guidance. The TDN, a Navy missile used against the Japanese sea targets and some shoreline

PRINCIPLES OF GUIDED MISSILES AND NUCLEAR WEAPONS

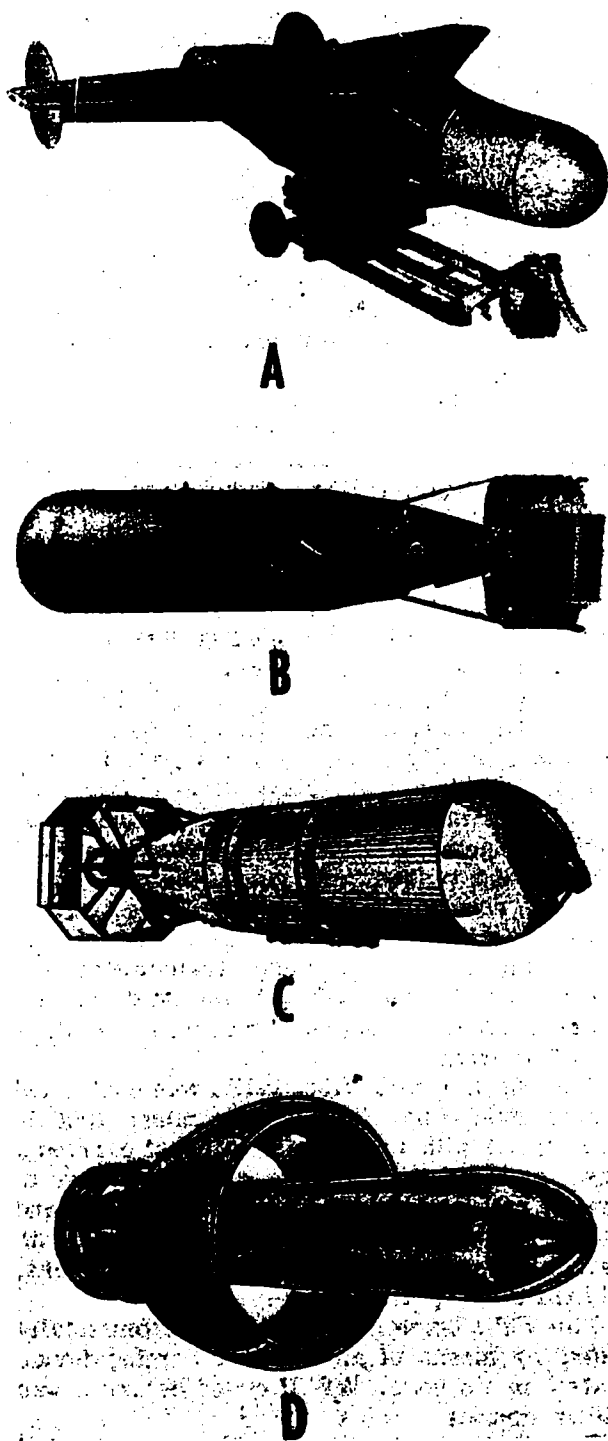

33.2-.5
Figure 1-1.—Early types of guided missiles:
A. Bat, radar guided; B. Azon, radio command
guidance; C. Felix bomb, infrared homing
guidance; D. Roc missile, radio-control and
television guidance.

targets in the South Pacific, also used television-radio command guidance. The Navy's air-to-surface guided bomb, Walleye, uses TV contrast homing guidance.

GUIDED MISSILES IN WORLD WAR II

During World War II, the Japanese developed and used two devices of interest in the history of guided missiles. One of these was an air-launched, radio-controlled, rocket-assisted glide bomb. Its performance was limited. It had to be launched from a plane at low altitude, within two and a half miles of the target. This made the launching planes highly vulnerable to antiaircraft fire, especially after we began to use the proximity fuze. The Japanese dropped this project before the end of the war.

The second Japanese missile was the Baka bomb. This was a rocket-propelled glide bomb designed for use against shipping. It carried a human suicide pilot; for this reason we can't call it a true guided missile. The Baka bomb had poor maneuverability, and because of this we were able to shoot down a great many of them with antiaircraft fire.

Of the guided missiles used during World War II, those made by the Germans were the most advanced, and the most effective. The V-1 was developed early in the war, and was successfully flight tested at Peenemunde as early as the spring of 1942. By 1943, the Peenemunde center was working on 48 different antiaircraft missiles. The work was later consolidated into 12 projects in an effort to get the missiles into production in time to influence the outcome of the war.

The V-1 was a robot bomb—a pulsejet mid-wing monoplane with a conventional airframe and tail construction. It used gyro stabilization and preset compass guidance. It was launched from a ramp with the help of boosters, and had to reach a speed of about 200 mph before its engine developed enough thrust to keep it airborne. Their 1-ton warheads did serious damage, but the V-1 missiles were slow. After proximity fuzes were rushed to England to combat them, about 95% of them were brought down by antiaircraft fire.

The V-2 was a large missile, propelled by liquid-fuel rockets. Its total weight at launching was over 14 tons, including a 1650-pound warhead. It was launched vertically, and preset to tilt over to a 41- to 47-degree angle a short time after launching. When it reached a speed

Chapter 1—INTRODUCTION TO GUIDED MISSILES

calculated to take it to the target, its propulsion system was shut down by radio command, and it then traveled a ballistic trajectory. Its accuracy was not high, and its maximum range was only about 200 miles. But it descended almost vertically on its target, at speeds of from 1800 to about 3300 mph. No V-2 missile was ever intercepted, or shot down by anti-aircraft fire. Because it was supersonic, it would hit the target before it was heard approaching.

Five other German missiles which were in various stages of final testing when the war ended, are worth a brief mention:

Rheinbote was a surface-to-surface missile propelled by a three-stage rocket, with booster-assisted take-off. It reached a speed of over 3200 mph about 25 seconds after launching, and had a range of about 135 miles.

Wasserfall was a supersonic surface-to-air missile, propelled by a liquid-fuel rocket guided by radio command; speed: 560 mph; range: 30 miles.

Schmetterling was a smaller version of Wasserfall, intended for use against low-altitude targets at ranges up to 10 miles. It carried a 55-pound warhead.

Enzian was another surface-to-air missile, designed for use against large bomber formations. It was propelled by a liquid-fuel rocket, and was launched with four solid-fuel booster rockets.

The X-4 was an air-to-air missile designed for launching from fighter aircraft as shown in figure 1-2. It was propelled by liquid-fuel rockets and stabilized by four fins placed symmetrically. Its range was 1-1/2 miles; speed 560 mph at an altitude of 21,000 ft. The X-4 was guided by commands from the launching aircraft, through a pair of fine wires that unrolled from two coils mounted on the tips of the missile fins.

Several missiles developed in the United States were mentioned above with regard to their guidance systems. The Army Air Corps began the development of guided glide bombs in 1941. These included Azon, Razon, Tarzon, and Roc. Roc and Tarzon, controlled in azimuth and range, were developed during WW II but were not used in combat. Tarzon was used successfully during the Korean war.

In 1944, we carried out a glide-bomb mission against Cologne, Germany, and a majority of the bombs reached the target area. In this same year, aircraft were used to control television-sighted, explosive-laden bombers (called "Weary Willies") unfit for further service. These radio-controlled bombers saw some service over Germany.

Our first jet-propelled missile was a radio-controlled flying wing of the GORGON series of missiles; a later version was a copy of the German V-1, with a few improvements.

By the end of WW II, the Navy had a number of guided missile projects in various stages of development. The Gargoyle was an air-launched, liquid-rocket engine powered, radio-controlled glide bomb with a flare for visual tracking. Another Navy glide bomb, the Glomb, carried a television monitor through which the pilot of the launching aircraft could observe its approach to the target; it was guided by radio command. The Loon was a U. S. Navy version of the German V-1, intended for shore bombardment. The Gorgon IIC was propelled by a ramjet engine, tracked by radar, and guided by radio command. In 1944, the Navy assigned development of the Bumblebee project to the Applied Physics Laboratory of the Johns Hopkins University. This project has produced Terrier, Talos, and Tartar.



Figure 1-2.—Launching an X-4 missile with wire guidance.

PRINCIPLES OF GUIDED MISSILES AND NUCLEAR WEAPONS

Missile developments after World War II

As we have shown, the principal guided missile developments during World War II were German; the United States lagged far behind. Japanese and British missile developments were insignificant, and as far as we know, the Russians had none at all. In 1945, the Russians captured most of the production engineers and technicians of the V-2 project, as well as several tons of missile data and perhaps a few V-2 missiles. The design staff of the Peenemunde project, including von Braun and his principal assistants, surrendered to the Americans rather than to the Russians. We captured and shipped to the proving ground at White Sands, New Mexico, enough intact V-2s and spare parts to make, eventually, about 70 complete missiles.

During the first few years after the war, both American and Russian missile effort was partially devoted to assimilating the German developments. Our own experiments with the captured V-2s provided valuable training for launching crews, and valuable knowledge of missile engineering. Our "V-2 Program" ran from March 1946 to June 1951. One of its principal successes was a high-altitude record of 250 miles, achieved by a WAC-Corporal missile boosted by a V-2. This record stood for many years.

Postwar missile development has been rapid. Many missiles are now operational; many others have been abandoned at various stages of development, or rendered obsolete by more advanced weapons. We will not try to cover these developments here; a list of obsolete missiles would be longer than a list of those now current.

CLASSIFICATION OF UNITED STATES MISSILES

GENERAL

Although missiles are popularly known by their names, such as Sidewinder or Terrier, every missile is assigned a designation consisting of letters and numerals. In the designation system used until the recent change (required by DOD Directive 4000.20 and implemented by BUWEPSINST 8800.2), the first

three letters indicated the intended use of the missile:

AAM—air-to-air missile
ASM—air-to-surface
AUM—air-to-underwater
SAM—surface-to-air
SSM—surface-to-surface
UAM—underwater-to-air
USM—underwater-to-surface

These designations will not disappear from use in the immediate future. Publications will not be revised merely to change missile designations, but the new, uniform designations will be used in new and in revised publications. The new designation indicates the launch environment (where launched and from what type of launching device), mission, delivery vehicle type, design number, and series symbol of the missile. Attachment 6 to the BUWEPSINST lists the current designation, former designation, popular name, and service of missiles, rockets, and probes in all the United States services at the time of publication. New missiles and rockets are assigned the next consecutive design number within the appropriate basic mission.

NEW DESIGNATIONS FOR MISSILES

The following table explains the new designations and lists the Navy missiles and rockets with their current and former designations.

The design number is a number assigned to each type of missile with the number "1" assigned to the first missile developed. For example, all five modifications of the Terrier missile (BW-0, BW-1, BT-3, BT-3A and HT-3) have the design number "2". Tartar missile modifications (Basic and Improved Tartar) have the design number "24".

To distinguish between modifications of a missile type, series symbol letters beginning with "A" are assigned. Therefore, the Terrier BW-0 has been assigned the symbol letter "A" and the Terrier BW-1 has been assigned the symbol letter "B". The series symbol letter follows the design number. Incidentally, to avoid confusion between letters and numbers, the letters "I" and "O" will not be used.

If necessary, a prefix letter is included before the military designation. A list of applicable prefix letters is shown at the bottom of the table on the following page.

All Navy missiles are assigned mark (Mk) and modification (Mod) numbers. These numbers

Chapter 1—INTRODUCTION TO GUIDED MISSILES

Navy Missile and Rocket Designations

(Reprinted from Naval Aviation News, September 1963)

LAUNCH ENVIRONMENT SYMBOLS			Popular Name	Current Designation	Former Designation
Letter	Title	Description	Missile Series		
A	Air	Air launched.	Terrier BW-0	RIM-2A	SAM-N-7
B	Multiple	Capable of being launched from more than one environment.	Terrier BW-1	RIM-2B	SAM-N-7
C	Coffin	Horizontally stored in a protective enclosure and ground-launched.	Terrier BT-3	RIM-2C	SAM-N-7
			Terrier BT-3A	RIM-2D	SAM-N-7
H	Silo Stored	Vertically stored below ground level and launched from the ground.	Terrier HT-3	RIM-2E	SAM-N-7
			Sparrow I	AIM-7A	AAM-N-2
L	Silo Launched	Vertically stored and launched from below ground level.	Sparrow II	AIM-7B	AAM-N-3
			Sparrow III	AIM-7C	AAM-N-6
M	Mobile	Launched from a ground vehicle or movable platform.	Sparrow III	AIM-7D	AAM-N-6A
			Sparrow III	AIM-7E	AAM-N-6B
P	Soft Pad	Partially or nonprotected in storage and launched from the ground.	Talos (6B)	RIM-8A	SAM-N-6B
R	Ship	Launched from a surface vessel, such as ship, barge, etc.	Talos (6BW)	RIM-8B	SAM-N-6BW
			Talos (6B1)	RIM-8C	SAM-N-6B1
U	Underwater	Launched from a submarine or other underwater device.	Talos (6BW1)	RIM-8D	SAM-N-6BW1
			Talos (6C)	RIM-8E	SAM-N-6C1
D	Decoy	Vehicles designed or modified to confuse, deceive, or divert enemy defenses by simulating an attack vehicle.	Sidewinder I	AIM-9A	AAM-N-7
			Sidewinder IA	AIM-9B	AAM-N-7
			Sidewinder IC-SAR	AIM-9C	AAM-N-7
			Sidewinder IC-IR	AIM-9D	AAM-N-7
			Ballpup	AGM-12A	ASM-N-7
			Ballpup	AGM-12B	ASM-N-7A
			Ballpup	AGM-12C	ASM-N-7B
			Ballpup Trainer	ATM-12A	ASM-N-7 (Martin-Marietta)
			Ballpup Trainer	ATM-12B	ASM-N-7A (Maxson)
			Hawk	MIM-23A	M-3
			Tartar Basic	RIM-24A	SAM-N-7
			Tartar Improved	RIM-24B	SAM-N-7
I	Intercept-Aerial	Vehicles designed to intercept aerial targets, defensive or offensive.	Polaris A1	UGM-27A	
			Polaris A2	UGM-27B	
Q	Drone	Vehicles designed for target, reconnaissance, or surveillance purposes.	Polaris A3	UGM-27C	
			Firebee	BQM-34A	Q3C
T	Training	Vehicles designed or permanently modified for training purposes.	Firebee	AQM-34B	KDA-1
			Firebee	AQM-34C	KDA-4
U	Underwater Attack	Vehicles designed to destroy enemy submarines or other underwater targets or to detonate underwater.	Firebee	MQM-36A	KD2R-5
			Firebee	AQM-37A	KD2B-1
W	Weather	Vehicles designed to observe, record, or relay meteorological data.	Firebee	AQM-38B	RP-78
			Firebee	MQM-39A	KDB-1
M	Guided Missile	Unmanned, self-propelled vehicles designed to move in a trajectory or flight path all or partially above the earth's surface and whose trajectory can be controlled remotely or by homing systems, or by inertial and/or programmed guidance from within. This term does not include space vehicles, space boosters, or naval torpedoes, but does include target and reconnaissance drones.	XQM-40A		EDCG-2
			Petrel	AQM-41A	AUM-N-2
			Redeye	XMM-43A	
			SUBROC	UUM-44A	
			Strike	AGM-45A	ASM-N-10
			Condor	AGM-53A	ASM-N-11
			Phoenix	ADM-54A	AAMN-11
			Phoenix	FGM-56A	CT-41
			Weapon Alpha	RUR-4A	
			ASROC	RUR-5A	
N	Probe	Non-orbital instrumented vehicles not involved in space missions that are used to penetrate the aerospace environment and report data.	Rocket Series		
			STATUS PREFIX SYMBOLS		
			J Special Test (Temporary)	Vehicles especially configured simply to accommodate test.	
			N Special Test, (Permanent)	Vehicles so modified they will not be returned to original use.	
R	Rocket	Self-propelled vehicles without installed or remote control guidance mechanisms, whose trajectory cannot be altered after launch.	X Experimental	Vehicles under development.	
			Y Prototype	Preproduction vehicles for test.	
			Z Planning	Vehicles in planning stage.	

PRINCIPLES OF GUIDED MISSILES AND NUCLEAR WEAPONS

and the name of the missile constitute the official nomenclature approved by BuWeps. Missiles having two-stage propulsion systems (separate boosters), for instance, the Terrier and Talos, have one Mk and Mod number for the complete round. However, the individual missile and booster sections have their own mark and modification numbers.

All missiles in service, as well as most of those still under development, have been given popular names. Some of these names follow this pattern:

AGM, AIM—Winged creatures. Example: Sparrow, Bat.

RIM—Mythological terms. Example: Talos.

UGM, RGM—Astronomical terms. Examples: Polaris, Regulus.

At the present time, most missiles appear to be exceptions to the above "rules." For example, Sidewinder and Bullpup are not winged creatures; Terrier is not a mythological term; Asroc and Alfa are not astronomical terms.

Many of the air launched missiles are named after birds: Falcon, Quail, Hawk, Petrel, Redhead Roadrunner, Shrike, and Condor. Note that all of these except one (Quail, used as a decoy) are birds of prey marked by characteristics of swift, aggressive action, and therefore appropriate for missile names.

CURRENT U.S. SERVICE MISSILES

GENERAL

Because of the rapid developments in the guided missile field, the lists given below will be out of date before you can read them. Some of the missiles listed may have become obsolete. Others, now under development, will probably be announced.

ARMY MISSILES

Nike-Ajax (MIM) is the Army's first supersonic anti-aircraft guided missile. It is designed to intercept and destroy attacking enemy aircraft regardless of evasive action. Nike guided missile units are now deployed around vital industrial, highly populated, and strategic areas of the United States. Nike-Ajax is about 20 ft. long and 1 ft. in diameter, with two sets of fins for guidance and steering. It is boosted to supersonic speed by a solid-propellant booster, and maintained by a liquid-fuel sustainer motor.

The missile and booster together weigh more than a ton. There are 12 launchers in each Nike battery, which is operated by about 100 officers and men.

Continued developmental work with the Nike missile has resulted in improvements in the original missile. Two mods of the Nike-Hercules, the MIM-14A and MIM-14B, are operational. Batteries of Nike-Hercules (replacing the Nike-Ajax) are deployed in the United States and in Europe (NATO countries only). The Nike-Hercules has a range of about 75 miles and a weight of 10,000 pounds. It is capable of carrying a nuclear warhead; it is designed for use against either single aircraft or whole formations of aircraft. The missile is 27 ft. long; the booster 14-1/2 ft. long. Both use solid propellant. The warhead is provided with a safety feature, so that it can detonate only at altitudes sufficiently high to prevent damage to friendly surrounding terrain.

Nike-Zeus (XLIM) is an antimissile missile equipped with a nuclear warhead, and designed to defend the United States against attack by enemy intercontinental ballistic missiles. It has a 200-mile range and weighs 22,800 pounds. It is more than twice as long and three times greater in diameter than the Nike-Ajax. The "X" in its designation indicates that it is experimental and not yet deployed (at time of this writing).

The Nike-X is under development; it is planned to intercept submarine-launched missiles. The most advanced portions of the Nike-Zeus are used in it.

Hawk (XMIM) is designed to supplement the Nike missile system by destroying attacking aircraft at low altitudes. The launching facilities are sufficiently portable to be used by fast-moving combat troops. Hawk is propelled by a solid-fuel rocket. The missile is about 17 ft. long, and about 14 inches in diameter. It has a 22-mile range and weighs about 1275 pounds. Operational mods are deployed in Europe, Panama, Okinawa, and the U.S.; advanced mods are being produced and tested. Hawk has intercepted Corporal, Honest John, and Little John rockets in flight.

Corporal (MGM) may be equipped with either a nuclear or a conventional warhead. It was the first guided missile capable of carrying a nuclear warhead. It can engage tactical targets at ranges of 75 miles or more. Corporal gives the Army field commander great firepower on the battlefield, and enables him to strike selected

Chapter 1—INTRODUCTION TO GUIDED MISSILES

targets deep in enemy rear areas. Corporal follows a ballistic trajectory during most of its flight; weather and visibility conditions place no restriction on its use. The propulsion system uses a liquid-fuel rocket motor. The missile travels through space at several times the speed of sound. Corporal battalions are now deployed in Europe, but are being replaced by the more potent Sergeant.

Sergeant (XMG) is a single-stage, solid-propellant, ballistic guided missile intended to replace Corporal, with improvements in power, range, and accuracy. It has entirely replaced the first atomic artillery, the 280-mm "Atomic Annie," with 8-inch howitzers firing an atomic shell.

Redstone (PGM) is a supersonic single-stage ballistic missile with a range of about 200 miles, designed to extend and supplement the range and fire power of Army artillery. It is deployed in Europe but is being replaced by Pershing.

The Pershing (XMG) is a two-stage, 10,000-lb solid-propellant missile. It is transported on a tracked vehicle or helicopter. The Pershing has a 400-mile range, compared to the 200-mile range of the Redstone. Its warhead is nuclear; its trajectory is like that of an intercontinental ballistic missile.

Jupiter (PGM) was the Army's intermediate-range ballistic missile (no longer in service as a missile). Its range is in the order of 1500 miles, and it is propelled by a liquid-fuel rocket. In 1956-57 the Navy tried to make it a submarine-launched missile, then decided that the liquid propellant system made it unsuitable for submarine use, and dropped the project to begin development of the Polaris. The Jupiter-C (without the warhead, of course), was used for the Vanguard earth satellite program by providing a back-up satellite launching capability.

Lacrosse (MGM) is used in close tactical support of ground troops. It is an all-weather missile, propelled by a solid-fuel rocket motor, with a maximum range of 20 miles, and capable of carrying warheads highly effective in area-type bombing (rather than pinpoint bombing). It was designed to supplement, and perhaps eventually to replace, conventional artillery. The Lacrosse system includes the missile, a launcher mounted on a standard Army truck, and other ground equipment. It is operational in Europe, but is being phased out of inventory, to be replaced by Lance.

Lance (XMG) was formerly designated Missile B. It will replace the Honest John and Lacrosse. Its range is 3 to 30 miles, and it carries either a nuclear or a conventional warhead. Its high mobility makes it a valuable aid to troops.

Davy Crockett (MGM) may be mounted on a jeep, mechanical mule, or armored personnel carrier, and one version may be carried by two men. It has a sub-kiloton nuclear warhead and is meant as a defensive rather than an offensive weapon.

Redeye is a new development in hand-carried weapons. It is a shoulder-fired, solid-propulsion, heat-seeking missile to be used against low-flying aircraft and helicopters. It is not operational at this time. One model is designed for Marine Corps use.

Honest John (MGR) is an unguided rocket type with a 12- to 20-mile range. It has a nuclear warhead. The Army is replacing it with the Lance. The Marine Corps also formerly used it.

Little John (MGR) has a 10-mile range. It supplements the heavy artillery in airborne divisions and air-transportable commands. It may be replaced by Lance. It may have a nuclear or a high explosive nonnuclear warhead.

The Army has several missiles to be used as drones for target, reconnaissance, or surveillance purposes. Redhead Roadrunner (MQM), Kingfisher (AQM), and Cardinal (MQM) are so used.

Two missiles acquired from the French are the SS-10 (MGM) and the SS-11 (XAGM). Both are wire-guided missiles, principally for anti-tank use.

Other antitank missiles are the Entac (MGM), Shillelagh (XMG), TOW, and M-72 (LAW). The Shillelagh is the first guided missile to be fired from a gun tube from which conventional ammunition can also be fired. It is to be installed on the General Sheridan assault vehicle, and on assault helicopters.

AIR FORCE MISSILES

Matador (MGM) is a tactical missile driven by a turbojet engine at a speed of 650 mph. It has a length of about 40 ft and a wing span of about 29 ft. It can carry a nuclear warhead, and may be guided by radio command or by a navigational system. Its range is more than 650 miles. Tactical missile groups armed with Matador are now deployed in Europe and on

PRINCIPLES OF GUIDED MISSILES AND NUCLEAR WEAPONS

Formosa, but no more Matador missiles are being procured; it is being replaced by Mace.

Falcon (AIM) comes in several versions; one has radar guidance; another has infrared homing; still another has a hybrid infrared radar guidance. Falcon is a supersonic missile, propelled by a solid-fuel rocket. It weighs about 100 pounds; and is about 6 ft long. One model carries a nuclear warhead. At last count, thirteen models were in operational or experimental stages. Its range is about 5 nautical miles.

Genie (AIR) is a rocket-propelled air defense missile that may be armed with a nuclear warhead with proximity fuzing. Note that it is classified as a rocket, and is unguided. It was formerly called Ding-Dong.

Bomarc (CIM) is a long-range air defense missile that can destroy attacking aircraft at ranges of more than 100 miles and altitudes above 60,000 ft. The missile is about 47 ft long, has a wing span of about 18 ft, and weighs about 15,000 pounds. It is launched vertically by solid-fuel boosters, and is sustained in flight by twin ramjet engines. Bomarc B attains a speed of Mach 2.7 and has a range of more than 400 nautical miles and carries a nuclear warhead.

Thor (PGM) is the Air Force's intermediate-range ballistic missile (IRBM). It is propelled by a liquid-fuel rocket at a speed of Mach 10; range is over 1500 miles. Thor is provided with an inertial guidance system.

Thor has been phased out as a missile and is being converted for space boosters. Thor Able, a series of multistage rockets using the Thor missile, has been used for a series of lunar probes and for carrying a recoverable data capsule (containing a mouse) over its 6000-mile flight range.

Atlas (PGM) is an intercontinental ballistic missile with a range of more than 5000 miles. It is launched by rocket engines that develop many tons of thrust, and millions of horsepower, within a few seconds. Atlas reaches a top speed of about Mach 15—more than 10,000 miles an hour. It will descend on its target at that speed, from a height of about 800 miles. This huge liquid-propellant missile is launched vertically from a fixed base. It carries a nuclear warhead. It is being phased out for missile use and being developed as a launch vehicle for the space program. The first Mercury spacecraft to orbit the earth, with Colonel John H. Glenn Jr. aboard, was boosted into orbit by an Atlas booster.

A second liquid-fueled giant is the two-stage Titan. Titan I (HGM) and Titan II (LGM) are intercontinental ballistic missiles. In general, Titan is similar to Atlas, except that Titan has a second-stage motor. It has the greatest payload and range of any of our ICBMs. Titan II is being used for the Gemini spacecraft, which is a three-ton, two-man vehicle planned to rendezvous equipment in space and assemble it, and to test the effect of prolonged weightlessness in man.

One of the most publicized missiles is the Minuteman (LGM). As the name implies, readiness for prompt firing is an important feature. It is called a second generation ICBM, which means that it incorporates many improvements over the first ICBMs, the Atlas and Titan. It is a 5500-mile range, inertially guided, solid-propellant ballistic missile with three stages. Numbers of Minuteman missiles are deployed in hardened and dispersed silos. Once set up and checked out, the missile is ready to fire at a moment's notice, requires very little supporting equipment, and is able to stand by, ready to fire, for long periods of time with very little maintenance. Minuteman II has an improved guidance and control system and an improved reentry vehicle.

Two types of the Mace are used by the Air Force, one launched from a mobile base (MGM) and one from hard sites (CGM). Both types are deployed at sites. It is an air-breathing surface-to-surface missile with inertial guidance. It is turbojet powered and may have either a conventional or a nuclear warhead. The B model has a 1200-mile range. Its predecessor was the Matador. The recoverability of training missiles was demonstrated with the Mace.

Quail (ADM) is an air-launched decoy designed to confuse enemy defenses. It is deployed at SAC bases, to be carried by B-52s. Its range is about 200 miles; the turbojet powered advanced version has a range of about 400 miles.

Hound Dog (AGM) is launched by intercontinental bombers. It is an air-breathing, air-to-surface standoff missile with a range of over 500 nautical miles. The B version has a nuclear warhead, and is turbojet powered.

Missiles that are used by the Air Force and the Navy are Bullpup, Sidewinder, Sparrow III, and Shrike. These are described in the next section.

In the process of developing and perfecting missiles, some are dropped from the program. Two examples are the Snark, begun about the

same time as the Matador, and the Rascal. The Snark was actually a pilotless aircraft and the Rascal was a rocket-powered missile.

NAVY MISSILES

Sidewinder (AIM) (fig. 1-3) is probably the simplest and cheapest of all guided missiles. It is about 9 ft long, and weighs about 155 pounds. It has only about 24 moving parts, and no more electronic parts than a table radio. It attains a speed of Mach 2 relative to the launcher, and a range of several miles; it is designed to destroy high-performance aircraft from sea level to altitudes above 50,000 ft. It has an infrared homing system. Sidewinder was named after a desert rattlesnake. (The Sidewinder snake, like all of the pit vipers, has infrared receptors on its head that enable it to detect the presence of prey by its body heat.) Sidewinder is now the primary airborne missile used by squadrons in the Sixth Fleet in the Mediterranean, and the Seventh Fleet in the Western Pacific. The Sidewinder-1C version has an improved rocket motor and has switchable guidance, infrared or radar-guided. The physical appearance of the improved Sidewinder is very similar to that of its predecessors but its performance is quite different. The Air Force also uses the Sidewinder missile.

Sparrow I (AIM) is 12 ft long and weighs 300 pounds; it reaches a speed of Mach 2.5 relative to the launcher, within a few seconds after launching. It is provided with beam-rider guidance, and is propelled by a solid-fuel rocket. Navy planes can carry two to four of the missiles, and can fire them singly or in salvos.

Sparrow II (AIM) was developed as an experimental missile, and not intended to become operational. It has, however, been adopted for operational use by the Royal Canadian Air Force.

Sparrow III (AIM) is very similar to Sparrow I, but with a much more sophisticated semi-active CW homing guidance system. It is slightly heavier than Sparrow I, a little faster, and has a longer range. It will first supplement, and then replace Sparrow I in the fleet.

Sparrow III (AIM) is also used by the Air Force. Several versions of Sparrow III are in use, and research is continuing to improve the missile further. Temperature-resistant explosives, greater seeker sensitivity, greater range, higher maximum altitude, increased re-



144.1
Figure 1-3.—Pilot in high-altitude flight suit stands beside the Sidewinder missile.

sistance to countermeasures, and longer electrical power burn time are improvements included in the Sparrow III.

Petrel (AQM) is newly obsolete; although a few of these missiles may still be found in the

PRINCIPLES OF GUIDED MISSILES AND NUCLEAR WEAPONS

fleet, they are no longer in production. Petrel is a subsonic missile with radar homing, powered by a turbojet engine. Its payload is not a warhead, but a homing torpedo. As its designation indicates, it is now used as a drone.

Bullpup (ASM) is 11 ft long and weighs about 540 pounds. It is relatively inexpensive, simple in design, and extremely accurate. Bullpup is a tactical missile with a conventional warhead, designed for use by carrier-based aircraft against small targets such as pillboxes, tanks, and truck convoys, in support of ground troops. It is powered by a solid-fuel rocket, and has a range of 15,000 ft at a speed of Mach 2.

Bullpup B is a big brother version of the original missile. It is longer, heavier, faster (with a consequently greater range) and carries a 1000-lb warhead instead of a 250-lb warhead. It is not intended to replace Bullpup A, but to complement it. Many of the components are interchangeable. The Bullpup B has an all-weather capability which the A did not have; it can locate and destroy its target in foul weather, at night, or in poor visibility.

One version of Bullpup has a prepackaged liquid motor and a nuclear warhead. Several years of research were needed to produce a fuel combination with good storage properties, and reliability, that could be handled with safety. Not all problems with the liquid propellant engine have been solved.

Bullpup is also used by the Air Force.

The Navy's 3 Ts—Terrier, Talos, and Tartar—have undergone many changes since their inception. The Typhon program, which was to incorporate all three missiles into one system, has been set back for further research. New research is going on to develop a system in which the 3 Ts can be used as part of a system, possibly using the same launching system.

Our first missile ship, the U.S.S. Gyatt (DDG-1), was equipped with Terrier missiles.

Terrier (RIM) (fig. 1-4) is a supersonic beam-riding anti-aircraft missile with a range of more than 10 miles. (The HT-3 Terrier uses semi-active homing guidance.) It is launched by a solid-fuel booster rocket, and is propelled by a solid-fuel sustainer rocket.

Terrier is about 15 feet long without its booster, and weighs 1-1/2 tons. Terrier batteries have been installed on the guided missile cruisers Boston, Canberra, Topeka,

Providence, and Springfield; the attack aircraft carriers Kitty Hawk, America, and Constellation; the nuclear-powered cruiser Long Beach; on frigates, plus several destroyers of all DLG classes.

Advanced Terrier is quite different from the early Terrier. A nuclear warhead is available for it, and improvements have been made in the conventional explosive warheads. Important changes have been made in the control system, which, although not a part of the missile, is indispensable for its operational use.

Although considerably smaller, the Tartar (RIM) is similar in function to Terrier, except that it is propelled by a dual-thrust rocket, and is launched without a separate booster. The Tartar system, designed for DD's, is installed aboard the guided missile destroyers numbers 2 through 24, and aboard the cruisers Chicago, Columbus, and Albany. At present writing, six destroyer escorts (DEGs) also are to be armed with Tartar missiles. On cruisers, it supplements the Talos missile. Its launching system is compact and rapid firing, which makes it adaptable to destroyers, and even smaller ships. Figure 1-5 shows a Tartar missile leaving the launcher, which holds two missiles. A smaller model launcher holds only one Tartar missile at a time.

Talos (RIM) (fig. 1-6) is a two-stage missile designed to bring down enemy aircraft and missiles at ranges of 65 miles or more. It is 20 feet long, and weighs 1-1/2 tons. It is launched with solid-fuel boosters, and is sustained in flight by a ramjet; it reaches a speed in excess of Mach 2 within about 10 seconds of launching. It can be used with either a nuclear warhead or a conventional warhead. During the first part of its flight, Talos is a beam rider. As it approaches its target, it switches over to homing guidance. Talos systems are installed on the cruisers Galveston, Little Rock, Oklahoma City, Albany, Columbus, Chicago, and Long Beach.

Polaris (UGM) (fig. 1-7) is the Navy's intermediate-range ballistic missile, with a range up to 2500 miles. It is designed for launching either from surface ships or from submerged submarines, for bombardment of shore targets. It is propelled by solid fuel. At present, nineteen submarines capable of launching Polaris are operational. Each submarine carries 16 missiles. At this time, developmental work on the Polaris is centered on improvement of the submarine-launched missile.

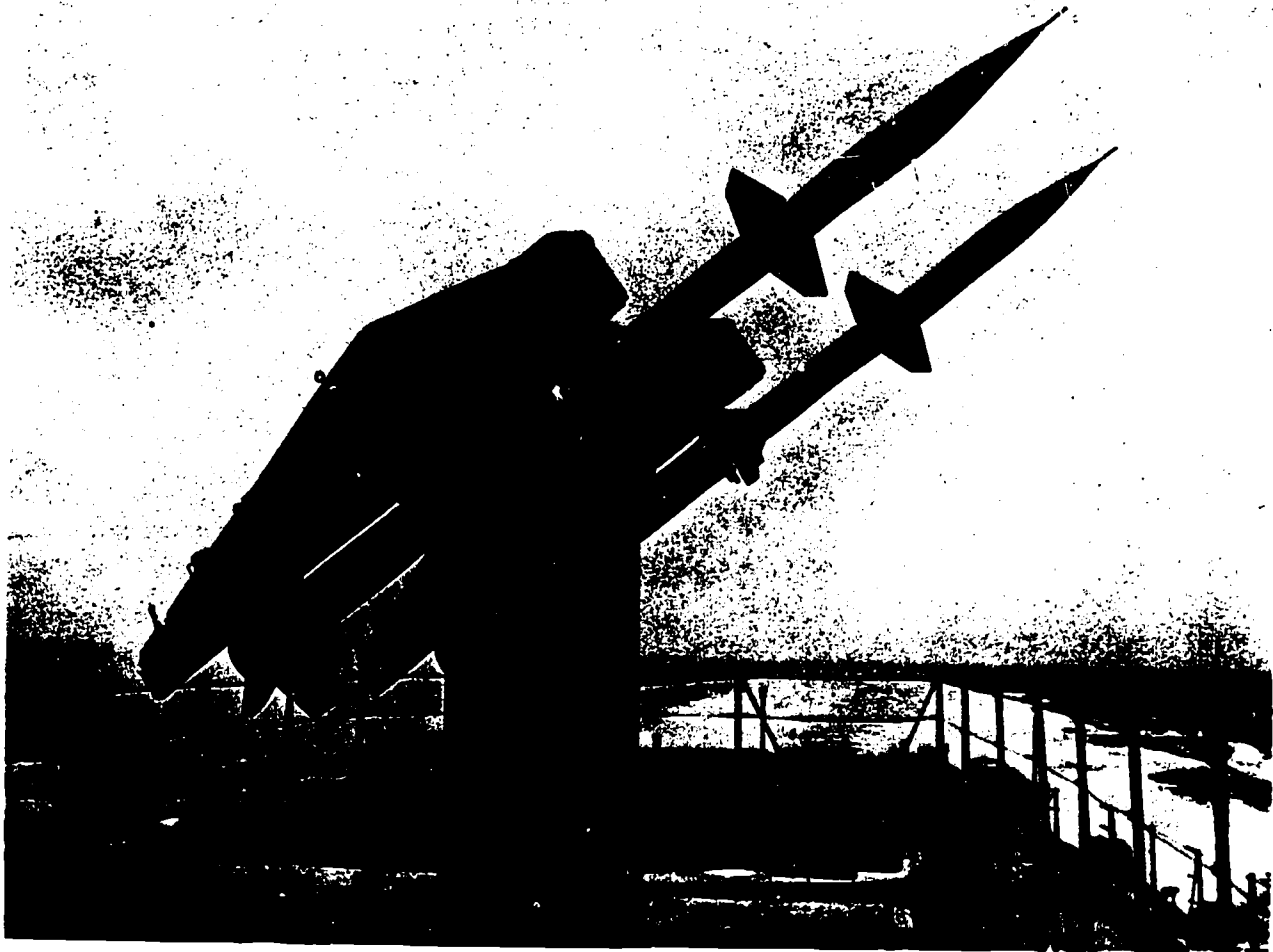

Figure 1-4.--Terrier missiles and launchers.

33. 262

Three versions of Polaris have been developed: A-1, A-2, and A-3. The A-1 and A-2 are operational; the A-3 has been successfully tested and soon will be aboard submarines, replacing the older mods. The Poseidon missile is being developed from the Polaris technology.

The increase in range, from 1500 miles for the A-1 to over 2500 miles for the A-3, is one of the most striking improvements. With their nuclear warheads, Polaris submarines can deliver a blow on the enemy which can eliminate several large industrial areas within minutes after an attack on the United States.

The emphasis currently is on antisubmarine warfare (ASW), and several weapons are being developed or improved.

Although Asroc (RUR) is not a guided missile, but a rocket-propelled torpedo or a depth charge, it is one of the important missiles of the Navy. It is part of the missile armament of many destroyers, including destroyer escorts, and of four cruisers. One form of the Asroc is a surface-ship launched, rocket-propelled homing torpedo and the other is a nuclear depth charge, also rocket propelled. Both forms can be fired from the same deck-emplaced launcher.



33.264

Figure 1-5.—Tartar missile leaving launcher.

Some destroyers have the DASH (Destroyer Anti-Submarine Helicopter) system, which delivers the Asroc to the target by means of a remote-controlled helicopter. An Advanced Asroc is under development.

Two other antisubmarine weapons are the Astor and Subroc (UUM). Astor is a wire-guided torpedo and Subroc is a submarine rocket fired from a torpedo tube. Subroc was installed on the ill-fated submarine Thresher, and is being installed on other submarines of the Thresher class.

An antisubmarine surface-to-underwater missile developed and built in Norway, the Terne, is being purchased by the Navy to install on two destroyer escorts. It is comparable

to our Weapon Alfa (formerly called Weapon Able), which is being phased out.

Other missiles of the Navy in various stages of development and use are:

Shrike (AGM), an antiradiation missile with passive radar homing, which was formerly called ARM. The Air Force also plans to use it.

Walleye (AGM), an air-to-surface glide bomb with TV guidance controlled by a pilot in the mother plane, no propulsion, but a powerful conventional warhead. It has shown amazing accuracy at a range of several miles.

Zuni, a Navy and Marine Corps rocket, air-to-surface, has a 5-mile range. It can be armed with various heads, including flares, fragmentation, and armor piercing.

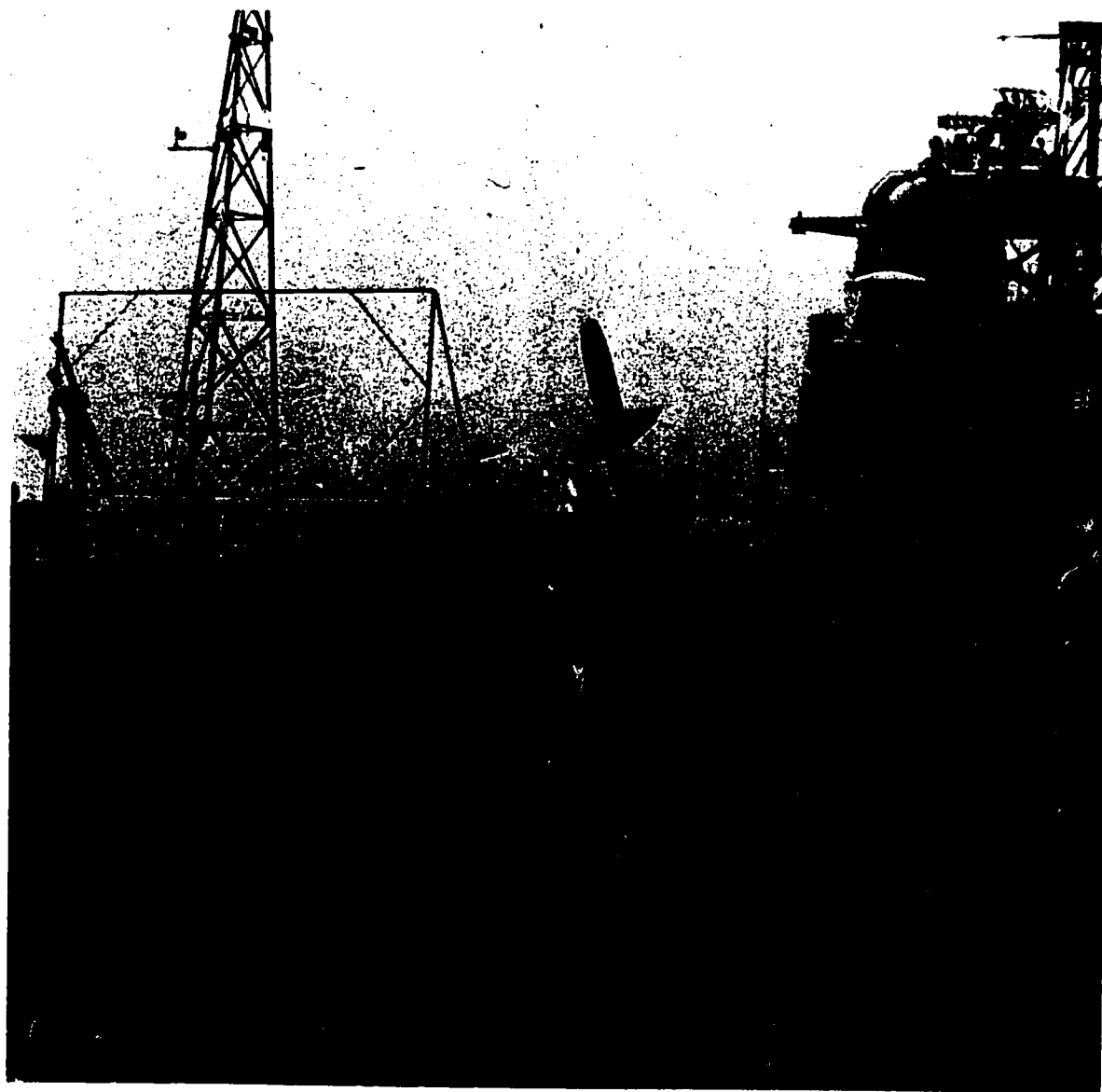

Figure 1-6.—Talos missiles on launcher aboard ship.

3.143

Condor (AGM) is a long-range missile designed to enable aircraft to destroy tactical targets while outside the range of enemy defenses. A gyro-stabilized television camera is the target seeker.

Phoenix (AIM) is a long-range air-to-air missile designed to be carried by the TFX Navy plane.

Figure 1-8 shows the configurations of some Navy missiles and rockets.

PRINCIPLES OF GUIDED MISSILES AND NUCLEAR WEAPONS



Figure 1-7.—Polaris.

3.78

Chapter 1—INTRODUCTION TO GUIDED MISSILES

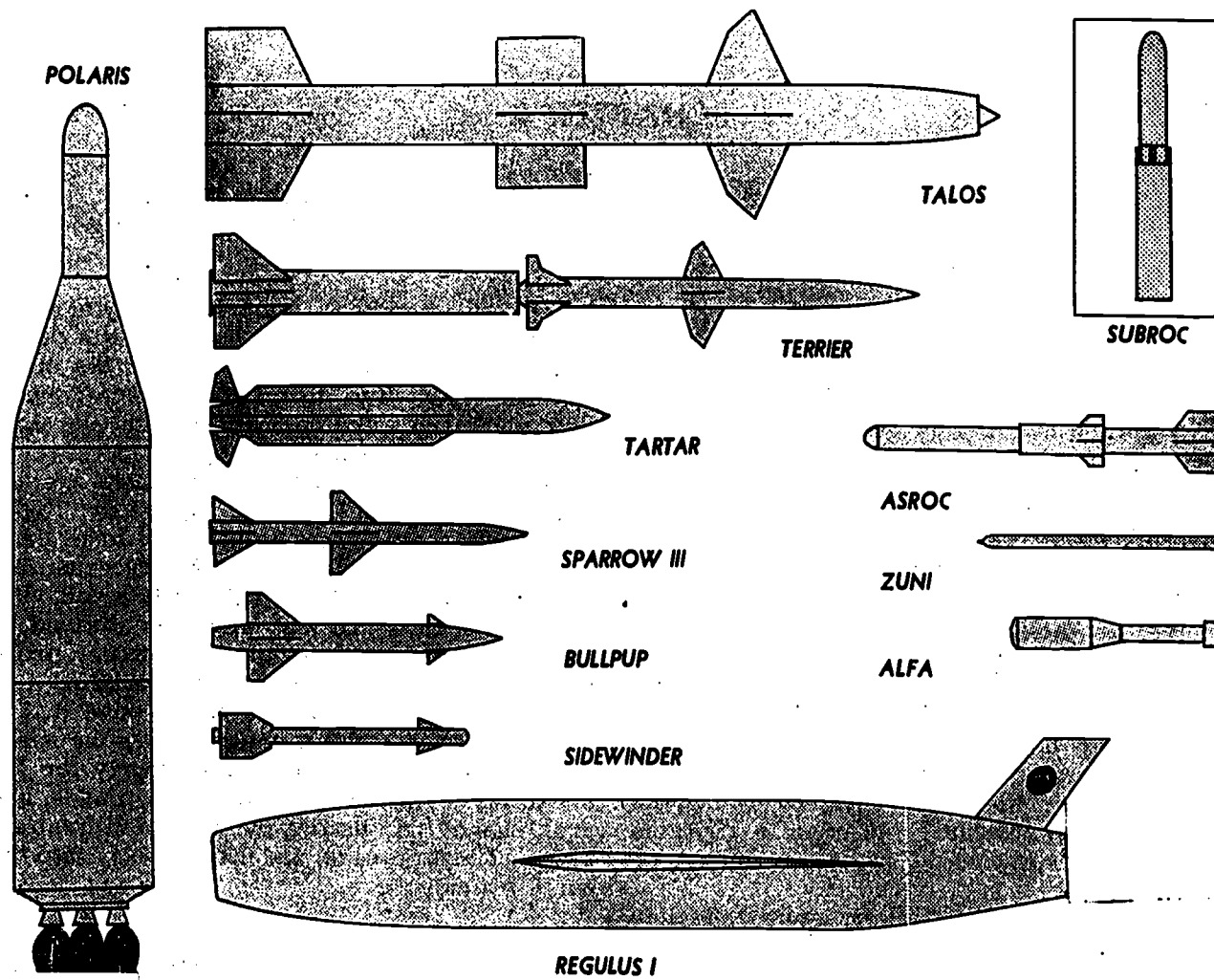

Figure 1-8.—Navy missiles and rockets; comparative sizes and silhouettes.

144.2

CHAPTER 2

FACTORS AFFECTING MISSILE FLIGHT

A. INTRODUCTION

GENERAL

A guided missile, by definition, flies above the surface of the earth. Aerodynamic long-range missiles, as well as all missiles of short and medium range, are subject throughout their flight to the forces imposed by the earth's atmosphere. Ballistic missiles, though they follow a trajectory that takes them into space, must climb through the atmosphere after launching, and must descend through it before striking the target. All missiles are subject to gravitational and inertial forces. This chapter will briefly discuss the principal forces that act on a guided missile during its flight. It will show how the missile trajectory may be controlled by designing the missile airframe and control surfaces to utilize or overcome the forces acting on them.

Before proceeding further, some brief definitions may be helpful.

Aerodynamics may be defined as the science that deals with the motion of air and other gases, and with the forces acting on bodies moving through these gases. An aerodynamic missile is one that uses aerodynamic forces to maintain its flight path. A ballistic missile does not depend upon aerodynamic surfaces to produce lift; it follows a ballistic trajectory after thrust (from its booster) is terminated. A guided missile can alter its flight path by means of internal or external mechanisms.

The earth's atmosphere is a gaseous envelope surrounding the earth to a height of roughly 250 miles. The characteristics and properties of the atmosphere change with altitude, and therefore missile flight is affected differently.

An understanding of missile aerodynamics requires a familiarity with several of the basic laws of physics. These laws will be

briefly summarized. A detailed study of air in motion, and the mathematical analysis of the various forces present, are beyond the scope of this text. The discussion will be general and qualitative, and no mathematical development will be attempted.

In general, missile aerodynamics are the same for both subsonic and supersonic flight. The basic requirement is common to all craft intended to fly: in order to fly successfully, the craft must be aerodynamically sound. But the high speeds and high altitudes attained by current guided missiles give rise to new problems not encountered by most conventional aircraft. An example is the shock wave that is produced when a flying object attains the speed of sound. Problems of oxygen supply for air breathing missiles arise at high altitudes, and problems of skin heating by friction with the air arise at high speeds, and upon reentry into the earth's atmosphere.

THE ATMOSPHERE

As mentioned above, the earth's atmosphere extends upward about 250 miles. Although there are some differences of opinion as to where the atmosphere ends and space begins, the limit defined is generally accepted. The atmosphere is quite definitely divided into three layers, troposphere, stratosphere, and ionosphere (fig. 2-1), each with its distinct characteristics.

CHARACTERISTICS OF THE ATMOSPHERE

One of the most important characteristics of the atmosphere is the change in air density with a change in altitude.

With increasing altitudes the density of the air decreases significantly. At sea level, the density of air is about .076 pound per cubic foot. At 20,000 feet, air density is only about

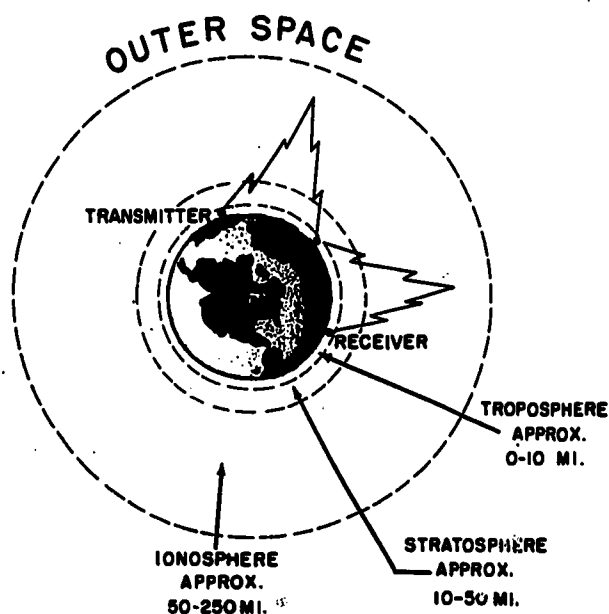

Figure 2-1.—Atmospheric regions. 33.21

The procedure then repeats itself—that is, a second temperature minimum is reached, and then, after a short constant-temperature zone, it starts rising again. These temperature minimums mark the boundaries between the three regions of the atmosphere: the troposphere, the stratosphere, and the ionosphere, shown in figure 2-1.

LAYERS OF THE ATMOSPHERE

Troposphere

The troposphere is the lowest layer of the atmosphere and extends from the surface of the earth to a height of 10 miles. It is made up of 99% nitrogen and oxygen by volume, and accounts for three-fourths of the weight of the atmosphere. Within this layer temperature decreases with altitude, and it is in this layer that clouds, snow, rain, and the seasonal changes exist.

Because of the high density of the troposphere, aerodynamic surfaces can be used efficiently to control missiles in this region, and propellers are practical for low speed power plants. However, this high density causes a

.0405 pound per cubic foot. Because of the gradual decrease in air density with altitude, a missile flying at 35,000 feet encounters less air resistance—that is, has less DRAG—than does a missile flying close to sea level.

The absolute pressure existing at any point in the atmosphere also varies with altitude. The pressure acting on each square inch of the earth's surface at sea level is actually the weight of a column of air one inch square, extending from sea level to the outer limits of the atmosphere. On a mountain top, this column of air would be shorter, and thus the weight (pressure) acting on each square inch would be less. Therefore, absolute pressure decreases with increased altitudes.

Another characteristic of the atmosphere which varies with altitude is temperature (see figure 2-2). However, unlike density and pressure, temperature does not vary directly with altitude. From sea level to about 10 miles, the temperature drops steadily at a rate of approximately $3\frac{1}{2}^{\circ}$ F per thousand feet. It then remains fairly constant at -87° F up to about 105,000 feet. Then it increases at a steady rate until another constant-temperature zone is reached. This zone lasts for several miles, at which point the temperature starts decreasing.

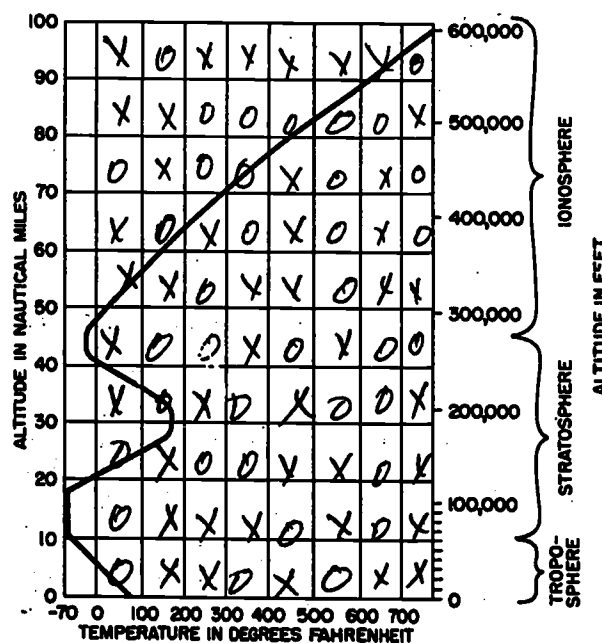

Figure 2-2.—Temperature varies indirectly with altitude. 33.20

PRINCIPLES OF GUIDED MISSILES AND NUCLEAR WEAPONS

large amount of drag. The dense lower atmosphere slowed down the German V-2 from 3300 to 1800 mph. At extremely high speeds the friction caused by this dense air produces such high skin temperatures that ordinary metals melt.

Stratosphere

The stratosphere is the layer of air above the troposphere. Its upper limits are around 40 to 50 miles above sea level. In this region temperature no longer decreases with altitude but stays nearly constant and actually begins to increase in the upper levels. Higher temperatures in the upper levels are caused by ozone, which is heated by ultraviolet radiation from the sun. (Ozone is a gas which is produced when electricity is discharged through oxygen.) The composition of the stratosphere is similar to that of the troposphere; however, there is practically no moisture in the stratosphere. Propeller-driven vehicles cannot penetrate this region because of the low air density, and aerodynamic surfaces have greatly reduced effect in controlling missiles.

Ionosphere

Above the stratosphere and ranging up to about 250 miles above sea level is the ionosphere. This is a region rich in ozone and consists of a series of electrified layers. The ionosphere is extremely important because of its ability to refract (bend) radio waves. This property enables a radio transmitter to send waves to the opposite side of the world by a series of refractions and reflections taking place in the ionosphere and at the surface of the earth.

The characteristics of the ionosphere vary with daylight and darkness, and also with the four seasons. Until recent years we have known very little about the physical characteristics of this region. During the past few years many instrument-carrying rockets have been sent into the ionosphere to obtain information about the temperatures, the pressures, the composition of the air, and the electrical characteristics of the various layers.

The lower part of the ionosphere (20 to 60 miles up) is sometimes called the chemosphere.

Higher Atmospheres

The reaches of space beyond the ionosphere have not been fully explored and much of the

information about them is conjecture. The sphere or layer immediately above the ionosphere has been named the mesosphere and is believed to contain many mesons and other cosmic particles. A meson is an unstable particle, between electron and proton in mass, first observed in cosmic rays. Two types have been identified as mesons, π mesons and μ mesons. Some are positively charged, and evidence indicates that some are neutral. Another theory is that mesons are the binding energy between protons and neutrons.

Space beyond 600 miles is called the exosphere. It is approximately 1/3000 of the earth's atmosphere in terms of mass. Air particles are few and far apart in this area.

Much information about the upper air has been transmitted to earth from orbiting satellites, which carried instruments to measure radiation, temperature, meteorites and micro-meteorites, and weather information.

PHYSICS OF FLIGHT

FORCES ACTING ON A MISSILE IN FLIGHT

The flight path of a missile is determined by the forces acting upon it. Some of these forces are due to nature; others are man made. The natural forces are not fully controllable but their action on the missile can be modified by causing the missile to fly slower or faster, higher or lower, adding (or removing) control surfaces such as wings and fins, increasing the propelling force, and similar control. Although natural forces are not fully controllable, they are to a considerable extent predictable. Various combinations of natural forces and manmade forces produce different effects on the missile flight path.

Gravity, friction, air resistance, and other factors produce forces that act on all parts of a missile moving through the air. One such force is that which the missile exerts on the air as it moves through it. In opposition to this is the force that the air delivers to the missile. The force of gravity constantly attracts the missile toward the earth, and the missile must exert a corresponding upward force to remain in flight.

Figure 2-3A illustrates the forces acting on a body in level flight through the air, at a uniform speed. Note that the force tending to

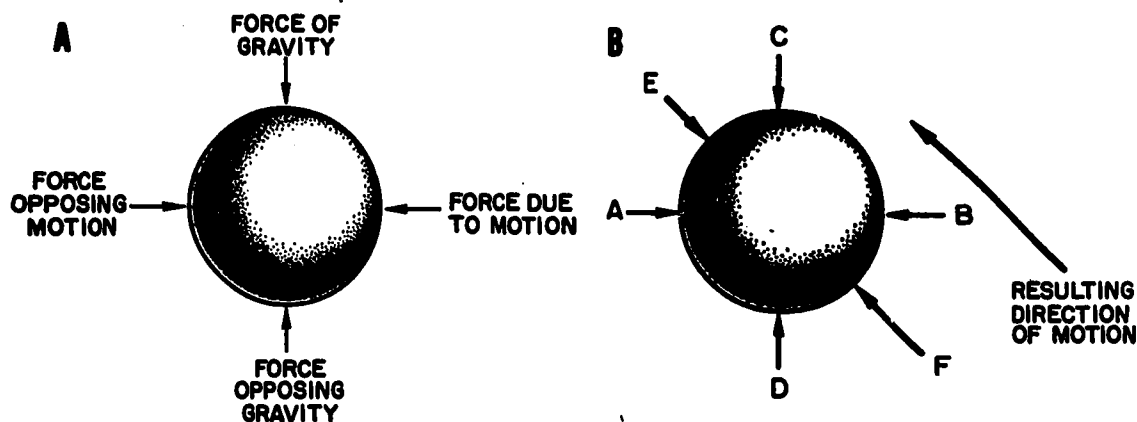

Figure 2-3.—Forces acting on a body moving through air: A. Equal forces; B. Unequal forces. 144.3

produce motion (toward the left) exactly balances that resisting the motion. The force of gravity is exactly opposed by the lifting force. In accordance with Newton's first law (discussed below), a moving body on which all forces are balanced will continue to move in the same direction and at the same speed.

Figure 2-3B illustrates the effect of unbalanced forces acting on a body. The length of the arrows is proportional to the respective magnitude of the forces, and the arrowheads point in the direction in which these forces are applied. The illustration shows that forces A and B are equal and opposite, and that C and D are equal and opposite. But force F is opposite to and greater than force E. As a result, the body shown will accelerate in the direction of force F. This figure is an example of vector representation of the forces acting on a body. Any number of forces may be shown by vector representation. They can be resolved, or simplified, into resultant force that is the net effect of all the forces applied.

Note that in the illustration, forces are acting on a spherical body. By changing the shape of the body acted upon, the action of the forces can be modified. These effects are discussed later in the chapter.

RELATIVITY OF MOTION

To an observer standing on the ground and watching the flight of a missile through the air, it appears that the missile is moving and the air standing still. It would seem that the oppos-

ing force exerted by the air is entirely the result of the missile motion through it. But if it were possible for an observer to ride the missile itself, it would appear that the missile is standing still, and that the air is moving past the missile at high speed.

This illustrates the basic concept of relativity of motion. The forces that the air exerts on the missile are the same, regardless of which is considered to be in motion. The force exerted by the air on an object does not depend on the absolute velocity of either but only on the relative velocities between them. This principle can be put to good use in the study of missile aerodynamics, and in the design of missile airframes and control surfaces. In a wind tunnel, the missile or model remains stationary, while air moves past it at high speed. The measured forces are the same as those that would result if the missile, or model, were moving at the same relative speed through a stationary mass of air.

NEWTON'S LAWS OF MOTION

Although Newton lived long before the missile and space age (1642-1727), the laws of motion which he discovered and formulated are valid for missiles and other objects passing through the atmosphere.

Newton's first law states: "A body in a state of rest remains at rest, and a body in motion remains in uniform motion, unless acted upon by some outside force." This means that if an object is in motion, it will continue

PRINCIPLES OF GUIDED MISSILES AND NUCLEAR WEAPONS

in the same direction and at the same speed until some unbalanced force is applied. And, whenever there are unbalanced forces acting on an object, that object must change its state of motion. For example, if you were to push against a book lying on a table, you would have to supply sufficient force to overcome friction in order to set the book in motion. If you would eliminate all of the restraining forces acting on the book once it is in motion, it would continue to move uniformly until acted upon by some outside force. It is these restraining forces with which we are mainly concerned in the study of aerodynamics.

Newton's second law states: "The rate of change in momentum of an object is proportional to the force acting on the object, and in the direction of the force." The momentum of an object may be defined as the force that object would exert to resist any change of its motion.

Newton's third law states: "To every action there is an equal and opposite reaction." This law means that when a force is applied to any object, there must be a reaction opposite to and equal to the applied force. If an object is in motion, and we try to change either the direction or rate of that motion, the object will exert an equal and opposite force. That force is directly proportional to the mass of the object, and to the change in its velocity. This can be stated as:

Force = Mass times Acceleration,

or

$$F = ma$$

Thus any object in motion is capable of exerting a force. Whenever a force is applied through a distance, it does work. We can express this as:

Work = Force times Distance

or

$$W = Fd$$

Any mass that is in motion is capable of applying a force over a distance, and therefore of doing work. Whenever the motion of a mass is changed, there is, in accordance with Newton's second law, a change in momentum.

LIFT AND DRAG

Figure 2-4 represents a flat surface moving through an airstream. In accordance with the principle of relativity, the forces acting on the surface are the same, regardless of whether we think of the surface as moving to the left, or of the airstream as moving to the right. One of the forces acting on the surface is that produced by friction with the air. This force acts in a direction parallel to the surface, as indicated by

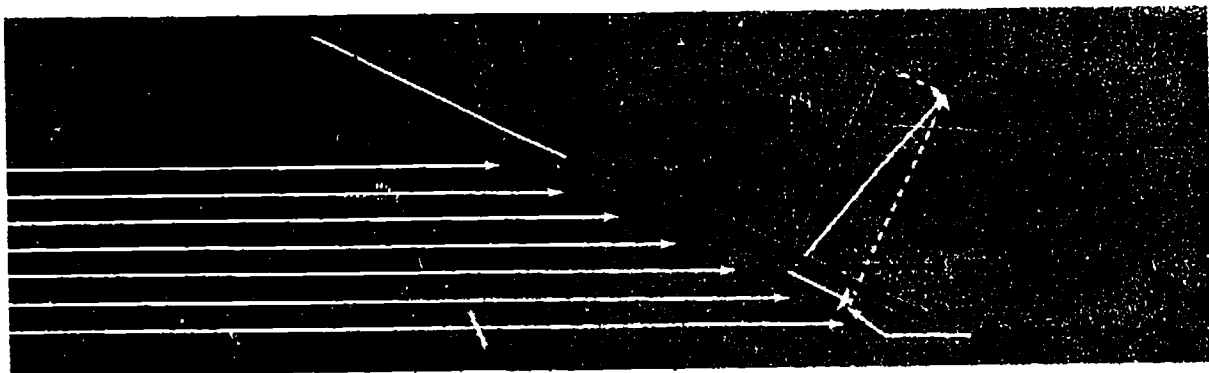

Figure 2-4.— Forces acting on a flat surface in an airstream.

Chapter 2—FACTORS AFFECTING MISSILE FLIGHT

the small white arrow at the lower right. As the air strikes the surface, the air will be deflected downward. Because the air has mass, this change in its motion will result in a force applied to the surface. This force acts at a right angle to the surface, as indicated by the long black arrow in figure 2-4. The resultant of the frictional and deflection forces, indicating the net effect of the two, is represented by the long white arrow. The horizontal component of this force operating in a direction opposite to the motion of the surface, is drag. The vertical force, operating upward, is lift. The angle that the moving surface makes with the airstream is the angle of attack. This angle affects both the frictional and the deflection force, and therefore affects both lift and drag.

Another scientist, Daniel Bernoulli (1700-1782), discovered that the total energy in any system remains constant. That is, if one element in any energy system is decreased, another increases to counterbalance it.

This is called Bernoulli's theorem. Air flowing past the fuselage or over the wing of a guided missile forms a system to which this theorem can be applied. The energy in a given air mass is the product of its pressure and its velocity. If the energy is to remain constant, it follows that a decrease in velocity will produce an increase in pressure, and that an increase in velocity will produce a decrease in pressure.

Figure 2-5 represents the flow of air over a wing section. Note that the air that passes over the wing must travel a greater distance than air passing under it. Since the two parts of the airstream reach the trailing edge of the wing at the same time, the air that flows over the wing must move faster than the air that flows under. In accordance with Bernoulli's theorem, this results in a lower pressure on

the top than on the bottom of the wing. This pressure differential tends to force the wing upward, and gives it lift.

Figure 2-5 represents the general shape of a section of the wing of a conventional aircraft. In such an aircraft, the major part of the necessary lift is provided by the Bernoulli effect. As we will explain later, a wing of this shape is not suitable for use on missiles flying at or above the speed of sound. None of the Navy missiles listed in chapter 1 depends on a wing of this shape for lift. All of them get the necessary lift entirely from the angle of attack, as illustrated in figure 2-4.

Air tends to cling to the surface of the plane. This thin region of nearly static air is called a boundary layer. Within the boundary layer the fluid velocity ranges from zero at body surface to free-stream velocity a short distance away. Sudden changes in velocity, density, and pressure cause disturbance waves in the flow in the boundary layer. If the flow is smooth, it is said to be "laminar;" if it is disturbed it is called "turbulent," and skin friction is greater than in laminar flow. If the surface is rough, the turbulent layer is increased and skin friction is greater. Even a comparatively insignificant proturbance on the surface, such as rivet heads, can produce turbulent flow. The term "streamlining" has come to describe the technique of designing shapes to give low resistance or drag and prevent or delay boundary-layer turbulence. In supersonic conditions the formation of shock waves causes the boundary layer to thicken at the point of contact with the shock wave and aerodynamic pressure can be transmitted forward through the boundary layer. Boundary layer

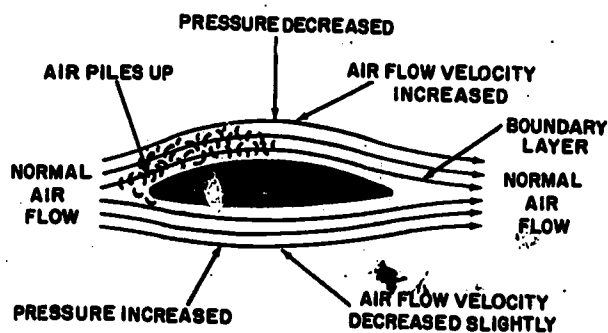

33.38

Figure 2-5.—Air flow over a wing section.

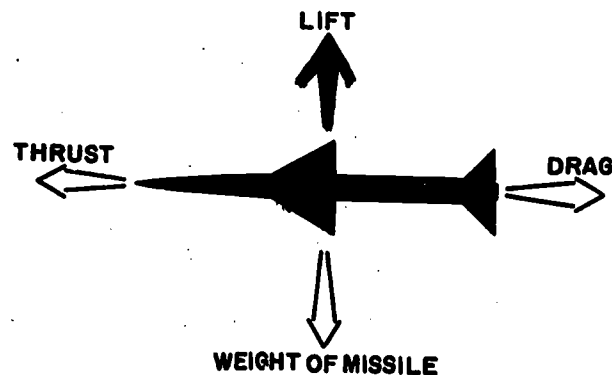

33.23

Figure 2-6.—Forces acting on a moving missile.

PRINCIPLES OF GUIDED MISSILES AND NUCLEAR WEAPONS

effects and shock waves are present side by side in supersonic flow and their effects contribute to each other. A very small shock wave is sufficient to disturb the flow over an entire wing surface behind it. Since lift depends on the flow of air past the surface, reduction in flow produces a reduction in lift. The boundary layer effect has been reduced by using highly polished surfaces, as free as possible from any irregularities. A complete and precise theoretical explanation of the processes which cause a laminary boundary to become turbulent has not been formulated.

AERODYNAMIC FORCES

All present day guided missiles have at least part of their flight paths within the earth's atmosphere; therefore it is important that you understand the principles of aerodynamics.

The principal forces acting on a missile in level flight are **THRUST**, **DRAG**, **WEIGHT**, and **LIFT**. Like any force, each of these is a vector quantity which has magnitude (length) and direction. These forces are illustrated in figure 2-6.

When the missile is not flying in a straight line, an inertial force, termed centrifugal force, acts on the missile. In a turn maneuver, this causes an acceleration greater than gravity, and the missile weight and centrifugal force combine to form the resultant force.

TERMINOLOGY

A discussion of the problems of aerodynamic forces involves the use of several flight terms that require explanation. The following definitions are intended to be as simple and basic as possible. They are not necessarily the definitions an aeronautical engineer would use.

AIRFOIL. An airfoil is any structure around which air flows in a manner that is useful in controlling flight. The airfoils of a guided missile are its wings or fins, its tail surfaces, and its fuselage.

DRAG is the resistance of an object to the flow of air around it. It is due in part to the boundary layer, and in part to the piling up of air in front of the object. One of the problems of missile design is to reduce drag while maintaining the required lift and stability.

STREAMLINES are lines representing the path of air particles as they flow past an object, as shown in figure 2-5.

ATTITUDE. This term refers to the orientation of a missile with respect to a selected reference.

STABILITY. A stable body is one that returns to its initial position after it has been disturbed by some outside force. If outside forces disturb a stable missile from its normal flight attitude, the missile tends to return to its original attitude when the outside forces are removed. If a body, when disturbed from its original position, assumes a new position and neither returns to its origin nor moves any farther from it, the body is said to be neutrally stable. If the attitude of a neutrally stable missile is changed by an outside force or by a change in its controls, the missile remains in the new position until other forces influence it.

A third type of stability is negative stability, or instability. In this case a body displaced from its original position tends to move even farther away. For example, if an unstable aircraft is put into a climb, it tends to climb more and more steeply until it stalls.

MISSILE MOTIONS. Like any moving body, the guided missile executes two basic kinds of motions: **ROTATION** and **TRANSLATION**. In pure rotation all parts of the body pivot about an imaginary axis passing through the center of gravity (fig. 2-7), describing concentric circles around the axis. In movements of translation (linear motions), the center of gravity moves along a line and all the separate parts follow lines parallel to the path of the center of gravity.

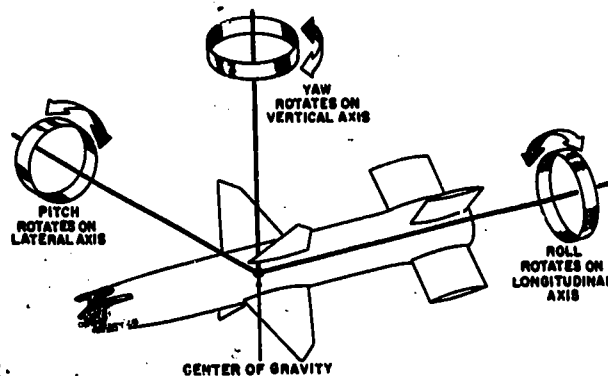

Figure 2-7.—Missile axes; flight attitude of a guided missile.

33.22

Chapter 2—FACTORS AFFECTING MISSILE FLIGHT

All the parts have the same velocity and the same direction of movement, as in forward movement. Any possible motion of the body is composed of one or the other of these motions, or is a combination of the two.

The three axes of rotational movement are represented in figure 2-7 as pitch, yaw, and roll. The missile ROLLS, or twists, about the longitudinal axis, the reference line running through the nose and tail. It YAWS, or turns to right or left, about the vertical axis. PITCH, or turning up or down, is a rotation about the lateral axis, the reference line in the horizontal plane running perpendicular to the line of flight. Rotary motions about any of these three axes are governed by the steering devices of the missile, such as the aerodynamic control surfaces. A fourth motion is necessary for control as well as for flight. This is the motion of translation, the forward movement resulting from the thrust provided by the propulsion system.

AXES. A missile in normal level flight can be considered to move about three axes, as shown in figure 2-7. Whenever there is a displacement of a missile about any of these three axes, the missile may do any one of the following:

1. It may oscillate about the axis (oscillation).
2. It may increase its displacement and get out of control.
3. It may return to its original position readily, without oscillation (damping).

The last possibility, which indicates a stable missile, is the one desired. We will show later how this problem of stability is met in missile design.

EFFECTS OF AERODYNAMIC FORCES

The aerodynamic forces—lift, drag, weight, and thrust—must all be considered in missile design in order to take advantage of the forces and make the missile fly as intended.

Lift

Lift is produced by means of pressure differences. There are dynamic pressures, or the pressure of air in motion, and differences in the static pressure of the atmosphere, which is exerted by the weight of the column of air above the missile. Dynamic pressure is the primary factor contributing to lift. The air pressure on the upper surface of an airfoil (wing) must be

less than the pressure on the underside. The amount of lifting force provided is dependent to a large extent on the shape of the wing. Additional factors which determine the amount of lift are the wing area, the angle at which the wing surface is inclined to the airstream, and the density and speed of the air passing around it. The airfoil that gives the greatest lift with the least drag in subsonic flight has a shape similar to the one illustrated in figure 2-8.

Some of the standard terms applied to airfoils are included in the sketch. The foremost edge of the wing is called the leading edge, and that at the rear the trailing edge (fig. 2-8A). A straight line between the leading and the trailing edges is called the chord. The distance from one wingtip to the other (not shown) is known as the SPAN. The ratio of the span to the average chord is the ASPECT RATIO. The angle of incidence (fig. 2-8B) is the angle between the wing chord and the longitudinal axis of the fuselage. In figure 2-8C, the large arrow indicates the relative wind, the direction of the airflow with reference to the moving airfoil. The angle of attack is the angle between the chord and the direction of the relative wind.

Center of Pressure

The relative wind strikes the tilted surface, and as the air flows around the wing, different amounts of lifting force are exerted on various points of the airfoil. The sum (resultant) of all these forces is equivalent to a single force

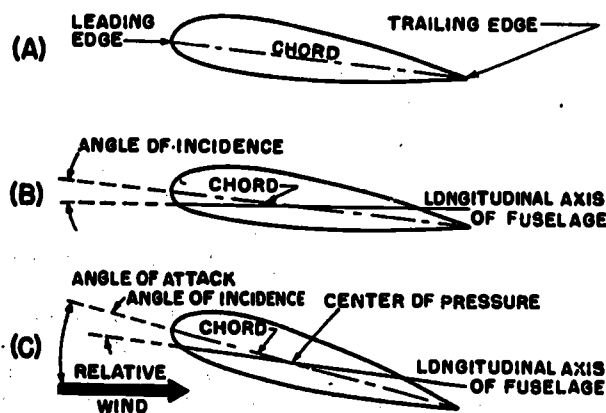

33.24
Figure 2-8.—Standard nomenclature applied to airfoils.

PRINCIPLES OF GUIDED MISSILES AND NUCLEAR WEAPONS

acting at a single point and in a particular direction. This point is called the center of pressure. From it, lift can be considered to be directed perpendicular to the direction of the relative wind.

The dynamic or impact force of the wind against the lower surface of the airfoil also contributes to lift, but no more than one-third of the total lift effect is provided by this impact force.

As we have shown, the resultant force on a wing can be resolved into forces perpendicular and parallel to the relative wind; these components are lift and drag. If a missile is to continue in level flight, its total lift must equal its weight. As the angle of attack increases, the lift increases until it reaches a maximum value. At the angle of maximum lift, the air no longer flows evenly over the wing, but tends to break away from it. This breaking away (the burble point) occurs at the stalling angle. If the angle of attack is increased further, both lifting force and airspeed decrease rapidly.

Angle of Attack

In actual flight, a change in the angle of attack will change the airspeed. But if for test purposes we maintain a constant velocity of the airstream while changing the angle of attack, the results on a nonsymmetrical wing will be as shown in figure 2-9. The sketches show a wing section at various angles of attack, and the effect of these different angles on the resultant force and the position of the center of pressure.

The burble point referred to in the lower sketch is the point at which airflow over the upper surface becomes rough, causing an uneven distribution of pressure. The burble point is generally reached when the angle of attack is increased to about 18° or 20° . At this angle of attack the separation point is placed so near the leading edge that the upper airflow is disrupted and the wing is in a stall (fig. 2-9D). At moderately high angles of attack, the flowing air can follow the initial turn of the leading edge but it cannot follow the wing contour completely; then the stream separates from the surface near the trailing edge (fig. 2-9C). At small angles of attack, the resultant is comparatively small. Its direction is upward and back from the vertical, and its center of pressure is well back from the leading edge. Note that the center of pressure changes with the angle of attack, and the resultant

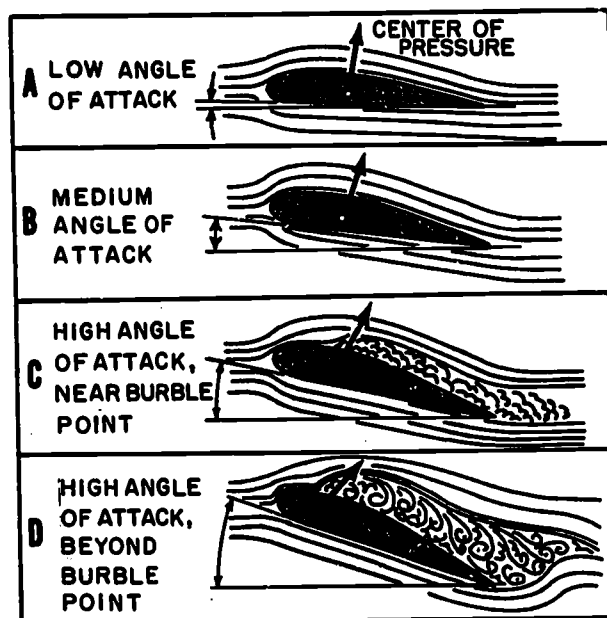

33.24

Figure 2-9.—Effect of angle of attack on center of pressure and air flow.

has an upward and backward direction (fig. 2-9)). At a positive angle of attack of about 3° or 4° , the resultant has its most nearly vertical direction (fig. 2-9A). Either increasing or decreasing the angle causes the direction of the resultant to move farther from the vertical.

Drag

Drag is the resistance of air to motion through it. The drag component of the resultant force on a wing is the component parallel to the direction of motion. This force resists the forward motion of the missile. If the missile is to fly, drag must be overcome by thrust—the force tending to push the missile forward. Drag depends on the missile area, the air density, and the square of the velocity. Air resists the motion of all parts of the missile, including the wings, fuselage, tail airfoils, and other surfaces. The resistance to those parts that contribute lift to the missile is called induced drag. The resistance to all parts that do not contribute lift is parasitic drag.

From Newton's laws, we know two things: First, if all the forces applied to a missile are in balance, then if the missile is stationary it will remain so; if it is moving, it will continue to move in the same direction at the

Chapter 2—FACTORS AFFECTING MISSILE FLIGHT

same speed until an outside force is applied to it. Second, if an unbalanced force—one not counteracted by an equal and opposite force—is applied to the missile, it will accelerate in the direction of the unbalanced force.

Thrust

At the instant of launching, missile speed is zero, and there is no drag. (We will, for the moment, disregard air-launched missiles.) The force of thrust developed by the propulsion system will be unbalanced, and as a result the missile will accelerate in the direction of thrust. (A solid-fuel rocket develops full thrust almost instantly. When a long-range liquid-fuel rocket is launched, it may be physically held down until its engines have developed sufficient thrust.) When thrust-weight ratio reaches its maximum value, acceleration of the missile is at a maximum. But, during the launching phase, missile speed quickly increases. Because drag is proportional to the square of the speed, drag increases very rapidly. The force of thrust is thus opposed by a progressively increasing force of drag. The missile will continue to increase in speed, but its acceleration (rate of increase of speed) will steadily decline. This decline will continue until thrust and drag are exactly in balance; the missile will then fly at a uniform speed as long as its thrust remains constant.

If the propulsive thrust is decreased for any reason (such as a command from the guidance system, or incipient fuel exhaustion) the force of drag will exceed the thrust. The missile will slow down until the two are again in balance. When the missile fuel is exhausted, or the propulsion system is shut down by the guidance system, there is no more thrust. The force of drag will then be unbalanced, and will cause a negative acceleration, resulting in a decrease in speed. But, as the speed decreases, drag will also decrease. Thus the rate of decrease in speed also decreases. A missile will maintain a uniform forward motion when thrust and drag are equal. The power required to maintain uniform forward motion is equal to the product of the drag and the speed. If drag is expressed in pounds, and speed in feet per second, the product is power in foot-pounds per second. By definition, one horsepower is 550 ft-lb per

second. The horsepower expended by a missile in uniform forward motion is then

$$hp = \frac{DV}{550}$$

where D is the drag in pounds, and V the speed in feet per second.

Acceleration

This term has been freely used in the chapter without positive definition. Acceleration is change either in speed or in direction of motion. A missile accelerates in a positive or negative sense as it increases or decreases speed along the line of flight. A missile also accelerates in a positive or negative sense if it changes direction in turns, dives, pullouts, or as a result of gusts of wind. During accelerations a missile is subjected to large forces which tend to keep it flying along its original line of flight. This is in accordance with Newton's first law of motion: A particle remains at rest or in a state of uniform motion in a straight line unless acted upon by an external force.

Acceleration is measured in terms of the standard unit of gravity, abbreviated by the letter "g." A freely falling body is attracted to the earth by a force equal to its weight, with the result that it accelerates at a constant rate of approximately 32 feet per second per second. Its acceleration while in free fall is said to be one "g." Missiles making rapid turns or responding to large changes in thrust will experience accelerations many times that of gravity, the ratio being expressed as a number of "g's." The number of "g's" which a missile can withstand is one of the factors which determines its maximum turning rate and the type of launcher suitable for the weapon. The delicate instruments contained in a missile may be damaged if subjected to accelerations in excess of design values.

PROBLEMS OF MISSILE CONTROL

A missile must be so designed and constructed that it will fly a specified course without continual changes in direction. The degree of stability of a missile has a direct effect on the behavior of its controls, and for this reason a high degree of stability must be maintained.

PRINCIPLES OF GUIDED MISSILES AND NUCLEAR WEAPONS

As the speed of a missile increases, its stability is changed by shifts in the center of pressure. A pressure shift causes changes in the airflow acting on the missile surfaces. Even in pure supersonic flow, variations in speed will cause shifts in center of pressure.

The use of fixed fins, and spinning of the missile, are the simplest means of stabilizing a missile in flight. Movable control surfaces react with air according to the laws of aerodynamics to control the missile in flight. Figure 2-10 shows examples of control surface designs and locations. Fins may be used to stabilize a

missile in flight by reacting against the medium through which the missile is passing. They are obviously not useful for missiles that travel in a vacuum (or in high altitudes where the air is very rarefied). In high-speed missiles, the control surfaces can be made smaller; under certain conditions they can be eliminated altogether.

Stability in Subsonic Flight

Figure 2-11 represents a missile in flight; it is longitudinally stable about its lateral axis through the center of gravity. Airflow over the wing is deflected downward. This angle of deflection is called the downwash angle. When lift decreases as a result of reduced speed, this downwash angle decreases, and produces pressure changes. At certain speeds, unstable conditions are set up as a result of such pressure shifts. When an unstable condition occurs, the control system must quickly compensate by moving the control surfaces or changing the missile speed; otherwise the missile may get out of control. Unstable conditions are most serious at transonic speeds. Most missiles have dive control and roll recovery devices to overcome unstable conditions. For example, the horizontal tail surfaces may be placed high on the fin to minimize the effects of downwash. (At supersonic speeds, the downwash problem disappears.)

Unstable airflow over the wings of a missile may cause the ailerons to oscillate, creating a condition known as "buzz." A similar condition called "snaking" may exist about the yaw axis as a result of rudder oscillation. The troubles

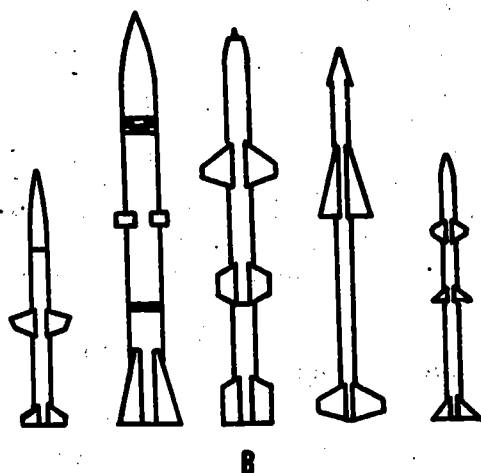
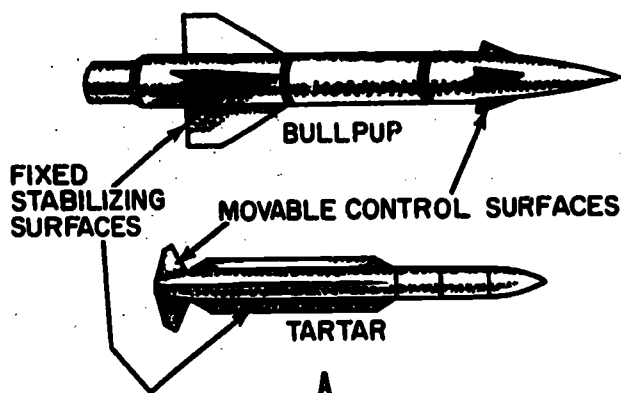

144.5

Figure 2-10.—Control surfaces: A. Fixed and movable surfaces; B. Control surface designs and locations.

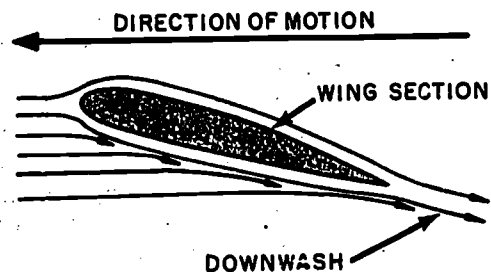

144.6

Figure 2-11.—Downwash (indicating the closing of the streamlines under the wing and the subsequent downwash).

Chapter 2—FACTORS AFFECTING MISSILE FLIGHT

may be partially compensated for by nonreversible control systems, or by variable-incidence control surfaces.

In a stable aerodynamic body, an oscillation caused by an outside disturbing force tends to be damped and to disappear instead of becoming greater. The missile must be stabilized about three axes of flight to maintain a steady flight condition, so the missile neither increases nor decreases its angle of attack.

Stability about the vertical axis is usually provided for by vertical fins. If a missile begins to yaw to the right, air pressure on the left side of the vertical fins is increased. This increased pressure resists the yaw, and tends to force the tail in the opposite direction. In some missiles the vertical fin may be divided and have a movable part, called the rudder, that is used for directional control. In addition to the rudder, there may be trim tabs that can be set for a particular direction of flight relative to the prevailing wind. The vertical sides of the fuselage also act as stabilizing surfaces. The same action takes place here as on the fin, but with a lesser correcting force.

Another means for obtaining yaw stability is by sweepback of wings. Sweepback is the angle between the leading edge of a wing and a line at right angles to the longitudinal axis of the missile. If a missile yaws to the right, the leading edge of the left sweepback wing becomes more perpendicular to the relative wind, while the right wing becomes less so. This puts more drag on the left wing, and less on the right. The unbalanced drag at the two sides of the missile tends to force it back to its original attitude.

STABILITY ABOUT THE LONGITUDINAL AXIS may be provided by dihedral—an upward angle of the wings. As the missile starts to roll, the lift force is no longer vertical, but moves toward the side to which the missile is rolling. As a result, the missile begins to sideslip. This increases the angle of attack of the lower wing, and decreases that of the upper. Lift on the lower wing will therefore increase, while lift on the upper wing decreases. This unbalanced lift tends to roll the missile back to its original attitude.

STABILITY ABOUT THE LATERAL AXIS is accomplished by horizontal surfaces at the tail of the missile. The stationary part of these surfaces is the stabilizer; the movable part is the elevator. Pitch stability results from the change in forces on the stabilizer

when the missile changes its angle of attack. For example, if the missile nose begins to pitch downward, the force of the airstream against the upper surface of the stabilizer will increase. This will tend to push the tail downward, and thus return the missile to its original attitude.

Since most modern missiles are supersonic, with only a few seconds of flight at subsonic speeds, the forces that affect missile flight at supersonic speeds are of more importance to you. They are discussed in the next section.

AERODYNAMICS OF SUPERSONIC MISSILE FLIGHT

So far we have discussed the principles of producing lift by using cambered (curved) wings. Cambered wings are still used on conventional aircraft but are not used on most present day guided missiles. Most operational missiles use streamlined fins to provide stability and some lift.

Before discussing aerodynamics of supersonic missile flight, let us define some of the terms used.

REYNOLDS NUMBER

During the development of a new missile design, scale models of the proposed missile are tested in wind tunnels. But the performance of the model does not necessarily indicate the performance of the actual missile, even when all known variables are scaled down. In some cases the effect of a given variable on the model may be opposite to its effect on the full-size missile. Reynolds number is a mathematical ratio involving relative wind speeds, air viscosity and density, relative sizes of the model and missile, and other factors. The use of this ratio makes it possible to predict missile behavior under actual flight conditions from the behavior of the model in the wind tunnel. The Reynolds number is also applicable in hydrodynamic testing.

MACH NUMBERS AND SPEED REGIONS

Missile speeds are expressed in terms of **MACH NUMBERS** rather than in miles per hour or knots. The Mach number is the ratio of missile speed to the local speed of sound. For example, if a missile is flying at a speed equal

PRINCIPLES OF GUIDED MISSILES AND NUCLEAR WEAPONS

to one-half the local speed of sound, it is said to be flying at Mach 0.5. If it moves at twice the local speed of sound, its speed is then Mach 2. (The term "Mach number" is derived from the name of an Austrian physicist, Ernst Mach, who was a pioneer in the field of aerodynamics. It is pronounced "mock.")

Local Speed of Sound

The speed expressed by the Mach number is not a fixed quantity because the speed of sound in air varies directly with the square root of air temperature. For example, it decreases from 760 miles per hour (mph) at sea level (for an average day when the air is 59°F) to 661 mph at the top of the troposphere. The speed of sound remains constant between 55,000 feet and 105,000 feet, then rises to 838 mph, reverses, and falls to 693 mph at the top of the stratosphere. Thus you can see that the speed of sound will vary with locality.

The range of aircraft and missile speed is divided into four regions which are defined with respect to the local speed of sound. These regions are as follows.

SUBSONIC FLIGHT, in which the airflow over all missile surfaces is less than the speed of sound. The subsonic division starts at Mach 0 and extends to about Mach 0.75. (The upper limit varies with different aircraft, depending on the design of the airfoils.)

At subsonic speeds, sustained flight is dependent on forces produced by the motion of the aerodynamic surfaces through the air. When the surfaces of airfoils are well designed, the stream of air flows smoothly over, under, and around them, and the air stream conforms to the shape of the airfoil. In addition, when the airfoils are set to the proper angle, and motion is fast enough, the airflow will support the weight of the aircraft or missile.

TRANSONIC FLIGHT, in which the airflow over the surfaces is mixed, being less than sonic speed in some areas and greater than sonic speed in others. The limits of this region are not sharply defined, but are approximately Mach 0.75 to Mach 1.2. Under these conditions, shock waves are present; the airflow is turbulent, and the missile may be severely buffeted. A high-speed missile should be made to accelerate through the transonic zone in the least possible time to prevent these disturbances.

SUPERSONIC FLIGHT, in which the airflow over all surfaces is at speeds greater than sound

velocity. This region extends from about Mach 1.2 upward. In supersonic flow, little turbulence is present.

HYPERSONIC FLIGHT. When any object moves through the air, the molecules of air require a finite time to adjust themselves to its presence, and to readjust themselves after it has passed. This period of adjustment and readjustment is called the relaxation time. If the time required for a missile to pass a given point is equal to or less than the relaxation time, the missile is moving at hypersonic speed. Relaxation time is longer at high altitudes, and the beginning of the hypersonic speed zone is correspondingly lower. Velocities that are not hypersonic at sea level may become so at high altitudes. Under most conditions, the hypersonic speed zone begins somewhere between Mach 5 and Mach 10.

HEAT BARRIER

This is not a barrier in a physical sense, but its effect tends to limit the maximum speed of a missile through the atmosphere. Heat results not only from friction, but from the fact that at high speeds the air is compressed by a ram effect. The temperature rise caused by the ram effect is proportional to the square of the Mach number. The average temperature at sea level is considered to be 59°F; temperature decreases steadily with altitude to about 46,000 feet, above which it is assumed to be constant. At sea level, ram temperature is about 88°F at Mach 1—29° higher than the standard temperature. At Mach 2, ram temperature at sea level is about 260°F, and at Mach 4 about 1000°F. Missiles capable of flying at these speeds must be capable of withstanding these temperatures. This problem is particularly serious with ballistic missiles intended to plunge down into the atmosphere at speeds in the order of Mach 12. A significant part of the development effort for long-range ballistic missiles has been devoted to development of nose cones capable of withstanding extreme temperatures.

SHOCK WAVE

The term "shock wave" is often used in describing effects of nuclear explosions but it is not a phenomenon occurring only in tremendous explosions. The same interaction of forces produces a shock wave in less overpowering situations.

Chapter 2—FACTORS AFFECTING MISSILE FLIGHT

As a missile moves through the air, the air tends to be compressed, and to pile up in front of the missile. Because compressed air can flow at speeds up to the speed of sound, it can flow smoothly around a low-speed missile. But as the missile approaches the speed of sound, the air can no longer get out of the way fast enough. The missile surfaces split the airstream, producing shock waves. A shock wave is a sharp boundary between two masses of air at different pressures.

Shock waves can seriously alter the forces acting on a missile, requiring radical changes in trim. The missile tail surfaces may be seriously buffeted and wing drag rises. Any deflection of the control surfaces in an attempt to overcome these conditions may cause new shock waves, which interact with those already present. For this reason there may be certain speeds at which the controls become entirely useless. In some cases the controls become reversed, and the action which usually results in a turn to port may result in one to starboard instead. These effects and many others may be the result of compressibility, a property of the airstream which is not prominent at low speeds but which cannot be ignored at high speeds.

THE NATURE OF COMPRESSIBILITY.—When an object moves through the air, it continuously produces small pressure disturbances in the airstream as it collides with the air particles in its path. Each such disturbance—a small variation in the pressure of the air—is transmitted outward in the form of a weak pressure wave. Each expanding pressure wave travels at the speed of sound. Although each pressure wave expands equally in all directions, the important direction is that in which the object generating it is moving.

As long as the object is moving at low subsonic speed, its position with respect to the pressure wave it produces is similar to that shown in figure 2-12A. The pressure wave expands in all directions. Since its speed is high compared with that of the body, the variation in pressure travels well ahead and agitates the air particles in the path of motion. Hence, when the body arrives at any given point, the air particles there are already in motion and can easily and smoothly flow around it.

In figure 2-12B and C, the object is represented as increasing in speed but as still traveling below sonic velocity. As speed increases, the object at any moment is nearer the undisturbed air particles in its path. This

means that the greater the speed of the moving body, the fewer the number of air particles that will be able to move from its path, with the result that the air begins to pile up in front of the body.

When the object reaches the speed of sound, the condition represented in figure 2-12D occurs. The pressure wave can no longer outrun the object and prepare the air particles in the path ahead. The particles then remain undisturbed until they collide with the air that has piled up in the airstream just ahead of the object. As a result of the collision, the airstream just ahead of the object is reduced in speed very rapidly; at the same time its density, pressure, and temperature increase.

As the speed of the object is increased beyond the speed of sound, the pressure, density, and temperature of the air just ahead of it are increased accordingly; and a region of highly compressed air extends some distance out in front of the body. Thus a situation occurs in which the air particles forward of the compressed region at one moment are completely undisturbed, and at the next moment are compelled to undergo drastic changes in velocity, density, temperature, and pressure. Because of the sudden nature of the transition, the boundary between the undisturbed air and the compressed region is called a shock wave.

You cannot see these changes taking place in air but you can see the same type of action occurring in water. Using a boat on a lake in our analogy, the changes might be described as follows.

For the purposes of the illustration, we'll assume that the waves or ripples formed on the lake will move at 10 mph, and the Mach number is the ratio of boat speed to wave speed.

With the boat at rest, the waves made by the boat bobbing up and down will spread out in concentric circles at the rate of 10 mph (fig. 2-13A). Now if the boat moves at the rate of 5 mph (representing a speed of Mach 0.5), the ripples will still spread out at the rate of 10 mph but they will no longer be concentric (fig. 2-13B). In figure 2-13C, the boat is moving at the same speed as the speed of wave propagation, representing Mach 1, and all the waves are tangent to each other at the bow of the boat. In figure 2-13D, the boat is moving at twice the wave speed—Mach 2—and it leaves the ripples behind. The wave pattern now becomes a wedge on the surface of the water. In the air, with three-dimensional flow, the pattern would be a cone.

PRINCIPLES OF GUIDED MISSILES AND NUCLEAR WEAPONS

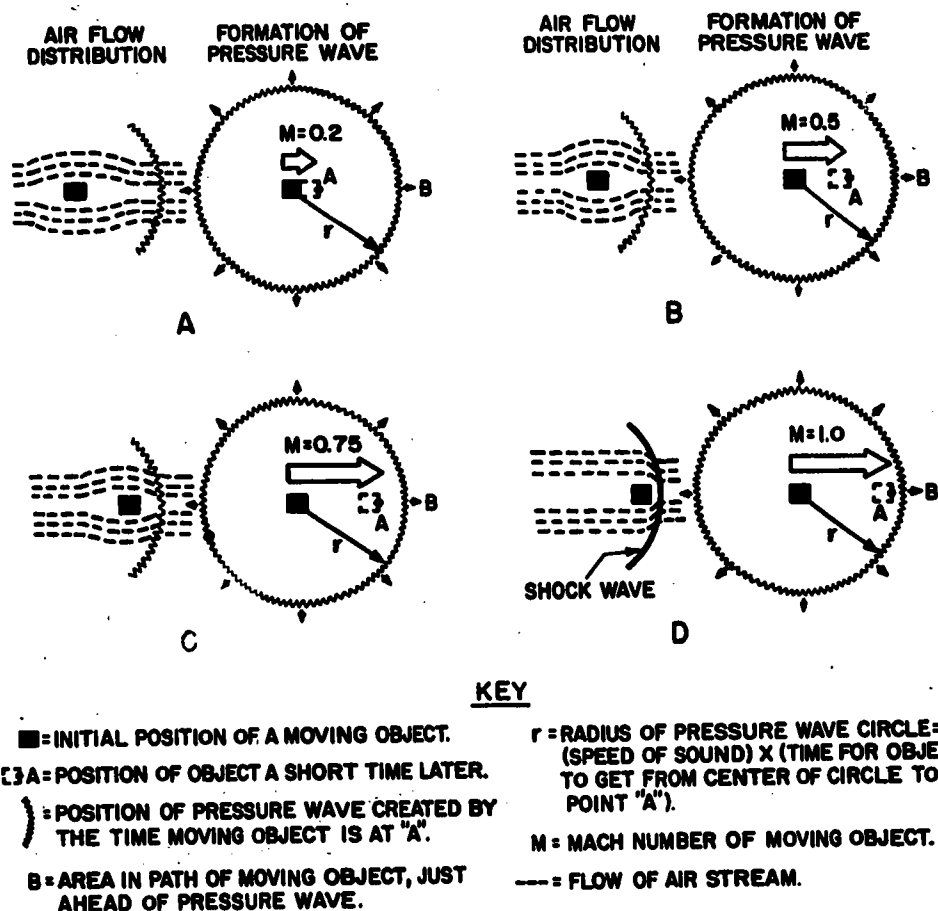

33.26

Figure 2-12.—Compressibility of air at various speeds.

The semivertex angle is the **MACH ANGLE**. The greater the speed above Mach 1, the smaller the angle. The shock waves form at the point of greatest density, where ripples meet. The bow wave of the boat is closely analogous to the conical shock wave that spreads from the nose of a supersonic missile. Both have the same cause: the fact that an object is moving through a fluid faster than the fluid itself can flow.

Types of Shock Waves

There are several types of shock waves, the principal classes being the **NORMAL** and the **OBLIQUE**. These differ primarily in the way in which the airstream passes through them. In the normal (or perpendicular) wave, the air passes through without changing direction, and

the wavefront is perpendicular to the line of flow (fig. 2-14A). The normal shock wave is usually very strong; that is, the changes in pressure, density, and temperature within it are great. The air passing through the normal shock wave always changes from supersonic to subsonic velocity.

OBLIQUE shock waves are those in which the airstream changes in direction upon passing through the transition marked by the wavefront (fig. 2-14B). These waves are produced in supersonic airstreams at the point of entry of wedge-shaped and other sharply pointed bodies. The resulting wavefronts make angles of less than 90° with the line of flight. Like the normal shock wave, the oblique wave occurs at a point of change in velocity from a higher to a lower value. The change in speed is usually from supersonic to subsonic but not always so. In

Chapter 2—FACTORS AFFECTING MISSILE FLIGHT

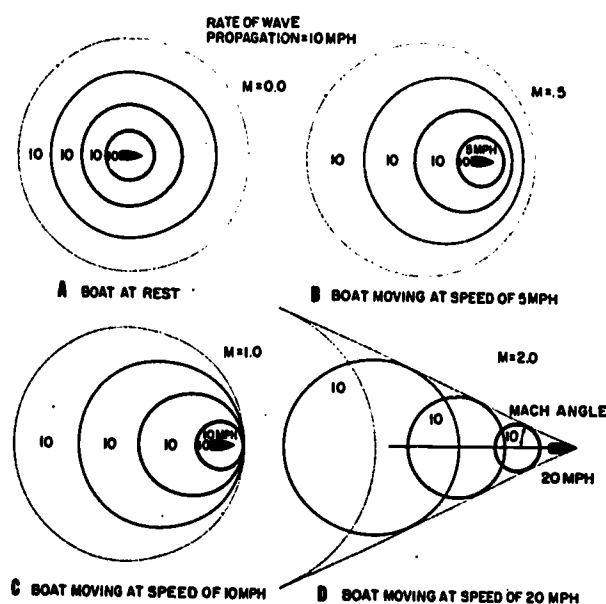

Figure 2-13.—Mach angle analogy.

some cases the airflow is supersonic both upstream and downstream of the oblique wave. In general, the variations in density, pressure, and temperature are less severe in the oblique wave than in the normal shock wave. As we have said, a shock wave is a sharp boundary between two masses of air at different pressure. Air behind the oblique shock wave has a lower relative speed than that in front, and therefore has a higher pressure.

NORMAL shock waves can occur over the wing surfaces of a subsonic aircraft that exceeds its maximum safe operating speed (fig. 2-15A). The high speed (but still subsonic) airstream flows up over the leading edge of the wing, increasing in velocity as it does so, and passes the speed of sound. At a point on the wing slightly rearward of the leading edge, the velocity of the flow decreases, changing from a supersonic to a subsonic value. At the point of transition a normal shock wave is formed. This process illustrates the following rule which always holds true: The transition of air from subsonic to supersonic flow is smooth and unaccompanied by shock waves, but the change from supersonic to subsonic flow is always sudden and is accompanied by large variations in pressure, density, and temperature. Figure

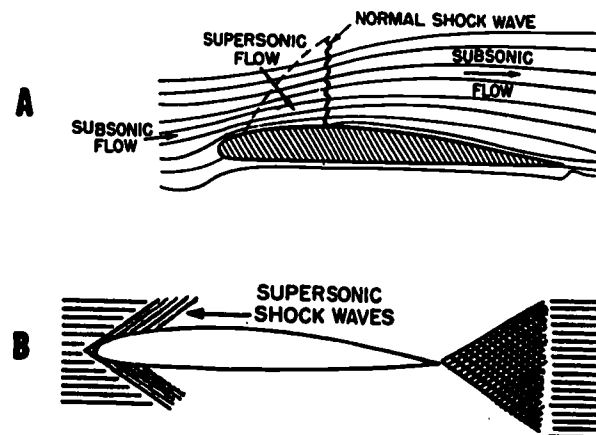

Figure 2-14.—Formation of shock waves: A. Normal shock waves; B. Oblique shock waves.

2-15 shows the manner in which shock waves behave at increasing airfoil speeds. In figure 2-15A, the airfoil is traveling at Mach 0.75. The airflow over the upper surface is fast enough to cause the formation of a shock wave on the upper surface. As the airfoil speed increases to Mach 0.90 (fig. 2-15B), the airflow becomes fast enough to cause an additional shock wave to form on the lower surface. Figure 2-15C shows the waves moving toward the trailing edge as the airfoil speed is increased to Mach 0.95. Finally, when the airfoil reaches supersonic speed (fig. 2-15D and E), the upper and lower shock waves move all the way back to the trailing edge and, at the same time, a new shock wave is produced in front of the leading edge.

CONTROL OF SUPERSONIC MISSILES

Aerodynamic control is the connecting link between the guidance system and the missile flight path. Effective control of the flight path requires smooth and exact operation of the missile control surfaces. The control surfaces must have the best possible design configuration for the intended speed of the missile. They must be moved with enough force to produce the necessary change of direction. Methods must be found for balancing the various controls, and for changing them to meet the variations of lift and drag at different Mach speeds so as to maintain missile stability.

PRINCIPLES OF GUIDED MISSILES AND NUCLEAR WEAPONS

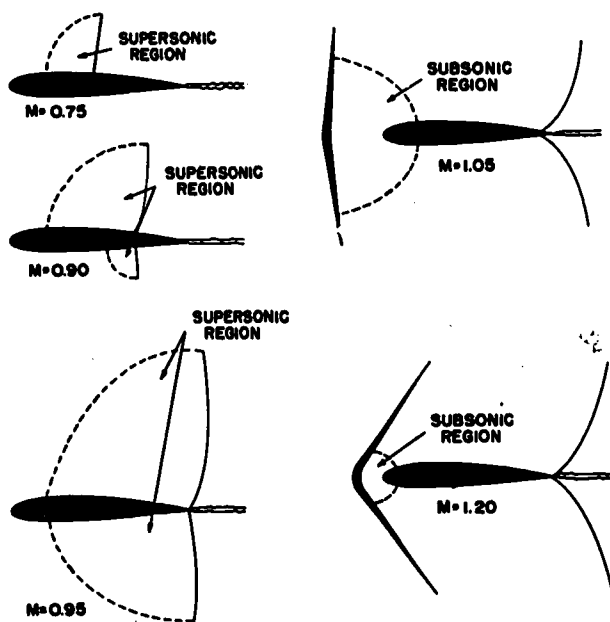

Figure 2-15.—Shock waves at various speeds of airfoils.

33.28

In some modern missiles lift is achieved entirely by the thrust of the main propulsion system. The Polaris missile, for example, has no fins. It is important that you realize that fins cannot control a missile outside the earth's atmosphere. The methods of achieving control in space will be discussed later in the course.

External Control Surfaces

The simplest control surfaces are fixed fins. The flight of an arrow is an example of the stability provided by fixed fins. The feathered fins on an arrow present streamlined airflow surfaces which ensure accurate flight. Since supersonic missile fins are not cambered, a slightly different lift principle is involved than with the conventional wing. At subsonic speeds a positive angle of attack will result in impact pressure on the lower fin surface which will produce lift just as with the conventional wing. At supersonic speeds, the formation of expansion waves and oblique shock waves also contributes to lift. Figure 2-16 shows a cross section of a supersonic fin and airflow about it. Due to the fin shape, the air is speeded up through a series of expansion waves. This results in a

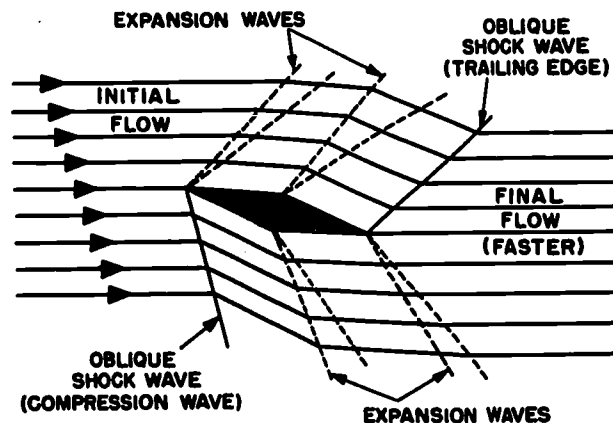

33.30

Figure 2-16.—Airflow about a supersonic fin.

low pressure area above the fin. Beneath the fin, the force of the airstream (dynamic pressure) and the formation of oblique shock waves result in a high pressure area. The differences in pressure above and below the fin produce lift. Fixed fins are usually called vertical stabilizers or horizontal stabilizers, depending on their position and function.

Guided missiles may also be provided with movable control surfaces, since stationary fins cannot provide the precise control needed to keep the missile on a desired course. Movable control surfaces can be divided into two types: primary and secondary. The primary controls include ailerons, elevators, and rudders (fig. 2-17). Secondary control surfaces include tabs, spoilers, and slots. Primary control devices are responsible for maintaining missiles along desired trajectories. If no unstabilizing conditions were present, primary control could function satisfactorily. A missile can be controlled more accurately and more efficiently, however, by the use of secondary controls, in various combinations, working in conjunction with primary controls.

Ailerons, elevators, and rudders are attached to fixed wings and tails as in a conventional aircraft.

In figure 2-17, ailerons are attached to the trailing edges of the wings. When one aileron is lowered, the other is raised. Movement of the ailerons changes the wing camber and brings about roll control. The wing with the raised

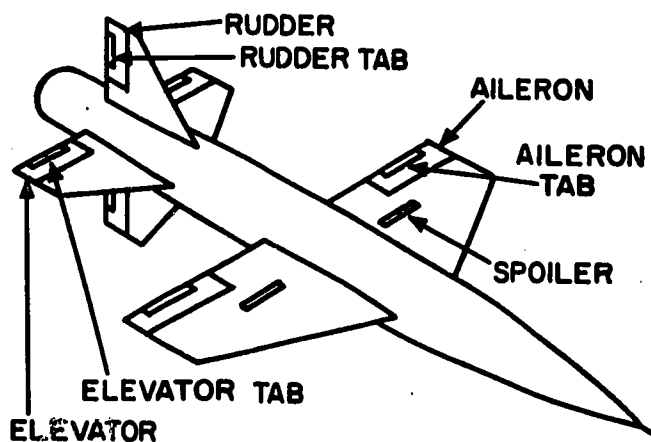

33.39
Figure 2-17.—Control devices on conventional type missiles.

aileron moves down and the other wing moves up.

Elevators attached to the horizontal tail stabilizers may be used for pitch control. The elevators are raised or lowered together.

Rudders attached to the vertical stabilizers (fig. 2-17) may be used for yaw control.

If the rudder moves to the right the tail moves to the left, and the missile yaws to the right.

Tabs are hinged to primary control surfaces, and the force exerted by these devices is directed to act against a primary control and not the missile itself. For example, consider a tab (fig. 2-17) on an elevator. If the tab moves upward, the deflected air will exert a downward force on the elevator. The elevator will then move down. Note that it is still the elevator, not the tab, that directly controls the missile. A fixed tab is preset for a given condition of stability; a trim tab is controllable and its setting can be varied over a wide range of conditions. A booster tab is used to assist in applying force to move control surfaces of large areas.

A spoiler can be any of several devices-- for example, a hinged flap on the upper surface of the wing. Suppose that a gust of air causes the left wing to lose lift. The spoiler on the right wing can be raised to "spoil" the smooth flow of air over it, and thus decrease its lift to equal that of the other wing.

A slot is basically a high-lift device located at the leading edge of the wing. At a normal angle of attack, it has no effect. At high angles

of attack the slot can be opened to allow air to spill through and thus prevent a stall.

Dual Purpose Control

The primary and secondary control devices discussed above are used on older type missiles, although the Bullpup missile uses a type of tab. For high-speed missiles, new control surface designs have been developed. Examples of such surfaces are eleyons, rollerons, ruddervators, and ailevators. As the names indicate, these are multipurpose control devices. For example, an elevon replaces an elevator and an aileron, allowing control of pitch and yaw by a single control mechanism. The Regulus missile used this device. If operated together, they serve as elevators; if operated differentially, they serve as ailerons. If the missile tail surfaces were inclined upward, to form a V with the missile axis, controls on the trailing edges of these surfaces could be used as ruddervators. By suitable combinations of movements, they could control the missile in both pitch and yaw. Figure 2-10A shows the fixed and movable stabilizing surfaces on Tartar and Bullpup missiles. The Tartar has four fixed trapezoidal dorsal fins the length of the rocket section, and four independently movable tail fins. The tail fins are folded during handling and stowage.

The Terrier BT-3 has fixed dorsal fins and folding tail surfaces. Four booster fins are mounted 90° apart around the after end of the booster, and are in line with the missile tails and the dorsal fins. The Terrier BW-1 has fixed tails.

The Talos missile has four movable wings in a cruciform arrangement at approximately the missile longitudinal center of gravity. Four fixed fins near the after section are mounted in line with the four wings. The booster also has four fins, which are attached to the exit nozzle. After the booster propellant has burned out, the booster airframe drops off.

Control at Starting Speeds

Surface-launched missiles start out with zero velocity, and accelerate to flying speeds. For a short time after launching, airspeed over the control surfaces is slow, and these surfaces are unable to stabilize the missile or control its course. With small, booster-launched missiles, this problem is not serious. Terrier, for example, builds up enough speed for aerodynamic

PRINCIPLES OF GUIDED MISSILES AND NUCLEAR WEAPONS

stability in a fraction of a second. But heavy intercontinental ballistic missiles rise slowly from their launching pads, and may require auxiliary control devices for a number of seconds after launching. Two types of auxiliary control have been used.

EXHAUST VANES are surfaces mounted directly in the exhaust path of a jet or rocket engine (fig. 2-18B). When the exhaust vanes are moved, they deflect the direction of exhaust, and thus produce a lateral component of thrust that can be used to keep the missile pointed in the desired direction. This is possible because the exhaust velocity is very high, even when the missile has just begun to move. Because of the tremendous heat in the exhaust, the life of exhaust vanes is short. The German V-2 used exhaust vanes made of carbon. The melting point of carbon is far above the exhaust temperature. But because carbon burns, the vanes were eroded rapidly. By the time the V-2 reached a speed at which the vanes were no longer needed, they were burned away completely. Exhaust vanes are also used to stabilize missiles in travel outside the atmosphere.

JET CONTROL (fig. 2-18) is similar to exhaust vane control in that both deflect the exhaust to produce a lateral component of thrust. One method of jet control consists in mounting the engine itself in gimbals, and turning the whole engine to deflect the exhaust stream (fig. 2-18C). This system requires that the engine be fed by flexible fuel lines, and the control system that turns the engine must be very

powerful. Another method of jet control consists in mounting several auxiliary jets at various points (fig. 2-18A) on the missile surface. By turning on one or more of the auxiliary jets, it is possible for the guidance and control systems to change the missile course as required. Heat shields are necessary to protect the main body of the missile from exhaust heat generated by the jets. The use of auxiliary jets makes it possible to eliminate the outside control surfaces entirely. This is the steering method most likely to be used for control of missiles after they leave the atmosphere (and eventually, for the control of space ships).

VECTOR CONTROL. Man-made forces may exert velocity vector control of missiles in flight. A ballistic missile before rocket burn-out, when it is receiving rocket thrust with gyro control of the direction of motion (fig. 2-19), is receiving velocity vector control—the missile path is being shaped as desired, at each instant. On the other hand, a rocket under pure thrust, uncontrolled in magnitude and with no direction control, is not considered as receiving velocity vector control. A missile experiencing thrust may have its velocity vector controlled by the use of auxiliary devices to control the speed and direction of missile flight. The thrust itself may be controllable in magnitude and direction. Both of these types are directional controls, achieved by the following general steps: tracking the target; predicting its future position; and converting target data to directional orders, either inside or outside the missile. In the case of guided missiles or ballistic missiles before burnout, the directional orders are implemented in the missile so as to produce directional control forces. This may be achieved by the use of fins or rudders, by controlling the direction or magnitude of the main thrust, or by auxiliary side thrusts (rockets). In the last example there is a slight overlap between thrust and directional control; here directional control is achieved by means of the thrust itself (fig. 2-19B). A guided missile is usually under the combined influence of natural and man-made forces during its entire flight. Man-made forces include thrust and directional control. The vector sum of all the forces, natural and man-made, acting on a missile at any instant, may be called the total force vector (fig. 2-19C). It is this vector, considered as a function of time, in magnitude and direction, which provides velocity vector control.

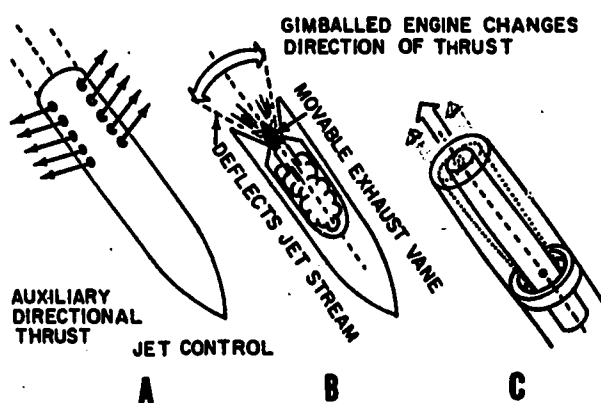

33.177-181

Figure 2-18.—Jet control of flight attitude.

Chapter 2—FACTORS AFFECTING MISSILE FLIGHT

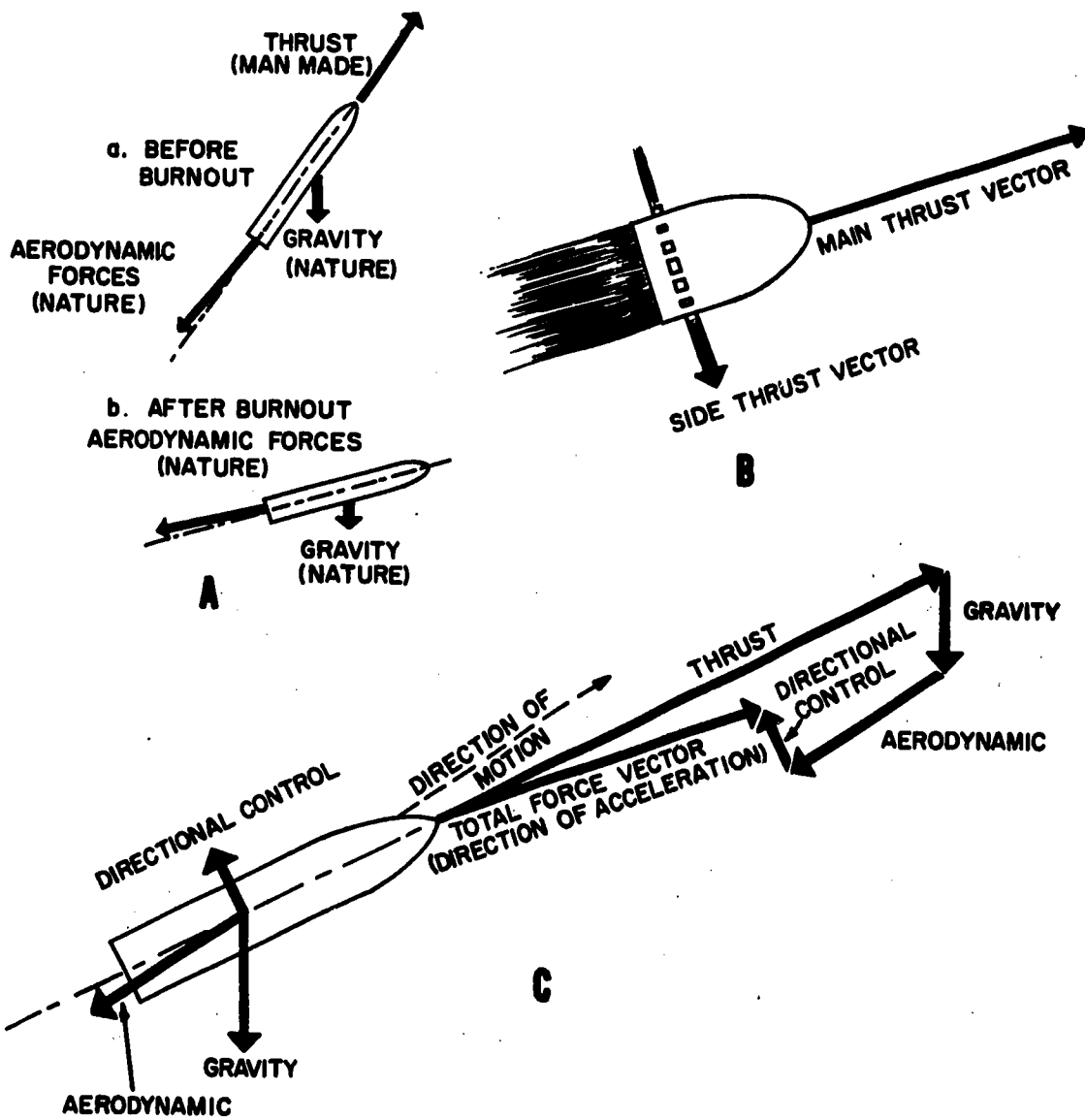

Figure 2-19.—Vector control: A. Before and after burnout; B. Thrust vectors; C. Total force vector. 144.9

Vector control as achieved in some mods of the Polaris missile will be described briefly. The Polaris has no controllable aerodynamic surfaces, and must therefore be stabilized and controlled by other means. Its flight control subsystem provides control and stabilization of the missile during its powered flight. The propulsion subsystem provides thrust and thrust vector control. The combustion gases from the

burning propellant are exhausted through four nozzles, and each nozzle has a jetevator which can be moved to deflect the gases as ordered by the flight control subsystem. Figure 2-20 illustrates the action of the jetevators in stabilizing and steering the missile. For convenient reference, the nozzles are numbered clockwise as seen from the rear. The jetevators, one on each nozzle, are pivoted on the top and

PRINCIPLES OF GUIDED MISSILES AND NUCLEAR WEAPONS

bottom on nozzles 2 and 4, and at either side on nozzles 1 and 3. The jetevators normally function in pairs. Those on nozzles 2 and 4 can deflect the gas stream either to the right or the left, and those on 1 and 3 can deflect it either upward or downward. Figure 2-20 shows how the jetevators function in the missile to produce pitch up, yaw to the right, and missile clockwise roll. Positioning jetevators 1 and 3 as shown in figure 2-20A, deflects the gas stream upward, which causes the missile to pitch upward. In part B of the figure, jetevators 2 and 4 deflect the gas stream to the right and cause the missile's nose to yaw to the right. In part C, each jetevator pair is set differentially (No. 1 deflects the gas stream downward, No. 3 deflects it upward; No. 2 deflects it to the right, No. 4 to the left); this drives the missile into a clockwise roll. The jetevators are moved by signals from the flight control subsystem of the missile.

EFFECTS OF MISSILE CONFIGURATION

The configuration of a guided missile is the principal factor controlling the drag and lift forces that act on it. And these two forces largely determine the overall efficiency of the missile. Missile configuration and strength are dependent on the required missile maneuverability, stability, speed, and operating altitude.

Both lift and drag are directly proportional to the square of missile speed.

DRAG REDUCTION. It is essential that supersonic missiles be designed for minimum drag. A low drag configuration makes it possible to use a smaller power plant, with a lower rate of fuel consumption. The resulting saving in bulk and weight can be used to extend the range of the missile, add to its warhead payload, reduce its overall size, or any combination of these three.

The effects of thickness distribution, Reynolds number, surface imperfection, and Mach number all influence missile drag. Wing drag is influenced by thickness ratio, sweepback, aspect ratio, and section of airfoil. Total drag of the missile is made up of fuselage drag, wing and fin drag, and another factor not present in subsonic flight: mutual interference between the drags of the individual parts. For example, the drag of a wing may be strongly affected, for better or worse, by the shape of the body on which it is mounted. Since drag is directly proportional to velocity squared, minimum drag design becomes of paramount importance as missile velocity increases.

LIFT EFFECTIVENESS. A steady lift force, equal to the weight of the missile, must be maintained to keep the missile in level flight. Additional lift must be available for maneuvering.

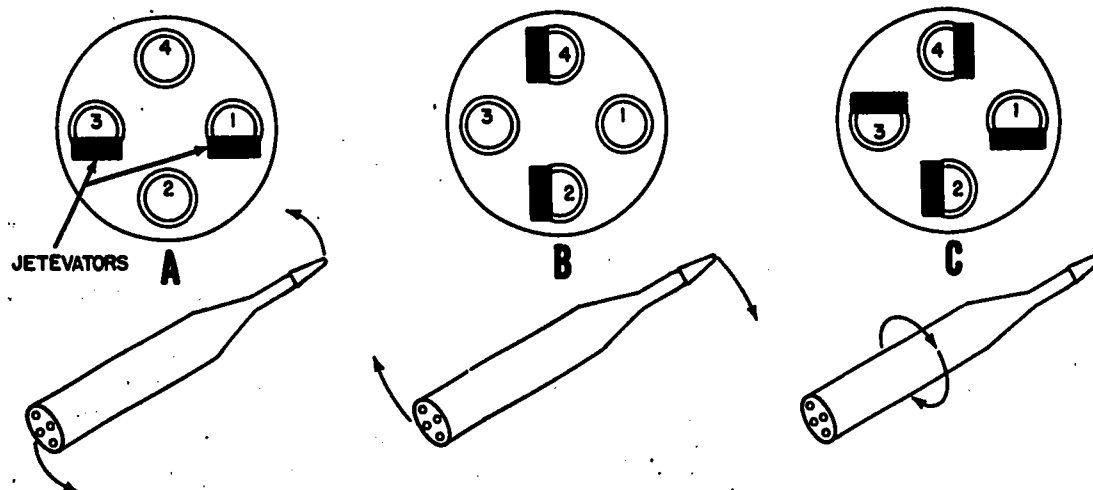

Figure 2-20.—Jetevator action for missile control: A. Jetevators positioned to cause missile to pitch up; B. Jetevators positioned for yaw to the right; C. Jetevators positioned for clockwise roll.

144.10

Chapter 2—FACTORS AFFECTING MISSILE FLIGHT

A missile must be so designed that the necessary lift is provided with minimum drag. And, for satisfactory control response, lift must vary smoothly with the angle of attack.

The conditions of flight associated with subsonic airflow are well known. Airflow phenomena at supersonic speeds are orderly, and can be analyzed mathematically. But in the transonic speed range, major design problems arise. A great deal remains to be learned about airflow in this range.

Airflow over an ideal wing would be subsonic until the missile reaches a velocity of Mach 1, and it would then immediately become supersonic. In other words, an ideal wing, if it were possible to make one, would eliminate the transonic range. Actually, the transonic range begins when the flow over any part of the missile becomes supersonic, and continues until the flow over all parts of the missile becomes supersonic. The free-stream Mach number at which transonic flow begins on any given missile is called the critical Mach number for that missile.

Every missile is designed for a cruising speed either below the transonic region or above it; no missile is intended to cruise within this region. For supersonic missiles, the effects of the transonic zone can be minimized in two ways. First, the range of speeds included within the transonic zone can be narrowed by suitable design of the missile. Second, by maintaining maximum powerplant thrust until after supersonic velocity is reached, the missile can pass through the transonic region in minimum time. Supersonic missiles are often launched with the help of boosters. A booster may be considered as an auxiliary powerplant. It consumes fuel at a rapid rate, and develops a high thrust. After the missile has passed through the transonic region its booster falls away. The missile is then propelled at supersonic speed by its own powerplant, which has a lower rate of fuel consumption and a smaller thrust than the booster.

Figure 2-10B represents locations and designs of control surfaces of current guided missiles. The optimum arrangement of airfoils on a missile is governed by many factors, such as speed, rate of acceleration during the launching phase, range, and whether or not the missile is to be recovered. The sketches in figure 2-21 show some of the more common arrangements of missile airfoils. In some missile designs, arrangements shown in the figure

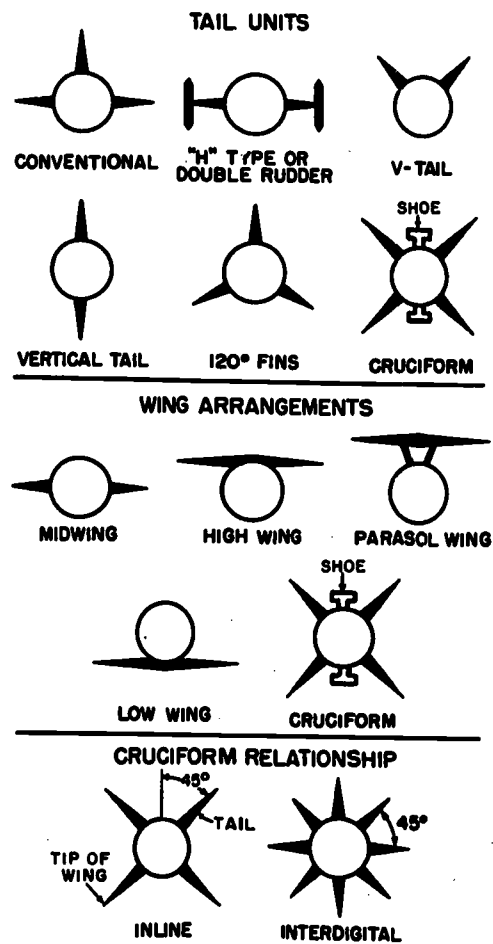

Figure 2-21.—Arrangements of control surfaces.

33.35

as "tail units" may be used at the mid-section or even at the nose of the missile; in others, some of the "wing arrangements" shown in the figure may be used as tail units.

The CONVENTIONAL and CRUCIFORM are the most popular tail arrangements. The HIGH WING and cruciform wing arrangements are used for most missiles. The INLINE cruciform arrangement is widely used, especially for supersonic missiles. The INTERDIGITAL form is used on older mods of Terrier.

In some supersonic missiles, body lift may be the only lifting force. In such high-speed applications, control surfaces can be made smaller or eliminated altogether, as in Polaris, thus counteracting the increased drag at high speeds.

PRINCIPLES OF GUIDED MISSILES AND NUCLEAR WEAPONS

At supersonic speeds, the advantages of camber (curve) of the airfoils no longer exist, and wing designs must be modified. The wing receives its lift as a result of the angle of attack rather than of any increase in velocity of the air stream over the upper surface as compared with the lower surface. A smooth flow of air over the wing (or fin) surface keeps down the drag; anything that increases turbulence of the airflow increases drag.

FIN DESIGNS. Supersonic fins are symmetrical in thickness cross section and have a small thickness ratio—the ratio of the maximum thickness to the chord length. The **DOUBLE WEDGE**, shown in figure 2-22A, has the least drag for a given thickness ratio, but in certain applications it is inferior because it lacks strength. The **MODIFIED DOUBLE WEDGE** has relatively low drag (although its drag is usually higher than a double wedge of the same thickness ratio) and is stronger than the double wedge. The **BICONVEX**, also shown in the figure, has about one-third more drag than a double wedge of the same thickness ratio. It is the strongest of the three but is difficult to manufacture.

The planform of the fins—the outline when viewed from above—is usually either of the **DELTA-MODIFIED DELTA** (raked tip) or **RECTANGULAR** types shown in figure 2-22B. These shapes considerably reduce unwanted shock wave effects. The combination of a raked tip and cathedral droop (fig. 2-22C) of the wings permits better control as the swept-back wings delay air compressibility.

Most missile bodies are slender cylindrical structures similar to those shown in figure 2-22B. Several types of nose sections are used. If the missile is intended for supersonic speeds, the forward section usually has a pointed arch profile in which the sides taper in lines called **OGIVE** curves (fig. 2-22D(a)). Missiles which fly at lesser speeds may have blunt noses as shown in figure 2-22D(b). The Sidewinder is an example of a missile with such a nose. An air-breathing missile nose which includes the duct for the ramjet propulsion system is also shown (fig. 2-22D(d)).

Hydrodynamics

Since surface-fired missiles for underwater attack are part of the missile armament of many ships, you need to know something about the effect of water on missile shape, speed, trajectory, and other aspects. The development

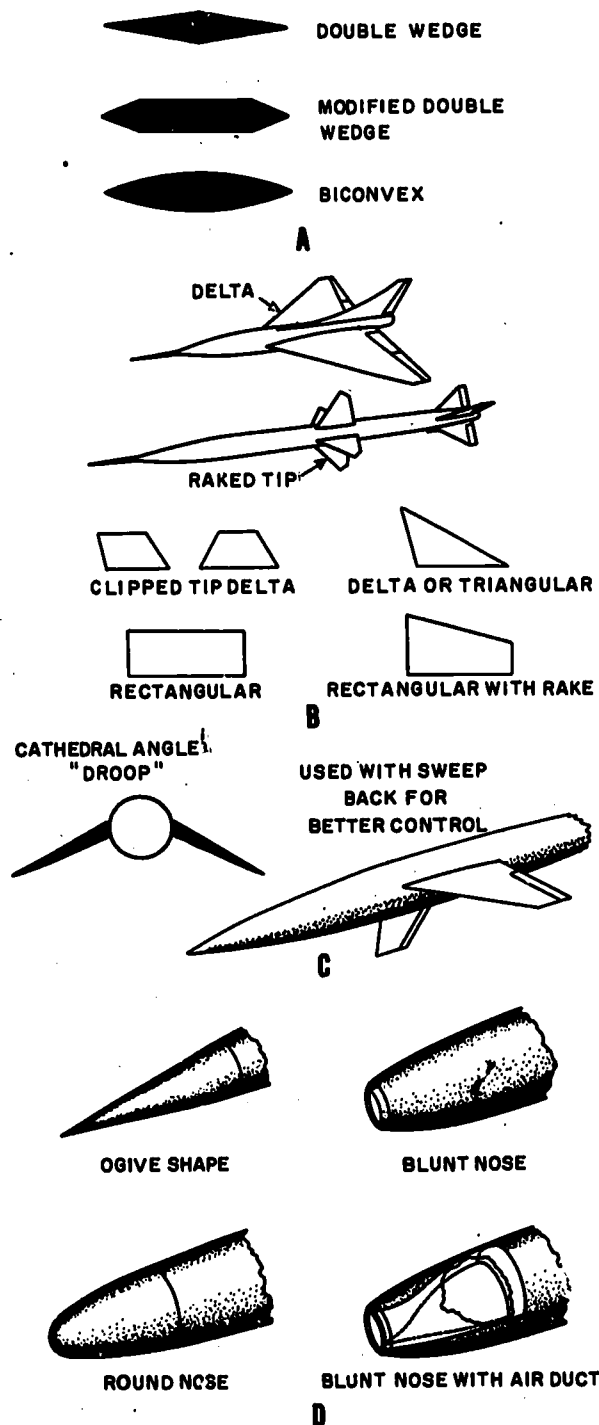

Figure 2-22.—High speed configuration characteristics: A. Supersonic fin cross-sectional shapes; B. Supersonic fin platforms; C. Wing angle; D. Missile noses.

Chapter 2—FACTORS AFFECTING MISSILE FLIGHT

of lift on a surface moving in water differs substantially from the same phenomenon in air because water is almost incompressible while air is highly compressible. When a missile moves through air, a change in the density of the air occurs at various points of the missile and its airfoils. The same motion through water produces a different effect. The flow of water past an inclined plane (the hydrofoils) can be treated as two separate motions. The first is the streamline flow (fig. 2-23A), just as is encountered in air, and the second is a circulation (fig. 2-23B). The circulation component is due directly to the incompressibility of water. The net flow (resultant) is the sum of the two components (fig. 2-23C). The resultant velocity is greater above the plate than below it, and there is therefore a powerful uplift force. The drag force is parallel to the direction of motion.

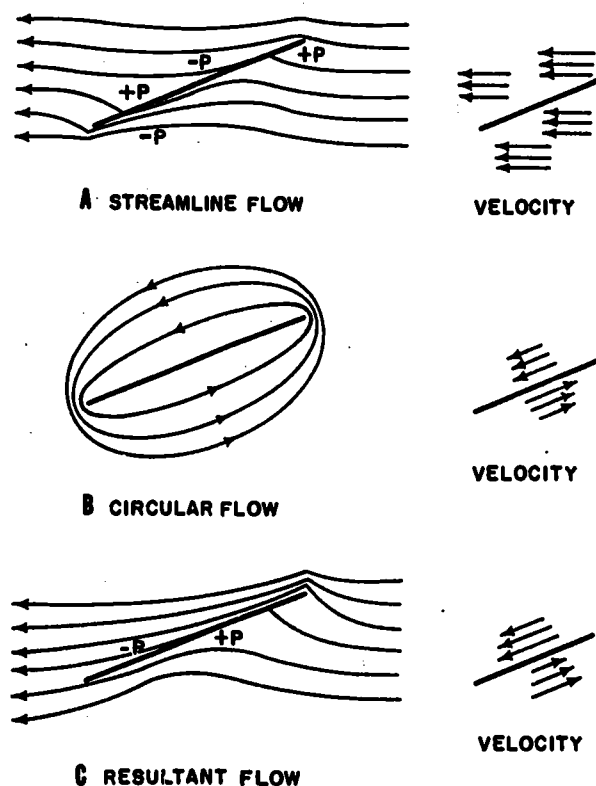

Figure 2-23.—Flow of water about an inclined plane: A. Streamline flow; B. Circular flow; C. Resultant flow.

The greater the lift required of the hydrofoil, the greater must be the effective angle of attack at which it moves, within the normal range of angle of attack. As speed increases, water, like air, cannot get out of the way of the moving foil fast enough. Discontinuities of flow occur, causing cavitation (formation of areas of vacuum), and lift decreases, drag increases, and buffeting and other undesirable phenomena may occur. This is called the stalling point, comparable to the burble point in air.

Designers of missiles whose trajectory is partly through air and partly through water must consider both aerodynamic and hydrodynamic effects on the missile shape and its wings and fins. This requires compromises in design. For example, an airfoil should be thin to achieve the smoothest flow of air over the surfaces, but a hydrofoil must have thick sections, or at least the leading edge must be relatively thick because of the extremely wide range of attack angles to which it may be subjected. Therefore, some lift has to be sacrificed in order to have a foil able to withstand water forces. Water has greater buoyancy than air, so less lifting force is needed, but at the same time, the drag force is greater, so a greater propulsive force is needed. Ricocheting or skipping at water entry must be prevented. All these factors must be considered in the missile configuration.

GUIDED MISSILE TRAJECTORIES

The trajectory of a missile is its path from launch to impact or destruct. There are two basic types of missile trajectories: ballistic and aerodynamic (including the "gravity-biased" aerodynamically supported trajectory). A number of other trajectories are named according to the path traveled. Some of these trajectories are: aeroballistic, glide, powered flight, terminal, zero lift, skip, and standard or ideal. The chapters on guidance illustrate some of the trajectories.

In a **BALLISTIC** trajectory, the missile is acted upon only by gravity and aerodynamic drag after the propulsive force is terminated. Gun projectiles have a purely ballistic trajectory; ballistic missiles have at least the major part of the trajectory a ballistic one.

An **AERODYNAMIC** missile is one which uses aerodynamic forces to maintain its flight path; it usually has a winged configuration.

144.11

PRINCIPLES OF GUIDED MISSILES AND NUCLEAR WEAPONS

TRAJECTORY CURVES

Missile trajectories include many types of curves. The exact nature of the curve is determined by the type of guidance and the nature of the control system used. For some missiles, the desired trajectory is chosen before the missile is designed, and the missile is closely limited to that trajectory. Missiles may offer a choice of trajectories.

HYPERBOLIC TRAJECTORY.—A missile using a hyperbolic guidance system will first climb to the desired altitude, then follow an arc of a hyperbola before diving on its target. If the control stations are ideally located with respect to the target, the hyperbolic course is a close approach to a straight line. This system is not used with any of our guided missile systems at present. It operates on the Loran principle, with a "master" and a "slave" station sending radio signals to fix the location of the target.

PURSUIT CURVE.—Some homing missiles, and some beam riders, follow a pursuit curve. At any given instant, the course of the missile is directly toward the target. If missile and target are approaching head-on, or if the missile is engaged in a tail chase, the pursuit curve may be a straight line unless the target changes course. But a missile that pursues a crossing target must follow a curved trajectory. As the missile approaches a crossing target, the target bearing rate increases, and the curvature of the missile course increases correspondingly. In some cases the extreme curvature of the pursuit course may be too sharp for the missile to follow.

LEAD ANGLE COURSE.—Some homing missiles follow a modified pursuit course. The deflection of the missile control surfaces is made proportional to the target bearing rate. The missile flies not toward the target, but toward a point in front of it. The missile thus develops a lead angle, and the curvature of its course is decreased.

A further refinement is possible if a computer, either in the missile or at a control station, can use known information about the missile and target to calculate a point of intercept which missile and target will reach at the same instant. Because the missile is guided directly toward the point of intercept, its trajectory is a straight line. If the target changes course during the missile flight, a new point

of intercept will be calculated, and the missile course will be turned toward the new point of intercept.

BEAM-RIDER TRAJECTORY.—As we will explain in a later chapter, a beam-rider missile may follow either a pursuit curve or a lead-angle course, depending on the type of system used.

FLAT TRAJECTORY.—An intermediate-range or long-range air-breathing missile is usually made to climb as quickly as possible to the altitude at which its propulsion plant operates most efficiently—somewhere between 30,000 and 90,000 feet. After reaching this altitude the missile flies a flat trajectory to the target area. The missile is made to climb steeply to a desired altitude, level off, fly a flat trajectory to the target area, then dive straight down.

BALLISTIC TRAJECTORY.—Polaris is launched vertically, so that it can get through the densest part of the atmosphere as soon as possible. At a certain altitude, which may be controlled by either preset or command guidance, the missile turns to a more gradual climb. After burnout, or shutdown of the propulsion system by radio command, the missile "coasts" along a ballistic trajectory to the target.

From launch to warhead detonation, long range ballistic missiles follow a trajectory approximating that shown in figure 2-24, separating into three flight stages. Missiles that are launched vertically travel only a comparatively short distance before turning to a slant angle. If launched from under water, as the Polaris, most of the vertical part of its flight path is underwater. Powered flight continues until the end of the second stage, when ballistic flight begins. The distance to the target determines the point at which it is necessary for the missile to go into the ballistic curve that will bring it down on the target. Computations are made by missile system computers before missile firing.

COMBINATION TRAJECTORY.—A special case is the trajectory of the Asroc weapon (fig. 2-25). It is fired from a launcher on a surface ship and is boosted into the air by rocket thrust (phase 1). After burnout of the rocket it goes through the air in a ballistic trajectory (phase 2) until it strikes the water surface. It falls straight down through the water for a short time. Then it begins hunting for the target (phase 3), and homes on it (phase 4) when it has been located.

Chapter 2—FACTORS AFFECTING MISSILE FLIGHT

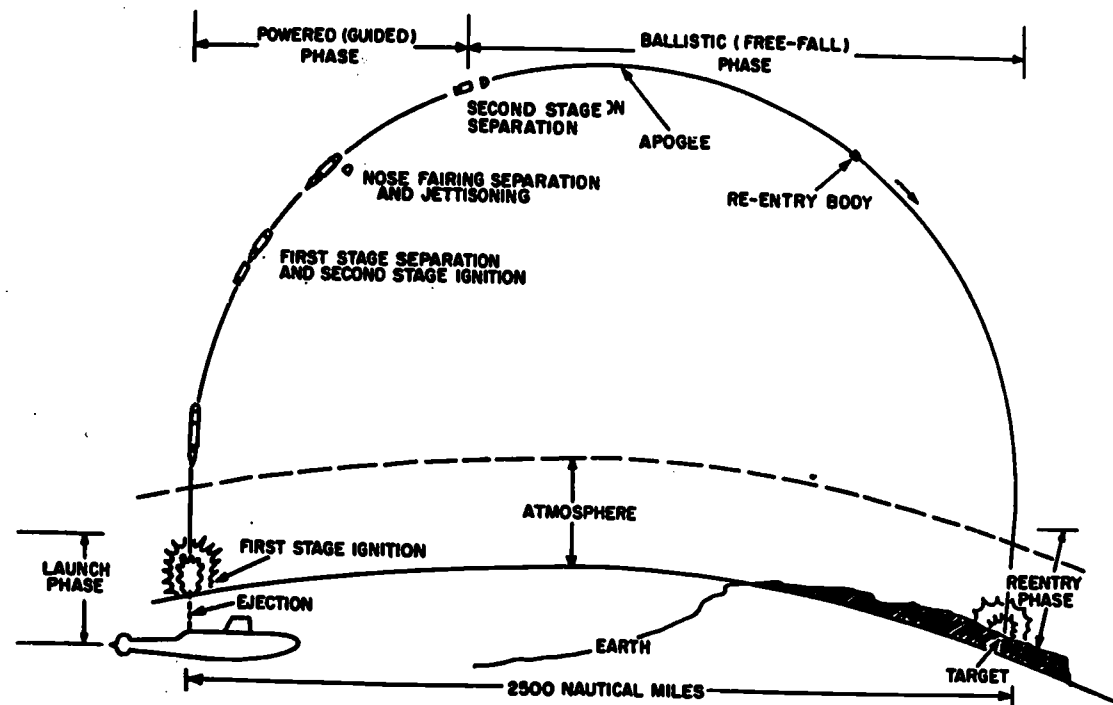

Figure 2-24.—Typical trajectory of an ICBM (Polaris).

33.269

The Subroc missile also follows a combination trajectory through air and water, but it is launched from submerged submarines.

PROPORTIONAL NAVIGATION COURSE.—Proportional navigation is a homing guidance technique in which the missile turn rate is directly proportional to the turn rate in space of the line of sight. The seeker tracks the target semi-independently from the missile maneuvers. Lead angles and navigation ratios (N) can usually be chosen so that the missile acceleration will exceed the target acceleration only slightly.

FACTORS AFFECTING MISSILE TRAJECTORY

The principal factors affecting a missile's trajectory are, of course, the design of the missile and its guidance system, which are man made. Natural external forces affecting the trajectory include wind, gravity, magnetic forces, and the coriolis effect. In the use of any long-range missile, all of these must be taken into account.

WIND.—All missiles fly through the atmosphere, either during their entire flight or at the

beginning and end of it. They are therefore liable to be pushed off the desired course by the force of the wind. The magnitude and direction of the prevailing winds at various points on the earth are well known. But the prevailing winds are much modified by a number of factors such as local topography, thermal updrafts due to local heating of the earth's surface, the distribution of high-pressure and low-pressure air masses, and storms and their associated turbulence. All of these factors can be predicted to some extent, but the reliability of the prediction decreases with both time and distance. For that reason, air-breathing missiles must be provided with means for correcting any deviation in course that might result from unpredicted winds. A ballistic missile may be subject to correction as it rises through the atmosphere. But it descends on its target at such a speed that the effect of wind is unlikely to produce a serious error.

GRAVITY.—A long-range missile using a navigational guidance system may use the direction of the center of the earth as a reference.

PRINCIPLES OF GUIDED MISSILES AND NUCLEAR WEAPONS

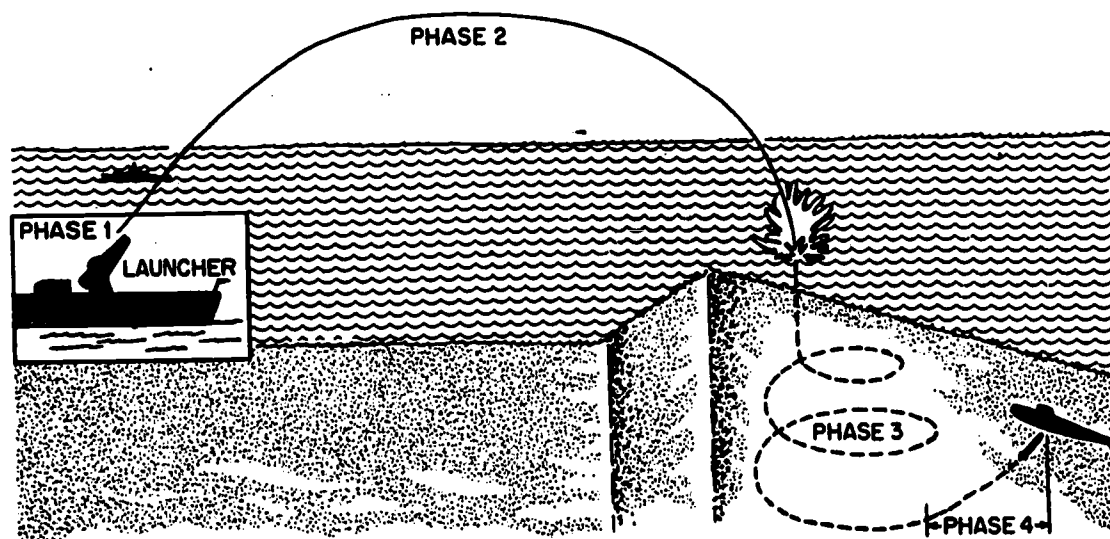

15.115

Figure 2-25.—Trajectory of an Asroc missile.

It does so by using a pendulum, plumb bob, or some similar device, to measure the direction of the gravitational force. The measuring device is acted on by two forces: gravity, which tends to pull it toward the center of the earth; and centrifugal force, caused by the earth's rotation, acting at a right angle to the earth's axis. The direction indicated by the measuring device is that of apparent gravity—the resultant of the two forces. The motion of the missile itself will create additional forces that tend to disturb the gravity-measuring device. Any missile guidance system that uses a gravitational reference must compensate for these disturbing forces.

MAGNETIC FORCES.—Some missiles may use the strength or the direction of the earth's magnetic field as a reference for navigation. Both strength and direction of the field vary from point to point on the earth. In general, these variations have been measured and plotted. But at any given point on the earth, the magnetic field is subject to annual, monthly, and even daily variations. It is subject to nonperiodic variations in "magnetic storms" that result from bursts of ions or electrons radiated from the sun. Most of these variations are predictable with reasonable accuracy, and can be taken into account in the missile guidance system.

The **CORIOLIS FORCE** must also be compensated for. It is caused by the earth's rotation, and tends to deflect a missile to the right in the northern hemisphere, and to the left in the southern hemisphere. As the earth turns on its axis, its surface moves toward the east at a rate determined by latitude. At the equator, the earth's surface is moving to the east with a speed of more than 1000 mph; at the poles, its speed is zero.

Assume that a missile is launched directly northward in the northern hemisphere. At the instant of launching, it will be moving to the east at the same rate as the surface from which it is launched. But as it moves northward, it flies over points whose eastward velocity is less than its own. As a result it will be deflected eastward, or toward the right. Now imagine a missile fired southward in the northern hemisphere. It will fly over points whose eastward velocity is greater than its own. It will therefore be deflected westward (still to the right) with respect to the surface.

The amount of deviation produced by the coriolis force depends on the latitude, length, and direction of the missile flight. Since it can be accurately predicted, suitable corrections can be made by the missile guidance system.

CHAPTER 3

COMPONENTS OF GUIDED MISSILES

INTRODUCTION

GENERAL

This chapter is intended to provide an overall view of a guided missile and its various components. Most of the material in this chapter is covered in more detail elsewhere in this text. Airframes and control surfaces, for example, were treated in chapter 2. Propulsion systems, control systems, and guidance systems are each given one or more separate chapters. Their principal features will be briefly summarized here. Warheads, (except nuclear) which are not covered elsewhere in this text, will be treated in some detail.

The principal components of a guided missile are:

WARHEAD.—The warhead may be designed to inflict any of several possible kinds of damage on the enemy. The warhead is the reason that the missile exists; the other components are intended merely to ensure that the warhead will reach its destination.

AIRFRAME.—The airframe is the physical structure that carries the warhead to the target, and contains the propulsion, guidance, and control systems.

PROPULSION SYSTEM.—This system provides the energy required to move the missile from the launcher to the target.

CONTROL SYSTEM.—The control system has two functions. It keeps the missile in stable flight, and it translates the commands of the guidance system into motion of the control surfaces, or into some other means for modifying the missile trajectory.

GUIDANCE SYSTEM.—This system determines whether the missile is on the ordered trajectory of the ordered velocity. If the missile is off course, the guidance system sends error signals to the control system.

Figure 3-1 shows some typical locations of components. The arrangement of the components is not the same for all missiles. Most modern missiles are made up of a missile assembly (with all its components), and a booster, the whole being called a complete round. Tartar missile is an exception--it does not have a separate booster.

AUXILIARY POWER SUPPLY. All missiles must contain auxiliary power supply (APS) systems in addition to the main engine required for thrust. The APS systems provide a source of power for the many devices needed for successful missile flight. Some APS systems rely on the main combustion chamber as the initial source of energy; others have their own energy sources completely separate from the main propulsion unit.

AIRFRAME

GENERAL

The term AIRFRAME has the same meaning for guided missiles as it has for the conventional airplane. It serves as a vehicle to carry all the other parts of the missile, and it provides the aerodynamic characteristics required for successful flight. Research on airframes is a major part of our missile development effort.

Since the guided missile is essentially a one-shot weapon, its structure can be simpler than that of a conventional aircraft. Missile bodies are designed so that inner components are readily available for testing, removal, and repair. The major components are mounted to form independent units.

Most modern missiles are made up of several sections (fig. 3-2). (Older mods do not have this construction.) Each section is a cylindrical shell machined from metal tubing rather than a built-up structure with internal bracing. Each

PRINCIPLES OF GUIDED MISSILES AND NUCLEAR WEAPONS

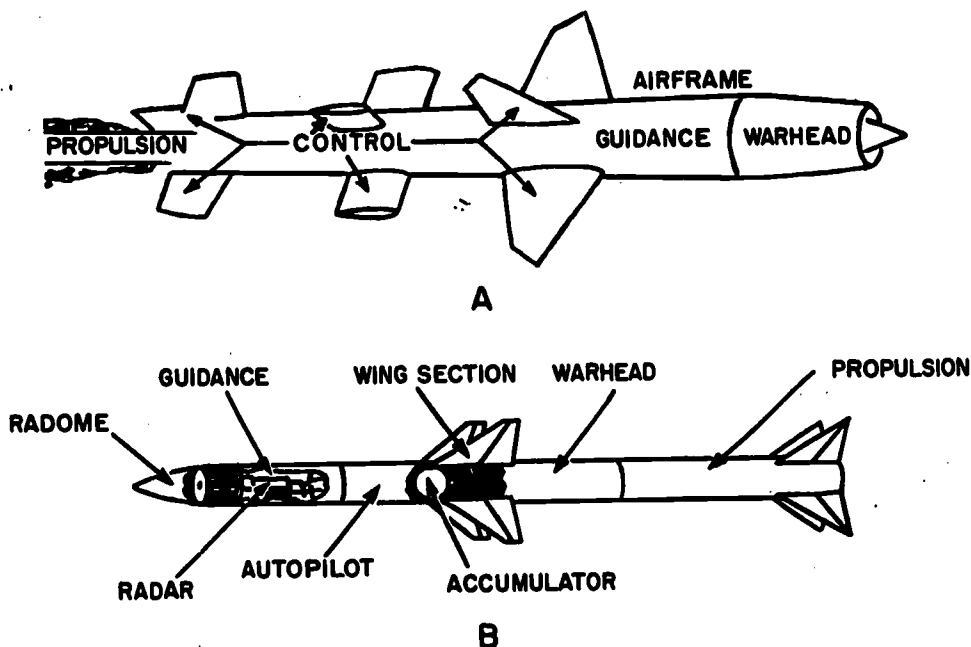

144.12

Figure 3-1.—Location of components in guided missiles:
A. Talos missile; B. Active homing missile.

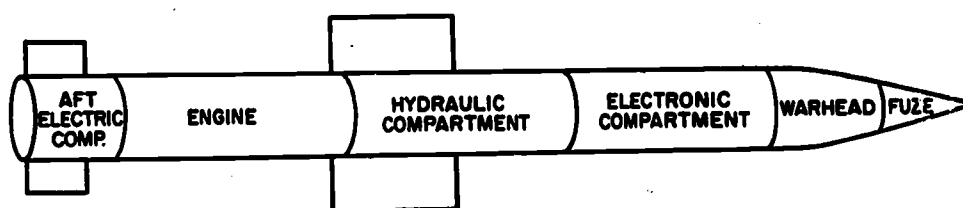

144.13

Figure 3-2.—Sectionalization of a missile.

shell contains one of the essential units or components of the missile, such as the propulsion system, the electronic control equipment, the warhead, or the fuze assembly.

Sectionalized construction has the advantage of strength with simplicity, and also provides ease in replacement and repair of the components, since the shells are removable as separate units. The sections are joined by various types of connections designed for simplicity of operation. Access ports are sometimes provided in the shells, through which adjustments can be

made prior to launching. Covers and access doors are sealed to prevent moisture and dirt from entering the missile.

Basically, the missile is designed to carry the warhead to the target. The size and weight of the warhead must be accommodated by the missile structure. The missile must be as light and compact as possible, yet strong enough to carry the warhead (and other components), and withstand the forces to which it will be subjected, such as gravity, air (or water) pressure, winds, heat, stresses of acceleration and deceleration,

Chapter 3—COMPONENTS OF GUIDED MISSILES

and other forces. For every pound of weight saved in the missile structure, less propulsion energy is required. The weight and balance relationships must be given careful consideration. The initial location of the center of gravity is of extreme importance. The center of gravity can change during missile flight because of the burning of the propellant, and separation of the booster after burnout. These factors and others must be carefully included in the calculations of the missile designers to produce a structure that will perform as expected.

BODY CONFIGURATION

The Navy missiles described and illustrated in chapter 1 show the range of body configuration found in operational missiles. In general, the design of the airframe is determined by performance requirements. Early types of missiles were strikingly similar in appearance to a jet fighter of similar performance, in the high subsonic speed range. The wings, like those of carrier aircraft, could be folded. Before launching, the wings were extended and locked in place.

Most modern missiles have wings that are folded (Tartar) or removed (Terrier, Talos) when stowed, but the size, shape, and location of the wings and fins have undergone extensive changes for use at supersonic speeds. Newest mods of Tartar (fig. 2-10) and Terrier have dorsal fins,

Terrier, Sidewinder, and Talos are typical of present day airframes. In general, the airframe is a long, slender cylinder without wings. Its tail fins provide weathercock stability. A second set of fins, mounted near the center of the missile or forward of the center, provide additional stability. Control of the missile is accomplished by pivoting one or more pairs of fins, rather than by the use of conventional ailerons, rudders, and elevators. Note that, as in Terrier, the forward fins may be mounted at 45° angles to the horizontal and vertical.

The nose shape is determined by other requirements. The Terrier nose (not all mods) is long and slender, because that shape has been found highly efficient at supersonic speeds. Sidewinder, although it travels at a comparable speed, has a hemispherical target. This is necessary because of the infrared seeking device located immediately behind the nose surface.

The nose of Talos contains the air intake for the ramjet engine.

Talos is, in effect, a double-walled tube. Its central part is taken up by the ramjet engine. All of its other components—warhead, fuel tanks, guidance and control systems—are crowded within the space between the inner and outer walls. (In one model, one of these components is carried inside the central diffuser in the nose.) The middle part of Terrier is taken up by a chamber filled with solid rocket propellant. The warhead, fuze, and the major part of the guidance and control systems, are located forward of the fuel chamber. But a part of the guidance and control system is located in the double-walled cylinder that surrounds the exhaust duct at the after end of the missile. Electric cables and pneumatic lines to maintain communication between the two parts of the guidance system pass through covered channels along the outside of the missile.

Polaris, pictured in chapter 1, represents still a third type of missile body configuration. Note that there are no external control surfaces; any necessary changes in trajectory are accomplished by jet deflection. Note also that the nose is bluntly rounded. Its trajectory (fig. 2-24) takes it far beyond the earth's atmosphere; it descends on its target at a steep angle, and at tremendous speed. As it re-enters the atmosphere, friction with the air generates a great deal of heat. The Polaris nose cone shape and construction have been determined by the requirements of this problem. The materials for the outer surface have been especially developed to resist high temperature. Suitable insulation is provided between the outer skin of the nose cone and the internal components, to prevent damage to the warhead. Advances in technology have permitted changing from the blunt nose of earlier mods to the pointed nose of the A3.

The two configurations of Asroc (anti-submarine rocket; is not a guided missile) differ in size but each has four major assemblies: payload (warhead), airframe, ignition and separation assembly, and rocket motor. During the ballistic flight (fig. 2-25) of the missile, the rocket motor drops away when the required velocity is reached, and the airframe drops away near the end of ballistic flight, freeing the warhead to continue to target intercept. The torpedo configuration has a parachute which opens after the rocket motor and the airframe have dropped away and carries it to water entry. Both torpedo and depth charge configurations have a nose cone

PRINCIPLES OF GUIDED MISSILES AND NUCLEAR WEAPONS

streamlined for aerodynamic flight but which shatters upon water entry. The depth charge has fin extension tips on the fail fins. The extension tips are sheared off upon water entry. The fin extension tips provide aerodynamic stability to the depth charge from the time of airframe separation until water entry. Two of the fins are plain fins and two are tee fins.

Because of the underwater-to-air-to-water operational cycle of Subroc, its design had to include the hydrodynamic qualities of a torpedo and aerodynamic characteristics of a missile. In size and shape it had to be made to fit a standard submarine torpedo tube, from which it is fired.

PROPULSION SYSTEMS

GENERAL

Because chapter 4 is devoted to propulsion systems, they will be covered very briefly here. The powerplants of guided missiles have been referred to as "reaction engines." But strictly speaking, any engine designed to propel a vehicle is a reaction engine. All of them operate in accordance with Newton's third law, which states that for every action there is an equal and opposite reaction. For example, the force that the tires of a car apply to the road is opposed by an equal and opposite force and it is this reaction that drives the car forward. A propeller-driven aircraft operates by increasing the momentum of the air; the resulting reaction is applied to the propeller and its shaft, and, through a thrust bearing, to the airframe. As we have pointed out earlier, speed requirements make it impossible to use propeller-driven missiles. Because the speed of the propeller tip exceeds the speed of the airframe, the propeller tip enters the transonic zone while the aircraft speed is considerably below the speed of sound. In the transonic zone, the thrust developed by the propeller drops off rapidly, and a further increase in aircraft speed becomes impracticable. Therefore, all current guided missiles depend on some form of jet propulsion.

TYPES OF JET PROPULSION SYSTEMS

Popular terminology makes a distinction between jets and rockets: a jet takes in air from the atmosphere, and propels itself forward by increasing the momentum of the air; a rocket

needs no outside air supply, since it carries its own source of oxygen. But this is a rather arbitrary distinction. Both types of engines operate by expelling a stream of gas at high speed from a nozzle at the after end of the vehicle. For our purposes, a rocket can be considered as a type of jet engine.

The pulsejet, which propelled the German V-1, was used by the Navy to propel an early missile that is now obsolete. No current missiles are driven by pulsejets. Talos is propelled by a ramjet. The Navy used turbojets for its Regulus I and II, and for the now obsolete Petrel. Terrier, Sidewinder, and Polaris are propelled by solid-fuel rockets. Tartar, too, has a solid-propellant rocket motor, though it is different from the others—it is a dual-thrust rocket motor (DTRM), which develops both booster and sustainer thrust, eliminating the need for a separate booster and sustainer for the missile.

Current developments appear to indicate that, until the advent of nuclear propulsion, most if not all of our future missiles will be powered by solid-fuel rockets. Research on nuclear propulsion engines is being conducted for use in spacecraft as well as in missiles.

Although liquid-fuel propulsion has been considered too complicated for use in missiles, a prepackaged and sealed liquid-fuel engine developed for the Bullpup air-to-surface missile has been highly successful in tests. For this application, liquid-fuel propellant and a propellant pressurizing medium are permanently sealed in a tank which is integral with the rocket thrust chamber. An outstanding feature of this engine is that it requires no shipboard tests or checkoff prior to mounting on the aircraft nor before launching.

The liquid-fuel rocket is used in the Air Force Titan, and in that application it has certain advantages. Liquid fuel provides more energy than an equivalent weight of solid fuel, and can maintain a high thrust for a relatively long time. A liquid-fuel propulsion system can be shut down by radio command at any desired instant, whereas a solid-fuel system presents complications, although shut-down and restart have been accomplished in experimental models. The liquid-fuel rocket must have a rather complex system of fuel and oxidizer lines and pumps, and it requires relatively elaborate equipment at the launching site. At present, a large missile propelled by a liquid-fuel rocket requires a lengthy "countdown" before firing. The last two

Chapter 3—COMPONENTS OF GUIDED MISSILES

factors make the liquid-fuel rocket impracticable for ship-launched missiles.

The liquid-fueled Atlas, developed by the Air Force as an ICBM, is being phased out for missile use and is being changed for spacecraft use. It, too, requires a long countdown, which reduces its value as a deterrent missile.

WARHEADS

GENERAL

The warhead is the reason-for-being of any service guided missile; it may contain any of a large number of destructive agents. This versatility must not be confused with interchangeability, because the design of the missile and warhead must be thoroughly integrated.

The guided missile fuze may be defined as that device which causes the warhead to detonate in such a position that maximum damage will be inflicted on an average target. A fuze may be any of several types, such as impact, time, or proximity.

Guided missiles are precision-built weapons; they are expensive in manpower, materials, and money. The most accurate control and guidance systems will be of little value if the warhead cannot produce enough lethal effect at the right time to destroy or at least cripple the target. The warhead problem must be solved for each type of missile, to permit final crystalization of any integrated missile plan.

The ultimate aims and desires of weapon-makers have always been to strengthen the "arm" of the user. The rock in the hand of primitive man added strength and distance to the blows that he could deliver; the bow and arrow greatly multiplied man's effective striking distance; and the rifle and cannon have progressively increased the strength and range of his striking power. Guided missiles are a new means for lengthening the arm of the user. But the striking effect depends on the nature of the warhead and on how accurately it can be delivered to the intended target. The warhead of a guided missile is its payload, and justification for employment of the missile lies in its ability to deliver its payload to the target.

A guided missile may carry one of the various types of warheads, and one or more fuzes. Missile warheads intended for use against ships or land targets present design problems similar to those of older weapons. Surface-to-air

missiles present a somewhat different problem. The effective radius of damage from a high-explosive warhead in the air depends on the type, shape, and size of the charge, and on the nature of the target itself.

The designer of the payload for any type of military weapon is faced with a number of variables, some of which are unpredictable. For example, in the design of an anti-aircraft missile, he must consider the following factors:

1. Altitude affects the lethal radius of a fragmentation warhead; the fragments maintain a lethal velocity through a greater distance at high altitudes.

2. The relative velocity of target and missile has a direct bearing on the optimum angle of ejection of fragments. The designer must determine the angle at which the greatest mass of fragments should be ejected. The timing sequence of fuze operation, as well as the guidance system of the missile, must function with great precision if the target is to be destroyed. The fuze must be both sensitive and fast to ensure success against high-speed aircraft or supersonic missiles.

3. The armor of the target, if any, influences the design specifications for fragment size and velocity. Fragments that are effective against conventional aircraft of today may be too light or too slow to penetrate the protective covering of the airplanes or missiles of the future.

The multiplicity of types of ground targets has led to the development of numerous types of lethal devices—from hand grenades to hydrogen bombs. A 500-pound bomb may be armor-piercing, semi-armor-piercing, or general-purpose. It may be equipped with an impact fuze, a time fuze, a proximity fuze, or a combination of these types.

The type of target is the most influential factor in warhead design. A fragmentation-type warhead might be effective against conventional aircraft, or against missiles of moderate speed. But a missile intended for use against a whole fleet of attacking bombers, a city, or against a high-speed ballistic missile, would require an entirely different type of warhead. Because of the wide variety in types of surface targets, it is necessary to have missiles that can use several types of warheads interchangeably, or to develop a whole family of missiles.

The third component of the warhead, the safety and arming device (S&A), is of critical

PRINCIPLES OF GUIDED MISSILES AND NUCLEAR WEAPONS

importance with nuclear warheads. The S&A device must prevent accidental detonation and must initiate detonation at the moment desired. In nuclear warheads there are several devices to prevent accidental or premature detonation.

TYPES OF WARHEADS

The types of warheads that might be used with guided missiles include: external blast, fragmentation, shaped-charge, explosive-pellet, chemical, biological, nuclear, continuous rod, clustered, thermal, illuminating, psychological, exercise, and dummy. Those that are intended for use against an enemy are not true warheads within the definition of warhead, and are usually referred to as heads, such as exercise heads. Some types of warheads will be discussed in a classified course, Navy Missile Systems, Nav-Pers 10785-A.

BLAST-EFFECT WARHEAD. The blast effect warhead consists of a quantity of high-explosive material in a metallic case. The force of the explosion sets up a pressure wave in the air or other surrounding medium; the pressure wave causes damage to the target. This type of warhead is most effective against underwater targets, because water is incompressible, and relatively dense. Torpedo warheads are of this type. Blast-effect warheads have been used successfully against small ground targets. They are considerably less effective against aerial targets because the density of the air, and therefore the severity of the shock wave, decreases with altitude.

FRAGMENTATION WARHEAD. The fragmentation warhead uses the force of a high-explosive charge to break up the warhead casing into a number of fragments, and to propel them with enough velocity to destroy or damage the target. The size and velocity of the fragments, and the pattern in which they are dispersed, can be controlled by variation in the design and construction of the warhead. The velocity of the fragments depends on the type and amount of explosive used, and on the ratio of explosive-to-fragment weight. The average size of fragments depends on the shape, size, and brittleness of the warhead casing, and on the quantity and type of explosive. Greater uniformity in fragment size can be achieved by scoring or otherwise weakening the casing in a regular pattern, as shown in figure 3-3.

The damage produced by a fragmentation warhead depends (in part) on the amount of metal available to form fragments, and on the amount of explosive available for breaking the casing and propelling the fragments. Aerial targets are more susceptible to damage by fragments if the warhead explodes a short distance away, rather than in contact with the target. Against a partially protected surface target, a fragmentation warhead is most effective when exploded in the air above the target, rather than on the ground. Figure 3-4 shows this effect. Fragments from the air burst strike the partially protected target and the entrenched personnel.

A fragmentation warhead can have a greater miss distance than a blast warhead and still remain effective. The pattern of fragmentation also makes a difference in effectiveness, as

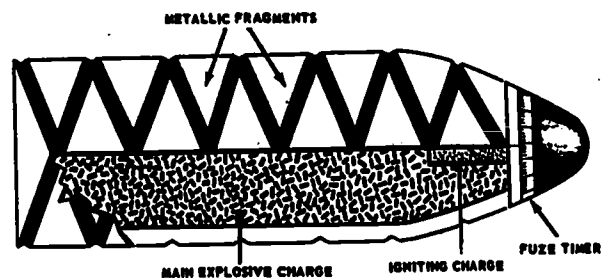

33.8

Figure 3-3.—Basic construction of a fragmentation warhead.

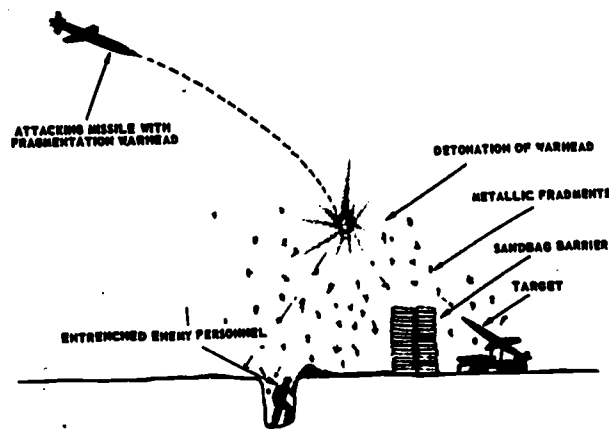

144.14

Figure 3-4.—Effect of fragmentation warhead on surface target.

does the velocity. The payload can be designed to "propagate" its energy and material in all directions. This is called isotropic propagation (fig. 3-5B). When the payload is designed so that more fragments or energy are released in one direction than another, the propagation pattern is called nonisotropic (fig. 3-5A). It is more effective than an isotropic payload of the same size and weight if you know where to aim it. This directing of the explosion is the basis of the shaped charge effectiveness. A large part of the warhead's explosive energy is directed to the target in a narrow beam.

Advanced Types of Fragmentation Warheads

A knowledge of fragmentation propagation is a basic requisite in designing many types of warheads. Theories are checked out with the use of scaled models, using different types of explosives, and varied missile shapes and casing thicknesses. These studies have resulted in the development of warheads with controlled size, shape, number, and initial velocity of fragments. The initial velocity of the fragments depends on

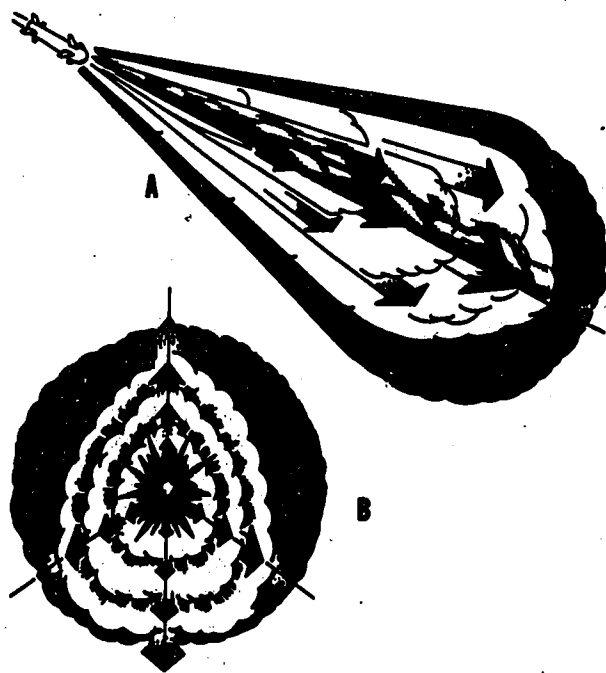

Figure 3-5.—Payload propagation:
A. Nonisotropic; B. Isotropic.

144.15

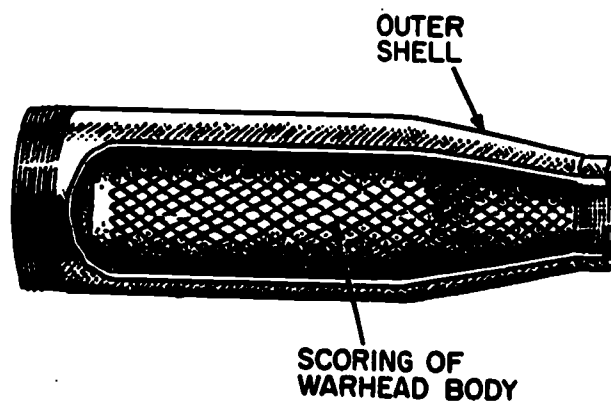

Figure 3-6.—Controlled fragmentation warhead.

144.16

the charge-to-mass ratio of the missile, the type of explosive used, and the shape of the fragments. Test firings have substantiated the value of the controlled designs. One type of controlled fragmentation warhead is shown in figure 3-6. Various shapes and sizes of fragments have been tested for different types of targets. The most effective types have been adapted for some missile warheads.

Shaped-Charge Warhead

A shaped charge consists of a casing and a quantity of high explosive. The explosive is so shaped that the force of the blast it produces is largely concentrated in a single direction. As a result, a shaped charge has high penetrating power. It is widely used against armored surface targets. For example, the antitank bazooka used during World War II and in Korea used a shaped charge.

Figure 3-7 shows how the shape of the charge affects the penetrating ability of the blast. All three of the charges shown in the figure have the same weight and type of explosive. The flat charge at the left produces an explosive force rather evenly distributed over a given area of the target; this charge produces little penetration. The shallow-cone shape of the middle charge produces a greater concentration of the explosive force, and penetration of the target is deeper. The deep-cone shape at the right has concentrated the explosive force so as to penetrate the target armor. Metallic fragments of the armor can now reach the interior of the target, and do additional damage.

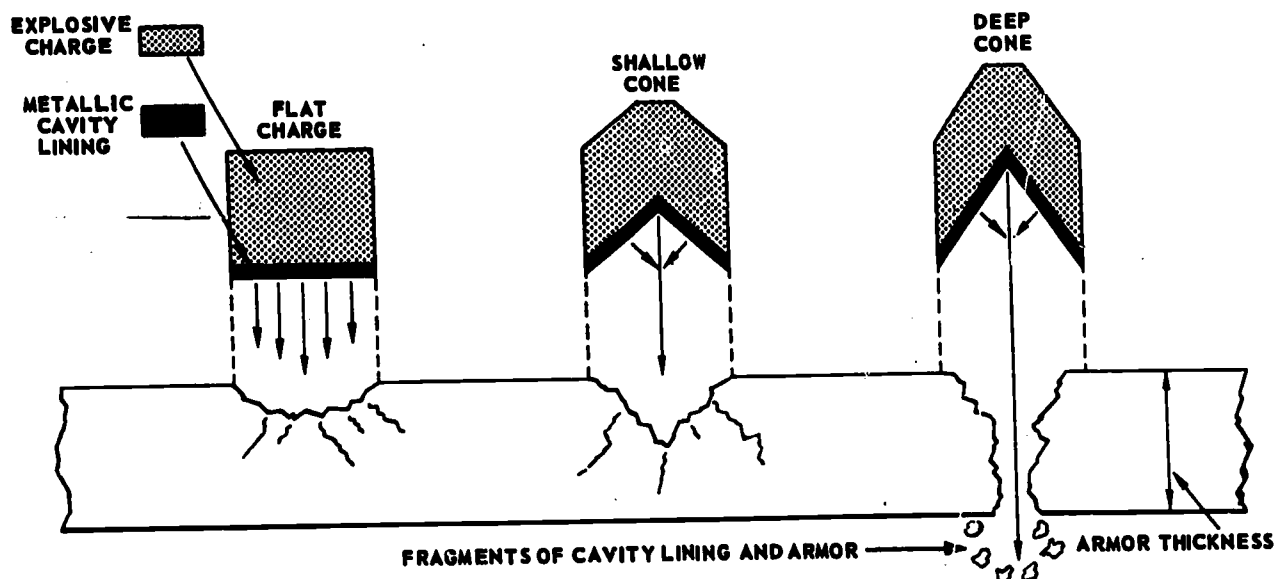

Figure 3-7.—Penetration effectiveness of various shaped charges.

33.9

In the explosion of a shaped charge, a beam of very hot gas (called the jet) is ejected at an extremely high velocity. If the cavity is lined with some material that can be broken into small pieces or can be melted by the explosion, the efficiency of the charge is greatly increased. The small particles of the liner are carried by the jet, which is thus increased in weight. As a result it can penetrate a thick target.

When used in guided missile warheads, shaped-charge explosives have possibilities of great effectiveness against both aircraft and heavily armored surface targets.

Explosive-Pellet Warhead

An explosive-pellet warhead consists of a group of separately fuzed explosive pellets housed in a casing. The casing contains an additional quantity of explosive to eject the pellets from the main warhead casing. The pellets themselves do not explode until they contact or penetrate the target. If the target is an aircraft or missile, maximum destruction can be accomplished when the pellets are detonated after penetrating the outer skin of the target. Each pellet contributes both blast effect and high-velocity metallic fragments when detonation occurs.

The explosive-pellet is an ideal weapon for use against aerial targets. Its full development is dependent upon perfecting a fuze for the

individual charges that can withstand the initial blast of the principal warhead while still ensuring explosion at or within the target.

Chemical Warheads

A chemical warhead is designed to eject poisonous or corrosive substances and thus produce personnel casualties, or to destroy combustible targets by the use of incendiary materials. Warheads containing gases may liberate any of the well-known types such as mustard gas, lewisite, or some newly developed chemical. The effects produced are either denial of the use of the target area or personnel casualties within the area. Missiles equipped with chemical warheads also serve as possible counterthreats to initiation of gas warfare by the enemy. It is likely that quantities of poisonous war gases are included in the arsenal of every major power, and the possibility of their use remains a threat. However, the certainty of retaliation in kind has served as a deterrent since World War I.

A variety of disabling gases have been developed. These gases temporarily inactivate military and/or civilian personnel by a variety of effects, without death or permanent disability. The possibilities of these agents have been explored in research and tests and some have been used in riot situations.

The incendiary warhead contains a material that burns violently and is difficult to extinguish.

Chapter 3—COMPONENTS OF GUIDED MISSILES

Chemical weapons are useful principally against ground targets, but may also be effective against aerial targets that contain combustible materials. Incendiary materials suitable for use in warheads include magnesium, jellied oil or gasoline, and phosphorous. Incendiary warheads are also referred to as thermal or fire warheads.

Biological Warheads

A biological warhead contains bacteria or other living organisms capable of causing sickness or death. The biological agent can be specifically chosen for use against personnel, livestock, or crops. Antipersonnel agents might be chosen to cause either temporary disability or death, depending on the objectives of the attacker. An explosive charge placed in a biological warhead would ensure ejection and initial dispersion of the biological agents. Special attention must be given to the design and construction of biological warheads, in order that the bacteria or other agent will remain alive, and be carried to the target under the most favorable conditions.

Probably every major nation has an arsenal of biological material to use in "germ warfare" in such a variety of ways that it would tax the imagination of the average person. Use of "germ warfare" has been restrained, as in the case of chemical warfare, for fear of retaliation in kind.

Other Special Purpose Warheads

Several other special types of warheads may be used. These include: radiation, illumination, psychological, exercise, and dummy warheads.

RADIATION warheads may use radiological material in the same manner as chemical or biological agents, scattering the radioactive material according to plan. The possibilities and ramifications of this type of warfare will not be explored further here.

ILLUMINATING warheads have long been used in projectiles during night attacks to point out or silhouette enemy fortifications. This has been especially useful during shore bombardment. Illuminating warheads are also used in aircraft bombs and rockets to assist in the attack of ground targets and submarines. No application has been made in guided missiles.

PSYCHOLOGICAL warheads do not carry lethal or destructive agents, but carry material designed to create a psychological effect on the enemy rather than actual physical damage. Payloads may be propaganda leaflets, mysterious objects that appear dangerous, inert or dummy

warheads. Decoy warheads may carry "window," which causes false radar echoes, or noise-makers to confuse sonar operators of antisubmarine ships.

A **DUMMY** warhead has only the outward appearance, the size, shape, and weight of a real warhead. It is used in training and practice operations.

EXERCISE or training warheads do not contain any explosive material but otherwise contain the parts of a real warhead, so they can be assembled, disassembled, tested for electrical continuity, and otherwise used for training exercises.

The **ASROC** (Rocket Thrown Torpedo) uses a torpedo for its warhead.

Nuclear and Thermonuclear Warheads

A number of present day guided missiles are equipped with nuclear or thermonuclear warheads. The blast effects and radiation effects which result from the detonation of these warheads cause immediate physical damage to a large target area, and sickness and death to personnel a considerable distance from the explosion. The blast effects are, of course, many times greater than those effected by the detonation of conventional explosives. After effects caused by the settling or fallout or radioactive material can result in sickness and death of personnel at great distances from the explosion, depending on wind and other atmospheric conditions.

The development of tactical nuclear weapons with varied methods of delivery makes obsolete the concept that nuclear weapons are used only to devastate whole cities or metropolitan areas. We still have the large bombs and missiles to do the strategic job, but we also have the much smaller weapons to gain tactical objectives.

FUZES

A fuze is a device that initiates the explosion of the warhead. In a guided missile the fuze may or may not be a physical part of the warhead. In any case, it is essential to proper warhead operation. A large variety of fuze types is available. The fuze type for a given application depends on characteristics of the target, the missile, and the warhead. To ensure the highest probability of lethal damage to the target, fuze design must be based on the location, vulnerability, speed, size, and physical structure of the target.

PRINCIPLES OF GUIDED MISSILES AND NUCLEAR WEAPONS

Impact Fuze

Impact fuzes are actuated by the inertial force that occurs when a missile strikes a target. Figure 3-8 is a schematic representation of an impact fuze and the explosives it sets off in the warhead. As shown in the left-hand diagram (fig. 3-8A), a charge of sensitive explosive is contained in the forward end of the fuze; a movable plunger is mounted in the after end, where it is held in place by a spring or other suitable device. (The booster and main charge are not part of the fuze.)

During the flight of the missile, the plunger remains in the after end of the fuze. When the missile strikes the target, it decelerates suddenly, and the inertia of the plunger carries it forward. As shown in the right-hand diagram, figure 3-8B, the plunger strikes the shock-sensitive priming mixture and detonates it. This charge in turn detonates the booster charge which detonates the main bursting charge of the warhead (fig. 3-9A). A time delay element is sometimes used in conjunction with an impact fuze, so that the warhead can penetrate the target before detonation (fig. 3-9B).

An impact fuze may be used in conjunction with a fuze of another type, such as a proximity fuze. If the proximity fuze fails to operate as

the missile approaches the target (fig. 3-9C), the impact fuze will still function on contact. This combination of fuzes has been used chiefly on air-dropped bombs. The Sidewinder and Sparrow also use such a combination.

Time-Delay Fuze

Time delay fuzes are used in some types of gun projectiles. This fuze is designed to detonate the warhead when a predetermined time has elapsed after firing or launching. One type of time-delay element consists of a burning powder train; another uses a clocklike mechanism. In either type, the time interval cannot be changed after launching. For that reason, preset time-delay fuzes are unlikely to be used in guided missile warheads. Preset time-delay fuzes can be used for stationary targets. With a moving target, especially a fast moving one like a missile or aircraft, the time delay would be in error most of the time. If the delay problem is considered one of distance rather than time, the fuze can be placed at the rear of the warhead, and the desired result could be obtained as the warhead would penetrate the target before the fuze could function. Such fuzes are usually used for armor-piercing projectiles, and antitank missiles.

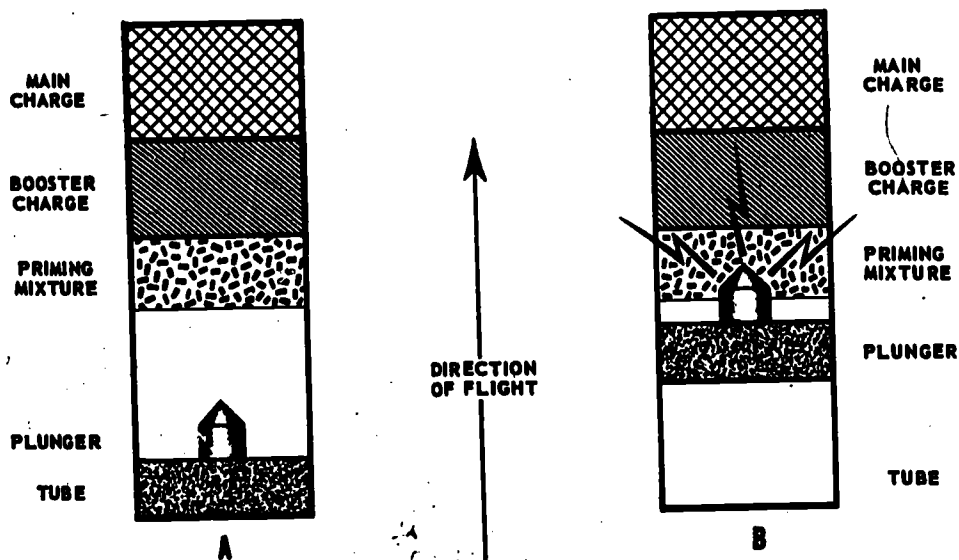
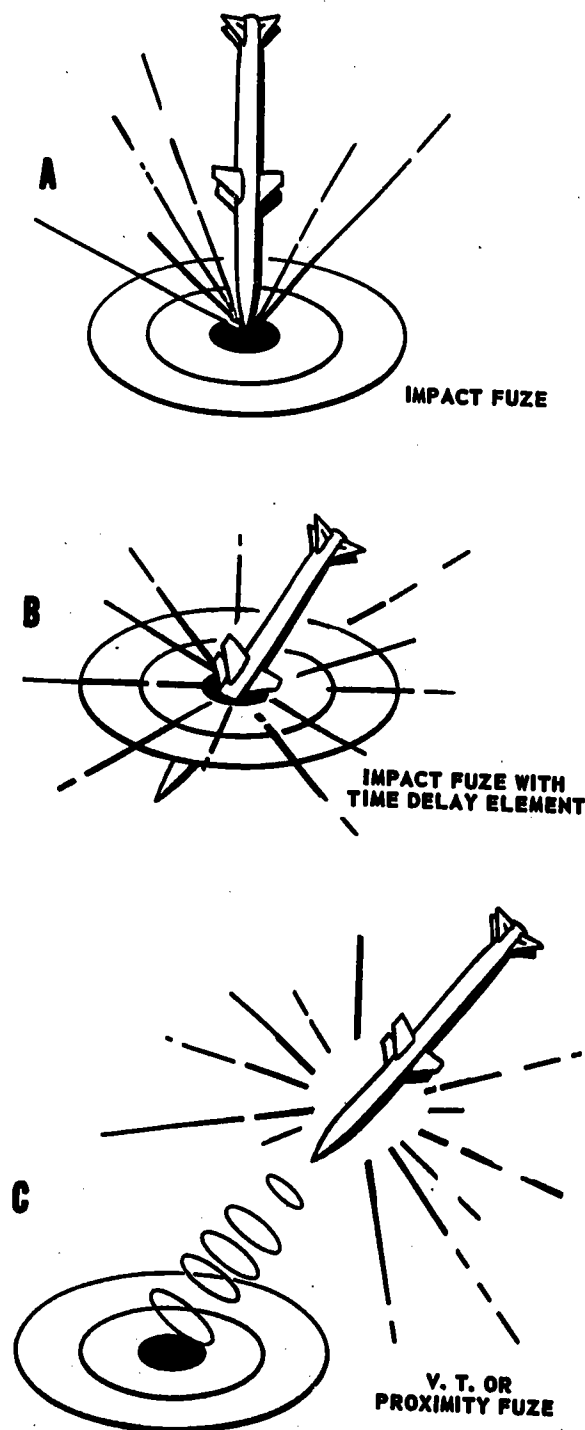

Figure 3-8.—Impact fuze action: A. Before impact; B. After impact.

Proximity Fuzes



144.17
 Figure 3-9.—Influence of fuze type on point of warhead detonation: A. Impact fuze; B. Time-delay impact fuze; C. Proximity fuze.

Proximity fuzes are often called VT (variable time) fuzes. They are actuated by some characteristic feature of the target or the target area (fig. 3-9C). Several types of proximity fuzes are possible; for example, photoelectric, acoustic, pressure, radio, radar, or electrostatic. Each of these types could be preset to function when the intensity of the target characteristic to which it is sensitive reaches a certain magnitude.

Proximity fuzes are designed so that the warhead burst pattern will occur at the most effective time and location relative to the target. Designing the fuze to produce an optimum burst pattern is not easy, since the most desirable pattern depends largely on the relative speed of missile and target. If targets with widely varying speeds are to be attacked, it might be possible to adjust the fuze sensitivity for the speed of the individual target, as predicted by a computer. Proximity fuzes activate the warhead detonating system after integrating two factors: the distance to the target, and the rate at which the range is closing.

Since a proximity fuze operates on the basis of information received from the target, it is subject to jamming by false information. This is one of the important problems in proximity fuze design. The fuzes are designed for the maximum resistance to countermeasures consistent with other requirements. If the fuze is made inoperative by jamming, the missile cannot damage the target unless it scores a direct hit. A more serious possibility is that jamming, instead of making the fuze inoperative, might cause premature detonation of the warhead before the missile came within lethal range of the target. Some counter-countermeasures (CCM) have been devised to counteract or bypass the effects of enemy countermeasures.

Although any of the effects listed above—photoelectric, acoustic, pressure, electromagnetic (radio, radar), or electrostatic—can be used as the basis for proximity fuze action, and although all of them have been used at least experimentally, it has been found in practice that the radio proximity fuze is more effective than any of the others. This fuze transmits high-frequency radio waves, which are reflected from the target as the missile approaches it. Because of the relative motion of missile and target, the reflected signal, as received at the

PRINCIPLES OF GUIDED MISSILES AND NUCLEAR WEAPONS

missile, is of a higher frequency than the transmitted signal. The two signals, when mixed, will generate a Doppler frequency, the amplitude of which is a function of target distance. When this amplitude reaches a predetermined level, the fuze functions and detonates the warhead. A radio fuze uses signals of a lower frequency than a radar fuze.

ACOUSTIC systems (actuated by sound waves from the target) are obsolete because of the speed of present day missiles, which outrun sound. Acoustical sensors are still used to activate mines and torpedoes. A diaphragm type mechanism vibrates when sound waves under water strike it, exerting pressure on an internal crystal that sets off the mine. The acoustic fuze must react only to specific sounds, not to all sounds. The need for sensitive but selective acoustic fuzes is one of the reasons for the Navy studies on sounds made by fish and sea mammals.

MAGNETIC induction mines can be set off by the magnetic field of an approaching ship, but this system is not used in guided missiles. Magnetostatic fuzing is also used for subsurface targets, but its use in air systems is still in the developmental stage. The magnetic field that surrounds the earth, and the variation in the earth's magnetism, called induced magnetism, are the forces used in magnetostatic fuzing.

ELECTROMAGNETIC fuzes may operate with radio, radar (microwave), infrared, or ultraviolet waves. The basic proximity fuze must have a transmitter-receiver, amplifying circuitry to amplify the return signal so it will activate the detonator, electrical safety devices to prevent premature detonation, and a power supply to generate and provide electrical power to the fuze.

ELECTROSTATIC fuzing has application over short distances. It may use active, semiactive, passive, or semipassive modes of operation. Air targets become electrostatically charged as they pass through the atmosphere, but water vapor or rain dissipates much of the charge, which poses a problem for the fuze.

HYDROSTATIC fuzes are operated by the pressure variations in the ocean as caused by the passing of a ship or submarine. To avoid premature firing by natural wave action, pressure-firing mechanisms are designed so they will not be affected by such motion of the water. Pressure-firing mechanisms are seldom used alone, but are generally combined with other influence-fired devices. A hydrostatic fuze may

also be called an AMBIENT fuze, that is, a fuze acted upon by the environment of the target, rather than by the target itself.

AMBIENT type fuzes might be used against stationary ground targets but they could not react swiftly enough to follow the almost instantaneous changes of altitude that a missile or modern aircraft could undergo. Also, a target could be thousands of miles from the launching point of the missile and it would be extremely difficult to know the best air pressure value to set into the fuze for detonation.

PHOTOELECTRIC fuzes react to external light sources and ordinarily are inoperable in conditions of low visibility.

Ground-Controlled Fuzes

In ground- or ship-controlled fuzes, some device is employed to measure the distance from missile to target. The control device is not mounted in the fuze, but at some remote control point. When the proper distance exists between missile and target, a signal is sent from the control point to cause detonation of the warhead. This method is most often used with nuclear warheads. Our missiles in silos (Minuteman, for example) are ground controlled. Studies are underway to make possible control from the air.

Design Considerations

A fuze must be reliable, accurate, and safe. It must be safe for the men who must handle it and also safe against countermeasures by the enemy. At the same time, it must be sensitive enough to detonate upon signal. To increase the probability of an optimum detonation, the weapon designer may put in duplicate systems (redundancy), or he may have two types of fuzes, so that if one fails there is another. The many variables that must be considered in designing a fuze for a guided missile make it a difficult and complicated problem requiring constant study and experimentation to make improvements.

SAFETY AND ARMING.—Each fuze has a safety and arming (S&A) device to control the detonation of the payload, so there will not be a premature detonation nor a dud. While this is important for all weapons, it is especially so for nuclear warheads. Redundancy is used to ensure arming at the proper instant and safety at all other times. The safety device shown in figure 3-10 is a physical barrier between

Chapter 3—COMPONENTS OF GUIDED MISSILES

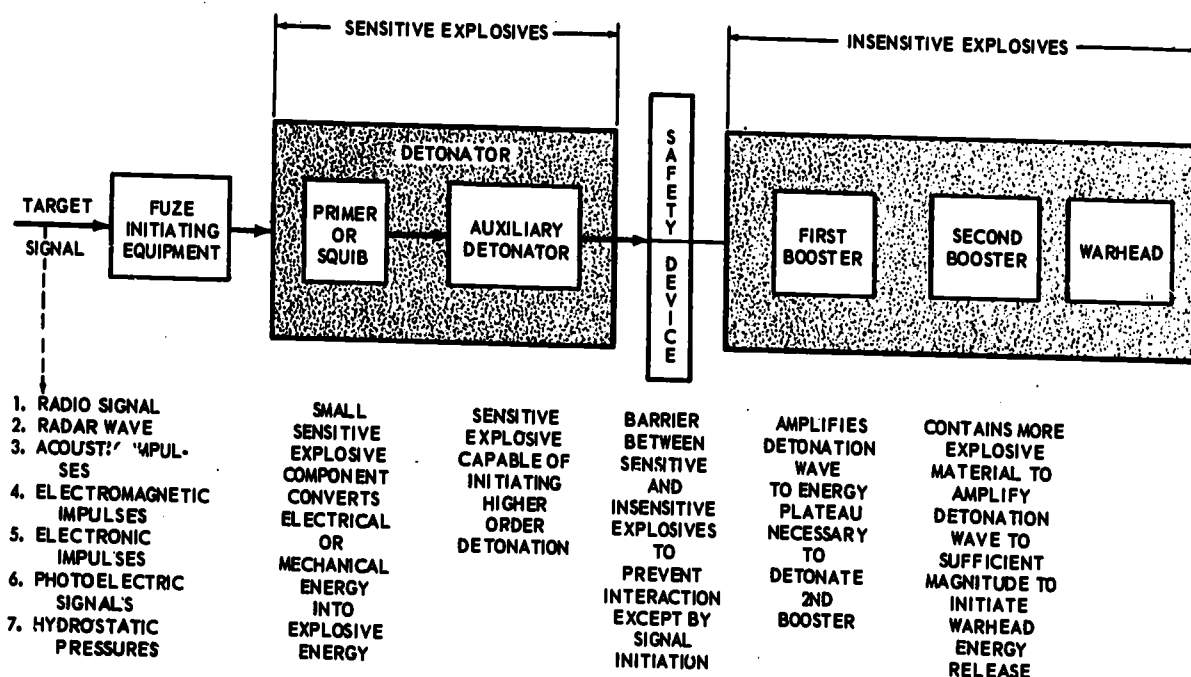

Figure 3-10.—Schematic of typical explosive train with safety device.

144.18

the sensitive and insensitive segments of the explosive train. This physical barrier is not removed until armed status is required. It is usually of metal and acts as a fuze might. The purpose of this barrier is to prevent detonation of the large segments of insensitive explosive if the fuze is unintentionally activated.

The safety devices included in the S&A are designed to prevent accidental activation. The purpose of the primary safety mechanism is for safe functioning of the missile; the secondary safety device is mainly for the purpose of overcoming countermeasures. This is becoming increasingly complex.

Since the arming device is actuated by a specific signal, such as the radar waves from a target, the countermeasure may supply a false target signal. By launching a decoy, or by some other method the enemy may deceive the arming device. The safety device must prevent arming by the false signal. As mentioned before, this is a complex problem which requires constant study. A further complication is the fact that the S&A device cannot be given a complete test, for to do so would destroy the S&A in most

cases. This is too costly. Instead, redundancy is used in both safety and in arming devices to achieve a high reliability.

FUZE POSITION IN WARHEAD.—In general, fuzes may be classified as NOSE FUZES, located in the nose of the warhead, or BASE FUZES, located at its after end. The fuze or combination of fuzes to be used, and their location in the warhead, depend on the mission at hand and the effect desired. Proximity fuzes are always in the nose of the missile.

SIGNAL AMPLIFICATION.—The signal received from the target may need to be amplified to be of sufficient strength to be read by the fuze. The type of amplifier used depends on the signals received by the target detection device (TDD), whether they are infrared rays from the target, radar waves, or audio signals.

The fuze booster amplifies the detonation signal sent by the fuze. The amount of explosive in the fuze itself is very small but very sensitive. The fuze booster is larger and less sensitive; it multiplies the strength of the fuze signal and initiates the detonation in the next portion of the explosive train.

PRINCIPLES OF GUIDED MISSILES AND NUCLEAR WEAPONS

TELEMETERING SYSTEMS

THE NEED FOR TELEMETERING

When any complex device or system is under development, it must be given an exhaustive series of tests which will reveal its operating characteristics and serve as a basis for its tactical evaluation. With most devices and systems, conditions are such that human observers can study these characteristics close at hand and measure numerous quantities while the device or system is in actual operation. For example, a new airplane is repeatedly flown under varying conditions by a skilled test pilot. Each flight provides first hand information to the pilot, as well as information derived from specialized recording instruments carried in the plane. Should the plane crash, with the loss of the pilot and recording equipment, the cause of failure may never be determined.

The problems encountered in missile development are greater than those met in airplane development since the missile cannot be flight-tested by a human pilot. In most cases a missile is lost forever shortly after launching—being reduced to junk on striking the surface of the earth, or falling into the sea.

The test versions of Regulus were designed for intact recovery after test flights, and recording equipment to indicate the second-by-second performance of missile components could be carried within the missile itself. But most missiles are nonrecoverable. Telemetering equipment is therefore essential to an evaluation of component and system performance, and to indicate the cause of component failure.

As you know, guided missiles are subjected to a series of rigid systems tests on the ground during and after their development. However, the results obtained on the ground may be very different from those obtained from a missile in flight. Temperatures, pressures, and accelerations encountered in flight may significantly change the operation of the missile. Electronic and other types of control system equipment may react very differently under the stress of flight conditions than they do on the ground. For these reasons, certain flight-test methods have been developed to provide ground personnel with an accurate basis for determining in-flight performance.

These flight-testing methods rely on a process called **TELEMETERING**. The word "telemeter" is of Greek origin and means "meas-

urement from a distance." In actual telemetering practice, the measurements are done by various equipments in the missile while it is in flight. These measurements are then transmitted to a ground station by electronic means and analyzed partly during the flight and partly after the flight. This telemetering permits the measurement and study of missile component performance from a remote point.

PHOTOGRAPHIC RECORDS

Photographic or other recordings made in the missile itself are not considered telemetering, because there is no great distance between the measuring and the recording instruments.

One basic exception is visual measuring (sometimes referred to as external telemetering) that is done at remote stations rather than in the missile. An example is the use of cameras (at the launch site or other points) which are used to photograph the missile's flight. One such camera, the **THEODOLITE** camera, takes pictures of the missile in flight, and, at the same time, continuously records the azimuth and elevation of the camera, as well as the time at which each frame is exposed. By using two or more of these cameras and a triangulation process, a missile's range, bearing, altitude, and velocity can be computed for any instant of flight. This data can then be plotted to show the missile's flight path. Other information, such as missile flight attitude, control surface movements, target intercepts, and any breaking up of the missile due to malfunction, can also be obtained from the pictures. The information obtained from visual recordings is, of course, limited by the quality of the camera (resolving power, etc.), the weather, and the range of the missile. Although visual recording data is very valuable in missile development and flight testing, it is limited to overall missile performance and therefore cannot show the internal operation of the missile components.

An instrument panel observed through a television camera constitutes a form of telemetering with a large number of channels, in which quantitative information is made immediately available for observation and recording.

RADIO TELEMETERING

Telemetering of data relating to the missile's internal operation is accomplished by the

Chapter 3—COMPONENTS OF GUIDED MISSILES

use of a radio link. Radiotelemetry has been in use since the mid-thirties, especially for transmitting weather data gathered by balloon-supported instruments. This data is emitted to remote stations by radio transmitters. The principal element of this kind of equipment is called **RADIOSONDE**, and is still one of the aerographer's most important weather-predicting devices. Suspended from weather balloons, radiosondes provide weather information by sampling the readings of various meteorological instruments in sequence. Resistance values are caused to vary with humidity, temperature, etc. This variation in turn causes modulation of the transmitter carrier frequency.

A simple telemetering system might measure only "yes-no" information such as whether or not the fuze is armed at any given instant. This type of system tells an observer when an event has taken place. A usual method is to change an audio modulation frequency each time an event takes place. The frequency change gives evidence that the transmitter was working both before and after each successive event. In such a transmitter no rigid demands are made on the stability of the audio frequency, or upon its waveform.

Missile radio telemetering systems (including ground equipment) are usually designed to carry out the following major processes:

1. Observation of missile functions.
2. Conversion of the measured quantities into electrical signals.
3. Transmission of the signals from the missile to a receiving station.

The receiving station performs the following functions:

1. Receives the transmitted signals.
2. Decodes the signals.
3. Displays various data in visual form.
4. Records information permanently for future use.

The requirement that the telemetering system accurately transmit a large amount of data in a short period of time has resulted in the development of very reliable radio telemetering systems which employ **MULTIPLEXING** to provide the necessary number of data channels.

TELEMETERING REQUIREMENTS

Guided missiles present their own peculiar problems, caused by limited space, high launching acceleration, high speed, and the varied and numerous measurements required.

A great deal of information is needed during the various stages of a missile test or development program, on such subjects as launching performance, flight data, and operation of the control and guidance systems. Data measured by the telemetering systems of guided missiles include (1) changes of attitude in roll, pitch, and yaw; (2) flight data such as air speed and altitude; (3) missile acceleration during launching or maneuvering; (4) ambient conditions of temperature, humidity, and pressure; (5) structural information such as vibration and strain; (6) control functions, such as operation of the control receiver, autopilot operation, servo operation, displacements of control surfaces, and operation of the homing or other target-seeking equipment; (7) propulsion information, including fuel flow and thrust, temperatures and pressures in the rocket assembly; (8) ordnance functions such as fuze arming time; (9) upper-air research data, such as sampling for cosmic radiation; (10) the performance of the electric, hydraulic, and pneumatic systems; and (11) information on the performance of the telemetering equipment itself, including reference voltages for calibration and time marks, to permit synchronizing recordings as received by several different receivers located along the flight path.

Many of these measurements are inter-related. Some of them require a high order of time resolution, especially as the speed of the missile increases. For others, a few samplings per second are adequate. A telemetering system must be capable of transmitting large amounts of varied data each second. With so much information to be handled, a multi-channel system is plainly indicated, because a single commutated channel would not give sufficient time resolution.

The missile-borne telemetering equipment must meet certain design specifications which include:

1. Being sufficiently light in weight so the flight characteristics of the missile will not be affected.
2. Being rugged enough to withstand the severe forces, pressures, and temperatures encountered during missile flight.
3. Being small enough to permit ease of installation.
4. Being expendable.
5. Being reliable enough to ensure that the quantities being measured are faithfully transmitted to the receiving station. Because most

PRINCIPLES OF GUIDED MISSILES AND NUCLEAR WEAPONS

missiles are fired only once, the telemetering must be reliable or a sizable expenditure of time and money will be wasted. Accuracy, stability, and simplicity are imperative. Because of these requirements, telemetering personnel check their calibration work just prior to launching. Launching subjects the missile-borne telemetering equipment to severe conditions of acceleration, vibration, and sometimes condensation. For example, when a missile is launched at high altitude from a parent plane, its parts may be cold. When the missile reaches a lower altitude, the condensation that takes place may impair operation of the telemetering equipment.

The missile may roll, or it may be thrown into a climb or dive, and through all these gyrations the telemetering equipment must continue to function. A directional antenna may cause the signal to be lost entirely, long with valuable information, at a critical time; such an antenna requires a number of data-receiving stations to ensure continuous reception. The pattern of the antenna on the missile should be such that reception is not impaired by changes in missile attitude. The antenna should be designed for minimum aerodynamic drag; with supersonic missiles, this requirement is particularly important. Nose probes or an insulated section of the missile nose are sometimes used as radiating surfaces. In some missiles, a part of the airframe itself is excited by a feedline and serves as a transmitting antenna.

As in any system of measurement, the telemetering system should neither impair the operation of the equipment it monitors, nor exert an undue influence on the quantities it measures. In small missiles, the distribution of telemetering instruments must be so arranged that the center of gravity remains undisturbed.

COMPONENTS OF A TELEMETERING SYSTEM

The nature of the telemetering installation is determined by the requirements of the particular test, and the exact functions to be telemetered for each flight must be carefully chosen. For example, a small number of functions may be studied with great precision, rather than a larger number of functions on a time-sharing basis. Such a selection might

also result in a saving in the time required for missile instrumentation.

Missile telemetering systems in general consist of the components shown in figure 3-11. The END INSTRUMENTS located in the missile measure the desired quantities, and produce corresponding data signal voltages which are led to a bank of subcarrier oscillators. Here the data signals frequency-modulate the oscillators. The resulting signals are combined to produce a single complex signal which is then impressed on a v-h-f carrier signal and transmitted by the missile telemetering antenna. At the remote receiving station, the transmitted signal is received and eventually broken down into its components, permanently recorded, and analyzed.

End Instruments

The end instruments are the sensing devices which are carried in the missile to observe the components on which information is to be telemetered.

End instruments that are common to all systems fall into two classes: PICKOFFS and TRANSDUCERS. (Transducers are sometimes referred to as pickups.) In telemetering parlance, the term "pickoff" is usually reserved for devices which collect data in electrical form and relay that data in electrical form.

The term "transducer" generally is reserved for the devices that convert nonelectrical indications—for example, mechanical motion—to voltages which can be used for telemetry transmission purposes.

(Because of the necessity for compact missile equipment, telemetering end instruments are very often built into the missile as integral parts of the overall system.)

The exercise head is the location of the major components of the missile telemetering equipment. When the exercise head is installed, connections are made to the missile components that are to be tested.

The most common type of telemetering system used for guided missiles is the f-m/f-m, or DOD (Department of Defense) system. Pulse telemetering systems are also used to a limited extent.

The f-m/f-m telemetering system uses the basic techniques of frequency modulation and can be used to transmit large quantities of missile data very rapidly.

Chapter 2—COMPONENTS OF GUIDED MISSILES

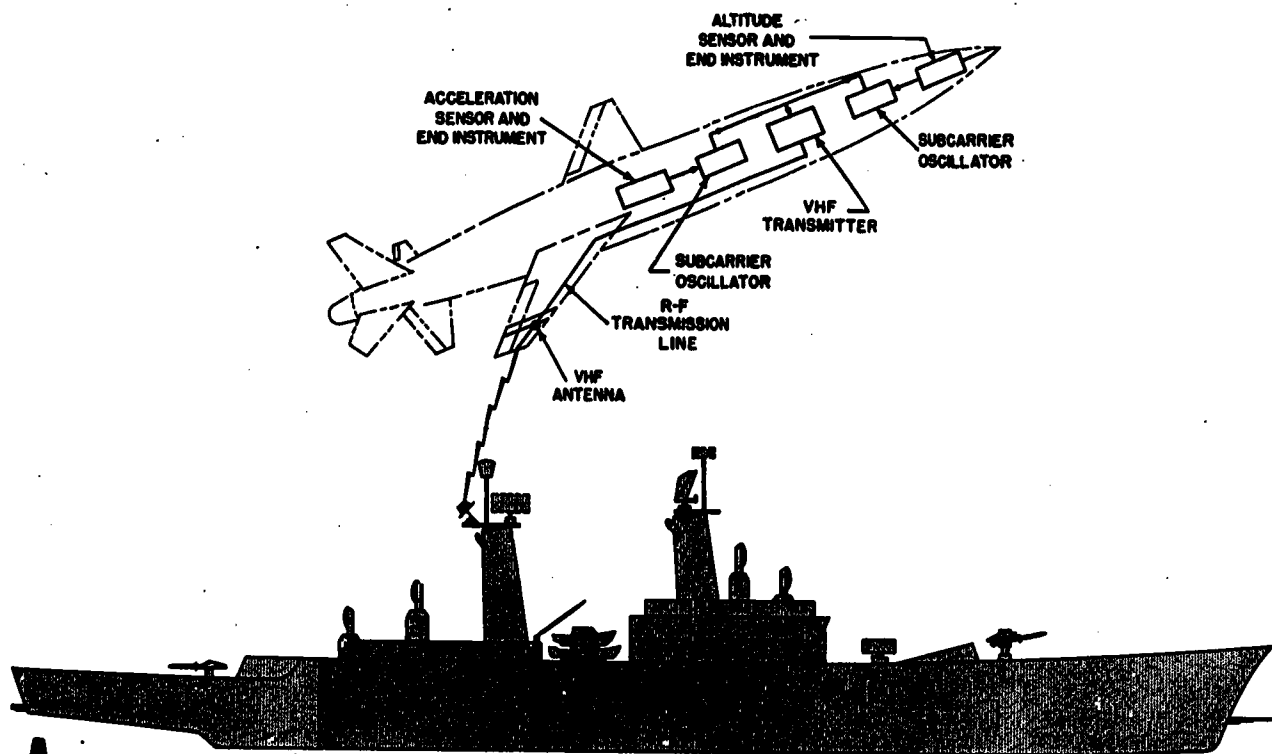

A

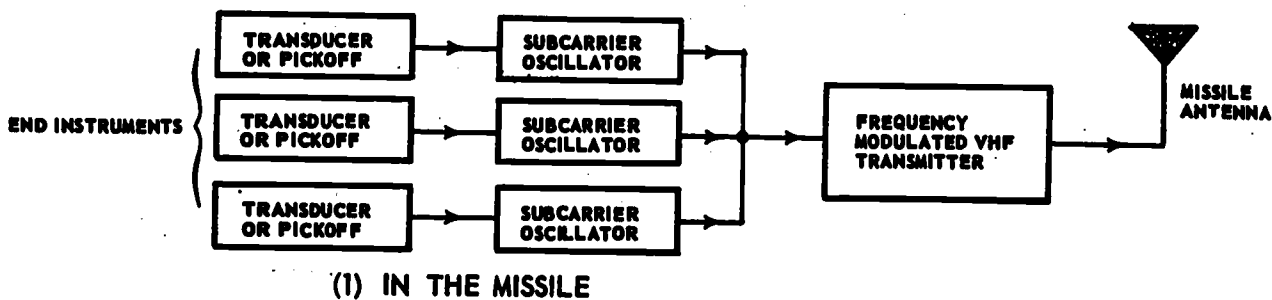

END INSTRUMENTS

(1) IN THE MISSILE

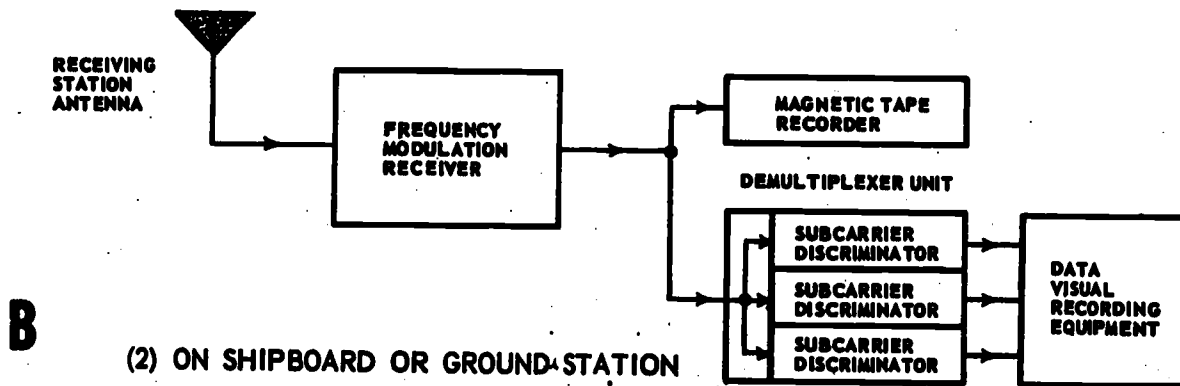

(2) ON SHIPBOARD OR GROUND STATION

Figure 3-11.—Basic telemetering system. A. Location of components in missile; B. Simple block diagram of a 3-channel f-m/f-m telemetering system.

33.209:213

PRINCIPLES OF GUIDED MISSILES AND NUCLEAR WEAPONS

Pulse telemetering systems operate on a time-sharing basis; that is; they transmit separate items of information one at a time and in a regular sequence. The missile data supplied by all the channels are transmitted on the same carrier wave; but each channel is sampled for comparatively short intervals of time and is permitted to modulate the transmitter only dur-

ing those intervals. This process is often referred to as TIME-DIVISION MULTIPLEXING.

Data transmitted from the missile may be observed on instruments as the flight progresses, and simultaneously recorded on film or magnetic tape. Suitable decoding and computing equipment are used to facilitate the work of data reduction and analysis.

CHAPTER 4

MISSILE PROPULSION SYSTEMS

INTRODUCTION

A brief history of the evolution of missile propulsion systems was presented in chapter 1. Chapter 3 gave an overview of the types of propulsion used in present-day missiles, and of possible future developments. This chapter will present the principles of operation of the different propulsion systems and the application of basic laws of science to them. The different types of propellants used and the methods of using them are discussed. Advantages and disadvantages of each type are recounted. New combinations and experimental propellants are touched upon.

GENERAL

The propulsion system of a missile is the entire system required to propel the missile, including the engine, accessories such as pumps and turbines, pressurization system, tankage and all related equipment.

Until the start of World War II, the reciprocating engine-propeller combination was considered satisfactory for the propulsion of aircraft. We have already explained the speed limitations of propeller-driven craft. As the speed of the propeller approaches the speed of sound, shock waves form and limit the development of thrust. This condition requires the use of extremely large engines to produce any further increase in speed. Research in the design of propellers may make it possible to overcome some of their limitations. But at present, some form of jet propulsion is required for high subsonic and supersonic speeds.

Guided missiles must travel at high speeds to lessen the probability of interception and destruction by enemy countermeasures. Although a few high-subsonic missiles are still operational for use against surface targets, most of those on hand are used for target practice. The

increasing efficiency of countermeasures tends to make all subsonic missiles obsolete. Missiles intended for use against high-speed enemy missiles and manned aircraft must be capable of high speeds. All air-to-air and surface-to-air missiles now operational fly at supersonic velocities and depend on some form of jet engine for propulsion.

Jet propulsion is a means of locomotion brought about by the momentum of matter expelled from the after end of the propelled vehicle. This momentum is gained by the combustion of either a solid or a liquid fuel. Compared to reciprocating engines, jet propulsion systems are simple in construction. The basic components of a jet engine are a combustion chamber and an exhaust nozzle. Some systems require accessory components such as pumps, injectors, turbines, diffusers and ignition systems.

CLASSIFICATION OF JET SYSTEMS

Jet propulsion systems used in guided missiles may be divided into two types: ducted propulsion systems (also called atmospheric jets) and rockets.

Missiles using a ducted propulsion system are air-breathing missiles; they are incapable of operating in a vacuum. The missile takes in a quantity of air at its forward end, increases its momentum by heating it, and produces thrust by permitting the heated air and fuel combustion products to expand through an exhaust nozzle. This process may be broken down into the following steps: air is taken in and compressed; liquid fuel is injected into the compressed air; the mixture is burned; and the resulting hot gases are expelled through a nozzle. The air may be compressed in any of several ways. In a turbojet engine, air is compressed by a rotary compressor, which in turn is operated by a turbine located in the

PRINCIPLES OF GUIDED MISSILES AND NUCLEAR WEAPONS

path of the exhaust gases and mounted on the same shaft as the compressor. (A turboprop engine, now used in some manned aircraft but not in guided missiles, makes use of a propeller mounted at the forward end of the compressor turbine shaft.) In a pure duct system, such as the ramjet, air is compressed by the forward motion of the missile through it. The now obsolete pulsejet also depends on forward motion for compression. It differs from the ramjet in that combustion is intermittent, rather than continuous.

Rockets do not depend on air intake for their operation, and are therefore capable of traveling beyond the atmosphere. A rocket engine carries with it all the materials required for its operation. These materials usually consist of a fuel and an oxidizer. The oxidizer is a substance capable of releasing all the oxygen required for burning the fuel.

Figure 4-1 charts the types of jet propulsion systems. Both types, rockets and atmospheric jets, receive their thrust as reaction to the exhaust of combustion gases. Jet engines frequently are called reaction motors, since the exhaust gases produce the action while the opposite motion of the missile or aircraft represents the reaction. Both types can be called thermal jets because they are dependent on the action of heat. The reaction which propels the jet engine occurs WITHIN the engine, and does not occur as a result of the exhaust gases pushing against the air.

PRINCIPLES OF JET PROPULSION

BASIC LAWS AND FORMULAS

Before taking up propulsion systems, let us review the way gases are affected by variations in pressure and temperature. Gases at high temperatures and pressures are used in the main propulsion systems of missiles, as well as for driving various mechanisms within many missiles. These gases may be in the form of high pressure air (or other inert gases) stored in flasks, or in the form of fuel combustion products. The use of stored compressed gas has been limited to small vernier rockets in ballistic missile reentry bodies, but flasks of compressed gas are used to operate parts of missiles, for launching Polaris, and for duds-jettisoning some missiles.

Absolute Pressure

Although we live at the bottom of an ocean of air, we do not feel the pressure which the atmosphere exerts on us because it is nearly equal in all directions.

In all problems involving the laws of gases, pressure should be figured in pounds per square inch absolute, which is the gauge pressure plus 14.7 psi at sea level.

Absolute Temperature

The temperature of a gas can be measured with respect to an absolute zero value. This

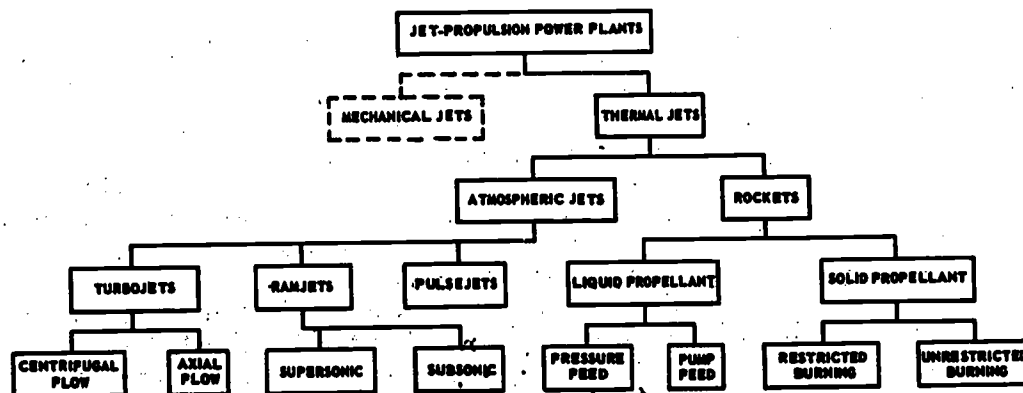

Figure 4-1.—Classification of missile jet power plants.

Chapter 4—MISSILE PROPULSION SYSTEMS

value, which is usually expressed in terms of the centigrade scale, represents one of the fundamental constants of physics. It was established experimentally during a series of tests made in the study of the kinetic theory of gases.

According to this view, a gas, like other forms of matter, is composed of molecules made up of combinations of atoms. Normally, the molecules of any substance are in constant motion. In the gaseous state, the motions are assumed to be entirely random. That is, the molecules move freely in any direction and are in constant collision, both among themselves and with the walls of the container. The moving particles possess energy of motion, or kinetic energy, the total of which is equivalent to the quantity of heat contained in the gas. When heat is added, the total kinetic energy is increased. When the gas is cooled, the thermal agitation is diminished and the molecular velocities are lowered.

The molecules do not all have the same velocity, but display a wide range of individual velocities. The temperature of the gas, according to the kinetic theory, is determined by the average energy of the molecular motions. Pressure is accounted for by considering it as resulting from the bombardment of the walls of the container by the rapidly flying molecules. The particles are considered to have perfect elasticity, so that they rebound from the walls with the same velocities with which they strike them.

In accordance with the kinetic theory, if the heat energy of a given gas sample could be reduced progressively, a temperature would be reached at which the motions of the molecules would cease entirely. If known with accuracy, this temperature could then be taken as the absolute zero value. It was assumed from the experiments that -273°C represents the theoretical absolute zero point at which all molecular motion ceases, and no more heat remains in the substance. All gases are converted to the liquid state before this temperature is reached.

Gas Laws

In the experiments to determine absolute pressure and absolute temperature, the behavior of gases under different pressures and temperatures revealed the laws of gases. Any change in the temperature of a gas causes a corresponding change in the pressure, making it necessary to consider temperature, pressure,

and volume together. The same ratios of change of volume and pressure were found to be present in all gases, and they were found to be constant over a wide range of temperatures.

The first law of gases is Boyle's law:

The volume of any dry gas, the temperature remaining constant, varies inversely with the pressure on it; that is, the greater the pressure, the smaller the volume becomes.

This is true only if the temperature has remained the same.

In general, when the pressure is kept constant, the volume of a gas is proportional to its absolute temperature. This is known as Charles' law:

All gases expand and contract to the same extent under the same change of temperature, provided there is no change in pressure.

Finally, since the volume of a gas increases as the temperature rises, it is reasonable to expect that if a confined sample of gas were heated, its pressure would increase. Experiments have shown that the pressure of any gas kept at a constant volume increases for each degree centigrade rise very nearly $1/273$ of its pressure at 0°C . Because of this finding it is convenient to state this relationship in terms of absolute temperatures. For all gases at constant volume, the pressure is proportional to the absolute temperature.

The general gas equation comes from a combination of Boyle's law and Charles' law, and it is expressed by combining their equations into one. That is:

$$\frac{P_1 V_1}{T_1} = \frac{P_2 V_2}{T_2}$$

where P_1 and T_1 are the original pressure and temperature and P_2 and T_2 refer to the new pressure and temperature; and V_1 refers to the original volume and V_2 refers to the new volume. In using this formula be sure that pressure and temperature are in absolute units.

All real gases depart somewhat from the Boyle-Charles law (ideal gas law). Missile designers must apply the laws, with the variation for the gas to be used, in their design of the jet propulsion systems. The gases are produced by the burning of the propellant (liquid or solid); the missile design must channel the gases to produce the most thrust available from them.

PRINCIPLES OF GUIDED MISSILES AND NUCLEAR WEAPONS

APPLICATION OF BASIC LAWS TO MISSILE PROPULSION

The two most common methods by which we produce thrust are by mechanical means (pumps or fans), and by thermal means (chemical reaction). The squid is an example of the mechanical jet found in nature. It draws water into its body and then by muscle contraction forces this water rearward through a small opening at an increased velocity, thus propelling itself forward.

In our study of guided missiles we are concerned with thermal jets—those that operate by reaction to the exhaust of combustion gases.

With the help of some elementary mathematics, we will show how a jet-propulsion system develops the thrust required to propel a guided missile. All jet-propulsion systems are based on the principles expressed in Newton's second and third laws of motion, discussed in chapter 2. According to Newton's second law, the acceleration of a body acted on by an unbalanced force is in the direction of the applied force, directly proportional to the magnitude of the force, and inversely proportional to the mass of the body. This relation can be expressed as a formula:

$$F = Ma$$

or, force equals mass times acceleration, with force expressed in pounds, acceleration in feet per second per second, and mass in SLUGS. (A slug is a unit of mass; the mass of a body in slugs is equal to its weight, in pounds, divided by the acceleration due to gravity in feet per second per second.) The weight of any given mass varies, depending on the force of gravity, which varies with the distance from the earth's center. The relation between weight and mass can be expressed in the formula:

$$M = \frac{W}{g}$$

in which M is the mass in slugs, W the weight in pounds, and g the acceleration due to gravity in feet per second per second (approximately 32.2 ft/sec² at sea level).

Acceleration is the rate of change of velocity. This is expressed in the formula

$$a = \frac{v_2 - v_1}{t}$$

where v_1 is the initial velocity of a mass, v_2 its final velocity, and t the time during which this change of velocity occurs. If we substitute the above value of acceleration in the original formula, $F = Ma$, we get

$$F = \frac{Mv_2 - Mv_1}{t}$$

Since Mv is momentum, the above formula shows that the thrust produced by a jet engine is equal to the rate of change of momentum of its working fluid. We can write the above formula as follows:

$$F = m(v_2 - v_1)$$

where m represents M/t , and is called the mass rate of flow of the working fluid in slugs per second.

In the original equation, $F = Ma$, we can substitute the equivalent weight for mass, and get

$$F = \frac{Wa}{g}$$

When we apply this formula to a jet propulsion system, F is the unbalanced force that accelerates the working fluid through the exhaust nozzle, and a is the acceleration of the fluid in feet per second per second. In accordance with Newton's third law of motion, the forward thrust developed by the jet propulsion system is equal and opposite to the unbalanced force applied to its working fluid.

Now, let W equal the total weight of working fluid that flows through a missile propulsion system during the time the system is producing thrust, and let t equal the total time during which the system develops thrust. Then W/t is the weight rate of flow of working fluid, in pounds per second. Letting $w = W/t$, we can now write a formula for the thrust developed by a jet propulsion system:

$$T = \frac{w}{g}(v_2 - v_1)$$

where T is the thrust in pounds; w is the weight rate of flow of the working fluid, in pounds per second; v_1 is the initial (intake) velocity of the working fluid; v_2 is the final (exhaust) velocity of the fluid; and g is the acceleration due to gravity. This equation gives the thrust applied

Chapter 4—MISSILE PROPULSION SYSTEMS

to expel the working fluid from the exhaust nozzle of the engine. And, in accordance with Newton's third law of motion, the same equation also expresses the forward thrust developed by the propulsion system to propel the missile.

Figure 4-2 represents a jet engine which is taking in air at its forward end at a speed of 1000 feet per second. The burning fuel within the engine heats the air and increases its speed to 2000 feet per second. If we assume that the working fluid flows through the engine at the rate of 64.4 pounds per second, application of the thrust formula shows that this engine is developing a thrust of 2000 pounds.

Note that the thrust developed by an engine is always expressed in pounds of force, not in terms of work or horsepower. A jet engine that is fired in a test stand does not move. It therefore does no work, and consequently develops no horsepower, although it may exert its maximum thrust. At a velocity of 375 miles per hour, one pound of thrust will develop one horsepower. For a missile in actual flight, it is possible to calculate the horsepower developed by the propulsion system from the formula:

$$\text{Horsepower} = \frac{VT}{375}$$

where V is the missile velocity in miles per hour, T is thrust in pounds, and 375 is a constant having the dimensions of mile-pounds

per hour. For example, assume that a missile traveling at 3750 mph has 56,000 pounds of thrust. The above equation shows that the engine is developing 560,000 horsepower:

$$\frac{3750 \times 56,000}{375} = 560,000 \text{ hp}$$

Although it is possible to calculate the horsepower developed by the propulsion system of a missile in flight, the student should remember that jet-propulsion engines are always rated in terms of pounds of thrust, rather than in horsepower.

A rocket engine takes in no air from the atmosphere; its working fluid consists of the combustion gases resulting from burning fuel. Since the rocket carries its own supply of oxygen as well as its fuel supply, the initial velocity of the working fluid, relative to the missile, is zero. Thus, the formula for the thrust developed by a rocket engine reduces to

$$T = \frac{w}{g} v_e$$

where w is the rate of fuel and oxidizer consumption in pounds per second, and v_e is the exhaust velocity of the gases. But the above formula expresses only the thrust due to momentum of the working fluid. If the pressure of the working fluid, after it leaves the

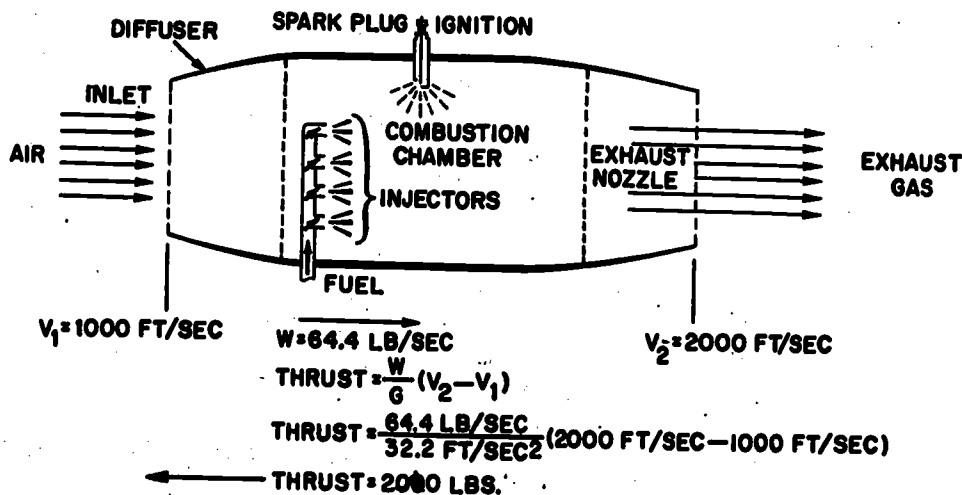

Figure 4-2.—Development of thrust in a propulsion system as an example of Newton's second and third laws of motion.

PRINCIPLES OF GUIDED MISSILES AND NUCLEAR WEAPONS

exhaust nozzle, is greater than the pressure outside the missile, the actual thrust is less than that given by the above formula. It is obvious that if the gases that have left the missile are at a higher pressure than the surrounding atmosphere or space, these gases are capable of doing work. That work, which might have been used to propel the missile, will be wasted. A more accurate formula for rocket thrust is:

$$T = \frac{W}{g} v_e + (P_a - P_e) A_e$$

in which P_a is the pressure of the surrounding atmosphere (or space), P_e is the pressure of the exhaust jet, and A_e is the cross-sectional area of the exhaust jet. If the exhaust nozzle can be so designed that it decreases the pressure of the exhaust jet to that of the surrounding space, the pressure term in the above equation becomes zero. This condition represents the maximum thrust available for any given propellant and chamber pressure. Although this condition cannot be fully attained in actual practice, well-designed nozzles make it possible to approach it closely.

It is a common misconception that jet engines operated by pushing against the surrounding air. Ducted jets depend on air as a working fluid, but they do not need air for the exhaust to push against. Rockets require no air. Air acts only to impede the motion of a rocket, first by drag, and second by hindering the high-speed ejection of the exhaust gases. Thus rockets operate more efficiently in a total vacuum than they do in the atmosphere.

COMPONENTS OF JET PROPULSION SYSTEMS

To achieve high thrust, it is necessary to produce large quantities of exhaust gases at high temperatures and pressures. To produce these exhaust gases, jet propulsion systems consist of a combustion chamber, an exhaust nozzle, and a fuel supply. Liquid-fuel systems require additional parts, such as injectors, pumps, and ignition systems. Air breathing engines require diffusers at the air intake.

COMBUSTION CHAMBER

The combustion chamber is that part of the system in which the chemical action (combustion)

takes place. Combustion is necessary to provide thrust. Useful thrust cannot be attained in an atmospheric jet unless the combustion products are exhausted at a velocity greater than that of the intake gases.

In all thermal jets, the heat energy released by the combustion process is converted to kinetic energy through expansion of the gases of combustion as they pass through the exhaust nozzle.

The chamber is usually a cylinder, although it may sometimes be a sphere. Its length and diameter must be such as to produce a chamber volume most suitable for complete and stable combustion. The chamber length and the nozzle exit diameter are determined by the propellants to be used. Both must be designed to produce the optimum gas velocity and pressure at the nozzle exit.

EXHAUST NOZZLE

An exhaust nozzle is a nonuniform chamber through which the gases generated in the combustion chamber flow to the outside. Its most important areas are the mouth, throat, and exit, identified in figure 4-3. The function of the nozzle is to increase the velocity of the gases. The principle involved was announced many years ago by a Swiss physicist, Daniel Bernoulli. Bernoulli's principle applies to any fluid (gas or liquid). It may be stated as follows: "Provided the weight rate of flow of a fluid is constant, the speed of the fluid will increase where there is convergence in the line. It will decrease where there is a divergence in the line." Figure 4-4 illustrates this principle. The velocity of the fluid will increase at point #1. At the point of divergence, point #2, the speed of the fluid will decrease. The increase in speed between points #1 and #2 is caused by a conversion of potential energy (fluid pressure)

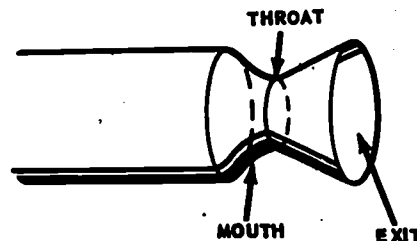

Figure 4-3.—Location of nozzle areas.

33.13

to kinetic energy. Thus the pressure drop of the fluid through the restriction is proportional to the velocity gained. When the fluid reaches point #2, the kinetic energy is again converted to potential energy. At point #2, the fluid velocity decreases, and the pressure of the fluid increases.

This relationship holds true for subsonic flow of gases. In the convergent nozzle in figure 4-5 A, the speed will increase up to the speed of sound, depending on the degree of convergence. Such nozzles are often used on subsonic turbojets. It has been found that, with a nozzle of this type, if the internal pressure of the combustion chamber is more than about 1.7 times the external pressure, an excess pressure remains in the gases after they leave the nozzle. This excess pressure represents wasted energy. The performance of combustion systems using this type of nozzle is therefore limited.

In the divergent nozzle in figure 4-5B, gases at subsonic speeds will slow down, depending on the degree of divergence.

Gases at supersonic (faster than sound) speed behave differently. As these gases pass through the divergent nozzle, their velocity is INCREASED because of their high state of compression. The drop in pressure at the point of divergence causes an instantaneous release of kinetic energy, which imparts additional speed to the gases. To obtain supersonic exhaust velocity, the DeLaval nozzle, figure 4-5C, is commonly used. This nozzle first converges to bring the subsonic flow up to the speed of sound. Then the nozzle diverges, allowing the gases to expand and produce supersonic flow.

The Prandtl nozzle (fig. 4-5D) is more efficient than the straight-coned DeLaval nozzle but is more difficult to engineer and produce. It increases the rate of flow at a higher rate

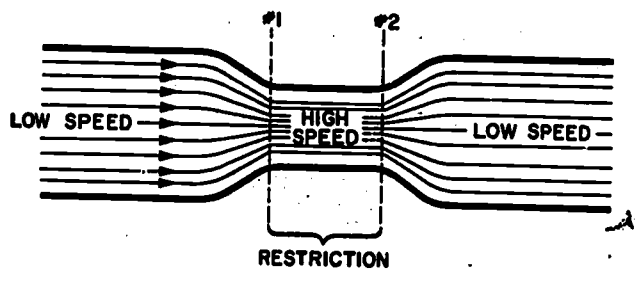
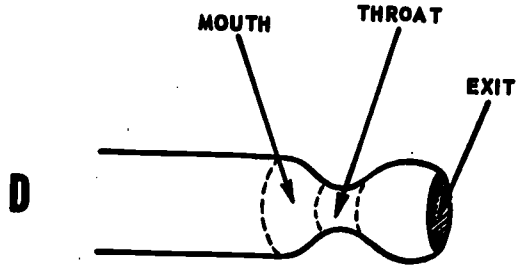
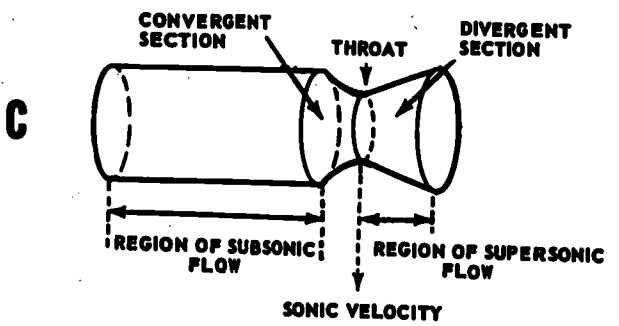
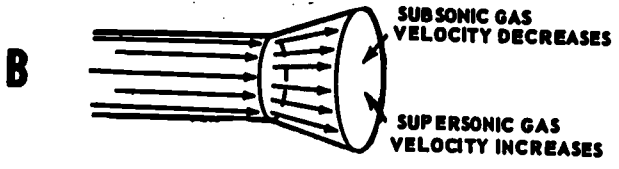
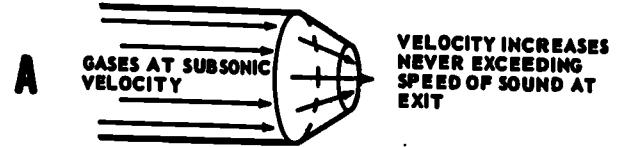

Figure 4-4.—Fluid flow through a restriction.

Figure 4-5.—Gas flow through nozzles: A. Subsonic flow through a convergent nozzle; B. Flow through a divergent nozzle; C. Convergent-divergent nozzle (DeLaval); D. Prandtl nozzle.

PRINCIPLES OF GUIDED MISSILES AND NUCLEAR WEAPONS

than the normal convergent-divergent type. The shape of the nozzle determines the characteristic of gas flow, which must be smooth.

Other nozzles of increasing importance are the adjustable area type in which the nozzle area is varied to suit varying combustion environmental conditions.

The best size for the nozzle throat is different for different propellants. In each case, the best size has to be determined by experiment and calculation. The nozzle must be designed for a specific set of propellant and combustion characteristics to obtain higher velocity and increased thrust. The area of the throat section is determined by the weight rate of flow. The area at the exit of the divergent cone is determined by the desired ratio of expansion of the gases between throat and exit.

FUEL SUPPLY

The fuels and oxidizers used to power a jet engine are called propellants. The chemical reaction between fuel and oxidizer in the combustion chamber of a jet engine produces large quantities of high-pressure high-temperature gases. When these gases are channeled through an exhaust nozzle, a large part of the heat energy they contain is converted into kinetic energy to propel the missile. When you read of an engine that can travel faster than a gun projectile, operate in a vacuum, deliver a great deal more energy than a reciprocating engine, and do so with a few or no moving parts, you may get the idea that some very complex chemical mixture is used as the propellant. This is not so. Jet-propulsion engines can operate on such fuels as kerosene, gasoline, alcohol, gunpowder, and coal dust.

However, in the search for an ideal propellant, many complex fuels have been tried. A mere listing takes up a whole page in the encyclopedia. The search goes on for more powerful propellants, particularly for boosting space vehicles. For example, liquid hydrogen (which becomes liquid at 423° F below zero or -252° C), when mixed with liquid oxygen in a rocket engine, produces about 35 percent more thrust than the kerosene type fuels now used. It will be used to propel Centaur and other unmanned earth orbital and interplanetary flights as well as upper-stage rockets now being developed for manned lunar landings. Fluorine is being studied as an oxidizer to help produce more thrust.

With regard to their physical state, propellants may be either solids, liquids, gases, or various combinations of these. However, gases are rarely used as missile propellants, for two reasons. First, liquids or solids have a higher density than most gases, even when the latter are highly compressed; thus a larger quantity of solid or liquid propellant can be carried in a given space. Second, a greater energy transformation results when a substance goes from solid or liquid to gas than results when a gas is merely accelerated to a higher velocity.

Rating or Comparing Propellants

Several means have been worked out for rating, or comparing, various rocket fuels (propellants). Comparison is made by determining total impulse. Total impulse is the product of the thrust in pounds times burning time in seconds. Or,

$$I_T \text{ (Total Impulse in lb-sec)} = \\ T \text{ (Thrust in lbs)} \times t \text{ (Duration in secs).}$$

Solid propellants are rated, or compared, on the basis of SPECIFIC IMPULSE, the amount of impulse produced by one pound of the propellant.

In pound-seconds per pound, this is equal to the total impulse divided by the weight of the propellant. Stated as a formula, it is:

$$I_{sp} \text{ (Specific Impulse in lb-sec/lb)} = \\ \frac{I_T \text{ (Total Impulse in lb-sec)}}{W \text{ (Weight of Solid Fuel in lbs)}}$$

A common method of comparing liquid propellants is on the basis of specific thrust. Specific thrust is equivalent to specific impulse for solid propellants but is derived in a slightly different way. Specific thrust is defined as the thrust in pounds divided by the weight rate of flow of fuel in pounds per second. Or,

$$T_{sp} \text{ (Specific Thrust in lbs/lb/sec)} = \\ \frac{T \text{ (Thrust in lbs)}}{W \text{ (Weight Rate of Flow in lb. per sec)}}$$

Specific thrust is frequently expressed in seconds.

Chapter 4—MISSILE PROPULSION SYSTEMS

Specific propellant consumption is the reciprocal of specific thrust; it is the rate of propellant flow, in pounds per second, required to produce one pound of thrust. Or,

$$\text{Specific Propellant Consumption} = \frac{\text{Weight Rate of Flow (lbs/sec)}}{\text{Thrust (lbs)}}$$

Other terms you should know are mixture ratio and exhaust velocity.

Mixture ratio designates the relative quantities of oxidizer and fuel used in the propellant combination. It is numerically equal to the weight of oxidizer flow divided by weight of fuel flow. Exhaust velocity is determined theoretically on the basis of the energy content of the propellant combination. The actual velocity of the exhaust gases is of course less than this theoretical value since no jet engine can completely convert the energy content of the propellant into exhaust velocity. Thus, effective exhaust velocity is sometimes used and is determined on the basis of thrust and propellant flow:

$$\text{Effective Exhaust Velocity} = \frac{\text{Thrust (lbs)}}{\text{Mass Rate of Flow (lbs/sec)}}$$

Solid Propellants

Solid propellants are of two types. One of these consists of a fuel, such as a hydrocarbon, mixed with a chemical capable of releasing large quantities of oxygen (a chlorate or a nitrate). A second type consists of a compound, nitrocellulose, for example, that releases large quantities of gases and heat when it decomposes. When mixed with additives (in small quantity as stabilizers), this type is called a double-base propellant. It is used most for small rockets.

Of course it is possible to combine the two types in a single propellant mixture called a composite propellant. This is the type most used for missile propellants.

The ingredients of a solid propellant are mixed so as to produce a solid of specified chemical and physical characteristics. Some examples of materials used in making solid propellants are asphalt-oils, nitroglycerin,

asphalt-potassium perchlorates, black powder with ammonium nitrate, and other recently developed combinations. Perfluoro-type propellants, and aluminum or magnesium metal components combined with an oxidant have given higher specific impulse than other combinations. The finished product takes the shape of a grain, or stick. A charge may be made up of one or more grains. Combustion of solid propellants will be discussed later in this chapter.

An ideal solid propellant would:

1. Have a high specific impulse.
2. Be easy to manufacture from available raw materials.
3. Be safe and easy to handle.
4. Be easily stored.
5. Be resistant to shock and temperature changes.
6. Ignite and burn evenly.
7. Be non-water-absorbent (nonhygroscopic).
8. Be smokeless and flashless.
9. Have an indefinite service life.

It is doubtful if a single propellant having all of these qualities will ever be developed. Some of these characteristics are obtained at the expense of others, depending on the performance desired.

Liquid Propellants

The liquid propellants are classified as monopropellants or as bipropellants.

Monopropellants are those which contain within themselves both the fuel and oxidizer and are capable of combustion as they exist. Bipropellants are those in which the fuel and oxidizer are kept physically separated until they are injected into the combustion chamber. An example of a monopropellant would be the mixture of hydrogen peroxide and ethyl alcohol; an example of a bipropellant would be liquid oxygen and kerosene.

When oxygen or an oxygen-rich chemical is used as an oxidizer, the best liquid fuels appear to be those rich in both carbon and hydrogen.

In addition to the fuel and oxidizer, a liquid propellant may also contain a catalyst to increase the speed of the reaction. A catalyst is a substance used to promote a chemical reaction between two or more other substances.

Inert additives which do not take part in the chemical reaction are sometimes combined with liquid fuels. An example is water, which is often added when alcohol is used as a fuel.

PRINCIPLES OF GUIDED MISSILES AND NUCLEAR WEAPONS

Although it does not take part in the chemical reaction, the water does provide additional particles which contribute to a higher thrust by increasing the rate of mass flow through the system.

Most liquid-fuel rockets use the bipropellant type liquid fuel, as it is less likely to react to shock and heat than monopropellants. When separated, as they are before entrance into the combustion chamber, the fuel and oxidizer are generally incapable of chemical reaction. Bipropellants which ignite spontaneously upon contact with each other are called hypergolic. An example is Dimazina (unsymmetrical dimethylhydrazine (UDMH)), or Aerozine 50, used in Titan II and III with nitrogen tetroxide as oxidizer. Those which require the addition of energy (electric spark, igniter, or other) to cause chemical reaction are said to be diergolic. Thixotropic propellants are jellied substances with metallic substances (aluminum) suspended in them, which greatly increases the propellant density and the specific impulse of the liquid engine. There are a large number of liquid fuels but there are few known practical oxidizers. Some highly effective oxidants are too dangerous to store and handle.

While solid propellants are stored within the combustion chamber, liquid propellants are stored in tanks and injected into the combustion chamber. In general, liquid propellants provide a longer burning time than solid propellants. They have a further advantage in that combustion can be easily stopped and started at will by controlling the propellant flow.

An ideal liquid propellant would:

1. Be easy to manufacture from available raw materials.
2. Yield a high heat of combustion per unit weight of mixture.
3. Have a low freezing point.
4. Have a high specific gravity.
5. Have low toxicity and corrosive effects.
6. Have stability in storage.
7. Have low molecular weight of the reaction products.
8. Have a low vapor pressure.

As with the solid propellants, it is unlikely that all of these characteristics can be combined in a single fuel.

Two disadvantages of liquid propellants are the low pressure limits of some of them, and the problem of sloshing of the liquid in the tanks, which can shift the center of gravity of

the missile and cause erratic behavior. Some liquid propellants will react spontaneously if subjected to pressures above their limit. Solid propellants also have pressure limits but they are much higher than for liquid propellants.

SPECIAL PARTS

In addition to the combustion chamber, exhaust nozzle, and fuel supply, which all reaction type engines must have, liquid-fuel engines also use injectors and igniters, and air-breathing missiles must have a diffuser or intake duct, where the high-speed air is converted into low-speed, high-pressure gas for entry into the combustion chamber as an oxidizing element.

Injectors

The injector is similar in function to the carburetor in a reciprocating engine. It vaporizes and mixes the fuel and oxidizer in the proper proportions for efficient burning.

Figure 4-6 shows schematic sketches of three types of injectors. In the multiple-hole impingement type (fig. 4-6A), oxidizer and fuel are injected through an arrangement of separate holes in such a way that the jet-like streams intersect each other at some predetermined point, where the fuel and oxidizer mix and break up into vapor-like droplets. A spray injector (fig. 4-6B) has oxidizer and fuel holes arranged in circles, so as to produce conical or cylindrical spray patterns that intersect within the chamber. The nonimpinging injector, shown in the lower sketch in figure 4-6, is one in which the oxidizer and fuel do not impinge at any specific point, but are mixed by the turbulence within the chamber.

Ignition Systems

Unless the fuel and oxidizer form a combination that ignites spontaneously, a separate ignition system must be provided to initiate the reaction. The igniter must be located within the combustion chamber (fig. 4-2) at a point where it will receive a satisfactory starting mixture that ignites readily. If either fuel or oxidizer accumulates excessively in the chamber before ignition begins, an uncontrolled explosion may result. In some systems, ignition is brought about by a spark plug (fig. 4-2) similar to those used in reciprocating engines. An electric

Chapter 4—MISSILE PROPULSION SYSTEMS

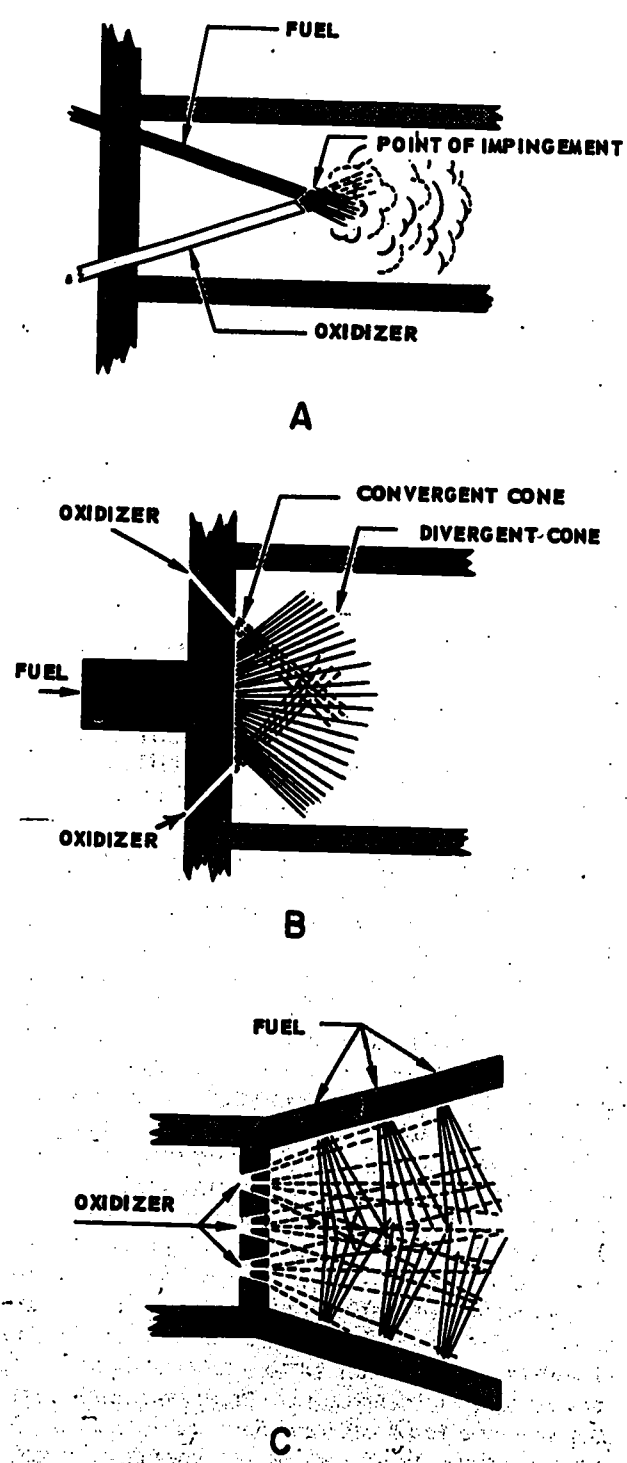

144.20
 Figure 4-6.—Types of injectors in liquid-fuel rockets: A. Multiple hole impingement injector; B. Spray injector; C. Non-impinging injector.

igniter squib type is shown in figure 4-7. A powder-charge ignition system (fig. 4-7) is often used for solid-fuel rockets. It consists of a powder squib which can be ignited electrically from a safe distance; it burns for a short time, with a flame hot enough to ignite the main propellant charge. A catalytic ignition system uses a solid or liquid catalytic agent that brings about chemical decomposition of the propellant.

Diffusers

The purpose of the air intake and diffusion system is to decelerate the velocity of the air from its free stream speed (fig. 4-2) to the desired speed at the entrance of the combustion chamber with a minimum of pressure loss. As mentioned above, only air-breathing engines need diffusers. Diffusers are of two general types: subsonic, and supersonic. Diffusers are illustrated in the section on ramjet engines.

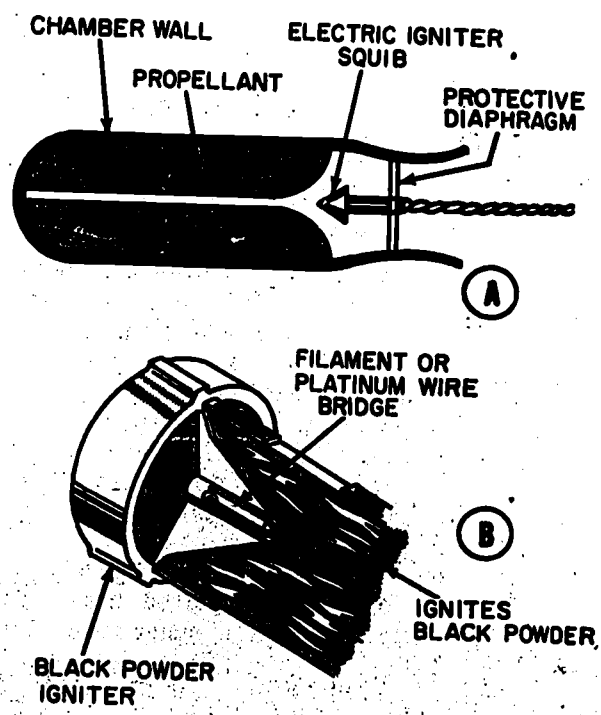

144.21
 Figure 4-7.—Types of igniters: A. Electric igniter squib type; B. Black powder charge igniter.

PRINCIPLES OF GUIDED MISSILES AND NUCLEAR WEAPONS

SUBSONIC DIFFUSERS.—Subsonic diffusers may be internal compression diffusers or external compression diffusers. Although the principles are known, no completely successful external compression diffuser has been developed. Velocity decrease at a point external to the air inlet would permit simplification of the air diffuser design.

An internal compression diffuser is a duct located at the forward end of the engine between the air intake and the injector. Between these two points, the diameter of the duct increases (fig. 4-11A), and as a result, the velocity of the air decreases and the pressure increases. If the pressure change is to be kept small, the diffuser length must be increased. Too great a length could result in pressure losses due to skin friction, so a compromise value usually has to be used.

SUPERSONIC DIFFUSERS.—At supersonic speeds the intake air must be reduced to subsonic speed with a minimum loss of pressure. A problem of diffusion at supersonic speeds is the production of shock waves at the inlet. Supersonic diffusers may be classified as: (1) Normal shock (fig. 4-11B); (2) converging-diverging; and (3) conical or "spike" diffusers, also called "center body" diffuser (fig. 4-11C). In a normal shock diffuser, a diverging duct is used, which reduces the diffusion process to two steps. The normal shock wave at the input section reduces the velocity to approximately the speed of sound; then the air is diffused to subsonic speeds in the diverging duct.

The converging-diverging diffuser principle is similar to that of the DeLaval nozzle (fig. 4-5C) except that the process is in reverse, also in two steps. While the supersonic air stream is passing through the converging portion of the duct, its velocity is decreased to the speed of sound (Bernoulli's theorem). Its velocity is further decreased, to the desired velocity, while it is passing through the divergent portion of the diffuser.

In the "center body" diffuser (fig. 4-11C), a conical nose or spike is placed inside the diffuser assembly. When the supersonic flow of air approaches the cone, a conical shock wave is formed and the supersonic flow through this shock field is slowed to subsonic velocity. The diffusion is completed in the subsonic portion of the diffuser. This type of diffuser is used on ramjets traveling at speeds of Mach 2 or greater.

ATMOSPHERIC JETS

GENERAL

Any jet-propelled system that obtains oxygen from the surrounding atmosphere to support the combustion of its fuel is an atmospheric jet engine. Pulsejets, ramjets, turbojets, and turboprops are all of this type, although the latter are not used in guided missiles. Obviously, the operation of these engines is limited by the amount of oxygen available, and they can operate only at altitudes where the oxygen content of the air is adequate. The upper limit of operation depends on the type of design of the particular engine.

The first successful application of atmospheric jets to missile propulsion was the pulsejet engine used in the German V-1 missile.

PULSEJET

Pulsejet engines are so called because of the intermittent or pulsating combustion process. Although pulsejet engines were used by the U.S. Navy to propel an early missile, they are now considered obsolete, and we will give them only brief treatment here, to explain the principles of their operation.

Figure 4-8 illustrates the fundamental construction of the pulsejet. The principal parts of a pulsejet are the diffuser, grill assembly (containing air valves, air injectors, and fuel injectors), the combustion chamber, and the tail pipe (exhaust nozzle). The DIFFUSER is a duct of varying cross section at the forward end of the engine, between the air intake and the grill. Between these two points the diameter increases; as a result, the velocity of air entering the diffuser decreases, and its pressure increases.

The grill assembly carries the fuel injectors, injectors for starting air, and the air-intake "flapper" valves. The latter are spring loaded, and are normally closed, so as to completely block off the diffuser from the combustion chamber. Air and fuel mixed in the combustion chamber are ignited initially by a spark plug; thereafter, the mixture is ignited spontaneously. The tailpipe is of uniform cross section and, for a given engine diameter, has a specific optimum length.

Operating Cycle

As the engine moves through the air, ram-air pressure builds up in the diffuser. When this

Chapter 4—MISSILE PROPULSION SYSTEMS

pressure exceeds that of the combustion chamber and the valve spring, the valves open and air enters the combustion chamber. Fuel is then injected, and the air-fuel mixture is ignited by a spark plug. The fuel and air pass through venturis (fig. 4-8), which atomize the fuel and mix it thoroughly with the air, so it ignites readily.

The burning fuel rapidly produces combustion gases that create a pressure of 25 to 35 psi in the combustion chamber. The spring-loaded air intake valves (fig. 4-9) in the grill assembly prevent these gases from escaping forward.

As the pressure in the combustion chamber rises, it exceeds the pressure in the fuel system, and automatically shuts off the flow of fuel. The flaming gases rush down the tailpipe and exhaust to the atmosphere at a speed greater

than that of the inlet air. The resulting pressure differential creates a thrust in the direction of flight.

Because of the speed with which the combustion gases rush down the tailpipe, they over-expand and produce a partial vacuum within the combustion chamber. The ram pressure in the diffuser then exceeds the pressure in the chamber; the flapper valves open (fig. 4-9B), and a fresh supply of air enters the chamber. Because of the decrease in pressure, the pressurized fuel system is able to inject a fresh supply of fuel. As a result of the partial vacuum, a portion of the hot exhaust gas is drawn back into the chamber; the temperature of this gas is high enough to ignite the air-fuel mixture, and a new cycle begins. Note that the spark plug ignition is required only to start the engine; after starting, its combustion cycle is self-sustaining (similar to a diesel engine).

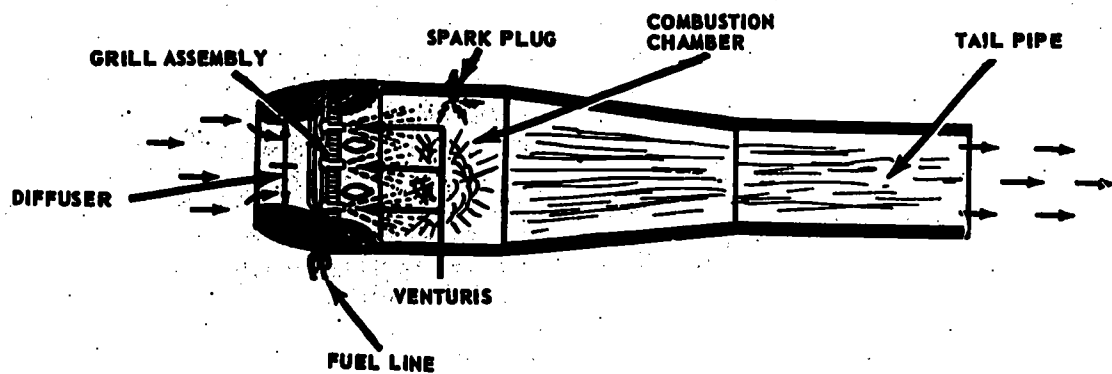

Figure 4-8.—Cross section of a pulsejet engine.

12.29

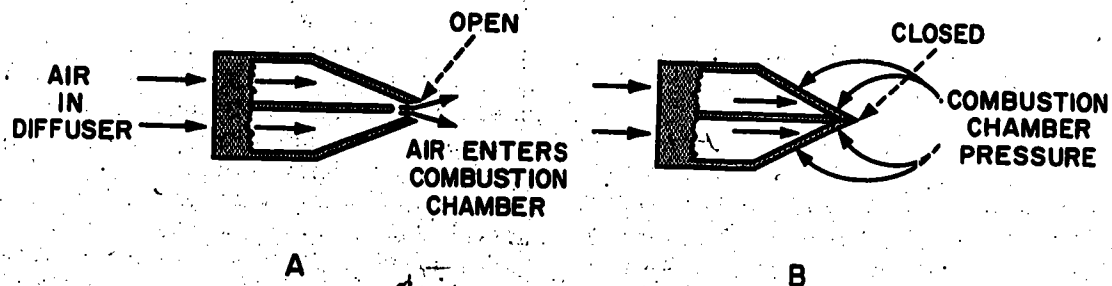

Figure 4-9.—Air intake valve used in pulsejet engine, cross-sectional view:
A. Open; B. Closed.

33.16

PRINCIPLES OF GUIDED MISSILES AND NUCLEAR WEAPONS

The frequency of the combustion cycle is the resonant frequency of the combustion chamber and tailpipe. A formula for resonant frequency of a closed pipe is:

$$\text{Frequency} = \frac{\text{Velocity of sound}}{4 \times \text{length}}$$

The frequency of various pulsejet engines that have been used in the past ranges from about 50 to over 200 cycles per second. It was this intermittent cycle which gave the name "buzz bomb" to the German V-1 rocket.

Limitations of Pulsejets

One of the disadvantages of pulsejets is that, at the instant of launching, there is no ram pressure in the diffuser. For that reason, most pulsejets are incapable of developing enough static thrust to take off under their own power. They are therefore launched with the help of compressed air injected into the chamber along with the fuel, or from a catapult, or with booster rockets, or by a combination of these means. The speed of a pulsejet is limited to the low subsonic range because at higher speeds the ram pressure developed in the diffuser exceeds the chamber pressure at all times throughout the combustion cycle; the flapper valves therefore cannot close, and the cycle cannot maintain itself. Also, this type of engine has a low efficiency index because its fuel consumption rate is high.

TURBOJETS

A turbojet engine is an air-dependent thermal jet-propulsion device. It derives its name from the fact that its compressor is driven by a turbine wheel, which is itself driven by the exhaust gases. Turbojets may be divided into two types, depending on the type of compressor. These are centrifugal-flow turbojets (fig. 4-10A) and axial-flow turbojets (fig. 4-10B). Both types are the same in operating principles.

Components of Turbojets

The major components of both types of turbojets are an accessory section, compressor section, combustion section, and exhaust section.

The accessory section serves as a mounting pad for accessories, including the generator, hydraulic pump, starter, and tachometer, for various engine components, such as units of the

fuel and oil systems, and for the front engine balancing support.

The primary function of the compressor section is to receive and compress large masses of air, and to distribute this air to the combustion chambers. The centrifugal compressor consists of a stator, often referred to as a diffuser vane assembly, and a rotor or impeller (see fig. 4-10A). The rotor consists of a series of blades which extend radially from the axis of rotation. As the rotor revolves, air is drawn in, whirled around by the blades, and ejected by centrifugal force at high velocity.

The stator consists of diffuser vanes that compress the air and direct it into the various firing chambers: Air leaves the impeller wheel at high velocity. As it passes through the diffuser vanes it enters a larger space; its velocity therefore decreases, and its pressure increases.

The axial compressor is similar to a propeller. The rotor consists of a series of blades set at an angle, extending radially from the central axis. As the rotor of the axial compressor turns, the blades impart energy of motion in both a tangential and axial direction to the ram air entering through the front of the engine. The stator does not rotate. Its blades are set at an angle so as to turn the air thrown off the trailing edge of the first-stage rotor blades, and redirect it into the path of the second-stage rotor blades. One rotor and one stator comprise a single-stage compressor. A number of rotors and stators assembled alternately make up a multistage compressor, as in figure 4-10B.

In a multistage compressor, air from the first row of compressor blades is accelerated and forced into a smaller space. The added velocity gives the air greater impact force. This compresses the air into a smaller space, causing its density to increase. The increase in density results in a corresponding increase in static pressure. This cycle of events is repeated in each successive stage of the compressor. Therefore, by increasing the number of stages, the final pressure can be increased to almost any desired value.

The axial-flow turbojet is longer than the centrifugal-flow type, but has a smaller frontal area, and therefore is more streamlined. The centrifugal compressor is simpler than the axial and has a higher pressure ratio per stage. The axial-flow compressor, however, has a higher per stage efficiency.

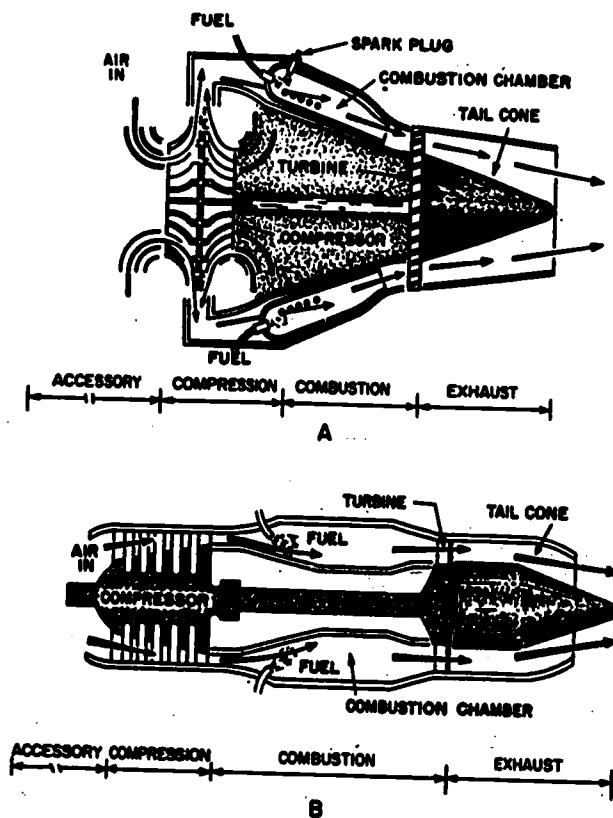

12.28A
Figure 4-10.—Cross-sectional views of turbojets: A. Centrifugal; B. Axial-flow turbojet.

The combustion section includes combustion chambers, spark plugs, a nozzle diaphragm, and a turbine wheel and shaft. The combustion chambers, or burners, in both types of turbojet engines, have the same function and produce the same results. They differ in size and number, depending on the type of engine. Each combustion chamber has the following parts: outer combustion chamber, inner liner, inner liner dome, flame crossover tube, and fuel-injector nozzle.

The outer combustion chamber retains the air so that a high-pressure supply is available to the inner liner at all times. This air also serves as a cooler jacket. The inner liner houses the area in which fuel and air are mixed and burned. Many round holes in the inner liner allow the air to enter and mix with the fuel and high-temperature combustion gases. The forward end of the inner liner is allowed to slide over the dome to accommodate expansion and contraction. The after end of the

burners are convergent to increase the velocity of the gases just before they pass through the nozzle diaphragm. The flame crossover tube connects one chamber to the next, allowing ignition to occur in all chambers after the two chambers containing sparkplugs have fired.

The exhaust section consists primarily of a nozzle and an inner cone. This assembly straightens out the turbulent flow of the exhaust gases caused by rotation of the turbine wheel, and conveys these gases to the nozzle outlet in a more perfect and concentrated gas-flow pattern.

The exhaust-nozzle diaphragm is composed of a large number of curved blades standing perpendicular to the flow of combustion gases and arranged in a circle in front of the turbine wheel. By acting as both a restrictor and a director, this diaphragm increases the gas velocity. Its primary function is to change the direction of the gases so that they strike the turbine-wheel vanes at, or nearly at, a 90° angle. The impact of the high-velocity gases against the buckets of the turbine wheel causes the wheel to rotate. The turbine-wheel shaft is coupled to the compressor-rotor assembly shaft. Thus, part of the energy of the exhaust gases is transformed and transmitted through the shaft to operate the compressor and the engine-driven accessories.

Operating Cycle

The operation of a turbojet may be summarized as follows: The rotor unit of the compressor is brought up to maximum allowable speed by the starter unit, which is geared to the compressor shaft for starting. Air is drawn in from the outside, compressed, and directed to the combustion chambers. Fuel is injected through the fuel manifold under pressure, and mixes with the air in the combustion chambers. Ignition occurs first in the chambers containing the spark plugs, and then in the other chambers an instant later by way of the flame crossover tubes. High-pressure combustion gases and coolant air pass through the exhaust nozzle diaphragm and strike the turbine blades at the most effective angle. Part of the energy of the exhaust stream is absorbed by the turbine, resulting in a high rotational speed. The remainder is thrust. The turbine wheel transmits energy through the coupled turbine and compressor-rotor shafts

PRINCIPLES OF GUIDED MISSILES AND NUCLEAR WEAPONS

to operate the compressor. Once started, combustion is continuous.

The afterburner is an important part of jet fighter aircraft, but has limited application in guided missile propulsion. It was developed to give additional thrust when needed for short periods of time, as in launching or during a steep programmed climb.

The additional thrust is obtained by burning additional fuel in the tailpipe section. That portion of the air which served only as a coolant for the main combustion chambers is sufficient to support combustion of the additional fuel. The added thrust is large, but the overall efficiency of the turbojet decreases because the specific fuel consumption is greatly increased. During a missile launching, an afterburner could provide approximately 30% increase in thrust; when the missile reaches a speed of 600 mph, an afterburner can increase its thrust by from 70% to 120%.

The thrust augmentation by afterburning increases substantially with increase in flight speed. At about Mach 2 speed, the thrust is 2.5 times as great as that without afterburning. However, the specific fuel consumption is roughly three times as great as without the afterburner. This disadvantage decreases with speed, so that at Mach 3 or 4 and higher, the afterburner engine is more efficient than the simple turbojet engine. An afterburning engine must be provided with a variable area discharge nozzle and for supersonic speeds it should also have an adjustable inlet diffuser.

Turbojets with an afterburner are called turboram jets. They are not used in any of our guided missiles, but supersonic missiles also take advantage of the ram air pressure at high speeds. The thrust of the turbojet decreases with increasing altitude, but it is nearly constant over a speed range of from 0 to 650 mph for a given altitude. There is a slight increase in thrust as speeds in excess of about 300 mph are obtained because of the beneficial effects of ram air compression. The specific fuel consumption of a turbojet decreases with increases in altitude.

This, plus the fact that the thrust increases slightly at high speeds, places the optimum operating point of the turbojet in the high-speed, high-altitude region.

Three missiles of the Air Force are turbojets—Matador, Mace, and Hound Dog. The Navy's Regulus, now being phased out, is a turbojet.

Turbojets are well suited to aircraft and missiles because of their low fuel consumption.

In addition, the turbojet is capable of providing sufficient static thrust to permit an aircraft or missile to take off under its own power. The disadvantages of turbojets (compared with other types of jet engines) include the following:

1. They are large and bulky in comparison to other types of jet engines.
2. They are delicate and complex mechanisms with many moving parts.
3. Their maximum speed is in the low supersonic range.

RAMJET

A ramjet engine derives its name from the ram action that makes its operation possible. (This engine is sometimes referred to as the athodyd, meaning aerothermodynamic duct.) It is the simplest of the air-breathing propulsion engines, and has no moving parts.

Ramjet operation is limited to altitudes below about 90,000 feet because atmospheric oxygen is necessary for combustion. The velocity that can be attained by a ramjet engine is theoretically unlimited. The faster a ramjet travels the more effectively it operates, and the more thrust it develops. But its upper speed is limited, in practice, to about Mach 5.0, because of frictional heating of the missile skin. The major disadvantage of a ramjet is that the higher the speed at which it is designed to operate, the higher the speed to which it must be boosted before automatic operation can begin.

Components of Ramjets

Basically, a ramjet consists of a cylindrical tube open at both ends, with a fuel-injection system inside. From this, the term "flying stovepipe" originated. Even though all ramjets contain the same basic parts, the structure of these parts must be modified to produce satisfactory operation in the various speed ranges. The principal parts of a ramjet engine are a diffuser section, a combustion chamber that contains fuel injectors, spark plugs and flameholder, and an exhaust nozzle (fig. 4-11).

The diffuser section serves the same purpose in the ramjet as it does in the pulsejet. It decreases the velocity and increases the pressure of the incoming air. Since there is no wall or closed grill in the front section of a ramjet, the pressure increase of the ram air must be great enough to prevent the escape

Chapter 4—MISSILE PROPULSION SYSTEMS

of the combustion gases out the front of the engine. Diffusers must be especially designed for a specific entrance velocity, or predetermined missile speed. In other words, the desired pressure barrier is developed only when air is entering the diffuser at the speed for which that particular diffuser was designed.

The combustion chamber is of course the area in which burning occurs and high-pressure gases are generated. The fuel injectors are connected to a continuous-flow fuel supply system, adequately pressurized to permit fuel to flow against the high pressures that exist in the forward section of the combustion chamber. Combustion is started by a spark plug; once started, it is continuous and self-supporting. The flameholder prevents the flame front from being swept too far toward the rear of the engine, thus stabilizing and restricting the actual burning to a limited area. The flameholder also ensures that the combustion-chamber temperature will remain high enough to support combustion.

A flameholder is a metal grid or shield punctured with a variety of sharp-edged holes (usually not round), designed to stabilize a flame. Burning propellants tend to linger in these holes and this ensures continuous ignition of the injected fuel throughout the operating cycle. Flameholders are necessary to prevent "blowout" of the burning fuel by the air rushing through the combustion chamber. The configuration and location of the flameholders is a crucial development problem in the ramjet. The flame speed varies with different fuels, but in general the flame speed is slower than the air speed through the combustion chamber. The flameholders reduce the local air speed to accommodate the slower flame speed.

The design and location of the fuel injection nozzles and the control system for fuel injection are important to get the correct proportion of air and fuel mixture in the combustion chamber.

The exhaust nozzle performs the same function as in any jet-propulsion engine.

Types of Ramjets

Ramjets may be subsonic or supersonic. The latter may be low supersonic or high supersonic.

Subsonic Ramjets

A subsonic ramjet engine cannot develop static thrust; therefore, it cannot take off under

its own power. If fired at rest, high-pressure combustion gases would escape out the front as well as the rear. For satisfactory operation, the engine must be boosted to a suitable subsonic speed so that the ram air entering the diffuser section develops a pressure barrier high enough to confine the escape of combustion gases to the rear only. Figure 4-11A is a diagram of a subsonic ramjet engine. Note the simple tubular construction, and the openings at front and rear.

As ram air passes through the diffuser section (fig. 4-11A) the velocity of the air decreases while the pressure increases. This is brought about by the increase in cross section of the diffuser, in accordance with Bernoulli's theorem for incompressible flow. Fuel is sprayed into the combustion chamber through the fuel injectors. The atomized fuel mixes with the incoming air, and the mixture is ignited by the spark plug. As previously stated, burning is continuous after initial ignition, and no further spark plug action is needed.

The gases that result from the combustion process expand in all directions, as shown by the arrows in the central part of the combustion chamber (fig. 4-11A). As they expand in the forward direction, the gases are stopped by the barrier of high-pressure air and the internal sloping sides of the diffuser section, as indicated in the diagram by the short, wide black arrows. The only avenue of escape remaining for the combustion gases is through the exhaust nozzle, and here another important energy conversion occurs: The pressure energy of the combustion gases is converted to velocity. The gases enter the exhaust nozzle at less than the local speed of sound. But, while they pass through the convergent nozzle, the pressure energy of the gases decreases and the velocity increases up to the local speed of sound at the exhaust nozzle exit.

Thrust is developed in the ramjet as a result of the imbalance of forces acting in the forward and rearward directions. The bombardment of combustion gases against the sloping sides of the diffuser and the ram-air barrier exert a force in the forward direction. This forward force is not balanced by the combustion gases that escape through the exhaust nozzle. The unbalanced force constitutes the thrust that propels the missile.

PRINCIPLES OF GUIDED MISSILES AND NUCLEAR WEAPONS

Supersonic Ramjet

The operation of a supersonic ramjet is the same as that of a subsonic ramjet, with the following exceptions. First, the supersonic jet must be boosted to a supersonic speed. Second, a higher pressure barrier exists in the supersonic engine, resulting in greater thrust.

In order to operate, a low-supersonic ramjet must be boosted to a supersonic speed, approximately equal to its operating speed, before ignition. When the forward speed of the ramjet becomes supersonic, a normal shock wave forms at the entrance to the diffuser section. The location of this shock wave is shown in figure 4-11B. On the upstream side of the normal shock wave, the free-stream air is moving at a low supersonic velocity. As the supersonic air passes through the shock wave, its velocity drops abruptly to a subsonic value, with a corresponding increase in pressure. Thus the shock wave produces a sudden increase in air pressure at the diffuser entrance. As the compressed subsonic air flows through the diverging diffuser section, an additional increase in pressure and decrease in velocity occurs.

As in a subsonic ramjet, fuel is mixed with the highly compressed air, the mixture is ignited initially by a spark plug, and burning is continuous thereafter. The potential energy possessed by the combustion gases is converted into kinetic energy by the exhaust nozzle.

The convergent-divergent nozzle shown in figure 4-11B allows the gases to exceed the local speed of sound. Therefore, with proper design modifications, the ramjet engine can travel efficiently at supersonic speed.

Now, assume that we want to design a ramjet that will travel at higher supersonic speeds. At speeds of around Mach 2.0, shock waves formed at the diffuser inlet are oblique (fig. 4-11C) rather than normal. Air velocity in front of an oblique shock wave is high supersonic. When supersonic free-stream air passes through an oblique shock wave, an increase in pressure and a decrease in velocity occur, but the velocity is still supersonic. For example, air with a free-stream velocity of 1500 mph may pass through an oblique shock wave and still have a velocity of 900 mph. Also, when supersonic air flows through divergent-type diffuser sections, as shown in figures 4-11A and 4-11B the velocity of that air increases and the pressure decreases. Therefore, the diffuser design for high-supersonic ramjets must be modified so that in

progressing from diffuser inlet to combustion-chamber entrance, the obliqueness of the shock wave successively decreases until a normal shock wave followed by subsonic flow is produced.

This energy transformation is achieved by using a diffuser of the type shown in figure 4-11C. The diffuser centerbody decreases the obliqueness of the shock waves, allowing supersonic air to flow inside the diffuser inlet.

As supersonic flow passes through the convergent section of the diffuser, the velocity is steadily decreased and the pressure correspondingly increased. At some predetermined point in the diffuser, air velocity approaches the sonic value and a normal shock wave forms. As previously stated, when low-supersonic air flows through a normal shock wave, an abrupt decrease in velocity and increase in pressure results. The subsonic air produced by the normal shock wave flows through the divergent section of the diffuser, where it undergoes an additional velocity decrease and pressure increase. Here again the diffuser has achieved a pressure barrier at the entrance to the combustion chamber. The exhaust nozzle shown in the diagram is of the convergent-divergent type designed to produce supersonic flow at the exit.

A ramjet is designed to operate best at some given speed and altitude. The pressure recovery process in a diffuser designed for oblique shock waves is more efficient than that in diffusers designed for subsonic flow or single normal shock waves. For that reason the ramjet engine operates best at high supersonic speeds. To attain this speed, a rocket or other type of booster is used, and it is generally larger and heavier than the ramjet itself.

This engine is ideally suited to long-range high-speed missiles, since the thrust increases with speed, and the rate of fuel consumption per unit of thrust decreases with speed.

ROCKET MOTORS

GENERAL

Unlike a jet engine, a rocket carries within itself all the mass and energy required for its operation. It is independent of the surrounding medium. In a rocket, the chemical reaction takes place at a very rapid rate. This results in higher temperatures, higher operating pressures, and higher thrust development than in

Chapter 4—MISSILE PROPULSION SYSTEMS

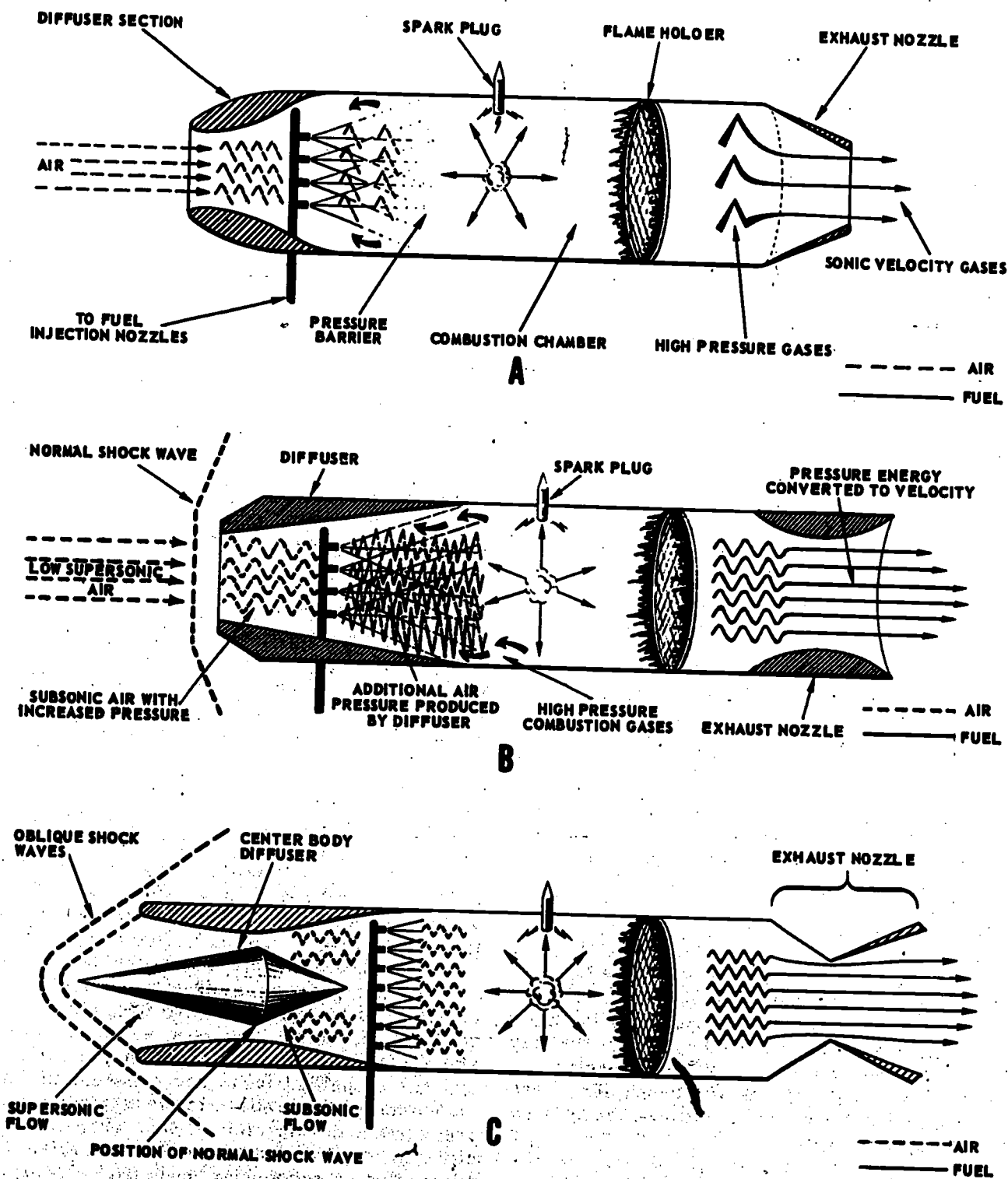

Figure 4-11.—Structure of ramjets and combustion processes in them:
 A. Subsonic ramjet; B. Low supersonic ramjet; C. High supersonic ramjet.

144.22

PRINCIPLES OF GUIDED MISSILES AND NUCLEAR WEAPONS

jet engines. Because of the high pressures developed in rocket motors, the convergent-divergent nozzle is used so that more of the energy can be extracted from the gases after they have passed the throat section. The basic principles involved in the action of other jet-propulsion units also apply to rockets.

Depending on the physical state of the propellant used, rockets are designated as either solid or liquid type.

A solid rocket has a short burning time, simple design, heavy construction, and non-intermittent operation. It is therefore primarily used for booster units, and as a powerplant for relatively short-duration, high-speed missiles. Recent research seems to indicate that solid fuels will have increasing future applications in long-range missiles. The Navy's Polaris (ICBM) is propelled by a solid-fuel rocket.

The liquid rocket unit has a longer burning time, relatively complicated design, and intermittent operation possibilities. This system has been widely used as a powerplant for high-altitude, long-range missiles, and space craft.

To summarize, the more important characteristics of all rocket engines are:

1. The thrust of a rocket is nearly constant, and is independent of speed.
2. Rockets will operate in a vacuum.
3. Rockets have relatively few moving parts.
4. Rockets have a very high rate of propellant consumption.
5. Burning time of the propellant in a rocket is short.
6. Rockets need no booster. They have full thrust at takeoff; therefore, when rockets do employ boosters it is for the purpose of reaching a high velocity in minimum time.

LIQUID-FUEL ROCKETS

The major components of a liquid-rocket system are the propellant, propellant-feed system, combustion chamber, igniter, and exhaust nozzle. The propellant-feed system is the only part which has not been explained, in principle, in the preceding sections of this chapter. Feed systems may be of the pressure-feed type or the pump-feed type.

Pressure-Feed Systems

Pressure-feed systems may be subdivided into stored-pressure and generated-pressure

systems. In the stored-pressure system, air or some other gas is stored under pressure in the missile before launching. It is injected, in controlled amounts, into the propellant storage tanks, causing a pressurized flow toward the combustion chamber. In a generated-pressure system, substances are carried within the missile to generate the high-pressure gas as it is needed. An example of such a substance is hydrogen peroxide, which, when passed through a catalyst, decomposes to form a high-pressure vapor. This vapor is then injected into the propellant storage tanks.

Many other devices such as valves, regulators, delivery tubes, and injectors, are necessary for the successful operation of either system.

Figure 4-12 shows the general relationship of the various major parts of a stored-pressure feed system. In the system shown, air is stored under pressure. The hand-arming valve is opened manually, just before launching. This allows the system to be pressurized up to the motor-start valve. The air-pressure regulator decreases the pressure to the desired value required for operation of the system components. Most liquid-fuel rocket systems use higher pressure than shown in the illustration. Also, instead of air, a light, inert gas, such as helium, is used. This permits weight reduction and also eliminates a fire and explosion hazard which is present with pressurized air. Nitrogen also may be used because it is fire-safe; tanks may be pressurized to about 2000 psi. The pressure on the fuel and oxidizer tanks has to be greater than the pressure in the combustion chamber, but much less than in the nitrogen flask. Reducing valves are used to reduce the pressure.

The motor-start valve is electrically operated. It is opened from a safe distance after all personnel have cleared the immediate launching area. Pressurized air or inert gas enters and pressurizes the fuel and oxidizer tanks. These tanks must be made of material that is not affected by the respective propellants. In addition, they must be strong enough to withstand the added pressure. At the same time that the propellant tanks are pressurized, air also enters the hydraulic accumulator and pressurizes the hydraulic fluid. (Pressurized nitrogen may be used to open the fuel valve, or other flow control may be used instead of hydraulic control.) The hydraulic fluid displaces the piston in the propellant valve actuating cylinder, which in turn opens the propellant

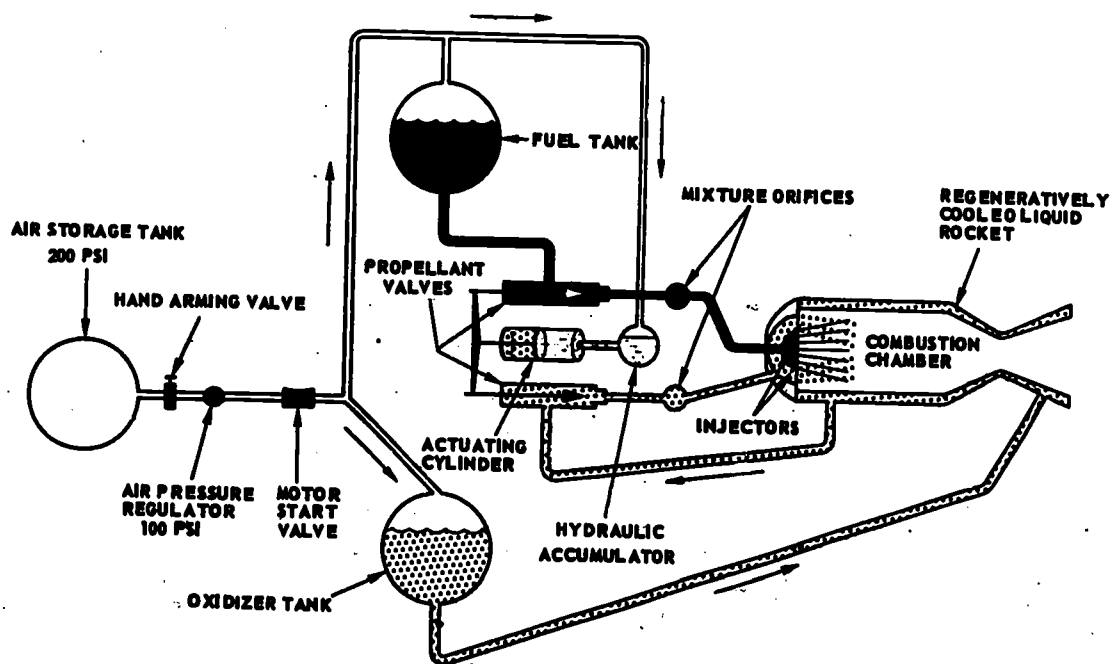

Figure 4-12.—Stored-pressure feed system of a liquid rocket.

144.23

valves. Fuel and oxidizer, under pressure, now flow through the respective mixtures orifices, which regulate the flow so that the correct mixture ratio is maintained. These orifices are simply restrictions in the line, and are flow-checked prior to installation. In some cases the injectors perform this operation, and orifices are not necessary. The propellants are atomized by the injectors. Note that the oxidizer (propellant in some systems) first circulates between the walls of the combustion chamber before passing through the cutoff valve. This action is called regenerative cooling. It makes possible the use of thin-walled combustion chambers (reducing the weight). The fact that the engine is cooled permits longer burning than if it were not cooled. A further advantage is that the propellant is preheated before injection into the combustion chamber, which results in more complete combustion and greater release of heat energy. Other methods of cooling are also in use. Three general methods of cooling rocket motors are: film method, regenerative (mentioned above), and sweat cooling. It is necessary to control the temperature to prevent destruction of the metallic parts of the rocket motor before the warhead is carried to the target.

Figure 4-13A sketches the main parts of a generated-pressure system. The gas is produced by chemically reacting a liquid or solid propellant at a steady, uniform rate. Note that there is a return flow from the combustion chamber to the chemical pressure system.

Pump-Feed System

The pump-feed system (fig. 4-13B) is nearly the same as the pressure-feed system, except that the pressurized flask is replaced by pumps which force the propellant and oxidizer into the combustion chamber. To power the pumps, a steam generating plant may be provided to operate a turbine which in turn drives the pumps. This system has the advantage of having lightweight tanks but is, of course, more complicated than the pressure feed system.

Pump-feed systems are used with power plants designed to burn large volumes of propellants, and with plants requiring a high weight rate of flow. A pump-feed system consists of a fuel pump and an oxidizer pump, both driven by a turbine wheel. Power for driving the turbine wheel may be provided by a gas generated by chemicals carried within the missile for that

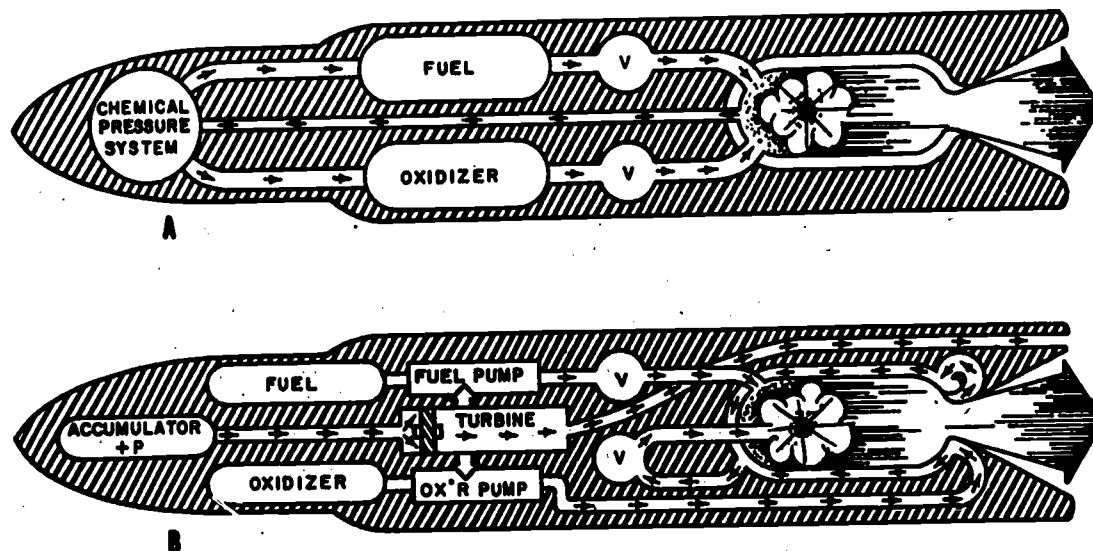

144.24

Figure 4-13.—Liquid propellant feed systems:
 A. Generated pressure system; B. Pump-feed system.

purpose (turbine-pump system), or the turbine wheel may receive its power from the exhaust gases of a rocket motor (turbo-pump system). Figure 4-13B illustrates the major components of a liquid fuel rocket that uses a turbine pump-feed system.

Because pressure is felt only on the combustion chamber side of the pumps, the fuel and oxidizer tanks can be of lighter weight than in pressure-feed systems. A disadvantage is that the auxiliary devices and controls of a pump-feed system are far more complicated than those of a stored-pressure system. This complexity means that a complicated checkout is necessary and the reliability is lessened.

Because of the intense heat developed in liquid-rocket combustion chambers, it is important that the inner walls of the chamber, throat, and exit be cooled. Uncooled operation over a prolonged period reduces physical strength and may even melt parts of the motor.

The regenerative cooling method shown in figure 4-12 is often used. Before injection into the chamber, the fuel or oxidizer is circulated from front to rear between the walls of the combustion chamber. The heat absorbed by the fuel or oxidizer cools the chamber and adds to the energy originally contained in the propellant.

A film-cooling procedure consists of low-velocity injection of a portion of the fuel, oxidizer, or some nonreactive liquid into the chamber at critical points. The fluid forms a protective film on the inner walls, and absorbs heat from the walls as it evaporates. It may be used in combination with regenerative cooling.

Sweat (transpiration) cooling is achieved by use of a porous chamber wall through which the liquid slowly flows. The evaporation of the liquid from the surfaces causes cooling of the surfaces. It is used on aerodynamically heated surfaces and combustion chambers.

A look at the names of missiles that use liquid-fuel rocket engines shows that most of them are earlier day missiles or are being used to boost space vehicles into orbit: Corporal, WAC Corporal, Centaur, Titan, Thor, Jupiter, Redstone, Aerobee, Explorer, Gargoyle, Gorgon II-A, Navaho, Viking, Nike, Rascal, and Vanguard. The large missiles use one or more stages with solid propellant. The development of a prepackaged liquid-fuel engine as used in Bullpup, may be the start of a trend to the use of liquid propellants. One of the important disadvantages of the liquid-fuel engines was that they could not be fueled and stored for any

length of time. The prepacking method may overcome this handicap.

Description of Liquid Fuels

Earlier in this chapter, liquid propellants in general were described, and advantages and disadvantages were stated. Specific fuels will be described here.

Aniline, hydrazine hydrate, and ethyl alcohol are among the more commonly used liquid rocket fuels. Aniline is an oily clear liquid with a specific gravity of 1.022. (Specific gravity of water is 1.000.) It has a boiling point of about 363°F and a freezing point of about 21°F. On contact with red fuming nitric acid, it ignites spontaneously. A fuel and oxidizer combination that reacts in this manner is said to be **HYPERGOLIC**. This combination was successfully used in the WAC Corporal, Corporal, Aerobee (sounding rocket) and Gorgon II-A missiles.

Hydrazine hydrate is a colorless liquid, slightly heavier than water. It is explosive when its concentration is above 25%. Hydrazine hydrate gives a hypergolic reaction with hydrogen peroxide.

Ethyl alcohol is a clear liquid, lighter than water. It is stable to shock and temperature changes. It is readily available because of its wide commercial market in the chemical and liquor industries. Ethyl alcohol (ethanol) has a low heat value and a low vapor pressure. For use in missiles it is commonly mixed with distilled or deionized water. Methyl and furfuryl alcohols are also used for propellants.

Liquid oxygen, referred to as LOX, and various forms of nitric acid, are among the most commonly used oxidizers in liquid rockets. Liquid oxygen is made by liquefying air and boiling off the nitrogen and other gases. This bluish liquid has a boiling point of about minus 297°F, and a freezing point of minus 363°F. Because of its low boiling point, its rate of evaporation is very high. For this reason, storage and shipment to launching areas presents serious problems, and results in appreciable loss. When poured on metal at ordinary temperature, liquid oxygen acts like water dropped on a red-hot stove. Evaporation loss in the German V-2 missile was about 4.4 pounds per minute between the time of fueling and launching. Under the best conditions, the loss of liquid oxygen during fueling amounts to 7 to 10 percent by weight. Storage requires a nearly perfect insulation and/or some form of refrigeration.

Liquid oxygen tends to react violently with oil vapors, often causing them to burn spontaneously. Any bituminous materials or petroleum products must be kept away from areas where it is handled.

The extremely low temperature of liquid oxygen causes water vapor from the surrounding atmosphere to collect and freeze on pipes and valves. This is a serious problem, which has yet to be fully solved. Liquid oxygen is noncorrosive and nontoxic, but will cause severe damage if it comes into contact with skin.

In spite of the many problems connected with its manufacture and handling, liquid oxygen is an excellent propellant; it is the best oxidizing agent available.

Nitric acid is used in several different forms as an oxidizer for liquid rockets. The most commonly used and the most powerful of these is **RED FUMING NITRIC ACID (RFNA)**, which consists of nitric acid in which nitrogen dioxide is dissolved. It varies in color from orange to brick red, and gets its name from the reddish color of the nitric oxide fumes it gives off. RFNA is highly corrosive, and stainless steel must be used for storage tanks and delivery pipes. Its high vapor pressure presents storage and transfer problems. The fumes are extremely poisonous, and severe burns result from bodily contact with the liquid. This oxidizer has been successfully used with aniline, giving up approximately 63.5% of its oxygen content for combustion. It is also used with kerosene, hydrazine, and compounds of hydrazine.

Hydrogen peroxide is a colorless liquid which, in concentrations of from 70% to 90%, may be used as a monopropellant in guided missiles. When in contact with a suitable catalyst (calcium permanganate, manganese dioxide, platinum, silver, and other materials) it decomposes, forming steam and gaseous oxygen. When 90% hydrogen peroxide decomposes, about 42% of the total weight of the decomposition products is gaseous oxygen. Therefore, it is also used as an oxidizer with such fuels as alcohol and hydrazine hydrate. A third use for hydrogen peroxide is as a pressurizing agent. The gaseous products of decomposition may be jetted against a turbine wheel which drives fuel and oxidizer pumps connected to the turbine shaft.

In the search for storable liquid propellants with a high specific impulse combined with safety in handling and storing, availability, and low cost, numerous combinations have been

PRINCIPLES OF GUIDED MISSILES AND NUCLEAR WEAPONS

tried. Among the most promising is nitrogen tetroxide plus hydrazine. Nitrogen tetroxide (N_2O_4) can be stored without refrigeration and is not difficult to handle. It is also noncorrosive to steel. Another good storable liquid fuel is perchloryl fluoride, which is also noncorrosive.

Fuels which have a higher heat energy than the hydrocarbons are sometimes called exotic fuels, or zip fuels. Boron compounds are frequently the basic ingredient.

SOLID-FUEL ROCKETS

A solid rocket unit consists of the propellant, combustion chamber, igniter, and exhaust nozzle (fig. 4-14).

The combustion chamber of a solid rocket serves two purposes. First, it acts as a storage place for the propellant. Second, it serves as a chamber in which burning takes place. Depending on the grain configuration used, this chamber may also contain a device for holding the grain in the desired position, a trap to prevent flying particles of propellant from clogging the throat section, and resonance rods to absorb vibrations set up in the chamber.

The igniter consists of a small charge of black powder, or some other material that can be easily ignited by either a spark discharge or a hot wire. As it burns, the igniter produces a temperature high enough to ignite the main propellant charge.

The exhaust nozzle serves the same purpose as in any other jet-propulsion system. It must be of heavy construction and/or heat-resistant materials, because of the high temperatures of the exhaust jet.

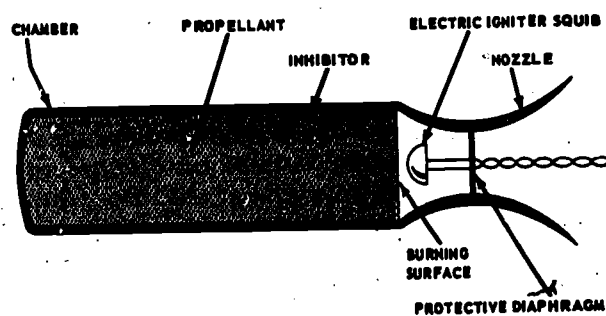

Figure 4-14.—Components of a solid rocket motor, with end-burning grain.

Operation of a solid rocket is simple. To start the combustion process, some form of electrically detonated squib is ordinarily used to ignite a smokeless or black powder charge. Upon igniting, the powder charge provides sufficient heat and the pressure to raise the exposed surface of the propellant grain to a point where combustion will take place.

Types of Solid Propellant Charges

Solid propellant charges are of two basic types: restricted burning or unrestricted burning. A restricted-burning charge has some of its exposed surfaces covered with an inhibitor (fig. 4-14). This makes it possible to control the burning rate by confining the burning area to the desired surface or surfaces. The use of inhibitors lengthens the burning time of the charge, and helps to control the combustion-chamber pressure. A burning cigarette can be considered as a model of an inhibited rocket grain, with the paper representing the inhibitor.

A restricted-burning charge is usually a solid cylinder which completely fills the combustion chamber and burns only on the end. (fig. 4-15A). The thrust is proportional to the cross section area of the charge, and burning time is proportional to length. The restricted burning charge provides relatively low thrust and long burning time. Uses of this type of

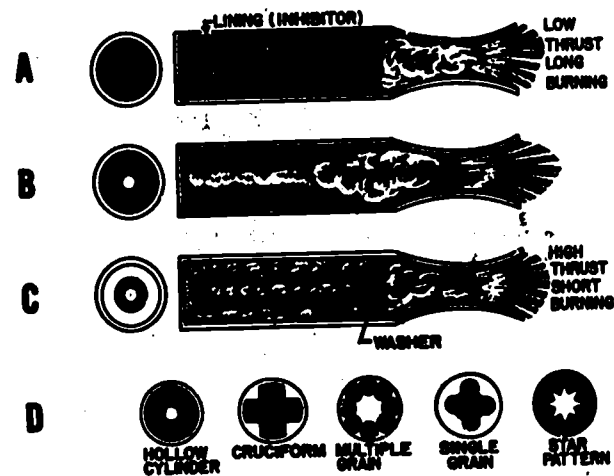

Figure 4-15.—Solid propellant grains: A. Restricted burning; B. Restricted bored; C. Unrestricted burning; D. Grain patterns.

12.26

Chapter 4—MISSILE PROPULSION SYSTEMS

charge include JATO (jet-assisted takeoff) units, barrage rockets, and sustaining rockets for guided missiles.

A modification of the restricted burning charge is the bored restricted charge (fig. 4-15B). The main difference is that the longitudinal hole in the charge provides somewhat more burning surface and thus a higher thrust and shorter burning time.

Unrestricted-burning charges are permitted to burn on all surfaces at once. The unrestricted grain delivers a relatively large thrust for a short time. An unrestricted burning charge is usually hollow, and burns on both the outside and inside surfaces (fig. 4-15C). Thrust is again proportional to the burning area. Since the inside area increases while the outside area decreases during burning, it is possible to maintain a nearly constant burning area. The burning time of hollow grains depends on the web thickness—the distance between the inside and outside surfaces. This type of charge is commonly used in booster rockets.

It should be clearly understood that in both the restricted and unrestricted burning charges, the burning rate is controlled—there is no explosion. Controlling the burning rate of a solid propellant has always presented a problem to rocket designers. You will recall that one of the properties of an ideal solid propellant would be that it ignite and burn evenly. The burning rate may be controlled in several ways. One is by means of inhibitors. An inhibitor is any substance which interferes with or retards combustion. The lining and the washer shown in figure 4-15 are examples of inhibitors. Another way that burning is controlled is by use of various grain shapes. Examples are the shapes shown in the lower part of figure 4-15D. Resonant burning or "chugging" may be offset by the use of resonance rods. These metal or plastic rods are sometimes included in the combustion chamber to break up regular fluctuations in the burning rate and their accompanying pressure variations. The purpose of the various designs is to maintain a constant burning area while the surface of the grain is being consumed.

Until recently, a serious disadvantage of the solid propellant had to do with the problem of dissipating the extreme heat of combustion.

One way this has been overcome is by use of the internal burning grain. Since the burning process actually takes place within the grain,

the outer portion of the grain provides a shield between the intense heat and the combustion chamber wall until the grain is almost completely consumed.

Burning Rate of Solid Propellant Grains

The burning rate of a solid propellant is the rate at which the grain is consumed; it is a measure of linear distance burned, in inches per second, in a direction perpendicular to a burning surface.

As stated earlier, thrust depends on mass rate of flow and the change in velocity of the working fluid. For large thrust, a large burning area is necessary in order to yield a large mass flow. A smaller burning area produces less mass flow and less thrust. Therefore, by varying the geometrical shape and arrangement of the charge, the thrust developed by a given amount of propellant in a given combustion chamber can be greatly influenced.

The burning characteristics of a solid propellant depend on its chemical composition, initial temperature, combustion-chamber temperature and pressure, gas velocity adjacent to the burning surface, and size and shape of the grain. One propellant grain may burn in such a way that the burning area remains constant, producing constant thrust. This type of burning is known as NEUTRAL BURNING. End-burning propellant grains are of this type. Another important neutral-grain design is the uninhibited, internal-external burning cylinder (fig. 4-15C), which is used where a short-duration thrust is needed, as in bazooka type rockets. The propellant burns so rapidly that heating of the chamber walls is not excessive.

Another type of grain increases its burning area as burning progresses. In this case, PROGRESSIVE BURNING is taking place. Thrust increases as the burning area increases. Still another grain may show a constantly decreasing burning area as burning progresses. This is called DEGRESSIVE BURNING. It results in a decreasing thrust. Various star-shaped perforations (fig. 4-15D) can be used to give neutral or degressive burning characteristics, but design changes can make them progressive burning.

Propellant grains are often formed by extrusion; these, of course, are installed in their

PRINCIPLES OF GUIDED MISSILES AND NUCLEAR WEAPONS

cases after forming. But certain types of composite propellants, bonded by elastomeric fuels, can be cast directly in the rocket chamber, where the binder cures to a rubber and supports the grain by adhesion to the chamber walls. This is called case-bonding.

It permits full use of the chamber space. Most high-performance rockets are made by this technique.

Description of Solid Propellants

One limitation of solid propellants is sensitivity to temperature. The initial temperature of a grain noticeably affects its performance. A given grain will produce more thrust on a hot day than it will on a cold day. The percentage change in thrust per degree Fahrenheit temperature change is referred to as the temperature sensitivity of the propellant. A grain designed to produce 1000 pounds of thrust at 80° F may deliver only 600 pounds of thrust at 30° F. The initial temperature also affects the burning rate. Because of these characteristics, solid propellants must be stored in areas of controlled temperature until they are used.

Temperature also affects the physical state of solid-propellant grains. At extremely low temperatures, some grains become brittle and are subject to cracking. Cracks increase the burning area and burning rate and therefore increase the combustion-chamber pressure. If this pressure exceeds that for which the chamber was designed, the chamber may explode. A propellant exposed to high temperature before firing may lose its shape, and become soft and weak. This, too, results in unsatisfactory performance. The temperature range for most solid propellants is from about 25° F to 120° F. Correct storage temperature retards the decomposition of propellants that contain nitrocellulose (almost all of them do), which inevitably deteriorate with time, in spite of the addition of stabilizers.

Pressure limits play an important part in solid propellant performance. Below a certain chamber pressure, combustion becomes highly unstable. Some propellants will not sustain combustion at atmospheric pressure. Ordinarily, chamber pressure for solid propellants must be relatively high. For a given propellant composition and burning area, the chamber

pressure is determined by the area of the exhaust nozzle throat. If the throat area is too large, for example, proper chamber pressure cannot be maintained.

Decomposition and hygroscopic tendencies are other weaknesses of solid propellants, but both can be minimized by the use of certain additives. Change in the moisture content changes the gaseous energy output of the propellant with unpredictable results.

Some of the more common propellants are discussed below. The chemical formulas of some of them are given, to show the carbon and/or hydrogen content, and the oxygen content of the oxidizers.

One of the first solid propellants used was BLACK POWDER. Its approximate composition is:

Potassium nitrate (KNO_3)	61.6%
Charcoal (C)	23.0%
Sulphur (S)	15.4%

Both charcoal and sulphur react readily with oxygen. Potassium nitrate, as shown by its formula, contains large quantities of oxygen. The three ingredients are thoroughly mixed, using some substance such as glue or oil as a BINDER.

When heat is applied to black powder, the potassium nitrate gives up oxygen. The oxygen reacts with the sulphur and carbon, producing intense heat and large volumes of carbon dioxide and sulphur dioxide. These two gases make up the major part of the exhaust jet. The heat produced by the reaction gives high velocity to the exhaust gases. Black powder has a specific impulse of about 65 lb-sec/lb. One of its drawbacks is that it is quite sensitive to storage temperatures, and tends to crack. Its exhaust velocity ranges from 1500 to 2,500 feet per second. It is now used primarily for signal rockets, and as an igniter for other solid-propellant grains.

BALLISTITE is a double-base propellant; it contains two propellant bases, NITROCELLULOSE and NITROGLYCERINE. It also contains small amounts of additives, each performing a specific function. A STABILIZER absorbs the gaseous products of slow decomposition, and reduces the tendency to absorb moisture during storage. A PLASTICIZER serves as a binding agent. An OPACIFIER is added to absorb the heat of reaction and prevent rapid thermal decomposition of the unburned part of the grain. A FLASH DEPRESSOR cools the exhaust gases before they escape

Chapter 4—MISSILE PROPULSION SYSTEMS

to the atmosphere, thus preventing a burning-tail effect. A typical ballistite composition is

Nitrocellulose	
$C_{24}H_{40}O_{20}(NO_3)$	51.38% (propellant)
Nitroglycerine	
$C_3H_5(NO_3)_3$	43.38% (propellant)
Diethylphthalate	3.09% (Plasticizer)
Potassium nitrate	1.45% (flash depressor)
Diphenylamine	0.07% (stabilizer)
Nigrosine dye	0.10% (opacifier)

Ballistite has a specific impulse of about 210 lb-sec/lb. Its exhaust is relatively smokeless. Storage temperatures between 40° F and 120° F are necessary to prevent rapid decomposition. The ingredients of ballistite are subject to detonation, and are toxic when they come in contact with the skin. The manufacturing process is difficult and dangerous.

Galcit consists of about 25% asphalt-oil mixture, which serves as both fuel and binder, and 75% potassium perchlorate ($KClO_4$), which serves as an oxidizer. In its finished form, Galcit resembles stiff paving tar. Recommended temperature limits for firing are 40° F to 100° F. The specific impulse of galcit is about 186 lb-sec/lb. It is quite stable to temperature; storage temperature limits are minus 9° F to 120° F. Galcit is relatively easy to manufacture. It is nonhygroscopic—that is, it does not absorb moisture. Its major disadvantage is that its exhaust develops dense clouds of white smoke. It is only about one-fifth as sensitive to temperature changes as ballistite, but it becomes brittle at low temperatures and soft at high temperatures.

NDRC propellants were developed through research sponsored by the National Defense Research Committee. A typical composition consists of about equal parts of ammonium picrate and sodium nitrate (46.5% each), and 7% resin binder (usually urea formaldehyde). This propellant has good thermal stability. It is hygroscopic, and must therefore be stored in sealed containers. Heavy smoke develops in the exhaust gases.

Solid propellant rockets are particularly adaptable to shipboard use. They are easily stored and ready for immediate use. So great have been the improvements in solid propellants in the past few years that they are now used in such long-range missiles as the Navy's Polaris and the Air Force's Minuteman.

ADVANCED PROPELLANTS AND PROPULSION SYSTEMS

The need for greater specific impulse and higher energy propellants, particularly for use in space flights but also for missile use, has stimulated research. The achievements of other nations have spurred our own efforts in this field. The future of space flight is closely dependent upon propellants that yield far higher energy and impulse than are available from combustion of chemical propellants.

Thus far, we have discussed only combustion of chemical propellants, liquid and solid, as a source of energy. It is possible to get energy from chemical propellants by free radical (molecular fragment) recombination, or by exothermic decomposition (controlled explosion). Free radical propulsion is still in the research stage and it may take a long time to yield practical results. As for exothermic decomposition, at the present time no material is available that releases sufficient energy upon controlled decomposition to make it preferable to combustion systems. Further research may change this.

Experiments have been made in the use of solar energy and arc-heated or electric systems, but thus far, their low efficiency has made them impractical. Progress in the field of direct power conversion or large improvements in conversion efficiency could change this. A solar-heated system uses the radiant energy of the sun. An electric system uses the acceleration of charged atoms, molecules or particles in electric fields. If the particles are atoms or molecules, the system is an ion (or ionic) system; if they are solid particles or droplets, the system is a charged particle system.

NUCLEAR-POWERED ROCKETS

Considerable research and development work is being done to achieve the use of nuclear power for missile propulsion. A nuclear powerplant would greatly increase both the speed and range of missiles. Present propulsion systems would become obsolete as major powerplants for long range missiles or for space flights. But they may still serve as boosters for takeoff and initial acceleration, to prevent radioactive contamination of the launching area.

One of the main advantages in the use of nuclear power is that it provides an almost

PRINCIPLES OF GUIDED MISSILES AND NUCLEAR WEAPONS

inexhaustible source of heat. In a missile propelled by nuclear energy, the fuel supply would remain practically constant throughout the flight. Enough fuel to start the reaction would be enough for sustained operation. But other material, such as water, is required in the missile to absorb the heat developed by the powerplant, and to be accelerated to produce thrust.

The major problems confronting the engineers are protecting the launching personnel from radiation damage, and developing a nuclear powerplant small enough to be carried in a guided missile. Many years of extensive technical development may be needed before nuclear energy can be harnessed for use as a missile powerplant. But the outlook is promising.

Nuclear systems can be fission, fusion, or photon systems. (A photon is a quantum of electromagnetic energy.) A photon system uses a source of light photons to develop thrust. The only sufficiently powerful photon source is the fusion process. There is much development work yet to be done on this type of rocket engine. Much greater advancement has been achieved in the development of a nuclear fission rocket engine than in fusion-photon systems.

Most of the research on advanced propellants is being done for use in space flights. Significant reduction in weight and size requirements may be achieved and may make new propulsion methods applicable to guided missiles as well as space ships.

HYBRID PROPULSION

A hybrid engine consists of a liquid oxidizer, a solid fuel, and its associated hardware. The liquid oxidizer is valved into a chamber containing the solid propellant. Ignition is usually hypergolic. Neither of the propellants will support combustion by itself in a true hybrid rocket. The combustion chamber is within the solid grain, as in a solid-fuel rocket; the liquid portion is in a tank with pumping elements as in a liquid-fuel rocket. This type is sometimes called a forward hybrid to distinguish it from a reverse hybrid, in which the oxidizer is solid and the fuel is liquid. Figure 4-16 is a sketch

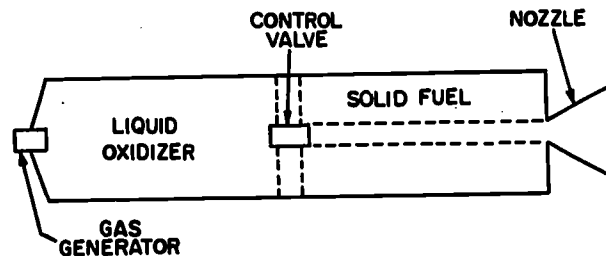

144.26

Figure 4-16.—Sketch of a hybrid propulsion engine.

of the elements of a simple forward hybrid engine. Combustion takes place on the inside surface of the solid fuel, after the liquid fuel is injected, and the combustion products are exhausted through the nozzle to produce thrust as in other rockets. Nozzle systems and vector control methods are the same as in other reaction engines. Variable thrust is achieved by varying the flow of the liquid oxidizer. Thrust termination and restart are accomplished by shutting down and re-opening the oxidizer flow system.

Missiles which use a solid-fuel booster and a liquid engine, such as the Talos, are not hybrids; the propellants do not interact.

The biggest advantage of hybrids is the ability to use reactions denied to other propulsion systems. A second advantage is that high density can be achieved, with concurrently good specific impulse (I_{sp}). The third great advantage is safety. The solid grain is inert. Normal grain defects do not affect performance. A malfunction in combustion is unlikely—excess liquid and a badly cracked solid grain could cause a pressure surge, but the chances of both defects occurring together is small.

Although research and development have been carried on in several areas since the 1950's, there are still many problems to be solved before a hybrid engine can be used in missiles. European research apparently is ahead of ours. A successful hybrid launching was made in France on 25 April 1964. Research and development work is continuing in the U.S., but much of it is classified.

CHAPTER 5

MISSILE CONTROL COMPONENTS AND SYSTEMS

INTRODUCTION

GENERAL

This chapter will introduce some of the numerous devices that may be used to control the flight of a guided missile. We will discuss basic types of control systems: pneumatic, pneumatic-electric, hydraulic-electric, and electric. Throughout the chapter we will deal with general principles, rather than the actual design of any specific missile.

Chapter 2 described the external control surfaces of guided missiles, such as wings, fins, elevators, tails, and tabs, and described the effects of natural forces acting upon them. The use of internal mechanisms such as jet vanes and fixed jets was described briefly and illustrated. This chapter tells how the control surfaces are controlled to keep the missile in its proper attitude on its ordered trajectory.

DEFINITIONS

Guidance and control are sometimes spoken of as if they were one and the same. They are two parts of the problem of getting the missile to the selected target after it is fired. The main reason for controlling a missile in flight is to gain increased accuracy for long ranges.

A missile guidance system keeps the missile on the proper flight path from launcher to target, in accordance with signals received from control points, from the target, or from other sources of information. The missile control system keeps the missile in the proper flight attitude. Together, the guidance and control components of any guided missile determine the proper flight path to hit the target, and control the missile so that it follows this determined path. They accomplish this "path control" by the processes of (1) TRACKING, in which the positions of the target and the missile

are continuously determined; (2) COMPUTING, in which the tracking information is used to determine the directions necessary for control; (3) DIRECTING, in which the directions are sent to the control units; and (4) STEERING, which is the process of using the directing signals to move the missile control surfaces by power units. The first three processes of path control are performed by the guidance system, and steering is done by the control system.

In order for these processes to be accomplished the missile must be in stable flight. The control of missile stability is called ATTITUDE CONTROL, and is usually accomplished by an AUTOPILOT, which is a part of the control system.

Flight attitude stabilization is absolutely necessary if the missile is to respond properly to guidance signals. When the control system determines that a change in missile attitude is necessary, it makes use of certain controllers and actuators to move the missile control surfaces. The guidance system, when it determines that a change in missile course is necessary, uses these same devices to move the control surface. Thus the guidance and control systems overlap. For convenience, we will assume that the controllers and actuators are a part of the control system, rather than the guidance system. We can therefore say that the output signals from the guidance system are put into effect by a part of the control system. The input signal represents the desired course to the target. The missile control system operates to bring the missile onto the desired course. If there is a difference between the desired flight path and the one the missile is actually on, then the control system operates to change the position of the missile in space to reduce the error.

To summarize: the missile control system, discussed in this chapter, is responsible for missile attitude control. The guidance system,

PRINCIPLES OF GUIDED MISSILES AND NUCLEAR WEAPONS

discussed in chapter 6, is responsible for missile flight path control. Let us not forget that missile guidance and missile control are part of the overall weapons control system which includes the weapons direction system and the fire control system, linked by communication systems, all working together to get the missile to the target. Radars (and sonars) for detecting and tracking targets, and computers are part of the fire control system. The speed of modern aircraft and missiles makes computers a practical necessity to compute target speed, target angle, etc., in time to align the launcher and missile and send the missile to intercept the target. The weapons direction equipment is a roomful of electronic equipment that includes a target selection and tracking console, director assignment console, weapon assignment console, and guided missile status indicator. This chapter will not discuss the operation of any of the above equipments; it will tell only how they affect the behavior of the missile in flight.

PURPOSE AND FUNCTION: BASIC REQUIREMENTS

The first requirement of a control system is a means of sensing when control operations are needed. The system must then determine what controls must be operated, and in what way. In an airplane, the pilot checks his instru-

ments or visually observes angular and linear movement. On the basis of his observations, he repositions the control surfaces as necessary to keep the plane where he wants it.

Since there is no pilot in a guided missile to note these movements, we install devices that will detect them. It is important to mention here that some guided missiles do not detect linear movement while others do. All guided missiles detect angular movement. This will be explained clearly in the chapters which discuss the various types of guidance. The control system is made up of several sections that are designed to perform, insofar as possible, the functions of a human pilot. To accomplish this purpose, the control surfaces must function at the proper time and in the correct sequence.

After a missile has been launched, it receives certain controlling orders called guidance signals. The guidance signals may originate from an external point or from within the missile itself. To respond to the guidance signals, the missile must "know" two things: it must continuously "know" information regarding its movement, and it must continuously "know" the positions of the control surfaces.

Figure 5-1 shows a simplified block diagram of a missile control system. As mentioned before, not all of these components will be in the missile itself. The location of some of the components varies with the type of guidance used by the missile.

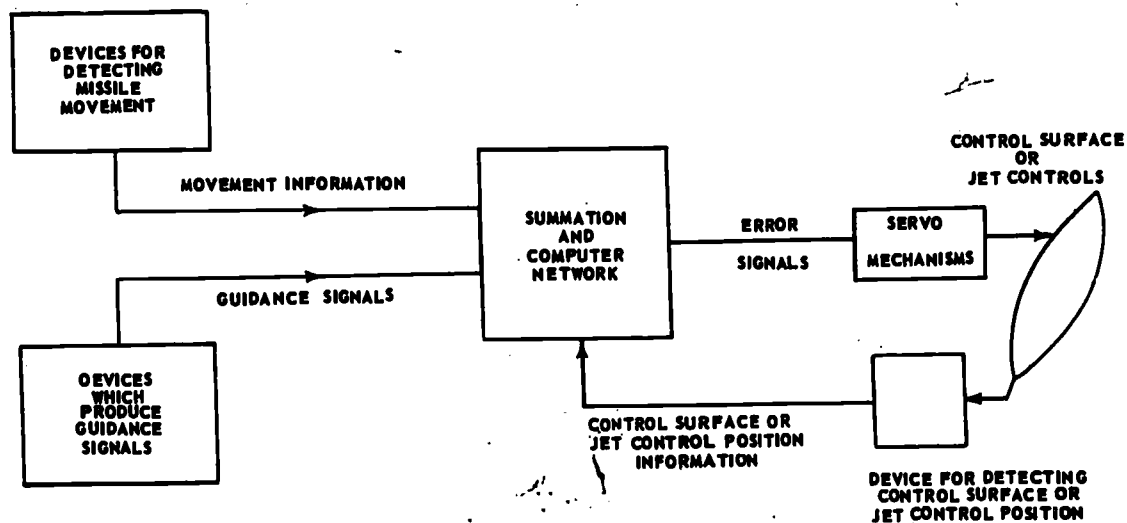

Figure 5-1.—Simplified missile control system.

Chapter 5—MISSILE CONTROL COMPONENTS AND SYSTEMS

FACTORS CONTROLLED

Missile course stability is made possible by devices which control the angular movement (also called rotational movement) of the missile about its three axes. The three flight control axes are shown in figure 2-7. These are the pitch, yaw, and roll axes. Chapter 2 describes how missile control surfaces are used to maintain the stability of the missile in flight. The second type of movement called translation, includes any LINEAR movement of the missile. For example, a sudden gust of wind or an air pocket could throw a missile a considerable distance off the desired trajectory without causing any significant angular movement. If you have ever flown in an airplane, this should be fairly easy to understand. If the plane hits an air pocket, it may drop several hundred feet but still maintain a straight and level attitude. Any linear movement, regardless of direction, can be resolved into three components: lateral movement, vertical movement, and movement in the direction of thrust. Thus, in addition to the three angular degrees of movement, we have three linear degrees of movement. A missile in flight can therefore be said to have six degrees of movement.

METHODS OF CONTROL

We have discussed missile control from the standpoint of moving the missile control surfaces. Since some operational guided missiles function at extremely high altitudes where control surfaces are not effective (due to low air density), other means of correcting the missile flight path have been devised. The basic concepts of missile control—without the use of control surfaces—are outlined in chapter 2. These are the exhaust or jet vanes placed in the jet stream of the propulsion system (fig. 2-18B); fixed jets placed around the missile (fig. 2-18A); and the movable jet (fig. 2-18C), which is a gimballed engine mounting. (The gimballed arrangement is not unlike that used to permit universal movement of a free gyro.) The engine is mounted so that its exhaust end is free to move and thus direct the exhaust gases in a desired direction.

The gimballed engine mounting does not give full control about all three axes. It cannot control roll. To get control on all axes, two gimbal-mounted jets can be positioned as shown in figure 2-18C. Both jets must be free to move

in any direction, and each jet must respond to signals from any of the three control channels (pitch, roll, and yaw).

A control system using four movable jets is shown in figure 5-2. Each jet turns in only one plane. Two of the jets, #1 and #3, control yaw. Jets 2 and 4 control pitch, and all four jets are used together to control roll.

The first stage of Polaris A3 uses four movable nozzles to control pitch, yaw, and roll of the missile. The actuators, which are moved by hydraulic power, are connected directly to the rotatable nozzles. Control signals are received from the electronics package in the missile.

The second stage of Polaris A3 uses a fluid injection system in which pressurized Freon is injected into one or more of four fixed nozzles, upon signal from the electronics package of the missile. Two injector valves are mounted diametrically opposite each other on each motor nozzle. Older mods of Polaris use jetevators (see chapter 2) to control missile movement.

Positions of the jets are controlled by hydraulic cylinders linked to the engine housing. One cylinder and linkage is required for each engine. The direction in which hydraulic pressure is applied is determined by an actuator.

The signals produced by errors about the missile axes of translation and rotation are combined by the missile computer network to form

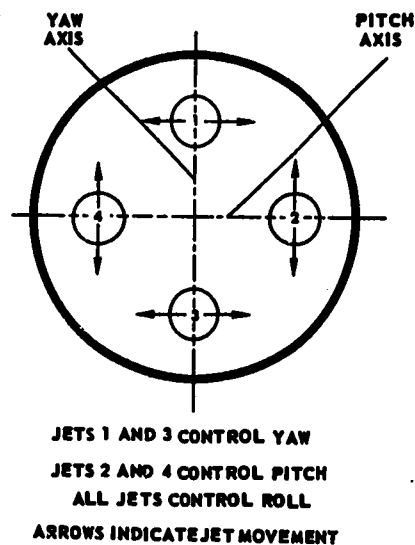

Figure 5-2.—Control by four jets (aft view of missile).

33.180

PRINCIPLES OF GUIDED MISSILES AND NUCLEAR WEAPONS

correction signals. When these correction signals are applied to the controller mechanisms, action of these mechanisms results in keeping the missile in its correct flight path and at the proper attitude.

TYPES OF CONTROL ACTION

The basic control signals may come from inside the missile, from an outside source, or both. To coordinate the signals, computers are used to mix, integrate, and rate the signal impulses. In a missile control system, the remembering is done by integrating devices and the anticipation (of what to do next) is done by rate devices.

The computer network can be thought of as the brain (or the pilot) of the missile. The computer network takes into account guidance signals, missile movement, and control surface positions. By doing this continuously, it can generate error signals. These signals cause control surface movements, or a change in the jet stream direction as described above, that tend to keep the missile at its design attitude and on its correct trajectory. Actually, a missile is rarely at its design attitude or exactly on its prescribed trajectory. Like a ship, the missile continuously yaws, rolls, and pitches, and experiences movements of translation. The computer network can be compared to the helmsman on a ship. Both are always making corrections. Seldom is either absolutely right.

The terms "error signal" and "correction signal" are used almost interchangeably. Strictly speaking, the signal that orders movement of the control surfaces to correct errors is a correction signal. It originates in the control section of the missile. Signals that tell the computer about deviations in flight path are error signals and originate in the guidance system. Since all of these signals concern errors they may be called error signals.

An automatic control system of this type is generally referred to as a **SERVOMECHANISM**, discussed later in this chapter.

The job of a computer in a fire control system is to convert available information such as speeds, locations, and ballistic data, into required information such as fuze settings, and missile orders. It does this by use of a complex of components and devices that make up the computer network. According to their manipulation of control signals, they may be classed as:

MIXERS.—The mixer combines guidance and control signals in the correct proportion, sense, and amplitude. In other words, a correction signal must have the correct proportion to the error, must sense the direction of error, then apply corrections in the proper amplitude.

PROPORTIONAL.—The proportional control operates the load by producing an error signal proportional to the amount of deviation from the control signal produced by a sensor.

RATE.—Rate control operates the load by producing an error signal proportional to the speed at which the deviation is changing. This output is usually combined with a proportional signal to produce the desired change in missile attitude or direction.

These are not names of single components, but rather, they designate the type of action performed by one or more components in the system.

TYPES OF CONTROL SYSTEMS

Regardless of which method of trajectory control is used, whether by movement of control surfaces, jet vanes, movable or fixed jets, movable or fixed nozzles, or fluid injection, all must use some source of power to make the movements. This power is initially produced by hot gases, compressed or high pressure air, or electrical means. The power is transmitted from the supply sources to the movable controls by **PNEUMATIC**, **ELECTRICAL** or **MECHANICAL** means, or by using a **HYDRAULIC** transfer system in conjunction with the sources mentioned above.

Before getting into the details of specific types of control, let us first take a general look at several possible controllers and compare some of their advantages and disadvantages.

A pneumatic system which depends on tanks of compressed air is obviously limited in range. Since air or any other gas is compressible, the movement of a pneumatic actuator is slow due to the time it takes to compress the air in the actuator to a pressure sufficient to move it. Hydraulic fluid is practically incompressible and will produce a faster reaction on an actuator, especially when the actuator must move against large forces. Thus, large, high speed missiles are controlled by hydraulic actuators.

Chapter 5—MISSILE CONTROL COMPONENTS AND SYSTEMS

A hydraulic system normally weighs more because it needs a pump, reservoir, and accumulator. Also, a hydraulic system is hard to maintain, requiring filling and bleeding operations.

At the high altitudes at which most missiles are intended to fly, temperature and pressure are severely reduced. This has an effect on any type of control system. At extreme altitudes hydraulic fluid may be useless due to severe changes in its viscosity. Air bubbles in metal parts may expand and create malfunctions. High altitude lubrication of mechanically moving parts must be considered. Changes of temperature also affect the operation of electronic parts.

Very few missiles have been designed which do not have some part that operates by electricity. The use of an all electric control system would place all the equipment, except the propulsion unit, within the electrical field. This would simplify manufacture, assembly, and maintenance. Also, it would be easier to transmit information or power to all parts of the missile by wires, rather than by hydraulic or pneumatic tubing. Disadvantages of all-electric control systems will be discussed later in this chapter.

An all-mechanical control system in a missile is not very probable. In an all-mechanical system, error information would be transferred from a mechanical sensor by some mechanical means such as a gear train, cable, rotating or sliding shaft, or chain linkage. This linkage would then connect to the correcting devices such as control surfaces or movable jets. In addition, any computing devices in the system would also be mechanical.

The major disadvantages of a mechanical control system are that too much power would be required to move the necessary (and heavy) gear trains and linkages, and the fact that installation of an all-mechanical system would be extremely difficult in the small space allotted.

To gain advantages and offset disadvantages of the different types of control, combinations are used, such as pneumatic-electric, hydraulic-electric, hydraulic-mechanical, or others.

ENERGY SOURCES

Missiles contain auxiliary power supply (APS) systems in addition to the main engine required for thrust. The APS systems provide a source of power for the many devices required for successful missile flight. Some of

the APS systems rely on the main combustion chamber as the initial source of energy. Others have their own energy sources completely separate from the main propulsion unit. Whatever the initial source of energy, APS systems may be placed in two broad categories—STATIC and DYNAMIC. In the static systems energy is used in the same form in which it is stored. In the dynamic systems energy is changed from one form to another by a conversion unit.

System Requirements

Before taking up specific systems, there are several general requirements for an APS system that we will mention briefly. First, the system must be able to deliver the necessary power during all conditions of missile flight. Second, the system must be able to respond quickly and accurately to demands made on it. Third, the system must be of minimum size and weight consistent with the requirements it must meet. Fourth, the system must be durable enough to withstand long storage under severe conditions.

STATIC SYSTEMS.—As previously mentioned, the static APS systems use energy in the same form in which it is stored. For example, the electrical energy in a storage battery may be used directly to operate solenoids. Compressed air also may be used directly to operate control system components. Static systems require no rotating machinery for energy conversion.

DYNAMIC SYSTEMS.—In dynamic systems energy is changed from one form to another. For example, the potential energy in compressed air may be changed to electrical energy through an air-driven turbine and electric generator. The same is true of combustion gases taken from either the main combustion chamber or a separate auxiliary combustion chamber. Liquid fuel may be tapped off the main propulsion fuel tank and used to drive an auxiliary engine.

Auxiliary Power Supply Unit

The components of the auxiliary power supply may be packaged as a unit. The unit includes a separate and special generator, usually of the gas turbine variety, used for the production of on-board power. It can be either a solid propellant or a liquid propellant hot gas generator that is duct-connected to a turbine which in turn is connected by a shaft to an electric generator. The turbine is an energy conversion

PRINCIPLES OF GUIDED MISSILES AND NUCLEAR WEAPONS

unit, converting potential energy to kinetic energy. The Terrier BT-3 missile, for example, has two hot-gas generators, each with its package of solid propellant. The hot-gas exhaust from one generator is fed to the missile's turbohydraulic system and the other goes to the turboelectric system. The Tartar missile has similar hot-gas generator systems to power the hydraulic and the electric components of the missile. These hot-gas generators provide a significant saving in space and weight over the compressed air system formerly used in the Terrier missile. They are placed in the aft section, near the tail, which is controlled by the hydraulic system. All-electric systems are planned to replace hot-gas generators.

Other power supply units, usually with a battery source, are assembled as "package units" that can be easily installed or removed from the missile. The Tartar missile, for example, has five "wheels" in its electronic section, each with its own power supply, so if there is failure in one "wheel" it does not affect the operation of the others and the defective one can be replaced without disturbing the others.

These internal power supplies are not used until after the missile is in flight. As long as the missile is on the launcher, power is supplied from the ship's (or aircraft) power. (Talos uses some of its internal battery power momentarily before warmup power is applied on the launcher.)

Not all missiles use hot-gas generators to provide auxiliary power. The Talos missile

has an air-driven hydraulic pump assembly which uses air taken in through the diffuser in the missile nose. The power system consists of an accumulator, a pump, and the air-driven hydraulic pump.

Descriptions of solid-propellant and liquid-propellant hot-gas auxiliary systems follow.

A BASIC SOLID PROPELLANT SYSTEM is diagrammed in figure 5-3. It does not represent any specific auxiliary power supply system now in use.

The propellant chamber or combustor contains the propellant charge—a ballistite or related type of powder grain—and a black-powder igniter and squib, in a propellant train sequence. After the squib is ignited (usually just before launch) the propellant burns and evolves hot gas to build up pressure in the chamber. The pressure is regulated by a regulating valve, which admits air to a gas turbine (either multiple- or single-stage). The turbine is geared to a hydraulic pump and pressure regulator and to an alternator. In the system diagrammed, hydraulic fluid output goes direct to the hydraulic servos and other hydraulic system units, and is then recirculated back to the pumps. Alternator output goes direct to those units that requires a-c, and through a rectifier and voltage regulator to furnish regulated d-c. A flyball governor (in principle similar to those on old-fashioned stationary reciprocating steam engines) may be used to govern alternator speed to regulate a-c frequency and voltage. In one

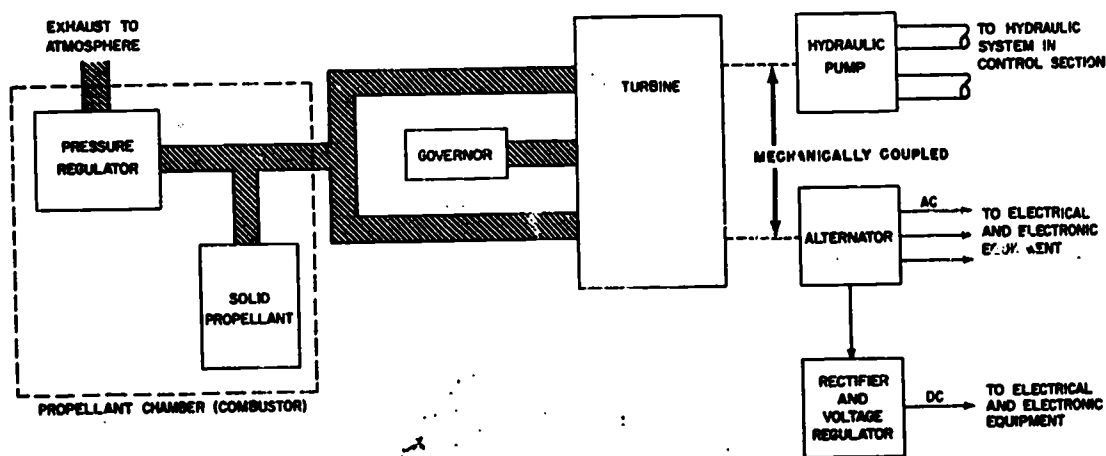

Figure 5-3.—Typical solid-propellant auxiliary power supply.

Chapter 5—MISSILE CONTROL COMPONENTS AND SYSTEMS

design, a separate turbine-driven rotor generates a current which is fed back to an induction brake to regulate turbine speed.

In other designs, there is no hydraulic pump; instead, the turbine exhaust charges an accumulator to develop hydraulic pressure. If the system uses pneumatic actuators, combustor exhaust may be led direct to the actuator control valves.

Both Terrier and Tartar hot-gas auxiliary systems use a single stage, axial flow impulse type turbine of the type shown in figure 5-4A. In this turbine, the gases expelled through the nozzles are not reversed in direction, but make only one pass through the turbine blades. In a Terry turbine (fig. 5-4B), the products of combustion are led through a gas manifold ring and pass through the nozzles. The gases then impinge at high velocity on the semi-circular recesses (buckets) milled into the periphery of the wheel. In passing through the buckets the direction of flow is reversed 180 degrees. The gases are then caught by a semicircular reversing chamber in the casing, where they are again reversed 180° and returned to the wheel. The process is repeated five times through a 90° arc of the turbine housing, after which the gases are exhausted. Reversing the hot gases several times gives a multiple-stage effect, thereby using more of the potential energy in the gases.

The electrical, mechanical, and hydraulic components discussed here may, of course, be used equally well with liquid-fueled gas turbines.

A BASIC LIQUID PROPELLANT SYSTEM is shown in figure 5-5. High-pressure inert gas flows from the gas flask through the arming valve and the pressure reducer valve. The arming valve is tripped just before launch. The gas flows into and inflates the fuel tank bladder. The fuel tank (fig. 5-6) consists of a metal tank with a plastic bladder inside it. The fuel (in this case concentrated H_2O_2 —hydrogen peroxide) is stored in a metal tank. As the pressurized gas fills the bag at a regulated rate the fuel is forced out of the tank at a corresponding rate. A check valve prevents a return fuel flow and transmission of pressure waves from the decomposition chamber to the fuel tank.

The throttle valve regulates fuel flow to the decomposition catalyst tank. When the fuel comes into contact with the decomposition catalyst ($NaMnO_4$ —sodium permanganate) it breaks down into free oxygen (O_2) and steam.

(Other chemical changes take place, too, but this is the main power-producing reaction.) The heat energy produced in this process is as much as can be used efficiently in small turbines; hence there is no need to burn the free oxygen produced by the decomposition of the peroxide. The turbine

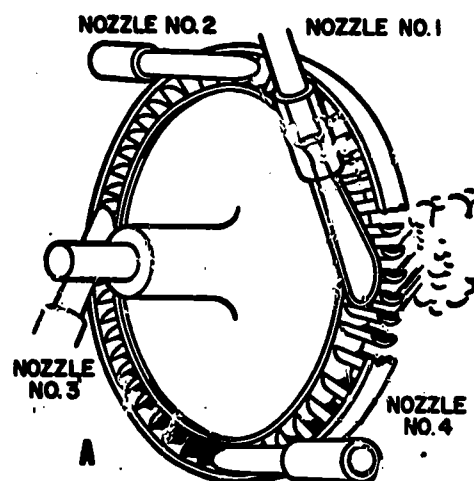

33.45:46
Figure 5-4.—Turbines used in auxiliary power supply (APS): A. Impulse turbine; B. Terry turbine.

PRINCIPLES OF GUIDED MISSILES AND NUCLEAR WEAPONS

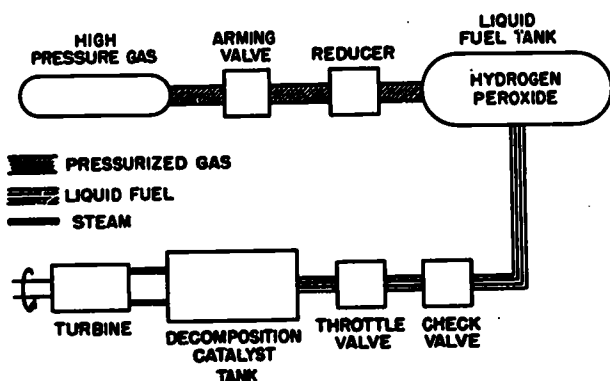

144.28

Figure 5-5.—Basic liquid-propellant auxiliary power supply.

drives a hydraulic pump and electrical generators much as in the solid propellant unit.

Because the shaft speed of the turbine is so very high it is necessary to use a set of reduction gears between the turbine and the alternator and the hydraulic pump.

AUXILIARY SYSTEMS USING OTHER POWER SOURCES.—One Navy missile used the main engine's propellant to drive an auxiliary power unit. This was Corvus, now obsolete, in which a small gas turbine was used to drive the engine's fuel and oxidizer pumps. The auxiliary power supply of the Regulus was driven by the main engine (turbojet) of the missile. In Talos, an air-driven turbine drives the hydraulic pump which pressurizes the hydraulic fluid used to operate the external control surfaces. During the boost phase, accumulators of high-pressure nitrogen supply the pressure to the hydraulic fluid.

ACCUMULATORS are used for storing high-pressure inert gas (such as nitrogen) in some missiles. This arrangement is one of the two types of static power units to be found in Navy missiles. The arrangement for fuel feed described above for liquid-propellant auxiliary power supplies is one typical method of using such an energy storage unit. Another is to valve the gas directly into pneumatic cylinders to operate aerodynamic control surfaces.

CHEMICAL BATTERIES utilize chemical reactions to develop d-c voltages. Common dry cells and lead-acid storage batteries are familiar to every one. Missile power supplies rely on

less common types because of their lower weight per unit energy storage, longer shelf life, better voltage characteristics; greater sturdiness, and resistance to extremes of temperature. The types used are silver-zinc, nickel-cadmium (so-called "Edison" type), and mercury. The first two are technically secondary or storage cells that can be recharged, while the last is a primary type that cannot be easily recharged. However, in the necessarily narrow vocabulary of missile and space specialists, any chemical battery is considered a primary type if it is intended to be used once only, regardless of its nominal rechargeability.

The silver-zinc battery, which required the addition of the electrolyte (potassium hydroxide solution) at the time the power was needed, has been largely replaced by a nickel-cadmium battery which can be recharged. The need for a viable battery in the missile has motivated much research, and decided improvements have resulted. While the batteries in a missile will be used only once, when the missile is fired, they may be in position in the missile a long time before this event. Long storage life and rechargeability are two important qualities. The newer type nickel-cadmium batteries have both of these. While their shelf life is good for several years, to be absolutely sure of full

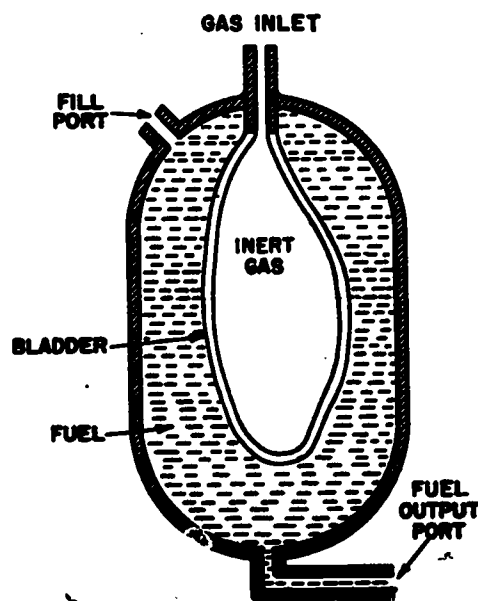

144.29

Figure 5-6.—Fuel tank in liquid-propellant auxiliary power system.

Chapter 5—MISSILE CONTROL COMPONENTS AND SYSTEMS

battery power, the battery is removed from each missile every 30 days and is completely recharged. In this way, there is always a fresh battery in the missile. These batteries can be recharged 200 to 300 times.

In some missiles, mercury batteries are used instead of the old type dry cell batteries where a small voltage is desired.

Another type of battery which is inert until activated is one in which the electrolyte is in solid form until shortly before the missile is to be launched. The battery will not develop an output voltage unless the electrolyte is in liquid form. In this arrangement, a detonating voltage is transmitted to a squib in the battery just before launch. The squib ignites a chemical heating mixture; this causes the electrolyte to liquefy and the battery is energized.

This type is called a thermal battery because it requires heat to cause it to activate. Its storage life is indefinite, either in or out of the missile. Another advantage is that it does not have caustic or acid electrolyte that can spill out and be a hazard.

The fuel cell is a type of chemical battery unlike primary and storage batteries of the kind discussed above. In fuel cells, electric current is produced directly from oxidation of a fuel, or from a similar chemical reaction. The reaction is speeded by a catalyst; platinum is used at present, but search is continuing for a cheaper catalyst. So far no fuel cell has been developed to a point where it has been adopted for use in a Navy missile, but it is likely that some such development will come in the relatively near future. Successful experimental fuel cells have been produced which use hydrazine fuel with oxygen as the oxidizer. A hydrogen-oxygen cell is specified for the two-man Gemini flights. Fuel cells will also be used for the Apollo moon flights.

OTHER TYPES OF BATTERIES.—At least in theory, batteries of types other than chemical can be used in guided missiles for auxiliary power supply. At the present writing, solar cells have been used successfully to power satellite sensors and data transmitters, but so far they have not been employed in guided missiles.

A solar battery converts the energy of light into electric energy. The most common solar cell is a silicon photovoltaic cell; selenium cells are also used. Temperature has a considerable effect on the output. Contrary to the usual effect, the output goes up as the temperature decreases.

Nuclear power cells similar to those developed experimentally by the Atomic Energy Commission's SNAP program might also be used in missiles, although at present this seems unlikely because of the anticipated high cost of such units and because their principal characteristics do not seem to meet the requirements of missile systems. Specifically, nuclear cells characteristically can produce a fairly constant current over a period of years, but in their present state of development require substantial shielding. Satellites require a reliable power supply over a prolonged period, but missiles do not, and the penalty of either radioactive hazard or heavy shielding seems like an unnecessary one to pay so far as missiles are concerned.

In use, batteries either feed d-c directly to electronic and electrical units that require it, or drive alternators to furnish a-c. D-c motor-driven hydraulic pumps furnish hydraulic fluid under pressure. (A battery can also drive a vibrator-type a-c supply.)

REQUIREMENTS OF A MISSILE-CONTROL SERVOSYSTEM

We mentioned before that the missile control system is a servomechanism. In performing its function, a servomechanism takes an order and carries it out. In carrying out the order, it determines the type and amount of difference between what should be done and what is being done. Having determined this difference, the servomechanism then goes ahead to change what is being done to what should be done. In order to perform these functions, a servomechanism must be able to:

1. Accept an order which defines the result desired.
2. Evaluate the existing conditions.
3. Compare the desired result with the existing conditions, obtaining a difference between the two.
4. Issue an order based on the difference so as to change the existing conditions to the desired result.
5. Carry out the order.

For a servomechanism to meet the requirements just stated, it must be made up of two systems—an error detecting system and a controlling system. The load, which is actually the output of the servo, can be considered part of the controller.

PRINCIPLES OF GUIDED MISSILES AND NUCLEAR WEAPONS

By means of servosystems, some property of a load is made to conform to a desired condition. The property under control is usually the position, the rate of rotation, or the acceleration of the load. The system may be composed of electrical, mechanical, hydraulic, pneumatic, or thermal units, or of various combinations of these units. The load device may be any one of an unlimited variety; a missile control surface, the output shaft of an electric motor, and a radar tracking antenna are a few typical examples.

DISCONTINUOUS AND CONTINUOUS CONTROL

The simplest form of control can be illustrated by the elementary circuit shown in figure 5-7A. The circuit contains a source of power, a switch, or controlling device; and an unspecified load. The elements are connected in series. When the switch is closed, energy flows to the load and performs useful work; when the switch is opened, the energy source is disconnected from the load. Thus, the flow of energy is either zero or a finite value determined by the resistance of the circuit. Operation of this general type is called DISCONTINUOUS CONTROL.

In figure 5-7B, the circuit is modified by substitution of a rheostat for the switch; and the circuit now provides CONTINUOUS CONTROL. By displacing the rheostat contact, the circuit resistance is varied continuously over a limited range of values. The energy expended in the load is then varied over a corresponding range rather than by intermittent, or on-off action as in discontinuous control. Both these simple examples represent a fundamental property of control systems in general: the energy required to control the system is small

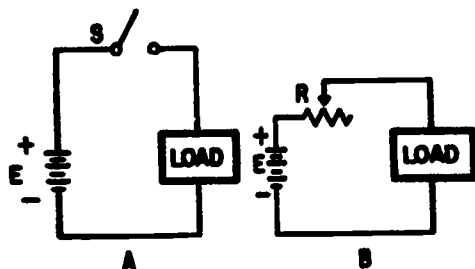

33.60

Figure 5-7.—Elementary control circuit:
A. Discontinuous control; B. Continuous control.

compared with the quantity of energy delivered to the load.

OPEN- AND CLOSED-LOOP SERVOSYSTEMS

In the examples given above, the power source is controlled directly by manual adjustment of a switch or of a rheostat. In more complicated servosystems, control signals are applied to the power device by the action of an electrical or a mechanical device rather than by manual means.

Automatic servosystems can be divided into two basic types: open-loop and closed-loop systems. The essential features of each are indicated by the block diagrams in figure 5-8.

In both systems, an input signal must be applied which represents in some way the desired condition of the load.

In the open-loop system shown in figure 5-8 A, the input signal is applied to a controller. The controller positions the load in accordance with the input. The characteristic property of open-loop operation is that the action of the controller is entirely independent of the output.

The operation of the closed-loop system (fig. 5-8B) involves the use of followup. The output as well as the input determines the action of the controller. The system contains the open-loop components plus two elements which are added to provide the followup function. The output position is measured and a followup signal proportional to the output is fed back for

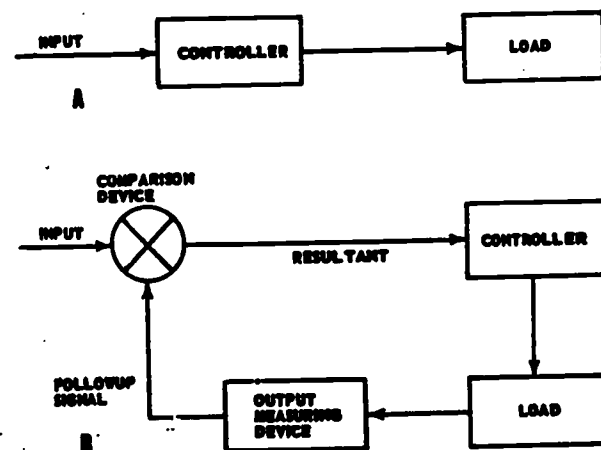

33.61

Figure 5-8.—Basic types of automatic servosystems: A. Open-loop; B. Closed-loop.

Chapter 5—MISSILE CONTROL COMPONENTS AND SYSTEMS

comparison with the input value. The resultant is a signal which is proportional to the difference between input and output. Thus, the system operation is dependent on input and output rather than on input alone.

Of the two basic types, closed-loop control (also called followup control) is by far the more widely used, particularly in applications where speed and precision of control are required. The superior accuracy of the closed-loop system results from the followup function which is not present in open-loop systems. The closed-loop device goes into operation automatically to correct any discrepancy between the desired output and the actual load position, responding to random disturbances of the load as well as to changes in the input signal.

CONTROLLABLE FACTORS

The missile control system is actually a closed-loop servomechanism in itself. It is able to detect roll, pitch, and yaw, and it is able

to position the movable control surfaces in accordance with this attitude information. It is very important that you understand that the control surfaces are not positioned on the basis of attitude information alone. It is again pointed out that movement information, guidance signals, and control surface position information are continuously analyzed in the computer network. The correction signals are continuously generated on the basis of all this information.

OVERALL OPERATION

Before studying the individual components of the missile control system, let us take a brief look at the operation of the system as a whole. Figure 5-9 shows the basic missile control system in block diagram form. You will notice that the system is shown in considerably more detail than that in figure 5-1. Free gyroscopes provide physical (spatial) references from which missile attitude can be

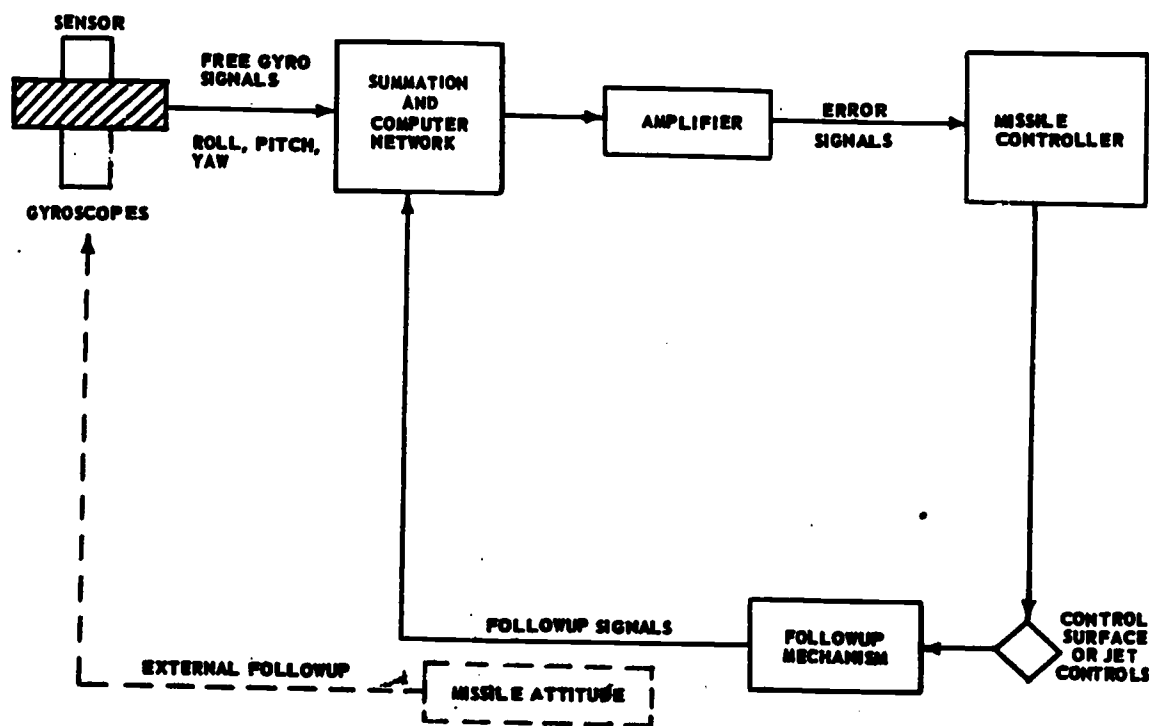

Figure 5-9.—Basic missile control system.

PRINCIPLES OF GUIDED MISSILES AND NUCLEAR WEAPONS

determined. For any particular missile attitude, free gyro signals are sent from the gyroscopes to the computer network of the missile.

These signals are proportional to the amount of roll, pitch, and yaw at any given instant. After these signals have been compared with other information (for example, guidance signals), correction signals result. The correction signals are orders to the controller to position the control surfaces. The purpose of the amplifier is to build the weak correction signals up to sufficient strength to cause actuation of the controller. As in any closed-loop servosystem, followup information plays an important role. A followup mechanism continuously measures the positions of the control surfaces and relays signals back to the computer network.

External Followup

In addition to the internal followup which is actually measured by a mechanism, we can think of the missile's movement detecting devices as providing an external followup feature. The fact that the gyroscopes continuously detect changing missile attitude introduces the idea of external followup. This is represented by the dotted line in figure 5-9.

COMPONENTS OF MISSILE CONTROL SYSTEMS

Figures 5-1 and 5-9 have named parts of a missile control system and some of the components have been discussed. The components may be grouped according to their functions. They cannot be strictly compartmentalized as they must work together and there is overlapping. Devices for detecting missile movement may be called error-sensing devices. The amount and direction of error must be measured by a fixed standard; reference devices provide the signal for comparison. Correction-computing devices compute the amount and direction of correction needed and correction devices carry out the orders to correct any deviation. Power output devices amplify the error signal, but the prime purpose is to build up a small computer output signal to a value great enough to operate the controls. The use of feedback loops provides for smooth operation of the controls.

Do not confuse the missile control system with the weapons control system. The weapons

direction system and the fire control systems and their related components comprise the weapons control system. These shipboard equipments control all weapons aboard, including guns, missiles, and torpedoes. The missile control systems are in the missile, and may receive direction from shipboard equipment.

REFERENCE DEVICES

In order to determine errors accurately, the complete control system must have reference values built in. The system is then capable of sensing a change, comparing the change to a reference, determining the difference, then starting a process that will reduce the difference to zero.

The reference units in a missile control system are of three kinds—voltage references, time references, and physical references.

PURPOSE AND FUNCTION

The reference device (comparison device, fig. 5-8) provides a signal for comparison with a sensor signal, so that equipment in the missile will "know" when the missile has deviated from the desired attitude. The reference section is connected to the computer section. If the reference section were omitted from the control section, the computer would be unable to compute error signals.

TYPES OF REFERENCE

The three types of reference signals will be described separately to show how each type functions in the complete control system.

Voltage

In some control systems, the ERROR SIGNALS are in the form of an a-c voltage which contains the two characteristics necessary to make proper corrections in the flight path. These are the amount of deviation, and the direction of sense of the deviation.

The amount of deviation may be indicated by the amplitude of the error signal so that, as the deviation increases, the amplitude increases; and if the deviation decreases, the amplitude decreases. Therefore, when the missile attitude has been corrected and there is no longer a deviation, the error signal amplitude drops to zero.

Chapter 5—MISSILE CONTROL COMPONENTS AND SYSTEMS

The direction of deviation may be carried by the a-c signal as a phase difference with respect to the phase of a reference signal. Only two phases are required to show direction of deviation about any one control axis. When a phase-sensitive circuit, such as a discriminator, is used to compare the error signal with the a-c reference signal, the direction of error is established and the output containing this information is fed to other control sections.

In most cases, the a-c reference voltage is the a-c power supply for the control system. It also furnishes the excitation voltage for the sensor unit that originates the error signal.

The controller unit (fig. 5-1) usually requires a d-c signal, which must include the information contained in the original error signal. The amplitude of the d-c signal shows the amount of deviation. The direction of deviation is indicated by the polarity of the d-c signal. To keep the d-c signal from becoming so large that it would cause overcontrol, a limiter circuit is used. Limiters require a d-c reference voltage, and function as a part of the reference unit.

Time

The use of time as a reference is familiar to everyone. One common application is in the automatic home washer. A clock-type motor drives a shaft, which turns discs that operate electric contacts. These contacts close control circuits that operate hot- and cold-water valves, start and stop the water pump, change the washer speed, spin the clothes dry, and finally shut off the power. Each operation runs for a specified time interval. This kind of timer can be used for certain missile control operations. A timer may be used to start a variety of control functions. Sometimes a timer is used strictly as a safety device.

Timer control units vary considerably in physical characteristics and operations. All of them require an initial, or triggering, pulse. Since all timers in a complete system are not triggered at the same time, each must have its own trigger. This is usually an electrical signal. It may be fed to a solenoid which mechanically triggers the timing device.

Mechanical, electrical, and pneumatic timers are used in missiles. The principles are applicable to most variations you will run across.

The use of timers in guidance systems is described in the chapters on the different types of guidance.

MECHANICAL TIMERS.—The mechanical timers used in guided missiles are generally of the clock type, and are very similar in operation to a mechanical alarm clock. The ordinary alarm clock can be set for a time delay up to twelve hours. The timers used in guided missiles can usually be set only for time durations in seconds or minutes. As with the alarm clock, the mechanical timer in a missile receives its power from a compressed spring. Since the timers used in missiles are not normally started until the missile is in flight, it is necessary to provide some type of triggering mechanism to initiate the timing operation. Usually the mechanism consists of a linkage which is actuated by energizing a solenoid.

It is also possible to trigger timers by the use of other timers. For example, a 5-minute timer could trigger a 1- or 2-minute timer.

ELECTRICAL TIMERS.—Two types of electrical timers are commonly used in guided missiles. These are motor timers and thermal timers. In either type, the triggering is done by an electrical signal, and the time interval begins when the trigger voltage is applied.

MOTOR TIMERS.—Figure 5-10 illustrates the principle of the motor timer. A voltage is applied to the motor to cause it to rotate. The speed of the output shaft is reduced by a reduction gear calibrated in accordance with the amount of time delay required. The switch will be opened or closed by the output shaft, depending on the particular function under control. The output current could be applied to a gyro torquer or a throttle valve. By the addition of several items, the timer may be made to recycle itself as shown in figure 5-11. The automatic clutch in the figure releases the actuating arm when the arm makes contact with the microswitch. The spring returns the arm to its initial position and the cycle is repeated. Another method of releasing the clutch uses mechanical means. In this type, a linkage between the actuating arm and the clutch would perform the same function as the electrical release signal.

The length of time required for the actuating arm to travel from the starting position to the point where contact is made is the delay time of the unit.

THERMAL TIMERS.—Another triggering method involves the application of an electrical signal to a heater coil which heats a bimetal

PRINCIPLES OF GUIDED MISSILES AND NUCLEAR WEAPONS



Figure 5-10.—Principle of the motor timer.

33.122

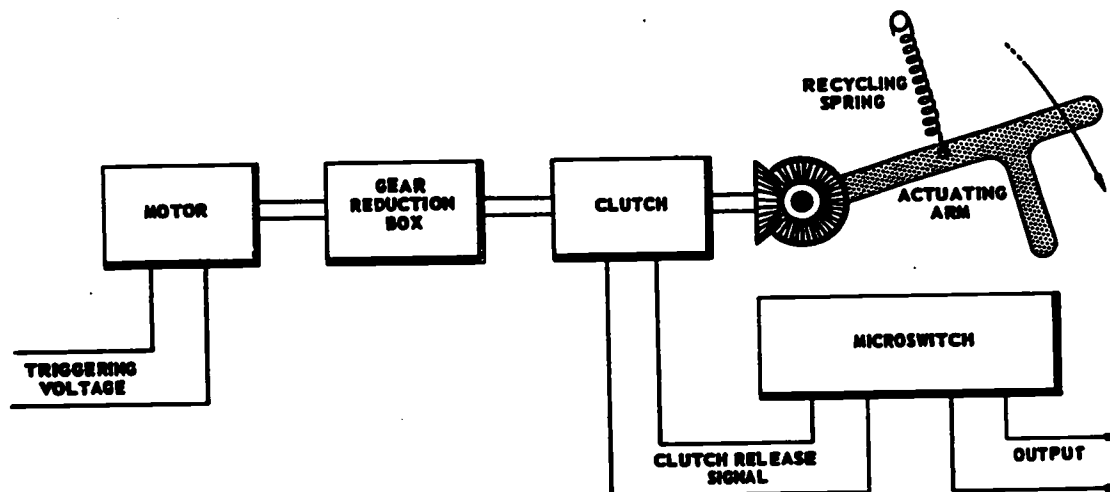

Figure 5-11.—Motor timer with automatic recycling feature.

33.123

strip and causes it to bend, thus opening or closing electrical contacts. This method may be more familiar when you contemplate the operation of a typical thermostat like the one found in the home.

Thermal delay tubes and thermal relays have been used extensively to perform time delay functions. These timers have a great advantage over the electrical timers in the ease with which they recycle themselves; however, they are not as accurate as the electrical timers. Figure 5-12 shows a thermal delay tube. Its components are bimetallic strips, a heating coil, and a set of contacts.

When a triggering voltage is applied, the heating coil heats ONE of the bimetallic strips. As the temperature rises, the strip deforms and its contact moves toward the other contact. When the bimetal strip has heated sufficiently, the contacts touch and the output circuit is completed, causing the preset function to occur.

The amount of time between application of the triggering voltage and closing of the con-

tacts is determined by the contact spacing, the temperature characteristics of the metals in the strips, and the characteristics of the heater coil. The delay time is preset by the manufacturer; the assembly is then placed in a tube-type enclosure, and the air is pumped out of the tube. This type of construction (electron tube) prevents any adjustment of the time delay.

PNEUMATIC TIMERS.—Pneumatic timers operate on the basis of the time required for a quantity of compressed air to escape through a needle valve. The opening in the needle valve can be adjusted (time adjustment, fig. 5-13). The smaller the orifice, the longer it will take the piston to come down far enough to close the contacts.

There are two general types of pneumatic timers—piston and diaphragm.

PISTON TYPE TIMERS.—Figure 5-13A shows the operation of a piston type pneumatic timer. This type of timer is often employed immediately on launching a missile. The sudden

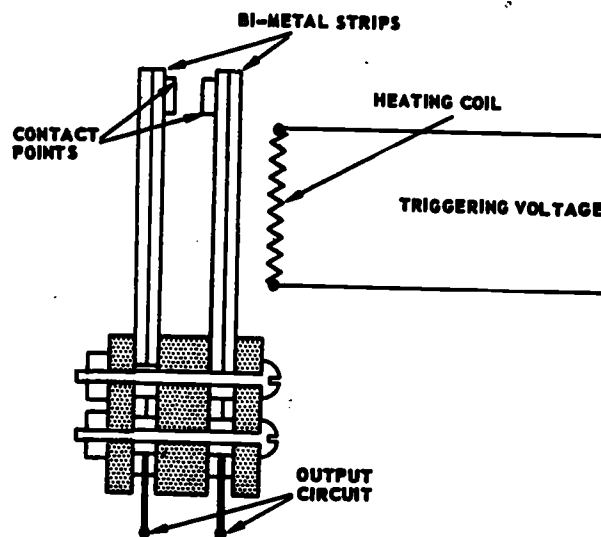

Figure 5-12.—Thermal delay tube.

33.124

acceleration of the missile at launch causes the inertia block to move in the direction indicated. This releases the catch, and the timer is then in operation. Compressed air under the felt washer is permitted to escape through the preset opening of the needle valve. As the plunger moves down, due to the decreasing air pressure and the force of the spring, the contacts come closer together. After the proper time delay, the contacts will meet and the output circuit will be energized, causing actuation of some mechanism in the missile.

DIAPHRAGM TIMERS.—Another type of pneumatic timer is the diaphragm timer shown in figure 5-13B. The same principle is involved with this timer as with the piston type. Prior to being put into operation, the solenoid is energized, thus holding the core and spring in the position shown. At this time, the leather diaphragm is stretched so that air is permitted to enter the inlets. When the solenoid is deenergized, the spring will force the piston upward, closing the air inlets. The air will then be forced to escape at a preset rate through the needle valve. As with the piston type timer, a function in the missile will be actuated when sufficient air escapes to allow the contacts to meet.

Physical References

There are a number of references for missile control systems other than the voltage and time

classifications we have discussed. The remaining types have been grouped under the heading of physical references. They include gyros, pendulums, magnetic devices, and the missile airframes. They may be compared to bench marks, or fixed positions from which measurements can be made.

GYROS.—Although gyros are physical references, they are discussed under the heading of sensors. The gyro rotor in itself cannot determine missile attitude information. Pick-offs must be used in conjunction with gyros to determine missile attitude information. The gyro pickoff system can sense any change in missile attitude with respect to the gyro.

Pendulum

The pendulum may be used to establish a vertical reference line in a guided missile. Any object within the earth's gravitational pull is attracted directly toward the center of the earth. If a weight is suspended on a string, the weight will come to rest in such a way as to cause the string to represent the direction of the true local vertical. This principle finds a common application in the carpenter's plumb-bob.

Some gyros are precessed to a vertical position by a pendulum device called a "pendulous pickoff and erection system." The complete gyro system is called a vertical gyro; it may be used to measure the pitch and roll of a missile.

MAGNETIC DEVICES.—Magnetic compasses have been used for centuries to navigate the seas. The compass enables a navigator to use the lines of flux of the earth's magnetic field as a reference. A similar device, known as a "flux valve" is used in some missile control systems. Its primary purpose is to keep a directional gyro aligned with a given magnetic heading. The directional gyro can then be used to control the yaw of a missile.

A bar magnet will attempt to align itself in accordance with the direction of the earth's magnetic field. When the bar is aligned in a north-south direction, it may be used as a reference to determine bearings around it.

MISSILE AIRFRAME.—The airframe of the missile must be used for certain references. For example, the movement of flight control surfaces cannot be referenced to the vertical, or to a given heading, because such references change as the missile axes change. Therefore,

PRINCIPLES OF GUIDED MISSILES AND NUCLEAR WEAPONS

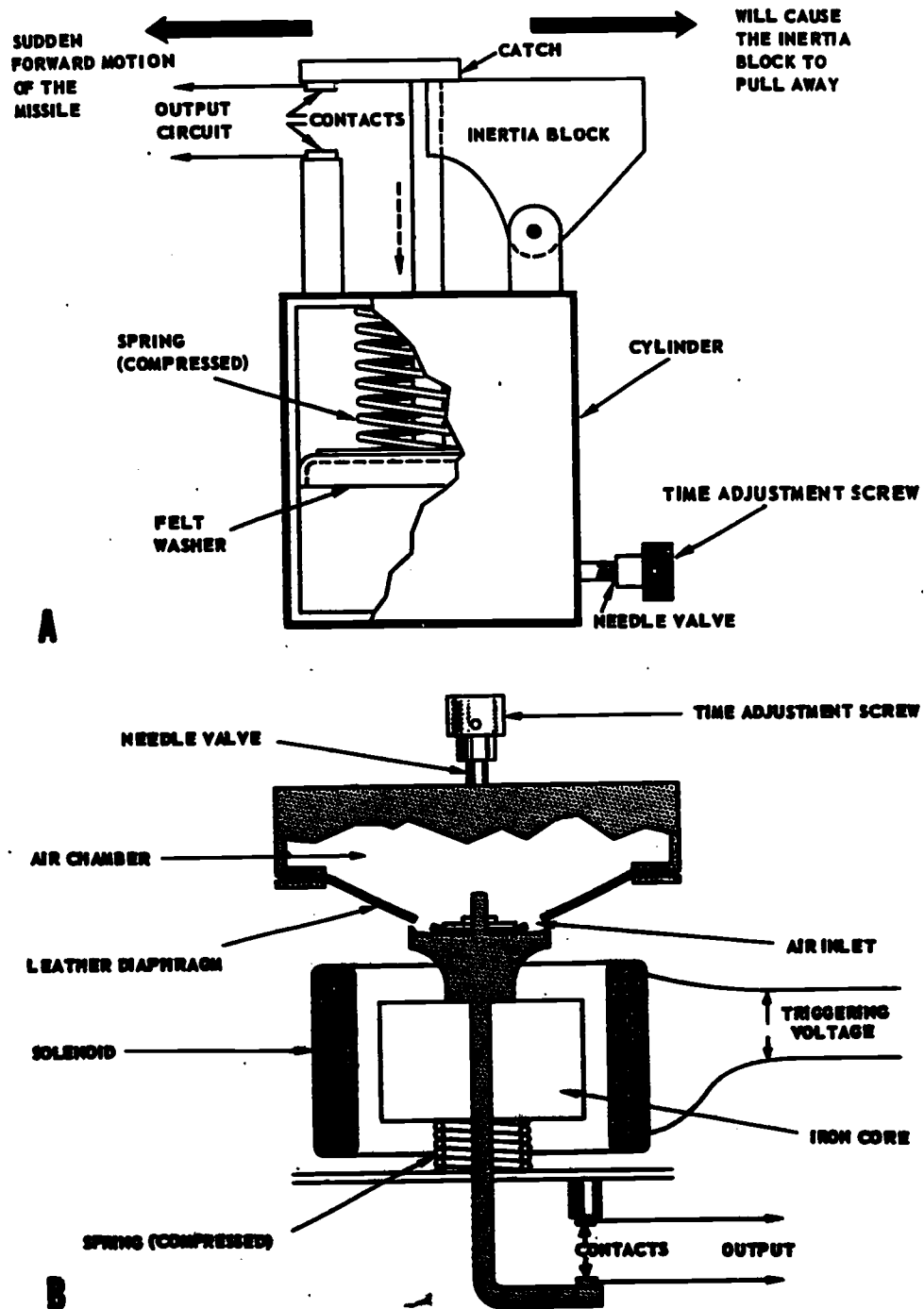

Figure 5-13.—Pneumatic timers: A. Piston type pneumatic timer; B. Diaphragm timer. 33.125:127

Chapter 5—MISSILE CONTROL COMPONENTS AND SYSTEMS

movement of flight surfaces are referenced to the missile airframe.

Synchro indicators can be used to indicate the angular position of control surface with respect to the missile airframe. A potentiometer can be used in the same way by mounting it on the missile airframe so that its shaft will be driven by the flight control surface movements.

SENSOR UNITS

GENERAL

The sensor unit in a guided missile control system is a device used to detect deviation from the desired attitude. In this section, we will discuss the use of gyroscopes, altimeters, and transducers as sensing units. Gyroscopes are generally considered to be the basic sensor unit in any missile control system. Other types of sensors, such as altimeters and transducers, are classed as secondary units.

As mentioned above, the gyro itself is a physical reference unit; the pickoff is the sensor.

GYROS

One of the most important components of the missile control system is the gyroscope, or gyro. A gyroscope contains an accurately balanced rotor that spins on a central axis.

Gyros used for missile control applications are divided into classes: gyros used for stabilizing (control) purposes and gyros used for both guidance and stabilization. If turns or other maneuvers are necessary, a third gyro is required so that there will be one gyro for each sensing axis.

A minimum of two gyros is necessary for missile flight stabilization. Each gyro sets up a fixed reference line from which deviations in missile pitch, roll, and yaw are detected and measured.

These vertical and horizontal gyros are free gyros, that is, each is mounted in two or more gimbal rings (fig. 5-14A) so that its spin axis is free to maintain a fixed orientation in space.

In addition to the control signals from the vertical and horizontal gyros, which are proportional to the deviation of the missile from the desired attitude, a signal that is proportional to the rate of deviation is required for accurate control and smooth operation. A RATE GYRO (fig. 5-14B) furnishes the rate of deviation signal.

The basic difference between the free gyro and the rate gyro is in the way they are mounted. Figure 5-14B shows a simplified view of a roll rate gyro. Notice that the rotor is mounted in single gimbals rather than the two sets of gimbals which supported the free gyro. This arrangement restricts the freedom of the gyro rotor. When the missile rolls, the gyro mounting turns about the roll axis (arrow A), carrying the gyro rotor with it. This causes a force of precession at a right angle to the roll axis, which causes the rotor to turn about the pitch axis (arrow B).

Restraining springs may be attached to the gimbals as shown. The force on the springs

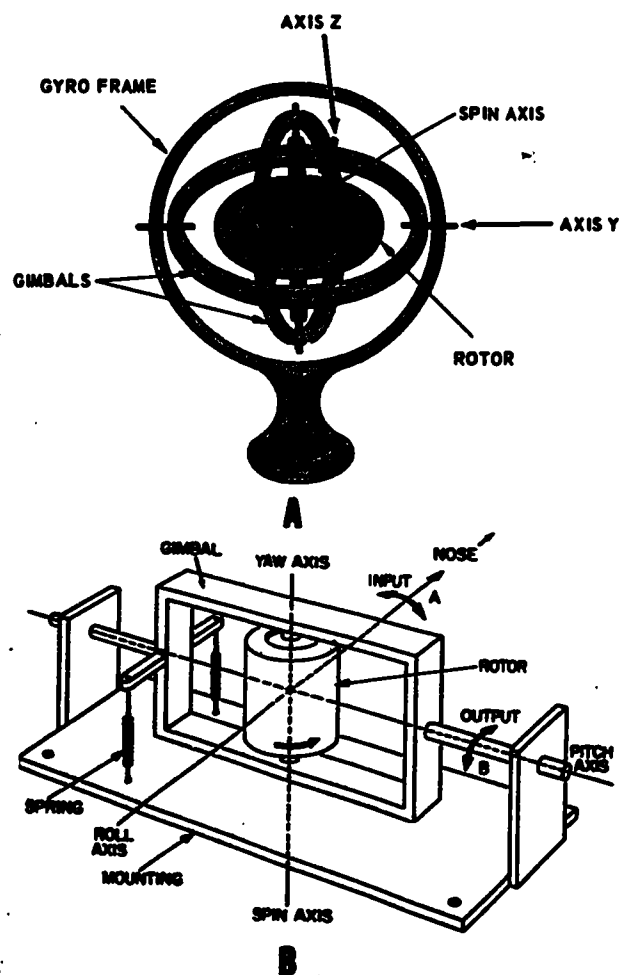

33.63:71
Figure 5-14.—Gyroscopes used in missiles:
A. Free gyroscope; B. Roll rate gyroscope.

PRINCIPLES OF GUIDED MISSILES AND NUCLEAR WEAPONS

would then be proportional to angular acceleration about the roll axis.

Three rate gyros are normally installed in a missile to measure the accelerations about the three mutually perpendicular missile axes. When the input is torque and the output is precession, the gyro is called an integrating gyro. The restraining force is viscous damping instead of a spring restraint. It may be a hermetically sealed integrating gyro (HIG). Like a rate gyro, it has only a single degree of freedom. The restraining force is proportional to the gyro precession rate instead of displacement.

Basic Properties of Gyros

Gyroscopes have two properties which make them useful in serving as space references in guided missiles:

1. The gyro rotor tends to remain in a fixed plane in space if no force is applied to it.
2. The gyro rotor has a tendency to turn at a right angle to the direction of an outside force applied to it.

INERTIA.—The idea of maintaining a fixed plane in space is easy to show. When any object is spinning rapidly it tends to keep its axis pointed in the same direction. A toy top is a good example. As long as it is spinning fast, it stays balanced on its point. It resists the tendency of gravity to change the direction of its spin axis.

The resistance of the gyro against any force which tends to displace the rotor from its plane of rotation is called rigidity in space. It may also be called gyroscopic inertia.

PRECESSION.—The second property of the gyro is that its spin axis has a tendency to turn at a right angle to the direction of a force applied to it (fig. 5-15A). This characteristic of a gyro is the cause of precession. There are two types of gyro precession: **REAL** and **APPARENT**. Real precession is sometimes called **INDUCED PRECESSION**.

DIRECTION OF GYROSCOPIC PRECESSION.—When a downward force is applied at point A, the force is transferred through pivot B (fig. 5-15A). This force travels 90° and causes downward movement at C. This movement at a right angle to the direction of the applied force is called **PRECESSION**. The force associated with this movement (also at right angles to the direction of the applied force) is called the **FORCE OF PRECESSION**.

Figure 5-15B illustrates the direction of precession caused by the application of a force tending to turn the rotor out of its plane of

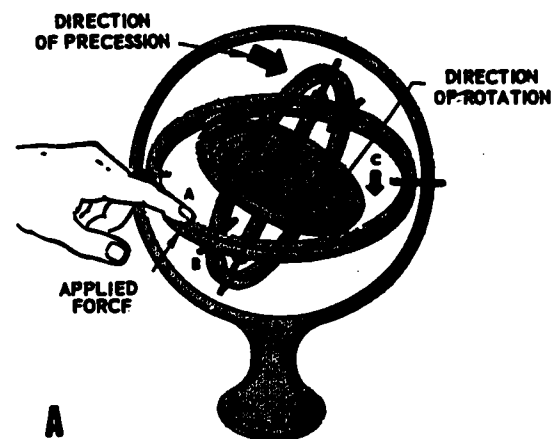

A

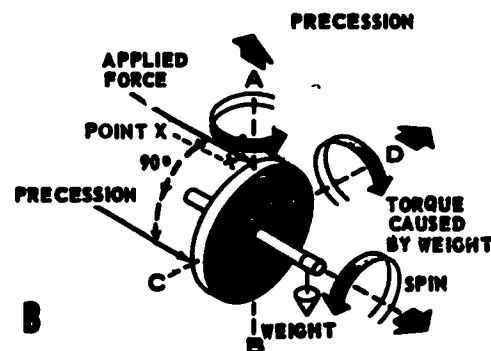

B

33.64:65

Figure 5-15.—Gyroscopic precession: A. Application of force; B. Direction of precession.

rotation. In the figure, a weight is attached to the spin axis. This is in effect the same as applying a force at point X. The resulting torque tends to turn the rotor around axis CD. But due to the property of precession, the applied force will be transferred 90° in the direction of rotor spin, causing the rotor to precess around axis AB. Thus, it may be seen that precession tends to rotate the spin axis toward the torque axis. This type of precession is called **REAL** precession.

A force applied to a gyro at its center of gravity does not tend to tilt the spin axis from its established position, and therefore does not cause precession. A spinning gyro can be moved in any direction without precession, if its axis can remain parallel to its original position in space. Therefore, the gyro can measure only those movements of the missile that tend to tilt or turn the gyro axis.

APPARENT PRECESSION.—A spinning gyro on the earth's surface will appear to tilt (or precess) with the passage of time. Actually, the spin axis does not tilt with relation to space; the apparent precession is due to the earth's rotation. Figure 5-16 shows the gyro at the equator with its spin axis horizontal at time 0000. The earth is rotating in the direction of the arrow and is making one revolution in 24 hours. An observer in space would see that the spin axis always points to the same position in space while the earth rotates. But to an observer on earth, the spin axis appears to tilt 45° every 3 hours. This is called **APPARENT PRECESSION**.

In some missiles, apparent gyro precession, sometimes called apparent gyro rotation, adversely affects flights of long duration, unless some kind of compensation is used to keep the gyro in a fixed relation to the earth's surface. The compensating mechanisms are gyro erection and slaving circuits.

UNWANTED GYRO PRECESSION (DRIFT).—Once the gyros are spinning in their proper planes, they theoretically should remain in their same relationships with space. Unfortunately there are certain imperfections in the gyroscopes which result in a drift away from the original planes of rotation. For example, even the slightest imperfection in the gyro rotor will cause some unwanted precession at high

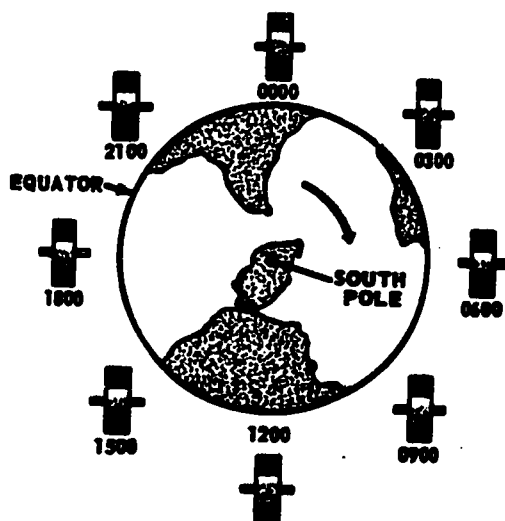

Figure 5-16.—Apparent gyroscopic precession.

rotor speeds. Rotor and gimbal bearing friction is actually the main cause of gyro drift. The problem of improved gyro stability has been approached with a view toward reducing this friction.

The main cause of random drift in gyros is friction in the gimbal bearings. Energy is lost whenever a gimbal rotates. The larger the mass of the gimbal, the greater the drift from this source.

Erection Systems

Some missiles are provided with compensating mechanisms to keep the gyros in their proper reference frames. These mechanisms are a vertical gyro erection system, and horizontal gyro slaving systems.

VERTICAL GYRO ERECTION.—A vertical gyro erection system consists of a precession sensor, the gyro, an amplifier, and a torque motor. This system represents one of the many secondary servoloops within a guided missile. The precession sensor detects the deviation of the gyro rotor from its proper plane of rotation. The resultant electrical signal is amplified and then used to drive a torque motor which precesses the gyro back to its proper plane.

The precession sensor may consist of one of the pickoffs described in this chapter. The varying output of the pickoff will be determined by the movement of a pendulous weight suspended in the gyro housing. The movement of the weight in seeking the local vertical results in corresponding signals which would cause the gyro rotor to retain its proper plane of rotation.

HORIZONTAL GYRO SLAVING SYSTEMS.—In some missiles, horizontal gyro slaving systems are used to keep the horizontal gyro rotor aligned with a specific magnetic heading for a portion, or for the duration of a missile flight. This may be accomplished by the use of a flux valve—a unit that senses the earth's magnetic field. The flux valve consists of an exciting coil and three pickoff coils wound on a metal core. The application of flux valves in guidance systems is discussed in the next chapter.

Improvements in Gyros

Figure 5-17 shows two types of improved gyros.

FLOATED GYRO UNIT.—A floated gyro unit (fig. 5-17A) is an example of the progress that has been made in the development of more

27.132

PRINCIPLES OF GUIDED MISSILES AND NUCLEAR WEAPONS

accurate gyros. In this gyro, the gyrohousing is floated in a viscous damping fluid. Because of the floating action, gimbal bearing friction is greatly reduced. Thermostatically controlled heaters may be included in the unit to maintain the damping fluid at proper viscosity. Another type of gyro uses a nonviscous fluid. It is known as a position-integrating gyro. It is used extensively to control stable platforms.

AIR BEARING GYROS.—An air bearing gyro is another example of a friction reducing device. The gimbal bearing shown in figure 5-17B is mounted in such a way that a cushion of compressed air continuously flows around the bearing surfaces. Bearings using compressed air as a lubricant are precision-machined so that the clearance at the bearing surface is only about .002 inch. When the air is flowing around the bearing surface, friction is practically negligible. Although not shown in figure 5-17B, compressed air may also be ported to the spin

axis bearings, thus minimizing friction at these points. Gases other than air may also be used for this purpose.

Use of Gyros in Missiles

While gyros have numerous applications in many types of equipment, machinery, etc., we will consider only their use in missiles.

FREE GYROS IN GUIDED MISSILES.—To illustrate how free gyros are used in detecting missile attitude, let us first refer to figure 5-18. Suppose that the design attitude of the missile is horizontal, as shown in figure 5-18A. The gyro within the missile has its spin axis in the vertical plane, and is mounted in gimbals in such a manner that a deviation in the horizontal attitude of the missile would not physically affect the gyro. In other words, the missile body can roll around the gyro and the gyro will still maintain its same position in space (fig. 5-18B). Note that the missile has rolled approximately 30° , but the gyro has remained stable in space. If we could measure the angle between the rotor and a point on the missile body we would know exactly how far the missile deviated from the horizontal attitude. Having determined this, the control surfaces could then be positioned to return the missile to the horizontal.

Actually, a minimum of two free gyros is required to keep track of pitch, roll, and yaw. The vertical gyro just described can also be used to detect missile pitch as shown in figure 5-18C. To detect yaw, a second gyro is used with its spin axis in the horizontal plane and its rotor in the vertical plane. Yaw will then be detected as shown in figure 5-18D.

RATE GYROS.—The free gyros just described provide a means of measuring the AMOUNT of roll, pitch, and yaw. The free gyros therefore can be used to develop signals, which are proportional to the amount of roll, pitch, and yaw. Due to the momentum of a missile in responding to free gyro signals, large overcorrections would result unless there were some means of determining how fast the angular movement is occurring. For example, suppose that a correction signal is generated which is proportional to an error of 10° to the left of the proper heading. The control surfaces are automatically positioned to bring the missile to the right. The missile responds by coming right. But because of its momentum it will pass the correct heading and introduce an error to the right. To provide correction signals that take

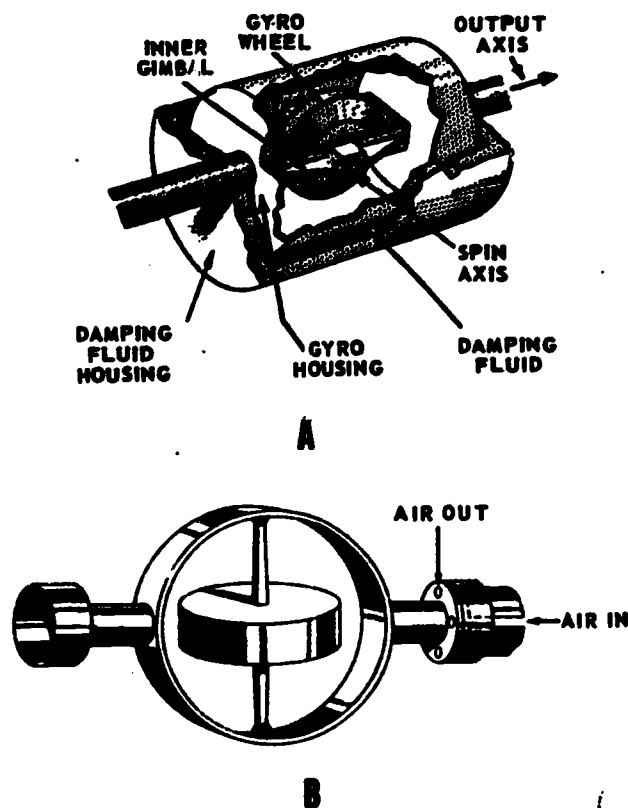

33.80:81
 Figure 5-17.—Friction-reducing gyro units:
 A. Floated gyro unit; B. Air breathing gyro.

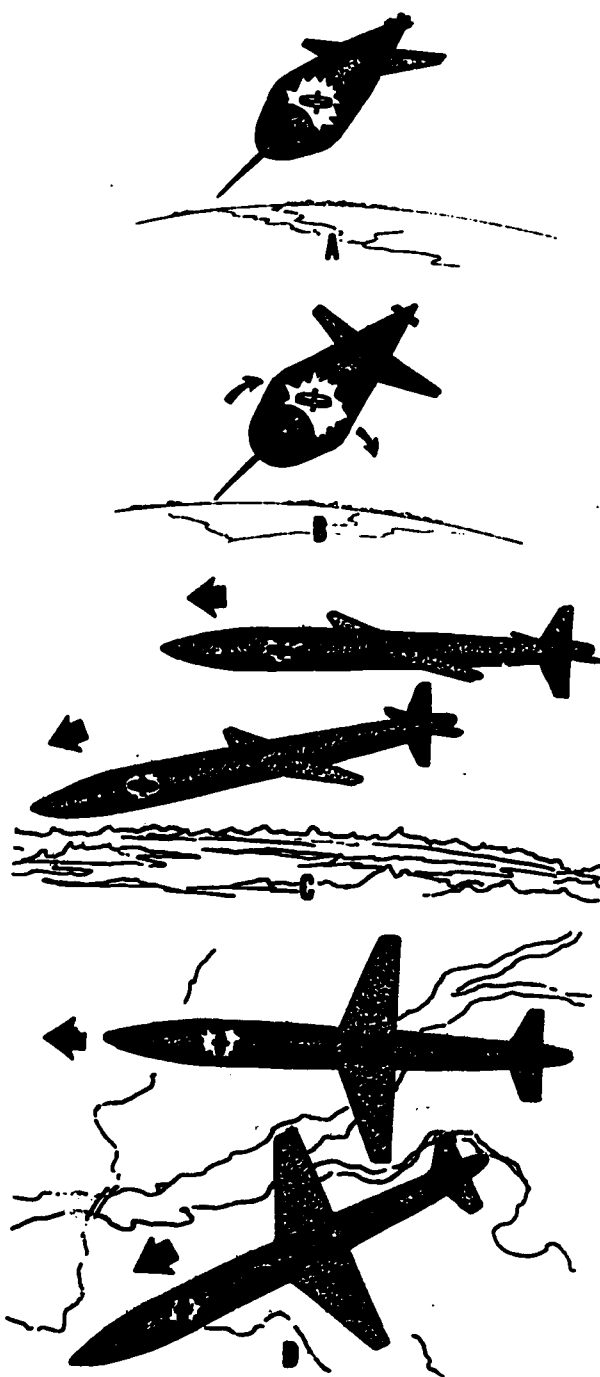

33.67-.70
 Figure 5-18.—Free gyro behavior in missiles:
 A. Missile horizontal—gyro stable in space;
 B. Missile rolls—gyro remains stable; C. Mis-
 sile pitches—gyro remains stable; D. Mis-
 sile yaws—gyro remains stable.

momentum of the missile into account, rate gyros are used. These gyros continuously determine angular accelerations about the missile axes. By combining free gyro signals with rate signals from the rate gyros, the tendency to overcorrect is minimized and a better degree of stability is obtained. The rate gyro actually provides a refinement or damping effect to the correcting process. Without rate gyros, a missile would overcorrect constantly.

A rate gyro (fig. 5-14B) supplies the rate-of-deviation signal. The rate gyro is free to rotate about only one axis. A yaw rate gyro is mounted with its spin axis parallel to the missile line of flight. A roll rate gyro is mounted so that its spin axis is parallel to the pitch axis, at right angles to the line of flight. A pitch rate gyro is mounted with its spin axis parallel to the yaw axis of the missile and at right angles to the line of flight.

Pickoff Systems

A "pickoff" is a device that receives energy from the sensors and transmits this energy, either in the same form or in another form, to a point where it is put to practical use. Most of the pickoffs used in guided missiles are electrical devices. In addition to transmitting energy from the sensors, they are also used to measure outputs of physical references, such as gyros. In this second respect, the pickoffs themselves act as sensors. The gyro rotor in itself cannot determine missile attitude information. Pickoffs must be used in conjunction with free and rate gyros to determine missile attitude information. The gyros indicate the linear and angular displacement; the pickoff must be able to measure the amplitude and direction of the displacement and produce a signal that represents both quantities.

ALTIMETERS

To ensure that missiles stay within prescribed height limits or perform functions at specified altitudes, devices called altimeters may be used. Two basic types of altimeters are pressure altimeters and absolute altimeters (radar altimeters).

Pressure Altimeters

Pressure altimeters are simply mechanical aneroid barometers. The aneroid barometer

PRINCIPLES OF GUIDED MISSILES AND NUCLEAR WEAPONS

consists of a small, bellows-like airtight chamber from which most of the air has been removed. Atmospheric pressure (which varies with altitude) works to collapse the chamber against spring pressure. As altitude increases, the compression effect decreases. The slight motion of the spring is magnified through linkages or detected by pickoffs. The resulting signals may be used to precess the pitch gyro, or they may be converted directly into control surface movement via the missile computer network. Unfortunately, variations in pressure with altitude are not always exactly constant, thereby requiring the use of a standard rate of change of pressure with altitude. This rate is referred to as the "standard pressure lapse rate." For any change of pressure, the altimeter is calibrated so that its output is proportional to the change of altitude in accordance with the standard pressure lapse rate.

Altimeter Cell

An altimeter cell also detects changes in altitude and converts this information into an electrical signal. The unit consists of a filament of fine platinum wire, heated by an electric current and enclosed in a vented envelope. The vent is always connected to a static pressure line. When the altitude or static pressure changes, the rate at which the filament can release its heat changes, and the temperature and resistance of the filament also change. This characteristic is utilized by connecting the filament as an arm in a Wheatstone bridge. Usually two cells are placed in the bridge as shown in figure 5-19. One cell is vented and one sealed in order to compensate for surrounding temperature changes. The signal output of the bridge is proportional only to pressure changes

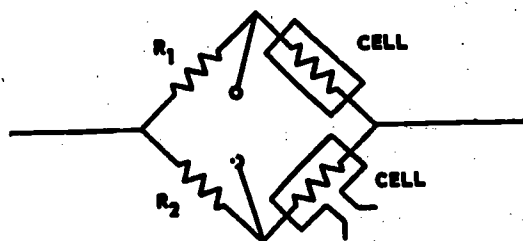

Figure 5-19.—Altimeter cell.

since both cells change with temperature while only one changes with pressure.

An altimeter cell measures altitudes as high as 500,000 feet. This wide range gives the cell an advantage over a mechanical aneroid.

Absolute (Radar) Altimeters

Radar altimeters are used to measure absolute altitude—the distance between the missile and the terrain beneath it rather than above sea level. It measures the time required for a radar pulse to reach the ground, be reflected, and return. Since the operation does not depend on atmospheric data, the radar altimeter is free from some of the disadvantages of the barometric types. One type of radar altimeter is the continuous-wave (c-w) frequency-modulated (f-m) altimeter.

In the c-w system, the transmitted microwave signal is varied regularly in frequency in accordance with a sawtooth modulating voltage. The signal is directed toward the ground where a portion of it is reflected back to the receiving antenna. The echo wave is compared in the receiver with the instantaneous output frequency of the transmitter. An interval of time passes between the moment the signal is transmitted and its arrival by reflection at the receiver. This time interval is directly proportional to the altitude of the missile. During this same time interval, the transmitted frequency has been intentionally varied. By comparing the new transmitted frequency with the echo frequency, a difference frequency or time lag is obtained which is proportional to the elapsed time interval and to the altitude of the missile.

AIRSPPEED TRANSDUCERS

Speed measuring devices are used in some missiles to cause specified functions to occur during flight. One of these devices shown in figure 5-20 is called an airspeed transducer. Its principle of operation is similar to that of the aneroid barometer just discussed. A transducer is a device which is operated by power from one source and supplies power to another device in the same or a different form. In most missile applications, a transducer is used to change mechanical motion to an electrical voltage. The ram air pressure experienced by the missile in the atmosphere is transmitted to the bellows and converted to an electrical signal

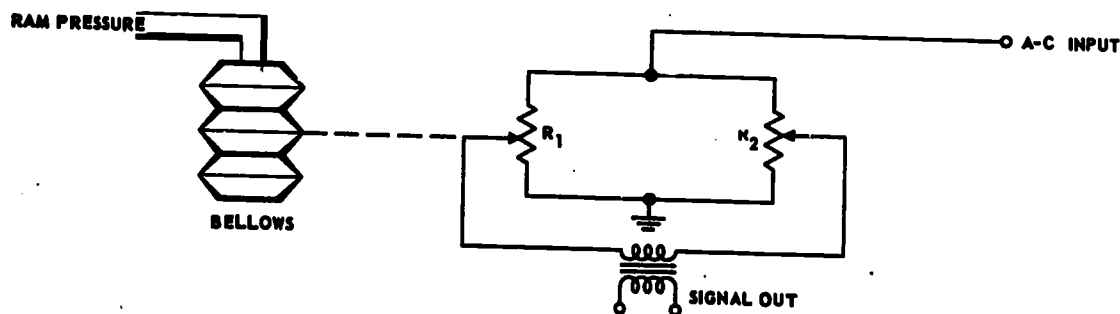

Figure 5-20.—Airspeed transducer.

33.129

through a bridge type electrical circuit (fig. 5-20) the output signal will vary with the ram air pressure, which is proportional to missile speed. Other types of electrical pickoffs also may be used to convert bellows movement into electrical information.

Another type of speed measuring device depends on the transmission and reception of r-f energy, and is similar in principle to the radar altimeter. A slight shift in frequency of the transmitted energy provides a basis (Doppler effect) for electronically determining missile speed. The use of Doppler radar will be discussed in some detail in a later chapter of this course.

PICKOFFS

Pickoffs, briefly described in connection with gyros, are important in the missile control system because they produce signals from the intelligence developed by a sensor unit. The signal must be one that is suitable for use in the control system. The pickoff must be able to determine the direction of displacement and then produce a signal that indicates the direction. In electrical systems the indication may be a phase, polarity, or voltage difference.

The ideal pickoff should have a considerable change in output for a small movement of the pickoff. It should also have minimum torque or friction loss since these losses would be reflected to the sensor element and affect its operation. Small physical dimensions and light weight are additional requirements. The null point (no output) should be sharply defined.

Electrical pickoffs are extremely sensitive and reflect little torque back to the sensor or reference unit. It is primarily these qualities

which make them useful in guided missiles. The most common types of electrical pickoffs are:

1. Reluctance pickoffs
2. Potentiometer pickoffs
3. Synchro pickoffs
4. Capacitance pickoffs

VARIABLE RELUCTANCE PICKOFFS

Figure 5-21 shows an internally operated variable reluctance pickoff which may be used with a rate gyro. The pickoff consists of an E-shaped metal block with coils wound around its ends and a permanent magnet located in the

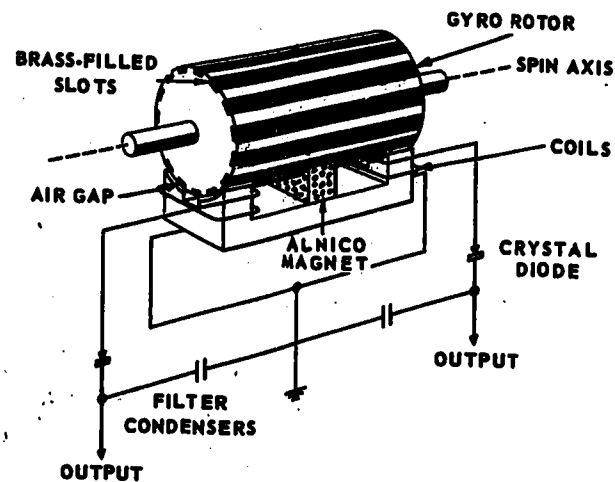

Figure 5-21. Internally operated reluctance pickoff.

33.72

PRINCIPLES OF GUIDED MISSILES AND NUCLEAR WEAPONS

center. The gyro rotor is made of ferrous metal and has brass strips spaced around its periphery. The permanent magnet causes a magnetic flux to be established. The spinning rotor causes regular variations in flux density. As a result, an a-c voltage component is induced in the two coils. When there is no precession the air gaps are equal and the a-c components cancel one another. When the gyro precesses because of an angular acceleration, the air gap is increased at one end and decreased at the other. This change in the air gaps causes different voltages to be induced in the two coils. The difference between the two voltages is proportional to the angular acceleration. After being rectified and filtered, the resultant d-c voltage is the rate signal. The output sense (direction of deviation) is indicated by positive or negative polarity.

EXTERNALLY OPERATED RELUCTANCE PICKOFF

The externally operated reluctance pickoff most commonly used in guided missiles is usually referred to as a differential transformer. This pickoff, shown in figure 5-22 consists of a laminated steel rotor attached by a shaft to the rate gyro gimbal. Two E-shaped laminated steel cores are attached to the gyro mounting. Around the outer legs of each of the cores is a primary winding connected in series opposition. There is a secondary winding (pick-off coil) around the center leg of each core.

When the rotor is in the position shown in figure 5-22A, the flux lines from the excitation windings cutting the secondary are equal and 180° out of phase. In this condition, no voltage is induced in the secondary windings.

When the gyro precesses because of angular acceleration, the rotor turns because it is directly coupled to the gyro gimbal. In figure 5-22B, one end of the rotor is shown displaced to the left. This displacement of the rotor decreases the reluctance to the magnetic flux in the left leg and increases the reluctance in the right leg. This results in more flux lines from the left primary cutting the secondary winding. Thus an a-c output is induced in the secondary winding. This voltage is 180° out of phase with the a-c excitation voltage. The output voltage is proportional to the displacement of the rotor. Displacement of the rotor to the right will have an opposite effect and an in-phase output voltage will result.

This pickoff has many applications in guided missiles in addition to serving as a rate gyro pickoff.

POTENTIOMETER PICKOFFS

A potentiometer is a device for translating a quantitative motion (angular or linear) into a proportional electrical resistance. It measures by comparing the difference between the known and the unknown electrical potentials. Figure 5-23 shows the principle of the potentiometer pickoff. The circuit shown in the figure is

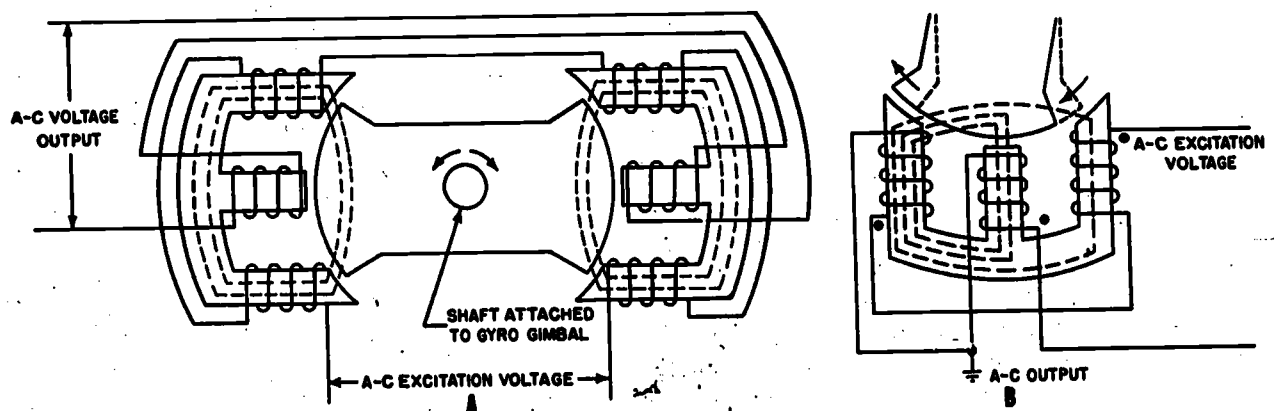

Figure 5-22.—Externally operated reluctance pickoff:
A. Balanced condition—no output; B. Rotor displaced to left, causing output.

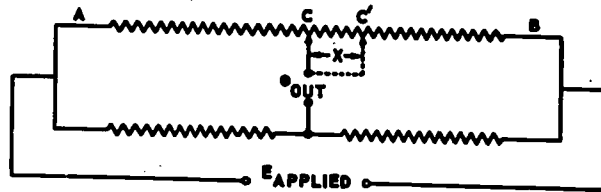

Figure 5-23.—Principle of a potentiometer pickoff.

33.74

referred to as a bridge circuit. When the wiper arm is at C, there will be no output (e_{OUT}) since the input ($E_{APPLIED}$) is placed across equal resistors. Now, if the wiper arm is moved to C' the output will be proportional to the displacement of the arm due to an imbalance in resistance in the line AB.

Potentiometer pickoffs consist of wire-wound resistors and movable sliding contacts (fig. 5-24A). The resistance wire is wound on a strip which is bent in the shape of a cylinder. The wire and strip together are referred to as the resistance card. The wiper arm can be positioned at any point around the circumference of the card.

The position of the moving arm determines the amount of voltage, but it is also possible to use the variation in resistance as the control medium. If the shaft of the potentiometer is mechanically connected to the sensor, the output voltage will vary according to the moving arm displacement. With the wire-wound method of construction however the output of the potentiometer does not change smoothly as the wiper arm is moved. Instead, the output voltage changes in jumps, each jump being proportional to the distance between adjacent turns of wire and the voltage drop across each turn. A potentiometer having 1,000 turns of wire is said to have a resolution of 1 part in 1,000 or a resolution of .1 percent. To improve resolution, the resistance wire is sometimes wound in a helix as shown in figure 5-24B.

A potentiometer wound in this manner is known as a helipot. The wiper arm shown in the figure would make ten turns around the circumference of the card to cover the entire voltage range. The advantage is in the fact that the wiper arm maintains continuous contact

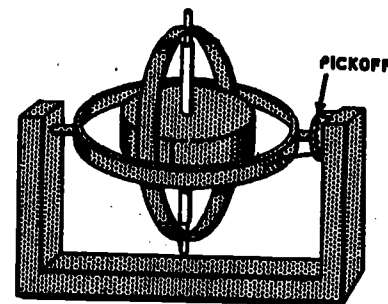
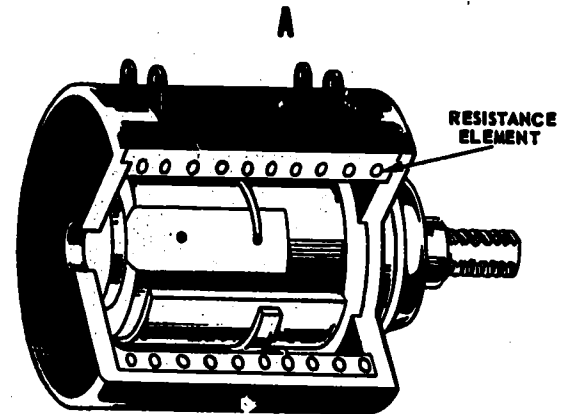
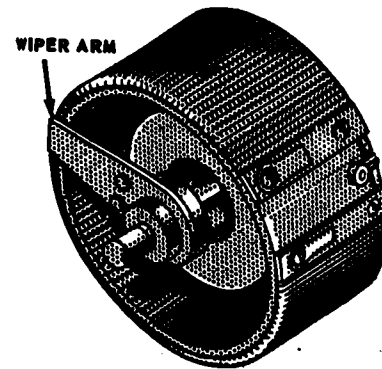

33.75-.77

Figure 5-24.—Potentiometers: A. Wire wound potentiometer; B. Helipot; C. Potentiometer pickoff used with a free gyro.

with the resistance wire, thus eliminating the jumpy output inherent in the conventional potentiometer. Figure 5-24C shows a potentiometer pickoff used with a free gyro.

PRINCIPLES OF GUIDED MISSILES AND NUCLEAR WEAPONS

SYNCHRO PICKOFF AND CONTROL TRANSFORMERS

The term synchro is applied to a group of devices used for transmitting either angular data or torques of fairly small magnitude without the use of a mechanical linkage. The simplest synchro system contains a transmitter which is electrically connected to a receiver. The transmitter is a transformer with a rotatable primary that converts a mechanical input into an electrical signal, and transmits the signal to the receiver. The synchro receiver receives the signal and converts it into a mechanical output. If the rotor of the synchro transmitter is coupled to a sensor or reference, the movement of the reference will cause a corresponding movement of the transmitter rotor. Due to the electrical connection of the receiver, its rotor will move in exact correspondence to the motions of the transmitter rotor.

Unlike the combination described above, the synchro control transformer is used to produce a voltage proportional to the movement of the synchro transmitter rotor, rather than an angular movement. Such a voltage may be amplified and then used to power other units within a control system.

Synchro pickoffs are sometimes called sel-syns, autosyns, or microsyns.

The fundamental types of synchro units and their principles of operation are discussed in Basic Electricity, NavPers 10086-A.

CAPACITANCE PICKOFF

As shown in figure 5-25 capacitance pickoff is composed of two outer plates that are fixed in position. A movable plate is centered between the two fixed plates and connected to the sensor. The capacitance between the center plate and the

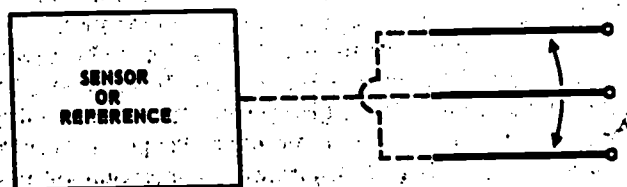

33.78

Figure 5-25.—Capacitance pickoff.

two outside plates is equal when there is no output from the sensor. If, however, a signal from the sensor causes the center plate to move toward the bottom plate, the capacitance between these two plates will increase and the capacitance between the top plate and the center plate will decrease.

This change in capacitance can be used to vary the tuning of an oscillator. The change in oscillator frequency is then used for sense control. This type of pickoff is the most sensitive of all, since a very slight change in plate spacing will cause a large change in frequency.

The electrical pickoffs just described are common to many guided missiles. Other types and variations of those described will be covered in later chapters with the equipments with which they are associated.

PICKOFFS AND FREE AND RATE GYRO SIGNALS

Not that you have a basic understanding of some of the pickoffs used in guided missiles, let us see how signals from the free gyros and signals from the rate gyros are combined to form resultant signals.

When a missile experiences an unwanted angular acceleration, the rate signal is combined with the free gyro signal in such a way as to return the missile smoothly to its desired attitude. For example, assume that the prescribed attitude of a missile is horizontal, and that an outside force causes the missile to roll in a clockwise direction. Figure 5-26A shows the roll rate gyro signal and the roll free gyro signal during a period of 40° clockwise roll and return to proper attitude. At time T_0 there is no output from either the rate gyro or the free gyro, because the missile is not rolling and is in the proper attitude. As the missile begins to roll, the roll rate signal increases until the missile roll rate becomes steady, at which time (T_1) the rate signal reaches a constant level. Note that the roll rate signal always opposes roll movement of the missile. The free gyro signal continues to increase as long as the missile is rolling from its proper attitude. At time T_2 , the control surfaces begin to slow the missile's roll and the rate signal begins to drop off. The missile is still rolling, but at a slower rate, between T_2 and T_3 . The roll free gyro signal continues to increase until a maximum roll of 40° is reached at T_3 , at which time the rate signal is zero.

Chapter 5—MISSILE CONTROL COMPONENTS AND SYSTEMS

The missile now begins to roll back to the desired attitude. Between times T_3 and T_4 , the roll free gyro signal decreases, while the rate signal increases in the opposite direction. At time T_4 , the signals cancel each other and have caused the control surfaces to return to neutral. After T_4 , the rate signal is greater than the roll free signal and causes the control surfaces to be actuated in opposition to the direction of missile movement. This action continues until the missile is stabilized at the prescribed attitude.

By opposing the free gyro signal during the roll back to the horizontal attitude, the rate signal can be said to be anticipating the

return to correct attitude. It is this opposing or damping feature which prevents the over-correcting effects which would occur if only a free gyro were used.

The free and rate signals are continuously led by their pickoffs to a summing circuit in the missile computer network. Here they are combined to form the resultant shown in figure 5-26B.

The dotted line in figure 5-26B represents control surface movement during the entire period of roll.

Although the actions described above apply to missile roll caused by an outside force, the same actions are applicable to pitch and yaw caused by outside forces.

The block diagram of the missile control system in figure 5-27 includes the gyros and pickoffs covered in this chapter.

COMPUTING DEVICES

GENERAL

Computers appear in missile systems in a variety of forms. The computer may be a simple mixing circuit in a missile, or it may be a large console type unit suitable for use at ground installations or on shipboard.

We have shown that sensor units detect errors in pitch, roll, and yaw, and that a reference unit furnishes a signal for comparison with the sensor output.

Although the sensor output represents an error to be corrected, it is seldom used to operate control surfaces directly. It must be changed to include additional information, and then amplified in order to operate the controls. These operations are represented by the block labeled "computer" (fig. 5-1). The computer section is normally composed of mixers, integrators, and rate components.

The large volume of information to be processed, and the brief time available to handle it, make the use of high-speed data processing equipment essential in modern weapon systems. Data processing equipment is a group of devices, each capable of performing a mathematical operation on data furnished to it, and of producing results in usable form. The term

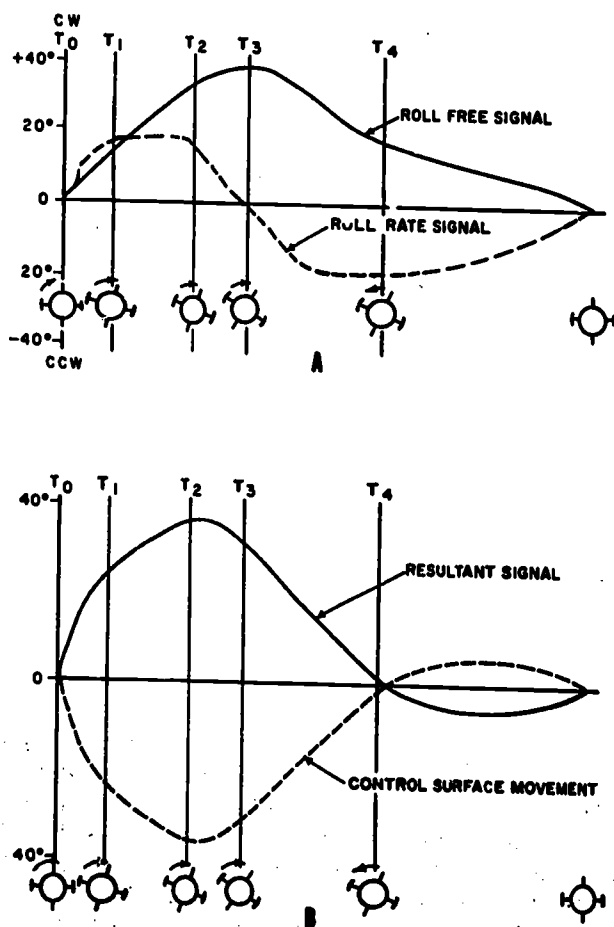
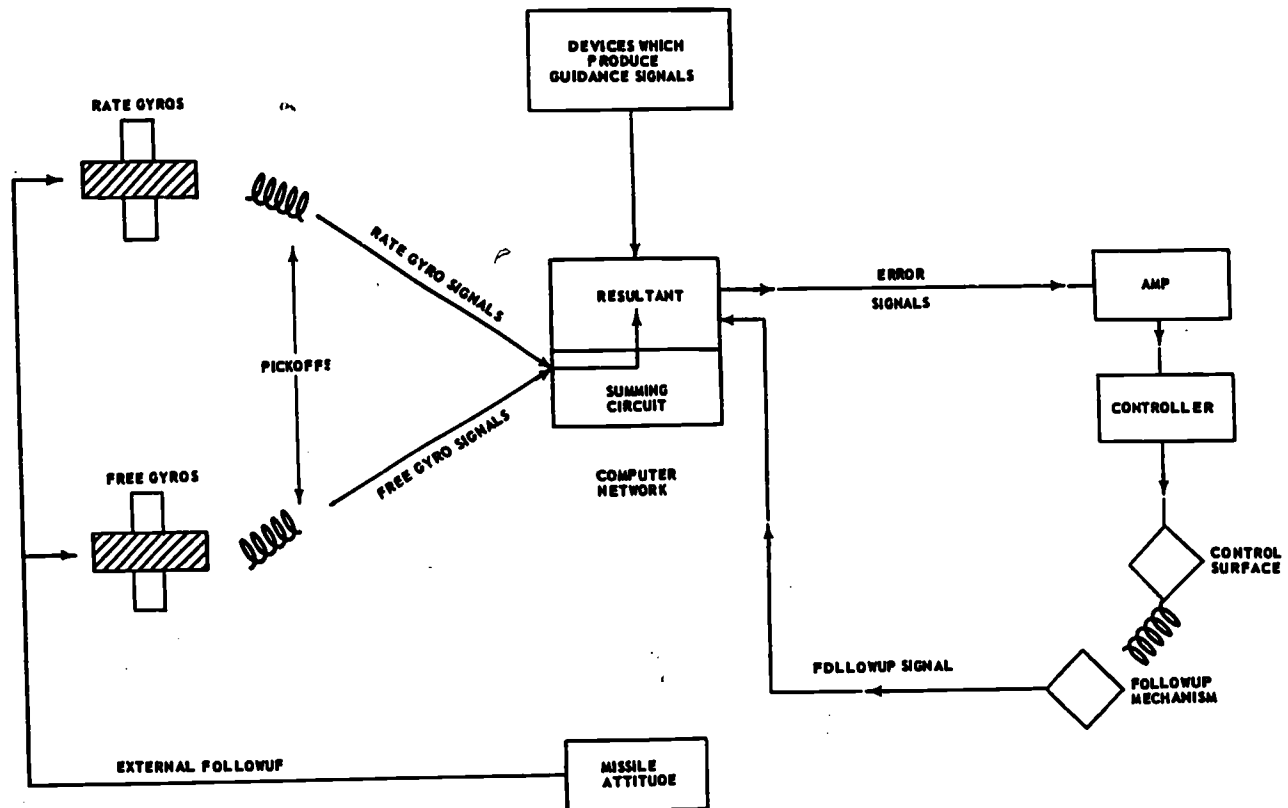

Figure 5-26.—Gyro signals combined to correct missile attitude: A. Roll free gyro and roll rate gyro signals; B. Resultant signal and control surface movement.

33.79

PRINCIPLES OF GUIDED MISSILES AND NUCLEAR WEAPONS



33.86

Figure 5-27.—Missile control system showing gyros and pickoffs.

“mathematical operation” includes not only such obvious processes as multiplication and addition, but includes analytic, arithmetic, and logic operations. It excludes such processes as judgment, induction, conjecture, and generalization—a computer cannot think.

The term “computer” refers to the data processing device that is capable of differentiating between data received. Other parts of the data processing equipment may translate data from one form to another, store data, or produce data from stored information on demand.

Computers produce answers in numerical form for statisticians, or in physical form for use in fire control systems and industrial control equipment. By physical form we mean voltages or shaft and gear revolutions. Because computers can quickly solve simultaneous equations, they can be used to direct gunfire or missiles against fast-moving enemy aircraft

or missiles. Computers are also used against surface, underwater, and shore targets. Computers within the missiles operate on the same principles as those in the weapon system.

FUNCTION AND REQUIREMENTS

One important function of a computer is the coding and decoding of information relating to the missile trajectory. It is necessary to code and decode control information in order to offset enemy countermeasures and to permit control of more than one missile at the same time.

Another function of the computer is the mixing of signals from sensor and reference units to produce error signals. Figures 5-1 and 5-9 show, in block form, how the computer is linked with other sections of the complete system. The signals from the sensor and reference units may be mixed in a preset

Chapter 5—MISSILE CONTROL COMPONENTS AND SYSTEMS

ratio, or they may be mixed according to programmed instructions.

The error signals produced by mixing are amplified and passed to the control actuating system and the followup section. The output of the followup section is then fed back to the computer for reprocessing. The purpose of feedback is to reduce overcontrol that would cause the missile to oscillate about the desired attitude.

The computer section may also compare two or more voltages to produce error signals. For this purpose, voltage or phase comparator circuits are added. The synchro units discussed in the previous section are used in computers to convert signal voltages into forms that are better suited for processing.

Airborne computers are generally classified according to the phase of missile flight in which they are used. The computers may be separate units or they may be combinations of prelaunch, launch, azimuth, elevation, program, and dive-angle computers.

TYPES OF COMPUTERS

Computers are classified according to purpose as general or special, and according to whether they use analog or digital principles. Computers used in weapons systems are designed specifically to solve problems arising in weapons systems, and therefore are usually special purpose computers. They occur in a wide variety of forms and may have little in common with each other. While general purpose computers are used to solve problems directly related to weapons systems, most computers that are part of a weapons system are special purpose, connected to solve a particular problem, or a small number of problems. A ballistic missile guidance computer, for example, will solve only the equation for a ballistic trajectory, but can be made to guide the missile to any target within range.

Analog and Digital Computers

The two basic types of computers—*analog* and *digital*—may be combined to form a hybrid computer with both analog and digital characteristics.

The technique used to determine the magnitude of the variable is different in the two types. The analog device will continuously measure a changing variable; it recognizes a

variable as a whole quantity, such as displacement of a pointer, rotation of a shaft, and voltage of a circuit.

The digital method is a counting method. The digital device recognizes quantity as a number of basic units: number of days, number of ohms, etc.

Analog computers can be used in weapons systems wherever problems of calculations from continuous data, simulation, or control are encountered. In target detection and tracking, analog computers are used to direct search radars and tracking devices, store data on target location and velocity, and predict future target motion. The calculations necessary to direct weapons launchers, and actually control launchers and missiles are performed by computers. In addition to actual operation of weapons, analog computers are used to simulate targets for training purposes, and evaluate the performance of the weapons systems in engaging the simulated targets.

A digital computer also can solve problems, but does it quite differently. The actual numbers are used; it performs simple arithmetic on them and produces the answer in the form of individual digits.

Basically, the analog computer deals with a continuous system, while the digital computer works with discrete numbers. While the analog computer is faster than the digital, it is much less accurate.

Also, the digital computer can only give the answer to one specific arithmetic problem at a time, but the analog computer can present the overall picture of an entire system.

The functions of the digital computer in the improved Minuteman missile include preflight testing, countdown, staging, and control of penetration aids such as decoys or radar chaff, in addition to flight-path control.

Computers may solve the problem by electrical means, using voltages and current; electromechanical, using voltages and shaft positions; and mechanical, using angular rotations of shafts and linear movements of shafts and linkages. There are many electronic devices in digital computer circuits. Relays may be open or closed; diodes pass current in one direction but not the other; vacuum tubes and transistors may be conducting or nonconducting; magnetic cores may be magnetized clockwise or counterclockwise. In addition, a variety of exotic devices with unique characteristics have been applied to digital circuits: cryotron,

PRINCIPLES OF GUIDED MISSILES AND NUCLEAR WEAPONS

magnetic film, tunnel diode, twistor, and apertured plate. To describe the functioning of each of these would require a volume in itself. Refer to Principles of Naval Ordnance and Gunnery, NavPers 10783-A, for more information on digital and analog computers.

We will describe the computer elements according to the general type of function they perform. These types were briefly described at the beginning of this chapter as MIXERS, INTEGRATORS, and RATE COMPONENTS.

Mixers

A mixer is basically a circuit or device that combines information from two or more sources. In order to function correctly, the mixer must combine the signals that are fed to it in the proper PROPORTION, SENSE, and AMPLITUDE.

The type of mixer used will depend mostly on the type of control system. Most systems use electronic mixers. However, mixers may also use mechanical, pneumatic, or hydraulic principles.

Electronic mixers may use a vacuum tube as a mixing device. It is also possible to use a network composed of inductors, capacitors, and resistors for mixing. Regardless of the type of mixer, the signals to be combined are represented by the amplitude and phase of the input voltages. Voltages from such sources as pickoffs, rate components, integrators, followup generators, and guidance sources may be combined by the mixer section to form control signals.

Mechanical mixers consisting of shafts, levers, and gears can also be used to combine information. Another mechanical mixer uses gears to combine position or angular velocity information. The gear arrangement is similar to that of an automobile rear axle differential. If the input shafts contain position information, they will move slowly and maintain approximately the same average position. The position of the output shaft constantly indicates the difference between the two shaft positions. If the information is represented by the speed of the shaft rotation, the angular velocity of the output shaft represents the difference between the two input shaft speeds.

It is possible to arrange the input shafts so that the output represents the sum of the inputs rather than the difference. Weighting factors

can be controlled by changing the gear ratios in the differential.

Sometimes information is transferred through air or hydraulic tubes. The signals are created by varying the pressure inside the tube. Two signals can be combined by joining two tubes into one.

Integrators

An integrator performs a mathematical operation on an input signal. The integral of a constant signal is proportional to the amplitude multiplied by the time the signal is present. Assume that the integrator output is four volts when the duration of the constant input signal is one minute. Then if the same input signal had lasted for one-half minute, the output would have been two volts.

But, an actual missile error signal is not constant, as we assumed in the above example. The amplitude and sense of the error change continuously. The integrator output is proportional to the product of the operating time and the average error during that time. Should the sense of the error change during the integration period, a signal of opposite sense would cause the final output of the integrator to decrease. The integrator can be considered as a continuous computer, since it is always producing a voltage that is proportional to the product of the average input voltage and time. Therefore, the integration of an error with respect to time represents an accumulation of intervals of time and errors over a specified period.

Any integrator has a time lag effect.

Although the input signal goes from zero to maximum with zero time lag, there is no output at that instant. Time is required before the output reaches an appreciable amplitude. Approximately the same length of time is required for the output amplitude to drop to zero after the input pulse ends. The additive effect of two successive negative pulses is made possible by the time lag, and is used to give more precise control action.

The output signal from the integrator is used to support the proportional error signal, to make sure that enough correction will always be made by the control system.

Keep in mind that the degree of control exerted by a pure proportional (unamplified) signal is limited. Overcontrol, or undercontrol causes excessive movement of the missile about

Chapter 5—MISSILE CONTROL COMPONENTS AND SYSTEMS

the desired trajectory. There are times when proportional control alone is not enough to overcome a strong, steady force that is causing the missile to deviate from the correct path. In a case of this kind, the proportional error signal will have a steady component that affects the integrator. The error signal sense remains constant, so that the integrator output increases with time. This output increase reinforces the proportional signal until correction of the flight path takes place.

Integration may be performed by a motor, the speed of which is proportional to the amplitude of the input signal. The motor drives a pickoff, and the distance the pickoff moves is proportional to the integral of the input signal.

The direction of motor rotation will depend on the polarity or phase of the input signal. The amplitude of the error signal varies irregularly; the sense of the signal may reverse, causing reversal of the motor rotation.

Other types of integrators use ball-and-disk mechanical arrangement, resistance-capacitance (RC) circuits, resistance-inductance (RI) circuits, and thermal devices. The ball-and-disk type (fig. 5-28A) is the oldest type of integrator still in use in missiles. A more sophisticated integrating circuit is shown in figure 5-28B. It adds an amplifier to a simple resistor-capacitor circuit. The resistor (R) produces the proportional current from the input signal voltage. The capacitor (C) voltage is the integrator output. The use of a high gain feedback amplifier produces more accurate results.

ance (RC) circuits, resistance-inductance (RI) circuits, and thermal devices. The ball-and-disk type (fig. 5-28A) is the oldest type of integrator still in use in missiles. A more sophisticated integrating circuit is shown in figure 5-28B. It adds an amplifier to a simple resistor-capacitor circuit. The resistor (R) produces the proportional current from the input signal voltage. The capacitor (C) voltage is the integrator output. The use of a high gain feedback amplifier produces more accurate results.

Rate Systems

The rate section in a missile control system should produce an output signal proportional to the RATE OF CHANGE of the input signal amplitude.

The time lag present in integrator circuits makes rate circuit necessary. Missile deviation cannot be corrected instantly, because the control system must first detect an error before it can begin to operate.

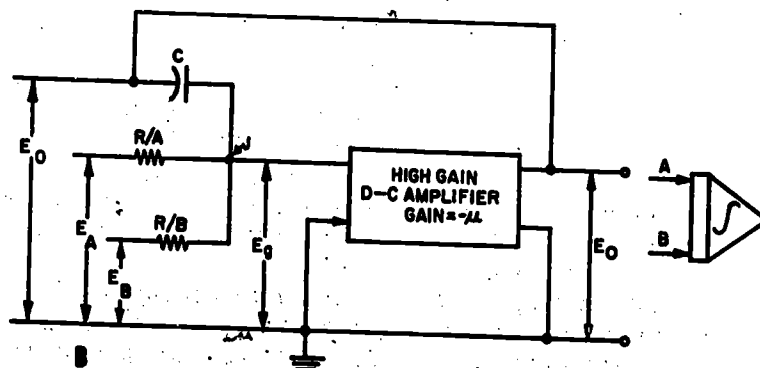
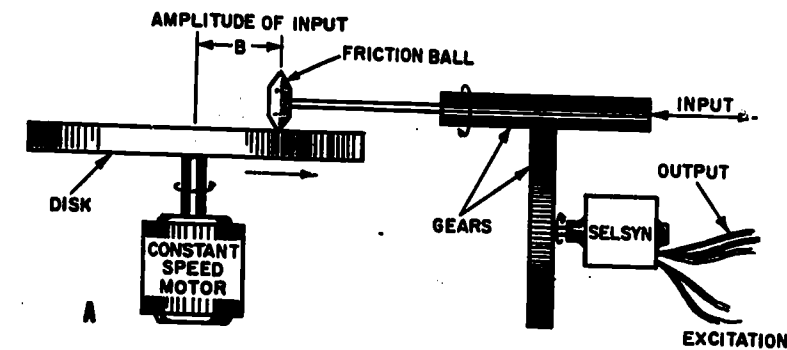

Figure 5-28.—Some integrators used in missile control:
A. Ball-and-disc integrator; B. Integrating amplifier circuit and symbol.

144.30

PRINCIPLES OF GUIDED MISSILES AND NUCLEAR WEAPONS

The ideal control system would have zero time lag, thus permitting zero deviation during the missile flight. Control surfaces are designed to correct missile flight deviations rapidly. The control surfaces are moved rapidly by actuators, which are operated by amplified error signals. But it is possible to have a signal so large that the missile is driven beyond the desired attitude, and an error occurs in the opposite direction. This error drives the missile back in the first direction. The end result is a series of swings back and forth across the desired trajectory.

These unwanted swings are known as oscillation (or hunting) and the addition of a rate signal has the effect of damping (retarding) the oscillation. The amount of damping may be classed as CRITICAL, UNDERDAMPING, or OVERDAMPING. The function of damping is to reduce the amplitude and duration of these oscillations.

The simplest form of damping is viscous damping. Viscous damping is the application of friction, to the output shaft or load, that is proportional to the output velocity. This type of damper absorbs power from the system and slows up its response. You will find viscous damping slows up its response. You will find viscous damping used on servos in the older computers.

Damping of servos in the newer computers is provided by the rate generators. This method of damping, sometimes called error-rate damping, overcomes the disadvantages of viscous damping. By combining the rate signal and the error signal, the system can be made to respond to a constant error. It is also possible to combine an attitude rate signal with a guidance signal.

Perhaps the most common method of producing a rate signal is by using a separate sensor unit, such as a rate gyro. The gyro displacement is detected by a pickoff, and the output of the pickoff is the rate signal.

AMPLIFIERS

An amplifier is a device for increasing the magnitude of a quantity. There are many types of amplifiers and many uses for them. In electronics and electrical applications, three types widely used are vacuum tube, transistor, and magnetic amplifiers. The first two are discussed in Basic Electricity, NavPers 10087-A, and the last named is described in Basic Electricity, NavPers 10086-A.

PURPOSE

Both POWER and VOLTAGE amplifiers are used in missile control systems to build up a weak signal from a sensor so that it can be used to operate other sections of the control system. These sections normally require considerably more power or voltage than is available from the sensor. Most amplifiers use electronic tubes. Regardless of the method used, the prime purpose of an amplifier is to build up a small sensor signal to a value great enough to operate the controls.

OPERATING PRINCIPLES

Some functions in missile control systems require a series of flat-topped pulses, called square waves, at a definite frequency. It is possible to convert other wave shapes to square waves with vacuum tube amplifiers and clippers. It is also possible to accomplish the same result with an electromechanical device known as a chopper, or by a vibrator.

Choppers

A chopper is usually an electromechanical switch designed to operate a fixed number of times per second, opening and closing the contacts periodically. Fundamentally, a chopper serves as a suppressed carrier square-wave modulator. A cutaway view of a mechanical chopper is shown in figure 5-29A. This unit has the contacts arranged for single-pole double-throw switching, center OFF position.

The contact arrangement is shown near the bottom of the drawing. Leads are brought out separately from each of the two fixed contacts and the vibrating reed to pins on the base. These pins are arranged so that the chopper can be plugged into a conventional radio tube socket. In order to reduce operating noise, the entire mechanism is enclosed in a sponge rubber cushion before it is placed in the metal can. By using the chopper in connection with a conventional transformer, amplification can be obtained at the pulse frequency.

An electromagnet, driven by a source of alternating current, sets a reed in vibration. The reed carries a moving contact that alternately contacts one or the other of two fixed contacts in a signal circuit. Thus the signal is periodically interrupted. The permanent magnet

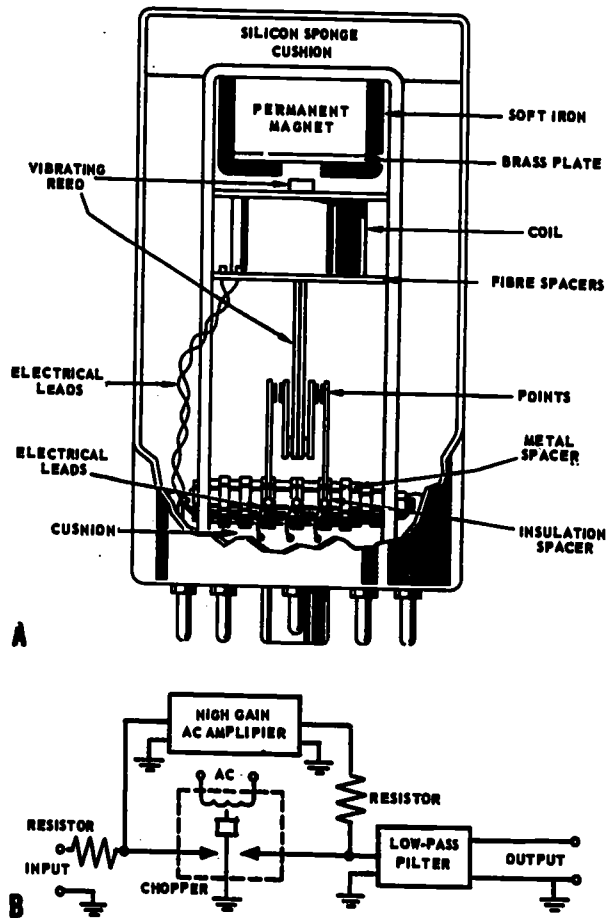

144.31
Figure 5-29.—A. Cutaway view of mechanical chopper. B. Chopper—stabilized d-c amplifier.

is incorporated in the pole structure of the coil so as to polarize the coil. The a-c excitation of the coil alternately reinforces and reduces the magnetism supplied by the permanent magnet, so that the vibrating reed executes one oscillation for each oscillation of the applied voltage. The resonant frequency of the reed is not made equal to the excitation frequency because then small changes in the exciting frequency would result in large phase shifts between the reed oscillations and the coil drive. A typical circuit is shown in figure 5-29B. The d-c input voltage is modulated by one contact of the chopper into an a-c voltage. This voltage is amplified in a standard a-c amplifier and is then demodulated by the other contact of the chopper. The signal is smoothed in a low-pass filter to reconstruct as an amplified version of the original input.

The chief advantage of electromechanical choppers in their extremely low noise and drift. They have been used successfully to amplify minute voltages such as those generated by thermocouples.

Vibrators

A current can also be chopped electronically by passing it through a multivibrator or other switching circuit. A vibrator, an electromechanical device used primarily to convert direct current to alternating current but also used as a synchronous rectifier, is closely related to the chopper. There are two major classes of vibrators: interrupters, in which the vibrator serves to interrupt, periodically, the direct current input, and synchronous vibrators, in which the vibrator periodically interrupts the input, then synchronously rectifies the resulting alternating current.

Vacuum Tube Choppers

Vacuum tubes can be used as electronic choppers. Other amplifiers, known as saturable reactors, are used for a-c motor control. This type of amplifier may sometimes be used in combination with vacuum tubes. Neither the vacuum tube nor the transistor alone can function as an amplifier; each must be associated with appropriate input, output, or biasing circuits.

Control systems in guided missiles make extensive use of chopping, generally to change a direct current signal into an alternating current signal, which can be more readily amplified.

An autopilot amplifier receives signals from the outputs of the gyroscopic reference system and the rate gyroscopes, and converts the signals to a form usable for guidance of the actuator assemblies.

The use of amplifiers in the guidance system is discussed in the next chapter.

CONTROLLER UNITS

The first part of this chapter discussed the purpose and function of control, the factors controlled, methods of control, types of control action, and types of control systems. In this section we will discuss controller units other than amplifiers.

PRINCIPLES OF GUIDED MISSILES AND NUCLEAR WEAPONS

A controller unit in a missile control system responds to an error signal from a sensor. In certain systems an amplifier which is furnishing power to a motor serves as a controller.

TYPES

There are several types of controller units, and each type has some feature that makes it better suited for use in a particular missile system.

Solenoids

A solenoid consists of a coil of wire wound around a nonmagnetic hollow tube; a moveable soft-iron core is placed in the tube. When a magnetic field is created around the coil by current flow through the winding, the core will center itself in the coil. This makes the solenoid useful in remote control applications, since the core can be mechanically connected to valve mechanisms, switch arms, and other regulating devices. Two solenoids can be arranged to give double action in certain applications.

Transfer Valves

Figure 5-30 shows an application in which two solenoids are used to operate a hydraulic transfer valve. The object is to move the actuator which is mechanically linked to a control surface or comparable device.

The pressurized hydraulic fluid, after it leaves the accumulator, is applied to the transfer valve shown in figure 5-30B. The valve is automatically operated by the response of the solenoids to electrical signals generated by the missile computer network.

If solenoid #1 in the figure is energized, it will cause the valve spool to move to the left. This will permit pressurized fluid to be ported to the right-hand side of the actuator and cause its movement to the left. If solenoid #2 is energized, the valve spool will move to the right, causing actuator movement to the right in the same manner. When neither coil is energized, the valve is closed (fig. 5-30A).

The transfer valve just described has one disadvantage in that it operates in an on-off manner. This means that it provides positive movement of the control surfaces, either full up or full down, full right or full left. A finer control is usually more desirable in missile systems. The servovalve (fig. 5-31) provides

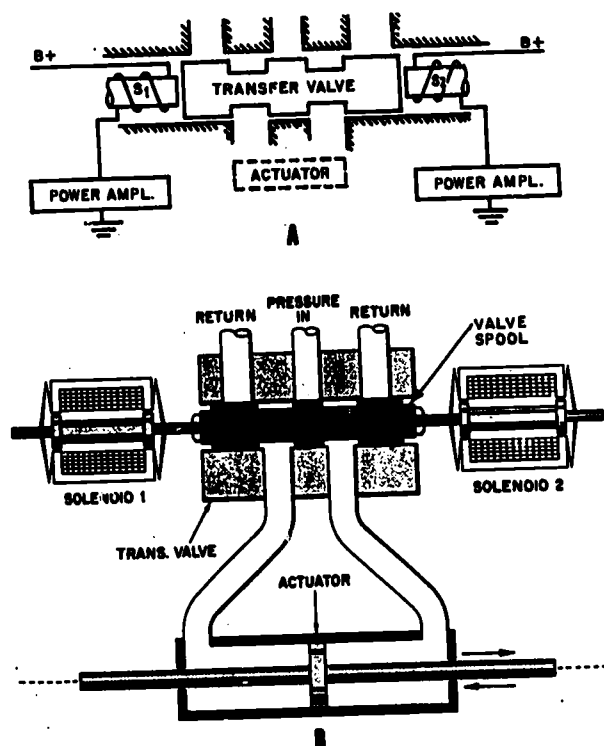

33.184

Figure 5-30.—Transfer valve: A. Closed position (schematic); B. Hydraulic transfer valve and actuator.

this control. With neither of the windings energized (or a balanced current flowing through both), the magnetic reed is centered as shown (fig. 5-31). In this condition, high pressure hydraulic fluid from the input line cannot pass to the actuator since the center land of the spool valve blocks the inlet port. The pressurized fluid flows through the alternate routes, through the two restrictors (fixed orifice), passes through the two nozzles, and returns to the sump without causing any movement of the actuator. If the right-hand solenoid is energized, the magnetic reed will move to the right, blocking off the flow of high pressure fluid through the right-hand nozzle. Pressure will build up in the right pressure chamber. This will move the valve to the left. In moving left, the center land will open the high pressure inlet and permit fluid flow directly to the right-hand side of the actuator. At the same time, the left-hand land of the spool will open the low pressure return line and permit flow to the sump from the left-hand side of the

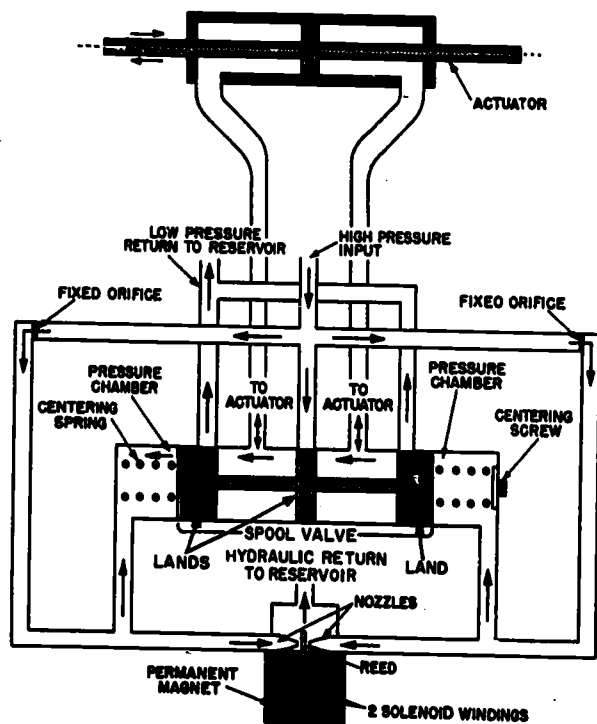
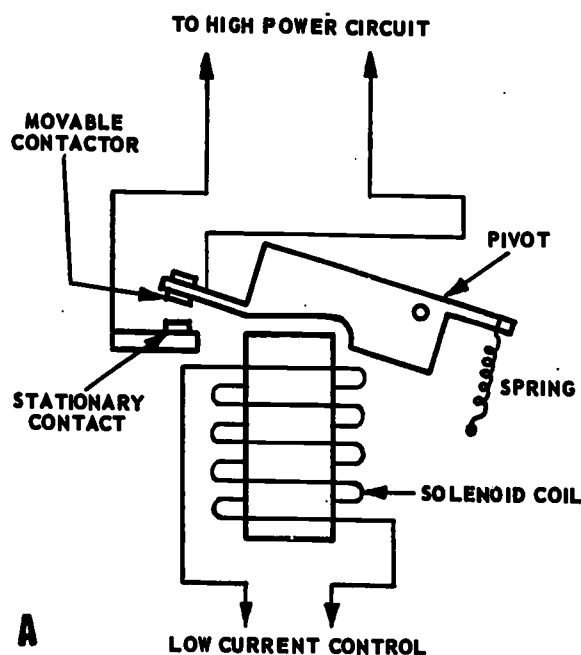

Figure 5-31.—Servovalve.

33.185



A

LOW CURRENT CONTROL

actuator. This process will cause actuator movement to the left. By energizing the left-hand solenoid, the reed will move to the left, and the entire process will be reversed, the actuator then being moved to the right. The actuator can be used to physically position a control surface.

Relays

Relays are used for remote control of heavy-current circuits. The relay coil may be designed to operate on very small signal values, such as the output of a sensor. The relay contacts can be designed to carry heavy currents.

Figure 5-32A shows a relay designed for controlling heavy load currents. When the coil is energized, the armature is pulled down against the core. This action pulls the moving contact against the stationary contact, and closes the high current circuit. The relay contacts will stay closed as long as the magnetic pull of the coil is strong enough to overcome the pull of the spring.

The relay just described has a fixed core. However, some relays resemble a solenoid in

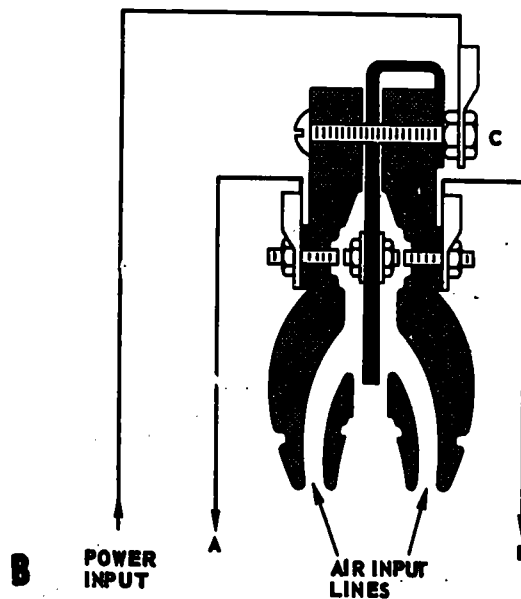

B

POWER INPUT

AIR INPUT LINES

144.32

Figure 5-32.—Some types of relays in missiles: A. Low current relay; B. Air-actuated relay.

PRINCIPLES OF GUIDED MISSILES AND NUCLEAR WEAPONS

that part of the core is a moveable plunger. The moving contacts are attached to the plunger, but are electrically insulated from it.

Figure 5-32B shows a form of relay that can be used in a pneumatic control system. Two air pressure lines are connected to the air input ports. The relay operates when its arm is displaced by air pressure. A modified design of this type relay might be used in a hydraulic-electric system, in which case the diaphragm would be moved by hydraulic fluid pressure.

Ampidyne

An ampidyne can be used as a combined amplifier and controller, since a small amount of power applied to its input terminals controls many times that amount of power at the output. Figure 5-33 shows an ampidyne arrangement.

The generator is driven continuously, at a constant speed, by the ampidyne drive motor. The generator has two control field windings that may be separately excited from an external source. When neither field winding is excited, there is no output from the generator, even though it is running. If follows that no voltage

is then applied to the armature of the load driving motor. (The field winding of the motor is constantly excited by a d-c voltage.) The ampidyne generator amplifies a low-power signal (error signal) into one strong enough to move a heavy load.

The control field windings of the generator are arranged so that the polarity of the excitation voltage from the sensor will determine the polarity of the generator output voltage. The generator output is connected to the load driving motor armature through the latter's commutator. Since the field of the motor is constantly excited by a fixed polarity, the polarity of the voltage applied to the armature will determine the direction of armature rotation.

Ampidynes have long been used in power drives for positioning guns and launchers, although none are used in current missiles.

ACTUATOR UNITS

The actuator unit is the device that converts the error detected by the sensor into mechanical motion to operate the appropriate control device that will correct the error or compensate for it.

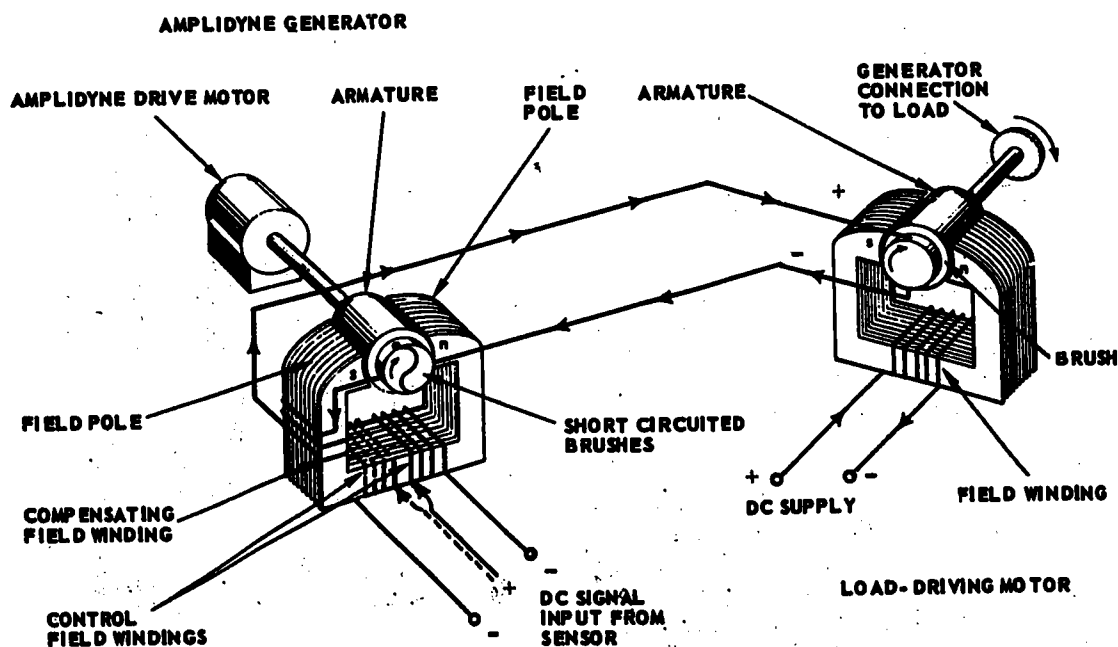

Figure 5-33.—Ampidyne controller.

Chapter 5—MISSILE CONTROL COMPONENTS AND SYSTEMS

The actuator must be able to respond rapidly, with a minimum time lag between detection of the error and movement of the flight control surfaces or other control device. At the same time, it must produce an output proportional to the error signal, and powerful enough to handle the load. Figure 5-30B shows a double-acting piston-type hydraulic actuator in which hydraulic fluid under pressure can be applied to either side of the piston. The piston is mechanically connected to the load.

PRINCIPAL TYPES

Actuating units use one or more of three energy transfer methods: hydraulic, pneumatic, or electrical. Each of these has certain advantages, as well as certain design problems, mentioned earlier in this chapter. Control devices make use of more than one method of energy transfer but are classified according to the major one used. Combinations are hydraulic-electric, and pneumatic-electric. Mechanical linkages are used to some extent by all of them.

HYDRAULIC ACTUATORS

Pascal's Law states that whenever a pressure is applied to a confined liquid, that pressure is transferred undiminished in all directions throughout the liquid, regardless of the shape of the confining system.

This principle has been used for years in such familiar applications as hydraulic door stops, hydraulic lifts at automobile service stations, hydraulic brakes, and automatic transmissions.

Generally, hydraulic transfer units are quite simple in design and construction. One advantage of a hydraulic system is that it eliminates complex gear, lever, and pulley arrangements. Also, the reaction time of a hydraulic system is relatively short, because there is little slack or lost motion. A hydraulic system does, however, have a slight efficiency loss due to friction.

Hydraulic-Electric Control Devices

The hydraulic-electric method of actuating movable control surfaces (or movable jets, nozzles or vanes) has been used more than any other type of system. As previously mentioned, the most important advantages of this type of system are the high speed of response and the

large forces available when using hydraulic actuators.

You have studied several of the components shown in the simplified block diagram of a hydraulic-electric controller (fig. 5-34). This system is comprised of (1) a RESERVOIR which contains the supply of hydraulic fluid, (2) a MOTOR and a PUMP to move the fluid through the system, (3) a RELIEF VALVE to prevent excessive pressures in the system, (4) an ACCUMULATOR which acts as an auxiliary storage space for fluid under pressure and as a damping mechanism which smooths out pressure surges within the system, and (5) a TRANSFER VALVE which controls the flow of fluid to the actuator.

Most of these components of the system have been covered in the preceding pages. The theory of hydraulic piston displacement is explained in Fluid Power, NavPers 16193-A and hydraulic pumps are also illustrated and explained. Pumps used in missile systems generally fall into two categories—gear and piston. They are usually driven by an electric motor within the missile.

RESERVOIR.—The reservoir is a storage compartment for hydraulic fluid. Fluid is removed from the reservoir by the pump, and forced through the hydraulic system under pump pressure. After the fluid has done its work, it is returned to the reservoir to be used again. The reservoir, called a sump, is actually an open tank because of the atmospheric pressure inlets.

VALVES.—The valves in the piston pump are of the flap type, which operate with very small changes in pressure. Another type of valve used

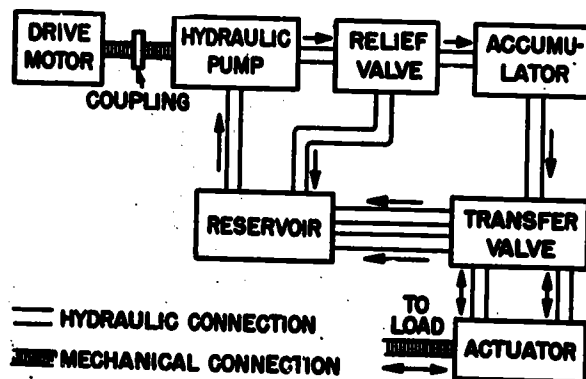

Figure 5-34.—Basic hydraulic controller.

33.182

PRINCIPLES OF GUIDED MISSILES AND NUCLEAR WEAPONS

in hydraulic systems is the pressure relief valve. As its name implies, it is used to prevent damage to the system by high pressures. Some combination systems used hydraulic pressure regulating switches instead of pressure relief valves.

A typical hydraulic relief valve consists of a metal housing with two ports. One port is connected to the hydraulic pressure line and the other to the reservoir return line. The valve consists of a metal ball seated in a restricted section of the pressure line. The ball is held in place by a spring, the tension of which is adjusted to the desired lifting pressure. This pressure is chosen so that it will be within the safe operating limits of the system.

Should the system pressure become greater than the spring pressure, the ball will be forced

away from the opening, and fluid will flow into the port that leads to the reservoir return line. Thus the pressure can never exceed a safe limit; and, since the fluid is returned to the reservoir, no fluid is lost.

These valves, and others, are described and illustrated in *Fluid Power*, NavPers 16193-A. Transfer valves were described earlier in this chapter.

ACCUMULATORS.—Accumulators are of three types as shown in figure 5-35. Part A of the figure shows the floating piston type, consisting of a metal cylinder which is separated into two parts by a floating piston. The upper part of the cylinder contains hydraulic fluid. Below the piston is an air chamber which is charged with compressed air. The accumulator shown in figure 5-35B is the diaphragm type

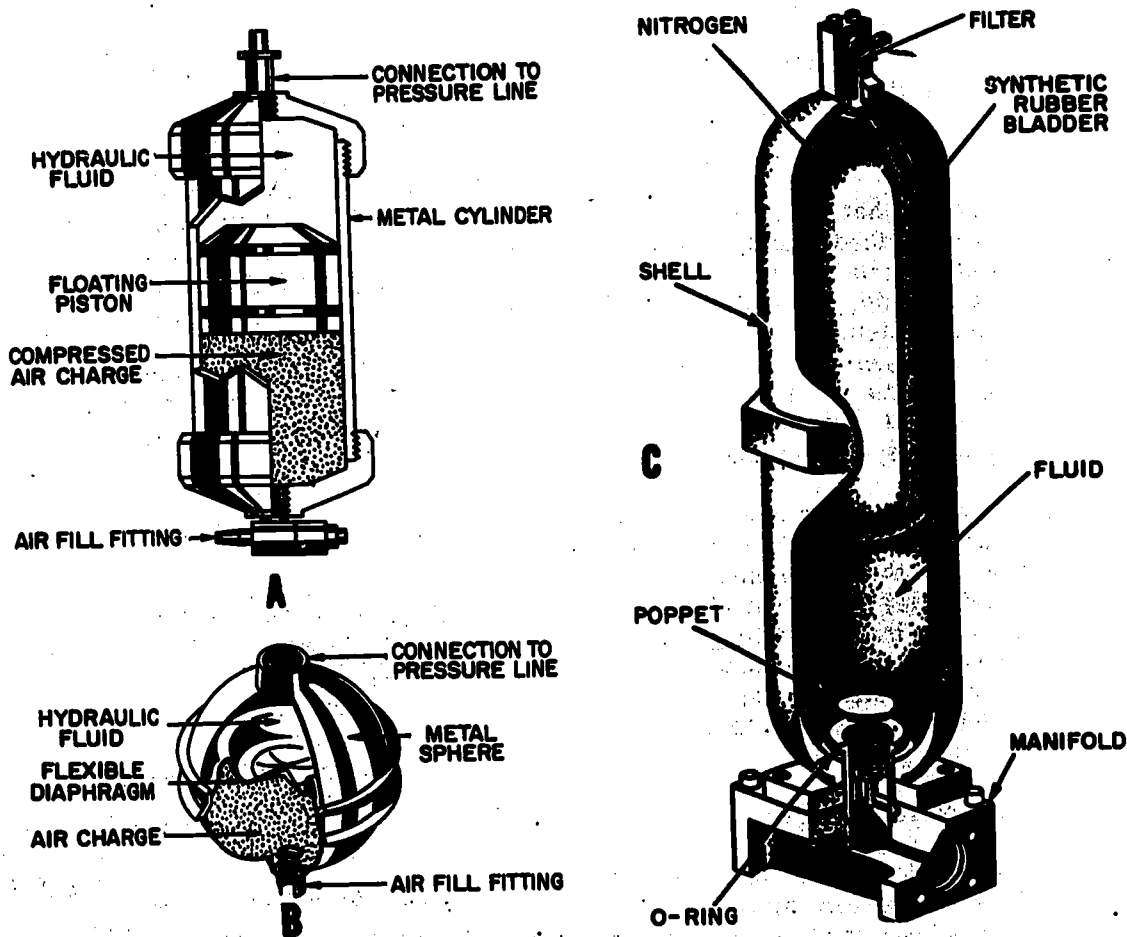

Figure 5-35.—Hydraulic accumulators: A. Floating piston type; B. Diaphragm type; C. Bag type, cutaway view.

Chapter 5—MISSILE CONTROL COMPONENTS AND SYSTEMS

which consists of two hemispherical sections separated by a flexible diaphragm. The upper chamber contains the hydraulic fluid and the lower chamber the compressed air charge.

Although the construction of the accumulators is somewhat different, they operate on the same principle. The air chamber is charged with compressed air to a pressure corresponding to the desired pressure, which is less than the line pressure of the hydraulic system. With the hydraulic line pressure higher than the air pressure hydraulic fluid will be forced back into the upper compartment. This fluid forces the diaphragm (or floating piston) down against the compressed air charge, increasing the pressure until a working pressure is reached. If the pressure output of the pump should drop suddenly, the compressed air charge would force the diaphragm or piston upward, thereby maintaining a constant pressure in the system. By building up air pressure in the accumulator, any pressure surges in the hydraulic system will be smoothed out, permitting a smooth operation of the load.

Air as the pressurizer is replaced with nitrogen for reasons of fire safety. The piston type of accumulator is being phased out.

The third type, illustrated in figure 5-35C, is the bag type. The outside of the bag type is a metal shell; the bag, of neoprene, is inside, and contains the nitrogen. The bladder will fill approximately three-fourths of the inside area of the cylinder when the hydraulic pump forces oil into the flask. A spring-loaded poppet valve at the bottom of the flask prevents the bladder expanding down into the manifold if there is no hydraulic fluid (or only a small amount) in the flask.

CONTROL SYSTEM INTERNAL FOLLOWUP.—The followup unit (a servomechanism) in a missile control system plays an important part in obtaining a smooth trajectory with minimum oscillation. There are two basic types of followup associated with missile control (fig. 5-27). The first is internal followup (also referred to as minor followup), and the second is external followup (sometimes called major followup). Internal followup involves devices installed to measure missile control surface position, and to relay this position information back to the missile computer network. External, or major, followup involves the sensing of missile attitude by the gyros.

The purpose of the internal followup loop (also called feedback loop) is to increase the speed at which a missile responds to an error

thus providing fine control. If missile attitude (external followup) were the only guide to correct the control surfaces, reaction would occur too late to provide fine control. In other words, the reaction would be too late because of aerodynamic lag. Suppose, for example, that a missile WITHOUT internal followup turns to the right due to a gust of wind. The free gyros would sense the amount of error and cause control surface deflection to bring the missile back to the left. The rate gyros would sense the rate of attitude deviation and relay this information to the missile computer network. To make proper use of the free and rate gyro information in providing control surface correction signals, the missile computer network must also be kept informed of the instantaneous control surface positions. Devices such as the pickoffs (also called followup or response generators) discussed in the chapter are commonly used to measure deflection of the control surfaces with respect to the missile airframe and to relay this information to the missile computer network. As a result, the correction signals from the computer network will provide smooth and fine control. There are various other types of control surface pickoff devices.

An electrical followup (feedback) system is shown in figure 5-36. In this system, the error signal is supplied to an electronic mixer where it is combined with the smaller signal from the response generator. The difference, or resultant, of these signals is fed through an amplifier and controller to the actuator section that operates the control surface. A portion of this signal is also fed to the response generator, so that the response signal is proportional to the flight surface deviation from the axis line.

It is also possible to use a mechanical followup. When this method is used, the followup mechanism may be a part of an air relay as shown in figure 5-37. The control surface position in relation to the missile axis is indicated by a force which is reflected to the controller by a spring.

To see how this system operates, assume that the signal from a pneumatic pickoff moves the air relay diaphragm up. The followup arm will then move clockwise. This movement causes the valve spool of the air valve to move upward. The valve action admits high-pressure air to the relay, and the pressure forces the piston of the pneumatic actuator to the left. When this happens, the followup spring is compressed and tends to turn the followup arm in a counterclockwise

PRINCIPLES OF GUIDED MISSILES AND NUCLEAR WEAPONS

direction. Since the followup force is in opposition to the original motion of the followup arm, we have the desired inverse feedback.

A large signal will create a larger flight control surface deflection before the feedback force becomes great enough to return the

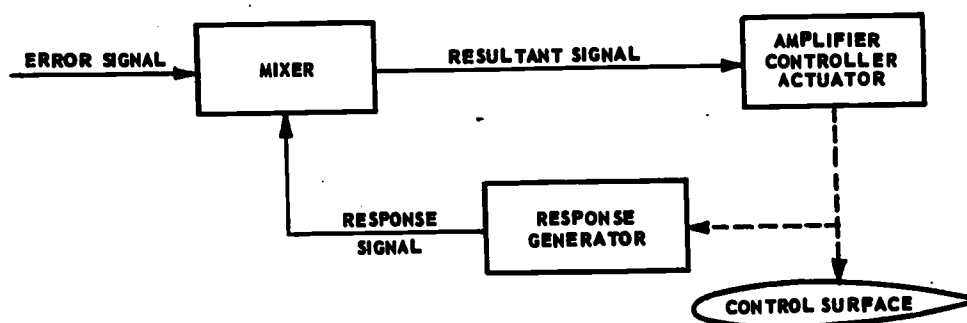

144.8

Figure 5-36.—Followup loop of missile control system.

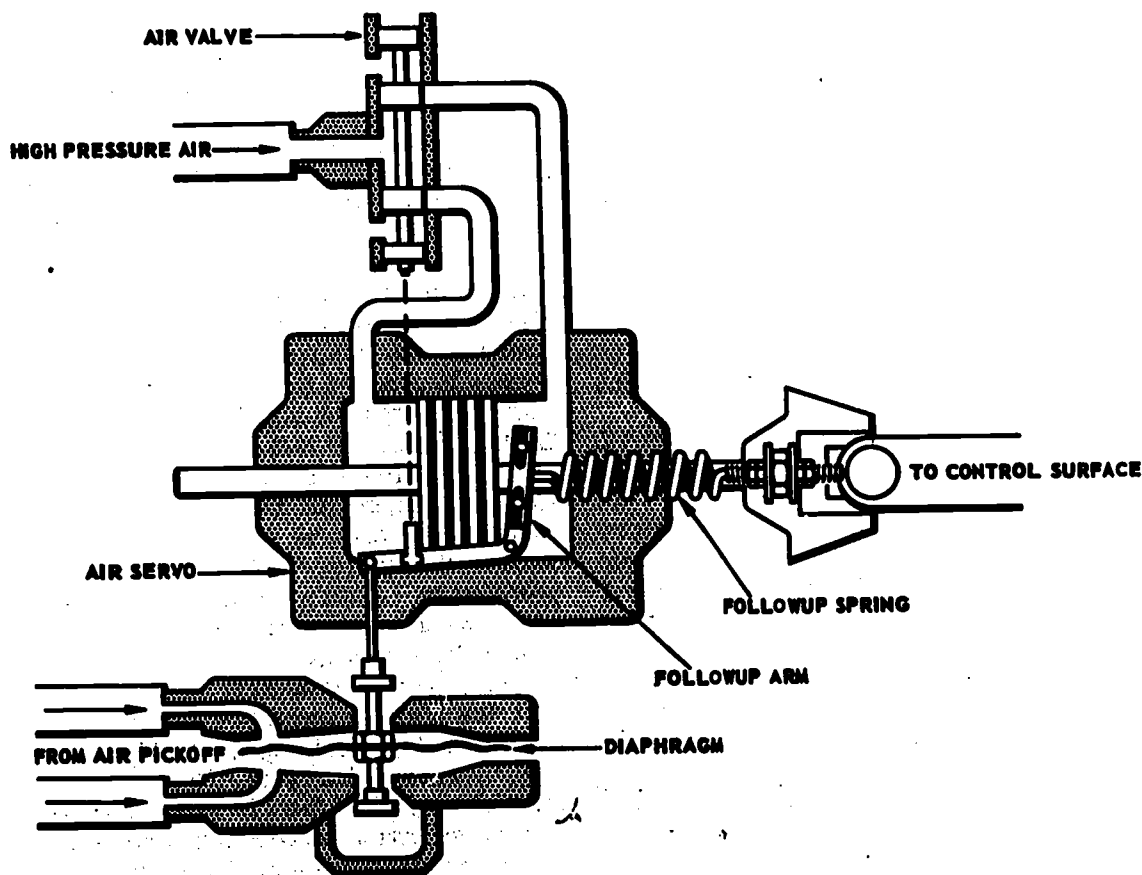

33.195

Figure 5-37.—Air relay with mechanical followup.

Chapter 5—MISSILE CONTROL COMPONENTS AND SYSTEMS

followup arm to zero. The spring will then push the followup arm and the air valve in the opposite direction, to move the flight control surface back. Therefore, the spring acts to limit flight surface deflection to a value determined by the error signal, and to return the flight control surface to a position parallel with the missile axis.

Hydraulic-Electric Control System

Figure 5-38 shows a simplified block diagram of a hydraulic-electric channel for roll control. Notice the similarity between this figure and the basic control system diagrams in figures 5-1 and 5-9. Since the pitch and yaw control systems are very nearly the same as the roll control system, there is little necessity to describe them in detail separately.

CHANNEL INTERCONNECTION.—Very often the roll, pitch, and yaw channels are interconnected either electrically or hydraulically. Figure 5-39 shows a possible method of electrically connecting the channels. Four movable jets are controlled by the system (fig. 5-2). In figure 5-39 the interconnection occurs just prior to the four servoamplifiers.

The electrical distribution occurs by means of the output of the three channel amplifiers. The amplifiers produce two outputs which are 180° out of phase. The pitch signal affects jets #4 and #2 by feeding into the respective servoamplifiers. Assuming that a signal of certain phase produces clockwise movement of all the jets, then the signal to jets #4 and #2 must receive signals of opposite phase for pitch control. The double-ended channel amplifiers

produce these required out-of-phase signals. The yaw signal also feeds into the other two servoamplifiers in the same manner. The roll signal feeds into the input of all four servoamplifiers, and affects the operation of all four jets. Rate control has also been included in the system, the rate signals being obtained from the rate gyros. The many synchros are used as pickoffs and mixers to combine information from the various sources shown in the figure.

Many followup paths exist in this system. In each case, actuator position information is fed to the input of the respective servoamplifier. This feeding produces jet movement which is proportional to the servoamplifier input. Also, actuator-position information is fed back to a certain two of the three channels (yaw, roll, or pitch). This is necessary because each actuator produces an effect on the missile in two axes. The roll channel has four followup signals, since each actuator affects the missile in roll. Thus, the combination of actuator followup signals to any channel produces a resultant signal which represents the true followup for that channel.

HYDRAULIC INTERCONNECTION.—The control channels may also be interconnected by hydraulic means. This involves a fairly complex system of hydraulic lines which link the actuators of the roll, pitch, and yaw channels. Since such systems require rather extensive hydraulic equipment, they are seldom used in modern missiles because of their excessive weight. All-electric systems will replace hydraulic systems in new missiles.

INTEGRATOR ACTION.—The purpose of an integrator in a hydraulic-electric system is to detect an error of a certain sense that has existed for a comparatively long period of time. This is done by producing an output which is not only proportional to the magnitude of error, but also to the length of time the error has existed. The integrator actually accumulates the error over a period of time. The signal thus generated is then mixed with the other error signals to cause complete correction of the error. Refer to explanation of integrator action earlier in this chapter.

Pneumatic Control Systems

Even though pneumatic control systems are not commonly used in missiles today, it will be helpful to look into this system before taking up the more widely used pneumatic-electric systems.

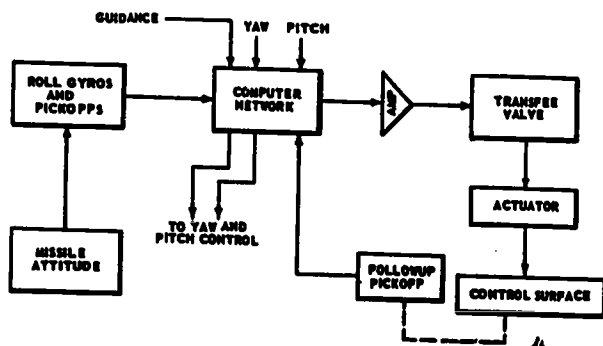
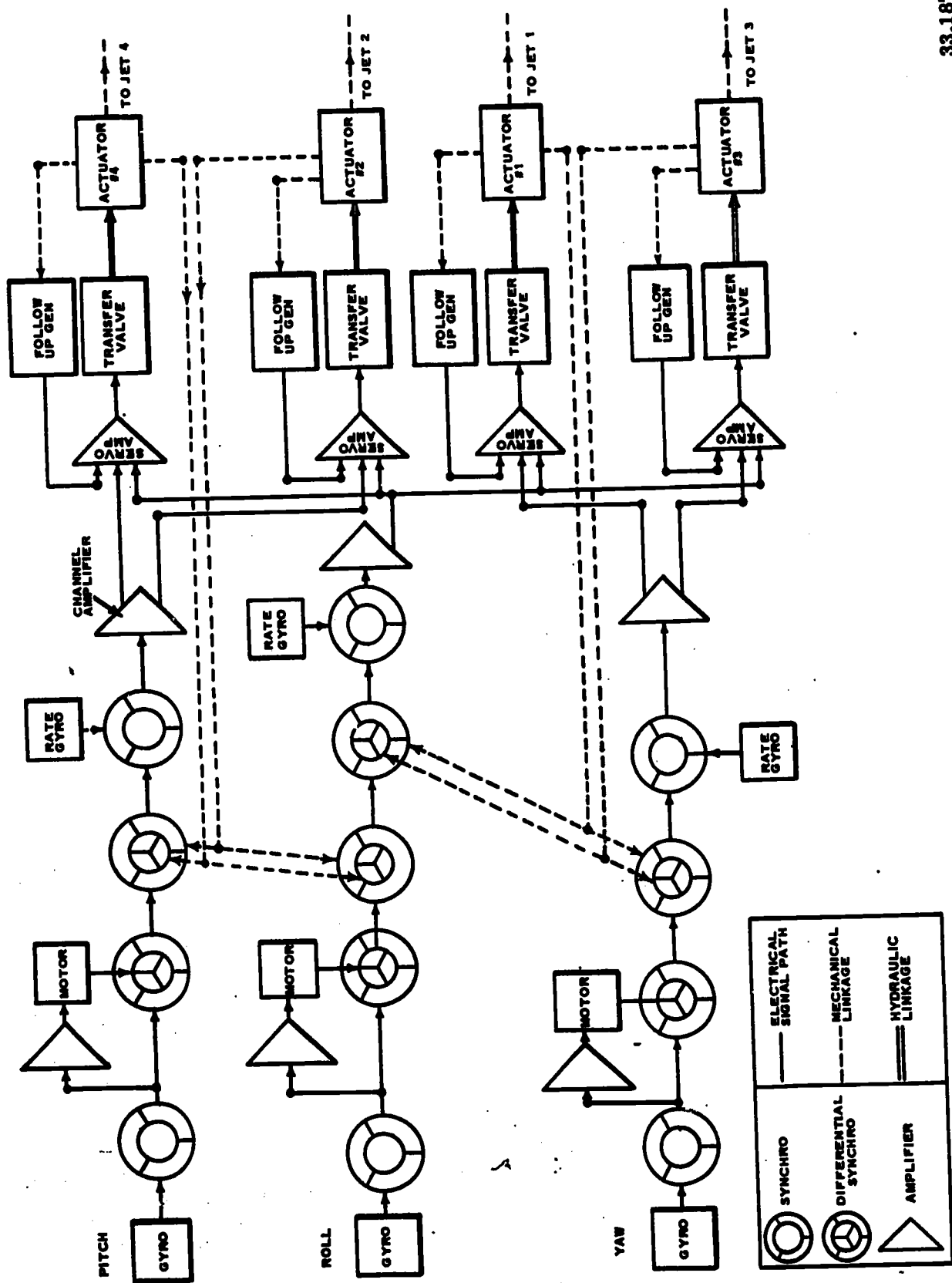

Figure 5-38.—Hydraulic-electric channel for roll control.

33.186



33.187

Figure 5-39.—Electrical interconnection of channels in hydraulic-electric control system.

Chapter 5—MISSILE CONTROL COMPONENTS AND SYSTEMS

The principal difference between a hydraulic system and a pneumatic system is the use of air rather than hydraulic fluid, as the working medium.

GENERAL OPERATION.—The pneumatic control system is almost entirely operated by compressed air.

The rotors of the gyros are powered by air. The gyro pickoffs are all air blocks; therefore, the control information is in the form of varying air pressures. The control surfaces are moved by air pistons. Air from a pressure tank passes through delivery tubes, valves, and pressure regulators to operate mechanical units. After the air has done its work, it is exhausted to the atmosphere. It cannot be returned to the tank for reuse. Consequently, air must be stored at a much higher pressure than is necessary for operating the loads in order to have enough pressure to operate the controls as the air supply in the tank diminishes.

Figure 5-40 shows one possible pneumatic system. Note that this system contains three gyros—one displacement (free) gyro and two rate gyros.

For simplicity of illustration, the figure shows conventional control surfaces. The basic principles outlined in the following paragraphs hold regardless of which control method is used.

Starting with the displacement gyro, the pitch and yaw errors are sensed by air-block pickoffs. Each signal is sent by means of varying air pressures to an air relay. The air relay acts like a combination amplifier and controller. The input to the relay is in the form of small charges of air pressure from the airblock pickoffs. The output of the relay is a pressure which is high enough to actuate an air piston. The two rate gyros also produce a pneumatic signal which joins with the free gyro signal of the respective channel. The addition of these signals in the proper ratio can be considered to be computer functions of this system.

The followup signal is actually a mechanical force exerted by a spring (fig. 5-40A). Both the diaphragm and spring exert force on the servovalve spool. Movement of the spool to either side of normal produces a varying force on the air relay valve. This action tends to return the servovalve spool to the normal or midposition to produce streamlined control surfaces.

The corrective signal to the servovalve spool must be somewhat dependent on the instantaneous position of the control surface. This position is indicated by the followup signal. Again, a com-

puter function is performed as spring-force information is combined in proper sense and ratio with air pressure information at the air relay.

YAW CONTROL.—At the yaw rate gyro, the rate signal appears as an unbalanced air pressure between two holes in an air-block pickoff. Now suppose the nose veers to the right. A displacement gyro signal develops at the pickoff (yaw control air jet). The yaw control air jet pivots to increase air pressure in the left hole of the pickoff (when facing the direction of flight). This air pressure is transported in the lower of the two air tubes to the diaphragm of the air relay. The diaphragm is forced to the left. This controls high pressure air which forces the actuator to the right. Mechanical linkage moves the rudder to the left, correcting a nose-right deviation.

Again consider the nose-right attitude. As the nose is moving right, an error signal is produced by the yaw rate gyro. By the law of gyro precession, the yaw rate gyro exerts more force on the right restraining spring because force on the gimbal precesses the gyro a small amount. As it precesses, more air is received by the left hole. This increases the pressure in the same tube that contains the high pressure signal from the displacement gyro. The rate gyro is SUPPORTING the error signal of the displacement gyro.

PITCH CONTROL.—In the missile under discussion, a pendulous device is used for pitch control. Figure 5-40B shows the relationship of the pendulous device, yaw torquer coils, pitch pickoff, and barometric altitude control. The diagram shows how the devices operate together.

When the missile deviates in pitch, more air is directed into one hole of the pitch pickoff block than the other. This pressure difference represents a pitch error signal which connects to an air relay. The air relay controls air pressure used to move the elevator.

Since the rotor of the gyro tends to maintain a constant plane of rotation in space due to gyro rigidity, the gimbal and gyro disc also maintain a constant angle since they move with the gyro. The disc is rigidly connected to the gimbal. The gyro cradle normally moves with the airframe. The pitch pickoff pivot and block are connected to the cradle and also move with the airframe. When the missile deviates in pitch, the cradle and pitch pickoff also deviate in pitch, but the gyro disc maintains the same position in space. The pitch arm pivots as it rides in the slotted

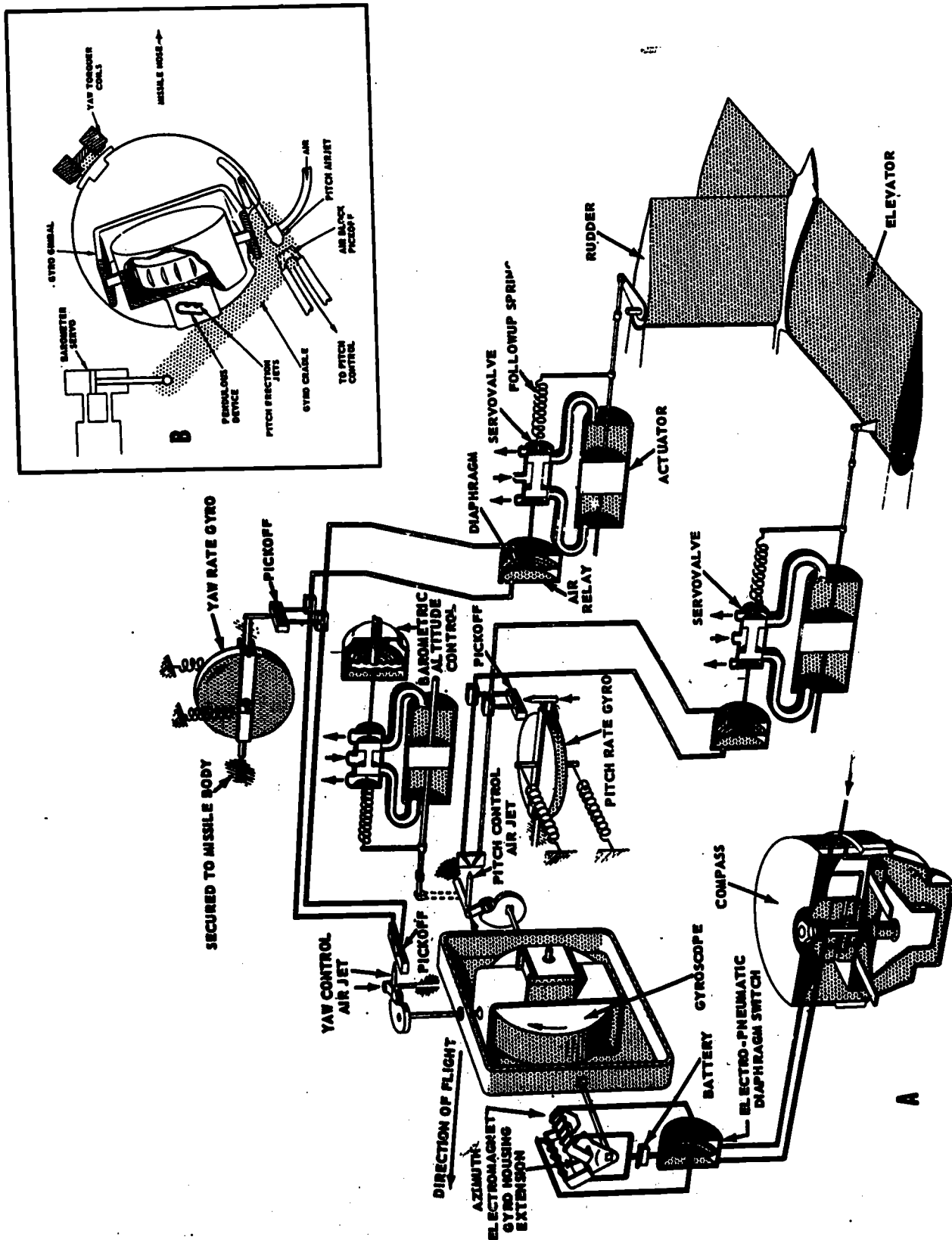

Figure 5-40.—A. Pneumatic control system; B. Detail of pitch control assembly.

Chapter 5—MISSILE CONTROL COMPONENTS AND SYSTEMS

disc and produces the pressure difference between the two holes of the pickoff block.

BAROMETRIC ALTITUDE CONTROL.—Pitch can also be controlled by a barometer servo. The servo (fig. 5-40B) is connected mechanically to the gyro cradle. The gyro cradle remains fixed with respect to the airframe unless the barometer servo should move it. When the barometer actuator moves, the position of the gyro cradle with respect to the missile frame changes by pivoting. Also, when the gyro cradle moves, the nozzle and block of the pitch pickoff move with it. Since the gimbal and disc remain stationary, the pitch pickoff arm pivots and produces a pitch signal. This, of course, also produces elevator movement and missile pitch reaction.

The stability of this missile in pitch is produced by the relation of the missile and the gyro. The initial climb angle and altitude of the trajectory are controlled by the barometer servo operating the gyro cradle.

Pneumatic-Electric Control Systems

Some missile control systems have been designed which use a combination of pneumatic and electrical apparatus. Such systems usually use electrical pickoffs, which are the most accurate and reliable. The pneumatic equipment is used to move the actuators.

The change from electric to pneumatic operation takes place at the air servovalve (fig. 5-40A). The air servomotor rotates the torque tubes which are connected to the control surfaces and extend into the center section of the missile. The deflection of the control surfaces is proportional to the input signal.

Electric Control Systems

An electric control system consists entirely of components powered by electricity. Thus, no pneumatic or hydraulic transfer system is necessary.

Except for the controller and actuator, the components used are similar to those used in the hydraulic-electric system.

ACTUATORS OF ELECTRONIC CONTROL SYSTEMS.—Electric motors are used for actuators in electric control systems. It is not practical to apply the torque of the motor directly to the control surface by using the motor shaft as the control-surface pivot. Such a motor would have to be very large to exert

enough torque to move the airfoils sufficiently. A large motor cannot be used because of its excessive weight.

A small motor running at high speed has the same power potential as a larger motor which runs at some lower speed. Therefore, a small motor is connected to the control surface through a reduction gear train. The mechanical advantage yielded by the gear train results in a large torque exerted on the control-surface pivot. The motor is either a constant speed motor, operating through a clutch, or a variable speed motor.

The high rotation speed of an electric motor introduces a major disadvantage to an electrical system. The inertia of an electric motor introduces a lag in the system which makes fine control difficult to achieve. If the lag is great enough, the system operates with insufficient sensitivity or with a tendency to oscillate.

VARIABLE SPEED ACTUATOR.—Figure 5-41 illustrates a variable speed motor used to move a control surface. A signal is sent to a motor which rotates in a given direction depending on the sense of the signal. The motor turns at a speed which is roughly proportional to the strength of the signal. Since the motor is coupled to the elevator through a reduction gear train, the elevator movement is proportional to the speed of the motor.

CONSTANT SPEED ACTUATOR.—The effects of inertia when starting and stopping a variable speed motor can be eliminated by using a drive motor which runs continuously and maintains uniform speed. In this case the motor is connected to the control surface through a clutch. The clutch varies the power transmission from the motor to the control surface. The use of two clutches and a gear differential would allow control in both directions.

Figure 5-42 shows a system output using clutches. The friction clutch discs make contact by means of a solenoid from the channel power amplifier. The amplifier needs to supply power only to operate the solenoids.

Mechanical Linkage

We have discussed the various control systems, but have not discussed in detail the mechanical means of linking the flight control surfaces to the actuator. In addition to providing a coupling means, the linkage may also be used to amplify either the force applied or the speed of movement.

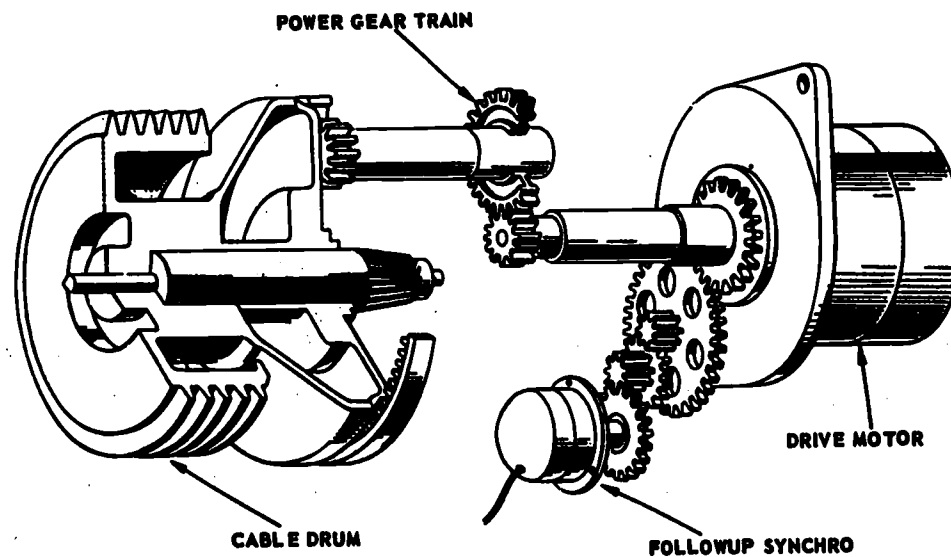

33.190

Figure 5-41.—Electric actuator (variable speed motor).

A mechanical linkage between an actuator and a load is shown in figure 5-43A. The distance d , on the drawing represents the distance from the control surface shaft to the point where the force is applied. The control surface moves because force exerted by the piston is applied at a distance from the axis of rotation, and thus produces a torque. Other mechanical linkages

may consist of an arrangement of gears, levers, or cables (fig. 5-43B).

A number of mechanical systems may be grouped together to form a combination system. This system uses levers, cables, pulleys, and a hydraulic actuator. However, a system using this kind of control is not suited for high speed missiles.

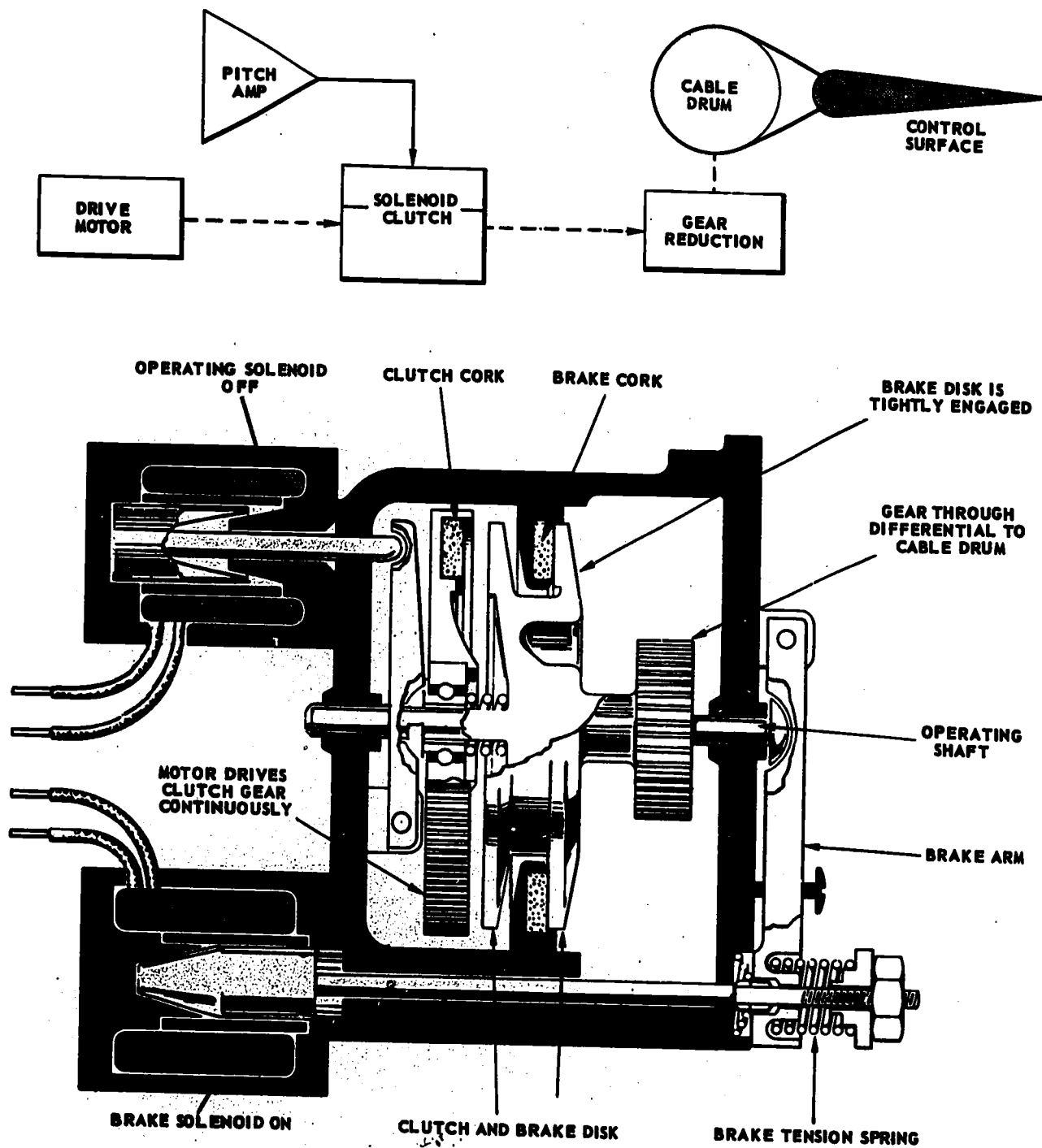
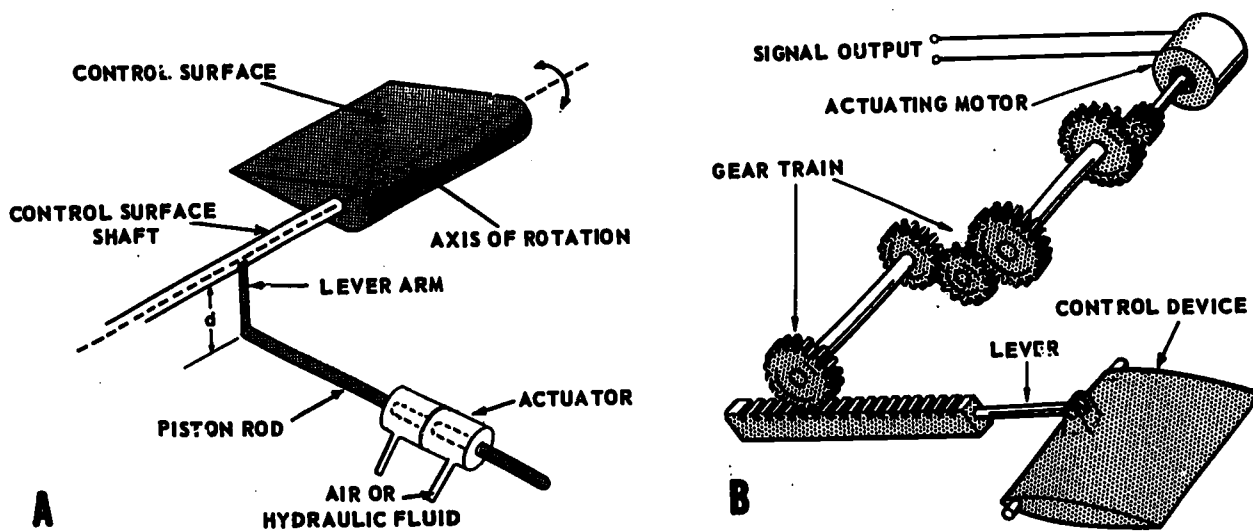

Figure 5-42.—Control system using constant speed actuator motor.

33.191

PRINCIPLES OF GUIDED MISSILES AND NUCLEAR WEAPONS



33.194

Figure 5-43.—Mechanical linkages: A. Actuator and load linked by lever arm; B. Gear train type of mechanical linkage.

CHAPTER 6

PRINCIPLES OF MISSILE GUIDANCE

INTRODUCTION

Preceding chapters have discussed missile airframe and control surfaces, propulsion systems, warheads, and control systems. Chapter 5 defined guidance and control, and set up an arbitrary division of functions and components of those two systems. This chapter shows the basic functional components of guidance systems. Some of them are in the missile and some are aboard the launching ship.

There are several methods of providing guided missiles with the guidance signals necessary to bring about a collision with a target, but two broad categories can include all of them. The first category includes those guided missiles that maintain electromagnetic radiation contact with manmade devices outside of the missile proper (devices on the ship or ground station). Examples of these devices include radar transmitters, radio transmitters, and the target itself. The second category includes those guided missiles which do not maintain electromagnetic radiation contact with manmade devices. In this category are missiles which rely on either electromechanical guidance devices or electromagnetic radiation contact with natural sources. The preset and inertially guided missiles rely primarily on electromechanical devices within the missile. The celestial and terrestrial guided missiles rely primarily on electromagnetic radiation contact with natural sources.

Modern guidance systems are far advanced. Progress in electronic and allied equipments is rapid. The basic principles stay the same, though the "hardware" may change tremendously, such as the change from vacuum tubes to transistors. This chapter and the following ones explain principles of different guidance systems.

DEFINITIONS

A distinction was made in chapter 1 between missiles and guided missiles. They may also be called controlled missiles and uncontrolled missiles. Uncontrolled missiles follow a ballistic trajectory which is determined by their initial velocity, initial attitude, and the forces of nature present (gravity, wind, and air resistance). Arrows, bullets, artillery projectiles, and bombs are examples of missiles that follow a purely ballistic trajectory after release. Missiles which are propelled by reaction propulsion systems and which are without control guidance after flight, such as free (unguided) rockets, follow ballistic paths after engine cutoff.

A missile whose flight path is controlled after launching is considered to be guided. Internal equipment may sense deviation from the prescribed path and operate to correct it, or the missile may be commanded from an external source to make certain changes in its flight path. Many missiles use a combination of guided and unguided phases of flight.

PURPOSE AND FUNCTION

The purpose of a guidance system is to control the path of the missile while it is in flight. This makes it possible for personnel at ground or mobile launching sites to hit a desired target, regardless of whether that target is fixed or moving, and regardless of whether or not it takes deliberate evasive action. The guidance function may be based on information provided by sources inside the missile, or on information sent from fixed or mobile control points, or both.

Every missile guidance system consists of an attitude control system and a path control system. The attitude control system functions to maintain the missile in the desired attitude

PRINCIPLES OF GUIDED MISSILES AND NUCLEAR WEAPONS

on the ordered flight path by controlling the missile in pitch, roll, and yaw. The attitude control system operates as an autopilot, damping out fluctuations that tend to deflect the missile from its ordered flight path. The function of the path control system is to determine the flight path necessary for target interception and to generate the orders to the attitude control system to maintain that path.

Thus, the missile guidance system is essentially a weapon control system, inherently associated with the weapon direction phase. Although guidance and control systems have distinct functions, they must operate together. The guidance system detects and tracks the target, determines the desired course to the target, and produces the electrical steering signals that indicate the position of the missile with respect to the required path; the control system responds to the signals to keep the missile on course.

BASIC PRINCIPLES

The guidance system in a missile can be compared to the human pilot of an airplane. As a pilot guides his plane to the landing field, the guidance system guides the missile to the target. Using an optical device, the guidance system "sees" the target. If the target is far away or otherwise obscured, radio or radar beams can be used to locate it and direct the missile to it. Heat, light, television, the earth's magnetic field, and loran have all been found suitable for specific guidance purposes. When an electromagnetic source is used to guide the missile, an antenna and a receiver are installed in the missile to form what is known as a sensor. The sensor section picks up, or senses, the guidance instructions. Missiles that are guided by other than electromagnetic means use other types of sensors.

The operation of the guidance and control system is based on the closed-loop or servo principle. The control units make corrective adjustments of the missile control surfaces when a guidance error is present. The control units will also adjust the control surfaces to stabilize the missile in roll, pitch, and yaw. Guidance and stabilization are two separate processes although they occur simultaneously.

PHASES OF GUIDANCE

Missile guidance is generally divided into three phases—boost, midcourse, and terminal.

These names refer to different parts of the flight path. The boost phase may also be called the launching or initial phase.

INITIAL (BOOST) PHASE

Navy surface-to-air missiles are boosted to flight speed by means of the booster component. This boosted period lasts from the time the missile leaves the launcher until the booster burns up its fuel. In missiles with separate boosters, the booster drops away from the missile (fig. 6-1) at burnout. Discarding the burnt out booster shell reduces the weight carried by the missile and enables the missile to travel farther.

The problems of the initial phase and the methods of solving them vary for different missiles and their means of projection. However, the basic purposes are the same. The boost phase must get the missile off to a good start or it will not hit the target. The launcher, holding the missile, is aimed in a specific direction on orders from the fire control computer. This establishes the line of sight (trajectory or flight path) along which the missile must fly during the boosted portion of its flight. At the end of the boost period the missile must be at the calculated point.

There are several reasons why the boost phase is important. If the missile is a homing missile, it must "look" in the predetermined direction toward the target. The fire control computer (on the ship, or plane, or ground station) calculates this predicted target position on the basis of where the missile should be at the end of the boost period. Before launch, this information is fed into the missile.

When a beam-riding missile reaches the end of its boosted period, it must be in a position where it can be captured by the radar guidance beam. If the missile does not fly along the prescribed launching trajectory as accurately as possible, it will not be in position to be captured by the radar guidance beam to continue its flight to the target. The boost phase guidance system keeps the missile heading exactly as it was at launch.

During the boost phase, in some missiles (fig. 6-1), the missile's guidance system and the aerodynamic surfaces are locked in position. Some missiles (for example, Talos) are guided during the boost phase.

Chapter 6—PRINCIPLES OF MISSILE GUIDANCE

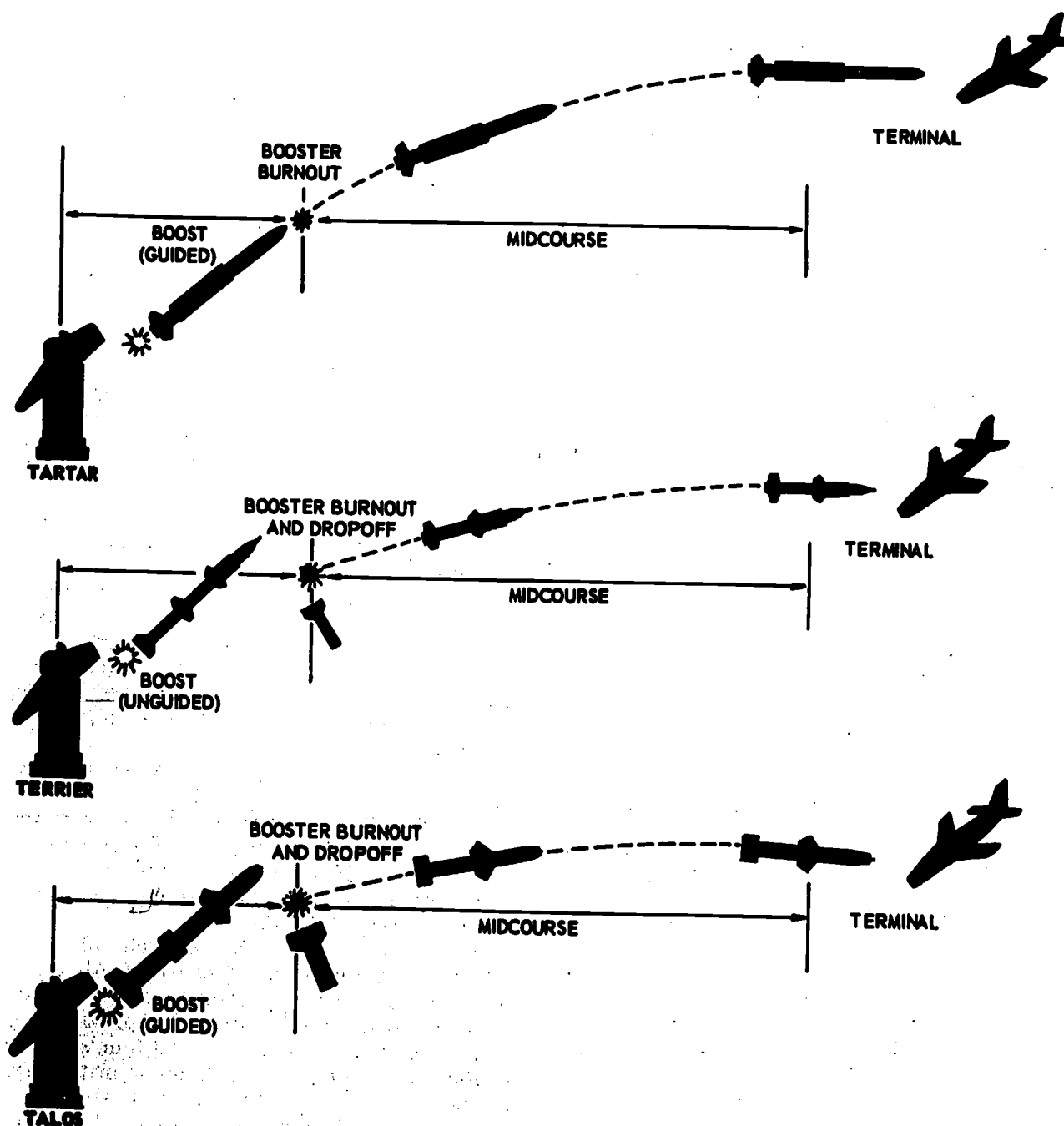

Figure 6-1.—Guidance phases of missile flight.

83.18

MIDCOURSE PHASE

The second, or midcourse phase of guidance is often the longest in both distance and

time. During this part of the flight, changes may be required to bring the missile onto the desired course, and to make certain that it stays on that course. During this guidance

PRINCIPLES OF GUIDED MISSILES AND NUCLEAR WEAPONS

phase, information can be supplied to the missile by any of several means. In most cases, the midcourse guidance system is used to place the missile near the target, where the system to be used in the final phase of guidance can take over. But, in some cases, the midcourse guidance system is used for both the second and third guidance phases.

TERMINAL PHASE

The terminal phase is of great importance because it can mean a hit or a miss. The last phase of missile guidance must have high accuracy as well as fast response to guidance signals.

Near the end of the flight, the missile may lack the power necessary to make the sharp turns that are required to overtake and score a hit on a fast-moving target. In order to decrease the possibility of misses, special systems are used. These systems will be described in the following chapters.

In some missiles, especially short-range missiles, a single guidance system may be used for all three phases of guidance. Other missiles may have a different guidance system for each phase.

COMPONENTS OF GUIDANCE SYSTEMS

The units of the guidance system may be located in the missile (active and passive homing, inertial), or they may be distributed between the ship and the missile (beam-riding and semiactive homing).

GENERAL REQUIREMENTS

A missile guidance system involves a means of determining the position of the missile in relation to known points. The system may obtain the required information from the missile itself; it may use information transmitted from the launching station or other control point; or it may obtain information from the target itself. The guidance system must be stable, accurate, and reliable.

In order to achieve these basic requirements, the guidance system must contain components that will pick up guidance information from some source, convert the information

into usable form, and activate a control sequence that will move the flight control surfaces (or other control forms) on the missile. It is difficult to separate the control and guidance operations. However, the flight control section is concerned with flight stability. Missile accuracy is primarily a function of the guidance section. Missile reliability depends on both sections. We will list the components and briefly describe the basic function of each before going into the individual types of guidance systems. The components of the control system were described in chapter 5.

SENSORS

In some respects, the sensor unit is the most important section of the guidance system because it detects the form of energy being used to guide the missile. If the sensor unit fails, there can be no guidance.

The kind of sensor that is used will be determined by such factors as maximum operating range, operating conditions, the kind of information needed, the accuracy required, viewing angle and weight and size of the sensor, and the type of target and its speed.

Sensors used in the control system were described in chapter 5, and included gyros, pickoff systems, altimeters, and air-speed transducers.

Guidance sensors depend on some form of electromagnetic radiation, which includes the entire range of propagation by electric and magnetic fields. The range includes gamma rays, X-rays, ultraviolet rays, infrared rays, radar, and radio rays. Missiles use light, infrared, radar, and radio rays.

All radiations may be considered as a method of transmission of energy. All electromagnetic radiations propagate through space at the speed of light, which is approximately 3×10^{10} centimeters per second (cm/sec), or 186,300 miles per second. In other materials, such as glass or water, the speed is less.

By including devices within a guided missile that can detect the presence of electromagnetic radiations, several different types of guidance methods have been developed. The devices in the missile that detect the electromagnetic radiations come under the general heading of sensors. Following are brief descriptions of several types of such sensors. The advantages and disadvantages of each will be covered in

Chapter 6—PRINCIPLES OF MISSILE GUIDANCE

the discussions of the guidance system in which each is used, although some will be mentioned here.

Light-Sensitive Sensors

At about the end of the 19th century, Hertz discovered that electrons were ejected from certain metallic surfaces when these surfaces were exposed to light. From this discovery emerged the photoelectric cell. The photoelectric cell shown in figure 6-2 represents a practical light sensor for missile guidance. The cell is composed of a light-sensitive cathode and an anode. These two elements are covered with a clear glass bulb. The unit is about the size of the average radio tube. As light waves impinge on the surface of the cathode, the cathode emits electrons. These electrons are collected on the anode, resulting in a current flow through the circuit. By installing appropriate pickoffs which detect the direction of a light source, a missile may be made to home (or guide) itself toward a light-emitting target, such as a factory, city, aircraft, or enemy ship. Modern photoelectric cells are quite sensitive to light variations, but, because light is easily interrupted, the system is subject to interference.

Another device which may be thought of as a light sensor is a television camera. Installation of a television camera and transmitter in a missile provides a means of guidance based on a continuous picture of the target which is relayed to a remote control point.

There are several very serious disadvantages associated with the light-seeking sensor

devices. The first and most important is that the target must be optically visible. If the target is obscured by clouds, rain, snow, etc., the light-seeking sensors will be ineffective. The fact that light sensors cannot discriminate between light sources with any degree of certainty is also a handicap. A disadvantage of television as a guidance device is the fact that television is technically complicated. Furthermore, television equipment places large space and weight requirements on a missile. Another serious disadvantage of the light-seeking sensors is that they can be jammed with relative ease. For example, if the lights in the target (ship, plane) were turned off, the missile would be unable to reach the target. In view of these disadvantages, light-seeking sensors are not presently used in guided missiles which depend on the target for a source of light. They are used in the celestial guidance method, however, which will be discussed later.

Infrared (Heat) Sensors

The infrared portion of the electromagnetic spectrum offers another means of missile guidance. All objects on earth radiate some heat energy in the form of electromagnetic waves. Devices which can sense this radiated heat energy are installed in some guided missiles to enable them to home on targets which radiate significant amounts of heat.

Actually, the principle involved is not unlike that of the photoelectric cell just described. The invisible infrared radiation causes certain substances to produce an electron flow in the same manner as does visible light. By carefully controlling the sensitivity of infrared seekers (sensors) they may be used very successfully in missile guidance. Control of sensitivity is extremely important since the heat-seeking missile must be able to discriminate between the target and background sources of heat radiation.

Heat, or infrared sensors use an active element called a THERMOCOUPLE, or an element known as a BOLOMETER. Either sensor may be used with a lens and reflector system.

Missiles which depend on detection of infrared radiations are very suitable for use against air targets. The propulsion systems of missiles and conventional aircraft radiate tremendous amounts of heat in comparison with background radiation. The fact that these sources of heat radiation cannot be turned off

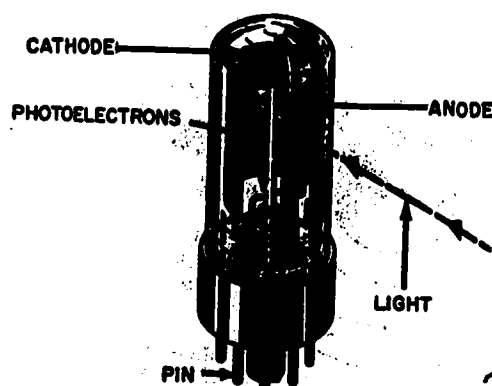

Figure 6-2.—A photoelectric cell.

33.89

PRINCIPLES OF GUIDED MISSILES AND NUCLEAR WEAPONS

gives infrared guidance a distinct advantage over the visible light sensors. In addition to use against air targets (fig. 6-3), the infrared method is adaptable to effective use against industrial areas and military installations. In the latter application, however, it is possible to decoy a heat-seeking missile by starting fires at some distance from the target.

Radio Sensors

Although radio receivers are not commonly thought of as sensors, they actually perform the same basic function as any sensor—that is, they serve as energy detectors. Radio provided the first method of controlling model aircraft and target drones. A radio-controlled model airplane was first flown successfully in 1935. The principle of controlling a missile or aircraft in flight by radio is very easy to understand. By installing a radio receiver in the missile and a radio transmitter at a remote control point, we have established the necessary electromagnetic link between the control point and the missile. By observing the missile's flight either optically or by radar, the control point determines what changes are desired in the missile flight path. The transmitter is then keyed in a manner representative of the desired change. The signal travels to the receiver in the missile and is subsequently converted into control surface movement. Although commonly used in control of drone aircraft, radio control is little used in present day guided missiles due to the advantages of radar in high speed missile guidance.

Radar Sensors

Shortly after World War II began, a detection system known as RADAR (Radio Detection And Ranging), was developed. It was used with great success in piloting and target detection during and after World War II, and more recently has come to provide one of the most important means of missile guidance.

As will be shown later, certain missiles are guided on the basis of radar energy transmitted from control points and detected by receivers within the missile. Other types of missiles detect reflected radar energy from a target, and use this energy as a basis for generating guidance (steering) signals.

Acoustic Sensors

Listening as a means of target detection is used chiefly by submarines. Surface ships at high speed produce considerable noise. This interferes with their detection of the sounds made by other ships, especially the low frequency sounds of submarines. On the other hand, this difference in noise output enables a submarine to detect a surface ship rather easily.

Acoustics or sound detection systems were used in earlier days for the detection and tracking of aircraft. These systems used large horn microphones, manually operated, to detect approaching aircraft. Other devices, called hydrophones, have been used by the Navy to determine the presence and position of submarines and ships. A hydrophone is a

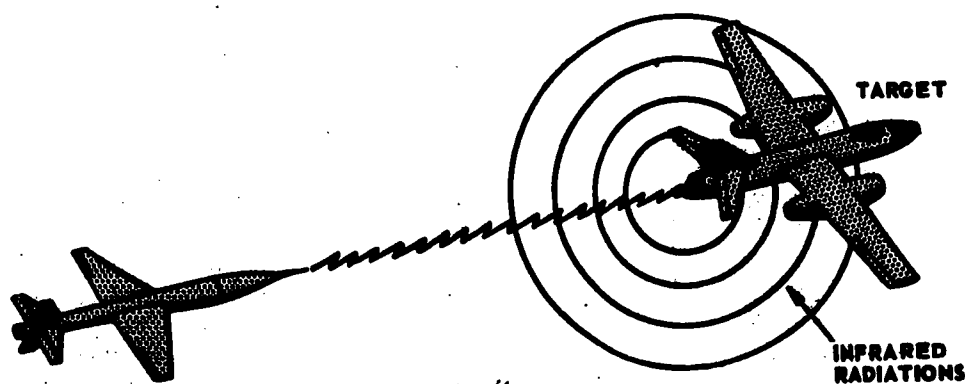

Figure 6-3.—Missile using infrared homing method against air target.

Chapter 6—PRINCIPLES OF MISSILE GUIDANCE

microphone that works underwater, sensing vibrations given off by underwater targets.

REFERENCE UNITS

The preceding chapter discussed reference units used in the control system of the missile. A quick review follows.

The signals picked up by the sensor must be compared with known physical references such as voltage, time, space, gravity, the earth's magnetic field, barometric pressure, and the position of the missile frame. The sensor signal and the reference signal are compared by a computer, which will generate an error signal if a course correction is necessary. The error signal then operates the missile control system.

Gyroscopes are used for space reference. A reference plan is established in space, and the gyro senses any change from that reference.

The earth's gravity can be used as a reference; a pendulum can sense the direction of the gravitational force. Some gyros are arranged for vertical reference by a pendulous pickoff and erection system. Gyros used in this manner are called vertical gyros; they may be used to control the pitch and roll of the missile.

An instrument called a FLUX VALVE has the ability to sense the earth's magnetic field, and can be used for guidance. The primary purpose of this device is to keep a directional gyro on a given magnetic heading. A gyro operated in this manner may be used to govern the yaw controls of a missile.

Barometric pressure can be used to determine altitude. A guided missile that is set to travel at a predetermined altitude may use an altimeter to sense barometric pressure. Should the missile deviate from the desired altitude, an error signal will be generated and fed to the control section.

Another pressure type sensor is used to determine airspeed. It compares static barometric air pressure with ram air pressure. The difference between these two pressures provides an air speed indication.

The axis of the missile frame is used as a reference to measure the displacement of the missile control surfaces. (The movement of the control surfaces cannot be referenced to the vertical, or to a given heading, because the reference would change when the missile position changes.)

Selsyns (synchro pickoffs) may be used to indicate the angular position of the flight control surfaces with respect to the missile axis. It is also possible to use potentiometers (variable resistors) for this purpose. When this method is used, the potentiometer is fastened to the missile frame and the potentiometer wiper-arm shaft is moved by the control surface.

AMPLIFIERS

The subject of amplifiers was introduced in the preceding chapter. There are many variations in each of the three types of amplifiers named—vacuum tube, transistor, and magnetic.

Vacuum-Tube Amplifiers

Vacuum-tube amplifiers may be classified according to the method of coupling used—resistance-coupled (RC), impedance-, transformer-, or direct-coupled. They may be tuned, untuned, broad-band, or narrow-band amplifiers. Tube type amplifiers may use triodes, tetrodes, pentodes, or beam power tubes. According to their application, they may be audio-frequency (a-f), radio-frequency (r-f), or intermediate-frequency (i-f) amplifiers. Radar receivers commonly use 30 mc to 60 mc i-f amplifiers. A discussion of electron tube theory may be found in Basic Electronics, NavPers 10087-A.

Vacuum tube amplifiers are often used as voltage amplifiers. Many missile applications require an amplifier whose output is not only greater than the input, but also proportional to the input. Suppose the input is 1 volt and the output 15 volts. Then, if the input is 3 volts the output must be 45 volts. Most electronic amplifiers are based on vacuum tubes.

In any vacuum-tube amplifier circuit, the fundamental operation is the use of grid voltage to control the flow of plate current. The plate-current change is utilized in various ways, giving rise to several standard classifications of voltage amplifiers. One type is a resistance-coupled circuit. With the proper choice of circuit components, the voltage on the second grid can be many times that impressed on the first grid. Pentode tubes are normally used for resistance-coupled amplifiers because of their higher gain.

PRINCIPLES OF GUIDED MISSILES AND NUCLEAR WEAPONS

Another type of amplifier is transformer-coupled, and uses the current change in the plate circuit. Because they give wider frequency range with transformers than other types of tubes, triodes are normally used for such circuits.

A third type of amplifier, rarely used, is impedance coupled; its output voltage appears across a choke or impedance coil.

In many applications it is necessary to get power from an amplifier, so at least the final stage is adjusted to give power rather than a voltage output. The tubes used are somewhat larger as a rule than those of voltage circuits, and are specially designed for large current outputs.

Transistors

The advent of the transistor in the field of electronics has as much significance and importance as the development of the vacuum tube in the early days of radio. The transistor proves that amplification, accomplished before mainly by vacuum tubes, can take place in a solid. This device has opened a new field of experiment and study in "solid-state" physics.

Two scientists, John Bardeen and W. H. Bratten, working under William Shockley of Bell Telephone Laboratories, developed the transistor (point-contact type) in 1948. Later (1949), Bell Telephone Laboratories announced that William Shockley had developed a junction transistor. Since then, transistors have been developed into practical and dependable electronic devices and the field of electronics has rapidly expanded the use of these "solid-state" devices.

The term transistor is coined from "TRANSFER" and "RESISTOR." Transistors are lighter, smaller, longer lived, more rugged, more efficient, and potentially less costly than most vacuum tubes. Furthermore, they require no filament power, they draw comparatively small currents in operation, and they generate negligible amounts of heat. Another advantage is that the transistor is ready to operate instantly at the application of operating voltage because the transistor does not require preheating, and consumes no standby power.

Because the transistor is a solid, it can withstand the force of acceleration and deceleration many times that of the force of gravity.

Many new circuit ideas have been developed from the use of the transistor, but its full

capabilities are not yet realized. At the present time there are many types of transistors in use, and many more are being developed.

Some of the transistors that are in use are the point contact, junction, drift, tetrode, uni-junction dynistor, and surface barrier. Each has its own unique characteristics, advantages, and areas of application. The junction transistor is the most commonly used.

A serious problem with transistors is that of unreliability at high temperatures. The use of feedback circuits tends to stabilize the collector current with respect to temperature. Also, they are ineffective at the extremely high frequencies present in many vacuum tube circuits. However, this problem has been largely overcome in transistor applications in missiles. Some modern missiles are completely transistorized.

The operation of transistor depends upon the electrical properties of a class of substances known as semiconductors. A semiconductor is a solid material that has greater conductivity than an insulator and less conductivity than a conductor. Some semiconductors are compounds, such as copper oxide, zinc oxide, indium antimonide, gallium arsenide, and silicon carbide, while other semiconductors are elements, such as germanium and silicon. The most common semiconductors in use at present for transistors are germanium and silicon to which certain impurities have been added, in minute quantities of specific materials.

Transistors are generally connected in one of three basic circuits. These configurations are: common-base amplifier, common-emitter amplifier, and common-collector amplifier. The term "grounded" is sometimes used instead of the term "common" but the element said to be grounded is really common to both the input and output circuits and is not necessarily grounded. The common-collector circuit is rarely used.

Transistors may be combined with sources of power and passive elements (resistors, inductors, and capacitors) to form transistor circuits of many forms which are used for generation, amplification, shaping, and control of electrical signals. Many transistor circuits are similar to vacuum tube arrangements, but much more is involved than merely replacing the electron tube with a transistor.

For information on atomic structure and valence bonds in transistor materials, types and combinations of materials, operations of circuits, uses of transistors as audio amplifiers,

Chapter 6—PRINCIPLES OF MISSILE GUIDANCE

cascade amplifiers, diodes, triodes, and oscillators, see Basic Electronics, NavPers 10087-A. For a less comprehensive coverage, see Introduction to Electronics, NavPers 10084; it describes the principles of operation of transistors.

Magnetic Amplifiers

Magnetic amplifiers are not new devices by any means, having been reported in use over fifty years ago. A magnetic amplifier is essentially a device which controls the a-c reactance of a coil by utilizing a d-c signal to modify the permeability of the magnetic material upon which the coil is wound.

In the early stages of development this basic idea was incorporated into devices, usually designated as saturable reactors, and used to control large electrical loads such as theatrical lighting and electric furnaces. However, the use of the SATURABLE REACTOR, the heart of the magnetic amplifier, was limited in its ability to control the load until the recent development of improved magnetic materials and efficient metallic rectifiers. The utilization of these improved materials resulted in the use of the saturable reactor in more elaborate circuits and led to the distinguishing term MAGNETIC amplifier.

Many different trade name devices, such as self-saturating magnetic amplifiers, Magamps, Transductors, and Amplistats, have been used to identify the more elaborate saturable reactor circuits.

The advantages of the magnetic amplifier are based principally on the fact that it is a completely static device. With the exception of the rectifiers used, its mechanical construction is comparable to that of an iron-core transformer. There are no contacts, moving parts, filaments, or other features which account for most of the failures associated with other types of amplifiers (except for those using transistors). The need for frequent inspection and maintenance is cut to a minimum. The life of the magnetic amplifier is more or less indefinite, and it is especially suited for shipboard installation where there are adverse operating conditions such as vibration and shock.

In order to understand the theory of magnetic amplifiers, it is necessary that you possess a knowledge of magnetism and magnetic circuits. This information may be found in the Navy Training Course Basic Electricity, NavPers 10086-A.

COMPUTERS

A computer is necessary in missile guidance systems in order to calculate course corrections rapidly. In one type of missile the computer is simply a mixing circuit. On the other hand, the computers used at launching sites may be large consoles performing many calculations.

Computers have been mentioned in several places in the text, and chapter 5 gave a brief description of the two general types of computers, digital and analog. Either or both may be used in missiles. In the Polaris missile, for example, the electronics package is in essence an analog computer. It responds in a linear manner to input signals from a variety of sources, for example, the various gyros in the missile. The computer generates commands (based on the input information) which are fed to the flight control electronics package, where the pulses are converted into signals that cause the flight controls to maneuver the missile as commanded. Pitch, roll, and yaw of the missile are controlled by such commands. The commands are a series of digital pulses which are converted to analog information in the autopilot and cause the pitch, roll, or yaw maneuvers.

In an electronic analog computer, the input and output variables are represented by voltages, and the computations are performed by electronic circuits.

Specific Differences Between Analog and Digital Computers

INPUT.—The input to the analog computer is never an absolute number, and an approximate position on a continuous scale. Thus, it is impossible to set the potentiometer dial at exactly 75 ohms; there is always some error, no matter how small. On the other hand, the number fed into the digital computer is precisely the one desired; no more, no less.

OUTPUT.—The output of an analog computer is never an absolute number, but an approximate position on a continuous scale. The digital computer, however, produces a specific series of digits for an output.

SPEED.—Most analog computers will produce an answer as soon as you have put in the problem. This ability is vital in military operations such as fire control, where there is not much time to compute the position of a flying target.

PRINCIPLES OF GUIDED MISSILES AND NUCLEAR WEAPONS

A digital computer does not work instantaneously. It produces an answer some time after the problem is fed to it. But don't think that this makes it a slow machine. The "some time after" may be a few millionths of a second. However, because the digital computer must do arithmetic, there is always a time lag between problem and solution.

Classification of Computers

Computers may also be classified physically and functionally. Physically, computers are classified as mechanical, electrical, and electromechanical computers. The classification of analog computers is determined by the type of computing elements used. These computing elements may be mechanical, electromechanical, or electronic. Mechanical elements used in the mathematical processes include differentials, linkages, cams, slides, multipliers, and component solvers. Most explanations of computer basics use the mechanical type because it is easier to illustrate graphically, and easier to understand.

In electromechanical computers, the mathematical processes are performed by using combinations of electrical signals and mechanical motions. Synchros, potentiometers, and resolvers are examples of parts used. Mechanical displacements (as of shafts and cams) are converted into voltages.

Electronic computers use only electrical voltages to perform the computations. Amplifiers, summing networks, and differentiating and integrating circuits are components used in electronic computers. Lightness, compactness, and speed of computation are achieved more easily with electronic computers than with mechanical ones. Therefore, the trend in development of computers has been toward the electronic type. Vacuum tubes were a frequent source of failure, but this trouble has been largely eliminated by the use of transistors in place of the vacuum tubes.

A type of electronic analog computer that has proved useful in missile design is the DIFFERENTIAL ANALYZER. This device is sometimes called a SIMULATOR, because it can be given electrical inputs that simulate both the characteristics of a proposed missile and the conditions under which it will operate. The action of the computer will then show how the proposed missile will perform under the specified conditions. It is thus possible to test

new missile designs without building actual prototype missiles, and this procedure results in a considerable saving in both time and money.

CONTROLLERS AND ACTUATORS

If a missile wanders off its proper course, this fact will be detected by the sensing mechanism previously described. The computer within the guidance system will evaluate the information provided by the sensing mechanisms, determine the direction and magnitude of the error in missile course or position, and produce a suitable error signal output.

At this point, the functions of the guidance and control systems overlap. The primary purpose of the control system is to correct errors in the attitude of the missile. The primary purpose of the guidance system is to correct errors in the missile flight path. Both types of error are corrected in the same way: by moving the missile flight-control surfaces or the jet controls (jetevators, jet vanes). Movements are governed by the same controllers and actuators, regardless of whether the error signal is developed by the guidance or the control system.

FEEDBACK SYSTEMS

The final section of a guidance system is known as a "feedback" or "followup" unit, also called a closed-loop system. This unit measures the position of the flight control surfaces or jet controls in relation to the reference axis of the missile, and compares this value with the error signal generated by the computer.

Without the followup signal, there would be nothing but the varying air pressure to prevent the flight control surfaces from swinging to their maximum limits any time the sensor caused an error signal to be generated. By using feedback, the deflection of the flight control surface can be made proportional to the size of the error. The feedback loop thus gradually returns the flight control surfaces to neutral as the error is corrected.

To accomplish these results, the feedback signal is used to oppose the error signal. When the feedback signal becomes as large as the error signal, no further deflection of the flight control surface takes place because the two signals are equal and opposite, and their sum is zero.

Chapter 6—PRINCIPLES OF MISSILE GUIDANCE

If the error signal voltage is large, a large deflection of the flight control surface can take place before the feedback signal voltage becomes strong enough to exactly equal the error signal.

As the missile approaches the desired course, the error signal becomes less than the feedback signal, and the resultant voltage difference reverses polarity. The reversal in polarity moves the flight control surfaces in the opposite direction until they are in neutral. This action is smooth and rapid, and cannot be duplicated by systems that use ON-OFF switching.

Followup loops were described and illustrated with block diagrams and schematics in chapter 5. Figure 6-4 shows a block diagram of a servomechanism loop from a computer (followup unit is a colloquialism for servomechanisms). The error detector computes a voltage proportional to the error. This error voltage is damped in the controller, amplified by the amplifier, and finally supplied to the servomotor for its control. The mechanical output is furnished by the motor and drives the rate generator. From this generator a voltage proportional to the output velocity is supplied to the controller. After being modified by the computing elements in the controller, the modified voltage is combined with the error voltage to stabilize operation and increase the accuracy of the servomechanism.

TYPES OF GUIDANCE SYSTEMS

The subject of missile guidance was introduced early in chapter 1, with a listing of the

types of guidance followed by a history of the development of guidance systems. The guidance system is an important part in the descriptions of the individual missiles. At the beginning of this chapter, we classified missile guidance systems into two broad categories: missiles controlled by manmade electromagnetic devices, and those controlled by other means.

All of the missiles which maintain electromagnetic radiation contact with manmade sources may be subdivided into two further categories.

1. Command guidance missiles
2. Homing guidance missiles

Command guidance missiles are those which are guided on the basis of direct electromagnetic radiation contact with friendly control points. Homing guidance missiles are those which are guided on the basis of direct electromagnetic radiation contact with the target. Command guidance generally depends on the use of radio or radar links between a control point and the missile. By use of guidance information transmitted from the control point via a radio or radar link, the missile's flight path can be controlled.

RADAR COMMAND GUIDANCE

Radar command guidance may be subdivided into two separate categories. The first category is simply referred to as the command guidance method. The second is the beam-rider method, which is actually a modification of the first, but with the radar being used in a different manner.

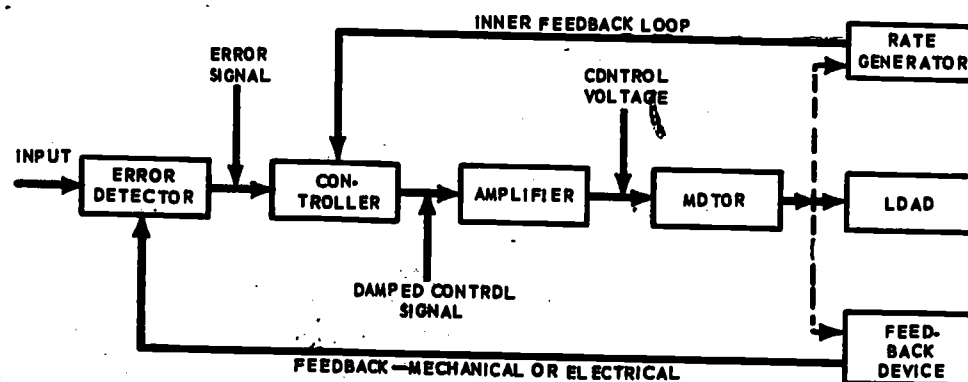

Figure 6-4.—Complete servomechanism loop block diagram for a computer.

PRINCIPLES OF GUIDED MISSILES AND NUCLEAR WEAPONS

RADIO COMMAND SYSTEMS. Radio has been used as a guidance link for such purposes as model airplane flying, steering model boats and cars, controlling target drones, and even for maneuvering old battleships during bombing tests. Therefore, when the question of command guidance for missiles came up, radio was among the first methods used. But once a radio command system was developed, a new problem arose—that of keeping track of the missile when it was beyond the range of normal vision. Radar can locate objects not visible by ordinary means.

COMMAND GUIDANCE

The term **COMMAND** is used to describe a guidance method in which all guidance instructions, or commands, come from sources outside the missile. To receive the commands, the missile contains a receiver that is capable of receiving instructions from ship or ground stations or from aircraft. The missile receiver then converts these commands to guidance information, which is fed to the sections following the sensor unit.

In the command guidance method, radar is used to track the missile and the target. Guidance signals are sent to the missile by varying the characteristics of the missile tracking radar beam, or by the use of a separate radio transmitter. Figure 6-5 will give you an idea of how this method works in actual practice. As soon as radar #1 in the figure is locked on the target, tracking information is fed to the computer. The missile is then launched and is tracked by radar #2. Target and missile ranges, elevations, and bearings are continuously fed to the computer. This information is continuously analyzed by the computer, which determines the correct flight path of the missile. The guidance signals generated by the computer are sent to the missile via either the missile tracking radar or a radio command transmitter. They are subsequently converted into correction signals by the missile computer network. The resulting control surface movement causes collision with the target.

The radar command guidance method can be used in ship, air, or ground missile delivery systems.

BEAM-RIDER METHOD

The main difference between the beam-rider method and the radar command guidance method

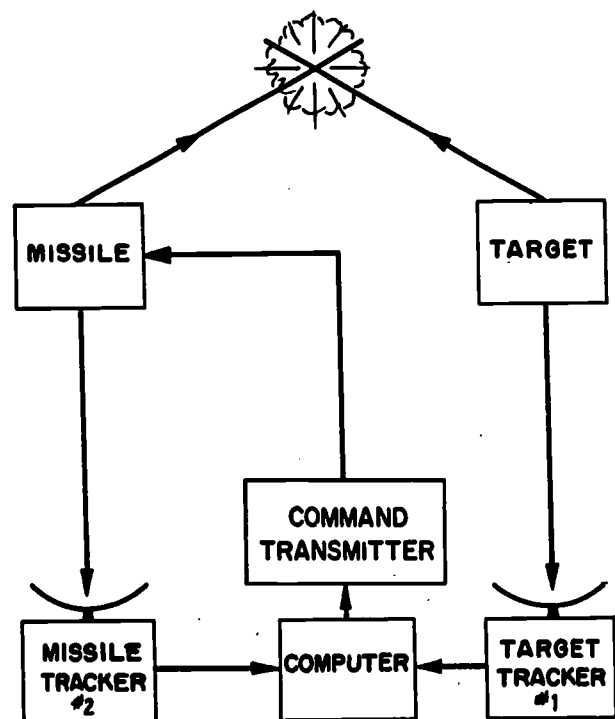

33.92

Figure 6-5.—Command guidance system.

is that the characteristics of the missile tracking radar beam are not changed in the beam-rider system. Rather than sending individual orders to the missile via the tracking beam, the missile has been designed so that it is able to formulate correction signals on the basis of its position with respect to the radar scan axis. Usually, only one radar is used in beam-rider systems. Therefore, this method lends itself extremely well to shipboard use.

A computer in the missile keeps it centered in the radar beam. It locates the center of the beam and sends the necessary signals to the control system to remain in it. The radar system keeps the beam pointed at the target and, if desired, several missiles may "ride" the beam simultaneously. Figure 6-6 illustrates a simple beam-rider guidance system, a typical line of sight (LOS) course. The accuracy of this system decreases with range because the radar beam spreads out and it is more difficult for the missile to remain in its center. If the target is moving, the missile must follow a continuously changing path, which

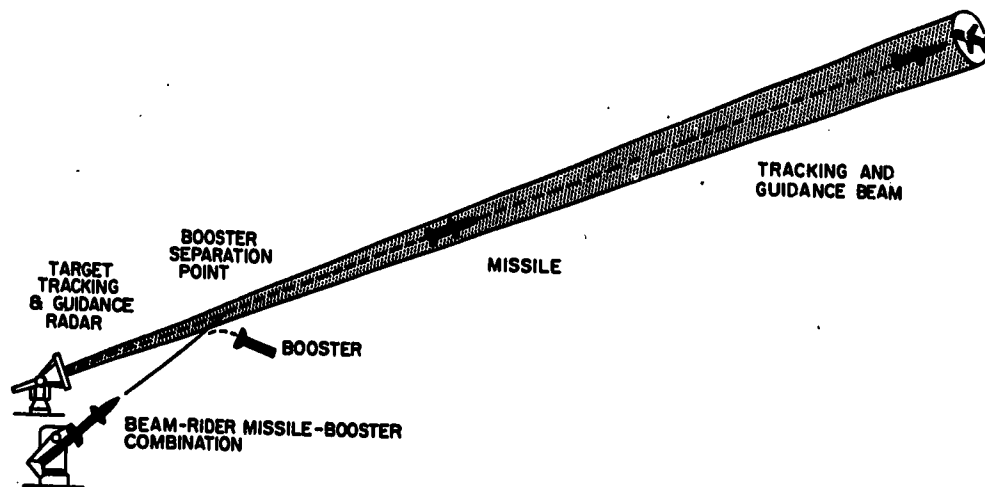

Figure 6-6.—Simple beam-rider guidance system.

12.32

causes it to undergo excessive transverse accelerations.

A modified beam-rider system uses two radars, a target-tracking radar and a missile guidance radar (fig. 6-7). The target-tracking radar feeds target data into a computer, which calculates a collision point at which the missile will intercept the target. The second radar is pointed toward the calculated collision point and the missile follows this beam. The modified-beam-rider system requires equipment that is too large and complex for aircraft use, but is used on shipboard.

Modified beam-rider systems are similar to command guidance systems. In both systems, target information is collected and analyzed by suitable devices at the launching point or other control point, rather than by devices within the missile. In both systems, the missile makes use of the guidance signals transmitted from the control point.

The principal difference between radar command guidance and beam-rider guidance is that in the command system the guidance signals are specific commands to the missile to "turn left," "turn right," etc. The control transmitter of a beam-rider guidance system transmits only information, not commands. It indicates the direction of the target or the calculated point of interception. The guidance

system within the missile must interpret the information and then formulate its own correction signals. The missile is said to "ride" the beam to the target.

Hyperbolic Guidance

Another command guidance method is the so-called hyperbolic guidance. This method was designed primarily for long-range surface-to-surface missiles. It depends on the loran principle. A loran system is a modern electronic aid to navigation which was developed primarily for long-range navigation over water. The system requires at least two transmitting stations. These two stations are separated by a distance of several hundred miles, and the geographic location of each station is accurately pinpointed. The principle of loran is based on the difference in time for pulsed radio signals to arrive at a given point from these stations. The missile makes flight path corrections on the basis of the time difference of reception of these "Master" and "Slave" signals emanating from the two fixed transmitting stations. Corrections are made only in azimuth by this method.

The hyperbolic guidance system has not been used in any missile and will therefore not be explained in detail.

PRINCIPLES OF GUIDED MISSILES AND NUCLEAR WEAPONS

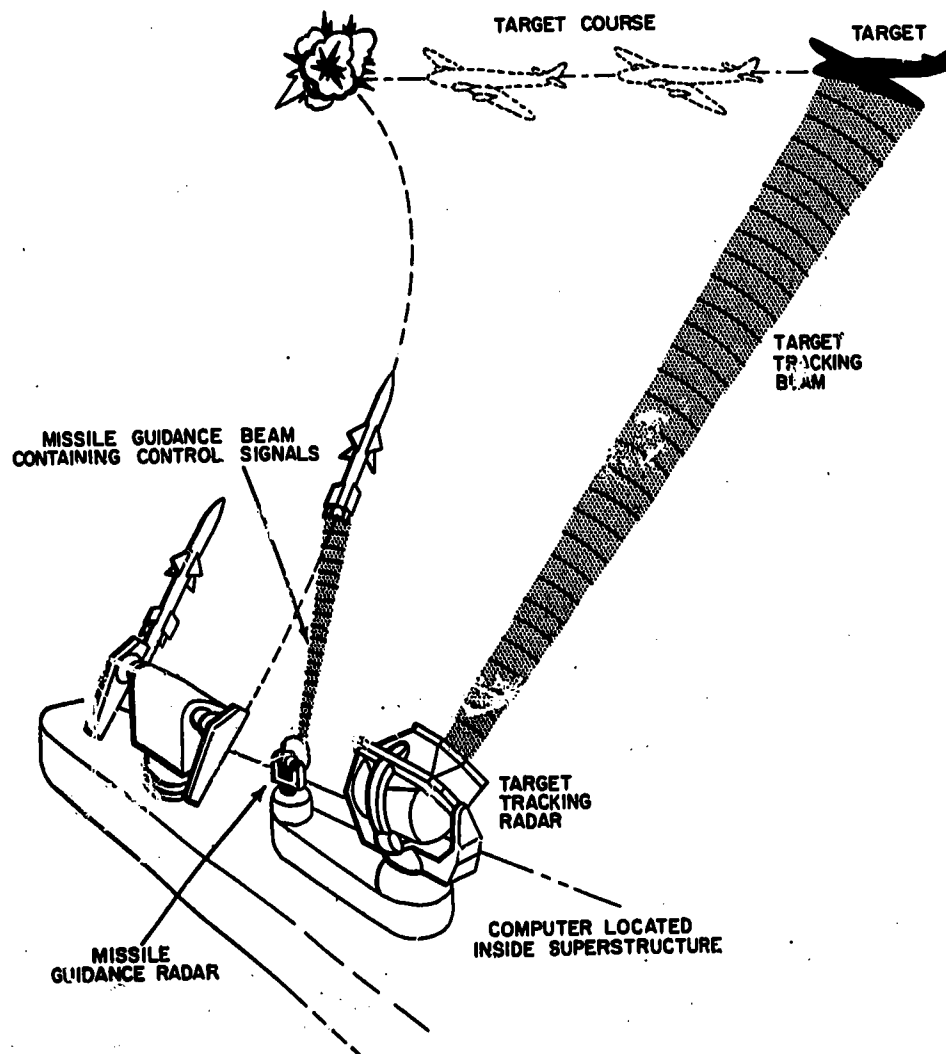

12.33

Figure 6-7.—Modified beam-rider guidance.

HOMING GUIDANCE

Homing guidance systems control the path of the missile by a device in the missile that reacts to some distinguishing feature of the target. The homing device, usually located in the nose, detects some type of radiation given off by the target. Homing guidance depends upon the maintenance of electromagnetic radiation contact between the missile and the TARGET. Homing guidance methods may be divided into three types: ACTIVE homing, SEMIACTIVE homing, and PASSIVE homing (fig. 6-8). All three may use radar; however,

infrared is commonly used in passive homing against air targets.

ACTIVE HOMING.—In active homing, the missile contains both a radar transmitter and receiver. With the transmitter it sends signals to strike the target. A nose antenna receives the return signal reflected from the target. From the time interval between the transmitted and received pulses, the computer calculates the distance to the target. The missile is able to track the target and generate its own correction signals on the basis of the tracking information.

Chapter 6—PRINCIPLES OF MISSILE GUIDANCE

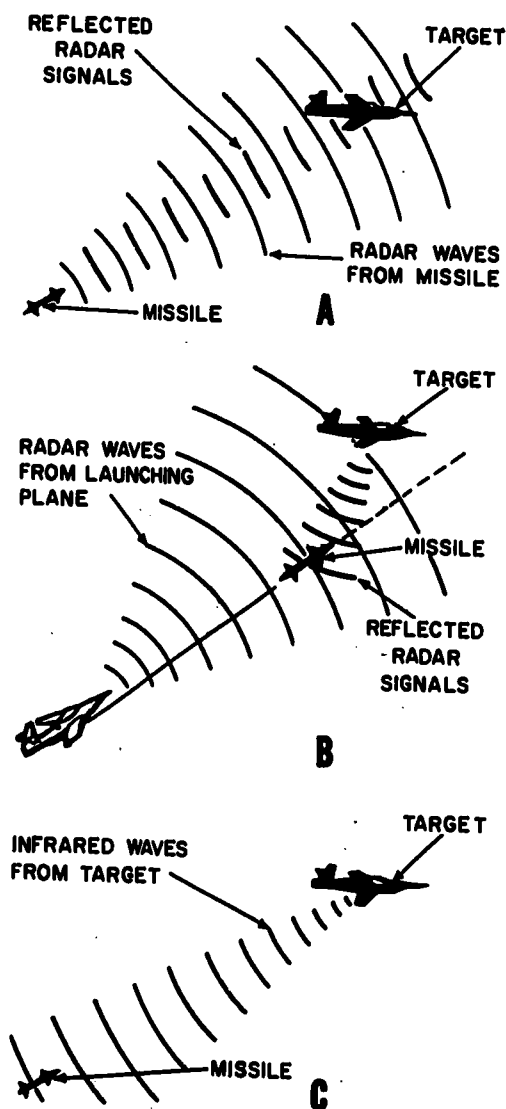

144.34
Figure 6-8.—Homing guidance: A. Active homing; B. Semiactive homing; C. Passive homing.

SEMIACTIVE HOMING.—In semiactive homing, the target is illuminated by a tracking radar at the launching site or other control point. The missile is equipped with a radar receiver (no transmitter) and, by means of the reflected radar energy from the target, formulates its own correction signals as in the active homing method.

PASSIVE HOMING.—Passive homing depends only on the target as a source of electromagnetic radiations. The heat and light sensors

described earlier provide means of passive homing. Missiles may also be made to home on radar or radio radiations emanating from ships, aircraft, etc. Television is another homing guidance medium which, while otherwise suitable for this purpose, has limited value because it can be used only in daylight, and only when visibility is good. One of the most common uses of passive homing is in air-to-air missiles which depend on heat sensors. As in the other homing methods, the missile generates its own correction signals on the basis of energy received from the target rather than from a control point.

Homing is the most accurate of all guidance systems because it uses the target as its source for guidance error signals. Its superior accuracy is shown when used against moving targets. There are several ways in which the homing device may control the path of a missile against a moving target. Of these, the more generally used are PURSUIT homing and LEAD homing. These will be discussed in the chapter on homing guidance.

COMPOSITE SYSTEMS

No one system is best suited for all phases of guidance. It is logical then to combine a system that has excellent midcourse guidance characteristics with a system that has excellent terminal guidance characteristics in order to increase the number of hits. Combined systems are known as composite guidance systems, or combination systems.

Many missiles rely on combinations of the various types of guidance. For example, one type of missile may ride a radar beam until it is within a certain range of a target. At this time the beam-rider guidance may be terminated and a type of homing guidance commenced. The homing guidance would then be used until impact with the target or detonation of a proximity-fuzed warhead.

CONTROL MATRIX.—When composite systems are used, components of each system must be carried in the missile. Obviously, the sections must be separated so there is no interaction between them and yet be located close to the circuits they are to control. In addition, some provision must be made to switch from one guidance system to the other.

Control of the missile guidance system may come from more than one source. A signal is set up to designate when one phase

PRINCIPLES OF GUIDED MISSILES AND NUCLEAR WEAPONS

of guidance is over and the next phase begins. This signal may come from a tape, an electronic timing device, or from a radio command.

The device that switches control systems is called a control matrix. It automatically transfers the correct signal to the control system regardless of conditions. If the midcourse guidance system should fail, the matrix switches in an auxiliary guidance system to hold the missile on course. Should the original midcourse guidance system become active again, the matrix will switch control from the auxiliary back to the primary system.

If the target uses jamming devices the matrix can switch to another guidance method, even in the terminal phase of flight. Several of our missiles have such sophisticated guidance systems.

HYBRID GUIDANCE.—A combination of command guidance and semiactive homing guidance is termed hybrid guidance. It achieves many advantages of both systems. It attains long-range capabilities by maintaining the tracking sensors on the delivery vehicle (ship, aircraft, or land base) and transmitting the data to the missile. By having the missile compute its own weapon line drive orders, the entire mechanization of the fire control problem can be simplified.

Some texts call the beam-riding guidance system a hybrid system. The modified beam-rider system is similar to command systems with the commands being used to position the antenna of the guidance beam rider and thus directing the missile to the predicted point of collision. The missile must determine its location with respect to the beam and must move to keep itself in the center of the beam.

SELF-CONTAINED GUIDANCE SYSTEMS

The self-contained group consists of the guidance systems in which all the guidance and control equipment is entirely within the missile. Some of the systems of this type are: **PRESET, TERRESTRIAL, INERTIAL, and CELESTIAL-NAVIGATION.** These systems are most commonly applicable to surface-to-surface missiles, and countermeasures are ineffective against them. The system neither transmits or receives signals that can be jammed.

Preset Guidance

The term **PRESET** completely describes one guidance method. When preset guidance

is used, all of the control equipment is inside the missile. This means that before the missile is launched, all information relative to target location and the trajectory the missile must follow to strike the target must be calculated. After this is done, the missile guidance system must be set to follow the course to the target, to hold the missile at the desired altitude, to measure its air speed, and, at the correct time, cause the missile to start the terminal phase of its flight and dive on the target.

A major advantage of preset guidance is that only limited countermeasures can be used against it. One disadvantage is that after the missile is launched, its trajectory cannot be changed from that which has been preset at the launch point. It is relatively simple compared to other types of guidance; it does not require tracking or visibility.

An early example of a preset guidance system was the German V-2, where range and bearing of the target were predetermined and set into the control mechanism. The earliest mod of the Polaris missile was designed to use preset guidance during the first part of its flight, but this was soon modified to permit changing the course during flight.

The preset method of guidance is used only against stationary targets of large size such as land masses or cities. Since the guidance information is determined completely prior to launch, this method would, of course, not be suitable for use against ships, aircraft, enemy missiles, or moving land targets.

Navigational Guidance Systems

When targets are located at great distances from the launching site, some form of navigational guidance must be used. Accuracy at long distances is achieved only after exacting and comprehensive calculations of the flight path have been made. The mathematical equation for a navigation problem of this type may contain factors designed to control the movement of the missile about the three axes—pitch, roll, and yaw. In addition, the equation may contain factors that take into account acceleration due to outside forces (tail winds, for example) and the inertia of the missile itself. Three navigational systems that may be used for long-range missile guidance are inertial, celestial, and terrestrial.

INERTIAL GUIDANCE.—The simplest principle for guidance is the law of inertia. In

Chapter 6—PRINCIPLES OF MISSILE GUIDANCE

aiming a basketball at a goal, you attempt to give the ball a trajectory that will terminate in the basket. In other words, you give an impetus to the ball that causes it to travel the proper path to the basket. However, once you have let the ball go, you have no further control over it. If you have not aimed correctly, or if the ball is touched by another person, it will miss the basket. However, it is possible for the ball to be incorrectly aimed and then have another person touch it to change its course so it will hit the basket. In this case, the second player has provided a form of guidance. The inertial guidance system supplies the intermediate push to get the missile back on the proper trajectory.

The inertial guidance method is used for the same purpose as the preset method and is actually a refinement of the preset method. The inertially guided missile also receives programmed information prior to launch. Although there is no electromagnetic contact between the launching site and the missile after launch, the missile is able to make corrections to its flight path with amazing precision controlling the flight path with ACCELEROMETERS which are mounted on a gyro-stabilized platform. All in-flight accelerations are continuously measured by this arrangement, and the missile generates corresponding correction signals to maintain the proper trajectory. The use of inertial guidance takes much of the guesswork out of long-range missile delivery. The unpredictable outside forces working on the missile are continuously sensed by the accelerometers. The generated solution enables the missile to continuously correct its flight path. The inertial method has proved far more reliable than any other long-range guidance method developed to date.

Inertial guidance is so accurate that the submarine Nautilus, on its first cruise under the polar ice cap, was able to use an inertial navigation system that was originally developed for use in long-range guided missiles.

ACCELEROMETERS.—The heart of the inertial navigation system for ships and missiles is an arrangement of accelerometers which will detect any change in vehicular motion. To understand the use of accelerometers in inertial guidance, let us first examine the principle of accelerometers in general terms.

An accelerometer, as its name implies, is a device for measuring the force of an acceleration. In their basic principles, such devices are simple. For example, a pendulum, free to swing on a transverse axis, could be used to measure acceleration along the fore-and-aft axis of the missile. When the missile is given a forward acceleration, the pendulum will tend to lag aft; the actual displacement of the pendulum from its original position will be a function of the magnitude of the accelerating force. Another simple device might consist of a weight supported between two springs. When an accelerating force is applied, the weight will move from its original position in a direction opposite to that of the applied force. The movement of the mass (weight) is in accordance with Newton's second law of motion, which states that the acceleration of a body is directly proportional to the force applied, and inversely proportional to the mass of the body.

A simple illustration of the principle involved in accelerometer operation is the action of the human body in an automobile. If an automobile is subjected to acceleration in a forward direction, you are forced backward in the seat. If the auto comes to a sudden stop, you are thrown forward. When the auto goes into a turn, you tend to be forced away from the direction of the turn. The amount of movement is proportional to the force causing the acceleration. The direction of movement in relation to the auto is opposite to the direction of acceleration.

If the acceleration along the fore-and-aft axis were constant, we could determine the speed of the missile at any instant simply by multiplying the acceleration by the elapsed time. However, the acceleration may change considerably over a period of time. Under these conditions, integration is necessary to determine the speed.

If the missile speed were constant, we could calculate the distance covered simply by multiplying speed by time. But because the acceleration varies, the speed also varies. For that reason, a second integration is necessary.

The moving element of the accelerometer can be connected to a potentiometer, or to a variable inductor core, or to some other device capable of producing a voltage proportional to the displacement of the element.

PRINCIPLES OF GUIDED MISSILES AND NUCLEAR WEAPONS

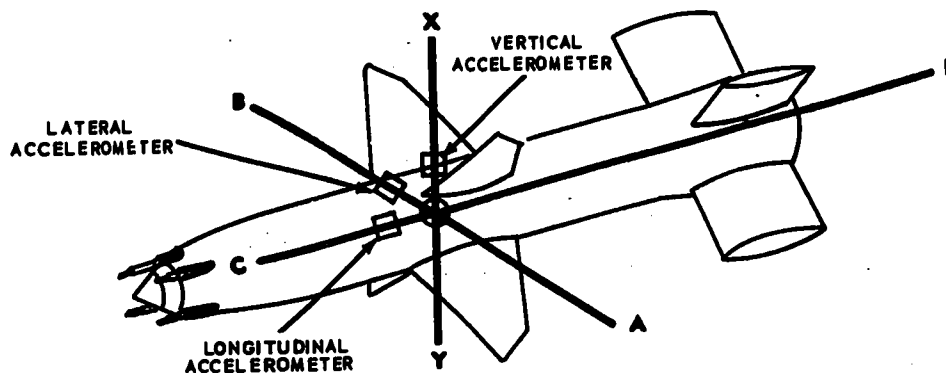

33.134

Figure 6-9.—Accelerometers in guided missiles.

Usually there are three double-integrating accelerometers continuously measuring the distance traveled by the missile in three directions—range, altitude, and azimuth. (fig. 6-9). Double-integrating accelerometers are devices which are sensitive to acceleration, and by a double-step process measure distance. These measured distances are then compared with the desired distances, which are preset into the missile; if the missile is off course, correction signals are sent to the control system.

Accelerometers are sensitive to the acceleration of gravity as well as missile accelerations. For this reason, the accelerometers which measure range and azimuth distances must be mounted in a fixed position with respect to the pull of gravity. This can be done in a moving missile by mounting them on a platform which is stabilized by gyroscopes or by star-tracking telescopes. This platform, however, must be moved as the missile passes over the earth to keep the sensitive axis of each accelerometer in a fixed position with respect to the pull of gravity. These requirements cause the accuracy of the inertial system to decrease as the time of flight of the missile increases.

To eliminate unwanted oscillations, a DAMPER is included in the accelerometer unit. The damping effort should be just great enough to prevent any oscillations from occurring but still permit a significant displacement of the mass. When this condition exists, the movement of the mass will be exactly proportional to the accelerations of the vehicle.

Figure 6-10 shows a mass suspended by one spring in a liquid-damped system. If the case experiences an acceleration in the direction indicated by the arrow, the spring will offer a restraining force proportional to the downward displacement of the mass. The viscous fluid tends to oppose the movement of the mass, and therefore damps its action and prevents its oscillation. By including an electrical pickoff in the system, we can measure

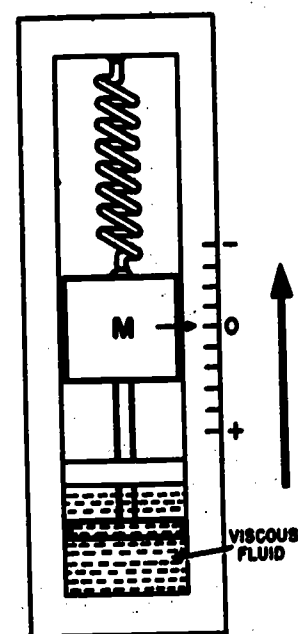

33.131

Figure 6-10.—Liquid-damped system.

Chapter 6—PRINCIPLES OF MISSILE GUIDANCE

the displacement of the mass, which is proportional to force and acceleration.

Figure 6-11 shows a system which is electrically damped. The mass (m) is free to slide back and forth in relation to the iron core (c). When the vehicle experiences an acceleration, the voltage (e), which is proportional to the displacement of the mass, is picked off and amplified. The current (i) (still proportional to mass displacement) is sent back to the coil around the core. The resulting magnetic field around the coil creates a force on the mass, which damps the oscillation. In this system the acceleration could be measured by the displacement of the mass, by the voltage (e), or by the current (i).

VARIATIONS IN ACCELEROMETER DESIGN.—There are actually many variations in accelerometer design. For example, one type of accelerometer depends on a change of inductance between two electrically excited coils. If one coil is attached to the mass and another to the vehicle, the inductance between them will vary due to their relative movement brought about by vehicular accelerations.

Another accelerometer uses wire strain gauges as the suspension elements for the mass.

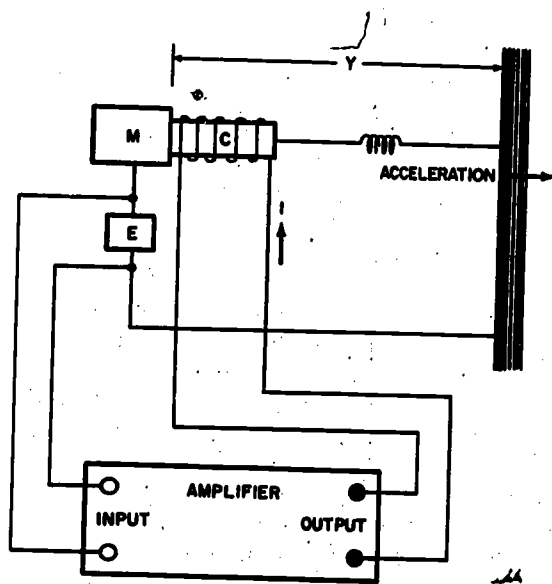

Figure 6-11.—Electrically damped accelerometer.

33.132

The strain gauges form the arms of a bridge. A change of acceleration causes a change of the electrical resistance of the circuit, giving an a-c output that is an indication of the acceleration.

Still another type of accelerometer is the manometer. In this type (fig. 6-12), accelerations are measured by the electrolyte flow toward one or the other end of the manometer. This action provides current control between pairs of electrodes. The venturi shown in the figure damps the oscillations of the manometer by controlling the electrolyte movement.

You will undoubtedly run across other types of accelerometers; however, the basic principles will always hold.

CELESTIAL REFERENCE.—A celestial navigation guidance system is a system designed for a predetermined path in which the missile course is adjusted continuously by reference to fixed stars. The system is based on the known apparent positions of stars or other celestial bodies with respect to a point on the surface of the earth at a given time. Navigation by fixed stars and the sun has been practiced for centuries and is very dependable. It is highly desirable for long-range missiles since its accuracy is not dependent on range. Figure 6-13 sketches the application of the system as it might be used for a guided missile.

The missile must be provided with a horizontal or a vertical reference to the earth, automatic star tracking telescopes to determine star-elevation angles with respect to the reference, a time base, and navigational star tables

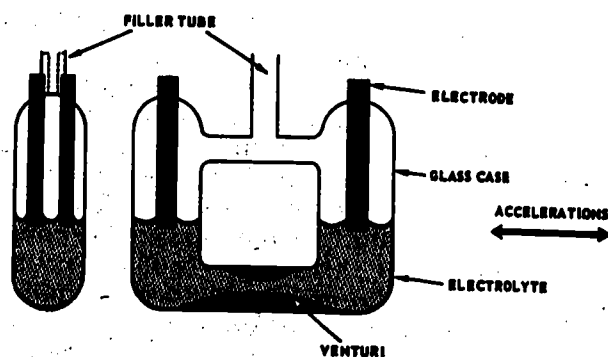
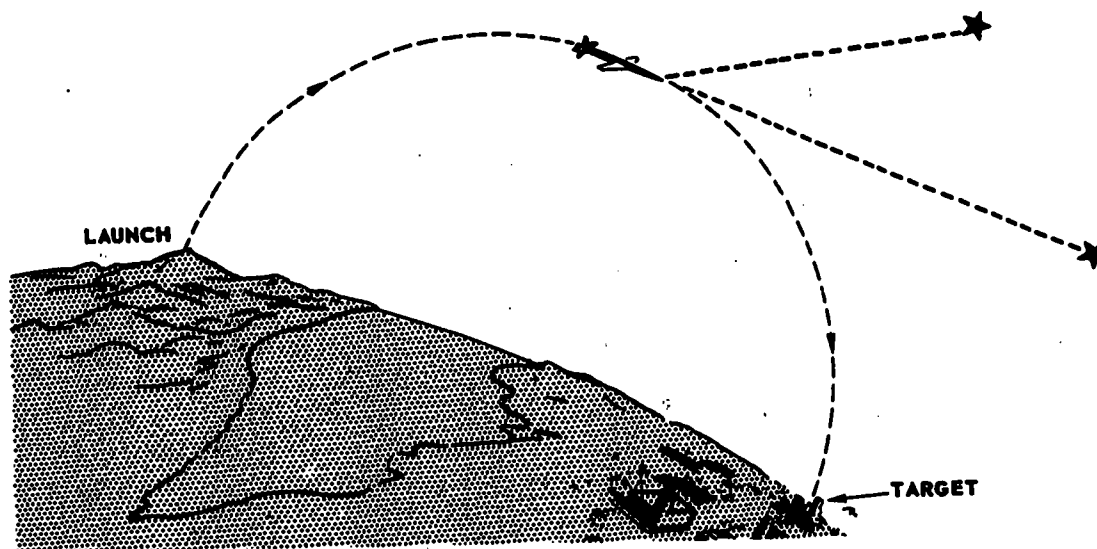

Figure 6-12.—Manometer accelerometer with venturi damper.

33.133

PRINCIPLES OF GUIDED MISSILES AND NUCLEAR WEAPONS



33.94

Figure 6-13.—Celestial guidance.

mechanically or electrically recorded. A computer in the missile continuously compares star observations with the time base and the navigational tables to determine the missile's present position. From this, the proper signals are computed to steer the missile correctly toward the target. The missile must carry all this complicated equipment and must fly above the clouds to assure star visibility.

Celestial guidance (also called stellar guidance) was used for the Mariner (unmanned spacecraft) interplanetary mission to the vicinity of Mars and Venus. No guided missile system at present uses celestial guidance.

TERRESTRIAL GUIDANCE METHOD.—Various picture and mapmatching guidance methods have been suggested and devised. The principle is basically the same for all. It involves the comparison of a photo or map or the terrain over which the missile is flying with observations of the terrain by optical or radar equipment in the missile. On the basis of the comparison (fig. 6-14), the missile is able to cause the actual track to coincide with the desired track. The system is, of course, quite complicated and is usable only against stationary targets such as large land masses and industrial areas.

Radar mapmatching will be described in a later chapter.

PROPORTIONAL NAVIGATION.—This is a homing guidance technique in which the missile turn rate is directly proportional to the turn rate in space of the line of sight. The seeker (in the missile) tracks the target semi-independently from the missile maneuvers. The control system used determines the flight path followed by the missile.

APPLICATION OF NATURAL PHENOMENA

Two types will be discussed briefly as applied in missile systems: magnetic field of the earth, and Doppler effects.

EARTH'S MAGNETIC FIELD

Three characteristics of the earth's magnetic field that are useful in missile guidance are: (1) lines of equal magnetic deviation, (2) lines of equal magnetic inclination, and (3) lines of equal magnetic intensity. The magnetic deviation or declination is the angle between the magnetic and the true meridians. The magnetic inclination or dip is the angle from the horizontal. The dip varies from the horizontal at the magnetic equator to 90 degrees at the magnetic poles.

Magnetic charts of the world are available which show the dip, the intensity of the horizontal component and of the vertical component,

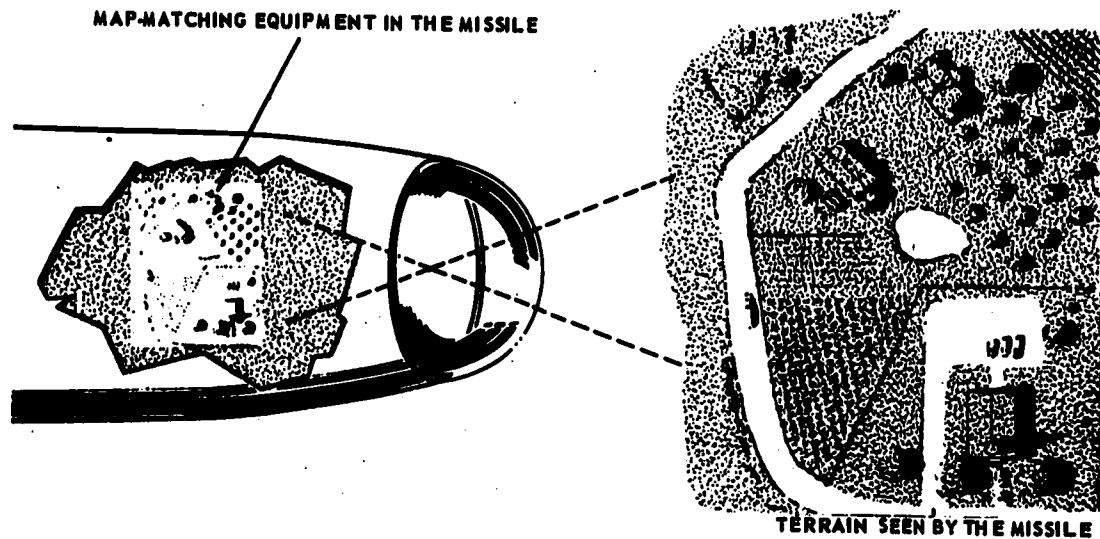

Figure 6-14.—Terrestrial guidance.

33.93

the total magnetic force, the north-south component, the east-west component, and the variation. The earth's magnetic field is subject to changes in intensity and direction, and during magnetic storms the changes are unpredictable.

Despite all the possible and unpredictable variations, magnetic devices have been used for missile guidance. The German V-1 used a magnetic compass as part of its guidance system. The magnetic compass controlled the missile in azimuth only; its altitude was controlled by a barometric altimeter, and its range by an air log. This was a relatively simple but rugged guidance system that could guide the missiles to a selected geographical area but could not pinpoint targets, and could not be used against moving targets.

A refinement of the magnetic compass is the flux valve. The flux valve consists of primary and secondary windings on an iron core. The primary is supplied with a-c of a fixed voltage and frequency. When no external magnetic field is present, the device acts as a simple transformer; the frequency of the secondary voltage is the same as that of the input voltage. But when an external field is present, it will alternately add to and subtract from the field generated by the primary current, during successive half-cycles. As a result a second harmonic, at twice the input frequency, is superimposed on the output voltage. If the

flux valve is properly aligned with the external magnetic field, the amplitude of the second harmonic voltage will be proportional to the strength of that field.

In figure 6-15A and B, you will see that the number of flux lines set up by the earth's magnetic field will vary in three spider legs, depending on the heading of the missile. By exciting the core with an a-c current, these flux lines may be caused to alternate back and forth across the pickoff coils. The induced current in each pickoff coil will then be proportional to the number of flux lines cutting that coil. The resultant of the induced currents will be proportional to the amount of precession of the gyro away from the original magnetic heading. Again, an amplifier and torque motor are used to exert a force on the gyro, the force being equal and opposite to the force of precession.

The flux valve is sometimes called a flux gate compass. Because of the physical arrangement of the cores, only one possible combination of voltages will exist for any given compass heading. It is a type of gyrostabilized magnetic compass. A gyrostabilized magnetic compass is one in which the magnetic compass element is stabilized by a vertical gyro so that it measures only the horizontal component of the earth's magnetic field. A gyromagnetic compass consists of a gyroscope which is positioned by a

PRINCIPLES OF GUIDED MISSILES AND NUCLEAR WEAPONS

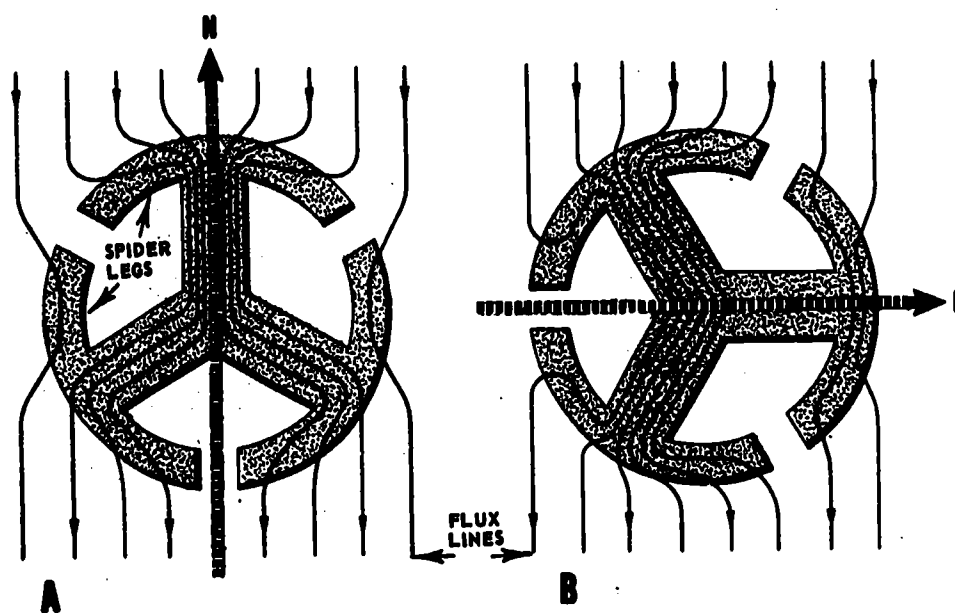

Figure 6-15.—Flux valve: A. Missile heading north; B. Missile heading east.

33.85

magnetic compass. Its function is to maintain a steady directional indication.

DOPPLER PRINCIPLE

The Doppler effect is a change in the observed frequency of sound, light, or other waves, caused by the motion of the source or of the observer. A familiar example is the increase or decrease in sound waves, as of a train whistle. As the train approaches, the pitch (frequency) of the whistle increases, and appears to decrease as the train passes and moves into the distance. The effect is based on the fact that the listener perceives as frequency the number of sound waves arriving per second. The acoustical Doppler effect varies with the relative motion of the listener and the source, and the medium through which the sound passes. The optical Doppler effect is similar to the acoustical Doppler effect in some ways but is definitely different in three fundamental ways:

1. The optical frequency change does not depend upon whether it is the source or the observer that is moving with respect to the other.

2. An optical frequency change is observable when the source or the observer moves at right angles to the line connecting the source and the observer. (No acoustical change in this case.)

3. The motion of the medium through which the waves are propagated does not affect optical frequency.

The laws affecting light and other electromagnetic waves, applied to radar, gave us the Doppler radar system to measure the relative velocity of the system and the target. The operation of those systems is based on the fact that the Doppler frequency shift in the target echo is proportional to the radial component of the target velocity. One homing guidance system makes use of doppler principles.

Doppler homing equipment can be divided into two groups—FM-CW doppler systems, and pulse doppler systems. There are major differences in the circuitry of the two systems. In the FM-CW system, the frequency of an echo signal has a relationship to the speed of the target with respect to the receiving antenna. This echo signal can be converted into an indication of target velocity with respect to the missile.

Chapter 6—PRINCIPLES OF MISSILE GUIDANCE

The difference between the frequency of the transmitted signal and the frequency of the echo is due to the doppler effect.

This principle is illustrated in figure 6-16. Note that the received wave from a distant moving object is shifted both to the right and upward with respect to the original transmission. Consequently, the beat frequency will be alternately very small and very large on succeeding half cycles. The sum of the two different values of beat frequency thus produced is a measure of the distance of the missile from the target and the difference between the two values of beat frequency is a measure of velocity of the missile with respect to the target.

Thus frequency-modulated radar determines the distance to a reflecting surface by measuring the frequency shift between transmitted and reflected waves.

When the two signals are mixed in an electronic circuit, the circuit will develop a "beat" frequency equal to the difference between the two signal frequencies. The beat note developed in this manner will have a pitch that is proportional to the relative velocity between the target and the radar antenna. To eliminate the possibility of homing on objects other than the target, a band-pass filter (which will pass only a narrow band of frequencies) is inserted in the control circuit to eliminate interfering signals.

A receiver which is automatically tuned over the frequency range passed by the filter is used to choose and lock on a target. An automatic frequency control (AFC), in the missile receiver, maintains the receiver on

the selected target. At the closest approach point to the target, the doppler shift becomes zero because there is then no relative motion between the missile and the target. The zero shift can be used to detonate a missile and destroy a target that would otherwise be missed. This system does not provide a means of range measurement. If this feature is desired, additional circuits are required.

A pulsed doppler system performs the same functions as an FM-CW system and, in addition, can select a target by its range. Like other pulsed radar systems, it has greater operating range for a given average power output than a CW system.

The guidance control signals are sent as a series of timed pulses. The receiving system in the missile must contain circuits that will match the transmitted pulses in both pulse timing and r-f cycles. The matching is accomplished in electronic circuitry known as the coherent pulse doppler system. In this system the transmissions are short pulses at a repetition frequency that can be continuously varied. Low-intensity power, which is used to obtain phase coherence between successive pulses, is generated by the stabilized local oscillator. A duplexer provides low-impedance paths to keep the oscillator energy in the desired circuits.

The stabilized oscillator also provides a suitable local oscillator signal which is mixed with the receiver signals to generate a receiver intermediate frequency. The doppler receiver contains a type of filter, called a

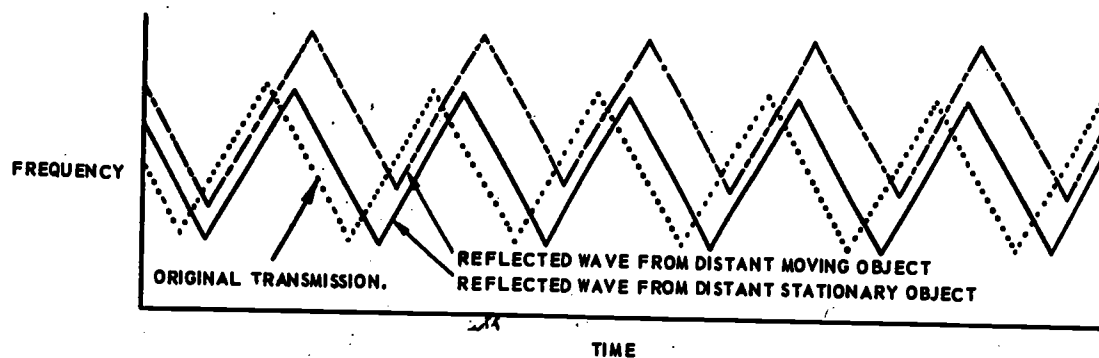

Figure 6-16.—Doppler effect on frequency modulation (sawtooth wave).

PRINCIPLES OF GUIDED MISSILES AND NUCLEAR WEAPONS

velocity gate, which filters out all undesired doppler frequencies.

Velocity-Damping Doppler Radar

A Doppler radar used for velocity damping of an inertial system is somewhat different from the homing type of Doppler. The velocity-damping Doppler requires antennas to measure the forward and lateral components of velocity. These antennas have to be direction stabilized so that the velocities along, and normal to,

the flight path can be measured to nullify errors that a drift angle creates.

The antenna mounting has two antennas looking down and forward at a slight angle away from the roll axis of the missile. A third antenna looks to the rear. A comparison between the signals from the two front antennas is used to align the direction of the missile. A comparison between the forward and rear antenna signals gives the forward velocity. Drift is computed from the angle between the antennas' fore and aft axis and aircraft heading.

CHAPTER 7

COMMAND GUIDANCE

INTRODUCTION

GENERAL

For maximum effectiveness, the FIRST missile fired at a target should strike that target. Cost, size, and the necessity for surprise prohibit the firing of ranging shots (as is done with gunfire).

To strike the target on the first shot, the trajectory of the missile must be accurately controlled. This control is necessary because forces, natural or otherwise, can cause the missile to deviate from its predetermined course. Even though it functions perfectly, a missile without accurate guidance may miss a selected fixed target by several miles. Moving targets can take evasive action; without guidance, the missile would be unable to compensate for this action. Therefore, an accurate, fast-acting guidance system is of prime importance.

As with other guidance techniques, applied command systems vary from simple to complex. However, command systems can be the simplest of all the techniques considered. Command guidance was therefore the first guidance system to be demonstrated, both on the surface with remote control of boats, tanks, and cars, and in the air with remote control of drone aircraft and glide bombs. Command guidance is the most broadly applied of all the guidance techniques that we will discuss. It is used for control of many mechanisms other than guided missiles.

Current missiles controlled by command guidance include Bomarc, Bullpup, and Nike.

A review of the history of guided missiles (chapter 1) will recall the names of early missiles, drone aircraft, and glide bombs that used command guidance or a combination of command guidance and some other type, such as preset. The Germans had several versions

of command-guided missiles and glide bombs which they used with effectiveness in World War II.

DEFINITIONS

COMMAND GUIDANCE means that intelligence (in the form of commands) is transmitted from an outside source to the missile while the missile is in flight to the target. Missiles which use command guidance are guided by direct electromagnetic radiation from a **FRIENDLY** control point.

A command guidance system incorporates two links between the missile and the control point.

One, an **INFORMATION LINK**, enables the control point to determine the position of the missile relative to the target; the other, the **COMMAND LINK**, makes it possible for the control point to correct any deviations from the desired path.

PURPOSE AND APPLICATIONS

The purpose of any guidance system is to secure direct hits on a selected target. Perfect performance is difficult to obtain because of natural disturbances and, in wartime, enemy countermeasures. However, because command guidance makes it possible to change the flight path of the missile by signals from the control point, most of these difficulties can be overcome.

COMPONENTS

Missile Components

The command guidance equipment components that are built into the missile will be determined by the guidance system being used.

PRINCIPLES OF GUIDED MISSILES AND NUCLEAR WEAPONS

The most complex guidance system has a television camera, television transmitter, radio command receiver, and the tone filter equipment built into the missile.

A relatively simple guidance system, so far as total equipment in the missile is concerned, is based on a radar transmitter that sends guidance commands to the missile on the tracking radar beam. With this system, only a receiver for the radar pulses is needed in the missile. The output of the receiver controls activating circuits that function when pulses of the correct amplitude and sequence are received.

The most widely used command guidance system uses a radar tracking unit and a radio command link. The missile contains a frequency modulated (fm) receiver and audiofrequency (af) channel selectors.

Launching Station Components

The missile course computer, missile tracking radar, missile plotting system components, and the command transmitter are located at or near the launcher. These, and the guidance components in the missile, are discussed later in this chapter.

OPERATION OF A TYPICAL SYSTEM

When command guidance is used, a ground, shipboard, or airborne station determines the position of the missile by radar tracking equipment or other means. It determines the error, if any, between the actual position of the missile and the desired position. It then sends out control impulses (commands) to bring the missile to the desired course.

If the flight path is long, and a large part of the path is over friendly territory or waters, several stations might track the missile as it comes into their range. These stations would then send commands to the missile to correct any deviations from the desired course.

A typical command guidance system might be used to control a surface-to-surface missile fired by a ship against a fixed installation ashore. The missile, during the early part of its flight, would be tracked by radar aboard the firing ship. Because the geographical location of the target and the firing ship are both known, the required missile course can be accurately calculated. Information from the missile-tracking radar may be fed to a computer, or it

may be plotted on a visual display, or both. When the tracking data indicates that the missile has turned from its calculated course, commands can be transmitted to return it to the desired course. The commands to the missile are transmitted by a radio transmitter in a radio command system and by a radar transmitter in a radar command system. For long-range command guidance missiles, control can be shifted from the launching ship to ships or aircraft down range.

INFORMATION LINKS

The use of command guidance requires an accurate knowledge of the missile position, since all guidance comes from outside the missile. This knowledge is obtained through information links. The accuracy and dependability of the information link determines to a great extent the overall accuracy of the complete system.

The information link enables the control point to determine the amount of error existing between the actual position of the missile and the desired position. Once this is known, correction signals can be sent to the missile.

Information links may use optical or electronic observation methods.

OPTICAL OBSERVATION. The optical, or visual, command guidance system has limited value, since the missile must always be visible from the command station. Such a system might use the unaided eye, telescopes, or optical rangefinders. But these devices are not effective at long range; and smoke, fog, clouds, or darkness make them useless. Some target drones and air-launched missiles still employ an optical observation link.

ELECTRONIC OBSERVATION. Much effort has been expended to develop an accurate and dependable electronic information link. A number of electronic systems have been designed and tested. The limitations of each system have been determined, and continuing efforts are being made to improve the most promising systems. Electronic observation is accomplished by radar both in the radio command and radar command guidance systems.

COMMAND LINKS

The equipment used to send commands to a missile may be compared to a radiotelephone circuit between a piloted plane and a ground

Chapter 7—COMMAND GUIDANCE

station. Instead of voice communications, the instructions are sent as a single pulse or a series of spaced pulses. The pulses may be modulated or unmodulated, depending on the complexity of the system in use.

In other words, missile functions (dives, turns, etc.) are controlled by either radio or radar commands.

Wire links were used in some early missiles as command links, and are presently used in an antitank weapon. The German X-4 missiles (air-to-air) used in World War II had wire links. Limitations on the use of wire guidance for supersonic missiles are obvious. The signals cannot be jammed, but a very limited length of wire can be unrolled and trailed behind a missile.

COMPONENTS AND FUNCTIONS

Insofar as guidance is concerned, the principal functions prescribed for command systems are the sighting and tracking means, computation of flight path error, communication of this intelligence to the missile, and sensing and responding mechanisms in the missile to effect flight path correction. In the command guidance system, measurement of relative position and motion of missile and target are accomplished at a location outside the missile. Computers perform the calculations. The information gained must be sent to the missile in the form of commands to correct missile position with relation to the target.

Except at short ranges where visual detection and tracking of targets is possible, radar detection and tracking is the method used. Detection, lock-on, and tracking are the normal sequence. Continuous monitoring of a moving target is necessary. Detection may involve search, identification, designation, and acquisition.

The function of the computer is to generate command signals that will result in collision of the missile with the target. From the position and rate information received from the radar tracking system, the computer predicts the optimum point of impact, and sends the steering signals to the missile to cause it to fly the indicated course.

Figure 7-1 is a block diagram of the components of a generalized command guidance system. Many variations are possible. The local missile guidance system contains prin-

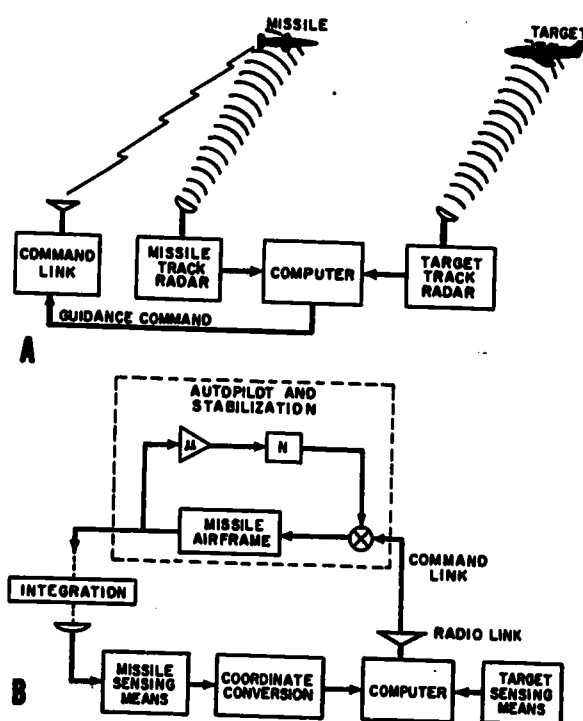

83.22
Figure 7-1.—Generalized command guidance system: A. Ground (shipboard) station components; B. Missile components with connecting link.

cipally the receiver-demodulator (detection), servodrives for airframe control members, the airframe itself, and autopilot feedback for stabilization and reference. Missile sensing and tracking equipment (tracking radar, fig. 7-1) locate the missile by measuring its position and motion, obtaining information on missile range and time derivatives. Guidance commands are computed from this information. The integrated range and angle information usually requires coordinate conversion before delivery to the computer. Requirements for target sensing and tracking are similar.

The command signals generated by the computer are sent to the receiver in the missile via the command link, which usually is a radio link. Guidance intelligence is derived in the missile by demodulation of the modulated radio frequency carrier. The electrical information is converted to mechanical displacement of the airframe control members, the airframe

PRINCIPLES OF GUIDED MISSILES AND NUCLEAR WEAPONS

itself, and the autopilot feedback for stabilization and reference, correcting the missile flight path.

The type of trajectory required for the tactical situation influences the response of the elements of the guidance system. Besides steering instructions, the command link may be required to transfer other information to the missile, such as arming, receiver gain setting, detonation of warhead near the target, or self-destruction. Carrier frequency and power requirements must be suited to the effective range in which the missile system is to be applied.

The N block in figure 7-1 is the common reference direction, such as "up," which must be established for the control loop and maintained throughout the control period. It takes the place of the pilot in keeping the missile correctly oriented. The prealignment of the missile gyros establishes this reference.

TRANSMITTERS. Early target drone command transmitters were simple one-tube units that sent out a pulse when keyed by the operator. This system made it possible to control the rudder. But to control engine speed and altitude, additional transmitters turned to other frequencies were required. As a result, the system became so large and complex that it was unsuitable. Consequently, work was started on a simpler, more reliable transmitter that would reduce the number of radio-frequency (RF) channels needed for command guidance. The result of this work is the modern command guidance transmitter, which is similar to any medium power PM (phase modulated) transmitter.

RECEIVERS.—In early missile systems, receivers used for remote control were simple one-tube superregenerative sets. A relay was connected in the plate circuit of the tube; when a signal was applied to the input of the tube, its plate current changed and operated the relay. The closing of the relay contacts activated another circuit which moved the control surfaces.

The disadvantage of this system is that separate receivers are required for each control function. In addition, the superregenerative receiver, in its most sensitive condition, is a low-powered transmitter that could interfere with other receivers in the missile.

But receiver development kept pace with transmitter development, and simple one-tube

sets were replaced by superheterodyne receivers. These sets are identical to standard frequency-modulation (FM) receivers (PM can be picked up by an FM set) up through the discriminator stage.

The receiver is in the missile and therefore its size and weight are important considerations. Designers aim toward the reduction in size and weight of the components that are placed in the missile.

TYPES OF COMMAND GUIDANCE

Command guidance may be exercised by one or more ground stations, shipboard stations, or aircraft. The guidance point influences the type of command guidance used. Since all command systems are subject to enemy jamming of the control circuit, the closer the missile can be launched to the target the better. A shorter time required for the missile to travel from the launcher to the target means less time for the enemy to jam the controls.

Electronic command guidance systems are divided into four principal groups: television, radio radar, and hyperbolic. Within each group are one or more subgroups. The paragraphs gives a brief introduction to each group.

TELEVISION GUIDANCE SYSTEM

Television command guidance is well suited for some missions where the control point is in a mother aircraft. The control aircraft can stay out of range of hostile antiaircraft defenses and yet launch the missile reasonably close to the target. Because the target is picked up by the missile's TV camera before the missile is launched from the aircraft, the personnel in the plane can see the target through the missile camera from the time the target is first picked up until the missile strikes. Because of the close range at the time of firing, the system is quite accurate; and because of the short time between launching and striking, there is less chance of enemy jamming. But this is essentially an optical system, and is not suitable for use when the target is obscured by overcast, smoke, fog, or darkness.

Chapter 7—COMMAND GUIDANCE

RADIO AND RADAR COMMAND GUIDANCE

These two systems are much alike. Each is based on a transmitter at the control point, and a receiver in the missile. The transmitter sends out a carrier wave, which is modulated in accordance with the command signals. The receiver interprets the modulation so that the missile can execute the transmitted commands. The two systems differ in two ways. First, radar operates at a higher frequency. Second, the radio transmitter usually sends out a continuous carrier wave, whereas the radar transmitter sends out its signals in the form of short pulses, with resting intervals between.

HYPERBOLIC GUIDANCE SYSTEM

A hyperbolic guidance system can be used for both long and short range missile guidance. It consists of master and slave stations that send out low-frequency pulses at constant intervals. The slave station is triggered by the master station, and sends out its pulses a few microseconds after the master pulse is transmitted. These pulses are picked up by receivers in the missile and fed to an automatic computer in the missile. The computer then establishes the missile position by an imaginary line of position set up by the master and slave stations. Hyperbolic guidance is not used by any missiles and will not be discussed further in this course.

Long range hyperbolic navigation was developed primarily for long range navigation over water and for aircraft. LORAN (Long Range Navigation) makes use of a master radar station and one or more slave stations separated by several hundred miles. A form of loran is used by the Matador missile.

RADIO COMMAND SYSTEM

BASIC PRINCIPLES

A radio command system contains a means of accurately determining the missile position in relation to the control station, the target, and the desired trajectory. A computer is usually used to determine the error between the actual missile position and the desired position. A command transmitter is located at the control point, and a receiver is contained

in the missile. The receiver activates the missile control circuits when it receives command signals from the transmitter. This equipment makes it possible to follow the missile's flight and correct for errors which would cause a miss.

Many of the early missiles were radio controlled. The use of radio for command guidance of high-speed missiles makes it necessary to use a transmitter that can do more than send simple ON-OFF pulses (Bang-bang control). Further experimentation with missiles led to the successful use of tone channels. By modulating the transmitter with various audiofrequencies it became possible to control many missile functions by using only one carrier frequency and therefore only one r-f transmitter and receiver. Each of the audiofrequencies was made to represent one particular function such as fly right, fly left, etc. Whereas the number of operations capable of being handled by the system of multiple receivers was only about four, the modulated system was capable of handling twenty possible functions.

Tone systems, however, were troubled by interference from outside sources. Radiofrequency waves modulated by the same frequencies as those used by the missile (but not associated with the missile guidance system) would sometimes cause unwanted actuation of the missile controls. An attempt to prevent this interference was made in using an f-m system. However, outside f-m interference also caused difficulties. Finally, a system was developed which used coded tone pulses. In this system a particular missile function would occur only on the missile's reception and recognition of a specific series of pulses at the correct tone. The chance that random or intentional interference would exactly duplicate the coded pulses in this type of system is minimized.

APPLICATIONS

Radio command guidance may be used to control missiles aimed at ground or air targets from surface sites or from aircraft. The controlled missile may be of any of the following types: surface-to-surface, surface-to-air, air-to-surface, or air-to-air. A recent use is in spacecraft boosters to replace inertial guidance systems. It permits a considerable reduction in weight.

PRINCIPLES OF GUIDED MISSILES AND NUCLEAR WEAPONS

Missiles that are used against moving targets usually have another form of guidance for part of the trajectory. The Nike is an example of such a missile. Many of the glide bombs in the World War II era were radio controlled, as were target drones.

LIMITATIONS

The limitations of a radio command system are imposed by transmission conditions, distance, and enemy countermeasures. Early systems, which used AM tone modulation, had additional limitations. As an example, an interfering signal containing the control-tone frequency would cause the missile control surfaces to act. Often harmonics or sideband frequencies of voice-modulated carriers would upset the whole control system.

The use of PM (phase modulation) eliminated a large part of the voice interference, but manmade interference with PM characteristics could still affect the control system. This disadvantage was overcome by using coded combinations of tone channels. With this system, no control operation can take place unless the proper tones appear at the missile receiver in the correct order and spacing. The adoption of this control method practically eliminates the chance that an interfering signal will duplicate the control combination.

COMPONENT OPERATION

Radio Command Transmitter

Figure 7-2 shows a block diagram of the type of radio command transmitter used in modern systems. The master oscillator is crystal-controlled and provides a very stable carrier frequency. Accurate frequency control is of prime importance since the command receiver in the missile is tuned to the command frequency before the missile is fired, and the receiver tuning cannot be changed while the missile is in flight. Therefore, the transmitter frequency must remain stable or the command link will be lost.

The output of the crystal oscillator is built up by r-f amplifier stages. Some of these stages operate as frequency multipliers, but the output stage operates as a straight-through r-f power amplifier.

TRANSMITTER MODULATION.—The use of PM results in considerable saving of space,

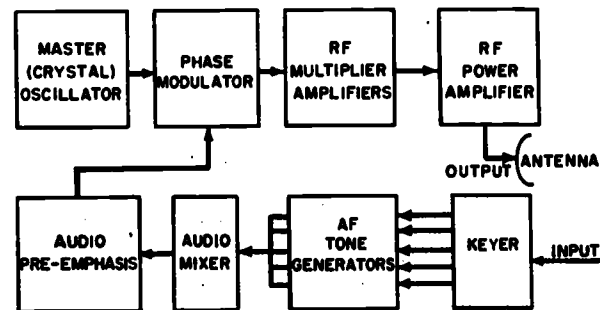

33.139

Figure 7-2.—Phase modulated radio command transmitter.

power, and cost, since modulation takes place at a low level and requires less audio power that does high level AM.

Modulation is in the form of tones that are generated by tone generators. Starting at the input of the transmitter, each a-f tone generator may be keyed separately or in combination with others. The tone generator outputs are fed to an audio mixer circuit and, as a result of the mixing, a composite tone appears at the output of the mixer stage.

The composite tone is fed to an audio preemphasis network. The network builds up (emphasizes) the higher audio frequency components of the composite signal, which are later deemphasized in a network of opposite characteristics in the receiver. This action is desirable because atmospheric noise usually consists of high frequency components. Because the noise appearing with the signal consists of high frequency components, preemphasis is used only on the high frequency tones, and thus causes the signal-to-noise ratio to remain more constant throughout the audio range.

As shown in figure 7-2, the composite tone from the preemphasis network is fed to the phase modulator stage, which is connected between the crystal oscillator and the first frequency multiplier stage. After modulation, the fundamental frequency is multiplied and amplified as in any other transmitter. It then passes to the antenna and is radiated into space.

In order to understand how phase modulation (PM) takes place it is necessary to remember that the frequency of an alternating current is determined by the rate at which its phase

changes. If the phase of the current in a circuit is changed, there is an instantaneous frequency change during the time that the phase is being shifted. The amount of frequency change, or deviation, depends on how rapidly the phase shift is accomplished. It also depends on the amount of phase shift. In a properly operating PM system, the amount of phase shift is proportional to the instantaneous amplitude of the modulating signal. The rapidity of the phase shift is directly proportional to the frequency of the modulating signal. Consequently, the frequency deviation to pm is proportional to both the amplitude and frequency of the modulating signal. Thus the crystal oscillator output signal is varied in both amplitude and phase by the modulating signal.

The rf section of the transmitter operates continuously, but is modulated only when one or more of the tone generators are operated by the keyer section.

Missile Receiver

The receiver in the mission is the conventional f-m receiver shown in the block diagram in figure 7-3. An addition to the conventional receiver is the carrier fail relay. When the incoming carrier signal falls below a specified value (thus becoming unreliable), the fail relay is actuated. The operation of this relay may cause self-destruction of the missile or keep it on present course (depending on the desired objectives).

After amplification, the discriminator (detector) output is applied to the a-f selector channels. There is one selector channel for every tone that the transmitter may send. The

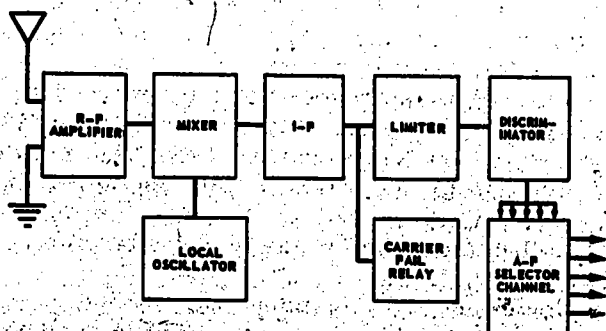

33.140

Figure 7-3.—Command receiver in missile.

selector channel, a breakdown of which is presented in figure 7-4, is usually an amplifier with a band-pass filter at the input and a relay in the plate circuit.

USE OF TONE CHANNELS.—The discriminator output is fed to a-f channel selectors and there is one receiver channel selector for each tone the transmitter may send.

The sections of an a-f channel selector are shown in figure 7-4. A sharply tuned band-pass filter (one that passes certain frequencies better than others) is at the input of an amplifier stage.

The grid bias of this stage is adjusted so that plate current is cut off when no signal is being fed to the stage. When a signal is applied to the input of the stage, the effective grid bias is reduced to the point where plate current flows. The change in plate current operates the relay; its contacts close, and activate the missile control surfaces in accordance with the commands.

Proportional Control

Thus far, we have discussed radio command guidance from the standpoint of on-off (bang-bang) control. In some missiles, radio commands are used in proportional control of missile functions. For example, throttle control, turn control, and pitch control may be gradually varied in proportion to the varying characteristics of the radio command signals. Usually, pulse width is varied with pulse repetition rate (PRR) remaining constant. By manipulating controls at the command station, varying voltages are produced. These voltages are converted to varying width gated signals from subcarrier oscillators. The gate widths are directly proportional to the desired changes in missile

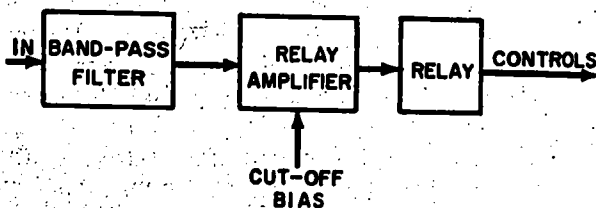

33.141

Figure 7-4.—Selector channel with band-pass filter.

PRINCIPLES OF GUIDED MISSILES AND NUCLEAR WEAPONS

function. The missile will interpret the gradually varying characteristics of the subcarriers and respond by correcting pitch, heading, and throttle control in proportion to those variations.

LAUNCHING STATION COMPONENTS

MISSILE COURSE COMPUTER. Ordinary forms of missile course determination require a large number of calculations, and considerable time. Since calculations are time consuming, and since speed is an absolute necessity, electronic course computers have been developed for this use.

The computer, located at or near the launching site, performs two functions. First, it determines the course that should be followed by the missile during its flight to the target. It then compares this desired course with the actual course of the missile, as determined by the tracking radar. Any deviation between the two is instantly detected, and an error signal is sent to the command transmitter keying unit. The keying unit modulates the transmitter with the desired tone and spacing sequence. When these signals are picked up by missile receiver, the proper control surfaces are activated to bring the missile back on course.

MISSILE TRACKING RADAR. When command guidance is used, the position of the missile in relation to the control point, desired course, and the target area must be known at all times.

Since radar can provide information as to range, elevation, and direction, it is well suited for short- and medium-range missile tracking. In general, missile-tracking radars use the same principles as search, fighter-director, and fire control radars.

Radar ranging is accomplished by time measurement. The range is found by measuring time elapsed time between the transmission of a pulse and the arrival of the echo reflected from the missile. Radar waves travel at the speed of light (186,000 miles per second). The distance to the target is found by multiplying the elapsed time by the speed of the radar wave and then dividing the result by two. The division by two is necessary because the elapsed time includes time out and time back, so that the actual time to the target is one-half the elapsed time.

The time sequence for the radar set is started in the timing generator. The trigger action of the timing generator controls the

modulator section, which in turn produces the high-voltage output pulse.

The same trigger pulse is also sent to the range unit, and starts its time-measuring device. After a short, fixed delay, the range unit forms a range gate. The gate is developed by a voltage which is present during a relatively short part of the main time cycle. This voltage is applied to the gain control circuit of the receiver. When the range-gate voltage is present, the receiver gain is high; during the rest of the time cycle, the gain is very low. Thus, when the range gate is "open," signals picked up by the antenna will pass through the receiver; when the gate is "closed," they will not.

A definite time is required for the transmitted signal to reach the missile, and for the reflected signal to return. The total time depends, of course, on the range of the missile. The timing circuits can be adjusted to open the range gate shortly before the reflected signal is due to reach the radar antenna, and to close it shortly afterward. Thus the range gate permits only the echo signals reflected from the missile to pass through the receiver; echoes from other objects will be rejected. The reflected signals, through servo systems, control the position of the radar antenna, so that it will track the missile automatically.

A single antenna is used for both transmitting and receiving. This requires some means for switching the antenna from the transmitter to the receiver, and then back to the transmitter again. The device usually used for this purpose is called a duplexer. The duplexer makes it possible to operate the transmitter and receiver simultaneously, but keeps the powerful transmitter signals from entering the receiver directly.

For missile tracking, a lobing or conical scanning system is used, because accurate angle data cannot be obtained from a single beam on the antenna axis. This type of scanning is described in chapter 8.

Video signals produced by the reflected signal from the missile may be used to modulate the display on a cathode-ray tube. The method of modulating the display will depend on the type of indicator used in the radar set. Either the deflection or the intensity of the beam trace may be modulated.

Command systems using radar tracking have a relatively high degree of accuracy, and the weight of the equipment required in the missile is comparatively small. However, tracking

Chapter 7--COMMAND GUIDANCE

errors will be introduced by limitations of the radar system. In general, radar range information is accurate, and elevation and azimuth information is accurate to within a few mils. The range and accuracy of the guidance system can be improved by using a different form of terminal guidance, such as homing guidance.

Missile Plotting System

The use of radar for missile tracking makes it possible to obtain information on the missile's elevation, bearing, and horizontal range. This information may be plotted so that personnel controlling the missile will have a complete picture of the operation.

An example of a basic plotting system is shown in figure 7-5. The tracking radar is shown at the left of the drawing, and the plotting board at the right. The boom on the plotting board revolves around a center pivot, and is positioned by the missile bearing data. The tracing pen trolley (mounted on the revolving boom) is positioned by the horizontal range data. The pivot of the boom represents the tracking radar location, and the pen position represents the instantaneous location of the missile.

The radar can provide only slant range, bearing, and elevation angle. The horizontal range data used to position the tracing pen trolley can be obtained from the product of the slant range and the cosine of the elevation angle. The elevation of the missile is the product of the slant range and the sine of the

elevation angle (or of the horizontal range and the tangent of the elevation angle). Successive positions of the missile can be marked on the plotting chart at regular intervals, to provide an indication of the missile's course. In modern systems, plotting of the target and the missile's position is usually done in the Combat Information Center (CIC) of the ship.

TELEVISION COMMAND GUIDANCE

Television has been used in various weapon systems to obtain target information. Assault Drone, a pilotless aircraft, used by the U. S. Navy against Japanese and German targets in 1944, employed television and radio control in a "mother" airplane to effect guidance. Several guided bombs using television command guidance were developed by the United States during World War II. The GB-4 was successfully used by the U. S. Air Force against U-boat pens, V-1 and V-2 launching sites, and German industrial centers. The television camera was in the bomb; the operator in the "mother" or launch aircraft monitored the TV picture and guided the bomb to the target, using a radio command link. The Robin and the Roc were similar types developed in the United States.

Television guidance generally has made use of the electromagnetic frequencies in the range between radio and radar applications for transmission. The sensor units operate on the visual band of the spectrum.

Television is the information link of the system; radio is normally used for the command link.

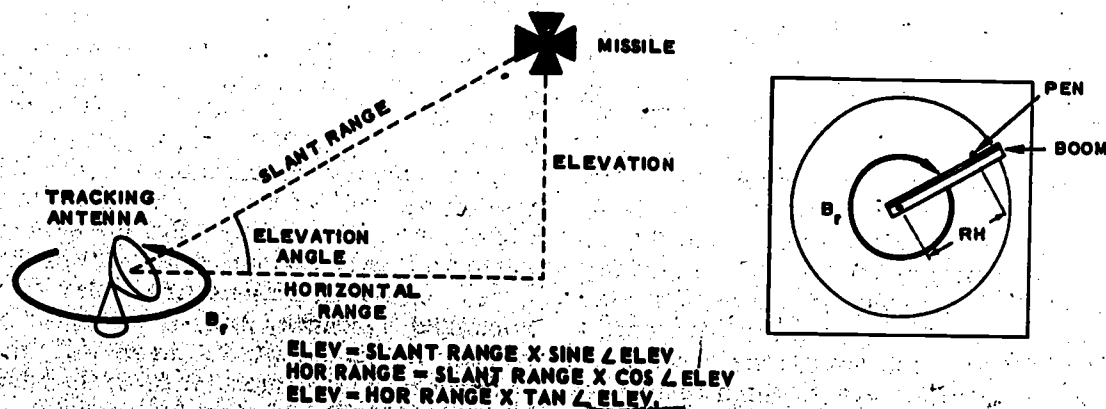

Figure 7-5.--A basic missile plotting system.

PRINCIPLES OF GUIDED MISSILES AND NUCLEAR WEAPONS

At present, the Navy has under development an air-to-surface missile using the television system.

RADAR COMMAND SYSTEM

GENERAL

If a command system is to be used with supersonic missiles, some form of radar tracking employing an automatic computer must be used to obtain a reasonable degree of accuracy. In this system, both the guided missile and the target are tracked by radar (fig. 7-1), and the information concerning range, range-rate, azimuth, and elevation is fed to an automatic computer. Telemetered information from the guided missile may also be sent to the computer. The computer determines the control signal which must be sent to the guided missile to steer it to a collision with the target.

There is great similarity between radio and radar command guidance systems. Each is based on a transmitter at the control point, and a receiver in the missile. In both systems the transmitter sends out a carrier wave, which is modulated in accordance with the desired commands. The receiver interprets the modulation so that the missile can execute the transmitted commands.

OPERATION OF RADAR COMMAND GUIDANCE

Most radar command guidance systems depend on "sampling" control, since it is not possible to control all of the missile functions at once. Each must take its turn in the control sequence. Consequently, after a given function has received a command, there will be a time delay before the next command is received. The length of this delay will depend on the number of functions to be controlled.

When radar is used for control, the fidelity or accuracy of control is limited by the allowable variations in pulse rate or amplitude. (Excessive variations will affect the tracking accuracy.) The accuracy of control is also limited by the ability of the missile equipment to measure these variations accurately.

There are several ways in which commands can be sent by radar. For example, the pulse repetition rate (PRR) of the radar may be frequency modulated in order to turn the missile

in the desired direction. If the PRR is unmodulated, no control signal is sent to the missile. If the PRR is modulated so that it increases, the missile will turn in a certain direction; if the PRR decreases, the missile will turn in the opposite direction. Since the PRR can be varied by the modulation frequency, it is possible to make the amount of turn proportional to the deviation from the normal PRR, and thus obtain accurate control.

This system requires some form of multiplexing or switching control, so that operations take place in a definite sequence. As an example, there may be five possible operations and each may be controlled by a 1/100-second signal of the proper pulse rate. A complete set of control signals could then be sent every 1/20 second.

The control pulses may be coded in sequence so that each pulse controls a particular operation. As soon as a full set of operations is covered, the sequence starts over again. The pulses may be modulated either in amplitude or by their position on a time scale.

Several means of controlling missile functions by the radar tracking beam are illustrated in figure 7-6. Multiple pulses may be grouped as shown in block A, the number of pulses in each group determining the specific command. Block B shows dual pulses with the spacing between the pulse determining the command. In block C, every other pulse is displaced in time, the direction of displacement in time determining the command. Block D shows pulse width variation representative of commands.

The use of the missile tracking radar beam as a control medium results in economy of equipment because the radio control transmitter is no longer needed.

As in any other communications equipment, the bandwidth of the modulated signal determines the amount of information that can be transmitted in a given time. A radar signal with a pulse repetition rate of 2000 cycles per second would limit the number of functions that could be controlled as well as the rate at which the control signals could be changed. But for some missile systems this bandwidth is adequate because only a few missile functions are under control by command guidance. And, if the rate of signal change is not too great, there will be enough bandwidth to allow modulation of the radar beam with several signals simultaneously.

If there are missiles in the vicinity of the beam other than the one being tracked, some

Chapter 7—COMMAND GUIDANCE

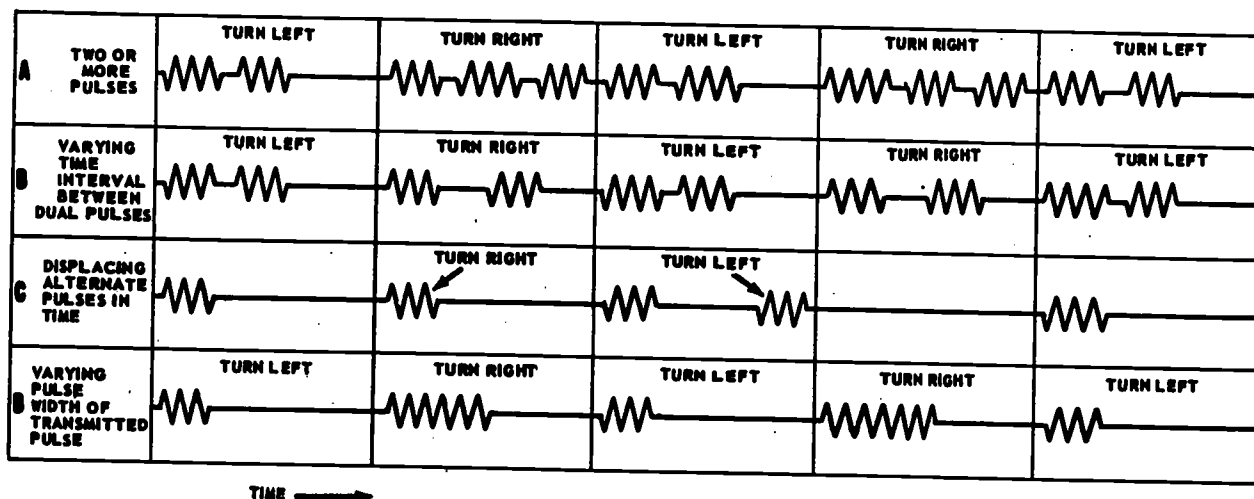

Figure 7-6.—Methods of transmitting commands by radar pulses.

33.143

coding or frequency discrimination method must be used so that each missile will respond only to its own command signals. This is true in either the continuous wave or pulse system. Therefore, if there is any likelihood that the spacing between radar beams is not sufficient, each missile launched from a particular control station must have either special coding equipment or at least a special receiver adjustment to ensure response to the correct signal.

to accept command signals. When used for this purpose, an additional set of coded pulses is added to the transmitted signal for the missile tracking radar. The beacon accepts these signals and channels them into a computer which decodes them for the intelligence they contain.

There is no generalized radar beacon system; each system is designed for a particular application.

RADAR BEACON

To extend the tracking ranges, some missiles have radar beacons installed. This beacon is actually a small radar set which is actuated by the remote missile tracking radar. When triggered by a coded pulse from the tracking radar, the beacon returns a stronger signal to the tracking receiver than would be received only by reflection. Figure 7-7 shows a block diagram of such a system. The combined action of the beacon receiver and transmitter raises the signal level. Radar-beacon ranges are generally limited only by the radar horizon. The beacon transmitter operates on a slightly different frequency than does the tracking radar. The tracking receiver is tuned to the beacon transmitter frequency so it can detect the beacon signal without confusing it with the reflected echo. The beacon receiver can also be arranged

FUTURE OF COMMAND GUIDANCE SYSTEMS

It should be kept in mind that command guidance systems are in a state of constant development, and that future systems may differ considerably from those described here. Systems that were tried in early missile developments and were discarded may be improved and placed in new missiles. An example is the Wall-eye, a guided air-to-surface bomb being developed. Television contrast homing guidance is being used for it. Another example is wire guidance, which was considered inadequate and was discontinued in the air-to-air missiles a number of years ago. It is being used in some present-day surface-to-surface short-range missiles, including the French SS-10 and SS-11 antitank missiles, and our own Army antitank missiles, Entac and TOW.

PRINCIPLES OF GUIDED MISSILES AND NUCLEAR WEAPONS

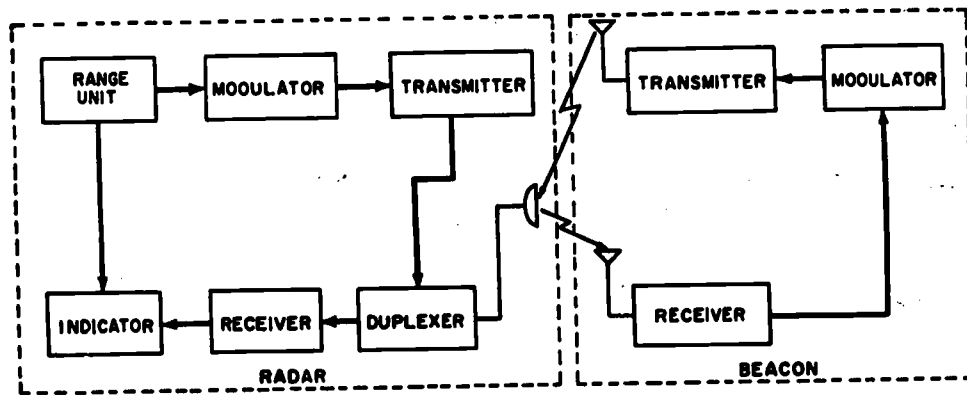

Figure 7-7.—Radar beacon system in missile guidance.

144.38

CHAPTER 8

BEAM-RIDER GUIDANCE

INTRODUCTION

GENERAL

The beam-rider guidance method may be considered to be a form of command guidance, since the beam-rider missile maintains direct electromagnetic radiation contact with a friendly control point.

Beam-rider guidance is similar to radar command guidance. In both systems, target information is collected and analyzed by devices at the launching site or other control point rather than by devices within the missile. In both systems, the missile makes use of guidance signals transmitted from the control point.

The principal difference between radar command guidance and beam-rider guidance was stated in chapter 6. The guidance equipment in the missile formulates its own steering signals from the information contained in the radar beam. These correction signals produce control surface movement on the missile to keep it as nearly as possible in the center of the radar beam which pinpoints the target. The missile can thus be said to "ride" the beam to the target. (See figs. 6-8 and 6-9.)

The beam-rider system is highly effective for use with short-range and medium-range surface-to-air and air-to-air missiles. For missiles of longer range, a beam-riding system may be used during the midcourse phase of flight, while the missile is still within effective range of the beam-transmitting radar. As it approaches the limit of beam-riding range, the missile may switch over to some other form of guidance.

The beam-rider missile system has both advantages and disadvantages. It permits the launching of a large number of missiles into the same control beam, since all the guidance equipment is carried in the missiles. This,

however, makes each missile large and expensive. The radar problem is simple since only one radar set is required (two radars may be used), but the controlling beam must be reasonably narrow to be directive, and this increases the chance of loss of the missile through target maneuvering and evasion.

APPLICATION TO U. S. NAVY MISSILES

The U. S. Navy missile program is one of continuous research and improvement in all phases. Two missiles, Terrier and Talos, developed under the Bumblebee (1944) program, has been operational for some time. Both of these are surface-to-air missiles using beam-rider guidance. The BW-1 Terrier is a beam-riding, wing-controlled missile; the BT Terriers are beam-riding, tail-controlled missiles; and the Terrier HT type uses homing guidance. The Talos is a beam rider in the midcourse stage of its flight, switching to homing for the terminal phase of its flight.

This chapter will give information of a general nature on beam rider guidance systems that might be used with this type missiles. It should be kept in mind that security requirements prevent a detailed description of the guidance system of any specific missile.

SYSTEM COMPONENTS

GENERAL

There are several important components, other than the missile and radar, in a complete guided missile system.

A major part of the equipment is at the launching site. The number and type of components will vary with individual systems, and a mobile setup will differ from a fixed, permanent launching site.

PRINCIPLES OF GUIDED MISSILES AND NUCLEAR WEAPONS

Figure 6-6 is a simple diagram of a beam-riding missile guidance system which includes the basic elements when a radar beam is used as the guiding beam. The example shown is a surface-to-air application. The radar is used to develop the beam along which the missile is to travel. Its antenna is directed so that the center of the beam is on the target. The missile launcher, if trainable, is used to point the missile so it is able to enter the beam after launching. The beam-riding missile contains the mechanisms that permit it to measure its position with respect to the center of the radar beam and to move to correct its position.

Two types of beam-rider systems are in use. In the simplest type, a single radar is used for both target tracking and missile guidance. In the second type one radar is used for target tracking, while another radar generates the guidance beam. The monopulse system, which is not a type of guidance system, but a radar technique used in tracking, is described later in this chapter.

LAUNCHING STATION COMPONENTS

The launching station may be on or in the ground, aboard a ship, or in an aircraft. The components used in aircraft are necessarily limited in size, weight, and amount of power required to operate them. These components are the radar (or radars), computer, information display scopes (oscilloscopes) and, of course, the missiles which are to be used. Figure 8-1 pictures the components that may be found aboard a ship. The radars and launchers are above deck, but the computers, display consoles, and direction equipment are below decks.

All changes detected by the radars or made by the missile or the target are instantly flashed on the consoles below decks so the course can be followed and combat decisions made on the basis of the information supplied.

The target is usually picked up at long range by a search radar. When the target is identified, the tracking radar takes over the job of following it, and determines its direction (elevation and bearing) range rate (radial velocity), and range. This information is converted rapidly into usable form by the computer.

Because the computer is given the course, speed, bearing, elevation, and instantaneous range of the target, it can calculate the course, and position of the target at any future time, assuming that it does not change course or speed. In some cases, the computer may calculate the

speed of the target. The computer is also given the average speed of the missile. With this information, it is able to determine the direction in which the missile must be launched to intercept the target. It is unlikely that a missile will be fired as soon as the tracking radar acquires the target. The target range is constantly changing, and the target may change course or speed as well. The computer must therefore produce a continuous solution to a continuously changing problem. At any given instant, the computer output provides the correct solution to the problem as it exists at that instant.

In a two-radar system, the computer continues to calculate the missile course after the missile has been launched, and until the target has been destroyed. Through servo mechanisms, it turns the control radar in the proper direction. The computer output is used to train and elevate the missile launchers in such a direction that the missile will enter the capture beam (described later) at the optimum angle. If this angle is too large, the missile must make a sharp turn to get into the control beam. If it is too small, there is some danger that the missile will evade the capture beam and self destruct.

MISSILE COMPONENTS

The receiving antenna in the missile is a very important part of its electronic installation. Through it must come all guidance signals from the control radar. There are several difficulties in determining the optimum location of an antenna on a missile. First, the antenna must not interfere with the aerodynamic stability of the missile. Second, it must be located at a point where it will not be damaged by the rapid acceleration as the missile is launched, and where wind will not tear it loose. Finally, the antenna must be located where it can effectively pick up the signals of the guidance beam. The antenna location that has been found most satisfactory is at or near the missile after surfaces.

The missile antenna is highly directional, and most sensitive to signals received from behind the missile. The roll-control system of the missile keeps it stabilized so that the antenna polarization remains constant. Another purchase of the roll-control system is to establish an up-down, right-left guidance coordinate.

The guidance signals picked up by the missile antenna are fed to a receiver. After the signals are amplified and demodulated by the

Chapter 8—BEAM-RIDER GUIDANCE

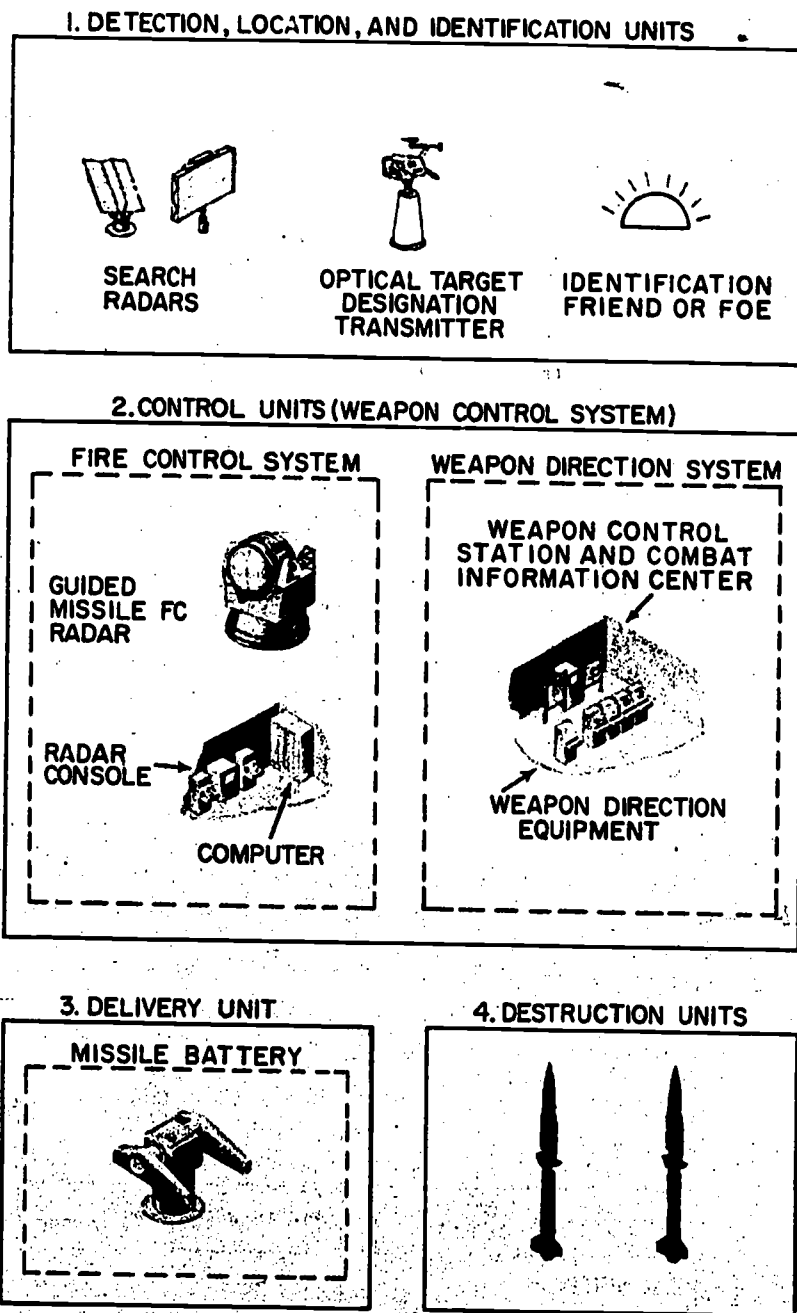

Figure 8-1.—Components at the launching station (shipboard representation).

12.41

PRINCIPLES OF GUIDED MISSILES AND NUCLEAR WEAPONS

receiver, they are fed to a computing network in the missile. Demodulation is the process of extracting information (direction, etc.) about the target from the beam's carrier signal. If the missile is off the scan axis of the guidance beam, the computer will determine both the direction and the magnitude of the error. It will then give the correction signals required to bring the missile back onto the scan axis.

Figure 8-2 is a block diagram of the essential components of a beam-rider guided missile. The computer includes all the necessary circuitry to separate the up/down and left/right correction signals contained in the output of the receiver. The separate signals are then amplified and drive the servomotors which actuate aerodynamic surfaces or other means of control to change the position of the missile and cause it to move toward the center of the beam.

The missile also needs to be roll-stabilized. This is done by placing a gyroscope inside the missile with its axis oriented so that an output is produced if the missile tends to roll. The output is amplified to operate control surfaces that neutralize the tendency of the missile to roll.

TARGET

The target for any guided missile must have some unique characteristic as seen by the tracking radar. This characteristic often is the reflective property of the target compared to its surroundings. For example, an airplane flying in free space has high radar reflectivity as

compared to its surroundings and therefore is a good radar target. An important point is that the missile velocity must be greater than the target velocity.

PRINCIPLES OF BEAM-RIDER GUIDANCE

Since the beam used in beam-rider guidance is a radar beam, a knowledge of the basic principles of radar is necessary to understand how the system operates. The first volume in this series, Principles of Naval Ordnance and Gunnery, NavPers 10783-A, contains a chapter on the detecting and assigning of air targets for guns. The radar principles apply equally to guidance systems for missiles.

GUIDANCE ANTENNAS

The antenna system consists of waveguides, switching tubes, a reflector for beaming the radiated energy, a mechanism for nutating the feed during operation, and servo units which position the antenna reflector. Its purpose is to radiate microwave energy developed by the transmitter and to receive echo signals from the target and apply them to the receiver.

General

The radar energy that forms the guidance beam is transmitted by an antenna at the control point. Radiated energy tends to spread out equally in all directions, but by mounting a suitable reflector behind the antennas, a large part of the radiated energy can be formed into

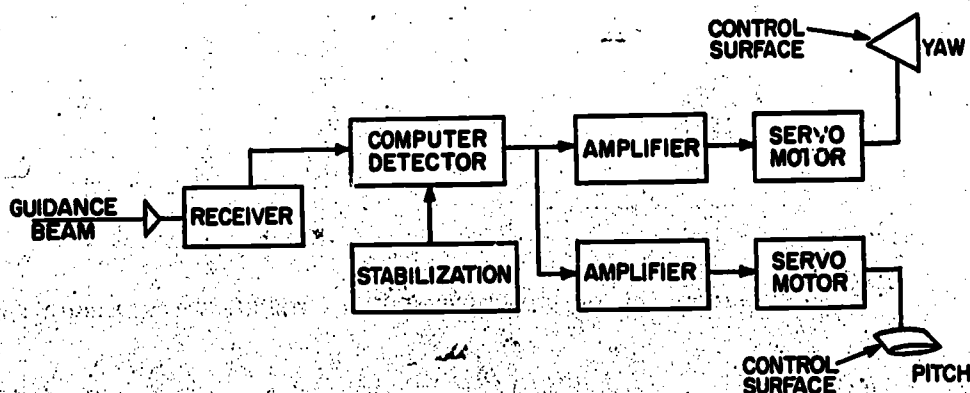

Figure 8-2.—Beam-rider guided missile, block diagram (essential components).

Chapter 8—BEAM-RIDER GUIDANCE

a relatively narrow beam. A narrow beam can point out the target direction with sufficient accuracy for the missile to score a hit, and concentration of the radiated energy into a beam extends the effective range of the system.

Figure 8-3 compares the radiation from a radio antenna with that from a lamp. Both light waves and radio waves are electromagnetic radiation; the two are believed to be identical, except in frequency of vibration. From both sources, energy spreads out in the form of spherical waves. Unless they meet some obstruction, these waves will travel outward indefinitely at the speed of light. Because of its much higher frequency, light has a much shorter wavelength than radio waves. This is suggested in figure 8-3, but it cannot be shown accurately to scale. The wavelength of radar transmission may be measured in centimeters;

the wavelength of light ranges from about three to seven ten-thousandths of a millimeter.

You are, of course, familiar with the use of polished reflectors to form beams of light. An automobile headlight is an example of this, although it produces a fairly wide beam. A spotlight produces a more narrow beam.

Figure 8-4A represents the reflection of light by an "ideal" reflector. The emerging rays are parallel; the beam is no wider than the reflector itself, and it does not diverge. But an ideal reflector is hard to achieve in practice. It must be a paraboloid of revolution—that is, the surface generated by a parabola rotated on its axis. It must be highly polished;

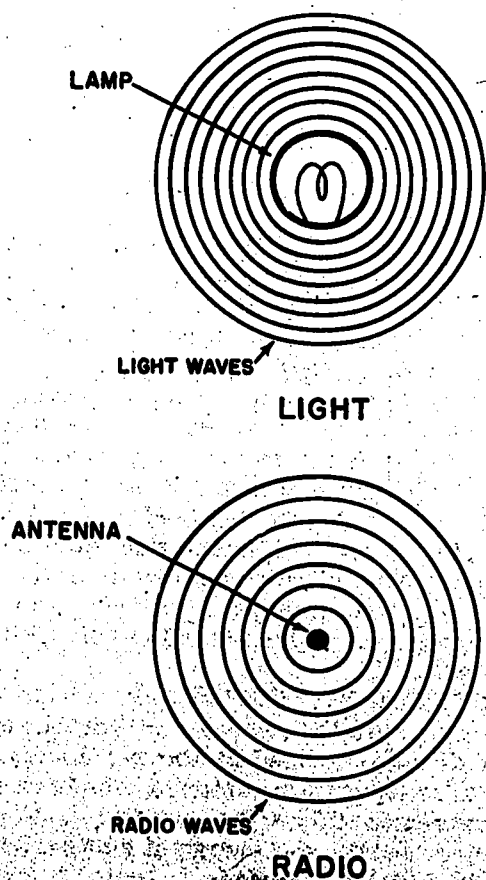
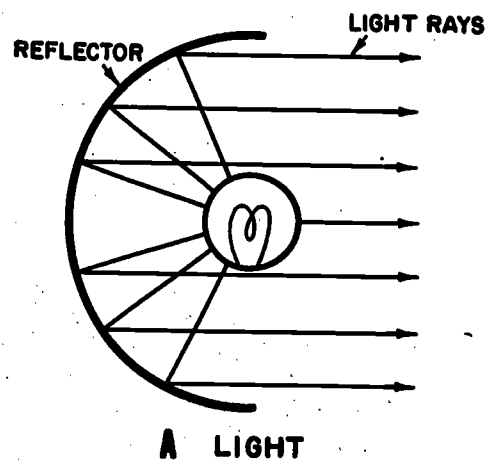
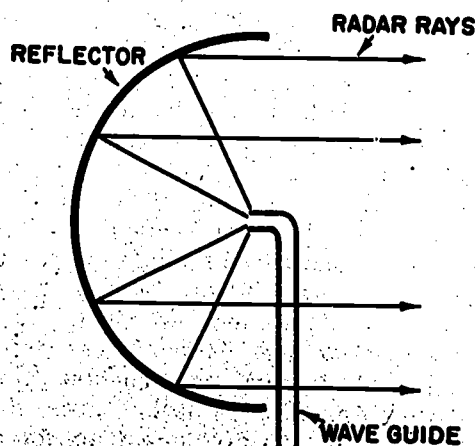

Figure 8-3.—Radiation, unrestricted, from a lamp and a radio antenna.

144.38



A LIGHT



B RADAR

Figure 8-4.—Radiation of light and radar waves as affected by a reflector.

33.145

PRINCIPLES OF GUIDED MISSILES AND NUCLEAR WEAPONS

its surface irregularities must be small compared with the wavelength of light. And the light source must be a single point, located at the focus of the paraboloid.

Figure 8-4B represents the reflection of radar waves. Again, the surface of the reflector is paraboloid, but it need not be highly polished, because of the longer wavelength of radar. The source of radiation is the end of a waveguide. Unfortunately, this is not a point source; it must have a finite area.

It should be noted that a light RAY is simply a convention used in diagrams. Such rays do not exist in nature. They are imaginary lines that indicate the direction in which the wavefronts are moving. Although RADAR RAYS are not a familiar convention, they are used in figure 8-4B to show the direction in which the radar waves are moving.

Of course the lamp shown in figure 8-4A is radiating light in all directions. The light from the front surface, which does not strike the reflector, will be scattered widely. In some spotlights, the front surface of the lamp is shielded, so that the only rays that leave the spotlight are those that have been reflected. Such a spotlight produces a sharply defined beam, with little or no scattered light. The same effect is achieved in radar by directing the opening of the waveguide backward, toward the reflector.

But no radar can produce an ideal beam of parallel "rays." For one thing, the end of the waveguide is large, compared to the ideal point source. For another, a reflector of practical size is not sufficiently large compared with the wavelength of the radiated energy. A radar beam therefore diverges and forms a lobe, like the one in figure 8-5. This is the main lobe or beam. The student should clearly understand that such a lobe is merely a convenient way of representing the beam on paper; it is in no sense a "picture" of the beam. Some of the radiated energy will be scattered outside the main lobe, and will form side lobes, usually of lesser intensity, and much shorter range. They are undesirable lobes that exist in close proximity to the transmitter, and may confuse the fire-controlman. And the radiation does not end abruptly at a certain distance from the transmitter, as the diagram implies. The lobe, if it can be pictured in three dimensions, can be thought of as a surface, all parts of which receive an equal amount of energy. This can be considered the minimum energy that is useful

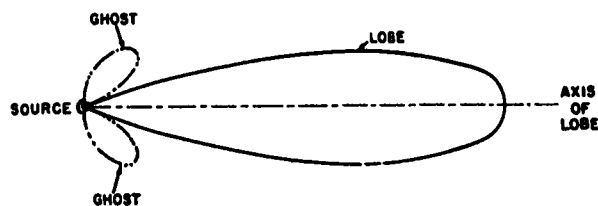

33.146

Figure 8-5.—Lobe formation of radar beam.

for our purpose (missile guidance or target tracking). The lobe in figure 8-5 is not drawn to scale. The diameter of the reflector is in the order of two feet; the length of the lobe may be from 20 to 50 miles. Its useful width may be four or five degrees. At any given distance from the transmitter, the signal is strongest along the axis of the lobe.

In a beam-rider guidance system, radar must accomplish two things; it must track the target, and it must guide the missile. It would be difficult to do either of these things with a simple lobe like the one in figure 8-5.

Nutation

Nutation is difficult to describe in words, but easy to demonstrate. Hold a pencil in two hands; while holding the eraser end as still as possible, swing the point through a circle. This motion of the pencil is nutation. (The pencil point corresponds to the open, or transmitting, end of the waveguide antenna.) The important thing is that polarization of the beam is not changed during the scanning cycle. This means that the axis of the moving feed must not change horizontal or vertical orientation while the feed is moving. You might compare the movement to that of a ferris wheel; the position of the seats must remain the same regardless of the position of the wheel.

NUTATING WAVEGUIDE.—A waveguide is a metal pipe, usually rectangular in cross section, which is used to conduct the r-f energy from the transmitter to the antenna. The open end of the waveguide faces the concave side of the reflector, and the r-f energy it emits is bounced from the reflector surface.

A conical scan can be generated by nutation of the waveguide. In this process, the axis of the waveguide itself is moved through a small

conical pattern. This three-dimensional movement in an actual installation of the waveguide, is fast and of small amplitude. To an observer, the waveguide appears merely to be vibrating slightly.

NUTATING LOBE.—By movement of either the waveguide or the antenna it is possible to generate a conical scan pattern, as shown in figure 8-6. The axis of the radar lobe is made to sweep out a cone in space; the apex of this cone is, of course, at the radar transmitter antenna or reflector. At any given distance from the antenna, the path of the lobe axis is a circle. Within the useful range of the beam, the inner edge of the lobe at all times overlaps the axis of scan.

Now assume that we use a conically scanned beam for target tracking. If the target is on the scan axis, the strength of the reflected signals will remain constant (or change gradually as the range changes). But if the target is slightly off the axis, the amplitude of the reflected signals will change rapidly and periodically. For example, if the target is ABOVE the scan axis, the reflected signals will be of maximum strength as the lobe sweeps through the highest part of its cone; they will quickly decrease to a minimum as the lobe sweeps through the lowest part. Information on the instantaneous position of the beam relative to the scan axis, and on the strength of the reflected signals, can be fed to a computer. This computer in the radar may be called angle tracking or angle servocircuit, or angle error detector. If the target moves off the scan axis, the computer will instantly

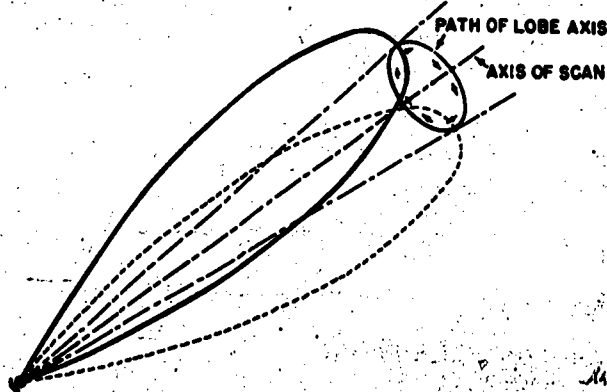

Figure 8-6.—Nutating lobe, conical scanning.

determine the direction and amount of antenna movement required to continue tracking. The computer output can be used to control servomechanisms that move the antenna, so that the target will be tracked accurately and automatically.

When a conically scanned radar beam is used for missile guidance, the desired path of the missile is not along the axis of the beam, but along the axis of scan. It is possible to produce a conical scan by any of several methods.

Types of Antennas

DIPOLE.—Although not used by any of the newest modifications of our missiles, several types of missiles have used a rotating dipole antenna. The antenna was not rotated about its center, for this would have changed the polarization as the antenna turned. Such a condition would have caused erratic control of the missile. The antenna is mounted in a plane that passes through the focal point at a right angle to the reflector axis. As the antenna rotates it stays in this plane. The same relative motion can be produced by having a stationary antenna and rotating the reflector about a point off its axis.

LENS ANTENNAS.—Lens antennas of two types have been developed to provide easy steerability in both azimuth and elevation for tracking radars, while avoiding the problems associated with feed horn shadow in reflector antennas. (The shadow is a dead spot directly in front of the feedhorn.) These are conducting type and dielectric or delay type. They are also called microwave lenses. The lens is substantially transparent to microwaves but inserts a phase change over the cross section of the exit side of the lens to make the microwaves converge or diverge. The lens is placed in front of a point source of r-f energy, such as a feedhorn. While a feedhorn is not a "point" source, for analysis of electromagnetic wave propagation it is often considered as a point source of energy.

The conducting type, which is a wave guide, is illustrated in figure 8-7A.

This type accelerates wave transmission as it passes through the lens. It consists of flat metal strips placed parallel to the electric field of the wave and spaced slightly in excess of one-half of a wavelength. To the wave these strips look like waveguides with each hypothetical waveguide having a dimension in a direction

PRINCIPLES OF GUIDED MISSILES AND NUCLEAR WEAPONS

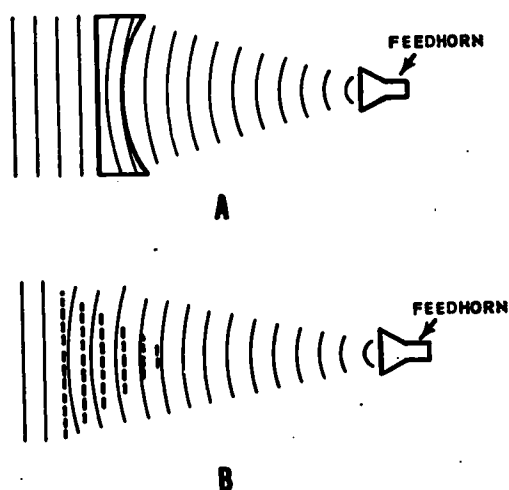

55.62:63

Figure 8-7.—Antenna lenses: A. Waveguide (acceleration) type microwave lens; B. Metal strip (delay) type microwave lens.

perpendicular to the electric field corresponding to the spacing between the parallel strips. The velocity of phase propagation of a wave is greater in a waveguide than in air. This, since the lens is concave, the outer portions of the transmitted spherical wave are accelerated for a longer interval of time than the inner portion. The spherical waves will emerge at the exit side of the lens (lens aperture) as flat-fronted parallel waves. The waveguide type lens is frequency sensitive.

The other type lens is the dielectric, or metallic delay lens, shown in figure 8-7B. The delay lens, as its name implies, slows down the phase propagation as the wave passes through the lens. This lens is convex, and consists of dielectric material. The delay in the phase of the

wave passing through the lens is determined by the dielectric constant or refractive index of the material. In most cases, artificial dielectrics consisting of conducting rods or spheres that are small compared to the wavelength are used. Artificial dielectrics, or conducting insulators, used in r-f transmission systems are covered in *Basic Electronics*, NavPers 10087-A. In this case the inner portion of the transmitted wave is decelerated for a longer interval of time than the outer portions.

In a lens antenna the exit side of the lens can be regarded as an aperture across which there is a field distribution. This field acts as a source of radiation just as fields across the mouth of a reflector or horn. For a returning echo the reverse effects take place in the lens.

It can be seen that the reflector uses the law of reflection while the lens uses the law of refraction. The rear feed arrangement of the lens antenna eliminates spillover radiation in the backward direction. Also, this arrangement puts the radiator out of the path of the beam, thus reducing shadows.

MISSILE RECEIVER.—The purpose of the receiving antenna, located in the missile, was described briefly at the beginning of this chapter. Figure 8-8 shows the location of receiver antennas in a beam-rider missile, near the control surfaces. In some missiles the antennas are part of the electronics section. The function of the missile receiver is to receive the signals from the radar transmitter, amplify and rectify the signals and feed them to the missile computer. In order to keep the receiver in tune with the guidance transmitter, a system of automatic frequency control is used in the receiver. This is to reduce acceptance of stray signals or countermeasure signals. The automatic frequency control keeps the receiver intermediate frequency from drifting.

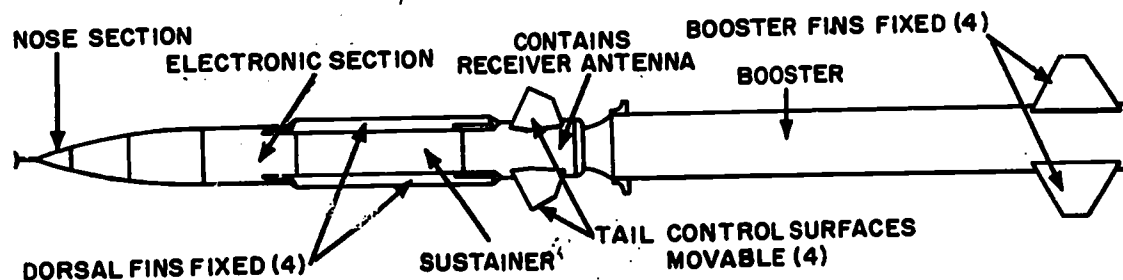

Figure 8-8.—View of beam-rider missile, showing location of control surfaces and receiver antennas.

Chapter 8--BEAM-RIDER GUIDANCE

SCANNING

In addition to radiating and focusing energy into a narrow circular beam, the antenna system must provide a means for searching for a target and for determining its position. This process is called scanning or lobing. Lobing can be divided into two broad categories--(1) sequential lobing and (2) simultaneous lobing. Examples of sequential lobing are conical scanning and lobe switching. Simultaneous lobing is best illustrated by a fairly recent lobing technique called monopulse. We shall discuss this method in considerable detail later. But first a brief review of more familiar scanning processes is in order so that you can see how and why monopulsing was developed.

Stationary Lobe and/or Single Lobe System

A single lobe system is the simplest form of sequential lobing. A stationary lobe cannot satisfactorily track a moving air target, let alone simultaneously provide guidance information to the missile.

Assume that a target is somewhere on the lobe axis, and that the receiver is detecting signals reflected from the target. If these reflected signals decrease in strength, it will be apparent that the target has flown off the axis, and that the beam must be moved to continue tracking. The beam might be moved by an operator who is tracking the target with an optical sight; but such tracking would be

slow and inaccurate, and would be limited by conditions of visibility. An automatic tracking system requires that the beam SCAN, or search, the target area.

Again, assume that a missile is riding the axis of a simple beam. The strength of the signals it receives (by means of a radar receiver in the missile) will gradually decrease as its distance from the transmitter increases. If the signal strength decreases suddenly, the missile will know that it is no longer on the axis of the lobe. But it will NOT know which way to turn to get back on the axis. A simple beam does not contain enough information for missile guidance.

Double-Lobe System

The double-lobe system multiplies by several times the accuracy obtainable with a single-lobe system. The double-lobe system employs two overlapping beams. For ease of illustration, assume that two antennas are used side by side. Two signals are obtained when the beams cross a target, one from each beam. On the radar-scope they appear either side by side or back to back. The two signals are the same amplitude only when the target is on the line of intersection of the two beams, as in figure 8-9. The operator rotates the antennas until the signals are matched in amplitude. At this point, he knows that the target lies on the **LINE OF INTERSECTION** of the two beams. The target is located on the basis of returns from the side of

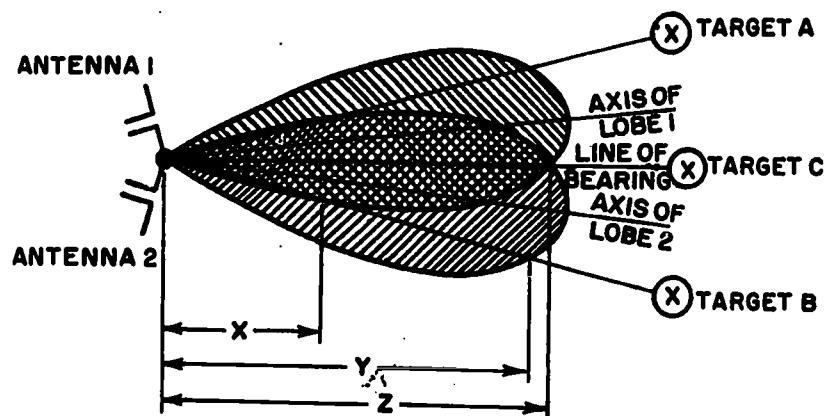

Figure 8-9.--Double-lobe system, showing relation between axis of intersection and target bearing.

33.114

Chapter 8—BEAM-RIDER GUIDANCE

scan cycle. The a-m signal will thus be small, indicating a small error. Now, looking at figure 8-10, imagine the missile at some point on the circular path of the lobe axis. The variation in its distance from the lobe axis during the scan cycle is now at a maximum. The a-m signal will also be at a maximum, producing the maximum error signal and maximum movement of the control surfaces.

(It is apparent that if the missile moves to a point OUTSIDE the circular path of the lobe axis, the error signal will decrease. But this does not happen in practice, unless the missile is defective. The guidance and control systems are too sensitive to allow so large an error to develop.)

Using Two-Lobe Scanning System

How the missile determines the DIRECTION of its error can best be explained in two steps. Figure 8-11 shows an imaginary scanning system in which the lobe of radar energy, instead of sweeping out a cone, has only two positions—up or down. The two lobes are transmitted alternately. The figure shows the missile below the scan axis, near the axis of the lower lobe. The missile will receive signals from both lobes, but those from the lower lobe will be of greater amplitude. If we can provide the missile with some means for distinguishing between the two lobes, so that it can tell WHICH ONE has the stronger signal, it can determine the direction of its error. For

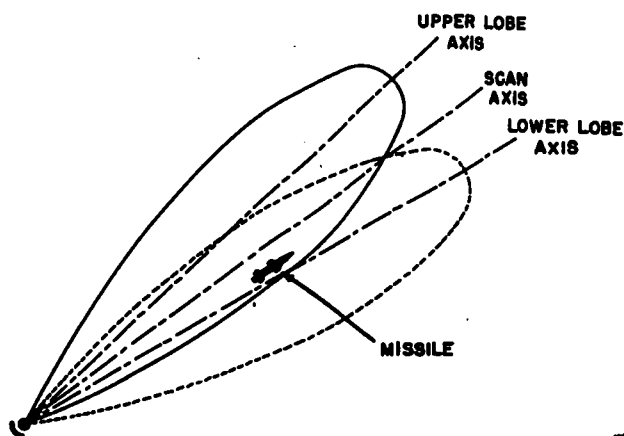

Figure 8-11.—Two-lobe scanning system.

example, if the missile in figure 8-11 can determine that it is the LOWER lobe that has the stronger signal, it will know that it must move up to get back on the scan axis.

There are two fairly simple ways in which we can identify the two lobes so that the missile can distinguish between them. (We cannot, of course, make them of different amplitude, since a missile on the scan axis would then detect a false error signal.) Beam-rider radar transmission consists of an extremely high-frequency carrier wave, which is transmitted in short bursts, or pulses, separated by periods of no transmission. The pulse repetition rate is ordinarily in the order of from one to a few thousand per second. We can identify the two lobes shown in figure 8-11 by making them differ either in carrier frequency or in pulse repetition frequency. In either case the missile could easily be provided with a means for distinguishing between them, and could then determine the direction of its error.

Thus the imaginary two-lobe scanning system could be used for guiding a beam rider in a vertical plane. If we add two additional lobes, each of which the missile can distinguish from the other two, it would also be possible to guide the missile to right or left. It should now be apparent that we can guide the missile in any direction by using a conical scan.

Conical Scanning

Look back at figure 8-10. Assume that we vary the signal frequency (either the carrier or the pulse rate) sinusoidally at the scan frequency. Assume that when the lobe is at its highest point, the signal frequency is at a maximum. As it moves around to the right side of its circular path, the signal frequency decreases to its average value. At the lowest position of the lobe, the signal frequency is at a minimum. It increases to average value as the lobe approaches the left side of its path, and to a maximum as it returns to its highest position. Thus the signal of the guidance beam is frequency modulated at the scan frequency. Note that the f-m signal is always present at the missile, regardless of whether it is on or off the scan axis.

The missile receiver is provided with an f-m section, the output of which is a sine wave that indicates the instantaneous position of the lobe in its scan cycle. The sine wave will

PRINCIPLES OF GUIDED MISSILES AND NUCLEAR WEAPONS

have a maximum positive value when the signal frequency is maximum; it will pass through zero as the signal passes through its average frequency; it will reach its maximum negative value when the signal frequency is at a minimum.

The missile can determine the direction of its error by comparing the phase of the f-m signal with that of the a-m signal. Refer to figure 8-10 again; here the missile is directly below the scan axis. The signal will be strongest, and the a-m signal will reach its maximum positive value, as the lobe passes through its lowest point. At that time the signal frequency will be minimum, and the f-m signal will be at its maximum negative value. Thus the two signals are 180° out of phase. If the missile were above the scan axis, the a-m signal would be strongest at the instant when the f-m signal reached its highest frequency. Both signals would be at their maximum positive value, and therefore exactly in phase. There is a definite phase relationship for every off-axis position of the missile. If the missile is directly to the right of the axis, the f-m signal leads the a-m signal by 90°; if it is directly to the left, the f-m signal lags 90° behind the a-m.

Phase comparison is a fairly easy job for an electronic computer. The computer has been designed to measure the phase relationship to determine the direction in which the missile must move to return to the scan axis and to send the necessary orders to the control system. The control system in turn, moves the control surfaces to change the missile course in the required direction.

To summarize: The guidance beam is conically scanned, and frequency-modulated at the scan rate. If the missile detects an a-m signal, it will know that it is off the scan axis; if it detects no a-m signal, it will know that it is on the axis. The amplitude of the a-m signal indicates the size of the error. A large error will produce a large movement of the missile control surfaces. As the missile approaches the beam axis the error decreases, and the position of the control surfaces gradually returns to neutral to prevent overshooting. The phase relation between the a-m and f-m signals indicates the direction of the error.

Lobe Switching or Sequential Lobing

In either single- or double-lobe scanning, described above, the antenna or antennas are

moved by the operator, and at the same time he must compare the signals. With fixed or slow-moving targets he can, with practice, perform these functions efficiently; however, when a target flies at a high speed, it is almost impossible for a human being to do all the functions required for precise target tracking and direction finding. Some World War II fire control radars overcame this problem by using one antenna and a motor drive device to switch lobes without moving the antenna. When this technique, called lobe switching, is used, lobing takes place at a rapid rate; thus more signal amplitude comparisons can be made in a given time.

Briefly, this is how the system works to provide target direction in the horizontal plane. The antenna produces two beams, one at a time, switching rapidly from one to the other. The feed is alternately changed in phase to create the double-lobe effect. This phase shifting is done mechanically or electrically by switching feed lines, which eliminates the need for two antennas and two receivers. The directions of the two lobes differ by a small angle equal to about one beam width. Signals are returned to the radar as each beam strikes the target. When the two echoes are compared, the strength of one with respect to the other depends upon the position of the target in relation to the antenna direction, as shown in figure 8-12.

The returning signals are equal in strength only when the reflecting object lies on the line

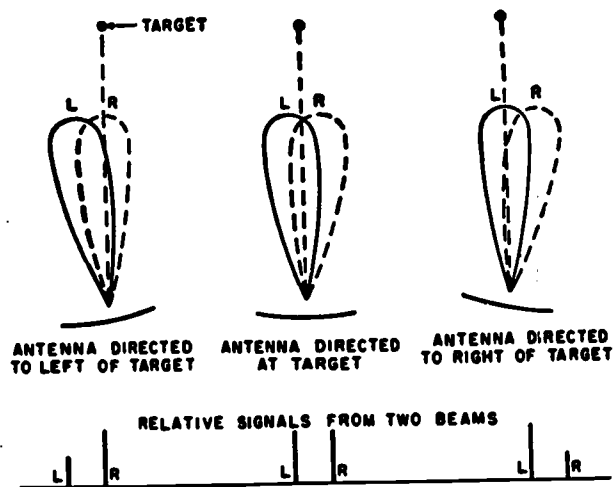

Figure 8-12.—Lobe switching.

bisecting the angle of intersection of the two lobes. If the target is situated on either side of this line, the echoes differ in amplitude in such a way as to indicate whether it is to the left or to the right of the antenna direction. The two signals are compared visually, and the radar operator moves his train handwheels to adjust the antenna direction for equal amplitudes of the received signals. To track an air target, a second pair of beams is used to determine target elevation. These beams are lobed in a vertical plane.

When lobe switching is used however, the process itself introduces mechanical and electrical problems which reduce the reliability and tracking accuracy of the radar. The limitations just mentioned spurred the development of newer techniques to be used with automatic tracking circuits. Conical scanning was the result of this development program. It provides the three-dimensional sequential lobing necessary to determine a target's position and to track it with high precision.

MONOPULSE SCANNING

The methods of scanning that you have just studied are sometimes called sequential lobing, because target information must be gathered from a series or sequence of pulses. Another scanning technique, called monopulse or simultaneous lobing, can obtain information on target range, bearing, and elevation from a single pulse.

For target tracking, the radar discussed here produces a narrow circular beam of pulsed r-f energy at a high pulse repetition rate. Each pulse is divided into four signals which are equal in amplitude and phase. The four signals are radiated at the same time from each of four feed horns grouped in a cluster as shown in figure 8-13. The radiated energy is focused into a beam by a microwave lens of the type mentioned previously. Energy reflected from targets is refocused by the lens into the feedhorns. The amount of the total energy received by each horn will vary, depending on the position of the target relative to the beam axis. This is illustrated in figure 8-14 for four targets at different positions with respect to the beam axis. Be sure to notice, and remember, that a phase inversion takes place at the microwave lens similar to the image inversion in an optical system.

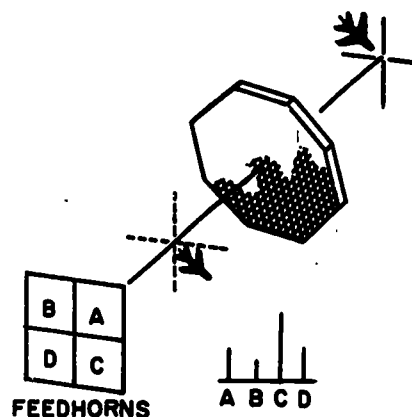

Figure 8-13.—Monopulse technique of radar scanning. 55.68

The amplitude of returned signals received by each horn is continuously compared with those received in the other horns, and error signals are generated which indicate the relative position of the target with respect to the axis of the beam. Angle servocircuits receive these error signals and correct the position of the radar beam to keep the beam axis on target.

The traverse (train) signal is made up of signals from horns A and C added and from horns B and D added. By waveguide design the sum of B and D is made 180° out of phase with the sum A and C. These two are combined and the traverse signal is the difference of $(A+C) - (B+D)$. Since the horns are positioned as shown in figure 8-14, the relative amplitudes of the horn signals give an indication of the magnitude of the traverse error. The elevation signal consists of the signals from horns C and D added 180° out of phase with A and B, i.e., $(A+B) - (C+D)$. The sum or range signal is composed of signals from all four feedhorns added together in phase. It provides a reference from which target direction from the center of the beam axis is measured. The range signal is also used as a phase reference for the traverse and elevation error signals.

The traverse and elevation error signals are compared in the radar receiver with the range or reference signal. The output of the receiver may be positive or negative pulses, the amplitude of which is proportional to the angle between the beam axis and a line drawn to the target. The polarity of the output pulses

PRINCIPLES OF GUIDED MISSILES AND NUCLEAR WEAPONS

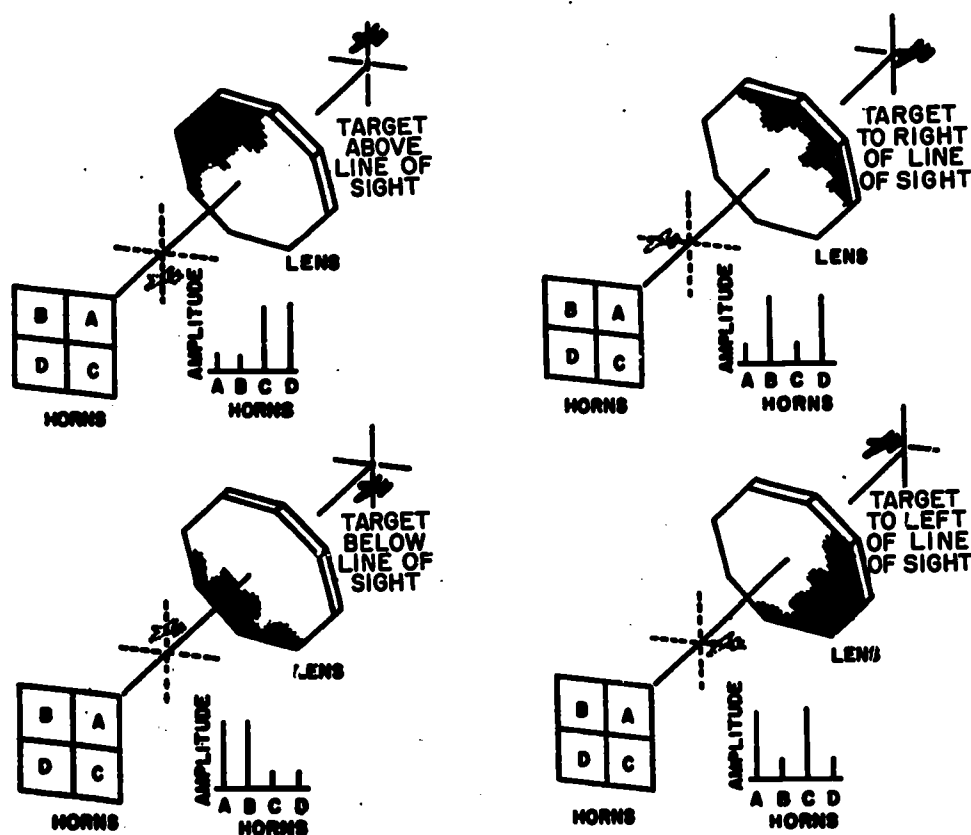

55.69

Figure 8-14.—Monopulse scanning—amplitude changes of received energy with target position.

indicates whether the target is above or below, to the right or to the left of the beam axis. Of course, if the target is directly on the line of sight, the output of the receiver is zero, and no angle tracking error is produced.

An important advantage of a monopulse tracking radar over one using conical scan is that the instantaneous angular measurements are not subject to errors caused by target scintillation. (As the target maneuvers or moves, the radar beams bounce off different areas of the target and cause random reflectivity which may lead to tracking errors.) A monopulse tracking radar is not subject to this error because each pulse provides an angular measurement without regard to the rest of the pulse train; no cross-section fluctuations can affect the measurement.

An additional advantage of monopulse tracking is that no mechanical action is required,

such as a whirling scanner to accommodate while trying to do precise tracking.

CONTROL AND TRACKING RADAR TRANSMITTERS

A missile fire control system may use two separate radar sets to perform the tracking and guidance functions. When sets are grouped in this manner, a separate synchronizer unit (called a master synchronizer) is used to generate timing pulses for each radar set and to coordinate their operation.

The transmitter's purpose is to generate and deliver pulses or continuous waves of r-f energy to the antenna system where it is radiated into space. Missile fire control radars usually operate in the C-band, with a frequency range from approximately 5400 to 6000 mc. Transmission may be by pulse radar method,

Chapter 8—BEAM-RIDER GUIDANCE

continuous wave (c-w) method, or a combination pulse-Doppler radar method. A pulse radar transmitter generates a very short pulse of high energy radio frequency. The pulse radar can measure range accurately and can detect both stationary and moving targets.

In a c-w radar set, the transmitter generates a continuous wave of r-f energy, which is radiated from the antenna. When the radiated energy strikes a target, a portion of the energy is reflected back and is picked up by the receiver antenna. If the target is moving toward the transmitter, the frequency of the echo is higher than the transmitted frequency; if the target is moving away, the echo frequency is less than the transmitted frequency. If the target is not moving, the frequency is not changed. The shift in the frequency of the reflected energy is due to the characteristic of wave motion called the Doppler effect (discussed previously), or Doppler shift. This difference is used for target detection. An experienced operator can obtain much information about the target.

The pulse-Doppler radar combines the best features of the c-w and pulse radar. The pulse-Doppler method uses high frequency c-w, in the form of short bursts, or pulses. The pulse repetition rate (PRR) is much higher than that of a conventional pulse radar, and the pulse length is longer. The pulse-Doppler technique makes it possible to track targets through unrelated noise and clutter that would mask the targets for a conventional pulse radar. The c-w radar cannot be used to measure range of the target, but pulse-Doppler radar can.

Basically, the transmitter is an r-f oscillator that uses magnetrons, klystrons, or traveling wave tubes to generate microwave energy. The operation of the transmitter is controlled by a signal received from the synchronizer. Strictly speaking, control of the transmitter, such as turning it on and off, is provided by a section within the transmitter called the modulator. In pulse and pulse-Doppler radars, the modulator is a special circuit designed to supply power to the r-f oscillator when it receives the appropriate signal from the synchronizer. C-w radar transmitters are also controlled by a modulator, which may have another name, but its purpose is the same—to superimpose intelligence on the carrier. Coding the illuminating signal prevents the missile from homing

on a target illuminated by a radar other than the missile's companion illuminator.

The transmitter section of the control radar provides coded pulse groups of r-f energy to the antenna (fig. 8-15A). The modulator receives the coded pulse groups and provides triggers to the magnetron to cause it to oscillate for the duration of each individual pulse.

The r-f pulses then go to the antenna where they are radiated into space. The transmitting antenna or waveguide is nutated at the same rate as the tracking radar antenna by a nutation motor. If desirable, a reference generator is mechanically coupled to the nutation motor to provide a reference signal to the synchronizer to vary the PRR. Figure 8-15A is a block diagram of a typical control radar including the nutation motor and reference generator. Figure 8-15B is a block diagram of a typical tracking radar.

The operation of fire control radars differs from that of most search radars in that a single object is tracked.

OVER-THE-HORIZON RADAR

One of the factors limiting the effective range of the radars described is the curvature of the earth. Increasing the height of either the transmitting or receiving antenna will increase the effective range. Thus it appears that a missile, because of the altitude at which it travels, can be controlled at extremely long range. But this is not true. The transmitter power necessary to deliver a satisfactory control signal increases rapidly with distance. Therefore, for long range missiles, a single beam-rider guidance system would be unsatisfactory. These limitations can be overcome by using beam-rider guidance during the first part of the missile flight, then switching to a different guidance system before the missile flies beyond control of the radar beam.

This method of extending the range has been used for some of our missiles. However, missile-makers have not been content with this expedient. Work has been carried on for a number of years to produce a radar system that could look over the horizon, and a breakthrough has been announced. This may obsolete all the line-of-sight radars now in use. The Naval Research Laboratory has produced system called Madre (magnetic drum receiving equipment), and another one called Teepee (so-called because the electromagnetic wave

PRINCIPLES OF GUIDED MISSILES AND NUCLEAR WEAPONS

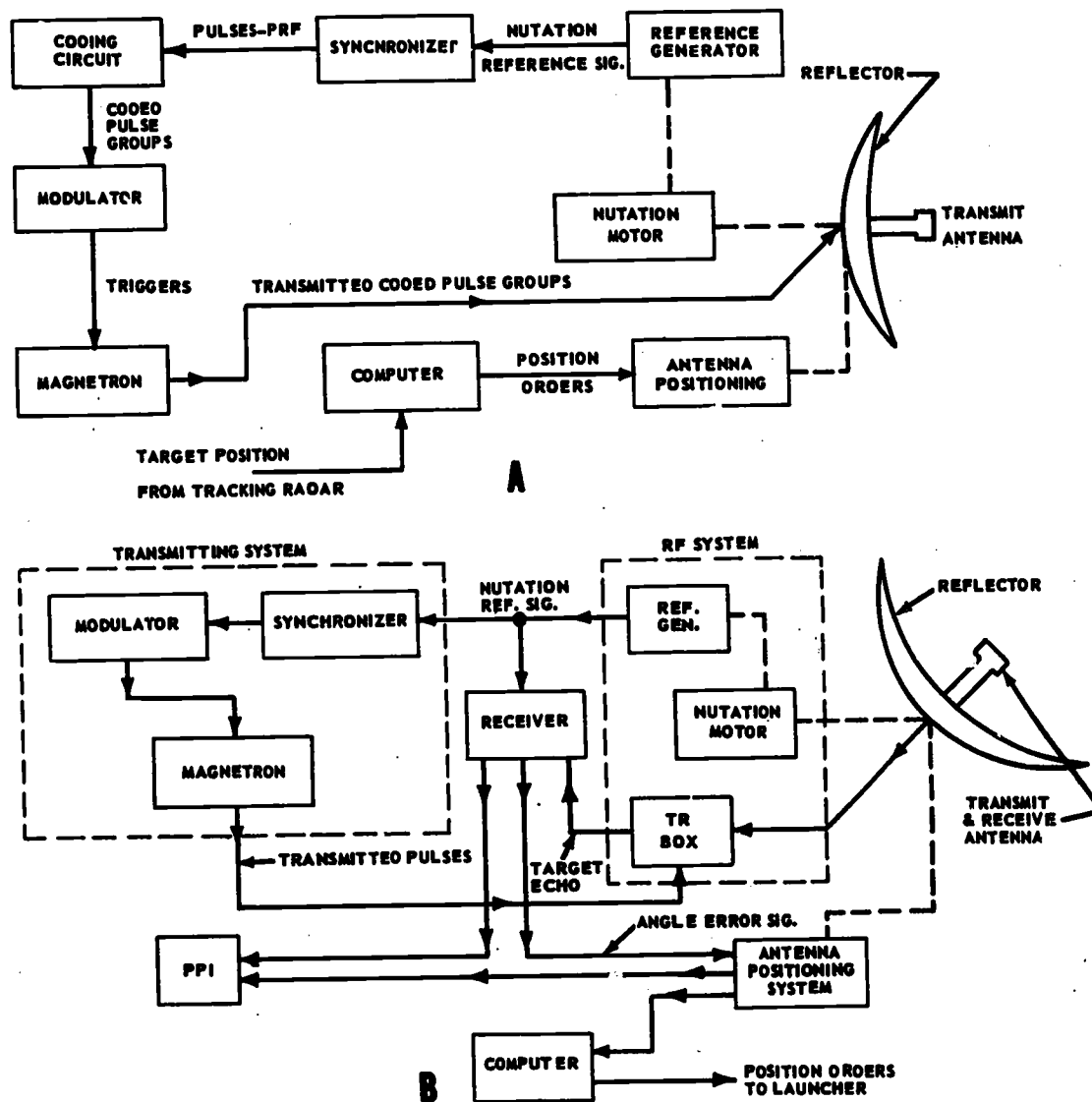

33.150

Figure 8-15.—Block diagrams of weapon system radars: A. Control radar; B. Tracking radar.

follows a path that looks like a row of Indian tents). Industrial firms have also been developing similar systems. They all operate by bouncing signals off the ionosphere. Technical details of the operation have not been made public.

SYSTEM OPERATION

Each component of a weapon system must function properly if the weapon (missile or

other type) is to achieve its purpose of destruction of the target. Radars used in the system have been classified according to the type of modulation used, the method of scanning, their general or specific use, or the method of transmission. There are other bases of classification, but these are the ones most commonly used. According to specific use, we have search radars, tracking radars, and control or guidance radars. Search radars scan the surface and the air for possible approaching

targets. When a possible target has been detected a tracking radar is assigned to it.

TRACKING RADAR

The tracking radar furnishes information as to the position of the target. All target position references are made with respect to the scan axis of the tracking lobe.

The amount of energy in the beam falls off rapidly at points away from the center of the lobe. Figure 8-16 shows the relative amounts of energy transmitted at various angles to one side of the lobe axis. Because of the variation in transmitted energy, there will be a corresponding variation in the strength of signals reflected by targets at various angular distances from the center of the lobe.

The tracking system is automatic. After the tracking radar has acquired the target, tracking is maintained without the help of a human operator. But the action of the tracking system is monitored by an observer, who may take over and track the target manually if the automatic system fails.

Display of Information

At the monitor station (fig. 8-1, part 2) indications of target position relative to the scan axis of the tracking beam are presented on two cathode-ray tubes (CRTs) mounted in display consoles. Figure 8-17 shows how the vertical position of the target, relative to the scan axis, is presented on a CRT. In figure 8-17A, the target is on the scan axis. Remember that the tracking lobe is scanning a conical pattern in space. The lobe is shown in the

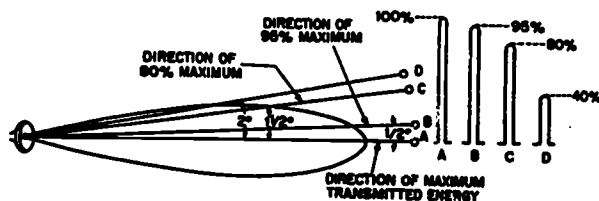

Figure 8-16.—Variation in radiated energy with distance from lobe axis.

highest and the lowest positions of its scan pattern. For each of these two positions, the CRT produces a pip, the height of which is proportional to the strength of the reflected signal. Since the two pips are of equal height, they indicate that the reflected signals are of equal strength when the lobe is in its highest and lowest positions. This can occur only when the target is vertically centered with respect to the lobes—that is, in a transverse plane through the axis of scan.

Figure 8-17B shows the effect of a target above the scan axis of the beam. When the lobe is in its highest position, the target is directly on the lobe axis, and the height of the CRT pip is a maximum. When the lobe is in its lowest position the target is far off the lobe axis; its reflected signal will be much weaker, and the pip on the CRT correspondingly small. This indicates that the target is above the scan axis.

A second CRT indicates the relative strength of the reflected signals when the lobe is at its extreme left and extreme right positions. In an emergency, the operator can track the target manually by moving the radar so as to keep the pairs of pips of equal height on both CRTs.

Each console (fig. 8-1, part 2, weapons direction system) has a visual indicator which is an oscilloscope, a cathode-ray tube with a fluorescent screen. Figure 8-18A shows the principal indicator on a target selection and tracking console, called the Plan Position Indicator (PPI). It displays the bearing and slant range of all the targets picked up by a selected search radar. Targets are displayed on the scope as radar video (pips). To select a target and assign it to a tracking channel, the operator positions the pantograph sighting ring over the target pip and then presses a channel button on the console. Pressing the button gains electrical access to that channel and simultaneously causes an identifying channel letter to appear next to the target pip. Successive corrections of pantograph position by the operator develop target course and speed data that are inserted in the tracking channels and the computer.

Figure 8-18B and C shows two plots provided on the director assignment console—the plan plot and the multipurpose plot. The plan plot shows three range rings with true bearing north at the top. Each target being tracked appears on the display as a letter, and moves as the target moves. The sector between the

144.39

PRINCIPLES OF GUIDED MISSILES AND NUCLEAR WEAPONS

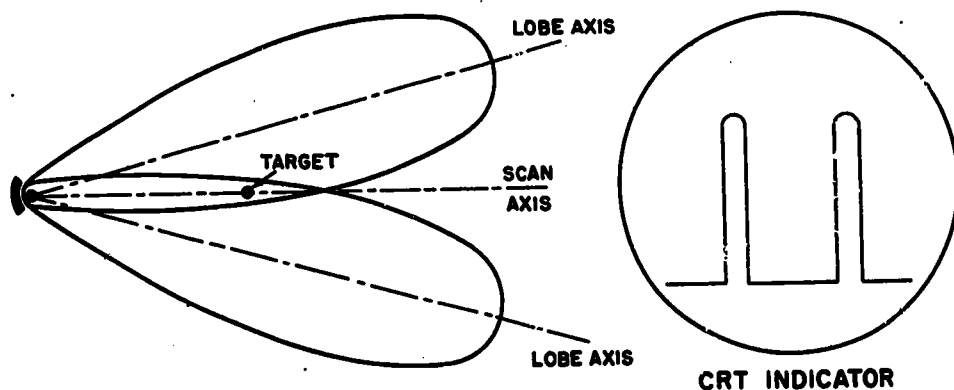

A TARGET ON SCAN AXIS

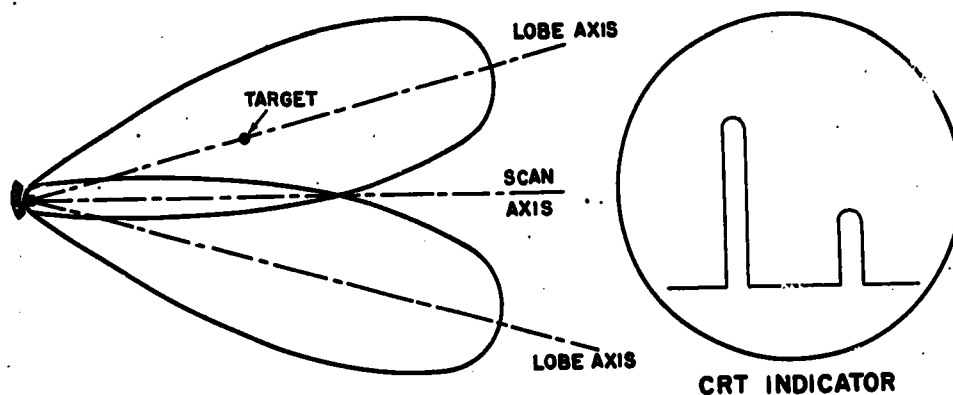

B TARGET OFF SCAN AXIS

33.157

Figure 8-17.—Pips on the cathode-ray tube indicate target position in relation to the scan axis.

clearance lines (fig. 8-18B) indicates the area in which a missile director would lose track because its radar beam would strike the ship's superstructure. The clearance lines and the ship's heading mark move electronically as the ship moves.

The multipurpose plot is used primarily for making time comparisons, and is also used to indicate the speed and height of targets being tracked. The three vertical lines A, B, and C in figure 8-18C represent the tracking channels being used to track targets A, B, and C. Changes are indicated vertically and you can read the values as you would read a thermometer.

The speed of missiles makes computers necessary to perform the fire control calculations. The computer determines the proper lead angle for the launcher and transmits the signals, electrically, that drive the launcher to the proper aiming position. The computer also transmits tactical data such as present target position, future target position, and missile time to target intercept (time of flight), to display units.

CONTROL RADAR

The components of a control (guidance) radar are shown in figure 8-15A; the components in the

Chapter 8—BEAM-RIDER GUIDANCE

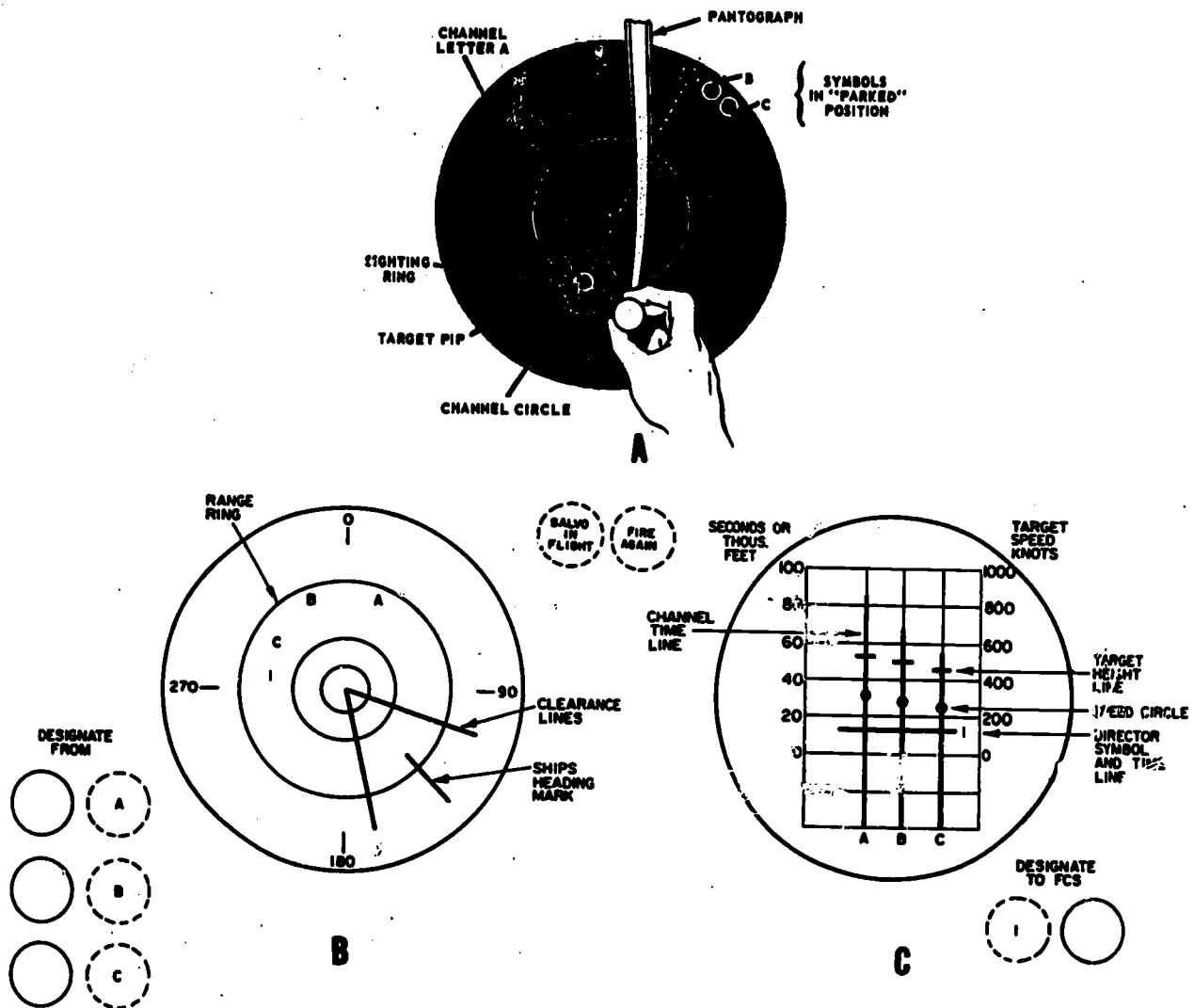

12.42:43

Figure 8-18.—Target information displayed on weapon console scopes: A. Target tracking console display; B. Weapon direction equipment console plan plot display; C. Multipurpose plot.

missile which make use of the signals are shown in figure 8-2.

As explained earlier, a conical scan is one in which the lobe axis of the radar beam is moved so as to generate a cone. The vertex of this cone is at the antenna. It is possible to produce a conical scan by any of several methods.

STABILIZATION

Attitude stabilization of beam-rider missiles is necessary in addition to the guidance infor-

mation transmitted by the control radar. As with other types of missiles, gyroscopes are used to indicate deviations about the missile axis of rotation. Gyroscopes also provide a spatial reference for the missile which is related to the vertical and horizontal axes of the control radar beam. In effect, the missile can tell which way is up or down, right or left, on the basis of its attitude with relationship to the gyros. For example, when it receives an indication from the control radar that it is above the scan axis, the gyros provide the

PRINCIPLES OF GUIDED MISSILES AND NUCLEAR WEAPONS

internal references on which the missile determines that it must turn downward to get back on the axis.

Accelerometers are also included in some beam-rider missiles. Instead of providing positional information as in the inertial navigation systems, they provide a refinement which tends to prevent the missile from oscillating along its axes of translation and prevent overshoot as the missile slides into beam center.

ONE-RADAR SYSTEM

In a one-radar system, the guidance beam is always pointed directly at the target, since the same beam is used for tracking. One or more missiles can be in flight at the same time toward the same target. The traffic handling capacity of the system is limited only by mutual interference between missiles in the beam. Once a missile has entered the beam path, no further operations are necessary at the launching site, except to maintain target tracking.

Countermeasures

One factor must always be considered when an offensive weapon is used. That is, the enemy will always try to find countermeasures that will enable him to offset, or completely nullify, the effectiveness of the weapon. Some attempted countermeasures are fairly easy to overcome; others may be highly effective.

Since radar is used as a guidance control, the system is subject to any form of countermeasure that will interfere with the radar beam. The interference may take the form of small sheets of metal foil, called "window," dropped by the target to give false information to the tracking radar. The radar might, under some conditions, be led to track the foil sheets rather than the target.

Another form of countermeasure might be an enemy radar set working on the same frequency as the guidance radar. This type of interference is called "jamming." The nature of the beam-rider guidance system gives good anti-jamming characteristics because the beam is narrow and directional. The missile carries its receiving antennas on its after end—often on its rear airfoils. These antennas are also directional; they are most sensitive to signals originating behind the missile, and relatively insensitive to signals originating in front. To

jam the guidance beam effectively, the jamming transmitter must get behind the missile. Thus a jamming transmitter would be of little value as a defensive measure for a target aircraft, because once the target gets behind a given missile, it has already successfully evaded that missile.

It is also possible to transmit the guidance beam as a series of pulses having a definite, coded sequence and amplitude. The missile can be set to accept guidance signals only if they follow the proper coded sequence, and to reject all other signals. By using a variety of code sequences, and by changing them often, it is possible to make successful jamming very unlikely.

Capture Beam

Beam-rider guidance is used by both air-to-air and surface-to-air missiles. In neither application is the missile actually in the guidance beam at the instant of launching, and the problem of getting it there must be solved. For air-launched missiles, this is relatively easy; the missiles are carried beneath the wings of the aircraft, fairly close to the guidance radar, and they are fired directly forward. In most situations this is toward the target, and thus parallel to the guidance beam.

But when a surface-to-air missile is launched from the deck of a ship, the "capture" problem is more complex. The missile may be trained at almost any angle (except into the ship's superstructure). Because the blast of hot gases from the missile booster is deflected along the deck at the time of launching, a large area around the launcher must be kept clear. The guidance radar must therefore be located at some distance from the launcher. The missile cannot be launched directly toward the target, on a course parallel with the guidance beam. Instead, it must be launched in such a direction that it will CROSS the guidance beam a few seconds after launching. It will then turn toward the target, after it has been captured by the beam.

But because the guidance beam is narrow, merely aiming the missile to cross it is not enough to ensure capture. To make capture more certain, a broad CAPTURE BEAM (fig. 8-19) is superimposed on the narrow guidance beam. Because the energy in the capture beam is spread out over a large area, its effective range is short.

Chapter 8—BEAM-RIDER GUIDANCE

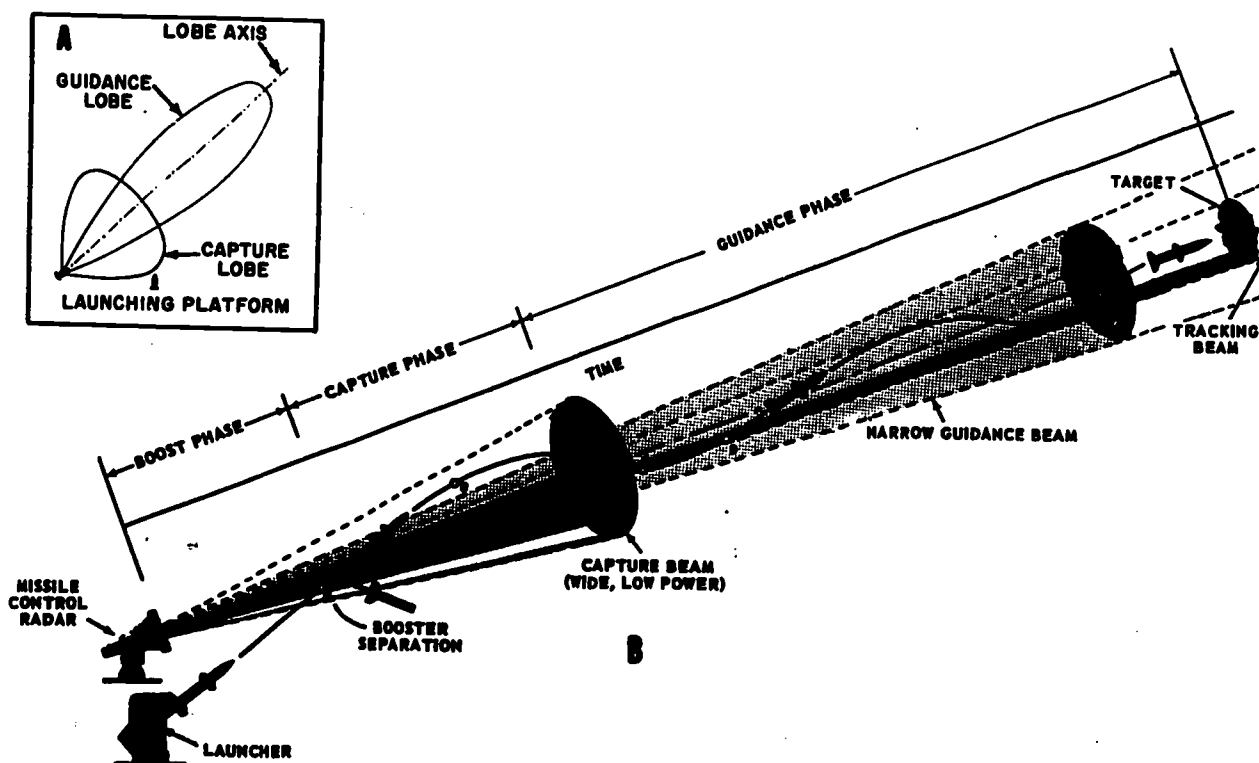

Figure 8-19.—Beam-rider guidance: A. Relationship of guidance lobe and capture lobe; B. The missile and capture, guidance, and tracking beams.

33.154:12.38

During the launching phase of missile flight, the control surfaces on the missile usually are locked and the guidance system is inoperative. The booster propels the missile in a direction calculated to place it within the capture beam. When the booster drops away, the control surfaces are unlocked and the guidance system takes over. The missile receiver is tuned to respond to the capture beam, and to seek its axis. In so doing, it turns itself toward the target and aligns itself in the guidance beam, which has the same scan axis as the capture beam. After a preset interval, a timing device within the missile changes the receiver tuning. The missile will then reject signals from the capture beam, and respond only to those in the guidance beam, which has a different coded signal.

Close-In Targets

The single-radar beam-rider system, because it uses only one radar instead of two,

has the advantage of simplicity. But the use of a single radar results in a serious problem. Remember that the guidance beam is also the tracking beam, and must therefore be pointed at the target throughout the missile flight. Except in one special case—when the target is flying directly toward the transmitter—the radar must be trained in order to follow the target. For a nearby, high-speed, crossing target, the angular rate of train will be high. The missile course, therefore, cannot be a straight line. The missile must constantly move sideways in order to stay in the beam. While the missile is relatively close to the transmitter, its lateral rate is small. But, as the missile approaches the target, the same angular rate of train will require increasing lateral acceleration of the missile.

Figure 8-20 illustrates this problem by showing three successive positions of the target and the missile. In this example, the beam is trained to the left at an almost uniform

PRINCIPLES OF GUIDED MISSILES AND NUCLEAR WEAPONS

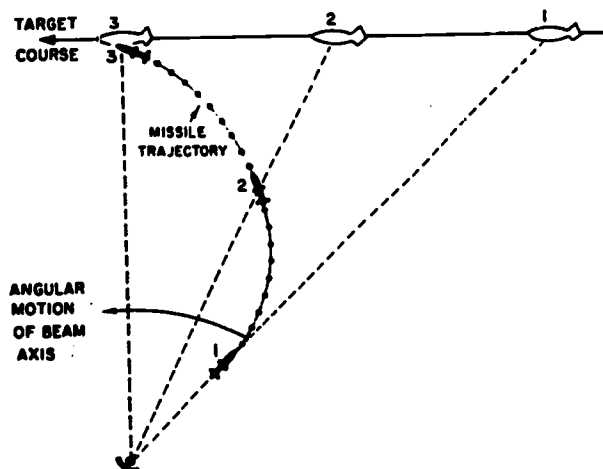

33.155
Figure 8-20.—Beam-rider missile following line of sight (LOS) course, increases lateral acceleration as it nears target.

rate. The missile, in order to stay in the beam, must accelerate to the left at a rapidly increasing rate. In the extreme case shown in the figure, the missile as it nears the target, must follow a path almost at a right angle to the beam. Even with its control surfaces in their extreme positions, the missile would probably be unable to turn at the required rate. Thus a one-radar beam rider might be useful against approaching targets, but ineffective against high-speed crossing targets.

TWO-RADAR SYSTEM

The two-radar beam-riding system uses one radar to track the target and a second radar to guide the missile (fig. 8-21A). A computer is used between the two radars and controls the guidance radar. The computing system uses information from the tracking radar to determine the trajectory necessary to ensure a collision between the missile and the target. Because the same radar beam is no longer used for both tracking and guidance, the missile need not follow a line of sight path, as was the case with a one-radar system. The guidance beam may be directed into space along a programmed target intercept path (fig. 8-21B). The speed of the missile is known, the speed of the target is calculated, and the

collision point is computed from these facts. The guidance beam can then be directed (programmed) to the calculated point, and the missile follows the guidance beam as soon as it orients itself after capture by the capture beam. This is sometimes called an "up-and-over" type of flight path. It permits the missile to reach high altitudes rapidly, where the propulsion system can operate more efficiently, thereby achieving greater speed and range. It also makes enemy countermeasures more difficult.

Equipment

The two-radar beam-guidance system is more complex insofar as ground equipment is concerned, because of the addition of a computer and a second radar (fig. 8-21A). The equipment in the missile is the same for either system.

From the information that has been given, it may be seen that the computer is an important part of a two-radar guidance system. The computer takes information—speed, range, and course—from the tracking radar. From this information, it computes the course that must be followed by the missile. Since the computer receives information constantly, it can and does alter the missile course as necessary to offset evasive action or changes in course by the target. The output of the computer controls the direction of the guidance radar antenna. Required course changes are instantly transmitted to the missile by pointing the guidance beam toward the new point of intercept.

Countermeasures

The same countermeasures which would affect a one-radar system could be used against the two-radar system. But it would be more difficult to destroy control effectiveness, because of the two radar beams and the computer action. The computer stores guidance information as it determines the trajectory the missile is to follow. Therefore, even if the tracking beam were interrupted by countermeasures for a short time, the computer would still be able to maintain the guidance beam, and hold the missile on a probable collision course with the target.

As we mentioned earlier, lateral acceleration presents a serious problem when a one-radar guidance system is used, because the

Chapter 8—BEAM-RIDER GUIDANCE

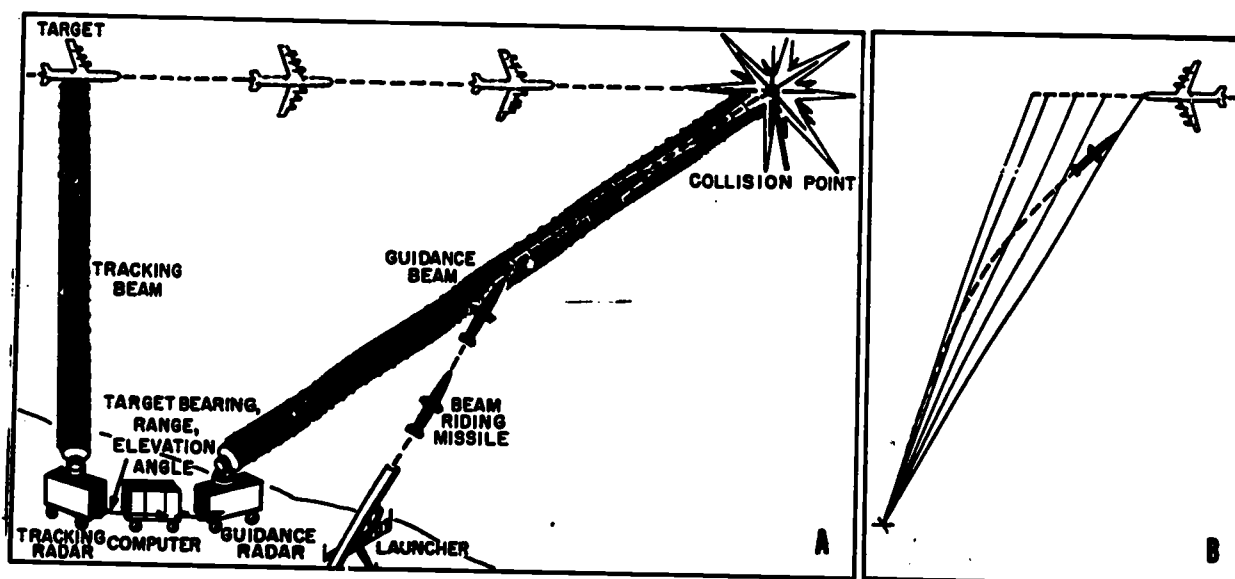

Figure 8-21.—Beam-rider guidance: A. Two-radar beam riding guidance; B. The programmed beam-rider.

144.40

missile course is changed by the angular movement of the tracking beam. This problem is not present in a two-radar guidance system because the missile course is directed toward a collision point (fig. 8-21B), rather than toward the constantly changing position of the target. Because course information is continuously fed to the missile guidance radar, the missile trajectory is straight or only slightly curved from the launching point to the target.

Countermeasures have become a standard part of military operations. The counter-countermeasure must eliminate the effects of the countermeasure so the system can still perform successfully.

Any countermeasure, such as chaff and decoys, which gives false target information tends to obscure the true target position and may overload the system with false targets. A highly trained operator or an accurate discerning mechanism capable of distinguishing false targets from real ones is the most effective counter-countermeasure. Jamming signals cause loss of the target signal and therefore loss of target position. Effective antijamming devices have been developed and are installed on some ships and aircraft.

It is imperative that false targets be recognized in the initial stages, for once the weapon system starts tracking the false target, the purpose of the false target is accomplished. A large number of targets, real or false, can overload the tracking system and cause a breakdown.

LIMITATIONS

Every mechanical or electrical system has limitations that cannot be exceeded. When working with complex mechanisms, such as guided missiles, it is as important to know limitations as it is to know the capabilities. Unless the limitations are known, a costly missile might be wasted.

One important limitation is the maximum range at which reliable control can be maintained. We have mentioned line of sight limitation. Bear in mind that this statement does not mean that the missile must remain within range of vision. It does mean that control may be lost if the path between the missile and the guidance radar extends over the horizon or is blocked by hills or mountains. The perfection of over-the-horizon radar systems will make this limitation a thing of the past.

PRINCIPLES OF GUIDED MISSILES AND NUCLEAR WEAPONS

Another limitation, previously mentioned, is transmitter power. In theory, at least, any amount of power can be generated. Radar systems through pulse techniques make it possible to get large peak power output while keeping the average power output within reasonable limits. Practical guidance systems have power limitations due to cost, size, and weight. Obviously, bulky equipment cannot be easily transported or installed aboard ships or aircraft. Therefore, a compromise must be reached to ensure useful results with equipment of reasonable size.

It should also be kept in mind that the radar beam increases in width and decreases in power as the range is extended, resulting in a decrease in both tracking and guidance accuracy at long ranges. Great improvements in both range and accuracy have been made by modern advances in radar technology.

The susceptibility of a guided missile to countermeasures is a limitation to its use. The effectiveness of countermeasure action can be greatly reduced by using coded-pulse modulation of the radar guidance beam.

Missile enthusiasts at first believed that missiles would replace all other types of ordnance, including small arms. Reflection and experience have shown that guided missiles are not the complete answer to the defense problem. Most guided missile ships are equipped with 3-inch or 5-inch guns as well as missiles and other forms of ordnance. Some of the early conversions to guided missile ships, in which the guns were removed to make room for an all-missile installation, are now being re-equipped with guns to supplement the missiles. Although there are many sizes and types of missiles, they are not the best solution for every defensive or offensive tactic.

CHAPTER 9

HOMING GUIDANCE

INTRODUCTION

GENERAL

In previous chapters, we have discussed guidance systems that are designed to place and hold a missile on a collision path with its target. As we have explained previously, missile guidance can be divided into three phases: launching, intermediate or midcourse guidance, and terminal guidance. The proper functioning of the guidance system during the terminal phase, when the missile is rapidly approaching its target, is of extreme importance. A great deal of work has been done to develop extremely accurate equipment for use in terminal-phase guidance.

This chapter will discuss some of the homing systems that have been found to be effective for terminal guidance, as well as some systems that, in their present state of development, have serious limitations.

The expression **HOMING GUIDANCE** is used to describe a missile system that can "see" the target by some means, and then by sending commands to its own control surfaces, guide itself to the target. (Use of the word "see" in this context does not necessarily mean that an optical system is used. It simply means that the target is detected by one or more of the sensing systems that will be described later in this chapter).

Homing guidance is used not only for the terminal guidance of some missiles, but also for the entire flight, particularly for short-range missiles. The radar-homing Lark is the first antiaircraft missile known to have intercepted and destroyed a target drone. The Bat, used against Japanese shipping in World War II, was the first successful radar homing missile.

BASIC PRINCIPLES

Some homing guidance systems are based on use of the characteristics of the target itself

as a means of attracting the missile. In other words the target becomes a lure, in much the same manner as a strong light attracts bugs at night. Just as certain lights attract more bugs than others, certain target characteristics provide more effective homing information than others. And some target characteristics are such that missiles depending on them for homing guidance are very susceptible to countermeasures.

Other homing systems illuminate the target by radar or other electromagnetic means, and use the signals reflected by the target for homing guidance.

The various homing guidance systems have been divided into **PASSIVE**, **SEMIACTIVE**, and **ACTIVE** classes. The name of the class indicates the type of homing guidance in use.

The **PASSIVE** homing systems are based on use of the characteristics of the target itself as a means of attracting the missile. The target becomes a lure, as described above. One such system uses radio broadcast waves from the target area as signals to home on.

If the target is illuminated by some source other than itself or equipment in the missile, the system is known as a **SEMIACTIVE HOMING** system. For example, the target might be illuminated by radar equipment at the missile launching station.

If the target is illuminated by equipment in the missile, the system is called an **ACTIVE HOMING** guidance system. An example is a system that uses a radar set in the missile to illuminate the target, and then uses the radar reflections from the target for missile guidance.

A modified version of the semiactive guidance technique is known as a quasi-active homing guidance system.

The components of homing guidance systems are essentially the same in all types of homing, but there are differences in location and in methods of using the components.

PRINCIPLES OF GUIDED MISSILES AND NUCLEAR WEAPONS

TYPES OF MISSILE RESPONSE

When the control surfaces of the missile are activated by one of the guidance systems, the missile is showing response to the guidance signals. A number of systems have been developed to respond to a variety of signal sources. These sources are: sound, radio, radar, heat, and light.

Sound

If we go through the frequency spectrum from low to high, we can list systems in order of frequency and start in the audio (low) range. Sound has been used for guidance of naval torpedoes, which home on noise from the target ship's propellers. But a guidance system based on sound is limited in range. The missile or torpedo must use a carefully shielded sound pickup, so that it will not be affected by its own propulsion noise. And while the speed of a torpedo is low compared to the speed of sound, most guided missiles are supersonic. Because of these limitations, no current missile uses a guidance system based on sound detection.

A system based on sound detection is known as an acoustic system. During World War II the Germans were developing two types of acoustic guidance systems for use on the X-4 missile, but the war ended before they were tried in combat situations. An acoustic homing system is practically impossible to jam, and decoy devices are equally impractical. But the disadvantages mentioned above have not been offset by discoveries or inventions that make adequate use of the advantages. However, sound waves behave differently under water than in the air. Guided missiles whose terminal phase is under-water make use of sound waves for guidance. Torpedoes and antisubmarine missiles are of this category.

Radio

Most homing guidance systems use electromagnetic radiations. Radio waves are used in one passive homing system. Homing is accomplished by an automatic radio direction finder in the missile. The equipment is tuned to a station in the target area, and the missile homes on that station. This homing system is not restricted by weather or visibility. But it is unlikely that a radio transmitter would be

operating under war conditions. In addition, radio jamming can do a most effective job of confusing a missile that uses radio for homing guidance for it would receive signals from several directions at the same time.

While it is possible to do a thorough job of confusing a radio homing guidance system, there is one possibility that cannot be overlooked. The enemy must use electromagnetic systems for communications and search, and these systems can be used as a source of guidance signals. Also, it is possible for subversive agents to plant small, hidden radio transmitters in target areas.

Several radio navigation techniques have been applied to missile guidance. During World War II the Germans devised a complex radial system called Sonne. Circular methods of radio navigation were used for blind bombing. Position of the target was determined by finding the location on a circle or circles about known locations, measured by two ground station signals.

Radar

Although radar can be used for all classes of homing guidance, it is best suited for the semiactive and active classes. At present, radar is the most effective source of information for homing guidance systems. It is not restricted by weather or visibility, but under some conditions it may be subject to jamming by enemy countermeasure equipment.

Radar guidance is the type most used for homing. Terrier, Talos, Tartar, and Sparrow III use the semiactive homing.

Heat

One form of passive homing system uses heat as a source of target information. Another name applied to this system is INFRARED homing guidance. Heat generated by aircraft engines or rockets is difficult to shield. In addition, a heated path is left in the air for a short time after the target has passed, and an ultra-sensitive heat sensor can follow the heated path to the object. One present limitation is the sensitivity of sensor units. As sensor units of higher sensitivity become available, infrared homing guidance will become increasingly effective. Such systems will make it difficult to jam the homing circuits, or to decoy the missile away from the target.

Chapter 9—HOMING GUIDANCE

Light

A passive homing system could be designed to home on light given off by the target. But, like any optical system, this one would be limited by conditions of weather and visibility. And it would be highly susceptible to enemy countermeasures.

A quasi-optical system which uses a television camera in the nose of the missile has some interesting possibilities. The TV senses the missile-aiming error, transmits the picture to the launching aircraft, ground station, or ship, where the corrective orders are computed and sent to the missile.

USE IN COMPOSITE SYSTEMS

In command and beam-rider guidance, the missile is controlled from the launching site, or from some other point at a considerable distance from the target. But neither of these systems is very effective against moving targets, except at relatively short ranges. The reason is obvious. The closer the missile gets to the target, the farther it is from its control point. At long range, a very small angular error in target tracking, missile tracking, or beam riding could cause the missile to miss its target by a wide margin.

Sidewinder is a Navy missile that uses homing as its only source of guidance. It has been used very effectively at relatively short range. But homing systems are based on information radiated from, or reflected by, the target itself. For targets at intermediate ranges, such signals are extremely weak, and could be used only by missiles with powerful and heavy guidance equipment. At long range, such signals are entirely unavailable.

An answer to this problem lies in the use of a composite guidance system. In this system, the missile is guided during its intermediate phase by information transmitted from the launching site, or other friendly control point. During the terminal phase, it is guided by information from the target. For intermediate-range missiles, either command or beam-rider guidance is suitable during the midcourse phase. A long-range missile would depend either on preset or navigational guidance to bring it to the target vicinity. Missiles of both classes can switch over to homing guidance, based on infrared or radar radiations, as they enter the terminal phase. At intermediate range, the

switchover is usually accomplished by radio command. At long range, it is controlled by a navigational device, or by some form of built-in programing system.

The U.S. Navy missile program makes use of composite guidance systems in several of its operational missiles. Talos is a beam rider during its midcourse phase, and switches to radar homing for terminal guidance. Other missiles, such as Terrier, Sparrow, Shrike and Tartar, use homing guidance systems in one form or another for terminal guidance. Although Asroc is called an unguided missile, it uses active acoustic homing guidance in its underwater phase.

HOMING TRAJECTORIES

A homing missile uses one of two methods in approaching a moving air target. When the missile flies directly toward the target at all times, its flight path is described as PURSUIT HOMING, or ZERO BEARING HOMING. When the missile anticipates the future position of target, it uses the LEAD HOMING method.

PURSUIT HOMING

As shown in figure 9-1, the use of pursuit homing results in a rigorous chase. Note that the line of sight (LOS) is always pointing directly ahead of the missile, thus the term zero bearing.

All of the homing guidance systems we have described have had the sensor unit (thermopile, light cell, microphone, television camera, or antenna) mounted in the nose of the missile. The sensor is fixed to the missile frame so that it maintains a constant relationship to the missile axis. The equipment in the missile is then able to process the information picked up by the sensor, so that the missile can be continually pointed toward the target.

Notice in figure 9-1 how the flight path must curve as the missile approaches the target. The sharp curvature in the path sets up strong lateral accelerations during the terminal phase of flight. These transverse accelerations present a strong objection to the use of a zero-bearing approach against high-speed air targets.

There are two basic objections to the pursuit method. First, the maneuvers required of the missile become increasingly difficult during the last (and critical) stages of flight. Second,

PRINCIPLES OF GUIDED MISSILES AND NUCLEAR WEAPONS

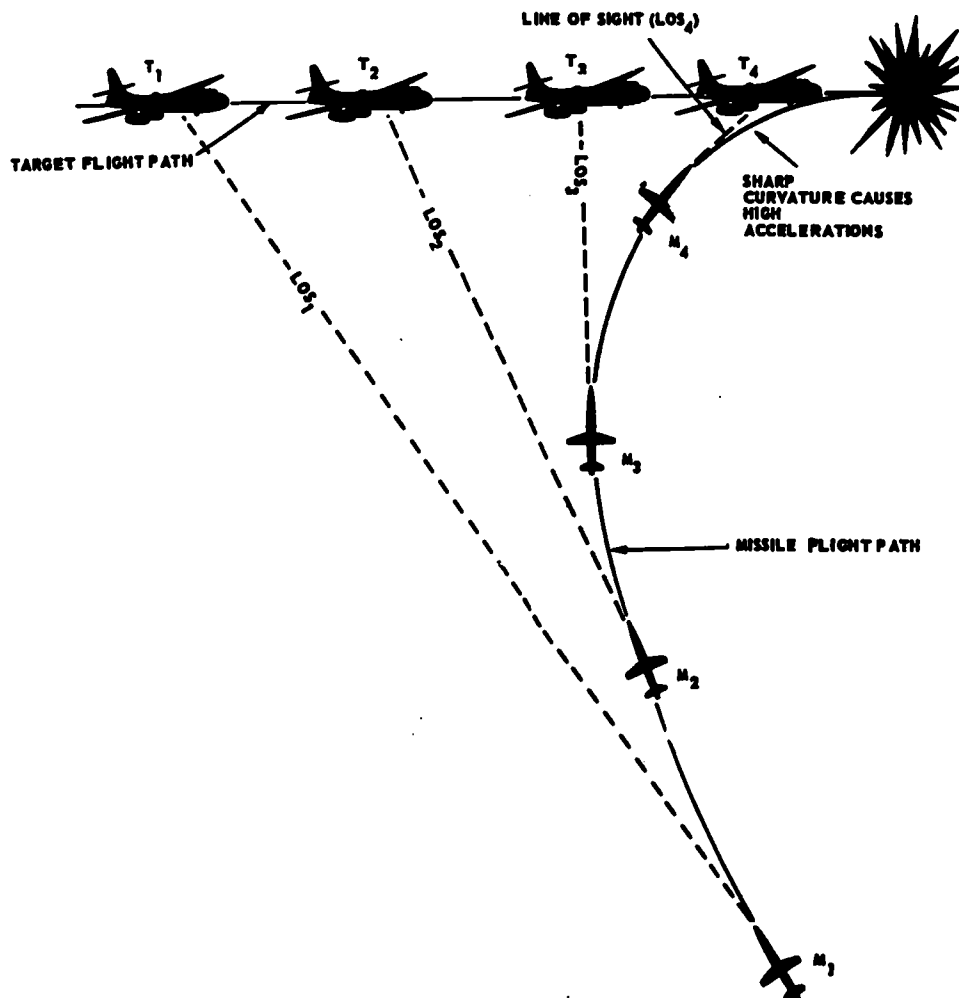

12.35

Figure 9-1.—Pursuit homing, or zero bearing flight path.

missile speed must be considerably greater than target speed. As shown in the figure, the sharpest curvature of the missile flight path occurs near the end of the flight. At this time, the missile must overtake the target. If the target is attempting to evade, the last minute acceleration requirements placed on the missile could exceed its aerodynamic capability, thereby causing a miss. Near the end of the flight, the missile is "coasting" because the booster and rocket motor thrusts last for a short part of the flight. More power is required to make sharp radius, high speed turns at a time when the missile is losing speed and has least turning capability.

The most favorable application of pursuit courses is against slow moving targets, or for missiles launched from a point to the rear of the target or directly toward a head-on incoming target.

LEAD ANGLE OR COLLISION COURSE

The second method of approach to the target is called LEAD ANGLE course. It is also known as a CONSTANT BEARING or COLLISION course or PROPORTIONAL NAVIGATION. The trajectory of a ground-to-air missile using this method of approach is shown in figure 9-2.

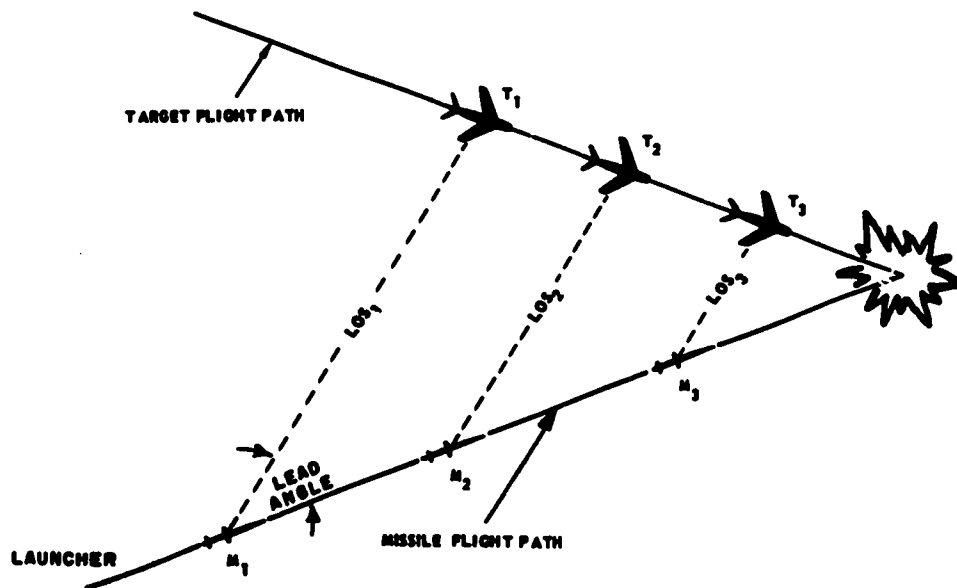

Figure 9-2.—Lead angle method of approach to target.

33.158

Notice that the missile path from the launcher to the collision point is a straight line. The missile has been made to lead the target in the same manner as a hunter leads a bird in flight. In order to lead the target and obtain a hit, a computer must be used. The systems devised for computing lead angle for guns have been adapted for missile firing. Lead angle has always had to be computed in order to obtain a hit on a moving target. The hunter has to estimate mentally how far ahead to aim in order to hit the running game or flying bird. Early gunners devised various mechanical aids to help them locate the target, estimate its speed, determine its direction of movement, and compute the amount of "lead" necessary so they could fire where the target was going to be at the time the bullet or shell would get there. Modern rapid-firing guns and supersonic missiles are much too swift for such calculations. Computers are necessary to make calculations as speedy as possible, and electronic control signals are needed to keep the missile on the calculated course.

The computer continually predicts the point of missile impact with the target. If the target takes no evasive action, the point of impact remains the same from launching time until the missile strikes. Should the target take evasive

action, the computer automatically determines a new collision point. It then sends signals to the guidance package or control unit (autopilot) in the missile, to correct the course so that it bears on the new collision point.

As shown in figure 9-2, the collision point and the successive positions of missile and target form a series of similar triangles. If the missile path is the longer leg of the triangle, as it is in the figure, the missile speed must be greater than the target speed—but it need not be as great proportionally as with a zero-bearing approach.

The transverse acceleration required of a missile using the lead-angle approach is comparatively small.

In lead homing missiles, the missile computer network calculates the rate of change of lead angle and generates a solution which, when applied to the controllers, will cause flight path corrections to reduce the rate of change to zero. When this has been done, the missile will be on a collision course with the target. Should the target change course, the lead angle will change. The missile sensors will detect this change, and the computing network will determine a new solution to put the missile back on a collision course. The missile turns at a rate proportional to the rate of the line of

PRINCIPLES OF GUIDED MISSILES AND NUCLEAR WEAPONS

sight rotation and in the proper direction to reduce the rotation of the line of sight to zero (proportional navigation). The final (and most important) part of the flight path will be a straight line. Therefore, the accelerations required by the missile at this time are negligible.

PASSIVE HOMING SYSTEM

GENERAL

As mentioned earlier in this chapter, passive homing systems can be used when the target itself radiates information. Therefore, all of the response systems, with the possible exception of radar, might be used. The exception to radar would not apply if a signal from the target could be picked up by a radar receiver set in the missile. This system would be unreliable; the only source of target information would be under enemy control, and could be switched off at will. But missiles using such a system would have one distinct advantage: they would deny the enemy the use of his own radar.

Passive homing guidance can be used for air-to-air, air-to-surface, surface-to-surface, or surface-to-air missiles. One main advantage of a passive system is missile equipment simplicity. No transmitter is needed in the missile, and the missile tracking equipment can be very small and compact. A second advantage is that the passive system is an independent system once the target is acquired.

BASIC PRINCIPLES

The passive homing systems most widely used at present are based on infrared radiation from the target. The sensing mechanism is so designed that it can determine the direction from which the infrared radiation is received; the guidance system can then steer the missile in that direction. There are several ways in which the sensing device can be made to determine the direction of an infrared source. For example, two sensors could be mounted with a baffle between them, so that the one on the right can receive radiation from straight ahead, or from any point to the right of the missile yaw axis. The other sensor will receive radiation coming from straight ahead or from the other side of the yaw axis. When both sensors receive the same amount of radiation, the target is directly ahead. If the radiation is stronger on one side, the tar-

get is obviously on that side. A second pair of sensors could be mounted vertically to sense radiation above and below the pitch axis.

Another infrared passive homing system makes use of a sensing device mounted in gimbals, and driven by servomechanisms. The system is so designed that the sensing device will constantly be trained on the target. Thus the train angle of the sensor with relation to the heading of the missile can be used to produce correction signals.

A passive homing device that uses radio frequency intelligence is a radio direction finder. Intelligence may be derived by comparison of phases, as with a pulse type radar. However, detectors of this type depend on radio or radar radiation from the target. If the target maintains radio and radar silence during an attack, this means of detection is useless. For practical reasons, therefore, a passive homing system should rely on only those sources of energy that cannot be controlled by the target. Heat and light are two such sources, although lights can be blacked out to prevent detection.

Properties of Heat Radiation

Before examining several types of infrared sensors, let us take a closer look at the subject of heat radiation.

Heat is produced by any material whose temperature is above absolute zero (-273.16°C . or -459.69°F .). Heat is a result of the motion of molecules; it is a form of kinetic energy which can be transferred by only three processes.

In the process of CONDUCTION, the heat energy is transferred from molecule to molecule by actual contact. Metals, in general, are good conductors of heat. Gases are much poorer conductors of heat than solids, due to the relatively large distances separating gas molecules.

CONVECTION is the process of transferring heat by movement of a heated substance. For example, a home furnace warms the air around it. Due to its increase in temperature, the air will rise and therefore carry the heat to another location.

Our main source of heat—the sun—supplies us with heat energy through the vacuum of space. This heat energy is transferred by the process of RADIATION, that is, the process of electromagnetic wave transmission. The electromagnetic waves which produce heat in any object that absorbs them are called infrared waves. Figure 9-3 shows the infrared portion of the

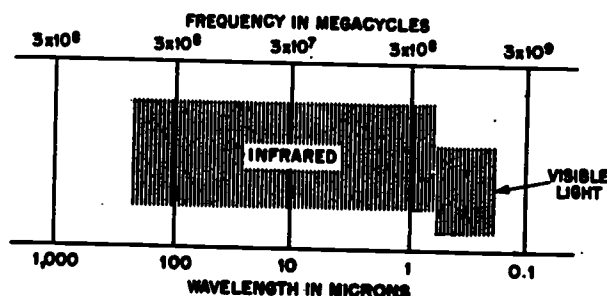

Figure 9-3.—Infrared portion of electromagnetic spectrum.

33.159

electromagnetic spectrum. It is between the visible light and the microwave (radar and radio) regions. The frequencies in the infrared spectrum are in the millions of megacycles. In this illustration, the wavelengths are in microns. A micron is equal to 1×10^{-6} meters in length.

The infrared spectrum may be subdivided into the near-infrared (NIR) (0.76 to 2.00 microns), the intermediate infrared (IIR) (2.00 to 6.00 microns), and the far infrared (FIR) (6.00 to 1000 microns).

It is interesting to note that the frequency of infrared radiations emanating from a body is determined by the motion of the surface molecules. Since this motion is random, the infrared radiations consist of many frequencies. The frequency of maximum radiation, however, depends on the temperature of the body. Figure 9-4 is a plot of the radiation from four objects of different temperatures. Note that very high temperatures produce both visible and infrared radiation, and that cooler objects produce only infrared.

Heat-Detecting Sensors

In view of the rather simple methods of countering light sensors and radiosensors (dis-

cussed earlier in this text), the infrared sensors have proved most satisfactory for the passive homing systems. Some of the heat sensors which might be used in passive homing missiles are described below.

THERMOCOUPLE.—One of the basic heat detectors is the thermocouple. When two dissimilar metals such as iron and copper are joined together and heat is applied to the junction, a measurable voltage will be generated between them. This is sometimes called the Seebeck (a German physicist) effect. Figure 9-5 shows a basic thermocouple.

The voltage difference between the two metals is quite small, but the sensitivity can be increased to a point where the thermocouple becomes useful as a detector of heat. The increase in sensitivity is obtained by connecting, or stacking, a number of thermocouples in series, so that they form what is known as a **THERMOPILE**. The complete thermopile action is similar to that obtained when a number of flashlight cells are connected in series. That is, the output of each individual thermocouple is added to the output of the others. Thus, ten thermocouples with individual output voltages of .001 volt, would have a total output of .010 volt when connected in series.

The sensitivity of a thermopile can be further increased by mounting it at the focal point of a parabolic reflector. When this method is used, heat given off by the target is focused on the thermopile by the reflector. By making the device rotatable, the source of highest intensity of heat radiation may be located.

BOLOMETERS.—A bolometer is a device made of a very sensitive material whose resistance will vary, depending on the amount of infrared radiation to which it is exposed.

There are two main classes of bolometers—**BARRETTERS** and **THERMISTORS**. A barretter consists of a short length of very fine wire

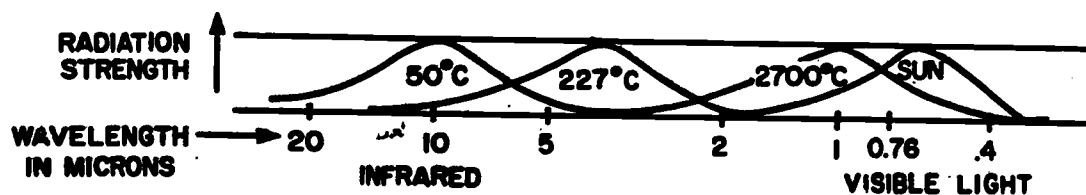
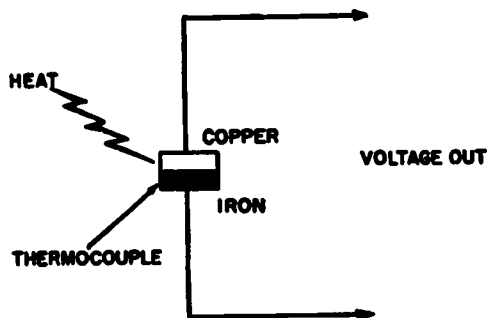

Figure 9-4.—Infrared radiation at different temperatures.

33.160



33.161

Figure 9-5.—A basic thermocouple.

(usually platinum) which has a positive temperature coefficient of resistance. (A resistance has a positive temperature coefficient if its value increases with temperature, and a negative coefficient if its value decreases with an increase in its temperature.) The thermistor is a type of variable resistor made of semiconducting material, such as oxides of manganese, nickel, cobalt, selenium, and copper. The thermistor has a negative temperature coefficient of resistance. Thermistors are made in the form of beads, disks, rods, and flakes, some of which are shown in figure 9-6. The bead thermistor (fig. 9-6B) could be used as a sensing-element pickoff unit as well as in a control system. It has small mass and a short time constant.

The heat-sensitive materials of thermistors are mixed in various proportions to provide the specific characteristics of resistance versus temperature necessary for target detection. The thermistor has the larger temperature coefficient of resistance, and therefore is the more sensitive.

Figure 9-7 shows a simple modern bolometer; it consists of four nickel strips supported by phosphor bronze springs. These springs are supported by mounting bars, which have electrical connection leads attached to them. A silvered parabolic reflector (mirror) is used to focus infrared rays on the nickel strips. The bridge unbalance current, produced as a result of resistance changes, is used to set in motion the other sections of the guidance system to produce correction signals.

GOLAY DETECTOR.—Still another form of infrared detector is a **GOLAY DETECTOR** shown in figure 9-8. It is also known as a pneumatic detector. This detector is a miniature heat engine. The Golay heat cell operates on the prin-

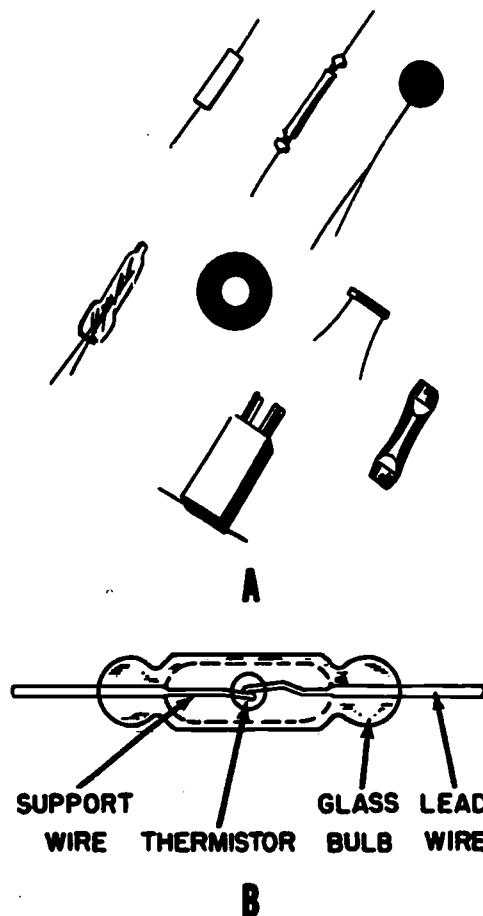

33.162

Figure 9-6.—Thermistors: A. Various thermistor forms; B. Construction of bead thermistor.

ciple that a pressure-volume change occurs in a gas when its temperature is changed. At the forward end of the cell is a metal chamber which encloses the gas. The front of the chamber is covered by a membrane, which acts as a receiving element. The back of the chamber is closed by a flexible mirror membrane. Infrared energy entering the window raises the temperature of the gas in the chamber and causes expansion of the gas. The resulting increase in pressure distends the mirror membrane.

The lamp at the after end of the detector emits a light beam which is focused by the lens and then passes through the grid and onto the reflecting diaphragm. The expansion and contraction of the gases between the window and the diaphragm will cause the diaphragm to change

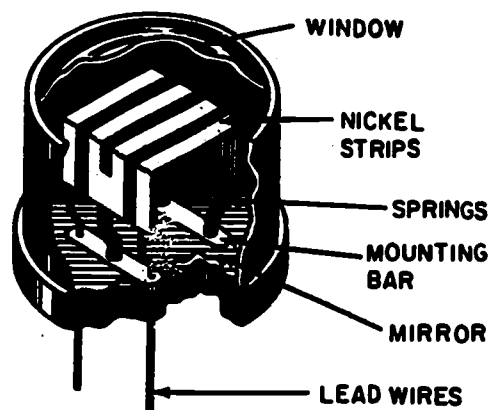

Figure 9-7.—A simple modern bolometer.

33.164

its shape in proportion to the amount of infrared entering the window. Changes in shape of the diaphragm will cause its light-reflective properties to vary accordingly. The light reflected from the diaphragm will then pass back through the grid, which is designed to intensify the variations of the reflected light. After passing through the grid, some of the light strikes the mirror and is reflected to a photocell of high sensitivity (not shown in the figure). The output of the photocell is a voltage proportional to the intensity of the infrared radiation entering the window.

The Golay detector has the most rapid response of any infrared detector, but it can operate only when radiant heat is received intermittently. For some guidance systems this factor makes the Golay detector useless; in others it causes no difficulty.

PHOTOELECTRIC CELLS.—In the light-homing guidance systems, the pickup device or sensor is a photoelectric cell. The operation of this device is based on the fact that certain metallic substances emit electrons when they are exposed to light. Modern photoelectric cells are quite sensitive to light variations; but, because light is easily interrupted, the system is subject to interference. One type of photoelectric cell is shown in figure 6-2.

The objection to photoelectric cells has been partially removed by the recent development of cells with a sensitivity in the infrared region. However, the extension of the range of operation changes the sensor from a pure photoelectric device to a thermoelectric device. It is then similar in operation to a heat sensor.

Rapid advances in the theory of photoconductivity and in the technology of constructing practical radiation detectors based on this phenomenon have greatly improved the facility with which measurements can be made in the region 1 to 5 microns. The materials used are sensitive throughout the visible spectrum as well as in the infrared. The cell that is sensitive over the widest range of wavelengths is not necessarily the best choice for each application. Photoconductive cells do not depend for their response on being warmed by the incoming radiation.

Photodetectors are of three types—photoconductive, photovoltaic, and photoemissive. The photoconductive type is the one we have been describing. It uses material that varies in resistance according to the radiation exposure. The elements used are usually lead sulfide, lead selenide, lead telluride, and germanium.

Photovoltaic cells are used chiefly in photographic light meters. They are usually not sensitive enough for communication purposes.

Photoemissive cells produce an electrical charge when exposed to light waves. They are relatively insensitive but provide high fidelity and low signal-noise levels. One of the limiting factors in photocells is the signal-to-noise ratio.

Other Radiation Detectors

LUMINESCENT DETECTORS.—Luminescent effects are those that appear as a visible glow on films or screens that have been exposed to radiation. The term fluorescence means that the process of emission of electromagnetic radiation is the result of absorption of energy by the fluorescent system. Fluorescent materials glow only as long as the radiation continues, while phosphorescent materials continue to glow for some time afterward.

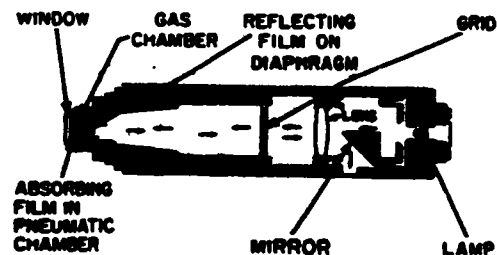

Figure 9-8.—A Golay detector.

33.165

PRINCIPLES OF GUIDED MISSILES AND NUCLEAR WEAPONS

CHEMICAL DETECTORS.—Photographic emulsion plates chemically coated with substances that are sensitive to the shorter wavelengths are being developed by the Navy.

TARGET CHARACTERISTICS

In passive homing, the target itself must provide all the necessary information for missile guidance. For this reason the characteristics of an individual target will determine which types of homing system can be used against it, and under what conditions they can be used.

If the target is fixed in location, and has some characteristic by which the missile can readily distinguish it from the surrounding area, the homing guidance problem is simplified. Figure 9-9 represents an air-to-surface or surface-to-surface missile, using a light-sensing guidance system to home on an industrial building. While such a missile might be useful in a surprise attack, industrial plants would certainly be blacked out during a war. A light-homing missile would then have no way to distinguish the target from its background. But infrared passive homing could be used in this application. And it would probably be more effective than light-homing, since the heat generated by an industrial plant can not be readily controlled.

Figure 6-3 represents a passive infrared homing missile attacking an aircraft. The Navy's Sidewinder uses this type of guidance. The tailpipe of a jet aircraft is a strong source of infrared radiation, which cannot be concealed. In a tail-chase attack, the Sidewinder is highly effective. Against an approaching jet aircraft, missiles dependent upon this type of guidance would be quite useless. Improvements in the Sidewinder missile guidance system have been

directed toward remedying this shortcoming of the early models of the missile.

A sound-homing system might also be used against a jet aircraft target, even though both target and missile are traveling faster than sound. Such a system might be used in a tail chase, provided the target does not maneuver radically. But you have probably observed that when a jet passes over at moderate altitude, the sound appears to come from a point at some distance behind the aircraft. A sound-homing missile would steer itself toward the source of sound, rather than toward the target itself. For an approaching or crossing target, the required trajectory would be too sharply curved for the missile to follow.

MISSILE COMPONENTS

When passive homing guidance is used, the missile must contain ALL of the equipment needed to pick up, process, and use the information given off by the target. The kind and amount of equipment required is determined to a large extent by the guidance system used, and by the characteristics of the target. Consideration must also be given to: the maximum range, information required, accuracy, operating conditions, type of target, and speed of the target. The components of the guidance system in the missile can be sectionalized for separate discussion. We will explain the purpose of each section. Figure 9-10 shows a block diagram of a passive homing guidance system.

Antenna or Other Sensor

Since information given off by the target is to be used for guidance, some means must be

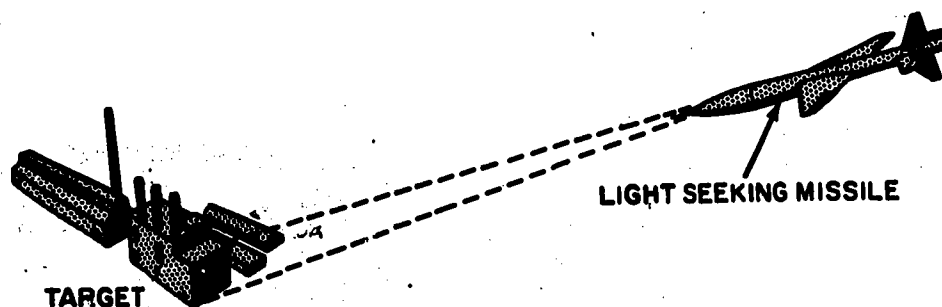

Figure 9-9.—Missile using light-homing guidance.

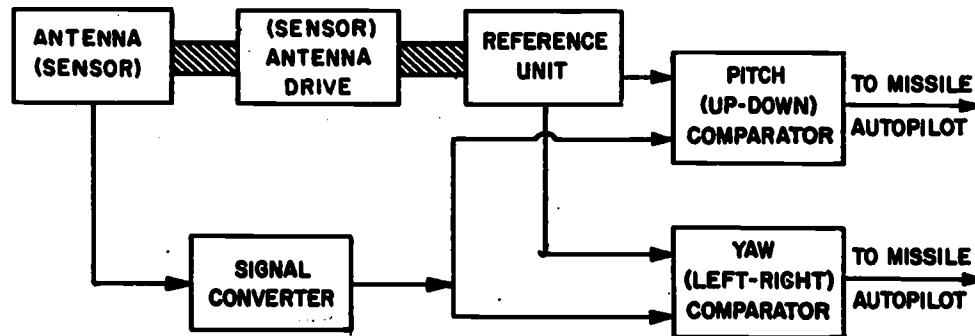

Figure 9-10.—Passive homing guidance system, block diagram.

144.41

provided to pick up the information. For electromagnetic systems, a conventional radio or radar antenna (streamlined into the missile) would be used.

A heat-sensing detector, rather than an antenna, is used with infrared homing guidance systems.

Antenna or Sensor Drive

Previous chapters have described antenna scanning methods. The reflectors mentioned for heat or light homing sensors act in the same way as a radar reflector. Therefore, greater control accuracy can be obtained by scanning a target with the reflector and sensor units.

Should the sensor temporarily lose sight of the target, a spiral or sawtooth/scan, as shown in figure 9-11, could be used to find the target again. Notice that both types of scan cover a large area.

In spiral scanning the amount of tilt given the dish is varied as the dish is nutated, resulting in a spiral pattern. Sawtooth or vertical scanning is used to determine position angle and altitude of the target. (Position angle is the angle between the horizontal and the line of sight to the target.)

The scanning action is controlled by the antenna or sensor drive unit, which is shown in the block diagram of figure 9-12.

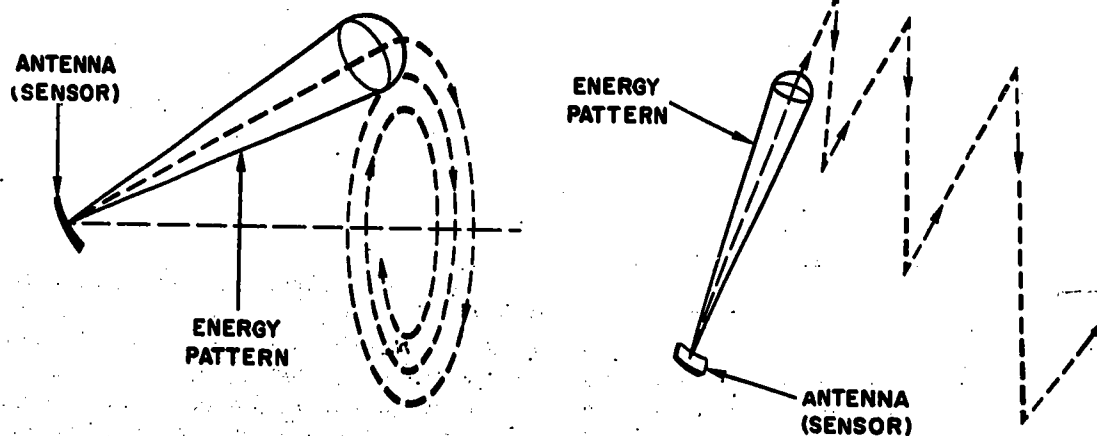
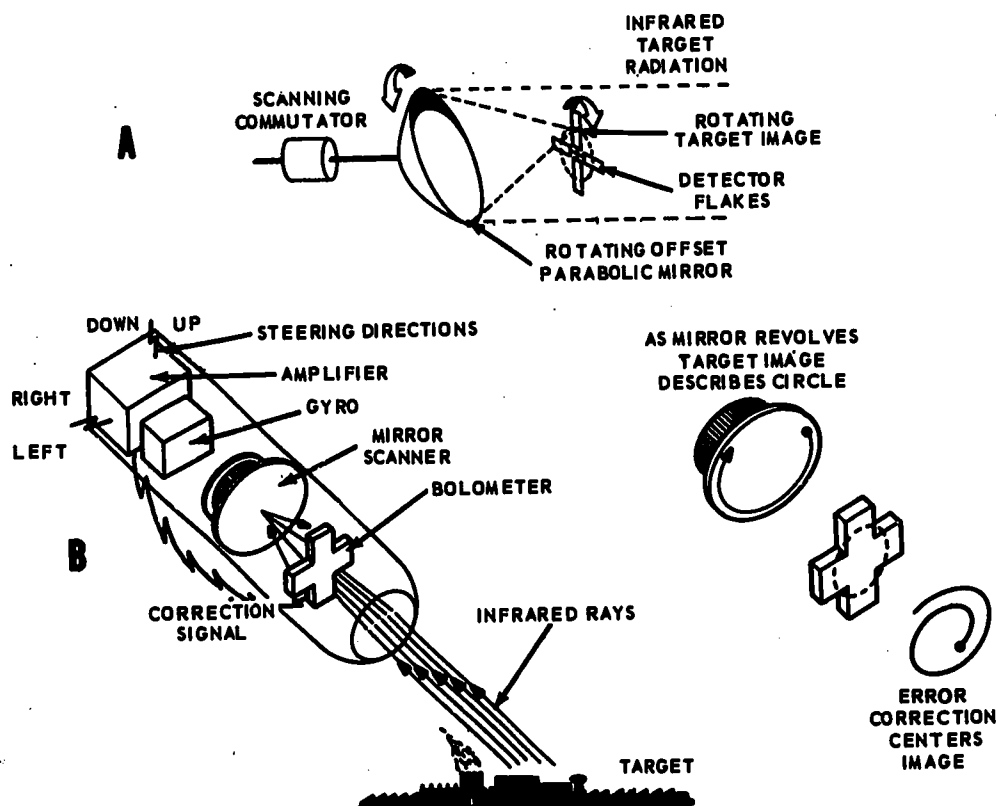

Figure 9-11.—Spiral scanning and sawtooth or vertical scanning.

144.42

PRINCIPLES OF GUIDED MISSILES AND NUCLEAR WEAPONS



33.166

Figure 9-12.—Infrared target detection: A. Infrared detector which uses four bolometer arms; B. Guidance system using a bolometer.

After the antenna or sensor has picked up the information, other equipment in the missile must convert the information into error signals, if the missile is off course. Before this can be done, however, there must be something to compare with the sensor signal.

Reference Unit

The comparison voltage is taken from the reference unit. This voltage may be obtained from an outside source, or it may be taken from recorded information that was put into the missile before launching. Actual operation of the missile guidance controls takes place only when an error signal is present. Note that the reference unit is connected to both the pitch and yaw comparators in the block diagram of figure 9-10. Various types of reference units and reference devices were discussed in chapters 5 and 6.

Signal Converter

The output of the sensor unit is an extremely small voltage. This voltage is fed to a signal converter, which builds up the strength of the signal and interprets the information contained in it. The output of the signal converter is fed to the pitch and yaw comparators along with the signal from the reference unit.

Comparators

The comparators are electronic calculators that rapidly compare reference and signal voltages and determine the difference (error), if any, between the two signals. It is possible for an error signal to be developed in the pitch comparator while no error signal is developed in the yaw comparator. Should this happen, the missile would be higher or lower than the desired

Chapter 9—HOMING GUIDANCE

trajectory. The output voltage from the pitch comparator is then fed to the missile automatic pilot.

Autopilot

The automatic pilot, or autopilot, operates missile flight controls in much the same way as a human pilot operates airplane controls. The components making up the autopilot assembly have been described elsewhere in this text. In order to shift the flight controls, the autopilot must get "orders" from some circuit. The orders are in the form of error signal voltages from the comparators. The error signal voltages operate motors or hydraulic valves which, in turn, operate the flight control surfaces.

INFRARED TARGET DETECTION

Regardless of what materials are used in infrared detectors, the sensing elements are usually placed at the focal point of a parabolic mirror, or are used in conjunction with lenses which provide maximum concentration of the infrared signals at the sensitive surface. The sensor unit is commonly referred to as a homing head.

One method of obtaining directional information is by the use of a rotating mirror whose optical axis is offset from its axis of rotation so that the focal point describes a small circle. In this arrangement, the detector often consists of four bolometer elements arranged in a cruciform pattern. It is placed so that the focused radiation sweeps across each of the elements in succession, as shown in figure 9-12A.

In addition to the mirror and detector, two commutators are included in the homing head, each of which contains a pair of conducting segments separated by insulating spaces. One commutator connects one pair of bolometer flakes to the left-right control circuits, while the other connects the remaining pair to the up-down circuits (fig. 9-12B). Each commutator has a rotating arm which is driven by the mirror shaft. When the target is dead ahead, the rotating target image formed by the mirror describes a circle centered with respect to the bolometer arms. As a result, the bolometer arms divide the circle into four 90° sectors. In this condition, each time the image intersects one of the bolometer arms, the signals developed cannot pass to the control circuits, because at this instant the commutator arms are on one of

the insulating segments, and no error signal results. With an off-center target, the circle of the rotating target image is now offset from the center of the bolometer. In this condition, the bolometer arms divide the circle into unequal sectors and, as a result, the image intersects the flakes when the commutator arms are on the conducting segments, and the proper error signals are developed.

As the mirror scans the target area (fig. 9-12B), the thermal image of the target is reflected onto the flakes, causing their resistance to change. When the resistance of each changes, the voltage at the junction of each pair will rise or fall, depending on which flake is affected, thus transforming the infrared signals into electrical voltage pulses. These pulses are transmitted to the amplifier section as either vertical or horizontal information. The commutator converts the two channel signals into four channels of intelligence corresponding to UP, DOWN, LEFT, or RIGHT in the ERROR-DETECTOR section. The terms horizontal and vertical as used here refer to the signals developed by the vertically and horizontally positioned bolometer flakes, and do not necessarily imply that such signals will cause corresponding turning of the homing head. The exact designation of the intelligence is not available until the signals reach the SENSING CIRCUITS in the error detector.

The function of the amplifier section is to amplify and rectify the pulse signals delivered by the bolometer so that only positive pulses of high amplitude are available at the outputs for the error detector. There are two complete channels in the signal amplifier and error-detector sections; one channel processes the signals from the horizontal bolometer flakes; the other uses the signals from the vertical pair. (The two channels are identical.)

The gyroscope is used for stabilizing the homing head and for measuring the angular rates about the line of sight (LOS).

RADIO FREQUENCY PASSIVE HOMING GUIDANCE

A passive homing device using radio frequency intelligence is the direction finder. The intelligence may be derived from phase comparison techniques (such as an interferometer) if the energy transmitted by the target is of such form as to make this possible. For example, if the target is operating a pulse type radar, phase

PRINCIPLES OF GUIDED MISSILES AND NUCLEAR WEAPONS

comparison techniques would be possible. Another means of deriving intelligence from the energy transmitted by the target is by comparison of the amplitude of the received signal during the scan cycle. Such techniques can be used only if information is available concerning the frequency band in which the target is transmitting. In addition, it is necessary that the missile receiver be capable of being tuned over this frequency band.

SEMIACTIVE HOMING SYSTEM

BASIC PRINCIPLES

In a semiactive homing system, the target is illuminated by some means outside the target or the missile. Normally, radar is used for this type of homing guidance, by sending a radar beam to the target. The beam is reflected from the target, and picked up by equipment in the missile. The radar transmitter might be located at a ground site, or it might be aboard a ship or aircraft. See figure 6-8. Because the energy transmitter is not in the missile, but on the larger delivery vehicle (ship, aircraft), the size and weight of the transmitter can be much larger than in passive homing missiles, permitting the use of longer-range, high power transmitters. The missile, without a transmitter, has space for additional explosive material to increase the area of damage, more propellant to increase its range, or more guidance equipment to increase its accuracy. However, these advantages are gained at a price. Since the missile operates solely on energy from the transmitter on the ship (or aircraft), the ship cannot break off the attack, or attack another target, while it has missiles in flight. While the time of flight is very short, it could be a decisive moment during which the transmitter is not free.

A modified version of the semiactive technique has the transmitter located in the missile and the receiver of the reflected energy at some remote point. Computation of the desired flight path takes place at the remote point and suitable commands are sent to the missile. This system is known as a quasi-active homing guidance system.

Semiactive homing is used for all or part of the trajectory of several of our best-known missiles, including Terrier, Talos, and Tartar.

LAUNCHING STATION COMPONENTS

In a semiactive homing guidance system, the launching station components are similar to those required for a beam-rider guidance system (chapter 8). The target is tracked by radar. The tracking radar itself may be used as the source of target illumination for missile guidance, or a separate radar may be used for this purpose.

The transmitter may be a surface installation on the ship or at a shore station, or it may be in an aircraft. The transmitted energy may be in the form of radio, light, or heat. The missile launcher may be in close proximity to the transmitter, but not necessarily so.

MISSILE COMPONENTS

The missile, throughout its flight, is between the target and the radar that illuminates the target. It will receive radiation from the launching station, as well as reflections from the target. The missile must therefore have some means for distinguishing between the two signals, so that it can home on the target rather than on the launching station. This can be done in several ways. For example, a highly directional antenna may be mounted in the nose of the missile. Or the doppler principle may be used to distinguish between the transmitter signal and the target echoes. Since the missile is receding from the transmitter, and approaching the target, the echo signals will be of a higher frequency.

The radar receiving antenna in the head of the missile is called the seeker or seeker head. It receives echoes from the target. The semiactive homing antenna system locates the target and automatically tracks it. The tracking process locates the line of sight between the target and the missile. A computer in the guidance system uses this tracking information to produce steering signals. The missile, however, does not fly along a line of sight, but follows a collision course, or rather, a refined collision course. The missile receives this refinement before it is launched. It receives this navigational information through the warmup contactor of the launching system. Most of our missiles are given a warmup period just before loading on the launcher and a final warmup while on the launcher, just before firing.

To intercept high-speed targets like a supersonic aircraft or a missile, the semiactive

Chapter 9—HOMING GUIDANCE

homing missile must follow a lead (collision) course. If the target flies a straight-line constant-velocity course, the missile can also follow a straight-line collision course if its velocity does not change. In actual situations, there usually are variations in speed, change in path, maneuvers of the target, etc. The missile has to adjust its direction to maintain a constant bearing with the target. The components in the missile must be able to sense the changes and make the necessary adjustments in its course to the target. Missile velocity seldom is constant. Irregular propellant burning changes thrust and therefore affects speed. Wind gusts and/or air density can change the speed and path of the missile. The same factors can influence the target. The missile must use proportional navigation, described in chapters 2 and 6, and at the beginning of this chapter, to achieve target intercept. If the missile path is changed at the same rate as the target bearing (fig. 9-13A), the missile will have to turn at an increasing rate (positions 1 to 6), and will end up chasing the target (positions 6 and 7). This flight path follows a pursuit curve and the missile cannot maintain a constant bearing with the target. It is just keeping up with changes in target bearing and may not be able to catch up with the target.

To achieve the desired straight-line course during the final and critical portion of the attack, the missile must turn at a rate greater than the line of sight is turning. By overcorrecting the missile path, a new collision heading is reached and the bearing angle will remain almost constant, especially near intercept. This technique results in a proportional navigation course (fig. 9-13B). It is sometimes called the N factor, or navigation ratio, which is the ratio of the rate of turn of the missile to the rate of turn of the line of sight (rate of change of target bearing). The missile fire control computer on shipboard computes the ratio and transmits it to the missile launching system for transfer to the missile's guidance and control system.

For the purposes of this text, we can think of the missile guidance components as divided into several distinct sections. These are shown in block diagram form in figure 9-14. Note that these are the components in the missile; launching station guidance components are not shown. A comparison of figures 9-10, 9-14, and 9-15 will show much similarity of components. As pointed out at the beginning of this chapter, all types of homing guidance use the same blocks of components. Their location and/or use will differ.

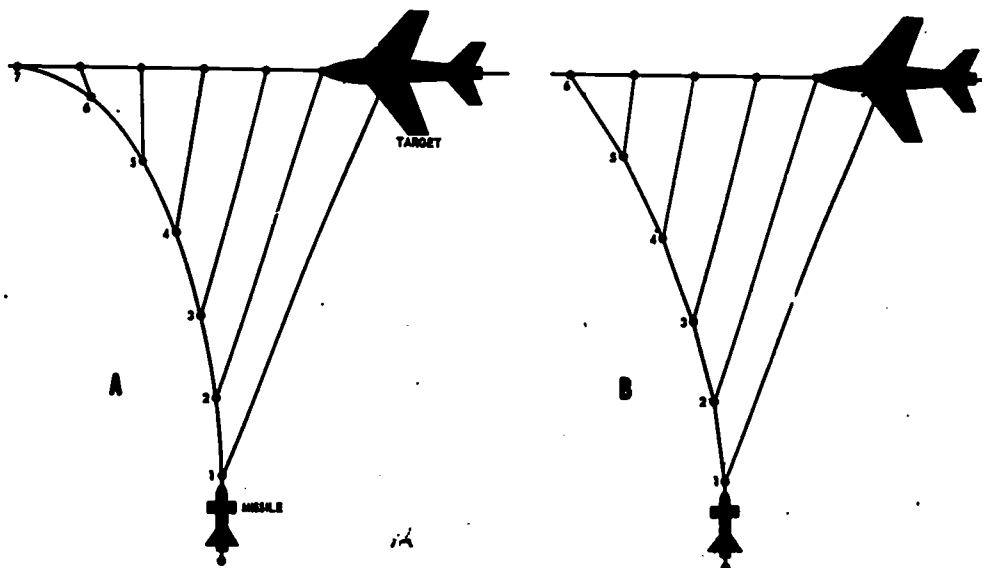
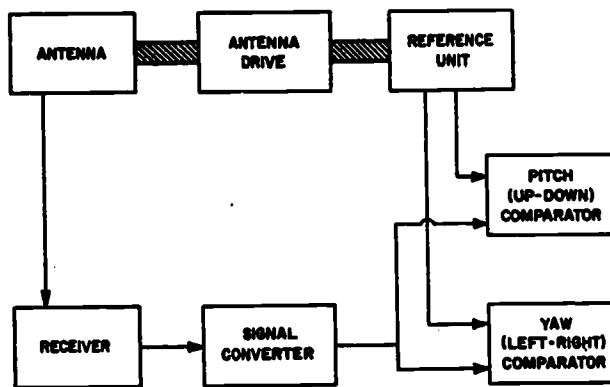

Figure 9-13.—Proportional navigation: A. Pursuit curve; B. Overcorrection to produce proportional navigation.

PRINCIPLES OF GUIDED MISSILES AND NUCLEAR WEAPONS



144.43

Figure 9-14.—Semicative homing systems; block diagram.

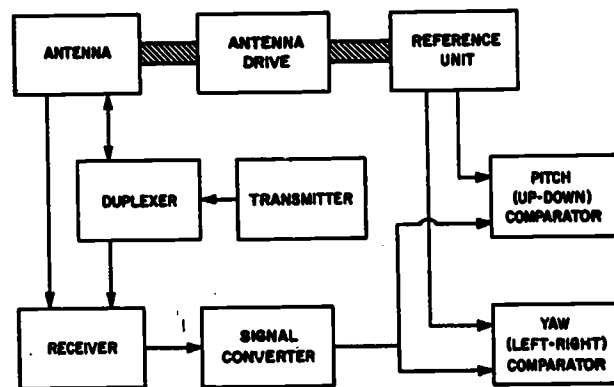

144.44

Figure 9-15.—Active homing system; block diagram.

In both the active and semiactive homing systems, the missile receiving antennas and associated equipment must be designed in such a way as to produce directional information which will enable the missile to be guided to the target.

To carry out this function, the receiving antennas are mounted in a gyro-stabilized homing head. The gyros provide the up-down, right-left references on which the missile will base its maneuvers to approach the target by the proportional navigation method.

Antenna

Radar is generally used for semiactive homing guidance. The antenna in the missile must therefore be capable of detecting radiation at radar frequencies. It is mounted in the nose of the missile, since information is being obtained from the target area and the missile is approaching the target nose first. When a beam-riding system is used for the intermediate phase of guidance, a separate beam-rider antenna is mounted near the tail of the missile. Some missiles with a semiactive homing system also have a small antenna at the after end of the missile, rearward-looking, to receive illuminator energy directly from the illuminator radar. This rear signal is used as a reference to which the front signal is compared to determine the missile-target closing rate. This closing rate (range rate) is detected by measuring the Doppler effect which causes a frequency difference between the incoming front and rear signals. The Doppler

shift is proportional to the range rate. The range rate, plus antenna turning rates and position, are supplied to the autopilot, which steers the missile on a proportional navigation course to intercept.

Antenna Drive

In some systems, the homing guidance antenna may use a form of conical (or nutating) scan in order to take full advantage of the guidance signal. Conical scanning (fig. 8-6) has the advantage that the antenna can receive signals from points off the missile axis. This decreases the chance that the missile, while homing, may lose its target and go out of control. The drive unit keeps the antenna continually pointed at the target.

Receiver

A radar-type receiver must be used in the missile when radar is used for semiactive homing. The signals picked up by the antenna as it scans the target area are fed into the receiver. The receiver operates in a conventional manner as described in chapter 7. The signals at the output of the receiver are not suitable for use in activating the missile flight controls without further processing.

Signal Converter

The receiver output is fed to the signal converter, which changes the signal to a form that

Chapter 9—HOMING GUIDANCE

can be used for comparison with signals from another section of the missile electronic equipment.

Reference Unit

The reference unit furnishes the comparison signal. This information might be placed in the missile just prior to launching. It could be stored in a variety of forms, such as magnetic wires, magnetic tapes, punched paper tapes or punched cards. Before a guidance system can function, an error signal must be produced. The error in flight path, if any, can be determined by comparing the reference signal and the signal from the converter section. Comparison of the two signals takes place in other sections of the missile electronic equipment.

Comparators

The missile flight controls may be used to correct the lateral or vertical trajectory of the missile. Since it is possible for the missile to be on the right course vertically but off course laterally, two comparators are used. The output from the reference unit and the output from the signal converter are fed to both the pitch and yaw comparators.

Should there be no difference in the two signals at either comparator, the controls would remain in neutral position. However, should there be a difference in the two signals at either comparator, error signals will be generated. The error signals are not suitable for use in controlling the missile flight surfaces and must be sent to other sections of the guidance system before they can be used.

Autopilot

The missile flight control surface operation is controlled by autopilots. These devices are a combination of gyroscopes and electrical units which have been described elsewhere in this manual. The autopilot controls operation of the hydraulic or electric system which, in turn operates the flight control surfaces. There are two autopilots—one for the pitch control surfaces and one for the yaw control surfaces.

COMPARISON WITH PASSIVE HOMING

The passive guidance system obtains all guidance information from the target, without

assistance from any other outside source. The semiactive homing system needs some source outside the target or missile in order to obtain course information.

The advantage of the passive system is that it needs no source of information other than the target. The equipment carried by the missile is less than that required for most other systems. The disadvantage of the passive guidance system is its dependence on the target. It is highly unlikely that an enemy would leave target areas lighted, or permit electromagnetic broadcasting from the target areas.

In the semiactive system, control information comes from a source outside the missile or target area. A semiactive homing system depends for guidance on equipment outside the target area or the missile. This requires extra equipment, both in the missile and at the launching or control point. Semiactive homing systems, like most guidance systems, are subject to jamming and other forms of interference.

However, anti-jamming devices in modern missiles, and switching capability that permit switching to another method when the signal is jammed by the target, have greatly reduced the effectiveness of jamming tactics.

ACTIVE HOMING GUIDANCE

BASIC PRINCIPLES

The active guidance system uses equipment in the missile to illuminate the target, and to guide the missile to the target. (See fig. 6-8). Usually, a radar set is used for target illumination. The signals return to the missile as radar echoes, which are processed for use as guidance signals.

MISSILE COMPONENTS

The missile components in an active homing guidance system include all those used in a semiactive homing guidance system, plus a radar transmitter and duplexer. The principal components are shown in the block diagram of figure 9-15.

Antenna

The antenna is the same as described for the semiactive system, and is mounted in the nose of the missile.

PRINCIPLES OF GUIDED MISSILES AND NUCLEAR WEAPONS

Antenna Drive

When the target area is conically scanned, the antenna driving unit provides the power needed for this purpose.

Transmitter

The transmitter carried in the missile is similar to a conventional radar transmitter. It may use either FM or pulsed modulation. Since homing guidance does not require long range equipment, the transmitter power can be considerably less than that used for command guidance or tracking. The method of modulating the transmitter can be changed frequently to lessen the effectiveness of enemy countermeasures.

Duplexer

The duplexer is a form of electronic switch. In operation, it serves to connect the antenna to the transmitter during the sending of a pulse. At the same time, it presents a high impedance (electrical opposition) at the receiver input. This keeps the powerful transmitter pulse from damaging the receiver.

As soon as the pulse is transmitted, the duplexer then offers a low impedance path from the antenna to the receiver. The action of the duplexer provides an automatic switching means, so that the same antenna can be used for both transmitting and receiving.

Reference Unit

The reference unit in the active homing guidance system serves the same purpose as those in the passive and semiactive homing guidance systems.

Signal Converter

The output of the receiver is fed to the signal converter, so that the reflected signal will be suitable for comparison with the output of the reference unit. The purpose and operation of the signal converter is the same as for the semiactive homing guidance system.

Comparators

The comparators serve the same purpose as those in the semiactive system.

Autopilot

The missile flight controls are operated by the hydraulic system, which is activated by the autopilot in the same way as described for the semiactive system.

COMPARISON WITH SEMIACTIVE HOMING SYSTEM

The active homing guidance system may be used in any application where the target can be distinguished from the surrounding area by the radiation it reflects. Of course, the more prominent the target, the greater the accuracy of homing guidance.

An advantage of the active homing guidance system is its independence from any outside source of target illumination. At the same time, this is a disadvantage because of the added equipment needed in the missile. Also, the system is subject to countermeasures. But this problem is less serious than it might be, because the homing guidance equipment is active for only a relatively brief part of the missile's flight time.

INTERFEROMETER HOMING

Interferometer homing is homing guidance in which target direction is determined by comparing the phase of the echo signal as received at two antennas precisely spaced a few wavelengths apart. The interferometer is a device for measuring interference, using the interference as the measuring tool. Acoustic interferometers measure velocity and attenuation of sound waves in a gas or liquid. The Michelson stellar interferometer solves the problem of measuring the diameter of stars too small or distant for telescopic measurement. Various other interferometers are used for other exacting measurements.

Missile pitch and yaw rates are compared with the interferometer signal and the difference is used as the steering signal. Both active and semiactive homing systems make use of the interferometer principle.

INTERFEROMETER PRINCIPLE

To determine the target's position with respect to the missile, the receiving antenna system in the missile relies on the interferometer principle. To understand how this principle is applied, first refer to figure 9-16. In this

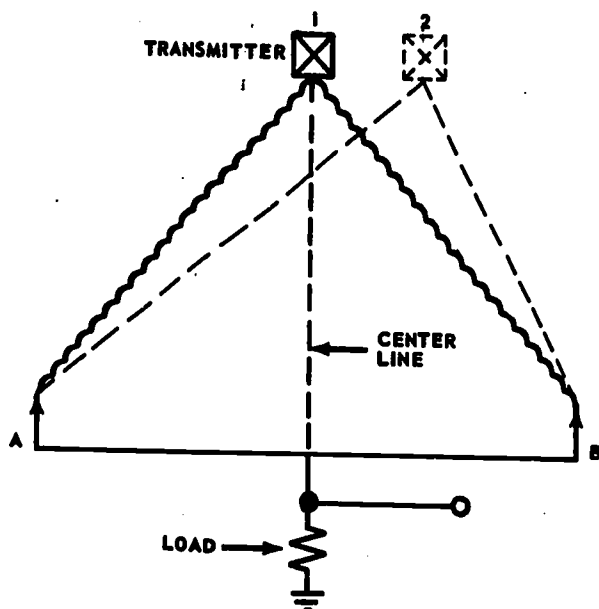

Figure 9-16.—Interferometer principle. 33.170

figure, a pair of stationary receiving antennas (A and B) are receiving information from a transmitter located equidistant from them (at point 1). (The transmitter can be considered to be relaying reflected radar energy from a target.) Since the antennas are equidistant from the transmitter, the signals from the transmitter will arrive at the two antennas in phase. The signals will therefore add across the load to produce a resultant signal of maximum amplitude. If the transmitter were now moved to point 2, the differences in distance from the transmitter to the antennas would cause the signals to arrive at the antennas in a different phase relationship, thereby resulting in a different amplitude of the combined signal. If we continue to move the transmitter to the right, the amplitude of the combined signals will vary sinusoidally. We can therefore say that the direction of the transmitter from the antenna system can be determined by the amplitude variation of the combined signal.

The RATE of transmitter movement will cause the combined signal to vary at a specific rate. For example, if the transmitter moved to the right at 4° per second, the combined signal might vary at 2 cycles per second. As the transmitter moved to the right at 8° per second, the

combined signal would vary at 4 cycles per second, etc. Thus, by using the interferometer, we can determine both the direction and the rate of movement of the transmitter.

Unfortunately, if the transmitter were moved to the left in the foregoing example, the same variations of the combined signal would result. To allow the interferometer to determine whether a target is moving to right or left, it is necessary to add a phase shifter to one antenna (fig. 9-17). The phase shifter provides the effect of scanning the antenna B sensitivity lobes at, for example, 200 cycles per second. With the transmitter on the center line, the signal from antenna A will vary at 200 cycles per second with respect to the signal from antenna B. Now, if the transmitter moves, the 200-cycle component associated with antenna B will increase or decrease to indicate the direction of target motion. If the target moves to the right, for example, this component might increase to 201 cycles per second. If the target moves to the left, the component might decrease to 199 cycles per second.

With the phase shifter included in the antenna system, the missile can now detect changes in target motion to the right or left as well as the

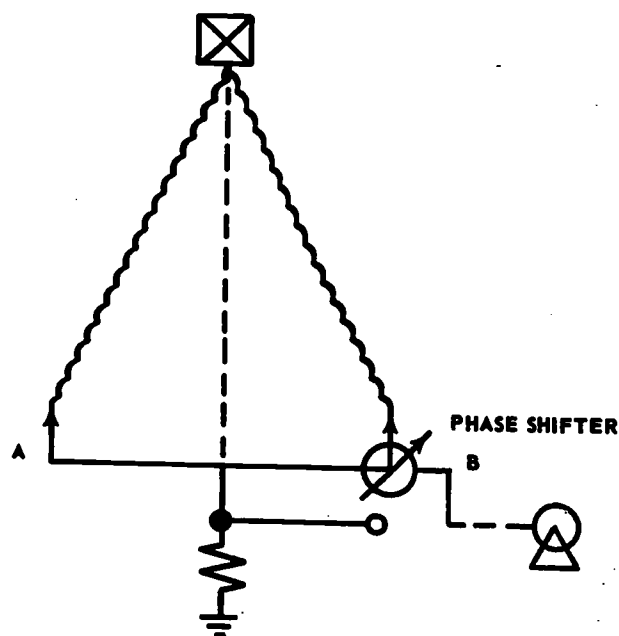

Figure 9-17.—Interferometer with phase shifter on antenna B. 33.171

PRINCIPLES OF GUIDED MISSILES AND NUCLEAR WEAPONS

rate of target motion in either direction. To detect target motion in the vertical, the same principles are involved in installing a separate antenna system and phase shifter in the missile nose, one antenna being located above the other.

You will remember from the early part of this chapter that proportional navigation was based on a nonrotating LOS. Since the resultant signals produced in the antenna system just

described are produced by LOS rotation, the missile accepts these signals and generates control surface correction signals which tend to reduce the LOS rotation rate to zero. When this has been achieved, the missile will be on a collision course with the target. Any changes in target course and speed will be immediately sensed by the antenna system in the missile, and further corrections will be made as necessary.

CHAPTER 10

OTHER GUIDANCE SYSTEMS

PRESET GUIDANCE

INTRODUCTION

In earlier chapters we described guidance systems in which the missile trajectory depends on information received from one or more control points, or from the target itself. But, under certain conditions, these systems are impractical. This is especially true for long-range missiles. In this chapter, we will discuss several guidance systems in which the missile is independent of control points and target signals.

Perhaps the simplest of these is the PRESET GUIDANCE system. In this system, all the information needed to make the missile follow a desired course, and terminate its flight at a desired point, is set into the missile before it is launched. This information includes the desired heading, altitude, time or length of the flight, and programmed turns (if any).

The preset missile is PROGRAMMED to carry out certain functions along its flight path. Examples of the functions which a preset missile may carry out are changes of course and speed, arming of the warhead, and commencing a dive on a target (terminal phase).

In the preset missile, information relating to the target's location must be set into the missile prior to launch. The position of the launching site must also be known with accuracy. With this information known, the preset functions enable the missile to attain the proper altitude and course, measure its own airspeed, and, at the correct time, initiate the terminal phase of flight.

Preset guidance may be used when the target is beyond the range of control points, or when it is necessary to avoid countermeasures such as jamming of radio or radar signals, that might be effective if the missile were guided by outside signals.

It may also be used for one phase, usually the initial phase, of the trajectory of a missile.

In setting up a flight plan for preset guidance, missile speed is used to determine the required time of flight. Assume, for example, that a missile is to be fired at a target 500 miles north of the launching site. The direction and distance of the target from the launch site have been accurately determined. Assume that the speed of the missile can be controlled, or at least can be predicted with enough accuracy to program the flight.

If we assume an average missile speed of 2000 miles per hour, the missile would require 15 minutes to travel from the launch site to the target. The built-in control system would take the missile to cruising altitude, keep it headed north for 15 minutes, and then move its flight surfaces to make it dive straight down on the target.

Preset guidance has several limitations. Such things as headwinds and crosswinds will obviously affect the speed and course of the missile. To compensate for the effects of wind, the missile needs some means for measuring its ground speed, and for changing its air speed as required. But, when solid fuels are used, changing the air speed of the missile is difficult.

Crosswinds may exist at one altitude but not at another. Thus, the altitude at which a missile operates may have a pronounced effect on its course. If the effect of wind on missile heading cannot be controlled by choice of altitude, then it must be controlled by programmed steering of the missile. One of the greatest limitations of a preset guidance system is that the flight program cannot be changed after the missile is launched. Therefore, precise information on winds along the missile flight path is needed for accurate programming.

PRINCIPLES OF GUIDED MISSILES AND NUCLEAR WEAPONS

The most publicized preset guided missile, the German V-1, achieved devastating success in spite of its limitations (until the British found a way to intercept it).

INFORMATION SET IN THE MISSILE

The initial course, or heading, of a missile may be preset by training the launcher to the proper bearing. This operation is of course similar to training a gun mount. Some missiles may be fired vertically, and then take the proper course on the basis of programmed information. Once the missile is started on the correct heading (initial phase), its own control equipment takes over.

Physical references such as gyros and magnetic compasses may be used to determine deviations from the preset course and to keep the missile on the correct heading.

The missile altitude may be corrected by changing the pitch of the missile. A barometer-type sensing element is connected to a servo mechanism that operates the flight control surfaces. When the barometric pressure changes because of a change in altitude, the servo acts to bring the pressure back to the preset value by correcting the missile's altitude. Although this method of altitude control is not extremely accurate, the control pressure can be preset to fairly close tolerances before the missile is launched.

One of the most precise components of a preset guidance system is its timing section. Accurate timing elements are available to fit almost any requirement. The distance covered by a missile during its flight is determined by its ground speed and the length of time it is in the air. Therefore, if the speed of the missile is known, the controls may be preset to dive the missile at the end of a definite time interval after launching. The timing element can be anything from a simple watch movement to an electronic circuit controlled by a tuning fork or a crystal oscillator. The time interval may be set at any time before launching, but of course it cannot be changed during flight.

It is important that you realize at this point that the actions carried out by a missile in flight may be preset to occur either after a certain amount of TIME has elapsed, or when a certain CONDITION has been achieved.

For example, a missile may be programmed to assume level flight 30 seconds after launch—or it may be programmed to assume level flight

only after a specific altitude has been reached, this altitude being determined by an altimeter. As another example, missile booster separation may be scheduled to occur 6 seconds after launch—or it may be programmed to occur at the point that a certain thrust acceleration has been achieved. Course and speed changes as well as other functions can be carried out with relation to the elapse of specified time intervals or on the occurrence of other preset conditions.

Depending on the objectives of a missile using preset guidance, various timers, speed measuring devices, etc., have been devised to enable the missile to carry out the preset functions. Many of these devices may also be found in missiles which are not of the purely preset type. For example, a homing guidance missile, although not classified as a preset missile, may be equipped with one or more of the devices.

Various types of timers used in missiles were described and illustrated in chapter 5. The timing system in a missile activates a series of actions from prelaunch to target interception.

It is reemphasized that the preset missile is distinguished from other types of missiles in that there is no electromagnetic radiation contact between the control point and the missile and that ALL missile functions are programmed.

HEADING REFERENCE

The use of the term "reference" with regard to missiles was explained in chapter 5. The missile control systems must have a reference from which to measure the up-down or right-left deviation of the missile. Since the desired heading is a compass direction, the sensing unit may be a form of compass.

The flux valve and its uses in control systems were described in chapter 6. If magnetic headings are to be followed, the flux valve may be used as the sensing element. By using a time reference in combination with a magnetic reference, the missile controls may be preset to follow a single heading for the required time. Or changes in heading can be programmed to occur at preset times.

The electrically driven gyro is another type of heading control. The gyro's spin axis is tangent to the earth's surface. At the time of launching, with the gyro wheel spinning rapidly, the axis is pointed in the desired direction before the gyro is uncaged. During the missile flight the gyro axis continues to point

Chapter 10—OTHER GUIDANCE SYSTEMS

in the original direction, and the missile can therefore use it as a steering reference.

The function of gyros in missiles was described and illustrated in chapter 5.

ALTIMETERS

In previous chapters we have shown that an altimeter can be used to control missile altitude within small limits. Altitude control is an important part of preset guidance, since it is possible to get favorable wind direction or avoid unfavorable winds by choosing the proper altitude.

With supersonic missiles it is important to get the missile above the earth's atmosphere into the higher regions where the air is thinner and the pressure is much less, so that the missile can fly faster and farther. The trajectory of the missile is dependent to a great extent on the altitude at which it flies, and the altitude set for it is determined in part by the distance to the target.

The reference for preset altitude control is normally a potentiometer in one arm of a bridge circuit. A potentiometer in an adjacent arm of the bridge is operated by a pressure-sensitive bellows system. The bridge can be preset for balance at the desired altitude. When the missile reaches the preset altitude, its flight control surfaces will bring it into level flight. Any subsequent change in pressure will unbalance the bridge, and the amount and direction of unbalance will determine the correction to be applied. This system will be described in more detail later in this chapter.

The two basic types of altimeters, barometric pressure altimeters and absolute or radar altimeters, were discussed in chapter 5. An altitude transducer is an altimeter with an electric output. Because of its simplicity and accuracy, the altitude transducer is used as the primary altitude control or reference in even the latest guidance systems.

LENGTH OF FLIGHT

In low-speed missiles an AIR LOG, as well as a timing device, can be used to measure the distance covered during missile flight. The air log operates on the principle of an air screw, or impeller, which makes a specific number of revolutions while moving through the air for a given distance at a given speed. The number of revolutions per unit of distance depends on both the pitch of the blades and the density of the air.

Generally, an air log is attached to the outer surface of the nose of the missile, and consists of a small four-bladed impeller mounted on a shaft that drives a reduction gear with a ratio of 30 to 1; that is, for every 30 revolutions of the air screw, the driven gear makes 1 revolution.

The driven gear is made of insulating material, and carries a pair of contacts mounted at diametrically opposite points. These contacts close a magnetic relay circuit twice in each revolution of the gear, or once for each 15 revolutions of the air screw.

The magnetic relay is connected to a device called a digital indicator (originally called a Veeder counter). The counter mechanism is similar to that of the total mileage indicator (odometer) of an automobile. The counter is shown in cross-section in figure 10-1.

To use the air log for length-of-flight regulation, the calibrated drums are turned to a setting that represents the desired distance of travel for the missile. Each time the contacts of the magnetic circuit close, they trip the

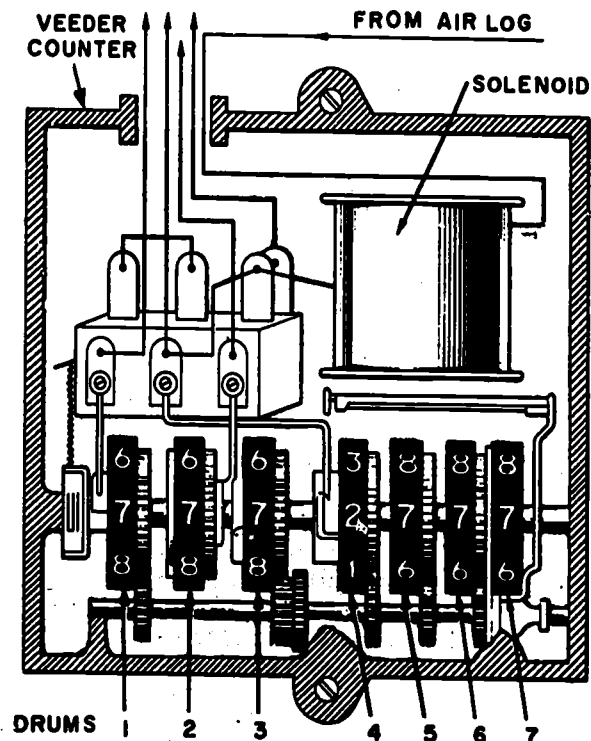

144.45
Figure 10-1.—Mechanical digital indicator, cross section.

PRINCIPLES OF GUIDED MISSILES AND NUCLEAR WEAPONS

counter mechanism, thus indicating that a certain specific distance has been traveled. Each time the mechanism is tripped, it moves the drums back one digit from the preset figure. When the count reaches zero, the predetermined destination has been reached. This may be either the point where the warhead is to be detonated, or the point at which the missile is to start its terminal dive on the target.

Note that this method of measuring speed is used for LOW SPEED missiles.

Figure 5-20 is a diagram of an airspeed reference and transducer unit, which may be used to measure airspeed and to control it. See chapter 5 for a discussion of its operation. Transducers were also touched upon in chapter 3, in connection with telemetering equipment.

The use of doppler radar to determine the missile-target closing rate (range rate) was described briefly in chapter 9 for the homing system. Doppler principles were explained in chapter 6. The doppler signal varies directly with the range rate. The application of the mechanical, electrical, and electronic components to measure the doppler frequency, filter out noises, amplify the difference frequency, and supply the information to the computer vary with the missile system. An electronic circuit called a speedgate locates the doppler signal, acts as a bandpass filter, and closely follows any frequency shift in the signal. The range rate information gained from the doppler signal is fed to the autopilot to keep the missile on course. (A "gate" in electrical and electronic terms is a circuit that permits another circuit to receive input signals only at set intervals, or only when a certain set of input conditions have been met. The appropriate combination of "gating pulses" opens the gate.)

USE IN COMPOSITE SYSTEMS

A composite guidance system is made up of two or more individual guidance systems. These systems may work together during all phases of the missile's flight, or they may be programmed to operate successively. It is sometimes necessary to combine systems because of the wide differences in requirements that must be met to ensure that the missile reaches the target. Let us review these requirements, to see how preset guidance may be used in a composite system.

During the launching period, high acceleration puts a great strain on normal guidance components and prevents their use. The acceleration forces may close relays, precess gyros, and saturate accelerometers far beyond the sensitivity needed for normal guidance. For this reason, most midcourse guidance systems must be modified extensively to withstand the launch acceleration. The modification may involve the use of comparatively insensitive components, or a temporary alteration of the regular components.

The precautions against high acceleration damage to components include careful balancing and positioning of elements that are not used during the launch cycle. In addition, movable parts of regular guidance systems are locked in position, or the circuits in which they operate are neutralized to withstand the launch acceleration.

Missiles are designed to have sufficient flight stability during the initial period of high acceleration, before the regular guidance system takes over. The regular guidance system may be unlocked by an internal timer, or it may be activated when the booster section, if any, drops off.

A preset guidance system might be used for the midcourse part of a flight. When used in a composite system, the preset system would turn the missile control over to a separate terminal guidance system when the missile approaches the target. In an application of this type, the preset guidance system might be set up to take over control again in the event the terminal guidance system did not operate. Then, when the missile reached the approximate location of its target, the preset guidance system would either detonate it or cause it to dive, depending on the setting.

We've mentioned World War II missiles that used preset guidance or a combination of guidance methods. Of later vintage is the Corporal, an Army surface-to-surface nuclear weapon deployed in Europe (being replaced by the Sergeant). It uses a combination of preset and command guidance. (The Corporal missile will be used for other purposes, with a different type of warhead.)

Most missiles have some values preset into the guidance system, although the preset values may not control the whole flight. The time of booster cutoff, for example, is a preset time as determined for a given missile, although the missile may be a beam rider. Before the

missile is launched, a timer in it is set for the calculated period.

BALLISTIC MISSILES

Our best known ballistic missile, the Polaris, makes use of a number of preset values in its course. It therefore seems appropriate to discuss ballistic missiles immediately after preset guidance systems.

A ballistic missile is a missile which, during a major part of its flight, is neither guided nor propelled. During this part of the flight it follows a free ballistic trajectory, like a bullet or a thrown rock. A number of factors operate to determine the trajectory of a bullet, a rock, or a ballistic missile. These factors include the point of origin, the initial direction and velocity, air pressure, wind, and other factors discussed in chapter 2 of this text. If all of these factors are accurately known, it is possible to calculate the point at which the ballistic object will strike the earth. And, if the desired point of impact is a target at a known location it is possible, for any given launching point, to calculate an initial course and velocity that will result in a hit.

The matter of "leading" a moving target in order to hit it was explained in a previous chapter. If you have had any target practice you know that there are several factors to calculate when aiming at a stationary target and additional problems when the target is moving. You know about "allowing for the wind." The effect of the wind varies, of course, with its strength and direction. The force of gravity steadily pulls the projectile downward, so you have to raise your gun and aim above the target to offset the downward pull. The greater the angle of gun elevation, the greater the range—up to a point. Temporarily ignoring air resistance, we find that range increases with the angle of launcher or gun elevation, up to 45 degrees. After that point, increasing the elevation increases the height reached by the projectile, but decreases the range. Figure 10-2 shows some theoretical trajectories. Figure 10-3 compares trajectories in air and in vacuum. Since many of our missiles have part of their trajectory through higher areas of the atmosphere where the pressure is very low (not a complete vacuum), the effect on the trajectory must be calculated. Refer to figure 2-24 (trajectory of the Polaris missile). Note

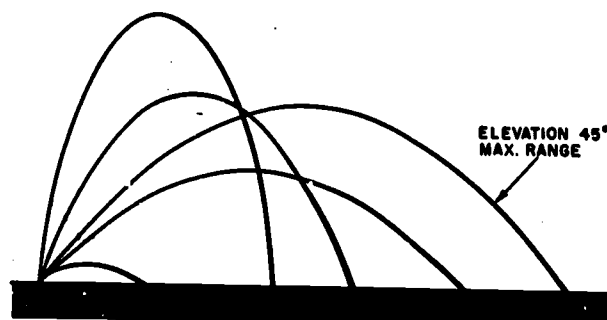

12.3
Figure 10-2.—Theoretical trajectories at various gun elevations (ignoring air resistance).

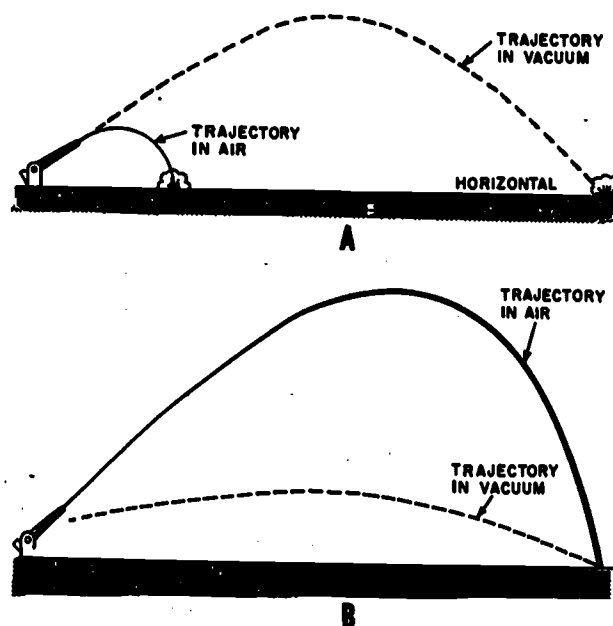

12.4:5
Figure 10-3.—Comparison of vacuum and air trajectories: A. In range; B. In elevation.

that the missile is launched vertically. Since the Polaris passes through more than one atmospheric region, the effect of the different conditions upon the trajectory must be calculated. The proportionate differences between air and vacuum trajectories represented in figure 10-3 are not accurate for all projectiles or missiles because the effect varies with characteristics of the object. It does show how drastically air resistance affects trajectory.

PRINCIPLES OF GUIDED MISSILES AND NUCLEAR WEAPONS

A fourth factor that affects trajectory is drift, which is a product of the interaction of three other factors—the spin of the projectile, the force of gravity, and air resistance. These cause the projectile to veer toward the right or left, and is determined by the direction of spin.

The fifth factor that distorts the trajectory is the earth's rotation and curvature (really two separate factors). For most gun projectiles it makes little difference; but for long-range missiles, both effects must be entered into the computations for missile trajectory. The deflection in the flight path is known as the Coriolis effect. It affects the time of flight, the lateral deviation, and the range deviation. In the northern hemisphere the deflection is to the right; in the southern hemisphere it is to the left.

The mass of calculations necessary for each shot is performed by computers. Many of the calculations are performed in advance and tables set up to be applied as needed. In modern missile systems the application of the calculations is also done by computers. Remember, however, that the computer does not think; it can work only with what is put into it.

The ballistic missile presents a more complex problem than a gun projectile. Its range may be measured in thousands of miles, rather than thousands of yards, and its initial velocity is lower than that of a gun projectile. Thus the forces that would tend to influence its trajectory have a much longer time to act. But, at long ranges, ballistic missiles have several outstanding advantages. First, they may leave the earth's atmosphere completely; a large part of their flight is in space, where they cannot be affected by wind or air pressure. Second, they dive on the target at a steep angle, at many times the speed of sound; this makes interception nearly impossible. Finally, a ballistic missile is invulnerable to electronic countermeasures during the major portion of its flight. Any guided missile is subject to jamming or deception by electronic countermeasures, although coded guidance systems may make this difficult to do. But a ballistic missile, because it is unguided during the terminal phase of its flight, is no more susceptible to electronic countermeasures than is a gun projectile or a rock.

The ICBMs are, as the name tells you, ballistic missiles. These include Atlas, Minuteman, Thor, and Polaris.

The foregoing discussion of preset guidance applies principally to aerodynamic missiles, in which the control surfaces are capable of correcting the trajectory throughout the flight. But preset guidance has features that make it useful in the initial control of ballistic missiles. One possible ballistic system combines features of both preset and command guidance. Another combination is preset with inertial guidance for the guided portions of the trajectory. The problem has already been stated: from known factors, it is possible to calculate an initial velocity and direction that will produce a ballistic trajectory ending at the target. The target location is known; because of the great range, target location is determined from maps, rather than by observation. The location of the launching point is also known. In the development of the Polaris missile system, a major part of the total effort was devoted to development of a Ship's Inertial Navigation System (SINS), by which the Polaris launching ship can determine its own position with the required accuracy. Note (fig. 2-24) that only the last stage of the Polaris trajectory is ballistic.

But other factors, such as air pressure and wind at various altitudes, cannot be determined with comparable accuracy. And, because of the extreme range, a small error in the initial direction or velocity will result in a large error at the target. The ballistic missile system deals with this problem by controlling the missile's direction and velocity not at the instant of launching, but at a later time—after the missile has risen above most of the atmosphere, but while it is still within range of radio.

Ballistic missiles are launched vertically, and climb straight up in order to get out of the atmosphere as quickly as possible. At a preset altitude, the guidance system turns the missile onto the required heading, with the required angle of climb. The missile is tracked continuously from the launching point, so that its position is known as long as it is within radar range. Its instantaneous velocity can be determined either by establishing a range rate, or more accurately, by doppler ranging. In the doppler ranging system, a radio or radar signal is transmitted from the launching point. This signal is received and re-transmitted by the missile. By comparing the frequency of the original signal with that of the signal returned by the missile, it is possible to determine the missile speed with great accuracy.

Chapter 10—OTHER GUIDANCE SYSTEMS

There are a number of combinations of missile course, position, and speed that would result in a ballistic trajectory ending at the target. But because the missile is constantly changing position at high velocity, no human computation can keep up with the problem. The known factors (position of the target and launching site, and preset heading of the missile) and the measured factors (velocity of the missile, and its position relative to the launching site) are fed into an electronic computer, which produces a continuous solution for the instantaneous values of the problem. When the computer determines that the missile's course, position, and velocity will result in the proper ballistic trajectory, the missile propulsion system is instantly and automatically shut down. The last stage of the missile then follows a ballistic trajectory, without further propulsion or guidance.

This system can be used effectively with missiles propelled by liquid fuel rockets, since the propulsion system can be shut down simply by stopping the fuel supply. If, like Polaris, the missile is propelled by a solid fuel rocket, the system cannot be used without modification. Successful tests of propellant cutoff and restarting have been reported for solid propellant rockets. Application of this method can make major changes in present management of propellant systems during missile flight. A description of the guidance methods used in the present mods of Polaris may be found in Navy Missile Systems, NavPers 10785-A.

NAVIGATIONAL GUIDANCE SYSTEMS

In addition to the preset guidance systems discussed above, other guidance systems which do not depend on electromagnetic contact with manmade sources are terrestrial, celestial, and inertial guidance methods. They were introduced in chapter 6 with brief descriptions of their principles.

INERTIAL GUIDANCE

Inertial guidance is defined as a guidance system designed to project a missile over a predetermined path, wherein the path of the missile is adjusted after launching by devices wholly within the missile and independent of outside information. These devices make use

of Newton's second law of motion. This law, which relates acceleration, force, and mass, states that the acceleration of a body is directly proportional to the force applied, and inversely proportional to the mass of the body. These devices, accelerometers, were described and illustrated in chapter 6.

The three accelerometers (fig. 6-9) are usually set up with the sensitive axis of one of them vertical and the other two in the horizontal plane, one along the flight path and the other at right angles to it. The output of the one along the flight path is the distance traveled in range. If the output of the one at right angles to the flight path is maintained at zero, then the missile is on the desired path in azimuth. The vertical accelerometer keeps the missile at the desired altitude (some missiles use a barometric altimeter).

With an inertial guidance system, a missile is able to navigate, from launching point to target, by means of a highly-refined form of dead reckoning. Dead reckoning is simply a process of estimating your position from information on: (a) previously known position; (b) course; (c) speed; and (d) time traveled. For example, assume that a ship's navigator determines his ship's position by astronomical observations with a sextant. The ship's position, and the time, are marked on the chart. Assume that the ship then travels for three hours on course 024, at a rate of 20 knots. From the known position on the chart, the navigator can draw a line 24° east of north, representing the ship's course. By measuring off on this line a distance representing 60 nautical miles (20 knots times 3 hours), the navigator can estimate the ship's new position by dead reckoning. If the ship changes course, the navigator will mark on the chart the point at which the change occurred, and draw a line from that point representing the new course.

A missile with inertial guidance navigates in a similar way, but with certain differences. It determines the distance it has traveled by multiplying speed by time. But it can not measure its speed directly if it is traveling at supersonic velocity outside the earth's atmosphere. However, it can use an accelerometer to measure its acceleration, and determine its speed by multiplying acceleration by time.

To summarize:

$$\begin{aligned} \text{velocity} &= \text{acceleration} \times \text{time} \\ \text{distance} &= \text{velocity} \times \text{time} \end{aligned}$$

PRINCIPLES OF GUIDED MISSILES AND NUCLEAR WEAPONS

The acceleration, of course, is not constant. It may vary because of uneven burning of the propellant. It will tend to increase as the missile rises into thinner air. Positive (forward) acceleration will become zero at burnout. If the missile is still rising at that time, it will have a negative acceleration because of gravity; if it is still in the atmosphere, it will have a negative acceleration because of air resistance. Acceleration will cause a constantly changing speed, and changing acceleration will change the rate at which the speed changes. If the missile is to determine accurately the distance it has traveled under these conditions, its computer circuits must perform a double integration. Integration is, in effect, the process of adding up all the instantaneous values of a changing quantity. The integrators are computer elements.

Both the accelerometers and the integrating circuits are fairly complex. But we can describe a simple, hypothetical system that will be correct in basic principles. Assume that the accelerometer (fig. 10-4) is a weight that can slide back and forth along the axis of the missile. The weight is mounted between two springs, which hold it in a neutral position when there is no acceleration. If there is a positive acceleration (tending to make the missile go faster), the weight will lag aft against the spring tension. If the acceleration stops, the weight will return to neutral position. If there is a negative acceleration (tending to slow the missile down), the weight will move forward from its neutral position.

Now assume that the weight is connected to a potentiometer, in such a way that the potentiometer output is zero when the weight is at the neutral point. If the weight lags aft, the

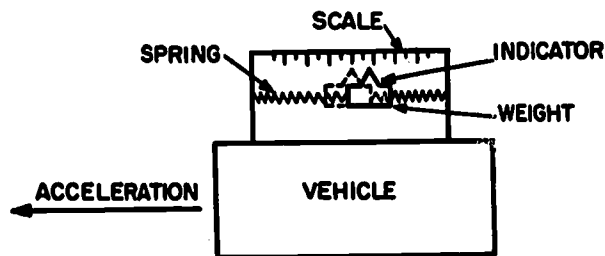

144.46

Figure 10-4.—Elementary accelerometer, spring-mounted.

potentiometer output is a positive voltage; if the weight moves forward from the neutral point, the potentiometer output is a negative voltage. For an integrator, we can use a simple capacitor. During positive acceleration, the capacitor will gradually take on a positive charge from the potentiometer. If the acceleration then becomes zero, the charge on the capacitor will stop increasing, and will remain constant (indicating a constant speed). If the acceleration becomes negative, the charge on the capacitor will begin to drain off (indicating a decreasing speed). Thus the charge on the capacitor is the output of the first integrator.

If the first integrator output voltage is applied to the grid of a vacuum tube, it can be used to determine the rate at which current flows through the tube and into a second capacitor. The rate of current flow at any instant is proportional to the first integrator output, and therefore to missile velocity at that instant. Thus the charge on the second capacitor is the output of the second integrator, and represents the total distance traveled up to any given instant.

Figure 10-5 is a block diagram of a simple inertial guidance system. This system has two channels—one for lateral and one for longitudinal acceleration. It uses both the direction channel and distance channel to determine missile position. Each channel contains an accelerometer and a circuit for double integration. The accelerometers detect missile velocity changes without the use of any reference outside the missile. The acceleration signals are fed to a computer which continuously produces an indication of both lateral and forward distance traveled by the missile. This is accomplished, in each channel, by integrating the missile acceleration signal to obtain a missile velocity signal. When this velocity signal is integrated, the result indicates the total distance that the missile has traveled. This method of double integration is built into each channel.

The actual electronic circuits used for integration are rather complex, but here again the basic principle is simple. In one type of integrator the input consists of a series of evenly spaced electrical pulses representing increments of time. The amplitude of each pulse is controlled by the accelerometer, so as to represent the instantaneous value of acceleration. Thus the quantity of electricity in

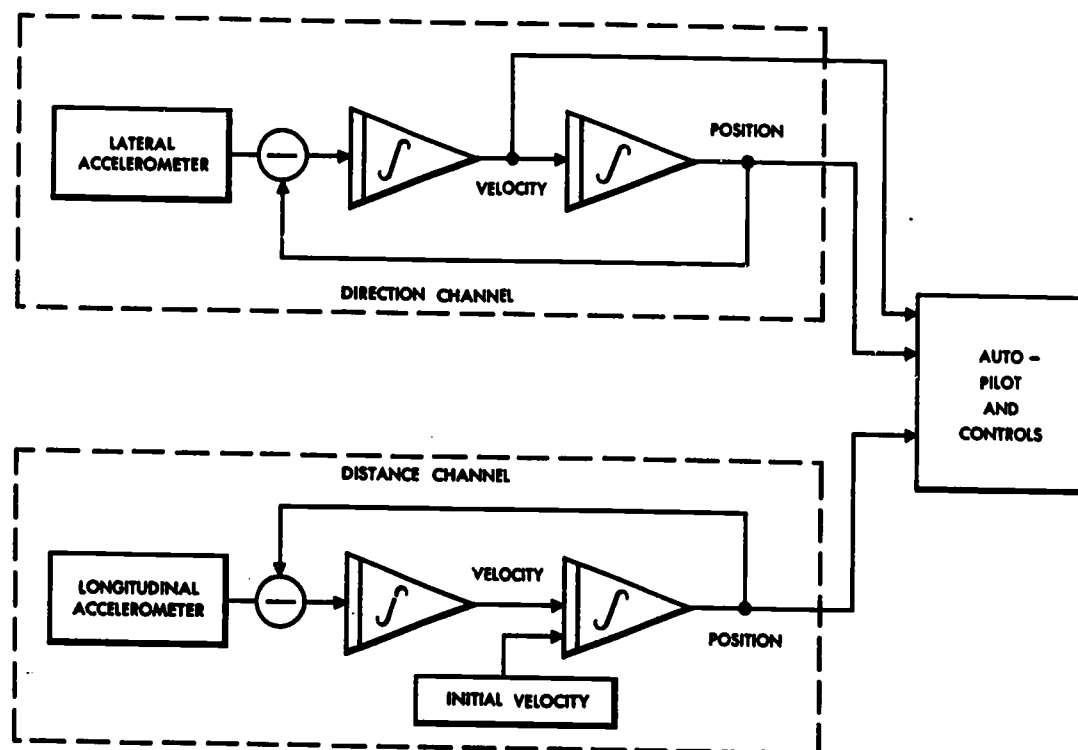

Figure 10-5.—Simple inertial guidance system.

33.135

each pulse represents an increment of speed. The pulses are passed through a rectifier (so that no current can flow in the opposite direction) and stored in a capacitor. The capacitor will, in effect, add up all of the input pulses. Thus the voltage across the capacitor will, at any given instant, provide an indication of missile speed at that instant.

An acceleration may, of course, be applied to the missile in any direction. Thus, if the missile is to determine its own position at any given instant, two accelerometer channels are necessary. For any given acceleration, one of these measures the component of force along the fore-and-aft missile axis; the other measures the component across that axis.

The distance and direction channels are identical in operation. The output voltage of the first integrator indicates the missile velocity. The output voltage of the second integrator is proportional to the distance the missile has traveled.

Direction Channel

If the missile is on course, the output of the direction channel will be zero at all times.

If the missile drifts off course, the output voltage of the second integrator will show, by its amplitude and polarity, the distance and direction the missile is off course. The output of the first integrator in the direction channel is the direction rate signal. Both of the integrator voltages are used by the autopilot to determine the amount and direction of control required to bring the missile back on course.

The accelerometer measures any force applied to the missile. The force of gravity is applied to the missile throughout its flight, and some types of accelerometers will be affected by it. In order to prevent a false output, the effect of gravity must be neutralized, so that only the true acceleration of the missile will be measured. This can be done in either of two ways. A part of the second integrator output can be fed back to the input of the first integrator, as in figure 10-5. Another system compensates for the effect of gravity by applying a fixed voltage bias to the output of the first integrator.

Distance Channel.

The operation of the distance channel is much like that of the direction channel. The output

PRINCIPLES OF GUIDED MISSILES AND NUCLEAR WEAPONS

magnitude of the first integrator indicates missile longitudinal velocity. The second integrator output voltage is proportional to the distance the missile has traveled. If the system does not start operating until after the launching phase is completed, the missile velocity at that time must be accounted for in the distance computation. A separate signal, representing initial velocity, must be fed to the input of the second integrator. It can then be combined with the output of the first integrator to indicate missile velocity at any given instant.

A comparison must be made between the distance the missile has traveled and the known distance between the launch point and the target. To do this, a voltage representing the distance to be traveled is set up as an initial condition just before missile launching. This preset voltage is combined, with opposite polarity, with the output of the second integrator. Thus the output of the distance channel decreases as the flight progresses. When the output falls to zero, the target has been reached.

There is one drawback to this system—the fact that for flights of several thousand miles, very large integrator output voltages would be required to get an accurate indication of distance traveled. The preset voltage that represents the target range would be equally large. In order to keep these voltages within reasonable limits, the voltage representing distance covered is continuously programmed during the flight by a suitable device such as a tape recorder. The programmed distance is compared to the measured distance, as represented by the computer output, in such a way that both are carried as reasonably small quantities.

Figure 10-6 shows another method of keeping signal voltages within reasonable limits by

using a specified velocity signal. The specified velocity signal is combined with the first integrator output so that any voltage above or below the specified voltage is fed to the second integrator as an error signal. The output of the second integrator is then proportional to the missile error from the desired position on the course.

A third channel for measuring missile altitude is usually included in the system. The principles of integration of the vertical accelerometer output are essentially the same as for distance and direction.

(In deriving missile velocity and distance, the integrators are electronically solving two basic formulas which relate acceleration, velocity, distance, and time.) For example, if a missile is traveling at a velocity of 50 yards per second and experiences an acceleration of 8 yards per second per second for 5 seconds, its new velocity can be determined by the formula $v = v_0 + at$, where v_0 is the initial velocity, v is the final velocity, a is acceleration, and t is time. By substitution:

$$v = 50 \frac{\text{yd}}{\text{sec}} + \left(\frac{8 \text{yd}}{\text{sec}^2} \times 5 \text{ sec} \right) = 90 \text{ yd/sec}$$

The average velocity of the missile during the 5-second period of acceleration is equal to

$$\frac{v + v_0}{2}$$

or

$$\frac{90 \text{ yd/sec} + 50 \text{ yd/sec}}{2} = 70 \text{ yd/sec}$$

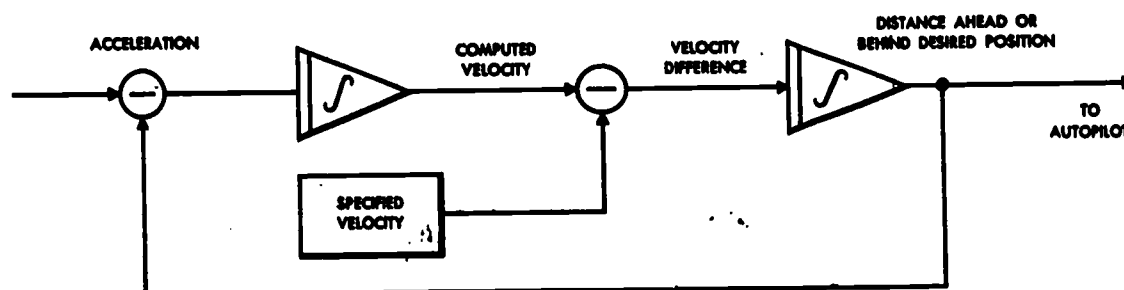

Figure 10-6.—Computer using specified velocity.

Chapter 10—OTHER GUIDANCE SYSTEMS

The distance traveled during this 5-second period is equal to

$$\frac{v + v_0}{2} \times t$$

or

$$\frac{90 \text{ yd/sec} + 50 \text{ yd/sec}}{2} \times 5 \text{ sec} = 350 \text{ yds.}$$

An inertial guidance system, such as the one just described, would be all that was needed if the missile flew straight and level at all times. But outside factors, as well as some errors introduced by the equipment itself, prevent straight level flights. Therefore a means for stabilization must be provided.

For an inertially guided missile to constantly determine its position while in flight, all linear accelerations of the missile must be measured. To do this, three accelerometers are mounted in the missile as shown in figure 8-9. Any movement of the accelerometers with relation to the missile will be proportional to the outside forces acting on the missile, and therefore to the accelerometers of the missile. Since these accelerometers are mounted on three mutually perpendicular axes, any accelerations of the missile along axis AB will be measured by movement of the lateral accelerometer. Any accelerations along axis CD will be measured by the longitudinally mounted accelerometer. Any accelerations along axis XY will be measured by the vertically mounted accelerometer.

If the missile is to determine its position at any point along its flight path, the accelerometers must be mounted in mutually perpendicular axes which continuously maintain their same relationships with some fixed reference point.

In some missiles and in shipboard inertial systems, the center of the earth is taken as the fixed reference point. When the center of the earth is used as the reference, all vehicular motion is determined on the basis of accelerometer outputs with reference to that point. In this type of inertial system it becomes necessary to stabilize the accelerometer axes so that they always maintain their same relationships with the earth's center. Since the lines of latitude and longitude on the earth's surface bear a permanent relationship to the center of the

earth, it was decided to relate two of the accelerometer axes to these north-south and east-west lines. The third accelerometer is logically oriented to the center of the earth. These relationships are shown in figure 10-7. (Shipboard systems need only two accelerometers since altitude is of no consequence.) To stabilize the accelerometers so that they will maintain these relationships throughout a long flight over a round and moving earth at first posed a difficult problem. It was overcome by mounting the accelerometers on a GYRO-STABILIZED platform. Since gyros are inherently space references (rigidity of plane), they must be adapted to maintain the platform in the desired earth relationships in this type of system. In other words, if three gyroscopes can be maintained in east-west, north-south, and the vertical attitudes, the platform (and the accelerometers) can be kept in the same earth relationships throughout the flight or cruise. With the platform stable, all movements of the accelerometers will indicate ship (or missile) movement with respect to the center of the earth.

Assuming that we have stabilized the platform, let us now see how a missile can determine its position and control its trajectory.

For the missile to keep track of its position, it must continuously determine its accelerations and velocity along the three stabilized accelerometer axes. Since acceleration is defined as the rate of change of velocity, the process of INTEGRATION will yield missile velocity. Integration is, in effect, the process of adding up all of the INSTANTANEOUS values of a changing quantity.

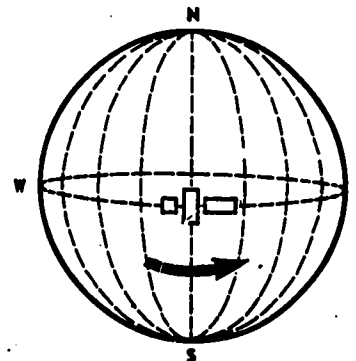

Figure 10-7.—Orientation of accelerometers with reference to the earth.

12.150

PRINCIPLES OF GUIDED MISSILES AND NUCLEAR WEAPONS

Attitude Control

Thus far we have considered the inertial system from the standpoint of determining and correcting missile position in a coordinate system which is stabilized in reference to the earth. As mentioned earlier, this coordinate system is maintained by mounting the three accelerometers on three mutually perpendicular axes on the gyro-stabilized platform. Any linear deviations along the missile AXES OF TRANSLATION will be detected by accelerometer movement and corrected on the basis of the accelerometer outputs. In addition to correcting for deviations in position, we must also keep the missile at its proper attitude along the trajectory. By mounting pickoffs on the missile frame, any deviation in roll, pitch, or yaw will be detected with reference to the stable platform. The resulting attitude signals are related to the missile positional information generated by the accelerometers. We can therefore say that the correction signals generated by the computer network of the missile are composed of corrections along the axes of translation as detected by the accelerometers, and corrections about the axes of rotation as determined by missile angular movement with relation to the stabilized platform. These correction signals will then be applied to the controller in such a way as to keep the missile on its proper trajectory AND in the proper attitude throughout the flight.

Stabilizing the Platform

Up to this point we have assumed that the platform has been stabilized with reference to the earth. For a shipboard inertial system, the exact position of the ship must be known at the time of missile launch. It is therefore necessary to keep the Shipboard Inertial Navigation System (SINS) stabilized with reference to the center of the earth at all times. This is done by torquing the platform in accordance with the ship's movements over the earth. Chapter 5 presented the effects of apparent gyroscopic precession at the Equator. The character of the apparent precession exhibited by a gyroscope as the earth turns depends on the gyroscope's location on the earth's surface AND the angle that its spin axis makes with the spin axis of the earth.

Figure 10-8A shows how accelerometers may be stabilized by mounting them on a gyro-

controlled platform. The gyros are arranged to detect errors in the pitch, roll and yaw axes of the missile. Thus the output of the gyros will indicate any departure from stable flight. The error signal voltage is amplified and fed to a servomechanism that corrects the platform position.

The accelerometer platform can be stabilized by mounting the platform in a gimbal system provided with gyroscopes (fig.10-8B, insert).

Chapter 5 in this text explained how the gyro may drift because of bearing friction. Accuracy requires that compensation for gyro drift be provided. The compensation is obtained by adding an integrating loop to the system as shown in figure 10-9.

Two loops are shown, one representing fast control and the other representing slow integration. Both loops use the gyro error voltage as a control signal. The fast loop functions rapidly to correct platform deviations from a level condition. The slow loop sums up the gyro drift error signals during the complete flight, because it cannot respond to rapid variations. During a normal flight, the random drift from a straight, level condition may be first to one side and then to the other. As a result, the sum of random drift over the entire flight will usually produce only a small total error.

Pitch Correction for Earth's Curvature.

The provision for keeping the platform level and preventing drift introduces a new problem. A normal missile trajectory is an elliptical path above the earth's surface. The gyro's characteristic of being fixed in space would mean that the gyro stabilized platform could be tangent to the earth's surface at only one place (fig. 10-10A), at the time of launch. Unless it is corrected, the missile might conclude that the line DE (fig. 10-10A) is tangent to the earth's surface. In order to keep the platform tangent to the earth as the missile travels along its trajectory, the forward edge of the platform must be depressed at a rate proportional to the velocity of the missile around the earth. This keeps the platform level about the pitch axis with respect to the surface of the earth, as shown in figure 10-10B.

Normally, gravity is used as a reference for slaving the gyro. But this is not done in an inertial guidance system. Instead, the platform is maintained in a level position by dividing, in the computer, the measured missile velocity

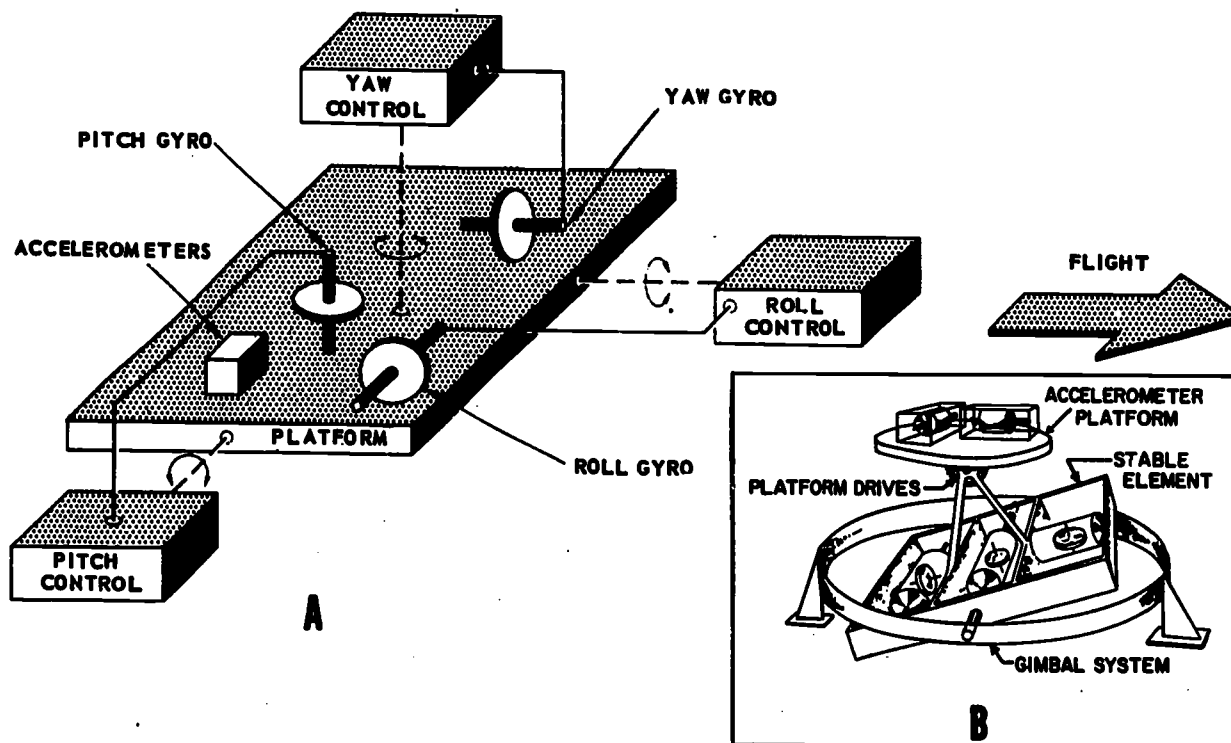

Figure 10-8.—A. Basic gyro-stabilized system; B. Stabilization of accelerometer platform. 144.49

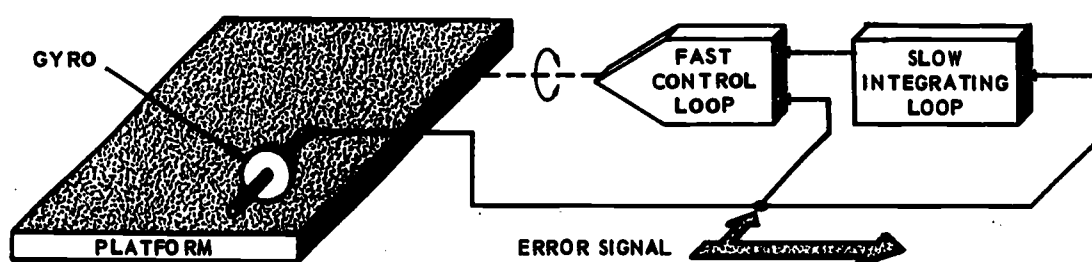

Figure 10-9.—Gyro-drift compensation. 144.51

by the distance between the missile and the center of the earth. The result of this division is a function of the angular velocity of the missile. The geometric relationship of the velocity factor is shown in figure 10-11. A study of the diagram will show that if the pitch angle of the platform is changed at the same angular velocity, the platform will remain tangent to the earth as the pitch axis changes. The platform angle can be changed by precession of the pitch gyro.

This precession is brought about by equipment in the computer section of the missile control system.

In operation, the output of the first integrator, which is proportional to the missile velocity, is divided by the distance (R in fig. 10-11) to the center of the earth in order to give the missile angular velocity (W in fig. 10-11) in radians. The result is fed through the gyro

PRINCIPLES OF GUIDED MISSILES AND NUCLEAR WEAPONS

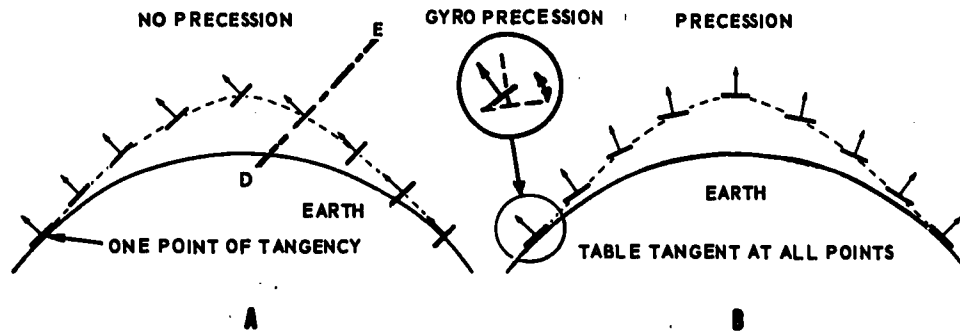

144.52

Figure 10-10.—Pitch gyro precession for tangency with the earth: A. Gyro not depressed—no precession; B. Gyro depressed at rate proportional to missile speed around the earth.

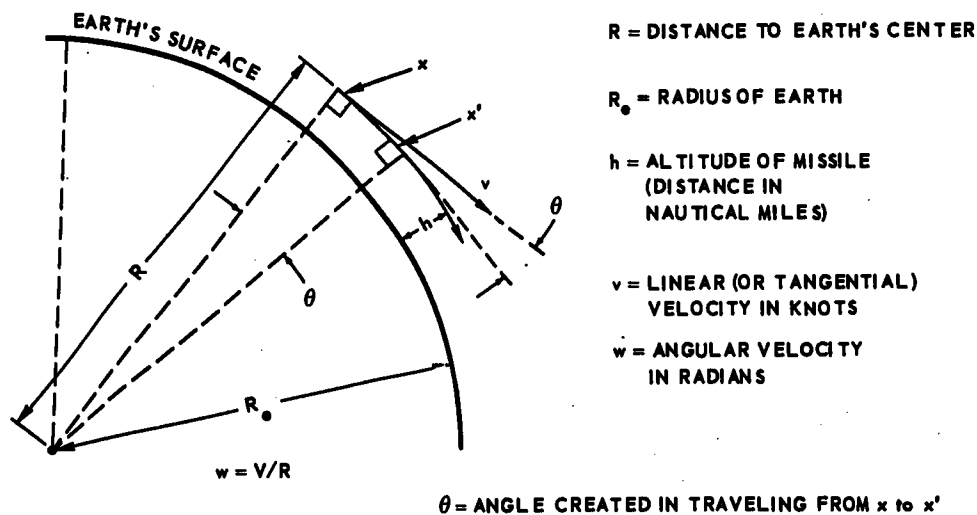

144.53

Figure 10-11.—Applying angular velocity to platform leveling.

torquer to precess the gyro at an identical angular rate.

It would be possible to make similar corrections for roll axis motion. The error in tangency would be small, however, because the missile moves such a small distance to either side of the desired course in comparison to the total length of the flight. Therefore, a simpler process is used to correct for roll. Instead of leveling a platform, a proportional bias voltage is applied to the accelerometer to correct its output signal.

Previous chapters of this text have shown that accelerometers, gyros, computers, and

other sections of a complete control system can take many different forms. Individual devices may be mechanical, electromechanical, electronic, or a combination of these types.

TERMINAL INERTIAL SYSTEMS

Short-range missiles that are transported to the vicinity of the target, such as air-to-air missiles and antitank missiles, do not need more than one type of guidance system. Longer range missiles may combine the midcourse phase and the terminal phase of guidance. It is in missiles intended for long-range use that the midcourse

Chapter 10—OTHER GUIDANCE SYSTEMS

and terminal phases of guidance are distinct and more than one method of guidance may be used. As the range of the missile system increases, the missile-to-target miss distance tends to increase for both beam-rider and command techniques. If the miss distance becomes excessive, a more accurate terminal guidance phase may be necessary. In a number of air-to-air and surface-to-air missiles, homing guidance is used in the terminal phase. Falcon and Sparrow are two examples. It is in the long range surface-to-surface missiles that combined systems are most useful. The function of any terminal guidance system is to place the missile directly on the target, rather than just in the general vicinity of the target. Thus, an accurate terminal guidance system can compensate for minor inadequacies in the midcourse guidance system.

In this section, we will discuss a terminal inertial guidance system. This system uses a stabilized platform as a reference plane to carry the accelerometer sensors for a constant-dive-angle system.

The terminal guidance phase starts at a point in space known as the release point. This is where the midcourse guidance system is made

inoperative, and the terminal guidance system takes over. There are two specific terminal inertial guidance systems. They are known as the constant-dive-angle system and the zero-lift system.

Constant-Dive Angle

A block diagram for a constant-dive-angle system is shown in figure 10-12. This equipment is able to compute the missile's position, during the dive to the target, with respect to the release point.

The output signals from the accelerometers are changed to velocity signals by the integrator. In the direction channel, signals then undergo a second integration to convert them into signals representing position. For a constant-dive-angle approach, the distance channel does not need position-error information. It therefore has only one integrator. The velocity signal is sent to the pitch servo system. If the velocity signal has the correct value, there will be no output from the computer to the pitch servo. If there is an error signal, it is fed to the pitch servo, which then corrects the dive angle.

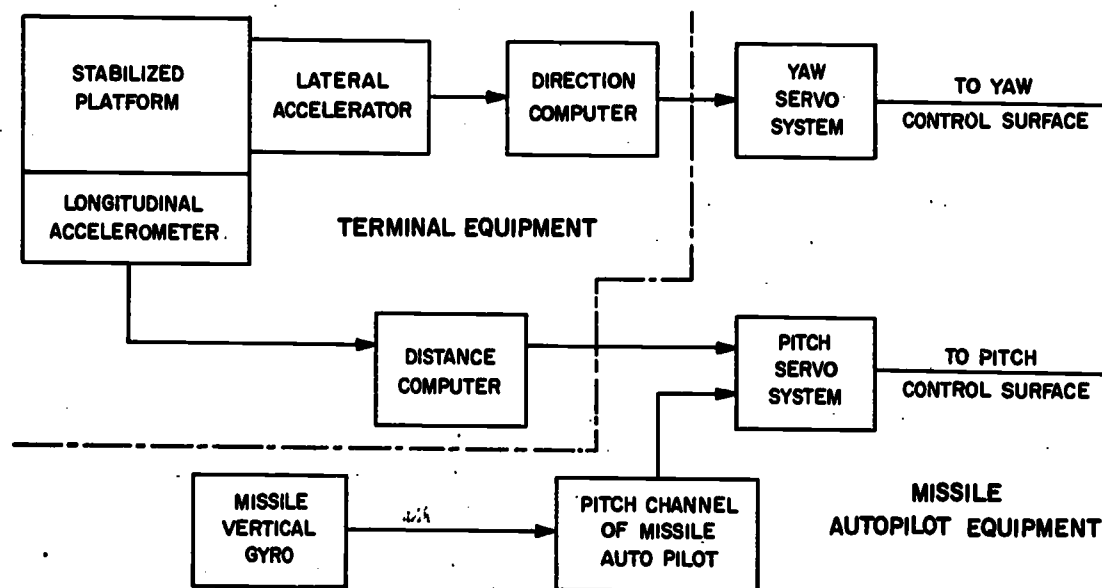

Figure 10-12.—Constant-dive-angle system for missiles.

144.54

PRINCIPLES OF GUIDED MISSILES AND NUCLEAR WEAPONS

Vertical-Dive System

The vertical-dive system is a variation of the constant-dive-angle system. The principal difference between the two is the location of the release point with respect to the target position. The constant-dive-angle system has the dive starting at a considerable lateral distance from the target. The system then sets up a constant-dive-angle which is maintained all the way to the target. The vertical-dive system release point is almost directly over the target, so that the missile can dive straight down.

The nose-over maneuver is accomplished by precessing the vertical gyro of the missile autopilot about its pitch axis. While there are a number of factors that determine the amount and rate of precession of the vertical gyro, the dive angle path to be followed is the primary factor in determining the number of degrees of vertical precession. The angle of incidence of the wings is another factor. This angle of incidence introduces a dive trajectory problem as shown in figure 10-13. Looking at figure 10-13A, we see that if the missile longitudinal axis were absolutely vertical, there would be some lift from the wings, which would pull the missile out of its vertical dive. In order to compensate for the lift of the wings, the controls are set for a slight over-control, so that the lift from the wings will keep the missile in a vertical dive (fig 10-13B).

When the pushover arc is completed, the missile is at the dive point. The autopilot is then cut off from the yaw and pitch servos, and has no further effect on the missile flight control surfaces.

Zero-Lift Inertial System

The block diagram in figure 10-14 shows the zero-lift inertial system and the relation between it and the missile autopilot. This equipment has two functions. The first is to establish the flight path, which is programmed on tape. The programmed pulses drive a constant-speed motor, whose rotor drives the moving arm of a potentiometer. The second function is to keep the missile on the programmed path through the action of the accelerometer.

To accomplish the first function, the moving contact of the potentiometer must be moved from the ground end of the resistance strip

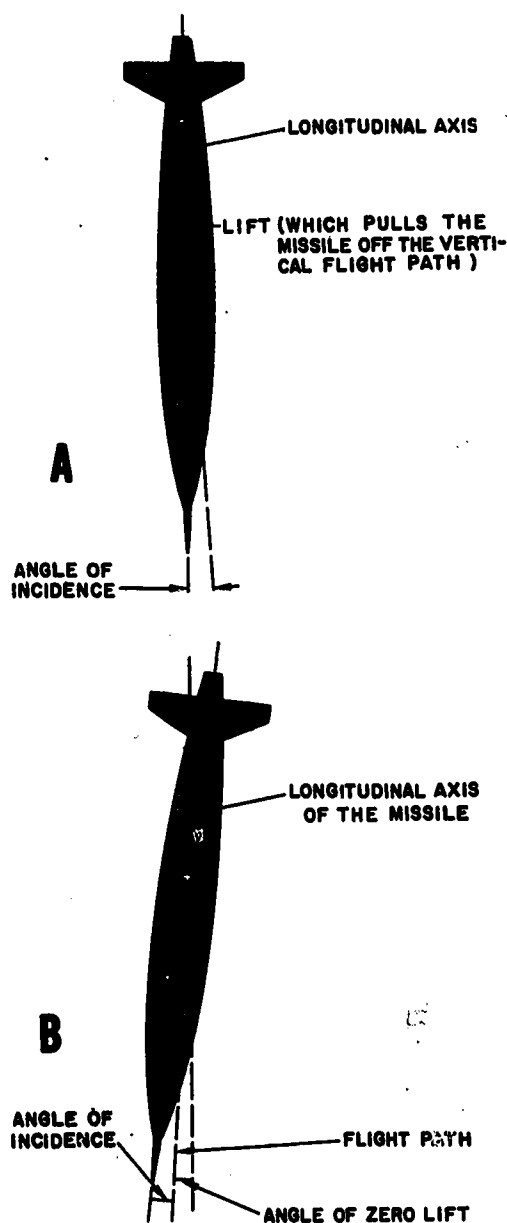

144.55
Figure 10-13.—Missile dive attitude: A. Missile diverted from vertical path by lift of aerodynamic surfaces; B. Over-control of missile is offset by lift to keep missile on vertical flight path.

to the other end at a constant rate of speed. Then, if the voltage between the moving arm and ground is plotted against time on a graph, the result will be a straight line. When this

Chapter 10—OTHER GUIDANCE SYSTEMS

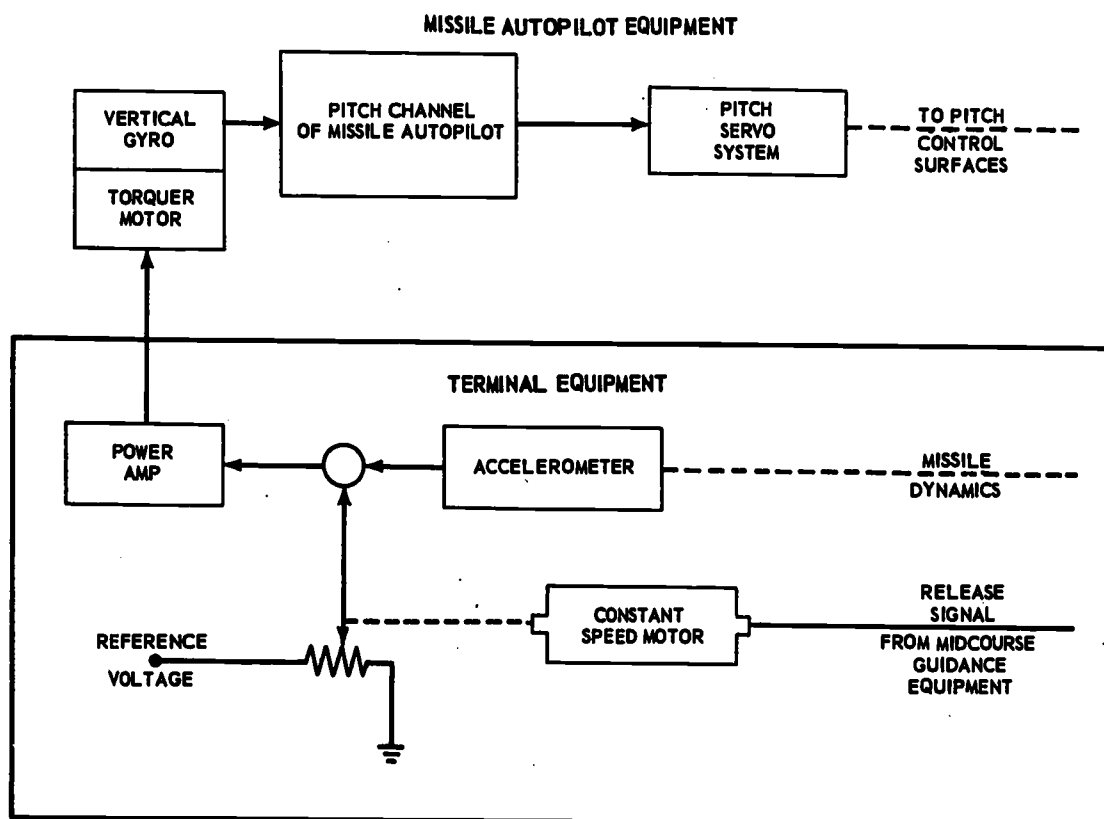

Figure 10-14.—Zero-lift inertial system.

144.56

straight-line voltage is fed into a motor, the resultant displacement of the motor's rotor is an integration of the input voltage. Because the integral of a constant-slope line is a parabolic curve, the missile path from the release point to the target will be as shown in figure 10-15. This is a zero-lift trajectory, in which the control system acts to maintain a condition of no aerodynamic lift on the missile.

With a parabolic path as a reference for the pitch axis, the missile will try to follow that path. However, because of the wing angle and the engine thrust, the missile will actually fly a different path unless some compensation for these factors is made.

Compensation is provided by an accelerometer that is mounted so as to be sensitive to accelerations along the vertical axis of the missile. Therefore, if the wings exert a lifting force, the accelerometer senses the lift and originates a signal that corrects the vertical gyro precession. If the wings are ex-

erting some lift due to a programmed signal, the signal from the accelerometer adds to the programmed signal in the mixer stage and causes the gyro to precess at a faster rate. If the missile noses over too far, there will be negative lift and the accelerometer sends a signal that subtracts from the programmed signal in the mixer, and slows up the precession rate of the gyro. Thus the missile flies the course shown in figure 10-15.

The actions just described provide the basis for the name of the system. The name zero-lift is used because the signal from the accelerometer compensates for any lift in the vertical axis of the missile.

CELESTIAL-INERTIAL SYSTEM

Celestial navigation has been used for many years. The navigator uses a sextant to measure the angular elevation of two or more known

PRINCIPLES OF GUIDED MISSILES AND NUCLEAR WEAPONS

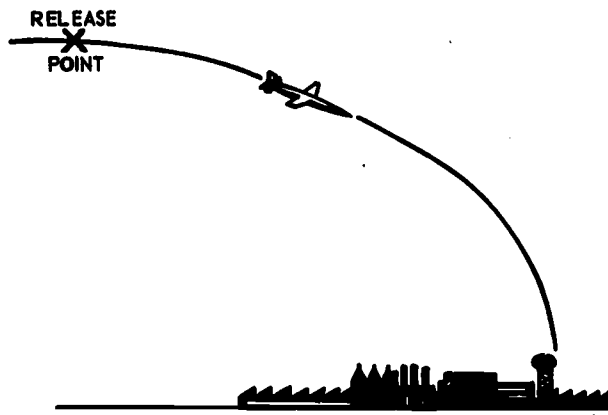

144.57

Figure 10-15.—Flight path of zero-lift inertial missile.

stars or planets. From these measurements, a ship's position can be plotted.

The celestial-inertial navigation system uses a simplified approach to the problem; it uses an inertial system that is supervised by a series of fixes. One of these systems is known as Stellar Supervised Inertial Autonavigator (SSIA) another is called:

Automatic Celestial Navigation (ACN).

The Snark missile used the SSIA system. The gyro that controls the position of the accelerometers is subject to random drift, and the result is an error that tends to increase with time. The error may be as much as half a mile for a flight that lasts 45 minutes. For longer flights, the error would naturally increase. Random gyro drift varies in both direction and magnitude.

One method that may be used to overcome the random drift error involves the use of star sights. The checking is done in much the same manner as a human navigator would check his position by observing an object, such as a star, having a known position. The missile does not carry a human navigator; it must use a mechanical substitute.

Stellar Supervised Inertial Autonavigator

In the stellar supervised autonavigator, periodic sights are taken on known planets or stars to check on gyro drift.

To make the check, an automatic sextant is mounted on a platform in the missile so that it can be turned on elevation and azimuth axes. An automatic sextant is shown in figure 10-16.

The sextant is moved on two axes by motors. These motors are connected to the sextant-positioning system.

Figure 10-17 shows a sextant positioning system in block form. Note that the elevation servo generator and the azimuth servo generator both receive signals from the tape reader. The generators are connected to servo motors. The shafts of these motors are mechanically connected to the sextant positioning gears, so that the sextant position is actually controlled by the information on the tape.

The desired flight path of the missile is programmed on a tape (fig. 10-17). The tape is pulled through a tape reader at a constant speed by the drive motor. The signals on the tape contain elevation and azimuth commands which are automatically fed to the sextant drive motors via servos. The tape is prepared prior to launching the missile and contains all the necessary position and rate data for the entire flight. To get accurate position checks, the sextant azimuth and elevation information must be read from the tape at the proper time. This is of paramount importance since a given star is at a particular angle with respect to a certain spot on earth only at a particular instant.

The position of the sextant is checked by a section called the STELLAR ERROR DETECTION CIRCUIT, which determines whether or not the star is centered in the telescope field. If the star is not centered in the field, an error signal is generated and processed to show the amount of sextant error. The error detection circuit is shown in block form in figure 10-18.

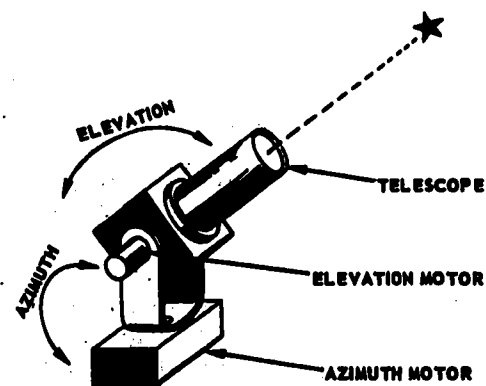

Figure 10-16.—Automatic sextant.

33.172

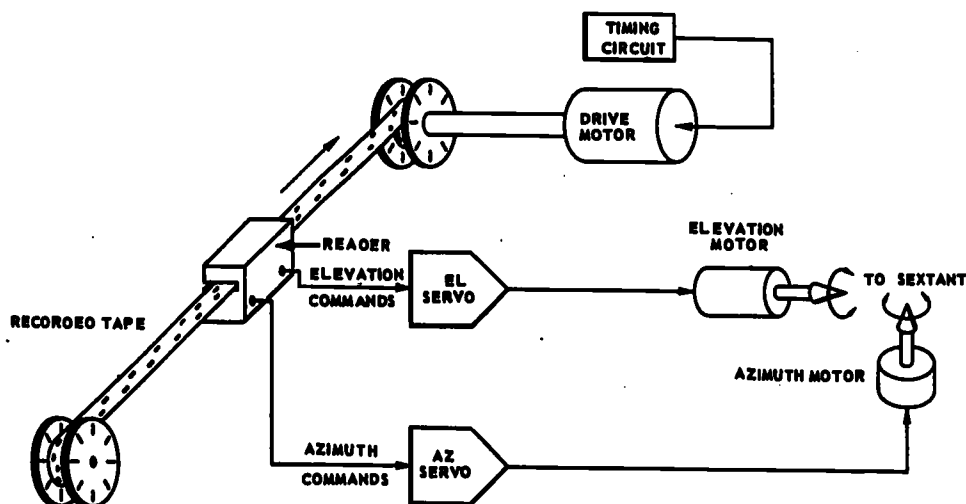

Figure 10-17.—Sextant-positioning system.

33.173

The sextant is trained on a given star by information taken from the tape, and then continues to follow the star on the basis of the programmed tape. The output of the automatic sextant is fed into an error-detecting system (fig. 10-18).

The scanner is used to detect errors in centering the star in the optical field of the sextant. The scanning system includes a light-chopper, or interrupter, and a phototube. The output voltages of the error-detection system are proportional to the missile deviations in roll, pitch, and yaw. The light from a star, after passing through the scanner, which contains a chopper which modulates the light beam at a given rate, falls on the light-sensitive cathode of the photo-cell. The cell output voltage is proportional to the light intensity. The output is then fed to a selective amplifier that selects the signal from the noise. The amplifier output is then fed through a detector section to a resolver, which breaks down the signal into azimuth and elevation error signals.

The direction resolver has two outputs. One goes directly to the yaw comparator; the other goes to a second resolver section. The second resolver is controlled from the tape signals. The same signal that sets the sextant position sets the resolver for elevation error output. Unless the elevation signal is resolved in this manner, there is no way to determine whether the error exists in pitch or roll. (If the sextant

were raised and pointed directly forward along the missile heading, any elevation error signal from the sextant would be assumed to be an error about the pitch axis. If the sextant were pointed out the side, in a lateral direction, any elevation error would be a function of missile roll. Therefore a resolver is necessary to determine whether the error signal is caused by pitch, roll, or by a combination of the two.)

An ideal way to use a star-sighting system is first to check a star whose line of position is parallel to the missile course, and then to check another whose line of position is at right angles to the missile course. The information from the first star would then be applied to the computer direction channel, and that from the second would go to the distance channel. These signals would then correct the gyros to a new position, and compensate for any gyro drift that might have occurred. With the gyros corrected, errors in roll, pitch, and yaw can then be measured and used to position the control surfaces. Remember that the missile equipped with this system is also inertially guided. The outputs of the celestial system correct any errors made by the inertial equipment. It is not possible to obtain proportional control with this system because of the delay in signals getting through the circuits, and damping by the rate function. However, the system does tend to return the missile to the correct course as soon as possible without over-control oscillations.

PRINCIPLES OF GUIDED MISSILES AND NUCLEAR WEAPONS

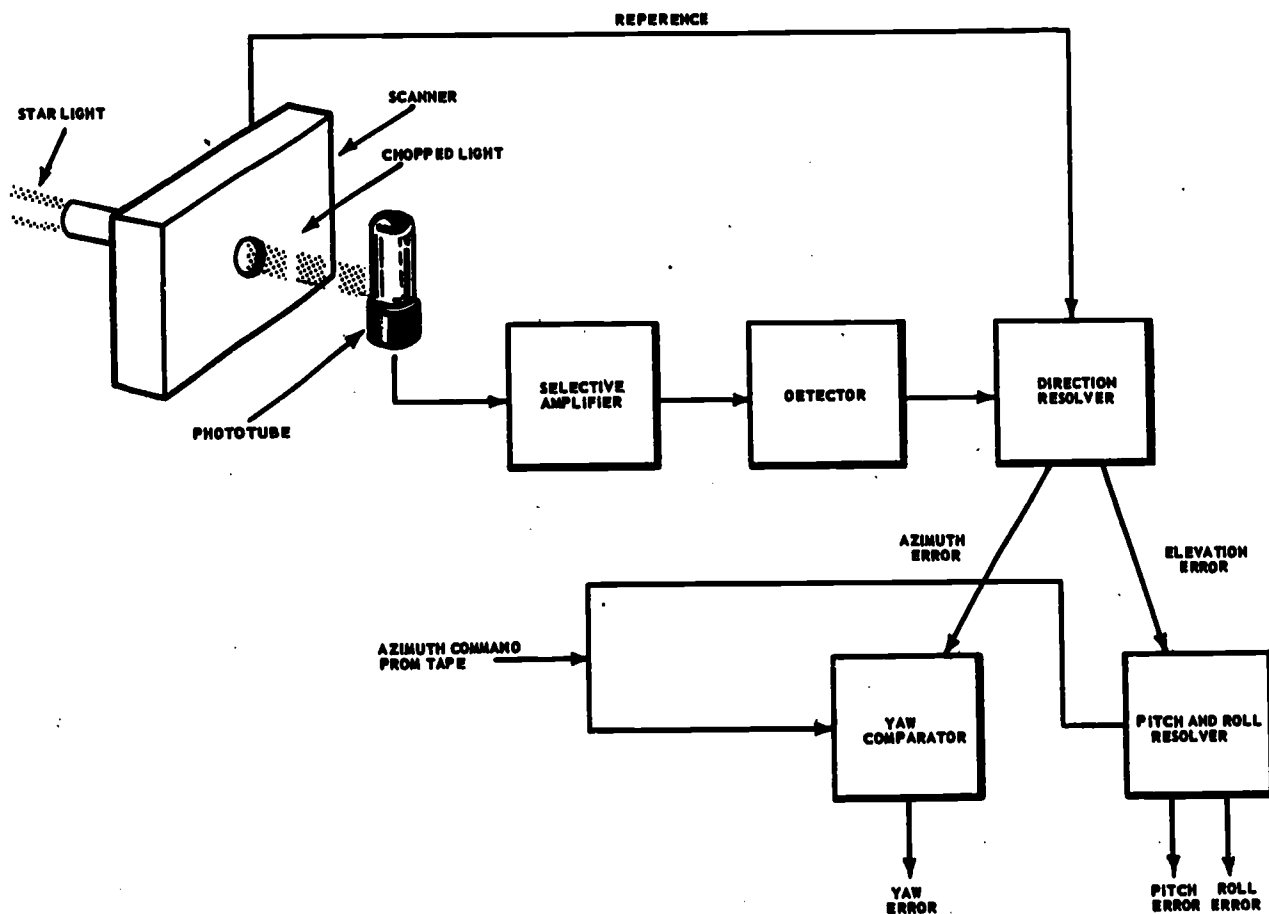

33.174

Figure 10-18.—Stellar error-detection circuit.

AUTOMATIC CELESTIAL NAVIGATION

The most difficult problem to overcome in the system just described is gyro bearing friction. The problem may be solved by using a continuously supervised system. The automatic celestial navigation (ACN) system is continuously referenced by stellar fixes. This does not mean that there is no longer a necessity for inertial supervision; the inertial principle is still used by the autopilot between guidance commands.

The platform equipment for ACN requires one or more automatic sextants in addition to those already mentioned. Two sextants operate simultaneously to obtain a series of fixes, rather than a line of position. With fixes on two stars at the same time, there is less

chance of error. It is possible that a standby sextant might be added to the equipment, so that it can zero in on the next star in the navigation sequence without interfering with the fixes that are being made.

One disadvantage of the multiple sextant system is the need for a window big enough to view a large area of the celestial sphere. Such a window would need optical characteristics that would add greatly to its cost. In addition, the larger window area is more subject to damage by natural forces at high speeds.

LIGHT DISPERSION BY SHOCK WAVES.—As light passes through any light-conductive material, a certain amount of refraction or bending, takes place. The higher the density of the material, the greater is the degree of bending. Rays of light are refracted when

they pass obliquely through the shock waves that are generated by any missile traveling (in air) at or above the speed of sound. This effect may be severe enough to limit the use of celestial navigation to missiles operating at less than sonic speeds, or those operating out of the atmosphere. Figure 10-19 shows the effect of shock waves on optical systems.

NOISE FILTERS.—In a practical application, noise exists in the output of the velocity-measuring component. The noise is in the form of short bursts, or peaks, of energy. It may be effectively removed by choosing component values to give the proper time constant (delay) in the circuit. But a filter of this type is not suitable for use in removing noise of a continuous nature. If some steady error, due to noise, is present in the signal that indicates velocity, the entire computer output will be in error. The elimination of errors caused by noise requires a circuit that will block noise error signals but pass other signals. A circuit with the desired characteristics is a high-pass filter that uniformly passes a-c of the higher frequencies, but blocks any signal of a lower frequency.

High-pass filters using inductive and capacitive components are easy to construct; but precision components are necessary to get sharp frequency characteristics, and this fact increases the cost considerably. To avoid costly components, a d-c amplifier with integrator feedback is used as a high-pass filter.

The integrator section is designed to respond slowly to an input signal. It may take as long as 10 minutes for the integrator signal to build up enough to cancel a steady amplifier input signal. Therefore, all voltages that vary at a faster rate will go through the circuit before the feedback becomes effective.

TERRESTRIAL REFERENCE NAVIGATION

The search for accurate, foolproof missile guidance systems has turned up many possibilities. Some of those that seem the most fantastic are based on sound reasoning. The examples that follow fall into this category.

Several picture and mapmatching guidance systems have been suggested and tried. As mentioned in chapter 6, terrestrial reference navigation relies on comparisons of photos or maps carried in the missile with an image of the terrain over which the missile is flying at that time.

The basic idea can be shown by using the common photograph as an example. If a photographic negative is placed over its coinciding positive, the entire area will be black. If the positive were in the form of a transparency, the entire area would be opaque and no light would get through. If either the negative or the positive is moved slightly with respect to the other, light would show through where the two prints were not matched. If one transparency, say the negative, were in the form of a strip

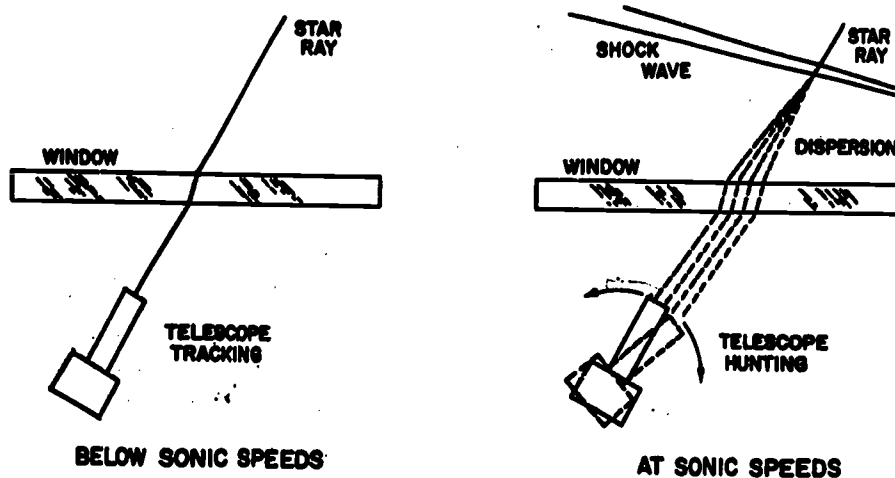

Figure 10-19.—Effect of high speeds on optical systems.

PRINCIPLES OF GUIDED MISSILES AND NUCLEAR WEAPONS

that was pulled through a frame or window by a motor, it would be possible to devise a control system that would automatically match the images. However, instead of a transparency for the positive image, the projected image of the terrain from a lens of radarscope would be used (6-14).

Daylight systems are ruled out because they would be seriously affected by clouds, fog, and smoke. The use of photographs of the actual course or target area would not be suitable for the reasons outlined above, and because such a system would be susceptible to countermeasures. On the other hand, a radar map-matching system has greater effective range, and is not limited by conditions of visibility.

Radar Mapmatching

A guidance system that uses radar map-matching has, among other parts, a radar, PPI, lens, scanning motor, map holder, and phototube. Figure 10-20A represents the components of a mapmatching system.

A map of the terrain over which the missile is passing must be previously prepared on a negative transparent film. This fact calls attention to a weak point in the map matching method—landmarks can change or disappear, or new landmarks can be added; and therefore the map of the area must be very recent.

In operation, the comparison is made by projecting the radar image from the PPI tube, through a negative radar map transparency of the same region, onto a photomultiplier tube. (A photomultiplier tube is an electron tube so constructed that it produces current amplification. A very weak light source can be greatly amplified by a tube with multiple stages.) The lens (fig. 10-20B) through which the PPI image passes is rotated in much the same manner as a radar antenna is scanned. The mirror rotation causes the PPI image to be moved in a small circular pattern over the film. When the image from the PPI tube exactly coincides with the map image, minimum light gets through to the photo-multiplier tube.

When the output of the photomultiplier tube amplifier is properly commutated by the commutator section, left-right and fore-aft information is obtained.

The pulses from the commutator are applied to d-c discriminators and integrators. Then, as shown in figure 10-20A, the information is fed to two loops, lateral and longitudinal.

The left-right information is fed to a servo-amplifier which drives the film carriage laterally to keep the images matched. The position of the carriage is picked off as an error signal voltage for the missile control system. As the missile turns on its yaw axis to the correct heading, the film carriage is moved and the error cancels out.

Fore-aft information is fed to the longitudinal servoloop that pulls the film through the holder at the correct speed to maintain a match between the film image and the PPI tube image. This means that the film speed must be proportional to the ground speed of the missile. It is possible to key the film to cause course changes or to start the terminal phase.

Errors can result from a difference in altitude between reconnaissance (radar mapping) and tracking (actual missile flight) runs because of slant range distortion and altitude-return delay.

It is necessary to have angular matching to within one degree before accurate left-right and fore-aft information can be obtained. Angular matching can be obtained by means of a magnetic auxiliary such as a compass. Matching is maintained by the azimuth loop of the system.

Two types of film holders can be used. The frame type is the larger, and more complicated mechanically. It switches separate frames into the scanning area and is easier to lock on with the system. However, a better method seems to be the one shown in figure 10-20, in which the film is scanned through a mask with a semicircular opening.

If the film strip used in this system is pulled through the viewer at a speed corresponding to the missile ground speed, its length will be about 1/20 of that required for a frame-type map.

Errors can result from a difference in altitude between reconnaissance (radar mapping) and tracking (actual missile flight) runs because of slant range distortion and altitude-return delay.

It is necessary to have angular matching to within one degree before accurate left-right and fore-aft information can be obtained.

The reference maps may be obtained by actual radar mapmaking flights over the terrain that is to be traversed by the missile. These flights may be made at high altitudes in almost any kind of weather. Another method involves the use of synthetic maps.

The synthetic maps are prepared by using maps of the area, aerial photos, and other

Chapter 10—OTHER GUIDANCE SYSTEMS

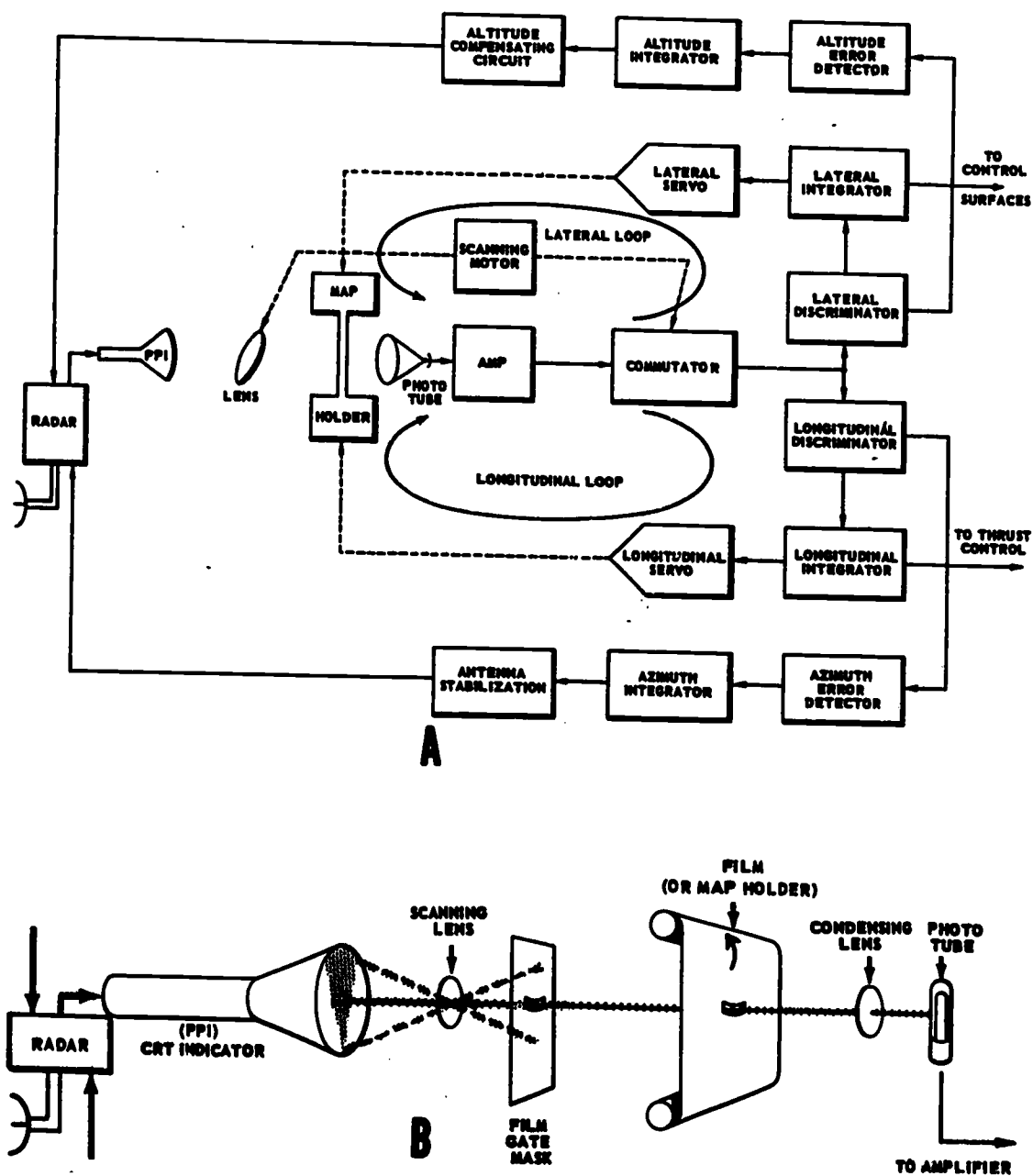

Figure 10-20.—Radar mapmatching: A. Block diagram of system; B. Film holder operation for strip map.

33.175:176

information. A relief map is built up from this information and then photographed. Maps prepared in this manner are only slightly inferior to actual maps.

Radar mapmatching is limited by the capacity of the film magazine. Also it cannot be used over water, or over land that lacks distinguishing features. The system is also subject to

PRINCIPLES OF GUIDED MISSILES AND NUCLEAR WEAPONS

electronic countermeasures, but it has some immunity because of the highly directive antenna system.

Therefore, this system is best suited for use as a part of a composite system that uses nonradiating midcourse guidance. The map-matching system would be used for a minimum time prior to the arrival of the missile at the target. This method affords the greatest element of surprise, and represents the best method of evading countermeasures.

Magnetic References

The use of the earth's magnetic field as a reference for missile guidance systems has been discussed in another chapter. The sensor units used in this system are refinements of the simple magnetic compass, and are called the flux gate compass and the gyrosyn compass.

Studies made during the International Geophysical Year, and the information obtained by submarines cruising under the ice at the North Pole, have given new insight into the nature of the earth's magnetic field. These studies will continue. And, as more information is gained,

magnetic reference systems will become more practicable.

The present accuracy of magnetic systems is within about 7 miles, but is limited to the course line only. This means that a missile using this system would need to be launched near, or flown to, the vicinity of a line of magnetic intensity that crossed the target area. Magnetic storms would prevent the use of the system until the earth's magnetic field returned to normal.

Keep in mind that, as more knowledge is obtained about the behavior of the magnetic field, it may become possible to predict magnetic conditions in much the same manner as weather is predicted today. There is, according to present knowledge, one major difference in the two types of predictions. Weather predictions may prove inaccurate for a given area because of purely local conditions. On the other hand, the earth's entire magnetic field is disturbed under magnetic storm conditions, and there are no strictly local effects. Should extremely accurate magnetic condition forecasts become feasible, it is possible that the disturbed conditions might be used to advantage in missile guidance.

CHAPTER 11

GUIDED MISSILE SHIPS AND SYSTEMS

INTRODUCTION

GENERAL

This chapter describes the current guided missile ships and systems of the Navy. It will orient the student to the missions, functions, and general nature of the Navy's missile program.

The confidential text in this series will describe in more detail those characteristics of missile ships and systems which have been omitted here because of security.

MISSION OF MISSILE SHIPS

Before proceeding with descriptions of the missions of missile ships, it is necessary that the reader be familiar with certain definitions.

The **MISSION** of a ship is a broad statement of its designed purpose in the Navy. In a more restricted sense, the term mission can be applied to the component parts of a ship. Thus the term is also used in reference to missile systems.

Tasks of the mission specifically define what the ship is expected to do at a given time. There are two broad categories into which missions are sometimes divided—**STRATEGIC** and **TACTICAL**. A full discussion of the meaning and significance of these terms could extend the length of this chapter. Quick insight can be grasped however, by remembering that tactics is the art of battle, and that strategy is the art of war. Therefore, a tactical mission is one that has a direct influence on the course of battle in progress. A strategic mission is far-reaching—it is one that may have no direct or immediate influence. The job of providing close

fire support to permit the advance of friendly troops would be tactical in nature. The destruction of ball bearing factories deep in enemy country, thereby affecting the enemy's war-making potential, would be strategic.

Tactical targets, as opposed to strategic ones, are fleeting in nature; they can be successfully attacked only by weapons that can reach them in minimum time and with a high degree of accuracy. One should not consider, however, that these definitions are hard-set. For example, consider the destruction of an enemy airfield. In one phase of a battle this may have strategic significance. But the destruction of the same airfield in support of a landing operation would have tactical significance.

TYPES OF MISSILE SHIPS

GENERAL

Because of the rapid changes brought about by many recent scientific breakthroughs, the design of missile ships or missile systems is still changing. But there are certain patterns that can be considered fundamental. At the time of writing this text, all but one of our missile cruisers are conversions from older ships. Conversion rather than construction is an economical approach to a guided missile Navy. In many ways it is a necessary approach, since many problems in ship construction for missile needs must be worked out. In addition to the conversions, however, there are now in commission many new ships designed from the keel up as guided missile ships, and many more are in the building or planning stage. No guided missile destroyers are conversions.

GUIDED MISSILE CRUISERS

In general, the mission of missile cruisers is to provide AA defense, to bombard enemy

PRINCIPLES OF GUIDED MISSILES AND NUCLEAR WEAPONS

shore installations, to carry a force commander, to control aircraft, and to conduct combat operations against enemy surface craft.

Cruisers are being designed to include an ASW capability. This will enable them to provide defense against enemy subsurface attack, and thus permit a field of action much greater than that of conventional cruisers. Figure 11-1

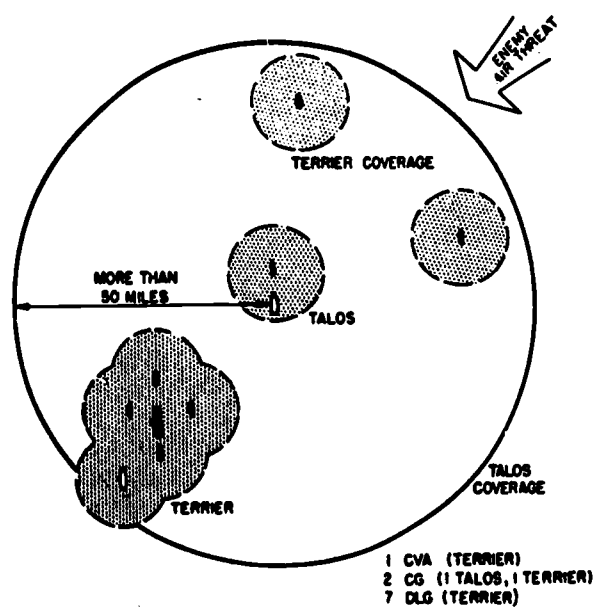

Figure 11-1.—A possible disposition of a missile-equipped task force.

144.50

indicates a possible task force formation of the future. Note that the force is spread out over many miles of ocean.

There are five classes of guided missile cruisers. First, there are the CAG (Terrier) conversions. Figure 11-2 is a picture of the USS Canberra (CAG-2). This class of ships is the result of conversion of World War II heavy cruisers. From outward appearances, the conversion consists of removing the after 8"/55 triple turret, three after 5"/38 twin mounts, and the after conventional fire control directors, and substituting two twin Terrier launchers and two Terrier directors.

Figure 11-3 shows a second class of missile cruisers—the CLG (Terrier) class. These ships are conversions of World War II light cruisers. The armament of the CLG (Terrier) consists of the following:

- 1-twin Terrier launcher
- 2-missile guidance systems
- 1 or 2-6"/47 triple turrets
- 1 or 3-5"/38 twin mounts

A CLG (Terrier), converted to include fleet flag facilities, will have further modification of its gun batteries.

Of the CLG (Terrier) conversions, the USS Providence, Springfield, and Topeka have become the CLGs 6, 7, and 8, respectively.

The third class of guided missile cruiser is the CLG (Talos). For the purpose of this book,

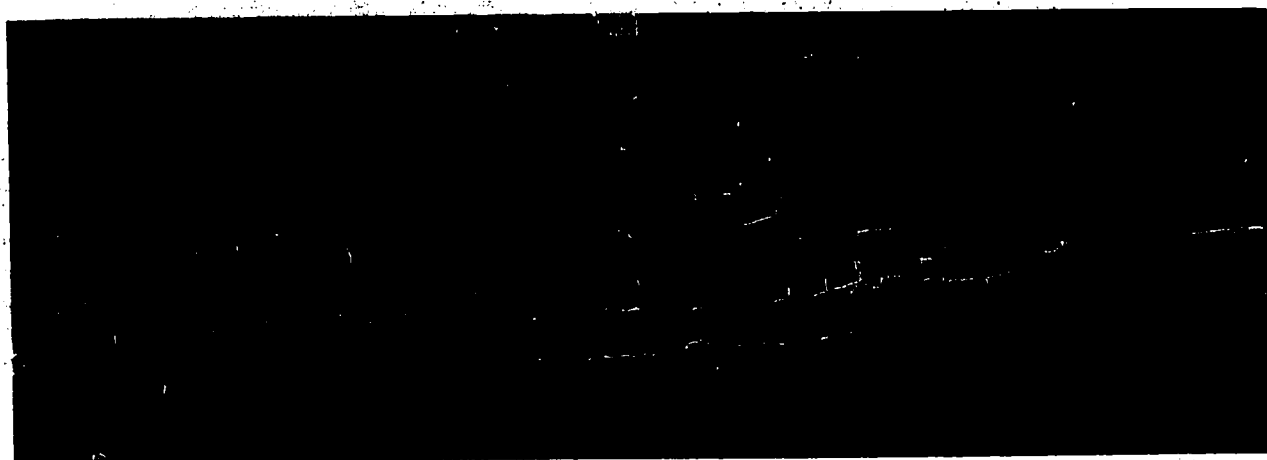

Figure 11-2.—USS Canberra (CAG-2).

3.73

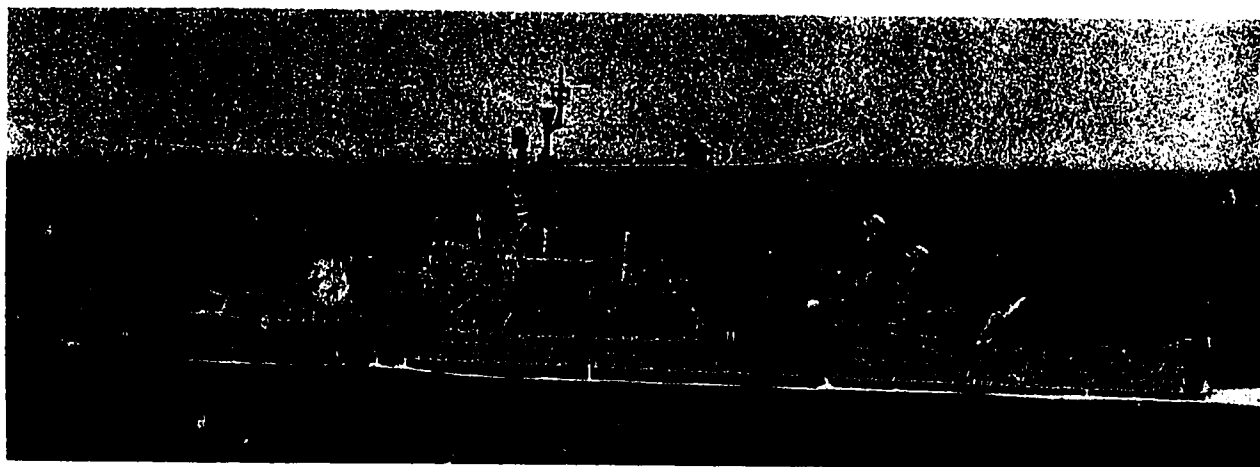

Figure 11-3.—USS Springfield (CLG-7).

33.263

the only significant difference between the Terrier- and Talos-equipped CLGs is in the capabilities of the missiles themselves. The CLG (Talos) is converted from the same class of light cruiser, and the resulting armament is essentially the same as that described for the CLG (Terrier). In the CLG (Talos) class, there are the USS Galveston, Little Rock, and Oklahoma City, CLGs 3, 4, and 5, respectively.

The fourth class missile ship conversions are the all-missile cruisers USS Albany, Chicago, and Columbus, CGs 10, 11, and 12, respectively. These were formerly World War II heavy cruisers. The conversion to guided missile cruisers has been more complete with this class, however, as all gun turrets, gun mounts, and conventional fire control directors have been removed. In their stead, Talos launchers have been installed fore and aft; a Tartar launcher on each side, and Talos directors and Tartar directors have been emplaced. However, two single 5"/38 twin mounts have been re-installed amidships. Figure 11-4 is an illustration of the USS Albany (CG-10).

To complete the picture, there is the nuclear-powered guided missile cruiser, which is the only cruiser designed since World War II from the keel up. Figure 11-5 shows the USS Long Beach (CGN-9). Like the USS Albany class, it is armed with both long and medium range surface-to-air missiles, but it also has the latest ASW armament. Nuclear propulsion gives this class a far greater operating range than ships with conventional propulsion.

GUIDED MISSILE DESTROYERS

Present planning provides for four classes of destroyer types having a missile capability. The mission of each of these types is to screen task forces and convoys against enemy air, surface, and submarine threats. They also provide air control, give radar picket duty, make offensive strikes, and carry DASH. The first of these is the guided missile destroyer (DDG). The DDG is similar to the conventional destroyer in displacement and other general characteristics. Figure 11-6 shows USS Barney (DDG-6). The following are typical armament installations on a DDG:

- 2-5"/54 gun mounts
- 1-twin or single Tartar launcher
- 1-Asroc launcher
- 2-Mk 32 triple torpedo tubes

The second DD family is the guided missile frigate (DLG). The DLG is the big sister of the DDG, with longer endurance and better sea-keeping abilities. DLGs are equipped with the Terrier missile system. Those of the Leahy class (fig. 11-7) carry a Terrier launcher both forward and aft, while those of the Farragut class have but one Terrier launcher mounted aft. In place of the forward launcher, a 5"/54 gun mount is installed on these ships. In addition to the above, all DLGs carry two twin 3"/50 RF (rapid firing) gun mounts, Asroc, and ASW torpedoes. An important new addition to the DLG ranks is the nuclear-powered guided missile frigate, USS Bainbridge (DLGN-25). The

PRINCIPLES OF GUIDED MISSILES AND NUCLEAR WEAPONS



Figure 11-4.--USS Albany (CG-10).

144.60



Figure 11-5.--USS Long Beach (CGN-9).

134.82

Chapter 11—GUIDED MISSILE SHIPS AND SYSTEMS



Figure 11-6.—USS Barney (DDG-6).

3.76

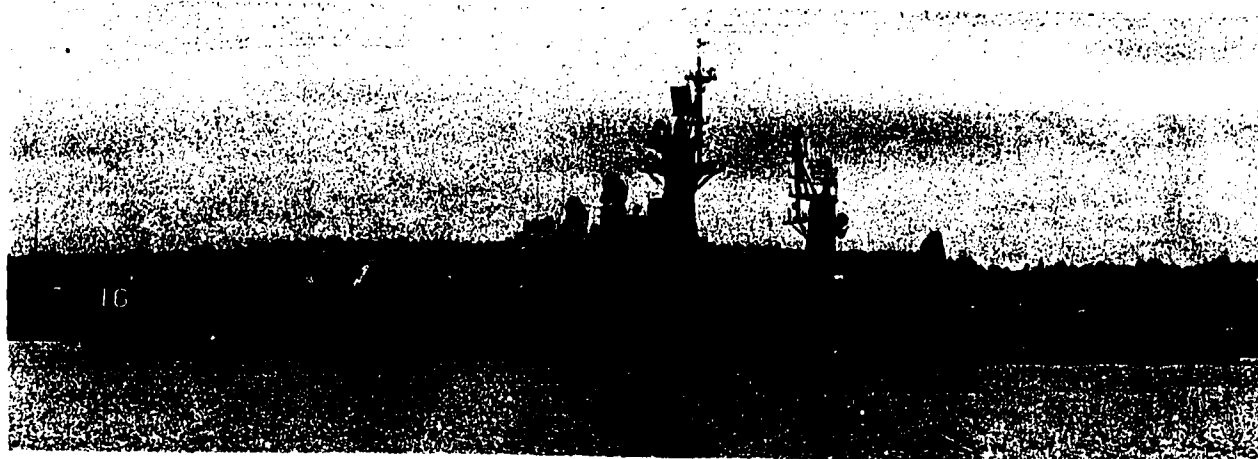

Figure 11-7.—USS Leahy (DLG-16).

134.84

armament of the USS Bainbridge is the same as that of the DLG-16 class (see fig. 11-7, USS Leahy (DLG-16)), but her operating range is vastly greater.

The newest members of the guided missile destroyer family are the DEGs, guided missile destroyer escorts. The DEGs are designed to locate and destroy enemy submarines. They will be fitted with a Tartar missile launcher, and will also carry a 5"/38 gun mount, Asroc, two Mk 32

triple torpedo tubes, and two Mk 25 torpedo tubes.

GUIDED MISSILE SUBMARINES

The primary mission of the guided missile submarine is to deliver guided missile attacks against enemy shore installations. Its tasks include the launching and control of missiles, and self-defense by means of underwater

PRINCIPLES OF GUIDED MISSILES AND NUCLEAR WEAPONS

launched weapons. The foremost of our guided missile submarines are those designed to carry the Polaris ballistic type missile. These long ranging nuclear-powered ships with their formidable weapons are a powerful deterrent to any consideration our enemies might have of making the "cold war" a "hot" one.

A new type of missile, Subroc, an underwater to air-to-underwater missile, is being developed and is expected to be operational soon. Subroc is designed to be launched from standard torpedo tubes using conventional ejection methods. Subroc, when fully operational, will provide submarines with a radically improved kill capability.

OTHER MISSILE SHIPS

The Navy intends to eventually replace many of its conventional aircraft gunnery systems with missile systems. In the future, amphibious craft, and service craft will take their place in the missile Navy. At the present time, three CVAs, the USS Kitty Hawk (CVA-63), USS America (CVA-66), and the USS

Constellation (CVA-64) (fig. 11-8), are each fitted with twin Terrier launchers. It is planned that other carriers to come, plus some already in commission, will be fitted with missile systems.

SURFACE SHIP MISSILE SYSTEMS

GENERAL

This section will outline the fundamentals of a surface-to-air missile system as it might be found on a surface ship. Specifically, this section will take up the Terrier (RIM) system as found on DLGs. The missile systems on these ships may be considered typical of a surface ship missile system.

ORGANIZATION OF MISSILE SHIPS

The organization of missile ships is comparable to that of other ships with similar missions. Most of the equipment and personnel associated with the missiles are under the cognizance of the weapons officer.



Figure 11-8.—USS Constellation (CVA-64) launching Terrier missile.

3.71

Chapter 11—GUIDED MISSILE SHIPS AND SYSTEMS

Figure 11-9 is the Weapons Department organizational chart for the USS Farragut (DLG-6). There are variations to suit the needs of each ship, but figure 11-9 illustrates the type of organization.

The men who are responsible for the operation and maintenance of the missile itself are under the missile officer. Weapons control equipment of the missile system is under the cognizance of the fire control officer.

The missile system also gets an assist from Operations Department personnel, as Radarmen perform certain plotting and liaison functions in the weapons control system.

TERRIER (RIM) MISSILE SYSTEM

The Terrier missile system of a guided missile ship consists of four major subsystems: (1) the missile, (2) the ship, (3) the

weapons control system, and (4) the missile stowage, loading, and launching system.

The Missile

As you will recall from the first part of this volume, the Terrier (RIM) is a medium-range beam rider, or a homing missile, depending on the mod, propelled by a solid-fuel sustainer rocket, and launched with a solid-fuel booster. It is capable of carrying a fragmentation or a nuclear warhead. It can be used against surface, shore, or air targets.

The Ship

The second major subsystem is the ship itself, which provides the launching platform, and transports the missile part way to the target. It also provides the basic services necessary for the maintenance and operation of the

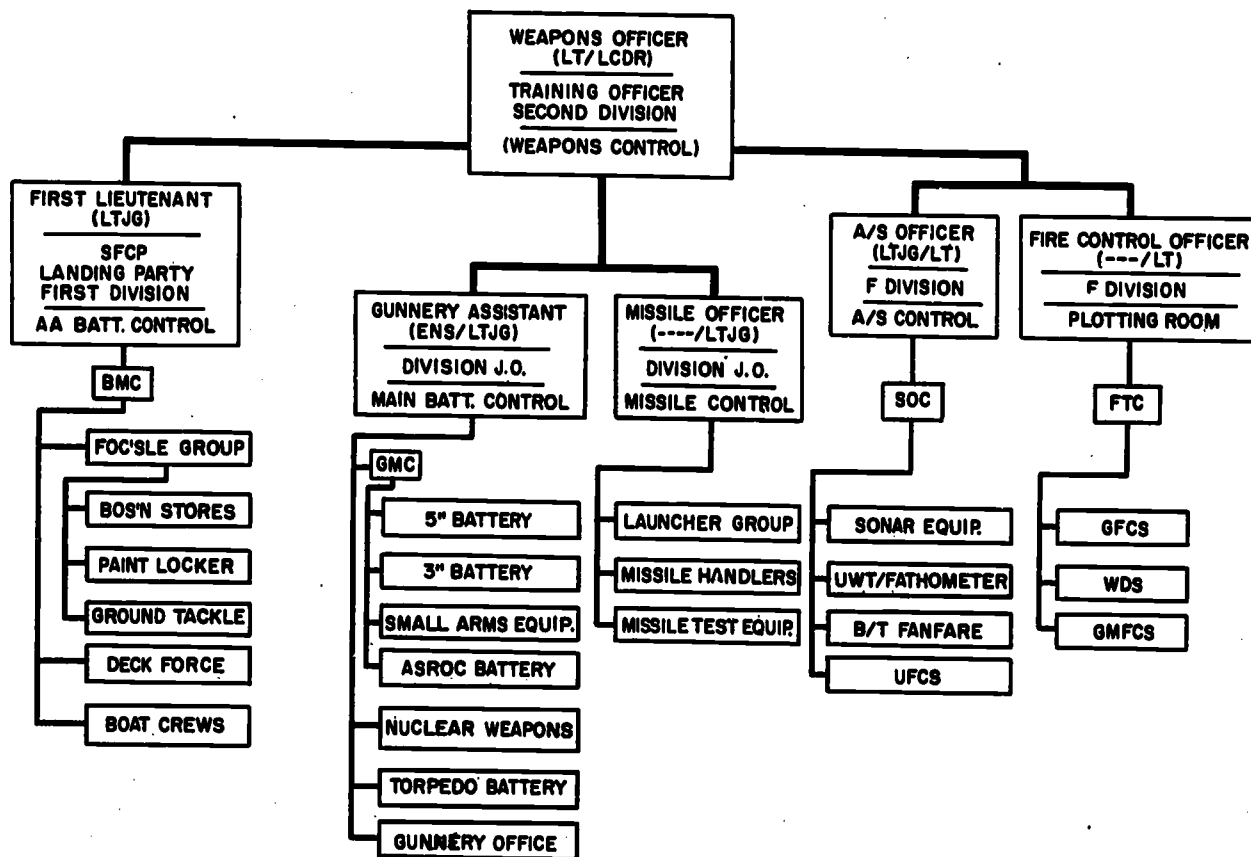

Figure 11-9.—Organization chart, Weapons Department, USS Farragut class DLG.

PRINCIPLES OF GUIDED MISSILES AND NUCLEAR WEAPONS

missile system. These basic services include electric power, communications, testing facilities, compressed air and nitrogen, logistics support, etc. The ship also provides early warning and other CIC functions required for target acquisitions, target tracking, and computer solutions for fire control problems.

The armament of a DLG varies, of course, on one-ended (Farragut class) or the double-ended (Leahy class) ships. Figure 11-10 illustrates the placement of components on a DLG class 9 ship.

Weapons Control System

This is the third major subsystem. It encompasses both the gun and missile fire control equipment. The weapons control system will be described in some detail in this and the succeeding section.

Consider that an aircraft at 20,000 feet, traveling at 600 knots, will reach its bomb-

release point more than 10,000 yards from its target. Consider, also, that this aircraft is traveling 20,000 yards a minute, and that the total problem may consist of two, three, or more aircraft. Finally, recall that in order to destroy an aircraft with a missile or a projectile it will be necessary to do all of the following BEFORE the target aircraft reaches its bomb-release point:

- (1) Detect the target aircraft with radar
- (2) Identify the target as "friend or foe"
- (3) Designate to a selected director to acquire the target
- (4) Obtain a solution with director's associated computer
- (5) Assign weapons to the tracking director on a priority basis, and position these weapons in train and elevation
- (6) Fire
- (7) Wait until the projectile or missile reaches the point of impact with the target

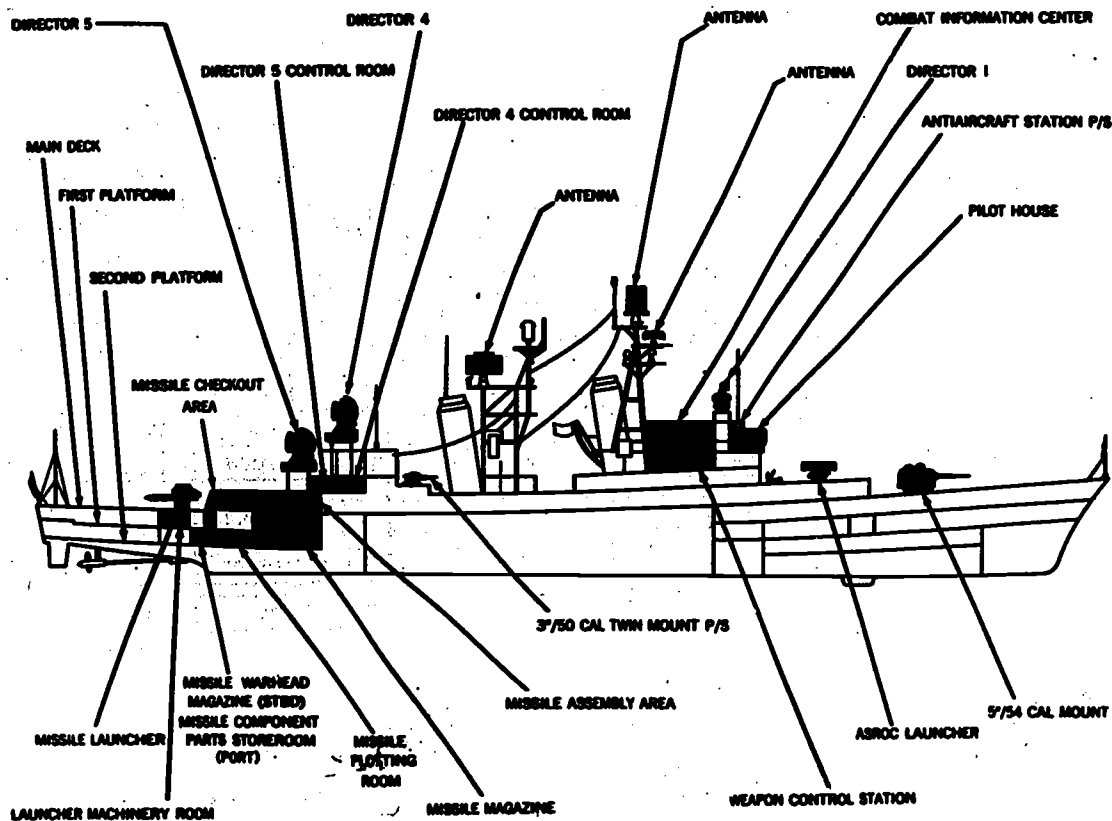

Figure 11-10.—DLG class 9 weapons system.

Chapter 11—GUIDED MISSILE SHIPS AND SYSTEMS

The need for urgency, and the complexity of the AA problem, were the reasons for development of the complex weapons control system found on the missile ships. The missile ship weapons control system was conceived to hold to a minimum the time required for acquisition of targets, and to permit simultaneous engagement of multiple targets.

The weapons control system can be divided into fire control equipment and weapons direction equipment.

The FIRE CONTROL equipment supplies the basic intelligence and control functions for effective engagement of targets by the ship's weapons. Thus, with conventional gunnery, there is a need to compute gun orders. With

missiles, there is a need to solve for launcher and in-flight guidance orders.

The WEAPONS DIRECTION EQUIPMENT provides the displays and controls required for the proper utilization of the ship's weapons. This utilization requires full evaluation of targets, assignment of missile (or gun) directors to the proper targets, proper selection of missiles and loading of launchers, tactical evaluation prior to firing, and, finally, continued evaluation to ascertain that targets are effectively encountered and that target priorities remain as first evaluated. Figure 11-11 is a sketch of a weapons control station, which contains most of the weapons direction equipment. Other missile ships use similar equipment, often the same mark and mod.

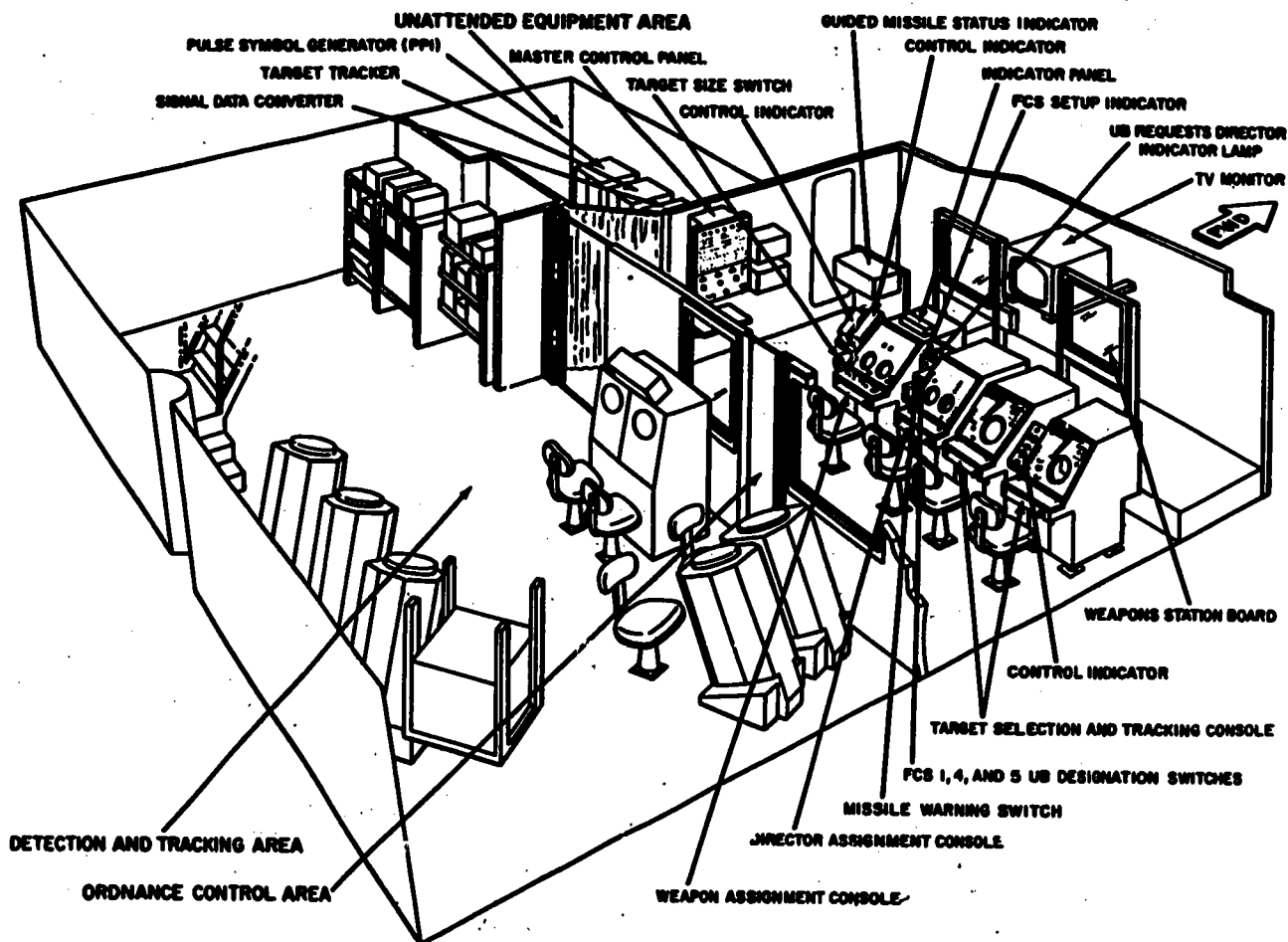

Figure 11-11.—Weapons control station.

36.81

PRINCIPLES OF GUIDED MISSILES AND NUCLEAR WEAPONS

Missile Stowage, Loading, and Launching Systems

In general, it can be said that the missile is handled in the same way that conventional ammunition and weapons are handled. However, certain missile characteristics modify the handling and stowage problem. The Terrier missile is heavy and unwieldy, since its length with booster is over 26 feet, and its weight is in the neighborhood of 2400 pounds. The electronic equipment, and the powder grains that make up the booster, require a controlled environment in order to maintain missile reliability. If subjected to cold, the boosters and sustainers become brittle and are more likely to fracture upon normal handling. A missile propellant that is cracked will burn faster than it normally should, becoming unreliable and perhaps extremely dangerous. Excessive heat and/or moisture will also have an adverse effect on the missile booster and sustainer propellants.

Each missile launcher has an associated magazine, ready service magazine, and wing-assembly area. The missiles are stored in a condition ready to be launched on short notice. Also because of the rapidity with which the AA problem develops, provision is made for rapid loading of additional missiles and the jettisoning of malfunctions. With the exception of wing and fin assembly, the Terrier loading cycle is fully automatic.

A more detailed study of missile loading and launching systems will be included in the confidential volume of this series.

THE AA PROBLEM

Figure 11-12 is a block diagram that will help the reader to understand the functioning of the Terrier weapons system as it concerns the AA problem.

Detection and Identification

A target is detected by the ship's air search radar, by an Airborne Early Warning (AEW) system, or perhaps by another ship acting as a picket. Another source of information is the Navy Tactical Data System (NTDS), discussed later. This target information is presented to CIC and the weapons control station in a conventional manner. The target is interrogated, plotted, and assigned a designation according to its status as friend or foe.

Tracking, Evaluation, and Director Assignment

In addition to the conventional search and fire control radar normally found on Navy ships, a designation radar is installed as part of the weapons control system. The designation radar is a hemispherical scan radar, and it provides a continuous 360° HORIZON TO A GIVEN ELEVATION radar scan. Thus, the designation radar will supply range, bearing, and elevation of all targets within its range. All targets within the scope of the hemispherical scan radar are made available as inputs to the automatic tracking (TWS: track-while-scan system) feature of the weapons control system. Automatic tracking is necessary because of the requirement for speed, and because the number of targets may exceed the number of directors available, or the capability of human tracking. The Terrier weapons control system is able to retain all target information in a ready-to-use form, for transmission to directors as rapidly as they are able to take successive targets.

Too, because of the limited time available, provision is made within the weapons control system for as much automatic evaluation (as opposed to human operation) and director assigning features as is possible. Thus an aircraft attacking so as to be the most serious threat will automatically be given priority in director assignment.

Weapons Control System Phases

Within the weapons control system are three successive phases of actions and equipments, although the interaction of modern equipment has tended to break down separation into phases.

PHASE I.—This is a combined phase I for gun and missile use, whereby targets are selected by the phase I equipment operators for automatic tracking. These phase I operators, aided by what is presented on their radar scopes and by the information received from CIC, then institute the automatic features of the TWS system. To summarize, phase I equipment provides for display, detection, initial selection, and tracking of targets.

PHASE II.—This and succeeding phases will be discussed only insofar as they concern the missile problem. Parallel capabilities for target acquisition are provided for the gunnery problem. Phase II equipment for missileery

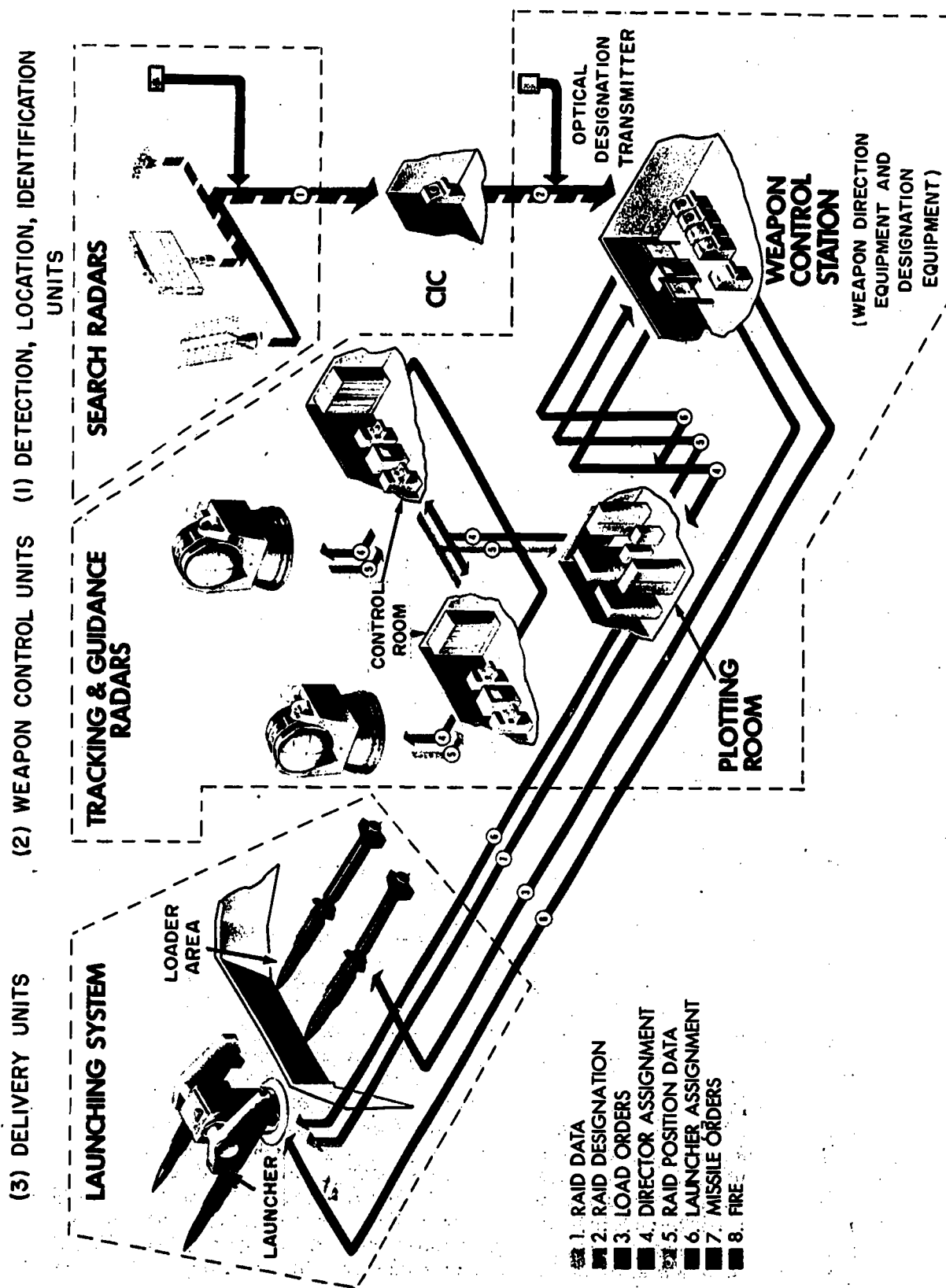

94.8

Figure 11-12.—Terrier weapons system, flow of information and directions.

PRINCIPLES OF GUIDED MISSILES AND NUCLEAR WEAPONS

provides for evaluation and assignment to a particular missile director, or for rejection as a missile target. If the target is rejected for missilery at this point (or at any other time), designation to a gunnery director must be considered. (The phase II equipment for gunnery will function automatically to assign to a gun director for acquisition any target that meets the priority requirements.) Duplication of effort is prevented by the fact that targets are normally engaged with missiles long before their priority dictates serious consideration by the gunnery assignment equipment. To sum up the phase II equipment operators select and assign priorities to missile targets; they then assign the targets, in order of "threat", to the missile directors for acquisition.

PHASE III.—The function of the phase III equipment is to receive and display all the comprehensive information necessary to select launchers and successfully fire the appropriate missiles against the selected targets. Information, such as unclear areas, launcher availability, maximum and minimum missile capabilities, present and advance target position, etc., are available to the phase III equipment operators.

Fire Control

A director, having acquired the target designated by the weapons direction equipment, will, together with its computer, complete a solution. The solution is in the form of missile launcher orders and missile guidance orders. The AA problem is completed when the target is destroyed, or when a director is released because of change in target priorities.

MISSILE LOGISTICS

Missile logistics is the problem of keeping the operating forces supplied with a stockpile of missiles and spare parts. Initially, missile components are shipped in sections from the manufacturers to storage depots located throughout the continental United States and at its advanced bases. Each of the sections that make up the missile is packaged in a reusable metal container. The containers are sealed, and contain desiccant in order to provide an environment least likely to cause unreliability in the component. When necessary to supply the operating forces with a missile, it is the

depot's responsibility to test, assemble, and transfer a complete missile in the form required by the recipient. A missile, being extremely complex and of large unit size and value, requires more care in transport and handling than does a conventional round of ammunition. For this reason, all handling equipment and shipping containers are designed to realize maximum missile reliability.

Once aboard the ship the missiles are again tested to ensure reliability. Missiles must either pass the rigid tests or be repaired. When any missile component fails in test, it is replaced with a spare and the rejected part is shipped back to a depot for complete overhaul. The ship is equipped to make minor repairs and component substitutions, but not to make extensive overhauls. All the steps in missile manufacture, storage, handling, and testing are for maximum missile reliability.

Missile ships are equipped to receive replacement missiles both while in port and while under way. Transfer at sea is usually conducted by use of the burtoning method. Some of the newest ships use the FAST (Fast Automatic Shuttle Transfer) system. Both the supply ship and the receiving ship must have the equipment. The FAST system compensates for roll, pitch, and station alignment. It increases the missile transfer speed, and is able to handle the largest missiles expeditiously and safely. It is planned to equip all ammunition supply ships (AEs) with the FAST system.

NAVY TACTICAL DATA SYSTEM (NTDS)

The Navy Tactical Data System (NTDS) was planned to provide more accurate target information to a task group. Six ships are now equipped with NTDS; current plans call for all major U.S. warships to be fitted with it. Future plans may extend it to smaller ships. It is a system for automatically and rapidly disseminating among all the NTDS-equipped ships in the data-gathering area such information as aircraft early warning; positions and identities of all aircraft, surface ships, and submarines; and command decisions.

Own ship target data gathered by search radars and the fire control system are stored and processed at high speed by one or more digital computers and displayed on a target evaluation and weapon assignment console. The processed data are transmitted to all the other NTDS-equipped ships in the area. Targets

Chapter 11—GUIDED MISSILE SHIPS AND SYSTEMS

detected by a screening ship, for example, are automatically transmitted and displayed on other ships' consoles, with provision for target sorting to avoid duplication.

The existing NTDS network is basically a surface operation, with airborne data link, but it does not now include a direct tie-in with submarines.

NTDS equipment includes up to four Univac USQ-20 stored-program general-purpose digital computers aboard each ship; CVA's carry four; DLG's carry two. Each ship also carries from four to 25 displays which are direct-view cathode ray tubes (CRT's) and are used for on-line digital computer information from the computers and for radar-derived data.

In exercises with NTDS aboard carriers, the system was able to handle any number of targets, beyond the saturation point of conventional CIC equipment. In simulated raids with large numbers of aircraft, NTDS could track all the targets.

The airborne portion of NTDS is carried aboard E2A aircraft. Some success has been achieved with it in over-water flights but technical problems remain in developing a radar that can pick out moving targets over a land mass background (clutter and other radar interference).

SUBMARINE MISSILE SYSTEMS

GENERAL

Undoubtedly, the most feared and respected retaliatory weapon in our present arsenal is the powerful and deadly accurate Polaris missile as carried by our nuclear-powered ballistic submarines (SSBNs). Another submarine missile system being developed for defense against enemy submarines is nearing operational status. This system, Subroc, will eventually be installed in most of our submarines, both conventional and nuclear-powered types.

Polaris and Subroc were briefly described in chapter 1. In this chapter we will, within the limitations imposed by classification, give you a fuller look at each of them.

MAKEUP OF A SUBMARINE MISSILE SYSTEM

Four major subsystems make up the guided missile submarine system. These are: the

missile; missile guidance equipment; the submarine; and missile stowage and launching systems.

To ensure a successful flight of our first subsystem, the missile itself, a reliable guidance system must be employed. The principles of the various missile guidance system were explained earlier in this book. The type of guidance used depends on such things as desired accuracy, cost, simplicity, reliability, and probable countermeasures. Guidance selection, although it has a direct bearing on the design and operation of the missile system, is beyond the scope of this chapter. This chapter will deal primarily with the fundamentals of the submarine missile system that are common to all guidance techniques.

The third subsystem, the submarine itself, provides a launching platform, basic services, fuel, and other logistic support functions. Also included on the submarine are a navigational system, and missile fire control equipment.

The launching of missiles toward targets miles away can be compared to a very long-range gunfire problem. The submarine will usually have no direct observation of the target, or of a known geographical reference. But the position of the guiding craft must be fixed with extreme accuracy. Location, heading, ground speed, and other reference data, all have an effect on the CEP (Circular Probable Error) of the missile.

The SINS system (ships inertial navigation system) is presently the most sophisticated of the navigational systems now installed on missile submarines. The heart of SINS is an inertial guidance package based on the principles of inertial guidance explained in preceding chapters. Included within SINS are numerous gyros and accelerometers whose function it is to generate the submarine's position and speed, and to establish true north and a vertical reference. SINS, then, acts like a dead reckoning computer/analyzer whose function it is to provide continuous and extremely accurate navigational and reference data. It also has the ability to weigh, analyze, and make corrections to its dead reckoning solution based on optical and electronic navigational inputs.

In addition to the navigational system, a fire control system is included on the submarine. The function of the fire control system is to transfer reference information to the missile,

PRINCIPLES OF GUIDED MISSILES AND NUCLEAR WEAPONS

and to control and monitor the missile during preflight checks.

The last subsystem to be considered is for **MISSILE STOWAGE AND LAUNCHING**. Figure 11-13 sketches the interior of a Polaris submarine and shows arrangement of the missiles. The handling equipments and launcher components are in the same area.

THE UNDERWATER PROBLEM

Target Considerations

Because of the high unit value of submarine-launched UGM and UUM missiles, certain factors must be considered, such as the importance of the target to the enemy, and target

nature, vulnerability, size, and location. With strategic targets, these factors are evaluated well in advance of the mission. Tactical targets require faster military decisions. Both planning estimates, however, are usually accomplished on a much higher planning level than the launching ship.

Flight Planning

In addition to the target considerations, additional planning must be given to the flight plan of the missile. Thus, whereas the missile would be most likely to remain undetected at very low altitudes, the range to the target may prohibit such employment. Intelligence and the immediate tactical situation also play an important part in missile flight planning.

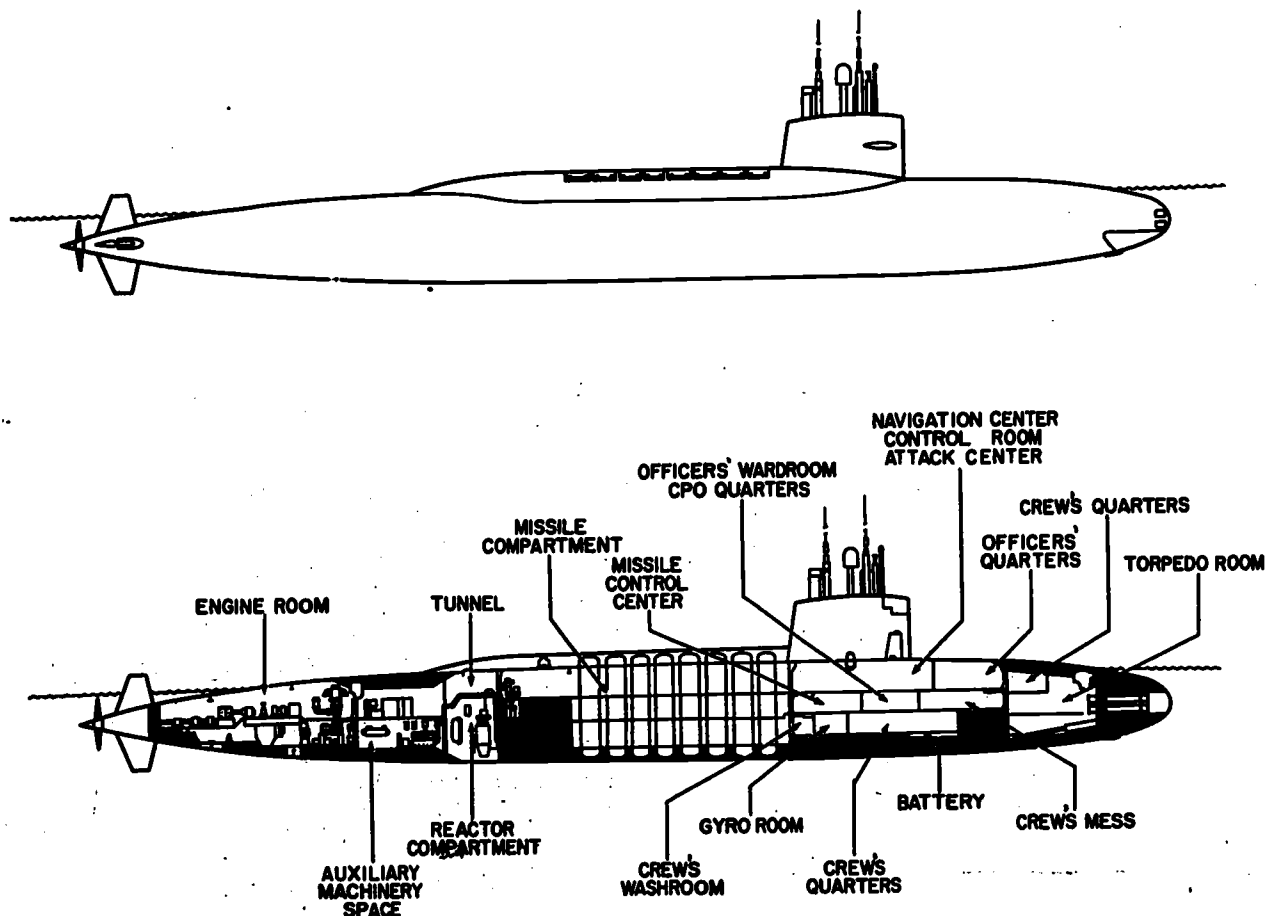

Figure 11-13.—SSB class submarine.

POLARIS MISSILE SYSTEM

The Polaris (UGM) is a 2-stage surface-to-surface or underwater-to-surface inertially guided ballistic missile with an approximate range of 2500 nautical miles (Polaris A3). The earlier A1 and A2 Polaris missiles had somewhat lesser ranges. The Polaris is designed to be launched from a submarine cruising on or below the surface. The two powerful, solid-propellant rocket motors are capable of lifting the warhead high above the range of any known anti-missile missile at a speed exceeding ten times that of sound, and placing it into a free-fall trajectory which will carry it to its target with deadly accuracy. The warhead of the Polaris is a compact and powerful nuclear device. The explosive power is one shipload of sixteen missiles exceeds the total amount of explosive power expended by all of the participating countries in World War II, INCLUDING the two atomic bombs dropped on Japan.

In a submerged launch, ignition of the first stage rocket takes place shortly after the missile breaks the surface of the sea (fig. 11-14). This is the beginning of powered flight and the inertial guidance portion of the trajectory. The first stage propels the missile far into the atmosphere. The first stage then separates and

the second stage rocket motor continues to propel the missile to a point above the earth's atmosphere. When the missile has reached the proper velocity and point on the trajectory, the reentry subsystem separates and the warhead follows a ballistic trajectory to the target. The time of reentry subsystem separation determines the range which the missile warhead will span. Polaris range can be varied in this way from about 575 to about 2500 nautical miles.

Since there are no external control surfaces on Polaris, changes in the trajectory are accomplished by deflecting the jet stream from its motors. A pre-computed ideal trajectory is preset into the missile. The preset information takes into account the movements of the target, the launching point, and the missile with respect to inertial space during the time of flight. The warhead release velocity which the missile must attain along its trajectory on the basis of a fixed time of flight is also preset. The launching submarine accurately determines its launching position by use of an inertial navigation system, and the position of the target on the earth's surface is determined by reliable charts. While in the power stage of flight, the missile continuously measures its linear accelerations on the basis of its inertial system and alters its trajectory to offset the outside

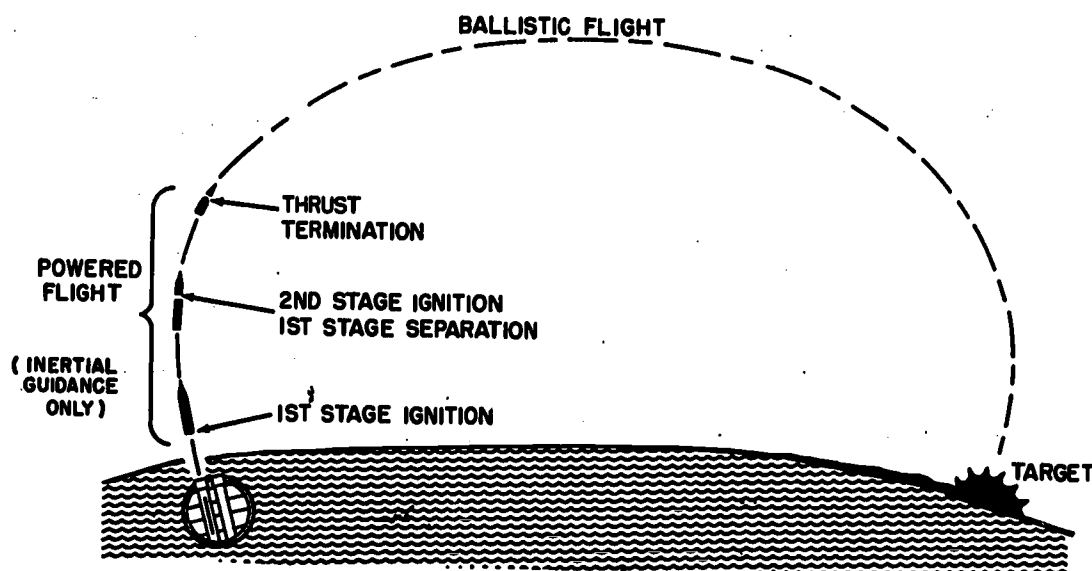

Figure 11-14.—Polaris trajectory (not to scale.)

PRINCIPLES OF GUIDED MISSILES AND NUCLEAR WEAPONS

forces causing unwanted accelerations. When the missile is on a proper trajectory and a correct velocity has been attained, the warhead is released and proceeds on toward the target with no further correction possible.

The warhead dives on its target at a steep angle and at several times the speed of sound. The materials for the outer surface of the warhead have been specially developed to resist the high temperatures generated by friction with the atmosphere at reentry speeds, and suitable insulation is provided between the outer skin and the internal components to prevent damage to the warhead.

The SSBNs from which the Polaris is fired provide a mobile launching platform which is extremely difficult to detect. It can remain submerged for very long periods of time and cruise to most any position within the oceans of the world. By use of its inertial navigation system, it can provide the precise fire control data required to place Polaris right on target.

SUBROC MISSILE SYSTEM

Subroc (UUM) is an underwater-to-air-to-underwater missile designed to destroy enemy submarines at long range. The missile consists essentially of a depth bomb and a rocket motor joined together. Either a nuclear or a conventional depth bomb warhead can be employed. The launching submarine carries the equipment for detecting and tracking the enemy submarine, the fire control equipment for computing the target information and providing the necessary pre-launch missile information, and the equipment for launching the missile. The missile is designed to be launched (fig. 11-15) from a standard submarine torpedo tube using conventional ejection methods. Upon being launched, the rocket motor is ignited at a safe distance from the firing ship. The missile's flight through the air is controlled by an inertial guidance system which functions in accordance with the fire control information set in prior

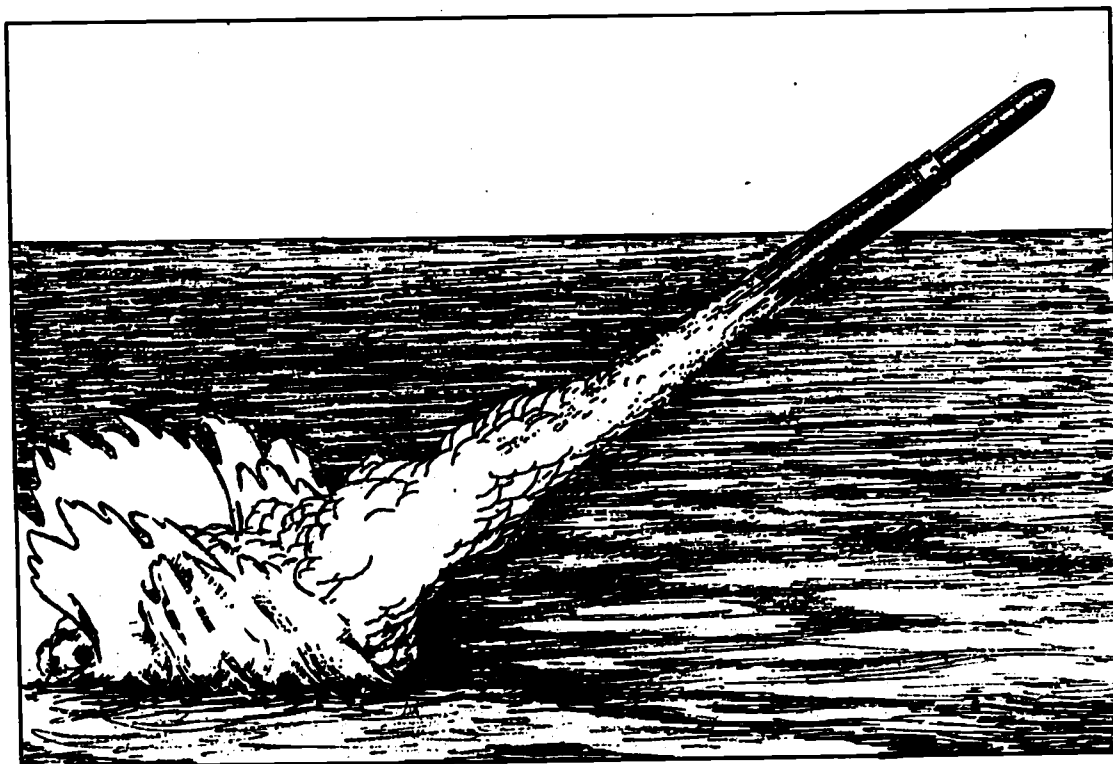

Figure 11-15.—Subroc launching from a submarine.

88.54

Chapter 11—GUIDED MISSILE SHIPS AND SYSTEMS

to launch. In addition to providing the propulsive force for the missile, the rocket motor furnishes power for controlling the thrust vectoring mechanism during the boost phase, and the thrust reversal necessary to accomplish rocket motor separation. At the proper point in its trajectory, the rocket motor separates and the missile continues in a free-fall flight. At the time of separation, the control of the missile is switched from the thrust vectoring mechanism to aerofins. During the ballistic portion of the flight, the aerofins control the missile in roll and azimuth. Pitch guidance is initiated at, or near, the zenith of the trajectory to direct the missile to the desired point of impact on the water surface. Guidance is terminated at a predetermined height above the water, and the aerofins are locked in the zero position to provide for proper underwater travel. At water impact, a timer mechanism starts and causes the warhead to detonate at the proper time.

More detailed information on both Subroc and Polaris can be found in the appropriate classified publications.

AIRCRAFT MISSILE SYSTEMS

GENERAL

There are two broad classifications of aircraft missile systems: air-to-air and air-to-ground. The Sidewinder and Sparrow families are examples of AIM systems. Bullpup is an example of a Navy AGM system. Figures 11-16 and 11-17 are pictures of the Sparrow, Sidewinder, and Bullpup missiles on appropriately configured aircraft.

The Sparrow family is a typical aircraft missile system. The student will recall that there are three major missiles in the Sparrow family. Sparrow II will not become operational in the U. S. Navy. Sparrow III, while in many respects greatly different from Sparrow I, has the same general characteristics such as length, weight, and configuration.

THE AIRCRAFT (SPARROW) MISSILE SYSTEM

There are four major subsystems that can be considered to make up the Sparrow missile system: These are:

1. the missile,
2. the aircraft carrier (or land base),

3. the aircraft, and
4. the missile guidance equipment.

The Sparrow I missile is a beam rider. It includes a warhead, an influence fuze, a guidance and control section, power supplies, and a rocket motor. Sparrow I was the nation's first air-to-air guided missile, and is much less sophisticated in guidance principles than its more recent sister, the Sparrow III. Sparrow I is an optically sighted beam rider, while Sparrow III is fully radar operated. Both missiles fulfill the design requisite of having a high single-shot probability of kill and a range longer than can be achieved with conventional AA guns. Up to four Sparrow missiles are carried on appropriately configured aircraft. Missile aircraft can also carry mixed loads of Sparrow and Sidewinder missiles (fig. 11-16).

Additional data concerning specific airborne missiles is contained in chapter 1, and in the confidential course supplementing this text.

The AIRCRAFT CARRIER (or land base) is needed to provide operational and logistic support for the missile and missile aircraft. Test equipment, training facilities, and provisions for handling and stowage are included on the mobile base. Additionally, as integral parts of the system, are the fighter director facilities which must direct the missile aircraft to the vicinity of the target. Maintenance of the missile is on a "Go-No-Go" basis, as is the practice with many other operational missiles. That is, missiles which do not pass surveillance or preflight tests are rejected, and defective sections are returned to centralized maintenance facilities for repair or overhaul. This system speeds up acceptance testing, and eliminates the widespread need for extensive maintenance facilities.

The missile AIRCRAFT is of course the delivery vehicle. Aircraft configured to carry and launch radar-guided missiles must carry extensive electronic equipment for missile guidance. Other equipment to aid in target acquisition, and to furnish "course-to-steer" and "in-range" information, may also be included on the aircraft as part of the missile system.

The last subsystem is that of the MISSILE GUIDANCE EQUIPMENT. The principal function of this equipment is to determine the displacement of the missile from the tracking radar beam, and to send the necessary control information to the missile so that the missile will fly the beam.



3.112

Figure 11-16.—A4D Skyhawk with Sparrow and Sidewinder missiles.

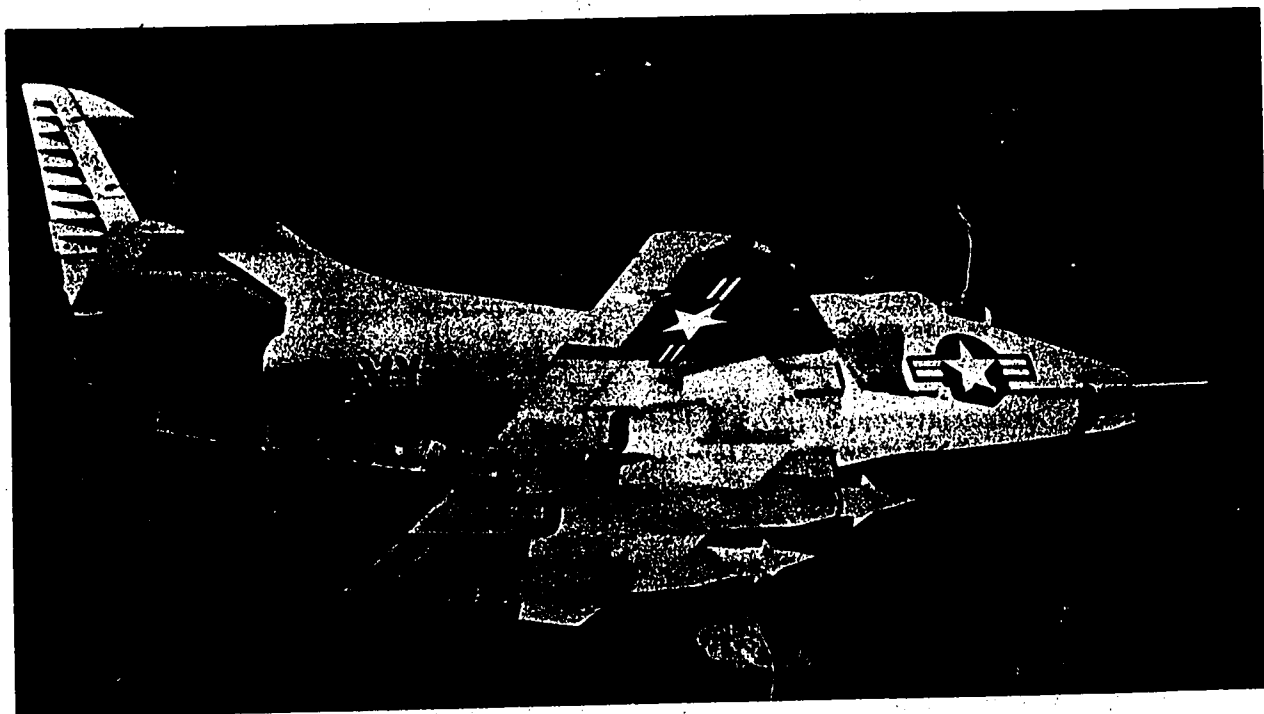

3.112

Figure 11-17.—A4D Skyhawk carrying three Bullpup B missiles.

Chapter 11—GUIDED MISSILE SHIPS AND SYSTEMS

THE AIR-TO-AIR MISSILE PROBLEM

To illustrate the AIM missile problem, let us take the classic example of an aircraft carrier providing air cover for a task force at sea. Our missile aircraft will be alerted to the presence of enemy aircraft by the force fighter director organization. The missile aircraft will be vectored to the general vicinity of the enemy, where it will be in a position to acquire the target. For the mission to be fully successful, the attackers must be intercepted and destroyed before they are in position to delivery an attack with their weapons. Upon acquiring the target, a proper pursuit course is then followed until firing range is reached. When within range, the missile is fired and is captured by the guidance radar beam. The missile then follows the guidance beam until within destructive range of the target, where an influence fuze will detonate the warhead. The above description is of the basic AIM beam-rider sys-

tem. The more sophisticated the missile system becomes, the more automatic the various steps become. The earliest AIM missiles required visual contact and mental computations, whereas the latest systems perform most of the steps automatically.

BIBLIOGRAPHY

The confidential volume which expands this text, Navy Missile Systems, NavPers 10785-A, gives more detailed information on missiles and missile weapon systems. The following material also may be consulted for further information.

Guided Missile Systems of the Department of the Navy, dated 3/12/58. Copies should be requested from the Chief, BuWeps(ReS), Navy Department, Washington, D.C. - 20390

BuWeps Information Bulletins

Navy Department technical manuals on specific missiles or systems.

PART II. — NUCLEAR WEAPONS

CHAPTER 12

FUNDAMENTALS OF NUCLEAR PHYSICS

INTRODUCTION

There are some entirely new technological principles involved in nuclear weapons, as compared with conventional weapons. In the case of conventional explosives, energy is released through chemical reactions; i.e., rearrangement of the atoms of the explosive substance. In the nuclear explosion, energy is produced as a result of the formation of different atomic nuclei, by the redistribution of the protons and neutrons inside the atom itself. What is commonly referred to as atomic energy is really nuclear energy, since it results from nuclear interactions. For this reason atomic weapons are now preferably called nuclear weapons.

SCOPE

This chapter will cover those aspects of physics that pertain to the structure of the atom, the nature of its component parts, and the predictable behavior of the several atomic components. It will also cover very briefly the means man has developed, or is now developing, for the liberation of the energy available inside the nucleus of the atom.

Within the limits allowed by security restrictions, subsequent chapters will trace the uses of nuclear energy in naval weapons.

ATOMIC RESEARCH PRECEDING THE BOMB

By 1939, a number of scientists had theorized that an atomic bomb for military uses was a possibility. Nuclear reactions had been studied extensively during the previous ten years. These studies had been done on only a small scale because of the scarcity of radioactive materials.

By 1940, it was discovered that three radioactive elements—uranium, thorium, and

protactinium—were sometimes split into two approximately equal parts when bombarded by neutrons, but that only uranium 235 could be split or fissioned by slow (thermal) neutrons. It was also discovered that during this process from 1 to 3 more neutrons were released, making the multiplying chain reaction a distinct possibility.

In 1942 a special government project, called the Manhattan Engineer District, was established in the Army Corps of Engineers. Scientists from various universities working on this project gathered at the University of Chicago to build a self-sustaining chain-reacting pile to determine for sure if an atomic bomb was feasible.

The pile was constructed on a lattice principle, with graphite bricks as a moderator to slow the neutrons, and with uranium placed at intervals as the reacting material. Recording instruments at various points inside and outside the pile gave an indication of neutron intensity. Movable rods of neutron absorbing material were placed at intervals inside the pile during construction for safety and control. It was fortunate these strips were used in this manner, as the pile reached a critical condition at a much earlier stage of construction than was anticipated. On December 2, 1942, all was in readiness to find out if the previous predictions were true. All but one control rod was removed from the pile; then the last rod was slowly removed. The predictions proved to be correct; the pile was maintaining a nuclear chain reaction.

Much work was done in the following three years; and in 1945, this work produced, on the floor of the New Mexico desert, the first explosion of an atom bomb. A few weeks later two bombs were dropped over Japan, ending the war and beginning a new era in warfare.

As every reader of this text is undoubtedly aware, the military and industrial uses of atomic

Chapter 12—FUNDAMENTALS OF NUCLEAR PHYSICS

energy have become a major concern of the United States, its allies, and its potential enemies. Much military thinking has been revised, and much more is in the process of revision. Regardless of his specialty, no military man can afford to ignore the atom. These chapters are intended to prepare prospective naval officers for further study of this subject.

OBJECTIVES

This chapter will take up, first, the nature of matter. It will begin with the definitions of the component parts of the atoms that make up matter. The interpretation of atomic structure will be covered, although the major emphasis will be on the atom and its component particles.

The second major division of the chapter will deal with radioactivity. This natural phenomenon gave the scientists some of their most significant clues in learning the nature of the atom. Because of its bearing on health and safety, radioactivity has become a primary concern for industrialists, community leaders, and the officers and men of the Armed Forces.

The last part of the chapter will be concerned with nuclear reactions. These reactions are the real source of the power that is commonly called nuclear energy.

THE NATURE OF MATTER

DEFINITIONS

Man has long wondered about the nature of matter. With the advent of better scientific methods, man has discovered the natural elements that make up all matter in nature.

COMPOUNDS—Under certain conditions, two or more elements can be combined chemically to form what is called a compound. The resulting substance may differ widely from any of its component elements. For example, water is formed from two gases, hydrogen and oxygen, chemically combined.

Whenever a compound is formed, two or more atoms of the combining elements join chemically into what is called a molecule. A molecule is the smallest unit that shares the chemical characteristics of a compound. Water in this instance consists of one atom of oxygen and two atoms of hydrogen.

ELEMENTS—Each element has its own characteristics and its own characteristic atoms. An element is a substance which cannot be separated into simpler substances by ordinary chemical means. There are 92 natural elements ranging from hydrogen, the lightest, to uranium, the heaviest. Several others have been produced artificially, one of these being plutonium.

ATOMS—An atom is the smallest unit of an element that possesses the chemical characteristics of that element. Scientists have broken the atom down to three fundamental particles called electrons, protons, and neutrons.

NUCLEUS—Protons and neutrons make up the central part of the atom; electrons move in orbits around this central core. This central core of the atom is called the nucleus. Most of the weight of the atom is in the nucleus.

ATOMIC WEIGHT—Since the atom is very small, it is difficult to state the mass of an atom because the common units of mass are too large. For this purpose a new unit was defined: the atomic mass unit (amu). Chemists found that the oxygen atom is approximately 16 times as heavy as the hydrogen atom. Therefore, oxygen was assigned the arbitrary figure of 16.00000 atomic mass units. The masses of other atoms were then determined by comparing them to oxygen 16. For example, uranium 235 was assigned the figure 235.11750 atomic mass units.

Since one amu is defined as 1/16 the mass of the oxygen atom, the mass in grams corresponding to one atomic mass unit is approximately 1.66×10^{-24} grams.

The most convenient unit for describing the energy of atomic or nuclear systems is the electron volt, abbreviated ev. One ev is the energy which an electron will pick up in accelerating through an electric field of one volt potential. One ev is equal to 1.6×10^{-12} ergs. The unit Mev (million electron volts) is also used. Since one Mev = 1.6×10^{-6} ergs, one amu (1.66×10^{-24} grams), converted to energy in accordance with the formula $E = mc^2$, would correspond to 931 Mev.

Atomic Table

Figure 12-1 is a standard table of the elements called the periodic table. The atoms are grouped according to the number of electrons in their outer shells. When successive elements are built up by the addition of outer electrons, there are fairly sharp changes in chemical

PRINCIPLES OF GUIDED MISSILES AND NUCLEAR WEAPONS

	I	II	III	IV	V	VI	VII	VIII	IX	X	
1	1 H HYDROGEN 1, 2, 3		All isotopes found in nature are listed. A few of the artificially produced isotopes are listed				Radioactive isotopes are underlined: 232				2 He HELIUM 3, 4
2	3 Li LITHIUM 6, 7	4 Be BERYLLIUM 9	5 B BORON 10, 11	6 C CARBON 12, 13, 14	7 N NITROGEN 14, 15	8 O OXYGEN 16, 17, 18	9 F FLUORINE 19			10 Ne NEON 20, 21, 22	
3	11 Na SODIUM 23, 23	12 Mg MAGNESIUM 24, 25, 26	13 Al ALUMINUM 27	14 Si SILICON 28, 29, 30	15 P PHOSPHORUS 31	16 S SULFUR 32, 33, 34, 36	17 Cl CHLORINE 35, 37			18 Ar ARGON 36, 36, 40	
4	19 K POTASSIUM 39, 40, 41	20 Ca CALCIUM 40, 42, 43, 44, 46, 48	21 Sc SCANDIUM 45	22 Ti TITANIUM 46, 47, 48, 49, 50	23 V VANADIUM 51	24 Cr CHROMIUM 50, 52, 53, 54	25 Mn MANGANESE 55	26 Fe IRON 54, 56, 57, 58	27 Co COBALT 59, 60	28 Ni NICKEL 58, 60, 61, 62, 64	
	29 Cu COPPER 63, 65	30 Zn ZINC 64, 66, 67, 68, 70	31 Ga GALLIUM 69, 71	32 Ge GERMANIUM 70, 72, 73, 74, 76	33 As ARSENIC 75	34 Se SELENIUM 74, 76, 77, 78, 80, 82	35 Br BROMINE 79, 81			36 Kr KRYPTON 78, 80, 82, 83, 84, 86, 87	
5	37 Rb RUBIDIUM 85, 87	38 Sr STRONTIUM 84, 86, 87, 88	39 Y YTRIUM 89	40 Zr ZIRCONIUM 90, 91, 92, 94, 96, 98, 99, 100	41 Nb NIOBIUM 93, 95, 97	42 Mo MOLYBDENUM 92, 94, 95, 96, 97, 98, 99, 100	43 Tc TECHNETIUM 99	44 Ru RUTHENIUM 96, 98, 99, 100, 101, 102, 104	45 Rh RHODIUM 103	46 Pd PALLADIUM 102, 104, 105, 106, 106, 108, 110	
	47 Ag SILVER 107, 109, 112	48 Cd CADMIUM 106, 108, 110, 111, 112, 113, 114, 116	49 In INDIUM 113, 115	50 Sn TIN 112, 114, 115, 116, 117, 118, 119, 120, 122, 124	51 Sb ANTIMONY 121, 123	52 Te TELLURIUM 120, 122, 123, 124, 125, 126, 128, 130, 132, 134	53 I IODINE 126, 127			54 Xe XENON 124, 126, 128, 129, 130, 131, 132, 134, 136, 137	
6	55 Cs CESIUM 133, 137	56 Ba BARIUM 130, 132, 134, 135, 136, 137, 138, 139	RARE EARTHS 57-71 (See below)	72 Hf HAFNIUM 178, 179, 177, 178, 179, 180	73 Ta TANTALUM 181, 183	74 W TUNGSTEN 180, 182, 183, 184, 186	75 Re RHENIUM 185, 187	76 Os OSMIUM 184, 185, 187, 188, 189, 190, 192	77 Ir IRIDIUM 191, 193	78 Pt PLATINUM 190, 191, 192, 194, 195, 196, 198	
	79 Au GOLD 197	80 Hg MERCURY 196, 198, 199, 200, 201, 202, 204	81 Tl THALLIUM 203, 205	82 Pb LEAD 204, 206, 207, 208	83 Bi BISMUTH 209, 210	84 Po POLONIUM 209, 210	85 At ASTATINE 210, 211			86 Rn RADON 210, 211, 212, 214	
7	87 Fr FRANCIUM 223	88 Ra RADIUM 223, 224, 225, 226, 228	RARE EARTHS 89-103 (See below)								

RARE EARTHS (Lanthanides)	57 La LANTHANUM 138, 139, 140, 141, 142	58 Ce CELIUM 138, 140, 142, 144	59 Pr PRASEODYMIUM 141	60 Nd NEODYMIUM 142, 143, 144, 145, 146, 148, 150	61 Pm PROMETHIUM 147	62 Sm SAMARIUM 144, 147, 148, 149, 150, 152, 154	63 Eu EUROPIUM 151, 153	64 Gd GADOLINIUM 152, 154, 155, 156, 157, 158, 160	65 Tb TERBIUM 159	66 Dy DYSPROSIUM 156, 158, 160, 161, 162, 163, 164	67 Ho HOLMIUM 163	68 Er ERBIUM 162, 164, 165, 167, 168, 170	69 Tm THULIUM 169	70 Yb YTTERIUM 168, 170, 171, 172, 173, 174, 176	71 Lu LUTETIUM 175, 176
RARE EARTHS (Actinides)	89 Ac ACTINIUM 227, 228	90 Th THORIUM 230, 231, 232, 233, 234, 235, 236, 238	91 Pa PROTACTINIUM 231, 232, 233	92 U URANIUM 232, 233, 234, 235, 236, 238, 239	93 Np NEPTUNIUM 237, 238	94 Pu PLUTONIUM 239, 240, 241, 242, 243, 244	95 Am AMERICIUM 241, 243	96 Cm CURIUM 246	97 Bk BERKELIUM 247	98 Cf CALIFORNIUM 251	99 Es EINSTEINIUM 252	100 Fm FERMIUM 257	101 Md MEDECIUM 268	102 No NOT ASSIGNED 264	103 Lr LAWRENCIUM 260

5.36

Figure 12-1.—Periodic table of the elements.

properties from element to element. (But in the rare earth series at the bottom of the table, this is not true. These successive elements are built up by the addition of electrons in the inner shells.)

ATOMIC STRUCTURE

The Nucleus and Electrons

The atom is composed of a positively charged central mass called the NUCLEUS. This mass is made up of protons, which have a positive charge, and neutrons, which have no charge. Around the nucleus, but at quite a distance from it, are electrons which move in orbits or SHELLS. These electrons have a negative charge. Since the proton is charged positively and the electron is charged negatively, we can

reasonably suppose that the atoms of which matter is composed are electrically neutral; that is, they contain no net charge. Atoms normally contain exactly as many electrons moving in shells around the nucleus as there are protons in the nucleus. Neutrons, having no charge, do not affect the chemical nature of the atom. It is the number of protons in the nucleus that determines the element to which an atom belongs. For an example, hydrogen has one proton and one orbital electron. Helium has two protons and two electrons, increasing for each heavier atom, until we come to the last natural element, uranium, which has 92 protons and 92 electrons.

Electron Shells

The electrons are not distributed at random about the nucleus, but exist in arrangements



PRINCIPLES OF GUIDED MISSILES AND NUCLEAR WEAPONS

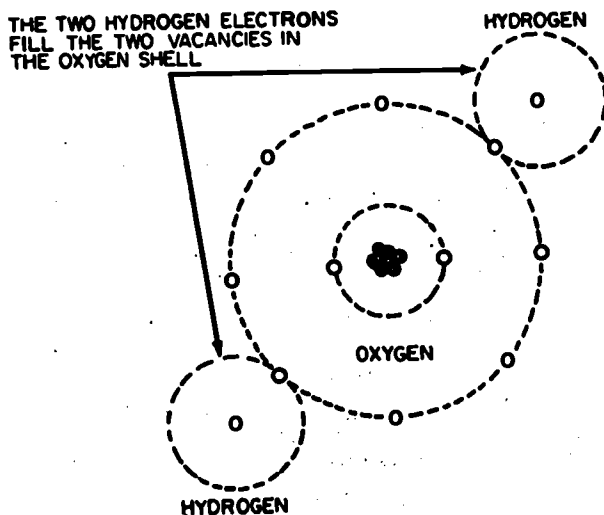

5.37

Figure 12-3.—A molecule is formed by a union of outer shells.

When an atom loses or gains an electron, the electrical balance of the atom is changed. It is said to be **IONIZED**. When an atom loses an electron it becomes a **POSITIVE ION**. When it gains an electron it becomes a **NEGATIVE ION**. The product of an ionizing event is usually an ion pair of equal and opposite charge.

Ionization does not alter the nucleus, and therefore does not change one element to another. As soon as conditions permit, an ionized particle reverts to its balanced or electrically neutral state.

Through excitation an electron can jump from one shell to the next. In this process a small amount of electromagnetic energy is given off; this energy is called a **PHOTON**.

NUCLEAR SYMBOLS

Before the discovery of the neutron, scientists identified the atom by one or two letter symbols representing its chemical name. For example, H was for hydrogen, He for helium, etc. This is known as **SYMBOL X**. In order to discuss the elements and atoms simply, a notational form is now used. It is based on the primary characteristics of the atom. The first of these characteristics is the number of protons in the nucleus, which in a neutral atom is the same as the number of electrons in the

shells around the nucleus. This number is the **ATOMIC NUMBER**, or **SYMBOL Z**. The next characteristic is the number of **NUCLEONS** (sum of protons and neutrons) in the nucleus; this is called the **ATOMIC MASS NUMBER**, or **SYMBOL A**. The standard notation takes the following form: ${}^A_Z X$, with X representing the symbol of the element to which the atom belongs, Z the atomic number, and A the atomic mass number. Using this notation, any atom can be easily described. For example, ${}^{92}_{235}U$ is an atom with 92 protons (symbol U for uranium), 92 electrons in shells around the nucleus, and a total of 235 nucleons in the nucleus. Since 92 of the nucleons are protons, this leaves 143 neutrons in this particular atom.

ISOTOPES

Isotopes are defined as atoms of the same element, but different atomic mass numbers. Hydrogen has three isotopes. The most abundant isotope of hydrogen has one proton and no

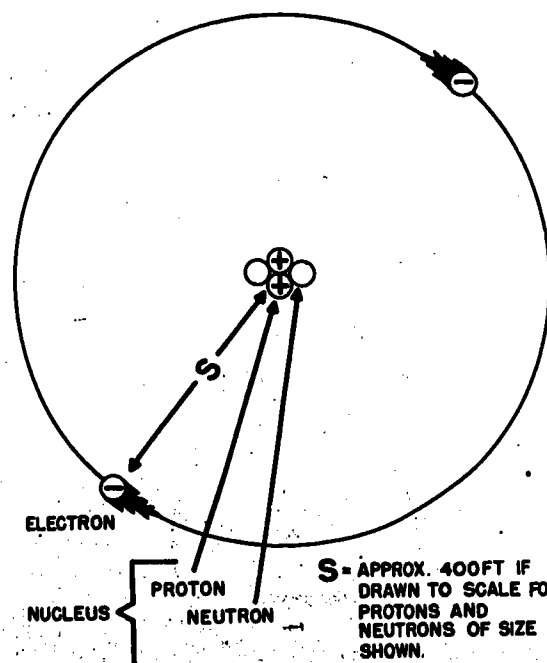

144.80.0

Figure 12-4.—Typical simple atom.

Chapter 12—FUNDAMENTALS OF NUCLEAR PHYSICS

neutron, as shown in figure 12-2. Another isotope of hydrogen, called deuterium, has one proton and one neutron. The third isotope, tritium, has one proton and two neutrons. (See figure 12-5.)

Another term which is sometimes important, and which you should not confuse with the isotope, is the isobar. Isobars are defined as different elements with the same atomic mass number, for example, tritium and helium 3, which are shown as: ${}^3_1\text{H}$ and ${}^3_2\text{He}$.

Isotopes will be mentioned frequently in later parts of this chapter and book.

OTHER NUCLEAR PARTICLES

Scientists found in certain uranium salts a curious phenomenon that caused exposure of photographic plates, although the plates had been shielded from light. This phenomenon was called RADIATION, and it emanated from the nucleus. Later, work was done using electric and magnetic fields to deflect this radiation. In this way three basic types of radiation were separated and identified (fig. 12-6). One type could not be deflected by a magnetic or electric field. This was called gamma radiation. Another type was deflected slightly and appeared to be positively charged; this was called alpha radiation. And still another type appeared negative in charge, with a further deflection. This type was called beta radiation. Under some conditions an excited nucleus emits another particle of the same mass as an electron, but with a positive charge; this is a positron. Remember that all of these radiations originate in the nucleus of the atom.

These different types of radiation are emitted because the unstable nuclei are trying to reach stability. These nuclei can attempt to reach stability by emitting a beta particle, an alpha particle, or a gamma ray. Different types of nuclei will have their own characteristic mode of radioactive decay. Some may always emit alpha particles; others may emit beta, gamma, or other particles.

STABILITY

It has long been known that the more protons a nucleus contains, the more neutrons it must have, proportionately, for stability. If a nucleus contains relatively too few neutrons it will be radioactive, emitting a positron when it decays; if it contains too many neutrons it will again be radioactive, emitting this time a beta particle when it decays. Stable light elements are found to have equal numbers of protons and neutrons, but the heavier elements contain increasing proportions of neutrons to protons. Thus, stable helium 4 has two protons and two neutrons in the nucleus; halfway up the table of elements a typical nucleus—a stable isotope of silver—has 47 protons and 60 neutrons, a neutron-proton ratio of 1.28; and, at the top of the table, uranium 235 has 92 protons and 143 neutrons, a neutron-proton ratio of 1.55.

The neutron-proton ratio is important to stability because of the slight tendency of protons to repel each other even though bound into a nucleus by nuclear forces. Because of their charge, the protons will tend to separate from one another. However, because of saturation

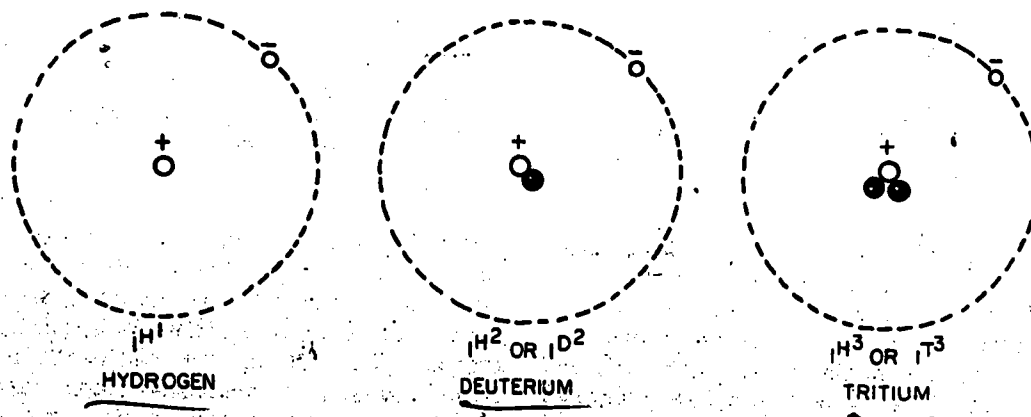
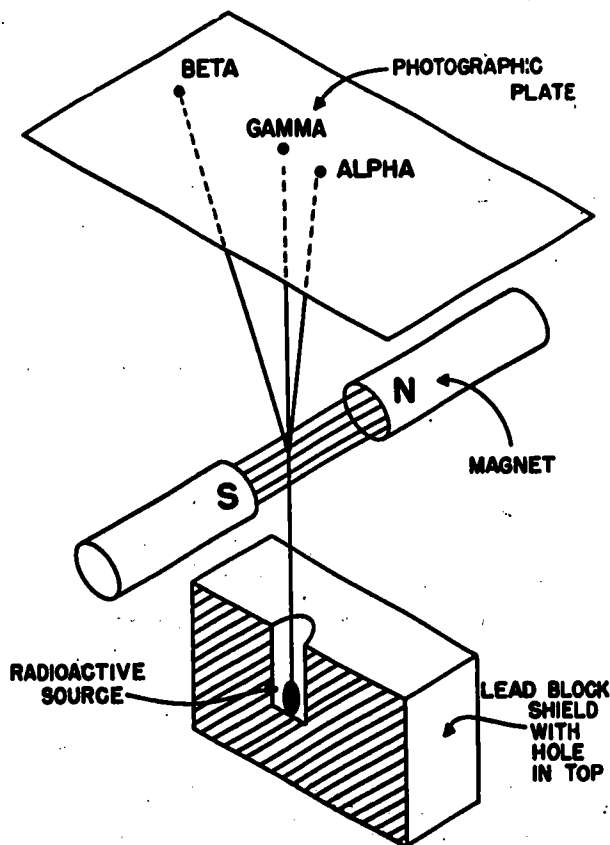

Figure 12-5.—The three hydrogen isotopes.

PRINCIPLES OF GUIDED MISSILES AND NUCLEAR WEAPONS



144.61
Figure 12-6A.—Radiation deflection experiment, showing three types of radiation.

and spin dependence in the forces, the protons cannot all be on the nuclear surface. To take up nuclear space, then, an excess of neutrons will be required, since these particles will experience no charge repulsion, but only nuclear forces. Protons on opposite sides of the nucleus will in fact experience no direct nuclear force, but only an electrostatic force. However, they are bound nuclearly to common intermediate internal nucleons, and so the small electric repulsion is not sufficient to expel them. In other words, since the binding force of a nucleon is greater than the electric repulsive force, the nucleus stays together.

When there are too many protons in a nucleus, however, the nucleus generally will remain bound, but it may be that a lower energy state will exist for an isobar (isobars are elements which have the same mass numbers but

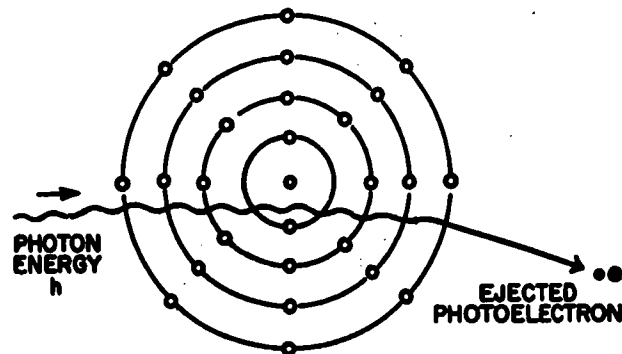

(a)

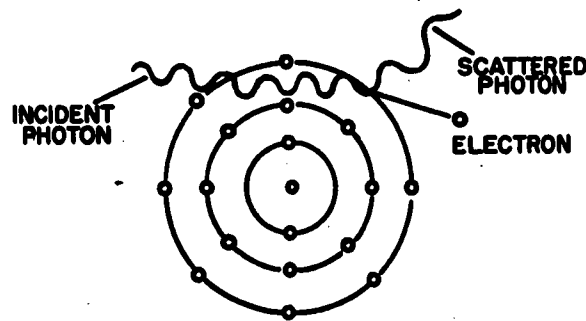

(b)

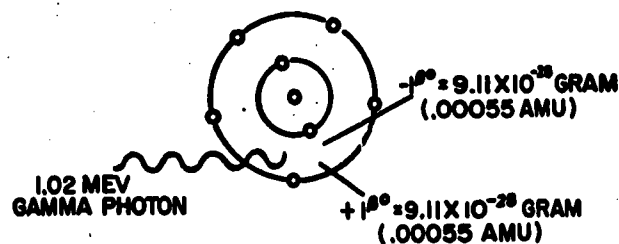

(c)

5.159:160
Figure 12-6B.—Absorption of gamma rays, showing (a) photoelectric effect; (b) Compton effect; (c) pair production.

different atomic numbers). In each case, the proton finds it desirable to change identity, becoming a neutron, and kicking off its charge in the form of a positive beta particle (positron). Therefore, β^+ radioactivity results from too low a neutron-proton ratio. In a similar process, and a more common type of radioactivity, a neutron may change itself into

a proton and a negative beta particle (electron), which is ejected. This type of change results from the fact that there are too many neutrons in the nucleus, and there is a lower energy state for the isobar with a lower n/p ratio. Therefore, β - radioactivity results from too high an n/p ratio.

When a radioactive isotope contains too many neutrons, a neutron in the nucleus changes to a proton and an electron, which is ejected as a beta particle. The new nucleus which is formed has no change in atomic mass number, but the atomic number increases by one. For an example:



When an alpha particle is emitted from the nucleus, this nucleus changes to a new nucleus because it loses the two protons and two neutrons which make up the alpha particle. An example of this would be:

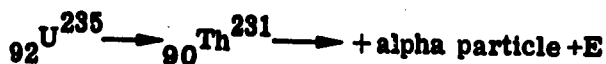

The emission of a gamma ray does not change the structure of the atom since it still has all of its protons and neutrons. Gamma decay may occur alone if the nucleus has more energy than is necessary for stability. More often gamma rays are emitted in conjunction with other products, especially beta rays.

CHEMICAL VERSUS NUCLEAR REACTIONS

Nuclear reactions involve atomic nuclei. They are quite different from chemical reactions. In chemical reactions, changes occur in electron configurations, but the atomic nuclei remain the same. An explosion results from the very rapid release of a large amount of energy. When equal masses are considered, nuclear energy release is of a much greater magnitude than chemical energy. Two kinds of nuclear reactions that satisfy the conditions for the production of a large amount of energy in a short time are "fission" and fusion." The complete fission of one pound of fissionable material can produce as much energy as 8,000 pounds of TNT; the fusion of one pound of fusionable material would release roughly the same amount of energy as 26,000 pounds of TNT. So you can see that the energy release of

nuclear reactions is tremendously greater than energy release of chemical reactions. We have covered nuclear reactions only briefly at this time; they will be covered more thoroughly in a later section of this chapter. Their practical importance will become evident in later chapters.

RADIOACTIVITY

PRELIMINARY

Radioactivity can be defined as the process by which one or more types of radiation are emitted from a nucleus because the nucleus is unstable. Although we can predict from experience and observation whether a nucleus is unstable, it is impossible to predict accurately when a particular nucleus will undergo radioactive decay. The rate of decay for a particular radioactive isotope is described statistically for a large number of atoms in much the same way that an insurance company can predict the lifespan of an "average" man living in the United States, although it is impossible to predict when any particular individual will die. This use of a large number of atoms is valid because even a small amount of material contains a very large number of atoms.

Natural Radioactivity

With very few exceptions, naturally radioactive materials will be found toward the end of the table of elements. (See figures 12-1.) Each nucleus has its own particular rate of radioactive decay; it may decay within a fraction of a second or it may take billions of years. Some scientists believe that all elements probably go through the process of decay; but for some the process is so slow that our instruments cannot detect it, so we say that these elements are stable. One of the active isotopes (uranium) finally becomes lead through a series of radioactive decay, but the process takes billions of years.

Induced Radioactivity

It is possible to change a stable element into a radioactive element by bombardment of its atoms in a nuclear reactor. All of the existing elements can now be made radioactive by bombardment in this manner. Hundreds of different radioactive isotopes can be produced

PRINCIPLES OF GUIDED MISSILES AND NUCLEAR WEAPONS

artificially. Their use is widespread in medicine and industry, as well as in research. For example, radioactive phosphorus is used to treat skin cancer; it emits beta particles, which do not penetrate very deeply. Radioactive iodine is used for the treatment of diseases of the thyroid because these glands have an affinity for iodine and attract it.

Figure 12-7 is a diagrammatic representation of manmade radioactivity, in this case a short-lived activity called **TRANSMUTATION**, or the changing of one element to another. A nitrogen 14 atom is bombarded by an alpha particle. It absorbs the alpha particle and is very briefly fluorine 18. The fluorine 18 quickly emits a proton, leaving a nucleus of 8 protons and 9 neutrons, which is oxygen 17, a stable isotope.

RADIOACTIVE SERIES DECAY

There are three families of naturally radioactive elements—uranium (fig. 12-8, the uranium series), thorium, and actinium. Each of these families has a separate isotope of lead as a final product. These isotopes disintegrate or decay in a definite series of steps, until a stable end product is finally formed. At each step in this process, either an alpha or a beta particle is emitted from each reacting nucleus; in some of these processes gamma rays are emitted. Figure 12-8 shows the steps in the decay of uranium.

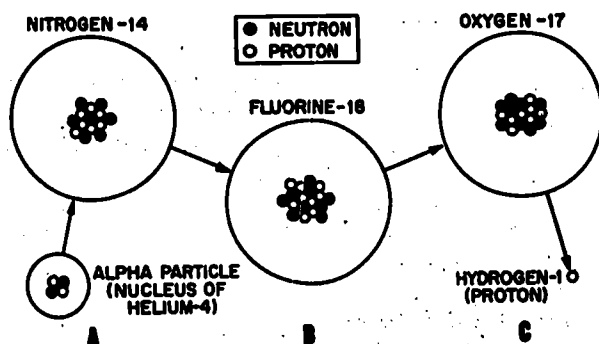

5.41

Figure 12-7.—Artificial or induced radioactivity. A. Bombardment of a nitrogen 14 atom with an alpha particle; B. The alpha particle is momentarily absorbed, forming fluorine 18; C. One proton cast off, leaving oxygen 17.

ELEMENT	SYMBOLS	HALF LIFE	RADIATION
Uranium	${}_{92}\text{U}^{238}$	4.5×10^9 years	α
Thorium	${}_{90}\text{Th}^{234}$	24.1 days	β, γ
Protactinium	${}_{91}\text{Pa}^{234}$	1.14 minutes	β, γ
Uranium	${}_{92}\text{U}^{234}$	2.35×10^5 years	α
Thorium	${}_{90}\text{Th}^{230}$	8×10^4 years	α, γ
Radium	${}_{88}\text{Ra}^{226}$	1612 years	α, γ
Radon	${}_{86}\text{Rn}^{222}$	3.825 days	α
Polonium	${}_{84}\text{Po}^{218}$	3.05 minutes	α
Lead	${}_{82}\text{Pb}^{214}$	26.8 minutes	β, γ
Bismuth	${}_{83}\text{Bi}^{214}$	19.7 minutes	β, γ
Polonium	${}_{84}\text{Po}^{214}$	1.5×10^{-4} sec	α
Thallium	${}_{81}\text{Tl}^{210}$	1.32 minutes	β
Lead	${}_{82}\text{Pb}^{210}$	22.2 years	β, γ
Bismuth	${}_{83}\text{Bi}^{210}$	4.97 days	β
Polonium	${}_{84}\text{Po}^{210}$	138 days	α
Lead	${}_{82}\text{Pb}^{206}$	stable	

144.62

Figure 12-8.—Table of the uranium series of decay.

Alpha Radiation

It has already been noted that alpha radiations are positively charged and have relatively little penetrating power. Due to the large positive charge of an alpha particle (+2), it has a strong attraction for electrons. Alpha particles passing through a material tend to strip electrons from the atoms in this material.

At first the alpha particles are traveling too fast to capture electrons. But while slowing down, or after stopping, the alpha particle gains two electrons and becomes a stable helium 4 atom. Although the fast alpha particles do not capture electrons, they are able to strip them from atoms of the material they pass through, so that positive ions remain in their path. Alpha particles are the most heavily ionizing radiation found in natural radioactivity, and can produce as many as 70,000 ion pairs in one centimeter of travel.

Beta Radiation

You will recall that beta radiation is characterized by a negative charge. Further analysis

Chapter 12—FUNDAMENTALS OF NUCLEAR PHYSICS

shows that beta particles have the same charge and mass as electrons; thus they were identified as high speed electrons of very high energy. Beta particles also have the ability to ionize atoms in material through which they pass; but because of the difference in size and speed, their ionizing ability is approximately one one-hundredth that of an alpha particle. The beta particle travels faster than the alpha particle, and therefore is more penetrating.

Gamma Radiation

The loss of an alpha or beta particle sometimes leaves a radioactive nucleus with an excess quantity of energy, which it emits almost immediately as a gamma ray. This radiation is different from the other types in that it is electromagnetic in nature. Since gamma rays have no charge, they are unaffected by magnetic or electric fields (fig. 12-6). Their ionizing ability is much less than that of either alpha or beta radiations, although they have much greater penetrating power.

Because gamma rays have no charge, and are electromagnetic in nature, you might expect that gamma interaction with matter would be impossible. This is incorrect, however, because gamma rays are able to interact in three separate ways—by the photoelectric effect, by the Compton effect, and by pair production.

PHOTOELECTRIC EFFECT.—Under certain conditions, a gamma ray can physically collide with an orbital electron. The electron is then ejected from the atom after absorbing the gamma ray completely (fig. 12-6B(a)), causing ionization. Photoelectric ionization by gamma rays is primarily a low energy interaction, and falls off rapidly with an increase in gamma energy. The greatest probability of the photoelectric effect occurring is in the higher Z numbered atoms and low energy gamma rays. The gamma rays emitted from the outer shells of atoms are of lower energy than those from the inner shells.

COMPTON EFFECT.—In this interaction, only part of the gamma ray is absorbed by the electron. The gamma ray suffers a loss of energy and is scattered as it ionizes the atom (fig. 12-6B(b)). This effect is maintained at higher energies than the photoelectric effect, but drops off rapidly in much the same manner.

PAIR PRODUCTION.—When a high-energy gamma ray passes near a nucleus, it can change from electromagnetic energy into an electron and

a positron (a particle with the same mass as the electron but with a positive charge). (See figure 12-6B(c).) Energy-mass transformation is represented by the equation $E = mc^2$. The mass of each particle is 0.00055 amu. One amu is convertible to 931 Mev. Using $E = m \times 931$, the minimum energy required for pair production is $(2)(0.00055)(931) = 1.02$ Mev. It has been found that energy cannot be converted to mass unless the nucleus is present to conserve momentum. There is another phenomenon called inverse pair production, or ANNIHILATION. This occurs when a positron and an electron react to form two photons of 0.5 Mev each.

Neutron Radiation

The dangers from alpha, beta, and gamma radiation have become well known. Another type of radiation hazard is presented by neutrons. These are usually found in dangerous numbers around nuclear reactors or in deposits of fissionable material. Neutrons are neutral particles with a mass slightly greater than that of the proton, about one amu. Since neutrons are uncharged, they cannot ionize atoms by attracting negative or positive particles. However, neutrons do cause ionization by indirect means. This secondary ionization may be produced by a recoil mechanism wherein a neutron collides with a proton (the nucleus of the hydrogen atom); the proton will then produce ionization as it moves through matter. This recoil mechanism is important because the human body is largely made up of compounds containing hydrogen (water being the most abundant).

Neutrons are both a cause and a result of fission and fusion reactions. They do not travel far because they are either quickly captured or undergo decay, which results in the release of radiation. Their range of travel depends on their speed; there are both fast and slow neutrons.

HALF LIFE

The spontaneous emission of radiation from radioactive material is a gradual process. It takes place over a period of time, at a rate depending on the nature and amount of the material. A useful term for expressing the rate of radioactive decay is HALF LIFE. The half life is the time required for one-half of a given amount of a radioactive isotope to decay. Again, this is a statistical term based upon a very large number of atoms. As long as we have a large number of

PRINCIPLES OF GUIDED MISSILES AND NUCLEAR WEAPONS

atoms of a radioactive isotope, one-half of these atoms will decay in one half life, so that eventually only a small fraction of the original isotope remains. If a given number of atoms of a particular radioactive isotope is allowed to decay for one half life, only 50% of the original isotope will remain. If allowed to decay for another half life, only 25% will remain. Likewise, during each additional half life of decay, one-half of the remaining atoms will decay (fig. 12-9).

Half life can be expressed in any convenient time units. The half lives can be found in suitable tables or nuclide charts. Some typical examples of half lives are:

${}_{92}\text{U}^{238}$ alpha emitter: 4.51×10^9 years

${}_{84}\text{Po}^{210}$ alpha emitter: 138.4 days

${}_{94}\text{Pu}^{239}$ alpha emitter: 24,300 years

${}_{38}\text{Sr}^{90}$ beta emitter: 28 years

When a nucleus undergoes radioactive decay, it is attempting to reach a more stable state, but the new nucleus that is formed may also be radioactive. In fact, a whole chain of radioactive "daughter" nuclei may be formed before a stable nucleus is finally reached. There are many chains of radioactive isotopes of this type. See figure 12-8 for the uranium series.

Practical Application

Rate of decay is very important when considering safety. It is this measurable feature of decay that makes it possible to reoccupy areas that have been contaminated by radiation from an accident or the debris from a nuclear explosion, after waiting for the radiation to be reduced by decay. After a few days or weeks (depending on the type of radioactive material), too few of the radioactive atoms are left to do much harm. Some of these atoms, of course, remain radioactive for years.

HALF THICKNESS

As has already been mentioned, radioactive substances emit particles and rays that produce ionizing reactions in previously normal atoms or molecules. Under competent control and proper safeguards, radiation can be harmless, as when a hospital corpsman makes a chest X-ray. It can even be a power for good, as when a surgeon trained in radiology destroys cancerous cells without damaging much of the patient's normal tissue. But out of control, or without proper safeguards, radiation can be one of the great hazards of our time.

It was previously explained that alpha particles have low penetrative power. Ordinary clothing, or even unbroken skin, will prevent them from entering the body from the outside. The only way one can suffer much ionization damage from alpha particles is by eating, breathing, or otherwise taking into the system, some

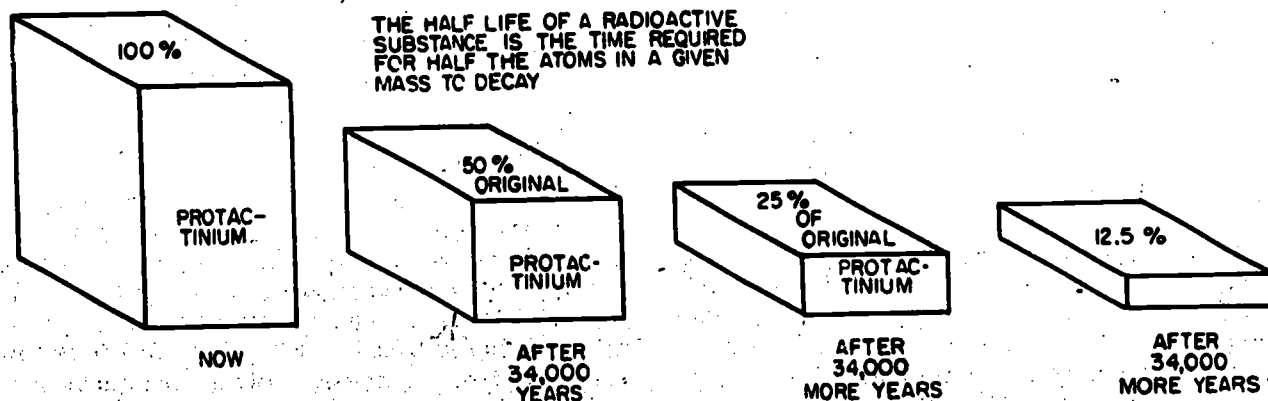

Figure 12-9.—The principle of half life.

radioactive isotopes that will become lodged in the body and remain there through a series of half lives.

Beta particles traveling in air are effective within about 10 feet of their source. Denser substances, like wood or water, limit their effective range to about a thousandth of its value in air. Normal clothing gives substantial (though not complete) protection against beta radiation.

It is, however, the gamma rays produced by all radioactive decay, and the free neutrons that characterize manmade nuclear reactions, that are grave threats to health and life. Nuclear power plants must be shielded to protect the operators and other personnel from these radiation hazards.

Although gamma radiation is never completely absorbed in passing through matter, absorption can be discussed in terms of half thickness. This is the thickness of a shielding substance necessary to cut the radiation intensity in half. As figure 12-10 shows, the half-thickness varies from one shielding substance to another. It also varies with the type of radiation (neutron or gamma) that is under consideration.

RADIATION UNITS

In order to discuss the effects of radiation damage quantitatively we must have a unit of radiation. The basic unit for the activity of a radioactive substance is the CURIE. This unit establishes the activity (that is, the decay rate) of radium as the standard with which the activity of any other substance can be compared.

By using a formula that takes into account the number of atoms per gram and the value of half life in seconds, scientists have determined that the activity of radium is equal to 3.7×10^{10} nuclear disintegrations per gram per second. This value is then a unit of comparison.

A curie of any radioactive substance, therefore, is the amount of that substance that will produce 3.7×10^{10} disintegrations per second. For example, it would take 6,615 pounds of natural uranium to produce one curie. In the manufacture of radioactive isotopes for medical and industrial purposes, the curie is too large a unit for convenient use. A commonly used submultiple of the curie is the microcurie, 3.7×10^4 disintegrations per second.

At the opposite extreme, the curie is too small a unit for measuring the high-order activity produced by a nuclear explosion. For this purpose the megacurie (3.7×10^{16}) is used.

Since radiation is detected by the ionization it produces, and since its effects on organisms are due to ionization, one way to measure radiation is by the amount of charge it produces in a given volume or mass. For this purpose a unit called the roentgen is used. A roentgen is defined only for gamma or X-radiations. It is the amount of X-ray or gamma radiation required to produce by ionization one electrostatic unit (esu) of charge in one cubic centimeter of air at standard temperature and pressure.

In the Radiation Health Protection Manual, NavMed P-5055, a roentgen is defined as "That amount of X- or gamma radiation which will produce 2.083×10^9 ion pairs in 1 cc of air under standard conditions. One roentgen of X- or gamma radiation is considered to deliver one Rad" (radiation absorbed dose.)

A rad is the absorption of 100 ergs/gram in whatever material is under discussion. Note that for this unit the type of material must be specified. This allows for a distinction between such things as soft tissue and bone.

Since the roentgen is the measurement of X- or gamma radiation, we need a term for

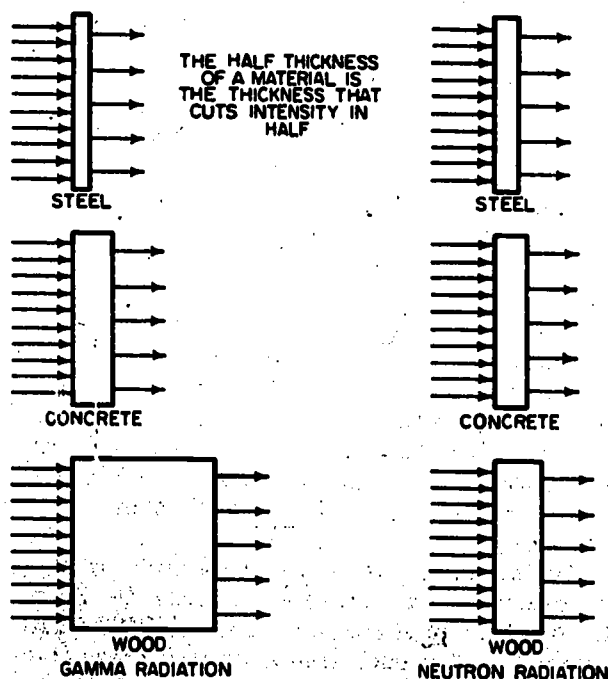

5.43
Figure 12-10.—Typical examples of relative half thickness.

PRINCIPLES OF GUIDED MISSILES AND NUCLEAR WEAPONS

alpha and beta radiations, as these particles also cause ionization. The proper term for this is the REM (roentgen equivalent mammal). A rem is the quantity of ionizing radiation of any type which, when absorbed by man or some other mammal, produces a physiological effect equivalent to that produced by the absorption of one roentgen of X- or gamma radiation.

There is another factor which is used by the Bureau of Medicine and Surgery to obtain a quantity which equates to a common scale the biological effectiveness of any type of ionizing radiation to which an individual is exposed. This is the Quality Factor.

For X-, gamma, or beta radiation the quality factor is 1

For neutrons of unknown energy, and protons, the quality factor is 10, that is, a given quantity of neutrons would cause ten times as much bodily damage as the same amount of gamma radiation.

For ionizing particles heavier than protons the quality factor is 20.

The Human Body

The human body is made up of many different systems, such as the respiratory system and the digestive system. These systems are further divided into organs, which in turn are made up of tissue. Although tissue may differ from organ to organ, there are remarkable similarities between tissues of different organs. All tissues are composed of cells. Because of differences in the response of various kinds of cells to radiation, the biological effect of radiation on different tissues will vary. Cells vary from tissue to tissue, but they have many common features.

Since radiation affects the cell, and individuals are composed of a large number of cells, you should know something of the effects of radiation on cells.

All cells with the exception of the red blood cells have common components including the membrane, cytoplasm, nuclear membrane, and nucleus (Note that "nucleus" is a biological term here unrelated to the atomic nucleus.) The nucleus is the controlling center of the cell, and is the part most susceptible to radiation damage. It is well known that the body is in a continuous state of decay and repair. Some cells are dying while others are dividing into two to replace them. During this process of division, the nucleus of the cell is particularly

sensitive to radiation; therefore the cells which divide the most rapidly are the most sensitive. You can classify cells into least sensitive and most sensitive types. The most sensitive are those of bone marrow, lymph glands, hair follicles, and skin. The least sensitive are those of the bones, nerves, muscles, and brain.

All this seems somewhat intricate, but it is necessary for a discussion of the effects of radiation on living matter. The effects of radiation exposure also depend on how fast the radiation is delivered. If it is delivered slowly, the body has time to repair some of the damage. For example 1,000 roentgens delivered in a few seconds would almost inevitably prove fatal within a month, but the same amount delivered uniformly over a lifetime would produce relatively little effect.

UTILIZING IONIZATION PHENOMENA

There are two terms commonly used in discussing ionization phenomena. They are dose and dose rate. Dose is the total quantity of radiation absorbed by an organism during a single radiation experience. Since the roentgen and the rad are concerned with the charge per unit of volume and the energy absorption per unit of mass, the part of the organism involved in a dose must be specified. For example, if a 1,000-rad dose were received in the forefinger, the effects would be quite different from those of a 1,000-rad whole body dose.

By dose rate is meant a radiation dose per unit of time. This could be expressed in roentgens per hour (r/h), milliroentgens per hour (mr/h), or rem/hour.

Radiation Detectors

Radiation cannot be detected by any of the human senses. Instruments must be used to detect the presence of radiation. These instruments, called radiacs (Radioactivity Detection, Indication, and Computation), are used to detect the interaction of radiation with some type of matter.

Of the many ways that a particle or photon of radiation can transfer energy to matter, the one that is of concern here is IONIZATION. Remember that each time an ionizing event takes place, an ion pair is formed. This pair consists of a positively ionized atom and a free electron. In a radiation detector, these free electrons are collected on a positive electrode.

To collect the free electrons there must be an electric field in the detector.

Figure 12-11 shows a basic radac circuit. Radiation interacts with the detector sensitive volume (usually a gas) and gives a pulse of electrons. A power supply is needed to provide the necessary power for detector operation. The electronic circuits shown are amplifiers, multivibrators, and other standard circuits. The output of the detector can be displayed on either a scaler or a count rate meter.

Most of the radiacs in current use are designated as beta-gamma detectors, alpha detectors, or neutron detectors. Although most of these instruments are designed to count pulses, their output indication depends on the type of radiation they are designed to detect. Beta-gamma instruments are calibrated in roentgens per hour or milliroentgens per hour. Alpha detectors are usually based on the number of radioactive disintegrations per minute that the material is undergoing, or counts of disintegration per minute that are being detected.

NUCLEAR REACTIONS

In a nuclear reaction there is usually a bombarding particle called the INCIDENT PARTICLE. When the incident particle hits a nucleus at rest, this nucleus is called the TARGET. If a particle is emitted in the reaction, this is the EJECTED particle.

The proton, neutron, electron, positron, alpha particle, and gamma ray all may cause a nuclear reaction.

Neutrons, when used as bombarding particles, have very little difficulty in penetrating into a target nucleus. Although there is a

positively charged electric field due to the protons already in the target nucleus, the neutron effectively does not "see" this electric field since it has no charge of its own. When the neutron comes within approximately 10^{-13} centimeters of the nucleus, it will be subject to the great cohesive (attractive) nuclear forces.

For the proton, or any other positively charged particle, the above process does not hold. The proton, for example, will encounter a positively charged force field due to the protons in the nucleus. Since the proton is positively charged, the force field is repulsive in nature. The repulsive field increases very rapidly until the proton gets to about 10^{-13} centimeters from the nucleus. The cohesive attractive forces start acting at this distance and overcome the repulsive forces. The proton may then enter the nucleus. The effect is as if there were a "wall" that the proton must penetrate. This "wall" is called a BARRIER. The barrier ends approximately 10^{-12} centimeters from the center of the nucleus.

LAWS OF MASS-ENERGY RELATIONSHIP

You no doubt have heard the expression that nothing is wasted or lost in nature. For hundreds of years, physics classes were taught that matter can be changed, but not destroyed. Burning a piece of wood changes it to smoke, heat, and ashes. This is called the law of conservation of matter.

Another conventional law of physics is the law of conservation of energy. This law states that one form of energy can be converted to another form, but the energy is not lost or destroyed.

These two laws were the basis on which all chemistry was built. The energy coming out of radioactive substances such as uranium puzzled the scientists—it seemed that energy was being created. Albert Einstein worked out the answer to this puzzle by his theory of relativity. He showed that matter and energy are different forms of the same thing. Matter can be destroyed, but energy is created. Einstein declared (and proved mathematically) that mass and energy are exactly equivalent—mass can be converted to energy, and even the reverse is true—energy can sometimes be converted to mass. It is the total mass-energy of the universe that remains constant. When an atom is split, some of its mass is changed to energy, that is, mass is destroyed to produce energy.

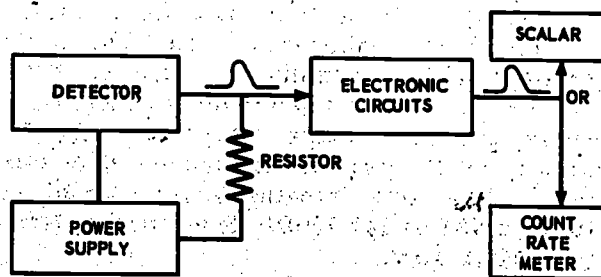

Figure 12-11.—Basic radac circuit.

144.63

PRINCIPLES OF GUIDED MISSILES AND NUCLEAR WEAPONS

Chemical changes, as we have learned, involve only the movement of the outermost electrons of atoms, and therefore relatively little energy is used to make a chemical change, freeing the electrons of one atom and recombining them with the electrons of another atom to form a molecule. The loss of energy is so small it cannot be measured with any laboratory instrument.

The forces binding together the parts of nuclei are vastly stronger than the forces binding together the atoms of molecules. To break these forces requires a large amount of energy. It is not entirely understood what forces hold the neutrons and protons together in the nucleus, but it is called **BINDING ENERGY**. Electrons are held in place by electrical force. The amount of energy that appears in a chemical change, such as the uniting of a carbon atom with two oxygen atoms, is only a few electron volts. When an unstable nucleus emits radiation, the nucleus that remains weighs slightly less (that is, has less mass) than the original nucleus. The small amount of mass that disappears is transformed into the tremendous amount of energy represented by the blast, heat, and radiation. This is the conversion of mass into energy, the fundamental fact behind the entire atomic energy field.

The amount of energy that would be released by the disappearance of a given amount of matter can be computed by applying Einstein's equation:

$$E = mc^2$$

E is energy in ergs

m is mass in grams

c is the velocity of light (3×10^{10} centimeters per second; when squared or multiplied by itself, this becomes 9×10^{20} , or 9 followed by 20 zeros)

We can use the positron-electron annihilation process as an example of the conversion of mass to energy (the form of energy is gamma rays). The mass of the positron and electron is 9.11×10^{-28} grams. The square of the speed of light is 9×10^{20} , so

$$E \text{ in ergs} = 2 \times 9.11 \times 10^{-28} \times 9 \times 10^{20} \text{ or} \\ E = 1.64 \times 10^{-6} \text{ ergs}$$

Since the energy of gamma rays is given in electron volts, we must convert ergs to electron volts. One electron volt is equivalent to 1.60×10^{-12} ergs, hence

$$\frac{1.64 \times 10^{-6}}{1.60 \times 10^{-12}} = 1.02 \times 10^6$$

or 1.02 mev.

From this example you can readily see that 1.02 mev of energy was created from the conversion of 18.22×10^{-28} grams of matter (.00110 amu).

BINDING ENERGY; MASS DEFECT

The table of atomic masses shows the proton, neutron, and electron to have masses of 1.00759, 1.00899, and 0.00055 atomic mass units, respectively. One might suppose that the mass of an atom could be determined by counting the number of neutrons, protons, and electrons, and simply adding the masses of these basic particles. Let's take a common isotope of fluorine, ${}^9\text{F}^{19}$, and see if this is true. This isotope has 9 protons, 9 electrons, and 10 neutrons. 9 protons would have a total mass of 9.06831, 9 electrons would have a total mass of 0.00495, and 10 neutrons would have a total mass of 10.08990. The sum of the atomic mass units would be 19.16316. From the table of atomic masses we find that the known mass of this isotope is 19.00445 amu. The difference between the known mass and the sum of the masses is 0.15871 amu. It appears that the fluorine atom is missing this amount of mass. This is not really an error, as it would seem. When an atom is formed from the basic particles, a certain amount of mass disappears and changes to energy, which is released in accordance with Einstein's $E = mc^2$. The mass that is lost is called the **MASS DEFECT**. Every different atom has a different mass defect. The energy that is released when the atom is formed is called **TOTAL BINDING ENERGY**. Conversely, this total binding energy is what is necessary to break an atom into its fundamental parts: protons, neutrons, and electrons.

The binding energy of an atom can be determined from the formula $E = M \times 931$, in which E is the energy in millions of electron volts (Mev), M is the lost mass (mass defect) in atomic mass units (amu), and 931 is the constant. This formula is derived from $E = mc^2$. It can be used to determine energy release whenever mass disappears, as, for example, in the isotope of fluorine discussed above. The total binding energy would be $0.15871 \times 931 = 147.75901$ Mev, or approximately 147.8 Mev.

An important factor in considering the stability of a nucleus is the average binding energy per nucleon. This is simply the total binding

Chapter 12—FUNDAMENTALS OF NUCLEAR PHYSICS

energy divided by the number of nucleons in the nucleus. The binding energy per nucleon in the above example would be: $147.8/19 = 7.8$ Mev per nucleon. This means it would take approximately 7.8 Mev to remove a proton or neutron from this atom.

Although total binding energy is larger for larger nuclei, binding energy per nucleon varies as shown in figure 12-12.

Because of the strong nuclear bonds in the nucleus, those with the highest binding energies per nucleon are the most stable and the least likely to undergo FISSION, the process of splitting a nucleus into two lighter nuclei, or FUSION, the process of combining two light nuclei into a larger nucleus.

NUCLEAR FISSION

PIONEER STAGES. During the late 1930's scientists were conducting several types of "atom-smashing" experiments. One of these experiments involved the use of the neutrons from the deuterium (heavy hydrogen) atom as high-velocity bullets to bombard small quantities of uranium. This experiment produced a result that even the specialists were reluctant to believe until all other possible explanations had been tried and discounted. Some of the uranium atoms had been split into almost equal parts, to form new atoms of barium and krypton.

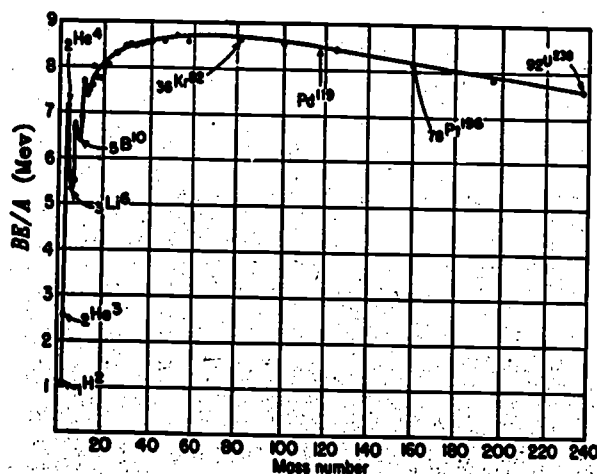

Figure 12-12.—Binding energy per nucleon chart.

The physicists could explain this phenomenon in only one way. The heavy uranium nucleus taxes its binding energy almost to the breaking point, much as an oversize dewdrop taxes its surface tension. If all conditions are favorable, a slight, sudden stab against the dewdrop, or the impact of a single neutron against the uranium nucleus, suffices to split either into two nearly equal parts.

The startling experiment was repeated a number of times, and the energy liberated by the reaction was carefully measured. The energy per atom proved to be about 5,000,000 times that of burning coal. Here, then, was a discovery that might have tremendous practical importance, provided the fission reaction could be sustained and controlled.

FISSIONABLE MATERIALS. An intensive search for fissionable materials revealed three substances with practical possibilities as nuclear "fuel." They are as follows:

- U²³⁵, a uranium isotope constituting 0.7% of natural uranium,
- Pu²³⁹, an artificial isotope of an element plutonium that is itself (for all practical purposes) man-made,
- U²³³, an artificial isotope of uranium, derived in a reaction involving thorium.

NEUTRON PRODUCTION. Free neutrons are the major tools of the nuclear physicist. They have the proper size and weight to invade the atomic nucleus, and their electrically neutral character keeps them from being repelled by the protons. For large-scale nuclear fission operations, man needs an abundant supply of neutrons.

For laboratory purposes, the physicist can bombard the atoms of a light element (boron or beryllium, for example) with alpha particles or gamma rays from certain radioactive isotopes, or with charged particles from a cyclotron or other accelerator. All these methods result in neutron emission.

In the practical production of radioactive materials, he secures free neutrons by the nuclear reactions themselves. Studies of radioactive series decay have shown that some fissions result in the freeing of at least one neutron. Under proper control, the free neutrons can be put to work.

CONTROLLING THE NEUTRON.—In any nuclear reaction except a planned explosion, both the production rate and the speed rate of free

PRINCIPLES OF GUIDED MISSILES AND NUCLEAR WEAPONS

neutrons must be kept under control. This is an essential safety precaution.

When emitted from their atoms, some neutrons travel fast—at about 1/20 the speed of light. For some purposes, such as the splitting of the heavy but firmly bound nuclide like U²³⁸, the high kinetic energy of fast neutrons is required. In other nuclear processes—including the fissioning of unstable heavy nuclides such as U²³³, U²³⁵, and Pu²³⁹—a much lower neutron speed is desirable; fast neutrons would simply pass through these nuclides, exciting them but failing to produce fission.

By control methods that will be mentioned shortly, it is possible to decrease the speed of neutrons to about 1/10,000 of the maximum possible value. At this low speed, the kinetic energy of the neutrons is about equal to that of a gas under standard conditions. For this reason they are called thermal neutrons.

The term slow neutrons includes thermal neutrons, but is much less restricted in meaning.

To slow down fast neutrons, the designers of nuclear reactors use substances or devices called moderators. Good moderating materials are elements from the low end of the table of the nuclides, and compounds formed from these elements. Moderating substances include (but are not limited to) hydrogen, carbon, beryllium, ordinary water, heavy water (in whose molecule deuterium replaces common hydrogen), and paraffin.

When a free neutron enters a moderator, it collides with (but does not penetrate) one nucleus after another, losing energy with each collision. Eventually it leaves the moderator at a greatly reduced velocity.

Moderating materials can be designed to serve as reflectors. These are layers or structures that turn stray neutrons back toward the parts of the reactor where they will serve a useful purpose.

Substances that allow free neutrons to enter but tend to hold them captive are called absorbers. These substances are used in the safety shields and control rods that are required in all designs for nuclear reactors. If unavoidably present where they are not desired, absorbing substances reduce efficiency.

NEUTRON REACTIONS.—Not all emitted neutrons behave alike. Frequently they cause non-fissioning reactions, typical examples of which are sketched in figure 12-13. The moderators and absorbers recently described are deliberately used to produce non-fissioning reactions. It is possible, however, for such reactions to occur even within fissionable substances.

In elastic scatter (also called elastic collision) a neutron or other particle touches or nearly touches the target nucleus, then bounces away. No nuclear energy is released, though the colliding particle may transfer some of its kinetic energy to the nucleus.

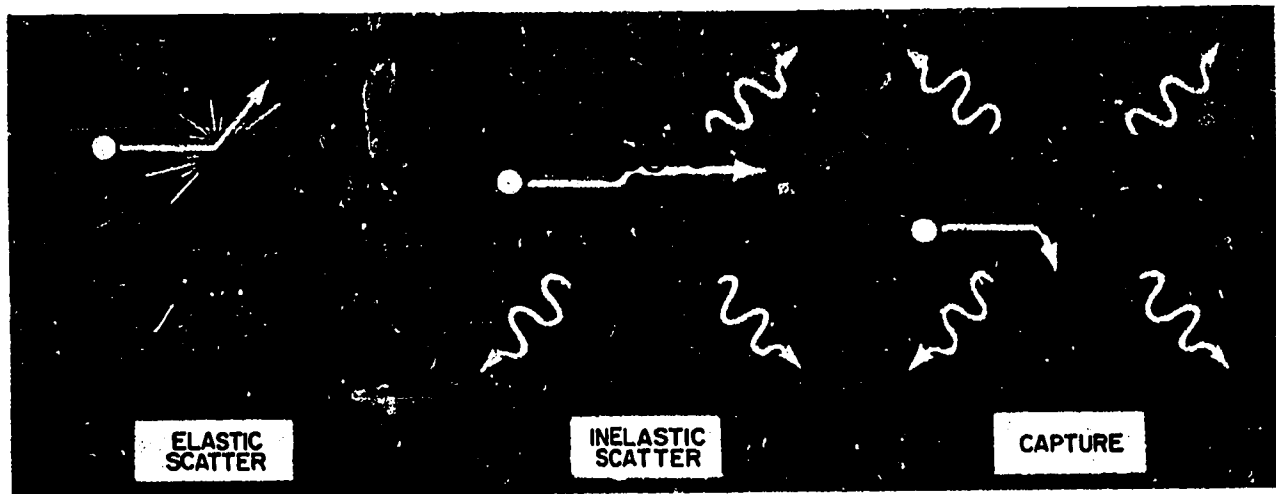

Figure 12-13.—Some non-fissioning reactions.

33.275

In inelastic scatter, part of the energy of the collision excites the target nucleus and causes it to give off gamma radiation. The bombarding particle may merely touch the target nucleus, or it may actually pass through it as shown in the central part of figure 12-13.

The reaction called particle ejection on bombardment resembles inelastic scatter, with the difference that one particle enters the nucleus and a different particle leaves it. Gamma radiation accompanies this reaction.

In CAPTURE a neutron (or, rarely, some other particle) enters the target nucleus and stays there. This reaction, once again, excites the target nucleus and produces gamma radiation. By the capture of a neutron, the nucleus changes from one isotope to another.

When the bombarding particle splits the target nucleus into two smaller nuclei, as shown in figure 12-14 the reaction is, of course, FISSION. Though omitted from this drawing for the sake of simplicity, the planetary electrons of the fissioning nucleus are divided between the product nuclei when the new atoms are formed. The result, then, is the production of two lighter and often more stable atoms.

Since fissionable substances have a high ratio of neutrons to protons, their transmutation to medium-weight substances is usually accompanied by the liberation of at least one spare neutron. This neutron is welcomed by the physicist, for it becomes a tool for possible use in producing the NEXT fission. It is the emission of free neutrons that makes possible a self-sustaining chain reaction.

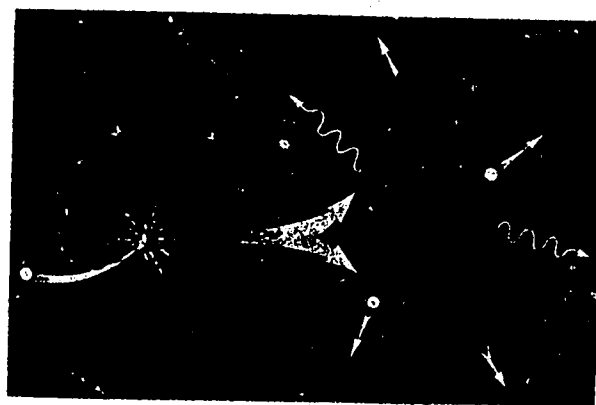

Figure 12-14.—A representative fission reaction.

5.44

CHAIN REACTIONS.—The two neutrons liberated by fissioning in figure 12-14 may behave in any of the various ways that have just been summarized. If conditions are especially favorable to fissioning, they may both produce fissions. Under slightly different conditions, one may cause fissioning and one may be captured. As long as any fissioning reaction can be traced back, step by step, to the original fission, the process is a chain reaction.

The term chain reaction is not the exclusive property of the nuclear physicist. It may be used to describe any chemical or physical process in which the products of one stage (sometimes called a generation) act to produce the next stage.

Chain reactions fall into three classes: nonsustaining, sustaining, and multiplying.

A nonsustaining (or convergent) chain reaction comes to a dead stop sooner or later. In this reaction, too few products of the various stages are effective in producing new stages. The process, therefore, cannot continue very long.

The nonsustaining chain reaction shown in figure 12-15 starts with one neutron as the initial fission particle. This produces three neutrons; 2 escape and 1 causes a second fission. The second fission produces 3 neutrons; 2 are captured by impurities, 1 escapes, and the chain reaction stops.

In a SUSTAINING (or stationary) reaction the gains by new fissions exactly balance the various types of losses. Consequently, as shown in figure 12-16 the reaction continues at a constant strength. Figure 12-17 shows a multiplying (or divergent) chain reaction. In each generation, the reaction products (in this instance, free neutrons) that are gained exceed those that are lost. If conditions were especially favorable, the ratio of gains to losses would be still higher.

The nature of any nuclear chain reaction depends, in part, on the purity of the fissionable material used. Impurities cause more neutrons to be lost through scatter or capture.

The nature of the reaction also depends, in part, on the mass and shape of the fissionable material. Even for highly refined fissionable substances, there are limits below which there are too few atoms to support a chain reaction. This brings us to the problem of criticality.

A mass (in a given shape) that is just great enough to support a sustaining chain reaction is called a CRITICAL mass. A SUBCRITICAL

PRINCIPLES OF GUIDED MISSILES AND NUCLEAR WEAPONS

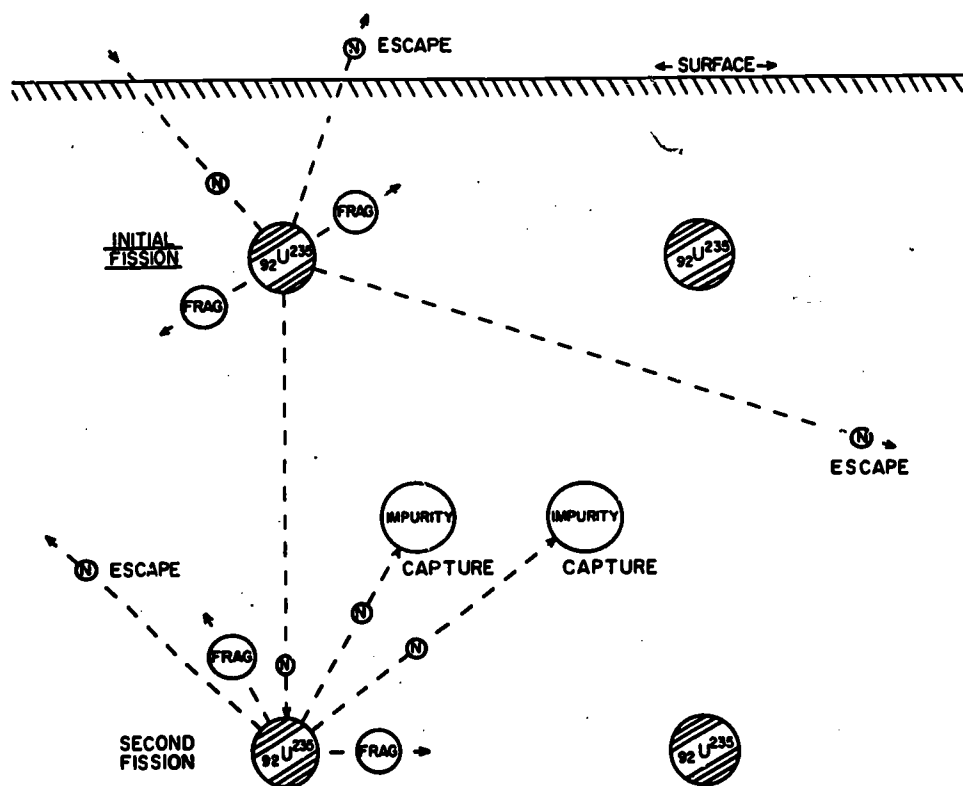

144.65

Figure 12-15.—Example of nonsustaining chain reaction.

(smaller than critical) mass will support only a nonsustaining chain reaction. A SUPER-CRITICAL mass will support a multiplying chain reaction.

FISSION BOMB POSSIBILITIES.—As a very necessary safety precaution, the masses of fissionable material present in a nuclear bomb must be kept subcritical until time for the bomb to be detonated. Then a supercritical mass must be formed very rapidly. One way of producing a supercritical mass is by forcing two or more subcritical masses together. Another way is to squeeze a subcritical mass tightly into a new shape and/or a greater density that becomes supercritical without the addition of any more substance.

In a weapon, an efficient, rapidly multiplying chain reaction is essential. Ideally, no free neutron should be lost to the process. If the first fission produced two free neutrons, each of these neutrons should produce two more fissions, each of which fissions should

liberate two neutrons, and so on. The fissions would then increase by geometric progression (1, 2, 4, 8, 16, 32, 64, 128, 256, 512, 1024, 2048, 4096, and so on).

The eighty-first step of this process results in 2.5×10^{24} fissions—enough to transmute a kilogram of refined uranium. The time required for the 81 steps is $1/10^8$ second. These are the types of numbers that had to be considered in the design of the Hiroshima bomb.

UTILIZING SUSTAINING REACTIONS.—When “atomic fuel” is used to produce power—as in some ships now in commission, other ships under construction, and certain experimental electric plants ashore—a sustaining type of chain reaction is required. Neutron production must not be allowed to get out of control; neither must it be allowed to die out.

The designers of nuclear reactors must face and solve many problems related to the production of an efficient, controllable chain reaction. These problems are beyond the

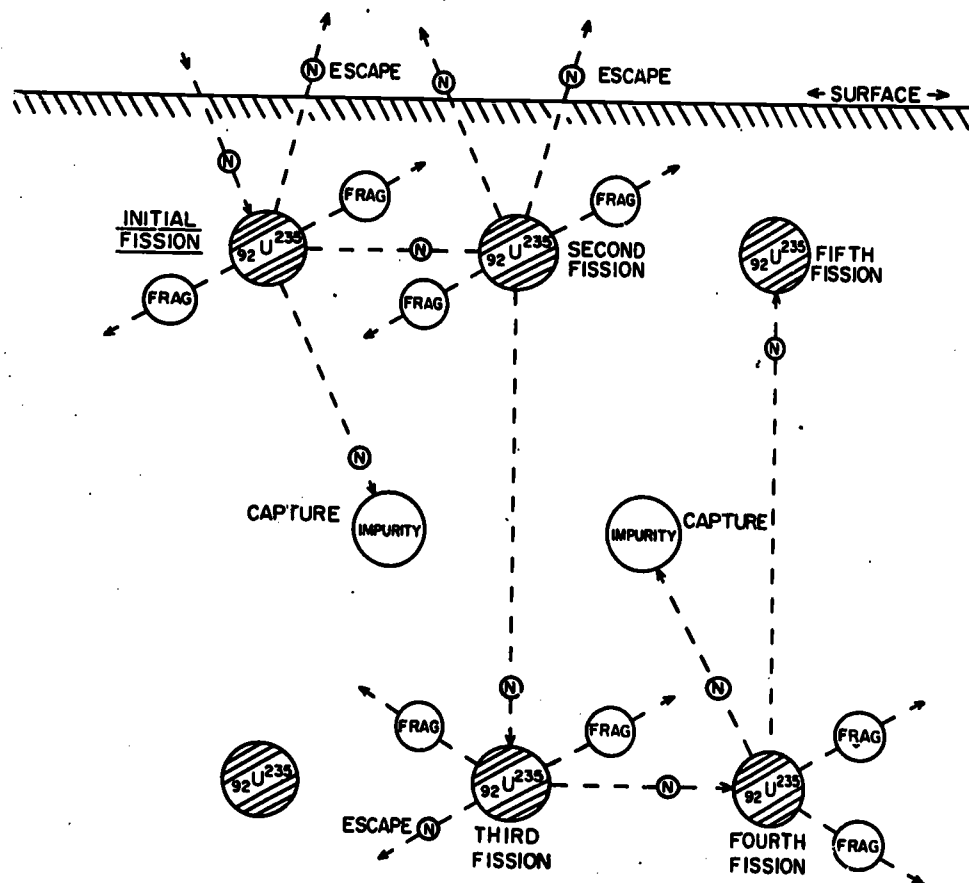

Figure 12-16.—Example of a sustaining chain reaction.

144.66

scope of this chapter, but are discussed in texts on nuclear power engineering.

Other problems center about the safety factors—both for the equipment itself and for the people who operate it or live near it. Even the disposal of waste products must be carefully planned to avoid present and future dangers.

NUCLEAR FUSION

As briefly mentioned before, fusion is the merging of two light nuclei to form a heavier one, with an accompanying conversion of mass to energy. For reasons that will be mentioned soon, fusion reactions are often called THERMONUCLEAR reactions.

SUITABLE SUBSTANCES.—In order to fuse, two nuclei must come very close together with enough kinetic energy to break the binding force

of one of the nuclei. Because protons repel one another, thus tending to keep the nuclei containing them apart, the single-proton hydrogen nuclei would seem to be the most promising materials for the fusion reaction.

Because they have no neutrons, two atoms of ordinary hydrogen cannot fuse to form a heavier element. Deuterium or heavy hydrogen, with one proton and one neutron per atom, is more promising. Experiments have shown that two atoms of deuterium can fuse, producing an atom of tritium (radioactive hydrogen) plus an atom of ordinary hydrogen. Alternatively, two atoms of deuterium can react to produce the helium isotope ${}_{2}\text{He}^3$ plus a free neutron. Either reaction liberates nuclear energy.

Any tritium produced by fusion can react with deuterium to produce the helium isotope ${}_{2}\text{He}^4$ plus a free neutron. This reaction again releases nuclear energy.

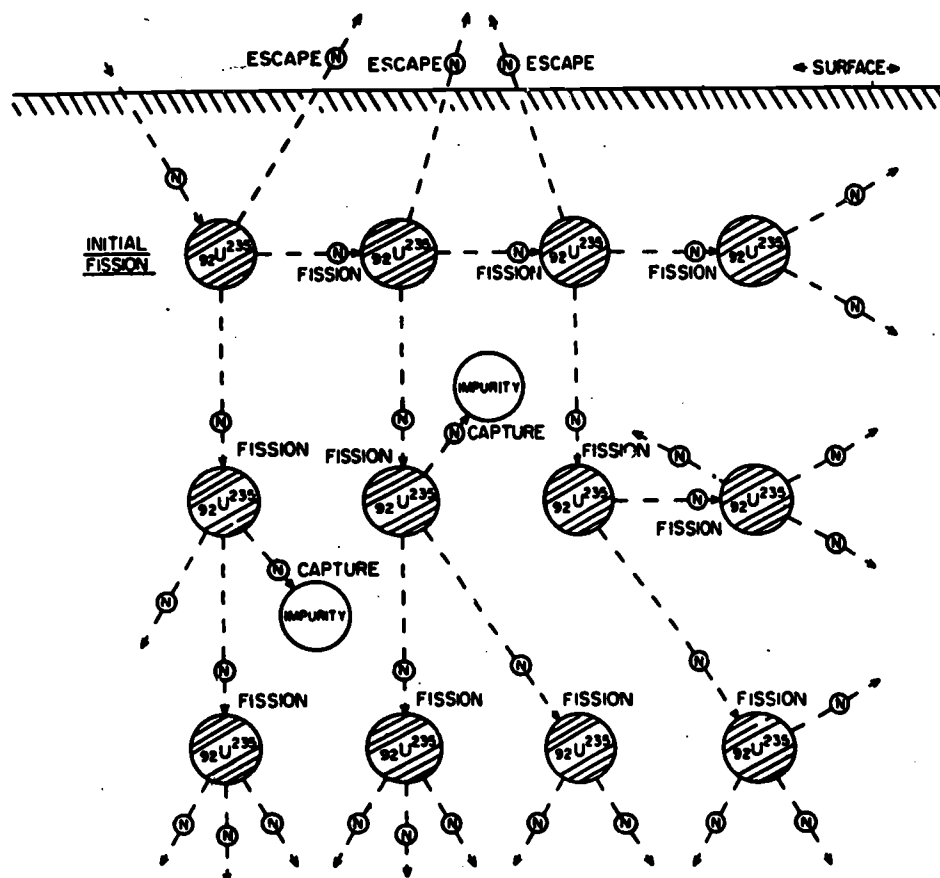

144.67

Figure 12-17.—Example of a multiplying chain reaction.

Deuterium, then, is an effective source of energy, provided it can be made to fuse at all. To achieve fusion, a very high value of kinetic energy must be expended in forcing any two deuterium nuclei to unite. In laboratory experiments, artificial acceleration of nuclear particles has produced enough energy to initiate small-scale fusion reactions. Mechanical acceleration of particles, however, is not feasible in nuclear weapons, nor is it adaptable to industrial energy production.

Thus far, heat has proved to be the only form of kinetic energy capable of initiating a fusion reaction large enough to have practical applications. Temperatures comparable to that of the sun—millions of degrees Centigrade—are required. A multiplying fission chain reaction produces these temperatures. Naturally the

container is vaporized by the reaction; this is suitable for a weapon.

Fusion weapons, then, are really fission-fusion weapons, in which fission occurs first and acts to trigger the still greater fusion reaction. Because heat provides the kinetic energy necessary for their functioning, fusion weapons are sometimes called THERMONUCLEAR weapons.

FUSION AND FISSION COMPARED.—Both fusion and fission liberate nuclear energy. The two reactions differ in several respects.

One aspect, the means of initiation, has already been discussed. Fission results when a supercritical mass of suitable heavy material is rapidly formed. The reaction occurs automatically as soon as the free neutrons, already present in the fissionable material, are supplied with a large enough number of atoms

Chapter 12—FUNDAMENTALS OF NUCLEAR PHYSICS

to support the process. Fusion does not occur automatically; it must be initiated by the application of extremely high kinetic energy to suitable light substances—namely, deuterium and tritium.

There is a practical limit to the size of a fission weapon and, therefore, to the amount of energy that can be released by this reaction. If a weapon contains more than a limited number of subcritical masses of fissionable material, it becomes unsafe to handle and transport. No such limit is placed on the amount of heavy hydrogen a fusion weapon can contain; this weapon may be as large as the available launching devices permit. Much greater de-

struction, therefore, is possible with fusion weapons.

Fission produces a large number of RADIOACTIVE PRODUCTS—gamma rays, nuclear particles, and isotopes of various middle-weight elements. Some isotopes decay in a short time. Others have a long half life and can remain dangerous for a comparatively long time. A few long-lived isotopes, including strontium⁹⁰, tend, if they enter the body at all, to become lodged in the bones. There they can cause radiation damage over a period of years. Fusion, on the other hand, has tritium as its only radioactive product, and the tritium is itself fused with deuterium to produce stable helium.

CHAPTER 13

PRINCIPLES OF NUCLEAR WEAPONS AND THEIR HANDLING

INTRODUCTION

SCOPE

This chapter will discuss hypothetical fission and fusion weapons, and will make some comparisons between the two types. The classification of this publication prevents the description of specific marks and models of nuclear weapons, but a general description will be given. The emphasis will be on underlying principles, rather than on design details and operational sequences.

Like the assembled weapons, the fuzes and other nonnuclear parts of nuclear weapons will be covered without reference to specific Service design.

The latter portion of this chapter will discuss the basic organization of the nuclear weapons field, and some of the problems related to the use and handling of nuclear weapons.

IMPORTANCE

The Navy has a wide variety of officer billets. Many of these billets are indirectly related to weaponry. All present officer billets, however, are concerned with security, safety, defensive measures, and, whenever necessary, disaster relief. All of these officer responsibilities are graver and more complex, now that nuclear warfare has become a part of the Navy. Whether or not he expects ever to be directly in charge of any phase of the nuclear weapons program, every young officer needs such information as he will find in this chapter and in other non-classified summaries.

FISSION WEAPONS

GENERAL REQUIREMENTS

It must be remembered that the nuclear material in a nuclear weapon is always in a sub-

critical condition until certain sequential steps have been accomplished; this ensures that there can be no spontaneous nuclear detonation. The importance of the critical mass must be emphasized. It is this inherent feature of the nuclear weapon which makes its operation unique among weapons. In fact, it is the requirement that criticality must first be attained that makes the nuclear weapon the safest weapon in the nation's defense stockpile.

In this course it is neither desirable nor permissible to cover all the details of nuclear weapons. However, some basic knowledge of how they operate is considered essential. The essentials for a practical nuclear weapon consist of the following:

- a. A sufficient quantity of fissionable material to produce the desired energy release. This material is in a subcritical state prior to the firing sequence of the weapon.
- b. A system for bringing these subcritical masses to supercriticality at the desired time.
- c. Conventional requirements for any weapon which would include a power source, fuzing and firing circuits, a means of control, and monitoring.
- d. Safety and safing devices.

As in conventional weapons, nuclear weapons require fuzing devices to detonate them. These fuzing devices consist of: Barometric pressure switches, sometimes called Baros; internal timers, both electric and mechanical; sensing radars; hydrostatic pressure switches, commonly called hydrostats; and contact crystals. Some weapons have more than one type of fuzing built into them and, therefore, have a fuzing option. The control crystals may be used as a backup device to preclude the possibility of a dud weapon.

Chapter 13—PRINCIPLES OF NUCLEAR WEAPONS AND THEIR HANDLING

Fissionable Material

As mentioned in chapter 12, fissionable material for use in nuclear weapons consists of suitable isotope of uranium or plutonium. When a mass of one of these isotopes—supercritical in size and shape—is very rapidly formed, a high order multiplying chain reaction automatically begins. If the design features of the weapon permit this reaction to continue, a powerful explosion will result.

If the design features do not favor a rapidly multiplying chain reaction, the fission will produce only a low order explosion; the weapon may even be a complete dud. In view of the tremendous cost of fissionable materials and the military importance of the targets at which fission weapons are directed, it is important that these weapons perform reliably. This section covers some of the practical problems that have been met and resolved by the designers of fission weapons.

Confining the Reaction

The presence of stray neutrons in the atmosphere makes it impossible to prevent a chain reaction in a supercritical mass of fissionable material. It is necessary that, before detonation, the weapon not contain any fissionable material that is as large as the critical mass for the given conditions. In order for an explosion to occur, the material must then be made supercritical within a very short time. Extreme rapidity is necessary, because if the chain reaction were to be initiated by stray neutrons before the fissionable material reached its most compact form, a relatively weak explosion would occur.

Obviously a nuclear reaction cannot be contained for very long. Yet this reaction must be confined until it has gained so much momentum that it will produce an explosion of maximum power.

One way to confine the fission reaction would be to use a high density material to provide inertia, which would delay expansion of the exploding material. This material acts like the familiar TAMPER in blasting operations. In addition to its primary function of confining the nuclear reaction during its early stages, the tamper also acts as a REFLECTOR from which neutrons bounce back into the reacting mass

much as a tennis ball bounces from a solid object. This also increases the efficiency of the weapon.

Achieving Criticality

The means of achieving criticality depends, among other things, upon the total mass of fissionable material present. If there is just enough mass present to produce a sustaining chain reaction, it is said to be a critical mass. If less mass were present, a subcritical mass which will only maintain a nonsustaining chain reaction results. A multiplying chain reaction is supported by a supercritical mass.

Some of the means used to increase criticality are:

1. Purifying the material chemically to decrease the possibility of capture.
2. Enrichment of the fissionable material; for example, increasing the amount of uranium 235 compared to uranium 238.
3. Surrounding the material with a high density material which will reflect escaping neutrons back into the material.
4. Increasing the density of the fissionable material, which also reduces the escape probability.
5. Using shapes with a minimum surface-to-volume ratio to reduce neutron escape (a sphere would be ideal).

There is one other method that is used to some extent. This is by bringing two subcritical masses together, thereby increasing the surface-to-volume ratio.

GUN PRINCIPLE

One of the methods by which subcritical fissionable material can be brought to criticality is used in GUN type nuclear weapons (fig. 13-1). In this type two separated subcritical masses are brought together to make a supercritical mass. Essentially this is attaining criticality by increasing the quantity of fissionable material.

The two subcritical masses of active material are separated sufficiently so that there is no possibility of a chain reaction developing; and hence no nuclear detonation. At the desired instant, two events take place. First, the two subcritical masses are brought together in a very short interval of time to form a supercritical mass. This is accomplished by means of firing conventional propellants which shoot

PRINCIPLES OF GUIDED MISSILES AND NUCLEAR WEAPONS

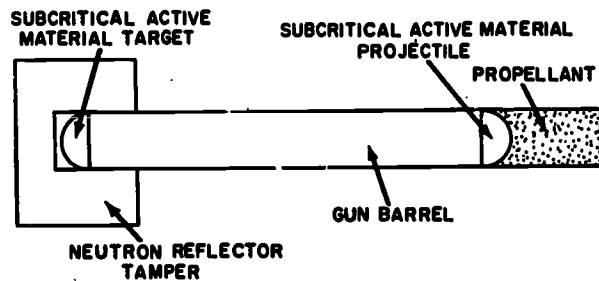

144.68

Figure 13-1.—Idealized gun type weapon.

the subcritical projectile mass through a type of gun barrel into and in contact with a subcritical target mass. When these two masses reach supercriticality, a nuclear detonation results. Second, by surrounding the target mass with a suitable tamper, it reflects neutrons back into the active material, increasing the reaction, and holds the active material together just a little longer, so that the enormous pressure built up increases the effectiveness of the explosion.

IMPLOSION PRINCIPLE

Another method by which subcritical masses can be brought to criticality is the basic design of the implosion type nuclear weapon (fig. 13-2).

In this type of nuclear weapon, criticality is not achieved by adding more material, but by squeezing the subcritical mass into a smaller volume by means of tremendous pressure. This increases the density and thus the criticality of the fissionable mass. The pressure applied to squeeze uranium or plutonium into a smaller volume is developed by detonating high explosives in such a way that the pressure wave moves inward. In other words, by implosion.

It is important to note that for a full scale nuclear detonation to take place, the implosion wave must move inward from all directions. To ensure this happening, a number of detonators are imbedded in the high explosive and all must detonate at the same instant.

When the explosive is detonated, a smooth shock wave moves inward against the sphere of active material, striking it with equal force at all points. As a result of this compression, the material is increased in density and a multiplying chain reaction automatically begins.

NEUTRON SOURCES

A question may arise as to the origin of the first generation of free neutrons in a fission weapon.

One neutron source is the uranium or plutonium as originally assembled in the weapon. Even in subcritical masses, these radioactive

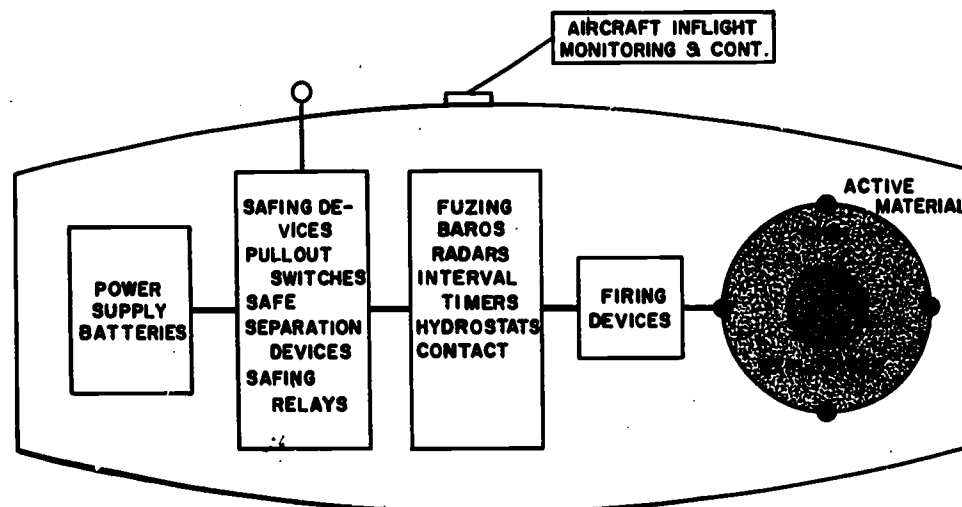

144.69

Figure 13-2.—Idealized implosion type weapon.

Chapter 13—PRINCIPLES OF NUCLEAR WEAPONS AND THEIR HANDLING

substances undergo a small amount of spontaneous fission that results in the release of free neutrons.

The designer of nuclear weapons, however, wishes to be absolutely certain that an abundance of neutrons will be available for use as soon as the mass becomes supercritical. Therefore he places in or near the fissionable material a special capsule called the INITIATOR.

This capsule contains two substances. One could be a reliable alpha emitter such as polonium or radium; the other a light element such as beryllium. When the light element is bombarded with an alpha particle, neutrons are emitted. The capsule is carefully designed to prevent any premature neutron development.

The same mechanical impulse that forms the supercritical mass shatters the initiator and makes emitted neutrons available to start the multiplying chain reaction.

FUSION WEAPONS

PRELIMINARY

As explained in chapter 12, nuclear energy is released not only by the splitting of heavy nuclei (the fission reaction) but also by the joining of light nuclei to form heavier ones (the fusion reaction).

FUSIONABLE MATERIAL is the material with low atomic numbers which produces nuclear energy by the fusion of nuclei. The low number atomic nuclei have lower binding energies than uranium or plutonium. Upon hearing this statement for the first time, one might question quite justifiably why fusion weapons were not developed first. The reasons are several; but the main reason is the amount of initiating energy required.

Energy Requirements

Neutrons, the particles used in producing large-scale fission reactions, possess the advantages of electrical neutrality. To cause fission, a free neutron has to pierce the binding energy of a heavy nucleus that is already in unstable equilibrium, but it does not have to overcome any electrostatic repulsion.

When two light nuclei fuse to form a heavier element, at least two mutually repellant protons are involved. One proton is in the nucleus that

(for the sake of simplicity) we can regard as the target; the other is in the nucleus that we can regard as the projectile. The projectile nucleus must be impelled with enough kinetic energy to pierce the nucleus of the target, in spite of the repulsive forces that act between the two protons or sets of protons.

The energy requirements do not have to be guessed; for the various combinations of target and projectile nuclei, they can be computed by standard formulas of nuclear physics. When the United States began in earnest to develop a nuclear weapon, the fusion reaction was ruled out as being unlikely of achievement, on a practical scale, by any means available to man. After fission detonations had been achieved and their effects had been studied, however, the physicists began to suspect that the thermal energy released by a fission reaction might possibly be adequate to start a fusion detonation.

A fission explosion reproduces—briefly and in small space—intensities of light and heat comparable to those in the sun. A fusion explosion does still more; it duplicates a part of the actual process by which the sun and OTHER stars produce their light and heat. This process is not a chemical burning reaction; it is a nuclear fusion reaction in which four nuclei of simple hydrogen become one nucleus of stable helium, with a conversion of mass to radiant energy. The next article will summarize the solar cycle.

SOLAR FUSION CYCLE.—Man has reproduced—on small scale under laboratory conditions—the six-stage process by which, according to the currently accepted theory, the sun “burns hydrogen as fuel.” The process involves carbon, which undergoes a series of transmutations as it captures one proton (hydrogen nucleus) after another, then suddenly emits all the captured hydrogen (now fused into a single helium nucleus) and regains its original identity. Figure 13-3 shows the sun’s continuously repeated cycle.

In the first stage simple carbon (C^{12}) fuses with hydrogen (H^1), with an accompanying release of radiant energy representing the mass lost in the fusion. A similar fusion and release of energy take place in the third and fourth stages. In the second and again in the fifth stage, the constantly growing nucleus emits a positive electron; this means, in each instance, that an excess negative charge remains on the nucleus and, in effect, converts a captured

PRINCIPLES OF GUIDED MISSILES AND NUCLEAR WEAPONS

proton to a neutron by counterbalancing its positive charge.

In the sixth and final stage a fourth proton is captured. If the previous pattern were followed, the growing nucleus would emit energy and become simple oxygen (O^{16}); but this doesn't happen. Instead, the nucleus becomes violently excited and emits all four of the captured particles, thus regaining its original identity as simple carbon.

By the time of emission, the four captured protons (two of which, as already noted, have been converted to neutrons) have achieved identity as an alpha particle, which is, of course,

simply a helium nucleus. The carbon has merely acted as a catalyzing agent to bring four hydrogen nuclei together and hasten their fusion into helium. This is the cycle by which, for its millions of years of existence, the sun has been heating and lighting our solar system. The astrophysicists estimate that enough hydrogen remains to keep the cycle going for ten billion more years.

FUSIONABLE MATERIALS

CHOICE.—In the sun, then, hydrogen and carbon nuclei take part in a revolving, self-perpetuating process in which carbon becomes

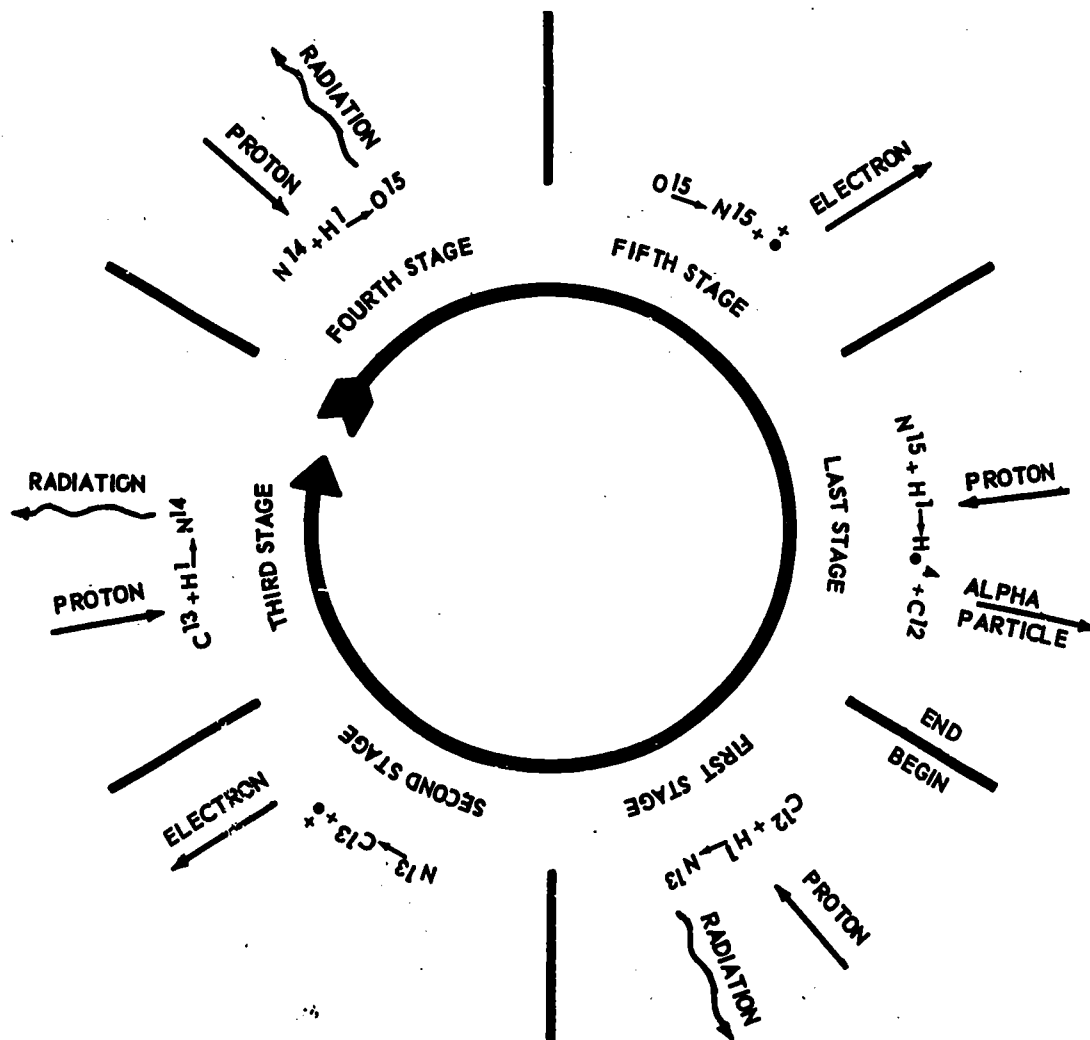

Figure 13-3.—Fusion in the sun.

33.278

Chapter 13—PRINCIPLES OF NUCLEAR WEAPONS AND THEIR HANDLING

nitrogen and oxygen isotopes, and then reverts to carbon when all the captured hydrogen fuses into helium. In designing the first fusion weapon, the physicists decided against trying to reproduce the carbon-hydrogen cycle.

The reason was a practical one. Through not complex, the carbon, nitrogen, and oxygen nuclei involved in this cycle have higher binding energies than the two hydrogen isotopes deuterium (${}^2_1\text{H}$) and tritium (${}^3_1\text{H}$). Since the problem of supplying adequate initiating energy was known to be difficult at best, it seemed wise to choose the simplest reagents possible. The reagents must have both neutrons and protons; this requirement ruled out ordinary hydrogen, but not deuterium and tritium.

PRACTICAL FUSION REACTIONS. As mentioned briefly in chapter 12, two deuterium nuclei can fuse in either of two ways, as follows:

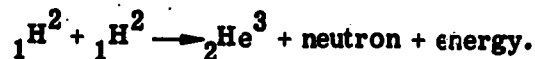
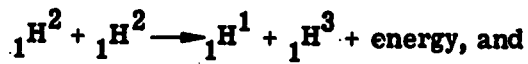

A fusion weapon can, then, be based on deuterium. The tritium produced in one of the two possible deuterium fusion reactions is the radioactive hydrogen isotope identified as H3 in figure 12-5. It does not become an end product, but rather enters into the fusion reaction by combining with deuterium, as follows:

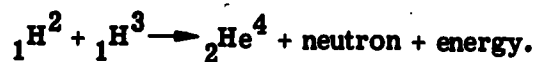

In the fusion weapon, then, as in the sun, hydrogen becomes helium, with a release of energy.

As a fusion reaction progresses and the heat intensifies, other nuclear reactions may (and sometimes do) take place. It is possible, for example, for the neutrons liberated during fusion to cause various fissions that would be unlikely to occur at lower temperatures.

Because it is usable from the beginning of the fusion process, tritium as well as deuterium may be included in the payload of a fusion weapon.

FUSION WEAPON CHARACTERISTICS

Nuclear fusion reactions can be brought about only by means of very high temperatures

(millions of degrees) and are referred to as thermonuclear processes; thus the term "Thermonuclear Weapon," or TN weapon.

Fusion Sequence

The first explosive reaction in a TN weapon is the detonation of a conventional high explosive or the burning of a conventional propellant. As a result, the mass of uranium or plutonium becomes supercritical, and fission begins. When the temperature becomes high enough, fusion of the deuterium (or deuterium and tritium) nuclei begins. As the fusion reaction progresses and the heat intensifies, other nuclear reactions may take place. The liberated neutrons may cause fissions that would not likely occur at lower temperatures. In general, the energy released in the explosion of a thermonuclear weapon originates in roughly equal amounts from fission and fusion processes.

WEAPON COMPARISONS

SIZE

When you studied the different types of weapons in use now and in the recent past, you found that the yield of fission weapons was in the kiloton range, while that of fusion weapons was in the megaton range. A fusion bomb can be many times more powerful than a fission bomb. A fission bomb is limited in size because the nuclear material must be no greater than the subcritical size. It would not be safe to handle or store if the amount of fissionable material in it were greater.

Fusion weapons are not limited in this way. It is no harder to detonate a large amount of deuterium or deuterium-tritium than a small amount; neither is it more susceptible to accidental detonation.

Through experimentation, physicists have found means for controlling the fusion reaction on a small scale. Further development of their techniques may make it possible to use the fusion reaction for nuclear power.

YIELDS

The power of a nuclear weapon is expressed in terms of energy release (or yield) when it explodes compared to the energy liberated by the

PRINCIPLES OF GUIDED MISSILES AND NUCLEAR WEAPONS

explosion of trinitrotoluene (TNT). Thus, a 1-kiloton nuclear weapon is one which produces the same amount of energy in an explosion as does 1-kiloton (or 1,000 tons) of TNT. Similarly, a 1-megaton weapon would have the energy equivalent of 1 million tons (or 1,000 kilotons) of TNT. The earliest nuclear bombs, such as those dropped over Japan in 1945, released roughly the same quantity of energy as 20,000 tons (or 20 kilotons) of TNT. Since that time, much more powerful nuclear weapons, with energy yields in the megaton range, have been developed.

The nuclear detonations in tests carried out by the United States have ranged from approximately 0.1 kiloton (in Nevada tests) to 15 megatons (in the Bikini tests).

FUZING TECHNIQUES

INTRODUCTION

In the hypothetical nuclear weapons described in this chapter, a conventional explosive reaction always acts as the trigger. This is followed by the fission and finally (if arranged for) the fusion reactions. Actually, then, the problem of fuzing a nuclear weapon is similar to the problem of fuzing conventional bomb type or gun type ammunition. The techniques may be somewhat more sophisticated, but the essential fuze components—arming system, detonator, safety arrangements, and so on—are all present.

A nuclear weapon may be designed to explode in the air, at the surface of the ground or water, or below one or the other of these surfaces. These considerations affect the choice of a fuze.

FUZING FOR AIR BURST

Heavy blast damage to a target area is frequently the most effective means of gaining a military objective. As chapter 14 will explain, a nuclear detonation in the air above a target produces widespread blast effect. Several types of fuzes can be used to initiate a detonation at a selected altitude.

RADAR TYPE. A fuze may be constructed to operate much like a small radar. It may transmit, receive, and compare electromagnetic pulses, and may fire when the signal (or combination of signals) meets specific built-in requirements.

The forerunner of current radar type fuzes was the proximity (or VT) projectile fuze of World War II. Because recent years have seen many improvements in electronic equipment, radar type fuzes are likely to be used extensively in the future.

BAROMETRIC TYPE.—As the reader will recall from earlier studies in basic sciences, the atmosphere exerts pressure. Like water pressure, atmospheric pressure increases with depth. The barometric switch (familarly called the BARO) is a fuzing device that responds to a predetermined value of atmospheric pressure.

The barometric initiating device has no exact counterpart in older bomb type weapons. It corresponds roughly, however, to the conventional hydrostats that are used in underwater ordnance.

TIMER.—Mechanical timing devices, representing various applications of the clock principle, are used in many conventional projectiles, bombs, and mines. Not all of these older clock mechanisms are used to cause firing at a preselected instant. Some are used, instead, to prevent firing from occurring before a given instant; these timers are associated with impact of influence devices that initiate the actual firing.

In an aircraft-launched nuclear weapon, of course, safety delays are vitally important to protect the launching craft and personnel. A timer can be designed to provide these delays, and also to close the firing circuit when the bomb has fallen a selected distance below the launching altitude. The dropping speeds of the various types of nuclear bombs are known; therefore the dropping distance is easily converted to an equivalent time interval.

FUZING FOR SURFACE BURST

A nuclear weapon, like a conventional one, may be designed to burst at the surface of the ground or water. An impact fuze, in which the shock of landing causes one operating component (or group of components) to move with respect to another, is used for surface bursts.

If a delayed explosion is desired, an impact fuze may contain a timing device that prevents the detonation from occurring immediately upon impact. A heavy weapon, falling from a high altitude, will penetrate some types of soil and may even bury itself. A delayed-action fuze permits this burial to take place.

Chapter 13—PRINCIPLES OF NUCLEAR WEAPONS AND THEIR HANDLING

FUZING FOR UNDERWATER BURST

Nuclear weapons, like conventional ones, are capable of underwater detonation by hydrostatic fuzes. Timing devices can also be used to produce underwater detonations.

SAFETY DEVICES

Because of the high destructive capacity of all nuclear weapons, the fuzes used in them must have positive protection against accidental or premature arming. Certain types of safety arrangements and accessories have performed reliably in conventional weapons. With adaptations and refinements, similar safety devices are usable in nuclear weapons.

ARMING WIRES.—The arming wire has long been familiar to naval aviators. This wire is threaded through a fuze to keep a movable component from taking its armed position. During launching, the fuzes (or equivalent devices) are freed from the arming wires.

In conventional aircraft bombs a delay period, provided by a windmill type vane and a gear train, keeps the fuze from becoming armed immediately after the arming wire has been removed. In the safe interval, the planting craft escapes from the danger zone.

OTHER SAFETY FEATURES.—Inertia, as the reader will recall from basic physics, is the natural tendency of a material object (if stationary) to resist being set in motion and (if moving) to resist any change in the direction or speed of motion. In weapons, the force of inertia can be utilized to produce a safety delay by retarding the relative motion between two components.

During the acceleration of a projectile in a gun barrel, inertia tends to force all parts of the fuze mechanism toward the rear. This manifestation of inertia—called **SETBACK** in gunnery—can be used to delay arming. Similarly, in several types of mine accessories and components, inertia is used either to prevent an undesired action or to cause a desired one.

Some fuzing arrangements for nuclear weapons use inertia as a means of achieving a safety delay.

Electrical arrangements constitute another means of assuring safety before and during launching, and for a selected period thereafter. Nearly all naval mines, for example, are assembled and planted with several breaks in the battery-to-detonator circuit. Each break

consists of a normally open switch that will not close until specific requirements have been met. Similar but not identical electrical interrupters are used in nuclear weapons.

PRACTICAL WEAPON TYPES

The active materials and other highly critical substances used in nuclear weapons are in limited supply as well as being very expensive. Therefore, a policy of attempting to make the fewest number of weapons cover as wide a range of military applications as possible has been pursued in the development of our nuclear weapons stockpile. This capability is achieved by planned interchangeability, and correlation of nuclear weapons design with concurrent planning and development of delivery vehicles. By means of conversion components, bombs can be converted to warheads, and warheads to bombs. In addition, by means of adaption kits, nuclear warheads can be made compatible with rockets, torpedoes, missiles and depth bombs.

BOMBS

Since the aircraft was the only practical delivery vehicle for large weapons during World War II, bombs were the first nuclear weapons to be placed in stockpile. A bomb is a stockpile storage configuration of an aircraft-delivered, free-fall, or retarded-fall nuclear weapon. Major components and nuclear components integrally contained in the basic assembly are considered to be a part of the bomb. A bomb is a major assembly designated by a mk-mod-alt system and stockpiled as a complete entity of one or more packages. Additional major assemblies such as fuze, firing set, radar, power supply, and nuclear components may be required to constitute a complete nuclear weapon.

MISSILE WARHEADS

Almost as soon as fission weapons had been proved practical, the thought of a guided missile with a nuclear explosive charge began to interest the ordnance engineers. Since that time, all of the armed services have developed reliable missiles capable of delivering nuclear payloads.

A nuclear warhead normally consists of a high explosive system, nuclear system, electrical circuitry, and the mounting hardware.

PRINCIPLES OF GUIDED MISSILES AND NUCLEAR WEAPONS

A check of unclassified sources indicates the following missiles as having a nuclear capability: The Navy's Polaris, Asroc, Subroc, Talos, and Terrier; the Army's Davy Crockett, Pershing, Sergeant, Little John, and the Nike-Hercules; and the Air Force's Atlas, Matador, Minuteman, Titan, Bomarc, and Genie.

OTHER APPLICATIONS

Projectile

The Army has developed a nuclear projectile that can be fired successfully from artillery howitzers.

Underwater Weapons

The Astor is a submarine-launched torpedo capable of carrying a nuclear warhead. The Navy also has developed a surface ship-launched rocket propelled weapon called ASROC, which may use a conventional torpedo or a nuclear depth charge as a warhead.

DELIVERY SYSTEMS AND TECHNIQUES

AIRCRAFT

The usual advantages and disadvantages of conventional aircraft bombing missions apply equally to missions involving nuclear weapons. The airplane is swift and maneuverable; it can penetrate far into enemy territory.

Because of the large blast damage of nuclear bombs, the crew must be protected from this damage once the bomb is dropped. One way to accomplish this could be to insert a timing mechanism in the bomb to provide a safe separation time. Another method would be to provide the bomb with a drag parachute to slow the bomb until a safe separation distance has been reached. This is described as a retarded-fall bomb. Both of these methods allow the aircraft to reach a point of safety prior to bomb detonation.

GUNS

As was previously stated in chapter 12, the gun is used by the Army and Marine Corps to fire nuclear projectiles at long ranges. Either a proximity fuze or timer can be used to detonate this weapon.

ATOMIC DEMOLITION MUNITIONS

ADMs are nuclear warheads adapted for use as emplaced demolition charges that can be used to destroy bridges, power stations, etc.

GUIDED MISSILES

There are several different types of guided missiles, for different applications, just as there are different types of launching systems, from the short range Terrier to the intermediate range Polaris, and the long range Atlas. Most of the guided missiles now in stockpile are adapted for conventional as well as nuclear warfare.

Safety is again of prime importance; a self-destruct package is an integral part of the warhead, to protect friendly personnel in case the missile goes off course, or fails in its intended mission.

In the Polaris missile system, a submerged submarine is, in effect, the launching platform for a deterrent or retaliatory missile. When used for this purpose, the submarine has many advantages. Nuclear propulsion and improved design have given the submarine a ranging power and a degree of maneuverability that would have seemed fantastic as recently as World War II.

UNDERWATER ORDNANCE

One of our newer weapons used the conventional torpedo tube as a launching platform. Subroc is a guided missile used for antisubmarine warfare. It is launched from a submerged torpedo tube, programmed through the air to reenter the water for a submarine kill. It provides ranges greatly in excess of present torpedo ranges.

SAFETY AND SECURITY

SAFETY PRECAUTIONS

In nuclear weapons, three main classes of components are subject to specific safety precautions. One class is the conventional high explosive or propelling charge. A second class is the complement of mechanical and electrical devices that provide for handling, arming, and firing. The third and final class is the nuclear material.

Chapter 13--PRINCIPLES OF NUCLEAR WEAPONS AND THEIR HANDLING

Conventional Explosives

As was explained previously, high explosives, propellants, and detonators are integral parts in the construction of nuclear weapons. Due to the presence of these explosive hazards, the danger from fire or an accidental detonation is always present, just as with conventional ammunition. High-explosive safety criteria developed for conventional weapons are equally applicable to nuclear weapons, whether or not any nuclear material is present.

Electrical and Mechanical Components

In addition to high explosive hazards there are also electrical and mechanical safety aspects of nuclear weapons. The same adherence to established safety criteria must prevail with respect to the handling and testing of electrical, electronic, and mechanical components of nuclear weapons. The same precautions used with high voltage, condensers, etc., are also applicable to nuclear ordnance. Similarly, conventional mechanical safety precautions in connection with handtools, power tools, chain hoists, dollies, etc., equally apply.

Nuclear Weapons Publications

These are publications promulgated by the Joint Atomic Weapons Publications System. Generally, all such publications are assigned an AEC-DASA number; those publications which bear upon the Navy have in addition a NAVY SWOP designation for Navy Special Weapons Ordnance Publication.

Publications include, for nuclear weapons and related equipment: General information or Definitions (4-), Reports (5-), Safety (20-), Assembly (35-), and Maintenance (40-) series of publications. For example, NAVY SWOP 20-1 is a publication on explosive safety.

Nuclear Components

All personnel assigned to work with fissionable or fusible materials must receive special training in the handling, storage, and accounting methods peculiar to these materials. Prior to such training they must possess at least a secret clearance based on a background investigation.

Although nuclear weapons are designed to prevent a nuclear yield in case of an accidental

detonation of a nuclear weapon, there is still a dangerous radiation hazard, unless proper safety procedures are followed. Uranium and plutonium may become dispersed as small particles as a result of impact or detonation of the high explosives, or as fumes if a fire occurs.

The Department of Defense and the U. S. Atomic Energy Commission have specially trained personnel prepared to deal with all aspects of accidents involving nuclear weapons. For example, our Explosive Ordnance Disposal school trains in all phases of high explosive recovery or disposal in case of an accident, and only trained personnel are authorized for this task.

SECURITY

Nuclear weapons, because of their strategic importance, vulnerability to sabotage, public safety considerations, and political implications, require greater protection than their security classification alone would warrant.

To prevent the possibility of accidental or deliberate launching or releasing of a nuclear weapon, there has been established a "two man" rule. This is that a minimum of two persons have access to nuclear weapons, each capable of detecting incorrect or unauthorized procedures in the task being performed.

Only properly cleared personnel who have need for access to a nuclear weapon, or who have a need to enter a space containing nuclear weapons will be allowed entry to these spaces. Only personnel of demonstrated reliability and stability will be assigned to this type of duty.

ELEMENTS OF ORGANIZATION

PRELIMINARY

When the secrets of nuclear energy were unlocked by the discoveries of scientists, men high in government realized that strict legal control must be enacted. The Atomic Energy Act of 1946 established the legal means for control and development of nuclear energy and the materials involved. This act was later amended by the Atomic Energy Act of 1954 to extend controls over the expanding research and use of nuclear energy, and to expedite research and development in this field for peaceful as well as military purposes.

PRINCIPLES OF GUIDED MISSILES AND NUCLEAR WEAPONS

ATOMIC ENERGY COMMISSION

The Atomic Energy Commission (AEC) took over control of all nuclear material from the Manhattan Engineer District in 1946. The AEC has outright ownership of all fissionable and fusionable material in the United States, and of all production facilities except those used for special research which are not adequate for production of nuclear materials in amounts sufficient for use in nuclear weapons.

The AEC is composed of five members, one of whom is designated as chairman. These members are appointed by the President of the United States, with the advice and consent of the Senate.

The Joint Committee on Atomic Energy is a congressional standing committee composed of nine Senators and nine Representatives. This committee makes continuing studies of the activities of the AEC and atomic energy.

The Military Liaison Committee is composed of a civilian chairman (assistant to the Secretary of Defense for Atomic Energy) and two representatives each from the departments of the Navy, Army, and Air Force. This committee advises and consults with the AEC on all matters that it believes relate to military applications of nuclear weapons or nuclear energy, including development, manufacture, use, and storage of nuclear weapons, and allocation of special nuclear material for military research, and the control of information relating to the manufacture or use of nuclear weapons. The chairman of the Military Liaison Committee is appointed by the President with the advice and consent of the Senate.

The Division of Military Application directs the research, development, production, testing, custody, and storage readiness assurance of nuclear weapons. It manages related AEC installations and communities, and assists in maintaining liaison between the AEC and the Department of Defense. The Director of the division is a member of the Armed Forces on active duty.

DEFENSE ATOMIC SUPPORT AGENCY

The Defense Atomic Support Agency (DASA) is the designated agency of the Department of Defense. It provides support to the Secretary of Defense, the Joint Chiefs of Staff, and the military departments in matters concerning nuclear weapons testing and such other nuclear

energy programs as directed by the Secretary of Defense.

The Director, DASA, is a military officer of three star rank appointed by the Secretary of Defense, upon recommendation by the Joint Chiefs of Staff. Normally the assignment as Director, DASA, is rotated among the military services.

Training

DASA supplies training courses to fulfill the requirements of the military departments for technically qualified personnel in the fields of nuclear weapons assembly, maintenance, nuclear hazards, safety, and emergency demolition of weapons; and other fields that deal with specific technical aspects of the overall nuclear weapons program. Team training of nuclear weapons assembly teams is usually accomplished at the Nuclear Weapons Training Centers for naval personnel.

Technical Services

DASA provides technical information and advice that is requested by the Services in connection with their operation of assigned storage sites, transportation, and other basic logistics functions required in support of forces assigned to the commanders of unified and specified commands. DASA prepares and submits to the Joint Chiefs of Staff for review and approval, integrated full-scale weapons effects test programs, and provides technical liaison and assistance for operational evaluation tests of weapons system involving nuclear detonations that have been approved by the Services.

STORAGE SITES

These are installations maintained for the storage of nuclear weapons material and ancillary equipment where storage inspection, storage monitoring, assembly, or retrofit (or any combination of these) may be performed.

National Stockpile Site

This is an installation located within the continental United States which has facilities for storage, storage inspection, assembly, and authorized modification of nuclear and non-nuclear components of nuclear weapons. Weapons stored at a National Stockpile Site are

Chapter 13—PRINCIPLES OF NUCLEAR WEAPONS AND THEIR HANDLING

normally in the custody of AEC. The installation is jointly operated and occupied by AEC and DASA.

Operational Storage Site

These sites have the same function as NSSs, except that they are jointly occupied and operated by AEC and one of the Services.

Service Storage Facility

This is a service-operated and controlled site, located within the continental United States, which has the capability for storage and partial or complete storage monitoring of nonnuclear components. It may also have this capability for nuclear components.

Ships as Sites

There are two classes of ships equipped to store nuclear weapons. These are classed as combatant ships and support ships.

Combatant ships have the capability for delivering a nuclear weapon to a target by means of aircraft or missiles. These ships may have a full or partial capability for storage inspection, maintenance, monitoring, and assembly of nuclear and nonnuclear components.

Support ships, such as AEs and AKAs, have facilities for the storage and transport of nuclear weapons and for performing partial storage monitoring. Weapons are stored in either stockpile storage or nonready storage.

STORAGE CONFIGURATIONS

Stockpile Storage

This is storage of weapon major assemblies in a disassembled state. Generally, each of these assemblies is packaged and sealed in an individual container.

Operational Storage

Operational storage is any storage condition occurring in the stockpile-to-target sequence following removal of the weapon components from stockpile packages for partial assembly.

Nonready Storage

This is storage of nuclear weapons that are partially assembled, or in an unpackaged condition which will require more assembly and testing than when in a ready storage condition. Nonready storage is used to reduce assembly time from that required for a stockpile condition, to conserve storage space, or afford greater ease of handling.

Ready Storage

Ready storage is storage of a nuclear weapon in a partially assembled and tested condition which will permit completion of assembly in the shortest time possible.

Assembled Storage

This is storage of nuclear weapons in a specific condition of operational storage and completely assembled, or less those components that are to be assembled at the time of loading or during delivery to the target.

CHAPTER 14

EFFECTS OF NUCLEAR WEAPONS

INTRODUCTION

PRELIMINARY

Whenever a new weapon is proposed, two questions arise. First, what can this weapon do for us in combat? Second, if the enemy uses the weapon against us, what defensive action can we take? The answers to these questions are seldom simple, even when the weapon is a "conventional" type. For nuclear weapons, the answers are complicated by two major factors: (1) the explosion is a very large one; and (2) the explosion is accompanied, and often followed as well, by ionizing radiation.

When these two facts first became public knowledge, a certain amount of hysteria was inevitable. Hysteria still characterizes much of the popular thinking about nuclear weapons. Unbiased information, honestly faced and analyzed, is an antidote to hysteria. A great deal of information on the effects of nuclear weapons has now been made available in unclassified Government publications. The data for these publications have come from two main sources—the World War II detonations over Japan and the postwar testing program.

Out of the wealth of available information this chapter endeavors to summarize the details that are most likely to be useful to a junior officer. Regardless of specialty, every officer has cause to be familiar with the effects of nuclear explosions.

PLAN

The brief second section of this chapter will review—and, where necessary, amplify—the major comparisons and contrasts between conventional and nuclear weapons. The body of the chapter will analyze the effects of several possible types of nuclear explosions. Concluding sections will analyze the types of damage

that can be expected, and will mention defensive measures.

COMPARISONS

CONVENTIONAL REACTION

A conventional explosion is a chemical reaction. An initiating impulse—usually heat or shock—is applied to a substance whose molecules contain oxygen, carbon, and hydrogen in abundance. When initiated, explosive substances oxidize (burn) much more rapidly than ordinary combustible materials. HIGH explosives (the substances used as the burster charge in conventional bomb-type ammunition) are said to detonate rather than to burn in the usual sense. The detonation propagates itself as an intense shock wave, followed immediately by a release of energy in the form of intense heat.

During this almost instantaneous process, the original molecules break up and their atoms recombine to form more stable compounds. Only the electrons in the outermost shells of the atoms are involved in molecule formation, and a comparatively small amount of energy is sufficient to free the atoms from one molecular formation and recombine them in another. The conversion of mass to energy in this process is small.

Most of the energy of heat is converted to energy of motion that bursts the container and sends a blast wave through the air, or a shock wave through the earth (or water). It is primarily this blast or shock wave that causes damage.

However, the amount and type of damage can be modified by a number of considerations. These include (but are not necessarily limited to) the type and amount of the explosive substance, the strength of the target, and the distance between the target and the point of detonation. Frequently

Chapter 14—EFFECTS OF NUCLEAR WEAPONS

the target is shattered; sometimes it is ignited immediately. More frequently, fire damage to the target occurs (if at all) as a secondary result of shock damage to fuel systems, stowed explosives, or power lines. If the target is a ship, it may sink because it has been damaged beyond its capacity for rapid repair; or it may remain waterborne but be unfit for combat.

A successful conventional detonation is likely to kill or injure at least a few personnel. Some fatalities or casualties occur immediately and are unavoidable. Still others occur as a result of secondary effects. Their causes may be falling or flying objects, short circuits, fire, flooding, or other resulting manifestations of explosive violence. A taut ship or station endeavors to keep secondary casualties to a minimum. This can be accomplished with enlightened foresight, training, and discipline.

The explosive force, detonation velocity, sensitivity, and other properties of military explosives vary for different types but all are measured in terms of TNT.

NUCLEAR REACTION

The forces binding the atomic nucleus together are vastly stronger than the forces binding atoms into a molecule. To break these forces, a comparatively large amount of matter must be converted to energy.

A nuclear explosive reaction, like a conventional one, is characterized by intense heat and a heavy wave of blast or shock. The heat is many times higher than in a conventional explosion; the shock wave, in addition to being stronger, moves more slowly and covers a much greater area. If all or even part of a nuclear explosion takes place in the air, winds of a high velocity are generated.

Secondary effects—falling and flying objects, damaged pipelines and wiring systems, and fires—are more numerous and extreme than after a conventional explosion. Unavoidable casualties may be numerous. Unhappily, other casualties, some of which could be avoided by using elementary knowledge and taking simple precautions, are liable to be very numerous.

In these respects a nuclear explosion differs from a conventional one in degree more than in kind. In another respect—the certainty of concomitant nuclear radiation and the possibility or probability of residual radioactive contamination—the nuclear explosion is in a

class by itself. Because nuclear radiation cannot ordinarily be discerned by any of the five senses, and because the average person has a vague and partially erroneous idea of the phenomenon, this aspect of a nuclear explosion—even more than the heavy blast and shock damage—is a possible source for panic.

The next section will describe the several major classes of nuclear explosions, and will summarize the effects of each on a target area.

NUCLEAR EXPLOSIONS

DISTRIBUTION OF ENERGY

When a nuclear explosion occurs, the strength of its blast or shock wave pressures is tremendously greater than from a chemical explosive (compared per unit weight of explosive). It also radiates an enormous amount of thermal energy (heat). The nuclear radiation released into the atmosphere is a more ominous aspect of the event.

Figure 14-1 shows how energy is distributed in a representative nuclear explosion. About 85 percent of the total energy appears first as intense heat. Almost immediately a considerable part of this heat is converted to blast or shock; the remaining thermal energy moves radially outward as heat and visible light.

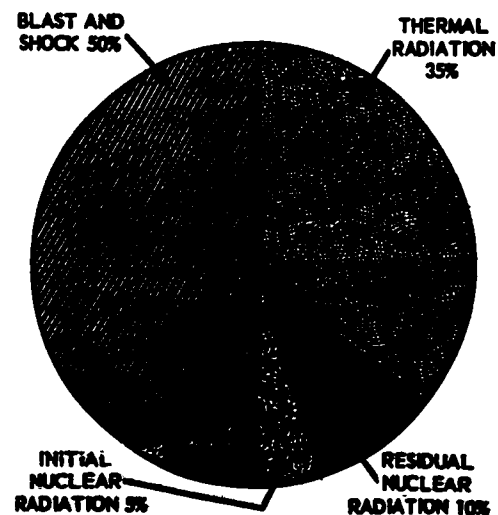

Figure 14-1.—A typical nuclear energy distribution graph.

5.166

PRINCIPLES OF GUIDED MISSILES AND NUCLEAR WEAPONS

Some 5 percent of the total energy appears immediately as invisible but extremely powerful nuclear radiation—alpha particles, beta particles, gamma rays, and neutrons. This is called initial (nuclear) radiation. The residual nuclear radiation occurs over a long time; it is produced by the decay of the numerous radioactive isotopes that are formed by fission reaction.

In nuclear fusion reactions, the actual quantity of energy liberated for a given mass of material depends on the particular isotope (or isotopes) involved.

The fraction of the explosion yield received as thermal energy at a distance from the burst point depends on the nature of the weapon and particularly on the environment of the explosion. For a detonation in the atmosphere below about 100,000 feet altitude, it ranges from about 30 to 40 percent. At higher altitudes where there is less air, the proportion of thermal energy is increased, and the proportion of fission energy converted to blast is decreased. At the other extreme, in an explosion completely confined under the earth, there would be no escape of thermal radiation.

The 15 percent allotted to nuclear radiation in figure 14-1 is appropriate for a fission weapon. In a thermonuclear (fusion) device, in which only about half of the total energy arises from fission, the residual radiation carries only about 5 percent of the energy released in the explosion. In contrast to thermal radiation, the quantity of nuclear radiation is independent of the height of burst. However, the attenuation of the initial nuclear radiation is determined by the total amount of air through which it travels, and the dispersion of the radiation products also varies with the height of the explosion. Other factors, such as wind, also affect the dispersion of radioactive particles.

REPRESENTATIVE AIR BURST

As chapter 13 mentioned, an air burst over a target is frequently the most efficient means of accomplishing a military objective. A 1-megaton detonation (equivalent in destructive power to a million tons of TNT) has been selected for study in this article. For a weapon of lower yield, the distance and the time intervals would be shorter; for a more powerful weapon, they would be longer.

The three parts of figure 14-2 show what happens during the first 11 seconds after detonation.

An air burst is defined as one in which the weapon is exploded in the air at an altitude below 100,000 feet, but at such a height that the fireball (at roughly maximum brilliance in its later stages) does not touch the surface of the earth. In a 1-megaton weapon the fireball may grow to nearly 5,800 feet (1.1 miles) across.

If the explosion takes place about 100,000 feet altitude, it is a high-altitude burst. The fireball characteristics are different because of the low-density air.

Very soon after the nuclear weapon is triggered, a rapidly multiplying nuclear reaction vaporizes all parts of the weapon and its container. The reacting matter appears as an extremely hot and brilliant fireball resembling a small sun. The fireball radiates heat, light, and nuclear emissions.

Blast Damage

The reaction causes a blast wave (the primary shock front) to move outward from the fireball. The air immediately behind this front acts as a terribly violent wind. In the first portion of figure 14-2 the blast wave has not yet reached GROUND ZERO (the point directly below the detonation point). The light rays and the equally swift gamma rays, however, have done so.

When the primary blast wave (incident wave) strikes ground zero with an impact like that of a tremendous hammer, a second or REFLECTED blast wave begins to move upward and outward from ground zero. The second part of figure 14-2 shows the reflected wave. At points on the surface, the impact of the two waves is felt simultaneously. This is true also, for practical purposes, of points ABOVE the surface in the vicinity of ground zero.

At points somewhat farther out, such a P^1 and p^{11} in figure 14-3, however, an object above the surface, such as the top of a tall smokestack or a television tower, would receive two distinct blows. It would be struck first by the incident wave moving radially outward from the fireball and, shortly thereafter, by the reflected wave moving radially outward from ground zero.

As one goes farther out from ground zero, however, the angular distance between the incident wave and the reflected wave decreases. In other words, the two waves are moving more nearly in the same direction. Also, the reflected

Chapter 14—EFFECTS OF NUCLEAR WEAPONS

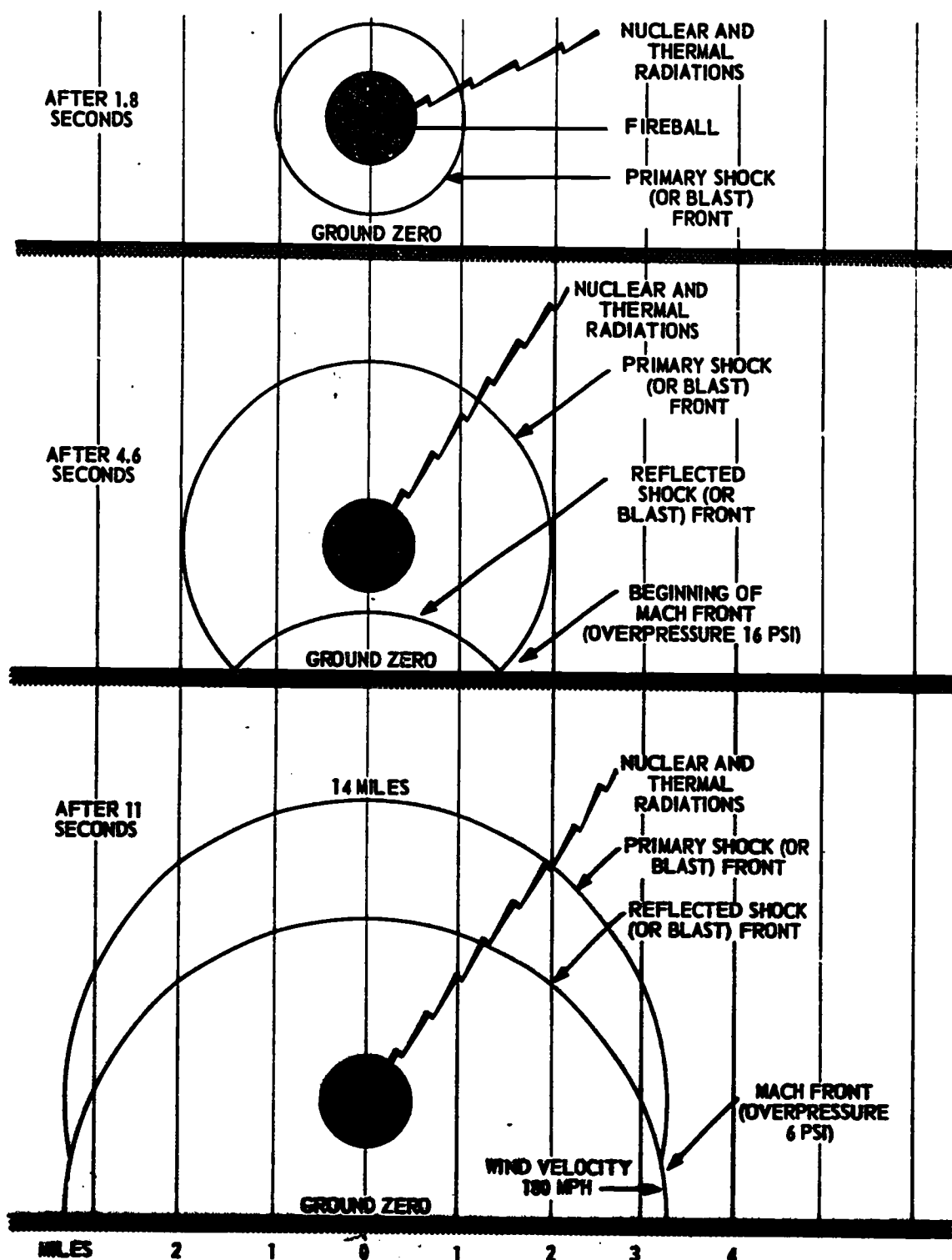
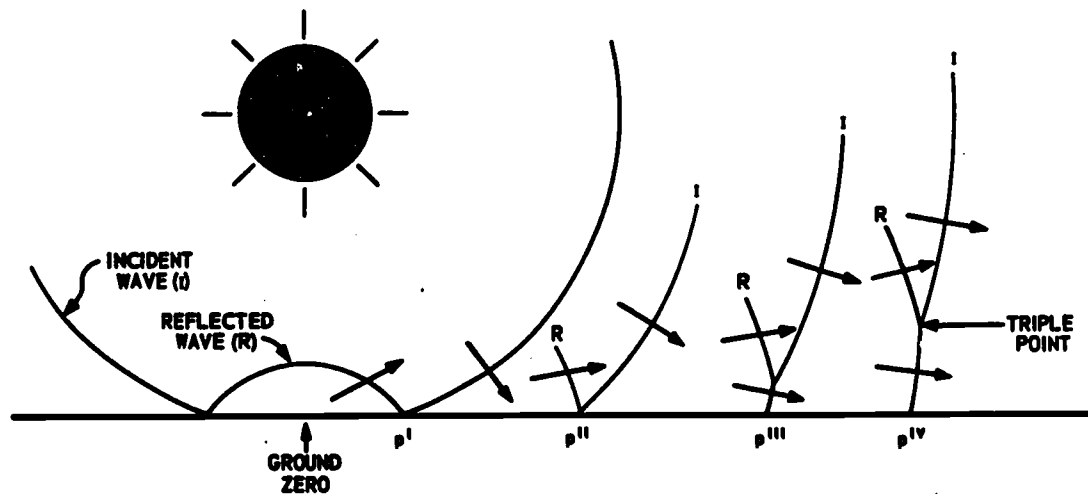

Figure 14-2.—Three stages in the development of a 1-megaton air burst at 6,500 feet height. 100.32-.34



5.169

Figure 14-3.—Formation of the Mach front.

wave tends to move faster, since the incident wave has compressed the air through which it will move. At some point between P^{II} and P^{III} in figure 4-13, the two waves begin to be felt as a single strong shock, not only at the surface (as before) but above it as well. This point marks the beginning of the MACH FRONT. For the explosion shown in figure 14-2, the overpressure (excess over normal atmospheric pressure) of the Mach front at its point of origin is 16 pounds per square inch.

As the combined waves move further from ground zero, the Mach front elongates itself, forming the Mach STEM, shown extending almost vertically from points P^{III} and P^{IV} in figure 14-3. An airplane or a tall object located ABOVE the triple point at the upper end of the Mach stem will feel two separate blast waves. An object BELOW the triple point will feel the combined blast waves as a single powerful blow. The Mach effect is one reason for the long-range shattering power of a nuclear air burst.

Behind the primary shock wave and, after its formation, behind the Mach stem, a strong, swift wind blows almost horizontally outward from ground zero. In its destructive power, this wind is like a concentrated, short-lived hurricane.

While the Mach front is being formed, the fireball is still radiating large amounts of heat, light, and nuclear emissions. By the end of 11 seconds, for a 1-megaton explosion, the Mach

stem has moved outward about 3 miles from ground zero. The overpressure is about 6 pounds per square inch, and the wind is blowing at 180 miles per hour. This is the situation shown in the third part of figure 14-2.

By the end of 37 seconds, however, significant changes have taken place, as shown in figure 14-4. The overpressure has dropped to a single pound per square inch, and the velocity of the wind behind the Mach stem is merely 40 miles per hour. The fireball has ceased to radiate much heat, but is still emitting gamma rays given off by the decay of various short-lived radioactive isotopes formed during the fission reaction. This is an example of residual radiation, as distinguished from the initial radiation given off as an immediate result of the explosion.

Though it no longer glows, the fireball is still very hot. It rises swiftly, like a hot-gas balloon, sucking air inward and upward after it. This suction phase of the burst creates strong winds, opposite in direction to the Mach wind. Near ground zero these AFTERWINDS pull upward a large amount of surface dirt plus much of the lighter debris from buildings shattered by the blast. This windborne material forms the stem or center column of the mushroom cloud that is characteristic of a nuclear air burst. In figure 14-4 the cloud has begun to form.

Within the second minute after a 1-megaton detonation, the top of the mushroom cloud is

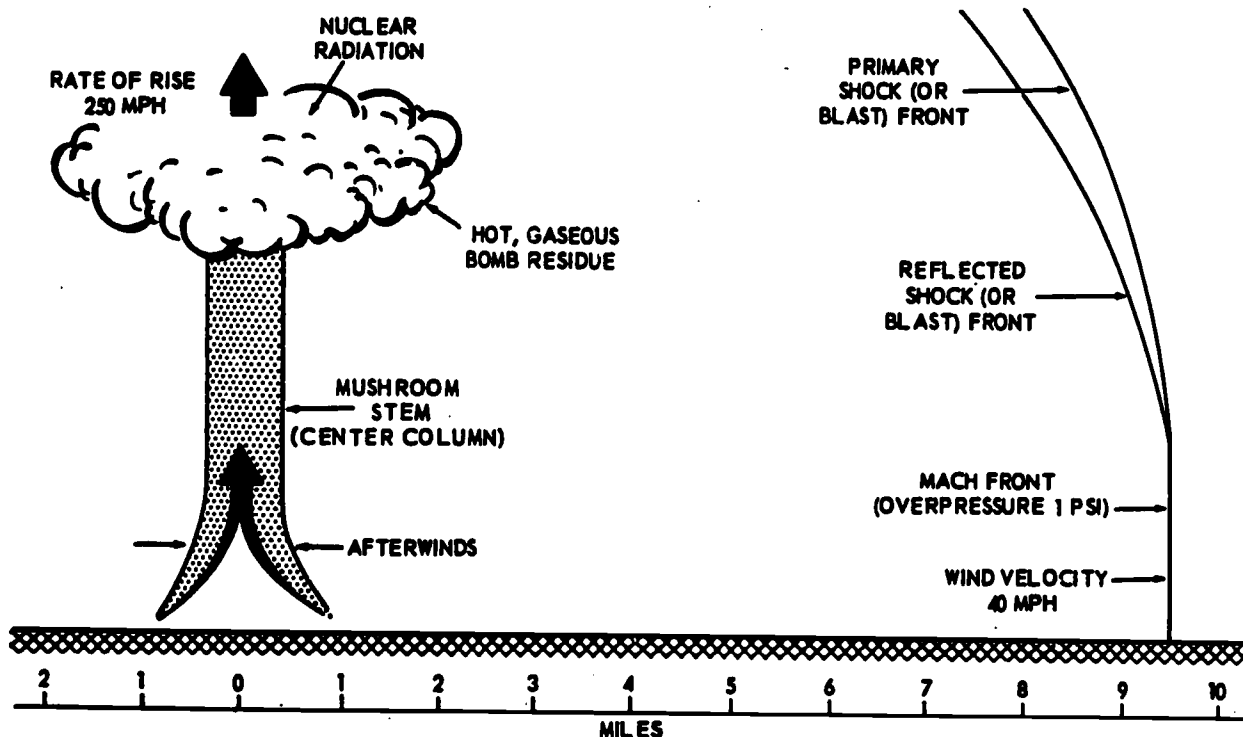

Figure 14-4.—Development of mushroom cloud and the Mach front after a 1-megaton air burst. 100.35

about 7 miles in the air. The afterwinds are blowing inward toward ground zero at about 200 miles per hour.

Radiation Hazard

The mushroom cloud consists mainly of vaporized fission products and other bomb residues, plus some of the lighter material carried up through the center column. The fission products, of course, are highly radioactive.

After 10 minutes the mushroom cloud is about 15 miles in the air and has spread out considerably. In time, normal winds disperse the cloud, thus spreading its contents over a wide area and diluting them.

Because some of the radioactive fission products have very short half-lives, the total radiation hazard is constantly decreasing by decay as well as by dispersal. It does not completely vanish, however. Fission products with long half-lives, and diminishing quantities of those with short half-lives, remain. Some

of these will, in time, be borne earthward on raindrops, fog droplets, or dust particles; or they may descend by their own weight. This returning radioactive material constitutes the fallout that is a peculiar hazard of nuclear explosions.

The fallout from a high air burst may be carried great distances by wind drift, to become a serious threat. Strontium-90 and cesium-137 are radioisotopes with long half-lives that have drifted over large areas of the earth as delayed fallout. They get into food and water and thus are a biological hazard. These tiny radioactive particles are carried in a jetstream of moving air that circles the earth at the edge of the tropopause, and are brought to earth by rain or snow or by gradual fallout. A rise in the strontium-90 count in milk in the United States may be a confirmation of a nuclear detonation over Siberia. Fallout from some of the other types of bursts, however, is a major hazard in the more immediate area of the burst.

The student should clearly understand that a nonfissioned water droplet or dust particle

PRINCIPLES OF GUIDED MISSILES AND NUCLEAR WEAPONS

does not itself become radioactive by acting as a vehicle for a radioactive isotope. All it does is to convey this product of the original explosion from the upper atmosphere to some place where it may possibly be picked up by a living organism.

In considering a bomb of greater or lesser yield than a megaton, the order and nature of the events in an air burst will be as outlined in this article but the statistical values will be different.

An air burst, then, produces intense heat (thermal) radiation, initial nuclear radiation from the fireball, residual nuclear radiation from the fission products in the mushroom cloud, great changes in atmospheric pressure, and strong, high-velocity winds, first away from ground zero and later toward it. At and near ground zero, any or all of the primary effects are fatal to personnel. The combination of pressure and wind destroys all light buildings, and possibly all buildings whatsoever.

Personnel Protection

Beyond the area of total immediate destruction, blast and wind damage are still heavy. Fires—resulting either from the initial heat radiation or from various secondary causes—soon reach dangerous proportions. Unprotected personnel may be killed or injured by radiation, by falling buildings, by blows or lacerations from falling or windborne objects, or by secondary fires. Many in underground shelters, and many above ground who have learned and applied elementary defense procedures, can save themselves or, if injured, can be saved by well-drilled rescue teams. The human body is much more tolerant of short-term overpressure than even the strongest buildings are. It is the secondary effects of overpressure—crumbling walls and flying glass, for example—that cause most injuries. The appalling casualties in the Japanese bombings were due in large measure to the twin elements of complete surprise and unpreparedness. Many thousands of lives could have been saved had the people been alerted and trained in self-protection in the event of nuclear attack. Extensive and intensive studies of all aspects of those bombings have shown quite clearly how to protect yourself. Various types of buildings and shelters have been tested during our nuclear weapons tests, and from these studies recommendations have been published

on preferred methods of construction and materials to use for shelters. These aspects are discussed later in this chapter.

Because it is particularly destructive of structures and equipment (and because of minimized radioactive after effects), an airburst above a target area is likely to be a preferred method of nuclear attack. Other classes of bursts are possible, however. It is therefore necessary to notice how each compares with an air burst.

SURFACE BURSTS

If an air detonation takes place at a very low altitude, part of the fireball, in its rapidly growing early stages, touches the surface of ground or water. This type of nuclear explosion is defined as a surface burst.

The intense heat of the fireball vaporizes a large amount of soil or water. This vaporized (but ordinarily not fissioned) extraneous material remains in the fireball as it rises. In addition, the suction phase of the explosion carries much more debris into mushroom stem (center column) than would be expected in an air burst (fig. 14-5).

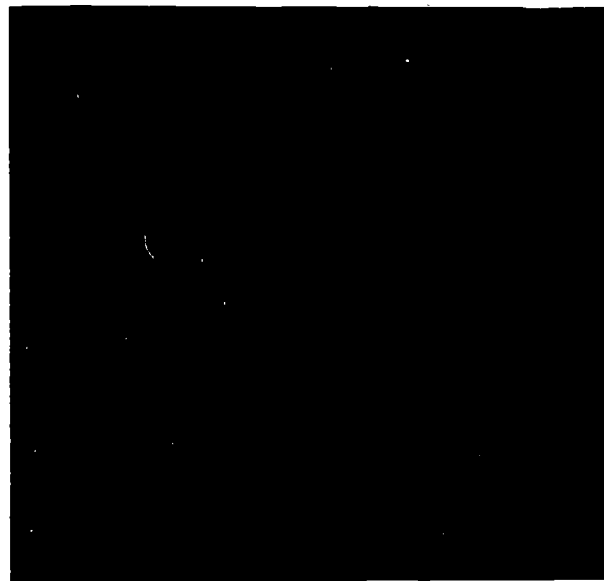

Figure 14-5.—Formation of dirt cloud in surface burst.

5.47

Chapter 14—EFFECTS OF NUCLEAR WEAPONS

As the fireball cools, the vaporized foreign material condenses into minute particles in the mushroom cloud. The heavier debris immediately falls back fairly near the point of burst; the lighter particles may remain airborne for a long time. Radioactive fission products may cling to any or all of the non-fissioned particles. The surface burst, therefore, carries a much greater threat of hazardous radioactive fallout than an air burst does. Though the danger from the fallout of heavy particles is greatest near the target (where damage from other causes is also severe) the airborne lighter particles may seriously contaminate wide areas. In the test at Bikini atoll in 1954, substantial contamination spread over an area of over 7,000 square miles. Fallout can continue even after the cloud can no longer be seen.

It is estimated, for example, that a 1-megaton bomb, exploded on the surface of the ocean, would convert about 20,000 tons of water to vapor. At a high altitude, this water vapor would condense into droplets like those in an ordinary cloud, with the serious difference that many droplets would be vehicles for radioactive fission products. By the time these contaminated droplets fall as rain, they might be hundreds of miles from the point of detonation.

If any significant portion of the fireball touches land, a crater remains to mark the site of the explosion. The crater is formed partly by vaporization of the soil and partly by up-draft into the center column during the suction phase. An observer at a distance can recognize a surface burst over land by the dirty color of the mushroom center column and cloud.

The size of the crater will vary with the size of the bomb, the height at which it was exploded, and the character and condition of the soil. Studies made following test explosions have yielded information on the size, shape, and depth of a crater to be expected from a particular size bomb in a particular type and condition of soil (rocky, sandy, wet, dry), and scalar tables have been compiled for predicting effects.

A varying portion of the kinetic energy of a surface burst goes into ground shock similar to that produced by a penetrating high-explosive bomb. This shock aids the atmospheric over-pressure in demolishing buildings near the point of burst.

Beyond the immediate area of the crater, the ground shock transmitted through the earth is usually small compared with the shock

transmitted by the blast wave passing over the surface. Cracks appear in the soil at varying distances from the crater, the size and distance of the cracks depending on the size of the explosion, distance from the surface, type and condition of soil.

The effects of underground shock from a nuclear explosion have been compared to an earthquake of moderate intensity. There are significant differences, but those in the business of detecting nuclear explosions in other areas cannot always be sure if an earthquake or a nuclear explosion caused the seismic wave recorded on their instruments.

Except in the region close to ground zero, where destruction would be virtually complete, the effects of blast, thermal radiation, and initial nuclear radiation will be less extensive than for an air burst of similar size. However, early fallout may be a very serious hazard over a large area.

SUBSURFACE BURSTS

If a nuclear explosion occurs under such conditions that its center is beneath the ground or under the surface of the water, it is classed as a subsurface burst. Since some of the effects of underground bursts and underwater bursts are similar, they can be considered together as subsurface burst effects. In a subsurface burst, most of the shock energy of the explosion appears as underground or underwater shock, but a certain proportion (which is less the greater the depth of the burst) escapes and produces air blast. Much of the thermal radiation and of the initial nuclear radiation will be absorbed within a short distance of the explosion. The energy of the absorbed radiations will merely heat the ground or the water. Some of the thermal and nuclear radiations will escape, varying with the depth of the explosion, but the intensities will be less than in an air burst. However, the residual radiations are of considerable significance since large quantities of earth or water in the vicinity of the explosion will be contaminated with radioactive fission products. If the burst is near the surface so that the fireball actually breaks through, the amount of fallout will be about the same as in a surface burst. If the burst is deep enough so that none of the fireball emerges from the surface yet quantities of dirt (or water) are thrown up as a column into the air, much of the rock, soil, and large debris (or water) will fall

PRINCIPLES OF GUIDED MISSILES AND NUCLEAR WEAPONS

back in the immediate area, but finer particles will be carried aloft and will descend later as fallout, perhaps far from the area.

Many subsurface tests of nuclear devices have been made, for weapon use and for possible commercial uses, such as blasting out ground to build a tunnel, or a canal, or to deepen a harbor, or open a mine. A large body of data has been collected, studied, analyzed, and charted, so that effects of explosions of different sizes, different depths, and under varied conditions can be predicted with considerable accuracy.

Underwater Bursts

A nuclear underwater burst is defined as one whose origin is beneath the surface of a body of water. Most of the energy of the underwater burst appears as underwater shock, but a certain proportion (dependent on the depth) may escape and produce air blast.

A "true" underwater burst is one in which the detonation and the formation of the complete fireball both occur below the surface of the water. The fireball is in the form of a great bubble. Because it is subject to hydrostatic pressure, the bubble is believed to be smaller than for a bomb of comparable yield detonated in the air. As the rising bubble touches the surface, its glow disappears, because the gases expand and cool when they meet the lesser resistance of the air.

While it is still under the surface, the fireball (or gas bubble) generates a shock wave, much as a fireball in the air generates a blast wave. A later paragraph will mention some of the peculiarities and military uses of this shock wave. The peak overpressure does not fall off as rapidly with distance as in air, but the duration of the shock wave is shorter than in air.

Two phenomena give advance warning that the fireball from an underwater detonation is approaching the surface. First a rapidly expanding white circle, called the SLICK, appears on the surface. The slick is composed of countless droplets of surface water that have been tossed up by the advancing shock wave. At the center of the slick, a dome of water and spray rises, directly over the detonation point.

Neither the slick nor the spray dome contains any radioactive matter. They are forerunners of the true explosion phenomena. (A

very deep detonation may fail to produce a spray dome.)

When the radioactive fireball (or gas bubble) touches the surface, the hot gases are violently expelled into the atmosphere, drawing up with them a hollow column (sometimes described as a PLUME, or a CHIMNEY) of water. The complex pressure relationships sometimes cause water droplets to form a "Wilson" condensation cloud about the hollow column. The cloud formation reproduces, on a large scale, the conditions in the laboratory cloud chamber. The Wilson cloud remains only for a second or two, and is not radioactive. The radioactive contents of the bubble are vented through the hollow column and may form a cauliflowershaped cloud at the top (fig. 14-6).

SHALLOW UNDER WATER BURST.—Figure 14-6 shows three characteristic steps in a typical underwater burst. (Baker test at Bikini atoll in 1946—a 20-kiloton weapon was used in comparatively shallow water.) Part A of the illustration shows conditions 2 seconds after detonation. Notice that the shock wave that surrounded the fireball in the water has become a blast wave in the air, surrounding the Wilson cloud.

Twelve seconds after detonation, as shown in part B of figure 14-6, the water column has reached a height of about 3,300 feet. (An estimated million tons of water were raised in the column in the Baker test.) The fission products venting through the center of the column have begun to condense into an atomic cloud resembling a giant cauliflower.

The cauliflower cloud is strongly radioactive, but is too high to be a serious threat to shipboard personnel at this time. A much greater immediate threat is the BASE SURGE that has begun to form around the lower end of the hollow column. The base surge consists of radioactive mist from the contaminated water in the hollow column, which is now dropping backward due to gravity. The base surge spreads radially outward, giving the appearance of a doughnut-shaped cloud on the surface of the water.

By this time, too, large water waves have begun to form and move outward from the base of the hollow column.

By the twentieth second after detonation, conditions are as shown in the third part of figure 14-6. The base surge is growing higher as it moves outward. Large quantities of contaminated water, the MASSIVE WATER FALLOUT, begin to

Chapter 14—EFFECTS OF NUCLEAR WEAPONS

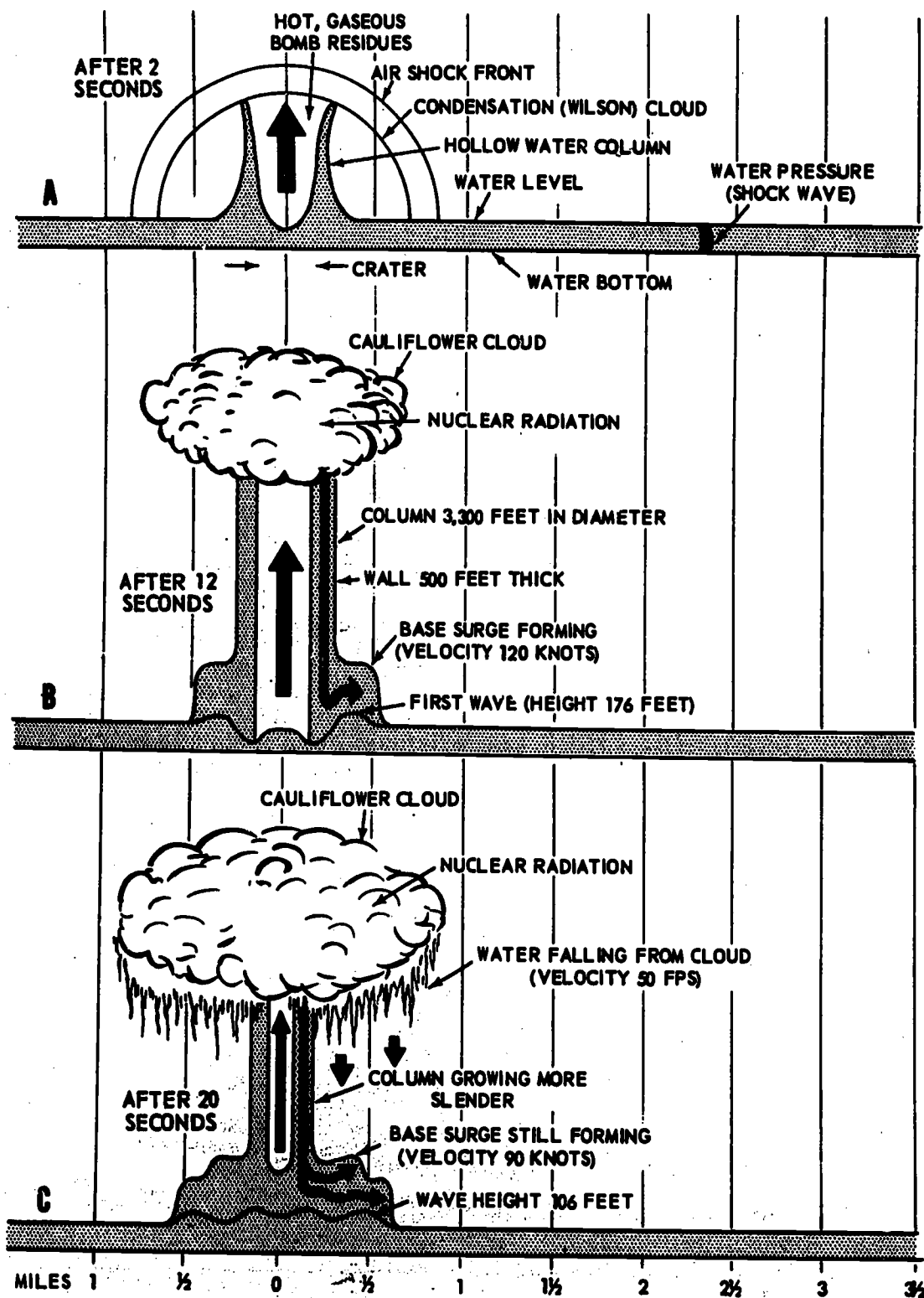

Figure 14-6.—Three stages in the development of a 100-kiloton shallow underwater nuclear burst.

5.163

PRINCIPLES OF GUIDED MISSILES AND NUCLEAR WEAPONS

pour down from the mushroom cloud. The hollow column is continuously shrinking.

A minute after detonation, the hollow column is much lower and the ring of outward-rushing base surge much higher. Contaminated water and spray from the cauliflower cloud encircle the hollow column. Water waves continue to form and move outward. The first wave has traveled almost a mile from the column. In the Bikini lagoon tests, beaches were inundated, as far away as 11 miles, some to twice the depth of the approaching wave, far more than had been anticipated.

Two and a half minutes after detonation, figure 14-7, the central column has been completely replaced by a radioactive mist or cloud that extends downward to the surface of the water. The base surge, still forming an outward-moving ring around the central cloud, has lifted slightly. It appears, therefore, as a low-hanging cloud from which radioactively contaminated rain is pouring. This rain is hazardous to surface vessels in its path.

Though diffusion and the natural decay of isotopes with short half-lives have reduced the intensity of the nuclear radiation given forth by the central cloud, the level of radiation is still dangerously high.

Eventually, the central cloud and the base surge mingle and are carried off in the downwind

direction. The base surge may extend downwind for several miles.

An underwater detonation at greater depth may fail to produce any of the phenomena shown in figures 14-6 and 14-7. Instead, the hot gas bubble may break into a large number of small bubbles as it rises through the water. When the small bubbles reach the surface, they may break into radioactive froth, perhaps with a thin layer of contaminated mist above it. The mist is not likely to create a large fallout problem, but dangerous amounts of the radioactive foam may be washed against surface vessels or even against the shore.

During any type of underwater nuclear explosion, all or a great percentage of the radiant heat is absorbed by the water. Many of the first neutrons and gamma rays are also absorbed. When and if the bubble reaches the surface and bursts, however, the various fission products are still emitting gamma rays and beta particles.

The hollow column, the cauliflower cloud, and the base surge all contain large numbers of radioactive particles. The fallout (or rainout) of these particles is liable to be the most serious danger to surface ships and shore installations **BEYOND** the region of heavy shock (and blast). It is important, therefore that naval officers in general should have knowledge of decontamination procedures (as well as other damage control and first aid procedures).

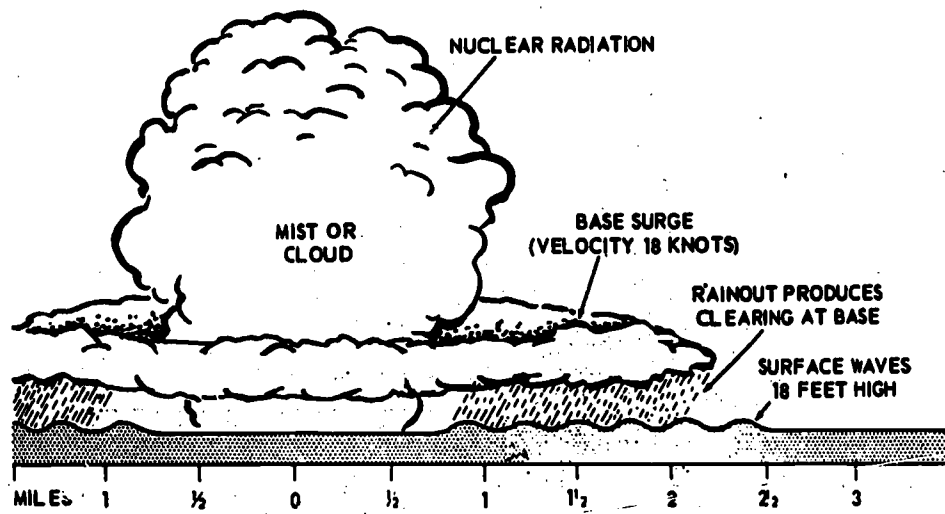

5.164

Figure 14-7.—Conditions 2.5 minutes after a 100-kiloton shallow underwater nuclear burst.

DEEP UNDERWATER BURST.—As observed in the WAHOO shot in 1958, deep underwater bursts do not produce an airborne radioactive cloud. The visible phenomena produced by this shot, which was 500 feet underwater, are shown in figure 14-8. No fireball could be seen, but a spray dome (fig. 14-8A) formed above the surface of the water. The hot steam and gas burst through this and formed multiple plumes (fig. 14-8B) in all directions. As the plumes collapsed, a base surge (fig. 14-8C) formed, extending for a distance of about 2 1/2 miles downwind and upward about 1,000 feet. The radioactivity was associated with the base surge. The residual nuclear radiation was slight.

In a deep underwater burst, very little of the energy escapes as air blast, but is absorbed by the water and produces a much greater shock wave than does a shallow burst. The peak overpressure does not fall off as rapidly in water as in air, therefore the shock wave can damage ships at considerable distances from the burst. At 3,000 feet from a 100-kiloton deep water burst the peak overpressure is 2,700 pounds per square inch, compared to only a few pounds per square inch in an air burst.

Underground Bursts

When the fireball is formed below the surface of the soil, the hot pressurized gas within it is mingled with bomb residues and vaporized earth. Upon breaking through the surface, the expanding gases throw up a hollow, outward-flaring column consisting of earth debris mingled with fission products.

SHALLOW UNDERGROUND BURSTS.—As in a shallow underwater burst, a hemispherical blast front surrounds the hollow column in its



100.45
Figure 14-8A.—Spray dome 5.3 seconds after explosion.



100.46
Figure 14-8B.—Plume after 11.7 seconds.



100.47
Figure 14-8C.—Base surge 45 seconds after explosion.

early stages. Figure 14-9A shows conditions two seconds after a 100-kiloton shallow underground burst. In addition to the phenomena shown in the drawing, this type of detonation produces a ground shock resembling a small earthquake, except that it occurs nearer the surface.

In rising, the hollow column produces a throwout of contaminated debris. The lighter products of the explosion form a radioactive cloud about the upper part of the column.

By the end of 9 seconds, as shown in figure 14-9B, the expanding cloud is still giving off hazardous amounts of radiation. Some of the heavier fragments in the throwout are falling back to the earth.

Forty-five seconds after detonation (fig. 14-9C) the throwout is rapidly falling to the ground. It can be expected that finer dust particles from the hollow column will form a ring of base surge, much like the mist surge that characterizes a shallow underwater burst. The dust particles in the base surge are heavily contaminated with nuclear byproducts.

PRINCIPLES OF GUIDED MISSILES AND NUCLEAR WEAPONS

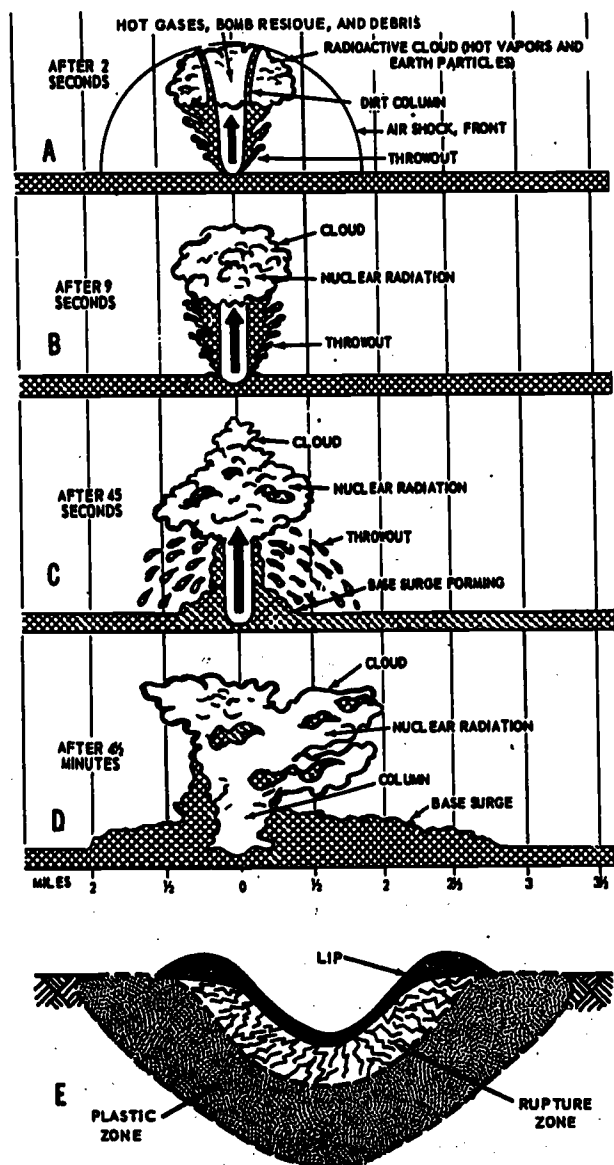

5.165

Figure 14-9.—Development of a 100-kiloton shallow underground burst: A. Two seconds after detonation; B. Nine seconds after detonation; C. After 45 seconds; D. After 4 1/2 minutes; E. Formation of crater.

After a few minutes, as shown in figure 14-9D, the central column loses its separate identity. The lightest particles from the column have now become part of the radioactive cloud. This cloud spreads out, especially in the downwind direction. If a base surge has formed, it

rises toward the cloud and moves ahead of it in the downward direction. Thus, radioactive particles can be carried downwind for considerable distances, seriously contaminating a large area.

It is estimated that a 1-megaton shallow underground burst would blow into air some ten million tons of soil and rock. The area around the crater would be heavily contaminated, and the fallout of lighter particles might be hazardous over a great distance.

As a general rule, the thermal radiation will be almost completely absorbed by the soil material, so it represents no significant hazard.

The shock wave produced by the rapid expansion of the bubble of hot, high-pressure gases initiates a shock wave in the earth similar in some ways to an earthquake of moderate intensity. Theoretically, the disturbance should be equal in all directions, distinguishing it from an earthquake, in which there are slipping movements. However, this is not always true, and it is not always possible to distinguish between earthquakes and underground nuclear explosions by the recordings made by seismographs.

The formation of a crater by surface burst is shown in figure 14-9E. Similar deformation of the earth takes place in an underground burst. The size of each damage zone varies with the type and condition of the soil, the size of the detonation, and the depth of the detonation, but the types of damage are similar. Immediately beneath the visible or apparent crater are two more or less distinct zones, the rupture zone and the plastic zone. In the rupture zone, there are innumerable radial cracks in the earth or rock. Below that is the plastic zone, in which there are no actual cracks visible but the earth is permanently deformed and greatly compressed. In rock, the plastic zone will be much smaller than in soil. The cavity formed by the explosion is the true crater, but the visible or apparent crater may be smaller because of the fallback of debris.

The crater produced by a shallow underground burst is deeper and wider than the one produced by a surface burst of equivalent yield. A 100-KT surface burst would produce a crater 580 feet in diameter and 80 feet in dry soil, while a similar burst 50 feet below the surface would produce a crater 720 feet in diameter and 120 feet deep.

Mathematical formulas have been prepared, with corrections for different factors such as

Chapter 14—EFFECTS OF NUCLEAR WEAPONS

type of soil, so the expected crater size can be computed for any size weapon.

DEEP UNDERGROUND EXPLOSIONS.—One of the purposes of testing nuclear weapons deep underground is to prevent contamination of the air and the countryside. A number of nuclear test explosions have been carried out at various depths underground. Various soil characteristics, particularly the moisture content, affect the result. The data from the tests indicate that, in general, a scaled depth of 500 feet or more is necessary to contain the radioactivity below the earth's surface. By scaled depth we mean scaled according to the strength of the explosion. In the LOGAN shot (5-KT), for example, the actual depth of rock and earth cover was 830 feet, but the scaled depth was computed as 512 feet. The formula for computing the scaled depth is:

$$500 W^{0.3}$$

where W is the explosion energy yield in kilotons TNT equivalent. This formula applies if the overburden (rock and soil cover) is of dry soil and loose rock. If the overburden is solid rock, the result is multiplied by 0.8.

When the fireball does not break the surface of the earth, all the radiation and the radiant energy is retained in the earth. A year after the RAINIER shot, nearly all the energy was still retained in the immediate area of the explosion, which took place in a 6-by-6-by-7-foot chamber 790 feet below the surface in a type of rock called tuff. The explosion enlarged the space to a cavern with a 62-foot radius, and melted the rock to a depth of four inches. The roof of the cavern caved in, but radioactivity was not spread to the surface beyond the cave-in. Most of the radiation was retained in the molten rock, which congealed to glass. The shock caused seismic signals several hundred miles away. A 1.7 kiloton nuclear device was detonated in the RAINIER shot.

HIGH ALTITUDE BURSTS

A high-altitude burst is defined as one in which the explosion takes place at an altitude in excess of 100,000 feet. Above this level, the air density is so low that the interaction of the weapon energy with the surroundings is markedly different from that at lower altitudes, and varies with the altitude. The fireball characteristics are different at high altitudes. The fraction of the energy of fission converted into blast and

shock decreases with increasing altitude and a larger proportion is in the form of thermal radiation. However, the fraction of explosion energy emitted as nuclear radiation is not affected by altitude. The radiation can travel faster and farther in the thin air but will be so widely scattered in the stratosphere that there is little danger from the initial nuclear radiation from a high altitude burst. The residual radiation that reaches the earth can be very widespread.

Much of the thermal radiation will also be dissipated by the time it reaches the earth, so the effect is negligible. The blast wave set up by the explosion travels faster and farther in the low-density air, but by the time it reaches the earth, the overpressure and blast front has died down to a small amount, so no damage results.

The difference in the fireball is startling. The speed with which it develops, rises, and spreads to tremendous size is fantastic. The fireball from the 1-megaton TEAK burst in the Pacific could be clearly seen for over 700 miles. It appeared as a large red luminous sphere (fig. 14-10), and within seconds, a brilliant aurora appeared from the bottom of the fireball and purple streamers were seen to spread toward the north. The aurora was observed at a distance of 2,000 miles from the detonation, though the fireball could not be seen there.



100.38
Figure 14-10.—Fireball and red luminous spherical wave formed after the TEAK high-altitude shot. The photograph was taken at Hawaii, 780 miles from the explosion.

PRINCIPLES OF GUIDED MISSILES AND NUCLEAR WEAPONS

The extreme brightness of the fireball is capable of producing effects on the eyes at great distances.

The TEAK shot was made at an altitude of nearly 50 miles, and the ORANGE shot was made at an altitude of about 27 miles. The effects of the denser air in the ORANGE shot were clearly shown in the smaller size and lesser speed of the fireball and the diminished aurora.

Effect On Radio and Radar Communications

The detonations caused widespread disturbances in the ionosphere which affected the propagation of radio waves and other electromagnetic radiations of relatively long wavelengths. The TEAK and ORANGE shots disrupted radio communications in the very-low-frequency range at distances over 3,000 miles from explosion. Other frequencies were affected for different lengths of time and different distances. The disturbances caused by the initial radiation can be continued by the fallout radiation. This may occur hours after the detonation, continuing the communications blackout for many hours.

The effects on radar are similar if the signal must pass through the ionosphere. Interference with search and tracking radars in weapons systems can be important, even critical.

From observations of the high-altitude test shots, some charts have been prepared to show the effects on electromagnetic radiations used in radio and radar. Factors that influence the effects include moisture content of the air, density, of the air, wavelength used by the radio or radar, height of the burst, energy yield of the burst, location of the radio or radar station with relation to the burst, and a number of other factors. With so many variables affecting the result, it is difficult to predict just what will happen to the communications of a particular installation.

Although we have spoken of electromagnetic disturbances in connection with high altitude bursts, no matter where the burst occurs there are inevitably some disturbances. A somewhat similar explosive-excited occurrence in nature is lightning. The technical aspects of effects on radio and radar are not completely understood, but a reasonably accurate picture of effects of the burst on electromagnetic signals can be computed from the facts revealed by tests of nuclear devices.

EFFECTS OF NUCLEAR EXPLOSIONS

The effects of nuclear explosions may be classed as immediate and delayed effects. Those which occur within a few minutes after the explosion include air blast, ground or underwater shock, thermal radiation, and initial radiation. The delayed effects are chiefly those of radiation from fallout and neutron-induced radioactivity, but fires caused by effects of blast and shock may be considered delayed effects.

DAMAGE CRITERIA

Basic Graph

In assessing the damage caused by any explosion—whether “conventional” or nuclear—it is convenient to represent the various intensities or damage, and the areas subjected to each intensity, as a series of concentric circles about the detonation point. See figure 14-11.

Of course figure 14-11 is a simplified and generalized graph. To show the data gathered from the study of any particular explosion, this graph will have to be modified in one or several ways. For a nuclear explosion, the several kinds of damage, and their separate or combined effects on equipment and personnel, are so varied that a series of graphs often becomes necessary to tell the story.

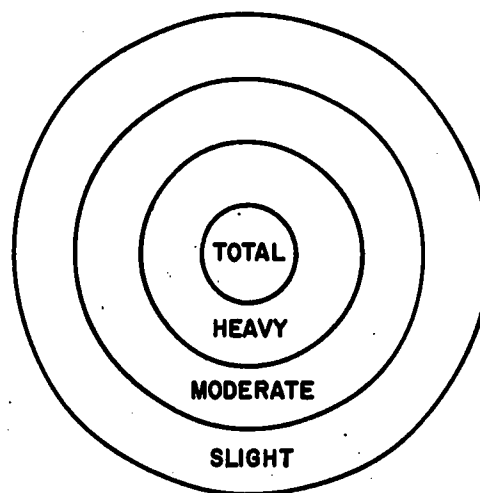

Figure 14-11.—Zones of damage by an explosion. 100.49

Chapter 14—EFFECTS OF NUCLEAR WEAPONS

It may be desirable, also, to show a larger number of damage intensities than the four indicated in figure 14-11.

In actual practice there are no lines of demarcation between one damage area and another. Furthermore, the damage areas will seldom be perfect circles; sometimes they will vary greatly from the circular form, except on the open sea. Winds, geographical features, and other factors can deflect the contours of the areas a great deal. Nevertheless, for preliminary considerations, figure 14-11 is a useful tool for defense and recovery planning.

Damage Areas

In any effective explosion of bomb type ammunition, there is a large or small area about the point of burst where total destruction of equipment and personnel must be taken for

granted. In a nuclear explosion at or below the surface, nothing within or near the fireball will be salvageable. With an air burst (except a very high one), ground zero and a greater or lesser area surrounding it can be considered completely demolished. For a nuclear weapon of any type, the area of TOTAL destruction is many times larger than for a conventional weapon of comparable size. Figure 14-12 illustrates graphically the damage areas for the different effects of nuclear explosions compared with explosion of conventional chemical explosives.

The size of the areas within which various degrees of destruction may be expected depend primarily upon the energy yield of the explosion and the conditions of the burst, that is, air burst, surface burst, etc., and the height or depth of the burst. The topography and the weather also affect the size of the areas.

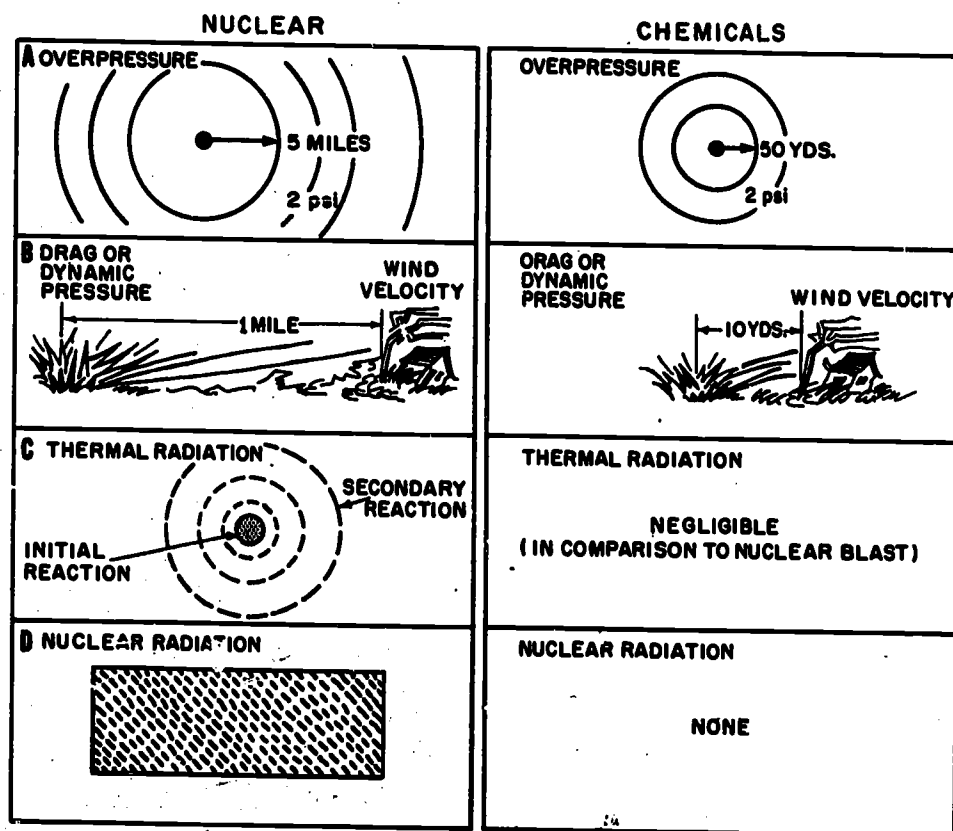

144.70

Figure 14-12.—Comparison of characteristics effects of nuclear vs. chemical explosion)
(assuming equal weight of explosive).

PRINCIPLES OF GUIDED MISSILES AND NUCLEAR WEAPONS

The general conclusions concerning expected effects of nuclear explosions on various targets are based on a combination of theoretical analysis with data obtained from actual nuclear explosions, both in Japan and at various test sites, as well as from laboratory studies. While no exact prediction of the effect on specific types of structures can be made, the conclusions are considered to be most representative for the situations that might be encountered in actual target complexes.

DAMAGE ZONES ASHORE.—In the area immediately surrounding ground zero (zone A, fig. 14-11), destruction is usually total; no personnel or ordinary buildings have much chance of survival. In the Japanese bombings, although some earthquake-resistant buildings were not demolished, the interiors were destroyed and all people in them were killed or died soon afterward from radiation received.

Zone B, the area of severe or heavy damage, is about three times as large as zone A. In this area personnel injuries and damage to buildings would be severe, but not complete. Many buildings, much equipment, and many persons would be lost, either within a few seconds after detonation or as a result of secondary phenomena. Some buildings and equipment, and some people as well, might suffer only minor primary damage. The final number of casualties in the heavy damage area would depend, in part, on the speed, level-headedness, ingenuity, and cooperation displayed by disaster-recovery personnel, and all personnel in the area, as well as on previous preparation for the emergency.

The C zone is a still larger circular belt of lesser damage surrounding the B zone. In the zone of MODERATE damage, there would, of course, be some heavy damage to light equipment and structures. There would also be some fatalities and severe casualties to personnel. Some persons, however, would be unharmed, and many would be able to do useful work after receiving simple first aid. The great problems would be (1) to prevent panic and (2) to utilize all able-bodied (and mentally or emotionally competent) personnel in damage control and disaster recovery. At a shore station, fire fighting (possibly with severely damaged equipment) would be vitally necessary.

Within the zone of SLIGHT damage, the main problems would be to prevent panic, to ascertain that previously trained teams and groups are functioning properly, and to make such adaptations as are ordered by higher authority. One

duty, even in this area, would be to watch for fires and get them under control.

This chapter will not go into details about "atomic defense" or "disaster control." As a junior officer you will receive further indoctrination in fundamental procedures and will be assigned a definite responsibility for some part of the total program of your ship or station.

SHIP DAMAGE.—The various degrees of ship damage that may result from nuclear detonations are grouped into damage categories. These are standard Navy definitions that apply to surface vessels. Each category is defined to describe the extent of impairment or loss of operational capability through material damage.

1 **Sunk.**—That degree of damage which results in loss of the ship due to uncontrollable flooding or loss of longitudinal strength.

2 **Immobilized.**—That degree of damage to the main propulsion equipment or its vital auxiliary machinery which precludes maintaining steerage way. Repairs at sea are impossible; salvage or own destruction required.

3 **Severe Damage.**—That degree of damage which renders the ship barely capable of making headway to the nearest facility either afloat or ashore. The military efficiency of the ship is near zero. Loss of the ship is imminent in followup attack. *20-45 dead crew members*

4 **Severe Topside Damage.**—That degree of damage to topside structure, armament, equipment, and appurtenances which destroys or seriously impairs the offensive aspects of military efficiency. Retirement from action at or near full power however, is possible. Restoration requires availability of a repair facility.

5 **Operational Damage.**—That degree of damage to some vital ship control equipment or offensive armament which prevents the ship from effectively carrying out her assigned mission. Outside assistance is required to restore casualty. Ship is capable of retirement and has reasonable capability for self-defense.

6 **Moderate Damage.**—That degree of damage that is within the capability of the ship's force to restore to an extent which will permit limited offensive employment of the ship. Repair facilities are required to restore full military capability.

7 **Light Damage.**—That degree of damage that is within the immediate capability of the ship's force to restore at sea and which will restore full military capability.

In modern naval formations, the most ships would probably be in the damage-survival area.

Chapter 14—EFFECTS OF NUCLEAR WEAPONS

The non-nuclear effects occur very quickly—in seconds to minutes after the burst. Of these, the mechanical effects can cause damage throughout the ship, but the thermal radiation can cause damage only to the surface exposed directly to the radiation. The types of damage and modes of destruction or damage are described in succeeding paragraphs. The conclusions reached about damage to ships are based on the observations of tests with nuclear devices. Effects on shore structures were determined by studies of the results of the Japanese bombings and of the tests made at the Nevada test site and at Eniwetok. Structures of different materials and of different construction were placed at varied distances in each of the several tests. Effects on personnel were studied following the Japanese bombings.

AIR BLAST

As already mentioned, an air burst of a nuclear weapon above a target has tremendous destructive capability and therefore great military usefulness. For a short distance from the fireball, the blast damage from a surface burst may be even greater, but the effective range tends to be shorter. Blast damage can also stem from shallow subsurface bursts.

The primary difference in blast effects from a nuclear explosion and from high explosives is one of magnitude; the nuclear explosion produces many times the damage of the high explosive. Another important difference is in the blast wave (fig. 14-12). In a nuclear explosion, the combination of high peak overpressure, high wind (or dynamic) pressure, and longer duration of the positive (compression) phase of the blast wave results in mass distortion of buildings, similar to that produced by earthquakes and hurricanes.

Blast damage from a nuclear explosion really has two distinct causes. One cause is the overpressure that has already been defined and described. The other cause is the drag exerted by the nuclear windstorm.

Overpressure Damage

A given point in space is subjected to peak overpressure when the primary blast wave (or, in the Mach region, the Mach wave) strikes it. This is the time when a structure or vehicle is most liable to collapse, as though from a hard

blow. After the peak, the atmospheric pressure at the given point gradually drops back to normal. Shortly afterward, the pressure is reduced below normal by the suction phase of the explosion. The drop below normal is never as great as the previous rise above it; but it, too, can cause damage.

Massive, comparatively low buildings of reinforced concrete, and low masonry buildings strengthened by heavy steel skeletons, are the only structures likely to withstand 15 or more psi (pounds per square inch) of peak overpressure without severe damage. Light wood or masonry buildings—typical living accommodations—receive moderate damage from 2 to 3 psi overpressure. How far this amount of overpressure is from ground zero depends on the height and the energy of the burst. In Japan, nearly everything at close range, except structures and smokestacks of reinforced concrete, was destroyed. Telephone poles were snapped off at ground level; large gas storage tanks were ruptured and collapsed by the crushing action of the blast wave.

Naval vessels are constructed to withstand battle shock and constant pounding from the waves. Peak overpressures of 5 psi cause light damage to most types of surface ships, while overpressures required for severe damage vary from 25 psi for destroyers to 40 psi for heavy cruisers. A ship's boilers, uptakes, and ventilation system are especially vulnerable to overpressure.

Some tanks and other heavy-duty shore equipment have withstood 20 to 30 psi.

Strangely enough, the human body has been known to stand short-term overpressures up to 100 psi without severe or permanent damage. The sharpness of the rise and the length of time under pressure make a difference.

Laboratory and field studies with animals indicate that a peak overpressure of 35 pounds per square inch (if the rise time is short) with a positive phase duration of 400 milliseconds (0.4 second) can cause death in human beings. The direct blast effect was not specifically recognized as a cause of fatality in Japan, but it no doubt was a significant cause of death in a large number of those who received additional lethal injuries from thermal and nuclear radiations, flying debris, falling walls, and fire. It was impossible to assign the specific cause of death of those who were in the zone of greatest damage. Beyond that zone, many must have died because of the complete disruption of medical services.

PRINCIPLES OF GUIDED MISSILES AND NUCLEAR WEAPONS

Of those who survived, lung hemorrhage was reported, but other injuries usually complicated the picture. Ruptured eardrums were more common. Temporary loss of consciousness was reported by some who survived with no other apparent serious injuries.

Direct blast injuries that result in early death are air (emboli) in the arteries, lung damage, and heart injury which cause death upon even slight activity after injury; various bone fractures, severing of major blood vessels, violent impact, and others. As pointed out above, it was impossible to determine incidence of specific injuries or specific overpressures in the Japanese cases. Direct blast injuries have been caused by conventional explosives, but the situation is different because of the short duration of the positive pressure phase in conventional explosions, which may be from about 1 to 15 milliseconds.

Drag Damage

Damage from a nuclear air burst is caused by static pressure variations, wind (or dynamic) pressure, and flying objects. Most of the damage to structures is caused by the positive phase of the pressures; however, there are some structures which suffer greater damage from the dynamic pressure. Pressure produced on a building as a result of overpressure is known as "diffraction loading." The air pressure bends or "diffracts" around the structure so that the structure is eventually engulfed by the blast wave, and approximately the same pressure is exerted on the side walls and the roof.

Forces produced on structures as a result of dynamic pressure are known as "drag loading." This type of loading is caused by the transient winds behind the blast wave front, and they push and pull or drag the structure down.

An air burst is characterized by violent winds blowing radially outward from ground zero and, a short time later, by afterwinds blowing inward. The drag of these winds is particularly destructive to lightweight walls, and to tall objects such as antennas and flagpoles. Power lines, bridge spans, and parked vehicles are also vulnerable to drag.

Tables have been compiled to show the types of buildings, structures, and equipment most often affected by each type of pressure, and the type and extent of damage suffered. Such tables,

graphs, and charts may be found in the references cited in the bibliography.

Drag, rather than overpressure, is the blast phenomenon that seriously threatens the many personnel who might otherwise suffer only slight injuries. The winds of a nuclear explosion can impel heavy or sharp objects with tremendous force, thus converting everyday materials into deadly weapons. A man who has survived peak overpressure intact may leave cover too soon, only to be killed by a brickbat hurled against his temple, or a glass splinter driven into or through his body. This is "missile hazard."

Table 14-1 and figure 14-13 given some indication of the relationships between overpressure, wind velocity and dynamic pressure (drag force). Dynamic pressure is a function of the wind velocity and the density of air behind the shock front. Like the peak shock overpressure, the peak dynamic pressure decreases with increasing distance from the explosion center, although at a different rate, as can be seen in the illustration. (The dynamic pressure decreases more rapidly than does the shock overpressure.)

For the purpose of this orientation, let it be said that certain structures are more susceptible to damage by the drag forces inherent with air blast, while others are more sensitive to shock overpressure. The material used in the construction is only one of the factors influencing the effects of the blast force.

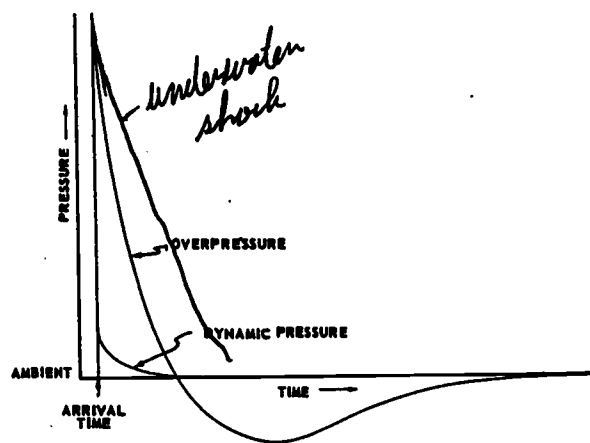

100.31
Figure 14-13.—Variation of overpressure and dynamic pressure with time at a fixed location.

Chapter 14—EFFECTS OF NUCLEAR WEAPONS

Table 14-1.—Overpressure, Dynamic Pressure, and Wind Velocity in Air at Sea Level for an Ideal Shock Front

Peak over-pressure (psi)	Peak dynamic pressure (psi)	Maximum wind velocity (MPH)
72	80	1170
50	40	940
30	16	670
20	8	470
10	2	290
5	0.7	160
2	0.1	70

The method of construction, size and shape of the building, and orientation with relation to the blast are some of the other factors in the damage resulting.

Considerable information on the effects of blast on different types of structures was obtained in tests at the Nevada Test Site, where different types of residential structures were constructed for the purposes of the test. Fallout shelters were built into many of the basements of these test structures, and provided invaluable information needed for recommendations on construction of fallout shelters.

Nuclear—High Explosive Comparison

Although the blast effects of nuclear and conventional explosives were compared in the beginning of this chapter, an additional difference between the two should be pointed out here. The combination of very high peak overpressures, together with the much longer duration of the positive phase of the blast wave from nuclear explosions, results in "mass distortion" of buildings and structures—similar to that caused by earthquakes. An ordinary explosion will usually damage only part of a large building, but the nuclear blast can surround and destroy it entirely.

SHOCK

When all or part of the fireball strikes or is formed below the surface, a shock front in the earth (or water) corresponds to the blast front in the air.

Ground Shock

As has already been mentioned, ground shock resembles a small earthquake, except that it originates much nearer the surface.

Ground shock is a threat to land-based personnel, because it can demolish or damage underground shelters. In the bomb crater, of course, these would be totally destroyed. For a short distance beyond the actual crater, the zone of total destruction would continue. Beyond that would be a zone of heavy damage consisting of severe distortion and partial collapse.

The effects of underground shock tend to fall off rapidly, however. Too, when shock ceases to be severe, effects from it become almost negligible. In a subsurface burst, if any part of the fireball breaks through the surface, the blast damage above ground is likely to be more extensive than the shock damage below it.

Buried utility pipelines would be destroyed within the crater and would be damaged at distances up to three times the radius of the crater. Near the crater, the pipes themselves would rupture. Farther out, the joints, especially between horizontal pipes and risers, would tend to rupture.

Well constructed tunnels and subways, particularly in granite bedrock, are resistant to underground shock. Complete demolition would be likely to occur only within or near the bomb crater.

As might be expected, the severity of ground shock is related directly to the size of the detonation. However, other factors are involved. The type and condition of the soil, the material and type of construction of the underground structures, and the orientation of the structures with relation to the explosion all influence the type and extent of damage. Shallow buried structures and utility pipes beyond the crater and rupture and plastic deformation zones are likely to suffer more damage from the air blast loading than from ground shock. Structures that are partly above ground and partly below ground will, of course, also be affected by the direct air blast.

Underwater Shock

A shock wave formed under the surface of the water behaves much like a similar wave in air. Since water is a denser fluid than air, the values of normal pressure and overpressure are correspondingly higher. The reduction after peak

PRINCIPLES OF GUIDED MISSILES AND NUCLEAR WEAPONS

overpressure is more gradual than in air. On the other hand, the duration of the shock wave in water is shorter than in air.

The velocity of sound in water under normal conditions is nearly a mile per second, almost five times as great as in air. When the peak pressure is high, the velocity of the shock wave is greater than the normal velocity of sound. The rate of motion of the shock front becomes less at lower overpressures and ultimately approaches that of sound, as it does in air.

The shock wave in water may produce a reflected wave by striking the bottom or any rigid submerged object. If conditions are favorable, the primary wave and the reflected wave may fuse to produce a phenomenon comparable to the Mach front in air.

When the shock wave touches the upper (or air) surface of the water, a peculiar phenomenon occurs. Because air is lighter and less resistant than water, the wave reflected back from the contact point is a RAREFACTION (or suction) wave. When the rarefaction wave reaches any given point below the surface, a sharp pressure reduction, called CUTOFF, occurs. This negative pressure phase is of short duration. The time interval between the arrival of the direct shock wave at a particular location (or target) in the water and that of the cutoff, signaling the arrival of the reflected wave, depends upon the depth of burst, the depth of the target, and the distance from the burst point to the target. If the underwater target (ship bottom) is close to the surface, then the time elapsing between the arrival of the two shock fronts will be small and the cutoff will occur soon after the arrival of the shock front. This may result in a decrease in the extent of damage sustained by the target.

One phenomenon tends to neutralize the other, thus reducing the damaging power of the explosion. For shallowly submerged targets, therefore, nuclear weapons may not always be fully effective.

The primary shock wave of an underwater nuclear explosion strikes the target ship or other object with a sudden violent blow. In this action a nuclear weapon resembles a conventional one—with one significant difference. The conventional weapon delivers its blow at a single point or over a comparatively small area, while the nuclear explosion acts simultaneously over a large area with all encompassing force.

Underwater shock damages a vessel in one (or both) of two ways. First, it may rupture or

at least weaken the hull. Second, it may distort, rupture, or break loose any of the various ship's components or installations. Piping, shafting, air vents, and boiler brickwork are susceptible to damage. Platforms supporting heavy equipment may be weakened or thrown out of proper alignment. Light objects may be thrown about so violently that they become a serious threat to personnel. Electronic, fire control, and guided missile equipment is likely to be rendered inoperative, at least temporarily. The damage to equipment appears to be related to the peak velocity imparted to the equipment by the shock wave. The damage to the hull of the ship is related to the energy per unit area of the shock wave, evaluated up to a time corresponding to the surface cutoff time at a characteristic depth. In the Bikini underwater test, light interior equipment, especially electronic equipment, was damaged at ranges considerably beyond the limit of hull damage.

Part of the shock energy of a shallow underwater burst is transmitted through the surface as a shock (or blast) wave of air. This air blast caused some damage to ship superstructures in the tests.

In the effects just mentioned, an underwater nuclear burst is similar to a conventional mine or depth charge. The major difference lies in the extended damage radius of the nuclear weapon. The nature and extent of damage sustained by a surface vessel from underwater shock will depend upon the depth of the burst, yield, depth of water, range, the ship type, whether it is operating or riding at anchor, and its orientation with respect to the position of the explosion. In vessels underway, machinery will probably suffer somewhat more damage than those at anchor. Underwater structures such as harbor installations, are damaged by the shock wave. In the Bikini test, the floor of the lagoon was drastically altered by the explosion.

From studies of the underwater burst at Bikini, charts have been prepared to show the extent of the various effects of such an explosion at different depths and distances. Some 70 ships of different types were placed in and near the test area. Figure 14-14 shows the exterior damage to one of them. Analysis and evaluation of the damage produced much valuable information on the effects of underwater bursts, and, conversely, ideas on how to prevent or minimize damage.

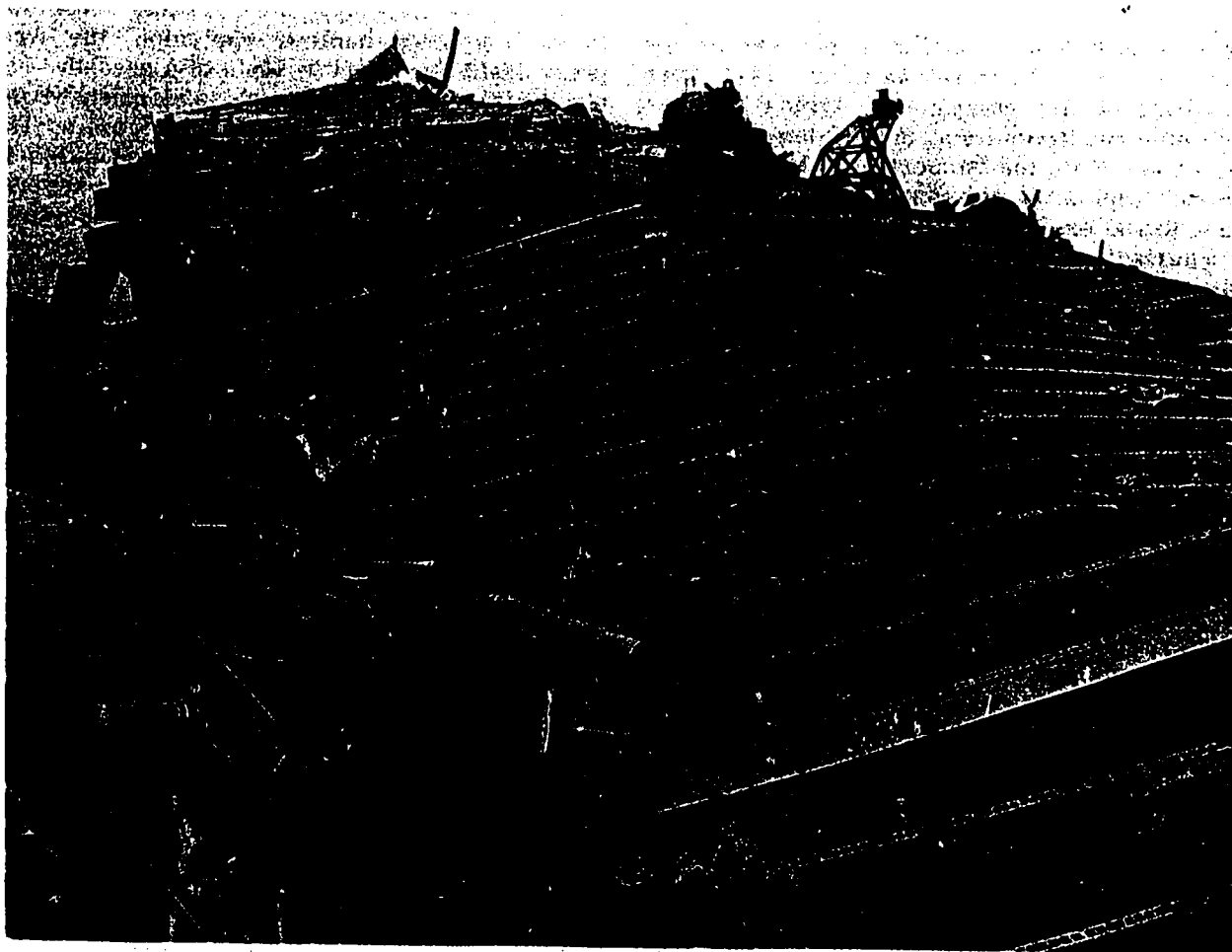

Figure 14-14.—Flight deck of carrier *Independence* after test at Bikini. Blast pressure entered the hangar deck from the side, through rupturing of side curtains. Flight deck was bulged upward whereas hangar deck below was dished downward. 5.49

THERMAL RADIATION

Description

Within a few milliseconds after the detonation of a nuclear weapon, intensely hot gases, at tremendously high pressures, rapidly form a highly luminous mass known as the "fireball" or "ball of fire." At about seven-tenths of a millisecond, the fireball from a 1-megaton nuclear weapon would appear to be more than 30 times as bright as the sun at noon to an observer 60 miles away. Although the size of the fireball will vary with the bomb energy, the luminosity does not vary greatly. How-

ever, the larger the yield of the weapon, the longer will be the PERIOD of luminosity. Within this seven-tenths of a millisecond from time of detonation, the fireball of a 1-megaton weapon will have reached a diameter of 440 feet. The fireball increases to maximum diameter of about 7200 feet at plus 10 seconds. It is then rising at the rate of approximately 200 mph. After a minute, the ball of fire has cooled to an extent that it is no longer visible.

The nuclear explosion has often been compared to the conventional high explosive detonation in that, except for the yield and nuclear radiation involved, they can be considered similar. When referring to thermal effects,

PRINCIPLES OF GUIDED MISSILES AND NUCLEAR WEAPONS

this can be a poor comparison because of the very large proportion of energy released as thermal radiation by a typical nuclear explosion. As was illustrated in figure 14-1, over one-third of the energy of a typical nuclear explosion manifests itself in the form of thermal radiation. Too, the temperatures involved in a nuclear explosion are much higher than with conventional explosives.

Thermal radiation travels with the speed of light, so that the time elapsing between its emission from the ball of fire and its arrival at a target a few miles away, is quite insignificant.

Much like the sun, the fireball radiates ultraviolet (short wave length) as well as visible and infrared (long wave length) rays. Due to certain phenomena associated with the absorption of thermal radiation by the air in front of the expanding fireball, the SURFACE temperature undergoes a curious change. While the interior temperature of the fireball falls steadily, the surface temperature decreases more rapidly for a small fraction of a second, then it increases again for a somewhat longer time, after which it falls continuously. In other words, there are effectively two surface-temperature pulses—the first of very short duration, the second lasting for a relatively long period of time (fig. 14-15). These surface-temperature pulses correspond to the pulses of thermal energy radiated from the fireball in

bursts below 50,000 feet. (In high altitude bursts there is only one thermal radiation pulse.) In a 1-megaton nuclear explosion, the first pulse lasts for about a tenth of a second. The temperatures are very high, and much of the radiation is in the ultraviolet region. The situation with regard to the second pulse is quite different. This pulse may last for several seconds and it carries about 99% of the total thermal radiation energy of the nuclear explosion. The temperatures are lower than in the first pulse, and most of the rays reaching the earth are visible or infrared (invisible) light. It is this radiation that is main cause of skin burns suffered by exposed individuals up to 12 miles or more, and of eye effects at even greater distances from a 1-megaton explosion. The warmth may be felt as far away as 75 miles. Since thermal radiation is largely stopped by ordinary opaque materials, buildings and clothing can provide protection. The radiation from the second pulse can cause fires to start at considerable distances from the burst. This difference between the injury ranges of thermal radiation and the other effects mentioned becomes more marked with increasing nuclear weapon yield.

The most important physical effects of the high temperatures resulting from the absorption of thermal radiation are: burning of the skin and scorching, charring, and possible ignition of combustible organic substances such as wood, fabrics, and paper.

Thin or porous materials, such as lightweight fabrics, newspaper, dried grass, and dried rotted wood, will flame when exposed to sufficient thermal radiation (with adequate oxygen supply).

Effects on People

Thermal radiation can be the cause of flash burns or flame burns. Flash burns are directly caused by the radiant energy of the fireball. Flame burns are distinguished from flash burns in that they are caused by fire, no matter what the origin. Flame burns occur as a secondary result of thermal radiation, for example, those resulting from the fires started by thermal radiation.

The very large number of flash burns was one of the most striking facts about the nuclear bombing of Japan in World War II. It has been estimated that 20 to 30 percent of the fatal

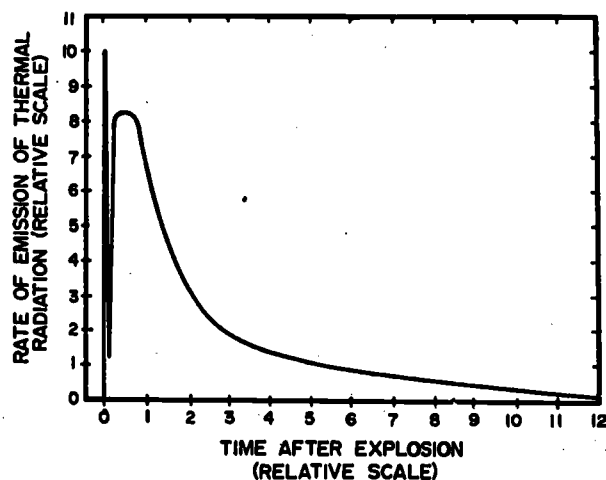

100.37
Figure 14-15.—Emission of thermal radiation in two pulses in an air burst.

Chapter 14—EFFECTS OF NUCLEAR WEAPONS

casualties at Hiroshima and Nagasaki were due to flash burns, as distinct from flame burns. Though significant, it should be realized that these illustrated results were magnified because the atmosphere was very clear and the summer clothing worn was light and scanty.

Moderately large doses of ultraviolet radiation can produce painful blisters. Even small doses can cause reddening of the skin. However, in most circumstances, the first pulse of thermal radiation is not a significant hazard as far as skin burns are concerned.

Perhaps the most serious consequence of thermal radiation is its ability to produce serious burn injury to personnel at long ranges.

Conventionally, burns are classified according to their severity, in terms of degree (or depth) of injury. In first-degree burns there is only redness of the skin. A moderate sunburn is an example of a first-degree burn. Healing should occur without special treatment and there will be no scar formation.

Second degree burns are deeper, more severe, and are characterized by the formation of blisters. A severe sunburn is an example of a second-degree burn.

In third-degree burns, the full thickness of the skin is destroyed. Unless skin grafting techniques are employed, there will be scar formation at the site of the injury.

The extent of the area of skin which has been burned is also important. Thus, a first degree burn over the entire body may be more severe than a third degree burn to one spot. The larger the area burned, the more likely is the appearance of symptoms involving the whole body. Further, there are certain critical, local regions, such as the hands, where almost any degree of burn will incapacitate the individual.

In other words, all persons exposed to thermal radiation from a nuclear explosion within a range in which the energy received is sufficient to cause second-degree (at least) flash burns will be potential casualties. Some will be protected to some extent against thermal radiation and may not be incapacitated.

From information available, calculations have been made of the thermal radiation necessary to produce each degree of burn. Differences in skin pigmentation cause variations, but an average is used. Other variations that are included in the computations are the size of the burst, the height of the burst, the atmospheric

conditions (clouds, smoke, moisture content), and the atmospheric pressure.

Figure 14-16 is included to show the ranges for moderate first-, second-, and third-degree burns from nuclear explosions. The graph is computed assuming a typical air burst with clear atmospheric conditions prevailing. For a typical surface burst, the distances would need to be scaled down to about 80 per cent of those stated.

If the detonation takes place at high altitude where the air pressure is quite low, the situation is different. If the atmosphere is hazy the distances shown on the chart may be too great. They are certainly too large if there is a substantial cloud layer of smoke below the point of burst.

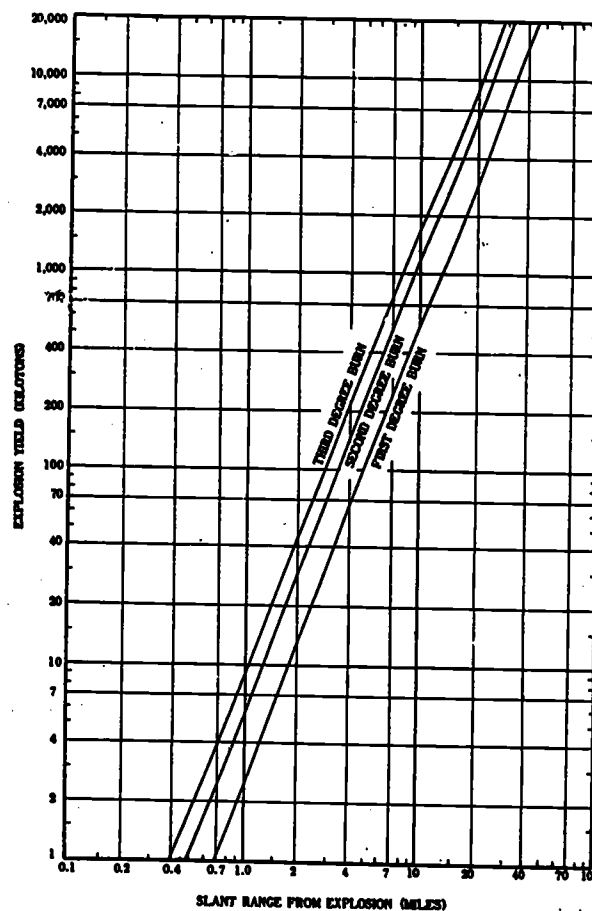

5.174
Figure 14-16.—Ranges for first- second- and third degree burns as a function of total energy yield.

PRINCIPLES OF GUIDED MISSILES AND NUCLEAR WEAPONS

Eye Damage

Another danger of a nuclear explosion is its possible affect on the eyes. Thermal radiation can cause both retinal burns and flash blindness.

The first pulse of thermal radiation, which seldom causes skin burns, is, however, capable of producing retinal burns (permanent or temporary effects on the eyes), especially in individuals who happen to be looking in the direction of the explosion. Numerous cases of flash blindness (temporary) were found among the Japanese, but only one case of retinal injury was reported.

This is because of the more or less remote chance that an individual will be looking directly at the ball of fire. The chance of temporary "flash blindness" or "dazzle," due to the flooding of the eye with brilliant light was much more prevalent than retinal burns. Flash blindness is of a temporary nature and vision is regained within a comparatively short time. However, flash blindness is of military significance, since it may extend to 2 or 3 hours.

Because of the focusing action of the lens of the eye, enough energy can be collected to produce a burn on the retina at such distance from a nuclear explosion that the thermal radiation intensity is too small to produce a skin burn. As a result of accidental exposures during nuclear tests, a few retinal burns have been experienced at a distance of 10 miles for the explosion of a 20-KT weapon. It is believed that under suitable conditions, such burns might have resulted at even greater distance. Retinal burns occur so soon after the explosion that reflex actions, such as blinking and contraction of the eye pupil, give only limited protection. In all instances, there will be at least a temporary loss of visual acuity, but the ultimate effect will depend on the severity of the burn and on its location on the retina.

Eye damage is greater under nighttime conditions. In tests with rabbits and a high altitude burst of 1-megaton, chorioretinal burns occurred at slant ranges up to 345 miles. No measurements were made beyond that range, so it is not known how far away retinal burns might have occurred. Although there are differences between human and rabbit eyes and the data have not been extrapolated for human eyes, it is believed that a 1-megaton high-altitude burst endangers the eyes of human beings at distances greater than 200 miles, and possibly as far as the eye can see.

Effects Upon Materials

When thermal radiation strikes any material or object, part may be reflected, part will be absorbed, and the remainder if any, will pass through and ultimately strike other materials. It is the radiation absorbed that produces the heat damage suffered by the material. The nature of the material and its color determine the extent or amount of absorption of the radiant heat.

Tables have been compiled showing the radiant exposure required to ignite different types of fabrics, household materials, and forest fuels. Table 14-2 lists some of the materials and the approximate number of thermal calories per square centimeter required to produce the burning or charring effect. The chart in figure 14-17 shows the thermal energy received at various slant ranges from different size weapons. The figures given are not absolute, since different conditions of the atmosphere cause variations in the amount of thermal energy reaching a certain point. The graph assumes a reasonably clear state of atmosphere, that is, a visibility of 10 miles or more.

Table 14-2

Effects	Approx. cal/cm ² required:		
	1 KT	100 KT	10 MT
Second-degree bare skin burn	4	5	9
Newspaper ignition	3	5	9
White pine charring	10	18	32
Army khaki summer uniform destruction	18	31	56
Navy white uniform destruction	34	60	109

Thermal energies are expressed in calories per unit area—square centimeter. Note that the amount of energy required for burning, charring, etc., varies inversely with the yield of the nuclear weapon. This is because of the rate at which the energy is delivered. For a given total amount of thermal energy received by each unit area of exposed material, the damage will be greater if the energy is delivered rapidly than if it is delivered slowly.

Chapter 14—EFFECTS OF NUCLEAR WEAPONS

This means that in order to produce the same thermal effect in a given material, the total amount of thermal energy (per unit area) received must be larger for a nuclear explosion of high yield than for one of lower yield, because the energy is delivered over a longer period of time, i.e. more slowly, in the former case.

Unless scattered, thermal radiation travels in straight lines like ordinary light. For this reason any solid, opaque material, such as a bulwark, gun shield, hill, or tree, between a given object and the fireball will act as a SHIELD and thus provide protection from direct thermal radiation.

These effects were seen in Japan in the areas beyond the areas of complete destruction. The sides of telephone posts facing the blast were charred and blackened while the opposite side was unharmed. The same effect was seen on other materials and objects.

The chart in figure 14-17 may be used to estimate the distance at which specific materials are likely to be ignited by a certain size nuclear burst. For example, how far from a 1-megaton burst can you expect ignition of household items such as oily dust mops, oily rags, and crumpled newspapers? The average radiant exposure required for ignition of such items is 5 calories per square centimeter (5 cal/sq.cm). On the chart, follow the line for 1 mt. until it intersects the slant line for 5 cal/sq.cm., which you'll find is 11 miles. On an average clear day, fires will be started by absorption of thermal radiation in the materials named. Under other conditions, this distance is decreased.

Fires that are caused directly by thermal radiation are called primary fires. Secondary fires are due to other causes, for which the blast is responsible, such as upset stoves, broken gas and fuel lines, and electrical short circuits. The evidence from Hiroshima and Nagasaki indicated that the great majority of fires were secondary in origin. Even though few fires may be started by the radiant heat from a surface burst, there will be many fires of the secondary type due indirectly to the blast damage.

FIRE STORM.—No matter what the immediate cause, a nuclear burst over a built-up area will result in many fires burning simultaneously over a wide area. Once the fires have started, the chances of their spreading will depend on the combustibility and closeness of the

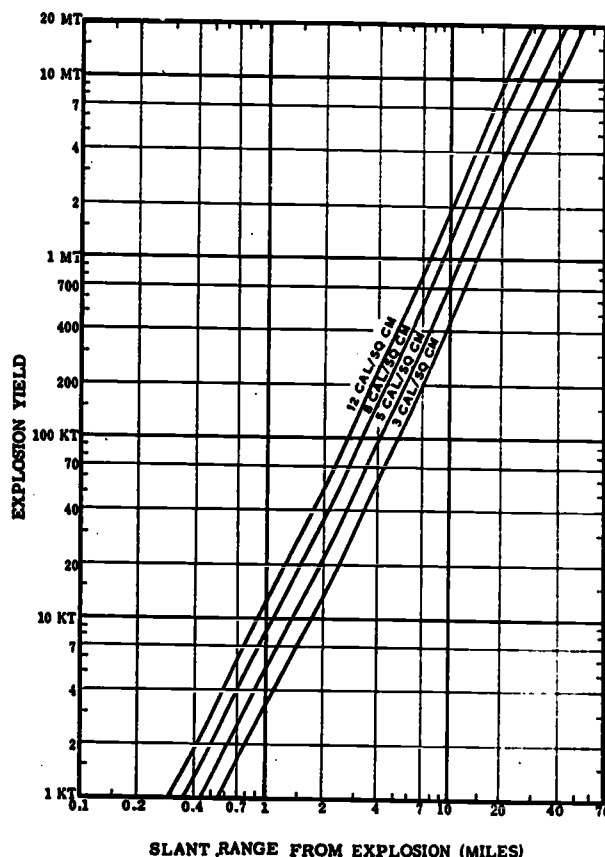

100.83
Figure 14-17.—Slant ranges for specified exposures as function of energy yield of the explosion.

buildings, the nature of the terrain, the weather conditions, and the adequacy of the defense.

When a large area is burning simultaneously, the phenomenon known as "fire storm" may develop. Individual fires merge into one gigantic inferno. As a result of the huge masses of hot air and gases rising from the fire, air is sucked in with great force. Strong winds consequently blow from outside toward the center of the area on fire. The effect is similar to the draft that sucks up a chimney under which a fire is burning, except that it is on a much larger scale. Everything combustible in the area is burned. A fire storm is not produced only by a nuclear explosion nor does it necessarily follow one. A fire storm can be caused by an earthquake that results in many "secondary" fires (San Francisco), or from a forest fire, or incendiary bombs. The great Chicago fire, started by Mrs. O'Leary's

PRINCIPLES OF GUIDED MISSILES AND NUCLEAR WEAPONS

cow, became a fire storm. The incidence of fire storms is dependent on the conditions existing at the time of the fire. Although many fires were started in Nagasaki by the explosion, there was no definite fire storm because the winds blew the fire toward a thinly populated narrow valley where there was little material to feed the fire.

RESISTANCE OF MATERIALS TO BURNING.—Highly reflecting and transparent substances do not absorb much of the thermal radiation and so are relatively resistant to its effects. A thin material will often transmit a large proportion of the radiation striking it, and thus escape serious damage. A dark fabric will absorb a much larger proportion of thermal radiation than will the same kind of fabric that is white. However, a light-colored material which blackens (or chars) readily in the early stages of exposure to thermal radiation will behave essentially as a dark material regardless of its original color.

Some bizarre skin burns were seen among the Japanese population. The pattern of the dress fabric was burned into the skin, with the deepest burns matching the dark stripes or pattern of the fabric.

Thick organic materials, such as plastics, heavy fabrics, and wood more than 1/2 inch thick, char but do not burn. Dense smoke, even jets of flame may be emitted, but the material does not sustain ignition. This type of behavior is illustrated in the photographs taken of a white-painted wood frame house during one of the nuclear tests in Nevada. As figure 14-18A indicates, at virtually the instant of the explosion, the house became covered with thick black smoke, and no sign of flame. Very shortly thereafter, but before the arrival of the blast wave, the smoke ceased, as indicated in figure 14-18B. The white paint coat reflected part of the thermal radiation and reduced the chance of fire. Presumably because the heat was partially conducted away from the surface, the temperature was not high enough during the short effective radiation pulse for the wood to ignite; however, thin combustible material would probably burst into flame at the same location.

Range of Thermal Radiation

ATMOSPHERIC CONDITIONS also play a part in the amount of thermal radiation received by a particular object. However, they do not play

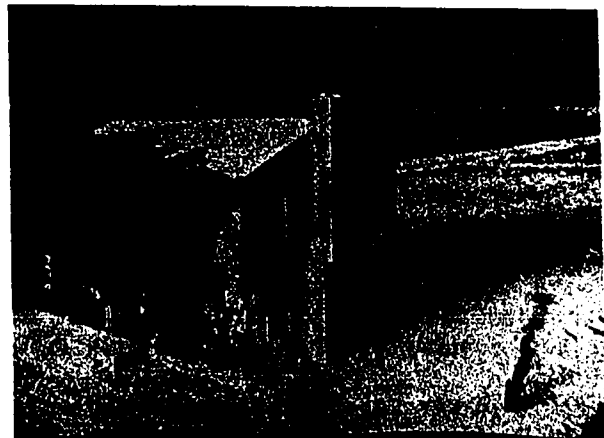

Figure 14-18.—Effects of thermal radiation on white-painted exterior of wood frame house: A. Almost immediately after explosion; B. Effects as seen about 2 seconds later.

as important a part in attenuating thermal radiation as was once suspected. When visibility is in excess of 2 miles (light haze or clearer), the total amount of thermal radiation received will be essentially the same as that on an "exceptionally clear" day (visibility more than 30 miles). This is because any decrease in direct radiation is largely compensated for by an increase in scattered radiation.

When visibility is less than 2 miles because of rain, fog, or dense industrial smoke, there will be a definite decrease in radiant energy (thermal) received at any specified distance.

CLOUDS can also affect the amount of radiant energy received. For example, if an explosion occurs about a cloud layer, there will be considerable attenuation at ground level.

Chapter 14—EFFECTS OF NUCLEAR WEAPONS

Conversely, should an explosion occur beneath a cloud layer, some of the radiation which would normally have been lost to space will be scattered back to earth.

Artificial white (chemical) SMOKE can be used to attenuate thermal radiation, for it acts like fog in this respect. A dense smoke screen between the point of burst and a given target can reduce thermal radiation to as little as one-tenth of the amount which would otherwise have been received at the target. However, there is not likely to be time to throw up an effective smoke screen in case of a nuclear explosion.

The effective range of thermal radiation is greater in open terrain and at sea, where there is no protection from the radiant heat, than in built-up areas, where much of the radiation is obstructed. The Bikini tests indicated that thermal radiation would not be an appreciable factor in producing damage at sea, since the exposed portions of naval vessels are practically fireproof. However, this does not exclude the possibility of secondary fires involving such combustibles as gasoline or explosives where there has been extensive blast damage.

NUCLEAR RADIATION

It has been previously pointed out that 15 per cent of the total energy yield of a typical nuclear weapon is distributed in the form of nuclear radiations (fig. 14-1). Let us explore further what this radiation consists of, how it occurs, and what its dangers are.

In any nuclear explosion there is an initial flux of radiations consisting mainly of gamma rays and neutrons. Both of these (especially gamma radiation) travel great distances through the air, and can penetrate great thicknesses of material. Remaining within the fireball are fission products and unfissioned bomb material. These fission products and unfissioned bomb material are also radioactive, and emit gamma rays and beta particles. This emission of beta particles and gamma rays from the radioactive substance is a gradual process, and its hazard therefore remains over a significant period of time.

INITIAL NUCLEAR RADIATION is arbitrarily defined as that radiation emitted within (approximately) the first minute after the explosion. Initial nuclear radiation includes those neutrons and gamma rays given off almost instantaneously, as well as the gamma rays given

off during the first minute by the radioactive fission products in the rising cloud. In that first minute the amounts of gamma radiation from the explosion and from induced activity are about equal.

Some alpha and beta particles are also emitted, but these have such short ranges and little penetrating power that they are not a source of danger in that first minute. Alpha particles can travel only 1 to 3 inches in air before being stopped; beta particles can go several hundred times farther, but even with their greater speed, they cannot penetrate a sheet of aluminum more than a few millimeters thick. It is the highly injurious nature and long range of gamma rays and neutrons that makes them such a significant aspect of nuclear explosions.

RESIDUAL RADIATION is that emitted after approximately one minute from the instant of a nuclear explosion. This radiation originates mainly from the bomb residues; that is, from the fission products and, to a lesser extent, from the uranium and/or plutonium which has escaped fission. Additionally, the residues will usually contain some radionuclides as a result of "neutron capture" by other weapon materials. Still another source of residual nuclear radiation is the activity induced by neutrons captured in various elements present in the explosion environment.

All of the nuclear radiation discussed thus far in this section is the result of fission reactions. Neutrons are the only significant nuclear radiations produced in pure fusion reactions. Thus, it can be seen that for explosions in which both fission and fusion (thermonuclear) processes occur, the proportions of specific radiations will differ from those of typical fission explosions. However, for present purposes, the difference may be disregarded. Since gamma rays and neutrons cause similar type injury to humans, the combined effect may be considered, although the relative biological effectiveness (RBE) of neutrons is much greater than that of gamma rays.

Fallout

As the height of burst of a nuclear explosion occurs nearer the surface of the earth (or sea), larger and larger proportions of the earth (or water) enter the fireball and are fused or vaporized. When sufficient cooling has occurred, the fission products become incorporated with the earth particles as a result of the

PRINCIPLES OF GUIDED MISSILES AND NUCLEAR WEAPONS

condensation of the vaporized products into fuzed particles of earth, etc. As the violent disturbance due to the explosion of the nuclear weapon subsides, these contaminated particles fall gradually back to the earth. This effect is referred to as the **FALLOUT**. The extent and nature of the fallout can range between wide extremes—dependent on the energy yield and design of the bomb, the height of the explosion, the nature of the surface beneath the point of burst, and the meteorological conditions. In the case of an **AIR BURST** occurring at an appreciable distance above the earth's surface, so that no large amounts of dirt (or water) are sucked into the cloud, the inherent radiation will be widely dispersed. On the other hand, a nuclear explosion occurring at or near the earth's surface can result in **SEVERE** contamination by the radioactive fallout.

It should be understood that fallout is a gradual phenomenon extending over a period of time. There can be considerable fallout many hours after the surface detonation of a nuclear weapon, and many miles away. Additionally, there is a phenomenon called **WORLDWIDE** or delayed **FALLOUT** which may continue for years after a nuclear explosion. Fallout that occurs within 24 hours of a nuclear explosion is referred to as **LOCAL** or early **FALLOUT**.

RADIOACTIVE DECAY.—Fission products, which make up the greatest hazard in residual radiation, are initially very radioactive. However, this activity falls off at a fairly rapid rate as the result of decay. Figure 14-19 shows the exponential rate of decay of fission products after a nuclear explosion.

The mixture of radioisotopes present after a nuclear explosion is so complex it is impossible to represent the decay as a whole in terms of half-life, as each radioisotope has its own definite half-life, ranging from a fraction of a second to a million years. The chart presents a fairly simple formula for calculating the approximate decrease in total radiation intensity in relation to time. The residual radioactivity for the fission products at 1 hour after nuclear detonation is taken as 100 and the subsequent decrease with time is indicated by the curve. At 7 hours after the explosion, for example, the fission product activity will have decreased to one-tenth (10 percent) of its amount at 1 hour. After 2 days, the activity would have decreased to about 1 percent of the 1-hour value.

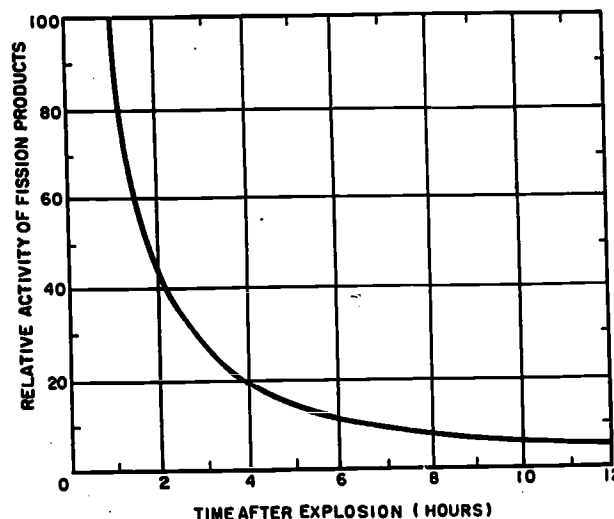

144.71
Figure 14-19.—Rate of decay of fission products after a nuclear explosion (activity rated as 100 at 1 hour after detonation).

Fallout and Type of Burst

Contamination of the earth's surface with radioactive material results from neutron activity after a nuclear explosion and from fallout. The amount of contamination and its distribution vary with the factors previously stated.

The cloud of a thermonuclear explosion rises rapidly to the highest levels of the atmosphere and spreads over hundreds of square miles in the first hours. During this time the particles are being acted upon by the winds, including those up to 60,000 or 80,000 feet, which may vary greatly in direction and velocity at different heights. Particle size will affect the rate of fall and as the material descends through the rain cloud bearing levels, the fallout may be slightly accelerated by rain or snow. The fallout may or may not be visible, but in any case, it can be detected with radiac equipment. Falling dust or ash, if visible, probably will be radioactive.

AIR BURST.—The **RADIOLOGICAL EFFECTS** from a typical **AIR BURST** are completely overshadowed by the effects of blast and thermal radiation. An exception to this would be a "low" air burst of a high yield weapon

Chapter 14—EFFECTS OF NUCLEAR WEAPONS

where there would be extensive induced radioactivity in the vicinity of ground zero. Radiological effects might also be of some consequence to those persons shielded from the primary causes of casualties, and to those beyond the areas of serious blast and thermal damage.

SURFACE BURST.—A surface burst nuclear explosion presents an entirely different picture. With a surface burst, even though the induced activity will be considerable, the activity of the **FALLOUT** will be of much greater consequence.

The surface burst causes large amounts of earth (water), dust, and debris to be taken up into the fireball in its early stages. Here they are fused or vaporized and become intimately mixed with the fission products and other bomb residues. As a result there is formed, upon cooling, a tremendous number of small particles contaminated to some distance below their surfaces with radioactive matter. In addition, there are considerable quantities of pieces and particles, covering a range of sizes from large lumps to fine dust, to the surfaces of which fission products are more or less firmly attached.

The larger (heavier) pieces, which will include a great deal of contaminated material scoured and thrown out of the crater, will not be carried up into the mushroom cloud, but will descend from the column. Provided the wind is not excessive, these large particles, as they fall, will form a roughly circular pattern around ground zero (though the circle will be somewhat eccentric as the result of any wind). Most of this heavier material referred to above will descend within an hour or so.

The smaller particles present in the atomic cloud will be carried up to a height of several miles, and may spread out some distance in the mushroom cloud before they begin to descend. The actual time taken to return to the earth, and the horizontal distance traveled, will depend upon the original height attained, the size of the particles, and upon the wind in the upper atmosphere.

The fraction of the total radioactivity of the bomb residues that appears in the fallout depends upon the extent to which the fireball touches the surface. Thus, the proportion of available activity increases as the height of the burst decreases and more of the fireball comes in contact with the earth (or water). In the case of a "contact burst," some 50% of

the total residual radioactivity will be deposited on the ground within a few hundred miles of the explosion. The remainder of the activity will remain suspended for a long period of time as with an air burst.

The intensity of the radioactivity is very high immediately after the burst, but decays rapidly. Therefore, since not much time will have elapsed, the particles reaching the ground near the burst will be highly radioactive, while those which are carried a long distance will have lost much of their radioactivity before they alight.

Although the areas seriously affected by heat and blast of thermonuclear weapons are large, they are small when compared to the area of residual radiation hazard produced by fallout. Because of many uncertainties, especially of wind direction and velocity at different heights, it is impossible to apply a standard fallout pattern to all detonations. An idealized fallout pattern has been prepared and a commanding officer can adjust the outlines according to whatever information is available to him at the time and plan his defenses for the area expected to receive fallout. Such knowledge would include information on wind and weather conditions in the area, the topography of the area, and location and nature of natural or manmade shelters.

As a general rule, the pattern of contamination will be as illustrated in figure 14-20. It becomes an elongated cigar-shaped area extending downwind from the point of burst. Of course this pattern will vary with the wind velocities and directions at all altitudes between the ground and the height of the atomic cloud. The actual fallout assumes a somewhat irregular shape, such as that shown in figure 14-21, which was from a 43-KT shot.

Note that the areas downwind are not immediately contaminated. Rather, most of the downwind area will not be seriously contaminated until hours after the explosion. For an example (fig. 14-20), a location 22 miles downwind will have a **DOSE RATE** of about 10 roentgens/hour one hour after the detonation. At 2 hours, the dose rate has increased to 1000 r/hr. Finally, at 18 hours, it is down to roughly 80 r/hr. The increase in dose from 1 to 2 hours means that fallout was not complete at 1 hour after the explosion. With respect to the **ACCUMULATED DOSE** received, at one hour after detonation, the 100-mile point will not have received any appreciable radiation because the fallout has only

PRINCIPLES OF GUIDED MISSILES AND NUCLEAR WEAPONS

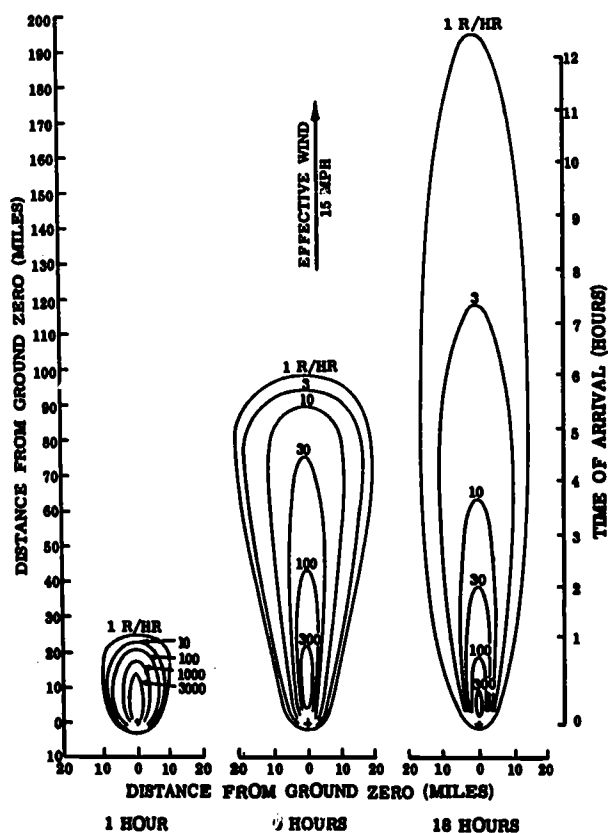

100.89
 Figure 14-20.—Dose-rate contours from early fallout at 1, 6, and 18 hours after a surface burst with 1-megaton fission yield (15 mph effective wind speed).

started to arrive. While at the end of 6 hours, the total dose has reached over 3000 roentgens. In general then, at any given location, at a distance from a surface burst, some time elapses before the fall out arrives. Time of arrival and amount of radiation vary with the size and type of burst, the wind, and other conditions.

Although the example given above is for the surface burst of a high fission yield, 1-megaton nuclear weapon, the fallout phenomena associated with a low fission yield weapon are essentially the same except for differences in degree. Thus, a high energy fission yield explosion will mean a larger area contaminated to a more serious extent than would a low fission yield weapon.

UNDERGROUND BURST.—The extent of residual radiation accompanying an underground burst will depend primarily on the depth of burst and the weapon yield. With regards to initial radiation, it is either nonapparent or inconsequential by comparison to the residual radiation.

If the explosion occurs at sufficient depth below the surface, essentially none of the bomb residues and neutron-induced radioactive materials will escape to the atmosphere. There will be no appreciable fallout.

On the other hand, if the burst is near the surface so that the ball of fire actually breaks through, the consequences as regards fallout will not vary greatly from those of a surface burst. Other circumstances being more or less equal, the contamination in the crater area following an underground burst will be about the same as for a surface explosion of equal fission yield. However, the total contaminated area for a shallow underground burst will be greater because of the larger amount of fission products present in the fallout.

UNDERWATER BURSTS.—Radiological effects of UNDERWATER BURSTS closely parallel those of underground origin. The base surge, consisting of a contaminated cloud or mist of small water droplets also has a parallel in the underground phenomena. During the first 15 minutes, the base surge is a source of contamination, but the radiation intensity declines rapidly. The total amount of radiation from the base surge and "rain-out" from the atomic cloud varies with the size and type of burst, the depth of the water, and other factors. In the BAKER test at Bikini, the early dose rate of the base surge was 100,000 roentgens per hour. From a deep underwater burst there would be no airborne cloud and consequently no fallout or rainout. As a general rule, the base surge is expected to present a considerable radioactive hazard for a distance of several miles, especially downwind. The parts of the ship that are exposed to the base surge can absorb a great deal of radioactivity.

An important difference between an underwater burst and one occurring underground, is that the radioactivity remaining in the water is gradually dispersed, whereas that in the ground is not. Therefore, as a result of diffusion of the various bomb residues, mixing with large volumes of water outside the contaminated area and the natural decay, the radiation intensity of

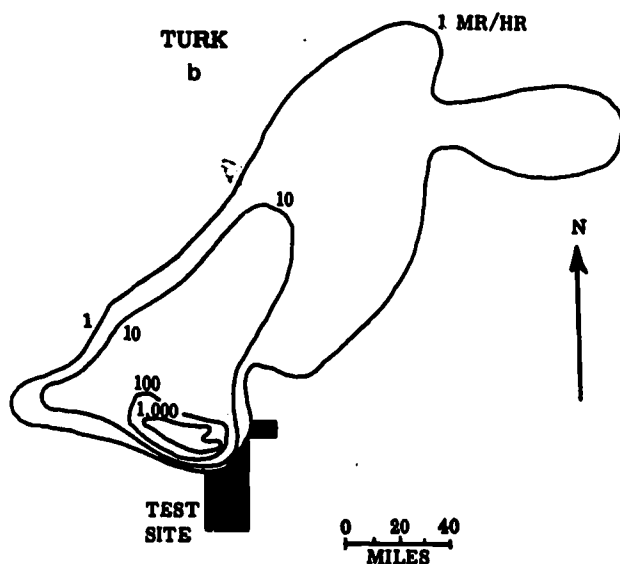

Figure 14-21.—Early fallout dose-rate contours from the TURK shot at the Nevada Test Site.

the water in which a nuclear explosion has occurred will decrease fairly rapidly. Additionally, fission products will settle to the bottom of the body of the water, thus greatly attenuating the radiological hazards.

The radiation hazard therefore is much less than the same amount of fallout over land. The radioactive water will be transported by prevailing currents, and if the currents are known, the radioactive areas can be charted and avoided.

Distilled water made from lightly contaminated sea water is perfectly safe to drink. This is because the radioactive material remains behind in the residual scale and brine of the distillation process. However, the ship's evaporators must be secured while the ship is in significantly contaminated waters, to avoid carrying dangerous contamination into the ship's interior. Also, it would be extremely difficult to decontaminate the evaporator and keep contamination from reaching the water tanks. It should also be emphasized that mere boiling of water is of no value as regards the removal of radioactivity.

Radiation Injury

As the student will recall from chapter 12, the injurious effects of nuclear radiation represents a phenomenon completely absent in

conventional explosions. For this reason, the subject of RADIATION INJURY will be discussed here in more detail.

The harmful effects of radiation appear to be due to the ionization (and excitation) produced in the cells that make up living tissue. As a result of ionization, some of the constituents that are essential to normal functioning are damaged or destroyed. Some of the products formed may act as cell poisons. Additionally, the living cells are frequently unable to undergo mitosis, so that normal cell replacement is inhibited.

The effects of nuclear radiations on living organisms depend not only on the total dose, that is, on the amount absorbed, but also on the rate of absorption, i.e., on whether it is ACUTE or CHRONIC. In an acute exposure, the whole radiation dose is received in a relatively short period of time. It has somewhat arbitrarily been defined as that dose received during a 24-hour period. Delayed radiations, like those which may be received from fission products, persist over a longer period of time and this type of exposure is of the chronic type.

The distinction between acute and chronic exposure lies in the fact that, if the dose rate is not too high, the body can achieve partial recovery from some of the consequences of the nuclear radiations while still exposed. In addition to the above, the percent of body exposure has significance. If follows then, that whereas a person would die as the result of acute exposure of 1000 rems whole-body radiation, he would probably suffer no noticeable external effects if the dose were spread over a period of 30 years.

The injury caused by a particular dose of radiation will depend upon the extent and part of the body that is exposed. Different portions of the body show different sensitivities to ionizing radiations, and there are variations in the degree of sensitivity among individuals. The age and the physical condition of the person also influence the result. Since practically all the information we have on the effects of radiation on humans is from the Japanese bombings, the influence of other injuries is hard to separate from radiation injuries. Large numbers of Japanese were exposed to doses of radiation ranging from insignificant to fatal. The results were complicated by other injuries, shock, and lack of medical attention, and many of the deaths were probably due to a combination of injuries. By combining the information available from the Japanese bombings with information gathered on

PRINCIPLES OF GUIDED MISSILES AND NUCLEAR WEAPONS

accidentally exposed persons and studies of animals exposed at test sites, tables have been compiled to show the effects of acute radiation of different amounts.

ACUTE RADIATION INJURY. Table 14-3 shows expected effects of acute whole-body radiation doses. Notice that the table begins with 150 roentgens; no noticeable effects are expected below that amount. Changes may nevertheless be occurring in the blood. Perhaps the most striking and characteristic biological consequence of exposure to whole-body nuclear radiation are the changes in the blood and the blood-forming organs. The effects may not be seen at once, but the loss of the ability to fight infections may result in death. For those who survive, recovery may take months or even years. Careful charting of the course of blood changes in Japanese victims and those in the Marshall Islands has furnished reliable data on these phases of radiation exposure.

It has been estimated that approximately 50 percent of the persons subjected to 450 roentgens

of acute radiation will die. It is believed that prompt medical treatment (care) would reduce this percentage. Everyone receiving 1000 r. or more would die within two or three weeks, if not sooner, in spite of the best medical care.

A further matter of note is that the sooner the symptoms of radiation sickness appear after exposure, the more serious the consequence will be. Additionally, there is a latent period between the first symptoms of radiation exposure and a further condition of sickness.

The clinical effects of radiation listed in the table are those noted in the Japanese population, where preexisting conditions were an unknown factor and little actual data recording was done until 2 weeks after the explosions. The most accurate data are from the cases of radiation exposure in the Marshall Islands test, but 200 r. was the limit for the exposure there.

LATE EFFECTS OF RADIATION.—If a person survives the acute effects of radiation, later effects may show up years later. These effects, like the acute ones, are caused by

Table 14-3. —General Nature of Radiation Sickness. (Acute exposure)

Time after exposure	Acute doses received over a large area of body		
	150-300 r	300-500 r	500-600 r
First week	Nausea and vomiting on first day.	Nausea and vomiting on first day. Otherwise, no definite symptoms.	Nausea and vomiting on first day; diarrhea, vomiting.
Second week	No definite symptoms.	Loss of hair, loss of appetite, general sick feeling.	Inflammation of mouth and throat, fever, rapid weight loss, mortality rate about 90 percent.
Later effects	Loss of hair, loss of appetite, general sick feeling, sore throat, pallor, skin hemorrhage, diarrhea, moderate weight loss, ultimate recovery likely in absence of complications. Mortality rate of 3 percent at 200 r.	Fever, inflammation of mouth and throat, pallor, skin hemorrhage, diarrhea, nose bleed, rapid weight loss, mortality rate of 50 percent at 450 r.	

Chapter 14—EFFECTS OF NUCLEAR WEAPONS

changes in the cells and tissues arising from the exposure. The replacing cells may not be quite normal.

One of the effects mentioned previously is that of cataracts. These are attributed to the initial nuclear radiation at the time of the explosion, chiefly by fast neutrons, which cause lens opacities more frequently than gamma radiation.

It is still too early to make a definite statement about the effect of radiation on the life span. At present there is no definite proof that whole-body radiation exposure hastens aging.

An increase in the incidence of leukemia cases was shown among the inhabitants of Hiroshima and Nagasaki, but the total number of cases definitely associated with radiation exposure is not large and there is still some uncertainty about interpretation of the statistics.

A twofold to fourfold increase in neoplastic disease (abnormal marked growths, i.e., tumors, cancers) was found in the Hiroshima population but a similar study of Nagasaki showed no such relationship. Studies are being continued on the relationship of cancer incidence to radiation exposure.

One of the most publicized results of radiation is that of sterility. Study of the Japanese cities shows that the sterility is temporary. To produce permanent sterility, a large radiation dose is required, which is likely to be fatal. Among pregnant women exposed, there was a marked increase in stillbirths and death of newborn infants. The surviving children showed a greater frequency of mental retardation. Children conceived after the nuclear exposures did not show an increase in abnormalities. Thus, the fear of effects on future generations has not been substantiated, although experiments with fruit flies and animals showed increased mutations.

INJURY FROM FALLOUT AND RESIDUAL RADIATION.—A few radiation phenomena, such as genetic effects, apparently depend primarily upon the total dose received and to a lesser extent on the rate of delivery. The injury caused to the germ cells under certain conditions appears to be cumulative. In the majority of instances however, the biological effect of a given total dose of radiation decreases as the rate of exposure decreases.

The effects of residual radiation are the same as for initial radiation, but not with such dramatic onset. The symptoms develop gradually as the radiation dose accumulates. The

blood changes and damage to the blood-forming cells in the marrow of the bones proceed unseen and may be advanced before detected.

The hazards of fallout are external and internal. The contaminated particles of the early fallout cause "beta burns" if they contact bare skin or skin protected by light clothing. Where fallout is heavy, the whole body may be exposed to beta particles. The effects were studied in the Marshall Island test explosion. The natives did not realize the significance of the ash-like dust falling on them about 5 hours after the detonation. The itching and burning sensation experienced at the time subsided and disappeared, but 2 or 3 weeks later, skin lesions, dark colored patches, and epilation began to appear among the exposed population. Discoloration of nails was attributed to gamma radiation. The skin lesions healed and the hair regrew in a matter of 6 months, but the studies of platelets and red blood cells showed they continued to be lower than normal 5 and 7 years after the exposure. This indicates that repair of the bone marrow injury was not complete.

Internal hazard from fallout occurs when radioactive particles are consumed with food and water, or are inhaled. The nose is a good filter, so there is not so much danger from inhalation of early fallout, most of which is too coarse for inhalation. It is also possible for radioactive material to get inside the body through cuts or other wounds in which the skin is broken. (Alpha particles cannot penetrate unbroken skin.)

Even a very small quantity of radioactive material in the body can do considerable damage, and the injury is continuous as long as the material is in the body. The organ most affected is determined by the type of radioactive material. Iodine, for example, tends to concentrate in the thyroid gland. The fission products strontium and barium are deposited in the calcifying tissue of bone. Cerium and plutonium also are "bone seekers." They are potentially very hazardous because they injure the sensitive bone marrow where many blood cells are produced. The damage to the blood-forming tissue thus results in a reduction in the number of blood cells and so affects the whole body adversely. The damage may not become apparent for some time. The primary hazard of inhaled plutonium is in the lungs and bronchial lymph nodes. Uranium causes damage to the kidneys but only as a heavy

PRINCIPLES OF GUIDED MISSILES AND NUCLEAR WEAPONS

metal poison (similar to lead poisoning), not because of its radioactivity.

The short-term hazard of early fallout ingested by the natives of the Marshall Islands was small. The long-term hazard of delayed fallout is another matter. The most important radioactive isotopes are probably cesium-137 and strontium-90. As explained earlier, the delayed fallout can spread to remote parts of the globe and can contaminate water, milk, and food. Cesium-137 has a radioactive half-life of 30.5 years and emits gamma rays as it decays. Strontium-90 has a radioactive half-life of 27.7 years and emits only beta particles of fairly low energy, but once it gets into the skeleton it stays there a long time. Experiments with animals indicate that the effects may be anemia, bone necrosis, cancer, and possibly leukemia.

As a result of the nuclear test explosions in various countries, there has been an increase in the strontium-90 content of the soil, plants, and the bones of animals and man. This increase is worldwide and is not restricted to the areas in the vicinity of the test sites, although naturally it is higher there.

The amount of carbon-14 in the troposphere has been increased by about 30 percent through weapons testing. It will be a source of radiation for many generations, as its half-life is 5,760 years.

ATOMIC WARFARE DEFENSE

GENERAL

The effects of nuclear weapons have been given with considerable detail derived from experience with nuclear detonations. But in planning protection from the consequences of a nuclear explosion, many uncertainties are encountered. It is impossible to know in advance where or when a weapon will be detonated, or what type it will be, or its size. Nevertheless, there are some basic principles which, if applied, can give a measure of protection to a large proportion of the population.

Foresightedness and an understanding of the effects of nuclear weapons will have great bearing on survival in event of nuclear warfare. In general, there are two broad categories of protection that can be used to avoid the stunning effects of nuclear weapons. They are DISTANCE and SHIELDING. In other words, it is necessary

to get beyond the reach of the effects, or to provide protection against them within their radii of damage.

SHIPBOARD PROTECTIVE MEASURES

The naval forces afloat have a distinct advantage in that they are readily dispersible. In addition to this, the ships of the Navy are so designed that they are comparatively resistant to the blast (and/or shock) and the thermal effects of nuclear weapons. Too, the features built into Navy ships for protection against gas attack provide some measure of protection against radiation hazards.

Both long- and short-range preparation go into proper readiness of Navy ships. Strict specifications are set for the designers and builders in order that the ships are as resistant as feasible to the effects of nuclear weapons. Command action is taken to keep fire and missile hazards minimized. Tactics include such things as greater than normal dispersal, the placing of all possible personnel under cover, establishing the highest state of material readiness, and the activation of WATER WASHDOWN systems.

After a nuclear explosion, the primary problem is to keep and/or return the particular ship to a maximum state of readiness by preventing the avalanching casualties resulting from secondary effects, by restoring normal services or rigging alternate (or emergency) services, attending to the wounded, conducting radiological surveys and decontaminating or localizing as applicable, and by assessing the extent and nature of damage and restoring the unit as nearly as possible to its original condition.

Tactics included after a nuclear explosion would include maneuvering to avoid, or to minimize the transit time through, any base surge, fallout areas, or radioactive waters.

Providing the maximum protection for the men will often reduce the ship's immediate operational capability (offensive and defensive). It may become necessary for the commanding officer to sacrifice personnel safety to preserve ship operational capability. In making his decision the CO must consider many factors, some of which are: the mission of the ship, the estimated extent and duration of the hazardous environments, exposure guidance (how long a man may be permitted to remain at a station in the contaminated area), rotation of

Chapter 14—EFFECTS OF NUCLEAR WEAPONS

personnel, means of decontamination available, and protection available. A ship with a wash-down system can prevent heavy contamination of the ship surfaces if the system is placed in operation before the nuclear explosion, but even if that was not possible, the washdown system will reduce topside contamination so decontamination teams can get to work sooner and men can be detailed to their stations for short times, determined by the amount of radioactivity present. The CO must know the actual or potential exposure hazards and the counter-measure capabilities of his ship in order to judge whether to continue, modify, or abort the action and/or mission. If he has a good disaster control plan and has the men trained in their individual and team duties, the chances of survival and successful mission are immeasurably increased. Not only the CO, but every officer on board ship and every petty officer and enlisted man has specific responsibilities and duties to perform before, during, and after a nuclear explosion.

SHORE BASE PROTECTION

Ashore, the military must also plan to disperse and/or provide suitable protection for personnel and material. The civil defense authorities should plan accordingly for the civilian population. Much can be done towards reducing blast and fire hazards in existing structures. Shelters and shelter areas can be provided. Disaster teams can be organized and trained to keep losses to a minimum.

Standards for shelter construction have been prepared by engineers with information from test buildings at test sites and from the results found in the Japanese bombings. Designs have been prepared for both public and private shelters for various situations. The building and stocking of shelters has been sporadic chiefly because people believe that nothing can save you in a nuclear attack. It is true that there is little chance of survival in the zone of heavy damage around ground zero, but the chances improve with distance. Just one quotation of statistics from the Japanese results should be convincing. At Hiroshima, of approximately 3000 school students who were in the open and unshielded within a mile of ground zero, about 90 percent were dead or missing after the explosion. In the same zone were nearly 5000 students who were shielded in one way or another; only 26 percent of them were fatalities.

The area over which protection could be effective in saving lives is roughly eight to ten times as large as that in which the chances of survival are small. It is in this possibly large area that preplanning of protective measures is of the utmost importance.

PROTECTIVE MEASURES—INDIVIDUAL ACTION

For an individual, in the event of a surprise attack, proper and immediate action can mean the difference between life and death.

From experience gained in both nuclear and conventional explosions, there is little doubt that as a general rule it is more hazardous in the open than inside a structure. In an emergency, therefore, the best available shelter should be taken.

Aboard ship, TAKE COVER should be directed at the appropriate time for those in exposed stations. Once properly shielded, and other operations permitting, personnel should take a position with knees flexed, and with a firm grip on a substantial piece of the ship's structure. This position should be held until passage of the blast and/or the shock wave.

Ashore, civil defense authorities (or military, where they have jurisdiction) should have designated shelter areas and/or shelters. Subways would provide a good emergency shelter; however, these are found in only a limited number of cities. As an alternative, the basement of a building should be chosen. In this connection, a fire-resistant, reinforced-concrete or steel frame structure is to be preferred, since there is less likelihood of a large debris load on the floor above the basement. Even basements of good buildings are not, however, an adequate substitute for a well designed shelter.

Should there not be any opportunity to take the best shelter, alternate immediate action will be necessary. The first indication of an unexpected nuclear explosion (other than a subsurface explosion) would be a sudden increase in the general illumination. It would be imperative to avoid the instinctive tendency to look at the source of light, but rather to do everything possible to cover all exposed portions of the body (another reason for proper and suitable battle dress). A person inside a building should immediately fall prone and crawl behind a table or desk. This will provide

PRINCIPLES OF GUIDED MISSILES AND NUCLEAR WEAPONS

a partial shield against splintered glass and other flying missiles. No attempt should be made to get up until the blast wave has passed, as indicated by the breaking of glass, cracking of plaster, and other signs of destruction. The sound of the explosion also signifies the arrival of the blast wave.

A person caught in the open by the sudden brightness due to a nuclear explosion, should drop to the ground, while curling up to shade the arms, hands, neck, and face with the clothed body. Although this action will have little effect against the initial nuclear radiation, it may help in reducing flash burns due to the thermal radiation. Of course, the degree of protection from thermal effects will vary with the energy yield of the explosion. For as you will recall, low yield weapons expel all their thermal radiation in a short interval of time, while the higher the yield, the longer the thermal pulses of energy will last. Nevertheless, there is nothing to be lost, and perhaps much to gain through such action. The curled-up position should be held until after the blast wave has passed.

Since eye injuries and skin burns from thermal radiation can occur at great distances from the explosion, this type of evasive action can be helpful over large areas. Ordinary sunglasses provide little or no protection of the eyes against damage by thermal radiation. The blink reflex is of doubtful help if the person is facing the blast point, especially if the thermal energy is released in one burst, as from lower energy weapons or those burst at high altitudes (above 20 miles). Fortunately, most flash blindness is temporary.

If a shelter of some kind, no matter how minor, e.g. in a doorway, behind a tree, or in a ditch or trench, can be reached within a second, it may be possible to avoid a significant part of the initial nuclear radiation, as well as the thermal radiation. But shielding from nuclear radiation requires considerable thickness of material and this may not be available in the open. By dropping to the ground, some little advantage may be provided by the ground and surrounding objects.

Putting out fires when they are just starting may be done by individuals in some instances. Every effort should be made to do this in order to prevent large fires which may become uncontrollable.

PROTECTION FROM FALLOUT

Protection against the residual radioactivity present in LOCAL FALLOUT presents a number of difficult and involved problems. This is because the radioactive products are not normally visible and require radiac equipment for detection and measurement, and because of the widespread and persistent character of the fallout, and too, because fallout prediction is a function of complicated meteorological processes.

Fallout Prediction

The fallout patterns charted after the various nuclear tests have been used to prepare a form to be used for predicting the area of fallout. It is called Radiological Fallout Forecasting (RADFO) and is made available to operational commands. Before a nuclear attack, information will not be available on the location of the burst, type of burst, or yield of the weapon, and after the detonation it is expected that disruption of normal activities will prevent obtaining much real information about the burst. The command will have information on the atmospheric wind structure, and with that information, can plot a tentative fallout area with the aid of the RADFO overlay (fig. 14-22). The RADFO diagram is usually drawn in grease pencil on a plastic sheet to be used as an overlay on an appropriate map or chart. Various essential data are included in the legend of the RADFO diagram. The legend also indicates the map scale or map identification number for which it is drawn. Each command requests maps for its particular area and keeps them on hand. The red outline marks the area of high fallout expected from a low-yield weapon, and the black outline marks the high fallout area for a high-yield weapon. The cross-hatched dot represents the point of detonation (surface zero). With the dot placed at the point of detonation (expected), the overlay can be rotated in line with the winds at the time, and it then outlines the approximate area where the fallout can be expected. The ship can be maneuvered to keep out of that area and the fallout preparations can be made aboard the ship.

The complete description and instructions for use of the RADFO diagram are given in the United States Navy Radiological Fallout Manual, (1962), OPNAV INST P3441.3A. The actual fallout area will vary from the RADFO plot, but planning can be based on the pre-

Chapter 14—EFFECTS OF NUCLEAR WEAPONS

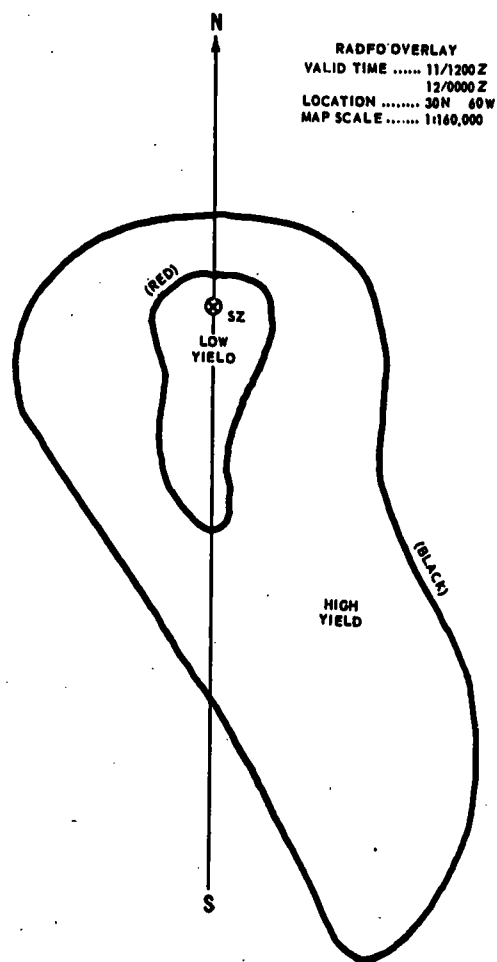

100.90
 Figure 14-22.—Example of fallout plot drawn with RAD FO overlay upon receipt of prediction or warning message.

liminary plot and early action can be taken on that basis. Plans can be made to minimize the hazards of fallout radiation, but they must be flexible so they can be adapted to the particular situation which develops after the attack.

Group Protection

Fallout from a surface burst can produce serious contamination far beyond the range of other effects such as blast, shock, thermal radiation, and initial nuclear radiation. The quantity of contaminated material produced by a surface burst of a megaton weapon with a fission yield is so large that the fallout may continue to arrive in hazardous concentrations up to perhaps 24 hours after the burst. It

may affect vast areas, and therefore may affect large numbers of people who must have protection for at least that period of time. Anyone acquainted with the daily traffic problems accompanying the routine working day transportation in any large metropolitan area must realize that attempting to evacuate the whole population of a threatened area upon short notice would result in a hopeless snarl. The alternative is to have prepared shelters, stocked with provisions, where large numbers of people can take refuge and remain perhaps for several days, or even weeks.

Where approved shelters are not available, even the basement of a frame house can attenuate nuclear radiation by a factor of about 10. Greater reduction is possible in large buildings or in shelters covered with several feet of earth. Three feet of earth will provide a radiation attenuation factor in the neighborhood of 1000.

Ships will have to depend on proper maneuvers, the GAS TIGHT ENVELOPE, water wash down systems and decontamination procedures for protection. Ashore, the civil defense and/or military authorities must make radiological surveys to ascertain the extent and nature of the contamination. Once this is known, it is possible to take other corrective actions, such as orderly evacuation of sheltered survivors and decontamination of essential areas or equipments. Shifting winds and other unknown variables complicate any prediction of safe evacuation routes. A person may leave a comparatively safe location and end up the loser for his effort.

Of the passive protective measures that can be taken, shelter is the foremost. Complete protection for all people is hardly feasible, but every Navy shore activity has areas designated as shelter areas where people are to go immediately if a nuclear alarm is given. Evacuation routes are planned so each person has an assigned place to go in case there is sufficient advance warning so people can get to designated gathering places. Know the location of the marked areas so you can go to the assigned one without hesitation when so ordered.

Civil Defense authorities have published pamphlets on methods of construction for home shelters. Family type shelters were widely used in England during World War II for protection against bombs, and were a great help in preventing casualties. Similar shelters, built according to Civil Defense standards to

PRINCIPLES OF GUIDED MISSILES AND NUCLEAR WEAPONS

reduce the entrance of nuclear radiation, can be of inestimable help in case of nuclear attack.

Protection Against Long-Range Fallout

The radiation from long-range fallout is too attenuated to be harmful as external radiation. Its harm comes from ingestion, whether through inhalation, from drinking water, or food. Except in cases of extreme overexposure, there is a latent period before signs and symptoms of radiation illness appear. Radioactive material within the body cannot be controlled by time, distance, or shielding; it continues to affect the cells of the body until it has been eliminated by natural processes or radioactive decay.

Risk of exposure can be greatly reduced by good housekeeping. Foods that might have received some of the radioactive fallout should be thoroughly washed before using. Exposed foods that cannot be washed should be disposed of. Cooking the foods or boiling the water does not reduce the radioactivity. A number of materials have been tested for possibilities as an agent to remove radioactive materials from the system. Various results have been reported. So far, none of the products so tested have been accepted as useful for removing radiation. Also, some materials have been tried for removal of radioactive fallout in milk. This is another problem left to be solved by further research.

EMPLOYMENT OF NUCLEAR WEAPONS EFFECT

GENERAL

Many factors enter into the selection of the burst height (or depth) and yield of a particular weapon. Among these are fuzing limitations, type of target, available delivery systems, and the degree of damage desired. Since nuclear missiles, torpedoes, and depth bombs have become part of the arsenal, the aspects of weapon selection have been multiplied.

From an EFFECTS standpoint, the basic criteria which govern weapon selection are peak blast wave overpressure, peak dynamic pressure, duration of the positive wave (of blast wave), crater extent, thermal radiation, initial nuclear radiation, residual fission product fallout, and induced ground contamination. These criteria apply to the selection of a weapon to

use on a stationary land target. For another type of target, an attacking aircraft, for example, entirely different criteria are necessary. Should a nuclear-tipped missile be launched from the ship or should an air-to-air missile be used? Perhaps conventional antiaircraft fire will take care of the situation. The officer in command must make the decision quickly. You can readily see that this is quite a different situation from, say, the planned obliteration of an enemy naval base.

The actual mechanics of weapon selection is a very complex operation. This operation is the function of relatively high echelons of command. The student should be aware that there also are great moral and political issues involved in the use of nuclear weapons. For these reasons, the actual committing of nuclear weapons to use by our country is the responsibility of the President of the United States. Notwithstanding, some generalized statements concerning the relative importance of various effects for different burst conditions is considered essential to a complete orientation in the nuclear weapons subject area.

The discussion following relates to the use of nuclear weapons to achieve certain effects on surface targets, either land or sea. Most of the material damage caused by either an air burst or a surface burst of a nuclear weapon is due mainly (directly or indirectly) to the shock or blast wave that accompanies the explosion. In considering the destructive effect of a blast wave, one of the important characteristics is the overpressure, that is, the pressure above the normal atmospheric pressure. Other characteristics of the blast wave that affect the degree of destruction are the dynamic pressure, duration, and time of arrival of the blast wave.

SURFACE BURST

A SURFACE BURST will increase the range at which peak overpressures greater than about 12 psi occur. It will reduce thermal radiation received by ground targets compared to that received from an air burst at the same slant range and it will produce significant cratering and ground shock. A peak overpressure of 12 psi will cause severe damage to all structures except those of reinforced-concrete, blast-resistant construction. It will also cause moderate to severe damage to most military equipments.

Chapter 14—EFFECTS OF NUCLEAR WEAPONS

Most naval ships operating today will be immobilized when subjected to 20 psi peak air overpressure. Five psi will cause light damage to all naval and mercantile shipping. Light damage to naval ships consists of damage to electronic, electrical, and mechanical equipments—however, the ships may still be able to operate effectively.

The surface burst will overdestroy some area. It is therefore not as economical (in its damage capabilities) as an air burst. Conceivably, therefore, the surface burst would be used against resistant targets or where assured destruction is desirable.

For weaker targets, which are destroyed or damaged at relatively low overpressures or dynamic pressures, the height of burst may be raised to increase the damage area, since the required pressures will extend to a larger range than for a low air or surface burst.

While the terrain has some effect on the blast wave, it is difficult to predict the effect on the damage resulting. The fact that the point of explosion cannot be seen from behind a hill does not mean that the blast effects will not be felt. Blast waves can easily bend around obstructions, and multiple reflections between buildings and streets might increase the overpressure and dynamic pressure.

The LOCAL FALLOUT associated with a surface burst is a very significant factor in nuclear weapons selection.

AIR BURST

An AIR BURST will increase the ground range at which overpressures of about 10 psi or less are obtained; maximize areas at which significant thermal radiation is received on the ground; and eliminate local fallout contamination. Windowpane breakage is associated with 0.5 psi overpressure, while severe damage to wood frame houses occurs with 3 psi, and to reinforced-concrete buildings with approximately 10 psi.

SUBSURFACE BURST

With a SUBSURFACE BURST, peak air overpressure, thermal radiation, and initial nuclear radiation decrease as the depth of the

burst is increased. Cratering, ground (or water) shock, and fallout contamination will increase with the depth of burst up to a maximum (the optimum depth depends on the effect being considered) and then decrease. Maximum water waves will be produced at a certain critical depth of burst.

SCALING LAWS

The atomic bombs dropped on Japan are referred to as 20-KT bombs or nominal yield weapons. The effects of those bombs have been studied and analyzed in all their aspects, including their blast, thermal, and radiation effects. Since that time, tests of nuclear weapons of different sizes and types in various environments have furnished much other data on the effects of nuclear weapons. From studies of these effects, scaling laws have been formulated. The effects of detonations of weapons other than the nominal 20-KT bomb can be calculated by means of these simple scaling laws.

Although the laws are only of an approximate nature, they do provide a rough means of comparing the effects of different energy releases. Scaling laws are applied to each of the effects of nuclear detonations—blast, thermal, and radiation effects.

In the case of blast effects, the scaling law states that the distance from an explosion at which any specified overpressure is reached is proportional to the cube root of the energy released. For a 20-KT burst, the limit of severe damage occurs in the region of 7-psi overpressure, about 1 mile from ground zero. Computing with the scaling formula, an overpressure zone of 7 psi would be 1.3 miles from ground zero with a 40-KT bomb. Note that the damage limit is not twice as great as for a 20-KT bomb. To double the limit of severe damage, the amount of explosive would have to be increased 8 times.

With regard to overall damage and casualties, the area affected by the burst is important. The area of the burst is proportional to the square of the radius; therefore the effective area of blast damage is proportional to two-thirds of the energy release. If the effective area for a 20-KT bomb is 4 square miles it is 6.4 square miles for a 40-KT bomb.

PRINCIPLES OF GUIDED MISSILES AND NUCLEAR WEAPONS

The amount of thermal energy reaching a point at a given distance from the explosion will be directly proportional to the total energy release of the bomb. If the thermal energy from a 20-KT bomb is $4\frac{1}{2}$ calories per square centimeter at 3,000 yards from ground zero, from a 40-KT bomb it would be 9 calories per square centimeter. The same proportional increase holds true for the immediate nuclear radiation. However, this proportion is reasonably accurate only up to 40-KT bombs. For higher energy releases, the proportion of initial nuclear radiation to the energy of the bomb becomes greater and greater as the yield of the

weapon increases. For example, a 100-KT bomb will produce 120 times the nuclear radiation that a 1-KT bomb will produce; a 500-KT bomb will produce 1,000-KT (1MT) weapon will produce 1,000 times the amount of nuclear radiation; and a 1,000-KT (1MT) weapon will produce 2,100 times as much.

The altitude of the burst affects the results, and the factor of height must be included to modify the calculations with the scaling laws. Curves have been drawn to represent many conditions of burst. Figure 14-23 accumulates certain cardinal damage criteria for air burst explosions.

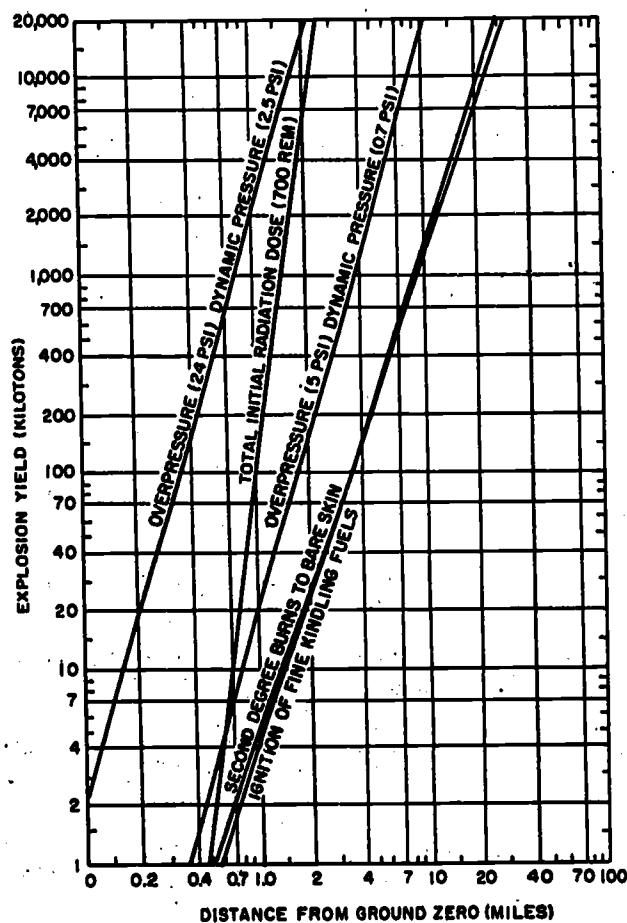

144.72

Figure 14-23.—Limiting distances from ground zero at which various effects are produced in an air burst.

BIBLIOGRAPHY FOR NUCLEAR WEAPONS ORIENTATION

- Glasstone, S., ed., The Effects of Nuclear Weapons, U. S. Atomic Energy Commission, Washington, D. C. 1962; 730 pp.
- Glasstone, S., Sourcebook on Atomic Energy, (U;U), Van Nostrand Company, Inc., 1958.
- Lapp, R. E., and H. L. Andrews, Nuclear Radiation Physics, Prentice-Hall, New York, 1963, 531 pp.
- Behrens, C. F., Atomic Medicine, T. Nelson and Sone, 1949, 416 pp.
- Saenger, E. L., editor, Medical Aspects of Radiation Accidents, U. S. Atomic Energy Commission, Washington, D. C., 1963, 357 pp.
- Principles of Radiation and Contamination Control, NavShips 250-341-3
Vol. 1, Radsafe for Everybody, 1959, 70 pp.
Vol. 2, Procedures and Guidelines Relating to Nuclear Weapons Effects, 1960, 340 pp.
Vol. 3, Technical Information Relating to Nuclear Weapons Effects, 1960, 154 pp.
- Atomic Energy Deskbook, (U;U), Government Printing Office, 1963.
- Basic Nuclear and Radiation Physics, (U;U), Atomic Weapons Training Group, FC DASA, Albuquerque, New Mexico.
- Fowler, J. M. (ed.), Fallout, A Study of Superbombs, Strontium-90, and Survival, Basic Books, Inc., New York, 1960.
- *Bethe, H. A., et al., Blast Wave, Los Alamos Scientific Laboratory, Los Alamos, New Mexico, March 27, 1958, LA-2000.
- *American Society of Civil Engineers, Design of Structures to Resist Nuclear Weapons Effects, ASCE Manual of Engineering Practice No. 42, ASCE, New York, 1961.
- *Johnston, B. G., Damage to Commercial and Industrial Buildings Exposed to Nuclear Effects, Federal Civil Defense Administration, February 1956, WT-1189.

*These publications may be obtained for a small charge from the Office of Technical Services, U. S. Department of Commerce, Washington, D. C. These are only a small sampling of the publications available to the interested student.

PRINCIPLES OF GUIDED MISSILES AND NUCLEAR WEAPONS

*Johnson, G. W., and C. E. Violet, Phenomenology of Contained Nuclear Explosions, University of California, Lawrence Radiation Laboratory, Livermore, California, December 1958, UCRL 5124 Rev. 1.

Disaster Control, (Ashore and Afloat), NavPers 10899-A, 1964, Government Printing Office, 359 pp.

Officer Correspondence Courses

Nuclear Ordnance, NavPers 10411. 5 assignments; 7 points (Confidential-Restricted data).

Nuclear Physics, NavPers 10901-B. 8 assignments; 32 points.

Radiological Defense, NavPers 10771-B. 12 assignments; 18 points.

*These publications may be obtained for a small charge from the Office of Technical Services, U. S. Department of Commerce, Washington, D. C. These are only a small sampling of the publications available to the interested student.

APPENDIX A

TABLE OF ATOMIC WEIGHTS AND BIBLIOGRAPHY

(The atomic weight column represents the mass of the most stable isotope of the element. All of the known elements are included. Oxygen 16 is used as the basic element.)

TABLE OF ATOMIC WEIGHTS

Z	ELEMENT	A	MASS	Z	ELEMENT	A	MASS
0	o/e/o	0	0.00055	35	Br	80	79.94401
0	o/n/1	1	1.00899	36	Kr	84	83.93806
1	1/P/1	1	1.00759	37	Rb	86	85.93852
1	H	1	1.00814	38	Sr	88	87.93375
2	2/a/4	4	4.00277	39	Y	89	88.93408
2	He	4	4.00387	40	Zr	92	91.93382
3	Li	6	6.01703	41	Nb	93	92.93526
4	Be	9	9.01505	42	Mo	96	95.93490
5	B	10	10.01612	43	Tc	99	98.93951
6	C	12	12.00380	44	Ru	102	101.96341
7	N	14	14.00752	45	Rh	103	102.93790
8	O	16	16.00000	46	Pd	107	106.93895
9	F	19	19.00445	47	Ag	108	107.93895
10	Ne	20	20.00050	48	Cd	113	112.94028
11	Na	23	22.99705	49	In	115	114.94050
12	Mg	25	24.99375	50	Sn	119	118.94100
13	Al	27	26.99008	51	Sb	122	121.94368
14	Si	29	28.98566	52	Te	128	127.94610
15	P	31	30.98356	53	I	129	128.94575
16	S	33	32.98189	54	Xe	132	131.94600
17	Cl	36	35.97969	55	Cs	133	132.94720
18	Ar	40	39.97505	56	Ba	138	137.94870
19	K	40	39.97665	57	La	139	138.94950
20	Ca	41	40.97523	58	Ce	141	140.95172
21	Sc	45	44.97007	59	Pr	141	140.95110
22	Ti	48	47.96312	60	Nd	144	143.95493
23	V	51	50.96004	61	Pm	146	145.95895
24	Cr	53	52.95746	62	Sm	150	149.96340
25	Mn	55	54.95540	63	Eu	152	152.00000
26	Fe	56	55.95264	64	Gd	158	159.97342
27	Co	59	58.95194	65	Tb	160	159.97775
28	Ni	60	59.94984	66	Dy	163	162.50000
29	Cu	64	63.99934	67	Ho	165	164.98110
30	Zn	66	65.94694	68	Er	168	167.98392
31	Ga	70	69.94814	69	Tm	169	168.94000
32	Ge	73	72.94645	70	Yb	174	173.98075
33	As	75	74.95440	71	Lu	175	174.99737
34	Se	79	78.94858	72	Hf	179	178.50000

PRINCIPLES OF GUIDED MISSILES AND NUCLEAR WEAPONS

Z	ELEMENT	A	MASS	Z	ELEMENT	A	MASS
73	Ta	180	180.00220	88	Ra	226	226.09600
74	W	183	183.00530	89	Ac	227	227.09888
75	Re	186	186.01070	90	Th	232	232.11080
76	Os	190	190.01740	91	Pa	232	232.11118
77	Ir	192	192.02470	92	U	238	238.12522
78	Pt	195	195.02640	93	Np	237	237.12220
79	Au	197	197.02748	94	Pu	244	244.14065
80	Hg	200	200.03191	95	Am	243	243.13748
81	Tl	204	204.03768	96	Cm	245	245.14209
82	Pb	207	207.04058	97	Bk	249	249.15252
83	Bi	209	209.04579	98	Cf	249	249.15252
84	Po	210	210.04850	99	E	244	244.14780
85	At	212	212.05693	100	Fm	252	252.16163
86	Rn	222	222.08690	101	Md	256	256.17383
87	Fr	223	223.08960	102	No	263	263.00000

APPENDIX B

GLOSSARY

INTRODUCTION

This glossary is intended as a convenience for the student. It explains briefly those technical terms used in this textbook with which the student should be acquainted in order to comprehend the subject matter. The explanations are not exhaustive. They take up only those senses or applications of each term that the text is actually concerned with, and do not attempt general expositions of them. For more information on any item in the glossary, the student should consult the index to locate further discussion in the text of this book. For more general and complete information, the student should consult a good technical dictionary or encyclopedia, an engineering handbook, or an engineering or physics text.

ACCELEROMETER.—An instrument that measures one or more components of the accelerations of a vehicle.

ACQUISITION.—The process of acquiring a target by radar; the initial contact with a selected or desired target prior to lock-on.

ACTIVE MATERIAL.—Fissionable material, such as plutonium (Pu^{239}), uranium (U^{235}), or the thorium-derived uranium isotope, U^{233} , which is capable of supporting a fission chain reaction. In the military field of atomic energy, the term refers to the nuclear components of atomic weapons exclusive of the natural uranium parts.

AERODYNAMICS.—The science that deals with the motion of air and other gases and with the forces acting on bodies moving through these gases.

AFC.—An abbreviation for automatic frequency control. A circuit that maintains accurate frequency control.

AFTERBURNING.—1. The characteristic of some rocket motors to burn irregularly for some time after the main burning and thrust has ceased. 2. The process of fuel injection and

combustion in the exhaust jet of a turbojet engine (aft or to the rear of the turbine).

AGC.—An abbreviation for automatic gain control. A circuit arrangement that automatically maintains the output amplitude (sound level in audio receivers) essentially constant, despite variations in input signal strength.

AIRSPPEED, TRUE.—Calibrated airspeed corrected for altitude effects, i.e., pressure and temperature, and for compressibility effects where high speeds are concerned. Not to be confused with ground speed.

AMBIENT CONDITIONS.—Environmental conditions; may pertain to pressure, temperature, etc.

ANGLE, DRIFT.—The horizontal angle between the longitudinal axis of an aircraft or missile and its path relative to the ground.

ANGLE, ELEVATION.—Angle between the horizontal and a line from an observer to an elevated object.

ANGLE, FLIGHT PATH.—The angle between the flight path of an aircraft or missile and the horizontal. Sometimes called **FLIGHT PLAN SLOPE**.

ANGLE, GLIDING.—The angle between the flight path during a glide and a horizontal axis fixed relative to the earth.

ANGLE OF ATTACK.—The angle between a reference line fixed with respect to an airframe and the apparent relative flow line of the air.

ANGLE OF ATTACK, ABSOLUTE.—The angle of attack of an airfoil, measured from the attitude of zero lift.

ANGLE OF ATTACK, CRITICAL.—The angle of attack at which the flow about the airfoil changes abruptly, as evidenced by abrupt changes in the lift and drag.

ANODE.—A positive electrode; the plate of a vacuum tube.

ANTENNA.—A device which radiates r-f power into space in the form of electromagnetic

PRINCIPLES OF GUIDED MISSILES AND NUCLEAR WEAPONS

energy. It also provides a means of reception of electromagnetic energy.

ANTISUBMARINE TORPEDO.—A submarine-launched, long-range, high-speed, wire-guided, deep-diving, wakeless torpedocapable to carrying a nuclear warhead for use in antisubmarine and antisurface ship operations. Also known as Astor.

APOGEE.—The point at which a missile trajectory or a satellite orbit is farthest from the center of the gravitational field of the controlling body (the earth) or bodies.

ASTRONAUTICS.—The science of traveling through space or sending missiles or guided vehicles into space.

ATHODYD.—A ramjet; an abbreviation for Aero-THERMODYNAMIC Duct.

ATTITUDE.—The position of an aircraft or missile as determined by the inclination of its axes to some frame of reference. If not otherwise specified, this frame of reference is fixed with respect to the earth.

AUDIO FREQUENCY.—A frequency which can be detected as sound by the human ear. The audio frequency range is normally understood to extend from 20 to 20,000 cycles per second.

AUTOSYN.—A Bendix-Marine trade name for a synchro, derived from the words AUTOMATICALLY SYNCHRONOUS. See "synchro." Also called Selsyn.

AZIMUTH.—The angular measurement in a horizontal plane and in a clockwise direction at a point oriented to north.

BAND-PASS FILTER.—A circuit designed to pass, with nearly equal response, all currents having frequencies within a definite band, and to reduce the amplitudes of currents of all frequencies outside that band.

BANDWIDTH.—The number of cycles, kilocycles, or megacycles expressing the difference between the lowest and highest frequencies of a portion of the frequency spectrum; for example, a TV or radio station channel assignment.

BANG-BANG CONTROL.—On-off control in which control surfaces are ordered either "full-over" or to the neutral position. Also called flip-flop control and flicker control.

BARO.—A pressure-sensitive device (essentially a pressure altimeter) used in some weapons to actuate circuits. The term is a contraction of "barometric switch," sometimes referred to as a "baroswitch." Not to be confused with barometer, an instrument which

measures atmospheric pressure, without a switch attachment or connection.

BASELINE.—A line joining a master and slave station in a Loran system.

BEAT FREQUENCY.—A signal which results when two signals of different frequencies are applied to a nonlinear circuit. The beating together of the signal results in a signal which has a frequency equal to the difference of the two applied frequencies.

BETA (β) PARTICLE (BETA RAY).—One of the particles which can be emitted by a radioactive atomic nucleus. It has a mass of about 1/1837 that of a proton. The negatively charged beta particle is identical with the ordinary electron, while the positively charged type (positron) differs from the electron in having equal but opposite electrical properties. The emission of an electron entails the change of a neutron into a proton inside the nucleus. The emission of a positron is similarly associated with the change of a proton to a neutron. Beta particles have no independent existence outside the nucleus, but are created at the instant of emission.

BINARY NUMBER SYSTEM.—A number system, which uses two symbols (usually 0 and 1) and has two as its radix (the fundamental number), just as the decimal system uses ten symbols (0, 1, 2, 3, etc.), and has ten as its radix. The system is widely used in electronic computation where electrical connections can be used to represent the binary conditions, such as, an open relay means 0, a closed relay means 1.

BIPROPELLANT.—A rocket propellant made up of two separate ingredients which are separately fed to the combustion chamber.

BOLOMETER.—1. A very sensitive type of metallic resistance thermometer, used for measurements of thermal radiation. 2. In electronics, a small resistive element capable of dissipating microwave power, using the heat so developed to effect a change in its resistance, thus serving as an indicator; commonly used as a detector in low- and medium-level power measurement.

BOOSTER.—1. A high-explosive element sufficiently sensitive so as to be actuated by small explosive elements in a fuze or primer and powerful enough to cause detonation of the main explosive filling. 2. An auxiliary or initial propulsion system which travels with a missile or aircraft and which may or may not separate from the parent craft when its

Appendix B—GLOSSARY

impulse has been delivered. A booster system may contain or consist of one or more units.

BREEDING (NUCLEAR).—A process whereby a fissionable nuclear species is used as a source of neutrons to produce more nuclei of its own kind. This is the function of a breeder nuclear reactor (atomic pile), which, by transmutation, produces a greater number of fissionable atoms than the number of parent atoms consumed.

BUBBLE.—The fireball formed in an underwater nuclear explosion, which contains hot gases and vapors. It expands and bursts after reaching the surface of the water.

BURTON METHOD (BURTONING).—Name sometimes given to the yard and stay method of handling a cargo. A method of replenishment at sea wherein a winch on each ship provides power and the single whips from the winches are shackled together. Also, a method of rigging tackles so that two sources of power are used.

CANARD.—A type of airframe having the stabilizing and control surfaces forward of the main supporting surfaces, while the main lifting surfaces are rigidly attached in the aft region of the body.

CAPACITOR.—Two electrodes or sets of electrodes in the form of plates, separated from each other by an insulating material called the dielectric, and used to store an electric charge.

CARRIER.—In electronics, the carrier is the basic r-f wave upon which other signals are superimposed to transmit information.

CATHODE-RAY TUBE (CRT).—A special form of vacuum tube used in various electronic applications, e.g., as the picture tube of a television receiver and as an oscilloscope tube.

CENTRIFUGAL FORCE.—A force caused by inertia exerted on a rotating object in a direction outward from the center of rotation.

CENTRIPETAL.—Moving inward, or directed inward, in a sense toward the center.

CHAFF.—Electromagnetic-radiation reflectors in the form of narrow metallic strips of various lengths and frequency responses used to create radar echoes for confusion of enemy radars. One type, called rope or rope-chaff, consists of a roll of metallic foil or wire.

CHAIN REACTION.—In general, any self-sustaining process, whether molecular or nuclear, the products of which are instrumental

in, and directly contribute to the propagation of the process. Specifically, a fission chain reaction, where the energy liberated or particles produced (fission products) by the fission of an atom cause the fission of other atomic nuclei, which in turn propagate the fission reaction in the same manner.

CHUGGING.—Intermittent burning of a propellant which results in low frequency pressure oscillations. Also called chuffing.

CIRCUIT BREAKER.—An electromagnetic or thermal device that opens a circuit when the current in the circuit exceeds a predetermined amount.

CIRCULAR ERROR PROBABILITY (CEP).—The radius of a circle about the aiming point within which there is a 50 percent probability of hitting. Also called Circular Probable Error (CPE). It describes the hitting accuracy of a guided missile or an artillery shell.

COAXIAL CABLE.—A transmission line consisting of two conductors concentric with and insulated from each other. The dielectric (insulator) may be either a solid or a gas. Coaxial cables are used as transmission lines for radio, radar, and television signals.

COLLECTOR.—Electrode in a velocity-modulated vacuum tube on which the spent electron "bunches" are collected. In a transistor, it is an electrode through which a primary flow of carriers leaves the interelectrode region.

COMPARATOR.—A circuit which compares two signals and indicates variances between them. The circuit is also known as an "add-or-subtract" circuit.

CONSOLE.—A grouping of controls, indicators, and similar electronic or mechanical equipment, usually mounted on a large table-like or panel type equipment, used to monitor readiness of and/or control specific functions of a system, such as missile checkout, countdown, or launch operations.

CONTINUOUS WAVE (C-W) RADAR.—A system in which a transmitter sends out a continuous flow of r-f energy to the target.

COSMIC RAYS.—A highly penetrating radiation apparently reaching the earth in all directions from outer space. Experimental observations show that the cosmic rays entering our atmosphere are composed almost entirely of positively charged atomic nuclei. The intensity of the rays decreases through collisions with other atomic particles while passing through the atmosphere.

PRINCIPLES OF GUIDED MISSILES AND NUCLEAR WEAPONS

CRITICAL MASS OR SIZE.—The amount of fissionable material that will just support a spontaneous chain reaction power level. This is related to the volume it occupies, or size. The mass of material may be referred to as crit, which, under a given set of conditions, is of critical size.

CRUCIFORM.—A configuration in the form of a cross with legs 90° apart.

CRYSTAL-CONTROLLED OSCILLATOR.—An oscillator whose frequency is controlled to a high degree of accuracy by the use of a quartz crystal. This frequency is dependent on the physical dimensions of the crystal, especially the thickness.

CRYSTAL MIXER.—A device using certain properties of a crystal (germanium, silicon) to mix two frequencies.

CRYOTRON.—A device used for switching, making use of the fact that the superconductive transition depends on temperature as well as electromagnetic field. A straight wire is placed inside a coil of different material and cooled to its superconductive temperature, at which a very small voltage will cause a persistent current to flow through the wire. If another current passes through the coil, the surrounding magnetic field causes the current in the wire to cease.

DEAD RECKONING.—The process of obtaining an approximate position using a fix for a reference point and then estimating the effects of winds, currents, etc.

DECIBEL.—A unit expressing the magnitude of a change in sound or electrical power level. One decibel (db) is approximately the amount that the power of a pure sine wave sound must be changed in order for the change to be just barely detectable by the average human ear.

DECONTAMINATION.—The process of removal of contaminating radioactive material from personnel, objects, structures, or an area. The problem of decontamination consists essentially of reduction of the level of radioactivity, chiefly by removal of the clinging radioactive material, and thus reduction of the hazard it imposes to a reasonably safe limit. The term can also be applied to the processes applied to biological or chemical agents.

DELAY CIRCUIT.—A circuit which delays the starting of a waveform.

DEMODULATOR.—A device which derives information from a modulated waveform.

DETECTOR.—In electronics, the receiver stage in which demodulation takes place, separating the modulation component from the received signal.

DIERGOLIC (NON-HYPERGOLIC).—A property of liquid propellants (oxidizer and fuel) whereby they do not react spontaneously when brought into contact, but require an auxiliary ignition system to initiate combustion.

DISCRIMINATOR.—A device (in electronics) used to convert input frequency changes to proportional output voltages. For example, in a radio receiver, the stage that converts the frequency-modulated signals directly to audio-frequency signals.

DISTORTION.—In electromagnetics, the production of an output waveform which is not a true reproduction of the input waveform. Distortion may consist of irregularities in amplitude, frequency, or phase.

DITHER.—A signal of controlled amplitude and frequency applied to the servomotor operating a transfer valve such that a transfer valve is constantly being "quivered" and cannot stick at its null position.

DOUBLER.—In electronics, a frequency-multiplier circuit that doubles the input frequency. It is often used in missile transponder equipment. The transponder signal can thus be distinguished from the ground transmitter signal that activated it, but can still be a known function of the original signal.

ELECTROMAGNETIC.—Pertaining to the combined electric and magnetic fields associated with radiation or with movement of charged particles. Electromagnetic radiation includes the entire range of radiations propagated by electric and magnetic fields, including x-rays, gamma, ultraviolet, light, infrared, heat, and radio rays. From the shortest wavelength (gamma rays) to the longest radio waves, all travel with the speed of light.

ELECTRONICS.—The broad field pertaining to the conduction of electricity through vacuum, gases, or semiconductors, and circuits associated therewith.

EMISSIVITY.—The rate at which the surface of a solid or a liquid emits electrons when additional energy is imparted to the free electrons in the material by the action of heat, light, or other radiant energy or by the impact of other electrons on the surface.

ENVELOPE.—In electronics—1. The glass or metal housing of a vacuum tube; 2. A curve drawn to pass through the peaks of a

Appendix B--GLOSSARY

graph showing the waveform of a modulated radio-frequency carrier signal.

EPILATION.—Falling out of the hair. Cases described in this text were caused by exposure to nuclear radiation.

ESCAPE VELOCITY.—The speed necessary to escape from the gravitational pull of a body. This is calculated at seven miles per second. A projectile accelerated from the earth's surface below this speed will gradually return to earth (following a ballistic trajectory) because of the gravitational pull of the earth.

EXPLOSIVE TRAIN (Explosive Chain).—In missile armament, a series of explosive elements including primer detonator, and booster, arranged to permit warhead explosion to be initiated by relatively weak fuze signals.

FAIL-SAFE.—A provision built into the mechanism of a potentially hazardous piece of equipment which provides that the equipment will remain safe to friendly users even though it fails in its intended purpose. A projectile fuze which is armed with an inertia setback device so that it remains safe until accelerated in firing is an example of a fail-safe device. A missile destruct system which operates automatically upon discontinuance of a control signal is a fail-safe device. All nuclear weapons have fail-safe appliances.

FIX.—An accurate navigational position obtained by lines of bearing on fixed objects or celestial observations.

FLASH DEPRESSANT.—A compound added to solid propellants (usually those of granular type) to reduce the intensity of the exhaust flame.

FLOWMETER.—An instrument used to measure the flow rate of a fluid in motion. In missile applications the rate of fuel flow is an important matter in the functioning of the propulsive system. Simple mechanical devices often are not usable because of highly corrosive fluids, or extremely cold fluids such as liquid oxygen.

F-M/C-W RADAR.—A radar which uses frequency modulation and the pulse of continuous wave energy for target tracking. Frequency modulation is used for determining target speed, while the continuous wave is used for determining range.

FREQUENCY.—The number of complete cycles per second existing in any form of wave motion. In electricity, the frequency is the number of complete alternations per second of an alternating current. The standard in

the United States is 60 cycles per second. In acoustics, the frequency represents the number of sound waves passing any point of the sound field per second. In light or other electromagnetic radiation, frequency is usually so enormous (500 million million per second for yellow light) that wavelengths or wave numbers (reciprocal of wavelength measured in cm) are ordinarily used instead. Radio frequencies are commonly given in thousands of cycles (kilocycles) or millions of cycles (megacycles) per second.

For example, 15 kc is understood to mean 15,000 cycles per second. A list of the frequency designations follows:

Very low... vlf...	Below 30 kc	
Low..... lf ...	30 to	300 kc
Medium.... mf...	300 to	3,000 kc
High..... hf ...	3,000 to	30,000 kc
	or 3-30mc	
Very high .. vhf...	30,000 to	300,000 kc
	or 30-300mc	
Ultrahigh... uhf...	300,000 to	3,000,000 kc
	or 300-3000mc	
Superhigh... shf...	3,000,000 to	30,000,000 kc
	or 3,000-30,000mc	
Extremely		
high..... ehf...	30,000,000 to	300,000,000 kc
	or 30,000-300,000mc	

FREQUENCY BAND.—A channel of frequencies associated with a modulated carrier. Modern radars operate in the microwave region (shf).

FREQUENCY, CARRIER.—The frequency of the unmodulated radio wave emanated from a radio, radar, or other type transmitter.

FREQUENCY, SUBCARRIER.—Intelemetering, an intermediate frequency that is modulated by intelligence signals and, in turn, is used to modulate the radio carrier either alone or in conjunction with subcarriers on other channels.

FUSE.—A protective device inserted in series with a circuit. It contains a metal that will melt or break when current is increased beyond a specific value for a definite period of time.

FUZE.—A device designed to initiate a detonation of a weapon under the conditions desired, such as by impact, elapsed time, proximity, or command.

GANGED DEVICE.—Components so arranged that an adjustment made to one will cause the same adjustment to be made to all.

PRINCIPLES OF GUIDED MISSILES AND NUCLEAR WEAPONS

GANTRY.—A device used for erecting and servicing large missiles. The large, crane type structure travels on rails and can be pushed away just before firing.

GATE.—An arrangement which permits radar signals to be received in a small selected fraction of the principal time interval.

GATE CIRCUIT.—A circuit which passes or amplifies a signal only on occurrence of a synchronizing signal.

GATING(CATHODE-RAY TUBE).—Applying a rectangular voltage to the grid or cathode of a CRT to sensitize it during the sweep time only.

GHOSTS.—False echo images on a radar scope.

GLIDE BOMB.—A winged missile powered by gravity. The wing loading is so high that it is incapable of flight at speeds of conventional bombardment aircraft. Such a missile must therefore be carried rather than towed to the point of release above the target.

GRAIN.—A mass of solid propellant, cast or extruded in a single piece or formed by cementing or pressing together smaller parts.

GROUND CLUTTER.—Unwanted radar echoes from terrain. Also called radar clutter.

GYROPILOT.—A form of rudimentary dead reckoning guidance which automatically controls a missile in attitude and flight path.

HEADING.—The horizontal direction in which the missile is pointed.

HEAT ENGINE.—An engine which converts heat energy into mechanical energy.

HEAT SHIELD.—A protective shield used to prevent destruction of a reentry subsystem by the heat generated in passing back into the atmosphere.

HEAVY WATER.—Water in which the hydrogen of the water molecule consists entirely of heavy hydrogen of mass two. It is used as a moderator in certain types of nuclear reactors and was essential in the production of the first atomic bombs.

HOT SPOTS.—Regions in a contaminated area in which the level of radioactive contamination is considerably higher than in neighboring regions.

HYDROGEN BOMB (or weapon).—A term sometimes applied to nuclear weapons in which part of the explosive energy is obtained from nuclear fusion (or thermonuclear) reactions.

HYGROSCOPIC.—Descriptive of a material which readily absorbs and retains moisture.

Solid propellants that are hygroscopic must be protected against moisture.

IMPEDANCE.—The total opposition offered to the flow of an alternating current. It may consist of any combination of resistance, inductive reactance, and capacitive reactance.

INDUCTANCE.—The property of an electrical circuit which tends to oppose any change of current in the circuit. The symbol for inductance is "L" and the unit of measure is the "henry."

INNER BODY.—Any closed body, located in a ramjet or other duct, around which the air taken into the diffuser or engine must flow.

INNER LOOP.—In guided missile control systems, the feedback loop consisting of the control system and missile aerodynamics, as contrasted to the outer loop, which consists of the external guidance system kinematics.

INTERVALOMETER.—Any device that may be set so as to accomplish automatically a series of like actions, such as taking of aerial photographs, at a constant, predetermined interval.

ISOBAR.—One of two atoms or elements having the same atomic weights or mass numbers but different atomic numbers.

ISOMER, NUCLEAR.—One of two or more nuclides having the same atomic number and the same mass number but existing for measurable time intervals in different states. The state of lowest energy is called the ground state; all those of higher energy are metastable states. The letter m added to the mass number in the symbol of the nuclide indicates it is a metastable isomer, as Br^{80m}.

JET STREAM.—In meteorology, a narrow band of high velocity wind in the upper troposphere or in the stratosphere. One is in the northern hemisphere in the middle to northern latitudes, and one is in the southern hemisphere. The velocity varies from 100 to 500 miles per hour.

In missiles, the jet stream is the stream of combustion products (exhaust gas, etc.) from a jet engine, rocket engine, or rocket motor.

JETTISON DEVICE.—A mechanism for casting loose or dumping a missile from a ship or launcher, to be used in case of a misfire or similar mishap when there is danger of the missile exploding on the ship. On a missile, a jettison device separates a section of the missile in flight, e.g., at staging of a ballistic missile.

Appendix B—GLOSSARY

JP-1, JP-2, JP-5, JP-6.—Kerosene type jet fuels with different flash points and burning characteristics. JP-5 is used almost exclusively by Navy jets.

JP-3, JP-4.—Jet fuels consisting of mixtures of hydrocarbons but with different burning characteristics. JP-4 is the most commonly used fuel for turbojets.

KILL PROBABILITY.—A measure of the probability of destroying a target.

KNOT.—A nautical mile (approx. 2,000 yd) or 1.1516 statute miles per hour. It is not a measure of distance, but of speed.

LAUNCH PHASE.—That portion of the missile trajectory from takeoff through booster burnout. For multistage missiles, it is the period from takeoff to first-stage burnout.

LAUNCHER, ZERO LENGTH.—A launcher that supports a missile in the desired attitude prior to ignition, but which exercises negligible control on the direction of the missile's travel after ignition.

LIMITER.—In electronics, a circuit that limits the maximum positive or negative values of a waveform to some predetermined amount. It is used in frequency modulated systems to eliminate unwanted variations of amplitude in received waves.

LORAN.—Derived from LOnG RAnge Navigation. An electronic navigation system in which two or more fixed transmitting stations utilize a pulse transmission technique. Aircraft and surface vessels receiving the transmitted signals may determine ranges to the stations and thereby establish the location of the receiver.

LOX.—The commonly accepted abbreviation for liquid oxygen. The term originally denoted liquid oxygen explosives (L for liquid, O for oxygen, X for explosive). Gaseous oxygen is often abbreviated GOX.

MAGNETIC TAPE.—A tape or ribbon of any material impregnated or coated with magnetic or other material on which information may be placed in the form of magnetically polarized dots. One use is in missiles with a preset or programmed flight path.

MAGNETRON.—A vacuum-tube oscillator containing two electrodes in which the flow of electrons from cathode to anode is controlled by an externally applied magnetic field. It is used to generate microwaves (radar frequencies) with high output power.

MARGIN OF SAFETY.—As used in missile design, the percentage by which the ultimate strength of a member exceeds the design load.

MARRIAGE.—The process of uniting physically the missile stages and all major subsystems.

MEGOHM.—A million ohms.

MEMORY UNIT.—A data storage device contained in a computer.

MERIDIAN.—A great circle on the earth that passes through the poles. Longitude is measured from the prime meridian, which passes through Greenwich (near London), England.

MEV.—Abbreviation for one million electron volts, a unit of energy.

MICRO.—A prefix meaning one-millionth. The abbreviation is the Greek letter mu, μ .

MICRON.—One-millionth of a meter.

MICROSECOND.—One-millionth of a second.

MICROSYN.—A name applied to a small type of synchro whose chief merit is that there are not electrical connections to the rotor. It can be used as an inductive potentiometer.

MICROWAVES.—Extremely short radio waves that are not more than a few centimeters in wavelength.

MISFIRE.—An unsuccessful attempt to start a rocket motor; usually but not always a case in which the igniter functions properly but the propellant does not ignite (or does ignite but goes out).

MXER.—In electronics, a stage in which two quantities are combined to obtain a third quantity. The third quantity contains the intelligence of the original inputs. Those quantities not further desired can be filtered out.

MODERATOR.—A material that slows neutrons. Used chiefly in a nuclear reactor, or atomic pile.

MODULE.—As used in the automation and electronics field, a single assembly of parts and/or components to form a larger component which meets a functional requirement by performing all of the resistive, inductive, and capacitive functions of a vacuum tube circuit.

As a combination of components within a package, or so arranged that they are common to one mounting, that provide a complete function or functions necessary for subsystem or system operation. This type of arrangement makes field (shipboard) repair simply a matter of removing the malfunctioning module and putting a new one in its place. The defective module is returned to the factory or other competent agency for repair.

PRINCIPLES OF GUIDED MISSILES AND NUCLEAR WEAPONS

MOLECULE.—The smallest particle of any substance that can exist free and still exhibit all the properties of the substance.

MONITORING.—1. The act of listening to, reviewing, and/or recording enemy, one's own, or friendly forces' communications for the purpose of maintaining standards, improving communications, for reference or for enemy information. 2. The detecting and/or assessing of known or suspected radioactive hazards, using radiation measuring instruments.

MONOCOQUE.—A type of airframe construction without framing which relies for its rigidity primarily upon the surface or skin; a shell-like structure.

MULTIPLEX.—Denotes the simultaneous transmission of several functions over one link without loss of detail of each function, such as amplitude, frequency, phase, or wave shape.

MULTIPLEXER.—A device by which two or more signals may be transmitted on the same carrier wave.

MULTIVIBRATOR.—A vacuum tube oscillator circuit whose output is essentially a square wave. A practical application is its use as a sweep generator in TV or radar circuitry.

NAUTICAL MILE.—A measure of distance equal to one minute of arc on the earth's surface. The United States has adopted the International Nautical Mile equal to 1,852 meters or 6080.20 ft. an hour. See: Knot.

NOMINAL WEAPON.—A nuclear weapon producing a yield of approximately 20 kilotons. See: Nuclear yields.

NUCLEAR ACCIDENT.—Any unplanned occurrence involving loss or destruction of, or serious damage to, nuclear weapons or their components which results in actual or potential hazard to life or property.

NUCLEAR INCIDENT.—An unexpected event involving a nuclear weapon, facility, or component, resulting in any of the following but not constituting a nuclear accident: a. an increase in the possibility of explosion or radioactive contamination; b. errors committed in assembly, testing, loading, or transportation of equipment, and/or the malfunctioning of equipment and material which could lead to an unintentional operation of all or part of the weapon arming and/or firing sequence, or could lead to a substantial change in yield, or increased dud probability; c. any act of God, unfavorable environment or condition, resulting in damage to the weapon, facility, or component.

NUCLEAR YIELDS.—The energy released in the detonation of a nuclear weapon. Usually measured in terms of the kilotons or megatons or trinitrotoluene (TNT) required to produce the same energy release. Yields are categorized as:

Very low	less than 1 kiloton
Low	1 kiloton to 10 kilotons
Medium	over 10 kilotons to 50 kilotons
High	over 50 kilotons to 500 kilotons
Very High	over 500 kilotons.

NUCLIDE.—A general term referring to all nuclear species, both stable (about 270) and unstable (about 500), of the chemical elements, as distinguished from the two or more nuclear species of a single chemical element, which are called isotopes. Each species of atom is distinguished by the constitution of its nucleus, which has a specified number of protons and neutrons, and energy content.

OSCILLOGRAM.—The record produced by an oscillograph.

OSCILLOGRAPHY.—A recording instrument for making a graphic record of the instantaneous values of a rapidly varying electric quantity as a function of time or some other quantity.

OSCILLOSCOPE.—An instrument for showing, visually, graphical representations of the waveforms encountered in electrical circuits.

OVERPRESSURE.—The pressure resulting from the blast wave of an explosion. It is referred to as "positive" when it exceeds the atmospheric pressure and "negative" during the passage of the wave, when resulting pressures are less than atmospheric pressure. It is usually expressed in pounds per square inch (psi) above the standard atmospheric pressure. Peak overpressure is the maximum overpressure caused by a nuclear explosion at any given distance from ground zero.

PARAMETER.—An arbitrary constant, as distinguished from a fixed or absolute constant: e.g., missile gross weight. Any desired numerical value may be given to a parameter. Mach number is a characteristic parameter used in computations in supersonic aerodynamics.

PASS BAND.—(Of a filter). That band of frequencies which are passed with little attenuation.

PENTODE.—A 5-element electron tube.
PERIGEE.—Point of orbit closest to the earth. The opposite is apogee, the highest point

Appendix B—GLOSSARY

in the trajectory of a missile, or in a satellite orbit, the point that is the greatest distance from the center of the earth.

PETECHIAE.—A condition characterized by small spots on the skin. It is caused by the escape of blood into the tissues.

PHOTON.—A photon (or x-ray) is a quantum of electromagnetic radiation which has a zero rest mass and an energy of $h\nu$ (Planck's constant) times the frequency of the radiation. Photons are generated in collisions between nuclei or electrons and in any other process in which an electrically charged particle changes its momentum. Conversely, photons can be absorbed (i.e., annihilated) by any charged particle.

PIEZOELECTRIC EFFECT.—The phenomenon exhibited by certain crystals of expansion along one axis and contraction along another when subjected to an electrical field. Conversely, compression of certain crystals generates an electrostatic voltage across the crystal. Piezoelectricity is only possible in crystal classes which do not possess a center of symmetry.

PILE.—A nuclear reactor. The term pile comes from the first nuclear reactor which was made by piling up graphite blocks and pieces of uranium and uranium oxide.

PIP.—The indication on the CRT or a radar caused by the echo from an aircraft or other reflective object. Also called BLIP. It may be in the form of an inverted V or a spot of light.

PLANCK'S CONSTANT (h).—A universal constant of nature which relates the energy of a quantum of radiation to the frequency of the oscillator which emitted it. It has the dimensions of action (energy X time).

PLASTICIZER.—A material that is added to a rocket propellant to increase plasticity, workability, or to extend physical properties.

POTENTIAL.—The amount of charge held by a body as compared to another point or body. Usually measured in volts.

PREAMPLIFIER.—A stage at the input end of an amplifier or receiver which increases signal strength.

PROPAGATION.—Extending the action of; transmitting, carrying forward, as in space or time, through a medium, as the propagation of sound or light waves.

PROPELLANT-WEIGHT RATIO.—The ratio of the weight of the propellant to the takeoff weight of the missile. This ratio is a measure of the efficiency of the missile configuration and the missile power plant.

PULSE LENGTH.—The time duration of the transmission of the pulse of energy, usually measured in microseconds or in the equivalent distance in yards, miles, etc.

PULSE REPETITION RATE.—(Also, Pulse Repetition Frequency (PRF)). These terms refer to the repetition rate or frequency of the pulses transmitted by radar. PRR describes the number of pulses transmitted per unit of time.

PURPURA.—Medical term for a symptom characterized by the appearance of purple patches on the skin and mucous membranes, due to hemorrhage in the fatty tissues beneath the skin.

QUANTUM.—A discrete quantity of radiative energy equal to the product of its frequency and Planck's constant. The equation is $E = h\nu$. A quantum of light energy is a photon.

QUANTUM THEORY.—The concept that energy is radiated intermittently in units of definite magnitude called QUANTA.

R-C CIRCUIT.—An abbreviation for resistance-capacitance circuit. It is one of the methods used to couple two electronic circuits together. Some of the characteristics of R-C coupling are wide frequency response and lower cost and size than that of transformer or other inductive coupling systems.

RADAR PICKET.—Any ship, aircraft, or vehicle stationed at a distance from the force or place protected, for the purpose of increasing the radar detection range.

RADARSCOPE.—The visual cathode-ray tube (CRT) display used with a radar set.

RADIAC.—A term devised to designate various types of radiological measuring instruments or equipment. This term is derived from the words "Radioactivity Detection, Indication, And Computation," and is normally used as an adjective.

RADIATION INTENSITY.—The radiation dose rate at a given time and place. It may be used coupled with a figure to denote the radiation intensity used at a given number of hours after a nuclear burst, e.g., RI3 is the radiation intensity 3 hours after the time of burst.

RADIATION SCATTERING.—The diversion of radiation (thermal, electromagnetic, or nuclear) from its original path as a result of interactions or collisions with atoms, molecules, or larger particles in the atmosphere or other media between the source of radiation (e.g., a nuclear explosion) and a point at some distance away. As a result of scattering, radiation (especially gamma rays and neutrons)

PRINCIPLES OF GUIDED MISSILES AND NUCLEAR WEAPONS

will be received at such a point from many directions instead of only from the direction of the source.

RADIO FREQUENCY (RF).—Any frequency of electrical energy capable of propagation into space. Radio frequencies normally are much higher than sound-wave frequencies.

RECTIFIERS.—Devices used to change alternating current (a-c) to direct current (d-c). These may be vacuum tubes, semiconductors such as germanium or silicon, dry-disc rectifiers such as selenium and copper-oxide, and also certain types of crystals. A full-wave rectifier circuit is one which utilizes both the positive and the negative alternations of an alternating current to produce a direct current.

REFLECTION INTERVAL, RADAR.—The length of time required for a radar pulse to travel from the source to the target and return to the source, taking the velocity of radio propagation to be equal to the velocity of light, 2.998×10^8 m/sec or 299.8 m/ μ s.

RELAY.—In electronics, there are two related meanings. First, the relay may be an electromechanical device which, when operated by an electrical signal, will cause contacts to make or break, thereby controlling one or more other electrical circuits. The solenoid is the basic mechanism of this type of relay. Second, the relay may be an electronic network to receive and transmit information. There is usually an amplification stage in the relay process.

RESISTOR.—A circuit element whose chief characteristic is resistance to the flow of electric current.

RESONANCE.—The condition existing in a series circuit in which the inductive and capacitive reactances cancel each other.

REYNOLD'S NUMBER.—An abstract number characteristic of the flow of a fluid in a pipe or past an obstruction, used especially in testing of scale model airplanes (and missiles) in wind tunnels. It is the ratio of the product of the density of the fluid, the flow velocity, and a characteristic linear dimension of the body under observation to the coefficient of absolute viscosity:

$$Re = \rho \frac{VL}{\mu}$$

where Re is Reynold's number, ρ is density of fluid, V is velocity of flow, L is linear dimension of the body in the flow, and μ is the coefficient of viscosity of the fluid.

SCALAR QUANTITY.—Any quantity that can be described by quantity alone, such as temperature, in appropriate units. See also: Vector quantity.

SEEBECK EFFECT.—A thermocurrent, developed or set in motion by heat; specifically an electric current, in a heterogenous circuit, due to differences of temperature between the junctions of substances of which the current is composed. A thermocouple produces a Seebeck effect; the two different metals in the junction respond at different rates.

SERVO-LINK.—A power amplifier, usually mechanical, by which signals at a low power level are made to operate control surfaces requiring relatively large power inputs, e.g., a relay and a motor actuator.

SHORAN.—Derived from the words "SHORt-Range Navigation." A precise short-range navigation system which uses the time of travel of pulse-type transmission from two or more fixed stations to measure slant-range distance from the stations. In conjunction with a suitable computer, is also used in precision bombing.

SLUG.—A unit of mass. Mass in slugs is always obtained by dividing the weight in pounds by the acceleration of gravity, 32 ft per sec². Turned around, we may define unit force (the pound) as that force which, applied to a mass of 1 slug, will give it an acceleration of a foot per second per second.

SPEED OF SOUND.—The speed at which sound travels through a given medium under specified conditions. The speed of sound at sea level in the International Standard Atmosphere is 1108 ft/second, 658 knots, 1215 km/hour. Speeds are: sonic, subsonic, transonic, supersonic, hypersonic.

SPEEDGATE.—The function of the speedgate is to locate the target doppler signal and track it, and assist in guiding the missile on a collision course. It is a narrow band-pass filter, that sweeps the specified band of frequencies to locate the signal. It may be called a gate, and the circuit a gate circuit.

SQUIB.—A small pyrotechnic device which may be used to fire the igniter in a missile booster rocket, or for some similar purpose. Not to be confused with a detonator, which explodes.

STAGING.—Act of jettisoning, at a predetermined flight time or trajectory point, certain missile (or spacecraft) components

Appendix B—GLOSSARY

(engines, tanks, booster equipment, staging equipment, and associated equipment) that are no longer needed.

SUPERHETERODYNE.—The term "heterodyne" refers to two frequencies mixed (or beat) together. The frequency mixing produces two beat frequencies which are the sum and difference between the two original frequencies. A superheterodyne receiver is one in which the incoming signal is mixed with a locally generated signal to produce a predetermined intermediate frequency. The purpose of the superheterodyne receiver is to achieve better amplification over a wide T-band of incoming signal frequencies than could be easily achieved with an RF amplifier.

SUPERREGENERATIVE SET.—A type of high frequency (VHF, UHF) receiver which is ultra-sensitive. Advantages are extreme sensitivity, simplicity, and reliability. Disadvantages are broadness of tuning (poor selectivity), and re-radiation that can cause interference in other receiving equipment.

SUSTAINER.—A propulsion system that travels with and does not separate from the missile. The term is usually applied to solid propellant rocket motors when used as the principal propulsion system, as distinguished from an auxiliary motor or booster. However, it sometimes denotes any missile stage except the booster.

SWEAT (TRANSPARATION) COOLING.—A technique for cooling combustion chambers or aerodynamically heated surfaces by forcing coolant through a porous wall. Film cooling at the interface results.

TERMINAL VELOCITY.—1. Hypothetical maximum speed a body could attain along a specified flight path under given conditions of weight and thrust if diving through an unlimited distance in air of specified uniform density. 2. Remaining speed of a projectile at the point in its downward path where it is level with the muzzle of the weapon.

THEODOLITE.—An optical instrument used for measuring angles.

TNT EQUIVALENT.—A measure of the energy release from a detonation of a nuclear weapon, or from the explosion of a given quantity of fissionable or fusionable material, in terms of the amount of TNT (trinitrotoluene) which would release the same amount of energy when exploded.

THIXOTROPIC PROPELLANT.—A propellant of gel-like consistency which flows like any

liquid propellant when agitated or pumped, and which, by the addition of powdered metal such as aluminum, produces twice the thrust of other propellants.

TONE GENERATOR.—An electronic or mechanical device whose function is to generate a frequency in the audio range.

TR BOX.—Common abbreviation for Transmit-Receive switch or tube. This switch, or tube, permits the use of a single antenna or a radar for transmission and reception. The TR box prevents the absorption of the transmitted pulse into the receiver system, thereby protecting the receiver circuit from damage, and also prevents the transmitter circuits from absorbing any appreciable fraction of the reflected echo signal. Also called Duplexer.

TRANSCEIVER.—A combination radio transmitter and receiver in a single housing with some of the electronic circuit components being used dually for transmitting and receiving.

TRANSPONDER.—A transmitter-receiver capable of accepting the challenge of an interrogator and automatically transmitting an appropriate reply (to IFF).

TUBALLOY.—A colloquial term which refers to natural uranium or to metal which is composed almost entirely of U-238. It is a contraction of "Tube Alloy," a code name used originally to mean naturally occurring uranium which is not easily fissioned.

UMBILICAL CORD.—A cable fitted with a quick disconnect plug at the missile end, through which missile equipment is controlled, monitored, and tested while the missile is still attached to the launcher.

VECTOR.—A line used to represent both direction and magnitude.

VELOCITY.—Time rate of change or displacement. Velocity is a vector quantity. The magnitude is expressed in units of length divided by time, and the direction is given relative to some frame of reference, such as fixed axes of the earth.

VERNIER.—A measuring device used for fine and accurate measurement, consisting of a short scale made to slide along the divisions of a graduated instrument, to indicate parts of divisions.

VERNIER ENGINE.—Rocket engine (usually liquid) used to adjust the final velocity of a long-range ballistic missile. The engines are also used to correct heading errors.

PRINCIPLES OF GUIDED MISSILES AND NUCLEAR WEAPONS

VIDEO.—The term is applied to the frequency band of circuits by which visual signals are transmitted. The term "video" is also used when speaking of a very wide band of frequencies, including and exceeding the audio band of frequencies.

WEATHERCOCK STABILITY.—1. An aerodynamic characteristic of a body which points it into the relative wind. 2. (Arrow stability) The partial derivatives of yawing and pitching moments with respect to angles of attack in yaw and pitch.

X-AXIS.—A horizontal axis in a system of rectangular coordinates; that line on which dis-

tances to the right or left (east or west) of the reference line are marked, especially on a map or chart.

Y-AXIS.—A vertical axis in a system of rectangular coordinates; that line on which distance above or below (north or south) the reference line are marked, especially on a map, chart, or graph.

YAW.—An angular displacement about the yaw axis of a missile.

ZENITH.—The point in the celestial sphere directly above the observer.

ZERO-LIFT TRAJECTORY.—A trajectory which is independent of aerodynamic lift.

INDEX

- AA problem, 258-260
Absolute temperature, 70
Acceleration, 33, 231-238
Accelerometers, 161, 231-238
Actuator units, missile control systems, 132-144
Aerodynamic forces, 29
Aerodynamics of supersonic missile flight, 35
Ailerons, 40
Air blast, 319
Air burst, 296, 304, 341
Aircraft missile systems, 265-267
Air flow over a wing section, 29
Airfoils, 31
Air Force missiles, 15-17
Airframe, 51-54
Airspeed transducers, 118
Alpha radiation, 276
Altimeters, 117
Amplifiers, 151-154
Antennas, beam-rider guidance, 187
Army missiles, 14
Atmosphere, effect on missile flight, 24
Atomic demolition munitions, 298
Atomic Energy Commission, 300
Atomic research, 268
Atomic structure, 270
Atomic table, 269, 270
Atomic warfare defense, 336-340
Atomic weights and bibliography, 345
Attitude control, 97
Automatic sextant, 242
Auxiliary power supply, 51
Auxiliary power supply unit, missile control systems, 101-105
- Ballistic missiles, 229-231
Ballistic trajectory, 48
Ballistite, 94
Barium, 335
Barometric switch, 296
Batteries used in guided missiles for auxiliary power supply, 105
- Beam-rider guidance, 156, 181-204
 application to Navy missiles, 181
 compared to command guidance, 181
 components, 181
 launching station components, 182
 missile components, 182-184
 target, 184
 limitations, 203
 operation of, 196-203
 control radar, 198
 one-radar system, 200-202
 stabilization, 199
 tracking radar, 197
 two-radar system, 202
 principles of, 184-195
 control and tracking radar transmitters, 194
 guidance antennas, 184-188
 over-the-horizon radar, 195
 scanning, 189-194
 radar beam, 193
Beam-rider trajectory, 48
Beta radiation, 276
Bibliography for nuclear weapons orientation, 343
Binding energy; mass defect, 282
Blast damage, 304
Blisters, 325
Bolometer, 212
Bombs, 297
"Bone seekers", 335
Boyle's law, 71
Burns, radiation, 325
Bursts, nuclear, 304, 331, 340
- Campini, 7
Celestial-navigation guidance, 160
Cerium, 335
Cesium, 336
Charles' law, 71
Chemical detectors, 214
Chemical versus nuclear reactions, 275
Chemical warheads, 58

PRINCIPLES OF GUIDED MISSILES AND NUCLEAR WEAPONS

- Choppers, 128
- Combination trajectory, 48
- Combustion chamber, missile propulsion system, 74
- Command guidance systems, 156, 169-180
 - components, 169
 - definitions, 169
 - functions, 171
 - future of, 179
 - launching station components, 176
 - operation of, 170
 - command links, 170
 - information links, 170
 - purpose and applications, 169
 - transmitters, 172
 - types of, 172-180
 - hyperbolic, 173
 - radar command, 173, 178, 180
 - radio, 173-177
 - television, 172, 177
- Command links, command guidance systems, 170
- Composite guidance systems, 159, 228
 - use in preset guidance system, 228
- Computer, missile course, 176
- Computer using specific velocity, 234
- Computing devices, missile control systems, 97, 100, 123-129
 - function and requirements, 124
 - operating principles, 128
 - types of, 125-128
- Constant-dive-angle system for missiles, 239
- Control and tracking radar transmitter, beam-rider guidance, 194
- Control components and systems, 97-144
 - actuator units, 132-144
 - auxiliary power supply unit, 101-105
 - computing devices, 123-129
 - control action, types of, 100
 - control systems, 100
 - controller units, 129-132
 - definitions, 97
 - energy sources, 101
 - factors controlled, 99
 - methods of control, 99
 - missile-control servosystem, 105-108
 - pickoffs, 119-123
 - purpose and function, 98
 - reference devices, 108-113
 - sensor units, 113-119
- Controllers and actuators, 154
- Control matrix, 159
- Control radar, beam-rider guidance, 198
- Coriolis force, 50
- Cruciform, 45
- Cruisers, guided missile, 249-251
- Damage from nuclear weapons, 316-333
 - areas, 317
 - ashore, 318
 - blast, 319
 - compared with chemical explosion, 317
 - drag, 320
 - eye damage, 326
 - nuclear radiation, 333
 - ship damage, 318
 - shock, 321
 - thermal radiation, 324
 - zones, 318
- Defense Atomic Support Agency, 300
- Degrassive burning, 93
- Delivery systems and techniques, 298
- Destroyers, guided missile, 251-253
- Diaphragm timers, 111
- Diffusers, 79
- Dirt cloud, 308
- Doppler homing equipment, 166
- Doppler principle, 166-168
- Doppler radar, 168
- Drag, 32
- Drag damage, 320
- Drag reduction, 44
- Ducted propulsion systems, 80-86
- Dummy warhead, 59
- Earth's magnetic field, 164-166
- Electrical control system, 133, 141
- Electrically damped accelerometer, 163
- Electrical timers, 109
- Electronic observation, command guidance systems, 170
- Elevators, 40
- Energy sources, missile control systems, 101
- Error signals, missile control systems, 108
- Exercise warheads, 59
- Exhaust nozzle, jet propulsion systems, 74-76
- Exhaust vanes, 42
- Explosions, 303
- Eye injuries, 326
- Fallout, 330
- Fallout, protection from, 338
- Feedback systems, 154
- Feed systems, liquid-fuel rockets, 88
- Fin designs, 46
- Fire storm, 327

INDEX

- Fission weapons, 290
- Flash depresser, 94
- Fleet ballistic missile, 2
- Formulas and laws, jet propulsion, 70-74
- Fragmentation warheads, 56
- Fuels, jet engine, 76
- Fuel supply, missile propulsion systems, 76-78
- Fusion weapons, 293-295
- Fuzes, guided missile, 59-64
- Fuzing for surface burst, 296
- Fuzing techniques, 296

- Galcit, 95
- Gamma radiation, 277
- Gas laws, jet propulsion systems, 71
- Gas tight envelope, 339
- Glossary, 347-358
- Goddard, Robert H., 7
- Golay detector, 212
- Ground zero, 342
- Guidance antennas, beam-rider, 184-188
- Guidance systems, 145-168
 - application of natural phenomena, 164-168
 - Doppler principle, 166-168
 - earth's magnetic field, 164-166
 - basic principles, 146
 - components of, 148
 - amplifiers, 151-154
 - controllers and actuators, 154
 - feedback systems, 154
 - reference units, 151
 - sensors, 148-151
 - phases of guidance, 146-148
 - purpose and function of, 145
 - types of, 155-164
 - active, 221, 222
 - beam rider, 156
 - celestial, 160
 - command, 156
 - homing, 205-224
 - inertial, 6, 160
 - navigational, 231-248
 - optical, 170
 - passive, 159, 210-217
 - radar, 185
 - radio, 173
 - television, 172, 177
 - terrestrial, 160
- Guided missiles, components of, 51-66
 - airframe, 51-54
 - auxiliary power supply, 51
 - body configuration, 53
 - control system, 51
 - guidance system, 51
 - location of components, 51, 52
 - payload, 57
 - propulsion systems, 51, 54
 - sectionalization of, 51
 - telemetering systems, 64-68
 - warheads, 51, 55-59
- Guided missiles, delivery systems and techniques, 298
- Guided missiles, introduction to, 1-23
 - after and during World War II, 10-12
 - classification of, 12
 - components of, 6
 - current U.S. service missiles, 14-23
 - Air Force missiles, 15-17
 - Army, 14
 - Navy missiles, 17-23
 - designations, 12
 - Navy missile and rocket, 13
 - guidance, 4-6
 - systems, 9
 - history of, 6
 - propulsion systems, 6-9
 - purposes and uses of, 2-4
 - symbols, 13
 - types of, 4
 - weapons systems, 2
- Guided missile ships and systems, 249-267
 - aircraft missile systems, 265-267
 - mission of, 249
 - submarine missile systems, 261-264
 - surface ship missile systems, 254-260
 - AA problem, 258-260
 - missile logistics, 260
 - missile stowage, loading, and launching systems, 258
 - Navy Tactical Data System, 260
 - organization of missile ships, 254
 - Terrier (RIM) missile system, 255-258
 - types of missile ships, 249-253
 - cruisers, 249-251
 - destroyers, 251-253
 - submarines, 253
- Guns, 291, 298
 - delivery techniques, 298
- Half life, principle of, 277
- Half thickness, examples of, 278, 279
- Heading reference, 226
- Heat barrier, 36
- High altitude bursts, 315
- Homing guidance, 205-224
 - active homing guidance, 221, 222
 - basic principles, 205
 - interferometer, 222-224
 - passive homing system, 210-217

PRINCIPLES OF GUIDED MISSILES AND NUCLEAR WEAPONS

- Homing guidance (continued)
 - basic principles of, 210-214
 - infrared target detection, 217
 - missile components, 214-217
 - radio frequency, 217
 - target characteristics, 214
- semiautomatic, 218-221
- trajectories, 207-210
 - lead angle or collision course, 208-210
 - pursuit homing, 207
- Hot-gas auxiliary system, 102
- Hybrid guidance, 160
- Hybrid propulsion engine, 96
- Hydraulic actuators, missile, 133
- Hydraulic-electrical control system, 133
- Hydrodynamics, 46
- Hyperbolic guidance system, 157, 173
- Hyperbolic trajectory, 48
- Hypersonic flight, 36

- Ignition systems, missile propulsion systems, 78
- Illuminating warheads, 59
- Impact fuse, guided missiles, 60
- Implosion weapon, 292
- Inertial guidance, 6, 160
- Information links, command guidance systems, 169, 170
- Infrared portion of electromagnetic spectrum, passive homing system, 210
- Infrared target detection, passive homing guidance system, 217
- Injectors, missile propulsion systems, 78
- Initiator, 293
- Inline cruciform, 45
- Intercontinental ballistic missile, 2
- Interferometer, homing guidance, 222-224
- Ionosphere, 26
- Isotopes, 272

- Jet, atmospheric, 44
- Jet control, 42
- Jet propulsion systems, 54, 69

- Launching station components, command guidance systems, 176
- Laws and formulas, missile propulsion systems, 70-74
- Lead angle course, 48, 208
- Lead homing, 159
- Lift, 31
- Lift and drag, 28
- Lift effectiveness, 44

- Liquid-damped system, 162
- Liquid-fuel rockets, 88-92
- Liquid propellants, 77
- Lobe formation of radar beam, 186
- Local fallout, 341
- Loran system, 157
- Lorin, Rene, 7
- Luminescent detectors, 213

- Mach numbers and speed regions, 35
- Magnetic forces, 50
- Manometer accelerometer with venturi damper, 163
- Mass-energy, laws of, 281
- Matter, nature of, 269-275
 - atomic structure, 270
 - atomic table, 269
 - chemical implications, 271
 - chemical versus nuclear reactions, 275
 - electrical implications, 271
 - electron shells, 270
 - isotopes, 272
 - nuclear symbols, 272
 - stability, 273
- Mechanical digital indicator, 227
- Mechanical timers, 109
- Missile configuration, effects of, 44-47
- Missile control components and systems, 97-144
 - actuator units, 132-144
 - auxiliary power supply unit, 101-105
 - computing devices, 123-129
 - function and requirements, 124
 - operating principles, 128
 - types of, 125-128
 - control action, types of, 100
 - control systems, 100
 - controller units, 129-132
 - electrical, 133, 141
 - hydraulic, 133
 - hydraulic-electrical, 133
 - pneumatic, 133, 137-141
 - pneumatic-electric, 141
 - definitions, 97
 - energy sources, 101
 - factors controlled, 99
 - methods of control, 99
 - missile-control servosystem, 105-108
 - pickoffs, 119-123
 - purpose and function, 98
 - reference devices, 108-113
 - sensor units, 113-119
- Missile course computer, 176
- Missile dive attitude, 240

INDEX

- Missile flight, factors affecting, 24-50
 - aerodynamic forces, 29
 - air flow over a wing section, 29
 - effects of, 31-33
 - missile control, 33-35
 - terminology, 30
- aerodynamics of supersonic
 - missile flight, 35-47
 - control of supersonic missiles, 39-44
 - heat barrier, 36
 - Mach numbers and speed regions, 35
 - missile configuration, 44-47
 - Reynolds number, 35
 - shock wave, 36-39
 - atmosphere, 24-26
 - coriolis force, 50
 - forces acting on a flat surface in an airstream, 28
 - gravity, 49
 - lift and drag, 28
 - magnetic force, 50
 - Newton's law of motion, 27
 - relativity of motion, 27
 - wind, 49
- Missile plotting system, 177
- Missile propulsion systems, 69-96
 - atmospheric jets, 80-86
 - pulsejet engines, 80-82
 - ramjets, 84-86
 - turbojets, 82-84
 - basic laws and formulas, 70-74
 - absolute pressure, 70
 - absolute temperature, 70
 - application of, 72-74
 - gas laws, 71
 - components of, 74-80
 - combustion chamber, 74
 - diffuser, 79
 - exhaust nozzle, 74-76
 - fuel supply, 76-78
 - ignition systems, 78
 - injectors, 78
 - jet propulsion systems, classification of, 69
 - principles of, 70-74
 - rocket motors, 86-96
 - hybrid propulsion, 96
 - liquid-fuel rockets, 88-92
 - nuclear-powered rockets, 95
 - solid-fuel rockets, 92-95
- Missile receiver, beam-rider guidance, 188
- Missile response, homing guidance signals, 206
- Missiles, components of, 51-66
 - airframe, 51-54
 - auxiliary power supply, 51
 - body configuration, 53
 - control system, 51
 - guidance system, 51
 - location of components, 51, 52
 - payload, 57
 - propulsion systems, 51, 54
 - sectionalization of, 51
 - telemetering systems, 64-68
 - warheads, 51, 55-59
- Missiles, current, U.S. service, 14-23
 - Air Force missiles, 15-17
 - Navy, 17-23
- Missiles, introduction to, 1-23
 - after World War II, 12
 - classification of, 12
 - components of, 6
 - current U.S. service missiles, 14-23
 - designations, 12
 - during World War II, 10
 - guidance, 4-6
 - history of, 6
 - propulsion systems, 6-9
 - purposes and uses of, 2-4
 - symbols, 13
 - types of, 4
 - weapons systems, 2
- Missile ships and systems, 249-267
 - aircraft missile systems, 265-267
 - mission of, 249
 - submarine missile systems, 261-264
 - surface ship missile systems, 254-260
 - types of missile ships, 249-253
- Missile stowage, loading, and launching systems, 258
- Missile tracking radar, 176
- Missile warheads, 297
- Motion, 27
- Motor timers, 109
- Mushroom cloud, 306
- Navigational guidance systems, 231-248
 - automatic celestial navigation, 244
 - celestial-inertial system, 241-243
 - inertial guidance, 231-238
 - terminal inertial guidance systems, 238-241
 - terrestrial reference navigation, 245-248
- Navy missiles, 13, 17-23
 - and rocket designations, 13
- Navy Tactical Data System, 260
- Neutron radiation, 277
- Neutron sources, 292

PRINCIPLES OF GUIDED MISSILES AND NUCLEAR WEAPONS

- Newton's laws of motion, 27, 73
- Nitroglycerine, 94
- Noise filters, 245
- Nuclear and thermonuclear warheads, 59
- Nuclear fission, 283-287
- Nuclear particles, 273
- Nuclear physics, fundamentals of, 268-289
 - atomic research preceding the bomb, 268
 - atomic structure, 270
 - chemical versus nuclear reactions, 275
 - isotopes, 272
 - nature of matter, 269-275
 - nuclear particles, 273
 - nuclear reactions, 281-289
 - binding energy; mass defect, 282
 - laws of mass-energy relationship, 281
 - nuclear fission, 283-287
 - nuclear fusion, 287-289
 - nuclear symbols, 272
 - objectives, 269
 - radioactivity, 275-281
 - stability, 273-275
- Nuclear-powered rockets, 95
- Nuclear radiation, damage from, 333
- Nuclear reactions, 281-289
- Nuclear symbols, 272
- Nuclear weapons, 290-301
 - Atomic Energy Commission, 300
 - atomic demolition munitions, 298
 - bombs, 297
 - comparison of, 295
 - Defense Atomic Support Agency, 300
 - delivery systems and techniques, 298
 - fission weapons, 290
 - fusion weapons, 293-295
 - fuzing techniques, 296
 - guided missiles, 298
 - guns, 291, 298
 - delivery techniques, 298
 - implosion principle, 292
 - importance of, 290
 - missile warheads, 297
 - neutron sources, 292
 - organization, 299
 - safety and security, 298
- Nuclear weapons, bibliography for orientation, 343
- Nuclear weapons, effects of, 302-342
 - air blast, 319
 - atomic warfare defense, 336-340
 - bibliography for nuclear weapons orientation, 343
 - bursts, 304, 330, 340
 - air, 330
 - surface, 331
 - underground, 332
 - comparisons, 302
 - damage, 316
 - eye damage, 326
 - dirt cloud, 308
 - employment of nuclear weapons effect, 340-342
 - air burst, 341
 - scaling laws, 341
 - subsurface burst, 341
 - surface burst, 340
 - explosions, 307
 - fallout, 329, 338-340
 - fire storm, 327
 - Mach front, 306
 - protection of personnel, 308
 - radiation hazard, 307
 - injury and sickness, 333
 - radiation, nuclear, 329-336
 - radiation, thermal, 323-329
 - shock, 321
- Nutating lobe, beam-rider guidance, 187
- Nutating waveguide, beam-rider guidance, 186
- One-radar system, beam-rider guidance, 200-202
- Opacifier, 94
- Optical observation, command guidance systems, 170
- Over-the-horizon radar, beam-rider guidance, 195
- Oxidizers, jet engine, 76
- Payload, guided missiles, 57
- Passive homing, 159, 210-217
 - basic principles of, 210-214
 - infrared target detection, 217
 - missile components, 214-217
 - radio frequency, 217
 - target characteristics, 214
- Photodetectors, 213
- Pickoffs, 119-123
- Piston type timers, 110
- Plasticizer, 94
- Plume, 313
- Plutonium, 335
- Pneumatic control system, 133, 137-141
 - electric, 141
- Pneumatic timers, 110
- Polaris missile, 2, 263
- Potentiometer pickoffs, 120
- Power plants, missile jet, 70
- Preset guidance system, 160, 225
 - altimeters, 227
 - heading, 226

INDEX

- Preset guidance system (continued)**
 information set in the missile, 226
 length of flight, 227
 use in composite systems, 228
- Progressive burning, 93**
- Propellants, 77**
 advanced, 95
 and propulsion systems, 95
 charges, solid, 92
- Propulsion systems, missile, 69-96**
 atmospheric jets, 80-86
 pulsejet engines, 80-82
 ramjets, 84-86
 turbojets, 82-84
 basic laws and formulas, 70-74
 absolute pressure, 70
 absolute temperature, 70
 application of, 72-74
 gas laws, 71
 components of, 74-80
 combustion chamber, 74
 diffuser, 79
 exhaust nozzle, 74-76
 fuel supply, 76-78
 ignition systems, 78
 injectors, 78
 jet propulsion systems, 69
 principles of, 70-74
 rocket motors, 86-96
 hybrid propulsion, 96
 liquid fuel rockets, 88-92
 nuclear-powered rockets, 95
 solid-fuel rockets, 92-95
- Protactinium, 268**
- Protection of personnel, 308**
- Proximity fuzes, 61**
- Psychological warheads, 59**
- Pulse-Doppler radar, beam-rider guidance, 195**
- Pulsejet engines, 80-82**
- Pursuit curve, 48**
- Pursuit homing, 159, 207**
- Radar-beacon, command guidance system, 179**
- Radar command guidance, 155, 173, 178, 180**
- Radar mapmatching, 246-248**
- Radar, missile tracking, 176**
- Radar beam used in beam-rider guidance, 184**
- Radar transmitters, control and tracking, 194**
- Radiac circuit, 281**
- Radiation, beam-rider guidance, 185**
- Radiation hazard, 307**
- Radiation, injury and sickness caused by, 333**
- Radiation, nuclear, 329-336**
 bursts, types of, 330-333
 fallout, 329
 injury, 333-336
 shock, 321
 sickness, 334
- Radiation, thermal, 323-329**
 Bikini tests, 329
 effects on materials, 326-328
 effects on people, 324-326
 burns and blisters, 325
 eye damage, 326
 fire storm, 327
 range of, 328
- Radiation warheads, 59**
- Radioactivity, 275-281**
- Radio and radar command guidance, 173**
- Radio command guidance system, 173**
- Radio command transmitter, command guidance systems, 174**
- Radio frequency passive homing guidance, 217**
- Radiotelemetry, 64**
- Ramjets, missile propulsion systems, 84-86**
- Receivers, command guidance systems, 172**
- Reference devices, missile control systems, 108-113**
- Relativity of motion, 27**
- Residual radiation, 335**
- Reynolds number, 35**
- Rocket engine, jet propulsion systems, 70**
- Rockets**
 designations, 13
 liquid fuel, 88
 motors, 86-96
 nuclear-powered, 95
 solid-fuel, 92
- Rudders, 40**
- Safety and security, nuclear weapons, 298**
- Scaling laws, 341**
- Scanning, beam-rider guidance, 189-194**
- Self-contained guidance systems, 160-164**
- Semiactive homing, 159, 218-221**
- Sensor units**
 guidance system, 148-151
 missile control system, 111-119
- Servomechanism, 100**

PRINCIPLES OF GUIDED MISSILES AND NUCLEAR WEAPONS

- Shaped-charge warhead, 57
- Shipboard protective measures, 336
- Ship damage from nuclear weapons, 318
- Shock caused by nuclear weapons, 321
- Shock wave, 36-40
- Shore base protection, 337
- Sidewinder, 4
- Slick, 310
- Slot, 41
- Solar fusion cycle, 293
- Solenoids, 130
- Solid-fuel rockets, 92-95
- Sparrow missile system, 265
- Spoiler, 41
- Stellar supervised inertial
 autonavigator, 242
- Stratosphere, 26
- Strontium, 335
- Submarine missile systems, 261-264
- Submarines, guided missile, 253
- Subroc missile system, 264
- Subsurface bursts, 309, 341
- Supersonic missiles, control of, 39-44
- Surface burst, 308, 340
- Surface ship missile systems, 254
- Symbols, 13

- Tab, 41
- Tail arrangements, 45
- Target, beam-rider guidance, 184
- Teak burst, 315
- Telemetry systems, missile
 propulsion, 64-68
- Television guidance system, 172, 177
- Terrestrial guidance system, 160
- Terrier (RIM) missile system, 255-259
- Thermal radiation, 323-329
 - Bikini tests, 329
 - effects on materials, 326-328
 - effects on people, 324-326
 - burns and blisters, 325
 - eye damage, 326
 - fire storm, 327
 - range of, 328
- Thermal timers, 109

- Thermistors, 212
- Thorium, 268
- Thrust, 33
- Time delay fuse, 60
- Timers, mechanical, guided missile
 control system, 109
- Timing devices, 296
- Tracking, guided missile, 97
- Tracking radar, beam-rider
 guidance, 197
- Training warheads, 59
- Trajectories, guided missile, 47-50
- Transfer valve, 130
- Transmitters, command guidance
 systems, 172
- Trinitrotoluene, 296
- Troposphere, 25
- Turbines used in auxiliary power
 supply, 103
- Turbojets, 82-84
- Two-radar system, beam-rider
 guidance, 202

- Ultraviolet radiation, 325
- Underground bursts, 313
- Underwater bursts, 310
- Underwater problem, 262
- U.S. Service missiles, 14-23
 - Air Force, 15-17
 - Navy, 17-23
- Uranium, 268
- Uranium series, 276

- Vector control, 42
- Velocity-damping doppler,
 radar, 168
- Vertical-dive system for
 missiles, 240
- Vibrators, 129

- Warhead, guided missile, 51, 55-59
- Weapons, nuclear, 290-301
- Whittle, Frank, 7

- Zero-lift inertial system, 240