

DOCUMENT RESUME

ED 068 287

SE 014 551

AUTHOR Savler, D. S.
TITLE Aircraft of Today. Aerospace Education I.
INSTITUTION Air Univ., Maxwell AFB, Ala. Junior Reserve Office
Training Corps.
SPONS AGENCY Department of Defense, Washington, D.C.
PUB DATE 71
NOTE 179p.

EDRS PRICE MF-\$0.65 HC-\$6.58
DESCRIPTORS *Aerospace Education; *Aerospace Technology;
Instruction; National Defense; *Physical Sciences;
*Resource Materials; Supplementary Textbooks;
*Textbooks

ABSTRACT

This textbook gives a brief idea about the modern aircraft used in defense and for commercial purposes. Aerospace technology in its present form has developed along certain basic principles of aerodynamic forces. Different parts in an airplane have different functions to balance the aircraft in air, provide a thrust, and control the general mechanisms. Profusely illustrated descriptions provide a picture of what kinds of aircraft are used for cargo, passenger travel, bombing, and supersonic flights. Propulsion principles and descriptions of different kinds of engines are quite helpful. At the end of each chapter, new terminology is listed. The book is not available on the market and is to be used only in the Air Force ROTC program. (PS)

DOD SE

AEROSPACE EDUCATION I

ED 068287

U.S. DEPARTMENT OF HEALTH,
EDUCATION & WELFARE
OFFICE OF EDUCATION
THIS DOCUMENT HAS BEEN REPRO-
DUCED EXACTLY AS RECEIVED FROM
THE PERSON OR ORGANIZATION ORIG-
INATING IT. POINTS OF VIEW OR OPIN-
IONS STATED DO NOT NECESSARILY
REPRESENT OFFICIAL OFFICE OF EDU-
CATION POSITION OR POLICY.

AIRCRAFT of TODAY

AIR FORCE JUNIOR ROTC
AIR UNIVERSITY/MAXWELL AIR FORCE BASE, ALABAMA

SE 014 551

ED 068287

Aerospace Education I

Aircraft of Today

D. S. Savler
Academic Publications Division
3825th Support Group (Academic)



AIR FORCE JUNIOR ROTC
AIR UNIVERSITY
MAXWELL AIR FORCE BASE, ALABAMA

1971

This publication has been reviewed and approved by competent personnel of the preparing command in accordance with current directives on doctrine, policy, essentiality, propriety, and quality.

●

This book will not be offered for sale. It is for use only in the Air Force ROTC program.

●

We gratefully acknowledge the contribution of Capt Fay A. Roe, AE-1 Course Director, AFJROTC, to the development of this text.

Preface

WHEN WE THINK of "aircraft of today" we are likely to think of giants and jets—aircraft either larger or faster than any ever flown before. For example, the Air Force's huge jet-powered transport, the C-5A Galaxy, can carry 110 tons of cargo at 500 mph nonstop without refueling for a distance of 3,500 miles. The C-5A has a wingspan of 223 feet and is able to take aboard the heaviest tanks and guns of a modern Army division. If speed rather than size is what fires your imagination, consider the F-4C Phantom, a fighter which flies at mach 2.5 (2½ times the speed of sound) and in one test climbed to a height of 98,000 feet. To date, only military aircraft fly faster than sound, but a British-French company will soon put into commercial service a large supersonic transport aircraft. Such a plane will enable a passenger to arrive in New York three hours "earlier" than he left London. The Soviet Union also has a supersonic transport nearing readiness for service.

Still, in this age of jets there are quite a few propeller-driven aircraft flying around. Are they obsolescent? Are they getting to be a thing of the past?

So far, the answer to this question seems to be a most emphatic *no*. The military services still find uses for what is called the "reciprocating engine" (propeller-driven) aircraft and others for the type known as "turboprop" or "propjet." Industry and commerce find many more. The usefulness of a helicopter that can rise from or land upon the top of a building or a piece of ground no larger than a tennis court is obvious. Not so obvious to the speed-conscious youth of today are

the many virtues of numerous different modern "fixed wing" aircraft performing the many unglamorous chores of modern aviation—the "jeeps," "buses," and "trucks" of the air. Even in combat, as recent experience in warfare against guerrillas has shown, "low and slow" aircraft have their place.

Modern aircraft come in many sizes and shapes, each suited to one or more of the many civilian or military demands placed upon them. These demands include speed and capacity, but they also include fuel economy, ease of loading and unloading, ability to fly above the weather, ability to fly "low and slow," ease and economy of repair work, ability to get into and out of small, soft or rough landing fields, and many more. Obviously, all these virtues cannot be combined in one miracle plane. Nevertheless, there are many versatile aircraft that have won the admiration of airmen, military leaders, and cost-conscious business men.

In the first chapter are described several great Air Force airlift "workhorses." By looking a little more closely at this class of aircraft first, we can learn much about aircraft in general, and the problems designers attempt to solve.

Contents

PREFACE	iii
<i>Chapter 1</i> — FROM "GOONEY BIRD" TO "GALAXY"	1
The C-47 Gooney Bird	2
Postwar Military Air Transport	5
Performance and "Trade-Offs"	15
What is Payload?	17
<i>Chapter 2</i> — SOME BASIC PRINCIPLES OF FLIGHT	19
Thrust, Weight, Drag, and Lift	20
Airfoils and Aerodynamic Forces	22
Faster-Than-Sound Terminology	24
Aircraft Performance Factors	28
<i>Chapter 3</i> — BASIC AIRCRAFT STRUCTURE, PARTS AND SYSTEMS	33
Major Parts of an Airplane	33
About Wings	39
Control Systems and Instruments	45
<i>Chapter 4</i> — PROPULSION UNITS	53
Common Propulsion Principles	54
Propellers	55
Reciprocating Engines	56
Jet Propulsion Units	60
Turboprop Propulsion Units	67
Rocket Motor—the X-15	68
<i>Chapter 5</i> — GENERAL AVIATION AIRCRAFT	75
Some Facts, Figures, and Trends	76
Some Representative Types	80
Do-It-Yourself Aviation	86

<i>Chapter 6</i> — COMMERCIAL AIRLINE AIRCRAFT . . .	89
Commercial Cargo Aircraft	90
Commercial Passenger Aircraft	91
The Supersonic Transport (SST) Controversy	100
<i>Chapter 7</i> — AIR FORCE AIRCRAFT	109
ATC Trainers	111
Tactical Warriors	112
ADC Interceptors and Warning Aircraft	127
The SAC Global Fleet	132
MAC Technical Specialists	135
What Do the Letters and Numbers Mean?	137
<i>Chapter 8</i> — ROTARY WING, STOL AND VTOL AIRCRAFT	143
Rotary Wing Aircraft	145
STOL Airplanes	152
Nonrotary VTOL and VSTOL Aircraft	159
BIBLIOGRAPHY	169
INDEX OF WORDS, PLACES, AND NAMES	171
INDEX OF AIRCRAFT	175

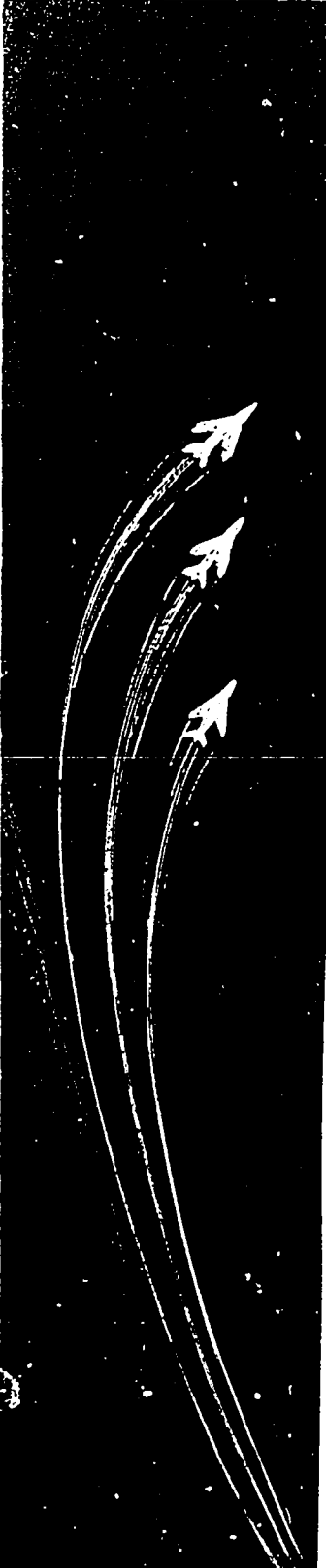

From "Gooney Bird" to "Galaxy"

THIS CHAPTER introduces you to the workhorses of aviation, transport aircraft. First it relates the long career of the C-47, better known as the "Gooney Bird," and describes the special features and abilities of this elderly model which make it still a useful part of the Air Force inventory. Next, it reviews the wide range of new and improved military transports that have been developed since the war, comparing them as to construction, performance, and function. The chapter concludes with some general remarks on aircraft performance and the compromises or "trade-offs" required to achieve it. The term "payload" is defined. When you have studied this chapter, you should be able to do the following: (1) give the history of the C-47 and explain its advantages for transport duty; (2) identify and describe some of the current military transports, giving details about the load capacity, performance, and special uses of each type; and (3) explain the civilian and military significance of "payload."

WHAT IS the most basic function of an aircraft? To carry something or somebody—transportation. In this chapter we begin talking about aircraft by considering that class of aircraft devoted to carrying men and supplies for the military services. To begin our story, we could go all the way back to the Wright brothers, or we could begin by describing the very latest. Instead, let us first consider an aircraft developed some time near the "middle" of aviation history. This history-making airplane did much toward bringing both civil and military aviation into their modern era.

AIRCRAFT OF TODAY

THE C-47 GOONEY BIRD

In its long career, a certain versatile medium-size two-engine low-wing transport plane has been known by many names. It began as the DC-3, a commercial airliner that was queen of the US airways in the late 1930s. The manufacturer's name for it was "Skytrain," with more luxurious versions dubbed the "Skysleeper" and "Skylounge." For short, it was called the "three." Drafted into military service in World War II, it became the Air Force's C-47 and the Navy's R-4D. The British called it "Dakota." The most commonly-used name today is "Gooney Bird." This nickname was picked up during World War II in the Pacific Theater and is also the nickname for the albatross, a large sea bird with notable talents for gliding and sustained flight.

The first Douglas DC-3s were the ultimate for their day in size, speed, capacity (21 passengers), and luxury available to the traveling public. In fact, there was very little American "traveling public" for airliners prior to the introduction of this aircraft. It took more than an average amount of courage to buy a ticket for a flight on a typical passenger plane of the early 1930s. Now more timid people began to discover the speed and convenience of flying, and commercial aviation began to grow into the major industry it is today. The size of the DC-3 was reassuring, as was its all-metal construction and wings that sprouted solidly from the body without seeming to be held in place by wires and braces. Its streamlined shape was a glimpse into the future. It had landing gear that folded neatly out of the way after takeoff and extended again for landing, along with wing flaps for greater lift and safety during takeoffs and landings. It had a cruising speed of around 170 mph and a top speed of 200 mph. The combination of all these features in one aircraft was a history-making breakthrough.

Today's skies are full of aircraft that are faster, larger, and more modern than the Gooney Bird, but many Gooney Birds still fly. A modern passenger on a Gooney Bird may grumble at the prospect of a long, slow ride, but this aircraft's reputation for safety, dependability, and ruggedness keeps it in service year after year. No new Gooney Birds have been manufactured since 1946. The old ones keep flying with new engines and other parts and sometimes changes to fit them for new roles. Ten thousand military and civilian Gooney Birds were manufactured. It has been estimated that half of these are still flying (Fig. 1).

FROM "GOONEY BIRD" TO "GALAXY"

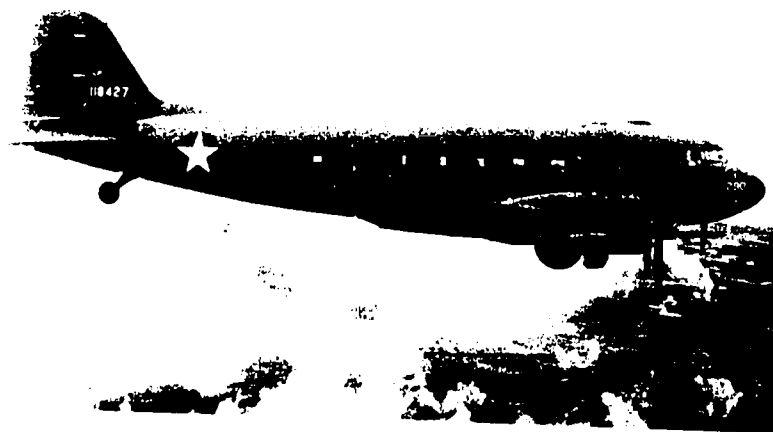

Figure 1. GOONEY BIRD, C-47, DC-3, Skytrain, or "Three," this aircraft has provided useful service since 1935.

Even in World War II days, military leaders considered the C-47 obsolescent and spurred the development of larger, faster and more efficiently designed military airlift planes. Nevertheless, the Gooney Bird island-hopped across oceans; it saw service in the famous "Hump" shuttle across the Himalayas between India and China; it dropped paratroopers over France ahead of the main invasion forces; and it rushed troops and supplies to many battlefronts throughout the world, and took out the sick and wounded. Its reputation for survival became a legend. Time after time, Gooney Birds with crumpled wings, gaping holes in their sides, or dead engines, made safe landings.

After World War II ended, the career of this aging queen went on and on. In 1948, when Soviet troops sealed off the roads and canals leading into Berlin, the Gooney Bird began the famous Berlin Airlift, before larger aircraft were brought in. It was used for Arctic exploration and weather observation and for cargo and passenger hauling between remote jungle and mountain communities all over the world. The Air Force uses it for routine transportation purposes, but there are also some 25 versions of this aircraft used for such special tasks as training, supplying remote scientific observation stations, technical experiments—and combat. A recent version of the old Gooney Bird called the AC-47 has seen military action in Vietnam. Armed with 100-round-per-second machine guns aimed out its side doors, this

AIRCRAFT OF TODAY

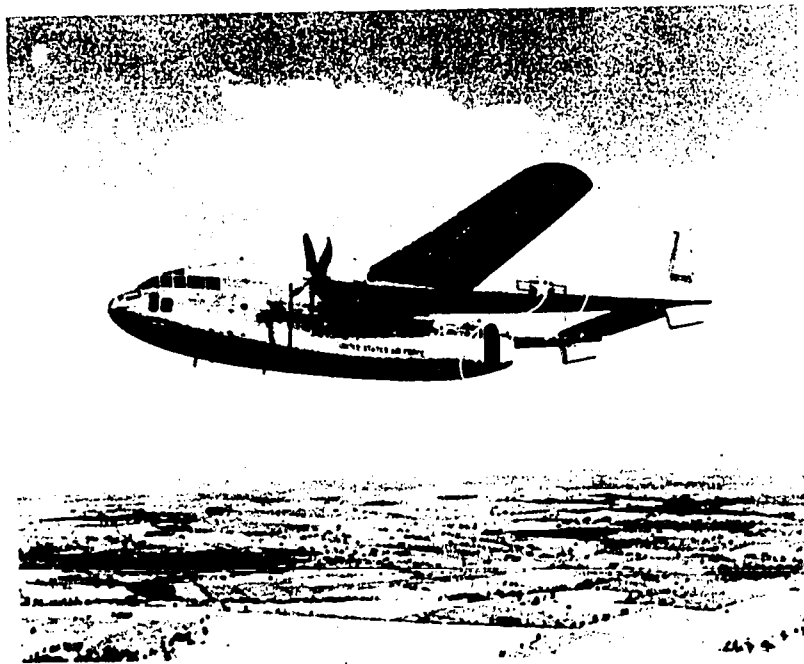

Figure 2. FLYING BOXCAR. C-47 is first aircraft especially designed as a military transport.

Gooney Bird can remain over a jungle battle area for hours, striking the same target again and again, while higher-performance aircraft must break off the attack and return to their bases for refueling and ammunition. Servicing and repair work on the C-47 are also simpler tasks than maintenance of modern "sophisticated" jets. For civilian use, there is one company today which takes DC-3s and replaces their engines with **turboprop*** units for higher speed and heavier lifting. The remodeled airplanes are called the "Turbo-Three."

The C-47 has a **wingspan** (measurement from wingtip to wingtip)* of 95 feet and a length of 64 feet 4 inches. Standard models have a single door in the side of the fuselage through which crew, passengers and cargo enter and leave the cabin. On some models this door is widened for more efficient cargo handling or other special purposes,

* **IMPORTANT NOTE.** Words and phrases with which you should become familiar during study of this unit are printed in boldface type. The more important of these words are listed at the end of each chapter. A *glossary index* at the end of the book refers to one page where each word is adequately defined or explained by context.

FROM "GOONEY BIRD" TO "GALAXY"

but there is no getting around the basic inconvenience of side loading. The total payload is officially rated at a modest 7,500 pounds or 28 troops, but the legend of the Gooney Bird includes many tales of how its capacity was successfully stretched beyond these limits. Most currently-flying Gooney Birds have two 1,200-horsepower engines, something of a power boost over the earlier models. It can fly as high as 23,000 feet, (about 4½ miles) with crew and passengers wearing oxygen masks, for the cabin is not pressurized. And, if not overloaded, the Gooney Bird has a range of a little over 2,000 miles.

By modern standards the C-47 achieves dependability at much sacrifice in performance. The first of the measurements cited above is important. The Gooney Bird's long wingspan gives it plenty of lift for getting it off short runways or bringing it down safely in an emergency landing, but also more drag to pull against the thrust of its engines and thus limit its speed and payload capacity. Such terms as "lift," "drag," and "thrust," and other basics of aircraft design and performance will be discussed later. Meanwhile let us consider some more steps in the evolution of military transport aircraft. This will give you a better appreciation of functional design—the idea of building an airplane to do a specific job.

POSTWAR MILITARY AIR TRANSPORT

Some of the shortcomings of the C-47, which designers of later military transport aircraft have overcome are lack of cargo capacity (both size and weight), lack of speed, lack of range, and difficulty of loading and unloading. Virtues of the C-47 which the same designers have tried to preserve or improve upon are reliability, safety, ruggedness, and ability to use small unpaved landing fields. Merely building a larger plane with more powerful engines is not the answer to all these problems.

Some Interim Designs

Some of these aircraft show us some interesting solutions to these problems. One is the Fairchild C-119 "Flying Boxcar," introduced in 1947—one of the earliest aircraft designed from the ground up as a military carrier (Fig. 2). Its twin-boom frame and low-slung fuselage (body) make it easier to load and unload and safer for parachute exit. Armed AC-119s, with heavier firepower than that of the AC-47, have been employed in combat in Southeast Asia. The largest plane in

AIRCRAFT OF TODAY

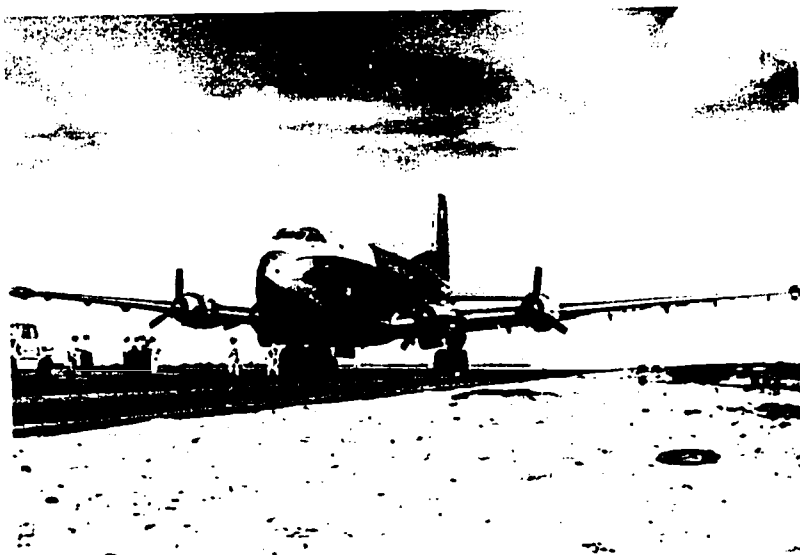

Figure 3. C-124 GLOBEMASTER, giant of the 1950s.

the air during the years 1950–1958, still flying, is the Air Force's great Douglas C-124 Globemaster, able to carry 200 fully-equipped troops, 127 litter patients, or 20 tons of cargo (Fig. 3). With four piston-driven engines it can fly across oceans at speeds of around 230 mph. Its huge clamshell doors in front open to permit a wide ramp to be lowered and large trucks or tanks to be driven aboard. Many Globemasters are still seeing service in Air Force, Air National Guard, and Air Force Reserve units.

An even greater giant, the Douglas C-133 Cargomaster was introduced in 1958 (Fig. 4). The Cargomaster's four **turboprop** engines gave it a cruising speed of 300 mph. Its size, and its front and rear clamshell doors made it a specialist for hauling missiles and other oversized cargo. In one test it lifted 59 tons, one of the heaviest loads for a turboprop plane, but more important than weight lifting was its ability to take a missile or other huge machine aboard and deliver it whole without the need for taking it apart and putting it together again. This, as you can see, is a more important time-saver than an extra 100 mph or so of speed.

A notable civilian among all these Air Force types is the Canadair CL-44, a big 400 mph Canadian turboprop freighter with a **swing tail**.

FROM "GOONEY BIRD" TO "GALAXY"

(Some of these are in the Civil Reserve Airlift Fleet.) The tail section of this aircraft swings aside on hinges for quick loading and unloading of bulky cargo. Another civilian contract-operator for the Government, Aero Spacelines flies a converted C-97, with a removable tail and a fuselage greatly expanded in diameter in the form of a great upward bulge, which gives it the name "Pregnant Guppy". It is a specialist in carrying Saturn rocket boosters and other missiles. An even larger version, named "Super Guppy" has a swing nose rather than a swing tail (Fig. 5).

THE C-123.—There is one medium-sized slow-flying two-engine piston-driven airplane that deserves special mention, the Fairchild C-123 Provider. It has been in service since the early 1950s. It carries 10 to 12 tons of cargo or 60 equipped troops and has a top speed of 230 mph. Its high-wing design gives it a curiously old fashioned look. Yet the C-123 is remarkable for two main reasons: One is that its basic design is the **prototype** (the original model) for a whole family of larger and faster military airlift planes. The aforementioned C-133 Cargomaster, the C-130 Hercules, the C-141 Starlifter, the C-5A

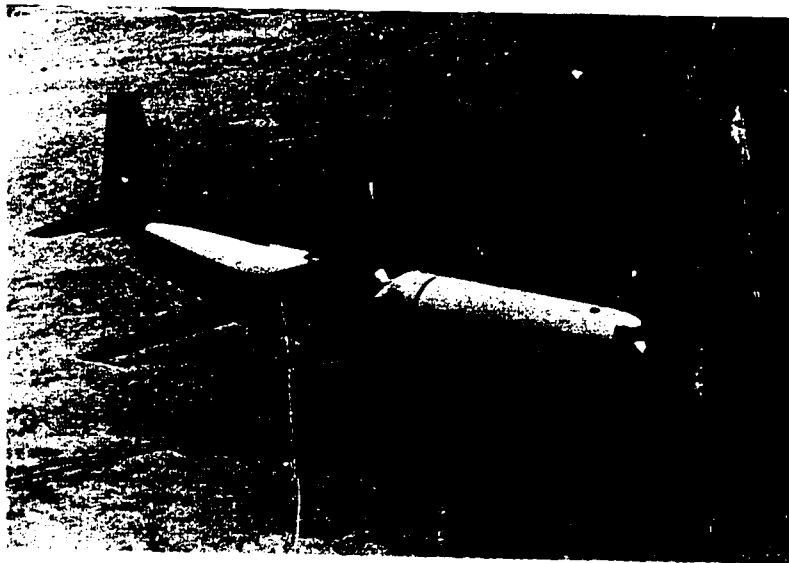

Figure 4. C-133 CARGOMASTER. This turboprop giant was the largest US transport plane before the C-5.

AIRCRAFT OF TODAY

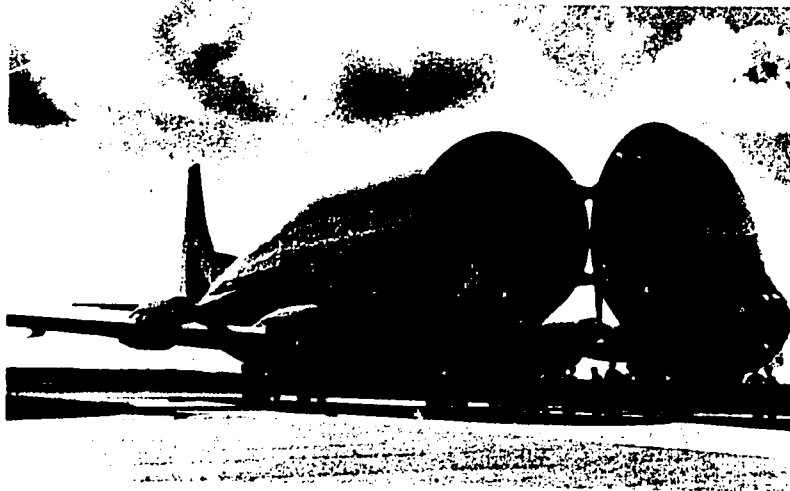

Figure 5. TAKE A C-97, cut off the top of the fuselage, add a giant balloon-like structure in its place, with the front section swinging open on hinges, and you have the SUPER GUPPY.

Galaxy, all owe something to the C-123. All have high wings, low fuselage, short and sturdy landing gear, and upswept tail to permit rear drive-in loading of vehicles, or straight-in truckbed-height loading of cargoes, or parachute or drop unloading. The other remarkable thing

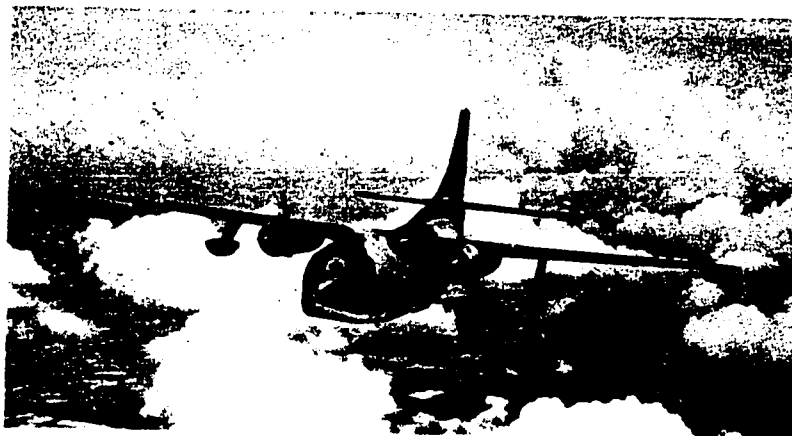

Figure 6. C-123K PROVIDER. This version of the tactical airlifter has auxiliary jet engines near wingtips for extra takeoff boost.

FROM "GOONEY BIRD" TO "GALAXY"



Figure 7. C-130 HERCULES, versatile turboprop-powered workhorse for tactical transport and numerous special uses.

about the C-123 Provider is its war record in Vietnam, where its parachute and drop talents, along with its ability to get in and out of short, soft landing strips, are of supreme importance. To improve their takeoff and landing ability and general performance, a substantial number of Providers have been modified (C-123K) by addition of two auxiliary jet engines (Fig. 6).

THE C-130.—Looking somewhat like a larger version of the C-123, the Lockheed C-130 Hercules is a four-engine turboprop troop and cargo carrier capable of carrying 25,000 pounds of payload 4,300 miles, of 35,000 pounds 3,500 miles, or 92 troops, or 64 paratroopers, or 74 litter patients (Fig. 7). This puts it in what we might call the "light heavyweight" class, since there are several heavyweights from the older C-97s, and C-124s to the jet-powered C-5s and C-141s of today that can carry bigger loads. The latter two also travel faster. Lacking in superficial glamor, looking fat and ungainly as it sits on the ground, no holder of either speed or weight-lifting records, the C-130 Hercules just happens to have a reputation for hard work under difficult conditions that rivals the legend of the Gooney Bird. Its bulky shape reflects as much designer's knowhow as the sleek contour of a supersonic jet. The first C-130s came into Air Force service in 1958, and improved models are still being manufactured for both military and commercial use.

AIRCRAFT OF TODAY

Like the C-123, the C-130 Hercules is used by the Air Force for tactical airlift in support of ground forces. This means getting troops and supplies as close to a battlefield or trouble area as possible. The methods of doing this include paratroop and paradrop operations, also dropping cargo without parachutes. On the battlefields of Southeast Asia, a widely used delivery method is called **LAPES (low altitude parachute extraction system)**, in which parachutes attached to the cargo are deployed out the rear opening of the C-130 and pull the cargo out after them as the aircraft flies low over the delivery point. The mighty Hercules is equipped to do all these things. It can also land on or take off from small or poorly-surfaced landing fields, which other aircraft, even some of lesser size and speed, must shun. Its short-field capability can be improved by adding auxiliary rockets called **JATO (jet-assisted takeoff) bottles**. **Aeromedical evacuation**, in which the Hercules is converted to a hospital plane for quick transportation of sick and wounded away from a battle zone or disaster area, is another important duty this aircraft performs.

One Hercules model, the C-130E, has extra fuel tanks under its wings to give it extra range and make it capable of overseas airlift. The **Military Airlift Command (MAC)** still uses a few of these. The Hercules is also employed by the Air Force, Navy, and Coast Guard in a number of interesting non-airlift jobs. These include photomapping, weather and other scientific observations, search and rescue, launch and control of drone targets for air defense training. In a space program of a few years ago it was used for catching instrument capsules as they parachute down from outer space after being ejected from orbiting satellites. We have mentioned the AC-47 and the AC-119. The AC-130 is the largest of these freighters converted to gunships. It has 20-mm guns that fire almost as fast as the "miniguns" of the other two.

The basic aircraft that performs all these functions is 97 feet long. It has a wingspan of 132 feet 7 inches. Its power is supplied by four turboprop engines of 4,050 shaft horsepower each. These features give the Hercules a normal speed of 311 mph, a top speed of 365 mph, a ceiling of over 30,000 feet—and also a mighty boost that permits the use of 3,000 foot runways even without JATO. Rollers in the floor of the cabin help speed loading and unloading. As with the C-123 and others of this family, a roomy interior, upswept tail and wide rear opening are the secret of much of its versatility, whether for carrying

FROM "GOONEY BIRD" TO "GALAXY"

heavy and complex banks of instruments in a flying laboratory, trailing mysterious gear for capsule catching, permitting paratroopers to jump two at a time, or simply carrying and handling cargo efficiently.

The Big Jets of the Military Airlift Command

Having described two aircraft used in tactical airlift, let us consider now the aircraft used to carry men and supplies across oceans in the global airlift service of the Air Force's Military Airlift Command (MAC). In the early 1960s, MAC (in those days called MATS, for Military Air Transport Service) began modernizing its fleet. First it added the C-130E Hercules and the all-jet Boeing C-135 Stratolifter. Each of these two aircraft has advantages the other lacks. The C-130E lacks the speed and size of the C-135, but, as we have seen, it can handle cargo efficiently and it can use small and poorly-equipped airports.

THE C-135 STRATOLIFTER.—The C-135 is a large, modern jet. It can fly nonstop without refueling 5,000 miles or more, carry up to 42 tons of payload, reach speeds of 600 mph, and heights of over 50,000 feet. (It cannot do all of these things at the same time. Later in this chapter we shall have a word to say about performance and "trade-offs.") These performance figures equal and in some cases excel those of the current C-141 Starlifter. As a military airlifter, however, the C-135 has certain drawbacks. Like other large jets in either commercial or military service, it needs the long runways of a major airport. Its passenger-plane airframe design is not the best for efficient cargo handling, for the C-135 is based upon smaller models of the Boeing 707 commercial airliner and loads and unloads through a side door.

Today most C-135s have been transferred from the airlift fleet to other Air Force organizations. C-135s serve as reconnaissance ships, as flying command posts, as weather observation ships, and in other special uses. We should make particular mention of the KC-135 tanker. It came into the Air Force even earlier than the C-135 transport and continues to serve as the main Air Force tanker. Being a jet airplane itself, it can link up with the swiftest fighters and bombers and keep pace with them during delicate aerial refueling operations.

THE C-141 STARLIFTER.—The first Lockheed C-141 Starlifters joined the MAC global airlift fleet in the mid-1960s, and by 1970 this aircraft had become the backbone of the fleet (Fig. 8). The C-141

AIRCRAFT OF TODAY

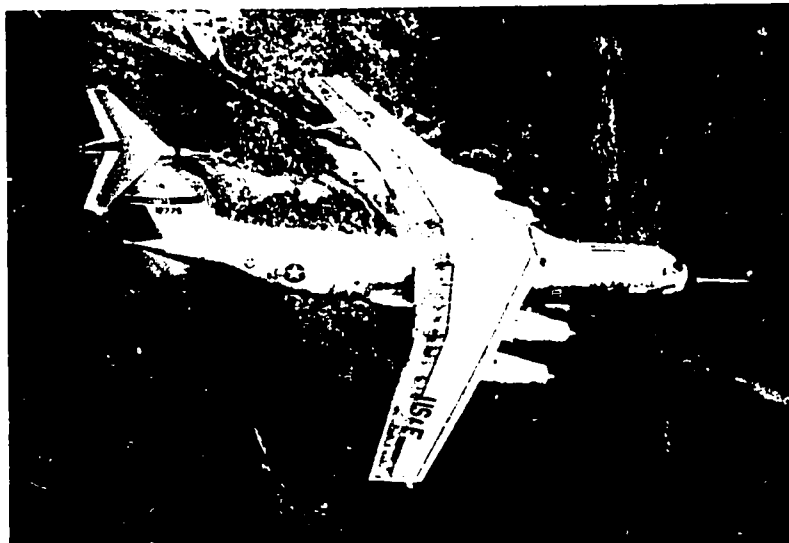

Figure 8. C-141 STARLIFTER, large all-jet transport, backbone of the Military Airlift Command.

does not outperform the C-135 in either speed, range, or maximum payload capacity. What it does is equal or almost equal the C-135 in these respects while also having the cargo-handling efficiency of the C-130E, because it has a similar body design, with high wings and a low belly for ease of rear loading and unloading as well as paratroop exit and airdropping by LAPES and other methods. The C-141 can take off fully loaded using little more than 4,000 feet of runway and clear a 50-foot-high obstacle less than 6,000 feet from the start of the takeoff run, a feat which no other jet aircraft of equal weight can perform. (Its landing run is even shorter because of the braking effect of reversible-thrust engines.) While this takeoff-and-landing performance does not equal that of the C-130E, it can extend the reach of this aircraft to thousands of small airports throughout the world which other big jet aircraft cannot use. The C-141 can carry 40 tons of cargo non-stop 3,500 miles. Or it can carry a 30-ton payload 4,600 miles, or 15 tons 5,800 miles. Its cruising speed is around 500 mph. Its wingspan is 160 feet and overall length 145 feet.

THE C-5A GALAXY.—Even while the C-141 was still being developed, work had begun on a larger jet aircraft, the Lockheed C-5A

FROM "GOONEY BIRD" TO "GALAXY"

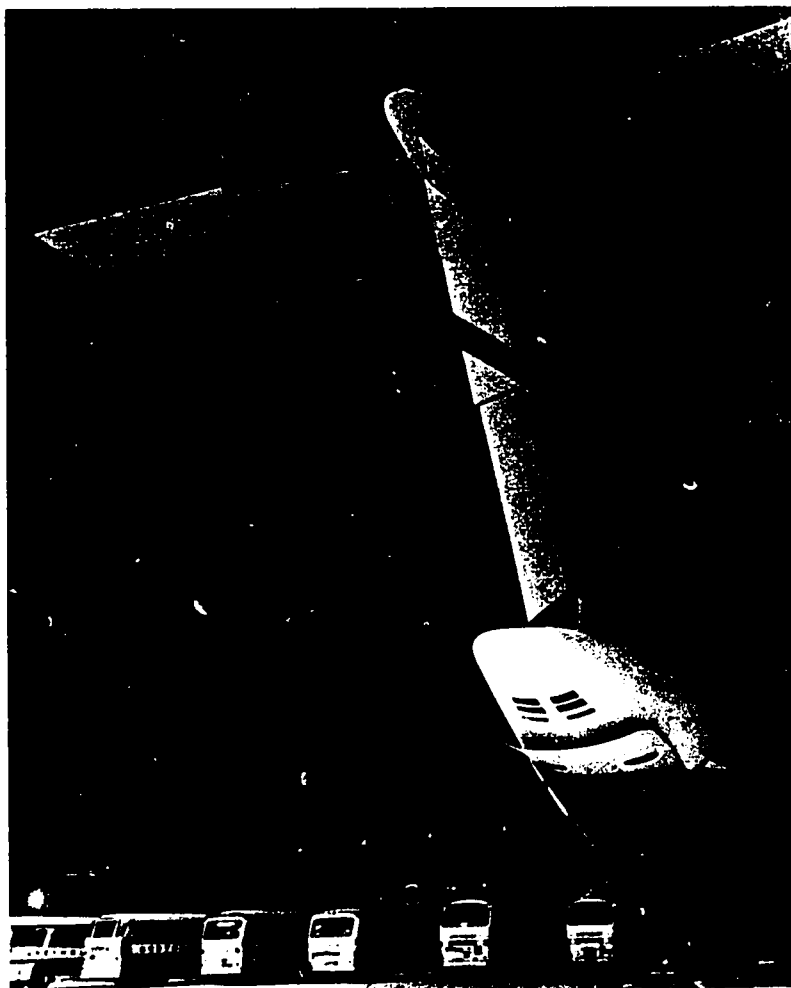

Figure 9. C-5 GALAXY, world's largest airplane, rear view. Note line of buses under wing for size comparison. Tail section is 63 feet high. Also note open rear cargo door.

AIRCRAFT OF TODAY

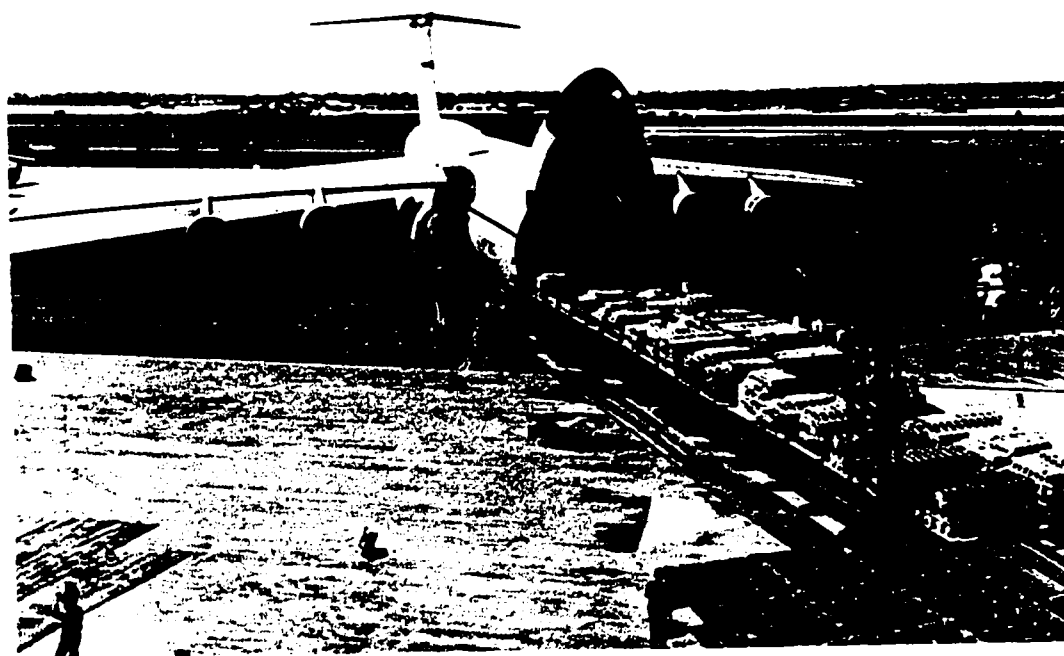

FIGURE 10. GALAXY loading through nose from air-transportable deck, which can be flown into a newly-established airbase in sections in C-5s and quickly assembled to speed loading and unloading of other C-5s arriving the next day.

Galaxy. In 1970, after many test flights, the first C-5As were delivered to MAC squadrons and put into airlift service. With an overall length of 246 feet and a wingspan of 233 feet, the Galaxy is the largest airplane in the world.*

The C-5A Galaxy is jet powered, but it will not break any speed records. Military planners do see the need for a supersonic (faster than sound) transport some day in the future, but they must put first things first. The immense size of the C-5A has a purpose other than mere record breaking. The aircraft is designed to hold bulky as well as heavy cargo, to carry tanks, guns, bulldozers, or just about any item of equipment an Army division owns. Like its predecessors, the C-130 and the C-141, it can load and unload from the rear (Fig. 9). As Fig-

* The second largest is the Boeing 747, a commercial passenger jet airplane, described in Chapter 6. Prior to the building of these two US giants, the world's largest airplane was the Soviet Union's turboprop-powered Antonov An-22 Antheus described in Chapter 4 under the heading "Turboprop Propulsion Units."

FROM "GOONEY BIRD" TO "GALAXY"

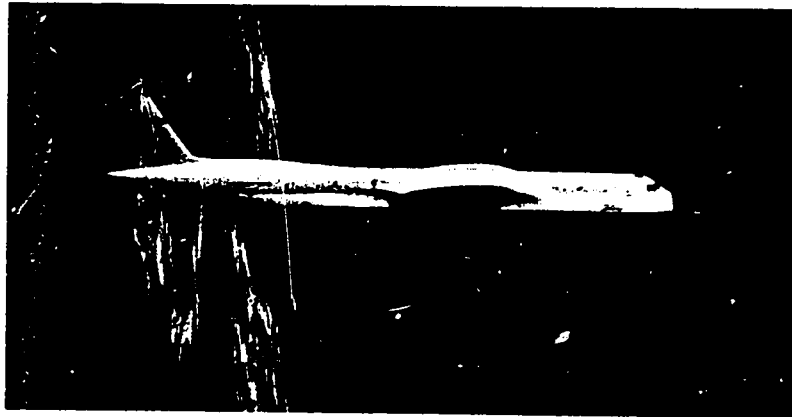

Figure 11. C-5 GALAXY in flight.

ure 10 shows, its nose lifts up for front loading too. Trucks and tanks can drive into its cavernous interior two abreast. They can be driven in one end and out the other without backing or turning. With this kind of cargo carrying and handling ability, the C-5A makes possible a whole new concept in military airlift. A combined fleet of C-141s and C-5As, one carrying troops and light equipment, the other heavy equipment, could airlift a whole Army division to any part of the world in a few days' time (Fig. 11).

Fully loaded, the C-5 weighs 728,000 pounds. It can carry a payload of 265,000 pounds a distance of 2,875 miles at a speed of 530 mph. Its range with a 100,000-pound payload is over 6,325 miles. On its 28-wheel landing gear, designed to distribute its immense weight evenly and make a "light footprint," its takeoff roll with a 100,000 pound payload is 7,500 feet. This is comparable to the takeoff of many jet transport aircraft of considerably smaller size.

PERFORMANCE AND "TRADE-OFFS"

Now that you have been introduced to some of the problems of designing aircraft, you will better understand that progress in aviation is a matter of constantly sacrificing one advantage in order to gain another. Engineers call this kind of compromise a **trade-off**. For example, we have mentioned the takeoff and landing performance of several transport aircraft. To be able to take off and land within a short distance is a decided advantage; but the bigger, heavier, and faster an

AIRCRAFT OF TODAY

aircraft is made, or the heavier a load it carries, the more runway it needs. The Wright brothers' very first aircraft required only a 40-foot run to get off the ground. Since then, much of the story of aviation progress has been that of the trade-off of this advantage for the sake of higher and higher speeds and heavier and heavier payloads. Nowadays, however, the advantages of **short takeoff and landing (STOL)** are becoming important for both civil and military aviation. We shall return to this subject in Chapters 5 and 8. Other trade-offs in aircraft design include payload capacity for speed or vice-versa, and ease of cargo handling for speed or fuel economy, or vice-versa. In this text, we shall learn of many more as they affect the design of aircraft for civil or military roles.

Some trade-offs are a matter of flight planning rather than aircraft design. Recall the statements made above about the ranges and payload capacities of certain aircraft. For example, the C-141 can carry 40 tons of cargo 3,500 miles, but to fly 4,600 miles nonstop, it must reduce its payload to 30 tons. The fuel carried in the huge tanks of such an aircraft is also measured by the ton; every flight must be calculated in terms of ratio between fuel weight and payload weight to stay within the maximum safe lifting capacity of the aircraft. At the opposite extreme from the problem of planning an ocean-spanning airlift of heavy cargo would be such an assignment as bringing a C-123 into a landing strip in a combat zone in order to bring out six wounded men. In this case, the home base may be only 100 miles away, so the aircraft would carry as little fuel as possible in order to improve its **STOL** capability and execute a faster climbout, possibly under enemy fire.

In this volume, we shall not flood you with performance statistics every time we mention an aircraft, but, as you can see, the full story of any aircraft's performance is always more complicated than we may make it seem.

FROM "GOONEY BIRD" TO "GALAXY"

WHAT IS PAYLOAD

In a commercial freight or passenger airplane, the term payload is easy to define. It is that part of the load of an airplane that makes money for the owner. Such an airplane would lose money rapidly if it had nobody aboard except its crew, and no load to carry except its own structural weight, fuel supply, engines, and other flight equipment. Only fare-paying passengers and their baggage and revenue-paying cargo are payload. These do nothing to assist or protect the flight, but the owners would soon be out of business without them. They constitute the main purpose (military people call it the "mission") of the flight.

If an airplane is used for purposes other than hauling passengers or freight for money, then its "payload" consists of those persons, materials or equipment that contribute to the main purpose of the flight but as a rule do nothing to accomplish or protect the flight itself. The payload of a crop duster, for instance, would be the chemicals to be sprayed on the crops. The payload of an aerial tanker would be the fuel to be delivered at a destination or transferred to another aircraft but not the fuel consumed by the tanker itself. If a man owns and flies an airplane for his own pleasure, or personal transportation, then the pilot is his own "payload," for carrying him is the main purpose of the aircraft. (Manufacturers of general aviation aircraft prefer the term useful load, and this term is meant to include the pilot and any other persons aboard the aircraft whether classed as "crew" or "passenger.")

In military aircraft, the idea is also the same. Payload in military aircraft is, according to the USAF Dictionary—"That part of the load that is expendable, deliverable, or ready for use in direct accomplishment of the special purpose of the air mission." In a photo reconnaissance plane, cameras and film are payload, but not flight instruments. Radar used in radar photography is payload, but not radar used for flight control. Ammunition, bombs, rockets, etc., used to attack enemy ground or air targets are payload, but not ammunition intended for defense of the aircraft against enemy attack.

WORDS, PHRASES AND NAMES TO REMEMBER

functional design	prototype
fuselage	short takeoff and landing (STOL)
jet-assisted takeoff (JATO)	swing tail
low altitude parachute extraction system (LAPES)	tactical airlift
Military Airlift Command (MAC)	trade-off
payload	useful load
	wingspan

AIRCRAFT MENTIONED IN THIS CHAPTER

Aero Spacelines Pregnant Guppy. Super Guppy transports
Boeing C-135 Stratolifter transport (KC-135 tanker)
Canadair CL-44 transport
Douglas C-47 Gooney Bird (DC-3 Skytrain. Dakota. "Turbo Three," AC-47 gunship)

AIRCRAFT OF TODAY

Douglas C-124 Globemaster transport
Douglas C-133 Cargomaster transport
Fairchild C-119 Flying Boxcar transport (AC-119 gunship)
Fairchild C-123 Provider transport (C-123K)
Lockheed C-5A Galaxy transport
Lockheed C-130 Hercules transport (AC-130 gunship)
Lockheed C-141 Starlifter transport

QUESTIONS

1. What are the features of the C-47 which have made it so valuable to the Air Force for so many years? Why is its wingspan so important?
2. Identify three later models of cargo planes which have been designed to correct some of the shortcomings of the C-47.
3. Which is the largest aircraft, civilian or military, in use today? What is its special ability?
4. Why is the C-123 considered to be a prototype for so many larger and faster airlift planes?
5. Compare the C-5A with the C-141 and the C-135.
6. Define "trade-off."
7. Define "payload" as applied to military aircraft.

THINGS TO DO

1. Start a scrapbook on modern aircraft. Begin with pictures of as many types of cargo planes as you can collect. Watch for news of the C-5A and add clippings on this or other developments in cargo planes to your book.
2. If there is an Air Force base near enough to visit, identify the cargo planes you see there.

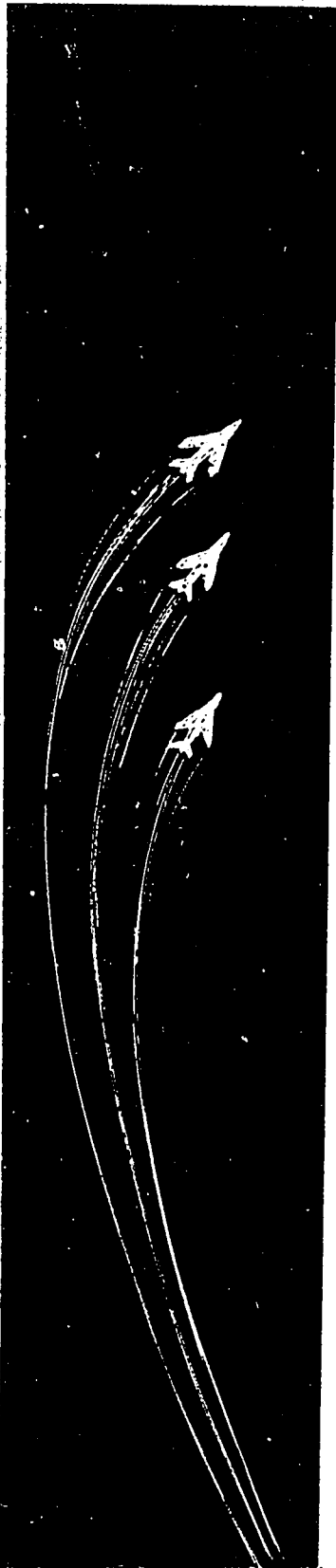

Some Basic Principles of Flight

THIS CHAPTER outlines the basic laws of aerodynamics and demonstrates how these laws relate to the functional design of aircraft. First, it describes the forces that act upon any object moving through the air and explains the effect of each force. Then, it discusses the features of aircraft construction that are designed to react against the forces of the air. When you have studied this chapter, you should be able to do the following: (1) define thrust, drag, weight, and lift and describe the effect of each force on an object in flight; (2) identify the parts of a plane known as airfoils and explain how each one functions; (3) discuss the principles of streamlining; and (4) define two important performance factors: cruising speed and ceiling.

A LARGE military jet transport like the C-141 looks different from a large, sleek jet passenger liner like a Boeing 707 or a Douglas DC-8, and now you know some of the reasons why. These reasons are summed up in two words: **functional design**. This means designing different aircraft to do different jobs.

But it is also true that there are some ways in which all aircraft—from the sport airplanes to jet fighters—are alike. Since they must obey the basic laws of aerodynamics—the laws of the air acting upon all bodies that pass through it. All aircraft must have certain design features in common to permit flight in obedience to these laws. In this chapter and the next, before we return to the subject of

AIRCRAFT OF TODAY

different types of modern aircraft, we shall consider some of these basics. Aerodynamics is a big subject, of course, and here we do not intend to tax a beginner's knowledge but merely introduce some simple ideas. Next year's course will go further into this subject.

THRUST, WEIGHT, DRAG, AND LIFT

An object moving through the air has four forces acting upon it. A baseball can serve as an example. The **thrust** is the force that moves it—a thrower's arm or a bat. Immediately as the ball, impelled by this thrust, begins its flight, the force of **gravity**, or **weight**, begins to pull it toward the earth. If the ball were much heavier, like an iron shot, for instance, this force would greatly shorten its flight, but if it were much lighter, another force would retard its flight and shorten that would-be home run into a pop fly! This would be the force of air resisting the flight of the ball. This force against the ball's motion is called **drag**. In this case, the main source of drag is air molecules bombarding the front of the ball, trying to push it backwards. In a moving ball, this effect is enhanced because the air flowing around the ball creates a partial vacuum behind the ball which allows the air molecules to exert an even greater push on the front of the ball.

Now, if this baseball had somehow been thrown or batted out in the far reaches of space, with neither force of gravity nor atmospheric drag working against it, another physical law, that of **inertia** would keep it moving forever in the same direction as its initial thrust. It would thus obey one of Sir Isaac Newton's famous **Laws of Motion** discovered some 300 years ago. But free motion in space is the subject of another unit. In this unit we are not discussing space flight but are sticking close to earth—where movement is opposed by the blanket of the earth's atmosphere and the strong pull of its gravity. Down here a flying body, to keep itself flying, must carry its own continuous thrust with it, in the form of an engine. Otherwise, like a baseball, it must come to earth as soon as the initial thrust force is overcome by the other two forces, gravity and drag.

But there is also the fourth force working upon the ball in flight, **lift**. Since it is not shaped to take much advantage of lift, our baseball may seem a rather poor example. Nevertheless, a high-arching fly ball stays aloft as long as it does partly through the effect of air resistance. Obviously flat surfaces, or wings, or more technically **airfoils** are the

SOME BASIC PRINCIPLES OF FLIGHT

features of a bird, kite, or airplane, that provide much better ways of taking advantage of the lift of the atmosphere.

Therefore, let us drop that baseball and think instead of the four forces—thrust, weight, drag and lift—acting upon an airplane in flight. The **thrust** of the airplane's one or more engines is what propels it toward its destination; it is also essential to provide **lift**. The aircraft has **weight**; we are indeed concerned here with heavier-than-air aircraft which cannot float like balloons but need thrust and lift to keep them aloft. Finally, there is **drag**, the powerful atmospheric force against which the other forces must work (Fig. 12).

Offhand one may think of two of these forces—lift and thrust—as being “friendly” to flight, and the other two—weight and drag—as “enemies.” But this is not the right logic. **Newton's Third Law of Motion** says that for every action there must be an equal and opposite reaction. One is impossible without the other. When weight and lift are equal, the aircraft flies level, neither climbing or descending. When thrust and drag are equal, the aircraft flies at a constant rate of speed,

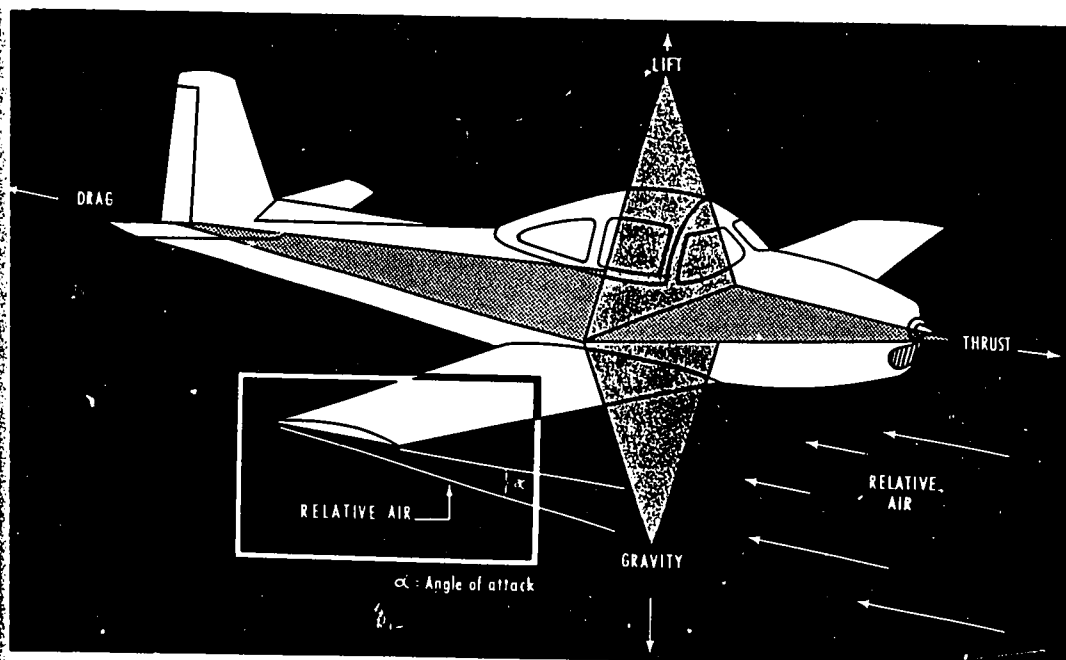

Figure 12. FOUR OPPOSING FORCES—thrust vs. drag; gravity vs. lift.

AIRCRAFT OF TODAY

neither **accelerating** (speeding up) or **decelerating** (slowing down). Therefore, all four of these forces are both friendly and hostile—forces to use and forces to overcome. The thrust of the engines produces the drag of the air rushing past the airplane. Without this drag, an airplane would be like a car without brakes or steering equipment. Weight, too, can be an asset. It provides stability and control. Fuel capacity and “payload”—the very things that make an aircraft a useful machine rather than a piece of sporting equipment—also mean weight. The more obviously useful forces, thrust and lift, must also be kept within limits of usefulness and safety. A designer who decreases drag by better **streamlining** must also reckon with decreased lift and longer takeoff run. Then he must ask himself all over again, “What is the function of this aircraft?” Designers achieve different capabilities by the different ways in which they balance the four basic forces. These are the trade-offs mentioned in the previous chapter.

AIRFOILS, AND AERODYNAMIC FORCES

All flat parts of an aircraft designed to react against air are known as **airfoils**. Wings, of course, are the airfoils that provide the main lift of an aircraft. Smaller airfoils, such as **ailerons**, **elevators**, **stabilizers**, **rudders**, etc., provide means of controlling flight.

Airfoils, as Newton might have told us, would be useless in still air. To act, they must have **reaction**—the force of air moving against them. If you put your hand out the window of a car moving at 60 mph, you will know how powerful this **aerodynamic force** can be. Actually the air may be so still that not a leaf is stirring on any tree, but upon a body moving through it at 60 mph the effect is the same as that of a 60 mph gale, which is strong enough to uproot some trees. If this **relative wind** is increased to 120 mph, its rush has the force of a violent hurricane that can unroof or topple some buildings. Yet an air-speed of 120 mph is rather slow by modern aviation standards. Modern high-performance aircraft are shaped and stressed to withstand aerodynamic forces many times more powerful than hurricanes. They are not designed to stand up to such forces like a stone wall but to live with them, ease into them, and make use of them.

But aerodynamic forces need not be that violent to keep aircraft aloft. Consider kites and gliders—motorless aircraft whose light weight and broad airfoils permit use of the force of a moderate breeze. Be-

SOME BASIC PRINCIPLES OF FLIGHT

tween the extremes of gliders and supersonic jets lies the whole range of powered aircraft, all designed to provide their own thrust to produce the force of air or **relative wind** against their airfoils.

Airspeed

It is important here to define the word **airspeed**. Airspeed is not necessarily a measure of actual distance covered in a certain amount of time; we call that **groundspeed**. If an airplane has an airspeed of 200 mph and is flying through absolutely still air, it will also have a groundspeed of 200 mph. If it is moving against a 20 mph head wind, its groundspeed will be reduced to 180 mph, or if it is being helped along by a 20 mph tail wind, it will have a groundspeed of 220 mph. In all these cases, airspeed, the measure of an aircraft's motion relative to the air, remains the same 200 mph. Airspeed not only gives an idea of the amount of movement; it is also a measure of the aerodynamic forces acting upon an aircraft in flight.

The Air Force, we should note, prefers to measure airspeed in **knots** rather than miles per hour. A knot is a unit of speed—one **nautical mile** per hour. A nautical mile is **one minute** of a **great circle** or $1/21,600$ of the circumference of the earth. This comes to about 6,080 feet or 1.1516 miles (give or take a few feet, because modern scientists are aware of irregularities in the shape of our planet). Although navigators have their own reasons for preferring to measure in knots, we shall continue to refer to both airspeed and groundspeed in the more familiar unit of miles per hour (mph). Sometimes we shall speak of airspeed in **mach numbers**. See the accompanying box, "Faster-than-Sound Terminology," for the vocabulary pertaining to the highest airspeeds.

More About Lift—Bernoulli's Law and Angle of Attack

Back in the eighteenth century, a Swiss scientist named Bernoulli discovered that as the speed of a fluid (liquid or gas) increases, its pressure decreases. Since air flows faster over the curved upper surface of a wing than under its relatively flat under surface, there is a **pressure differential**—a lower pressure above and a higher pressure below the wing. These both exert a lifting force upon the wing (Fig. 13). All aircraft make use of this principle, but this is not the only lifting force acting upon them.

AIRCRAFT OF TODAY

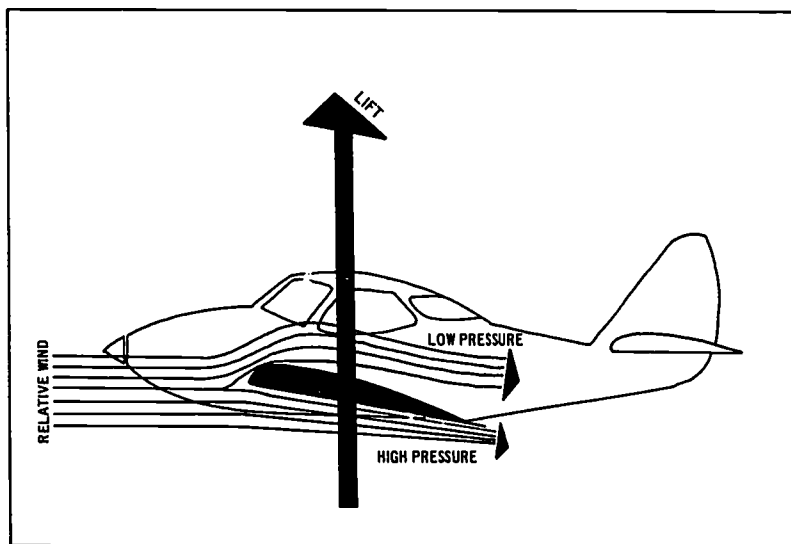

Figure 13. LIFT, according to Bernoulli's Law.

FASTER-THAN-SOUND TERMINOLOGY

Since this text will occasionally make reference to aircraft that can fly faster than the speed of sound, the student should be familiar with certain terms pertaining to the highest speeds of jet aircraft. The list is not alphabetical and should be read through in the sequence given.

sonic—equal to the speed of sound, which is 750 mph at sea level, somewhat slower at high altitude or low temperature.

subsonic—slower than the speed of sound

supersonic—faster than the speed of sound

mach number—number of times the speed of sound. For example, mach 2 equals twice the speed of sound. Subsonic speeds can be expressed as a fraction of mach 1 such as mach 0.85. The term is named after Ernst Mach (1838–1916), an Austrian physicist.

hypersonic—faster than mach 5

sonic boom—shock wave produced by aircraft in supersonic flight, discussed at the end of Chapter 6.

If an airplane's tail is forced downward by elevator action decreasing its lift, the whole aircraft—wings, engines and all—is aimed upward. The tilt of a wing into relative wind is called **angle of attack**.

SOME BASIC PRINCIPLES OF FLIGHT

With an upward angle of attack, air strikes the undersurface of the wing, producing **impact pressure**. This pressure also increases lift, but not quite as much as does the Bernoulli effect just described.* Too high an angle of attack, however, produces **turbulence** (swirling and other irregular movement of air), increases drag and weakens lift so that, with insufficient thrust, the aircraft will **stall** (begin to drop). However, when an aircraft is aimed upward, the thrust of its engine is also being exerted in an upward direction. This means also that the **relative wind** comes from an upward direction. A climbing aircraft maintaining a constant angle of climb is said to be flying level in regard to relative wind or angle of attack. It must work harder against gravity, of course, than in truly level flight, but a powerful engine can produce a rapid climb at a steep angle. When a jet fighter zooms skyward at a dizzy rate, it is using more upward thrust than the Bernoulli effect. On the other hand, when a seagull rides upon air currents with almost motionless wings, it is taking full advantage of the Bernoulli effect. Thus, both thrust from an engine and air flowing across a wing can produce lift.

More about Drag—Some Principles of Streamlining

If one tries moving his hand through water at right angles to the palm, it will be difficult to do. Water impact pressure builds up before the hand to oppose its movement. Obviously moving the hand sideways through the water is much easier. This simple fact is the first principle of streamlining; the less surface to oppose movement through a **fluid** (liquid or gas), the more easily a body moves (Fig. 14).

By this standard alone, however, the best airfoil would be as thin and sharp as a double-edge razor blade and the best fuselage as thin, sharp and elongated as a needle. The trouble with such shapes is that they prevent other functions. A fuselage must have bulk enough to carry crew, passengers, or whatever load it must carry. A wing or other airfoil must have a certain amount of bulge or camber, as it is called, to produce the action of Bernoulli's Law, discussed above. **Streamlining**, then, is the science of shaping objects so that air flows past them with a minimum of drag, yet permitting the objects enough bulk to function either as airfoils or carriers. Therefore, a rounded

* For example, impact pressure accounts for 30 percent of the total lift at an angle of attack of 10 degrees.

AIRCRAFT OF TODAY

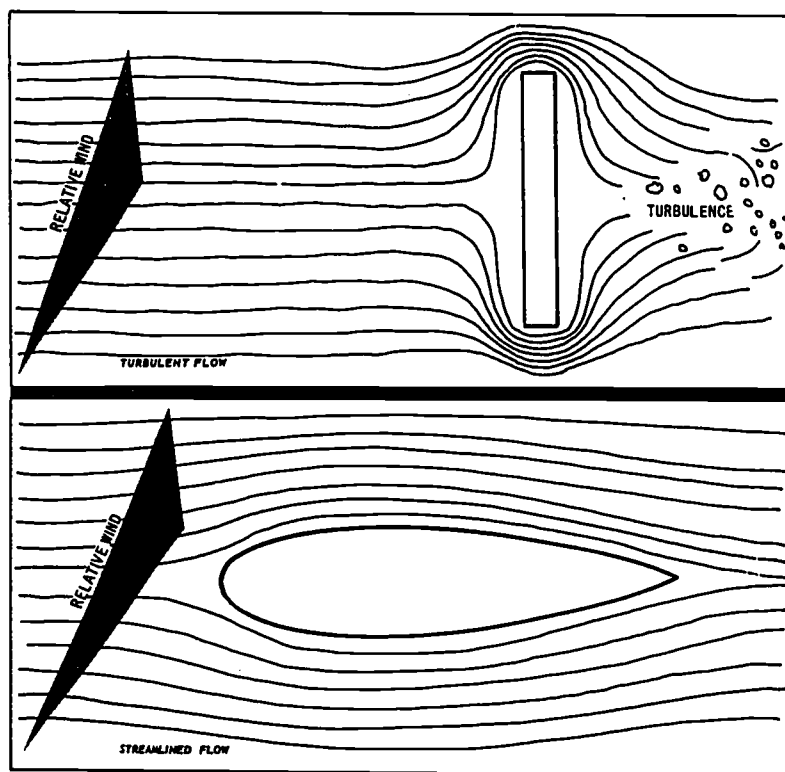

Figure 14. TURBULENT FLOW, compared with streamlined flow.

front and a tapered rear—the so-called “teardrop” shape—is the basic shape which designers of streamlined bodies try to match. Wings and other airfoils have a teardrop outline in cross section: rounded in front, sharp-edged in rear. We shall say more about airfoils later. Some general streamlining problems can be discussed first.

Anything external to the main body of an aircraft causes drag. Small, light aircraft can fly with exposed landing gear and external structural braces or struts, since these are not much of a problem considering the modest performance requirements of these aircraft and the relatively gentle aerodynamic stresses they undergo. Almost all other modern aircraft require attention to streamlining at every point.

SOME BASIC PRINCIPLES OF FLIGHT

The landing gear must be retractable. That is, it must be able to fold back or draw into the fuselage or wings immediately after takeoff and be lowered into position just before landing. Most modern aircraft are also designed so that no struts or other external bracing are needed. The wings are cantilevered or supported from within the fuselage. A stressed skin or monocoque type of construction is also used to help make struts unnecessary. This means that even the "skin" or the relatively thin metal shell of the aircraft contributes structural strength to the whole. (*Monocoque* is French for "single shell.") Wherever sharp angles occur, such as at wing roots, the joints are smoothed out with curved surfaces called fairings. If any part of an aircraft, such as an engine, cannot be contained within the fuselage or folded back out of the way, the next best thing to do is to put a streamlined shell around it. The radial engines (engines with cylinders arranged in a circle around the crankshaft) on *The Spirit of St. Louis* and other planes of 1920s vintage, exposed their cylinders to the wind, with much drag as a result. More modern aircraft with radial engines enclose these engines in circular hoods or cowlings, which do two jobs—reduce drag and direct the air for more effective air cooling. When an engine is located upon or suspended beneath a wing, its streamlined housing is called a nacelle. Fuel tanks, if carried externally, must also be teardrop shaped to minimize drag. In some fighters or attack aircraft, weapons, even machine guns, are mounted outside the body in elongated egg-shaped housings called pods. However, no amount of streamlining of nacelles, wing tanks, pods, etc., can solve the drag problem as well as enclosing these functions within a single streamlined shape of the fuselage—if it can be done.

Smoothing out major contours is the kind of basic streamlining that will improve speed and fuel economy in almost any aircraft. In high-performance aircraft, little things become important. Rivet heads should not protrude from the surface but should be flush with the skin. All surfaces must be highly polished, not for looks, but again, to reduce drag. When speed mounts to several hundred miles an hour and becomes supersonic, a new problem arises—heat. Friction of air, even the thin subzero air of high altitudes, rushing against the skin of the aircraft, raises its temperature. At this point, designers must balance a new factor with the others—heat resistance in metals and other materials.

AIRCRAFT OF TODAY

AIRCRAFT PERFORMANCE FACTORS

In descriptions of aircraft, such things are mentioned as useful load, payload, horsepower, range, top speed, cruising speed, ceiling, and takeoff and landing performance. Some of these items are self explanatory. Others are discussed in later chapters, where you may be better prepared to understand them. Here let us offer some explanation of **cruising speed and ceiling.**

Cruising Speeds

A given aircraft has a range of airspeeds, called cruising speeds, at which it flies with reasonable efficiency. At too high an airspeed, an aircraft burns fuel at an excessive rate, and both engine and airframe are subject to undue wear and stress. An aircraft's top speed is for emergencies only. Its maximum cruising speed is usually defined as that speed at which the engine is using about 75 percent of its available horsepower. Its most economical cruising speed is usually well below this maximum. Normal cruising speeds are between these two levels.

Ceiling and High-Altitude Performance

A given aircraft also has its best cruising altitude, at which it flies most efficiently. This capability depends upon airframe and wing design, discussed in the next chapter, and by engine type and performance, discussed in Chapter 4. The basic physical factor is that atmospheric pressure decreases—the air grows thinner—with altitude (height above sea level). When an aircraft, especially a jet, flies below its best altitude, it is slowed by the resistance of dense air. When it flies too high, it must increase speed beyond an efficient level to get lift from thin air. Thin air also means thin oxygen, and an air-breathing engine, like an air-breathing human, suffers from shortness of breath and reduced efficiency as it nears its ceiling.

An aircraft's ceiling is the highest altitude it can reach above sea level. More precisely, this is called its **absolute ceiling**. A more practical yardstick is **service ceiling**. In the United States and Great Britain, this is defined as the highest altitude at which a given aircraft can climb still higher at a rate of 100 feet per minute.

In adverse weather, an aircraft with a high service ceiling may have the advantage of being able to get "above the weather." This does not

SOME BASIC PRINCIPLES OF FLIGHT

necessarily mean getting up into the **stratosphere**,* above all the weather. Usually any increase in altitude improves the odds for a safe journey. Dangerous thunderheads can reach heights of 30,000 to 50,000 feet, but 10,000 feet might be enough altitude to put a flyer above the major part of the cloudiness so that he can see and avoid the thunderheads. An altitude of 15,000 feet might give him still better visibility, and so on. At lower altitudes, he would have to depend more upon his instruments and radio communications to avoid flying into a thunderstorm that could be hidden by surrounding clouds.

It is preferable not to go into a discussion about ceiling performance according to engine types at this point, since we shall have more to say about engines in Chapter 4. It might be useful, however, to list basic types of engines and the typical service ceilings of flying vehicles which use them. To repeat, these are *typical* service ceilings, not record-breaking performances:

Reciprocating (piston and cylinder)	15,000 feet
Reciprocating with turbosupercharger	30,000 feet
Turboprop	35,000 feet
Turbojet	50,000 feet
Ramjet	100,000 feet
Rocket	anywhere in aerospace

Human limits must also be considered in determining an aircraft's ceiling. Without artificial breathing help, the average human cannot fly for an extended period of time at an altitude much above 10,000 feet. The lack of oxygen suffered at high altitude brings on a condition called **hypoxia**, with both physical and mental ill effects resembling drunkenness, endangering both health and the safety of the flight. For flight at high altitude, an aircraft must be equipped with either oxygen breathing apparatus or a **pressurized cabin**. The latter is a means of keeping cabin pressure equal to or greater than normal atmospheric pressure at 8,000 feet regardless of how high the aircraft is flying.

* This term is more properly defined and described in the volume of the present series entitled *The Aerospace Environment*. Here we can define "stratosphere" loosely as a zone of clear air generally beginning at 25,000 to 50,000 feet and extending upward to about 150,000 feet.

AIRCRAFT OF TODAY

WORDS, PHRASES AND NAMES TO REMEMBER

aerodynamics	monocoque
airfoil	nacelle
airspeed	nautical mile
angle of attack	Newton's Laws of Motion
Bernoulli effect (Bernoulli's Law)	pod
camber	pressure differential
cantilevered wings	reaction
ceiling (absolute ceiling, service ceiling)	relative wind
cowling	retractable landing gear
cruising speed	stabilizer
drag	stall
elevator	stratosphere
fairing	streamlining
gravity	stressed skin
groundspeed	strut
hypoxia	thrust
inertia	turbulence
knot	
lift	

(See also box "Faster-than-Sound Terminology" in this chapter)

AIRCRAFT MENTIONED IN THIS CHAPTER

Boeing 707 civil passenger transport
Douglas DC-8 civil passenger transport
Lockheed C-141 Starlifter military transport
Ryan Spirit of St. Louis (Lindbergh New York-Paris flight, 1927)

QUESTIONS

1. Define "functional design."
2. Identify the four forces which affect a plane in flight and describe their action.
3. Explain Bernoulli's law and show how it applies to aircraft.
4. What does "angle of attack" mean?
5. Define the science of streamlining.

SOME BASIC PRINCIPLES OF FLIGHT

6. What is the British-American definition of "service ceiling?"
7. What is the main practical advantage of high-altitude capability?
8. What is "hypoxia"? What equipment is used to prevent it?

THINGS TO DO

1. Demonstrate "lift" by moving a strip of paper through the air or by blowing over the top of it. Either way, the paper will rise.
2. Demonstrate Bernoulli's law by holding two pieces of paper parallel to each other and blowing between them. The sheets will come together because the pressure of air on the outside is greater than that of the air moving between them.
3. Using a paper glider, experiment with "angle of attack" by folding the back edges down. When the glider is thrown the nose should go down. Reverse the fold and the nose will go up.

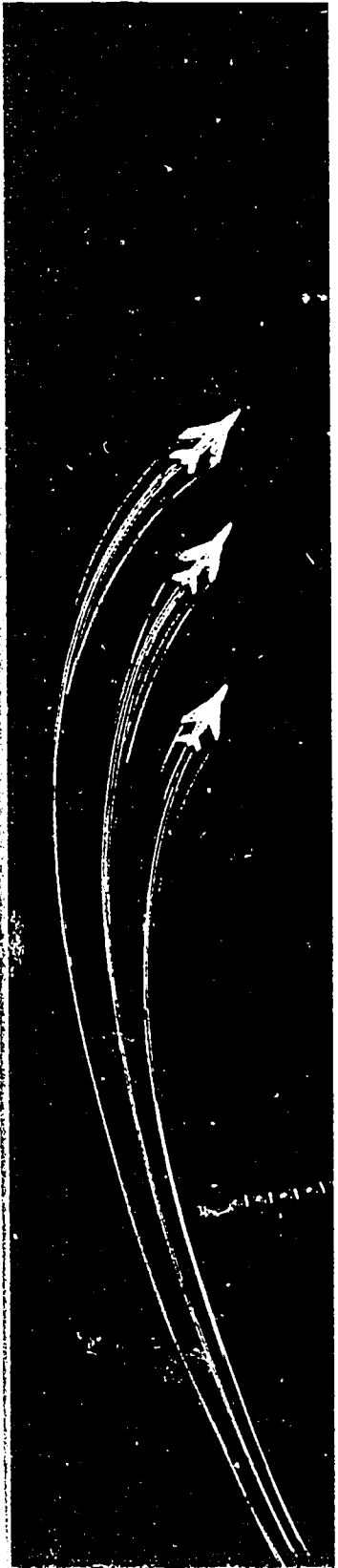

Basic Aircraft Structure, Parts and Systems

THIS CHAPTER acquaints you with the structural components, control systems, and instruments that are common to most types of aircraft. First, it identifies the major parts of a plane and explains their position and function in the overall assembly. Next, it compares wing designs and explains the functional purpose of each design. Then, it discusses the uses of hydraulic pressure and electric power in aircraft. Finally, it describes the numerous aviation instruments required on a modern aircraft, classifying them in groups according to their special function. When you have studied this chapter, you should be able to do the following: (1) identify and locate the structural components of a fixed-wing aircraft and explain the function of each part; (2) describe wing shapes in relation to aircraft performance and define the wing design terms referred to in this chapter; (3) discuss the uses of hydraulic pressure and electricity in aircraft operation; and (4) explain how aviation instruments are classified and tell what services each group performs.

WE HAVE already discussed some of the structural answers to the aerodynamic forces working on an aircraft. Now let us look at the airplane more systematically—its major structural parts, its hydraulic and electric systems, and some of the instruments of flight control. Power plants, or propulsion units, are the subject of Chapter 4.

MAJOR PARTS OF AN AIRPLANE

For purposes of identifying the major parts of an airplane, an “exploded” diagram of a light airplane with these parts labeled, is

AIRCRAFT OF TODAY

shown in Figure 15. With two exceptions, these parts are basic to all modern fixed-wing aircraft. The two exceptions are the propeller, not found on jet aircraft; and the wing struts, which, as we noted before, are found nowadays mostly on light or low-performance aircraft. Every other part shown and labeled is basic to all fixed-wing aircraft from low and slow "crop dusters" to the 4,000 mph X-15, which flew so high its pilots were awarded astronaut's wings!

Referring frequently to Figure 15, let us briefly describe the various parts of an airplane. For convenience, these are listed in two groups: miscellaneous, and flight-control airfoils.

Miscellaneous

Locate on Figure 15 the following parts of the aircraft shown: propeller, engine cowl, landing gear, wing struts, wings and fuselage.

PROPELLER.—Essentially the propeller is a curved airfoil with an angle of attack (either fixed or adjustable) that drives it through the air like a screw going into wood. Further discussion of propellers is provided in Chapter 4.

ENGINE COWL.—As noted before, the engine cowl encases the engine to protect it, direct air cooling, and provide a streamlined shape to reduce the drag that would result if the irregular shape of the engine itself were to be exposed. Not shown in the accompanying illustration

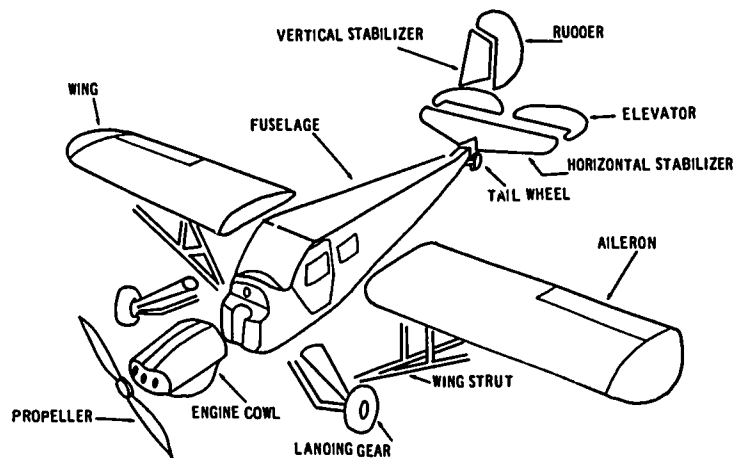

Figure 15. MAJOR PARTS of this light airplane are essentially the same for all airplanes.

BASIC AIRCRAFT STRUCTURES, PARTS AND SYSTEMS

are the nacelles in which engines of multi-engined aircraft are housed, located on or suspended from the wings. Behind the engine is a **fire-wall**, a fireproof, heat resistant partition. Engines themselves are also discussed in Chapter 4.

LANDING GEAR.—In general, this term includes the wheels upon which the aircraft lands and makes its takeoff run, together with their legs and other supporting members, shock absorbers, and the mechanism by which they are raised and lowered if **retractable**. For snow and ice, wheels are replaced by skis; for water, floats or pontoons. Whatever the surface, the airplane must be able to roll or glide on it for takeoff or landing, and landing gear provides the means of doing this. An equally important function of landing gear is to absorb the shock of **touchdown** (first contact between landing gear and ground). A skilled pilot can make this landing very gentle, but even at best, the force of the touchdown of a heavy aircraft is considerable. The tires and shock absorbing system of landing gear must be made to withstand the tremendous impact of bad landings (not always the pilot's fault) as well as good, and minimize the transfer of this shock to the rest of the aircraft.

WING STRUTS.—As noted before, many modern aircraft do not have **struts** or external bracing to provide structural strength but rely on **cantilever construction**. Shown in the diagram is the **semi-cantilever** construction of a typical light private airplane, in which slanting wing struts from wings to lower fuselage or fixed landing gear help strengthen and support the wings.

WINGS.—An entire section is devoted to wings below.

FUSELAGE.—The **fuselage** is the main structural unit. It houses crew, passengers, cargo, instruments, and other essential equipment or payload. On single-engine aircraft, the power plant is attached to it. There are two basic types of fuselage construction, **truss** and **monocoque**. In **truss** type construction strength and rigidity are obtained by joining steel or aluminum tubing or bars to produce a series of triangular shapes called **trusses**. In **monocoque** construction, as noted before, much of the strength is provided by the stressed skin, but this is shaped and braced by rings, formers and **bulkheads** (walls) of varying sizes. When these, in turn, are braced by lengthwise members called **longerons** and **stringers**, the type of construction is called **semi-monocoque**. This is the most common type of construction.

AIRCRAFT OF TODAY

Flight Control Airfoils

The remaining items in this list of major parts might be called **flight control airfoils**. They serve to change or stabilize the attitude of the aircraft in flight.

AILERONS.—The ailerons are attached by means of hinges to the trailing edge of both wing sections and serve to produce and control the banking of an aircraft in making a turn. An airplane is subject to **centrifugal force** (outward pulling force on a curve) just like an auto-

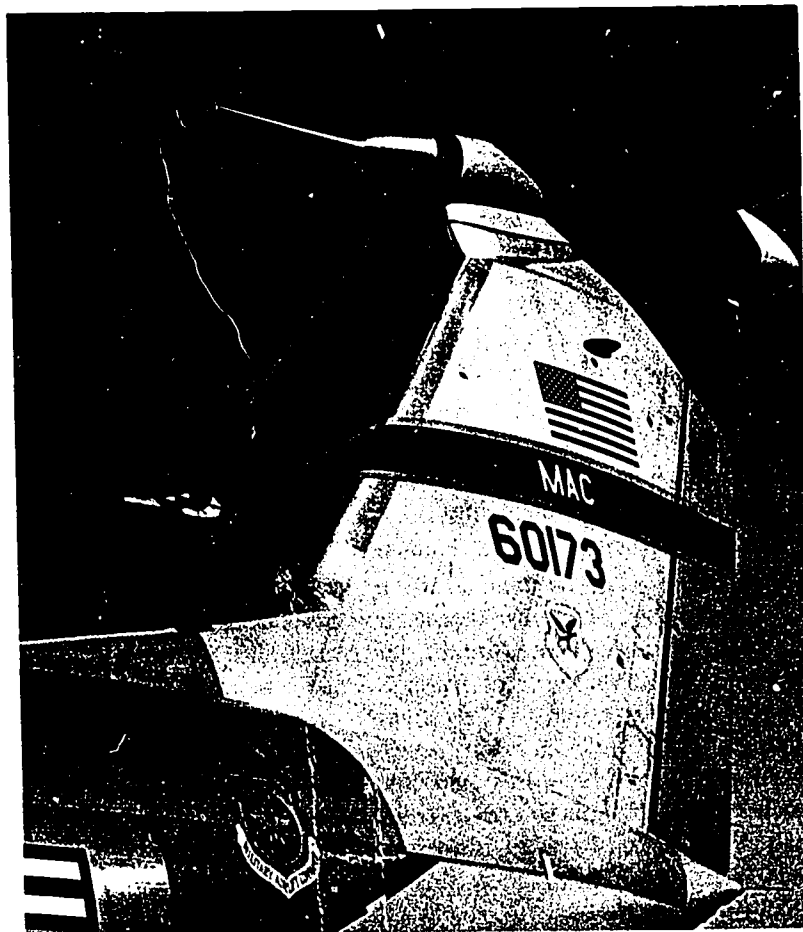

Figure 16. EMPENNAGE—large T-tail section of C-141.

BASIC AIRCRAFT STRUCTURES, PARTS AND SYSTEMS

mobile. If an automobile turns too sharply at too high rate of speed on a flat surface, this outward force will pull it into a skid; but if the road is sloped sideways or banked like the rim of a saucer, the pull of gravity will balance the centrifugal force, and the automobile will be able to hold its turn at high speed without skidding. Similarly an airplane can skid on a turn and go out of control unless it lowers one wing and raises the other, or banks while it is making the turn. The ailerons are designed to work from a single control simultaneously in opposite directions—increasing lift on one wing as it decreases it on the other. A third member of this team is the rudder, a vertical airfoil on the tail assembly, which may be used with the ailerons to make a well-coordinated turn.

EMPENNAGE (TAIL ASSEMBLY).—The horizontal and vertical stabilizers, the rudder and the elevators together usually comprise the tail assembly or empennage (Fig. 16). The basic arrangement shown is common to the majority of aircraft, but there are variations. On some airplanes, a v-shaped so-called butterfly empennage provides two symmetrical airfoils which serve as both rudders and elevators. In some delta-winged supersonic aircraft, such as the F-102 and F-106 fighters (Fig. 19), the rear location of the ailerons puts them in a position to function both as ailerons and elevators, but these two aircraft also have a more conventional vertical stabilizer with rudder attached. Members comprising the empennage are:

Horizontal and vertical stabilizers.—These rigid fin-like structures have two functions: they stabilize flight, helping to hold the aircraft level and in same direction; and they provide the supports from which the rudder and elevators are hinged.

Rudder.—The rudder functions like a rudder on any boat, steering the airplane right or left by turning to oppose the flow of air on either side. Like the elevators, it works by negative reaction. That is, pushing the tail left aims the nose and the direction of thrust right and vice versa.

Elevators.—Elevators are the main climb and descent control of the aircraft, also working negatively to provide negative lift. Thus increasing lift on the tail pushes the nose and the direction of thrust downward and vice versa. On some aircraft, the horizontal stabilizer and elevator are combined to form one solid but movable structure called a stabilator.

AIRCRAFT OF TODAY

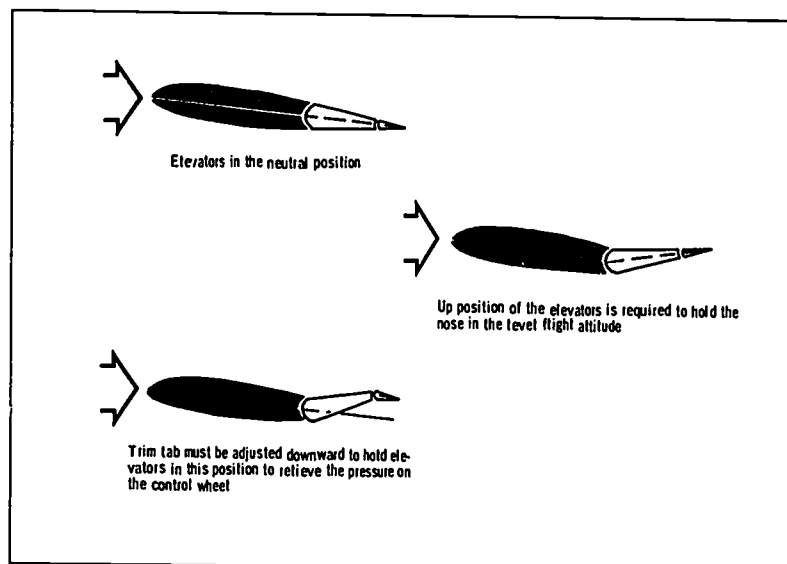

Figure 17. A TRIM TAB, and how it works.

AUXILIARY FLIGHT CONTROL MEMBERS.—In addition to the main airfoils shown and described above there are such items as trim tabs, balance tabs, and landing flaps. Below are described the functions of landing flaps, trim tabs, and a device called a spoiler.

Landing flaps.—These are attached to the trailing edges of wings and on high-speed aircraft to both leading and trailing edges. Their function is to increase airfoil camber and thus increase *both* lift and drag to act as aerial brakes. The purpose is to reduce landing speed or shorten takeoff run.

Trim tabs.—Trim tabs are located on rudders, ailerons and elevators. They help the pilot trim (change position slightly) and balance the aircraft while in flight. They also help him operate the main controls by reducing the amount of pressure needed to move such things as ailerons or rudders or hold them in a given position. Figure 17 shows a cross section of elevator and trim tab. On a wing, one might call the trim tab an aileron on an aileron. The lift of the wing is altered by the aileron, but to move or hold the aileron in the position shown is to move or hold it against the mighty force of the relative wind. With the trim tab properly adjusted, however, some of this force is exerted

BASIC AIRCRAFT STRUCTURES, PARTS AND SYSTEMS

upon it in an opposite direction to stabilize the aileron and make it easier to move.

Spoilers.—On some modern aircraft, including some big jet airliners, there are devices called **spoilers**. These are little fins or air barriers, recessed into the upper surfaces of the wings, to be pushed up into the airstream when needed. They are designed to fight Bernoulli's Law! That is, they "spoil" the flow of air over the wing to produce turbulence and thus decrease lift. Thus they assist ailerons in banking and serve as aerial brakes in approaches and landings.

Speedbrakes.—**Speedbrakes** are similar to spoilers but are attached to the fuselage rather than wings. They induce drag to slow a plane down when needed.

ABOUT WINGS

Modern aircraft reflect the wide variety of their functions in the variety of shapes of their wings.

The Crop Duster's Wings

Take, for instance, the agricultural airplane or **crop duster** (Fig. 18). Such a plane has an old-fashioned appearance, looking either like a **monoplane** of the 1920s or a World War I **biplane** fighter. Yet a good crop duster is every inch a modern aircraft, carefully designed

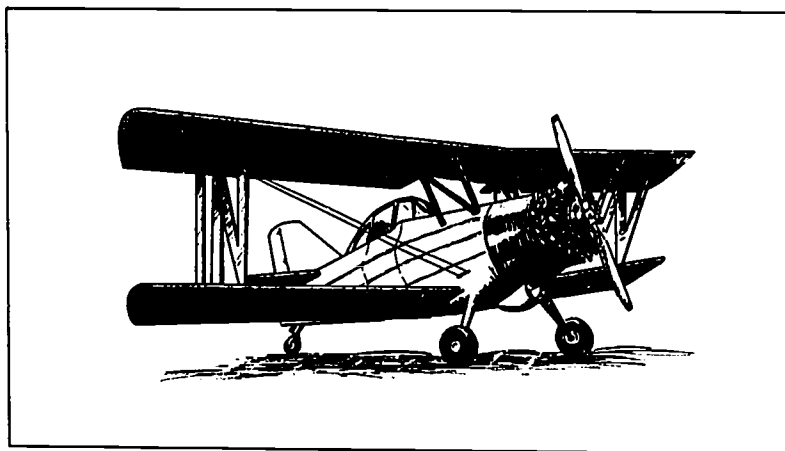

Figure 18. CROP-DUSTER BIPLANE has wings designed for maximum lift but low speed.

AIRCRAFT OF TODAY

(in some cases with the help of university research) to have the aerodynamic qualities and safety features necessary for performance of its special task. This is spraying fertilizer, insecticide, or other chemicals over crops. Slowly and precisely the crop duster flies back and forth over a field, making close turns between passes. Often it flies at below treetop level. If it flies too high or fast, its chemical payload will be spread too thin. At speeds at which many other aircraft would stall, the crop duster plies its useful but seemingly boring and unglamorous chore. The crop duster pilot has the respect and admiration of other airmen, however, for they know how tricky and dangerous his kind of flying really is. His aircraft must give him every kind of break for safe accomplishment of his task.

Therefore, the wings of a crop duster are long, straight, and squared-off at the ends. They are also quite narrow, or, to use the proper term, have a short **chord**. Because the aircraft's wings are long and narrow, they are said to have a high **aspect ratio**. Maximum lift (at the expense of high drag) is the idea—the kind of lift that will help the aircraft maintain steady level flight at slow airspeeds and be able to pull up sharply to avoid treetops and power lines, or to recover quickly when encountering the treacherous air currents found at low altitudes.

Supersonic Wings

Now let us look at the other extreme of wing design, that of the supersonic aircraft. Figure 19 shows four **interceptors** of the Aerospace Defense Command, designed to meet and destroy enemy bombers as far away from their intended target as possible, hence needful of all the speed designers can give them. Two of these, the F-102 and the F-106, have triangular or **delta** wings and are named, respectively, the Delta Dagger and the Delta Dart. (The Greek capital letter "delta" is shaped like a triangle.) The F-101 Voodoo also has extremely tapered and sweptback wings, but the F-104 Starfighter, which can compete with the others in speed, does not have such an extreme taper or sweepback to its wing design. Instead, the F-104 wings are stubby—of relatively long chord and short wingspan. Though their wings shapes vary, these aircraft, which can approach or exceed 1,500 mph or mach 2 in speed (except the F-102), have in common this same long **mean chord** (average chord length) and short span, or a

BASIC AIRCRAFT STRUCTURES, PARTS AND SYSTEMS

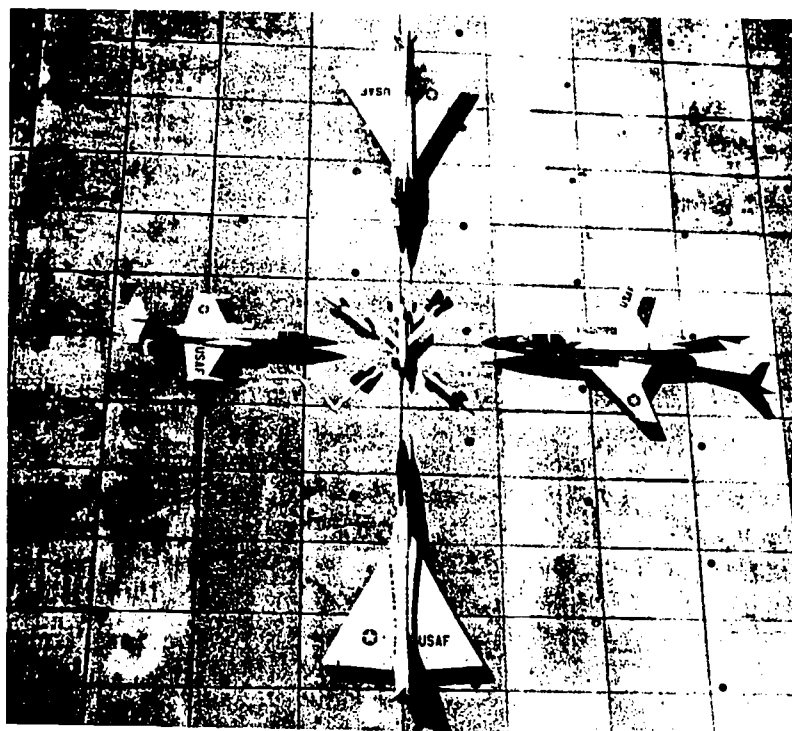

Figure 19. **SUPERSONIC WINGS.** These air-defense fighters have wings of low aspect ratio, permitting them to fly faster than sound. Top, F-102; right, F-101; bottom, F-106; left, F-104.

low aspect ratio. Their wings are also thin and have sharp leading edges. They require a much longer and faster takeoff run than an aircraft whose wings are designed for greater lift. Once these aircraft are off the ground, however, the super-streamlined shape of their wings contributes to an extremely steep angle of climb.

Wing Design Terms and Factors

Between the above two extremes—the crop duster and the supersonic fighter—lies the whole gamut of airplane wing design. Varying degrees of taper from wing root to tip, varying aspect ratios, varying thicknesses of camber, and varying degrees of sweepback from the conventional T-shape—these are some of the factors that determine the balance the designer would like to strike between reducing drag

AIRCRAFT OF TODAY

and increasing lift. Let us look at a few of these factors briefly, if only to know what some of the words mean.

CHORD.—The chord of a wing is a straight measurement through its cross section from leading (front) to trailing (rear) edge. A tapering wing, of course, would have chords of different length depending on where the measurement was made. Thus it is practical to speak of the average or mean chord of a tapering wing.

CAMBER.—Technically speaking, the camber of a wing is the ratio between the chord and the same distance measured along the curved surface, usually the upper surface. Putting it more simply, camber is the amount of curve or bulge in a wing. A high degree of camber in a wing would produce a high degree of lift according to Bernoulli's Law. A low degree of camber—of a flat knife-like wing—would produce minimum drag but less lift. More speed or a longer takeoff run would be required to get such wings airborne.

SWEEPBACK.—In the *USAF Dictionary*, sweepback is defined as "the backward slant of a wing, horizontal tail or other airfoil surface; the backward slant of a leading or trailing edge of an airfoil." Sweepback is another factor that decreases both drag and lift.

ASPECT RATIO.—Again we quote the *USAF Dictionary*: "The ratio between the square of the span of an airfoil and its area." What this amounts to is the fact that a long wingspan and a relatively short mean chord have a high aspect ratio—a characteristic of the crop duster, the Gooney Bird, and other aircraft of great lift. Low aspect ratios are characteristic of supersonic craft.

In Chapter 1, as you should recall, we discussed the matter of trade-offs in aircraft design. The most striking example of this is the basic shape of the wings, which determines the desired compromise between lift and speed for a given aircraft.

The Variable-Sweep Wing

The F-111 is a USAF fighter and the FB-111 a somewhat-larger bomber. These aircraft should be mentioned at this point because the most remarkable feature about them is a pair of wings that can change their aspect ratio in mid-flight. These are called variable-sweep wings, or swing wings. (The technical term is variable geometry.) The wings can be extended straight out to present a relatively high aspect ratio for landing, takeoff, and slow flight, as shown in Figure 20, upper left.

BASIC AIRCRAFT STRUCTURES, PARTS AND SYSTEMS

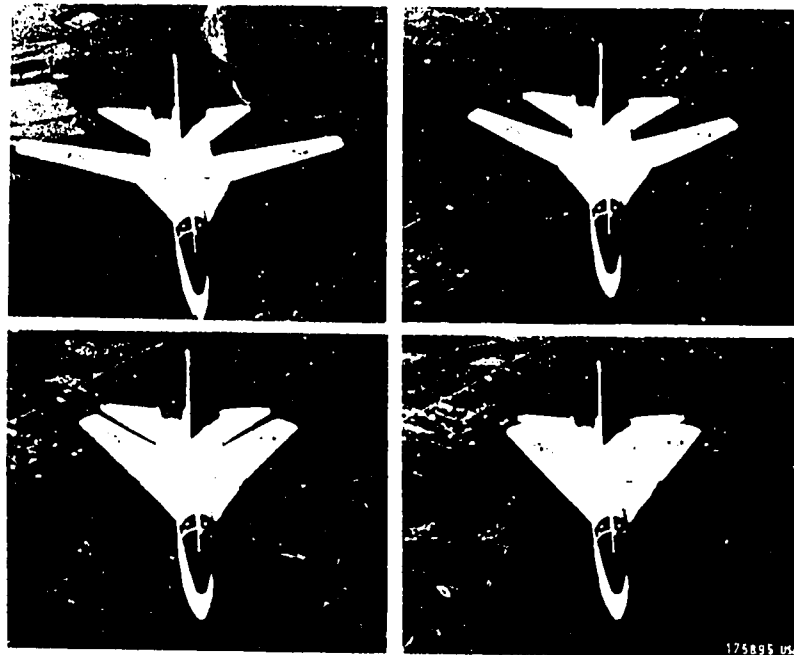

Figure 20. SWING WINGS—F-111, showing variable-geometry wings in different sweepbacks.

Or they can be swept back into a delta shape like that of the F-102 or F-106 for supersonic flight (Fig. 20, lower right). With wings in the half-swept position (Fig. 20, upper right), the aircraft is set for maximum-range cruising at high subsonic speed.

The F-111 has a top speed of about mach 2.5, or 1,800 mph. It is also capable of slow flight at a little over 100 mph. To take off with a normal load, the F-111 requires no more than 3,000 feet of runway—much less than is required by other supersonic jets. There have been some disputes about the high cost of this aircraft, but the swing-wing idea has attracted world-wide interest, and several nations have followed the US lead in developing similar models. The Soviets flew two experimental swing-wing fighters at an air show in 1967. France's Mirage G, another swing-wing fighter, was first flown in the same year. West Germany, Italy, Netherlands, and the United Kingdom are jointly developing a swing-wing MRCA, which stands for "multi-role combat aircraft." Plans to include this feature in the design of a US

AIRCRAFT OF TODAY

supersonic transport (SST) were abandoned, but plans for the B-1, a heavy intercontinental bomber designed to replace the B-52, include variable-sweep wings. Also under development is a carrier borne swing-wing fighter for the Navy, the F-14.

The Transonic Zone and the Supercritical Wing

Our discussion of wings concludes with a glimpse at a current research project into a new wing design called the "supercritical wing." It is designed to solve a problem of high speed flight, that of adverse flight conditions in the transonic zone.

The transonic zone is a range of airspeeds just below and above the speed of sound, from about mach 0.85 to about mach 1.2 or roughly between 600 mph and 800 mph. The beginning of the transonic zone is called **critical mach**. For most jet aircraft, critical mach begins at mach 0.85 or 600 mph air speed, at which point air begins flowing over some portion but not all of the aircraft at sonic speed, or mach 1. Usually this portion is that part of the upper surface of the wings which has the greatest curve or camber. When this speed is reached, shock waves begin to form and there is a sharp increase in turbulence behind the wings. Vibrations, roughness, difficulty of response to controls, and excessive drag combine to impair the efficiency and sometimes the safety of the flight.

The transonic zone is the so-called **sound barrier**, which was formerly thought to be a real barrier to supersonic flight. The sound barrier, of course, was broken long ago, and many aircraft of today are capable of supersonic flight. When such an airplane crosses the sound barrier, it again finds smooth flight conditions at supersonic speeds above mach 1.2, where it continues to build up a compression or shock wave, but the behind-the-wing turbulence is greatly diminished. The problem of roughness and extreme drag in the transonic zone itself continues.

At present there can be no smooth or economical flight at such an airspeed as 700 mph, which is subsonic but above critical mach for all modern aircraft. Modern subsonic jet aircraft are designed to cruise at about 600 mph or slower. A supersonic aircraft will also be held to an airspeed below 600 mph until it is ready to make a crossing of the transonic zone. Then more power must be used to break through the sound barrier and maintain speeds above 800 mph.

BASIC AIRCRAFT STRUCTURES, PARTS AND SYSTEMS

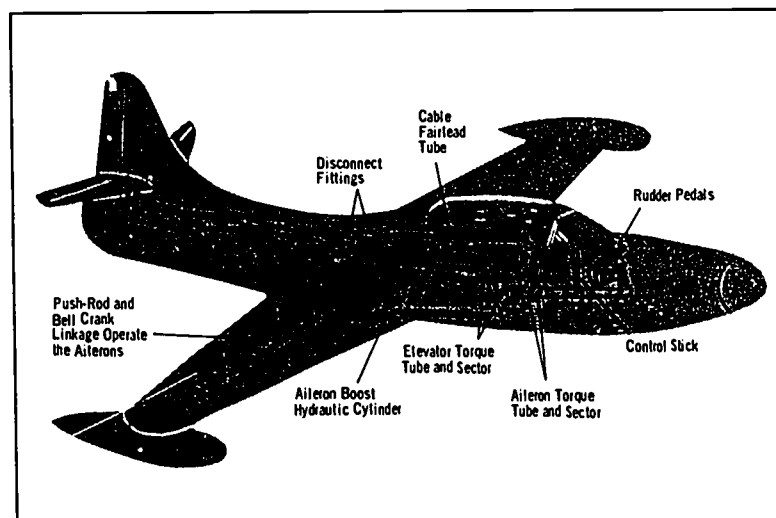

Figure 21. CONTROL LINKAGES—diagram of a typical system.

Researchers at the National Aeronautic and Space Administration (NASA)* are currently experimenting with the **supercritical wing**, designed to push back the critical mach point and make flight at top subsonic speeds smoother and more economical. The design exciting their interest is that of a swept wing that is flat on top, downward curving at the rear, somewhat like an upside-down ski in cross section. Since air, as we have learned, flows faster over that portion of a wing that has the greatest amount of curve or camber, this design displaces the zone of swiftest airflow toward the rear of the wing and reduces behind-the-wing turbulence at transonic speed. NASA has tested the supercritical wing concept in wind tunnels and began flight testing in early 1971. If it ever becomes practical, it will effect great improvements in both speed and economy of airline operations.

CONTROL SYSTEMS AND INSTRUMENTS

Figure 21 shows one system of linkages from the pilot's cockpit to the flight control airfoils of an aircraft. We are not describing it in detail, for there are many variations on this system by which pilot and

* NASA is more famous for its moon landings and other space exploits than for its work in aviation. The latter, however, is an important part of its mission. NASA tests all kinds of aircraft and aviation ideas for both civil and military use.

AIRCRAFT OF TODAY

crew members can control flight. Except in the lightest of aircraft, human muscle cannot do all the work of moving and holding rudders, ailerons, and elevators against the powerful force of "relative wind." Hydraulic pressure and electric power, and various combinations of such power, are important to the operation of such aircraft.

Hydraulic Pressure

Along with Newton ranks the name of another seventeenth-century scientist, Blaise Pascal, a Frenchman, whose many accomplishments include the discovery of the principle of hydraulics. This principle may be stated as follows: "A pressure exerted anywhere on a confined fluid is transmitted undiminished to every portion of the interior of the vessel containing the fluid. This pressure acts at right angles with an equal force on equal areas." The application of this principle makes it possible to increase a force originally exerted. If a cylinder with an area of one square inch is connected by a tube to one with an area of 10 square inches, and the whole assembly filled with liquid, then whatever pressure is exerted on a piston on the small cylinder will be multiplied tenfold on the large cylinder. And if it is a complicated hydraulic system, the same pressure is transmitted undiminished to all cylinders throughout the system. Thus in an automobile, the pressure of a human foot on the brake pedal is capable of bringing the whole car and its weight of cargo and passengers to a stop. An aircraft hydraulic system is thus able to transmit and multiply hand and foot controls to flight members and also operate brakes, lower and raise landing gear, change the pitch of a propeller, and perform other tasks.

Electric Power

Some aircraft make use of electric power to move flight-control airfoils, operate non-skid type brakes, change propeller pitch, etc. Pilots also depend upon electricity to provide radio communication for picking up signals broadcast from a range station, or two-way voice communication, or the operation of other electronic instruments, called **avionics**. The electricity generated in flight is also used for many purposes familiar to automobile users—charging storage batteries, supplying current to spark plugs, turning starters, providing signals to the dials of numerous instruments, etc. All this means that when aircraft are designed and their parts built and assembled, provision must be

BASIC AIRCRAFT STRUCTURES, PARTS AND SYSTEMS

made for magnetos, generators, storage batteries, and electric motors. It is also necessary, when assembling an aircraft, to install electric cables, linkage, and servomechanisms (devices working automatically by electric signals) which make it possible for the different electric motors to do their work.

Aircraft Instruments

On the dashboard of a typical automobile are such familiar instruments as an ammeter (or perhaps a mere emergency light to indicate electric power loss), a motor-temperature gauge, an oil-pressure gauge, fuel gauge, speedometer, odometer (mileage counter), radio tuner, and perhaps certain nonessential items appealing to the "gadget happy" individual, such as a compass. We might classify some of these automobile instruments according to their purpose. One group, for example, might be called "engine instruments," since their purpose is to



Figure 22. SIMPLICITY. This T-41 trainer's control panel has little more than the minimum number of instruments.

AIRCRAFT OF TODAY

keep the driver informed about the operation of his engine: Is it running too hot? Is it maintaining adequate oil pressure? Another group checks off the mileage and the speed. The radio and compass in a passenger automobile are luxuries nonessential to the accomplishment of the journey. There are no instruments that can be called "navigation instruments," for "navigation" on a highway is a matter of reading markers and signs, with occasional reference to a map. An occasional look at the odometer is helpful, but not essential. It is of some assistance in calculating the answer to the question "How many miles to Nashville?" But if the driver is on the right road, he will get to Nashville whether he bothers to check the odometer or not.

A pilot flying by visual navigation only cannot depend upon markers and signs. Without instruments he may be able, for instance, with



Figure 23. COMPLEXITY—training simulator of navigator's control panel of a supersonic long-range bomber, the B-58 (no longer in service).

BASIC AIRCRAFT STRUCTURES, PARTS AND SYSTEMS

careful map study, to identify a railroad or highway and follow it to Nashville. But let only one good-sized cloud temporarily blot out this fair-weather pilot's view of the landscape below, and he may be lost. Inside a cloud, especially if there is bumpiness or **turbulence**, he would not even know his own aircraft's **attitude**—whether it is in level flight, climbing, descending, or banked right or left. Instruments to him are both “road signs” and the “headlights” by which they can be read. It is not much of an exaggeration to say they are sometimes his means of telling up from down!

The minimum number of instruments found on the simplest of aircraft would, as a rule, be these six: **compass, airspeed indicator, fuel gauge, oil-pressure gauge, tachometer (engine speed indicator), and altimeter**. These six are sufficient only for fair-weather flying by **visual flight rules (VFR)**. Numerous other instruments are required for **instrument flight rules (IFR)** flying, and the instrument panel of a large multi-engined aircraft may contain well over 100 such devices and need the attention of two or three crew members for proper interpretation of all the information it reveals. (Figs. 22, 23).

Aviation instruments are classified by use in four major groups: **engine instruments, aircraft instruments, flight instruments, and navigation instruments**.

Engine instruments keep the pilots and flight engineer aware of engine rpm, engine temperature, oil pressure, fuel-flow, manifold temperature and carburetor pressure. Aircraft instruments, sometimes called the safety group, reveal air temperature, position of landing gears and flaps, hydraulic pressure, and the like. Flight instruments inform the pilot of his altitude, airspeed, and the attitude of his airplane. Finally comes the all-important group of navigation instruments, by which IFR flight at night, or in less-than-perfect weather, or above the clouds, can be accomplished. This group includes clock, compass, directional gyro, radar, and radio direction finders.

Another way of classifying aviation instruments is by principle of operation. This can be mechanical, liquid pressure, air pressure, or electrical. Radar and radio direction finders are distinguished from ordinary electrical instruments by ability to receive and/or transmit broadcast signals, and are commonly referred to as **avionics**. It is this avionics group that is essential to modern flight at night or in adverse weather, in landings and takeoffs at a crowded airport, where both automatic beam signals and the voice of the **air traffic controller** in the

AIRCRAFT OF TODAY

tower must be heeded. New developments in the field of avionics are constantly forthcoming—some are military applications such as the interceptor controls of a complex air defense system but others may be expected to add to the efficiency and safety of general or commercial aviation.

WORDS, PHRASES AND NAMES TO REMEMBER

aileron	racelle
air traffic controller	National Aeronautics and Space Administration (NASA)
altimeter	negative reaction (negative lift)
aspect ratio	rudder
attitude	servomechanism
avionics	skid
bank	sound barrier
biplane	speedbrake
camber	spoiler
centrifugal force	stabilizer (horizontal and vertical stabilizer)
chord (mean chord)	stringer
critical mach	supercritical wing
crop duster	sweepback
delta wing	tachometer
elevator	touchdown
empennage	transonic zone
firewall	trim tab
flap	truss
fuselage	variable sweep wing (variable geometry wing, swing wing)
hydraulics	visual flight rules (VFR)
instrument flight rules (IFR)	
longeron	
monoplane	

AIRCRAFT MENTIONED IN THIS CHAPTER

B-1 proposed heavy bomber
Boeing B-52 Stratofortress heavy bomber
Dassault Mirage G French fighter
General Dynamics-Convair F-102 Delta Dagger fighter
General Dynamics-Convair F-106 Delta Dart fighter
Lockheed F-104 Starfighter

BASIC AIRCRAFT STRUCTURES, PARTS AND SYSTEMS

McDonnell-Douglas F-101 Voodoo fighter
MRCA (multi-role combat aircraft), West European fighter
North American X-15 rocket airplane

QUESTIONS

1. Give two reasons other than streamlining for enclosing aircraft engines in cowlings.
2. What is the purpose of ailerons and how do they operate?
3. Define: landing flaps, trim tabs, spoilers.
4. Compare the wings of a "crop duster" with those of the F-102 and F-104.
5. Define "sweepback" and explain its importance in aircraft design.
6. Explain aspect ratio. Which aspect ratio is found on supersonic aircraft?
7. What is unusual about the wing design of the F-111? Why is this design valuable to the Air Force?
8. Explain the principle of the supercritical wing. At what speeds should it be most efficient?
9. State and explain Pascal's theory of hydraulics.
10. Identify and explain the use of each of the four major groups of aircraft instruments.

THINGS TO DO

1. Assemble a balsa wood glider. To demonstrate controlled flight, make ailerons, elevators, and a rudder and attach them in their proper places to the glider. By changing the angle of the controls, the glider can be made to fly in different directions.
2. Construct model planes with varying shaped wings from the crop duster type to sweepback. Observe the difference the wing shape makes in the speed of flight.

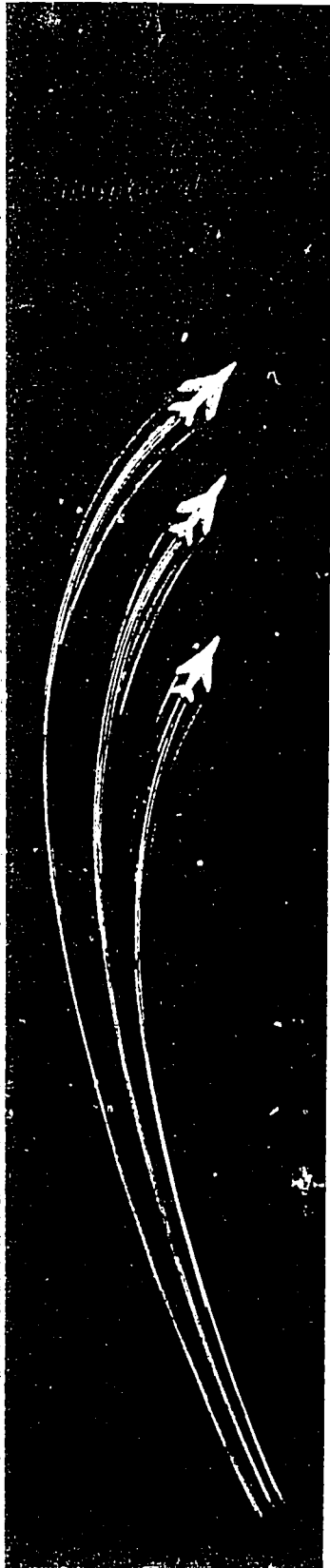

Propulsion Units

THIS CHAPTER surveys the range of aviation propulsion units, including both reciprocating and jet engines. First, it explains the two principles of propulsion that are common to the functioning of all types of units. Next, it discusses the design and operation of propellers. Then, it explains the general operating principles of reciprocating engines and compares the major classifications of cylinder arrangements. The rest of the chapter covers the special characteristics and performance capabilities of various types of jet propulsion units and gives a description of aviation uses of rocket propulsion. When you have studied this chapter, you should be able to do the following: (1) identify the two factors that all propulsion units have in common and explain how they operate to provide thrust; (2) explain what is meant by reciprocating engines, describe the cylinder arrangements of the three main classifications, and compare them as to performances; (3) discuss the different types of jet engines as to design and operating principles; and (4) explain how the X-15 differed from conventional aircraft.

HERE we consider the all-important factor of thrust, and the propulsion units that provide it. We prefer the term propulsion unit to "engine" in this instance, for it includes the method of propulsion as well as the engine. Thus, a reciprocating engine together with a propeller is one type of propulsion unit. A jet engine, producing its reactive forces through a rear nozzle, is another basic type of propulsion unit; and there is also the combination of jet engine and propeller called a turboprop or prop jet. Again, we shall go easy on technicalities, outline a few basic principles, and emphasize *function*. For each of these basic types of propulsion

AIRCRAFT OF TODAY

unit, and each variation within a type, has its own merits for doing a particular kind of task.

COMMON PROPULSION PRINCIPLES

All aircraft propulsion units have two things in common: (1) they operate according to Newton's Third Law of Motion, and (2) they operate by **internal combustion**.

Newton's Third Law Again

According to Newton's Third Law of Motion, action equals reaction. When a gun is fired, equal force is applied to the recoil of the gun and to the propulsion of the bullet. Another simple demonstration of this principle is to inflate a balloon, then release the neck of the balloon to let the air escape. Whichever way the neck is pointed, the balloon will fly off in the opposite direction as the air rushes out of the neck. The air escaping from the balloon is not, as some may think, "pushing" against the air outside the balloon. It is merely obeying Newton's Third Law of Motion and exerting equal force in two directions—one of which makes the balloon travel. But not until the air is allowed to escape—or accelerate rearward—do these forces come into play. (Release an air-filled balloon whose neck is secured with a rubber band, and all it will do is drop slowly toward the floor.) The open-neck balloon is "jet propelled," but the illustration also serves to demonstrate the action of a propeller, which creates a rearward acceleration of air plus a forward thrust of equal power. The same principle works whether in a Gooney Bird thrusting through dense air near sea level, or an F-106 streaking supersonically through thin air at high altitude, or even a rocket moving through the vacuum of space, with absolutely nothing to "push" against or "bore into." In all cases, air or expanding gases rush rearward at a speed increased or accelerated by the propulsion unit, and the vehicle moves forward.

Internal Combustion

The second common factor, as in the firing of a gun, is **internal combustion**. All propulsion units work on the principle that heat produces expansion of gas, and this expansion provides the propelling force. But aircraft propulsion units differ from a steam engine in that the **combustion** (burning) of fuel directly produces the driving pres-

PROPULSION UNITS

sure within the engine itself, whereas in a steam engine, this is done indirectly by using the heat in one chamber to make water in another chamber expand into gas (steam) to provide the driving pressure. Perhaps if nuclear power is ever successfully applied to aircraft propulsion, it may mark a return to the external combustion idea, but there are a lot of problems that must be solved before man can achieve nuclear aircraft propulsion. Let us get back to internal combustion by means of such fuels as gasoline, oil, kerosene, alcohol, and other chemical compounds. Whatever the fuel, both jet and reciprocating engines must mix it with air as a fine spray or vapor, compress the mixture, and burn it to produce heat energy. An essential ingredient for combustion is oxygen. For both jet and reciprocating engines, this doesn't cost a cent, for it is supplied by the air which the engine "breathes."

Different principles apply to the rocket motor. It, too, burns fuel and needs oxygen to burn its fuel. It carries its own oxygen supply in liquid or solid form, however, either separately or mixed in with the fuel itself. In either form, the rocket's oxygen supply outweighs its fuel supply.

PROPELLERS

Since propellers are common to both reciprocating and turboprop propulsion units, it is convenient to consider them separately. Each blade of a propeller is a curved airfoil, which, as mentioned before, is driven in a circular path to attack the air like a screw. This has the effect of accelerating the air it encounters and thrusting it rearward to provide the essential action and reaction.

Pitch

Propellers have two, three or four blades—the last being typical of today's heavy transport, usually turboprop-powered, aircraft. Simple, light aircraft usually have a straight two-bladed propeller of fixed pitch, with speed of rotation controlled simply by regulating the flow of fuel to the engine by throttle, like the accelerator of a car. More advanced aircraft have propellers of controllable pitch, which require the pilot to balance engine power with propeller rpm.

But what is "pitch"? It is the angle at which the blade is set to attack the air. When a propeller has adjustable pitch, this is set shallow

AIRCRAFT OF TODAY

for takeoff, with the propeller turning at maximum speed. For climbing, the pitch is increased; the propeller takes a bigger "bite" of air with each turn. In level flight, pitch is at maximum, and engine speed is reduced. The action is comparable to shifting gears in an automobile. Propellers can also be feathered, or turned so as to offer minimum resistance to the relative wind in case of engine stoppage, and keep it from windmilling (being turned by the wind). Some propellers have reversible pitch, to act as an aerial brake after landing.

Performance Limits

Theoretically a propeller-driven plane could fly at a maximum air-speed somewhat below the speed of sound—perhaps 600 mph at sea level. The reason for this speed limit is that, when a propeller-driven airplane reaches this speed, the tips of the propeller blades would have to be whirling at supersonic speeds. This would set up shock waves that would ruin aerodynamic efficiency and cause other troubles, some of them dangerous. The World War II fighter, the P-51 Mustang, could reach a speed of about 470 mph with a reciprocating-engine and propeller unit. Certain current turboprop aircraft of Soviet design approach this propeller-driven speed record, but since pure jet engines are more efficient for high-speed flight, efforts to push further toward the theoretical propeller-driven speed limit have not been made. It is a similar case with altitude limits. Propeller driven aircraft with reciprocating engines of World War II vintage could reach altitudes above 40,000 feet,* but modern aviation leaves high altitude flying to jets and generally stays below 35,000 feet with propellers.

RECIPROCATING ENGINES

In the original Latin, *reciprocus* means "back and forth," and that describes how a reciprocating engine works. In such an engine, pistons, put into motion by combustion in cylinders, move back and forth and, via connecting rods, turn a crankshaft. Aviation from the Wright brothers through World War II was carried from birth to maturity by reciprocating engines; and the usefulness of such engines today, in the jet age, remains supreme for many aviation tasks. Since this is basi-

* A world altitude record for heavier-than-air aircraft was set in 1938 by an Italian reciprocating-engine biplane—56,100 feet. It stood for 10 years before being broken by a British jet.

PROPULSION UNITS

ally the same kind of motor that drives all the cars, trucks, and buses that crowd America's roads, it is probably a very familiar part of your life, and perhaps little need be explained about its operation.

Principles of Operation

For the sake of comparison with jet engines, described below, however, we might review the four basic movements or strokes of a cylinder and piston in a reciprocating engine (Fig. 24). First, there is the **intake stroke**, in which the piston pulls back and sucks into the cylinder a mixture of fuel vapor and air; then the **compression stroke**, in which the piston pushes forward and squeezes or compresses this mixture in the cylinder; then the **power stroke**, in which the fuel mixture is ignited and burns, expanding with great force to drive the piston back; then the **exhaust stroke**, in which the piston, pushing forward again as

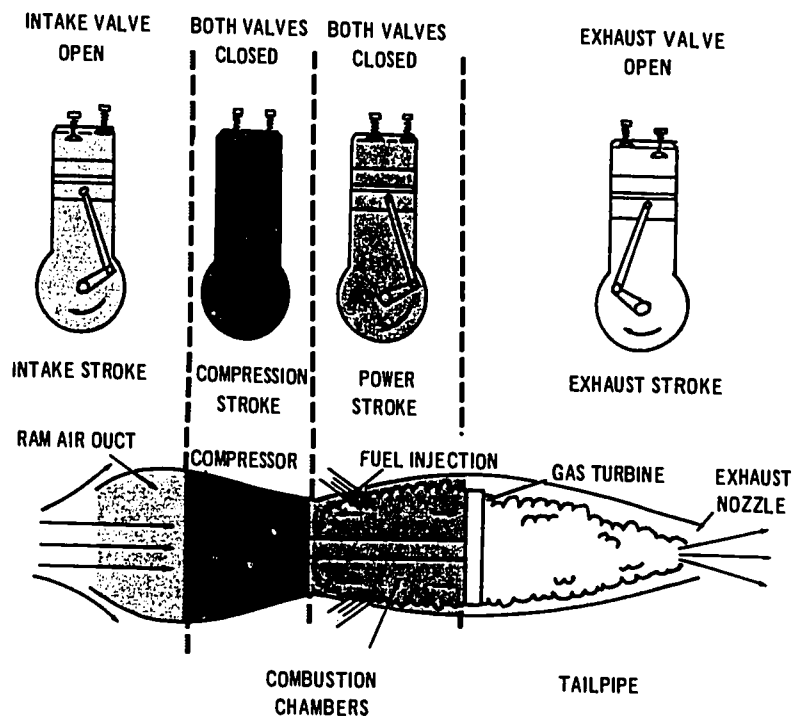

Figure 24. COMPARISON of a reciprocating and a jet engine.

AIRCRAFT OF TODAY

in the compression stroke, forces the burned-up gases out of the cylinder to clear it for the next intake stroke. Via connecting rods, the straight-line power from these cylinders is translated into turning action or torque on the crankshaft, like so many pairs of legs turning the wheels of a tandem bicycle. (One little difference in this comparison might be mentioned: the legs of the tandem-bicycle team work in unison, where the cylinders work most efficiently if they are precisely timed to fire in a certain order to apply their power in a smooth flow.)

In aviation usage, the reciprocating engine does its best work at speeds in the range of 1500–3000 rpm. Nowadays, reciprocating engines of great horsepower designed for heavy transport or high-speed use (above 300 mph) are built only as replacements to keep older or rebuilt aircraft flying. In general, modern manufacturers of reciprocating engines aim for the light and medium aircraft market with engines ranging in horsepower from about 50 to about 500, leaving both the speed and the weight-lifting championships to the makers of jet and turboprop engines. Nevertheless, reciprocating engines of modern design are hard to beat for efficiency and fuel economy in many general aviation and military uses.

Types of Reciprocating Engines

Reciprocating aviation engines can be classified by the way their cylinders are arranged. The most common designs are **radial** in which the cylinders (always an odd number of them) are arranged in a circle around the crankshaft; **in-line**, in which the cylinders are arranged in a single row along an elongated crankshaft; and **flat**, or more properly, **horizontally-opposed**, in which the cylinders (always even in number) are banked in two equal rows on directly opposite sides of the crankshaft.

From the 1920s into the post-World War II era, the radial engine was the most common. It powered high-speed fighters like the P-47 Thunderbolt, heavy bombers like the B-24 Liberator, and transports from the legendary Gooney Bird to the huge C-124 Globemaster and the sleek 300 mph Constellation, which was the swiftest and most luxurious commercial airliner of the early 1950s, before the jets took over. The radial engine is air cooled and a marvel of efficiency over a wide power range. Sometimes two radial engines are joined together, one behind the other, in a double row. The Caribou, a medium-light

PROPULSION UNITS



Figure 25. ENGINE RECOGNITION. Design of air intakes on either side of the propeller hub of this light airplane indicate a "horizontally opposed" reciprocating engine.

STOL transport of the Air Force, has two such engines, each consisting of two rows of 7 cylinders and delivering 1,450 horsepower. Mighty specimens of radial engines have been built, such as the four 3,800 hp monsters which power the C-124 Globemaster.

The "in-line" engine, with liquid cooling, was the power plant of two famed World War II fighters, the US Mustang and the British Spitfire. One advantage it has over the radial engine is that it has much less frontal area, a more slender shape, and thus fits better into a streamlined fuselage or nacelle.

Most reciprocating engines made today are of the horizontally-opposed type, with air cooling, the most efficient design for lighter engines. It has the advantage, of lightness, good fuel economy, and a neat, flat, compact shape that fits well into aerodynamic designs. Aircraft with horizontally-opposed engines can be identified by the flat shape of their engine cowling, with twin air intakes, one on each side of the propeller hub (Fig. 25).

Superchargers

Reciprocating engines have limited high-altitude capability. A typical light airplane with a simple reciprocating engine has a service ceiling of about 15,000 feet. The reciprocating engine, however, can be equipped with a device called a **supercharger**, which boosts the air in-

AIRCRAFT OF TODAY

take of the engine and thus permits operation at higher altitudes. The most effective type is the **turbosupercharger**,* which operates by means of a **turbine** (a machine turned by the force of a gas or liquid flowing through it). This turbine is turned by the exhaust gas of the engine. The higher the aircraft flies, the greater the difference in pressure between the exhaust gas and the ever-thinning outside atmosphere. Therefore, the exhaust flow speeds up and turns the turbine faster, making it pump air into the engine faster. Eventually the air gets so thin that a turbosupercharger will lose efficiency, but an aircraft so equipped can have a service ceiling of about 30,000 feet.

This device introduces you to the idea that exhaust gas from an engine need not be useless waste. It can be put to work. In the case of the turbosupercharger, it does a limited amount of work. In the engines described below, it does all the work.

JET PROPULSION UNITS

The same four actions that occur in a cylinder of a reciprocating engine also occur in a jet engine: intake, compression, power (or combustion), and exhaust. In a jet engine, these occur in a straight line in different parts of the engine rather than in a cycle in one chamber or cylinder. Other basic differences are that intake of air and fuel occur at different points along this line, combustion is steady and not in short bursts, and the exhaust is no mere expulsion of waste products of combustion but is the main thrusting force. The exhaust gases do the same work as the rush of air from a propeller. Further principles of operation are best described in terms of different types of jet engines.

The Ramjet Engine

Theoretically the simplest design of jet engine is the **ramjet**, which has no moving parts except the fuel compressing and injecting system. It takes in its air supply by scooping it in on the run through its open intake in front. As the air is thus "rammed" into its throat, it is compressed. Then pressurized fuel spray is added to the compressed air and ignited. To maintain the heat of combustion within the combus-

* You should not be confused by the fact that in trade names of aircraft, the prefix "turbo-" can be used to describe either an aircraft equipped with a turbosupercharged engine (Turbo-Bonanza, Turbo-Aztec) or one equipped with turboprop propulsion units (Turbo-Three—a DC-3 or C-47 refitted with turboprop units). It is always necessary to look more closely to see which type of propulsion is meant.

PROPULSION UNITS

tion chamber, there is behind it a perforated flame holder, which holds in the heat to maintain a steady fire while permitting the exhaust gases to escape rearward with great velocity to provide propulsion. Such an engine cannot function as an independent power unit because it must already be traveling at about 300 mph at sea level and much faster at high altitude before the "ramming" type of compression will begin to work properly. On the other hand, it cannot work in space because it needs air—tremendous amounts of it. It is also a greedy fuel consumer.



Figure 26. RAMJET—one of two engines on Bomarc missile.

AIRCRAFT OF TODAY



Figure 27. SCRAMJET—artist's concept of ramjet capable of higher speeds and altitudes than any air-breathing engine of today.

But the ramjet has some good points to offset these drawbacks. When it exceeds the speed of sound and climbs to high altitudes, it begins to get more efficient than other jet engines, actually traveling more miles per fuel weight consumed. To date, the only practical ramjets have been used on unmanned missiles, like the Air Force's stubby-winged Bomarc, an air-defense weapon, which is boosted into flight by rockets but cruises on twin ramjets, reaching ranges over 400 miles and speeds up to mach 3 at high altitudes (Fig. 26). Experimental ramjets can outdo turbojets in both speed and altitude. Current records are about mach 5 and 28 miles altitude (as compared to mach 3 and 20 miles (over 100,000 feet) for turbojet aircraft). Despite its need for air, and despite the thinness of the air at such high altitudes, the ramjet can scoop in what air it needs by virtue of its extreme speed. Research is being conducted on ultra-high-speed hypersonic ramjets called **SCRAMJETS** (for **supersonic combustion ramjets**). It is believed that, but for heat problems due to friction, the SCRAMJET

PROPULSION UNITS

could far exceed even the speed and altitude limits we have mentioned. If man ever develops a complete aerospace vehicle—one that is both aircraft and spaceship—the vehicle might include a ramjet motor or two for the high-atmosphere part of its journey. Such a ramjet stage might be a weight and money saver, providing rocket-like speed without carrying the rocket's burden of oxygen. (Fig. 27).

Now let us return from the future and backtrack into history for a moment to look at a primitive World War II version of jet propulsion.

The Pulse Jet Engine

The notorious German unmanned, winged V-1 or **buzz bomb** of World War II had a **pulse jet engine**, and this item is worth mentioning today only as a historical curiosity, a step in the evolution of jet propulsion. It combined jet propulsion with some of the principles of the reciprocating-engine cylinder. After intake, the fuel mixture was fired in a short burst or **pulse**, which closed a shutter at the forward end of the combustion chamber (in principle like a cylinder valve). The shutter then opened to let in another gulp of air at the same instant that another shot of fuel was injected and ignited. The cycle was repeated as rapidly as 60 pulses per second, the exhaust from these pulses providing the jet propulsion, and the characteristic loud buzz which announced its approach and struck fear in the hearts of Londoners. The buzz bomb, however, could be overtaken and destroyed by a fast interceptor. (The German V-2, by comparison, was a true supersonic rocket striking without warning and immune to any defense of those days.)

The Turbojet Engine

The **turbojet engine** (including the **turbofan**, which is discussed separately below) is the basic power plant of modern jet propulsion—the power plant of fighters, bombers, passenger liners, and freighters, both subsonic and supersonic.

Unlike the ramjet, the turbojet can operate independently. That is, it can serve as an aircraft's only power plant. The all-important work of air compression is done by a **turbine**. By means of electricity, the turbine can be started and run up to speeds high enough to draw in and compress air and begin combustion. Then the engine itself takes over the task of turning its own **turbine-compressor** as well as provid-

AIRCRAFT OF TODAY

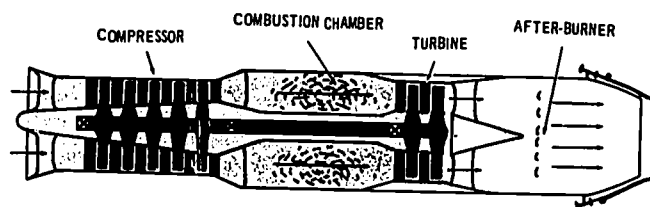

Figure 28. TURBOJET with afterburner.

ing thrust. As the aircraft gains speed, the turbojet engine increases in efficiency through the added compression of ramming. At high altitudes, thrust decreases, but so does drag, and the net result is even better efficiency. For long-distance and supersonic flying, turbojet-propelled aircraft generally seek altitudes above 35,000 feet, where fuel economy is best.

Again referring to Figure 24 you can note the basic sequence of the turbojet engine in flight. First, as in a ramjet, air rushes into the intake duct and achieves some compression by ramming. Then it enters the compressor, where the action of whirling blades within channels serves to decrease air velocity and greatly increase pressure. Then it enters the combustion chamber, where it is mixed with fuel, ignited and burned to form hot gases that expand with great force to provide the thrust. As the hot exhaust rushes rearward, it has one more bit of work to do besides providing thrust. It turns the blades of the turbine, which is connected by a drive shaft running forward through the center of the engine to operate the compressor.

Some turbojet engines are also equipped with **thrust reversers** for braking after landing. There are various types of these, all designed to block the rush of exhaust gas and deflect it forward.

AFTERBURNER.—Another diagram of a turbojet engine is shown in Figure 28. This model is equipped with an **afterburner**. Through this device, extra fuel is injected and ignited behind the turbine to provide extra thrust. Perhaps you have heard the sudden boom and increased roaring noise of a supersonic fighter “kicking in” its afterburner in flight. When this happens fuel consumption is greatly increased. Usually the afterburner is used only temporarily in a steep climb or other situation where a short burst of extra power is needed. The

PROPULSION UNITS

SR-71 (see Chapter 7), however, uses afterburners in supersonic cruise, and so do supersonic transport aircraft (Chapter 6).

THE TURBOFAN ENGINE.—A variation of the turbojet engine is the **turbofan engine**, sometimes referred to as the **ducted-fan** or **bypass engine**. In a way, this engine is half way between the turbojet and the turboprop, described below. To describe it briefly, a ducted fan (enclosed fan) around the compressor draws some of the compressed air into **bypass channels** so that it does not go through the combustion process (Fig. 29). This fan, however, whirls at extremely high speeds and gives this bypassed air a mighty boost rearward to add its thrust to the thrust of the turbojet engine. The fan can either operate off the main turbine of the engine, or by means of a second turbine placed in the exhaust channel. A turbofan engine has two advantages: relatively quiet operation, which is an asset for commercial airlines; and extra thrust during the takeoff and climbing phases of flight, when ordinary turbojets are not at peak efficiency. The Air Force has gone to turbofan engines for its heavy lifters like the C-141 Starlifter, the C-5A Galaxy, and the more modern version of the great B-52 Strategic bomber. None of these is supersonic. Formerly it was felt that the turbofan engine was not well adapted to supersonic flight because of the increased diameter added by the fan, requiring a bulky cowling rather than that surrounding a radial engine. This objection seems to have been overcome, however, in the design of the supersonic F-111, which has turbofan engines.

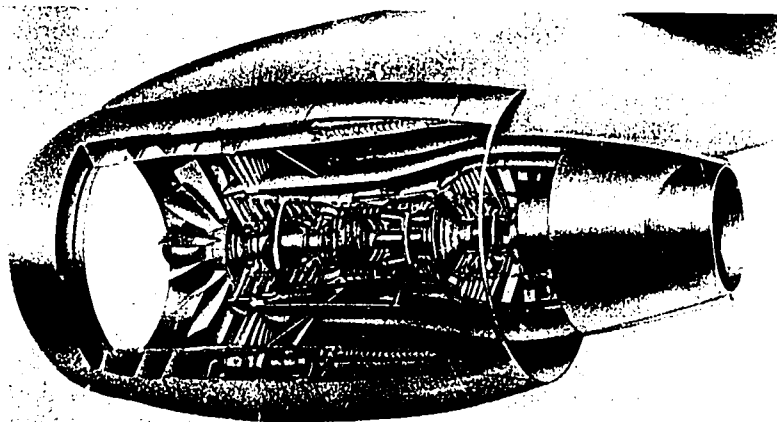

Figure 29. TURBOFAN. Cutaway diagram shows engine designed for giant "airbus" (See Chapter 6). This engine can deliver more than 40,000 pounds of thrust on takeoff.

AIRCRAFT OF TODAY

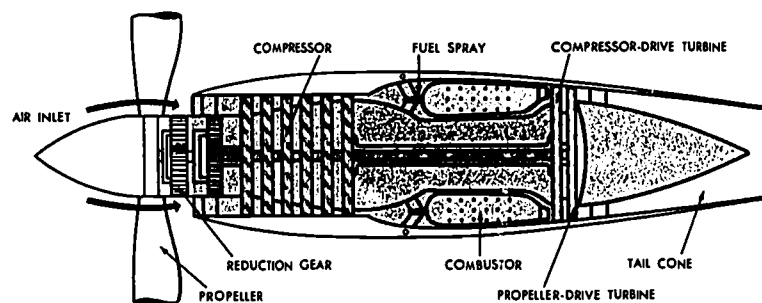

Figure 30. TURBOPROP. This diagram shows turboprop unit with air intake surrounding propeller hub. Compare with Figure 31.

Jet Propulsion Power Rating

Because jet engine efficiency varies so much with speed, engineers find the usual horsepower (hp) unit unrealistic and prefer to use the term **pounds of thrust**. It so happens that at one speed, 375 mph, pounds of thrust equals horsepower. To reckon a jet engine's equivalent horsepower at another speed, simply multiply pounds of thrust by that speed in mph and divide by 375.

To get a notion of how many pounds of thrust can do how much aviation work, let us compare two Air Force jets, a supersonic fighter and a heavy lifter.

The F-4C Phantom II, a tactical fighter, fully loaded with all its weapons and ammunition, weighs 58,000 pounds. Its two after-burner-equipped turbojet engines develop a total thrust of more than 34,000 pounds. At mach 2 or 1,400 mph, this would equal approximately 136,000 hp. At less than maximum weight, the aircraft can reach speeds above mach 2 and a ceiling of over 57,000 feet.

Maximum power and carrying capacity has been achieved in the C-5A Galaxy, described along with its performance capabilities in Chapter 1. To lift its maximum takeoff weight of 728,000 pounds, the C-5A has four turbofan engines rated at 41,100 pounds of thrust each, or a total of almost 165,000 pounds of thrust. The C-5 engines thus have a total thrust of a little less than five times that of the F-4C engines but can lift almost 11 times the weight. On the other hand, the F-4C has more than three times the top speed of the C-5. This one comparison suggests the general relationship between engine power,

PROPULSION UNITS

whether measured in thrust pounds or horsepower, and aircraft performance, whether in weight lifting or speed.

TURBOPROP PROPULSION UNITS

The turboprop engine was first developed later than the turbojet. Hence, with speed records being set, sound barriers broken, and airline schedules dramatically shortened by its more glamorous cousin, the turboprop never quite enjoyed its "day in the sun" of public attention. Nevertheless, the turboprop is a propulsion unit with a reputation as a workhorse of great power.

As the diagram in Figure 30 shows, the turboprop is a turbine engine, similar to a turbojet propulsion unit, used to turn a propeller. Air enters in front (under the forced draft of the propeller itself). The air intake duct can surround the propeller or be in the form of an air-scoop directly above or below the propeller hub (Fig. 31). The air then passes through a compressor and is mixed with fuel and burned in a combustion chamber just as in a turbojet engine. Then the powerful exhaust as it passes through the rest of the engine, turns two turbines: one driving the compressor, and the other the propeller. By the time the exhaust gas leaves the rear nozzle, it has very little energy left in it for providing jet propulsion thrust. Most of its energy has been



Figure 31. ENGINE RECOGNITION. Airscoop below propeller hubs of this business airplane identify one type of turboprop engine.

AIRCRAFT OF TODAY

used up turning the turbines. Since the turbines whirl at speeds of 7,000 to 12,000 rpm (rotations per minute) it is necessary to install a set of reduction gears in a forward position in the engine to make the propeller shaft run at a satisfactory speed of 1,500 to 3,000 rpm. (Remember, a propeller turning in free air must keep its blade tips at subsonic speed.)

Since the end product of this complicated power system is power applied to the crankshaft, turboprop engines are rated in units of **shaft horsepower (shp)**. Unlike the turbojet, a turboprop does not depend upon high speed to develop its full potential but works equally hard in takeoff and climb. It is currently the power plant of some of the world's heaviest cargo airplanes. Shp ratings of the largest turboprop engines go beyond the horsepower ratings of the heaviest reciprocating aircraft engines ever built. The four turboprop units on a C-130 Hercules, for instance, are rated at 4,050 shp each. The Hercules has a maximum gross takeoff weight of 135,000 to 155,000 lbs (depending upon whether extra fuel tanks are carried in the long-distance version) and a top speed of 360 mph. It thus has a more powerful total power plant than that of the heavier C-124, and outperforms it not only in speed but also in short runway capability. One of the world's largest and heaviest airplanes, the Soviet An-22, is also turboprop powered. The following performance data are claimed for it: maximum gross takeoff weight 500,000 pounds, maximum payload 176,000 pounds, top speed 422 mph. Each of its four tremendous 15,000 shp engines turns *two* four-bladed counter-rotating (rotating in opposite directions) propellers.

As noted before, the US bid for mastery in this vital heavy logistic field is the turbofan-powered C-5A which exceeds the dimensions and performance of the An-22. The future heavyweight championships will undoubtedly be taken away from the turboprop by turbofan engines, which also have a greater speed potential. Nevertheless, turboprop units still figure in current programs to develop STOL aircraft. **Shaft turbine engines**, the same in principle as turboprop units, are also standard for modern helicopters.

ROCKET MOTOR—THE X-15

The principles of rocket propulsion are discussed briefly in the AE-1 text *Spacecraft and Launch Vehicles*. They are discussed in

PROPULSION UNITS



Figure 32. ROCKET PROPELLED--X-24 experimental lifting body.

depth in the AE-III text *Space Technology: Propulsion, Guidance and Control of Space Vehicles*. Rockets can be mentioned here, in an aviation context, because auxiliary JATO rocket motors are sometimes used to give an extra boost to an airplane on takeoff, and certain experimental aircraft have been rocket powered.

One such aircraft currently being used for scientific research by the Air Force is the Martin-Marietta X-24 **lifting body**. It can be described as wingless, although it has a flat undersurface acting as its main lifting airfoil (Fig. 32). It has a rocket engine of 8,000 pounds of thrust, which is ignited after the aircraft is launched at high altitude from a B-52, and which boosts the vehicle to mach 2 speed. It also has two small rocket motors for control purposes. The main purpose of the X-24 is to provide data to be used for designing a vehicle that could return from space orbit and make an airplane-like landing at a conventional airfield instead of a **splashdown** at sea. In addition to the Air Force's X-24, two similar lifting-body rocket-powered aircraft are being used in experiments by NASA.

An even more spectacular rocket-powered aircraft, now retired after a ten-year program of experimental flights (1958-68), was the North American X-15 (Fig. 33). Three of these were built and were flown during the program by Air Force, Navy, and civilian pilots for the Air Force and NASA. One X-15 was destroyed in an accident. The other two are now on permanent display, one at the Smithsonian

AIRCRAFT OF TODAY

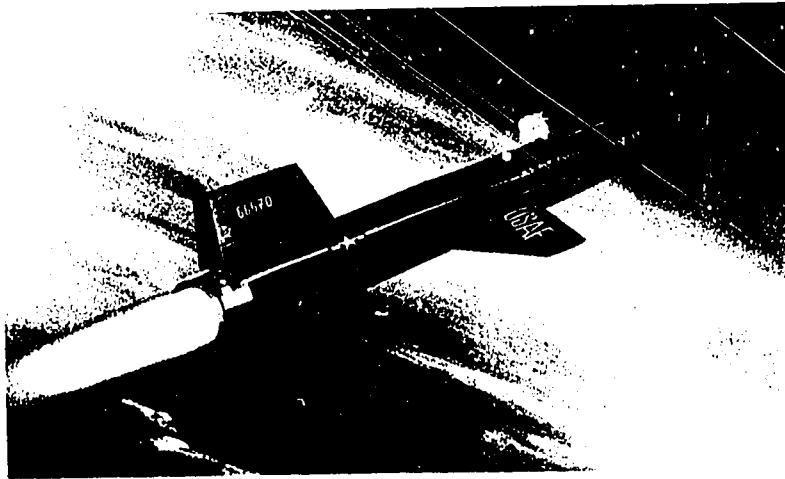

Figure 33. NO AIR NEEDED. To fly in the airless fringes of space, the X-15 had a rocket motor.

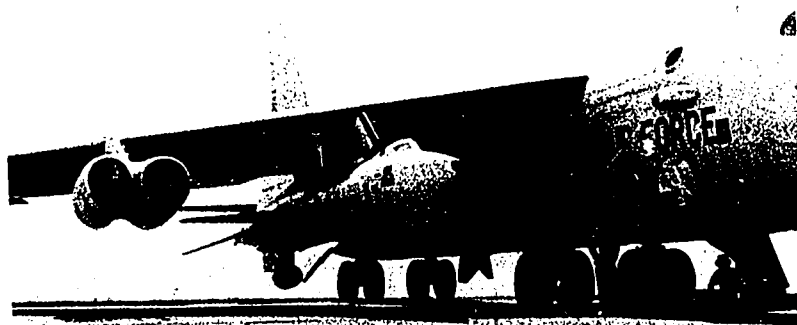

Figure 34. HITCHHIKER. Unable to take off from the ground, the X-15 was carried aloft to high altitude by a B-52 bomber and launched from under its wing.

PROPULSION UNITS

Institute in Washington, DC and the other at the Air Force Museum at Wright-Patterson Air Force Base, Ohio. The X-15 had no single purpose but contributed scientific data to many different research projects. Only incidentally did it set such records as an altitude of 354,000 feet (67 miles) and a hypersonic speed of mach 6.73 (4,543 mph).

The X-15 had a **liquid-propellant** (burning liquid fuel and oxidizer) rocket motor of 57,000 pounds of thrust. Like the X-24, it was launched at high altitude from a B-52 (Fig. 34). Its own motor then was ignited and propelled it up to the fringes of space, where the atmosphere is so rare as to be incapable of supporting combustion even in a SCRAMJET—and also so rare as to make the wings and empennage of the craft virtually useless as airfoils for either lift or control. At these altitudes, the X-15 flew like a rocket or space ship, but on descent into denser air it regained the use of its airfoils for a controlled landing.

As noted before, a rocket motor must carry its own oxygen supply, which outweighs its fuel supply. The X-15 used pure liquid oxygen to burn ammonia. There are many other combinations of fuel and oxidizer used in rocket motors. Pure oxygen must be chilled to -297°F to turn into a liquid for use as a propellant and must be carried in an insulated tank aboard the vehicle, but various other chemicals can be used as oxidizers and carried in liquid or solid form at normal temperatures. Most liquid rocket motors carry fuel and oxidizer in separate tanks. These liquids mix and are ignited in a combustion chamber similar to that of a jet engine. They produce thrust by means of a rearward rush of gases formed from the combustion of the liquids. No air is used, whether the vehicle is traveling in air or in the vacuum which is space. A solid rocket motor is much simpler. Fuel and oxidizer are combined in one solid chunk fused to a tough casing, so that propellant supply and combustion chamber are all in one piece. When this chunk (or **grain** as it is called) is ignited, it burns forcefully without air and sends its combustion gases rearward through a nozzle for thrust.

For space travel, the rocket is the only known way; but for aviation, it has its drawbacks. Liquid or solid, the space rocket carries a heavy load of propellants in heavy tanks or casing and burns them up at an extravagant rate for the sake of a few minutes of thrusting time, then throws away the empty tanks, casing or even the engines themselves to

AIRCRAFT OF TODAY

reduce the load for smaller rocket engines that will propel it onward. The very fact that it loses weight rapidly is the reason why it can acquire enough speed to thrust itself free of gravity on a trip into space.

The X-15 did not throw away any part of its airframe but brought all of itself down for a safe landing. It was a recoverable vehicle. However, it was not the complete aerospace vehicle we mentioned earlier. It made great contributions to science but was short on range, payload, and other factors that make an aircraft useful in either a civil or a military way. As long as air is free and adds no weight to a flying vehicle, air-breathing engines will continue to serve most of the needs of aviation better than rockets.

WORDS, PHRASES, AND NAMES TO REMEMBER

acceleration of air	pulse jet
afterburner	radial engine
airscoop	ramjet engine
bypass engine (turbofan)	reciprocating engine
compression stroke	recoverable vehicle
ducted fan (turbofan)	reversible pitch
exhaust stroke	rocket engine
external combustion	rotations per minute (rpm)
feathered propeller	shaft horsepower (shp)
flame holder	shaft turbine engine
horizontally opposed (flat) engine	shock wave
horsepower (hp)	splashdown
in-line engine	supercharger
intake stroke	supersonic combustion ramjet (SCRAMJET)
internal combustion	thrust reverser
lifting body	torque
liquid-propellant rocket	turbine
oxidizer	turbine compressor
oxygen	turbofan engine
pitch	turbojet engine
pounds of thrust	turboprop (prop jet) engine
power stroke	vertical takeoff and landing (VTOL)
propulsion unit	windmilling

PROPULSION UNITS

AIRCRAFT MENTIONED IN THIS CHAPTER

Antonov An-22 Soviet transport
Boeing B-52H Stratofortress bomber
Boeing Bomarc unmanned air defense missile
Consolidated B-24 Liberator World War II bomber
De Havilland C-7 Caribou Canadian STOL transport
Douglas C-124 Globemaster transport
General Dynamics F-111 fighter
Lockheed C-5A Galaxy transport
Lockheed C-121 Constellation transport
Lockheed C-130 Hercules transport
Lockheed C-141 Starlifter transport
Lockheed SR-71 strategic reconnaissance airplane
Martin-Marietta X-24 experimental lifting body
McDonnell-Douglas F-4C Phantom II fighter
North American P-51 Mustang World War II fighter
North American X-15 experimental rocket airplane
Republic P-47 Thunderbolt World War II fighter
V-1 "buzz bomb" unmanned German World War II missile
Vickers Supermarine Spitfire British World War II fighter

QUESTIONS

1. What two factors do all propulsion units have in common?
2. Define "pitch." What does controllable pitch accomplish?
3. Describe the basic actions of cylinder strokes.
4. What types of cylinder arrangements are used in reciprocating aircraft engines?
5. What is the purpose of a turbosupercharger on a reciprocating engine?
6. Explain the interest in ramjet engines for future aerospace vehicles.
7. What unit of power is used to rate turboprop engines? Why?
8. Which type of jet propulsion unit is best suited for heavy cargo planes? Why?
9. How does rocket propulsion differ from jet propulsion?

THINGS TO DO

1. Carve a balsa propeller about four inches long. Force the point of a pencil in the hub and spin between your hands. When you push the propeller into the air, it will rise due to the thrust of the revolving blades.
2. From outside reading, report on some model of turbojet engine not described in this chapter. Accompany your report with a diagram and tell which types of aircraft use it.

73 / 74
78



General Aviation Aircraft

THIS CHAPTER introduces you to the world of civilian flying. First, it relates the growth of aircraft production for general aviation usage and describes some of the models available in this category ranging from the small, family type monoplane to the king-size, luxury aircraft used by large corporations. This section also relates some facts about the high cost of private flying, but includes some information about home-built aircraft which are not so expensive.

When you have studied this chapter, you should be able to do the following: (1) summarize the present and future growth of general aviation; (2) describe several examples of general aviation aircraft showing how they vary in size, equipment and price.

AT THE BEGINNING of this unit, one category of aircraft was discussed, the military airlift aircraft. This served to introduce the concept of functional design. Then basic principles common to the flight and construction of any and all aircraft were set forth, and the preceding chapter discussed power and propulsion. In the latter half of this book, let us return to a survey of the wide variety of aircraft types that comprise modern aviation. These will be considered by broad categories, both civil and military. The first of these categories is called **general aviation**, a term meaning practically all aviation other than airline and military aviation. General aviation aircraft are owned by individuals, corporations, or Government agencies other than the military. They are used for sport, pleasure, family transportation, business transportation, and special purposes such as

AIRCRAFT OF TODAY

crop dusting, aerial photography, or fire fighting. General aviation also includes passenger aircraft for hire, or air taxis. Without bothering with the technicalities of just where the line is drawn between air-taxi and commercial-airline operations, we can merely state that most general aviation aircraft are smaller than most commercial airliners, and in this section we discuss a range of small and light airplane types. (Helicopters will be taken up in Chapter 8). There are more than 100,000 airplanes classed as general aviation currently flying in the United States, comprising about 98 percent of all the Nation's civil aviation (nonmilitary) aircraft.

SOME FACTS, FIGURES, AND TRENDS

To the reader whose only experience with flying is via commercial airliners, the above figures may seem surprising. But if he has seen the busy traffic at such airports as Opa-Locka, Florida, near Miami, or Teterboro, New Jersey, near New York, he will find them more believable. These airports are among the busiest in the United States, ranking alongside such airline hubs as O'Hare, Chicago, and Kennedy, New York, in number of takeoffs and landings per month; and they handle nothing but general aviation traffic, as do thousands of other airports.

Americans hold half a million pilot licenses, including student licenses (permitting solo flights without a passenger and within a restricted zone). Thus about one American in 400 is able to fly an aircraft of some kind. There are about four or five qualified or student pilots to every aircraft flown. More than 50,000 aircraft can be classed as "personal." Membership in the Aircraft Owners and Pilots Association (AOPA) is about 150,000. The time has not yet arrived when the privately-owned aircraft is as commonplace as the family automobile. It is doubtful, furthermore, that our crowded airways would permit such widespread use of general aviation even if prices and training requirements did. Nevertheless, throughout the 1960s, the growth of general aviation was rapid. Since business and air-taxi aircraft carry numerous passengers, the claim of an AOPA spokesman that "half of all the people who fly from city to city go by general aviation"* is plausible.

* As reported by Burton Bernstein, "The Piper Cub vs. the 747," *New York Times Magazine*, March 8, 1970, pp. 34-35.

GENERAL AVIATION AIRCRAFT

Aircraft Production and Prices

During the decade of the 1960s, the US aircraft industry produced more than 100,000 general aviation aircraft at an annual rate that climbed from 7,000 in 1960 to over 12,000 in 1969. During these same years, the average price of a general aviation aircraft also climbed—from about \$19,000 in 1960 to almost \$47,000 in 1970. The latter average covers a range of prices from \$10,000 for a light family-type plane to \$800,000 for an eight-seat business jet and more for larger jets. We shall examine some typical price tags a little later, for a better idea of what a general-aviation dollar will buy. The rise in average price was due less to inflation than to a trend toward more sales of larger and better-equipped aircraft to business executives and corporations.

Airport Availability

In the more densely-populated parts of the United States, crowding of airports and congestion of airways has become a severe problem for both general and airline aviation. But in many parts of the country there is still plenty of room for general aviation. An important factor is airport availability.

In the entire United States, there are about 10,000 airports, not counting many more thousands of fields and pastures used by flying ranchers and other rural aviators. When we consider which airports can handle which types of airplanes, however, the numbers decrease and decrease. Only the smaller and lighter types of general aviation aircraft have their choice of all 10,000 airports as possible destinations. Most of these "airports" are little more than sod landing strips, some of them even lacking a fuel pump, a telephone, or a full-time attendant. About 2,100 have some maintenance facilities and paved runways for safe takeoff and landing of the heavier types of general aviation aircraft. Of these, about 1,000 handle "Airline" traffic, including all the small branch airlines. About 500 of these have paved runways long and solid enough to accommodate at least the smaller jet airliners. but even this number includes many cities off the main traveled routes. Two thirds of all air passenger traffic in the United States are routed through fewer than 50 airports, servicing most of the jet airliners and their throngs of passengers on high-density, (heavy passenger traffic) transcontinental, and transoceanic routes.

AIRCRAFT OF TODAY

More and more Americans, then, travel through a small number of large airports. On the other hand, the availability of large numbers of small airports to farm, factory, and small-town merchants is converting numerous salesmen and executives to private flying. Private flying at 150 to 200 mph provides the quickest city-to-city transportation over a one- to three-day area. Even over much longer distances, such flying may provide faster point-to-point service than jet airline travel at 500 mph, since the latter often includes indirect routing, various delays, and long surface rides to or from major airports. These are the major reasons why general aviation has grown in recent years. There is much room for future growth in the improvement of the existing 10,000 airports without acquiring more land for building new ones.

TAKEOFF AND LANDING PERFORMANCE.—The subject of airport availability is closely related to that of takeoff and landing performance, so it might be pertinent to discuss this aspect of aircraft performance at this point. In this talent, the light aircraft usually outshines the heavier aircraft. The smallest and lightest custom-built sport airplane can clear an obstacle 50 feet high located only 500 feet from the beginning of its takeoff run. It can also do the equivalent on landing—come down over a 50-foot-high obstacle and stop within 500 feet of it. An eight-seat business jet, normally loaded, requires about 3,500 feet to clear a 50-foot obstacle, but even this distance is less than half that required for a large jet airliner. The business jet also puts less weight on the runway pavement. Thus even business jets are permitted to use hundreds of airports not served by jet airliners. Most of general aviation's 100,000-plus airplanes are propeller driven and have landing and takeoff capabilities considerably better than those of any jets.

In Chapter 8, we shall take a look at some new ideas in short takeoff and landing STOL aircraft. Aside from special STOL designs discussed there, the main factor in takeoff and landing performance is engine horsepower per aircraft weight. On light aircraft, reciprocating engines are good takeoff-and-landing performers. On heavier aircraft, turboprops are the best STOL performers. With jets comes a trade-off of takeoff and landing performance for the sake of speed and altitude.

Training Requirements

If there is a trend in general aviation toward larger and better-equipped aircraft, it is because business flying demands more aircraft

GENERAL AVIATION AIRCRAFT

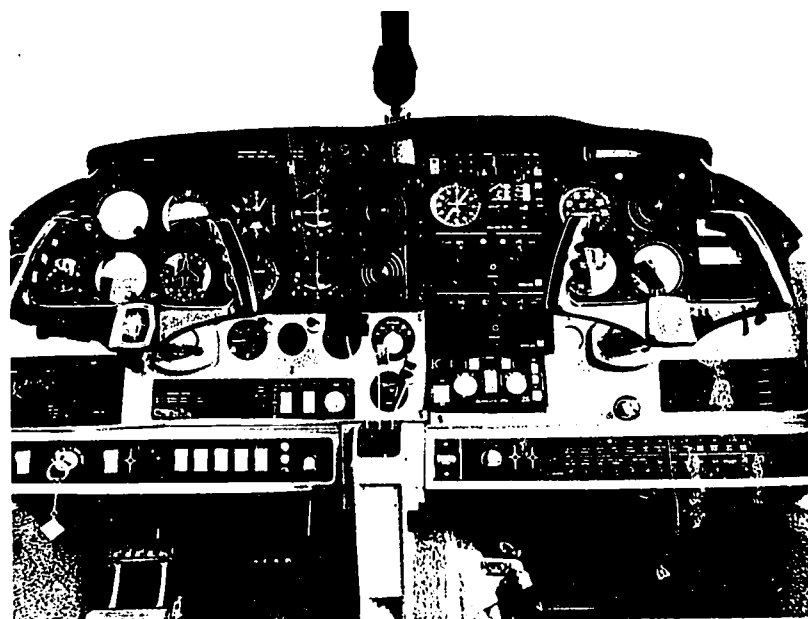

Figure 35. **HOMEWORK REQUIRED.** This instrument panel of a Piper Comanche C reveals that even a single-engine general aviation aircraft, if well-equipped with instruments, can demand advanced training of its pilot. Compare with figures 22, and 23.

performance than pleasure flying. To cut down on delays, serious flyers need planes that are designed to fly at night and get through around, and above the kinds of weather conditions that would keep lighter and simpler aircraft on the ground. In turn, this means stricter training standards, more professionalism in flying.

If you hope to fly an airplane of your own some day, you may feel discouraged by the prices and other facts we have mentioned. You might, however, take comfort in certain other facts. For one thing, bargains in used aircraft are available. Building your own is another way to personal aircraft ownership at relatively low cost, but demands much skill and patience. (See the box, "Do It Yourself Aviation.") The convenience of private flying can be enjoyed in rented aircraft, and aviation clubs provide it on a shared-cost basis.

One hard necessity remains—training: basic flight training to obtain a license to fly simple airplanes of limited performance under VFR conditions, more and more advanced training for instrument flying, multi-engine flying, and other higher ratings (Fig. 35).

AIRCRAFT OF TODAY



Figure 36. LIGHTWEIGHT. This Piper Cherokee 140 is typical of the lightest class of general aviation aircraft.

SOME REPRESENTATIVE TYPES

Ignoring many varieties of special-purpose or sport aircraft, we shall consider here general aviation's main function, transporting people. Below are described aircraft typical of different classes of enclosed-cabin monoplanes. Prices of aircraft, as of 1970, are quoted not to provide a shopper's guide but only to help you form a general idea of how cost relates to capacity and performance.

Single Reciprocating Engine Aircraft

Our first example is a single-engine aircraft seating two adults side by side, with a padded bench behind to increase the seating capacity, if desired, by one more adult or two children. The Piper Cherokee 140 (Fig. 36) has a 150 hp engine to provide a top airspeed of 142 mph and a cruising speed of 133 mph. Its 36-gallon fuel tank gives this little airplane enough fuel for four hours' flying. Its service ceiling is 14,300 feet. Its total useful load is 937 pounds. The 1970 price was \$10,400. This airplane is at the bottom of the line of one major aircraft manufacturer specializing in general aviation aircraft, but it is well above the bare minimum of airplane size and performance as produced in the custom and home-built field for hobby flying (see the box, "Do It Yourself Aviation.")

From another manufacturer's line, we can get an idea of a higher performer among single-reciprocating-engine aircraft. With a 285 hp fuel-injection engine, the Beechcraft A36-Bonanza has a seating capacity of 4 to 6 and can carry a useful load of 1,580 pounds. Its top

GENERAL AVIATION AIRCRAFT

speed is 204 mph. Cruising speeds range from 167 to 195 mph, and service ceiling is 16,000 feet. Its range with a normal load is about 980 miles. Its total takeoff distance over a 50-foot obstacle is 1,525 feet. The 1970 price was \$45,550, with full avionic equipment.

Twin Reciprocating-Engine Aircraft

A second engine provides not only additional power and performance but improves safety and reliability. In case of failure of one engine, a twin-engine aircraft can stay aloft on the other engine (at reduced speed and ceiling, of course) until it reaches either its destination or a suitable alternate airport.

The lower end of the price range of twin-engine aircraft in 1970 was around \$50,000. One example of an aircraft near this minimum, the Cessna Skymaster, is worthy of mention because it serves as a military as well as a private-type passenger plane (Fig. 37). In the Air Force, this aircraft is the O-2, used as a low-altitude observation and general-utility aircraft, well suited to combat conditions in Southeast Asia. In that theater, simplicity of maintenance, flight endurance, good

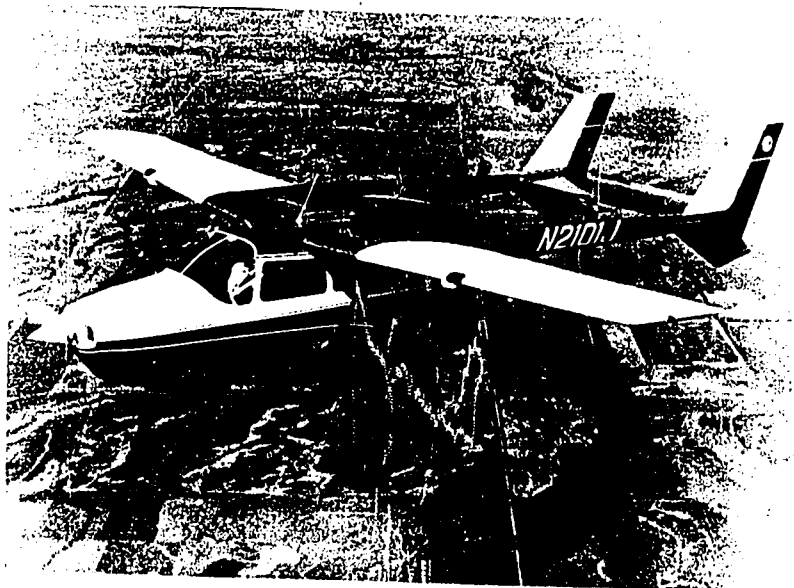

Figure 37. TANDEM ENGINES. Cessna Skymaster, designed as private airplane, also serves the Air Force as O-2 observation airplane.

AIRCRAFT OF TODAY

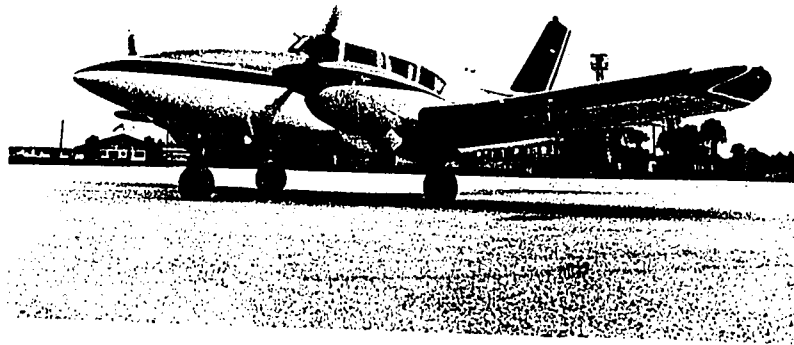

Figure 38. TURBOSUPERCHARGED. Twin-engine Piper Aztec E can reach 30,000 feet altitude.

STOL characteristics, good cabin visibility and ability to fly low and slow for **visual observation** often count more than high speed or heavy armament. These also happen to be the same qualities a private buyer is likely to want. Rather than design such an airplane from the ground up, the Air Force found it could get an adequate airplane cheaper and faster by buying this "off-the-shelf" item from the civilian market. The Air Force formerly used a lighter and slower single-engine airplane, the O-1 Birddog, for observation purposes but needed the somewhat better speed and performance the O-2 offers. The O-2 has a top speed of 200 mph, a cruising speed of 190 mph, and a service ceiling of 19,500 feet. Its twin engines are 210 hp each, and it can take off over a 50-foot obstacle in 1,545 feet. The civilian version of this aircraft can seat 4 to 6, including the pilot, and carry a useful load of 1,745 pounds. As Figure 37 shows, this aircraft has a unique arrangement of its two engines, which are located in **tandem** fashion, fore and aft of the pod-shaped fuselage. The manufacturer claims in its advertising that this engine arrangement gives the aircraft the power and security of two engines with **center-line thrust** like that of a single engine aircraft, for ease of handling.

As we have noted, the O-2 and its civilian counterpart are near the minimum in twin-engine aircraft. Moving up to more performance and

GENERAL AVIATION AIRCRAFT

luxury, consider this \$75,000 Piper Turbo-Aztec: two turbosupercharged 250 hp engines, capacity of six seats or a useful load of 2,145 pounds, a cruising speed of more than 230 mph, and a service ceiling of 30,000 feet (Fig. 38). On one engine, it has a service ceiling of 18,500 feet. It can take off over a 50-foot obstacle in 1,250 feet. For high-altitude flying, this aircraft is equipped with an oxygen tank with breathing apparatus for six persons, but it is not pressurized. A pressurized aircraft with turbosupercharged engines and approximately the same performance and capacity would cost more than twice as much. Examples are the Cessna Golden Eagle and the Beechcraft Pressurized Duke (Fig. 39).

Heavier General Aviation Aircraft

The aircraft described so far have a seating capacity up to six, a useful load capacity of up to a ton or slightly more, and cruising speed of less than 250 mph. Judging from the prices quoted, you should be able to guess the cost of exceeding these limits. Airplanes heavier than those mentioned may be owned by business firms for quick transporta-

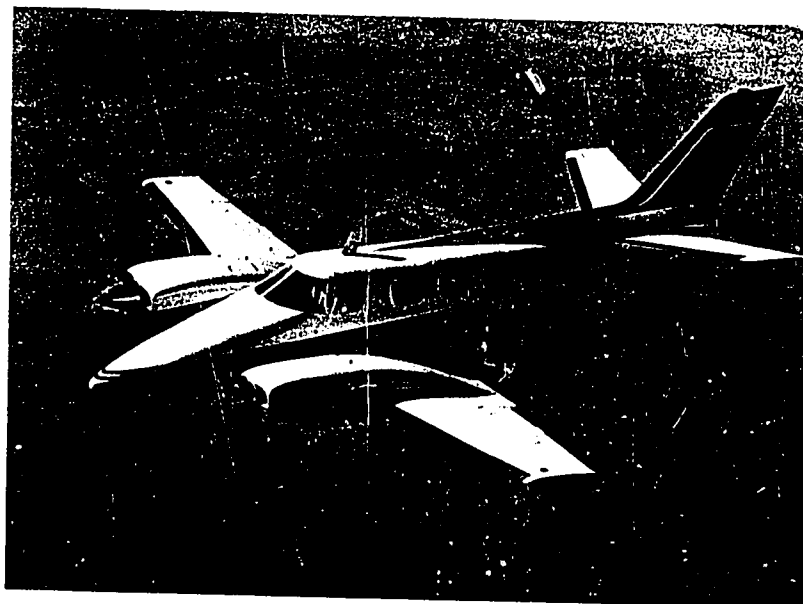

Figure 39. PRESSURIZED. Beechcraft Duke has twin turbosupercharged engines, pressurized cabin, and seats six.

AIRCRAFT OF TODAY



Figure 40. TURBOPROP. Business aircraft of heavier capacity like this Beechcraft King Air 100 are often turboprop powered.



Figure 41. JET. The ultimate in private air transportation is the 500 mph corporation jet. Examples are the 8-passenger Learjet or this larger Beechcraft-Hawker 125.

GENERAL AVIATION AIRCRAFT

tion of executives and employees, or sometimes quick delivery of small cargoes, to any point in the Nation.

Usually the crew compartment of such an airplane is separated from the passenger's cabin. The latter might be set up to seat a maximum of ten or more, or a smaller number around a table in a "flying conference room." To fly and maintain such an aircraft, a business firm must keep full-time aircrews and mechanics on its payroll.

Instead of citing specific features of given models, we might speak generally of heavier general aviation aircraft and their requirements. The majority of aircraft in this field are still powered by reciprocating engines. These are the most economical to buy and operate, and they still retain the smaller airplane's ability to get in and out of small airports. Turboprop engines give more speed and lifting power to an airplane without increasing takeoff and landing runs, but they cost more to buy and maintain, and they are heavy fuel consumers. The Beechcraft King Air 100 is a 250 mph turboprop aircraft with a seating capacity of up to 15 in a pressurized cabin and carries a \$600,000 dollar price tag (Fig. 40). The Learjet is an eight-passenger jet aircraft costing \$800,000, the lowest price of owning your own 500 mph transportation. Larger corporate jets, obviously, are priced in excess of a million dollars (Fig. 41). Some firms find it worth while to own converted jet airliners with interiors set up as flying executive suites.

As we turn to commercial and military aviation, we shall make no further mention of prices. You now have a broad notion of what the first million will buy, and that more or less corresponds to what is called "general aviation aircraft."

AIRCRAFT OF TODAY

DO-IT-YOURSELF AVIATION

In backyards, garages and workshops throughout the world, hundreds of home-made airplanes and even rotorcraft take shape every year. Their makers form clubs, which stage annual "fly ins" in the United States, France, and other countries. Small operators do a brisk business in plans, kits, engines, raw materials, and equipment for these amateur builders. In an effort to live up to its name, that eminent British publication, *Jane's All the World's Aircraft*, lists and describes numerous specimens of these home-built aircraft from all over the world right alongside the products of major manufacturers. In the United States, the national organization for home aircraft builders is the Experimental Aircraft Association (EAA). Its *Directory for the Homebuilder* lists more than 100 different fixed-wing, powered airplanes plus some 30 gliders, sailplanes, and rotor aircraft, including one true helicopter.* Almost 3,000 of these aircraft are registered with the Federal Aviation Administration, and the number increases by almost 300 a year.

An article, "All Those Planes You Can Build from Plans," by Thomas Haak, in the June 1970 issue of *Popular Science*, lists 20 examples of fixed-wing airplanes ranging in estimated construction costs from \$1,000 to \$4,000. What is the thousand-dollar specimen like? As you may guess, it is very near the minimum in powered flight. It is a small wood-frame open-cockpit single seater with a cruising speed of 70 mph and a range of 250 miles. It is powered by a 40 hp Volkswagen automobile engine. The set of plans for this model amounts to 73 11"x17" pages. More ambitious builders can make a speedy 200 mph single-seat replica of the World War II Mustang fighter for an estimated \$2,700—or a four-seater with a range of 700 miles and a cruising speed of 170 mph. The estimated construction cost of the latter is not stated.

Patience is as important a resource as money for the homebuilder. From 500 to 1,000 manhours can be spent on building an aircraft, and there are some jobs beyond the reach of most amateurs. The recommended procedure on welding a metal tube frame, for example, is to do only the tack welding yourself and call in a professional to finish the job. The aircraft must have rigid government inspection before it is certified for flight.

A related field is the building and flying of powerless aircraft known as gliders or sailplanes. This activity is especially popular in Europe but it also has its American devotees. Such aircraft are launched either by means of a cable and electric-powered winch or by towing with an automobile or an airplane. They stay aloft through ability to ride air currents and take advantage of updrafts. Certain sailplanes, however, are semi-airplanes, able to take off or sustain flight by means of light engines and propellers, some only two feet in diameter. These engines can be shut off and the propeller blade feathered for gliding. In one model the engine and propeller fold back into the fuselage during glide. "Go-Kart" engines are adequate power units for this purpose.

Aircraft building and flying can be a club as well as individual project. Some have been built by faculty-led high-school clubs or classes.

* This directory (\$2.50) and other EAA publications and information can be obtained by writing Experimental Aircraft Association, P.O. Box 228, Hales Corners, Wisconsin 53130.

GENERAL AVIATION AIRCRAFT

WORDS, PHRASES, AND NAMES TO REMEMBER

Aircraft Owners and Pilots Association (AOPA)	general aviation aircraft
airport availability	general utility airplane
air taxi	glider
center-line thrust	high density route
civil aviation	observation airplane
commercial airline	sailplane
Experimental Aircraft Association (EAA)	tandem engines

AIRCRAFT MENTIONED IN THIS CHAPTER

(Note: all these are classed as general aviation aircraft; propulsion type is stated)

Beechcraft A-36 Bonanza single engine reciprocating
Beechcraft Pressurized Duke twin engine reciprocating
Beechcraft King Air 100 twin turboprop
Beechcraft-Hawker 125 twin jet
Cessna Golden Eagle pressurized twin engine reciprocating
Cessna Skymaster twin engine reciprocating
Learjet twin jet
Piper Cherokee single engine reciprocating
Piper Turbo-Aztec twin engine reciprocating

QUESTIONS

1. Define "general aviation aircraft."
2. Discuss the pros and cons of owning your own plane.
3. How many airports in the United States handle mainline airline traffic? How many are available for general aviation?
4. Describe an airplane that can be home built for \$1,000; one that can be purchased for \$10,000; and one that can be purchased for \$75,000.
5. What features of the O-2 make it useful for both civil and military purposes?

THINGS TO DO

1. If you can visit an airport that is available to privately-owned planes, notice the kinds and sizes using the facility.
2. Look over several current issues of aviation magazines, examining airplane advertising as well as editorial matter. Jot down data on airplane capacity, performance, and prices, and compare with examples cited in this chapter.

87/88



Commercial Airline Aircraft

THIS CHAPTER discusses aircraft used in commercial aviation. There is a brief section on commercial cargo aircraft, but the emphasis is on jet passenger airplanes. Although numerous propeller-driven carriers ply the aerial byways of the world, jet airliners not only have taken over all of the job of long-distance air transportation but increasing amounts of the shorter city-to-city traffic all over the world. Three main types of jet passenger airplanes, designed for different segments of the passenger trade, are described here. A concluding section discusses the future of the supersonic transport and some of its problems. When you have studied this chapter, you should be able to do the following: (1) explain how aircraft especially designed for cargo rather than passenger carrying can serve the civil market; (2) list at least three current types of passenger jet aircraft and the principal functions of each; (3) describe the British-French and American versions of the supersonic transport, and (4) state some problems connected with SST development.

THE COMMERCIAL airline category of aircraft consists, as a rule, of aircraft heavier than those of the general aviation field. They are used to carry freight or passengers, usually on fixed schedules. As aircraft types, the general and commercial categories overlap somewhat, especially in regard to the many light carriers that operate over the aerial branch lines and byways of the world. Here, however, our emphasis is on jet passenger carriers that serve the more heavily traveled routes. A brief section on commercial aerial freighters precedes this discussion.

AIRCRAFT OF TODAY

COMMERCIAL CARGO AIRCRAFT

Aircraft especially designed for hauling cargo were discussed in Chapter 1, which described the evolution of military cargo and troop-transport aircraft. Here our remarks on the subject of commercial cargo aircraft will be brief because these are usually either the same types as the military airlifters described in Chapter 1 or as the commercial passenger aircraft described below.

In the future, it is expected that commercial airlines will make a heavier bid for freight business with aircraft especially designed for it. Such a plane is designed for ease of loading, unloading, and securing cargo, or for carrying outsize cargo, even if such design calls for a trade-off of speed. The rear-loading turboprop C-130 Hercules, workhorse of the Air Force, is now widely used by civil carriers as a freight hauler. The Canadian-built swingtail turboprop CL-44 and the bulbous-shaped converted C-97s of the Guppy series, also mentioned in Chapter 1, are also in business as civil carriers. The Guppies are specialists in hauling such outsize civil cargoes as fishing yachts and oil drilling rigs. Besides savings in shipping time, the outsize air cargo carrier can in some cases save time otherwise spent in taking apart and reassembling a machine before and after shipment. In the future, it is expected that such military jet airlifters as the Lockheed C-141 and C-5 will find a civil market. Indeed, a commercial version of the Galaxy, the L-500 is being planned. It will have a larger payload capacity than that of the C-5. It will not have a rear-loading ramp but will use only its nose door for loading and unloading cargo. Cargo versions of such new or forthcoming passenger giants as the Boeing 747, the Lockheed L-1011, and the McDonnell-Douglas DC-10, described later in this chapter, are also planned.

The civil market is also interested in development of medium-weight airlifters of good STOL capability, of sizes comparable to the C-7 Caribou or the C-123 Provider. These offer the possibility of direct air delivery of cargo to a landing strip alongside a factory, mine, or construction site, thus avoiding the delays of long surface hauls from the nearest large airport to such locations. Nowadays, light airplanes and helicopters handle point-to-point light-delivery chores routinely, but what is wanted is STOL plus more lifting muscle—and more range and speed than those of current helicopters. Chapter 8 will go into this subject further.

COMMERCIAL AIRLINE AIRCRAFT

COMMERCIAL PASSENGER AIRCRAFT

Commercial passenger planes might be compared to the expresses and locals of a railroad system—those which travel respectively the main lines and the branch lines.

All types of reciprocating and turboprop aircraft continue to operate on the branch lines, reaching remote locations in the United States and all over the world, including some places that depend entirely upon air transportation as their only link with the outside world. Turboprop propulsion is favored for new medium-capacity aircraft, sometimes required to carry mixed passenger and cargo loads, and in need of combining heavy lifting with ability to negotiate small, poorly-equipped airports.

Our concern here is with the leading types of aircraft, all jets, that provide rapid connections between the larger towns and cities of the United States and abroad, on main and secondary routes. Until recently, one could speak of two basic types of passenger jets: (1) large and long range, for the transcontinental and transoceanic trade, also used on shorter runs between hub airports because of their large passenger capacity, and (2) smaller jet aircraft, seating 100 passengers or fewer, of short to medium range, for intercity runs.

Today the world's aircraft manufacturers are making or developing a variety of jet airliners. For convenience, we shall consider them in three broad classes: (1) the standard large, long-range type; (2) the medium-size short-to medium-range type; and (3) the newest and largest class of aircraft, known as the jumbojet, or, depending on use, the airbus. A fourth type, not yet in service, is the supersonic transport (SST), discussed separately below.

Currently ten companies, both private and government owned, in various countries, design and make jet airliners. In the United States, the firms are Boeing, Lockheed, and McDonnell-Douglas; in the United Kingdom, British Aircraft Corporation (BAC) and Hawker-Siddeley. Other foreign firms include Fokker of the Netherlands; Dassault and Sud Aviation of France; Deutsche Airbus of Germany; and Ilyushin and Tupolev of the Soviet Union. Many other nations operate airlines and some have well-developed aircraft industries, but they buy their jet airliners from these sources, and the international competition is keen.

AIRCRAFT OF TODAY

Standard Large, Long Range

For many years, the tried-and-true American jet airliners have been the Boeing 707 and the McDonnell-Douglas DC-8. These cross continents and oceans and fly the world's airlines in competition with the United Kingdom's BAC Super VC-10 and the Soviet Union's Ilyushin Il-62. Cruising speeds of these aircraft are high subsonic—550 to 600 mph. Range varies with usage. For transoceanic runs an aircraft in this class usually can carry enough fuel to fly up to 6,000 miles nonstop with a profitable payload and still have some reserve fuel for emergencies. For shorter runs, fuel capacity can be reduced to accommodate more passengers or cargo.

BOEING 707.—The intercontinental version of the 707 (707-320B) carries as a rule 120 passengers, 45 in first class and 75 in tourist class. If set up for all tourist class, it can carry as many as 199. It has an overall length of 153 feet, a wingspan of almost 146 feet, and a maximum gross takeoff weight of 312,000 pounds. Four under-the-wing turbofan engines deliver 18,000 thrust pounds each and give this plane a cruising speed of over 600 mph. Earlier models of the 707 had turbojet engines, but the great majority of these aircraft, as well as other passenger jet aircraft, have turbofan engines.

The Air Force operates four of this type, designated as the VC-137 (Fig. 42). These include the Presidential Air Force One and three



Figure 42. AIR FORCE ONE. Boeing 707-320B passenger liner with interior refitted as presidential plane.

COMMERCIAL AIRLINE AIRCRAFT

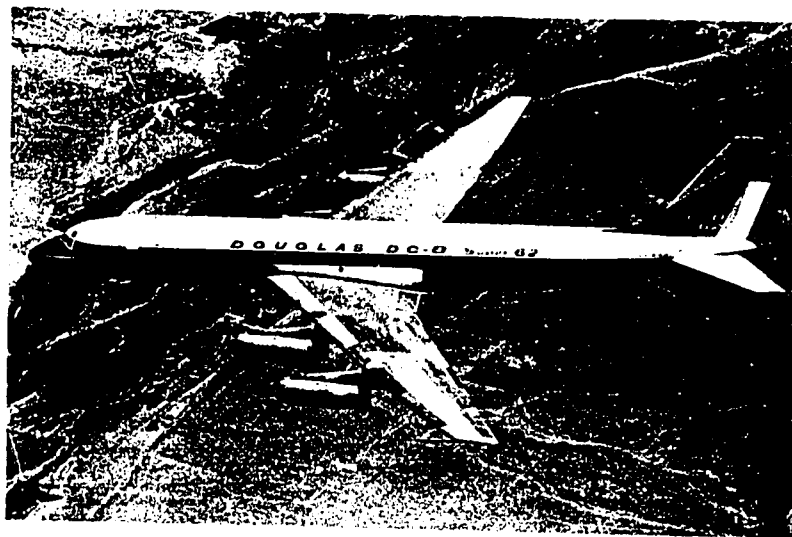

Figure 43. DOUGLAS DC-8, another of today's long-range commercial airliners.

others, all especially fitted as flying executive suites and with communications equipment for carrying the President and other top Government personnel on special missions to any part of the world. Somewhat smaller versions of the 707 are used by commercial airlines for the domestic trade. The Air Force also has adaptations of these, the KC-135 tanker and the EC-135 flying command post, mentioned in Chapter 1 and again in Chapter 7.

THE McDONNELL-DOUGLAS DC-8.—Like the Boeing 707, the McDonnell-Douglas DC-8 carries four turbofan engines in an under-the-wing position, each rated at 18,000 thrust pounds. Its size and seating capacity are generally comparable to those of the 707 (Fig. 43). One version of the DC-8, called the Trader, is designed for mixed freight and passenger use. It has a movable interior bulkhead (wall) separating the passenger and freight compartments so that one can be enlarged and the other made smaller as needed.

FOREIGN TYPES.—The British Aircraft Company's VC-10 Comet comes in several versions, one of which carries 16 first class and 123 economy class passengers. Another has a mixed freight-passenger capability and is equipped with an American mechanized freight-handling system. This airplane has a length of almost 172 feet, 18 feet longer than the 707, and a wingspan of 146 feet. It has four 21,000

AIRCRAFT OF TODAY.

thrust-pound turbofan engines mounted in pairs on either side of the rear of the fuselage. The Soviet Il-62 measures 174 feet long by 142 feet wingspan. Its power plant consists of four 23,000 thrust-pound turbofans located in pairs on either side of the fuselage. Depending on seating arrangement, this aircraft can carry up to 186 passengers.

Standard Medium- to Short-Range

The medium- to short-range airliner, generally seating fewer than 100 passengers, is actually a somewhat newer development than the transoceanic or transcontinental jet. In previous editions of this text, we stated:

Currently most of the local traffic is carried in reciprocating or turbo-prop-powered airplanes . . . but the aviation industry is now moving into the growing local trade with short and medium-range jets seating from 40 to 90 passengers.

Since 1966, when the above words were written, this trend has continued. On more and more commercial routes, propeller-driven planes are disappearing and jets are taking their place. Airports serving cities of 100,000 down to 50,000 population and even smaller have been improved to meet FAA requirements for handling jet airliners. In turn, the aircraft industry has produced more medium-sized turbofan planes with improved takeoff and landing performance, which meet FAA requirements for making stops at airports formerly out of bounds to the jet trade. It is the jet airliner of this type that is helping to put more and more American "Middletowns" and even much of rural America in closer touch with metropolitan centers of the Nation and the world.

Nations all over the world have a need for jet airliners of short to medium range, and this is the type that is most widely produced. The list includes the Fokker of Netherlands F-28 Fellowship; the United Kingdom's Hawker-Siddeley Trident; France's Sud Aviation Caravelle and Dassault Mercure; and the Soviet Union's Tupolev Tu-124 and Tu-134. American models include the Boeing 727 and 737, and the McDonnell-Douglas DC-9.

In describing these aircraft as "short- to medium-range," we mean any range up to about 2,000 miles, again adding reserve fuel for holding above a congested airport or flying to an alternate airport if necessary.

COMMERCIAL AIRLINE AIRCRAFT

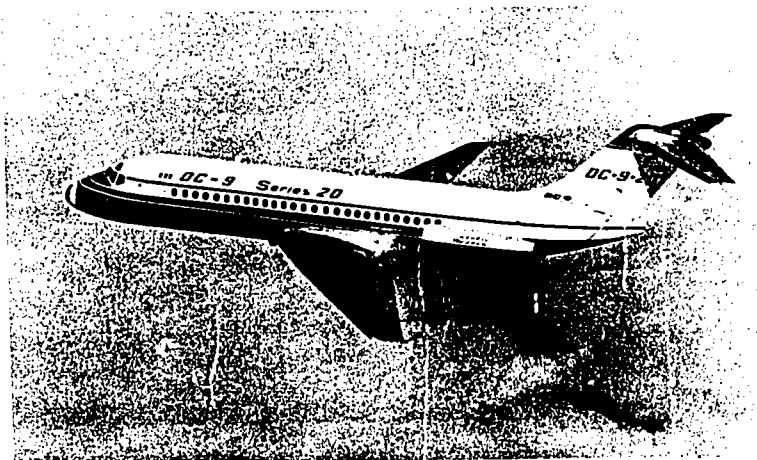

Figure 44. DOUGLAS DC-9. This medium-range 90-passenger airliner has helped bring the jet age to "Middletown."

The DC-9 (Fig. 44) seats 80 to 90 passengers. It is 119 feet long, with a wing span of 93 feet and a maximum takeoff weight of 108,000 pounds. It is powered by twin turbofan engines of 14,500 pounds of thrust each, located at the rear fuselage. An Air Force adaptation of this aircraft, the C-9 Nightingale hospital plane, is described in the next chapter.

The Boeing 727 is a tri-jet powered by three turbofan engines located at the rear of the aircraft, two on either side of the fuselage and one above it, at the base of the T-tail empennage. Each engine delivers 14,000 pounds of thrust. The aircraft normally accommodates 94 passengers in mixed classes and can be set up to carry as many as 131, all sitting six abreast in economy class. The Boeing 737 is a smaller twin-jet aircraft. There is also a stretched (enlarged) 727, which borders on the definition of "airbus" as described below. This aircraft is twenty feet longer than the standard 727, somewhat wider, and carries 178 passengers.

Jumbojets and Airbuses

A new class of aircraft is coming onto the commercial aviation scene. It consists of aircraft of much greater seating capacity than that of the 707 and DC-8 class. The Air Force's C-5 Galaxy, also under

AIRCRAFT OF TODAY

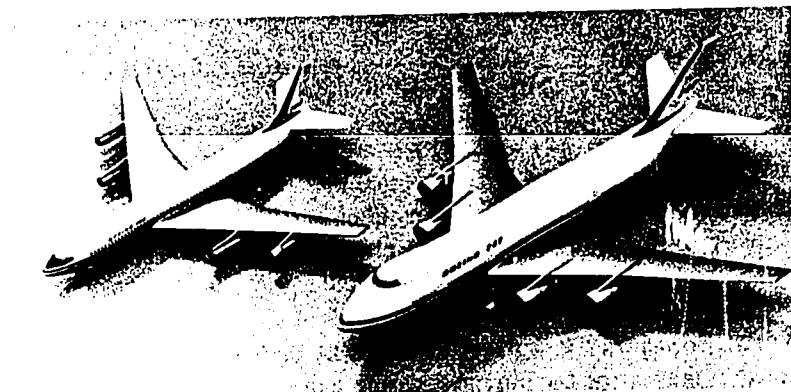
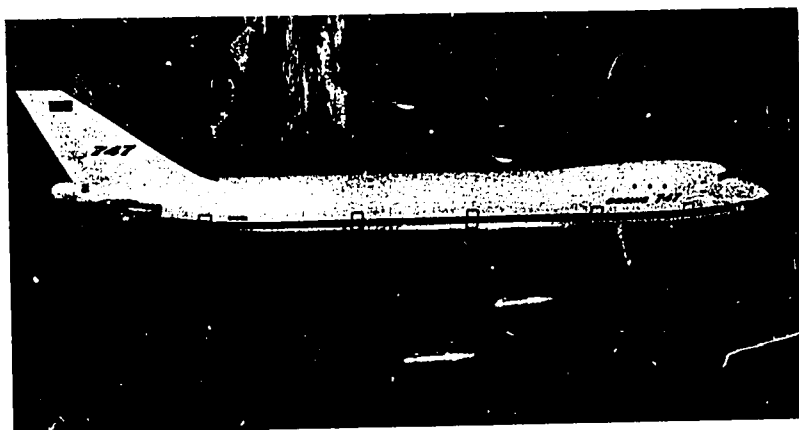

Figure 45. JUMBOJET. Boeing 747, shown at top in flight, is world's second largest airplane (after the C-5) and world's largest commercial airliner. Models in center panel show comparison of size between 707 (left) and 747 (right). Roomy first-class accommodations of 747 are shown at bottom.

COMMERCIAL AIRLINE AIRCRAFT

development as the L-500 civil freighter, might some day be developed into a giant passenger liner that would be the top of this class.

Meanwhile, the four-engine Boeing 747 is the first and largest of the new class of jumbojets (Fig. 45). It was first put into regular passenger service late in 1969. As presently employed, the 747 flies the Atlantic and other long-distance routes and is set up for comfort rather than mass transportation. Even so, it accommodates more than 300 passengers in mixed-class seating. A spacious refreshment lounge on a separate deck is one of its features. The 747 is 231 feet long and has a wingspan of 196 feet. It has four engines delivering more than 43,000 thrust pounds each, located under its wings.

The 747 may have a future role different from its present one as luxury liner. Its huge dimensions could be exploited for increased seating capacity—minus the lounge and other luxuries. So adapted, the 747 would be able to seat up to 490 people as an all-economy-fare super airbus. This and other long-range airbuses of the future may put foreign travel within reach of greater numbers of students and other people of modest income.

Overseas flying, however, is not the main reason for development of the airbus. A more immediate use will be on the most heavily-traveled routes, long or short. The example that comes most easily to mind is the New York-Chicago route. Thousands of people travel daily be-

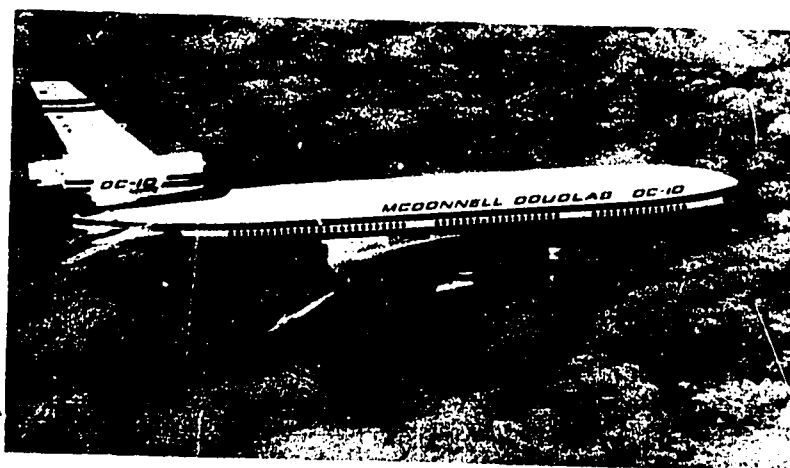

Figure 46. ANOTHER GIANT. This McDonnell-Douglas DC-10 "airbus" can seat up to 345.

AIRCRAFT OF TODAY

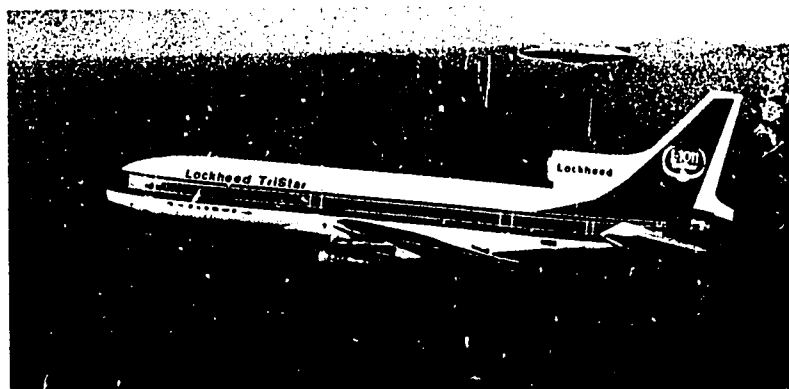

Figure 47. LOCKHEED TRI-STAR L-1011 airbus can also seat up to 345.

tween the two largest cities in the United States; thousands of other people, traveling between other cities, are funneled between the great hub airports of Kennedy and O'Hare, serving these cities. Currently this passenger traffic is carried by numerous competing airlines flying a variety of medium-size to large airplanes. In the future, the development of the airbus may mean fewer flights carrying more passengers per flight, thus relieving runway congestion at the busiest airports.

Examples of airbuses currently under development are the McDonnell-Douglas DC-10, the Lockheed Tri-Star L-1011, and the European A-300 being developed jointly by Sud Aviation of France, and Deutsche Airbus of West Germany. In comparison with the 707 and DC-8, these aircraft are larger in all dimensions, especially in body width. They have two or three engines instead of four, but these engines are very large and powerful.

The DC-10 measures 180 feet in length by 155 feet in wingspan and is powered by three huge turbofan engines producing 49,000 pounds of thrust each (Fig. 46). It seats 270 in mixed class or 345 in all economy class. The DC-10 was undergoing test flights in late 1970 and was near readiness for regular airline service.

The TriStar L-1011 made its first test flight in November 1970. It has three giant 40,600-thrust-pound turbofan engines and a seating capacity of 245 in mixed class or 345 all economy class. Its wingspan is 155 feet and overall length 178 feet (Figs. 47 and 48).

The international European Airbus will have a wingspan of 147 feet and an overall length of 165 feet—only slightly larger than the Boeing

COMMERCIAL AIRLINE AIRCRAFT

707 in these dimensions, but, like the other airbuses, much greater in body width. It will seat 261 in mixed classes and 295 in single class on short-range runs. It will have two engines of 49,000 pounds of thrust each but is designed to take engines of as much as 53,000 pounds of thrust.



Figure 48. 40,600 POUNDS OF THRUST on takeoff is the claim for this giant airbus turbafan engine.

AIRCRAFT OF TODAY

THE SUPERSONIC TRANSPORT (SST) CONTROVERSY

The so-called supersonic transport (SST) is a large jet passenger plane capable of sustained speeds of mach 2 or higher. Currently the race to be first with an SST seems to be led by a British-French combine, BAC and Sud Aviation backed by their respective governments, producing an aircraft called the Concorde. At the time of this writing, the first Concorde had been built and was undergoing a long program of flight tests. It had made several of these at supersonic speed and one at mach 2. The Concorde is 191 feet long, has curved wings of extreme sweepback, somewhat in the shape of a pointed arch in front, somewhat bell shaped at rear, with a span of only 84 feet, and four turbojet engines of 37,000 pounds of thrust each. It has a maximum cruising speed of over mach 2 (about 1,450 mph) and a maximum cruising altitude of over 60,000 feet. It will seat about 120 passengers. A Soviet SST, the Tupolev Tu-144, is neck-and-neck with the Concorde in development. According to Soviet sources, it too has successfully passed supersonic flight tests. It is similar to the Concorde in size, shape and capacity. It will have four engines of an estimated 28,500

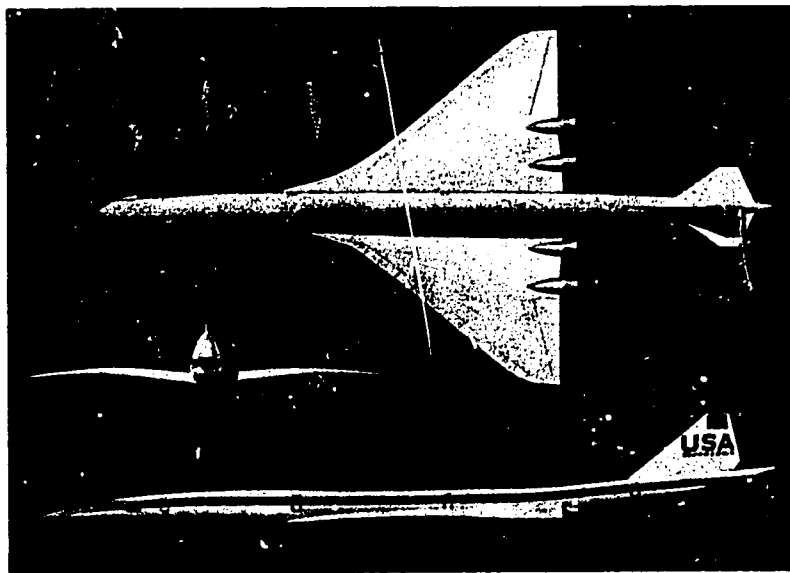

Figure 49. SUPERSONIC TRANSPORT—top, front, and side views of proposed US design shown in drawings.

COMMERCIAL AIRLINE AIRCRAFT

pounds of thrust each. Total power plants of these aircraft are comparable to those of the airbuses we have mentioned.

The United States entry in this race suffered a setback in December 1970 when the Senate rejected a \$290 million appropriation, passed by the House, to keep the project going. About \$700 million had already been spent. The American SST was being developed by Boeing and its engines by General Electric, with the financial assistance of the Federal Government. At the time of this writing, Congress had delayed debate on a compromise on a smaller appropriation. Opponents were threatening to block that too, and the issue was very much in doubt.* Whatever the outcome, our purpose in presenting this discussion is not to take sides but to acquaint you with facts and pro and con arguments on the SST. Our wish is only that you, the AFJROTC student, be well informed—better informed than most adults—on the subject of aerospace. The SST is an important part of that subject.

If it ever flies, the American SST will eclipse its rivals in size, speed, and range (Fig. 49). It is designed to be 280 feet long, with a wingspan of 142 feet, a capacity for 350 passengers, a range of 4,000 miles, and a cruising speed of mach 2.7—more than 1,800 mph. Its power plant would be the mightiest that ever took to the air—four engines delivering 67,000 pounds of thrust each! This total of 268,000 pounds of thrust would lift a somewhat lighter load than the 165,000-pound power plants of the world's heaviest airplanes of today, the Boeing 747 and the Lockheed C-5, but would be needed for speed.

Development Problems and Achievements

The air forces of many nations have been flying supersonic combat aircraft for many years. One might wonder why SST development has been so slow and difficult.

The military supersonic planes, however, have been much smaller and lighter than actual or proposed SSTs. To pay its way, the SST must be built much larger and have a much greater payload capacity and range than those of any supersonic aircraft yet flown—even the XB-70 (described below). Take, for example, the matter of range. Some supersonic military aircraft have achieved long range without refueling only by holding their speed down in the subsonic range. They can maintain supersonic speed only for a short time—an ability known

* In March 1971, both houses of Congress refused further funding for the SST.

AIRCRAFT OF TODAY

as supersonic dash, (like that of a runner who can do the 100-yard "dash" in 10 seconds but must maintain a slower pace to run a mile). Supersonic dash is a valuable advantage in combat, but it would not make a big enough difference to count in commercial competition, where long-range supersonic cruise is needed to cut a transoceanic schedule by a substantial amount. This is one instance in which commerce demands more performance of an aircraft than war. Usually it is the other way around.

Tremendous fuel capacity—encroaching on payload capacity—is needed for supersonic cruise. Another technical problem is aircraft skin heat due to atmospheric friction at prolonged supersonic speed. Much use of titanium, a light but heat-resistant metal, will be featured in the skin and structural parts of SSTs.

From your study of other chapters in this text, you should recognize other problems of SST development. Extreme sweepback of wings, for example, would be necessary for supersonic flight but would decrease lift and demand more runway for takeoff and landings. The size and weight of the aircraft would also produce a need for more runway. As we have noted, the vast power, weight, and fuel appetite of the American SST engines would exceed those of the monstrous power plants of the jumbojets and airbuses just described.

In the early 1960s, the General Dynamics B-58 Hustler, a three-seat medium US supersonic bomber then in service, established several records for long-range supersonic flight with the help of aerial refuel-

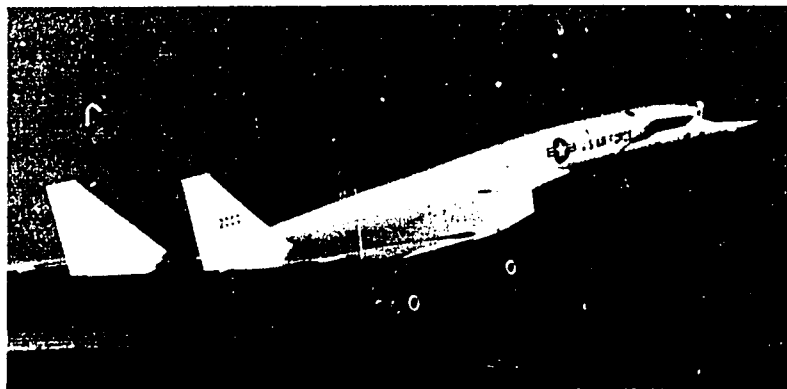

Figure 50. XB-70 VALKYRIE, important contributor to SST technology.

COMMERCIAL AIRLINE AIRCRAFT

ing. One of these was a flight from New York to Paris in 3 hours 20 minutes at an average speed of 1,089 mph, on 26 May 1961. The North American XB-70 Valkyrie, a huge 500,000-pound delta-shaped experimental plane flown by the Air Force during the 1960s (Fig. 50), had ample fuel tanks and supersonic cruise capability without aerial refueling. It was 185 feet long and had a wingspan of 105 feet. It had six engines of 30,000 pounds of thrust each (the most powerful airplane power plant so far) but its payload capacity was much less than that of the subsonic B-52 heavy bomber it was originally designed to replace. As an experimental plane in a long flight test program, however, it made many valuable contributions toward the technology of both a long-range strategic bomber (discussed in the next chapter) and an SST. The XB-70 is on display at the Air Force Museum at Wright-Patterson Air Force Base, Ohio.

Pros and Cons

The SST has been a subject of controversy from the very beginning. Although three US presidents—Kennedy, Johnson, and Nixon—have backed the project enthusiastically, they have had to fight opposition all the way. Opponents have long deplored the spending of huge sums of money on a project whose economic and social value they consider dubious. What real need, they ask, is served by getting passengers across the Atlantic from New York to London in 2½ hours instead of 7? If the SST is useful or profitable, they also ask, why can't private industry foot the bill without Government help? They have also long stressed the problem of the sonic boom and, more recently, engine noise at airports and on takeoff over cities and the unknown effects of atmospheric pollution or disturbance at high altitudes. If the ill effects of supersonic flight by military aircraft have not been a major problem so far, these opponents predict that the problem will be greatly aggravated when regular and frequent supersonic commercial service goes into effect. Somewhat the same arguments have also been heard in England and France, but apparently so far they have been less of a hindrance to SST progress.

Advocates of the SST, on the other hand, argue that there will be a worldwide demand for it whether as luxury or necessity. A passenger will prefer a 2½-hour ride to a seven-hour ride because the latter is more confining and fatiguing, and he will choose the SST if the fare is

AIRCRAFT OF TODAY

not excessive. It should not be excessive, the argument goes, because the SST can compete economically through ability to make more round trips in a given time span than a subsonic plane. Meanwhile, however, Government money is needed because all important aerospace developments are costly and are Government subsidized, with mutual benefits for both Defense and the economy in the long run. Foreign SSTs will meet the demand if no American SST is available. Advocates believe it is bad for the Nation's morale and economy to fall behind in a competition where other nations are forging ahead. More important are America's technological abilities in aerospace. Advocates argue that the Nation's very skills and knowledges that have kept us in the forefront of this field in modern times could decline from lack of support for the SST and for private and government aerospace development in general.

The Sonic Boom

Of all the problems complicating the SST controversy, that of the sonic boom is the one that stirs the most argument. Whether or not an American SST is developed, the problem has long been a familiar one because of military flights.

A "sonic boom" is a continuous shock wave sent out into the atmosphere by an airplane in supersonic flight. It is so called because it sounds like a boom or explosion when heard from the surface. A sonic boom made by a low-flying aircraft can be strong enough to damage buildings or injure people. Not only is the source of the shock wave close by in this case, but the greater density of the air at low altitude increases the sound's intensity. On the other hand, a sonic boom emitted from the high stratosphere might be heard on the ground as a dull thud, no louder than distant thunder, and would not disturb most people. The noise in this case is reduced by both distance and the thinness of the atmosphere at the point where the sound originates. In between these extremes lie varying degrees of noise nuisance. Would the night passage of an SST leave in its wake barking dogs, crying babies, and annoyed adults? Or would everybody, dogs and babies included, get accustomed to it and sleep peacefully through it?

Wind, moisture, and other atmospheric conditions affect the intensity of a sonic boom. Aircraft design and other technological approaches to the problem of reducing sonic booms are under study.

COMMERCIAL AIRLINE AIRCRAFT

Keeping supersonic flights as high as possible and as far from populated areas as possible seem to be at present the only known feasible attack on the problem.

The Air Force for years has usually limited supersonic flying to relatively unpopulated areas and high altitudes. Once in a while these limits are broken, and complaints are heard. (The Air Force has also cooperated with other Government agencies in experimental supersonic flights over some cities to study the sonic boom problem.) When SST service begins, the governments concerned will probably establish the corridors and required altitudes for supersonic flight to minimize sonic booms. The required minimum altitude might be 50,000 feet or higher, depending on the laws of the nation or state overflown. It is also possible that supersonic flight would be permitted only over oceans.

Altitude rules, at any rate, would make shorter supersonic flights impractical. Probably any supersonic flight of less than 1,000 miles would use up a good deal of that distance in climbing and descending at subsonic speed for the sake of a few minutes of supersonic flight in mid-journey at the permitted altitude. This would save only a few minutes of flying time and hardly be worth while.

On transcontinental or transoceanic flights, however, supersonic speed at high altitude could be attractive to customers and save them important amounts of time, even allowing for time for subsonic climb and descent. SST advocates have pointed out that high altitudes are best for jet flight anyway, regardless of rules. Subsonic jets perform most efficiently at altitudes above 30,000 feet and supersonic jets even higher. The three present and proposed SSTs are all designed to cruise at 60,000 feet or higher.

To turn briefly to other problems—the engine-noise problem is based, of course, on the fact that SSTs have tremendous power outputs. The Concorde and Tu-144, however, have power plants no greater than those of the Boeing 747, Lockheed C-5, and other jumbojets and airbuses which are already flying. Therefore, they should make no more noise on or near the ground. Advocates of the Boeing SST claim that this aircraft's steep rate of climb would put it 2½ times higher than a 707 over any point near an airport, where it would sound no louder than a 707. The issue of air pollution at high altitudes is more difficult to argue either way, since factual data are lacking.

AIRCRAFT OF TODAY

The American SST has a doubtful future at the time of this writing. Even if it survives upcoming Congressional debates, it will have to come to Congress for more money in the future, and open up the arguments anew. We hope you now have a better idea of what the arguments are about!

WORDS, PHRASES, AND NAMES TO REMEMBER

airbus	supersonic cruise capability
bulkhead	supersonic dash capability
jumbojet	supersonic transport (SST)
sonic boom	titanium
stretched airplane	tri-jet

AIRCRAFT MENTIONED IN THIS CHAPTER

Aero Spacelines Guppy series transports
BAC Super VC-10 Comet British transport
BAC-Sud Aviation Concorde British-French supersonic transport
Boeing 707 transport
Boeing 727 transport
Boeing 737 transport
Boeing 747 transport
Boeing SST supersonic transport
Canadair CL-44 Canadian transport
Dassault Mercure French transport
De Havilland C-7 Caribou Canadian STOL transport
Deutsche Airbus-Sud Aviation A-300 German-French transport
Fairchild C-123 Provider transport
Fokker F-28 Fellowship Dutch transport
General Dynamics B-58 Hustler bomber
Hawker-Siddeley Trident British transport
Ilyushin Il-62 Soviet Transport
Lockheed C-130 Hercules transport
Lockheed L-500 (Galaxy) transport
Lockheed L-1011 Tri-Star transport
McDonnell-Douglas DC-8 transport
McDonnell-Douglas DC-9 transport
McDonnell-Douglas DC-10 transport
North American XB-70 Valkyrie experimental airplane

COMMERCIAL AIRLINE AIRCRAFT

Sud Aviation Caravelle French transport
Tupolev Tu-124 Soviet transport
Tupolev Tu-134 Soviet transport
Tupolev Tu-144 Soviet supersonic transport

QUESTIONS

1. Describe the intercontinental model of the Boeing 707 passenger jet.
2. Compare the dimensions of the 707 and the 747.
3. What is the present use to which airlines are putting the 747? What other function might it and other new large passenger aircraft have?
4. What important effect have such medium-size passenger jets as the Douglas DC-9 and others had on the growth of aviation in America and throughout the world?
5. If the SST goes into service, what principal solution to the problem of the sonic boom will probably be offered?

THINGS TO DO

1. Visit a commercial airport and identify the kinds of aircraft you see there. Obtain flight schedules of all lines using this airport and determine the amount of daily airline traffic.
2. Watch current newspapers and magazines for latest news of SST development, controversies and problems. Make a scrapbook of pertinent articles.



Air Force Aircraft

THIS CHAPTER will acquaint you with the variety of tasks, combat and noncombat, which manned aircraft perform in the Air Force, and some of the design features which adapt them to their tasks. Some of these aircraft have been mentioned in previous chapters. Here the emphasis is on function. First, the chapter tells which Air Force commands are principal users of aircraft. Then, it devotes a section to each of these commands, explaining its mission and describing the design, special features, and functions of the aircraft types it uses. When you have studied this chapter, you should be able to do the following: (1) name the principal-user commands of the Air Force; (2) describe the kinds of aircraft used by each command and show how the design and performance of each aircraft relates to the mission of the command it serves; and (3) explain the meaning of the alphabetical and numerical prefixes used to designate aircraft types, giving examples in several categories.

IT IS A HARD FACT of history that much of man's technological progress has depended upon war to stimulate it. This is especially true of aviation. If a book on *Aircraft of Today* is to tell a complete story of the capabilities of modern aviation, we cannot limit our subject to aircraft used in the peaceful pursuits of commerce, industry, and agriculture. The highest speeds and the most ingenious and accurate means of aircraft navigation are in the service of war. Peaceful uses of such technology, as a rule, follow military uses.

This chapter surveys the aircraft of the United States Air Force. Technically, the Air Force refers to its aircraft not as "aircraft"

AIRCRAFT OF TODAY

but as systems. This gives us an idea of what complex fighting machines they are. An F-4 fighter weapon system, for example, includes the aircraft, its power plant, its controls, its guns, bombs, and rockets, its radar and other electronic and automatic devices for navigation and fire control, (the accurate aiming and delivery of weapons against fast-moving targets), and its communications.

Space does not permit our taking an international approach to this subject, although it would be instructive indeed to discuss the weapon systems of the Soviet Union and other nations. The full variety of flying machines of war is flown by our own Air Force. We can classify them according to five primary using Air Force commands: the Air Training Command (ATC); the Tactical Air Command (TAC); the Aerospace Defense Command (ADC); the Strategic Air Command (SAC); and the Military Airlift Command (MAC)—whose main airlifters have already been described in Chapter 1, but not its various special-purpose aircraft. There are 15 major commands in the Air Force, 9 of which have some kind of flying as a major part of their mission, but the 5 mentioned are sufficient to cover the variety of Air Force types and how they are employed.

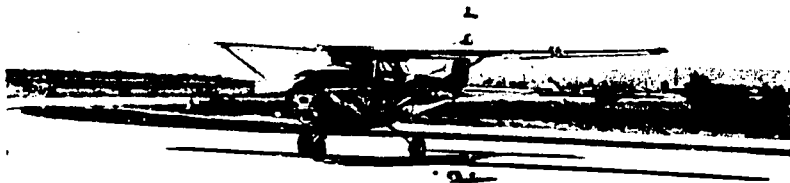

Figure 51. PRIMARY TRAINER—light, propeller-driven Cessna T-41.

AIR FORCE AIRCRAFT

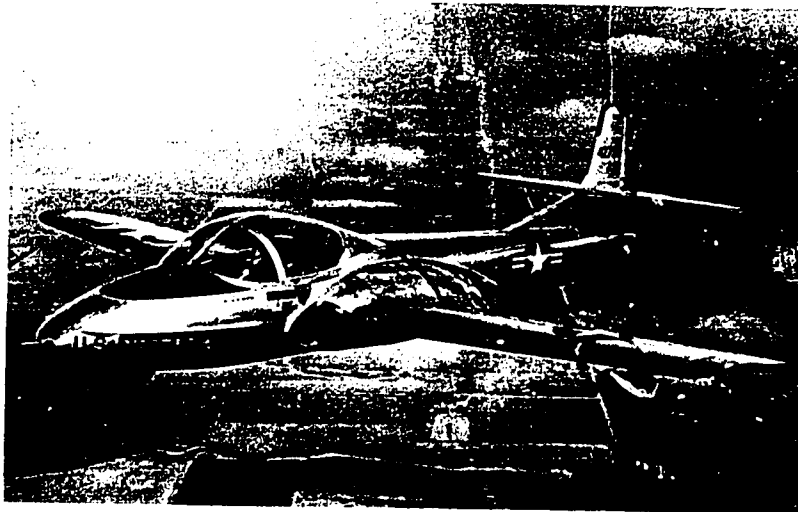

Figure 52. JET TRAINER—Cessna T-37 (see also Figure 60.)

Let us introduce the Air Force line of aircraft the way it is introduced to a new pilot.

ATC TRAINERS

The Air Force pilot wins his wings by completing the **Undergraduate Pilot Training (UPT)** program of the Air Training Command. This program makes him a jet pilot no matter what kind of advance training he will later take in one of the operational commands like SAC or TAC. In UPT, only a minimum amount of time—30 hours—is spent behind a propeller. The rest of this intensive program calls for 90 hours in a subsonic jet and 120 hours in a supersonic jet.

The three aircraft used in this program are—

1. The Cessna T-41A, a light two-seater private-type airplane fitted for instructional purposes with dual controls. It has a 145 hp piston-driven engine and a simple fixed-pitch propeller (Fig. 51).

2. The Cessna T-37, (affectionately called the "Twecety Bird"), a twin turbojet, one of the lightest turbojet aircraft made. It weighs 6,600 pounds and has a wingspan of 35 feet. It has a speed of 350 mph and a ceiling of 35,000 feet. Its engines are rated at 1,050 thrust pounds each. It has seats for student and instructor side by side (Fig. 52).

AIRCRAFT OF TODAY

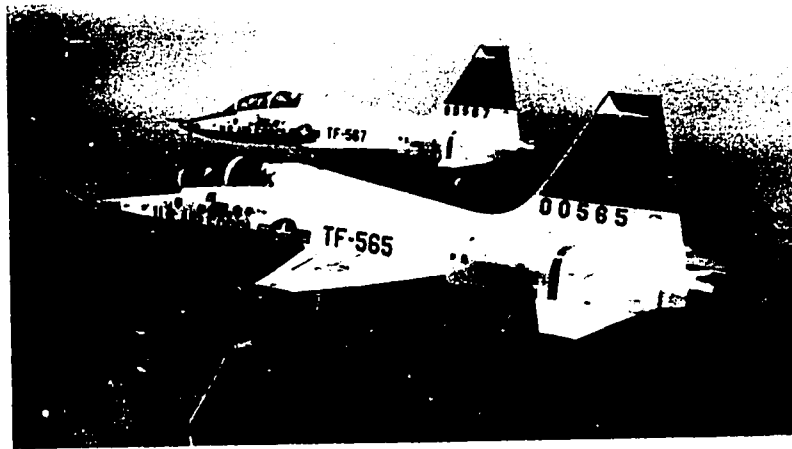

Figure 53. SUPERSONIC TRAINER—Northrop T-38.

3. The Northrop T-38. This one can go supersonic, with a top speed of 850 mph or mach 1.2. This 11,600 pound aircraft has a power plant of two 3,850 thrust pound turbojets with afterburners, set closely side by side in the tail. It can reach over 55,000 feet altitude (Fig. 53).

Another training aircraft of ATC is the Convair T-29 Flying Classroom, for instructing navigators, bombardiers, radio operators and other crewmen. This large twin-engine piston-driven aircraft is an adaptation of the C-131, a former transport and hospital plane (there is a commercial airliner version still in use). The T-29 is fitted with multiple stations for students, each equipped with panels of working flight instruments and avionics. The T-29 is identifiable from the outside by a row of astrodomes along the top of the fuselage (Fig. 54). It has room for 14 students and two instructors. The Air Force may possibly adapt a jet airliner of the DC-9 or 727 class for this purpose.

TACTICAL WARRIORS

The Tactical Air Command (TAC) trains and equips units to be ready for combat in any part of the globe. Many of these units are then transferred to a geographical overseas command like the **United States Air Forces in Europe (USAFE)** or **Pacific Air Forces (PACAF)**, which are also part of the Nation's tactical air forces. Tactical

AIR FORCE AIRCRAFT

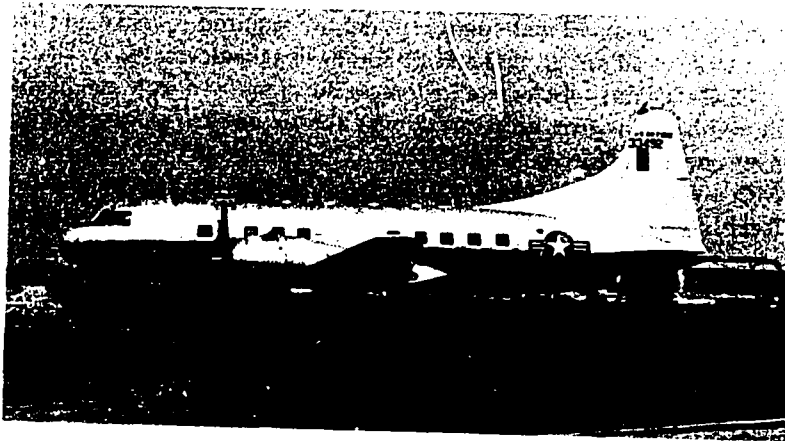

Figure 54. NAVIGATION TRAINER. Convair T-29 is based on C-131. Note row of astrodomes.

type aircraft usually lack global range because they are designed for a variety of combat missions in close or indirect support of ground forces within a zone of operations called a theater. Korea and Vietnam are examples of such theaters where the United States has fought tactical air wars in modern times. In the Middle East, tactical air warfare has been fought between Israel and her Arab neighbors. In fact, since World War II ended, the world has avoided another global war but it has not known peace. Numerous limited wars have been fought throughout the world, and tactical rather than strategic air and ground forces have borne the brunt of them. In the Air Force, the greatest number and variety of aircraft are flown by TAC and associated commands. New tactical aircraft must be designed for the possibility of other limited wars in the future.

Missions of Tactical Airpower

Tactical airpower has five main missions: **counterair**, **interdiction**, **close support**, **reconnaissance**, and **airlift**. Different types of Air Force tactical aircraft are designed to perform one or more of these missions. Navy and Marine Corps aviation is all tactical in nature, has similar missions, and uses similar aircraft. Army aviation (mostly helicopters plus a few light propeller-driven airplanes) also performs certain of these missions. Close cooperation and a well-organized radio and radar

AIRCRAFT OF TODAY

equipped **command-and-control system** are required to make an effective team of all air, ground and sea forces in a theater.

COUNTERAIR.—Before other forces, air or surface, can be effective in combat, it is first necessary to win the air battle—gain supremacy over enemy air forces in the theater. This can mean air-to-air combat with enemy aircraft. **Counterair** includes theater air defense, but preferably it is offense. The counterair battle is best won by destroying enemy airpower while it is on the ground by bomb and rocket strikes at enemy airbases, radar sites, and other ground installations.

INTERDICTION.—**Interdiction** is the effort to seal off enemy troops from their lines of reinforcement, supply, and communications. **Interdiction** strikes are made behind enemy lines at roads, bridges, supply depots, truck columns, radio and radar sites, and other targets.

Both the counterair and interdiction missions require flights deep into enemy territory, strikes against well-defended targets, and possible encounters with enemy fighter planes. Therefore, these missions demand the use of well-armed supersonic aircraft classified as **fighters**, (indicated by an "F" prefix, such as in "F-105" or "F-4"—see the box "What Do the Letters and Numbers Mean?").

CLOSE SUPPORT.—**Close support** means backing up the firepower of ground troops with that of aircraft. Strikes are made at enemy troop positions or fortifications at the request of ground forces. Either fighters or subsonic attack ("A" prefix) aircraft can be used in close support missions. Army helicopter gunships are also heavily used.

RECONNAISSANCE AND OBSERVATION.—Tactical air **reconnaissance** includes all means of keeping watch on the enemy from the air—by photography, radar, and other sensors, or by plain visual observation. Reconnaissance missions deep behind enemy lines require the use of fighter-type reconnaissance airplanes ("RF") for the sake of high speed and evasion of enemy fighters and ground fire. The reconnaissance plane is usually unarmed because of the weight of the cameras, electronic gear, and other equipment of this system.

One problem of modern air reconnaissance is that photographs and other recorded images require time for processing and careful study before any worthwhile information can be passed on to ground or air commanders. Therefore, there is still a place for low-and-slow flying for **visual observation**. The airborne observer uses his radio to report what he sees instantly, and to produce instant response from ground or air units in the vicinity. Visual observation is usually done from small,

AIR FORCE AIRCRAFT

light airplanes like the O-2 described in Chapter 5. A **forward air controller (FAC)** flying in such an airplane has the job of spotting enemy positions on the ground. Then he calls in strike aircraft, marks the target by means of smoke rockets, and directs the air strike against it. This type of observation and control is a part of the close-support mission.

AIRLIFT.—Tactical airlift aircraft were described along with those used in global military airlift in Chapter 1. The tactical airlift mission is shared with the Army, which uses its own helicopters for positioning troops on a battlefield and much of its short-range troop-carrying and resupply missions. The Army draws on the Air Force whenever there is a need for more range, speed, or payload capacity. Further discussion of tactical airlift is found in Chapter 8, where the emphasis is on helicopters and STOL and VTOL airplanes. Such aircraft are important in tactical airlift and its future development.

Below are described aircraft used in the other four tactical air missions. These can be conveniently divided into two classes: supersonic and subsonic.

Supersonic Fighter and Reconnaissance Aircraft

By definition, a fighter airplane is one "designed primarily for intercepting and destroying other aircraft in the air." So says the *USAF Dictionary*, published back in 1956. That definition still holds, even though tactical fighter aircraft have been employed more against ground targets than air targets in modern times.

Ever since the Air Force began using the F-100 Supersabre in the mid-1950s, the main feature of fighter aircraft has been supersonic speed. It is essential for survival, if not victory, in modern air-to-air combat, or in a strike against a target surrounded by a modern well-coordinated air defense system of ground-based missiles and guns guided by radar. The modern fighter airplane is also much larger and heavier than its earlier-day counterpart. It still carries only a one- or two-man crew, but its maximum takeoff weight has grown from 18,000 pounds* to 40,000 and on up to 80,000 pounds of "weapon system."

Much of the weapon payload is carried under the wings of the fighter. Fighters cannot fly at supersonic speed when they are thus

* This was the maximum gross takeoff weight of the F-86 Sabrejet, the top-performance fighter of the Korean War (1950-53).

AIRCRAFT OF TODAY

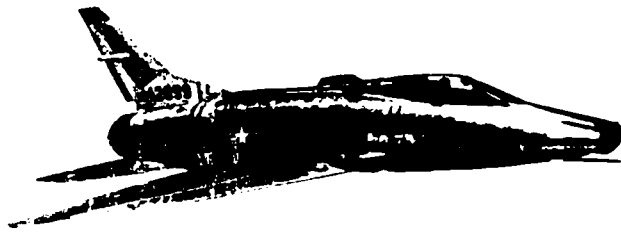

Figure 55. F-100 SUPERSABRE was the first US supersonic fighter.

overloaded. The supersonic capability is mainly for the purpose of fast penetration of enemy defenses with a reduced weapon load, mostly carried internally, or a quick getaway after the rockets have been fired and the bombs dropped.

FIGHTER TYPES.—TAC fighter weapon systems in current use include the North American F-100 Supersabre; Republic F-105 Thunderchief; McDonnell-Douglas F-4 Phantom II; and General Dynam-



Figure 56. F-105 THUNDERCHIEF—heavy-hitting supersonic strike aircraft.

AIR FORCE AIRCRAFT

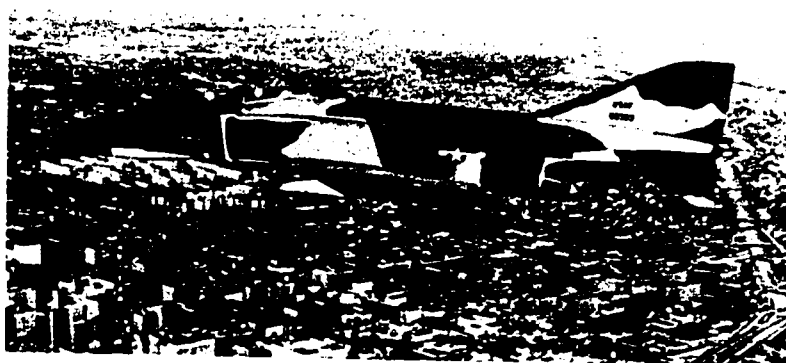

Figure 57. F-4E PHANTOM II is current top US fighter (shown over St. Louis).

ics F-111. The first two of these are no longer manufactured, but remaining ones are still in use. The latter two are current models in production.

The F-100 Supersabre (Fig. 55) has a single 15,000 thrust-pound turbojet engine with afterburner and a maximum weight of 38,000 pounds. It has a speed of over mach 1 or 800 mph. It carries a heavy mixed-armament load, including four 20 mm. cannons, plus rockets, bombs and other munitions. No longer a first-line fighter, it has been used mainly in close-support ground-attack roles, but a two-seat version has also been used in deep interdiction raids as a so-called **Super FAC** airplane to direct strikes by other fighters.

The larger and faster F-105 Thunderchief (Fig. 56) has a maximum gross takeoff weight of over 50,000 pounds and a single turbojet of 26,500 pounds of thrust to give it a speed of mach 2.25. It is armed with a 20 mm. multibarreled **Vulcan Gatling Gun** capable of firing up to 4,000 rounds per minute and can carry up to 6 tons of bombs and rockets. There are one- and two-seat versions of this aircraft, some designed to carry both bombs and reconnaissance equipment on the same mission, others to carry special weapons for knocking out enemy air-defense radar systems.

Current backbone of the tactical fighter fleet is the two-seat F-4 Phantom II—used in different versions by the US Air Force, Navy, and Marines, and also exported to certain allies. It has a maximum

AIRCRAFT OF TODAY

gross takeoff weight of 58,000 pounds and is powered by twin jets, both in the rear fuselage, with 17,000 or more pounds of thrust each. Speed is mach 2.5, ceiling above 66,000 feet (Fig. 57). Bomb and armament load is 7 tons. Some models carry internal "Gatling Guns" (Fig. 58). It has proven to be a superior air-to-air fighter over North Vietnam and (in the hands of Israeli flyers) in the Middle East.

Largest of all the tactical fighters is the swing-wing F-111, described in Chapter 3. It is 74 feet long, has a wingspan that varies from 32 to 63 feet depending on variable sweep, and a maximum weight of 80,000 pounds. It can cross the Atlantic unrefueled. Aside from its famous swing-wing feature, the F-111 is notable for its advanced avionics and fire-control equipment, which gives it the ability to navigate and hit targets in all kinds of weather and visibility conditions.



Figure 58. F-4E PHANTOM II, showing internally-mounted 20 mm. Gatling Gun.

AIR FORCE AIRCRAFT

Although it is not in the USAF lineup, the Northrop F-5 Freedom Fighter should be mentioned. This aircraft of American manufacture is currently flown only by the South Vietnamese and other foreign air forces. Relatively light and simple compared to other fighters, it still has supersonic speed. It is an adaptation of the previously-described T-38 supersonic trainer, but with increased capacity for carrying armament and increased engine thrust to match.

After years of emphasis on building bigger and heavier fighter-bombers, the Air Force is now taking renewed interest in the fighter airplane's capabilities for air-to-air combat. The development of the Mig-23 and other advanced Soviet fighters has stimulated this interest. Under research and development is the F-15, a single-seat fighter designed primarily for the air-superiority battle. The F-15 is expected to weigh about 40,000 pounds. It will probably have a mach 2.5 speed, no faster than that of the F-4, but it will have an airframe better built to withstand the stresses and strains of maneuverability at high speed and will have other features of both airframe and armament to give it the edge in air-to-air combat and a secondary ability to strike at ground targets.

RECONNAISSANCE AIRPLANES.—As we have noted, the reconnaissance mission often requires the speed and performance of a supersonic fighter. Indeed, the most advanced fighter is often the one picked for modification for this purpose. Currently the only "RF" aircraft active in the Air Force is the RF-4, which has replaced all RF-101s in both Southeast Asia and Europe. The RF-4's payload of reconnaissance equipment includes a variety of cameras, radars (including some that make images almost as clear as photographs) infrared sensors, and other devices that can pick up images or signals from the ground, sometimes penetrating fog and clouds to do so.

Subsonic Attack, Observation, and Special Aircraft

Many uses have been developed for combat aircraft that are not supersonic. If air superiority has been established over a battle zone, then subsonic aircraft can operate with little or no danger of being attacked by enemy jets. Subsonic jet or propeller-driven attack ("A" prefix) aircraft are especially effective in close support. It may seem odd that front-line combat conditions would demand less speed of an airplane, but the front is often a place where the enemy does not have

AIRCRAFT OF TODAY

time to set up an elaborate radar-controlled air defense system. The danger from enemy ground fire is present, but these slower but more maneuverable aircraft have their own ways of coping with it.

SUBSONIC JETS.—The leader among the Air Force's attack aircraft is at present the Ling-Temco-Vought A-7D Corsair II (Fig. 59), originally designed for the Navy. Despite the fact that it is not supersonic, it is every inch a modern weapon system. Its maximum takeoff weight is more than 40,000 pounds, including a bomb, rocket, and Gatling Gun ammunition payload of over 7 tons, much of it carried under the wings. Somewhat more lightly loaded, yet carrying 4 tons of weapons, it can achieve a combat radius of 400 miles plus one hour of loiter time in the target area before returning to its base. Its speed is over 600 mph.

In some combat situations this attack plane is deemed more survivable than some supersonic fighters because of its armor plate and avionics. The latter allow it to fly low to escape enemy radar detection, at the same time avoiding hills and other obstructions. It can be used on some interdiction as well as close-support missions.

A lighter jet, much used in close-support strikes in South Vietnam, is the Cessna A-37, based on the T-37 jet trainer (Fig. 60). Like the

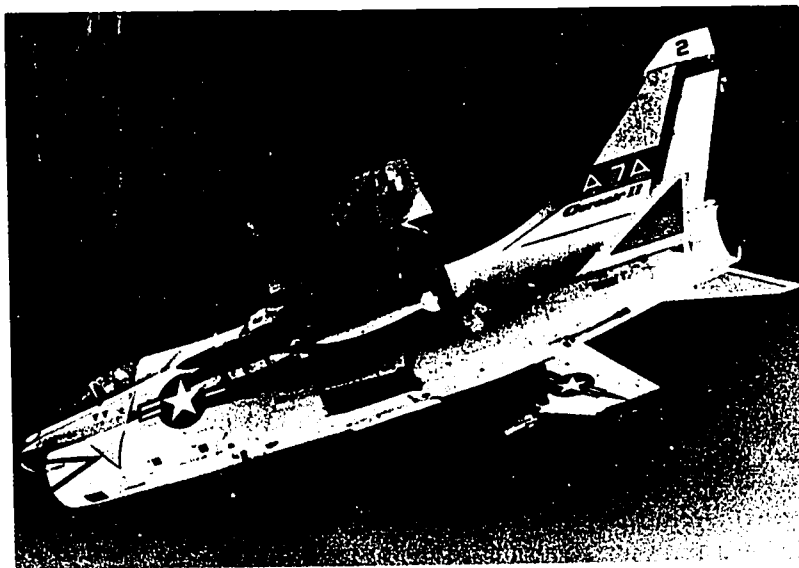

Figure 59. A-7 CORSAIR II is subsonic but thoroughly modern attack airplane.

AIR FORCE AIRCRAFT

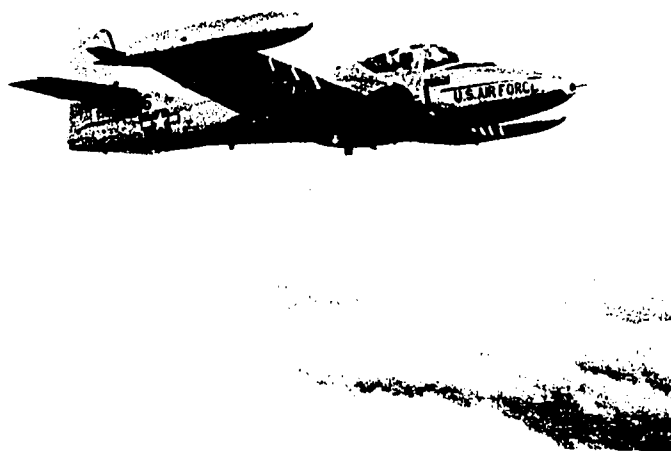

Figure 60. A-37-ATTACK airplane adapted from T-37 trainer.

F-5, the A-37 has a heavier payload and more thrust than its original trainer model. It can carry a payload of 5,500 lbs and a crew of one or two. Its maximum gross takeoff weight is 14,000 pounds.

An older medium-size subsonic jet that has seen combat in recent years is the McDonnell-Douglas EB-66, a former bomber redesigned as a reconnaissance aircraft and more recently as an electronic jamming aircraft (Fig. 61). This 80,000 pound aircraft has a speed of over 600 mph. Another long-surviving warrior of the same class is the Martin-Marietta B-57 Canberra, a British-designed bomber that has been extensively remodeled by its American manufacturer. The basic model has a length of 65½ feet and a wingspan of 64 feet (Fig. 62). Other versions have wingspans of over 100 feet and can reach altitudes well above 65,000 feet. There is an RB-57 for reconnaissance, and a newly-redesigned B-57G is a specialist in attacking ground targets at night and in bad weather. Speed is 600 mph.

The Air Force hopes to add yet another jet attack plane to its lineup. Tentatively it is called the A-X. It will be a single seater designed to supplement the new A-7s in a modernized ground-attack force as older attack jets and propeller-driven types are retired from

AIRCRAFT OF TODAY



Figure 61. EB-66 DESTROYER, former bomber now adapted to special tasks.

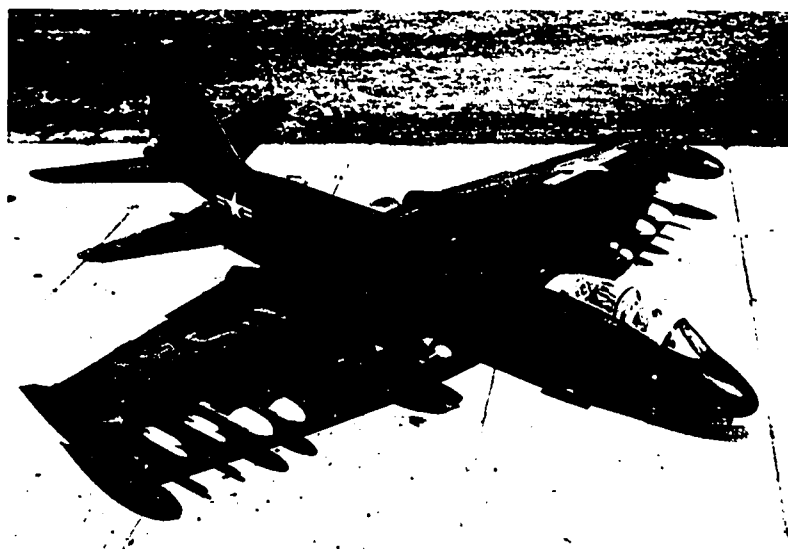

Figure 62. B-57 CANBERRA, another multi-role former bomber.

AIR FORCE AIRCRAFT

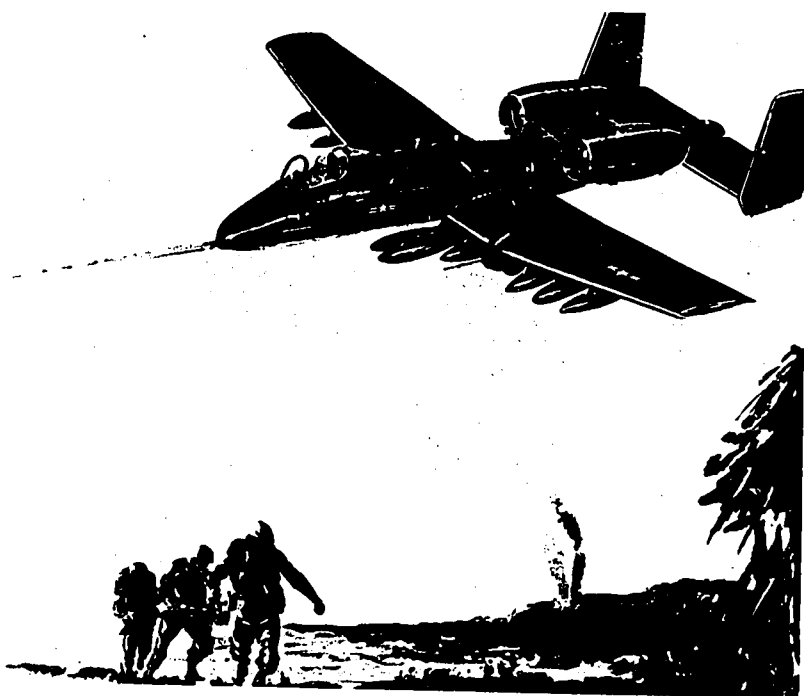

Figure 63 a and b. TWO VERSIONS OF A-X. Both of these competing designs for future attack plane show turbofan engines.

AIRCRAFT OF TODAY

service. It will carry a somewhat lighter payload than that of the A-7 and be slower, with a top speed under 500 mph. It will be more economical to build and operate, however, and will also have advantages of STOL and maneuverability which, up to now, have been limited to propeller-driven aircraft. For a while, it was thought that the A-X would be turboprop powered, but two companies currently competing for the contract to make the A-X have come up with designs for twin-turbofan airplanes (Figs. 63A and B).

PROPELLER-DRIVEN ATTACK AND SPECIAL AIRCRAFT.—In one mission in South Vietnam, reciprocating-engine Douglas A-1E Skyraiders made a strike at an enemy camp in a valley under a blanket of clouds that was lower than the surrounding mountaintops. The Skyraiders maneuvered through holes in the overcast, flew under the clouds to make the strike, then flew up through the clouds to escape. This kind of maneuverability is one of the reasons why propeller-driven aircraft have continued to see much combat in Southeast Asia and why some new or proposed Air Force aircraft feature turboprop rather than jet

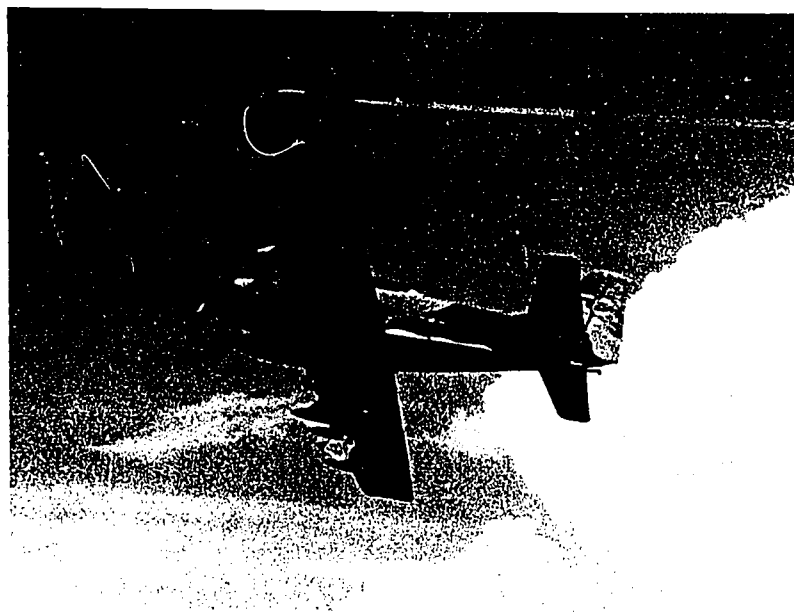

Figure 64. A-1 SKYRAIDER, reciprocating-engine attack plane heavily employed in Southeast Asia, shown armed with 500-pound bombs.

AIR FORCE AIRCRAFT

propulsion. Another advantage of propeller-driven aircraft in such a combat theater is **loiter capability** or ability to fly slowly for great lengths of time without refueling. Good STOL capability, of course, is still another. It permits combat aircraft to be dispersed at many locations rather than concentrated and hence more vulnerable at one big air base.

Propeller-driven aircraft are used in tactical warfare for close-support ground attack, for FAC and other observation tasks, for leaflet scattering, airlift and many other purposes. We must repeat, however, that all these uses of propeller-driven aircraft depend upon the establishment of air superiority in a theater in the first place. Behind all these operations stands the jet fighter, whether or not there is any need for its employment at the time.

The aforementioned A-1 Skyraider (Fig. 64) has seen much action in Southeast Asia. It has a maximum weight of 19,000 pounds and can carry up to 8,000 pounds of payload. It is powered by a 2,700 hp reciprocating engine and has a top speed of 365 mph. The Air Force is now replacing them with A-7s and hopes that the A-Xs of the future will also fill the gap left by this versatile warrior.

In Chapter 1 we mentioned three transports converted to gunships. The first of these was the AC-47 Gooney Bird, followed by the



Figure 65. FIGHTING BOXCAR—AC-119 Flying Boxcar transport converted to attack plane, shown over Vietnam.

AIRCRAFT OF TODAY

AC-119 and then, largest of this type so far, the AC-130 Hercules. All of these aircraft are armed with side-firing machine guns of the extremely rapid-firing multi-barrelled Gatling Gun type. The AC-47 mounts three 7.62 mm "Miniguns"; the AC-119 four Miniguns (Fig. 65) and the AC-130 four Miniguns plus four 20 mm Vulcan cannons. The advantage of using transports for gunships is large capacity for both fuel and ammunition so that the target can remain under sustained attack for hours. Again, however, we must note that both enemy airpower and ground-based air defenses must be weak to permit such relatively slow airplanes to operate. They have been effective in warfare against guerrillas.

Light observation aircraft such as the O-1 Birdog and the O-2 Skymaster were mentioned in Chapter 5 because these are military adaptations of general-aviation type aircraft available on the civilian market. In addition to these, the Helio U-10 Courier and the North American Rockwell OV-10 Bronco should be mentioned. The U-10 (Fig. 66) is a light transport and utility plane, seating four to six, with amazing STOL capability, being able to take off over treetops 500 feet away from starting point. It has a cruising speed of 150 mph and can stay aloft at speeds as low as 30 mph. The OV-10 Bronco (Fig. 78) is a turboprop-powered observation, light reconnaissance, and light at-

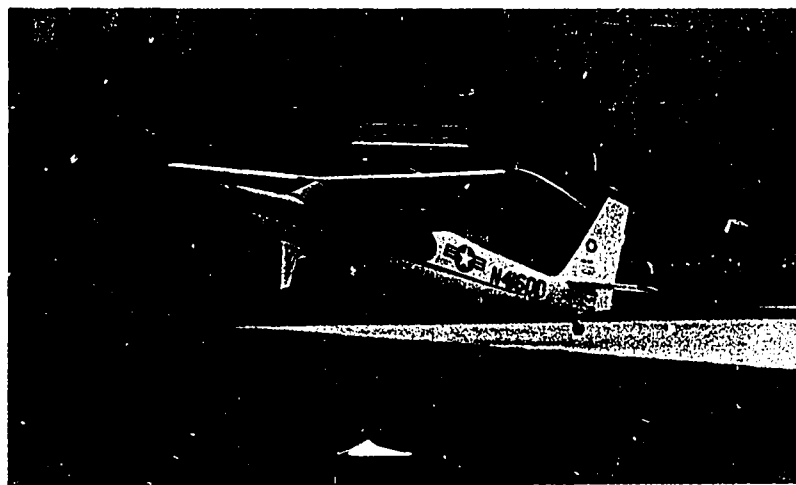

Figure 66. STOL DEMONSTRATION. U-10 Courier shows unique STOL capability in front of Pentagon in Washington, D.C.

AIR FORCE AIRCRAFT

tack airplane. It has a twin-tail construction similar to that of the O-2 but is larger, heavier, and more powerful. Its twin turboprop engines of 715 shp each give it a top speed of 280 mph and a payload capacity of 3,200 pounds. Its STOL performance is equal to that of much lighter planes.

ADC INTERCEPTORS AND WARNING AIRCRAFT

The Aerospace Defense Command (ADC), is the USAF component of the North American Air Defense Command (NORAD)—a combined two-nation command which includes aerospace defense forces from all US services and Canada. NORAD operates a vast complex of radar and communications networks and weapons for defense against any enemy airborne or spaceborne threat to our continent—manned or unmanned. The weapons include surface-to-air missiles like the Army's Hercules and Hawk missiles and the Air Force's ramjet-powered Bomarc (mentioned in Chapter 4. See again Figure 26). It also includes the new Safeguard system being erected against possible enemy intercontinental missile attack.

Our interest here, however, is only in the manned aircraft used by ADC and Canadian Air Force units to protect the continent against the enemy manned-bomber threat. While military experts consider this threat to have been minor for many years, they also know it exists and could increase. Consequently, the ADC manned-aircraft force is at present small, but efforts are made to keep it modern and capable of rapid growth if necessary. This manned-aircraft force consists of ground-controlled fighters called interceptors and large radar planes to provide early warning. Under development is a large radar plane and flying command post called Airborne Warning and Control System (AWACS).

Fighter Interceptors

Turn back to Chapter 3, Figure 19, and again note the four ADC interceptors shown in one picture. Actually, most of ADC's present small interceptor force are General Dynamics-Convair F-106 Delta Darts, shown at bottom. Its predecessor, the F-102 Delta Dagger, has been turned over to Reserve and Air National Guard units. Small numbers of McDonnell F-101 Voodoos (right) remain in ADC; others serve with Canadian units. The Lockheed F-104 Starfighter (left)

AIRCRAFT OF TODAY

no longer flies with ADC, but West German and other European air forces fly the F-104G, which is manufactured abroad. The function of the air defense interceptor is best described by talking about the F-106.

The interceptor must travel light. It is not loaded down with bombs and rockets for pouring heavy fire on ground targets but has a select few weapons reserved for the brief encounter of the air-to-air battle. It does not rove the skies like a hunter but is more like a watchdog, guarding a specified piece of property. It waits for emergencies on ground alert, ready to scramble or take off instantly when given the alarm. After being airborne, the interceptor is still controlled from the ground. The ground controller sits in an installation which is a nerve center of radar communications and computers, and a command post for the air battle. The ground controller guides the interceptor to the target area where the aircraft's own radar and weapons system will pick up and identify the suspected aircraft. In an F-106 much of this guidance is automatic; the pilot is almost like a man riding inside a guided missile, but he is monitoring the action and can switch to manual control when he feels it is necessary. In other interceptors, this

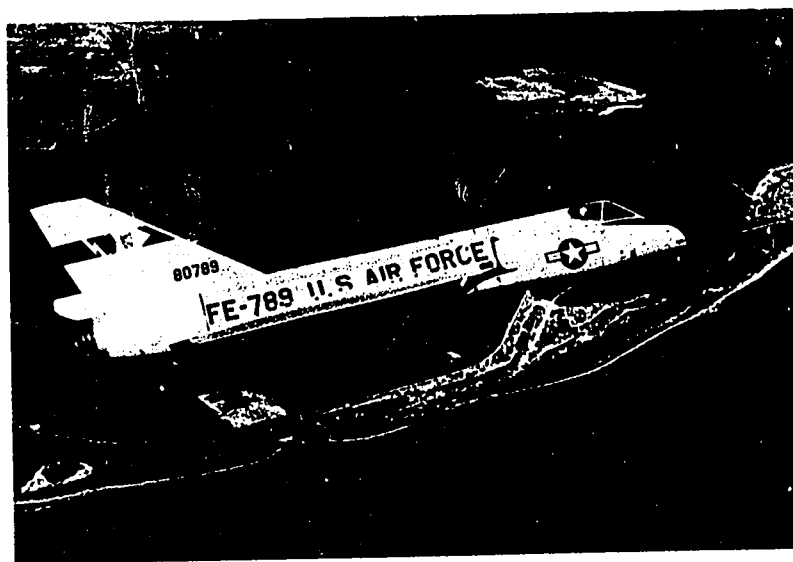

Figure 67. F-106 DELTA DART, fighter-interceptor especially designed and equipped for ground-controlled air defense.

AIR FORCE AIRCRAFT

guidance may be by signal or voice, but in all cases, the ADC interceptor carries a complex array of airborne radar and other avionics to maintain constant communication between pilot and ground controller, and fire and guide weapons when necessary.

In all of NORAD's history, no hostile aircraft has ever entered the North American airspace, but ADC interceptors have been scrambled frequently to check on suspicious tracks on ground-based radars only to find that they were the tracks of innocent commercial or private aircraft whose pilots had failed to file correct flight plans. Our air defense system cannot afford to act otherwise, cannot let down its guard. Yet, in all these incidents, no innocent aircraft has been fired upon. Such is the basic advantage of the *manned* interceptor. After the aircraft's speed and guidance system get it out to the point of intercept in due time, the man in the cockpit takes over, inspects the suspicious aircraft, questions its pilot by radio or checks its identifying radio signals, and uses his own judgment about firing or not firing his weapons. An unmanned air defense missile, once launched, is committed to destroy

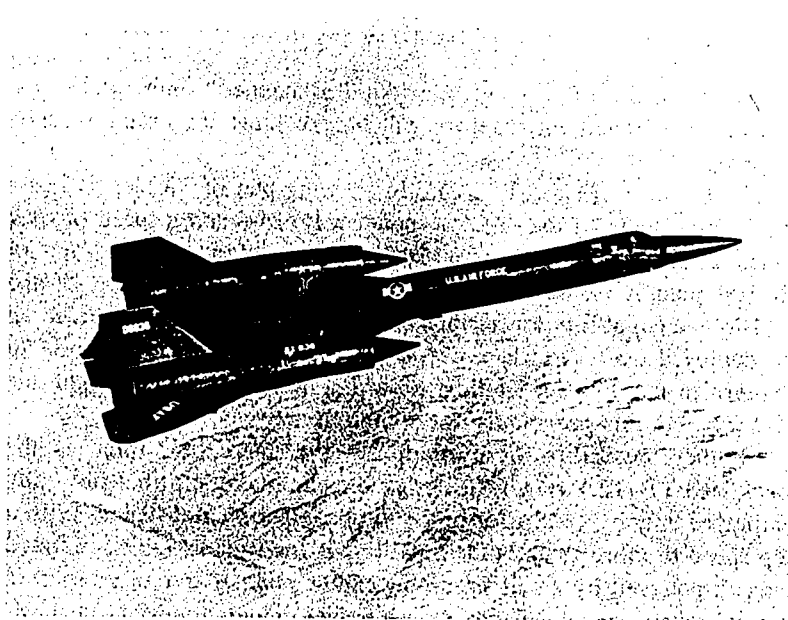

Figure 6B. WORLD'S FASTEST air-breathing manned aircraft (mach 3) is YF-12A, designed as an interceptor.

AIRCRAFT OF TODAY

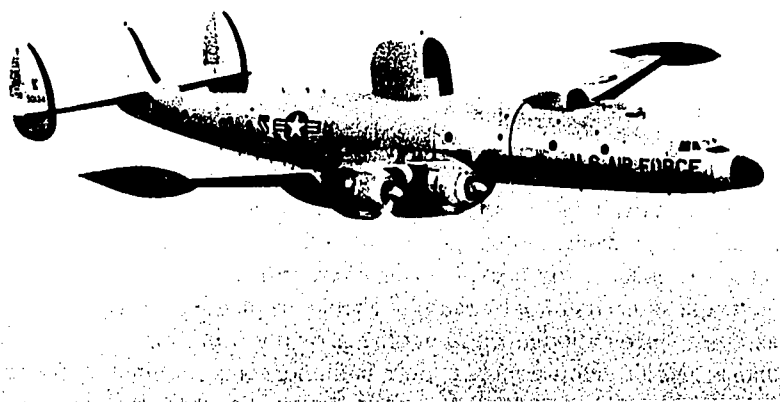

Figure 69. WARNING STAR. EC-121 provides long-range radar warning.

its target. Therefore, as long as any kind of manned bomber threat exists at all, manned interceptors will be the most important weapon against it.

The F-106 is 71 feet long and has a wingspan of 38 feet. It has a maximum weight of over 35,000 pounds. It can reach a speed of over mach 2 and a ceiling of over 50,000 feet with its one turbojet of 24,500 pounds of thrust (Fig. 67). One recent modification of the F-106 is a capability for aerial refueling, so an interceptor force can be deployed overseas when needed. More changes can be made to modernize the F-106, leading toward a weapon system called the F-106X, but this program is not at present active.

Another possibility for modernizing the interceptor force is the Lockheed YF-12A (Fig. 68), designed as an interceptor but presently employed only by NASA for high-altitude experimental flights. With a top speed of more than 2,000 mph, this is the world's fastest manned aircraft powered by an air-breathing engine and capable of unassisted ground takeoff and landing.* A new Soviet fighter, the Mig-23, how-

* We must state all these conditions because of the higher performance records of the X-15. The X-15 rocket ship could be called a "manned aircraft" but it did not have an "air breathing" engine, and it could not take off from the ground.

AIR FORCE AIRCRAFT

ever, has challenged some of the YF-12A's performance records. The YF-12A was designed to employ a special long-range air-to-air missile and operate at extremely high altitude. If necessary, it could seek and intercept its own targets independent of ground control. It is 101 feet long and has a wingspan of 55 feet, and is powered by two 30,000 thrust pound turbojets with afterburners.

Early Warning and AWACS

For many years ADC has flown the Lockheed EC-121 Warning Star (Fig. 69) based on the C-121 Constellation. (The Constellation, a former commercial airliner and Air Force transport with four reciprocating engines and a speed of 300 mph, is flown today by Reserve and Air National Guard units.) As remodeled for ADC, the EC-121 carries 6 tons of radar and other electronic equipment, part of which is housed in bulging radomes above and below the fuselage. Its function is that of an offshore-patrolling flying radar platform guarding the sea approaches to the continent. Some EC-121s have been deployed to



Figure 70. AWACS IN ACTION. Artist's concept shows AWACS guiding interceptors toward approaching enemy bombers (far left).

AIRCRAFT OF TODAY

Southeast Asia, where they serve as radar escorts providing early warning to tactical fighters.

AWACS is a new concept, currently in the design stage. It is a large jet transport-type aircraft which combines the early-warning flying radar function of the EC-121 with that of a flying command post like the EC-135 (Fig. 70). The airframe will be a redesigned Boeing 707, larger than the EC-135 and altered in appearance by a large saucer-shaped radome on top. The aircraft will also have double engine nacelles under the wings to provide eight rather than four engines. The outboard radar will have much greater range than that of a small radar that could be contained within the fuselage. It will also have the ability to "look down" and spot enemy aircraft trying to penetrate at low altitude to escape detection by ground radar. Multiple controller stations will be able to direct numerous interceptors at once. This airborne control system, furthermore, should be much less vulnerable to enemy attack than a ground-based system. Both AWACS and a force of interceptors could be deployed overseas as a team to set up an instant air defense system anywhere in the world. Therefore, TAC is also interested in the concept.

THE SAC GLOBAL FLEET

With its mission of deterring aggression by maintaining the power of instant retaliation, SAC has missiles and manned bombers capable of reaching targets anywhere in the world. Manned aircraft of the SAC fleet are designed to achieve or support this global capability.

Bombers

Mainstay of the SAC manned bomber force remains the mighty Boeing B-52 Stratofortress (Fig. 71). This giant is 156 feet long, has a wingspan of 185 feet, and a maximum takeoff weight of up to 500,000 pounds. It is powered by eight jet engines, those in the B-52H being turbofans of 17,000 pounds of thrust each. It can reach speeds of over 600 mph. Ranges of various models are from 6,000 to more than 9,000 miles unrefueled. The G and H models have fuel tanks built into the wings.

The B-52 Stratofortress has played a part in the Vietnam conflict, where its tremendous payload capacity is used for conventional bombs used in tactical-type missions, not the kind of missions for which the

AIR FORCE AIRCRAFT



Figure 71. B-52 STRATOFORTRESS being refueled in flight by a KC-135 tanker.

B-52 was designed, but typical of the Air Force's flexibility in meeting new problems.

The B-52, however, is an old airplane. It has been flying since the early 1950s. Even the latest models are almost ten years old at this writing. And in an age of intercontinental missiles, the question of the deterrence power of a B-52 or even a more modern manned bomber keeps arising. So far Air Force leaders have favored keeping a strategic bomber fleet. They reason that a land-based missile could be a "sitting duck" for an enemy missile, while a manned bomber could be airborne before the enemy missile struck. A manned bomber could be recalled in case of false alarm. And even the present B-52 has ways of evading and penetrating enemy defense systems that a missile cannot use. Plans, therefore, call for keeping the B-52s flying at least until the mid 1970s and then replacing them with new type strategic bombers.

One such bomber, already flying, is the General Dynamics FB-111. This is an enlarged version of the F-111 fighter. With a payload of more than 30,000 pounds, it can fly at intercontinental range at high subsonic speed. It can reach mach 2.2 after dropping its wing load and sweeping back its wings.

The hoped-for replacement of the B-52 is called the B-1. It, too, may have variable-sweep wings, but will be much larger than the

AIRCRAFT OF TODAY

FB-111. It is even expected to carry a larger payload than the B-52, although its gross weight might be less (Fig. 72). Besides its bombs, it will carry very advanced airborne missiles designed to confuse or destroy enemy defense systems and attack targets at long range. It will probably have supersonic dash capability but not necessarily the supersonic cruise capability of an SST. Like the B-52, it may also be used in tactical warfare as a conventional bomber.

Other SAC Aircraft

Earlier in this chapter we mentioned the YF-12A, an extremely advanced mach 3 aircraft that might serve as an interceptor. The SR-71 is a slightly longer version of the YF-12 (see again Figure 68) which is employed by SAC for strategic reconnaissance. It has sufficient range and the extremely-high altitude capability for this task.

In Chapter 1 we mentioned the Boeing KC-135 tanker (see again Figure 71). For SAC's long-range operations, and even for many tactical operations, aerial refueling is a must. SAC has the task of acrial

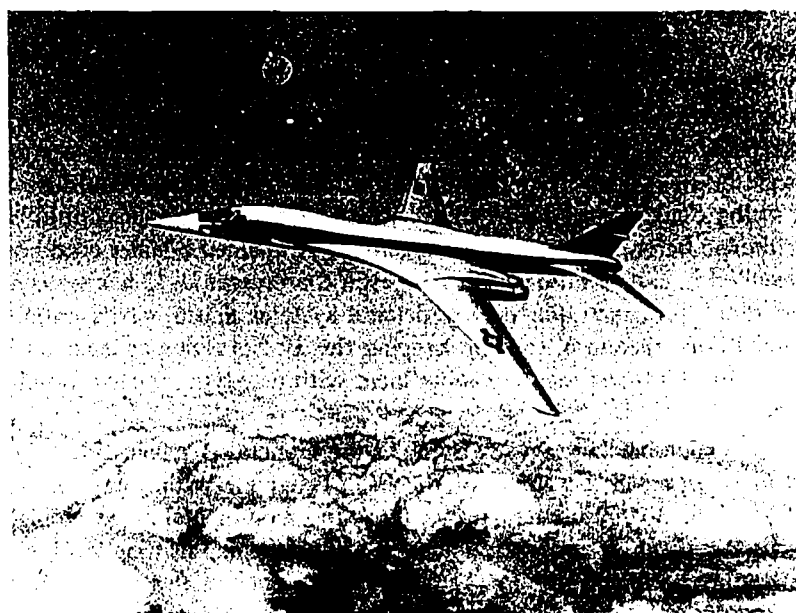

Figure 72. PROPOSED B-1 BOMBER. Artist's concept shows swing wings.

AIR FORCE AIRCRAFT

refueling for aircraft of its own and other commands. Serving tactical aircraft, the KC-135 has been a mainstay of the air effort in Southeast Asia. You should by now be familiar with the C-135 military transport and 707 commercial airline roles of this versatile aircraft. SAC also has EC-135s fitted out as flying command posts, others as RC-135 radar reconnaissance planes. Still other uses of this aircraft are described below.

MAC TECHNICAL SPECIALISTS

Aircraft of the Military Airlift Command (MAC) were described in Chapter 1 of this unit. In addition to its primary mission (most basic task) of global airlift, MAC has attached to it certain branches known as technical services. Included in these services are the Aerospace Rescue and Recovery Service (ARRS), the Air Weather Service (AWS), and the 1370th Photomapping Wing, each having unique aircraft tasks.

Associated with the main airlift mission is the operation of flying specially equipped hospital planes—the Douglas C-9 Nightingale on domestic missions and the Lockheed C-141 Starlifter for bringing home sick and wounded personnel from overseas with a maximum of speed and comfort. The C-9, a twin-jet aeromedical transport, cuts in half the time it formerly took to transport patients by air from one point to another within the United States. The C-9 uses the DC-9 commercial transport airframe (see again Figure 44) but the interior has been designed to meet the requirements of medical services for the sick and wounded. Some special features of this jet-propelled hospital are an isolated special-care compartment equipped with a germ-killing ultraviolet filter exhaust system and humidity and pressure control; an inclined ramp and stairways; and seats with flat-folding backs to serve as leg rests. The passenger capacity varies from 30 to 40 depending on the number of litter patients.

Aerospace Rescue and Recovery Service is famed for rescuing downed flyers on land and sea all over the world and occasionally pops into the news when its pararescue men come to the aid of astronauts and their space vehicles after a splashdown at sea. ARRS is perhaps better known for flying helicopters than fixed-wing aircraft. In fact, since a 1967 agreement with the Army about use of helicopters, rescue has been the principal mission of helicopters in the Air Force.

AIRCRAFT OF TODAY

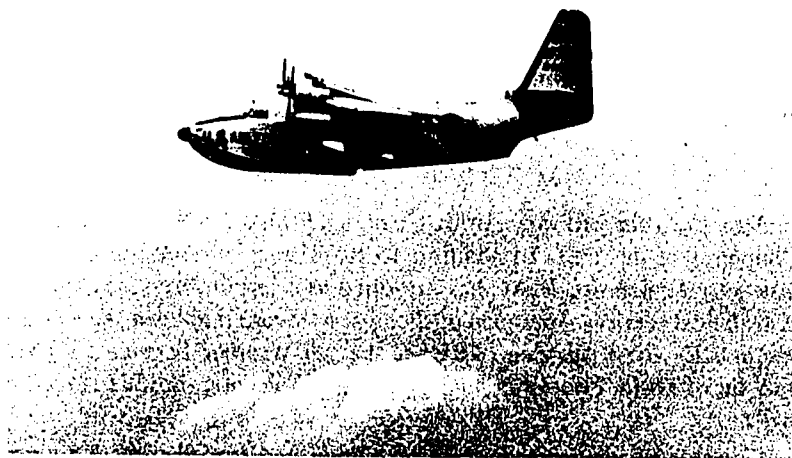

Figure 73. FLYING BOAT. U-16 Albatross, used by Air Rescue Service, is Air Force's only amphibian aircraft.

ARRS-trained men fly the famed Sikorsky HH-3 "Jolly Green Giant" and the larger Sikorsky HH-53 on rescue missions over the combat zones of Southeast Asia as well as smaller helicopters for crash rescue near airbases. (Helicopters are described in the next chapter.) Some of the fixed-wing aircraft flown by ARRS are the Boeing HC-97, an old heavy reciprocating-engine transport which has the advantage of long range and endurance on searches over oceans; and the Grumman U-16 Albatross. The U-16 is the one amphibian or seaplane in Air Force service. It can carry 10 passengers plus rescue and aid equipment (Fig. 73). A few years ago, ARRS also had the space-age mission of flying the HC-130, a specialized version of the C-130 transport (see again Figure 7) in its mission of fielding capsules dropped from orbiting satellites.

The 1370th Photomapping Wing makes use of the RC-130 on precision photomapping flights in many parts of the world.

With Air Weather Service, aerial weather reconnaissance is an important and widespread operation. Various aircraft have been converted to the task of long flights to make regular weather observations over oceans and wilderness areas where weather stations are few and

AIR FORCE AIRCRAFT

far between, and for hurricane hunter flights right into the centers of violent tropical storms. AWS also conducts radiological sampling flights. (When the Atomic Energy Commission issues an estimate of the yield of a nuclear test in China, chances are that AWS flights were the main source of this information.) The Air Weather Service flies the WB-57, previously described as an attack aircraft (see again Figure 62) on high-altitude sampling missions. The WC-135 and the WC-130, specially fitted for weather observation, are yet other versions of these endlessly versatile transports.

AIRCRAFT OF TODAY

WHAT DO THE LETTERS AND NUMBERS MEAN?

The letters and numbers which designate military aircraft, such as B-52H, are easy to read once you know the system. The prefix letter or letters indicate the mission or type of the aircraft. The numerals indicate the specific make and model. The suffix letter indicates major design change in series. Thus B-52H means "bomber, model 52, seventh major design change," (after A). In this case, the H model differs from the G in that it has turbofan rather than turbojet engines—a change considered important enough to rate a new suffix letter.

Sometimes there are two or even three prefix letters to be read in combination. These are set down in a certain order, explained below along with examples; but first let us list prefix letters. The following list is not complete, but covers only the military aircraft mentioned in this unit. The same system is used for aircraft of all US military services.

- A—Attack (for use against enemy ground targets only).
- B—Bomber
- C—Cargo or passenger.
- E—Electronic (special surveillance equipment such as early warning radar)
- F—Fighter (air-to-air capability).
- H—Helicopter (single or final prefix only).
- H—Search and rescue or other Air Rescue Service mission (first prefix only).
- K—Tanker
- O—Observation
- R—Reconnaissance (photographic or electronic)
- S—Strategic (unique case of SR-71).
- T—Trainer
- U—Utility (usually a small aircraft, miscellaneous uses).
- V—Staff (aircraft with interior furnished for staff or key personnel transportation—first prefix letter only).
- V—Nonrotary VTOL or STOL aircraft (final prefix letter only).
- W—Weather (aircraft with meteorological equipment permanently installed).
- X—Experimental
- Y—Prototype (aircraft procured in limited quantities to develop the potentialities of the design).

Combination Prefixes

The prefixes listed above are of three types: (1) current status (examples are X and Y); (2) modified mission, meaning purpose for which the aircraft is now used if converted from some other use; (3) basic type, original mission, (or intended mission if preceded by X or Y). When combination prefixes occur, they are set down in the above order. Even three-letter prefixes are sometimes used—for example YAT, meaning a prototype of an attack aircraft converted from a trainer. The following examples should help clarify.

- EC-121—Electronic (early warning) aircraft modified from C-121 cargo aircraft.
- HC-130—Search and rescue (ARRS mission) aircraft modified from C-130 cargo aircraft
- WC-130—Weather airplane, also modified from C-130.
- HH-3—Search and rescue helicopter.
- OV-10—Observation airplane with STOL capability.
- VC-137—Staff aircraft, modified from cargo or passenger aircraft (note: the combination CV would mean something different: a cargo plane with STOL or nonrotary VTOL capability. The designation CV-2 was formerly used for what is now the C-7 Caribou).
- YF-12A—Prototype of a fighter.
- F-12—Same as YF-12A—Short, informal designations like this are often used instead of full designation.
- XB-70—Experimental, intended as bomber.
- X-19—Experimental (no specified intended mission).

AIR FORCE AIRCRAFT

WORDS, PHRASES, AND NAMES TO REMEMBER

Aerospace Defense Command (ADC)
Aerospace Rescue and Recovery Service (ARRS)
Airborne Warning and Control System (AWACS)
Air Training Command (ATC)
Air Weather Service (AWS)
amphibian aircraft
attack aircraft
close support
command and control system
counterair
early warning
fighter aircraft
fighter weapon system
fire control
forward air controller (FAC)
Gatling Gun (Vulcan)
hurricane hunter flights
interceptor aircraft
interdiction
loiter capability
MAC 1370th Photomapping Wing
Military Airlift Command (MAC)
North American Air Defense Command (NORAD)
observation aircraft
Pacific Air Forces (PACAF)
primary mission
primary using command
reconnaissance
scramble
Strategic Air Command (SAC)
strategic forces
strategic warfare
super FAC
systems
Tactical Air Command (TAC)
tactical forces
tactical warfare

AIRCRAFT OF TODAY

Technical Services (of MAC)
Undergraduate Pilot Training (UPT)
United States Air Forces in Europe (USAFE)
visual observation

AIRCRAFT MENTIONED IN THIS CHAPTER

A-X proposed attack airplane
B-1 proposed strategic bomber
Boeing AWACS planned air defense flying command post
Boeing B-52 Stratofortress bomber
Boeing C-135 transport, EC-135 electronic, RC-135 reconnaissance, WC-135 weather
Boeing C-97 Stratocruiser transport, HC-97 rescue
Boeing VC-137 Air Force One special transport
Cessna A-37 attack airplane
Cessna T-37 trainer
Cessna T-41 trainer
Convair T-29 Flying Classroom navigation trainer
Douglas A-1 Skyraider attack airplane
F-15 proposed fighter
Fairchild AC-119 attack airplane
General Dynamics F-111 fighter FB-111 strategic bomber
General Dynamics-Convair F-102 Delta Dagger fighter
General Dynamics-Convair F-106 Delta Dart fighter
Grumman U-16 Albatross rescue amphibian airplane
Ling-Temco-Vought (LTV) A-7D Corsair II attack airplane
Lockheed C-121 Constellation transport, EC-121 Warning Star early warning
Lockheed C-130 Hercules transport, AC-130 attack, HC-130 space-capsule retrieving, RC-130 photomapping, WC-130 weather
Lockheed C-141 Starlifter transport
Lockheed F-104 Starfighter fighter
Lockheed SR-71 strategic reconnaissance airplane
Lockheed YF-12A prototype fighter
Martin-Marietta B-57 bomber, EB-57 electronic, WB-57 weather
McDonnell F-101 Voodoo fighter, RF-101 reconnaissance
McDonnell-Douglas C-9 Nightingale aeromedical transport

AIR FORCE AIRCRAFT

McDonnell-Douglas EB-66 electronic warfare airplane
McDonnell-Douglas F-4 Phantom II fighter, RF-4 reconnaissance
Mikoyan-Gurevich Mig 23 Soviet fighter
Northrop T-38 trainer, F-5 Freedom Fighter
Sikorsky HH-3 Jolly Green Giant rescue helicopter
Sikorsky HH-53 Super Jolly rescue helicopter

QUESTIONS

1. Which Air Force commands are principal users of main aircraft types?
2. Identify the aircraft used in the UPT program. What are the distinctive features of each?
3. Define: close support, interdiction, counterair, and two types of reconnaissance.
4. What is the meaning of the designation "weapon system"?
5. What advantage will the proposed F-15 have over present tactical fighters?
6. What is the mission of the F-106? What are its capabilities?
7. What features of the B-52 make it the most important aircraft used by SAC?
8. Identify the aircraft used by MAC as flying hospitals. Which type is used on domestic missions? Which for overseas evacuation?
9. What is the mission of the following: HC-97, U-16, HC-130, RC-130, WB-57?
10. Military aircraft are designated by certain letters, numbers, or combinations of the two. Define the following: E; K; VC-137 RF, A-7, FB-111.

THINGS TO DO

1. Select one of the "principal user" Air Force commands and construct plastic or balsa models of some of the aircraft used by it.
2. Watch newspapers and magazines for new developments in aircraft design and propulsion systems. Add clippings and pictures to your scrapbook.

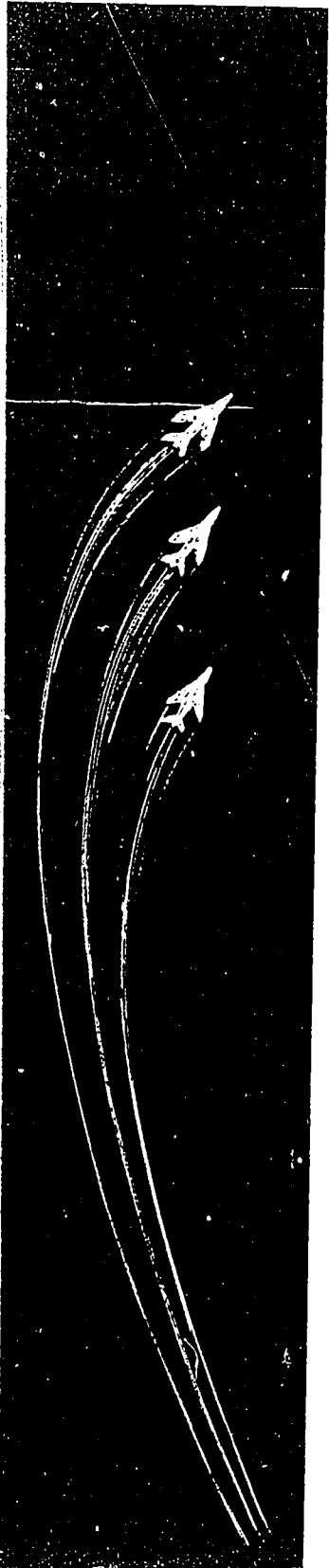

Rotary Wing, STOL and VTOL Aircraft

THIS CHAPTER surveys some special aircraft models designed to overcome the problems arising from the necessity of lengthy runways. Since vertical takeoff and landing is the outstanding characteristic of helicopters, the chapter begins with a review of the development of rotary-winged aircraft, describes the performance of some of the current models, and points out the limitations of helicopters as compared to fixed-wing aircraft. Then, it introduces you to the new concepts of aircraft design which combine the takeoff and landing features of the helicopter with the superior capabilities of fixed-wing aircraft in payload, speed, altitude, and range. These unusual aircraft are designated as VTOL or STOL according to their takeoff and landing ability. The chapter describes several models in both categories, some that are already in use and others still in the experimental stage. When you have studied this chapter, you should be able to do the following: (1) trace the development of helicopters and describe performance limits; (2) explain the meaning of VTOL and STOL and define the Air Force standard of STOL performance; and (3) identify the VTOL and STOL aircraft now in use or being developed and discuss their special features of design and function.

THE AIRCRAFT described so far in this unit have one problem. To get off the ground, they must move swiftly across the ground, creating a rush of relative wind strong enough to build a sufficient pressure differential, according to Bernoulli's Law, for lift. So much for technicalities (review Chapter 2 if you feel rusty).

AIRCRAFT OF TODAY

As we have noted, some light airplanes can get off the ground in only a few hundred feet. For aircraft with more payload and performance, more runway is needed—up to two miles for some heavyweight jets. For safety, equal amounts of runway may be needed for landings as for takeoffs (although reversible propellers or reversible-thrust jets can shorten the run once a plane so equipped has landed).

In civil-economy terms, this means reserving acre upon acre, square mile upon square mile, of valuable real estate for the purpose of providing aerodynamic lift—areas of barren land where neither crops nor trees may grow nor buildings be constructed. It means locating airports far outside city limits, inconvenient to business or industrial centers. On the other hand, remote jungle or mountain communities often cannot be served by conventional fixed-wing aircraft because of a lack of cleared, level areas suitable for takeoff and landing. Tactical warfare involves a constant effort to position men and weapons to advantage on a battlefield, often in places hard or impossible to reach either by land or by conventional airplane. This final chapter concerns aircraft that provide or aim to provide some of the answers to such varied problems, both military and civil.

One category is rotary-wing aircraft, or helicopters. These are already an established and important part of both civil and military aviation. On the battlefields of Southeast Asia, Army helicopters provide the means of landing in small clearings in the midst of rugged terrain to rescue wounded soldiers and bring in supplies, and hovering to provide fire support for ground troops in action. By contrast, in New York, large passenger helicopters make regular shuttle runs from the roof of a skyscraper in midtown Manhattan to the Kennedy International Airport, thus avoiding up to an hour's battle with urban traffic jams. In both military and civil situations, whether in wilderness or teeming metropolis, helicopters the world over solve the same problem: They land and take off at locations convenient to the scene of operations.

But present-day helicopters have their limits in speed, range, and payload. Therefore, efforts are being made to develop either advanced helicopters or other types of aircraft which can achieve vertical takeoff and landing (VTOL), or short takeoff and landing (STOL), or both (VSTOL). These would not be worth developing, of course, unless they outperformed existing helicopters in important respects. A little further on, we shall take a brief look at some of the experimental air-

ROTARY WING, STOL AND VTOL AIRCRAFT

craft in this field. First, however, you should learn something about helicopters and other rotary wing aircraft, a large and vital portion of modern aviation.

ROTARY-WING AIRCRAFT

The term **rotary-wing aircraft** includes helicopters, autogiros, and possibly certain other aircraft, of the future, that would employ the basic principle of the rotor instead of the wing for lift.

The Autogiro

The first rotary-wing aircraft was the **autogiro**, developed in the 1920s by a Spanish inventor, Juan de la Cierva. Early autogiros were powered by a conventional airplane engine-propeller unit. They were controlled by means of a conventional rear empennage with rudder and elevators. The very first models also had a pair of stubby wings, not to provide lift but merely to support ailerons. The lift was provided by a freely-rotating three- or four-bladed horizontal windmill or rotor atop the aircraft. Each blade was like a long, narrow wing, with lift augmented by its rotary motion. Forward motion, as supplied by the conventional propeller, was necessary to cause the rotors to swing and to provide a takeoff run to get the craft into the air, but with each new model that Señor de la Cierva produced, this takeoff run got shorter and shorter, until the average was well under 100 feet. This aircraft, virtually stall proof, could reach speeds up to about 120 mph or as little as 30 mph. The groundspeed in the latter case could be made still slower by skillfully heading the craft into the wind.

Late model autogiros, made in the early 1930s, verged on the helicopter in that the rotors were coupled to the engine for powered rotation and practically vertical takeoff. Once this craft was airborne, however, the rotor was declutched and provided lift in mid-flight by free **windmilling**, while the conventional propeller supplied the thrust. Unpowered windmilling rotor action is the distinguishing feature of the autogiro to this day.

The autogiro today has been almost entirely replaced by the helicopter, but there has recently been a renewal of interest in the autogiro (sometimes called a **gyroplane** or **gyrocopter**) as a light, private-type aircraft in both factory and home-built versions. In 1970, the Air Force was conducting experiments with a very small gyrocopter as an

AIRCRAFT OF TODAY

escape vehicle for a pilot forced to bail out over enemy territory. The Bensen Gyrocopter, designated the X-25, would take the place of a parachute and be presumably easier to control. Both propeller-driven and glider models were being tested.

Helicopter Characteristics

The first practical helicopters were developed during World War II and saw some service in that war. It was the Korean conflict of the early 1950s that first put these craft in the public eye as a military workhorse for rescue, troop carrying, and supply and resupply operations. Civil usage also became widespread at about the same time, not only as a means of downtown-to-airport passenger and mail service in big cities, but also in a variety of other uses from **bush pilot** service in remote wilderness areas, to **flying crane** use in construction projects.

Where the autogiro is somewhere between rotor and conventional aircraft, the helicopter depends upon rotors not only for lift but for forward propulsion and for the controls provided on conventional aircraft by flat airfoils such as rudder, elevators, and ailerons.

The engine can be a reciprocating type, but the **shaft turbine**, similar in principle to the turboprop, is standard on all but the lightest of currently-manufactured models. Powering the main rotor, the engine on takeoff whirls it to provide vertical lift without any takeoff run, and can let the craft down for the proverbial "landing on a dime."

Forward thrust in flight, as well as side or backward motion, or stationary hovering, all under complete pilot control, is achieved basically by variation of the pitch of the rotor blades during each cycle of rotating, known as **flapping**. With only the main rotor operating, however, the craft would rotate too. Hence the second rotor, which on most helicopters is smaller, located on the tail and turned vertically and sideways to provide a secondary thrust that steers the helicopter and keeps it stable. Some helicopters, however, have twin horizontal rotors turning in opposite directions, or **counter-rotating**, to achieve the same stability and control.

The control and maneuverability of helicopters is remarkable and the skill demanded of a helicopter pilot is very high. A typical training standard requires the student to do the following stunt: he must insert a narrow boom fixed to the nose of the craft into a ring of a few inches diameter, attached to the top of a pole, lift the ring off the pole, and

ROTARY WING, STOL AND VTOL AIRCRAFT

"hand" it to an instructor standing on the ground! The helicopter is a wonderfully useful and versatile instrument of war or peace. If it were not for its limitations, it would probably have made airplanes obsolete by now. Therefore, you should know the present-day limits of helicopter capacity and performance as a kind of "yardstick" for measuring the value of helicopters of the future as well as VTOL and STOL airplanes.

COST.—Helicopters are expensive. The very lightest two seaters cost four times as much as a light airplane of similar capacity. They are also complex machines and demand more skill of a pilot than light airplanes and the best of mechanical skills for their upkeep. They are not economical fuel consumers. Hence the continued interest by general aviation users and all military services in light, relatively cheap airplanes of good STOL capability.

SPEED.—Some experimental advanced helicopters of the compound type (see below) have reached top speeds above 300 mph. So far, however, only two helicopters in actual use have top speeds of over 200 mph. One is the Army's Bell AH-1 Hueycobra (a more stream-



Figure 74. U-1 IROQUOIS, otherwise known as the "Huey," is Army's most widely used light transport helicopter.

AIRCRAFT OF TODAY

lined armed attack version of a slower 10-passenger light transport helicopter, the Bell UH-1 Iroquois or "Huey" shown in Figure 74). The other is the big Sikorsky CH-53 Sea Dragon flown by the Marines as a troop carrier and the Air Force as a search and rescue ship (HH-53 Super Jolly) (Fig. 75). Most helicopters cruise at speeds between 100 and 150 mph.

PAYLOAD.—The largest and heaviest helicopters are represented by military types, although civil cargo and passenger versions are also in use or planned. They can carry as much payload as a C-123 or other transport airplane of the "medium light" class. The aforementioned CH-53 can carry up to 9 tons or 60 passengers. The Army's widely-used twin-rotor CH-47 Boeing Vertol Chinook (Fig. 76) in its latest version (CH-47C) can carry more than 11 tons (and also reach a top speed of 183 mph). The Army's Sikorsky CH-54 is a slow flying-crane type, which has a maximum takeoff weight of 19 tons with a payload of 11 tons. The CH-54 can pick up cargo or passenger loads in detachable vans and can also carry heavy outside objects by means



Figure 75. HH-53 "SUPER JOLLY," large transport helicopter in air rescue version for Air Force.

ROTARY WING, STOL AND VTOI AIRCRAFT



Figure 76. TWIN ROTOR design is featured in CH-47 Chinook, Army's heavy transport helicopter.

of a winch and sling. The world's heavyweight helicopter lifting championship, however, apparently belongs to the Soviet Union's Mil Mi-10, another flying crane with detachable vans, for which a maximum payload of 16 tons is claimed.

Currently a typical commercial passenger helicopter is the Sikorsky S-61, which can carry 28 passengers. Helicopters of this class are used to shuttle air passengers from one airport to another within the same metropolitan area, or between airport and inner city. Could they be used for ordinary local transportation? Currently the costs—hence the fares—are much too high to permit widespread use of helicopters by suburb-to-city commuters as a daily habit. Helicopters are more promising as a means of short city-to-city transportation.

RANGE.—High fuel consumption and short range are the worst drawbacks to helicopters in competition with airplanes. Most military and civil helicopters must operate within a radius of 100 miles or less or go farther only at the expense of reduced payload. In the military services, Air Force search-and-rescue operations have the greatest need for range and flight endurance, for such missions may require long hours over sea or jungle. The Air Force's Sikorsky HH-3E Jolly Green Giant, with the help of two tip tanks, can extend its range to 748 miles without refueling. The larger and heavier HH-53 Super Jolly has a range of 575 miles without refueling. Both of these helicop-

AIRCRAFT OF TODAY

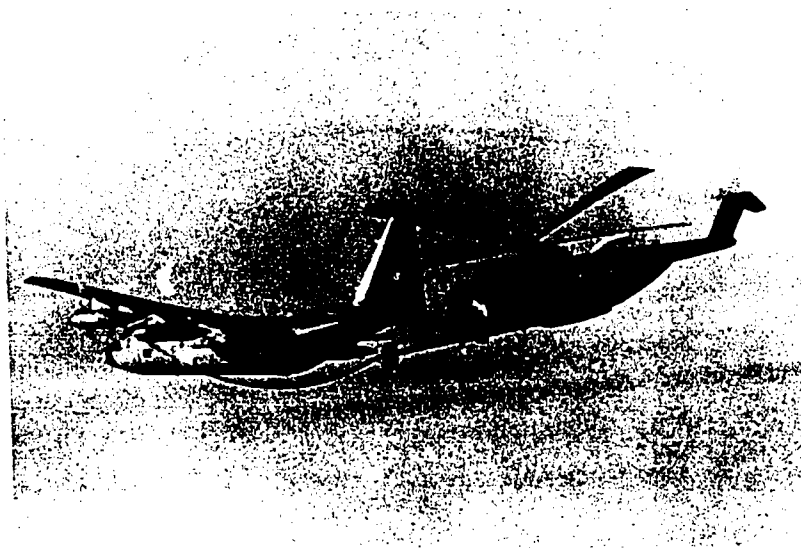

Figure 77. HH-3E "JOLLY GREEN GIANT," right, famed rescue helicopter of the Air Force, being refueled in air by HC-130P, tanker version of versatile Hercules transport plane.

ters can be refueled from the HC-130P (the ever-versatile Hercules transport airplane modified as a tanker). (Fig. 77). These are the longest-ranged helicopters.

Compound and Hybrid Helicopters

Before considering STOL and VTOL airplanes, let us see what ideas have been offered for improving the helicopter itself. Basically, there are two concepts, which can be called **compound helicopters** and **hybrid helicopters**.

COMPOUND HELICOPTERS.—The compound helicopter is simply a conventional helicopter with extra forward thrust provided by either jet or propeller unit. De la Cierva, as we noted above, employed this principle in his autogiros, but compound helicopters also have powered rotors. The compound helicopter can have short wings or an airplane-like empennage for control purposes. Experimental compound helicopters have been flown for a number of years. One compound gunship type, the Lockheed AH-51 Cheyenne, came very near being adopted by the Army but was rejected because of its high cost.

ROTARY WING, STOL AND VTOL AIRCRAFT

Among other features, it had a rigid rotor, with blades kept in a flat plane, without the "flapping" mechanism mentioned above and common to most helicopters. It had a smaller control rotor mounted above the main rotor, as well as the standard side-thrusting rotor on the tail. Higher rotation speed and a higher forward speed are the advantages of this system. The Cheyenne had a top speed of 250 mph.

HYBRID HELICOPTERS.—A variety of advanced helicopter concepts can be lumped together as a category called **hybrid helicopters**. In general, these go further than compounds toward combining the airplane and helicopter. In one way or another, they try to solve this problem which the compound helicopter does not solve: use the rotor for vertical takeoff and landing but do not let it impede forward flight! As long as that bulky, long-bladed, unstreamlined rotor structure sits spinning on top of the aircraft, both economy and performance will suffer. Below are three ideas for doing something about this problem: (1) get the rotor out of the way, (2) turn it into a propeller, or (3) turn it into a wing. These ideas have been or may still be in research and development. One is a West German project. Descriptions of the other two were gleaned from paid advertising in US aviation magazines of recent years. We are not trying to evaluate any of the three—only do a little "brainstorming" and offer various designers' thoughts on the subject.

The stowable rotor.—This German concept would be either a jet or propeller-driven airplane with the added feature of a helicopter engine and rotor mounted on the fuselage. After vertical takeoff by means of the rotor, the airplane engines would be started. Then the rotor unit would be stopped, feathered, and retracted inside the fuselage during forward flight. Before vertical landing, the stowable rotor would be deployed and the rotor engine restarted.

The Proprotor.—This aircraft would have an airplane-like basic structure but would have twin vertical engines powering long-bladed helicopter-type rotors called **Proprotors** out on the wingtips. After vertical takeoff like a helicopter, the engines and Proprotors without stopping, would swing from vertical to forward position and become long-bladed forward-thrusting propeller units. In a further refinement, the rotor blades would telescope to a shorter length as they swing forward, for higher rpm and more efficient forward thrust. For landing, the propulsion units would swing back up to the vertical position while the blades extended, converting the props back into rotors.

AIRCRAFT OF TODAY

The delta-wing rotor.—This aircraft would have a large, flat, triangular airfoil on top of the fuselage, which would be made to spin and provide lift like a rotor. The rotor would be jet powered. That is, it would spin by means of long ducts from a jet engine in the fuselage emitting jet exhaust at the tips of the triangle. (The same US firm that advertised this concept a few years ago, has actually flown an experimental helicopter with jet-tipped rotor blades.) In midair, the pilot would shift some baffles in the jet engine so that all the exhaust would be shut off from the rotor drive and be vented straight to the rear as in a conventional jet engine, for forward flight. The spinning delta-wing rotor would be stopped with one point of the triangle forward and become a delta wing like that of the F-102 or F-106. The advertiser claimed a speed of 500 mph for this concept.

STOL AIRPLANES

In previous chapters throughout this text we have mentioned airplanes with unusually good short takeoff and landing capabilities. Frankly, in describing these, we have used the term STOL loosely, as many do, to indicate any kind of airplane takeoff and landing performance that is relatively good considering the size, weight, and speed of the airplane. By this meaning, what is good STOL for a jet fighter would be very poor takeoff and landing performance for a light general-aviation type of plane. The Air Force, however, has a precise definition of STOL, as given in the *US Air Force Glossary of Standardized Terms*.*

The ability of an aircraft to clear a 50-foot obstacle within 1500 feet of commencing takeoff, or in landing, to stop within 1500 feet after passing over a 50-foot obstacle.

Many light airplanes can clear a 50-foot obstacle in 1,500 feet total distance. To achieve it in heavier lifters or high-speed airplanes, however, requires advanced design of both engine and airframe. It is one of the big challenges of modern aviation technology.

The Value of STOL

There are differences of opinion whether or not STOL is a worthwhile goal when full VTOL or VSTOL capability is another goal that

* Air Force Manual 11-1, 1 September 1970.

ROTARY WING, STOL AND VTOL AIRCRAFT

is being pursued. Most agree, however, that the pursuit of STOL is a worthwhile effort and will not be made obsolete by VTOL progress for many years to come. As things look now, STOL can be more easily combined with better all-round aircraft economy and performance. Full VTOL capability demands more engine weight, more fuel consumption, and less payload.

In war, of course, there will always be situations in which STOL is not good enough and only VTOL airplanes or helicopters can be used. Examples are rescuing a downed flyer from a jungle or supplying a mountaintop firebase. In other military situations, however, advanced STOL capability would be highly useful. Higher performance STOL airplanes that could use short, unprepared landing strips could transport men and supplies faster and over longer distances than can present-day helicopters. STOL attack or fighter planes could be dispersed over many small rather than a few large bases.

As for civil use, we have already spoken of the advantages of light general aviation aircraft in being able to use numerous small, ill-equipped airports where airline service does not reach. Heavier advanced STOL airplanes are currently being studied as a means of fast city-to-city transportation on short routes such as New York to Washington or Chicago to Milwaukee. Possibly STOLports nearer to downtown business districts could be developed to avoid the present-day long surface trips to major airports in outlying suburban districts. Real-estate requirements for STOL would actually amount to little or nothing more than those for VTOL or helicopters. A 1500-foot runway requires less than 12 acres of land. A 40-acre tract (a square quarter mile) would be enough for a STOLport with three short runways for takeoffs and landings into the wind in various directions. Heliports or VTOLports would require practically as much land. Indeed, in urban areas, because of both noise and safety problems, there would probably be laws requiring either VTOL or STOL operations to be some distance away from inhabited buildings, regardless of how little space the respective aircraft needed for takeoffs and landings.

Some STOL Characteristics and Problems

A review of Chapters 3 and 4 will help you recall those features of aircraft design that make for shorter takeoffs and landings. Wings on STOL airplanes tend to be long in span and have considerable bulge or camber in cross section. (Those on the previously-mentioned

AIRCRAFT OF TODAY

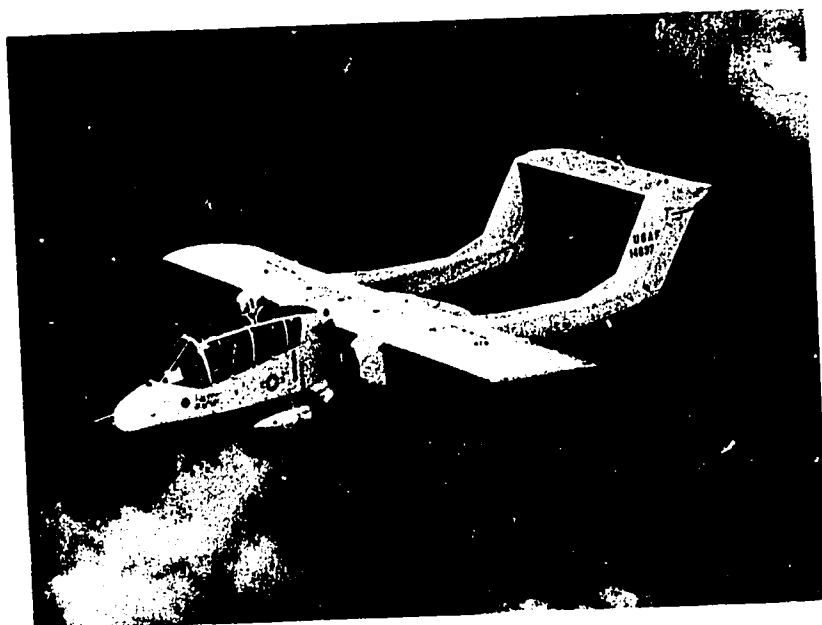

Figure 78. OV-10 BRONCO, versatile STOL observation plane, light transport, and gunship, over Southeast Asia. Note straight, narrow wing and connecting tailplane in rear, features contributing to STOL capability.

OV-10 Bronco are straight, with absolutely no taper or sweepback.) (Fig.78). Some STOL types have additional airfoil areas such as connecting tailplanes between twin rudders, or a connecting airfoil between high-mounted twin engines, which provide additional lift. Engines are relatively powerful for the weight of the airplane. They provide extra thrust to help make up for the loss of speed entailed by STOL design. They are also especially efficient for takeoffs and landings. Hence turboprop engines are favored for many STOL designs, but other successful STOL designs feature reciprocating engines; and the Soviets have demonstrated the jet-lift STOL principle on some of their supersonic fighters. Retractable wing flaps have long been standard on conventional aircraft. Those on STOL aircraft tend to be larger or of special design. Slots in flap and wing surfaces add to lift. Ridges or "fences" across the wings also increase lift.

Slow STOL.—One advanced feature of some STOL aircraft is the deflected slipstream. This is a system for spreading the backwash from the propellers evenly over the top of the wings to intensify the Ber-

ROTARY WING, STOL AND VTOL AIRCRAFT

noulli effect. Thus the aircraft can move forward at a slow velocity while getting the same lift it would ordinarily get at a faster velocity. Consequently it would need less runway for takeoffs and also land at slower speeds. A necessary safety feature on such an airplane is a system of interconnected or cross-coupled engines so that, if one engine fails, power is supplied evenly to all propellers.

One experimental six-passenger plane flown for a number of years is the Custer channel wing. It has a pair of semicircular downward dips in the wings, inside which the engines are housed, with propellers located at the rear. This system also intensifies the Bernoulli effect, and the plane can take off over a 50-foot obstacle in 250 feet—75 of them on the ground!

At present, however, safety rules prohibit any extreme application of Bernoulli's Law at slow speed. Both the Air Force and the FAA insist that aircraft must maintain a certain minimum speed on takeoffs and landings so that, in case of engine failure, they will have enough forward momentum to glide to a safe landing and not immediately stall and crash. Certain experimental advanced STOL airplanes are capable of slower approaches and takeoffs than those allowed. For the time being they must either continue to operate as purely experimental aircraft or, if passengers are carried, maintain the required takeoff and landing speeds.

FAST STOL—THE NAVY WAY.—Another way of intensifying the rush of air over a wing, otherwise known as the Bernoulli effect, without using up runway, is to achieve very sudden acceleration on takeoff. We have mentioned the use of rockets, so-called JATO, as takeoff boosters. Another example is the use of auxiliary turbojet engines on the C-123K. These fast takeoff methods, however, do not solve the problem of short landing.

No discussion of STOL would be complete without mention of the Naval aircraft carrier. Even supersonic fighters like the F-4, without any STOL features in their design at all, can take off from and land on aircraft carriers with flight decks shorter than 1,000 feet. In this Navy method, the STOL features are in the carrier, not the aircraft. Steam catapults provide takeoff boost. Flexible and resilient cables or arresting gear catch the aircraft on landing and absorb its forward momentum. The carrier has additional advantages. Its flight deck is elevated above the surrounding sea. Its own superstructure is to one side, out of the line of flight. There are no obstructions to clear on landing or

AIRCRAFT OF TODAY

takeoff—no buildings, trees, or hills. The carrier can also be steered so that all takeoffs and landings are made directly into the wind.

In combat in Southeast Asia, the US Marines, whose flyers are trained in carrier operations, have carried some but not all of these advantages onto dry land. They have developed the **SATS (short airfield for tactical support)**. A SATS is a rapidly-constructed landing strip made of metal landing mats and equipped like a carrier with **catapult and arresting gear**. Nevertheless, the Navy and the Marines are as much interested in STOL and VTOL aircraft development as are the Army and Air Force. Many experimental projects in these fields have been interservice sponsored.

Representative STOL Types

Out of a large variety of STOL designs, other than those we have already mentioned, we must limit ourselves to describing a few. Perhaps these are the ones that represent the future trend, but we cannot be sure.

PROPELLER MODELS.—Since it does not seem feasible to allow a jet engine to blow its hot exhaust over a wing surface, the aforementioned deflected-slipstream principle is limited to propeller-driven airplanes. Other features of STOL airframe design also lend themselves to propellers better than jets. The jet STOL principle, described later, is something entirely different.

Otter, Caribou, and Buffalo.—These three aircraft by De Havilland of Canada have been employed as transports by the US armed services. They are relatively good STOL performers with interesting possibilities for improvement in this respect.

The standard U-1 Otter is a single-engine high-wing airplane of about 8,000 pounds maximum weight. It can be equipped with wheels, skis, or pontoons for takeoffs on different surfaces. It carries ten passengers plus a crew of two and has been used by the armed services as utility or light transport plane. A special twin turboprop Otter has been used by the Canadian government in a long series of experiments testing different STOL principles such as deflected slipstream and reversed thrust *before landing*.

A number of Caribous were transferred from the US Army to the Air Force in 1967. The C-7 Caribou is a high-wing transport plane of the same general weight class as the time-honored C-47 Gooney Bird

ROTARY WING, STOL AND VTOL AIRCRAFT

(Fig. 79). It has two 14-cylinder double-row engines of 1,450 hp each. It can cruise at 182 mph and can clear a 50-foot obstacle in a total distance of 1,185 feet fully loaded—remarkably good STOL for an airplane of this capacity. The Caribou has seen much service in Southeast Asia.

The C-8 Buffalo is an enlarged version of the Caribou, with twin turboprop engines of 2,850 shp each, and a maximum cruising speed of 270 mph. It can carry a payload of almost seven tons, and clear a 50-foot obstacle in a total distance of 1,540 feet. The few Buffalos owned by the United States are now in the hands of NASA, which is using them for testing STOL principles and other performance factors for civil or tactical military transports.

French STOL transport.—A STOL transport of the same general class as the Buffalo is now being made by McDonnell-Douglas under license after many years of development by a French firm. The Breguet 941 or Mc-Donnell-Douglas 188 has the same high-wing upswept-tail design that characterizes most military tactical transports



Figure 79. C-7 CARIBOU—medium-light transport with reciprocating engines and outstanding STOL capability.

AIRCRAFT OF TODAY

of today. Currently however, the 941 or 188 seems to be attracting more commercial than military interest in this country. Powered by four turboprop engines, this aircraft has a wingspan of almost 77 feet and a length of 78 feet. It has cross-coupled engines, slotted wings, and uses the deflected-slipstream, and other STOL principles. It can carry payloads of up to 11 tons or 56 civil passengers. STOL performance is unexcelled in this aircraft's weight class. Its maximum cruising speed is 270 mph. Operating on convenient schedules from small airports located close to the inner city, it can give passengers faster point-to-point service than jets traveling at 500 mph or faster, on short city-to-city routes (Fig. 80). It has undergone flight tests on such routes in both Eastern and Middle Western regions.

SOVIET JET-LIFT STOL FIGHTERS.—At this point we are introduced to an entirely different idea—the use of downward jet blast to get upward thrust for short or vertical takeoff and to cushion short or vertical landing. What this really is is a direct application of Newton's principle that for every action there is an equal and opposite reaction. Rockets and space vehicles are launched in this fashion. Soft landings

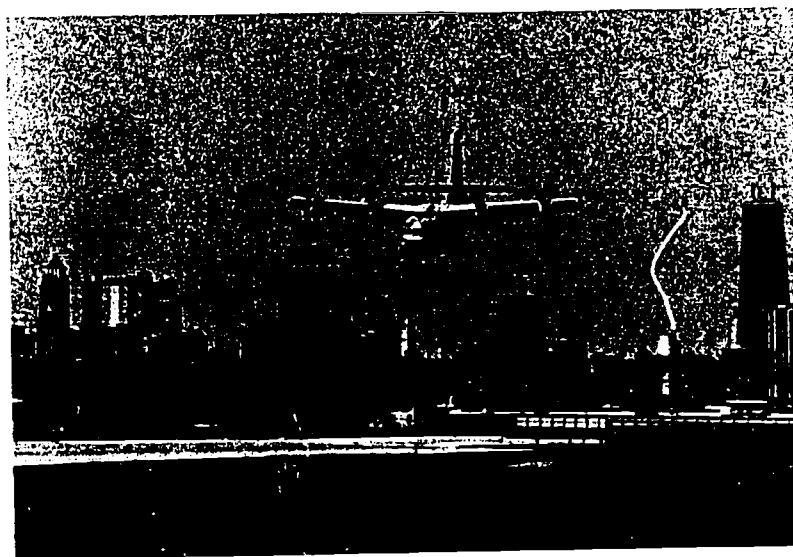

Figure 80. LANDING ON CHICAGO'S FRONT DOORSTEP. McDonnell-Douglas 188 STOL passenger plane landing at Meigs Field, close to downtown Chicago. Conventional passenger airliners must use airports located 15 and 20 miles away.

ROTARY WING, STOL AND VTOL AIRCRAFT

on the moon also use this principle. Winged aircraft too can be made to rise vertically or settle gently by the force of downward jet action.

When this principle is used for STOL rather than full VTOL, the force of the downward jet (upward thrust) is applied at the same time that forward thrust is applied by the regular jet engines. The aircraft thus gets conventional Bernoulli-effect takeoff lift from its forward run plus additional lift from a vertically-mounted jet engine, and accomplishes a short takeoff. Similarly the vertical jets can be used to cushion a steep landing.

In 1967 the Soviets staged a big airshow at a military air base near Moscow. Western observers were impressed by the takeoff and landing performance of several jet aircraft of the supersonic-fighter type, which were equipped with under-the-fuselage downward-blasting jets for STOL assist. These airplanes also had air scoops on top of the fuselage to feed air to the vertical jet engines on takeoffs and landings; these were closed during mid flight. One of the jet STOL aircraft also had swing wings.

No details can be given about these aircraft, nor any specifics on their total takeoff or landing distance over a 50-foot obstacle. Nor is any further news of their development since 1967 available. At least one model could be operational by now. One possible reason why a jet-lift STOL could be more practical than a jet-lift VTOL aircraft like the Harrier described below is that the vertical jets would not need to be quite so powerful and heavy as those with full VTOL capability. Therefore, they would encroach less on payload and performance. The aircraft would be able to operate from small fields along a battlefield and possibly also perform like a first-line fighter.

NONROTARY VTOL AND VSTOL AIRCRAFT

Finally we come to aircraft which are capable of airplane-like forward flight and can also take off and land without any horizontal movement at all. Many principles for such flight have been tested, and many successful test flights of experimental VTOL aircraft have been made. With only one exception, however, no VTOL aircraft has been put into actual use, either military or civil, in any country. That exception is the British Fighter called the Harrier. It has been accepted by the Royal Air Force and is being delivered to squadrons as a fully operational aircraft. All others are in experimental status.

AIRCRAFT OF TODAY

Indeed, if we are to mention workable and important VTOL or VSTOL concepts, it is necessary to speak of some discontinued projects—for example, the XC-142 tiltwing or the XV-4B jet Hummingbird. Experimental projects are expensive, and sometimes promising ones are discontinued for lack of funds. Sometimes, as in the case of the XC-142, the aircraft did suffer from dangerous faults. Nevertheless, if it is proven that the basic concept is workable, the hope remains that it may some day be applied to a safe and reliable aircraft. Here we need not try to distinguish between current and discontinued experimental aircraft, or suggest which may be safer or better than others. Again, we are “brainstorming” and setting forth—in addition to hybrid-helicopter concepts already described—more concepts for VTOL and VSTOL flight.

In speaking of these aircraft, the terms VTOL and VSTOL are practically interchangeable. Almost all experiments of recent years have been with aircraft that could achieve VTOL with reduced loads and various degrees of STOL with various heavier loads. (Even a conventional helicopter can carry a heavier load if allowed to make a short takeoff or landing run.)

Again it is possible to classify these aircraft by two basic means of power and propulsion—propeller (turboprop) and jet.

Turboprop VSTOL Concepts

In a sense, turboprop VSTOL aircraft could be called “hybrid helicopters” in that they depend upon upward-aimed propellers for VTOL. Like the Proprotor concept previously described, the propellers tilt straight upward for VTOL and forward for level flight. They can also tilt obliquely upward for STOL. The difference is that, in all positions, these propellers do not change length to become rotors but remain short propellers. They must churn at high rpm with a heavy output of energy to accomplish vertical takeoff or soft vertical landing.

Three projects formerly sponsored by US military services can serve to demonstrate the variations of this principle. In the four-engine XC-142 (and the two-engine Dynavert, a Canadian counterpart that is still an active project), the propellers and wings tilt together. In two other experimental craft—the X-19 and the X-22 the propulsion units tilt but the wings remain level. The X-22, a Navy project still active, has four engines and propellers encased in huge barrel-like tilt-

ROTARY WING, STOL AND VTOL AIRCRAFT

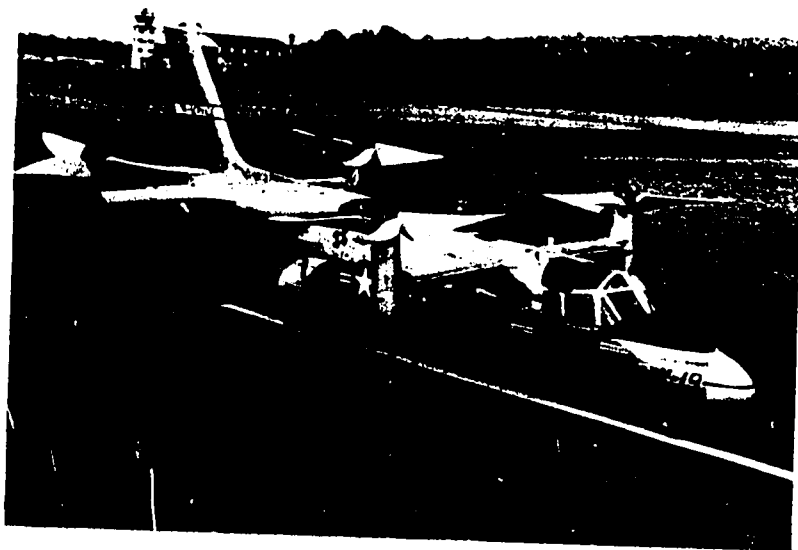

Figure 81. TILTING PROPELLER PODS were features of the X-19, shown here ready for vertical takeoff. Note the width of the propeller blades.

ing ducts outboard of the wings and a foreplane. The tri-service X-19, now cancelled, had centrally-located twin turbine engines in the fuselage with geared power trains leading out the wings and empennage to wide-bladed propellers on tilting nacelles (Fig. 81). The X-19 and X-22 were light six-passenger aircraft. Because it was heavier and showed some promise as a tactical transport aircraft, the XC-142 might be given a little more attention here.

The tiltwing XC-142 was built and test-flown under tri-service sponsorship. It accomplished many successful flights, but also suffered from accidents. Three of five built were destroyed in accidents. Problems of instability in takeoff and landing were never quite overcome, and finally the XC-142 project was abandoned in early 1970. One XC-142 has been put on permanent display in the Air Force Museum at Wright-Patterson Air Force Base.

The XC-142 (Fig. 82) had a maximum gross takeoff weight of 41,500 pounds in STOL or 37,500 pounds in VTOL. It could carry a payload of 12,000 pounds in STOL or 8,000 pounds or 32 fully

AIRCRAFT OF TODAY

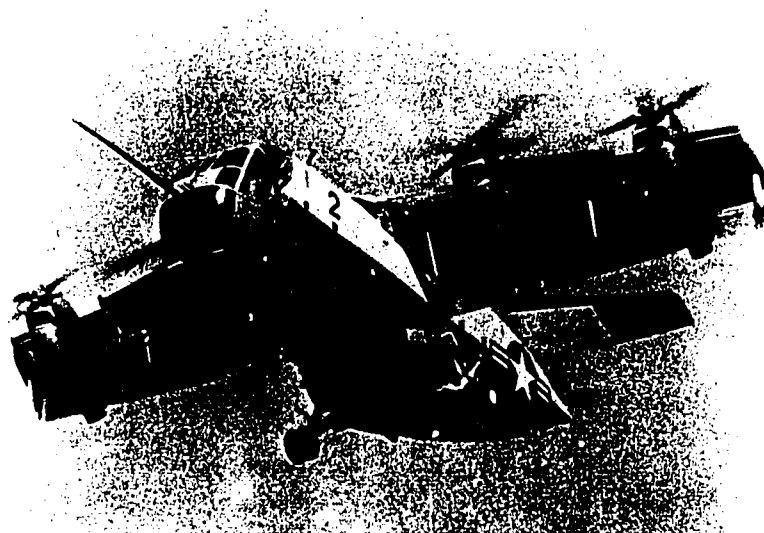

Figure 82. TILTWING XC-142, shown with wings and engines tilted obliquely for STOL.

equipped troops in VTOL. It had a length of 58 feet and a wingspan of $67\frac{1}{2}$ feet. It had four interconnecting turboprop engines of 3,080 shp each—a tremendous power plant for the size of the aircraft but necessary to accomplish VTOL, STOL, and top-speed level flight. In level flight it cruised at 285 mph and could reach a top speed of over 400 mph. It could hover stationary in air and fly backwards as well as forwards. Its STOL performance was perhaps even more impressive than its VTOL performance. In STOL it leaped rapidly into the air after a very short run and landed softly after a steep descent. VTOL, by comparison, was slow, noisy and cumbersome—but it could be done. The promise of good, safe performance in another tilting-propeller aircraft remains, even if the XC-142 itself is not the answer.

Jet VSTOL Concepts

We mentioned Soviet jet-lift STOL fighters. Jet-lift VSTOL works much the same. The difference is that the vertical thrust must be more powerful to accomplish VTOL as well as STOL. At the same time, forward thrust must be provided.

ROTARY WING, STOL AND VTOL AIRCRAFT

There are various ways of accomplishing jet-lift VSTOL. The jet engine can have a swiveling exhaust nozzle to provide vertical or horizontal thrust. Another way of shifting thrust between vertical and horizontal is to do it by means of shifting ducts inside the aircraft. The aircraft can have separate rigid-mount jet engines, some aimed horizontally, some vertically. Or the whole engine can pivot from horizontal to vertical position. There is also the jet-powered fan-in-wing VSTOL principle. One aircraft can employ a combination of more than one of these principles.

The swiveling-nozzle principle is the one used in the world's only currently operational (now in service) jet-lift VSTOL aircraft, the Hawker-Siddeley Harrier. All the others are or were purely experimental aircraft. All have been tried with some degree of success. All have flown; all have accomplished VSTOL under varying conditions. Again we shall briefly describe without evaluating. The Harrier may or may not employ the best of these jet-lift VSTOL principles. It is operational today because it works and because it meets a British military need as the British see it. Let us describe four examples, concluding with the Harrier.

PIVOTING ENGINE.—West Germany's VJ-101C, developed with US cooperation, flew a long test program in the mid-1960s. It was a light single-seater with two vertical jet engines in the fuselage and two jet engines in pods at the wingtips which could pivot between vertical and horizontal position. The VJ-101C boasts one important record—the world's only VTOL aircraft to achieve supersonic speed in level flight.

FAN IN WING.—The fan-in-wing VSTOL principle has been experimented with in both West Germany and the United States. In the United States it was an Army project, now under NASA. The US aircraft, the Ryan XV-5A, mounts two jet engines high in the fuselage. These provide regular forward thrust, but some of the exhaust is ducted (turbofan-fashion) to flat lift fans in the wings which provide VTOL thrust. The two main lift fans are more than five feet in diameter and rotate in opposite directions. A third and smaller fan is located under the nose for pitch control. In level flight, doors close over the fans to seal them off from the slipstream. The twin engines are rated at 2,900 pounds of thrust each, and a top speed in excess of 500 mph has been reached.

COMBINATION ENGINES—THE HUMMINGBIRD.—The XV-4 Hummingbird (Fig. 83) was a test vehicle flown at different times under

AIRCRAFT OF TODAY

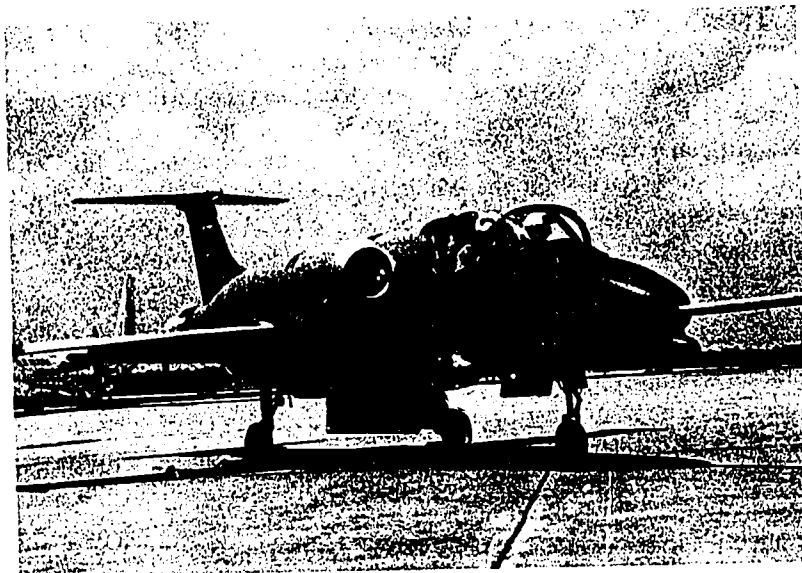

Figure 83. JET VSTOL. The XV-4 has been tested by both the Army and Air Force.

Army and Air Force sponsorship but now grounded. It had six jet engines, four vertically mounted mainly for lift and two horizontally mounted mainly for thrust. Each set of engines, however, contributed to the other's effort. By means of swiveling nozzles, the thrust engines contributed to lift on takeoff. By means of shifting ducts, the vertical engines piped added thrust into the horizontal engines. Speeds were less than 500 mph.

THE HARRIER/KESTREL.—Finally we come to the world's first operational VSTOL military plane, the P.1127 Harrier, as it is called in the United Kingdom. This aircraft was developed with the aid of US funds and tested by a squadron of US, British, and West German air force flyers. During its development stage, the aircraft was called the Kestrel. It is still known by that name in the United States, where, as the XV-6A Kestrel, it is undergoing more testing under NASA sponsorship (Fig. 84) and is being considered for use by the Marines.

The Harrier is a light single-seat fighter with short, sweptback wings. A notable feature is stilt-like landing gear, tipped by small wheels, at the wingtips. These fold back in flight. The aircraft's maximum takeoff weight is 12,400 pounds in VTOL and 15,500 pounds in

ROTARY WING, STOL AND VTOL AIRCRAFT

STOL, when it can carry up to 4,000 pounds of weapons on its wings. It has broken mach 1 in a shallow dive and has achieved very close to sonic speed in level flight. In a trade-off to achieve VSTOL, the Harrier sacrifices both top fighter performance and heavy attack payload. Nevertheless, the British have a warplane that can fight when others cannot.

The Harrier's VSTOL ability comes from its single turbofan Pegasus engine. The present RAF version has a thrust of 19,000 pounds. The Pegasus has four swiveling jet nozzles which can be aimed straight downward for VTOL, straight rearward for forward thrust, at varying angles downward for STOL, and even sideways. In fact, since the nozzles rotate vertically through 100° rather than 90° , the Harrier can point its nozzles downward and slightly forward and fly backward at speeds up to 30 mph. It can fly sideways up to 70 mph. Small attitude-control jets in the wings are also fed by the central power plant.

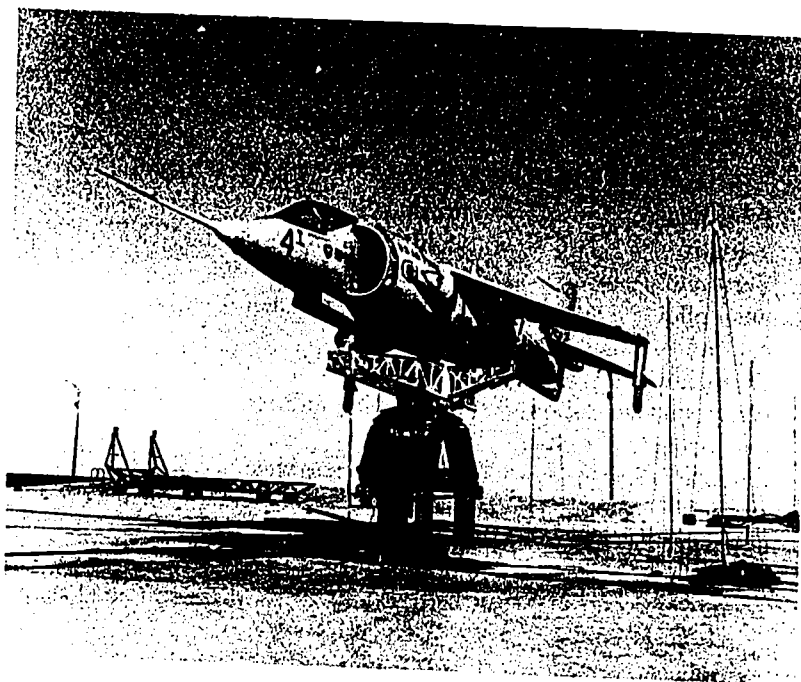

Figure B4. NOW OPERATIONAL. Shown here is the XV-6A Kestrel, an experimental version of the Harrier, now an operational British fighter. Aircraft is shown on test stand at Edwards AFB, California.

AIRCRAFT OF TODAY

In this chapter, we have described a variety of new and experimental aircraft. Frankly, they leave a good many unanswered questions. Are such aircraft practical? Are they worth the cost? Do they have enough speed, or carry enough payload, or enjoy the fuel economy of more conventional aircraft? With a good many of these aircraft, the answer is still no. But the research and development goes on and on, for each question with an unsatisfactory answer today means a challenge for tomorrow.

In this text we have not attempted to describe even a majority of airplanes currently being used in the United States. We have, though, tried to include representative planes of the major types which can be seen today.

Before the ink used in printing this book is dry, new and startling developments in aircraft design and development undoubtedly will have occurred. To remain current in this area, therefore, one needs to read newspapers, and such magazines as *Air Force and Space Digest*, *Flying*, *Aviation and Space Technology*, *Interavia*, and a host of others. We hope that your appetite for more information has been whetted to the extent that you will watch for and read about aerospace developments which you and your generation will enjoy.

WORDS, PHRASES, AND NAMES TO REMEMBER

arresting gear	hybrid helicopter
autogiro	jet-lift STOL or VTOL
Bernoulli's Law	operational status
bush pilot	pressure differential
catapult	Proprotor
channel wing	relative wind
compound helicopter	rotary-wing aircraft
cross-coupled engines	rotor
deflected slipstream	shaft turbine engine
delta-wing rotor	short airfield for tactical support (SATS)
experimental status	STOLport
flapping of rotor	stowable rotor
flying crane	vertical and/or short takeoff and landing (VSTOL)
gyrocopter	VTOLport
gyroplane	windmilling
helicopter	
heliport	

ROTARY WING, STOL AND VTOL AIRCRAFT

AIRCRAFT MENTIONED IN THIS CHAPTER

Bell AH-1 Hueycobra attack helicopter
Bell UH-1 Iroquois (Huey) general-utility helicopter
Bell X-22 experimental VSTOL airplane
Bensen X-25 Gyrocopter experimental aircraft
Boeing-Vertol CH-47 Chinook transport helicopter
Breguet 941 (McDonnell-Douglas 188) French STOL transport
Canadair Dynavert Canadian experimental VSTOL airplane
Curtiss-Wright X-19 experimental VSTOL airplane
Custer Channel Wing experimental STOL airplane
De Havilland C-7 Caribou Canadian STOL transport
De Havilland C-8 Buffalo Canadian STOL transport
De Havilland U-1 Otter Canadian light transport (Twin Otter
experimental STOL airplane)
EWR VJ-101C German experimental jet VSTOL airplane
Hawker-Siddeley P.1127 Harrier (XV-6A Kestrel) British jet
VSTOL fighter
Lockheed AH-51 Cheyenne experimental attack compound heli-
copter
Lockheed HC-130P Hercules tanker
Lockheed XV-4 Hummingbird experimental jet VSTOL air-
plane
LTV-Hiller-Ryan XC-142 experimental VSTOL transport air-
plane
McDonnell-Douglas 188 (Breguet 941)
Mil Mi-10 Soviet flying-crane helicopter
Ryan XV-5 experimental jet VSTOL airplane
Sikorsky CH-53 Sea Dragon transport helicopter (HH-53 Super
Jolly rescue helicopter)
Sikorsky CH-54 flying-crane helicopter
Sikorsky HH-3 Jolly Green Giant rescue helicopter
Sikorsky S-61 civil transport helicopter

QUESTIONS

1. What is the significance of VTOL and STOL in aircraft design?
2. Explain the basic difference between the autogiro and the helicopter.
3. What is the payload of the CH-53A, its range, cruising speed, and ceiling?
4. Discuss the limitations of helicopters as compared to fixed wing aircraft.

AIRCRAFT OF TODAY

5. Define the Air Force standard of STOL ability.
6. Describe the major features of the XC-142, the Harrier, the XV-5, the Hummingbird. Which of these is operational?

THINGS TO DO

From outside reading, report on the latest experiments in VTOL and STOL aircraft. Describe the design, propulsion system, speed, range, and payload of each. Pictures and articles on experimental models will make a good addition to your scrapbook. Notice particularly when any model "graduates" from the experimental stage and is accepted for military or civil use (becomes operational).

Bibliography

- ALLEN, RICHARD SANDERS. *Revolution in the Sky*. Brattleboro, Vermont: The Stephen Green Press, 1967.
- BERNARDO, JAMES V. *Aviation in the Modern World*. New York: E. P. Dutton and Co., 1968.
- BERNSTEIN, BURTON. "The Piper Cub vs. the 747." *The New York Times Magazine*, March 8, 1970, pp. 34-35+.
- COLBY, C. B. *Jets of the World*. New York: Coward-McCann, Inc., 1966.
- COOMBS, CHARLES. *Aerospace Power*. New York: William Morrow and Co., 1966.
- FLOHERTY, JOHN J. *Aviation from the Ground Up*. Philadelphia: J. B. Lippincott Co., 1963.
- GABLEHOUSE, CHARLES. *Helicopters and Autogyros*. Philadelphia: J. B. Lippincott Co., 1967.
- "Gallery of USAF Weapons," *Air Force and Space Digest*, latest "almanac" issue.
- GLINES, CARROL and MOSELY, WENDELL F. *The DC-3, the Story of a Fabulous Airplane*. Philadelphia: J. B. Lippincott, 1966.
- HALLACY, D. C., Jr. *33 Miles a Minute*. New York: Julian Messner, 1966.
- HOOK, THOMAS. "All Those Planes You Can Build from Plans," *Popular Science*, June 1970.
- INGELLS, DOUGLAS J. *The Plane that Changed the World*. Fallbrook, California: Aero Publishers, Inc., 1966.
- MCMINN, ROBERT E., WOOD, CHARLES J., and JOHNSON, JAMES O. *Aircraft in Flight*. Maxwell AFB, Alabama: Civil Air Patrol.
- MISENHIMER, TED G. *Aeroscience*. Culver City, California: Aero Products Research, Inc., 1970.
- MUNSON, KENNETH. *Bombers: Patrol and Transport Aircraft*. New York: Macmillan Co., 1966.
- _____ *Civil Airliners since 1946*. New York: Macmillan Co., 1967.
- _____ *Fighters: Attack and Training Aircraft*. New York: Macmillan Co., 1966.
- _____ *Private Aircraft: Business and General Purpose Since 1946*. New York: Macmillan Co., 1967.
- National Aerospace Education Council. 1967 United States Aircraft, Missiles and Spacecraft, National Aerospace Education Council, publ., Washington, D.C.
- STAMBLER, IRWIN. *Space Ship: The Story of the X-15*. New York: G. P. Putnam Sons, 1961.
- TAYLOR, JOHN W. R. (ed.). *Jane's All the World's Aircraft*. Great Missenden, England: Jane's (latest available edition).
- USAF-Air Force Systems Command. *Military Aircraft, Rockets and Guided Missiles*. Wright-Patterson Air Force Base: Aeronautical Systems Division (SEPDT), 1968.
- VAN DEVENTER, C. N. *An Introduction to General Aeronautics*. American Technical Society, 1965.
- VAN SICKLE, MAJ. GEN. NIEL D. (ed.), *Modern Airmanship*. Princeton, N.J.: Van Nostrand, Third Edition, 1966.

169/170

170

INDEX OF WORDS, PHRASES, AND NAMES

The following is a grand single listing of the "Words, Phrases, and Names to Remember" listed at the end of each chapter, with some additional items. Abbreviations are cross-referenced to full names or phrases. Terms in these lists are printed in boldface in the text where they first appear and elsewhere as deemed necessary. Page references locate passage or passages where the term is defined, discussed, or adequately explained by its context.

A

acceleration of air, 54
 ADC (see Aerospace Defense . . .)
 aerodynamics, 19
 aeromedical evacuation, 10
 Aerospace Defense Command (ADC), 127
 Aerospace Rescue and Recovery Service (ARRS), 135-36
 afterburner, 64
 aileron, 36-37
 Airborne Warning and Control System (AWACS), 132
 airbus, 97
 aircraft owners and pilots association (AOPA), 76
 airfoil, 22, 36-39
 airport availability, 77-78
 airscoop, 67
 airspeed, 23
 air taxi, 76
 air traffic controller, 49-50
 Air Training Command (ATC), 111
 Air Weather Service (AWS), 136-37
 altimeter, 49
 altitude, 28
 amphibian aircraft, 136
 AOPA (see Aircraft Owners . . .)
 angle of attack, 24-25
 arresting gear, 155-56
 ARRS (see aerospace rescue . . .)
 aspect ratio, 40-41
 attack aircraft, 119
 ATC (see air training . . .)
 attitude, 49
 Autogira, 145-46
 avionics, 49
 AWACS (see Airborne Warning . . .)
 AWS (see Air Weather . . .)

B

bank, 37
 Bernoulli effect (Bernoulli's Law), 23

biplane, 39
 bulkhead, 35
 bush pilot, 146
 bypass engine (turbofan), 65

C

canister, 42
 cantilevered wings, 27
 catapult, 155-56
 ceiling (absolute ceiling, service ceiling), 28
 center-line thrust, 82
 centrifugal force, 36
 channel wing, 155
 chord (mean chord), 42
 civil aviation, 76
 clamshell doors, 6
 close support, 114
 combustion, 54-55
 command and control system, 114
 commercial airline, 76, 89
 compass, 49
 compound helicopter, 150-51
 compression stroke, 57
 counterair, 114
 counter-rotating propeller, 68, rotors, 146
 cowl, cowling, 27, 34
 critical mach, 44
 crop duster, 39-40
 cross-coupled engines, 155
 cruising speed, 28

D

deflected slipstream, 154-55
 delta wing, 40
 delta-wing rotor, 152
 drag, 25-27
 ducted fan (turbofan), 65

E

EAA (see Experimental Aircraft . . .)
 early warning, 131-32

elevator, 37
empennage, 37
engine cowl, 34
exhaust stroke, 57
Experimental Aircraft Association (EAA), 86
experimental status, 159
external combustion, 54

F

FAC (see forward air...)
fairing, 27
feathered propeller, 56
fighter airplane, 115
fighter weapon system, 110
fire control, 110
firewall, 35
flame holder, 61
flap, 38
flapping of rotor, 146
flight-control airfoils, 36-39
fluid, 25
flying crane, 145, 148-49
forward air controller (FAC), 115
functional design, 5
fuselage, 35

G

Gatling Gun (Vulcan), 117
general aviation, 75-76
gravity, 20
groundspeed, 23
Gyrocopter, 145-46
gyroplane, 145-46

H

helicopter, 146-150
heliport, 153
high-density route, 77
horizontally-opposed engine, 59
horsepower (hp), 66
hurricane hunter flights, 137
hybrid helicopter, 151-52
hydraulics, 46
hypersonic, 24
hypoxia, 29

I

IFR (see instrument flight...)
impact pressure, 25
inertia, 20
in-line engine, 59
instrument flight rules (IFR), 49
intake stroke, 57
interceptor aircraft, 40, 127-31
interdiction, 114
internal combustion, 54-55

J

JATO (see jet assisted...)
jet-assisted takeoff (JATO), 10
jet-lift STOL or VTOL, 158-59
jumbojet, 95-99

K

knot, 23

L

LAPES (see low-altitude...)
Laws of Motion, 20, 21
lift 20, 23-25
lifting body, 69
liquid-propellant rocket, 71
loiter capability, 125
longeron, 35
low-altitude parachute extraction system (LAPES), 10

M

MAC (see Military Airlift...)
MAC 1370th Photomapping Wing, 135
mach number, 24
Military Airlift Command (MAC), 10-11, 135-37
monocoque, 27
monoplane, 39

N

nacelle, 27
NASA (see National Aeronautics...)
National Aeronautics and Space Administration (NASA), 45
nautical mile, 23
negative reaction (negative lift), 37
Newton, Sir Isaac, 20
NORAD (see North American...)
North American Air Defense Command (NORAD), 127

O

observation, 114-15
observation aircraft, 81-82, 126-27
oil-pressure gauge, 49
operational status, 158
oxidizer, 71
oxygen, 55

P

PACAF (see Pacific Air...)
Pacific Air Forces (PACAF), 112
payload, 17
pitch, 55
pod, 27
pounds of thrust, 66

power stroke, 57
pressure differential, 23
pressurized cabin, 29
primary mission, 135
primary using command, 110
propeller, 34
prop jet (turboprop), 67-68
prop rotor, 151-53
propulsion unit, 53
prototype, 7, 137
pulse jet, 63

R

radial engine, 58-59
ramjet engine, 60
reaction, 21
reciprocating engine, 56-60
reconnaissance, 114
recoverable vehicle, 72
relative wind, 22-23
reversible pitch, 66
reversible thrust, 12
retractable landing gear, 27
rocket motor, 68
rotary wing aircraft, 145
rotations per minute (rpm), 68
rotor, 145
rudder, 37

S

SAC (see Strategic Air ...)
safeguard system, 127
sailplane, 86
SATS (see short airfield ...)
scramble, 128
SCRAMJET (see supersonic combustion ...)
semi-manoeuvre, 35
servomechanism, 47
shaft horsepower (shp), 68
shaft turbine engine, 68, 146
shock wave, 45, 56, 104
short airfield for tactical support (SATS), 156
short takeoff and landing (STOL), 16, 152
skid, 37
slatted wing, 158
solid rocket motor, 71
sonic, 24
sonic boom, 24, 104-06
sound barrier, 44
speedbrake, 39
splashdown, 69
spoil, 39
SST (see supersonic transport)
stabilator, 37
stabilizer (horizontal and vertical stabilizers), 37
stall, 25
STOL (see short takeoff ...)

STOLport, 153
stowable rotor, 152
Strategic Air Command (SAC), 132-35
strategic forces, (strategic warfare), 113
stratosphere, 29
streamlining, 25
stressed skin, 27
stretched airplane, 95
stringer, 35
strut, 26
subsonic, 24
supercharger, 59-60
supercritical wing, 45
super FAC, 117
supersonic, 24
supersonic combustion ramjet (SCRAMJET), 62-63
supersonic cruise capability, 102
supersonic dash capability, 102
supersonic transport (SST), 100-106
sweepback, 42
swing tail, 6-7
swing wing, 42-43
systems, 110

T

TAC (see Tactical Air ...)
tachometer, 49
Tactical Air Command (TAC), 112
tactical airlift, 10, 115
tactical forces (tactical warfare), 113
tandem engines, 82
technical service (of MAC), 135-37
theater (military), 113
thrust, 20
thrust reverser, 64
tilting aircraft, 160-61
titanium, 102
torque, 58
touchdown, 35
trade-off, 15-16
transonic zone, 44
tri-jet, 95
trim tab, 38
truss, 35
turbine, 60, 63-64
turbine compressor, 63
turboprop engine, 65
turboprop engine 63-65
turboprop (prop jet) engine, 67-68
turbosupercharger, 60
turbulence, 25

U

Undergraduate Pilot Training Program (UPT), 111-12
United States Air Forces in Europe (USAFE), 112

UPT (see undergraduate pilot . . .)
USAFE (see United States . . .)
useful load, 17

V

variable sweep wing (variable geometry
wing, swing wing), 42-44
VFR (see visual flight . . .)
vertical and/or short takeoff and landing
(VSTOL), 144, 159-65

vertical takeoff and landing (VTOL), 144,
159-65
visual flight rules (VFR), 49
visual observation, 114-15
VSTOL (see vertical and/or . . .)
VTOL (see vertical takeoff . . .)
VTOL part, 153

W

windmilling, 145
wingspan, 4

INDEX OF AIRCRAFT

The following is a grand single listing of the aircraft mentioned in this text and listed at the end of each chapter. Text and picture references are listed under manufacturer's name only (except in the case of a few proposed aircraft for which a manufacturer has not yet been assigned). Aircraft are also listed here by name and by letter and/or numerical designators, cross-referenced to manufacturer's name.

Numerical Without Letter

125 (Beechcraft-Hawker)
188 (McDonnell-Douglas)
707 (Boeing)
727 (Boeing)

737 (Boeing)
747 (Boeing)
941 (Breguet)

A

A-1 (Douglas)
A-7D (Ling-Temco-Vought (LTV))
A-36 (Beechcraft)
A-37 (Cessna)
A-300 (Deutsche Airbus-Sud Aviation)
AC-47 (Douglas C-47)
AC-119 (Fairchild C-119)
AC-130 (Lockheed C-130)
Aero Spacelines
Pregnant Guppy transport airplane, 7
Super Guppy transport airplane, 7, Fig. 5
AH-1 (Bell)
AH-51 (Lockheed)
Air Force One (Boeing VC-137)
Albatross (Grumman)
An-22 (Antonov)
Antheus (Antonov An-22)
Antonov An-22 Antheus Soviet transport airplane, 14, Fig. 68
Autogiro (Cierva)
AWACS (Boeing)
A-X proposed attack airplane for USAF, 121-24, Fig. 63
Aztec (Piper)

B

B-1 proposed strategic bomber for USAF, 43, 133-34, Fig. 72
B-24 (Consolidated)
B-52 (Boeing)
B-57 (Martin-Marietta)
B-58 (General Dynamics)

BAC (British Aircraft Corporation) Super VC-10 Comet British transport airplane, 93-94
BAC-Sud Aviation Concorde British-French supersonic transport airplane, 100
Beechcraft
A-36 Bonanza general aviation airplane, 80-81
Duke general aviation airplane, 83, Fig. 39
King Air 100 general aviation airplane, 85, Fig. 40
Pressurized Duke (Duke)
Beechcraft-Hawker 125 general aviation airplane, 85, Fig. 41
Bell
AH-1 Hueycobra attack helicopter, 147-48
UH-1 Iroquois (Huey) utility helicopter, 147-48, Fig. 74
X-22 experimental VSTOL aircraft, 160-61
Bensen X-25 Gyrocopter experimental aircraft, 146
Birdog (Cessna O-1)
Boeing (see also Boeing-Vertol)
707 transport airplane (VC-137), 92, Fig. 42
727 transport airplane, 95
737 transport airplane, 95
747 transport airplane, 90, 97, Fig. 45
AWACS warning and control airplane, 132, Fig. 70
B-52 Stratofortress strategic bomber airplane, 65, 132-33, Fig. 71
Bomarc missile, 62, Fig. 26

C-97 Stratocruiser transport airplane (HC-97, Pregnant Guppy, Super Guppy), 7, 90, 136, Fig. 5
 SST supersonic transport airplane, 101-02, Fig. 49
 VC-137 (707)
 Boeing-Vertol CH-47 Chinook transport helicopter, 148, Fig. 76
 Bomarc (Boeing)
 Bonanza (Beechcraft A-36)
 Breguet 941 (McDonnell-Douglas 188)
 French STOL transport airplane, 157-58, Fig. 80
 British Aircraft Corporation (see 8AC)
 Bronco (North American OV-10)
 Buffalo (De Havilland C-8)

C

C-5A (Lockheed)
 C-7 (De Havilland)
 C-8 (De Havilland)
 C-9 (McDonnell-Douglas)
 C-47 (Douglas)
 C-97 (Boeing)
 C-119 (Fairchild)
 C-121 (Lockheed)
 C-123 (Fairchild)
 C-124 (Douglas)
 C-130 (Lockheed)
 C-133 (Douglas)
 C-135 (Boeing)
 C-141 (Lockheed)
 Canadair
 CL-44 Canadian transport airplane, 6-7, 90
 Dynavert, Canadian experimental VSTOL aircraft, 160
 Conberra (Martin-Marietta B-57)
 Caravelle (Sud Aviation)
 Cargomaster (Douglas C-133)
 Caribou (De Havilland C-7)
 Cessna
 A-37 attack airplane, 120-121, Fig. 60
 Golden Eagle general aviation airplane, 83
 O-1 Birdog observation airplane, 81, 126
 O-2 Skymaster observation and general aviation airplane, 81-82, 126, Fig. 37
 T-37 training airplane, 111 Fig. 52
 T-41 training airplane, 111, Figs. 22, 51
 CH-53 (Sikorsky)
 CH-54 (Sikorsky)
 Cherokee (Piper)
 Cheyenne (Lockheed AH-51)
 Chinook (Boeing-Vertol)
 Cierva Autogiro historic rotary-wing aircraft, 145
 Comanche C (Piper)

Comet (British Aircraft Corporation Super VC-10)
 Concorde (8AC-Sud Aviation)
 Conroy Turbo Three converted Douglas C-47, 4, 60 f.n.
 Consolidated B-24 Liberator WWII bomber, 58
 Constellation (Lockheed C-121)
 Convair (see also General Dynamics-Convair) T-29 Flying Classroom navigation training airplane, 112, Fig. 54
 Corsair II (Ling-Temco-Vought A-7D)
 Courier (Helio U-10)
 Curtiss-Wright X-19 experimental VTOL aircraft, 160-61, Fig. 81
 Custer Channel Wing experimental STOL airplane, 155

D

Dakota (Douglas C-47)
 Dassault
 Mercure French transport airplane, 94
 Mirage G, French fighter airplane, 43
 DC-3 (Douglas C-47)
 DC-8 (McDonnell-Douglas)
 DC-9 (McDonnell-Douglas)
 DC-10 (McDonnell-Douglas)
 De Havilland
 C-7 Caribou Canadian transport airplane, 58-59, 156-57
 C-8 Buffalo Canadian transport airplane, 158, Fig. 79
 Twin Otter Canadian experimental STOL airplane, 156
 U-1 Otter transport airplane, 156
 Delta Dagger (General Dynamics-Convair F-102)
 Delta Dart (General Dynamics-Convair F-106)
 Deutsche Airbus-Sud Aviation (see also Sud Aviation) A-300 French-German transport airplane, 98-99
 Douglas (see also McDonnell-Douglas)
 A-1 Skyraider attack airplane, 124-25, Fig. 64
 C-47 Goosy Bird transport airplane (AC-47, Dakota, DC-3, Skytrain—see also Conroy Turbo-Three), 2-5, Fig. 1
 C-124 Globemaster transport airplane, 6, 59, Fig. 3
 C-133 Cargomaster transport airplane, 6, Fig. 4
 Duke (Beechcraft)
 E
 EB-57 (Martin-Marietta B-57)
 EB-66 (McDonnell-Douglas)
 EC-121 (Lockheed C-121)
 EC-135 (Boeing C-135)

EWR VJ-101C German experimental jet
VSTOL aircraft, 163

F

F-4 (McDonnell-Douglas)
F-5 (Northrop)
F-15 (McDonnell-Douglas)
F-28 (Fokker)
F-100 (North American)
F-101 (McDonnell)
F-102 (General Dynamics-Convair)
F-104 (Lockheed)
F-105 (Republic)
F-106 (General Dynamics-Convair)
F-111 (General Dynamics)
Fairchild
C-119 Flying Boxcar transport airplane
(AC-119), 5, 126, Figs. 2, 65
C-123 Provider transport airplane (C-
123D), 7-9, Fig. 6
FB-111 (General Dynamics F-111)
Fellowship (Fokker F2-8)
Flying Boxcar (Fairchild C-119)
Fokker F-28 Fellowship Dutch transport air-
plane, 94
Freedom Fighter (Northrop F-5)

G

Galaxy (Lockheed C-5A)
General Dynamics (see also General Dy-
namics-Convair)
B-58 Hustler strategic bomber, 102-03,
Fig. 23
F-111 fighter, FB-111 strategic bomber,
42-43, 65, 118, 133, Fig. 20
General Dynamics-Convair (see also Con-
vair and General Dynamics separately)
F-102 Delta Dagger fighter airplane, 40,
127, Fig. 19
F-106 Delta Dart fighter airplane, 40,
128-30, Figs. 19, 67
Globemaster (Douglas C-124)
Golden Eagle (Cessna)
Gooney Bird (Douglas C-47)
Grumman U-16 Albatross amphibian air-
plane, 136, Fig. 73
Gyrocopter (Bensen X-25)

H

Harrier (Hawker-Siddeley P.1127)
Hawker (see Beechcraft-Hawker, Hawker-
Siddeley)
Hawker-Siddeley
P.1127 Harrier (XV-6A Kestrel) British
VSTOL fighter aircraft, 164-65, Fig. 84
Trident British transport airplane, 94
HC-97 (Boeing C-97)
HC-130 (Lockheed C-130)

Helio U-10 Courier STOL airplane, 126, Fig.
66

Hercules (Lockheed C-130)
HH-3 (Sikorsky)
HH-53 (Sikorsky CH-53)
Hiller (see LTV-Hiller-Ryan)
Huey (Bell UH-1)
Hueycobra (Bell AH-1)
Hummingbird (Lockheed XV-4)
Hustler (General Dynamics B-58)

I

II-62 (Ilyushin)
Ilyushin II-62 Soviet transport airplane, 94
Iroquois (Bell UH-1)

J

Jolly Green Giant (Sikorsky HH-3)

K

KC-135 (Boeing C-135)
Kestrel (Hawker-Siddeley P. 1127)
King Air 100 (Beechcraft)

L

L-500 (Lockheed C-5)
L-1011 (Lockheed)
Lear Learjet general aviation airplane, 85
Learjet (Lear)
Liberator (Consolidated)
Ling-Temco-Vought (see LTV)
Lockheed
AH-51 Cheyenne attack helicopter 150-
51
C-5A Galaxy (L-500) transport airplane,
12-15, 65, 66, 90, 96-97, Figs. 9, 10, 11
C-121 Constellation transport airplane
(EC-121) 58, 131-32, Fig. 69
C-130 Hercules transport and special
purpose airplane (AC-130, C-130P,
HC-130, RC-130, WC-130), 9-11, 68,
90, 126, 136, 137, Figs. 7, 77.
C-141 Starlifter transport airplane, 11,
12, 65, Figs. 8, 16.
F-104 Starfighter (F-104G) fighter air-
plane, 40, 126-27, Fig. 19
L-1011 Tri-Star transport airplane, 90,
98, Fig. 47
SR-71 strategic reconnaissance airplane
(YF-12A), 64-65
XV-4 Hummingbird experimental VSTOL
aircraft, 163-64, Fig. 83
YF-12A test aircraft (fighter type) (SR-
71), 130, Fig. 68
LTV (Ling-Temco-Vought) A-7D Corsair II
attack airplane, 120, Fig. 59
LTV-Hiller-Ryan XC-142 experimental
VSTOL aircraft, 160-62, Fig. 82

M

Martin-Marietta
 B-57 (B-57G, RB-57, WB-57) Canberra bomber airplane, 121, 137, Fig. 62
 X-24 experimental lifting-body aircraft, p. 69, Fig. 32
 McDonnell (see also McDonnell-Douglas)
 F-101 (RF-101) Voodoo fighter airplane, 4D, 119, 127, Fig. 19
 McDonnell-Douglas (see also McDonnell and Douglas separately)
 188 STOL transport airplane (Breguet 941), 157-58, Fig. 80
 C-9 Nightingale hospital airplane (DC-9), p. 135
 DC-8 transport airplane, 93, Fig. 43
 DC-9 transport airplane (C-9), 95, Fig. 44
 DC-10 transport airplane, 90, 97-98, Fig. 46
 EB-66 electronic airplane, 121, Fig. 61
 F-4 (F-4C, F-4E, RF-4) Phantom II fighter airplane, 66, 110, 117, 119, Figs. 57, 58
 F-15 planned fighter airplane, 119
 Mercure (Dassault)
 Mi-10 (Mil)
 Mig-23 (Mikoyan-Gurevich)
 Mikoyan-Gurevich Mig 23 Soviet fighter airplane, 119, 130-31
 Mil Mi-10 Soviet Flying-crane helicopter, 149
 MRCA (multi-role combat aircraft) proposed West European fighter airplane, 43
 Mustang (North American P-51)

N

North American (North American Rockwell)
 F-100 Supersabre fighter airplane, 117, Fig. 55
 OV-10 Bronco observation airplane, 126-127, 153-54, Fig. 78
 P-51 Mustang WWII fighter airplane, 59
 X-15 experimental rocket aircraft, 34, 68-72, Figs. 33, 34
 XB-70 Valkyrie experimental bomber airplane, 103, Fig. 50
 Northrop
 F-5 Freedom Fighter fighter airplane, 119
 T-38 training airplane, 112, Fig. 53

O

O-1 (Cessna)
 O-2 (Cessna)
 Otter (De Havilland U-1)
 OV-10 (North American)

P

P-51 (North American)
 P. 1127 (Hawker-Siddeley)
 Phantom II (McDonnell-Douglas F-4)
 Piper
 Aztec general aviation airplane, 82-83, Fig. 38
 Cherokee general aviation airplane, 80, Fig. 36
 Comanche C general aviation airplane, Fig. 35
 Turbo-Aztec (Aztec)
 Pregnant Guppy (Aero Spacelines)
 Pressurized Duke (Beechcraft Duke)
 Provider (Fairchild C-123)

R

R8-57 (Martin Marietta B-57)
 RC-130 (Lockheed C-130)
 RC-135 (Boeing C-135)
 Republic
 F-105 Thunderchief fighter airplane, 117, Fig. 56
 P-47 Thunderbolt WWII fighter airplane, 58
 RF-4 (McDonnell-Douglas F-4)
 RF-101 (McDonnell F-101)
 Ryan (see also LTV-Hiller-Ryan)
 Spirit of St. Louis historic airplane, 27
 XV-5 experimental VSTOL aircraft, 163

S

S-61 (Sikorsky)
 Sea Dragon (Sikorsky CH-53)
 Siddeley (see Hawker-Siddeley)
 Sikorsky
 CH-53 Sea Dragon transport helicopter (HH-53) Fig. 75
 CH-54 flying-crane helicopter, 148
 HH-3 Jolly Green Giant rescue helicopter 136, 149-50, Fig. 77
 HH-53 Super Jolly rescue helicopter (CH-53), 136, 148, 149-50, Fig. 75
 S-61 transport helicopter, 149
 Skymaster (Cessna O-2)
 Skyraider (Douglas A-1)
 Skytrain (Douglas C-47)
 Spirit of St. Louis (Ryan)
 Spitfire (Vickers Supermarine)
 SR-71 (Lockheed)
 SST (Boeing)
 Starfighter (Lockheed F-104)
 Starlifter (Lockheed C-141)
 Stratocruiser (Boeing C-97)
 Stratofortress (Boeing B-52)
 Stratolifter (Boeing C-135)

Sud Aviation (see also BAC-Sud Aviation and Deutsche Airbus-Sud Aviation)
Caravelle French transport airplane, 94
Super Guppy (Aero Spacelines)
Super Jolly (Sikorsky HH-53)
Supermarine Spitfire (Vickers)
Supersabre (North American F-100)
Super VC-10 (British Aircraft Corporation)

T

T-29 (Convair)
T-37 (Cessna)
T-38 (Northrop)
T-41 (Cessna)
Temco (see Ling-Temco-Vought (LTV))
Thunderbolt (Republic P-47)
Thunderchief (Republic F-105)
Trident (Hawker-Siddeley)
Tri-Star (Lockheed L-1011)
Tu-124 (Tupolev)
Tu-134 (Tupolev)
Tu-144 (Tupolev)
Tupolev
Tu-124 Soviet transport airplane, 94
Tu-134 Soviet transport airplane, 94
Tu-144 Soviet supersonic transport airplane, 100
Turbo-Aztec (Piper)
Turbo-Three (Canoy)
Twin Otter (De Havilland)

U

U-1 (De Havilland)
U-10 (Helio)
U-16 (Grumman)

V

V-1 German WWII missile, 63
V-2 German WWII missile, 63
VC-10 (British Aircraft Corporation)
VC-137 (Boeing)
Vertal (see Boeing-Vertal)
Vickers Supermarine Spitfire WWII British fighter airplane, 59
VJ101C (EWR)
Voodoo (McDonnell F-101)
Vaught (see Ling-Temco-Vought (LTV))

W

Warning Star (Lockheed C-121)
WB-57 (Martin Marietta B-57)
WC-130 (Lockheed C-130)
WC-135 (Boeing C-135)

X

X-15 (North American)
X-19 (Curtiss-Wright)
X-22 (Bell)
X-24 (Martin-Marietta)
X-25 (Benson)
XC-142 (LTV-Hiller-Ryan)
XV-4 (Lockheed)
XV-5 (Ryan)

Y

YF-12A (Lockheed)

AU-GAFB, AL (712933) 7/71, 35M.