

DOCUMENT RESUME

ED 052 751

24

HE 002 435

AUTHOR Huff, Robert A.  
TITLE Program Budgeting at Micro-U. A WICHE Management Information Systems Training Document.  
INSTITUTION Western Interstate Commission for Higher Education, Boulder, Colo.  
BUREAU NO BR-8-0708  
PUB DATE Jan 70  
CONTRACT OEC-0-8-980708-4533 (010)  
NOTE 90p.  
AVAILABLE FROM Western Interstate Commission for Higher Education, P.O. Drawer P, Boulder, Colorado 80302  
EDRS PRICE EDRS Price MF-\$0.65 HC-\$3.29  
DESCRIPTORS Higher Education, \*Information Systems, \*Management Systems, Program Development, \*Resource Allocations, \*Systems Development, \*Training Techniques  
IDENTIFIERS Micro-U, \*WICHE Management Information Systems, WICHE MIS

ABSTRACT

This booklet uses the example of Micro-U--a hypothetical example intended as a training tool-- to illustrate the application of WICHE's basic Management Information Systems (MIS) concepts. Micro-U embodies a microcosm of higher education management problems related to the instructional functions MIS is designed to address. This initial version of the Micro-U training module is used to explain program budgeting concepts and techniques. The explanation includes a resource requirements prediction model designed for Micro-U and programmed for a computer. A flow chart of the model is included in the appendices. (JS)

ED052751

BR-8-0708  
PA-24  
HE

# PROGRAM BUDGETING AT MICRO-U

U.S. DEPARTMENT OF HEALTH,  
EDUCATION & WELFARE  
OFFICE OF EDUCATION  
THIS DOCUMENT HAS BEEN REPRO-  
DUCED EXACTLY AS RECEIVED FROM  
THE PERSON OR ORGANIZATION ORIG-  
INATING IT. POINTS OF VIEW OR OPIN-  
IONS STATED DO NOT NECESSARILY  
REPRESENT OFFICIAL OFFICE OF EDU-  
CATION POSITION OR POLICY.

HE 002 435

**A Training Document  
prepared by the**

**WICHE Management Information Systems Program**



**WICHE Executive Director:**  
Robert L. Kroepsch

**Associate Director, WICHE, and  
Director, Management Information  
Systems Program:**  
Ben Lawrence

**Program Director for Development and  
Applications Unit:**  
Warren W. Gulko

**Program Director for Training Unit:**  
Robert Huff

**Program Associate for Information  
Systems:**  
Charles R. Thomas

**Staff Assistant:**  
Nancy Eklund

**Principal Investigator for  
WICHE-AACRAO Space Analysis  
Manuals Project:**  
Thomas R. Mason

**Staff Analyst for Planning and  
Programming:**  
Dennis P. Jones

**Staff Analyst for Procedures  
and Methods:**  
Leonard C. Romney

The Western Interstate Commission for Higher Education (WICHE) is a public agency through which the 13 western states work together

- ... to increase educational opportunities for westerners.
- ... to expand the supply of specialized manpower in the West.
- ... to help universities and colleges improve both their programs and their management.
- ... to inform the public about the needs of higher education.

The WICHE Management Information Systems Program was proposed by state coordinating agencies and colleges and universities in the West to be under the aegis of the Western Interstate Commission for Higher Education. The MIS Program proposes in summary:

To design, develop, and encourage the implementation of management information systems and data bases including common data elements in institutions and agencies of higher education that will:

- provide improved information to higher education administration at all levels.
- facilitate exchange of comparable data among institutions.
- facilitate reporting of comparable information at the state and national levels.

ED052751

PROGRAM BUDGETING AT MICRO-U

A WICHE Management Information Systems  
Training Document

by

Robert A. Huff

The WICHE Management Information Systems  
Program is supported by the U. S. Office  
of Education, Bureau of Research, Division  
of Higher Education Research.

Western Interstate Commission for Higher Education  
P. O. Drawer P                      Boulder, Colorado 80302

January, 1970

## INTRODUCTION

Micro-U is a basic training tool which WICHE expects to use with a wide variety of audiences. The presentation which follows is the initial version of the Micro-U training module. As the WICHE MIS developmental work continues, additional features will be attached to Micro-U to enable it to display additional management procedures and concepts.

Currently, Micro-U is being used to explain program budgeting concepts and techniques. Also, a resource requirements prediction model has been designed for Micro-U and programmed for a computer. A flow chart of the Micro-U RRPM can be found in the appendices of this document. By carefully studying the text of this publication and the accompanying visuals, individuals wishing to improve their understanding of the concepts basic to the WICHE MIS effort should experience a meaningful exercise.

## **MICRO-U**

- 1) A microcosm of higher education management problems**
- 2) convenient vehicle for MIS application example**
- 3) the example will be simplified— but not simple-minded**

## PROGRAM BUDGETING AT MICRO-U

Descriptions of Management Information Systems which involve little more than broad generalizations tend to have relatively little value for those who wish to fully grasp the essentials of the new management approaches to higher education. When MIS concepts are presented in abstract form, they are sometimes deceptive and often elude full understanding. In order to avoid this circumstance, this presentation will use a very simple example of MIS application in an attempt to give greater meaning to the basic MIS concepts.

The name Micro-U was chosen for the hypothetical institution which will be used throughout this presentation because it is felt that the example embodies a microcosm of those higher education management problems related to the instructional function which the MIS Program is designed to address. The Micro-U example will be simplified in order that excessive involvement with arithmetic, and large quantities of data may be avoided, but it will not be simple-minded. That is, in a very simplified fashion the Micro-U example will seek to illustrate the concepts which are the underpinnings of the WICHE Management Information Systems approach to analysis of resource allocation problems.

# MICRO-U

## Academic Departments

History

Mathematics

Biology



Micro-U has three academic departments; history, mathematics, and biology.

## MICRO-U

### Academic Disciplines Taught

History

Mathematics

Botany

Zoology

Through the three academic departments, Micro-U offers instruction in four disciplines; history, mathematics, botany, and zoology. Botany and zoology courses are offered under the auspices of the Biology Department.

## MICRO-U

### Degree Programs Offered

History

Mathematics

Botany

Zoology

Micro-U offers degree programs which correspond to the four disciplines in which courses are offered. Thus, students at Micro-U may obtain a degree in history, mathematics, botany, or zoology.

## **MICRO-U**

### **Support Services**

Central Administration

Physical Plant Maintenance

Library

In order to operate the institution, certain support services must be provided. These include central administration, physical plant maintenance, and the library.



## From the "Traditional" Accounting System

### Per year expenditures:

Central Administration	\$58,000
Physical Plant Maintenance	57,000
Library	43,000
History Department	77,000
Mathematics Department	77,000
Biology Department	119,500
	<hr/>
	<b>\$431,500</b>



The traditional accounting system at Micro-U allows us to ascertain the total per year expenditures for the various organizational units which comprise the institution. We may note that central administration consumes \$58,000 per year; physical plant \$57,000; and the library \$43,000. The History Department and the Mathematics Department each operate on \$77,000 annual budgets, while the Biology Department's yearly budget is \$119,500. Thus, the total annual budget for Micro-U is \$431,500.

**MICRO-U**  
**DEPARTMENT DATA AND PARAMETERS**

	History	Mathematics	Biology
F.T.E. Administrators	1	1	1
F.T.E. Teaching Faculty	3	3	5
Average Faculty Load	9 WCH	9 WCH	9 WCH
Total Sections Offered	9	9	15
Average WCH per Section	3	3	3
Average Class Size	20	20	20

To increase our familiarity with Micro-U, we may examine pertinent data and parameters related to the three academic departments. These are some of the important variables we will be working with as we follow this illustrative exercise.

**From the MICRO-U Information System —**

**Weekly Student Contact Hours:**

	Majors	Others	
History Department	432	+ 108	= 540 WSCH
Mathematics Department	378	+ 162	= 540 WSCH
Biology Department	792	+ 108	= 900 WSCH

Micro-U operates an information system which is probably equivalent to that of the average higher education institution in the nation. The Micro-U information system allows us to determine the total number of weekly student contact hours (WSCH) associated with the courses offered by each of the three departments. Furthermore, the information system is able to determine the portion of the weekly student contact hours in each department which is generated by students majoring in the discipline of that department as opposed to the weekly student contact hours generated in serving students majoring in other disciplines under other departments. For example, the History Department counts 540 weekly student contact hours. Four hundred thirty-two of these are generated by history majors, while 108 weekly student contact hours are generated by students from the other disciplines. The Mathematics Department also counts 540 weekly student contact hours, 378 by mathematics majors, and 162 by other students. The Biology Department, which is somewhat larger, has 900 weekly student contact hours, 792 of which are generated by botany and zoology majors, and 108 generated by history and mathematics majors.

## Number of Course Sections Taught:

(3 Credit Hour Courses)

History Department	9		
Mathematics Department	9		
Biology Department	15	Botany	6
		Zoology	9

For convenience, we establish the average class size at Micro-U to be 20 students and the contact hours for all classes to be 3 per week. Therefore, we are able to say that the History Department offers 9 course sections, each of which meets three hours per week, in generating the 540 weekly student contact hours. The Mathematics Department also offers 9 course sections, and the Biology Department offers 15 sections of various courses. The information system tells us that the Biology Department course sections display a distribution of 6 in botany and 9 in zoology.

## **Examples of Analysis Based on Department Related Data**

- 1) Biology department consumes approximately 1½ times as much dollar resources as the history and mathematics departments.**
- 2) Library consumes approximately 10% of the total budget.**
- 3) The average departmental cost for each history course section per year is \$8,555.**
- 4) The average departmental cost for a WSCH in mathematics for one year is \$143.**



The traditional accounting system and the data generated by the information system are quite useful to Micro-U. Several kinds of analysis based on department-related data can be carried out. For example, it can be determined that the Biology Department consumes one and one-half times as much dollar resources as either the History or the Mathematics Department. We can quickly determine that the library consumes approximately 10% of the total Micro-U budget. Other examples of analysis based on department-related data could be cited. The use of such data is quite familiar to institutional personnel and will continue to be very useful. However, it is not these kinds of analysis that we are most concerned with in this example, but the new and different kinds of analysis which are made available as a result of the implementation of a management information system.

## Developing a Discipline Budget and a Degree Program Budget

**Assumption:** Degrees are proxies for institutional outputs.

**Needed:** Classification Structure for Disciplines and Degree Programs.

**Problem:** To translate dept. resource consumption data to  
*Disciplines and Degree Programs*

- a) It cost \$119,500 for the Biology Dept., but how much for Botany and how much for Zoology?
- b) How much does it cost from each dept. to provide the instruction necessary to produce a history degree?

Having identified the organizational structure of Micro-U and having displayed some of the basic data related to that organizational structure, we are now ready to begin the illustration of a program budget system. Our problem is to develop, for Micro-U, a budget by discipline and a degree program budget. In doing so, we will assume that degrees and partially completed degree programs are proxies for institutional outputs. Therefore, when we seek to analyze the output oriented programs of Micro-U we will wish to associate cost data with students enrolled in degree programs and with the degrees produced. We will need a classification structure which will allow us to identify the disciplines in which degrees are produced in a manner which is exhaustive and mutually exclusive. At Micro-U, the program classification structure for the instructional function will be very simple. It will consist of 4 discipline specialties; history, mathematics, botany and zoology. Our problem will be to transfer the resource consumption data associated with the various academic departments to the disciplines and to the degree programs so that educational outputs can be related to the costs of the institution. It is useful to know that the Biology Department costs \$119,500 to operate for one year, but we also need to know how much of that resource is consumed by botany and how much is consumed by instruction in zoology. A degree in history is not produced by the History Department alone. History majors may take courses in mathematics, botany and zoology as well as in history. Thus, a degree in history is actually produced by instruction provided through a number of the departments within the institution. To determine the total cost of producing a history degree, it is necessary to determine how much it costs for each department to provide the instruction necessary to produce a typical history degree.

## Translating Department Cost Data to Disciplines

<b>History Department</b>	<b>\$ 77,000</b>	→ History Discipline	\$ 77,000
<b>Mathematics Department</b>	<b>\$ 77,000</b>	→ Mathematics Discipline	\$ 77,000
<b>Biology Department</b>	<b>\$119,500</b>	→ Botany Discipline	\$ 47,800
		↘ Zoology Discipline	\$ 71,700
	<u><b>\$273,500</b></u>		<u><b>\$273,500</b></u>

**\*Rationale: 40% of Biology Department course sections are in Botany while 60% are in Zoology.**

The first step in our exemplary program budget approach is to translate department related cost data into discipline related cost data. In many cases, college and university departments are organized around discrete disciplines and such a translation of cost data may be carried out on a one-to-one basis. For example, the History Department has a budget of \$77,000 and, therefore, we know immediately that the direct instructional costs of the history discipline are \$77,000. Likewise, the Math Department's \$77,000 translates automatically to the math discipline. The Biology Department poses a problem, however, since instruction in two disciplines, botany, and zoology, are offered by the one department. In our simplified example, we will use only one criterion as the rationale for allocating Biology Department expenses across the two disciplines. The Micro-U information system tells us that 40% of the course sections offered by the Biology Department are in botany, while 60% of the course sections are in zoology. Using this rationale, the \$119,500 Biology Department budget is allocated across the botany and zoology disciplines. Thus, the botany discipline is found to consume \$47,800 of direct costs while the consumption of the zoology discipline is \$71,700. You will note that the total costs for instruction in all disciplines is \$273,500 which equals the total budget for all three Micro-U academic departments.

## Determining Weekly Student Contact Hours by Discipline

	Majors	Others		
<b>History Department</b>	432	108	→ History Discipline	540
<b>Mathematics Department</b>	378	162	→ Mathematics Discipline	540
<b>Biology Department</b>	792	108	→ Botany Discipline	360
			→ Zoology Discipline	540
<b>Total WSCH</b>				<b>1980</b>

**Given: The Micro-U information system shows that 40% of the Biology Department WSCH are in Botany while 60% are in Zoology.**

After translating the department costs to academic disciplines, we must determine the weekly student contact hours by discipline. Again there will be many one-to-one translations. The History Department's 540 weekly student contact hours become 540 weekly student contact hours for the history discipline, and a similar translation process will serve in mathematics. The Biology Department again poses a translation problem, since it must be determined how biology's 900 weekly student contact hours are distributed across botany and zoology. The Micro-U information system again provides needed data. We learn that all of the classes at Micro-U are of the same size and that 40% of the Biology Department weekly student contact hours are generated by botany classes while 60% are generated by zoology classes. Thus, the botany discipline generates 360 weekly student contact hours and the zoology discipline is responsible for 540 weekly student contact hours. The total weekly student contact hours for all disciplines at Micro-U is 1,980. This is equal to the number of weekly student contact hours generated by the combination of the three academic departments.

**Pro-ration of Central Administration Costs to Disciplines**  
**\$58,000**

**Rationale for pro-ration:**

**Per cent of Teaching Faculty per Discipline**

History Discipline	27.27%	\$15,818
Mathematics Discipline	27.27%	\$15,818
Botany Discipline	18.18%	\$10,546
Zoology Discipline	<u>27.27%</u>	<u>\$15,818</u>
	<b>99.99%</b>	<b>\$58,000</b>



If one assumes that the principal reason for the existence of Micro-U is to instruct students, then it follows that this institution would not exist if instruction in the four disciplines was not carried on. Logically, the support services exist to benefit the instructional process and the costs of the support services must be taken into account when calculating the total cost for providing instruction in any given discipline. Spreading the cost of central administration across the four disciplines of Micro-U requires some rationale or pro-ratio scheme. For this illustration, we will use the percentage of Micro-U's F.T.E. teaching faculty per discipline as the rationale for this allocation process. Since the history discipline generates 27.27% of Micro-U's F.T.E. teaching faculty, 27.27% of the \$58,000 budget for central administration is allocated to the history discipline. This equals \$15,818. The same method is used in allocating central administration costs to the other disciplines. Obviously, the total of the central administration costs allocated to the various disciplines must equal the total budget for central administration.

## Pro-ration of Physical Plant Costs to Disciplines

\$57,000

### Rationale for pro-ration: Per Cent of course sections taught per discipline

History Discipline	27.27%	\$15,545
Mathematics Discipline	27.27%	\$15,545
Botany Discipline	18.18%	\$10,365
Zoology Discipline	<u>27.27%</u>	<u>\$15,545</u>
	<b>99.99%</b>	<b>\$57,000</b>

Pro-ration of the physical plant costs across the four disciplines is done in this illustration on the basis of the number of course sections taught in each discipline. The history discipline generates 27.27% of the total course sections taught at Micro-U, and therefore receives 27.27% of the total \$57,000 budget for physical plant maintenance, and operation, which turns out to be \$15,545. As with central administration costs, we note that the total of the pro-rated physical plant costs equals the total budget for physical plant maintenance and operation.

**Pro-ration of Library Costs to Disciplines**  
**(\$43,000)**

**Rationale for pro-ration: equal distribution**  
**(based on library survey)**

History Discipline	25 %	\$10,750
Mathematics Discipline	25 %	10,750
Botany Discipline	25 %	10,750
Zoology Discipline	25 %	10,750
		<u>          </u>
		<b>\$43,000</b>

The final support function which must be allocated across the four disciplines is the library. The rationale for this pro-ration at Micro-U is based on a survey of library utilization and services which disclosed that any major discipline at Micro-U requires a more or less standard collection of books and materials in the Micro-U library. Although the number of students studying in various disciplines may fluctuate, it is necessary that the standard collection for each discipline be available in order to successfully conduct studies in each area. Thus, equal distribution becomes the scheme for distributing library costs across the four disciplines and each discipline receives 25% of the allocated library costs, or \$10,750.

## MICRO-U BUDGET BY DISCIPLINE

	Disciplines				<b>Totals</b>
	History	Math	Botany	Zoology	
Departmental Costs	\$77,000	\$77,000	\$47,800	\$71,700	<b>\$273,500</b>
Central Administration	15,818	15,818	10,546	15,818	<b>\$ 58,000</b>
Physical Plant	15,545	15,545	10,365	15,545	<b>\$ 57,000</b>
Library	10,750	10,750	10,750	10,750	<b>\$ 43,000</b>
<b>Totals</b>	<b>\$119,113</b>	<b>\$119,113</b>	<b>\$79,461</b>	<b>\$113,813</b>	<b>\$431,500</b>

We are now ready to prepare a Micro-U budget by discipline. Along the left side of the table the expenditures are arrayed by type. Across the top of the table are the four Micro-U disciplines. By summing the vertical columns, we arrive at the total expenditures for each discipline. Summing the horizontal rows provides the total for each type of expenditure. The sum of all expenditure totals and the sum of all discipline costs must equal \$431,500, which is the total budget for Micro-U. This table allows us to quickly determine the variations in costs among the four Micro-U disciplines. We may note that botany is the least expensive in terms of total cost. However, it is perhaps more meaningful to look at the disciplines costs per weekly student contact hour.

### Discipline Costs per WSCH

**History— \$220.58 per WSCH**

**Mathematics— 220.58 per WSCH**

**Botany— 220.73 per WSCH**

**Zoology— 210.76 per WSCH**



When we divide the total cost for each discipline by the number of weekly student contact hours in that discipline we find that history and mathematics both cost \$220.58 per unit. Botany, the discipline with the smallest total expenditure, costs \$220.73 per weekly student contact hour, while zoology with a cost of \$210.76 per weekly student contact hour, now assumes the role of the least expensive discipline.

# RESOURCE REQUIREMENTS PREDICTION MODEL

COST CATEGORIES	Discipline Specialties, e.g.				Totals
	Chemistry	Physics	Geology		
Academic Salaries					
Support Salaries					
Equipment					
Space					
Student Services					
Library					
Administration					
Maint. & Overhead					
Totals					

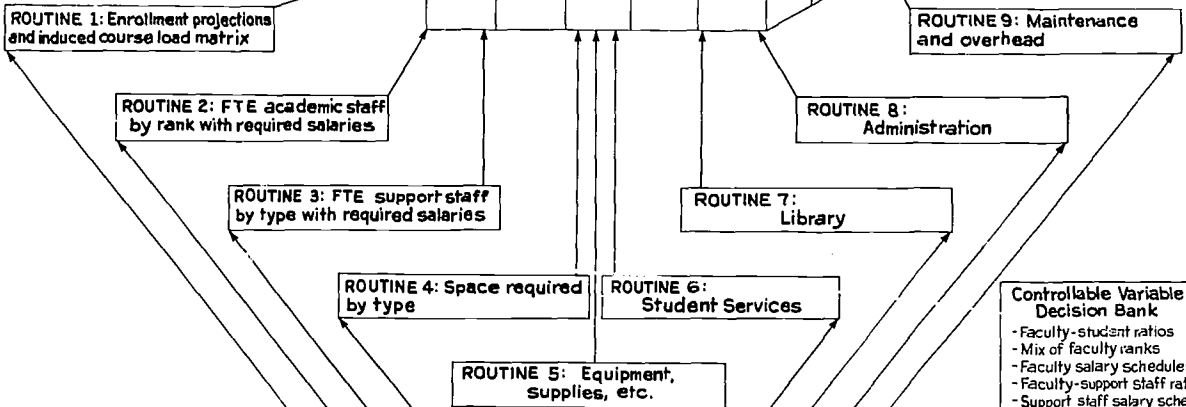
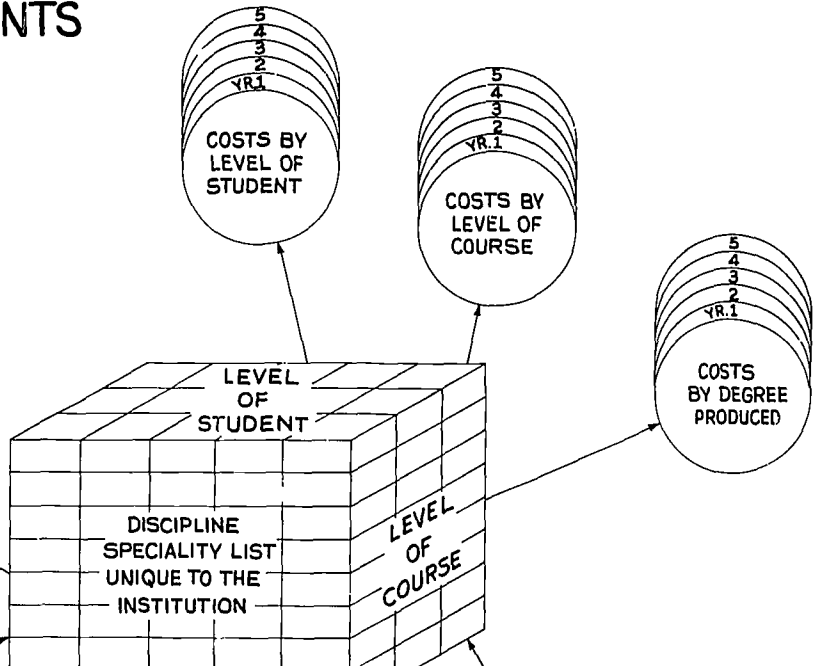

- Controllable Variable Decision Bank**
- Faculty-student ratios
  - Mix of faculty ranks
  - Faculty salary schedules
  - Faculty-support staff ratios
  - Support staff salary schedules
  - Desired mix of room types and sizes
  - Sq. ft. per student by types of space
  - Desired sizes for types of classes and instruction
  - Ratio of faculty time on dept. research, professional activities, etc.
  - Relationship (ratios) of library, administrative & maintenance space to total space
  - Other

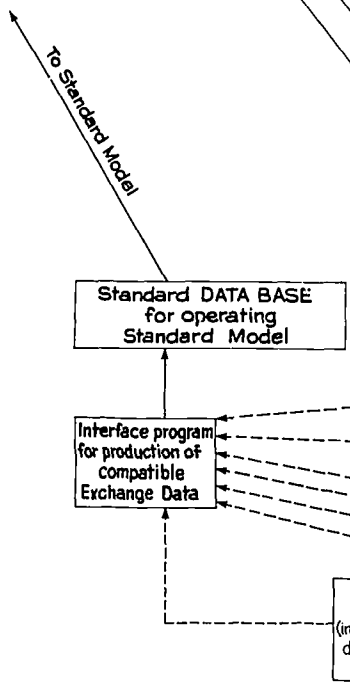

Decisions relative to controlled variables

Additional data needed for specific models

PREPARED BY:  
MANAGEMENT INFORMATION SYSTEMS PROGRAM  
WESTERN INTERSTATE COMMISSION FOR HIGHER EDUCATION

The Micro-U example is consistent with the WICHE MIS Resource Requirements Prediction Model. In this diagram of the RRPM, we see that a number of routines to calculate salaries, equipment, overhead, maintenance and other types of costs are completed by drawing information from the data base. These cost categories are then "tied" to the discipline specialty list unique to the institution. When using the model to generate a budget by discipline, such as we have just described for Micro-U, that discipline specialty list would consist of all of the disciplines in which the institution offers course work. The tri-dimensional matrix provides a means of aggregating the cost categories by discipline so that a budget by discipline, as shown in the upper left hand portion of the diagram, may be constructed. In the case of Micro-U, the discipline specialty list on the front of the tri-dimensional matrix would include only four disciplines; namely, history, math, botany, and zoology. In the case of Micro-U, we have not discussed the attachment of level of student and level of course indicators to the various disciplines in preparation for generating cost by level of student and cost by level of course. However, it is well within our technical capability to attach such level indicators. Later, we will see that the WICHE RRPM may also be used for predicting resource requirements in a degree program budget format.

## **Uses of Discipline Related Data**

- 1) Analysis of Costs by Discipline**
- 2) Standard Reporting**
- 3) Exchange**

We have already seen that discipline related data are useful for analysis of various costs by discipline, such as the cost per weekly student contact hour in various disciplines. In addition, the discipline related data will be useful for standard reporting and for exchange of comparable data among cooperating institutions. The advantage of exchanging discipline related data as compared to department related data lies in the fact that disciplines tend to provide unique, standard definitions of sets of activities and courses, while departments with similar names in different institutions may house different sets and mixtures of disciplines. For example, if data related to the Micro-U Biology Department, which contains a large component of zoology and a smaller component of botany were compared to a Biology Department in an institution which taught a great deal of botany and little or no zoology, the comparison could be very misleading.

## **Developing A Degree Program Budget**

### **TASKS**

- 1. Develop induced course load matrix (WSCH).**
- 2. Calculate coefficients.**
- 3. Use coefficients to translate the Discipline Budget into a Degree Program Budget.**

Having developed a budget by discipline, we are now ready to proceed with the development of a degree program budget. Three tasks are involved. First, we must develop an induced course load matrix based on the number of weekly student contact hours generated by students from each major taking courses in each discipline. Second, we must calculate two types of coefficients on the basis of the induced course load matrix and finally, we must use the coefficients to translate the discipline related cost data into a degree program budget format.

## Induced Course Load Matrix (WSCH)

		Degree Programs				
		History	Math	Botany	Zoology	<b>WSCH Totals</b>
<b>Disciplines</b>	History	432	54	54	0	<b>540</b>
	Mathematics	0	378	108	54	<b>540</b>
	Botany	0	0	216	144	<b>360</b>
	Zoology	54	54	108	324	<b>540</b>
<b>WSCH Totals</b>		<b>486</b>	<b>486</b>	<b>486</b>	<b>522</b>	<b>1980</b>



The induced course load matrix is produced by deriving, from the information system of Micro-U, the total number of weekly student contact hours generated by those students majoring in each degree program as they take courses in each of the four disciplines. We note, for example, that history majors generated 432 weekly student contact hours in history courses, and 54 weekly student contact hours in zoology courses. Math majors accounted for 54 weekly student hours in history courses, 378 weekly student contact hours in Math courses and 54 weekly student contact hours in zoology courses. Only the botany majors took course work in all four Micro-U disciplines. The sum of each column indicates the total number of weekly student contact hours in all disciplines generated by enrollees in each degree program. We note that both the sum of the rows and the sum of the columns equals 1980, the total number of weekly student contact hours at Micro-U.

**Induced Course Load Matrix  
(Type 1 Coefficients)**

$$\frac{\text{Degree Program  
WSCH per discipline}}{\text{Total WSCH for  
the Degree Program}} = \text{Coefficient}$$

<b>History Degree Program</b>			
<b>WSCH taken in the</b>			
<b>History Discipline</b>	—————→	<b>432</b>	
		—————	<b>= .888 = .89</b>
<b>Total WSCH for the</b>	—————→	<b>486</b>	
<b>History Degree Program</b>			

The next step is to replace the numbers of weekly student contact hours in the induced course load matrix with decimals or percentages which shall be called Type 1 coefficients. These Type 1 coefficients indicate the portion of the WSCH for each degree program provided by each discipline. Type 1 coefficients are calculated by dividing each degree program's WSCH per discipline by the total WSCH for the degree program. For example, 432 history degree program weekly student contact hours are taken in the history discipline. The total of the weekly student contact hours for the history degree program is 486. If we divide 432 by 486 we arrive at the decimal .888 which may be rounded to .89.

## Induced Course Load Matrix (Type I Coefficients)

		<b>Degree Programs</b>			
		History	Math	Botany	Zoology
<b>Disciplines</b>	History	.89	.11	.11	0
	Mathematics	0	.78	.22	.10
	Botany	0	0	.45	.28
	Zoology	.11	.11	.22	.62
		<b>100%</b>	<b>100%</b>	<b>100%</b>	<b>100%</b>

This Type 1 coefficient is then placed in the appropriate space in the induced course load matrix to represent the portion of the history degree program weekly student contact hours generated through courses in the history discipline. Following the same mathematical routine, we may calculate the Type 1 coefficient for each space in the matrix. We now see that 11% of the botany degree program weekly student contact hours are taken in history, 22% in math, 45% in botany and 22% in zoology. By totaling the vertical columns, we may check our coefficients to see if we have accounted for all 100% of the weekly student hours in the various degree programs.

## Uses of Type 1 Coefficients

- 1) **Determine the portions of degree programs provided by disciplines.**
- 2) **Simulate the impact of any projected enrollment in any given degree program on all disciplines.**

The Type 1 coefficients we have placed in the induced course load matrix will obviously be useful in determining the portions of degree programs provided by the various disciplines. Also, these coefficients will allow us to simulate the impact of any projected enrollment in any given degree program on all disciplines. For example, if we are told that the mathematics department enrollment is expected to double in size during the next year, we could quickly determine the impact not only on the mathematics discipline (and hence the mathematics department) but also on the history discipline and the zoology discipline. Colleges and universities may use resource requirements prediction models and enrollment projections for coming years to simulate the resources required for anticipated programs. The use of Type 1 coefficients is basic to such simulation procedures.

**Induced Course Load Matrix  
(Type 2 Coefficients)**

$$\frac{\text{Degree Program  
WSCH per Discipline}}{\text{Total WSCH for  
the Discipline}} = \text{Coefficient}$$

$$\begin{array}{l} \text{History Degree Program} \\ \text{WSCH taken in the} \\ \text{History Discipline} \longrightarrow 432 \\ \text{Total WSCH for} \longrightarrow 540 \\ \text{the History Discipline} \end{array} = .80$$



The induced course load matrix may also be used to calculate a second type of coefficient. These Type 2 coefficients indicate the portion of the total weekly student contact hours in each discipline which is generated by students in each degree program. Type 2 coefficients are calculated by dividing each degree program's weekly student contact hours per discipline by the total WSCH for that discipline. For example, 432 weekly student contact hours are generated by history degree program majors in the history discipline. The total of the weekly student contact hours in the history discipline is 540. We divide 432 by 540 to arrive at the decimal, .80.

## Induced Course Load Matrix (Type 2 Coefficients)

		<b>Degree Programs</b>				
		History	Math	Botany	Zoology	
<b>Disciplines</b>	History	.80	.10	.10	0	<b>100%</b>
	Mathematics	0	.70	.20	.10	<b>100%</b>
	Botany	0	0	.60	.40	<b>100%</b>
	Zoology	.10	.10	.20	.60	<b>100%</b>

This decimal may then be placed in the appropriate space to indicate that 80% of the 540 weekly student contact hours in the history discipline are generated by history degree program enrollees. Following the same mathematical routine, we may calculate the appropriate Type 2 coefficient for each space in the matrix. By summing the rows horizontally, we check to see if we have accounted for 100% of the weekly student contact hours in each discipline. This form of the induced course load matrix allows us to observe that 10% of the weekly student contact hours in zoology are generated by history degree majors, 10% by math majors, 20% by botany majors, and 60% by zoology majors.

### Computation of a Degree Program Budget

<p><b>(Type 2)</b>  <b>degree program</b>  <b>coefficient per</b>  <b>discipline</b></p>	<p><b>X</b></p>	<p><b>total budget</b>  <b>for that</b>  <b>discipline</b></p>	<p><b>=</b></p>	<p><b>portion of total</b>  <b>budget for that</b>  <b>discipline consumed</b>  <b>by that degree program</b></p>
--	-----------------	--	-----------------	---

<p><b>.80</b>  <b>(History Degree</b>  <b>Program)</b></p>	<p><b>X</b></p>	<p><b>\$119,113</b>  <b>(History</b>  <b>Discipline)</b>  <b>Budget)</b></p>	<p><b>=</b></p>	<p><b>\$95,291</b>  <b>(History Discipline</b>  <b>portion of History</b>  <b>degree program budget)</b></p>
--	-----------------	--	-----------------	--

Using the Type 2 coefficients we may compute a degree program budget. This is accomplished by multiplying the degree program coefficient for each discipline times the total budget for that discipline. The product will equal the portion of the total budget for that discipline which is consumed by that degree program. For example, the Type 2 coefficient for the history degree program is .80. If we multiply .80 times the history discipline budget of \$119,113, we arrive at the product, \$95,291, which represents the history degree program portion of the history discipline budget. Following this same mathematical procedure for each space in the induced course load matrix, we complete the first step toward computation of a Micro-U degree program budget.

## MICRO-U Degree Program Budget Format No. 1

### Relationship of Degree Program to Discipline Costs

		Degree Program Costs				
		History	Math	Botany	Zoology	Totals
<b>Discipline Costs</b>	History	\$ 95,291	\$ 11,911	\$ 11,911	0	<b>\$119,113</b>
	Mathematics	0	83,379	23,823	11,911	<b>\$119,113</b>
	Botany	0	0	47,677	31,784	<b>\$ 79,461</b>
	Zoology	11,381	11,381	22,763	68,288	<b>\$113,813</b>
	<b>Totals</b>	<b>\$106,672</b>	<b>\$106,671</b>	<b>\$106,174</b>	<b>\$111,983</b>	<b>\$431,500</b>

This first stage, or first format, of the degree program budget relates the degree programs to disciplines in terms of cost. For example, we see that the history degree program consumes \$95,291 of the total history discipline cost of \$119,113. Likewise, the botany degree program consumes \$22,763 of the zoology disciplines total budget of \$113,813. By summing the columns, we arrive at the total cost for each degree program. The sum of the total costs for all degree programs must equal the total budget for Micro-U. Summing the horizontal rows, we again arrive at the total cost for each discipline. The total of all discipline costs must also equal the entire Micro-U budget.

### DEGREE PROGRAM COSTS PER WSCH

History Degree Program	<b>\$219.49</b> per WSCH
Mathematics Degree Program	<b>219.49</b> per WSCH
Botany Degree Program	<b>218.47</b> per WSCH
Zoology Degree Program	<b>214.53</b> per WSCH



A useful method of comparing the cost of degree programs is to determine the cost per WSCH for each degree program and then compare those unit costs. When this is done for Micro-U, we find that zoology, with a cost of \$214.53 per WSCH is the least expensive program in terms of unit cost.

**COST PER STUDENT MAJOR PER ACADEMIC YEAR**  
**(FTE = 15 WSCH)**

History Degree Program .....	<b>\$3292</b>
Mathematics Degree Program .....	<b>\$3292</b>
Botany Degree Program .....	<b>\$3277</b>
Zoology Degree Program .....	<b>\$3218</b>

The total cost per F.T.E. student major (degree program enrollees) per year may be calculated by multiplying the cost per WSCH of each degree program times the defined number of WSCH for an F.T.E. enrollee in that degree program. When this is done for Micro-U, we find that zoology majors with an annual cost of \$3218 are the least expensive majors.

## COST PER DEGREE PRODUCED

(at a given point in time)

<b>Degree Program</b>	<b>Average Number of Academic Years F.T.E. Attendance Required</b>	<b>Cost Per Major Per Academic Year</b>	<b>Estimated Total Degree Cost</b>
History	4	\$3,292	\$13,168
Mathematics	4	\$3,292	\$13,168
Botany	4	3,277	13,108
Zoology	4.5	3,218	14,481

\*The estimated degree costs do not reflect resources expended on students who drop out prior to program completion.

If we know the average number of academic years of F.T.E. attendance required for completion of a zoology degree program at Micro-U, we may estimate the total cost of producing a zoology degree as of a given point in time. For example, if the zoology program at Micro-U required 4-1/2 academic years of F.T.E. attendance, the total cost for producing such a degree at this point in time would be \$14,481. If a history degree required only 4 years of F.T.E. attendance, the cost of a history degree would be \$13,168. Thus a history degree would cost less at current prices than a zoology degree even though the WSCH unit costs are higher for history majors than for zoology majors.

## Computing A Degree Program Budget Related to Type of Expenditure

**Example:**

The History Degree Program consumes--  
.8 of the Departmental costs  
of the History Discipline = \$61,600

+ .1 of the Departmental costs  
of the Zoology Discipline = \$ 7,170

---

**Total History Degree Program Departmental Costs \$68,770**

Our final step in computing a degree program budget is to calculate the relationships between degree programs and various types of expenditures. Our methodology for this final step consists of multiplying the Type 2 coefficients for each degree program times the cost for each type of expenditure for each discipline and summing the results for each degree program. For example, the history degree program consumes .80 of the departmental costs of the history discipline, or \$61,600. The history degree program also consumes .10 of the departmental costs of the zoology discipline, or \$7,170. Thus, the total history degree program departmental costs from across all disciplines equals \$68,770.

**MICRO-U Degree Program Budget  
Format No. 2**

**Relationship of Degree Programs to Type of Expenditure**

	<b>Degree Programs</b>				<b>Totals</b>
	History	Math	Botany	Zoology	
Departmental Costs	\$68,770	\$68,770	\$66,120	\$69,840	<b>\$273,500</b>
Central Administration	14,236	14,235	14,237	15,292	<b>\$58,000</b>
Physical Plant	13,991	13,991	13,992	15,026	<b>\$57,000</b>
Library	9,675	9,675	11,825	11,825	<b>\$43,000</b>
<b>Totals</b>	<b>\$106,672</b>	<b>\$106,671</b>	<b>\$106,174</b>	<b>\$111,983</b>	<b>\$431,500</b>



The \$68,770 figure for departmental costs for the history degree program is now placed in the appropriate cell in this final format of the Micro-U degree program budget. Following the same procedure for central administration costs, we determine that the history degree program consumes \$14,236 of this type of expenditure. The history degree program is also found to account for \$13,991 of physical plant expenditures and \$9,675 of library expenditures. Thus, the total cost for all types of expenditures for the history degree program is \$106,672. Similar computations for the mathematics program, the botany program, and the zoology program complete the matrix. In this program budget format, each type of expenditure across all the degree programs may be summed horizontally, while all types of expenditures for each degree program are summed vertically. Again, the grand total of the matrix, both horizontally and vertically, must equal the total budget for Micro-U.

## **Analysis Using Degree Program Budget Data**

- 1. Determine relative total costs of existing degree programs.**
- 2. Determine total cost of each degree produced.**
- 3. Determine contribution of each department and discipline to each degree program.**
- 4. Determine relative costs of degree programs by type of expenditure.**

Using the degree program budget data, a number of types of analysis may be performed which would be unavailable to college and university administrators who had only department-related data at their disposal. First, the degree program budget allows analysis of the relative total costs of existing degree programs. In addition, the total cost for each degree produced may be calculated by means of a few additional computations. The degree program budget also allows analysis of the part each department and discipline plays in the generation of degrees. It is also possible to determine the relative cost of degree programs by each type of expenditure.

# RESOURCE REQUIREMENTS PREDICTION MODEL

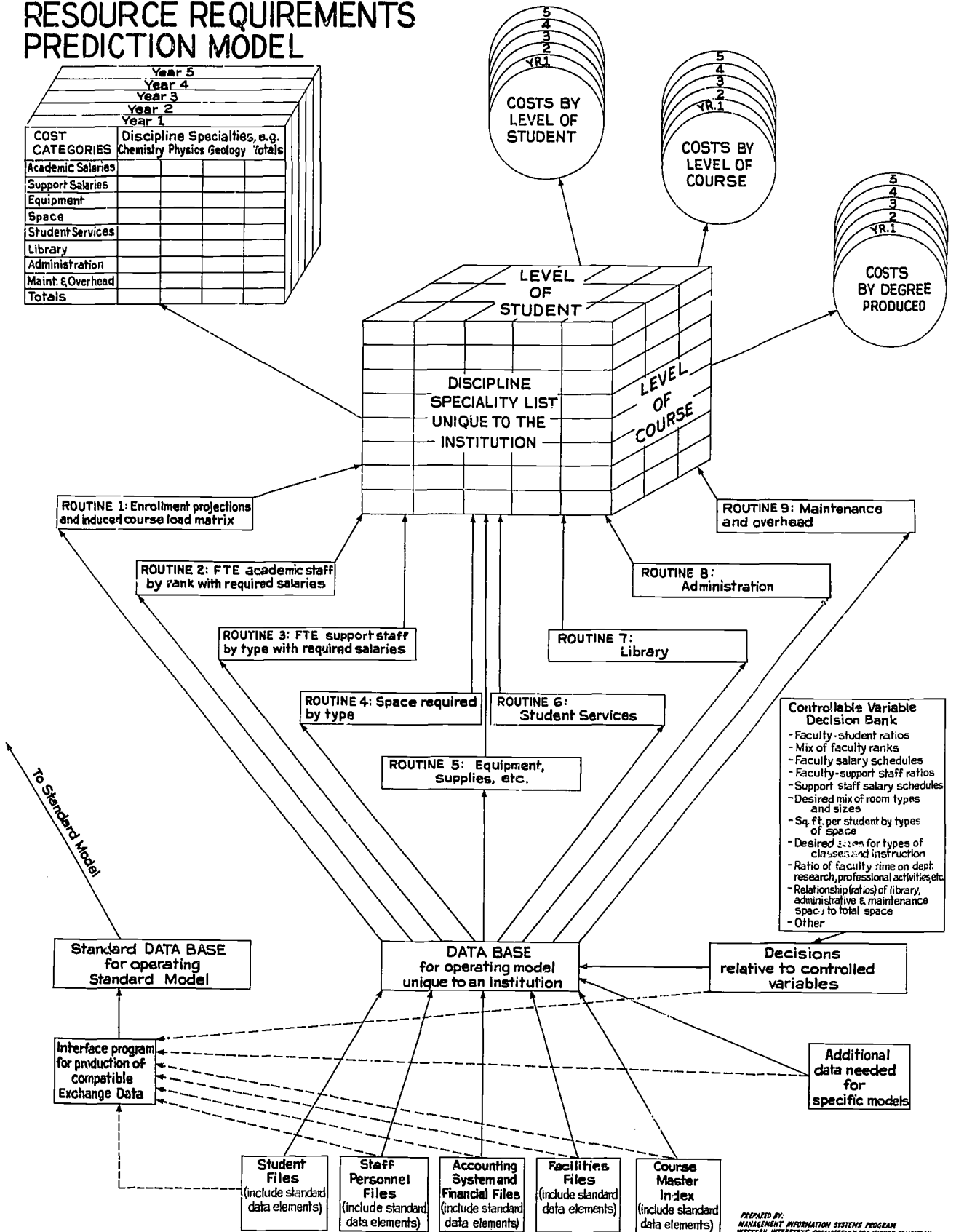

PREPARED BY:  
MANAGEMENT INFORMATION SYSTEMS PROGRAM  
WESTERN INTERSTATE COMMISSION FOR HIGHER EDUCATION

Previously, we described how the WICHE Resource Requirements Prediction Model could be used to develop a budget by discipline. In that instance, the costs calculated by the various routines were attached in the tri-dimensional matrix to a list of disciplines (i.e., collections of similar courses). When the RRPM is used to estimate a degree program budget, certain additions are made to the routines in order to utilize coefficients calculated from an induced coarse load matrix in computing the proper cost data. Also, the list of disciplines on the face of the tri-dimensional matrix must represent the various degree programs of the institution. In order to arrive at some standardization of the degree program titles which will be used by the WICHE Management Information Systems, the HEGIS Taxonomy of Instructional Programs has been made a basic part of the WICHE Program Classification Structure. Thus, Micro-U would select from the HEGIS Taxonomy the discipline specialties which represent its four degree programs (i.e., history, mathematics, botany, and zoology). Standard definitions of degree program titles will allow Micro-U to produce standard degree program information which will be compatible with information from other institutions which are also using the standard forms of the WICHE MIS models.

## Analysis Using Simulation Model

### **1. Incremental analysis problems:**

- a) add a new degree program.
- b) drop a current degree program.
- c) predict impact of projected enrollments.
- d) determine marginal costs.

### **2. Parameter manipulation problems:**

- a) alter class size.
- b) alter faculty teaching load.
- c) alter salary schedules.
- d) alter faculty rank mix.

The WICHE Resource Requirements Prediction Model may be used to simulate contemplated changes in the degree programs offered by an institution. The RRPM will mathematically replicate the relationships among the various factors at play in the institution. Inputs to the RRPM will include enrollment projections and decisions regarding controllable variables. By inserting the enrollment projection for a given program and the decision parameters which describe that program, administrators may use the model to simulate the resource consumption which will occur as a consequence of the program.

Basically, simulation models such as the RRPM are applicable to two kinds of analytic problems. First, there are incremental analysis problems. What would be the effect if Micro-U added a degree program in chemistry? What would be the effect if Micro-U discontinued the teaching of botany? What would be the impact on the various departments if the enrollment in the History Department at Micro-U doubled? If Micro-U added a degree program in philosophy what would be the impact and the marginal costs to the various departments?

A second type of analysis made possible through the use of simulation models has to do with the manipulation of institutional parameters. For example, what would be the effect on costs of operating the institution if the average class size was altered, or if the average class size in a few major departments was changed? What would happen if faculty teaching load was increased or decreased? What would be the financial impact of alterations in salary schedules for various levels of faculty and support staff? What changes could be expected in the resource requirements if, over a period of time, faculty rank mixture was altered?

**Administrative  
Art**

**+**

**Management  
Science**

**=**

**New Approach to  
Higher Education  
Administration**



Simulation models will never make decisions for administrators. They will, however, provide better information regarding the various options which are available to administrators. Increasingly those who manage educational organizations are being asked to validate their decisions. Management Information Systems are intended to provide the data administrators must have if they are to make quality decisions which will stand the test of close scrutiny. The WICHE Management Information Systems Program is based on the assumption that colleges and universities should have clearly stated objectives, that they should describe and analyze the alternative approaches to pursuing those objectives, and that educational administrators and faculty must use wisdom and good judgement in selecting the alternatives to be implemented. The administration of educational institutions has often been termed an "art". Management Information Systems are intended to add an element of management science to this administrative art.

APPENDICES

## MICRO-U

Chart of AccountsSchedule of Current Funds Expenditures

## Educational and General:

	Instruction and Departmental Research	
100	History Department	\$ 77,000
200	Mathematics Department	77,000
300	Biology Department	119,500
		<u>\$273,500</u>
400	Library	
401	Administration	\$ 18,000
402	General	25,000
		<u>\$ 43,000</u>
500	Operation and Maintenance of Physical Plant	
501	Administration	\$ 18,000
502	Custodial Services	17,000
503	Maintenance of Buildings	17,000
504	Utilities	3,000
505	Property Insurance	2,000
		<u>\$ 57,000</u>
600	Central Administration	
601	President's Office	\$ 32,000
602	Academic Vice President's Office	25,000
603	Public Relations	1,000
		<u>\$ 58,000</u>
	Total Educational and General Expenditures	<u>\$431,500</u>

## BUDGET ACCOUNTS

Budget Allocations for Estimated Expenditures  
(Anticipated Transactions)

Salaries:		
Central Administration		
601.11	President	\$ 25,000
602.11	Academic Vice President	20,000
		<u>\$ 45,000</u>
Library		
401.11	Library Administrator	\$ 15,000
402.11	1 Librarian	9,000
402.11	1 Assistant Librarian	6,000
		<u>\$ 30,000</u>
Physical Plant		
501.11	Physical Plant Superintendent	\$ 12,000
		<u>\$ 12,000</u>
History Department		
100.11	Chairman	\$ 16,000
100.11	1 Professor	16,000
100.11	1 Associate Professor	14,000
100.11	1 Assistant Professor	12,000
		<u>\$ 58,000</u>
Mathematics Department		
200.11	Chairman	\$ 16,000
200.11	1 Professor	16,000
200.11	1 Associate Professor	14,000
200.11	1 Assistant Professor	12,000
		<u>\$ 58,000</u>
Biology Department		
300.11	Chairman	\$ 18,000
300.11	1 Professor (Botany)	16,000
300.11	1 Professor (Zoology)	16,000
300.11	1 Associate Professor (Botany)	14,000
300.11	1 Associate Professor (Zoology)	14,000
300.11	1 Assistant Professor (Zoology)	12,000
		<u>\$ 90,000</u>
	Total Salaries	<u>\$293,000</u>

## Wages:

	Central Administration	
601.12	President's Secretary	\$ 5,000
602.12	Academic Vice President's Secretary	5,000
		<u>\$ 10,000</u>
	Physical Plant	
501.12	Superintendent's Secretary	\$ 5,000
503.12	Maintenance Engineer	9,000
502.12	1 Custodian	5,000
502.12	1 Custodian	5,000
502.12	1 Custodian	5,000
		<u>\$ 29,000</u>
	History Department	
100.12	Chairman's Secretary	\$ 5,000
100.12	1 Faculty Secretary	5,000
		<u>\$ 10,000</u>
	Mathematics Department	
200.12	Chairman's Secretary	\$ 5,000
200.12	1 Faculty Secretary	5,000
		<u>\$ 10,000</u>
	Biology Department	
300.12	Chairman's Secretary	\$ 5,000
300.12	Faculty Secretary	5,000
300.12	Faculty Secretary	5,000
		<u>\$ 15,000</u>
	Total Wages	<u>\$ 74,000</u>

## Supplies and Expendables:

	General Office Supplies	
601.21	Central Administration	\$ 2,000
401.21	Library	3,000
501.21	Physical Plant	1,000
100.21	History Department	4,000
200.21	Mathematics Department	4,000
300.21	Biology Department	5,500
		<u>\$ 19,500</u>
	Instructional Supplies	
100.22	History Department	\$ 1,000
200.22	Mathematics Department	1,000
300.22	Biology Department	3,000
		<u>\$ 5,000</u>

	Other Supplies	
	Physical Plant	
502.23	Custodial	\$ 2,000
503.23	Maintenance	8,000
		<u>\$ 10,000</u>
	Expenses	
504.24	Physical Plant Utilities	\$ 3,000
505.25	Physical Plant Property Insurance	2,000
603.26	Central Administration, Public Relations	1,000
	Travel	
100.27	History Department	\$ 4,000
200.27	Math Department	4,000
300.27	Biology Department	6,000
		<u>\$ 20,000</u>
	Total Supplies and Expendables	<u>\$ 54,500</u>
	Capital Purchases:	
402.31	Library Collections	\$ 10,000
		<u>\$ 10,000</u>
	TOTAL OF ALL BUDGETARY CONTROL ACCOUNTS	<u>\$431,500</u>

# MICRO-U RPPM FLOW CHART PHASE I

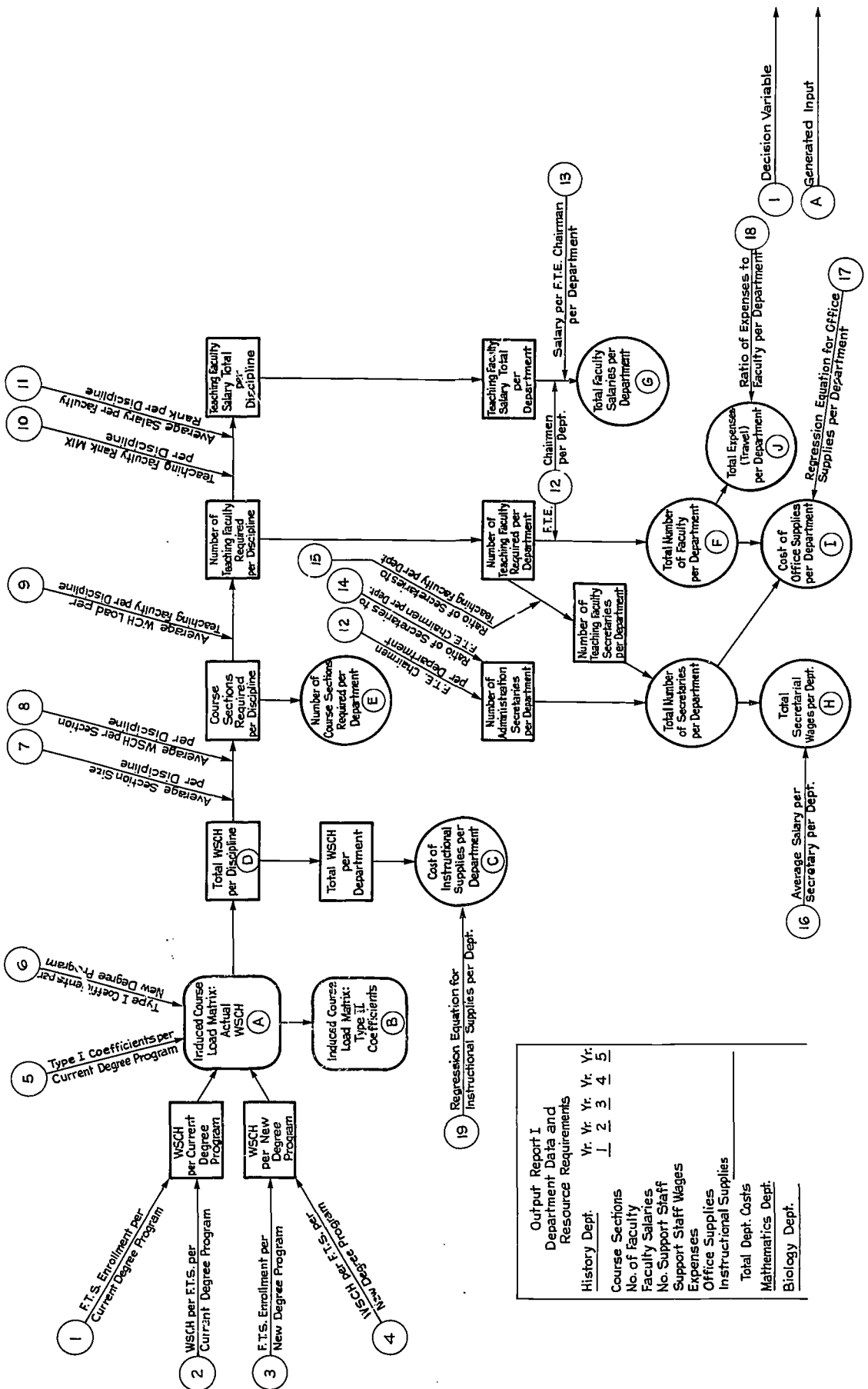

Output Report I  
Department Data and Resource Requirements

History Dept.	Yr.	Yr.	Yr.	Yr.	Yr.
	1	2	3	4	5

Course Sections  
No. of Faculty  
Faculty Salaries  
No. Support Staff  
Support Staff Wages  
Expenses  
Office Supplies  
Instructional Supplies  
Total Dept. Costs  
Mathematics Dept.  
Biology Dept.





## MICRO-U RRPB FLOW CHART PHASE III

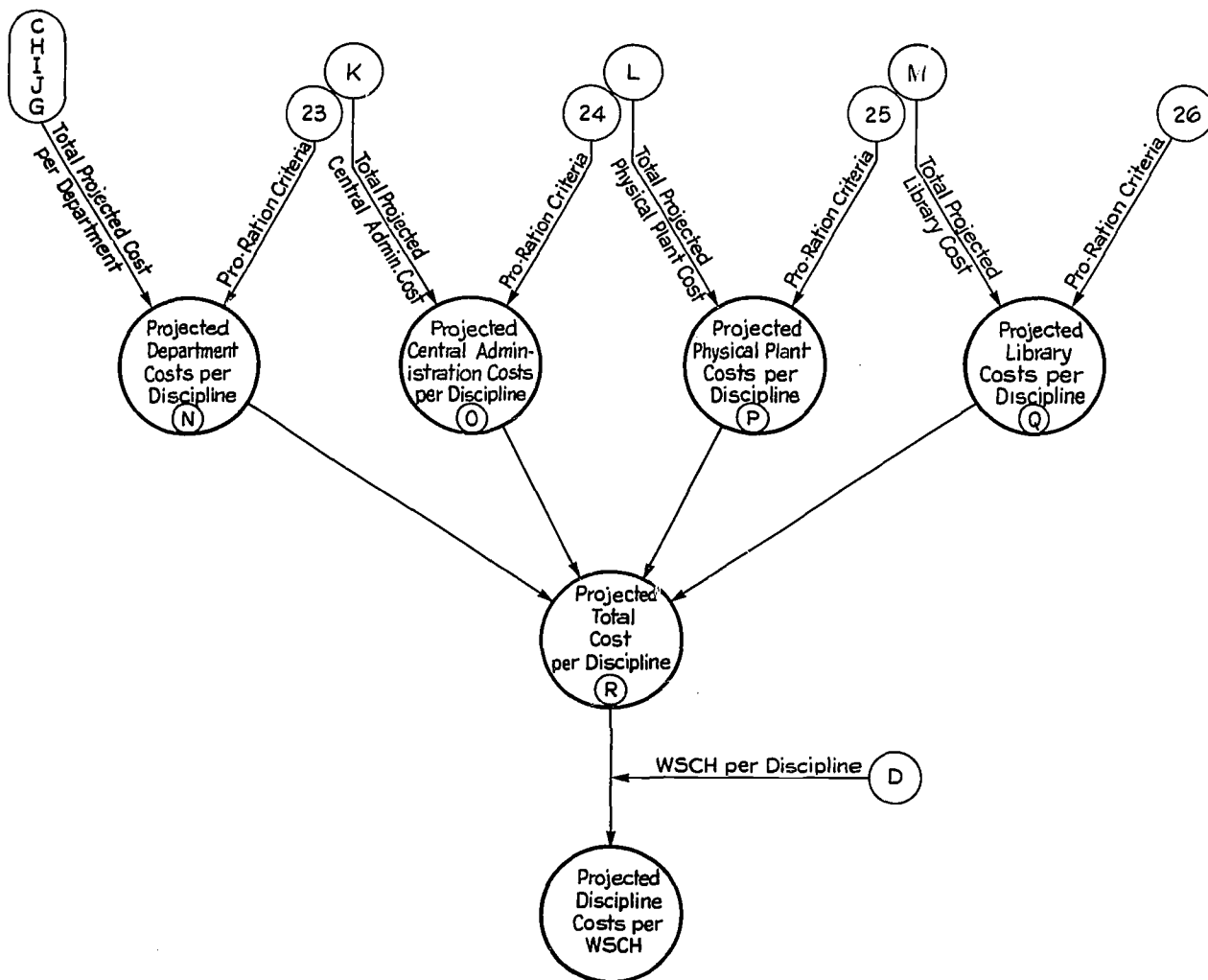

Output Report III					
Projected MICRO-U Budget By Discipline					
	Yr.	Yr.	Yr.	Yr.	Yr.
	<u>1</u>	<u>2</u>	<u>3</u>	<u>4</u>	<u>5</u>
History Disc.					
Math. Disc.					
Botany Disc.					
Zoology Disc.					
Other Disc.					
<b>Total</b>					

Output Report IV					
Projected Discipline Costs per WSCH					
	Yr.	Yr.	Yr.	Yr.	Yr.
	<u>1</u>	<u>2</u>	<u>3</u>	<u>4</u>	<u>5</u>
History Disc.					
Math. Disc.					
Botany Disc.					
Zoology Disc.					
Other Disc.					
<b>Total</b>					

## MICRO-U RRPM FLOW CHART PHASE IV

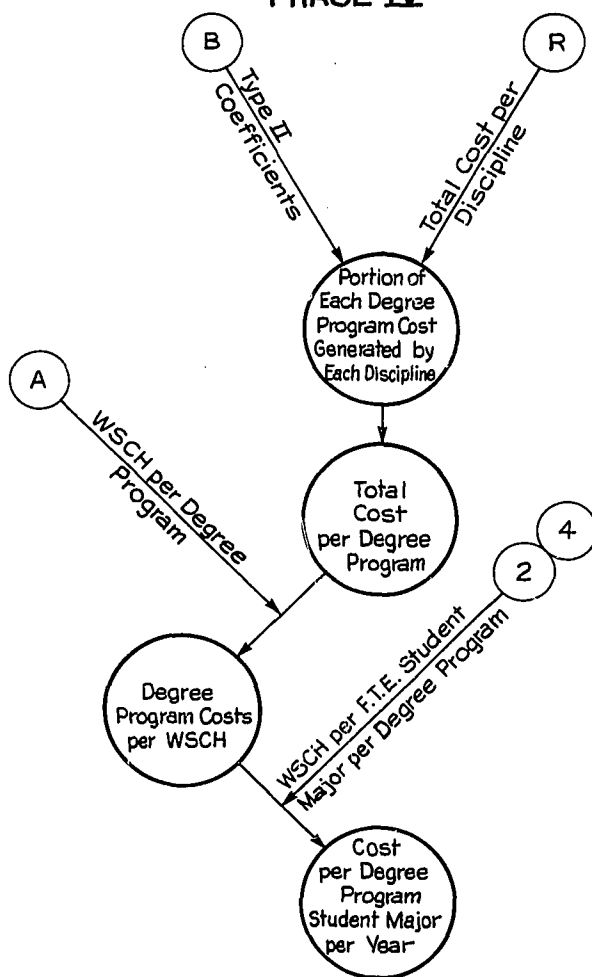

Output Report V MICRO-U Degree Program Budget Format No. 1					
	Yr.	Yr.	Yr.	Yr.	Yr.
	1	2	3	4	5
History Degree Program					
History Disc.					
Math. Disc.					
Botany Disc.					
Zoology Disc.					
Other Disc.					
Total					
Mathematics Degree Program					

Output Report VI Degree Program Costs per WSCH					
	Yr.	Yr.	Yr.	Yr.	Yr.
	1	2	3	4	5
History Degree Program					
Math. Degree Prog.					
Botany Degree Prog.					
Zoology Degree Prog.					
Other Degree Prog.					

Output Report VII Costs per Student Major per Year in Degree Programs					
	Yr.	Yr.	Yr.	Yr.	Yr.
	1	2	3	4	5
History Degree Program					
Math. Degree Prog.					
Botany Degree Prog.					
Zoology Degree Prog.					
Other Degree Prog.					

## MICRO-U RRPM FLOW CHART PHASE V

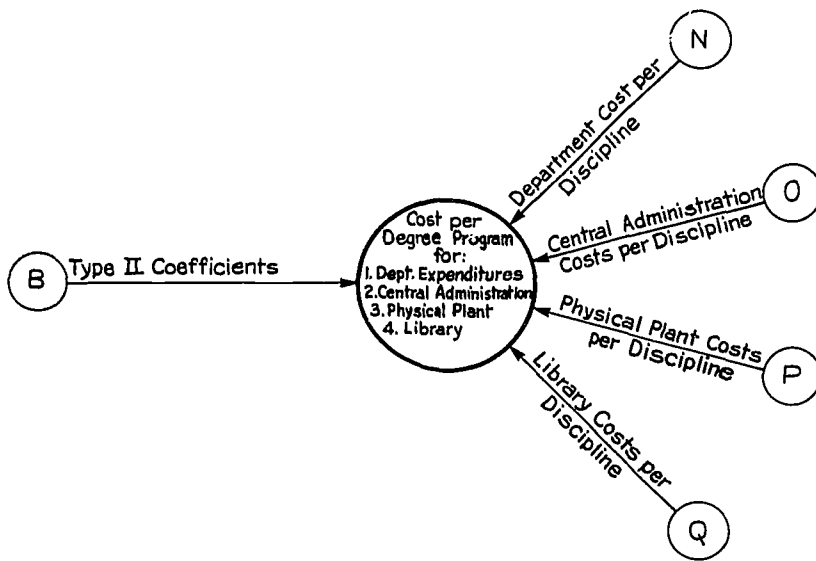

Output Report VIII MICRO-U Degree Program Budget Format No. 2					
History	Yr.	Yr.	Yr.	Yr.	Yr.
<u>Degree Program</u>	<u>1</u>	<u>2</u>	<u>3</u>	<u>4</u>	<u>5</u>
Departmental Costs					
Central Administration					
Physical Plant					
Library					
Total					
Mathematics					
<u>Degree Program</u>					