

DOCUMENT RESUME

ED 043 986

EC 030 422

AUTHOR Wiedel, Joseph W.; Groves, Paul A.
TITLE Tactual Mapping: Design, Reproduction, Reading and Interpretation. Final Report.
INSTITUTION Maryland Univ., College Park. Dept. of Geography.
SPONS AGENCY Social and Rehabilitation Service (DHEW), Washington, D.C.
PUB DATE 69
NOTE 129p.

EDRS PRICE EDRS Price MF-\$0.75 HC-\$6.55
DESCRIPTORS *Maps, Map Skills, Raised Line Drawings, Research Projects, *Tactile Adaptation, *Visually Handicapped, *Visually Handicapped Mobility, *Visually Handicapped Orientation

ABSTRACT

Reported are the findings of a research project conducted to design easily reproducible, large-scale maps for use by the blind to improve their mobility and orientation. The emphasis was on maps varying in scale from general orientation maps of metropolitan areas to mobility maps of neighborhoods or individual buildings. The design, construction, reproduction, and reading of the maps are described. Many photographs of samples of tactual mobility maps, instructions for use, and a map reading test are included. (KW)

ED0 43986

TACTUAL MAPPING:

Design, Reproduction, Reading and Interpretation

Joseph W. Wiedel and Paul A. Groves

Department of Geography
University of Maryland

FINAL REPORT
RD-2557-S 1969

Department of Health, Education, and Welfare

030 422 E

SIGNIFICANT FINDINGS FOR REHABILITATION WORKERS

Maps can play a multiple role in the life of the blind. The importance of maps in facilitating mobility and orientation is basic. Their use by the blind provides a further option to depending upon sighted help, particularly when it comes to the acquisition of new routes and familiarization with a new area. By making available a range of maps, from those of the immediate neighborhood to those of the world, along with an appropriate training program, we help to broaden the cognitive activities of the blind, especially of the young. One must also take into account the enjoyment of the blind user as well as the considerable importance of maps in providing a motivating force. The use of maps adds purpose to the exercises in mobility. Travel skills, acquired with considerable effort by all concerned, may be less likely to deteriorate through disuse or boredom if the challenge of selecting alternative approaches to the same goal are a possibility.

TACTUAL MAPPING:

Design, Reproduction, Reading and Interpretation

Joseph W. Wiedel and Paul A. Groves

**Department of Geography
University of Maryland**

"This investigation was supported, in part, by Research Grant No. RD-2557-S from the Division of Research and Demonstration Grants, Social and Rehabilitation Service, Department of Health, Education, and Welfare, Washington D.C. 20201."

U.S. DEPARTMENT OF HEALTH, EDUCATION & WELFARE
OFFICE OF EDUCATION

THIS DOCUMENT HAS BEEN REPRODUCED EXACTLY AS RECEIVED FROM THE PERSON OR ORGANIZATION ORIGINATING IT. POINTS OF VIEW OR OPINIONS STATED DO NOT NECESSARILY REPRESENT OFFICIAL OFFICE OF EDUCATION POSITION OR POLICY.

FINAL REPORT

RD-2557-S 1969

Department of Health, Education, and Welfare

FORWARD

Blind Mobility and Maps.

The consequence of any disability can be regarded as a reduction in the range of options, of choices of activity, which are normally available to those who are in no way disabled. In the case of blindness one of the most drastic curtailments of options is in the area of mobility: "There cannot be complete equality with the sighted in all respects. The chief sphere is that of free mobility. This limitation can never be completely circumvented." These are the words of an eminent blind commentator, Le Gros Clark, in his 1969 monograph on the British war blinded. It is one of the functions of those who provide services for the blind in education, rehabilitation, or welfare, to broaden the range of options in as many ways as possible and to aim at eventual equality with the sighted, bearing in mind the important distinction between means and ends: a person without sight cannot use sighted means to achieve sighted ends. But he may be able to achieve the same ends by using non-visual means. The concept of the availability of options serves another purpose: it stresses the fact that though options may become available, there need not be any outside pressure to take them up.

In recent years we have seen one development in the direction of widening the range of options as a consequence of greater stress being laid on the teaching of mobility techniques to the blind. The most important point about this development is not that it has enabled some blind people to be more mobile than any blind person had ever been before. Indeed this may well not be true in any case. Much more to the point is that there is now an opportunity for a fairly wide range of blind people to achieve varying degrees of independent travel, and that this achievement can be brought about by formal teaching rather than through painful trial and error. In this process the blind client becomes temporarily dependent upon a sighted teacher in order to achieve a greater degree of independence from the sighted as a whole in the long run.

But, at present, there is still one area of very considerable forced dependence on the sighted when it comes to the acquisition of new routes and familiarization with a new area. It is here that maps for the blind serve their primary purpose. They are yet a further step in reducing the degree of dependence. And it is to be noted here again that this is in the nature of an option: a blind person with good mobility technique, who knows how to make use of maps, and who can be provided with maps, still has the choice between consulting a map or asking for sighted help. But the very fact that the choice exists makes it easier to adopt the latter course in the same way as it does for the sighted road user.

There is a second role for maps in the life of the blind, and particularly in that of the blind youngster. By providing maps, ranging from those dealing with the immediate neighbourhood to those of the world, we may help to broaden the cognitive activities of the blind youngster. We make it possible for him to gain a better understanding of spatial and geographical concepts by enabling him to experience in a real situation that which all maps must represent at a symbolic level.

And finally, there is the very considerable importance of maps in providing a motivating force. It is rarely appreciated how lonely and dull the exercise of mobility is for the average blind person. In most cases blind people walk for a specific purpose only; to get to work, to do the shopping, to visit a particular friend. At present, for most blind people, the range of such purposes is narrow indeed. So narrow that travel skills, acquired with considerable effort by all concerned, may deteriorate rapidly through disuse or plain boredom. "One route is pretty much the same as any other" was how a participant in a recent discussion put it rather bluntly. There are, no doubt, a few blind people, who will find extra purposes, or who like exploring on their own just for the sheer joy of exercising their skill. I suspect that the wider acceptance and provision of maps for the blind may be of considerable help to the less determined, for instance, in trying out alternative approaches to the same goal.

Now, while there is already quite a fair amount of knowledge in this new field, there is as yet little acceptance. Some of the reasons for this are purely sociological, but others are more closely connected with the difficulties in handling as well as in producing suitable maps. It is here that research has a vital role to play and, making virtue of necessity, it is good to know that for once research appears to be ahead of user demand. This research effort has to be truly interdisciplinary: cartographers, geographers, teachers of the blind, psychologists, and of course the blind users all need to be involved. We need to know a great deal more about what is worth doing, and for whom; what solutions are capable of short term implementation and which ones will take some time to develop; what are the relationships between the physical properties of the maps and the training requirements.

The authors of this report are among the very small band of pioneers who have tackled some of these problems in a systematic way. And note again, that it is this systematic approach which is the novel feature and not the idea of maps for the blind as such. It was therefore with very great pleasure, and in thankfulness, that I accepted their offer to write this foreword to indicate the interaction between mobility and maps. In current terminology, it is very much a participating and ongoing interaction: it is not possible for a blind person to derive much benefit from a map without a good formal technique, while at the same time one has good reason for believing that his mobility will become enhanced by the use of maps.

J. Alfred Leonard, Ph.D.
Department of Psychology
University of Nottingham

ACKNOWLEDGEMENTS

The authors are indebted to the many mobility instructors and teachers of the blind who donated their time in administering tests and who contributed many valuable suggestions during the testing period. Although specific enumeration cannot be made, many ideas should be credited to such sources.

The authors were fortunate to have the assistance of the State Vocational Rehabilitation Directors, whose offices supplied the contacts needed for testing our materials.

The authors also wish to acknowledge the valued assistance received from the directors and staff of the College Orientation Project for Blind of Syracuse University, Syracuse, New York, and the Maryland School for the Blind, Baltimore, Maryland. Each of these Institutions provided the persons, facilities and time necessary for the initial testing and developing stages.

Professionally, the authors wish to acknowledge the valued assistance of Professor J. Alfred Leonard, Ph.D., of the Department of Psychology, University of Nottingham, England and W. James Pickles, of the Worcester College School for the Blind, Worcester, England. Doctor Leonard, well known for his work with the blind in mobility, gave generously of his time in personal consultation and read much of our material. He offered helpful suggestions and guidance both during and after our testing program. Mr. Pickles, who is responsible for mobility at the Worcester School, has been most helpful, both in the development of materials and techniques and in consulting on problems involved in the teaching of the blind using graphic material.

For assistance in the tedious but responsible work involved in organizing, duplicating and mailing test materials the authors are deeply grateful to Mrs. Susan Britton, and for secretarial services as well as preparing the final typed copy of the manuscript we are grateful to Mrs. Mary Terry.

While acknowledging gratefully all assistance rendered, the authors, of course, accept full responsibility for such shortcomings and errors as may be found.

Joseph W. Wiedel
and
Paul A. Groves
Department of Geography
University of Maryland

C O N T E N T S

	Page
Significant Findings for Rehabilitation Workers...	Inside Cover
Title Page.....	i
Forward.....	iii
Acknowledgements.....	vii
Preface.....	xiii
Abstract.....	xv
Research Brief.....	xvii
 Chapter	
I INTRODUCTION.....	1
II INITIAL RESEARCH PROJECT.....	8
Braille.....	14
Size and Scale.....	16
Summary.....	17
III METHODOLOGY.....	18
Informal Program.....	18
Formal Program.....	22
Liaison With British Workers.....	29
Summary.....	30
IV RESULTS OF STUDY.....	31
The Tactual Map: Design and Reproduction ..	31
Construction of Master.....	36
Reproduction.....	40
Maintenance and Revision.....	40
Test of Abstract Map.....	41
Areas of Immediate Concern.....	49
V DISCUSSION, AND IMPLICATIONS OF RESULTS.....	52
Lack of Exposure to Tactual Maps.....	52
Paucity of Identifiable Non-Visual Landmarks.....	53
Travel Competence.....	54
Standardization.....	55
Other Map Types.....	56
Other Components.....	56
Conclusions.....	57

C O N T E N T S (CONTINUED)

	Page
APPENDIX	
I Orientation and Mobility Map Reading Test.....	59
II Synopsis of Birmingham University Conference.....	67
III Samples of Mobility Maps	72
IV Instructions for the Use of the Metal Master	99
V Publications by Authors of this Report.....	101
BIBLIOGRAPHY.....	105

L I S T O F F I G U R E S

Figure

1. Symbol Sheet, Virginia State School for the Deaf and Blind, Staunton, Virginia.....	9
2. Statler-Hilton Hotel, New York City.....	10
3. Library of Congress - 1st Plan	12
4. Library of Congress - 2nd Plan	12
5. Library of Congress - Architects Plan	13
6. Campus Plan, Virginia State School for the Deaf and Blind, Staunton, Virginia	15
7. Route Guide, Dodge House, Washington, D.C.	19
8. Route Guide, Dodge House, Washington, D.C.	19
9. Campus Plan, Syracuse University, New York	21
10. Neighborhood Map, Test Sheet.....	23
11. Shopping Center, Test Sheet.....	24
12. Explanatory Key, Test Sheet	25
13. Symbol Sheet for Mobility Maps.....	32
14. Photo of Stylus, A.B. Dick and R.N.I.B.	38
15. Performance Graph, All Respondents and Two Selected Schools.....	48

C O N T E N T S (CONTINUED)

LIST OF TABLES		Page
Table		
1.	Sample Content of Returns.....	27
2.	Sample Distribution.....	28
3.	Percentage Scores by Age Group and Blind Category	42
4.	Percentage Scores by Age Group and Map Reading Training.....	44
5.	Percentage Scores by Age Group and Mobility Instruction.....	45
6.	Percentage Scores by Age Group and Mobility Proficiency.....	46

PREFACE

This report maintains the thesis that all tactual graphics are a necessary tool to improve the orientation, and the mobility, of the blind. This does not, however, presuppose that all blind users will be able to use mobility maps, as indeed all sighted are not capable of using maps. But for those blind who are, or who are potentially good travelers the orientation and mobility maps open new horizons for exploration.

A great many blind people find maps fascinating. They love to pour over maps of places for enjoyment as well as for information. Today their thoughts concerning the world are sharpened by articles in magazines and newspapers and by TV news and documentaries. Yet, few of them are fortunate enough to ever study a map of their local area. Maps are for getting around; for locating places that are unfamiliar; for selecting a route between two or more objectives; for understanding ones' surroundings. How many blind ever get to know even their home area intimately?

The maps we propose in this study for use by the blind are intended to be read, not looked at. They are as clear as we, as cartographers, can make them, but they are not simple. They often present complex situations, because the area around us is complex. Thus, the reader must take time to study them. In particular, it is important to understand the symbols used and the basis for their selection.

We, in Cartography and Geography at the University of Maryland, are delighted to have been able to contribute to knowledge about blind mobility. We have been surprised and rather shocked at how little tactual graphic material has been published for mobility and orientation. Thus, we hope this study will stimulate new interest in tactual graphics for mobility and a better understanding of their applicability for improved mobility of the blind.

ABSTRACT

Analysis of tactual maps of various scales from a national and international survey indicates the need for well designed, easily reproducible, large-scale mobility and orientation maps for use by the visually handicapped.

This study reports on the findings of a research project aimed at meeting this requirement. Its scope is limited by three factors. First, the emphasis is on design and production of large-scale maps - varying in scale from general orientation maps of metropolitan areas to mobility maps of neighborhoods, shopping centers or single buildings. Map coverage is limited by the degree of symbol complexity; that is the amount of information to be carried as it relates to the closeness of individual symbols and lines, and also by the Thermoform reproduction process used. Second, the maps meet mobility needs. They are directed at providing the visually handicapped person with a guide to a particular area. The successful mobility map provides just sufficient information to meet the specific movement requirement of the person involved. Third, the designed map is capable of reproduction in reasonable quantities. This excludes the production of single, unique maps that are incapable of reproduction at low cost.

On the basis of completed research, eight areas of concern are delineated. These are Linear Scale, Starting Point or Points, Size, Simplicity in Design, Brailleing, Compass Direction, Map Reproduction, and Training in Map Reading.

Findings indicate that assuming well designed tactually discrete maps are available a major requirement remains for a systematic teaching program of map interpretation.

RESEARCH BRIEF

The blind traveler is confronted with two problems, namely obstacle avoidance and orientation. It is to the latter point that this research project addresses itself. The authors of this study are concerned with the design and production of tactual maps for the legally blind. These maps are to meet mobility needs. In this sense, they are directed at providing the blind person with a tactual graphic which is to serve him as an orientation guide to a particular area. This enhances his mobility by enabling him to select routes either with or without sighted help.

The authors, through experimenting and testing, developed the capability of producing tactual maps by several satisfactory methods and in sufficient quantities for testing purposes with controlled groups. The tests were designed for obtaining information on the quality of selected symbols, components of design, and methods of reproduction. On the basis of this work, and a review of available tactual materials and writings from a number of countries, areas of immediate concern were delineated.

With tests, developed as a result of the above program, the research progressed on both a formal and informal basis. The formal program followed a systematic and progressive testing and development program in line with the general progress of the research. The informal program developed largely out of the demands from various individuals and organizations.

IMPLICATIONS FOR ACTION

Maps reduce the degree of dependence. A blind person with good mobility technique, who knows how to make use of maps, and can be provided with maps, has the choice between consulting a map or asking for sighted help. This option, heretofore, was open only to the sighted.

Maps provide a motivating force. With the proper map the range as well as the purposes for travel are increased.

Not to be discounted are the number of blind who read maps and explore for the sheer joy of exercising their skills. They look at maps in much the same way as the sighted look at pictures in a book.

FINDINGS

Tactual maps must hold enough information to meet the needs of the user but not so much as to confuse them.

Clutter can be partly eliminated by use of elevation difference of symbols according to a selected criteria; Braille .02 inches, line and area symbols .04 inches, and point symbols .06 inches.

Symbolization must be standardized in order to facilitate design and use.

The north edge of the sheet must be marked - a north indicator is not adequate.

Braille need not be placed all horizontal. With north at the top the Braille may be placed at any angle as long as it can be read from "West to East" or "South to North."

Multi-layered maps can be used. In fact they are desirable when large amounts or different types of information are needed.

Selection of information to be mapped on Mobility and Orientation maps must be made by personal inspection. The landmarks and information required by the Blind do not appear on existing map sources.

CHAPTER I

INTRODUCTION

This investigation began initially as a Pilot Study concerned with the feasibility of production and use of large-scale mobility and orientation maps. As the project developed the scope of the research was limited by three distinct factors. First, the emphasis is on the design and production of large-scale maps. These vary in scale from general orientation maps of metropolitan areas to maps of the internal outlay of a single building. The coverage of the maps is limited by the degree of symbol complexity, that is the amount of information to be carried on the map, as it relates to the closeness of individual symbols, and lines; and also by the reproduction process used. Generally, however, the finished product will be on a braille page size. Second, the maps are to meet mobility needs. In this sense, they are directed at providing the blind person with a guide to a particular area. The successful mobility map will provide just sufficient information to meet the specific movement requirements of the blind person. Third, the designed map is to be capable of reproduction in reasonable quantities, that is 25 copies and up. This excludes the production of single, unique maps that are incapable of reproduction at low cost. This does not mean that such single, unique maps were not considered to be of great value in providing information on suitable symbolization and the degree of generality required in maps for the blind. A number of such maps, for example, have been produced by individuals and at several schools for the blind and serve a continuing need in terms of providing the students with a degree of orientation to their surrounding neighborhood campus. In summary, the research is directed at the design and production of large-scale mobility maps capable of reproduction in substantial numbers.

1. Methods of Reproduction

There are three reproduction methods that are currently in use with respect to mobility maps. In order of preferability for the particular research under way they are: Thermoform,

Silk Screening and Thermocraft. Each of these processes has particular advantages and disadvantages and some attempt is made here to assess the major factors governing their use.

a. Thermoform

This process is used for testing at a later stage in the research project. It is the most widely used of the processes and the lowest cost in terms of the production of a limited number of copies. The cost of production per copy is constant. It allows for different levels of elevation and will take typewritten or mimeograph lettering. The latter is important as many of the legally blind have light perception and can, with optical aids, read large type. This type also helps sighted people who are working with the blind. The master is produced by inscribing on Braille paper or a metal foil which is backed with white plastic or paint. Scribing tools of the type used for cutting mimeograph stencils or the newly designed ones being produced by the Royal National Institute for the Blind (R.N.I.B.) are used and produce various line textures. Additional textured materials can be stuck onto the face of the master as well.

b. Silk Screening

This process is not used for reproduction of tactual material in the United States, but is common in Japanese work. The results are particularly effective in terms of point and dotted line work; not as effective with respect to solid line and area symbols. Combined with the relatively high degree of tactual readability is the advantage of the use of colors. This means that the process provides multi-purpose material which can be read visually as well as tactually. The masters can be made photographically which means that a change in

scale is made possible. As a reproduction process silk screening is useful for from 30-200 copies. It does, however, require specialized equipment and rather extensive training before satisfactory results in relief can be achieved. The continuous readability of the image also leaves something to be desired. The subjects tested could read it for only a very short time before they began to have difficulties and complained of its affect on their sense of touch. The problem appears to arise from the sharpness of the raised image and its tendency to powder - undoubtedly related since the edges tend to "powder off" because they are so sharp. This leaves a "dust" on the fingers and makes reading very difficult.

The Silk Screen process was discontinued for the above reasons and the unavailability of it as a process readily available to instructors of the blind.

c. Thermocraft

This process allows for the use of color, and for the use of large type which provides a final product which can be used both visually and tactually.

Experimentation with various papers and resins on both the offset and letterpress led to the use of 70 lb. clay-coated paper with permanent gloss extra coarse No. 6 resin, and printed on letterpress. The clay coated paper has a very smooth hard surface and absorbs little ink, thus leaving more ink available as an adhesive for the resin. The resin used is a ground plastic with a low melting point. The letter-press is capable of depositing a greater amount of a slower drying ink than the offset press. With the automatic thermocraft machine attached to the press it is possible to reproduce up to 1,500 copies per hour in two colors at a total cost

of less than six cents per copy for 1,500 copies, the unit cost decreasing with larger runs.

While suitable for the production of from 200 copies up, there are strong limitations resulting from technical problems. If fillers are added to produce a textured line, there is a breakdown in the legibility of the braille dots. If no filler is used then the plastic is smooth and reads like medium-worn braille. Although it does have advantages in that it is made photographically which allows for scale change, the master plate for the letter-press is expensive. At present it is the only process which can be used for the production of large quantities and has a decreasing unit cost.

The Thermocraft process was used in the initial research in an attempt to find a method of reproduction capable of producing our designs in large quantities at low cost. With commercially available materials the raised image is uniform at .007 of an inch. Experiments for increasing the relief and developing a textured line through the use of silicon fillers proved only moderately successful under laboratory conditions. All data on the Thermocraft method of reproduction was turned over to Mr. Freedman of Howe Press for further research and development.

d. Other Methods

There are, of course, other means of reproducing tactual illustrations. In the United States one of the most pertinent items is the Xerox Corporation's current research in tactual reproduction through Xerography. All methods have certain limitations, however, and for testing purposes Thermoform, Silk Screening and Thermocraft were selected because of their versatility, economy and general accessibility.

2. Symbolization and Design

The development of appropriate symbols could be carried only so far through recognition testing techniques. It very soon became apparent that, with the symbols being an integral part of the design, the two would have to be developed in unison.

The testing of symbols began, through necessity, as a study of simple recognition. After developing several distinct symbols they were placed in the context of a map. This brought to light the real complexity of the problem. Special properties were required, i.e. a linear symbol must not only be discrete but the blind user must be able to follow it through "a jungle" of other symbols composed of Braille lines, points and areal patterns. This will be covered in more detail in Chapter IV. Results of Study.

In the initial stages attempts were made to keep the drawings simple and the symbols distinct. It was soon discovered that stylized pictorial symbols would only have meaning for adventitiously blind and partially sighted. We therefore eliminated them, since as stated earlier, the attempt was to be a basic map readable by totally and congenitally blind as well as other categories of blind. Symbols we found to be distinct in our recognition tests often were confused when placed on the map in proximity to other symbols. It was found necessary to explain every symbol and to either develop new symbols or go into lengthy explanations of symbols when the information required that they be rotated.

3. Relevant Literature

A survey of the relevant literature is a less difficult undertaking since it is all very recent. Little of importance can be noted prior to 1958 when Heath produced an unpublished Ph.D. thesis at the University of Washington dealing with some aspects of discriminability of textural surfaces on maps. This was reviewed and developed further by Morris and Nolan of the American Printing House in the International Journal for the Education of the Blind in 1963. Sherman, University of

Washington, in his assessment of Map Resources and Needs first published in 1964 emphasized the lack of research and development in this field and the need for graphic materials designed for blind users.

Leonard, University of Nottingham, became concerned with blind mobility in 1963 but did not consider the use of maps in the program until 1966. Since that time he has spearheaded the work in Great Britain and has been responsible for a considerable number of studies delving into the development and use of maps for mobility. His concentration on blind mobility began in 1966 with a study on Stopping Distance as a Function of Speed in Blindfold Walking and quickly intensified with his studies directed Toward A Unified Approach to Mobility (1966) and Aids to Navigation (1967). The latter contains a very good discussion of the problems faced by blind travellers and their use of maps as mobility guides. This paper was also read at St. Dunstan's conference in London and appears in their publication. Dr. Leonard continued on in 1967 with two more studies in blind mobility, one concerned with Mobility as a School Subject and the other dealing with Spatial Orientation in the Blind. Both of these studies consider the role of maps in the training of the blind. There are three more studies to date by Dr. Leonard that emphasize the use of maps in mobility - two in 1968 and one in 1969. He has also served as an advisor on the collecting and publishing of the British Government Social Survey's Report on Mobility and Reading Habits of the Blind, by Gray and Todd. The reader is referred to the selected bibliography for a listing of publications.

Another significant contribution from Great Britain is the work produced by Colonel Angwin. Published in two parts, his study of Maps for Mobility 1968, is the product of several years of working individually with blind persons in an attempt to orient and guide them through the use of large scale tactual maps.

The authors of this study also entered this field quite recently, Wiedel in 1963 while studying at the University of Washington and Groves in 1967 with the beginning of this project.

The authors are Geographer/Cartographers and have entered into this field with knowledge and experience in various aspects of the field of mapping. The research and publications have therefore been directed toward the special requirements in design and symbolization that are prerequisites to the development of useful tactual maps for blind users.

CHAPTER II

INITIAL RESEARCH PROJECT

Initial research was carried out prior to this three year project. During this period tests conducted at the Virginia State School for the Deaf and Blind showed that symbols indicated by asterisk on Figure 1 were tactually the most discrete in the various categories. With some modifications made necessary by reproduction methods these have become the basic set of symbols used on the preliminary maps. The following Figures 2 - 6 give some indication of the evolution of symbols as well as design as they were "married" through clinical testing. The first opportunity to test the efficiency of the symbols as well as the utility of the map as a whole was provided by the convention for the American Association of Workers for the Blind which was held at the Statler-Hilton Hotel, New York City in July 1964. The major advantage of using the occasion was that the blind are in normal daily contact with such objects as furnishings, stairs, and doors, and thus would be in a position better to evaluate the accuracy with which certain symbols portrayed the objects that they were designed to represent.

Figure 2 is a set of floor plans for the Statler-Hilton Hotel. The plan on the left is of the ground floor, with the streets, entrances, lobby and shops. The plan on the right is the ballroom floor of the hotel where most of the meetings were held. The Braille at the top identifies by number the items shown on the map. The bottom two lines of this Braille are the legend. The explanations and legend were made as complete as possible, since these plans were to be handed out by the American Association of Workers for the Blind at the convention without further explanation. This plan was designed to aid the blind in moving about the hotel and to locate meeting rooms.

Some of the items on these plans (Figure 2) that generated the most comment were the lengthy list at the top, the symbol for the stairs on the plan, the arrow indicating direction and the fact that the blind could not ask a sighted person for explanations since the legend was solely in Braille.

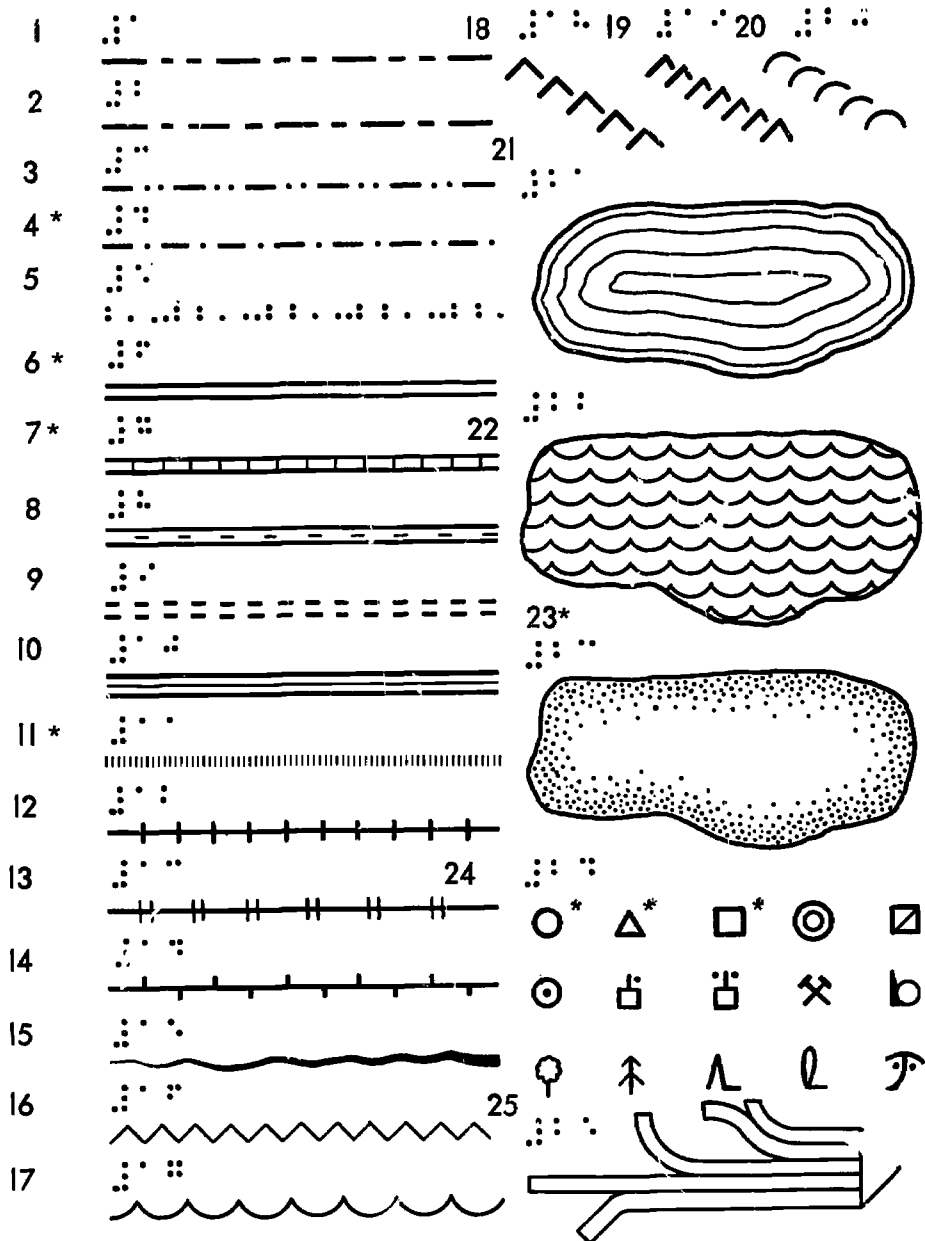

Figure 1. Symbol Sheet, Virginia State School for the Deaf and Blind, Staunton, Virginia.

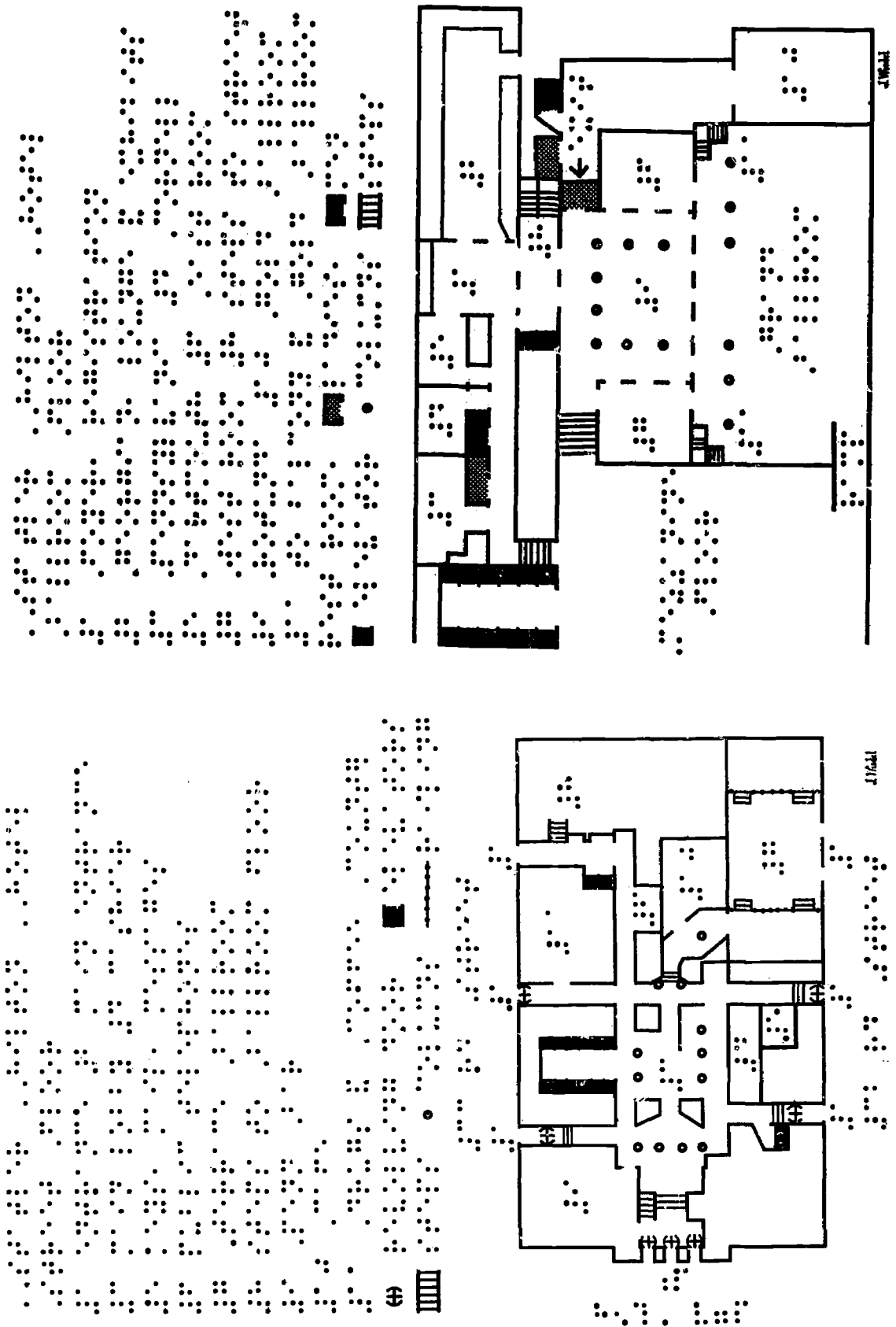

Figure 2. Statler-Hilton Hotel, New York City.

The second attempt (see Figure 3) is a ground floor plan of the Library of Congress. The legend is very small since the plan was designed to label all rooms and facilities whose locations a prospective user may need to become familiar with. Figure 3 is a proof copy and does not show the overprint for the sighted that was also included in the final version. It was tested by both blind and sighted persons, who were blindfolded for the purpose of testing.

This plan was preferred over the earlier hotel plans and presented only three real problems. The names in Braille that were placed vertically instead of horizontally, because of space requirements, caused a little confusion. The legend was placed within the plan in order to keep the sheet size to 8 X 10-1/2 inches and was headed by the word "legend." This too caused confusion, and there was the ever-present problem of the steps. The symbol could not be turned and still be interpreted as the same symbol. That is, a separate symbol or a lengthy explanation would be necessary to differentiate between stairs that go up and stairs that go down.

After testing, the plan was redrawn, incorporating not only the suggested changes, but additional information that the blind users requested (see Figure 4). The lines have been thickened to obtain more relief (or textural difference) and the symbol for steps was changed and more fully explained in the legend. A red overprint was added to facilitate the sighted in helping the blind.

Space, qua space, is of little importance in the design of graphic materials. Instead, it is the relative position of the information shown that is of primary importance. The external configuration of the building and many of the internal partitions on which the architect places major emphasis are of no importance to a floor plan, since the blind do not come in contact with them. Other items that are barriers to the blind are very often added later to a building. These include, for example, temporary partitions or heavy permanently placed furniture locations not indicated in the architectural designs. Such additions usually must be noted by personal inspection. All of the markings on the original floor plan were added through inspection. Figure 5 is the architect's drawing; Figure 4 is the author's design of the same building for the blind.

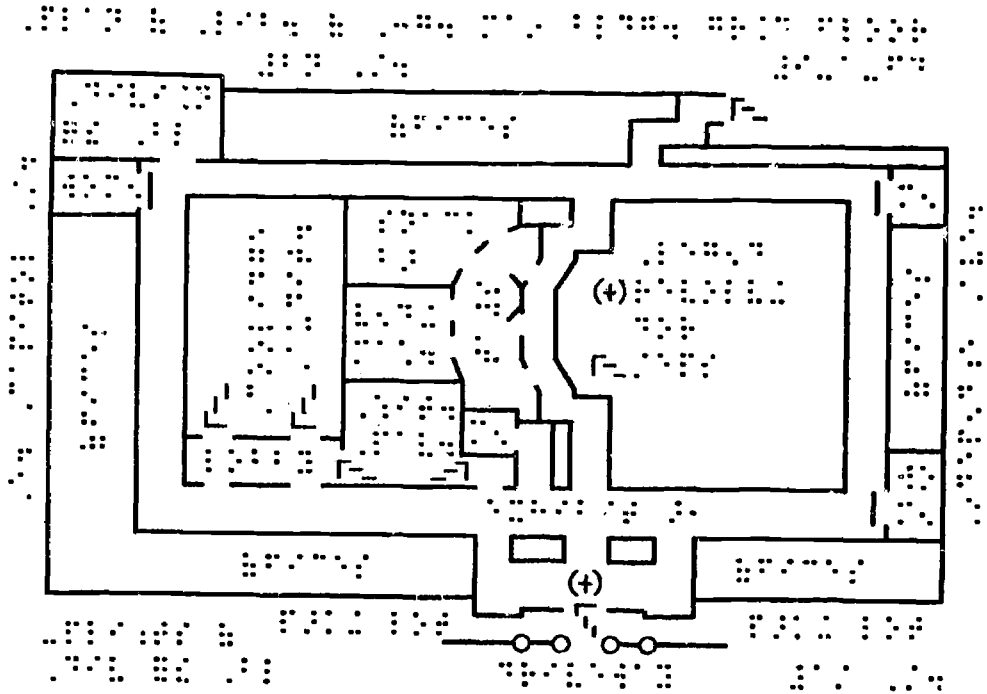

Figure 3. Library of Congress - 1st Plan.

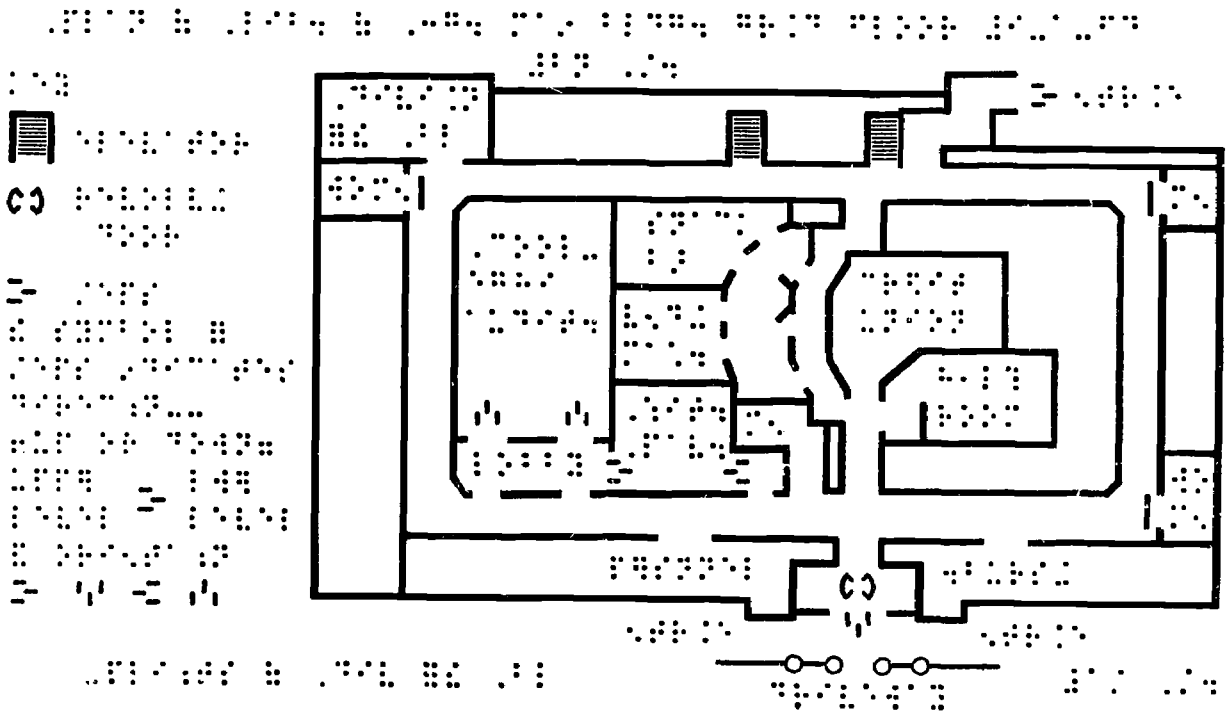

Figure 4. Library of Congress - 2nd Plan.

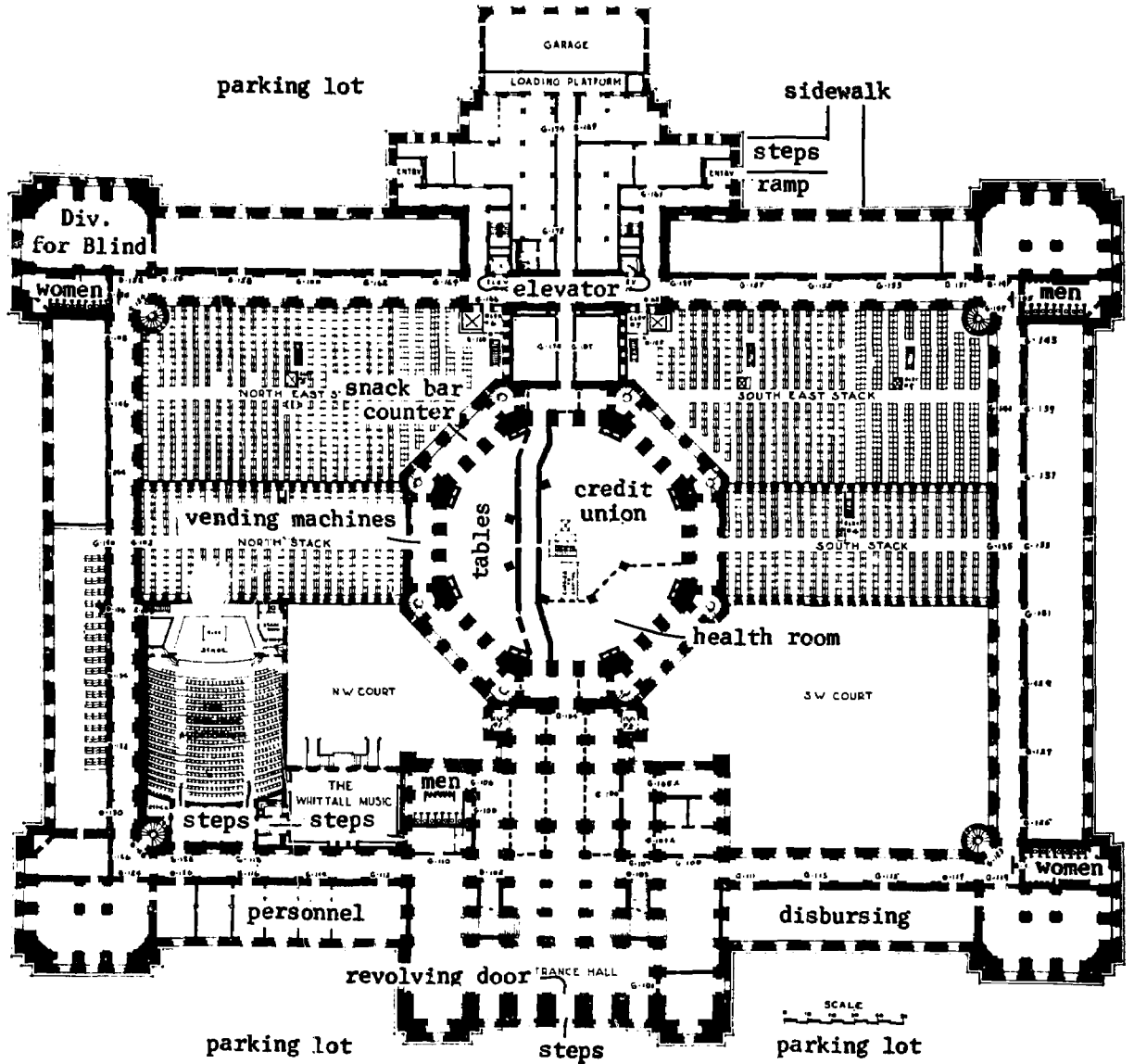

Figure 5. Library of Congress - Architects Plan.

In the preparation of the campus map of the Virginia State School for the Deaf and Blind (Figure 6) the poor quality of the original map necessitated not only a personal inspection of the campus but the possibility of several changes before a satisfactory plan could be developed. When Letterpress plates and raised printing, the method of reproduction to be used in this case, are involved, changes are very expensive. Almost 60% of the students had some degree of light perception, and with optical aids most of them could read the maps with large type. Since the final map was to be used both by the partially sighted and the totally blind it would have to have large type as well as Braille, so the preliminary drawings were made on tracing paper and low-cost ammonia process copies were run off and tested using the students that could read large type. In this manner changes could be made and new designs tested very quickly and cheaply. When the test results were satisfactory the Braille was added to the line drawing and reproduced in black and raised printing on a sheet which had the large type pre-printed in red. In this way many of the users had the opportunity to pre-test the final map, and since graphics for the partially sighted present many problems that are very similar to those of the blind, a rapid low-cost method was devised to improve the final plan.

1. Braille

Braille, as most type styles, is designed to be read in a horizontal line. Unlike other type, however, Braille cannot be reduced, slanted or otherwise varied. This, plus the fact that the Braille reader has never seen the type in any other form or position than that found on a printed page, presented very special problems in mapping. One must often design parts of the map around the lettering rather than the usual selection of lettering to fit within the map design. The space between the Braille cells and the line work of the drawing is critical, and though it does not bother some tactual readers to turn the page if the lettering is placed other than horizontal, for most persons it causes confusion. Second grade Braille is more convenient in the design of graphics since it uses a number of contractions, and is understood by most Braille readers.

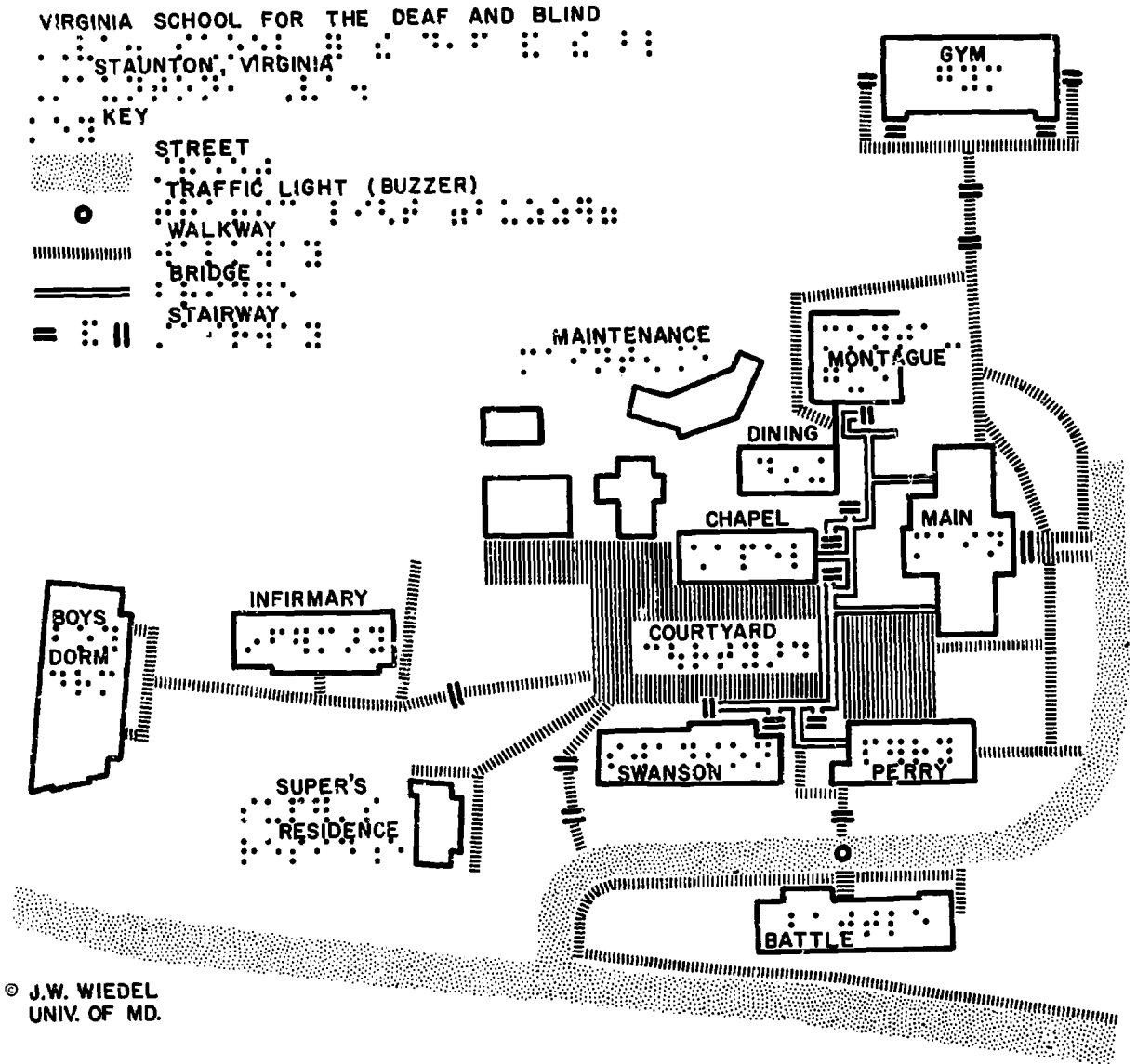

Figure 6. Campus Plan, Virginia State School for the Deaf and Blind, Staunton, Virginia.

2. Size and Scale

In the initial stages of research plans were kept to standard page size, for example, 8-1/2 x 11 inches or 8-1/2 x 14 inches, but the standard Braille page of 11 x 11-1/2 inches was used for the Virginia State School for the Deaf and Blind and proved a more practical page size to work with.

Size of a plan or map is an important factor, since the blind can read an area only as large as their finger tips and to facilitate orientation of the various components it should be made possible for the user to cover a significant portion within a one hand span. This also places a constraint on the scale and level of detail that can be shown on a plan. Visually we observe the whole, then consider the detail of the parts. The tactual reader on the other hand observes the parts and constructs a whole. For the blind to read a page size map has been likened to a sighted person reading a large wall map from a normal reading distance of about 10 inches.

Perhaps even more important is the problem of spatial orientation and the ability of the blind to equate a graphic representation to reality. This was found to be a particularly difficult problem for the congenitally blind.

Through contacts and correspondence with various schools and instructors that appear to have good mobility and orientation programs and by clinical research methods the authors consider a solution for many of the blind to the above problems lies in the scale of the initial graphic materials used. Most of the blind users were able to develop good map reading technique and to orient themselves as well as their graphics to their surroundings when they were introduced to very large scale maps of well known areas. These areas may be of their classroom, home or even a road intersection. A portable map of a well known, accessible area that can be examined on location is of

tremendous value not only for spatial orientation of the immediate surroundings but also of spatial orientation within a much enlarged area. It leads naturally to the introduction of progressively smaller scale maps of larger areas.

3. Summary

In summary, the initial research established that graphics for the blind must be capable of reproduction in moderate quantity and by a method that allows for the addition of large type to the raised line drawing. At present the most economical versatile and generally available method is the Thermoform.

The maps should be designed without neatlines and borders. The title should be at the top of the sheet followed by any necessary explanations and keys. Symbols should be kept to a minimum, clearly explained in the key and constructed with as much contrast as possible. Second grade Braille should be used and it should be kept horizontal, if at all possible. Plans of areas that may require the help of a sighted person to answer location or orientation questions or maps that will be used also by the partially sighted should be printed with large type, with 14 to 18 points as the minimum size. The maps are more useful to the blind and can almost always serve multiple purposes as the map of the Virginia State School for the Deaf and Blind, if large type is used in conjunction with Braille. Assuming well designed maps are available the major requirement is for a systematic teaching program in map and graphic interpretation. This is best introduced through very large scale maps of well known areas and developed progressively to the mapping of larger and unknown areas. The scale will necessarily be reduced since the size of the map itself should be kept to a standard Braille page of 11 x 11-1/2 inches. This is necessary in order for the reader to cover a significant portion of the map within a "one hand span".

CHAPTER III

METHODOLOGY

The pilot project (see page 2), on the basis of an evaluation of methods of reproduction, selected Thermoform as the appropriate one. The research that was continued from those findings concentrated on the design, and associated symbolization, of large scale orientation-mobility maps. These varied initially in scale from general orientation maps of metropolitan areas, to maps of the interior layout of a single building. As research continued, however, it concerned itself progressively with mobility maps, i.e. maps that the blind person could use for extending his repertoire of routes. Data collected by Gray and Todd (1968) in the United Kingdom confirms the need for such maps by indicating that only 15 per cent of the blind population of working age had added anything new to their repertoire of routes during the three months preceding the survey. At the present time the blind traveller in first setting out to cover a new route has to rely on his memory - tactual maps provide one way of overcoming this serious disadvantage.

The development of adequate symbolization and design in tactual maps has been approached along two distinct methodological avenues. On the one hand, a systematic and progressive testing and development program has been followed in line with the general progress of the research. On the other, largely due to demands from various individuals and organizations, a more informal ad hoc program has been followed. Each in separate, and sometimes collusive, ways has been important to the research project.

1. Informal Program

This has been important in two respects. First, it has provided the opportunity to produce maps for the blind for a wide variety of different functional areas - hotel lobbies, guide dog training areas, schools, buildings, etc. - and also to experiment with different route guides (see Figures 7 and 8). Second, it has provided the opportunity to test and develop a

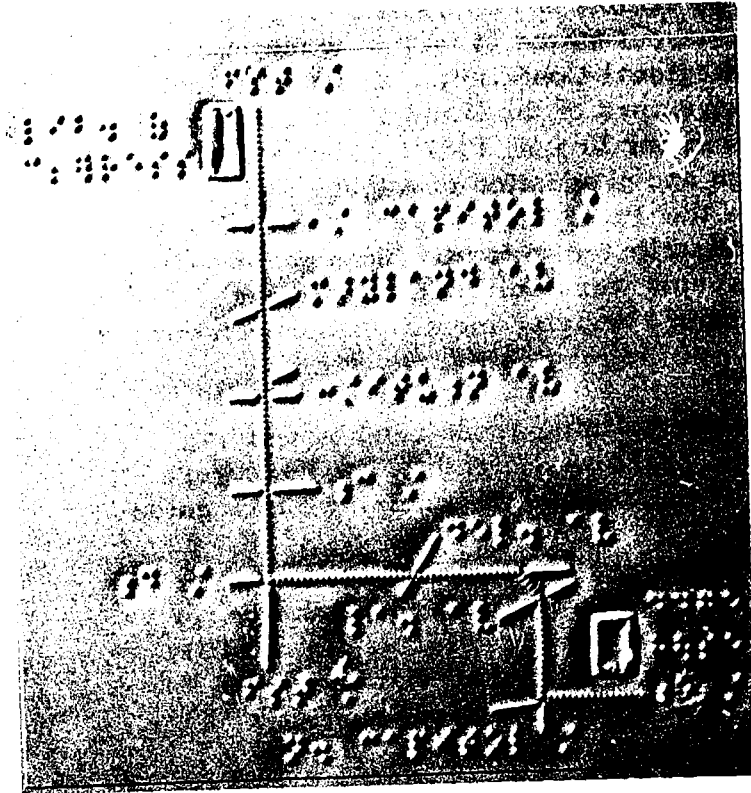

Figure 7.

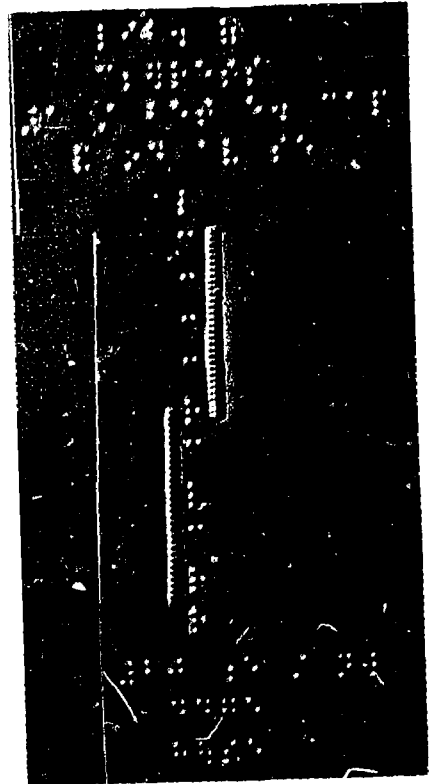

Figure 8.

Route Guides from Dodge House Hotel to Library of Congress, Washington D.C.

broad range of symbols and to test out in small group situations a number of new symbols.

Three examples of such specific map production follow.

- a. Upon request an exhibit of materials and equipment representing the current status of tactual mapping was prepared for the Regional Conference of the American Association of Instructors of the Blind at Harrisburg, Pennsylvania (November 10 - 11, 1967). This also involved the design and production of a lobby map of the conference hotel - the Penn-Harris - and some fifty of these maps were distributed to totally blind persons in attendance. Comments were solicited concerning readability, clarity of symbols, mobility improvement resulting from use of the map, etc.
- b. Three maps of the training areas used by Guiding Eyes for the Blind, Yorktown Heights, New York were prepared for use by trainees when acquiring a new guide dog.
- c. A neighborhood map of the Maryland Workshop for the Blind (Baltimore) was produced for use in mobility training and as a route map for blind visitors to the Workshop dependent on public transportation.

We have also had the excellent cooperation of a number of test groups at various age levels. These were extremely useful in preliminary investigations. At the Elementary-Secondary School level they were selected from students in Montgomery and Prince Georges counties in Maryland; at the Junior-Senior High School level from students at the Overbrook School for the Blind, Philadelphia, Pa.; at College level from students gathered at a Pre-College Orientation Program at Syracuse University, N. Y. in 1967; and finally a group of working adults were selected through the cooperation of the Maryland Association for the Visually Handicapped, the Office of Special Education, the Social Security Administration, and the Maryland Workshop for the Blind.

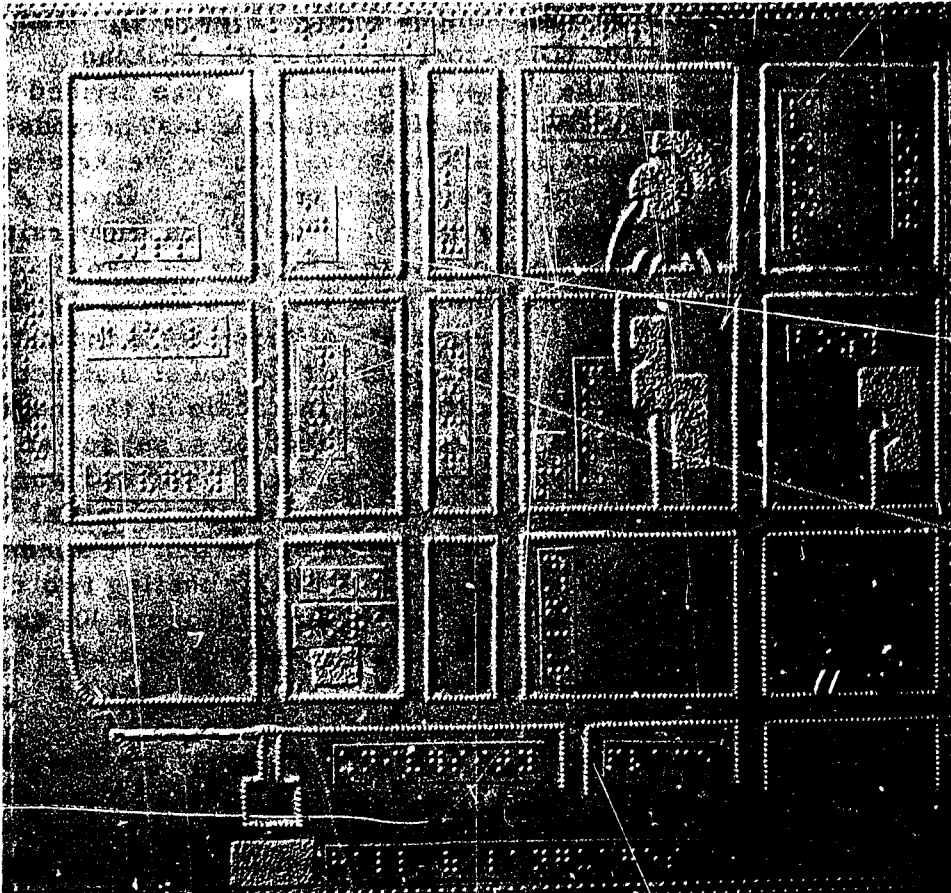

Figure 9. Campus Plan, Syracuse University, New York.

2. Formal Program

The first controlled tests were held at the pre-college orientation program at Syracuse University in June and July 1967 using a Syracuse campus map. (Figure 9). With the aid of Mr. Pauline (Director) and Miss R. Gilligan (Mobility Instructor) the twenty-two students were divided into two groups (A and B), and three separate test periods were arranged - second day after arrival, three weeks after arrival, and at the end of the six week program. Group A received the map one week prior to arrival at the University. Group B received the map along with a lecture on map reading and interpretation (which also included Group A) just prior to the second test. The results of these tests indicated a marked improvement with only a short period of instruction on map reading but also indicated that the scale of the map was too small (that is, it covered too large an area) for an introduction to the area in which the students lived and worked. A majority of students expressed preference for an initial map covering only 9 - 12 blocks instead of the more extended area shown in Figure 9. On the basis of this testing two maps were produced - a sample neighborhood map (Figure 10) and a sample shopping center plan (Figure 11) - along with an explanatory key (Figure 12).

Pre-testing of these maps was carried out at the Maryland School for the Blind at Overlea with 68 totally blind elementary and secondary school children ranging in age from eleven to twenty. A sighted group of 35, nine and ten year old children from a local elementary school were also examined on a sighted version of the test to measure map reading competence at the initial stages of training in map usage. This testing resulted in modification of the instruction and question sheet. The final question and instruction sheet (see Appendix 1) together with the maps and Key (Figures 10, 11, 12) were distributed to pre-selected residential schools, special education teachers, vocational rehabilitation centers, and Mobility Instructors throughout the United States.¹

¹ Correspondence was initiated with these groups through listings of State Vocational Rehabilitation Directors supplied by the Office of Social and Rehabilitation Services.

SHOPPING CENTER

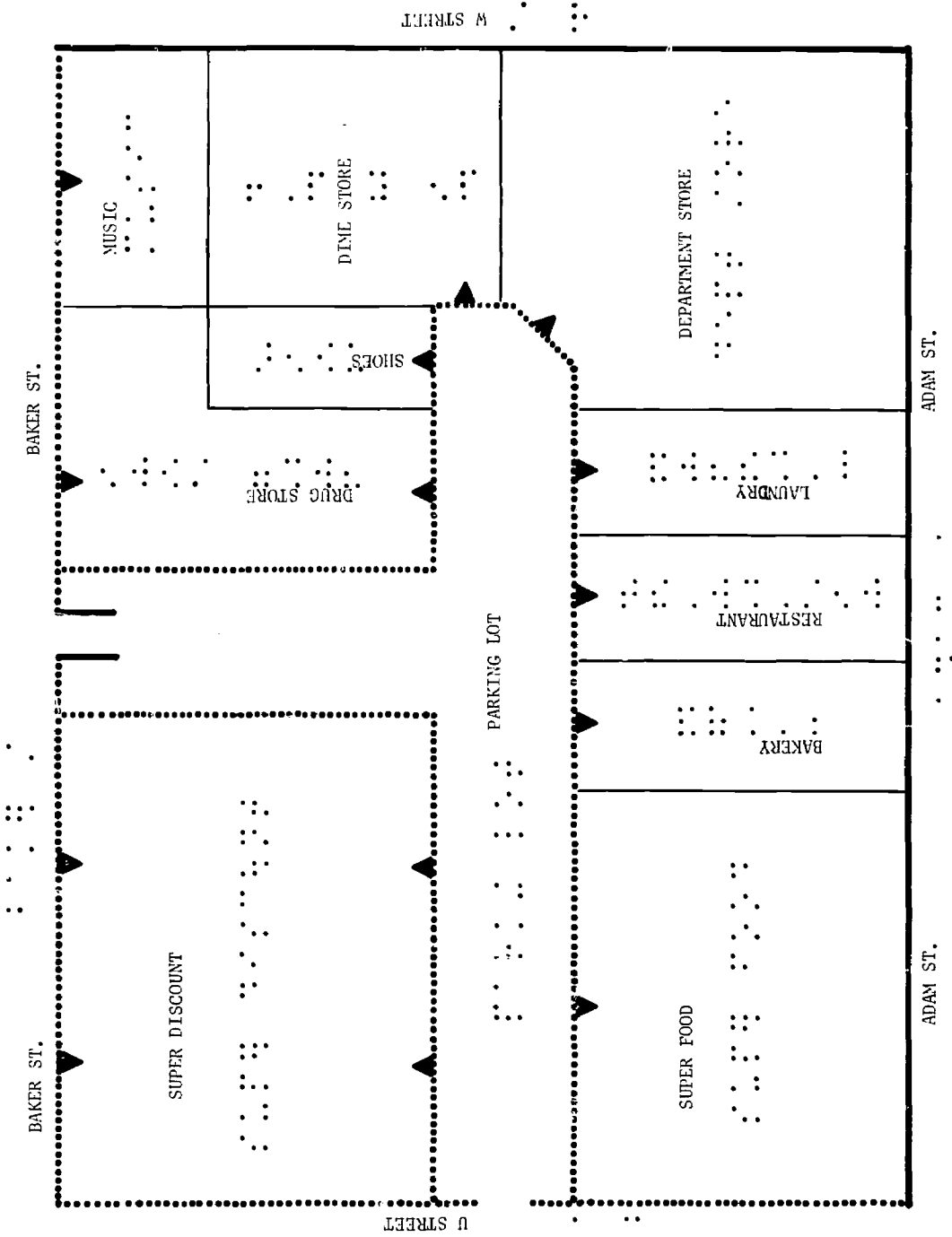

Figure 11. Shopping Center, Test Sheet.

NEIGHBORHOOD MAP

PLAYGROUND

PARK

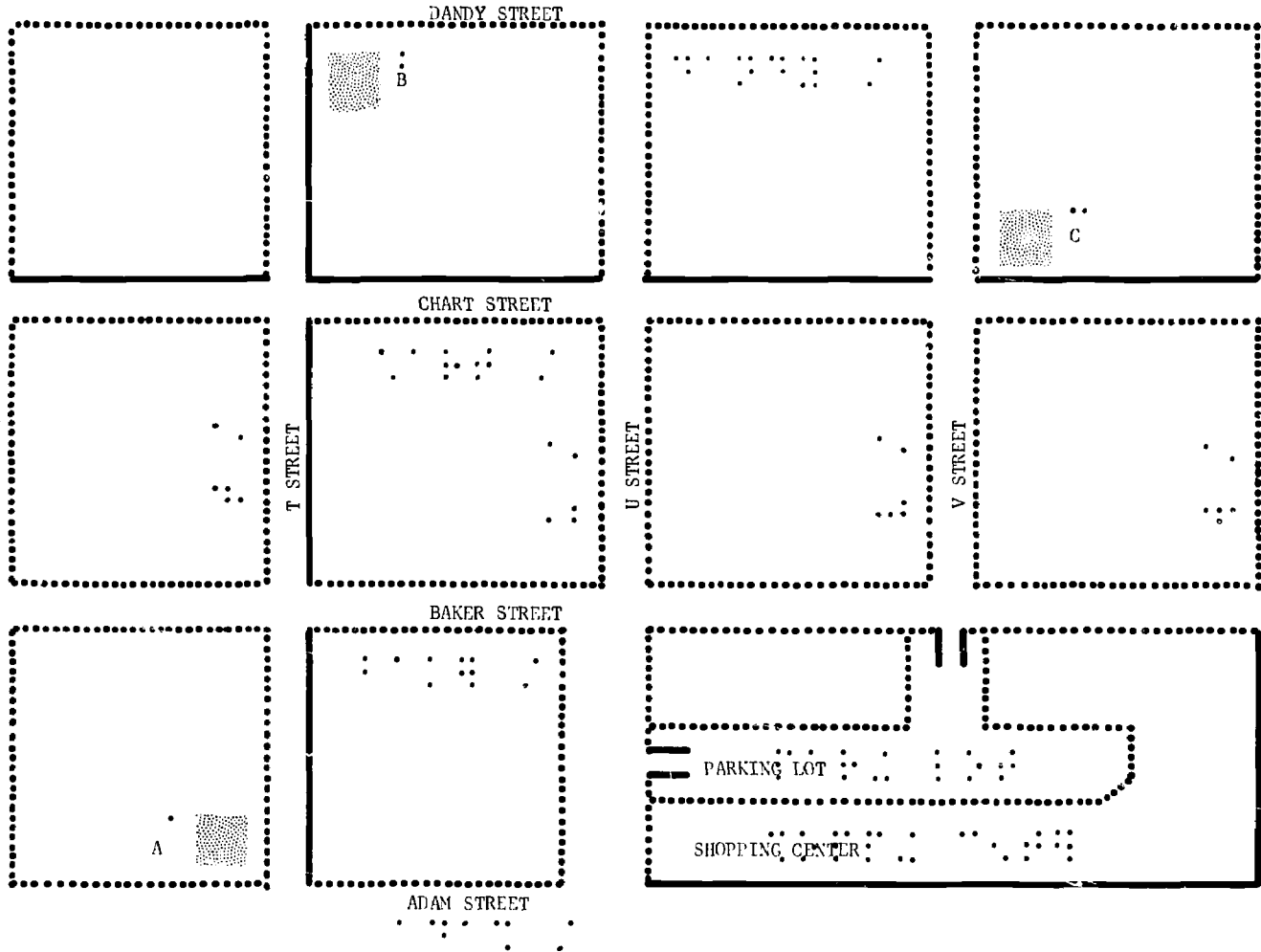

Figure 10. Neighborhood Map, Test Sheet.

Some 760 maps and attendant questionnaires were distributed within the United States and the United Kingdom, and of these, a usable return of 367 was received. Each of these returns gave information concerning vision level, education, age, map reading training, mobility instruction, and mobility proficiency together with scores on the map reading test. The test was constructed so as to measure the proficiency of the subjects in three areas of map reading - route finding, orientation, and symbol identification. The composition of the sample is shown in Table 1 on the following page. (Page No. 27).

The information was deliberately collected in finer subdivisions than was necessary, and then regrouped into broader categories. It was felt that this would increase the validity of the findings, especially where the initial categorization was on a fairly subjective basis, e.g. the degree of map reading training. In addition, the assessment of mobility instruction could be given by a teacher other than the mobility instructor which in turn, meant a problem in terms of categorization. As a result of such considerations outlined above the map reading training categories were reduced to two - (some map reading training and no map reading training), those for mobility instruction into two (none-very limited and moderate-extensive), and those for mobility proficiency into three (buildings: grounds and immediate neighborhood: and extended area). These groupings left the sample distributions shown in Table 2 on Page 28.

Some additional comments are pertinent with respect to certain elements of the sample, and the questionnaire-test map.

a. Vision Level

All participants in the testing program had to be tactual readers (even if they could read large type) and also braille readers. Of 293 participants providing information, 254 (87 per cent) could read tactually only, while the remaining 39 (13 per cent) could read both tactually and visually.

KEY TO MAPS

- 1 The maps are titled at the top of the sheet
The top of the sheet is also north unless otherwise indicated.
- 2 The following key refers to the symbols used on the various maps. Note that the meaning of each symbol changes with the type and scale of map.

Shopping Center Map

.....	Sidewalks
————	No Sidewalks
▲	Door Entrance
————	Division Between Shops

Neighborhood Map

.....	Sidewalks
————	No Sidewalks
■	Buildings

United States Maps

————	Physical Boundaries and Features - Shoreline, Waterways, Etc.
.....	Artificial Boundaries - Political (State and National) Boundaries, Time Zone Boundaries
■	Mountains
●	Cities.

Figure 12. Explanatory Key, Test Sheet.

TABLE I
SAMPLE CONTENT

a) Vision Level	
Congenitally blind	235
Adventiously blind	96
No data	36
b) Education	
Residential	292
Public	50
Tutor	7
Other	4
No data	14
c) Age Levels	
10 - 13	27
14 - 17	169
18 - 21	110
22 and over	59
No data	2
d) Map Reading Training	
None	152
Very limited	111
Moderate	79
Extensive	4
No data	21
e) Mobility Instruction	
None	105
Very limited	49
Moderate amount	149
Extensive	61
No data	3
f) Mobility Proficiency	
Building	64
Building (inacc. area)	10
Grounds	61
Neighborhood (surr. blocks)	65
Extended Area	103
No data	65
Total Usable Returns	367

TABLE 2

SAMPLE DISTRIBUTIONS USED FOR ANALYSIS FOR
MOBILITY PROFICIENCY, MAP READING TRAINING,
AND MOBILITY INSTRUCTION.

Mobility Instruction:	
None-Very limited	154
Moderate-Extensive	210
No data	<u>3</u>
	367
Mobility Proficiency:	
Buildings	74
Grounds and Immediate Neighborhood	126
Extended Area	102
No data	<u>65</u>
	367
Map Reading Training:	
No training	158
Some training	198
No data	<u>11</u>
	367

b. Education

The large majority of the tests (85 per cent) were given in residential schools, with the number of public schools providing information necessarily low. As the tests were generally given to larger groups in residential schools and as the proportion of individual testing was larger in public schools it was felt unfair to use type of education as a variable.

c. Age

The participants in the test program were grouped into four age levels, broken to represent as closely as possible education levels. These levels were (with absolute numbers in the sample of 367 in parentheses); 10-13 years of age (27), 14-17 years of age (169), 18-21 (110), and 22 years of age and over (61). The grouping attempts to reflect educational attainment and study program. For example, the lowest age was restricted to that at which maps are first (if at all) introduced into the study program. The age sample is heavily weighted in the 14-21 age group. The over 22 group contains a wide variety of working adults with a variety of educational backgrounds.

3. Liaison With British Workers

The only country where there is on-going research of a similar nature is the United Kingdom. The necessity of personal liaison with researchers in that country became obvious after a visit to the University of Maryland by W. J. Pickles (Worcester College for the Blind) in August 1967. During the period January 22 to February 12, 1968, the investigators visited the following individuals at their institutes; W. J. Pickles (Worcester College for the Blind), C. W. Garland (Royal National Institute for the Blind), J. A. Leonard (Department of Psychology, University of Nottingham) and P. Angwin (St. Austell). In addition to individual meetings with the above persons who are engaged in research and

development of tactual maps, a conference was held at the Department of Education, University of Birmingham (February 7, 1968) attended by all of the above, plus five educators involved in the use of tactual maps in a teaching situation. The results of that conference and general points of agreement reached by the participants are outlined in Appendix II. One noteworthy agreement resulted from research carried out by Pickles. Based on a completely independent research project he had reached the same conclusions on two basic map design components, namely the use of a smooth line to represent a non-trafficable route, and the use of 20 dots to the inch as the most readable dotted line symbol. The work of Leonard (see literature survey) is particularly relevant to the research at Maryland.

4. Summary

Methodologically, the research has depended on both a formal and informal research design and has benefitted from contact with fellow researchers in the United Kingdom. The research program has produced two results; first, a method of design and reproduction of tactual maps which meets the requirements set out earlier; second, this map has been tested with a broad range of subjects to ascertain what types and degrees of training are necessary for a reasonable reading of the maps. It is these two results which are discussed in the following chapter.

CHAPTER IV

RESULTS OF STUDY

As indicated in the summary to the preceding chapter, the results of the study are twofold. First, a "readable" tactual map has been produced through the testing of methods of reproduction, design elements, and symbolization. Second, an abstract map has been tested with a broad sample to establish the relationship between the ease of reading the map tactually (as measured by test scores) and certain variables such as map reading training, mobility proficiency, mobility training, etc.

1. The Tactual Map: Design and Reproduction

The chief problem facing any designer of spatial tactual maps is to ensure that it holds enough information to meet the needs of the user but not so much as to confuse him. This problem is made more difficult by the restrictions in numbers of symbols that can be used and the degree of generalization required.

Our findings indicate that some of the principles used in designing graphics for the sighted are applicable to tactual graphics as well. For example, the cluttered appearance is eliminated from a sighted map by varying line weights and type styles. On the tactual map this can be done by varying the height of the symbols thus allowing the blind reader to scan the obvious or major items much the same way a sighted reader's attention is drawn by bold lines. This gives a rather schematic view of the area which we found to be helpful in orientation. Braille which tends to clutter the maps because of its space requirement and the amount of it generally needed is placed at the lowest elevation (.02 inches). Line and area symbols are placed at the next highest elevation (approximately .04 inches) with point symbols which are generally used for orientation placed at the highest elevation (approximately .06 inches). With this type of design the reader can use as much of the map as required with a minimum of effort.

FIGURE 13

SYMBOLS







<u>Building Plan</u>		<u>Neighborhood Map</u>
North (Across top of Sheet)	North (Across top of Sheet)
Broad Paved Area		Broad Paved Area
Sidewalk or Pathway	Sidewalk
Wall or Barrier	—————	Edge of Street Without Sidewalk
Counter or Partial Barrier	- - - - -	Division Between Buildings, Fence
		Traffic Light
Pole or Column		Tree, Pole
Column (Square)		Column or Barrier (Square)
Entrance		Entrance
Revolving Door		
Steps	Upper Level ... Lower Level	Steps
Escalator		

Figure 13. Symbol Sheet for Mobility Maps.

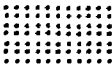
We have also had requests for North orientation on tactual maps. This, we found, cannot be satisfied with a small indicator as used on maps for the sighted. It is necessary to use an indicator which is easily located and identifies the entire north edge of the sheet (see Figure 13). It is most desirable to have the title of the map directly below this line.

In considering the several types of symbols needed it is convenient to group them into the three categories used on two dimensional maps, i. e., line, point and area.

Linear symbols can be further subdivided into lines indicating pathways to be followed and lines locating barriers or non-trafficable boundaries. The former are constructed of dotted or broken line symbols and the latter of smooth line symbols. This system is used since our testing indicates that broken or dotted lines are more easily identified and followed tactually than smooth lines. Of the broken line symbols tested, 20 dots per linear inch proved to be best suited for continuous reading and is therefore used for sidewalks and recommended pathways.

Point symbols will undoubtedly prove to be the most difficult to apply any standards to. They are needed for so many different sorts of objects and so few styles can be readily identified that Braille labels are often required. The round dot elevated above the line symbols has proven best for quick identification and is therefore used for permanent obstacles that may also serve as orientation points, such as trees and poles. The square and circle have been reserved for items with the same general shape such as columns, buildings or walls. The circle constructed with a dotted line is used for controlled intersections, information very often required on mobility maps. The other easily identifiable symbol, the triangle, is used for entrances.

Areal symbols are also needed for a variety of items but the broad paved areas have been given priority on Mobility maps because of the problems they present to the user. The pattern is produced by a series of parallel dotted lines at the same elevation as the sidewalk or pathway symbol.

If this much can be standardized on Mobility and Orientation Maps it will greatly reduce the amount of information required on a key and a great deal will be achieved toward making the reading and interpretation of maps easier for the blind user.

When the map area is very complex or large enough to require more than one sheet a simple rectangular reference system is valuable but it should only consist of labelled marginal ticks.

The problem of placing braille for street names is particularly difficult. We have prepared test maps with the labeling in the blocks above the street, in the street, on the underside of the map sheet and on an overlay sheet. Although all systems have their merits and each are preferred by some users we found the method of labeling in the block above the street presented the least difficulty to the largest number of users when only a limited explanation was given. The major problem with labeling in the street is the size (height) of the Braille cell. This forces the displacement of the sidewalks or street edges and aside from restrictions on the amount of area that can be shown on a braille page because of the increase in scale we have found that more users have difficulty in following the street pattern. The optimum width of a street on a Mobility Map appears to be around .2 of an inch and less than .3 inches. In labeling on the underside of the map sheet we found it required very lengthy explanations and the method of reading differed among the users to the extent that placement of the Braille to insure its being read correctly was virtually impossible. Labeling on an overlay sheet has the obvious disadvantage of having two sheets instead of one but was found to be quite usable especially when large amounts of Braille were required.

The multi-layered map is quite usable and in fact desirable when large amounts or different types of information are wanted and portability not required. It is quite easy to register the sheets using a two-hole punch and in this manner they can be placed together in any combination desired. We also found it to be advantageous to Thermoform the base map on the thicker Brailon (.008) and to have at least two reference points that appeared on all sheets.

The need for the suggested standardization is accented by the requirement of a key. Since the key can seldom if ever be placed on the same sheet as the map without being interpreted as part of the map itself it required a separate sheet, with obvious disadvantages associated with it if portability is desired. Once these few basic symbols are accepted as the standards for Mobility Maps a key can almost always be eliminated since additional items can be labeled on the map itself or identified, if required, in accompanying explanatory material which may be given verbally, by tape or by Brailled text.

Some form of mobility map is quite definitely required. The Blind are quite capable of reading and understanding large scale maps with only a limited amount of training in map reading and interpretation. Apart from their utilitarian purpose is the often overlooked enjoyment the blind receive from looking at maps. We have found that the blind gain considerable pleasure as well as knowledge from well designed maps. We have tried a variety of methods and designs in preparing mobility maps and have found that almost all methods tried have enabled some of our subjects to walk along new routes, under supervision, but with very little or no intervention on our part. Samples of various methods and designs with comment appear in Appendix III.

The great divide between the congenitally blind and the rest does become much more important when it comes to the conceptualization of spatial patterns and the translation of a small tactual pattern to a life-sized pattern in real space. It is useful to recognize what has been a frequently confirmed observation that the mere transliteration of sighted maps into tactual form meets with considerable difficulties among the totally and especially the congenitally blind. The problem is not that blind people cannot detect and use landmarks with training and experience, but is rather that of translating landmarks from a map to those encountered in real space. This means that the mapmaker must try to devise ways of representing the landmark in such a way as to help the blind reader appreciate from the map what it looks like and precisely where it is located. This again emphasizes the need for more measures of standardization.

It also introduces a further problem, that of selection of information to be mapped. The type of landmarks and information required for the blind must be gathered by personal inspection. This is made necessary by the fact that existing map sources are not only designed for the sighted user but for the motorist. It is very rare indeed to find a map in the United States designed for use by a pedestrian, and even then if one should be so fortunate, the information required for a tactual user would differ. To date the authors have found it absolutely necessary for a sighted person to walk the area to be mapped and personally note the key features that serve as landmarks for the blind traveller.

a. Construction of Master

The Thermoform method of reproduction is an extremely versatile process. While it makes the use of a wide variety of materials possible for master plates it also allows for a degree of standardization since low cost and useful materials and tools are readily available. In our research we found the method used by Recording for the Blind in New York City the most adaptable to our needs. With some modifications it has become our standard method of producing master plates which we refer to as "Metal Masters". (See Appendix IV).

The metal used is the aluminum sheet purchased in rolls of varying length from American Handicraft stores. The process is carried out in three stages. (1), The transfer of the drawing to the metal plate; (2), the inscribing of the metal plate; and (3), the Brailleing or labeling of the metal plate.

The transfer of the drawing to the metal plate can be carried out by the use of several processes but here let us introduce a relatively simple process that requires a minimum of equipment. Begin by making your drawing at the same size as your final copy (10 x 10-1/2 inches) using tracing paper and a soft pencil. When completed, tape the drawing

face down to a piece of the aluminum foil cut to 10 x 10-1/2 inches. In order to make the drawing easier to read when transferred to the metal plate we spray the aluminum on one side with a flat white paint. The lowest cost one available, in an aerosol can, has worked the best for us. If yet a darker line image is desired a sheet of carbon paper may be inserted as you tape your drawing, face down to the white side of the aluminum. Place this on a firm pad and retrace the drawing with a ballpoint pen, stylus or firm pencil. When completely retraced untape the drawing from the aluminum sheet. The drawing is now "mirror image" on the white side of the metal plate.

The metal plate is now ready for inscribing the line work. This is done by placing the aluminum sheet, white side up on a rubber pad. Surgical rubber sheeting in thicknesses of 1/32, 1/25 and 1/16 inches have all been used with satisfactory results. The choice of thickness is a matter of ones personal preference, however, it is easier to maintain a uniform depth of line at the desired height of .04 inches with the 1/32 or 1/25 inch thickness. Select the stylus for the line symbol desired. A stylus with a ball point or small wheel will work best since they will roll over the metal surface and be less likely to stretch the metal or "bunch" the rubber mat as you draw. There are several types of satisfactory stylus available at a wide range of costs. Four of the types produced by the A. B. Dick Co. for cutting Mimeograph stencils have proven more than satisfactory and retail for less than fifty cents each. Another combination tool containing six different tips was developed at the Worcester School for the Blind in England and is being manufactured by the Royal National Institute for the Blind in London. (See Figure 14) This latter tool contains several points that were designed specifically by Mr. Pickles to meet his and the authors requirements for preparing maps. Other tools may be found by checking the various catalogs. To inscribe the metal master a uniform and firm pressure must be applied while tracing the drawing. Make repeated checks of the



A. B. Dick Stylus number 467



A. B. Dick Stylus number 469



A. B. Dick Stylus number 454 (1412 old no.)



A. B. Dick Stylus number 460



RNIB Prototype of model. When produced will have six interchangeable tips.

reverse side of the metal to ensure uniform and adequate height of the symbol. Care should be taken in the tracing since corrections, though possible, are difficult to make. Punctures in the metal do not harm the reproduction except when a smooth continuous line is required. Height of symbols can be controlled by using rubber mats of different thicknesses or by "working" the metal by repeated tracings.

Braille or labeling may be done with a slate or on paper and glued to the metal surface. Our best results have been achieved by using the Braille typewriter and cutting the labels into strips for gluing on. It is best to round off all corners before sticking down the strips since corners have a tendency to curl and often are interpreted as a Braille dot when thermoformed. For the sticking down of the strips we have found rubber cement to be permanent and easy to work with. It should be applied to both surfaces in a thin coat and allowed to dry before contact. Other glues work well but tend to be slower drying and more difficult to remove the excess from the metal surface. Double stick tape is also useful but gives added height to the Braille strips. The plastic tapes used in the Tape-writer will not thermoform and although metal tapes can be used one is still restricted to grade one Braille. The above methods of applying the Braille will also work for sticking down other textured material as well. Tests should be made of all materials before use to determine their thermoforming qualities.

It is usually necessary to carry out a certain amount of touch-up work before thermoforming and it is at this stage that a final check of the drawing can be made. With the metal master "right reading" (unpainted side up) and on a firm pad trace lightly along sides of lines and around symbols with a ball point pen or stylus. This will make the sides of the elevated lines more vertical and they will

reproduce sharper and have more strength than if they are left with wide rounded bases as sometimes happens if the rubber mat is not rigid enough. With at least one sheet of Braille paper under the metal master use a needle and punch small holes through the metal at all inside corners and in enclosed areas. This is necessary since the air must be withdrawn in the vacuum forming process and the metal is non-porous.

b. Reproduction

To Thermoform stick the metal master to a standard size sheet of Braille paper by using small squares of tape or glue at the corners only. The paper will extend by 1/2 inch on all four sides of the metal master. This allows for the necessary escape area for the air in the vacuum forming part of the thermoforming process. The paper margin is also useful for writing in notes, construction and revision dates, titles, filing codes etc.. Set the heat gauge on the thermoform machine slightly higher than normally used for straight reproduction of Braille and allow for a little more vacuum time. If the heavier Brailon (.008) is used the timer must be increased even more. The heavier Brailon is recommended if the maps are to be carried and used while travelling or serve as a base with standard Brailon overlays.

c. Maintenance and Revision

The metal masters should be stored in a vertical position if space allows, preferably in envelopes and suspended by holes punched in the envelope and/or the paper margin. If stored flat, sheets of used Braille can be sandwiched between the masters for cushions and unless they are stacked too high no problems should develop. The metal masters generally hold up very well in storage if only a minimum amount of care is taken. Damage is more

likely to occur by sliding them in and out of their storage or by rough handling in the Thermoform machine. During these operations one is more likely to snag the material glued to the surface and curl the edges or pull it loose. The masters should of course be checked carefully each time they are brought out for reproduction. If folds or dents are found they should be smoothed with a broad flat burnisher with the master placed right reading on a firm surface. Care must be taken that the metal is not stretched by too heavy a pressure as this will produce bulges. Line work and symbols can be touched up as discussed previously.

Revisions can be made quite easily if they consist of additions. Changes or deletions if extensive may best be handled by cutting out the section involved and taping in a new piece of metal. The Scotch brand Magic Mending tape serves well for this purpose since it is thin, is not affected by the heat of the Thermoform and does not contract with age. If stuck on to the surface it covers the line where the two pieces of metal are joined. This tape has also proven useful to cover areas where corrections have left rough surfaces or holes in the metal and where smooth lines are required and the metal has been punctured by too much pressure.

2. Test of Abstract Map

The test sample has been fully described in the chapter on Methodology (pages 22-29). The questions asked of the participants fell into three categories, namely symbol identification (questions 1, 2, 3, 11, 12 and 13), orientation (questions 4, 5, 6, 14, 15, 16) and route finding (7, 8, 9, 10, 17, 18, 19, 20). These were considered to be the three prime areas for testing, and most of the results presented herein are classified by age level and by the three above-mentioned categories. The conclusions drawn from the testing are stated below with supporting statistics from the sample.

Congenitally blind have greater difficulty in using tactual maps than the adventitously blind. The purpose of the tactual (or raised) map is to help the visually handicapped overcome the ambiguities and inaccuracies of his concepts of the world around him. The adventitously blind have an advantage over the congenitally blind as they have, however poorly remembered, some spatial concepts. This is illustrated by the test scores in the following table.

TABLE 3

PERCENTILE SCORES BY AGE GROUP AND BLINDNESS CATEGORY ON TEST INVOLVING SYMBOL IDENTIFICATION, ORIENTATION, AND ROUTE SELECTION.

Age in years	Symbol Identification		Orientation		Route Selection	
	C	A	C	A	C	A
10 - 13	50	72	55	72	45	70
14 - 17	47	65	62	72	50	61
18 - 21	50	63	60	68	56	60
22 and over	62	70	77	90	68	77

Note: C = Congenitally blind. A = Adventitously blind.

Based on 367 test results. All scores in this and subsequent tables are rounded off to the nearest whole number.

As Leonard (St. Dunstons, 1966) has stated "the great divide between the congenitally blind and the rest does become much more important when it comes to the conceptualization of spatial patterns and the translation of a small tactual pattern to a life-sized

pattern in real space. . . . For the moment it is useful to recognize what appears to be a frequently confirmed observation (not to say fact) that the mere transliteration of sighted maps into tactual form meets with considerable difficulties among the congenitally blind". The above table shows that among all age groups and on each set of scores (symbols, orientation, route finding) the congenitally blind have lower scores than the adventitiously blind. This does not mean that, assuming well designed maps, they do not benefit immensely from their use. On the basis of test results, however, it appears that the adventitiously blind will have less difficulty reading tactual maps and, other things being equal, will be able to operate at a higher degree of efficiency.

Blind subjects with some map reading training are more successful in reading tactual mobility maps than those with no map reading training. This is particularly true in orientation and route finding when compared with symbol identification, success in which is probably more closely associated with skill in reading Braille. The table on the following page (Table 4) illustrates this point.

It is worth noting that with map reading training, scores in orientation and route finding improve more than in the case of symbol identification. Averaging the percentile improvements by age groups (not weighted) there is an average improvement of four percentage points in symbol identification between the two groups (column "a" and "bcd"), nine percentage points in orientation, and eight and a quarter in route finding. It is obviously in orientation and route finding, therefore, that map reading training is the most beneficial in terms of the blind persons ability to read tactual maps.

Map reading ability increases with the amount of mobility instruction that a blind subject has received. Again, however, the amount of improvement is greater in orientation and route finding than in symbol identification.

TABLE 4

PERCENTILE SCORES BY AGE GROUP AND MAP READING TRAINING ON TEST INVOLVING SYMBOL IDENTIFICATION, ORIENTATION, AND ROUTE SELECTION.

Age in years	Symbols		Orientation		Routes		Numbers in Sample
	a	bcd	a	bcd	a	bcd	
10-13	53	53	53	58	40	52	26
14-17	50	53	59	70	50	56	160
18-21	55	58	61	66	54	62	110
22 -	66	76	75	90	73	80	60

Note: Based on 356 test results. Columns headed "a" = subjects with no map reading training, column headed "bcd" = subjects with some map reading training. Column headings identify options in questionnaire.

TABLE 5

PERCENTILE SCORES BY AGE GROUP AND AMOUNT OF MOBILITY INSTRUCTION ON TEST INVOLVING SYMBOL IDENTIFICATION, ORIENTATION, AND ROUTE FINDING.

Age in years	Symbols		Orientation		Routes		Numbers in Sample
	ab	cd	ab	cd	ab	cd	
10-13	54	53	54	65	48	55	27
14-17	47	57	57	71	45	59	167
18-21	53	59	57	67	53	63	110
22 -	65	75	78	88	70	80	60

Note: Based on 364 test results. Column headed "ab" = subjects with none or very limited mobility instruction, column headed "cd" = subjects with moderate or extensive mobility instruction.

Averaging the percentile improvement by age groups (not weighted) there is an average improvement of 6.25 percentage points in symbol identification between the two groups (columns "ab" and "cd"), 11.25 percentage points in orientation, and 10.25 percentage points in route finding.

The ability to read tactual maps increases with proficiency in mobility. The highest set of scores for symbol identification, orientation, and route finding among all the variables tested was found among those test subjects who indicated the maximum level of mobility, namely "neighborhood stores and extended area". Within all age groups, excepting the 10-13 category, there were progressively higher scores achieved as the mobility proficiency level increased. The table below illustrates these findings.

TABLE 6

PERCENTILE SCORES BY AGE GROUP AND MOBILITY PROFICIENCY ON TEST INVOLVING SYMBOL IDENTIFICATION, ORIENTATION, AND ROUTE FINDING.

Age in years	Symbols			Orientation			Routes			Numbers in Sample
	ab	cd	e	ab	cd	e	ab	cd	e	
10-13	50	44	-	58	70	-	41	58	-	18
14-17	45	54	80	53	68	91	48	53	69	136
18-21	50	53	68	52	67	73	47	59	64	93
22 -	48	63	84	63	84	90	64	74	83	57

Note: Based on 304 test results. Column headed "ab" = mobility within buildings, "cd" = mobility around grounds and surrounding blocks, "e" = mobility around neighborhood stores and extended area.

Mobility proficiency is a better indicator of the ability to read symbols and correctly solve orientation problems than of the ability to follow routes. This is indicated by the smaller improvement in scores as between the "ab" and "e" columns in route finding than in orientation and symbol identification, and also by the generally lower scores - among those with the highest mobility proficiency - for route finding as compared with symbol identification and orientation.

Wide variations exist between test groups on the basis of educational program. This is illustrated by the scores obtained by two school groups particularly when compared with the average scores of all test subjects. School A is an English residential Grammar school where the pupils take Geography as an examined subject for 5 hours per week up to the age of sixteen (and sometimes beyond). The fact that Geography is a major subject forces them to use maps and become familiar with spatial concepts as a result. The school is also highly selective in its admissions policy. All blind children in England are educated in schools for the blind, and School A is considered one of the best of these. A sample of 45 students from School A took the test with an average total score of 69 per cent. School B is an American residential private school where Geography is not part of the curriculum to anything like the same extent that it is in the English school. The State in which school B is located also has a special education program that includes blind children in the public school system so the American school cannot be selective in terms of admission policy. A sample of 84 students from School B took the test with an average total score of 45 per cent. The scores for Schools A and B should be compared with the average score of all respondents (367 total) of 60 per cent. Figure 15 following shows the breakdown for all respondents, School A and School B by individual question and grouped by general category (symbol identification, orientation, and route finding). It should be noted that in only four questions (numbers 8, 13, 17 and 20) did School A do worse than School B. It has been suggested in

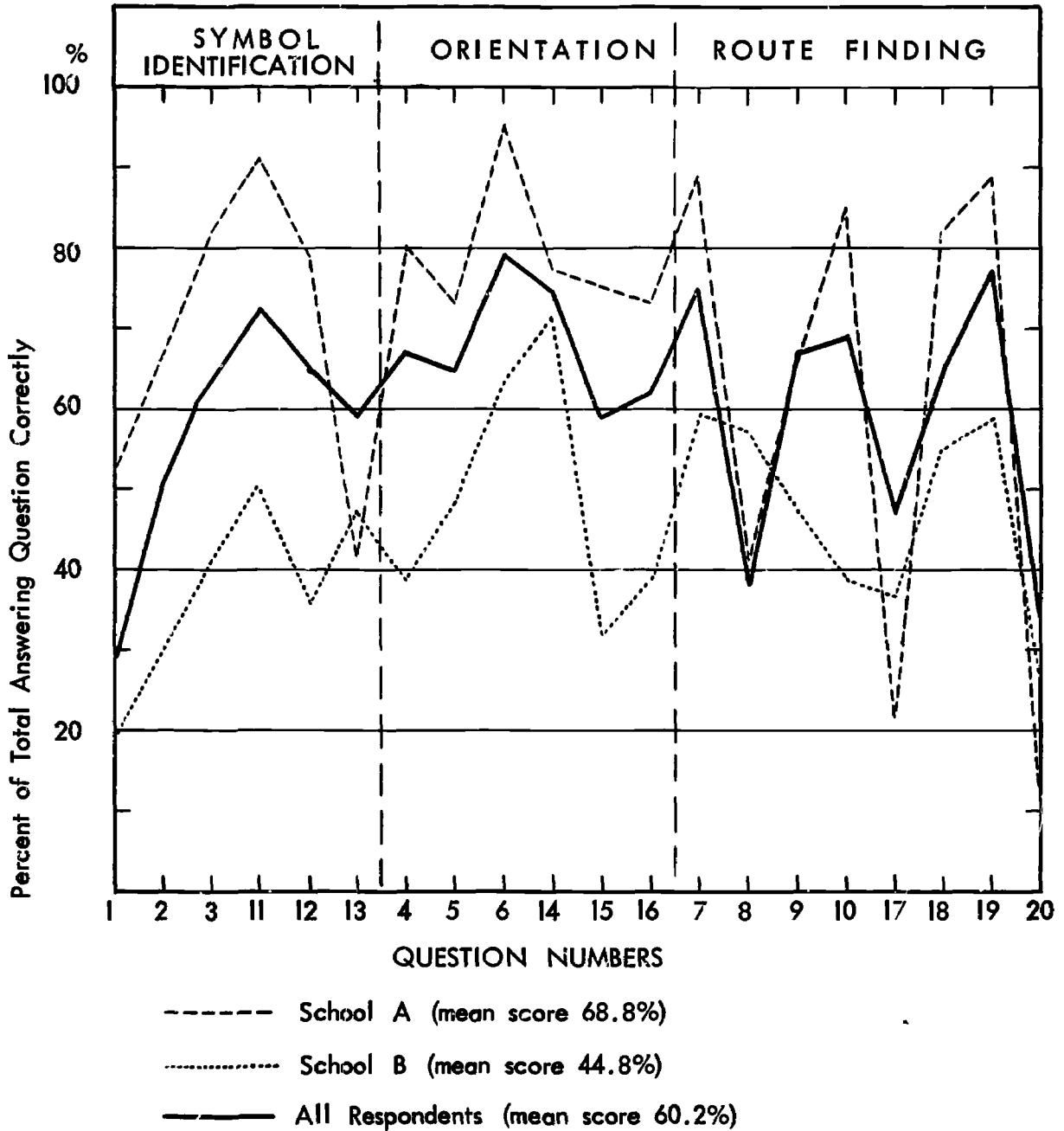

Figure 15. Performance Graph, All Respondents and Two Selected Schools.

England that the poor performance on these four questions is a result of unfamiliarity with concept or word usage within the question. Unfortunately, it is impossible to determine at the present time whether this was the case with the subjects tested. However, there does appear to be some similarity in the four questions in that they make reference to compass directions.

3. Areas of Immediate Concern

On the basis of completed research eight areas of concern are delineated. These are:-

- a) Linear Scale is of little importance on maps of smaller scale than downtown city plans or campus maps. As a general rule, its importance increases with the increase in scale. For example, a city plan need show only the number of blocks, not the relative length of different blocks, while a building plan requires a linear scale related to a known distance, such as the length of a corridor.

- b) The use of a starting point or points should be emphasized for readers of each illustration since this is necessary for orientation. For example, a dormitory in which each student lives would be emphasized as a starting point on a University Campus map. In design the starting point serves the same function as the focal point in a visual illustration. It is easily located and serves as a central point to which the blind person can spatially attach the bits of information that he collects as he tactually reads the map. The starting point must be prominent in the design - elevated above the level of all other information depicted. The blind reader must be able to readily locate it by scanning since all other information obtained from the map must be spatially oriented to some fixed point. The way a blind person is forced to read a map is analogous to the sighted reading through a tube about one inch in diameter.

- c) Size should be such that the user can cover a significant portion of the map with one hand orienting him from his starting point. Maps which may through necessity have to be larger than the preferred Braille page size should have orientation points spaced within one hand span of each other.

- d) Simplicity in symbolization and design is, of course, a necessity. It is better to make several keyed for reference than to complicate one design (map) with too many symbols. Whereas in sighted maps visual clutter is avoided by the use of color and varying line weights, in the tactual map this is accomplished by different symbol elevations (see pages 31 and 49). Other methods of avoiding tactual clutter and maintaining a readable image are available because the blind person is incapable of reading a map with the same degree of precision as a sighted person. This allows, for example, the proportional displacement of symbols but does preclude the direct transliteration of sighted maps.

- e) Brailleing is greatly preferred where possible. When used with symbols, it should use initials (i.e. LC - Library of Congress) rather than alphabetical or numerical keys. Although it is desirable to have Braille placed on the map horizontally, with a minimum amount of training the blind have little or no difficulty in reading Braille rotated at various angles across the map. Since the amount of Braille required on a map may be rather substantial it is preferable to have Braille at a lower elevation than other symbols. With the height of Braille standardized at about 15 mils, the other symbols must be elevated from 10 to 15 mils above the Braille.

- f) Compass direction. With the development of electronic devices it is now a simpler operation for the equipped blind person to determine directions. Consequently the north edge of the map is indicated by a textured margin which should extend the full width of the sheet.

- g) Map production. It is absolutely essential to walk the area to be mapped in detail to ensure accuracy of the final product. One should not, and cannot, rely on tracings of sighted maps. For even basic street pattern information this is necessary, particularly in the United States where adequate large-scale maps are not available.

- h) Training. Findings indicate very strongly that, assuming well designed maps are available and that they are tactually discrete, there remains a major requirement for standardization of symbols and a systematic teaching program of map interpretation for the blind student. The different scores between School A and School B indicated earlier provide an illustration of this requirement. Standardization of symbols on tactual maps is of even greater importance than on sighted maps because of limitations imposed by tactual identification.

The discussion and implications of the results described in some detail above are deferred to the following chapter.

CHAPTER V

DISCUSSION, AND IMPLICATIONS, OF RESULTS

The research established a tested method of map design and reproduction. Perhaps as important as these technical solutions was the realization that this is only part of the problem of successfully introducing tactual graphics to the blind. Three problems can be separated out as basic in the introduction of graphic materials.

1. Lack of Exposure to Tactual Maps.

Few blind, particularly congenitally blind, have had much exposure to any kind of symbolic representation of information relevant to spatial orientation. The test sample used in this study indicated that some 45 per cent of the 356 test subjects had had no map reading training at all. By age group the percentages were: 10-13 age group - 15 per cent no map reading training, 14-17 - 50 percent, 18-21 - 41 per cent, and 22 and over - 50 percent. This would tentatively indicate that younger children are obtaining more training in map usage than their predecessors. When one considers that the test sample is heavily biased in favor of subjects at school, the overall figure for those blind persons who have had no map reading training is obviously somewhat greater than the sample indicated 45 per cent. Added to this is the lack of standardization in teaching form. A survey carried out by Blust (1967) of 22 mobility specialists indicated that, among this highly specialized sample, 95 per cent used maps and models to aid in concept formation. More important, from the standpoint of this research, was the fact that eleven different types and forms of teacher made maps were produced. Thus, while the use of tactually presented maps and diagrams among this group was high (as one would expect), there was no standardization of map production or design and, resultantly, no common experience in terms of map reading training among the students.

Research of the type previously described has to operate in its final form along two parallel lines. One is to deal with the existing population of congenitally and adventitiously blind whatever age they are. Thus, hopefully, blind who have never used a map will gain from this research. Second, there is the obvious need to establish a systematic progressive training in map reading as a companion, and accessory to, the mobility syllabus. Some thinking along the lines of a map reading syllabus has been going on in England and Leonard (1966) has produced a suggested syllabus for map reading teaching of blind children. Thinking along these lines is in a very formative stage, however, and should be treated as a tentative approach to an important area of future research. Such a syllabus should however, be as strongly related to other subject materials as possible. Geography is an obvious subject for map usage and training and, as the test results have shown, school children who take this subject are more successful in reading maps than those who do not. (see page 47). There is, however, no reason why maps should not be used in literature classes. This has been successfully undertaken in England where maps appearing in books for the sighted have been successfully translated into tactual maps. Examples of books used in this way are "Treasure Island", "Sunnybrook Farm", and "We Didn't Mean to go to Sea". It is such integration of tactual maps into other subject areas (other than mobility instruction) which will enable familiarity with, and competence in the use of, tactual maps.

2. Paucity of Identifiable Non-Visual Landmarks.

When compared to the possibilities available to the sighted, there is a paucity of identifiable non-visual landmarks which the blind can use to obtain a "fix" or to update their information. In considering the perceptual horizon of a totally blind person it is not merely that there is no non-visual equivalent for a "distance landmark" such as a tall building. It is far more to the point that a mail box or pole at a certain cross-road has to

be tactually encountered and identified and that a blind person may walk straight past it, missing the vital cue by inches. From an analysis of work produced and a study of guide dog training, the street block has been accepted as the basic unit for orientation. A route can thus be set up as a succession of blocks with the end-of-block the non-visual landmark. Certain end-of-blocks are further identified by easy to locate additional landmarks such as a pole, tree or other permanent object. This, in turn, reduces the memory load of the user. In this manner, the user may set up a series of shorter, three to four block long, routes between major landmarks in order to reach his destination. Directly related to this is the necessity, whenever possible, of the use of visual lettering on a tactual map. This not only provides additional information for the partially sighted, but also enables the blind person to obtain a 'fix', or during initial use of the map confirmation of a 'fix', from a sighted person.

3. Travel Competence.

Directly related to the above is the users travel competence. Functional maps of the type we are concerned with demand adequate travel competence from the user. This also requires a measure of training in map use and interpretation which takes us back again to the school. There is little point in making maps for people with low travel competence. First, because they are unsafe and may blame the map producer for having given them the maps and encouraged them to use them. Second, because the usefulness of a map depends on the ability to encounter and identify landmarks, and unless you have a sufficiently high travel competence you cannot do this.

Functional maps, such as the mobility and orientation maps considered here, are a stepping stone to the understanding of smaller scale or geographical maps introduced in academic studies. An additional point bears on travel competence. That is the fact that the blind user of the map must have confidence in the accuracy of that map. An accurate map can only be produced by the map designer or other competent person walking the area and attempting to identify landmarks that are meaningful

to the blind. There is nothing to be said in favor of copying a sighted map as these all too often contain minor inaccuracies which, if transplanted onto a tactual map, destroy the confidence of the blind map user. For mobility maps, therefore, walking the area prior to map design is an absolute must.

It is relevant, in this section, to make comment on three other areas of interest to researchers in tactual maps, namely, standardization, the availability of other types of tactual maps, and the possibility of including other components in tactual maps of the future.

4. Standardization.

It is generally agreed that standardization of design components, symbols, and reproduction method is beneficial. It is agreed that map reading training is required and part of that training should involve the standard use of symbols, etc. Also, since people at the local level will have to be taught how to make maps, they are going to have a training procedure and this interacts with the training program. The more general arguments for standardization are similar to those for standardization of any mapping form, i. e., ease of information identification, reduction of required key, easier reading after initial exposure, etc. There is some question as to how far standardization should go. At the moment, it would appear that all basic design elements, etc., should be standardized, but that room should be left for the application to any map of information which the individual user thinks would be useful. The question revolves largely around the user population. The maps described in this research are aimed at sizeable user populations and, as such, need to be highly standardized. That is, they involve the production of maps of University campuses, shopping centers, downtown areas, etc., which would be useful to a broad user population. However, the techniques developed in this research can be used for providing the basic map design for a single user and then additional components can be added to suit that individual's needs. Standardization, even in the latter case, will reduce the memory load of the user because of his familiarity with the conventional symbols, etc.

5. Other Map Types.

In terms of providing maps for mobility a number of other types of maps and memory guides have been produced. At Nottingham, Leonard and Newman (1968) have carried out experiments with disks on which route information was coded, with tape-recorders as memory guides, and route maps. All of these were attempts to provide the blind person with information on a new route, but only showed such information for "a preferred route of travel". As such, therefore, these maps perform a more specialized task than the maps produced in the described research. The investigators themselves have produced route maps upon request. They are, of course, successful as Leonard and Newman (1968) have shown for extending the blind travellers environment along a preferred route. Within the context of the described research they would be useful as an introductory step towards the use of area mobility maps. While the described research has concerned itself with area mobility maps many other types are what might be called linear mobility maps. The usefulness of the latter as a lead in to the former is self-evident.

6. Other Components.

A number of other components have been suggested by researchers in the field of tactual maps. These include landmarks indicated by smell (gas station, bakers shop, flower stall, etc.), by slope (breaks in slope on sidewalks, uphill and downhill designations, etc.), and by texture (different textured sidewalks, etc.). While recognizing the importance of these as landmarks for blind travellers, some were rejected on the basis of their lack of permanency (particularly smell features) and others on the basis of the difficulty of producing a design component that was both suitable and simple enough to avoid cluttering the map. Further testing of the possibility of using

such components is needed. A major problem under this heading is that of corners. The United States is fortunate in that, unlike European countries, the grid pattern of streets is generally common. This reduces the incidence of difficult corner types, in that most corners are square. Further research into the problems of mapping difficult corner types is an obvious requirement.

7. Conclusions.

The problem of orientation is a continual one for the blind traveller, and orientation-mobility maps are primary tools for mobility instruction. There are an increasing number of people preparing tactual maps, but these maps, with rare exception, are transliterations of visual maps into tactual form. They are rather elaborate versions of standard visual presentations and are for the most part, composite maps of unique, unreproducible type. It is a confirmed observation that mere transliteration of sighted maps into a tactual form present considerable interpretation difficulties to the congenitally blind. Some of the visually handicapped are being introduced to graphics more frequently today than in the past, and the interest and enjoyment resulting from the use of tactual maps is a strong positive factor in map training. However, the use of graphic material in mobility training still varies with the individual instructor.

The purpose of the raised map in orientation-mobility instruction is to help the visually handicapped person overcome the ambiguities and inaccuracies of his concepts of the world around him. The adventitiously blind have an advantage over the congenitally blind as they have, however poorly remembered, some spatial concepts. For all the blind, however, the map enables the traveller to gain factual and conceptual information about his surroundings. He can judge, by using the map, along what lines movement is possible and the route available to

approach an objective. It gives the traveller a framework for understanding the component parts of an area and their geographical relationships.

As map reading training becomes more proficient the amount of information that can be carried on a map can be increased by establishing conventional symbols thus reducing the amount of explanation (braille) required on the map. It is the capability of the user, together with the limits imposed by the reproduction process which restrict the amount of material that can be obtained from any individual map.

APPENDIX I

ORIENTATION AND MOBILITY MAP READING TEST

Purpose

We are at the developmental stage in our investigation on the use of tactual graphics for the blind. Tests on blind persons in various age groups who read tactually play an essential part in the progress of our research.

We have developed what appear to be satisfactory symbols and design elements of map layout which need further testing. We also feel that it is especially necessary to test with larger numbers of subjects with a much wider range of capabilities than has hitherto been possible. This map testing is designed to reveal: (a) the efficiency and clarity of symbol association; (b) the usefulness of the map for orientation, and (c) the efficiency of the map as a mobility guide.

Requirements

1. Personal history information requested must be filled out for each subject tested.
2. Test subject must be legally blind and must read Braille.
3. Test is taken with map in possession of subject tested and is to be read tactually only - no visual scanning should be permitted.
4. The 20 questions and instructions are to be read aloud by the person administering the test.
5. Approximately 35-45 minutes per person are required for individual testing, and 45-55 minutes are required for group testing.
6. Individual Testing: Where the test is given individually the test administrator should record the subject's answers on the question paper provided. The information requested on the reverse side of the question sheet must be filled out for each individual.

7. Group Testing: When a group is simultaneously tested, each subject must be provided with the means to record his answers in Braille on the Braille paper provided. The information requested on these Braille sheets must be filled out for each individual tested, preferably in advance.

Instructions (Read aloud)

I am going to read you a list of questions designed to measure the usefulness of maps which you have been given. Look at the first sheet in front of you, "Instruction and Key for Reading Maps". Listen and follow carefully while we read the sheet containing the key. (When everyone understands the key - a copy of which appears on the reverse side of this sheet - then continue.)

After I read the question, pick the correct answer using the map indicated. You may refer to the key at any time during the test. Before we start the test let us try a sample question to make sure we understand how to answer. Look at the Shopping Center map. Now I will read the sample question.

How many entrances are there to the Drug Store?

The correct answer is Two.

(If any student experiences difficulty with the above question, time should be taken for a brief explanation.)

(Read Aloud) - We will now proceed with the test using the Shopping Center map. Let me repeat, after I read the question write down the number of the question and your answer following it.

(Proceed with questions 1-10, on the question sheet pausing for the student to record each answer. Before the students start on Question 11, read aloud the following: We will now change maps and use the neighborhood map.)

Instructions and Key for Reading Maps

The following mobility maps are designed to tell you where objects are within the limited area shown on the map. Having located these objects, for example, buildings and streets, the map allows you to select a variety of connecting routes between specific objects.

The maps are titled at the top of the sheet. The top of the sheet is also north unless otherwise indicated.

Shopping Center Map

- Sidewalks
- No Sidewalks
- - - - - Division between shops
-  Door entrance

Neighborhood Map

- Sidewalks
- No sidewalks
-  Buildings

SHOPPING CENTER MAP
BAKER ST.

MAP 1

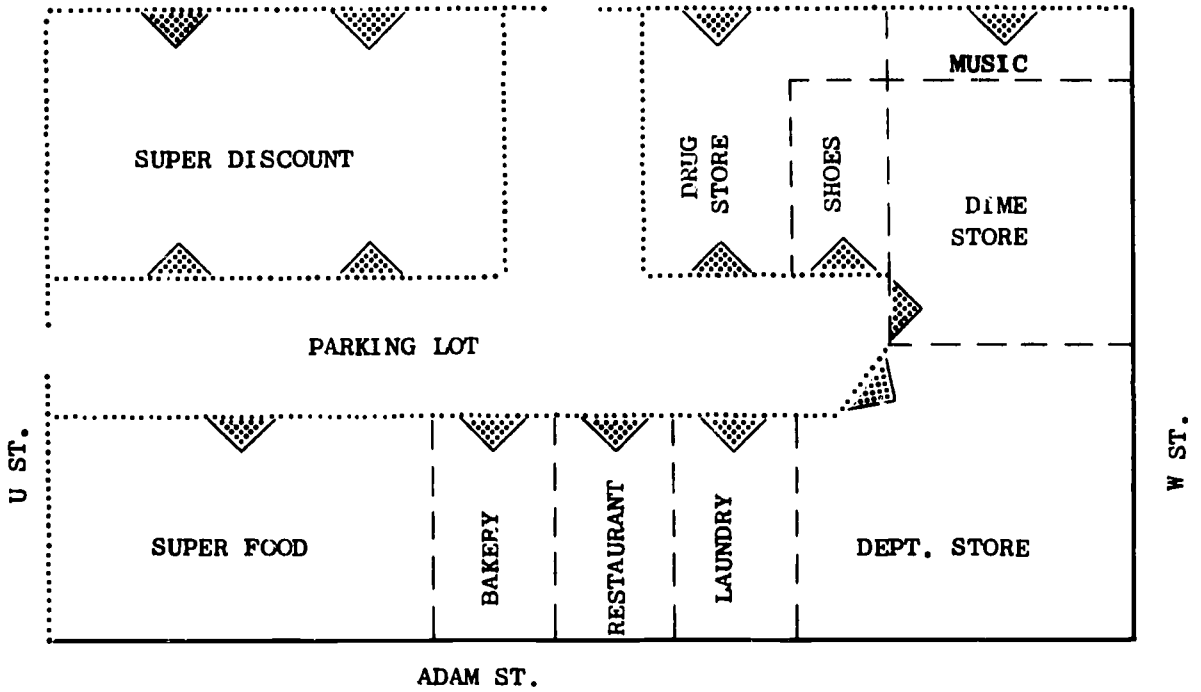

NEIGHBORHOOD MAP
PLAYGROUND

MAP 2
PARK

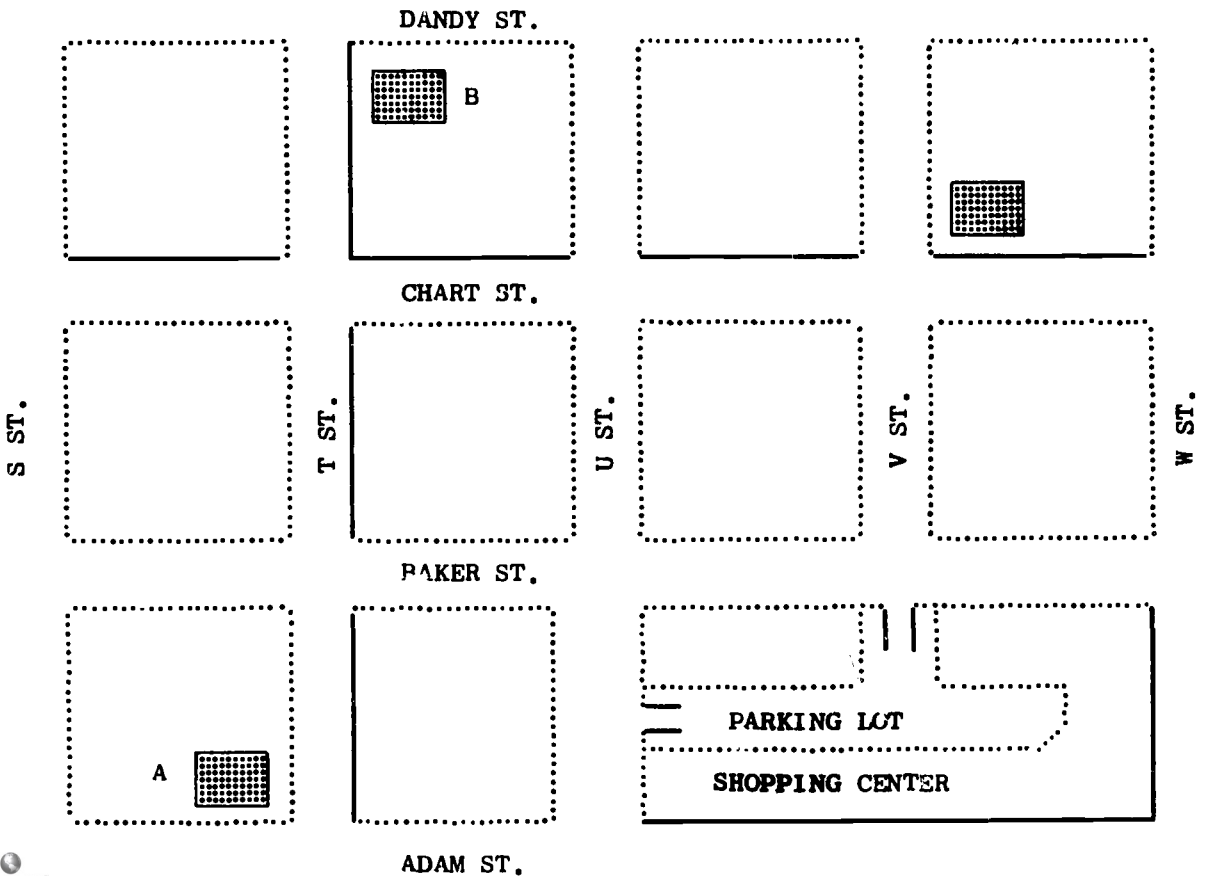

QUESTION SHEET

TIME: _____ START _____
FINISH _____

(Allow 3 to 5 minutes for tactual scanning before marking time)

MAP NO. 1 - SHOPPING CENTER

1. How many stores are in the shopping center?
2. How many stores can be entered from Baker Street?
3. How many car entrances to the parking lot are there?
4. Cars may enter the parking lot from Baker Street and; U Street, W Street, Adam Street?
5. All buildings may be entered from the parking lot. Yes No
6. How many entrances are there to Super Discount from the Parking Lot?
7. Super Food store entrance is closest to; Adam Street, Department Store, U Street?
8. How many stores do you pass if you go from the Super Food Store to the shoe Store?
9. If you are in the Super Food store and must go to the (1) Laundry, (2) Dime Store, (3) Drug Store, (4) Department Store, considering shortest distance only, in which order would you visit the stores? (a) 1243; (b) 1423; (c) 2341; (d) 1234.
10. The Music Store is the first, second or third store from the corner of U Street and Baker Street?

MAP NO. 2 - NEIGHBORHOOD MAP

11. How many houses are shown on the Neighborhood Map?
12. Does the sidewalk run the entire west side of W Street? Yes No
13. House B is located at the corner of (a) Dandy Street and U Street; (b) Baker Street and T Street; (c) Dandy Street and T Street?
14. T Street runs east-west or north-south?
15. What direction is House A from the Shopping Center? North; South; East; West.
16. What direction is House C from House B? North; South; East; West.
17. Going from House C to House A you would walk on the (a) south side of Chart Street and the east side of T Street; (b) north side of Chart Street and the east side of T Street; (c) south side of Chart Street and west side of T Street?
18. If you are going from House B to House A, you would walk on the east or west side of T Street?
19. You are leaving House A to go to the playground, your friends from Houses B and C are to join you. Would you meet at; House A; House B; House C?
20. If you are going from the shopping center to House B, you would walk on; (a) the west side of V Street and the south side of Dandy Street; (b) the north side of Baker Street and the east side of T Street; (c) the east side of U Street and the north side of Dandy Street.

PLEASE FILL OUT THE FOLLOWING INFORMATION FOR EACH PERSON WHOSE ANSWERS ARE RECORDED ON THE REVERSE SIDE OF THIS SHEET.

_____ Birth Date _____ Present grade level
(or highest grade completed)

_____ I.Q. or mental age

Vision Level:

- (a) Congenitally blind
- (b) Totally Blind. Number of years ()
- (c) Read tactually only
- (d) Read visually and tactually

Education:

- (a) Residential institution
- (b) Public School
- (c) Tutored
- (d) Other (specify)

Previous Map Reading Training:

- (a) None
- (b) Very limited
- (c) Moderate amount
- (d) Extensive

Mobility Instruction:

- (a) None
- (b) Very limited
- (c) Moderate amount
- (d) Extensive

Mobility (Indicate maximum Proficiency):

- (a) Building (accessible areas; classroom, office, etc.).
- (b) Building (inaccessible area; supply room, etc.).
- (c) Grounds (immediate area; playground).
- (d) Neighborhood (surrounding blocks).
- (e) Neighborhood Stores and extended area.

APPENDIX II

The following is a synopsis of a conference on Tactual Mapping held at the School of Education, University of Birmingham, on the 7th of February, 1968.

1. Points of Agreement

a. Standardization

There should be maximum standardization of all the topics listed below to ensure ease of production, reproduction, training of map users and map makers.

b. Training

There must be a measure of training for map users.

c. Travel Competence

Functional maps, particularly 'mobility' and 'special purpose' (see 2 below) demand adequate travel competence from user. He must be safe and he must be able to encounter landmarks reliably.

d. Education

It was agreed that, as far as schools are concerned, functional maps are a stepping stone to the understanding of geographical maps, and that as educational tools, the two are complementary.

e. Dissemination of Information

It was agreed that we should prepare for publication a statement which would outline the present state of the art and indicate current lines of research. The statement to include names of major suppliers of 'geographical' maps and of those engaged in work on 'functional' maps.

2. Basic Terminology

We suggest two classes of maps merging into each other: Geographical maps and Functional maps.

Geographical

Functional

World

Continents

Countries

Regional

Skeleton Locality or Town..... Orientation

Neighborhood..... Mobility

Street Route..... Special Purpose

3. Geographical

State of the art to be reported on taking into account latest RNIB series. In practice this class of maps includes at present only world, continents, and countries.

4. Functional

To the best of our knowledge these are at present being produced systematically only by Wiedel and Groves, University of Maryland, U.S.A., Angwin, Cornwall, England and Pickles, Worcester College for the Blind, Worcester, England.

a. Methods of Production

i. drawing based on ground survey, existing town-plan or aerial photography.

ii. enlargement and mirror-imaging where required, can be done by sketching with blocks, photographically or by direct use of projector.

- iii. engraving: using either metal, manila, or photography, with appropriate tool(s).
- iv. deposition: drawing overlaid with double adhesive, line(s) and symbols produced by string-pencil, solder wire and assorted materials, excess adhesive killed by ballatini.
- v. combination: engraving and depositing can be combined, and a wide range of deposited materials can be used.

b. Methods of reproduction

By thermoform whenever possible having regard to nature of material deposited.

c. Lines

- i. Width approximately .02 inches but less than .03 inches can vary.
- ii. Height at least twice as high as that of braille dot to be employed. Height of line can be used as a coding dimension though details of this need working out.
- iii. Texture at present rough and smooth, with former denoting 'active' or 'relevant' side of street, etc.
- iv. Single or Double single line presentation clearly saves map space, but may be hard to grasp for many blind people when used other than on orientation type of maps.

d. Symbols

Will have to be kept to a minimum. Two 'vocabularies' have to be reconciled:

- i. Tactually discriminable set of symbols, bearing in mind overall constraints on dimensions.
 - ii. Situations and objects maximally likely to be of use for blind travel.
- e. Braille
- i. Size of cell: If micro-dot cells can be read easily this may be of great help. If it can be easily distinguished from standard size, one has an extra coding dimension by virtue of braille size. For present continue with standard Braille.
 - ii. Direction: Braille to be placed in such a manner that it is read either from left to right or from bottom to top.
 - iii. Separation: Sufficiently clear of other symbols to prevent tactual masking.
- f. Legends - to be referred to as keys. If placed on the same sheet as the map must be provided in such a manner that blind user can recognize easily that it is not part of map configuration. Method of boxing by thick lines and offset from map-margin suggested.
- g. Map Orientation

There should be clear indication of North on map; differently textured margin on edge across the top of map preferred, but the cutting off of the top left hand corner suggested as an alternative.

This conference was attended by the following:

D. Amor	R.N.I.B. 224 Great Portland Street London, W.1., England
Col. J.B.P. Angwin, M.B.E., F.R.I.C.S., (R.E. Ret'd)	Tregye Bungalow Carnon Downs Truro Cornwall, England
G. Breeks	College for the Blind Worcester, England.
Paul A. Groves	Department of Geography University of Maryland College Park, Maryland U.S.A.
R. James	Lickey Grange School for the Blind Bromsgrove, England
W. F. King	Royal Normal School Rowton Castle N. Shrewsbury, England
A. J. Leonard	Psychology Department University of Nottingham Nottingham, England
W.J. Pickles	College for the Blind Worcester, England
Ann Ward	Royal Normal School Rowton Castle N. Shrewsbury, England
Joseph W. Wiedel	Department of Geography University of Maryland College Park, Maryland U.S.A.

APPENDIX III

Samples of Various Mobility and Orientation Maps.

The following maps are selected to show the type and range of illustrations prepared during this research project. They also give some idea of the evolution of design and symbol elements since they were prepared over a period of two years.

The order of placement, following the test maps and sample keys, is primarily one of scale; the largest scale route maps being placed first. The preponderance of hotel lobby maps is indicative of the type of request, since large numbers of blind generally attend conventions. The two maps illustrating the Maryland Workshop neighborhood (pages 86 and 87) mark a change in technique and design. The latter one (page 87) proved to be far more readable and easier to interpret correctly.

The maps on pages 88, 89 and 90 were prepared at the request of The Guiding Eye, guide dog training center and were tested with a new group in residence when they received their dog. The response from the group was extremely favorable and the center retained copies of the maps to incorporate in future training programs.

Maps on, and following, page 91 were prepared for individuals with more training in map reading or to enhance the educational program for blind students in the sighted schools. Such maps as the map of Maryland and the two maps of Prince George's County, Maryland, are part of a set keyed to fit together as overlays; a system proven to be quite practical when a wide array of information is needed for the same area.

APPENDIX III (CONTINUED)

	Page
Text	73
Test Key	74
Shopping Center	75
Neighborhood	76
Sample Key	77
Sample Key	78
Route Maps (2) Dodge House - Library of Congress	79
Penn-Harris Hotel Lobby, Harrisburg, Pennsylvania	80
Americana Hotel Lobby, New York City, New York	81
Royal York Hotel Lobby, Toronto, Canada	82
Royal York Hotel Mezzanine, Toronto, Canada	83
High Point High School, Beltsville, Maryland	84
Syracuse University Campus, Syracuse, New York	85
Maryland Workshop, No. 1, Baltimore, Maryland	86
Maryland Workshop, No. 2, Baltimore, Maryland	87
Peekskill, New York	88
White Plains, New York	89
Guiding Eyes Training Center, Yorktown Heights, New York	90
Philadelphia, Pennsylvania	91
Washington, D. C.	92
Beltway, Washington, D. C.	93
Prince George's County, Maryland, Political	94
Prince George's County, Maryland, Major Roads	95
Maryland, Political	96
Ethiopia	97
Northeast Africa	98

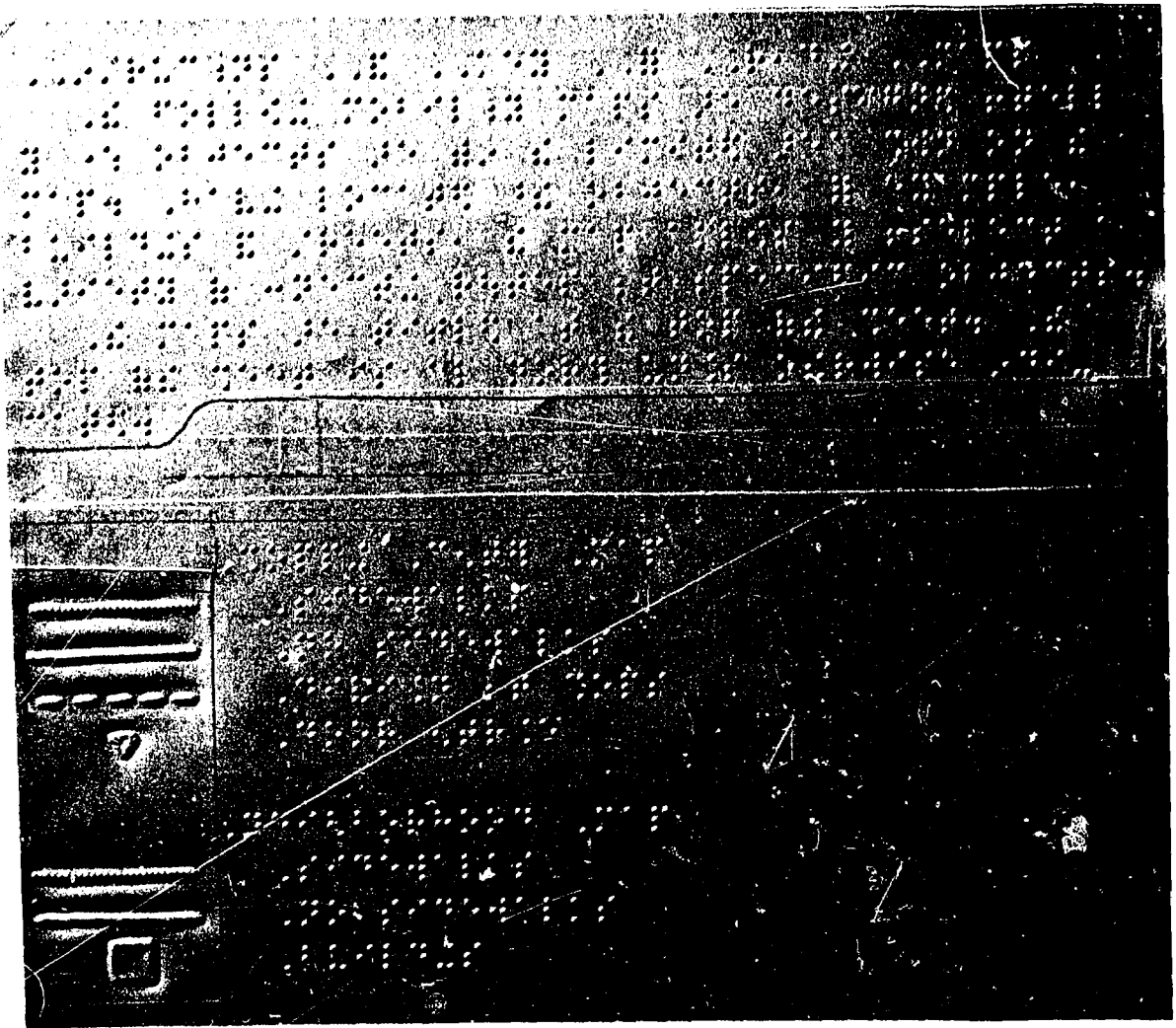

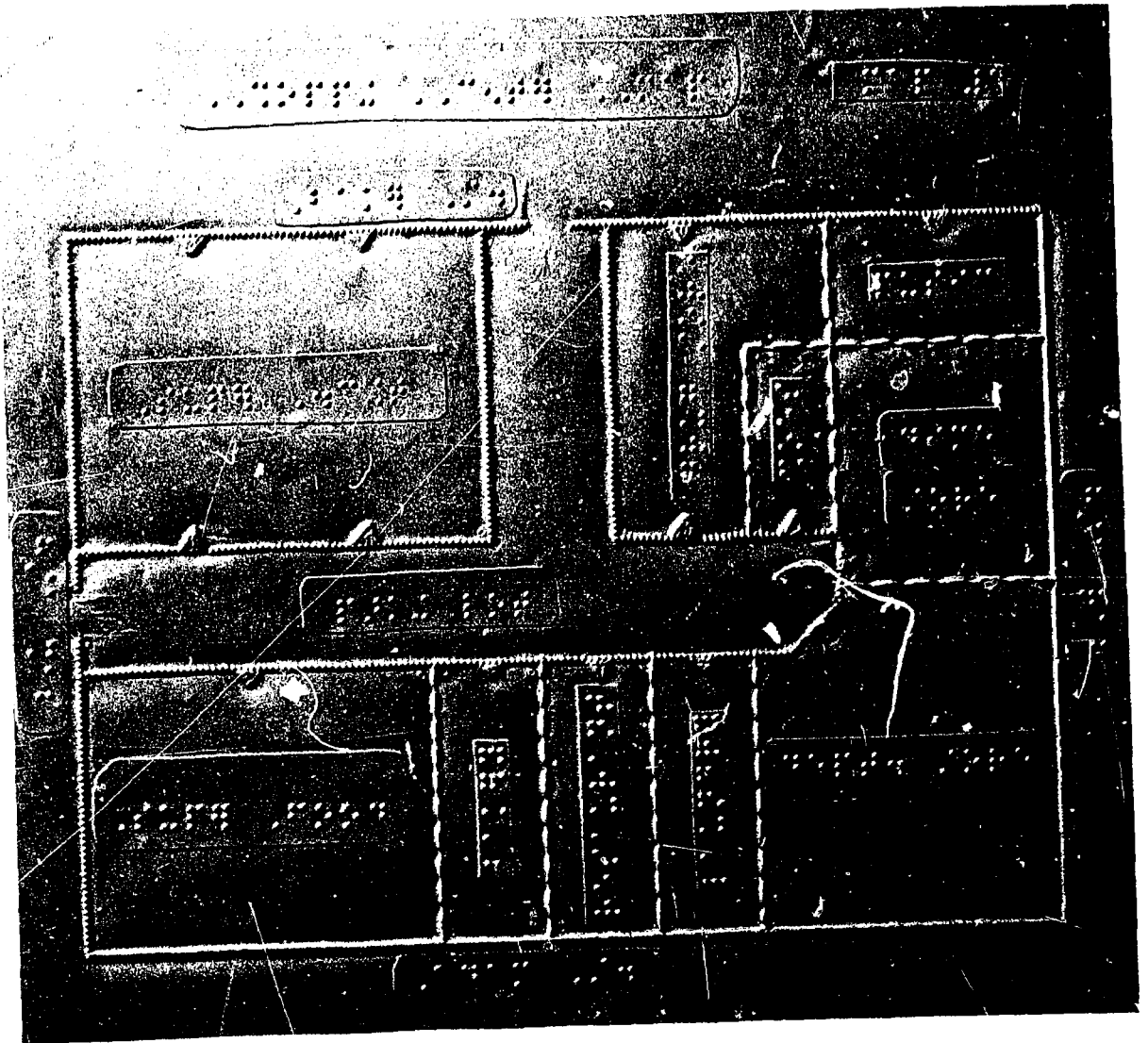

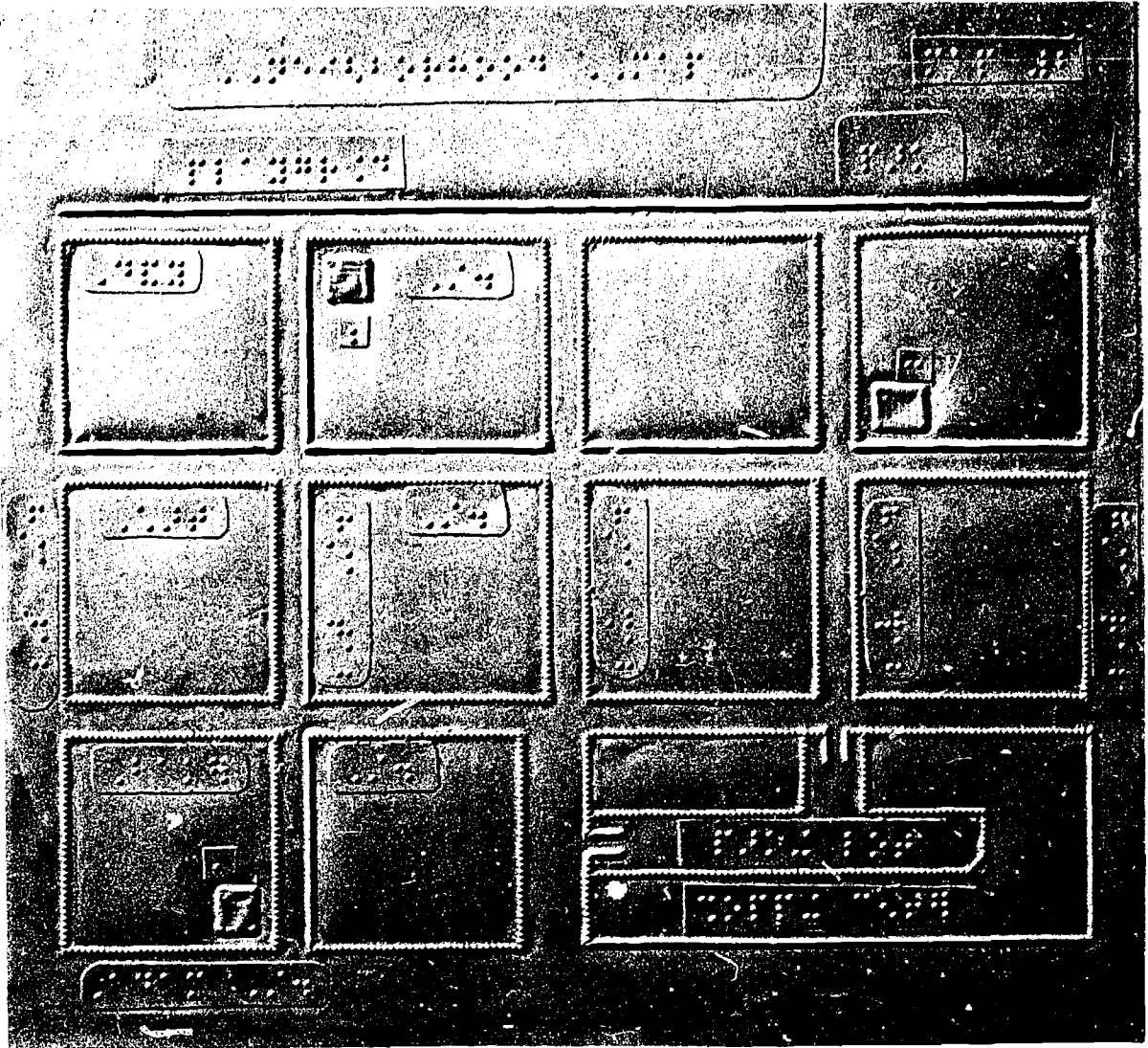

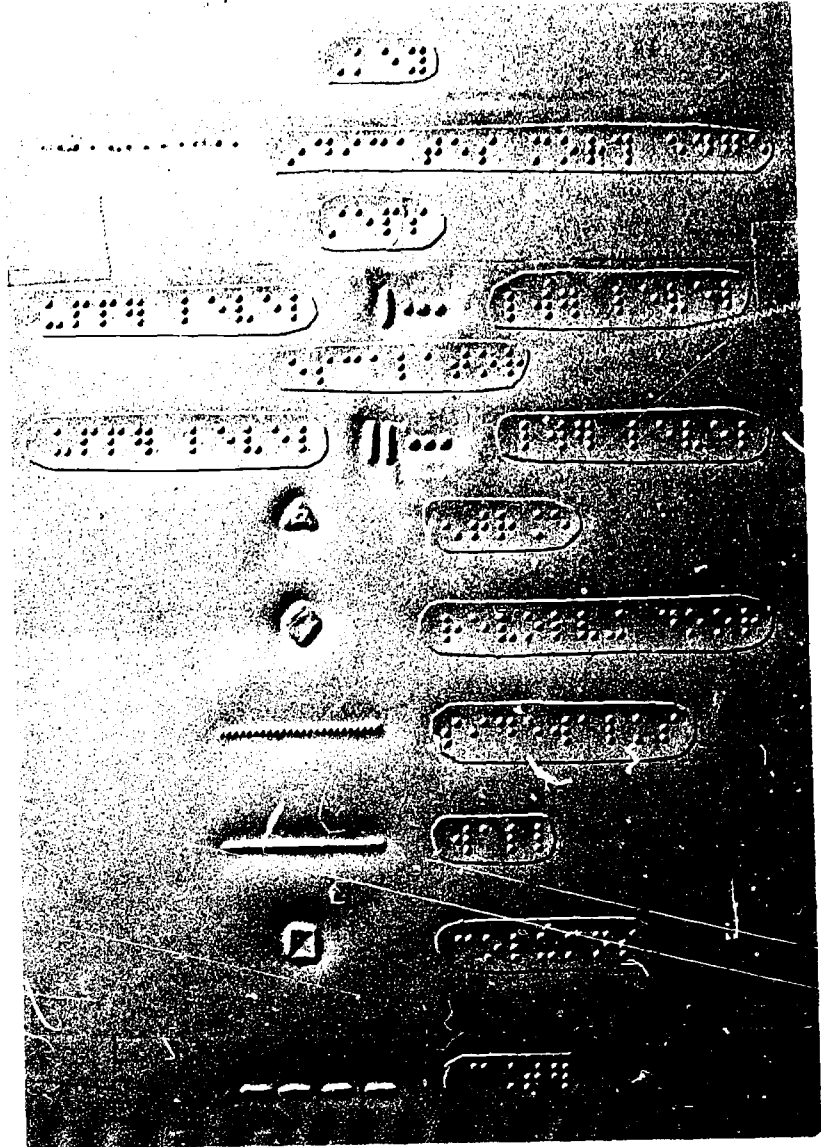

This page contains musical notation. On the left side, there is a vertical column of symbols and markings, including a dotted line, a solid line, a dashed line, a small dot, a triangle, a circle, and some illegible text. The main body of the page is filled with musical notation, including notes, stems, and beams. A large, grainy, and mostly illegible section occupies the right half of the page, possibly representing a corrupted scan or a very faded part of the document. A small rectangular box containing a few notes is visible near the bottom center of the main notation area.

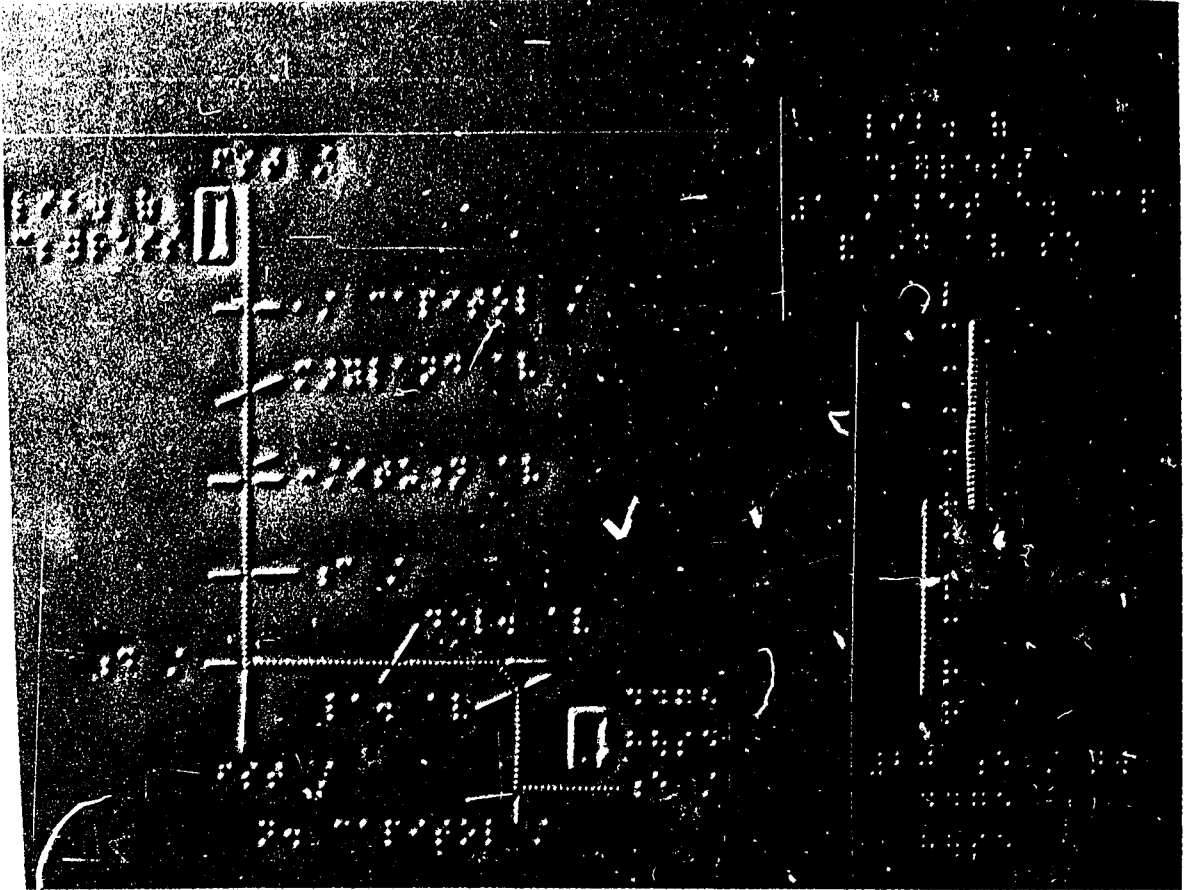

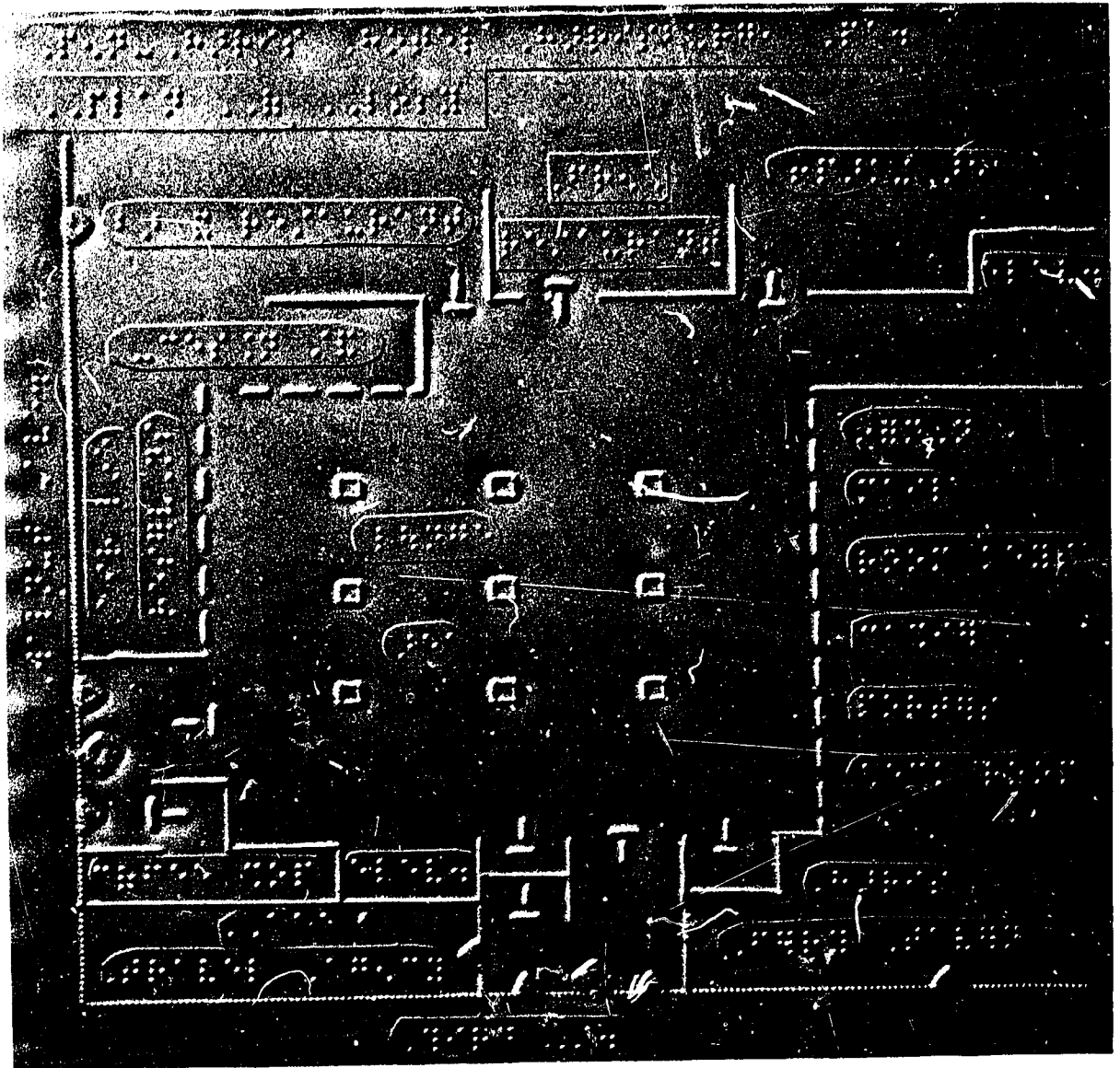

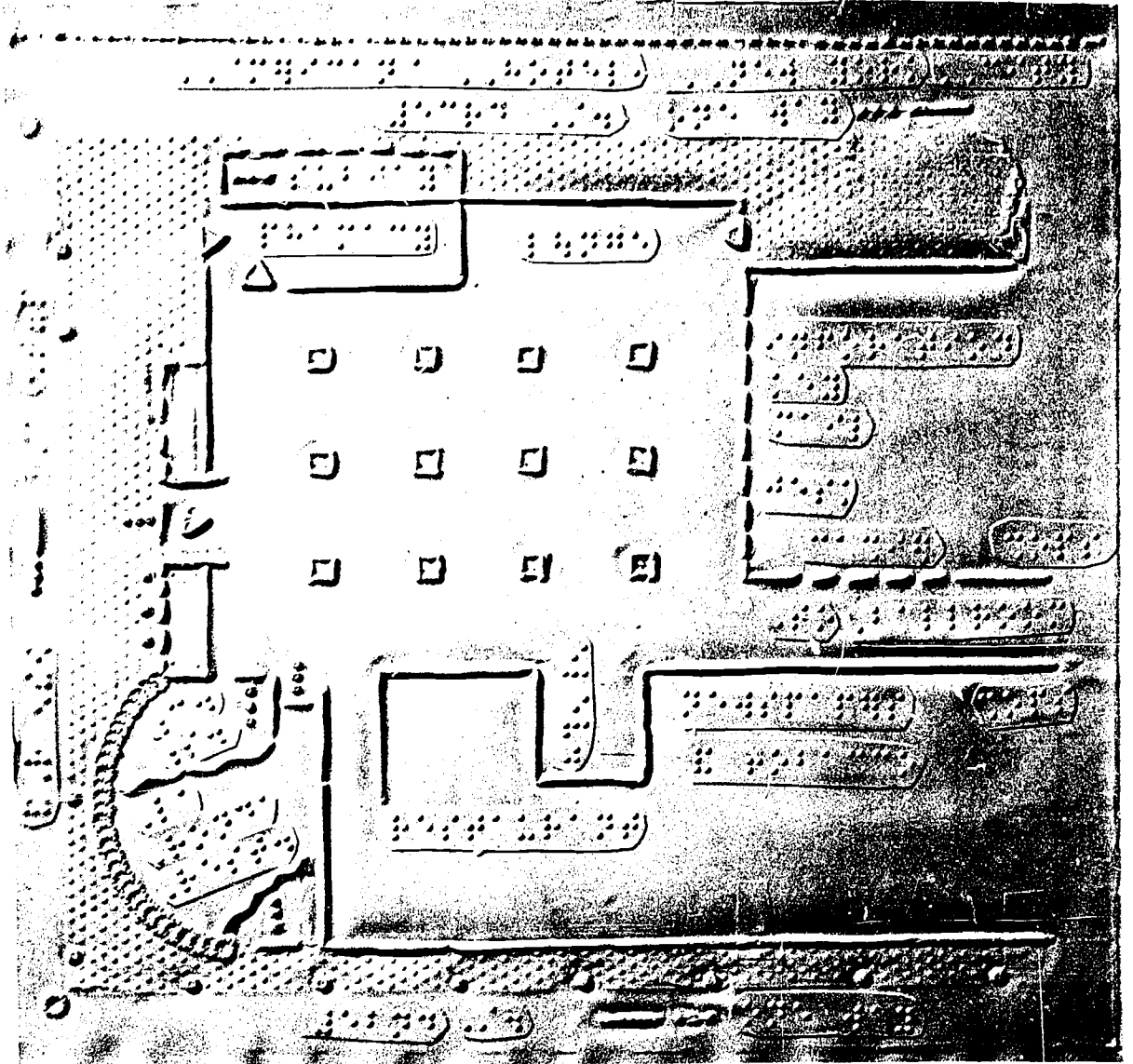

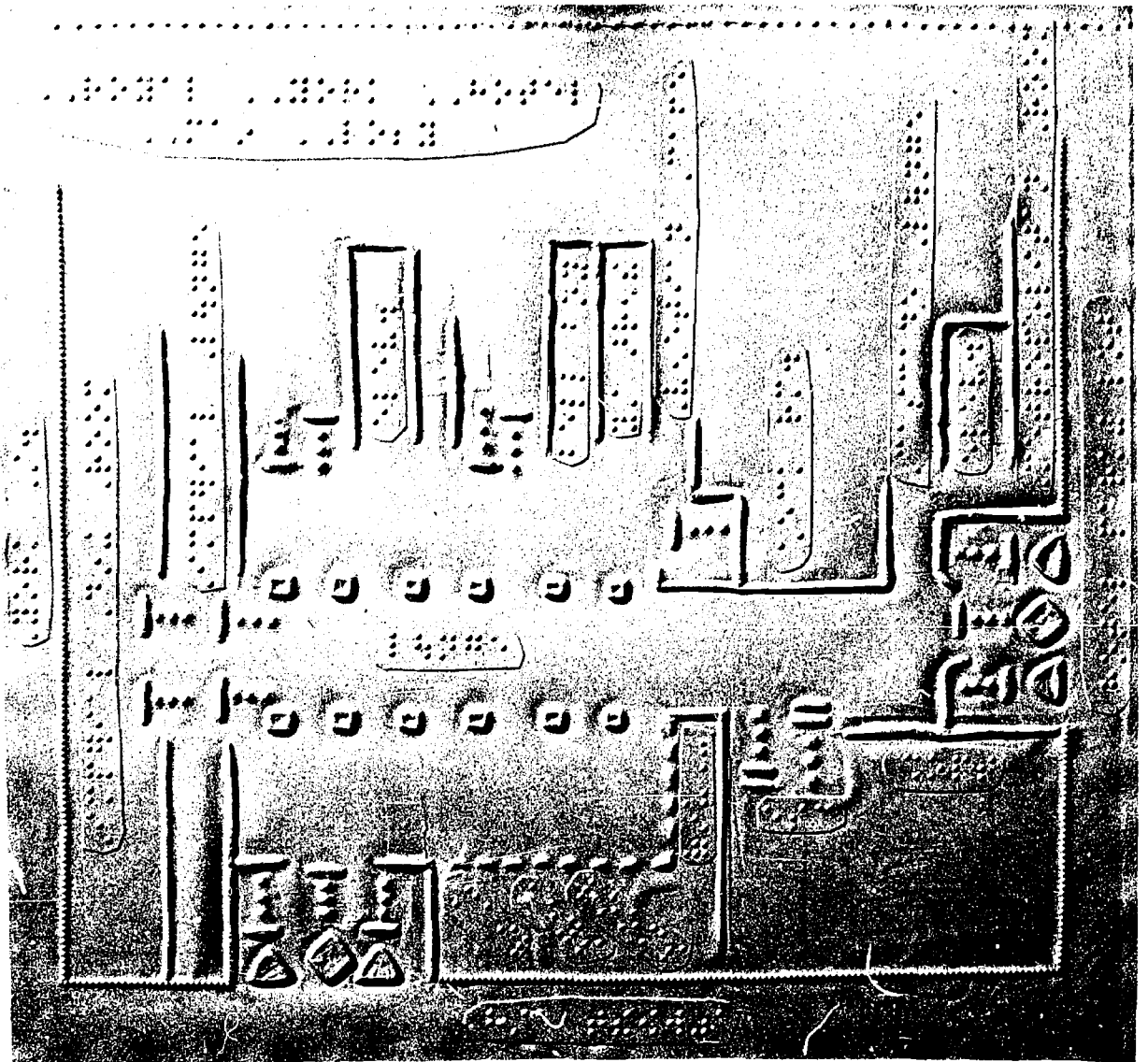

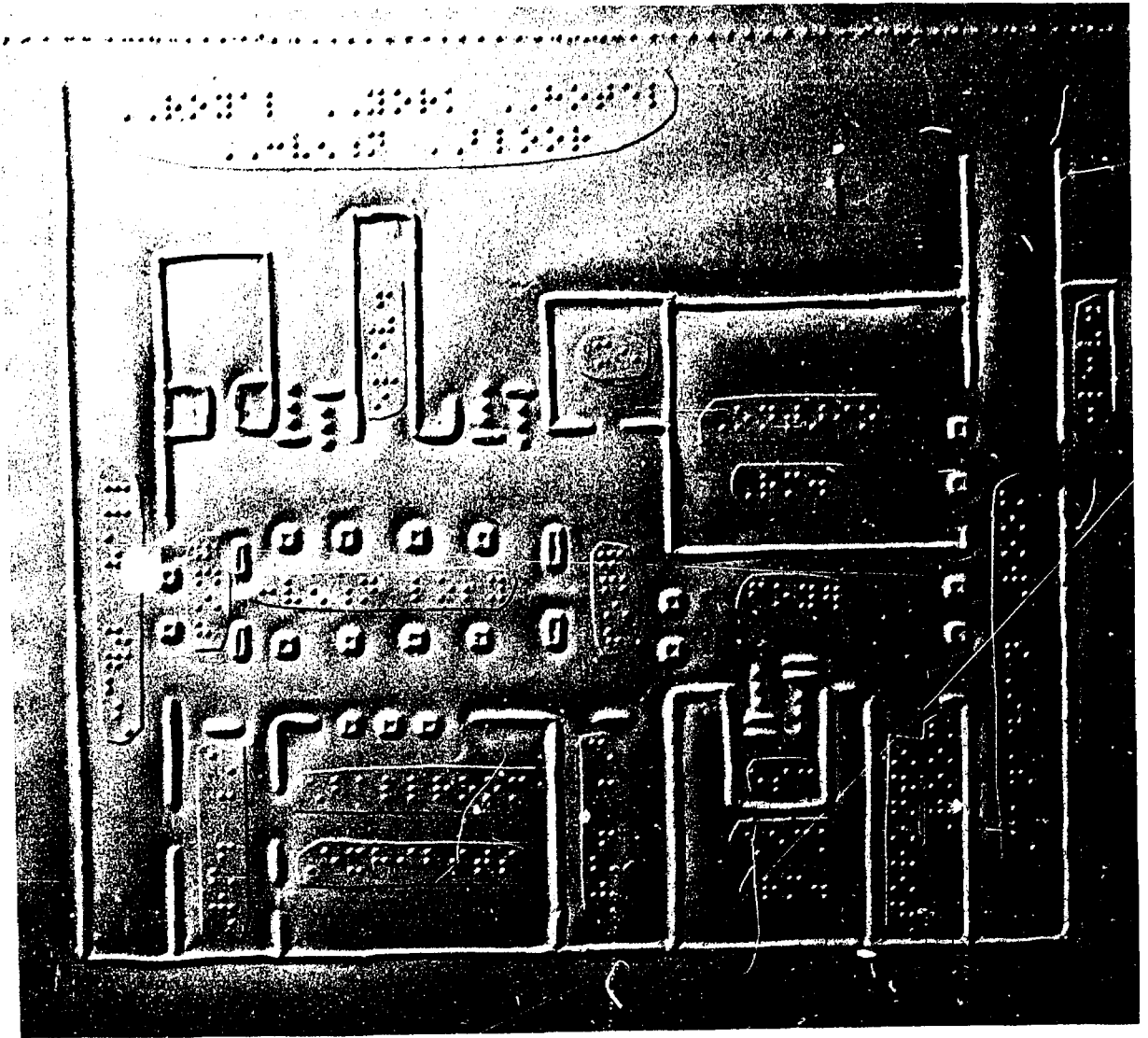

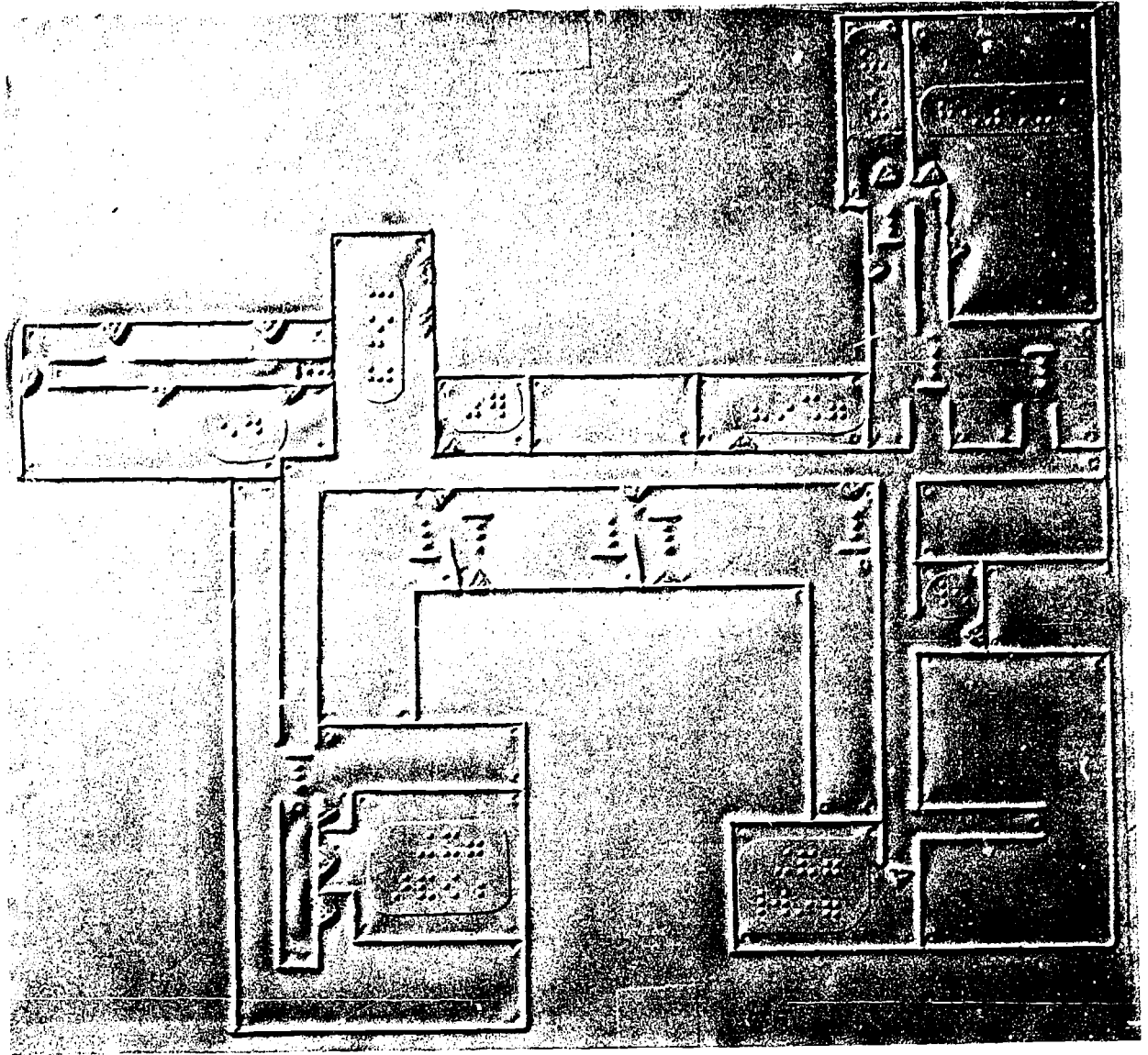

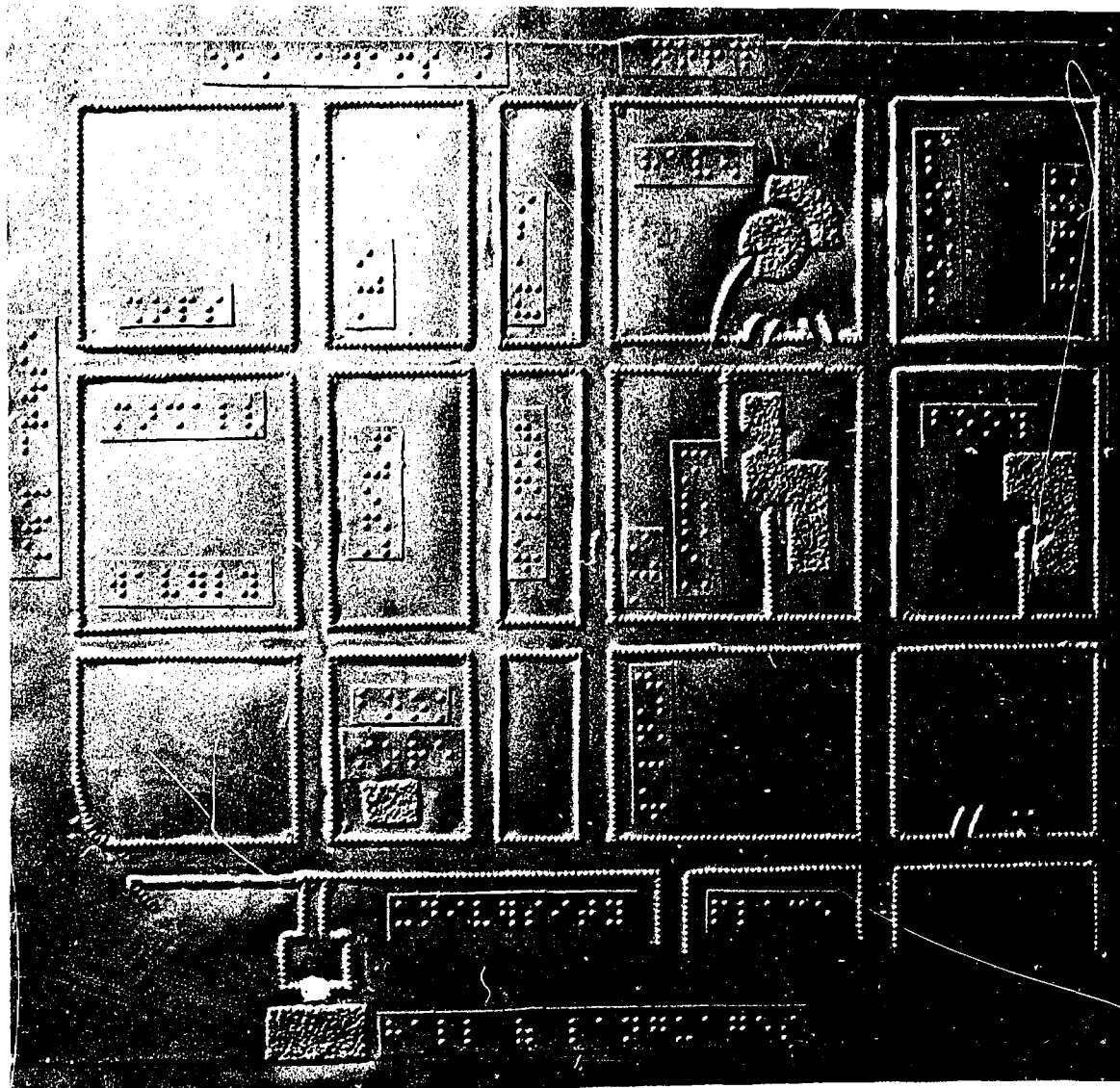

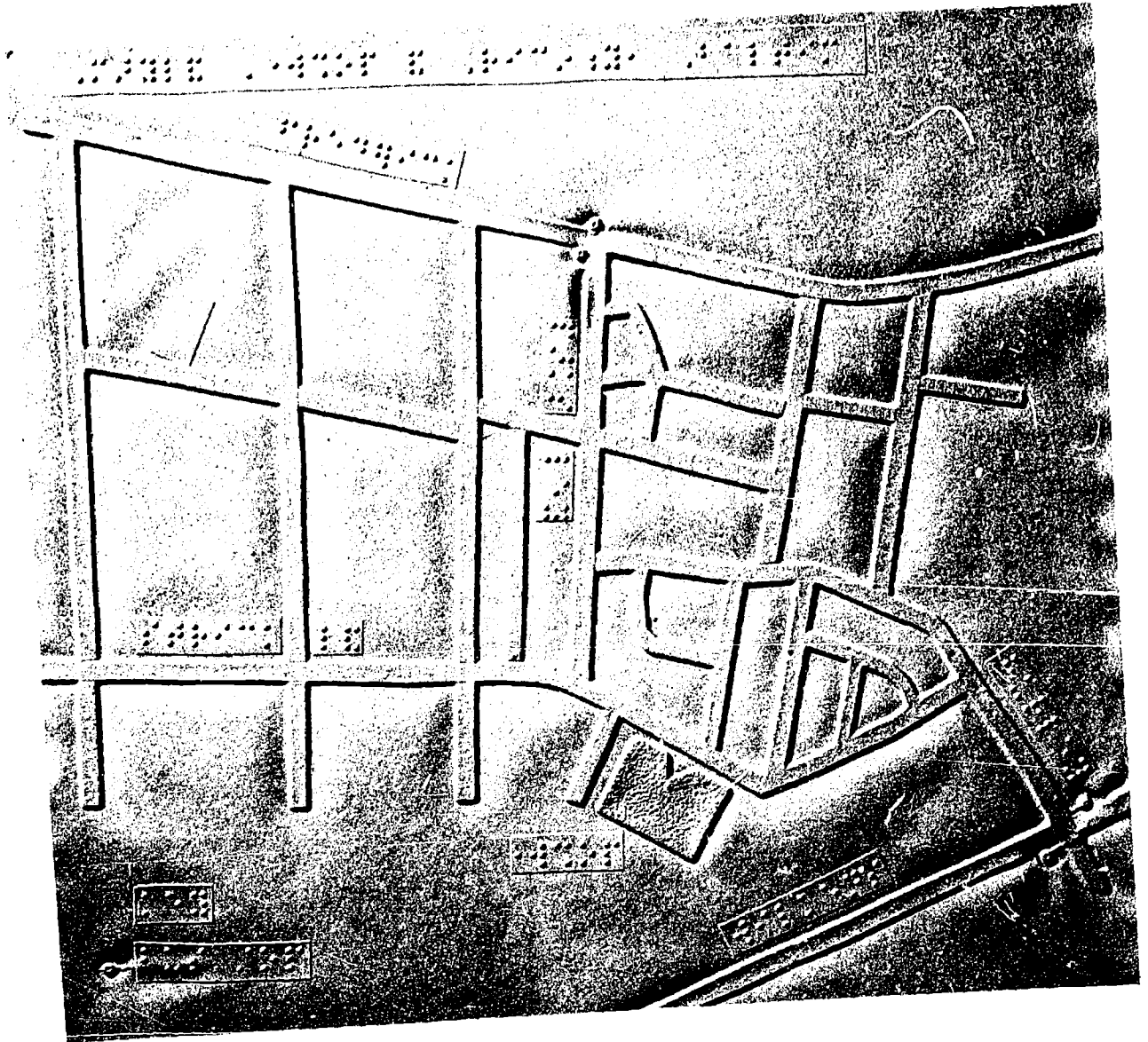

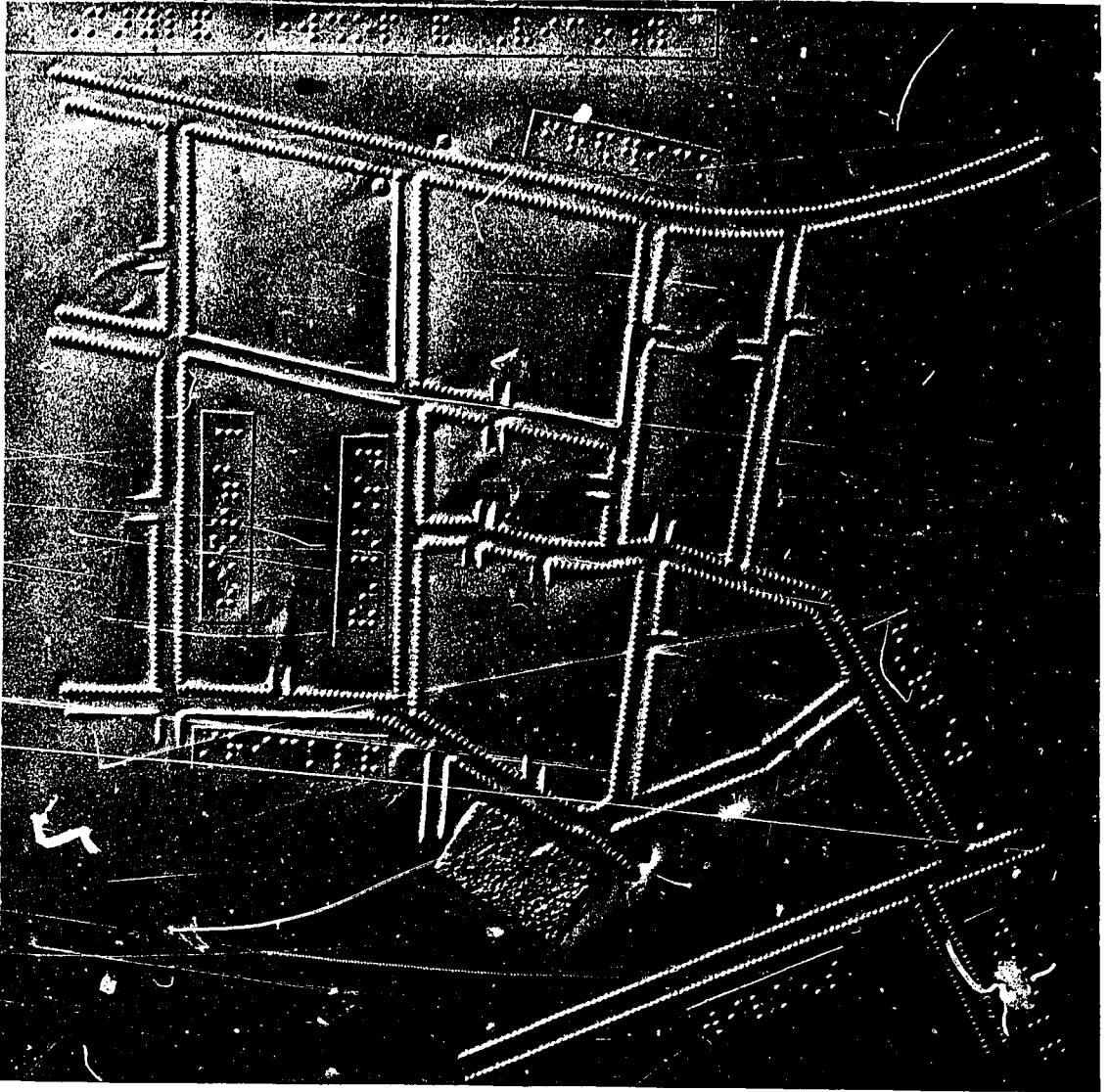



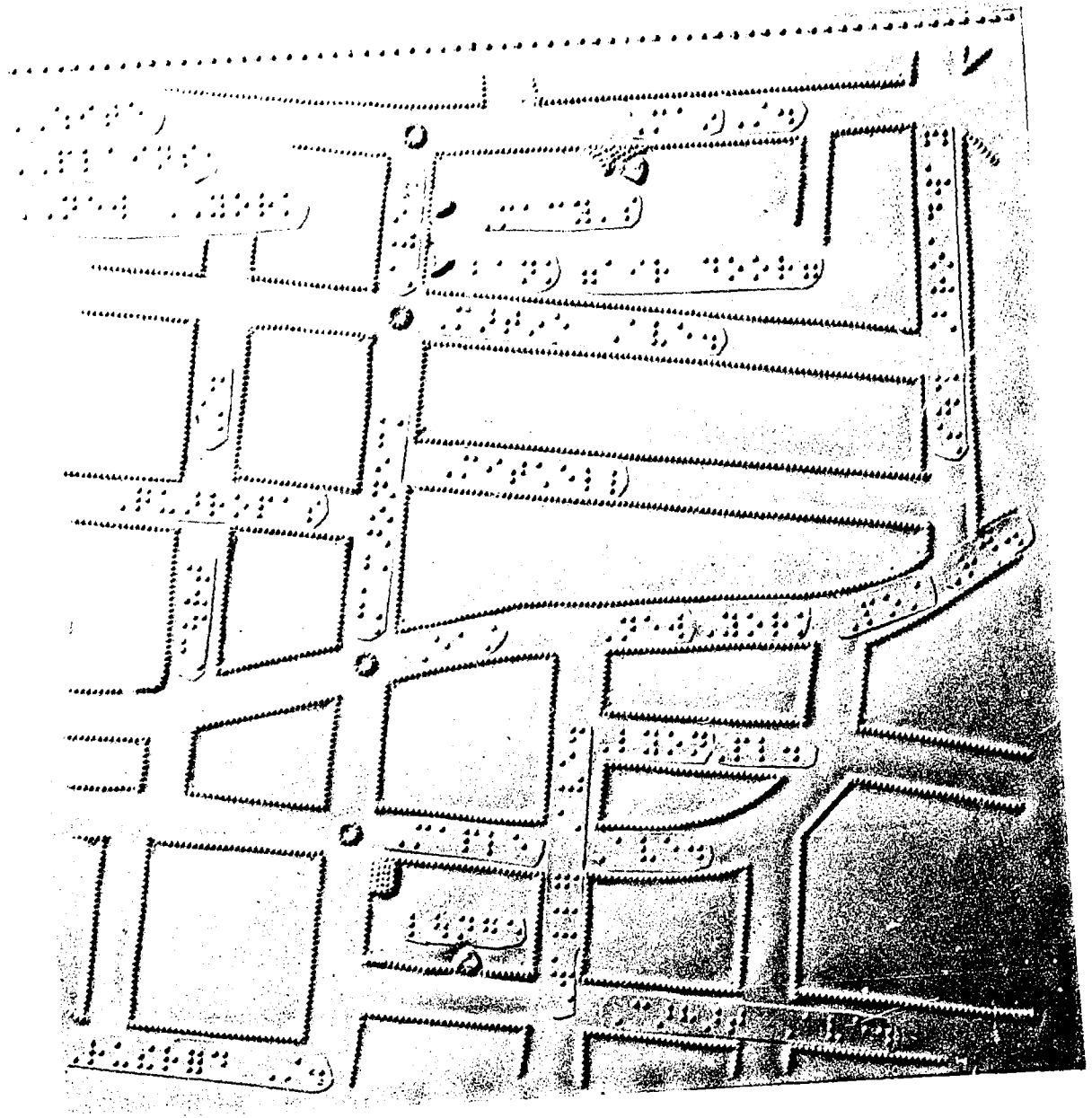

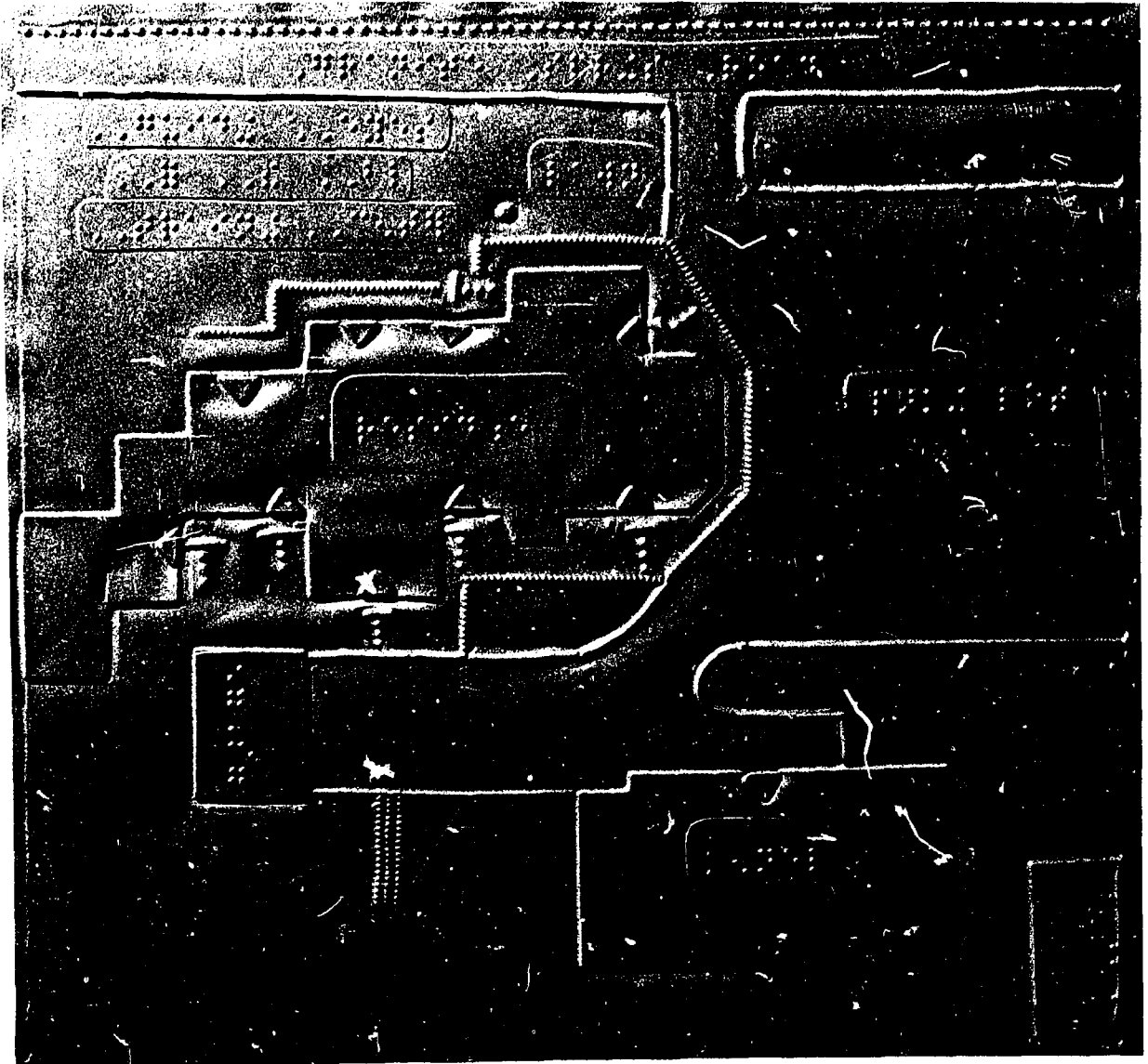

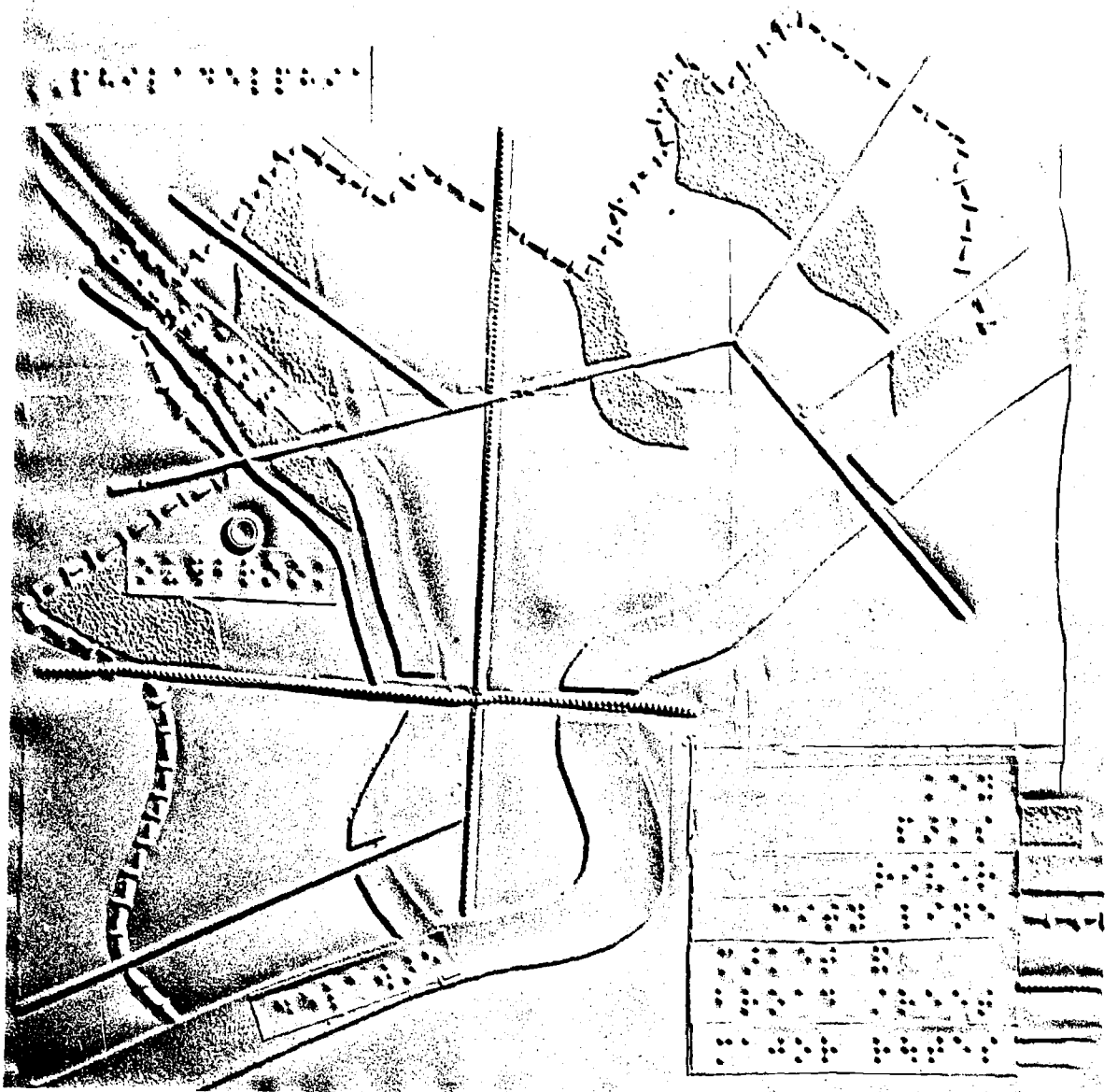

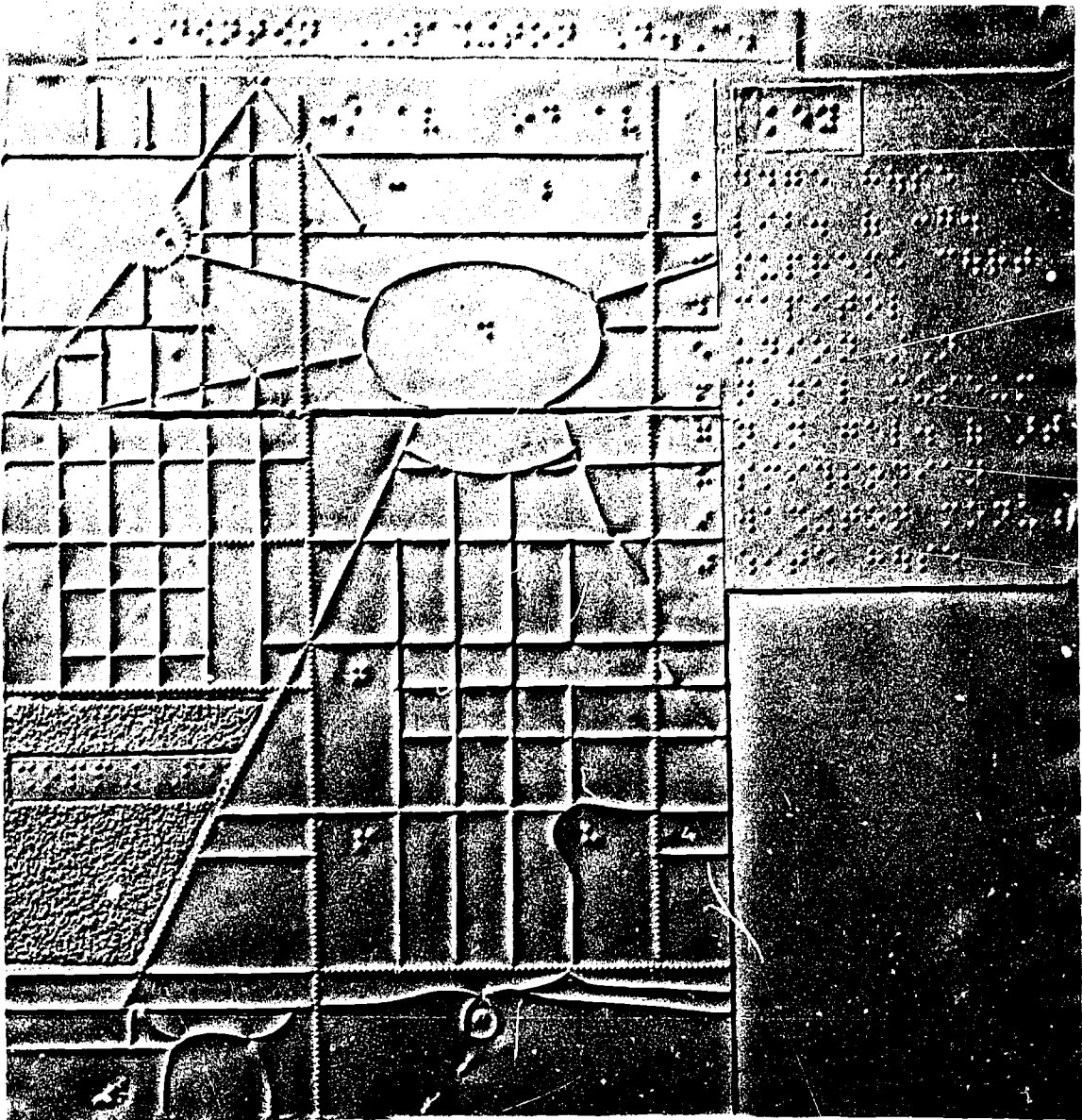

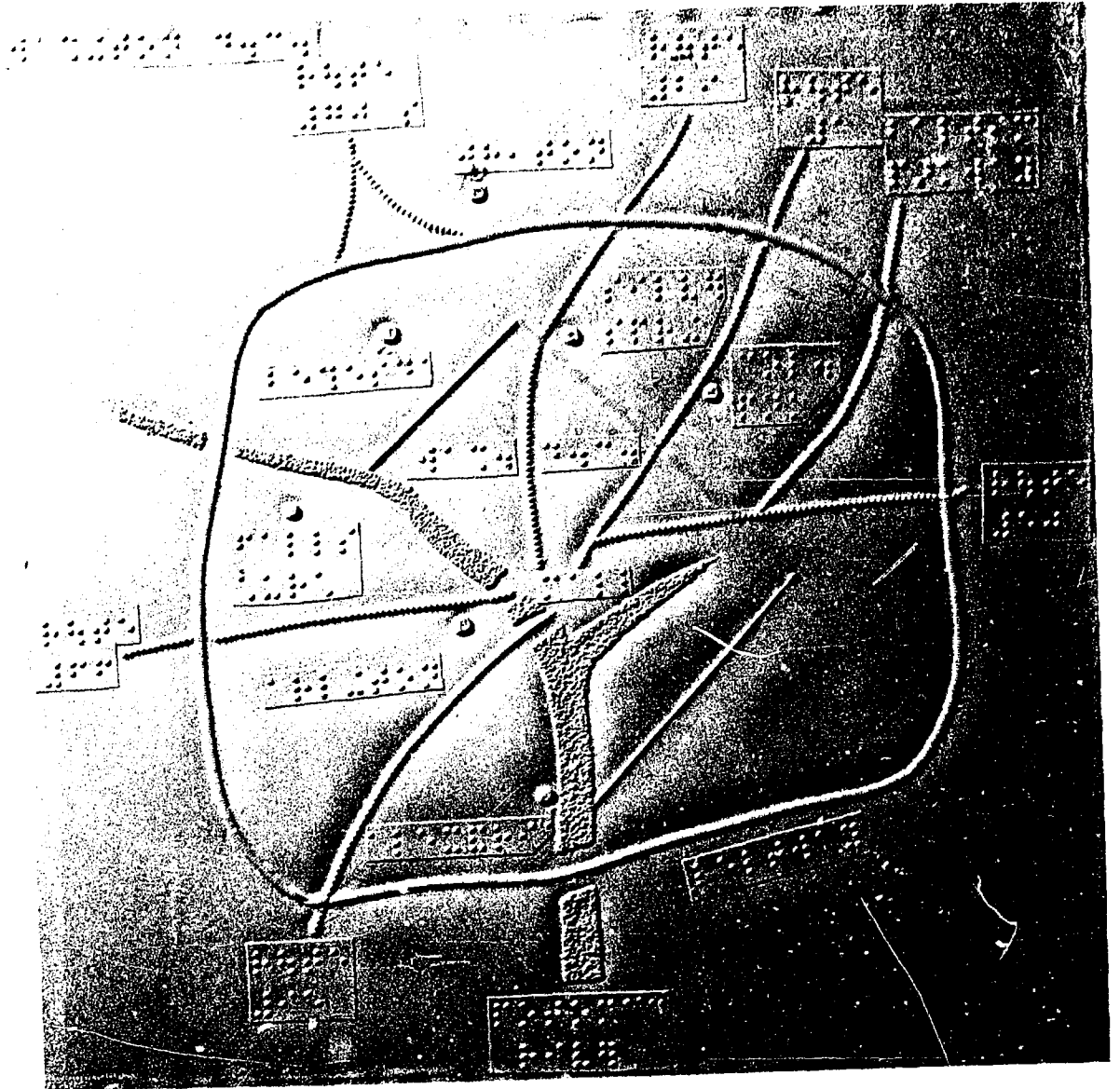

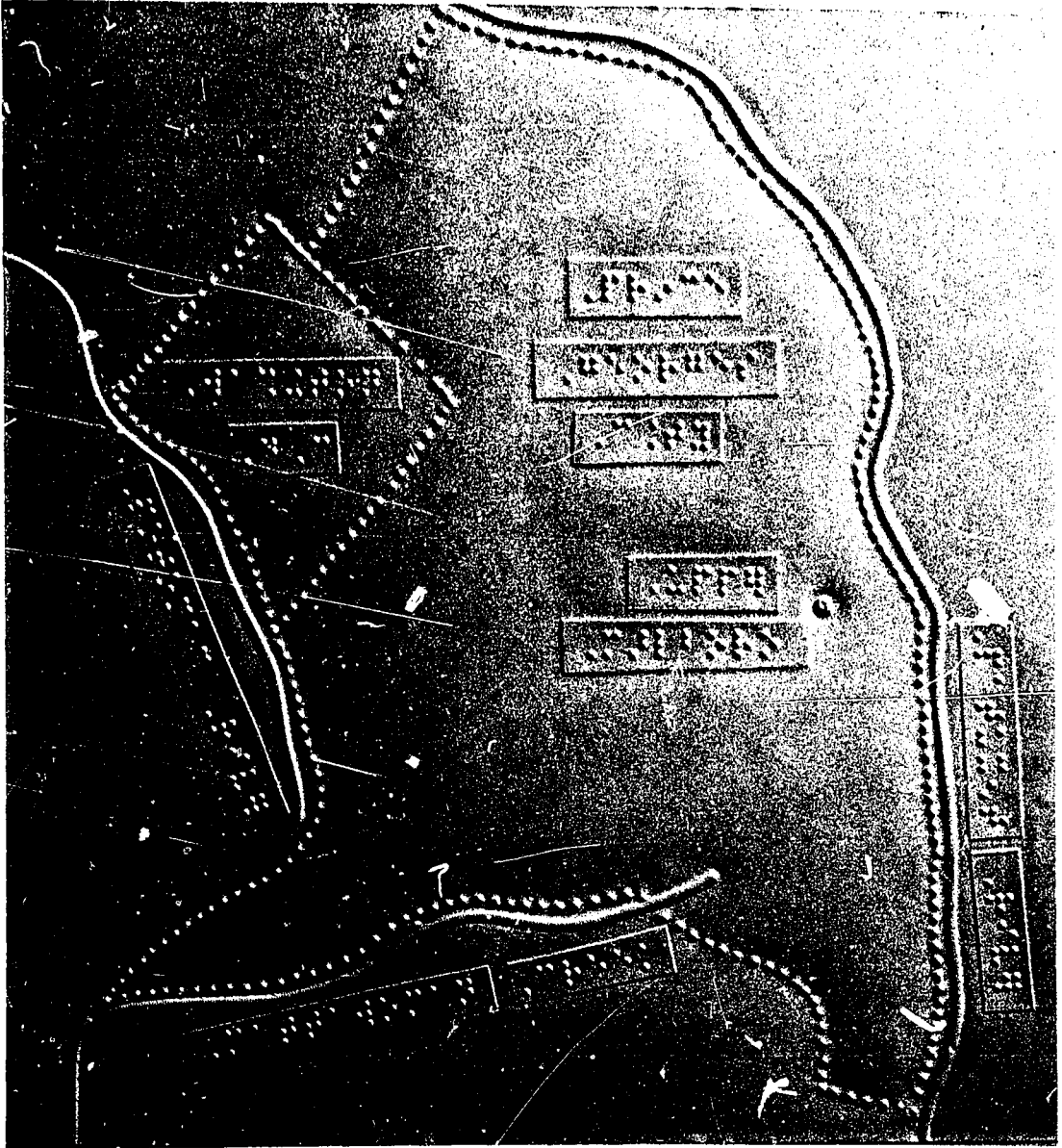



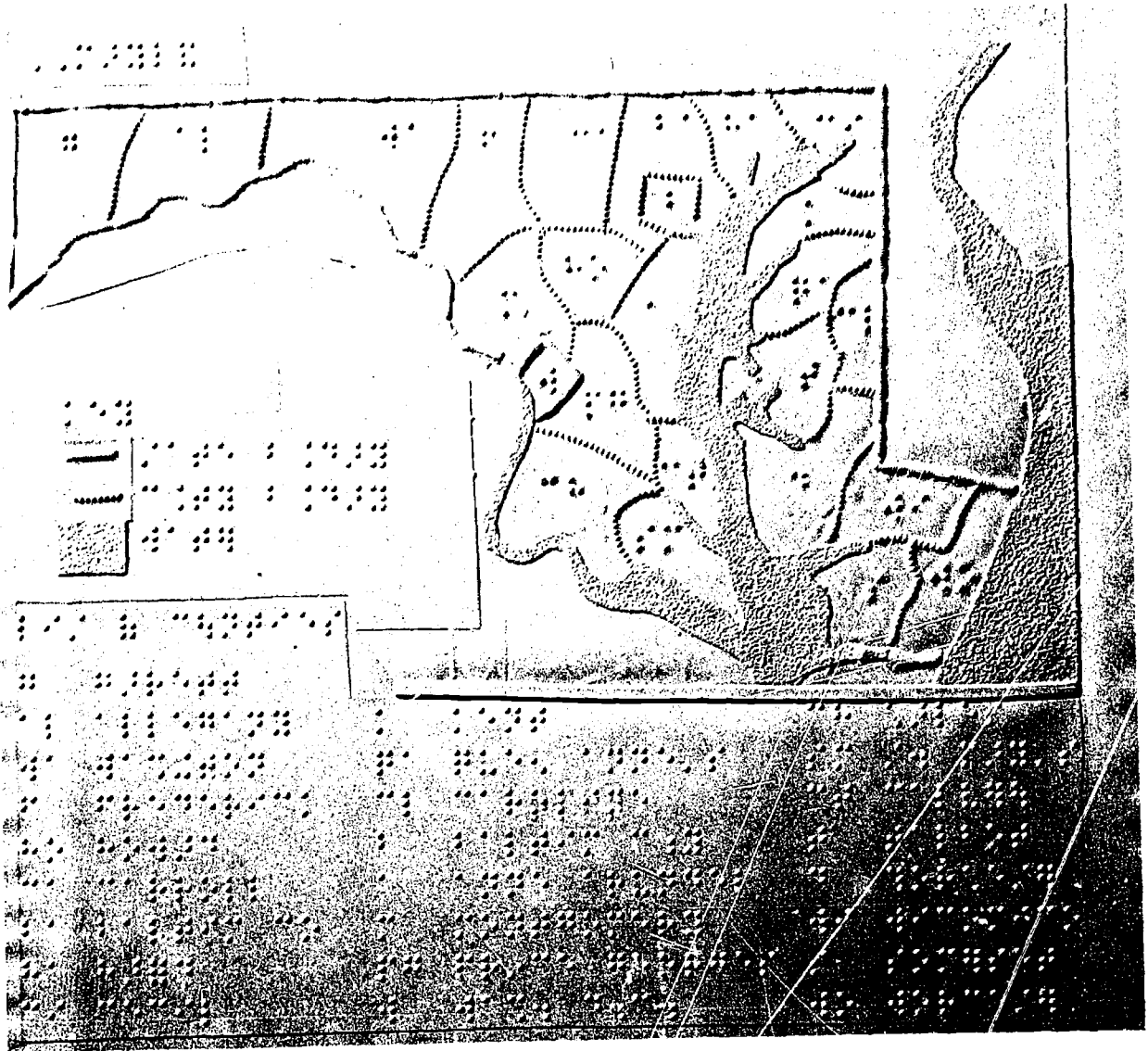





APPENDIX IV

Instructions for the Use of the Metal Master

1. Spray one side of the 10" x 10-1/2" sheet of aluminum with flat white paint.
2. Make your tracing or drawing on a sheet of tracing paper.
3. Tape drawing, face down to the white side of the aluminum sheet. A sheet of carbon paper may be inserted for a darker image.
4. With the aluminum sheet on a firm pad retrace the drawing with a ball-point stylus or pen.
5. Remove drawing from aluminum sheet. The drawing is now "Mirror Image" on the white side.
6. Place aluminum sheet, white side up on a rubber pad - 1/32", 1/25" or 1/16" in thickness.
7. Select stylus for line symbol desired. Applying firm pressure, trace over the drawing so as to leave an impression on the metal. Check reverse side to ensure adequate height of symbol.
8. Brailleing can be done with slate or on paper and then glued to the surface with double stick tape, rubber cement or several other types of glue. Other textured material may be applied the same way.
9. Touch-up work necessary to sharpen symbols and improve detail should be carried on at this stage. With the aluminum side up (right reading) small holes should be punched through the metal at inside corners and in enclosed areas in order to achieve the best possible vacuum forming.
10. Tape corners (using small squares of tape) of the metal sheet to a sheet of Braille paper before thermoforming.

APPENDIX V

Publications by Authors

Wiedel, J. W. "Virkotype Process of Raised Printing", Circular 64-10, Division for the Blind, Library of Congress, Oct. 1964, (with Alfred Korb).

"Tactual Maps for the Visually Handicapped: Some Developmental Problems," The Professional Geographer, Journal of the Association of American Geographers, May 1966. Reprinted in The New Outlook, American Foundation for the Blind, March 1969.

"Development and Standardization of Symbols and Improvement in the Design of Tactual Illustrations for the Blind," Report, Research Grant No. RD-2287-S, Vocational Rehabilitation Administration, Department of Health, Education and Welfare, July, 1967.

Wiedel, J. W. and Groves, P. A. "Tactual Mapping: Design, Reproduction, Reading and Interpretation," Report Research Grant No. RD-2557-S-67, Social Rehabilitation Service, Department of Health, Education and Welfare, Feb. 1968.

"Tactual Mapping: Problems of Design and Interpretation," The International Journal for the Education of the Blind, March 1968.

"Designing and Producing Tactual Maps for the Visually Handicapped," The New Outlook, American Foundation for the Blind, September, 1969.

"Tactual Maps," The International Yearbook of Cartography, 1969.

APPENDIX V (CONTINUED)

Invitational Exhibits and Papers read at Professional Meetings.

Wiedel, J. W. "Maps for the Blind," Exhibit and Paper presented at The Association of American Geographers, Annual Convention, April, 1965.

"Developing Graphics for the Blind," Exhibit and Lecture, Eastern Conference of Home Teachers for the Blind, Oct. 1966.

Wiedel, J. W. "Tactual Orientation and Mobility Mapping," Annual and Groves, P. A. Conference of American Association of Instructors of the Blind, Nov. 1967.

"Orientation and Mobility through Tactual Maps," Exhibit and Workshop, The Council for Exceptional Children, New York City, N. Y., March, 1968.

"Use of Maps for Mobility," Exhibit and Workshop, Annual Conference of American Association of Workers for the Blind, July, 1968 and Annual Conference of American Association of Instructors of the Blind, June, 1968.

"Tactual Maps," Paper presented to the International Cartographic Association Bi-annual Meeting, New Delhi, India, Dec. 1968.

Miscellaneous Professionally Related Activities.

Wiedel, J. W. Three patent proposals relating to tactual map production processes and materials (researched and declared patentable by University Patent Attorney).

Television appearances (National Broadcasting Company) on the educational series of the University of Maryland on use of maps for mobility.

Maryland Association for the Visually Handicapped, Consultant and Resources Chairman, 1965-66.

APPENDIX V (CONTINUED)

Wiedel, J.W. Participated in the production of a training film pertaining and Groves, to instructional materials for the blind, June 1967.
P.A.

Organizers and participants in Conference on Mobility Graphics at University of Birmingham, Birmingham, England, Feb. 1968.

Organized and conducted a pilot workshop for instructors in Mobility and Rehabilitation for the blind, initiating the use of materials developed through research, University of Maryland, Aug. 1968.

BIBLIOGRAPHY

- Abel, Georgie Lee. Concerning the Education of Blind Children. New York, American Foundation for the Blind, 1959.
- Allport, Floyd H. Theories of Perception and the Concept of Structure. New York: John Wiley & Sons, Inc. (1955, 1962) 709 pp.
- Angwin, J.B.P. "Maps for Mobility," The New Beacon, 1968. Part I, pp. 115-119, Part 2, pp. 143-145.
- Anonymous. Standards for Mobility Instructors. American Foundation for the Blind, 1962.
- Armstrong, J.D. "A Combined Mobility System for the Blind." Submitted to Nature, 1969.
- Arnheim, Rudolf. Art and Visual Perception, Berkeley, Calif.: University of California Press (1954), 408 pp.
- Asher, Harry. Experiments in Seeing. Greenwich, Conn.: Fawcett Publications, Inc.; & New York: Fawcett World Library (1966), 271 pp. (paperback ed. No. t292).
- Austin, T.R. and Sleight, R.B. "Accuracy of Tactual Discrimination of Letters, Numerals, and Geometric Forms", Journal of Experimental Psychology, XLIII, (March 1952), pp. 239-247
- Axelrod, Seymour. Effects of Early Blindness, Performance of Blind and Sighted Children on Tactile and Auditory Tasks. New York, American Foundation for the Blind. Res. Ser. 1958, No. 6.
- Bahn, C. "Plastic Maps and Globes", Journal of Geography. Vol. 59, Jan. 1960. pp. 41-43.
- Bailey, Jane Lee. "Meaningful Maps for the Blind and Seeing", The New Outlook for the Blind, March 1956.

- Ball, John and Brynes, Francis C., ed., Research Principles and Practice in Visual Communication, Washington: National Education Association, Department of Audiovisual Instruction (1960), 160 pp.
- Bartley, S. Howard. Principles of Perception, New York: Harper & Brothers, Publishers (1958), 482 pp.
- Batema, Barbara. "The Modifiability of Sighted Adults' Perceptions of Blind Children's Abilities", The New Outlook for the Blind, May 1964, pp. 133-135.
- Bauer, Herbert J., "Discrimination of Tactual Stimuli," Journal of Experimental Psychology, XLIV, No. 6, December 1952.
- Bennett, Edward, et. al., Human Factors in Technology, New York: McGraw Hill Book Co., Inc. (1963), 685 pp.
- Berger, C. "Stroke-width, Form and Horizontal Spacing of Numerals as Determinants of the Threshold of Recognition" Journal of Applied Psychology, Vol. 28, June, 1944.
- Blust, V. Unpublished survey on Value of Maps/or Models in Mobility Training, 1967.
- Brandt, Herman F. The Psychology of Seeing, New York: The Philosophical Library, Inc. (1945), 240 pp.
- Brunswick, Egon. Perception and the Representative Design of Psycho-Physical Experiments, Berkeley: University of California Press (1956), 153 pp.
- Burklen, Karl. "Das Tastlesen der Blindenpunktschrift," Zeitschrift für Angewandte Psychologie, V., No. 14-17, 1917-1918.
- Carroll, Thomas J. Blindness: What it is, what it does, and how to live with it. (Little, Brown & Co., Boston 1961).
- Chapanis, Alphonse. Research Techniques in Human Engineering, Baltimore: The Johns Hopkins Press (1959), 316 pp.

- Cherry, Colin. On Human Communication, Cambridge, Mass.: M.I.T. Press, & New York: John Wiley & Sons, Inc. (1957), 323 pp.
- Cornog, D. Y., Rose, F.C., Walkowicz, J.L. Legibility of Alpha-numeric Characters and Other Symbols - A Permuted Title Index and Bibliography, Washington, D.C.; U.S. Dept. of Commerce, National Bureau of Standards, Misc. Publ. No. 262-1, (Dec., 1964), from G.P.O., 100 pp.
- Critchley, MacDonald. "Tactile Thought: With Special Reference to the Blind", Resume of President's Address, Proceedings of the Royal Society of Medicine, XLVI (London 1953) p. 281.
- Curtin, George T. "Mobility: Social and Psychological Implications", The New Outlook for the Blind, Jan. 1962. pp. 14-18.
- Cutsforth, T.D. "An Analysis of the Relationship between Tactual and Visual Perception," Psychological Monographs, XLIV, No. 1. 1933.
- Dean, Sidney I. "Some Notes on Research Problems with the Blind," New Outlook for the Blind, June, 1956.
- Delaney, A. "Making a Contour Map Model" Journal of Geography, Vol. 61, October, 1960. pp. 310-312.
- Dember, William N. The Psychology of Perception, New York: Henry Holt & Co., (1960), 402 pp.
- Dickinson, J.A., Leonard, J.A., "The Role of Peripheral Vision in Static Balancing." Ergonomics, 10, 1967, pp. 421-429.
- Dickinson, J. "Further Experiments on the Role of Vision in Static Balancing." Submitted to Ergonomics. 1968.
- Dickinson, J. "The Training of Mobile Balancing in a Minimal Visual Cue Situation." To appear in Ergonomics. 1969.
- Edwards, Allen L. "Balanced Latin-Square Designs in Psychological Research," The American Journal of Psychology, LXIV, October, 1951.

- Ekman, G. Lindman, R. William-Olsson, W. "A Psycho-Physical Study of Cartographic Symbols" Perceptual and Motor Skills, December, 1961.
- Fano, Robert M. Transmission of Information, Cambridge, Mass.: M.I.T. Press, & New York: John Wiley & Sons, Inc. (1961), 389 pp.
- Fisher, G.H. "Spatial Localization by the Blind", American Journal of Psychology, 1964, No. 77.
- Fraser, C.F. "Psychology of the Blind," American Journal of Psychology, XXVIII, No. 2, April, 1917.
- Fulker, Wilber H. and Mary, Techniques with Tangibles, Springfield, Illinois, Charles C. Thomas, 1967, 72 pp.
- Garry, Ralph, and Ascarelli, Anna. An Experiment in Teaching Topographical Orientation and Spatial Organization to Congenitally Blind Children, U.S. Office of Education, Department of Health, Education, and Welfare, Undated.
- Gatti, Alessandro, "The Perception of Space by Means of Pure Sensation of Touch", The American Journal of Psychology, L., No. 1-4. November, 1937.
- Geldard, Frank A., "Adventures in Tactile Literacy," American Psychologist, XII, No. 3, March, 1957.
- Gibson, J.J. "Observations on Active Touch" Psychological Review, 1962, No. 69.
- _____ "Perception as a Function of Stimulation" In S. Kock (ed.) Psychology: A Study of a Science. New York.: McGraw Hill, 1959.
- _____ The Perception of the Visual World, Boston.: Houghton Mifflin Co. (1950), 242 pp.
- Gilson, Charles, Wurzburger, Burdell and Johnson, Daniel E. "The Use of the Raised Map in Teaching Mobility to Blind Children", The New Outlook Feb. 1965.

- Graham, Clarence H., ed. Vision and Visual Perception, New York: John Wiley & Sons, Inc. (1965), 637 pp. (excellent ref. citations)
- Gray, P.C. and Todd, J., Mobility and Reading Habits of the Blind, U.K. Government, Ministry of Health, 1968.
- Grings, William W. Laboratory Instrumentation in Psychology, Palo Alto, California: The National Press (1954) 282 pp.
- Heath, W. R. Maps and Graphics for the Blind: Some Aspects of the Discriminability of Textural Surfaces for Use in Areal Differentiation, Ph.D. thesis, University of Washington, 1958.
- Herrig, Gerhard. "Ueber die Eindringlichkeit von Tastsymbolen" Der Blindenfreund Nr. 3, 1959.
- Hochberg, Julian E. Perception, Englewood Cliffs, N.J.: Prentice-Hall, Inc. (1964, 1965) 118 pp. illustrated (paperback ed.)
- Hovland, Carl I., et al, Experiments on Mass Communication, Princeton, N.J.: Princeton University Press (1949), 345 pp.
- International Journal for the Education of the Blind American Association of Instructors for the Blind. Quarterly.
- Karp, S. Research Bulletin No. 2, Dec. 1962. (compiled by the Division of Research and Statistics of the A.F.B.) "Experiments in Tactual Perception".
- Kilpatrick, Franklin P. Exploration in Transactional Psychology, New York: New York University Press (1961), 405 pp.
- Kleinrock, Leonard. Communication Nets, New York: McGraw-Hill Book Co., Inc. (1964), 209 pp.
- Koffka, K. Principles of Gestalt Psychology, New York: Harcourt Brace, 1935.
- Kohler, W. Gestalt Psychology, New York: Liveright, 1947.
- Kruger, Irving J. "Orientation and Mobility in the Vocational Area" The New Outlook for the Blind, Mobility and Orientation - A Symposium, March 1960, pp. 87-90.

- Lashley, Karl S. "Psychological Problems in the Development of Instrumental Aids for the Blind," Blindness, ed. Paul A. Zahl, Princeton University Press, 1950.
- Le Duboc, Jesse. "Some Questions Teachers Ask Concerning Map Study in the Intermediate Grades", Journal of Geography, XXXII, No. 6. September, 1933.
- Leibowitz, Herschel W. Visual Perception, New York: The Macmillan Co., (1965), 177 pp.
- Leonard, J. A. "Mobility and the Blind - A Survey." Med. Electron. Biol. Eng. I, 1963, pp. 465-481.
- _____. "Report on a Study Trip on Blind Mobility." U.S.A. May 1964. (originally privately circulated).
- Leonard, J. A., Wycherley, R. J. "Stopping Distance as a Function of Speed in Blindfold Walking." Bull. Brit. Psychol. Soc., 20. 1966.
- Leonard, J. A. "Towards a Unified Approach to the Mobility of Blind People." Southern Regional Review, 40, 1966, pp. 1-14.
- _____. "Experimental Maps for Blind Travel." The New Beacon, L, 586, 1966, pp. 32-35.
- _____. "Aids to Navigation. A Discussion of the Problems of Maps for Blind Travellers." Sensory Devices for the Blind, 9-29, St. Dunstan's, London, 1967.
- _____. "Mobility as a School Subject." Teacher of the Blind, 55, 1967. pp. 102-107.
- Leonard, J. A., Newman, R. C. "Spatial Orientation in the Blind." Nature, 215, 1967. pp. 1413-1414.
- Leonard, J. A., Wycherley, R. J. "Towards the Measurement of Performance in Blind Mobility." Conf. Proc. M.I.T., 1967, pp. 27-45.

- Leonard, J.A. "Static and Mobile Balancing Performance of Blind Grammar School Children." New Outlook for the Blind, in press. 1969.
- Leonard, J.A., Newman, R.C. "A Comparison of Three Types of Portable Route 'Maps' for Blind Travel." Bull. Brit. Psychol. Soc. 21, 1969.
- Liddle, Don. "Mobility: A Survey." Part I. The New Beacon, Vol. 49, May 1965, pp. 115-122.
- _____. "Mobility: A Survey." Part II. The New Beacon, Vol. 49, June 1965, pp. 142-149.
- _____. "Mobility: A Survey.: Part III. The New Beacon, Vol. 49, July 1965, pp. 170-182.
- Life Magazine, "How to 'See' through the ears." Sept. 30, 1966.
- Locke, P. "The Heart Rate of Blind and Sighted Pedestrians." Submitted to Nature and Ergonomics. 1969.
- Lowenfeld, Berthold, "Psychological Foundation of Special Methods in Teaching Blind Children," Blindness, ed. Paul A. Zahl. Princeton: Princeton University Press, 1950.
- Major, D.R. "Cutaneous Perception of Form," The American Journal of Psychology, X, No. 1. October, 1898.
- Massie, Dennis. "Guidelines for Research in the Education of Partially Seeing Children," The New Outlook for the Blind, February, 1965. pp. 57-58.
- McCormick, Ernest J. Human Factors Engineering, New York: McGraw-Hill Book Co., Inc. (1957, 1964), 653 pp.
- Merry, R.V. "To What Extent can Blind Children Recognize Tactually Simple Embossed Pictures?" Teachers Forum (Blind), 1930, 3, 2-5.

- Merry, R.V. and Merry, Frieda K. "Tactual Recognition of Embossed Pictures by Blind Children," Journal of Applied Psychology, 1933, 17, pp. 148-163.
- Miller, Josephine. "Mobility Training for Blind Children: Possible Effects of an Organized Mobility Program on the Growth and Development of a Blind Child", The New Outlook for the Blind, December, 1964. pp. 305-307.
- Mobility Guidelines, Prepared by Working Party of the College of Teachers for the Blind, Nottingham University Printing Unit, 1968, 241 pp.
- Morgan, C.T., Cook, Chapins, Lund, eds., Human Engineering Guide to Equipment Design, New York: McGraw-Hill Book Co., Inc. (1963), 615 pp.
- Morris, June E. "Minimum Sizes for Areal Type Tactual Symbols", International Journal of Education for the Blind, 1963, No. 13.
- Mueller, Conrad G., Sensory Psychology, Englewood Cliffs, N.J.: Prentice-Hall, Inc. (1955), 120 pp. illustr.
- Muses, C. A. ed., Aspects of the Theory of Artificial Intelligence. New York: Plenum Press, Inc. (1962), 283 pp.
- Nolan, C. Y. and Morris, June E. "Tactual Symbols for the Blind", Final Report, OVR-RD-587. Unpublished report, American Printing House for the Blind, Louisville, Kentucky, 1963.
- Norton, Elizabeth, "Teaching with Maps in the Intermediate Grades", Journal of Geography, XXVII, No. 9, December, 1928.
- Postman, Leo and Egan, James P., Experimental Psychology: An Introduction, New York: Harper & Bros., Publ. (1949), 520 pp.
- Research Bulletin. Vol. 1, January 1962. Vol. 2, December 1962. New York, American Foundation for the Blind.
- Revesz, Geza, Psychology and Art of the Blind, Translated by H.A. Worlf, (New York, Longmans, Green, 1960).

- Revesz, Geza, "The Problem of Space", The American Journal of Psychology, L, No. 1-4, November 1937.
- Ritter, Charles G., "Devices to Aid the Blind", Blindness, Ed., Paul A. Zahl. Princeton: Princeton University Press, 1950.
- Rosenblith, Walter A., ed., Sensory Communication, Boston: M.I.T. Press, (1961) 844 pp. (paperback ed. available).
- Rusalem, H. "The Dilemma in Training Mobility Instruction", The New Outlook for the Blind, Mobility and Orientation - A Symposium, March, 1960, pp. 82-87.
- Ryan, T.A., "Dynamic Physiognomic, and Other Neglected Properties of Perceived Objects: A New Approach to Comprehending", American Journal of Psychology, 1938, No. 51.
- Schiff, William, "Research of Raised Line Drawings", The New Outlook, April, 1965.
- Schrock, Clara. "Gradations in Map Learning," Journal of Geography, XXXVIII, No. 5, May, 1939.
- Schumann, Wolfgang, "Experimentelle Untersuchungen über die Tastwahrnehmung der Muller-Lyerschen-Tauschungsfigur", Der Blindenfreund, Nr. 2, 1959.
- Seashore, Carl and Ling, T.L., "The Comparative Sensitiveness of Blind and Seeing Persons", Psychological Monographs, XXV, No. 2, (1918) pp. 145-158.
- Shannon, C.E., "A Mathematical Theory of Communication," Bell System Tech. Journal, V. 27, n. 3. (July, 1948) pp. 379-423.
- Sharpes, L. "Helping the Partially-sighted: Sub-normal Vision," The New Beacon, Vol. 49, 1965.
- Sherman, John C., "Current Map Resources and Existing Map Needs for the Blind," Surveying and Mapping, Dec. 1964, Vol. XXLV, No. 4, pp. 611-616.

- "Needs and Resources in Maps for the Blind," The New Outlook, April 1965.
- Silver, Robert, "Helping the Partially-sighted: Using Residual Vision," The New Beacon, Vol. 49, April, 1965.
- Slepian, David, "Bounds on Communication," Bell System Tech. Journal, Vol. 42, n. (May, 1963), pp. 681-707.
- Stevens, S. S., ed., Handbook of Experimental Psychology, New York: John Wiley & Sons, Inc. (1951, 1965) 1736 pp. illustra.
- Stewart, D. Stenhouse, "Learning to See: Some Problems of the Partially Sighted," The New Beacon, August 28, 1958, pp. 169-172.
- Stone, L. J., "An Experimental Study of Form Perception in the Thermal Senses," The Psychological Record, I. No. 19, October, 1937.
- Suhrweier, Horst (& Heinold, Hans.), Beitrage zur Blindenpadagogik und-psychologie, Allgemeiner Deutscher Blinden-Verband. (No date).
- Sylvester, R. H. "The Mental Imagery of the Blind," Psychological Bulletin, X, No. 5, May, 1913.
- Taylor & Taylor, Special Education of Physically Handicapped Children in Western Europe. (published by International Society for the Welfare of Cripples) 1960.
- Teevan, Richard C. and Birney, Robert C., ed., Color Vision, Princeton, N.J.: D. Van Nostrand Co., Inc. (1961), 214 pp. (paperback ed.)
- Tolansky, S., Optical Illusions, New York: The MacMillan Co., (1964), 157 pp.
- Vernon. M. D., The Psychology of Perception, Baltimore, Md.: Penguin Books, Inc.: Pelican No. A530 (1962, 1963), 265 pp.

Weiner, J., Leikind, M.C., Gibson, J.R., eds., Visibility: A Bibliography, Washington, D.C.: U.S. Library of Congress, Technical Information Division/ NRC Vision Committee - ONR Contract No. 13-47 (1952); Microprint Cat. No. 9455 (June, 1953) from G.P.O., 90 pp.

Wexler, A., Experimental Science for the Blind. 1961/2.

_____, "Shape Recognition and Drawing by the Blind," The New Beacon, Part i, Sept. 1965, Vol. 49, pp. 228-233, Part ii, October, 1965, Vol. 49, pp. 254-258.

Whitcomb, Milton A., ed., Recent Developments in Vision Research, Washington, D.C.: Armed Forces - NRC Committee on Vision, Publ. No. 1272 (1966), 227 pp.

White, H. "Diagrammatic Map Making," Journal of Geography, Vol. 32, September, 1933, pp. 242-244.

Whitstock, R.H., "Orientation and Mobility for Blind Children," The New Outlook for the Blind, Mobility and Orientation - A Symposium, March 1960. (pp. 90-94).

Wiedel, Joseph W., "Virkotype Process of Raised Printing," Circular 64-10, Division for the Blind, Library of Congress, Oct. 1964, (with Alfred Korb).

_____, "Tactual Maps for the Visually Handicapped: Some Developmental Problems," The Professional Geographer, Journal of the Association of American Geographers, May 1966. Reprinted in The New Outlook, American Foundation for the Blind, March 1969.

_____, "Development and Standardization of Symbols and Improvement in the Design of Tactual Illustrations for the Blind," Report, Research Grant No. RD-2287-S, Vocational Rehabilitation Administration, Department of Health, Education and Welfare, July, 1967.

Wiedel, Joseph W., and Groves, Paul A., "Tactual Mapping: Design, Reproduction, Reading and Interpretation," Report Research Grant No. RD-2557-S-67, Social Rehabilitation Service, Department of Health, Education and Welfare, Feb. 1968.

_____, "Tactual Mapping: Problems of Design and Interpretation," The International Journal for the Education of the Blind, March 1968.

_____, "Designing and Producing Tactual Maps for the Visually Handicapped," The New Outlook, American Foundation for the Blind, Sept. 1969.

_____, "Tactual Maps," The International Yearbook of Cartography, 1969.

Worchel, Philip, "Space Perception and Orientation in the Blind," Psychological Monographs, LXV, No. 15 (1951), pp. 1-28.

Wyburn, G. M., et. al., Human Senses and Perception, Oliver and Boyd, Ltd., Edinburgh and London, U.K. (1964), 340 pp.

Wycherley, R.J., Nicklin, B., "The Heart Rate of Blind and Sighted Pedestrians on an Unfamiliar Route." Presented at the July EPS, and Submitted to Ergonomics. 1968.

Zigler, M. J. and Barrett, R., "A Further Contribution to the Tactual Perception of Form," Journal of Experimental Psychology, X, No. 2, April 1927.

Zigler, M.J. and Northrup, K.M., "The Tactual Perception of Form," The American Journal of Psychology, XXXVII, No. 3, July, 1926.