

DOCUMENT RESUME

ED 037 840

EC 004 904

TITLE Exceptional Child Education; DeSoto County Board of Public Instruction, Arcadia, Florida.

INSTITUTION DeSoto County Board of Public Instruction, Arcadia, Fla.

PUB DATE Apr 69

NOTE 72p.

EDRS PRICE EDRS Price MF-\$0.50 HC-\$3.70

DESCRIPTORS Academic Education, *Educable Mentally Handicapped, *Educational Specifications, Equipment, *Exceptional Child Education, Facility Requirements, Home Economics, Horticulture, Hygiene, Leisure Time, *Mentally Handicapped, Program Descriptions, *Program Guides, Secondary Education, Speech Therapy

IDENTIFIERS DeSoto County (Florida)

ABSTRACT

Educational specifications of the program for secondary educable mentally handicapped students in DeSoto County (Florida) are described. Specifications for the overall philosophy, purposes, objectives, activities, space and equipment requirements, and special considerations are provided in the following areas: academics, food preparation, clothing maintenance, home living, care of invalid and infirmed, grooming, horticulture and yard maintenance, home maintenance, leisure time activities, teacher workroom and equipment storage, and speech therapy. (RD)

ED037840

EDUCATIONAL
SPECIFICATIONS

SECONDARY
EMR

EXCEPTIONAL CHILD EDUCATION
DeSOTO COUNTY BOARD OF PUBLIC INSTRUCTION
ARCADIA, FLORIDA

April, 1969

Mr. Charles O. Weaver
Superintendent

Mrs. Marilyn P. Mizell
Coordinator

U.S. DEPARTMENT OF HEALTH, EDUCATION & WELFARE
OFFICE OF EDUCATION

THIS DOCUMENT HAS BEEN REPRODUCED EXACTLY AS RECEIVED FROM THE
PERSON OR ORGANIZATION ORIGINATING IT. POINTS OF VIEW OR OPINIONS
STATED DO NOT NECESSARILY REPRESENT OFFICIAL OFFICE OF EDUCATION
POSITION OR POLICY.

ED04704E

F O R M A T

	Page
I. General.	3
A. Philosophy	
B. Curriculum	
C. Objectives	
II. Academic Area.	9
III. Food Preparation Area.	11
IV. Clothing Maintenance Area.	15
V. Home Living Area	18
VI. Care of Invalid and Infirm	19
VII. Grooming Area.	20
VIII. Greenhouse, Ornamental Horticulture, Nursery and Yard Maintenance Areas	22
IX. Home Maintenance Area.	26
X. Leisure Time Activities.	30
XI. Teacher Workroom and Equipment Storage	32
XII. Speech Therapy Room.	35
XIII. Space Relationship Diagram	37
XIV. Sources.	38

SECONDARY EDUCABLE MENTALLY RETARDED
EDUCATIONAL SPECIFICATIONS
COMMITTEE

DeSoto County School Board
Joe Mottashed, Committee Member

Educational Specifications Chairman
Marilyn P. Mizell

Secretary
Harriet Southwell

Steering Committee

County Superintendent - C. O. Weaver
Secondary Supervisor - V. L. DeShazo
DeSoto High Principal - A. Perry Geiger
Coordinator, Special Education - Marilyn P. Mizell

Area Committees

Academic Area - Marilyn P. Mizell
Laura H. Johnson

Speech Therapy and Conference
Room - Arlene Kincaid
Ted Doras
Tom Muller

Food Preparation Area - Susie H. Williams
Virginia Campbell

Clothing Maintenance - Bertha B. Perkins
Lois O. Mayo

Home Living Area - Joel Corley

Care of Invalid and Infirm - Joel Corley

Grooming Area - Joel Corley

Home Maintenance Area - Amos Louis
Carl Bradshaw
Joel Corley

Leisure Time Activities - Lois Henderson

Greenhouse, Ornamental Horticulture,
Nursery and Yard Maintenance - Bill Fletcher
Don Trotman
Joel Corley

Teacher Workroom and Equipment
and Materials Storage Areas - Louise Johnson
Don E. Dewey

TARGET DATES

- March 19 - Steering Committee Meeting
Sections to be approved:
Philosophy
Objectives
Curriculum
Total Format
Calendar of Target Dates
- March 24 - Format to teachers and mailed to State
Department
- April 9 - Area Committee Reports due to Coordinator,
Special Education
- April 12 - Reports of Area Committees to Steering
Committee, Architect, School Board, and
Lay Advisor
- April 18 - Educational Specifications due in rough
draft form to State Department
- April 28 - Returned by State Department to Coordinator
of Special Education for final draft
- May 1 - Final draft completed
- May 13 - Approved by DeSoto County Board of Public
Instruction

I. GENERAL

A. Philosophy

The DeSoto County School Policy Handbook states that "a primary aim of the schools of DeSoto County is to enable each student to develop to a maximum extent his potentialities, aptitudes, abilities, and character.

Major objectives are to help students develop spiritually, emotionally, intellectually, economically, and socially, in order that they may contribute in a wholesome way to life in a democratic society...

In order to fulfill these aims and objectives, it is necessary to secure for each child a wholesome climate for growth."

We believe that Exceptional Children should participate as much as possible in the regular school activities and in experiences which are appropriate to their individual needs and abilities.

However, we recognize that it is our responsibility to provide special arrangements which will enable the handicapped child to make greater progress toward optimal growth and development in order to prepare him to take his place in our society.

We also recognize that there are wide deviations or differences among children in their physical, mental, emotional, or social needs. It follows that an instructional program - organization of the program, housing facilities, instructional methods - must differ to meet fully the educational needs of children who deviate from the average to the extent that they require special education to develop their maximum potential.

Children participating in the program of this facility will be enrolled in the homerooms of grades seven through twelve.

Unless prevented, for medical reasons, all will participate in the physical education program of their age group.

Hopefully, some children will be integrated into the band and vocal music programs, also.

As vocational education programs become a reality at DeSoto High School, these students will be involved in the courses in which their special education teachers feel that they would be most successful.

However, because there are no courses in grades ten through twelve in art, vocational shop, and vocational home economics, integration into general education has not been as successful as we would hope it might be with broader course offerings.

Therefore, this facility includes some areas of learning that might not be necessary under other circumstances.

B. Curriculum

The Illinois Plan for Special Education of Exceptional Children, adopted as a guide for teachers of the educable mentally retarded in DeSoto County, specifies ten functions which persist throughout the life of the individual in a democracy and which typify the desirable product of educational procedures. These are listed as functions in:

- Citizenship
- Communicating
- Home and Family
- Leisure Time
- Management of Materials and Money
- Occupational Adequacy
- Physical and Mental Health
- Safety
- Social Adjustment
- Travel

Identifiable within each Life Function are the behaviors and skills necessary to their performance. These behaviors and skills can be viewed as proficiencies in subject matter to be acquired in the course of school participation.

C. Objectives

1. Citizenship Objectives

a. Cooperating Citizen

- (1) Cooperating with peers
- (2) Cooperation with persons in authority
- (3) Participation in community activities

b. Contributing Citizen

- (1) Care of self
- (2) Self supporting
- (3) Care of others
 - (a) Family
 - (b) Private organizations
 - (c) Contributions

2. Communicating

a. Purposeful Listening

- (1) Auditory discrimination
- (2) Auditory comprehension

- b. Purposeful Observing
 - (1) Visual discrimination
 - (2) Visual comprehension
 - c. Effective Communication Through Speech
 - (1) Comprehensive speech
 - (2) Logical organization of speech
 - d. Effective Communication Through Writing
 - (1) Legibility
 - (2) Logical organization of written materials
3. Home and Family
- a. Family Relationships
 - (1) Cooperation
 - (2) Contributing
 - (3) Family values
 - b. Areas of Family Living
 - (1) Homemaking skills
 - (2) Financing a family
 - (3) Planning for a family
 - (4) Child care, good health habits
 - (5) Enjoying a family
 - (6) Community relationships
 - c. Sources of Help for Family Problems
 - (1) Family service agencies
 - (2) Medical and health agencies
 - (3) Churches
4. Leisure Time
- a. Activities Available for Participation at Home
 - (1) Selection of activities
 - (2) Selection of companions
 - (3) Selection of appropriate time for doing
 - (4) Consideration of cost
 - b. Activities Available for Observation at Home
 - (Same as above)
 - c. Activities Available for Participation in the Community
 - (Same as above)

- d. **Activities Available for Observation in the Community**
 - (Same as above)
- 5. **Management of Materials and Money**
 - a. **Obtainment and Use of Materials**
 - (1) Value of materials and money
 - (2) Management of materials and money
 - (3) Conservation of materials and money
 - b. **Obtainment and Use of Money**
 - (1) Earning
 - (2) Budgeting
 - (3) Buying
 - (4) Saving
 - (5) Borrowing
- 6. **Occupational Adequacy**
 - a. **Personal Competencies for Working**
 - (1) **Good work habits**
 - (a) Care of equipment
 - (b) Conservation of materials
 - (c) Organization of time, effort, task
 - (d) Attention to safety
 - (e) Regular and punctual attendance
 - (2) **Self care and appraisal**
 - (a) Grooming
 - (b) Health
 - (c) Abilities
 - (d) Limitations
 - b. **Social Competencies for Working**
 - (1) Getting along with others
 - (2) Social security
 - c. **Academic Competencies for Working**
 - (1) Conservation
 - (2) Reading
 - (3) Writing
 - (4) Arithmetic

7. Physical and Mental Health

a. Physical Health

- (1) Basic health needs
- (2) Body structure and function

b. Mental Health

- (1) Self-appraisal
- (2) Sensitivity to behavior limits
- (3) Sensitivity to social values

c. Health Services

- (1) Private physician
- (2) Private dentist
- (3) Clinics
- (4) Hospital
- (5) Public Health Department
- (6) Public laws

- (a) Alcohol
- (b) Narcotics

8. Safety

a. Preventive Safety Measures

- (1) Safety rules and laws
- (2) Fire prevention
- (3) Disaster aids

b. Corrective Safety Measures

- (1) First aid
- (2) Disaster aids
- (3) Insurance

9. Social Adjustment

a. Interpersonal Relationships

(1) Self help

- (a) Health
- (b) Grooming
- (c) Manners

(2) Sharing

- (a) Listening
- (b) Talking
- (c) Playing
- (d) Working

b. Group Relationships

(1) Cooperating

(a) Follower

(b) Leader

(2) Contributing

(a) Follower

(b) Leader

10. Travel

a. Fundamentals for Moving About

(1) Directions

(2) Landmarks

(3) Maps

(4) Schedules

b. Sources of Help for Traveling

(1) Schedules

(2) Individuals

(3) Agencies

c. Ways to Travel

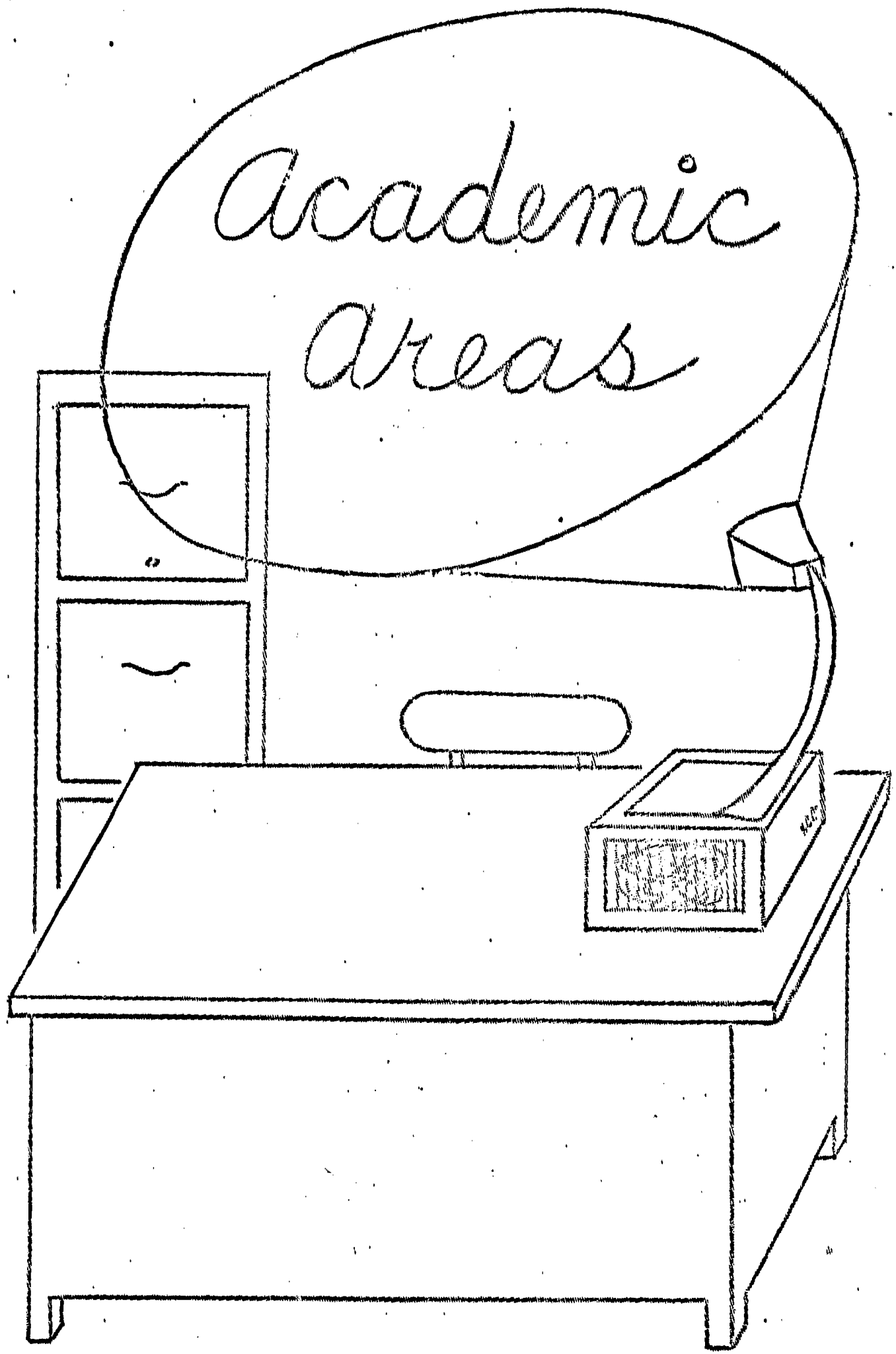

II. ACADEMIC AREA

A. Philosophy, Purposes, and Objectives

Because we believe that the educable mentally retarded student must receive instruction in areas of academic skills to the maximum of his/her ability, we feel that space allocated for this primary purpose is essential.

Academic competencies necessary for occupational adequacy that are to be included are:

1. Arithmetic
2. Fine Arts
3. Language Arts
4. Science
5. Social Relationships

B. Instructional Program

1. Activities

a. Describe what the teacher does

- (1) Individual and small group instruction
- (2) Class discussions
- (3) Demonstrations
- (4) Uses audio-visual aids

b. Describe what the student does

- (1) Participates in class discussions
- (2) Individual activities
- (3) Small group activities
- (4) Demonstrates, dramatizes, role plays
- (5) Uses audio-visual aids

2. Groupings

- ##### a. Size of groups - individual to group of six, eighteen for large group activities, such as films, demonstrations, lecture

C. Space Requirements for Academic Area

1. Square feet - Eight hundred fifty (850) for general classroom and approximately three hundred (300) square feet for study area
2. Display space - Twenty feet of tackboard, approximately 36" from floor
3. Chalkboard space - Twenty feet approximately 36" from the floor. Movable partitions may be of chalkboard and tackboard also.

4. Counters and storage cabinets - One wall of storage space to include the following:
 - a. Lockable closet with shelves for storage of materials and supplies
 - b. Counter with formica top on remainder of wall base cabinets and adjustable shelves above
 - c. Tote trays in lockable cabinet for 18 students
 5. Movable resource center cabinets dividing the space between classroom and study area
 6. Furniture
 - a. Student desks, teacher's desk and chair, folding table and chairs, two equipment carts, filing cabinet, metal storage cabinet - all purchased in 1968-69 school year
 - b. Portable television set to be purchased
- D. Special Considerations
1. Floor coverings - acoustical floor covering in a neutral color
 2. Communication system - intercom, bell, and fire alarm system
 3. Climate control - "Climate-controlled" ventilation is desirable with a few windows for emergency ventilation purposes
 4. Light control - illumination of 50 foot candles should be provided for general work. Special work centers may need more illumination.
 5. Plumbing - sink and cabinet in classroom with mirror. A drinking fountain should be located adjacent to the classroom.
 6. Sound control - the classroom should be treated acoustically
 7. Utility requirements
 - a. Strip outlets along two walls
 - b. Conduit for commercial and closed circuit television
 - c. Wall clock
 - d. Outlets for wet study carrels in study area
 - e. No telephone in academic area
 8. Outside exit and entrance directly into academic area and opening into laboratory areas

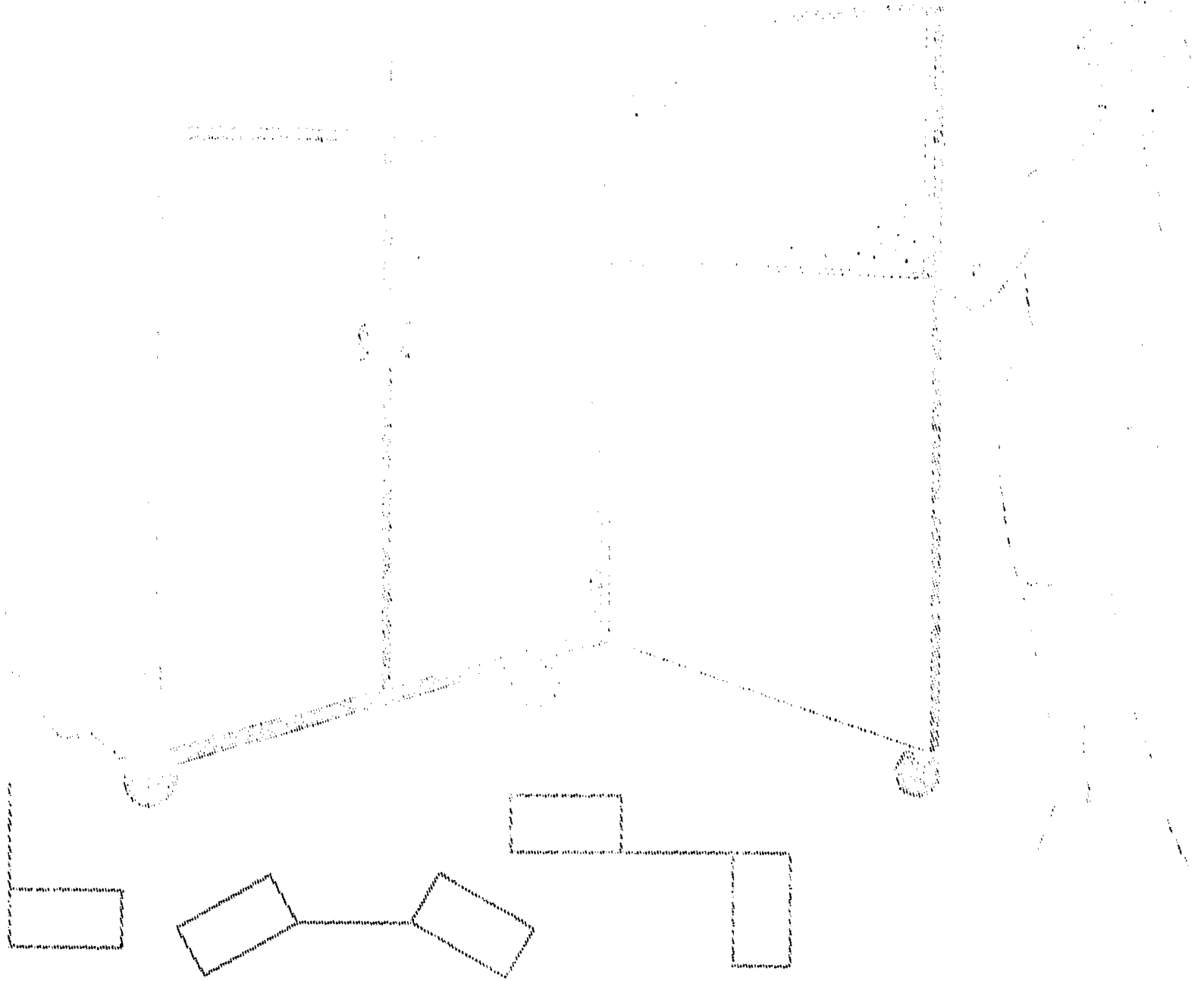

The average value of the function $f(x)$ over the interval $[a, b]$ is given by the formula:

$$\frac{1}{b-a} \int_a^b f(x) dx$$

For the function $f(x) = x^2$ over the interval $[0, 2]$, the average value is:

$$\frac{1}{2-0} \int_0^2 x^2 dx = \frac{1}{2} \left[\frac{x^3}{3} \right]_0^2 = \frac{1}{2} \left(\frac{8}{3} - 0 \right) = \frac{4}{3}$$

The average value of the function $f(x) = x^2$ over the interval $[0, 2]$ is $\frac{4}{3}$.

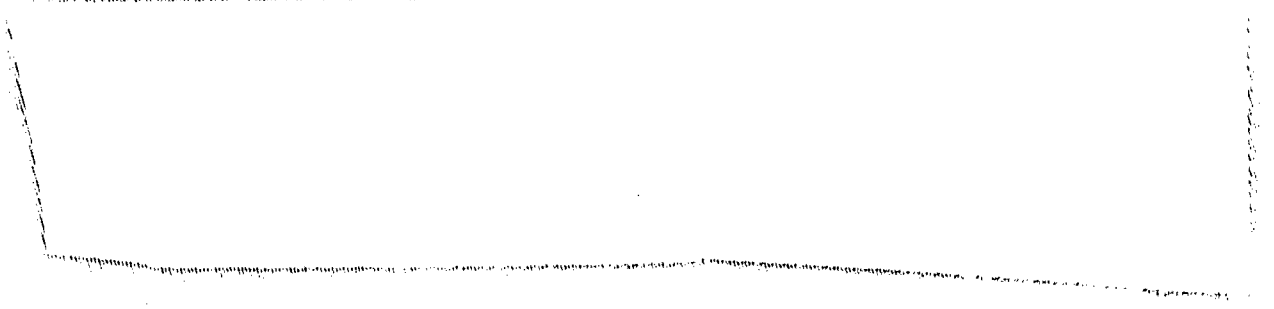

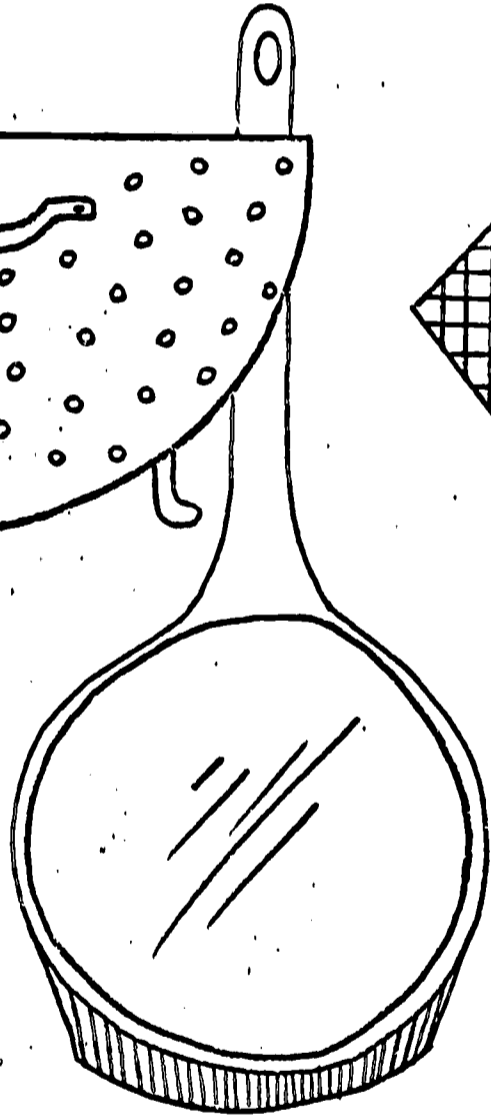
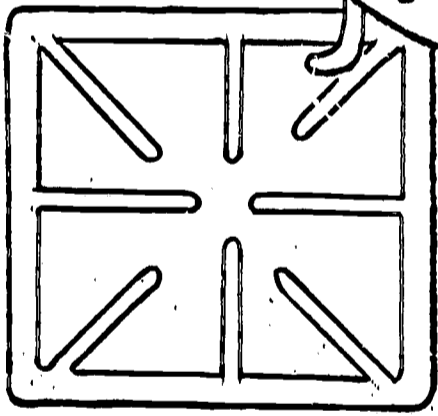
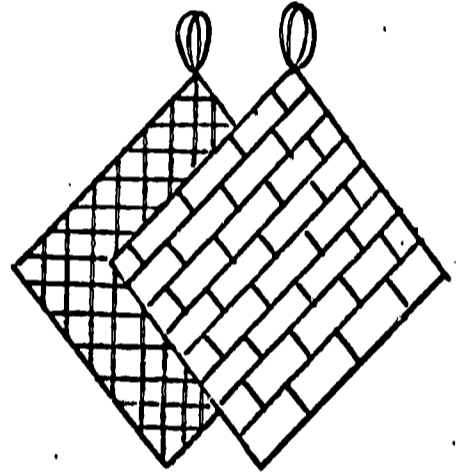
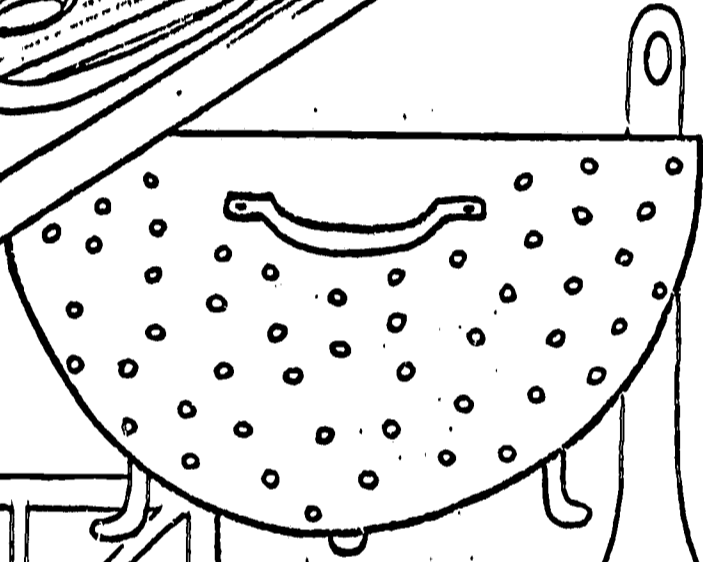
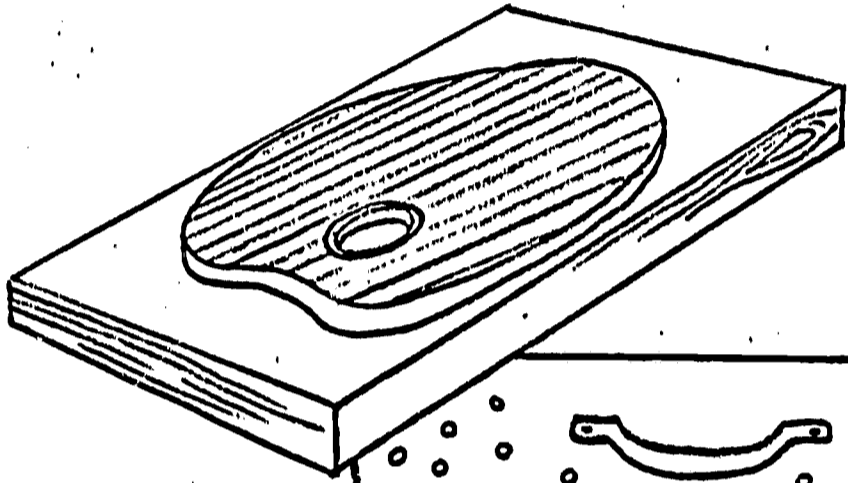
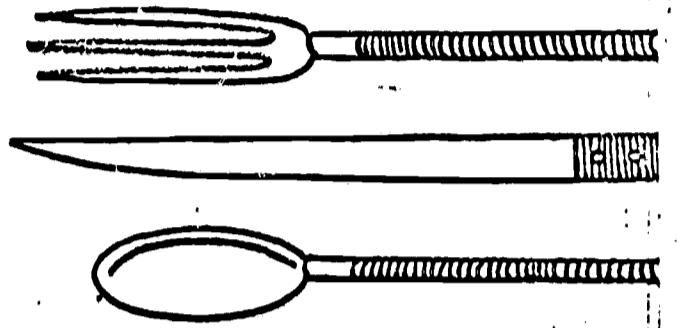
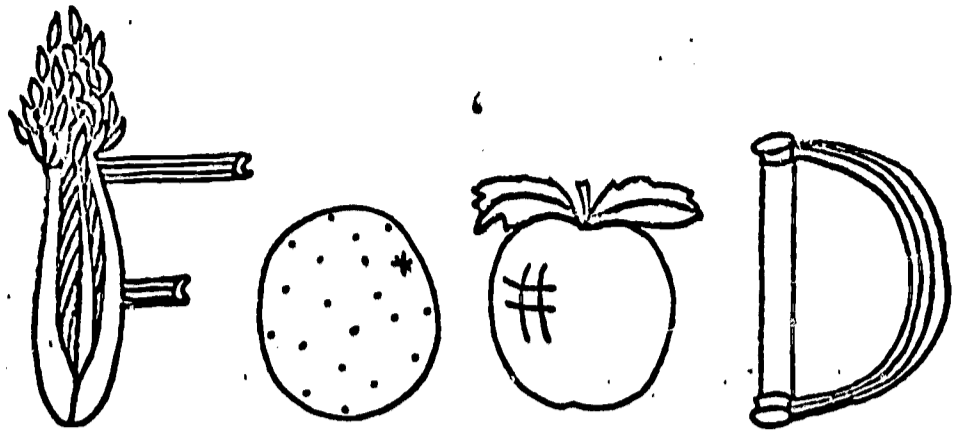

PREPARATION

III. FOOD PREPARATION AREA

A. Philosophy, Purposes, and Objectives

Home economics is a phase of formal training that deals with the ideas, attitudes, convictions, purposes, understanding, and loyalties about a way of living.

Home economics education is especially concerned with and contributes to better health, to citizenship, use of leisure time, ethical character, worthy home membership and vocational efficiency. One important responsibility of home economics is to improve family life.

The purpose of home economics education for the educable mentally retarded is to help the student develop understanding of commitment to family unity and loyalty and the wise management of energy, money, abilities, material goods, and services.

A complete unit on food preparation will be stressed. This will include mixing, preparation, cooking, clean-up, storage, and cleaning of small and large equipment. The students will be taught skills that will extend into their daily living. The laboratory will serve as an on-the-job training program that will enable the students to go into simple public employment, such as short order cook, cafeteria helper, and drug store fountain worker.

1. Specific objectives of this area are:
 - a. To learn the skills necessary for effective food preparation
 - b. To participate in activities that will improve home life today and in the future
 - c. To develop more independence in solving food problems intelligently and satisfactorily
 - d. To demonstrate new ways to make meals attractive and interesting
 - e. To practice using the equipment in the food preparation area
 - f. To estimate the food needs of a family over a short period of time
 - g. To demonstrate ways of preparing and serving food for commercial purposes

B. Instructional Program

1. Activities

a. The teacher will discuss and demonstrate food preparation

- (1) Talk about different foods
- (2) Assign scrapbooks and posters on foods
- (3) Teach basic food groups
- (4) Teach the planning of menus
- (5) Teach use and care of cooking utensils
- (6) Teach sanitary methods of handling food
- (7) Teach table setting and serving
- (8) Teach good safety practices in the kitchen
- (9) Relate class work to home experiences

b. The student will

- (1) Check nutrition habits by keeping written record of food intake
- (2) Learn to prepare and serve simple, nutritious, and economical meals
- (3) Learn to prepare meats in a variety of ways
- (4) Learn to entertain with grace and ease
- (5) Learn "short order" preparation

2. Groupings

Size will depend upon activities
Minimum of four

C. Space Requirements

1. Amount of space needed will be 400 - 500 square feet for the food preparation area

2. Movable chalkboard (4' x 8') and fixed tackboard (4' x 8')

3. Counters and storage cabinets

a. Wall cabinet for book storage (32" x 46" x 13")

b. Base cabinets to be 36" x 29" x 15 linear feet. Upper hanging cabinet to be 28" x 16½" and placed 15" from lower cabinet

- (1) One piece formica counter top with post form splash boards and rolled front edges and in-caps.
- (2) Wall area between counter top and wall cabinets to be formica

- (3) Cabinet finishes should be of a durable material which is easily cleaned
- (4) Magnetic door closures should be on all cabinet doors
- (5) Cleaning closet for storage of mop, bucket, brooms, dust pan, and cleaning supplies
- (6) Garbage can (buried in ground) near rear exit adjacent to the kitchen area

4. Walls - permanent with washable finish

5. Furniture for each space

- a. Two 30" stoves. One electric stove donated by Florida Power and Light Company (White) and one gas range
- b. 17.6 cu. ft., no frost, refrigerator-freezer (White)
(66" H x 30-3/8" D x 30 1/2" W)
Electrical ratings: 115 Volts AC/60 Cycles
100 Volts AC/50 Cycles
- c. Portable dishwasher with built-in soft food disposer (White)
Dimensions: 32 1/2" H, 22" W, 27-7/8" D
Volts: 120 AC
- d. Hot water heater described in Clothing Maintenance Area
- e. Two compartment sink built into the counter with garbage disposal unit and spray attachment. Switch for garbage disposal to be under sink inside cabinet.
- f. Two multi-purpose tables with four chairs each. Tables should be of wood with formica tops and will double as study tables.
- g. Institutional size grill unit to be built in with exhaust over grill area.

D. Special Considerations

- 1. Floor covering - slip resistant and easily cleaned
- 2. Communication system - Intercom, bell, and fire alarm systems
- 3. Climate control - Air-conditioned and heated with exhaust fan over grill unit and stove area
- 4. Light control - dropped ceiling with "mixed" lighting. Spot lights over sink and stove area for additional lighting.
- 5. Plumbing - adequate plumbing to take care of sink wastes, garbage disposal, and dishwasher waste water.

6. Television conduit
7. Sound control - acoustical ceiling
8. Utility Requirements
 - a. Number outlets: Eight polarized outlets for use with small appliances. These should be placed under the top cabinets but not adjacent to the sink area where students might receive an electrical shock from handling a faucet while operating an electrical appliance.
 - b. Voltage: 220 volts or adequate to take care of electric ranges (2), refrigerator, garbage disposal, dishwasher, grill, and small appliances
 - c. Kitchen clock
 - d. Gas outlets for range and grill
9. Fire extinguisher and fire blanket
10. Drinking fountain in laboratory

FOOD PREPARATION AREA

17.6 cu. ft.

NO FROST REFRIGERATOR-FREEZER

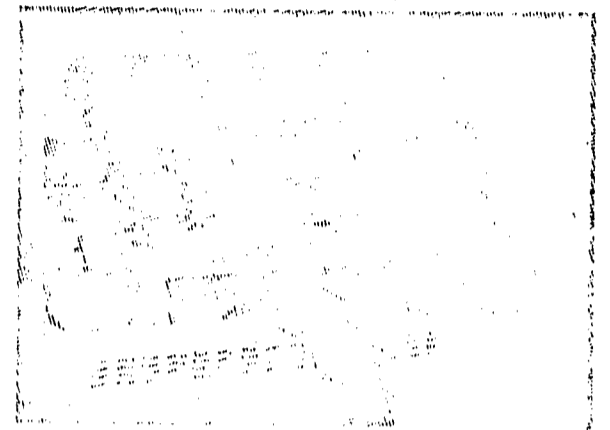
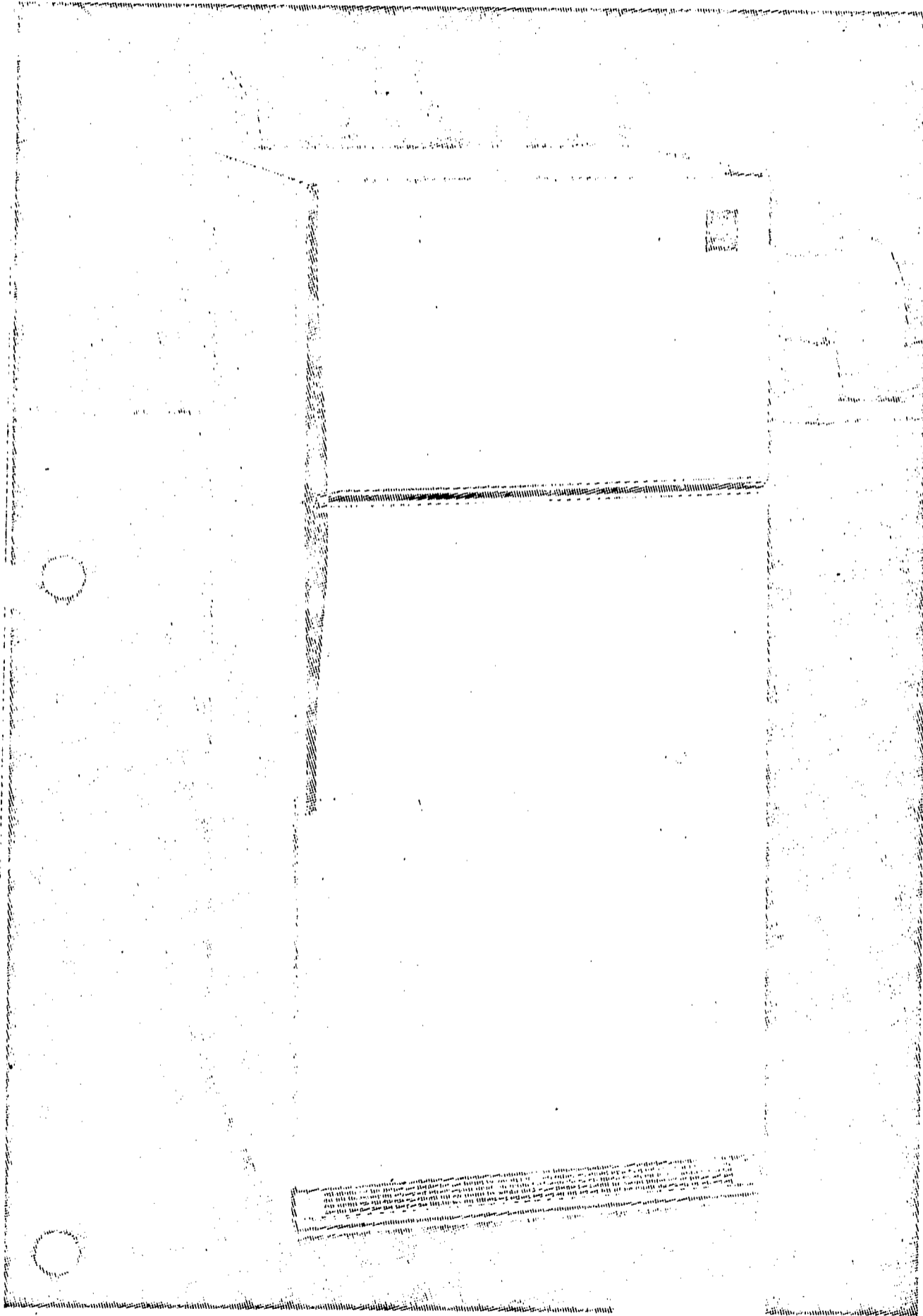

Jet Freeze Ice Compartment. Sub-zero air blows over trays, extra-fast ice. Freezer holds up to 165 lbs.

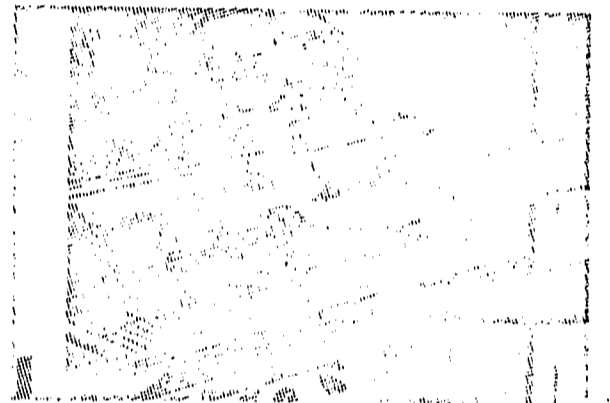

Storage convenience, four cabinet shelves, 1 adjustable, 1 slides out.

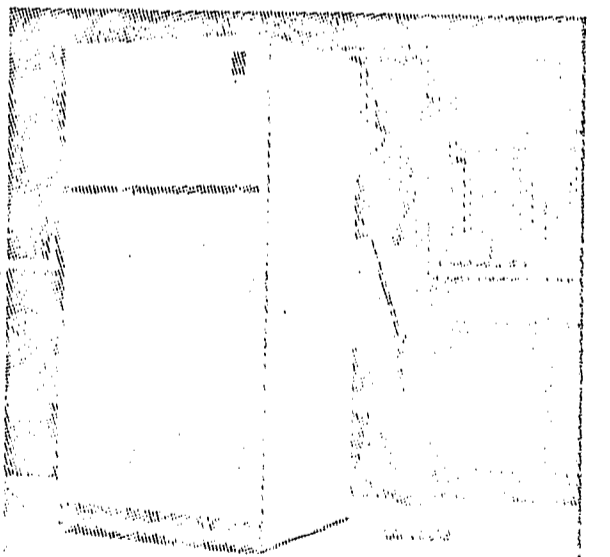

Rolls out on wheels for easy cleaning. Locks in place for normal use.

Mobile Cold, separate temperature controls for each section!
No defrosting—ever!

17.6 cu. ft. NO FROST REFRIGERATOR-FREEZER Model TBF-18SE

Jet Freeze Ice Compartment
Sub-zero air blows over trays, freezes ice extra fast!

Storage Convenience
Four cabinet shelves, 1 adjustable, 1 slides out.

Rolls out on Wheels
Makes cleaning and redecorating easy! Simple to retrieve lost articles.

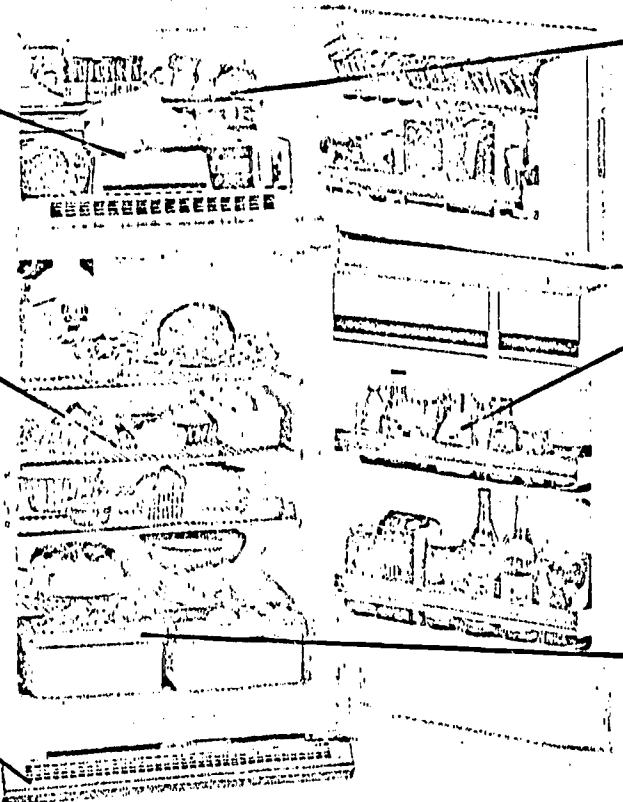

Giant zero-degree Freezer
Holds up to 165 lbs.
Flip-up shelf, door shelf and rack for 11 juice cans.

On the door storage
Two full width shelves including deep shelf for 1/2 gal. milk cartons, tall bottles.
Butter compartment.

Twin Vegetable Bins
Hold up to 2/3 bu.
Porcelain-on-steel, easy to clean.

Colors: Avocado, Coppertone, Harvest and White.

Eye-level freezer convenience!
And no defrosting in refrigerator or freezer — ever!

IN THE FRESH FOOD SECTION
Four cabinet shelves, 1 adjustable, 1 slides out.
Twin vegetable bins hold 2/3 bu., porcelain-on-steel.
Door shelves, one deep for 1/2 gal. milk cartons, tall bottles.
Butter compartment and removable bin for 18 eggs.

IN THE FREEZER
Jet Freeze Ice Compartment, extra-fast freezing, trays protected and easy to handle.
Door shelves for 1/2 gal. ice cream cartons and 11 juice cans.
Flip-up storage shelf.

GENERAL FEATURES
Rolls out on wheels, makes cleaning and redecorating easy.
Mobile Cold with continuous air movement and separate temperature controls for each section—ideal temperatures throughout.
Coil-free back and door stops to protect walls and cabinets.

Magnetic door latch, opens easily, closes silently and securely.
Beautiful warmth-of-walnut handles, won't show fingerprints, easy to clean.
Available with right or left hand door openings.

QUALITY CONSTRUCTION
Wrap-around steel cabinet, one-piece, rust resistant finish.
Baked-on-enamel, two coats.
Porcelain-on-steel cabinet liners resist stains and acids.
Glass fiber insulation.
Permalon inner door resists oils, greases, cracking.
Fungus-resistant door gasket prevents mold growth, unsightly stains.

REFRIGERATION SYSTEM
Quiet compressor, sealed in steel; safe from air, dust and moisture.
Requires no oiling, exclusive General Electric oil cooler prolongs life.

PRODUCT WARRANTY
All General Electric refrigerators carry a one-year repair warranty against manufacturing defects on all parts of the entire refrigerator and an additional four-year warranty on the sealed refrigerating system only.

We strive constantly to improve our products. Changes in specifications or colors may be made without notice.

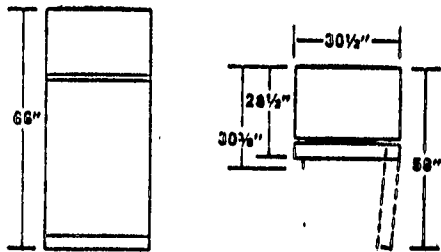

Add 1/2" to all dimensions to facilitate installations.

Net Volume: 17.6 cu. ft.
Fresh Food Section: 12.90 cu. ft.
Freezer Section: 4.74 cu. ft.
Frozen Food Capacity: 165.9 lbs.
Shelf Area: 26.6 sq. ft.
Electrical Ratings:
115 Volts AC/60 Cycles
100 Volts AC/50 Cycles
Three-prong grounding plug

You'll seldom need service on a refrigerator, but it's good to know, wherever you live, GE quality service is there.



All volumes and shelf areas are certified correct by the Association of Home Appliance Manufacturers.

Pub. No. 2-1218-14

**30" RANGE
LIFT-UP, REMOVABLE COOK TOP**



STANDARD FEATURES

COOK TOP ... Slant-front controls • High performance lifetime cast iron burners • Lift-up and removable cook top • No drip, recessed cook top • Porcelain burner box

OVEN ... Red Wheel Lo-Temp oven control • Gray porcelain oven interior • Chrome plated, non-tilt oven racks • Removable oven door and door seals

BROILER ... Roll-out broiler • 2-piece broiler pan
PLUS ... 4 leg-levelers

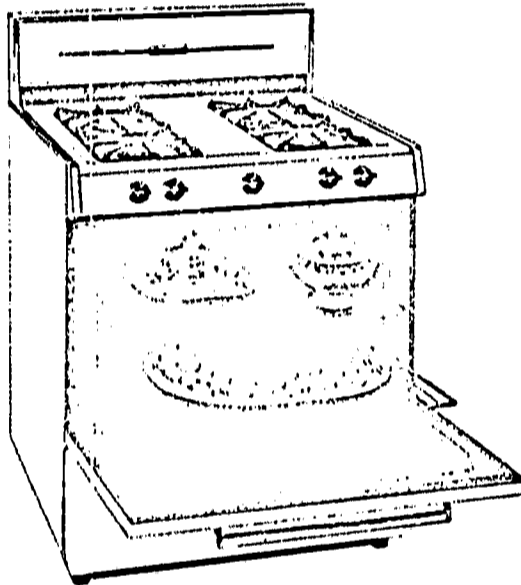

MODEL 380-1
Includes all standard features

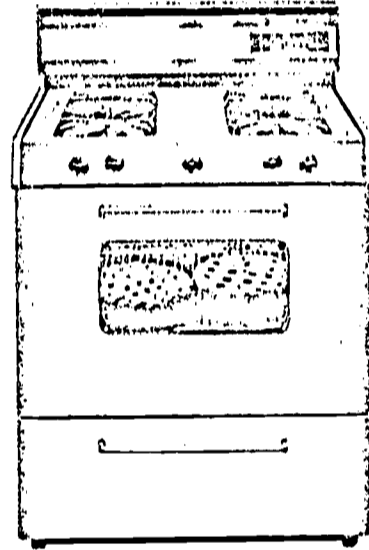

MODEL 380-2W
Includes all standard features,
plus: Clock with 1-hour timer
• Oven window and light

SPECIFICATIONS FOR 380 SERIES

MODEL	RANGE			OVEN			Approx. Ship. Wt.
	W	D	H	W	D	H	
380-1, 380-2W	30"	25 $\frac{3}{4}$ "	44 $\frac{1}{2}$ "	25"	19"	15 $\frac{3}{4}$ "	235
380-3W, 380-3PW	30"	25 $\frac{3}{4}$ "	46 $\frac{3}{4}$ "	25"	19"	15 $\frac{3}{4}$ "	240

TO ORDER COLOR: Insert key letter after series number as follows: Coppertone—C; Avocado—V; otherwise, White range will be shipped.

LEGEND P AutoMagic Cook and Keep Warm oven control
W Oven Window and Light

SPECIFICATIONS SUBJECT TO CHANGE AT MANUFACTURER'S OPTION

Portable DISHWASHER

with Built-in Soft Food Dispose

FOOD PREPARATION AREA

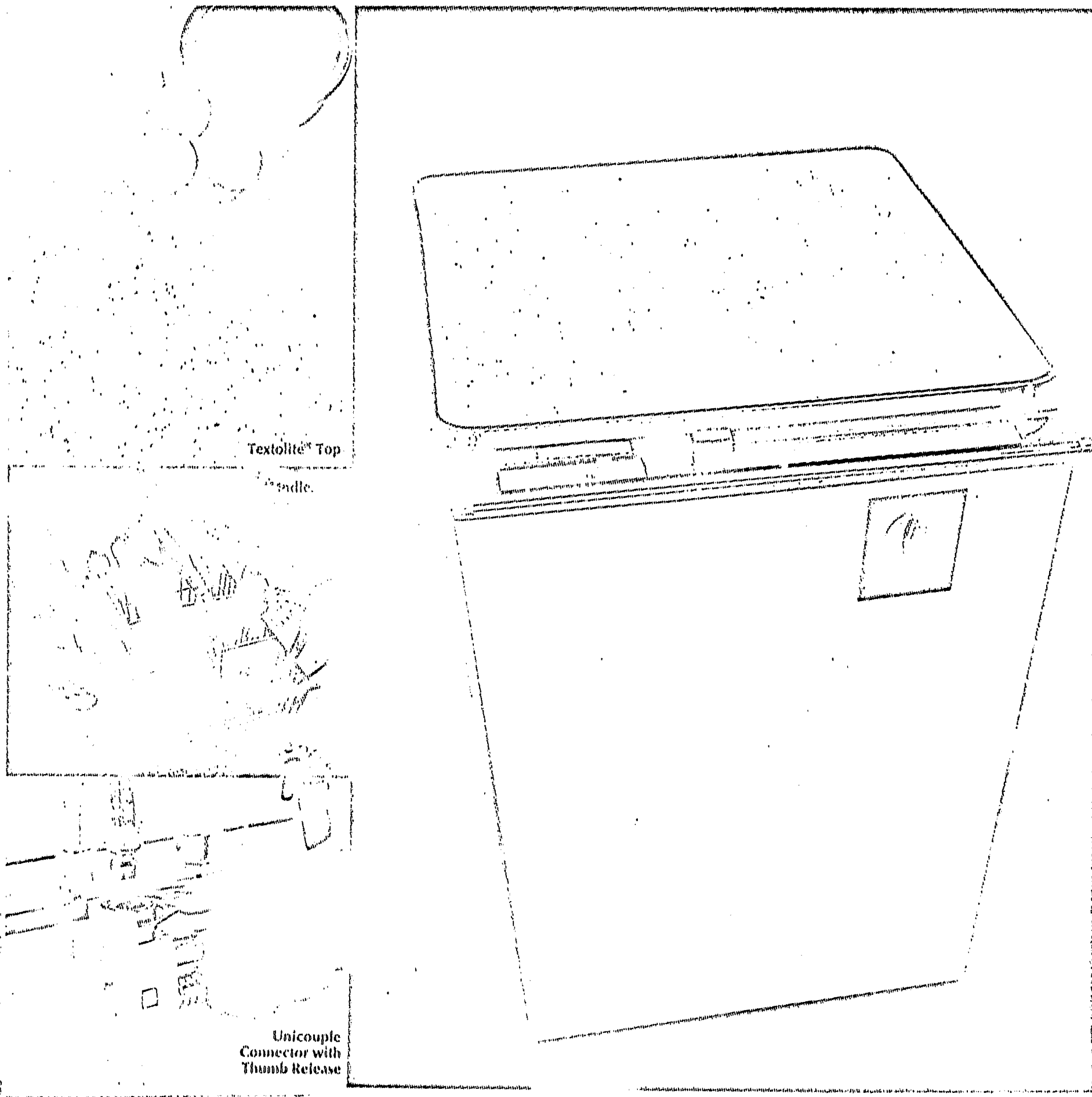

Textolite® Top

Handle

Unicouple
Connector with
Thumb Release

Quietest, most efficient operation ever with Power-Flo mechanism

The revolutionary Power-Flo mechanism—now introduced for the first time ever on a top-load portable dishwasher—gives you three outstanding advantages:

1. It reduces the sound level appreciably—makes this probably the quietest dishwasher you've ever heard.

2. It introduces a new standard of washability—gets your dishes the cleanest ever.

3. It assures you of superior levels of quality, economy and dependability.

It's the finest dishwasher power mechanism ever made.

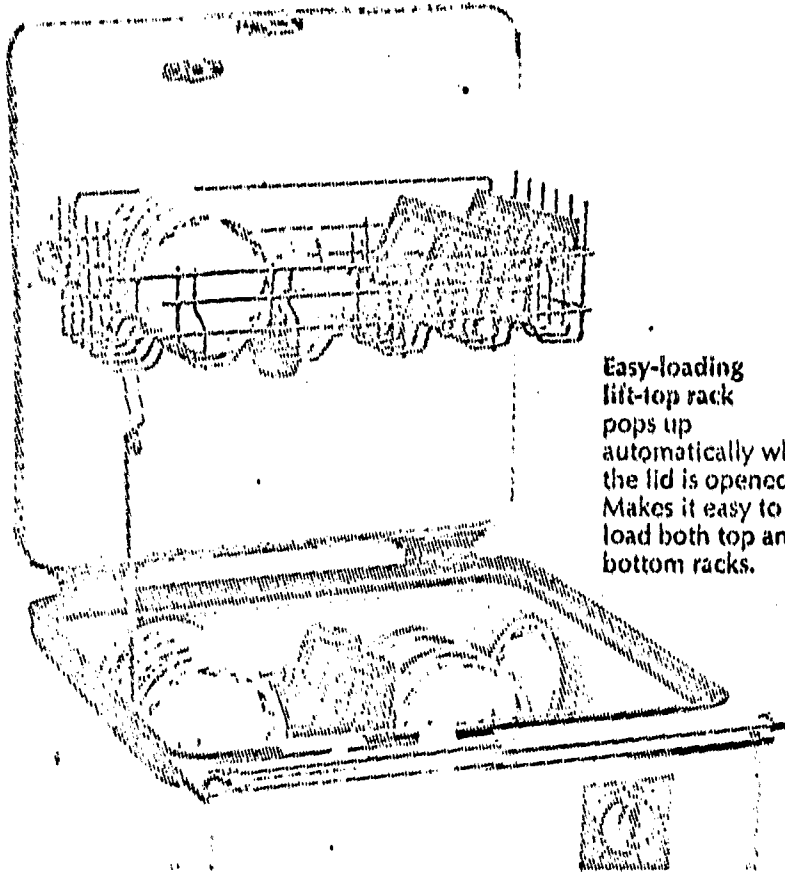

Easy-loading lift-top rack pops up automatically when the lid is opened. Makes it easy to load both top and bottom racks.

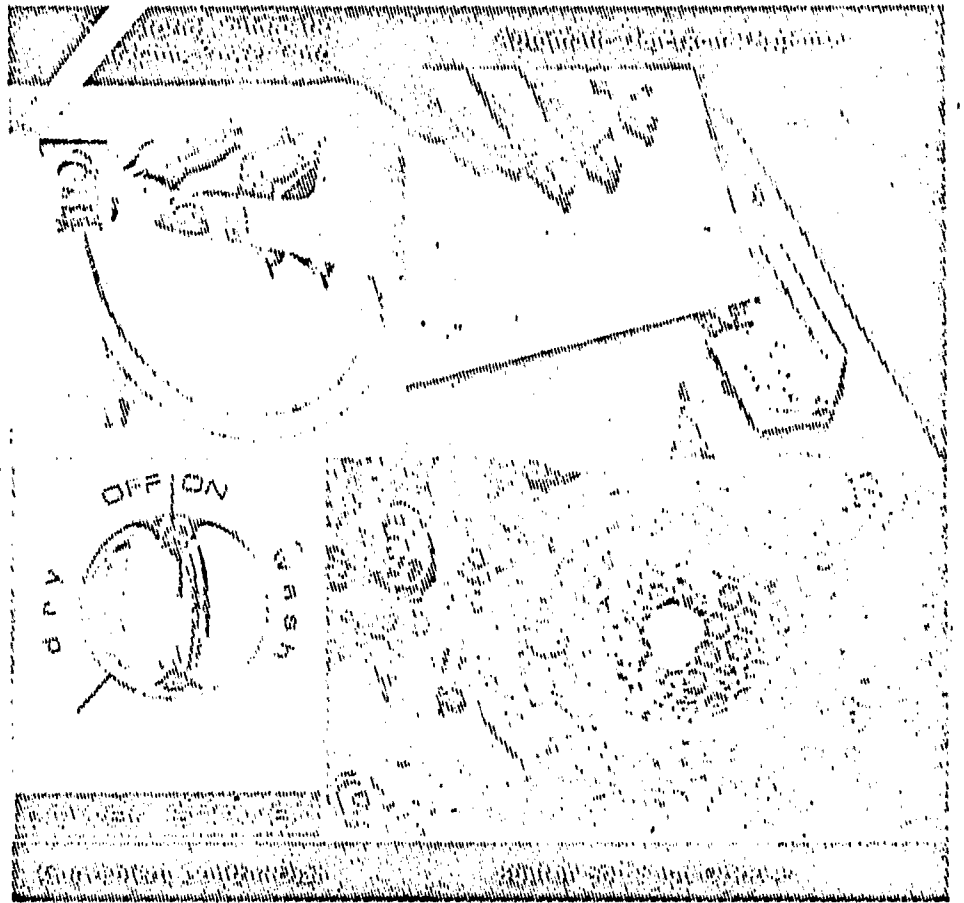

OTHER FEATURES:

Cushion Guard Tub helps protect delicate items, muffles sound • Full-width Chrome Handle and smooth rolling casters let you move the dishwasher easily from table to sink • Beautiful Cold Fleck Pattern Textolite® Top, lets your dishwasher double as a convenient roll-around kitchen work surface.



Available in: WHITE, DARK COPPER

No hand rinsing or scraping...ever...with
3-LEVEL THORO-WASH AND BUILT-IN SOFT FOOD DISPOSER



Power Arm washes all around, thoroughly scrubs and rinses dishes, pots and pans.

Power Tower forces strong jets of detergent solution up over dishes to supplement Power Arm action.

Power Shower washes down, catches dishes in powerful cross-fire with Power Tower.

Soft Food Disposer liquefies soft food scraps and washes them away. All you do is tip off large or hard food scraps.

SPECIFICATIONS

ELECTRICAL DATA CIRCUIT REQUIREMENTS

Volts 120 A.C.
Cycles 60
Amps 6.0
KWH/Cycle5
Motor Amps 6.0
Heater Watts 700

WEIGHTS (pounds approx.)

Shipping 115
Net 95

DIMENSIONS (inches)

Height 32½
Width 22
Depth 27½

WASH SEQUENCE

Pre-Rinse
Rinse
Wash
Power Rinse

Power Rinse
Power Rinse
Dry
Cycle Time—58 min. (approx.)



**FIRST
FOR
FASTEST,
TASTIEST,
MOST ECONOMICAL
COOKING**

Available in Black or Stainless Steel finish. All models feature Automatic Lighting as standard equipment. Open Burner Units (Hot Plates) can be installed on either side of Garland Griddles for "made to order" appearance.

The Grease Container is easily and quickly removed from front of griddle unit.

Griddle itself is highly polished cast iron with raised edges that prevent spill-overs. Griddle has $1\frac{3}{4}$ " high flange at the rear.

Bar type burners distribute heat evenly, making entire top a frying area. Open burner sections have round burners with port holes positioned for easy cleaning.

ALL MODELS ARE $8\frac{1}{2}$ " HIGH
GRIDDLE MANIFOLD SIZE IS $9\frac{1}{4}$ "
HOT PLATE MANIFOLD SIZE IS $1\frac{1}{2}$ "



Model 324 Griddle and Model 26 Hot Plate

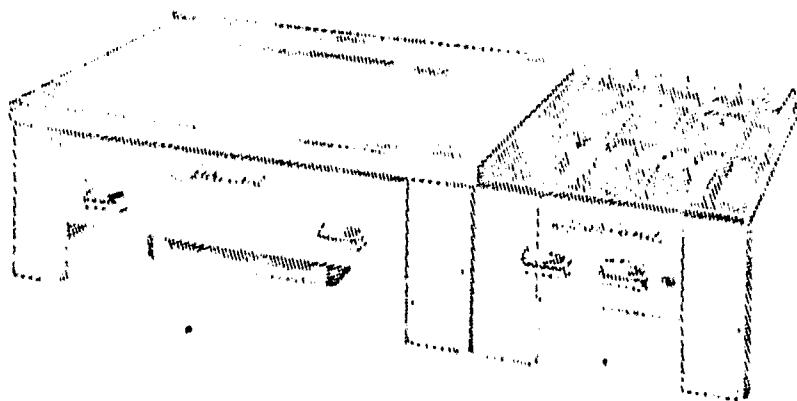

Model 324-2 Griddle and Model 26-2 Hot Plate

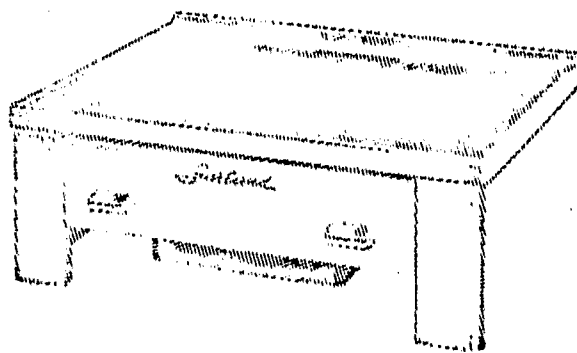

Model 324-2 Griddle

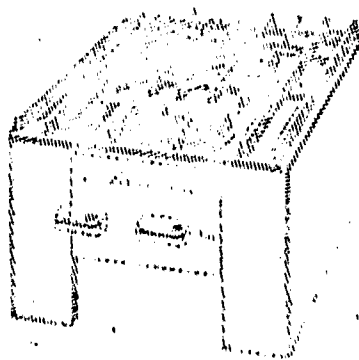

Model 26-2 Hot Plate

SEE REVERSE SIDE FOR DIMENSIONAL DRAWINGS

COUNTER GRIDDLES AND HOT PLATES

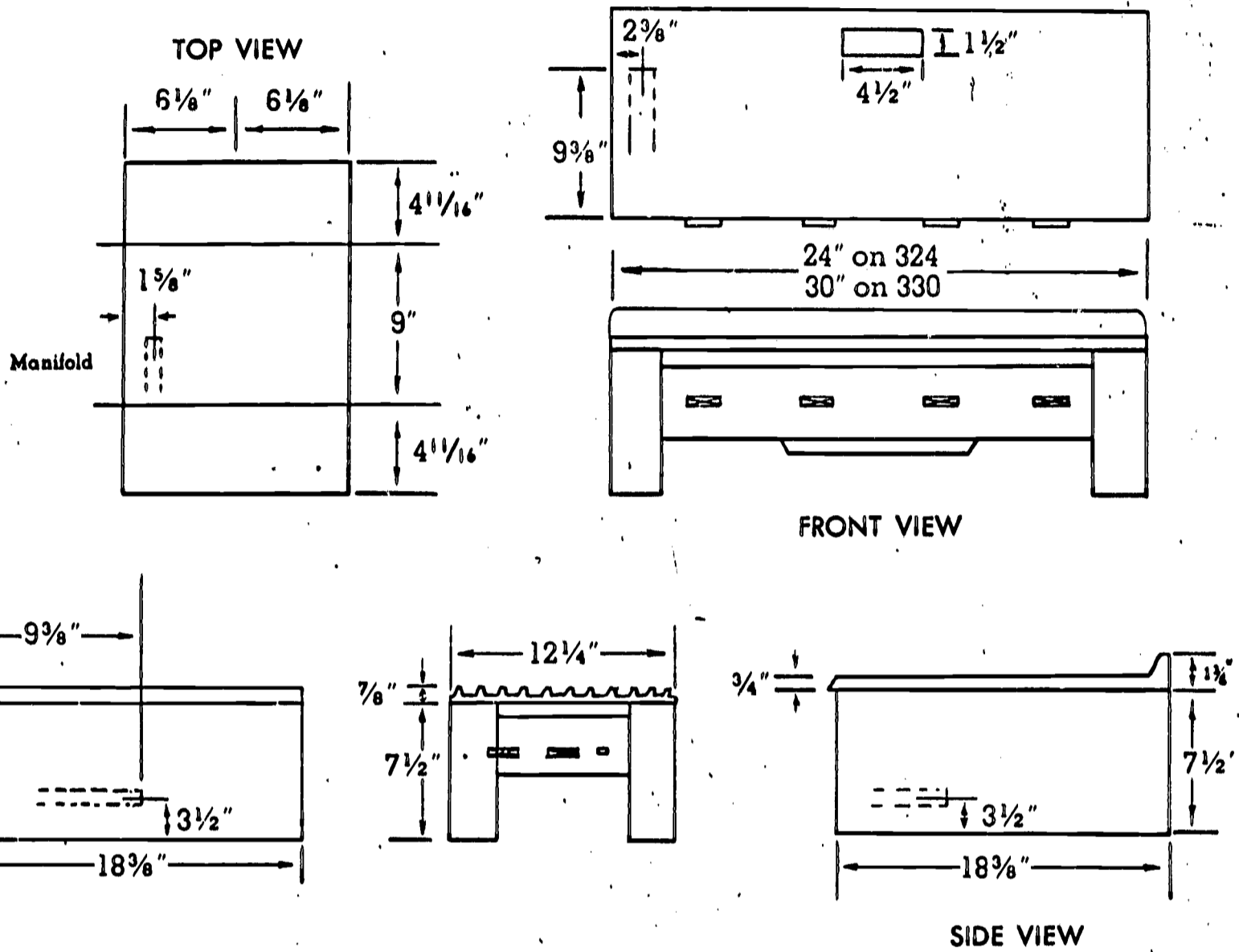

Black Japan	Stainless Steel	Unit	Space Required in.	Griddle Size in.	Graze Size in.	Grease Box Capacity Gal.	Griddle Burners	Open Burners	Shipping Weight Pounds
324	324-2	Griddle Only	19 x 24	18 $\frac{3}{8}$ x 24		1	Two (2) 12,000 B.T.U. Each		67
330	330-2	Griddle Only	19 x 30	18 $\frac{3}{8}$ x 30		1	Four (4) 12,000 B.T.U. Each		84
26	26-2	Hot Plate	12 $\frac{1}{4}$ x 19		12 x 18			Two (2) 10,500 B.T.U. Each	39

SPECIFICATIONS AND DESIGN SUBJECT TO CHANGE WITHOUT NOTICE

5-PIECE GROUP INCLUDES:

- Round Extension Table
42" x 42" x 54"
- 4 Mates Chairs

Mar proof & heat resistant
hi-pressure plastic tops.

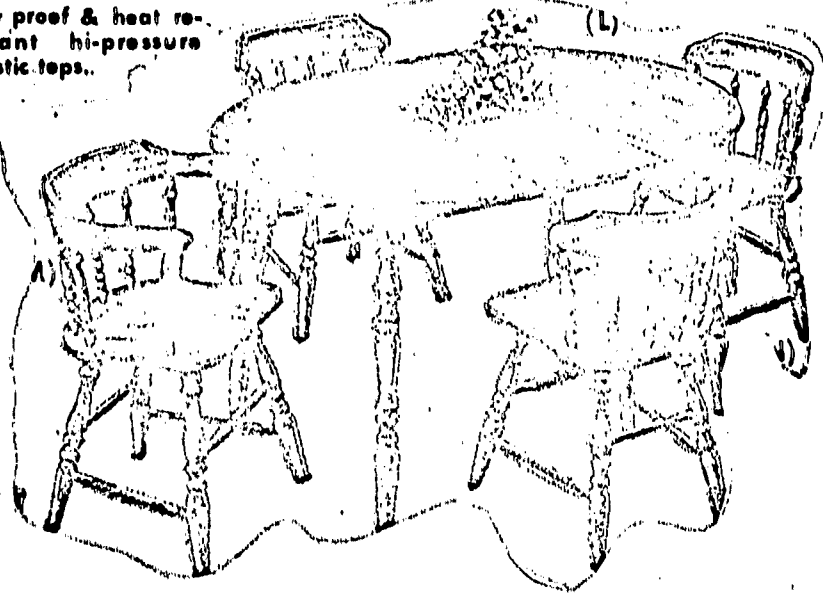

FOOD PREPARATION AREA

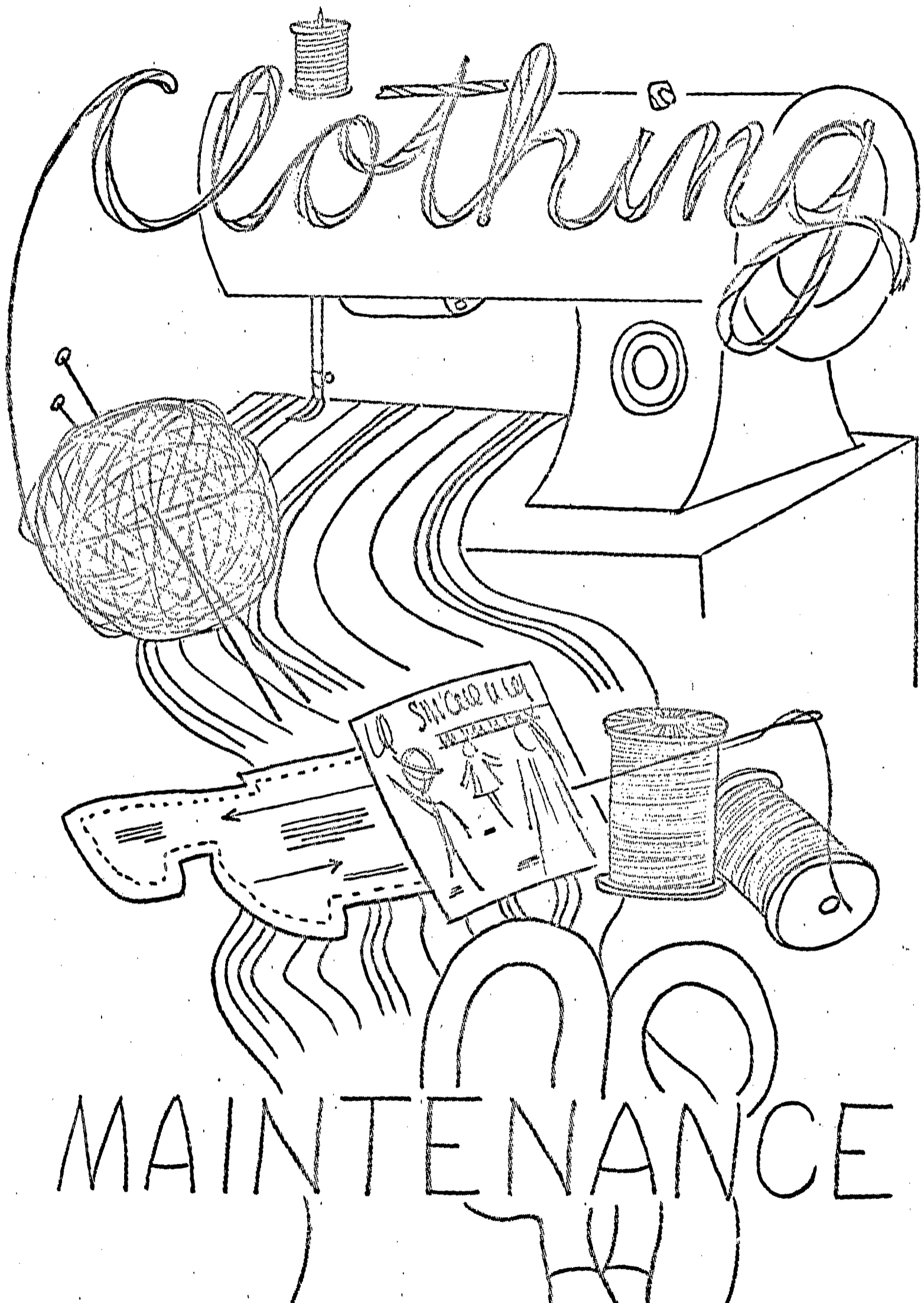

MAINTENANCE

IV. CLOTHING MAINTENANCE AREA

A. Philosophy, Purposes, and Objectives

It is our belief that an individual learns by doing. In a secondary class for educable mentally retarded this can be fulfilled by providing domestic skills which will prepare the individual to live in society as a self-sufficient and competent citizen.

Clothing maintenance and repair will provide an opportunity to develop social attitudes as well as to learn the beginning steps in clothing construction and care. The ultimate aim for each class member is to show appreciable growth within the following areas.

1. To follow verbal instructions for clothing construction
2. To show growth in learning various steps in clothing construction
3. To complete a project once it is started
4. To get along with classmates
5. To handle materials and equipment carefully
6. To help each other when asked
7. To willingly follow regulations of classroom procedure
8. To know and practice the safety measures needed in handling electrical appliances
9. To assume some responsibility
10. To show self-control
11. To improve personal appearance
12. To become interested in learning to do new things
13. To develop traits which will help one to be a more grown-up person
14. To begin to make some decisions for oneself and to accept what happens as a result
15. To begin to make plans for future work
16. To plan and carry out home responsibilities
17. To take a fair share of responsibility for helping in the care and management of the home

18. To use creative ability in making home more livable and attractive
19. To learn more about what a homemaker's job really is
20. To learn to enjoy homemaking

B. Instructional Program

1. Activities

- a. The teacher will lecture, demonstrate, and use visual aids while instructing students in the following skills:
 - (1) Daily care of clothes
 - (2) Simple repairs of clothing
 - (3) Weekly care of clothes
 - (4) Remodeling and constructing garments
 - (5) Use and care of washer, dryer, and irons
- b. The student will practice and perform the skills listed above.

2. Grouping

- a. The minimum amount of students will be five and the maximum will be ten.
- b. The arrangement of grouping will vary according to the type of activity.

C. Space Requirements

1. Laundry and clothing construction area to be approximately 400 - 500 square feet
2. Movable chalkboards and tackboards each to be approximately 4' x 8'
3. Counters and storage cabinets
 - a. Tote tray storage, 48" x 24" x 37", lockable and fixed
 - b. Cabinet with 4-way mirror and display closet, 46" x 26" x 82", lockable and fixed
 - c. Wall cabinet, 32" x 46" x 13" for storage of books
 - d. One multi-purpose table with storage for five (5) portable sewing machines
 - e. Storage for washer, dryer, 3 ironing boards with racks, 3 irons, and a clothes hamper

4. Furniture Requirements

- a. Ten straight chairs (17 $\frac{1}{4}$ H)
- b. Five portable sewing machines (9 $\frac{1}{4}$ x 17-3/4 x 13 $\frac{1}{4}$)
- c. Washer and electric dryer
- d. Three irons, ironing boards, and a clothes hamper

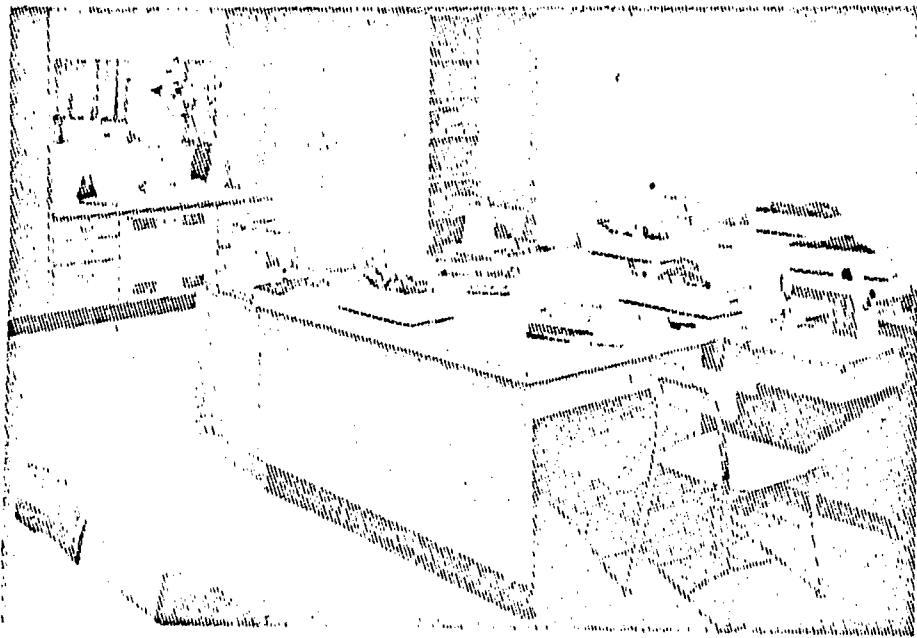

Classroom sewing area--efficient, colorful, creative.

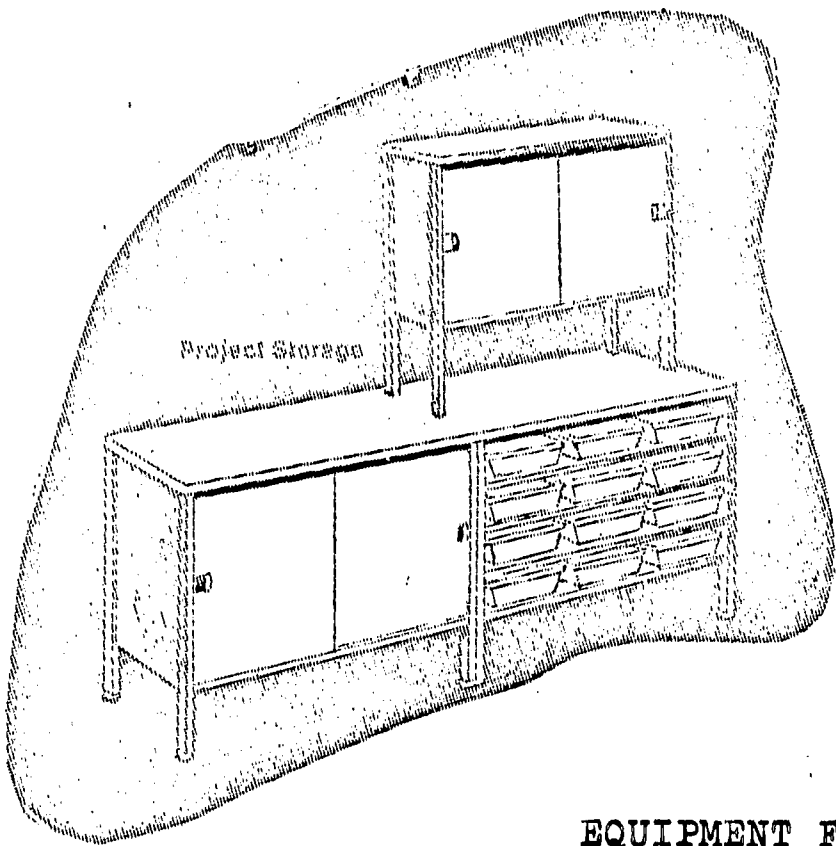

EQUIPMENT FOR CLOTHING MAINTENANCE AREA

WASHING MACHINE FOR CLOTHING MAINTENANCE AREA

Automatic WASHER

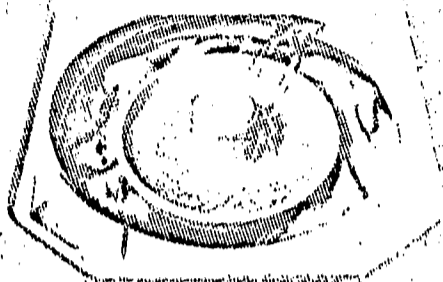
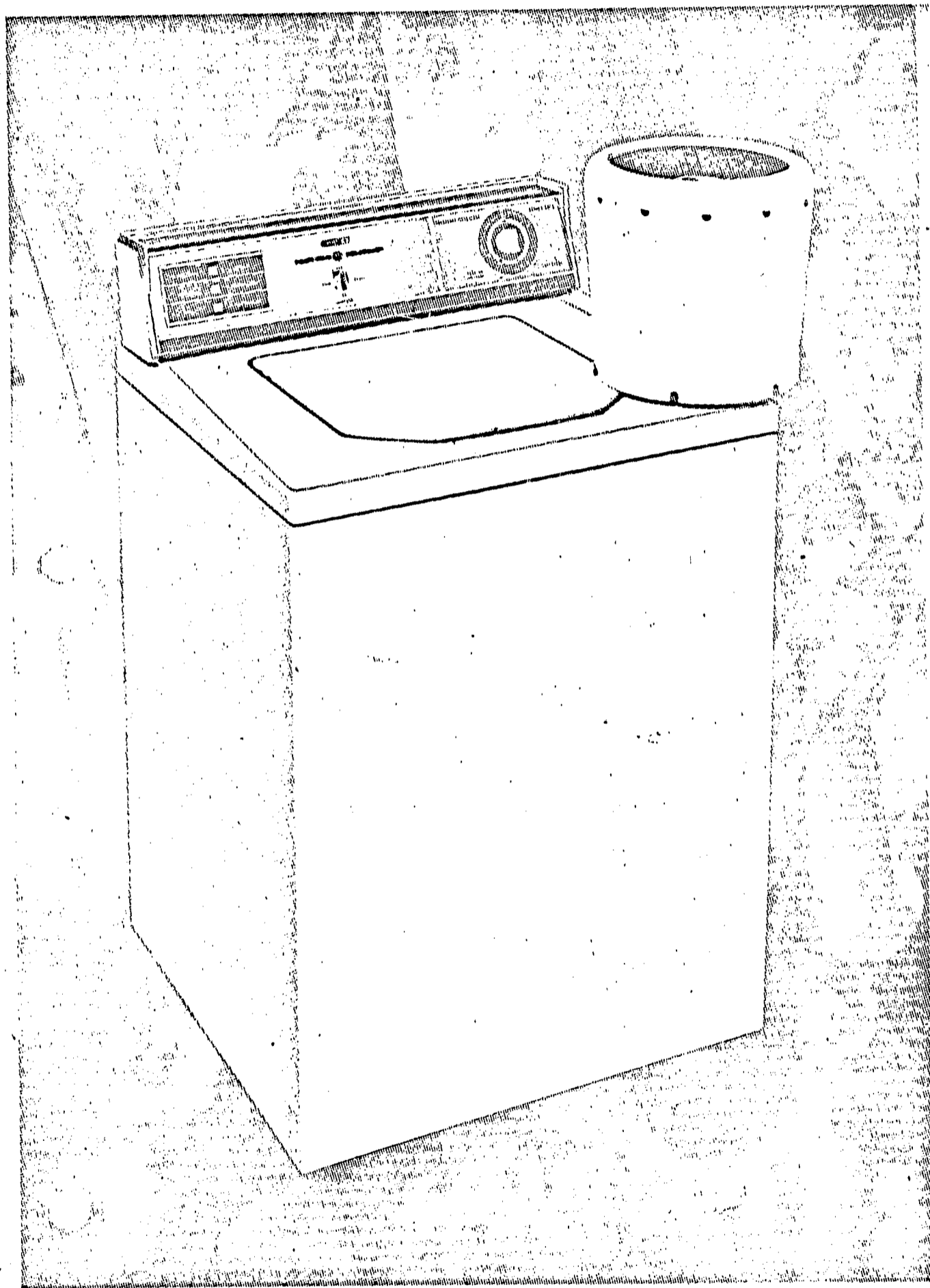

Famous Filter-Flo® Washing System

Traps lint fuzz in non-clogging, moving filter.

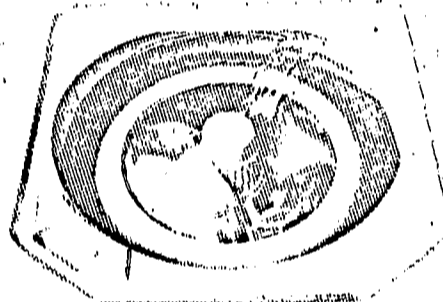

Exclusive Mini-Basket†

Carefully launders up to 2 pounds of leftovers or special garments you'd normally wash by hand.

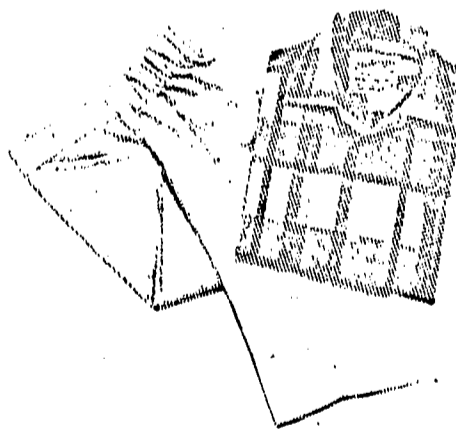

Permanent Press Cycle

Special cooldown spray rinse prevents spin set wrinkles. Keeps your ironing at a minimum!

perfect for today's new world of fabrics

Two Speed Washer with Mini-Basket Model WA 740E (Suds return model WA745E)

Tough family loads or just a handful of leftovers, let this take the hard work out of laundering. Designed to give just right care to any type of washable, simply set the selector buttons and turn the dial to suit the kind of fabric being laundered—including PERMANENT PRESS.

Two Wash Speeds/Two Spin Speeds—to pamper all your clothes from the most fragile to the toughest. Clothes stay new and fresh looking longer because correct wash and spin speeds assure washing conditions to meet requirements of each fabric.

Best in Laundering Features

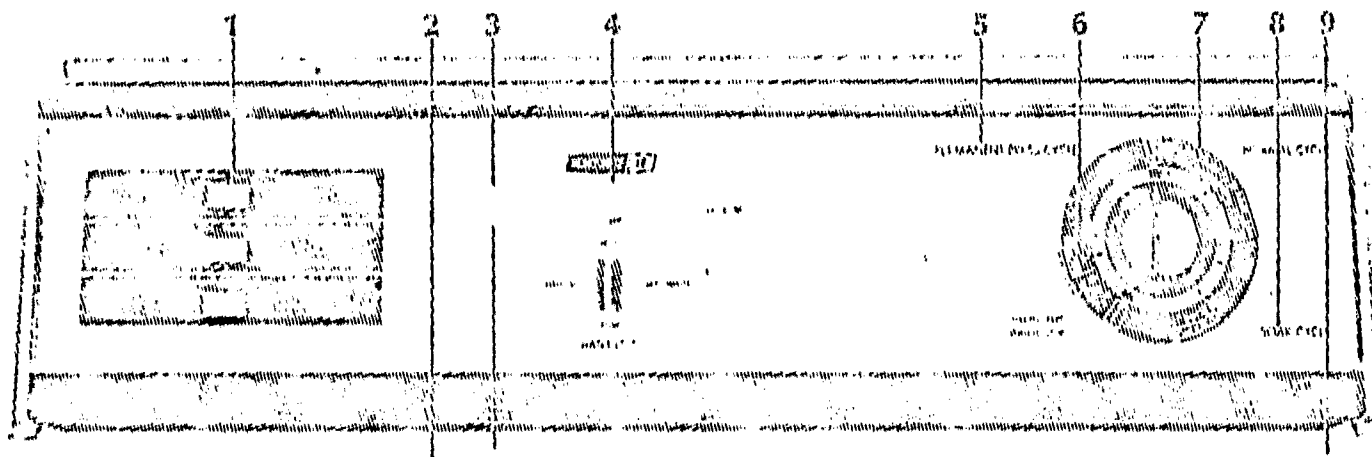

1. Multiple selector switches for wash and spin speeds; wash and rinse temperatures allow you to select the correct wash "recipe" for any type fabric load—clothes stay new and fresh looking longer.
2. Bleach Dispenser mixes bleach with wash water in outer tub. Diluted bleach then filters into load for proper bleaching action.
3. Porcelain enamel lid—underside permanently printed with brief operating instructions.
4. Four water saver load selections. Positive fill—water fills to selected level regardless of water pressure fluctuations.

5. Permanent Press Cycle sprays cold water during spin to eliminate hard creases.
6. Delicate selection shortens wash time; protects fine fabrics and fragile clothes.
7. Extra Wash lengthens the normal cycle for maximum washability without extra water or detergents.
8. Soak Cycle helps prepare heavily soiled and stained fabrics to launder truly clean.
9. Porcelain enameled top, tub, basket—durable finish resistant to water, bleach, and detergent.

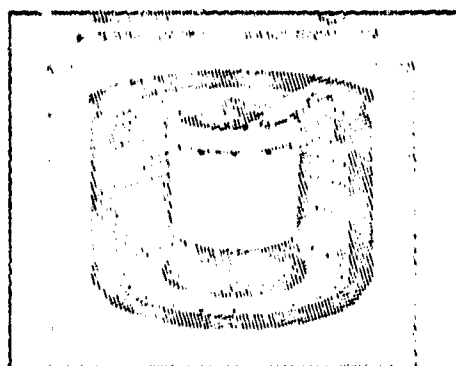

Exclusive Mini-Basket—Mini-Basket's gentle action makes it perfect for delicate items you'd normally wash by hand, and ideal for things you'd wash separately like colored things that run. Its thorough action is great for nuisance loads like sneakers; and it's made to order for small or leftover regular loads. Saves time, water, and detergent.

Hinged Cover Assembly—Provides easy service access to major components.
Cabinet—heavy gauge steel; has sturdy back struts and corner reinforcing. Cover, lid, washbasket and tub finished in porcelain enamel to resist rust, acids and alkalis.
Suds Return System (Model WA745E)—when using the normal wash cycle, hot sudsy water can be drained into a separate tub. When needed, the water is automatically pumped back into the washer for use with another clothes load. Saves water. Saves detergent. Reduces hot water heating. A set tub with minimum capacity of 27 gallons is required for "storing" the wash water.
Weight—Model WA740E approximately 221 pounds uncrated; Model WA740L approximately 227 pounds uncrated.

- Permanent Press Cycle**—automatically cools down clothing with a cold water spray; prevents "set" wrinkles.
- Filter-Flo Washing System**—effectively traps lint fuzz. Clothes are uniformly cleaned as wash water constantly recirculates through the moving, non-clogging filter.
- Unbalanced Load Control**—no-spring suspension system with aircraft type cable, gives washer high operating stability. Unbalanced loads are washed and rinsed without stopping action. Eliminates need for reset buttons or buzzers.
- Large Washbasket Capacity**—gets 16 pound loads thoroughly clean. Hole pattern assures effective removal of light soil and detergent suds; heavy substances disperse through bottom of tub.
- Transmission**—completely and permanently lubricated for life of unit; engineered for large, family size loads.
- Heavy Duty Motor**—High starting torque 1/2 HP motor provides the extra power essential for big loads. Permanently lubricated; never needs oil.
- Positive Fill**—ignores water pressure fluctuations; assures selected amount of water before washer begins to agitate.
- Self-Leveling Feet**—Rear feet automatically pivot to match manual adjustment of front feet for solid footing on any floor.

DRYER FOR CLOTHING MAINTENANCE AREA
programmed electric **DRYER**

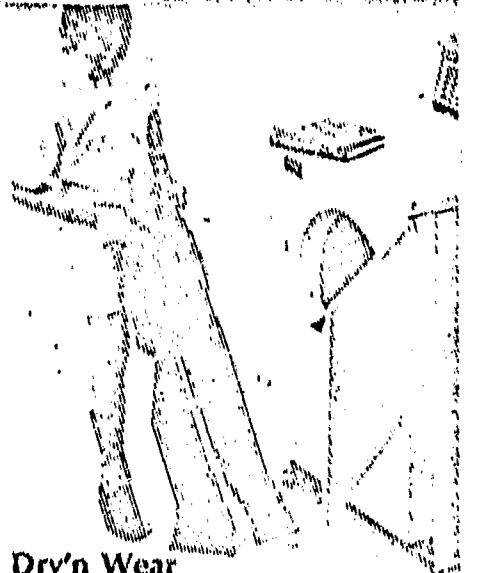
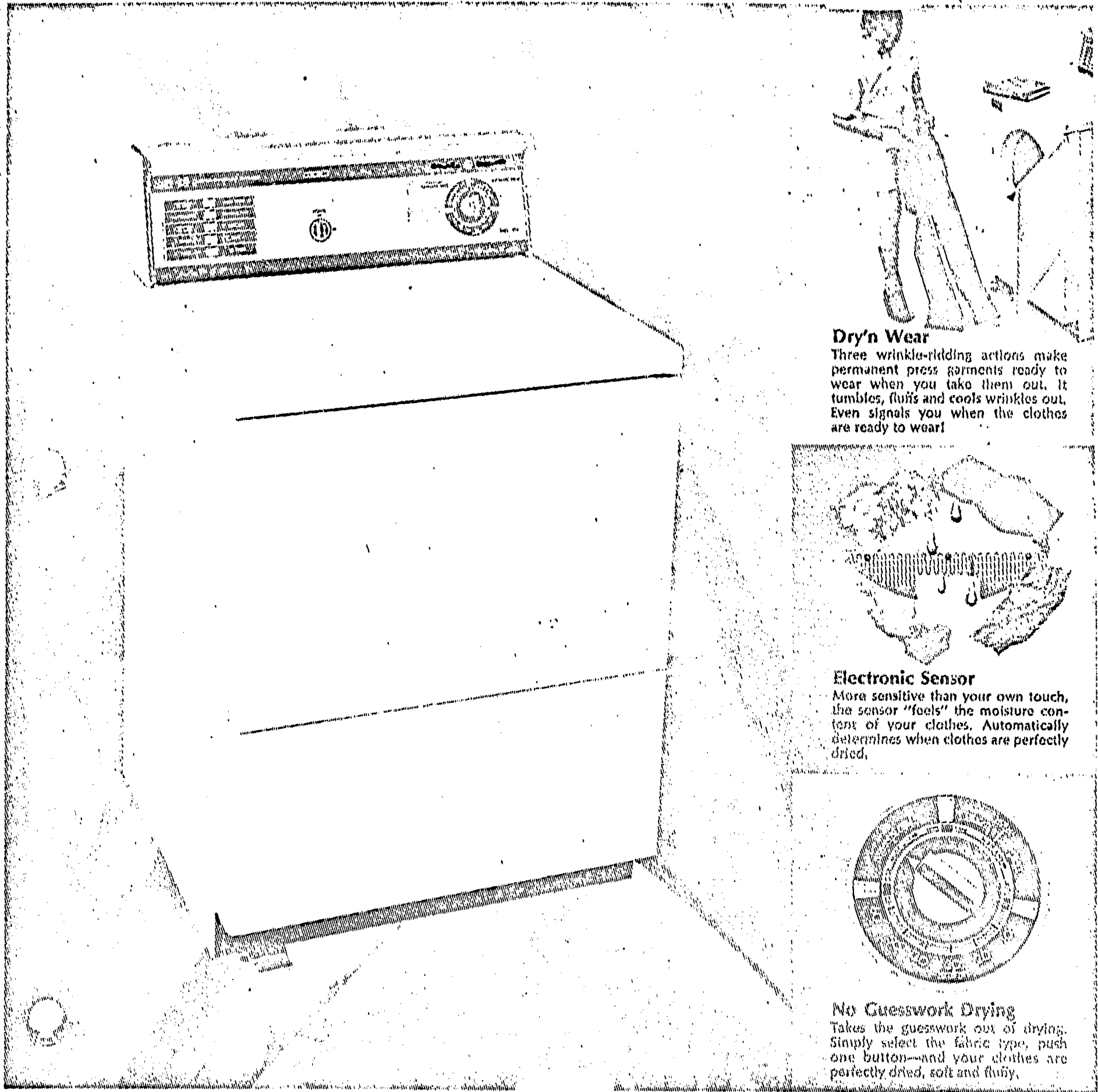

Dry'n Wear

Three wrinkle-ridding actions make permanent press garments ready to wear when you take them out. It tumbles, fluffs and cools wrinkles out. Even signals you when the clothes are ready to wear!

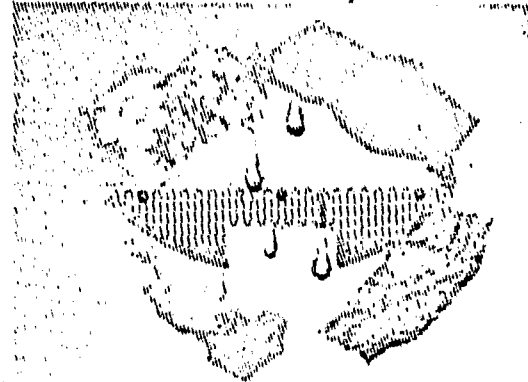

Electronic Sensor

More sensitive than your own touch, the sensor "feels" the moisture content of your clothes. Automatically determines when clothes are perfectly dried.

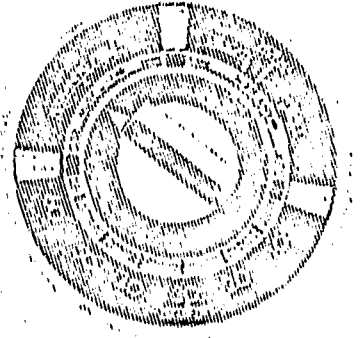

No Guesswork Drying

Takes the guesswork out of drying. Simply select the fabric type, push one button—and your clothes are perfectly dried, soft and fluffy.

perfect for today's new world of fabrics

VERSATRONIC DRYER with Electronic Sensor

Automatic Programmed drying with Permanent Press Selection Model DE 820E

No-Guesswork drying—synthetics, rugged cottons, sheers or fragile garments, this new Versatronic Dryer takes the guesswork out of drying clothes. Just push one button—dial the fabric type—and clothes come out with the correct degree of dryness. They're soft and fluffy to the touch—no harsh overdrying; no nuisance underdrying. The electronic dry control removes wrinkles from permanent press garments . . . or

you can dust draperies . . . fluff pillows . . . damp dry clothes for ironing.

Dry'n Wear—tumble drying with controlled heat in a Dryer relaxes wrinkles and fluffs the permanent press fabric to its original shape. An automatic cooldown period then reduces fabric temperature making it wrinkle resistant. Garments are then ready to wear.

The best in laundering features

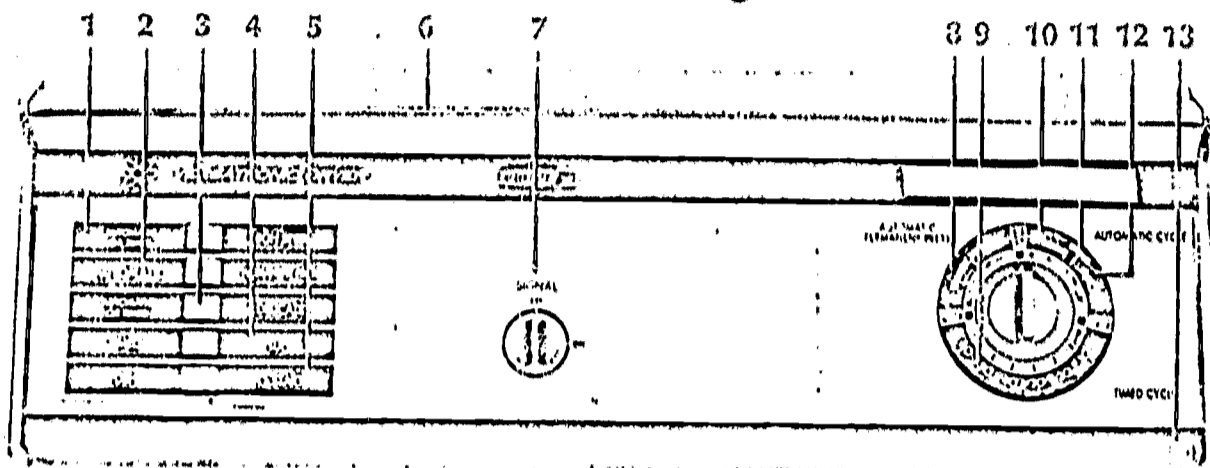

1. Automatic selector button establishes correct drying conditions for fabrics requiring high speed drying.
2. Selector button for correct drying conditions for best permanent press "no iron" results.
3. Selection for delicate fabrics like silks and synthetics that release moisture quickly.
4. Fluff gives a gentle no-heat tumbling action. Freshens stored stale clothes; put new life in shag rugs, chenille bedspreads.
5. Start button starts dryer only after door is closed. Drum stops automatically if door is opened; push button to restart. Helps prevent accidental starting.
6. Canopy shields light from eyes—brightens work surface. Turns off when drying cycle is complete.

7. Optional end-of-cycle signal buzzer sounds for one minute before completion of cycle; tells when clothes are ready.
8. Permanent press position for drying and de-wrinkling synthetics and blends.
9. Timed cycle allows manual selection of drying times up to 60 minutes.
10. Delicate setting for silks and synthetics that release moisture quickly.
11. Normal setting for cottons and linens—the things you dry most often.
12. Heavy setting for hard to dry loads. Bedspreads, bathmats, and blue jeans are thoroughly dried.
13. Porcelain enamel top and clothes basket.

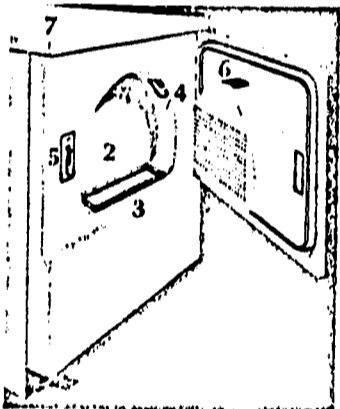

1. Porcelain enamel clothes drum for long life and protection for your clothes.
2. Full width door with large clothes-load opening—easy to load and unload Dryer.
3. Large Lint Trap—Fine mesh screen effectively filters lint from tumbling clothes. Easy to see and reach inside door opening.
4. Interior Illumination—Light inside door turns on automatically when door is opened. Brightens area when loading, unloading or cleaning. Bayonet style base lamp is easy to remove and replace.

5. Magnetic Door Latch—Foot pedal opens door wide, freeing hands when transferring clothes from washer to dryer.
6. Operating Instructions—Simplified operating instructions are conveniently located on the inside of the Dryer door.
7. Porcelain enamel top—long wearing, easy to clean.

High Air Flow System—draws volumes of properly warmed air through the tumbling clothes, drying them quickly and naturally no matter what the weather. More practical than open-air drying, perfect moisture and temperature control keeps colors bright and prolongs life of garments.

Four Way Exhaust Venting—Dryer may vent directly into room or exhaust to outside . . . through either side, rear or bottom of cabinet.

Cabinet—top and clothes basket finished in durable, easy-to-clean

porcelain enamel. The rest of the cabinet finished in baked acrylic enamel to resist rust, chipping and cracking.

Adjustable Feet—keeps Dryer perfectly level in all installations.

Electrical Rating—for 240 volt operation: 240 volts, 60 cycles, 5600 watts, single phase. A 30 amp, 3 wire circuit required. For 208 volt operation: 60 cycle, 3 wire, single phase, dryer wattage is 4400 watts.

Motor—cushion mounted, permanently lubricated ¼ HP motor with overload protection; resets automatically.

Weight—approximately 141 lbs. uncrated.

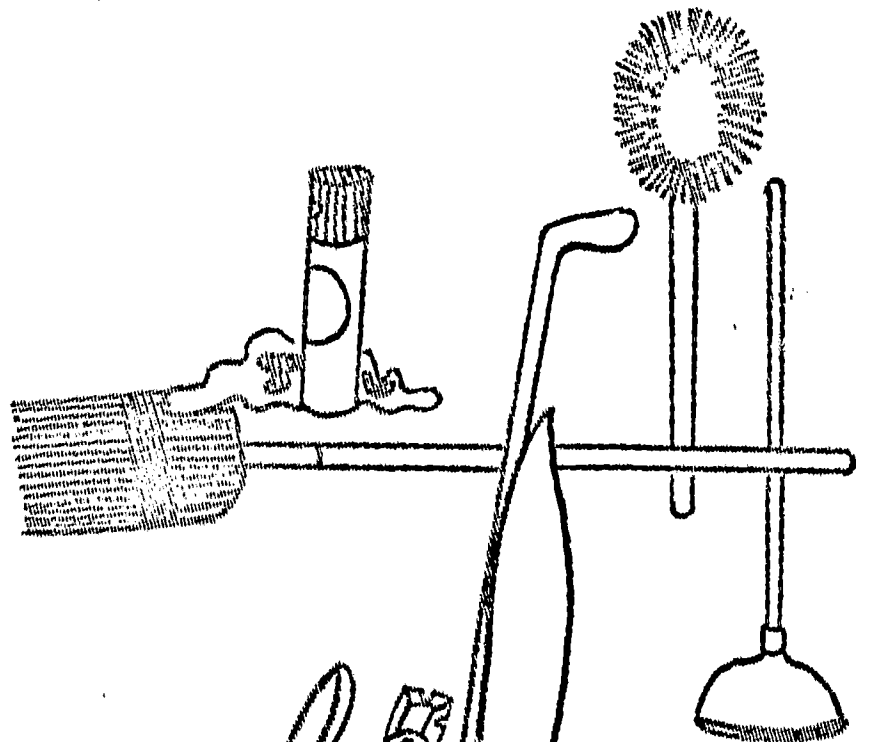
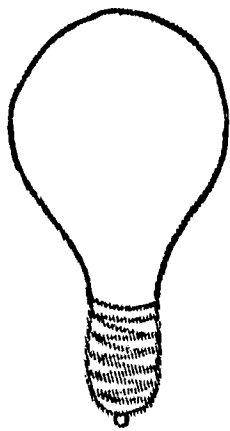
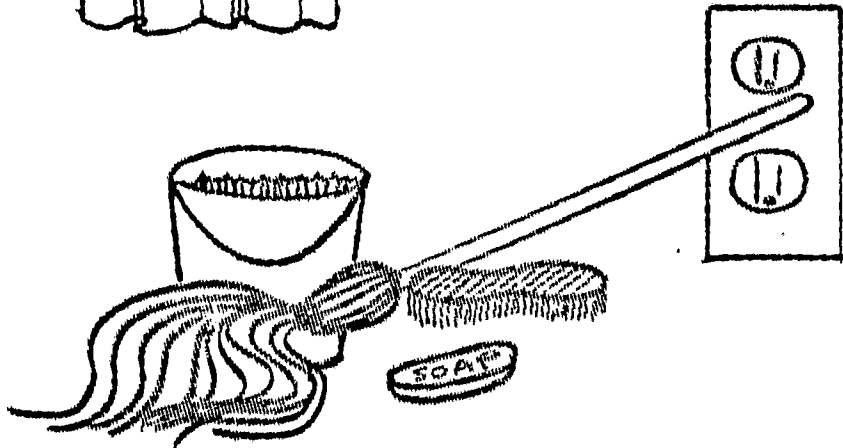
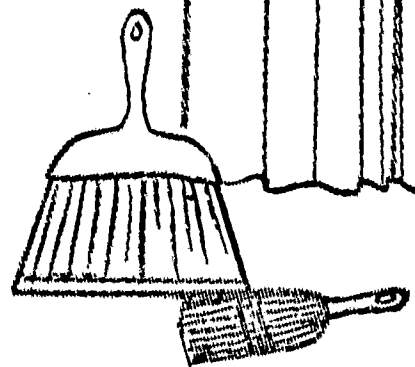
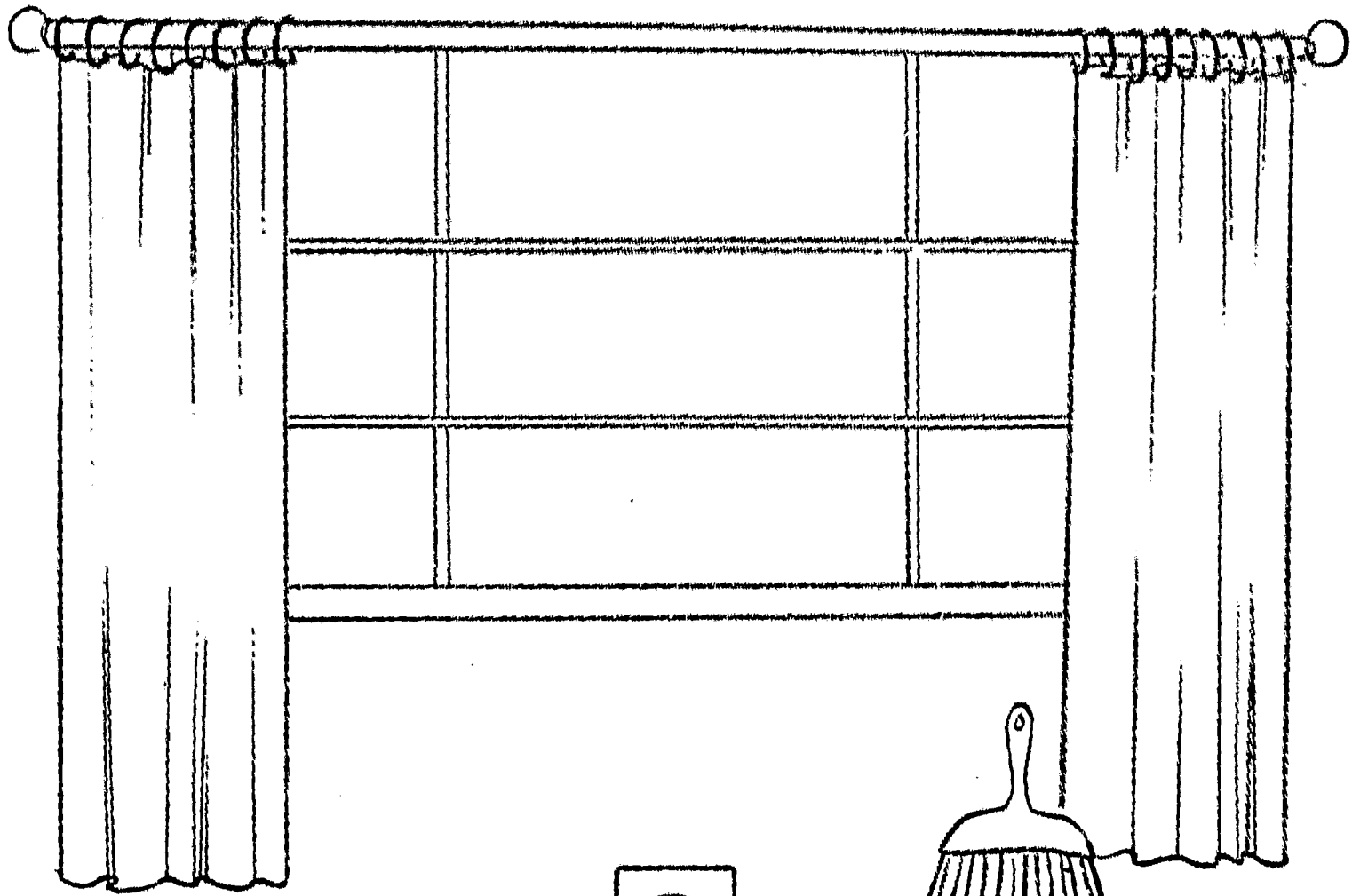

Homemaking

V. HOME LIVING AREA

A. Philosophy, Purposes, Objectives

The purpose of the Home Living Area is to enable the educable mentally retarded student to learn home living skills through use of a simulated living area to afford the practices of proper furniture maintenance skills and attractive arrangement of furniture.

B. Instructional Program

1. Activities

- a. A teacher will demonstrate techniques and instruct small groups in home living skills.
- b. Student will practice proper furniture maintenance skills and learn attractive arrangement of furniture.

2. Groupings

Minimum of one and maximum of six students

C. Space Requirements

1. Square feet needed: 108
2. Display space near home living area
3. No chalkboard or tackboard space
4. No counters or storage cabinets
5. One small clothes closet for wraps of visitors
6. Furniture
 - a. One sectional sofa that will seat six students and can be arranged in a variety of groupings
 - b. One corner table to complement sofa
 - c. One coffee table
 - d. One lamp for corner table
 - e. One pair of drapes for wall behind sofa grouping
 - f. One rug, approximately 6' x 9'

D. Special Consideration

One restroom facility for teachers and guests to be located near teacher workroom and entrance to facility

DANISH MODERN

Delightfully smart Danish styling for today's modern homes. This group brings you style, beauty, and years of comfort and durability.

- Hardwood Frames
- Zippered Cushions
- Walnut Finish

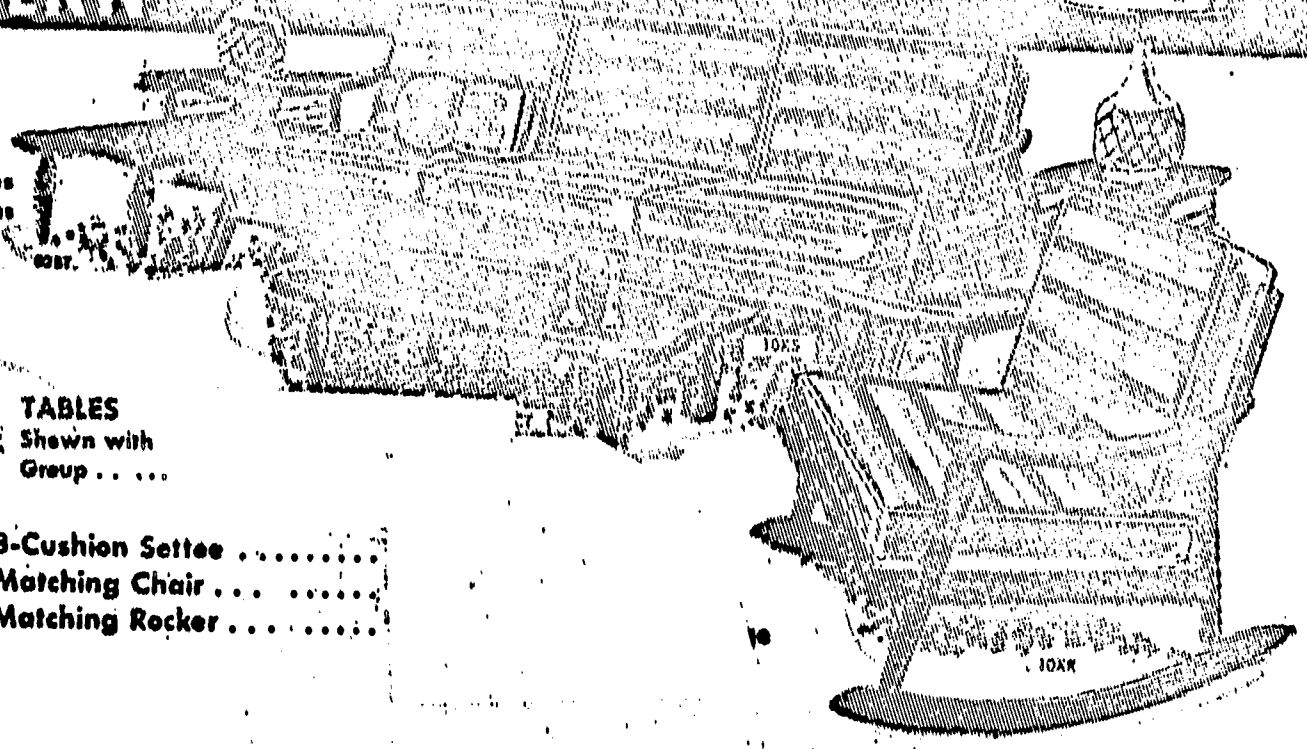
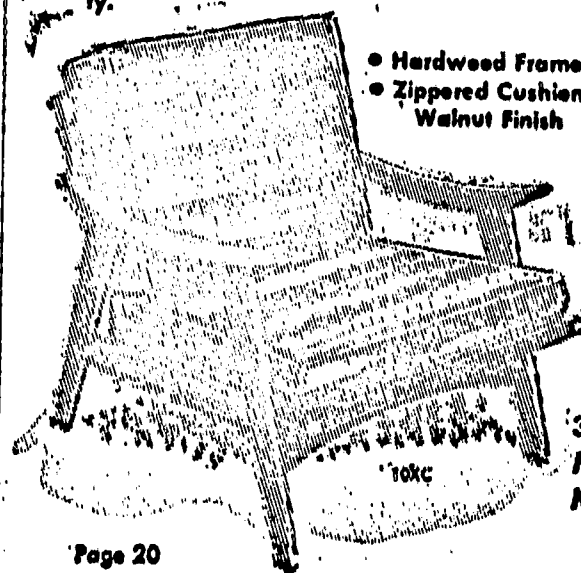

TABLES
Shown with
Group

- 3-Cushion Settee
- Matching Chair
- Matching Rocker

HOME LIVING AREA

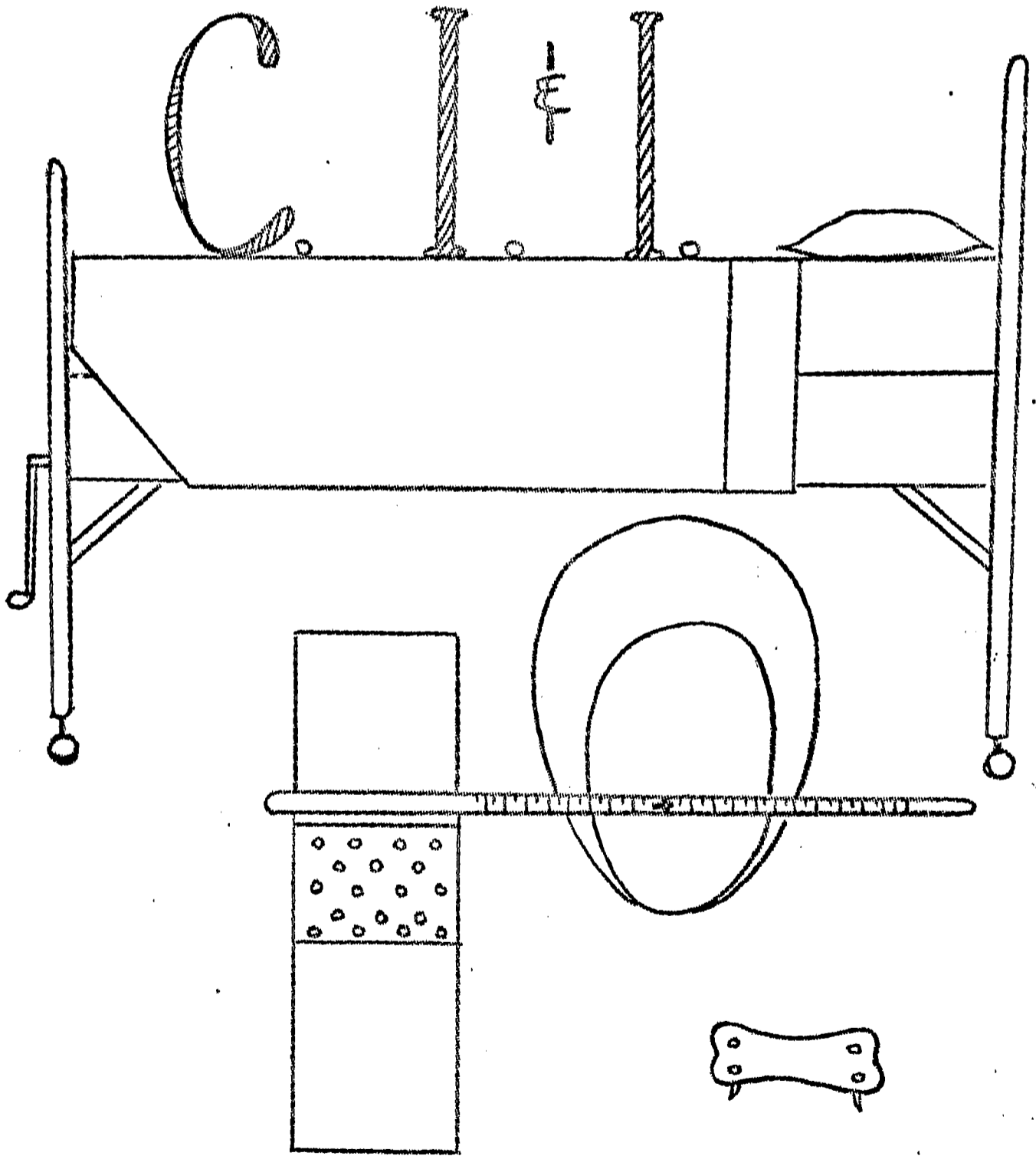
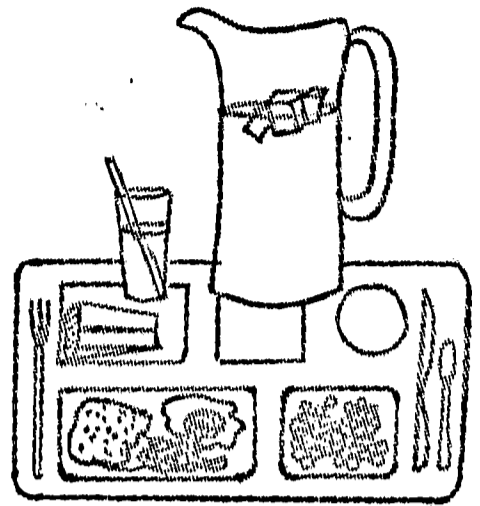
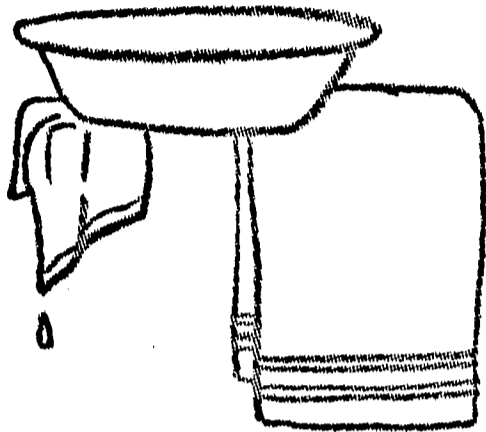

VI. CARE OF INVALID AND INFIRM

- A. Because of the number of job opportunities in the geographical area that relate to the care of the invalid and infirm, the facility will house a limited amount of equipment and materials for this purpose.
- B. Instructional Program's Activities
 - 1. Teacher will instruct in subject matter and skills, as well as, supervise student practice and performance of skills necessary to care of invalid and infirm.
 - 2. Students will work toward the development of the knowledge, skills, and attitudes which will make them employable.
- C. Space Requirements
 - 1. Square feet required - approximately 36
 - 2. No special display space, chalkboard, or tackboard space
 - 3. One cabinet, fixed and lockable, 9'W x 4'D x 6'H, to house hospital bed and night stand for same. Shelves to be placed in cabinet above bed and night stand are to be used for storage of additional hospital equipment and materials.
- D. Special Considerations

None

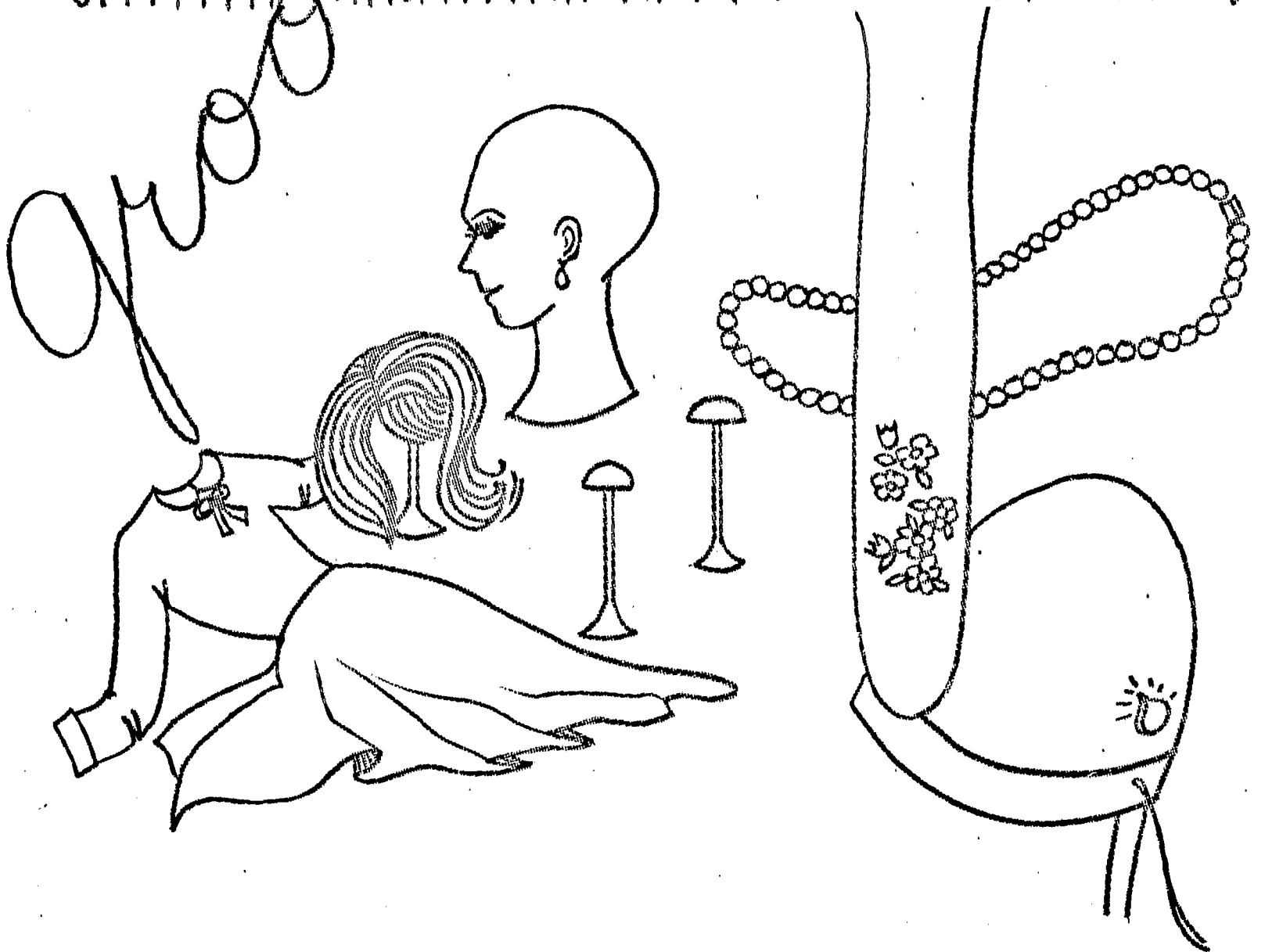
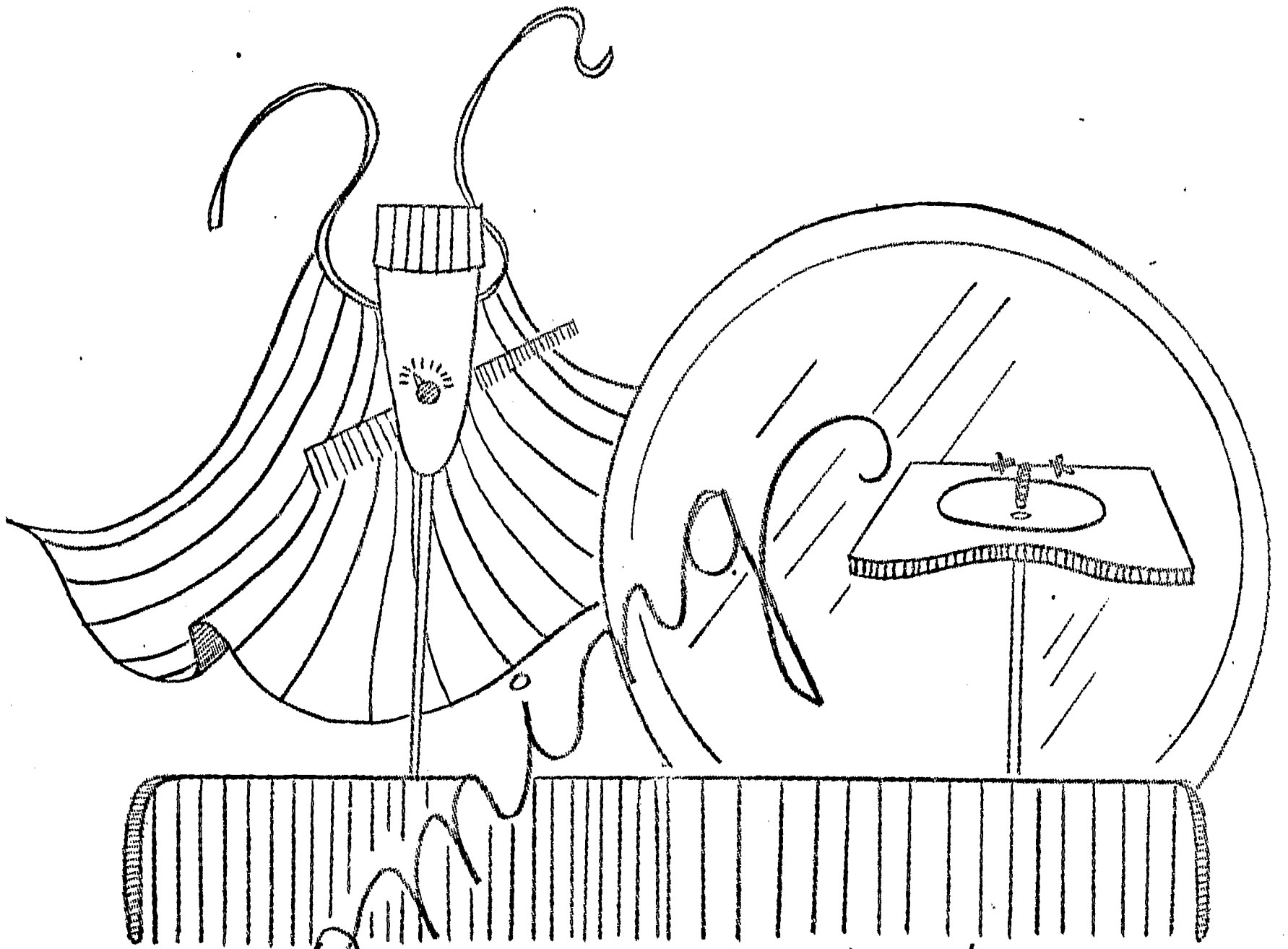

VII. GROOMING AREAS

A. Philosophy, Purposes, and Objectives

In addition to the basic academic areas of training and development and to the learning laboratory experiences, attention will be given continually to the strengthening of personal characteristics which are considered essential to employability. Some of the most important characteristics are good habits of personal grooming.

B. Instructional Program

1. Activities

- a. The teacher instructs in skills necessary for personal grooming, care of hair, nails, and complexion
- b. The teacher supervises students' practice in performance of skills of personal grooming
- c. The teacher instructs and supervises students' practice in cleaning and care of beauty shop equipment
- d. Students will work toward the development of the knowledge, skills, and attitudes toward personal care and grooming that will make them employable

C. Space Requirements

1. Square feet requirements approximately 80, for a beauty bar
2. Rest room facilities for girls and boys to include showers. Boys' rest room to be located near shop areas and girls' near food preparation areas, if practicable.
3. One cabinet, lockable and fixed, 2'D x 3'H x 30"W, to be centered between the two stations, drawered, to store beauty equipment
4. No display, chalkboard, or tackboard space except on dividers used for privacy from classroom area
5. Counter top area - 8'L x 30"W x 3'H

D. Furniture Requirements

1. One beauty parlor sink
2. One operator's chair
3. One mirror - approximately 6' x 3'
4. One reclinable chair, to be used for washing at sink
5. One hair dryer

E. Special Considerations

1. Flooring to be of easily cleaned tile, or urethane flooring
2. Intercom, bell, and fire alarm systems
3. Air-conditioned and heated
4. Indirect lighting to be highlighted on the two stations and the mirror
5. Plumbing for sink
6. Outlets for hair dryer
7. Two double electrical outlets at each station

YARD

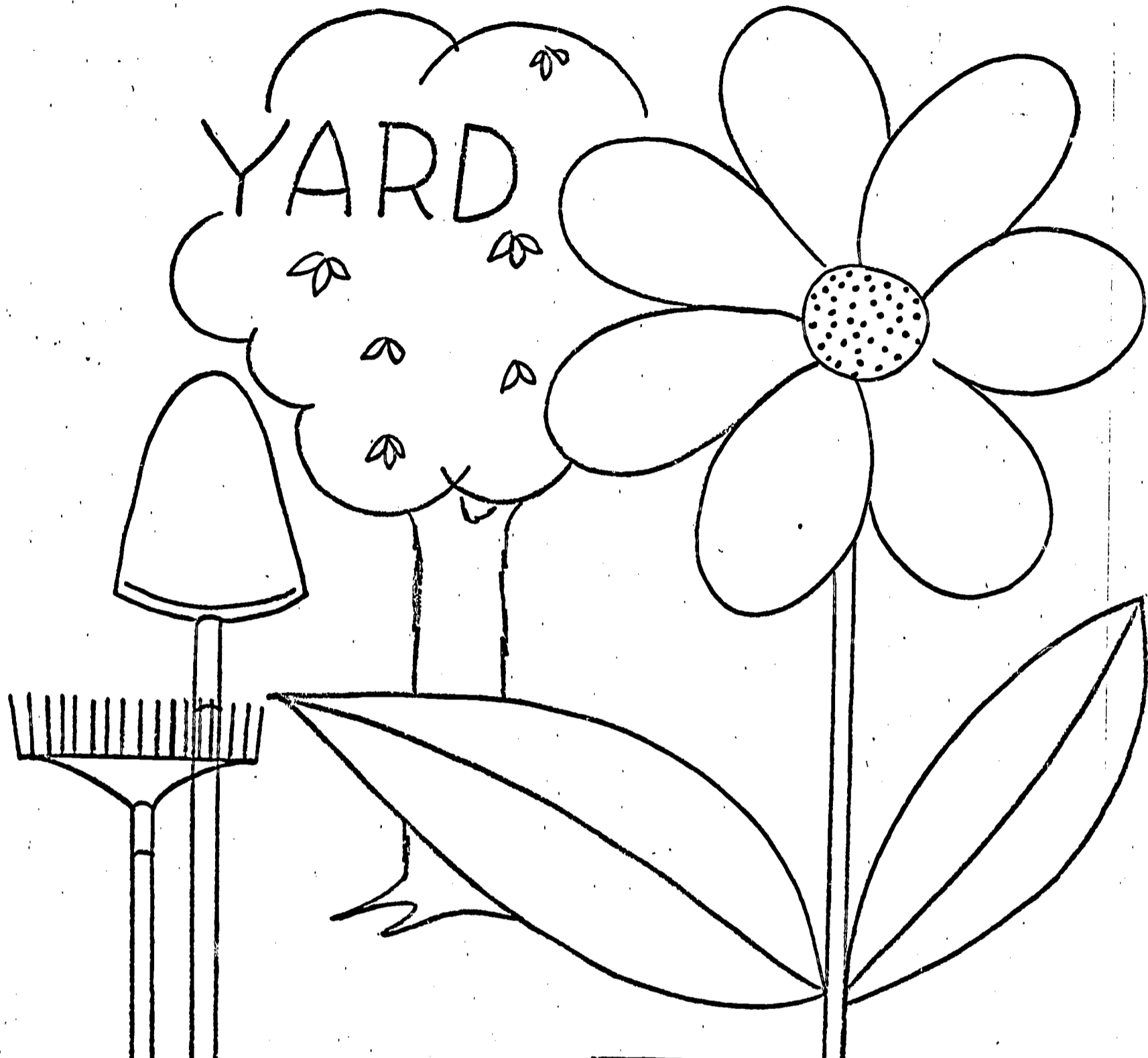

NURSERY &

Gardening



VIII. GREENHOUSE, ORNAMENTAL HORTICULTURE, NURSERY,
and YARD MAINTENANCE AREAS

A. Philosophy

To educate, enlighten, and encourage the individual so that he might equip himself to meet both his vocational and his civic responsibilities to the limit of his capabilities. To assist the individual student in preparing himself for establishment in yard maintenance, greenhouse, ornamental horticulture, and nurseryman skills.

B. Objectives

1. To develop the abilities needed to exercise and follow effective leadership in fulfilling occupational, social, and civic responsibilities.
2. To develop an understanding of and an appreciation for career opportunities in yard and greenhouse maintenance.
3. To develop competencies needed by individuals engaged in or preparing to engage in yard and greenhouse maintenance.

C. Curriculum Trends

To have value as vocational education the instructional program in greenhouse and yard maintenance must place major emphasis on actual practice under supervision in as many instructional areas as can be arranged.

D. Program

1. Development of greenhouse and yard maintenance competence through:

a. Academic program

- (1) Mathematics skills
- (2) English/reading skills
- (3) Science skills
- (4) Effective living skills

b. Laboratory program

- (1) Ornamental horticulture skills
- (2) Yard maintenance skills
- (3) Landscaping skills

c. On-the-Job program

- (1) Occupational adjustment
- (2) Occupational proficiency
- (3) Occupational competence
- (4) Appropriate greenhouse and yard maintenance skills

2. Instructional Activities

- a. Lecture: Teacher introduction and reinforcement of new or re-introduced materials. Principally, teacher-active; student-passive activity
- b. Discussion: Teacher-pupil follow-up of introduced materials. Purpose of discussion is to emphasize important points of lecture and text of academic or vocational subjects.
- c. Demonstration: Teacher performance of vocationally oriented projects for purpose of concrete learning experiences prior to actual performance of such projects by students
- d. Practical Performance: Student performance of demonstration. Actual manipulation of laboratory equipment
- e. Evaluation: Teacher-student rating of work performed in laboratory
- f. Follow-up: Review of all aspects of instructional unit. Re-emphasis of important points and clarification of aspects remaining unclear. Occupational involvement assessment.
- g. On-the-Job: Work experience with yard maintenance and greenhouse skills in an actual job atmosphere

3. Grouping

a. Academic program

- (1) Maximum 18
- (2) Minimum 1

b. Laboratory program

- (1) Maximum 6
- (2) Minimum 1

c. On-the-Job

One-to-one ratio of student to employer

d. Hours*

- (1) Academic Program will be approximately 3 to 4 hours daily
- (2) Laboratory Program will be 2 to 3 hours daily
- (3) On-the-Job - training will be three hours daily

* Hours may vary according to immediate need

E. Space Requirements

1. Greenhouse with glass roof and sides and concrete floor - 20 square feet per pupil with a maximum of six (6) pupils
2. One 4' x 6' x 6' storage cabinet, locked and fixed, to house all hand tools and yard and greenhouse equipment.
 - a. Six garden rakes
 - b. Six fan rakes
 - c. Six round point shovels
 - d. Six square point shovels
 - e. Six garden hoes
 - f. Six scuffle hoes
 - g. Six lawn edgers
 - h. Six hedge shears
 - i. Twelve 5/8 garden hose
 - j. Three - three-gallon hand sprayers
 - k. Twelve hand spades
 - l. Two wheelbarrows
 - m. Three sprinkling cans
 - n. Six buckets
 - o. Six budding knives
 - p. Twelve hand rakes (finger rakes)
3. Storage space for Gravelly tractor and attachments and two Clinton mowers, to be pre-fabricated building purchased by the District School Board of DeSoto County.
 - a. One rotary mower
 - b. One riding sulky
 - c. One utility cart
 - d. One reel attachment
 - e. One sprayer attachment
4. Two 4' x 6' x 3½" mist benches
(4 mist heads with automatic timer)

F. Utility Requirements

1. Four utility outlets (one on each wall of greenhouse)
2. Lighting in greenhouse and yard
3. Plumbing - potting sink and water facilities in greenhouse
4. Three water outlets - two in center and one at end of the greenhouse

G. Special Considerations

Humidity and heat controls for greenhouse

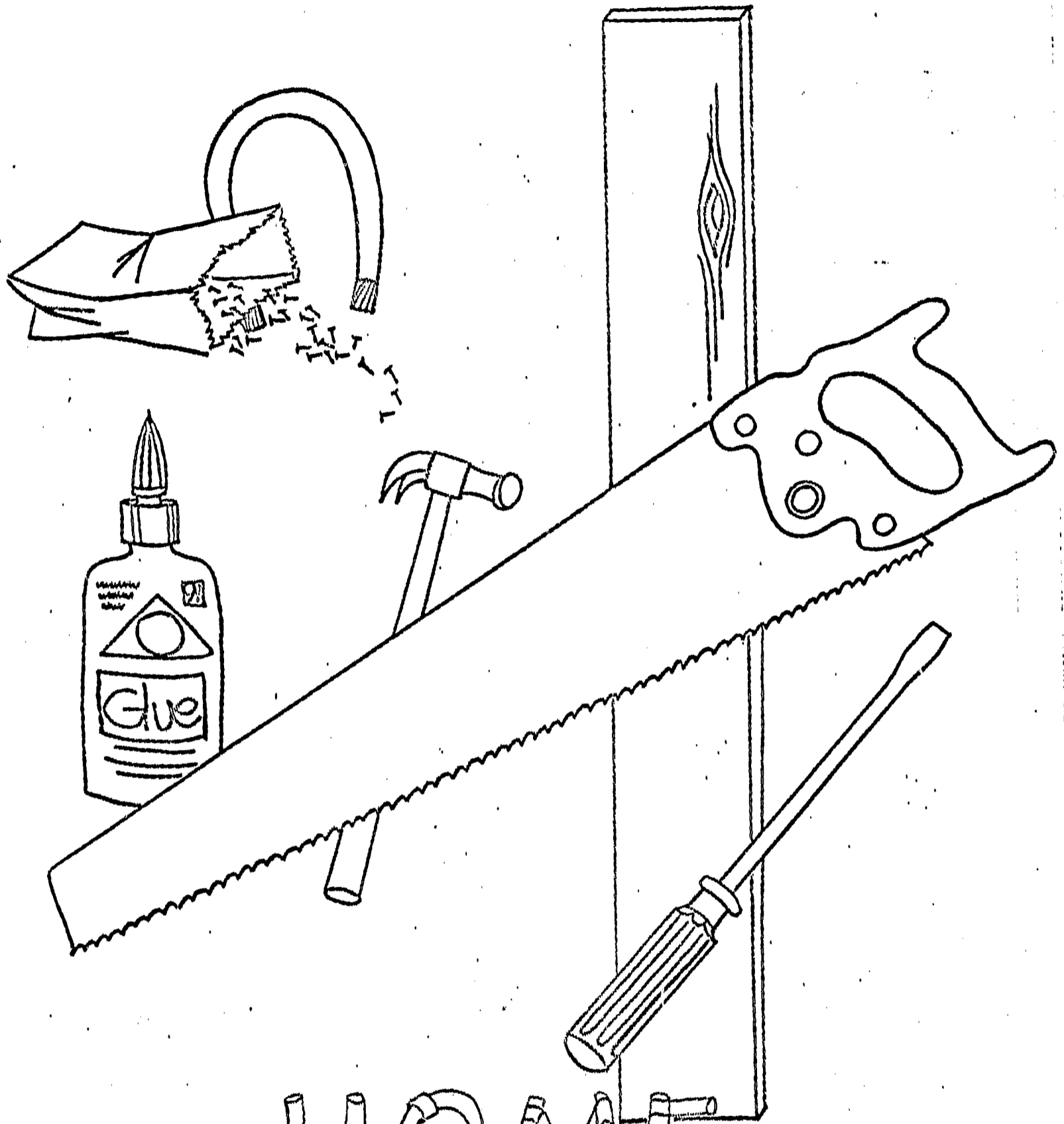

HOME

MAINTENANCE

IX. HOME MAINTENANCE AREA

A. Philosophy, Purposes, and Objectives

The philosophy of the home maintenance area is to stress through efficient vocational guidance and training the development of (1) social competence, (2) personal adequacy, and (3) occupational competence.

Curriculum

The curriculum planned for this area will provide successful experience in the area of home maintenance through the use of a laboratory facility including a special education classroom and an operable and functional laboratory.

B. Instructional Program

1. Development of home maintenance competency through

a. Academic Program

- (1) Mathematics skills
- (2) English/reading skills
- (3) Effective living skills

b. Laboratory Program

- (1) Woodworking skills
- (2) Painting skills
- (3) Plumbing skills
- (4) Electrical skills
- (5) Metal skills

c. On-the-Job Training

- (1) Occupational adjustment
- (2) Occupational proficiency
- (3) Occupational competence
- (4) Appropriate home maintenance skills

2. Instructional Activities

Describe what the teacher and the student do

- a. **Lecture:** Teacher introduction and reinforcement of new or re-introduced materials. Principally, teacher-active, student-passive activity.
- b. **Discussion:** Teacher-pupil follow-up of introduced materials. Purpose of discussion to emphasize important points of lecture and text of academic or vocational subjects.

- c. **Demonstration:** Teacher performance of skill projects for purpose of concrete learning experience prior to actual performance of such projects by students
- d. **Practical Performance:** Student performance of teacher demonstration. Actual manipulation of laboratory equipment
- e. **Evaluation:** Teacher-student rating of work performed in laboratory
- f. **Follow-up:** Review of all aspects of instructional unit. Re-emphasis of important points and clarification of aspects remaining unclear. Occupational involvement assessment.
- g. **On-the-Job:** Work experience with home maintenance skills in an actual job atmosphere

3. Grouping

a. Academic Program

- (1) Maximum - 18
- (2) Minimum - 1

b. Laboratory Program

- (1) Maximum - 6
- (2) Minimum - 1

c. On-the-Job

One-to-one relation between student and employer

4. Hours*

- a. Academic Program - 3 to 4 hours daily
- b. Laboratory Program - 2 to 3 hours daily
- c. On-the-Job - 3 hours daily

* Hours may vary according to immediate need

C. Space Requirements

1. Laboratory (maximum of six students)

- a. 100 square feet per pupil; 600 square feet

2. Chalkboard space (4' x 8')

3. Equipment

a. Woodworking and Metal working Area

- 1 - Stanley Woodworking Kit - 42" x 30½" x 26½"
- 2 - Sets Wood Carving Tools
- 1 - Porter-Cable Drill - Model 50¼"
- 1 - Sabre Saw - Model 60
- 1 - Hanson Drill Set No. S-113A
- 6 - 7" Vise (woodworking) 7 CDW
- 2 - 4" x 5" (metalworking) Vise - Morgan 4A
- 6 - Wilton 200 Series "C" Clamps
- 6 - Hargrave Bar Clamps - 4-foot opening
- 2 - Disston No. 368 Hack Saws
- 4 - Awls or Metal Scribers
- 2 - Hand Seamers
- 2 - Dividers - 10"
- 2 - Riveting Hammers
- 2 - Setting Hammers
- 1 - Circumference Rule
- 2 - Snips
- 2 - Hawk-bill Snips
- 2 - Aviation Snips - 1 (L) - 1 (R)

b. Painting Area

12" x 36" x 48" space for equipment

c. Plumbing Area

- 1 - Set 00-R Rigid Pipe Die
- 1 - 1A Rigid Pipe Cutter
- 1 - 20 Rigid Pipe Vise
- 1 - Set S-106 Tubing Benders
- 1 - 150 Flaring Tool, Tubing
- 2 - 12" Rigid Pipe Wrench
- 2 - 14" Rigid Pipe Wrench
- 1 - 274-FB Tubing Cutter

d. Electrical Area

- 2 - Pr. 37007 Kraeuter Pliers Diagonal 7"
- 2 - Pr. 36006 Kraeuter Pliers long chain nose 6"
- 2 - Pr. 38307 Electrician's Side Cutting Pliers

4. Storage Needs

a. Woodworking and Metalworking Area

One cabinet, fixed and lockable, 30" x 48" x 96", to house Stanley Woodworking Kit and all woodworking and metalworking supplies

b. Painting Area

One cabinet, fixed and lockable, 12" x 36" x 48" to house all paint equipment and supplies

c. Plumbing and Electrical Area

One cabinet, lockable and fixed, 30" x 48" x 96", to house all plumbing and electrical equipment and supplies

5. Furniture Requirements

- 3 - 2-Position Woodworking Tables ML5-OV 28" x 64"
- 1 - 2-Position Metalworking Table SML5LOV 28" x 64"
- 8 - Stools to use at tables

6. Special Considerations

- a. Cement floor with urethane flooring
- b. Intercom, bell, and fire alarm system
- c. Climate control with air-conditioning, heat, and ventilation
- d. Lighting - Fluorescent and incandescent or totally indirect
- e. T.V. conduit, clock and plumbing facilities
- f. Electrical outlets - 115 volts spaced 8' around perimeter of room
- g. Acoustical Treatment - Wall and ceiling acoustically treated
- h. Neutral wall color
- i. Traffic Flow - availability to classroom, outside, and washrooms
- j. Size Flexibility - openness outside working area through metal double doors



No. 793 HANDY SREAMER

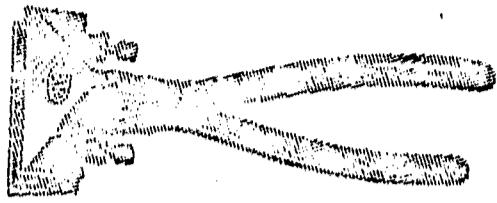

Blade is $\frac{7}{8}$ x $3\frac{1}{2}$, adjustable for seams from $\frac{1}{8}$ to $\frac{3}{8}$ inches wide.



LONG CHAIN NEEDLE NOSE PLIERS

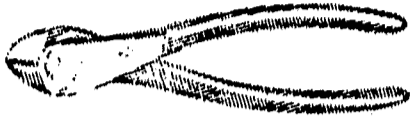

HEAVY DUTY DIAGONAL CUTTING PLIERS

Cutter is close to the joint, supplying added leverage for heavy wire work and close cutting. With Cushion Grip handles.

No.	Old Part No.	Size	Each
26107	(GG 4410)	7"	\$3.70



ELECTRICIANS SIDE CUTTING PLIERS

General electricians' tool for installation of domestic and industrial wiring, plant maintenance and repair work. With Cushion Grip handles.

No.	Old Part No.	Size	Each
26108	(GG 1830)	6 $\frac{1}{2}$ "	\$3.60

WISS AVIATION SNIPS

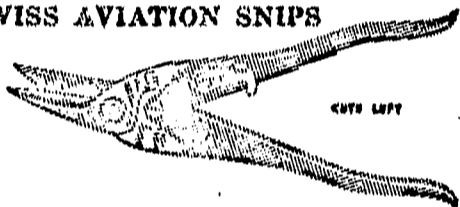

A widely used snip for cutting compound curves and intricate designs. The compound leverage does twice the cutting with half the effort.

M2 cuts to the right and M1 cuts to the left. Jaws have fine serration to hold material.

WISS TIN SNIPS



With curved blades for circular work.

Steel laid.
No. W 90—8" cut, overall 12 $\frac{1}{2}$ ".
Pair\$11.75

WISS COMBINATION SNIPS

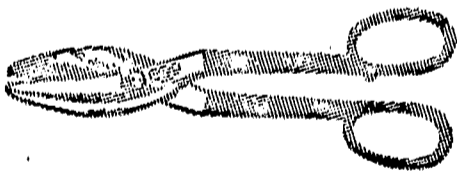

Straight or curved work.
W18, 8 $\frac{1}{2}$ " cut.
Pair \$8.60
W19, 8" cut.
Pair 7.75



TINNERS RIVETING HAMMERS

No. 461—8 oz. Each \$4.80
No. 462—12 oz. Each 4.80

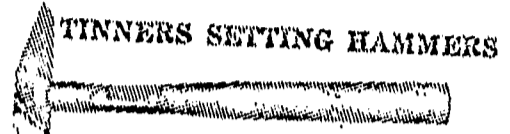

TINNERS SETTING HAMMERS

Pointing or setting. Full polished.
No. 452—12 oz. Each \$4.80

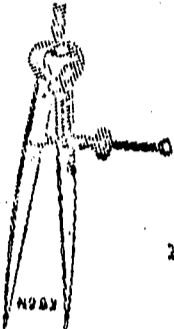

No. 83 DIVIDERS

Solid Nut Construction

Size, in. 4 6 8

Price Ea. \$3.75 \$3.95 \$4.95

No. 70A SCRIBER



Made of steel tubing. Knurled and nickel plated. No. 70A Handle, $\frac{1}{4}$ " diameter, Blade 2 $\frac{3}{4}$ " long.
Price each \$1.15

No. 95 TINNERS CIRCUMFERENCE RULE



Gives liquid and dry measure dimension tables for laying out work. Also standard measurements to 8ths, and circumferences.
Length, 3 feet. Polished. Each \$9.75

RIDGID PIPE

Exposed Ratchet Type



Die heads lock in or release by pull of ratchet knob — won't fall out. Convenient carrier furnished with each set.

Set 00-R. Threads $\frac{1}{8}$, $\frac{1}{4}$, $\frac{3}{8}$, $\frac{1}{2}$, $\frac{3}{4}$, 1" \$61.40

EQUIPMENT FOR HOME MAINTENANCE AREA.

SINK UNIT

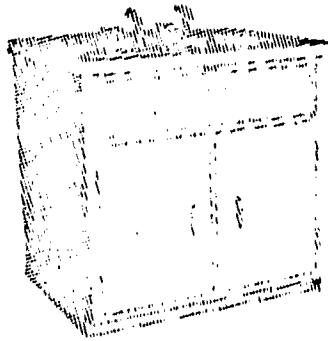

CC1325

Hardwood cabinet 35" wide x 28" deep with double door opening to galvanized lined waterproof metal clay storage space. Inside dimensions are 30" deep, 24" high, 34" wide. Unit contains a double basin stainless steel sink 21" x 32" overall with hot and cold water faucets, spray hose and nozzle. Sink has strainers and clay interceptor trap for easy cleanup.

Price.....\$284.00

IG TABLES

Model 624RA

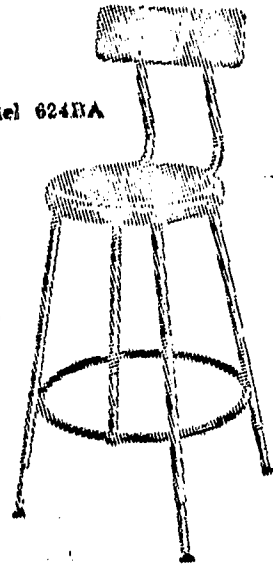

INSTRUCTORS' CHAIRS

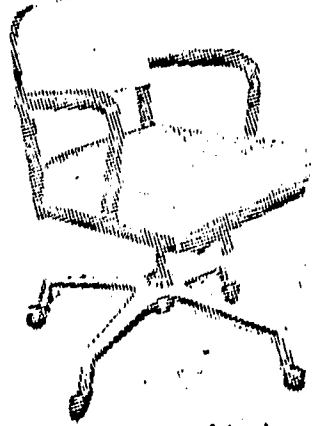

MODEL SML5-L LEG MODEL

Top is 12 gauge mild steel folded over 2" solid wood core, welded and ground at 4 corners. Top size 28 1/2" x 64".

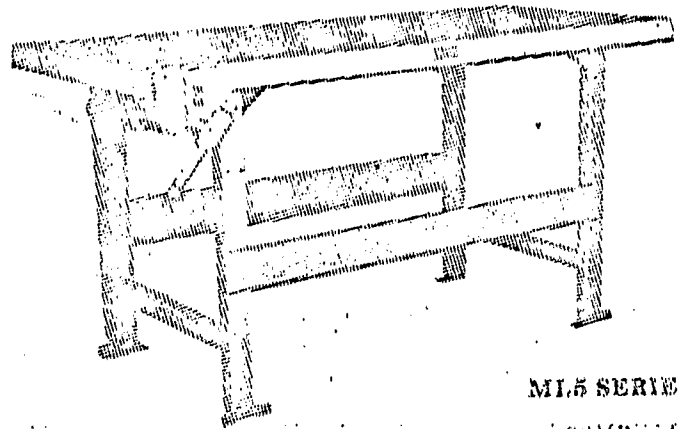
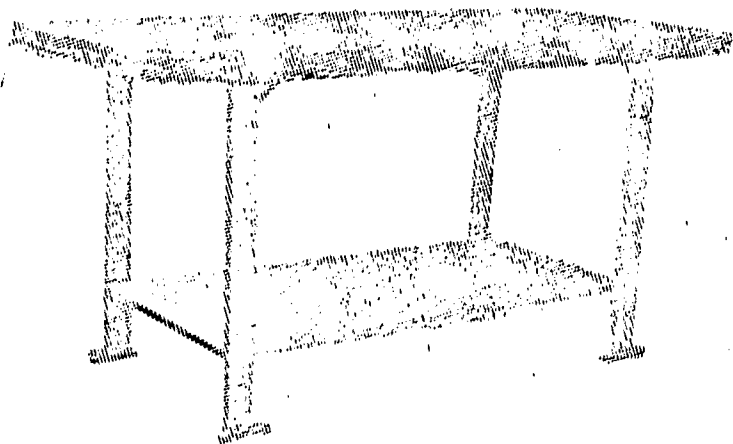

ML5 SERIES

Top is 2 1/4" thick laminated maple, size 28 1/2" x 64". Sturdy steel leg frame 31" high in olive green, gray, or vista green, shipped knocked down. Overall bench height 33 1/4". Vises are Columbian 7CDT, Wilton 61A, or equal.

MODEL SML4-L LEG MODEL

Top is 12 gauge mild steel folded over 2" solid wood core, welded and ground at 4 corners. Top size 54" x 64".

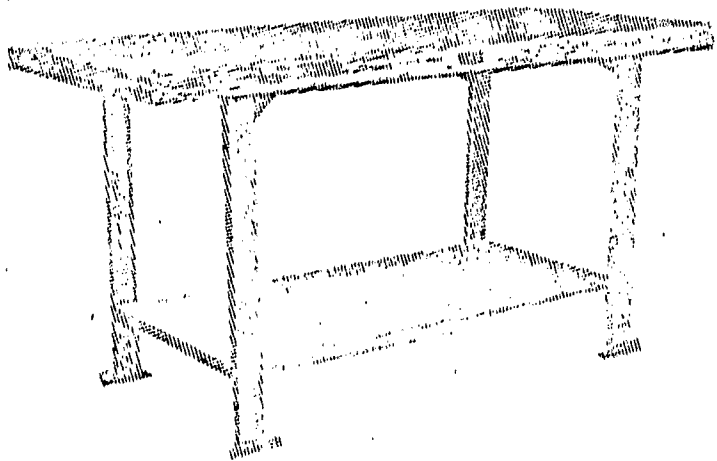

A space-saving pedestal desk with the single pedestal on the right side.

Available in gray, frost tan or frost green. Other colors can be supplied by request.

No. 4023—Desk (top size 48" x 24")..... \$104.00

PLANNING TABLE

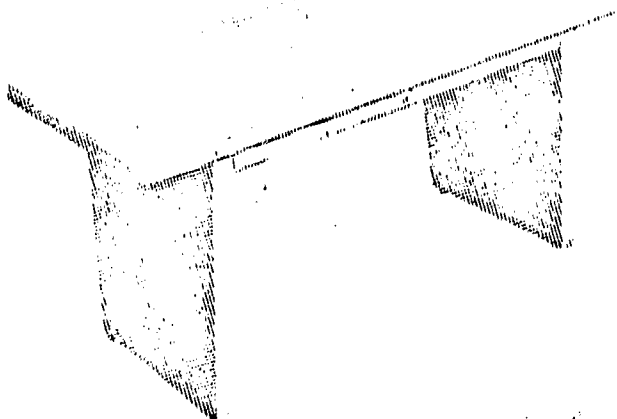

No. 540 P "C" CLAMPS

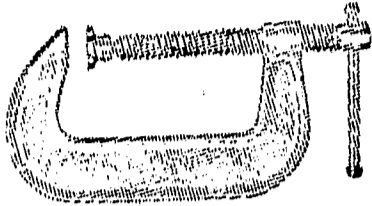

Steel screw. Clamp made of metal more durable than malleable iron.



The "I-Bar" is high carbon steel $1\frac{1}{2} \times \frac{3}{8} \times \frac{1}{8}$ ". Screw is $\frac{5}{16}$ " diameter with Acme thread. Slide dogs are tempered steel.

RIDGID HEAVY DUTY PIPE CUTTERS

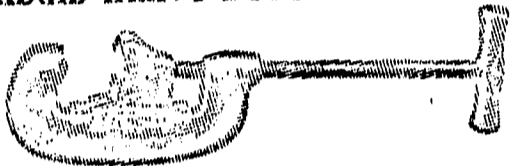

Efficiently balanced for easy working. Heavy duty alloy steel cutter wheels. Strong malleable frame.

No. 1A Pipe Cutter, capacity $\frac{1}{8}$ " to $1\frac{1}{4}$ ".

No. 100 TUBING BENDER

All sizes $\frac{1}{4}$ " to $\frac{3}{8}$ ".

$\frac{1}{4}$ " O.D. \$.30 $\frac{7}{16}$ " O.D. \$.45
 $\frac{5}{16}$ " O.D. .35 $\frac{1}{2}$ " O.D. .50
 $\frac{3}{8}$ " O.D. .40 $\frac{5}{8}$ " O.D. .55

Set contains one each of above sizes in plastic bag.
 \$106..... \$2.60

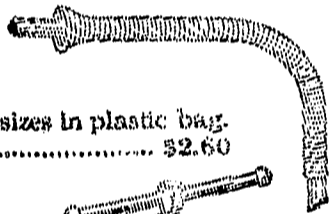

No. 150 FLARING TOOL

For $\frac{3}{8}$ ", $\frac{1}{2}$ ", $\frac{5}{8}$ ", $\frac{3}{4}$ ", $\frac{1}{2}$ " and $\frac{3}{8}$ " O.D. tube.

No. 150..... each \$5.80

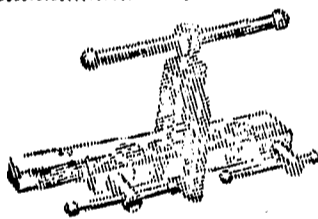

RIDGID PIPE VISES

Pipe jaws of fine tool steel, carefully hardened. Malleable iron frame self-locking.

No. 20 Pipe Vise, capacity $\frac{1}{8}$ " to $1\frac{1}{4}$ ". Price, each..... \$12.80

Guaranteed Unbreakable

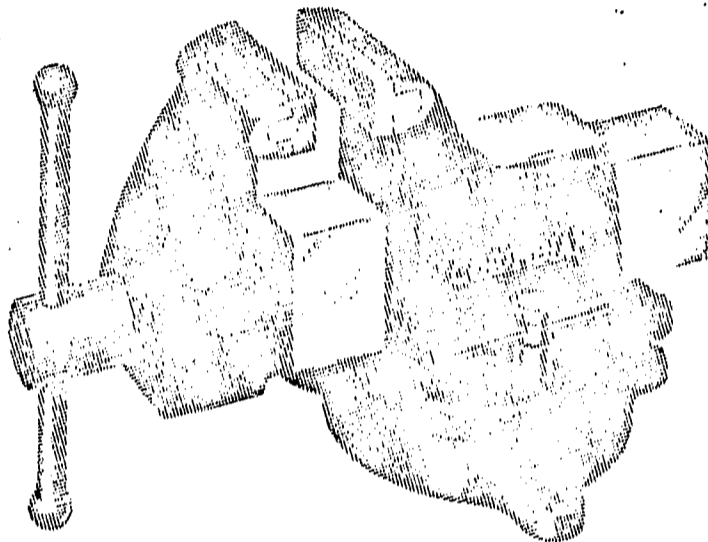

Replaceable "T" section jaw faces
 Self-lubricating bronze thrust bearing
 Large ground and polished anvil
 Unbreakable malleable iron castings

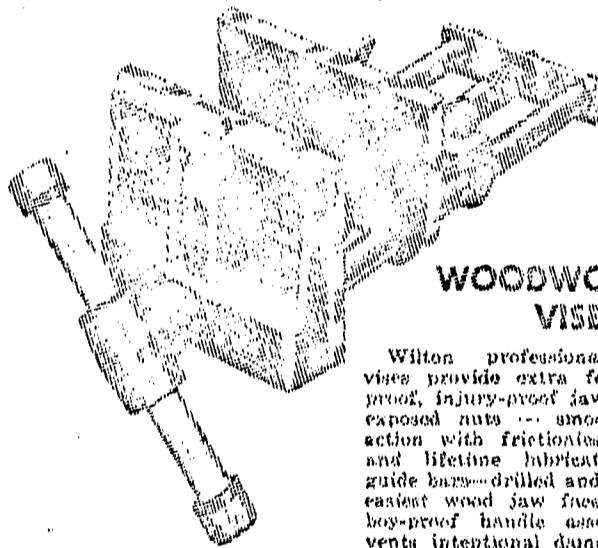

WOODWORKERS' VISES

Wilton professional woodworkers' vises provide extra features: tamper-proof, injury-proof jaw design with no exposed nuts -- smoothest tightening action with frictionless thrust washer and lifetime lubricated spindle and guide bars--drilled and tapped jaws for easiest wood jaw face replacement -- boy-proof handle assembly that prevents intentional damage -- plus the new Wilton rubber-faced dog in front jaw that provides secure grip, but that never mars fine finishes. Bench mounting takes only three minutes. Rapid action models provide fastest push-pull sliding action, most convenient tightening ever.

Catalog Number	Jaw Size	Type of Handle	Max. Opening	Approx. Wt. Lbs.	Price Each
CONTINUOUS SCREW ACTION					

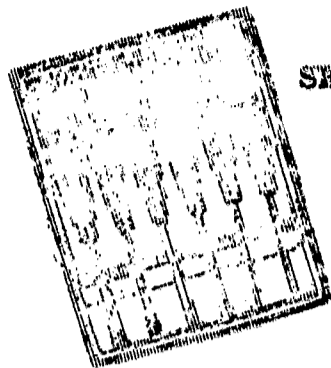

SET No. 106

A set of six carefully selected tools to give as wide a range of operation and effects as possible in light wood and linoleum carving.

Length of tools, 6 1/4"; forged and heat-treated steel blades; straight chisel, 3/16"; bent gouge, 3/16"; bent chisel, 3/16"; U tool, 3/16"; skew chisel, 3/16"; veining tool, 3/16".

Set\$7.60

ELEMENTARY WORK CENTERS

STANLEY MOBILE TOOL CART

MOBILE TOOL CART NO. 37-148

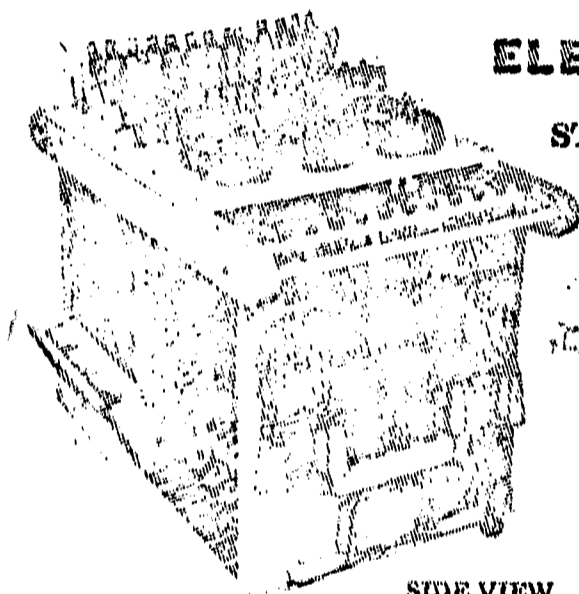

SIDE VIEW

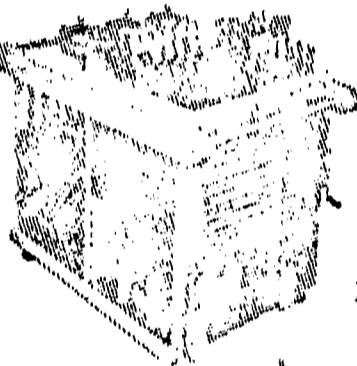

FRONT VIEW

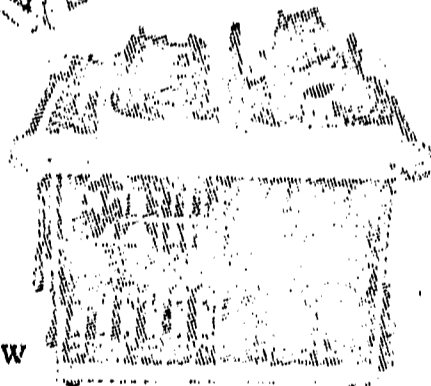

BACK VIEW

Contains these basic tools:

- 1 -- Auger Bits, 18 sizes
- 4 -- Back saws
- 2 -- 5" Bit Braces
- 16 -- 4" "C" Clamps
- 12 -- Coping Saws
- 12 -- Coping Saw Blades
- 8 -- Cross Cut Saws
- 1 -- 3/4" Countersink
- 2 -- 6" Dividers
- 7 -- Files, Assorted
- 2 -- File Cards
- 12 -- Hammers
- 2 -- Hand Drills
- 3 -- Keyhole Saws
- 2 -- Nail Sets

- 12 -- Planes
- 1 -- Pliers, Comb.
- 1 -- 6" Pliers, Side Cutting
- 1 -- Rip Saw
- 6 -- Rules
- 1 -- Scratch Awl
- 3 -- Screwdrivers
- 2 -- Scissors
- 4 -- Squares, Comb.
- 4 -- 6" Squares, Try
- 8 -- SURFORM Blades
- 6 -- SURFORM Tools
- 6 -- Vises

No. 37-148 Tool Cart Complete...\$520.00

For Elementary Industrial Arts Wood-working Programs

- To encourage and implement industrial arts training in elementary grades -- kindergarten through fifth grade.
- Mobile -- readily moved from classroom to classroom.
- Contains the basic tools needed to meet children's needs, interest and abilities.
- Provides means for administering and scheduling programs for any number of classes, groups up to 20 children.
- Enables instruction and programming at minimum cost.

RUGGEDLY CONSTRUCTED

The Stanley Tool Cart is built to withstand hard use. All surfaces are sanded

smooth and protected with clear gloss lacquer finish. Specially constructed slots and racks provide for the safe storage of all 158 tools and replacement blades. Bins are provided for nails and miscellaneous fasteners. Instructors can tell at a glance when a tool is missing. Cart shipped completely assembled.

2

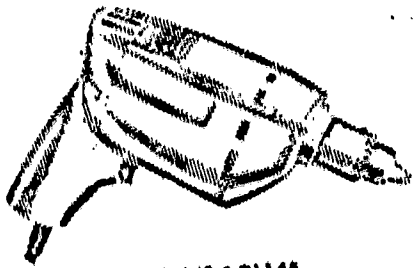

Models 91048 & 91145

A HEAVY DUTY ORBITAL-ACTION FINISHING SANDER--91036--tops in its field for fine finishing or refinishing work. Includes 83219 (H436) asso. abrasive paper. Universal type motor AC-DC; 60 cycles or less. Voltages 115, 230 1.5 amps at 115V. Pad size 3 1/4" x 9". Orbit Size--1/16" at 4500 C.P.M.

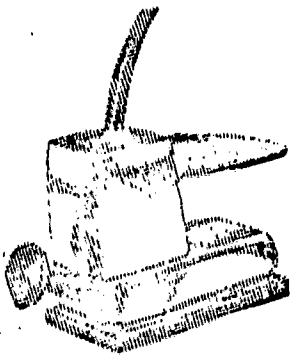

No. 368 HACK SAW FRAME

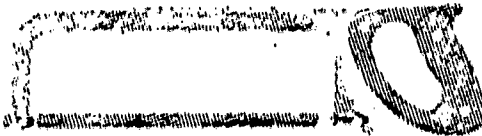

Adjustable -- 10, 12 inch.

Rigid frame. Complete reinforced handle. A superior tool, finely finished.

RIGID STRAIGHT PIPE WRENCH



Housing guaranteed. Strong alloy steel jaws will not slip or lock on pipe. Replaceable heel jaw, full floating hook jaw with handy pipe scale.

SCHOOL SAFETY GOGGLES

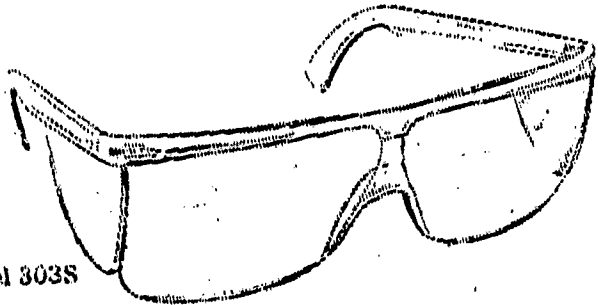

Model 303S

Fire Extinguishers by American La France

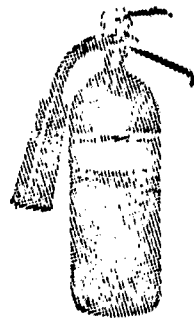

Carbon Dioxide

A cloud of odorless, harmless CO2 gas and snow kills electric, grease and flammable liquid fires fast. Leaves no residue. 5 lb. capacity size especially suited for kitchen stove fires. Complete with wall hanger. 5 lb. Capacity UL rated 4 BC-Model 5MK1..... \$40.80
Other sizes 10-15 and 20 lb.
Vehicle Brackets for 5 lb. Unit Price..\$3.45

LEISURE TIME

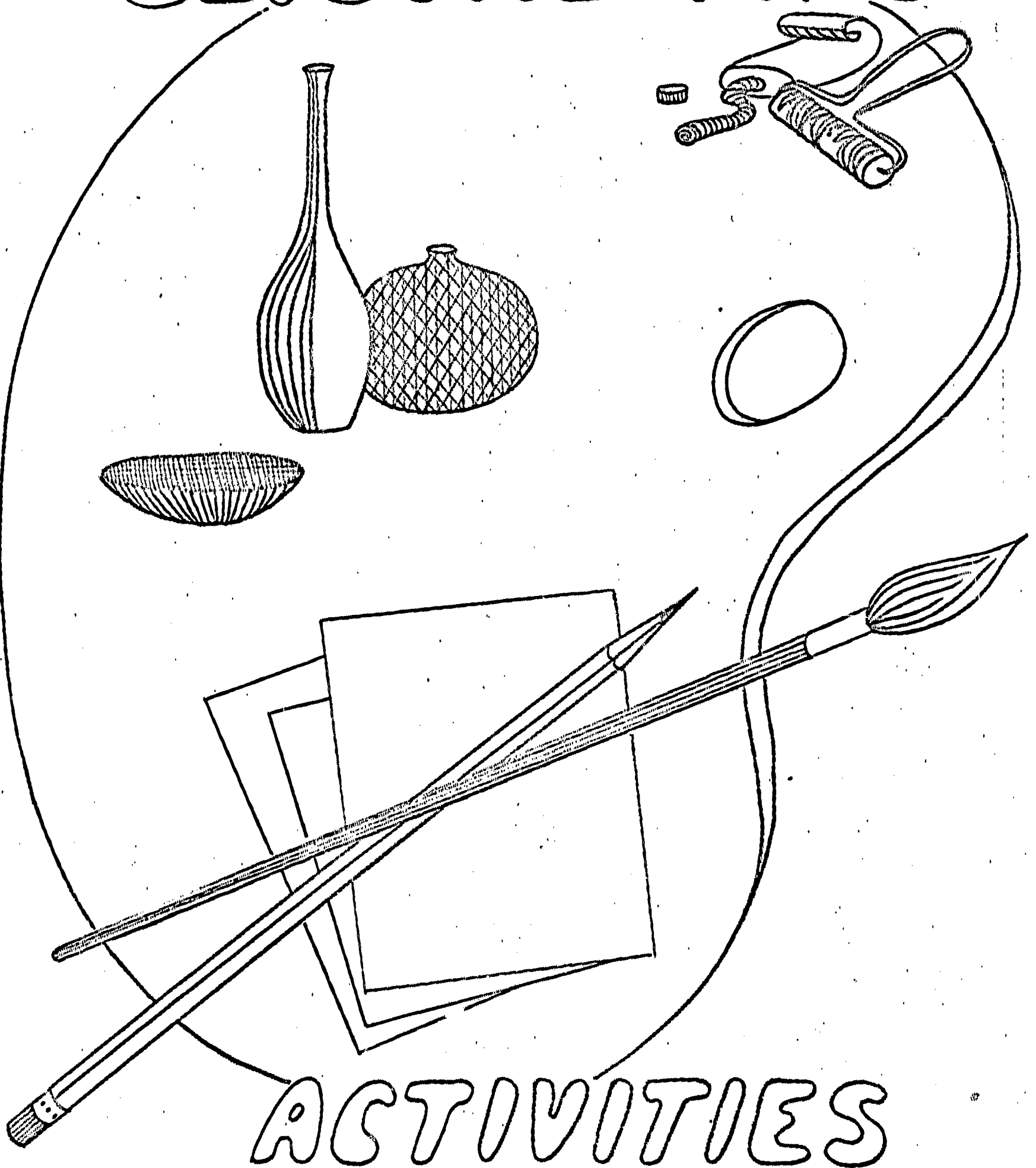

ACTIVITIES

X. LEISURE TIME ACTIVITIES

A. Philosophy, Purposes, and Objectives

A planned program in creative art and handicraft activities will provide opportunities for the student to:

1. Understand himself better
2. Gain insight into the values of society
3. Make qualitative judgments concerning personal ideas, nature of materials, and organization of visual elements
4. Develop creative abilities
5. Provide skills that will enable the student to use leisure time to the fullest extent
6. Bring the student a step further in sequential development of symbol form
7. Prepare the student in work habits and skills applicable to a possible future job

B. Instructional Program

1. Various Art Activities

- a. The teacher motivates and instructs in basic skills
- b. The student constructs, draws, paints, creates, acquires skills in ceramics, weaving, leather-craft, model cars, small engines, and woodworking

2. Grouping

- a. Maximum - 16
- b. Minimum - 1
- c. Arrangement of groups by interests and abilities

C. Space Requirements

1. This area to be a part of the Home Maintenance Area with floor space, storage, and tables utilized for both areas
2. A secured, 9'21" x 3'9" bulletin board on wall
3. A secured, 9' x 4' chalkboard on wall
4. Counters and storage cabinets

4. Counters and storage cabinets

- a. Space for 1 kiln 24" x 24" x 60"
- b. Space for 1 kiln 24" x 24" x 30"
- c. Space for 1 stainless steel wet box 24" x 24" x 48"
- d. Space for 2 looms - 30" x 30" x 16'
- e. Miscellaneous shelving on walls above sink and kiln

D. Special Considerations

- 1. Cement floor with urethane cover
- 2. Intercom, bell, and fire alarm system
- 3. Air-conditioning, heat, and ventilation
- 4. Overhead fluorescent-incandescent lighting
- 5. A large sink - 18" x 24" - of stainless steel
- 6. Television conduit
- 7. Acoustically treated walls and ceiling
- 8. Utility Requirements
 - a. Outlets for kilns
 - b. Voltage - 110 - except for kilns
 - c. Spacing - Strip outlets (8 in the strip) over a wooden work surface against the wall, under which are more storage cabinets (for shop use)
 - d. Locations - 3 outlets on long walls. Outlets to be placed 1' from floor
 - e. Television, Clock, Plumbing
 - f. Neutral color on walls
- 9. Size Flexibility

Teacher's Workroom

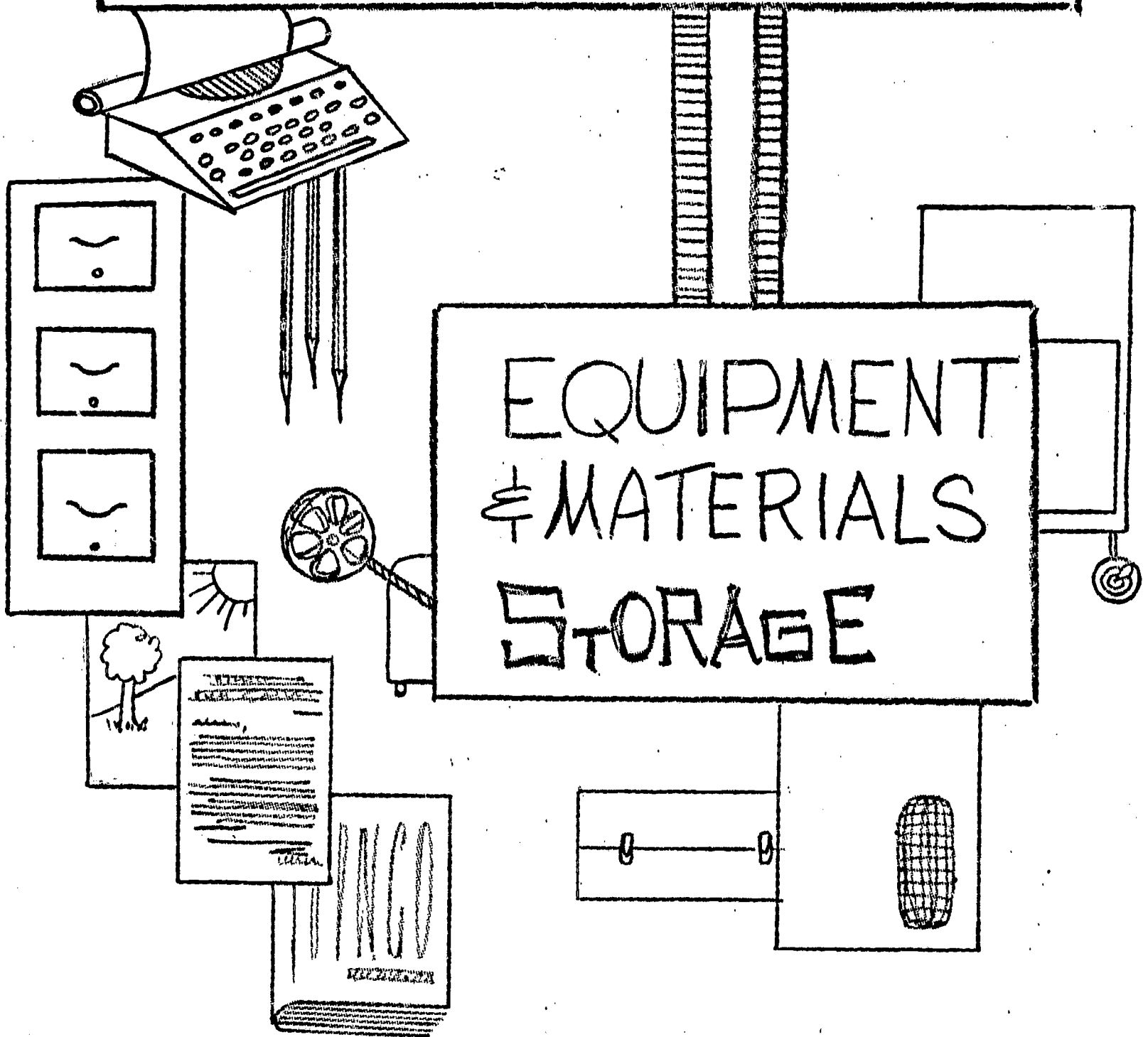

XI. TEACHER WORKROOM AND EQUIPMENT AND MATERIALS STORAGE

A. Space Requirements

1. Number of square feet
Size of room to be approximately 300-400 square feet
2. Display Space
None for this area
3. Chalkboard Space
None for this area
4. Counters and Storage Cabinets
 - a. Teacher working or desk counters with 3 or 4 lockable drawers. Each counter will need 2 sets of 4 drawers, making a total of 4 desk areas. Counters should be desk height (31½" high and 24" wide)
 - b. Audio-visual equipment and material cabinets, with locks, to be placed on an outside wall
 - c. One wall of cabinets for storage of audio-visual equipment and materials as follows:
 - (1) Cabinets on the floor
 - (a) Six (6) cabinets for audio-visual equipment to be 39" H x 25" D x 28" W. These cabinets will provide a counter area and will be combined with the wall cabinets above.

Equipment to be housed:

- 2 Projector tables - 36" H x 25" L x 20" W
- 2 Overhead projectors - 36" H x 25" L x 20" W

Two of these cabinets will have a horizontal shelf for small equipment

Top Shelf - 2 filmstrip projectors
Bottom Shelf - 1 overhead projector table 17" H

Top Shelf - 2 tape recorders
Bottom Shelf - 1 overhead projector table 17" H

- (b) One floor cabinet with horizontal dividing shelf:

Top Shelf - Record player and listening center
Bottom Shelf - 16 MM projector 39" H x 25" D x 20" W

- (c) Three-drawer letter file for transparencies
- (d) Two-drawer phonograph record file, approximately 13½" wide
- (2) Wall cabinets (7 cabinets) for audio-visual materials, 15" D x 24" H x 24" W, with adjustable shelves for filmstrips, filmloops, and tapes
- (3) One large closet approximately 36" W x 25" D x 6' H for coats of teachers, etc. One side of this closet should contain shelves.
- (4) Two letter size filing cabinets, with locks, stationed in center of wall
- (5) Walls

Outside walls will not have windows

The two inside walls will have glass windows for observing students from the workroom area. Draw drapes will be used for privacy.

(6) Furniture

Four (4) teacher chairs to be used at desks

B. Special Considerations

1. Acoustical floor covering
2. Communication System
 - a. Intercom, bell, and fire alarm systems, with control panel for intercommunication system in workroom area
 - b. Safety control measures for the entire building with control in teacher workroom
 - c. Telephone to be placed in teacher workroom
3. Climate control for air-conditioning and heating, with thermostat in teacher workroom
4. Light control with ample lighting for each desk
5. Plumbing to include a sink with base cabinet
6. Closed circuit T.V. conduit

7. Acoustical floor covering and acoustical ceiling

8. Utility Requirements

- a. Ample electrical outlets for using audio-visual equipment for previewing and pre-listening in the workroom area
- b. Wall clock to be located above student record file cabinets

9. Flow of Traffic

A door should lead into the teaching area of the building

oo-oo-oo
R-R-R-R
S-S-S-S-S

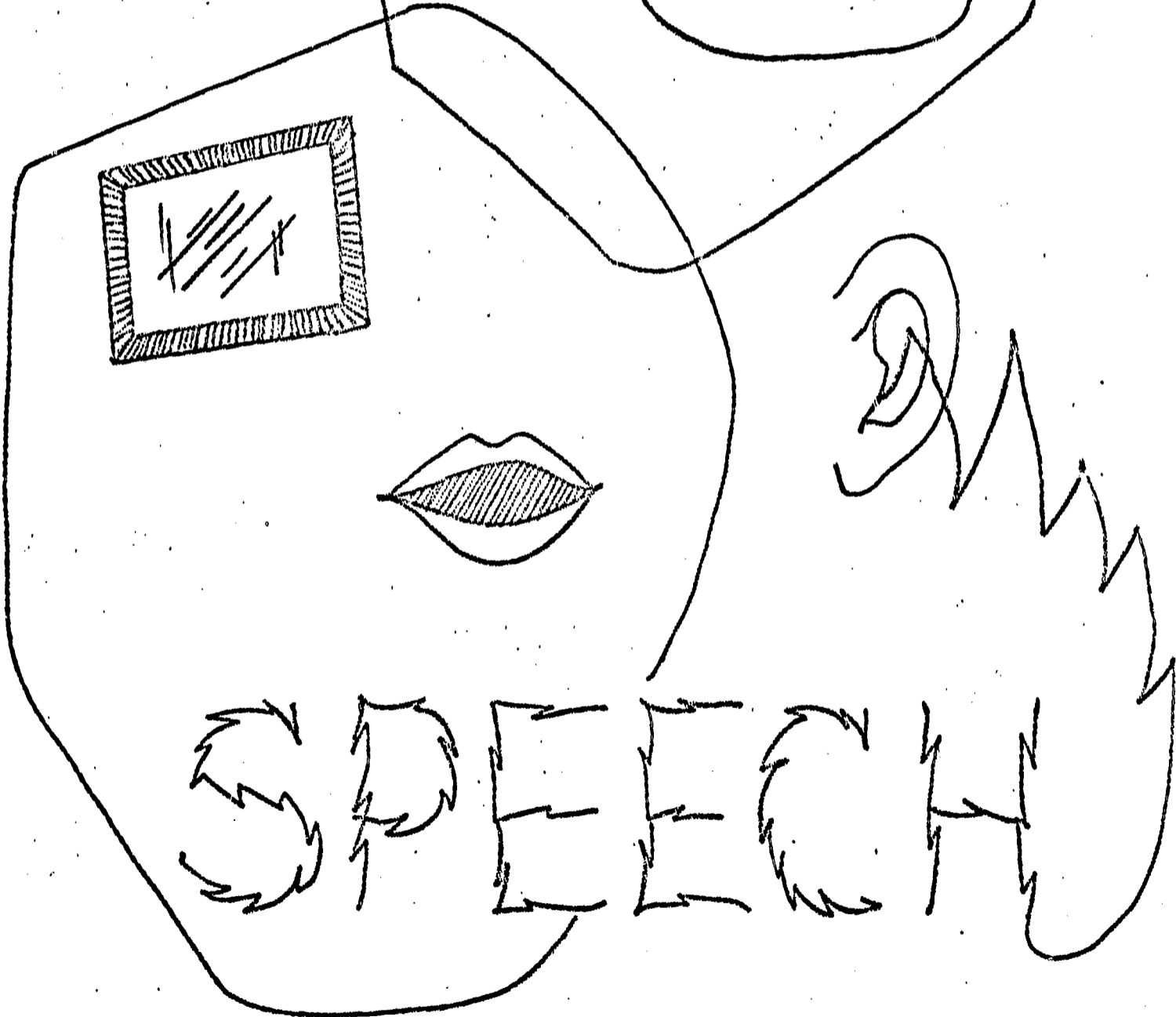
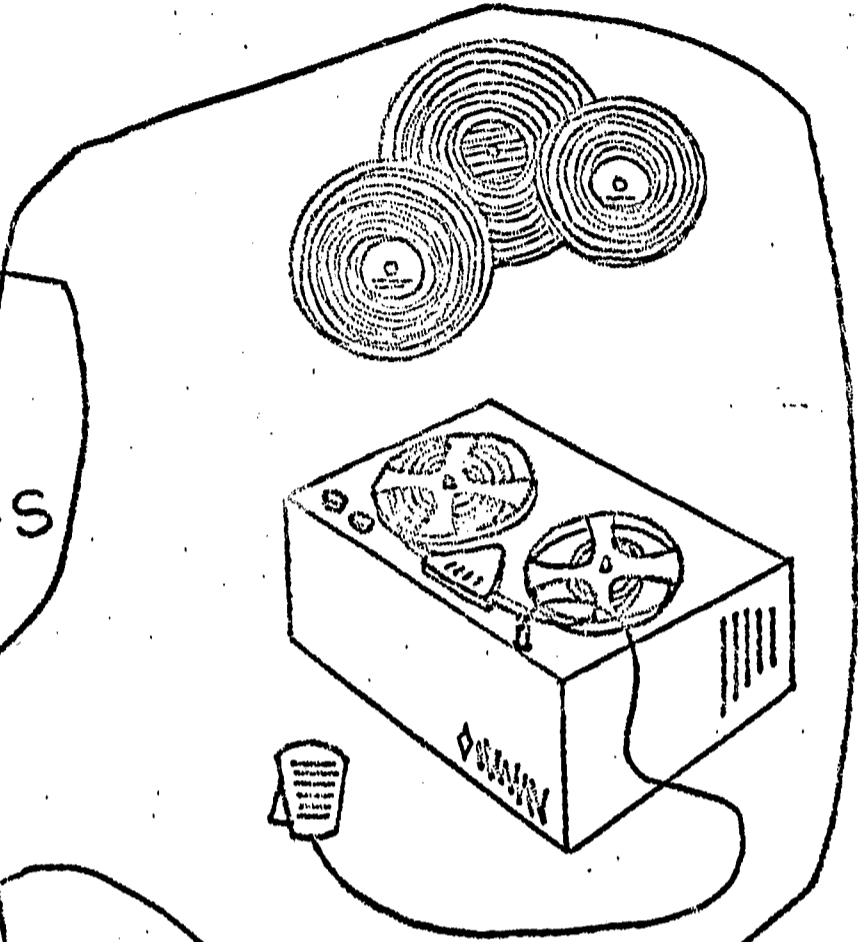

XII. SPEECH THERAPY ROOM

A. Philosophy, Purposes, and Objectives

The purpose of speech therapy is to retrain students in the area of speech and hearing in order that they might obtain adequate communication skills.

B. Instructional Program

1. Activities

a. Therapist

- (1) Re-trains the students in articulation through discrimination, game ideas, drills, etc.**
- (2) Works with stutterers to gain confidence and control**
- (3) Works with hearing problems through discrimination, sound production and lip reading**

- b. Students learn to use the speech mechanism properly in the production of "problem" sounds. Through discrimination, drills, and game activities, the students work for complete carry over in conversation.**

2. Groupings

- a. Classes are grouped from one to seven children**
- b. Children are grouped according to the speech and/or hearing problem, taking into consideration the age of the child.**

C. Space Requirements

- 1. Square feet required: 200 - 250 square feet**
- 2. Display space - one wall with built-in storage cabinets**
- 3. Chalkboard (4' x 6') and tackboard (4' x 4')**
- 4. Counters and a storage cabinet (5' x 3' x 1½') lockable and fixed for the following equipment and materials**
 - a. Phonic mirror**
 - b. Language master**
 - c. Audiometer**
 - d. Speech games**
 - e. Speech books**

5. Walls - fixed and permanent with one observation window (26" H x 36" L) to be 46" from floor. Window to have speaker and draw drapes for privacy.

6. Furniture

a. Round table - 48" in diameter with adjustable legs

b. Teacher chair (17 $\frac{1}{4}$ " H)

c. Six students' chairs (17 $\frac{1}{4}$ " H)

d. Two file cabinets on storage wall

D. Special Considerations

1. Floor covering - acoustical floor covering

2. Communication system - Intercom, bell and fire alarm system

3. Climate control - air-conditioning, heat, ventilation

4. Standard light control

5. Adequate sound control - floor covering

6. Utility Requirements

a. Two electrical outlets per wall to be located above the counter space

b. Clock

XIII. SPACE RELATIONSHIPS DIAGRAM

Students between the ages of 15 and 21 who are unable to utilize their intellectual assets in such a way as to make possible their development in the regular classroom, may be expected to profit from special educational facilities designed to promote development of physical competencies, personal and social competencies, and vocational proficiencies.

The classes should be located in a building with students of comparable chronological age. In selecting a site, it is desirable to choose a location that will offer the greatest number of opportunities to participate in the activities of the school, to use the equipment and other facilities, and to receive the services of the special teaching staff, such as counselor, speech correctionist, music, art, and physical education teachers. It is desirable that the classes be in a centrally located school building. Neither the classroom nor the students should be segregated from the total school population.

(See attached space relationship diagram)

SPACE RELATIONSHIPS DIAGRAM

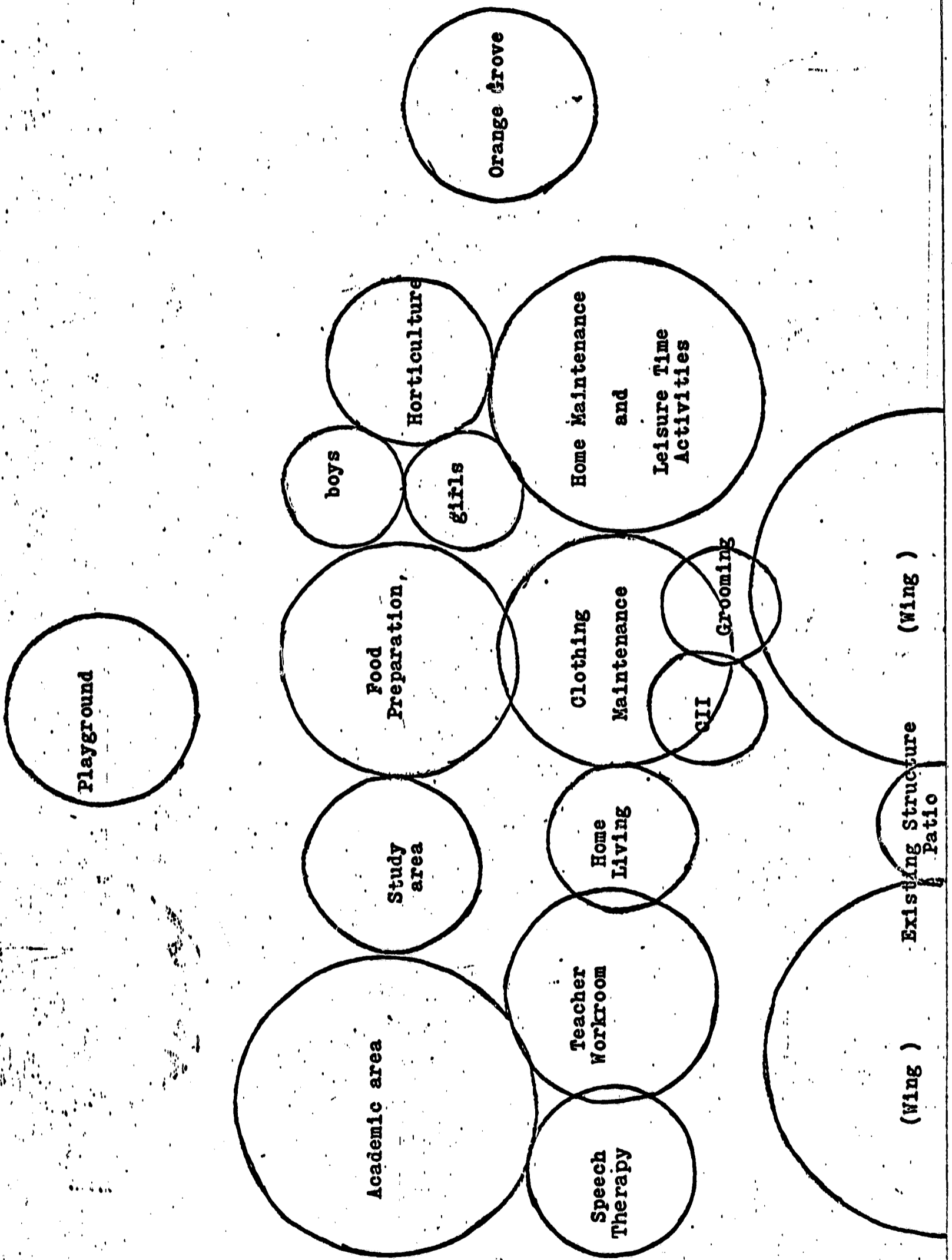

SOURCES

1. Application for Facilities for Exceptional Child Education Program. Fiscal Year 1968-69. Manatee County, Fiscal Year 1968-69, Bradenton, Florida
2. Architectural Considerations for Classrooms for Exceptional Children. Texas Educational Agency, Division of Special Education, Austin, Texas, January, 1967
3. Educational Specifications for an Elementary School, Sarasota County Schools, 1968, Sarasota, Florida
4. Educational Specifications, Special Disadvantaged Project. Manatee Area Vocational and Technical Center, Bradenton, Florida
5. Equipment and Materials for Special Education Classrooms. Texas Education Agency, Division of Special Education, Austin, Texas, 1961.
6. Facility Planning Special Education Services for Exceptional Youth in Secondary Programs. Duval County, Board of Public Instruction, Jacksonville, Florida
7. Illinois Curriculum Guide for the Teachers of the Educable Mentally Retarded. Interstate and Publishers, Inc., Danville, Ill.
8. Mende, Robert, "Meeting the Needs of Every Student," School Management
9. Mende, Robert, "Fitting the Facilities to the Child," School Management
10. Mende, Robert, "What You Should Know About Teaching Handicapped Children." School Management
11. Occupational Training Program, a Senior High School Program for the Retarded, Duval County, Jacksonville, Florida
12. Proposed Accreditation Standards for Florida Schools, State Department of Education, Tallahassee, Florida, 1968-69
13. Proposed Plans of Facilities for Physically Handicapped Children. Duval County, Board of Public Instruction, Jacksonville, Florida