

DOCUMENT RESUME

ED 035 181

EF 001 475

AUTHOR Revnon, John  
TITLE Designs for Education 1963; Third Annual Report from the School Planning Laboratory Western Regional Center, Educational Facilities Laboratories.  
INSTITUTION Stanford Univ., Calif. School Planning Lab.  
PUB DATE 63  
NOTE 27p.  
EDRS PRICE EDRS Price MF-\$0.25 HC-\$1.45  
DESCRIPTORS Building Plans, \*Flexible Facilities, \*Individual Study, \*School Construction, \*School Design, \*School Planning

ABSTRACT

Topics discussed in this report include--(1) Space for Individual Study. (2) The Quest for Flexibility, (3) Toward Improved Construction, and (4) Overall Instructional Planning. Plans, drawings, and photographs are provided. (RK)

A REPORT FROM  
SCHOOL PLANNING  
LABORATORY CENTER  
FOR LOCAL, STATE,  
AND NATIONAL INSTITUTIONS  
AND ORGANIZATIONS

# DESIGNS FOR EDUCATION

1 9 6 3

SP

U.S. DEPARTMENT OF HEALTH, EDUCATION & WELFARE  
OFFICE OF EDUCATION

THIS DOCUMENT HAS BEEN REPRODUCED EXACTLY AS RECEIVED FROM THE  
PERSON OR ORGANIZATION ORIGINATING IT. POINTS OF VIEW OR OPINIONS  
STATED DO NOT NECESSARILY REPRESENT OFFICIAL OFFICE OF EDUCATION  
POSITION OR POLICY.

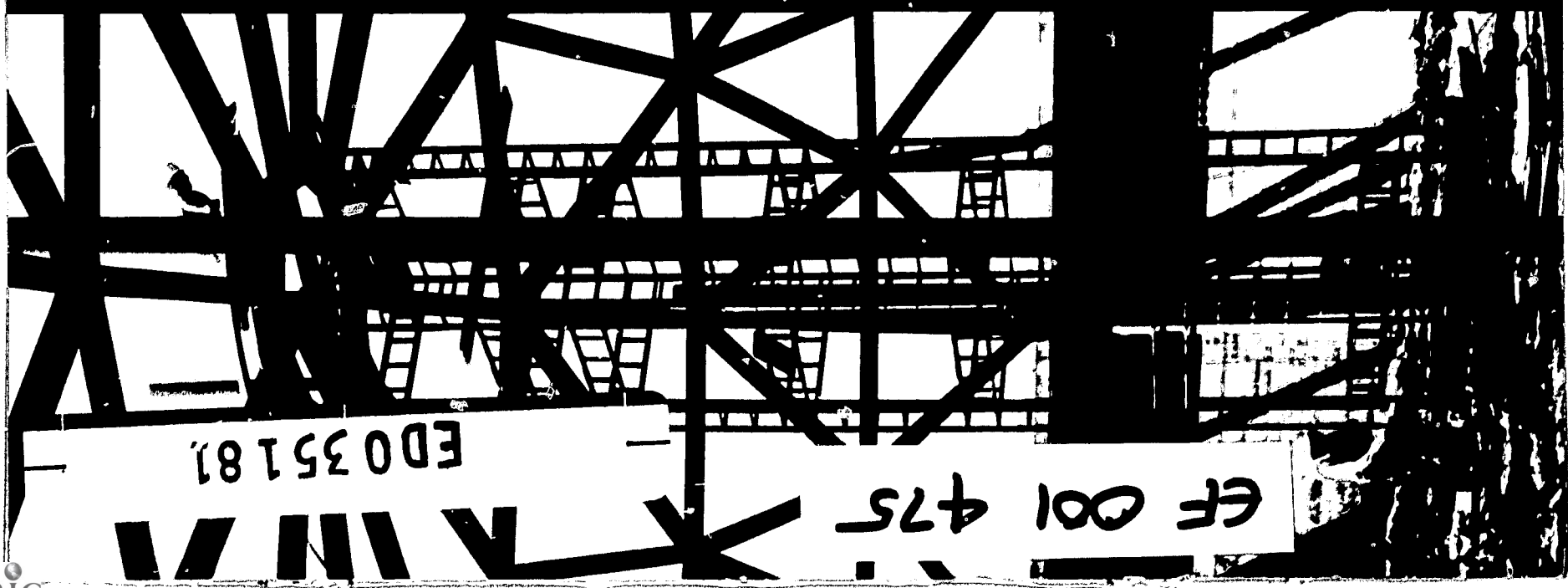

ED035181

EF 001 475

Educational Facilities Laboratories, Inc. is a non-profit corporation established by the Ford Foundation in 1958 to help American schools and colleges with their physical problems by encouragement of research and experimentation and the dissemination of knowledge regarding educational facilities. The School Planning Laboratory serves as Educational Facilities Laboratories' Western Regional Center and assists in activities related to the western states.

**Officers of the Educational Facilities Laboratories:**

Harold B. Gores, President  
Jonathan King, Secretary and Treasurer

**Directors and staff of the School Planning Laboratory:**

James D. MacConnell, Director  
Don L. Davis, Associate Director  
John R. Boice, Associate Director  
John Beynon, Research Associate  
John T. Condon, Research Assistant  
Richard T. Dankworth, Research Assistant  
Carl B. Franzen, Research Assistant  
Clarence L. Hall, Research Assistant  
Ernie A. Hickson, Research Assistant  
Robert G. Lamp, Research Assistant  
David E. Rawnsley, Research Assistant  
Albert J. Riendeau, Research Assistant

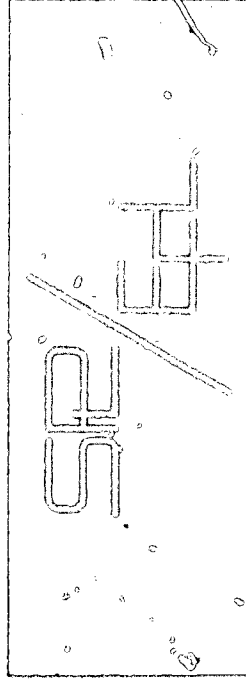

Additional copies are available from the School Planning Laboratory, School of Education, Stanford University, Stanford, California.

FD0 351 81

**DESIGNS  
FOR EDUCATION**

**1 9 6 3**

**THIRD ANNUAL REPORT FROM THE SCHOOL PLANNING LABORATORY  
WESTERN REGIONAL CENTER, EDUCATIONAL FACILITIES LABORATORIES**

Compiled By  
**John Beynon**

## ABOUT THE SCHOOL PLANNING LABORATORY

In line with the field service philosophy of Stanford's School of Education the School Planning Laboratory has been working since 1950 with schools and industries to keep school facilities in pace with changing educational programs. Each year since then new research results, innovations in building materials and techniques, along with changes in teaching methods, have all combined to present a new set of problems to be solved by school planners. It has been our role to insure that new ideas are reflected in the school buildings that are built to house new programs.

When the Ford Foundation-sponsored Educational Facilities Laboratories designated the School Planning Laboratory as its Western Regional Center in 1959, the

School Planning Laboratory assumed responsibility for administering numerous Educational Facilities Laboratories grants to schools in the western states. In addition, funds became available for conferences, research of a general nature, and publications.

The past year was one highlighted by conferences that varied from flying sixty school administrators to fifteen of the country's newest and most significant schools, to assessing the impact of independent study of Industrial Arts facilities. Between conferences, work on a wide variety of unique school planning and school building projects was continued.

## FUNCTIONS OF THE SCHOOL PLANNING LABORATORY

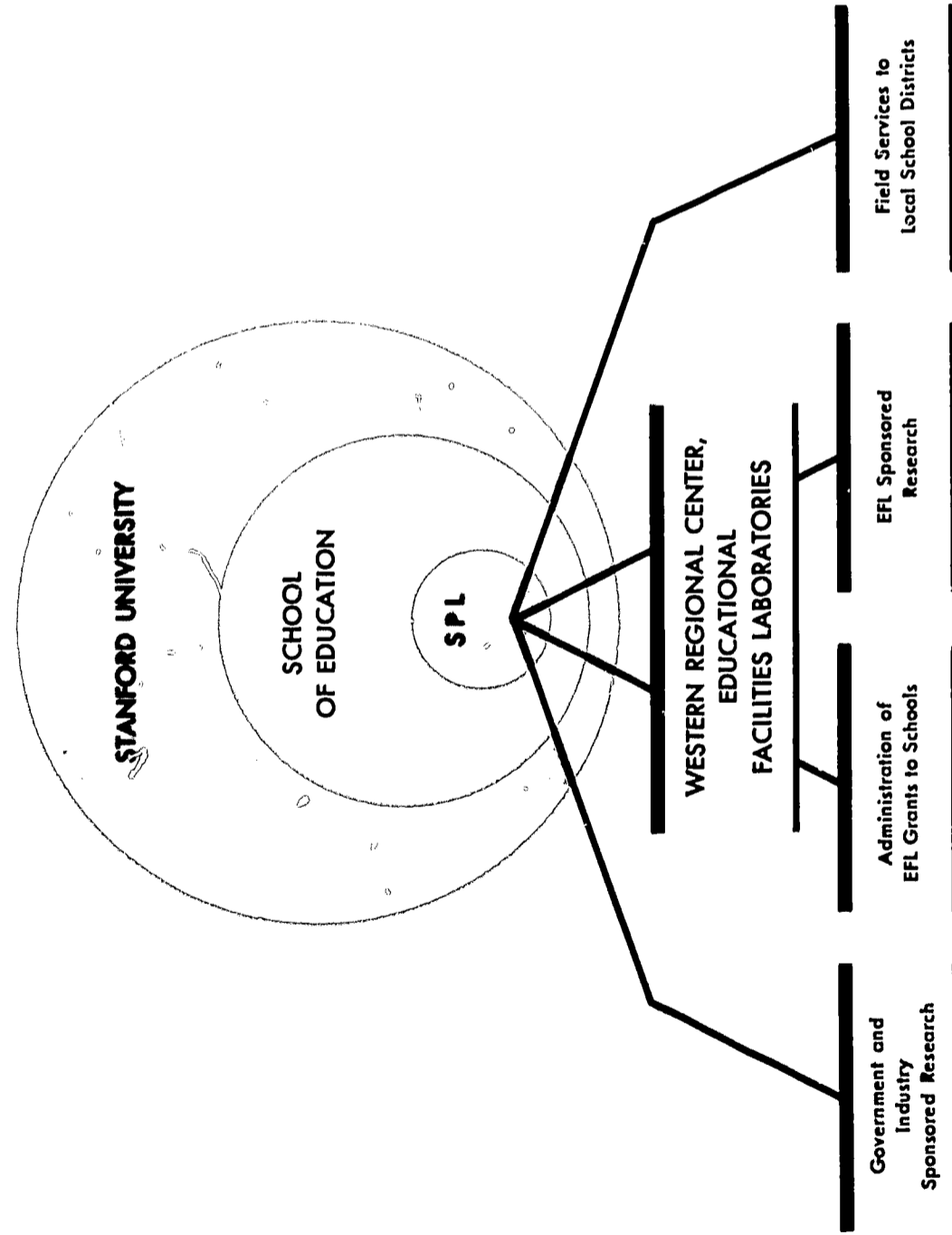

In recent years research has come to be vital to our national existence and added responsibility has been thrust on colleges and universities to serve as research centers. University research is far from limited to programs in space travel and atomic energy. Along with other fields educational research is increasing at a rapid rate. The results are gradually being incorporated into experimental school programs and will eventually bring widespread changes. Research on applications of computer programming to student scheduling is helping to make it feasible to consider abandonment of the lock-step grade system; research on learning has resulted in the introduction of teaching machines and programmed texts; curriculum studies now under way in almost all subjects are changing course content; and finally, it is apparent that educational changes as basic as these are going to reshape the school-house itself. Stanford University's School of Education is striving to help speed the improvement of education through varied research programs which are concerned with all the aspects of education mentioned above and others as well.

The School Planning Laboratory originally created to serve local districts by helping them directly with planning problems, has been increasingly called upon to carry on research that is more basic in nature and which will be useful to schools and colleges nationally. It is our hope that this research on facilities will have a major impact on the efforts to improve education that are now under way.

I. James Quillen  
Dean, School of Education  
Stanford University



New ideas in education almost always have an impact on school architecture. Recent ideas for tailoring education to individual students and increasing the utilization of staff through varying class sizes have sprung loose a complete reanalysis of school building functions. These ideas coupled with new industrial developments that make such things as carpeting and air conditioning commonplace in schools have shaped 1963's buildings.

Educators have projected their ideas of what future educational forces will have an impact on facilities in drawing up educational specifications for these buildings. These documents hopefully will give our buildings a useful life that will extend

Modern innovative educators have proposed a balanced program that includes lectures, seminars and traditional classes along with an individual study program designed to allow students to progress in their studies at their own rates. While a number of schools have been built to contain a varied program such as this, the development of appropriate spaces and equipment for individual study has lagged several years behind the development of spaces and equipment for small and large groups. While areas in these schools are often labeled as space for individual work, close examination of what goes on in them is often indistinguishable from the activities of the time-honored study hall.

But new jargon doesn't mean better education, and in scattered places educators are trying to make independent study be significantly more than what schools have offered in the past. Educationally, this means putting vast amounts of information at the students' fingertips. Equipment-wise it means more books and better books, coupled with utilization of new tools such as television, movies, and teaching machines. Architecturally it means a special place where a student can work unmolested by other students and undisturbed by the bustle of activity that necessarily pervades a school with a working independent study program.

Expanded library budgets and lower book costs through paper backs are answering part of the expanded information problem. Electronic devices are teaming up to answer other parts of the information problem, and the study carrel, a newcomer to schools (though old and familiar in universities) is serving to house this exchange of information from carrier to student.

At this stage, however, there is no unanimity on just how much and which parts of the teaching-learning process should go on inside the carrels. Should every student have a person-

well into the 21st century. Yet these new ideas cannot be approached without recognition of the taxpayers' over-worked dollar. In certain instances we have found that building changes wrought by improving educational space have lowered costs, not increased them. In other cases, it has been found that while better quality, more amenable buildings mean higher initial cost, they save dollars in the long run by reducing maintenance.

The projects illustrated in this report have received aid either directly or indirectly from the Educational Facilities Laboratories in the form of grants which have enabled the School Planning Laboratory to assist these districts with production of educational specifications and design.

## SPACE FOR INDIVIDUAL STUDY

alized carrel? Should they be assigned only to honor students? Should expensive electronic equipment be built-in? Do students store their belongings there? Even science laboratory facilities have come under new scrutiny. The Hamilton Memorial Foundation provided fellowship research funds for studying the new requirements for laboratory furniture created by the revised biology curriculum. While newly designed equipment is not yet available, it is fair to say that after thirty years of little change, science laboratory facilities are due for a drastic overhauling.

The increasing independence of students is changing the complexion of industrial arts as well. Where this program was once almost wholly reserved for the reluctant learner, it is now serving the advanced students who need a place to assemble science fair projects, build mathematical models and the like.

This past year has only established the questions. The suggested answers have been widely divergent. The Bassett School District in Bassett, California, for example, began its high school planning on the premise that a carrel would be provided for every student. Here he would be expected to spend up to sixty per cent of the school day. On the other hand, in California's East Side Unified School District, the new Mt. Pleasant High School will have carrel spaces for a very small percentage of the students. In Cedar City, Utah, the carrels are concentrated in spaces that surround the library. Proponents of both centralization and decentralization are in sharp conflict, each convinced that their approach is the right one. The one thing on which educators do seem to agree, is that *independent study space, coupled with independent study materials, is essential for an up-to-date program—and that over the long haul independent study will increase.* The next five pages show recently planned schools that are dedicated to providing a place for individual students to pursue their studies.

# SPACE FOR INDIVIDUAL STUDY

## SCATTERED STUDY ROOMS

The Mt. Pleasant High School planned for the East Side Unified School District near San Jose scatters its independent study centers around the school. Small rooms adjacent to teachers' offices and classrooms are specifically designed to accommodate the independent study program of each department. Some include carrels, others have work tables, and Science will have individual labs.

This school is an attempt to achieve the efficiencies of compactness along with the amenities of campus-plan schools. The result is a large single building composed of nine sub-units interspersed with small courts.

The school was planned for 1800 students.

Superintendent: Frank Fiscalini

Architect: Kump Associates

Over-all plan of Mt. Pleasant High School showing each department arranged around a court.

Illustration of language center layout showing independent study spaces.

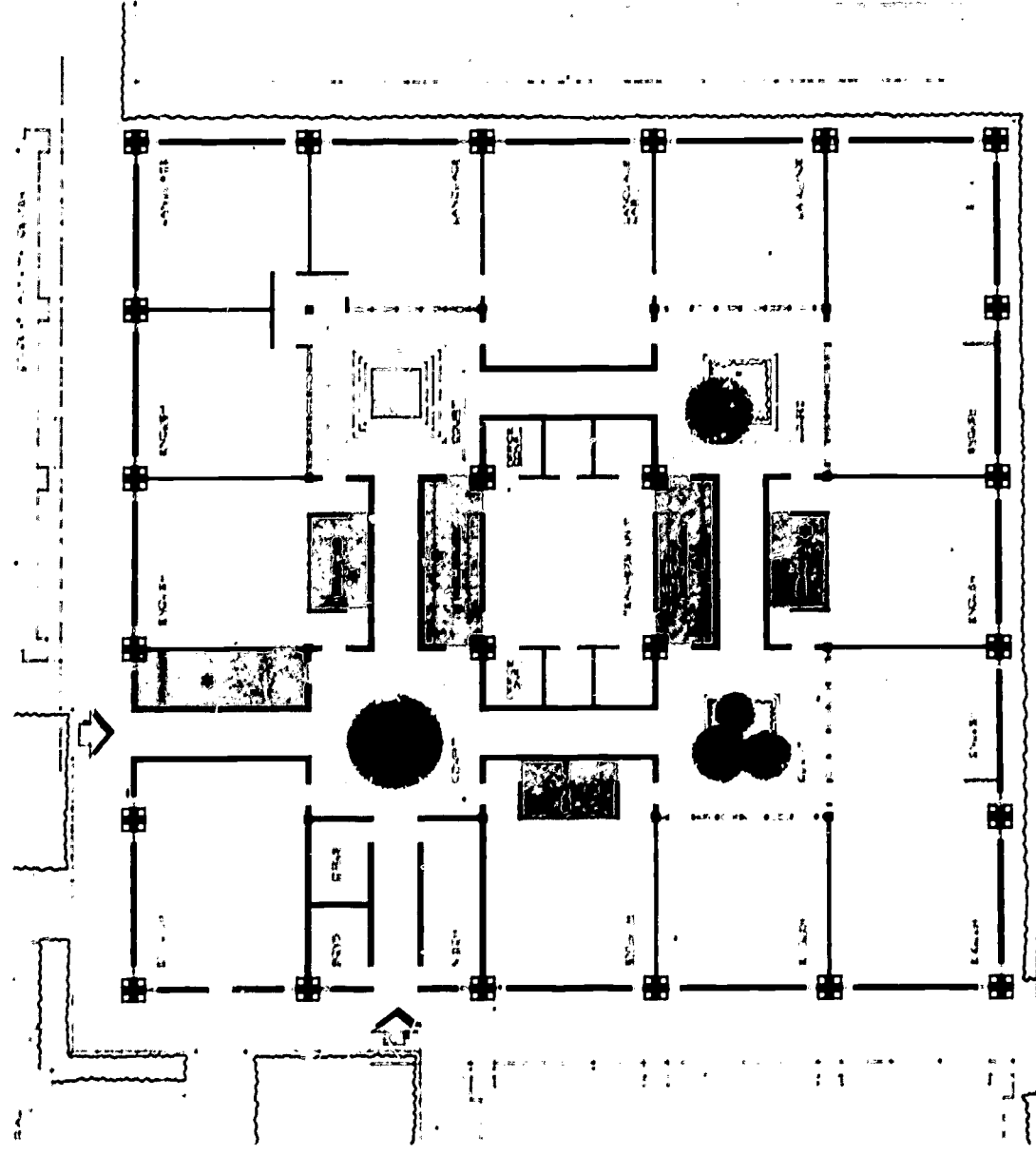
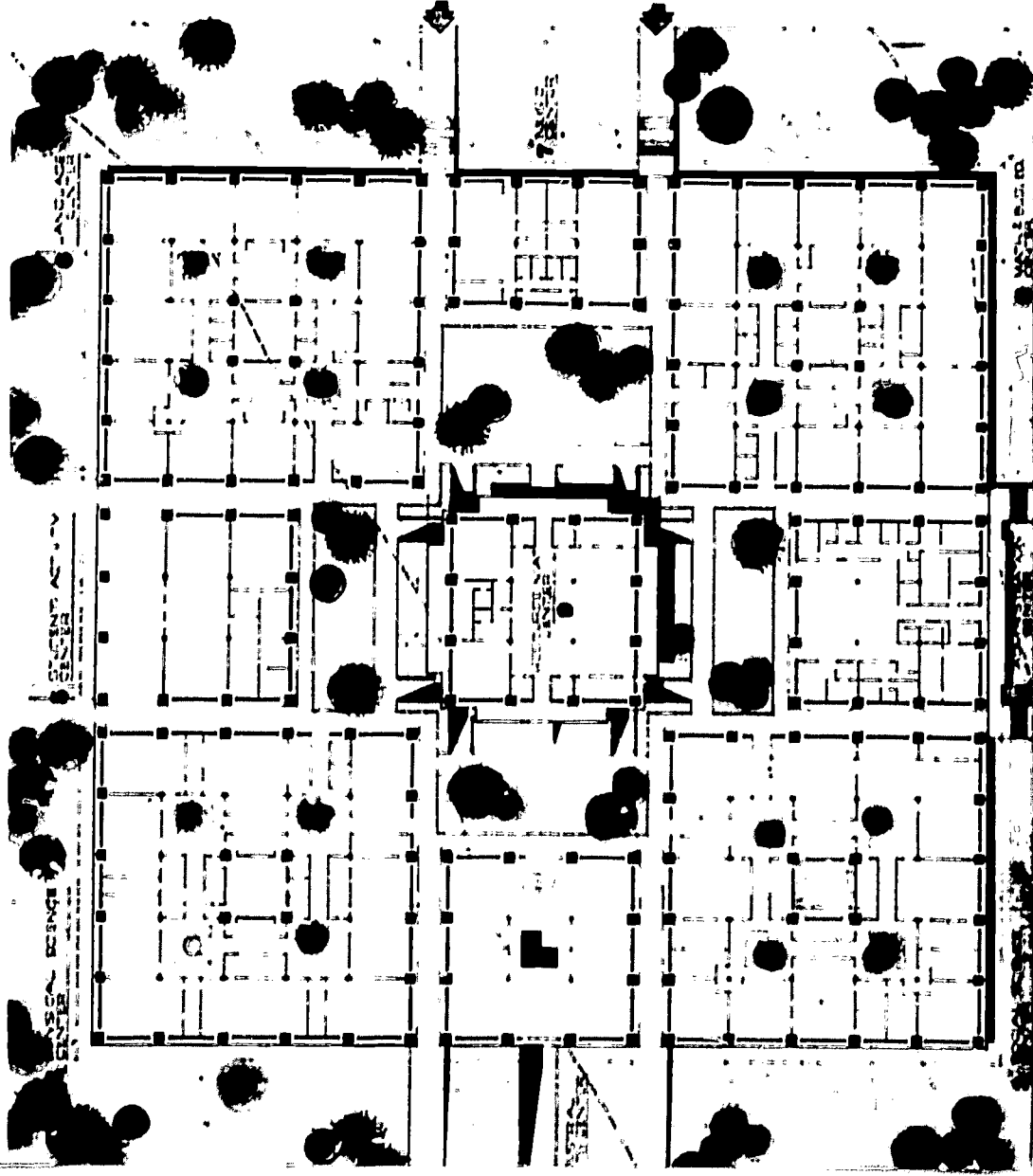

\* Designates special rooms for independent study

## CARRELS CLUSTERED AROUND THE LIBRARY

In Utah, Cedar City's new high school will have an instructional plan based on a traditional pattern but supplemented by large group instruction and independent study. The building designed to house this program is shown here.

Unlike Mt. Pleasant, independent study areas and small group conference areas are planned in close physical relationship to the library to encourage reference work and independent investigation.

Academic classrooms are clustered around a common materials storage space. A cart system will move teaching materials to laboratories and classrooms.

A special money-saving construction feature of the Cedar City High School is the gymnasium roof. To eliminate columns, a "folded plate" roof structure spans the building's width. The zig-zig geometry adds strength to the concrete roof much as corrugations add stiffness to sheet metal. Tensioned cables keep the structure from sagging.

Building plan showing library surrounded with carrel rooms.

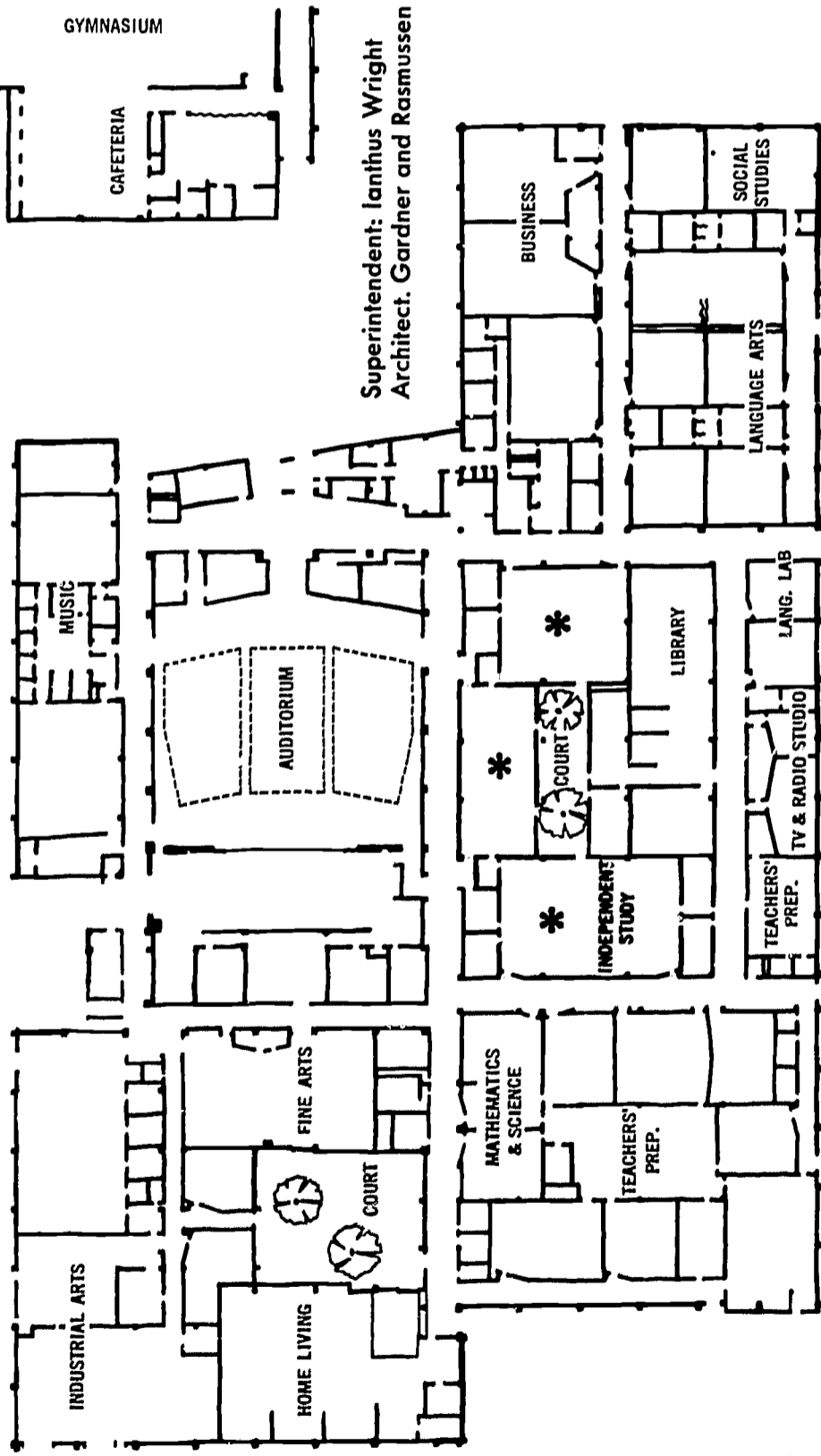

\*Designates special rooms for independent study



Exterior view of Cedar City High School.



Preparation for pouring roof concrete. Cables which were later brought under tension lie in place.

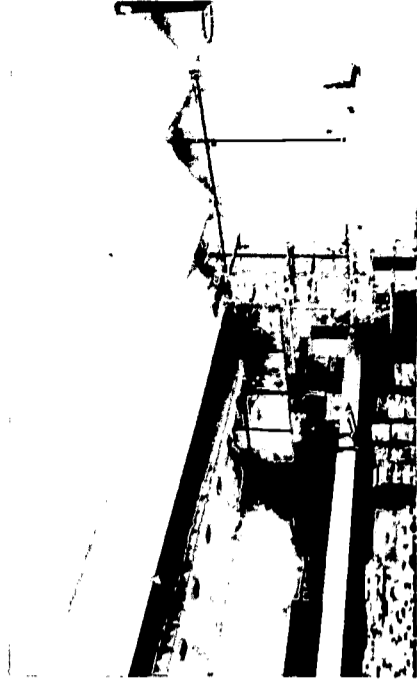

Inside view showing expanse of gymnasium. Skylights separate roof segments.



## A CARREL FOR EVERY STUDENT

The Bassett Unified School District's first high school was conceived around the concept of ultimately providing individual study facilities for each student. At some future date a Bassett student may spend as much as sixty percent of his school day at his individual carrel, leaving it only for consultation with instructors or for laboratory work or physical education.

Bassett will begin with a small student body and a curriculum of individual study in three courses only; mathematics, grammar and foreign language. Until new curriculum materials are available, the large carrel areas will be divided into more or less conventional classrooms that will be carpeted but without doors. As the individual-study program grows, the classroom partitions will be removed. Control rooms for supervision, lavatory facilities and counseling and discussion rooms are located together in a bay between each pair of carrel areas.

The carrels of the Bassett School will provide lockers, facilities for study and home bases for each student.

Superintendent: James Ketcherside  
 Architect: Flewelling and Moody

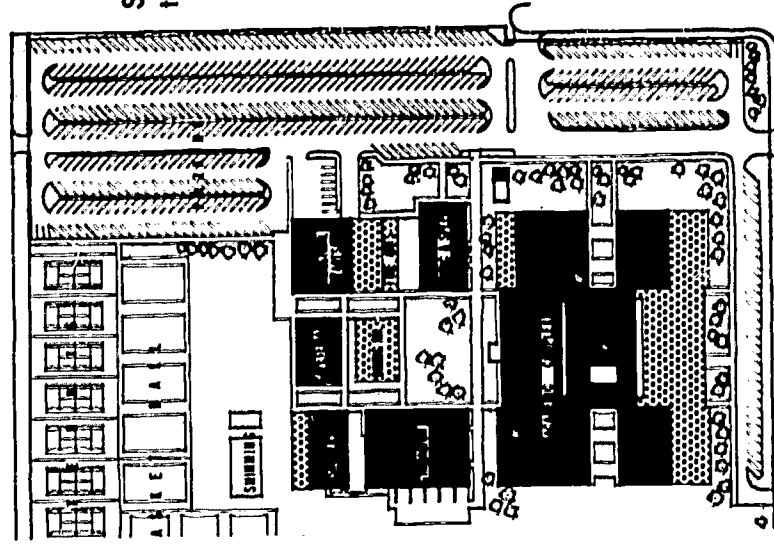

Site plan of the total building complex.

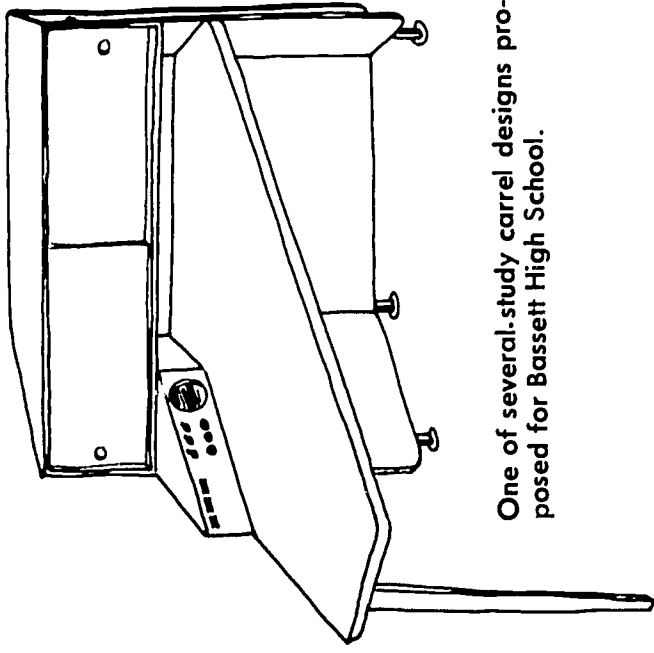

One of several study carrel designs proposed for Bassett High School.

\* Designates special rooms for independent study

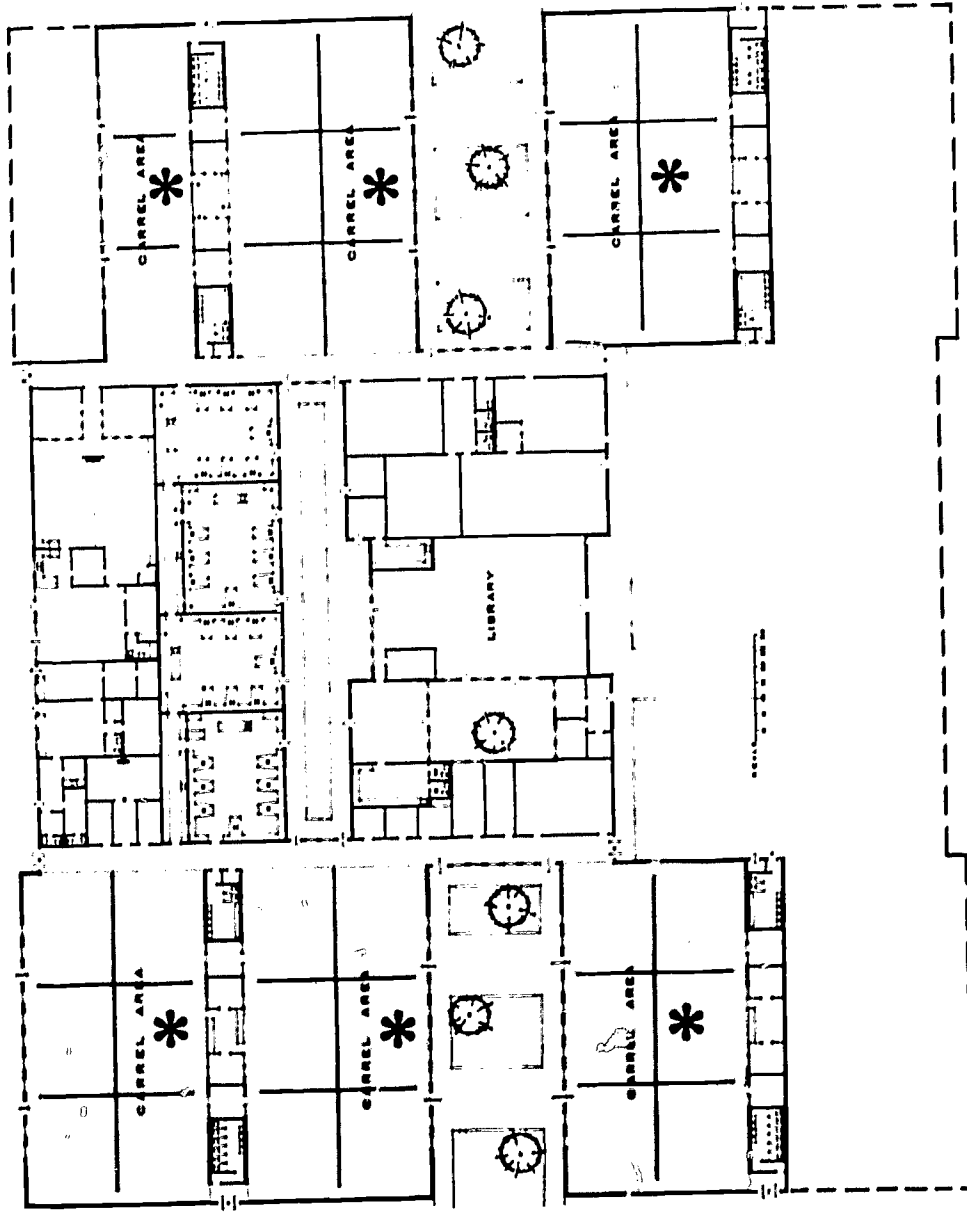

Small, fixed spaces form the building's central spine with open areas for 225 carrels on each side. Dotted line shows future building expansion.

# SPACE FOR INDIVIDUAL STUDY

## A MULTI-USE CARREL AREA & CLASSROOM

This school uses several large classrooms as carrel areas. These rooms are adjacent to studios where teachers can consult with small student groups, the sizes of which are determined by the number of students requiring the same help from the teacher.

The carrels designed for Weber have lower than standard visual dividers and are used in a room with a raised teaching platform. This permits the room to be used in a conventional classroom setting since the teacher can be seen over the carrel dividers. Movable partitions make room sizes variable. Besides the teachers' studios, special testing rooms are located adjacent to carrel areas. Here students are provided with places for individual evaluation. Tests are administered and corrected by aides.

The centrally located Curriculum Coordinating Center provides an office for the Assistant Principal in charge of curriculum as well as the Materials Preparation Center, library facilities, and Audio Visual (including T.V.) Control Center. Several additional individual student carrels are located in the library area. The courts of the school are designed with individual places where studies may be pursued in semi-seclusion.

Superintendent: William Boren  
Architect: Keith Wilcox

Architect's rendering

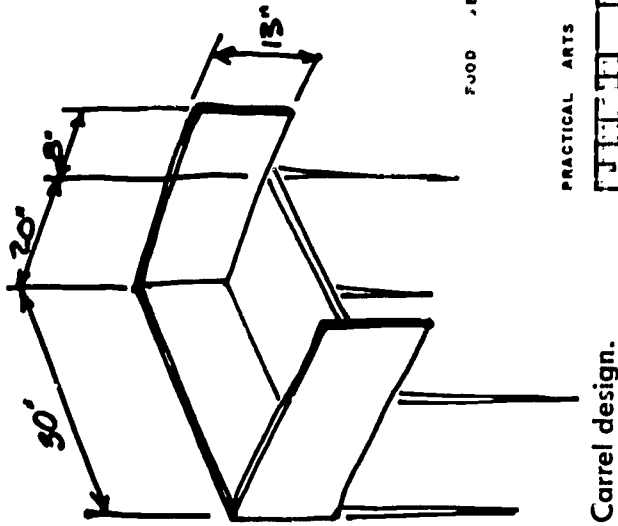
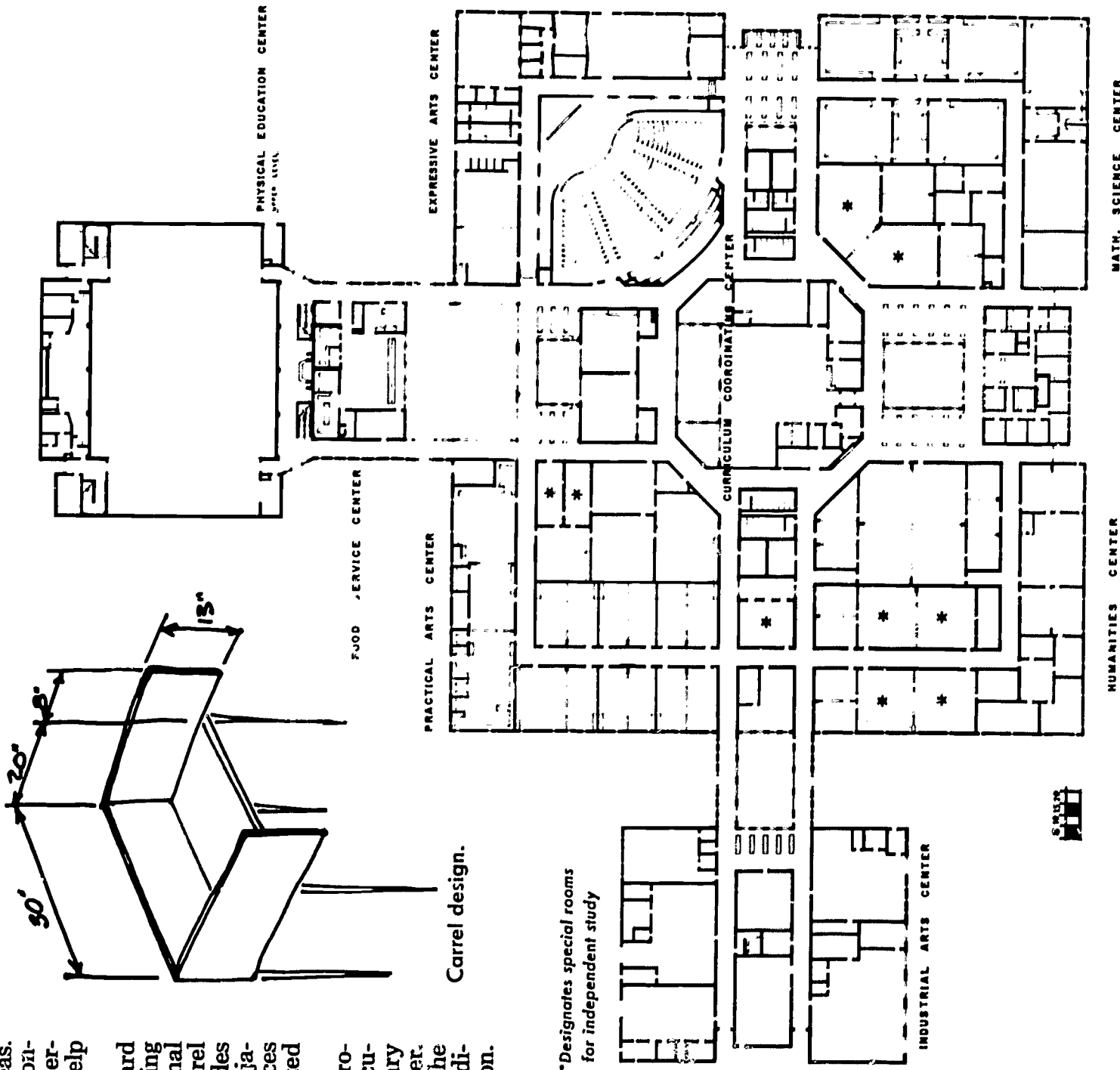

Plan of the total school plant. Darkly toned rooms are furnished with carrels.

# SPACE FOR INDIVIDUAL STUDY

8

## CARRELS IN RESOURCE CENTERS

The plan for Covina's new high school provides a variety of places where individuals and small groups can work effectively. The Humanities Center illustrated here features a complex of individual student carrels and conference areas surrounding the Humanities Library and Reference Area.

Both the Art Center and the Mathematics-Science Center are well equipped with special rooms, adjacent to laboratories for individual student projects requiring operation of apparatus over an extended period of time.

The Instructional Resource Center provides for research and reading by faculty and students alike, and includes a special listening and viewing area for individuals.



Photograph of a model of the school.

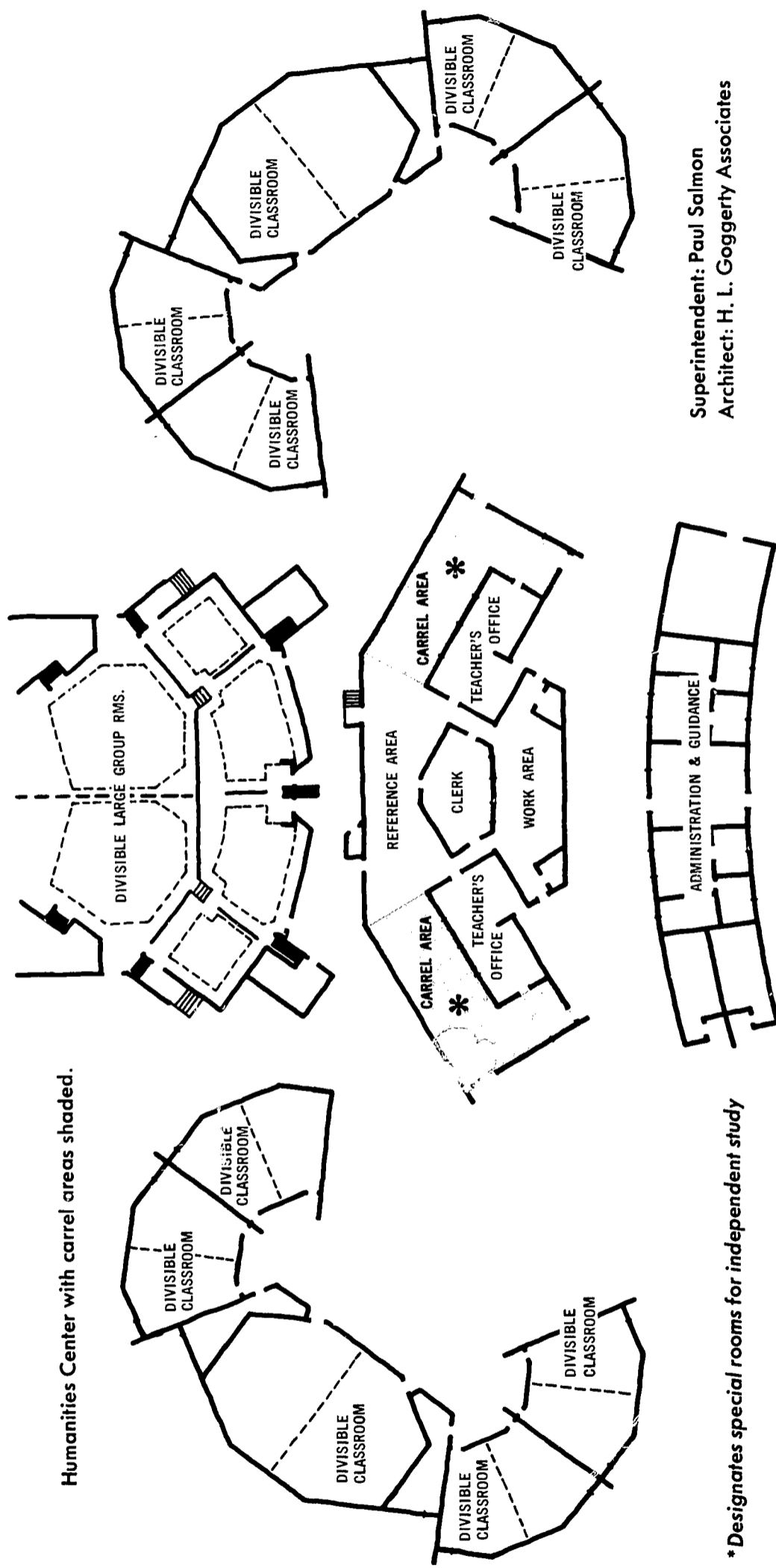

Humanities Center with carrel areas shaded.

\* Designates special rooms for independent study

Superintendent: Paul Salmon  
Architect: H. L. Goggerly Associates





## THE QUEST FOR FLEXIBILITY

Hand in hand with the decreased emphasis on the thirty student class group is the requirement that class groups both smaller and larger than thirty be accommodated. Since class sizes often fluctuate from hour to hour, the best manner of providing classrooms that can accommodate these groups is to make them adjustable in size by incorporating a certain number of operable walls into the building design. Oftentimes, however, bad planning negates their usefulness. A poorly designed space that results from flowing two spaces together is little more useful than a single classroom. As these partitions have become broadly accepted, unusual new classroom shapes that flow together easily have been designed. Two of the best solutions are the Roy Elementary School and the Bates Elementary School, both in Weber County, Utah. Photos on Page 12.

Another step toward getting increasingly flexible school space is to build schools without walls. At the Dilworth Elementary School in the sprawling Cupertino District, school authorities decided to experiment with carpet rather than building room-dividing partitions in a four-classroom quad. So far the results are exciting. The teachers are enthusiastically working together and wouldn't entertain for an instant the notion of trading the carpet in return for walls—operable or

fixed. Clark County, Nevada, is following Cupertino's example and is now building a complete elementary school out of similar clusters. Drawings and photos on Page 13.

Equipment can increase flexibility, too. Again with help from the Hamilton Memorial Foundation, the School Planning Laboratory has been studying the practicability of mobile elementary science equipment that can be moved from room to room.

The University of Arizona has built an open loft-space into its new education building which will serve as a lab for student grouping experiments. Movable panel walls and furniture subdivide the large space into suitable smaller rooms.

In other studies ETV has been the flexibility-giving tool. Page 16 shows two high school designs that use closed circuit TV to carry both live and prerecorded lessons into classrooms.

Yet another kind of flexibility is multiple use. The Stanford Research Institute, working on a Federal government contract, asked the School Planning Laboratory to study the available precedents for using appropriately designed schools as fallout shelters. Our nationwide survey disclosed a number of interesting proposals and several existing schools with shelter capability.

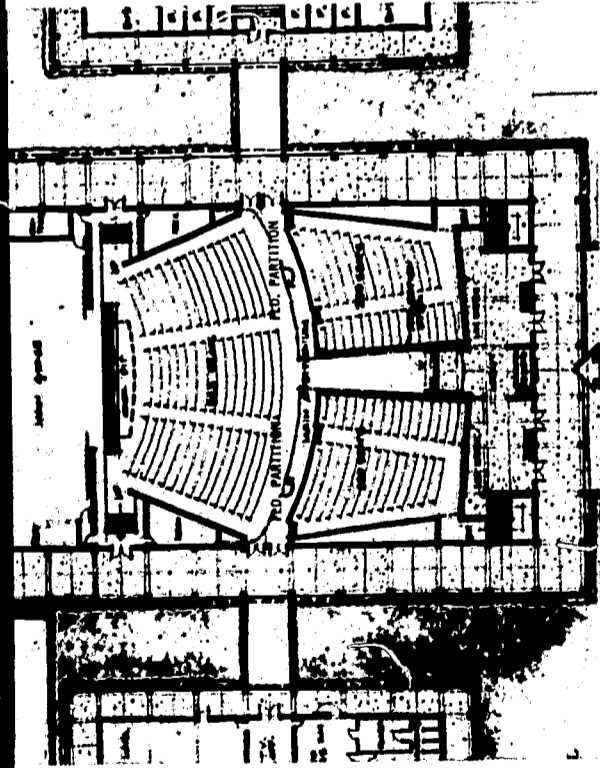

**Henry Gunn High School, Palo Alto, California:**  
A 965-seat auditorium which is divisible into a small theater with 525 seats and two lecture halls with 220 seats each.  
Superintendent: Harold Santee Architect: Kump Associates

**Mt. Pleasant High School, San Jose, California:**  
Here a basically circular design is divided into three equal segments of 150 seats each. A number of different combinations of these spaces is possible.  
Superintendent: Frank Fiscalini Architect: Kump Associates

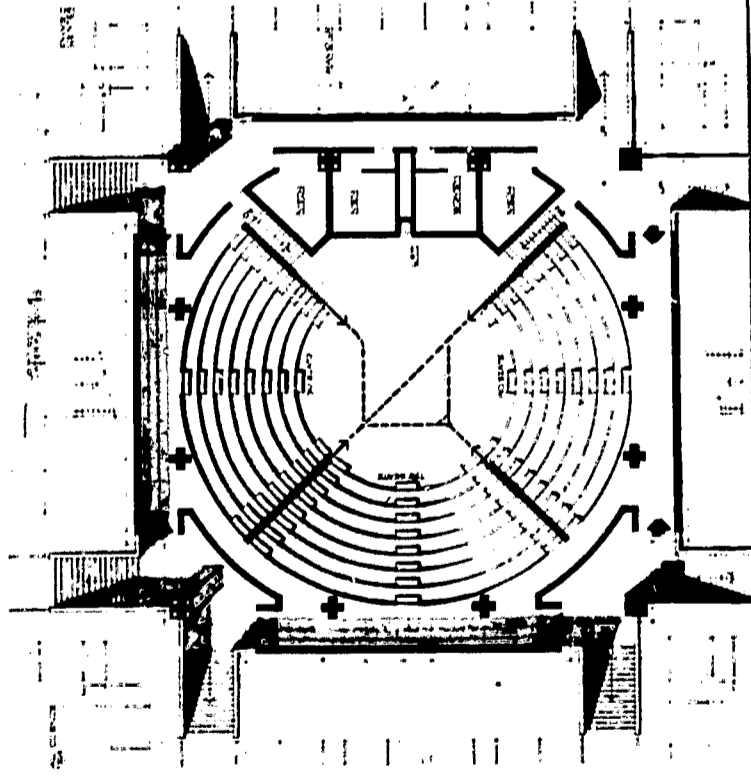

**THREE SUBDIVISIBLE AUDITORIUMS**

The expense of building large school auditoriums is difficult to justify because of their infrequent use. The contemporary approach is to build auditoriums that can be divided into smaller areas to serve multiple functions. Since the Boulder City, Nevada, divisible school auditorium was opened in 1962, many variations of subdivision have been attempted, three of which are presented here.

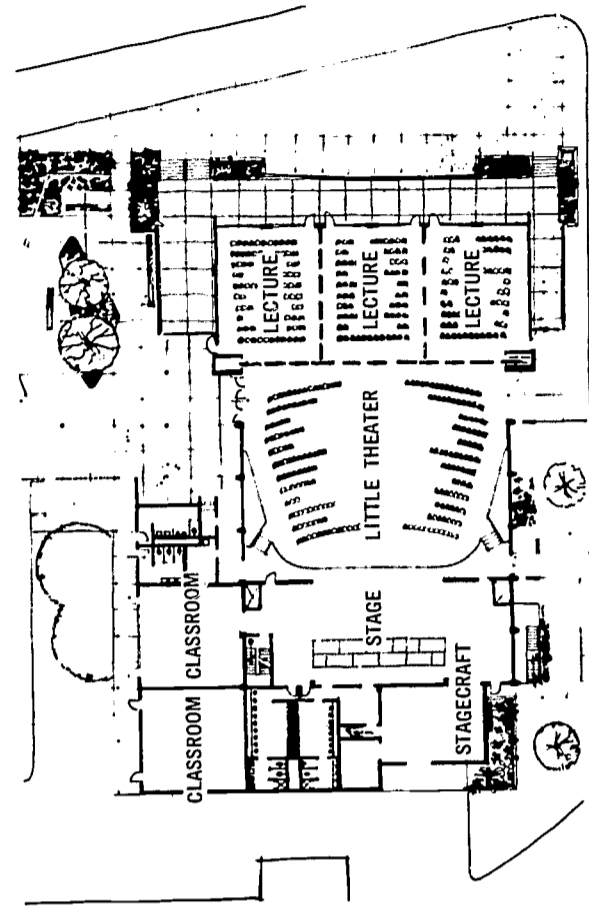

**Edison High School, Stockton, California:**  
This plan divides the auditorium into a little theater and three smaller lecture halls.  
Superintendent: Donald R. Sheldon  
Architect: Cloudsley and Whipple

Edison's sub-divisible auditorium under construction. Tiered lecture halls can be seen in the rear of the space.

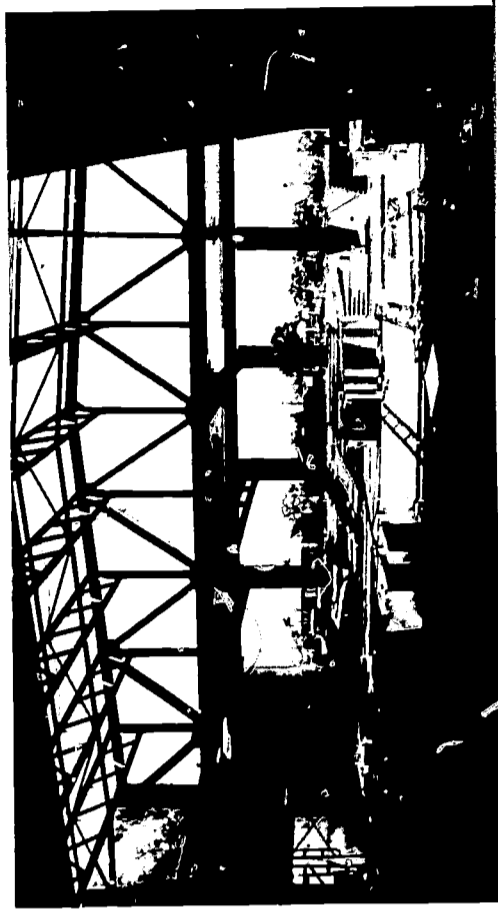



# THE QUEST FOR FLEXIBILITY

New programs are provoking educators to cluster students in groups other than thirty. Consequently they are creating a need for adjustable-size classrooms. Key planning and building implications are 1) installing operable walls, 2) elimination of interior load-bearing walls, 3) proportioning spaces that are appropriate both when opened together and subdivided.

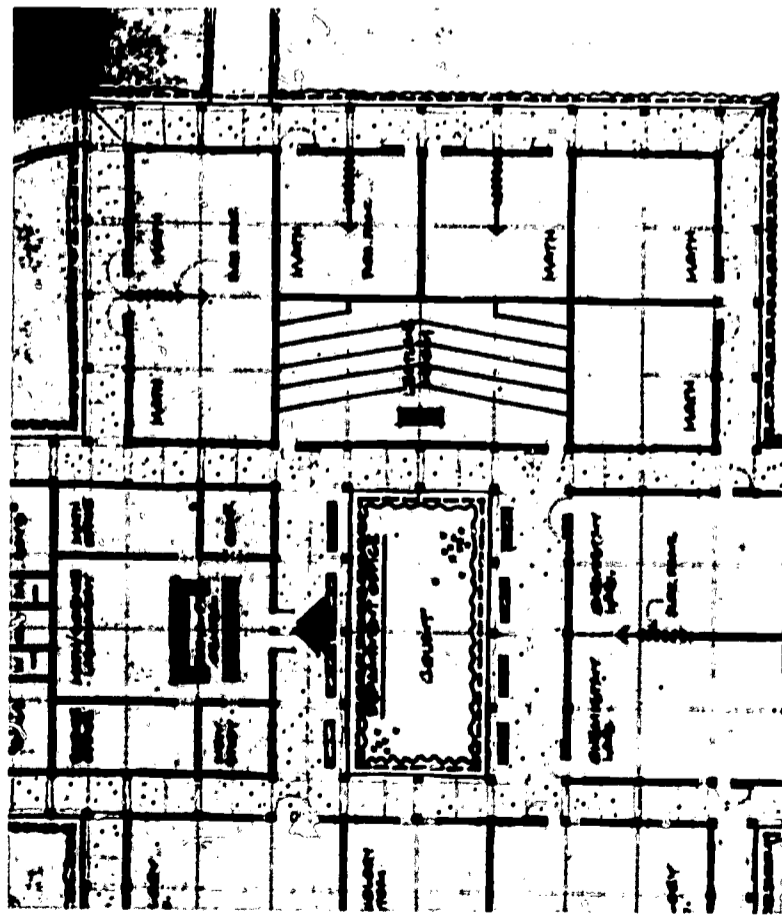

Henry Gunn High School, Palo Alto, California:

Four 14-foot-square modules constitute a standard classroom but operable walls reshape the space for both larger and smaller groups.  
 Superintendent: Harold Santee Architect: Kump Associates

This rendering of the Gunn High School shows the load-bearing column structure.



This ceiling grid installed in a Stanford University classroom provides light, acoustical treatment, and conditioned air to the space below. The grid pattern permits subdivision of the space at four-foot intervals with demountable panel walls.

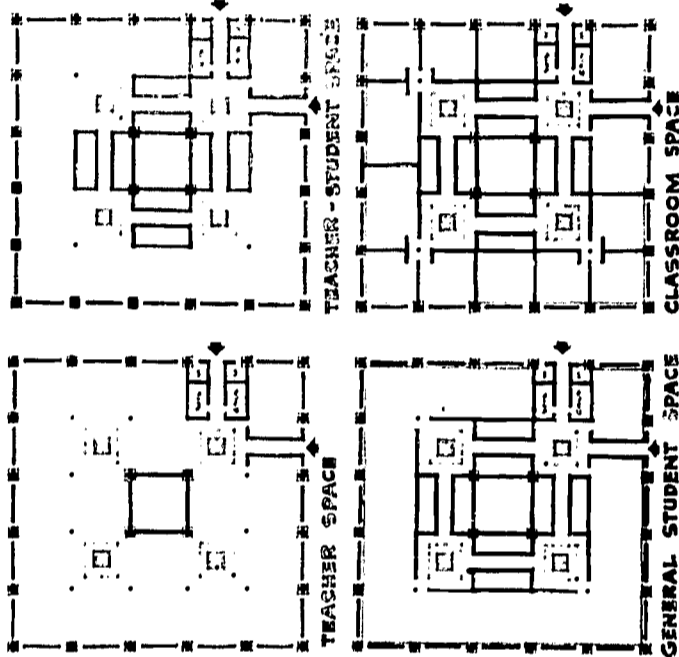

Mount Pleasant High School, East Side District, San Jose, California:

Beginning with open space, the architects have subdivided the academic clusters into spaces of various sizes.

Superintendent: Frank Fiscalini  
 Architect: Kump Associates

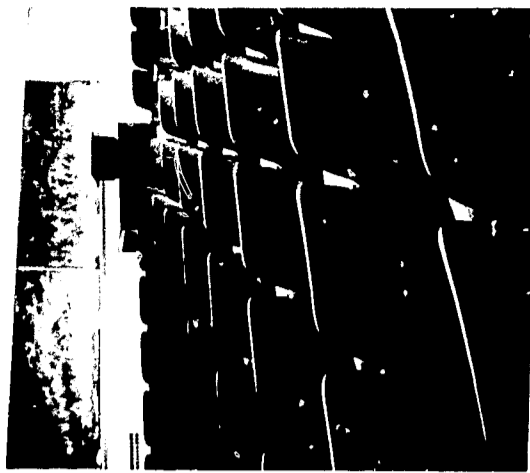

Overfelt High School, East Side District, San Jose, California:

Operable walls are used to subdivide a large flat-floored multi-purpose room into several classrooms and a large lecture room.

Superintendent: Frank Fiscalini  
 Architect: Al Walters

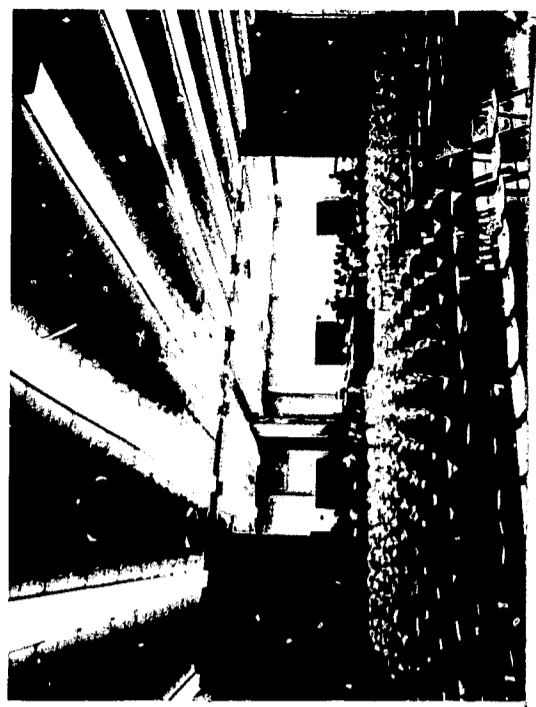

## TWO CLUSTER PLAN ELEMENTARY SCHOOLS

School officials in Weber County, Utah, have consistently experimented with building design in an attempt to find room shapes and arrangements that are practical for cooperative teaching. The current plan calls for three clusters of three rooms each.

Each cluster has the rooms arranged to maintain good sightlines even when the operable walls separating them are opened. Thus large group instruction space results from merely moving the operable partitions.

Each classroom has a work area for small group discussions or project work. A central teacher preparation and materials center is provided for teacher planning. The entire school, though of uncomplicated design, provides basic elements for planning, individual work, seminar and large group instruction.

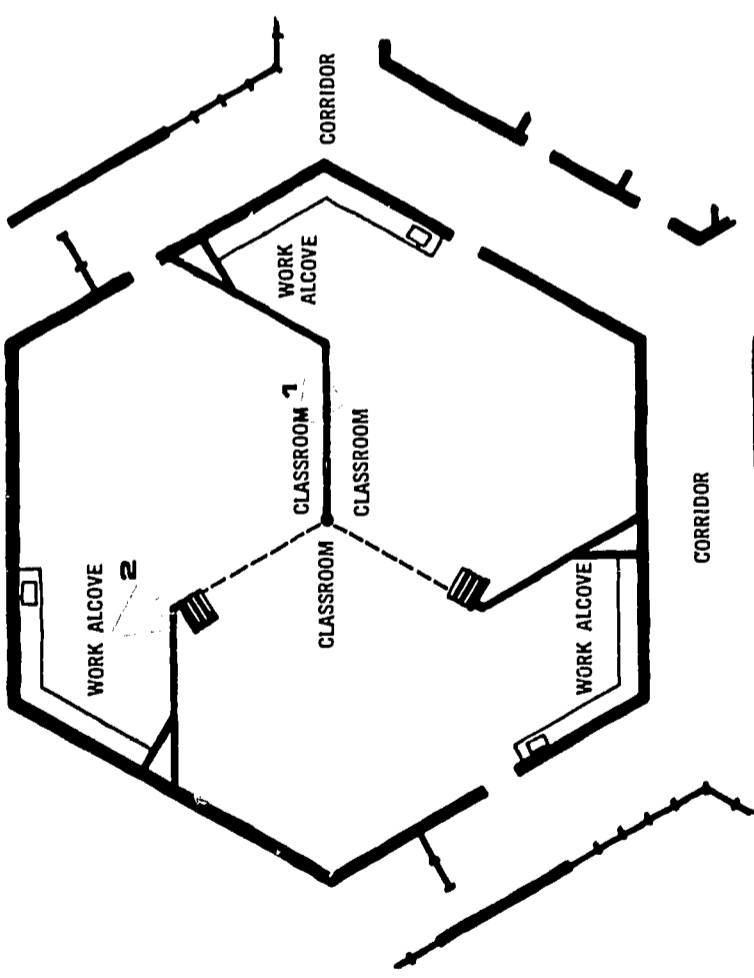

Plan of the Roy Elementary School addition.

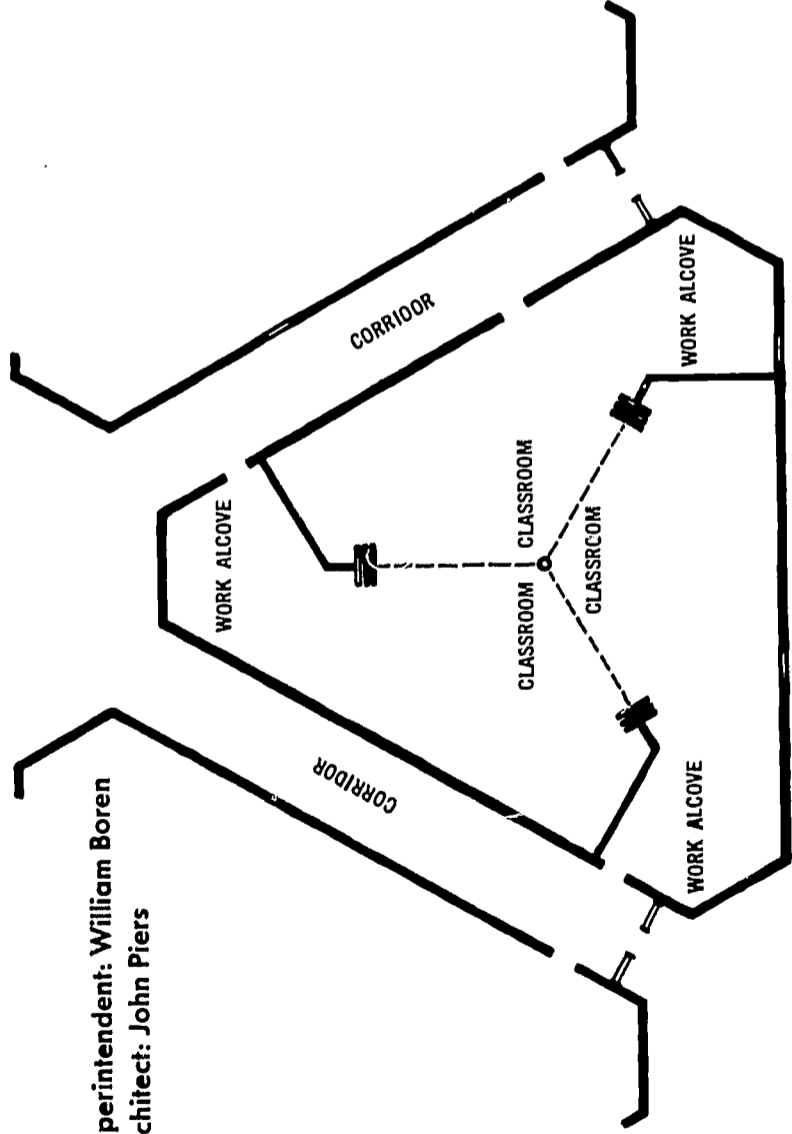

Superintendent: William Boren  
Architect: John Piers

The Bates Elementary School.



1

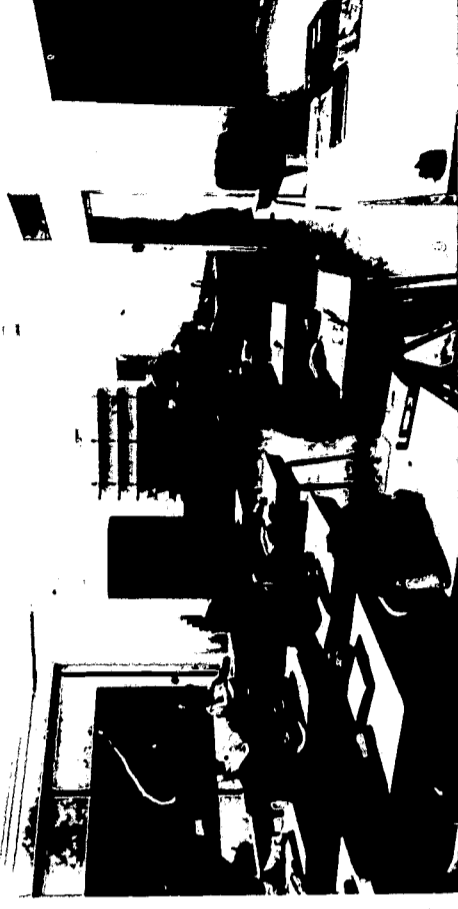

2

## OPEN PLAN ELEMENTARY SCHOOLS

School enrollment in Clark County, Nevada, is growing so rapidly that elementary schools are planned in groups of six. In the calendar year September, 1962, to September, 1963, total enrollment increased nearly 9,000 students. Enrollment growth is continuing at this high rate and school officials face dual problems of providing new school housing yet improving each successive set of buildings.

In the next set of six elementary schools, to be opened in September, 1964, one building will have four classroom clusters that will serve as experimental units similar to Cupertino's Dilworth School. Its open plan will be carpeted throughout with short partitions coming into the room from midway along each of the walls. These partitions are calculated to give some privacy but the primary emphasis is on openness. The entire center of the room is left open, making for easy exchange of students as well as providing a space for large group instruction. Should this scheme be successful the other schools can be remodeled along similar lines.

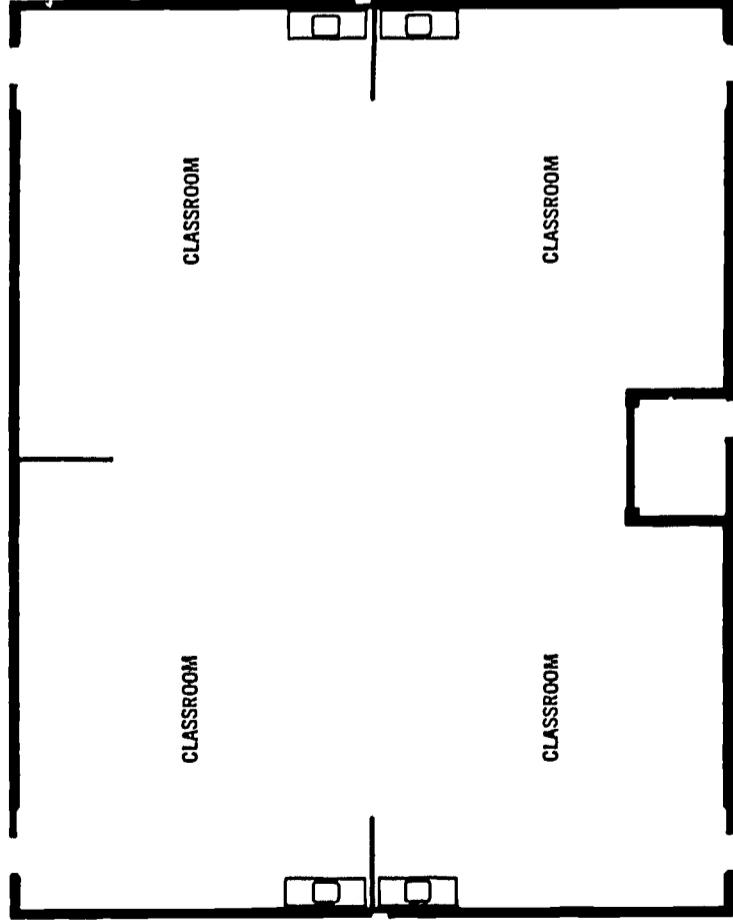

Floor plan of an open cluster, Clark County, Nevada.

### CLARK COUNTY

Superintendent: Leland B. Newcomer  
Architect: Julius Gabriel

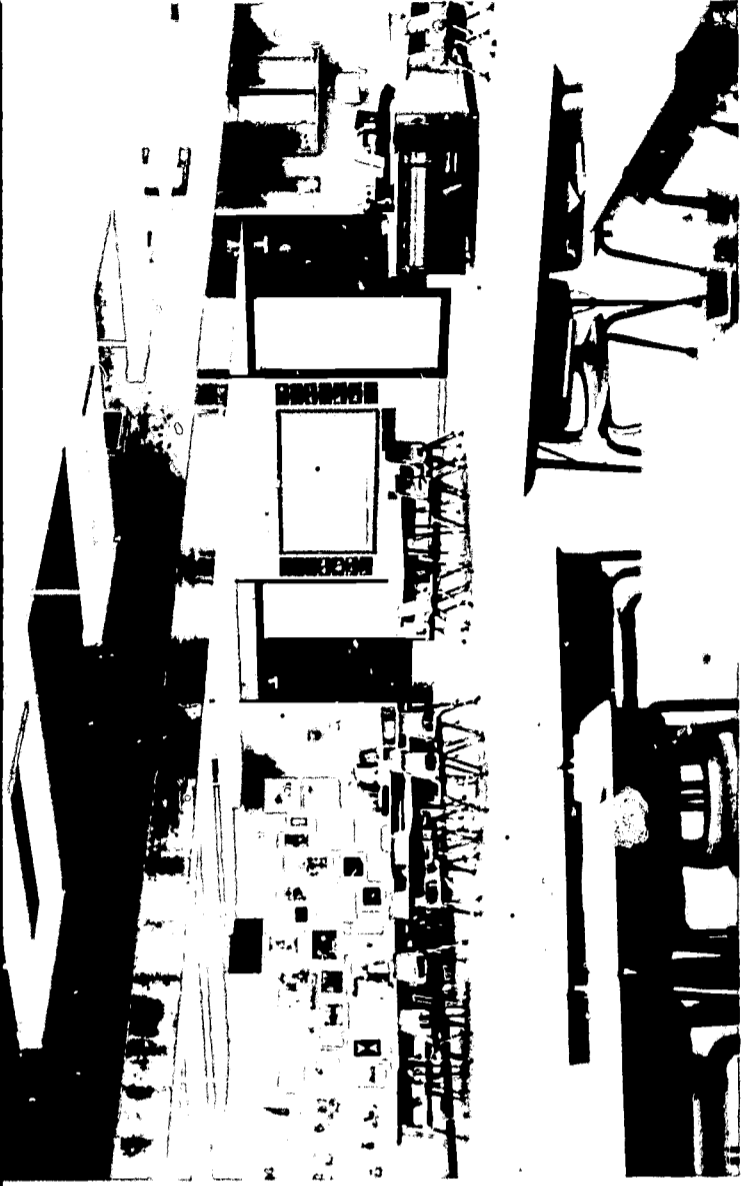

Photo of the Nelson Dilworth School, Cupertino Elementary School District. (Note tackboard wall.)



Rendering of the Clark County Elementary School.

### CUPERTINO

Superintendent: Charles Knight  
Architect: Kal H. Porter

## FLEXIBLE MULTI-PURPOSE ROOM

The multi-purpose room at Ewa Beach is composed of a circular room surrounded by wedge-shaped spaces, a stage and a storage room. The circle is defined by semi-circular walls which can be moved to an open position, leaving a major portion of the multi-purpose room in view of the stage. Folding partitions extend from the exterior walls of the building towards the center, dividing the space for classroom use.

Spaces within the facility may be arranged to accommodate varying group sizes, from thirty to six hundred.

Floor plan of Ewa Beach  
Elementary School  
Multi-Purpose Building.

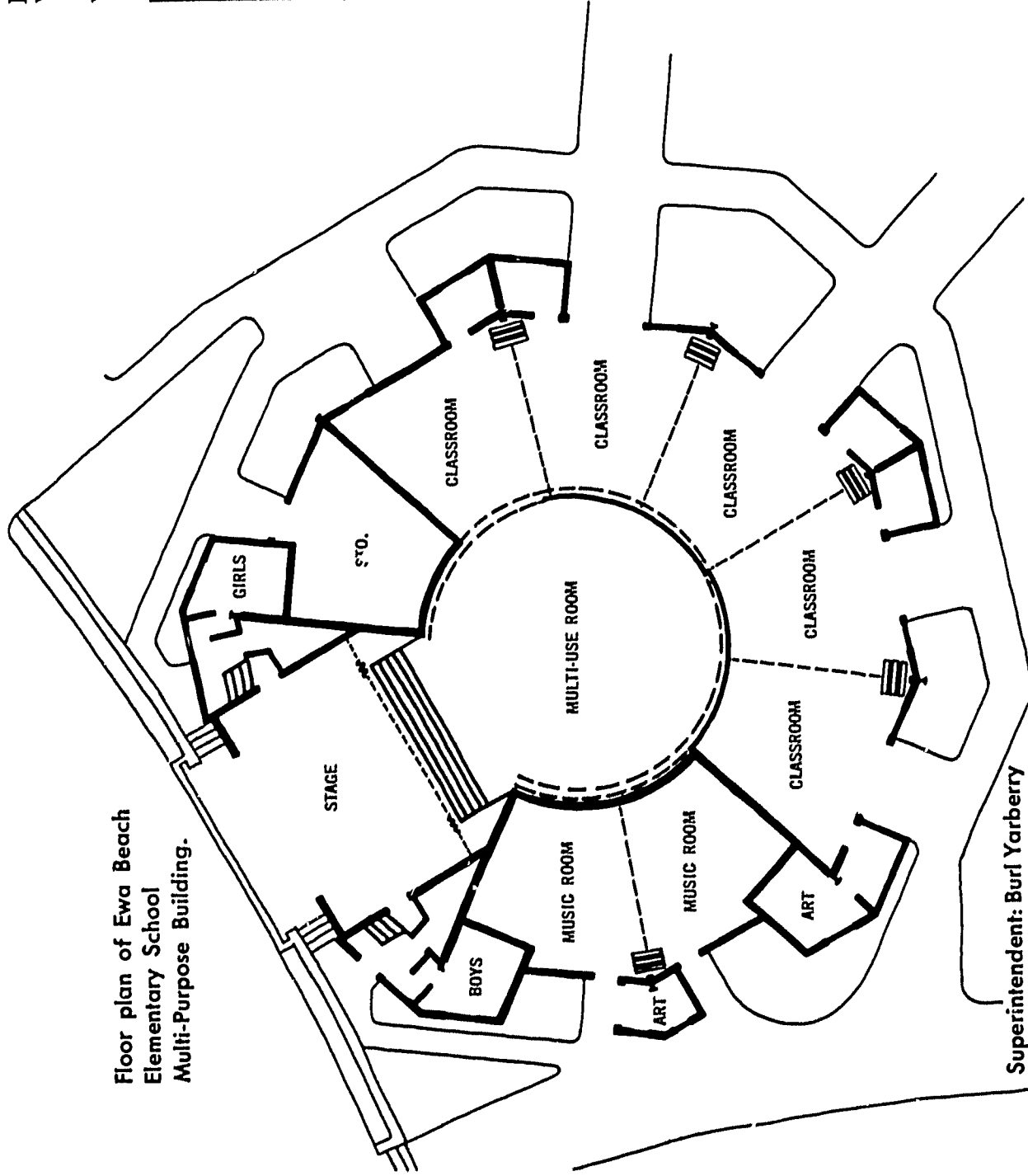

Superintendent: Burl Yarberry  
Architect: Frost and Frost

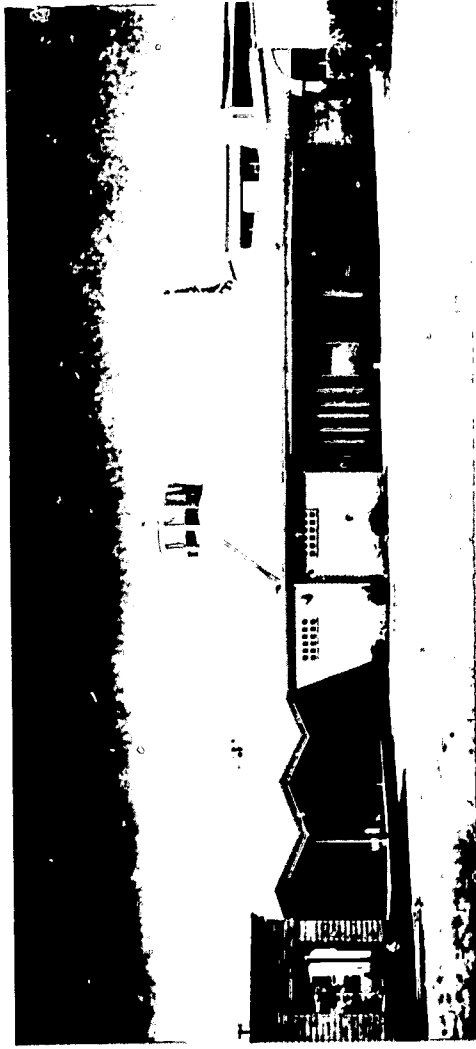

Exterior view.



A semi-circular moving wall.



## SEMI-ENCLOSED GYMNASIUM

This gymnasium facility for South Hills High School in Covina, California, is planned to maximize natural ventilation for both spectators and athletes. Air flows through the overhead doors on each side of the building, while a variety of space arrangements is made possible by locating sliding walls across the building.

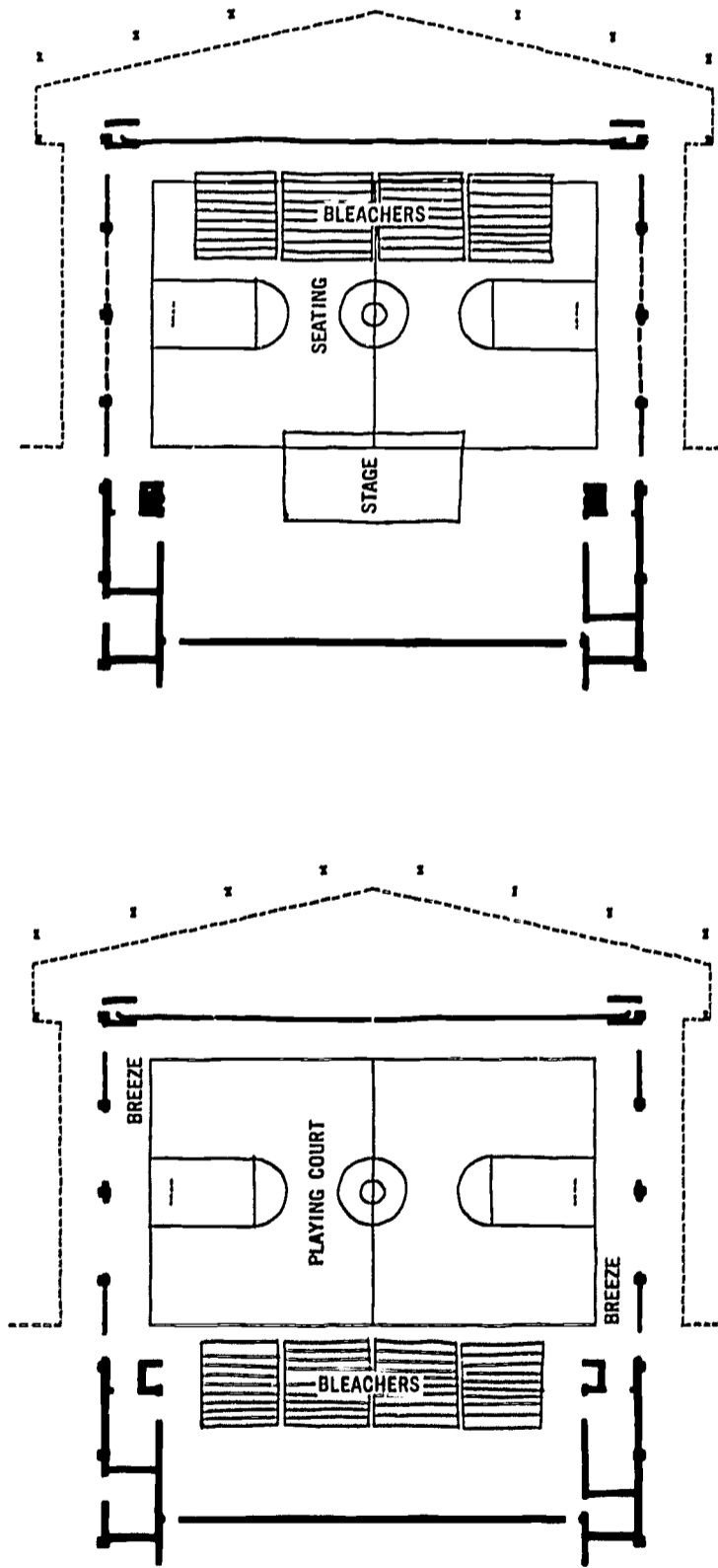
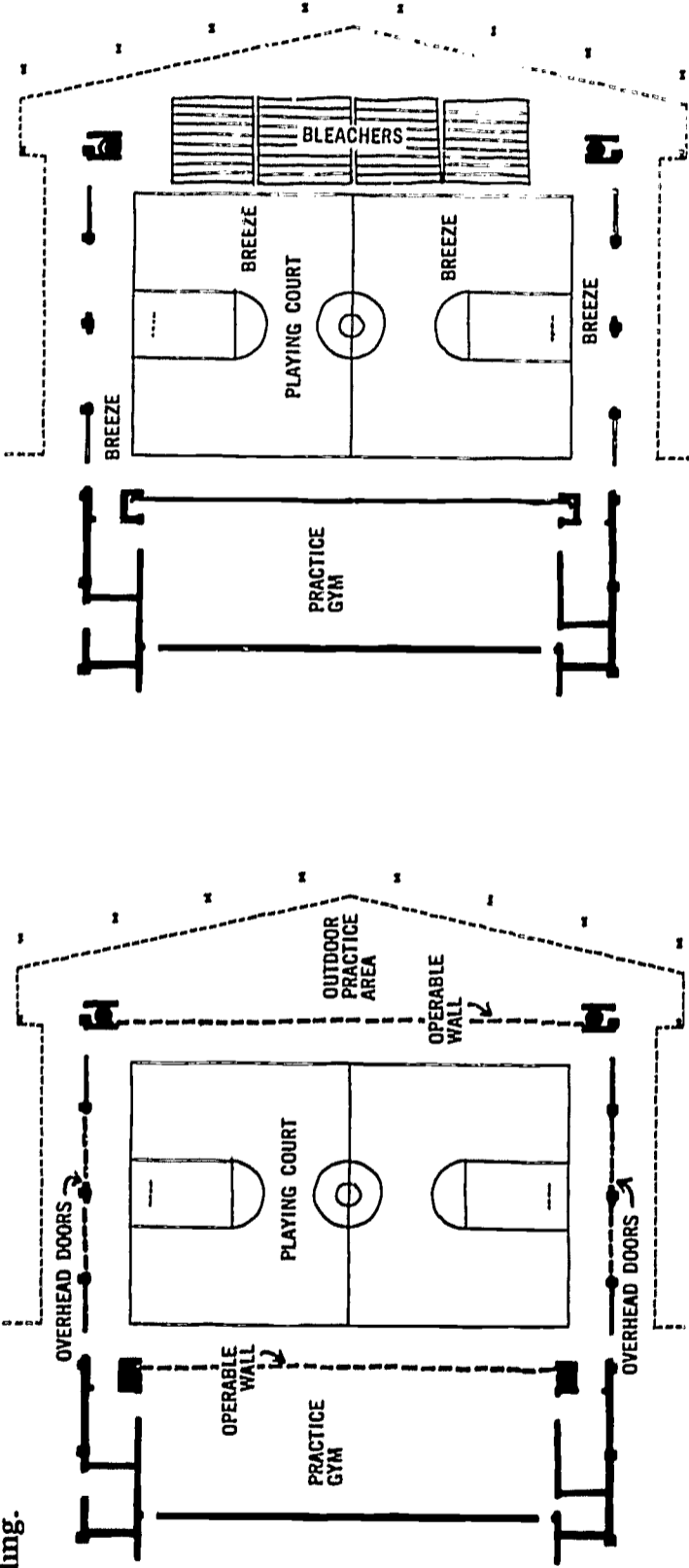

Superintendent: Paul Salmon  
Architect: H. L. Gogerty Associates



# THE QUEST FOR FLEXIBILITY

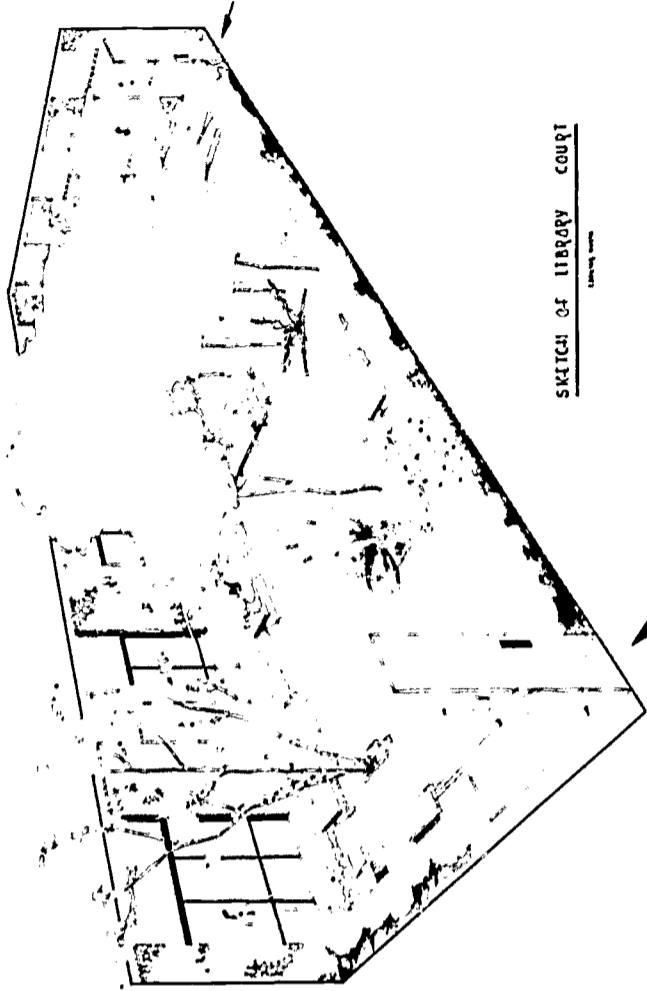
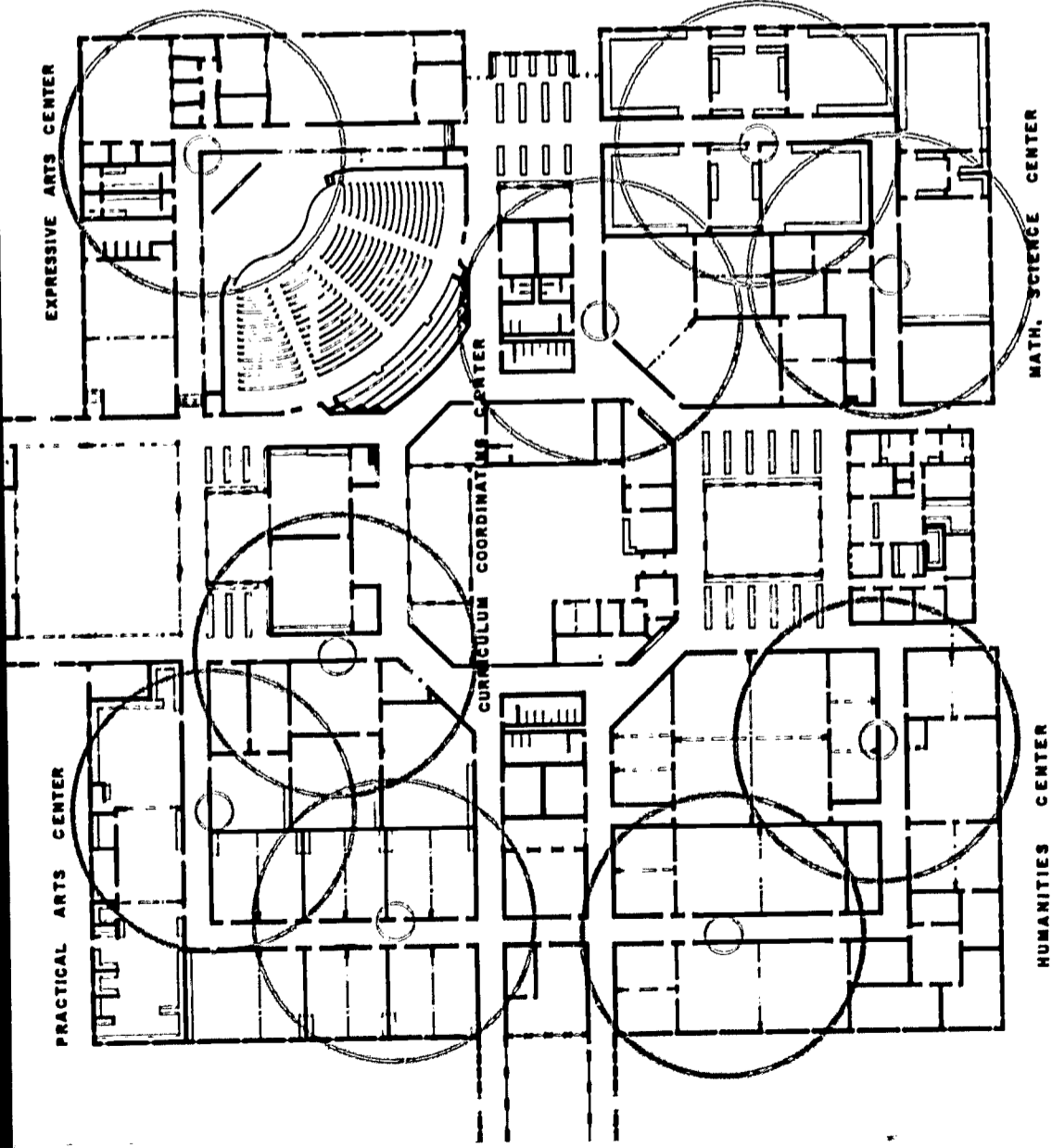

Amenity in schools is important too. This sketch shows one of the several landscaped courts planned for the Roy High School.

## TWO SCHOOLS WITH ETV

Television is another way of gaining flexibility. At the Roy High School, each classroom can be used as a remote studio simply by bringing in a special cart with lights, camera, and other paraphernalia. Extension cords connect two cameras to one of the nine outlets. The picture goes to the central control room where it is routed to appropriate classrooms.

The Fullerton Union High School District, on the other hand, is exploring the opportunities for linking its new high school to nearby Orange State College. This new high school will not only have closed circuit TV that will enable any classroom to be a studio or a receiving point, but its classrooms will, through television, serve as demonstration classes for Orange State's School of Education.

### WEBER COUNTY, UTAH

Superintendent: William Boren

Architect: Keith Wilcox

### FULLERTON UNION SCHOOL DISTRICT

Superintendent: Ernest Blake

Architect: Blurock, Ellerbroek & Associates



## TOWARD IMPROVED CONSTRUCTION

Besides influencing building planning, the School Planning Laboratory is playing a key role in influencing construction. Under a special Educational Facilities Laboratories grant to Stanford University, the School Construction Systems Development was established to take a fresh look at how we build our schools. This system involves thirteen school districts which will be building simultaneously twenty-five million dollars' worth of school construction. The object of gathering together this large consortium is twofold. On the one hand it makes possible the designing of components especially suited to schools. At the same time, such volume is expected to result in lower costs.

The approach to design has been to develop a system of basic components which can be assembled in a variety of ways, thus assuring the advantages of mass production without resulting in mass produced schools.

Industries are teaming up to provide package proposals for complete new school building systems designed according to performance specifications set by these districts.

A prototype school will be completed on Stanford's campus in 1964. The other School Construction Systems Development schools are scheduled to open in 1966 and 1967.

Several other buildings designed with SPL help, where unusual structure has been important, follow.

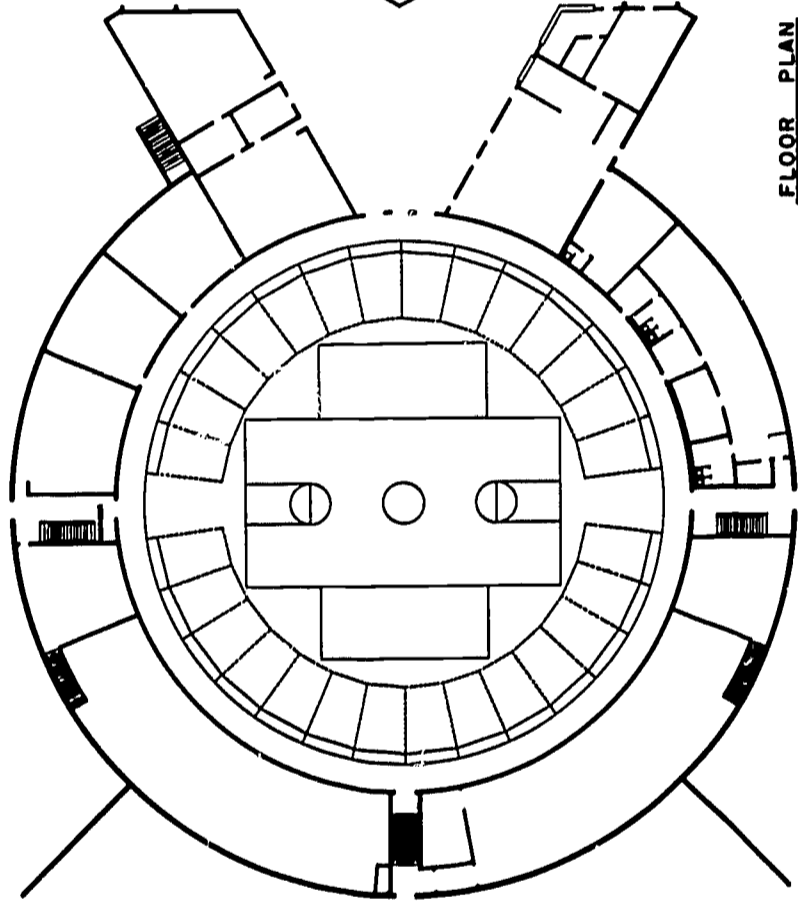

FLOOR PLAN

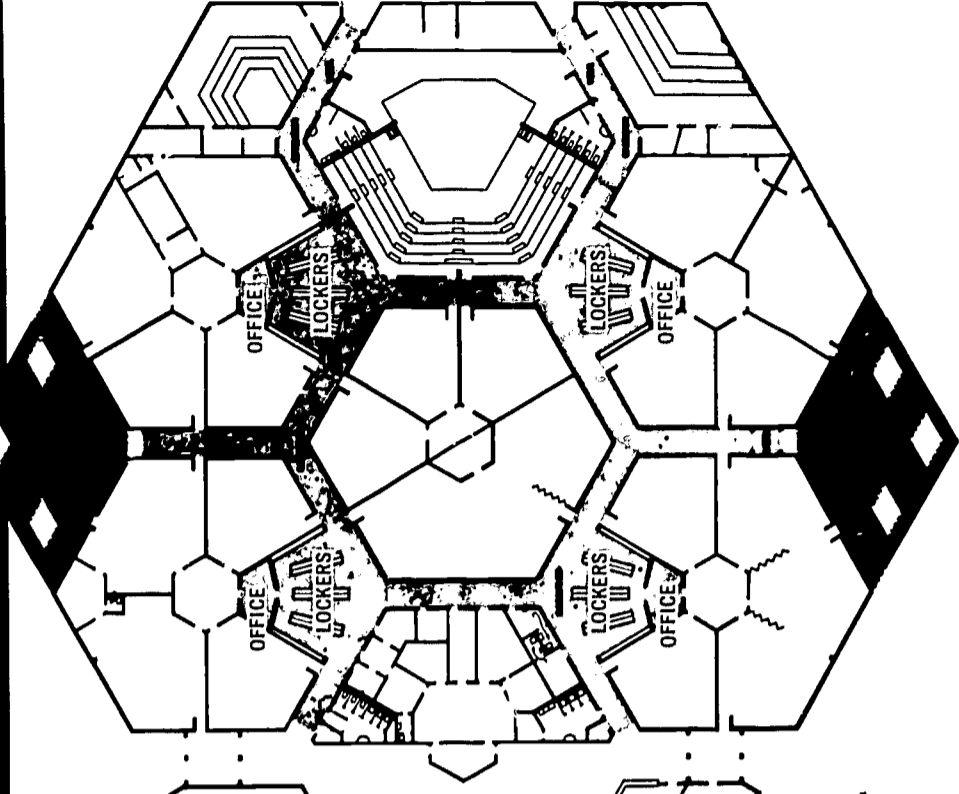

**A COMPACT PLAN HIGH SCHOOL**

Some architects have found that traditional ways of building schools are not always the best or the cheapest. At the McPherson, Kansas, High School, compacting the plan, air conditioning the space, minimizing outside glass, using a thin-shell concrete roof structure, and planning with hexagonal classroom clusters, have all added up to an inexpensive school

well adapted to varying class sizes and teacher teams. The money savings that resulted from these steps were great enough to include air conditioning and still keep both the square foot and per pupil costs of McPherson High School below the average of other schools in the area — none of which had air conditioning.

Superintendent: Joe Ostenberg  
 Architect: Shaver and Company

Classroom view showing operable wall open thereby combining two classrooms.



The activities center serves for parties, eating space and general traffic flow.

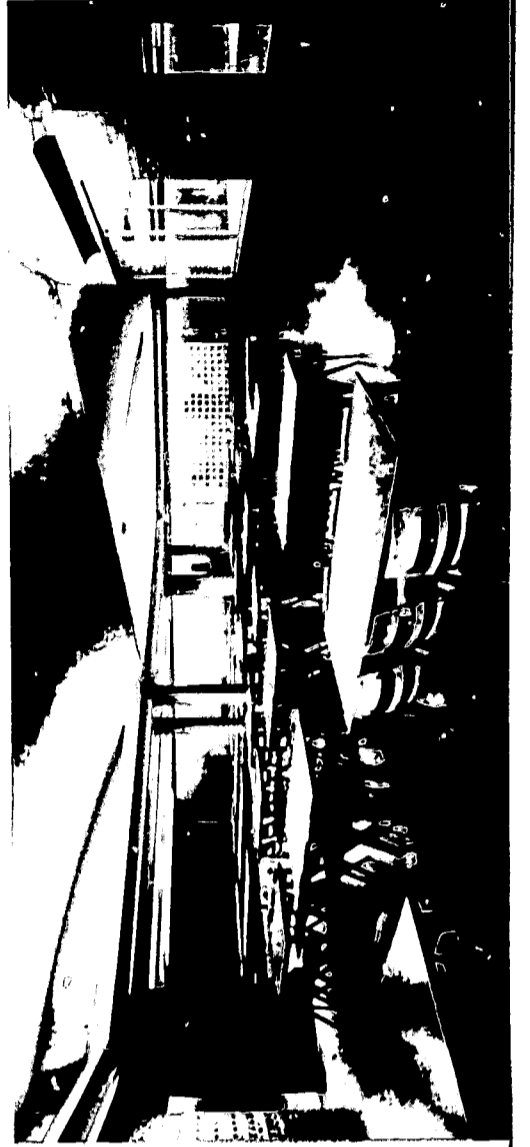

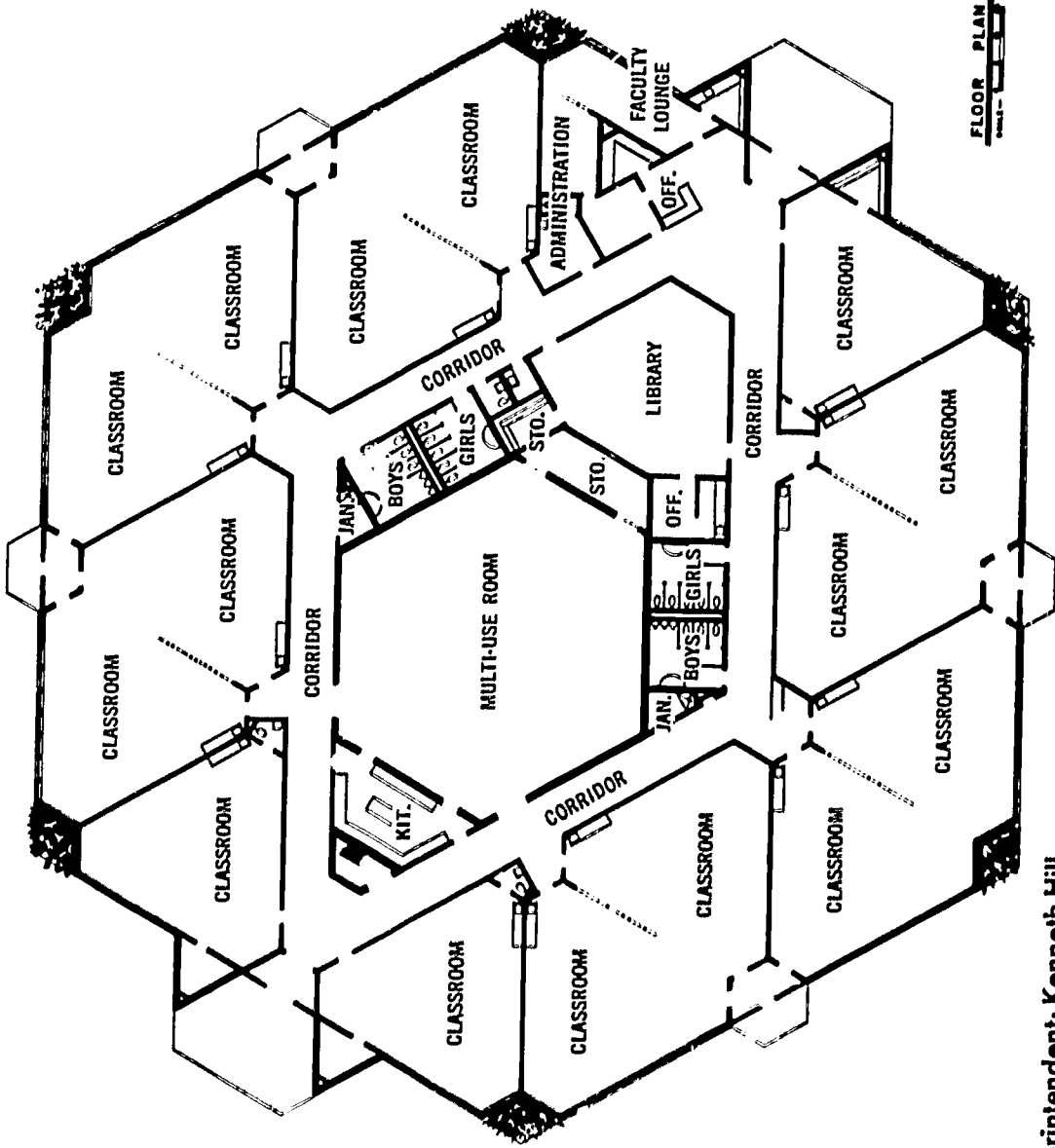

Superintendent: Kenneth Hill  
 Architect: Shaver and Company

## A COMPACT PLAN ELEMENTARY SCHOOL

At the Pratt Elementary School, concrete umbrella paraboids are the roof. Under these umbrellas, both exterior and interior walls are non-loadbearing. This geometry easily accommodates back-to-back classrooms separated by operable walls which lend themselves to team teaching.

To facilitate flexibility, heating and air conditioning were kept off the floor. The utility lines are hung from the roof above the corridor.

The square foot cost figure of 11 dollars includes both air conditioning and cabinetry.

A portion of the teaching space. Note the carpeted floor and folding wall.



View of Pratt Elementary School showing four of the twelve concrete umbrellas which cover the school.

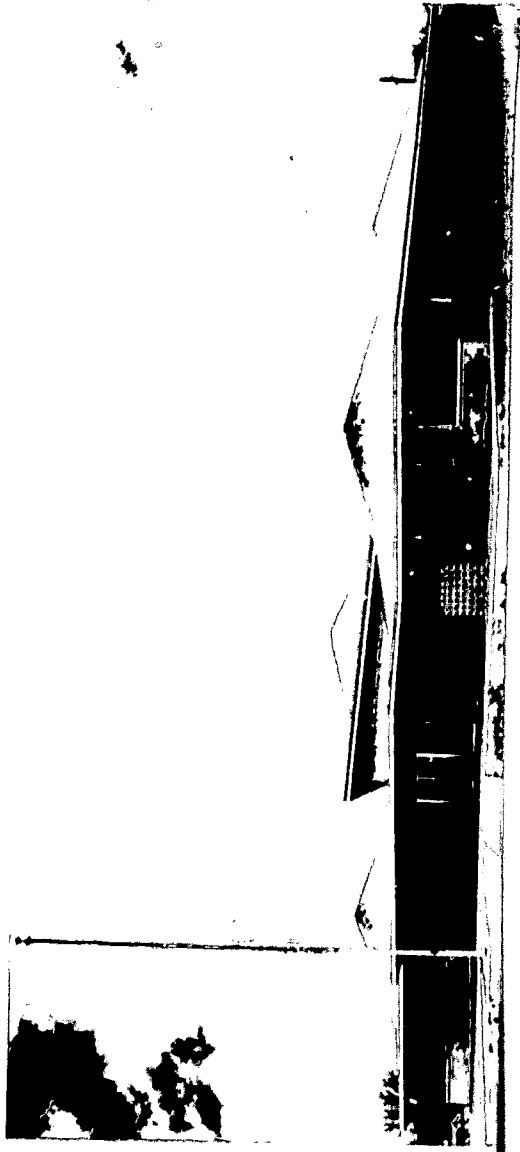





## OVERALL INSTITUTIONAL PLANNING

Almost everyone is in favor of planning, but planning without action is only wasted energy. We have attempted through several projects to make campus planning an effective tool that will bring positive results to colleges and universities across the nation.

At Saint Benedict's College, a master plan was prepared to help it grow from a school of 750 to one with 1500 students. Space utilization studies, building renovation, new construction, building demolition and even the relocation of a cemetery all were part of the program. The final result was a model that will determine Saint Benedict's future growth. (Page 2.)

To deal with campus planning on a broad scale, a Campus Planning Institute was held during July of this year. Nearly

one hundred persons from across this country, Canada, and Great Britain attended. In addition to reviewing twelve significant recent campus plans, several days were devoted to discussions of what the future may bring. This glimpse into the future saw the urban institutions taking an increasingly important role, with even rural campuses expected to strive for certain urban characteristics. Interdisciplinary research also was expected to influence strongly designs of the future.

(Careful planning can be important for the small individual building as well. The Charter Oak School District has, through extensive work with consultants from many disciplines, developed a basic approach to planning an administration building.)



## A CAMPUS PLAN

Saint Benedict's College stands as an example for colleges over the nation. An increased enrollment in the late 'sixties was anticipated and officials at Saint Benedict's decided to develop a systematic plan for growth.

Educational Facilities Laboratories made a grant to Saint Benedict's to help cope with the planning problem. The study which resulted included three phases: 1) assessment of existing facilities to determine the amount and structural quality of usable space available, 2) determination of alternate uses for existing facilities and, 3) projection of facility needs based on assessment of facilities and anticipated growth.

A master plan model was built to show the probable campus layout, as shown in the accompanying photographs.

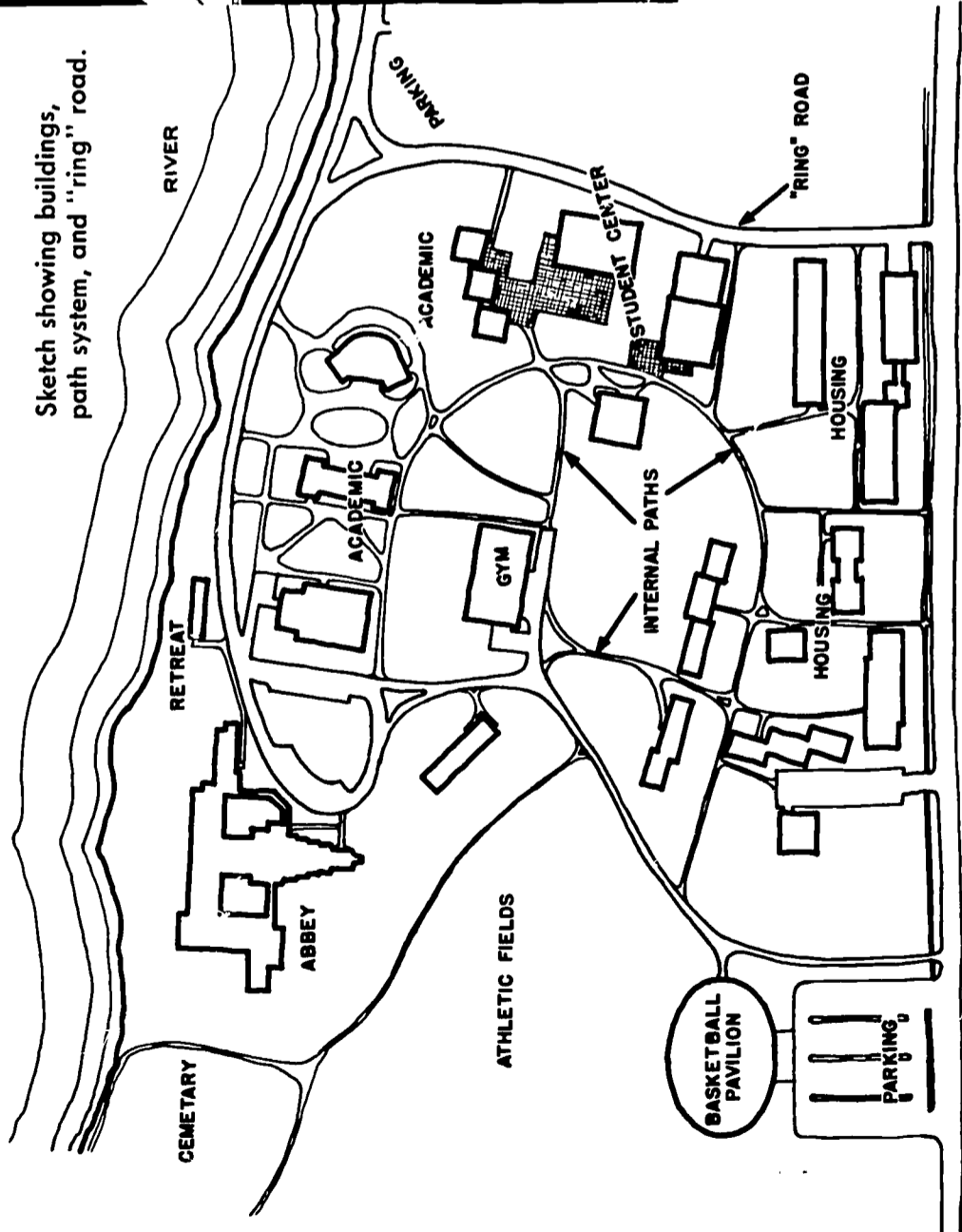

Sketch showing buildings, path system, and "ring" road.

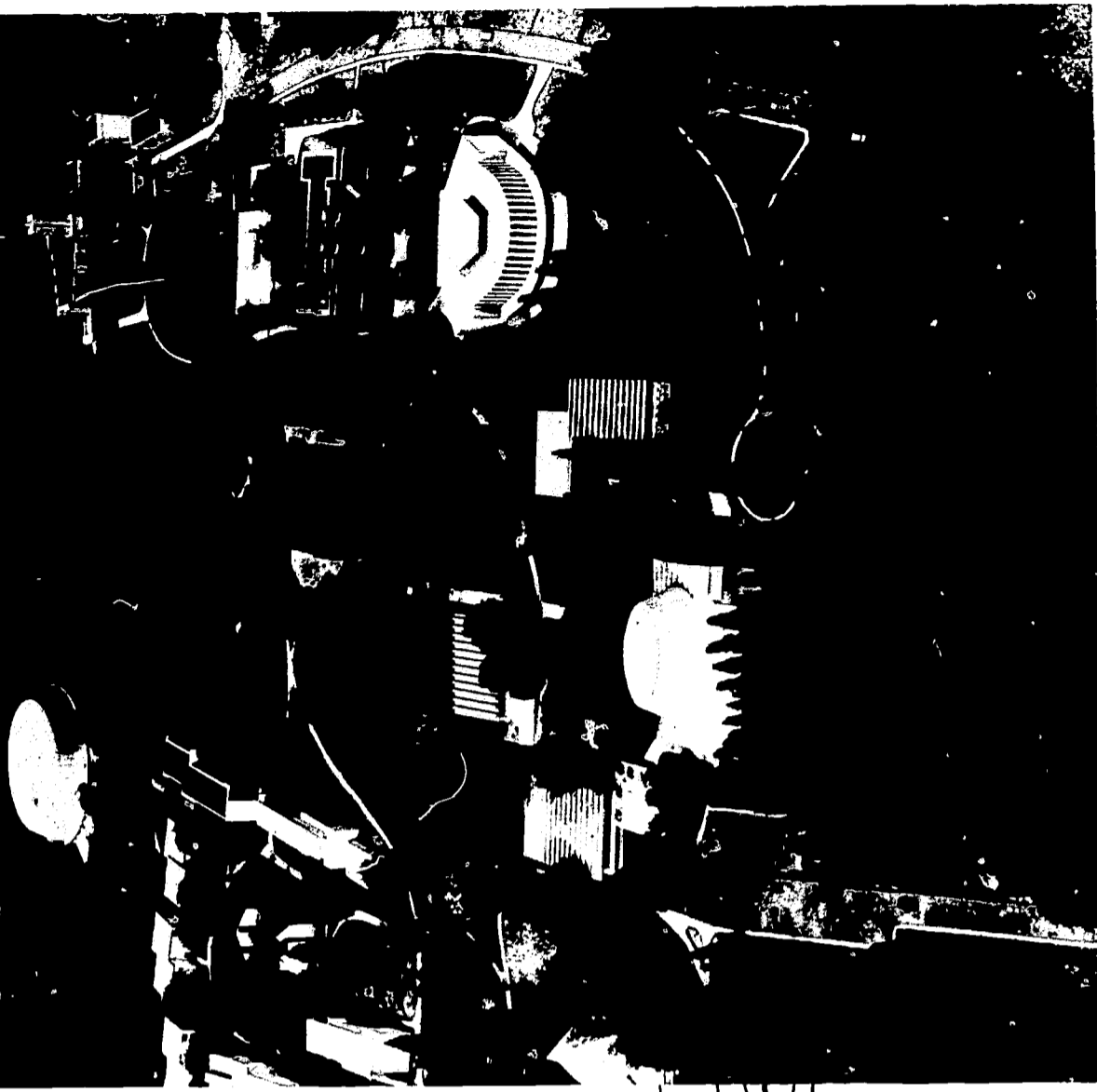

Photo of the model.

President: Rev. Alcuin Hemmen  
Architect: Shaver and Company

# INFORMATION DISSEMINATION

22

A letter from a tour member.

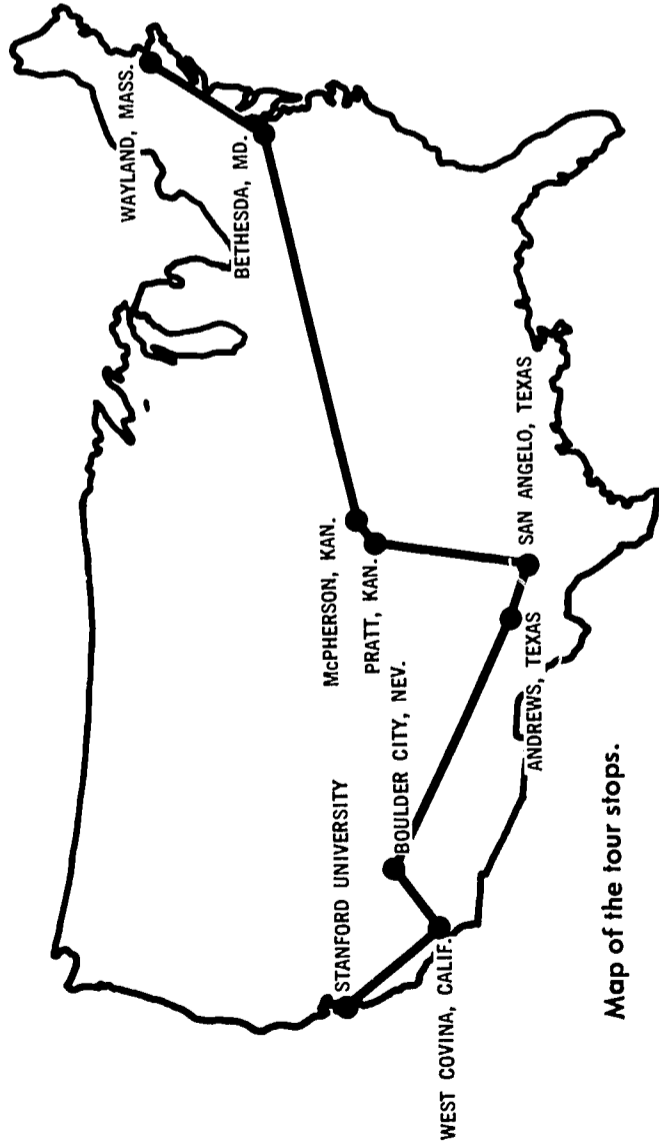

Map of the four stops.

## NATIONWIDE TOUR

In any kind of research it is important to get the results into the hands of the users, and school building research is no exception. Through EFL's five years, many publications have been made available by mailing list or by request. The School Planning Laboratory not only distributes these reports to visitors, but also takes a hand in producing reports of its own.

To insure that ideas generated under EFL grants would be picked up and used by other schools across the country, School Planning Laboratory chartered an airplane in the Summer of 1962 to take administrators of the country's sixty fastest growing school districts to visit fifteen schools from Massachusetts to California—most of which were planned with help from EFL. As the accompanying letter indicates, many of the ideas incorporated in the buildings seen on the tour are being included in new construction elsewhere.

### TYLER PUBLIC SCHOOLS

1319 W. 9TH ST. P. O. BOX 237  
TYLER, TEXAS

8 July 1963

Dr. James D. McConnell, Director Western Regional Center  
Educational Facilities Laboratories, Inc.  
Stanford University, Stanford, California

Dear Doctor Jim: Here on the first anniversary of E.F.L. "Flying Classroom", I thought perhaps you might be interested in school development at Tyler, Texas

Shortly after the conclusion of the Tour, the Tyler Public Schools embarked upon a five million dollar construction program. While on the Tour I secured some two hours of colored slides showing many of the features seen in the significant schools visited from coast to coast. Before we began our construction program, our Superintendent and School Board invited all of the interested Architects and School People in our community to view the slides and hear my explanation of the schools.

Prior to the selection of architects, our people had many comprehensive discussions regarding our school needs and our educational specifications. Again the slides and notes from the Tour played a significant part.

Late in 1962, we began our building program which includes additions to three elementary schools, one new Junior High School, and one new Senior High School. Five different architects were selected. The initial phase of our program began with the three elementary school additions.

Enclosed with this letter you will find newspaper clippings that will indicate the types of schools that are now being built in Tyler. I believe that you will be pleased to learn that our new schools are all being designed with flexibility and group teaching facilities as key features. Although time has not permitted us to make detailed educational specifications for each project, we elected to use group meetings with architects and staff personnel as our means of direct communication regarding ideas and concepts. Also included with this letter you will find series of Planning Reports which indicate some of our procedures.

I think you can conclude from the information in this letter that the Tyler Public Schools have benefited directly from the E.F.L. Flying Classroom. I want to thank you again for the opportunities afforded by the Educational Facilities Laboratory. I sincerely hope that one of your many trips will bring you to Tyler, Texas so that you may see some of our accomplishments.

Best personal regards.

*Brad*

Brad Holmes, Purchasing Agent/School Planning Coordinator  
TYLER PUBLIC SCHOOLS

cc: Mr. E.N. Demard, Superintendent  
TYLER PUBLIC SCHOOLS

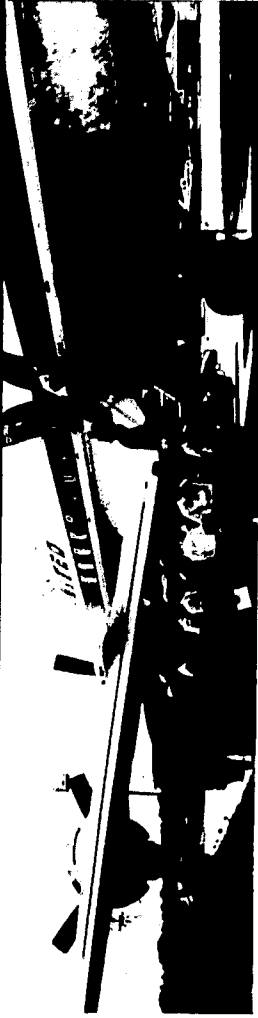

School tour group leaves Kansas for the next stop — Texas.



Large group instruction room in Wayland, Massachusetts.  
Architect: The Architect's Collaborative



The divisible auditorium in Boulder City, Nevada.  
Architect: Zick & Sharp

Foothill College, Los Altos Hills: California.  
Architect: Kump Associates

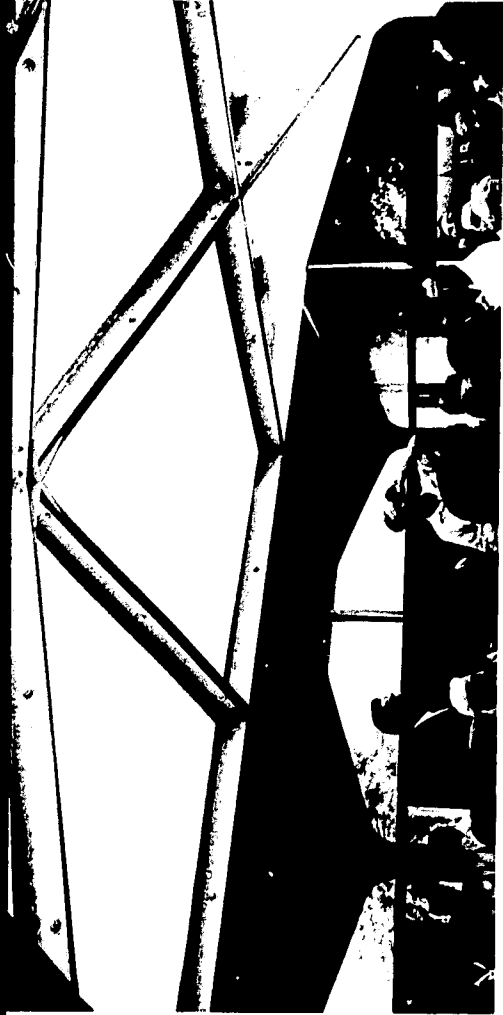

Experimental building at MIT.  
Architect: Marvin Goody

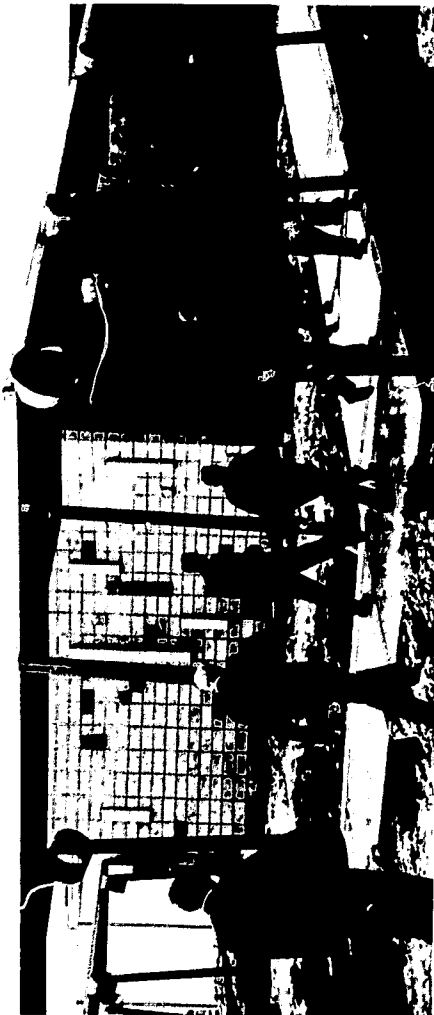

A "middle school" under construction at Colma, California.  
Architect: H. L. Gogerty, Associates

The domed commons area in Andrews High School, Andrews, Texas.  
Architect: John Lyon Reid

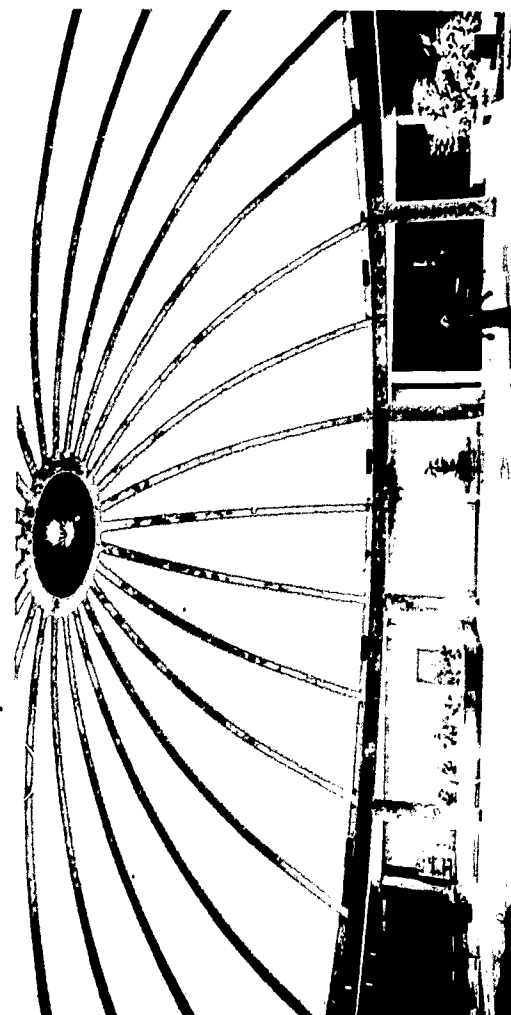



## ON THE HORIZON

Besides opening up new areas for research, this next year will bring further refinements to the already familiar problems of accommodating individual study and planning for flexibility.

Carrel designs, uses, and locations are still in an experimental state and many more ideas can be expected to emerge. The use of audio-visual devices for independent work will have a major effect on carrel design. Films and tapes which have traditionally been considered "group media" are being ingeniously adapted for use by students one at a time. Methods of linking students to centralized information repositories are expensive but not far fetched when sensibly used. If individual schools will build their own core libraries of books, programs and films to satisfy most student needs, they will be able to afford supplemental, less often called for information brought electronically from regional or district centers. This approach to moving information will create the need for special receiving centers. SPL already has published one report on study carrel designs and will present a second up-dated report this fall.

The never-ending quest for flexibility will continue. New structures that eliminate columns to afford spaces more easily arranged will be developed. New data on acoustics and teacher

reactions to various acoustical environments now makes it possible to imagine schools in which carpeting and visual space dividers will virtually eliminate interior walls as we know them today. Open planning will be the rule rather than the exception. The Cupertino and Clark County open plan elementary school clusters are indications of what the future will bring.

A new area of extensive research is that of the effect of the physical environment on its inhabitants. How does it affect learning—if at all? Do building patterns affect friendship patterns? Does design really influence people's attitudes toward an institution?

If our buildings are to make their full contribution as appropriate educational environments, our Institutions must be planned with the reactions and attitudes of the future inhabitants in mind. The social sciences will have to contribute consultation and research.

The School Planning Laboratory has undertaken a special research project for EFL that will attempt to answer some of these questions for community-commuter colleges. We expect that techniques established in this research will be useful for analysis of other types of institutions as well.



Reports available upon request from the School Planning Laboratory, School of Education, Stanford University, Stanford, California.

#### EDUCATIONAL FACILITIES LABORATORIES PUBLICATIONS

Ring the Alarm!  
The Cost of a Schoolhouse  
Design for ETV  
To Build Or Not To Build  
The School Library  
College Students Live Here  
Ten Designs/Community Colleges

#### Case Studies of Educational Facilities:

- #1 Conventional Gym vs. Geodesic Field House — West Bethesda High School, Montgomery County, Maryland
- #2 Space and Dollars: An Urban University Expands — Based on the Case of Drexel Institute of Technology
- #3 Laboratories and Classrooms for High School Physics
- #4 A Divisible Auditorium, Boulder City, Nevada
- #5 New Campuses for Old: A Case Study of Four Colleges that Moved
- #6 A College Health Center

#### Project Reports:

##### School Construction Systems Development

- #1 Project Outline
- #2 British Prefabricated School Construction

##### University Facilities Research Center

Parking Programs for Universities  
Plumbing Fixture Requirements  
Horizontal and Vertical Circulation  
University Research Buildings for Short-Term Grant Programs

##### Profiles of Significant Schools:

Belaire Elementary, Texas  
Heathcote Elementary, New York  
Montrose Elementary, Texas  
Two Middle Schools, Michigan  
Hillsdale High School, California  
Newton South High School, Massachusetts  
North Hagerstown High School, Maryland  
Rich Township High School, Illinois  
Schools for Team Teaching  
High Schools 1962  
Holland High School, Holland, Michigan

#### SCHOOL PLANNING LABORATORY PUBLICATIONS

Study Carrels  
Space for Teachers

#### CREDITS

Design — Stadler/Cowman Advertising  
Typography — Atherton's Advertising Typography, Inc.  
Printing — Micropoint, Inc.

#### Drawings and Photos

##### Page

4. Drawings — Kump Associates
5. Photos — Pratt Bethers  
Drawings — Ernie Hickson
6. Building drawings — Flewelling and Moody, Architects  
Carrel drawing — John Beynon
7. Building drawing — Keith Wilcox, Architects  
Carrel drawing — John Beynon
8. Photo — Herbert Bruce Cross  
Drawing — Ernie Hickson
9. Photo — Morris
10. Drawings Mt. Pleasant and Henry Gunn High Schools —  
Kump Associates  
Drawing Edison High School — Clowdsley and Whipple
11. Drawings — Kump Associates
12. Drawings — Ernie Hickson  
Photos — Morris
13. Drawings — Ernie Hickson  
Photo — Robert Lowman
14. Drawing — Ernie Hickson
15. Drawings — John Beynon
16. Drawing — Keith Wilcox, Architects
17. Photo — George Zimbal
18. Drawing — Shaver and Company  
Photos — Hayes Photo
19. Drawing — Shaver and Company  
Photos — Hayes Photo
20. Photo — Stanford Univ. News & Publications
21. Drawing — John Beynon  
Model — Architectural Models Inc.  
Photo — Louis G. Alley
22. Map — Ernie Hickson
23. Photos — George Zimbal