

ED 032 711

EF 002 267

By-Pinnell, Charles; Wacholder, Michael

Guidelines for Planning in Colleges and Universities. Volume 3. Physical Plant Planning, Land Use, and Traffic.

Pub Date Jul 68

Note-148p.; Volumes 1 and 2 have been announced as ED 024 119 and ED 024 120

EDRS Price MF-\$0.75 HC-\$7.50

Descriptors \*Campus Planning, Design Needs, Facility Inventory, Flexible Facilities, \*Higher Education, \*Land Use, \*Master Plans, Pedestrian Traffic, School Expansion, \*Traffic Circulation, Transportation, Vehicular Traffic

The third of five volumes concerned with higher educational planning is divided into two distinct sections--(1) land use planning, and (2) traffic planning. The first section commences with certain definitions and interpretations which are meant to overcome any misunderstandings. Actual land use planning process follows and can be identified by six general stages--(1) the informational input concerning the goals of the institutional programs, financial capabilities of the institution, as well as information regarding its physical requirements, (2) the analysis and interaction of the various planning functions, (3) evaluation and selection of design factors, (4) synthesis of the land use plan, (5) detail design and implementation, and (6) the concept of continuous planning. The traffic planning section discusses various techniques which can be utilized to obtain required data in order to develop a traffic plan. Access, internal circulation, and parking are discussed relative to the daily traffic problem. The traffic studies may provide data which will influence other aspects of the total planning process. Likewise, the location of buildings and other traffic generating facilities on a campus will also have a major bearing on the traffic plan. A section of the development of a traffic plan summarizes the total process. (NI)

ED0 3271 1

EF 002 267



VOLUME THREE

**GUIDELINES FOR PLANNING**  
PHYSICAL PLANT PLANNING  
LAND USE AND TRAFFIC

U.S. DEPARTMENT OF HEALTH, EDUCATION & WELFARE  
OFFICE OF EDUCATION

THIS DOCUMENT HAS BEEN REPRODUCED EXACTLY AS RECEIVED FROM THE  
PERSON OR ORGANIZATION ORIGINATING IT. POINTS OF VIEW OR OPINIONS  
STATED DO NOT NECESSARILY REPRESENT OFFICIAL OFFICE OF EDUCATION  
POSITION OR POLICY.

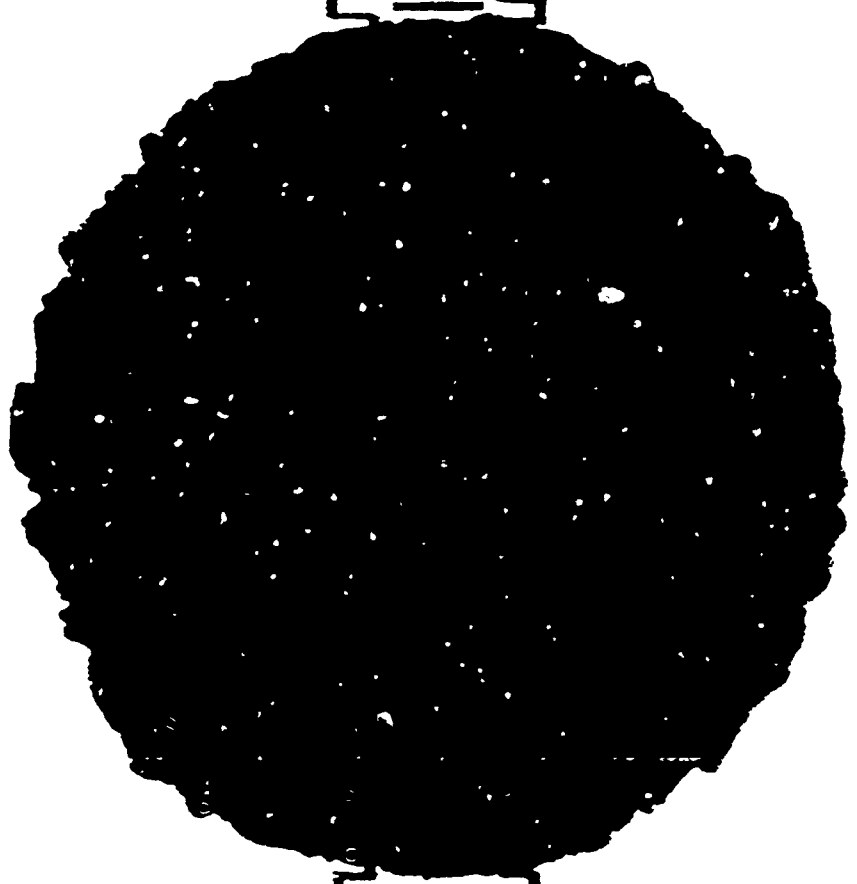

PLANNING FACILITIES



"PERMISSION TO REPRODUCE THIS  
COPYRIGHTED MATERIAL HAS BEEN GRANTED  
BY William J. Martin, Director,  
Facilities Planning  
TO ERIC AND ORGANIZATIONS OPERATING  
UNDER AGREEMENTS WITH THE U.S. OFFICE OF  
EDUCATION. FURTHER REPRODUCTION OUTSIDE  
THE ERIC SYSTEM REQUIRES PERMISSION OF  
THE COPYRIGHT OWNER."

All rights reserved. Written permission must  
be granted before reproduction in whole or  
part. Coordinating Board • Texas College  
and University System. Copyright application  
pending. March 1968.

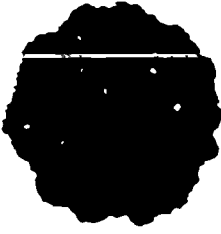

**GUIDELINES FOR PLANNING  
IN  
COLLEGES AND UNIVERSITIES**

**VOLUME THREE · PHYSICAL PLANT PLANNING · LAND USE AND TRAFFIC**

**Report Developed For**

**THE COORDINATING BOARD • TEXAS COLLEGE AND UNIVERSITY SYSTEM**

**By  
Dr. Charles Pinnell • Project Director**

**and  
Mr. Michael Wacholder • Associate Project Director**

**Texas A&M University • July 1968**



**COORDINATING BOARD**  
**TEXAS COLLEGE AND UNIVERSITY SYSTEM**  
SAM HOUSTON STATE OFFICE BUILDING  
AUSTIN, TEXAS 78701

JOHN E. GRAY  
Chairman

NEWTON GRESHAM  
Vice-Chairman

RAYBURN BELL

G. V. BRINDLEY, JR., M.D.

VICTOR BROOKS

J. G. CIGARROA, JR., M.D.

MRS. JOHN T. JONES, JR.

J. C. LOONEY

EUGENE McDERMOTT

CHARLES PROTHRO

HARRY PROVENCE

C. G. SCRUGGS

J. J. SEABROOK

TOM SEALY

W. HARVEY WEIL

D. M. WIGGINS

DAN C. WILLIAMS

H. B. ZACHRY

JACK K. WILLIAMS  
Commissioner

In creating the Coordinating Board, Texas College and University System, the 59th Texas Legislature directed the Board to "require and assist the public senior colleges and universities, medical and dental units, and other agencies of higher education in developing long-range plans for campus development."

An early step by the Coordinating Board in carrying out this legal mandate was to conduct a statewide survey of the status of institutional master planning in Texas. In January, 1967, the Board published a report indicating that many colleges and universities in the State did not have master plans which could be considered comprehensive in scope.

As a result, the Coordinating Board entered into a contract with Texas A&M University to prepare a model system for planning in colleges and universities. The volumes which make up the "Guidelines for Planning in Colleges and Universities" are the product of this contracted project.

Student enrollment in Texas colleges and universities will increase rapidly and dramatically during the next decade, and the importance of sound planning cannot be too strongly emphasized.

The process of planning described in these volumes focuses on the creation of a system to permit institutions to identify that which is innovative and unique about their educational program and objectives and to plan in depth within the context of their institutional objectives. Master planning is conceived in these volumes as encompassing the total decision-making framework of the institution. Under such a condition, an institutional master plan becomes a complex document in which the design and location of buildings is but one of the components.

The distribution of these "Guidelines for Planning in Colleges and Universities" by the Coordinating Board is not intended to standardize all planning procedures in Texas higher education or to force colleges and universities into a lockstep approach, physically or otherwise. Rather, the purpose of the volumes is to provide to both public and private institutions illustrations and suggested approaches. We ask that the volumes be accepted in this context.

The Coordinating Board staff expresses deep appreciation to Dr. Charles Pinnell, Michael H. Wacholder, and other members of the research staff at Texas A&M University for the work they applied directly to this study and the direction they gave to the consultants providing assistance to them.

A handwritten signature in cursive script, appearing to read "Jack K. Williams".

J. K. Williams  
Commissioner

# ACKNOWLEDGEMENTS

The research and development work that has gone into the preparation of "Guidelines for Planning in College and Universities" has been a most challenging and rewarding experience. The staff members of this study are sincerely grateful for the opportunity to have worked on the project and wish to express their gratitude to those who made it possible.

First, our thanks are extended to the Coordinating Board, Texas College and University System, for sponsoring this research project. The group, under the direction of Dr. Jack K. Williams, is providing significant leadership to higher education in Texas, and we are proud to have been associated with their work. Mr. Kenneth H. Ashworth, Assistant Commissioner for Federal Programs and Facilities Planning and Mr. William J. Martin, Director of Facilities Planning of the Coordinating Board Staff provided support and assistance in all aspects of the study and contributed significantly to the research effort.

Sincere appreciation is expressed to President Earl Rudder and Vice-President Wayne C. Hall of Texas A&M University for their support of this project. Many facets of the planning system were developed and tested utilizing data, staff, and facilities of Texas A&M University. The availability of this real-life laboratory contributed greatly to the research and development effort, and we are extremely grateful for the support and cooperation obtained at all administrative levels.

This study was financed from funds provided by the Coordinating Board, Texas College and University System, the U.S. Office of Education, and Texas A&M University. Appreciation is expressed to these agencies for their support.

Finally, numerous members of the faculty and staff at Texas A&M University have provided guidance and assistance to this project, and this contribution is gratefully acknowledged.

Dr. Charles Pinnell  
Project Director

# PROJECT STAFF

CHARLES PINNELL - Project Director  
B.S., Civil Engineering, Texas Technological College, 1952;  
M.S., Civil Engineering, Purdue University, 1958;  
Ph.D., Management and Engineering Science, Northwestern  
University and Texas A&M University, 1964.

MICHAEL H. WACHOLDER - Associate Project Director  
B.S., Landscape Architecture, University of California at  
Berkeley, 1965;  
M.S., Urban Planning, Texas A&M University, 1968.

LESTER WOOD - Computer Systems for Space Utilization and Reporting  
B.A., Mathematics, Texas A&M University, 1959;  
M.S., Computer Science, Texas A&M University, 1968.

ELLIOTT BRAY - Automated Scheduling of Teaching Facilities, Management  
Information Systems  
B.S., Mathematics, Lamar State College of Technology, 1962;  
M.S., Computer Science, Texas A&M University, 1967.

MEL H. LASELL - Facilities Reporting, Management Planning  
B.A., Business Administration, Texas A&M University, 1967;  
M.S., Management, Texas A&M University, 1968.

JOHN F. REGLIN - Traffic Planning  
B.S., Civil Engineering, University of Texas at Arlington, 1967;  
M.S., Civil Engineering, Texas A&M University, 1968.

ROBERT DUNPHY - Traffic Planning  
B.S., Civil Engineering, Catholic University, 1965;  
M.S., Civil Engineering, Texas A&M University.



ROBERT BRADLEY - Quality Analysis for Facilities  
B.S., Building Construction, Trinity University, 1966;  
M.S., Urban Planning, Texas A&M University, 1968.

RAY ABBOTT - Physical Plant Planning and Publications  
B. Arch., Texas A&M University, 1966;  
M.S., Urban Planning, Texas A&M University, 1968.

JOE DAVIS - Space Utilization, Management Planning  
B.S., Industrial Technology, Texas A&M University, 1967;  
M.S., Computer Science, Texas A&M University, 1968.

SUPPORTING PERSONNEL

DR. VERGIL STOVER  
PROFESSOR JAMES GARDNER  
CLIFF GUILLETT  
DAVID KEATING  
RONALD PERRY  
MRS. PAM ROWE  
MRS. LYNN WILLIAMS  
MISS MARY MARGARET GIBBS

PUBLISHERS

WALLACE PRINTING CO.  
Bryan, Texas



# FOREWORD

The first volume of this series entitled "Guidelines for Planning in Colleges and Universities - Planning System" outlined a planning system which included the following phases:

- (1) Management and Program Planning
- (2) Physical Plant Planning, and
- (3) Financial Planning

The emphasis in the initial volume was on a brief presentation that permitted the reader to review and conceive the total planning system. The emphasis in Volume Two was upon a presentation of the techniques and details involved in Management and Financial Planning. This volume (number three) as well as Volumes Four and Five present techniques involved in Physical Plant Planning.

Physical Plant Planning has been divided into four functions which cover (1) Land Use Planning; (2) Traffic Planning; (3) Facilities Studies; and (4) Utility Studies. This division, however, is not intended to imply that these functions comprise totally independent or individual planning processes. On the contrary, each process is an essential and inseparable part of the total Physical Plant Planning Process.

# PHYSICAL PLANT PLANNING PROCESS

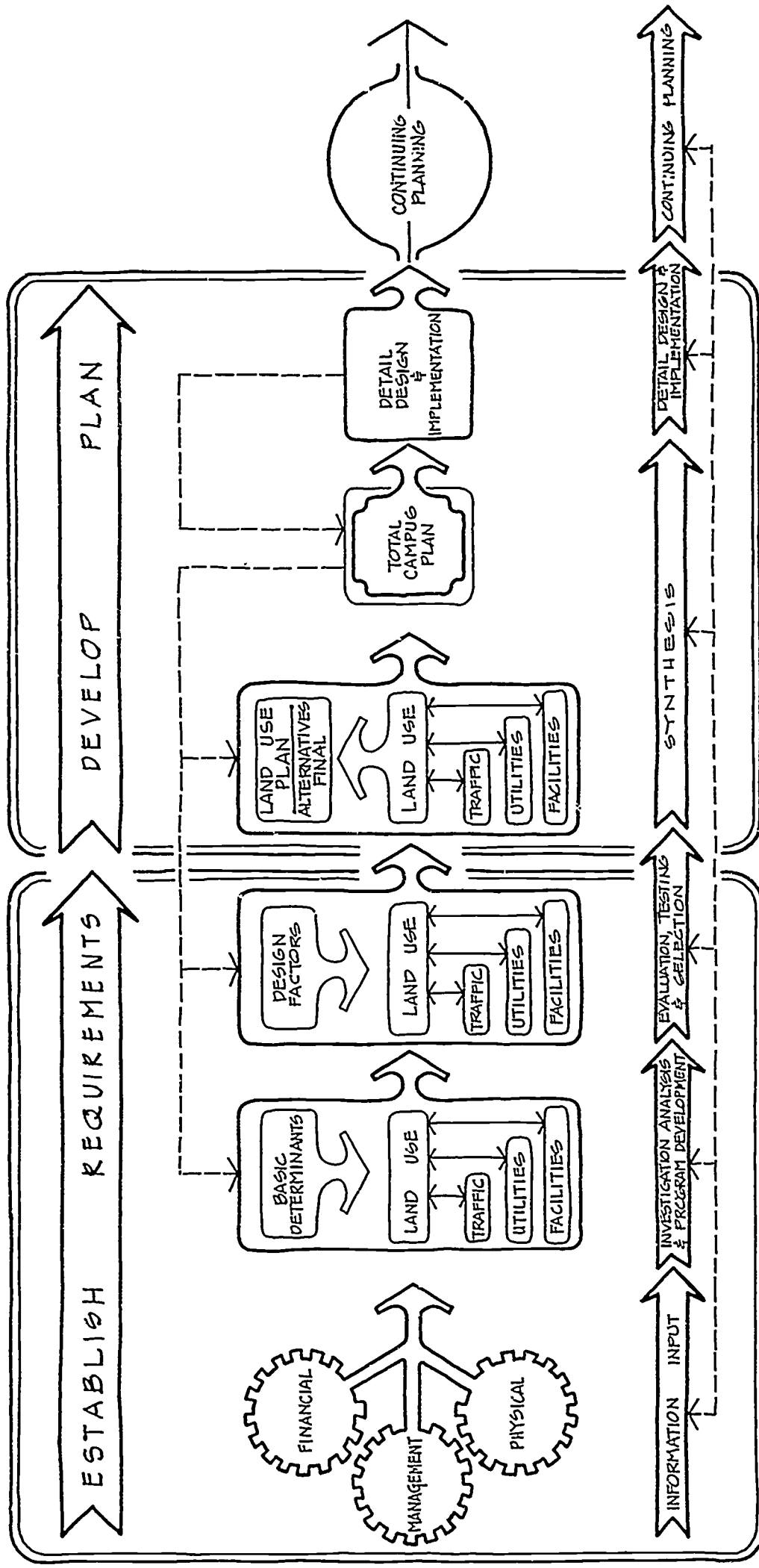

The figure on the opposite page illustrates the Physical Plant Planning process and the roles of the planning functions within this process. Each major planning function, or element, contributes to the ultimate physical plant plan, and it is necessary that they are conducted concurrently in order to insure consistency. Decisions in each individual process will produce implications upon decisions relating to the other processes and the total plan. Consistency, based upon a recognition of the interdependency of these individual processes, must be achieved. This consistency is based upon a well-coordinated total effort that is comprised of integrated and cooperative parts. As the planning process progresses through each phase, it is dependent upon inputs and interactions between land use, traffic, facility and utility considerations. This insures that each significant decision involves all the relevant determinants.

The material in this volume will be presented in two separate sections. Techniques and details of the Land Use Planning Process will be discussed in Section 1 and a similar approach is taken with the Traffic Planning Process in Section 2.

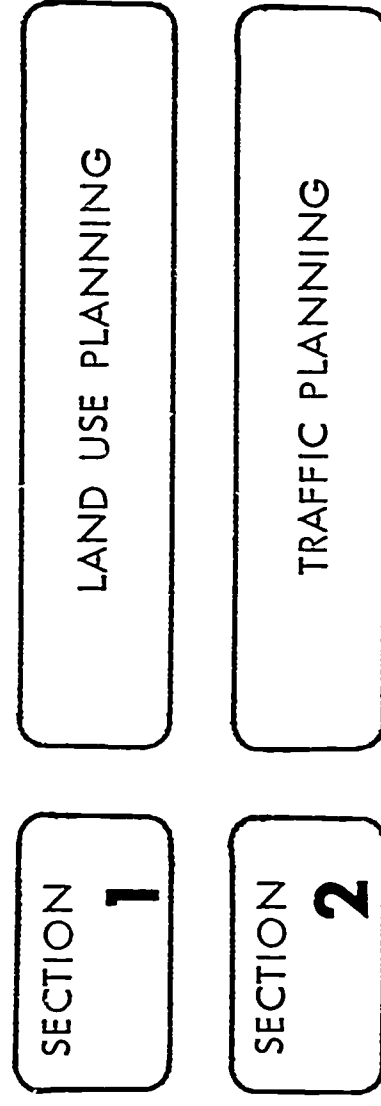

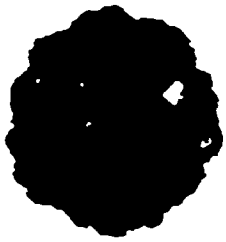

# LAND USE PLANNING



SECTION  
**2**

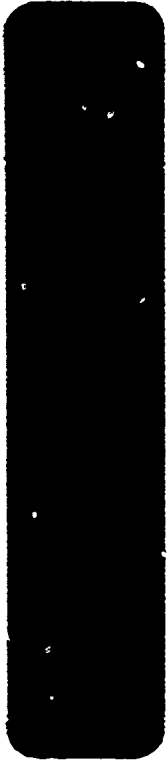

TRAFFIC PLANNING

# CONTENTS

## LAND USE PLANNING

I. INTRODUCTION	
A. Basic Determinants	6
B. Design Factors	8
C. Land Use Planning Concepts	13
D. Land Use Planning Process	20
II. INFORMATIONAL INPUT	
A. Management	25
B. Financial	26
C. Physical	27
III. BASIC DETERMINANTS - INVESTIGATION, ANALYSIS AND PROGRAM DEVELOPMENT	
IV. DESIGN FACTORS - EVALUATION, TESTING AND SELECTION	
A. Academic Program	44
B. Common Uses	47
C. Circulation	49
D. Support Functions	51
E. Building Density	56
F. Flexibility (or Convertibility)	58
G. Expansion	59
H. Social Interactions	60
I. Aesthetics	61
J. Institutional Personality	61
V. LAND USE PLAN - SYNTHESIS	
Land Use Scales	66
VI. DETAIL DESIGN AND IMPLEMENTATION	
VII. CONTINUOUS PLANNING	

# INTRODUCTION

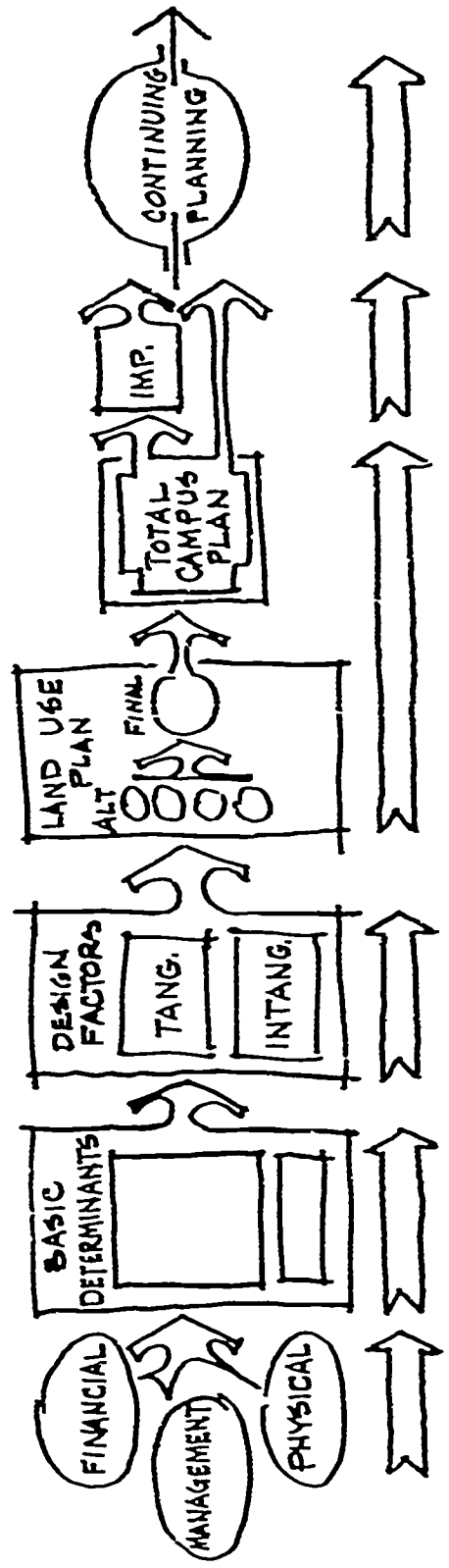

Land use planning is an essential component of the total campus planning process. The responsibilities of this planning procedure might be best described as the translation of abstractions and singularly dimensional goals and objectives into the second, third and fourth dimensions--physical forms over time. Effective physical planning is by no means an independent process--it is dependent upon interactions and inputs from other relative planning processes such as educational, managerial, financial, etc. This translation process encompasses a broad spectrum of considerations and it is the object of this section to present a systematic guideline outlining and organizing these complex considerations.

The land use text is organized into two sections. The purpose of the first section is to define and illustrate the vocabulary relative to land use planning (which is similar to the material presented in Volume 1). Semantics is frequently identified as a principal factor contributing to the misunderstanding and lack of communications that exists among professions. Therefore, the first section provides the reader with the necessary tools to overcome the communications barrier--as applied to this report and hopefully applicable to inter-professional communications. The second section concentrates upon the land use planning process which can be identified by six general stages--input, analysis, evaluation, synthesis, detail design and implementation, and continuing planning. This process was not conceived to be interpreted as a specific methodology. A methodology implies rigidity and absolute order in responding to a problem. The problems associated with university planning are unique and peculiar to individual institutions and the problem solving system employed must recognize this fact.



The following outline and discussion identifies some basic considerations regarding the development of a plan for growth and expansion of the campus. These considerations have been separated into three interrelated categories. They are: Basic Determinants, Design Factors, and Land Use Concepts.

Each item in each category requires careful analysis and evaluation in relation to all of the variables. These considerations will be defined and discussed briefly in this section and will be treated in depth in the second part of the report. The primary purpose of this chapter is to merely establish a vocabulary relative to land use planning concepts.

All of the considerations in question are equally applicable in the case of either an existing campus or the totally new campus scheduled for construction. The difference in application lies in the order and emphasis of analysis and evaluation.

The outline indicated below illustrates the basic considerations that will be discussed in the following sections:

- I. Basic Determinants
  - A. Management goals of the institution
  - B. Financial capabilities
  - C. Physical characteristics

- II. Design Factors
  - A. Tangible components
    - 1. Academic program
    - 2. Common uses
    - 3. Support functions
    - 4. Circulation
    - 5. Building density
  - B. Intangible components
    - 1. Flexibility (convertibility)
    - 2. Expansion
    - 3. Social interactions
    - 4. Aesthetics
    - 5. Institutional personality

- III. Land Use Planning Concepts
  - A. Concentric
  - B. Sector
  - C. Linear
  - D. Cluster (satellite)
  - E. Random

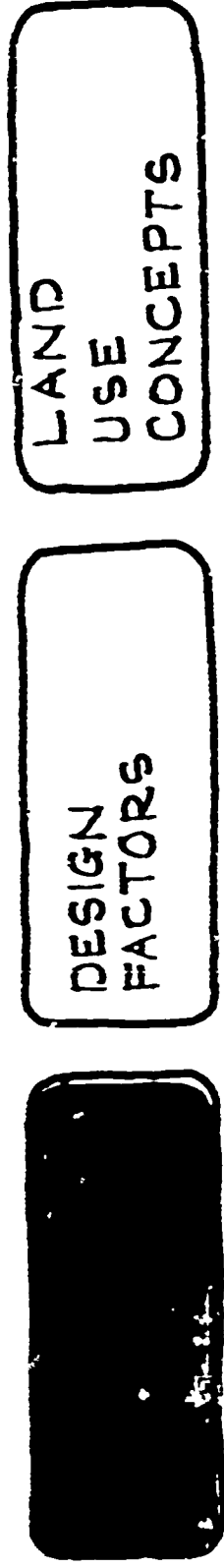

## BASIC DETERMINANTS

The basic determinants are, as the term implies, the foundation of the overall, comprehensive physical planning process. They are the factors which will, individually and collectively, greatly influence the decision-making process that is involved in ultimately selecting a particular planning concept.

The basic determinants are input factors that have resulted from the management and financial phases and specific physical plant studies. These factors are concerned with management goals of the institution, financial capabilities of the institution, and physical characteristics of the campus. The ideal set of determinants are rarely completed, and effective planning must recognize the input needs and be directed toward securing this information. The determinants should not, however, be regarded as inflexible, fixed factors. It may be indicated in subsequent stages of planning that there are inconsistencies, and some policies and objectives may require change or modification. This illustrates the effect of feedback which is the backbone of effective planning.

## Management Goals of the Institution

Management goals express the basic intentions of the Institution relating to the extent and character of the present and future educational objectives. They include the academic plan which indicates the curricular emphasis, policies relating to research orientation and extension services, administrative policy, student life programs, etc. The goals are especially significant because they "can convey prime distinctions, account for speculative thought, and indicate the impact of both real and possible conditions on physical planning".<sup>2</sup> It is a thorough identification and interpretation of these goals that establishes the framework of the physical plan.

## Financial Capabilities of the Institution

The financial determinant is an indicator of the amount of money, currently and in the future, that is or will be available for necessary capital improvements. Financial capabilities may, in the final analysis, be one of the strongest determinants influencing the ultimate form of the campus. Such considerations may also necessitate some modification of the goals of the institution when each factor is evaluated with respect to one another.

## Physical Characteristics

The physical determinants are those factors relating to the physical structure of the campus. These considerations present a significant impact upon the physical plan when one is expanding an existing campus. Under such circumstances, the characteristics of the site, the location, and the existing facilities will have a profound effect upon the solution. Physical factors relative to either a new or an existing campus would include recognition of the facility needs as a result of the management goals.

---

<sup>2</sup> *Campus Planning*, Richard P. Dober, Reinhold Publishing Corp., 1963

BASIC  
DETERMINANTS

LAND  
USE  
CONCEPTS

## DESIGN FACTORS

In addition to the basic determinants, there is another set of considerations that influences the configuration of the physical plan. These considerations are identified as the Design Factors and are divided into Tangible and Intangible components. It is essential that they be analyzed, evaluated, and resolved in light of the basic determinants prior to a definite commitment to a particular land use plan. These factors are essentially the separate components of a campus plan that must first be recognized individually and then subsequently molded into a comprehensive plan.

## TANGIBLE COMPONENTS

The tangible components of the Design Factors are divided into several categories and sub-categories which are as follows:

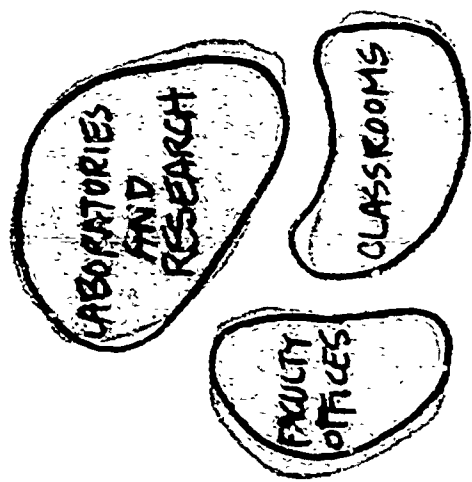

## FUNCTION ORIENTED

Academic Programs are structured about essentially one of two basic orientations which are organization according to function or organization according to discipline.

In the case of the academic program that is structured around a functional orientation, facilities are grouped according to their specific uses. Facilities such as laboratories are grouped together in one area and classrooms are grouped in another area. A functional orientation provides a greater degree of personal contact and interaction between different disciplines. The extent of this personal interaction, of course, depends upon the detailed design.

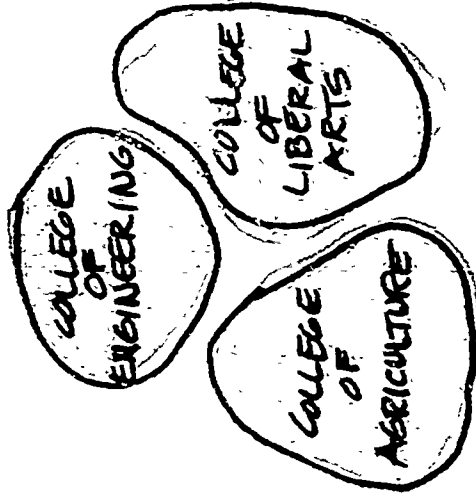

## DISCIPLINE ORIENTED

A discipline oriented plan groups facilities according to the colleges they serve. For example, all classrooms, laboratories, faculty offices, etc., serving a College of Liberal Arts would be located in a single area. This kind of arrangement also provides a good deal of student-to-student and student-to-faculty exposure. However, this exposure is limited primarily to individuals and groups from the same discipline.



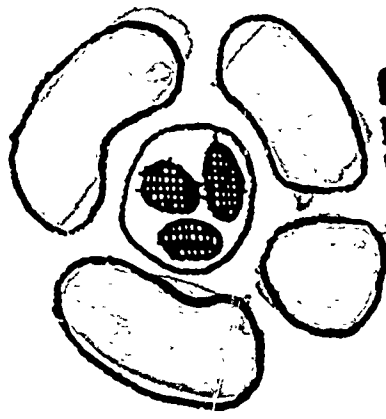

**CENTRALIZED  
COMMON USES**

Common Uses on a campus refer to those facilities which are frequently used by all persons regardless of their classification. Common uses which fall into this category include such facilities as libraries, student unions, book stores, dining halls, and, in some cases, faculty offices and administrative offices. These common use areas may be either centralized or decentralized in the physical layout of the campus. The decision is largely a matter of scale and consideration of educational objectives. It is generally agreed by both administrators and planners that it is most advantageous to centralize or group together common uses from the standpoint of economy and accessibility. Centralization, however, does not necessarily mean that this grouping of facilities must be located at or near the center of the campus. These uses may be located in a section of the campus somewhat removed from the center and still be centralized.

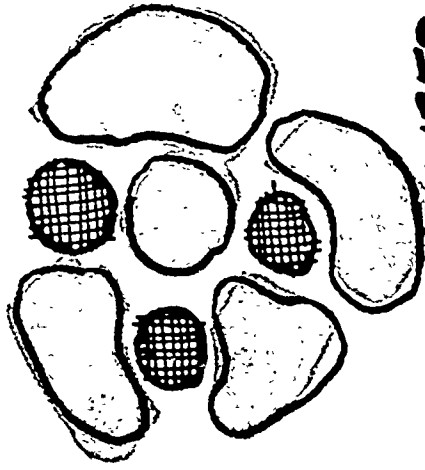

**DECENTRALIZED  
COMMON USES**

The matter of decentralized common uses requires relatively little explanation insofar as it implies that separate facilities of high use may be separated and scattered throughout the campus.

Support Functions refers to such facilities as housing, utility services, recreation areas, and open space. These are the elements of the campus plan which can exert a significant influence on the selection of a land use plan and on policy decisions but which are often treated rather lightly or taken for granted. With respect to housing, for example, decisions must be made as to whether an institution will be fully or partially resident or totally non-resident. Any decision on this matter will certainly affect management and financial policy.

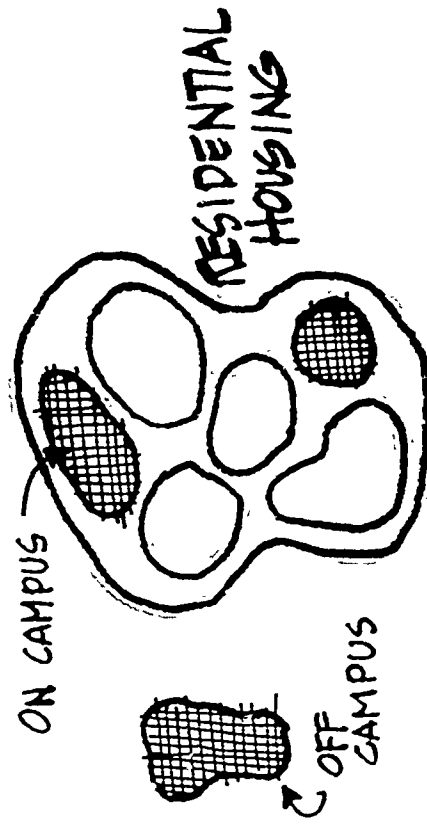



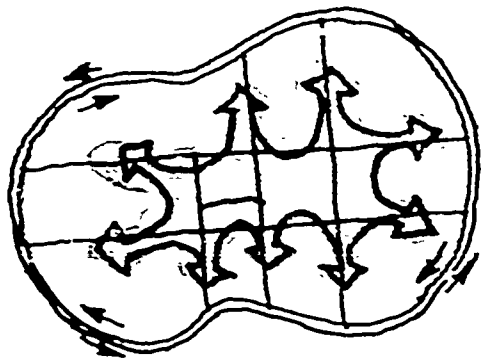

**AUTOMOBILE  
ORIENTED**

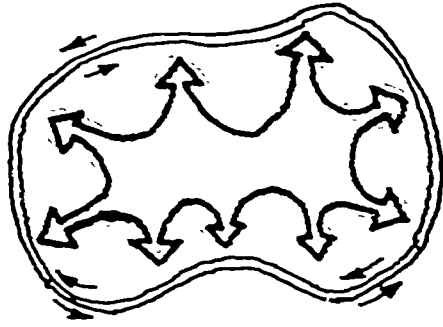

**PEDESTRIAN  
ORIENTED**

Circulation refers to the movement of the faculty, staff, visitors, and student body in, through, and around the campus. There are essentially three alternative decisions that can be made with respect to the circulation system. A campus may be oriented totally toward the automobile as a mode of transportation, totally toward pedestrian movement, or there may be a combination of the two modes with emphasis upon a particular orientation.

Generally, the combined orientation is the one that prevails. The selection of a circulation system may be one of the most vital decisions in the planning process. A commitment to an automobile orientation, for example, requires that more land area be used resulting in wide spacing of buildings. A pedestrian orientation, on the other hand, allows a more compact arrangement of facilities.

Building Density refers to that aspect of the campus plan which deals with such components as the coverage, bulk, and horizontality and/or verticality of the buildings on the campus. Policy decisions must be made with respect to the direction in which a campus will grow. Selection of either a vertical or horizontal theme will necessarily have an effect on the coverage and bulk or spacing of buildings, which will in turn affect the ultimate plan.

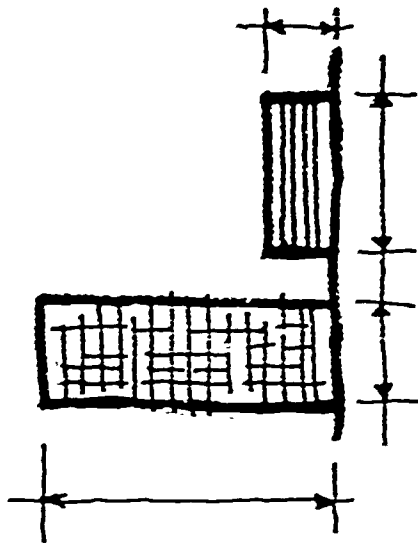

## INTANGIBLE COMPONENTS

The intangible components do not assume a particular form nor do they directly occupy space (as do the tangible components), but they are highly significant because they do exert substantial influence upon the configuration of a form or space.

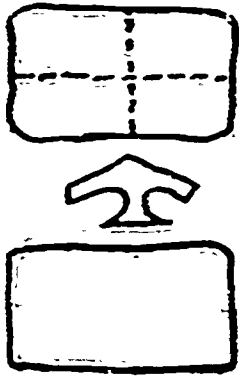

Flexibility is the capability of responding or conforming to changing or new situations -- or simply, the ability to accommodate change. This factor must be applied at all scales -- from a particular classroom to the total campus structure.

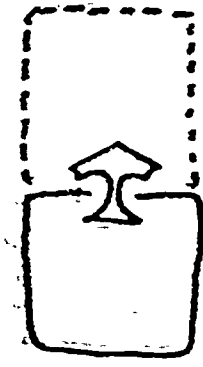

Expansion, as differentiated from flexibility, is the ability to accommodate growth. This factor also requires consideration and application at all scales.



Social Interactions imply the need for consideration of the total spectrum of interactions that will occur, as well as will be encouraged to occur, on the campus. This would include student(s) to student(s), student(s) to faculty, university to community, etc.

Aesthetics include those considerations relative to the beauty, attractiveness, and meaning that are expressed in particular facilities as well as the total environment.

Institutional Personality relates to the recognition and response to the influence of traditions and the pursuit of an image that will affect many decisions.

BASIC  
DETERMINANTS

DESIGN  
FACTORS

## LAND USE PLANNING CONCEPTS

The previous discussion dealt with those considerations -- basic determinants and design factors -- which are essential to the ultimate development of a land use concept. The following material focuses upon a generalized identification and definition of the basic land use concepts which are to be applied as tools of reference. As a matter of clarification, the term "concept" in this context is considered to be synonymous with the word "form". The actual "concept" is the form-giving idea which is derived from careful analysis and evaluation of the previous sections. The material in this section is simply a synthesis of the many concepts that have been developed. The implications involved in the formulation of a land use concept--relative to the specific institution--are too complex to even suggest that these concepts should be directly applied. There are innumerable variations and combinations of each basic approach, and it is within this spectrum of solutions that an ultimate land use plan will be conceived.

## CONCENTRIC CONCEPT

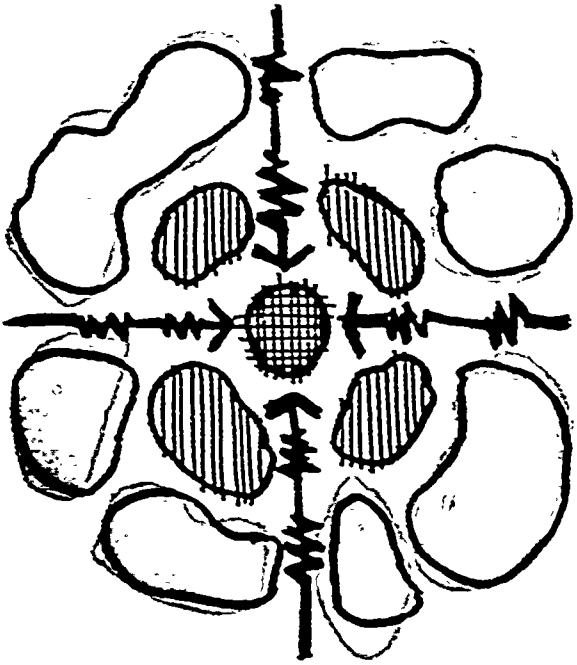

Campus land uses guided by this concept would place the highest concentration of common uses and interaction in a centralized location on the campus. This area would then be encircled by the next highest use categories, and these, in turn, would be encircled by those facilities which are less frequently used, etc. This concept and its hierarchy of rings can be easily applied to either a function or discipline orientation.

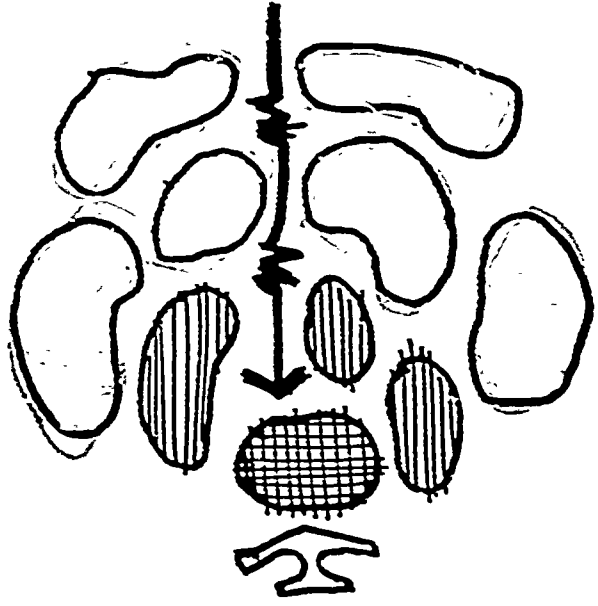

With respect to an existing campus, facilities may be strewn in a random location. It is conceivable that facility utilization may be reallocated to achieve this concept with relatively little change to the existing physical structure. This may result in high initial expenditures at the time of conversion to this concept, but, viewing this from a long-range perspective, it may be the least costly course to pursue.

## SECTOR CONCEPT

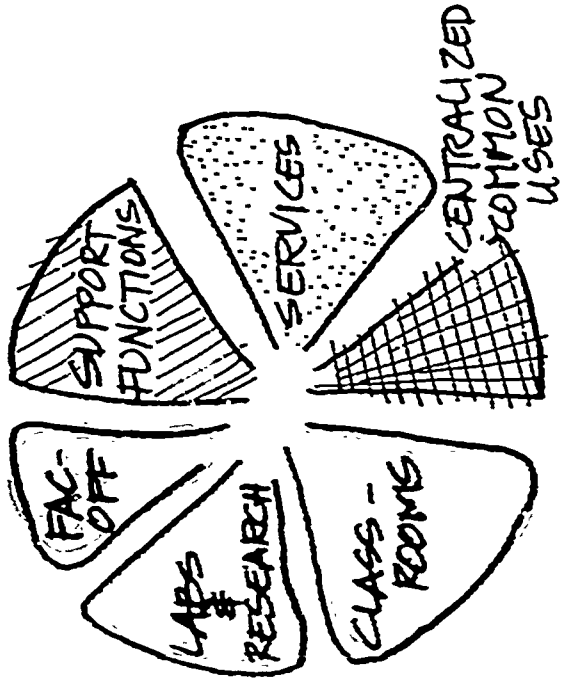

## FUNCTION-ORIENTED SECTOR

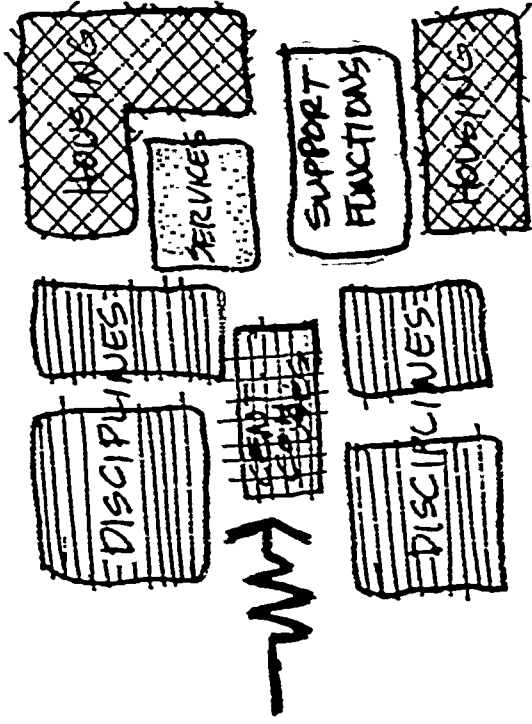

## DISCIPLINE-ORIENTED SECTOR

This approach divides the major facilities of the campus into sectors or particular districts. The sectors are usually organized with reference to a function or discipline orientation. Many of the existing campuses illustrate, to some degree, this approach -- and they are most frequently discipline oriented. This is generally due to the growth of these campuses "over time" accompanied by the addition of new programs.

## LINEAL CONCEPT

This concept represents basically the same theory of location of facilities according to function or discipline, outward from a central area on the basis of frequency of use (similar to concentric). The essential difference is in terms of physical form. The lineal concept is most applicable to a small college or university with a limited physical space, and one that may be subject to future growth.

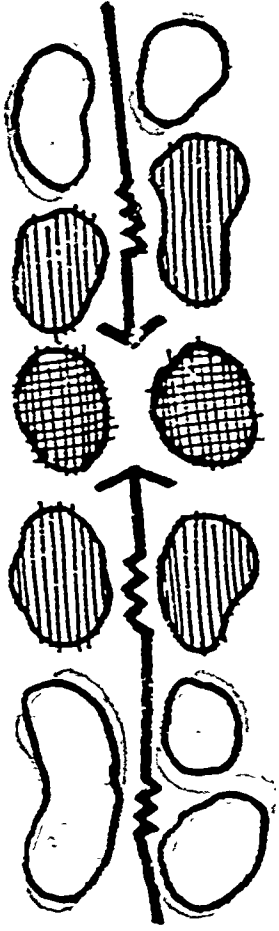

LINEAL

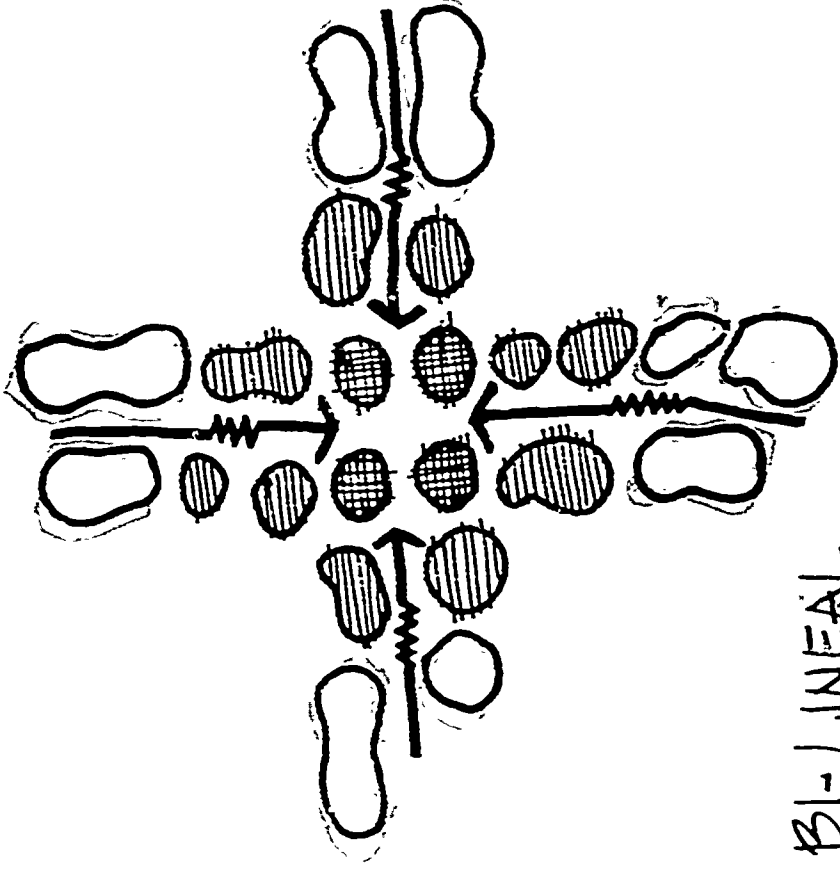

BI-LINEAL



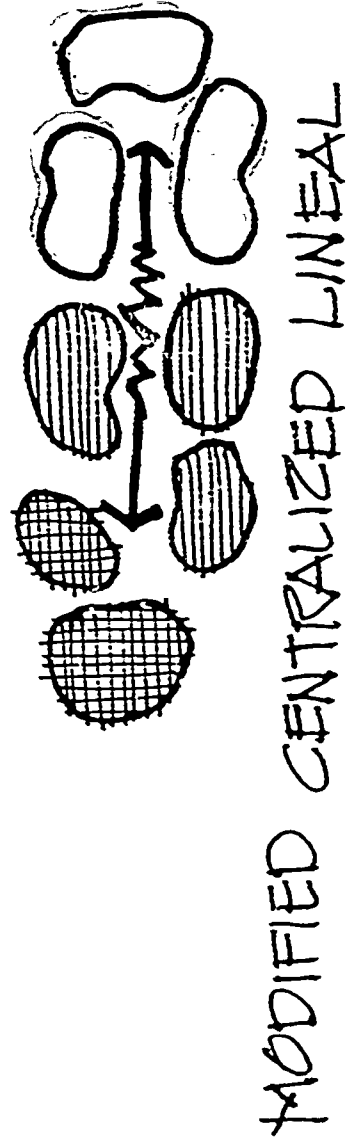
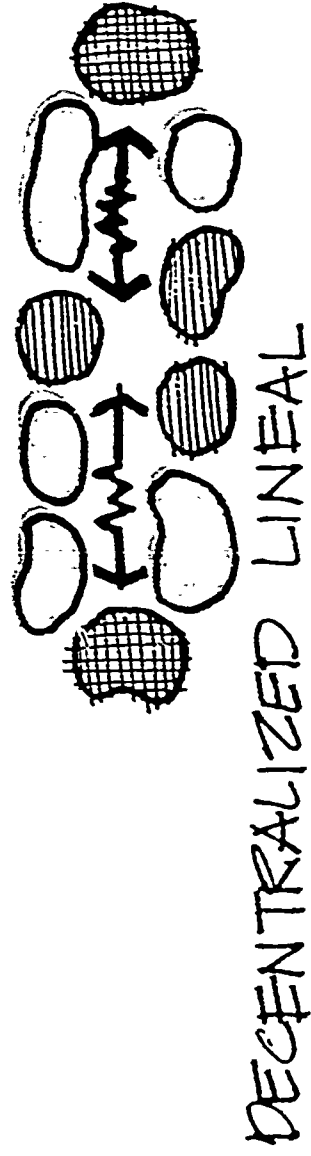
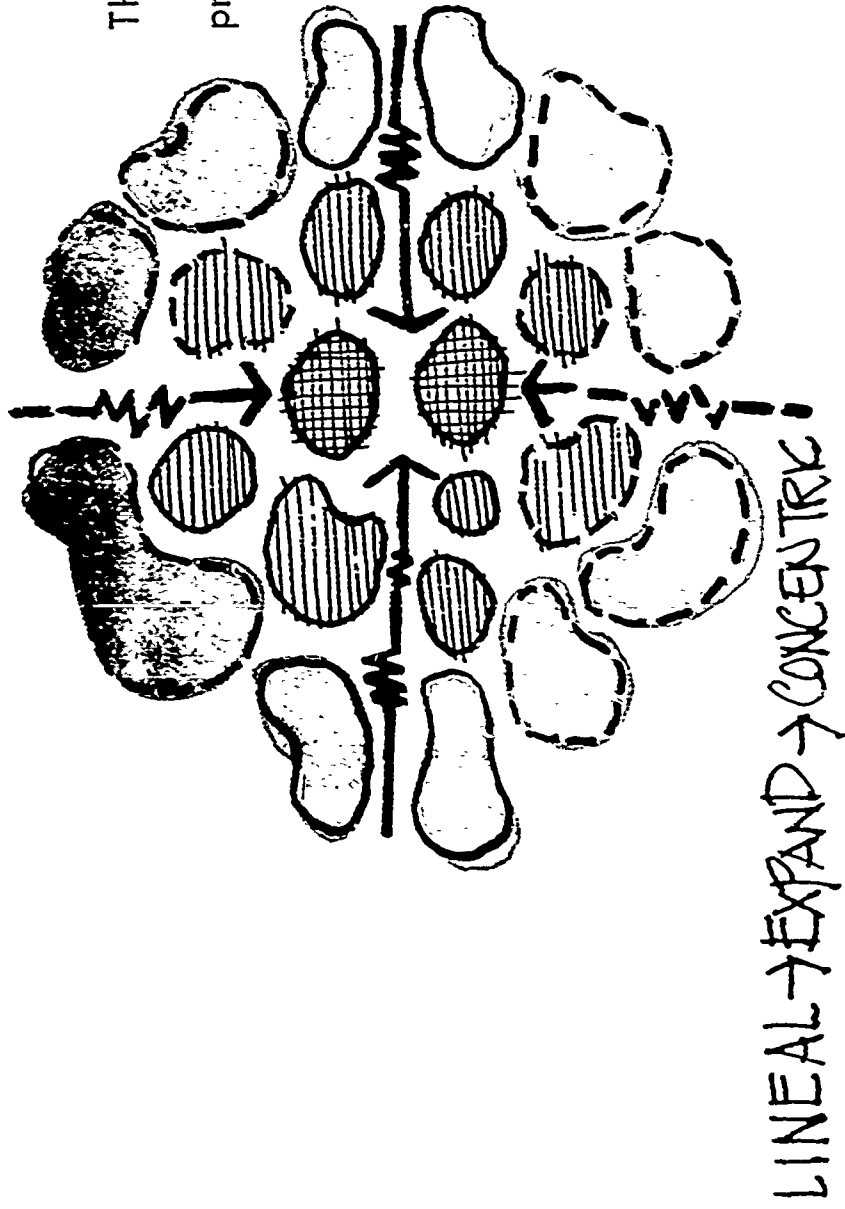

The future expansion based on this concept lends itself to two probable alternatives:

- (1) By expanding vertically if ground space is limited. This consideration should be made at the initial construction stage in order to provide for additional floors;
- (2) If additional land is available, this lineal configuration lends itself to conversion to a concentric form by expanding horizontally. Again, it is necessary to note that consideration for future development and expansion would have to be made during the initial planning stages.

The lineal concept is often modified to locate the common use facilities at the points of entry rather than centrally. This is especially applicable when the entrances are well defined and require emphasis. Another modification might be the location of the common uses at the major entrance to the campus rather than in the middle or at both ends.



## CLUSTER CONCEPT

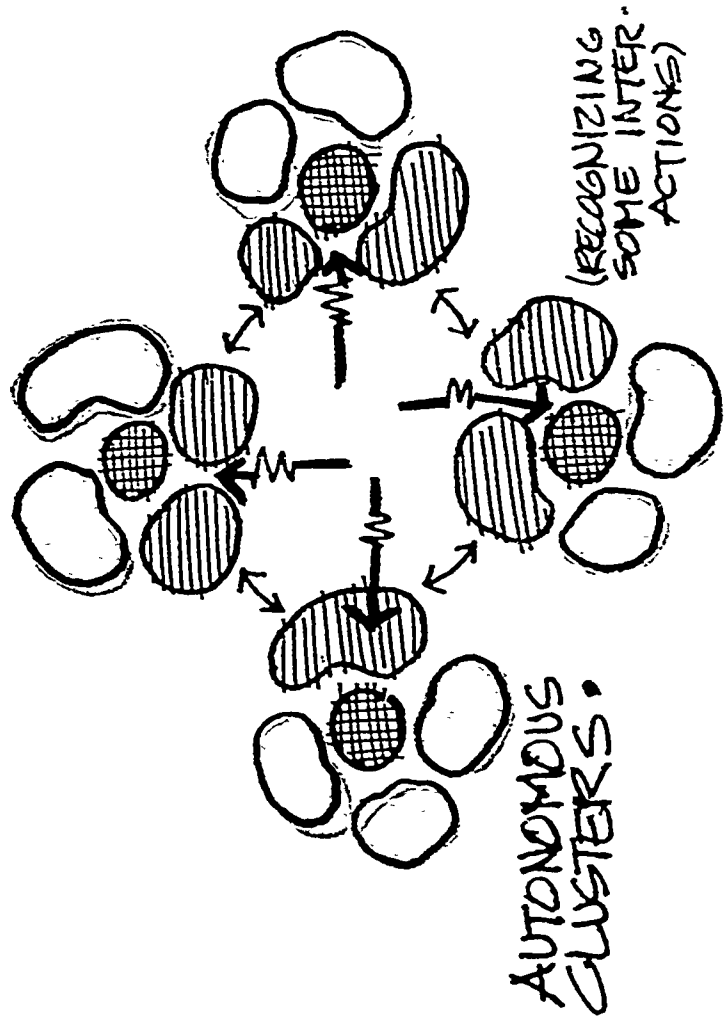

This concept focuses on the creation of individual, autonomous units that function independently from other units. However, relationship to the total campus structure may be achieved by centralizing the common uses. At the other end of the spectrum, autonomy may be enhanced by centralizing the common uses within each cluster or satellite. There are, of course, a variety of alternatives in a cluster plan that are between the two examples cited.

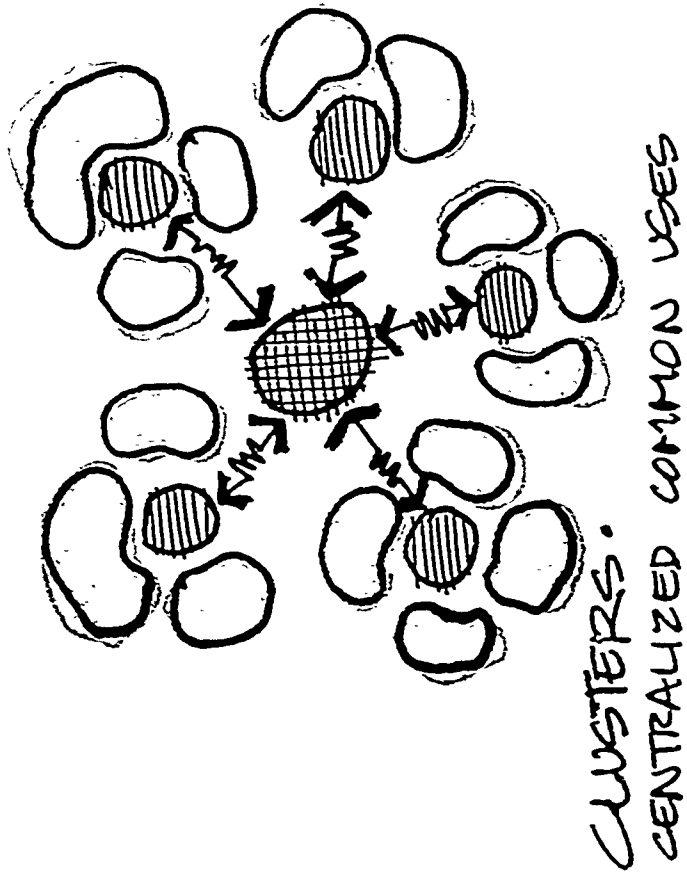

A typical application of this concept would be that the College of Engineering, for example, would occupy one cluster with all of the disciplines and functions required to attain a degree being provided in the cluster (e.g., Math, English, Business, etc.). However, library and administrative facilities may be located in a central common area accessible to all satellites.

## RANDOM CONCEPT

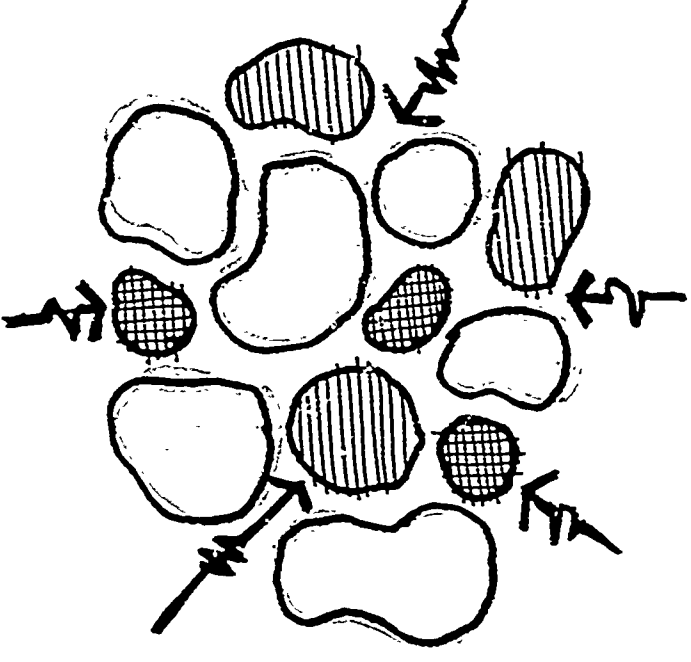

This concept is most frequently applicable to the existing campus and can be generally attributed to a situation in which a campus was developed without the benefit of a plan. If a plan did exist, the resulting random configuration illustrates either a poorly conceived plan or that an adequate plan was not adhered to. However, if well conceived, the random concept might be a desirable approach for the new campus.

It is felt that the land use concept for any given institution will fit into one or a combination of the concepts previously discussed. The problem that exists is selecting that land use concept which would be best for any given institution. Obviously, this selection is affected and influenced by the studies of facilities, traffic, utilities, and by the results of management and financial studies. Thus, the need for a systematic and logical process of determining a desired land use concept for any given institution is identified.

# LAND USE PLANNING PROCESS

The land use information discussed previously (illustrating the threefold context or framework within which decisions regarding physical planning take place) is interpreted into a procedural flow diagram, illustrated in Figure 1. The application of this framework as a guideline or checklist in the decision-making process for campus land use planning is what will be discussed in the following sections.

This procedure recognizes the basic considerations relative to educational institutions. However, it is essential to note that the considerations identified are more within the realm of generalizations than absolute specifics. The specifics assume a significant role when the general process is applied to a particular university situation. It must be realized that each university situation is unique and requires specific interpretation of the relevant factors. The intent in presenting a land use planning model is to establish a general guideline or decision-making framework. Each consideration identified must still be appropriately analyzed, weighed, and evaluated when applied to a specific situation.

This approach has been conceived to be applicable to both existing and new campuses. Under both circumstances, basically the same considerations have to be made and where distinctions do exist they are noted in the following discussion.

The application of the elements of this threefold approach consists in general, in segregated analysis and integrated evaluation with considerable emphasis on feedback. For the analytical purposes of this report, each category has been interpreted separately, however, in actual application the essential elements of feedback and interrelationships of categories produce more of a concurrent operation.

FIGURE 1 • LAND USE PLANNING PROCESS

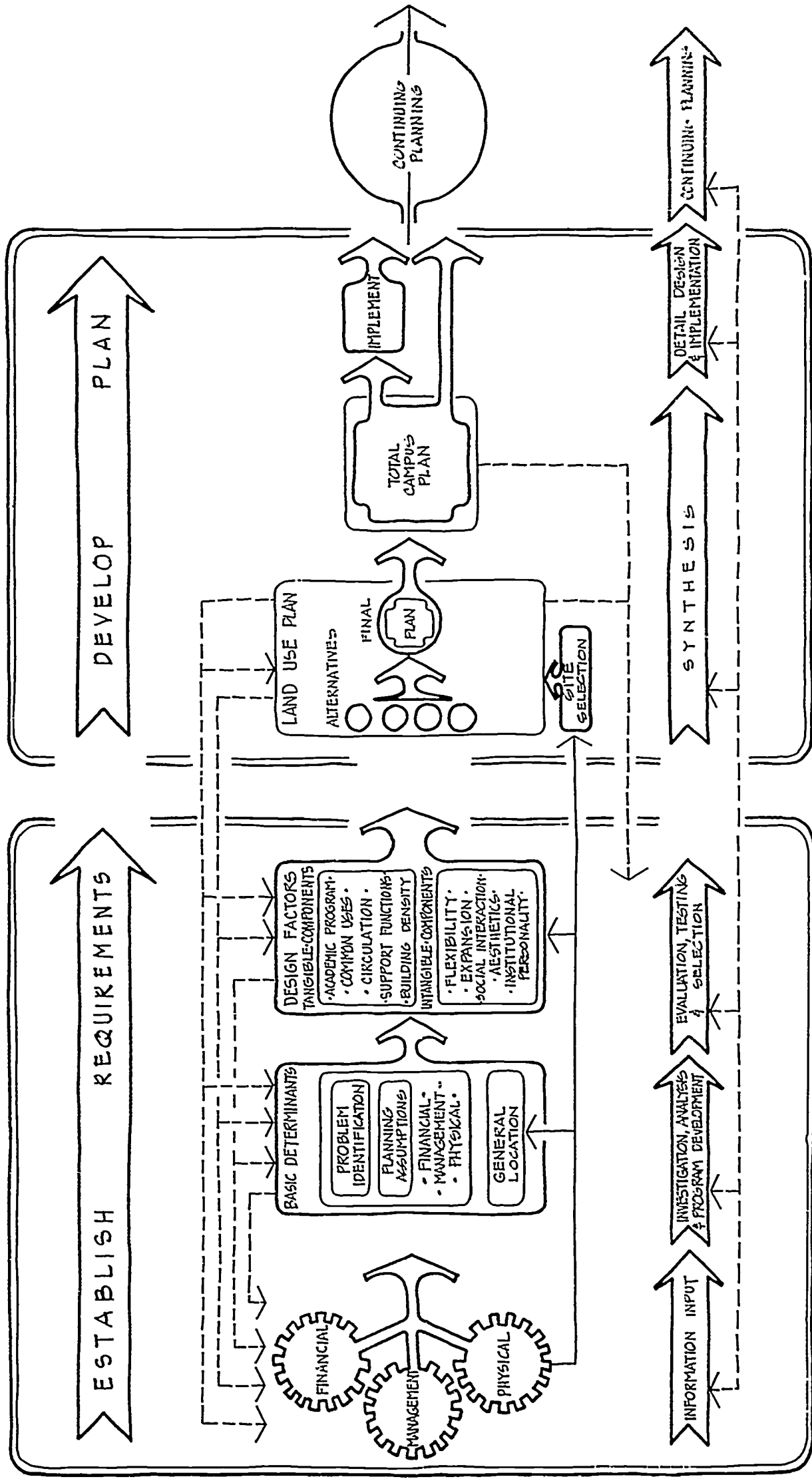

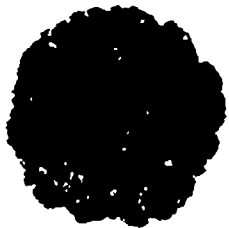

# INFORMATIONAL INPUT

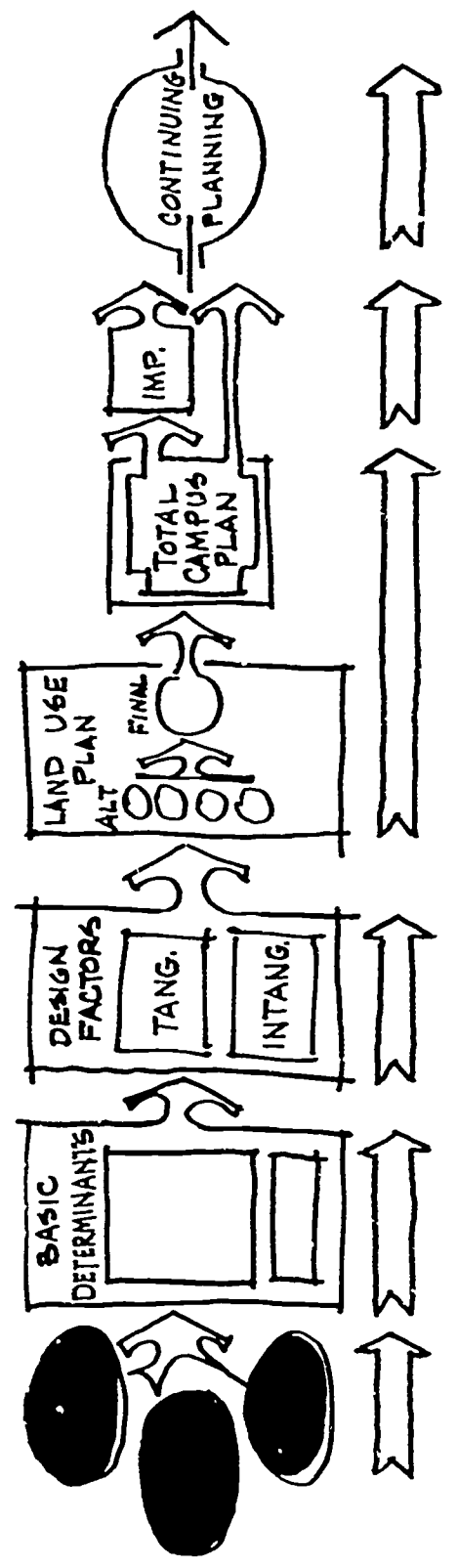

The initial requirement in developing a land use plan is to secure relevant institutional information. This information would generally relate to administrative decisions regarding the essential aspects of managerial goals of the institution, financial capabilities and physical determinants. Campus planning programs have frequently been built upon inadequate or non-existent information regarding especially managerial or financial considerations. As a result, considerable amounts of needless expenses have been incurred in trying to unify an already fragmented operation. Therefore, effective physical planning can only take place when previously effective administrative planning has advanced to the point of committal to a certain direction. At this point the physical planner can interpret the administrative input into an applicable problem statement. Before discussing that planning phase of investigation, analysis and program development in depth, it is essential to expand on the administrative input that is required at the initial stage of development:

## **MANAGEMENT**

The essential managerial input with reference to the physical planning process relates to the goals of the institution and to the requirements of the desired programs. Indications of projections of student enrollment must be secured. Comprehensive information regarding the composition of the student body is also required, including such data as: coed status, graduate and undergraduate ratios, percent married students, full time and part time students, residential and/or commuter students, etc. Faculty and staff employment factors are equally significant considerations.



The educational objectives of the institution must be well defined so that the planner is aware of the relative emphasis among the instructional, research, and public service aspects. The implications of these objectives are illustrated by the type of programs that will be offered. For instance, whether the institution offers technical terminal training, or Bachelor of Arts programs, or doctoral programs, etc. These programs are then translated into specific programs relating to the academic organization of particular colleges, schools, and departments.

Faculty, student, staff, visitor, etc. needs are also indicated from the program input and analysis. These needs can be broken down into educational, social-cultural, and physical and would include such relationships as: educational assignments, facilities requirements, social objectives, inter-communications, and town-gown.

## **FINANCIAL**

Informational input regarding the financial capabilities of the institution in question is as critical as managerial information. A campus can assume many forms and the costs vary with each form. There are many cost saving devices, frequently, at the expense of other objectives, that may be applied. It is imperative that some indication of the monies available for development be submitted so that a realistic approach can be achieved in the planning process. The immediate construction costs are not the only concern. A plan must also represent consideration for the continued operating costs. For example, a low budget construction program, while being desirable initially, may prove to have been more expensive than it was worth when it is analyzed in the long run. Another frequently overlooked aspect of facilities costs is that the cost of placing a new building on campus involves much more than the construction of the building itself. Furniture and equipment are required in addition to the cost of extending utilities, roads, etc., and the cost of site development and landscaping. A well conceived plan must reflect an



awareness of the relationship between available monies and development costs. The plan must also reflect an operating cost that can be maintained by the future budget potential of the institution.

## PHYSICAL

Information regarding the physical requirements of the institution is also essential. In many instances this information may already be established, as in the case of existing institutions, but still the relevant considerations must be recognized and recorded. It may be indicated that the physical conditions present certain barriers and are not conducive to the realization of managerial goals and financial capabilities. However, this is more frequently the exception rather than the rule, and in most situations on existing campuses one must plan for growth based upon the existing physical characteristics. Therefore, on the existing campus, the site as well as many structures, utilities and circulation and parking spaces are established. Input regarding new physical requirements is generally established at the managerial level. If firm decisions have been made about new requirements then this information must be recorded along with the existing physical features.

Physical inputs for the totally new campus are very closely aligned with the managerial inputs. Management studies define the needs of the institution and many of these needs will be translated into physical forms. These requirements should be identified into specific forms. For example, a projected enrollment of 10,000 students may indicate a need for 3500 parking spaces which can be translated into a land requirement which is in excess of 40 acres. This information will begin to define the planning directives including the actual facilities as well as the size and location of the site.

## SITE ANALYSIS

The site is undoubtedly one of the most significant factors in physical plant planning. Regardless of whether the site is existing or to be selected, there are basic considerations that require analysis. Those considerations would relate to 1) characteristics of the particular site, and 2) characteristics of the location of the site. This discussion will focus on site analysis and selection criterion in general. It must be added, however that the final site selection would not necessarily be an initial function of the planning process. It is recommended that the final selection does not occur until the land use alternatives have been prepared. This procedure will be discussed in more depth in following sections of this volume.

Size is one of the first and most obvious site characteristics that is considered. For new campuses enough space is generally desired to provide for future growth, support functions, and permanent open spaces. In some new campus situations, as in urban areas, excesses of space may not be available. But still, a significant site selection factor with relation to size, would be a location where the future acquisition of adjacent space is conceivable. When looking at existing campuses consideration of size should indicate the amount of growth that could be accommodated, and would provide direction in selecting the most applicable planning concept to accommodate the projected growth.

In addition to size, factors relating to the shape and composition of the site must be thoroughly investigated. Topography, existing vegetation, soil conditions, natural hazards and natural features, etc., would effect the choice of a site or the emphasis of growth on an existing site - climatic conditions also require investigation. The accessibility of people by the various means of transportation - auto, bus, rail, transit, bike and on foot - as well as the accessibility of services will strongly effect decisions about a site.

With reference to existing campuses there are additional site characteristics that are essential to analyze. Circulation and parking conditions frequently pose delicate problems. Parking requirements absorb considerable amounts of surface space, and any alternative decisions - such as structures or off campus - generally involve high financial or inconvenience costs. Coinciding with a survey of the parking and circulation conditions, additional surveys of buildings, structures and spaces are necessary to determine their structural and aesthetic conditions. Conditions surveys should also include space utilization studies with reference to present and future space requirements to determine the highest degree of operating efficiency.

In cases where the site is to be selected the location of the site in relation to the surroundings would also play a significant role in the selection process. Similarly, if the site has been chosen, locational considerations would effect the direction and emphasis of growth. This consideration of location, although seldomly completely overlooked, is frequently underemphasized. The existence of a campus has a pronounced effect upon the community and region in which it is located and conversely the community and region has an effect upon the campus. Therefore, the political, economic, social-cultural, etc., aspects of town-gown relations must be fully recognized and emphasized. Equally important are the considerations of community and regional land use patterns which may include investigation regarding development plans, legal codes on land zoning, alternatives for growth, etc. Recognition of the rural or urban context in which the campus is located and the subsequent features associated with this context are essential factors in campus planning.

Physical planning cannot proceed independently - it is a process that functions interdependently with other planning processes. In this case it is quite clear that other levels and areas of planning - managerial and financial - must contribute those goals, objectives, capabilities and determinants that have been derived from comprehensive planning studies. This interaction does not only take place at the offset of the planning process, but as shall be seen, continually throughout. And it is only through an effort of constant interaction, which performs the function of "checks and balances" that a comprehensive solution can be achieved. But rarely can we assume that without guidance and direction will each individual planning function be fully cognizant of the implications derived from the other studies. ". . . The barriers of misunderstanding are not bad communications but a lack of communications."

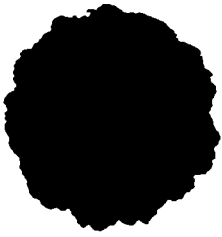

# BASIC DETERMINANTS - INVESTIGATION, ANALYSIS AND PROGRAM DEVELOPMENT

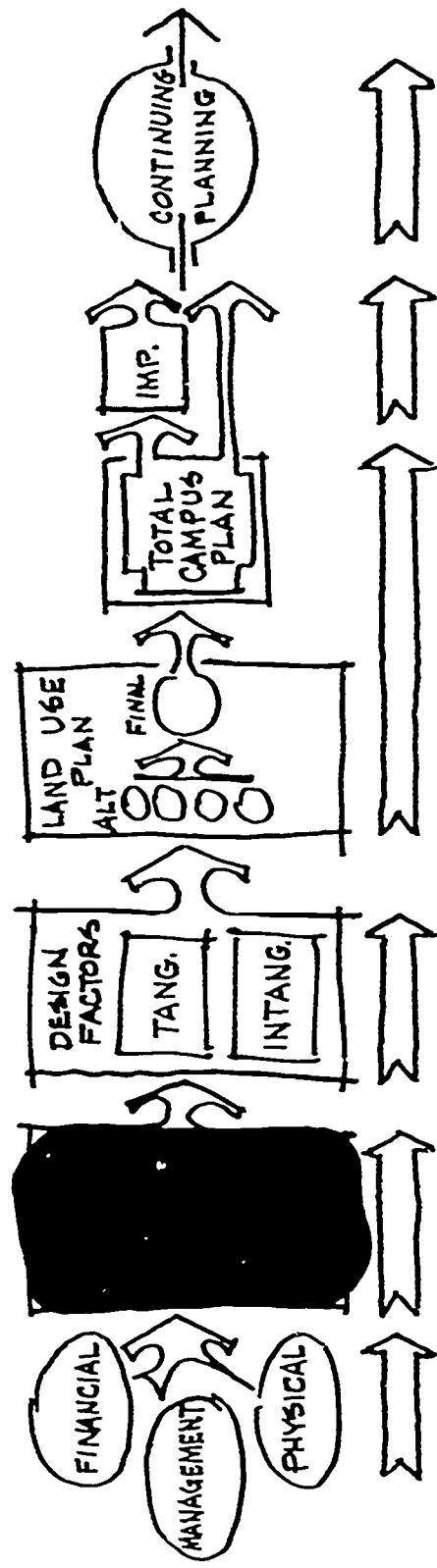

It is more frequently the exception rather than the rule that the input requirements just discussed are developed to the extent that they can be readily interpreted and applied. Therefore, an immediate responsibility is to recognize the critical or primary determinants that will effect the decision-making process. If commitments have not been made regarding this information then studies must be encouraged that are directed at isolating the critical planning determinants. When these inputs have been established - such as a preliminary financial framework and an indication of the educational objectives relating to program emphasis and enrollment size - then the general planning program can be established and preliminary studies can be issued. This information must be analyzed as to its feasibility and practicality relating to the physical application.

The essential need for interaction of the planning functions has been emphasized and this stage further illustrates this need. For example, it may be ascertained that the finances available are not sufficient to realize the educational objectives or that the educational objectives conflict when manifested physically. Or, if a site has been submitted, it may be indicated that it is not consistent with some financial or managerial determinants. The recognition of such conflicts or inconsistencies illustrates the function of feedback and effective feedback is based upon continual interaction amongst the planning teams in developing a comprehensive workable program.



The formulation of an effective planning program is predicated upon a thorough identification of the problem. The problem statement reflects and translates the objectives and intentions that have been established by the administrative studies. Again it must be emphasized that each campus problem represents a specific situation and the determinants must be analyzed thoroughly so that the specific needs of the institution are realized. As a result of detailed analysis and investigation, relative values can be assigned to the determining factors that will be reflected throughout the planning process.

A problem statement cannot be solely derived from the inputs of the administrative efforts. There are responsibilities that must be assumed on the part of the planner. Educational objectives are usually generalized and infrequently specific to the extent that the physical manifestations sought can be readily recognized. There is a cloudy gap - a "no man's land" - between an intention or an objective and the means by which it can be realized. Unfortunately, this "no man's land" is dealt with in just the way the phrase implies - it is avoided.

One jumps from the problem, and often the problem is not even clarified, to a solution which may be subsequently justified. But that which is pursued here is a procedural justification and clarification that not only precedes, but determines and directs an applicable solution. And how is this gap effectively dealt with - this is the real problem - and the answer is certainly not in jumping it. The answer is found in these processes of investigation and analysis, testing and feedback and recognition of the need for integrated and cooperative efforts. The physical planner is not an "island" as neither is the financial or educational planner.



The first problem solving step must be directed toward recognition and clarification of the problem. When the validity of the problem statement has been demonstrated, then, and only then, can the techniques in solving the problem be formulated.

The role of the physical planner in the total process is unique - as he must translate a theoretical idea into a tangible, physical form - and in so doing, many decisions must be based upon assumptions. However, the validity of the planning assumptions can be paralleled to the depth in which the objectives of the institution had been interpreted. These assumptions, or they might be called "approaches to translation", must be analyzed and subsequently tested with reference to their consistency in realizing an applicable solution to the problem.

The identification of the problem and the program defined for its solution will be affected by the site and location of the campus. The deciding factor is whether the site is existing or to be selected. If the site was existing or "given" as part of the problem then this situation would be handled somewhat differently than if the site were to be selected. An existing site would be recognized as a basic determinant - or a determining factor that essentially restrains the alternate approaches that might be taken. On the other hand, if site selection were part of the problem, then it should be regarded as a flexible factor that could reinforce the planning objectives.

Under circumstances of an existing site, the site itself and its location must first be thoroughly analyzed and then evaluated in relation to its consistency with the intended objectives. Generally, both the managerial and financial objectives would be relatively consistent with those limitations that might be imposed by an existing site. But situations do arise when there are obvious inconsistencies and consequently alternatives must be proposed. For example, the site on one hand might be extremely hilly while, on the other hand, the academic intentions might be to create a highly autonomous campus structure at minimum initial expenditures. If the problem arises on an established campus than the most obvious alternative course would be to re-evaluate the objectives. However, if the campus had not as yet been established, but the site was selected then one could propose that other sites be considered and/or re-evaluation of the objectives. Whatever the situation, it is essential to recognize and plan for probable limitations and restraints that may be imposed by an existing site.

Site considerations shift to the other end of the spectrum when the site is to be selected. The site is responded to as a flexible factor (as opposed to inflexible) and its selection would be complementary to the design objectives. Under these circumstances the most applicable approach is to avoid a final site selection until the planning process has progressed to the point where alternate land use concepts have been proposed. In this way the site does not dominate as a determining factor but contributes as a reinforcing factor. It must be assumed that in most cases more than one land use concept will satisfy the requirements projected and when alternates are proposed then the site or sites can be applied to evaluate the most optimum realization of the intended objectives. (This situation is discussed further when the synthesis of land use plans is discussed.)

The basic determinants assume a significant and undeniable role in the planning process. They identify the problem and problem assumptions, they define the problem-solving program and they establish the basic design parameters in progressing toward an ultimate plan. Therefore, considerable emphasis must be extended upon this stage of the process. The situation must be first investigated in attempting to identify the determinants. The determinants must then be analyzed in order to establish consistency with the institutional objectives. And finally, a program must be developed that reflects the direction specified by the basic determinants.

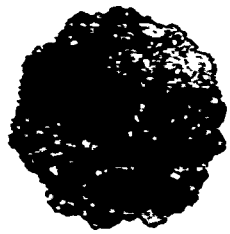

# DESIGN FACTORS - EVALUATION, TESTING AND SELECTION

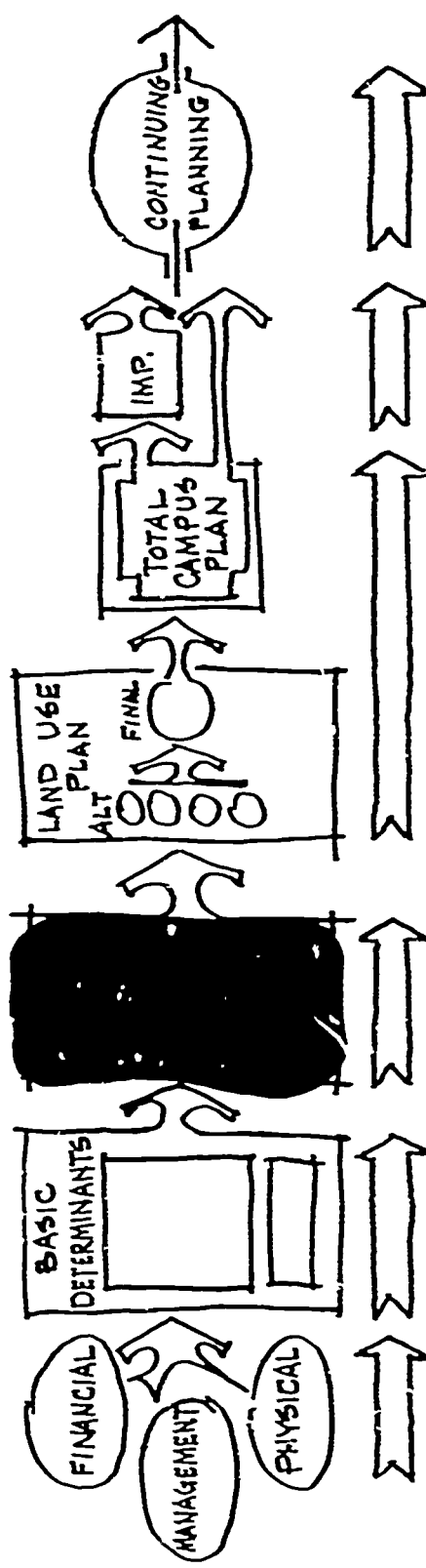

Thus far the discussion has focused upon the necessary informational inputs and the relationships they bear upon the physical planning program development. It has also been alluded to that an essential ingredient is the consideration of translating theoretical objectives into a physical context. At this stage, the focus is upon evaluating, testing and selecting the physical design factors that are essential to physical planning and that will be derived from the objectives and the planning program.

As illustrated in the first part of this section on land use planning, the design factors are classified as either tangible or intangible. Included are the major considerations that are, in general, common to all campuses. The tangible factors relate to those design considerations that involve the assignment of physical space and include the academic program, common uses, support functions, circulation and building intensity. The intangible design factors are those design considerations that are not directly related to the assignment of space nor are they directly manifested in a physical form. However, they do have an indirect effect upon space and form. Included as intangible design factors are flexibility (or convertibility), expansion, social interactions, aesthetics and institutional personality.

When a totally new campus is being considered, all the factors are flexible ingredients about which decisions can be made relative to the program objectives. They are not, however, absolutely flexible or variable as the inputs and objectives (for example financial considerations) will restrain or direct many decisions. On the existing campus the planner is confronted with the reverse situation - where most of the factors are initially somewhat inflexible or fixed. In these cases it is the inputs and objectives (i.e., again financial considerations) that will determine the degree to which an established factor can be changed. Each campus represents a unique and specific situation and generalized values should not be assigned to these design factors until one evaluates the actual campus.

Evaluation and selection of the design factors leads to the establishment of the foundation of the form and structure of the campus - and it is upon this foundation that the land use concepts are synthesized. Therefore, the fundamental design criterion will be established as a result of testing and evaluating the physical components of the campus form. This decision-making process is as subjective as it is objective and once again the process of feedback assumes a significant role. Each design factor must be reconsidered, re-evaluated and retested not only to determine its consistency with the overall program but also the consistency of one factor to another.

The design factors listed represent the essential components or criterion of campus form. The decisions required relate to the direction and emphasis that each factor will assume when applied to a specific situation. These factors must be examined individually and collectively as the subsequent land use forms are basically an assimilation of these considerations. Therefore, there is a great responsibility associated with this phase and great care and consideration must be extended in determining the most appropriate decisions.

The following discussion focuses upon a more detailed examination of the design factors. Each factor is discussed in two contexts - the first relating to the generalities of the subject and the second is a more specific analysis (in outline and diagrammatic form) of the essential considerations involved in making any appropriate decision regarding the application of each factor. A few comments are in order regarding the second part prior to reading the material.



It may become apparent to the reader that there is some redundancy of essential considerations among factors. This illustrates two points: (1) This is a systematic approach and each phase must be effectively and thoroughly explored as decisions in a following phase are dependent upon the information derived from a subsequent phase. For example, many of the decisions regarding these factors are dependent upon the informational inputs and their subsequent interpretation into determinants and a program. (2) It is essential to establish the weights (or degree of significance) of the particular considerations relative to the specific factor and institution. It is through this assignment of these weights or values (especially since so many considerations are the same for different factors) that will lead to appropriate decisions.

The objective of this discussion is to simply point out the relative elements that are essential to consider. It is however, essential to bear in mind that all considerations are not to be held equal. The weight or value of each element (in relation to the others) is dependent upon an evaluation of the objectives, etc., of the particular institution. It is the degree to which these elements are considered that will direct the final decision.

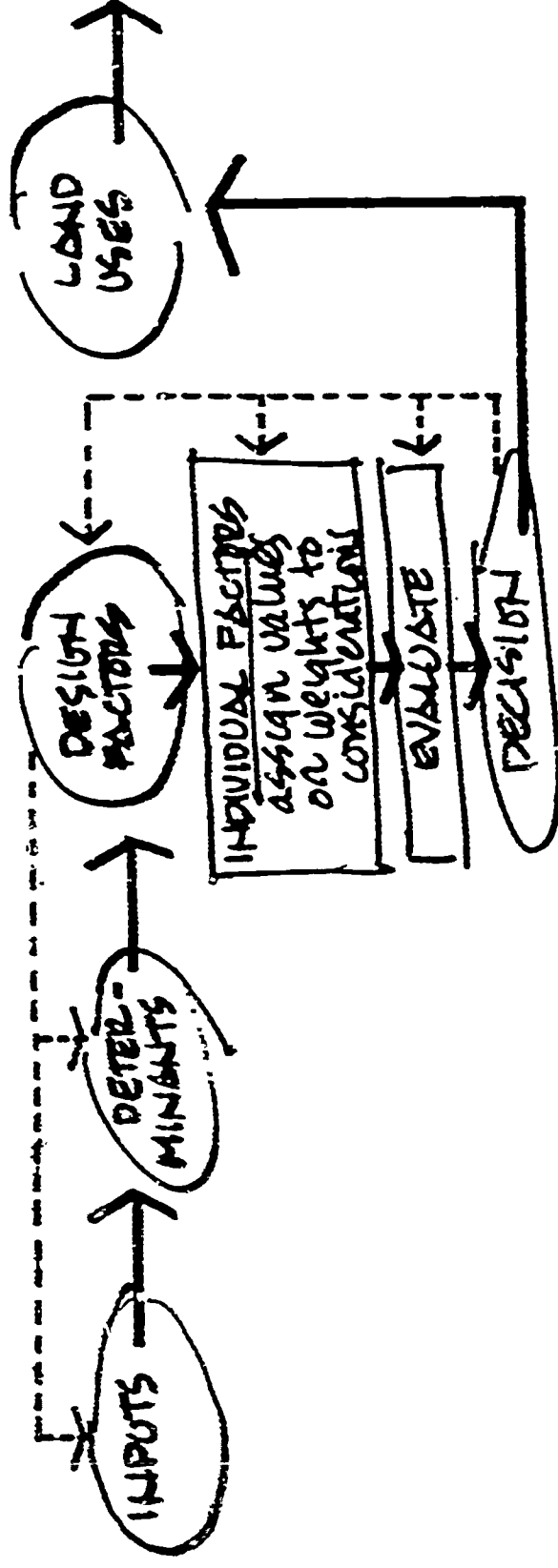



## ACADEMIC PROGRAM

FUNCTION oriented or DISCIPLINE oriented campus. This is generally the singularly most significant decision that must be made. Most campuses are committed to one principal or the other, however, very seldom is there a campus that represents an absolute reflection of either extreme. Generally one approach can be recognized as having been emphasized, but there are still indications of the presence of the other approach. For example, most established universities are discipline oriented due to their continuous growth over time characterized by the addition of new programs.

But still there are usually on these campuses some high use, function oriented buildings that are not assigned to a particular discipline. The function oriented campus is more of a recent phenomena that is most frequently associated with the development of the community college.

From a purely theoretical standpoint the function oriented academic program is generally regarded as the most advantageous. It exhibits the greatest flexibility in terms of facilities utilization and emphasizes considerable intra-departmental as well as inter-departmental interaction. However, the discipline oriented academic program has proven to be the most popular. This popularity can be attributed to the development "over time" of most campuses in association with considerable emphasis upon inter-disciplinary interaction. It is essential that the selection of an academic orientation is consistent with the educational objectives of the institution. Generally, the choice incorporates both orientations and the degree of emphasis of one or the other is dependent upon the specific situation.

## Design Factor Analysis - Function Oriented or Discipline Oriented:

- Administrative input
  - Educational Objectives
  - Program Identification
  - Instructional, Research, Extension
  - Degree Programs
  - Organization
  - Financial Capabilities
  - Immediate Costs
  - Continuing Costs
- Existing Campus
  - Present Orientation
  - Capacity for Change
  - Utilities Considerations
  - Circulations
  - Community
  - Campus Circulation - Pedestrian/Auto
  - Student Interactions

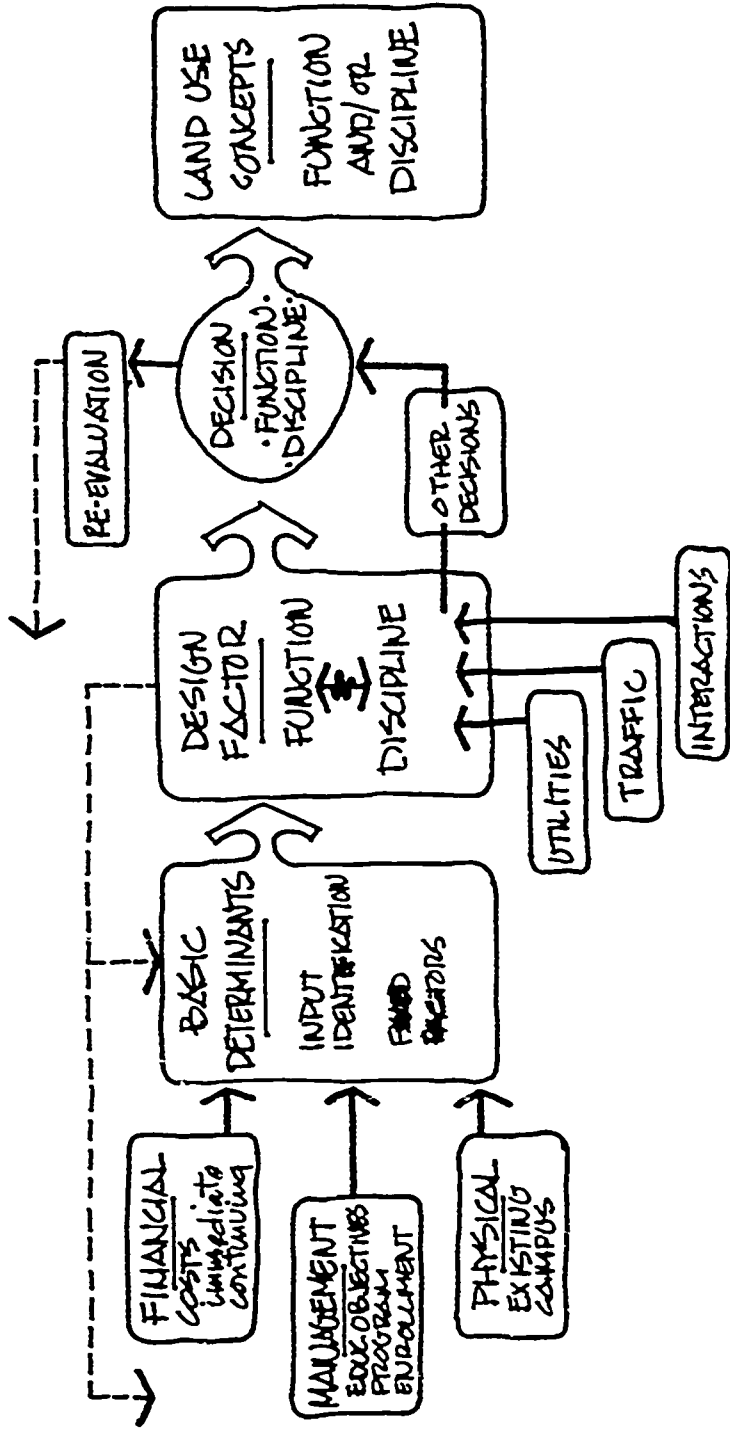

The outline above lists the essential considerations involved in analyzing the function/discipline factor. The diagram above is based upon the land use planning flow diagram and has been modified to illustrate the inputs relative to the particular factor.

The initial considerations would revolve around the informational inputs. From a financial standpoint, cost comparisons must be made between the function and discipline approaches. Such comparisons should examine both immediate and continuing costs and the results should be overlaid against the financial capabilities and the academic objectives of the institution.

The managerial considerations would include a review of the educational objectives of the institution. This review would include identifying the degrees of emphasis among the instructional, research and public service programs. A decision relating to a function or discipline orientation, which is basically an academic question, would require further investigation into the particular academic degree programs and the objectives and attitudes of these programs. Furthermore, enrollment trends of the total institution and the particular programs must be analyzed. On the existing campus, physical considerations would be especially significant as the present function or discipline orientation would have to be determined as well as the capacity for change of that particular orientation. Once the relevant managerial, financial and physical considerations have been identified individually, they must also be evaluated collectively in order to determine their consistency in regard to the decision that is required. The emphasis is upon these considerations which are relatively inflexible and will basically determine the most appropriate direction.

The diagram, however, also illustrates additional considerations that will contribute significantly to the ultimate decision. These relate to utilities, traffic and student interactions and the information is usually generated from complementary studies. There is an obvious distinction between the utilities requirements for a function-oriented campus (all laboratories, classrooms, etc. in particular areas) and a discipline-oriented campus (where the facilities are grouped by academic discipline). Existing utilities or the cost of one approach as compared to the other will certainly exert an influence. Similarly, the same distinctions apply to circulation considerations. Available space must be considered as well as the length and ease of movements and the means by which the movements are made. The type and frequency of student interactions that are to be encouraged is another significant consideration. This also has bearing upon the circulation consideration especially as applied to pedestrian movements. A discipline orientation would emphasize intra-disciplinary interactions while the functional orientation would encourage inter-disciplinary interactions. This consideration also relates to the academic objectives of the institution.

The input and review of these considerations form the basis for an appropriate decision as to which orientation should be emphasized. This decision should not, however, be regarded as final. Decisions must still be made about other factors which may indicate a need for re-evaluation of previous decisions in order to ensure the greatest collective consistency among factors.

The procedure for design factor analysis has been examined rather closely using the function/discipline factor as an example. The following material is based upon the same format but it will not be presented in as much detail as the procedure is very similar.

# COMMON USES

CENTRALIZED common uses or DECENTRALIZED common uses. There are certain facilities on every campus that are common in use to most students and faculty. The question posed in regard to these facilities (such as the library, student center, administrative office, etc.) is whether they should be centralized and grouped together, or decentralized, and dispersed at preferably strategic locations throughout the campus. In either case, it must be recognized that these common use facilities are the focal points of campus life - generating the greatest amount of activities and interactions.

A strong case can be presented in support of either approach. Generally, however, the centralized approach (completely or modified) is most frequently desired. The common uses are clustered in a focal area, most frequently in some proximity to the center of the campus or at the major point of entry, where student movements occur at the greatest frequency. It is not to be implied that decentralization of the common uses are any less desirable. Unfortunately most examples of decentralized facilities on today's campuses had been randomly located and unplanned - but this approach, when well planned, can contribute considerably to the structure and utilization of the campus. In many cases there are several major points of entry or several interior focal areas that require emphasis. It must be kept in mind that when the common uses are dispersed, thought and planning must not only be given to the location, but also to the designation of the common use that will occur at that location.

There are innumerable variations and modifications that accompany either approach and it is often difficult to differentiate as to which approach is dominant. Rarely are situations developed where there is absolute interpretation of one concept or the other. There is instead a tendency to compromise (with emphasis on the approach that indicates the greatest consistency with the determinants, objectives and other design factors).

### Design Factor Analysis - Centralized Common Uses or Decentralized Common Uses:

- Administrative Input
  - Educational Objectives
  - Program Emphasis
  - Faculty Information
  - Financial Analysis
  - Cost Comparisons
- Existing Campus
  - Present Orientation
  - Capacity for Change
  - Function ----- Discipline Orientation
  - Student Interactions
    - Student, Faculty, Administration, etc.
    - Circulation

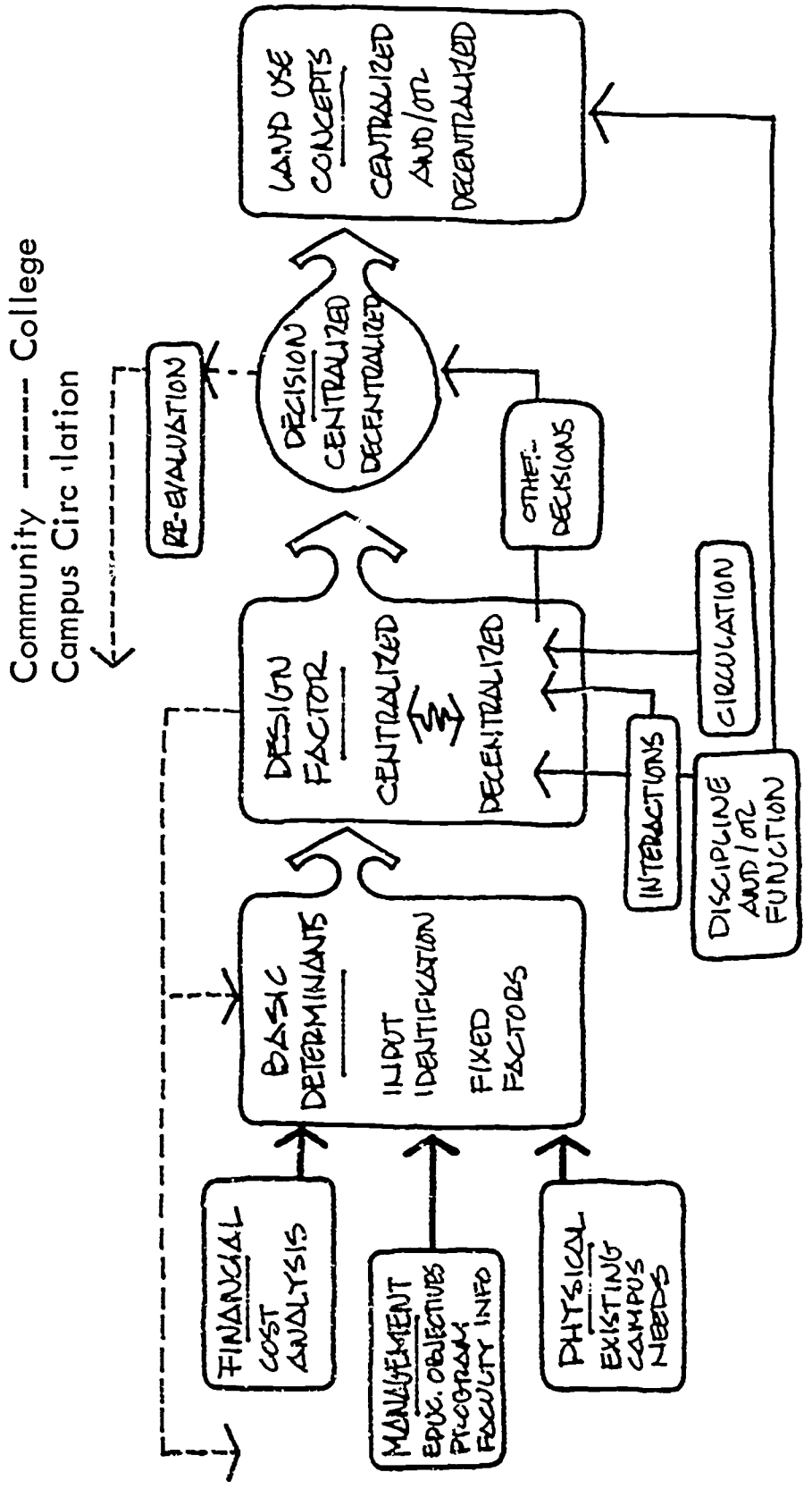



# CIRCULATION

PEDESTRIAN oriented or AUTOMOBILE oriented campus. The resolution of the circulation factor is probably the most widely publicized problem confronting the campus. (The second part of this volume is devoted to traffic planning). It has been recognized as a problem because of the numerous difficulties associated with the automobile - especially those of space and pedestrian conflict. On established campuses the problem is generally shifting the automobile from the central academic area to peripheral areas. On new campuses the problem is generally the same except that the automobile doesn't have to be transferred - only kept out.

Ideally the pedestrian campus is desirable. Automobile and pedestrian traffic are separated and the academic area is restricted to pedestrian movements. This approach recognizes that education does not only take place in the classroom or laboratory, but also through interactions that occur between classes. These interactions can be encouraged by proper design and the main tool is pedestrian spaces, as opposed to automobile spaces, between the buildings. There are, of course other design implications that supplement this approach such as facility locations and spacing. It must also be recognized that a pedestrian approach does not preclude all automotive considerations in the central campus area. As a matter of fact, automobile access requirements frequently become design standards for pedestrian malls. Emergency access (for fire, ambulance, etc.) cannot be overlooked. There are also service requirements that may be satisfied along pedestrian malls during low use hours. Faculty parking requirements must also be considered and interior space and access routes may penetrate the central campus areas. But, through proper design and spatial allocation, these parking and access areas may not be imposing and dominant and at the same time can satisfy some of the service and emergency requirements. Therefore, the automobile regardless of the extent of pedestrian emphasis, still assumes a major role in resolving central as well as peripheral campus spaces.



The automobile can and frequently does become the dominant factor of campus structure. Parking lots often occupy valuable spaces that could be better used for academic functions. Streets become impersonal, hazardous channels that divide and fragment the campus. The campus structure should be unified and the atmosphere should encourage personal relations and interactions. The circulation factor is a major tool in creating the campus environment - an environment that is to be consistent with the goals and objectives of the institution.

Design Factor Analysis - Pedestrian Oriented or Automobile Oriented:

- Administrative Input
- Educational Objectives
- Program Emphasis
- Enrollment Trends
- Congestion
- Financial Analysis
- Relative Costs
- Existing Campus
- Present Circulation
- Capacity for Change
- Density
- Function ----- Discipline Orientation
- Traffic Studies
- Community ----- College
- Campus Circulation - Pedestrian/Automobile
- Student Interactions
- Safety Factors
- Distractions - Noise
- Intangible Factors
- Aesthetic:
- Flexibility

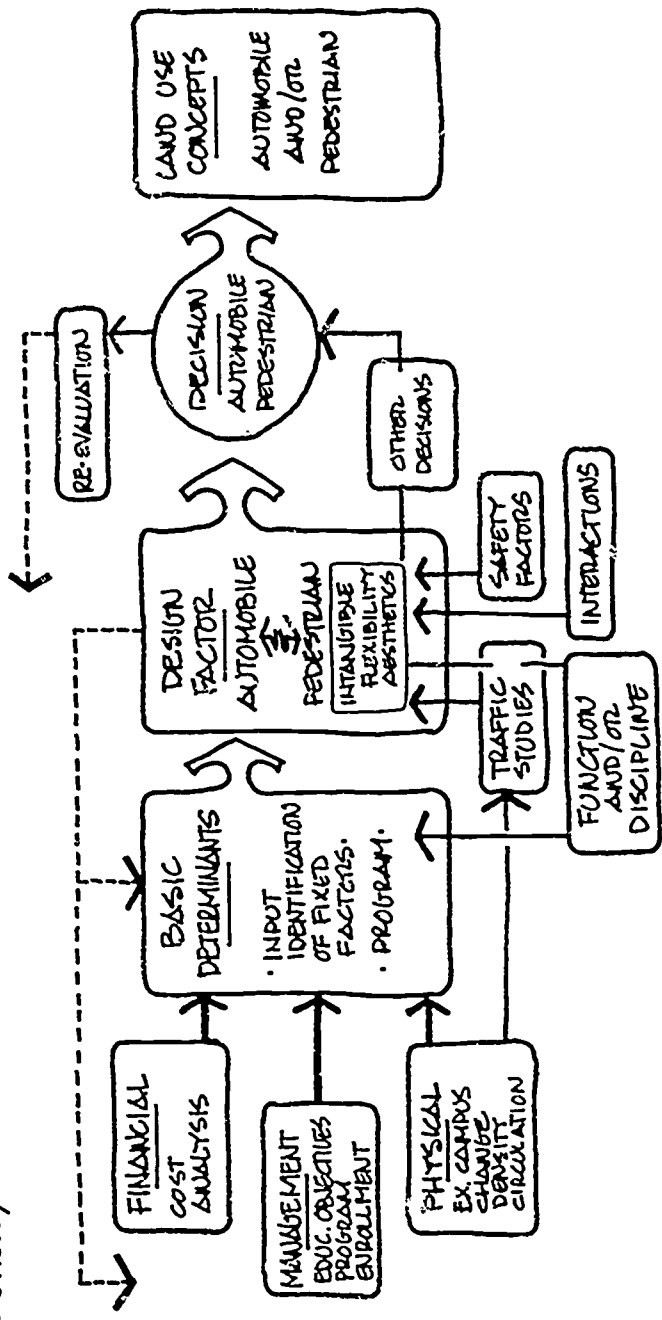

# SUPPORT FUNCTIONS

RESIDENT OR NON-RESIDENT CAMPUS. The residency question confronting campus plans is generally dependent upon administrative intentions. In most cases, with the exception of the community colleges, campuses assume some of the responsibility for housing their students. The dormitory is the most common facility and lower classmen are generally encouraged to occupy them. Many colleges also provide some facilities for married students. The concept of the community college is to primarily serve those students from the community and therefore the campuses are most frequently non-resident (on the assumption that the students will be living at home). At the other extreme, very few campuses are completely residential. The residential approach was, however, emphasized in the past and has currently received considerable attention. The problem, therefore is not whether the campus will be residential or non-residential, but more specifically, the amount and type of housing to be provided.

Housing is becoming a crucial problem. Enrollment in the nation's colleges has illustrated a remarkable increase over the last ten years and the expectations for the next decade are even greater. Universities must assume some of the responsibility in meeting these increasing housing demands. Many colleges maintain that they cannot afford to enter the housing business and as a result the students frequently suffer. However, many schools have illustrated that they can supply housing and do so at a profit to both the school and the student. Other schools have illustrated that successful partnerships can be arranged with private enterprise through which equitable housing is supplied and the school still maintains the necessary controls. There are ways to cope with student housing needs - ways that keep the best interests of the students in mind. The responsibility of the college is to thoroughly explore those various alternative approaches and assume an active role in supplying this need.

Design Factor Analysis - Resident or Non-Resident Campus:

- Administrative Input
  - Educational Objectives
  - Program Emphasis
  - Enrollment Trends
- Financial Analysis
  - Capabilities
  - Cost Analysis
- Existing Campus
  - Previous Factor Decisions
    - Function ----- Discipline
    - Pedestrian ----- Auto
  - Interactions
    - Campus ----- Community
  - Community Analysis
  - Circulation and Traffic Studies
    - Community ----- College
  - Campus Circulation
    - Housing Study

UTILITY SERVICES. The effect of utility services is a specialized problem and frequently requires the guidance of a consulting engineer. (Volume V deals with the aspects of utilities considerations in considerably more depth). Every building requires water, plumbing, electricity, etc. and even though these services are generally not visible, they do effect the location of facilities. These considerations are especially significant on existing campuses where expansion is being planned. The utility sources are already established and services have been installed. Expansion requires the extension of these services and the most feasible areas would be indicated by analysis of utility location and carrying capacity. If expansion areas are inconsistent with existing utilities then needless additional expenses are incurred (unless, of course, the decision was intentionally based upon the satisfaction of other objectives).

Utility considerations on the new campuses are somewhat more flexible. But still, when locating land uses and structures, awareness of the implications of utility services should effect the ultimate decision.

### Design Factor Analysis - Utility Services:

- Administrative Input
  - Managerial Directives
- Financial Analysis
  - Immediate Costs
  - Continuing Costs
- Existing Campus
  - Present System
  - Capacity for Change
  - Economy of Change
- Building Study
  - Building Program
- Utility Study
  - Demands
  - Program Emphasis
  - Projections of Future Needs
  - Previous Factor Decisions
  - Academic Programs
  - Circulation

RECREATION. Recreation is a factor that requires considerable amounts of space for such facilities as play fields, tennis courts, football fields, etc. Many campuses in urban areas have minimum acreage and consequently recreation space is at a premium - especially when it must compete with the parking need. Under these circumstances, which appear to be relatively frequent, the planner must thoroughly evaluate the implications of all the alternative solutions available. For example, recreation space may be sacrificed for parking space or vice versa if recreation had been recognized as an essential need and previous investigation indicated that some parking needs could be absorbed elsewhere. Or the two uses may be combined, as some campuses have chosen, by constructing a below surface parking structure with a playfield above. Whatever the decision, it is obvious that it would be based upon the previous financial, managerial and physical input studies as well as the impact it would have upon the other design factors.

On campuses with more extensive acreages the provision of recreational space does not present as many difficulties. However, this need cannot be overlooked and treated as a secondary item that will be "added later" in the remaining spaces. In order to effect a comprehensive plan, all factors must be considered somewhat simultaneously - so that the greatest efficiencies can be realized. Recreation, for example, even on the large campus, should be planned to properly relate to the other campus facilities. Furthermore, it should relate to the physical site, utilizing those areas that require minimum amounts of earth work.

#### Design Factor Analysis - Recreation:

- Administrative Inputs
  - Educational Objectives
  - Program Emphasis
  - Enrollment Trends
- Financial Inputs
- Existing Campus
  - Present Development
  - Available Land
  - Conflicting Needs
- Projections of Future Recreation
  - Needs and Demands
- Community Analysis - Facilities
  - New Campus - Available Lands
  - Intangible Factors
    - Flexibility
    - Expansion
    - Aesthetics

OPEN SPACE. Open space is a design factor that requires considerable attention. This term usually implies large, extensive, unimproved areas - but, with regard to campus planning, the reference is to all outdoor areas - from the intimate space as defined by a cluster of buildings to the expansive space. Each open area, with reference to its scale, function and utilization is significant and, in the final analysis, is the ultimate determinant of campus structure.



There are two approaches to the designation of open space that are necessary to consider. Open Space may be regarded as a RESERVE for future expansion needs or it may be PRESERVED as an integral factor of campus structure. In many cases these distinctions have not been made and expansion programs frequently assume random locations. Open space reservation and preservation are essential design factors that effect the sequential and ultimate composition of the campus.

An expansion program of an existing campus, therefore, must include a thorough inventory and analysis of the open space. As a result, the most optimum expansion areas and building locations can be ascertained, while those open areas recognized as essential to the campus function and aesthetic can be maintained. On the new campus, open space considerations are equally important and should not be regarded as an after thought, but as an essential factor in the design process.

#### Design Factor Analysis - Open Space:

- Administrative Inputs
    - Educational Objectives
    - Program Emphasis
  - Financial Analysis
  - Existing Campus
    - Present Development
    - Available Land
  - New Campus - Available Lands
  - Student Interactions
  - Circulation Studies
- Previous Factor Decisions
    - Discipline
    - Circulation
    - Support Function
  - Intangible Factors
    - Flexibility
    - Expansion
    - Aesthetics
  - Building Studies



# BUILDING DENSITY

HORIZONTAL or VERTICAL. Considerations relating to cost and space are the principal determinants of the degree of vertical or horizontal emphasis of the buildings on the campus. Most vertically oriented campuses are located in urban areas on sites that are generally restricted in size relative to the student enrollment. Those campuses that are predominantly horizontal are located on sites where there has been adequate space. Generally, from a financial standpoint, the horizontally oriented campus is preferred as lesser costs are associated with this type of construction. Therefore, many campuses are completely horizontal (or ranging from 1 to 4 stories in height) while a completely high rise campus is still quite unusual. In most cases the campus represents a combination of the two approaches and one approach can be isolated as having been emphasized more than the other. There are also frequent cases where the original building program was horizontal and dispersed and, as the campus has expanded, the program has gradually, or even rapidly, shifted to higher rising buildings. This occurrence is especially common to the urban campus as it has progressed through various stages of growth. The responsibility here is to recognize this trend and convert it into a well conceived plan for present and future growth.

Financial cost and physical space should not be reacted to as exclusive determinants of height. Other significant factors must be recognized and evaluated. With regard to cost, financial outlay is only one aspect. Thorough evaluation of the social and time costs may reverse the opinion formulated upon a financial basis. Circulation - horizontal and vertical, automobile and pedestrian - will effect the decision. Utilities, open space, and density also require consideration. The relationships to the academic program requires particular emphasis. And finally there is the aesthetic factor -- the effect of the third dimension of the campus. This vertical dimension is what the observer reacts to - and campus plans are too often preoccupied with only a two-dimensional approach.

COVERAGE. There is no absolute formula that one can apply to determine the density that will most appropriately satisfy the objectives of a campus. Building Coverage is expressed in two forms that are dependent upon one another. One form relates to the intensity of use of particular structures which determines the other, which is the amount and relationship of required structures. Both aspects must be thoroughly analyzed and evaluated in order to reflect the particular objectives of the institution. Such factors as the academic program and the financial, managerial and physical inputs should illustrate significant bearing upon the coverage factor.

The intensity of use determines the sizes or bulk of particular buildings. Once these needs have been established then the quantity of facilities is determined - and finally the relationships of facilities. The relationship of facilities is not only dependent upon the densities, but height and open space considerations as well. Similarly height and open space considerations will effect the relationships. It was stated that there is not an appropriate formula in determining the density factor - but it must be realized that there are appropriate solutions. These solutions are derived from thorough evaluation and testing of all the factors and objectives relative to the specific problem. (Volume V deals with the aspects of facility studies in considerably more depth).

#### Design Factor Analysis - Building Density:

- Administrative Inputs
  - Educational Objectives
  - Program Emphasis
  - Enrollment Trends
  - Financial Feasibility
  - Immediate Costs
  - Future Costs
- Existing Campus
  - Present Orientation
  - Capacity for Change
  - Site Availability
- New Campus
  - Available Space
  - Student Interactions
  - Circulation Studies
- Previous Decisions
  - Discipline Function
  - Circulation
  - Support Functions
  - Intangible Factors
  - Flexibility
  - Expansion
  - Aesthetics
  - Personality
  - Facility Studies

Those design factors discussed previously are the tangible design factors -- which have a direct bearing upon the synthesis of the ultimate campus form. But these factors are not all-inclusive. There are also the intangible factors which have constant overtones in the planning process and especially effect the selection and emphasis of the tangible design factors. The following discussion focuses upon the intangible design factors.

## **FLEXIBILITY (OR CONVERTIBILITY)**

Education is a dynamic institution. The processes involved are constantly changing and improving. The demands for education are rapidly increasing and frequently even the most liberal projections are outdated prematurely. A technique of response to this unpredictable aspect of educational needs is summed up by the concept of flexibility -- the ability to accommodate change. The concept of flexibility encompasses many scales -- from the campus as a whole to particular facilities and individual spaces within those facilities.

Each decision in the planning process -- from administrative inputs to design factors -- must include the overtones of considerations for flexibility. These considerations cannot only be applied in theory, but must also be applied in the translation of theory into form and design. A flexible campus is one that can accommodate, for example, changes in curricula. The implications of such changes do not only involve the reassignment of space, but effect all design factors from utilities to circulation -- and effect all scales from the demands of the particular space to those of the entire campus. Another example, which is becoming increasingly more common to many

campuses is the need for smaller teaching spaces. The roots of this change can be associated to administrative changes in academic emphasis and new theories in teaching techniques. These changes become costly unless this concept of flexibility had been recognized and applied.

Campus planning must recognize and respond to the dynamics of technology, automation, teaching techniques, etc. Flexibility has become the key to the response – but it must be applied as more than a word or a theory. As such it is only a key without a door. The responsibility is in opening the door and ensuring that if the door is changed, the key will still work.

## **EXPANSION**

Expansion and flexibility are somewhat synonymous and there are correlations between the two concepts. However, a significant distinction does exist. Expansion encompasses the design capacity to accommodate GROWTH (in a preferably orderly fashion) as differentiated from flexibility which focuses on the capacity to accommodate CHANGE. This expansion factor must be incorporated into all facets of the campus plan to include consideration of foreseen as well as unforeseen growth. The ability to expand is obviously dependent upon the application of the concept of flexibility – as evidenced by a situation of unforeseen expansion which requires flexibility in order to compensate for this need.

Expansion, as flexibility, must be considered at all scales. The probability of future growth of the total campus must be planned for initially and not in a piecemeal fashion as the demands arise. Similarly, the relationship of buildings and the spaces defined must consider the effect of expansion. Frequently, expansion programs at this scale are foreseen and decisions such as horizontal or vertical expansion can be made initially without sacrifice to the functioning of the facilities or spaces.

Just as expansion must consider all scales, it must also include all relative factors. When an academic program is expanded or a new one added, then such factors as utility services and circulation must also be expanded. With reference to a utility such as water, this may simply involve the connection to a nearby line that was designed to carry increased capacities. Or it may involve the changing or relocation of the line in order to accommodate the increased need. Or it may even involve changes at the source of supply. With reference to the parking function of circulation, expanded facilities may require additional surface parking areas. Or the alternative of a multilevel parking structure might be considered. Whatever the case, the need for the consideration of the expansion factor, and its relation to the concept of flexibility is readily illustrated.

## **SOCIAL INTERACTIONS**

The most significant element of the educational process is the interaction of people. The concept of the classroom, or interaction of individual to group (teacher to student) has not experienced any significant changes since man's first schools. There have been changes in role, approach, technique, and comforts provided, but it is interesting to note that the basic concept has continued unaltered. The focal point of the educational process is still the classroom. However, the recognition of the concept of interaction and its relation to the educational process has been considerably expanded to include more than this one facility. The concept, in theory and theoretical application, recognizes the necessity of, and rewards from, interactions at all levels. For example, student(s) to student(s), faculty to student(s), student(s) to faculty, faculty to faculty, faculty to administration, student(s) to administration, and at even broader scales of university to community, university to society, etc.



The responsibility of campus planning is not to once again simply recognize this theory, but to use it - to translate it into physical forms that encourage interactions. These ideas cannot be dealt with in theory - theory only recognizes their existence - they must be applied in form - as form implies their use.

## **AESTHETICS**

Edward G. Glanz, in discussing aesthetics, inferred that man cannot afford to separate beauty and meaning from the actual business of life. He added that . . . "the objects of the artist" (designer) "are products of a culture and reflect man's understanding of his total existence." These observations are so broad and yet so appropriate as to the concept of aesthetics that there is very little left to add. Aesthetic considerations must play a significant role in the planning process. Design is not only an expression of function and usefulness, but also an expression of beauty. And beauty should not be considered independently or separately, but as an integral factor of the total process.

## **INSTITUTIONAL PERSONALITY**

Every campus has a "personality". This is portrayed through particular images and traditions that are associated with the specific institution. On the existing campus, this personality must be recognized and then responded to - either positively or negatively. A positive response would reinforce and augment a desirable personality. A negative response would be directed at modifying or changing an undesirable personality. On a new campus, one is afforded the opportunity of defining and then translating through design a meaningful personality. In either case, this represents an unavoidable responsibility in ultimately realizing the most appropriate and consistent total campus environment.



The design factors have been identified and examined. The responsibility, with reference to the planning process, is recognition and response. Each factor plays a significant role and requires considerable attention – both as an influence upon the other factors and the total process.

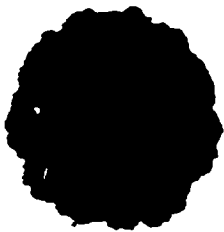

# LAND USE PLAN - SYNTHESIS

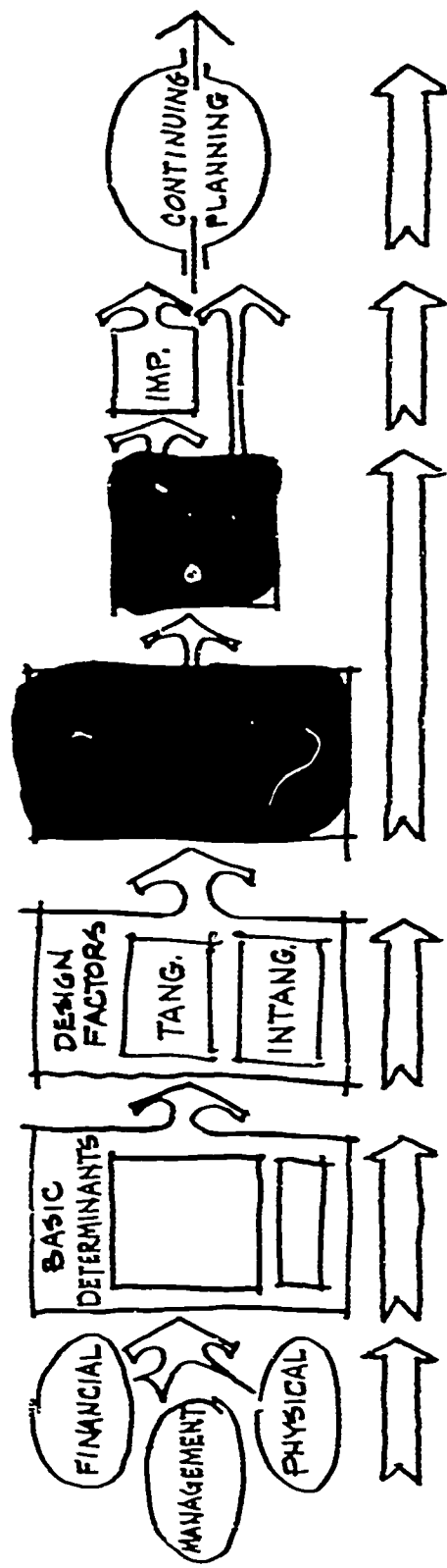

The various decisions associated with the prior phases lead to the formulation of a land use - or facilities - plan. The basic concepts (of form) of land use plans were defined and illustrated in the first section and the ultimate form established will reflect one or more of the approaches previously discussed. However, it is essential to recognize that the concepts - concentric, lineal, cluster, sector and random - are very broad generalizations established merely as a tool of reference. The implications involved in the formulation of a land use concept are too complex to imply that direct translation of those concepts should be applied. On the contrary, there are innumerable variations and combinations of each basic approach and it is within this spectrum of solutions that a land use plan will be conceived.

This attitude is mentioned and encouraged because of the inefficiencies that are so frequently illustrated as a result of a categorized response. Under such circumstances, the responses to the conditions and objectives are limited due to prematurely conceived approaches. The most applicable approach is to conscientiously avoid imposing superficial restraints and develop a process in which the conditions and objectives will define and determine the alternative approaches. Thus the goal of the planning process - to develop a solution that most appropriately reflects the desired conditions and objectives previously isolated - is reinforced throughout the decision-making process.

It must also be recognized that, given any set of particular conditions, they can be developed into numerous applicable solutions. These solutions must be fed back through the previous stages to evaluate their comparative consistency with the design factors and basic determinants. Again, the process reinforces the goal of developing the most appropriate solution. Often, however, the alternatives are frequently limited by fixed restraints, such as a given site. This condition further illustrates the necessity of identifying various solutions as some objectives may be

sacrificed or reduced in emphasis in realizing a solution that is consistent with the site (or some fixed restraint). Therefore, evaluation of the alternatives will appropriately weigh the modifications.

The campus land use plan is "a technique of adapting means to ends, a method of bridging the gap between fact-finding and policy-making". The plan as a means of control, is designed to promote the orderly development of the campus, minimize the problems and conflicts common to disorderly development and foster the most optimum efficiencies in use.

## LAND USE SCALES

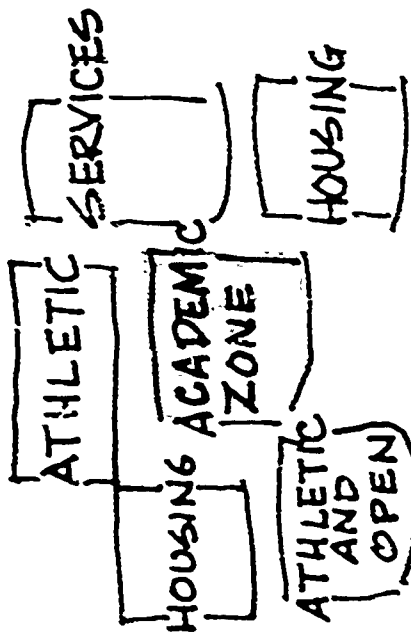

## GENERAL LAND USES

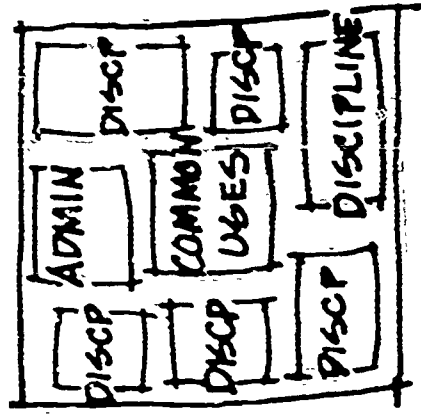

## COMPONENT LAND USES (ACADEMIC ZONE)

There are two major contexts (or scales) in which a land use plan must be considered. First, one must explore all the general uses that comprise the campus - such as academic zone, student housing, athletic, services, etc. - and resolve these general relationships. Secondly, the major land uses relative to each general use can then be resolved. For example, the area of greatest emphasis is the academic zone which must still be broken down to its component parts - administration, disciplines or functions, common uses, etc. It may also be argued that there is still another significant

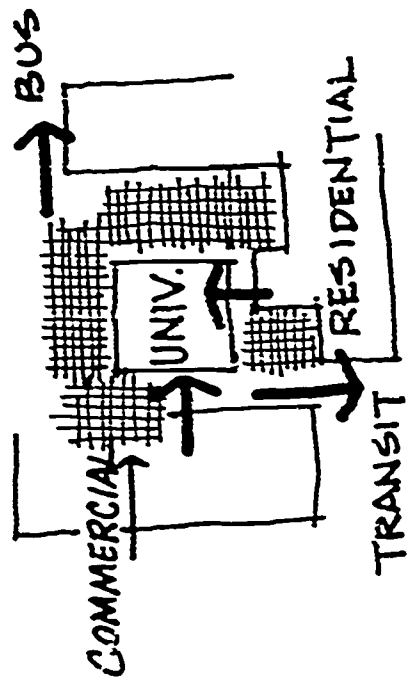

## UNIVERSITY- COMMUNITY LAND USES

scale or context of land use that has been overlooked. This would relate the campus (as a land use) to the major community and regional land uses. But over-emphasis presumes that this consideration is the principal determinant of site location and that site selection should precede consideration of the other contexts of land use. This approach is questionable - not as over-emphasis of the land use context, but over-emphasis at the wrong time. More will be said about this point in the following discussion.

The approach to land use classification is dependent upon the development status of the particular institution in question. The variables would include: an existing campus, a new campus (but with a selected site) and a new campus requiring the selection of the site. When the site is a fixed factor then the first context of land to be considered would be that of regional and community analysis and growth projections. Then attention would focus upon the total campus lands. In the case of the existing campus, the major use zones would either be extended or reidentified to accommodate for the projected growth (as illustrated below).

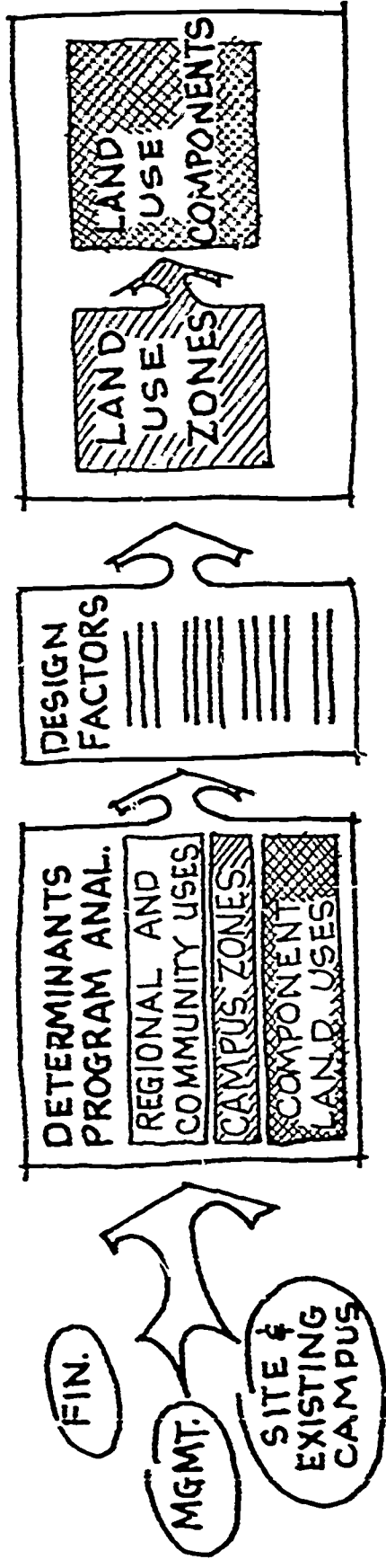

If the campus is to be constructed then site and locational analysis, coupled with program analysis and evaluation of the design factors would equally contribute to the determination of the zones. From there, each zone would be broken down into its essential components (as illustrated below).

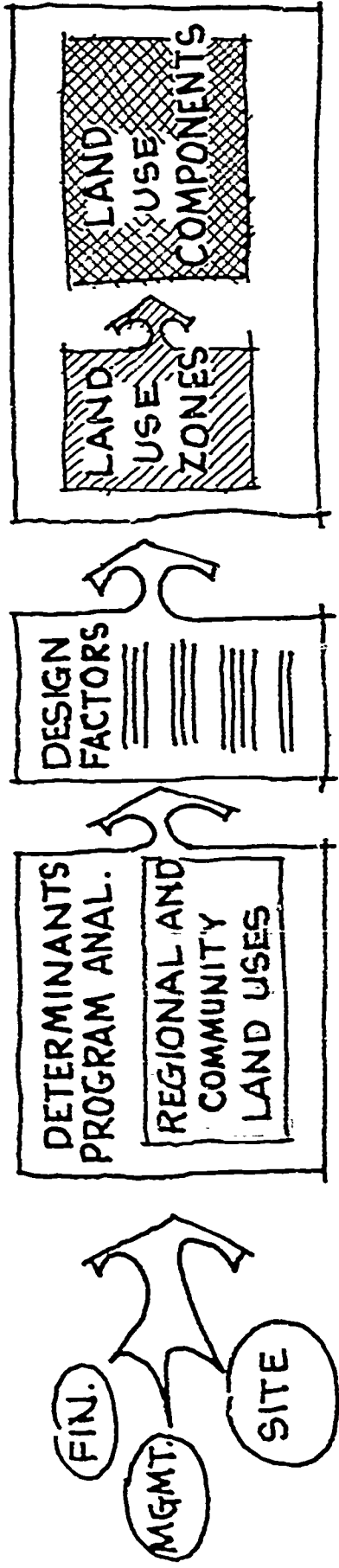

The approach to the totally new campus including site selection calls for some modification of the procedure. This is based upon the assumption that the principal objective of campus planning is to realize, in the most effective way, the goals of the institution. Therefore, contributing factors, such as the site, should be reacted to as variables and not fixed until such a time that it is illustrated that they are reinforcing the principle objectives. The first decisions would relate to establishing the principle campus zones - which would reflect analysis of the determinants and evaluation of the design factors. Then the components of each zone would be established. The alternative solutions would then be fed back through the decision-making criteria and evaluated in relation to the alternate sites to determine the most appropriate solution. Regional and community analysis would, at this time, contribute to the selection of the alternative site and plan (as illustrated at top of following page).



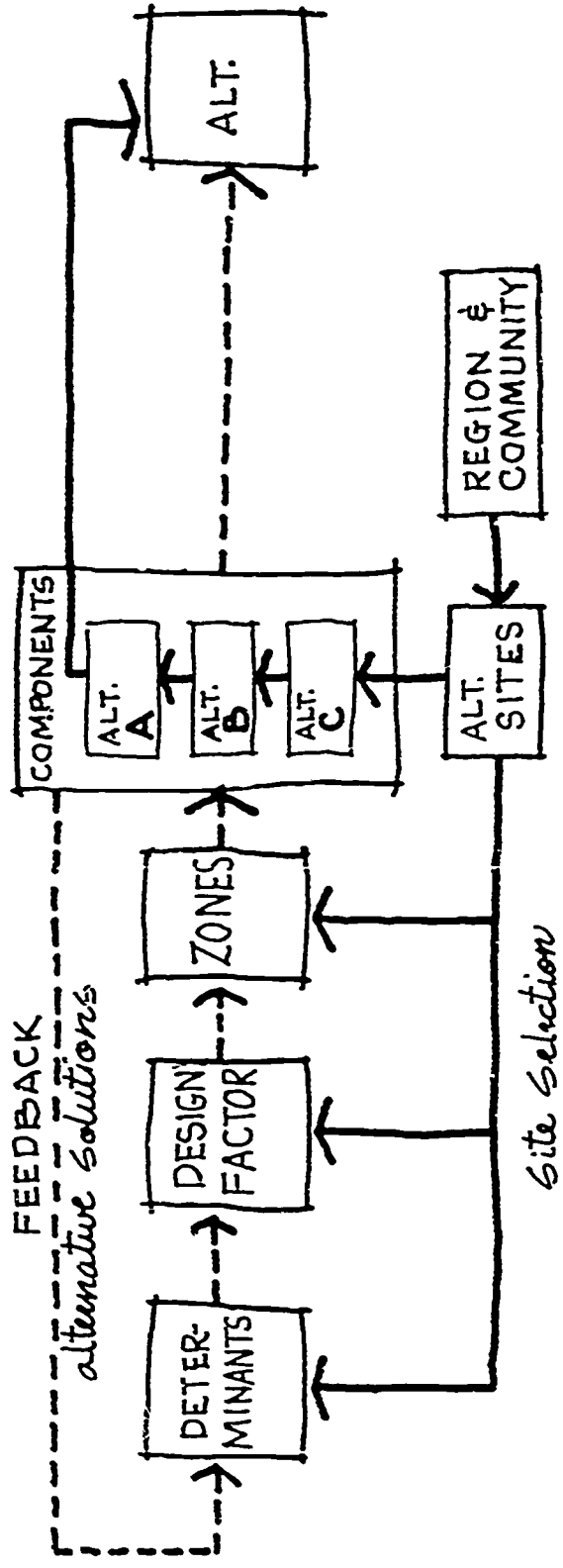

Still, however, when the appropriate alternate is selected in either case presented, it should not be regarded as the final solution. It was presumably preferred on the basis of being the most appropriate alternative and may require modifications based upon significant parts of other alternatives that were sacrificed. The land use plan must now be finalized by feeding it back through the alternatives, design factors and determinants to ensure that it will most appropriately reflect the principle objectives (as illustrated below).

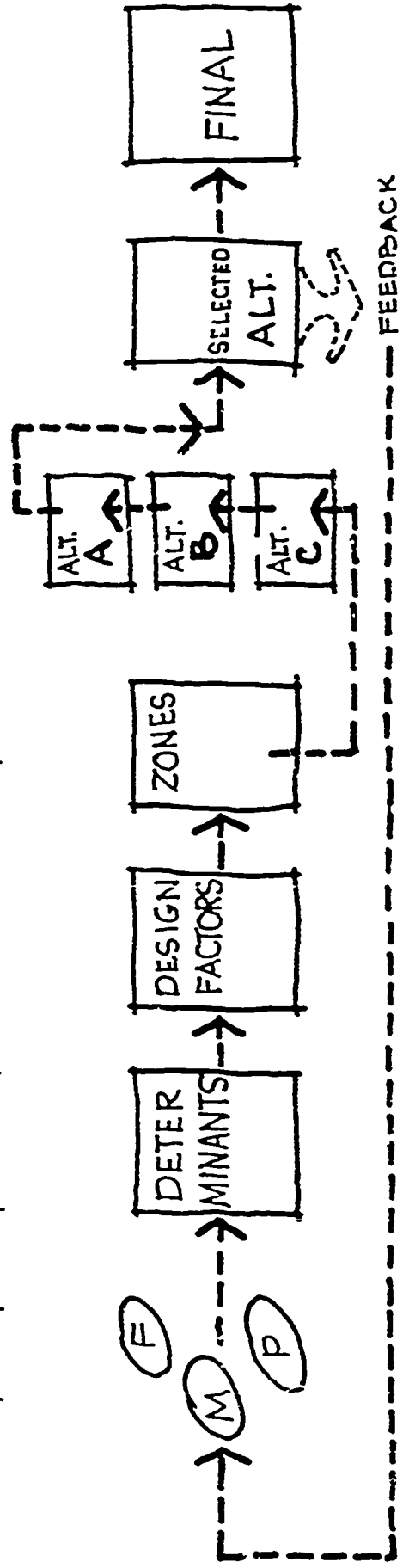

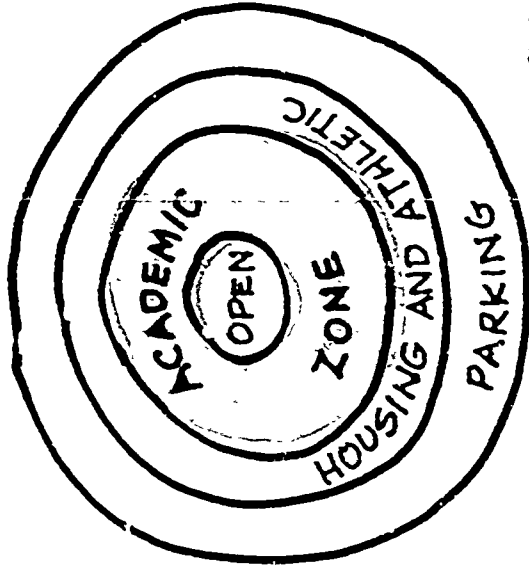

**A • MAJOR UNIVERSITY LAND USE ZONES**

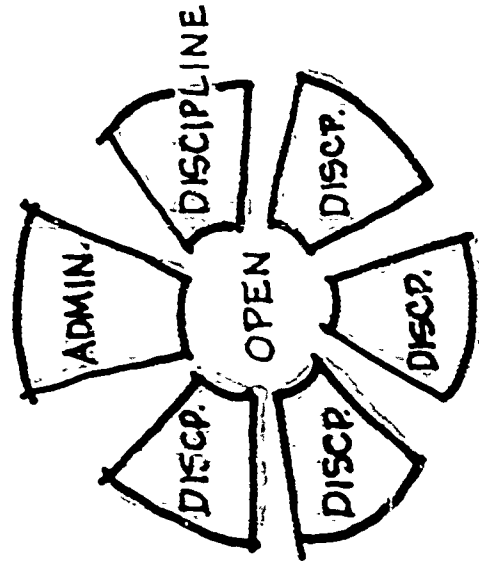

**B • COMPONENT LAND USES OF ACADEMIC ZONE**

These two major schools of thought relative to land use plans - (1) avoiding a categorized response and encouraging consideration from a spectrum of choices, and (2) awareness of the contexts of land use scales - can now be combined to further illustrate the validity of this approach to comprehensive land use planning. The University of California campus at Irvine affords a particularly good example. The zoning of major campus land uses is readily identifiable and would most appropriately relate to the general land use category of concentric - as illustrated in A. But this concentric response was not rigidly adhered to in developing the component parts of each major use. The diagram on the left (B) illustrates the academic zone and it is obvious that this relates to a discipline oriented sector approach (and even to a degree the cluster concept). Therefore, the approaches differed, as did the responses, in relation to each context. In this case a discipline oriented academic program, in conjunction with the other design factors and determinants, was most appropriately resolved within the area of a sector approach in contrast to the concentric approach which guided the first decisions. Obviously if one approach would have guided the entire process then the solution would not have been an appropriate translation of the problem.

The land use plan is the most effective device in the planners vocabulary. It is a timely and necessary transition between design criterion and implementation. It synthesizes previous efforts and provides the basis of direction for those to come. It is the essential ingredient in the transition of an idea into form.

# DETAIL DESIGN AND IMPLEMENTATION

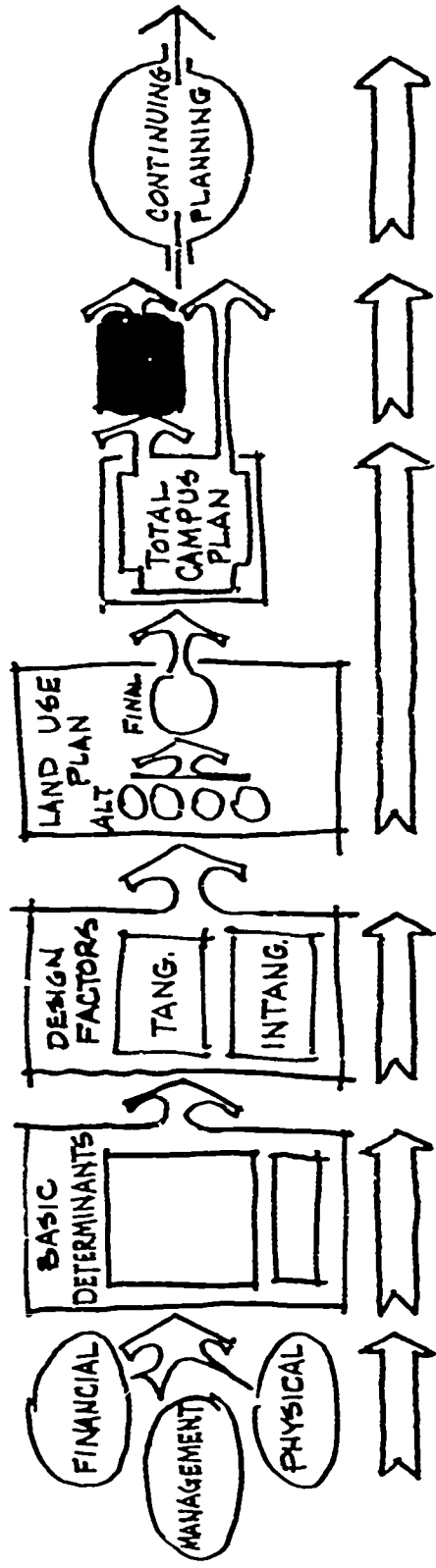

This volume is principally devoted to those procedures discussed in the previous material involved in developing a land use plan. However, a land use plan is not an entity in itself -- an attractive multi-colored two-dimensional drawing on a wall. More appropriately, it is a three-dimensional frame of reference for the next, and more specific stage of design. It is within this stage when the actual campus forms are realized. And if those forms are to be meaningful to the total campus structure, they should be conceived not as independent units but as segments of a meaningful whole.

Considerable attention must be focused upon the complexity of detail design and implementation. Each structure or space must be designed to house particular functions and still, at the same time, the designer must recognize that it is the totality of these functions that defines the educational institution. The attention that the phase of detail design and implementation requires is the subject of a further series of studies supported by the Coordinating Board • Texas College and University System. The first volume of this series, entitled **COLLEGE AND UNIVERSITY PHYSICAL PLANT IMPLEMENTATION - PROCEDURAL GUIDELINES FOR BUILDING DESIGN AND CONSTRUCTION** has been prepared by Caudill, Rowlett, and Scott, Houston, Texas, and is available for distribution.



# CONTINUOUS PLANNING

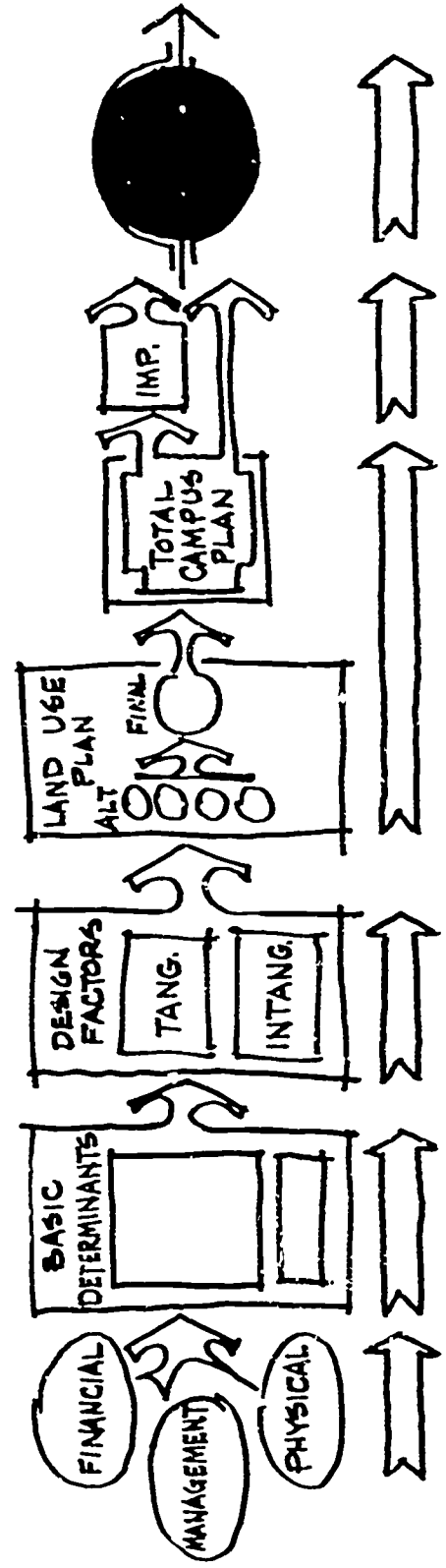



The continuous planning process, as discussed in Volume One, must be initially directed at a review and projection of the activities of each organizational unit as well as an examination of the institutional objectives. The satisfactory accomplishment of these tasks establishes the necessary directives for effective review and update procedures relative to Physical Plant Planning.

The planning process is by no means a static process. Similarly, a plan, once developed, should not be construed as completed. More than a product, planning is a process - a process that encompasses the fourth dimension of time. Therefore, a "plan", however valid at a particular time, cannot retain its validity over time. Change has become a fact of life and the institution of education is no exception. The concept of "The Plan" must be broadened into a concept of a "continuing process" which produces plans only to identify particular periods in the process.



# TRAFFIC PLANNING

SECTION  
**1**

LAND USE PLANNING



# CONTENTS

## TRAFFIC PLANNING

I.	INTRODUCTION	
II.	ACCESS	
	A. Street Network Inventory	10
	B. Public Transit	13
	C. Demand or Movement Characteristics	14
	D. Summary	24
III.	INTERNAL CIRCULATION	
	A. Facilities Inventory	29
	B. Movement Characteristics	30
	C. Summary	36
IV.	PARKING	
	A. Inventory	41
	B. Demand	45
	C. Facility Types	49
	D. Summary	56
V.	SPECIAL EVENT TRAFFIC	
	A. Attendance	61
	B. Routing	62
	C. Control Coordination	63
VI.	TRAFFIC PLAN	
	A. Requirements	69
	B. Facilities	69
	C. Traffic Control	71
	D. Summary	73

### LIST OF ILLUSTRATIONS

FIGURE		
1	Traffic Planning Process	5
2	Access Development Plan	25
3	Internal Circulation Development Plan	37
4	Parking Development Plan	57

# INTRODUCTION

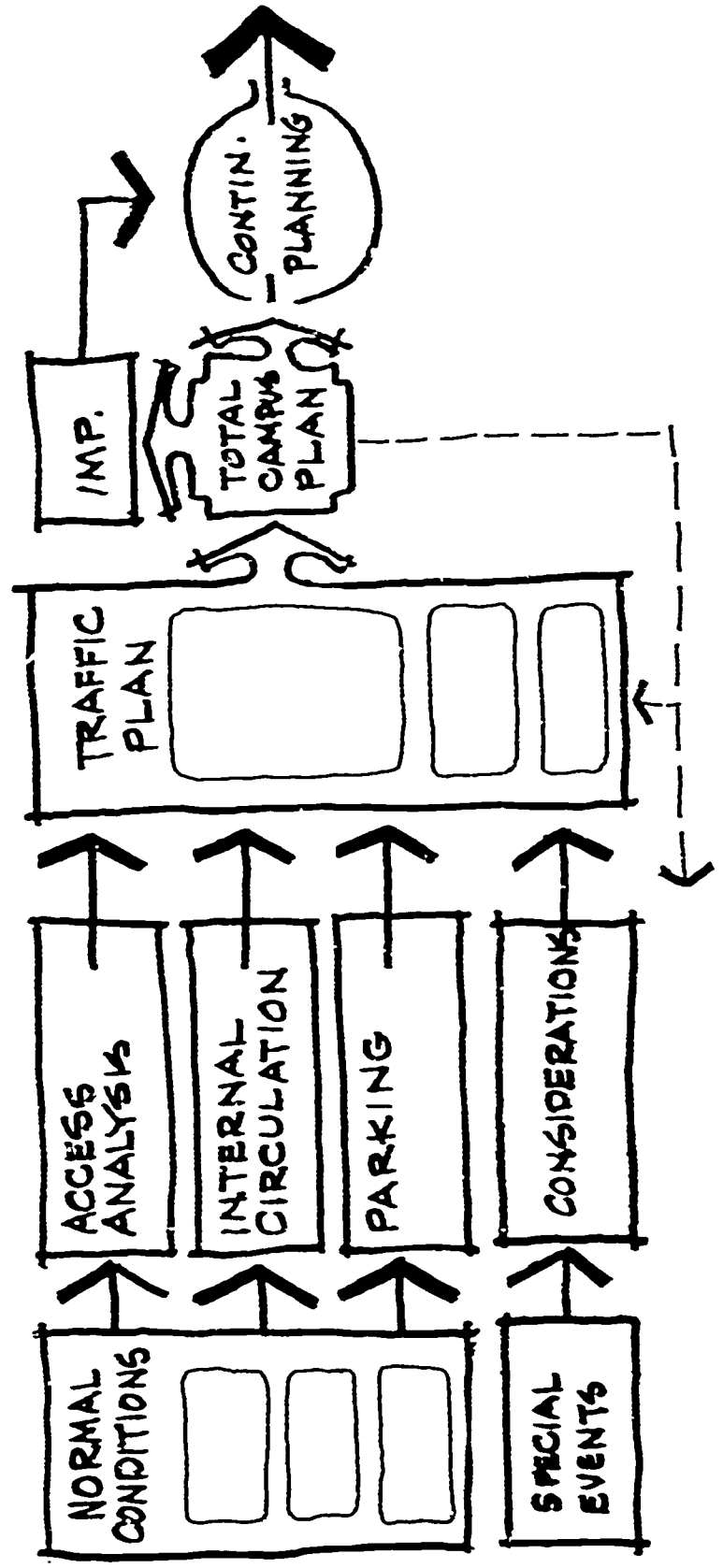

Providing for the safe and efficient movement of people and goods is a major university problem for which adequate planning is vital. Many universities that were founded before the invention of the automobile must now provide for the daily access, storage, and egress of thousands of vehicles.

Many institutions may have long-standing attitudes regarding the role of the automobile in the institutional environment and may often wish to delegate the associated problems to the surrounding community or other governmental agencies. It must be recognized, however, that the automobile is the primary means of personalized transportation and that it is necessary to either plan facilities to accommodate the automobile or to develop plans to restrict its use. Other forms of transportation (pedestrian, transit, etc.) which will provide for the movement of people and goods to and from the institution must be planned and developed if the automobile is restricted.

The university campus is a major traffic generator similar to a central business district (CBD), industrial center, or major airport. The university may be the only traffic generator in a small community while, in a large urban area, it is only one of many. The two major categories of university traffic problems are:

- (1) Normal (daily) Traffic
- (2) Special Event Traffic

The normal (daily) traffic problem is composed of the following basic elements:

- (1) Access to and from the campus
- (2) Internal circulation (within the campus)
- (3) Vehicular storage

The special event problem is one of providing access, parking, and quick, efficient egress for large numbers of persons and vehicles attracted and dispersed over a short period of time by events such as football games and graduation exercises.

The following sections of this volume discuss techniques that can be utilized to obtain required data and to make necessary analyses in order to develop a traffic plan. The elements of access, internal circulation, and parking are discussed relative to the daily traffic problem and a section on special events is presented to suggest procedures relative to this problem. Finally, a section on developing a traffic plan summarizes the total process and indicates the desired results of a traffic planning study.

Figure 1 illustrates the major components and logical flow of the traffic planning process that will be discussed in the following material.



FIGURE 1. TRAFFIC PLANNING PROCESS

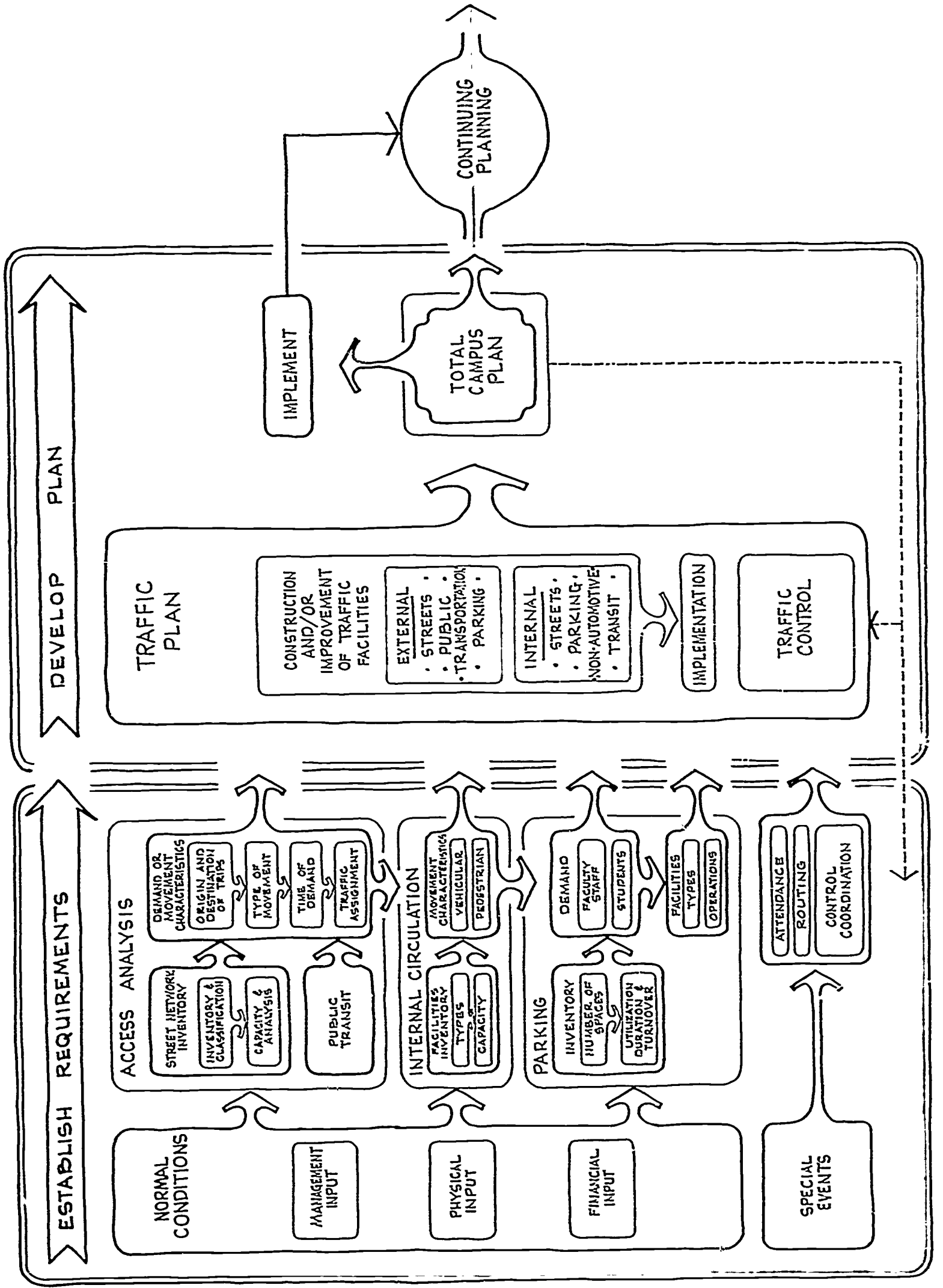

# ACCESS

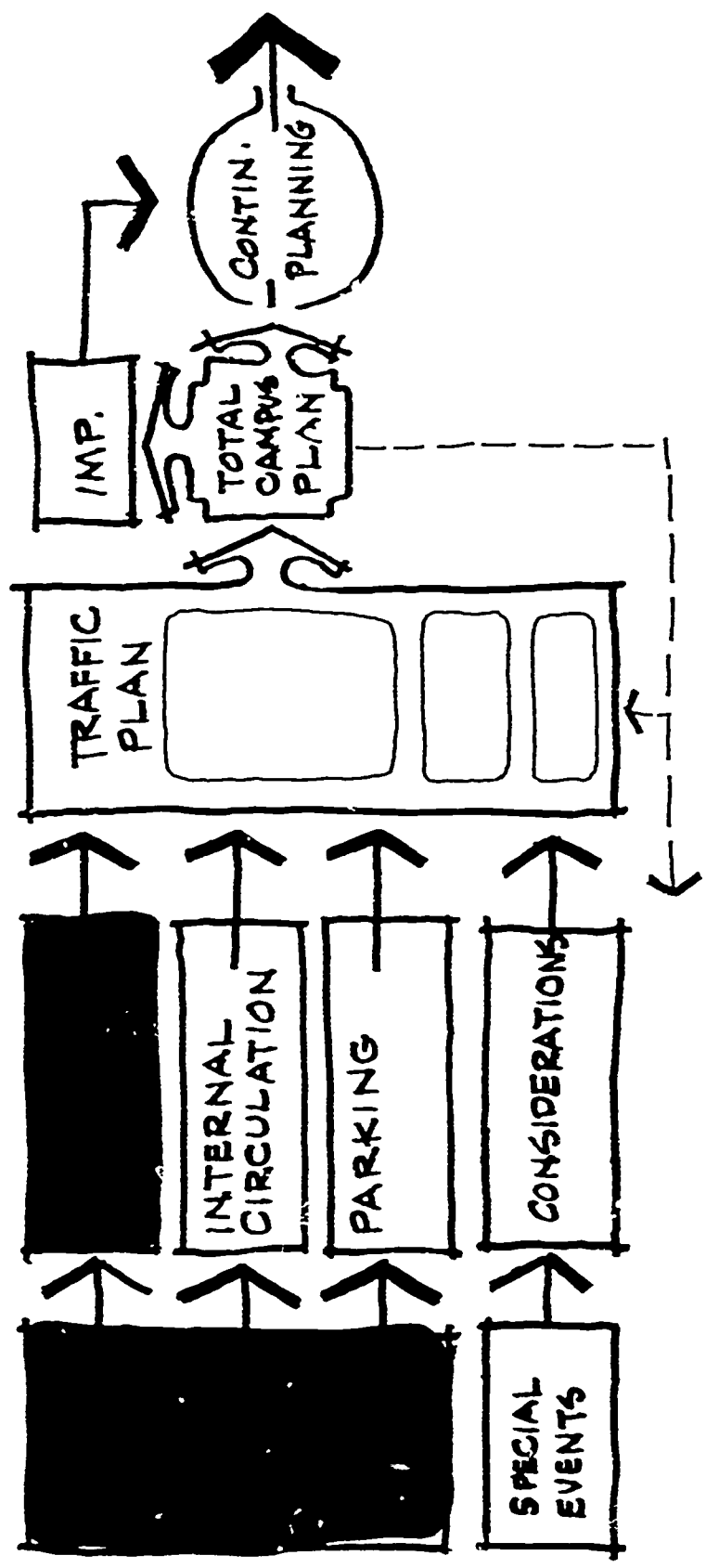

Access, the ability to approach, enter, and leave the campus of an institution, is a major component to be considered in a traffic study. The basic concern in the access study is to provide for the movement of people and goods to and from the surrounding community and points external to the community. The sketch below illustrates traffic interactions between a university campus and a community.

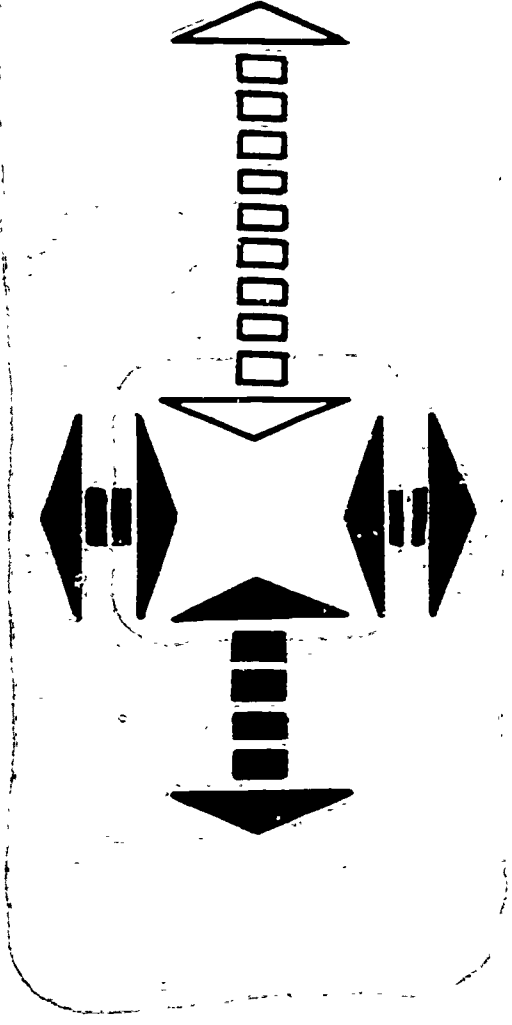

An access study should provide answers to the following questions:

- (1) What transportation facilities exist for moving people and goods to and from the campus?
- (2) What is the capability of these transportation facilities to provide for movement?
- (3) What is the present and future demand for movement?
- (4) What are the deficiencies (present and future) in these transportation facilities?

In order to answer these questions, the following studies are necessary:

- (1) Street network inventory
- (2) Public transit inventory
- (3) Movement demand inventory

# STREET NETWORK INVENTORY

A street network inventory will furnish information on the street facilities that exist for moving vehicular traffic to and from the campus. Although the university may not have any direct control over the construction and maintenance of street facilities external to the campus, any deficiencies in these facilities should be defined so that factual requests for action on the part of local and state agencies can be presented. The university may also be able to pursue direct action to improve the streets adjacent to the campus where traffic converges and major congestion is most likely to occur.

The street network inventory consists of an inventory, classification and a capacity study of the streets. These steps are discussed below.

## INVENTORY AND CLASSIFICATION

The first step in the analysis of the street network is an inventory of the condition of pertinent existing facilities to obtain the following data:

- (1) Street width
- (2) Surface type and condition
- (3) Location, type, and number of parking spaces
- (4) Location, type, and condition of all traffic control devices

A functional classification of pertinent campus and perimeter streets is desirable in order to determine what standard of operating service is applicable. Streets should be classified with regard to the functions they serve, as defined below.

Freeway - This class of facility is devoted entirely to traffic movement, and does not provide direct land service. This classification is characterized by complete control of access, with no at-grade intersections. Freeways provide for large volumes of traffic at relatively high speed and are primarily intended to serve the longer trips from one part of the urban area to another, and provide the major connections to other portions of the state and nation.

Arterial - The primary function of an arterial is to move traffic. Arterials bring traffic to and from the freeway and provide for major movements of traffic within or through a metropolitan area not served by freeways. Arterials interconnect the principal traffic generators within the city and serve to connect satellite cities within the central city. Arterials handle trips between the more important areas of the city and form an integrated system; typical trip lengths exceed one mile, and truck, bus, state and federal routes are located on arterials. This concentration of major traffic requires the provision of such traffic aids as progressive signalization and the restriction of parking and loading, which may be required in order to improve capacity and traffic flow.

Collector - The collector accommodates the internal movement within a portion of a city and provides access to the arterial system. Collectors do not handle long, through trips and need not be continuous for any great length. In a gridiron street pattern, however, a street several miles long may serve as a collector rather than an arterial if its predominant use is to reach the next junction with an arterial. Collectors are rarely designated as state or federal numbered routes; however, they may connect less important rural roads with the urban arterial system. Collectors may be used for bus or truck movements that give direct service to a particular area, but are rarely used for through routes. The collector street supplies access to abutting property, while at the same time serving local traffic movement.

Local - The function of local streets is to provide access to adjacent land. Local residential streets, in most cases, carry daily volumes of 1,500 vehicles or less. Most trips begin on local streets, which in turn provide access to either collector or arterial streets.

The classification of each street within the network into one of the above categories should be accomplished in cooperation with the local community and state highway department. The sketch below illustrates a campus in relation to the adjacent street system. Ideally, a campus is directly serviced by local streets and has access to a freeway or major arterial via collectors and other arterials, but the campus should not be fragmented by these collectors, arterials, and freeways.

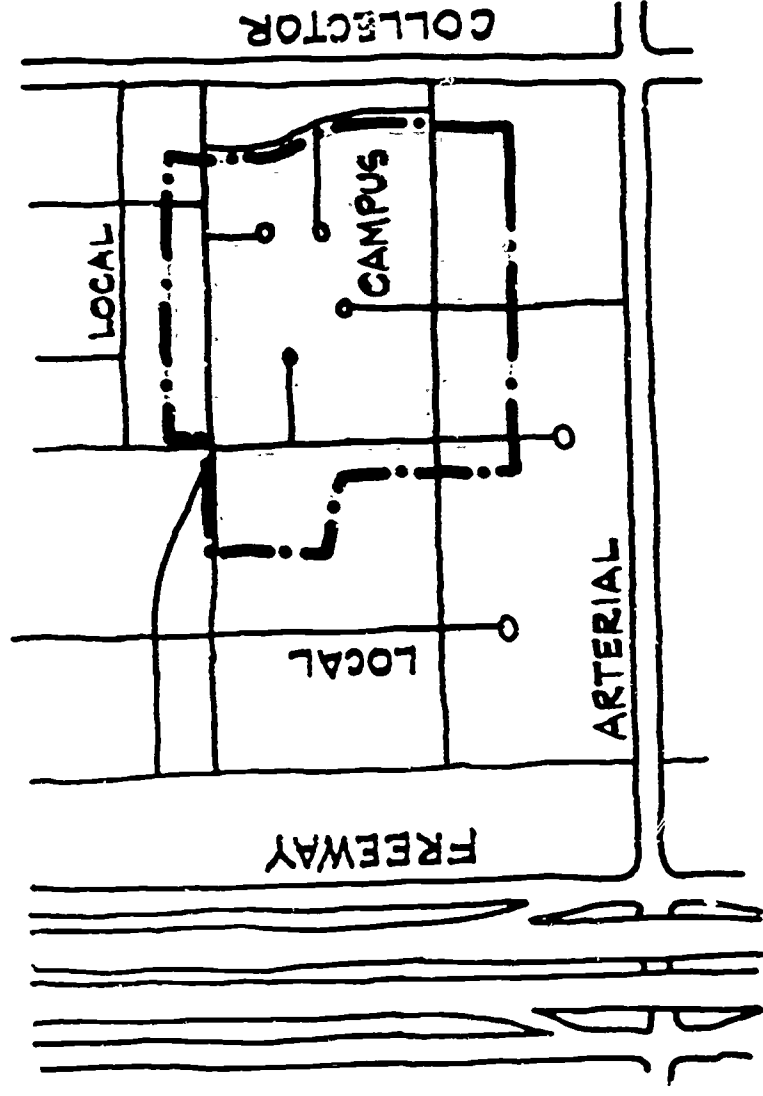



## CAPACITY ANALYSIS

The second part of a street network inventory is an analysis of the capacity of various sections of the street network, particularly those near the campus. The techniques used to calculate street capacities are discussed in detail in the Highway Capacity Manual<sup>1</sup> and "A Study of Peaking Characteristics of Signalized Urban Intersections as Related to Capacity and Design."<sup>2</sup> Use of these references is recommended to provide the necessary direction for the capacity analysis.

It is also desirable to evaluate the operation of the street network in the vicinity of the campus. Ground counts of existing demand should be made for selected street sections, and volumes and the efficiency of operation should be noted. If volumes are approaching capacity, the present critical deficiencies in the street system can be detected.

## **PUBLIC TRANSIT**

A detailed study of existing public transit should be conducted. This would include an inventory of equipment operated, present routing plans, and routing times, i.e., when and where public transit makes scheduled stops. Naturally, this study is made with the idea of benefitting the university by improving its accessibility. Discussions should take place between the transit authorities and university personnel concerning the university's potential as a source of ridership.

---

<sup>1</sup>Highway Research Board, *Highway Capacity Manual*, Special Report 87, 1965.

<sup>2</sup>D.R. Drew and C. Pinnell, "A Study of Peaking Characteristics of Signalized Urban Intersections as Related to Capacity and Design", *Highway Research Board Bulletin* 352, 1962, pp.1-54.

Estimates of existing transit usage by university-associated persons (students, faculty, staff) should be made. This could be done by interviewing (personal or postcard) persons associated with the university who do not live on-campus.<sup>3</sup> Changes in transit routes and/or routing times could be made if transit authorities were reasonably sure that such changes would pay off in increased transit revenue. Buses might even be routed through the campus during certain parts of the day. By increasing the convenience of riding transit to the campus, and thus encouraging persons to leave their automobiles at home, automobile congestion on the campus could possibly be reduced by a significant amount. Certainly public transit has a potential as a source of movement to and from a university campus, and the traffic planner can ill afford to overlook its possibilities.

## DEMAND OR MOVEMENT CHARACTERISTICS

In order to plan properly for ingress to and egress from the campus, it is necessary to study the travel patterns of persons moving to and from the campus. An inventory of travel patterns will provide information on trip patterns, the type and location of areas to which trips are made, and the mode of travel used to make the trip. This study will identify the origins and destinations of trips moving to and from the campus and provide characteristics relative to this movement. The origin and destination data can then be used to assign traffic to the street network or transit facilities in order to study the deficiencies that may exist at present or in the future.

---

<sup>3</sup>National Committee on Urban Transportation, *Manual 2A, Origin-Destination and Land Use*, Public Administration Service, Chicago, Illinois, 1958.

## ORIGIN AND DESTINATION OF TRIPS

In order to study travel patterns, it is necessary to obtain information on the origin and destination of all trips having one end on the campus. This information can be obtained from one of two sources:

- (1) Interview survey
- (2) University records on faculty and students

The interview survey method consists of interviewing (personal or postcard) a controlled sample of the population involved and obtaining complete information on all pertinent trips made during a sample day.<sup>4</sup> The records method utilizes available data - taken from university records - relative to faculty, staff, and students, so that travel patterns can be predicted. This latter method is recommended because it can be done in less time and with fewer personnel. A map of the area should be utilized. The basic techniques involved will be discussed in the following material.

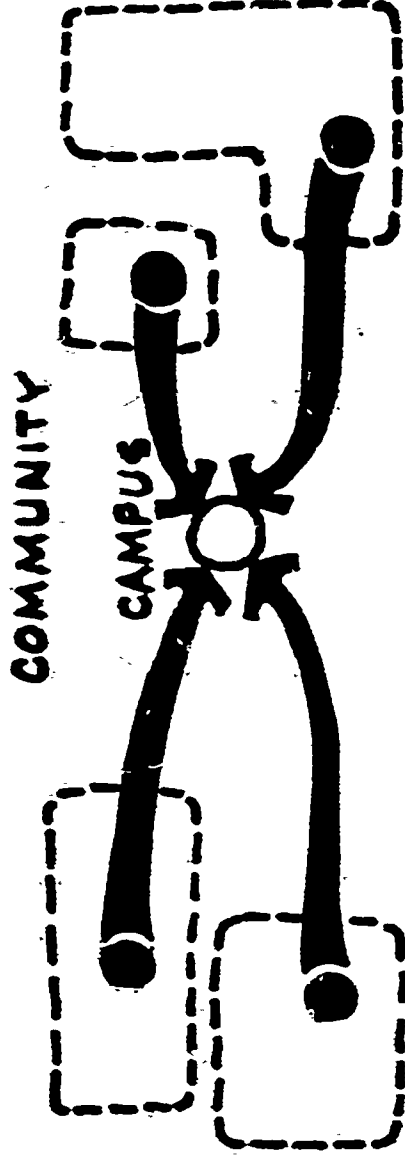

---

<sup>4</sup> *Ibid.*

Definition - Only trips made from a person's home (origin) to the campus destination will be considered because other trips are generally either not predictable or irrelevant to the study. These trips are generally made (except for pedestrian trips) by using the street network system described under Street Network Inventory. In summarizing trip information, it is necessary to divide the area into "zones" for traffic purposes. The procedure for doing this is outlined in the section on Traffic Assignment.

Faculty-Staff Trips - Home and office locations for each member of the faculty and staff must be identified. The office location is accepted as the "destination" because it is assumed that the faculty-staff member will park very near his office. If this is not the case, parking location may have to be used. Residence-campus location information may be available from the personnel and office space records. In most cases, however, this information will not be available in a form which is convenient for computer processing; consequently, it must be summarized manually. Care should be taken so that double-counting (counting a part-time student as both student and faculty) is avoided.

If a continuing planning study is to be instigated, it is readily apparent that there is a need for a record system which can furnish planning data of this type. It is recommended that the existing record system be updated so that such pertinent information can be computer oriented.

Student Trips - The demand made on the network by students is somewhat different from that made by faculty-staff due to their place of residence. Students living on-campus must be considered if they drive their automobiles from their dormitories to their classes; only if they walk or ride bicycles can they be disregarded. In most cases, regulations either have been or should be made to prohibit on-campus students driving to class. All off-campus students who drive automobiles to the campus (generally those having parking permits) must also be

considered. The information needed for each student considered consists of home (or dormitory) location and a destination as identified by his first class location.

Visitor Trips - The demand made on the network by visitors is often scattered and difficult to predict. However, prediction is possible in some cases and may become important as far as the campus network is concerned. Attendance figures for short courses and seminars held on-campus for non-university persons are generally available and should be taken into account, especially concerning the campus network.

### TYPE OF MOVEMENT

People and goods travel to a university campus by various modes. The major modes are discussed in the following material.

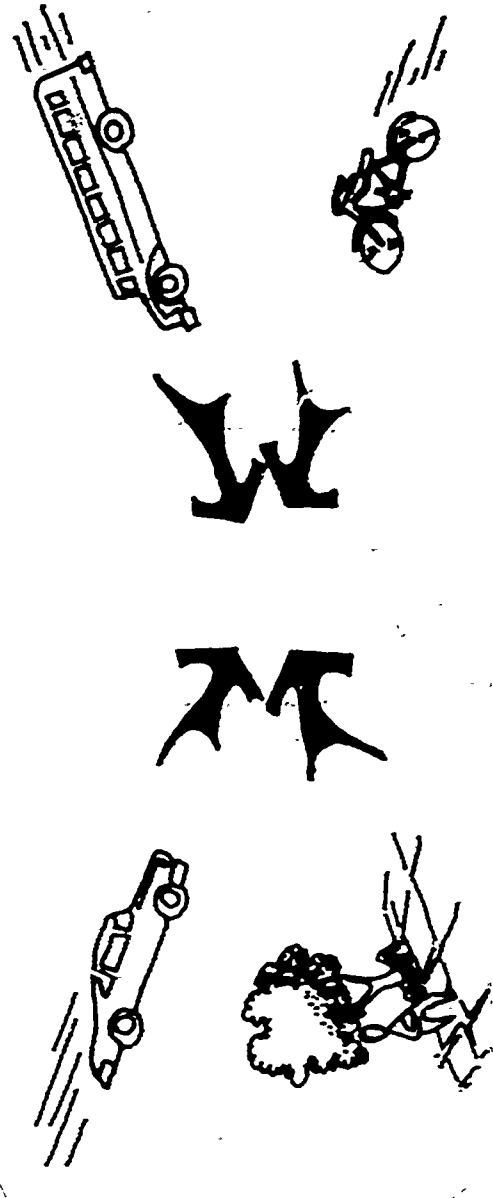

Automobile - One of the major modes of movement to the campus is the automobile. Students and faculty generally rely more heavily on the automobile than public transit because the demand from any particular area of the city may not be heavy enough to sustain transit, and the variety in class schedules causes trips to be spread throughout the day.



Campus housing has a definite bearing on the amount of automobile movement generated by the campus. There will be little student automobile traffic on the street network system if most students are housed on-campus because it is expected that campus residents will walk to class. However, when large numbers of students live off-campus, movement to the campus via the street network system will increase, and this portion of the total movement to the campus can become so large as to cause severe congestion problems on the campus as well as immediately adjacent to it. On a campus where sufficient housing is provided, problems associated with access, internal circulation, and parking will generally be less critical because a larger proportion of student movement will be generated within the campus.

Transit - Transit systems exist to make it possible for concentrations of people to move together more rapidly than would otherwise be possible. These people must be collected and deposited at a minimum number of points. Students moving to campuses in large urban areas may be able to utilize the city's transit system. A study should be made to determine both the present and the potential student, faculty, and staff transit usage. This should also include a study of the times of peak demand made on transit by students, faculty members, and staff personnel. A transit study may result in some schedule and/or route changes provided that university-based ridership represents a significant portion of overall transit patronage.

Pedestrian - Most pedestrian trips made to the campus will be by students living near, or adjacent to, the campus. Faculty and staff members generally live in residential areas located further from the campus than students and, therefore, drive or ride transit to the campus. Conflict is created between these pedestrian trips and vehicular trips, and the amount of conflict increases as the number of vehicular and/or pedestrian trips increases.



Other - Other modes of travel to the campus are motorcycle (or motor scooter) and bicycle. In some cases, the volume of trips using these modes may warrant special considerations pertaining to parking and internal circulation. However, most universities can absorb these modes of travel without using means other than providing limited numbers of special parking spaces.

### TIME OF DEMAND

The demand made on the street network system by students, faculty, and staff is not a steady, uniform demand throughout the day. Instead, it tends to pulsate, having definite peak and off-peak periods. These pulses affect the entire street network, and are the most pronounced at points near the campus perimeter.

Peak - The peak time of demand created by students, faculty, and staff generally occurs just prior to the first class because large numbers of campus users have early morning business on the campus. Other peak periods occur if class hours and faculty-staff work hours coincide. For instance, if classes begin at 8:00 a.m., these peaks would be at 8:00 a.m., 12:00 noon, 1:00 p.m., and 5:00 p.m. For this reason there are benefits to be gained by starting classes thirty minutes ahead of campus work schedules, i.e., starting classes at 7:30 a.m., if normal work hours are 8:00 a.m. to 5:00 p.m. In general, the late afternoon peak created by persons going home is lighter than the early morning peak because many campus users, especially off-campus based students, leave the campus intermittently throughout the day. Therefore, it is apparent that if most students live off-campus and drive to school, the morning peak will be much higher than the afternoon peak. If most students live on-campus, the peak morning and evening demands will be more nearly equal.

Off-Peak - Demands made on the street network system by campus users during the off-peak periods present no particular problem.

Another important consideration is the relation between the peak time of demand created by campus users and that created by normal, everyday work trips by the city's populace. Congestion on the city street network system results from the high demands made on the system due to the peak

flows of traffic. If the peak time of demand for campus users coincides with the peak created by business, an additional amount of congestion is created. This could be alleviated if campus class hours and campus work (office) hours were shifted, with relation to local work hours, by some amount of time. If community work hours begin at 8:00 a.m., campus class and work hours could begin at 7:30 a.m. instead of 8:00 a.m. By doing this, congestion could be noticeably relieved, provided that the campus is a major traffic generator within the community. A study of traffic volumes will provide the data necessary to recognize and respond to circulation conflicts.

### TRAFFIC ASSIGNMENT

Once the origin and destination of each trip has been determined, the last step in the data reduction stage is to determine which routes will be taken. The usual procedure is to assume that a driver will follow the minimum time path from his origin (home) to his destination (point on campus). The basic item for use in summarizing this data is a zone map, as illustrated below.

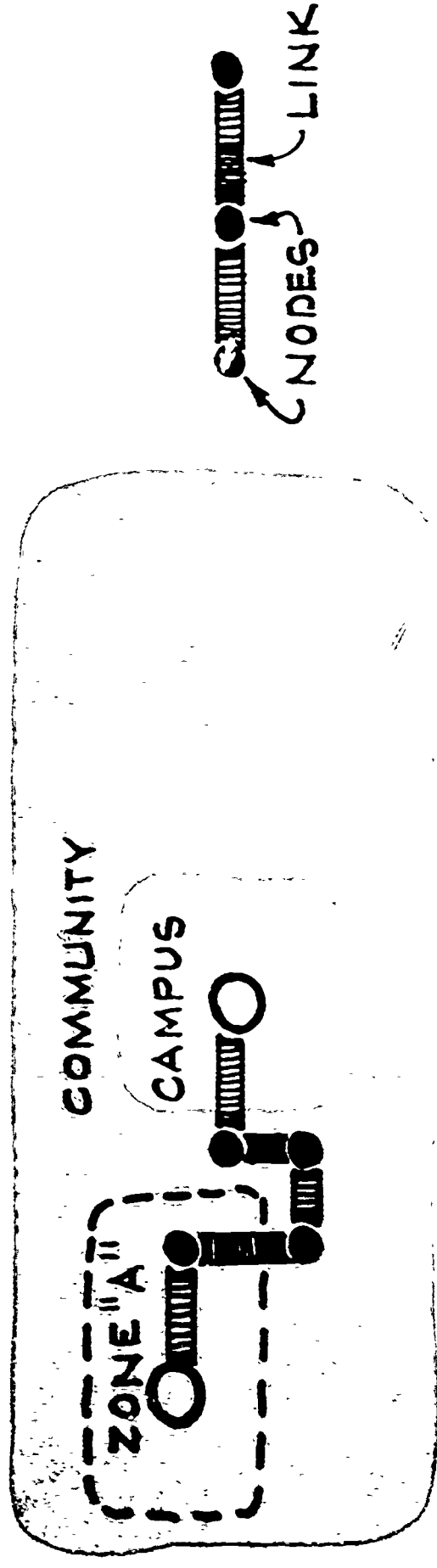

Before establishing zones, it is necessary to decide what level of detail is required for traffic assignment. The traffic assignment network for a college campus should include all major traffic arteries through the campus, all arterial streets leading to the campus, most collector streets and some local streets. It may be that one street on the assignment network will represent more than one on the ground and this should be considered in interpreting an assignment. The level of detail should be greatest in the vicinity of, and within, the campus. The importance of the network is to recognize at what points and in what numbers the students, faculty and staff enter the campus, and where they go once they enter.

Since it is desired to code the location for a person's home address as well as his campus destination, it is necessary to zone areas outside the campus. External zones can be rather generalized since it is only necessary to make a reasonable estimate of the route followed by all trips originating in a given zone.

The zone map is used to show only student, faculty and staff trips made to the campus; therefore zones will be defined for residential and campus areas only.

#### Current Traffic Assignment

Faculty--Staff Trips - Once the information on the origin and destination of trips has been summarized for each member of the faculty and staff, it is necessary to assign these trips to the street network. Logical routes taken by faculty--staff members in arriving at their offices must be examined. The usual assignment procedure is to select the minimum time path from each home to the associated office. It should be taken into account that two neighbors may enter the campus at different points if their offices are located in different buildings on campus. This illustrates that the route taken is a function of both home and office location, and therefore, each trip must be considered independently.

After trips have been assigned to the network, information on the number of trips anticipated at any one time can be calculated. The maximum case would occur if all faculty-staff members needed to get to the campus within the same hour; however, this is unlikely. An estimate that is representative of the actual case must be made so that the volumes assigned to each campus entry point can be appropriately adjusted to show the maximum expected condition. This estimate can be made by counting all staff members whose normal work hours begin prior to, or coincide with, the beginning of classes, adding one faculty member for each first period class, and adding an appropriate percentage that would account for other faculty members arriving on the campus prior to first period classes.

Student Trips - Only students who have registered their automobiles on the campus and are allowed to drive to class will be assigned to the street network. In addition, only students having a first period class, plus an appropriate percentage of other students (percentage based on estimates of the number of students arriving prior to first period classes who do not have a first period class), will be considered. These students, having a trip origin, associated with some type of housing, and a campus destination, are assigned to the network in much the same manner as faculty-staff trips. However, the destination of student trips made to the campus presents a more difficult problem than faculty-staff trips. Because students must often park in an area which is not adjacent, or even close, to their campus destination, the assignment procedure for students is reversed in that the assignment starts with the student's destination and works backward to his origin (housing). Therefore, students are assigned (on paper only) a parking space in the area closest to their first classroom

destination. (This includes both students having a first period class and the extra percentage described above. It is felt that this "extra percentage of students", who do not have a first period class but arrive prior to their first class, will park near their first class even though their immediate destination may be the Student Center). The car ownership ratios (defined and discussed in section on Parking Demand) and the defined capacity of the area must both be taken into account. When the nearest area (or areas) is filled, the assignment procedure must move to another area.

After the campus assignment has been made, students are then assigned the most logical routes leading to the zone in which their housing is located. In a large city where transit usage is significant, campus-bound automobile traffic will be comparatively lower and a special survey of transit usage, especially transit stops within or close to the campus, may be needed.

The faculty-staff and student trip assignment procedure described above can be checked and validated to a certain extent by utilizing a peripheral cordon count survey. This survey will give a measure of the number of vehicles on the campus, but will yield no information as to their origins or destinations. In employing this method, an imaginary cordon line is drawn around the campus perimeter (study area). The traffic volume crossing this line at every point is recorded for the duration of the study period. The volumes entering and leaving can be accumulated and, from this, the number of vehicles remaining within the cordon line can be determined.



## Future Traffic Assignment

The traffic assignment procedure for the future is handled in a manner similar to the current assignment procedure. A problem does develop, however, because the origin of future trips is not definitely known. It is therefore necessary to look at trends in land use development in all areas from which campus-bound trips might originate. Naturally, the projection year is a pertinent variable in determining logical trip origins. Faculty-staff and student enrollment estimates for the projected year should be obtained from management studies as discussed in Volume II - Management and Financial Planning. Projections for both five and ten year periods are recommended so that the development of transportation facilities can precede, or at least keep abreast of demand.

The traffic planner should analyze faculty-staff, graduate and undergraduate students separately with respect to the location of future housing. This is necessary because different types of campus users generally live in different areas and facilities. For instance, faculty members are more likely to live in residential developments than in apartment complexes located adjacent to the campus.

## **SUMMARY**

The sequential procedure necessary for a study of access is perhaps best illustrated through the use of a flow diagram, shown in Figure 2. This arrangement of steps within the diagram allows one to logically relate each step to the entire access study.



FIGURE 2. ACCESS DEVELOPMENT PLAN

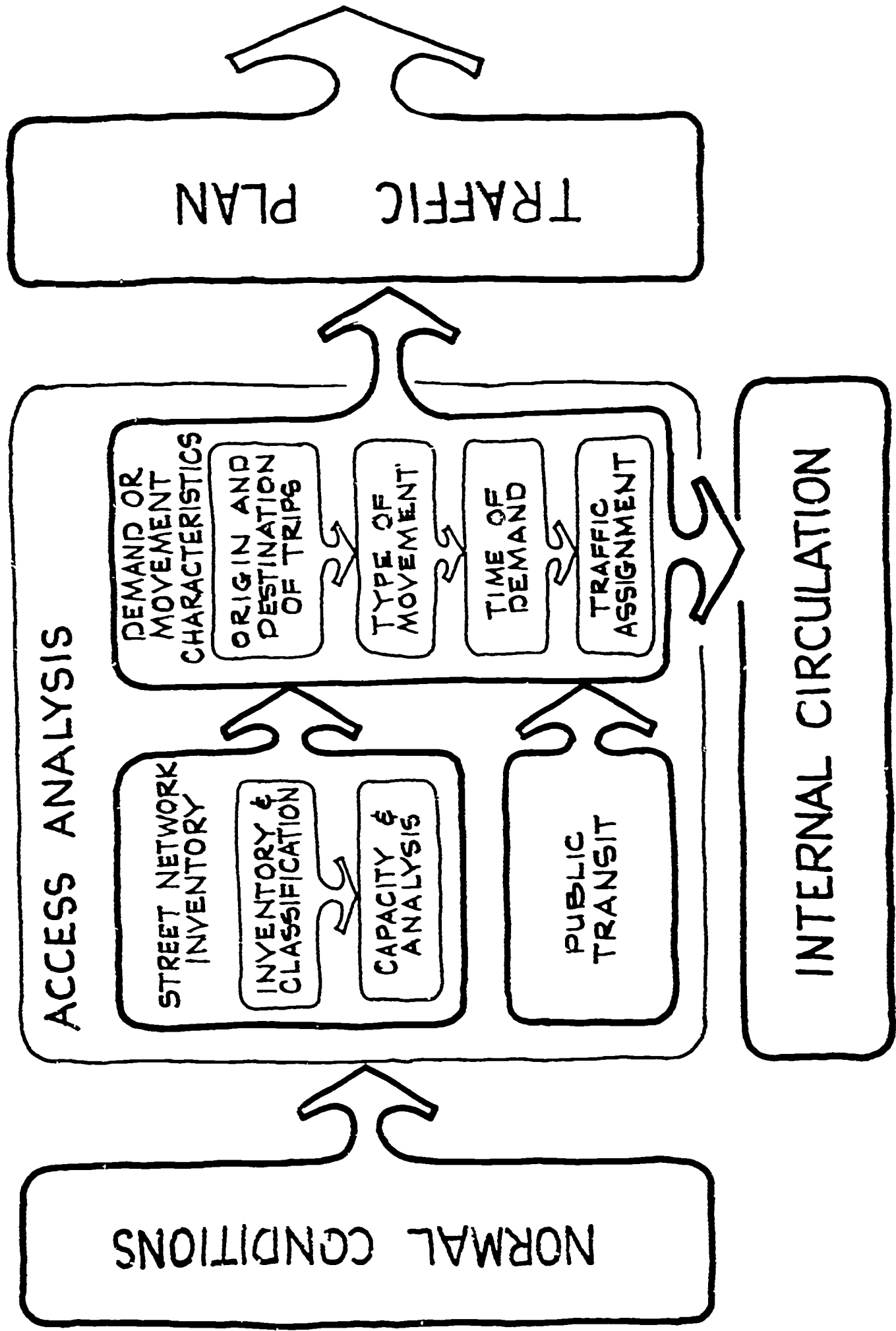

# INTERNAL CIRCULATION

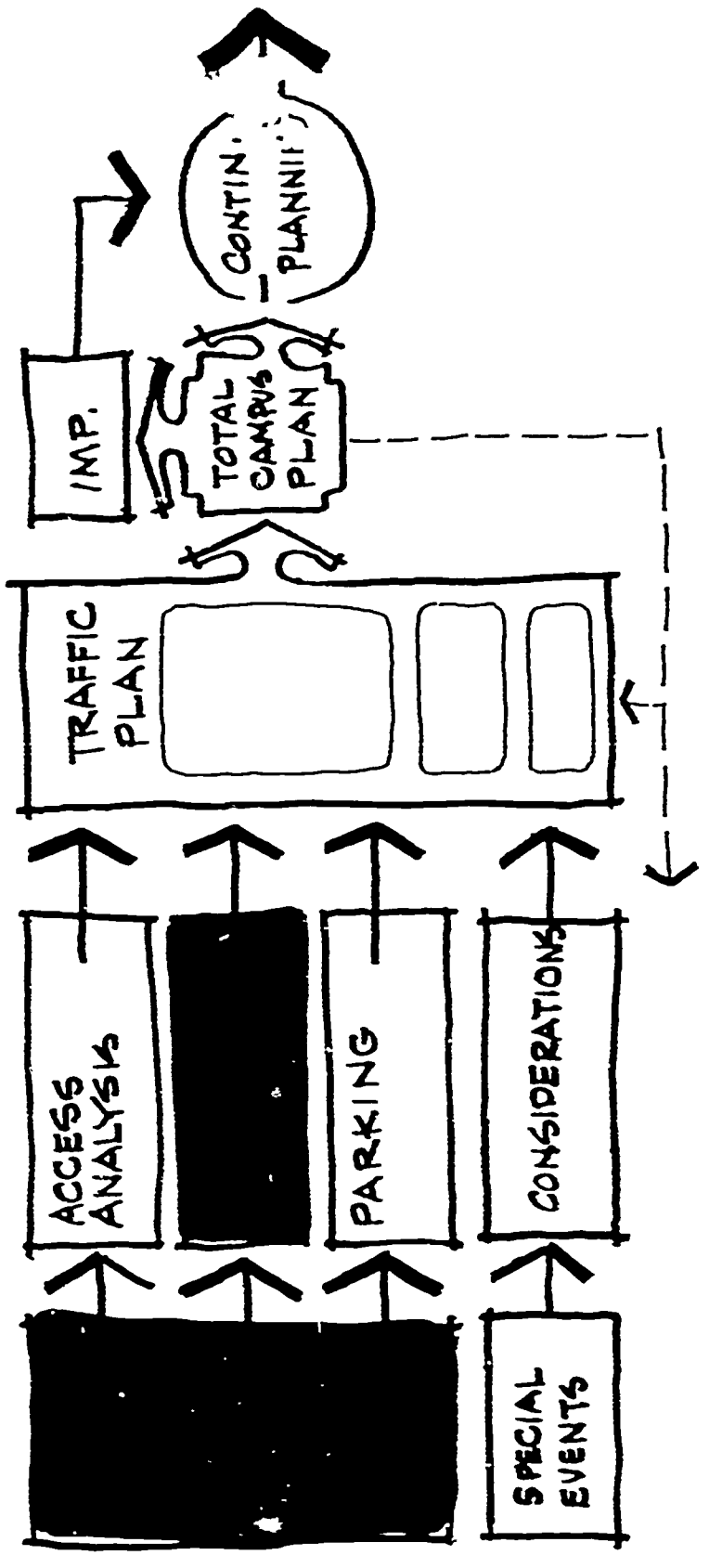

The movement of persons and vehicles within the campus is also of primary importance. Information necessary to make decisions regarding this movement comes essentially from two sources - an inventory of campus travelway facilities with regard to capacity, and an examination of the various modes of internal movement. Questions pertinent to internal circulation which should be answered are as follows:

- (1) What facilities exist for moving traffic within the campus?
- (2) What is the ability of the facilities to move traffic?
- (3) What are the demands for movement (present and future) on the facilities?
- (4) What vehicle-pedestrian conflicts exist?
- (5) What are the deficiencies (present and future) of the facilities?

## FACILITIES INVENTORY

### TYPES

Streets - The campus street system should be inventoried to obtain the following:

- (1) Street width
- (2) Surface type and condition
- (3) Location, type, and number of parking spaces
- (4) Location, type, and condition of all traffic control devices

A functional classification of the campus street system should already have been completed. Information obtained from the campus street inventory and classification should be recorded and it is suggested that a set of maps be used for graphical display and visual review.

Sidewalks - Sidewalk locations and widths should be obtained and the ability to accommodate pedestrian movement considered. It is suggested that this information also be recorded on a map for visual review.

Others – Other travelways, such as well-worn paths and bicycle pathways, should be noted and recorded on a map.

## CAPACITY

The capacity of each street within the campus should be determined using the references noted previously. Traffic volume counts should also be made so that any deficiencies in the existing campus street system can be noted.

# MOVEMENT CHARACTERISTICS

## VEHICULAR

Automobile – Automobile movements within and through the campus can be analyzed using traffic volume counts. From results of this analysis, appropriate control measures, such as those mentioned below, can be taken. Traffic passing through the campus should be eliminated if possible; however, any action taken will certainly involve joint action between the university and community leaders. The sketch shown to the right illustrates a typical campus and its major through streets – the first drawing shows the streets before any regulatory action has been taken, and the second drawing shows a discontinuous major through-street system which eliminates most through-campus movements. Within-campus automobile movements should be restricted if the minimization of vehicle-pedestrian conflicts is sought. A third control measure is to restrict all vehicle movements within the central core. This will help in the development of a pedestrian oriented campus core, which is discussed in the first section of this volume, Land Use Planning.

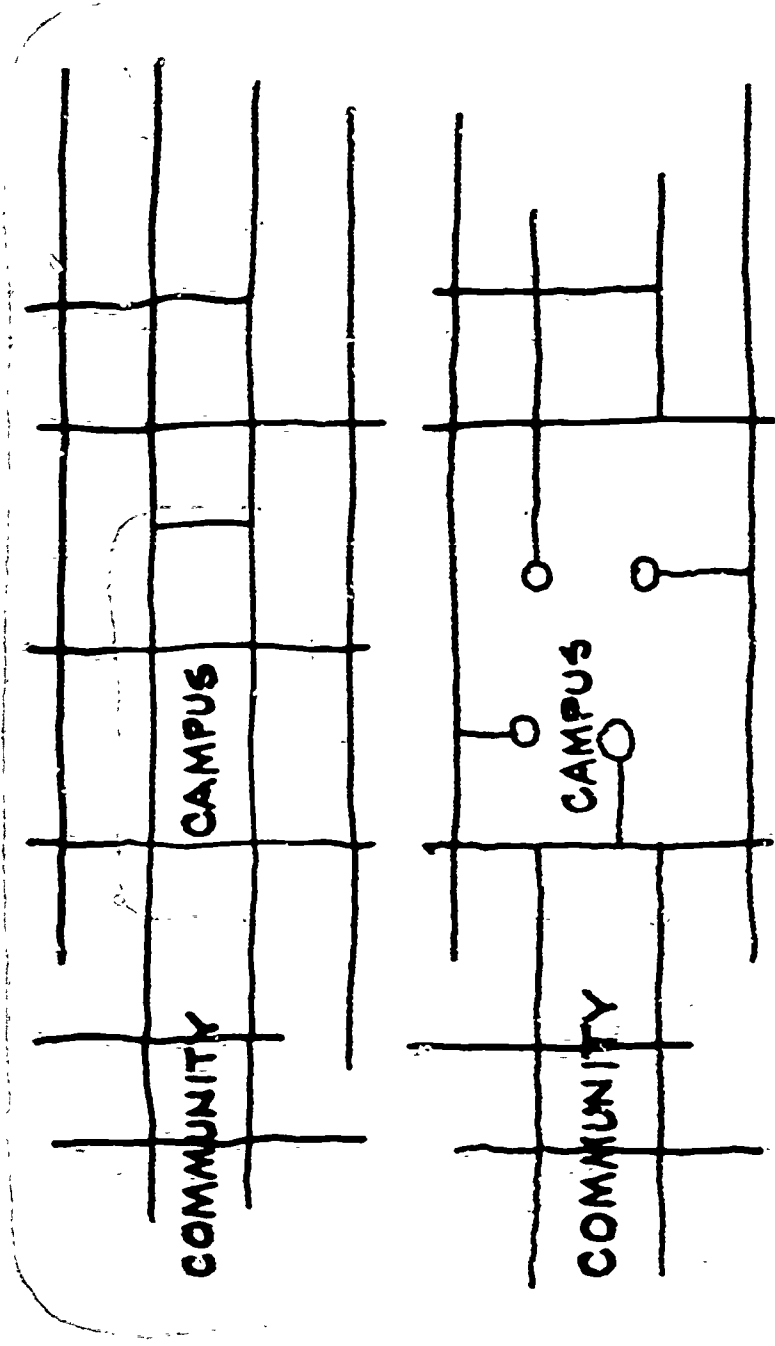

Delivery and emergency - Delivery and emergency vehicles must be allowed access to the campus. Emergency vehicles must be able to gain access to the campus at any time during the day, and provision must be made for access to the central core of the campus, even to the extent of allowing use of pedestrian malls. If pedestrian malls and/or sidewalks are to be used by emergency vehicles, their paved width must be at least ten feet, and should probably be twelve feet, and all corners must have a radius which these vehicles can negotiate. Deliveries, however, can be restricted to off-peak hours - this would not only eliminate some vehicle-pedestrian conflicts but would also increase the capacity of the campus street system during peak periods.

Bicycle - Bicycle movements are usually minor on most campuses, but this may not always hold true. If bicycle movements become heavy enough to seriously restrict pedestrian, and even automobile, movements, separate bicycle pathways may be needed. Certainly, storage racks for bicycles should be provided at various points about the campus so that an uncluttered campus appearance is retained.

## PEDESTRIAN

The major reasons for studying the characteristics of pedestrian movement are to minimize automobile pedestrian conflicts, insure that new structures are built in appropriate locations, insure that the building use is correct for each building's location, and minimize overall travel distances (times) for students.

Pedestrian movements are more difficult to analyze than automobile movements because pedestrians are not restricted to a limited street system, since they have the capacity to move freely around the campus. It is usually necessary to consider only movement because that movement represents a major part of the total on-campus pedestrian circulation.

Origin and Destination Study - The analysis of internal campus traffic is not an easy task and very little research, to date, has been documented. A very thorough analysis of this movement is possible, however, and would provide valuable data for both traffic and land use planning. A study utilizing the student records of a university is herein proposed as a new and promising approach to the study of internal campus traffic.



The buildings on a campus can be designated as the nodes of a traffic network as shown below.

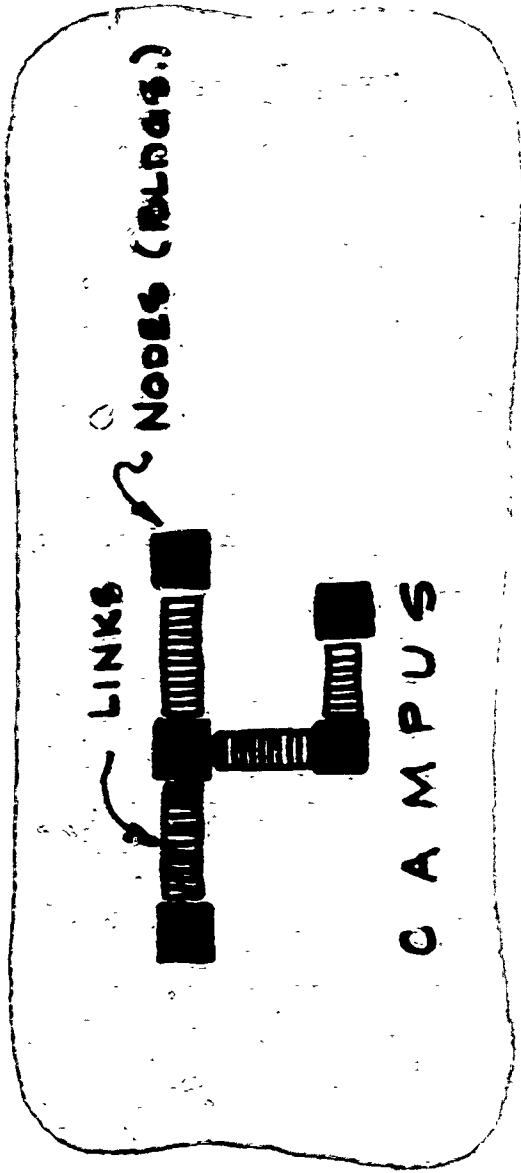

The movement of students between these nodes can then be determined using each student's schedule as obtained from the university registration records. By examining the class schedule of each individual student and by recording his trips from building to building during a typical day, movement data of the type shown below can be developed.

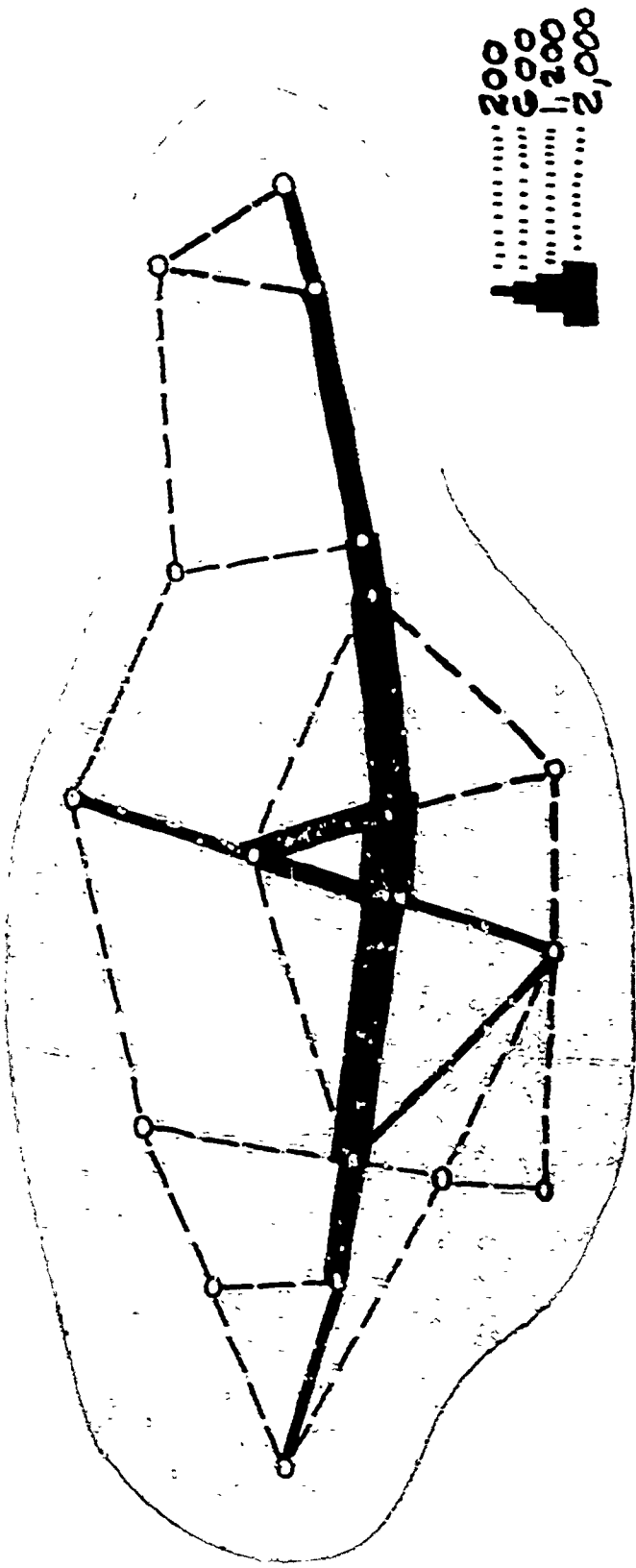

It is obvious that the proposed procedure would be very difficult and time consuming if performed manually. Therefore, the study would logically require the use of a computer. This should not present a major problem since most universities now utilize computers to handle student records. However, a special program would be needed so that the steps shown in the following logic diagram could be executed.

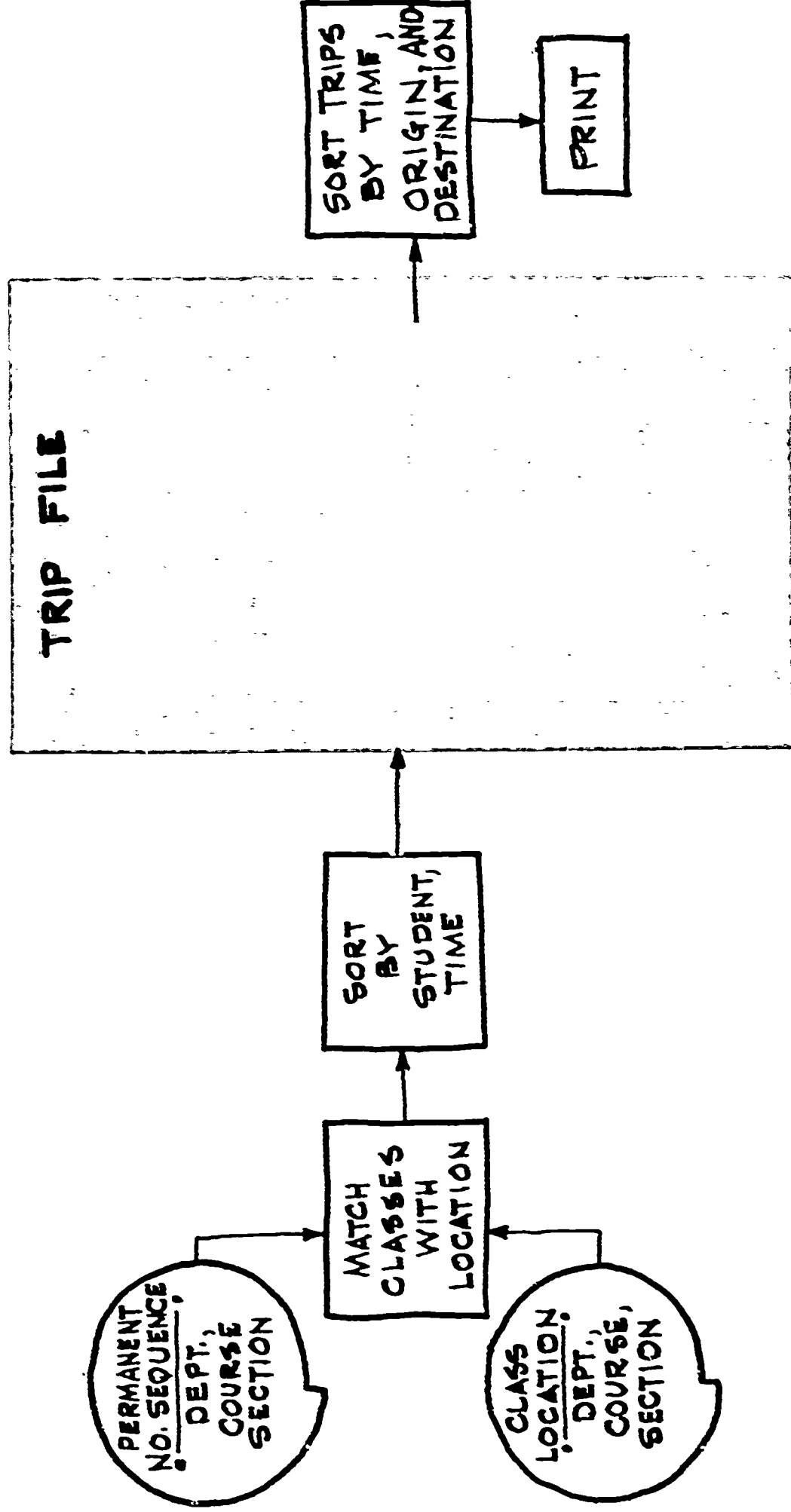

The data obtained from the proposed study of student movement on the campus would be valuable for a number of uses, the most obvious of which are as follows:

- (1) Peak Movements - Data on peak movements would provide the opportunity to examine the ability of sidewalks and other pedestrian facilities to accommodate student movement between buildings.
- (2) Travel Times - By assigning normal travel times (time required to walk from one building to another) between all buildings and by analyzing the individual student trips, it would be possible to study the average travel time of students. This would provide information for class scheduling and building location or assignment.
- (3) Pedestrian-Vehicle Conflicts - It would be possible to identify the location and magnitude of pedestrian-vehicle conflicts by determining the volume of student trips that cross vehicular facilities.
- (4) Building Location - It would be possible to understand pedestrian interactions and their relation to building location and building use. For example, it may be found, using this study, that a building is in the correct location but its use is inappropriate. In that case an alternate use for the building could be assumed and the resulting pedestrian movement (volumes, person-miles or person-hours of walking) evaluated. This illustrates an essential tool applicable to the total planning process and, further, indicates the need for integrated and simultaneous planning procedures in the decision-making process. In this way, optimum land uses and locations for new buildings, as well as optimum use of existing buildings, can be attained.

## ADDITIONAL CONSIDERATIONS

As discussed in the previous land use section, a campus can be defined as automobile-oriented, pedestrian-oriented, or some degree of both. The basic orientation of the campus relative to traffic must be determined at an early stage in the studies.

The data on internal circulation that will result from the studies previously discussed should be combined with input from the land use studies and university objectives. It may be that the university is striving to create an atmosphere on campus that will exert great influence on the traffic orientation of the campus.

## **SUMMARY**

The sequential procedure necessary for a study of internal circulation is perhaps best illustrated through the use of a flow diagram, shown in Figure 3. This arrangement of steps within the diagram allows one to logically relate each step to the entire internal circulation study.

FIGURE 3 · INTERNAL CIRCULATION DEVELOPMENT PLAN

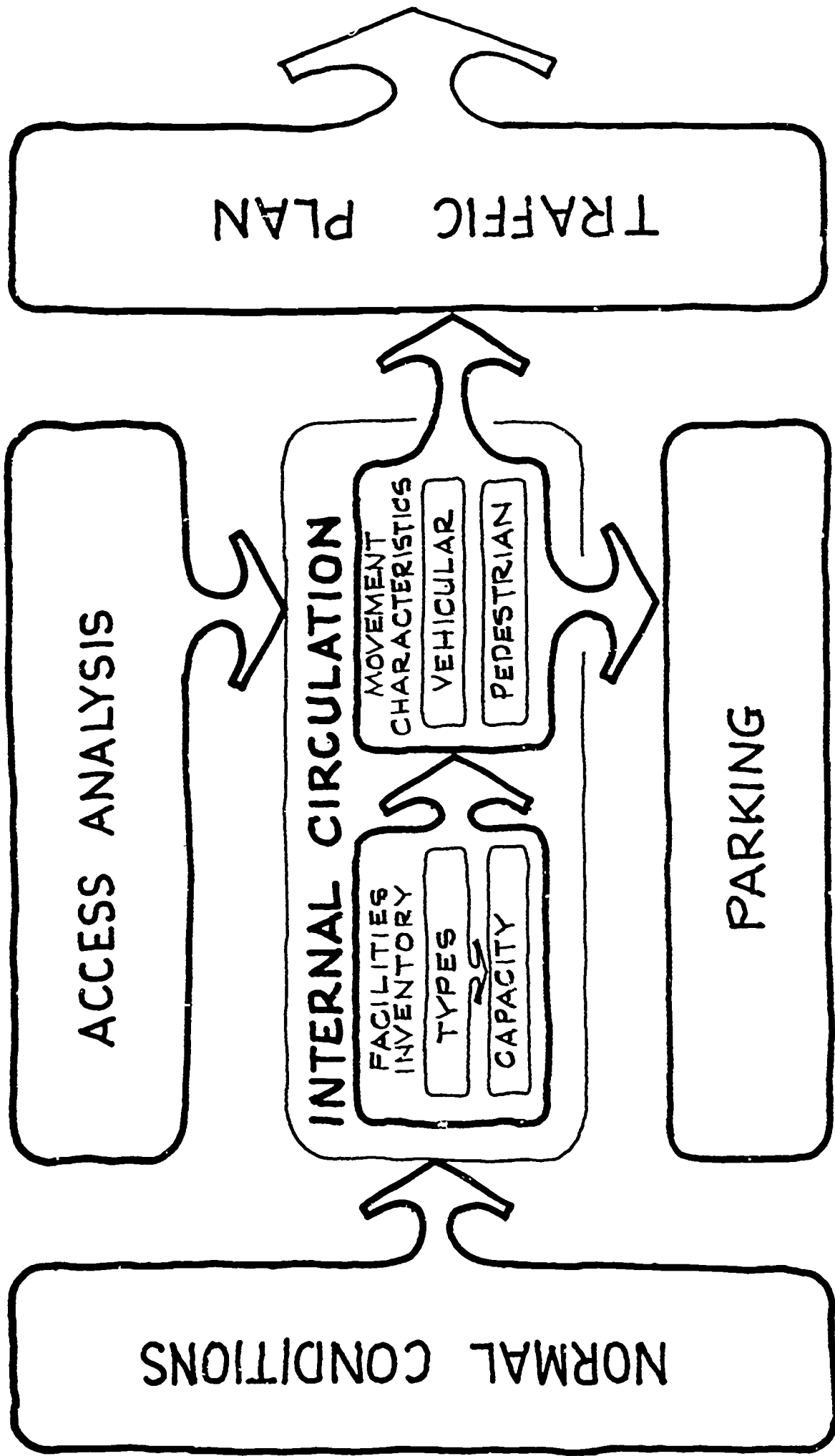

# PARKING

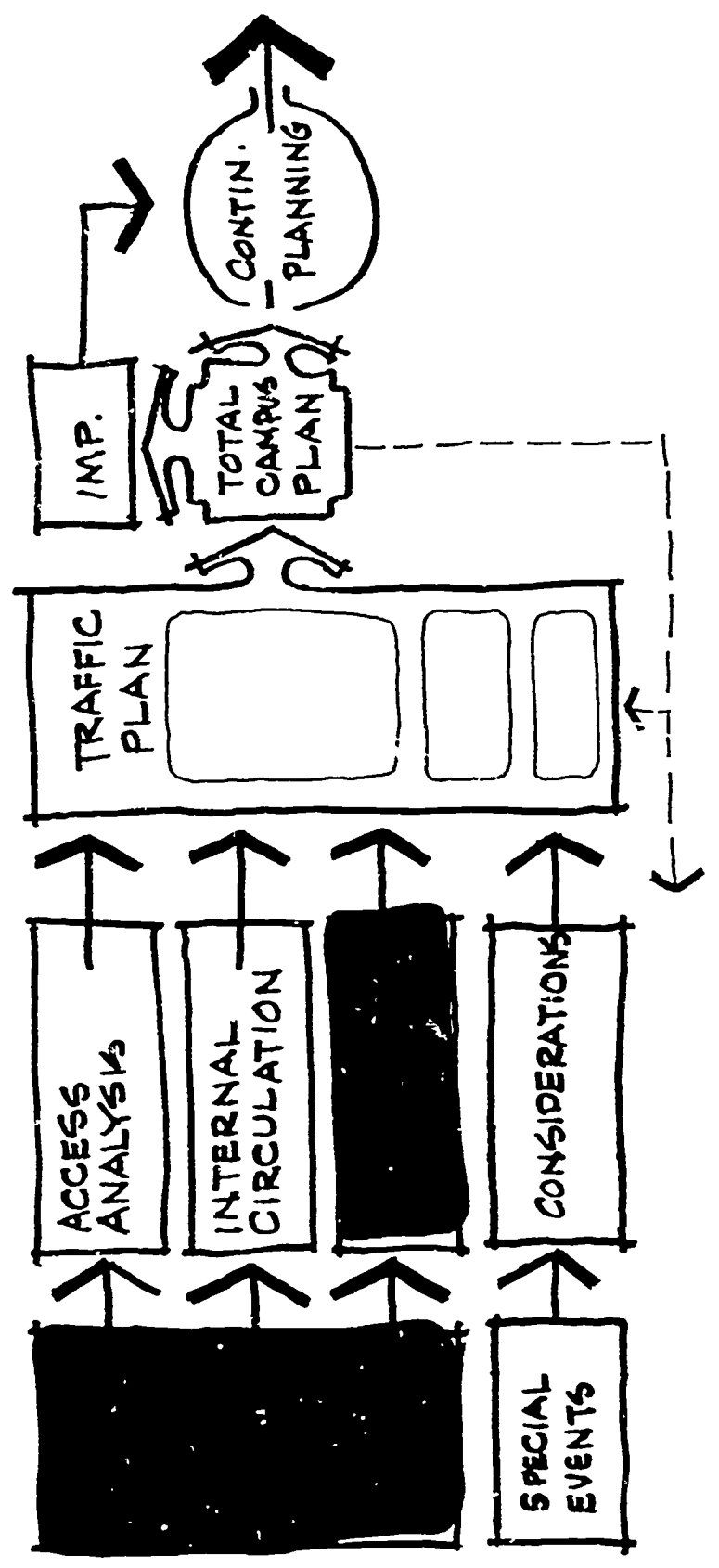



Providing parking space is one of the most troublesome problems associated with traffic planning. Intuitive decision-making concerning additional parking is not satisfactory from an economic point of view; quantifiable facts on parking are needed. An analysis of parking requires an inventory of existing facilities, the determination of parking demand, and decisions regarding parking restrictions. Questions pertinent to parking which should be answered are:

- (1) What parking facilities exist?
- (2) What is the ability of these facilities to store vehicles?
- (3) What is the present and future demand for parking facilities?
- (4) What deficiencies exist (present and future)?

## **INVENTORY**

The first step in any parking survey is an inventory of existing parking facilities (both permanent and temporary facilities). This inventory should include not only the facility but the regulations under which it operates. It is recommended that a base map of adequate scale (approximately 1" = 100') be used so that the location and number of parking stalls in each facility, and curb spaces along each block face, can be more easily recorded and perused. This inventory should be kept up to date through annual revision.

## NUMBER OF SPACES

The number of spaces within each lot and along each block face should be counted and their position recorded on the base map. All loading zones and illegally used spaces (In this context, illegal parking is defined only as the use of a space not intended for parking.) should also be recorded. The classification (student, faculty, reserved, etc.) of each stall should be noted, as should any metered facilities.

## UTILIZATION, DURATION, AND TURNOVER<sup>5</sup>

In this day of crowded parking facilities, and demands for more spaces, some measure of the adequacy of a facility is needed. The duration, turnover, and utilization of a facility help measure its characteristics and provide a basis of comparison with other facilities.

The first thing needed is a definition of terms. "Usage" refers to the number of hours (during the study period) a parking space is used. "Utilization" refers to the summation of usages (for the study period) over all parking spaces within the facility divided by the total number of spaces in the facility, and this ratio is to be multiplied by 100 percent. Thus, usage is in terms of percent - its maximum value being 100 percent.

<sup>5</sup>National Committee on Urban Transportation, Manual 3D, Conducting a Comprehensive Parking Study, Public Administration Service, Chicago, Illinois, 1958.

"Parking duration" refers to the summation of usages (for the study period) over all parking spaces within the facility divided by the summation of the number of different vehicles parked in each parking space within the facility during the study period. Parking duration is in terms of hours.

"Turnover rate" refers to the summation of the number of different vehicles parked in each parking space within the facility during the study period divided by the total number of spaces in the facility. Turnover rate is in terms of vehicles per parking space. A relationship for each of these terms is given below.

$$\text{Utilization} = \frac{\text{usage}}{\text{supply} \times 100\%}$$

$$\text{Parking duration} = \frac{\text{usage}}{\text{no. of different vehicles parked}}$$

$$\text{Turnover rate} = \frac{\text{no. of different vehicles parked}}{\text{no. of spaces}}$$

These characteristics may be computed for an individual stall, a curb face, a part of a parking facility, or the entire facility.

In order to conduct these studies, parking counts should be made every hour during the school day, and should be done on two days of a week. The days should be chosen as follows; one day from the Monday, Wednesday, Friday group and one from the Tuesday, Thursday, Saturday group. Two methods of gathering parts of those data are available: 1) Put out crews to make counts at all facilities; and 2) Fly the area with a low flying airplane using aerial photography. Certain advantages and disadvantages of each are immediately apparent. If ground crews are used, coordination is a problem because of the large numbers of people involved. A base map for each lot and curb face should be prepared for each crew. Maps should be large enough and orientation clear enough so that data can be recorded on the map.

The automobile sticker number, whether staff or student, could be recorded for each automobile parked in each stall. Empty spaces and cars illegally parked should also be noted. Reserved spaces should be noted because they affect the utilization of a facility. A facility full of reserved spaces can have a utilization no greater than 1.00; however, a facility with no reserved spaces does not have this limitation imposed on it. If there is no campus registration sticker on an automobile, the license number should be recorded.

The advantage of this method of data collection is that information on individual automobiles can be obtained. By knowing the campus registration numbers of the vehicles, the location of the individual's home can be found using Campus Security Office records. A good picture of each person's travel patterns is then known, since the origin and destination of each trip is known.

The other method of data collection, aerial photography, is much quicker and easier. However, this method gives no information on the identification of individual automobiles using the facilities. If this technique is used, the campus should be flown every hour. It is recommended that a standard aerial camera be used; however, if one is not available a 35mm. camera will suffice. The campus should be flown on two days, those days being chosen as stated previously. One must remember that vegetation can hide parking facilities unless the flights are made during the winter, and underground facilities must be handled by crews.

## DEMAND

There is sometimes confusion relative to the terms "usage" and "demand" as applied to parking facilities. The term "demand" is applicable in cases where the supply of parking spaces exceeds the number of parkers. The term "usage" is used when parking is at a premium, i.e., when there are more parkers than available spaces. In this case usage is not a direct indication of demand but is instead an indication of the relative desirability of existing facilities.

Demand is rather difficult to measure. In general, the only two methods used for such measurement are interviewing parkers or using cordon origin-destination surveys. These are long and expensive studies. Therefore, usage analysis is most often used (in preference to demand analysis) and is, in fact, a significant measure of parking adequacy.

In order to determine the parking usage on a campus, all facilities are categorized according to the type of user, such as resident student, non-resident student, or faculty-staff. A study of vehicle registration should be made for each category of user. The office responsible for vehicle registration and control will probably have information on the number and types of parking permits issued. It is important that historical as well as current information be gathered for each type. From this information, the ratios of persons to vehicles for all categories of parkers can be calculated. These ratios, called car ownership ratios (COR), are defined as:

$$\text{COR} = \frac{\text{No. of persons (such as graduate students)}}{\text{No. of vehicles registered (by graduate students)}}$$

The CORs for the historical information should be calculated so that general car ownership trends can be established.

#### FACULTY-STAFF

The car ownership ratios for faculty and staff are used in conjunction with the maximum expected numbers of faculty and staff members on campus at any one time in order to determine the number of faculty-staff vehicles on campus. By using historical and current car ownership ratios, projections of expected number of vehicles on campus, given the future number of faculty-staff members, can be made.



## STUDENTS

The car ownership ratios should be determined for freshmen, sophomores, and upperclassmen (juniors, seniors, graduates) on-campus students, and similar computations should be made for off-campus students. The number of students in class during the maximum class hour of the week is used with the CORs to determine how many student vehicles are on campus during the maximum hour (or time of peak usage). The number of resident-student vehicles in the parking lots will probably remain about constant during the week, as will faculty-staff requirements. However, non-resident student requirements will vary considerably during the day and this is the reason the peak class hour is used.

## FUTURE

The future usage of parking facilities is dependent only on the growth of the institution. Because exact numbers for students, faculty, and staff, in any given future year, are not known, predictive techniques must be employed. Most institutions have developed enrollment figures for future years as a result of management planning and it is recommended that the traffic planner adapt his work to these data. These figures, and any constraints under which they were developed, should be used by the transportation planner in the development of future usage figures. This is further discussed in Volume II - Management and Financial Planning.

An examination of the general trend of car ownership, using the past and present CORs for each category of parkers, will establish appropriate ratios for future years. It is expected that, with car ownership on the rise throughout the nation, and certainly with young people, these ratios will be no larger than the present CORs found and will probably be smaller. All future constraints should be taken into account. For instance, it should be recognized that, if the current administration's policy is not to build new dormitories and not to restrict enrollment, student enrollment increases will occur within the non-resident body. Therefore, very little, if any additional resident student parking will need to be provided. However, under these circumstances, non-resident student parking may quickly become critical. Faculty-staff parking projections are made in the same way. A thorough survey of administrative policy is again needed so that correct assumptions are made. It is also important that all projected figures on parking requirements be calculated for each year and not simply one set of figures for ten years in advance. It is only through an annual development of parking space requirements that supply can keep abreast of a rapidly changing demand.

It may be that there is some question as to the immediate need for additional parking spaces on a campus. Two indicators can be examined from the data compiled in the survey in order to determine this future need. One of these is the present facility utilization. Parking on campus has probably not become a serious problem if the utilization of the facilities is less than 95% during the peak class hours of the week. However, this does not mean that parking cannot become a serious problem within a short time. Recognition of a possible parking problem can be determined when car ownership trends and campus population figures are projected. A second indication is provided by examining the use of illegal spaces for parking. More parking spaces should be provided if the illegal spaces are consistently used during the peak class hours of the week.

## **FACILITY TYPES**

The construction and operation of some or all types of campus parking facilities, in the form of on-street (curb) and/or off-street (lots and garages), are important to the development of any comprehensive traffic plan. The principal factors controlling which type or types should be built are esthetics and economics.

### **ON-STREET**

Of the choices available for providing future parking, certainly on-street, or curb parking, is the least pleasing from an esthetic point of view. There is little reason to spend money in order to beautify a campus and then create an unsightly appearance by allowing vehicles to park along all curb faces. Curb parking also creates a hazard from the standpoint of pedestrian safety and reduces the capacity of the campus street system. It is therefore recommended that no additional curb parking be allowed on either pedestrian or automobile oriented campuses, and it would, in fact, be desirable to eliminate all campus curb parking, especially in core areas. It is realized that present curb spaces would have to be replaced by an equivalent number of off-street spaces - this would require an outlay of funds for which no additional spaces would be forthcoming. However, it is felt that the esthetic values realized from such a move can be as well justified as expenditures for landscaping, campus open spaces, and the architectural treatment of buildings.

## LOTS

Lots are generally the first class of off-street parking facility built on a campus. This is reasonable because construction and maintenance costs are less with this class than with others. The construction cost of a paved, off-street facility is approximately 50¢ per square foot. The area of a parking space, generally given as 250 to 400 sq. ft., is made up of the actual parking area (generally around 180-200 square feet) plus some part of the driveways. Therefore, a parking space usually costs between \$135 and \$200 (excluding land costs).

Geometric design and location of lots is of utmost importance. Layout alternatives should be investigated so that the best alternative from the standpoint of capacity and safety, can be chosen. Entrance points to the lot are also of major concern. Their location should be such that large queues do not form at the entrance waiting to drive into the lot. Since the majority of students usually arrive on campus prior to the first class period, but leave at various times during the remainder of the day, lot entry points must be so designed that large volumes of parkers can enter the lot in a small time space. It may be necessary to prohibit left turns into lots from two-way streets or to provide separate entry queueing lanes for traffic waiting to park in the lots. The flow pattern within the facility should be developed in a manner such that conflicting movements on the street (also at entrances and exits) are avoided. The exits should open onto more than one street, if possible, so that the demand imposed on any one street does not exceed its capacity. There are two basic lot locations relative to the campus - internal and peripheral (fringe). An illustration relating them to the campus is shown to the right - a discussion of each follows the sketch.

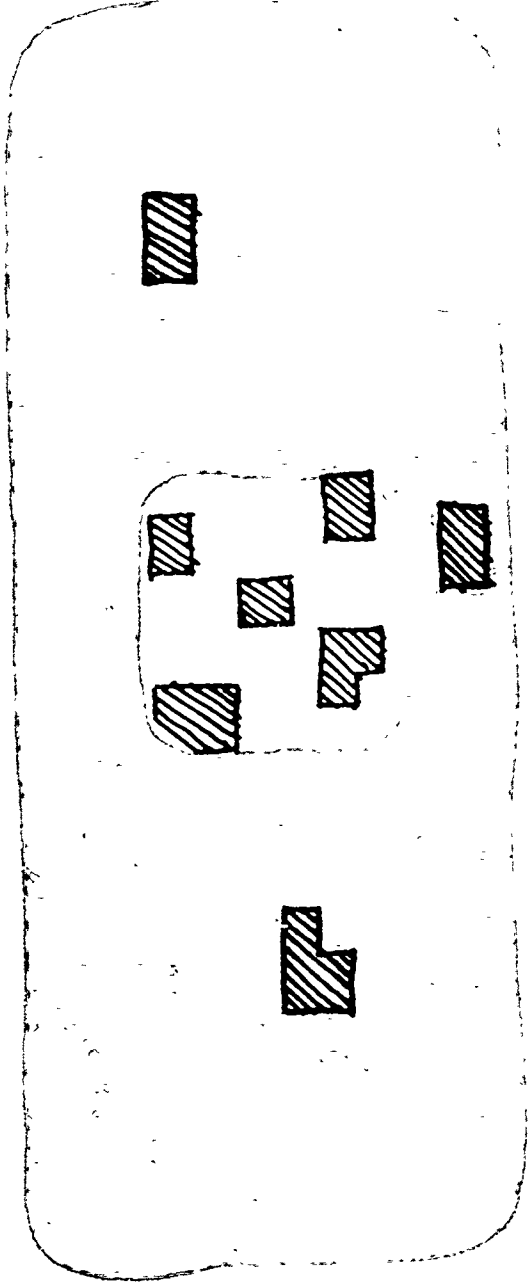

Internal Lots - Most campus lots qualify as internal lots because they are within the confines of the campus perimeter. These are sufficient for most campuses.

Peripheral Lots - Peripheral lots may either be located on the perimeter of the campus or some distance from its nearest edge. Transportation in the form of a shuttle-bus type service may be needed to transport students from these lots to the campus. This type of lot is recommended as an alternative to the construction of garages on a campus since it may be more economical to purchase land not connected with the campus, build a lot, and bus the students to the campus than to build multi-level garages.

## GARAGES

Garages, both above and below ground, are the most expensive parking facilities to construct. Entrances to garages are generally via ramps or elevators, the latter being more expensive. Above-ground garages with ramps connecting the various floors cost approximately \$3.75 to \$4.50 per square foot to construct. For cost-per-vehicle-space calculations, the actual area of the parking space (180 - 200 square feet) is added to some part of the driveways and other areas comprising the facility. Therefore, each vehicle space is usually considered to be about 400 square feet; thus the total cost is between \$1500 and \$1800 per vehicle space (excluding land costs). Underground garages with ramps connecting the floors cost in the range of \$7.50 to \$10.00 per square foot, so that the total cost per vehicle space is in the range of \$3000 to \$4000. The cost can be higher if there are more than two or three underground floors or if special measures are needed to keep out seepage. The use of automobile elevators is not recommended because they are quite expensive and cannot handle the peak period demands which would be placed upon them by campus users.

Land use is a pertinent factor in comparing lots and garages. Certainly a garage which can accommodate two hundred vehicles will take up less land area than a comparable lot, although the garage may take up more space (space includes vertical considerations). An example may best illustrate this consideration.



Suppose a campus whose area is 100 acres needs parking space for 6000 vehicles (graphically shown below). Assuming each parking stall averages 400 square feet, approximately fifty-five acres are needed for parking! The land area required would be only about fourteen acres if four-story garages are used.

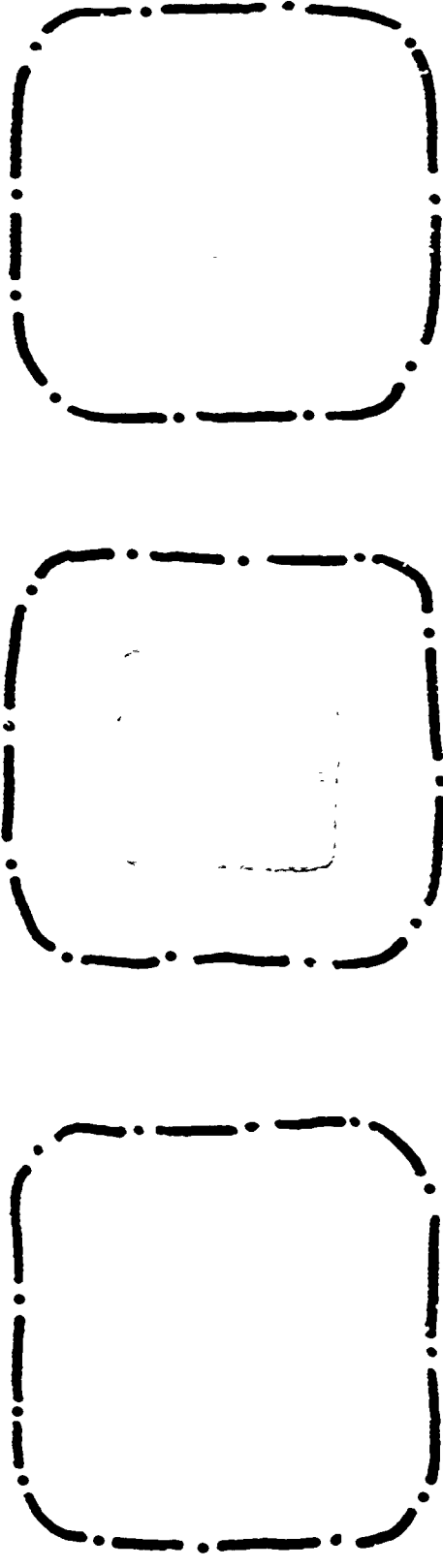

### OPERATION

Once parking facilities are established, some system is needed to regulate them. The method generally used is to attach a fee to the parking spaces. The fees charged for parking should be commensurate with the costs of construction, maintenance, and enforcement. Parking permits are generally issued to students, faculty, and staff. As the value of a lot increases, it may be that the price of parking there should rise. In this way, the location of the facility is taken into account in the economics of parking.

Parking near the center of a campus is certainly more desirable than parking a mile away from the nearest campus building. Those who park close to facilities, as faculty members generally do, should probably pay more for this privilege. New facilities can be partially financed from this added revenue. Increasing the charge for prime parking locations may also tend to reduce the demand for that parking.

Lot Operation - Lots are usually regulated by charging a fee for the use of the facility.

A parking permit sticker is often placed on the parker's windshield so that the legal users can be distinguished from those illegally using the facility.

The demand for parking spaces, particularly among students, may exceed the ability or desire of the university to satisfy that demand. In this event, certain regulatory actions should be taken. One is to increase the cost of parking in an attempt to decrease the demand. This can be done by either increasing parking permit charges or metering the facilities. The metering of individual parking stalls within a lot is not recommended. However, metering entrances or exits may be desirable. Coin or card operated gates seem to work well. Entrance and exit points should be controlled so that persons cannot park within the lots without paying. Because the operation involved in placing a coin or card in a meter and waiting for a gate to rise takes approximately 20 - 30 seconds, it is recommended that parkers not be required to pay when they enter the facility in order to avoid the development of long queues during peak periods. It is advisable to use a gate at the entrance however, to prevent parkers exiting through the entrance.

In most campus lots, parkers leave at fairly random times of the day so that large queues waiting to exit do not develop. It is therefore advised that parkers be required to pay at the exit. Differential counter equipment is available that will insure that no one is admitted to the lot unless there is an available parking space. This type of metering device is much easier to maintain for fee collection than are individual stall meters. However, this type of metering may not be best in lots which are heavily used for special events.

For events such as football games, large numbers of parkers desire to enter the lot quickly and also want to leave - all at the same time - as soon as the game is over. If parkers were required to pay at the exit, and assuming 30 seconds of time per auto, the time required to release 300 cars would be 2½ hours! It is therefore indicated that special attention to the operation of a metered lot may be required for special events. It may be desirable to discontinue the metered operation during the special event and to utilize some other fee collection system at this time.

Garage Operation - Garages are not only more expensive than lots but are also more difficult to operate on a campus. This operation problem is due to garage entrance and exit problems. As an example, consider a two floor self-parking garage with ramps connecting the floors. This is roughly equivalent to two lots whose sizes are equal to one floor each of the garage. Therefore, approximately twice as many vehicles will attempt to enter the garage as will attempt to enter one lot. In general, vehicles can enter a lot more quickly than a garage and the result is that large queues may build up at entrances to garages. This is accentuated if the garage has a toll gate at the entrance. It can therefore be seen that a critical problem associated with campus garage operation is that of vehicle queues at the entrances during peak periods.

## SUMMARY

The sequential procedure necessary for a study of parking is perhaps best illustrated through the use of a flow diagram, shown in Figure 4. This arrangement of steps within the diagram allows one to logically relate each step to the entire parking study.

FIGURE 4 · PARKING DEVELOPMENT PLAN

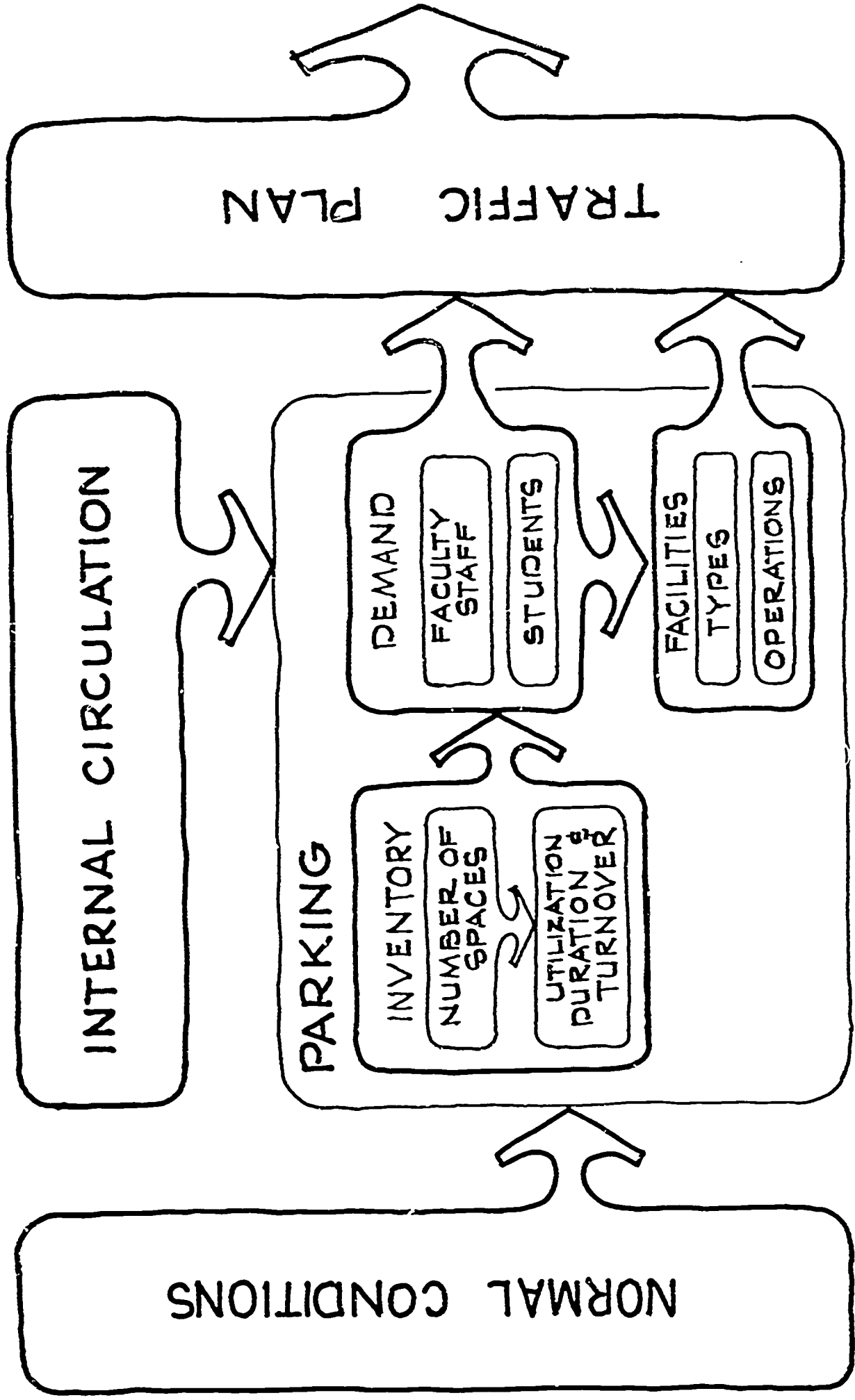



# SPECIAL EVENT TRAFFIC

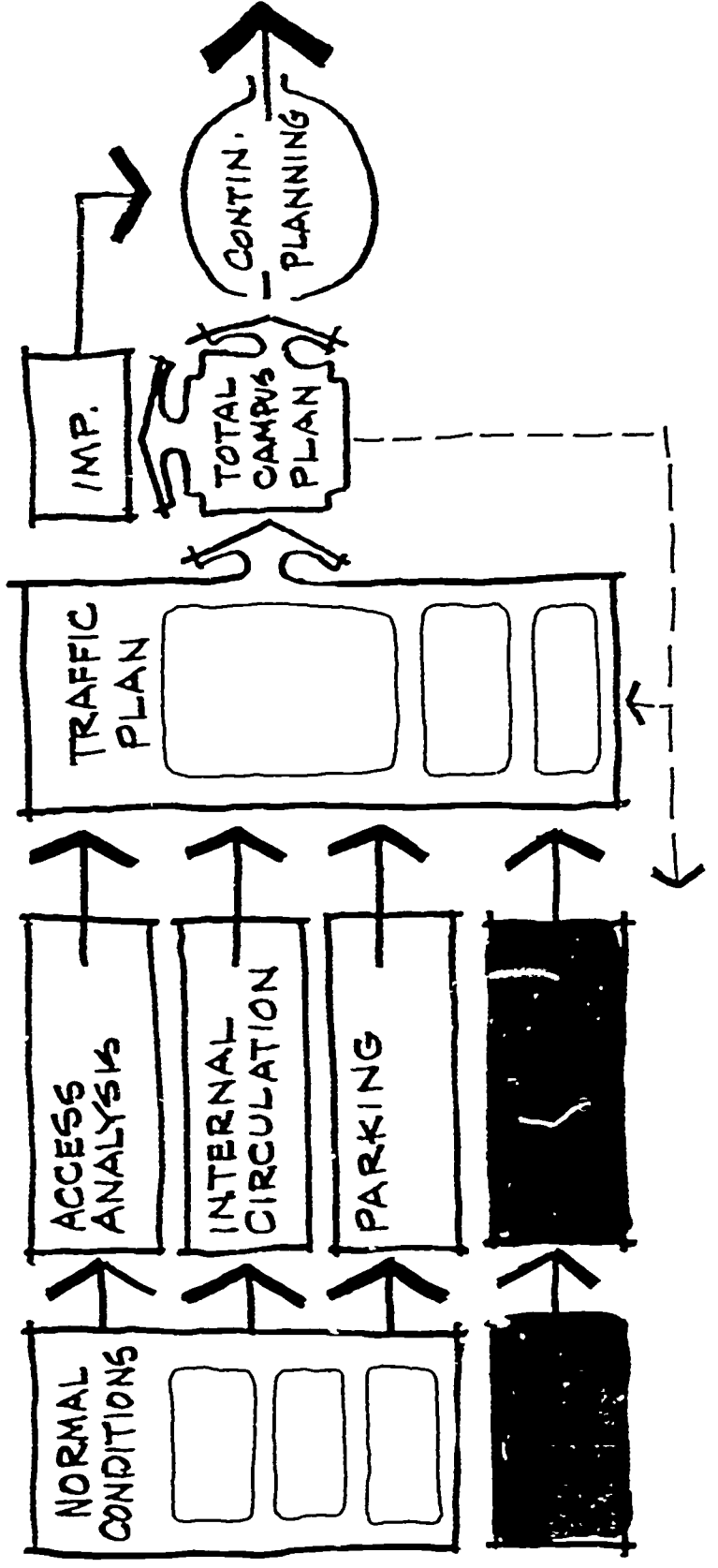



Special events, such as football games, present problems to the traffic planner which are different from the everyday problems. Many people enter the campus who are not familiar with the location of parking facilities or streets. A great deal of coordination and planning must be done so that these people can be handled efficiently. The expected attendance, routing of people approaching and leaving the campus, and control coordination while drivers are on or near the campus are all important considerations without which special events traffic becomes chaotic.

Questions pertinent to special events which should be answered in this section are:

- (1) What events require special traffic planning?
- (2) What traffic problems are associated with special events?
- (3) What methods are available for controlling special events traffic?
- (4) To what extent must advance traffic planning preparations be made?

## **ATTENDANCE**

The expected attendance at an event is an important consideration because parking space must be provided. Expected attendance statistics are usually available from the campus office in charge of (sponsoring) the event. From expected attendance figures, it is possible to determine the number of vehicles expected by estimating the number of persons per car. A survey taken during the event will establish the actual number of vehicles and where they were parked. It is also feasible to determine which lots are utilized in connection with various attendance figures. These statistics are excellent references for planning access, internal circulation, and parking for future events.

# ROUTING

The routing of trips to and from the parking facilities is very important. Dignitaries and persons bussed to the event via chartered buses must be handled separately from the masses. Also, arrangements should be made with the bus companies so that they are familiar with their role in the operation, i.e., their route to and from the special event and where they park during the event. This requires advanced planning. The direction from which the predominant number of out-of-town trips will come to the campus should be ascertained. It is then possible to identify the routes available for traffic and pedestrian movement before and after an event and to calculate the capacities on these routes. It should be kept in mind that many out-of-town people will probably not be familiar with approach routes to the campus or the campus street system.

Routing maps should be drawn up and distributed to all police officers and others involved in special events traffic control. Two maps should probably be given to each officer. The first would show pre-event routings in the form of origins to the campus that will most likely be used by incoming persons and routes to get to the parking facilities on campus. The second map would depict post-event routings. This will generally involve one-way routings on some streets and restrictions on certain parking facility entrances and/or exits. Men working in parking facilities would also get these maps in addition to parking facility diagrams. A copy of these maps should be sent with any tickets that are mailed for a special event.

# CONTROL COORDINATION

Control coordination is absolutely essential if large volumes of special events traffic are to be handled quickly and efficiently. This requires willing cooperation between state, county, city, and university traffic control personnel. One person should be put in charge of the entire special events traffic operation. In this way, all efforts could be coordinated through one person who would have the authority to delegate jobs to responsible individuals. A control center should be used and all persons connected with the traffic control should be in radio contact with this center. Also, any emergency vehicles at a special event should be in radio contact with the control center. If possible, an airplane should be utilized to observe post-event traffic flow. This would prove very helpful in understanding how the total system was operating. If the person in overall control were in the plane, necessary changes in the system could be made on the spot.

Police officers must be instructed in the general operation so that they can understand how their specific job must fit into the total plan. By doing this, they will be more cooperative. The officers also need some instruction in their specific job concerning coordination and the handling of serious problems such as bad collisions.

In the case of a bad collision, an alternate routing plan should be available. All traffic control personnel should be aware of such a plan and how to implement their part of it. This is one reason that radio contact with each of the traffic control personnel is a must. It may also be necessary to erect special signs and barricade certain streets before and after a special event. Finally, review of the operation, while it is taking place, should be undertaken so that corrections can be made and plans updated for the next special event.

The sketches at right illustrate two routing plans designed to facilitate the movement of traffic for a football game. The first sketch represents a pre-game plan and the second a post-game plan. Streets which may normally handle two-way traffic are made one-way for this special event. The direction of travel on some of the streets is reversed for post-game traffic. This type of plan requires advance planning and control coordination. Barricades and control officers are needed to insure compliance by spectators with this type of plan.

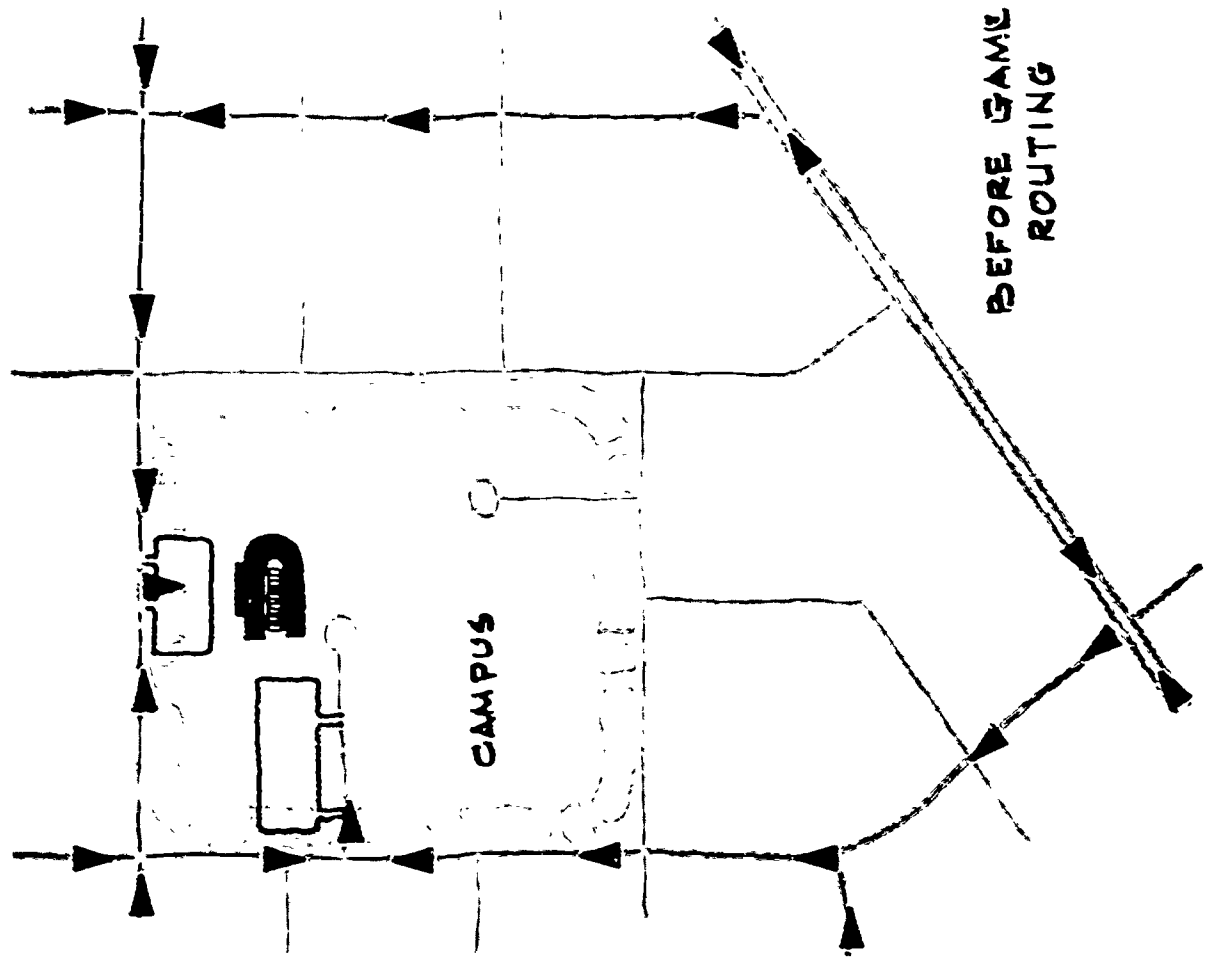
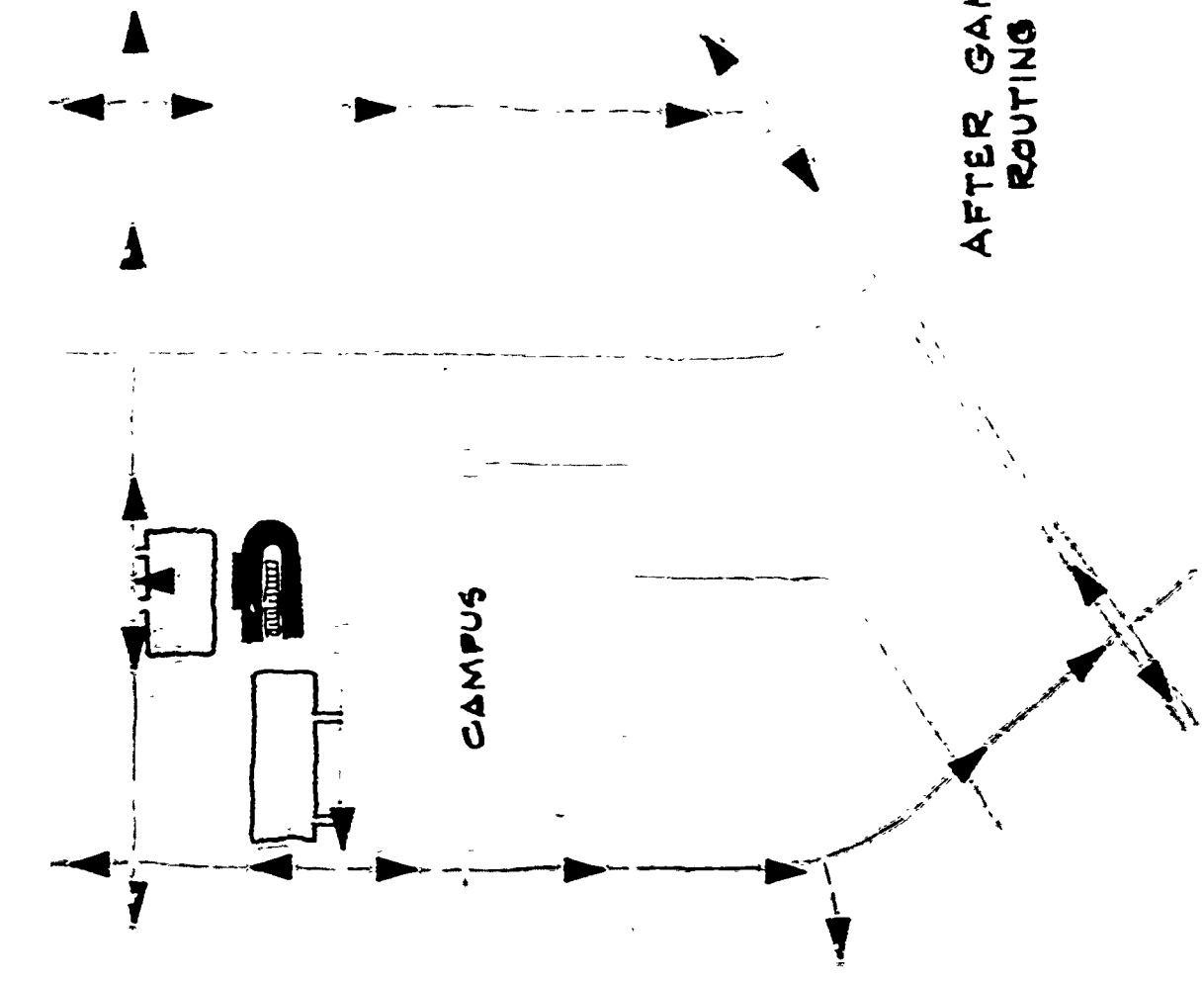

# TRAFFIC PLAN

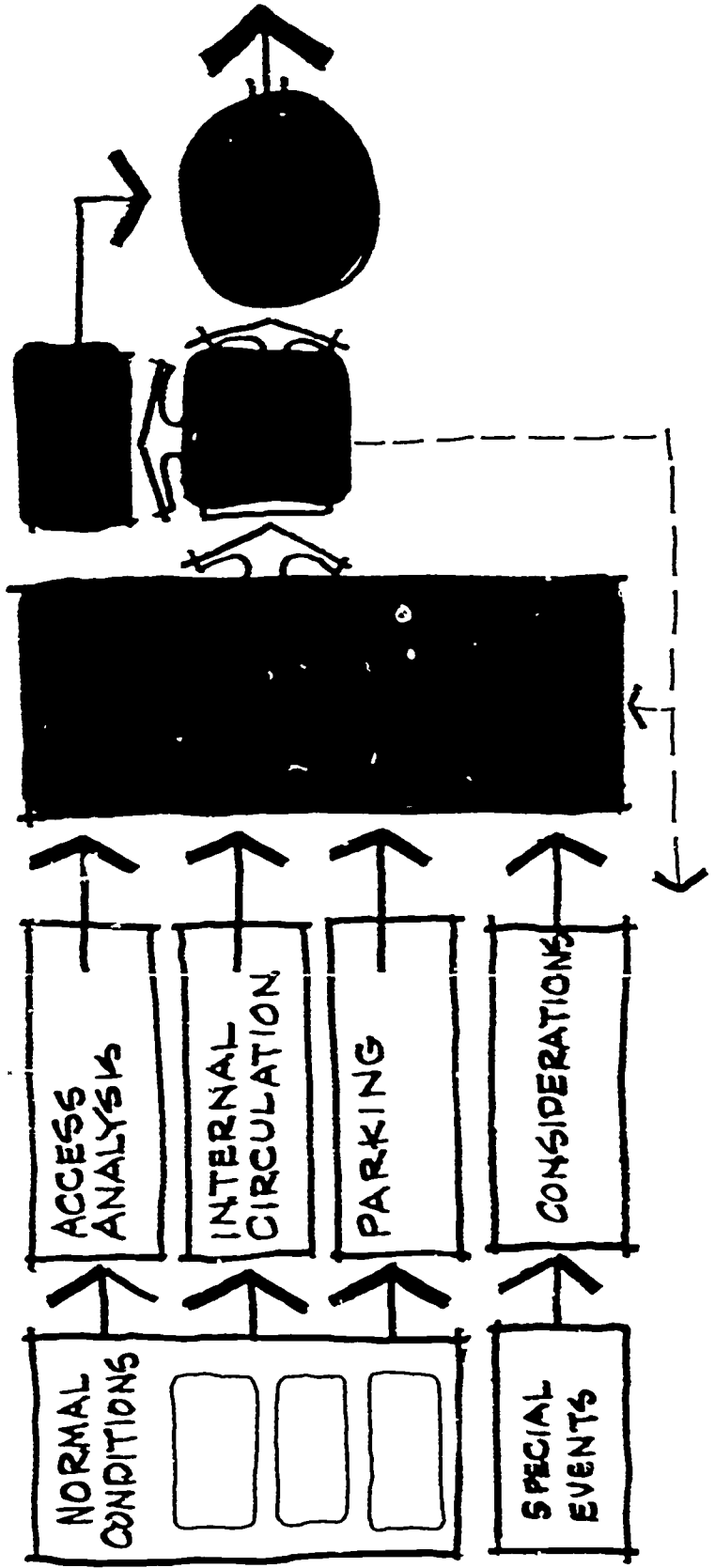



# REQUIREMENTS

The traffic planning techniques discussed in the previous sections have described various studies necessary for the development of an effective plan. This plan should provide answers to the following questions:

- (1) What new traffic facilities (streets, lots, garages, etc.) will be required?
- (2) What traffic controls (one-way streets, signalization, parking restrictions, etc.) will be required?
- (3) What influence will the traffic plan exert on other aspects of the university planning process?

The traffic plan should be reviewed in light of the overall university plan; particular emphasis should be placed on integrating it with the Physical Plant Plan. This requires a unique evaluation for each campus in order to properly reflect the type and form of campus desired.

Local and state agencies should be involved with the university in implementing the traffic plan. Certainly, interactions between these groups must occur if mutual problems are to be solved.

# FACILITIES

The need for the construction or provision of transportation facilities will be considered with respect to the following geographic locations:

- (1) External Facilities
- (2) Internal Facilities

## EXTERNAL FACILITIES

These facilities are located externally to the university campus. These would include:

- (1) New or improved streets
- (2) Public transportation
- (3) Parking

Recognition of the need for and justification of these facilities would result from studies of:

- (1) Street network
- (2) Public transportation
- (3) Parking

As stated earlier, the provisions of a major portion of the external facilities will probably be the responsibility of the surrounding community. However, the university should define its external facility needs, and should encourage the surrounding community to provide needed facilities.

## INTERNAL FACILITIES

These are facilities that would be provided within the campus. They would include:

- (1) Streets or street modifications
- (2) Parking facilities
- (3) Sidewalks or other facilities for non-automotive traffic
- (4) Transit operations

## IMPLEMENTATION

Since the traffic plan covers a ten year planning period, it is necessary to schedule the development of the various facilities to be provided. There is also a need to develop economic data on costs and income relative to the facilities provided. This data would provide an input to the overall financial planning phase of the university.

## **TRAFFIC CONTROL**

Numerous solutions to university traffic problems can be produced through an effective traffic engineering program. However, few universities have utilized the talents of professional traffic engineers to develop traffic control plans. It is therefore recommended that traffic engineering talents be added to the planning team.

The use of proven traffic engineering techniques can greatly increase the efficiency of existing facilities. These techniques will include such items as:

- (1) Placing of signs and markings
- (2) Installation of signalization
- (3) Provision of channelization
- (4) Development of one-way street operation
- (5) Development of desired parking restrictions

Particular emphasis should be placed on planning restrictive controls. These controls may include such items as:

- (1) Assignment of parking facilities
- (2) Prohibition of certain traffic movements
- (3) Prohibition of driving privileges

If deficiencies exist between the facilities available and those required, this imbalance between supply and demand can be partially resolved using restrictive controls. The planning and development of the proper control procedures is just as important as planning for the provision of new facilities. Again, the data developed in the previous studies should provide the basic information from which an effective traffic control plan can be established.

# SUMMARY

The traffic studies may provide data which will influence other aspects of the total planning process. For example, the university's decision regarding the provision of on-campus student housing may be influenced by the problem of transporting students to and from the campus. If they are housed on campus they can probably walk to and from class. However, if they live in off-campus housing located a considerable distance from the campus, there must be some consideration given to their method of transport to and from the campus. The traffic problems created by large numbers of students living off-campus can be severe. The location of buildings and other traffic generating facilities on a campus will also have a major bearing on the traffic plan.

This volume has sought to identify the studies and associated techniques necessary to develop adequate information for effective traffic planning. Traffic is a vital consideration in the overall planning process of a university and it should receive greater attention than it has in the past. It is desired that the material presented herein will be helpful in providing direction for planning to provide facilities and control for university traffic as an integral part of the total university planning process.

## ADDITIONAL VOLUMES

The following outlines describe the additional volumes in the series on Planning Guidelines:

## VOLUME I - PLANNING SYSTEM

- I. Introduction
  - A. Background
  - B. Planning Requirements
  - C. Project Scope
  - D. Project Organization
  - E. Project Presentation
  - F. Time Span
  - G. Community Considerations
- II. Management and Program Planning
  - A. University Objectives
  - B. Program Plans and Requirements
  - C. Planning Report • Academic Departments
  - D. College Summary
  - E. Planning Report • Research and Public Service and/or Extension
  - F. Planning Report • Support Organizations
  - G. University Summary
- III. Physical Plant Planning
  - A. Facilities Planning
  - B. Traffic Planning
  - C. Utilities Planning
  - D. Land Use Planning
  - E. Physical Plant Planning Process
- IV. Financial Planning
  - A. Multi-Year Budgets
  - B. Financial Evaluation
  - C. Cost Estimation
  - D. Income Estimation
  - E. Planning-Programming-Budgeting
- V. Total University Plan
- VI. Continuous Planning System
  - A. Dynamic Planning
  - B. Organization
- VII. Summary



## VOLUME II - MANAGEMENT AND FINANCIAL PLANNING

- I. Introduction
  - A. Planning System
  - B. Management and Program Planning
  - C. Financial Planning
  - D. Organization for Planning
- II. Institutional Objectives
  - A. Fact-Finding Study
  - B. Preliminary Objectives
  - C. Review and Modifications
- III. Organizational Unit Plans
  - A. Program Units
  - B. Support Units
- IV. Planning Report - Program Implementation Units
  - A. Format
  - B. Historical Section
  - C. Projections
  - D. Program Requirements
- V. Planning Report - Program Support Units
- VI. Management and Program Planning Summary
- VII. Organization for Planning
  - A. Basic Considerations
  - B. Development of Planning Organization
  - C. Staffing of Planning Organization
- VIII. Cost Model
- IX. Income Model
- X. Planning-Programming-Budgeting
  - A. Definition
  - B. Program Concept
  - C. Program Requirements
  - D. Resource Allocation

## VOLUME IV - PHYSICAL PLANT PLANNING • FACILITIES STUDIES

- I. Introduction
  - A. Problem
  - B. Required Studies
  - C. Presentation
- II. Inventory of Existing Facilities
  - A. Requirements
  - B. Facilities Manual - U.S. Office of Education
  - C. Special Requirements
- III. Utilization of Teaching Facilities
  - A. Considerations
  - B. Utilization Measurements
  - C. Reporting
- IV. Estimation of Space Requirements
  - A. Teaching Facilities
  - B. Non-Teaching Facilities
- V. Utilization of Non-Teaching Facilities
  - A. Considerations
  - B. Organizational Unit - Space Inventory
  - C. Proration System
  - D. Utilization Evaluation
- VI. Automated Assignment of Teaching Facilities
  - A. Master Schedule Construction
  - B. Student Sectioning
  - C. Summary
- VII. Quality Analysis of Existing Facilities
  - A. Physical Analysis
  - B. Cost Analysis
  - C. Intangible Analysis
  - D. Rating System
- VIII. Residential Housing Study
  - A. Single Students
  - B. Married Students
  - C. Faculty - Staff
  - D. Community Resources
- IX. Facilities Planning System
  - A. Flow Diagram
  - B. Output

## VOLUME V - PHYSICAL PLANT PLANNING • UTILITY STUDIES

- I. Introduction
- II. Energy Utilities
  - A. Chilled Water
  - B. Water Heating Systems
  - C. Steam
  - D. Condenser Water
  - E. Electric Lighting and Power
- III. Distribution Systems
  - A. Central Utilities Plant
  - B. Central Plant Distribution Systems
  - C. Controls for Central Utilities Plants
  - D. Total Energy Plants
- IV. Service Utilities
  - A. Water
  - B. Sewerage System
  - C. Surface Drainage
  - D. Domestic Hot Water
  - E. Compressed Air
- V. Communication Systems
  - A. Telephone Systems
  - B. Telegraph
  - C. Radio
  - D. Pneumatic Tube Systems
  - E. Clock and Signal Systems
  - F. Data Reclaim Systems
- VI. Summary