

ERIC REPORT RESUME

ERIC ACC. NO. ED 032 428		IS DOCUMENT COPYRIGHTED? YES <input type="checkbox"/> NO <input checked="" type="checkbox"/>	
CH ACC. NO. VT 009 314	P.A.	PUBL. DATE 66	ISSUE RIE JAN 70
		ERIC REPRODUCTION RELEASE? YES <input type="checkbox"/> NO <input checked="" type="checkbox"/>	
		LEVEL OF AVAILABILITY I <input type="checkbox"/> II <input checked="" type="checkbox"/> III <input type="checkbox"/>	
AUTHOR Brown, Howard C.; And Others			
TITLE Developing a High School Program in Ornamental Horticulture. Volume I, Nursery Management.			
BBB02243	INSTITUTION (SOURCE) California State Polytechnic Coll., San Luis Obispo		
SP. AG. CODE	SPONSORING AGENCY		
EDRS PRICE 0.50	CONTRACT NO.		GRANT NO.
REPORT NO.		BUREAU NO.	
AVAILABILITY Vocational Education Productions, California State Polytechnic College, San Luis Obispo, California 93401 (\$2.50)			
JOURNAL CITATION			
DESCRIPTIVE NOTE 121p.			
DESCRIPTORS *Nurseries (Horticulture); *Vocational Agriculture; *Management; *Program Guides; *Program Administration; Ornamental Horticulture Occupation; Managerial Occupations; Secondary Grades; Post Secondary Grades; Public Relations; Educational Facilities; Program Development; Curriculum			
IDENTIFIERS California			
ABSTRACT This manual is one of a 3-volume series prepared to guide the high school vocational agriculture teacher in teaching ornamental horticulture. Chapter I introduces the reader to ornamental horticulture and gives examples of how the subject can be integrated into an existing agriculture curriculum. Chapter II is devoted to the public relations implications of an ornamental horticulture program. Chapter III deals with the layout of physical facilities, discusses garden plot layout, and includes a list of plants recommended for each season. Presented in outline form so it may be used as a teaching unit, Chapter IV, "The Nursery Industry," includes suggestions for individual student and class projects. Suggestions on how to initiate an instructional program in ornamental horticulture in high school curriculums are presented in Chapter V, and Chapter VI considers the relationship of plant production and student project activity to classroom work as well as legal implications of plant sales. Chapter VII contains a suggested calendar of monthly operations in the garden and nursery and a list of monthly topics for classroom presentation. Information plans and illustrations describing construction of a lathe house for use in high school ornamental horticulture program conclude the document. (DM)			

ED032428

INSTRUCTIONAL MATERIALS FOR
USE IN TEACHING AGRICULTURE

Developing a High School Program in
ORNAMENTAL HORTICULTURE:

VOLUME I **NURSERY**
MANAGEMENT



A MANUAL DESIGNED FOR THE HIGH SCHOOL TEACHER
OF ORNAMENTAL HORTICULTURE

VT000113



PREPARED BY
CALIFORNIA STATE POLYTECHNIC COLLEGE

**Developing a High School Program
in Ornamental Horticulture**

VOLUME I -- NURSERY MANAGEMENT

by

Howard C. Brown, Ph.D

**Head, Ornamental Horticulture Department
California State Polytechnic College
San Luis Obispo Campus**

with

**Martin Koobation, Vice Principal
Carpenteria Union High School**

**Thomas C. Cunningham, Instructor
San Dieguito Union High School**

**Charles King, Instructor
Van Nuys High School**

**U.S. DEPARTMENT OF HEALTH, EDUCATION & WELFARE
OFFICE OF EDUCATION**

**THIS DOCUMENT HAS BEEN REPRODUCED EXACTLY AS RECEIVED FROM THE
PERSON OR ORGANIZATION ORIGINATING IT. POINTS OF VIEW OR OPINIONS
STATED DO NOT NECESSARILY REPRESENT OFFICIAL OFFICE OF EDUCATION
POSITION OR POLICY.**

**Instructional Materials Program
California State Polytechnic College**

M E M O R A N D U M

TO: The ERIC Clearinghouse on Vocational and Technical Education
 The Ohio State University
 930 Kinnear Road
 Columbus, Ohio 43212

FROM: (Person) Clyde Hostetter, Coordinator (Agency) Vocational Education Productions
 (Address) c/o California State Polytechnic College, San Luis Obispo, Calif. 93401

DATE: _____

RE: (Author, Title, Publisher, Date) Publisher: Vocational Education Productions
Nursery Management, 1966

(PROSPECTUS MANUAL)

Supplementary Information on Instructional Material

Provide information below which is not included in the publication. Mark N/A in each blank for which information is not available or not applicable. Mark P when information is included in the publication. See reverse side for further instructions.

(1) Source of Available Copies:

Agency Vocational Education Productions
 Address California State Polytechnic College, San Luis Obispo, Calif. 93401
 Limitation on Available Copies None Price/Unit \$2.50
 (quantity prices) ----

(2) Means Used to Develop Material:

Development Group College faculty and high school teachers
 Level of Group College and high school
 Method of Design, Testing, and Trial Review by teachers and subject-matter specialists of basic content requirements; review by similar group after completion of production

(3) Utilization of Material:

Appropriate School Setting High school or junior college ~~classroom~~
 Type of Program Vocational
 Occupational Focus Agriculture
 Geographic Adaptability National, with special Western interest
 Uses of Material Supplement regular school instruction
 Users of Material Students and teachers on high school & jr. college levels

(4) Requirements for Using Material:

Teacher Competency Average vocational agriculture teacher
 Student Selection Criteria average students in vocational agriculture at high school or junior college levels
 Time Allotment See notes on main form for discussion

Supplemental Media --
 Necessary) (Check Which)
 Desirable

Describe Standard textbooks in teaching of vocational agriculture

Source (agency) _____
 (address) _____

TABLE OF CONTENTS

	Page
Foreword	ii
Chapter I - Introduction	1
Chapter II - The Agriculture Department and Its Public Relations . . .	5
Chapter III - Garden Layout and Operation	11
Chapter IV - The Nursery Industry	25
Chapter V - Starting an Ornamental Horticulture Program	53
Chapter VI - Operating the High School Nursery	61
Chapter VII - Monthly Calendar of Activity and Content	69
Chapter VIII - Building a Lath House	80

FOREWORD

Ornamental horticulture is one of the most exciting and rapidly-developing fields of agriculture. Whether a person lives in a rural or urban environment, he comes into contact almost daily with some phase of horticulture. The plantings around his home, the trees that line his city's streets or border the country road, and the park or golf course where he spends his leisure time, are all examples of planning and development by someone engaged in horticulture.

When a country is young and developing, little attention is given to beautification of surroundings because most of the energy, of both the individual and the community, is directed toward mere subsistence. But as the country matures and its people begin looking beyond everyday necessities, they seek beauty, relaxation, and the other things that give life more meaning.

The United States and California, the nation's largest state, have both come of age. Nationally, over 30 million people list gardening as a hobby. Only the schools of communities can fulfill the education needs of both these amateur horticulturalists and the professionals who will grow and market the plants and services they will use. This learning experience must not only help them prepare for a career, but also must help them understand and appreciate the beauty of horticulture and how it can contribute to their lives. Fortunately, California is among the nation's pioneers in horticultural education.

Organization of the Manual

This manual has been prepared as a guide for the high school agriculture teacher. It should be of value to him in presenting the subject of ornamental horticulture as an important part of his total agriculture program, and is the first of a series of three such volumes designed to cover the entire field of ornamental horticulture at high school level.

It is not intended for reading from cover to cover in one sitting, but rather, to serve as an instructional guide with the development of the individual program on which the reader is working. This practical approach to development of an ornamental horticulture program, which emphasizes nursery management and the different uses intended for the various chapters, has made some repetition necessary from chapter to chapter.

Chapter I introduces the reader to ornamental horticulture and gives examples of how the subject can be integrated into an existing agriculture class or curriculum. Along this same line, Chapter II is devoted to the public relations implications of an ornamental horticulture program for an agriculture

department. It includes many examples of how ornamental horticulture programs have been employed by successful teachers to contribute to good public relations for their departments.

Chapter III deals with the layout of physical facilities, with emphasis on efficiency and easy supervision of students. In addition to building orientation, it also discusses garden plot layout and includes a list of plants recommended for each season. Presented in outline form so it may be used as a teaching unit, Chapter IV begins with a general discussion of the nursery industry in California. It also includes suggestions for individual student and class projects.

Project Work Discussed

Suggestions on how to initiate an instructional program in ornamental horticulture in high school curriculums are presented in Chapter V, which also includes listings of ornamental plants that are easy to produce and market. Chapter VI is devoted to discussion of the high school nursery as an important part of the instructional program. It considers the relationship of plant production and student project activity to classroom work. Methods of growing and marketing ornamentals, as well as legal implications of plant sales, are presented.

Chapter VII appears in two parts. The first consists of a suggested calendar of monthly operations in the garden and nursery, while the second constitutes a list of monthly topics for classroom presentation. Chapter VIII, which concludes the volume, contains information plans and illustrations describing construction of a lath house for use in a high school ornamental horticulture program. It is based, as are many of the other suggested plans and activities, on the experiences of a successful high school agriculture department.

In conclusion, special thanks for their kindness in allowing use of their illustrations and other material are due the General Electric Company, The Los Angeles City Schools, and the Kellogg Supply Company.

Mention of trade names of the names of firms in this manual is for the sole purpose of providing information and does not constitute recommendation, guaranty, or warranty of the product or firm, nor does it express approval of the product or firm to the exclusion of other comparable products or firms.

CHAPTER I

Introduction

Ornamental horticulture involves the production, processing, sale, and use of ornamental plants. It is an important segment of the economy of California. With every census of the state's resources and economic condition ornamental horticulture has increased in importance. In wholesale dollar value, California's nursery industry ranks fourth and the florist industry ranks fifth among all crops produced. Nursery stock grown in the state in 1964 had a field value of \$138 million and amounted to over 17 percent of the nation's total. Those amounts made California the number one shipping state, as well as the number one consumer, of nursery stock.

With the great variety of ornamental plants available, and the demand of the public for beautification, it is only natural that the landscape industry should also prosper. Because of higher income levels and other interests, the average homeowner is no longer content to beautify by trial and error. He is willing to pay for the services of a landscape architect or designer who plans in terms of overall beauty rather than on the basis of a few individual plants. To minimize maintenance the homeowner employs the services of a landscape contractor who does construction work and installs sprinkler systems, in addition to doing planting. Since the landscaper sells services, as well as material things, it is difficult to measure the value of landscaping, but the value of lawns in California is greater than \$900 million with annual maintenance costs amounting to \$300 million more. Landscaping is, consequently, a rapidly-expanding field and one in which a properly-trained individual can become self-employed and financially secure with a minimum of capital.

Closely associated with the nursery industry is the production of flowers and potted plants for interior decoration. This field is referred to as floriculture and the person who processes and merchandises these products for the consumer is called a florist. Because of desirable climate and high winter light intensity, California has long been the leading flower producing state of the nation. So efficient are its flower producers that they can grow flowers on the West Coast and deliver them to the Eastern and Midwestern markets in better condition and at a lower price than can local producers in those areas. Well over 50 percent of all the air freight shipped from San Francisco's International Airport is cut flowers en route to florists in the East.

Career Advantages

Among advantages of ornamental horticulture as a career are:

1. No geographical limitation -- A person engaged in ornamental horticulture is not limited to any geographic area of the state in the way a person employed in other industries might be. Whether the community

is urban, suburban, or rural he will find either a suitable environment for production of ornamentals or a demand for his services.

2. Desirable type of work -- Most people in ornamental horticulture are in the business because they like the nature of the work. They enjoy growing plants, serving the public, or expressing their artistic talents in design. It is not the type of business that one grows out of, but rather one adapted to people of all ages.
3. Opportunity for self-employment -- In many phases of agriculture, business, and industry it is almost impossible for a young person to be his own boss unless he comes from a family already engaged in the business or has good financial backing. This is not the case in ornamental horticulture. Although experience in the employ of someone else is desirable, it is quite possible for an individual to start his own business with limited capital.
4. Status in the community -- A person with good training in ornamental horticulture and a reasonable amount of initiative can earn well above the average income. Equally important, he commands respect because of his knowledge of plants and their uses. He has the personal satisfaction of knowing that he can and does contribute to the beauty and prestige of the community.

During the past ten years, urbanization has created many complex problems for California's agriculture economy. In some areas, animal farming has all but disappeared because of shrinking acreage, taxes and health problems associated with densely-populated areas.

One small community of 8,000 population, situated approximately 100 miles north of Los Angeles, is typical of this transformation. Cattle and dairy production has virtually disappeared. Avocados, lemons, poultry, and vegetable truck crops are rapidly being replaced by subdivisions and ornamental horticulture. Available land sells for from \$10,000 to \$15,000 an acre. This price factor necessitates a highly-specialized type of farming if the investor is to realize a profit and remain in business.

Urbanization Changes

Ornamental horticulture appears to be the answer to the problems of urbanization and increasing numbers of bedroom communities. Nurseries forced out of the large metropolitan areas can still farm profitably on less acreage and attract acceptable labor from outlying communities. High school students are adapting well to part-time job opportunities related to horticulture and are becoming aware of the many advantages offered in this vocation.

Since urbanization is rapidly becoming dominant, it appears that vocational agriculture will encounter many problems that were not apparent at the turn of the century and during the inception of the Smith-Hughes Act. Many high school agriculture departments may find it difficult to shift emphasis or even give token recognition to horticulture, but once the change has been made,

the instructor can face the new challenge with more confidence and dedication. Student interest in horticulture projects will gradually increase as new skills are introduced and acquired.

Facilities are important, but a new department can function with a few basic garden tools constructed in its shop, and an acre or two of land to propagate nursery stock.

One high school started an ornamental horticulture program ten years ago, utilizing an abandoned lath house and a glasshouse that were badly in need of repair. Shop classes renovated the buildings, substituting a rigid plastic material, which reduced maintenance costs to a minimum, for glass on the greenhouse. A hotbed was also installed in the greenhouse, shelves were constructed, and plumbing and electrical wiring were installed throughout the building. All of this work, which was done by the various agriculture shop classes, took two years to complete.

During the construction period, nursery practices and ornamental horticulture, in general, were not formally taught. Since the department had predominantly emphasized animal husbandry for 27 years, it was decided to make the change gradually with complete shift of emphasis seemingly in order by the time the upper classmen had been graduated. The instructor propagated plants during the construction period and for several months after the buildings were put into operation. Students were allowed to move in and out of the nursery area at will, but were never asked, or required, to work in any phase of the new operation, though many questions were posed. Interest was generated after the department won a first place prize at the local county fair for its exhibit in the Future Farmers of America educational division. The exhibit, which included a miniature glasshouse stocked with plants grown in the chapter nursery, received county-wide newspaper publicity and recognition from both the local community and the high school.

Subsequently, students who had worked on the fair exhibit began asking questions about horticulture, and requested information related to projects in the field. With interest obviously at a high level, the instructor then offered a series of lectures on ornamental horticulture, which also emphasized job opportunities in ornamental horticulture industry and its allied fields.

As more and more factual information was introduced, statistical comparisons were made with other vocations. Students could readily see the advantages of ornamental horticulture and how rapid urbanization of the Western United States was adding to the opportunity. They learned for the first time that, for less money, on fewer acres, with fewer risks and, in most instances, easier work, ornamental horticulture offers excellent opportunities. Finally, they learned that an ornamental horticulture program makes it possible for students living in the city to compete with those from the farm in project work.

Students must not be forced into horticulture projects. Since it is quite obvious an animal project may have more appeal and glamour than raising nursery stock, they must voluntarily want to venture into this area. Generally speaking, the vocational student will eventually embark upon a horticulture project if he has been properly oriented and exposed to its advantages.

Vocational agriculture teachers have a natural asset when offering ornamental horticulture projects. Most students who are interested in agriculture and who have a little ingenuity are able to participate actively in the program. On the other hand, animal projects may deter potentially interested agriculture students because of numerous problems. Students who live in the city and those with limited resources can satisfy vocational agriculture requirements by raising nursery stock in the back yard or on an assigned plot in the school nursery. Equally important, the loss of a few flats of nursery stock certainly cannot be as disastrous financially to the student, as would be the loss of a prize animal just prior to its entry into show competition.

Vocational agriculture teachers with limited ornamental horticulture experience should not hesitate to introduce horticulture if they are so inclined. Reference materials, periodicals, workshops, summer course offerings, and college specialists are available to the novice for the asking.

Teachers introducing ornamental horticulture for the first time must strive to present a practical down-to-earth course. Technical knowledge is desirable and has its advantages, but at the outset high school students really do not need that type of course. For more academically-oriented students, resource materials made available as a supplement to the regular course offerings are recommended. Instructors must cater to all the students, encouraging many of them to continue their education after graduation. Others, with a three or four year high school background in basic horticultural skills, can embark on promising careers in nursery work, park maintenance, estate and private property management, or in other allied agricultural pursuits.

Few other phases of training in the vocational agriculture field can begin to offer the many opportunities available in ornamental horticulture.

CHAPTER II

The Agriculture Department and Public Relations

I. Objectives of the Public Relations Program:

- A. To project a positive image of worthwhile, meaningful activities.
- B. To instill pride, to build "esprit de corps" in students for their department.
- C. To constantly improve and upgrade the department's program and help attract the best students possible.
- D. To reinforce the importance of agriculture in the curriculum.
- E. To demonstrate acquired skills to their best advantage.

II. The Teacher

- A. The teacher is a "walking billboard" constantly advertising his department and its primary product, his students. As such he should:
 1. Be convinced of the worth of his department's program.
 2. Realize that he is not teaching to a "dead end", but that he is training future leaders of a fast-growing industry with a great future.
 3. Speak well of his program, his students, and fellow teachers.
 4. Radiate enthusiasm.
 5. Be willing to give extra time and effort.
 6. Be willing to share his knowledge and experience with others.

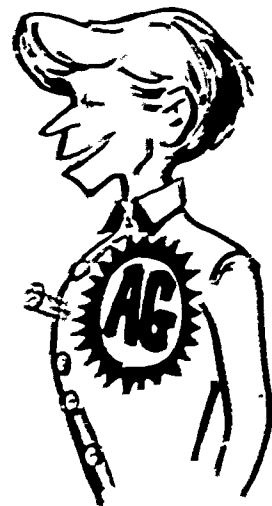

III. The Students

- A. As in any successful endeavor, the final measure of success is achievement of the goal or product.
- b. Students take pride in facilities that reflect good housekeeping.
- C. Vandalism, defacing furniture, and writing on walls are acts seldom performed by students thoroughly sold on their department's program.
- D. In more ways than can be realized, students reflect their teachers' attitudes.



IV. Public Relations Ideas and Techniques

A. For departments having general programs:

1. Departmental participation in civic beautification and other community projects.
2. Stories prepared and submitted to school and local newspapers and broadcasting stations. (Student "by-lines" should be used whenever possible.)
3. Tours of the agriculture department by nursery schools, Cub Scouts, and other similar groups. Trained and qualified student guides to explain the program and answer questions will be helpful and make good representatives for the department.
4. Class field trips to nearby business and industrial installations.
 - a. Don't disregard the reciprocal value of potential employers meeting students.
 - b. Pre-structuring for field trips pays off in good behavior and attention.
 - c. Follow up with "thank you" letters.
5. Printed or mimeographed brochures
 - a. Present to guests, interested parents, etc., who visit department, to explain agriculture program and facilities.

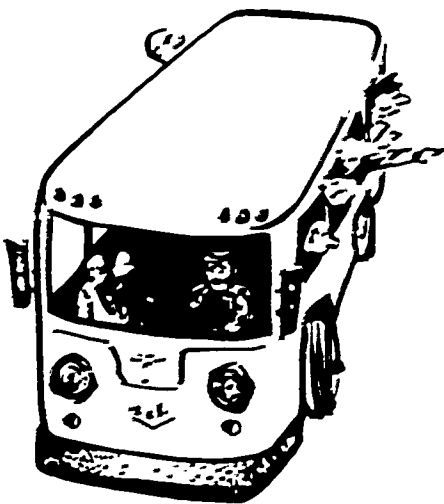

- b. Even the most disinterested may be captivated by an attractive folder beginning "Welcome to the Harover High School Agriculture Department."
6. Appearances before clubs, civic organizations, PTA's, etc.
 - a. May feature teacher as garden authority.
 - b. Students may demonstrate skills.
7. Plants for non-profit organizations
 - a. Such plants are primarily for groups which are unable to pay for plants or labor.
 - b. Be sure local nurserymen are aware of the fact that if such plants were not donated, groups using these plants would not be able to enjoy them.
8. Use agriculture department heading or letterhead on all printed or mimeographed "hand-out" material.
9. Attractively-lettered signs displayed either on fences around agriculture area or inside the area in prominent locations may be used to identify the department or indoctrinate guests and visitors through use of a motto such as "Learning by doing," "Our business is growing," etc.
10. Parent tours of department areas
 - a. Special open house
 - b. Special visiting day during which visitors may be given a small corsage or potted plant as a memento.
 - c. For visiting day, one school using the "area of responsibility" approach labeled the students' areas, "This area expertly maintained by Jim Gardener," etc.
11. Select students carefully for placement in off campus jobs.
 - a. Stress the fact that they go on the job as representatives "of our department."

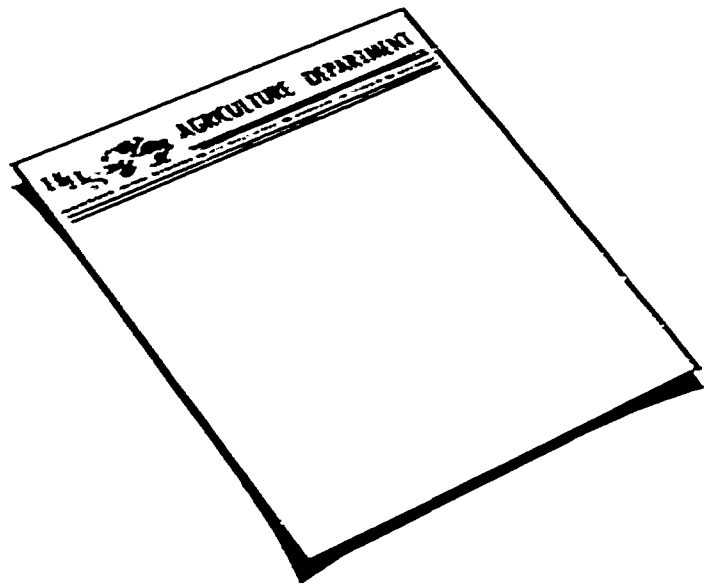

- b. A satisfied employer is an excellent public relations man for the department.

12. Printed pot labels

- a. Most print shops are able to print pot labels.
- b. Suggested wording: "Grown by students of the Hanover High School Agriculture Department"

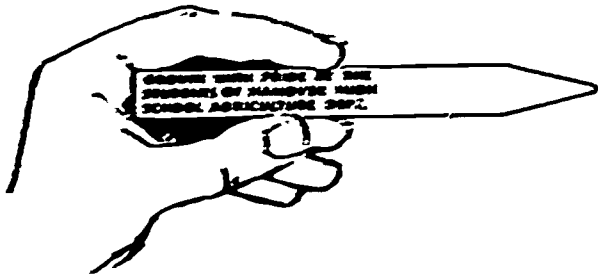

13. Send flowers to school offices on regular delivery basis, if possible.

- a. Send students to arrange for placement, delivery, etc., if possible.
- b. For best arrangement each week, a small printed card, worded: "Arrangement by Mary Gardner, Agriculture Department, Hanover High School," may be used at the base of arrangement to give added recognition and incentive.

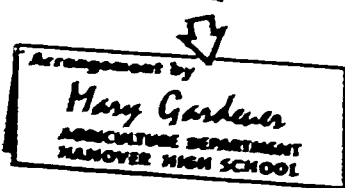

14. Floriculture displays

- a. Library exhibit areas are frequently available for special corsage or term project displays.
- b. Hall display cases and other areas may also be available to exhibit corsages for special occasions.
- c. A small, but often important point -- when girls complete corsages, insist that they wear rather than carry them. Doing so insures quality (who wants to wear a poor one?) and inspires such questions as, "Where did you get it?"

15. Invitations to visit agriculture department facilities

- a. To science, home economics, and other related classes
- b. To administrators, teachers, and other school staff members
- c. To parents and other community groups

16. Invite outside speakers to class.
 - a. Nurserymen may tell of experiences while getting started in business.
 - b. Landscapers may discuss needs for trained personnel, etc.
17. Exhibits in flower shows, fairs, etc.
18. Reproduce and distribute home owners' service information, brochures, etc.

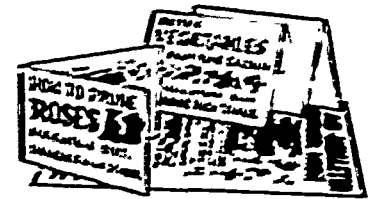

- a. County farm advisers have many "how to" publications which schools are free to reproduce.
 - b. Use under department heading, giving full credit to originating source.
 - c. Parents welcome mimeographed information on "how to rid your lawn of crabgrass," "how to control gophers in your lawn," etc.
19. Contacts with junior high and/or feeder schools
 - a. Present graduating students with brochure outlining agriculture department program and other facts.
 - b. Be sure counsellors at various schools are familiar with department's program.
 20. Keep school administrators, counselors, etc, informed. Never presume that they know; repetition may reinforce facts.
 21. Make slides or post photos of department students with successful projects.
 22. Keep a card file of alumni. Know where to find examples of success in the field.
 23. Keep exhibits and displays in the classroom and change them regularly.
 24. Acknowledge all gifts of materials, funds, equipment, etc., to the department.

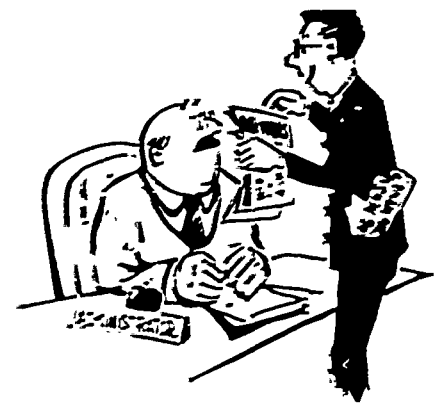

B. Additional suggestions for departments with Future Farmers of America chapters

1. Invite community leaders to speak at FFA meetings. Follow such appearances with letters of thanks.
2. Use the "Honorary Chapter Farmer" degree to express appreciation for services performed or contributions to chapter.
3. Encourage leadership by chapter members, in school activities, fund raising drives, etc. (Chapter may volunteer as ushers, etc., in jackets.) (see following item).
4. Wear the FFA jacket.
 - a. Wearing the jacket should be a privilege, not a right. Students earn points for the privilege.
 - b. Enforce behavior rules for FFA jacket wearers, i.e., "no smoking," etc.
 - c. Chapter members who present behavioral problems should never be permitted to obtain jackets.
 - d. Inaugurate "FFA Jacket Day" one day each week to recognize members who have earned privilege to wear the jacket.

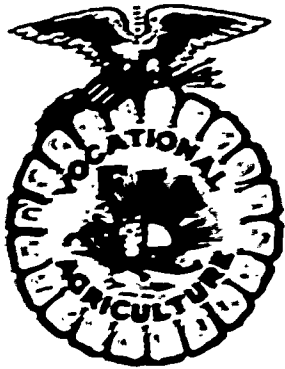

HHHS

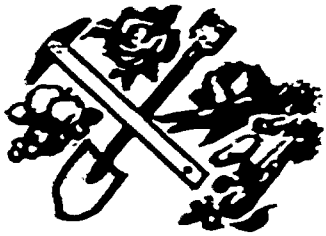

AGRICULTURE DEPARTMENT

HANOVER HIGH SCHOOL ■ 212 WEST STREET ■ HANOVER, CALIFORNIA ■ 685-9954

November 1, 1965

Mr. Ralph W. Jones, Owner-Manager
Commercial Nurseries, Inc.
1234 West Main Street
Hanover, California 93200

Dear Mr. Jones:

The Hanover High School Agriculture Department acknowledges with thanks your contribution of 50 orchid plants. Valued at \$2,000, according to your appraisal, they will be used to further the education of students of ornamental horticulture in our school.

As you know, gifts such as yours make it possible for Hanover High School, a tax-supported non-profit institution for public education, to offer such specialized courses as those which our department offers in ornamental horticulture.

Please accept our sincere thanks for your interest and generosity.

Sincerely,

Ralph W. Greenthumb
Director

Fig. 2.1: Suggested Format for Letter Acknowledging Gifts to the Agriculture Department

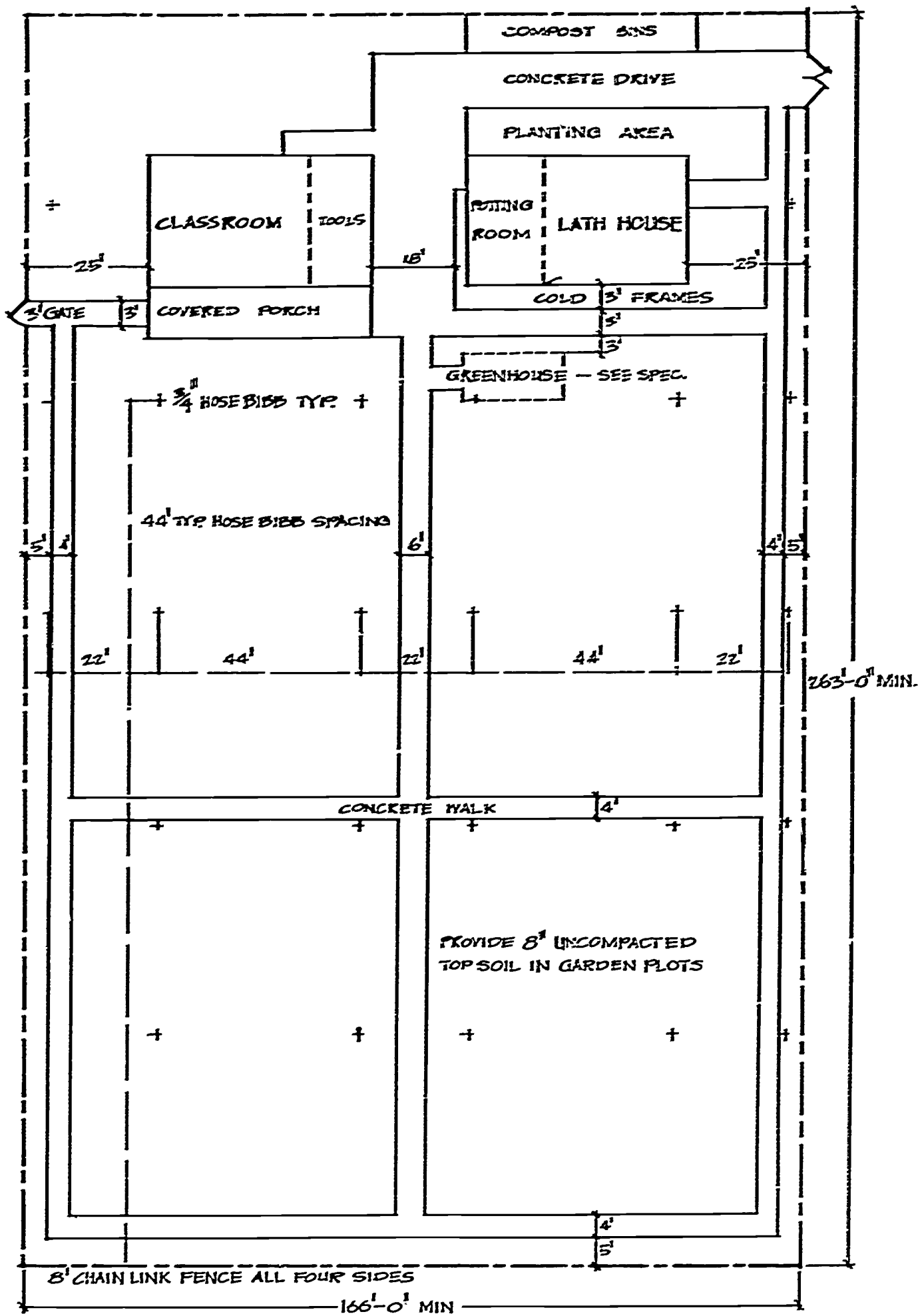

TYPICAL AGRICULTURE PLOT PLAN

MINIMUM AREA - ONE ACRE



REF. NORTH

Figure 3.1

USED BY PERMISSION OF LOS ANGELES CITY SCHOOLS

CHAPTER III

Garden Layout and Operation

I. Overview for Planning

- A. Traffic flow, availability of materials, relative location of various operations, and overall efficiency and supervision are all important factors in planning facilities for inclusion of ornamental horticulture in a high school agriculture department's curriculum.
- B. Suggestions for consideration of such factors can be readily obtained through visits and inquiries to departments and/or schools that have recently completed or are currently planning new ornamental horticulture facilities.

Figure 3.1 shows one method of locating facilities for efficient operation and use. Note that the area is entirely enclosed by an eight-foot chain-link fence with but 2 openings -- one, a five-foot pedestrian gate, the other, a 14-foot truck gate.

- C. Regardless of whether a plan such as that shown in Figure 3.1, or another, is chosen, both availability and accessibility must be kept in mind.
- D. Throughout the entire planning period, and especially during its early stages, future needs must be kept in mind and planned for.
- E. Establishment of a master plan for development of the department's facilities has its advantages. Among them are illustration of greater interest on the part of the department head or teacher; insurance of orderly, progressive development; and, based on an adequate mobility study, savings of countless hours of wasted effort.

II. Mobility Study

- A. A revealing analysis that will help determine the best and most efficient layout for an individual department's particular needs is the mobility study. A carefully-kept diary of all walking performed by the instructors during a week of typical teaching activity lists the approximate distance in feet (paced off or estimated) for each activity. Figure 3.2 illustrates how such activities can be entered.
- B. In addition to its value to planning for department facilities, a mobility study may provide two-fold value.

1. The surprising number of trips to various areas may lead to the natural inquiry, "How can I consolidate and reduce the gross number of times I repeat an activity in one day?"

Date	Activity	Distance
April 12	Entrance Ag area, to classroom	75 ft.
	Classroom to lath house (demo)	50 ft.
	Tool room to classroom	26 ft.
	Classroom to southern fence	166 ft.
	Southern fence to tool room	192 ft.
	Tool room to classroom	26 ft.
	Tool room to glasshouse	60 ft.
	Classroom to glasshouse	60 ft.
	Glasshouse to potting shed	20 ft.
	Potting shed to classroom	40 ft.

Figure 3.2: A Typical Mobility Study Diary

2. A second similar inquiry might be, "How can I more efficiently cluster my operations and activities so that those areas visited frequently are close and areas needing the least number of trips are farther away?"
- C. The diary illustrated in Figure 3.2 readily shows how even ten steps per day saved through proper location of a facility in an activity cluster can amount to considerable saving in time and energy over a period of years of departmental operation.
- III. Facility groupings -- with the efficiency approach in mind, the total agriculture department area may be thought of as a group of areas located according to activities.
- A. Receiving and materials storage area -- Features necessary to efficient operation include:
 1. Wide (14') gate from street or school campus area needed for easy truck deliveries.
 2. Compost bins for material storage and production of compost.

3. Adjacency to tool or equipment room (for receiving of supplies) and lath house and glasshouse (for shipping of stock).

B. Demonstration and activity areas

1. Facilities of greatest concentrated activity should be clustered near the classroom.
2. Facilities that may be included as part of the demonstration and activities area are:
 - a. Tool or equipment room.
 - b. Lath house.
 - c. Potting shed.
 - d. Glasshouse.
 - e. Cold frames.
 - f. Nursery area for display of container-grown plants.
3. In some situations, it may be profitable to combine the tool or equipment room and the lath house in a single unit.
4. Similarly, the potting shed and the glasshouse may also be combined.

C. Classroom area

1. Preferably situated so it commands an unobstructed view of practical work and laboratory areas.
2. Surrounding grounds should afford opportunity for landscape and lawn maintenance practice.

D. Practical work and lab area

1. Includes the garden plots and remaining departmental area.
2. Primary purpose of practical work area is to provide room for students to gain practical experiences in ornamental horticulture.

IV. Use of practical work and lab areas -- Use of part of the practical work area as garden plots should be governed by both the needs of the community and content of the department curriculum. The entire area should be regarded as a learning laboratory, a vital extension of the classroom based on the premise that "to learn facts is essential; to learn by doing is to translate facts into action." The area may be divided to include any or all of:

CLASSIFICATION AND USE OF FLOWERS

The purpose of this information is to help you understand how flowers are classified. Knowing this, you should be able to select a variety of flowers that will give your garden color all year.

CLASSIFICATION: (Flowers, like vegetables, are classified into three groups.)

- Annuals:** Plants that grow, flower, and produce seed within one year, and then die. Annuals are grown from seed only.
- Biennials:** Plants that require two years, or parts of two years, to mature. Biennials are grown from seed only.
- Perennials:** Plants that normally live more than two years, each year producing flowers. Perennials may be propagated from seeds, cuttings, divisions, layering, budding, or grafting.

USE:

Annuals may be grown in beds or borders which can be changed each year.

Examples:

Winter or early spring bloom (sow in late summer or fall)

african daisy	cineraria	snapdragon
bachelor button	larkspur	stock
calendula	marigold	sweet pea

Late spring or early summer bloom (sow in early spring)

african daisy	petunia	snapdragons
asters	primula	stock
cosmos	salvia	sweet alyssum

Summer or fall bloom (sow in late spring)

bachelor button	gaillardia	salvia
cockscomb	lobelia	sweet alyssum
coreopsis	pinks	zinnia

Biennials are not as common as annuals and perennials. Many biennials are grown as perennials and therefore should be placed in the garden or borders where they will not be disturbed. Sow in spring.

Examples:

cape forget-me-not	canterbury bell	hollyhock
chinese forget-me-not	foxglove	sweet william

Perennials have many uses. You can select varieties for shade or sun, for narrow or wide spaces.

Examples:

campanula	coreopsis	chrysanthemum
canna	ferns	penstemon
columbine	fuchsia	phlox

Fig. 3.6: (from Los Angeles Junior High School Manual)



Fig. 3.3: Lath House



Fig. 3.4: Nursery Display Area



Fig. 3.5: Centrally-Located Classroom

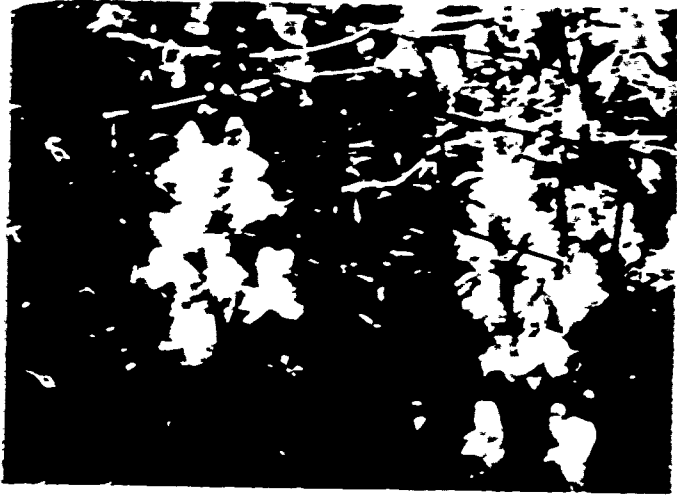

Fig. 3.9: Annual Flower—Snapdragon



Fig. 3.10: Perennial Flower—Marguerite



Fig. 3.11: An Instructional Rose Garden



Fig. 3.12: Specialized Flower Crop—Cymbidium Orchids

PLATE IV

A. **Floral Production** -- Sub-areas in the garden plot portion of the practical work area may be planned to correspond to growth characteristics (i.e. annual, perennial, etc.) of the plants to be grown. Figure 3.6 -- offers an example of how various floral plants can be located. Perennials and biennials should be planted and maintained in the same sub-area.

1. **Annual flower production** -- For use in production of annuals for cut flowers, garden color, or fragrance. Generally, production may be timed for maximum utilization by the school's grounds department through use of the charts presented in Figure 3.7 and Figure 3.8. See also, A Manual on Nursery Practices, by William P. Morgan, Jr.
2. **Perennial flower production** -- For production of perennial plants for cut flowers, garden color, or fragrance.
 - a. In this area, time of bloom is particularly important, both to provide flowers when annuals may not be obtainable and to provide flowers during the school year.
 - b. Suggested plants include: Spring bloom -- Columbine*, Marguerite*, Foxglove*, Iberis (Perennial Candytuft), Arctotis* (African Daisy); Late Spring bloom -- Shasta Daisy*, Delphinium*, Dianthus* (Pink), Echium (Pride of Madeira), Gaillardia*, Gerbera*, Penstemon*, Phlox*, Scabiosa*, Sweet William*, Carnation*; Fall bloom -- Chrysanthemum*, Delphinium*, Penstemon*, Carnation*. (Refer also to A Manual on Nursery Practices, by William P. Morgan, Jr.)
3. **Roses** - A rose garden gives practical experience in rose culture, pruning, propagation, and cut flower production.
 - a. Variety in rose plantings aids in study of identification.
 - b. Massing of varieties permits growing particularly choice roses in sufficient quantity for arrangements or corsage use.
 - c. Climbing roses trained to horizontal growth on chain link fences provide an abundance of bloom.
 - d. Local conditions will dictate choices of varieties.
4. **Specialized flower crops** - Many special crops such as Cymbidium Orchids, usually grown under glass or saran cloth; exotic orchids, usually grown under glass; and pot plants, such as Hydrangeas or

* -- May also be used as cut flowers.

FALL FLOWER CHART
PLANTING TO OPEN GROUND

Flower Kind	Height	Color	Season of Bloom	Distance Apart - Rows	Time To Bloom From Seed	Cultural Directions - Remarks
Antirrhinum "Snapdragon" Transplant	10" - 40"	White Yellow Pink Red	March - May	36"	6 - 8 months	Seed to flats in July - spot when 1" high. Transplant 24" apart in furrows
Calendula Seed	12" - 18"	Lemon Orange	Dec. - June	30"	4 months	Sow seed in place in 1" deep furrows and cover with sand - when 4" high thin to 18" spacing - keep cutting for continuous bloom. Hardy for handling by children
Larkspur Seed	24" - 48"	White Pink Lavender Purple	May - August	30"	4 - 6 months	Sow seed - broadcast in 6" wide furrows - set 30" apart - cover with sand. Broadcast- ing gives support against wind. Eliminates staking
Scabiosa Seed	12" - 24"	Various	Contin- uous	30"	7 - 10 months	Sow seed to single furrow - early as possible. Thin to 12" when 6" tall
Stocks Seed "Mathiola"	18" - 36"	White Purple Blue-Pink Ruby	Feb. - June	28" Ridge Centers	7 - 8* months	Dislike transplanting - drill seeds to single row on ridge. Thin columnar types to 6"
Sweet Pea Spencer - Fall-Sept. Cuthbertson - Spring-March -- Seed		Various	Feb. - June	48" if planted in plots-not against wall or fence	6 - 8 months	Drill seeds in row 4" deep. Gradually fill in as plant grows. Dust every two weeks-sulphur. Water - respond to blood meal. Build trellis before planting

* -- In many cases bloom from seed time will be as short as three months.

Fig. 3.7

SPRING FLOWER CHART
PLANTING TO OPEN GROUND

Los Angeles Junior
High School Manual

Flower Kind	Height	Color	Season of Bloom	Distance Apart - Rows	Time To Bloom From Seed	Cultural Directions - Remarks
Aster Transplant Seed	12" - 24"	Purple White Pink	July - Sept.	30"	3 - 4 months	Sow seed in hot bed in February or March - spot to flat or 2" pot. Transplant to "Y" furrow in April -- thin to 24"
Centauria	18" - 36"	Blue Pink White	March June	30"	4 - 6 months	Sow seed in place in January, Thin to 18", Spray for aphids - prefers cool weather
Celosia Dwarf forms	18" - 36"	Red Orange Pink	May - August	30"	4 - 6 months	Sow seed in single rows, Late spring - thin - easily transplanted - needs water, Long lasting flowers - likes heavy soils
Marigold Winter Border Tall (African)	12" - 36" (French)	Yellow Orange Brownish	May - Dec.	30"	3 - 4 months	Sow seed in single row furrows - cover with sand - thin to 12" - plants grown in flats set 2" deeper in open ground - handy for handling by children
Zinnia	8" - 36"	All Colors Except Blue	Late May August	30"	1-1/2 - 3 months	Seed sown in single row in early April - water by furrows - subject to mildew. Add lime to acid soils. Respond to seedling in flats. Good for teaching transplanting

Fig. 3.8

Lilies, cut flowers, such as Carnations or Chrysanthemums, require special growing conditions such as the growing bed shown in Figure 3.13. Once again, however, local conditions will dictate whether or not a portion of the agriculture area can be profitably devoted to production of such floral crops.

5. Flowering shrubs - Many shrubs can be grown for the dual purpose of identification and flower (or berry) production. Examples of such shrubs include Adenocarpus, Camellia, Chamaelaucium (Geraldton Wax Flower), Coloneaster, Erica (Heather), Genista (Broom), Hibiscus, Illex (Holly), Leptospermum hybrids (Hybrid Tea Trees), Philadelphus (Mock Orange), Pyracantha, Spiraea (Bridal Wreath), and Weigela.
6. Bulbs - Many bulb plants produce flowers of cut-flower quality and in seasons appropriate for school use.
 - a. Suggested plants include: Winter-Spring bloom -- Anemone, Daffodil, Freesia, Hippeastrum (Giant Amaryllis), Iris, Ranunculus, and Zantedeschia (Calla). Late Spring-Summer bloom -- Tuberous Begonia, Gladiolus, Hemerocallis (Daylily), Watsonia, and Zantedeschia (Calla).
 - b. Figure 3.15 provides blooming period, average bloom height, and planting depth information for common bulb plants.

B. Plant identification areas

1. Identification ("ID") garden -- In addition to those mentioned in discussion of the floral production area (Item A: 1-6, above), a number of shrubs and trees may be planted in plot areas or the perimeter of the agriculture area primarily for identification study and practice.
 - a. Beside beautifying the area, these shrubs and trees may also serve as stock plants for propagation and therefore should be the best obtainable quality.
 - b. Where space is limited, trees may be underplanted with shade-tolerant shrubs.
 - c. Groupings may be by height or leaf texture, but not alphabetically by name. Students tend to learn locations rather than specific characteristics.
 - d. Label adequately with botanical names. Inexpensive labels may be made of the adhesive-type plastic strips or of metal name plates under plastic and affixed to an adequate stake.
 - e. Plant labeling should be 100 percent accurate, not only as far as names of the varieties planted are concerned, but with meticulous attention to spelling.

1" x 6" REDWOOD FRAME

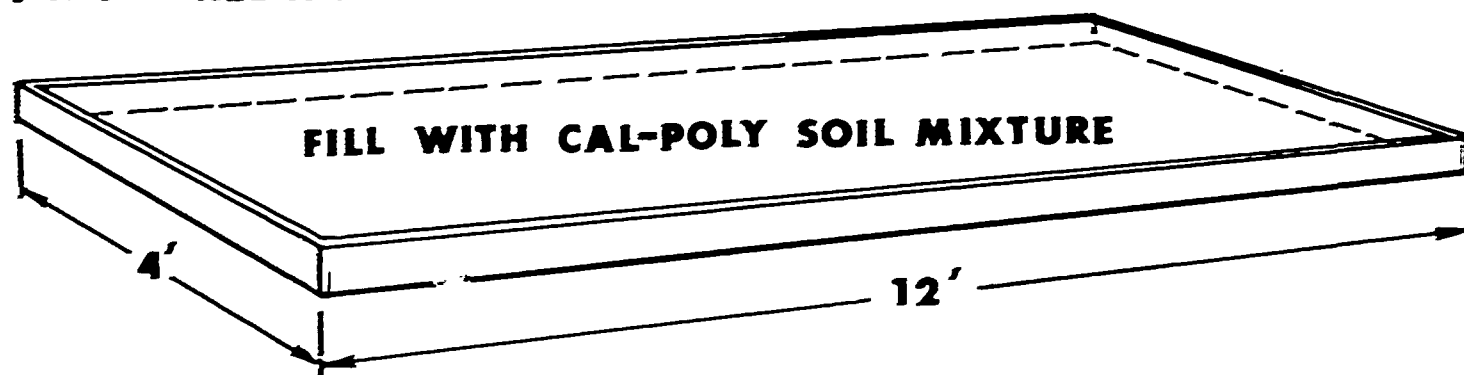

SKETCH OF CHRYSANTHEMUM OR CARNATION GROWING BED

Fig. 3.13

PLATE V

BULB CHART

BLOOMING PERIOD

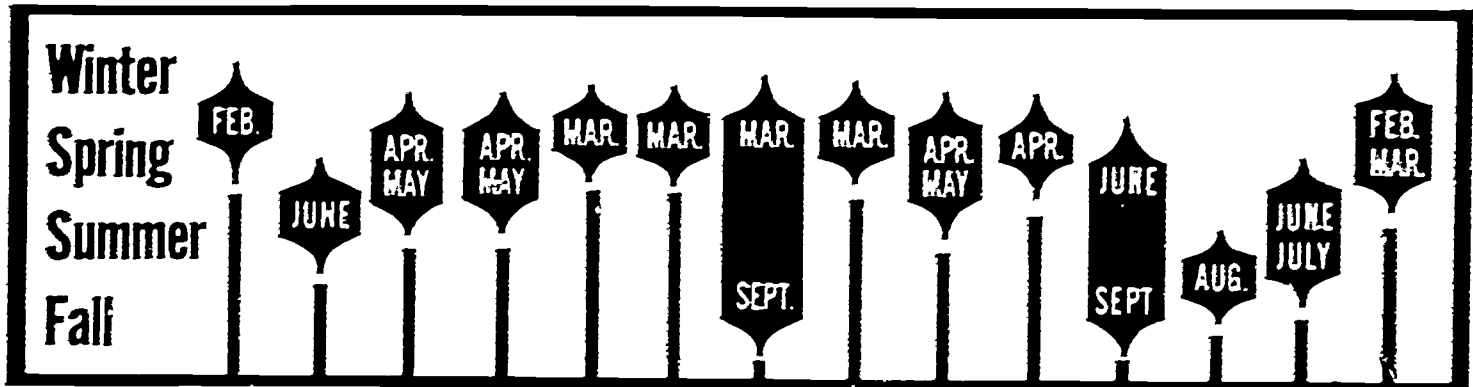

AVERAGE BLOOM HEIGHT

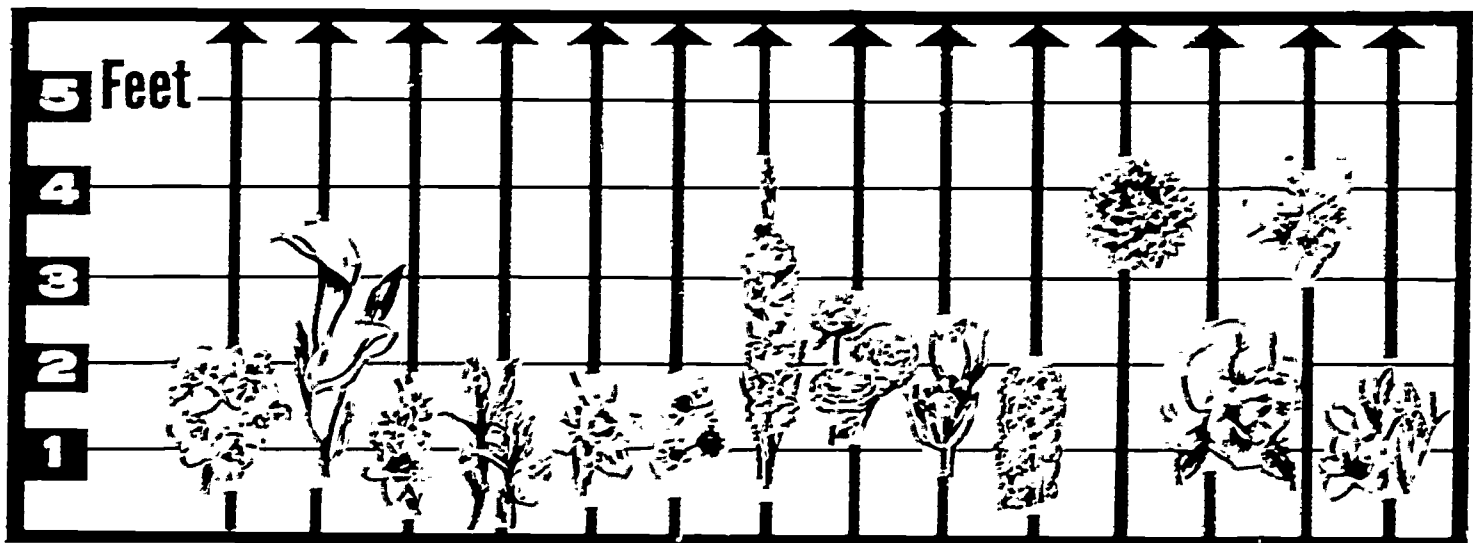

PLANTING DEPTH

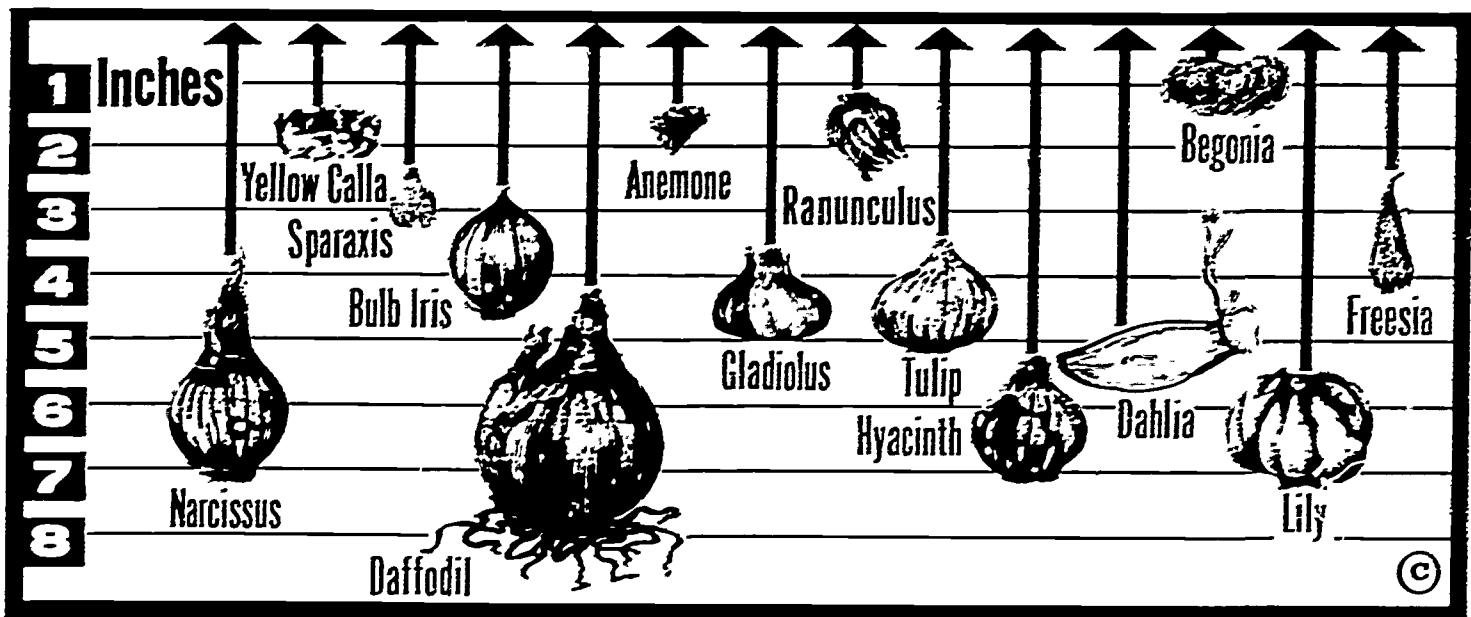

USED BY PERMISSION OF KELLOGG SUPPLY COMPANY

Fig. 3.15



Fig. 3.14: Flowering Shrub—Hibiscus

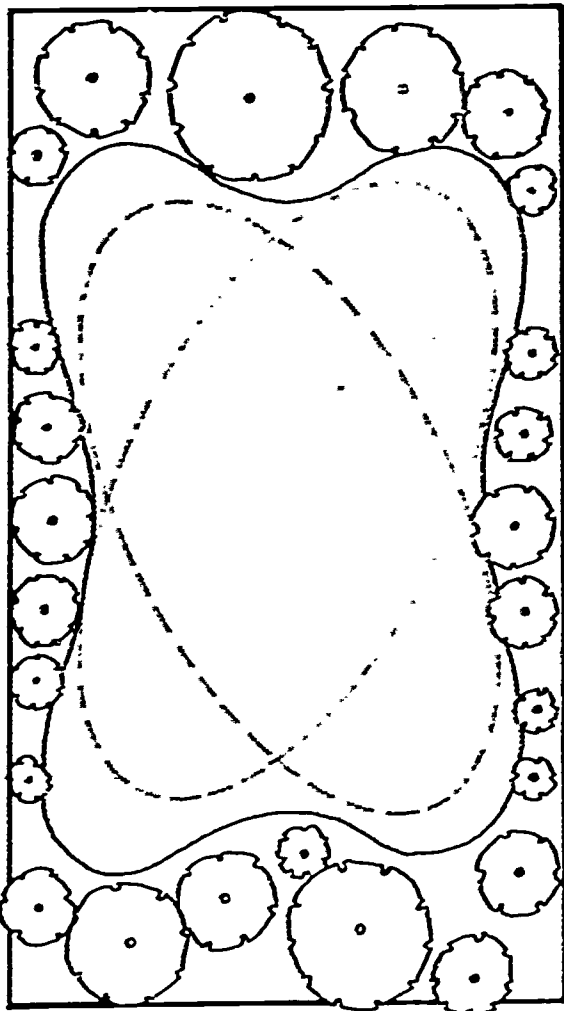

Fig. 3.17: Landscape Demonstration Area
—“Series of Ovals” Design



Fig. 3.16: Identification Stake with Embossed Label



Fig. 3.18: Maintenance of Field Growing Area

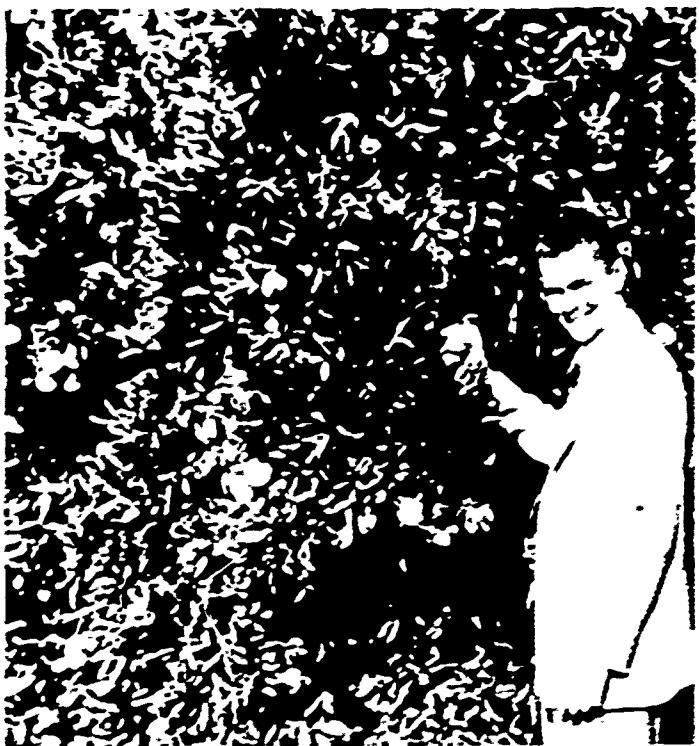

Fig. 3.19: Navel Orange—A Winter Fruiting Tree

PLATE VII



Fig. 3.20: Mixing Soil for Container Stock



Fig. 3.21: A Well-Maintained Turf in a Formal Garden

PLATE VIII

2. Landscape demonstration area -- Important lessons and experiences in landscape selection, use, and management may be enhanced by incorporating selected plants in landscape demonstration areas.

- a. Such an area can illustrate and reinforce classroom instruction in the importance of strong design; textural planting; special effects, such as tropicals or Sword Leaf Ferns; and use of accent plant and focal points.
- b. One suggestion for a landscape demonstration area shows how a simple "series of ovals" design may be made in header board and actually extended through the ground cover in the center of the area to dramatize the lines.
- c. Value of the landscape area is increased greatly when it is used to supplement the ID garden in plant identification study and practice.
- d. A "living lab" approach: this plan helps make abstract ideas tangible and may also be used to illustrate the axis and secondary axis with primary and secondary focal points.

C. Field growing area

1. Many trees and shrubs are best grown directly in the ground, rather than in containers, and provide excellent practice in maintenance, pruning, fertilizing, and balling and burlapping.
2. Field growing is usually a long-term project and it may be profitable to plant and harvest a portion of the area each semester instead of a mass-planting, mass-maintenance, mass-harvesting cycle which may provide limited learning experiences for students.
3. Suggested plant projects for field growing include Palms, Junipers, Pines, Deodars, Roses, Citrus, Avocados, deciduous fruit or flowering trees and street trees.
4. Plantings in field growing area should be spaced according to the size of individual specimens when they reach maturity appropriate for transplanting.

D. Fruit production area

1. Where space limitations are not a factor, a "living lab" of deciduous or evergreen fruiting trees may be of great value and, with a diversity of varieties, will provide pruning experiences, for example, on all types of fruiting wood on deciduous trees.
2. Selection of varieties for planting will determine fruit production time.

3. Greater interest will be stimulated among students if fruit varieties that will mature during the school year are selected.
4. Individual cultural demands will necessitate growing of deciduous fruit trees, citrus, or avocados in specialized area rather than in an indiscriminate mass.
5. "Raiding" of fruit by students may be minimized by carefully-kept records of fruit production maintained as a class project.
6. Fruit production plantings may also be used to provide valuable lessons relating to use of pruning, fertilizing, and weather as factors in production of fruit. Local farm advisors are excellent sources of information along this line.

E. Vegetable plots

1. Because of general ease of culture, rapid maturity and diversity, vegetable gardening provides a valuable learning experience.
2. Where possible, each student should be responsible for a row or double row of vegetables in addition to his other areas of responsibility.
3. Where the student is encouraged to harvest, bunch, and package his product before taking it home, vegetable crop projects offer real opportunities for "pride of production" activity.
4. If appropriate, crops may be timed so that students may donate a portion of their produce for use in serving either the FFA or agriculture department banquet.

F. Nursery area for container-grown stock

1. An attractive area for display of container-grown plant material may be outlined by 2" x 6" redwood header boards and decomposed granite walks, with pea gravel in the plant display areas.
2. Since all plants will be in containers, soil beneath the walk and display areas of the nursery may be treated with a soil sterilant to eliminate or reduce weed growth to a minimum.
3. A nursery area provides opportunity for students to gain experience in all phases of nursery management and operation.
4. Ultimate disposal of nursery plants offers an important problem. Most commercial nurserymen are cognizant of the fact that schools generally enhance, rather than compete with, the nursery industry. A solution that has generally proven to be workable would call for limiting sale of nursery plants to the school's (day and night school) students, faculty, and employees.

G. Turf management or test plot area -- Increasing demands for trained personnel for the turfgrass industry makes establishment of plots for turfgrass culture and identification worthwhile and desirable.

V. Objectives of practical work and lab areas -- The "living" lab should exist to provide practical experiences that will supplement classroom learning. Characteristics common to successful practical work programs in ornamental horticulture include:

A. Motivation - Importance and significance of work proposed is well established.

B. Pre-planning

1. Orderly development of facilities in the agriculture department is insured by pre-planning.

2. Maximum utilization of class time results from adequate structuring and pre-planning of projects.

C. "Busy Work"

1. Students feel their contributions are meaningful and important to objectives and goals of their course work.

2. Learning experiences are primary; students never feel they are being "used" as repetitious laborers.

D. Organization

1. Workman-like jobs performed in a workman-like manner are inspired by well-organized practical work projects.

2. Attitude of confidence among students inspired by positive ("Firm but friendly") leadership by teacher.

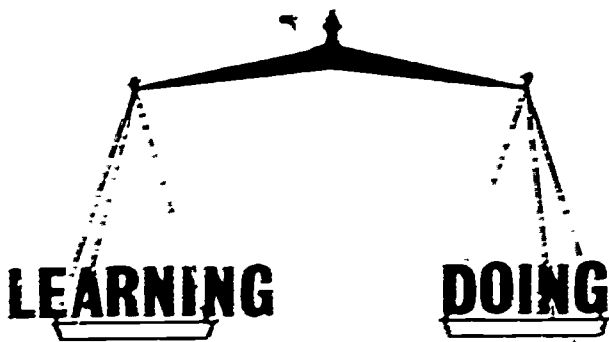

E. Balance - Well-balanced, meaningful horticulture program is assured by proper distribution of students' time between classroom experiences and practical work projects.

F. Evaluation - Periodic reviews of practical work program by students with positive suggestions for improvement, also provide ideas for possible new projects.

VI. Class organization for practical work projects

A. Individual assignments

1. Particularly suited to small classes, individual assignments permit great flexibility.
2. Assignments made from a chart prepared in advance assure diversity of work experiences. Assignments may also be given orally.

B. Squad assignments

1. May include a group composed of a pre-determined number of students in each squad, with one member selected as squad leader who may or may not assist in grading his crew.
2. Assignments may be made on basis of group participation rather than by individuals.

C. Group assignments

1. Class members, selected on basis of leadership or need for development of leadership, select small groups from among remaining class members to work with them.
2. Provides a good technique for initial practical work projects and getting students acquainted, both with each other and with ornamental horticulture.
3. Such assignments will provide an observant teacher with clues regarding the individual students other members of the class consider to be the best workers (those chosen first).
4. Problem students often among the last to be chosen or completely rejected, may for a while work better themselves. Individual assignments in these cases usually afford the teacher an opportunity to assess any physical or mental handicap that may be present.

D. "Area of responsibility" assignments

1. In this method, agriculture department facilities are divided into "areas", i.e., the ID garden, the landscape area, the nursery, etc., with one or two students assigned responsibility for each.
2. An overall plan for development of individual areas, arrived at in consultation with the teacher, may encourage students to plan and utilize their time well.
3. Assignments should be rotated to provide individual students with a variety of experiences.
4. A variation of this type assignment, used in conjunction with a unit on landscape layout, may call for each student to prepare a scale plan of his responsibility area, to be accompanied by a prepared "plan for development" of that area.

**THIS AREA IS
EXPERTLY MAINTAINED
BY JOE GARDENER**



Fig. 3.22: "Area of Responsibility" Assignments Encourage Student Initiative

PLATE IX



Fig. 4.1: Forest Tree Seedlings



Fig. 4.2: Park Department Tree Nursery



Fig. 4.3: State Nursery—A Source of Plants

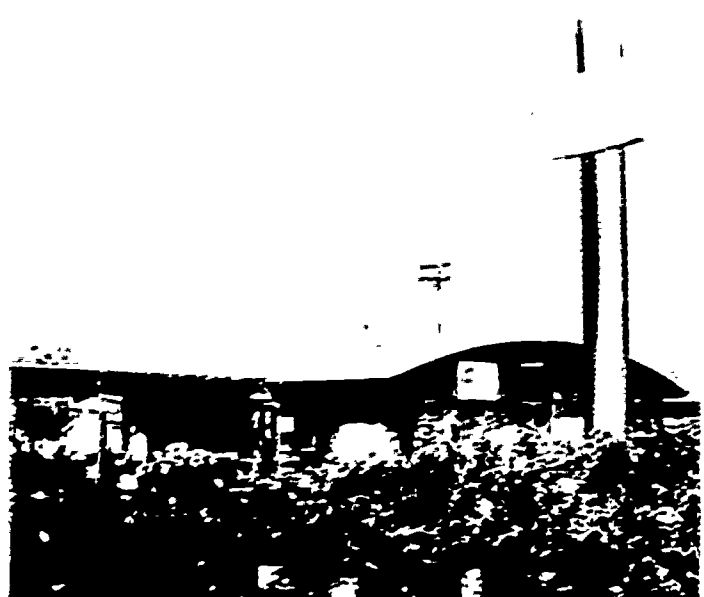

Fig. 4.4: A Modern Retail Nursery



Fig. 4.5: Pyracantha Blocks in Wholesale Nursery



Fig. 4.6: Flats of Bedding Plants

PLATE X

5. Since it assumes maturity and capability, this assignment system answers the need for challenge when used with advanced students who are already familiar with tools and techniques and anxious to take on specific responsibilities.
6. Assignments of this type provide practical work projects most closely similar to situations encountered by professional nurserymen, landscapers, gardeners, etc., where they might, for example, be responsible for a portion of a park, nursery, or landscaping job.

E. Entire class assignments

1. This method works well for small classes where facilities are adequate and the entire class may participate in one project at a time.
2. It allows the teacher to concentrate on one specific area of course content at a time and affords greater, and more enjoyable, teaching opportunities.

- F. Take advantage of individual initiative -** A competitive spirit between groups of individuals may be encouraged in a positive way to bring out the best possible effort. For example, assign four students to a plot of ground and ask (don't tell) them to weed it. Note the progress in a given period of time and then divide the area into four sections with string and assign each student to a section. Note the accelerated progress in a period of time similar to that used in the first instance.

Bibliography

Reference Books

Handbook for Teachers - A Supplement to the Instructional Guide for Gardening, Junior High School Agriculture, Division of Instructional Services, Los Angeles City Schools, Los Angeles, 1963.

Instructional Guide for Gardening, Junior High School Agriculture, Division of Instructional Services. Los Angeles City Schools, Los Angeles, 1955.

Morgan, William P., Jr., A Manual on Nursery Practices, El Corral Bookstore, California State Polytechnic College, San Luis Obispo, Calif., 1964.

Senior High School Agriculture, Division of Instructional Services, Los Angeles City Schools, Los Angeles, 1962.

CHAPTER IV

The Nursery Industry

California's progressive nursery industry offers many employment opportunities for young people who have a knowledge of ornamental horticulture. Many high school students are employed on a part-time basis in local nurseries, both retail and wholesale. Full-time jobs are available in nursery work for high school graduates who have a good background in agriculture and are willing to accept responsibility. Compensation is among the highest for any phase of agriculture and advancement is practically unlimited.

With these facts in mind, the following outline is suggested as a means of presenting nursery practices as a part of the agriculture curriculum:

I. Discussion of the nursery industry

A. Nurseries in California are businesses devoted to the production and sale of plants used in landscaping, home gardening, orchard work and forestry. Some nurseries carry on extensive propagating and growing operations. Others may do no growing at all, but instead merchandise plants and related products that they purchase from wholesalers.

B. Classes of nurseries

1. Private nurseries -- All plants grown are for use by the company or organization involved. Examples:
 - a. A lumber company producing tree seedlings for planting on its own land.
 - b. A citrus orchardist producing trees for use in extending his plantings.
2. Governmental nurseries - Publicly-supported organizations producing plants for a specific purpose. Examples:
 - a. City park department nursery growing trees for street and park planting.
 - b. California State Forestry Nursery at Davis growing plants for soil erosion control and state reforestation. Sales are made only for these purposes or for farm wood-lot and conservation planting.

24/25

- c. Federal government nurseries such as the Bureau of Plant Industry, Beltsville, Maryland, which is devoted to research on plant growth.

3. Commercial nurseries

- a. By far the largest and most important group.
- b. Anyone producing or selling more than \$100 worth of plants in a given year is a commercial nurseryman and must have a state license.
- c. In 1964 there were nearly 8,000 licensed nursery outlets in California. Approximately half of these were department stores, service stations, variety stores, and other non-nursery outlets, which sold plants only as a sideline. There were about 4,000 bonafide nurseries in the state in that year.
- d. Commercial nurseries are further classified according to specialties such as wholesale, retail, mail order, or landscape nurseries.

C. Status of the nursery business

- 1. According to the 1959 census, total wholesale value of nursery stock in the United States was \$600 million. California's wholesale value in nursery stock was \$100 million. With approximately 17 percent of the total nursery stock production to its credit, California was both the leading producing and the leading consuming state.
- 2. By 1964, wholesale value of nursery stock produced in the state was \$138 million, making nursery stock the fourth largest agricultural crop in the state--following after cotton, hay and grapes, in that order.
- 3. Leading counties in California's ornamental horticulture production in 1959 are shown in Figure 4.7.

II. Kinds of plants grown in California nurseries

A. Bedding plants

- 1. Annual or perennial flowering plants are usually grown from seed in flats of 100 plants for future planting in outdoor beds.
- 2. Some bedding plants are grown from cuttings or divisions and they may include plants grown for their foliage.
- 3. Examples of bedding plants include Petunia, Pansy, Snapdragon, Calendula, Marigold and Zinnia.

4. Prices usually range from \$1.50 to \$2.00 per flat, wholesale; and from \$.60 to \$.75 per dozen, retail.
5. Trends - Since the trend is toward self-service in nursery outlets, more growers are planting in small containers. Many bedding plants are marketed in small trays, such as Alumi-paks, Market Paks, or Pony Paks, containing 6 to 12 plants each.

County	Approximate Wholesale Value
1. Los Angeles	\$54,000,000
2. San Diego	10,000,000
3. Alameda	8,000,000
4. San Mateo	8,000,000
5. Orange	8,000,000
6. Santa Clara	8,000,000
7. Fresno	7,000,000
8. San Francisco	6,000,000
9. Kern	6,000,000
10. Sacramento	4,000,000

Fig. 4.7: California Counties Leading in Ornamental Horticulture Production

6. Comments

- a. Bedding plants make good class projects as well as individual, student projects, in many communities. Steps to be followed in starting such a project include:
 - (1) Find a market first. Good possibilities are FFA families, school friends and teachers, or local nurseries or feed stores.
 - (2) Plan your production program -- don't get too big.
 - (3) Buy good quality seed.
 - (4) Sow in flats of sterilized soil.

- (5) Set in greenhouse or holed at 60° to 70° F.
- (6) Keep uniformly moist.
- (7) Transplant seedlings when large enough to handle into small containers such as Pony Paks of 13 plants or flats of 100 plants.
- (8) Continue growth at 55° to 60° F. with good light.
- (9) Spray if necessary.
- (10) Sell when 6 to 10 weeks old.

b. Bedding plants grown by the agriculture class can make a valuable contribution to school grounds beautification. Soil in beds should be well-prepared and plants transplanted after they have been well hardened off. By selecting a crop like Calendulas or Marigolds, students will be able to observe the full cycle--from seed through flowering--in one semester. Don't be too ambitious, though. A small planting well-maintained is far better than a large one that is neglected.

B. Pot plants

1. These usually are flowering or foliage plants grown in pots for use in decorating homes, public buildings, or patios.
2. Plants remain in their containers after purchase; therefore, the container is usually decorative and may constitute a major part of the sale cost.
3. Examples of pot plants include:
 - a. Seasonal flowering plants -- Easter Lily, Poinsettia, Begonia, Hydrangea. These are plants to which controlled temperature and other environmental conditions are important. Production should not be attempted unless adequate facilities and know-how are available.
 - b. Non-seasonal flowering plants -- African Violet, Fibrous Begonia, Chrysanthemum, especially garden varieties in three-inch pots. These are all easy to propagate and grow under school conditions. Mums, however, will not flower naturally when days have 14 or more hours of light. They are practical plants to grow for use at FFA banquets and other occasions.
 - c. Foliage plants -- Coleus, Rubber Plant, Ivy, Philodendron, grown in any size from a two-inch pot to a 20-inch redwood tub. Most of these are easy to propagate from tip cuttings or air layers, and grow with limited care. Feed them frequently with blood meal and spray to control mealybug and red spider.

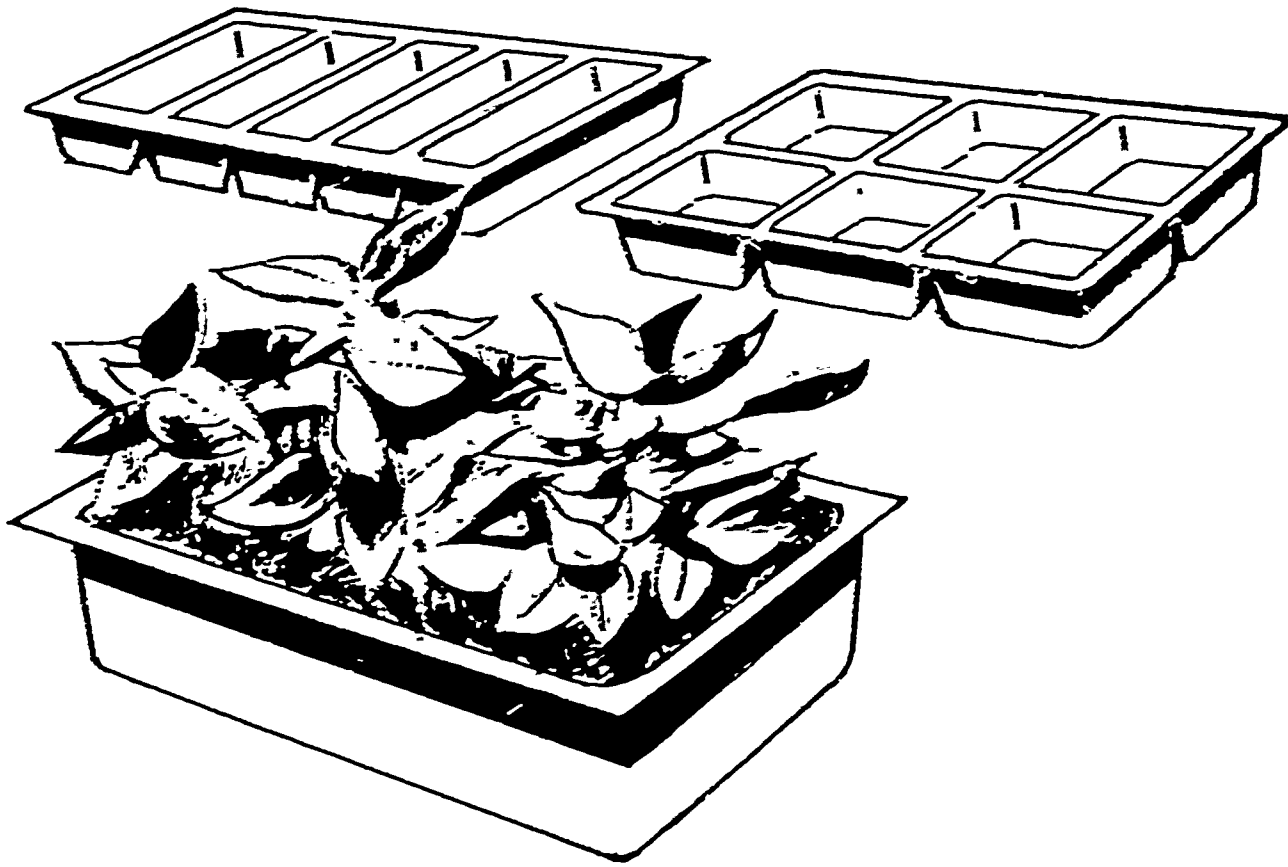

Fig. 4.8: Market Paks



Fig. 4.9: Seasonal Flowering Plants—Tuberous Begonia



Fig. 4.10: Foliage Plant—Philodendron

PLATE XI

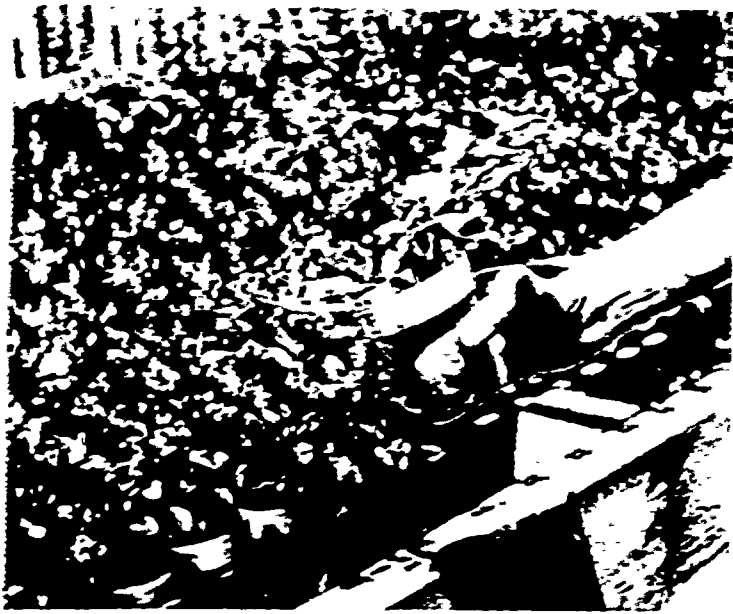

Fig. 4.11: Lining-Out Stock



Fig. 4.12: "Liners" Packed for Shipping



Fig. 4.13: Gallon Can Stock—Holly



Fig. 4.14: Five Gallon Can Stock—Camellia

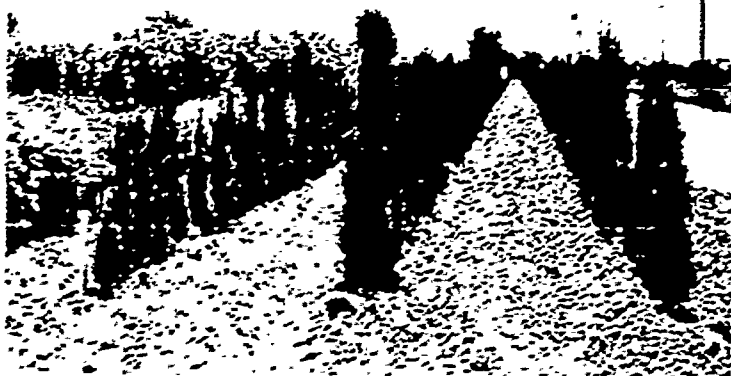

Fig. 4.15: Field-Grown Stock

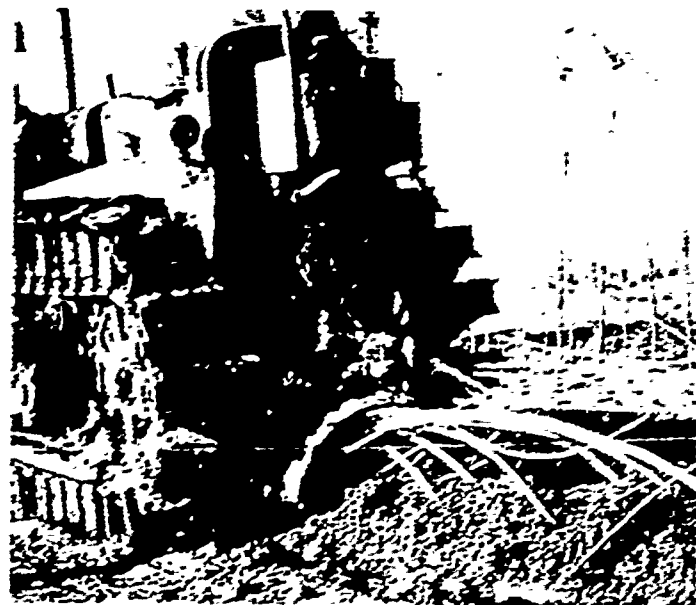

Fig. 4.16: Digging Bare Root Stock

Don't become sentimental about foliage plants--when they lose their vigor, throw them out.

C. Lining-out stock (Liners)

1. Traditionally, these are rooted cuttings or seedlings established in 2-1/4-inch pots. Some nurseries now sell them in two-inch or three-inch pots.
2. Never sold to retail customers because they are too small for landscape planting.
3. Named because they were formerly "lined-out" in rows in the field to be grown on to landscape size.
4. Now more commonly "shifted" into gallon cans for growing on.
5. Examples of lining-out stock are Privet, Eugenia, Oleander, Myrtle, Boxwood, and Juniper. In fact, almost all species of woody plants that grow in California can be grown in this manner.
6. Some high school agriculture departments have found a ready market for "liners" through local nurseries. Produce the species that can be rooted easily and grown to good quality. Avoid "touchy" items such as Gardenia, Azalea, Xylosma, and others that require special care.
7. Many high school projects with limited facilities purchase lining-out stock, from a wholesale nursery, for growing on in gallons. Shifted into gallons in the fall, these plants make plantable gallon can stock the same school year.
8. Lining-out stock requires careful care. It must be watered regularly, fed at least every two weeks, and sprayed for pest control. Plants should also be shifted to cans or larger pots before they become "root-bound."

D. Container-grown stock

1. These are plants grown in cans or similar containers for ease in handling and for future planting in the ground.
2. They do not remain in containers as do pot plants or tub specimens.
3. Sizes of containers used commercially include 1-, 3-, 5-, and 15-gallon cans.
4. Examples of container-grown stock are Juniper, Oleander, Boxwood, and Xylosma. Plants that can be grown in this manner include nearly all species of conifers and broad-leaf evergreen trees and shrubs.

5. Since container stock remains in the nursery longer than some other kinds of plants, it requires more fertilizing and spraying. Watering is a continual problem as is weed control and labeling. Regardless of size of container, the plant should not remain in it long enough to become "root-bound."

E. Field-grown stock

1. Includes lining-out stock or unrooted cuttings planted in rows in the field to be grown on for sale in larger sizes.

2. Classes of field-grown stock are:

- a. Bare root ("BR") stock.

- (1) These plants are dug during the dormant season with no soil remaining on the roots.
- (2) They are stored and shipped bare root to be planted before spring growth begins.
- (3) "BR" stock consists mostly of deciduous trees and shrubs which are government-graded according to height or caliper.
- (4) This is a very seasonal type of stock, usually handled only from late November to early February.
- (5) Examples of "BR" stock are Rose, bush berries, deciduous fruit trees (Apple, Peach, etc.), and deciduous shade trees (Modesto Ash, Fruitless Mulberry).

- b. Balled and burlapped ("B and B") stock.

- (1) This is field grown stock that is dug with a ball of soil around the roots and wrapped with burlap and securely tied to avoid breaking the ball of soil.
- (2) "B and B" plants are heavy and expensive to ship. They are less seasonal than bare root plants but must be planted before the burlap disintegrates.
- (3) They are usually stored under lath and packed in moist sawdust or shavings to prevent drying out.
- (4) Examples include conifers (Juniper, Spruce, Arborvitae), citrus and Avocado trees, broadleaf evergreen shrubs, and deciduous plants that have to be moved after the dormant season.

- c. Boxed specimens



Fig. 4.17: Bare Root Stock — Deciduous Shade Trees in a Wholesale Nursery



Fig. 4.19: Balled and Burlapped Stock—Boxwood

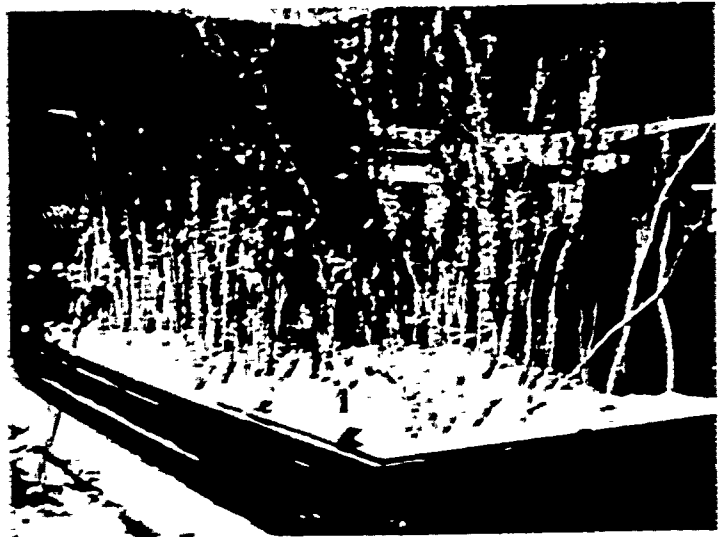

Fig. 4.18: Bare Root Stock — Deciduous Fruit Trees in a Retail Nursery



Fig. 4.20: Balled and Burlapped Citrus in Lath House



Fig. 4.21: Boxed Specimen—Pittosporum



Fig. 4.22: Flats of Ground Cover in Wholesale Nursery

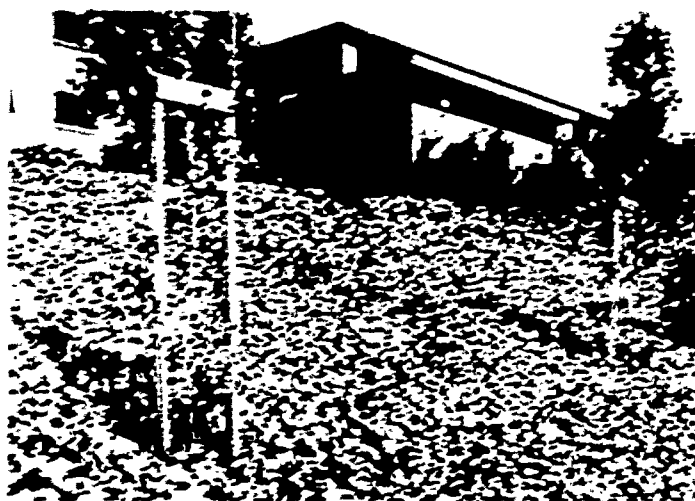

Fig. 4.23: Ground Cover Planting

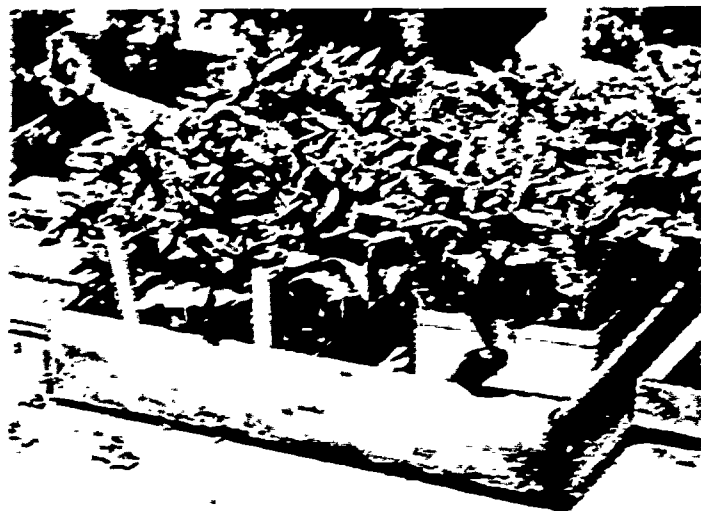

Fig. 4.24: Vegetable Plants — Bell Pepper

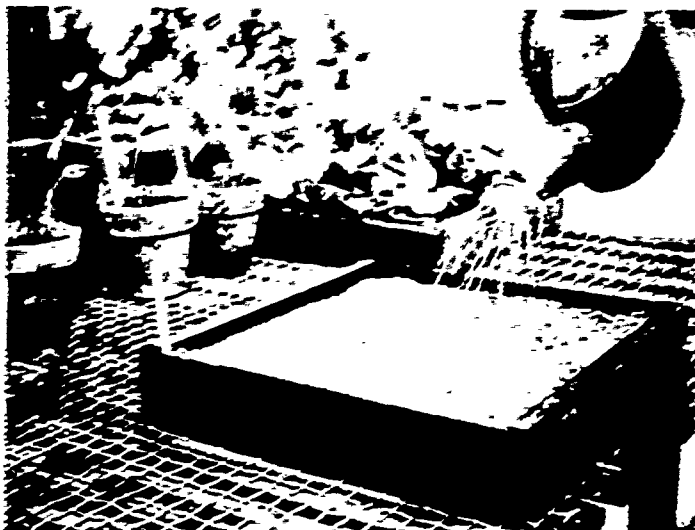

Fig. 4.25: Overhead Watering of Seed Flat



Fig. 4.26: Transplanting Seedlings



Fig. 4.27: Typical Rental Plant—Schefflera

PLATE XIV

- (1) These are the same kinds of plants that are balled and burlapped except that they are too large to be moved as "B and B" plants.
- (2) A large trench is dug around the plant and the root-ball is cut to a square shape. Then a prefabricated, tapered box is assembled around the plant and it is lifted from the hole.
- (3) The boxed plant may be used immediately in landscaping, or it may be held in the nursery for a period of time.
- (4) Box sizes usually run from 2-1/2 feet to 4 feet in diameter. Prices on boxed plants range from \$50 to \$1,000 a plant, depending upon the species and age of plant.
- (5) Examples are shade trees (Olive, Live Oak, Pepper), fruit trees (bearing-size citrus), and shrubs (Camellia, conifers, Holly).

F. Ground covers

1. These are low-growing shrubs or perennials, grown in flats for landscape planting in areas where lawn is not practical.
2. Classes of ground covers
 - a. Woody shrubs or vines (Algerian Ivy, Honeysuckle, Coyote Bush, and Cotoneaster microphylla)
 - b. Herbaceous perennials (Dichondra, Ivy Geranium, Ice Plant, Ornamental Strawberry, and Ajuga Reptans)
3. Dichondra is propagated by sowing thickly in flats and growing on in the greenhouse. Ajuga is propagated by dividing clumps and planting the divisions 100 per flat. Ivy Geranium and Ice Plant are propagated by sticking unrooted cuttings, 100 per flat, directly into flats of soil. Most other species are propagated from cuttings rooted under mist and then flatted up in flats of 100.
4. Ground covers are excellent plants to propagate in high school agriculture. Most of them root easily and quickly and are ready to plant out in a matter of a few weeks. Soil where they are to be planted should be well-prepared and free from weeds. The usual spacing for coverage within a year is 18 inches on center. Dichondra is usually planted by cutting the flatted material into two-inch squares and planting on six-inch centers. A special "plugging tool" is available in nurseries for this use.
5. School-grown ground covers oftentimes can be used by the school district, not only for beautification, but also to help instill pride on behalf of the students who helped produce and plant them.

6. Some agriculture departments have found ready outlets for project-grown ground covers.

G. Vegetable plants

1. May be plants of certain vegetables grown in flats or smaller containers for sale to home gardeners or commercial gardeners.
2. Examples include Tomato, Bell Pepper, Chili Pepper, Cabbage, Cauliflower, and Broccoli. Also popular are Parsley and Chives, but these may be more profitably grown in attractive two-or three-inch pots to be sold for kitchen window gardens.
3. Vegetable plants are grown in the same manner as bedding plants and fit in well with bedding plant projects.
4. Seasons:
 - a. Cabbage, Cauliflower, and Broccoli are cool season crops. They should be sown in September to be of sufficient size for garden planting by mid-October. Since aphids thrive on these plants a good spray program will be a necessity. Find a market before planting. These plants are quite difficult to sell in some communities.
 - b. Tomatoes and Peppers are warm season crops. They germinate best at temperatures above 60° F. and should be planted outside after the danger of frost is over. They are not as subject to insect attack in the nursery as those already mentioned, but are highly susceptible to "damping off." Since this disease is often carried on the seed coat, it is desirable to treat seed before planting by coating it lightly with Arasan or Spergon dust -- add a little of one of these materials to the seed packet and shake it thoroughly before planting. The soil and all tools used in planting should also be sterilized.
5. Suggested vegetable plant project:
 - a. Select seeds of one early and one late tomato variety adapted to your area, plus one variety each of Bell Pepper, Chili Pepper, Parsley and Chives.
 - b. Prepare flats, soil, and labels for each. (Accurate labeling is a must, because it is easy to mix varieties.)
 - c. Sow seeds, not too thickly, in rows in flats about February 1. Cover seeds two times their greatest diameter with soil. Place in warm (60° to 70° F.) greenhouse or hotbed, with plenty of natural light.
 - d. Transplant seedlings when they are a convenient size to handle, and before they have developed their second set of leaves. (Tomato

plants require 8 to 10 days to reach this size, others require about 21 days.) Transplant Tomatoes 13 plants per container (such as Alumipaks or student-built wooden tray 4-1/2" x 9"); and peppers, 7 plants per pak. Chives and Parsley should be transplanted 2 plants per two-inch plastic pot, and later thinned to one plant per pot.

- e. Grow seedlings another two to three weeks at 60° F. in greenhouse.
- f. "Harden them off" by moving to lath house or cold frame. Fertilize with a complete fertilizer and provide protection from birds, snails, and cold.
- g. By March 15 to April 10 the plants should be ready to sell.
- h. Having a good variety of plants will provide for much better acceptance than if but one variety is available. A retail "package deal" consisting of one dozen Tomatoes, a half dozen Bell Peppers, and one pot each of Parsley and Chives, priced at \$1.00, has proven successful. Collection of sales tax is not required on sales of vegetable plants.

H. Plant rentals

1. These usually consist of foliage or flowering plants available for rental for interior decoration.
2. The idea of plant rentals is a relatively recent concept in the commercial nursery business and is a service that is still not available in many communities.
3. Prices are usually based upon the retail value of the plant. Monthly rentals should be charged at about 25 percent of the retail price per month, with short period rentals charged at \$1.00 per day for large plants and \$.50 per day for smaller plants. These rates should not include daily care of the plants.
4. Plants commonly grown for rental purposes include Schefflera, Rubber Plant, Kentia Palm, Philodendron selloum, Coleus, Velvet Plant, Camellia, Boxwood and Grecian Laurel.
5. Many of these plants may be grown in an inexpensive lath house, or in five-gallon can nursery blocks. They may be plants that are normally used primarily for judging or identification, which will bring in revenue when put to this use.
6. Rental plants often come back to the nursery in poor condition and may be fit only for propagation or for cutting back and renovating. Consequently two plants growing and recovering for every one plant out on rental will be needed for an adequate plant rental operation.

7. Adequate proof that rentals can be profitable is the fact that in 1963 merchants of Costa Mesa, California, were leasing eight-foot-high container-grown Indian Laurel trees from a landscape leasing company for \$.25 per tree per day.
8. Advantages of a plant rental business are that it:
 - a. Provides plant growing experiences for students.
 - b. Provides business experiences for students.
 - c. Enables the department to maintain a greater selection of plants than could be otherwise justified.
 - d. Provides a community service not available in many areas.
 - e. Strengthens public relations between the agriculture department and the rest of the school by providing plants for dances, assemblies, and offices. (Plants for these occasions may be provided rent-free, but indirect results will still benefit the department.)

III. How nursery stock is grown (a suggested lecture outline)

A. Seed propagation

1. Requirements for germinating

- a. Viability of seed - Discuss seed processing and storage and seed viability charts (See Plant Propagation: Principles and Practices, by Hudson T. Hartmann and Dale E. Kester.)
- b. Moisture - Methods of providing moisture (See The Ball Red Book, by George J. Ball, Inc.)
 - (1) Overhead watering
 - (2) Sub-irrigation
 - (3) Enclosing flat in polyethylene plastic
- c. Temperature and temperature control
 - (1) Sunlight and solar radiation
 - (2) Enclosed structures
 - (3) Space heating
 - (4) Electric cable heating
 - (5) Ventilation

d. Oxygen or aeration - Provided through a well-aerated soil medium

(1) Stress importance of 25 percent pore space in seed germinating soil.

(2) Adequate pore space may be assured by adding Perlite or sharp sand, and maintained by proper watering.

e. Variable requirements

(1) Medium (or soil mixture) - Seed will germinate without it but on a practical production basis a soil mixture is necessary.

(2) Darkness - Most seeds germinate better in darkness. This is the main reason for covering them with soil.

(3) Light - Grand Rapids variety of lettuce germinates best in light with seed uncovered.

(4) Soil acidity (or pH) - Many seeds germinate best in acid soil. Sequoia gigantea, however, does best in pure granite or sand.

2. Advantages of seed propagation

a. Seed is usually less costly than cuttings, budwood, or bulbs.

b. Labor is usually less costly per unit.

c. Seedlings are often more vigorous than vegetatively propagated plants.

d. Ultimate size of seedlings is usually greater.

3. Disadvantages of seed propagation

a. Seedlings vary in size and character because they result from two parent plants.

b. Seed propagation requires constant care.

c. It is a slow method of propagating many woody plants. Some species of Holly and Rose require more than a year to germinate.

4. The seedage operation (See A Manual on Nursery Practices, by William P. Morgan, Jr., for content and reference.)

B. Vegetative propagation (See Chapter 4, Propagation of Plants, by M. G. Kains and L. M. McQuesten.)

1. Includes any method of propagation other than by seed.

2. Methods include propagation by:

- a. Cuttings
- b. Budding
- c. Grafting
- d. Layering
- e. Division
- f. Separation
- g. Spores

IV. Standardized soil mixtures

A. The objective of a standardized soil mixture is to have a single soil mix that is suitable for all plants. Since this objective is impossible to achieve, nurserymen have settled for a mixture containing several ingredients, the ratio of which can be adjusted to meet the needs of any plant.

B. Requirements for such a mixture include:

1. Suitability to the widest possible range of plants.
2. Ease and quickness of preparation.
3. Good results in respect to plant growth.
4. Materials economical, readily available, and not variable in consistency.

C. The U. C. Soil Mixture

1. Developed by Dr. Kenneth F. Baker and associates at University of California at Los Angeles as a standardized mix for California.
2. Has received wide acceptance in both the nursery and florist industries of the state.
3. Main ingredients are fine sand and peat, to which fertilizers are added.
4. California Agriculture Experiment Station Manual 23, The U. C. System for Producing Healthy Container-Grown Plants, by Dr. Baker, describes this mixture and its uses and is probably the best \$1.00 investment an agriculture department can make.

D. The Cal Poly Soil Mixture

1. A variation of the U. C. mixture, the Cal Poly mixture is typical of a standardized soil mixture that can be used for a wide variety of plant materials and can be sterilized after mixing without becoming toxic to plants.
2. The Cal Poly mixture also requires less frequent watering than most of the soils used by commercial nurserymen. It has worked out well under high school conditions.
3. Its ingredients are economical and readily available throughout most areas of the state. Although some growers would question the advisability of using manure, whether or not use of manure is satisfactory depends upon whether it is well-aged and treated the same each year.
4. Ingredients include:

a. Basic ingredients

<u>Proportions</u>	<u>by cubic feet</u>	<u>by wheelbarrow</u>
2 parts very fine sand	9 cubic feet	2 wheelbarrows
2 parts composted fir bark	9 cubic feet	2 wheelbarrows
1 part loam or compost	4-1/2 cubic feet	1 wheelbarrow
1 part aged steer manure	4-1/2 cubic feet	1 wheelbarrow
Total	<hr style="border: 0.5px solid black;"/> 27 cubic feet or 1 cubic yard	

b. Fertilizer ingredients (per cubic yard of soil)

3 lbs. single superphosphate	18%	P ₂ O ₅
2 lbs. hoof and horn meal	12%	N
1 lb. potassium sulfate	50%	K ₂ O
1 lb. dolomite lime		
7 lbs.	Total	

5. Since contractors' wheelbarrows hold approximately 4-1/2 cubic feet, ingredients are usually measured in wheelbarrow loads.

V. Compost and its use in nursery production

- A. Compost is the humus or almost completely decayed material resulting from the decomposition of organic wastes and added inorganic substances.
- B. It is useful in areas where good soil is not available or is extremely

expensive. Many nurserymen and gardeners use waste materials to a good advantage by composting it for future use.

C. If properly prepared, compost makes an excellent growing medium.

D. For the high school agriculture department with a limited budget, composting of materials is easily justified:

1. As a means of disposing of waste products such as prunings, lawn clippings, animal manures, sawdust and shavings, over-grown plants in flats and pots, and corn stalks.
2. As a means of providing a good component for improvement of soil in garden plots and containers.
3. As a means of teaching students a practice that will prove to be highly useful to them in the future.

E. Construction of the compost pile

1. For the successful composting program a good supply of oxygen is a must. Never attempt to compost materials in a pit or in a concrete bin. Without oxygen, fermentation is apt to take place rather than aerobic decomposition.
2. Build the pile on soil level and, if it must be confined, surround it with a section of snow fence.
3. Start with a six-inch layer of organic refuse (lawn clippings, prunings, bean straw, or chopped corn). Make it slightly concave and not more than six feet wide.
4. Add a three-inch layer of manure that is fairly well-pulverized. Keep the layers concave.
5. Apply an activator (ammonium sulfate, gypsum, calcium cyanamid, or super phosphate) at the rate of about one pound per square yard. The activator speeds up biological breakdown.
6. Add the final ingredient--a two-inch layer of topsoil. Keep it also concave. This is a good place to use any dumped flats of bedding plants, old potting soil, or soil from greenhouse beds.
7. Continue adding layers of material in the above order until the pile reaches five feet in height, five feet in width at the center, and any convenient length. Keep all layers concave to facilitate watering. The final covering should be the topsoil to eliminate any problems with odors or flies.

F. Management of the compost pile

1. Water it by sprinkler or soaker as soon as it is completed. Keep it uniformly moist, but not saturated.

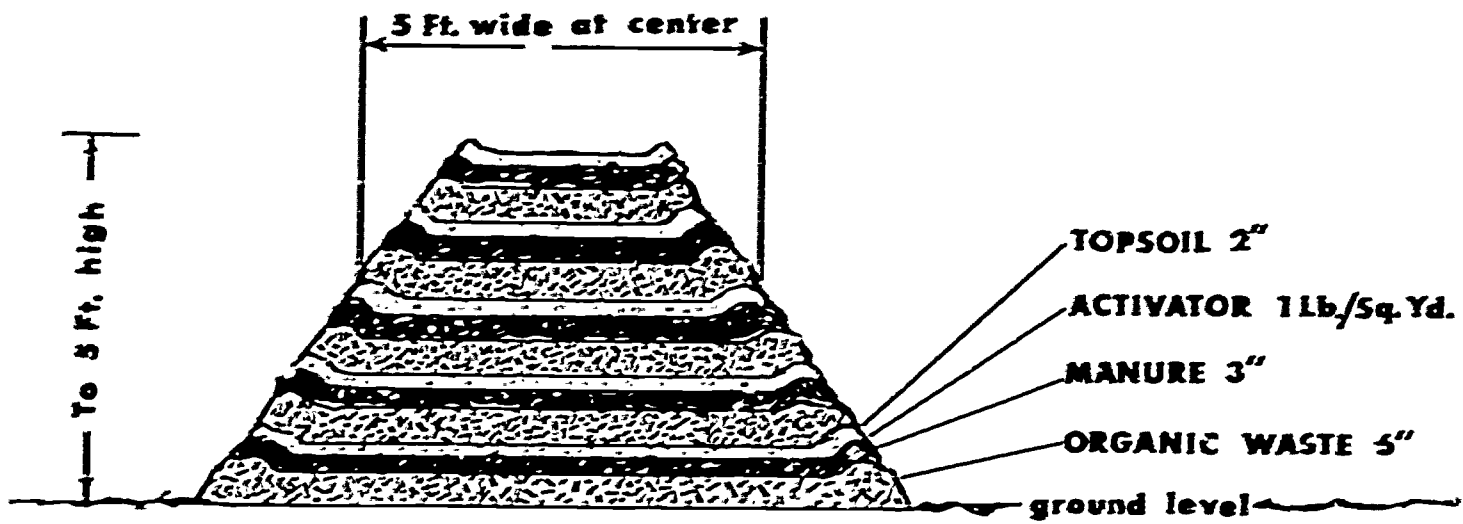

END VIEW OF TYPICAL COMPOST PILE

Fig. 4.28

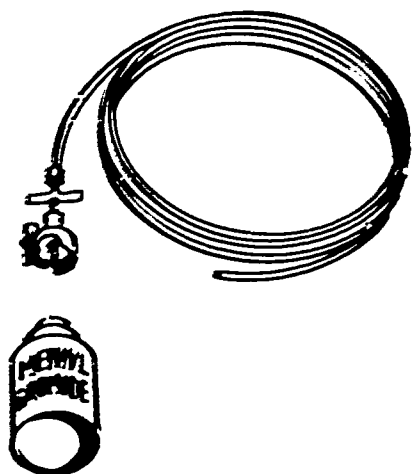
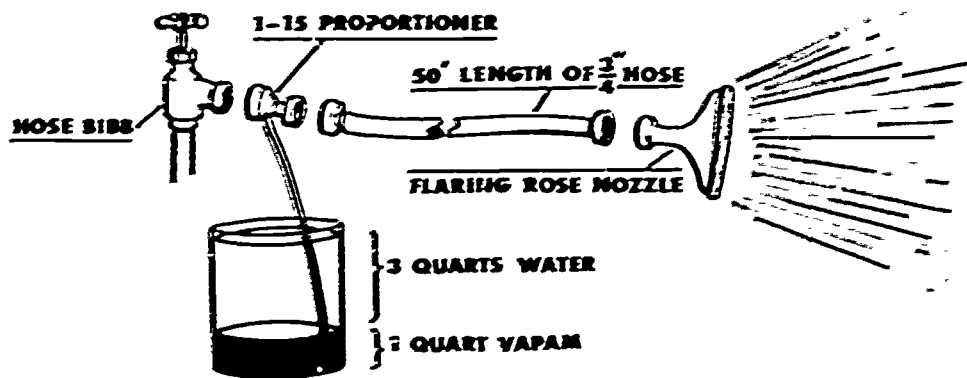
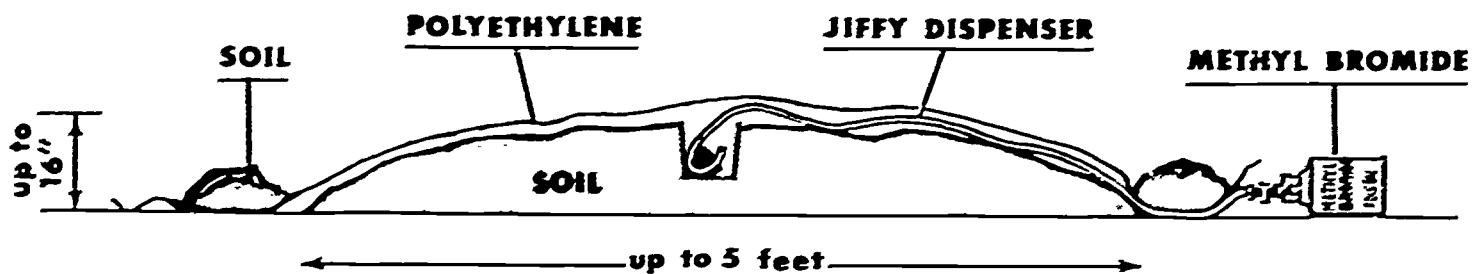

Fig. 4.29: Jiffy Dispenser



APPLICATION OF VAPAM

Fig. 4.30



SOIL FUMIGATION WITH METHYL BROMIDE

Fig. 4.31

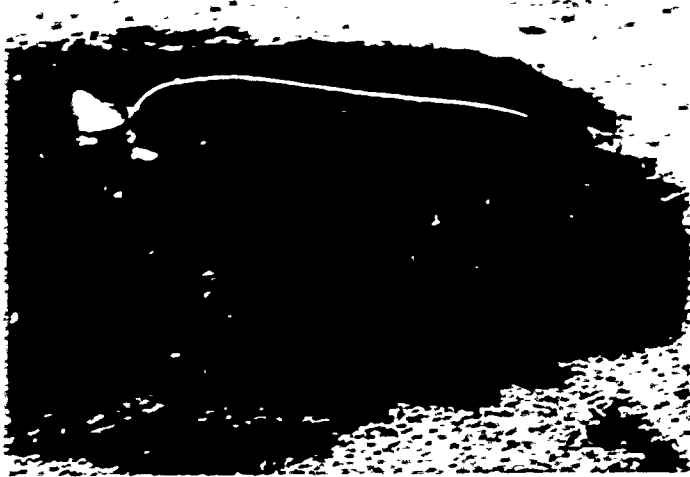

Fig. 4.32: Jiffy Dispenser Before Covering



Fig. 4.33: Injecting Methyl Bromide



Fig. 4.34: Weighting Polyethylene with Soil

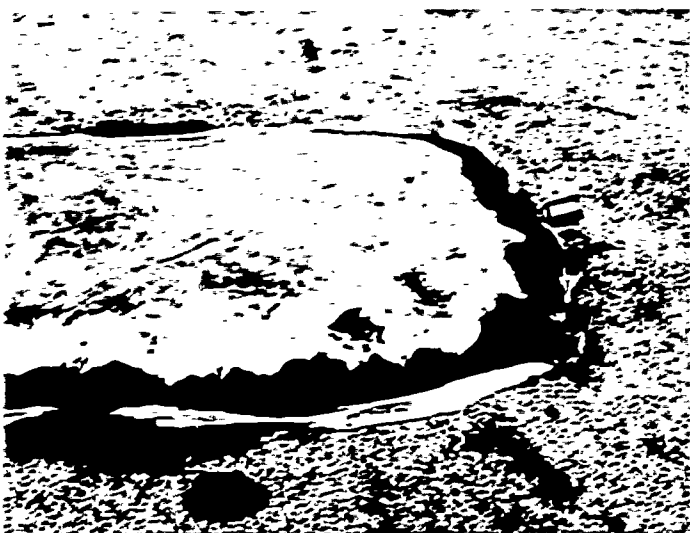

Fig. 4.35: Soil Pile Ready for Injection

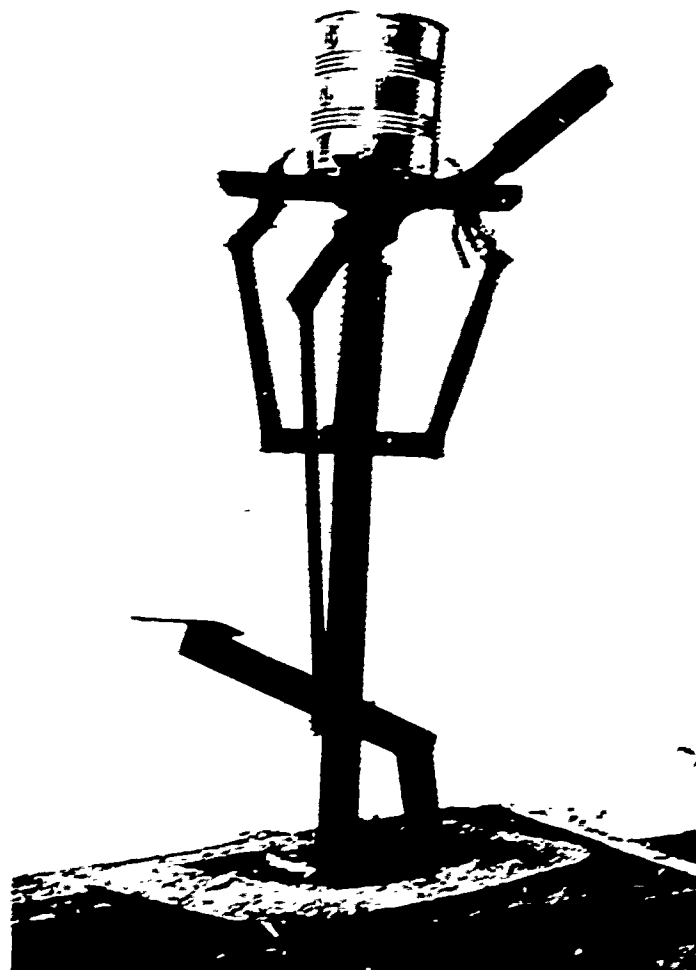

Fig. 4. 36: Multiple Can Punch

2. Control weeds by hand pulling, spraying, or covering with black polyethylene sheeting.
3. Add more topsoil to cover exposed sections of manure of organic waste.
4. Turn in three to six months, cut from top to bottom, place the outside of the pile in the center of the new pile, and the old center section on the outside of the new pile.
5. Cover again as outlined above.
6. Continue to keep it moist and control weeds.
7. Turn again in three to six months.
8. After screening through a mesh screen, compost is ready to use.
9. In theory, composting kills weed seeds, bermuda grass, stolons, and other propagative parts. In practice, it is a good precaution to sterilize with steam or a chemical sterilant (such as Vapam or methyl bromide).

G. Precautions

1. Impress students with the difference between compost pile and rubbish pile. Do not permit woody plant parts, cans, pots, or broken glass to be thrown in.
2. Compost is better used as one of the ingredients in a potting soil. It may be too fertile to be used alone for newly-rooted cuttings.
3. Even under good management it requires more time one year to make good compost than it does another year. Plan ahead, and build this year for next year's use.
4. Compost is excellent for top dressing of garden plots. However unless it is sterilized it may be introducing disease and sow bugs as well as weed seeds.

VI. Soil sterilization

- A. Defined as the elimination of disease organisms, insects, and weed seeds from a soil without destroying the capacity of that soil for good plant growth.
- B. Methods and materials used include:
 1. Steam
 - a. The soil is put into an air-tight chamber (such as an autoclave) or into a metal trailer covered with polyvinyl plastic, and heated slowly.

- b. Pasteurization is a more accurate term for this method than sterilization, because the temperature is raised only high enough to kill the pathogenic organisms. Most of the beneficial organisms are retained.
- c. A low pressure steam generator raises the soil temperature to 180° F. and holds it there for 30 minutes. If the temperature exceeds this level by many degrees, detrimental chemical changes may take place.

2. Methyl bromide

- a. An excellent material for sterilizing soil where steam is not available.
- b. Available in one-pound cans at about \$1.00 per can.
- c. Effective for control of weed seeds, insects, and all disease organisms except verticillium wilt.
- d. Cannot be used on soil for the growing of Carnations because the bromide is toxic to this plant.
- e. Potentially dangerous to use because it is colorless, tasteless, and odorless.
- f. Procedure
 - (1) Prepare the soil by mixing, screening, and watering. Spread it out in a pile not more than 16" high, up to 5' wide, and any convenient length (Figure 4.29).
 - (2) Bury a can or bucket in the center of the pile with its open top even with the soil surface (Figure 4.32).
 - (3) Put the hose end of a dispenser, such as a "Jiffy Dispenser", into the bucket and weight it down with a rock. Run the connection end past the edge of the pile and attach the can of methyl bromide to connection end (Figure 4.33).
 - (4) Cover the pile with a sheet of four mil. polyethylene plastic that is free from holes. Weight down all edges with soil. Leave the connection end of dispenser outside the plastic covering.
 - (5) Inject one pound of methyl bromide for each cubic yard of soil. If temperature is below 70° F. it is well to warm the methyl bromide first in a bucket of hot water, since it is less effective at low temperatures.
 - (6) Bury the used cans. Never permit them to be put into a trash can in a building.

- (7) Leave the plastic cover in place for 24 hours. Then remove it and let the soil air out for another 24 hours before using.
- (8) Avoid recontaminating the treated soil.

3. MC-2

- a. This is a preparation of 98 percent methyl bromide plus 2 percent chloropicrin (Tear gas) to serve as a warning agent.
- b. MC-2 is used in the same way as methyl bromide.

4. Vapam

- a. Vapam is a liquid soil fumigant manufactured by the Stauffer Chemical Company, available in quart, gallon, and five-gallon containers.
- b. It may be applied without a covering material.
- c. Rate of application is 1 quart per 100 square feet of surface. Retail cost is \$1.20 to \$2.00 per quart.
- d. Procedure (See Figure 4.30)
 - (1) Prepare soil by having it well-pulverized and moist.
 - (2) Layout area to be treated in 100 square foot plots.
 - (3) Pour one quart of Vapam into a gallon can and add three quarts of water.
 - (4) Attach a 1-to-15 fertilizer proportioner to the hose bibb and set the siphon end of it into the can.
 - (5) Attach a 50' length of 3/4" hose with a flaring rose or other fan-shaped nozzle.
 - (6) Turn on the hose bibb full force and let the water run until slightly purple. (Color is from the dye in the Vapam.) Water evenly over the entire 100 square feet until solution is gone.
 - (7) Fill the can with tap water and apply it to the plot, using the proportioner again, to water-seal the Vapam in. This also rinses out the proportioner.
 - (8) Allow two to three weeks of aerating before soil is used.

VII. Transplanting seedlings

- A. Seedlings of annual and perennial flowering plants are usually transplanted to flats of 100 plants as soon as they are sufficiently large to handle.

B. Reasons for transplanting, rather than sowing the seed directly in the flat, are:

1. **Economy of greenhouse space. It is more practical to have one flat of 1000 seedlings in the high temperature house than 10 flats of 100 seedlings.**
2. **Uneven germination. If 100 seeds are planted in a flat, some will not germinate at all and others will grow more slowly. Some transplanting to have a flat with uniform growth will still have to be done.**
3. **Better plants. During transplanting, grading for vigor, health, and, in some cases, such qualities as doubleness, may be accomplished.**

C. Timing of transplanting

1. **The general rule is that seedlings should be transplanted from the seed flat as soon as they can be handled economically and before the second set of leaves appear.**
2. **This time may vary from as little as four days after planting for Zinnias to as much as three weeks for Petunias.**

D. Method of transplanting seedlings (See A Manual on Nursery Practices William P. Morgan, Jr., for content and reference.)

VIII. Potting ornamental plants (See Propagation of Plants, by M. G. Kains and L. M. Mcquesten, for content and reference.)

IX. Canning nursery stock

A. Involves the shifting of lining-out stock or plants from flats into gallon cans for growing on to larger landscape size.

B. Reasons for canning nursery stock:

1. **To get away from seasonal aspects of handling bare root and balled and burlapped material. Gallon can stock is saleable year around in California.**
2. **Material growing in cans is easier to care for and maintain than plants handled by other means.**

C. Kinds of plants canned include broadleaf evergreen trees and shrubs, conifers, and deciduous trees and shrubs. In addition, quite a number of perennials including Chrysanthemum, Marguerite, Shasta Daisy, and Bird of Paradise are now being grown in cans.

D. Sources of cans

1. **The school cafeteria and local restaurants are good sources of gallon cans, usually at no cost to the department. If such**

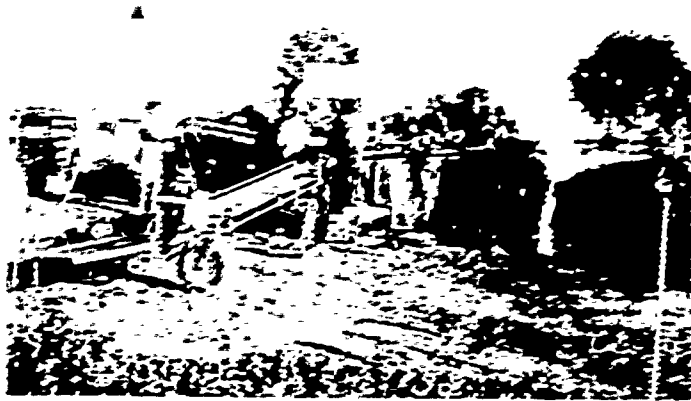

Fig. 4.37: Semi-Automatic Canning Machine

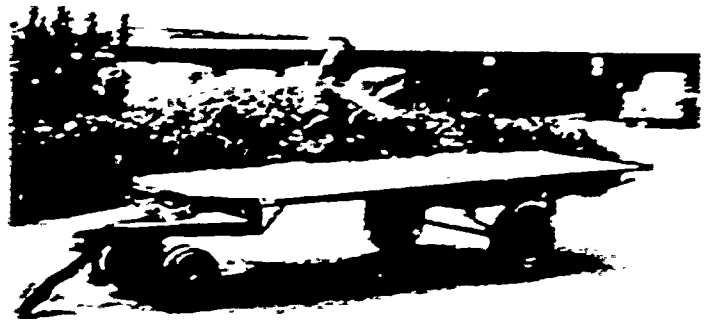

Fig. 4.38: Trailer for Canned Stock



Fig. 4.39: Gallon Can Blocks



Fig. 4.40: Labeled Container Stock Block

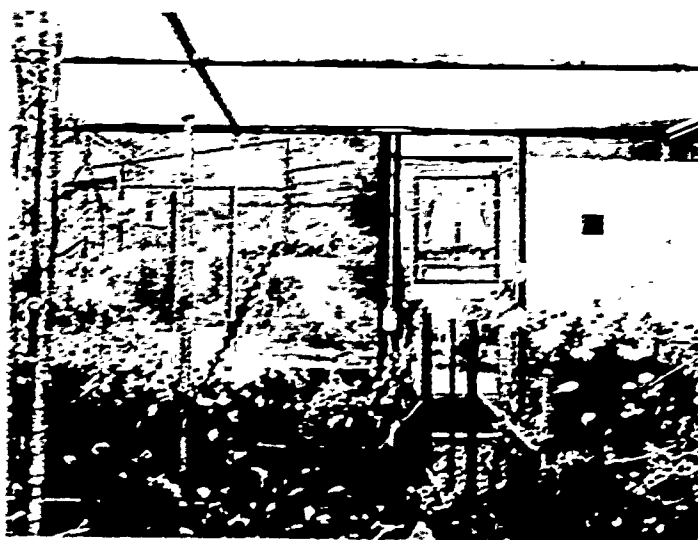
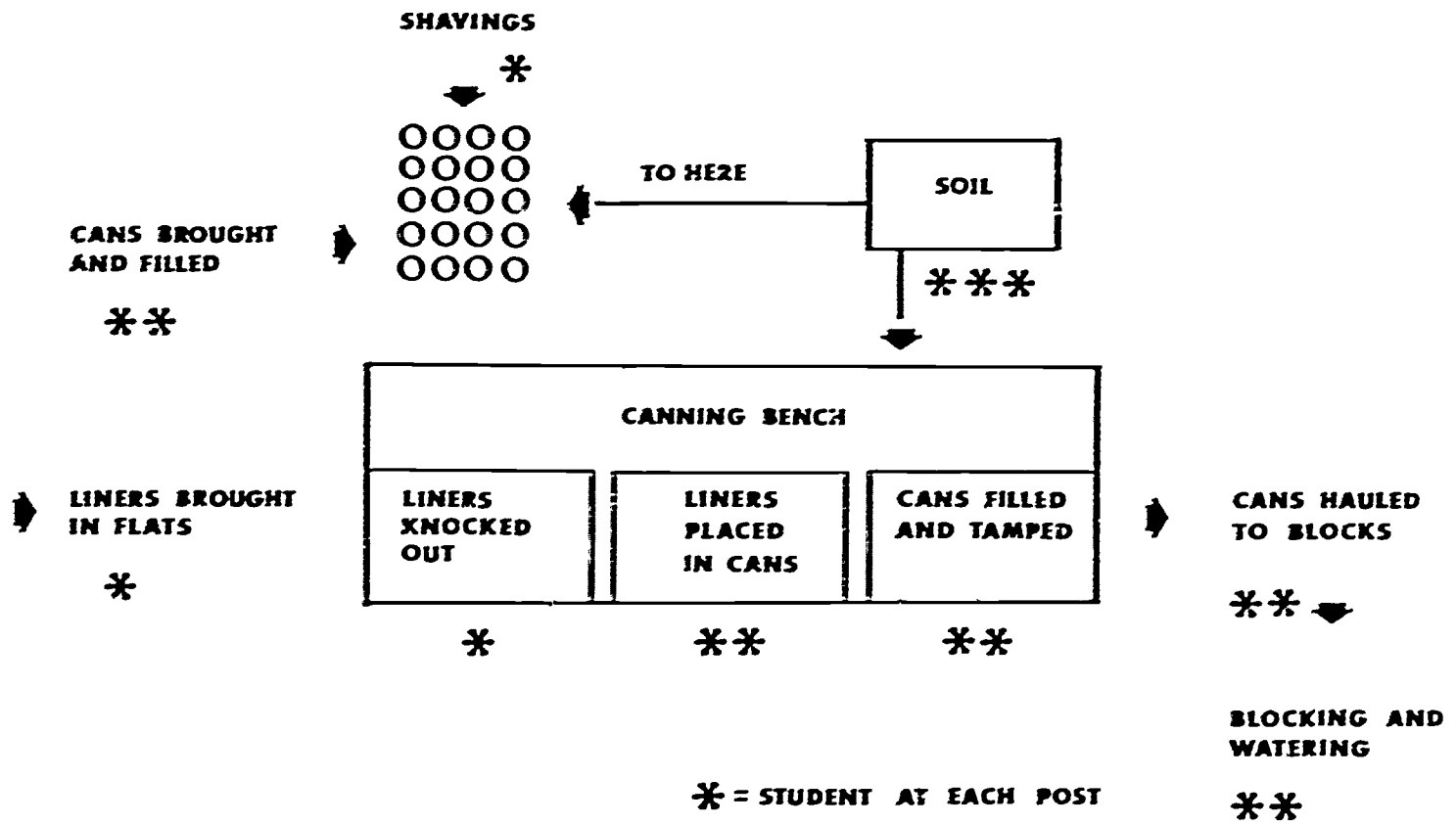
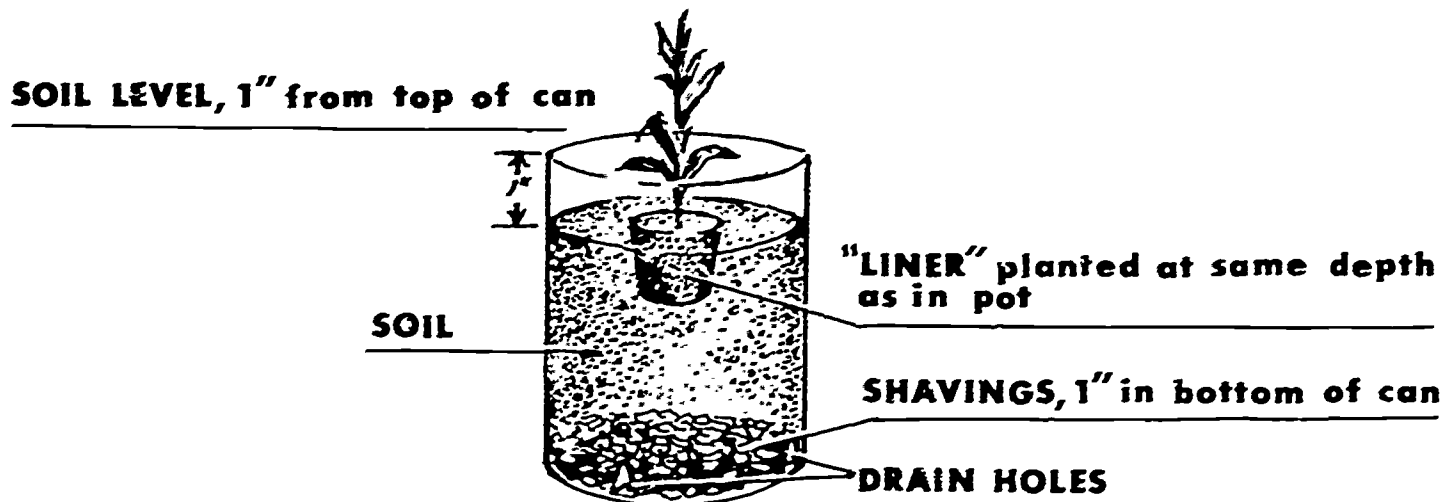

Fig. 4.41: Interior, Saran Screen House



SUGGESTED SET-UP FOR A 16-STUDENT CANNING CREW

Fig. 4.42



A PROPERLY CANNED PLANT

Fig. 4.43

arrangements can be made, cans should be picked up at regular intervals and washed as soon as received.

2. Three-gallon egg cans are often available at bakeries as well as at cafeterias. These are always in demand in the nursery industry and can be sold at a good profit if more than the department needs are gathered.
3. Round five-gallon cans are often available through the school custodial department since they are frequently used as containers for floor wax and solvents. Square five-gallon cans, used for shipment of cooking oil, are available through the cafeteria.

E. Processing of cans

1. If large volumes of cans are to be processed, purchase of a multiple can punch may be justified. The Ayer Line Company of Berkeley manufactures such a punch. Its cost is around \$75 but, with reasonable care, it should last for several years. Whether this machine or the conventional beverage can opener is used, four holes are needed in each can.
2. Labels and tops of cans should be removed before painting. An Army surplus can opener for use in removing the tops is a good investment.
3. The most commonly-used can coating in California nurseries is asphalt utility coating available from Standard Oil Company in 5- and 55-gallon lots. Costing about \$1.00 a gallon, it can be diluted with paint thinner for economy and easier spreading. Thinner costs about \$.40 a gallon. The dilution rate depends upon temperature but varies from a one-to-one mixture to a two-to-one (two parts thinner to one part utility coating) rate.
4. One gallon of diluted dip will coat about 200 one-gallon cans.
5. Some high schools use a paint purchased through surplus to give their containers a distinctive color.
6. Most commercial nurseries find it more practical to purchase cans than to process their own. A department having more cans than it needs can probably find a ready market for them at about \$.05 each.

F. The canning operation

1. Commercial nurseries have elaborate set-ups for canning plants--some involving the use of semi-automatic canning machines.
2. Even in small organizations, it is essential that the canning operation be planned to avoid wasted motion.

a. One such plan involves an assembly line arrangement with students lines up along a convenient bench.

(1) One crew brings the dipped cans and adds one inch of wood shavings to each can.

(2) A second crew fills the cans two-thirds full with soil and sets them on the bench.

(3) A third crew knocks out the lining-out stock, sets it into the partially filled cans and adds more soil to fill each can to within one-inch of the top. Care is taken to plant the "liner" at the same depth it was growing in the pot.

(4) A fourth crew hauls the newly-canned plants to the growing area, "blocks" them out, and hauls flats of liners back to canning bench.

(5) A fifth crew waters the newly-canned stock, using a water wand to avoid washing out the soil.

b. In using this plan it may be advisable for crews to rotate after every 20 to 25 cans so that each student has an opportunity to work in each phase of the operation.

3. Shavings in the bottom of the can are not generally used by commercial nurserymen because it slows down the canning operation. Their use, however, may be justified in a teaching situation for the following reasons:

a. They weigh less than regular soil mixes.

b. There is less danger of drainage holes plugging up and causing a water-logged condition.

c. There is less possibility of roots growing through the holes and into outside soil.

4. Possible nitrogen tie-up caused by use of shavings can be avoided by a good program of fertilizer application.

G. Transporting canned stock

1. In commercial nurseries, newly-canned stock is moved to the growing blocks by low bed trucks, trailers pulled by jeeps or tugs, or on pallets carried by fork lift tractors.

2. In some school situations, trucks or trailers are occasionally used, but in most instances wheelbarrows are the principal method of transportation.

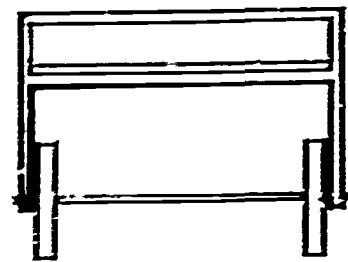
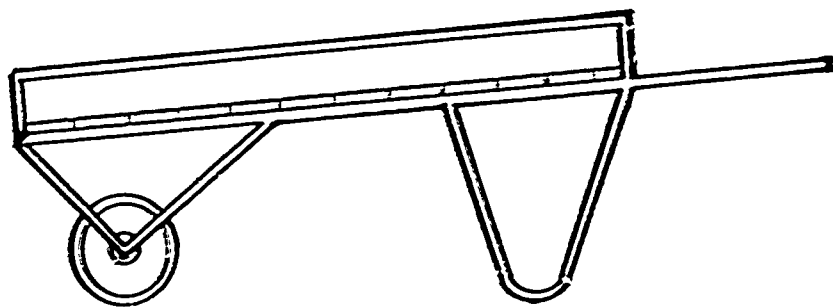
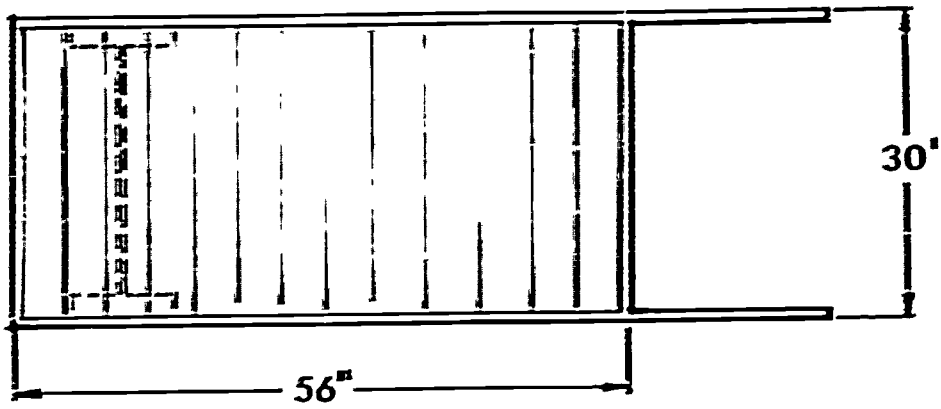

A FLATBED WHEELBARROW FOR CONTAINER STOCK

Fig. 4.44

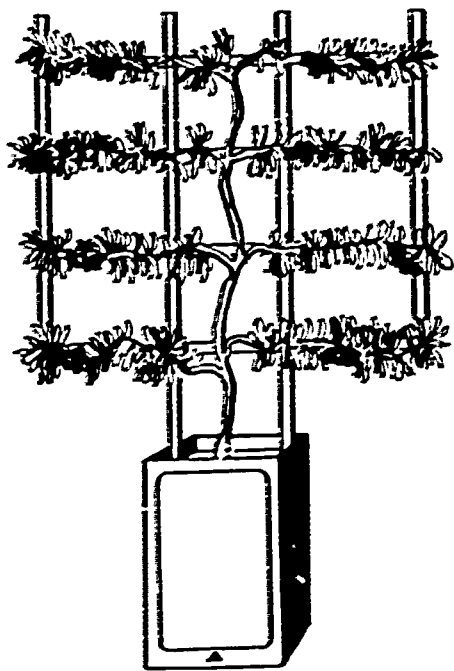

ESPALIER

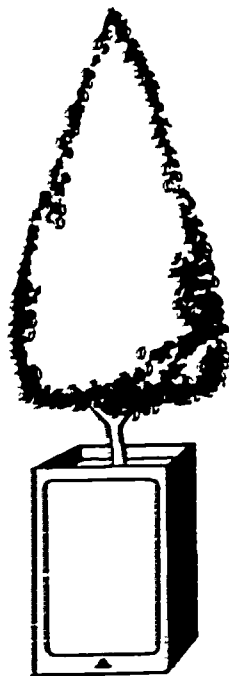

CONE OR PYRAMID

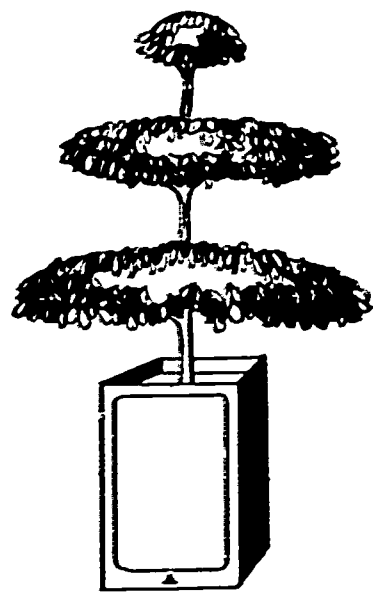

POODLE

ORNAMENTAL PLANTS PRUNED TO SHAPE

Fig. 4.45

PLATE XIX

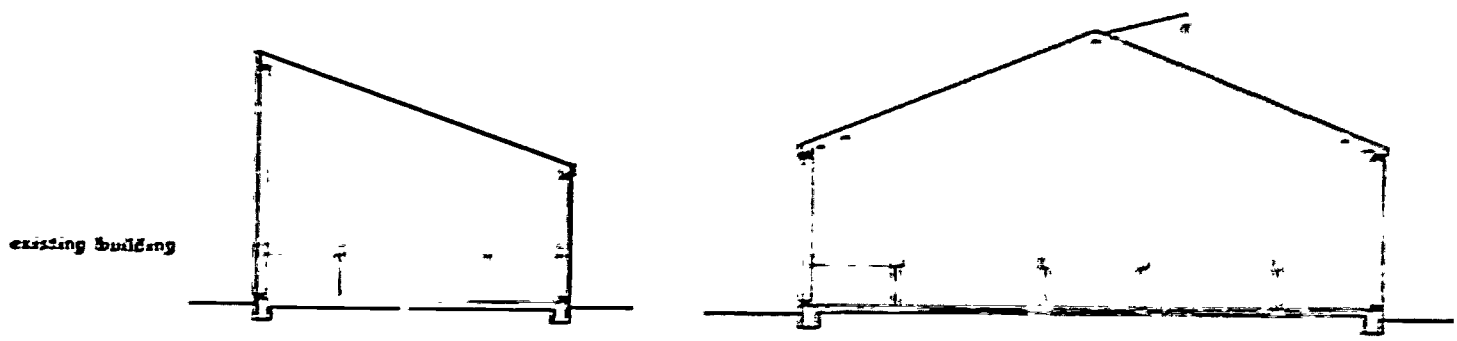

LEAN-TO

EVEN SPAN

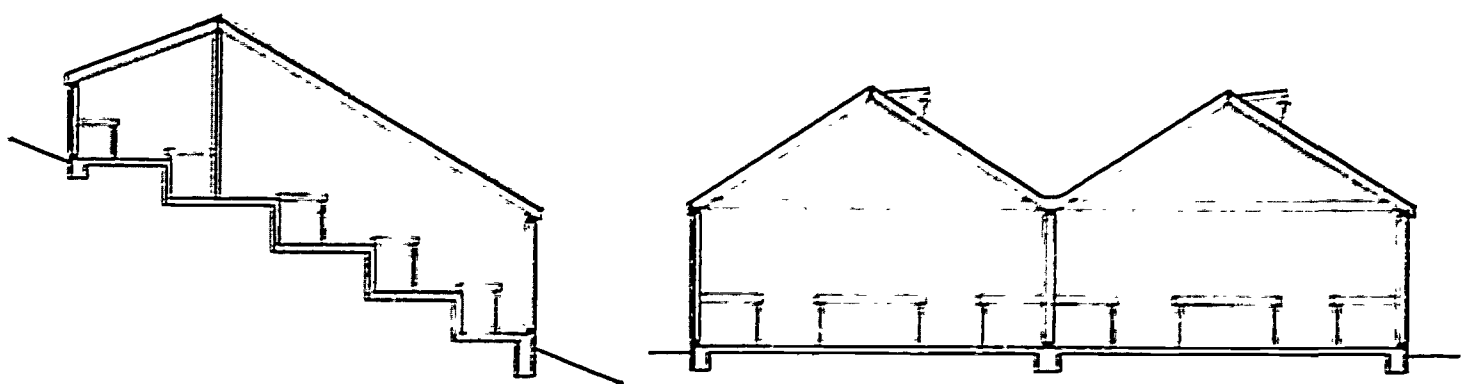

UNEVEN SPAN

RIDGE AND FURROW

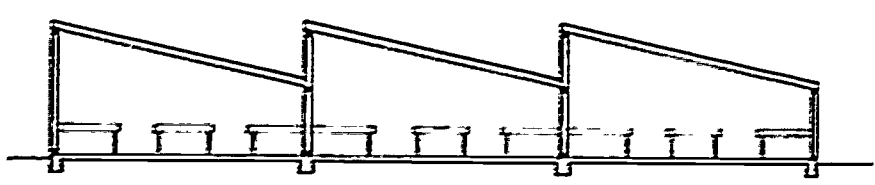

SAWTOOTH

Fig. 4.46: Types of Greenhouse Construction

PLATE XX

3. A flatbed wheelbarrow with two pneumatic tires is both practical and easy to build in a shop. (See Figure 4.44 - A Flatbed Wheelbarrow for Container Stock.) Standard wheelbarrow wheels are used with a frame made of 3/4" pipe and covered with 1" x 6" lumber. A pipe railing extending above the deck prevents the cans from falling off. Wheels should be far enough forward to avoid overtopping when loading.

H. Blocking-out canned stock

1. Regardless of whether the nursery is commercial or educational, container blocks should be neat and uniform.
2. Soil should provide good drainage as well as being free from weeds.
3. If possible, blocks should be defined by header boards made of 2" x 4" 's or 2" x 4" 's. Where header boards are not practical, the blocks may be laid out with stakes and string. Black polyethylene plastic or roofing paper (available from state educational surplus agencies) makes an excellent surface and simplifies weed control.
4. Gravel or concrete walks should be constructed.
5. Block sizes.
 - a. Gallon can blocks are usually 10 cans wide and up to 50 cans long. If longer than this they cause unnecessary walking.
 - b. Five-gallon cans are usually blocked 5 cans wide and 25 cans long.
6. Plants of similar characters should be grouped together.
7. Labeling accurately, one of the biggest problems for retail nurserymen, is no less important in the school nursery. Nurseries making retail sales are required by law to label all plant material and woody ornamentals by scientific names. California Agricultural Experiment Station, Manual 23, A Checklist of Woody Ornamental Plants of California, by Mildred E. Mathias and Elizabeth McClintock, lists correct names.

I. Care of container stock

1. Irrigation - A regular program of irrigation should be established, with responsibility assigned for it. Sprinkler irrigation is becoming increasingly popular because of its labor-saving nature. Container stock should be checked daily and often requires watering three or more times a week.

2. Fertilizing

- a. Even though fertilizer is added to the soil mixture, plants benefit from the addition of fertilizer because of the leaching action of frequent watering.
- b. Dry organic fertilizers, such as blood meal, have proven satisfactory during the warm season and are relatively free from danger of burning the plants.
- c. Liquid fertilizing is becoming increasingly popular because of its ease of application. The 1-to-15 fertilizer proportioner is an efficient applicator and is an excellent teaching device.
- d. Slow release fertilizers, either in tablet or granular form, show great promise. They are coated with a substance that makes the nutrients available slowly.

3. Pest control

- a. Woody plants are susceptible to damage from such pests as aphid, red spider, scale, and mealybug. Regular periods should be set up for inspection. Spraying to prevent insects and disease is good management.
- b. Since many of the common insecticides are highly toxic, their use and application should be an important part of course content. (Instructional materials on agricultural chemical safety are available through California State Polytechnic College.)
- c. Close supervision of the pest control program is a must.

4. Pruning

- a. For production of quality container stock, pruning and training should begin early. This may involve pinching or cutting the top out of a plant to make it branch, or staking and trying to develop a central leader.
- b. Pruning for interesting shape is again becoming popular in American gardening. Many plants are adapted to being grown as espaliers, cones, or "poodles" and such plants are in demand by landscapers.
- c. Such plants as Boxwood, Eugenia Olive, Juniper, and Pine adapt to pruning for interesting shapes.

X. Nursery structures

A. Head house

1. The main working area of a commercial nursery or wholesale florist establishment is the head house.
2. It is so named because it is usually located at the head or upper end of the greenhouse range.
3. It usually includes such facilities as benches, storage bins, sink and hose bibb, and adequate lighting and heating.
4. Doors should be wide enough to permit the entry of trucks and other equipment.
5. Such operations as seed sowing, transplanting, potting, grafting, and making of cuttings are performed in the head house.
6. In a school situation the laboratory room or potting building usually serves as the head house.

B. Glasshouse

1. A glasshouse is a glass-enclosed structure designed to provide ideal conditions of light, temperature, and humidity for the growing of ornamental plants.
2. Glasshouses come in sizes ranging from the amateur gardener's 7'x9' structure to commercial units measuring up to 35'x100' or larger.
3. Shapes of commercial glasshouses.
 - a. Lean-to
 - (1) Usually attached to the south side of an existing building.
 - (2) Roof is of only one span.
 - (3) Usually does not exceed 9' to 12' in width.
 - (4) Most economical to heat and humidify because of small area involved and protection offered by building to which it is attached.
 - b. Even Span
 - (1) The most common shape of glasshouse.
 - (2) Free-standing unit with the same slope on each side.
 - (3) May have center posts or truss construction without posts.
 - (4) Easy to construct and maintain.

c. Uneven span

- (1) Seldom seen in the United States today.**
- (2) Designed to take advantage of a south slope.**
- (3) Ground is terraced, with benches on different levels and interior posts required for support.**
- (4) Expensive to maintain because of long spans.**

d. Ridge and furrow

- (1) Common in large commercial nurseries.**
- (2) Consists of two or more even span houses with a gutter between.**
- (3) May have a separating wall or merely gutter posts for support.**
- (4) More costly to maintain because of gutter, but more economical to build.**

e. Sawtooth

- (1) Limited mainly to California where mild climate limits snow damage.**
- (2) Series of lean-to houses joined together to make a large range.**
- (3) Upper ridge section often left open to improve ventilation.**
- (4) Used mainly for the production of cut flowers.**

C. Plastic houses

1. Have become increasingly popular during the past 15 years and, because of their obvious advantages, have replaced many glass-houses.

2. Two general classifications:

a. Flexible plastic

- (1) Polyethylene film is the most commonly used covering material. Four mil, thickness is most popular for greenhouses.**
- (2) Has advantages of being economical to construct and,**

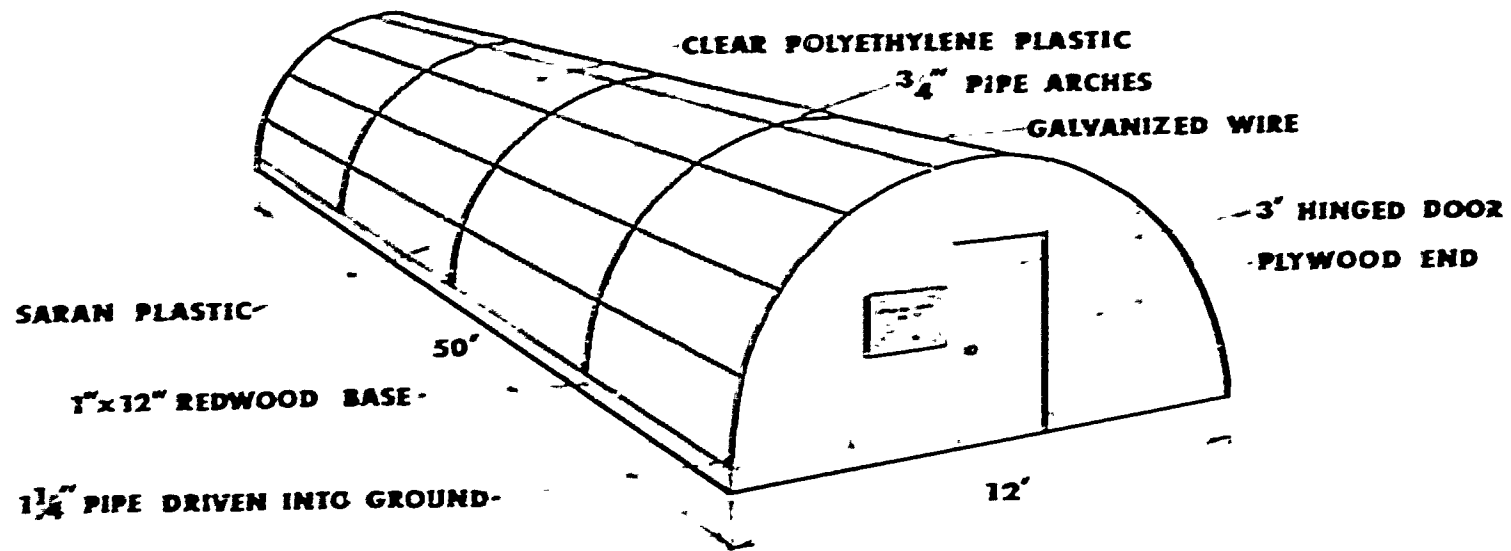

QUONSET-TYPE POLYETHYLENE HOUSE

Fig. 4.47

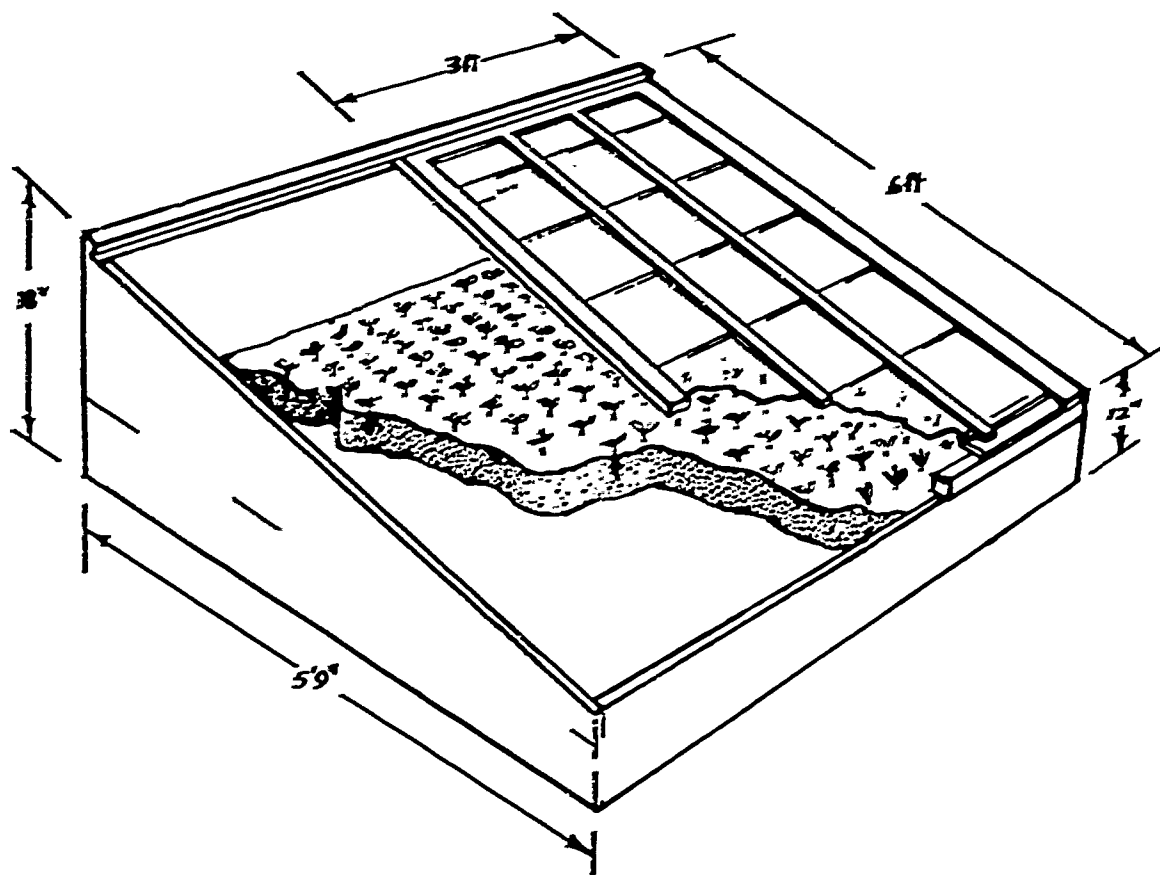

TYPICAL COMMERCIAL COLDFRAME

Fig. 4.48

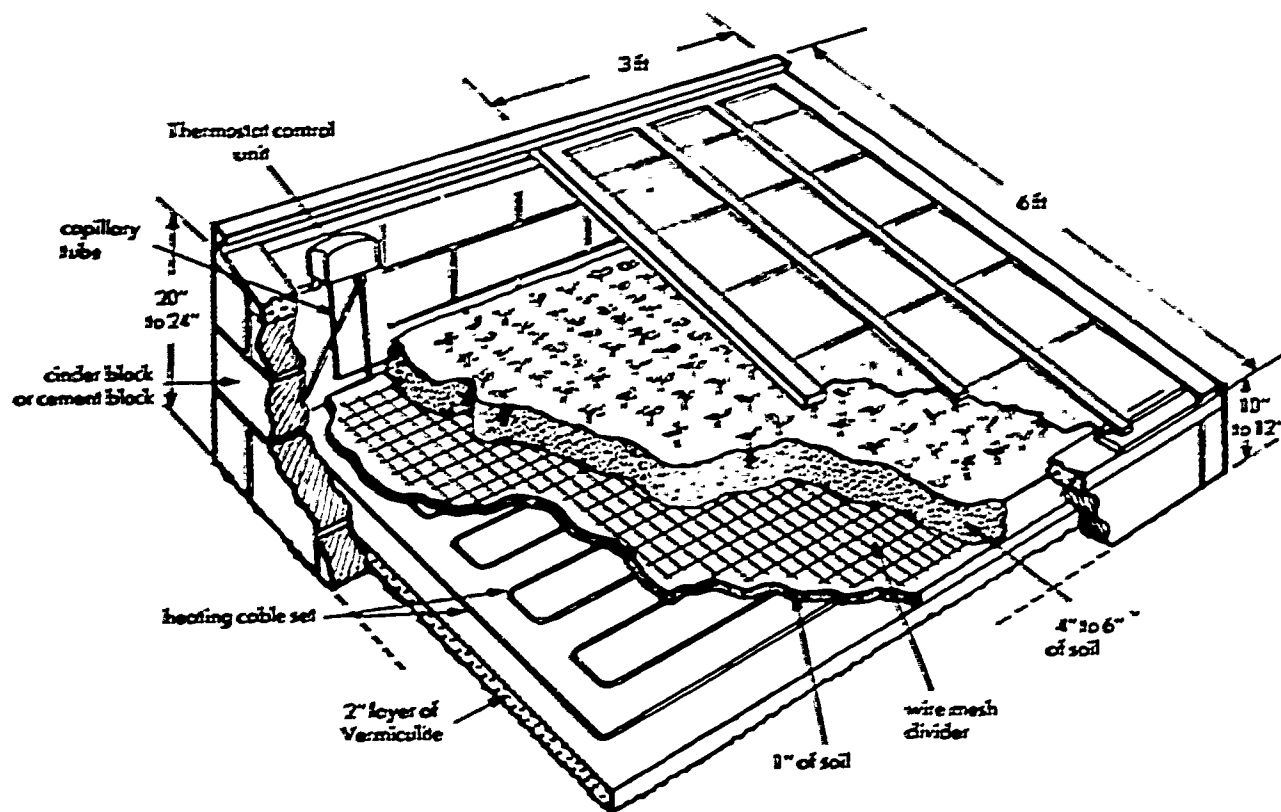

INSTALLATION OF HEATING CABLE IN A HOTBED

Fig. 4.49

since it is a temporary structure, is not taxable for personal property tax.

(3) Frame may be of a rather permanent nature but, because of deterioration in ultraviolet light, the plastic must be replaced yearly.

(4) Well-adapted to high school horticulture, where a permanent greenhouse is not available, since it can be constructed for only a few cents a square foot. This compares favorably with the cost of \$2.00 per foot or more for glass.

(5) Shapes for polyethylene houses

(a) Conventional, even span house with wooden frame

(b) Sawtooth construction

(c) Quonset type -- Easy to construct with student labor, highly wind-resistant, and most economical per square foot of floor space. Made by bending 3/4" pipes into a semi-circular shape, to serve as supports, and inserting them into larger pipe driven into the ground. These arches are then covered with stock fencing or 11-gauge wire. The polyethylene installed on top and 1"x12" boards on each side hold it tight at the base. A covering of saran plastic screen on top of the polyethylene provides shade, prevents billowing with the wind, and offers some protection against vandalism. Saran is available in different weaves ranging from 10 percent to 90 percent shade. The 50 to 60 percent grade is ordinarily best for this purpose.

b. Rigid plastics

(1) Because of their resistance to breakage and vandalism, rigid plastics, which include fiberglass and polyvinyl chloride, are replacing glass in plant houses in many areas.

(2) They are available in either corrugated or flat form and come in large sheets which may be cut with a saw and nailed in place. Rigid plastics are available under such trade names as Denverlite, Lascolite, Filon, and P V C.

(3) Since they are light in weight and strong they require less framing than glass.

- (4) Original cost is slightly higher per square foot than glass, but plastic may be justified where maintenance and vandalism are problems.

D. Lath house

1. The lath house is used for "hardening-off" greenhouse-grown plants and growing shade-loving plants.
2. Constructed of wood or aluminum, it is one of the most economical structures to build and operate. Costs range from \$.50 to \$1.00 per square foot.
3. Orientation of the lath is important in order to provide a constantly-moving shadow. Lath on the top should run north and south, while lath on the side should run vertically.
4. Spacing of lath is usually equal to the width of one lath apart, but may be varied to meet local conditions of sun and summer temperature.
5. Construction of a permanent frame, with the lath in removable panels, facilitates both installation and maintenance.
6. Lath houses for schools and retail nurseries should be painted either green or white to present the best appearance. Lath houses in wholesale nurseries usually are not painted.

E. Saran screen houses

1. These structures have replaced lath in many areas because of lower initial cost. Saran cloth should last up to seven years when it is properly supported and where allowance is made for its continual shrinkage.
2. Advantages of saran over lath are:
 - a. When properly constructed, it is bird-proof. (The Crown Sparrow is a serious winter pest of bedding and vegetable plants grown under lath.)
 - b. Distribution of light is more even.
 - c. Variable intensities of light are possible.
 - d. Because the droplets are diffused and there is no drip problem, less damage from rain results.
3. Wind damage may be a problem with saran and it is a common practice to run heavy clothesline wires diagonally between the posts both above and below the saran to prevent sagging and billowing.

F. Coldframe

1. The coldframe is among the simplest and most economical of all propagating structures.
2. It consists of a wooden or concrete block frame with heating supplied entirely by the sun.
3. It should run east and west with the low side toward the south in order to get the full benefit of solar radiation.
4. The cold frame is most suitable for germinating seed, rooting cuttings, and growing pot plants, vegetable plants, and bedding plants.
5. A cold frame may be covered with glass sash or suitable transparent substitute.
6. It requires constant care as far as light, shade, watering, and pest control are concerned.

G. Hot bed

1. The hot bed is similar to a cold frame except that some method of artificial heating (usually electric) is employed.
2. It is much more efficient as a propagating structure during cold weather because thermostatically-controlled heat speeds germination of seed, rooting of cuttings, and growth of plants.

H. Summary on structures -- While it is most desirable for an agriculture department to have a permanent glass or plastic house, lack of one should not discourage inclusion of ornamental horticulture as part of the curriculum. Any plant that can be grown in a greenhouse can be produced in a hotbed-lathhouse combination. It may be less convenient to operate the latter structures, but quality can be achieved. Some of the best high school horticulture programs in California have been carried on in temporary, home-made facilities.

Bibliography

Reference Books

All About Jiffy Pots, George J. Ball, Inc., West Chicago, Ill.

The Ball Red Book, George J. Ball, Inc., 10th Edition, West Chicago, Ill., 1964.

Baker, Kenneth F., and others, The U C System for Producing Healthy Container-Grown Plants, California Agricultural Experiment Station Manual 23, University of California Agricultural Extension Service, Berkeley, 1957.

Hartmann, Hudson T., and Dale E. Kester, Plant Propagation: Principles and Practices, Prentice Hall, Inc., Englewood Cliffs, N. J., 1959.

Kains, M. G. and L. M. McQuesten, Propagation of Plants, Orange Judd, New York, 1939.

Morgan, William P., Jr., A Manual on Nursery Practices, El Cerral Bookstore, California State Polytechnic College, San Luis Obispo, 1964.

Mathias, Mildred E., and Elizabeth McClintock, A Checklist of Woody Ornamental Plants of California, California Agricultural Experiment Station Manual 32, University of California Agricultural Extension Service, Berkeley, 1963.

Plantainer Growing, Container Division, Hill Stock Farm, Inc., Dundee, Ill., 1965.*

Periodicals

Grower Talks, George J. Ball, Inc., West Chicago, Ill.

* -- Available free of charge from Nursery Metal Pots, Inc., 310 Sansome Street, San Francisco.

CHAPTER V

Starting an Ornamental Horticulture Program

To introduce a program in ornamental horticulture, the school should make available one or two acres of open land where demonstrations can be held, skills taught and practiced, and nursery stock grown. The classroom is ideal for lecture purposes, but for effective practical teaching students should be able to work outdoors two or three hours a week.

Ornamental horticulture can be as popular as the instructor desires to make it. He will have to use a unique and motivating approach to introducing this subject matter, especially if it has not been offered before. There will be disappointments at the outset, but these will be overcome as the instructor acquires some of the necessary skills and uses a little ingenuity to cope with the new problems and situations.

There are many methods by which an instructor can motivate his students. One of the most readily apparent is to acquaint them with reasons for offering the course. Two or three lectures on job opportunities in ornamental horticulture compared to job opportunities in other parts of the agriculture industry is extremely important at this time. These lectures can be profitably followed by field trips to wholesale and retail nurseries, florist shops, a botanic garden (if one is near at hand), and professionally-landscaped estates or public parks. These will be especially valuable experiences if qualified people are able to speak to the class at each stop and if high school students respond well by asking questions while visiting commercial horticulture units. Another excellent method of creating class interest is to invite a landscape architect or designer to speak to the class. Landscape designs for homes, business and industrial buildings, and parks, rendered in pastel chalk by professionals and explained, always create unusual interest.

Class Crop Useful

These are but a few of the methods that have been successfully used in teaching ornamental horticulture to high school agriculture students. Another recommendation is to require the entire class to raise a nursery crop that can be propagated and sold to a commercial outlet during a regular school year period. Nursery crops that have been successfully raised in this manner are Poinsettias, Algerian Ivy, Roses, Fuchsias, Geraniums, and many others.

Hardwood double Poinsettia cuttings, that are propagated in mild climates during January and February, make attractive specimen plants for the holiday season. Triangularly spaced in gallon containers, three eight-inch cuttings, pinched every month until June or July, are in great demand by wholesale nurseries. In frost-free areas plants can be grown outside in direct sunlight. Inland areas would be forced to use polyethylene plastic for protection against low temperature, and possibly artificial heat beginning in October.

One California high school sells as many as 5,000 Poinsettia plants in early November to wholesale nurseries. Little technical knowledge is necessary to raise Poinsettias from hardwood cuttings and the cost of production is negligible.

Fuschias are also easily propagated by hard or softwood cuttings. Specimens rooted directly in gallon cans should be ready for sale to commercial outlets in full bloom by May or June. Softwood cuttings, propagated any season of the year in a greenhouse and rooted in four-inch plastic pots, can be sold as beautiful house plants. Care should be taken not to use patented varieties.

Algerian Ivy is another easy-to-propagate plant. Foundation stock planted around a cyclone fenced area will provide cuttings throughout the year. One high school agriculture department planted Ivy on a cyclone fence enclosing the nursery area ten years ago and since that time has sold thousands of flats of Ivy to wholesale and retail outlets. Local landscape contractors will buy all that can be raised, at or near the prevailing wholesale price if the quality is good. To guarantee 100 plants to a flat, it is best to give one free flat for every ten flats purchased.

Savings on Ivy Flats

All of the projects mentioned can be propagated and sold during a one-year growing season. Students can raise the stock in their backyards. Flats for Ivy cuttings can be made in the shop classes from discarded vegetable and fruit crates. These are good for one season and will save the student about \$.30 to \$.40 per flat. It also affords the shop students experience in measuring, cutting and nailing the flats together. For the wholesaler who requests redwood flats, the department should keep a stock on hand.

Future Farmer organizations finding it difficult to raise money for chapter activities can market quality stock with many wholesale nurseries at a reasonable profit.

Another project opportunity for students living in Southern California is the raising of Avocado seedlings. This involves planting certified seeds, which cost approximately \$.10 each in roofing paper cylinders. They can be sold for a good price after a nine month period. Desirable varieties of tip-grafted or budded rootstock will sell at premium prices during the spring months.

The novice should not plan to sell budded or tip-grafted seedlings until he has acquired proficiency in this skill. For practice purposes, 200 to 300 seedlings should be planted in quart cans every year. This will afford students an opportunity to graft and observe the results of the experiment but would not make salable plants because of restricted root system.

By the time a few flats of Ivy or cans of Fuschias have been sold, most agriculture students will undoubtedly have been convinced that ornamental horticulture is a fascinating and profitable major to pursue. Students who previously could not afford beef projects or provide suitable places to raise animals will now be able to engage in productive projects and eventually qualify for the FFA's State Farmer competition and other honors.

There are many other possibilities for project work in ornamental horticulture that the agriculture instructor can introduce as he acquires added background and experience. By now, the instructor should have enough confidence in himself to branch out into many of the other more technical aspects related to this field.

Budding roses is another skill that students can be taught with a minimum of equipment and effort. Year-old stock raised in gallon containers can be T-budded in September and the results observed by February. To assure success, students should practice on Willow wood before grafting onto rose stock. A knife (such as the Stanley 299, which sells for about \$1.00 and comes with 5 replaceable razor blades) is excellent for this purpose. Students can practice the T-bud operation on stock rooted in gallon cans after acquiring the necessary skill. If the bud does not take, the rooted stock can be budded again the following year.

Stock successfully budded will arouse great interest among the members of the class. Some of the students will go home and practice budding everything that grows. For novelty budding, a student may want to bud three or four rose varieties on the same rootstock. To do this successfully, the rose stock would have to have one cane available for each bud. There are many job opportunities for students acquiring skill in budding. An expert budder can earn \$30 to \$50 a day during the budding season, working in commercial wholesale nurseries.

This section has presented suggestions to help the agriculture instructor teaching ornamental horticulture for the first time, with ideas for project work that do not require elaborate nursery facilities. By the time the instructor has marketed his first nursery crop, he should have acquired enough basic skills, to embark successfully on an interesting and challenging career, teaching ornamental horticulture to all of his agriculture classes.

How to Get Started Propagating

The first important step in starting an ornamental horticulture program in high school agriculture is to start. The program may be begun in a very modest way, with rather limited facilities, by an instructor with limited experience and preparation. The first projects in seed and vegetative propagation may be started on a table or along a window sill in the classroom.

A suitable propagation frame may be developed by using a cold frame 4 feet wide and 8 to 12 feet long. A clear plastic cover with facilities to control shade will also aid in light control. The addition of a soil heating cable with a thermostat will increase the usefulness of the frame for propagation. In areas of low humidity a mist watering system with timer may be necessary.

Types of Plants to Grow

For the beginning ornamental horticulture program in a high school, the selection of the plant materials is very important. Plants should be selected that are hardy and easy to grow, and that may be propagated and grown to mature salable size during one school year. Much of the plant material that is

so produced can be utilized by landscaping the school or it may be sold to students, teachers, or the FFA chapter. Successful student projects in ornamental horticulture are important to establish the beginning program as an accepted well-founded part of the agricultural program by the students. A list of plants that have been used successfully for propagating projects in beginning programs in California is shown in Figure 5.1.

<u>Materials to be grown in flats</u>	<u>Method of Propagation</u>
<u>Ajuga reptans</u> , Carpet Bugle	divisions
<u>Festuca ovina gluca</u> , Blue Fescue	divisions
<u>Fragaria chiloensis</u> , Wild Strawberry	divisions
<u>Hedera canariensis</u> , Algerian Ivy	cuttings
<u>Mesembranthemum</u> , Ice Plant	cuttings
<u>Rosmarinus officinalis prostratus</u> , Trailing Rosemary	cuttings
<u>Ligustrum japonicum texanum</u> , Waxleaf Privet	cuttings
 <u>Materials suited for gallon container growing</u>	
<u>Acacia Sp.</u> , Acacia	seeds
<u>Eucalyptus Sp.</u> , Eucalyptus	seeds
<u>Euphorbia pulcherrima</u> , Poinsettia	cuttings
<u>Ligustrum joaponicum texanum</u> , Waxleaf Privet	cuttings
<u>Myoporum laetum</u> , Myoporum	cuttings
<u>Nerium oleander</u> , Oleander	cuttings
<u>Rosmarinus officinalis prostratus</u> , Trailing Rosemary	cuttings
<u>Melianthus major</u> , Honey Bush	seed

Figure 5.1: Plant Materials Often Used Successfully in Beginning Programs

In the beginning ornamental horticulture program a selection of desirable plant materials may be obtained by purchasing lining-out stock (started cuttings and seedling plants in 2-1/4" pots) from a wholesale nursery, at a cost of \$.10 to \$.25 per plant. Select a variety of plant materials that will be useful in developing plants for identification and other instructional units. Since one to five plants of each species or variety is enough for this purpose, it is possible to obtain a number of desirable plants with a limited investment. The

lining-out stock so obtained should be potted or canned and eventually moved to larger containers. These plants will be useful specimens for several years.

Soil Mixture

In order to be useful in a high school ornamental horticulture program a soil mixture should be simple and composed of materials available in the area where the department is located. It must also be such that it can be mixed by students with little difficulty. The ingredients of the mix can be measured by the wheelbarrow load. A suitable mixture composed of shavings (redwood or pine), sandy loam (fine loams with sand added), and leaf mold or compost has been used satisfactorily in a number of high school programs. The mixture may be hand mixed with shovels, but it is useful to run it through a soil shredder if one is available. A coarse screen may be used to screen out rocks or coarse materials. Sterilizing (with methyl bromide at rate of 1 pound per cubic yard for 24 hours) is recommended (especially if the soil is to be used for seeding) and, if desired, a basic fertilizer mixture may be added to the soil. (See Chapter IV)

This suggested soil mixture may be changed by the addition of leaf mold, compost, manures, peat moss, and soil conditioners to be suitable for use as a mixture for almost any plant materials. Screened with fine screen it may be used in flats and small containers. When used for seed propagation, an additional one-third of screened and sterilized peat moss or leaf mold should be added.

Bibliography

Textbooks (Class Sets)

The Ball Red Book, George J. Ball, Inc., 10th Edition West Chicago, Ill., 1963.

Sunset Western Garden Book, Lane Publishing Company, Menlo Park, Calif., 1961.

Western Fertilizer Handbook, California Fertilizer Association, San Marino, Calif., 1961.

Reference Books

Bailey, L. H., and Ethel Z. Bailey, Hortus Second, Macmillan Company, New York, 1941.

Bailey, L. H., Standard Cyclopedia of Horticulture, 3 Vols., Macmillan Company, New York, 1928.

Baker, Kenneth F., and others The U C System for Producing Healthy Container-Grown Plants, California Agricultural Experiment Station Manual 23, University of California Agricultural Extension Service, Berkeley, 1957.

Edwards, John P., How to Grow Roses, Land Publishing Company, Menlo Park, Calif., 1960.

Gardening in Containers, Lane Publishing Company, Menlo Park, Calif., 1959.

Graf, Alfred B., Exotica III, Roehrs Company, Rutherford, N. J. 1963.

Hartmann, Hudson T., and Dale E. Kester, Plant Propagation: Principles and Practices, Prentice-Hall Inc., Englewood Cliffs, N. J., 1959.

Horticulture Colour Charts, 2 Vols., British Colour Council, Henry Stene & Sons, Ltd., 1959.

Hoyt, Roland S., Ornamental Plants for Subtropical Regions, Livingston Press, Los Angeles, 1938.

How to Grow Camellias, Lane Publishing Company, Menlo Park, Calif., 1962.

Hudson, Roy L., Pruning Hand Book, Lane Publishing Company, Menlo Park, Calif., 1952.

Ideas for Color in Your Garden, Lane Publishing Company, Menlo Park, Calif., 1962.

Landscaping for Modern Living, Lane Publishing Company, Menlo Park, Calif., 1954.

Landscaping for Western Living, Lane Publishing Company, Menlo Park, Calif., 1956.

Lawn and Ground Cover Book, Lane Publishing Company, Menlo Park, Calif., 1960.

Mathias, Mildred E., and Elizabeth McClintock, A Checklist of Woody Ornamental Plants of California, California Agricultural Experiment Station Manual 32, University of California Agricultural Extension Service, Berkeley, 1963.

Morgan, William P., Jr., A Manual on Nursery Practices, El Corral Bookstore, California State Polytechnic College, San Luis Obispo, Calif., 1964.

Rector, Carolyn K., How to Grow African Violets, Lane Publishing Company, Menlo Park, Calif., 1956.

Pronouncing Dictionary of Plant Names, Florists' Publishing Company, Chicago, 1964.

Seasonal Garden Guide, Lane Publishing Company, Menlo Park, Calif., 1955.

Periodicals

Flower Grower, William Press, Inc., New York.

Grower Talks, George J. Ball, Inc., West Chicago, Ill.

Horticulture, Massachusetts Horticultural Society, Boston.

Landscape Design and Construction, Miramar Publishing Company, Los Angeles.

Pacific Coast Nurseryman, Cox Publishing Company, Arcadia, Calif.

Sunset, Lane Publishing Company, Menlo Park, Calif.

Other Useful Materials

(Note - In addition to those listed above and elsewhere in this manual, a number of other publications may be useful. Among them are seed and nursery catalogs and other pamphlets, manuals, and books from the University of California Agricultural Extension Service.)

CHAPTER VI

Operating the High School Nursery

Two types of horticultural projects often operated in the school horticultural laboratory are:

1. Garden and nursery projects conducted as instructional units and laboratory work for students in ornamental horticulture classes.
2. Similarly, student-owned and operated projects in high schools where vocational agriculture is offered.

Instructional projects in the garden and nursery are planned to accomplish meaningful learning experiences through use of the "learning-by-doing" technique. These projects should be planned to expose the students to the garden and nursery operations and to the performance of garden and nursery skills. In planning the projects, the instructor should avoid projects where students are engaged in activities that extend beyond instructional value or those which would have them perform routine nursery operations or skills that have been already learned and practiced. He should avoid projects developed solely to make money for the chapter or for public relations with school or community that do not meet the required objectives of a learning situation project. He should avoid growing one nursery item where only a few nursery operations are learned. He should avoid weeding, planting lawns, renovating lawns, and landscaping around the school beyond what is needed for practical and instructional purposes. The project system is not educationally justifiable unless the instructor and students are more than a crew of laborers.

Projects in the horticultural laboratory that are owned and operated by vocational agriculture students are to provide learning experiences in commercial garden and nursery production. These student-owned projects should be conducted under written agreement between the participating student and the high school horticultural laboratory or its Future Farmers of America Chapter. Such an agreement must clearly state what the student will provide and what will be provided for the student by the laboratory or chapter. (See Figure 6.1)

Before a student starts an ownership project he should know the nursery operations and should have developed the skills needed to produce the nursery crop successfully. New projects should be developed, based on success of previous nursery projects. The success of production projects will depend upon producing quality nursery plants, having a market for these plants when they are ready, and marketing the plants. Participating students should earn reasonable labor incomes for their efforts. They may form partnerships or corporations among themselves to produce an ownership nursery project. In this manner the experienced students can help train those new to the program. Work on

60/ 61

HHHS

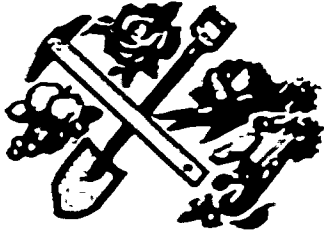

AGRICULTURE DEPARTMENT

HANOVER HIGH SCHOOL ■ 212 WEST STREET ■ HANOVER, CALIFORNIA ■ 685-9954

NURSERY PROJECT AGREEMENT

1. Hanover High School Future Farmer of America Chapter will:
 - a. Furnish all supplies, equipment and materials necessary for the production of the nursery project.
 - b. Receive 50 percent of the gross sales from plants sold and or 50 percent of the plants produced from this nursery project.
2. Participating student will:
 - a. Do or is responsible for all care and management of nursery project.
 - b. Surrender the project, if he has been found to be negligent or if he moves from Hanover School District or if he withdraws from study in the vocational agriculture department.
 - c. Receive an adjustment from the vocational agriculture student completing the agreement or the Hanover FFA Chapter if he moves away from the high school district.
 - d. Pay for all and any damages due to his carelessness or negligence.
 - e. Receive from the project all premium money when he exhibits plants at the fair.
 - f. Receive 50 percent of the gross sales from plants sold and or 50 percent of the plants produced.

SIGNED

Participating Student

Date

Parent or Guardian of Participating Student

Date

Instructor

Date

Figure 6.1 - Suggested Agreement Covering Nursery Project

SIMPLE COATING EQUIPMENT

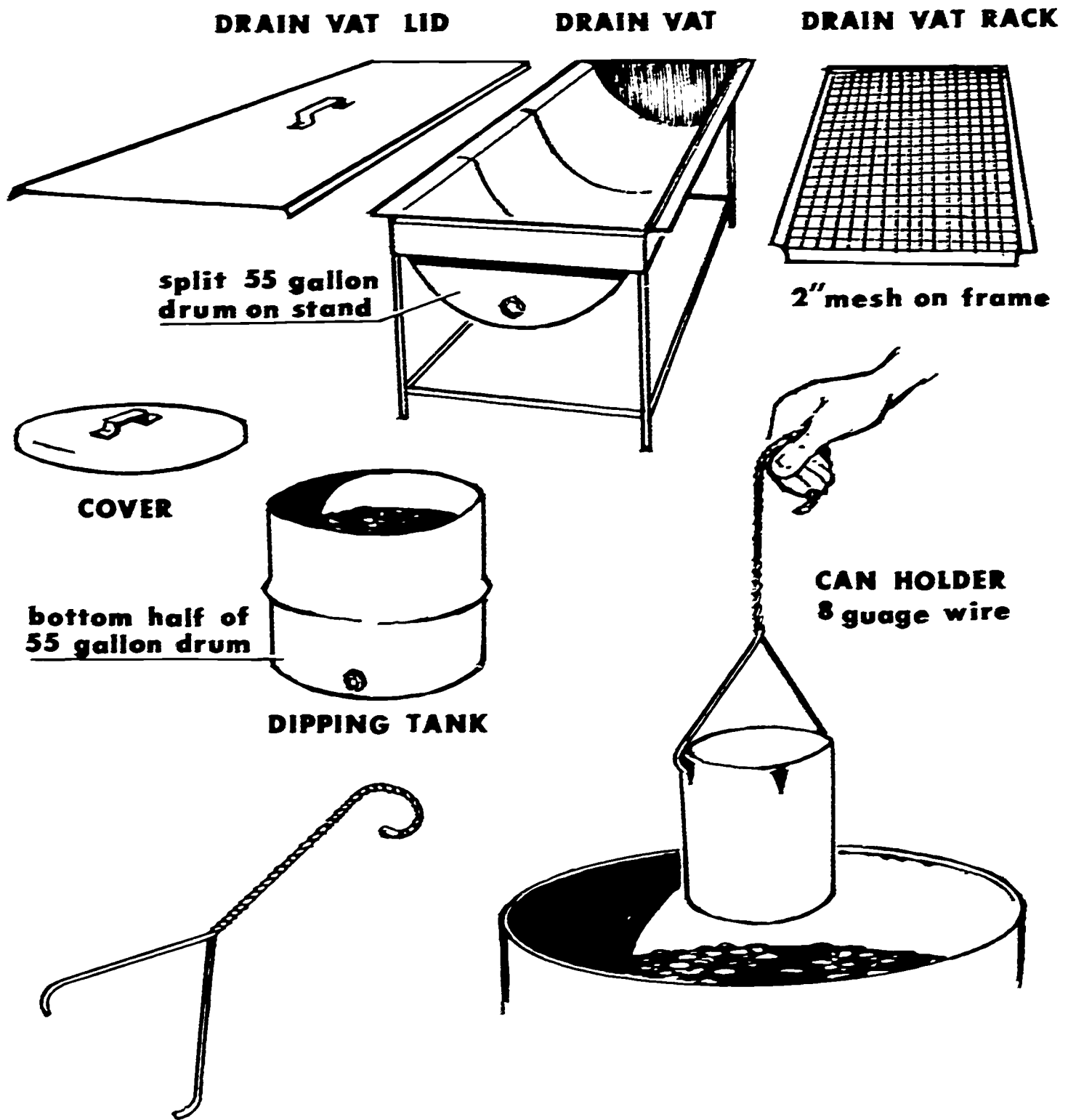
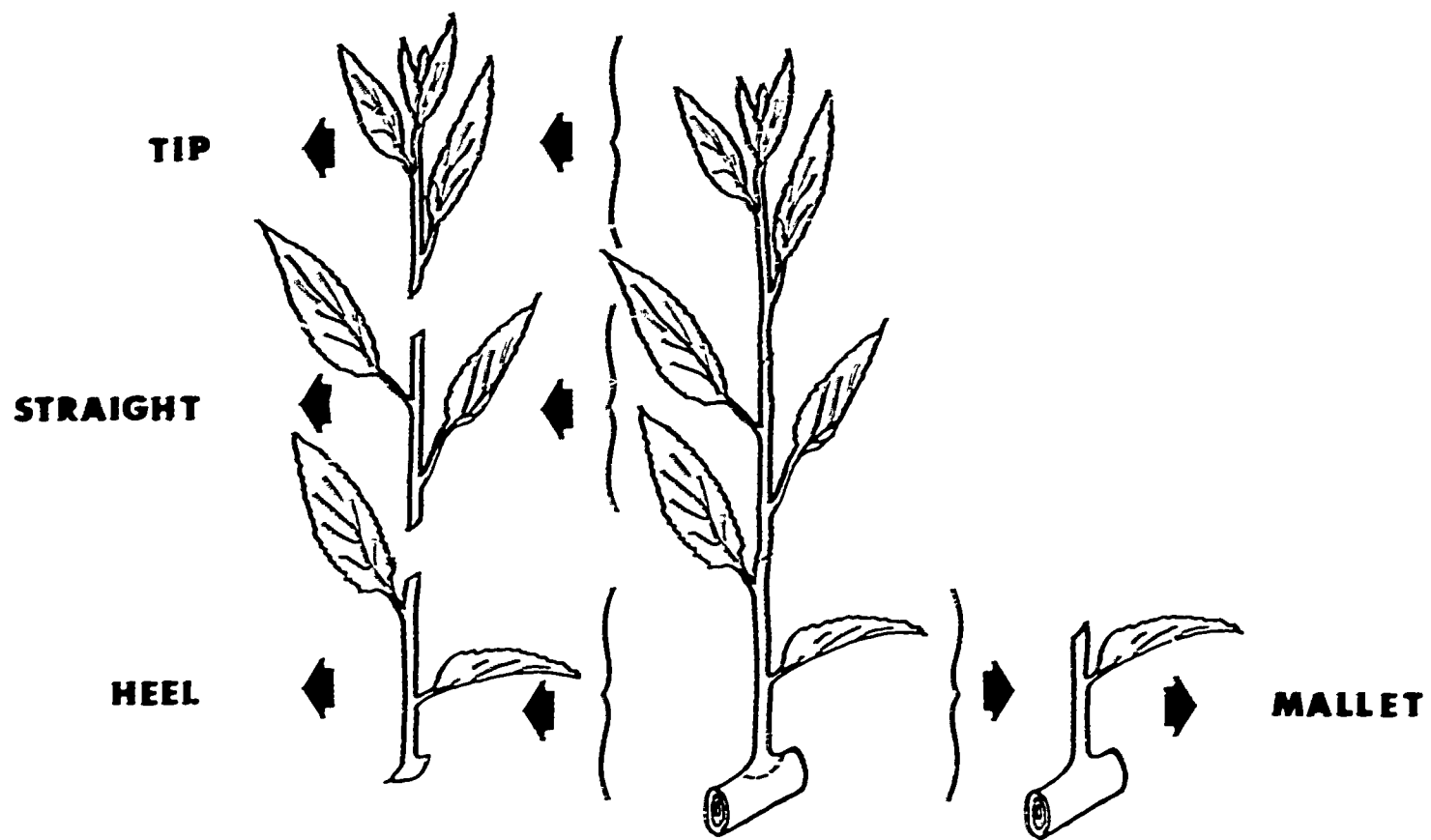

Fig. 6.2



STEM CUTTINGS CLASSIFIED ACCORDING TO SHAPE

Fig. 7.1

ownership projects is done by the students before and after school and during weekends, vacations, lunch periods, and study halls.

Relationship of the Nursery to Classroom Instruction

The ornamental horticulture facility provides a laboratory for the teaching of ornamental horticulture production. In the classroom the factual materials are learned, and with this background the students develop skills and techniques on the facility, putting to use knowledge learned in the classroom. The facility is used primarily as a regular laboratory for teaching nursery operation and methods.

Students are able to learn such fundamental skills and techniques of ornamental horticulture production as soil preparation, soil sterilization, seeding, irrigating, dividing, potting, canning, fertilizing, spraying, dusting, landscaping, and training and pruning plants in the lab-nursery. Set-up and organization of the nursery provides an opportunity for experimentation, permitting students to observe the advantages and disadvantages of the varied methods and techniques used in ornamental horticulture production.

Precautions in Management and Operation

An instructor teaching and operating an ornamental horticulture program for the first time will do well to take several important management and operating precautions. Six of the most important are:

1. For maximum effectiveness, ornamental horticulture facilities should be large enough to use standard equipment and practices. In order for the facility to be an effective teaching aid, the nursery and related facilities must be large enough to give a complete and practical view of the steps in ornamental horticulture production. Equipment and facilities should be up-to-date and of the type that are currently being used in commercial nursery production. These facilities are to be used as a laboratory for the teaching of standard methods of production and this necessitates their being large enough to put into operation these standard methods.

2. Ornamental horticulture facilities should be located on the campus if possible. They should be convenient to the agriculture department's classrooms to enhance their effective use in the instructional program.

3. Compensation should be provided all students for work beyond that of their instructional level. Monies used for this labor may be secured from sales of plants, credit received from the school district for plants used, or from an operating fund provided by the school district.

4. The nursery and related facilities must be primarily a laboratory and be organized and operated for the sole purpose of providing instructional materials, skills, and activities. Profit on the enterprises should be incidental to the operation for instructional purposes. (However, with proper management the nursery at any high school can produce plants that will provide for much of the operating expenses of its ornamental horticulture program.)

5. A thorough training program in the care, use, and operation of equipment and materials must be provided for each student. Safety rules must be

established for all the equipment and materials, such as pesticides used, and students should be instructed in safe operation of all electrical and mechanical equipment and poisonous materials. Lists of such rules on operation and use of equipment should be published and made available to each student. The teacher should plan a safety test on these rules that students must pass before permitting them to operate equipment or use poisonous materials. Certain equipment and materials, because of their danger to students, should be operated or used only by the instructor or under his direct supervision.

6. An excess amount of the instructor's and students' time must not be given to this phase of instruction, thus reducing the time they could spend on other desirable phases of the vocational agriculture and horticulture program. One instructor who has managed and operated a school farm for the past 10 years has found that it is easy to fall into the habit of using the farm chores as the lesson plan for the day. Most of the chore duty done by students before and after school should be handled as supervised farm projects or as supervised farm practice. Only a minimum amount of chore duty should be done during regular class, and then only when it fits in as part of a regular instructional unit.

For effective teaching the instructor will find it necessary to spend time in managing and supervising the nursery before and after the regular school day. Laboratory facilities will not reduce the workload or responsibility of the instructor. When the regular instructor is absent from duty, due to vacations and other reasons, some non-certificated employee can be designated to carry out needed work at the nursery.

Sale of Plants

Plants in excess of needs, which are produced by students working on supervised projects, may be sold wholesale to local retail nurseries. It may be profitable for the FFA chapter to maintain a wholesale nursery license to facilitate such an enterprise.

Some high school districts also will use surplus plants as they may be required for landscaping schools within the district. The district may want to credit the agriculture department or the ornamental horticulture laboratory at wholesale prices for plants used as a means of supplementing the operating expense of the facility.

Supervised Plant Projects

Vocational agriculture students may maintain plant projects under the supervision of the vocational agriculture instructor in the school ornamental horticulture facility. Students who do not have the required equipment or facilities at home may want to start plant projects at the nursery, then move the plants home to complete the project.

Students who maintain plant projects at the school usually do so under an agreement with the vocational agriculture department. Such an agreement should provide that the vocational agriculture department will supply all equipment and supplies needed for the project and will receive 50 percent of the gross sales

of the plants sold and/or 50 percent of the plants produced. (See Figure 6.1)

Cans as Containers

Why coat cans? When cans are used as plant containers they are dipped because coating the can with a suitable paint will double the useful life of the can as a plant container. The appearance of coated cans are usually more readily accepted by the nursery trade.

Coating cans. (See Figure 6.2) Cans may be prepared as plant containers by students by removing paper labels, cutting drain holes, removing tops, and painting. Labels may be removed by tearing off or soaking. Cans will come clean except for glue points, and drain holes may be punched in the sides near the bottom of gallon cans with a beverage can opener or a commercially-produced "multiple can punch," which is available for cans ranging from one- to five-gallon sizes. Four punched holes are usually evenly spaced around the bottom of gallon cans. Larger, heavier gauge cans may require the use of a chisel and hammer to cut drain holes. Can tops may be removed by a can opener or by the use of a chisel and hammer. An asphalt utility coating, diluted one-half with paint thinner, is commonly used to coat the cans. Certain paints are also used to coat containers. Cans are dipped in coating, open end first, and turned on their sides to insure coating the inside bottom of the can. Dipped cans are then set on a rack of heavy gauge hardware cloth or expanded metal with a catch vat under the rack to catch the excess coating that will drain from the cans. Cans may then be removed from the rack as soon as they drain, and stacked (bottoms up) to dry. Excess coating from the vat can be used again in the dipping tank. The vat can also be used for dipping and coating cans larger than gallon sizes.

Where do they come from? Good sources of cans for use in the ornamental horticulture program include school cafeterias, restaurants, bakeries, and service stations. They can often be obtained from such sources free for picking them up. To assure even coating, it is desirable to have cans washed when the normal contents are removed, and oil cans should be drained of oil before coating.

Suggested Greenhouse Projects

Greenhouse facilities enhance an agriculture program in many ways, but most important they offer students an opportunity to raise exotic subtropical plants and afford experiences in management practices which may help prepare students for occupations in research and industry.

However, the agriculture teacher venturing into ornamental horticulture for the first time should not feel that it is an absolute must to have greenhouse facilities immediately. It is recommended that a small lathhouse and possibly a coldframe or hotbed constructed by students be fully utilized before venturing into this more specialized area. Whether the greenhouse is built by students or not, the instructor must keep in mind that an empty or poorly-managed structure is the same as an expensive classroom that is not in use part of the day. With building costs high and school budgets low in most areas, it is difficult to justify to the taxpayers an investment that is not being used. It must also be remembered that a greenhouse requires special knowledge in management.

For the beginning teacher, this could add immensely to his many responsibilities and create a sense of insecurity during the important period of apprenticeship.

Philodendron varieties

Coleus blumei

Peperomia obtusifolia and Var. variegata

Ficus pandurata and F. elastica decora

Chamaedorea elegans (Parlor Palm)

Brassia actinophylla (Schefflera)

Begonia (Rex and Angel Wing)

Bedding plants

Vegetable plants

Chrysanthemum

Dieffenbachia

Caladium

Cissus rhombifolia

Sansevieria

Figure 6.3 - Plants for Glasshouse Culture in Beginning Programs

Students can pursue a number of plant projects in a greenhouse. Common plants, which can easily be grown, should be the nucleus of a beginning operation. Some of those that have been used successfully are listed in Figure 6.4.

Philodendron varieties are numerous and easily propagated. Philodendron cordatum is one of the best varieties for use as a house plant. It can be trained on a "totem pole" or allowed to trail on a mantle or shelf. Philodendrons are propagated by stem or leaf bud cuttings any time of the year.

Coleus are colorful plants propagated by seed or cutting indoors. They can be used outdoors as an accent plant in a northeastern exposure. As house plants they are showy and can be used very effectively in decorating banquet tables, offices, classrooms, etc.

Peperomia obtusifolia and its variegated varieties are easily propagated by leaf and stem cuttings. Raised in a greenhouse and allowed to grow for six months or more in a trailing manner, Peperomia will produce a beautiful mantle piece or television, radio, or shelf specimen plant. The plant should be pinched to encourage irregular and erratic growth. There is a big demand for this plant if it is allowed to reach its full growth potential.

Ficus, or Rubber Plants, are always in demand and offer the student an opportunity to practice air layering. They can also be propagated by cuttings. Rubber plants have many uses around the school and home, and in coastal areas do well out of doors.

Parlor palms, raised by seed for house specimens, sell readily. This miniature palm, often used for centerpiece decorating, probably has more appeal than any other miniature variety.

Schefflera may be started by seed in a greenhouse and used effectively as a house or patio plant. The shiny green leaves make it a beautiful specimen plant for tropical settings, and it tolerates a low light intensity.

The Rex Begonia is another showy plant that likes humidity. Students can learn to propagate this plant by leaf or stem cuttings. Leaves placed horizontally and fastened firmly on sand in a hotbed, with quarter-inch cuts across the veins, will put out numerous plants.

Bedding plants may be raised for school and community use. Unless quality plants are raised, however, they are difficult to sell. Vegetable plants must also be quality plants before nurseries will put them on the market.

Chrysanthemums may be raised year around in the greenhouse under controlled conditions and are very popular for sales purposes.

Dieffenbachia and Caladium are attractive foliage plants and in great demand.

Sansevieria, a hardy plant, may be propagated by section cuttings or divisions. It is ideal for planters and does nicely in the home and office because it is tolerant of dust, drought, and smoke conditions.

Cissus rhombifolia, or Evergreen Ornamental Grape, is another attractive office and house vine plant that may be trained on a trellis or left to trail.

There are numerous other plants that can be raised, and the foregoing list is but a beginning. More difficult plants can be raised as the student acquires the necessary skills.

Emphasis in horticulture should not be to earn money from the school facilities. In time, and with a little experience, the student can build a greenhouse shelter in his own backyard and raise plants for commercial outlets.

It is important when planning to sell plants produced by the ornamental horticulture program and student projects, that regulations regarding such sales in the California Agricultural Code be considered. County agricultural commissioners and the Nursery Service of the State Department of Agriculture,

located in Sacramento, can supply information on provisions of the code regarding nursery plant sales. In brief, the California code provides that a person selling plants in this state shall obtain an annual license before selling nursery stock. The ornamental horticulture program and students may meet the requirements of this provision by:

1. Obtaining, by application to the county agricultural commissioner, a restricted, fee-exempt license, which is allowable if all five of the following conditions are met:

- (1) The applicant is not regularly engaged in the nursery business.
- (2) His sales amount to less than \$100 in a fiscal year.
- (3) He has reported to the commissioner of his county his intention to make such sales.
- (4) All the plants he sells are of his own production.
- (5) He sells all such plants for planting within the county where grown.

2. Where a high school program does not meet the requirements for a fee exempt license, a license at the minimum fee of \$15 per year may be obtained.

Retail plant sales by both a high school ornamental horticulture program and students are subject to state sales tax provisions. An ornamental horticulture program may use the resale license assigned to its school's student body to handle taxes from retail sale of plants. A full statement of regulations covering retail sales and sales taxes can be obtained from the State Board of Equalization.

It must be remembered, however, that the only justification for plant sales is enhancement of the educational program. If sales lead to the involvement of more students in plant-growing projects, the production of better quality crops, or a partial defraying of educational costs, they should be encouraged. Care should be exercised, however, to avoid letting the sale of plants overshadow the educational value of the program.

CHAPTER VII

Monthly Calendars of Activities and Course Content

Calendars of monthly activities and course content, prepared in advance of the academic year, are extremely helpful in assuring that all of the important content units and nursery activities are covered during the year. Lists such as these serve as guides for both the instructor and students, and if the calendars have been thoughtfully prepared and followed, students who acquire the knowledge and skills included should, by the time they reach their junior or senior years, be able to set up their own part-time nursery businesses.

Suggested calendars -- one each of activities and content -- are presented in this chapter. Neither is complete, but both can be profitably used as guides for establishment of similar calendars for use in high school ornamental horticulture programs. Both are used in already-established successful high school programs in California and they are also flexible enough to be adjusted to fit the need of almost any situation or location in the state.

Calendar of Monthly Nursery Activities

This calendar of monthly operations, maintenance practices to be performed, and recommendations can, as mentioned, be expanded considerably. Numerous plants -- in fact, all those successfully grown in California -- could be added. With each plant added, more maintenance practices, recommendations, and operations would be needed. It is not necessary, however, to have such a large number of plants available. A list of plants such as that included in this calendar (and elsewhere in this manual) is sufficient for an adequate program. The important point is that plant materials must be available so that students have ample opportunity for practical application of their new knowledge. Rote learning is, of course, necessary. But the experience of applying that learning in practice is also necessary to continue growth of their knowledge of ornamental horticulture.

SEPTEMBER

Fertilize: Last feeding for Roses, Camellias and Azaleas.

Pest Control: Spray for black scale.

Planting: Sweet Peas, winter annuals, Calendulas, Stock, and Snapdragons.
Fall bulbs such as Ranunculus, Anemones, and others are available.

Watering: Water all plants frequently.

Deciduous Fruit Trees: Watch for peach tree borers on trunks of Cherry, Peach, Plum, and Almond trees. Sawdust, sap and gummy exudations are signs that borers are at work. Spray trunks with DDT at three-week intervals. Use an insecticide, such as Borersol, in infested trees.

Perennials: Fall flowering perennials, including Dianthus, Gazania, Penstemon, and Salvia are available in nurseries.

Attractive plants in September -- Crape Myrtle, Roses, Bougainvillea.

OCTOBER

Lawns: Best time to reseed Bermuda.

Planting: Winter annuals and perennials. Anything from containers.

Watering: Keep water on plants that are green.

Tuberous Begonias: Lift Tuberous Begonias after foliage is completely dead and stems pull away easily. Store tubers after they are thoroughly dried.

Berries: Cut back all old canes, leaving five to seven new ones on each plant.

Pest and Fungus Control: Insecticides and fungicides may be necessary for mildew and pest problems.

Attractive Plants in October - Early Camellias, early Azaleas, Cotoneasters, Ginkgo, Liquidambar.

NOVEMBER

Lawns: Renovate Bermuda lawns.

Watering: Continue to water if rain is scant.

Pest Control: Evergreen shrubs and trees can stand late fall spraying for red spider mites, aphids, and scale.

Citrus: Cut down on extra water and fertilizer.

Subtropical Fruits: Cut down on fertilization and watering.

Natives: Plant from cans or pots.

Roses: Continue to water to get blooms until Christmas.

Attractive Plants in November - Pyracantha, Cotoneaster, Camellias, Azaleas, Heather.

DECEMBER

Pest Control: Watch for boring insects.

Planting: Last chance for fall bulbs. Now is best time to plant coniferous evergreens, particularly if balled and burlapped.

Watering: Water only if rains have been scant.

Berries: Mulch cane berries with barnyard manure. Set out bare root blackberry and raspberry plants.

Bulbs: If rain is light, water bulbs set out in October.

Carnations: Take cuttings from non-flowering side shoots. Root in sand or favorite rooting medium.

Chrysanthemums: Cut back plants that have finished blooming.

Cuttings: Make hardwood cuttings of deciduous shrubs, vines and trees. Should be 6" to 8" long, diameter the thickness of a pencil. Place in a V-shaped trench to root during winter and spring.

Attractive Plants in December - Camellias, Azaleas, Pyracantha, California Holly, Heather, Poinsettia.

JANUARY

Pruning: Now is the time to prune roses, deciduous trees, shrubs, and vines. Detailed instructions on how to prune most types of evergreen and deciduous plants are included in Pruning Handbook, by Roy L. Hudson. Pruning models can be easily made from branches of trees. Trees and shrubs growing on campus or in the school nursery would present ideal laboratory situations. Home gardens located near the high school also offer excellent practice opportunities.

Pest Control: Dormant deciduous shrubs and trees should be sprayed for overwintering insects, insect eggs, and plant diseases. Use Bordeaux solution, lime-sulfur, or oil, at winter strength. Specifications are always printed on labels. Spray charts by chemical companies are also available for the asking.

Bare Root Plantings: Deciduous shrubs, trees, and vines should be moved this month. It is the best time to plant deciduous shrubs, fruit trees and shade trees. Sunset Western Garden Book describes bare root planting in detail.

Crabgrass Control: Crabgrass seed can be killed by products containing standard lead arsenate, calcium arsenate, or chlordane. Directions on product labels are important and should be followed closely.

Azaleas: Evergreen Kurume and Indicas may be planted for February through April blooming.

Bolting Plants: Iceland Poppies, Violas, Pansies, Primroses, Cyclamen, and Dianthus do well at this time.

Berries: Remove canes that produced fruit during the past season--remove suckers growing around base of new canes. Mulch with aged manure. Plant strawberries now for early crops.

Bulbs: Tuberous plants, bulbs, and corms are now available.

Cuttings: Hardwood cuttings (mature wood) should be taken from dormant material. May be rooted in sand or buried until calluses form. Among plants that will root easily from cuttings are Flowering Quince, Weigela, Crape Myrtle, Pomegranate, Rose, Wisteria, and Willow.

Deciduous Fruit Trees: Plant now.

Lawns: Fertilize with high nitrogen base compound. Don't plant Dichondra now. It requires warm soil.

Roses and Hardy Shrubs: Bare-root planting time.

Vegetables: Winter vegetables should be planted now.

Attractive plants in January -- Camellias, Pyracantha, Burford Holly, Heather.

FEBRUARY

Pruning: Finish work on roses and deciduous shrubs before growth starts. Thin and head back deciduous fruit trees, particularly peaches, nectarines, and apricots. Prune tropical plants, such as Hibiscus, after danger of frost is over.

Weed Control: Selective weed sprays are available for all-purpose applications. Refer to manufacturers' instructions for use.

Bare Root Stock: Deciduous shrubs and trees can still be planted if new leaf buds have not started to open.

Hardwood Cuttings: Dormant wood may still be used.

Spraying: Heavy infestation of aphids should be watched as new lush growth appears.

Fertilizing: Trees and lawns respond well to winter applications.

Annuals: Early-flowering plants are available in nurseries.

Azaleas: Good time to plant for March and April flowering.

Tuberous Begonia: Stored tubers should be planted as soon as pink buds appear.

Bulbs: Summer-blooming bulbs and tubers are available to nurseries and should be planted now.

Fruits: Peaches and nectarines should be sprayed for leaf curl with lime-sulfur or Bordeaux.

Roses: Prune as soon as buds begin to swell. (Refer to Pruning Handbook, by Roy L. Hudson.)

Chrysanthemums: Cut back and divide. Move to new spot each year for better blooms.

Lawns: Fertilize lawns, if yellow, with quick-acting nitrogen application.

Spraying: Use dormant spray on roses and deciduous trees and shrubs. An all purpose insecticide is recommended.

Attractive plants in February - Camellias, Azaleas, Flowering Cherries, Peaches, Plums, and Flowering Quince.

MARCH

Pruning: Camellias and Azaleas after blooming.

Pest Control: Continue to spray for aphids.

Fertilize: Citrus, Avocado, and other tropical fruit.

Bedding Plants: Perennials, Tuberous Begonias, Dahlias, and Caladiums.

Citrus: Spray Oranges, Tangerines, Lemon trees or any citrus on dwarf rootstock for citrus thrips. Use malathion, dieldrin, or DDT.

Trees: Trees in containers may be planted now and will make good growth by spring and summer. Feed older trees early this month. Deep-water old native oaks; after April keep on dry side.

Attractive plants in March - Azaleas, Fall-planted bulbs, Snowballs, Spiraea.

APRIL

Fertilize: Lawns, shrubs, trees.

Pest Control: General garden spraying, with special attention to aphids and mildew.

Planting: Bedding plants Dahlias, ornamental shrubs, Carnations, Chrysanthemums, and, as always, any plants from containers.

Annuals: Summer and fall-flowering annuals should be planted now. Ageratum, Cosmos, Dianthus, Marguerites, Marigolds, Petunias, and Phlox drumondii.

Azaleas: Fertilize established plants after last flowers have gone. Cottonseed meal or a specially-prepared commercial fertilizer is recommended at rate of one tablespoon to each two feet of height.

Bamboo: Divide and plant.

Berries: Top new shoots of blackberries and black raspberries during growing season to increase new wood. Manure and water often. One cup of complete fertilizer per plant is recommended.

Camellias: Established plants should receive first feeding now.

Citrus: Continue planting, but not in a lawn area watered by sprinkling system.

Dahlias: Tubers may be planted if soil is warm.

Deciduous Fruits: Thin Peaches, Plums, Apricots while pits can still be punctured by thumbnail or when small (the size of a marble).

Fuchsias: For coastal areas. They do not adapt well inland, unless planted in coolest spot of garden and kept moist.

Pelargoniums and Geraniums: Use small amount of bonemeal before planting. High nitrogen fertilizer will cause plant to run heavily to leaf with few flowers. Pinch tips to get bush plants. Full sun recommended for coastal areas; inland, eastern exposure recommended.

Lawns: Established lawns receptive to complete fertilizer application.

Roses: Apply cupful of fertilizer per plant to old, established stock.

Color plants available in April - Azaleas, Ceanothus, Roses, flowering deciduous shrubs, fall-planted bulbs, Shasta Daisies, Dianthus, Marguerites.

MAY

Fertilize: Lawns, shrubs, trees.

Pest Control: General garden spraying, with special attention to aphids and mildew.

Planting: Bedding plants, Dahlias, ornamental shrubs, Carnations, Chrysanthemums, and as always, any plants from containers.

Hibiscus: May now be planted without danger of being injured by frost. Prune older wood from established plants. Need a lot of water.

Roses: To keep roses in bloom, water throughout summer and fall. Apply Rose fertilizer. Keep faded flowers cut.

Chlorosis: First signs of yellowing may indicate iron chlorosis. Symptoms: leaf veins remain dark green while area between veins becomes yellow. Treat with iron chelate.

Chrysanthemum: In mid-May trim plants to within 6" to 8" of ground to control height. Make cuttings from tips of stems.

Herbs: Ideal time to plant herb garden.

Lawns: Fertilize Bermuda grass lawns with nitrogen fertilizer.

New Plantings: Citrus and Palms head list for warm-weather plantings.

Roses: Feed every six weeks between now and fall.

Spraying: Spray with malathion to control aphids. Spray Roses for mildew. Use chlordane to prevent ants.

Attractive Plants in May - Roses, Viburnum, Ceanothus, Fuchsia, Wisteria, and Rhododendron.

JUNE

Fertilize: Deciduous shrubs, Dichondra.

Prune: Deciduous flowering shrubs.

Pest Control: Work against snails, slugs, sowbugs, lawn moths, mildew, flies.

Planting: Bedding plants, Bougainvillea, any plants from containers.

Dahlias: Thin to three or four shoots. Feed. Water periodically.

Pruning and Pinching: Pinch back Azaleas, Camellias, and other shrubs to encourage branching. Pinch Chrysanthemums and Dahlias to force lower growth.

Deciduous Fruit Trees: Peaches, Nectarines and Plums may need thinning. Remove sucker growth.

Subtropical Fruit Trees: Provide shade for young Avocado trees with burlap covered frame and leave around tree all summer. Water regularly; if basin method is used, extend basin a little beyond drip line of branches.

Roses: Climbers that bear one crop, such as Paul's Scarlet Climber, should be pruned now. Wait until winter to prune other Roses.

Attractive Plants in June - Star Jasmine, Fuchsias, Hydrangeas, Jacaranda, Roses, Magnolia grandiflora.

JULY

Watering: From now on be sure to keep up long, deep watering.

Pest Control: Continue work against sowbugs, ants, flies, lawn moths.

Azaleas: Feed early this month with acid food to stimulate strong growth.

Tuberous Begonias: Apply monthly feeding of liquid fish emulsion or cottonseed meal. Sprinkle foliage with water when temperature rises above 80° F.

Bulbs: Lift early flowering gladiolus if blooms are finished and leaves have turned yellow or brown.

Camellias: July watering is extremely important to prevent bud drop next winter and spring. Deep irrigation is also important. Use slow-acting fertilizer such as cottonseed meal.

Fuchsias: Top dress with several inches of coarse leaf mold.

Roses: Water early in morning to prevent mildew.

Attractive Plants in July - Bedding plants, Lantana, Plumbago, Hibiscus, Gardenia.

AUGUST

Planting: Time to plant seeds for winter annuals such as Calendulas and Cinerarias. Sweet Peas planted now will bloom in December.

Watering: Deep watering is a must during August. Basins may have to be extended. Keep water away from trunks to prevent gummosis.

Attractive Plants in August - Bedding plants, Crape Myrtle, Hibiscus, Bougainvillea.

Calendar of Course Content

In the same way that a monthly calendar of activities provides a guide for planning practical experiences for students in ornamental horticulture, a calendar of course content supplies a planned approach to organizing content for the course. Like the activities list, the content calendar, because of the very nature of ornamental horticulture and its dependence upon seasons, climate, and weather, must follow the season cycle. Subject matter for any particular month must be planned so that the content for that period takes advantage of the special characteristics of that month. At the same time, the varied, monthly content units presented during the academic year must supplement each other to provide students with a unified knowledge of ornamental horticulture at their level of knowledge. It obviously will not be possible to teach everything there is to know about ornamental horticulture in one year, but this calendar of content should provide a good basis for planning.

SEPTEMBER

I. Budding

A. Types of budding

1. T-budding (June budding)
2. H-budding

B. Lecture (See USDA Bulletins and Plant Propagation in Pictures, by Montague Free, for information and reference.)

1. Reasons for budding
2. Tools and materials
 - a. Sharp knife (such as Stanley 299)
 - b. Plastic tape
 - c. Tree seal and pruning shears (snap cut)
3. Scionwood or budwood selection
 - a. Preferably from year-old stock
 - b. Storage 40° F. in moist sawdust
4. Season
 - a. Fall or early spring
5. Demonstration in classroom and application
 - a. Show models (can be made from tree branches or hollow cardboard cylinders)
 - b. Bud Roses in gallon cans - upper classmen can bud roses on high school campus or plants growing in nursery area.

OCTOBER

I. Vegetative asexual propagation

A. Classification of cuttings

1. Softwood cuttings - tip bends but doesn't break (use Ivy to demonstrate)

2. Semi-hardwood - breaks with audible snap (use Ivy to demonstrate)
 3. Hardwood - year-old or over (use Poinsettia to demonstrate)
- B. Plant parts used for cuttings**
1. Stem
 2. Root
 3. Leaf
- C. Lecture and Demonstration**
1. Definition
 2. Terms
- D. Methods (see Figure 7.1)**
1. Tip cuttings
 2. Straight
 3. Heel
 4. Mallet cutting
- E. Hormones or synthetic plant growth materials**
1. IBA (indole-3-butyric acid)
 2. Hormodin, Rootone, Cut Start
- F. Demonstration - Make a flat of Ivy cuttings with students watching. Go through entire operation, step by step.**
- G. Tools and equipment necessary for demonstration**
1. Redwood flat (standard - 18" x 18" x 2-3/4")
 2. Tamp
 3. Screed
 4. Spotting board
 5. Snap-cut pruning shears
 6. Other tools and equipment can be made in shop.

H. Participation

1. Group students in pairs and give them cutting material from Ivy growing in nursery.
2. Have each pair make one flat of cuttings for practice and label it.
3. Each team is graded on second flat made the following day. Students can observe growth progress if flats are properly marked.

I. Make other types of cuttings throughout year.

1. Upper classmen can practice leaf cuttings on house plants if glasshouse or hot bed is available.
 - a. Rex Begonia ideal for the demonstration
 - b. Sansevieria and Peperomia easily propagated by leaf cuttings

II. Turf maintenance and management

A. Introduction

1. Varieties
2. General purpose lawns
3. Recreational lawns
4. Golf courses

B. Maintenance - If land is available in the nursery, plant grass varieties that do well in the area in small 6' x 6' plots. Students can be taught all of the maintenance problems, i.e., mowing, fertilization, insect and fungus control, etc., associated with turfs. Seeing the finished product has a lasting effect. Having an area set aside for turf plots makes it possible for students to observe growth patterns, and plots also afford instructor an ideal laboratory facility to teach various phases of management throughout school year.

III. Sexual or seed propagation

A. Germination Practices

B. Preparing seed beds

C. Planting seeds in flats

October is an ideal time to teach seed planting. Winter annuals and perennials can be planted in nursery rows. Seeds planted in September and October will furnish cut flowers for school and community use during

the winter and are excellent for departmental public relations. (See Chapter II)

NOVEMBER

I. Nursery Structures

- A. Head house
- B. Glasshouse
- C. Plastic house
- D. Lath house
- E. Cold frame
- F. Hotbed

November is a good month to lecture on nursery structures. Materials on costs, plans, construction, management, etc., are available. (See Chapter III.) If the school already has these facilities, November would also be a good time to cover nursery management and plant propagation. In a department planning to build its own facilities, reference materials can be used to begin the planning stage during this period.

Building propagating structures is slow, tedious, and time consuming, but once they are completed, students invariably take an unusual interest in the finished product.

One California high school agriculture department built a greenhouse, hotbeds, lath house, and propagating benches for its ornamental horticulture program. After two years spent in completion of construction, names of students working on the projects were inscribed on a plaque fastened to the glasshouse. This is always a good device for use in getting other students interested in contributing their skills to development of permanent nursery facilities.

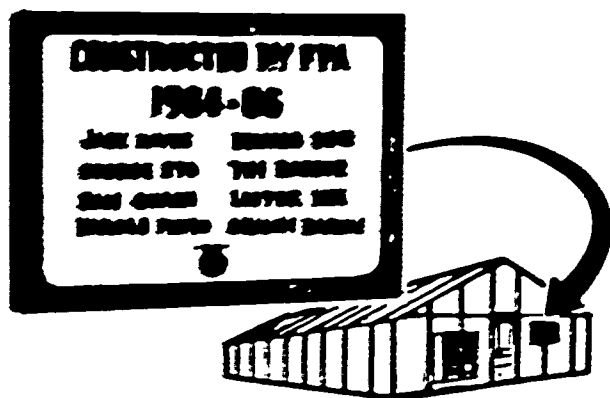

DECEMBER

I. Soils, propagating media, and fertilization

- A. Soil management
 - 1. Types of soil
 - 2. Soil problems
 - 3. Soil treatment

4. Sterilization of soils

Sample soils in jars can be shown to the class. Materials and pictures are always available and help hold interest of students. Soil demonstrations showing structure, permeability, and texture can be performed in the classroom or nursery area, and use of sterilants (such as Vapam or methyl bromide) can also be demonstrated outside.

B. Types of propagating media

1. Sand (builder's washed plaster sand)
2. Peat moss
3. Spaghnum moss
4. Vermiculite
5. Perlite

Many propagating media are available. Samples can be obtained from nurseries and should enable students to get acquainted with the different media by working with them. One method of presenting different media is to have students make cuttings of Coleus plants, root the cuttings in different media, and observe development of root structure in each medium.

C. Fertilizers

1. Types
2. Mixes
3. Liquid
4. Application
5. Uses

This is an important area and fertilizer samples are always available to help make it meaningful. Students should not be burdened with too many inorganic symbols, technical names, and trade names. A complete fertilizer (dry), one or two liquid, and possibly two organic (bloom meal or processed sewage) will suffice for a beginning high school class. It is important, however, to teach about both organic and inorganic fertilizers successively so students will know how to get immediate color and quality for sales purposes. Experiments may be conducted on the turf plots, container specimens, and greenhouse stock for fast sales.

JANUARY

- I. Pruning deciduous trees and shrubs (See Pruning Handbook, by Roy L. Hudson.)

- A. Lecture - Reasons for pruning
 - B. Pruning models can be made from branches of pruned fruit trees and are excellent for use in the classroom when discussing nomenclature.
 - C. Fuchsias, Roses, and other shrubs in nursery containers may be brought into the classroom and used for demonstration purposes. After lecture and demonstration students should gather around work tables, with one student at a time required to prune a rose. Teacher and other students should watch demonstration. After each member of the class has gone through this operation, students should be required to prune a rose bush for a grade.
- II. Pruning fruit trees and shrubs for practice
- A. Private home orchards afford excellent laboratory facilities for practice. Home fruit tree gardens located within walking distance from the campus are desirable for pruning and grafting demonstrations. Owners are usually receptive as long as class is small.
 - B. Shrubs around school campus also offer excellent opportunities for laboratory experience. Rose gardens on campus may be used to acquire pruning, budding, fertilizing, and insect control knowledge. Availability of plants on campus makes learning and acquiring of skills more realistic and meaningful. Students may observe the results of good management practices throughout the year.

FEBRUARY

- I. Cuttings propagated for commercial nurseries - Fundamentals of propagating hardwood cuttings in gallon cans
 - A. Hardwood plant materials propagated for summer, fall, and winter sales
 - 1. Poinsettias
 - 2. Fuchsias
 - 3. Hibiscus
 - 4. Roses
 - B. Algerian Ivy cuttings for late spring sales

MARCH

- I. Grafting sub-tropical fruit trees
 - A. Avocados and citrus

B. Methods

1. Tip grafting
2. Cleft grafting

If seedling stock has been raised and the trees are about the diameter of a pencil, March is the proper time to tip graft. Cleft grafting is recommended for stock over a half-inch in diameter. Students' grafts should be labeled so that the instructor will be able to grade them at the time of the operation and again, if, and when, the graft takes. This procedure always creates interest. Every student wants to out-do his classmate and as the grafts begin to grow, students will critically compare their specimens.

II. Corsage Making

A. Plant materials for demonstration

1. Cymbidiums
2. Carnations
3. Roses

This skill does not always appeal to the boys in the class initially, but when they find out that corsages sell for as much as \$2.00 or \$5.00 each during prom time, most of them get quite interested. Cymbidiums are easy to grow and will bloom for several months. First flowers appear as early as January and others appear through mid-June. Students can raise them in shaded back yard areas and sell them in gallon cans or in 6" pots for \$2.00 and \$3.00 each during the Easter season.

APRIL

I. Plant identification

- A. Introduction and history of plant material
- B. Plant parts
- C. Flower parts
- D. Scientific and common names and importance of learning scientific names.

Unless presented in a challenging manner, plant identification can be quite monotonous to most students. For effective teaching, the instructor should begin by taking the class on a tour of the campus and identifying all plant materials by both their scientific and common names. Later, leaf and branch specimens can be studied in the classroom. Nurseries will often loan gallon stock for this purpose.

An effort should be made to plant a border row of at least 100 shrubs, trees, and vines in the nursery area. Such a border usually does not prove as effective as stock grown according to a properly-landscaped plan, but is valuable since it also affords cutting material for project work.

After students have been exposed to plant names, a field trip should be arranged to a botanic garden or large nursery. There they will see labels on cans and before leaving should be convinced of the importance of learning scientific names, especially if they plan to work in a nursery or in landscaping. Teaching scientific names of plants in the communities where students live is very important.

Plant identification should be a continuing study spread over the entire school year. Too much at one time might dispel interest. One method of motivation that has proven successful in numerous situations is to set up a spelling bee arrangement in the classroom after the students have learned approximately 30 plants. Competition between teams arouses much interest and helps retention.

Students should not be forced to learn plants they won't see in their communities. These they forget. Those interested in majoring in ornamental horticulture in college will have ample time and opportunity for specialization in plant identification when they reach that point in their study.

II. Landscape design and planning

A. Introduction

B. Reasons for landscape design and planning

C. Methods used to interest student

Since it is a specialized field, landscape design cannot be presented properly unless the department has drafting facilities. Drafting tools and facilities used by the school's drafting department would be ideal for this study, but these facilities are not always available to the agriculture department.

An excellent method of teaching landscape design is to have the class draw a rough plot plan of a portion of the school campus that could be replanted with a minimum of effort. Such an assignment could be a group project, done either on the chalk board or individually pursued. Scale drawing at this point is not too important. Design classes should be offered to juniors and seniors who have acquired the scientific names of enough plants to make the project feasible. The class should not attempt to locate plants until they acquaint themselves with all of the problems and fundamentals. Visiting the area to be landscaped is most important.

Another recommendation is to have each member of the class make a scale drawing of his yard and home. During class time, and with supervision from the instructor, a landscape plan can be developed with plants properly placed by their scientific names.

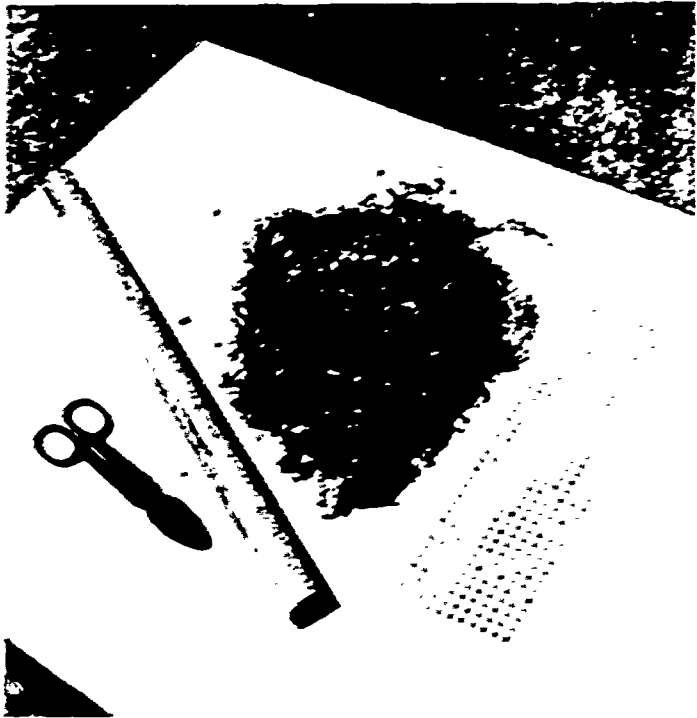

Fig. 7.2: Totem Pole Materials



Fig. 7.3: Molding Hardware Cloth



Fig. 7.4: Filling Frame with Sphagnum Moss



Fig. 7.5: Completed Totem Pole



Fig. 8.1: Student-Built Lath House Under Construction



Fig. 8.2: Erected Wall Frames

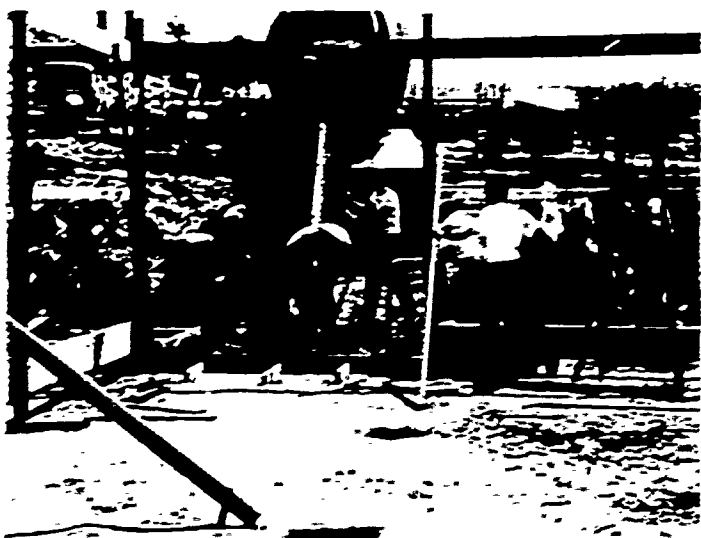

Fig. 8.3: Pouring Transit Mix Concrete

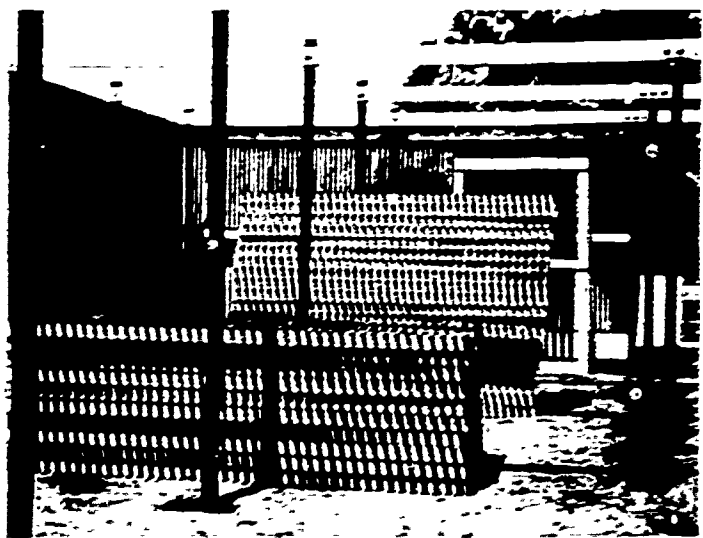
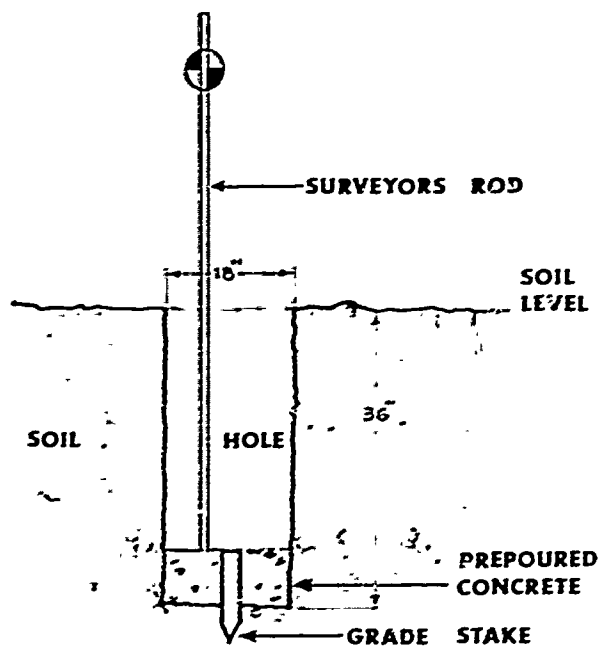

Fig. 8.4: Prefabricated Roof and Side Panels

**LEVEL FOR BOTTOM OF HOLE
FOR SUPPORTS OF LATH HOUSE**

Fig. 8.5



A new school in the district is always a good project to design and landscape. If the class can utilize plant materials raised by the agriculture department, this adds to the prestige of the project. At no time, however, is it recommended that agriculture students be exploited by being assigned work not compatible with the instructional program. In laying out a landscape plan for a new school, students should do only enough of the planting to assure practical experience. Trying to save the district money by exploiting student labor when no further learning is possible is a sure way of losing good students to other departments.

MAY

I. Plant supports

- A. Redwood poles (will not rot)
- B. Bamboo stakes for Cymbidiums and small house plants
- C. Totem poles (made out of hardware cloth or wire)

1. Making totem poles

- a. Use hardware cloth 18" long and 5" in diameter.
- b. Roll or mold on pipe or tube.
- c. Bring two sides together by interwinding wire with needlenose pliers.
- d. Pack sphagnum moss in tube.
- e. Place in 6" pot with end touching bottom.
- f. Pack soil halfway to rim.
- g. Water from top of pole in order to saturate sphagnum moss in cylinder.

Greenhouse plants require plant supports. Many types are available in nurseries but students can economically make their own. One of the most practical to make is the totem pole constructed from hardware cloth.

Philodendrons do well on totem poles, which can be made to fit any size pot, because moisture held in sphagnum moss helps to keep root appendages in healthy condition.

JUNE

During the two weeks prior to closing of school, many nursery jobs can be completed and students can also be taught such skills as composting, transplanting seedlings, mixing soils, dipping cans, etc., that have not been covered during the year.

Bibliography

Reference Books

Free, Montague, Plant Propagation in Pictures, Doubleday and Company, 1957.

Sunset Western Garden Book, Lane Publishing Company, Menlo Park, Calif., 1963.

Hudson, Roy L., Pruning Handbook, Lane Publishing Company, Menlo Park, Calif., 1952.

Other Useful Materials

(Note - In addition to those shown above and in bibliographies for other chapters, various bulletins issued by the United States Department of Agriculture may prove to be useful in developing content for class presentation.)

CHAPTER VIII

Building a Lath House

Buildings or structures designed both to house students and to be used as ornamental horticulture laboratories may be built by farm mechanics or horticulture students as part of the instructional program, but construction of these buildings (greenhouses, lath houses, potting sheds, etc.) poses some problems that are not inherent in that of farm structures not designed to house students.

Such buildings (those designed both to house students and as laboratories) are considered, by definition in the Administrative Code of the State of California, to be "school buildings." Consequently, they are subject to all the regulations of the code that cover school buildings. These regulations, found in Chapter I, Subchapter 8, "School Housing," of Title 5 - Education Code, must be carefully studied and followed during both the planning and construction stages.

Other problems to consider when planning and constructing such buildings are size of the project and amount of student time required. An entire class will usually be involved in the project and it should be planned and executed so the entire class can be used in both planning and construction. The instructor must be able to maintain supervision of the class. The construction job should, at the same time, provide meaningful instructional experiences for the students involved.

A lath house and storeroom, built by farm mechanics students of the vocational agriculture department of a Southern California high school, under supervision of their instructor, was completed recently and is described in this chapter. Steps and techniques used in construction of this lath house are shown to illustrate and offer a possible outline for construction of such buildings by other departments.

Steps in Planning and Constructing a Lath House-Storeroom

1. A sketch of the proposed lath house and storage room was developed by the farm mechanics class.
2. The drawing was submitted by the instructor to the high school principal and district superintendent for approval.
3. The drawing was submitted to the school board for approval, and the plan and project were approved.
4. The drawing of lath house and storeroom was given to the district architect who prepared necessary plans and specifications.

5. Plans and specifications were submitted to the Department of Public Works, Division of Architecture, for approval, and plans were approved.
6. From the plans and specifications the farm mechanics class prepared a list of materials (bill of materials) needed for construction.
7. From the list of materials the business office of the school district prepared a bid letter and sent copies to local lumber companies.
8. Local lumber companies submitted bids, and the low bid was accepted by the school.
9. Construction of the lath house and storeroom by the farm mechanics class was started as soon as materials were received.

The entire project, from planning to completion of the lath house and storeroom, required two years. One school year was required for planning, and the following year was required to complete construction of the building.

Notes on Construction

Principal technique used in constructing the building was prefabrication of as much as possible of the lath house and storeroom in the shop during farm mechanics classes. Reason for using this method was to permit the instructor to use the shop area for most of the work. It also helped provide for efficient use of student labor. Completion of the building, which had been designed with prefabrication in mind, proved the worth of this approach.

Tractor work to level the building area was done by a hired operator who also used a post hole digger to dig post holes 12" in diameter x 36" deep. The holes were squared to 18" x 18" x 36" deep by students.

Structural lumber for the building was construction grade Douglas Fir and was painted with two coats of white paint and cut to size before being used in the frame of the building.

The four corner posts were first set in concrete and used as a work point to lay out sides of the lath house. Corner posts were used as braces and, with side angle braces, the four wall frames of the lath house were erected and supported.

All posts were drilled for bolts, and caps were welded on top. They were then painted with rust-resistant paint before being used in the lath house. Leveling of posts was accomplished by pre-pouring concrete to level in the bottom of the post holes. A stake driven in bottom of the post hole was used as a guide for level of concrete. When the stakes were set, a leveling rod and level were used to level the top.

All roof and side panels measured 4' x 10' and were fabricated in the shop, using a jig to control construction procedure and to insure uniform size.

Of the 11 yards of concrete required for the entire job, each post hole took one-fourth yard. The four corner posts were set with concrete made by students in a small mixer. Transit-mix concrete was used for the remaining part of the concrete required and was delivered in two pourings of seven and four yards each.

Total cost of the math house, which measured 38'4" x 60', was \$1,300 or about \$.56 per square foot.

Bibliography

Reference Books

California Administrative Code, Title 5 - Education, California State Department of Education, Special Edition, 1960.

WOOD LATH 1" SPACING

2-4

2-5/8 BOLTS

2-2

STEEL TUBE COL. 3" x 1/8"

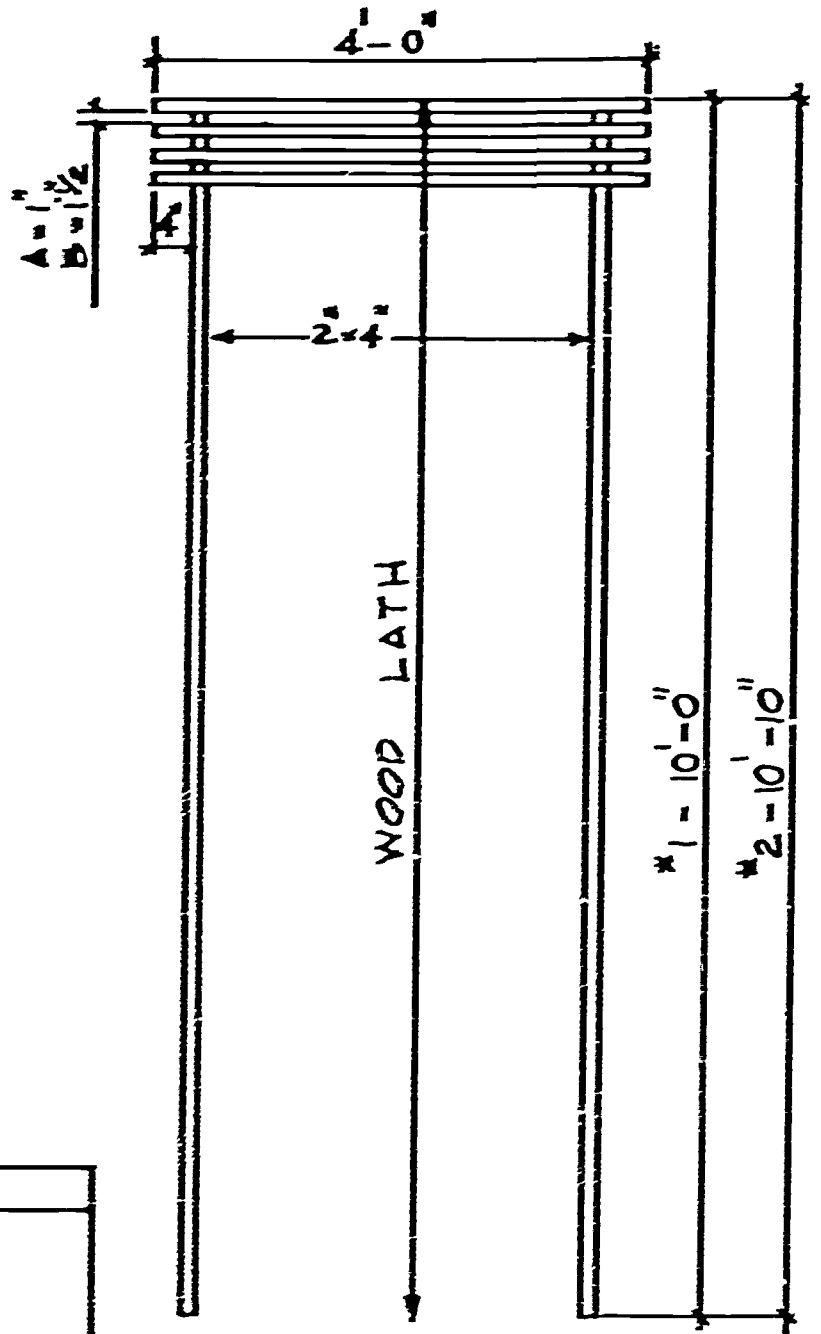
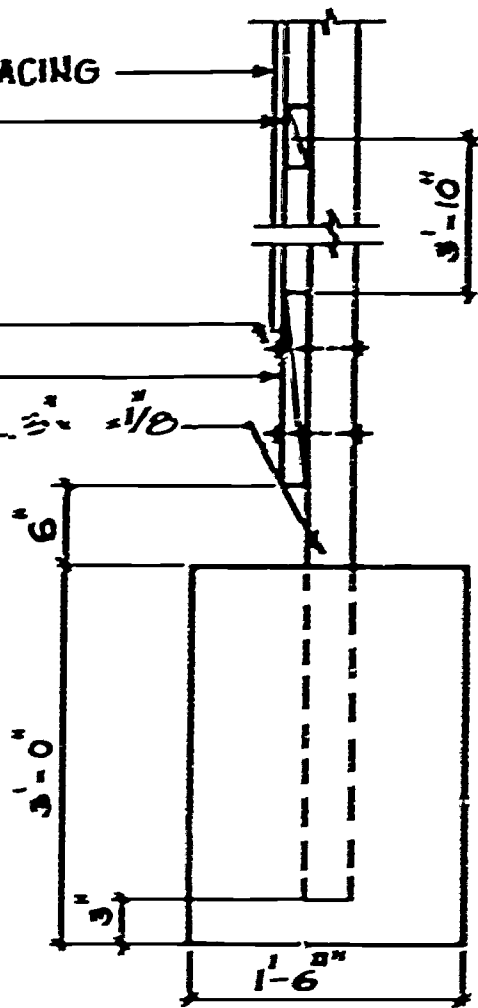

ROOF PANELS

PANEL NO.	NO. REQD.
1-A	20
1-B	20
2-A	10
2-B	10

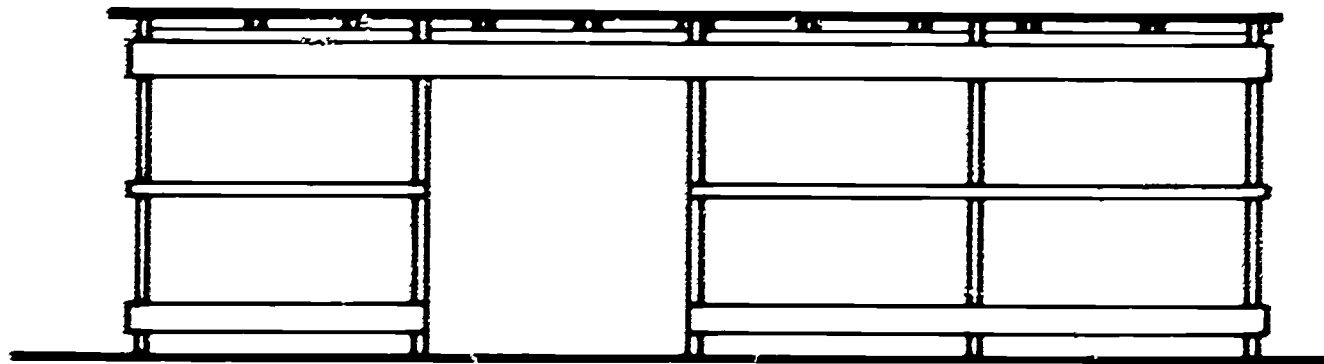

END ELEVATION

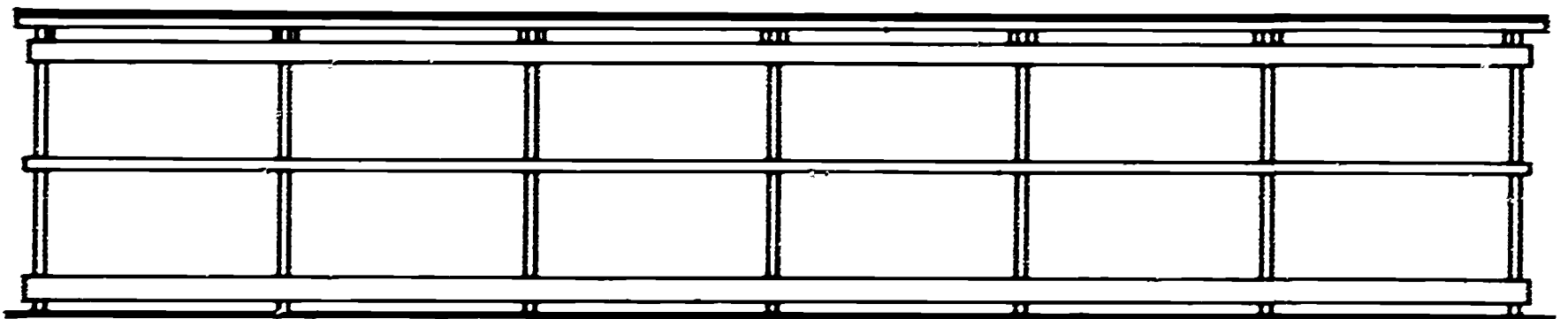

SIDE ELEVATION

scale 1/8" = 1'-0"

TYPICAL HIGH SCHOOL

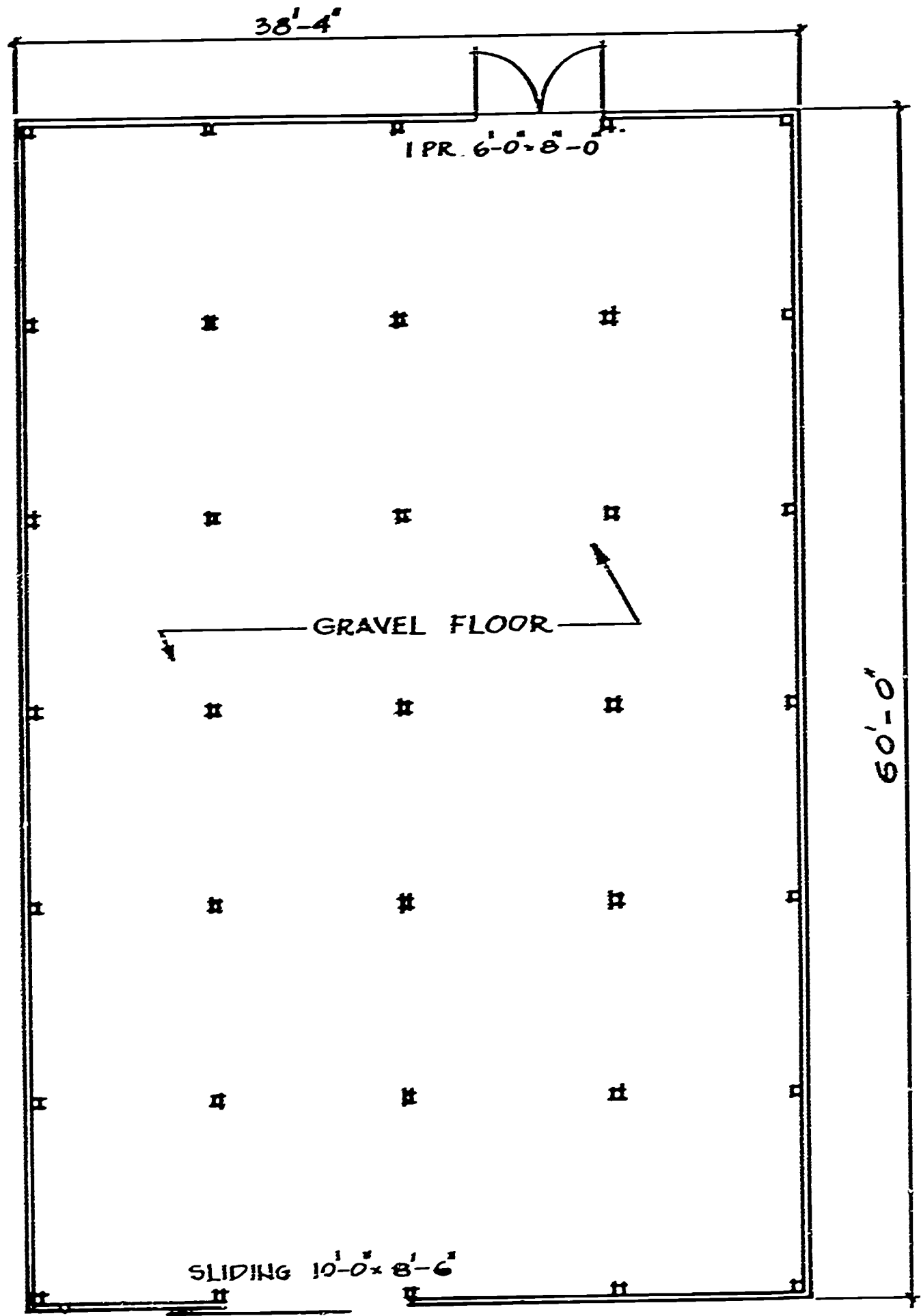

TOP VIEW PLATE XXVII

LATH HOUSE PLANS