

DOCUMENT RESUME

ED 031 409

SE 007 167

Pilot Project for Chemistry Teaching in Asia,  
United Nations Educational, Scientific, Cultural Organization, Bangkok (Thailand).

Pub Date Jun 69

Note-30p.; UNESCO Newsletter, Volume 2, Number 6, June 1969

EDRS Price MF-\$0.25 HC-\$1.60

Descriptors-\*Chemistry, \*Instructional Materials, \*Science Activities, \*Secondary School Science

Identifiers-Bangkok, Indonesia, Israel, Thailand, UNESCO

The major portion of this publication is devoted to the presentation of 20 chemistry experiments dealing with corrosion of metals. The experiments are intended for high school level students or for chemistry teachers for demonstration purposes. Diagrams and illustrations accompany the written directions. Also included in this publication are reports on curriculum reform activities in Indonesia and Israel, a description of a chemistry film loop made by Thai schoolboys and a column entitled "News Notes." (BC)

U.S. DEPARTMENT OF HEALTH, EDUCATION & WELFARE  
OFFICE OF EDUCATION

THIS DOCUMENT HAS BEEN REPRODUCED EXACTLY AS RECEIVED FROM THE  
PERSON OR ORGANIZATION ORIGINATING IT. POINTS OF VIEW OR OPINIONS  
STATED DO NOT NECESSARILY REPRESENT OFFICIAL OFFICE OF EDUCATION  
POSITION OR POLICY.



**PILOT PROJECT**  
**for**  
**CHEMISTRY TEACHING IN ASIA**

**NEWSLETTER**

VOLUME 2, NUMBER 6  
JUNE, 1969

**P.O. BOX 1425**  
**BANGKOK, THAILAND**

EDU 31407

SE 007 167

SE 007 167

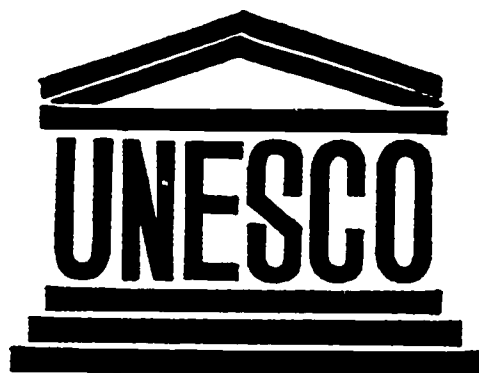

**PILOT PROJECT  
for  
CHEMISTRY TEACHING IN ASIA**

# **NEWSLETTER**

VOLUME 2, NUMBER 6  
JUNE, 1969

**P.O. BOX 1425  
BANGKOK, THAILAND**

# CORROSION OF METALS AND ITS CONTROL

(School Experiments)

by

Prof. S.A. Balezin and Prof. M.C. Pant

The destruction of metals under the influence of the environment e.g. of atmospheric oxygen and other gases contained in the atmosphere, of water, solutions of salts, acids and alkali as well as of electric currents is known as corrosion of metals.

Corrosion of metals is the process of regaining by metal its natural state i.e. the state in which it can be found in nature. The most common case of corrosion is the rusting of iron, its transformation into oxides and hydroxides.

This type of loss due to corrosion of metals is called "direct loss". A rough estimate shows that as a result of corrosion about 10% of the metal produced in one year is irretrievably lost. For example, if a country produces or uses one hundred million tons of metal, the amount lost due to corrosion is roughly 10 million tons. However, there occurs another type of loss due to corrosion, when as a result of corrosion, various machines, costly apparatuses, metallic constructions etc. are damaged and stop functioning. This loss is called "indirect loss" and its magnitude is much larger than that of direct loss.

Recent estimates show that in USA alone the total amount of the metal lost as a result of corrosion costs an enormous amount of 7 billion dollars annually. In other countries also more or less the same amount of loss occurs.

It is due to these reasons that a knowledge of what causes corrosion and of the methods for protection of metals becomes of great importance not for its cognitive value but also for its vital practical importance.

The experiments suggested here can easily be performed by pupils themselves even in schools with the least physical facilities of apparatus and chemicals.

Some of the experiments can be used by chemistry teachers as demonstrations.

## Useful Corrosion

### Corrosion of aluminium

On the surface of some metals one can find a firm oxide film which is formed as a result of the interaction between metal and the medium. This film protects the metal from further destruction.

Such films are particularly efficient when we have metals which are readily oxidised by atmospheric oxygen. One of such metals is aluminium. The oxide film formed on the surface of aluminium differs from those formed on other metals in this respect that, it is compact and impermeable. It cannot be seen with a naked eye since it is only 0.00001 cm thick.

However, if we remove the film, aluminium becomes unprotected.

### Experiment 1 :

#### Requirements and Chemicals :

Aluminium wire, or plates, 50 x 2 x 10 mm  
Beaker, 200 ml  
4% solution of NaOH  
1% solution of  $\text{Hg}_2(\text{NO}_3)_2 \cdot 2\text{H}_2\text{O}$   
Filter paper.

An aluminium plate (or a piece of wire) is dipped for one or 2 minutes into a 4% solution of caustic soda for dissolving the oxide film ( $\text{Al}_2\text{O}_3 + 2 \cdot \text{NaOH} = 2 \text{NaAlO}_2$ ). The salt  $\text{NaAlO}_2$  that is formed is readily soluble in water. Next the plate is washed with water to remove the traces of salt and alkali. To prevent the formation of an oxide film the aluminium plate (wire) is dipped for one minute into a 1% solution of  $\text{Hg}_2(\text{NO}_3)_2 \cdot 2\text{H}_2\text{O}^*$ . Next the plate is washed with cold water and wiped dry with filter paper or a soft piece of cloth. The aluminium freed from the oxide film will within minutes start corroding with the formation of a loose mass of aluminium oxide. The reaction occurs with liberation of heat and the plate gets wormed up.

Aluminium unprotected by the oxide film interacts with water releasing hydrogen.

#### Artificial Preparation of Protective Film

### Experiment 2 :

#### Requirements and Chemicals :

2 nails or iron plates (steel), 50 x 2 x 10 mm  
Sand paper, fine grain  
3 beakers, 200 ml

---

\* Mercury and its compounds should be handled with caution since they are poisonous.

7-8 N nitric acid

10-12% sulphuric acid

Two small steel plates or two nails are cleaned with sand paper and rinsed with water. One of the samples is carefully put for 1-2 minutes into a 7-8 N solution of nitric acid.

Nitric acid is an oxidiser. On the surface of the steel a firm oxide or, as it is often said a passive film will be formed. The sample of the passivated steel is then washed with water. Both samples - passivated and non-passivated, should be put into a 10-12% solution of sulphuric acid. It will be observed that the non-passivated sample will begin to dissolve with release of hydrogen whereas the passivated sample will not dissolve.

The oxide film thus formed can be easily removed; if we touch with a copper wire the sample just removed from the solution, the oxide film will crawl down as a drop (depassivation).

The depassivated sample, put into a solution of acids, will dissolve (Fig. 1.).

### Chemical Burnishing of Steel

#### Experiment 3 :

#### Requirements and Chemicals

8 steel plates, 50 x 2 x 10 mm

Desiccator or beaker, 500 ml

Sand paper

Vaseline

5% solution of HCl

Caustic soda (NaOH)

Sodium nitrate ( $\text{NaNO}_3$ )

Sodium nitrite ( $\text{NaNO}_2$ )

Eight pieces of steel plates or nails are carefully cleaned with fine grain sand paper. Next they are rubbed with soft cloth till an even surface is formed. It is now to be cleaned further to make it free of fat. To achieve this the sample is immersed for 5-10 minutes in a 10-15% solution of alkali heated to 70-80°C. The samples are then washed with hot water. To completely remove the traces of the oxide film from the surface of metal, the sample is again immersed for 1-2 minutes in a 5% solution of hydrochloric acid and washed with cold water.

Out of the samples thus prepared four are now immersed for 40-50 minutes in a solution of the following composition:

(the solution should be previously heated to  $80^{\circ}\text{C}$ ).

- a. Caustic soda ( $\text{NaOH}$ ), 35 grams.
- b. Sodium nitrate ( $\text{NaNO}_3$ ), 25 grams.
- c. Sodium nitrite ( $\text{NaNO}_2$ ), 125 grams.
- d. Water, 150 ml.

The samples are then taken out of the solution and washed with water.

On the surface of the sample there forms a dark-blue compact oxide film the colour of which reminds the colour of a crow's wing, owing to which the method was called "burnishing". Two of the burnished samples are now greased with vaseline and the remaining two are not greased. Two of the non-burnished samples are also greased with vaseline and the remaining two are not greased. All the eight samples are placed in desiccator or a large beaker on the bottom of which hot water is poured (fig. 2).

Observations are carried for about two months and the time is noted when the corrosion of the various samples starts.

One would observe that the samples which have been burnished do not corrode whereas the first corrosion starts in the unburnished and ungreased sample, followed by unburnished and greased samples (about 10 days).

#### Oxygen as a Cause of Corrosion

##### Experiment 4 :

##### Requirements and Chemicals :

- 2 test tubes with rubber stopper
- Iron wire
- Sand paper
- Stand for test tubes
- Crystallizer
- 2 flasks with delivery tube
- Glass for water
- Arrangement for preparation of hydrogen and oxygen
- 2 iron nails

Some iron wire is put into the upper part of two test tubes. One of the test tubes is filled with oxygen and the other with hydrogen. Both tubes are put up side down into a beaker filled with water as shown in fig. 3.

Fig. 1

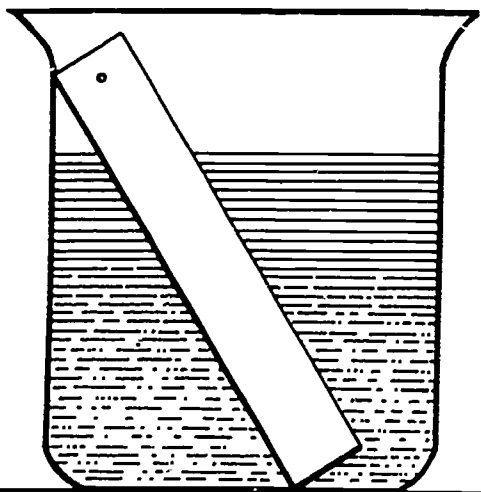

7-8N Nitric acid

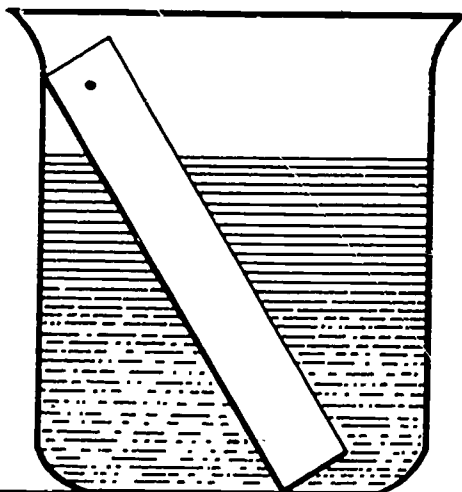

10% solution of sulphuric acid (passivated sample)

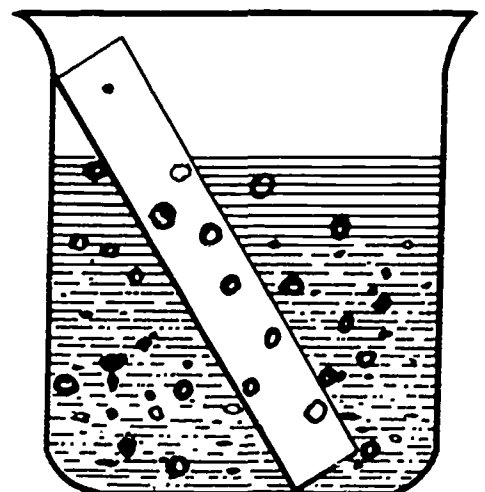

10% solution of sulphuric acid (non-passivated sample)

Fig. 2

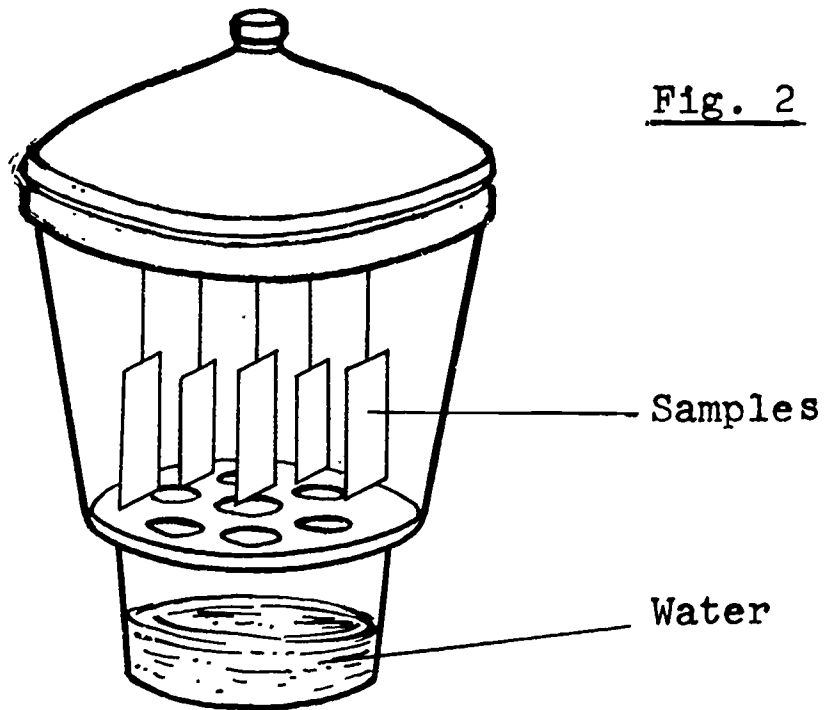

Samples

Water

Fig. 3

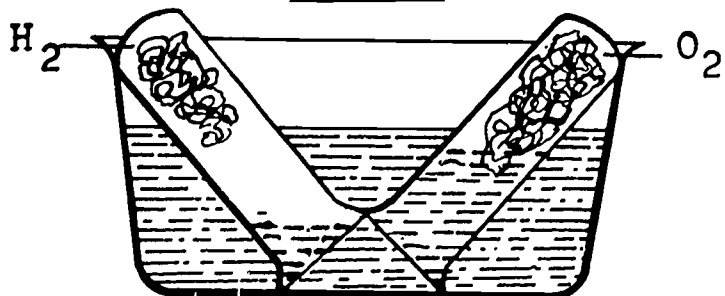
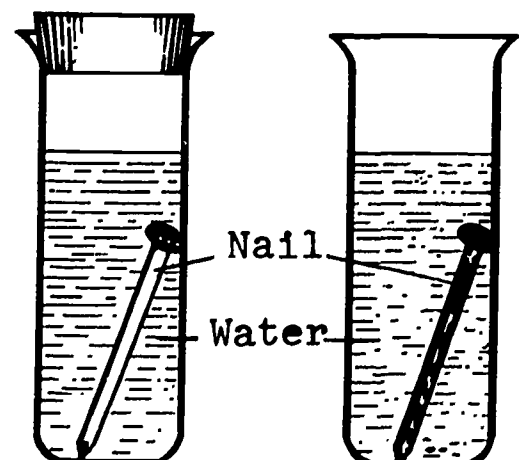

Fig. 4



Nail

Water



Part of the water will enter the test tubes. In 3-5 days water in the test tube with oxygen will rise, whereas the level of water in the test tube with hydrogen will remain more or less stationary. The wire in the test tube with oxygen is covered with corrosion products whereas in the test tube with hydrogen, no corrosion is observed.

This experiment will help students to realise that in atmospheric conditions, the primary cause of corrosion is oxygen and water vapours.

#### Experiment 5 :

Requirements and Chemicals : See Experiment 4.

Water is poured into two test tubes to fill three fourths of their volume. The water contained in one of them is boiled to remove the oxygen content in the water. A nail, previously cleaned from dirt and dust, is put into each of the test tubes (fig. 4). The test tube with the boiled water is now tightly stoppered with a cork to prevent dissolving of atmospheric oxygen in it. The rate of corrosion in each test tube is observed.

#### Experiment 6 :

Requirements and Chemicals : See Experiment 4.

A wire coil cleaned thoroughly with the sand paper is placed into two flasks of equal capacity. (Freshly prepared iron shavings can be used instead of wire). One of the flasks is filled with oxygen and the other with hydrogen. Both the filled flasks are tightly stoppered with corks fitted with delivery tubes, the ends of which are dipped into a beaker with coloured (for better visibility) water as shown in fig. 5.

It will take only a few hours to observe a rise in the level of water in the delivery tube connected with the flask containing oxygen and the appearance of rust on the surface of the wire.

### Electro-Chemical Corrosion

Based on the mechanism of action involved, corrosion of metals is divided into two categories, one "chemical corrosion" and the other "electro-chemical corrosion". Chemical corrosion is corrosion when metal interacts with a medium which does not conduct electricity. The reactions of oxidation and reduction which occur in this case are effected through a medium transfer of electrons from the atom of metal into the particle (molecule or atom) - oxidiser which is a composite part of the medium. The simplest example of chemical corrosion is interaction between metal and oxygen (particularly at high temperatures), halogens, hydrogen, sulphur gases, etc.

Electro-chemical corrosion is observed when oxidation - reduction processes take place in local areas where one area serves as the anode and the other as the cathode. In the anode areas the ions of the metal transfer into the solution while in the cathode areas the process of reduction takes place. Essentially electro-chemical corrosion is similar to what happens in galvanic cells. Most of the samples of metals used in technology contain impurities. In this case metallic spots serve as anodes while impurities as cathodes. Unlike in a galvanic cell, the cathode and anode in this case are short circuited.

When the metals are submerged into an electrolyte, say into a solution of an acid, the following process occurs :

On the anode :

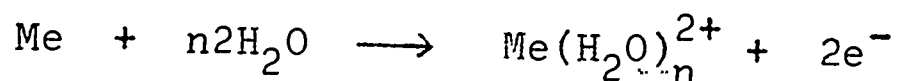

On the cathode :

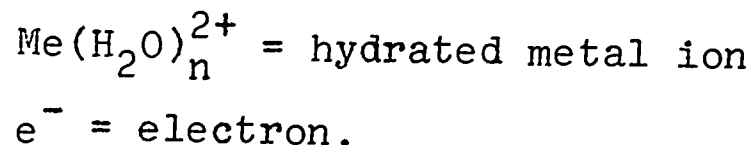
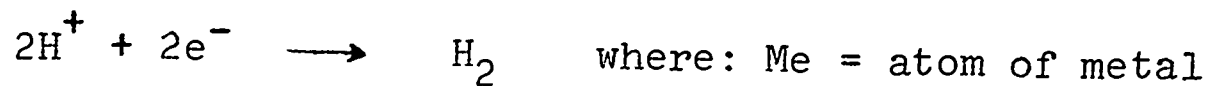

Consequently if the metal has no impurities and is very pure it will not dissolve in the acid.

#### Experiment 7 :

#### Requirements and Chemicals :

Pieces of melted pure zinc

Copper wire

2-3 N solution of HCl.

A piece of pure zinc is put into a solution of 2-3N hydrochloric acid. Zinc will not dissolve (hydrogen is not released). When it gets into contact with a piece of copper wire, zinc begins to dissolve quickly; hydrogen is released on the copper wire. (fig. 6).

#### Corrosion in Water

In water and neutral aqueous solutions of salts, in the presence of oxygen, the process of electro-chemical corrosion occurs and can be represented by the following scheme:

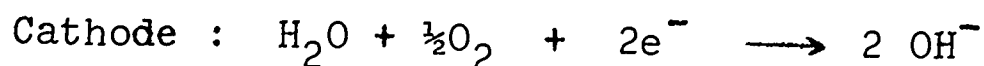

Thus the hydroxyl ions are accumulated on the cathode spots.

### Experiment 8 :

#### Requirements and Chemicals :

U-shape tube  
Freshly cleaned zinc and copper plates  
Copper wire  
Solution of phenolphthalein

Arrangement as indicated in fig. 7 is assembled. A freshly cleaned zinc plate is inserted into one of the arms of a U-shape tube as shown in fig. 7. Into the other arm is placed a copper plate. Both plates are connected with a copper wire. Some drops of phenolphthalein solution are added into both the arms of the U-tube.

In two to three hours, water in which we have the copper plate will become crimson, which indicates the formation of an alkali (i.e. presence of hydroxyl ions).

### Experiment 9

#### Requirements and Chemicals :

Porcelain dish  
2-3% solution of NaCl  
Phenolphthalein  
Copper wire  
Zinc wire  
Iron nail  
Solution of  $K_3[Fe(CN)_6]$  (0.2g in 200 ml  $H_2O$ )  
Sand paper  
Steel plate

A 3% solution of common salt (NaCl) to which 5-6 drops of a solution of phenolphthalein are added is poured into a porcelain dish. A piece of copper wire round which a zinc wire is tightly wound (the latter can be in the form of a narrow ribbon) is immersed in the above solution. The copper wire should be previously cleaned with sand paper (fig. 8). After two to three minutes crimson colour will form on the surface of the copper indicating excess of hydrogen ions on the surface of the copper. Here the copper plays the role of a cathode while the zinc that of an anode.

Fig. 5

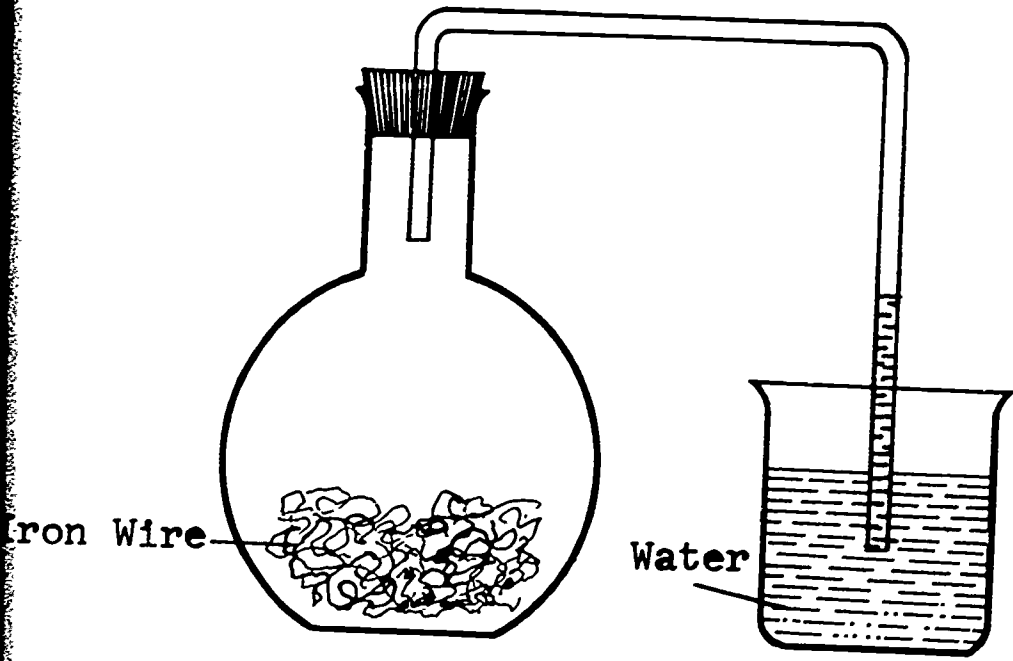

Fig. 6

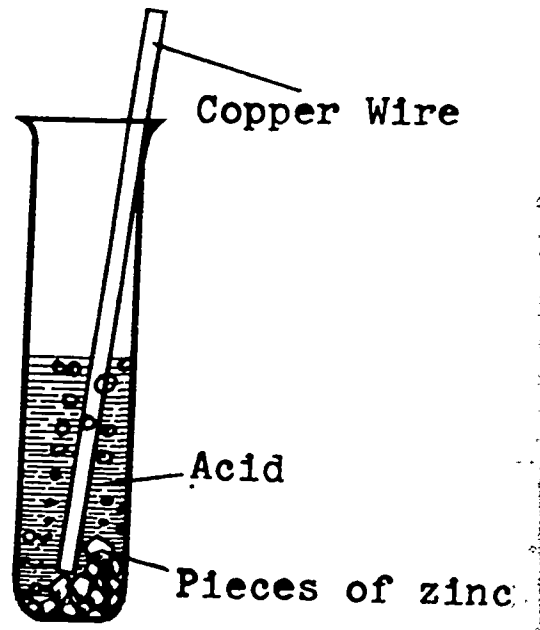

Fig. 7

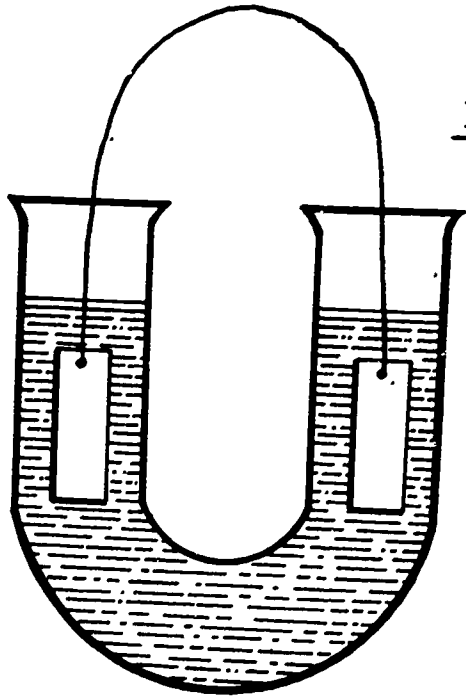

Fig. 8



Fig. 9



Fig. 10

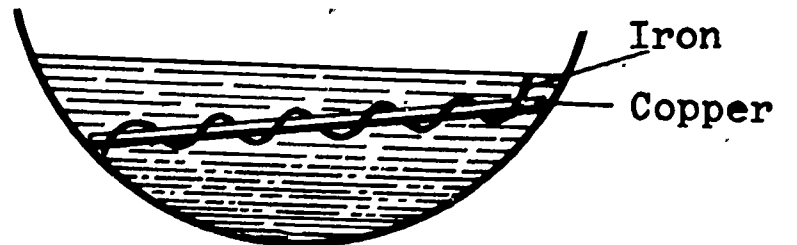

Experiment 10 :

Requirements and Chemicals : See Experiment 9.

The copper rod is replaced in this case by an iron nail round which is tightly wound some zinc wire. When the iron rod (nail) is immersed in the solution used in experiment 9, crimson colour appears on it. (fig. 9).

Experiment 11 :

Requirements and Chemicals : See Experiment 9.

This experiment can be performed to detect the cathode and anode areas in the case of two metals which are in contact and undergoing corrosion. A solution 0.2 g of  $K_3[Fe(CN)_6]$  in 200 ml  $H_2O$  and a few drops (5-6) of phenolphthalein solution are added to a 2-3% solution of common salt (NaCl). In this solution is immersed a copper rod around which is wound some iron wire. In two to three minutes red colour will appear on the copper, while dark blue on the iron (fig. 10.).

Experiment 12:

Requirements and Chemicals : See Experiment 9.

On the surface of a steel plate is placed a drop of a 2-3% filtered solution of common salt (NaCl) to which a solution of indicator has been added. The indicator can be prepared by adding 0.5 ml of a 1% solution of  $K_3[Fe(CN)_6]$  and 5-6 drops of phenolphthalein solution to a 100 ml of the solution of NaCl. As the medium is neutral, on the cathode along the boundary of the drop there occurs the process of reduction of oxygen with the formation of hydroxyl ions. Thus at the boundary of the drop develops the crimson colour. At the anode, in the central part of the drop, where less oxygen penetrates, oxidation of iron takes place resulting in the formation of the ferrous ions ( $Fe^{2+}$ ). When the ferrous ions ( $Fe^{2+}$ ) interact with  $K_3[Fe(CN)_6]$  the blue colour appears at the anode (the centre of the drop). On the boundary between the cathode and anode there appears a brown ring of rust resulting from the interaction of the  $Fe^{2+}$  ions with the  $OH^-$  ions and subsequent oxidation of  $Fe(OH)_2$  to  $Fe(OH)_3$  (fig. 11.).

Protection of Metals against Corrosive Destruction

To protect metals against corrosion, various methods are used depending on the conditions in which the metal is going to be used.

These methods are : painting, coating one metal with another, electro-chemical protection and treatment of the medium by introducing substances (in the atmosphere, water,

solutions of acids etc.) which inhibit corrosion. These substances are called inhibitors of corrosion.

### Electro-Chemical Control (protective control)

#### Experiment 13 :

#### Requirements and Chemicals :

Three 200 ml beakers

4 steel plates, 60 x 40 mm, one copper and one zinc plate of the same size.

Two beakers containing 3% solution of sodium chloride are taken. Into the first beaker two steel plates connected with copper or aluminium wire are placed and into the other a zinc and a steel plate connected with each other in a similar way are placed.

In two-three days it will be observed that the steel plates have begun to corrode whereas the steel plate linked with the zinc plate will not develop corrosion for quite a long time till the zinc plate has dissolved completely.

In this case zinc serves as anode and the steel plate as cathode.

Simultaneously one can perform another experiment by connecting the steel plate with a copper plate instead of the zinc plate. In this case the steel plate will soon begin to get covered with the products of rusting as in this case steel is anode and copper is cathode. (Fig. 12).

The above can be explained with reference to the normal redox potentials of these metals which are:

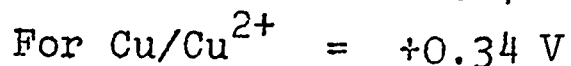
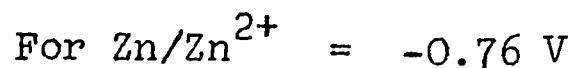

### Metallic Coatings

To protect metals from corrosion the process of coating one metal with another is often used. To coat steel one has to use more corrosion resistant metals like gold, silver, copper, zinc, chromium, nickel etc.

One of the most widely used methods of coating is the galvanic method. Essentially, it is a creation of a galvanic cell, where the metal to be coated is cathode while the metal used as a material for coating is anode.

When a direct current is passed, the anode oxidises with the formation of ions and at the cathode these ions are discharged (reduced) forming a solid protective film:

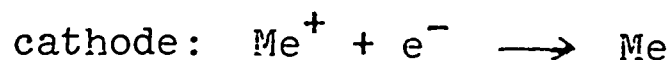
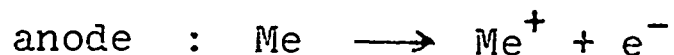

The galvanic method of coating is rather convenient as it enables one to obtain a layer of metal of a given thickness. As was stated above, gold, silver, chromium, nickel, copper and other metals are used for coating. Therefore, these coatings not only serve to protect the surface of the metal, but also improve the appearance of the main metal.

### Galvanic Nickeling of a Copper Sample

#### Experiment 14 :

#### Requirements and Chemicals :

One copper and 2 nickel plates, 60 x 40 mm

Copper wire

Rechargeable battery

Rheostat

Ammeter

Bath for nickeling

Desiccator

10-12% solution of  $\text{H}_2\text{SO}_4$

5% solution of HCl

Nickel sulphate ( $\text{NiSO}_4$ )

Boric acid ( $\text{H}_3\text{BO}_3$ )

Sodium chloride (NaCl)

Before nickeling, the copper sample in the form of a plate 6 x 4 cm is immersed for 10 minutes in a 10-12% solution of sulphuric acid after which it is washed with water and cleaned with sand paper. The sample is then freed from grease using the same method as indicated in the previous experiment No. 3 and is immersed for one minute into a 5% solution of hydrochloric acid.

The following solution is used for nickeling :

- (a) Nickel sulphate ( $\text{NiSO}_4$ ) - 40 g
- (b) Boric acid ( $\text{H}_3\text{BO}_3$ ) - 7 g
- (c) Common salt (NaCl) - 7 g
- (d) Water - 400 ml

The solution is filtered and poured into a bath (glass jar) for nickeling.

A circuit is then made as indicated in fig. 13. The current density in this case must be 2-3 amperes per square decimeter.

The above solution is heated to 30°C and poured into the bath (1), (fig. 13). A battery (2) is used as a DC source and the sample to be coated with nickel (3) is immersed in the solution and connected with cathode while 2 nickel plates are connected to the anode (4). The current is switched on and its intensity is adjusted by means of a rheostat. After 5-10 minutes, the current is switched off and the sample is taken out of the bath and is already coated with nickel. The sample is dried in the air and polished with soft cloth till it starts shining.

To check up the corrosion resistance, the sample coated with nickel and an sample that has not been coated are suspended in the desiccator on the bottom of which some hot water is placed.

The time necessary for each of the articles to start corroding is compared. The sample that has not been coated with nickel is the control sample.

### Chemical Coating with Silver

#### Experiment 15 :

#### Requirements and Chemicals :

- 200-300 ml beaker
- 10% solution of  $\text{AgNO}_3$
- 10% solution of  $\text{NaOH}$
- 20-25% solution of  $\text{NH}_3$
- 10% solution of glucose
- Steel or copper plates 60 x 40 mm in size

Along side galvanic coatings, chemical methods are also used especially for coating with silver.

For chemical silvering, the following solution is freshly prepared before the experiment. To 50 ml of a 10% solution of  $\text{AgNO}_3$ , is added a 10% solution of  $\text{NaOH}$ , until the formation of brown deposit of silver oxide stops. Now to this solution containing the deposit is added a 20-25% solution of ammonia ( $\text{NH}_4\text{OH}$ ) until the deposit dissolves completely. An equal volume of 10% solution of glucose is now added to this solution.

The sample to be silvered (steel, copper or bronze) is immersed in the solution. The samples should be previously



cleaned according to the methods described in the previous experiments. It will be observed that the samples will quickly get covered with a layer of silver. These are now taken out of the solution, washed in cold water and wiped with a piece of flannel till they start shining.

### Inhibitors of Corrosion of Metals

Metallic and lacquer coatings and electro-chemical protection are not applicable in all cases, as for example, in storage of precision measuring devices and instruments. An often used method to protect them from rusting was to cover them with grease and various lubricants which are relatively easily removed from the surface of metal. However, these methods are labour consuming and are not very efficient.

Scientists have developed a new method of protection which essentially consists in adding substances slowing down corrosion of metals into the medium, where metal articles are stored.

These substances are called inhibitors of corrosion.

Inhibitors of corrosion are divided into:

- (a) Inhibitors of acidic corrosion
- (b) Inhibitors of corrosion in neutral aqueous solutions, water and alkali
- (c) Inhibitors of atmospheric corrosion

Inhibitors are used in small amounts from 0.02 to 1%. The essence of their action lies in their adsorption on cathode and anode areas, thus disturbing the work of the microgalvanic cells emerging on the surface of metal. The method of their application are different, depending on the conditions.

### Inhibitors of Acidic Corrosion

#### Experiment 16 :

#### Requirements and Chemicals :

- 2 burettes, 50 ml each
- 2 crystallizers
- 2-3 N solution of sulphuric acid
- Urotropine (hexamethylenetetramine) and potassium iodide in powder form
- 2 funnels
- Rubber inflator
- 2 steel plates 50 x 2 x 8 mm

Fig. 12

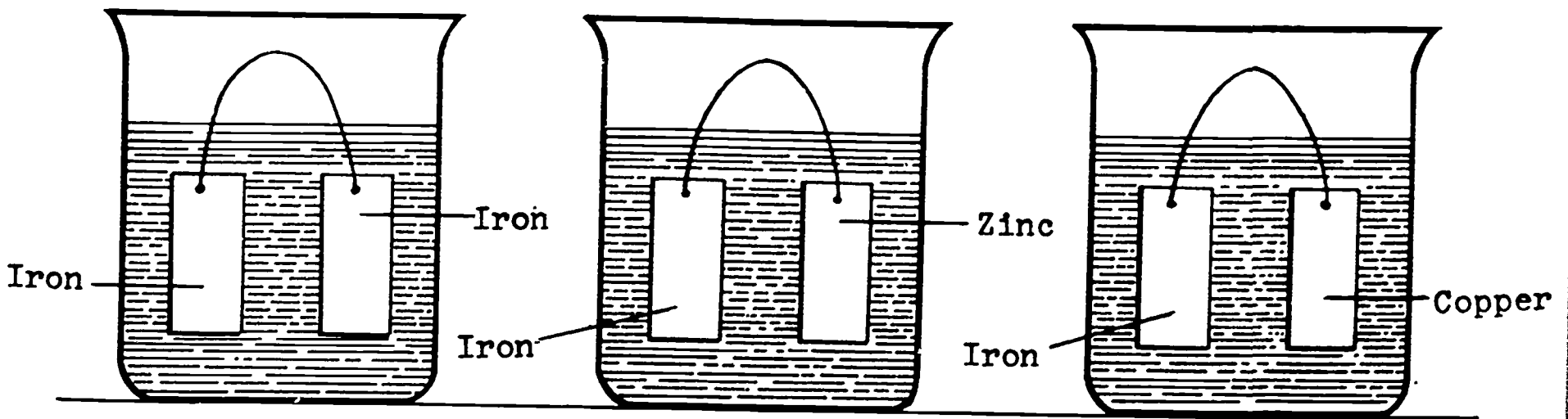

Fig. 11

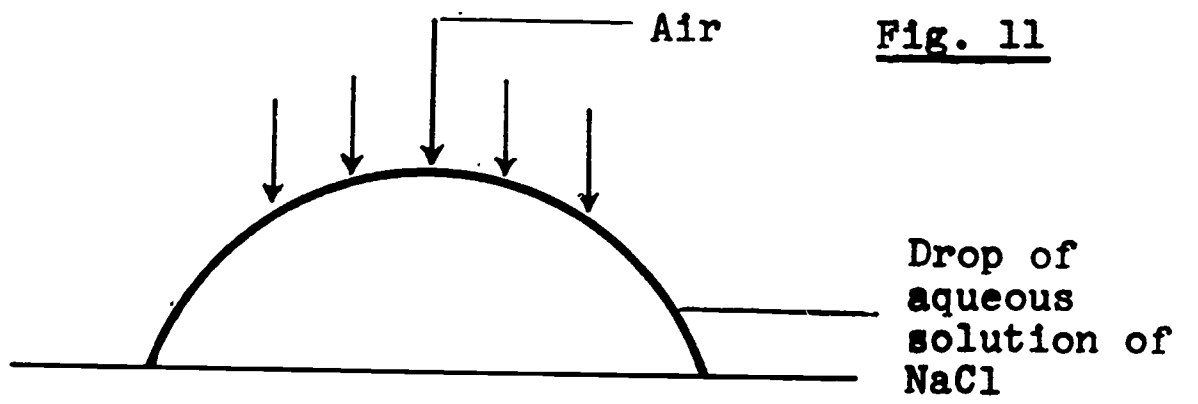

Fig. 14

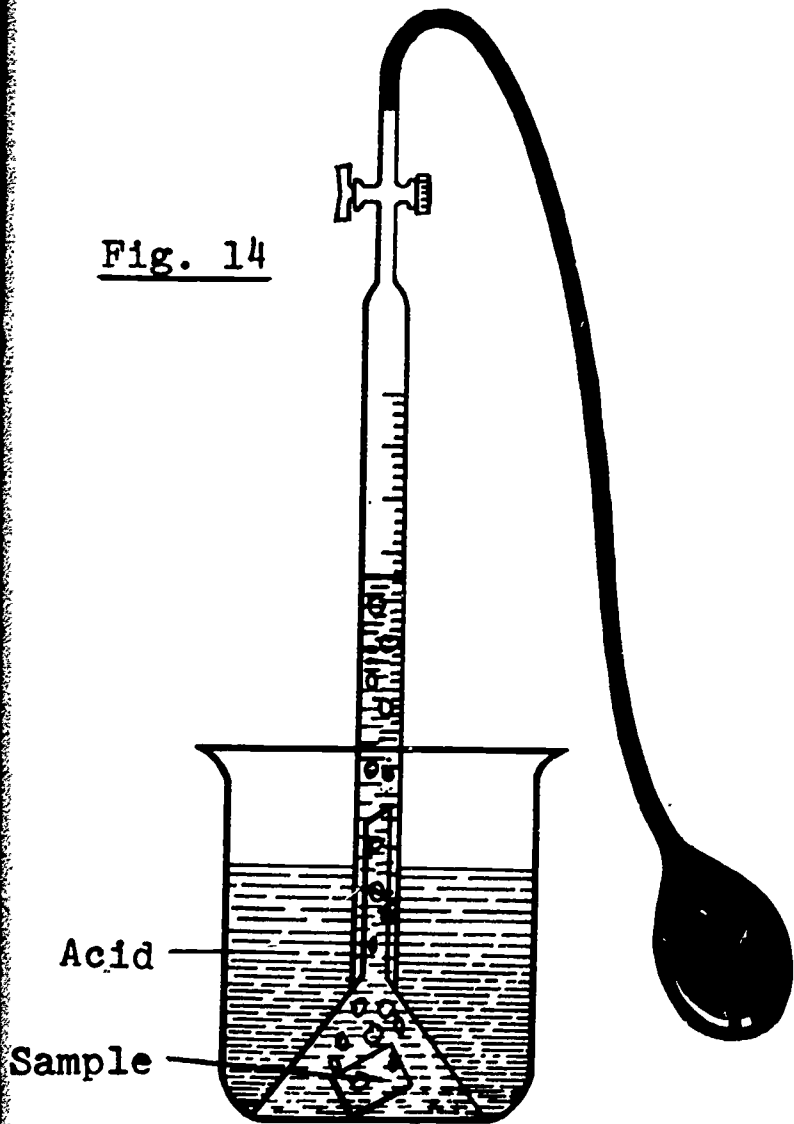
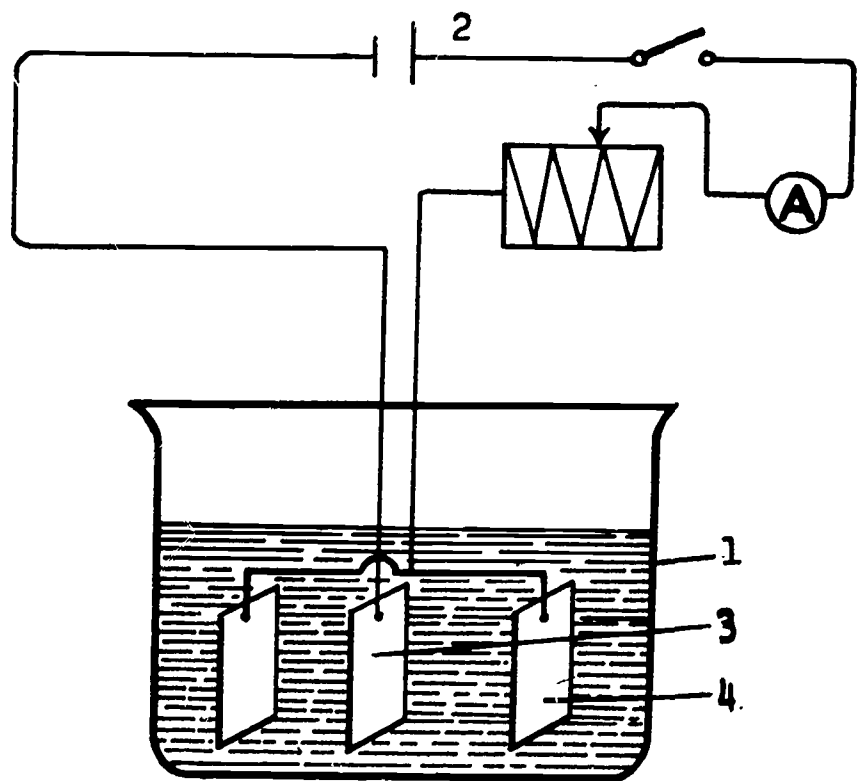

Fig. 13



Two arrangements are assembled as shown in fig. 14.

The open end of the burette is placed on the funnel under which a steel plate is placed. 2-3N solution of sulphuric acid is poured into two beakers. Potassium iodide or urotropine (hexamethylenetetramine) which serve as corrosion inhibitors, is added to one of the beaker solution up to a concentration of 0.5%. Then, with the burette stopper open, the burettes with the funnels and samples under them are each placed into the two beaker. With the help of rubber tubing the burettes are filled with the solutions and the taps are closed. In the solution without the inhibitor, the burette will soon be filled with hydrogen released due to the dissolving of the metal whereas in the solution with the inhibitor, this process will be considerably slower. Measuring after one hour, the volume of hydrogen in both the burettes, the inhibiting effect is calculated (the coefficient of inhibition of corrosion by the inhibitor) by using the formula:

$$\text{Coeff.} = 1 - \frac{V}{V_0}$$

where  $V_0$  is the amount of the released hydrogen in the uninhibited acid,  $V$  is the amount of hydrogen in the acid with the inhibitor.

#### Inhibitors for Water

##### Experiment 17 :

##### Requirements and Chemicals :

- 2 beakers, 400 ml each
- 2 steel plates, 80 x 40 mm and 2 plates 50 x 20 mm each
- $(\text{NH}_4)_2\text{CO}_3$  and  $\text{NaNO}_2$  in powder form
- 2 desiccators
- Filter paper
- Watch glass

Into two beakers containing 400-800 ml of distilled or tap water are put two steel plates cleaned with sand paper (one may use iron nails). In one of the beakers is added as inhibitor about 0.5 - 0.7 g of a mixture of two salts  $(\text{NH}_4)_2\text{CO}_3$  and  $\text{NaNO}_2$  (1:1 weight ratio). On the next day corrosion will be observed in the beaker without the inhibitor. The experiment may continue for a year provided water is added up to the original level (see fig. 15) to compensate for the loss due to evaporation.

### Use of Inhibited Paper

#### Experiment 18 :

Requirements and Chemicals : See Experiment 17.

Saturated solution of a mixture of  $(\text{NH}_4)_2\text{CO}_3$  and  $\text{NaNO}_2$  (by weight 1:1) is prepared and filtered. Wrapping or newspaper or any other paper without glue is soaked in this solution and dried in the open. The paper prepared in this way is called "inhibited paper". This paper is used to wrap up the samples which (as in previous experiments) should be previously cleaned and washed with distilled water. Similar samples (control samples) are wrapped up in uninhibited filter paper. Hot water (to speed up corrosion) is poured on the bottom of two desiccators as shown in fig. 16.

In one of the desiccators the samples wrapped in inhibited paper are placed on the porcelain disc while the sample with uninhibited paper are placed in the other desiccator. (Desiccators may be replaced by two beakers (500-800 ml). In this case the wrapped samples are wound with thread and suspended over the water. Every second month the samples are examined and compared.

### Inhibitors of Atmospheric Corrosion

#### Experiment 19 :

Requirements and Chemicals : See Experiment 17.

On a watch-glass is taken a small amount of the two salts :  $(\text{NH}_4)_2\text{CO}_3$  and  $\text{NaNO}_2$  (by weight 1:1).

The watch glass is placed in a desiccator or a beaker, on the bottom of which water is poured so that it does not fall on the vessel with the salt mixture. Two steel samples (in the form of plates) cleaned with sand paper are suspended over the vessel containing the mixture of the salts.

In the other desiccator (beaker with water) the control samples are suspended. In three-four days the control samples will begin to corrode (fig. 17).

The experiment should continue for a long time and the results should be observed from time to time, comparing the protected samples with the control samples.

### Inhibitors and Stimulators

When such substances as inhibitors of corrosion are selected, it is necessary to take into account what metal is to be protected. Thus, for instance, salts of ammonium and organic amines are effective protectors of steel while they intensify (stimulate), rather than control, the corrosion of copper and its alloys. The potassium or sodium hydrogen

Fig. 15

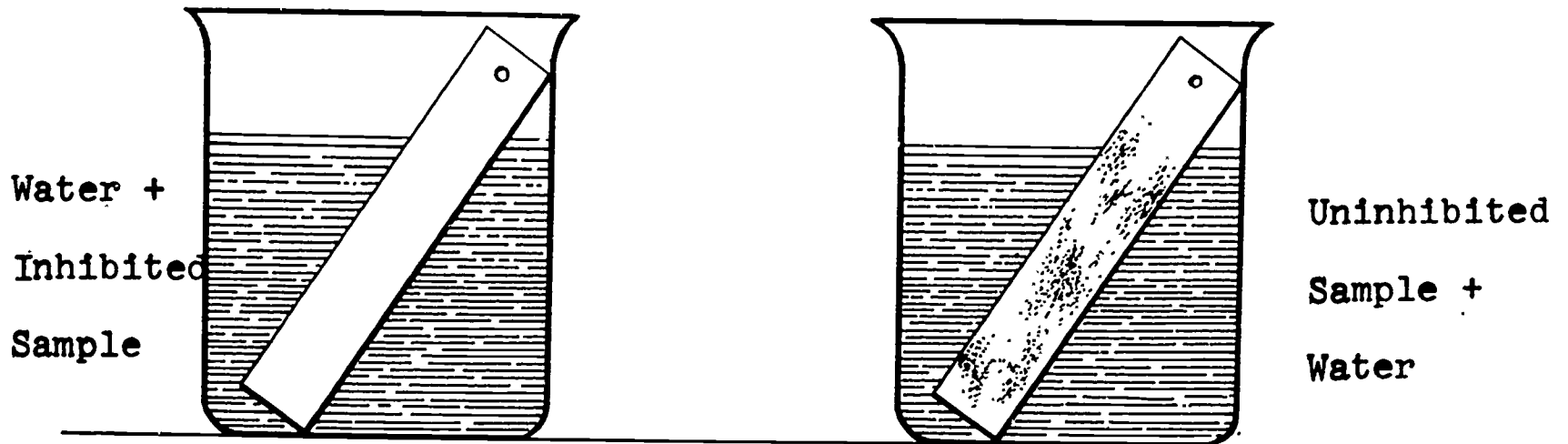

Fig. 16

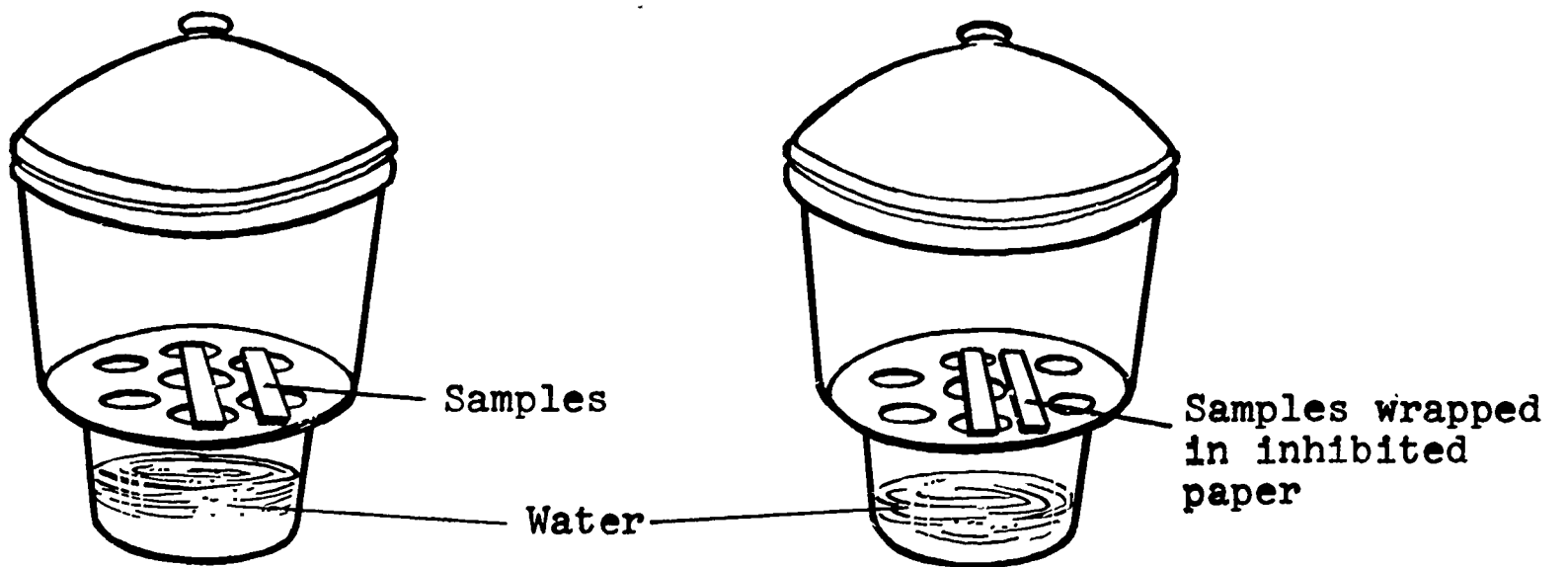
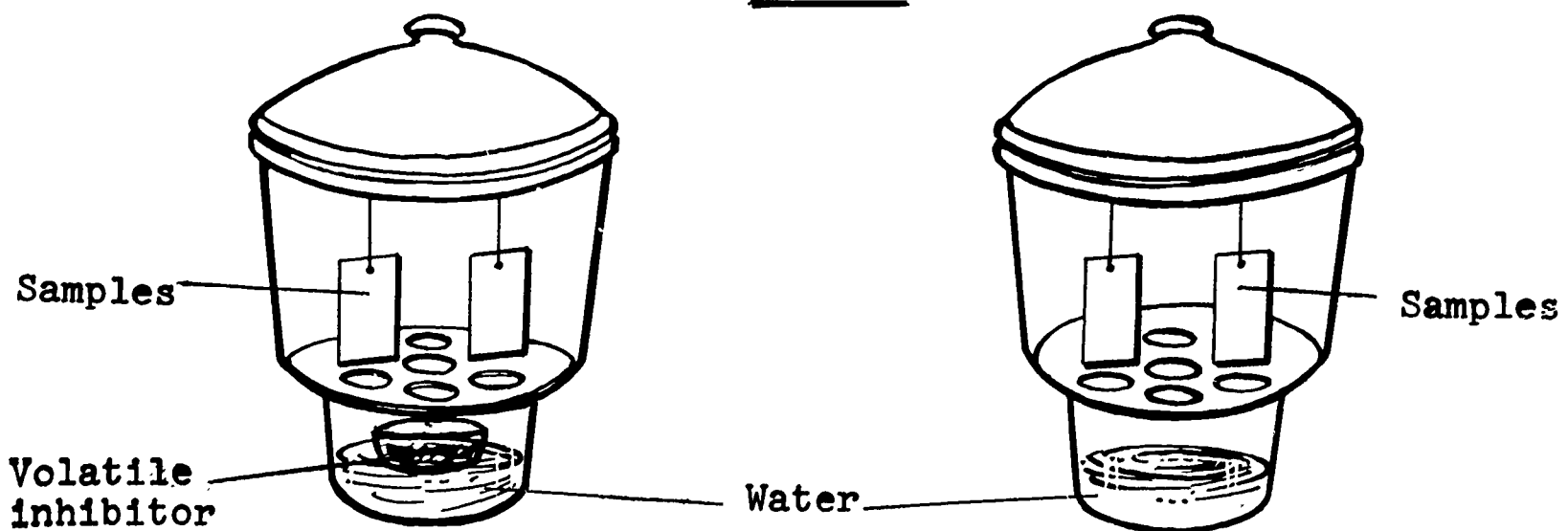

Fig. 17



sulphides protect zinc and aluminium in dilute solutions of alkalis, but they cause corrosion of silver, which under normal conditions, practically does not corrode.

The substances causing (stimulating) corrosion of metals are called stimulators of corrosion.

### Experiment 20:

#### Requirements and Chemicals :

3 desiccators

2 copper and 2 steel plates, 50 x 20 mm

Arrangement for preparation of chlorine

$(\text{NH}_4)_2\text{CO}_3$  in powder form.

Some water is taken in three desiccators or large size beakers (to create increased humidity) in order to speed up the corrosion process. In each of them, as shown in fig. 17, two copper and two steel samples are suspended, (pre-treated with sand paper, till they shine). One of the desiccators is filled with ammonia gas. In place of gaseous ammonia, one can place in the desiccator a small beaker containing the ammonium carbonate  $(\text{NH}_4)_2\text{CO}_3$ .

The second desiccator is filled with chlorine gas. The third is control with atmospheric air only. All the three desiccators (or beakers) are tightly closed.

It will take only a few hours to observe the corrosion of copper in the desiccator with ammonia and the corrosion of steel samples in the second and third desiccators. It would thus be observed that ammonia is a stimulator of corrosion of copper, while it is an inhibitor of corrosion in respect of steel.

### C o n c l u s i o n s

The experiments described above are simple to perform but some of them will take a long time before the final results are obtained. Therefore, part of experiments may better be performed with pupils as extra-curriculum activities, and the results of the experiments and observations can be used as demonstrational material.

Prof. M.C. Pant  
Department of Science Education,  
National Council of Educational  
Research & Training,  
NIE Blds., Mahrauli Road,  
New Delhi 16, India

Prof. S.A. Balezin  
Chief Technical Adviser  
Unesco Secondary School Science  
Teaching Project in India,  
National Institute of Education  
NCERT, Mehrauli Road,  
New Delhi 16, India

CURRICULUM REFORM ACTIVITIES IN OTHER AREAS

INDONESIA

The Chemistry Study Group in Bandung, Indonesia, was formed in February 1968, following a Seminar on Chemistry Teaching held in Bandung early in that month. Its formation was a manifestation of the need for modernization of high school chemistry teaching in Indonesia. The Group includes 2 representatives each from the University, Teacher Training Institute, National Institute of Educational Research and Development, High School Inspectorate, Indonesian Chemical Society, and 5 high school teachers. Its present Chairman is Dr. Sjamsul Arifin Achmad from the Bandung Institute of Technology who joined the Unesco Pilot Project in 1967 and 1968. It has a close association with institutions concerned with the science education and the Unesco Pilot Project in Bangkok, and has enjoyed their assistances. The Group has held meetings at least once every month since it was started.

In its first year, the Study Group has tried to create suitable atmosphere and promoted good understanding among institutions concerned with the teaching of chemistry. Its activities include regular lectures/demonstrations on current topics by University lecturers for the high school teachers, visits by the University staff to various high school in Bandung, and demonstrations on the use of film loops. Since October 1968 a regular meeting has been organized to discuss various topics, such as acid-base and oxidation-reduction. It is hoped that materials resulted from such a discussion may be used by the teachers at schools. Other materials from the above activities have been produced and distributed by the Group through its monthly bulletin. Eleven issues of the bulletin have been produced since April 1968, and 350 copies of each has been distributed among chemistry teachers throughout Indonesia.

The first major activity of the Study Group was organizing a Seminar/Workshop in co-operation with the Science Teaching Centre of the National Institute of Educational Research and Development, on the 20-30th January 1969. It was attended by 30 key chemistry teachers throughout Java, including 10 members of the Group. The first two days of the Seminar were provided to discuss the present situations of chemistry teaching in Indonesia, and recent activities for modernization of the teaching of the subject in Indonesia and overseas. Talks on CBA, CHEMS, Nuffield, Unesco Pilot Project and other curriculum projects were given in that sessions. The rest of the ten days were devoted to lectures, laboratory works, and discussions on various topics, such as stoichiometry, chemical equilibrium, chemical kinetics, corrosion, and organic chemistry. Laboratory experiments related to the above topics were selected from the CBA, CHEMS, Nuffield, Unesco Pilot Project and Ceylon Project materials. Related film loops produced by the Unesco Pilot Project were also shown.

Materials investigated at the Workshop are now being tested at University, Teacher Training Institute, and several high schools in Bandung by the Study Group itself. This trial will be used to develop new versions at the following workshop.

Some other highlights of the Study Group are as following.

- (a) May 1968 - visit of Professor Gordon H. Aylward (Macquarie University, Australia) who gave a lecture on "Chemical Equilibrium", and meeting with the Study Group.
- (b) August 1968 - visit of Dr. Robert H. Maybury (Unesco, Division of Science Teaching), and meeting with the Study Group.
- (c) November 1968 - visit of Professor Dr. J.G. Niesten (Technische Hogeschool, Eindhoven, Netherland).
- (d) November 1968 - Mr. Jahja Ratnawidjaja from the Science Teaching Centre in Bandung, and member of the Study Group, joined the Unesco Pilot Project for a short period.
- (e) March 1969 - visit of Dr. E.C. Watton (Macquarie University Australia, and 1967 Director of the Unesco Pilot Project), and meeting with the Study Group.
- (f) April 1969 - visit of Dr. H.A. Foecke (Director, Unesco Division of Science Teaching).

At the middle of 1968 two other Groups have been formed in Djakarta and Jogjakarta by the local chemistry teachers respectively. The Study Group in Djakarta is now a sub-committee of the "Djakarta Chemistry Teachers Association" formed on the 15th March 1969. A Chemistry Teachers Association in Bandung has also been formed by the local chemistry teachers early on March 1969. These Groups are in close co-operation with the Study Group in Bandung.

A number of activities are planned for 1969. A new concept for a new chemistry curriculum is being investigated in co-operation with the National Institute of Educational Research and Development. It is the first step of a proposed five year plan to develop a new chemistry curriculum.

Reported by: Study Group for Chemistry Teaching,  
School of Chemistry,  
Bandung Institute of Technology,  
Djalan Ganeca 10,  
Bandung, Indonesia.



A COMBINED PHYSICS AND CHEMISTRY PROJECT

FOR JUNIOR SECONDARY SCHOOLS IN ISRAEL

This project is led by Dr. Ruth Ben-Zvi and Mr. Nathan Orpaz from the Curriculum Centre, Ministry of Education and Culture, Jerusalem, Israel.

The program of the project consists of preparation of a comprehensive program for a combined Physics-Chemistry Course for Grades 7-9. The teaching materials will include: students text books, teachers handbooks, laboratory experiments and tests (all in Hebrew).

Outline of the Course:

In Grade 7 an introduction to structure of matter is given with the main idea: All matter is made up of particles.

The content of the Grade 7 course is as follows. Chapter I: Classifying and identifying materials. Specific weight. Chapter II: Separation of mixtures. Chapter III: Solids, liquids and gases. Distinguishing properties. Chapter IV: Diffusion, Brownian motion, crystal growing, facts and hypotheses, models, introduction of the theory: All matter consists of particles. Chapter V: Mixtures and compounds, analysis and synthesis of materials. Constant proportion in compounds, elements, atoms and molecules. Chapter VI: Approximate measurements, big and small numbers, order of magnitude, the oil film experiment - The life of an oil molecule.

Chapters I to IV have already appeared in print and are tested now in 450 classes from which a sample of 36 classes is taken for intensive follow-up, feedback and testing.

Grade 8 deals mainly with electricity and the gas laws. In the first part the main idea is that electric current in metallic conductors is due to the movement of charges (electrons) and the current in solutions is due to the movement of charged atoms (ions). The first two chapters of this subject dealing with simple circuits have been written in a preliminary version and are being tested now with small groups of children. Under the gas laws temperature and the kinetic theory of gases are discussed.

In Grade 9 the main topics are magnetism and electromagnetism, heat and energy. Only a first outline of concepts and ideas for grade 9 has been prepared.

Scheme of Work:

The project team includes teachers, science advisers, laboratory technicians, graphic artists and evaluators. It is governed in its work by a steering committee headed by Prof. S. Ofer and Dr. S. Yatziv of the Hebrew University in

Jerusalem. Scientists, School Inspectors and Project leaders of other Science Teaching projects in Israel participate in the work of the Steering Committee.

After preliminary versions of the students texts and apparatus and experiments have been developed, these are tested first on a small sample of 6 classes. In the second stage the material is tried out in a sample of 30-40 classes, and is revised according to the feedback received and will be re-written in its final form.

#### Teacher Training:

A Summer Institute was held for the teachers that take part in the testing of the material (15 teachers). The material for grade 7 is taught also in 450 classes and all the teachers meet in groups once a week during the school year for training and discussion of methods.

#### Outlook for the future:

Revision of the material for grade 7 for two levels of students - normal and slow learners. Completion of the material for grade 8 (writing texts, teachers' guide and new experiments). Outlining the structure for grade 9. It is expected that in a few years time work on pilot projects for science teaching in primary schools (grades 1-6) will be well advanced and then changes in the course for grades 7-9 will be needed.

(Based on a report by Dr. Ruth Ben-Zvi, Hebrew University, Department of Biological Chemistry, Jerusalem, Israel.)

### THAI SCHOOLBOYS MAKE CHEMISTRY FILM LOOP

In our last issue (News Notes, page 19) we reported that two Thai schoolboys, Pisit Lee Ah-tam, 18, and Viput Phoolcharoen, 17, both from Suankularb School in Bangkok, were spending their summer holidays learning how to make a film loop. The loop has now been successfully completed, and here is an account of how it all went.

Altogether, it took about five weeks from the time the subject was first agreed upon until the loop was finished. The topic was suggested by Professor Zyka and Dr. Herm, after a couple of other topics had been discussed and found unsuitable. The topic finally chosen was the shift in the equilibrium between the gases  $\text{NO}_2$  and  $\text{N}_2\text{O}_4$

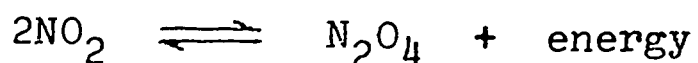

as the temperature of the gas mixture is changed. The mixture, a medium brown colour at room temperature due to the presence of brown  $\text{NO}_2$  in colourless  $\text{N}_2\text{O}_4$ , becomes a deeper brown at the temperature of boiling water, and becomes colourless at the temperature of a dry ice/acetone mixture ( $-79^\circ\text{C}$ ). Thus this topic satisfied one of the basic necessities for a good film loop, that there should be some pronounced visual changes.

Preliminary tests in the lab showed that a test-tubeful of the gases went darker immediately on being plunged into boiling water, and also lost its colour immediately on being plunged into the dry ice/acetone mixture. It was important for the film that these colour changes should be not only marked, but also rapid; for the boys wanted their 4-minute loop to include not only the heating and cooling demonstration, but also three other sequences - an opening sequence showing the generating of the gas mixture by putting a piece of copper foil into a test-tube containing nitric acid, some of the emerging clouds of gas being then collected in other test-tubes; an animated diagram to "explain" the colour changes produced by the temperature changes in terms of Le Chatelier's Principle; and another diagram showing the structures of the  $\text{NO}_2$  and  $\text{N}_2\text{O}_4$  molecules (the actual molecular mechanism of the reaction could not be shown since insufficient is known about it).

Roughly two weeks were taken up with the planning and experimental stage in the lab, including making tests for the gas generating sequence as well as for the actual temperature-change demonstration, and also four days' hard brain-cudgelling about exactly how to show the "explanation" in animated diagram terms. During part of this time the camera and tripod were brought into the lab to get the "feel" of the panning and zooming movements necessary, but without actually shooting any film.

The shooting itself was done in the air-conditioned, blacked-out film room in order to avoid three undesirable factors in the lab: (a) uncontrolled lighting conditions (for instance, on

fine days the lab becomes suddenly flooded for about an hour in mid-morning with dazzling sunlight reflected from the roof of the nearby Botany Department's glasshouse); (b) variations in temperature due to sudden gusts of wind blowing the bunsen flame; and (c) cluttered backgrounds full of irrelevant and distracting detail. Yet needless to say, as those readers who were at the Project during 1965-66 may remember, all experiments behave quite differently in the air-conditioned room, and this one was no exception. For some reason, the water refused to boil; so at the last minute we had to substitute the bunsen with an electric hot-plate.

Since neither of the boys had ever handled a cine-camera before, we decided on what proved a wise course and a good investment - we spent U.S.\$6 on two rolls of black-and-white film, on which we shot rehearsals. This could be processed overnight in Bangkok, so we were able to see the results the day after shooting them. This enabled us to check on all kinds of things - to discover, for instance, that one boy was much better than the other at smooth camerawork, while (luckily!) the other boy was far more skilful at dropping copper foil into acid without knocking the whole apparatus sideways. The test shooting also provided valuable experience in timing the various combinations and interplays between camera movements and the actions of the boy doing the experiment. Finally, it gave us a check on our lighting and exposure, and showed us that our decision to use a white background was correct. (Having by laborious trial and error got what we considered the optimum arrangements of lights for the two main sequences, the boys made detailed sketch-plans of these arrangements so that the lights could be placed exactly the same positions later on, when we came to film these sequences in colour).

Then the long process of drawing the storyboard and of creating the many captions and labels began. Finally everything was ready for the "live" shooting, that is, the sequences of gas generating and heating/cooling. With our lighting plans and the boys' previous experience in shooting the black-and-white tests (which we projected again and again as references, before as well as during the shooting of the colour), the actual colour shooting went pretty smoothly "on the day".

These shots, taken on double-8 Kodachrome Type A, were then sent off to Australia for processing, and should have come back to us after nine days. However, the Australians seem to have taken an unusually long Easter Holiday this year, and nearly three weeks passed by before, hot, impatient and apprehensive, our trembling fingers finally threaded the film into the projector and switched off the lights ..... We needn't have worried - the shots were excellent, and above all, the important colour changes showed up well on the film.

During these three weeks, however, the boys had been kept very busy on the animation sequences - first, preparing a master or "key" drawing in which a simplified symbol of a flame was to

represent the energy in the equation:

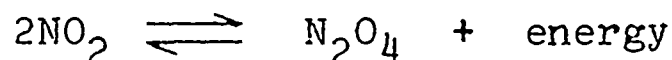

and was to grow larger and smaller to represent heating and cooling respectively. The boys then had to cut out some 60 "flames" of graduated sizes from yellow paper and stick these accurately in position on sheets of celluloid punched with registration holes. The  $\rightleftharpoons$  sign was also made to oscillate, with a preponderance in the  $\rightarrow$  or the  $\leftarrow$  direction to go with the cooling and heating respectively. All this involved a considerable number of boy-hours and careful, accurate work both in the drawing and in the frame-by-frame shooting which followed. All of it was entirely new to the boys; but they grasped the essentials very quickly, and the animation, like the "live" shooting, turned out successful.

Finally the boys edited the film down to the maximum 54-foot (4-minute) length which will fit into a loop cassette. We hope to have a few copies made and put into cassettes for running in Technicolor loop projectors.

Altogether, besides the two rolls of black-and-white film, the boys shot three rolls of Kodachrome. With lamps (photofloods) and stationery materials, the total costs of production were about U.S.\$35.

Meanwhile, like Oliver Twist, the two boys (who seem to be almost inseparable) keep coming back for more. Recently they have been doing some interesting experiments in shooting bean seeds germinating, using time-lapse filming. Everything went fine except that, on the day, the seed didn't germinate.....

Denis Segaller

---

NEWS NOTES

---

Dr. Harold A. Foecke, Director, Division of Science Teaching, UNESCO, Paris, saved time during his very busy programme in Bangkok, for a visit to the Project and for long and very useful discussions with the staff members. He arrived on 7th April and proceeded on 10th to Indonesia.

---

Dr. Sunt Techakumpuch, Co-director of the Project and professor at the Chemistry Department of Chulalongkorn University, and Dr. Sippanond Ketudat, University Development Commission, came back from about one month trip, having visited the universities in Europe, U.S.A. and Asia. During their stop in Paris they visited also the Division of Science Teaching in UNESCO.

---

Mr. S.B. Hosen from Institute of Educational Sciences and Teacher Training in Bandung, Indonesia, has joined the Project staff on UNESCO Fellowship. He is going to spend 6 months with the staff, develop new experiments and resource materials for teaching chemistry in his own country and to cooperate with the staff members on some experiments on rate of chemical reactions.

---

Thai translation of "Compound Formation", a Teachers Guide, Vol. 1 and "Experiments on Chemical Equilibria" appeared recently and are available in the Project. "Experiments on Compound Formation" is being translated into Thai by Miss Manee Chandavimol.

---

A Summer Course for Secondary School Teachers on Nuclear Science was held in Project's laboratories from 7 April to 2 May 1969. A film session organized by Mr. D. Segaller

on the Project's film loops on structure was included into the framework of the Summer Institute.

---

Dr. Herm and Dr. Zyka attended the Congress of Teacher Association in Kuala Lumpur. In their lectures they have informed the audience about the present state of the activities of the Project and were demonstrating experimental low-cost kits on Chemical Equilibria and Compound Formation. The Congress was well organized and very successful. In Kuala Lumpur and in short stops in Singapore and Penang, they were discussing with previous Project's participants and co-workers (Dr. A.K. Kiang from University of Singapore, Mr. C.K. Cheah from Teacher Training College Singapore, Miss Grace Liok from University of Singapore, Dr. F.C. Vohra from University of Malaya, Mr. Boey Chee Khiew and Mr. Khoo Chin Hock from Malayan Teachers College, Penang) some topics of mutual interest. They also had the opportunity to speak with Prof. F.P. Salinger, Associate Director, United States Peace Corps in Malaysia, about education and teaching chemistry in general and with Mr. T.B. Slattery from SEAMES Regional Center for Education in Science & Mathematics, about the extension of mutual cooperation.

---

Dr. Robert Chesley from the Teacher School, Ojai, California, visited the Project recently and informed the staff about the Harvard Project in Physics. He was on his way to India to join the staff of the National Science Foundation Project in New Delhi.

---

Mr. Kenkichi Nakajo, Chief of Science Section, Japanese National Commission for UNESCO, visited the Project recently and had a discussion with the staff members about the possibilities

of a closer cooperation. He was accompanied by Mr. Pongsak Roongrojpanich from the Thai National Commission for Unesco in Bangkok.

---

Mr. Robert E.A. Bordage, visited the Project several times during his briefing period in Bangkok. He came to Thailand as Unesco expert in Audio-Visual Teaching Aids (elementary Science and Mathematics) and is going to

join Improvement of Teacher Training Project in Mahasarakam.

---

Mr. Arun Kochar and Miss Salma Sultan from India, who won the contest of writing an essay about United Nations and were awarded the title of Mr. and Miss UN stopped at the Project during their Asian trip.

---