

ED 030 328

EM 007 304

This is NHK.

Japan Broadcasting Corp., Tokyo. Public Relations Board.

Pub Date 69

Note-63p.

EDRS Price MF-\$0.50 HC-\$3.25

Descriptors-Automation, *Broadcast Industry, Broadcast Television, Communication Satellites, Data Processing, Educational Television, Electronic Control, Electronic Data Processing, Electronic Equipment, Engineering Technology, Equipment Utilization, Foreign Culture, *Japanese, Mass Instruction, Networks, Public Opinion, *Public Television, *Radio, Social Environment, *Television, Television Repairmen, Television Research

Identifiers-NHK, Nippon Hoso Kyokai

Nippon Hoso Kyokai (Japan Broadcasting Corporation--NHK) is the only public service broadcasting corporation in Japan. Financed almost exclusively by subscribers fees, NHK runs two television services, two radio networks, and an FM service. Its 60 million viewers may choose from entertainment programming such as quiz shows, musicals, serials, and drama; educational programming for school children and adults; and news and information programming which draws on the resources of 25 overseas bureaus and a satellite hookup. Electronic data processing systems schedule, calculate and allocate facilities, equipment, and personnel, monitor for transmission trouble, and automate much of the operation of broadcasting and recording equipment. NHK trains television repairmen and production and engineering staff, operates an overseas radio station, conducts public opinion research, and does basic and applied research and development in broadcast engineering. A list of 14 English language publications of the NHK appears at the end of the report. (JY)

EDO 30328

this is **NHK**



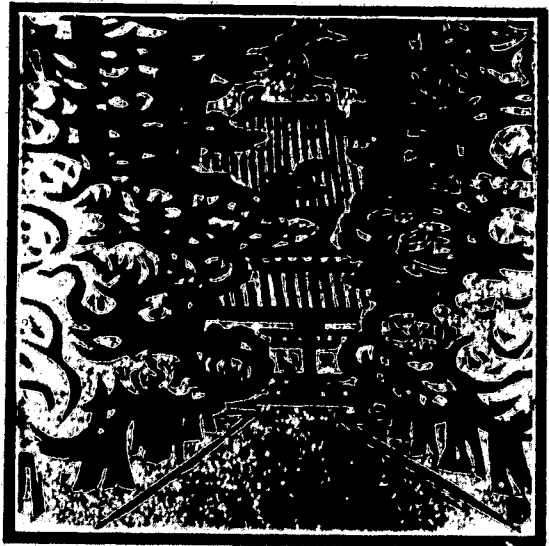

The woodcut print on the cover is by Kihel Sasajima, born in Mashiko, Tochigi Prefecture, in 1906.

Sasajima studied under Shiko Munakata and is famous as a black-and-white symbolic woodcut printer. His works have been entered in such international exhibitions as the International Biennial Exhibit of Print in Tokyo and the International Biennial of São Paulo.

Like "haiku," the 17 syllabled verse common in Japan, his works represent the profound expressions of Nature in simple forms.

The print depicts in sharply contrasting black and white the Todaiji Temple in Nara which houses a great bronze statue of Buddha. The upper space represents deep clear skies and white of the causeway, mother earth.

THIS DOCUMENT HAS BEEN REPRODUCED EXACTLY AS RECEIVED FROM THE
PERSON OR ORGANIZATION ORIGINATING IT. POINTS OF VIEW OR OPINIONS
STATED DO NOT NECESSARILY REPRESENT OFFICIAL OFFICE OF EDUCATION
POSITION OR POLICY.

ED030328

EM007304

this is **NHK**

Public Relations Bureau
Nippon Hoso Kyokai
(Japan Broadcasting Corporation)
Uchisaiwai-cho, Chiyoda-ku
Tokyo, Japan
1969

● Outline of NHK	2
Brief History and Character	2
Mission and Business Management	4
Finance	6
Audience Services	7
Organization of NHK	8
Overseas Bureaus	10
● National Networks	12
● Modernization of Management	14
NHK-TOPICS	15
● News, Sports Programs and Local Service ..	18
News Center	22
● Satellite Transmissions	24
● Educational and Cultural Programs	26
Outline	27
School Programs	28
Correspondence Educational Programs	29
Social Education Programs	30
Cultural Programs	32
● Musical and Entertainment Programs	34
● Overseas Service	40
● Techniques and Facilities	44
Outline	45
Technical Operation Center	46
Transmitter	48
Color Camera	49
Film Equipment	50
Audio Equipment	51
● NHK Broadcasting Center	52
● Researches and Investigations	54
Technical Research Laboratories	55
Broadcasting Science Research Laboratories ..	55
Radio and TV Culture Research Institute	57
Public Opinion Research Institute	57
Broadcasting Museum	58
Central Training Institute	59
● Publication	60
● Brief History of NHK	61

OUTLINE OF NHK

BRIEF HISTORY AND CHARACTER

Nippon Hoso Kyokai (Japan Broadcasting Corporation) is the only public service broadcasting organization in Japan. The outstanding feature of NHK is that it is financed entirely with receivers' fees paid by receiving set owners under a system starting in 1925, when its predecessor, Nippon Hoso Kyokai, was established as a corporate juridical person and radio service was inaugurated for the first time in Japan.

NHK became a special corporation under the Broadcast Law enacted in 1950, thus further clarifying its character as the "people's broadcasting organization". NHK does not depend on government financial aid or on any specific capital; its financial foundation rests with accumulation of receivers' fees or subscription fees paid by the people in general, who are radio listeners and television viewers. These receivers' fees serve as the powerful supporting pillar for NHK's independence in programming and program production as well as for NHK's public service status.

NHK's tie with the audience, i.e., the general public, is not limited to the financial aspect involving receivers' fees. The people's opinions and requests related to broadcasting programs are directly absorbed through public opinion surveys conducted periodically by NHK, through discussions at the Program Consultative Council composed of competent members selected from among the people, and through informal meetings with the audience representing various walks of life and from letters and monitor reports.

Broadcasting has become an essential part of life in Japan because of its diversified functions, including its capacity to provide information, education and entertainment. Its impact on society, therefore, is immeasurable. Moreover, broadcasting is an enterprise that should be operated for public interest because it utilizes radio and TV waves which are the common property of the people.

At present broadcasting in Japan is operated under a dual system, the public service represented by NHK and the commercial service represented by private

broadcasting companies. The two systems of broadcasting constantly strive for the development of their respective services through mutual stimulation, even while operating on their respective merits.

The year 1969 falls on the 44th anniversary of broadcasting, which was inaugurated in March 1925. In those days, the number of subscribers totaled no more than 5,400 or so. When the television service was inaugurated in 1953, there were only 900 TV subscribers. Today, however, the combined total of radio and television subscribers has topped 21 million households, which account for 87.3 per cent of the entire households in the country (24.1 million, according to 1965 census).

Meanwhile, NHK's broadcasting stations continue to increase annually, and as of March 1969, there

were 789 operating in the General TV Service, 787 in the Educational TV Service, 170 in the First Radio Network, 141 in the Second Radio Network and 170 in the FM Service. Their respective coverages are 96 per cent for the General TV and Educational TV, 99.7 per cent for the First Radio Network, 98.5 per cent for the Second Radio Network, and 81 per cent for the FM service.

In order to meet the requirements of the audience and to contribute towards elevation of the cultural level of the nation, NHK produces every week, including local programs, 4,000 television, 10,300 radio and 400 FM programs for a total of 14,700, 2,100 of which are presented daily. Moreover, a daily average of an estimated 60 million people view television programs and 9 million people listen to radio programs of NHK, which include news, educational, cultural, musical and entertainment items.

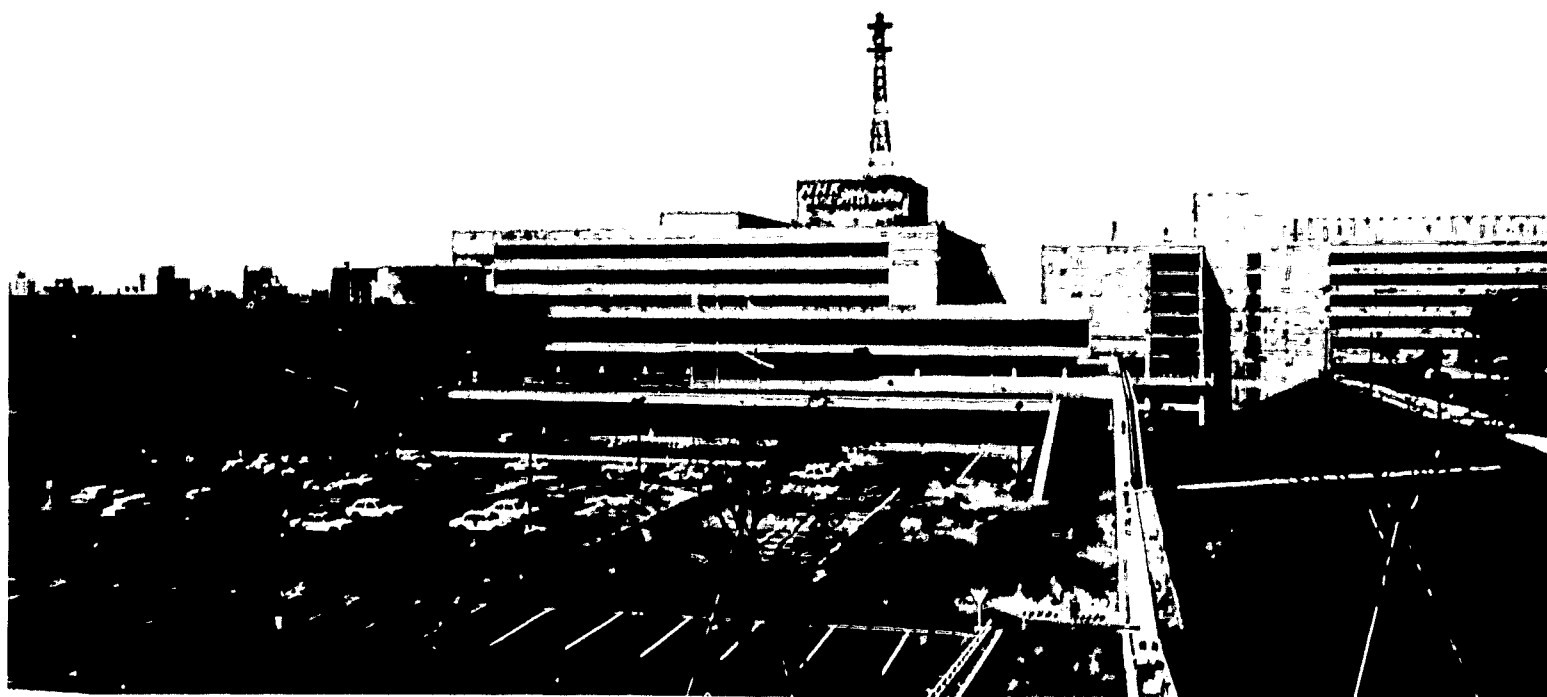

NHK Broadcasting Center

MISSION AND BUSINESS MANAGEMENT

The fundamental mission of NHK, which was established for the purpose of contributing towards greater welfare of the people and the elevation of the cultural level of the nation, is as follows:

1. To present good news, educational, cultural and entertainment programs in line with the requirements of the people and to contribute to the elevation of the cultural level of the nation.
2. To construct nation-wide networks so that the coverage will extend over the entire country and also to provide broadcasting stations for presenting local programs specifically for local communities.
3. To undertake researches and investigations necessary for the progress and development of broadcasting and reception thereof.
4. To provide programs and technical cooperation to commercial broadcasters as a means of contributing towards progress and development of broadcasting as a whole.
5. To operate an overseas broadcasting service and to provide overseas broadcasting organizations with exchange programs and technical cooperation.

In order to accomplish the above tasks, NHK operates two television services, two radio networks and an FM service. The television services comprise the General Service presenting nation-wide network and local programs for the general audience and the Educational Service presenting school programs, correspondence education programs and social education programs. Nation-wide colorcasts are also included in these two services.

The two radio services include the First Network presenting news, educational, cultural and entertainment programs intended for the general audience and the Second Network specializing in educational and cultural programs. The FM Service presents news intended for regional blocs comprising a prefecture as a unit, local programs and stereo musical programs which exploit the special characteristics inherent in FM broadcasting. NHK's overseas radio service is conducted for the purpose of contributing to the promotion of international amity and cultural exchanges.

NHK also maintains the Technical Research Laboratories, Broadcasting Science Research Laboratories, Radio and Television Culture Research Institute and the Public Opinion Research Institute for undertaking researches and investigations related to broadcast programs and engineering.

Besides the foregoing, NHK provides pertinent training not only to its own staff but also to overseas personnel in order to contribute towards further development of program production and broadcast engineering.

In order to accomplish the aforementioned mission as a "people's broadcasting organization," NHK is now implementing a third five-year program which commenced in 1968. The principal items included in this program are as follows:

1. Construction of about 1,000 stations for the General and Educational TV services for eliminating areas of difficult reception and thus expanding the coverage to 98 per cent of the total households in the country.
2. Construction of a high-power medium-wave stations to overcome interference from broadcasting stations of neighboring countries.
3. Further efforts at enrichment and renovation of programs as well as at repletion of local programs and increase of color programs.
4. Use of UHF bands for high-level educational and cultural programs in the event of allocation thereof, and compilation of programs like "Television University for the People."
5. Use of FM Service for prefectural local programs to cover those areas having difficulty in receiving medium-wave broadcasts and to present music, entertainment and cultural programs of high sound quality. Also, construction of some 240 stations to expand the coverage to 95 per cent.
6. Extension of overseas service time, more active exchange of programs with overseas broadcasting organizations and stress placed on programs via communications satellites.

In connection with exchange of programs, NHK, in 1965, established the Japan Prize International Educational Program Contest, through which mutual understanding with various countries of the world is promoted.

NHK hopes that the broadcasting organizations of the world will unite in contributing to world peace. With this in view, NHK actively cooperates with ABU and EBU. NHK also hopes to be able to establish a spiritual bridge between overseas nations and Japan through broadcasting utilizing world-wide communications expected to be developed in the near future.

In September 1967, NHK established NHK INTERNATIONAL so that all of NHK's quality programs might be distributed to overseas broadcasters, distributors and educational institutions. Also, an international educational library of educational and school programs was inaugurated for overseas distribution to emerging countries as well as

European and American schools and broadcasters.

With a view to stimulating utilization of its educational programs, NHK sponsors various study meetings and seminars, such as the National Seminar for Educational Broadcasts, etc. NHK also provides assistance to the NHK Correspondence High School established as a pilot school where educational programs may be fully utilized.

Besides these activities, NHK continues to develop the NHK Symphony Orchestra in order to enrich its own programs and help raise the musical standards of the nation. It also provides assistance to the Bunraku Kyokai (Association of Bunraku Puppet Shows) for the purpose of preserving this traditional art form. NHK further invites prominent cultural leaders and artists, both Japanese and foreign, for lectures and concerts; it also sponsors various amateur sports events which are broadcast widely over its networks.

RADIO AND TELEVISION PROGRAMS CLASSIFIED BY TYPES (As of Apr. 1969)

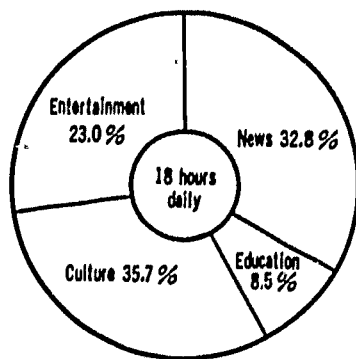

General TV Network

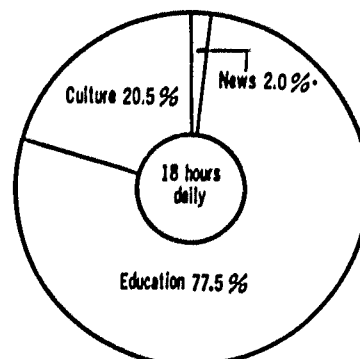

Educational TV Network

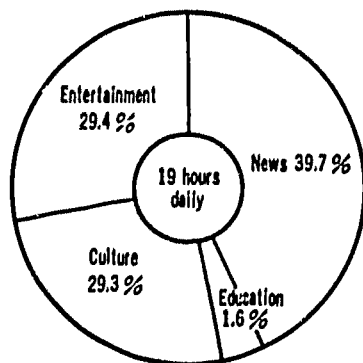

Radio 1st Network

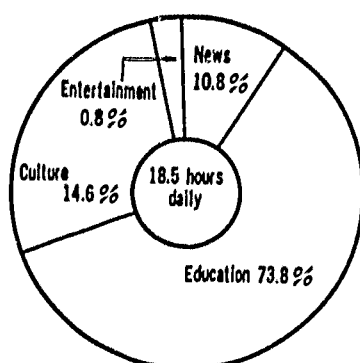

Radio 2nd Network

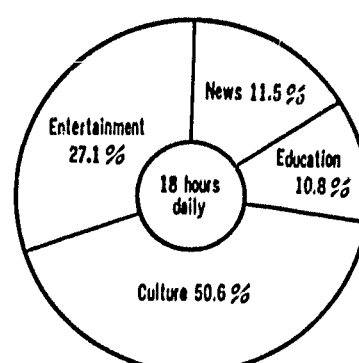

FM Network

FINANCE

NHK depends almost exclusively on receivers' fees paid by the subscribers as its financial source. For example, of the total business income of ¥83,750 million for fiscal 1969, ¥82,520 million were accounted for by income from receivers' fees.

Under the Broadcast Law, NHK concludes contracts with receiving households in the country, and collects the receivers' fees. The monthly amount, separately collected for color television and for monochrome television, is ¥465 for the former and ¥315 for the latter. No charge is made for radio. The rate of collection is nearly 100 per cent.

NHK's business income has grown large along with increasing popularization of television. However, with television subscribers reaching more than 80 per cent of all the households in the country, the rate of increase in the business income has become slower.

In order to maintain the freedom of programming of sound finances as the fundamental policy of management, NHK, therefore, is endeavoring to stabilize its operations by establishing receivers' fee system for color television with the expectations placed on the further popularization of this medium in addition to modernizing its management through adoption of the electronic computer system. Even then, NHK is likely to continue to face difficulties in its financial affairs because of an imminent shift to UHF television in the future.

NHK's budget of revenues and expenditures, business program and financial program are voluntarily drafted by NHK. These are submitted to the Ministry of Posts and Telecommunications after being approved by its own Board of Governors. The Minister of Posts and Telecommunications reviews the submitted programs and then submits them to the Diet, an organ composed of representatives of the people, together with his opinions, for approval. This is an outstanding feature of the budget system of NHK, which is the "broadcasting organization of the people."



AUDIENCE SERVICES

Service to Subscribers

It is the prime obligation of NHK to provide its subscribers with high-quality programs under good receiving conditions. The key to subscriber service, therefore, lies in the general effort to meet the requirements involved in the production of programs for the audience. Another important task is to implement various measures in all aspects of broadcasting to meet the demands of the listeners and viewers. It is for this purpose that NHK has established "NHK Consultation Rooms" in 68 stations throughout the country. Here questions and requests from the audience are studied and advices needed are offered, and the results compiled from these "consultations" are reflected, as far as possible, in the daily business operation of NHK.

NHK also makes endeavors in the field of reception so that the audience may receive its programs in good picture and sound quality.

NHK holds some 4,000 technical courses a year in various parts of the country in order to help improve the skill of repair technicians employed by radio and television service shops. In addition, NHK provides pertinent advices for telephone consultations from the audience; it also sends out visiting servicing teams to diagnose troubles and to provide guidance in the improvement of reception.

For remote, hilly areas and urban districts between tall buildings, where reception is not satisfactory, NHK, in cooperation with radio and television service shops, provides mobile repair services; it also assigns servicing cars to all important stations in the country to provide adequate repair services for the benefit of the audience.

In case of disasters, such as earthquakes and floods, NHK not only presents pertinent bulletins and information on the state and progress of disasters but also provides repair services for damaged receivers in cooperation with local repair shops.

Publicity for NHK's Activities

It is an important prerequisite for NHK as a public service broadcaster to publicize its mission, administration and details of programs as widely as possible among the audience. For such purposes, NHK utilizes all sorts of media.

As a means of public relations through broadcasting, NHK presents radio and television programs, such as the "Audience and NHK," a roundtable forum in which the President of NHK answers questions put to him by those present. Publicity through newspapers and magazines, as well as various other types of printed matter, is also actively undertaken.

There are also informal conferences with audience. Such conferences were established in various parts of the country in 1961 and are continued for the purpose of presenting the actual state of NHK and reflecting frank opinions of the audience regarding NHK's management. Such meetings were held for a total of 3,000 times up to January 1, 1969. The total attendance at these meetings was 55,000 subscribers.

Service cars stationed in various parts of the country for the technical service to the subscribers.



ORGANIZATION OF NHK

Board of Governors

This is the supreme administrative body of NHK which is vested with the power and responsibility for making decisions on important matters concerning the management and operations of NHK from the broad viewpoint of the interest of the people so that NHK may function properly in accordance with the desires of the people.

The Board of Governors deals with such important personnel matters as appointment of the President and the Auditors and it also gives consent to the appointment of the Vice-President and Managing Directors who are appointed by the President.

The Board of Governors is composed of 12 members, appointed by the Prime Minister with the consent of both Houses of the Diet as representatives of the people. It elects a chairman from among its members. Eight members of the Board are selected from throughout the country divided into eight blocs, and four other members from persons who are deemed highly in regard to public welfare and from among men of wide experience and learning representing equitably various fields of education, culture, science, industry, and other fields.

President, Vice-President, Managing Directors

The President, nominated by the Board of Governors, is the chief executive of NHK whose duty is to supervise the day-to-day business of NHK in accordance with the policy laid down by the Board of Governors, assisted by a Vice-President and the Managing Directors. Also, the President appoints the General Managing Directors from among the Managing Directors. The terms of office of the President, Vice-President and Managing Directors are three years.

As regards important matters, these are referred to the Board of Managing Directors composed of the President, Vice-President and Managing Directors for thorough deliberation so that there should be no mistake in formulating decisions.

With the consent of the Board of Governors, the President appoints the Vice-President and the

Managing Directors. They both participate in the deliberations of the Board of Managing Directors.

Auditors

In order to ensure adequate administrative operation, auditors are appointed by the Board of Governors. The auditors supervise the business operations managed by the President and other officers, operating completely independent from the executive body, and they report their findings to the Board of Governors.

Business Organization

In order to implement the basic policy on management laid down by the Board of Governors, NHK has a system of business organization as illustrated in the next chart.

To cope with the expansion and complexity of business, NHK is arranging the most up-to-date management system, that is, line and staff organization system for the clarification between the instructional route and the responsibility or competency. NHK operates seven regional key stations with the Tokyo Headquarters in the center. Under each of the seven regional key stations are many local stations. These regional key stations and local stations are all linked with the Tokyo Headquarters, forming a nation-wide network.

Staff Administration

NHK has efficient staff training facilities not only at its Central Training Institute but also at all its workshops to provide most rational training so that each individual member, whether as producer, reporter, announcer, technician or administrator, can make the best use of his individual talents. In the fiscal 1969 NHK employs the total staff of 16,060.

ORGANIZATION CHART OF NHK (As of Mar. 1969)

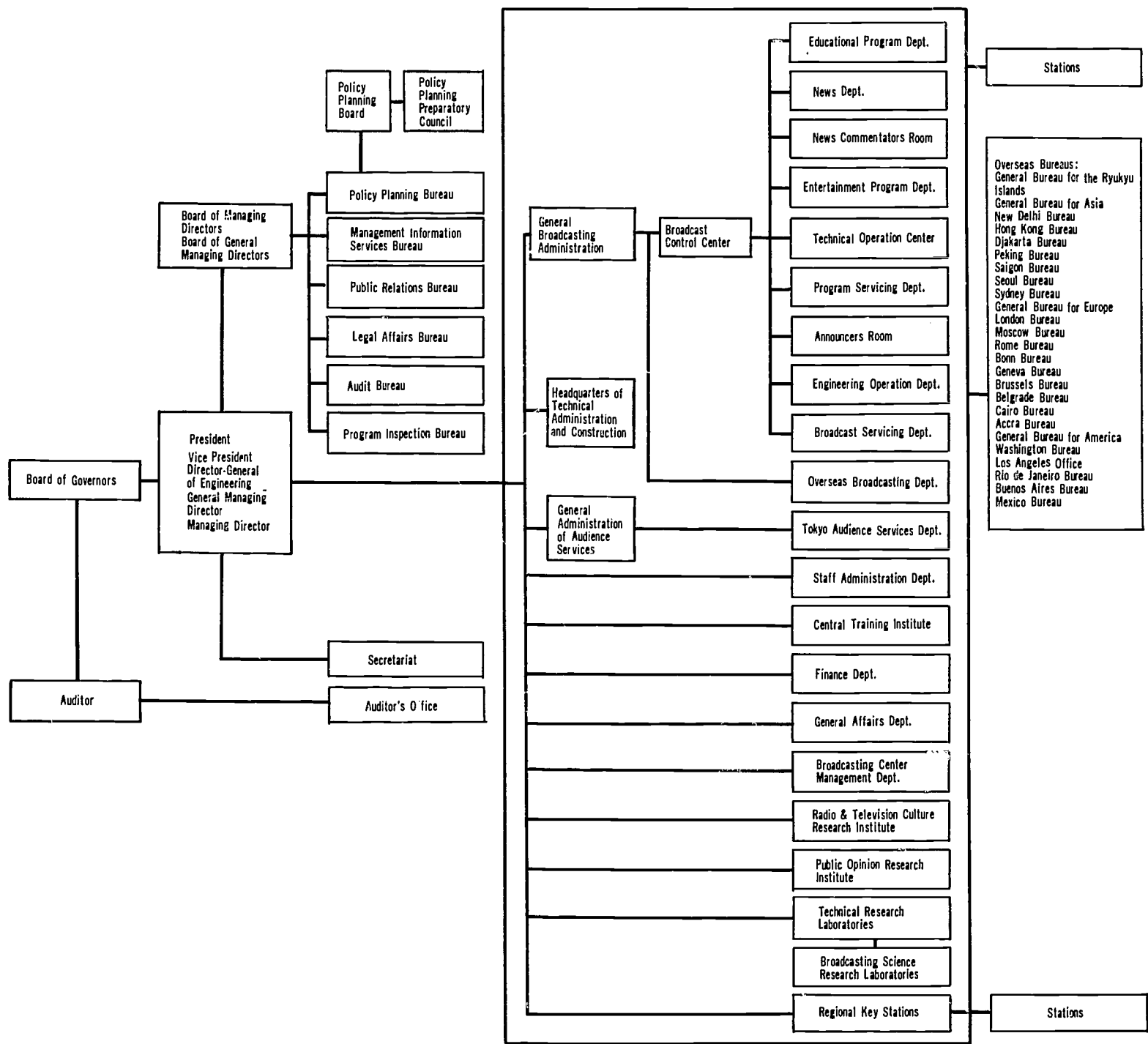

Chairman of the Board of Governors:
Taizo HIRATSUKA

Members of the Board of Governors:
Fumio IKEMATSU
Sakae WAGATSUMA
Nođuo SUZUKI
Mitsuru OTA
Kimio SAKURAUCHI
Saburo FUJITA
Sajuro ITO
Harusada SUGINOME
Tsuyoshi AMISHIMA
Shiroshichi KIMURA
Taki FUJITA

President:
Yoshinori MAEDA
Vice-President:
Kichiro ONO

Director General of Engineering:
Tatsuji NOMURA

General Managing Directors:
Shigetoshi TAKENAKA
Kozo KAWAKAMI
Masanobu SHIGA
Taiji NAGASAWA
Hiroyoshi SANO

Managing Directors:
Hiroshi SHO
Katsuki FUJISHIMA
Saburo OMURA
Hayao MATSUURA

OVERSEAS BUREAUS

(As of Mar. 1969)

NHK General Bureau for the Ryukyu Islands	2-44 Higashi-cho, Naha,	OKINAWA
NHK General Bureau for Asia	7 Soi Buna Sarn 28, Sukhumvidh Road, Bangkapi, Bangkok,	THAILAND
NHK New Delhi Bureau	C-411, Defence Colony, New Delhi 3,	INDIA
NHK Hong Kong Bureau	12 Wongneichong Gap Road, 9/F Block "A", Hong Kong,	HONG KONG
NHK Djakarta Bureau	DJL Suwirjo 52, P.O. Box No. 245/DKT, Djakarta,	INDONESIA
NHK Peking Bureau	C'33, Second Kungyu, Sanlitun Chaoangmen-wai, Peking,	PEOPLE'S REPUBLIC OF CHINA
NHK Saigon Bureau	45 Duy Tan, P.O. Box 1285, Saigon,	SOUTH-VIETNAM
NHK Seoul Bureau	Rm. 505, New Korea Hotel, 192-11 I-Ka, Ulchiro, Seoul,	REPUBLIC OF KOREA
NHK Sydney Bureau	Harrowgate House Rm. 72, 155 Castlereagh Street, Sydney N.S.W.,	AUSTRALIA
NHK General Bureau for Europe	10 Rue Chardin, Paris 16 ^e ,	FRANCE
NHK London Bureau	43 Shoe Lane, London E.C. 4,	ENGLAND
NHK Moscow Bureau	Sadovo Samochotinaya 12/24 Flat 13, Moscow,	U.S.S.R.

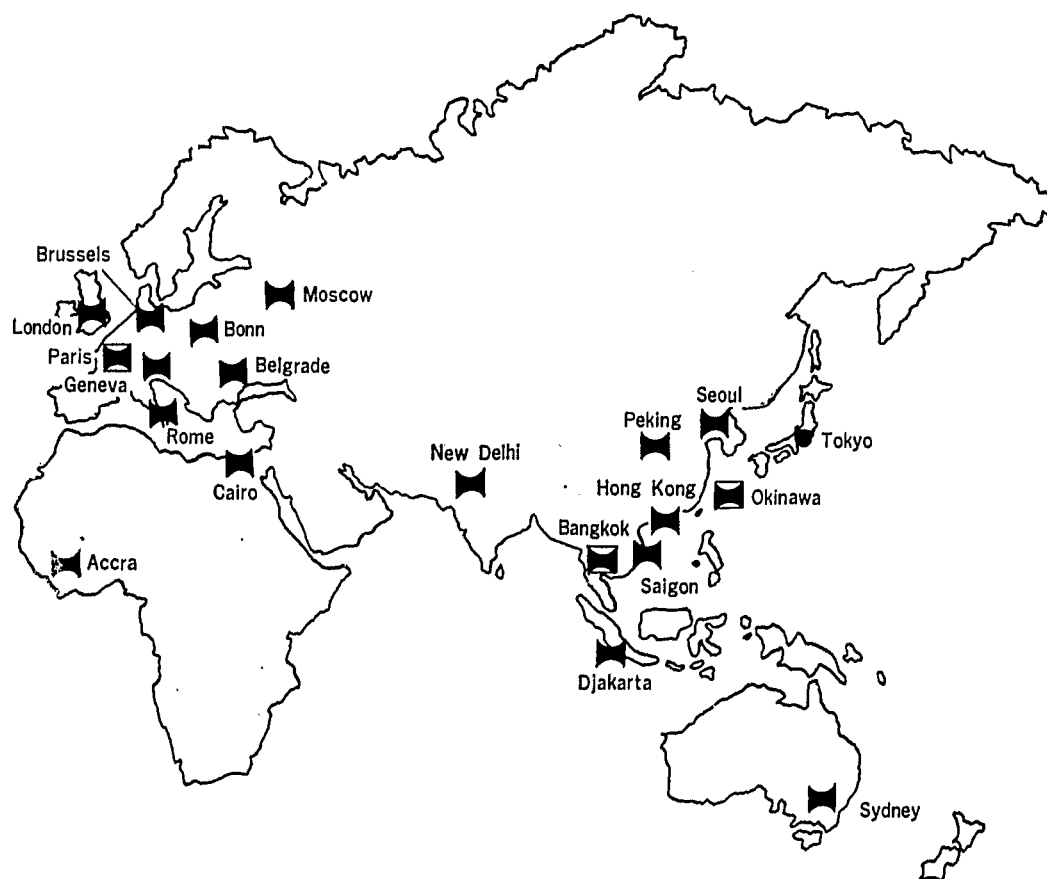

NHK OVERSEAS BUREAUS

NHK Rome Bureau	c/o RAI, via del Babuino 9, Rome,	ITALY
NHK Bonn Bureau	53 Bonn, An der Heuss-Allee 2-10 Pressehaus 1, Allianzplatz,	FEDERAL REPUBLIC OF GERMANY
NHK Geneva Bureau	10 Bis Ave., Godefroy, Geneva,	SWITZERLAND
NHK Brussels Bureau	7 Square de Biarritz, Brussels 5,	BELGIUM
NHK Belgrade Bureau	Bul Oktoarske Revolucije 56A, Belgrade,	YUGOSLAVIA
NHK Cairo Bureau	Flat 12, 22 Saraya El Guezita Street, Zamalek, Cairo,	U.A.R.
NHK Accra Bureau	House No. 19, East Cantonments, Accra, P.O. Box 1637,	GHANA
NHK General Bureau for America	Rm. 350, Graybar Bldg., 420 Lexington Ave., New York, N.Y. 10017,	U.S.A.
NHK Washington Bureau	Rm. 935, National Press Bldg., Washington, D.C.,	U.S.A.
NHK Los Angeles Office	812, South Orange Drive, Los Angeles 19, California 90036,	U.S.A.
NHK Rio de Janeiro Bureau	Rue Professor Luiz Cantanheda, No. 80PR Apto 101-S Laranjeiras, Rio de Janeiro, G.B.,	BRAZIL
NHK Buenos Aires Bureau	Virrey Liniers 378 4A, Buenos Aires,	ARGENTINA
NHK Mexico Bureau	Culiacan 33-301 Mexico 11,	MEXICO

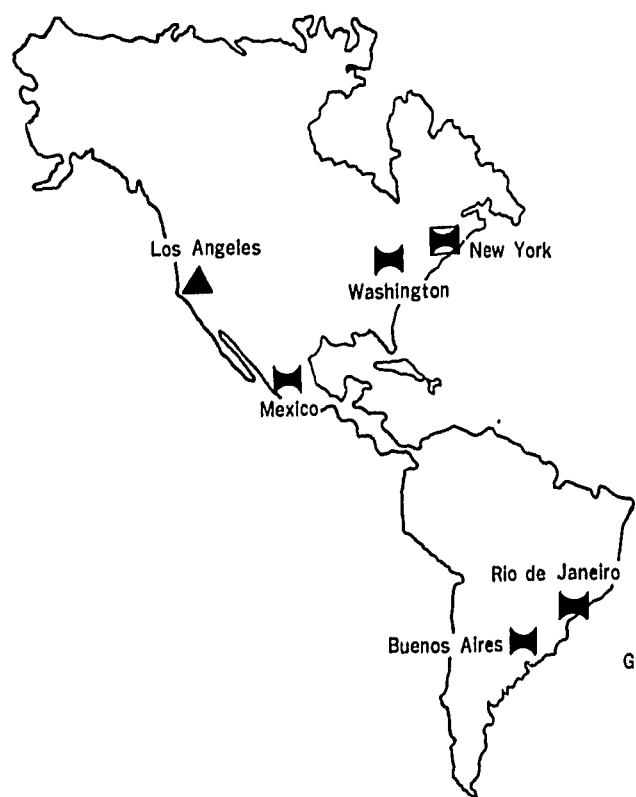

- Headquarters ● Tokyo
- General Bureau ◻ Okinawa (for Ryukyu) Bangkok (for Asia)
Paris (for Europe) New York (for America)
- Bureau ◻ New Delhi, Hong Kong, Djakarta, Peking, Saigon, Seoul, Sydney, London, Moscow, Rome, Bonn,
Geneva, Brussels, Belgrade, Cairo, Accra, Washington, Rio de Janeiro, Buenos Aires, Mexico.
- Office ▲ Los Angeles.

NATIONAL NETWORKS

COVERAGE OF RADIO NETWORKS (As of Mar. 1969)

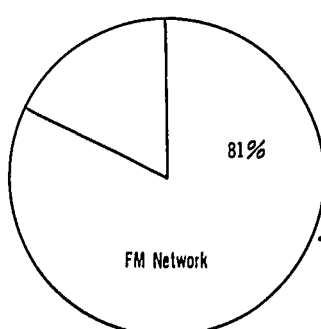
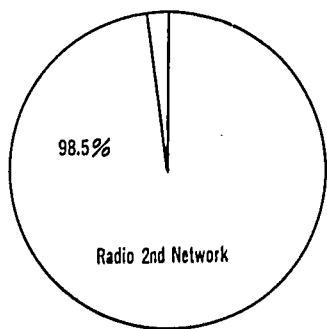
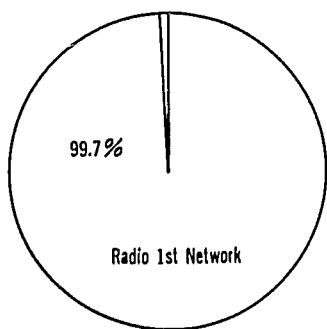

COVERAGE OF TV NETWORKS (As of Mar. 1969)

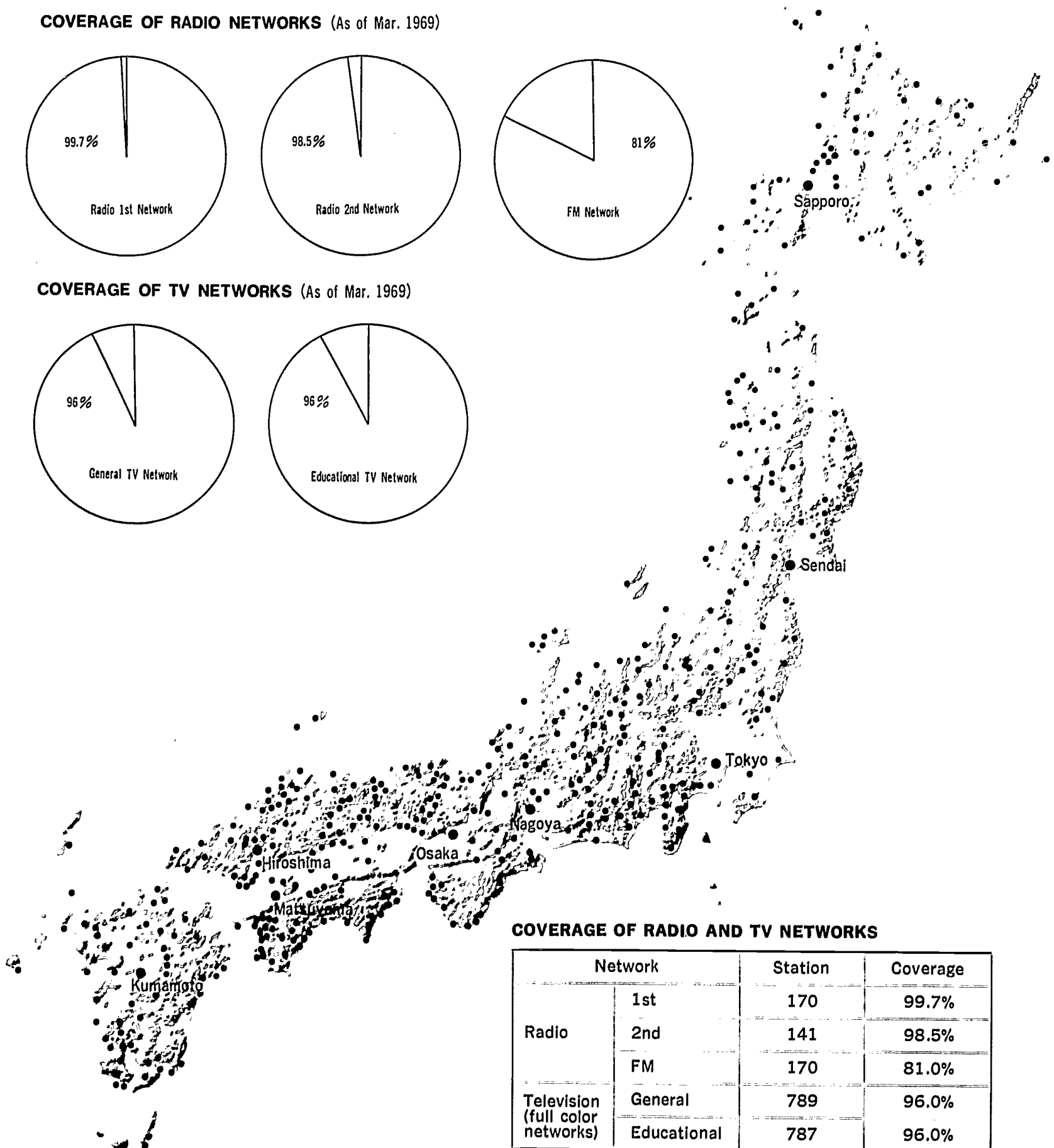
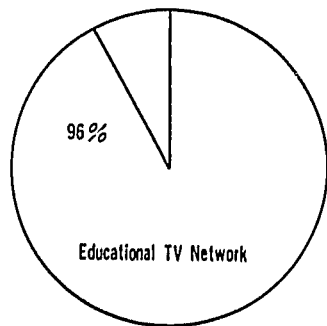
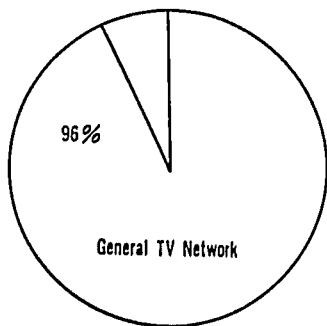

COVERAGE OF RADIO AND TV NETWORKS

Network		Station	Coverage
Radio	1st	170	99.7%
	2nd	141	98.5%
	FM	170	81.0%
Television (full color networks)	General	789	96.0%
	Educational	787	96.0%

(As of Mar. 1969)



Sapporo VHF TV Station (10 kW, unattended) on Mt. Teine (1,024 m)

MODERNIZATION OF NHK'S MANAGEMENT



Broadcast Control Center of NHK-TOPICS.

NHK-TOPICS

NHK's broadcasting services have made a remarkable growth and expansion in the past dozen or so years through extension of television program hours and the inauguration of color television, educational service and FM broadcasting. Furthermore, the demand for diversification of programs and enrichment of their contents has become strong. NHK's work has not only quantitatively increased but also has become qualitatively more complex.

NHK, which depends solely on receivers' fees as its financial resources, drafted a plan in 1961 for the modernization of management through induction of an electronic data processing system (EDPS) in order to improve the efficiency of work becoming ever more complex and diversified. And in 1967, the "audience service system," aimed at 20-million-subscribers was commenced.

In 1965, the policy of adopting the EDPS into the work of programming, production and transmission was decided, and the NHK-TOPICS (Total On-line Program and Information Control System), a system unprecedented in the world, was put into full operation in October 1968.

Principal subsystems expected to be developed in the future are: program cost calculation system, individual personnel management system, program evaluation system and program information retrieval system.



A program manager summons the computerized information through the terminal equipment.

Program production, when compared with productive activities in general, (1) is more individualistic, (2) requires cooperation of various functional staffs, (3) differs in procedures because of differences in the contents, (4) permits no repetitions, and (5) is difficult to standardize because of many changes in the process. The NHK-TOPICS, developed originally at NHK in consideration of the aforementioned character of program production, is attracting the attention both domestically and abroad as a pioneering computer system.

The NHK-TOPICS is divided into two parts in accordance with the principal purposes :

1. Scheduling Management and Allocating Resources Technique (SMART).
2. Automatic Broadcast Control System (ABCS).

SMART: Use of computers for program scheduling, calculations and allocations of facilities, equipment and personnel.

ABCS: Automation of connections to channels inside and outside the stations and operation of equipment during program recording or transmission and monitoring during trouble through computer control.

Through attainment of the above aims, those in control of program production (broadcasting and engineering staffs) can be relieved of miscellaneous tasks, the number of those assigned to simple tasks can be reduced, and the staff members, thus freed from unnecessary burdens, can be channeled into the "development of creativity," which is one of the basic requisites in program production.

NHK-SMART

In the program production, arrangements for facilities, equipment and personnel, and various contacts had to be executed by means of slips or telephone calls. Slips totaling more than 100 in kind had to be issued for a total of more than 5,000 a day. It took several hours to process these slips properly. Under the system, notices related to changes in schedules and arrangements for facilities and equipment seemed to be enormous tasks. NHK, therefore, decided to introduce the EDPS for this work to do away with slips and make instantaneous arrangements for facilities and equipment and information exchanges. The system used for this purpose is NHK-SMART.

The NHK-SMART operates as described below: Programing trends are determined at the BCC (Broadcast Control Center), and data on individual program, schedule of broadcasting, name of producer and so forth are fed into the computer as inputs.

Although the person in charge of programs makes up a production schedule in line with the direction, indications are made by the network according to the order of work. And these indications are fed into the computer as inputs by means of the terminal equipment (IBM 2260). At this time, the number of personnel and the number and type of facilities and equipment are requested. The computer then calculates the schedule time and makes arrangements for assignment of requested personnel and materials, and the result is immediately indicated on the terminal equipment.

As the types and numbers of facilities and equipment are stored in the memory system of the computer, they are allocated as long as they are available. Also, even when specified equipment have been allocated to some studio, the computer will seek out available equipment of similar scale or of even larger scale or availability outside the specified time and will indicate its answer. In case no allocation can be obtained despite such effort, or the equipment must be obtained then and there on account of schedule, BCC will process the matter by calling for the facility and equipment allocation list on the terminal equipment (IBM 2250).

With regard to allocation of personnel, the computer is not capable of giving the names of persons since only the number of personnel for each work is recorded in the memory system. Requests from the producers are classified and processed by the computer for each function and the results are indicated on the terminal equipment. For example, a request for announcers is indicated on the terminal equipment in the Announcers' Room in the form of a chart containing the program title, and the sex and number of requested announcers. Assignment is then made on the basis of this request.

A similar procedure is followed when there is any schedule change. The computer instantly grasps the effect of such change and gives an answer as to whether or not appropriate arrangement is possible.

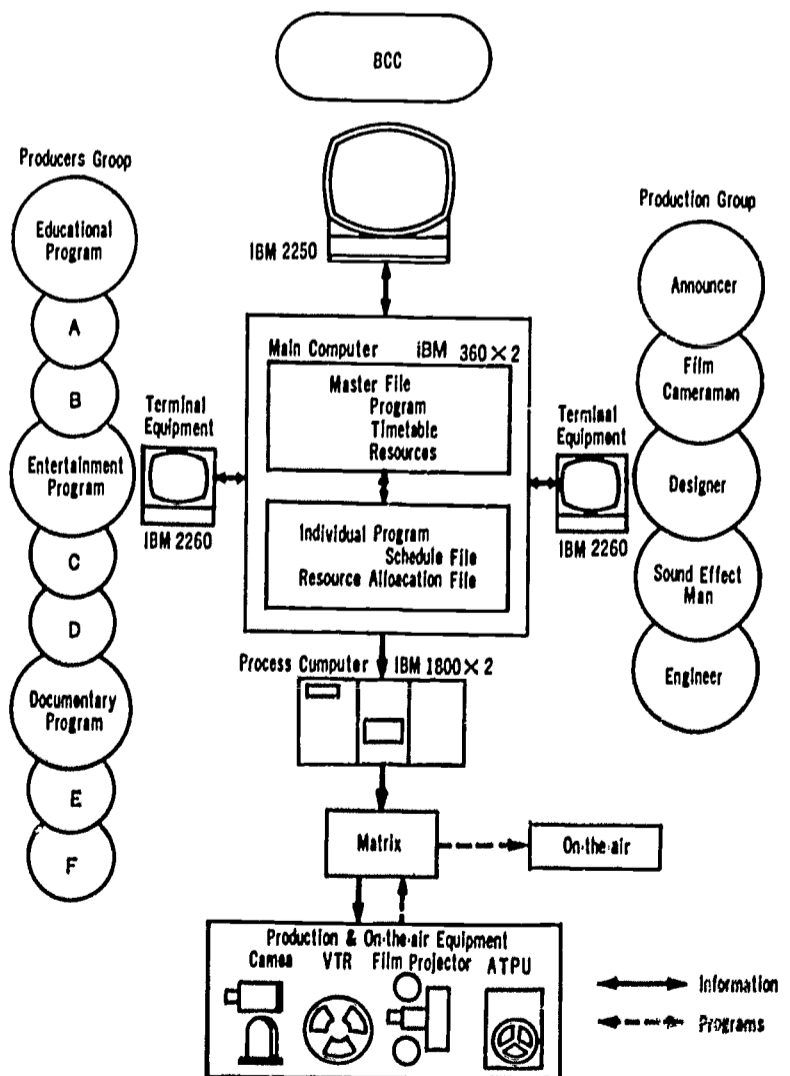

OPERATIONAL SETUP FOR TOPICS

NHK-ABCS

Programs for the five television, radio and FM services of NHK are automatically transmitted without the use of manual assistance. This is the principal function of ABCS, which is divided into the following three:

1. Automatic operation of program production equipment.
2. Automatic transmission of programs.
3. Automatic switching of channels for local stations, automatic program monitoring and an exclusive telephone exchange network.

Details of the functions of ABCS are as described below. Data on program transmission and allocation of facilities and equipment memorized in the main computer are transferred to the process computer every 10 minutes according to the schedule made with SMART. Then equipment, such as video tape recorders and film projectors, which are required for program production, are connected via the preset matrix in accordance with the data. By this means, manual work, which had been required for the operating room for connecting and operating equipment, has been eliminated. Only the technical personnel remotely control these equipment from the subcontrol room and produce programs.

Video tapes and sound tapes have merely to be mounted on the recorders, which automatically start and send the programs out. As the program number is provided at the beginning of the tape in electronic code, the computer verifies this number against the program schedule already fed into it as an input before the program is sent out. For this reason, there is absolutely no chance of a wrong program being transmitted.

Automatic transmission of programs is not limited to recorded programs; live programs like news, commentaries and sports relays are also switched automatically. The computer executes a connection of the News Center, studio and outside relay channels to the broadcasting channels by means of the transmitting matrix in accordance with the schedule.

NHK transmits its programs not only from Tokyo but from 53 other stations in the country, and switching of these local programs is also centrally controlled from Tokyo. In other words, electric signals are automatically generated at the beginning and the end of each program and these are sent to all the stations. Switching from network to local, and vice versa, is made according to the type of signal. In case a special news is to be presented, local programs being broadcast from local stations are forcibly switched over to the special news from the News Center in Tokyo.

Electric signals peculiar to five radio and television services are superimposed, and these are monitored at respective local stations. If these signals do not reach the local stations, an alarm is issued. The point where the alarm is issued is then indicated at the BCC and the Technical Operation Center in Tokyo, and a step against accident is immediately taken, as a result of which an apology broadcast is made.

ABCS also includes interstation telephone channels for contacts. With regard to the Technical Operation Center, which serves as the "brains" of ABCS, details are given in the section on "Techniques and Facilities" on P. 46.

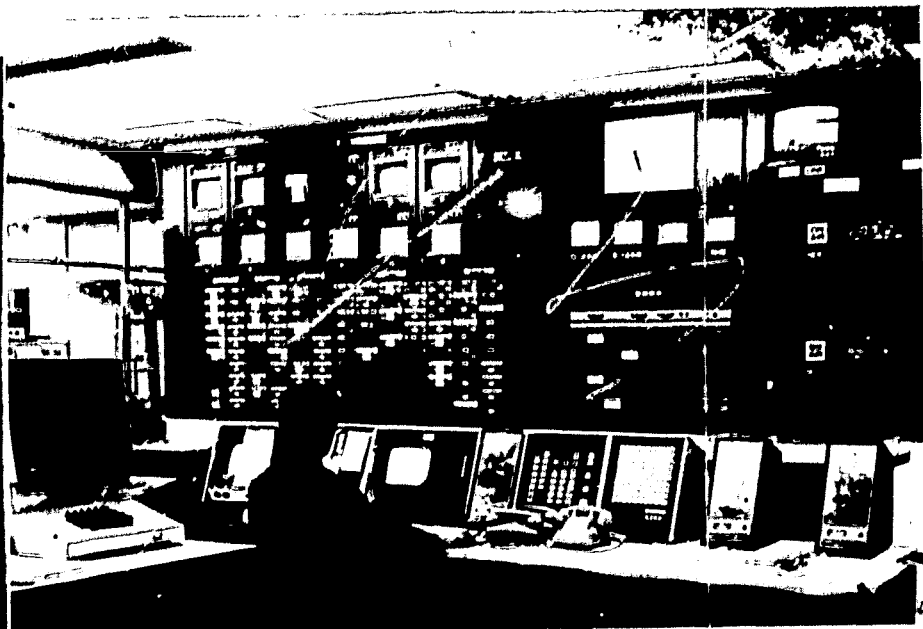

Technical Operation Center from which five services of TV, radio and FM are automatically transmitted.

NEWS SPOTLIGHT PROGRAMS
AND LOCAL SERVICE



Japanese Traverse Party approaching to the Pole Station across 2500 km expedition of Antarctica. (General TV)

In a rapidly changing modern society, the role of broadcasting as a medium of public communications is ever-increasing in importance. Lately, with satellite transmissions of television programs becoming routine and presentations of news and information programs in color increasing, expectations for newscasts are mounting.

In the General Television Service and First Radio Network, scheduled news and information programs are presented for 13 hours 27 minutes (36.5%) out of the combined total of 37 hours program time per day as of April 1969. Flexible program compilation is also undertaken as need arises in accordance with the current situation both at home and abroad. In particular, news and forecasts in the General Television Service have principally been carried in color.

NHK's latest surveys have disclosed that some 22 million people tune in to television news presented from 7:00 a.m. Through 7:00 a.m. news and followed news show titled "Studio 102," the public is provided with information on new events and trends at the beginning of the day. Between 7:00 and 8:00 p.m. NHK presents programs including news and information related to Japan and other countries. From 9:30 p.m. the day's news round-up is presented.



TV news cameraman through storm.

In radio, news bulletins are regularly broadcast, in principle, every hour on the hour and every 30 minutes, and weather forecasts before every hour on the hour news. Efforts are especially made for quick reports of local news, traffic conditions, market quotations of agricultural and fishery products and announcements of various functions and events of general public interest.

NHK maintains 970 news reporters and 284 news cameramen who form effective coverage teams throughout the country (as of April 1968). Also, for covering overseas events, NHK maintains four general bureaus and 20 bureaus throughout the world. Correspondents stationed at these bureaus undertake news coverage and gathering of materials for information programs as well as work involved in satellite transmissions.

Not only what appears on the surface of individual news items but also their backgrounds, points of issue and their impact as well as their outlook are comprehensively analyzed from an impartial point of view and presented as "News Features" and "News Commentaries." "Overseas Coverage Program" and "NHK Overseas Correspondent's Report" are also compiled for favorable evening hours.

Also, for providing information on political trends in Japan, the "Diet Relay" and "Political Forum" are compiled. Campaign programs related to traffic safety and public nuisance are also presented from time to time.

The role of broadcasting during natural disasters, such as earthquakes, tidal waves and floods and storms, is highly significant. In the disaster areas, where power supply has been cut off, people depend on news received by means of transistor radio. The radio informs these people about the condition and extent of damage, provides guidance for taking refuge and tries to find missing persons. Television, which has simultaneous audiovisual appeal, presents details of disasters throughout the country and plays the role of promoting relief measures.

Sports Programs

One of the fields in which the simultaneity and the sense of presence possessed by television can be exploited to the full is on-the-spot sports relay.

NHK covers various amateur sports meets, Japanese wrestling tournaments, professional baseball games, as well as the events of the Olympic Games. As a matter of fact, NHK annually presents some 600 relayed sports programs for a total of about 1,200 hours. NHK is especially interested in presenting Olympic events as has been proved by its relaying of all Olympiads since the Berlin meet.

For the 1964 Tokyo Olympics, NHK was entrusted by the Olympic Organizing Committee with all affairs related to broadcasting under the Olympic Charter. As a result, NHK's Broadcasting Center served as the key station for the entire world of satellite transmissions totaling 32 hours. Because of its achievements NHK was selected as one of the four broadcasting organizations of the world to be responsible for supplying programs on the events of the Mexico City Olympics. This enormous task required 113 staff members to accomplish. NHK was in charge of five events, including track-and-field and swimming, which are considered the main Olympic events. The programs were transmitted not only to Japan but to all parts of the world via satellites.

Local Service

NHK has been making special efforts to strengthen its local broadcasting service by stepping up the capacity of local broadcasting stations.

As of April 1969, local services are presented for TV 1 hour and a half, for radio 6 hours 10 minutes and for FM 1 hour 40 minutes daily on prefectural basis, containing local news and cultural topics of local communities. Consideration is given so that such programs may be broadcast during the most convenient hours for local people. In implementing such local broadcasting services, Local Broadcasting Program Deliberation Councils have been set up in eight regions of the country.



Activities of Japan Overseas Cooperation Volunteers are covered by NHK's correspondents. (General TV)

A special program "Talk with Prime Minister." (General TV)





The "Students' Power"—NHK Overseas Correspondents' Reports.
"National Gymnastics Championship."
News show in the morning, "Studio 102."

(General TV)

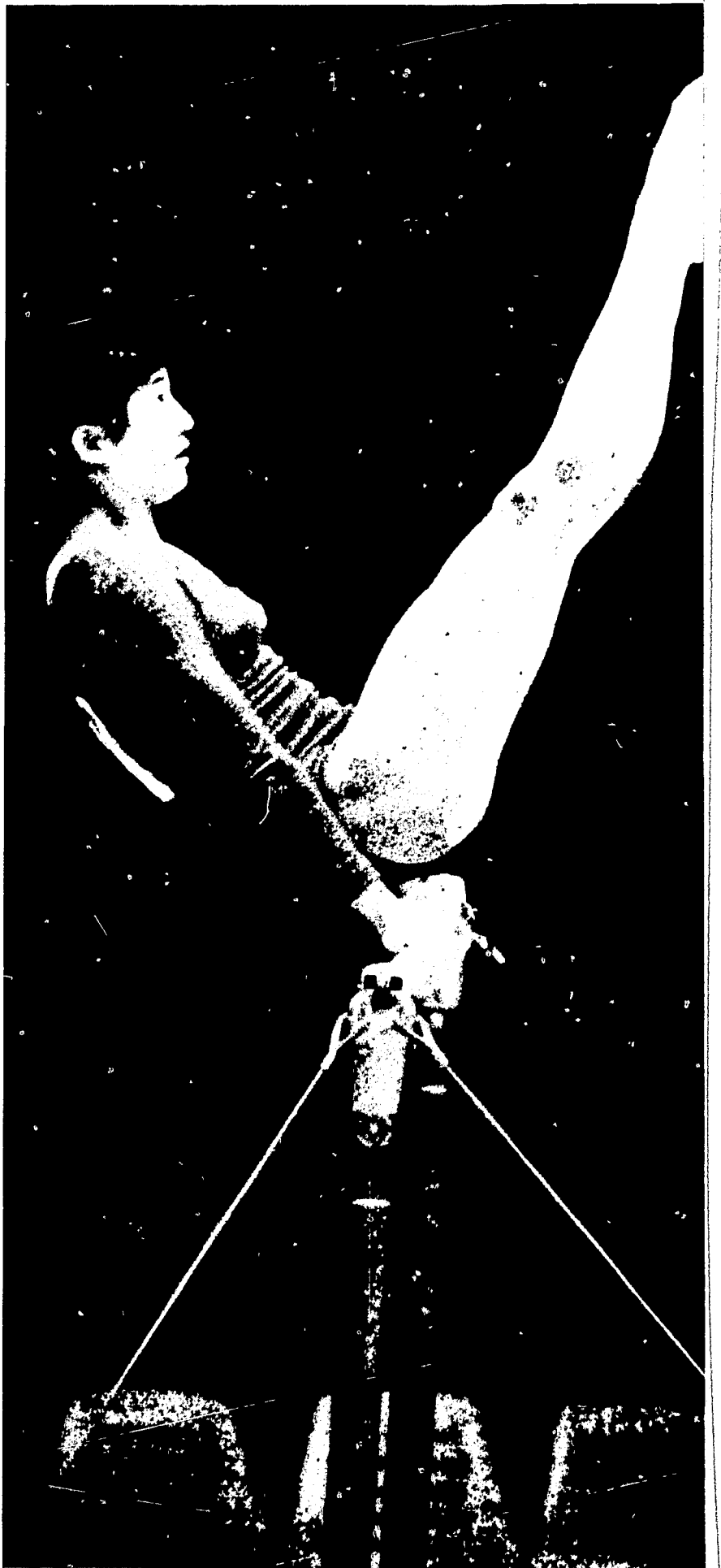

NEWS CENTER

NHK's news have been broadcast from the highly automated News Center since August 1968. The News Center constitutes a part of NHK-TOPICS instituted for modernization of operations. Here computers and other electronic techniques are used for covering, editing and presenting news.

Essential features of this system include:

1. Transmission of news, which had previously required a large personnel, has been automated.
2. For back-and-forth contacts and instructions among the coverage, editing and transmitting staffs, electronic techniques using ITV, facsimile, etc., have been adopted.
3. Gathering of news materials, delivery of scripts and transmission of news are now done by means of machines and equipment.
4. The studio, editing room and transmitting equipment have been concentrated in a single area so that news can be transmitted directly from the editing room.

As a result, the technical staff directly concerned with news transmission has been limited to those who check the equipment.

Also, as the production staff becomes adapted to the new system, complex procedures up to the transmission have been simplified and the energy formerly required for the work has been transferred to the work of improving the contents of news and of conceiving new ideas for program production and presentation.

The most important parts of this automated system include the resources random selector and the order arrangement control and display desk built around the control logic equipment unit comprising more than 4,000 integrated circuits.

Following is a description of the operation of the automated system; the desk selects the collected materials and arranges the titles of news items, using the order arrangement control and display desk.

When the titles of news items to be broadcast are written down and set to the allotted time scale, the lap time and total time are automatically indicated. The news items and the time are also shown on ITV monitors placed in various parts of the News Center.

The news order thus set is transmitted to the resources random selector through the electronic brain of the control logic equipment.

The producer arranges sign cards indicating instructions for production, such as the film, studio live camera, video tape recorder, etc., according to the production plan, and have them preset in the resources random selector.

As the instructions on the sign cards are read off by the resources random selector beforehand, the producer presses merely a button to switch among the studio live camera, quick starting film projector, video tape recorder, transmission from a local station, or a satellite.

In case a change in the order of items is desired, changing of the order of item indication plastic plates on the order arrangement control and display desk notifies the resources random selector of it. This allows even an emergency change of order without any mistakes or confusion.



News Center.

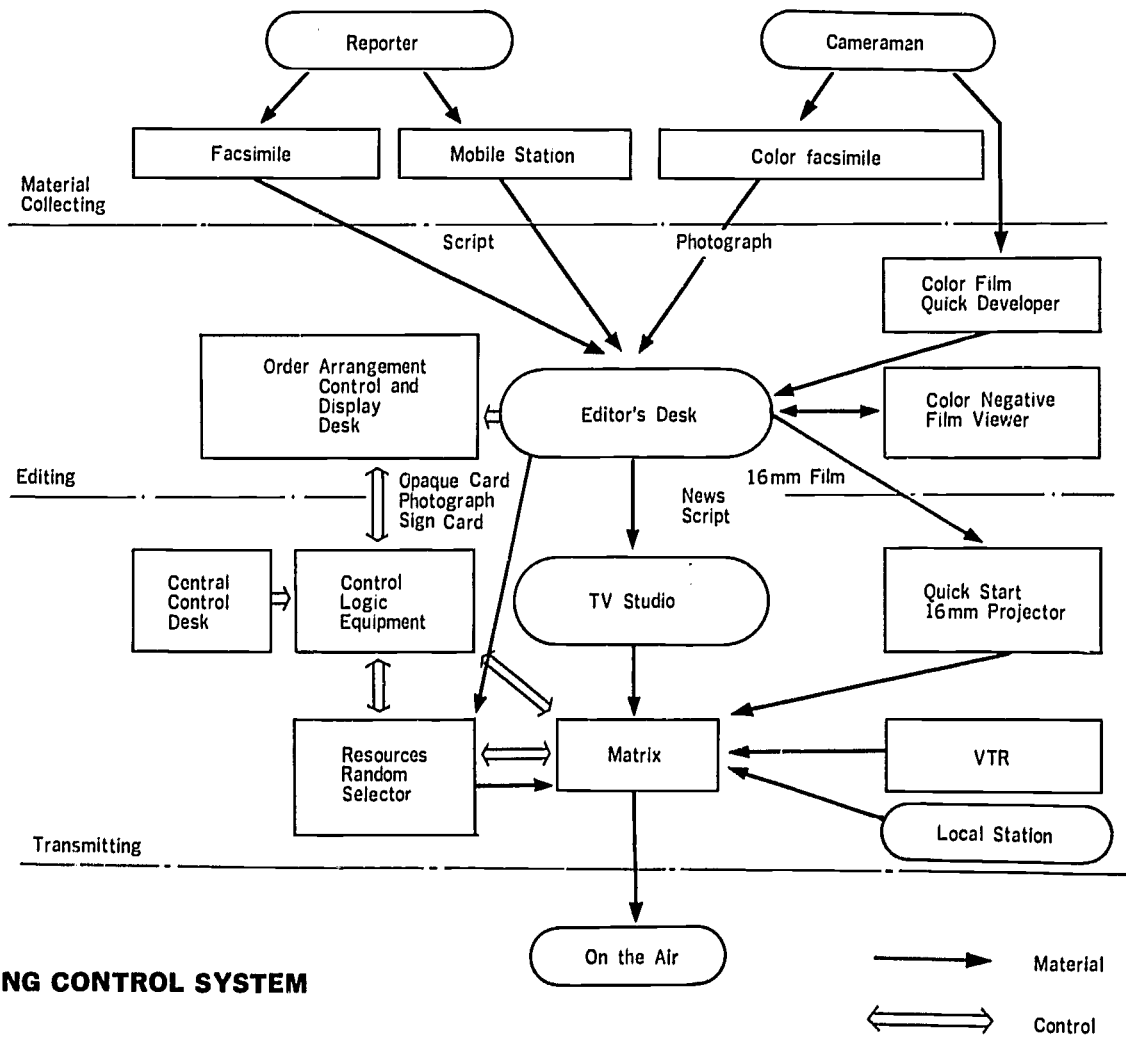

SATELLITE TRANSMISSIONS



The 19th Olympic Games in Mexico was covered by four broadcasting organizations including NHK. (General TV)

Since the first Japan-U.S. satellite transmission of television programs, which reported the assassination of President Kennedy, via the communications satellite Relay I in November 1963, NHK has undertaken repeated experiments in this field.

When the Tokyo Olympics was held in October 1964, NHK succeeded in making long transmissions to the United States, utilizing Syncom III.

Subsequently, with the inauguration of Japan-U.S. commercial satellite transmissions via Intelsat II satellites in January 1967, a full-scale satellite transmission age was ushered into Japan. Meanwhile, "Our World," a satellite transmission program presented on June 26, 1967 with the participation of 14 countries, using four communications satellites, and linking 31 points in 5 continents, was epoch-making as the first attempt in the history at simultaneous linking of the world.

NHK took part in this project representing Japan. The numbers of viewers of this program were estimated at 36 million in Japan and nearly 400 million throughout the rest of the world.

In March 1968, NHK jointly produced a program titled "Across the Equator" with ABC (Australian Broadcasting Commission) and presented simultaneously in Australia and Japan via ATS. In the satellite transmission of "Across the Equator," an electronic television system converter developed at NHK was used to convert the standard system between Japan and Australia.

Besides the above, the events of Mexico Olympics were relayed for a total of 32 hours via the satellites. The programs were not only supplied to the commercial stations in Japan but also relayed to South Korea from NHK.

Last year NHK received 77 satellite transmissions and transmitted 26 news and other programs.

If broadcasters are to utilize space effectively in the future, it will be necessary to promote development of "broadcasting satellites," which would be used for direct broadcasting and program relaying.



The parabolic antenna of Ibaraki Satellite Communication Center of the KDD (Japan's Overseas Radio and Cable System).

These may also be used as an effective means of program exchange among the international broadcasting organizations.

With regard to broadcasting satellites, NHK, in cooperation with competent organs, is now expediting comprehensive studies on such subjects as the transmission system, satellite structure, electronic equipment for mounting on the satellites and receiving equipment.

Also, since a world-wide communications network using Intelsat satellites is expected to be established this year, satellite transmissions linking Japan with other countries are likely to be more actively undertaken. Therefore, NHK is desirous of contributing to certain better mutual understanding and friendly relations through satellite transmissions of broadcast programs in cooperation with other broadcasting organizations in the world.

EDUCATIONAL AND CULTURAL PROGRAMS

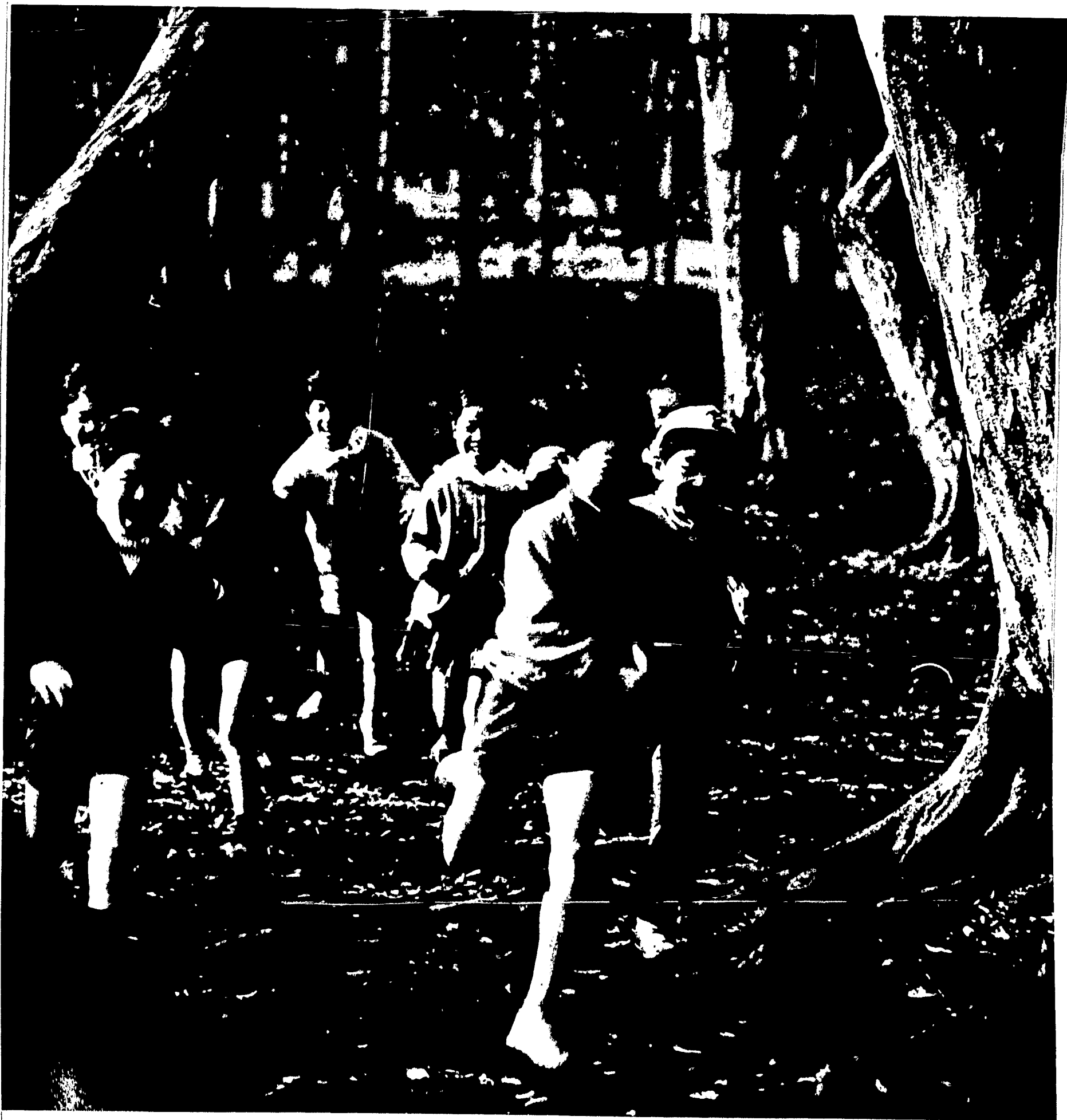

OUTLINE

The principle of attaching importance to educational and cultural programs has been consistently maintained since the beginning of the broadcasting service at NHK. At present, NHK presents a total of about 6 hours 57 minutes of educational and cultural programs on its five radio and television services a day.

NHK's school broadcasts are greatly contributing towards improving the results of classroom lessons when they are utilized under the guidance of the teachers, especially in such subjects as are more difficult for children and students to grasp merely from textbooks and lectures.

Under the principle of equal opportunity for education, which is the ideal of a modern society, NHK, which has been expanding its high school correspondence course programs year after year utilizing the features of broadcasting, established the NHK Correspondence Senior High School which is the first full-fledged correspondence course high school in Japan with a view to providing guidance to students.

To provide social and vocational education to adults, NHK has such programs as "Women's Classroom," "College for People," "Language Lessons," "Vocational Training Lessons," "Agricultural School," "Medium and Small Enterprises in Future," etc. These programs are compiled continuously and systematically over long periods. In broadcasting these programs, NHK places special emphasis on enhancing the effect of education by promoting the formation of listening or viewing groups for these programs and issuing textbooks for each program. NHK also directs serious attention to educational and cultural programs designed for the physically handicapped. "TV Deaf School," "For Mentally Handicapped Children," "Hour for the Blind," etc., are some examples.

NHK's cultural programs are very popular among the general public. Efforts are being made to improve the quality of these educational and cultural programs in the spheres of planning and production.

NHK's "General Campaign Programs," which are meant to appeal to the nation on some specific subjects, such as community development during a specific period, always achieve very impressive results, inviting enthusiastic reactions from all segments of the population.



Japan Prize

On the occasion of the 40th anniversary of broadcasting and of the Second World Conference of Broadcasting Organizations on Sound and Television School Broadcasting held in Tokyo in 1964, NHK established the Japan Prize aimed at improvement of educational programs. The first contest was held in 1965. This annual contest is the world's only educational program contest for the purpose of improving educational programs.

Participants at "Japan Prize" is as follows:

		Place	Country	Organization	Program
1st	1965	Tokyo	46	70	185
2nd	1966	Osaka	54	84	161
3rd	1967	Nagoya	61	86	202
4th	1968	Tokyo	53	75	167

Serious interest in the "Japan Prize" is particularly evident among the developing nations, where radio and television programs are being utilized to disseminate education more widely. It is hoped that this annual contest will serve to improve educational programs in many countries, and contribute to better international understanding and cooperation.

SCHOOL PROGRAMS

Sound Broadcasts

Since the radio programs for schools began in 1935, NHK has gradually increased the number of such programs. Currently (as of Apr. 1969), NHK transmits to schools 96 different types of programs, totaling 22 hours 35 minutes a week.

These radio programs for schools include Japanese language, morals, music, English, social studies, etc., and they are transmitted to primary schools, junior and senior high schools. One of the social studies programs is produced by each of the regional stations throughout the country for its own local service.

Television Broadcasts

NHK began its TV programs for schools in 1953, simultaneously with the commencement of telecasts. In 1959, with the introduction of TV Educational Service, NHK expanded its TV school broadcasts. Currently (as of Apr. 1969), NHK transmits to schools 117 programs, totaling 36 hours 30 minutes a week.

These television programs for schools include science, social studies, morals, music, English, arts, etc., and they are transmitted to kindergartens, primary schools, junior and senior high schools. All the programs for kindergartens and most of the programs for primary education are in color.

Programing of School Broadcasts

School programs cover the entire scope of school education, including all the school subjects, along with morals and special educational activities.

Programing is based not only on the course of study issued by the Ministry of Education but also on advice given by the Local Advisory Committees on School Broadcasting and the Central Advisory Committee on School Broadcasting. While plans for programs are thus adopted, production thereof is undertaken with the specialists' committees for respective series comprising competent Education Ministry officials, school teachers and educators.

Utilization and Studies of School Broadcasts

One of the outstanding features of school broad-

casting in Japan is that teachers, who use the service, NHK and the producers cooperate in its improvement. School teachers have voluntarily organized the National Federation of Broadcast Education Study Societies.

The Federation is made up of eight regional federations which comprise 54 prefectural associations. Its membership consists of educational institutions ranging from day-nurseries and kindergartens to high schools, totaling approximately 55,000. Since its inauguration in 1950, the Federation has expanded year by year, and at present an average of 1,700 study meetings are held annually in which an aggregate of about 300,000 persons participate.

Utilization and Results of School Programs

Among the schools which are equipped with both radio and television receiving sets, those which are utilizing the school programs systematically are as follows:

	TV		Radio	
	Per-centage	Number	Per-centage	Number
Kindergarten	91.1%	8,110	45.3%	8,840
Primary School	88.4%	22,300	63.5%	15,800
Junior High School	33.7%	3,810	46.6%	5,500
Senior High School	22.7%	870	53.4%	2,100

(As of Sep. 1968. By NHK Radio and TV Culture Research Institute)

Example of the program which enjoys the highest rating is the television science program for primary schools, viewed by more than 82 per cent of school classrooms throughout the country.

Television programs for social studies can enrich classroom learning activity by presenting conditions prevailing in various parts of Japan and other nations through films. The audio-visual method of teaching possible with school programs helps to promote greater interest in learning.

CORRESPONDENCE EDUCATIONAL PROGRAMS

Correspondence High School Course

NHK established "High School Course" programs in 1959, simultaneously with commencement of television school broadcasting. This was switched to the "Correspondence High School Course" in 1963, when the NHK Correspondence High School was established.

The "Correspondence High School Course" presented on television (Educational Service) and radio (2nd Network) now includes all the requirements consisting of 33 subjects. In connection with these subjects, television presents 30 programs for 15 hours a week, while radio presents 62 programs for 21 hours and 20 minutes a week. Should correspondence high school students utilize these programs, they are exempt from schooling (personal guidance) under the course of study issued by the Ministry of Education. This measure, together with school programs, has been a real help to study activities of working young people. Out of the total of 140,000 correspondence high school students in the country, approximately 70,000 are utilizing programs of NHK.

College Correspondence Course

NHK's college correspondence education broadcasts started in radio in 1961 and in television in 1965. At present, NHK college correspondence course programs are transmitted over the radio 12 programs 4 hours, over television 13 programs 3 hours 30 minutes, a week.

NHK Correspondence High School

NHK established, in April 1963, the "NHK Correspondence High School." The students of the school study by means of NHK's correspondence education broadcasts. This High School places no restriction on enrollment, and admits students who are living all over the country, since they can study by means of broadcasts. Seven thousand students are admitted to the school in May each year. This year, more than 1,600 students graduated from this school by the end of March. The ratio of correspondence high school students graduating on the basis of the utilization of broadcast programs is far higher than those utilizing other correspondence course.



SOCIAL EDUCATION PROGRAMS

In view of the educational importance of radio and television, NHK presents the following programs parallel with school programs:

1. Educational programs for homes for the purpose of cultivating knowledge and wholesome sentiments in infants and pre-school children, as well as promoting the wholesome development of young people.
2. Lecture courses in languages which directly serve in daily life; practical courses in vocational guidance.
3. Youth programs, women's programs which serve as livelihood guidance intended for group listening and viewing.
4. Programs for deaf and dumb children; special educational programs for mentally retarded children.

These are presented over the general and educational television services and over the 1st and 2nd radio networks at hours which are best suited to the potential listeners and viewers of respective programs.

Programs for Children

Programs directed at small children provide plenty of happy dreams and hopes. In radio nursery programs "Pippo Pippo Bon Bon," full of songs and music, is highly popular. In TV, there are numbers of programs for kindergartens and day-nurseries, as well as "With Mother" for mothers and their children to enjoy happy moments together.

Foreign Language Lessons

NHK's foreign language lessons which have a long history, cover English, French, German, Russian, Spanish and Chinese.

Vocational and Technical Lessons

NHK presents technical lessons directly linked with everyday living, such as the "Vocational Lessons" and the "Abacus Lesson." These programs are aimed primarily to assist viewers improve their ability and pass various state or public examinations for licenses or qualifications. Music lessons on the violin, piano and guitar are provided by first-class musicians.

Young People's Class

Since early in its history, NHK has been engaged in a long series of ambitious campaign programs designed to encourage the healthy growth of young people. From 1965, this program series was further consolidated, dealing with various problems from many angles, for the purpose of experimenting with group learning activity through the "Young Class" program.

NHK Women's Class

The "NHK Women's Class" groups were first organized voluntarily in 1959 for the purpose of systematically utilizing NHK's women programs. This program is presented in series of 2 months, each taking up one problem systematically.

Farmers' Programs

In order to contribute, under rapidly changing conditions in farming areas, the training of younger generation of farmers through such programs as "Radio Agricultural School" and "TV Agricultural Class," formation of "Agricultural Group for the Utilization of Broadcasts" is actively promoted.

Special Programs for Physically or Mentally Handicapped Children

Since the inception of the "TV School for the Deaf" in 1961, NHK has been placing particular emphasis on these special educational programs not only for the benefit of the unfortunate children but also for the purpose of creating public interest in the need of such education. The results achieved so far are highly appreciated, not only by the families of handicapped children, but also by educators. In 1965, the "Merry Class room," another TV special class for mentally retarded children was inaugurated. For stammerers, a special language training class is broadcast once a week in the Educational TV Service beginning in 1966.



A scene from a program for physically handicapped children. (Educational TV)



Infants Hour, "Dat, the Rabbit" provides plenty of dreams for children. (General TV)



A scene of the "Young Potter"—Young Generation. (Educational TV)



"French Lesson". (Educational TV)

CULTURAL PROGRAMS

Although NHK has been compiling talks and lecture courses as cultural programs since the radio service was inaugurated in 1925, these programs, including educational items, were transferred to the Second Network in 1932, when it was established for such purposes. Cultural programs of various kinds are also presented in the General and Educational Television Services.

With regard to general cultural programs, materials needed for social life are taken up in such programs as "Wisdom for Living," "This Man's Way of Life" and "Cultural Features." In these programs, problems that lie deep are probed into from various angles. Considerable importance is also attached to such science programs as "Step Toward Tomorrow" and "Science Film," which are in line with the trends of the age of technological innovations. In addition, campaign programs, designed to contribute to the elevation of national life and social welfare, such as traffic safety, public nuisance and campaign against cancer, are flexibly compiled in intensive form.

"Wisdom for Living"

This is a long-standing program that has continued on NHK television for 12 years. Themes are selected from everyday life and having unique view-points, and unexpectedness and practicability are stressed, while incorporating interesting experiments and questionnaires. It is widely popular with the audience.

"Japanese Concept of Beauty"

This is a program which replaced "Traditions of Japan," and is presented once a month in color. It is designed to review Japanese works generally considered beautiful in the light of modern view-point, against historical and endemic backgrounds, in order to rediscover beauty.

"Diagnosis of Japan"

A program setting forth in quantified form the opinions of large crowds by means of electronic computer instead of through interviews, it takes up questions of social interest, such as cancer and marriageable age, and brings the opinions of

crowds on the subjects into relief by means of relayed street corner interviews with data obtained from widespread public opinion surveys as the background and on the basis of predictions arrived at through computer calculations.

"Guidebook for a Life"

On the radio, this takes the form of a talk program in which people of all social strata with rich experience are invited to speak, in a 3-day series per person, on the lessons they have learned through experience, on wisdom for leading a rational life, and on the joys of life in the style of verbal essays. It, too, has been on the air for 10 years.

Women's Programs

Conspicuous among the women's programs are "Hello Madam," "Note for Women," two programs of wide coverage, including newscasts ranging from small topics picked up at street corners to political and economic subjects to give a "flowing sensation" for comfortable viewing.

The "Women's Useful Memo" helps women broaden their vision in their social contacts. Among the more practical programs is the TV cooking lesson "Today's Menu" in color. This deals not only with Japanese, Chinese and Western cooking, but also with dishes popular in particular countries or particular districts of Japan.

The "Encyclopedia for Women" gives lessons on dressmaking, handicrafts and efficient homemaking. In radio, the disk-jockey type "Living Room for All" is much appreciated as a very informative program.

NHK's educational and cultural programs have been highly esteemed at art festivals and overseas program contests, and requests for their distribution have greatly increased of late. To fulfil such requests by overseas broadcasting organizations, NHK has established NHK INTERNATIONAL, which unifies all work concerned of providing the requested programs. NHK INTERNATIONAL also actively invites overseas broadcasting organizations to use such programs of NHK.



A scene of "Nature and Man," series of documentary film on several foreign countries covered by NHK staff. (General TV)

"Hello Madam," the audience participation program. (General TV)

A scene of "Unknown Danger in Highway—from the view-point of the driver's physiology." (General TV)

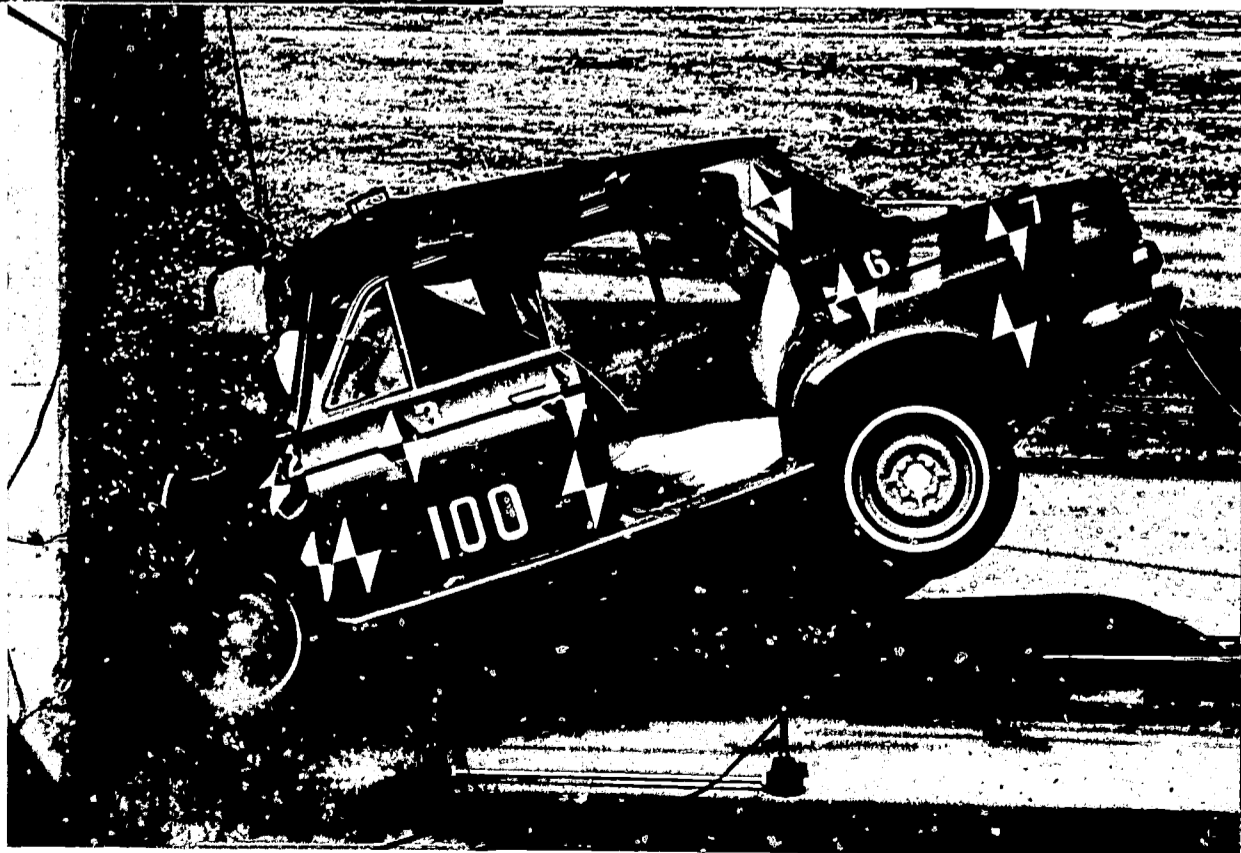



A scene of "Nature and Man," series of documentary film on several foreign countries covered by NHK staff. (General TV)

"Hello Madam," the audience participation program. (General TV)

A scene of "Unknown Danger in Highway—from the view-point of the driver's physiology." (General TV)

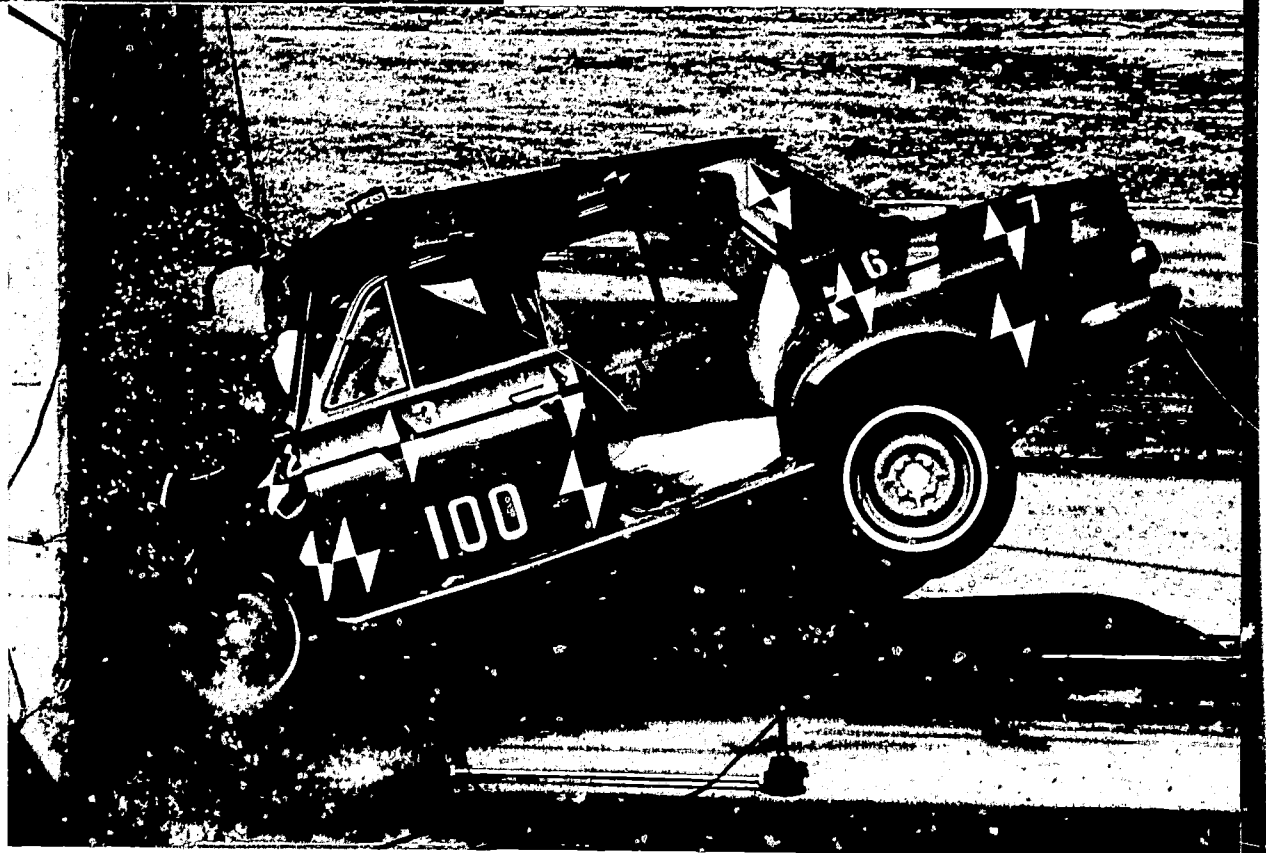



A scene of "Nature and Man," series of documentary film on several foreign countries covered by NHK staff. (General TV)

"Hello Madam," the audience participation program. (General TV)

A scene of "Unknown Danger in Highway—from the view-point of the driver's physiology." (General TV)

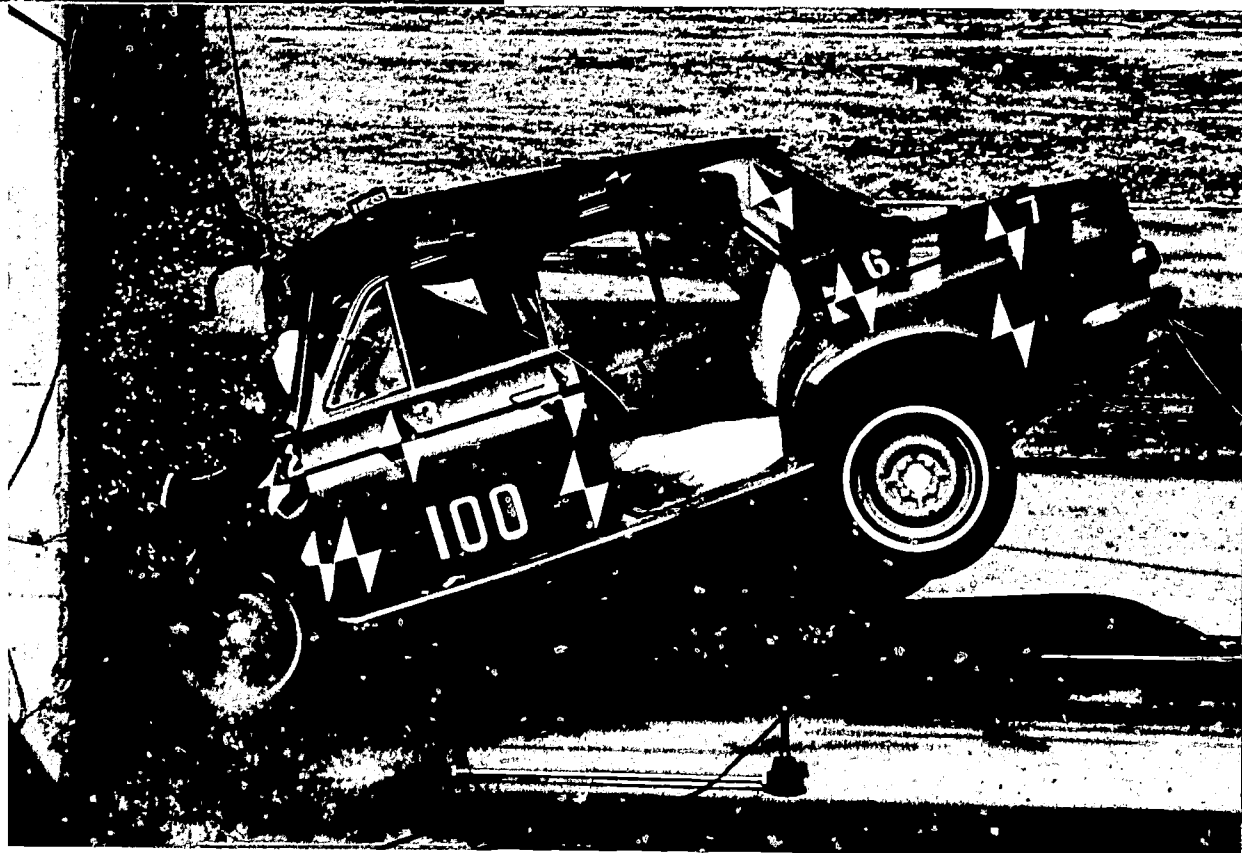

Musical and entertainment programs play a big role in familiarizing people with broadcasts and in helping build up happy homes. NHK's public opinion surveys indicate that television and radio are the most readily available sources of entertainment for people at large. NHK, which has national networks of both radio and television, intends to provide healthy entertainment and recreation to people through the medium of its programs.

Entertainment programs are broadcast mainly on the General TV Service, 1st Network of radio and FM. The programs comprise dramas, quiz shows, variety shows, etc., which are devised to be wholesome in character and attractive to general audience.

The serial morning television drama that began in 1961 has already become an indispensable living room companion. And "Ohanahan," one among such programs broadcast in 1966, attained more than 50 per cent program rating, which meant that it attracted 45 million viewers (together with a repeat presentation) daily. This trend still continues today. A 30-minute serial television drama is also to be presented, every evening through Monday to Friday, beginning in April this year.

The large-scale television drama presented on Sunday evenings is a 45-minute serial. This type of drama has been presented ever since "Hana no Shogai" was presented in 1963. These are very substantial programs enjoying a wide popularity. In these programs not only stage but talented younger performers and "new faces" are actively employed so that the fresh charm enveloping the programs stirs up wide interest. This series of programs was changed to color with "Ten to Chi to" (Heaven and Earth) depicting the life of an outstanding Samurai leader during the age of Civil Wars in Japan. This program is already widely popular.

The series "Japanese Folksong Festival" which commenced in 1966 takes advantage of NHK's functional nation-wide network to relay good folksongs full of locality from halls in all parts of Japan.

Scenes from TV serial drama, "Heaven and Earth," story of Samurai warriors in turbulent age of 16th century. (General TV)



Programs such as "Arts of Japan," "Appreciation of Arts" and "A Guide to Japanese Music" are intended to introduce the traditional arts of the nation, such as classical Japanese music, Noh plays, Noh comedies, Kabuki dramas, Bunraku puppet shows, and rustic folk music and dances, so that the high artistic values of these native cultural art forms may be properly appreciated among our people and thus our traditional arts may be preserved and fostered for posterity. On the other hand, we have such programs as "Modern Japanese Music" and a number of others which are intended to explore new fields of musical innovations.

Dramatic and theater programs largely depend on scenarios and performers in their planning and production. Therefore, such programs are studied carefully by committees of experts concerned with planning and production. Efforts are also made to discover talented new writers and performers.

As the number of music lovers increases in the nation, NHK's musical programs become more and more appreciated by them. Therefore, while striving to lend variety to its musical programs so as to meet the interests and taste of people of various classes with programs ranging from classical Japanese to modern Western music, NHK always concentrates on cultivating a high degree of musical appreciation among its audience. Especially on its FM broadcasts, NHK prepares many good stereophonic music programs, which are playing a big role in propagating FM broadcasts in the nation.

In order to improve the musical level of the nation, NHK is fostering its own NHK Symphony Orchestra (the oldest and one of the finest orchestras in Japan, having 120 members). On the other hand, NHK occasionally invites excellent musicians and orchestras from foreign countries, such as von Karajan, and the Berlin Philharmonic Orchestra, and the Italian Opera.



"Grand Musical Show." (General TV)

"Japanese Folk Festival." (General TV)

Programs such as "Arts of Japan," "Appreciation of Arts" and "A Guide to Japanese Music" are intended to introduce the traditional arts of the nation, such as classical Japanese music, Noh plays, Noh comedies, Kabuki dramas, Bunraku puppet shows, and rustic folk music and dances, so that the high artistic values of these native cultural art forms may be properly appreciated among our people and thus our traditional arts may be preserved and fostered for posterity. On the other hand, we have such programs as "Modern Japanese Music" and a number of others which are intended to explore new fields of musical innovations.

Dramatic and theater programs largely depend on scenarios and performers in their planning and production. Therefore, such programs are studied carefully by committees of experts concerned with planning and production. Efforts are also made to discover talented new writers and performers.

As the number of music lovers increases in the nation, NHK's musical programs become more and more appreciated by them. Therefore, while striving to lend variety to its musical programs so as to meet the interests and taste of people of various classes with programs ranging from classical Japanese to modern Western music, NHK always concentrates on cultivating a high degree of musical appreciation among its audience. Especially on its FM broadcasts, NHK prepares many good stereophonic music programs, which are playing a big role in propagating FM broadcasts in the nation.

In order to improve the musical level of the nation, NHK is fostering its own NHK Symphony Orchestra (the oldest and one of the finest orchestras in Japan, having 120 members). On the other hand, NHK occasionally invites excellent musicians and orchestras from foreign countries, such as von Karajan, and the Berlin Philharmonic Orchestra, and the Italian Opera.



"Grand Musical Show." (General TV)

"Japanese Folk Festival." (General TV)

In November 1968, a public performance at the Metropolitan Opera House of New York was recorded in color on video tape by NHK for the first time in its history. This stage performance was presented in Japan in beautiful color made possible by NHK's high-level color techniques.

Musical variety and musical shows are programs expected to gain popularity in the future. However, since production of these programs is greatly affected by the functions of studios, NHK has endeavored to establish a program production system through the construction of the NHK Broadcasting Center. Preparations are now in progress for presenting large-scale musical shows under some new production and directing systems, when the 1,150-square-meter studio at the Center is put into full operation.

It is also noteworthy that NHK is making steady endeavors in the presentation of avant-garde type programs useful in evolving new artistic fields. These include "Creative Ballet" and "Creative Dance" in the "Art Theater" series and "Modern Japanese Music" and stereo dramas in FM.

NHK's musical programs are always highly appraised at various international contests, as shown in the several times winning of the Italia Prize. And these prize-winning programs are constantly being requested by various stations in Europe and America.

History of the NHK Symphony Orchestra

Since its first subscription concert in February 1927, the year after its inauguration, this orchestra has given more than 500 subscription concerts up to the present time. In the early days, such noted Japanese conductors as Hidemaro Konoe, Kosaku Yamada, rendered great contributions to consolidating the foundation of the fledgling orchestra. A highly-talented conductor, Joseph Rosenstock, was invited as permanent conductor of the orchestra and he is mostly credited with the remarkable rise in the technical standards of the orchestra during the ten years' period since 1936. At present, Hiroyuki Iwaki is conducting as the permanent conductor.

Hiroyuki Iwaki, the permanent conductor of NHK Symphony Orchestra. (General TV)





"Mexico Folk Festival," video-recorded by the Olympic coverage team of NHK. (General TV)



"Barber of Seville" video-recorded in color at the Metropolitan Opera House, New York, by NHK staff. (General TV)

NHK invited Bamberg Symphony Orchestra. (General TV)





In December, the Hagolta Fair is held, it reminds Japanese people of the traditional way of life. (Hagolta is a racket of Japanese-style badminton, and ornamented ones are admired as an interior decoration).

Radio Japan Clubs which have been formed in various places throughout the world constitute groups of people who are interested in learning about Japan through NHK's Overseas Broadcasting Service. At present, such groups have been formed in 30 cities, such as Berlin, Hamburg, Vienna, São Paulo, Seoul, etc. The membership of these clubs is steadily expanding.

Improvement of Reception Conditions

While it is important to make efforts for the improvement of the programs, it is also required particularly for the Overseas Broadcasting Service to improve all means for the reception conditions. For this purpose, NHK is striving to have correct information regarding reception conditions of Radio Japan periodically from its listeners at various places of the world, program monitors assigned in each region and foreign broadcasting stations which are cooperating this task. On assessment of these reports, NHK is constantly striving to improve transmission facilities and adjust the frequency bands and broadcasting hours.

Program Exchange

NHK exchanges radio and television programs with stations in many countries to promote mutual understanding and also to add variety to its own domestic programs.

The Program Exchange Service of NHK edits excellent domestic and overseas broadcast programs of its own to be sent to overseas broadcasting stations. These programs are being utilized by many countries. Requests from foreign broadcasting stations for NHK's programs including those winning international awards, such as the Italia Prize, or those programs which have been entered in various international contests, are pouring into NHK in ever-increasing numbers every year. NHK has been conducting program exchange for the past 18 years. At present, NHK exchanges radio programs with 110 broadcasting organizations in 70 countries and television programs with 40. Radio programs exchanged or provided amount to about 4,000 tape recordings a year and the television programs to about 3,000 films a year.

REGIONAL SERVICE

TRANSMISSION	TIME (GMT)	BROADCAST HOURS PER DAY	LANGUAGE		
North American Service	2345-0045	1 hr.	English		
North & Latin American & Hawaiian Service	0100-0300	2 hrs.	Spanish, Japanese & English		
European Service	(0645-0845 1930-2100)	2 hrs. 1 hr. 30 min.	German, French, English, Swedish & Italian Russian, German, English & Swedish		
Middle East & North African Service	1745-1915	1 hr. 30 min.	English, French & Arabic		
Australian & New Zealand Service	0930-1030	1 hr.	English		
Southeast Asian Service	(0945-1115 1045-1215 1200-1530)	1 hr. 30 min. 1 hr. 30 min. 3 hrs. 30 min.	Standard Chinese, Fukienese & Cantonese English, Vietnamese, Indonesian & Malay English, French, Vietnamese, Burmese, Thai, Indonesian, Standard Chinese, Fukienese & Cantonese		
South Asian & African Service	1500-1730	2 hrs. 30 min.	Hindi, Urdu, Bengali, Swahili & French		
Asian Continent Service	(1230-1330 2300-2330 1130-1215 2200-2245)	1 hr. 30 min. 45 min. 45 min.	Russian & Standard Chinese Standard Chinese Korean		
Latin American Service	0900-1100	2 hrs.	Japanese, Portuguese & Spanish		
GENERAL SERVICE	0000-0030 0100-0130 0200-0230 0300-0330 0400-0430 0500-0530	0600-0630 0700-0730 0800-0830 0900-0930 1000-1100 1100-1130	1200-1230 1300-1330 1400-1500 1500-1530 1600-1630 1700-1730	1800-1830 1900-1930 2000-2030 2100-2130 2200-2230 2300-2400	English & Japanese

RADIO JAPAN COVERS THE WORLD

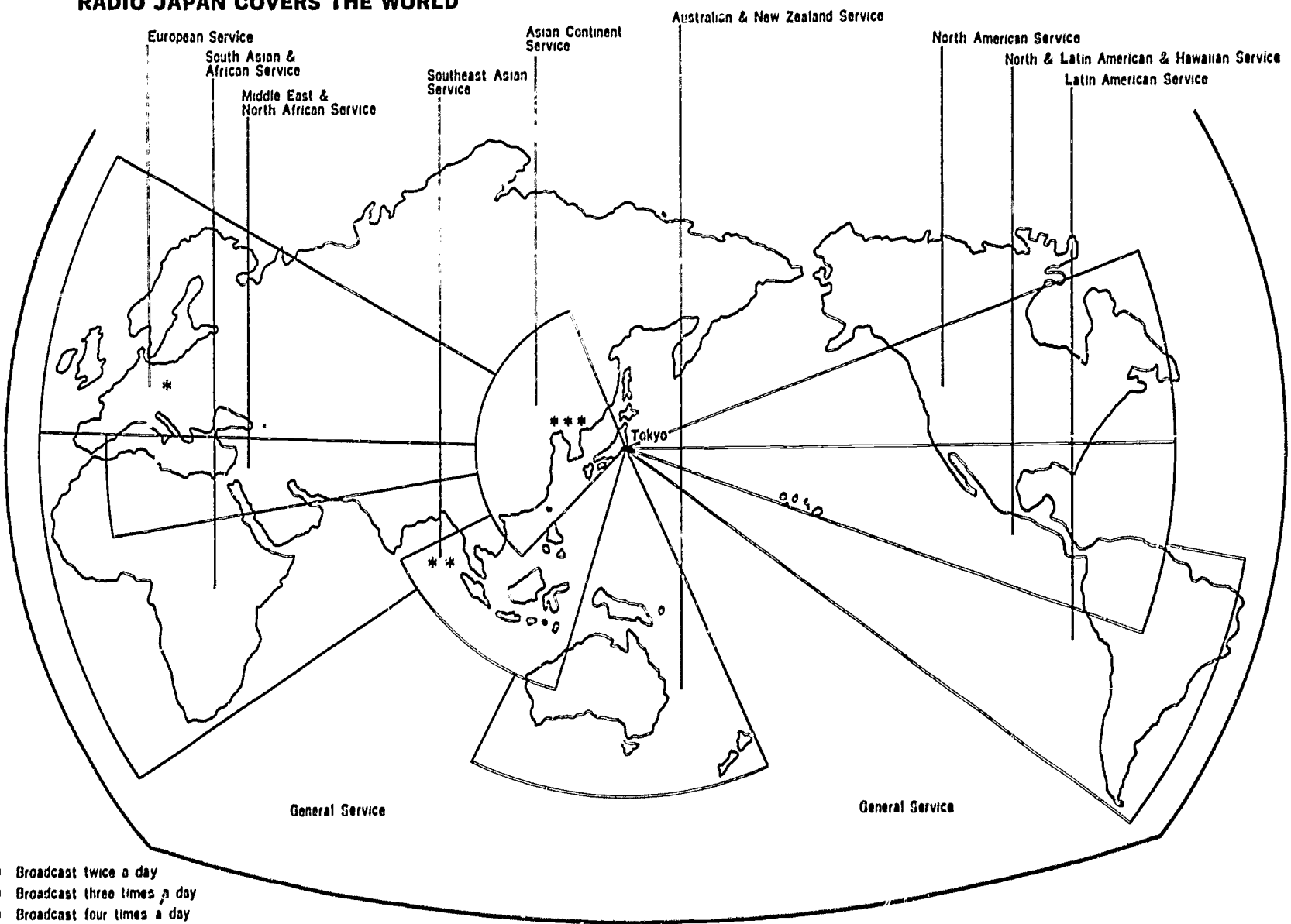

"Tokyo Report" in Portuguese.

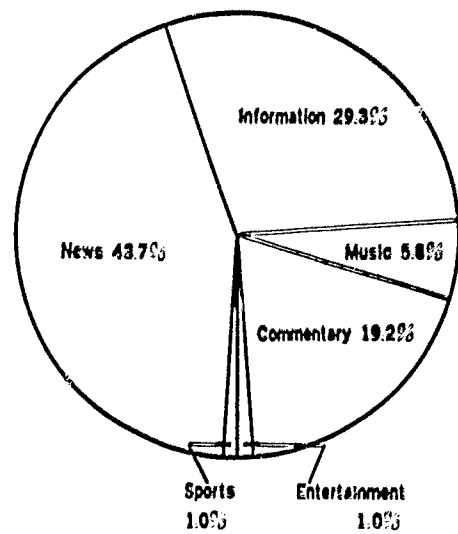
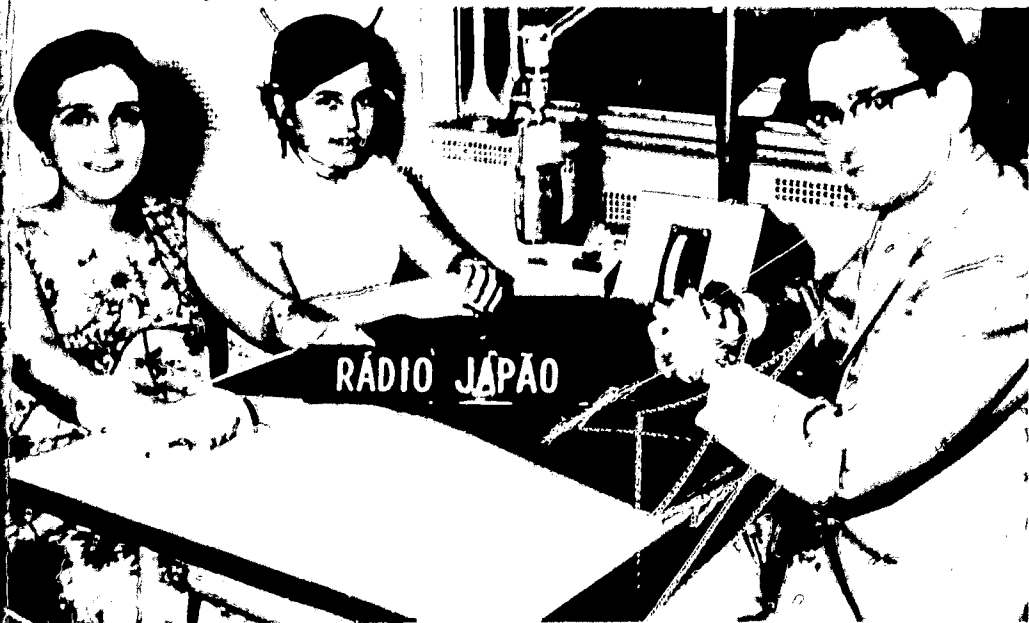

THE BREAKDOWN OF THE PROGRAMS OF RADIO JAPAN (As of April 1969)

TECHNIQUES AND FACILITIES

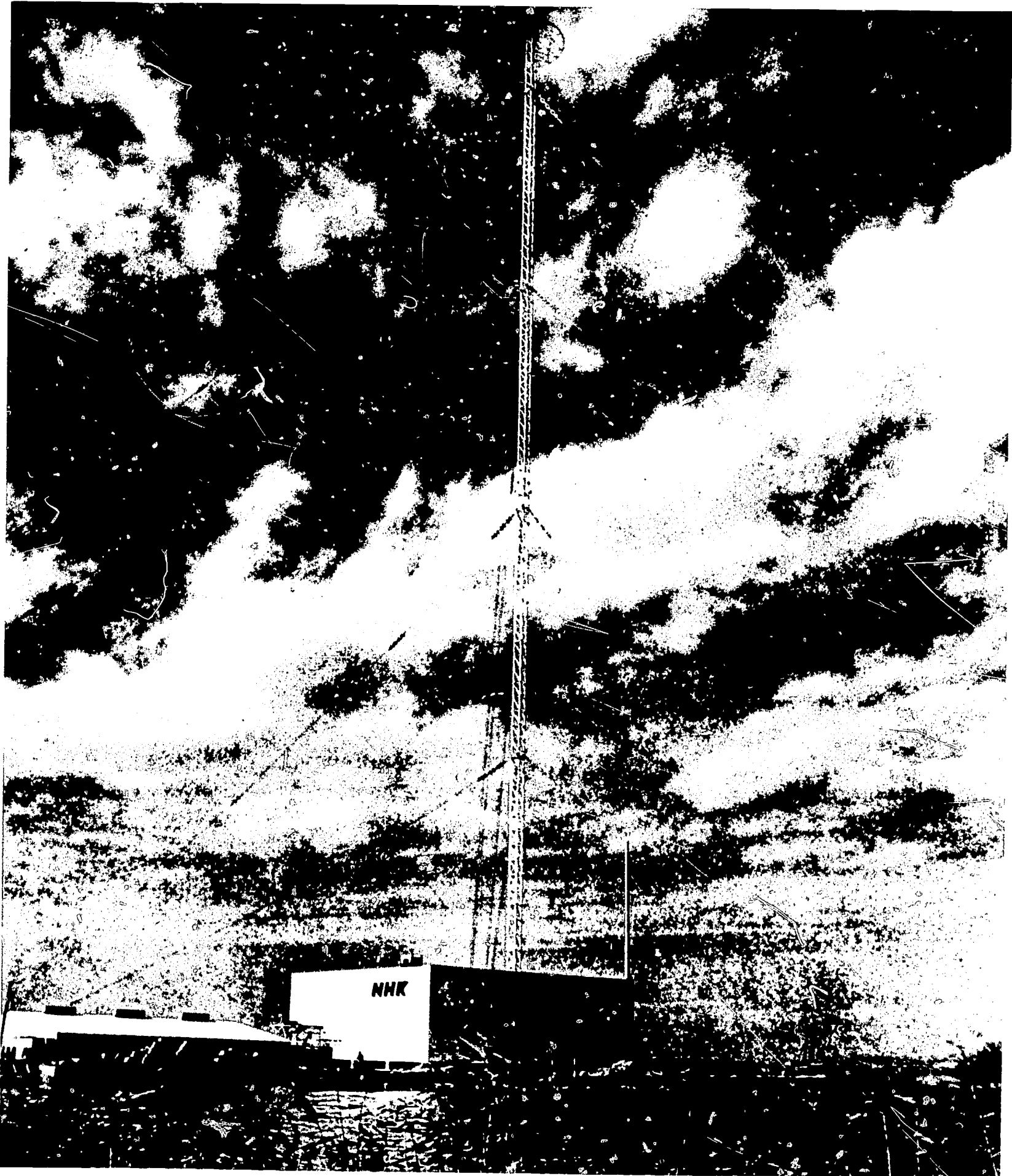

Osaka Radio Transmitting Station.

OUTLINE

It is incumbent upon NHK to complete its national radio and television networks to facilitate reception throughout the country. In line with this important mission, NHK is also striving to maintain and strengthen its broadcasting facilities so that its broadcasts may always be of high quality. For this purpose, NHK is much concerned about the improvement of its broadcast engineering to give fullest satisfaction to its viewers and listeners by modernizing its facilities and operation.

Television

On February 1, 1953, NHK inaugurated the first full-scale telecasting in Japan. NHK's experience in television, however, goes back many years. It began when research on television commenced at the Technical Research Laboratories in 1931. In that year, America's first experimental television station opened for service. In May 1939, television signals were transmitted for the first time in Japan from an experimental station set up in the Laboratories.

As the Pacific War intensified, studies on television were suspended. Experimental telecasting was resumed in Tokyo on March 21, 1950. This was followed by similar experimental telecasts in Osaka and Nagoya in 1952, and, in the following year, the first microwave relay channel linking Osaka and Nagoya with Tokyo was completed. This led to the inauguration of the full television service on February 1, 1953.

With the establishment of the Educational Television Service on January 10, 1959, expansion and repletion of this and the General Television Service are subsequently being expedited.

On February 20, 1968, the Tokushima Educational Television Station opened for service as Japan's first high-power UHF station. Up till that time, UHF stations in Japan had been limited to low-power translators, but, with the opening of this station, mixed propagation of VHF and UHF TV in larger cities became possible, thus bringing about a new age in the television world of Japan.

Basic studies in color television commenced in 1950. In December 1956, experimental color-casting was successfully tested on the NTSC system in UHF band. In December 1957, the frequency band was changed to VHF. The color television service was inaugurated in September 1960 in Tokyo and Osaka.

While the events of the Mexico City Olympics held in 1968 were relayed throughout the world in color via communications satellites, NHK was responsible for relaying the track-and-field and swimming events which formed the main events of the Games. NHK is confident that it has been able to present programs of excellent color quality. This must be attributed to the successful performance of the newly-developed color cameras and the relay techniques that have been mastered through years of experience.

Another event deserving special mention is the color video recording in the Metropolitan Opera House of New York for the first time in its history. The occasion was made possible by the use of high sensitivity pickup tubes developed by NHK.

Radio Broadcasting

NHK's radio broadcasting began in Tokyo on March 22, 1925, and in June of the same year, in Osaka and Nagoya. In 1928, Sapporo, Kumamoto, Sendai and Hiroshima also commenced broadcasting. At the same time, the above seven stations were linked with land lines, thus laying the foundation for a nation-wide network.

In 1952, experiments in stereo using radio networks commenced, and, in November 1953, regular stereo broadcasting using the First and the Second Network of the radio was inaugurated ahead of any overseas broadcasting organizations.

Experimental FM broadcasting commenced in 1957 and experimental FM-stereo broadcasting was begun in December 1963 under the pilot tone system. This was promoted to full service in March 1969 after many years of experiments.

TECHNICAL OPERATION CENTER

The pivotal facility of the broadcasting automation is the Technical Operation Center (TOC). There is one TOC at the Tokyo Headquarters and another at the Broadcasting Center, but these are linked with cables so that they form a single operational unit. The TOC at the Headquarters is for program transmission and the one at the Broadcasting Center is for program production.

The center of the TOC is the display unit, which indicates information on program transmission and production. The program transmission display unit is provided, in addition to the air monitors for television, with CRT display units indicating the program on the air and of the next program in letters and numerals for the five television and radio services. The indication includes the title of the program, the time broadcasting begins, the originating station, and the condition of the network. On the production data display unit, availability of VTR, film projector, audio tape playback unit, etc. can be seen at a glance. The availability of interconnected equipment, moreover, is indicated by flickering of the lamp operated by means of a button on the operation console.

The TOC is provided with large numbers of equipment. These include the transmitting matrix, preset matrix, lumped equipment group (VTR, film projector, camera control, audio tape playback unit), offering equipment (announce machine, FSS) and an exclusive telephone exchange.

The transmitting matrix consists of a group of switches for switching the transmitting programs from VTRs and studios to the transmitting stations or to the local stations in accordance with the schedule. The preset matrix is not only for program switching but also for simultaneous switching of the remote control line, sync line and lines for reading the material code recorded on the tape for automatic transmission.

The outstanding feature of lumped equipment group is that all of them can be remotely controlled or controlled with the electronic computer. The audio tape playback unit, in particular, has a capacity for playing 42 reels of tape, set in the order.

In case any trouble develops in the function of the TOC, the trouble must be quickly discovered from among these numerous equipment and must be repaired. A special line printer prints out information from the computer regarding the trouble, or it can input the information conversely into the computer. It can also cut off the equipment in which trouble has developed. If any trouble develops in the computer or the matrix, transmissions and production can be continued by manual operation, since a system-down backup unit, which is independent from the automatic control system, is provided for the purpose.

There is a video tape automatic editing room in the TOC. Unlike films, editing of video tapes is very difficult. This work has been made as easy as film editing and recording of cuts in dramas has been made possible by means of this video tape automatic editor. The device consists of two sets of standard VTRs, a simplified VTR for recording and editing, a simplified VTR for editing, an editing table, an address signal generator, an electronic computer, and a magnetic memory device.

At the time of recording, recordings are made both at the standard VTR and the simplified VTR for editing. At this time the respective address signals are recorded in the cue track. Then at the time of editing, the editing VTR reproduces in slow-motion or still pictures. And when the button is pressed on the editing table at the beginning and the end of each cut, the respective address signals are recorded on the memory drum.

Furthermore, the two sets of standard VTRs for reproduction and dubbing are automatically operated by the address signals recorded on the memory device, and the final tape exactly arranged as the program scripts is produced from the original tape recorded at random order.

The editing room can edit four programs simultaneously and automatically dub two programs in parallel.

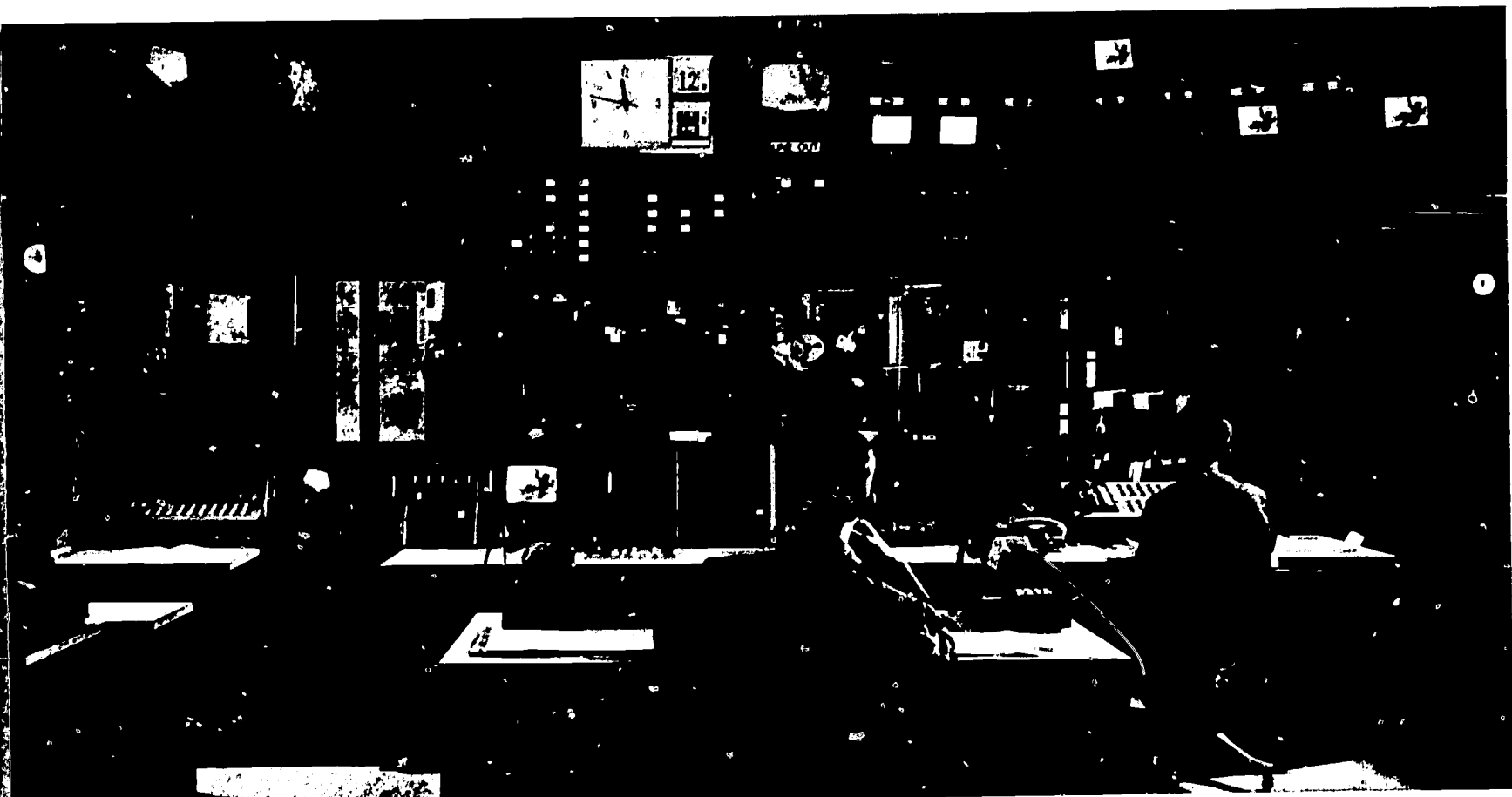

Technical Operation Center.

AUTOMATIC BROADCAST CONTROL SYSTEM

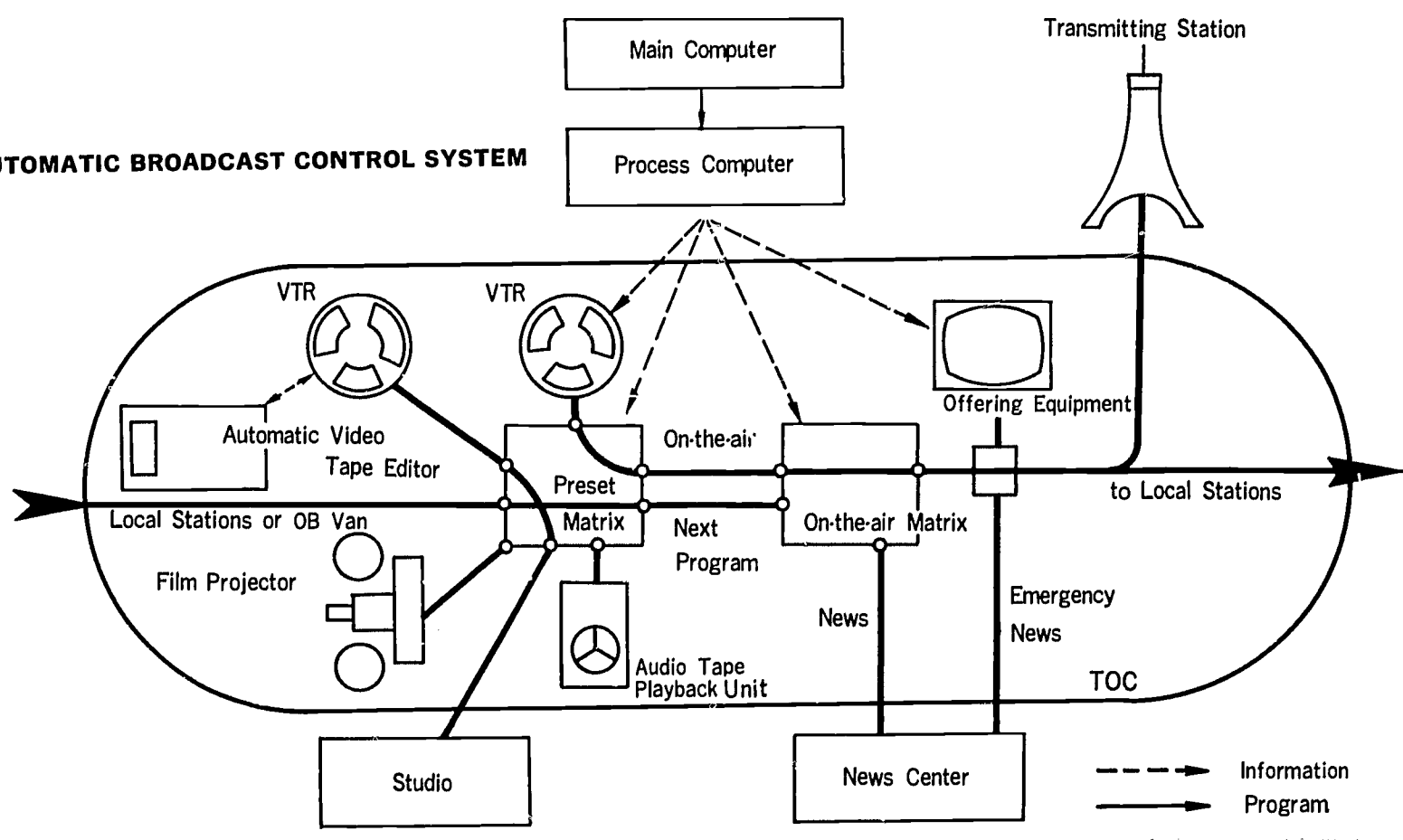

TRANSMITTER

NHK has been rapidly modernizing its operation through induction of computer systems and thereby improving efficiency. Thus, NHK-TOPICS was put in service in October 1968, as already mentioned. It has also been explained that ABCS for automatic computer control of transmission is included in the aforementioned TOPICS.

Meanwhile, automation systems and unattended operation systems of broadcasting equipment have also been expedited since 1958. In particular, since many of the television transmitting stations are set up on mountain tops not so easily accessible, 99.7 per cent of them, including two 10 kW stations, have been provided with automated equipment requiring no attendance. Also, 96.5 per cent of the radio transmitting stations have been automated. For example, even the 300 kW Osaka transmitting station, built in February 1969, is operated by remote control and monitoring from a studio.

Reliability of equipment poses important problems in the automation and unattended operation. In the circumstances, NHK has been endeavoring to improve the reliability of equipment on the basis of the development of new techniques. Transistorization and use of IC (integrated circuits) have also been actively promoted. Rebroadcasting equipment using IC may be considered the fruits of such efforts.

Miniature Rebroadcasting Unit Using IC

Two television rebroadcasting stations, opened for service in March 1969, are provided with miniature rebroadcasting units using IC for the first time in the world.

Both the transmitting and receiving units are 3.5 cm in width, 16.5 cm in height and 18 cm in depth (UHF transmitter only 12.5 cm in width). Each unit is housed in an iron casing together with the power supply unit and accessories. The receiving unit is mounted on the receiving antenna pole erected on top of mountain, while the transmitting unit is buried in the ground 1 meter deep in order to avoid seasonal changes in temperature.

The UHF unit has an output of 1W while the VHF unit of 100 mW, but optional outputs can be obtained by adding an output amplifier. Optional transmitting and receiving channels can also be used merely by changing local oscillator stage.

For the UHF unit 10 integrated circuits of 6 types are used, while for the VHF unit, 17 of 15 types are used. By this means, the units have been rendered highly stable, since no trouble is supposed to develop for five years. Maintenance has also been greatly simplified.

Fading Suppressor

This is a device for preventing a drop in the picture quality at TV rebroadcasting stations because of fading in the signals transmitted from key stations.

Selecting a point which is less subject to chances of simultaneous decline in field intensity, two antennas are erected. Signals received by two antennas are constantly added together automatically and electrically so that the sum of the signals would always be the maximum. This is the way this device prevents deterioration in picture quality. Meanwhile, the phases of the signals received by two antennas are constantly monitored, and if any difference develops, the ferrite phase shifter provided for one of the antennas is activated to match the phase.

This method is more efficient than the one switching two antennas to the received signals of higher intensity. It is now in use at the Hachijo TV translator station (Hachijo Island, off the coast of Tokyo)

COLOR CAMERA

Among NHK's color cameras, those using plumbicon tubes are predominant, but image-orthicon cameras successfully improved in sensitivity and the separate luminance cameras using two tubes are also used. These are all Japanese products.

Studio Cameras

For studio cameras, three plumbicons are used as pickup tubes and a dichroic prism is used for the three-color resolution system. The pickup lens is 20 to 200 mm zoom designed for exclusive use. For the base supporting the camera head, the cam gravity center balancing system has been adopted to broaden the angle of elevation. Moreover, the system improves the balance and ease of operation. For more efficient operation the camera units are controlled at the TOC. As a result, fine adjustments of the iris, color pedestal and gain are remote controlled from the control rooms.

Field Pickup Cameras

These are mostly on separate luminance system using one image-orthicon and three plumbicons. The luminance signals are taken out from the image-orthicon and the color signals from the plumbicons.

Although plumbicon is an excellent pickup tube, any object with marked light and shade picked up with it results in a white blur for the bright parts and their peripheries, thus losing the details of a picture. This is a serious defect in field pickup cameras used outdoors. This defect, however, is rectified by means of the image-orthicon tube in these field pickup cameras. Differences in the characteristics of plumbicon and image-orthicon are corrected automatically by means of the chroma correcting circuit.

Super-High-Sensitivity Color Camera

This color camera uses image-orthicon tubes with multi-alkali photo cathode, which has been developed at the NHK Technical Research Laboratories. It is capable of producing beautiful color pictures even under poor illumination.

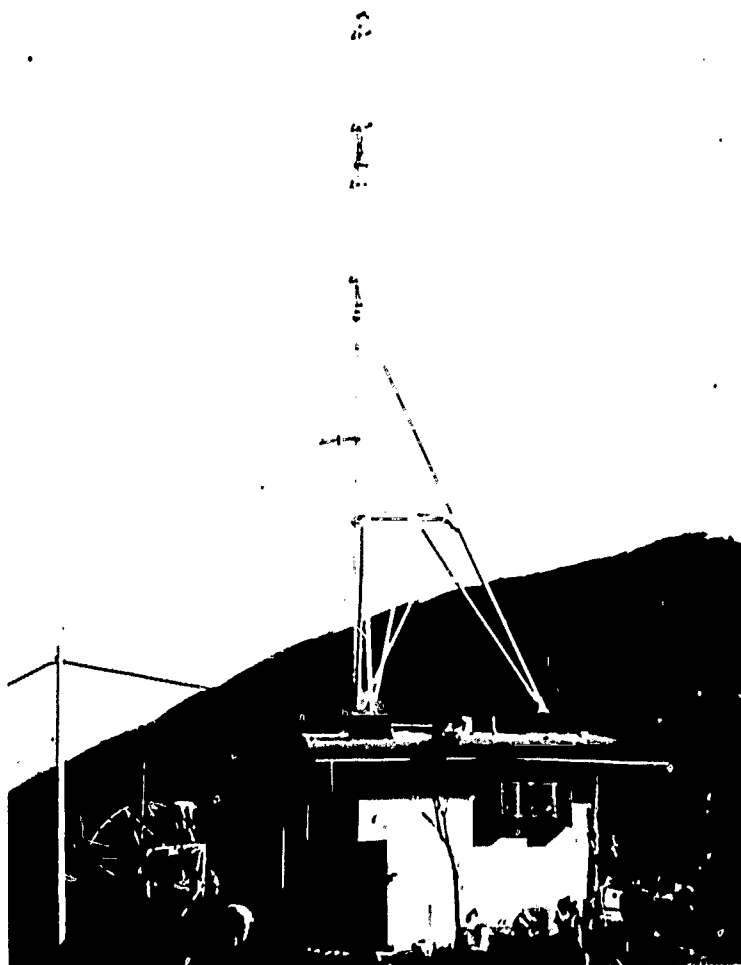

Anti-fading VHF TV Translator Station in Hachijo Island.

Field pickup color camera.

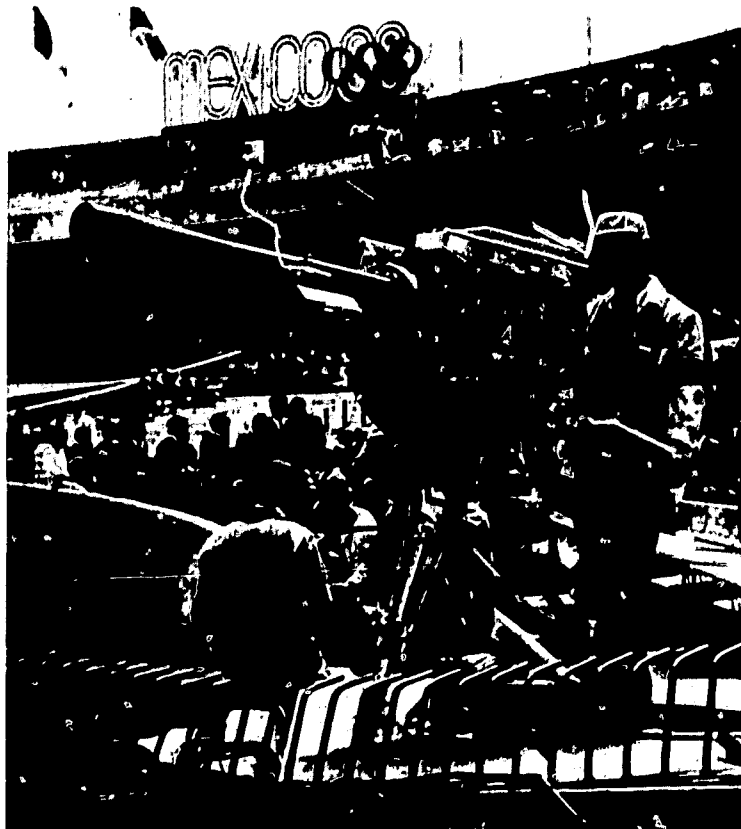

FILM EQUIPMENT

Negative Film Color Transmission System

For color newscast, positive films had to be used. As a result, news films consisted principally of reversal films, which could be made into positive directly by developing. This film, however, required nearly 30 minutes for developing and processing, and its latitude was quite narrow. These defects frequently posed difficulties in obtaining good picture quality under poor conditions of news coverage.

The color negative film, on the other hand, required little processing and a very short developing time. In addition, its latitude is quite wide, thus making it highly suitable for news film.

In this system, a negative film is projected directly, and three primary color signals are electrically reversed in the projector and presented as positive pictures on TV sets. The advantages of this system include suitability for quick developing and processing, wider latitude than the positive and easier pickup. In addition, this provides more or less feasibility to correct errors.

Color Negative Film Viewer

One defect of the negative film is represented by frequent cases of undistinguishable color tones and even nature of the picked up object, when a conventional viewer or projector is used for editing and previewing. These reversion viewer and preview unit were developed for editing and preview of negative films in positive pictures.

The viewer and the preview unit are identical in system. The light that has passed through the film is resolved into three primary colors by means of a rotary disc color filter. When these are picked up with plumbicons, field-sequence color signals are obtained in the output. As these signals show the complementary colors of the object, they are electrically reversed, fed into the field sequence color monitor and then into the picture tube which reproduces positive pictures.

The feature of this unit is its ability to operate negative, positive and reversible projection of 16 mm color and black-and-white films. Also, since

the reproduced pictures are shown on the CRT, no dark room is required for editing or preview, thus improving the efficiency.

As the continuous drum projection system using 16-face prism is adopted for this reversible viewer, no frame joints appear on the monitor screen. Also, since the film feeding speed can be optionally regulated and stopping or reverse feeding is possible, it is highly convenient for selecting the editing points in detail by manual operation.

Color Facsimile System

This is an equipment for sending still color pictures over telephone line or with portable wireless units. It comprises a transmitter set up at the news coverage base, such as the correspondent's office, and a receiver set up at a broadcasting station.

The color Polaroid photographic print exposed at some coverage site is wound around the rotary drum of the transmitter. The light from the dot light source that is reflected from the drum is received with the photo-electric tube through the color resolving filter. By this means, line sequence color signals are obtained.

The receiver reconverts the line sequence signals into lights of varying intensities by means of the discharge tube, and, after converting them into three primary color lights through a rotary color resolving filter, the pictures are impressed on the color Polaroid film.

The time required for sending one color photograph is 7.2 minutes, and since the color Polaroid developing time is one minute, the color picture can be broadcast about 10 minutes after the transmitter is set in motion.

AUDIO EQUIPMENT

UHF Wireless Microphone

Conventional wireless microphones use VHF in the 40 MHz band. This is the first microphone in Japan to use 465.25 MHz of UHF band and has the following features: both the transmitting and receiving antennas are no longer than 10 cm, and, in addition, the antenna efficiency is far better than that of conventional types. It is not so much affected by noise and shows little changes in sensitivity according to places even when it is used indoors.

Specifications are, output: 10 mW, transmitting bandwidth: 50-15,000 Hz, modulation system: direct crystal FM system, power supply (transmitter): 7.8 V mercury battery, operating time: 4 hours.

Ultra-Directional Line Microphone

This microphone is used for collecting clear sound from some distance, such as in case of field pickup for television or simultaneous recording of filmed program. Unlike conventional types, this microphone is provided with two acoustic tubes, long and short. The long tube sharpens the directivity for bass, while the short tube suppresses the directivity for treble, which is apt to become too sharp, in order to maintain uniform directivity. This microphone was originally made for collecting sound at 2-3 meters from the sound source, but outdoors in open surroundings, it is effective even at a distance of 4-5 meters. It also shows no change in the sound quality even when the sound aimed at drifts 25 degrees to the left or right.

Portable Reverberator

Echo rooms and iron plate type reverberation devices are used for artificially providing echo effect for singing voices and instrumental music, but these are too unwieldy to take to sites of field pickup.

In this reverberator a coiled spring is vibrated with sound, and gradual decline in vibration is utilized to provide reverberation effects. In addition, a magnetic sheet delay unit is provided for generating reflected sounds slightly after actual sound. This is inserted between direct sound and reverberation from the spring to simulate natural reverberation.



Line-microphone.

Color negative film viewer.

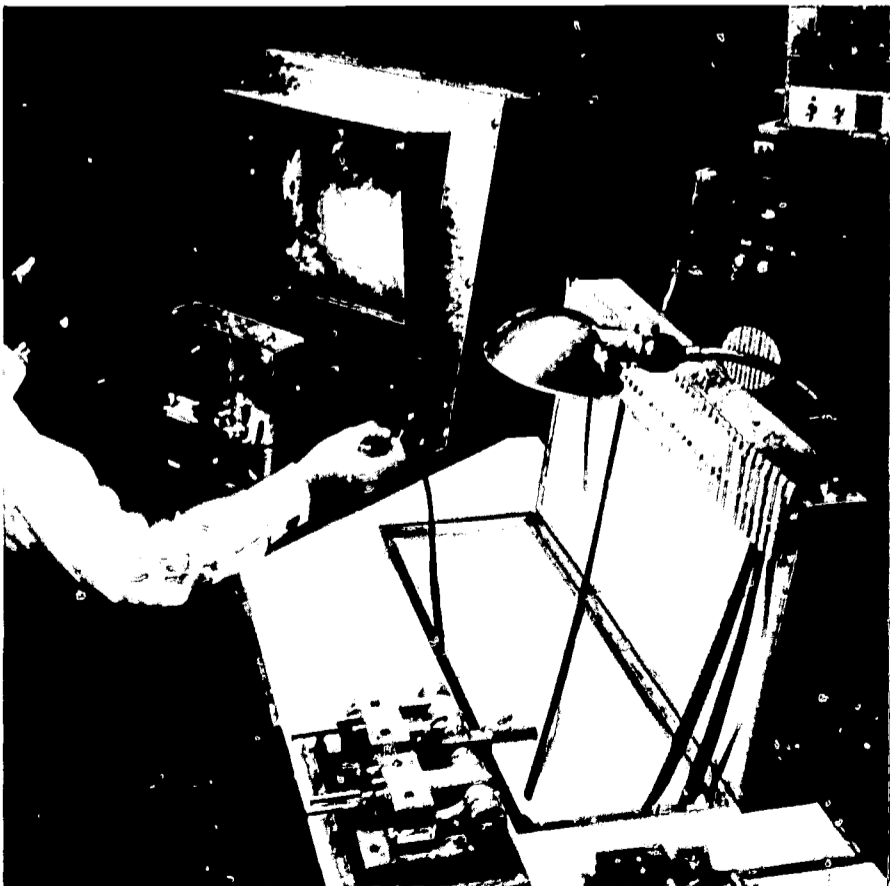

NHK BROADCASTING CENTER

The Broadcasting Center, adjacent Yoyogi Park in Tokyo, is literally the focal point of NHK's program production, turning out 855 radio and television programs a week.

It is an 8-storied building occupying a total floor space of 112,500 square meters and standing on a site 82,650 square meters in area. The building contains 20 television studios, seven of which are used for color and 23 audio studios, as well as a total of about 50 dubbing studios, echo rooms, rehearsal rooms and filming studios. Most of NHK's educational, cultural and entertainment programs are produced in these studios.

The Broadcasting Center started functioning in 1964, also as the center for satellite transmission and broadcasting the Tokyo Olympics all over the world. The Center began producing programs in October 1965 and was completed in May 1968.

The distinctive features of this Center include the concentrated arrangement of the rooms related to TV production on the first floor and rooms related to technical matters on the second floor, and, to assure that programs will be produced smoothly and efficiently, equipment are controlled centrally, and operation and maintenance are made more efficient.

On the first floor, television studios are located in the center, around which, at one side, are the waiting and makeup rooms and at another side, stage-setting shops, forming layers of circles with one central point. The studios have convenient entrances from walls adjacent to the internal rooms as well as the external rooms relative to them, leading to the performers' and producers' rooms. These also facilitate the carrying in and out of necessary properties and stage settings.

For illuminating TV studios, tungsten, iodine, and fluorescent lamps are used to suit various types of programs. Also baton hanger and one-point hanger devices, and such lighting adjustment devices as silicon control rectifiers and silicon symmetric switchers are utilized.

There is a central room for concentrated watching and control of the power supply, elevator, air conditioning, clocks, fire alarms, etc. The Center's electric power generators have a total capacity of 6,000 kVA.

The Broadcasting Center is open to the public for inspection at all times. NHK has provided a "visitors' course" so that people can freely come to see the various phases of broadcasting. From this course, visitors (expected to amount to 2,500,000 persons annually) can see actors familiar to them on the TV screen performing in various programs.

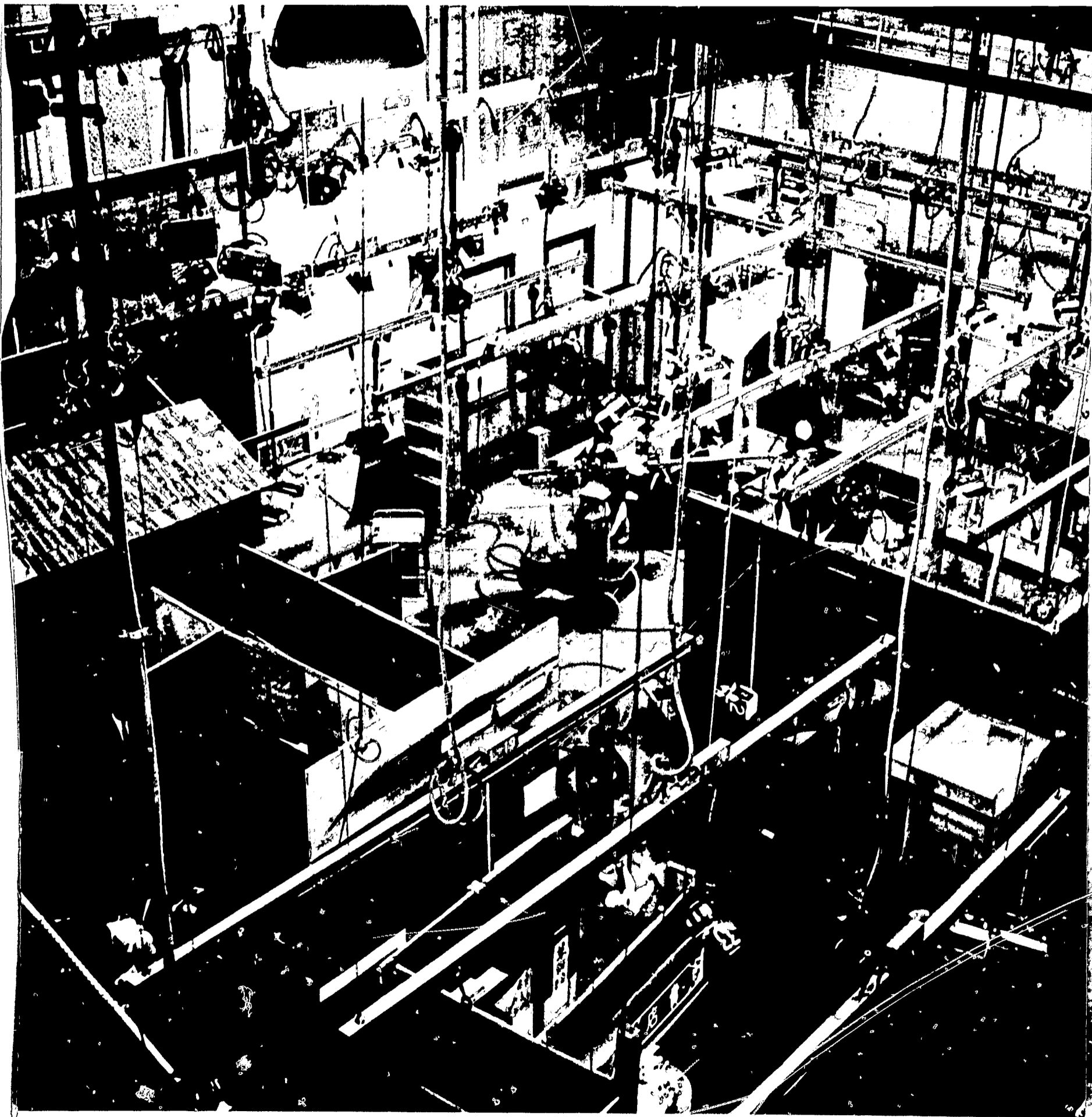

One of color studios in Broadcasting Center.

RESEARCHES AND INVESTIGATIONS



Space chamber.

TECHNICAL RESEARCH LABORATORIES BROADCASTING SCIENCE RESEARCH LABORATORIES

NHK Technical Research Laboratories, an organ devoted exclusively to researches in all technical aspects of broadcasting, was established on June 1, 1930. The principal work of the Laboratories during its early stages comprised researches in radio receivers, radio wave propagation, investigations regarding television, and matters connected with patents. Later, in order to meet rapid developments in the field of electronics, the scope of researches was expanded from telecommunications and electronics to physics, chemistry, machinery, architecture, physiology and psychology. Today, the Laboratories has become the world's few leading centers devoted to the study of broadcast engineering.

In January 1965, the Laboratories was separated into the Technical Research Laboratories devoted principally to comprehensive research and development in broadcast engineering and the Broadcasting Science Research Laboratories for undertaking basic research in solid states, visual and auditory senses in order to evolve future broadcast.

NHK, not only directly applies the results of work undertaken at its research organs for improving broadcasting techniques of its own, but also makes them available for the sake of elevating the technical level of the whole country by opening the laboratories for public inspection once a year, publicizing them at pertinent academic meetings, and providing allied industries with technical cooperation and guidance.

Technical Research Laboratories

This Laboratories undertakes basic and applied researches as well as development of practically applicable devices related to broadcasting in general, ranging from program production to reception in homes. Special emphasis is placed on requests from engineers engaged in field work and on the improvement of reception. Active work is also undertaken in the field of satellite development, laser utilization, and the study of new recording systems with a view to evolving new fields for future broadcasting.

In the field of receiving techniques, endeavors have been made to determine the technical standards of receiving equipment best suited to the new television age in which VHF and UHF systems are in concurrent operation, as well as towards developing receiving sets capable of receiving UHF bands.

Also in order to improve colorcasting which are being expanded annually, development of pickup tubes and color cameras, and the study of quantitative measurement methods for color reproducibility of television sets are being expedited. Last year, a new test signal for color monitor adjustment was discovered for eliminating individual differences in color monitor adjustment and for facilitating accurate and easy adjustment thereof. This is already in effective service in actual broadcasting.

As international relaying of television programs via communications satellites has become active and frequent, the Laboratories is now engaged in developing high-performance television standard converters so that program exchanges among various nations may be carried out more smoothly. Studies on sound multiplex broadcasting system using two languages and color television signal transmission system are being undertaken for facilitating more effective use of satellites. Furthermore, work on receiving sets and equipment for mounting on satellites is now being implemented preparatory to future satellite broadcasting.

Beside the foregoing, other diversified types of research and development efforts are being carried on at the Laboratories. These include development of subminiature microphones and ultra-directional line microphones, study of architectural acoustics, and relations of the structure of musical instruments, such as the Japanese flute to the produced sound, study of wireless communication involving antennas and wave propagation, and application of magnetic substances, plasma and ultrasonic waves to radio frequency circuits, as well as application of IC and thin film techniques to new devices.

Broadcasting Science Research Laboratories

In the study of audio-visual science, by what function of living things information obtained through visual and auditory senses are processed is investigated, and the knowledge thus acquired is applied not only to improvement of the quality of broadcasting but also to the development of new broadcasting systems and synthetic brains capable in the future of recognizing figures and sounds.

To accomplish the above objective, the pattern recognition function of the visual system and direction perceiving function of the auditory system are under study. The moving function of eyeballs is also being analyzed from the standpoint of control engineering. Regarding information processing function of visual nerves, cats and other animals are used in physiological studies.

Meanwhile, on the basis of knowledge acquired through such physiological and psycho-physical studies, efforts are being made towards making models of nerve links and the auditory system using electronic circuits for deducing the physiological functions of the visual and auditory systems. Another study being carried on is that of synthesizing the cognitive functions of the cerebrum by the use of electronic computers.

Research in solid states is aimed at developing new materials and components. Out of a wide scope of the researches in solid state, emphasis is at present being placed on physio-chemical phenomena related to light. Studies include, among others, problems of interconversion between light and electricity, relation of optical properties of powerful magnetic substances to magnetism, and the application of laser beams to communications.

Work has also been undertaken on the production of various crystals with useful properties as well as methods of making perfect crystals. Last year, a "crystal defects observation device" capable of producing any defects inside the crystal on the picture tube was developed at the Laboratories. Since this was the world's first device of its kind, it naturally aroused wide repercussion as providing new methods of research in crystals.

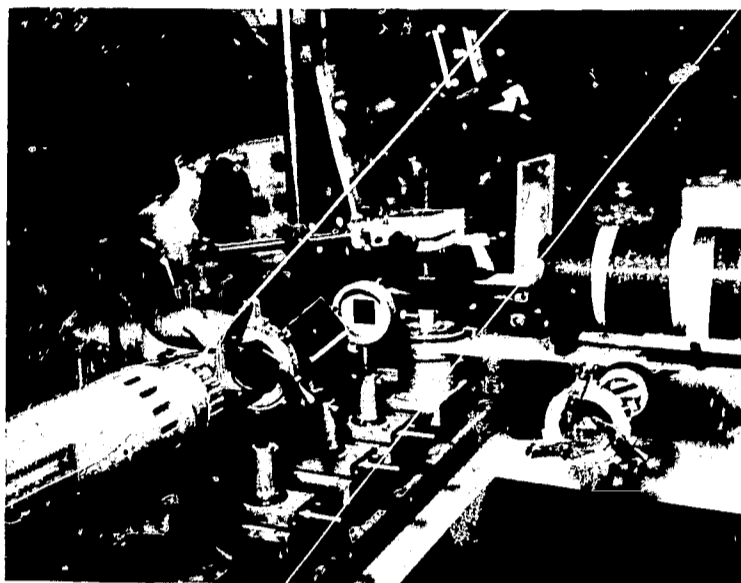

Study of the giant pulse laser.

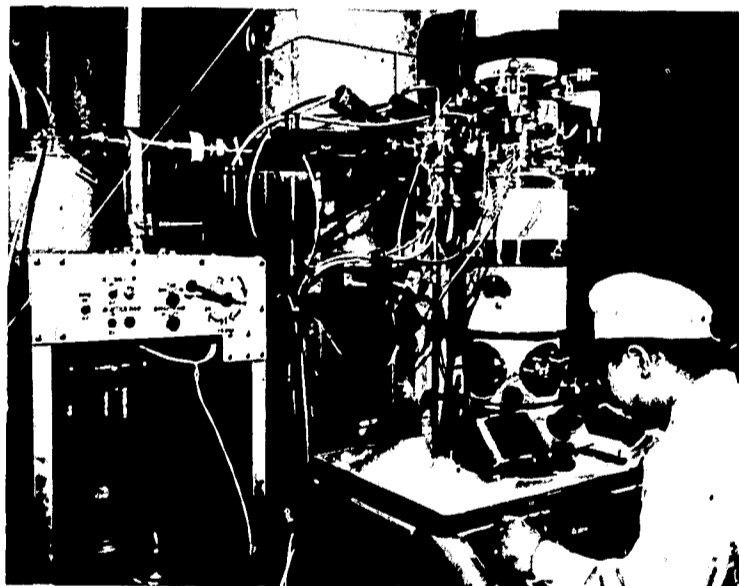

Electron microscope device.

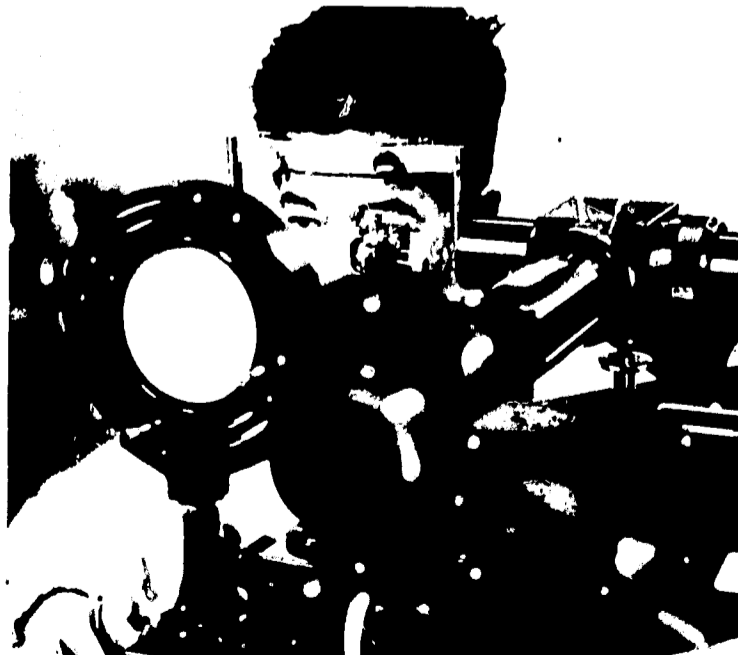

Study of the retinal motion on visual perception.

RADIO AND TV CULTURE RESEARCH INSTITUTE PUBLIC OPINION RESEARCH INSTITUTE

In order to improve broadcasting programs, it is essential that efforts be made to properly reflect public opinion at all times in the compilation of broadcasting programs. For this purpose, researches and studies on various phases of broadcasting are most indispensable for the development of broadcasting. In this field, NHK has its Radio and TV Culture Research Institute and Public Opinion Research Institute which are contributing to broadcasting progress through researches and studies.

The two institutes started out in 1946 as the "Broadcast Culture Research Institute" and have conducted various researches and investigations related to broadcasting. In 1965, the institute was divided into the aforementioned two organizations. Following is a brief outline of the work conducted by both.

Public Opinion Researches

The Public Opinion Research Institute conducts the following three categories of surveys.

1. Public opinion surveys, on programs. Nationwide program rating surveys are undertaken several times a year by the personal interview method. In addition, surveys of opinions regarding broadcasts are also undertaken.
2. Surveys related to public opinion on politics, economy and social affairs. Up to now, surveys on elections, home life, education, occupation, etc. have been undertaken.
3. The how-do-people-spend-their-time survey. In this survey, time spent in a day for certain behaviors by the samples during various times of the day are investigated. The survey has been conducted every five years since 1960.

Researches in Broadcast Programs

In this field, studies on the evaluation of program contents, the principle of educational and cultural program production, children's life and the role of television, television in relation to young people's thinking patterns, and utilization of school broadcasts are undertaken continuingly.

In particular, the utilization and effect of school

broadcasts and correspondence education courses are investigated, and the results are used not only as data for program compilation and production but also as basic data on researches in the educational methods and the effects of education.

Researches and Studies of Broadcast Language

NHK is always striving through its broadcasts to popularize an accurate Japanese spoken language among our people. For this purpose, NHK has established the Broadcast Language Committee to make studies of the broadcast language centering around oral language, orthography for TV and technical terms.

Researches of Broadcasting Affairs

For the progress of our broadcasting world, it is necessary to grasp an accurate picture of broadcasting both at home and abroad. For this purpose, NHK exchanges relevant materials and information with broadcasting organizations in other countries, as well as with research institutes, foreign diplomatic missions in Japan, and the like, so as to investigate the broadcasting system and programs now prevailing both in Japan and in foreign countries to utilize such findings for cultivating new fields of broadcasts, to improve its own programs, and also to rationalize its management.

Studies of Broadcasting Science

Since broadcasting has become an indispensable part of the people's life at present and its influence has become very significant, it is very important in view of its social impact to tackle scientifically the inherent nature of broadcasting and its social functions and to bring it under systematic study. For this purpose, NHK, in collaboration with various universities and research institutes, carries out an exhaustive analytical study of the science of broadcasting.

Compilation of the History of Broadcasting

NHK has already published, in Japanese, "The History of Broadcasting in Japan", compiled in three volumes. An English version has also been published. The "NHK Yearbook" (in English, "NHK Handbook") containing accurate records of its business operations has also been published.

BROADCASTING MUSEUM

Library

Various cultural properties, such as recordings made by deceased people of fame, well-known entertainment artists, historical announcements, and films like "The World of Yukar," a restoration of Ainu customs and manners, as well as personal records, recordings of music, dramas, entertainments and ethnic customs, are systematically filed and preserved in recordings and on films at the Broadcast Cultural Property Library (approximately 6,900 items preserved as of March 1969). These cultural properties are used not only as materials for broadcasting programs but, since these constitute valuable data on national science and culture, they are opened to public inspection at the Broadcast Museum.

Broadcast Museum

The Broadcast Museum was established in 1956 in commemoration of the 30th anniversary of broadcasting in this country. It was located in the JOAK station building, where the first radio broadcasts were begun in 1925. However, as the building became superannuated, a new one was constructed on the same site in 1968. The exhibit room, with an area of about 300 square meters, contains radio equipment made both in Japan and abroad, broadcasting scripts, photographs. These are exhibited in chronological order to show the progress of broadcasting since its inception. Also available are exhibits showing the principles of radio and television techniques and an experimental model studio that can be operated by visitors.

Centralized Supervision of Books

In 1968, a library for the two institutes was established to realize centralized supervision of their books, magazines and other materials and to promote more efficient uses thereof.

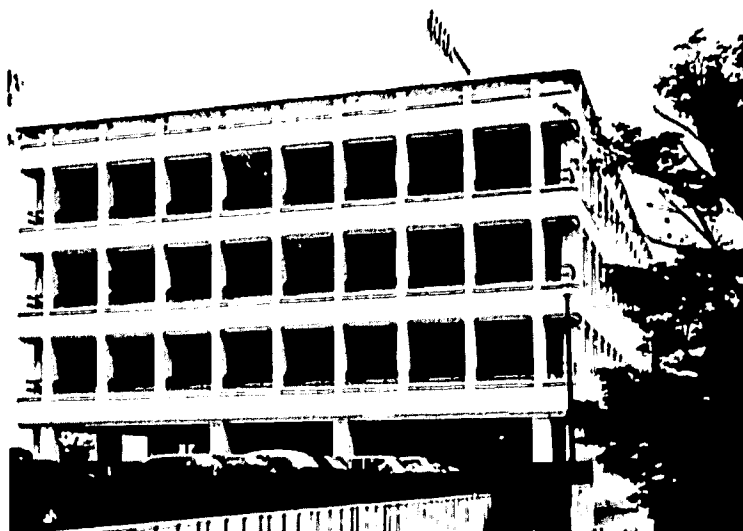

Broadcast Museum renovated in September 1968.
The old-fashioned radio set tells the history of broadcasting.

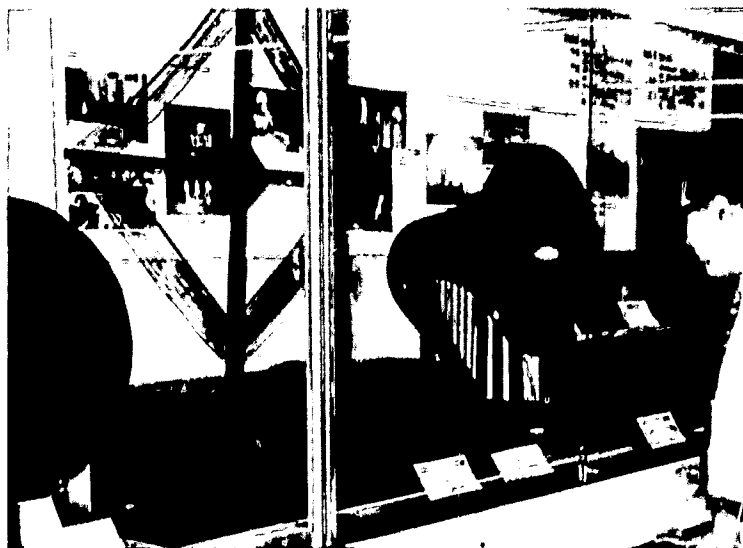

CENTRAL TRAINING INSTITUTE

The Central Training Institute is endeavoring, systematically and continuously, to work out plans of training as well as execution thereof. Besides training the NHK staff, the Institute, now regarded as a center of training for broadcasting activities in this part of the world, also undertakes to provide training to guest students from other countries.

Training of NHK Personnel

The Institute provides the following courses systematically under a long-range program with a view to helping the personnel in advancing their knowledge and skills needed in performing the tasks and duties assigned to them.

1. **Training of Newly Employed**
This program is designed to help new employees of NHK in comprehending the spirit and business of the organization and in acquiring a basic knowledge of the process of broadcasting.
2. **Training for Qualifications**
This aims to help employees in improving and preparing themselves for promotion so that they will realize the business of the organization in its broader aspects.
3. **Functional Training**
This is directed to assist each member of the staff not only in maintaining but also in developing his ability of performing his present tasks and duties and to help his ability to develop.

Commissioned Training Courses from Outside

The Institute also extends training courses on radio and television production and engineering to foreign students. The number of such guest students is steadily increasing, and in 1968 fiscal year about 22 students participated.

In addition, it arranges similar training courses on request by commercial broadcasters and other related organizations in Japan.

Overseas Technical Cooperation

In addition to welcoming foreign trainees, NHK provides technical cooperation by sending experts to foreign countries. Such technical cooperation is extended under the Colombo Plan and similar other programs. Under the above programs of

cooperation, NHK provides aid and guidance in broadcasting facilities, sending specialists and submitting technical data upon the request of the countries concerned. Recent principal cooperative activities NHK has undertaken are as follows: Guidance offered in construction of Pakistan Television Station, cooperation with Thailand Electric Training Center, instruction of television engineering for TV Republic Indonesia, cooperation in constructing of television networks in Uganda, cooperation with National Engineering School of El Salvador and cooperation with the National Television Station of Cambodia.

Training Facilities

NHK's training facilities include a fully equipped 180-sq-meter TV studio and a 160-sq-meter radio studio, as well as various other types of equipment and facilities for practical training in broadcasting techniques and in program organization. In addition, the NHK Central Training Institute has well-equipped lodging facilities that can accommodate 200 trainees.

Training of foreign broadcasting staff.



PUBLICATION

The main publication in English which introduce the activities of NHK are as follows:

(Publisher)

This is NHK

A pamphlet to introduce an outline of NHK such as its character, its business and otherwise.

NHK Today and Tomorrow

Monthly news bulletin.

Public Relations Bureau, NHK

Radio Japan News

A monthly news compiled for the listeners of Radio Japan. Besides the English edition (printed in English, German and French), the Asian edition (printed in Indonesian and Chinese), the Latin American edition (printed in Spanish and Portuguese), the Korean edition and the Japanese edition are published.

Text for "Let's Learn Japanese"

Text for the Japanese language lesson program broadcast by Radio Japan in English, German, French, Chinese, Korean, Indonesian, Vietnamese, Thai, Spanish and Portuguese.

Radio Japan

A pamphlet to introduce the whole aspects of Radio Japan, the overseas broadcasting service of NHK.

Radio Japan Programs

Time, frequency and programs of Radio Japan.

Overseas Broadcasting Department,
NHK

NHK Handbook 1968

A yearbook containing the activities of NHK from April 1966 to March 1967.

NHK's Research on Broadcasts and Audience 1965

Public Opinion Research of NHK

Pamphlets to introduce the survey and research activities of the NHK Radio and Television Culture Research Institute and the Public Opinion Research Institute.

Survey and Study of Educational Broadcasts, 1960-1966

A brief sketch of studies on educational broadcasts.

The History of Broadcasting in Japan

The first complete history of Japan's broadcasting covering the period from its inauguration to 1965.

Studies of Broadcasting

An annual publication containing Japanese and foreign studying and research papers concerning broadcasting.

How-Do-People-Spend-Their-Time Survey 1965

This contains an outline of the results of a survey of some 24,000 people as to how they spend 24 hours of a day, which was conducted in 1965.

(*) Radio and TV Culture Research
Institute, NHK

NHK Technical Research Laboratories, Broadcasting Science Research Laboratories

A pamphlet to introduce research and investigation activities of the NHK Technical Research Laboratories, Broadcasting Science Research Laboratories.

NHK Technical Monograph

NHK Laboratories Note

These introduce in detail the results of researches made by the NHK Technical Research Laboratories, Broadcasting Science Research Laboratories in both aspects theory and design. Published irregularly 4 or 5 times a year.

(*) Technical Research Laboratories,
NHK

Publication by these Institutes and Laboratories are to be donated to the overseas broadcasting organizations on an exchange basis.

BRIEF HISTORY OF NHK

- Mar. 1925** Initial radio waves were emitted in Japan (March 22 has since 1934 been set as Broadcast Day).
- Oct. 1925** Japan's first outside broadcast (on-the-spot coverage of the parade).
- Aug. 1926** NIPPON HOSO KYOKAI or Japan Broadcasting Corporation, a corporate juridical person, was established.
- Aug. 1927** First on-the-spot broadcast of a baseball match.
- Nov. 1928** First nation-wide relay broadcast (on-the-spot broadcasting of the Enthronement Ceremony of the Emperor).
- Feb. 1930** First successful long-distance short wave relay broadcast from London.
- Jun. 1930** NHK Technical Research Laboratories was established; research on TV began.
- Dec. 1930** First Japan-U.S. short wave exchange of Christmas programs.
- Apr. 1931** The Second Radio Network was put into operation.
- Jul. 1932** Deferred broadcasts of highlights of the 10th Olympic Games were relayed from Los Angeles.
- Nov. 1932** Japan's first recorded broadcast (speech of Ambassador Sato) beamed from Geneva.
- Apr. 1935** Nation-wide transmission of school broadcast began.
- Jun. 1935** Regular overseas broadcasts were inaugurated.
- Jun. 1936** On-the-spot broadcasts of the 11th Olympic Games in Berlin were successfully carried out.
- May 1939** Experimental telecast was successfully conducted by Technical Research Laboratories.
- Nov. 1941** First recorded relay broadcasting of a parliamentary session.
- Aug. 1945** Broadcast of the recorded decree by H. I. M. the Emperor stating the end of the Pacific War.
- Jun. 1946** Radio and Television Culture Research Institute was established.
- Jun. 1949** Use of magnetic tape-recorders began.
- Jun. 1950** Under the Broadcast Law, the corporate juridical person, Nippon Hoso Kyokai turned to a special juridical person. Board of Governors established.
- Nov. 1951** The Sound Library established within NHK.
- Mar. 1952** Dispatch of overseas representative to Paris. NHK succeeded in trial wireless color telecasting.
- Jul. 1952** On-the-spot broadcasts from the 15th Olympic Games in Helsinki.
- Dec. 1952** First stereophonic broadcast using two radios.
- Feb. 1953** NHK's Tokyo Television Station inaugurated regular television broadcasting in Japan.
- Jun. 1953** On-the-spot broadcast of the Coronation Ceremony of Queen Elizabeth II in a tie with BBC.
- Oct. 1954** First practical application of kinescope recording in a TV relay of a Kabuki drama.
- Nov. 1955** First broadcast of electronic music.
- Mar. 1956** Broadcast Museum opened in Radio and TV Culture Research Institute.
- Nov. 1956** On-the-spot broadcast of the 16th Olympic Games in Melbourne.
- Feb. 1957** Experimental short wave broadcasts to the Antarctic region started (suspended in February 1962).
- Jul. 1957** First Asian Broadcasters' Conference was held in Tokyo.
- Dec. 1957** Experimental FM broadcast on VHF band inaugurated in Tokyo area.
- Jul. 1958** Use of video tape recorder began.
- Jan. 1959** NHK inaugurated Educational TV Network in the Tokyo area.
- Apr. 1959** Special broadcast of the Wedding Ceremony of H. I. H. the Crown Prince.
- Nov. 1959** Dispatch of NHK's special overseas coverage teams was started.
- Aug. 1960** On-the-spot radio and TV broadcasts of the 17th Olympic Games in Rome.
- Sep. 1960** Regular color television broadcasts were commenced in Japan.
- Jun. 1961** Central Training Institute was established.
- Nov. 1962** NHK completed its TV broadcasting network across Japan.
- Apr. 1963** NHK Correspondence Senior High School was opened. Construction of NHK Broadcasting Center began.
- Nov. 1963** First experimental transmission by the communication satellite was conducted successfully (between Japan and U. S. A., Europe).
- Apr. 1964** The 2nd International Conference of Broadcasting Organizations on Sound and TV School Broadcasting was held in Tokyo by NHK.
- Oct. 1964** Broadcasting of the 18th Tokyo Olympiad.
- Oct. 1965** The first period of construction of NHK Broadcasting Center was completed. NHK established "Japan Prize" International Educational Program Contest (annually). 2nd General Assembly of ABU was held in Tokyo by NHK as host organization.
- Mar. 1966** Nation-wide color network completed.
- Jun. 1966** 1st ABU Administrative Council was held in Tokyo.
- Jun. 1967** First global live TV program "Our World" was broadcast jointly by 14 nations through 4 satellites.
- Jun. 1968** The 2nd period construction of NHK Broadcasting Center was completed.
- Oct. 1968** Colorcast of the 19th Olympic Games in Mexico with three other broadcasting organizations. NHK-TOPICS started its operation.
- Mar. 1969** The regular FM broadcast was commenced in Japan.